

NOVEMBER 10, 1977

**WHAT LIES AHEAD FOR 64-KILOBIT CCD MEMORIES/65**

E-beam lithography system turns out wafers fast/96

Signature analysis and emulation speed microprocessor testing/ 107

FOUR DOLLARS A MCGRAW-HILL PUBLICATION

# Electronics®

1420 N. 221st Lane  
Matt Neill  
Electronic Special Effects  
2516 NE Clackamas  
Portland OR  
97232



Triggered oscillators  
lock on precise  
time measurements

# Introducing HP's 3466A ...

## The right DMM decision means $1\mu\text{V}$ sensitivity and autoranging in a 4-1/2 digit instrument.

HP's 3466A gives you unusual measurement capability in a 4½-digit DMM. It combines autoranging with  $1\mu\text{V}$  sensitivity...meaningful resistance measurements to 1 milliohm with 2-terminal convenience...true RMS measurements with 100 kHz bandwidth...plus 5-function measurement ease.

**High ohm and DC volt sensitivity.** Now you can make meaningful measurements to  $1\mu\text{VDC}$  or 1 milliohm with this autoranging 4½-digit DMM. And for low value resistance measurements, you no longer need 4 terminals. The 3466A has a front-panel adjustment that lets you null lead and contact resistance for faster, more convenient measurements.

**True RMS Volts and Amps.** In addition to 100 kHz bandwidth with true RMS, the 3466A gives you selective DC coupling to allow DC plus AC true RMS measurements with both current and voltage (two extra functions you normally don't get with a DMM). That means you can make direct true RMS measurements of signals such as digital pulse trains as well as sinusoidal waveforms.

**Battery and probe versatility.** You can operate this DMM from the line or select rechargeable lead-acid batteries for complete portability. And to extend the 3466A's capabilities, choose from HP's wide selection of probe accessories, including RF, high voltage and Touch-Hold probes.

**Diode test.** Another added plus with the 3466A is a diode test function to speed equipment servicing and troubleshooting. You simply select the  $1\text{k}\Omega$  range and read the forward voltage drop across the diode or transistor junction directly on the digital readout.

**Excellent DMM value.** Five standard and three extra measurement functions, 38 ranges autoranging, high sensitivity, true RMS and more. And the 3466A has survived HP's demanding abuse testing program, so you know it's rugged and reliable. That's a lot of capability for a \$575\* DMM. Or get battery portability for \$650\*. Your HP field engineer has all the details. contact him today.

\*Domestic U.S.A. price only.

**HP DMM's-**  
the right decision



HEWLETT  PACKARD

1507 Page Mill Road, Palo Alto, California 94304

For assistance call Washington (301) 948-6370, Chicago (312) 255-9800, Atlanta (404) 955-1500, Los Angeles (213) 877-1282

Circle 900 on reader service card

World Radio History

# SURPRISE!



## Introducing HP's New Optically Coupled Line Receiver

Eliminate troublesome system ground loops and increase long distance communication noise immunity with HP's new easy-to-use optically coupled line receiver. An internal IC regulator serves as a line termination and allows direct connection to transmission lines without any additional components.

Use of a high-speed, high-gain output photo IC permits data rates in excess of 10 Mbits/second. An internal shield provides excellent common mode rejection even at these high data rates.

The HCPL-2602 is designed for high-speed data transmission applications such as computer-peripheral interface, instrumentation, and simplex/multiplex data transmission.

Priced at \$6.65\* in quantities of 1000, the HCPL-2602 is in stock at any franchised distributor. In the U.S., contact Hall-Mark, Hamilton/Avnet,

Pioneer Standard, Schweber, Wilshire or the Wyle Distribution Group (Liberty-Elmar) for immediate delivery.

In Canada, just call Hamilton/Avnet or Zentrionics, Ltd. \*U.S. Domestic price only

HEWLETT  PACKARD

1507 Page Mill Road, Palo Alto, California 94304

# Meet the first Serial Data Generator with 2048-bit memory and broad pattern generation flexibility

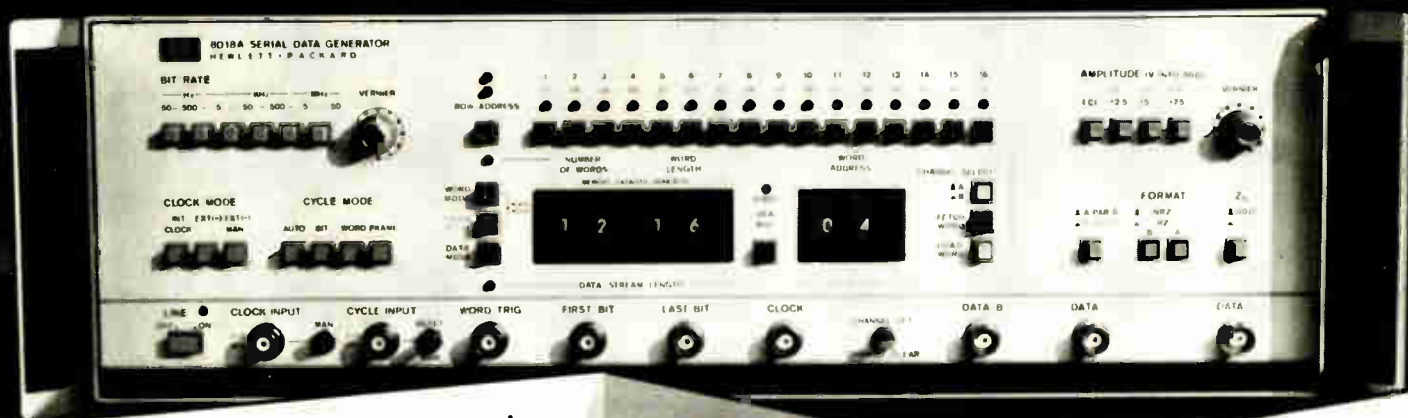

word -PRBS-word

word -PRBS-word

...word -PRBS-word

In MIXED MODE, HP's 8018A alternately generates PRBS and word information, simulating preamble-data message-postamble patterns.

Instrument is shown with optional handles.

## HP's new 8018A, for faster, easier serial system testing.

This new 50 Hz to 50 MHz Serial Data Generator greatly simplifies simulation of complex serial data such as disc and telecommunications patterns. You can easily program the 8018A with up to 2048 bits to design and troubleshoot serial interfaces and bus systems. The number of words, word length and PRBS length are conveniently set with thumbwheel switches letting you program the 8018A to generate a frame of words with selectable word length; a data stream with bit-by-bit variable length; a WORD-PRBS-WORD sequence; or a PRBS only. And you can select from AUTO, BIT, WORD and FRAME cycle modes.

Pushbutton selection of amplitude up to 15V (including fixed ECL) and bit rate also speeds setups. And data can either be programmed manually, or, with the HP-IB\*\* option (\$425\*), under calculator or computer control or with HP's 15263 Card Reader (\$600\*).

A look at the front panel shows that you can choose between a single 2048-bit channel or dual 1024-bit channels that are clocked simultaneously. You can also select either NRZ or RZ formats; internal or external clocking. You have outputs for word trigger, first and last bit, and clock.

Priced at \$3475\*, the 8018A gives you simulated serial data that used to require a computer. But it has the flexibility and high quality output needed for a variety of lab or production serial data-testing needs. Ask your local HP field engineer for all the details.

\*Domestic U.S.A. price only

\*\*HP's implementation of IEEE Standard 488-1975

HEWLETT  PACKARD

1507 Page Mill Road, Palo Alto, California 94304

For assistance call Washington (301) 948-6370, Chicago (312) 255-9800, Atlanta (404) 955-1500, Los Angeles (213) 877-1282

Circle 2 on reader service card

- 29 **Electronics Review**  
AUTOMATIC TEST EQUIPMENT: LSI testers hit price low, 29  
COMPUTERS: Vonderschmitt warns of Japanese computer threat, 30  
COMMUNICATIONS: Electronic mail system will broadcast messages, 31  
MEDICAL: Voice system generates messages for handicapped, 32  
SOLID STATE: Intel upsetting picture for large ROM pinouts, 35  
COMPUTERS: Lack of software may hurt DEC's 32-bit mini, 36  
PACKAGING & PRODUCTION: Laser directs harness assembly, 38  
CONSUMER: Focusing chip for camera matches images, 40  
NEWS BRIEFS: 42
- 55 **Electronics International**  
JAPAN: Laboratory is growing 5-in.-diameter ingots, 55  
WEST GERMANY: IC and sensor plate control light dimmer, 55  
AROUND THE WORLD: 56
- 65 **Probing the News**  
SOLID STATE: The CCD's future takes on a bright hue, 65  
PEOPLE: Matsushita's new chief to push R&D, 69  
COMMERCIAL: Solar cells click in irrigation test, 72  
COMMUNICATIONS: Motorola gets green light for cellular trial, 74
- 89 **Technical Articles**  
INSTRUMENTS: Ovenless oscillators will resolve 20-ps pulses, 89  
PACKAGING & PRODUCTION: E beam improves its throughput, 96  
DESIGNER'S CASEBOOK: Number-generator sequence extended, 102  
Optocoupler transmits pulse width accurately, 103  
Timer IC circuit separates repetition rate and duty cycle control, 105  
INSTRUMENTS: Diagnosis with emulation yields fast fault-finding, 107  
COMPONENTS: What you should know about data-converter drift, 111  
ENGINEER'S NOTEBOOK: Simple go/no-go tester checks op amps, 116  
One-shot and flip-flop add single-sweep option to scope, 117  
Shunt diode extends linear range of LED, 119
- 127 **New Products**  
IN THE SPOTLIGHT: Nodal tester handles semiconductors, 127  
COMPONENTS: Carbon resistor networks replace discretes, 131  
SEMICONDUCTORS: 16-k dynamic RAM has dual latch modes, 139  
DATA HANDLING: Graphics terminal has raster scan, 146  
SUBASSEMBLIES: Dc-to-dc converters handle 12 watts, 155  
INSTRUMENTS: 10-MHz logic analyzer plugs into scope, 163  
PACKAGING & PRODUCTION: TV system eases wafer dicing, 168  
MICROWAVES: Signal generator spans 10.0 to 15.5 GHz, 174  
MATERIALS: 189
- Departments**  
Publisher's letter, 4  
Readers' comments, 6  
News update, 8  
Editorial, 12  
People, 14  
Meetings, 20  
Electronics newsletter, 25  
Washington newsletter, 49  
Washington commentary, 50  
International newsletter, 53  
Engineer's newsletter, 120  
New literature, 191
- Services**  
Employment opportunities, 198  
Reprints available, 210  
Reader service card, 215

## Highlights

### Cover: Oscillator measures pulses faster, 89

A triggered oscillator that can be phase-locked permits time-interval generation with a resolution of 50 picoseconds and interval measurement with a 20-ps resolution. Ovens are not necessary because the circuits can be designed to be immune to component, temperature, and power-supply variations, within a given range.

Cover illustration by Mark Smith.

### CCDs bidding to replace floppy disks, 65

The time may be ripe for a shift to charge-coupled-device memories in the computer industry. With 65,536-bit CCDs becoming available, first widespread use probably will be as a successor to fixed-head storage, because no system redesign is necessary.

### Maskless e-beam unit has high throughput, 96

A lithography system with a large, square electron beam is printing 2.5- $\mu\text{m}$  patterns on wafers at the rate of 22 exposures an hour; a throughput found in commercial wafer production. Such systems use computer control rather than masks to form patterns, which can have 1- $\mu\text{m}$  geometry.

### Tester matches wits with microprocessors, 107

By using the microprocessor socket of a system under test, a new troubleshooting instrument can test the system's functions with in-circuit emulation. It also performs signature analysis for isolation of component faults.

### In the next issue . . .

New pyroelectric vidicon widens applications for thermal imaging . . . the technology behind Japanese video tape recorders . . . a calculator program that designs cascaded tuned circuits: the first of two parts.

EDITOR-IN-CHIEF: Kemp Anderson

EXECUTIVE EDITOR: Samuel Weber

MANAGING EDITOR: Arthur Erikson,  
*International*

SENIOR EDITORS: Laurence Altman, William F.  
Arnold, Ray Connolly, Lawrence Curran, John  
Johnsrud, H. Thomas Maguire, Stephen E.  
Scrupski, Gerald M. Walker

ART DIRECTOR: Fred Sklenar

ASSOCIATE EDITORS: Howard Wolff,  
Alfred Rosenblatt

DEPARTMENT EDITORS  
*Aerospace/Military*: Ray Connolly  
*Circuit Design*: Vincent Biancomano  
*Communications & Microwave*:  
Richard Gundlach  
*Components*: Lucinda Mattera  
*Computers*: Raymond P. Capece  
*Consumer*: Gerald M. Walker  
*Instrumentation*: Stephen E. Scrupski  
*New Products*: H. Thomas Maguire,  
Michael J. Riezenman  
*Packaging & Production*: Jerry Lyman  
*Solid State*: Laurence Altman

CHIEF COPY EDITOR: Margaret Eastman

COPY EDITORS: Ben Mason, Mike Robinson

ART: Charles D. Ciatto, *Associate Director*  
Paula Piazza, *Assistant Director*

EDITORIAL SECRETARIES: Janet Noto,  
Penny Kaplan

EDITORIAL ASSISTANT: Marilyn B. Rosoff

FIELD EDITORS  
*Boston*: Lawrence Curran (Mgr.)  
Pamela Hamilton  
*Los Angeles*: Larry Waller (Mgr.)  
*Midwest*: Larry Armstrong (Mgr.)  
*New York*: Bruce LeBoss (Mgr.)  
*San Francisco*: William F. Arnold (Mgr.)  
*Washington*: Ray Connolly (Mgr.)  
*Frankfurt*: John Gosch  
*London*: Kevin Smith  
*Paris*: Arthur Erikson  
*Tokyo*: Charles Cohen

McGRAW-HILL WORLD NEWS  
*Editor*: Michael Johnson  
*Brussels*: James Smith  
*Milan*: Andrew Heath  
*Moscow*: Peter Hann  
*Paris*: Andrew Lloyd  
*Stockholm*: Robert Skole  
*Tokyo*: Robert E. Lee

PUBLISHER: Dan McMillan

ADVERTISING SALES MANAGER:  
Paul W. Reiss

MARKETING ADMINISTRATION MANAGER:  
Wallis Clarke

CIRCULATION MANAGER: Karl Peterson

MARKETING SERVICES MANAGER:  
Tomlinson Howland

RESEARCH MANAGER: Margery D. Sholes

David Chu and Keith Ferguson, co-authors of the article on the triggered phase-locked oscillator and its applications in two new Hewlett-Packard instruments, have a long history of cooperation at HP. They worked together on the 5360 computing counter in the late 1960s, and again in the group that spawned the instruments described in the article on page 89.

Chu is the inventor of the triggered phase-locked oscillator, with a patent granted in 1975, and was the project leader for the 5370A counter. Ferguson was the project leader on the 5359A time synthesizer, which also uses the oscillator. He says that "it was a fortuitous circumstance that Dave came along with his invention just when we needed it." The instrument was originally conceived as a plug-in unit for a counter, but Ferguson says this idea was scrapped when they realized that much of the counter capability would go unused with the synthesizer. So they decided to design it as a separate box.

The two instruments have much in common, using identical power supplies, time-base sections, and micro-processor control sections. Moreover, Chu says, "leaders of all new projects make this group the first stop, to see what they can use before beginning the design."

Chu received his BSEE degree from the University of California at Berkeley and his MSEE and PhD from Stanford University. He has been with HP since 1962, with some time off for leaves of absence while he worked on his doctorate. He has also spent some time in Liberia teaching college-level mathematics and physics courses.

Ferguson has his bachelor's, master's, and doctoral degrees in electrical engineering from Massachusetts Institute of Technology and has worked at HP full time since 1965. He had previously worked some summers for the firm while doing graduate work.

Most designers "just don't understand how to determine the worst-case accuracy degradation due to temperature drift," says Paul Prazak, a design engineer with the data-conversion products group at Burr-Brown, who wrote the article on page 111. "They simply take all the drift parameters and add them together, so they often buy a better converter than they really need."

Prazak joined Burr-Brown about 4½ years ago and has since been busy making solid contributions in the converter area. Yet the job with Burr-Brown is his first in electronics. Prazak received his bachelor's degree in electrical engineering at California State University in Sacramento, going on to take his MSEE at the University of Arizona in Tucson.

As for the future, he sees higher levels of integration for data-conversion products. "We will be putting more and more in the hybrid package, and more and more on the chips inside the package. Rather than developing new technology, though, we'll be putting existing technology to better use with the refinement of production techniques."



November 10, 1977 Volume 50, Number 23 96,448 copies of this issue printed

Published every other Thursday by McGraw-Hill, Inc. Founder: James H. McGraw 1860-1948. Publication office 1221 Avenue of the Americas, N.Y., N.Y. 10020; second class postage paid at New York, N.Y. and additional mailing offices.  
Executive, editorial, circulation and advertising addresses: Electronics, McGraw-Hill Building, 1221 Avenue of the Americas, New York, N.Y. 10020. Telephone (212) 997-1221. Teletype 12-7960 TWX 710-581-4879. Cable address MCGRAW HILL N E W Y O R K.

Subscriptions limited to professional persons with active responsibility in electronics technology. No subscriptions accepted without complete identification of subscriber name, title or job function, company or organization, and product manufactured or services performed. Based on information supplied, the publisher reserves the right to reject non-qualified requests. Subscription rates: in the United States and possessions \$14 one year, \$25 two years, \$35 three years, company addressed and company libraries \$20 one year, \$36 two years, \$50 three years; APO/FPO addressed \$35 one year only, Canada and Mexico \$16 one year, \$28 two years, \$40 three years; Europe \$40 one year, \$71 two years, \$100 three years, Japan, Israel and Brazil \$65 one year, \$115 two years, \$165 three years, Australia and New Zealand \$90 one year, \$170 two years, \$240 three years, including air freight; all other countries \$45 one year, \$80 two years, \$112 three years. Limited quota of subscriptions available at higher-than-basic rate for persons allied to field served. Check with publisher for these rates. Single copies: \$4.00. Please allow four to eight weeks for shipment.

Officers of McGraw-Hill Publications Company: Gordon L. Jones, President; Paul F. McPherson, Executive Vice-President; Group Vice-President: Gene W. Simpson, Senior Vice-President; Russell F. Anderson, James E. Boddorf, Planning & Development; David G. Jensen, Manufacturing; Ralph R. Schulz, Editorial; Vice-Presidents: Denis C. Beran, European Operations; David P. Forsyth, Research; Douglas Greenwald, Economics; James E. Hackett, Controller; Robert L. Leyburn, Circulation; Edward E. Schirmer, Sales.  
Officers of the Corporation: Harold W. McGraw, Jr., President, Chief Executive Officer, and Chairman of the Board; Robert N. Landes, Senior Vice President and Secretary; Ralph J. Webb, Treasurer.

Title registered in U.S. Patent Office. Copyright © 1977 by McGraw-Hill, Inc. All rights reserved. The contents of this publication may not be reproduced in whole or in part without the consent of copyright owner.  
Subscribers: The publisher, upon written request to our New York office from any subscriber, agrees to refund that part of the subscription price applying to copies not yet mailed. Please send change-of-address notices or complaints to Fulfillment Manager, subscription orders to Circulation Manager, Electronics, at address below. Change-of-address notices should provide old as well as new address, including postal zip code number. If possible, attach address label from recent issue. Allow one month for change to become effective.

Postmaster: Please send form 3579 to Fulfillment Manager, Electronics, P.O. Box 430, Hightstown, N.J. 08520.

# \$295

U.S. PRICE



## YOUR BEST BUY IN SWEEP FUNCTION GENERATORS

The Krohn-Hite Model 1200 offers linear sweep (up or down) plus sine, square or triangle waveforms from .2Hz to 3 MHz. Features include: 1500:1 tuning dial plus vernier; external VC and CV output; push button control; DC offset control; auxiliary TTL output; separate HI and LO outputs and much more! Take advantage of this price while we're in a generous mood. Call (617) 580-1660 for more details.

# \$245

U.S. PRICE

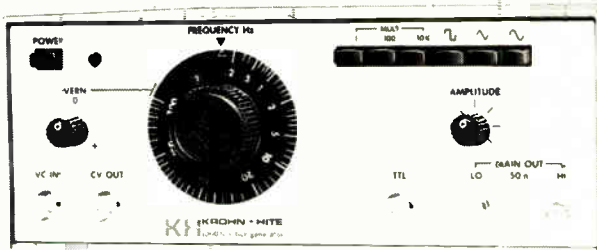

## SECOND BEST

**LESS SWEEP** The new Model 1000 has all the quality features of the 1200 except sweep!

# KH KROHN-HITE CORPORATION

Avon Industrial Park, Avon, Mass. 02322 • (617) 580-1660

Circle 5 on reader service card

SALES OFFICES ALA., Huntsville (205) 534-9771. ARIZ., Scottsdale (602) 994-5461. CAL., San Jose (408) 292-3220. Inglewood (213) 674-6850. COL., Denver (303) 773-1218. CONN., W. Hartford (203) 525-7647. FLA., Orlando (305) 894-4401. GA., Atlanta (404) 455-1206. HAWAII, Honolulu (808) 941-1574. ILL., Arlington Hts. (312) 394-3380. KS., Overland Park (903) 384-2711. LA., Lafayette (318) 984-3516. MASS., Wakefield (617) 245-5430. MICH., Southfield (313) 569-4497. MINN., St. Paul (612) 645-5815. MO., St. Louis (314) 741-5400. N.M., Albuquerque (505) 255-2330. N.J., Cherry Hill (609) 482-0054. N.Y., Elmont (516) 488-2400. ROCHESTER (716) 328-2230. SYRACUSE (315) 437-6666. VESTAL (607) 785-9947. N.C., Burlington (919) 227-3639. OHIO, Chesterland (216) 729-2222. Dayton (513) 434-8993. OKLA., Tulsa (918) 299-2636. ORE., Portland (503) 297-2248. TEX., Dallas (214) 661-0400. Houston (713) 688-1437. UTAH, Salt Lake City (801) 942-2081. VA., Falls Church (703) 573-8787. WA., Bellevue (206) 454-3400. CANADA, Montreal-Quebec (514) 341-7630. Ottawa-Ontario (613) 235-5127. Toronto, Ontario (416) 445-9900. Vancouver, British Columbia (604) 253-5555. MEXICO, Guadalajara (902) 454-8321. St. John's, Newfoundland (709) 726-2422.

**A filter so precise,  
filter characteristics  
for every setting  
are printed  
on top.**



We've built a variable electronic filter that's so precise, it has enabled us to print the cutoff frequencies, center frequency, bandwidth, noise bandwidth and filter gain, for every setting, on top of the instrument. Besides being the easiest-to-use filters on the market, our 4200 series filters are twice as accurate, have less than half the self-noise, and provide 10 dB greater outband rejection than other filters. Frequency coverage is .01 Hz to 1 MHz. Built-in selectable post-filter gain and remote preamplifiers are optional. A Butterworth response is used in the NORMAL mode and a Bessel response in the PULSE mode (transient response is superior to conventional "RC" or "Low Q" modes of other filters).

For complete specifications and your free copies of our variable electronic filter application notes, write to: Ithaco, Box 818-7R, Ithaca, New York 14850. For immediate response, call John Hanson at 607-272-7640 or TWX 510-255-9307.

**ITHACO**

## Readers' comments

### Revised picture

**To the Editor:** In your Sept. 29 article "New ITT unit has eye on the 1980s" [p. 72], you wrote: "France's CIT, probably ITT's most advanced European competitor, has reportedly run into cost problems on its E-10 and is thought to be changing its design concept for the larger E-12 system." We do not think this statement gives a true picture of our research and development strategy.

The E-10 system has, since 1970, achieved worldwide recognition as the first operational all-electronic digital time-division system. As our order book has now reached 1 million lines, production costs are coming down fast. The much larger E-12 system does not represent a change in our time-division design concept; rather, it will answer the market for very large central offices and transit exchanges, those requiring more than the 30,000-line capacity of the E-10 system.

R. de Bruin  
Compagnie Industrielle des  
Télécommunications  
Paris, France

### Key out

**To the Editor:** At least one error exists in the program in "SR-52 solves second-order differential equations" [Sept. 29, p. 113]. The keys column shows six strokes for locations 095-099, not five. The final key stroke, = (at location 100), is redundant and should be deleted. Otherwise, all strokes from 100 to 218 will be located one step later than listed.

R. O. Deck  
Palo Alto, Calif.

### Change of address?

**To the Editor:** After reading your editorial on Zenith, "Biting the Bullet" [Oct. 13, p. 12], I have one question: how come Japanese manufacturers find it profitable to manufacture color TV sets in the U. S., as Sony does in San Diego? Maybe Zenith should have moved its corporation overseas and kept the jobs in the U. S.

Heinz W. Georgi  
San Diego, Calif.



# Hot new circuit ideas with RCA op amps and arrays.

When you put RCA BiMOS op amps together with other RCA op amps and arrays, they have a way of making circuits easier, more effective and often less expensive.

## One-knob function generator.

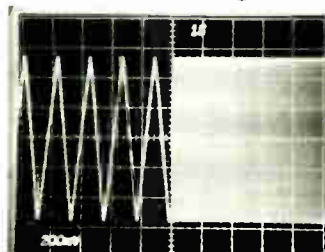

1,000,000/1 frequency range—1 Hz to 1 MHz—with a single control knob and just three op amps. Two CA3080 variable op amps (one on input, one as output hysteresis switch), plus one CA3160 internally compensated BiMOS op amp as buffer.

## Electronic alarm.



Wide signal swing of the CA3130 combined with the variable gain control features of the CA3094 produce yelp, wail, two-tone and other sounds in sirens and alarms.

## Low-power timing signal.

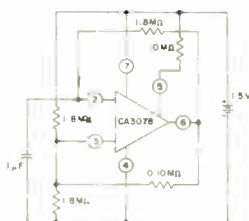

Multivibrator using CA3078 micropower op amp generates a timing signal from a 1.5 V battery supply with just 3 microwatts of power. A CA3078 exclusive.

## Bandgap reference supply.



For power supplies and DVMs, it provides 2.35 V reference. Uses a CA3078 micropower op amp as a buffer for the bandgap reference, the CA3086 transistor array. Eliminates need for discrete diodes.

## Audio power amp.

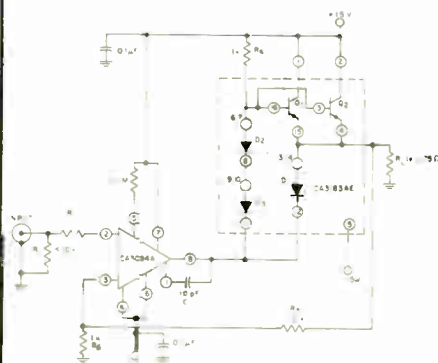

A CA3094 variable op amp plus a CA3183 transistor array provide push-pull output of 100 mA average. Drives high impedance speakers.

## Sample-and-hold system.

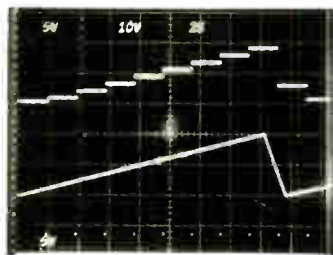

Ideal for single supply, low-cost applications. Samples inputs ranging from 0 to 10 V. The BiMOS CA3140 makes it possible.

## Wien bridge oscillator.

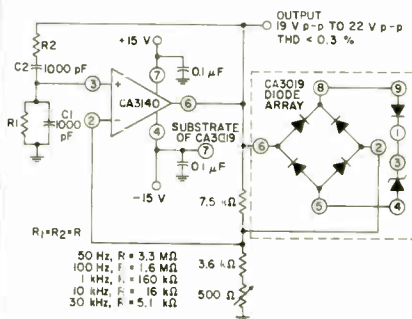

CA3140 op amp and CA3019 diode array combine to produce a low-cost wien bridge with 50 Hz to 30 kHz range.

## Battery voltage monitor.

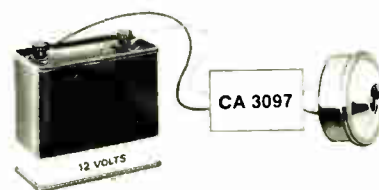

CA3097 array has all the diodes, transistors, SCRs and PUTs you need to provide a visual or aural signal indicating low battery charge.

There's a lot more you can do with RCA's full line of Linear ICs. Get complete details on these and other useful circuits in our new brochure.

Contact RCA Solid State headquarters in Somerville, NJ; Sunbury-on-Thames, Middlesex, England; Quickborn 2085, West Germany; Ste. Anne-de-Bellevue, Quebec, Canada; Sao Paulo, Brazil; Tokyo, Japan.

**RCA Linear IC experience is working for you.**

# RCA

# WE'RE #1 IN EQUIPMENT RENTALS



More people  
More plant  
More experience

The Continental concept of sales and service has grown to a team of more than 150 "Professionals" in 10 nation-wide offices.

Rental inventory, offices, service and calibration labs exceed 60,000 square feet of floor space.

In-house service, experienced personnel and four hundred thousand dollars/month in new equipment purchases keep us #1.

## Rent with Confidence

Get our  
FREE  
Catalog

# Call Continental Rentals

Div. Continental Resources, Inc.  
175 Middlesex Turnpike, Bedford,  
MA 01730 (617) 275-0850

FOR IMMEDIATE RESPONSE CALL:  
N.E. (617) 275-0850; L.I. (516) 752-1622;  
NY, NJ (201) 654-6900;

Florida (800) 638-4050;  
Gtr. Phila. (609) 234-5100;  
Wash., D.C. area (301) 948-4310;  
Mid West (312) 439-4700;  
So. Central (800) 323-9656;  
Costa Mesa, CA (714) 540-6566;  
L.A., CA (213) 638-0454;  
Santa Clara, CA (408) 735-8300.

## News update

■ Supporting its contention that cathode-ray-tube consoles will ultimately supplant the conventional massive analog displays now found in industrial instrumentation facilities, Honeywell Inc.'s Process Control divisions in Fort Washington, Pa., and Phoenix, Ariz., have made major enhancements of its two-year-old TDC 2000 digital process-control system.

Developed around the CP 1600 16,384-bit microprocessor from General Instrument Corp.'s Microelectronics group in Hicksville, N. Y., the TDC 2000 links microprocessor controllers and CRT-based operator stations via coaxial cable to one another or to a central process computer [*Electronics*, Nov. 13, 1975, p. 25].

The additions to the system, unveiled last month, include historical and real-time trend recording, alarm annunciation and displays, logging, CRT and keyboard interface with intelligent multiplexers, digital start/stop operations, and uninterrupted automatic control. The latter feature is a Honeywell development that automatically detects the malfunction of from one to eight basic controllers, announces that to the operator, switches in a reserve controller, and resumes control of the process, "all in less than a second," says L. Bruce Hilsee, the Honeywell divisions' manager of sales development.

Some of the enhancements are provided for the TDC 2000 system by modifications to the system software, at no cost to the user. Other system additions are through memory cards, costing \$1,000 to \$1,200 each. These cards plug into existing connectors and make it possible to update installed systems without massive wiring changes.

In the two years since it introduced the TDC 2000, Honeywell has sold more than 100 systems, involving more than 8,000 control loops, with a total value estimated at \$70 million to \$80 million. Systems have been ordered in the U. S. and Canada, Latin America, Europe, South Africa, Taiwan, and Japan.

**Bruce LeBoss**

# Tomorrow's testing is here!

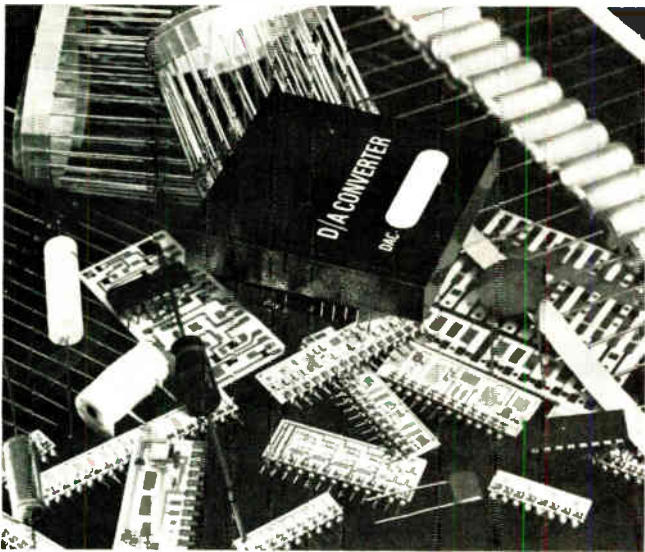

## The GR 2230 is testing:

- thick and thin film networks
- hybrid circuits
- discrete components on reels
- sequenced components
- diodes and transistors
- small functional modules/circuits
- switches and relays
- transformers
- hi-rel components
- D/A-A/D converters

## In all of these areas:

- production control
- incoming inspection
- quality monitoring
- environmental testing

## Components • Networks • Modules Test them all automatically on one tester — GenRad's 2230

### Automate your testing with a computer-controlled component, network and module tester for under \$20,000.

These days, multi-leaded networks and modules have become so complex, you simply can't get away with sample testing.

Yet in-house or calculator-based test systems are just too slow, and the computer-controlled ones cost an arm and a leg.

But now there's the GR 2230.

At the heart of this compact bench-top system is a small but powerful microcomputer. To give you computer-controlled speed, accuracy and flexibility.

The 2230 will test components, networks, modules, and small PC boards at speeds up to 80 tests per second, measuring to specified limits the performance of each circuit component.

It can be programmed by just about anyone, thanks to its unique English-language macro-instruction keyboard. Programs are then automatically stored on magnetic cards for easy retrieval.

In addition, the system will continuously print out all test data and can be easily interfaced to virtually any device handler.

The GR 2230. A computer-controlled tester you can afford. Now that you can't afford to be without a computer-controlled tester.



 **GenRad**

300 BAKER AVENUE, CONCORD, MASSACHUSETTS 01742 • ATLANTA 404 394-5380 • BOSTON 617 646-0550 • CHICAGO 312 884-6900 • DALLAS 214 234-3357 • DAYTON 513 294-1500  
LOS ANGELES 714 540-9830 • NEW YORK (NY) 212 964-2722, (NJ) 201 791-8990 • SAN FRANCISCO 408 985-0662 • WASHINGTON, DC 301 948-7071 • TORONTO 416 252-3395 • ZURICH (01) 55 24 20

## The hidden threat in capital-gains reform

Capital-gains taxes may seem a subject pretty far removed from most engineers and their everyday jobs. Yet there is a vital relationship between the two. Indeed, it has been the special tax status of dollars invested in such things as the stock of new, young companies that has fueled the financing of a whole generation of entrepreneurs brash enough to pit their technological edge against bigger, more conservative companies. The result, of course, has been companies that are now important factors in the nation's economy. Think, for example, of the jobs created by an Intel, by a Digital Equipment Corp., to say nothing of the jobs at all the companies supplying them and all the companies they supply.

Right now, there are moves afoot in Washington to end the special capital-gains provisions for taxation of the profits on investments—that is, on money put out at risk. Somewhat offsetting that elimination would be some new benefits such as investment tax incentives, liberalized depreciation, and the ending of double taxation of corporation dividends—first a tax on the corporations' profits, then one on the dividend paid to shareholders.

The trouble is, however, that the lower tax rates applied to capital gains, as compared with ordinary income, have been a great incentive to investors to take the higher risk inherent in buying the stock of fledgling companies. Up until the last few years, the small companies with strong technological positions have been able to find financial support in the venture-capital market. Without the capital-gains tax inducement, though, many executives fear, sources of venture capital will dry up. Why take a high risk with

your money, they ask, if you haven't a chance to get a big payoff?

More and more, perceptive executives are discovering this overlooked pitfall in the Administration's tax proposals. Ray Stata, president of Analog Devices, for one, points out that there is a vast difference between primary and secondary capital investment. Primary investment is the purchase of stock from a company, thereby giving it the capital it needs to function. Secondary investment is the later change in ownership of the stock, such as buying and selling on a stock exchange. Stata believes that, whatever is done with secondary investment profits, primary investment should keep the benefit of a preferential tax treatment—perhaps even be made free of tax—to promote the funding that has been so vital to new company start-ups.

What's more, a number of organizations are looking into what can be done to head off this tax "reform." WEMA has a task force already in operation, and it has the job of formulating a position on current tax proposals.

The group is now in the process of surveying member companies to obtain hard data to back up its arguments on the importance of preferential capital-gains taxes to new firms. So far some 200 returns have come in, and between 700 and 1,000 are hoped for.

WEMA plans to take the results before Congress and help shape pending legislation in favor of protecting and promoting the innovation that has made the U. S. economy so strong. Beyond that, both engineers and companies have a stake in this problem and should make their voices heard not only through group action, such as WEMA's approach, but through individually contacting their congressional representatives.

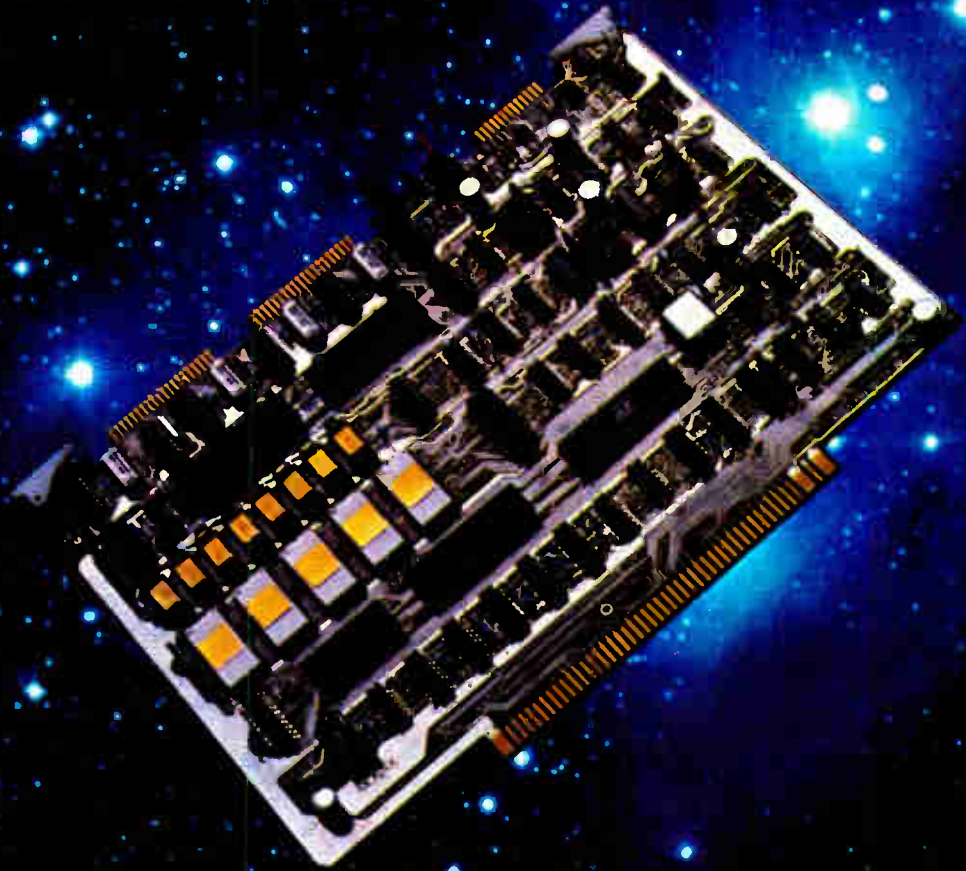

# Mostek's\* \$995 SDB-80 delivers Z80 power and 16K bytes of RAM.

## The solution for OEM applications.

For OEM applications, the SDB-80 is one of the most powerful, yet low-cost microcomputers available in the industry. For \$995 (single unit cost), the SDB-80 single-board microcomputer provides Mostek's Z80 CPU (MK 3880), eight MK 4116 16K RAM memories, two PIO's (MK 3881), one CTC (MK 3882), serial ASCII interface (110-9600 baud) sockets for up to 5K bytes of PROM or 20K bytes of ROM, plus a fully-buffered and

highly-sophisticated system bus for complete expandability (including multi-processor applications).

## The solution for software development.

For software development, the SDB-80 is available with a complete package of software development aids in ROM. This optional 10K byte firmware package may be located in sockets on the board to provide the ability to generate, edit, assemble, execute, and debug programs for all types of Z80 applications.

For users requiring even greater system capability, the SDB-80 is expandable with the use of optional add-on boards. In this way, the user may configure his system to include any amount of PROM, ROM, RAM or I/O desired, plus add such features as in-circuit emulation, floppy-disk interfaces, and PROM programming capability.

For more information on the SDB-80 and the complete range of optional support boards, software, and boxes, contact your local Mostek sales office or representative.

# MOSTEK

1215 West Crosby Road • Carrollton, Texas 75006 • (214) 242-0444 • **MOSTEK GmbH** • West Germany • Telephone: (0711) 701096 • **MOSTEK ASIA** • Hong Kong • Telex: 85148MKA HX

\*Single unit cost. Prices apply within the U.S. and Canada. Eurocard version available. Contact Mostek GmbH.

# Be sure you're using the most up-to-date GE miniature lamp design data.

Out-of-date information could affect your designs adversely and new data on new lamps could lead the way to new ideas. Take a minute to check the dates on these seven catalogs be sure you've got the most up-to-date information at your fingertips, and help you pick the best GE miniature lamps for each of your design needs.

- All catalogs are free.
- Data and information is current.
- Organized for quick, easy, accurate reference.
- Saves you valuable time.



#3-5257-R

### Halogen-Cycle Lamps

Revised April, 1977. The 12 pages feature greatly expanded data including lamp specifications, characteristics, design considerations and selection guide.



#3-7070

### Miniature Lamps

Revised April, 1977. Features almost 100 new lamps not previously listed; covers almost 600 lamps, 40 pages.

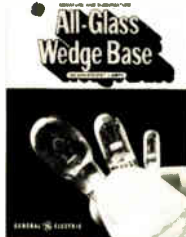

#3-5259R2

All-Glass Wedge Base Lamps  
Revised March, 1977. Contains all specifications and data for 11 newest wedge base lamps plus revised drawings and engineering specifications on the full line.



#3-6383

Farm Tractor Sealed Beam Lamps  
Revised September, 1976. Four pages feature the expanded line farm equipment, including diagrams of lamp beam patterns.



#3-6016

### Sub-Miniature Lamps

Revised May, 1976. Includes latest data on more than 194 lamps of 1/4" diameter and smaller, 28 pages.



Form 5000

### Miniature, Sealed Beam and Glow Lamps

Revised February, 1976. Features 36 pages of technical lamp data covering 950 lamps, both miniature and sealed beam. Lists lamps in numerical order.

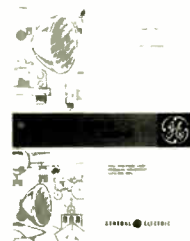

#3-5211

### Sealed Beam Lamps

Revised September, 1975. Lists electrical and physical specifications, applications and numerical index in 16 pages.

## To get your free GE lamp catalogs today.

Call your local GE Miniature Lamp Products Dept. Specialist. Or write: General Electric Miniature Lamp Products Dept. #3382, Nela Park, Cleveland, Ohio 44112.

**GENERAL ELECTRIC**

## People



**Noncopier.** James Campbell counts for sales on the desire to up office productivity.

facturing computer-controlled printers, telecopier units, electronic typing, or word-processing, systems, and remote terminals that can tie into a Xerox-operated computer service network. Linked together, these products add up to the so-called "office of the future," which has not exactly been living up to expectations as the replacement for conventional office gear.

**Change in regard.** Many companies found "you couldn't even force secretaries into such EDP [electronic data-processing] centers," explains Campbell, who joined Xerox in 1969 to set up the computer services unit after serving as president of Greyhound Computer Corp. and spending 15 years with IBM Corp. But time, coupled with the experience of using desk-side word processors and printers, has made potential operators more amenable to the new breed of equipment, he says. Now they regard them as helpful products rather than a threat, he maintains.

To make its impact on the marketplace, Xerox has been setting a lively pace this year with five major new office products introduced so far. The latest came only late last month—a family of 10 word-processing machines, an area in which Xerox had lagged. The company leads in the telecopier market, Campbell says, "growing in direct proportion to unhappiness with the U. S. mail."

"The challenge is to show the customer where he can get added values and cost benefits," he says. "And we have all the tools to make a real impact on business."

# EAROM

In a class by itself.



GI's EAROM is the most advanced memory chip available. It can do more things than a RAM, ROM, PROM or EPROM.

EAROM is non-volatile. Unlike a RAM, it doesn't lose its data in a blackout, or from battery failure. Another thing. An EAROM is *electrically* erasable and reprogrammable. So you don't get stuck with costly inventories like you can with one-shot programmed ROMs and PROMs. With an EAROM you're never locked in. You can program and reprogram it. You can erase and rewrite it electrically over and over again—in circuit or at-the-bench without an ultraviolet light. And unlike UV EPROMs, stray sunlight or X-rays can't accidentally wipe out an EAROM's data. EAROM is word alterable, too. There's no need to clear the memory completely.

Only General Instrument Microelectronics makes a full line

BITS	MEMORY ORGANIZATION	PART NUMBER	READ ACCESS	ERASE/WRITE MODE
512	32 × 16	ER2051	3μs	16 bit word
1024	256 × 4	ER1105	2μs	32 × 4 block 4 bit word
1400	100 × 14	ER1400	2.8μs	14 bit word
4096	1024 × 4	ER2401A	2μs	1024 × 4 block 4 bit word
		ER3400	650ns	4 bit word or 1024 × 4 block 4 bit word
		ER3401	950ns	
8192	2048 × 4	ER2805	2μs	2048 × 4 block 4 bit word

of EAROMs with bit densities from 512 to 8192. In fact, we wrote the book on EAROMs. Find out how GI microcircuitry can help put your product in a class by itself. Write or call General Instrument Microelectronics, 600 West John Street, Hicksville, New York 11802. Telephone (516) 733-3107.



We help you compete

**GENERAL INSTRUMENT CORPORATION  
MICROELECTRONICS**



# Intel delivers real-time industry's most complete

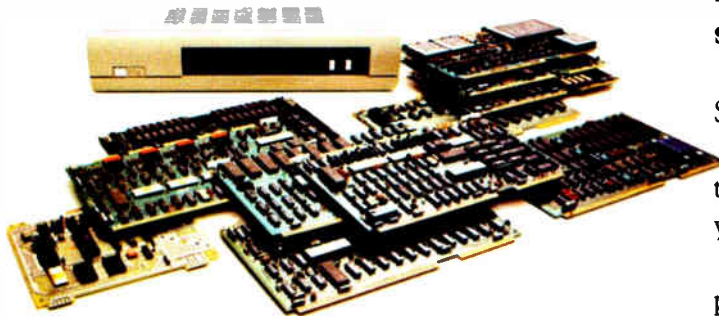

## It starts with the industry's broadest selection for design flexibility.

Intel's family of cost effective single board microcomputer products is growing to keep pace with a changing world.

We delivered the world's first complete computer on a single board in February 1976. It contained CPU, data and program memory, and both serial and parallel I/O. Today we're delivering five Single Board Computers. For cost-conscious, stand-alone applications there's our new SBC 80/04, under \$100\* in OEM quantities. At the high performance end of the spectrum is our SBC 80/20, with full multimaster system capabilities.

You can expand the capabilities of these SBCs and tailor a system to your specific application, selecting from over 25 memory expansion boards, digital and analog I/O boards, communications interface boards, mass storage systems and a high speed math processor. Or, you can choose one of our packaged System 80s with a customized complement of expansion boards.

INTEL SINGLE BOARD COMPUTERS				
Product	CPU	RAM (bytes)	EPROM (bytes)	Bus interface
SBC 80/20-4	8080A	4K	8K (2716) 4K (2708)	Multimaster
SBC 80/20	8080A	2K	8K (2716) 4K (2708)	Multimaster
SBC 80/10	8080A	1K	4K (2708)	Single master
SBC 80/05	8085	512	4K (2716) 2K (2708)	Multimaster
SBC 80/04	8085	256	4K (2716) 2K (2708)	None

## MULTIBUS™ architecture provides a standard you can live and grow with.

The key to efficient utilization of Intel's SBC family is our Multibus. It's the superior bus architecture designed to maximize system throughput and provide an industry standard you can build on.

Multibus enables you to add processing power to your system in modular increments. It fully supports

multimaster systems with up to 16 parallel processors and ensures efficient single master or multimaster system operation with multi-level vectored interrupt capability and bus transfers at up to five million bytes per second.

It's no wonder over 30 other manufacturers have already jumped aboard the Intel Multibus and are now supplying special purpose peripheral boards compatible with it. And, because Multibus is the accepted industry standard architecture, it's your link to future SBC developments.

## RMX /80™ Real-Time Multitasking Executive provides a framework for your application software.

RMX/80 is the most advanced multitasking operating system for any Single Board Computer. For applications that monitor and control a number of interrelated asynchronously occurring events, it can dramatically cut software development time and costs. You develop software only for the individual tasks of your application, and the RMX/80 operating system does the rest providing all intertask communications and



# multitasking software for the Single Board Computer family.

synchronization according to the task priorities you define.

RMX/80 is compact and modular, allowing you to expand and tailor your system software as easily and efficiently as your SBC hardware. The complete RMX/80 executive resides on board in a single 2K byte EPROM chip. Your task programs and the standard RMX/80 I/O drivers you select can reside in additional on-board memory, eliminating the need for bootstrap peripheral devices, or on diskette in modules that are callable by the executive.

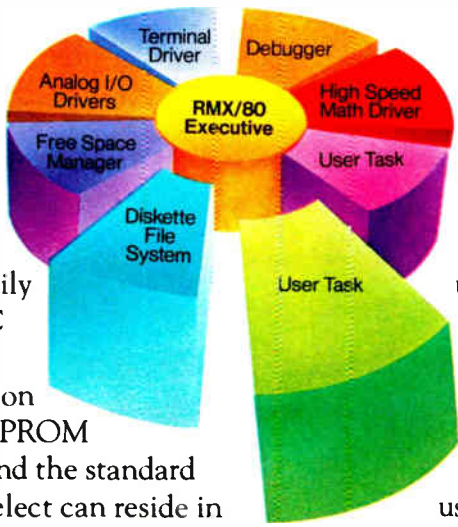

The Intellec® Microcomputer Development System enables you to build programs and debug them in modular form in assembly language or PL/M, our high level system programming language, then link them with standard RMX/80 modules using the Intellec ISIS-II operating system. And, integration of system software with system hardware is simplified by Intel ICE In-Circuit Emulation with symbolic debugging.

Intel gives Single Board Computer users a head start with our comprehensive SBC System Configuration Planning Kit. It's more than a catalog of our SBC products. It contains products, parameters and easy-to-use worksheets—everything you'll need to configure the optimum SBC solution for your application.



For your copy of the planning kit, or for on-site assistance in configuring and pricing your SBC system, contact your local Intel representative or distributor. Or write: Intel Corporation, 3065 Bowers Avenue, Santa Clara, California 95051. Telephone: (408) 246-7501.

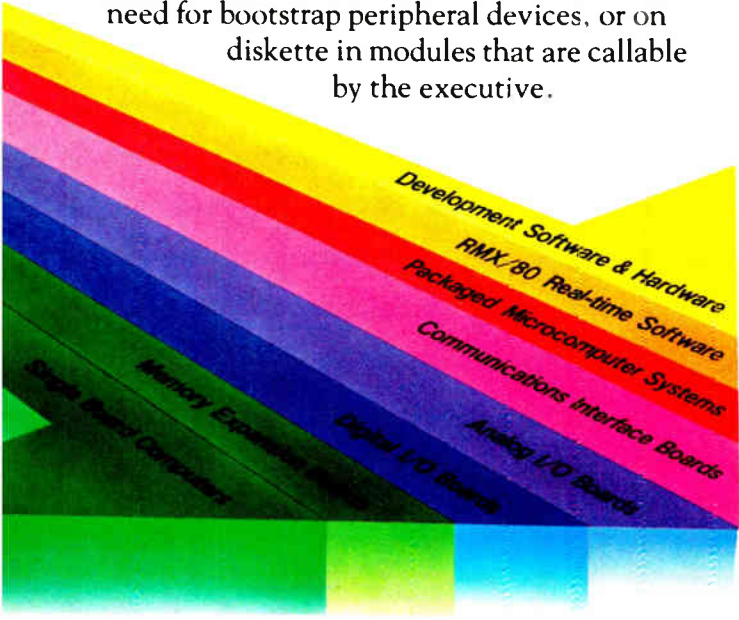

For solutions to real time multitask applications, RMX/80 software makes Intel single board microcomputers the sensible alternative to component-level designs or far more costly mini-computer systems.

## Intel development support gets you to market faster.

Intel stands behind you with development support that makes your job easier and less time consuming.

# intel® delivers.

\*100 quantity, domestic USA price only. I/O drivers, terminators, EPROMs or ROMs not included.

# We're first on the Buss\* (488)

... with programmable D.C. currents  
and voltages!

Our 501J meets the IEEE 488/1975\* interface  
specs to let your computer,  $\mu$ p's or programmable  
calculator call up voltages from  $0.1\mu\text{V}$  to  
200Vdc or current from 10nA to 100mAdc at  
speeds to  $50\mu$  seconds with accuracy to  $\pm 0.005\%$ .

Put these NBS traceable values to work checking  
A/D converters and other voltage or current  
sensitive function modules—Prices from \$1595.  
Contact Bob Ross at (617) 268-9696.



**Electronic Development Corp.**

11 Hamlin Street, Boston, Mass. 02127  
(617) 268-9696

## Meetings

**Electro-Time/77 U. S.—Design and  
Manufacture of Electronic Watches,**  
International Society for Hybrid  
Microelectronics, Florida Chapter,  
Marco Beach Hotel, Marco Island,  
Fla., Dec. 1–2.

**Semiconductor Interface Specialists  
Conference,** IEEE, Carillon Hotel,  
Miami Beach, Dec. 1–3.

**Chicago Fall Conference on Consum-  
er Electronics,** IEEE, Ramada-  
O'Hare Inn, Des Plaines, Ill., Dec.  
5–6.

**International Electron Devices Meet-  
ing,** IEEE, Washington Hilton Hotel,  
Washington, D. C., Dec. 5–7.

**National Telecommunications Con-  
ference,** IEEE, Marriott Hotel, Los  
Angeles, Dec. 5–7.

**1977 Winter Simulation Conference,**  
IEEE, National Bureau of Standards,  
Gaithersburg, Md., Dec. 5–7.

**Miami International Conference on  
Alternative Energy Sources,** U. S.  
Energy Research and Development  
Administration et al., Fountaine-  
bleau Hotel, Miami Beach, Dec. 5–7.

**Computer Networks Symposium,**  
National Bureau of Standards, Gaithersburg, Md., Dec. 15.

**1978 Winter Consumer Electronics  
Show,** Electronic Industries Associa-  
tion, Las Vegas Convention Center  
and Hilton Hotel, Las Vegas, Jan.  
5–8.

**Conference on Integrated and Guided  
Wave Optics,** IEEE, Salt Lake Hilton,  
Salt Lake City, Utah, Jan. 16–18.

**Reliability and Maintainability Con-  
ference,** IEEE, Biltmore Hotel, Los  
Angeles, Jan. 24–26.

**Power Engineering Society Winter  
Meeting,** IEEE, Statler Hilton Hotel,  
New York, Jan. 29–Feb. 3.

**International Solid State Circuits  
Conference,** IEEE, San Francisco Hil-  
ton, San Francisco, Feb. 15–17.

# Did you know that you can save \$1,005 by buying a Fluke 1953A Counter instead?



That's right.

Fluke's 1953A Universal Counter-Timer mainframe plus IEEE Programming option will cost you just \$1,595.\* Instead of the \$2,600 or more you'd pay for comparable models.

And you'll get excellent systems performance plus extras you didn't count on.

Like "clean dropout." If the signal is too small, the 1953A will show zeros. Theirs can give you a wrong reading.

Our frequency range on Channel A is 125 MHz. Theirs is 100 MHz.

Our Z-axis time interval marker is standard. Theirs is optional.

Board access is better on the 1953A. We use one custom I.C. They use many.

Our input capacity on Channels A and B is 30 pF. Theirs is 40 pF. And our Channel B frequency response is 25 MHz. Theirs is 10 MHz.

The 1953A is half the weight, consumes one-fifth the power and makes no noise at all. On theirs you'll hear the fan and switching regulator.

Our switch and control "feel" is as good as theirs, and our front panel labeling is much less confusing.

Where the 1953A shows 9 digits all the time, theirs offers 9 digits only on

Channel C.

And, if you need the option of Parallel BCD for both control and data out, we have it. They don't.

So, if you're in the market for a programmable counter, consider the Fluke 1953A.

And consider how much you'll save.

For data out today, dial our toll-free hotline, 800-426-0361. John Fluke Mfg. Co., Inc., P.O. Box 43210, Mountlake Terrace, WA 98043. Fluke (Nederland) B.V., P.O. Box 5053, Tilburg, The Netherlands. Phone: (013) 673-973. Telex: 52237.

\*U.S. price only

## The 1953A. A programmable counter at a reasonable price.



# Forget our products.

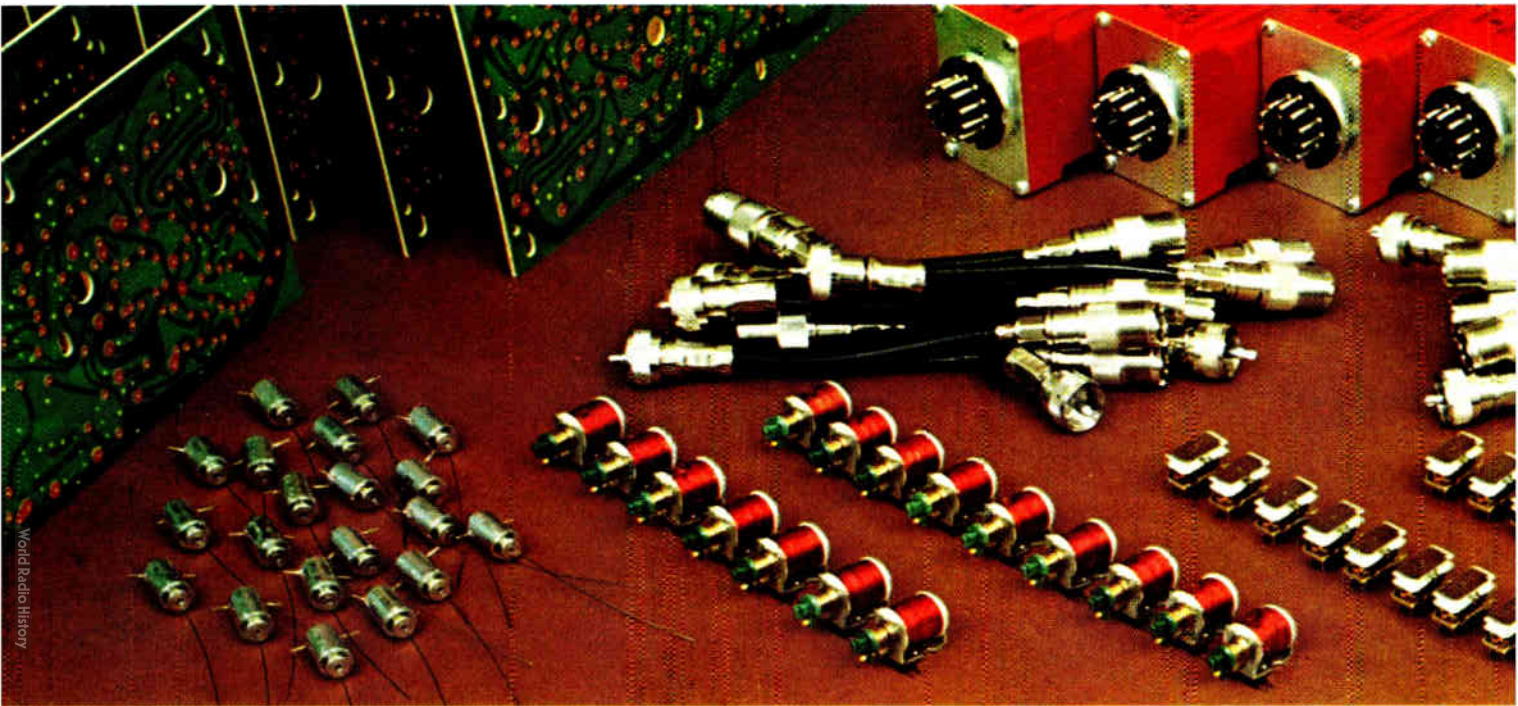

Major manufacturers forget them all the time. Polaroid. DEC. Honeywell. Tandy. Foxboro. Ford. Bendix. Our products are easy to forget. Because, once installed, all of

Hi-G's quality products (transformers, solenoids, timers, printed circuit boards and others) do what they are meant to do. Keep right on working.

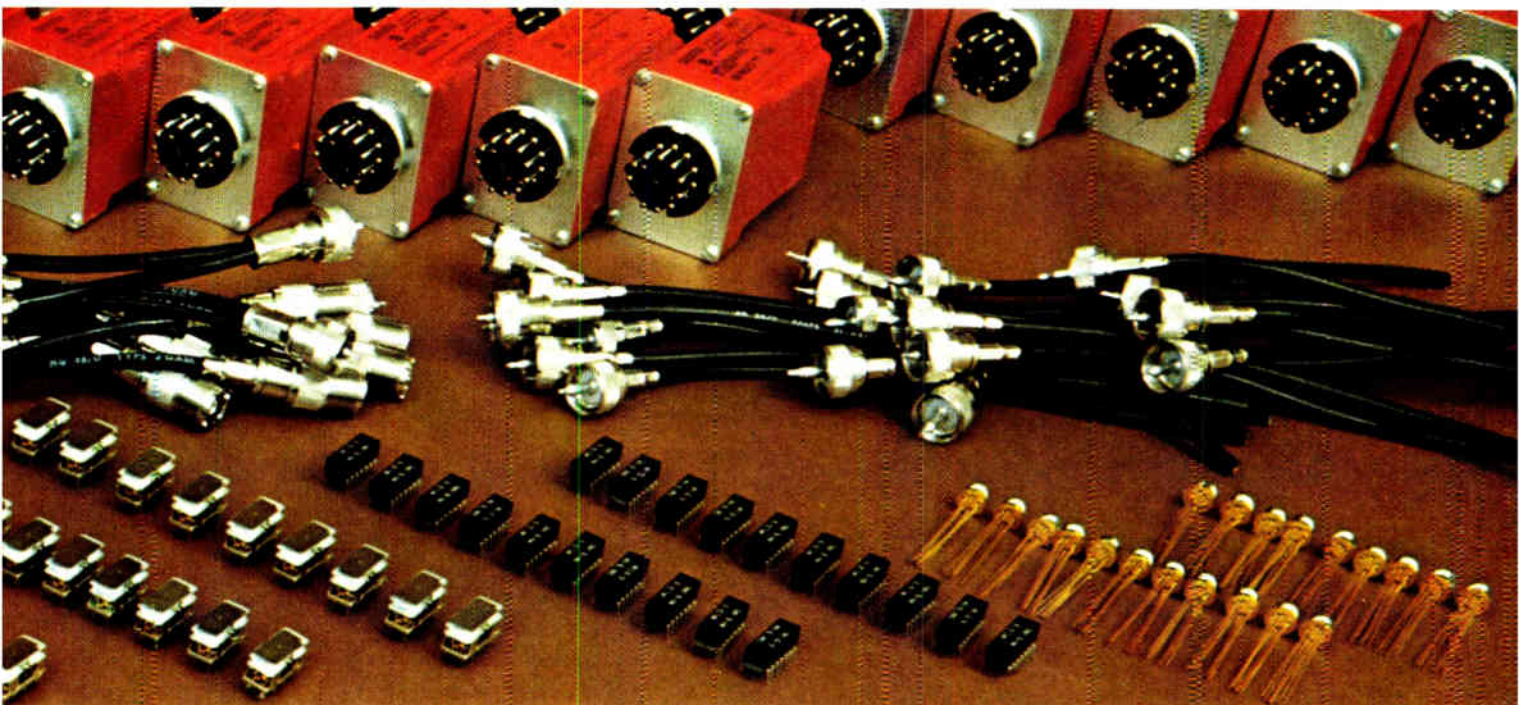

That's why Ingersoll-Rand depends on our time delay relays to preserve compressor life against insufficient oil pressure at start-up or on the job. Why the revolutionary 1978 Diesel Oldsmobile uses a Hi-G Magnetec solenoid to control the fuel supply. Why Tandy Communications Antennas/Radio Shack chooses communication connectors from Hi-G Cambridge Products for their CB radio antennas.

Our products work. And keep working. So it's fine with us if you forget them. Just remember our name. Hi-G Incorporated, 580 Spring Street, Windsor Locks, CT 06096.



# Remember our name.

# MOD-POT offers still more. New switch. New conductive plastic element.

Allen-Bradley introduces a new rotary switch for the MOD-POT series. Designed for signal level circuits. Tested for current levels as low as 15 milliamps, with 5-volt open circuit. Plus new conductive plastic resistance elements with low turning torque for velvet-smooth rotation. And CRV of typically less than 0.2%. Linear and modified log tapers (CW and CCW) available from 100 ohms to 1 megohm. All feature smooth characteristics, particularly at resistance roll-on and roll-off positions. Come to the original source for MOD-POTS. We have what you need; our distributors have them when your need is now. Ask for Publication 5217.

*Low detent torque* and low contact resistance.

*Smooth surface* for low turning torque, excellent linearity and ideal roll on/roll off.

*Variety of switch options:* rotary (CW or CCW actuation), push-pull or momentary push. Gang switching capability.

*Vernier drives* and concentric shafts also available.

*Conductive plastic* resistance track is embedded into substrate.

*Insert molded terminals* Choice of solder lug or PCB pins.

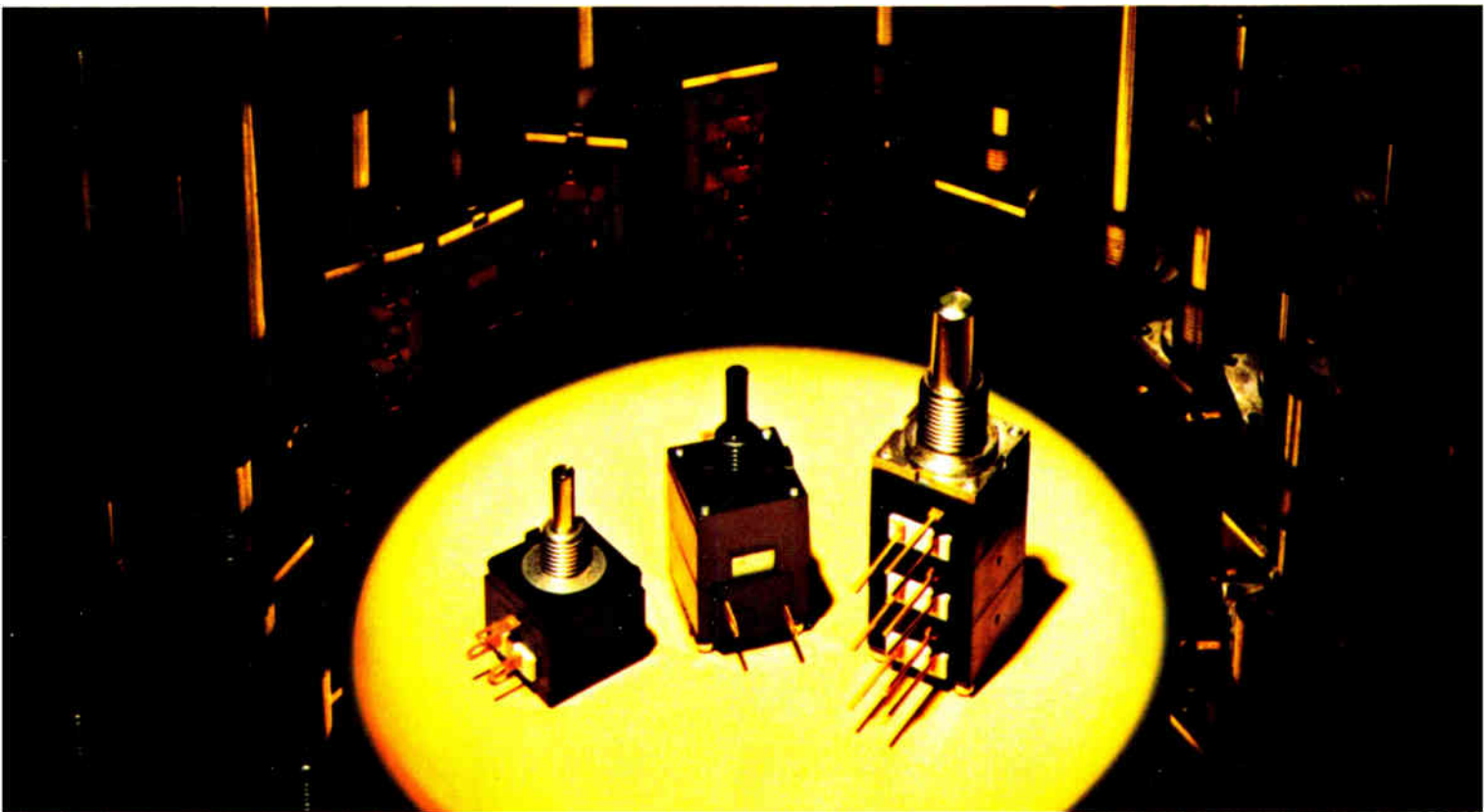
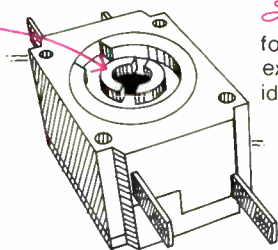

## Quality in the best tradition.



**ALLEN-BRADLEY**

Milwaukee, Wisconsin 53204

## **Smaller, cheaper son of LSI-11 to use 16-k RAM**

A second-generation LSI-11 microcomputer is expected to be announced later this month by the Components Group of Digital Equipment Corp., Marlboro, Mass. The new version, which will use the same basic DEC-produced four-chip set as the original, will introduce the 16-k random-access memory into the LSI-11 family. The microcomputer is believed to offer the same performance as the original, but some configurations will **cut the volume by two thirds and the price by about 40%**. Designated the LSI-11/2, it will consist essentially of a central-processing-unit board, a memory board, a new serial interface board, and a new mounting cage. A typical system, consisting of CPU board, 32,768 words of memory, interface board, and cage, will probably sell for less than \$2,000.

## **National developing 2-micrometer MOS process**

Very-large-scale MOS integrated circuits built with 2-micrometer pattern geometries are coming next year, according to Pierre Lamond, National Semiconductor Corp.'s new director of technology. While most of the industry is struggling with 4- $\mu$ m structures, Lamond claims that National has put together electron-beam masks and projection-printing techniques "that make possible 2- $\mu$ m prototype devices in the next 12 months and production in 1979." National's first such device will be a 64-k charge-coupled-device memory. The process is a payoff from the \$30 million-plus R&D effort launched by National this year. **Other projects are in subnanosecond logic, injection logic, and magnetic bubbles.** Like many U. S. semiconductor manufacturers, National is putting increased emphasis on n-MOS technology for next-generation devices.

## **AMD, Intel ready with 32-k ROMs**

Two of the biggest suppliers of MOS read-only memories will ship samples of high-performance 32-k parts by the first quarter. Advanced Micro Devices Inc. has already begun accepting 32-k orders, according to Ben Anixter, MOS marketing manager. The 350-ns, 5-v part is fully static and conforms to the industry-standard JEDEC pinout. Intel Corp., the largest supplier of big n-MOS ROMs, will begin shipping its fully static 32-k design with non-JEDEC pinouts (see p. 35). Equally important, at the same time Intel will make available **the industry's first fully compatible 32-k single-5-v erasable programmable ROM.**

## **Logic analyzer from HP aims at two systems**

Hewlett-Packard Co.'s Colorado Springs division is about to take the wraps off a new 20-megahertz logic analyzer for use in designing and troubleshooting both synchronous and asynchronous digital systems. Through simple keyboard control, **the new Model 1615A can be configured three ways**—as a 24-bit state analyzer 256 words deep, as an 8-bit timing analyzer 256 words deep, or as a combined 16-bit state and 8-bit timing analyzer each 256 words deep with both operating simultaneously. With an HP 180 series oscilloscope, the 1615A will cost about \$7,000.

## **Complete fiber-optic system for CATV shown at San Diego**

A company put together by communications entrepreneur and consultant Irving B. Kahn is likely to cause a stir at the Western Cable Show and Convention in San Diego (Nov. 9–11) with its first showing of a complete fiber-optic system tailored for the cable television industry. The company is Times Fiber Communications Inc. of Wallingford, Conn.; its system can transmit 12 color TV channels over a single fiber. The cable will

connect the optical signal source at the antenna to the CATV head end, then function as a supertrunk, or main cable, to carry the signal to distribution points. But, says Kahn, head of an array of companies making fiber-optic equipment for the cable TV business, "there's no reason why the same cable won't be used for distribution cable as well and **ultimately bring TV signals right into the subscribers' homes.**"

## **MicroNova line gets its first business machine**

Data General Corp. is announcing its first business computer in the microNova line. Less than \$14,000 buys a processor, 64 kilobytes of memory, a display terminal, and a dual-diskette drive. The language spoken is Data General's business version of Basic, which was previously available only on larger machines, since it required the disk-based real-time operating system. Adapting business Basic down to the microcomputer level, where it now runs on the diskette-based operating system, is just a start for Data General. The Southboro, Mass., manufacturer will soon **flood its microNova line with hardware and software products** as part of an aggressive campaign in both the boards and boxes.

## **Robot gets 'eyes' to find parts on conveyor**

Robots have long relied on a sense of touch to perform industrial operations, but now Auto-Place Inc. has given them eyes as well. Early next year, the Troy, Mich., firm will start shipping a standard robot that will **search for and pick parts from a moving conveyor before it does its other materials-handling or assembling tasks.** Under the control of an Imsai 8080 computer, which is built around a Z-80 microprocessor, and using a pattern-recognition scheme, the unit uses a pair of General Electric charge-injection-device cameras: one to direct the X-Y motion of the arm, and another on the end of the arm to orient the hand to the moving part. The system — called AP-C2 — will be tagged at a hefty \$50,000, **about five times the price of the simple Series 50 robot that it uses.** Earlier vision-equipped robots made by the firm have been limited to inspection chores. At Ford Motor Co., for example, they are used to weed out defective parts from those that will be used in transmissions. In that task, the robot detects whether holes have been drilled in the proper positions.

## **Beckman C-MOS DAC compatible with microprocessors**

Beckman Instruments is shipping samples of a pair of 12-bit hybrid digital-to-analog converters that are the first to provide the convenience of microprocessor compatibility plus the **low power dissipation of C-MOS circuitry.** Both units contain double-buffered input latches and can accept either TTL or C-MOS logic inputs. The internal C-MOS circuitry is laid out on a single chip that incorporates level translators, registers, analog switches, and switch drivers as well. One device, the 7545, is a four-quadrant multiplying unit that typically consumes less than 10 milliwatts of power. The other device, the 7546, is a complete general-purpose converter containing both a reference and an output amplifier. Beckman, which plans to have the new units in production during January, is pricing commercial versions of the 7545 at about \$22 and the 7546 at \$43 in hundreds.



# Signetics Op Amps: Fast Performers Ready For Fast Delivery.

Choose from three new op amps with high slew rates. One specifies the industry's lowest noise:  $4nV/\sqrt{Hz}$ !

The next time you find yourself searching the specification tables for a high-performance op amp, be sure to search ours. You'll find a broad offering—more than 60 models, each with package and temperature options. You'll also discover three new entries, one of which is likely to provide that exceptional spec you need.

#### Our Quiet Performer: SE/NE5534.

If low noise is critical to your design, then you need our new SE/NE5534. There's not another op amp around with better noise performance. With input noise specified at  $4nV/\sqrt{Hz}$  at 1 kHz, this device can drive a 600-ohm load. Great for quality audio equipment and instrumentation/control circuits. Our quiet performer also offers a generous 10-MHz bandwidth and a respectable  $13V/\mu\text{sec}$  slew rate.

When you compare the SE/NE5534 with standards like the  $\mu A741$  and LM307, you'll find that it offers superior performance—spec for spec. This outstanding op amp is internally compensated for gains equal to, or greater than, 3. And if you want to optimize frequency response for unity gain, capacitive load, low overshoot, etc., you can do so easily with an external capacitor.

**Two For High Slew.** For those designs demanding high slew rates, you should look into our super-fast performers—the SE/NE530 or SE/NE538. Internally compensated, both of these devices have excellent input characteristics.

The SE/NE530 is a superior replacement for any device in the  $\mu A741$  family. With high slew rates of  $18V/\mu\text{sec}$  (+1 gain) and  $25V/\mu\text{sec}$  (-1 gain)—plus a small-signal bandwidth of 3 MHz—this op amp is a veritable workhorse for numerous applications. Selecting it over a 741-type device translates to improved performance, greater design flexibility and reduced inventory.

With the SE/NE538, you get  $40V/\mu\text{sec}$  slew at a minimum gain of +5/-4. This guaranteed speed comes without power penalty, as the maximum supply current required is just 3 mA. If you're using op amps like the  $\mu A741$ , LM301A or BiFETs, you could be getting better performance with our 530 or 538.

Move up to better op amp performance. Move up to Signetics. For complete details, use the coupon below or contact your local Signetics distributor.

## signetics

a subsidiary of U.S. Philips Corporation

Signetics Corporation  
811 East Arques Avenue  
Sunnyvale, California 94086  
Telephone 408/739-7700

To: Signetics Information Services, 811 E. Arques Ave.,  
P.O. Box 9052, Sunnyvale, CA 94086

Please send technical data and sample(s) for the following op amp(s):

Low-Noise SE/NE5534     High Slew SE/NE530  
 High Slew SE/NE538

My need is urgent; have an applications specialist phone me at once: (      )      ext.     

Name \_\_\_\_\_ Title \_\_\_\_\_

Company \_\_\_\_\_ Division \_\_\_\_\_

Address \_\_\_\_\_ MS \_\_\_\_\_

City \_\_\_\_\_ State \_\_\_\_\_ Zip \_\_\_\_\_

I'm also interested in any other op amps you offer for this application: \_\_\_\_\_

Em1110

# The only Double-Balanced Mixers with a 2-YEAR GUARANTEE\*

## featuring Hi-Rel tested diodes -

Introduced in 1971 at \$7.95...

still only

**\$7.95**  
(500 pieces)  
\$9.95 (1-49)



\*including diodes!

Yes, a two-year guarantee for hermetically sealed DBM's is now a reality... made possible by an accelerated-life diode screening program adopted at Mini-Circuits.

Each Schottky diode used in Mini-Circuits' SRA-1 mixers is now preconditioned by the HTRB (High Temperature Reverse Bias) technique, previously reserved almost exclusively for semiconductors assigned to space applications. With HTRB testing, each diode is operated for 168 hours at 150°C with one volt reverse bias applied.

To screen out "infant mortality", the diodes are deliberately stressed to accelerate aging and to force time-related failure modes to take their toll. In conventional testing or "baking", the diode does not experience anywhere near the stress encountered with the HTRB program. Hence, the ability at Mini-Circuits' to locate the potentially-unreliable diodes before they are assembled into SRA-1 units. And, with double-balanced mixers, the overall reliability hinges almost entirely on the diodes used.

Yes, the HTRB procedure costs us more and screens out more devices. But our goal is to improve reliability to a level unmatched for off-the-shelf DBM's at no increase in cost to our customers. You — our customers by your overwhelming confidence in our product line have made us the number one supplier of DBM's in the world.

To earn your continuing support, we are now employing HTRB Hi-Rel testing for every diode used in the SRA-1, at no increase in cost to you. So, for the same low price of \$7.95, you can purchase our SRA-1, with a two-year guarantee, including diodes.

To ensure highest system reliability demand highest quality diodes on your source-control drawings and purchase orders. Specify SRA-1 mixers, with HTRB tested diodes from Mini-Circuits... where low price now goes hand-in-hand with unmatched quality.

### MODEL SRA-1

Freq. range (MHz)	LO	RF	IF	dc	500
Conversion loss (dB)	Typ.		Max.		
One octave from band edge	5.5		7.0		
Total range	6.5		8.5		
Isolation (dB)	Typ.		Min.		
Lower band edge to one decade higher	LO-RF	50	45		
	LO-IF	45	35		
Mid range	LO-RF	45	30		
	LO-IF	40	25		
Upper band edge to one octave lower	LO-RF	35	25		
	LO-IF	30	20		
Min. Electronic attenuation (20 mA)	3 dB				
Signal, 1 dB compression level	+ 1 dBm				
Impedance all ports	50 ohms				



## WE'VE GROWN

Customer acceptance of our products has been so overwhelming, we've been forced to move to larger facilities — THANKS

**International Representatives:** □ AFRICA: Altra (PTY) Ltd. P.O. Box 9813 Johannesburg 2000 S Africa □ AUSTRALIA: General Electronic Services 99 Alexander Street New South Wales Australia 2065 □ ENGLAND: Dale Electronics Dale House Wharf Road Frimley Green Camberley Surrey □ EASTERN CANADA: B.D. Hummel 2224 Maynard Avenue Utica NY 13502 (315) 736-7821 □ FRANCE: S.C.I.E. - DIMES 31 Rue George Sand 91120 Palaiseau France □ GERMANY, AUSTRIA, SWITZERLAND, DENMARK: Industriell Elektronik GMBH 6000 Frankfurt Main Klüberstrasse 14 West Germany □ INDIA: Gaekwar Enterprise Kama Mahal M.L. Dananjkar Marg Bombay 400 026 India □ ISRAEL: Vectronics Ltd. 69 Gordon Street Tel-Aviv Israel □ NETHERLANDS, BELGIUM, LUXEMBOURG: Comex Veldweg 11 Hatten Hpland

OUR NEW ADDRESS  
AND PHONE NO IS

**Mini-Circuits**  
MINI-CIRCUITS LABORATORY  
A Division of Scientific Components Corp.

2625 East 14th Street Brooklyn, New York 11235 (212) 769-0200  
Domestic and International Telex 125460 International Telex 620156

□ NORWAY: Datamatik AS, Odensveien 61 Oslo 6 Norway □ SINGAPORE & MALAYSIA: Electronics Trading Co. (PTE) Ltd. 87 Bukit Timah Road Singapore 9 Malay Peninsula □ SWEDEN: Ingered Elektronik AB Box 41 S-18251 Djursholm Sweden

U.S. Distributors □ NORTHERN CALIFORNIA: PENNSTOCK Co. Pacific Office Center 125 Fremont Avenue San Anis, CA 94522-4770 □ SOUTHERN CALIFORNIA, ARIZONA: Crown Electronics 11441 Crown Street Norwalk, Calif. CA 90651 □ NEW YORK: NEW YORK MICROWAVE DISTRIBUTORS COMPANY 61 Mall Drive Commack NY 11725 516-543-4776

## LSI testers are designed to sell for under \$40,000

Bench-top units from Megatest and Adar, fabricated with LSI, compete with testers in the \$170,000-and-up class

As the cost of increasingly complex microprocessors and peripheral chips plummets, the cost of testing them has been rising. The sophisticated circuitry requires complex testing equipment.

But what LSI has created, LSI can solve, say two firms marketing under-\$40,000 testers for large-scale integrated circuits—a far cry from the \$170,000-and-up systems like the Sentry series from Fairchild Systems Technology and Tektronix Inc.'s S-3260 systems.

Megatest Corp. of Sunnyvale, Calif., and Adar Associates Inc. of Burlington, Mass., showed their low-cost bench-top testers at the Semiconductor Test Symposium, Cherry Hill, N. J., in late October. Key to their equipment is the use of a level of LSI that is the same as in the devices to be tested. The more expensive—and older—systems rely on medium-scale integrated circuits.

Megatest, formed to build and market its new system, says it already has several of its Q8000 systems installed at Intel for testing 8080-family devices and other systems in place at “two other major semiconductor makers.” Adar, already on the market with LSI testers in the \$100,000-and-up class, is just introducing a system with many similarities to the California firm's products, but with a wider range of programmability, it says.

At the Cherry Hill symposium, manufacturers of the large systems were quick to point out the shortcomings of the low-cost systems, although some may have such models on their own drawing boards. “Big tester manufacturers have talked to us about small systems such as these,” says a spokesman for a major computer maker.

The price break in Megatest's Q8000 and Adar's MX-17 is possible because they use reference devices—duplicates of the device under test—to generate test patterns. They don't need large amounts of memory to store test stimuli and

the expected responses.

This approach allows programming at the device level—standard instructions applied to the reference device may be expanded over several clock cycles, just as microprocessors expand users' instructions. Thus the programmer need not tediously dissect the cycle-by-cycle operation of the device under test, another significant cost advantage.

For example, a microprocessor can be checked by writing a short program for the reference processor, which will generate the required test patterns for each clock cycle. The program runs in both processors, and



**Testy.** Small but powerful, new breed of LSI testers like the MX-17 from Adar fit on a tabletop. The testers derive their low cost from the use of LSI in their design. They are also relatively easily programmed in the language being used with the device under test.

the new testers compare the outputs.

Megatest president Stephen Bisset says a 2.5-kilobyte program for a microprocessor will generate a test sequence about 1 million clock cycles long—a test length that would require about 40 megabytes of storage with the usual stored-response testing. The use of reference devices in separate hardware modules also applies to other peripheral chips and even to the one-chip microprocessors, which include on-chip read-only memories.

However, such an approach means that a separate reference module is required for each new device to be tested. They can cost from \$3,000 to \$4,000 each, according to Bisset.

**Possible threat.** Do these low-cost testers pose a threat to the large Fairchild and Tektronix testers? Not really, claims Michael Chalkley, manager for Fairchild's Sentry systems in San Jose, Calif. He says that the low-cost testers are best in high-volume situations where one particular device is being tested. But since a separate reference module is required for each device, a typical user must invest in many costly modules.

Such thoughts are echoed by Douglas H. Smith, senior product engineer at Tektronix in Beaverton, Ore. "The machine is great, if you can get away with it—if, for example, you're a semiconductor manufacturer," he says. "But in incoming inspection, the problem is the product mix. Lots of different products are typically being used. And even supposedly identical devices from different manufacturers, although they may work alike in a system, may not test out alike."

To such comments, Bisset acknowledges that users with a high mix would have to make a substantial investment. But the more typical case, he says, is that of a user buying only about 10 different devices in a microprocessor family.

Another consideration is traceability of failures. Device customers generally prefer the same test equipment used by their suppliers, and this means the biggies. It makes it easier to agree when a device has

failed. Bisset says semiconductor makers using his system are considering supplying users with reference modules for just this reason. □

---

## Computers

---

### Vonderschmitt warns of Japanese threat

The U.S. computer industry is in danger of being surpassed by Japanese competition, just as the color television industry was. This was part of a warning issued late last month to American semiconductor and equipment manufacturers by Bernard V. Vonderschmitt, the vice president and general manager of RCA Corp.'s Solid State division in Somerville, N. J. He was speaking at the Semiconductor Test Symposium, a meeting that also heard representatives of American equipment manufacturers sing the praises of the quality of parts being supplied them by Japanese components makers.

Vonderschmitt gave notice that foreign competitors, particularly the Japanese, have set their sights on computers and digital components. "Their focus is on minicomputers, microcomputers, smart termi-



**Look out.** Computer manufacturing in the U.S. could go the way of the TV industry, says RCA's Bernard Vonderschmitt.

nals, and other peripherals," and, he adds, they are aiming to gain the advantage in these end-equipment markets through their massive development programs in large-scale and very-large-scale integration.

**Like 1969.** Of great significance to U.S. semiconductor and equipment manufacturers, Vonderschmitt notes, is that "foreign manufacturers can take complex devices and integrate them into equipment faster than has been demonstrated here." As a result, "the data processing industry is today where the color television industry was in 1969," with respect to Japanese competition. "By 1976, they caught and passed American industry. Unless we are more diligent, there will be major losses of market."

Vonderschmitt told the Institute of Electrical and Electronic Engineers' gathering of some 800 LSI vendors, users, and test-system manufacturers, that just as the Japanese focused on reliability in gaining the leadership position in the consumer market, they are doing the same in the digital electronics market. "Currently, foreign manufacturers are spending twice the amount of U.S. manufacturers in the testing of complex LSI devices," he notes, and this is evident in the quality and reliability of Japanese parts.

**Superior parts.** The already strong presence of Japanese manufacturers in U.S. semiconductor markets is indicated by users of LSI memories. "The threat is serious," says Paul Groner, manager of circuit design at Sperry Univac's minicomputer operations in Irvine, Calif. While Mostek Corp.'s 4,096-bit dynamic random-access memory is a mainstay of Univac's lines, Groner has looked at other vendors to supplement Mostek. "The Japanese parts are as good if not better than the American parts," he says.

Fujitsu Ltd. is the only Japanese vendor thus far given vendor approval by the Univac operation. But Groner is evaluating other vendors for 16,384-bit RAMs for future systems. "Again, the Japanese 16-ks look very good," he says.

The quality of Japanese parts is

"quite impressive," agrees L. Lloyd Morgan, quality control manager of Qantel Corp. in Hayward, Calif. The manufacturer of business computer systems uses large quantities of 22-pin 4-k dynamic RAMs from Nippon Electric Corp. "Incoming failure rates of Japanese 4-ks are 10 to 40 times lower than those of U.S. manufacturers," Morgan notes.

Once installed, the Japanese parts look good too. At Amdahl Corp. in Sunnyvale, Calif., "We're seeing roughly a three-times lower failure rate with Japanese 4-k dynamic RAMs, based on 20 million hours of device operation," says Stephan Margossian, test manager. □

## Communications

### Mail system will broadcast messages

Like to send a one-page letter in less than a minute to locations throughout the U. S. for about the price of a 13-cent stamp? It may be possible by January with an electronic system being put together for operation next January by Digital Broadcasting Corp., of Vienna, Va.,

expressly organized to provide such electronic mail service.

Digital Broadcasting plans to do it with a combination of new equipment and ideas, including specially developed low-cost terminals, its own computer-controlled communications network, and a frequency-modulated transmitting technique that broadcasts messages to their final destinations to avoid local telephone-line charges.

**Special terminals.** "We're counting on truly low-cost terminals we've developed that are implemented with microprocessors and bubble memory, our own switching network, and the use of the existing Telenet [packet-switching] network, and commercial fm stations," says William von Meister, president of both TDX Systems Inc. in nearby McLean, Va., and Digital Broadcasting, its subsidiary. "We'll be able to lease a cathode-ray-tube terminal to a customer for as little as \$10 a month or a printer terminal for about \$25." The terminals will receive transmissions from some 50 commercial fm stations located at major population centers that are being equipped to handle the messages. Transmitter terminals can be ordinary CRT or word-processing units a customer

may already be working with.

Digital Broadcasting's charges compare, for example, with the approximately \$90-per-month charge for a teletypewriter terminal leased from Western Union. With an additional charge for each message sent, teletypewriter costs are generally agreed to average out to 60 to 80 cents per message when a high volume of messages are being handled—at least five times the Digital Broadcasting figure. Some facsimile machines renting for under \$30 per month may sound cheaper, but dial-up charges between the facsimile terminals add to the costs.

Von Meister's terminals can also operate in a very unusual manner: the frequency-modulated data can be fed to any number of terminals over the 120-volt power mains in a building. All that is required is a single receiver-decoder driven by a master antenna.

**Enthusiasm.** When von Meister described his system at a seminar on electronic mail held in New York City late last month by Yankee Group, the Cambridge, Mass., market researchers, he was swamped with dozens of business cards from company representatives who wanted more information. Howard

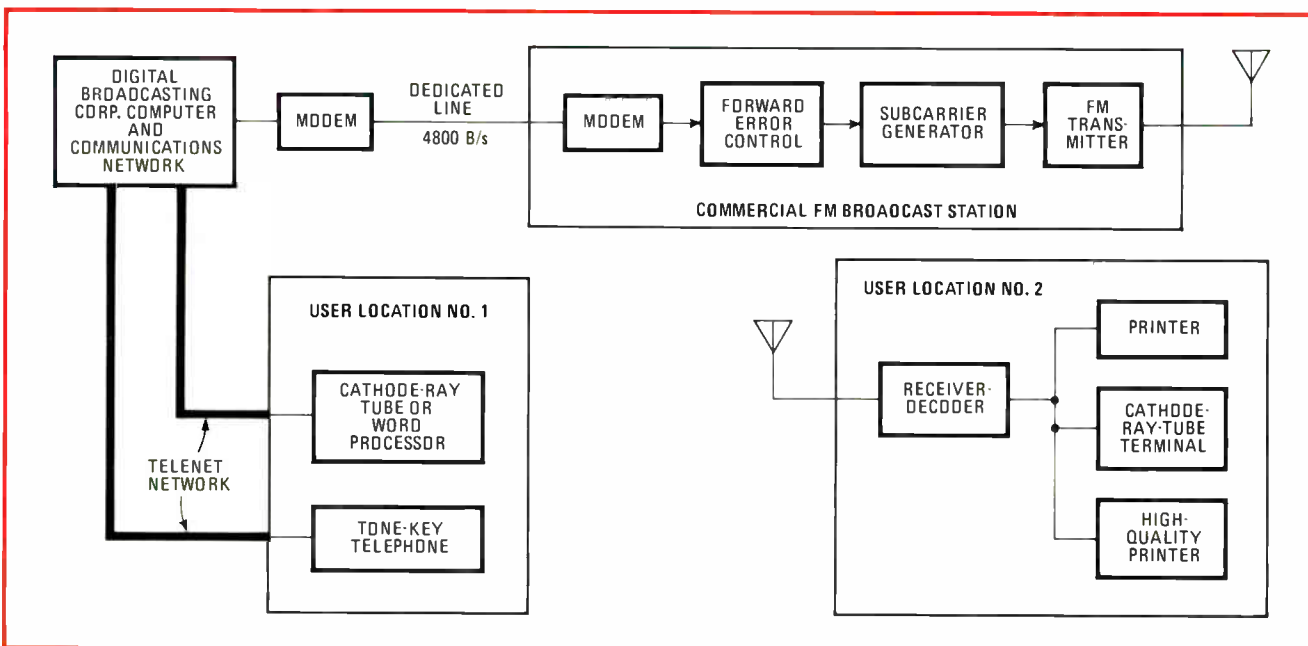

**Mail call.** Digital Broadcasting's electronic mail scheme needs no special sending terminals for access to the Telenet network. But on the receive end, the company will supply relatively inexpensive units it has designed that will decode signals broadcast by a local fm station.

Anderson, president of the Yankee Group, sees von Meister's approach as a move against the high local-access charges of the Bell system. "Von Meister has found a way to get to the local terminal inexpensively," says Anderson. "His packet-switched radio approach, which theoretically can be the equivalent of time-division multiplexing, offers the small and medium data-communications user some of the advantages that now only the larger Fortune 500 companies can afford."

Von Meister's digital broadcasting service allows a user to input data to Digital Broadcasting's host computer in McLean via Telenet's packet-switched network now available in some 80 cities across the nation. The computer determines, from the coding scheme attached, the destination of a message and routes it over dedicated 4,800-bit-per-second lines to the fm station nearest the recipient. The stations broadcast messages in digital format at a 4,800-baud rate over a portion of the unused fm subcarrier. This is the method often used by Musak to broadcast uninterrupted background music.

According to von Meister, each fm broadcast station will be equipped with encoding equipment consisting of microprocessor-implemented forward error-control circuitry and a subcarrier generator that allows the messages to be rebroadcast. A terminal at the user's location, equipped with a receiver-decoder, a microprocessor controller, and memory, receives and prints the message or displays it on a CRT.

The receiving terminals require no modems, data sets, or telephone connections. Three types of terminal will be available, along with the receiver-decoders: a CRT with bubble memory, produced in Japan—von Meister will not reveal by whom—capable of storing 10,000 characters, or more than 10 CRT pages of 640 characters; an electrostatic message printer made by SCI Inc., Huntsville, Ala. [*Electronics*, March 3, p. 31] that outputs 480 characters in 1 second; and a standard form-feed 120-character-per-second teleprinter for higher-quality hard copy. □

---

**Medical**

---

## Electronic voice system generates messages for vocally handicapped

Many vocally impaired children and adults, such as those handicapped by cerebral palsy, multiple sclerosis, and some nervous disorders, cannot even use pencil and paper to make themselves understood. It is for these individuals that the Votrax division of Federal Screw Works has developed a hand-held, battery-operated electronic voice system.

By modifying techniques it originally used for industrial voice-response systems, the Troy, Mich., firm has been able to package a programmable speech synthesizer in a box that resembles a beefed-up hand-held calculator. Called the Phonic Mirror HandiVoice, the device will sell for just under \$2,000 when it is available next April. It will be handled by HC Electronics, the Mill Valley, Calif., marketing division of American Hospital Supply Corp. that demonstrated prototypes at the annual convention of the American Speech and Hearing Association in Chicago earlier this month.

"HandiVoice speaks by stringing

together phonemes, the basic sounds that make up spoken words much the way letters make up printed words," explains R. Trezevent Wigfall, a product consultant to Votrax. The user builds messages by entering a series of three-digit commands on the device's calculator-like keyboard. The digit combinations correspond to words that are to be produced by the machine.

As many as 40 commands can be stored until the "talk" button is pressed; then they are fed to the phonetic synthesizer, an electronic analog of the human vocal system, which articulates the sounds through a 4-ohm, 400-milliwatt speaker built into the top edge of the 4-pound package, which is about 10 inches long, 5 in. wide, and 3½ in. high. "Theoretically, it has an unlimited vocabulary, since it stores the sounds that make up all words, not just a limited selection of words," Wigfall points out.

Votrax originally developed the synthesizer for such industrial applications as inventory control, person-

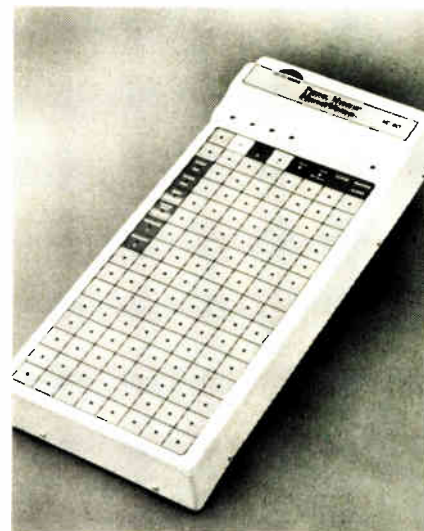

**Voices.** Calculator-like 4-lb HandiVoice from Votrax, at left, stores and produces up to 40 words keyed in via three-digit codes. For more severely handicapped, larger lap-sized synthesizer, at right, relies on 128 touch-sensitive keypads that correspond directly to specific words. The unit accommodates four different vocabulary overlays.

# Complete instructions on how to assemble a data acquisition system:

Buy National Semiconductor's new ADC0816 and plug it in.  
It's a complete data acquisition system on a chip. (Details on reverse.)

# Complete details on the data acquisition system on a chip.

Introducing a revolutionary new product from National.  
The first data acquisition system on a chip.  
ADC0816.

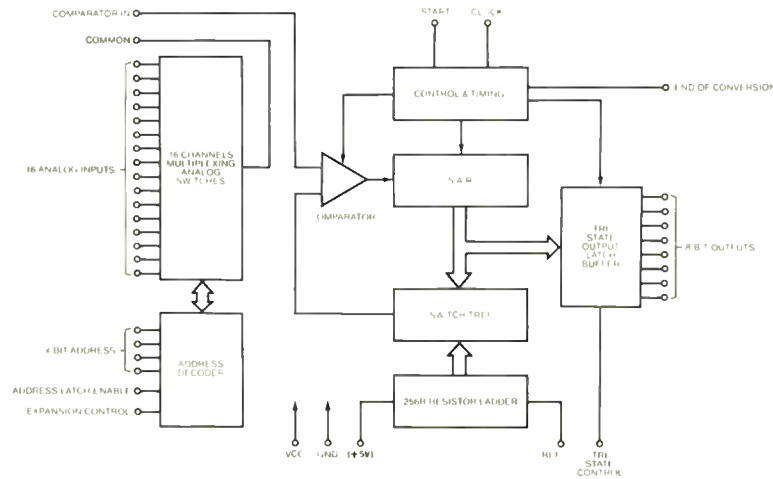

8-bit analog-to-digital converter, 16-channel multiplexer, latched address inputs, and TRI-STATE<sup>®</sup> latched outputs. In one ball of wax.

The converter provides absolute accuracy, so you can forget about error budget calculations. The total unadjusted error is  $< \pm \frac{1}{2}$  LSB.

Nobody has ever offered accuracy like that.

And at \$19.95 (100-piece price) this labor-saver will save you money, too. With 16 channels, it's only \$1.25 a channel. (Single 5V power supply.)

So next time you start to build a data acquisition system, why not just buy one instead?

11/10

National Semiconductor, 2900 Semiconductor Drive, Santa Clara, CA 85051

Gentlemen:  
Please send data sheets on your:

data acquisition system     references     microprocessors

Name \_\_\_\_\_

Company \_\_\_\_\_ Address \_\_\_\_\_

City \_\_\_\_\_ State \_\_\_\_\_ Zip \_\_\_\_\_

**National Semiconductor**



nel training, and voiced-output computer systems. Wigfall is reluctant to discuss the electronics of the synthesizer, except to say that it is made of a mix of standard and custom integrated circuits that produce and amplify phonemes. In HandiVoice, the electronics is built on a single printed-circuit board that is epoxy-potted for protection.

To keep size, weight, and power low on the portable synthesizer, Votrax researchers pared the vocabulary slightly, eliminating some intonation patterns, as well as phonemes uncommon in English.

**Microprocessor control.** The synthesizer is controlled by Motorola Inc.'s M6800 microprocessor, which also continuously scans the keyboard and drives a three-digit liquid-crystal readout that displays the codes as they are entered. Besides storing synthesizer commands necessary to pronounce 45 phonemes, the unit's 8,192 bytes of read-only memory are programmed with coded commands for 893 words, all 26 letters, 13 word prefixes and suffixes, and 16 short phrases. An additional 1.5 kilobytes of ROM stores the program.

"The microprocessor can also scroll through any of the display's digits, allowing the user to start and stop the display to select codes and any keyboard function with a single switch closure," Wigfall says. With an optional breath-, or muscle-activated switch, even the severely physically impaired can build and speak messages. Votrax has been testing a larger, breadboarded version since late 1975. Depending on the severity of their disability, patients have been able to construct messages after only minutes of instruction.

A second version of the synthesizer is configured as a lapboard with 128 touch-sensitive key-pad areas that can be overlaid with printed words or graphic symbols. "It's aimed at the individual with a lower level of cognition or abstraction," Wigfall says. "It requires just a pointing skill." As many as four vocabulary overlays boost the number of words the unit produces. □

## Intel upsetting large ROM pinouts by abandoning 16-k configuration

Digital system designers should brace themselves for a shoot-out in read-only memory pinouts—a situation that could seriously retard the market for high-density, next-generation ROMs. Here's the problem: for its upcoming 32,768- and 65,536-bit parts, Intel Corp., the biggest supplier of today's 2316E 16,384-bit ROMs, is abandoning the 16-k type of configuration approved by the Joint Electron Device Engineering Council other manufacturers are following [*Electronics*, Sept. 15, p. 73].

Intel is doing this because it wants to ensure compatibility with another product that only it is currently prepared to produce—the single-5-volt 32-k electronically alterable programmable ROMs that designers will use while developing a new system and before committing to masked ROMs. If enough of the industry follows Intel so that two ROM camps are formed, then once again, as happened with the 4,096-bit dynamic random-access memories, users will be denied an industrywide standard when shopping for parts.

In 1974, it was the nonstandard approach to pinout configurations by suppliers of RAMs that caused massive confusion among mainframe and peripheral equipment designers and set back the 4-k RAM market for two years. If pinout discrepancies develop in upcoming big ROMs, next-generation microcomputer designs could be in serious trouble, since high-density ROMs are essential for providing the large program storage needed in new microcomputer-based equipment.

**Critical pin 18.** According to Larry Jordan, Intel's strategic marketing manager for ROM products, "Our competitors simply have not looked ahead and made their new parts compatible with erasable PROMs and high-performance microcomputers. ROMs, erasable PROMs, and microcomputers all must be

designed as components in an integral system, not just piecemeal, as they apparently are doing."

Jordan points out that to maintain compatibility when going from the JEDEC-approved 16-k pinouts to 32-k and 64-k ROM levels, great care must be exercised in specifying which pins are to perform such functions as power down, chip select, and address enable. "As you go from the 16-k to the 32-k level, for example," says Jordan, "you must provide an additional pin for addressing the additional bits." This pin has to come out of a chip-select slot—there are three available on 16-k ROM devices.

"The problem is that other suppliers are specifying pin 18 for the new address or chip-enable slot, and that's just plain wrong, because pin 18 must be used for a power-down mode if the new 32-k ROMs are to be compatible with upcoming 32-k erasable PROMs," Jordan says. "Moreover, by choosing pin 18, these suppliers' future ROMs will not only be noninterchangeable with future erasable PROMs, but will not even have a power-down mode."

Intel's 32-k ROM, which will be available in the first quarter, together with its new 32-k erasable PROM, will maintain its pin 18 for power-down control as in the pinouts for the 16-k part, and make pin 20 the chip-select pin and pin 21 the new address enable. "This pinout configuration will be identical with our 32-k erasable PROMs," says Jordan, "so that users can prototype new systems with erasable PROMs and then switch part for part to the mask ROM in production."

As if there aren't problems enough with 32-k devices, Jordan sees even more confusion with 64-k ROMs. Early suppliers have indicated that they will keep the 64-k ROM in a 24-pin package, the same size as for the 32-k parts. "But," says Jordan, "if you do that, you lose the output-

control function—it must go as an additional address line. Without output control, you end up with 64-k ROMs that won't work efficiently with high-throughput microcomputers, where address control is used to manage the processor bus and maintain fast system speed. Our answer is to go to a 28-pin design, rather than give up output control."

Nevertheless, all other major suppliers of ROM and erasable PROM parts are sticking to the industry standard pinouts designated by recent JEDEC meetings. Included in this group are Mostek, American Micro Devices, General Instrument, Texas Instruments, Electronic Arrays, Motorola Semiconductor, Fairchild Semiconductor, and American Microsystems. According to Derrel Cocker, Mostek's memory marketing manager, "We view Intel's new pinout as simply the response of a supplier coming late into the 32- and 64-k ROM market. Unlike the fully static Intel parts, our edge-activated ROM designs can conform to the JEDEC pinouts for ROMs and PROMs and still provide all the necessary control functions for high-performance microcomputer systems. That's because edge-activated designs allow the user to control the duration that the outputs remain active. Therefore we don't need an additional output-enable function as is required in the Intel configuration." □

### Computers

## Software may slow DEC's 32-bit mini

With its newest minicomputer, Digital Equipment Corp. for the first time embraced 32-bit architecture. But the Maynard, Mass., minicomputer leader might find the 32-bit marketplace, which concentrates on scientific analysis and flight simulation, tough to penetrate. The reason? The new VAX-11/780, with a typical system cost of around \$200,000, might have trouble proving it is superior to other manufacturers' machines, despite some design niceties

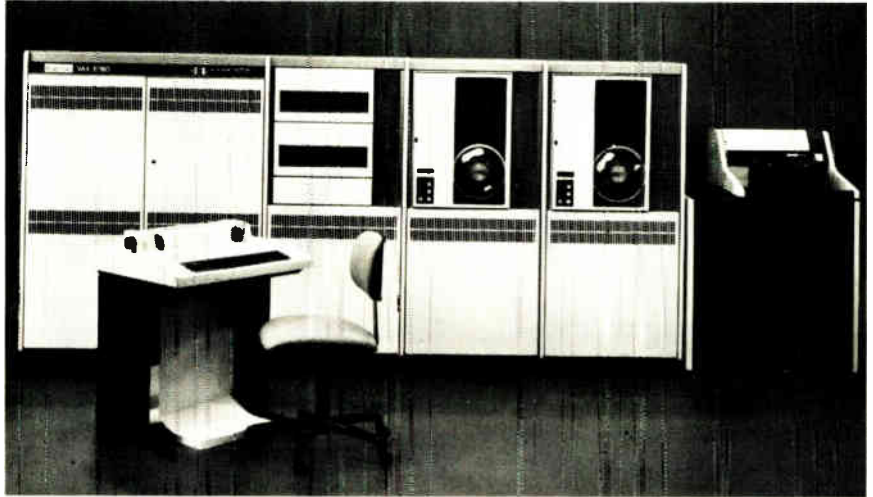

**Bigger mini.** New 32-bit system from DEC, ranging from \$128,000 up, will be competing for markets now dominated by Interdata and Systems Engineering Labs.

like a built-in LSI-11 microcomputer to perform self-diagnostics and a large instruction set.

DEC apparently has decided to concentrate on making its 32-bit entry suitable as an upgrading for users of its 16-bit PDP-11 line. In doing so, it has not yet produced the software tailored to a 32-bit design and may have compromised some of the hardware as well. It relies for now on an emulation mode that runs with software from the 16-bit machines. This mode forfeits many 32-bit performance advantages. True, a native 32-bit mode is available, but the only 32-bit package announced with the machine is a Fortran compiler for high-speed scientific applications. However, Bernard Lacroute, VAX's product manager, points out that its operating system is "the most powerful of any minicomputer, and it lays the groundwork for future software products." But, he adds, "one thing at a time."

"You cannot take advantage of a 32-bit machine unless you've got full 32-bit software across the board—and the development of that software is not trivial," says Harold R. Buchanan, processor product-line manager for Interdata Corp., Oceanport, N. J., the leading supplier of 32-bit machines for the simulation market. "It doesn't matter how big DEC is, you can only generate software just so quickly."

Interdata, which introduced its

32-bit machines in 1973, supplies most of the computers for simulators built by Singer Co.'s Simulation Products division in Binghamton, N. Y., and Singer has about 80% of what is expected to be a \$75 million-a-year computer market over the next five years. The other major 32-bit computer supplier is Systems Engineering Laboratories Inc., Fort Lauderdale, Fla.

**Hardware edge.** Besides software, the machines from Interdata and SEL have the edge in several hardware aspects. Interdata's 8/32 and SEL's 32/75 each offer a microprogramming feature that allows the user to tailor the processor for a special application. However, the VAX has no such feature, usually of interest to original equipment makers.

Moreover, the bus structure of the VAX appears to be inferior to those of the competition. Says Samuel H. Bosch, product marketing director for SEL, "The I/O rate of the VAX, at 13.3 megabytes per second, is half that of our 32/55 introduced over two years ago." Also, SEL's and Interdata's buses allow their computers to be hooked together in multiple-processing configurations. DEC's cannot, though it will support the company's network software, DECnet. Such multiple processing can be extremely important: the simulator for the space shuttle uses 18 Interdata minicomputers.

In time, DEC will develop its 32-bit

# Four ways to do 8x8 Multiplication

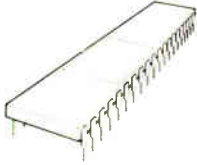
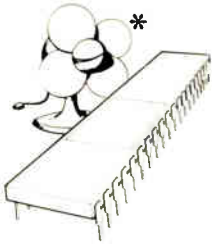
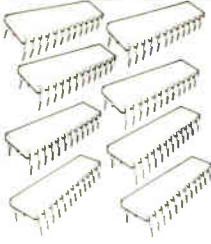
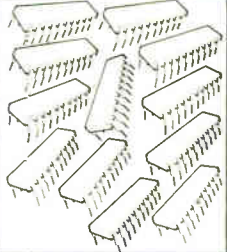
				
<b>DEVICE</b>	MMI 67558	TRW MPY-8	AMD 25S05 (FD 93S43)	TI (MSI) 74S274/5
<b>ORGANIZATION</b>	8 X 8	8 x 8	2 X 4	4 X 4
<b>TYPICAL SPEED</b>	100 NS	130 NS	75 NS	75 NS
<b>POWER</b>	1W	1.8 W	5W	5.4W
<b>PACKAGE</b>	40-PIN	40-PIN	24-PIN	20-PIN
<b>NUMBER OF PACKAGES</b>	1	1	8	12
<b>TECHNIQUE</b>	COMBINATORIAL (BOOTH)	COMBINATORIAL	COMBINATORIAL (BOOTH)	COMBINATORIAL (WALLACE)
<b>ROUNDING</b>	YES	YES	NO	NO
<b>MFG. PROCESS</b>	LS/TTL	TRIPLE DIFFUSION	S/TTL	S/TTL
<b>SECOND SOURCE</b>	YES	NO	YES	NO
<b>DATA REP.</b>	SIGNED and UNSIGNED	SIGNED ONLY	SIGNED ONLY	UNSIGNED ONLY
<b>TOTAL \$</b> <small>At 100 UP quantity</small>	<b>MIL</b>	110	115	210
	<b>COM</b>	64	70 <small>(Fan not included.)</small>	124
				≈140
				68

\*300 fpm cooling required.

**Europe**  
Monolithic Memories, GmbH  
8000 Munich 80  
Mauerkircherstr. 4  
West Germany  
Tel: (089) 982601, 02, 03, 04  
Telex: (841) 524385

**United States**  
Monolithic Memories, Inc.  
1165 East Arques Avenue  
Sunnyvale, CA 94086  
Tel: (408) 739-3535  
TWX: 910-339-9229

**(Second sourcing from ITT Semiconductor.)**

**For more information, phone, TWX or write.**

**Far East**  
MMI Japan KK  
Parkside-Flat Bldg.  
4-2-2, Sendagaya Shibuya-Ku  
Tokyo 151, Japan  
Tel: (3) 403-9061  
Telex: (781) 26364

# Monolithic Memories

# Thin-Trim<sup>®</sup> capacitors

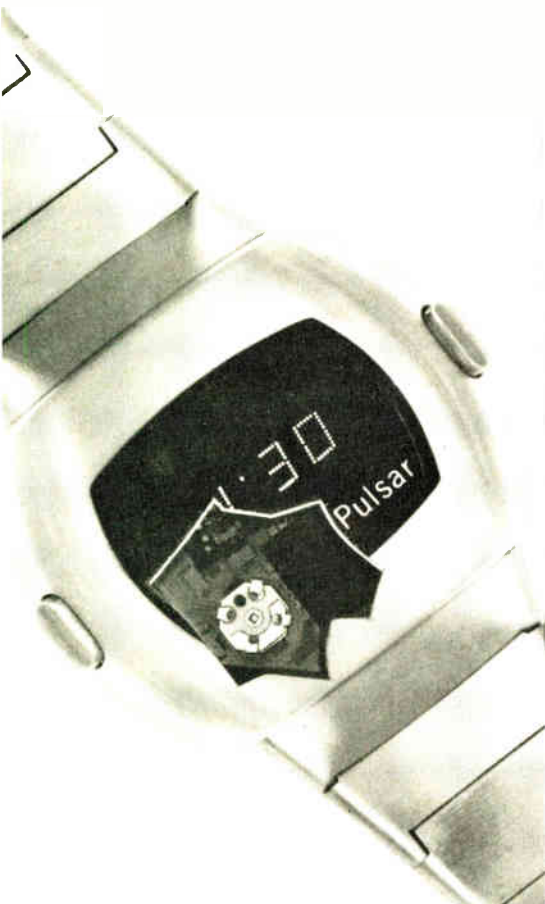

Tucked in the corner of this Pulsar Watch is a miniature capacitor which is used to trim the crystal. This Thin-Trim capacitor is one of our 9410 series, has an adjustment range of 7 to 45 pf., and is .200" x .200" x .050" thick. The Thin-Trim concept provides a variable device to replace fixed tuning techniques and cut-and-try methods of adjustment. Thin-Trim capacitors are available in a variety of lead configurations making them very easy to mount.

A smaller version of the 9410 is the 9402 series with a maximum capacitance value of 25 pf. These are perfect for applications in sub-miniature circuits such as ladies electronic wrist watches and phased array MIC's.

Johanson Manufacturing Corporation, Rockaway Valley Road., Boonton, N.J. 07005. Phone (201) 334-2676, TWX 710-987-8367.

MANUFACTURING CORPORATION

38 Circle 38 on reader service card

## Electronics review

software, even promising programs for business applications. But as it does, it will be faced with another problem: internal competition. The \$128,000 minimum-configuration cost of the VAX is well above that of the top-end PDP-11/70. But DEC might find larger VAX configurations competing with its mainframe line of 36-bit DECsystem units already on the market.

DEC, however denies there will be a problem. "We even expect to produce lower-end machines out of the mainframe line," says Andrew C. Knowles, a DEC vice president. DEC has announced a 32-bit Cobol compiler for late next year, so apparently it has business uses in mind. As for other applications, "we're interested in all markets," Lacroute says. □

## Packaging & Production

### Laser beam directs harness assembly

Borrowing from the technology of the automated supermarket check-out counter, Grumman Aerospace Corp. has hit upon a novel method for fabricating the giant electrical cable harnesses that go into the Navy's F-14 fighter. Dubbed the programmed light director, Grumman's system relies on tagging bundles of wires with a bar-coded label that resembles the new product coding of the supermarket. Scanned with a hand-held optical reader, information on the label is used to control a laser whose light beam traces out the path on a cable layout board that the wires must take. All a harness maker must do is follow the moving spot of the laser beam, pressing the wires into cable clamps fastened to the board.

"The light director has given us a 30% savings in labor and virtually eliminated wiring errors on our large harnesses," declares Walter Maier, group head of manufacturing tech-

**Tagged.** Optical reader of Grumman's assembly system scans coded tag that indicates where harness wires are to be run.

nology at Grumman's facility in Great River, N. Y. This savings adds up to quite a large number, points out Bruno Caputo, the facility's general manager, since Grumman's harness wiring operation handles more than 6,000 miles of wire in the course of a year.

**Thousands of wires.** Just the F-14's main harness alone can represent a staggering amount of work. It is 50 feet long and has 1,200 different wires routed over 490 paths. The paths for up to 48 wiring harnesses are stored in a disk memory accessed by a Digital Equipment Corp. PDP-8 minicomputer. The computer controls a positioning system that moves an arm carrying a standard 0.5-watt helium-neon laser over a wiring board 3 feet by 30 ft. The arm is driven horizontally by a stepper motor, while another stepper adjusts a mirror on the arm that projects the laser light, passed through a beam expander, to a 0.5-inch-diameter spot onto the board.

All wires going to the same destination must be bundled and labeled with their destination tag before they can be laid out with the light director. When the harness maker wants to position a group of wires, he

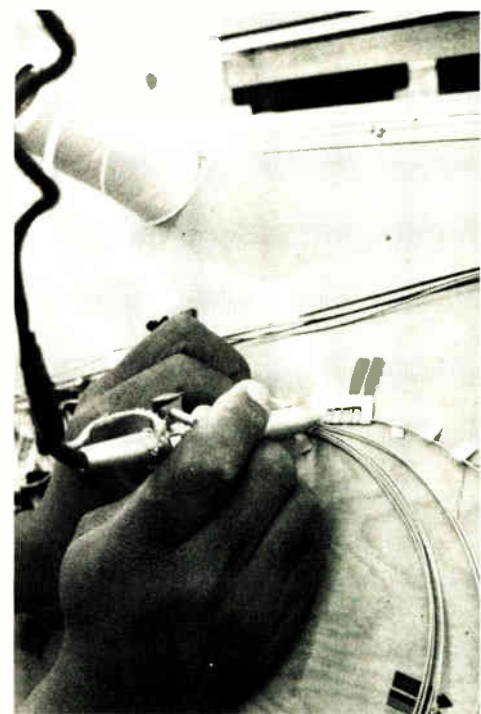

Electronics/November 10, 1977

# 13 ways to reduce waste from slice to circuit.

## All with Zeiss optics.

Zeiss has a lucky 13 microscopes for the electronics industry, and a new brochure that describes them. Between its covers you'll find money-saving, waste-cutting applications described for every step from slice to circuit.

The microscopes range in size from the small, economical Standard T for the daily routine of the production line to the Novascan 30 Scanning Electron Microscope.

Along the way you'll find such unique instruments as the revolutionary Axiomat that sets new standards of stability and image quality for microscopes, and the Light-Section Microscope that cuts a profile, non-destructively.

## Optics and versatility

Two invaluable characteristics distinguish all Zeiss microscopes, large and small:

1. **superior performance of Zeiss optics** for brightfield, dark-field, Nomarski differential interference contrast, polarized light, photography;
2. **easy switching** from one technique to another.

Send for this 10-page brochure with many striking photomicrographs and details on all 13 microscopes.

## Nationwide service

**Carl Zeiss, Inc., 444 5th Avenue, New York, N.Y. 10018** (212) 730-4400. Branches in: Atlanta, Boston, Chicago, Columbus, Houston, Los Angeles, San Francisco, Washington, D.C. In Canada: 45 Valleybrook Drive, Don Mills, Ont., M3B 2S6. Or call (416) 449-4660.

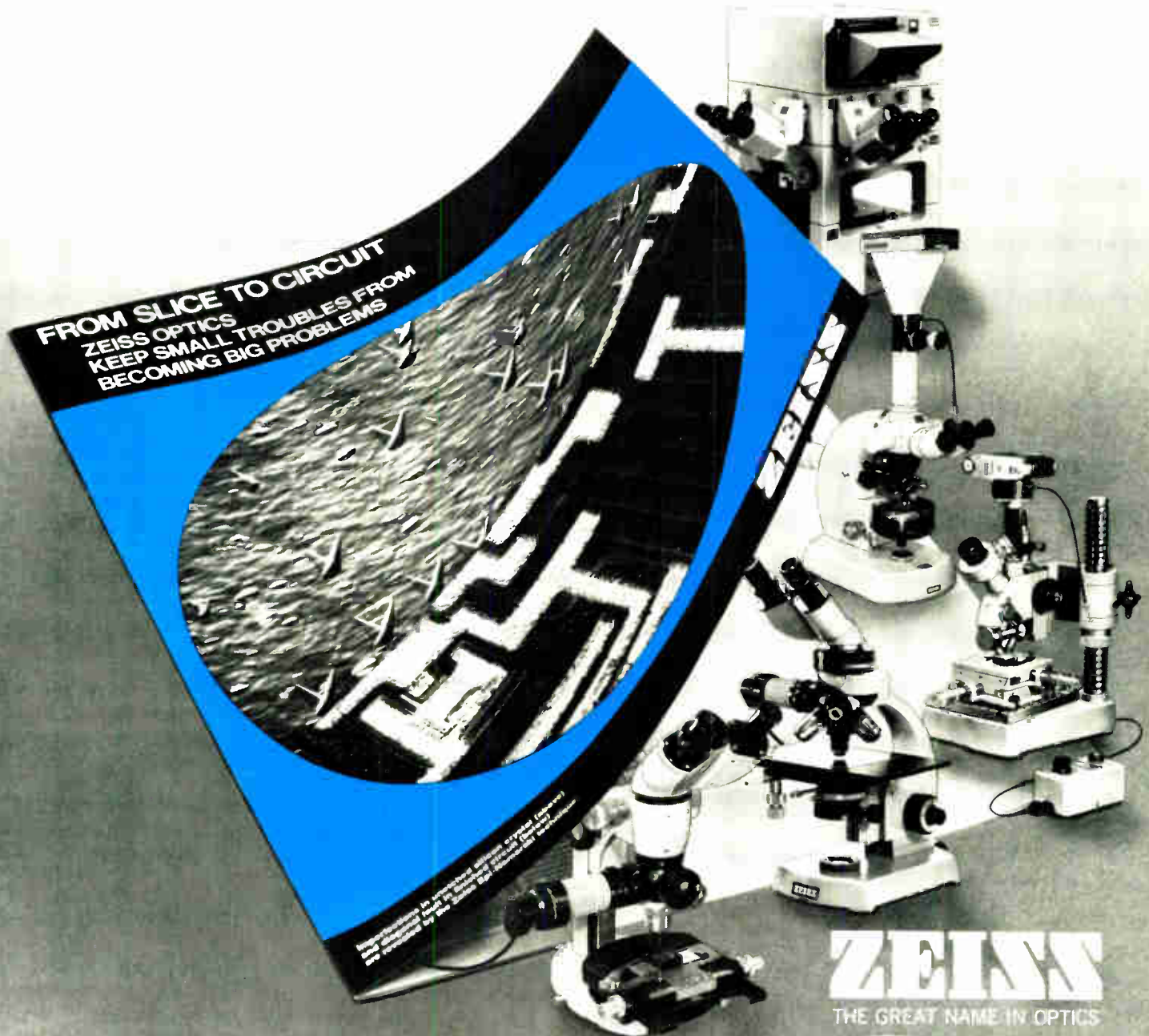

**ZEISS**

THE GREAT NAME IN OPTICS

CARL  
ZEISS

WEST GERMANY

Circle 39 on reader service card

## Using Z-80 and High Level BASIC

# SMART HOME COMPUTER M220

- Small business computer application
- Highest hobby computer



Features. M220 Standard Model

- Using "Z-80 CPU" "Z-80CTC", "Z-80 DMA", and 32 K Bytes memory, High Performance Computer
- Memory capacity of up to 128K Bytes
- High level BASIC language
- Display device capable of a maximum of 1920 alphanumeric characters; 64 alphanumeric, symbol characters and 64 graphic characters can be displayed
- Easy-to-operate matrix keyboard
- A single minifloppy disc is standard
- A 40-column journal printer is standard
- A RS-232 SIO for home-use tape recorder and standard printer
- 3-slot S-100 Bus is available for users
- Connection to host computer, MODEM interface is standard
- S-100 Bus and HP-IB Bus converter are optional

We would like distributors and OEM's to contact our office.

## SORD COMPUTER SYSTEMS, INC.,

● Head Office:—  
Isome No. 2 Bldg., 42-12 Nishi-Shinkoiva 4-chome,  
Katsushika-ku, Tokyo, Japan 124.

Telephone : (03) 696-6611  
Telex : 2622393 (SORD J)

Cable Address : SORDCOMPSYS TOKYO

● San Francisco Branch Office:—  
1333 Lawrence Expressway, Suite 216, Santa Clara  
California 95051, U.S.A.

Telephone: : (408) 247-1614, (816) 373-1300  
Telex : 352-045 (SORD SNTA)

### ● DISTRIBUTORS IN U.S.A.

DATA—TRON 30314 Euclid Avenue, Wickliffe, Ohio 44092. Telephone: (216) 585-8421 Branches: Pottsville, Pennsylvania. (412) 243-8421. Detroit, Michigan. (313) 354-6421. Dayton, Ohio. (513) 223-8421 DELCOMP CORPORATION 3303 Harbor Blvd., Suite K6, Costa Mesa, California 92626. Telephone: (714) 549-2575 SEIREX CORP. 14847 Don Julian Road, City of Industry, California 91746 Telephone: (213) 961-2535, (714) 595-1692. SUNSTONE BUSINESS COMPUTERS, INC. 2701 South 291 Highway, Independence, Missouri 64057 Telephone: (816) 373-1300 Branches: Chicago, Illinois 312-799-8256, Buffalo, N.Y. (716) 632-3409

### ● DISTRIBUTORS IN ASIA AND OCEANIA

ABACUS E.D.P. SERVICES PTY. LTD. 66-68 Albert Road, South Melbourne, 3205, Australia. Telephone: (03) 699-8555 Telex: 35621 (ABAGEN AA) SAMPO CORPORATION 217, Sec. 3, Nanking East Road, Taipei, Taiwan R.O.C. Telephone: 7712111, 7521311 Telex: 31109 (SEMCO)

### ● DISTRIBUTORS IN EUROPE

COMPTRONIX AG Drusbergstrasse 19, CH-8810 Horgen 1, Switzerland. Telephone: 01/725 04 10 Telex: 58799 (PSI CHI) DATAMARC NEDERLAND B.V. Maassluisstraat 258, Postbus 250, Amsterdam, Netherlands. Telephone: 17 88 43 Telex: 16703 (AOC A NL)

Welcome to Booth No. 214 & 215 at MINI/MICRO COMPUTER CONFERENCE & EXPOSITION in Anaheim, Dec. 6 to 8, 1977.

## Electronics review

simply scans its label with the optical scanner. The PDP-8 receives the data from the label and then commands the stepping motors to position the laser spot at the starting point of the wire bunch. A beep alerts the operator that this point has been reached.

With the wires fastened in the initial cable clamp, the next step is to scan the cable label a second time. As before, the system absorbs the coded data, beeps, and then proceeds to trace out the complete harness path. As the laser spot moves, the person laying the cable follows it, pressing the wires into cable clamps. Normally, the spot moves at anywhere from 200 to 300 inches per minute but speeds to 1,000 in./min are also possible.

**Subcontract interest.** Grumman's interest in cabling does not stop with the F-14 and its other aircraft projects, general manager Caputo is quick to point out. With aerospace business slack and his production capability operating under capacity, Caputo, who took over last March, has Grumman bidding on electronic assembly subcontracts the airframe manufacturer would have disdained in the past.

He not only is after cabling work—Grumman has also built a machine for twisting more than 90



**Spotter.** Beam projected by overhead laser traces out paths in which wires are laid.

wires into a flexible cable, plus cable-braiding machines that spin protective or magnetic shields over the wires—but he also will take on printed-circuit-board assembly and component insertion chores. □

## Consumer

### Honeywell's automatic-focus chip attracts a host of camera makers

There's more than first meets the eye to the new automatic-focusing system recently disclosed by Honeywell Inc. for Konica cameras made in Japan. At least a dozen other camera manufacturers have also been designing the linear integrated-circuit system into their products, asserts Norman Stauffer, Honeywell's manager for engineering and product development for the focusing system, which the company calls the Visitronic module. And at least five firms have put together prototypes in both still and movie

cameras—two of them besides Konica's maker, Konishiroku Photo Industries Co., are in Japan, and two are in Europe. So the focuser could be turning up in ever-increasing numbers in the camera marketplace.

Moreover, Honeywell's Stauffer indicates that the module could have other applications as well. One is the potentially huge home TV camera market expected to emerge next year as consumer video tape recorders boom. Another is in cameras being proposed for automated production systems. "In certain mass-produc-

# Put our new UART and BIT RATE GENERATOR together and what have you got?

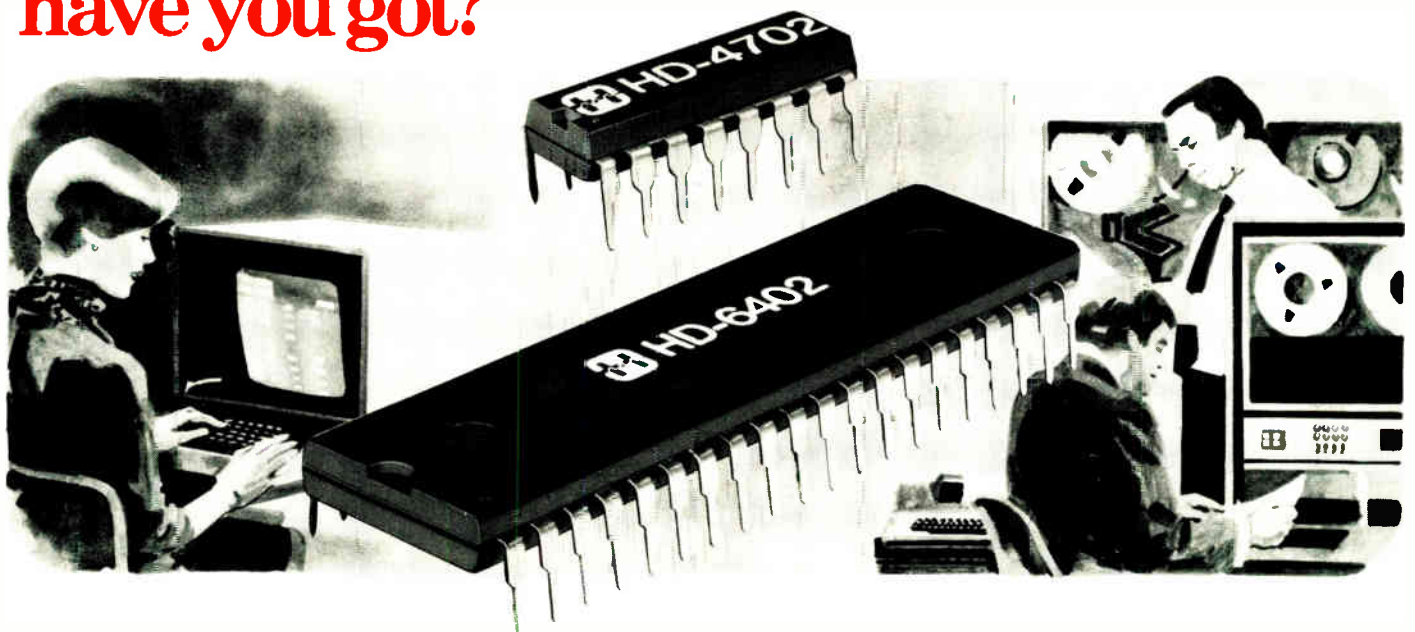

## The first programmable CMOS Communications System.

With the Harris HD-6402/6402A CMOS/LSI, and HD-4702/6405 CMOS Bit Rate Generator, you can convert parallel data to serial and back again asynchronously, substantially reducing the amount of interconnect in your data acquisition systems.

Now, all it takes is two lines to connect terminals to computers, for example, instead of the spaghetti of wire used in older systems.

And, only with Harris do you enjoy the benefits of all-CMOS technology. Like less power consumption, permitting remote, hand-held battery-operated systems. Faster speed. Fewer and smaller components for added economy in equipment costs. Plus full temperature ranges, including military.

The Harris HD-6402/6402A, designed to replace the older and slower P-channel types, is the industry's first CMOS UART. It features an industry standard pinout. Single power supply—operates on 4 to 11 volts. And it's fast... 125K Baud... the *fastest* UART in operation today.

The Harris all-CMOS Bit Rate Generator provides the necessary clock signals for the UART. The HD-4702 generates 13 commonly used bit rates, while the HD-6405 provides two additional bits and consumes significantly less power, with no pull-up resistors.

If you've been waiting for CMOS for your modems, printers, peripherals, and remote data acquisition systems designs, your wait is over! Now Harris technology has something you can really work with. And you can start *today!*

For full details, call the Harris Hot Line, or write:  
Harris Semiconductor, P.O. Box 883, Melbourne, FL 32901.

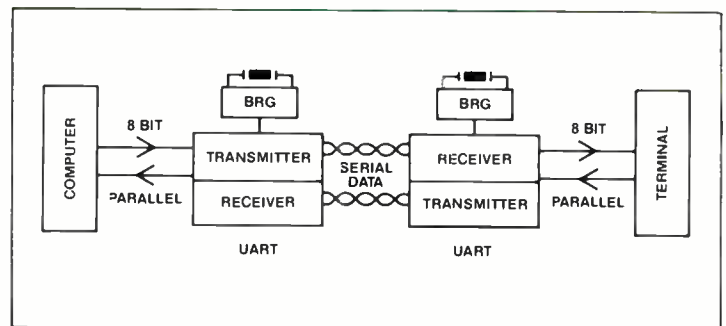

### HD-4702/6405 FEATURES

- CMOS
- TTL Compatible
- Low Power Dissipation: 4.0mW TYP. (6405); 4.5mW TYP. (4702)
- Conforms to EIA RS-404
- One unit controls up to eight transmission channels
- On-chip input pull-up circuit (4702 only)
- 16 pin Cerdip and Epoxy dual-in-line packages
- Second source available

### HD-6402/6402A FEATURES

- CMOS
- Operation from D.C. to 4.0MHz
- Low power—TYP. 10 mW @ 2.0MHz
- 4V to 11V operation
- Programmable word length, stop bits and parity
- Automatic data formatting and status generation
- Compatible with industry standard UART's
- Second source available

**HARRIS HOT LINE!**  
1-800-528-6050, Ext. 455

Call toll-free for phone number of your nearby Harris sales office, authorized distributor or expedited literature service.

Harris Technology... Your Competitive Edge

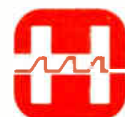

**HARRIS**  
SEMICONDUCTOR  
PRODUCTS DIVISION

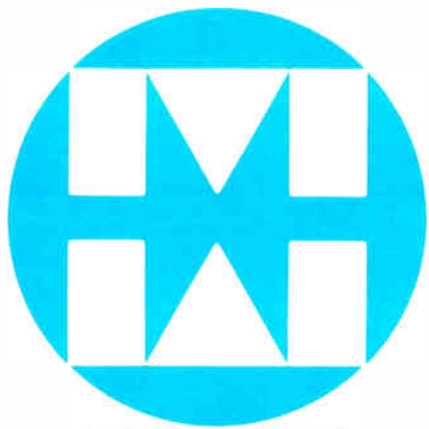

# MITEL

## MILITARY OR COMMERCIAL ANALOG SWITCH

CMOS ANALOG SWITCHES FOR MANY APPLICATIONS—CROSS-POINT, ANALOG-TO-DIGITAL AND DIGITAL-TO-ANALOG CONVERSION, ANALOG OR DIGITAL MIXING, TRANSMISSION GATING, ETC.

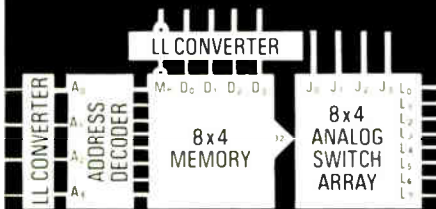

### MT8804B CMOS/LSI 8804B 8 x 4 ANALOG SWITCH ARRAY

#### FEATURING:

- TO 18v, ±9v PEAK DIGITAL AND ANALOG SIGNAL LEVELS
- 50Ω "ON" RESISTANCE OF SWITCHES (TYP.)
- 5Ω BETWEEN "ON" VALUES OF SWITCHES (TYP.)
- -50db CROSSTALK AT F<sub>IS</sub>=1 MHz BETWEEN SWITCHES
- 65 db "ON OFF" OUTPUT VOLTAGE RATIO (TYP.)
- LESS THAN 0.5% DISTORTION AT F<sub>IS</sub>=1 KHz
- MASTER RESET OF CONTROL MEMORY

#### OTHER CMOS ANALOG SWITCHES INCLUDE:

- MD4016B—QUAD BILATERAL ANALOG SWITCH/TRANSMISSION GATE
- MD4066B—QUAD BILATERAL ANALOG SWITCH/TRANSMISSION GATE
- MD4051B—8-CHANNEL ANALOG MULTIPLEXER/DEMULTIPLEXER
- MD4052B—DIFFERENTIAL 4-CHANNEL ANALOG MULTIPLEXER/DEMULTIPLEXER
- MD4053B—TRIPLE 2-CHANNEL ANALOG MULTIPLEXER/DEMULTIPLEXER

For more information write or phone

18 AIRPORT BLVD  
BROMONT, QUEBEC, CANADA  
J0E 1L0  
(514) 534-2321  
TLX 05 267474



# MITEL

Semiconductor

## Electronics review

### News briefs

#### EIA develops new interface standard for terminals

A new digital standard for the interface between data terminals and data circuit terminations has been developed by the Electronic Industries Association. Known as RS-449, the new standard retains all the functional capabilities of the earlier EIA RS-232C, which the association says is "now archaic," and introduces 10 new interchange circuits to enhance it. It provides standard 37-pin and 9-pin interface connectors, together with latching arrangements. In addition to greater noise immunity, RS-449 increases data-signaling rates to 2 megabits per second and permits increases up to 60 m (200 ft) in the length of an interconnecting cable. Copies of the new standard and the associated industrial electronics bulletin are available for \$9.50 and \$4.25, respectively, from EIA's Standards Sales Office, 2001 Eye St., N. W., Washington, D. C. 20006.

#### Collins qualifies first NBS data-encryption chip . . .

Rockwell International's Collins Group has become the first manufacturer to qualify a microelectronics chip for sale under the Federal Data Encryption Standard. The standard, adopted earlier this year by the National Bureau of Standards, is designed to protect data in computer memories from unauthorized access or modification during transmission [*Electronics*, March 3, p. 74]. The Collins Group at Newport Beach, Calif., says its device, known as MOS 765-5914-001, will be sold only as part of larger hardware systems.

#### . . . While Motorola tools up for faster device

Although Motorola's Government Electronics division in Scottsdale, Ariz., has not yet qualified its chip that executes the Data Encryption Standard algorithm [*Electronics*, July 7, p. 40], it is selling many of them for prototypes and promising to replace each one with a forthcoming faster chip. Expected by the first of the year, the new chip will be usable with standard 9,600-baud systems. Motorola also has plans for products that will eliminate awkward key handling. Hand-held units for key entry will store many keys that are identified by simple numbers.

#### TRW forms new Communications Group

TRW Electronics, the Los Angeles-based unit of TRW Inc. of Cleveland, is combining three of its data and telecommunications divisions into a new Communications Group, effective Jan. 1. In the new group are the present Communications Systems & Services division, which builds remote terminals for retail and financial markets, the Datacom division, which markets distributed data-processing equipment, and Vidar, a producer of digital transmission and switching equipment. Richard A. Campbell, presently general manager of the Communications Systems & Services division, will head the new group, expected to give TRW a share of what it regards as important business markets by combining the technology, marketing, and manufacturing of the three divisions.

#### Borg-Warner acquires interest in AMI, sets 5-year custom IC pact

Borg-Warner Corp of Chicago and Robert Bosch North America Inc., a wholly owned subsidiary of Robert Bosch GmbH of West Germany, have signed a 50/50 joint venture agreement to acquire the 25% ownership in American Microsystems Inc. of Santa Clara, Calif., previously sold to Bosch GmbH for some \$14 million [*Electronics*, July 7, p. 25]. Concurrently, AMI and Borg-Warner signed a five-year agreement calling for AMI to develop custom MOS integrated circuits for Borg-Warner, a producer of industrial, transportation, and air-conditioning equipment.

tion situations, automated equipment must sense the presence of a part or a component within limited boundaries," explains Stauffer at

Honeywell's facility in Denver, Colo. The Honeywell module could be used to focus the camera on the part. Designed by a research-and-devel-





# Your 16K ROM is already in our inventory.

**Two week delivery.**

We can have a 16K ROM in your hands in two weeks. Because we tear weeks of waiting out of the normal ROM prototype/production cycle. We do it by mass producing wafers — ready for final mask — so that we have them in inventory, ready for your code. It's like getting off-the-shelf delivery on a custom part. That saves you at least four weeks right there, and gives you a big jump on the competition.

With our last mask capability, we can start a new product cycle right now — instead of falling back to ground zero with a full 6 to 7 week turn-around staring us both in the face. The result: your prototype can be ready in two weeks, and you're ready to roll into production.

At Synertek, we give you choices. Whether your input media is paper tapes, punch card, EPROMs, Bipolar

ROMs, or even another 16K ROM, we can turn it around. Fast. Last mask, for a faster, less expensive production cycle.

For complete information, contact Bob Cushman at Synertek, or your local Synertek distributor, 3050 Coronado Drive, Santa Clara, Calif. 95051. Telephone (408) 984-8900. TWX. 910-338-0135.

# Synertek

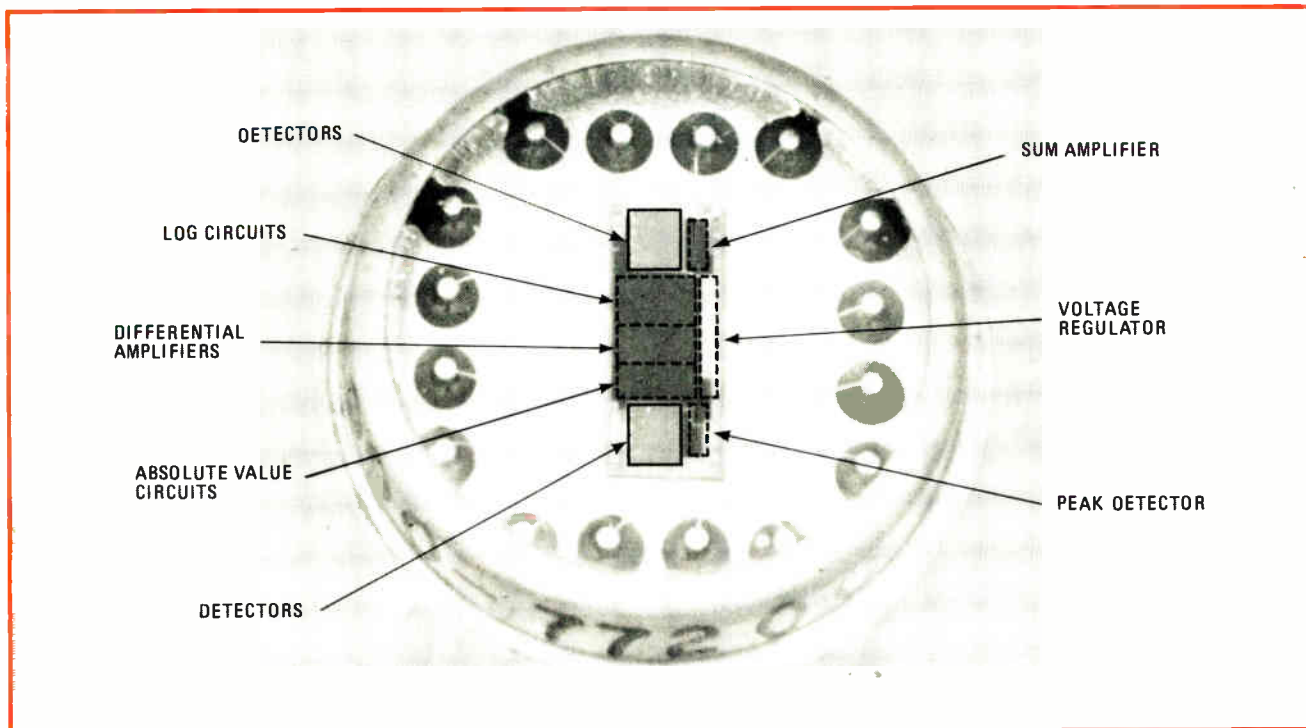

**Focuser.** Honeywell's Visitronic automatic focusing module relies on a 250-by-100-mil chip in a TO-8 can with glass top. Processed outputs from the two sensor arrays, on which images of the scene appear, should be as closely matched as possible when the camera is in focus.

opment group retained from Honeywell's former Photo Products division, which was sold several years ago, the Visitronic automatic focusing module is now in production in Denver. (Honeywell will not reveal its price.) The analog IC at the core of the module was designed and is being produced by the company's Solid State Electronics Center in Minneapolis.

Its performance is analogous to that of a conventional split-image focusing system, which superimposes two separate images of the scene being photographed. In the IC, packaged in a TO-8 can with a glass top (see photograph), the separate images are focused onto a pair of photodiode sensor arrays placed at opposite ends of a 250-by-100-mil chip.

**Matched outputs.** Each array receives the target's image reflected by its own little mirror. One array's mirror, a reference mirror, is fixed, while the other array's mirror, linked mechanically to the camera lens, is scanned down the scene. The object is to find when the outputs from the detector arrays match as nearly as

possible, indicating that at that moment both mirrors "see" the same image. The camera lens is then moved to the point that corresponds to this match, where it is in focus.

**Four quadrants.** To achieve the match, each sensor array is divided into four subareas, or quadrants, so that each detector produces four separate current outputs. The current outputs are each fed into one of eight logarithmic amplifiers and converted to a voltage. Next, the voltage outputs are gathered in pairs—from the corresponding quadrants of the two detectors—and each pair is fed into one of four differential amplifiers that are sensitive to the mismatch between the voltages. The four differential amplifiers feed their signals to four absolute-value circuits, where the signal is prepared so that it can feed a summing circuit.

The summing circuit also inverts the signal so that, when the two images match, the summing circuit output—which Honeywell calls the correlation signal—hits a peak.

This signal is then fed into a peak detector whose output is used to turn

on a solenoid that moves the lens so that it is focused at the best match point. The lens is moved into position after the moving mirror has nodded once down the scene to be photographed, in effect scanning from infinity to close range. This entire procedure is triggered when the shutter button is pressed. It is completed in the moment before the shutter opens in a still camera and is continuous in a motion-picture camera.

The result, in the Konica C35AF, which has not yet been priced, is a completely automatic camera. This model, to be introduced next spring, will also have IC-controlled automatic exposure, with automatic built-in flash as well.

The next step, according to David Fulkerson, manager of the circuit-design group, and Lavon Cooper, circuit designer at the electronics center in Minneapolis, is to reduce the size of the chip. "The major problem," Fulkerson adds, "is that we are working with very small photo currents in low light levels. It makes accurate component-matching vital." □

# The New Giant in optoelectronics

**Affiliation with Siemens  
gives Litronix all you  
could want from an  
optoelectronics source.**

---

**On OCTOBER 18, 1977,** Siemens A.G., an \$8 billion per year firm, acquired an 80% interest in Litronix through a wholly-owned subsidiary — bringing financial stability, new technologies and dozens of new products to the American firm.

Foremost among the new technologies and products are LCD displays, high-power infra-red emitters, green, yellow and red GaP LEDs, and a full line of photo detectors. Nearly all types of optoelectronic products will now be available from Litronix.

Litronix will operate under its own name and market all products in the U.S. and abroad through the same distributors and sales representatives as before.

## **All resources devoted to components**

Litronix ceased manufacture of calculators and digital watches in January 1977. All the design and production capability once devoted to these products is now directed entirely to components. The component portion of the company's business has always been highly successful. Now, operating from a strong financial position, Litronix will resume its place as

the leading source of advanced, cost-effective optoelectronic components.

## **New, advanced products coming fast**

Already in 1977 Litronix has developed 21 new products. With the recent affiliation, new product development is being further accelerated. The company's line of displays, lamps and other opto devices is being broadened and upgraded. Special emphasis is being placed on "intelligent" displays and indicators — devices which incorporate a display and integrated logic in the same package.

The recently introduced DL-1416 alphanumeric display, which interfaces exactly like a RAM, is an apt example. Such devices eliminate need for much associated interface and logic circuitry — simplifying design and producing a sizable net saving in the production cost of customers' products. Litronix is the uncontested leader in this promising extension of optoelectronic integration.

When you have need for virtually anything in optoelectronics, contact Litronix at 19000 Homestead Road, Cupertino, California 95014. Phone (408) 257-7910.

---

# litronix

An affiliate of Siemens.

# The better counter choice:

Counting is not complicated: unless you've got noise and transients on your measurement signals.

Noise can trigger the input circuitry just like the signal and thereby give a false count. Transients can destroy it.

Therefore Philips high-frequency counters employ unique, PIN-diode circuitry that automatically and continuously attenuates the input signal to a level just above the trigger window. The signal therefore triggers the input circuitry, the noise does not. At the same time the PIN-diode circuitry is fast acting, so transients are caught and attenuated in time.

This way, the operating sensitivity is conditioned to match the signal's amplitude, giving the counter a wide trigger window.

Time interval measurements, on the other hand, have fundamentally different requirements for the input circuitry. Timing demands a narrow trigger window in order to minimise the influence of hysteresis. Therefore error-free, high frequency counting and timing facilities cannot be provided by the same input circuitry without compromising one or both measurement parameters. Therefore all our instruments have separate input channels, each optimised for either frequency or time interval measurements. With Philips you can thus be sure of a better, as well as a bigger choice: whatever your application.

#### Fully automated counters:

80 MHz model PM 6661 (1) 520 MHz model PM 6664 (2) employing the unique HF PIN-diode input.

#### Universal counters:

all having 10 mV sensitivity, 80 MHz model PM 6611 (3) 80 MHz counter/timer PM 6612 (4) with 100 ns resolution. 250 MHz model PM 6613 (5) 520 MHz model PM 6614 (6) 1 GHz model PM 6615 (7); last three have separate HF input.

#### Compact timer/counters:

80 MHz model PM 6622 (8) with 100 ps resolution and trigger hold-off facility; 520 MHz model PM 6624 (9) and 1 GHz model PM 6625 (10) have same 100 ps resolution plus separate HF counting input.

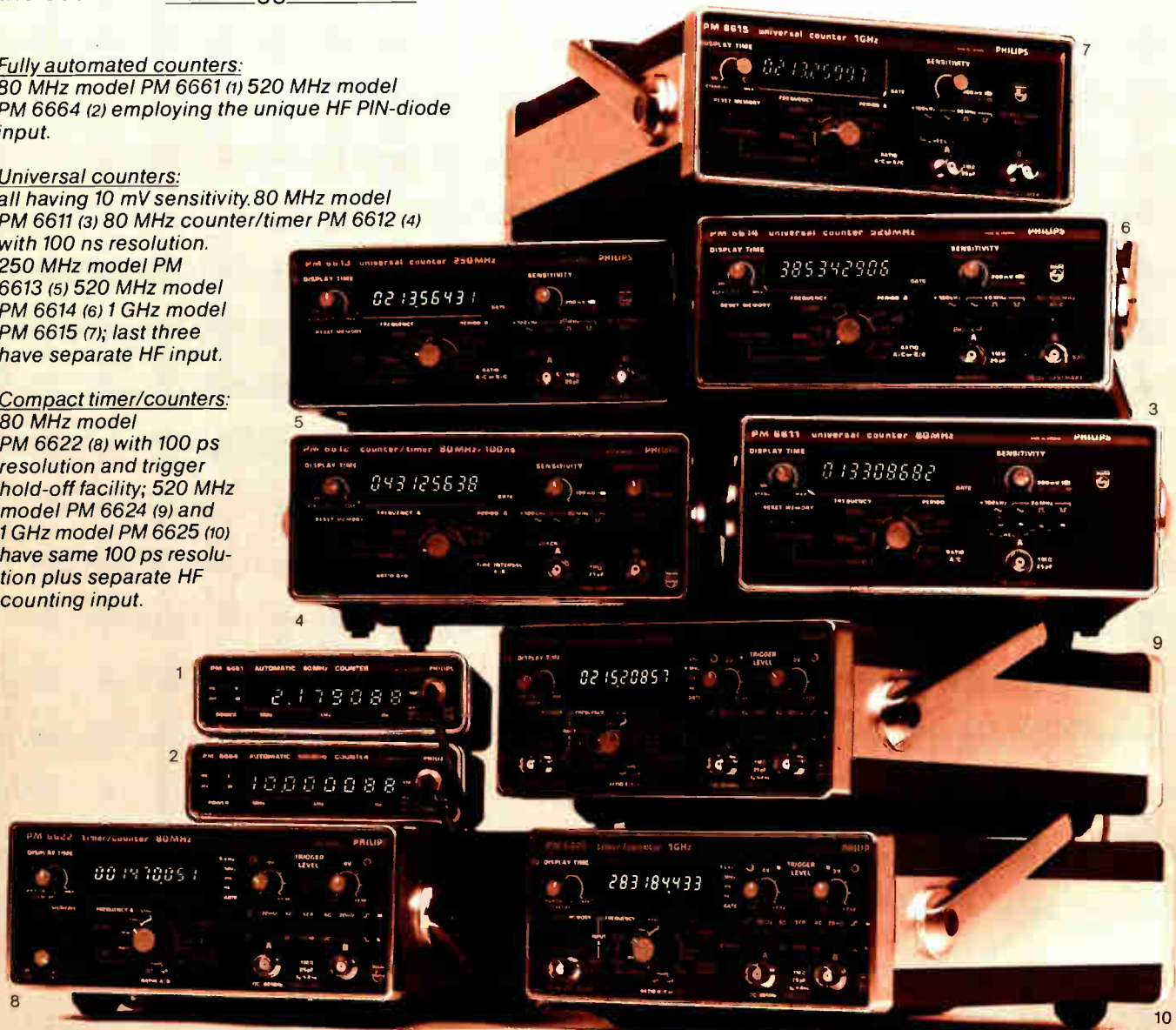

# timer/counters too

## An eleven-model choice of fully automatic counters; universal counters and counter/timers

### Fully automatic counting

Models PM 6661 and PM 6664 are fully automatic and represent the ultimate in easy operation, by having no controls other than the on/off switch. The former counts to 80 MHz, the latter to 520 MHz: both with optimum signal conditioning and high stability time-bases. Dimensions are extremely compact, weight only 1,45 kg and the 8-digit LED display is bright and easy to read.

### Error-free from 80 to 1000 MHz

Four universal counters and one counter/timer cover this frequency range, the VHF and UHF models having the unique Philips PIN-diode circuitry that is proof against noise and that maximises the value of a high 10 mV sensitivity. Moreover, optimum counting accuracy is ensured by a wide choice of high-stability X-tal oscillators, which match your individual needs. This accuracy is extended to the field via the optional built-in battery pack.

The basic 80 MHz instrument is model PM 6611, while the PM 6612 offers basic timing facilities in addition to error-free counting. Models PM 6613, 6614 and 6615

are dedicated counters having frequency ranges of 250 MHz, 520 MHz and 1 GHz.

The high-performance standards of all these instruments can be further extended by plug-in options that provide:

- a BCD output
- a D/A converter that gives an analog "magnifying glass" view of any three digits
- and a serial data output for operation with IEC/IEEE Bus interface systems.

### Compact timer/counters

The timer/counters feature powerful performance in the same compact housing as the previously described frequency counters. Each has specific measurement facilities. All have the following common features:

- 80 MHz direct frequency counting
- high DC-coupled 20 mV sensitivity
- versatile time interval (averaging) measurements down to 1 ns
- and period, ratio and conditioned pulse counting

Depending on your individual needs, you then select the

specific model with either:

- trigger hold-off to extend the timing capability as provided by model PM 6622. This allows spurious signals such as contact bounce to be ignored; enables period measurements to be made on double-pulse signals and permits a specific signal to be "picked-out" from a pulse train, to give just three examples of this instruments timing versatility.
- extended frequency counting, on a separate input, to 520 MHz for model PM 6624 or to 1 GHz for model PM 6625. These two instruments thus offer the same error-free counting facilities as the universal counters, while retaining the 100 ps resolution of the time interval averaging technique.

The timer/counters also offer the same choice of timebase as the universal counters and the same plug-in options and battery operation.

Get the full facts on the bigger, better counter and timer/counter choice. Tick the reader service number, fill in the coupon or contact Philips at the address below.

### A high-speed, high-resolution, systems instrument

Model PM 6650 below is a systems instrument that features accurate, noise- and transient-suppressed counting to 512 MHz on a special frequency channel. And time interval averaging measurements with up to 1 ps resolution on the timing channel. Plug-in modules extend the performance: two increase the frequency range to either 1 GHz or 12.6 GHz; another boosts the basic 50 mV sensitivity to 1 mV. User options are numerous.

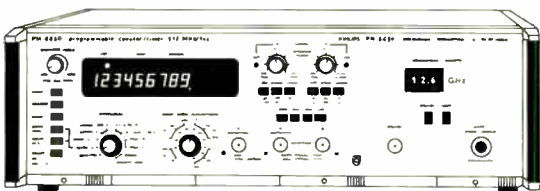

### Please send me full details on:

- Fully automated counters PM 6661 and 6664
- Universal counters PM 6611 to 6615
- Timer/counters PM 6622, 6624 and 6625
- Universal model PM 6650
- All Philips Test and Measuring Instruments

Name .....

Department .....

Company .....

Address .....

City ..... Country .....

For further information call our toll-free HOT LINE number 800 631-7172 or contact: Philips Test & Measuring Inc., 85 McKee Drive, Mahwah, New Jersey 07430 or in Canada: 6 Leswyn Road, Toronto, Ontario, Canada M6A1 K2 Tel. (416) 789-7188

Philips Test & Measuring Instruments Inc.  
A NORTH AMERICAN  
PHILIPS COMPANY

# PHILIPS

Circle 47 on reader service card

47

RCA announces the

# HEATPIPE SCR

**New dynamically cooled transcendent device  
delivers more watts per ounce, more amps per inch.**

RCA brings you a brand new solid-state way to handle big power. For motor speed controls. Welding controls. Electrochemical refining. Power conditioning. Electric vehicles. Induction heating. Military and space applications. Use it where size, weight and cooling are vital concerns.

Because the HEATPIPE SCR combines the outstanding heat-dissipation ability of isothermal heat pipes with the electrical functions of a silicon thyristor.

Heat from the silicon evaporates water within this unique heat-pipe system. Vapor travels along the interior of the heat-pipe, cools and condenses. Capillary action of the wick pumps the water back to be evaporated all over again.

### New design possibilities

This RCA breakthrough means you can pack more power into less volume and weight than ever before. Up to 400 A RMS, up to 1200V peak blocking voltage. 500 watt dissipation and low thermal impedance. In only 12 ounces and about 14 cubic inches. Other devices that reach

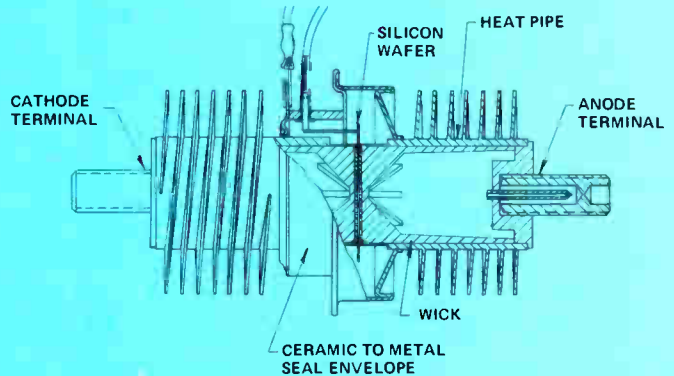

*Heat pipe literally pulls heat away from silicon chip, allowing higher power levels.*

the same levels weigh 10 to 15 pounds!

You can try whole new design approaches. Without heavy relays, bulky mechanical switches, or multiple devices in parallel. And you can design knowing that the HEATPIPE SCR has passed severe life, environmental, shock, vibration and surge tests.

We'll be glad to help you apply the HEATPIPE SCR and companion transistor and rectifier. For more information contact Marketing Manager, Solid State Power Devices, RCA, Lancaster, PA 17604. Or call (717) 397-7661.



# RCA

## **Four compete for U.S. overseer role in new IEC system**

To meet membership requirements of the new international components certification system known as IECQ, to be chartered in January by the International Electrotechnical Commission (see p. 50), the American IEC committee **will evaluate next month four proposals to set up an independent National Supervising Inspectorate.** Candidates include Underwriters Laboratories Inc., Inter Tek Services Corp., Los Angeles; Science Applications, Inc., Palo Alto, Calif.; and CASE—the Coordinating Agency of Supplier Evaluation. CASE was set up to serve the aerospace industry and is operated by Aerojet Liquid Rocket Co., Sacramento, Calif.

## **Peterson offered OTA directorship by Congress**

The congressional Office of Technology Assessment has found a candidate to fill the vacancy created by the July 1 resignation of director Emilio Q. Daddario. If he accepts the offer, the new director of the \$8.3 million OTA and its staff of more than 130 will be Russell W. Peterson, former Republican governor of Delaware and **research chemist who earlier headed Du Pont Corp.'s R&D division.** He now serves as chairman of the White House Council on Environmental Quality.

## **DOE lining up electric vehicle users for demonstration**

The Department of Energy is lining up two types of commercial organizations to participate in its demonstration program for electric and hybrid vehicles [*Electronics*, March 3, p. 49]. Selection of large fleet operators, like telephone companies or department stores, as well as organizations akin to automobile dealers that will lease or sell and maintain vehicles for individuals will begin next spring. **First participants in each category will be funded to buy 200 to 400 vehicles beginning about August 1978** from any of the 109 U. S. electric vehicle makers whose models meet the user's needs, according to Energy officials. The number of vehicles involved in the estimated six-year life of the program is expected to range from 7,500 to 10,000. The department has named Booz-Allen and Hamilton, Bethesda, Md., management consultants, to provide planning and management support for the project. Overall cost of the effort is expected to range from \$150 million to \$200 million.

## **NASA's Frosch confirms headquarters reorganization**

NASA is implementing its headquarters reorganization on Nov. 8, as promised by administrator Robert Frosch [*Electronics*, Oct. 27, p. 34]. In a new organization chart that Frosch says "looks like a much more simplified wiring diagram" **seven offices—including six assistant administrators' posts—were either abolished or retitled** and their responsibilities changed. Major assistant posts eliminated include: planning and program integration, with responsibilities going to the chief scientist and the associate for space and terrestrial applicants; institutional management, with duties now held within management operations excepting headquarters procurement which goes to the procurement director; industry affairs and technology utilization, with responsibilities spread through four offices; energy programs, now to be handled by aeronautics and space technology. Personnel programs becomes a part of management operations, as does the abolished systems management office. The program assurance office was also dropped and duties assigned to the chief engineer pending further study.

## IECQ: Will it help or hurt your business?

When the International Electrotechnical Commission convenes January 9 in Geneva, the three-day meeting will involve setting up a new system for international certification of the quality of electronic components. It is expected to have an enormous impact on world trade. Though the U. S. and the 16 other nations that have spent seven years structuring the system called IECQ—for IEC Quality Assessment System—and are preparing to become fully-certified members, many Americans are unaware of the system and its potential impact.

A voluntary worldwide quality-assessment system for components, the IECQ is open to any nation. Much as military specifications are applied in the U. S., a manufacturer will be able to certify performance and quality of products to a standard. The commission's standards will be the desired base for specifications, but in their absence a national or company standard may be used provisionally. The premise is that certified components will be acceptable by buyers in all participating countries without further tests.

### Only the beginning?

If it works, international-components trade would become simpler, faster, and more extensive. Moreover, its proponents hope that the system will be extended to include other products, notably instruments, after the bugs are worked out of the components program.

Who are the system's proponents? In the United States they include the Electronic Industries Association, which first proposed it, the U. S. National Committee of the IEC, and the American National Standards Institute. Of the IEC's 43 member countries, the 16 others active in setting up the IECQ system include: Australia, Belgium, Canada, Denmark, France, Germany, Hungary, Israel, Italy, Japan, the Netherlands, Norway, Poland, Sweden, the United Kingdom, and the USSR. Each has formed a national authorized institution to act for it in structuring the IECQ. In the U. S., that is the IEC National Committee. Additionally, each country must have a national standards organization and pay dues.

Now the preliminaries are over. The 17 nations have come up with basic rules for IECQ membership, a constitution and bylaws, and are near approval of detailed operating rules. In January, each country must decide if it wants to be a fully-certifying member with a vote. To qualify, a country must have formed a national

supervising inspectorate and a calibration service and must develop an operating plan called the National Statement of Surveillance Arrangements. It is a complex procedure, and one that will prove more complicated for the U. S. than for many other nations, which have government agencies to assist in these roles.

Even though the EIA first proposed creation of the IECQ in 1970, its board of governors only voted that the U. S. join as a fully-certifying member in October. It has been a tough selling job to persuade American component makers and distributors that they will gain more from the IECQ than it will cost them. The EIA engineering vice president, Allen Wilson, cannot be accused of overstatement when he says "There will be some rather intense activity over the next several months within EIA and the U. S. national committee of IEC in development of a needed organization and in determining its operational costs and interest within the producer and user segments for support of the system."

### Old and new challenges

Another laborer in the American vineyard planting the seeds of an IECQ system is Leon Podolsky, president of the U. S. IEC committee and chairman of EIA's exploratory committee on the program. For those in industry who question IECQ's benefits against its still uncertain costs in a highly price-competitive components market, it is worth recalling the origins of the 1970 EIA proposal. At that time it seemed a necessary substitute for the Cenelec Plan then being implemented in Western Europe. That plan would have barred all countries except members of the European Economic Community and the European Free Trade Association from components trade in that region. With American components dominating world technology, U. S. manufacturers viewed Cenelec as another artificial barrier to free market entry. But that was 1970.

In 1977, a growing number of Americans anxious to protect their home markets are adopting protectionist views—especially some smaller components makers who see themselves one day crushed between the jaws of a vise made up of American multinationals on one side and their Japanese and European counterparts on the other. Convincing them that the IECQ will ultimately work to their benefit is another task for the system's advocates that may prove as difficult as those they have already overcome.

**Ray Connolly**



## TYPE 192P PACER® FILM CAPACITORS



# BEAT THE SPACE/COST SQUEEZE

- Polyester-film dielectric, heat-shrinkable plastic sleeve . . . the kind of construction that saves both space and cost.
- Unique construction . . . all turns of extended foil electrodes terminated in metal end caps . . . assures best-possible non-inductive capacitor section.
- End caps provide controlled dimensions . . . suitable for automatic insertion on printed wiring boards.
- High humidity resistance . . . end caps over capacitor sections are effective moisture barriers.
- Voltage ratings from 80 to 600 WVDC. Capacitance values from .0001 to .39  $\mu$ F. Standard capacitance tolerances,  $\pm 5\%$ ,  $\pm 10\%$ ,  $\pm 20\%$ . Operating temperature range,  $-55^{\circ}\text{C}$  to  $+85^{\circ}\text{C}$ .

Write for Engineering Bulletin 2066C to  
Technical Literature Service, Sprague Electric Co.,  
35 Marshall St., North Adams, Mass. 01247.

THE BROAD-LINE PRODUCER  
OF ELECTRONIC PARTS



Circle 221 on reader service card

## TRIGATE® PULSE TRANSFORMERS



# THE INDUSTRY'S LOWEST-COST SCR TRIGGERS

- Dependable enough for industrial equipment, yet priced for high-volume commercial use.
- Balanced pulse characteristics and energy transfer, minimum saturation effect, fast pulse rise time, increased current capability, improved energy transfer efficiency.
- Variety of turns ratios available with line voltage ratings to 240 VAC or 550 VAC. Operating temperature range,  $-10^{\circ}\text{C}$  to  $+70^{\circ}\text{C}$ .
- Plug-in design, protected by thermoplastic sheath. Axial-lead and pre-molded designs also available.

Write for Engineering Bulletin 40003B to  
Technical Literature Service, Sprague Electric Co.,  
35 Marshall St., North Adams, Mass. 01247.

THE BROAD-LINE PRODUCER  
OF ELECTRONIC PARTS



Circle 222 on reader service card

## SERIES 207C300/207C400 MODULES



# ACTIVE FILTERS FOR USE WITH MODEMS

- Designed for low speed modem applications.
- Provide all necessary filtering for originate only, answer only, or answer/originate operation.
- Series 207C300 transmit modules feature 6-pole filter to suppress output sidebands, reduce harmonic distortion.
- Series 207C400 receive modules include 10-pole filter to eliminate noise and local carrier signals.
- Absolute max. ratings include supply voltages of  $+18\text{V}$  ( $V_{EE}$ ),  $-18\text{V}$  ( $V_{EE}$ ),  $5.5\text{V}$  ( $V_{DD}$ ). Operating temp. range is  $0^{\circ}$  to  $+70^{\circ}\text{C}$ . Storage temp. range is  $-40^{\circ}$  to  $+125^{\circ}\text{C}$ .

Write for Engineering Bulletin 22113 to  
Technical Literature Service, Sprague Electric Co.,  
35 Marshall St., North Adams, Mass. 01247.

THE BROAD-LINE PRODUCER  
OF ELECTRONIC PARTS



Circle 50 on reader service card

## TYPE 715P FILMITE® 'L' CAPACITORS



# LOW DISSIPATION FACTOR

- Polypropylene film dielectric . . . similar to polystyrene in high a-c current-carrying capability, but has added advantage of  $105^{\circ}\text{C}$  operation.
- Conformally coated with flame retardant epoxy.
- Ideal in solid-state TV vertical circuits, r-f generators, pulse-forming networks, plus other applications where high a-c current flow is found.
- Capacitance change with temperature less than 3% over operating temperature range of  $-55^{\circ}\text{C}$  to  $+85^{\circ}\text{C}$ .
- Capacitance values from .001 to .47  $\mu$ F, voltage ratings from 400 to 1600 WVDC.

Write for Engineering Bulletin 2090 to  
Technical Literature Service, Sprague Electric Co.,  
35 Marshall St., North Adams, Mass. 01247.

THE BROAD-LINE PRODUCER  
OF ELECTRONIC PARTS



Circle 51 on reader service card

# WHY ARE MORE LEADING COMPANIES AND UNIVERSITIES BUYING DEC® FROM FIRST COMPUTER?

## 1. DISCOUNTS

Everyone can qualify for discounts, which range up to 20%. Special discount plans for qualified educational and OEM organizations are available.

## 2. DELIVERY

Prompt delivery of factory-fresh DEC® components and products is provided off-the-shelf. Plus, we also stock DEC 11V03®, DECLAB® equivalent, and 11/03 Computing Systems, and can rapidly deliver both standard and customized systems.

## 3. SERVICE

Each customer and order is handled on a personalized basis. We can help you configure your system or select the proper component. Expedited delivery, rapid replies to information requests, and courteous treatment are assured.

## 4. CUSTOM CONFIGURATIONS

We will custom build systems to your specific requirements, with no resulting delays in delivery. We can package your system in a functional yet attractive desk, and provide additional memory, interfaces, terminals, and peripherals.

## 5. ADDED VALUE

Valuable software enhancements for each DEC 11V03®, DECLAB® equivalent, or 11/03 Computing System delivered by First Computer are provided from our continually growing software library. Custom configurations are built to order, fully integrated, and tested prior to shipment.

## 6. WORLD-WIDE FIELD SERVICE

Because all of our systems are thoroughbred DEC®, we can provide for on-site field service by DEC's own factory trained technicians world-wide.

## 7. WARRANTY

We provide the same warranty as DEC®, plus, ask us about our priority exchange plan.

## 8. RENTAL/LEASING

We offer short-term rental or long-term leasing of complete systems. Ask about how these programs can help you meet your system acquisition and budget requirements.

## WHAT THIS MEANS TO YOU

### COMPLETE SYSTEMS

Standard or custom DEC 11V03®, DECLAB® equivalent, or 11/03 Computing Systems with a \$1,000 savings and shipment in 30 to 60 days.

### COMPONENTS

A complete stock of LSI-11® and 11/03® products for immediate delivery—at ATTRACTIVE DISCOUNTS.

Call **FIRST** *first* to find out how much money and time you can save. Call Don Berteau at (312) 920-1050.

## FIRST COMPUTER CORPORATION

764 BURR OAK DRIVE WESTMONT, ILLINOIS 60559

Call **FIRST** *first*



### 11/03 Computing Systems

\* Registered trademark of Digital Equip. Corp. Maynard, Mass.

Circle 52 on reader service card

### LSI-11® Components

World Radio History

### DEC 11V03® Systems

## **Fiber-optic cable made with bulk process is in production**

In pilot production at the English glassmakers Pilkington Brothers Ltd. is a fiber-optic cable based on the bulk-chemical-treatment process developed by the Catholic University of America [*Electronics*, Oct. 27, p. 126]. The single-fiber cable is intended for communications over 1-km distances requiring a modest 50-kHz bandwidth. **Present attenuations are in the region of 15 dB/km, with samples achieving 10 dB/km.** Cost is 68¢ per meter for a 50-km package, but this should fall to around 17¢ once volume production begins. Pilkington has the exclusive European license for the process; Canada Wire and Cable Ltd. has the North American license; and Sumitomo of Japan has the Far East license.

## **Instrument maker in Germany seeks role in U.S. markets**

Before the end of the year, West Germany's VDO Adolf Schindling AG will start production at its new Winchester, Va., plant—initially turning out instruments for cars Volkswagen will be making in the U.S. **In another move to enhance its position in the U. S., the firm has bought 25% of Solid State Scientific Inc., Montgomeryville, Pa.** VDO has long used the American firm's complementary-MOS circuits in automobile quartz clocks. The new link provides for cooperation in developing C-MOS circuitry and other devices.

## **English word processor from Japan's Ricoh available in Great Britain**

Ricoh Ltd. has become Japan's first company to make and market an English-language word processor. It is starting production at a rate of about 100 units a month. The \$14,000 processor features a single-line cathode-ray-tube monitor for checking the text before typing and a double daisy-wheel printer that can type at 33 characters a second. Its floppy disk can store 225,000 characters. **Ricoh has been shipping the systems to Ultronic Data Systems Ltd. in Great Britain since August and will sell them in Japan** to trading companies, foreign companies, and law offices. The firm says it is also studying sales in the U. S.

## **Cobol package for microprocessors aimed at business**

Aiming to capitalize on the worldwide business investment in the Cobol high-level language, a small London software consultant, Micro Focus Ltd. has developed for microprocessor-based terminals a compact Cobol compiler that requires as little as 8 kilobytes of program storage. The firm's CIS (for compact interactive standard) Cobol will allow users to run existing programs and develop new ones on microcomputers, which have interactive capabilities that make it extremely easy to edit out syntax errors. The package has been developed for Dataskill, ICL's software subsidiary, at a cost in excess of \$100,000. It is being run on the ICL 1500 transaction processor inherited from Singer Business Systems. **Now the Micro Focus team, approved by Intel to develop user software, has its sights set on the microprocessors from the principal Silicon Valley makers.** All that is needed to adapt the compiler to a processor is a runtime system written in the appropriate machine language. To incorporate a bigger user dictionary, the compiler can occupy 16 kilobytes of program memory for 500 user statements and 1,000 commands.



# Action!

**It made us the leader in electronic equipment rentals.**

When you call Electro Rent, expect action.

Our representatives are action-oriented specialists who can answer your questions quickly and get you the necessary equipment in hours.

We back them up with the nation's largest electronic equipment inventory and a network of service centers from coast to coast.

Find out why more people rent or lease their electronic equipment from the leader. Call us now for equipment, applications assistance or a free catalog. Or write our Marketing Manager at: Electro Rent, 4131 Vanowen Place, Burbank, CA 91505.

**Call toll-free 800-423-2337 for immediate action!**

In California call 800-232-2173

  
**ElectroRent**  
A Teletor Company

Circle 54 on reader service card

Interested in buying quality used equipment?  
Ask for our Equipment Sales Division.

World Radio History

## Japanese laboratory is growing silicon ingots 5 inches in diameter

Yet another example of the Japanese determination to forge ahead in the semiconductor world is a successful laboratory effort to grow single-crystal silicon ingots that are 5 inches in diameter. These are not the first 5-in. ingots: American firms such as Dow Corning Corp., Midland, Mich., have samples of this size available. But the Japanese think they will be able to reduce the number of wafer defects significantly by their method of growing the ingots under low pressure.

So far, 5-in. ingots with lengths of 150 millimeters have been grown by the Czochralski method from 7-kilogram melts at the Musashino Electrical Communication Laboratory of the Nippon Telegraph and Telephone Public Corp. But they are only a start—the goal is 1-meter-long ingots.

Integrated-circuit makers are hardly ready to handle the 5-in. wafers—they are in the middle of switching their production lines to the 4-in. size, both in Japan and in the U.S. [*Electronics*, March 17, p. 78]. However, there is no question that they will be interested, because the larger the wafer, the easier it is to develop bigger very-large-scale ICs and to fabricate them economically.

**8 in. possible.** The crystal-growing furnace, made to order by Kokusai Electric Co., could grow ingots up to 8 in. in diameter, although not 1 m long. Essentially, it is a 3-in. growing unit scaled to twice the size in each dimension. The crucible can hold a 30-kg silicon melt—four or five times as much as a 3-in. unit. The hefty power requirements of the electrical heaters that give a large, high-efficiency hot zone dictate the use of three-phase ac power, rather than the usual dc, with thyristor phase control.

Where the unit differs from 3-in. furnaces is the growth of ingots in a crucible argon atmosphere at a



**Big melter.** Standing 4.5 m high, furnace is turning out 5-in.-diameter silicon ingots

10-torr partial vacuum, instead of argon at the normal atmospheric pressure of 760 torr. The reduced pressure is expected to greatly reduce the amount of oxygen that enters the melt from the silica crucible. Oxygen is undesirable because it leads to larger defect sizes during high-temperature wafer processing. Today's ingots often contain  $10^{18}$  oxygen atoms per cubic centimeter.

The reduced pressure also is

expected to slash the amount of pure argon required. While the 10-torr atmosphere is not hard to produce, it does pose some operating problems for the vacuum pump, so its efficiency is low in the 5-in. furnace, and the oil in the pump degrades. However, the lab is working with pump manufacturers to design more satisfactory equipment.

**Fewer faults.** The researchers have grown perhaps a dozen ingots so far—they will not give a precise number—and are still evaluating them. Their goal is no dislocations and the minimum density of stacking faults possible. With smaller equipment that operates at 10 torr, they have produced 3-in. ingots with no dislocations and fewer than 10 stacking faults per square centimeter for experimental 65,536-bit random-access memories. Run-of-the-mill wafers from production facilities have no dislocations and less than 500 stacking faults, with better quality available at a premium price.

The development of the 5-in. ingot is part of NTT's ongoing work on semiconductors for telephone equipment. However, the firm does cooperate with the Japanese semiconductor makers banded together in the VLSI effort to develop technology for general-purpose computers. □

### West Germany

## IC and sensor plate control dimmer switch

In today's world of microelectronics, one notable anachronism is the household dimmer switch that uses a knob controlling a rheostat to change the electric-light level in a room. At least, that is what engineers at West Germany's Siemens AG contend. To update dimmer design, they have developed an inte-

grated circuit that works with a touch-sensitive sensor plate to do away with the rheostat and the control knob.

With the new IC and the sensor plate, control of the light level is radically different from that with the conventional knob and rheostat. Touch the plate with a finger and the light comes on. Keep the finger on the plate for half a second or more, and the light either dims or brightens. The IC-plate combination will undercut the price of the rheostat. It is intended as an export item, notably for the U. S. market, as well as for domestic use.

The S566B is based on p-channel

metal-oxide-semiconductor depletion technology. It integrates some 1,000 transistors and contains essentially signal-evaluation circuitry, flip-flops, and comparison and counting circuits. The IC accepts the touch-initiated pulses and evaluates their duration. Using counting, timing, and pulse-shaping circuitry, it produces a staircase-shaped signal controlling an external triac that in turn controls the power applied to the light bulb.

When the sensor plate is touched, the resistance of an external resistor network changes as a result of the added resistance of the human body. This changes the input voltage to the

IC from 0 volts to about 8 v.

The IC's signal-evaluation circuitry determines how long the touch lasts and the control pulses for the triac are produced in subsequent circuitry. Phase control techniques for the gate of the triac are used over a range of 30° to 150°. In this 120° range, the triac input can have any of 86 levels, with each level representing a certain stage of brightness of the electric light.

If the finger is kept constantly on the plate, the light will go from one extreme to the other in about 3½ s, or 7 s from dark (30°) to bright (150°) and then to dark. This control sweep is repeated as long as the finger remains on the plate. If the finger is removed and reapplied, the evaluation circuitry detects the interruption of the input pulse that results, and a flip-flop then changes its state and initiates a reversal of the control action. Thus a dimming light may be made to brighten, and vice versa.

**Less than \$1.** An electronic gadget for which dimmer makers must pay a lot of money? "Not at all," says Gunter Katholing, product manager for consumer ICs in Siemens's Munich-based Components division. He says that in volume quantities the circuit will sell for under \$1—less than the cost of the rheostat. The sensor is simply a metallic plate that is part of a resistor network, so it is virtually a penny item.

The IC, in whose design the German light-fixture producer Kopp GmbH participated, will be available shortly. Early next year, one of the biggest American light-fixture producers (whose name Katholing prefers not disclose now) will start marketing light dimmers built around the S566B and the sensor.

Since the IC-based dimmer uses no mechanical parts, its operation is inaudible. Also, because the rheostat is eliminated, the dimmer can be made much smaller than a conventional type. But dimmer manufacturers will probably not exploit the advantage of reduced size, Katholing says. They may prefer to stick to the dimmer dimensions built into the standard wall boxes. □

### Around the world

#### Sealed magnetic switch to shrink phone exchange, power use

Coming up: sealed magnetic switches as replacements for miniature mechanical crossbar units in the Japanese D-10 electronic telephone exchanges. They will require only 40% of the space of the crossbars, and overall volume of the standard eight-by-eight matrix, including control equipment, is 70% that of the present setup.

This space savings will permit more efficient use of telephone offices in land-poor Japan. The new switches also will serve handily in export versions of the D-10. The unsealed crossbars need controlled environments to maintain high reliability. So for many foreign sales, the Japanese have had to use the more tolerant reed switches, which must be individually fabricated, sealed, and mounted on pc boards. The new switch package, with 16 contact pairs each, will be hermetically sealed in nitrogen.

A joint project of the Nippon Telegraph and Telephone Public Corp. and its four exchange suppliers, the new units have a drive power of 35 watts, instead of the crossbars' 90 W. Switching time is 5 milliseconds, instead of 8 ms. With about a third the different types of parts as the crossbar, they should be cheaper to make.

When the X and Y coils of a particular contact pair are energized by a pulse, only that pair operates. Other contacts are only half-selected, so they do not operate. Hysteresis of the iron core on which the fixed contact of each pair is mounted keeps the pair closed after power is removed. A negative pulse applied to the X coil releases them.

#### European Space Agency is set to launch a weather satellite

Poised for a November 15 launching at Cape Canaveral, Europe's first meteorological satellite, the Meteosat, is the European Space Agency's contribution to the United Nations' Global Atmospheric Research Program. It also is ESA's first nonresearch satellite.

Meteosat's multispectral radiometer system will photograph the earth and its clouds in both the visible and the infrared range by scanning in line-by-line fashion as the satellite rotates some 100 times a minute. The change from one line to the next is accomplished by tilting the telescope optics—an approach that ESA hopes will give a 1½-mile resolution with significantly better picture quality than the tilting mirror in front of the telescope optics in the U. S. satellites that are part of the UN program. The American system gives a resolution of ½ mi in the visible spectrum. Another feature of Meteosat is its electronic antenna-despinning system, rather than the usual mechanical system, to ensure steady antenna orientation toward the earth while the satellite spins.

# Now, a new generation of semiconductor-grade molding compounds.

World Radio History



# **Dow Corning 631 molding The advantages of silicone The advantages of epoxy. And something more.**

At first it might appear pretentious to announce a new generation of semiconductor-grade molding compounds. "New generation" implies a product so outstanding, so totally unique, that it overshadows all existing technology. But that is precisely what we have developed. We've taken the best advantages of silicone. The best advantages of epoxy. And put them together in one very unique product. Dow Corning<sup>®</sup> 631 silicone/epoxy molding compound.

What this new generation of molding compound means to you is that now you have the best advantages of silicone and epoxy in one product specifically designed for integrated circuit applications. And it means something more. It means that now every other molding compound is second best.





# compound. **Dow Corning 631. Better than silicone.**

Dow Corning 631 silicone/epoxy molding compound represents a breakthrough in a very real sense. It's the only molding compound that combines the compatibility and ease of molding of silicone compounds with the salt atmosphere resistance of epoxy compounds. The graph at right proves our point. After 600 hours' exposure to corrosive salt atmosphere, none of the devices that were molded in Dow Corning 631 silicone/epoxy compound failed. That's a major advantage over ordinary silicone molding compounds.

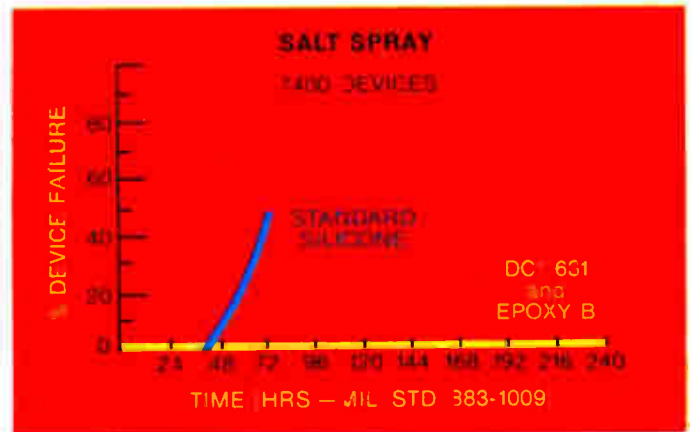

**Dow Corning 631. Better than epoxy.** Dow Corning 631's advantages over silicone are only half the story. It's also the only molding compound that combines the high strength and strong lead seal of epoxy with the

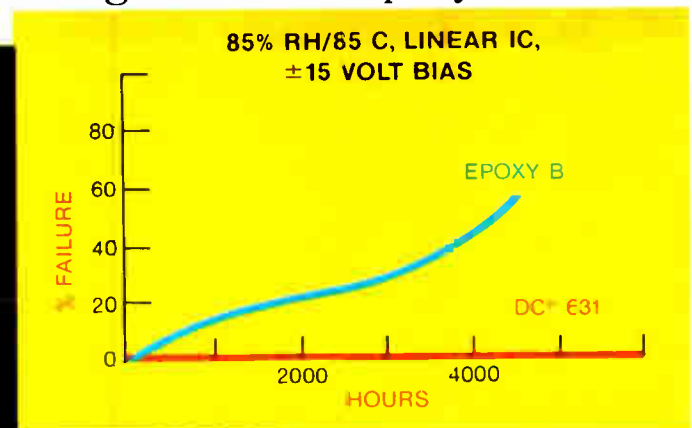

outstanding moisture resistance of silicone. The autoclave resistance of Dow Corning 631 is very nearly as high as that of an all-silicone molding compound. And look what happened on 85°C/85% R.H.-bias testing.

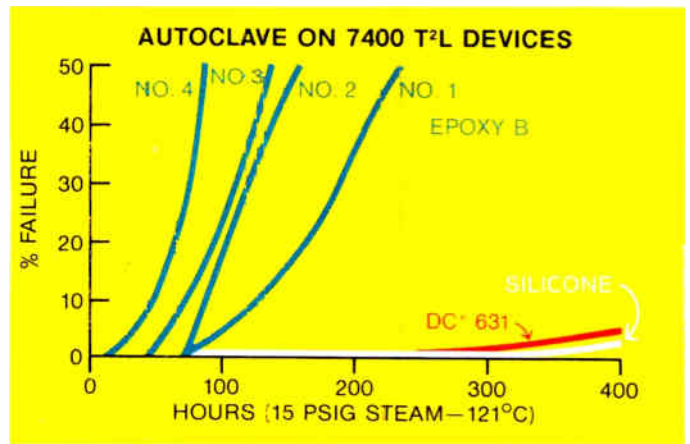
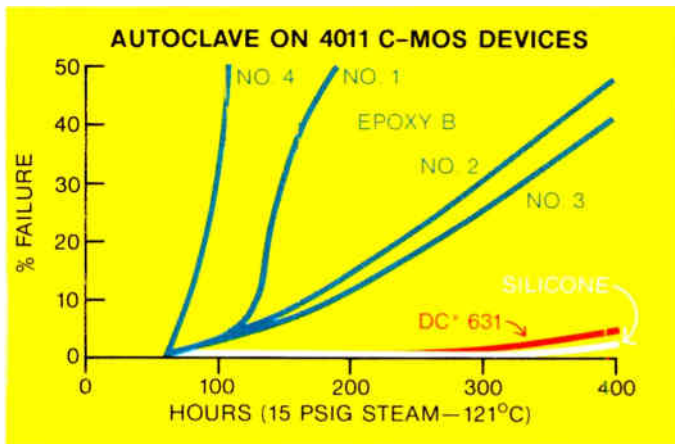

**Dow Corning 631. Unmatched design flexibility.** Dow Corning 631 silicone/epoxy molding compound gives you the compatibility, the moisture resistance and the unmatched ease of molding of silicone compounds. It gives you excellent 85/85-bias protection. It gives you the high strength, the strong lead seal, and the superb salt spray resistance of epoxy compounds. And it gives you all those advantages in one product. You can solve a problem with Dow Corning 631 that you wouldn't even approach with conventional molding compounds.

You have our word on how good Dow Corning 631 is. But we don't want you to just take our word for it. We want you to see for yourself. For samples and more information, write Dow Corning Corporation, Box 1767, Midland, Michigan 48640. Or, for immediate attention, call (517) 496-4682.

**Dow Corning 631 silicone/epoxy molding compound.  
Now everything else is second best.**

**Hong Kong**

Dow Corning Asia, Ltd.  
P&O Building, 9th Floor  
21 Des Voeux Road C  
Ph. 5-258035/7

**Toronto**

6747 Campobello Road  
Mississauga, Ontario L5N 2M1  
416/826-9700

**Brussels**

Dow Corning International, Ltd.  
Chaussee de la Hulpe, 177  
1170 Brussels, Belgium  
Ph. 02/673.80.60

**Munich**

Dow Corning GmbH  
8 Munchen 50  
Pelkovenstrasse 152  
Ph. 89/14861

**France**

Dow Corning SarL  
140 Avenue Paul Doumer  
92500-Rueil Malmaison, France  
Ph. 1/977.0040

**São Paulo**

Dow Corning do Brazil Ltda.  
Caixa Postal 4102-01000  
São Paulo, Brazil  
Ph. 52-2572, 52-8672

**Mexico City**

Dow Corning de Mexico, S.A.deC.V.  
Paseo de las Palmas 751, Piso 5  
Mexico 10, D.F., Mexico  
Ph. 905 5 40 31 10

**DOW CORNING**



# FOR RENT...

the truly universal PROM Programmers  
from Data I/O that enable you to program  
any of the more than 200 PROMs now available.

A single Data I/O programmer—the Model V or Model IX—can be used to program every single commercially available PROM.

Data I/O programmers are universal. You can use them to program any PROM, and more than 200 PROMs are currently available. This means you don't have to get a separate programmer to accommodate different PROMs. With either the Model V or Model IX and the appropriate personality card, you can program any PROM or its second source equivalent. Moreover, one personality module can be used to program all PROMs within a generic family and keep your yield at the maximum.

ROM emulation and editing capabilities are built-in, making software development a breeze and virtually eliminating PROM waste.

All the Data I/O programmers save lab time and slash your development expense. These are

portable, rugged, human-engineered and easy to use units. They're ideal for field service. Both the Model V and Model IX offer a direct display readout of PROM or RAM data at any address and offer unlimited data editing capabilities. Operation is totally automatic, and you can enter data manually through the keyboard or load it automatically from a preprogrammed master PROM. There are built-in error checking routines to insure accurate and correct data transfers, and serial or parallel I/O are standard. These unique PROM programmers and their personality cards are available now.

## Rental Electronics, Inc.

Another of the AMERICAL companies

More than 11,642  
electronic instruments...  
off-the-shelf, throughout North America.



Tell me more about the Data I/O PROM Programmers now! Call me at \_\_\_\_\_

Send me your Equipment Sales Catalog—I might be interested in buying some of your great "previously owned" equipment on a money-back guarantee.

I have a pressing need right now for the following: \_\_\_\_\_

Please phone me immediately at \_\_\_\_\_

Send me a copy of your free illustrated Rental Catalog.

Name \_\_\_\_\_  
Title \_\_\_\_\_  
Company \_\_\_\_\_  
Address \_\_\_\_\_  
City \_\_\_\_\_  
State \_\_\_\_\_ Zip \_\_\_\_\_  
Phone No. \_\_\_\_\_ Ext. \_\_\_\_\_

GSA #GS-045-21963 Neg  
©1977 Rental Electronics, Inc.

Complete this coupon and return it today to the world's oldest and largest electronic equipment rental firm, REI, 19347 Londelius St., Northridge, California 91324



Anaheim, CA (714) 879-0561 • Mountain View, CA (415) 968-8845  
Fort Lauderdale, FL (305) 771-3500 • Des Plaines, IL (312) 827-6670  
Burlington, MA (617) 273-2770 • Gaithersburg, MD (301) 948-0620  
Oakland, NJ (201) 337-3757 • Cleveland, OH (216) 442-0800  
Dallas, TX (214) 661-8082 • Houston, TX (713) 780-7218  
Seattle, WA (206) 641-6444 • Rexdale, Ontario, Canada (416) 675-7513  
Montreal Quebec Canada (514) 681-9246 • Northridge, CA (213) 993-RENT (7368)

ComputerAutomation's NAKED MINI® 4/10 is the most exciting spread we've ever dished up: a high-speed, versatile, 16-bit processor; up to 4K words of RAM/PROM memory, and four distributed I/O channels. All on a single board. And this powerful, multi-register minicomputer sells for micro prices.

Value, however, is a lot of things. Such as performance, versatility, and a faster, lower cost way of getting a product to market. For the 4/10, your real savings just begin to start with the sale price. Its large instruction set (including multiply/divide as standard) pays off with exceptional programming versatility, faster development, less memory used. Options include floating-point instructions and double-register shifts.

Its four distributed I/O channels are another money saver, cutting interfacing costs by up to half. Our unique Intelligent Cables (19 available) give you interface capability with a broad variety of standard and nonstandard peripheral devices. Distributed I/O has other advantages. Its auto I/O instructions are easier to program, take less memory, and execute faster than traditional programmed I/O. And it has the advantages of DMA at about half the cost.

# SMORGA

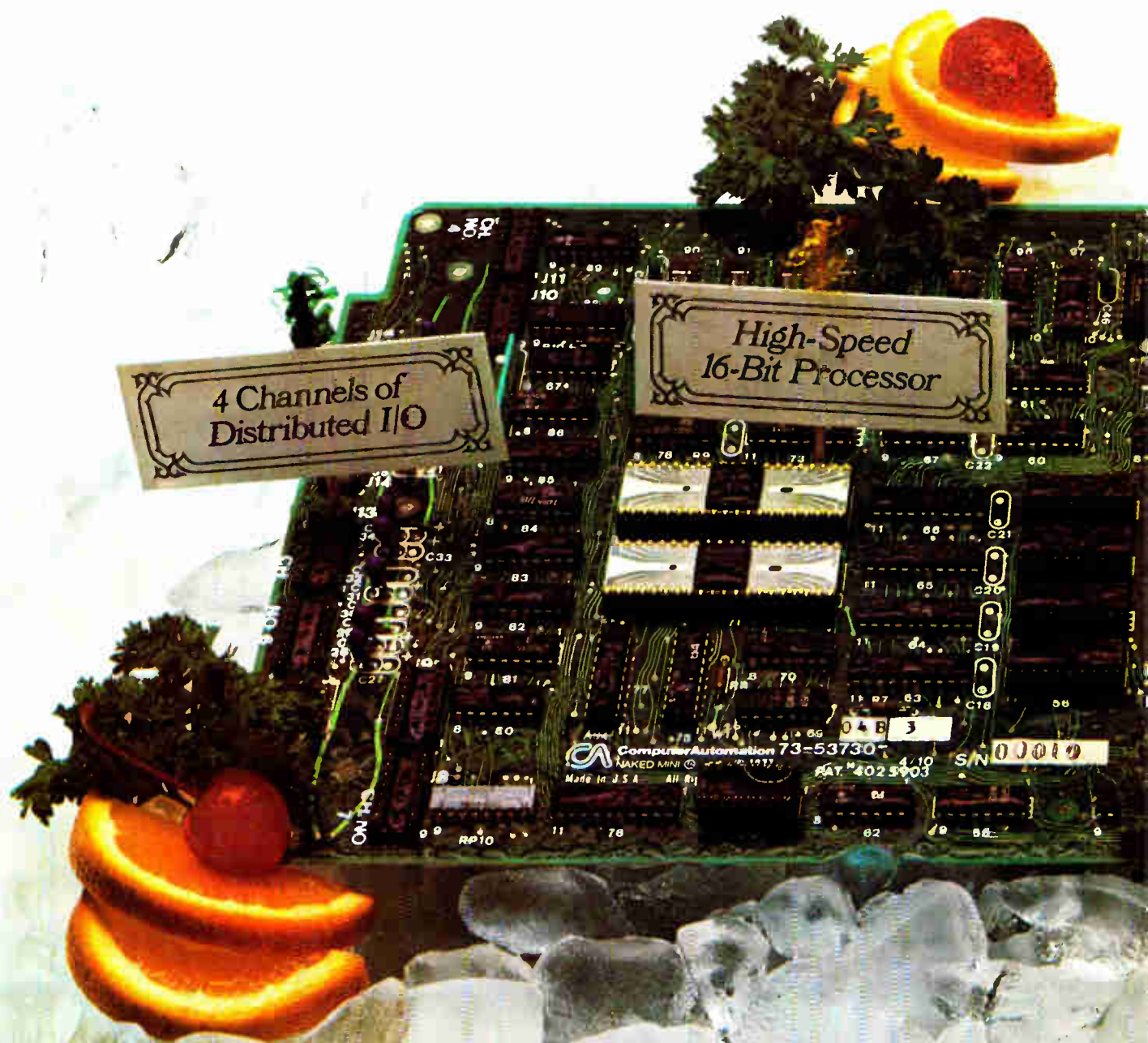

MAXI-BUS that allows interfacing with the wide variety of interchangeable memories and I/O controllers in the NAKED MINI 4 family.

What about software? It's one of the 4/10's real strengths. Not only a wide range of software, but also software optimized individually for both development and execution needs.

Available software ranges from the simplest—memory-based system that runs in as few as 4K

bytes of memory, to a full-blown, disk operating system that supports FORTRAN IV, BASIC, PASCAL, and MACRO 4 assembler.

In terms of hardware and software, the 4/10 is fully compatible with its higher performance brothers, the 4/30 and 4/90.

Okay, we've served up our new 4/10 mini with lots of standard and optional hors d'oeuvres. Still hungry for information? Contact Department 1161, NAKED MINI Division, 18651 Von Karman, Irvine, CA 92713, (714) 833-8830, for our new brochure. It's quite a bit of food for thought.

# SBOARD.



**ComputerAutomation**  
Naked Mini Division



NAKED MINI products are sold only under volume purchase agreements.

Circle 59 on reader service card

World Radio History

Dense, it is.

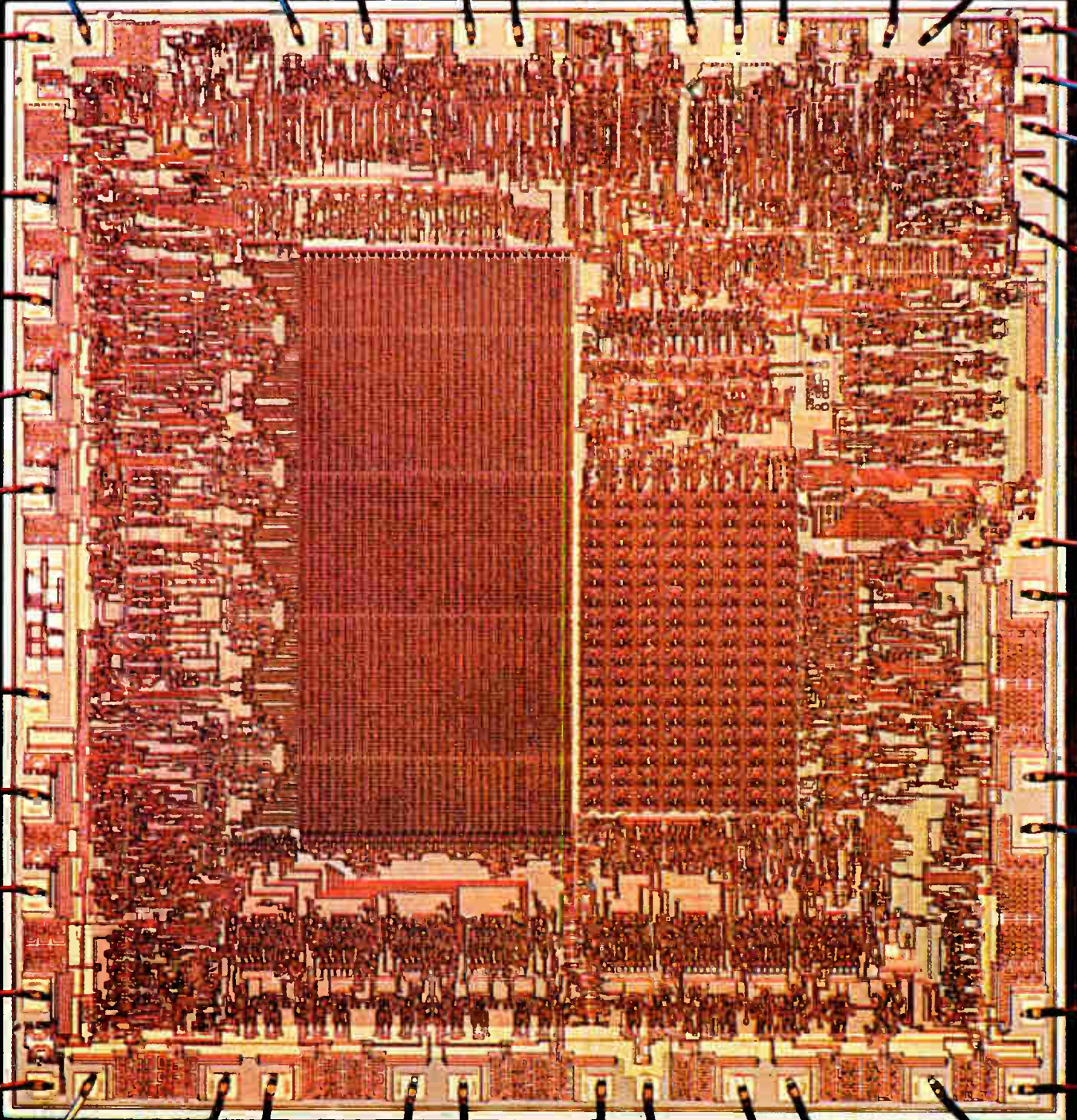

# Dumb, it ain't.

Our new S2000 microcomputer contains more than 13,000 transistors on a chip less than .2" square. It was designed specifically to run appliances. Yet it's flexible enough for all kinds of products now dependent on electromechanical controls.

The S2000 is an entire microcomputer on a single chip, with expandable program ROM and versatile I/O. So you can implement or enhance your control schemes quickly and easily.

It's an amazingly efficient circuit, too. All 51 instructions in its powerful software set occupy just one ROM byte apiece. All but two execute in four microseconds, a single machine cycle. And this fast NMOS device can operate from one power supply.

For less than \$5 each in quantity, each S2000 contains:

1. The CPU, including Control Unit, Arithmetic Logic Unit, Registers and Program Counter.
2. 1Kx8 ROM (externally readable and expandable to 8Kx8).
3. 256-bit RAM.
4. 29 I/O lines.
5. 7-segment display (normal or inverted) decoder and LED drivers.
6. Triac drive capability.
7. Line frequency (50/60 Hz) timer.
8. TouchControl capacitive switch interface.
9. Three-level subroutine stack and two flags.
10. Power-on reset and clock oscillator.

Soon, other S2000 family microcomputers will have vacuum fluorescent display drivers and on-chip 2K ROMs. In addition, AMI welcomes modifications to the S2000 to meet your particular I/O requirements, making your system even more cost effective.

Our Microcomputer Development Center (MDC) contains a powerful array of hardware and software tools to get your product to the market fast. Its intelligent 6800 microprocessor system controls a CRT with a flexible text editor, a smart macro-assembler, and a built-in PROM burner.

The DEV-2000 Development Board lets you do hardware emulation and software debug at the same time. The SES-2000 Static Emulator Module plugs right into your prototype. Our Logic Analyzer gives you computer power to create your own diagnostic display layouts and formats. And we even have software that simulates the S2000 within the MDC.

What more could you ask, except for some Application Engineers to help you do a fast turnaround. We have those, too. Specialists in the S2000 are ready and waiting for your call at (408) 246-0330. Or simply write to AMI Marketing, 3800 Homestead Road, Santa Clara CA 95051. You'll be amazed how smart one dense little chip can be.



**AMI**  
AMERICAN MICROSYSTEMS, INC.

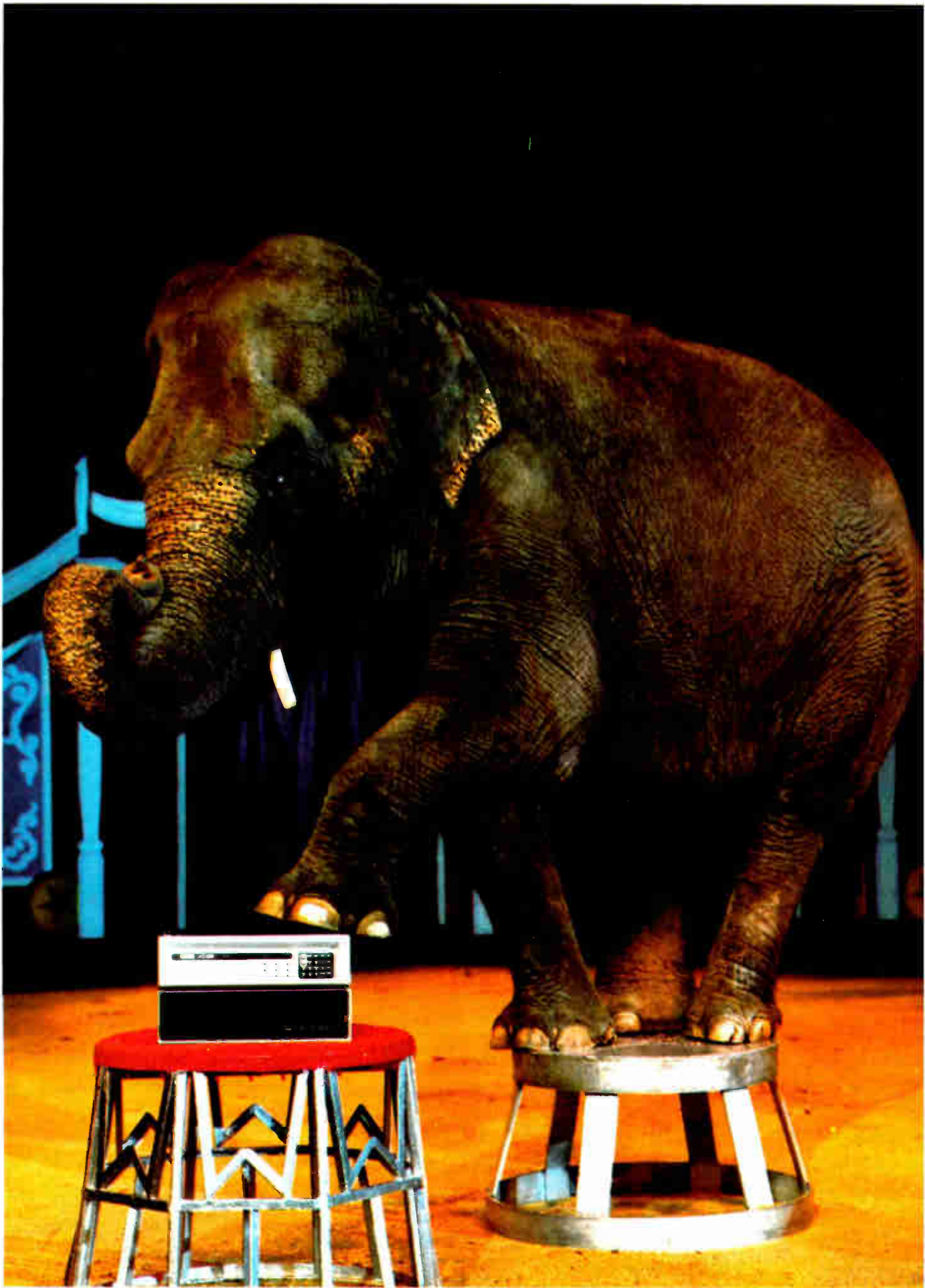



# Digital announces a PDP-8 with an enormous memory.

Something big has just happened to the world's most famous small computer. In fact, something enormous.

Digital has just put 128K of memory into the PDP-8.

This act is brought to you by a powerful new memory management option called KT8-A. And by two new MOS memory modules that fit large amounts of memory into small amounts of space. Simply by adding these 16K or 32K modules in whatever combination you choose, you now expand your PDP-8/A into something bigger. What's even better, you can mix MOS and core. And that means you can protect your program in non-volatile core while you expand your data base in MOS.

And thanks to the KT8-A all this memory is under new management. Not only does the KT8-A let you address up to 128K words of memory, but it also offers you memory relocation and memory protection, while asking little in operating system overhead so you get faster system performance.

What's the cost of these enormous advancements? What's the next attraction.

The new PDP-8A MOS memory models are available at prices that are as crowd-pleasing as their performance. For a 16K A205 you'll pay as little as \$3900 (quan. 1). 8A425 with 64K

is as low as \$11,000. And the top of the line 8A625 with 128K is yours for as little as \$18,050.

They're the new big-memory Eights from Digital. Step right up.

**Large memories aren't our only new trick.**

New hardware and software improvements are also in the PDP-8 spotlight.

The VK8-A is a new low cost PDP-8A option that provides high quality video output plus keyboard and printer interfaces. Video character generation uses a super-sharp 9x9 dot matrix for high resolution on single or multiple CRT monitors up to one thousand feet away.

Also new for PDP-8 users is MACREL/LINKER — a sophisticated assembler with MACRO facilities that lets you implement, expand and update your system faster while reducing software development time.

And last but not least there's DECNET 8 — a series of software protocols that let you

form your own PDP-8 network.

**The PDP-8. Bigger. Smaller. And better than ever.**

A short while ago, we made big news with DECstation 78. A low-end system that set new highs for ease of use and simplicity.

Now we're expanding the PDP-8 family up, as well as down, and that means new opportunities for OEMs and end-users alike. Look into what's happening with PDP-8s. Call your nearest Digital sales office today.

Or send the coupon to PDP-8 Marketing Communications, Digital Equipment Corporation, 129 Parker Street, PK3-1/M34, Maynard, Massachusetts 01754. European headquarters: 12, av. des Morgines, 1213 Petit-Lancy/Geneva. In Canada: Digital Equipment of Canada, Ltd.

**digital**

PDP-8 Marketing Communications  
Digital Equipment Corporation, 129 Parker Street, PK3-1/M34,  
Maynard, MA 01754  
Please send additional information about the PDP-8 family.

Name \_\_\_\_\_ Title \_\_\_\_\_

Company \_\_\_\_\_

Address \_\_\_\_\_

City \_\_\_\_\_ State \_\_\_\_\_ Zip \_\_\_\_\_

Phone \_\_\_\_\_ OEM \_\_\_\_\_ End-User \_\_\_\_\_

Application \_\_\_\_\_

E11107

# The P400 makes excuses obsolete.

A new product comes on line and the circuit boards start piling up. This is when the excuses begin:

"I can't get near the computer."

"I need more programmers."

"I just got schematics last week."

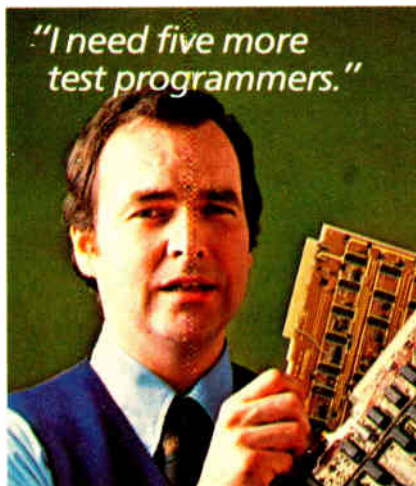

It's a difficult time for a test engineer because the success of an important product can hang in the balance.

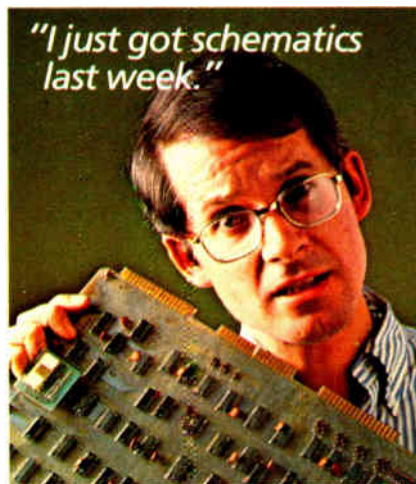

But Teradyne's P400 Automatic Programming System has changed all that. Used with L100 series test systems, the P400 creates the entire test program

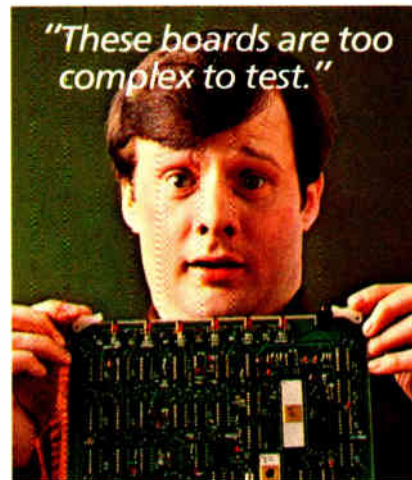

automatically. It gives you all input patterns, provides all diagnostic data, and resolves all races. It cuts programming time from weeks to days. And it does it all without tying up the computer on your production tester or increasing your programming staff.

Suddenly, new programs can be ready on time, even in the face of the tightest schedules. And even for the most complex boards.

Just as important, the P400 spares you all the boring work it usually takes to deliver new programs. You get typically better than 95% fault coverage simply by using the telephone to access a large computer containing the P400 software.



The P400 Automatic Programming System.

Now there's no reason for being late.

And we think that's the way you want it.

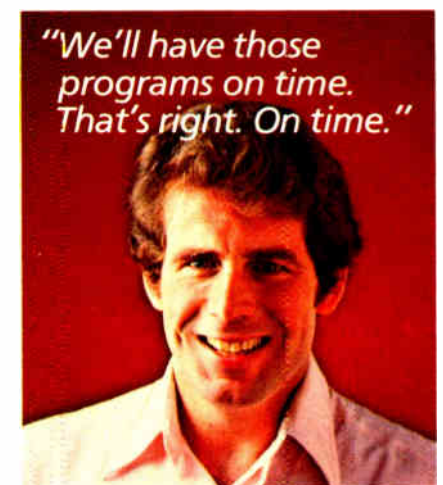

## TERADYNE

183 Essex Street, Boston, Mass. 02111

## The CCD's future takes on a bright hue

65-k devices, now available as samples from semiconductor houses, will initially replace fixed-head and floppy disk storage

by Larry Armstrong, Midwest bureau manager

The computer industry may be on the verge of embracing the charge-coupled-device memory. A pair of semiconductor firms are now shipping samples of 65,536-bit parts, and two more are talking about it. In all, they give users a choice of three different CCDs in the first size large enough to promise a cost-effective, solid-state replacement for mechanical storage.

Though most computer users are still playing with the new devices in their laboratories, the first widespread application of the CCD will probably be as a successor to fixed-head disk storage, especially low-end floppy disks. Like the CCD, mechanical disks store data in a serial format, easing the device's entry into that market without changes in system architecture.

But the high volumes that semiconductor producers are counting on will come from application as auxiliary or even main storage, supplanting metal-oxide-semiconductor and core random-access memories. That change, however, will not come about until there is a redesign of computer systems.

The time is ripe for a shift to CCDs, with the 65-k part the threshold size for widespread acceptance. "There has been a lot of interest at the 16-k level, with substantial numbers of units sold," reports Gilbert F. Amelio, vice president and general manager of Fairchild Camera & Instrument Corp.'s MOS/CCD Products division. "But the really big volume users—the main-frame computer houses and others—haven't entered. They've been bystanders, watching the smaller guys." Almost to a man, the large

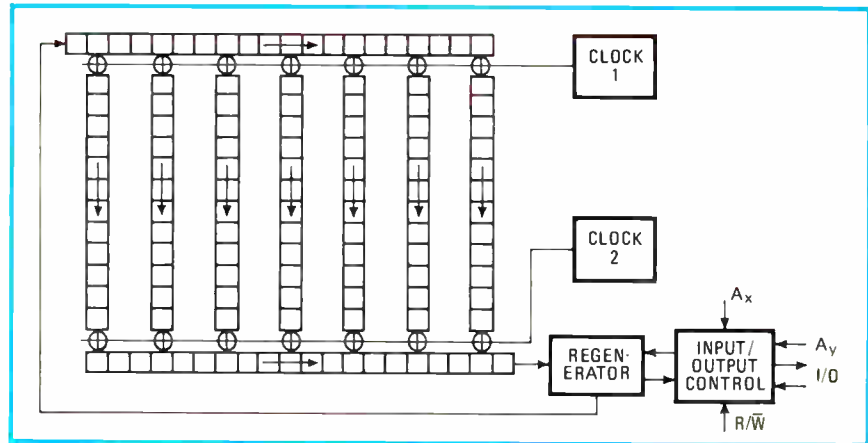

**Saver.** Serial-parallel-serial structure uses extra clock. Data is clocked in and out of each loop at 5 MHz, but runs at 156 kHz through 32 parallel shift registers. Device is from TI.

users now are saying "the CCD is it," adds Amelio.

Texas Instruments Inc., which had not sold CCD memories, led the foray when it took the wraps off its 65-k chip last March [*Electronics*, March 17, p. 38]. Fairchild, though, was fast on its heels with a scaled-up version of its earlier 16-k parts, and Intel Corp. plans samples of its 65-k CCD by March. The Intel part is due about the same time as Motorola Inc. is scheduled to produce a similar product, built with Fairchild masks. But with the exception of the Fairchild-Motorola team, the highly competitive semiconductor industry has made no attempt to standardize its designs.

Texas Instruments first unveiled its CCD in a unique 16-pin, 400-mil-wide ceramic package. But it has just completed a 36% smaller version that will fit into the standard 300-mil MOS package that is at least a dimensional match for the Fairchild part, although pinouts are different. Moreover, Intel is telling customers

about a device that requires 18 pins.

But the real differences are in organization. Fairchild and TI are offering CCDs organized as 16 by 4-k by 1, the industry parlance for 16 randomly accessible shift registers, each 4,096 bits long and arranged in an interleaved serial-parallel-serial structure that keeps power low and operating rate high.

**The look of a RAM.** Intel is trying to make its part look more like a random-access memory, with 256 loops of 256 bits each. "We chose to make our loops shorter, thus reducing latency time," says William Regitz, memory products manager at the Santa Clara, Calif., firm. "We believe that will be the factor that will establish CCDs with a broader base of customers," bringing the parts down the learning curve faster. Toward the same goal, the Intel version—unlike the other two approaches and its own earlier charge-coupled devices—is totally compatible with transistor-transistor logic.

Average latency time, a function

## Probing the news

of loop length and maximum data rate, is the time it takes to get access to a bit in the middle of a loop. It is roughly comparable to a RAM's access time. For the Intel part, which runs up to 2.5 megahertz, latency time is 125 microseconds. With their longer loops, the TI and Fairchild designs offer a 400- $\mu$ s latency time when they are being operated at their maximum data rate of 5 MHz.

Slow data access does not bother Intel's CCD competitors. "I maintain that the CCD is not intended to be used as a fast access device," says John Hewkin, manager of MOS memory marketing strategy at TI's Houston facility. "It's intended to store blocks of data. It will be the cheapest form of read-write storage known to man, and the system architecture will develop around the relative device costs." His firm considered building a CCD with many more shorter loops like Intel's, but rejected the design. "Each loop requires a regenerator and a sense amp, so overhead circuitry takes up less chip area on a 16-loop part than on one with 256 loops," he says.

**Latency isn't primary.** Adds Fairchild's Amelio: "Latency time is not the most important consideration to the user." It will take some rethinking of computer architecture to come

up with a memory system where latency time is transparent, he admits, but once that is done, no one will want to pay a premium for a low time. "Our strategy in the CCD marketplace is to give the user what he needs to get off the ground," he says, "but not to build in so much performance that it's not possible to get down the cost curve." In the long haul, he says, what will count is the bottom line of price per bit, not latency or transfer rate.

Designs similar to the virtual memory systems being shipped today could easily be implemented with CCDs. "We'll see configurations with CCD as main memory, and a fast static RAM buffer between it and the central processor," says David C. Ford, strategic marketing manager for memories at Motorola's Austin, Texas, MOS center. "Main memory will be shifted into the buffer in blocks as required by the system," he explains, much the same way as today's fast buffer cache memories use slower main storage. Data in the CCD would be loaded into the fast RAM buffer in page mode, adds TI's Hewkin. He points out that the data rate of TI's 65-k device—170 nanoseconds—exactly matches the page-mode data rate for its fastest MOS dynamic RAMs.

Every one of the manufacturers agrees that charge-coupled devices will be harder to use than dynamic RAMs, however. "There's got to be a

reason to go to CCDs," says Ford, "and that reason will be cost. Dynamic RAMs are more difficult to use than static RAMs, but people choose to go for dynamic RAMs because they're cheaper."

And the CCDs' cost advantage is significant: Fairchild's Amelio says that the parts will maintain a minimum 4-to-1 advantage over RAMs and quite possibly better. How soon the new devices will reach that low price is still a question with different replies, however.

"The 64-k CCD is now selling for \$70 to \$100, but within the next couple of months we'll see lower prices," says Hewkin. His company is sticking with its original projection of \$13 CCDs by the end of next year. That price figures out to about 20 millicents per bit, about half what the industry figures dynamic RAMs will sell for at the same time.

"But we expect to see CCDs at a third or a quarter of the bit cost of RAMs in 1979," Hewkin says. TI plans to further reduce the chip size of its 65-k device to that of its 16-k RAM by the end of 1979. This shrink will give the CCD a 4-to-1 real-estate advantage. Run on the same production lines as MOS RAMs, the CCD should be a better-yielding device, since top-level polysilicon electrodes are electrically connected, eliminating some of the shorts that cause dynamic RAMs to fail. In five years, CCD cost per bit will be about 2 or 3 millicents, or comparable in cost to moving-head disks, Fairchild's Amelio estimates.

But the key to final acceptance of CCDs, insists Intel's Regitz, is standardization. "Users expect at least some minimum compatibility," he reasons, "but they won't have it on the first round of 65-k CCDs." Regitz points out that suppliers of the devices have completely incompatible parts, all the way down to the socket level. "The closest any of the devices come to similarity is the fact that Fairchild and TI have both opted for 16-pin devices, and the 16-by-4-k-by-1 array," he says. "But Fairchild's is in the standard 0.3-inch-wide package and TI's is in the nonstandard 0.4-in.-wide configuration." For its part, Intel uses the 0.3-in. package, but it is an 18-pin device. □

## Beyond the computers

Besides the computer applications of charge-coupled devices—as main memory and disk replacement, or perhaps as secondary memories between the two—manufacturers of CCDs are targeting their products to noncomputer markets, where users are trying to solve special problems with memory.

These markets include such applications as television imaging or cathode-ray-tube refresh on terminals and audio storage between analog-to-digital and digital-to-analog converters. "They can be used for anything that requires serial data transfer, including telecommunications, radar, and time-related data transforms," says John Hewkin of Texas Instruments. "There seems to be an emerging volume of this type of application," says Fairchild's Gilbert Amelio, "each small to medium in volume, but in total adding up to a large number of units."

Another solid-state mass storage device, of course, is looming only a little further down the road: the bubble memory, which has the added advantage of being nonvolatile. Intel's William Regitz makes the point that "dynamic RAMs haven't replaced core, because there are certain applications where nonvolatility is an overriding concern." Eventually, he says, CCDs will beat disk and bubbles on cost, "but each will have their niche in the market. The only question is how big each niche will be."

# The Choice In Laboratory & Systems Measurement

Data Precision provides for precision laboratory or Automatic Test Equipment and Data Acquisition requirements by offering a selection of multimeters encompassing a wide range of specifications, features, and options... a selection that will meet almost all precision laboratory and monitoring control needs.

## MODEL 7500

Model 7500 is a 5½ digit multi-speed instrument that will perform a full conversion 1000 times per second! It is completely programmable in function, range, mode, timing, and conversion speeds. DCV accuracy is ±0.007% of input ±0.001% range ±1 l.s.d. for 6 months; sensitivity is 1μV DC and AC and 1mΩ; DCV and ACV measurement from 1μV to 1000V. As a true universal ratiometer, the 7500 also enables the user to choose both the numerator and denominator independently, and every measurement – DC Volts, AC Volts, and Resistance – can be made on a ratio basis to any other if desired.

Model 7500 provides for full incorporation into any computer-based, high-speed, multi-channel automatic test or data acquisition

system. In addition, a broad range of standard options are available, including built-in micro-processor-controlled IEEE 488 BUS or RS232/TTY Output. Base price is \$2995.00.\*

## MODEL 3500

Model 3500 is a full-function, autoranging, 5½-digit instrument with 6 months basic accuracy of ±0.007% of reading ±0.001% of range ±1 l.s.d. All important control and state signals are brought to rear panel connectors for use in automated control, test, and computing systems. Voltage ratio is included.

Time-buffered isolated BCD Output, brought out through Standard DTL/TTL interface circuits, permit asynchronous printing, recording, and/or display. In addition, Model 3500 features measurement of DC volts, AC volts, Resistance, Ratio and local/remote Ranging and Triggering plus excellent common-mode and normal-mode rejection. Base price is \$995.00.\*



## MODEL 3400

Model 3400 is the world's most accurate systems/lab 4½ digit multimeter. It is a fully programmable system multimeter and a highly versatile stand-alone, autoranging laboratory multimeter.

Full 100% overranging, basic DCV accuracy of ±0.007% of input ±1 l.s.d. for 6 months, measures from ±10 microvolts to ±1,000 VDC, ACV from 10 microvolts to 750V, resistance from 10 milliohms to 20 Megohms, AC/DC, DC/DC voltage ratio and full remote control up to 12 conversions per second. It has complete capacity, and its BCD output is fully printer-compatible. IEEE Standard 488 BUS is optional. Base price is \$795.00.\* With true RMS AC Volts-\$895.00.\*



Data Precision Corporation  
Audubon Road  
Wakefield, MA 01830 USA  
(617) 246-1600, TELEX (0650) 949341.

\*Price USA.

 DATA PRECISION<sup>®</sup>  
...years ahead



For Additional Information circle 66 on Reader Service Card  
For Demonstration circle 67 on Reader Service Card World Radio History

# The Ansley "D" Connector...



Our new series of male and female "D" connectors offer you a cost effective external mass termination cable and connector system second to none. Its uniqueness begins with a one-piece "D" connector package that meets industry standards for size, pin spacing, and contact reliability. With no loose parts to match up, positive cable-to-contact alignment is assured. Conductors are mass terminated in seconds with our standard BLUE MACS™ hand or bench tools. The results? Faster installation, higher reliability.

Contact pins are spaced on .0545" centers — a perfect fit for any standard inter-cabinet "D" type connector application. Our new "D" connectors are designed to mate with standard .050" pitch flat cable as well as our new, improved jacketed cable — the only flexible flat cable engineered specifically for out-of-cabinet use.

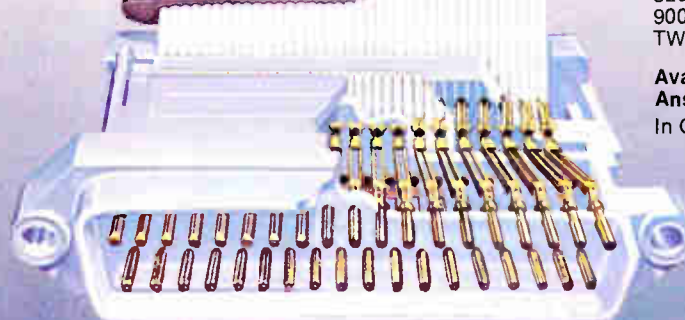
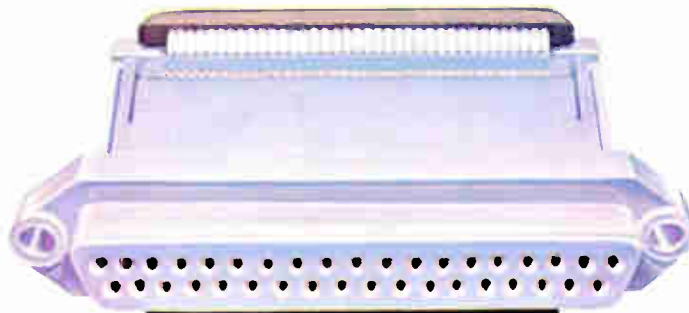

# a new meaning to cost effectiveness.



The Ansley BLUE MACS™ jacketed cable is U.L. listed for external interconnection of electronic equipment. Electrically, it outperforms standard jacketed twisted pairs in typical I/O applications. And there's no special zipper lock tubing required — reducing the need for an extra cable accessory. Installation is faster, easier. And like all Ansley connectors, you can daisy chain our "D" types anywhere in the cable — along with our DIP socket, card edge, or pc board connectors.

Cable alignment and high contact reliability is assured — because both cable and connector are grooved for absolute alignment. Our patented TULIP™ 4-point insulation-displacing contacts are permanently fixed and sealed-in to provide a reliable, gas-tight, corrosion-free mass termination.

For the full reliability/cost effectiveness story and technical data, call or write:

**T&B / Ansley**

The mass termination company.

**T&B/Ansley Corporation • Subsidiary  
of Thomas & Betts Corporation**  
3208 Humboldt St. • Los Angeles, CA  
90031 • Tel. (213) 223-2331 •  
TWX 910-321-3938

**Available through authorized  
Ansley distributors**

In Canada: T&B/Ansley, Ltd.  
700 Thomas Ave.,  
Industrial Park  
Iberville, P.Q.

People

## For Matsushita's chief, R&D is key

Yoshihiko Yamashita, at 57 a surprise choice to head giant consumer electronics firm, dislikes emphasis on exports

**When Konosuke Matsushita**, the 82-year-old founder and guiding hand of the giant Matsushita Electric Co. Ltd., broke precedent early this year and reached down through a score of senior company officials to elevate mountain-climbing enthusiast Yoshihiko Yamashita to the presidency of the company, it was widely hailed as the beginning of a youth movement.

Yamashita, 57, has very quickly established himself as a spokesman for one of Japan's most powerful electronics enterprises. Though an unassuming person very much like the founding Matsushita, Yamashita has shown some of his mountain climber's nerve in addressing the tough economic problems looming over Japan's electronics industries, particularly the consumer sector that Matsushita dominates.

How will the giant manufacturer continue to grow at home and abroad? Is Matsushita really on a youth movement? Here are Yamashita's views on these and other questions, elicited in an interview with *Electronics* editors at Matsushita's headquarters in Osaka.

*Q. What must Matsushita do to pick up the domestic consumer electronics market and at the same time cope with the contraction of its important export markets?*

*A.* One means of solving these problems is to stimulate the market with entirely new products, products that cannot be produced by anyone else. We must first concentrate on stimulating and expanding domestic demand. We have been relying too much on exports—it is not natural to depend so much on exports.

*Q. That may be easier to say than to*

*do. What new products do you have in mind?*

*A.* We are fortunate to be positioned in electronics, for there are no limits on new ideas. I have in mind development of new products related to housing, which is a major social problem in Japan—that is, for new houses of the future, not just improvements on present household appliances. These products would include energy-saving systems and systems designed to preserve the environment or make the living environment safer.

*Q. You mentioned that Matsushita should not depend so much on exports. Does this mean that you will reduce your overseas efforts?*

*A.* There has to be a balance between domestic and export business, and our export ratio cannot be too large. I cannot set a percentage; however, the export effort should depend on conditions of the individual countries. For example, when a country has introduced color television broadcasting but has no local color TV receiver manufacturing, it is open to export of our products. But in the case of America and Western Europe, there are local manufacturers and we see conflict, as happened last year. We have to be very careful, or rather considerate, of the local situation.

As I said before, we have to develop something different that these advanced countries do not have. If we can provide these new products, we can coexist. For example, the home video-tape recorder we are supplying to American companies has not created a conflict. That is why I want to emphasize research and development of new products.

*Q. Still another problem is the growing competition and increasing sophistication of producers in South Korea and Taiwan. Is increased automation by Matsushita the answer to this threat?*

*A.* Automation alone is not the answer or the sole solution to remain competitive. Korea, for instance, enjoys a low labor cost; they are hard-working and put in long hours. If we develop new machines to counter this advantage, before long



# Suppress Power Line EMI Comin' or Goin'

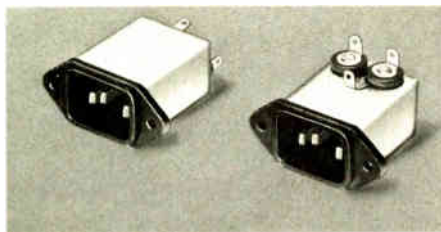

## Series JX5400 Filters reduce noise emanating from or interfering with equipment

UL recognized. Available in 4 different circuit configurations to solve specific EMI problems. Effective in suppressing both common mode (line-to-ground) and differential mode (line-to-line) interference. Two case styles, with load terminals extending from back or top of plated steel shielded housing, both incorporating standard IEC male line cord connector. Ideal for filtering external transients in 150 KHz—30 MHz range in equipment containing low-level logic circuitry.

For complete technical data, write for Engineering Bulletin 8212 to: Technical Literature Service, Sprague Electric Co., 35 Marshall St., North Adams, Mass. 01247.

**SPRAGUE**  
THE MARK OF RELIABILITY

### Probing the news

Korea will have the same equipment plus low labor rates. So we cannot compete with automation alone. Instead, I return to my original point—we must develop unique products that nobody else can make.

*Q. What market opportunities do American electronics firms have in Japan these days?*

A. The American electronics manufacturers are better at industrial products than the Japanese, and therefore Japan offers a good market with a big potential for these companies. American companies should study the Japanese market first, especially in industrial electronics. It is often said that it is impossible for Americans to succeed in Japan, but that is not true. For example, IBM has been very successful.

*Q. Your appointment as president of Matsushita has caused comment in Japan. Is this indeed a youth movement?*

A. It is a general trend and will continue. This company was led in the past by K. Matsushita, an outstanding leader and founder. But he cannot live forever. So we have

reached a turning point, a change from the traditional organization of Japanese companies to this new trend. Another change, caused by the growing size of this company, has been from one-man leadership to group effort. Communication is a problem in a large company. It is necessary to let all the employees know what is happening.

*Q. As manager of Matsushita's air conditioner department you gained a reputation for turning around a faltering operation. What did you learn then that will be useful now?*

A. I learned that the principles of good management are the same no matter where they are applied. The same fundamentals that were successful in a small operation can be used in operating a large enterprise.

*Q. Though you have just begun, having been president since February, what would you like to be remembered for when it comes time for you to retire?*

A. When I leave, I would like to see our younger employees busy and full of hope and ambition for the future. I hope to leave the company youthful, forward-looking, because when this atmosphere prevails, the company succeeds. □

### Japan's youth movement

There is a trend in Japan toward elevating younger managers to top spots, but it is contrary to the national tradition of moving people up based on seniority and age. Therefore, Konosuke Matsushita's move to bypass his own chain of command to put 57-year-old Toshihiko Yamashita in charge of the company he founded still raised some eyebrows in the island nation's tightly knit industrial community, although Yamashita is hardly a teen-ager, even by Japanese standards.

But the maneuver worked because the firm's hierarchy was well along in age and the company had just had a good business year, and because the decision came from the founder himself. Careful to ease the feelings of those passed over, Matsushita pointed out that he wanted someone who could be president for at least 10 years—thus eliminating most of the directors and managers in line for the job.

Other firms have made similar moves. For example, in January 1976 the cofounders of Sony Corp., Masaru Ibuka and Akio Morito, passed the presidency and vice presidency to Kazuo Iwama (then 56) and Norio Ohga (then 45). Two top executives, the brothers Hiroshi Kawashima, managing director of Nippon Gakki Co., and Kiyoshi Kawashima, newly appointed president of Honda Motor Co., are both in their forties. Also, SS Pharmaceutical Co. recently named 41-year-old Naokata Taido president, and the new president of Nittan Valve Co. is 46-year-old Teijiro Sugimoto.

According to one Japanese business publication, in the first quarter of 1977, 40 large corporations appointed new presidents; 20 were under 60, 17 were in their fifties, and 3 in their forties. Not exactly a tidal wave of youth, it is still a noticeable trend in this country so dominated by traditional practices and veneration of age.





# PUSH to initiate automatic in-circuit testing of all of your analog, hybrid and digital boards.



Test *all* of your printed circuit boards and, in many cases, completely eliminate costly functional testing. Faultfinders FF101C and FF303 in-circuit test systems give you the flexibility you need with a broad range of CPU/peripheral compatibility. And you can get full time utilization of the system computer with foreground/background programming to execute automatic program generation, text editing, data analysis or file maintenance *even while you're testing boards*.

You'll be testing more boards, bigger boards and more complex boards, so now is a good time to start checking on what Faultfinder in-circuit test systems can do to make the job more cost-efficient. Call your Faultfinder representative:  
Latham, Tom Coleman, (518) 783-7786,  
Chicago, Al Roraus, (312) 696-0335,  
San Francisco, Bruce Douglas, (408) 732-9020,  
Irvine, Chuck Hults, (714) 549-4901,  
Europe, Marty Liebman, (49) 6196-44008,  
England, Mike Cook, (44) 4204-3443  
Or start with the coupon.

**FFI** **FAULTFINDERS Inc.**  
15 AVIS DRIVE, LATHAM, NY 12110

## O.K., Start.

Show me how Faultfinder in-circuit test systems can improve our production testing

NAME \_\_\_\_\_ TITLE \_\_\_\_\_

COMPANY \_\_\_\_\_

ADDRESS \_\_\_\_\_

CITY \_\_\_\_\_ ZIP \_\_\_\_\_

PHONE \_\_\_\_\_

EL

Photovoltaics

# Solar cells click in helping record yield in irrigation test

by Lawrence Curran, Boston bureau manager

This summer the sun helped corn to grow in Nebraska as never before—by shining on the photovoltaic equipment driving irrigation machinery. The experiment at a University of Nebraska test site in Mead also used herbicides and a hybrid strain of corn to extract 150 to 180 bushels per acre from the land, well above the statewide average of 135 bushels.

The photovoltaic system was designed and built by the Massachusetts Institute of Technology's Lincoln Laboratory and is the largest solar-cell-powered unit in existence to date. Now that the harvest is in, it will drive fans in corn-drying bins. Eventually, plans are to employ it year-round, for irrigation and grain drying in summer and fall, and perhaps to drive motors used in fertilizer production and to power heating systems in livestock sheds.

Lincoln Lab, in Lexington, Mass., was prime contractor for the Department of Energy's division of solar technology [*Electronics*, Oct. 13, p. 26]. The lab won the \$1 million

contract last December and worked in conjunction with the University of Nebraska's agricultural engineering department in Lincoln, which has charge of the irrigation research.

Ervin "Bud" Lyon, assistant task leader for the irrigation experiment in Lincoln Lab's energy systems engineering group, says that a photovoltaic system of this kind would be prohibitively expensive for farmers now, mainly because solar cell costs, about \$5 per cell, are still too high. The system's success to date, however, indicates that photovoltaics could be a viable alternative to utility power for irrigation if cell costs are brought down to 10 to 20 cents within 10 years, especially in a state such as Nebraska, where the present energy cost for irrigation is about \$81 million a year.

**Three subsystems.** There are three principal elements in the photovoltaic system: the array, a battery trailer, and an equipment trailer. The array is huge, consisting of some 97,000 individual solar cells in two

325-foot-long rows, each containing 14 modules that can be tilted to the optimum angle to collect the sun's energy. The solar cells were supplied to the Department of Energy for the experiment by Sensor Technology Inc., Chatsworth, Calif., and Solarex Corp., Rockville, Md.

Lyon says that the system ran some 10 hours a day, driving a 10-horsepower dc motor to pump water from a re-use pit through pipes to the rows of corn. The re-use pit collects the runoff for recycling into the field and can be replenished from a nearby well that uses utility power to drive a 30-hp pump motor. The initial plan had been to experiment with both dc and ac pump motors for the re-use pit, but problems developed with the three-phase inverters that were to have converted the dc bus voltage to ac.

The dc pump motor gets its power from 28 solar panels. These are connected in parallel and produce 120 to 140 volts of dc bus voltage, with the dc bus connected to two strings each containing 19 lead-acid batteries, also connected in parallel. Lyon says the 6-v batteries have a total usable storage capacity of about 80 kilowatt-hours. The system produced 25 kilowatts peak power.

The control system for the installation, housed in the equipment trailer along with the data-collection switch gear and power-conditioning equipment, has been manual or semi-automatic. By December, Lyon says, Lincoln Lab engineers hope to have an automatic control system using an Intel 8080 microprocessor. Eventually, Lyon says, "we hope to automatically control the irrigation schedule itself." □

**Focusing the sun's glow.** Solar Array dominates Nebraska landscape in experimental irrigation system.

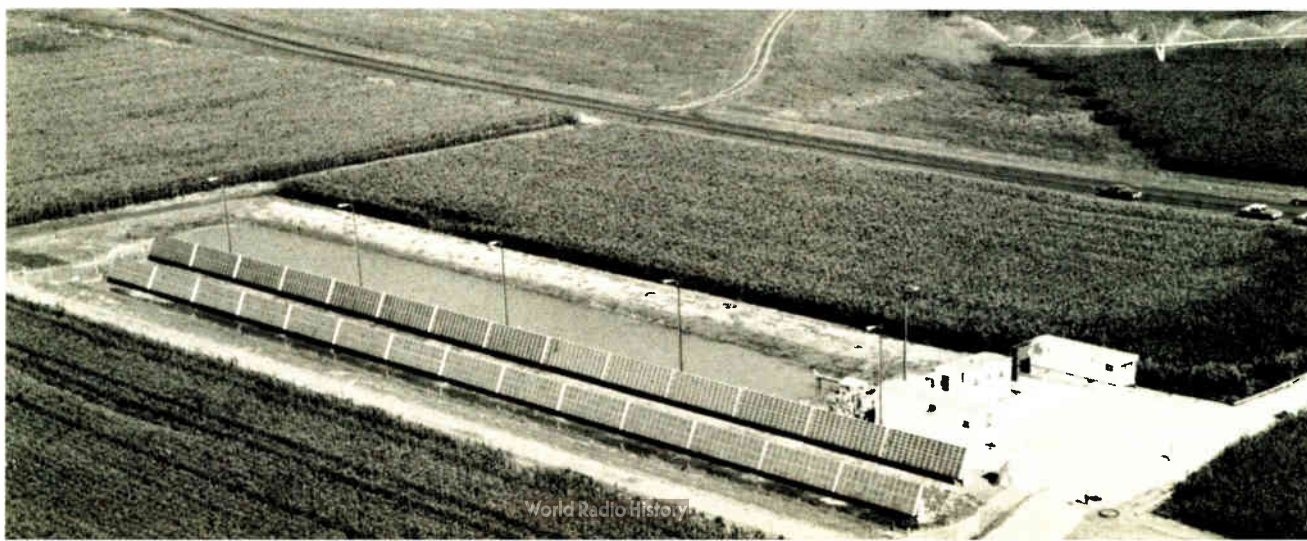

# BUSS ELECTRONIC FUSES.

Nearly every type of fuse and fuse holder you need to protect electronic circuits and devices you can get from us, easy. For example, Buss<sup>®</sup> Semiconductor Fuses; 700 volts, with extremely low  $I^2t$  and  $I_p$  let-thru values. TRON<sup>®</sup> Rectifier Fuses, ½ to 1,000 amps, up to 600 volts. Fusetron<sup>®</sup> dual-element time-delay fuses. Buss quick-acting glass tube fuses. Buss signal-indicating, alarm-activating fuses. TRON sub-miniature pigtail fuses. Buss sub-miniature GMW fuses. Buss telecommunications fuses. Buss military fuses. And Buss fuse holders and fuse blocks. Get your hands on exactly what you want. Write us now. Ask for Buss Bulletin SFB.

SUPPLY THE ECONOMICAL WAY  
THRU DISTRIBUTORS  
**BUSS FUSES**  
THE QUALITY LINE

BUSSMANN MANUFACTURING  
a McGraw Edison Company Division  
Earth City, Missouri 63045



**WE MAKE IT EASY  
TO GET YOUR HANDS  
ON WHAT YOU WANT.**

Communications

# Motorola cellular system gets nod

Baltimore-Washington test to star hand-held radio-telephone and antenna system dividing each geographic cell into six parts

by Larry Armstrong, Midwest bureau manager

With Federal Communications Commission approval in hand, American Radio-Telephone Service Inc. is poised to start building its high-capacity cellular radio-telephone system in the Baltimore-Washington area. The Baltimore-based common carrier will rely on Motorola Inc. for equipment and technical know-how during the 24-month, \$2.5 million developmental program [*Electronics*, March 3, p. 38]. The new 800-megahertz service promises to open mobile telephone service, now severely congested at 450 MHz and below in the large cities, to hundreds of thousands of new business subscribers by reusing the same channels in different areas, or cells, of each city.

The ARTS-Motorola team will be racing to make up the seven-month head start enjoyed by AT&T which is now installing similar gear in Chicago [*Electronics*, June 9, p. 75], with Illinois Bell Telephone Co. as the system operator. But for the only other announced competitor, Harris Corp., it's back to the drawing boards: the FCC last month returned as defective a proposal filed for Harris by a consortium of radio common carriers. The noncellular Harris concept did not meet the commission's desire for a high-capacity, frequency-reuse system.

That idea—frequency reuse—is central to the cellular concept, which also seeks to control transmission power and thus use the spectrum more efficiently. The system works this way: each base station's signal can be heard by users within the specific geographic area, or cell, that the signal reaches. A set of frequencies is allocated for each cell within a



**On the air.** Motorola's portable radio-telephone is shaped like the traditional home phone handset. It weighs 2 pounds and can fit into a briefcase or purse.

cluster of contiguous cells, with neighboring cells assigned to a different set of frequencies to avoid interference. But for cells that are far enough apart, simultaneous use of the same frequencies offers no problem. Then, by reducing transmitted power as well as the size of the cell, the same frequencies can be used more often. This opens the service for more subscribers by subdividing cells.

After several years of compromising on channel spacing and signaling schemes, AT&T and Motorola have compatible proposals—though there will be differences in execution. For example, Motorola prefers distributing its switching offices to

antenna sites as a way to lower start-up costs while Bell concentrates them in a single No. 1A ESS electronic switch. Also, Bell eventually will illuminate its cells from three corners; Motorola uses a single, central antenna. But the difference between systems that will catch the public's eye is the subscriber equipment: while both firms plan mobile radio-telephones, only Motorola is demonstrating a hand-held portable unit that its system will accommodate immediately, although the present model is too big to fit comfortably under a dashboard.

The key to Motorola's portable is the use, even in the start-up phase, of a sector-receive antenna, a central one in each geographic cell. When receiving signals, it divides each hexagonal cell into six triangular wedges. The receivers hand off the unit wedge to wedge as the subscriber roams, much the same way as the system hands off subscribers as they cross cell boundaries. Moreover, the sector antenna will pull in digital and voice signals from a 1-watt portable transceiver from as far away as 11 miles.

"Watts are dollars," says James P. Caile, marketing manager for common-carrier products at Motorola's Communications Systems division in Schaumburg, Ill. "Lacking the sector antenna, we could not introduce the portable into the system because its cost would be too high." It is the sector antenna, of course, that will help make it possible for the low-power units to transmit and receive. Caile envisions low-power dashboard-mounted mobile radio-telephones as well—perhaps a power-reduced version of the 10-w mobile

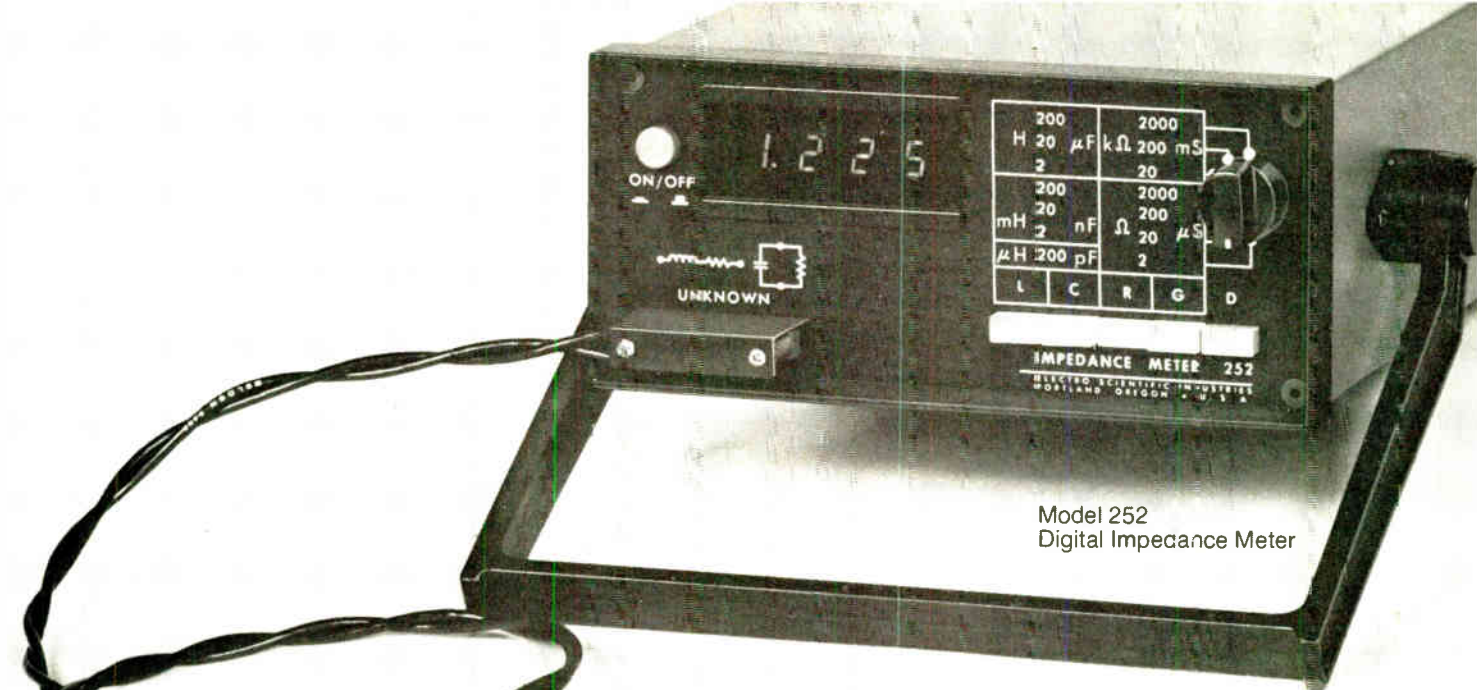

Model 252  
Digital Impedance Meter

# L-R-C Gotcha! ...and for only \$695

(U.S.A. only)

## Newest ESI "weeder" does it all - even Dissipation Factor.

At \$695, incoming inspection and evaluation of passive components becomes easily affordable. You not only measure L, R, C and G with high accuracy over wide ranges, but the dissipation factor reads out also. Check these features in this light, compact, easy to transport tester:

- Measures D as well as L, R, C, G, automatically.
- Light weight; tilt stand handle.
- 0.25% basic accuracy.
- Wide ranges.
- 1 kHz test frequency.
- 2 measurements/sec.
- External bias.
- 4-terminal connection.
- Analog outputs.
- Low power design.



- Large 3½-digit display
- Front panel dust cover (option).
- Input protection.

Measurements are simple, fast and accurate . . . Set the range and connect to unknown. Four-terminal KELVIN KLIPS® are included, and a front panel dust cover is optional. The Model 252 can also be combined with ESI's Model 1412B Limits Comparator for go/no-go testing.

Handy tiltstand handle completes this value buy, along with the assurance of our precision measurement name: Electro Scientific Industries, 13900 NW Science Park Dr., Portland, Ore. 97229. Units will be available in November, so request a demo today. Telephone 503/641-4141.

**esi**  
ELECTRO  
SCIENTIFIC

## Probing the news

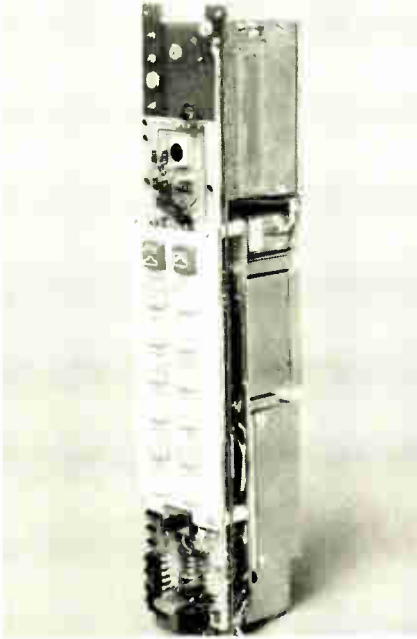

**On the inside.** The radio-telephone shown will be used with the Baltimore-Washington test. Newer model is on drawing board.

that Motorola is developing for Bell's system, he hints.

Motorola showed its first portable radio-telephone in 1973 after it petitioned the FCC for an experimental license to operate a portable system in New York City—a proposal the FCC never considered. The company has since redesigned the unit, which vice president Martin Cooper dubs "a second-generation technological demonstration." It now has a production model on the drawing boards, pushing the twin goals of lowering power consumption and raising the level of integration. "It still has a couple of problems," Cooper says. "It's bigger than we'd like it, and we'd like a unit that can be more easily carried. But within two years, we'll be producing a marketable product." It will sell for around \$2,000—just \$200 more than the present mobile, he adds.

**From the cupboard.** Motorola drew heavily on other products for some of the modules in the portable. For example, the second interme-

diante-frequency amplifier and discriminator in the unit's receiver section were slightly modified from the firm's Pageboy II paging receiver, and the audio preamplifier module came directly from the MX300 line of hand-held portable radios. These radios also supplied the transmitter audio amplifier and deviation limiter module, says Donald L. Linder, manager of Motorola's communications research laboratory at Schaumburg.

But the rest of the portable presented more of a challenge to Motorola designers. Since the radio is designed for full duplex operation, it requires substantial filtering to isolate the two signals. "The key in making the portable unit small is the size of the duplexer," Linder says. A cigar-box sized module in mobile radios, it has been reduced considerably. The miniaturization was eased by the cellular system's 800-MHz operation and 45-MHz separation between transmit and receive frequencies. However, the primary fac-

# We're showing off for Commonwealth Edison.

Chicago's Commonwealth Edison uses Ramtek color graphic displays for rapid display and status reporting of pipelines, valves, pumps, and other generating station data. A clear, color-coded display is updated every 5.0 seconds, giving near-instantaneous visual scan-log-alarm functions, bar graphs, one-line piping diagrams, flow status, etc.

Before the Ramtek systems were installed, status reporting was by hardwired mimic boards, black and white alphanumeric CRTs and typers.

The Ramtek system not only costs less, it also allows more information to be presented to the operator in a form that is quickly and easily under-

stood. This results in better operator efficiency, and faster alarm reaction time. In Commonwealth Edison's 16,000 Megawatt system, thirty Ramtek color graphics displays will be utilized.

tor is the portable's transmission at only 1 w, instead of the 30 w that today's systems demand.

The frequency synthesizer serves both transmitter and receiver, and is of the mix-down and divide type with a voltage-controlled oscillator at 70 MHz and complementary metal-oxide semiconductor programmable dividers, Linder says. The output of the synthesizer is stepped and multiplied to get the 666 channels spaced 30 kilohertz apart that both Motorola and Bell are using in their systems.

The cell concept requires that the transceiver operate at any one of four power levels, as directed by the base-station computer, "to prevent mobiles and portables close to the antenna from overloading nearby channels, and to reduce cochannel interference between reused frequencies when the unit is in a good position for propagating," Linder says. Motorola controls the current in the final state of the power amp with a dc feedback network that produces

the four levels in 6-decibel steps. It has come up with a very small circulator, a ferrite device that protects the power amplifier from energy reflected back from the antenna. Output power is fed through the circulator to the duplexer and finally to the printed-circuit antenna.

**Silence.** In addition, when the subscriber is not talking, the power amplifier is shut down entirely by a voice-operated switch that Motorola has developed to preserve battery life. The portable telephone uses 15 plug-in replaceable thick-film modules, some borrowed from other products and most designed specifically for the unit. In the transmitter, receiver, and synthesizer sections, these are built into metal boxes that shield the receiver.

Two custom and five standard integrated circuits control the synthesizer's programmable counters, recognize incoming calls that carry the unit's digital address, and provide an output signal to the transmitter when the user is requesting

service. This signal includes the portable's identification number that allows the system operator to bill the user for radio-telephone service. "In future designs, however, we'll use a C-MOS microprocessor for the logic functions," Linder says.

A pc board on the front of the radio carries the 14-switch array as well as a standard 1-MHZ crystal and tone generator IC that create tone signals when the keys are depressed. The board also holds light-emitting-diode indicators for transmit and busy signals, and a C-MOS flip-flop that latches on and off keys.

The back of the case is molded around six rechargeable nickel-cadmium batteries that supply 7.5 volts to the circuitry. "That gives the user a half-hour of conversation time and keeps the receiver on standby all day to pick up incoming calls," Caile says. "That's equivalent to 10 average mobile telephone calls, more than enough power to cover average mobile telephone usage, which is three to six calls per day." □

### BOILER 3 START-UP & BY-PASS

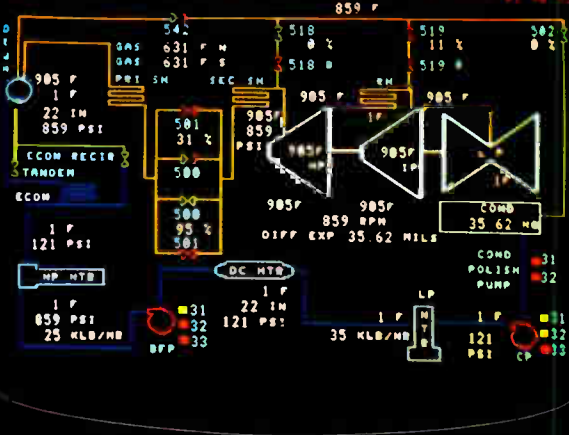

Commonwealth Edison monitors on-off, full-empty, flow status, and other parameters on a Ramtek FS-2400. Color is assigned for steam, water, no-flow, and oil flow to differentiate visually between materials and status. On the RM-9000, resolutions from 240 lines x 320 elements to 512 lines x 640 elements are available.

Commonwealth Edison is but one of a growing number of customers who are finding that Ramtek's raster scan modular graphics and imagery systems are giving them the expandability, flexibility, and increased productivity they need. Besides the basic alphanumeric and imaging capability, Ramtek offers a wide variety of other functions including graphics—vectors, conics, plots, bar charts—pseudocolor, and grey-scale translation.

Ask about our new Ramtek RM-9000 family that is totally controlled by a standard 8080 microprocessor that really makes it easy to develop and download your own control software.

To find out more about how Ramtek can show off for you, call or write: Ramtek Corporation, 585 North Mary Avenue, Sunnyvale, California 94086 (408) 735-8400.

# ramtek

Our Experience Shows

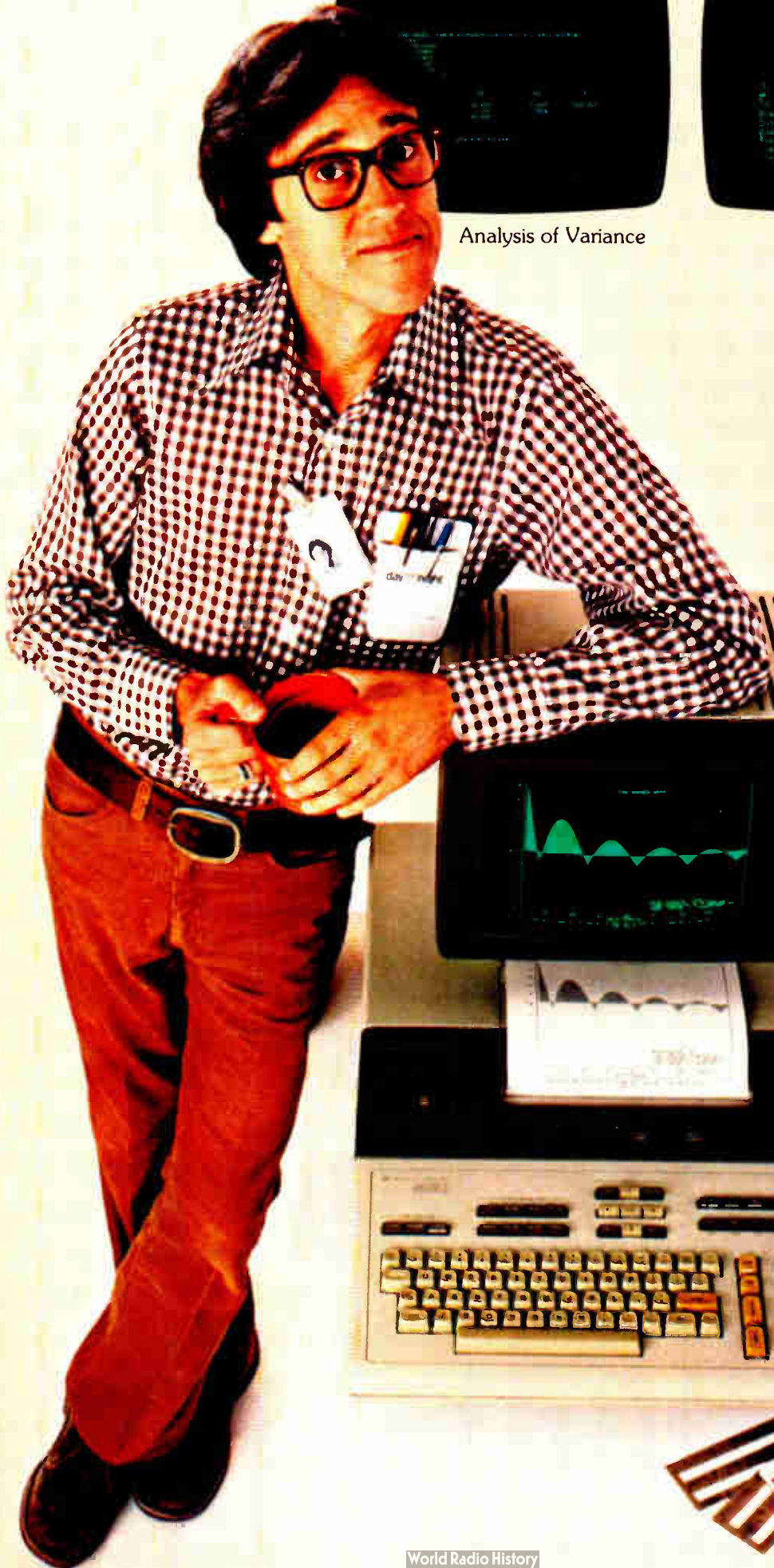

Analysis of Variance



Engineering Analysis & Schematics



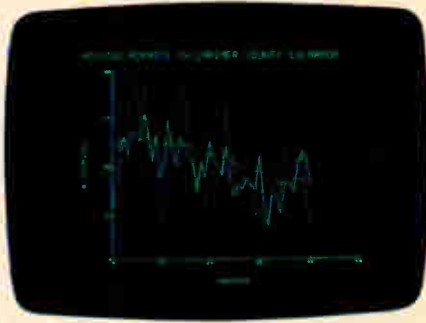

Time Series Analysis

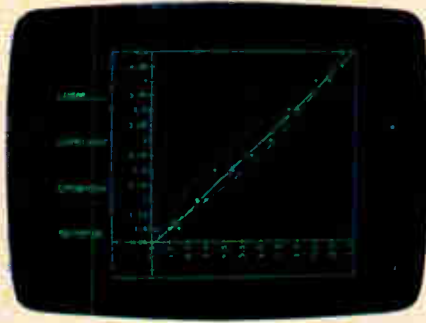

Regression Analysis

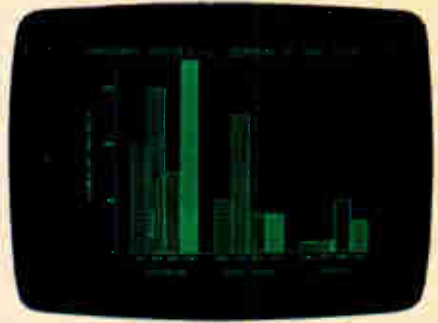

Business Analysis

# With our new friendly computer, solving problems won't seem like work anymore.

**Introducing System 45.** Formally, it's called the HP System 45 Desktop Computer, but you'll come to regard it as a valuable friend. It fits in your workstation, ready to go the instant you have a problem. Gives you the ability to perform more thorough analyses, faster, and with less effort than you ever imagined.

System 45's friendliness comes from the integration of several problem-solving capabilities in one compact chassis. It puts powerful graphics, high performance I/O, big memory, and mass storage all together at your fingertips. Most important, System 45's design enables you to fully exploit these capabilities without getting involved in its internal operating routines.

**The power to handle big tasks.** Though small enough to go wherever your work demands, System 45 is big enough to handle 85 x 85 matrix inversions or tenth-

order ordinary differential equations. You can easily handle most of the problems you've been assigning to a big computer: Clin-lab data base management, thermal analysis, high-speed data acquisition and control, state variable analysis, structural analysis for virtually any geometry, production scheduling and control, or electronic circuit analysis—to name but a few.

**Conversational Problem-solving.** Solutions are straightforward because you communicate with System 45 in conversational BASIC. The dialog is so relaxed it seems almost human. Type in your data and commands and System 45 presents your formatted results on its high-resolution CRT. Need hard-copy? A single command exactly duplicates your plot, drawing or data table on the optional built-in printer.

**A logical growth path.** Like any true friend, System 45 will stick by you as your problems grow and change. You can expand the mem-

ory, add performance options, or plug-in your choice of peripherals, including floppy and hard discs. For more convenience and versatility, you can round out your system with a selection of programs from our growing software library.

**Ask for an introduction.** To learn more, drop us a line in Loveland, home of the friendly computers. Or call your local HP Sales Office for an introduction to the System 45.

Please have a salesman call. E 11/10/77  
Phone \_\_\_\_\_

Please send more information.  
My application interest is:

- Engineering Design.
- Numerical Analysis.
- Data acquisition and control.

Name \_\_\_\_\_

Company \_\_\_\_\_

Address \_\_\_\_\_

City/State/Zip \_\_\_\_\_

P.O. Box 301, Loveland, Colorado 80537



P.O. Box 301, Loveland, Colorado 80537

For assistance call: Washington (301) 948-6370, Chicago (312) 255-9800, Atlanta (404) 955-1500, Los Angeles (213) 877-1282

4077

Circle 79 on reader service card



**Think about expanding  
your pulse generation capabilities...  
think about TM 500.**

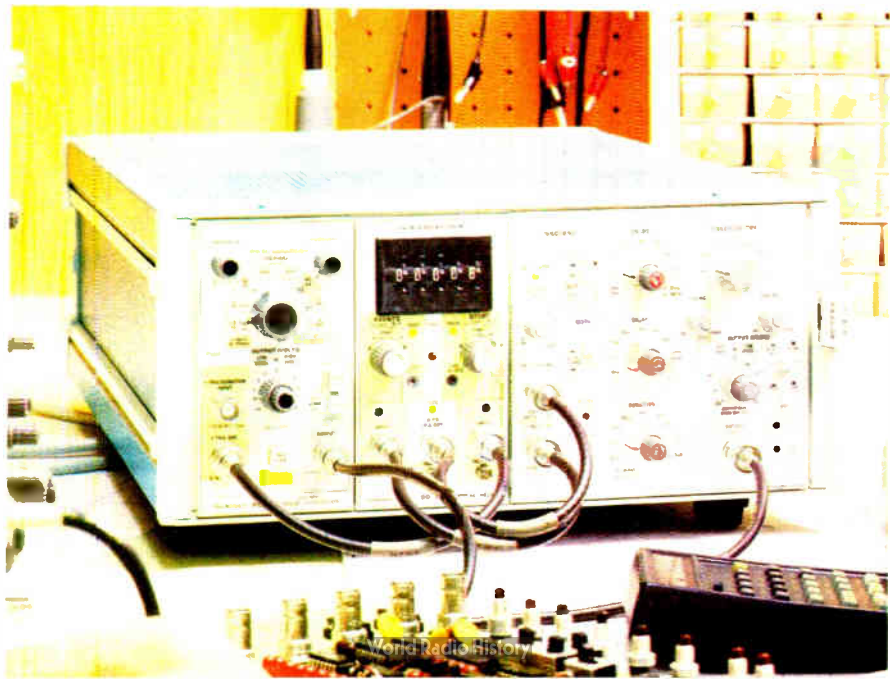

## More waveforms for more applications.

When you're working with today's logic systems, involving a variety of implementations, you need instrumentation built to perform complex functions. This TM 500 pulse generator is such an instrument.

Advanced stimulus functions such as overlapping and non-overlapping bi-phase clocks help solve race problems and determine critical timing.

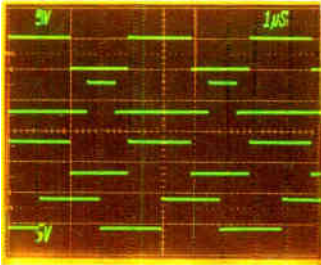

*Biphase Clocks*

When working with mixed logic systems, two-frequency synchronous clocks operating at different frequencies and different logic levels can be configured.

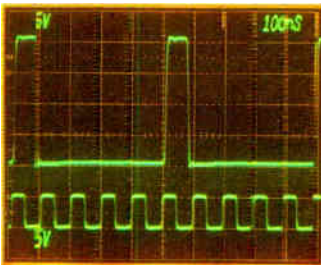

*Two Frequency Synchronous Clocks*

Also, this instrumentation provides translation capability between common logic families; CMOS to ECL or TTL to CMOS, for example. A unique pulse restoration or superbuffer capability, with high or low input impedance and 50Ω output impedance, helps you produce low aberration signals in unterminated lines.

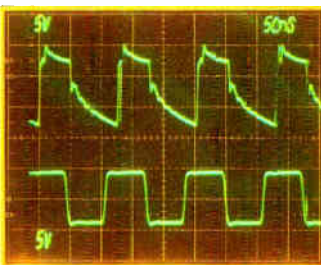

*Pulse Restoration*

Dual pulse generation within one unit provides self contained burst generation. In this mode, burst rate and width, and pulse rate and width within each burst can be individually controlled.

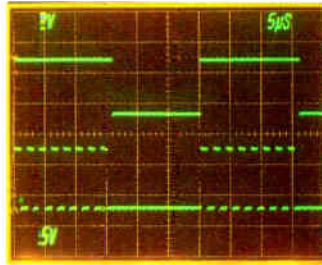

*Self Contained Burst*

A counted burst feature, with thumb-wheel switches, gives exact control when selecting pulses for use with shift registers, CCD delay lines and data transmission. With this instrumentation it is not necessary to reset burst control if width and duration is changed within the burst. When working with a large number of pulses, more stability and ease of resolution is assured.

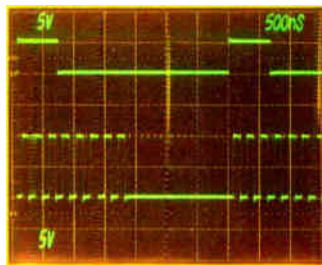

*Counted Burst*

When desired, two pulse generators are operable as independent instruments. Both outputs provide true and complement pulses, and other types of mixed pulses. Both outputs are controlled by independent high and low dials.

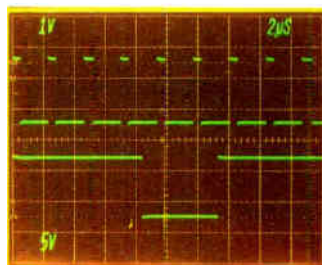

*Independent Pulse Generation*

Frequency capabilities are 50 MHz at 20V for MOS and CMOS logic and 250 MHz at 5V for ECL and Schottky TTL. Square wave trigger outputs can be viewed when narrow pulses decrease scope visibility, and simplify counter triggering.

Tektronix has designed a TM 500 pulse generator system capable of these functions and more. Two pulse generators (PG 508 and PG 502) and an independent digital delay (DD 501), packaged together in a versatile mainframe, meet a wider range of applications.

As a single package it's compact, portable and easily adapted to the lab or field. As part of the highly configurable TM 500 line its mechanical and electronic performance can be adapted to suit your specific needs.

If you prefer a bench set-up the three plug-ins (PG 502-PG 508-DD 501) can be installed in a TM 500 mainframe to sit conveniently and neatly on a bench top. When your needs demand a portable test unit, the three plug-in modules can be packed in the small-as-a-suitcase TM 515 Traveler Mainframe.

In addition to this mechanical configurability, your pulse generator unit can be combined with other TM 500 modules to expand your present test and measurement library.

A powerful combination of TM 500 modules—PG 502, PG 508, DD 501 and a mainframe—work for you in two ways: together to surpass their own individual limits, independently to continue meeting your instrumentation needs.

For further information or a demonstration of the TM 500 family of instruments, write or phone: Tektronix, Inc., P.O. Box 500, Beaverton, Oregon 97077, (503) 644-0161 Ext. 5283. In Europe: Tektronix Limited, P.O. Box 36, St. Peter Port, Guernsey, Channel Islands.

**Tektronix**  
COMMITTED TO EXCELLENCE

For Technical Data circle 80 on Reader Service Card  
For Demonstration circle 81 on Reader Service Card

**TM 500...designed for configurability.**

# Hewlett-Packard brings a bright new look to low-cost graphics.

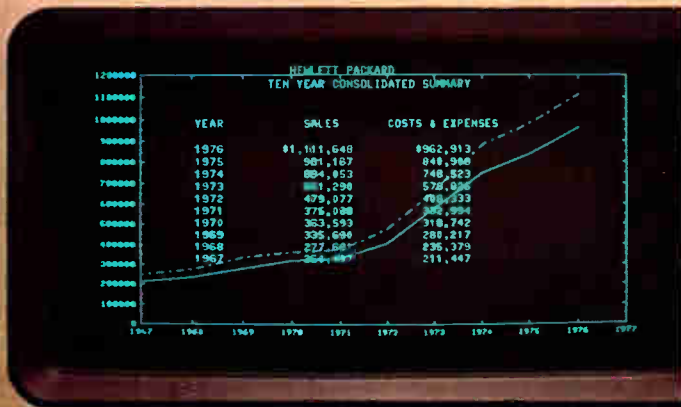

Auto-Plot

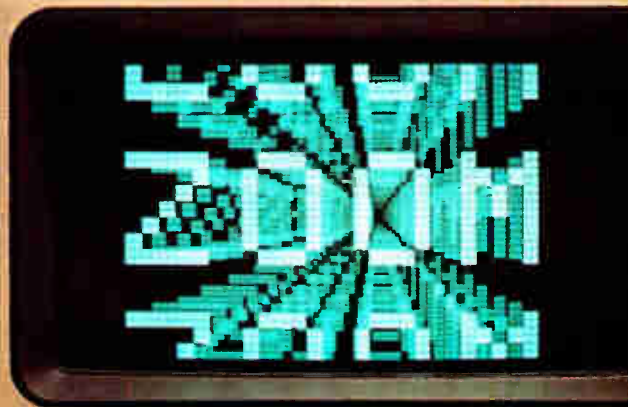

Zoom

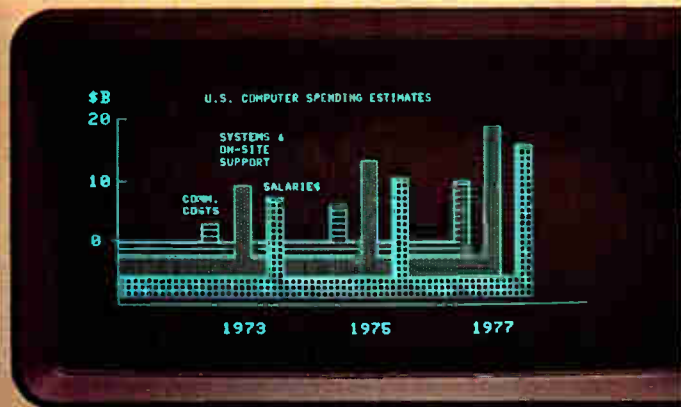

Area shading

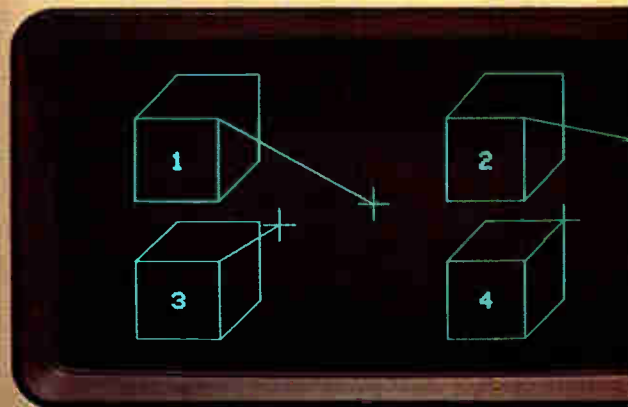

Rubber-band line

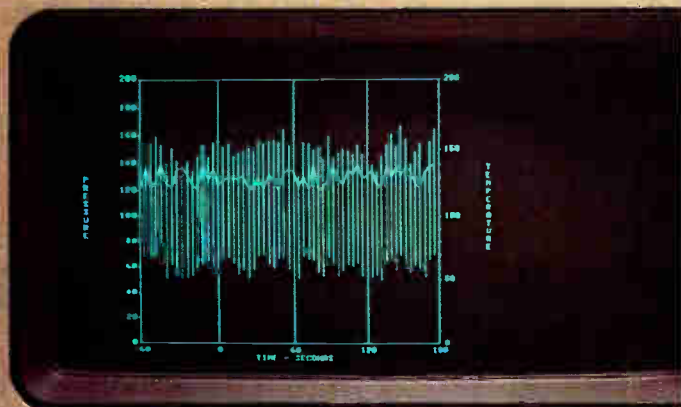

Typical application: scientific plotting.

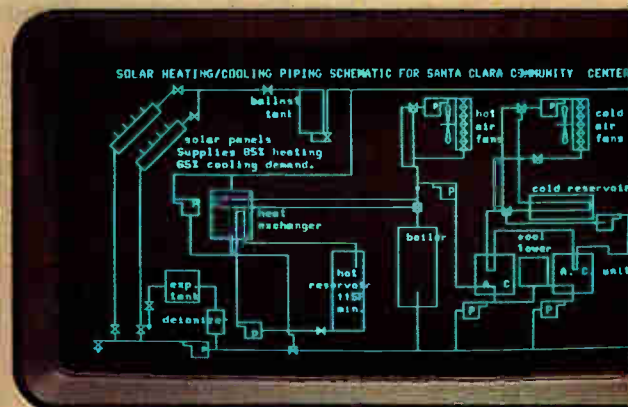

Typical application: process flow diagram

## The new Hewlett-Packard Graphics Terminal uses a microprocessor and raster scan technology to combine high performance with low cost.

The HP 2648A introduces a whole range of bright ideas to graphics. There's so much power built into the terminal itself that you can perform everything from auto-plots to zoom without any CPU help at all.

**Auto-Plot.** You don't need to know programming or invest in costly software. Once you've entered your facts and figures from the alphanumeric keyboard, press a few keys and your tabular data is plotted instantly.

**Raster Scan.** No more pulling down the blind to make your plots visible. Our display is clear and easy to read even in bright light. And the raster scan technology permits selective erase, cutting down the time it takes to modify your picture also.

**Zoom and Pan.** This lets you magnify any area of the display up to 16 times. And you can pan in any direction for closeup investigation of complex designs, without having to reinitialize the data.

**Area Shading and Pattern Definition.** This makes it easy to distinguish areas with similar shapes, such as bar charts, mechanical parts and architectural drawings.

**Rubber-band Line.** You can draw trial sketches, such as architectural floor plans, with or without CPU connection. Think of the time and money you'll save by cutting down mistakes.

**Independent Display Memories.** Both alphanumeric and graphic data can be shown independently or at the same time. And you can carry on a dialogue with the CPU without disturbing the picture.

The HP 2648A also has all the advantages of our popular HP 2645A alphanumeric terminal. Specifically: mass-storage on 110K byte cartridges (you can store graphics as well as data); 'soft keys' to speed up repetitive jobs; one-button self-test; plug-in PC boards for easy maintenance; extensive data communication and off-line capabilities.

This bright new look in graphic terminals is designed for such applications as electrical, mechanical and architectural design. For process and control. For scientific plots. And for business planning.

We'd like to give you a graphic demonstration of everything the HP 2648A can do. Send us the coupon and we'll set it up.

Or contact the nearest Hewlett-Packard sales office listed in the White Pages. We're sure you'll get the picture.



**HEWLETT**  **PACKARD**

Yes, I'd like to take a closer look at your low-cost HP 2648A Graphics Terminal.

Contact me to arrange a demonstration.

Send me complete information.

Name \_\_\_\_\_

Company \_\_\_\_\_

Phone \_\_\_\_\_

Address \_\_\_\_\_

City/State/Zip \_\_\_\_\_

Mail to: Ed Hayes, Marketing Manager, Hewlett-Packard Data Terminals Division, 19400 Homestead Road, Dept. 607, Cupertino CA 95014.

Circle 83 on reader service card

42703HP14

# Now you can mass terminate with ribbon connectors.

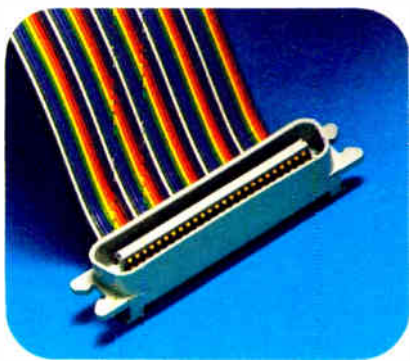

Here's another industry first from 3M that's good news for you: the Scotchflex brand Delta Ribbon Connector System for intra-system or I/O interconnections. In computer applications, in telecommunications, in any place or any way you want to use flat cable and ribbon connectors, this versatile system can do the job at sharply reduced assembly time and labor costs.

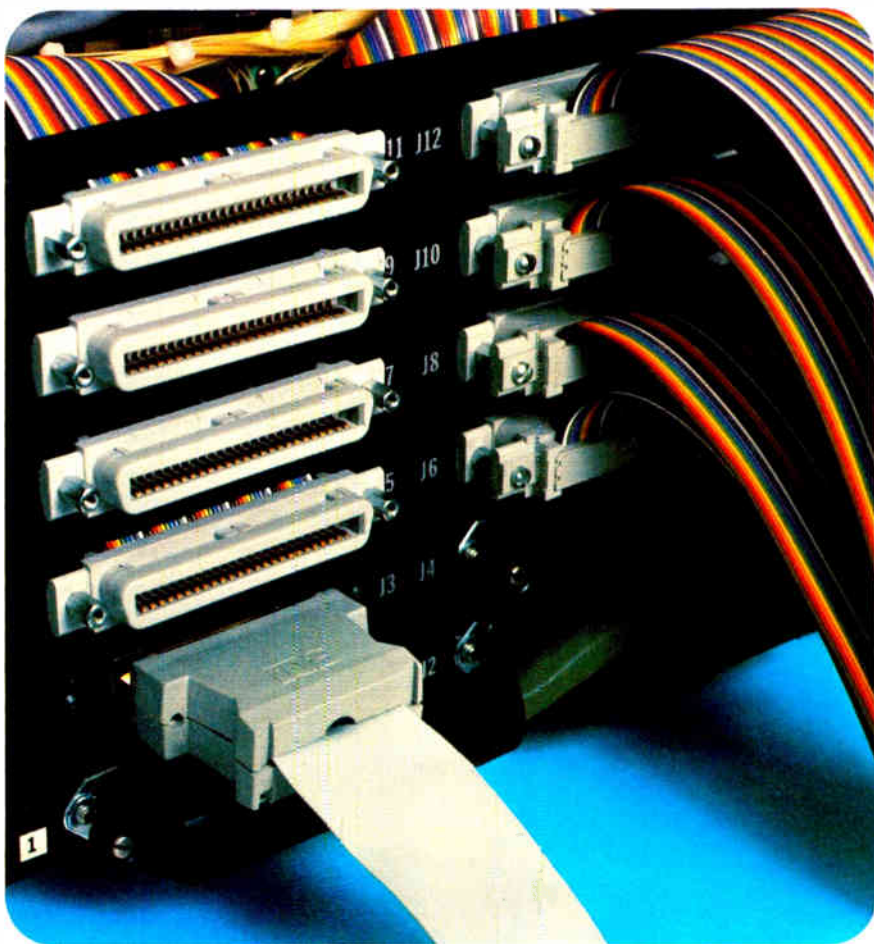

With Scotchflex Delta Ribbon Connectors, no stripping, soldering or other wire preparation is necessary. You can mass terminate a parallel-lay 50-conductor (25-pair) .0425" center-spaced flat cable in less than 30 seconds with one step. That's about ten times faster than other available methods. And thanks to 3M's field-proven, gold-plated beryllium copper U-contacts,

all connections are reliably corrosion-resistant and gas-tight.

After termination, there are more savings. You can buss from point to point without disassembling or breaking existing cables. And there's no need to redesign or rework first generation components. This Scotchflex system mates perfectly with all standard miniature ribbon connectors.

# in 30 seconds or less!

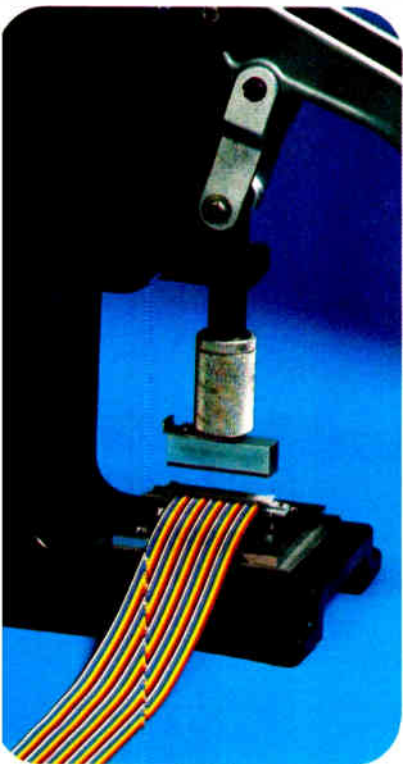

There's no costly investment to make in equipment or training. All you need are two locator plates and the Scotchflex manual or pneumatic assembly press. You can start mass terminating assemblies quickly and economically. No special operator skills are required. Rejects and reworking are greatly minimized.

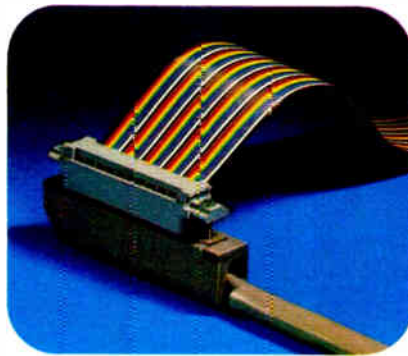

The Scotchflex Delta Ribbon system includes 50-position male and female connectors, plus appropriate bail mount, screw mount and jack screw kits, strain relief clips and dust covers. Color-coded flat cable is available in parallel-lay conductors #28 AWG stranded or #26 AWG solid.

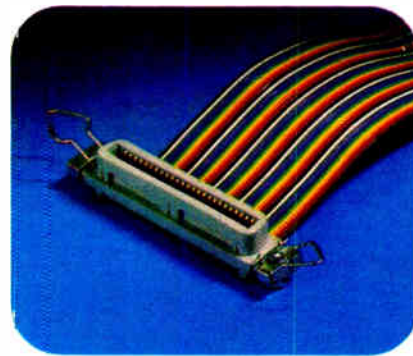

Only 3M offers you so broad a range of flat cable and system components. A nationwide network of stocking distributors. Best off-the-shelf availability. Proven performance. And the unmatched experience of the people who pioneered mass terminations.

"Scotchflex" is a registered trademark of 3M Co.

Scotchflex<sup>®</sup>  
systems  
from 3M.  
The source.



See our catalog in EEM, page 2256

TIME INTERVAL  
SECONDS

3.4168 - 6

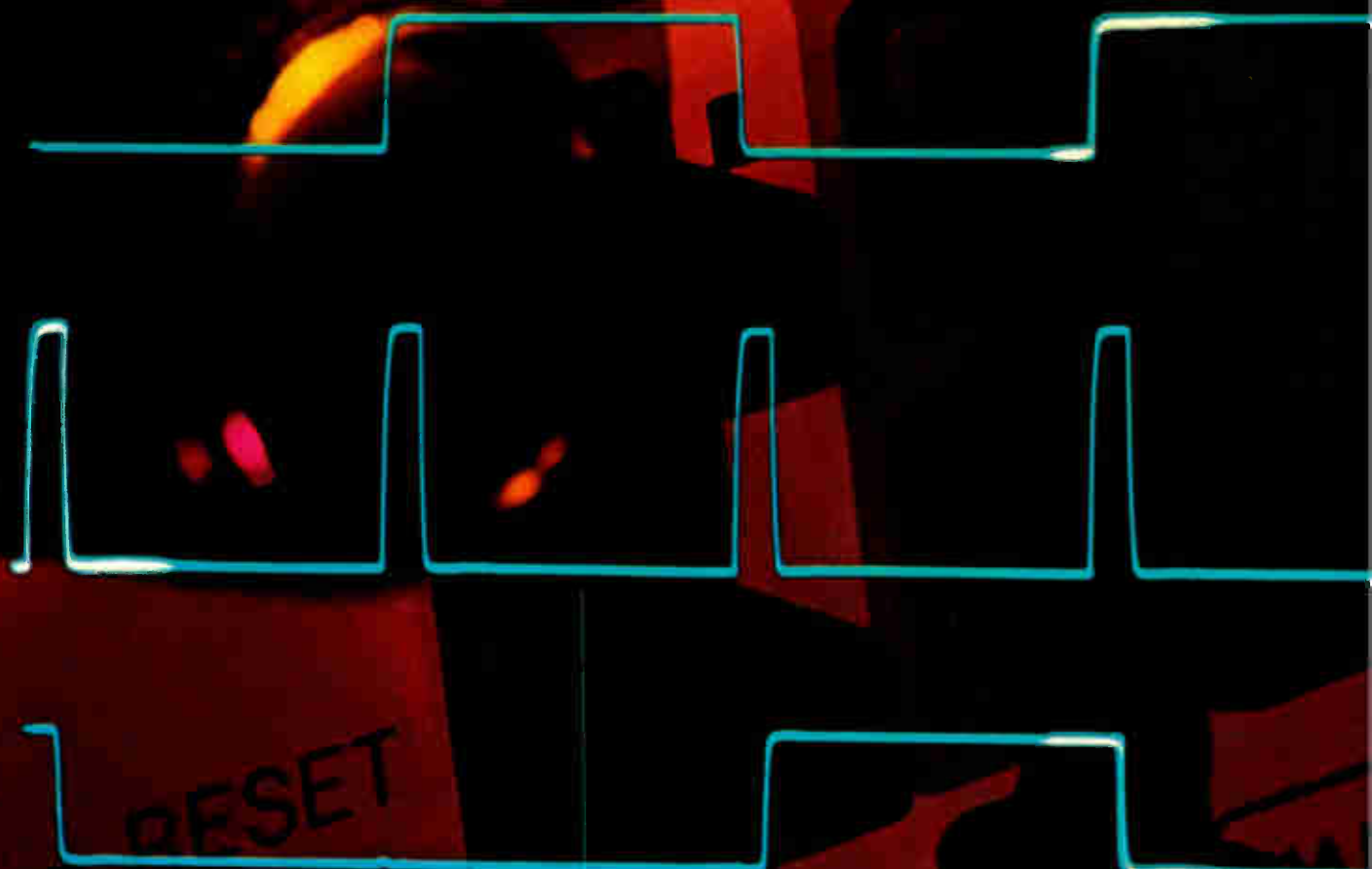



# Announcing a new standard in scope timing measurements.

## For $\Delta$ -time measurements to 0.002% accuracy\* and 100 psec resolution...

### HP's the Answer.

Here's a brand new concept in scopes. HP's revolutionary **1743A**. It has an internal crystal-oscillator time-base reference for high 0.002% accuracy\*... second-generation  $\Delta$ -time capability for added measurement flexibility and convenience...and a 5-digit LED readout for resolution to 1 part in 150,000.

Priced at just \$3300\*\*, this 100 MHz scope provides up to 200 times greater timing accuracy than previous  $\Delta$ -time scopes. And the combination of crystal-oscillator and second-generation  $\Delta$ -time capability means easier timing measurements:

#### Triggered delay measurements.

Now,  $\Delta$ -time measurements can be made automatically by positioning markers on the waveform. This means greater speed and convenience in measuring pulse widths and periods. Plus, direct readouts of changing time intervals without touching scope controls.

**Delay functions to zero.** Now you can measure  $\Delta$  time from the first pulse leading edge to any place on screen. That means greater resolution and accuracy, plus easy  $\Delta$ -time measurements with respect to noncyclical pulses such as flags and handshake signals.

**Continuously variable sweep that remains calibrated.** Now you can use the sweep vernier without changing the LED time-display calibration. Make one major division equal to a clock period, compress a long data train to keep it within the display window, or increase readout resolution up to

a factor of three and still read  $\Delta$  time directly and accurately.

**Trigger to channel A and B.** Now you can measure  $\Delta$  time between the trigger signal and events on both channels. This allows you to measure  $\Delta$  time between a flag and the start of a data train, to make phase measurements on dual clocks, or to measure skew between data channels.

And there's much more. Your local HP field engineer has the details.



And here's something NEW for scopes. HP's **Easy-IC Probes**. A new idea for probing high-density IC circuits that eliminates shorting hazards, simplifies probe connection to DIP's and generally speeds IC trouble-shooting. Ask your HP field engineer about them.



\* 15°C to 35°C specification.

\*\* Domestic U.S.A. price only.

087 10

HEWLETT  PACKARD

1507 Page Mill Road Palo Alto California 94304

For assistance call Washington (301) 948-6370 Chicago (312) 255-9800 Atlanta (404) 955-1500 Los Angeles (213) 877-1282

World Radio Inc. Circle 87 on reader service card

Our Model 3001 starts at \$2,750. For that you get a signal generator that's already frequency programmable with 0.001% accuracy over the 1 to 520 MHz frequency range. If you also want to program your output power, we have a programmable attenuator option available for \$500.

If you'd like to spend a little more, add our external frequency standard option for \$150. That makes the accuracy the same as your standard. Or spend another \$500 for an internal reference frequency standard with  $5 \times 10^{-9}$  day stability. But if you want to spend much more than that, you're going to have to buy some-

body else's signal generator. Count on at least \$10,000. Frankly, we think your money would be better spent buying another Wavetek Model 3001.

Here's another advantage. If you need to get on the bus (now or later), our new Model 3910 Converter makes you GPIB compatible. But before you spend anything on any signal generator, get a demonstration of our Model 3001. That won't cost you a cent.

#### SPECIFICATIONS

Frequency Range: 1-520 MHz  
Accuracy:  $\pm .001\%$   
Resolution: 1 kHz

Stability: 0.2 ppm per hour  
Output Range: +13 dBm to -137 dBm

Flatness:  $\pm 0.75$  dB  
AM Modulation: 0-90%  
FM Deviation: 0-10 kHz and 0-100 kHz

Internal Modulation Rates:  
400 Hz and 1 kHz

WAVETEK Indiana Incorporated,  
P.O. Box 190, 66 North First Avenue,  
Beech Grove, Indiana 46107,  
Phone (317) 783-3221,  
TWX 810-341-3226.

# WAVETEK®

# You can pay a lot more for a programmable signal generator.

## But why?



Circle 88 on reader service card

□ Time, a critical commodity in today's high-speed circuitry, can be controlled well only when it is measured well. Engineers have continually sought means to measure time intervals with greater and greater precision, and bench instruments today generally allow measurements down to around 100 picoseconds. Now, a new oscillator, which can be both triggered and phase-locked, allows routine time measurements of well below 100 picoseconds.

Triggered oscillators are generally used for time-to-phase conversion, when the phase information must be preserved. By observing the phase later, it is possible to estimate when the trigger pulse must have arrived to start the oscillation. But the oscillators cannot achieve the stability levels required for picosecond measurements, because their frequency is a function of variable internal circuit parameters. Moreover, any attempt to stabilize them by locking them to an external reference oscillator destroys the essential phase relationships that existed before the locking.

The new phase-locked triggered-oscillator circuit, however, responds to an input trigger not by starting but by suspending operation for a brief, known period of time. Then, after its restart, the phase-locked loop does not destructively pull the frequency back into its original phase, as an ordinary loop would, but instead locks the new phase to the reference. As a result, the first instruments (see Fig. 1) to use the circuit can generate time intervals with a resolution of 50 picoseconds (the Hewlett-Packard 5359A time synthesizer) and measure them with a resolution of 20 ps (the HP 5370A universal time-interval counter).

### Simple circuit

Yet the new circuit is very simple. Apart from passive elements and one ordinary operational amplifier, digital logic circuits are the only building blocks used. The frequency response of the components need not go very much beyond the oscillator frequency. There are no ovens, even for oscillators used in subnanosecond timing applications, since the circuits can be designed to be immune, within a given range, to variations in components, temperature, and power supply.

The basic triggered oscillator (Fig. 2) consists of an inverting gate and an external delay. When the input to the gate is low, the oscillator runs at a frequency with a

# Ovenless oscillators will resolve 20-picosecond pulses

---

Triggered and phase-locked, new circuits permit precise time measurement and synthesis

---

by David C. Chu and Keith M. Ferguson,  
*Hewlett-Packard Co., Santa Clara, Calif.*

**1. New units.** Two new instruments, the 5359A time synthesizer (left) and the 5370A universal time-interval counter (right) use new triggered phase-locked oscillator to provide picosecond resolutions. The synthesizer delivers precise time intervals down to within 50 ps, while the counter measures time intervals down to within 20 ps. Each also uses a microprocessor for computations and control.



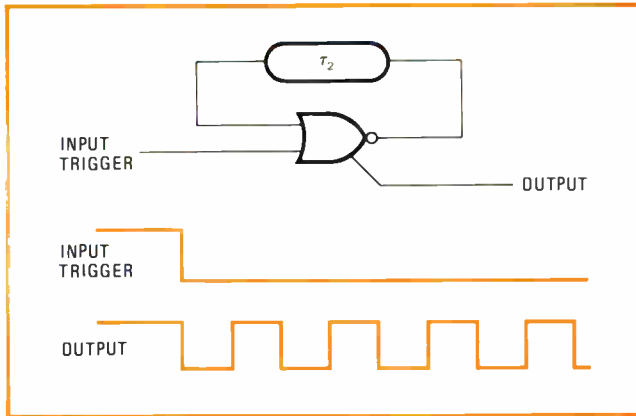

**2. Triggered oscillator.** The basic triggered oscillator comprises a gate with a delay in a feedback loop. The output is in phase with the input trigger, but frequency is determined by circuit parameters. The period of the oscillations is twice the loop delay.

period that is twice the delay around the feedback loop.

When placed in the basic phase-locked loop, the oscillation frequency is voltage-tuned across a narrow range by a varactor across the output (Fig. 3). Note that the tuning voltage to the voltage-controlled oscillator is a dc signal, changing very slowly to compensate for variations in temperature, power supply, and circuit component values. The output of the vco is fed to two channels: a mixer and a frequency scaler. The mixer generates a beat frequency with the external reference oscillator. The mixer's output is a signal at the difference frequency,  $f_o - f$ , where  $f_o$  is the reference frequency and  $f$  is the vco frequency. The frequency scaler produces an output at frequency  $f/N$ .

The two signals, at frequencies  $f_o - f$  and  $f/N$ , are then fed through inverting gates to a phase detector (Motorola MC12040), which monitors the positive transitions of the two inputs. The detector's output pulses are filtered and integrated, producing a voltage signal that tunes the vco via the varactor diode, thus closing the phase-lock loop.

Under locked conditions, the two signals to the phase detector, DV and MX, are of the same frequency and in phase:

$$f/N = f_o - f$$

Hence, the vco frequency,  $f$ , is:

$$f = f_o(N)/(N + 1)$$

Note that it is slightly offset from the reference frequency. If, for example,  $N$  is 256, then  $f = f_o \times 256/257$ , or  $f$  is about  $0.996 f_o$ . As long as the input is held low, this locked condition remains.

Two points are worth noting here. First, since mixing is done by a positive-edge-triggered D-type flip-flop, a positive transition at the mixer output,  $Q$ , signifies phase coincidence at the input between reference and vco frequencies. Second, the two phase-detector inputs, DV and MX, are in phase and at frequency  $f_o/(N + 1)$ . A positive transition in MX occurs at the same time as a positive transition in DV, which occurs when the scaler "turns over"—switches from the full count of  $N - 1$  to 0.

Figure 4 shows a simplified block diagram of the

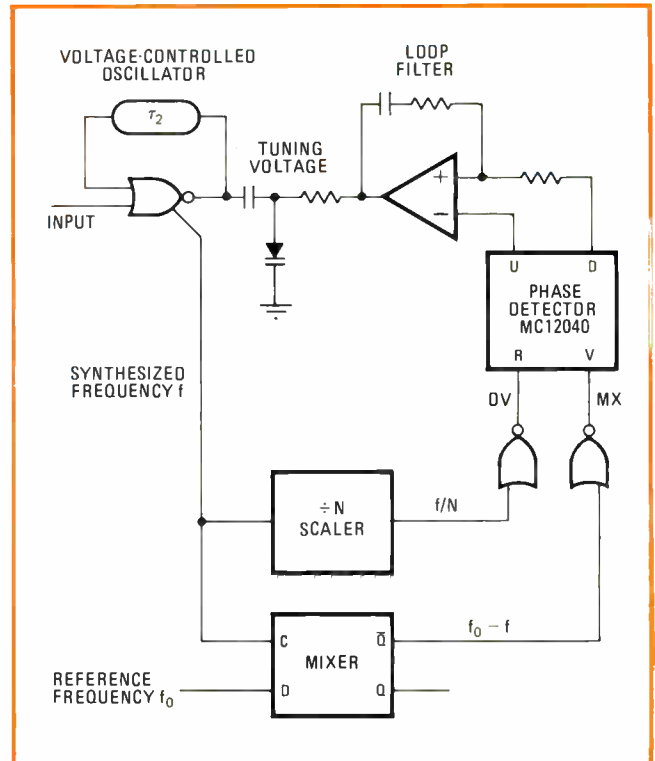

**3. Phase-locked loop.** Basic loop comprises voltage-controlled oscillator feeding its output to both a mixer and a scaler, or divider. Phase detector inputs are equal in frequency and in phase at positive transitions. Tuning is performed by varactor across VCO output.

complete phase-locked loop with a triggering input. Under quiescent conditions, the vco loop is operating at frequency  $f$ . An input trigger pulse sets the lockout flip-flop. The time difference,  $\tau_1$ , of the arrival of  $Q$  and  $\bar{Q}$  to the inhibit gate generates a positive pulse at the gate's output of duration  $\tau_1$ , which stops the oscillation of the vco within half a period,  $T/2$  ( $\tau_1$  is designed to be longer than  $T/2$ ). After  $\tau_1$ , the inhibit signal disappears and the oscillation recommences, but note that it is now in phase with the removal of the inhibit, which is precisely  $\tau_1$  in time after the trigger input.

Thus the phase of the new oscillations is directly related to the time of arrival of the trigger input. Also, it is independent of the phase of the oscillations before the trigger input arrival.

### Maintaining the new phase

Now, the goal is to maintain this new phase while the oscillator remains phase-locked to the reference. The new phase of the oscillator will be translated into a new phase of the beat frequency through the mixer by the same angle, but at the mixer output's lower frequency.

At this point, the phase detector must be disabled or else it will produce a sudden change in tuning voltage that will shift the vco frequency. The new phase of MX thus is momentarily shielded from the phase detector by the signal  $S$ , which goes high with output  $\bar{Q}$  of the lockout flip-flop. The signal  $S$  acts on the two inverting gates to the phase detector, causing both DV and MX to go low and thus disabling the phase detector. The same signal also resets the scaler and holds it at count 0.

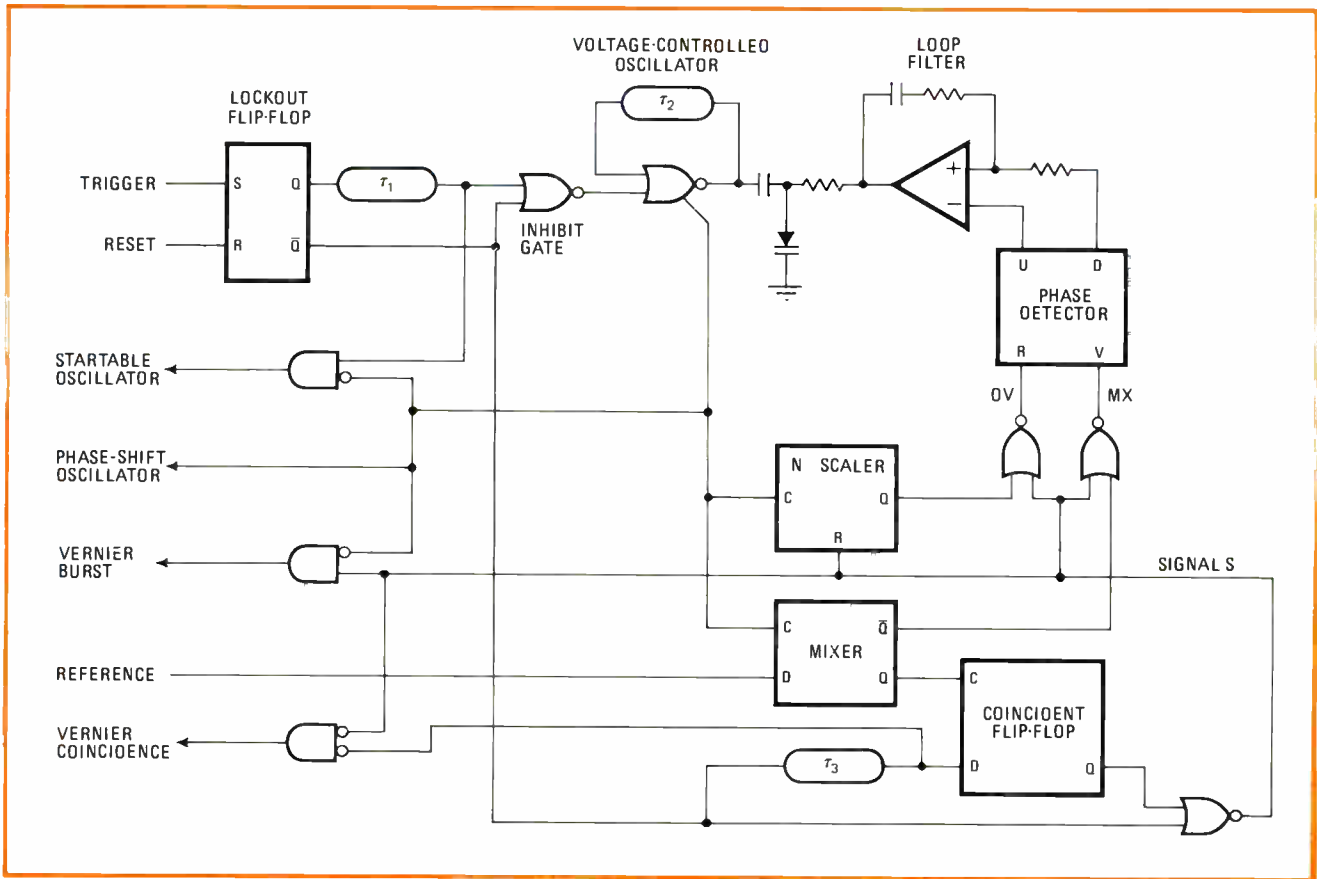

**4. Triggered loop.** To trigger the phase-locked loop of Fig. 3, a lockout flip-flop, a delay, and another gate are added at input. VCO operation is temporarily suspended for a known delay time, and when inputs to phase detector are again coincident, VCO is again locked.

Meanwhile, the new beat frequency signal from the mixer will reach a positive transition of its own accord, signifying that the vco and the reference are phase-coincident. This transition switches the phase-coincidence flip-flop to the low state, which in turn causes signal S to go low, allowing the scaler to start counting from 0 to 1, 2, . . . etc. (see waveforms in Fig. 5).

The removal of signal S also causes both DV and MX to rise simultaneously. The phase detector, which always monitors positive transitions from both inputs, accepts the rise as a satisfactory phase-locked condition, produces no significant correction pulses at its output, and therefore causes no frequency change in the vco.

From this point on, the loop acts precisely as it did before the arrival of the trigger input, but the new phase of the oscillator is preserved. Since the divider has been adjusted in phase to match the new mixer output phase, phase locking will continue at the new mixer phase. Note that should the lockout flip-flop be reset at this point, the vco will not shift phase, nor will the quiescent lock condition be affected. However, if a reset signal is applied to the lockout flip-flop, then the loop will be ready for another trigger input to change the phase of the vco once again, if desired.

As shown in Fig. 4, the output of the vco can be obtained directly as an output or as a startable oscillator through a gate that suppresses all oscillations before the arrival of the trigger input. Alternately, it can be used for vernier adjustment purposes, as is discussed later.

As for actual circuit values, in the 5370A, the triggered phase-locked oscillator uses a 200-megahertz reference  $f_0$ , and a scaler factor  $N = 256$ . Most circuits used are commercially available emitter-coupled logic. The exception is the mixer flip-flop, which is made with a proprietary HP process that produces bipolar transistors with an  $f_t$  of 5 gigahertz. The oscillator itself is a hybrid circuit with a 5-GHz transistor and is built in microstrip on a ceramic substrate. The op amp is an ordinary LM307. The lock range of the phase-locked loop is designed to cover the worst-case power supply and temperature variations.

### The time synthesizer

The 5359A time synthesizer uses the triggered phase-locked oscillator to generate pulses with precisely set delays after the arrival of the trigger pulse (Fig. 6). The external trigger signal starts a 100-MHz triggered phase-locked oscillator, the oscillations of which are then counted by the presettable down-counters. The main advantage of the startable oscillator is that it eliminates the jitter otherwise associated with the random-phase relationship between the external trigger and the internal crystal. The phase-locked loop assures timing accuracy over long intervals (up to 160 milliseconds).

The two digital dividers are each presettable to any count from 1 to 16,777,215. Each divider circuit consists of a single, custom integrated circuit built with emitter-function logic (multiple-emitter devices), which contains

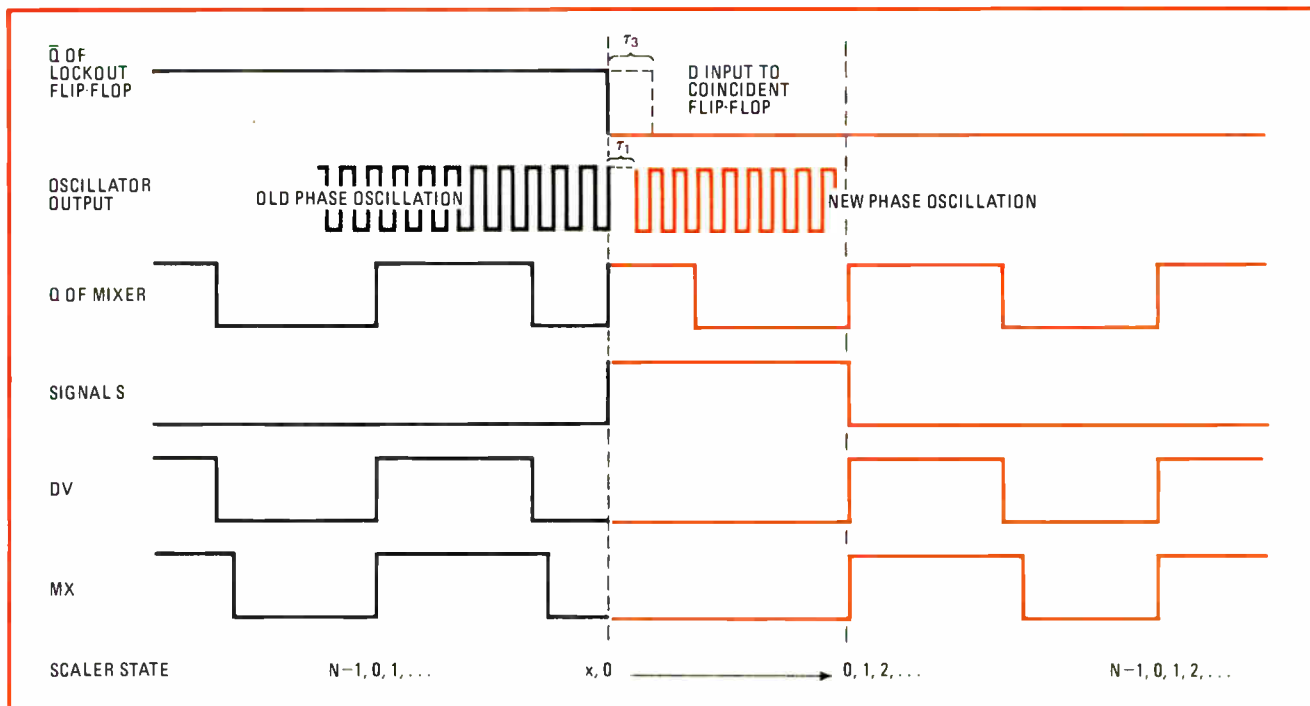

**5. Locking in.** Waveforms for the triggered phase-locked oscillator of Fig. 4 show that when trigger occurs, oscillator output is interrupted for known delay time. Signal S disables phase detector until signals DV and MX are in phase.

a 24-bit divider chain and a 25-bit holding register used for automatically reloading the count register with the preset number. Counting a 100-MHz clock, the dividers yield a resolution of 10 ns. Analog interpolators then divide this interval into increments of about 50 ps. The two timing channels allow a delay and a width to be specified with an external trigger or a period and a width to be specified for an internal trigger mode.

The scheme just described gives excellent incremental accuracy. However, to achieve absolute accuracy, it is necessary to take into account the various fixed delays through the various amplifiers and timing circuits. These delays will vary from instrument to instrument and will generally be a function of temperature, the aging of components, and the amplitude of the output signal. The 5359A provides an internal method of automatic calibration to compensate for these fixed offsets.

The 5359A has an automatic calibration feature, based on a pulse-coincidence detector and a microprocessor, which interprets the results. The autocalibration circuit has two functions: it injects signals into the timing path, which then follow precisely the same path that is to be followed by the signals generated during actual operation, and it provides a coincidence detector to compare the timing relationships of the output signals and internal references.

In designing a coincidence detector that is capable of detecting differences of less than a nanosecond, care must be taken to compensate for delay errors in the detector itself. The relationship of interest is the one that occurs at the input to the trigger amplifiers; however, this relationship is not necessarily the same as the one seen by the detector, because of delay differences in the amplifiers and the interconnections (as well as in the detector itself). In order for the detector to be useful, it

must compensate for these differences.

A block diagram of the coincidence detector is shown in Fig. 7a, and a timing diagram in Fig. 7b. The signal from trigger  $T_1$  starts a ramp, which is applied to one input of a voltage comparator. The other input is a level voltage from a digital-to-analog converter. Trigger  $T_2$  is delayed through an unknown but constant delay and then causes the output of the comparator to be sampled.

### Calibration

To calibrate the coincidence detector, the two trigger inputs are connected to the same signal, thus defining coincidence. The output voltage from the d-a converter is varied until the relationship shown in Fig. 7b is obtained, and it is then left constant for subsequent measurements.

In measuring coincidence, if the ramp has not yet crossed the voltage level when the comparator is sampled, trigger 1 is known to have occurred before trigger 2 and vice versa. In fact, the circuit might better be described as a "precedence detector," since it actually determines which of two signals occurs first—as the timing relationship is varied, the microprocessor defines coincidence as the point of reversal of the order of occurrence. Averaging is used to minimize the effects of random noise on the signals.

A single command either from the front panel or from the IEEE-488 interface bus starts the calibration process, which takes about 2 seconds and generates six constants. A recalibration should be performed if changes are made in the output amplitude or offset, if significant changes have occurred in the operating temperature, or whenever the greatest accuracy is required.

Whenever new delay, width, or period data is entered into the machine, the microprocessor automatically uses

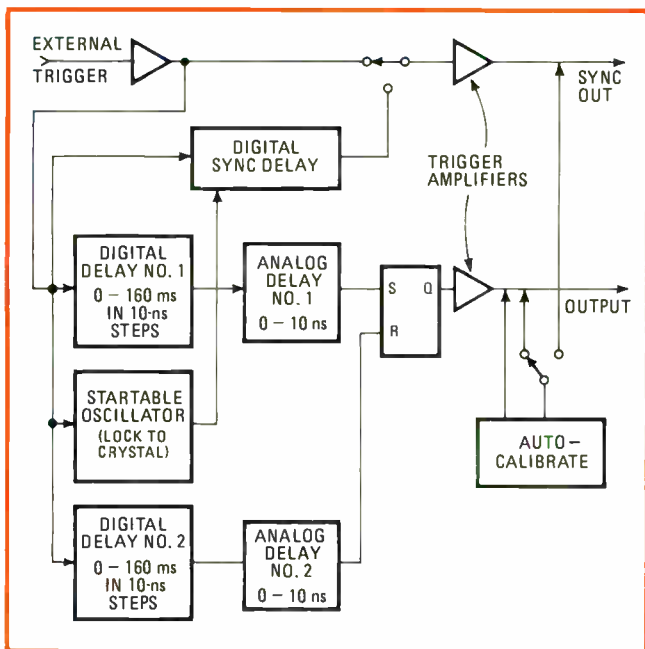

**6. Time synthesizer.** The 5359A time synthesizer uses the triggered phase-locked oscillator along with digital and analog delays to deliver pulsed outputs with known time intervals between them. Analog dividers control intervals down to about 50 ps.

the calibration constants in calculating the numbers to be supplied to the digital and analog delay circuits. Once these delays are set up, they operate independently from the microprocessor, allowing it freedom to monitor the front panel and the interface bus.

The trigger amplifiers are located just before the output connectors for the sync output and the main output (Fig. 6). As the output amplitude and offset are varied, the trigger level is readjusted to remain at the nominal 50% point of the output signal. By moving the output signal until it coincides with the sync output (or with a signal delayed a known number of clock periods from the sync output), the fixed delays in the circuit can be measured, stored, and used in subsequent computations. A similar technique is used to calibrate the width and the period for the internal trigger mode.

The same calibration circuitry is also used to calibrate the step size in the two analog interpolators. With the analog delay set to its minimum value, the output is adjusted for coincidence with an internal reference. The digital delay chain is then shortened by one clock period, and the analog delay adjusted to bring the signals back into coincidence. The value set into the analog delay at this point is known to represent one clock period of the oscillator, and from this the step size of the analog delay can be calculated (assuming linearity in the delay).

An additional benefit of this automatic calibration is the ability to sample the signals from the 5359A with external trigger amplifiers, thus correcting for delays external to the timing generator from, say, cables or amplifiers or waveshape-generating devices. The HP 5363 time-interval probes can be placed on the sync output and main output signals at the point of actual interest, and the outputs from these probes connected to the calibration circuits in the time synthesizer in place of

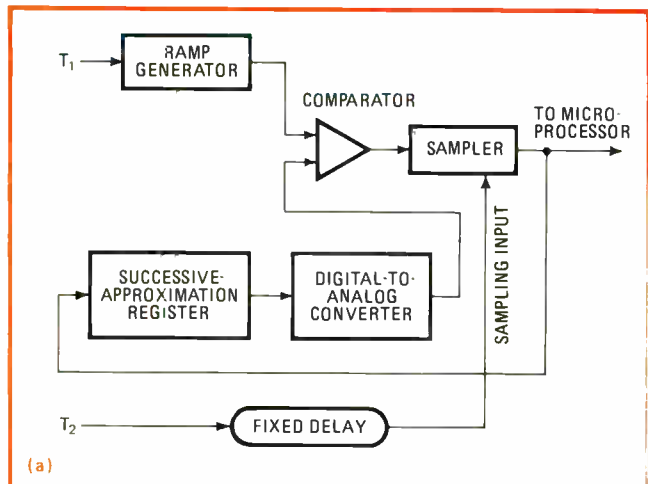

(a)

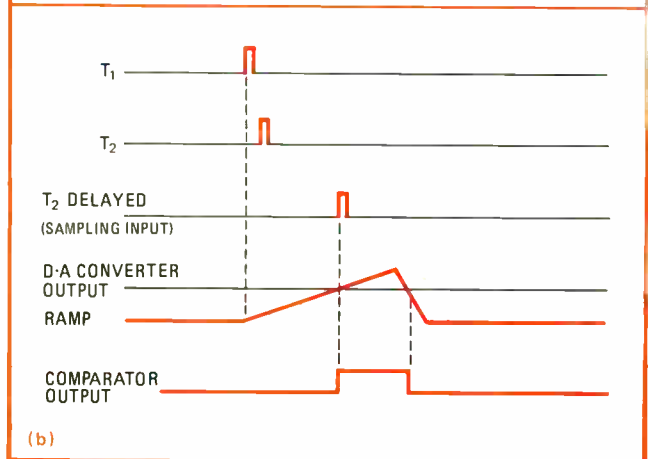

(b)

**7. Calibration.** Two trigger inputs generate a pulse whose width is set by the interval during which the ramp exceeds the d-a converter's output. Circuit also detects which of two triggers occurred first, since microprocessor can interpret comparator's output.

the trigger signals. The synthesizer provides control outputs to the probes to vary the trigger conditions as necessary to calibrate both delay and width.

In the vernier chronotron, the time between a trigger pulse and the next available clock pulse is measured in much the same way as the fraction of a graduation is indicated in a pair of vernier calipers. (This method has been used for many years by physicists in nuclear measurements and is, in fact, the principle used in the Eldorado 796 time-interval counter.) A trigger pulse starts an oscillator of period  $T_0[1 + (1/N)]$ , which beats against the clock period  $T_0$ , as shown in Fig. 8. Coincidence between vernier and clock is detected, terminating the vernier count,  $N_1$ . The time difference between trigger and the next clock is given by  $(T_0 N_1)/N$ .

### Hidden problems

The vernier method, neat as it appears, has many hidden practical problems. For one thing, the scheme is extremely sensitive to the frequency stability of the vernier train (the main clock is the time base and is assumed to be stable). An interpolation factor of  $N$  requires stability of the order of  $1/N^2$  under all conditions, long-term and short-term. Another difficulty is that subnanosecond coincidence resolution requires

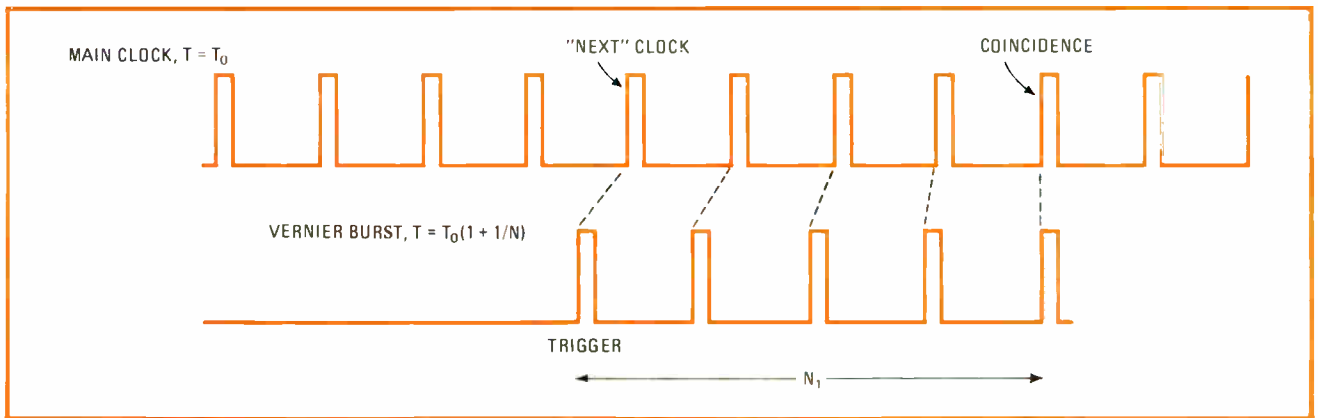

**8. Vernier interpolation.** The time interval between the input trigger pulse and the “next” clock can be determined by counting the number of pulses between the trigger and the point of next coincidence (in this case, four). Unknown interval is proportional to this number.

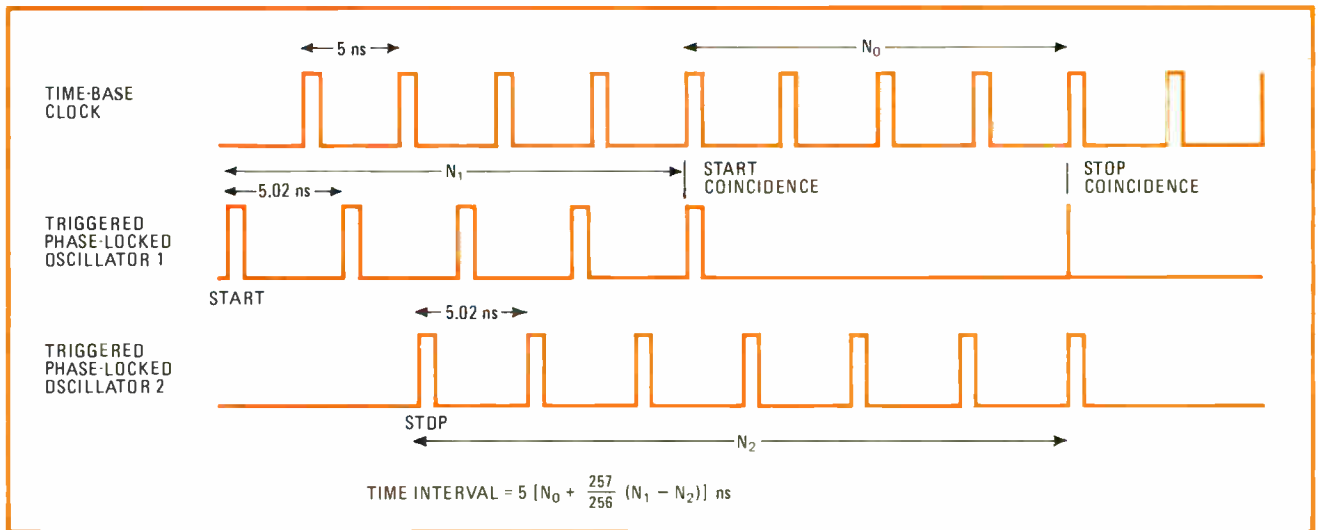

**9. Dual verniers.** In the 5370A time-interval counter, two triggered phase-locked oscillators are used, one triggered by the start pulse, the other by the stop pulse. A microprocessor computes the time interval after the vernier bursts have been counted.

subnanosecond detection. Also, the circuit must be able to identify the “next” clock pulse without  $\pm 1$  count ambiguity. Finally, both start and stop pulses must be accounted for, and both may appear randomly with respect to the main clock and to each other (stop may come before, during, or after the start).

The use of the triggered phase-locked oscillator solves the first two problems. Phase-locking eliminates all long-term drifts, the major difficulty, and a constantly running oscillator has no post-trigger frequency settling compared with one starting from rest, thus minimizing short-term instability. Note that the period of oscillation is precisely that required by the vernier scheme, i.e.,  $T_0[1 + (1/N)]$ . From the mixer, coincidence detection is automatically given by the phase crossover between reference and trigger oscillator. As shown in Fig. 4, the vernier burst and the coincidence signal are readily available.

Identifying the “next” clock pulse explicitly and gating it out may require some tricky decision making, since the trigger may be very close to the clock. However, it is extremely easy to identify it implicitly. Note that there is a one-to-one correspondence between each vernier clock and each main clock pulse up to

coincidence (dotted line on Fig. 8). Therefore, the “next” clock pulse must have occurred at a time before coincidence that is equal to  $T_0$  multiplied by  $N_1$ , the number of pulses in the vernier burst, in contrast to the trigger, which occurred  $N_1 T_0 [1 + (1/N)]$  seconds before coincidence.

Main clock counting may now begin at coincidence. The resulting count, when increased by  $N_1$ , is indistinguishable from starting counting at the “next” clock. Starting and stopping counts only at coincidences provide synchronous gating for both oscillators, main and vernier. There is no  $\pm 1$  count ambiguity in synchronous gating.

This synchronous gating idea is extended to account for both start and stop pulses in the dual vernier method of interpolation used by the 5370A universal time-interval counter for time-interval measurements. Both start and stop pulses are treated the same way. Systematic errors in the two interpolators are self-canceling, and there is no restriction that start must precede stop.

Figure 9 shows the timing waveforms of the dual vernier scheme. Start and stop pulses each start their own individual triggered phase-locked oscillator. The



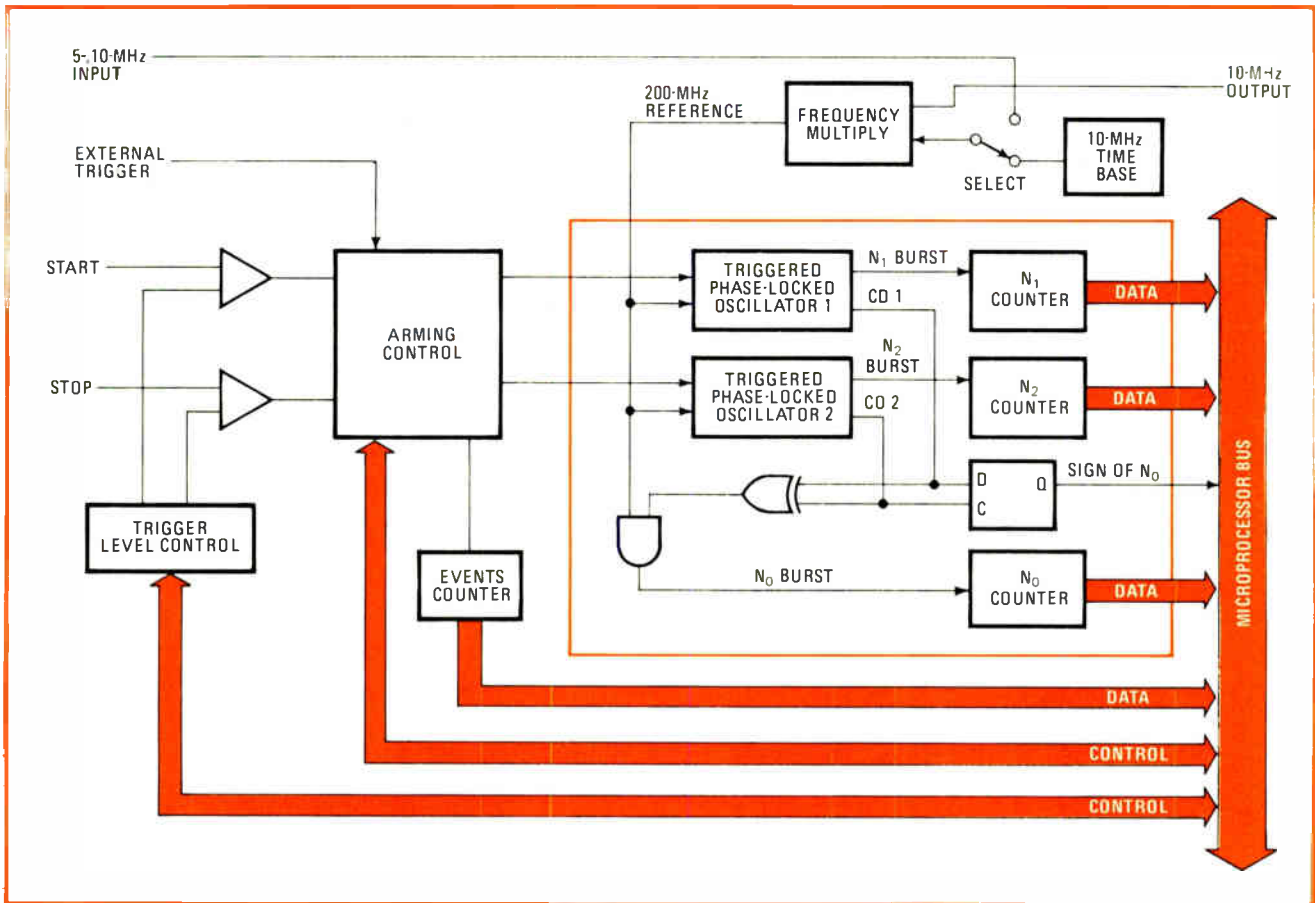

**10. Measurements section.** The 5370A counter has the two triggered phase-locked oscillators feeding their respective vernier-burst counters. Outputs go to the bus of the microprocessor, which then performs computations to determine unknown time interval.

period is the same for both,  $T_o[1+(1/N)]$ , where  $T_o$  is the main clock period. Coincidence between the start vernier and the main clock is detected (the point labeled "start coincidence"). This terminates the number of start vernier counts at  $N_1$ .

In exactly the same manner, the stop coincidence terminates the stop vernier count at  $N_2$ . The two coincidences are also used to gate the main clock, producing a main clock burst,  $N_o$ . The sign of  $N_o$  is positive if start coincidence precedes stop coincidence and negative if vice versa. (Sign is immaterial if they are simultaneous, since  $N_o=0$ ). All gating is synchronous and no  $\pm 1$  count ambiguity exists. The time interval is then computed by the microprocessor from:

$$\text{time interval} = T_o[N_o + \frac{N+1}{N}(N_1 - N_2)]$$

### The 5370A universal time-interval counter

Dual vernier interpolation and triggered phase-locked oscillators are combined with a microprocessor in the 5370A counter to provide a powerful time-interval measuring instrument (Fig. 10). In the instrument, statistical functions have been included to allow more complete characterization of time intervals. In addition to the mean, it is possible to display standard deviation, as well as to display maximum and minimum values within a sample.

In this unit,  $T_o$  is 5 ns, representing a 200-MHz clock, with interpolation factor  $N = 256$ , for a quantization resolution of approximately 20 ps. This figure compares with the quantization limit of 2 ns using the conventional technique of counting cycles of an internal 500-MHz clock. Taking into account system noise and other factors, the typical measurement jitter is 35 ps root mean square.

The instrument is capable of measuring positive or negative time intervals, where a positive time interval is one in which the start pulse occurs first and a negative time interval is one in which the stop occurs first. Also, a unique arming circuit prevents the measurement from fluctuating randomly between readings differing by one period. In addition to time-interval measurements, it is possible to measure frequency and period with high precision, either by using internally generated gates from one period to 1 second or by using external gating.

The number of events occurring within the gate can be monitored, giving both event and time information. Microprocessor-controlled light-emitting-diode push-button switches display the current status of the machine even when under program control via the interface bus. The microprocessor also measures the voltages of the trigger levels and displays them digitally. The statistical capabilities of the 5370A allow the instrument to self-characterize its jitter and offset. The offset may then be calibrated out by the set reference feature. □

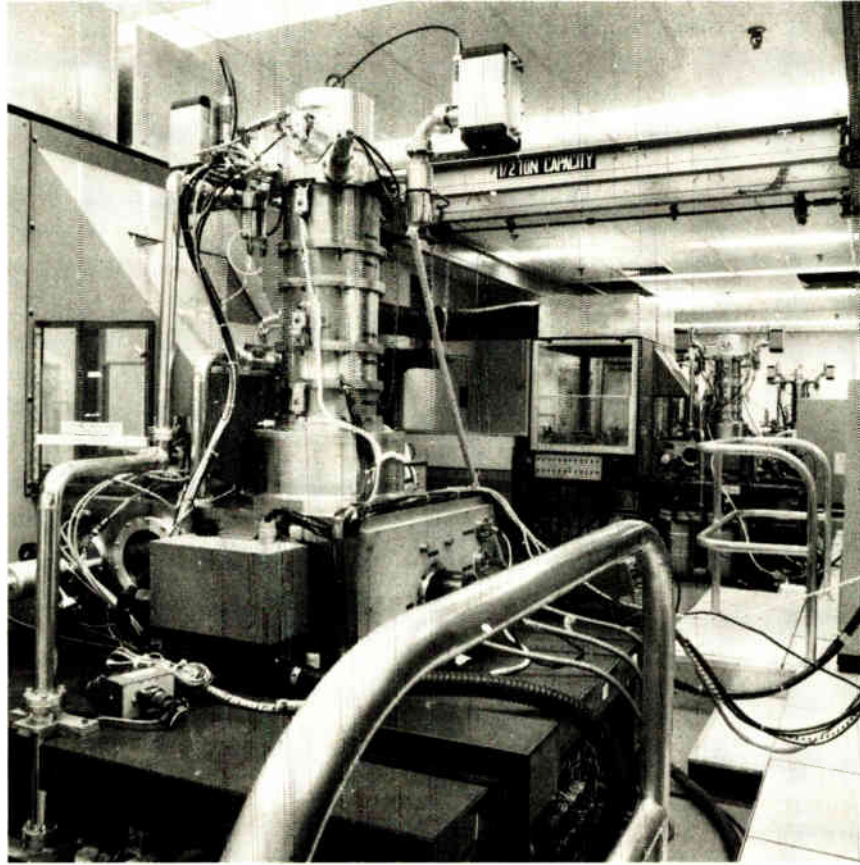

**1. Electron-beam line.** Electron-beam lithography systems of the EL-1 type on this semiconductor production line at IBM's East Fishkill, N. Y. facility have a throughput of 22 silicon wafer exposures per hour for 57-millimeter wafers with 2.5-micrometer lines and spaces.

## Scanning electron-beam system turns out IC wafers fast

by E. V. Weber and H. S. Yourke, *IBM Corp., Hopewell Junction, N. Y.*

□ Sometimes the answer to achieving the ever smaller geometries needed in semiconductor pattern-making is 'think big.' So it is with the first scanning-electron-beam system that achieves the throughput necessary for commercial chip production. The EL-1 (Fig. 1) scans the wafer with a square beam that covers much more of the surface than the round beam of other scanning systems. Thus more of a pattern can be exposed in an equivalent time, and wafer throughput rises dramatically. This one-of-a-kind machine points the way to commercial wafer production by electron-beam lithography.

The principal advantage of electron-beam lithography over optical lithography systems is that it avoids the limitations of resolution and depth of focus imposed by the wavelength of light. Scanning systems, which rely on computer control rather than masks to form the pattern, also have a high degree of pattern flexibility. For example, etching different patterns on adjacent areas of a wafer is accomplished easily and quickly. Moreover, eliminating the mask used in contact and projection

optical lithography systems saves time and reduces errors and defects.

Scanning systems also make it possible to control microscopic pattern distortions in real time. Finally, they excel in overlaying new patterns on previously etched levels of a chip. An example of a high-quality pattern of 2.5-micrometer dimensions that was produced by a scanning system is shown in Fig. 2. [For a full introduction to electron-beam technology, refer to *Electronics*, May 12, p. 89.]

### Raising throughput

The principal obstacle to full deployment of scanning systems in integrated-circuit production has been the difficulty of achieving the necessary throughput for cost-effective use. The throughput for the two commercially available scanning machines is only about one exposure an hour. Of course, these machines are primarily intended for mask making, but their production rate gives an idea of the distance that is to be traveled to meet

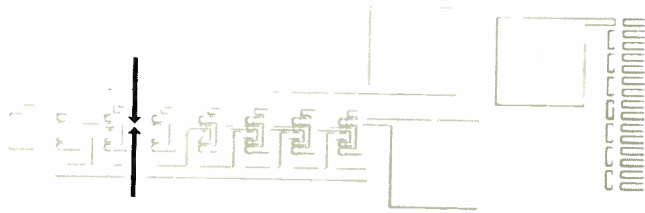

**2. Small patterns.** High-quality integrated-circuit chip was exposed by the electron-beam scan of the EL-1. Minimum conductor widths, such as in the line segment shown between arrows, are  $2.5\ \mu\text{m}$ . With minor modifications, this machine will be able to expose  $1\text{-}\mu\text{m}$  lines.

IC makers' standards of 20 to 30 exposures an hour.

The alternative electron-beam solution to the throughput problem is a projection system. Masks are used in such systems to expose all image points on a wafer at one time. While projection-system development is still under way, the problems of mask fabrication and handling have slowed progress toward a practical machine.

The EL-1 may be seen as a compromise: it uses the principle of the bigger exposure area found in projection machines together with the maskless flexibility of scanning units. In most other scanning systems, the beam is pencil-shaped, which gives a limited, round coverage of the wafer area. The square beam of the EL-1 produces an image as big as the smallest pattern element to be constructed—much bigger than other scanning systems' beams. The result is a throughput of 22 wafer exposures an hour, based on 57-millimeter ( $2\frac{1}{4}$ -inch) wafers with 2.5-micrometer geometry.

### Putting it to work

First use of the EL-1, at IBM's East Fishkill facility in Hopewell Junction, N. Y., has been for the production of bipolar large-scale integrated circuits. The unit's ease of data transfer, quick turnaround, and ability to balance inventory by mixing different patterns on a wafer make electron-beam exposure economically attractive even for IC patterns with line widths thick enough to be exposed with light optics.

Rapid pattern exposure is achieved by scanning a small, square wafer area, called a field, with a square projected image, called the spot. The sides of the spot are as long as the smallest dimension of the pattern that is being exposed. At a given current density, a  $2.5\text{-}\mu\text{m}$  square spot is equivalent to a 5-by-5 array of  $0.5\text{-}\mu\text{m}$  round spots, but it requires only  $1/25$ th the exposure time (Fig. 3).

The square spot scans the field in a stepped fashion, moving from one grid on the field to the next by magnetic and electric deflection. When the scan of the field is complete, the stepping table that holds the wafer moves it so that the adjacent unexposed field is within the deflection range of the beam.

The field-scan procedure (top of Fig. 4) produces an exposure with an edge gradient equal to the beam's edge slope (defined as the distance from the edge of the spot

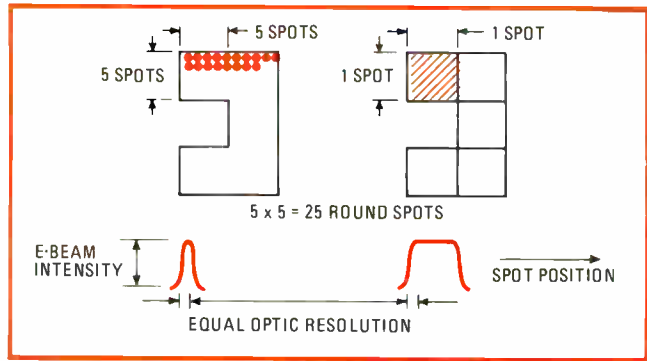

**3. On the spot.** Other electron-beam lithography systems scan the image of IC patterns with a small circular spot. In the EL-1, a square spot equivalent to many circular spots is scanned across the silicon surface of a wafer. This procedure drastically cuts exposure time.

that the beam's intensity takes to rise from 10% to 90% of its full value). In practical implementations, the square-beam approach provides better than an order-of-magnitude advantage in writing speed over other scanning systems.

Because limiting a pattern to a design made on a grid equal to the minimum line width of that pattern would be unduly restrictive, an offset capability is included in the EL-1. Spots may be displaced from their nominal location in increments of  $1/5$  of a spot (bottom of Fig. 4).

The electron-optical column that focuses and shapes the beam is designed to provide the maximum beam current and field size at the required edge slope. For instance, placing the deflection coil within the projection lens minimizes chromatic and electron-electron-interaction effects that result from the large currents used. Dynamic correction of focus and astigmatism keeps edge slope to less than  $1/10,000$  the length of the field.

To obtain a workable lithographic tool, many engineering tradeoffs were necessary among such key performance parameters as throughput, edge slope, field size, current density, and overlay. Moreover, the applications in which these machines are used may influence these parameters. For example, field size when exposing chips smaller than 5 mm on a side is best adjusted to equal the chip size. On the other hand, larger chips are easily fabricated by the use of interstitial registration marks that make it possible to stitch adjacent fields together with optimum overlay and throughput.

A set of performance specifications for the EL-1's initial application at East Fishkill is listed in the table. As product requirements demand, the system may be adjusted to make exposures with dimensions that are in the  $1\text{-}\mu\text{m}$  range.

### On the spot

The square spot as big as the smallest pattern dimension is the chief design feature giving the system its rapid exposure rate. But to achieve this high throughput and to get good overlay (layer-to-layer registration) and large exposure field sizes, other features play an important role. Among them:

- Advanced electron optics to obtain high beam current for quick large-field exposures with high resolution.
- A combination of narrow- and wide-bandwidth deflec-

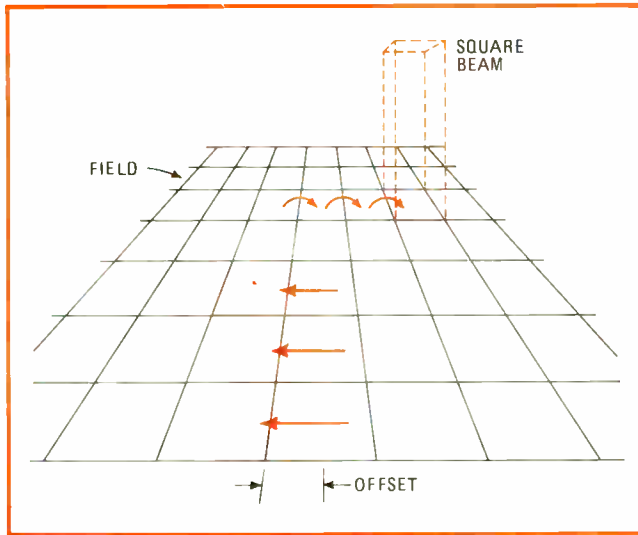

**4. Checkerboard scan.** For exposure purposes, a field is divided into a matrix of small squares. The shaped electron beam is stepped to each square in the matrix. It can be offset to expose lines centered on a grid of finer resolution than spot size.

tion of the beam for a good signal-to-noise ratio.

- A deflection cycle that repeats itself exactly, thereby ensuring that any errors are reproduced exactly—which aids error correction.
- Automatic measurement of deflection errors and compensation for them in order to attain maximum pattern accuracy.
- Four-mark registration with an associated deflection modification to give optimum overlay of patterns and to permit matching of boundaries on adjacent fields.
- A three-step highly automated sequence for wafer handling and alignment, which boosts throughput.
- Beam-deflection correction of errors in the position of the table that steps the wafer from field to field, thereby giving a high stepping speed and rapid settling.
- Use of servomechanisms to maintain beam current, spot focus, and column alignment over long periods.

### Combining deflections

Within a given exposure field, the electron beam is positioned chiefly by a large-range, narrow-bandwidth magnetic deflection. During writing, a bidirectional magnetic ramp (Fig. 5) deflects the beam in a bidirectional raster fashion. Superimposed on this ramp is a bucking sawtooth applied by a small-range, wide-bandwidth electrostatic deflection. This combination causes the beam to step. In addition, a small-range, moderate-bandwidth electrostatic deflection compensates for errors. Restricting these larger bandwidths to small ranges results in minimum deflection noise and minimum random pattern error.

The deflection cycle of the EL-1 is a three-part repetition. In standard operation, the cycle repeats even while a new wafer is being loaded. The object is a steady-state deflection, so that distortions due to eddy currents, thermal currents, etc., will repeat at all points.

During the registration part of the cycle (Fig. 6a), the computer scans the beam sequentially over the locations of four registration marks. During the writing part of the

TABLE: EL-1 EXPOSURE SYSTEM SPECIFICATIONS

Field size (maximum writing)	5 mm
Spot shape	square
Spot size (50% intensity)	2.5 $\mu\text{m}$
Edge slope (10 – 90%)	0.5 $\mu\text{m}$
Beam voltage	25 kV
Beam current (at 50 A/cm <sup>2</sup> )	3 $\mu\text{A}$
Overlay (3 $\sigma$ )*	0.5 $\mu\text{m}$
Throughput for 57-mm wafer (76 chips)	22 wafer exposures per hour
Writing grid	2.5 $\mu\text{m}$
Writing grid offset capability	0.5 $\mu\text{m}$ increments

\*the 3 $\sigma$  error between the centerlines of two patterns on different layers designed to be coincident.

cycle (Fig. 6b), the beam scans sequentially over the entire field. Each possible location is addressed, with the computer blanking out the beam at points that do not require exposure. This approach ensures that pattern differences will not change the deflection history. In general, densities of LSI patterns are high enough so that, even though throughput is slightly less than for deflection that addresses only the points to be exposed, the decrease is negligible and is far outweighed by the increase in accuracy.

The move part of the cycle is the time that it takes the stepping table to move the wafer to the next exposure field. During the move, a special deflection (Fig. 6c) is always executed. Occasionally, it is used in conjunction with a focus fixture in the electron-optical column for automatic sensing and correction of focus.

### Righting deflection errors

Repetitive deflection of the square beam gives the system its ability to define line widths and positions precisely. But repetition is not enough; the spots must be accurately positioned in order to obtain compatibility with different electron-beam or optical tools.

Accurate deflection is obtained by scanning a calibration grid on a special target and then compensating for sensed errors. The grid (Fig. 7) is an array formed by square openings in a layer of gold on a silicon substrate.

To measure deflection error, the grid is positioned on the stepping table, and the beam scans it. As the beam moves from the gold, which has a relatively high backscatter coefficient, to the silicon, which has a relatively low backscatter coefficient, the current changes in backscatter detectors. The time of this change is recorded.

A special program selects the times associated with selected grid points, edits and averages them to obtain centers, and then compares the results with a table of expected centers to obtain the deflection error. The table is based on calibrated locations of the grid marks on the target being used; thus the grid does not have to be perfect.

The error figure goes into programs that generate piecewise-linear corrections to the deflection. Usually, the error-measurement program applies previous corrections when directing the beam over the grid, and the new corrections are applied to the earlier ones. This iterative

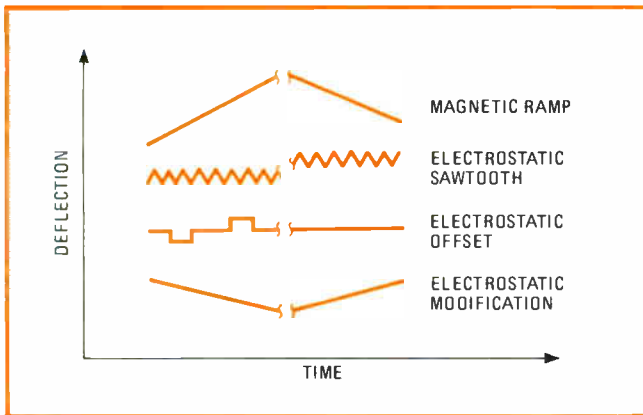

**5. Combined scan.** A combination of narrow-bandwidth magnetic deflection and wide-bandwidth electrostatic deflection precisely positions the electron beam. This combination scan reduces deflection error and noise to acceptable manufacturing levels.

procedure minimizes the accuracy required of the correction electronics, since it does not permit errors to accumulate. Typical errors before and after correction are illustrated in Fig. 8.

It also is necessary to coordinate the registration scan, when the beam checks four registration marks on the wafer, with the subsequent write scan. The calibration target comes into play here, too. After the correction process just described, which is a writing-scan correction, the program calculates the expected positions of several grid points designated as test registration marks—basing these calculations on a write scan of the grid. Then the electron beam operates in the registration-scan mode to locate these registration marks, and the difference between the observed and the calculated positions is sensed. This error information is stored and used during registration to adjust the sensed positions of the wafer registration marks so that they correspond with the writing scan.

These measurements and corrections of deflection errors bring the field being scanned on the wafer to within 30 parts per million of ideal. However, ideal deflection may not achieve optimum overlay of successive patterns required for the manufacture of semicon-

ductor devices. Some causes of deviations from the ideal are: imperfect mechanical positioning of the wafer on the table, wafer distortions caused by processing, and inaccuracies in previous patterns.

As in any photolithographic process, accurate registration is essential for optimum overlay of successive patterns on a chip and to properly mesh adjacent exposure fields on a chip. With the EL-1, registration goes a step beyond simple mechanical adjustment to registration marks, and the scanning beam is adjusted to them.

The system achieves optimum overlay by locating the registration marks in the four corners of the previous pattern and adjusting magnification, rotation, translation, and shape of the field to match it to the marks. Typically, the marks are features formed as a byproduct of earlier processing.

### Registration gives accuracy

The detection process is quite similar to the one used in deflection correction. It depends upon the fact that the energy distribution and quantity of back-scattered electrons are essentially constant when the beam scans a flat surface, but change when the beam crosses an edge formed by a change in material or by the topography of the wafer surface. Automatic gain-control circuitry compensates for wide signal variations between wafers of different types and between different processing levels on a given chip.

Each time the signal crosses a registration edge, special circuitry transmits the time to the control computer. To identify each of the marks, the computer edits the sequence of time samples and correlates it to a model. Then deflection modifications are generated to match the writing field to the registration marks.

The average error of magnification is used to obtain an approximation of height errors and to form a focus correction. Even though depth of focus is an order of magnitude greater than for light optics, this correction helps achieve accuracy.

The maximum size of the exposure field is limited, but chips can be made of more than one field—as large as a whole wafer, even—by stitching fields together. Marks

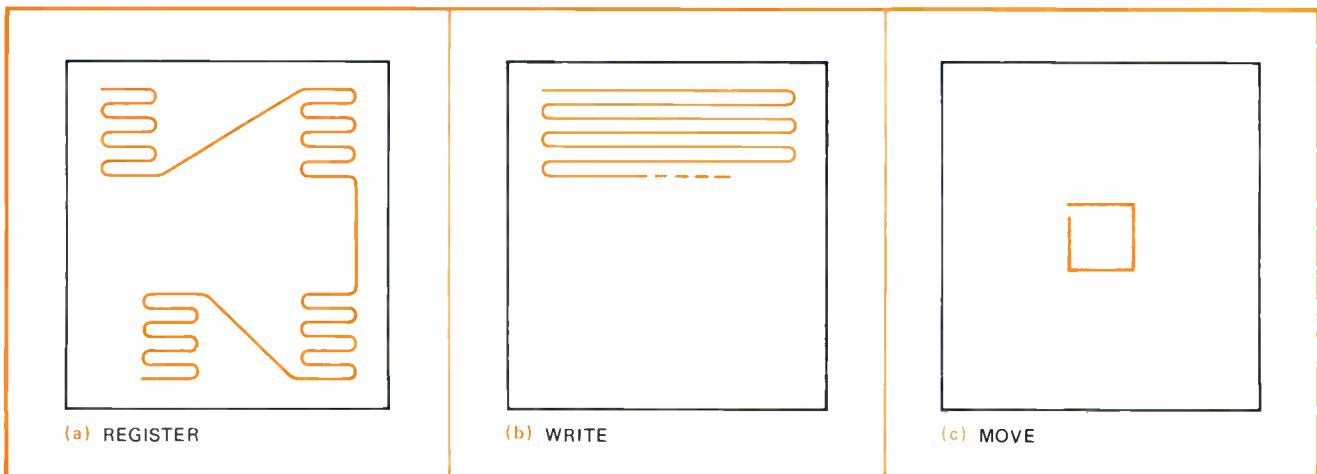

**6. Three-step.** A repeating three-part deflection cycle maintains distortion constant over all points in a field. First step (a) is a registration scan followed by a writing scan (b) over the entire field. Last is a move cycle (c) in which the beam steps to a new field.

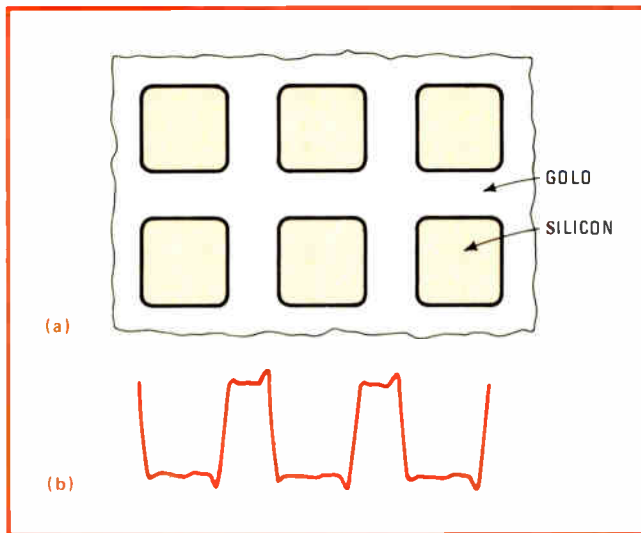

**7. Calibration.** A grid consisting of an array of square openings in a layer of gold on a silicon substrate (a) is the reference for the EL-1's circuitry for deflection error compensation. Signals (b) from the gold's high backscatter yield errors in grid position.

between adjacent fields are shared, thereby making their boundaries coalesce.

The system can write a new registration mark before an earlier one degrades to the point of unusability. Space is allocated for rewriting a mark three times, each at a new location. In some cases, rewriting can take place at a previously used location.

This four-mark registration is the final step in a three-part sequence designed to provide progressively finer adjustments of the wafer's alignment to the beam. First, as wafers enter the EL-1, a mechanical handler places them on carriers and subsequently positions them under the beam. The positioning locates the wafer relative to the beam to  $\pm 75 \mu\text{m}$ .

The second step is a registration process involving the entire wafer. It adjusts the magnification and rotation in

the individual field to provide an alignment of wafer and beam within  $2 \mu\text{m}$  to  $5 \mu\text{m}$  of each other. The necessary registration data is obtained by scanning two special marks on the wafer. Third, the four-mark registration procedure further positions and modifies the writing field to obtain an overlay of better than  $\pm 0.5 \mu\text{m}$ .

To provide rapid stepping of the table as it moves the wafer from one field to the next, a dc servo motor drive smoothly accelerates and decelerates to a stop without hunting for a precise position. Design emphasis was on rapid settling of the table to within  $\pm 7.5 \mu\text{m}$  of the desired position. Then a beam deflection in response to a position encoder achieves beam-to-table accuracy better than  $2.5 \mu\text{m}$ . This two-prong approach makes it possible for the table to move 5 mm to another field and settle within 250 milliseconds.

### Load and unload

Another design feature that speeds the production rate is a vacuum interlock combining the wafer transport with the valving mechanism that removes the air. The volume of air that must be removed is small enough so that the system can be rapidly pumped to an intermediate volume, then opened to the large main chamber, which is at vacuum, giving a transition from atmosphere to  $10^{-6}$  torr in 4 s. This combination of transfer and interlock makes it possible to exchange a wafer on the stepping table with the next wafer that is at atmosphere in about 15 s.

Another feature that insures maintenance of high throughput is a set of servomechanisms that monitor and adjust alignment of the electron-optical column and parameters of the electron-beam gun during the period in which the table is stepping the wafer from one field to the next. These servomechanisms insure satisfactory exposure quality over long periods of time. Periodically, the edge definition of the beam is monitored by the scanning of a focus target.

The various components of EL-1 go together as indi-

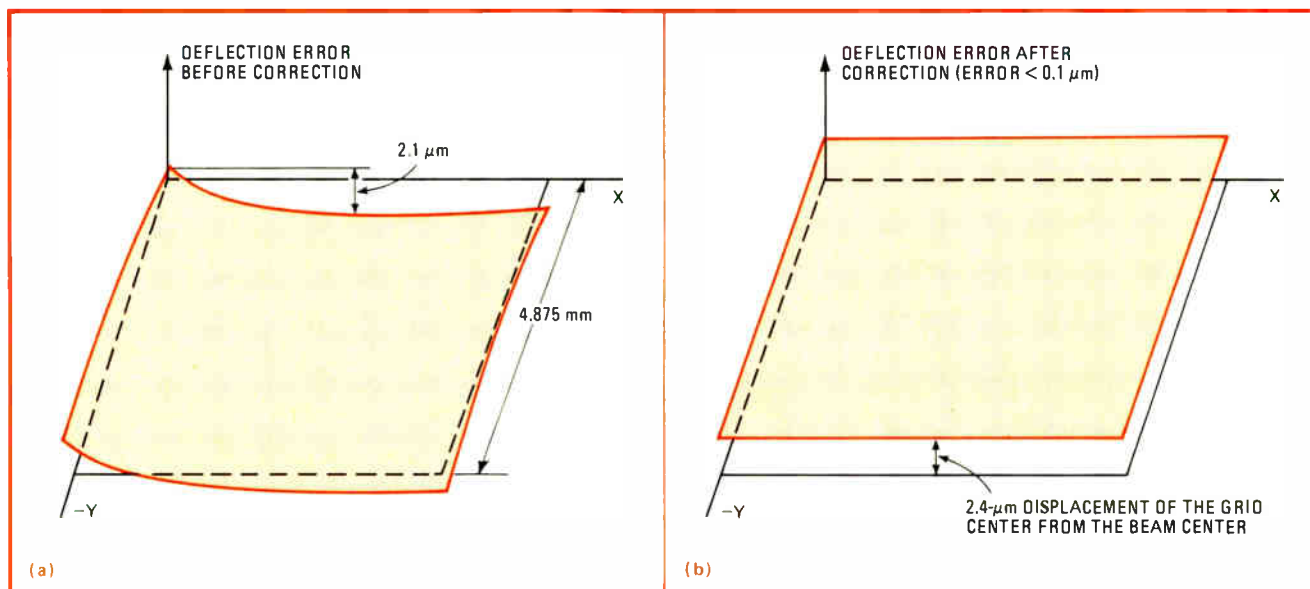

**8. Deflection correction.** Typical three-dimensional plots of X deflection error before and after correction (a and b, respectively) show how a scanning system can electronically correct itself. In this case, a  $2.1\text{-}\mu\text{m}$  error is reduced to less than  $0.1 \mu\text{m}$ .

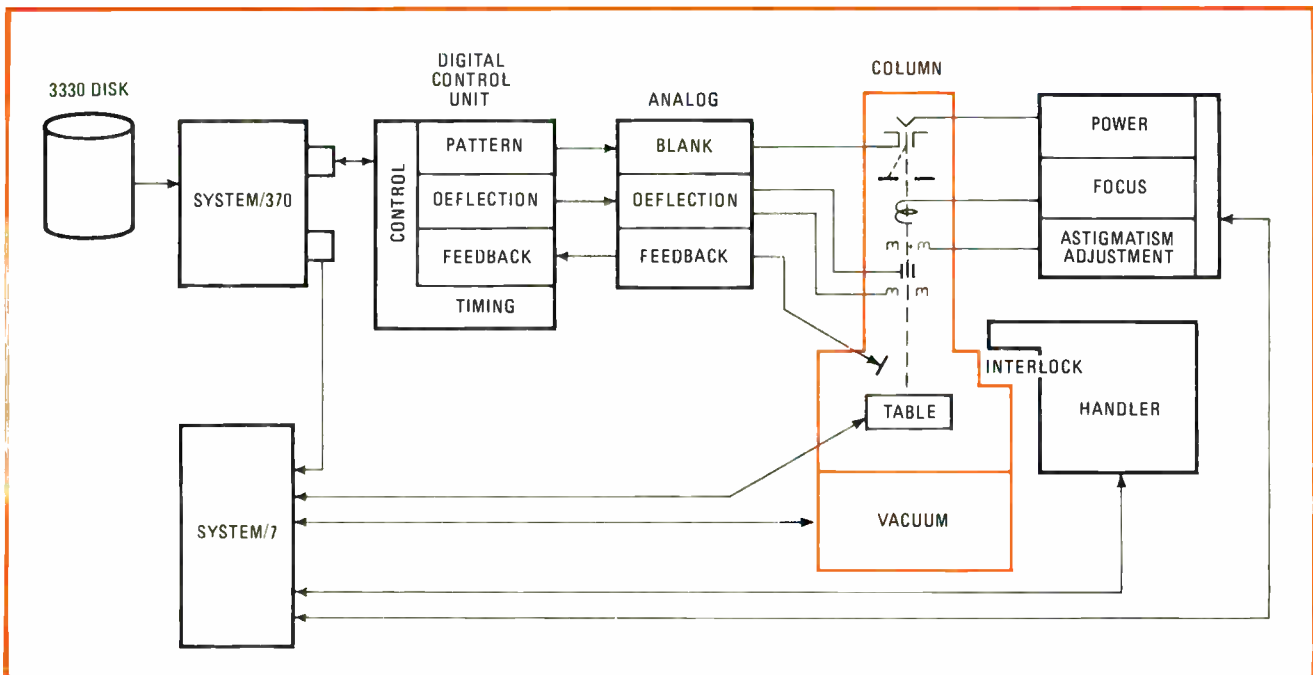

**9. Automated electron-beam.** The major components of the EL-1 are a vacuum beam-producing column with an automatic wafer handler, a digital control unit, analog correction circuitry, and an IBM System/370 plus magnetic-disk memory as the central controller.

cated in Fig. 9. A System/370 computer is the central control element. The principal information store is a 3330 disk storage, containing such key data as pattern descriptions, wafer maps describing pattern types and locations on the wafer, descriptions of deflection patterns to define field size, and the locations of registration marks.

As part of system preparation, a deflection path suitable for writing a pattern, is transferred from disk to the deflection memory in the digital control unit. Under control of the system clock in this unit's timing section, the deflection data causes a sequence of digital control signals to be transmitted to the deflection circuitry in the analog unit.

### Beam drive

This circuitry in turn produces the appropriate drive for the beam to follow the paths of Fig. 6. Once the deflection has stabilized, the System/370 control program causes the table to move the calibration target under the beam, transmits a pattern to the pattern section of the digital control unit, and activates the feedback sensors. When the beam is in the vicinity of the selected grid marks, the pattern section unblanks it. Back-scatter signals are processed by hardware and software to form the set of deflection corrections, which are placed in the correction memory of the digital control unit.

When the deflection has been corrected, the system is ready to write on the wafers. The operator tells the control program for the System/370 which wafer map to use. The control program initiates the transfer of the first wafer to the stepping table via a System/7 computer, which interfaces and monitors the subsystems. The wafer registration mark specified in the wafer map is then moved under the beam.

After the three-step registration cycle is completed at the first field, the pattern defined by the wafer map is called out, the field is corrected on the basis of the registration information, and the pattern is written.

The wafer moves to the next field site, and the sequence of four-mark registration, write, and move repeats for each of the fields on the rest of the wafer. Patterns could differ at each exposure, depending on what is specified in the wafer map. When the last exposure is completed, the table may move to the focus target or the calibration target to collect data and determine whether focus or deflection has drifted enough to call for an update. Such updates to corrections are required only infrequently.

If the following batch of wafers requires a different field size, an appropriate deflection and the corrections previously acquired for that deflection are loaded. The corrections are checked, but the previous corrections usually are adequate, so writing proceeds without correction convergence. Numerous different deflection cycles are available to optimize field size and accommodate different registration marks.

### Small dimensions

For the past three years, the EL-1 has been successfully exposing bipolar patterns on silicon wafers. High-quality images with minimum dimensions of  $2.5 \mu\text{m}$  and layer-to-layer registration of well under  $0.5 \mu\text{m}$  are being routinely achieved in the large-scale production of bipolar wafers.

In the future, this capability could easily be extended to pattern geometry with  $1\text{-}\mu\text{m}$  detail. Addition of higher-speed data-conversion circuitry to raise throughput to even higher levels and a redesigned wafer staging area for handling larger wafers are other possible system improvements. □

## Feedback extends sequence of random-number generator

by J. T. Harvey

AWA Research Laboratory, New South Wales, Australia

Altering the periodicity of its sequence from  $2^{n-1}$  to  $2^n$  makes a pseudorandom number generator more useful in such applications as frame synchronization, numbering, or identification in a digital communications system. The modification has little effect on the pseudorandomness of the number sequence, and it can be implemented with just a simple shift register and a slightly changed feedback loop.

The usual pseudorandom, or maximal-sequence, generator is shown in (a). It combines a simple feedback circuit with a shift register having a serial output that (in the binary case) is a modulo 2 sum of the  $n$ th stage output and one or more of the previous stage outputs. No matter what feedback taps are chosen, however, the output sequence will have a periodicity of  $2^{n-1}$ , because an  $n$ -bit register cannot cycle through the zero state (where the state is defined by its binary contents).

Obviously as the table in (a) indicates, it is impossible for all the stages simultaneously to contain a 0, because once in this state no new state can be generated with the simple logic used.

Most of the practical sequence generators therefore employ automatic detection of the 0 state on power up, in order to generate a logic 1 state at the output of one register, using a NOR gate as shown. After initialization, though, the random generator will cycle with a period of  $2^{n-1}$ , because the 0 state never recurs. However, as shown in (b), the number of states cycled through can be increased to  $2^n$  if the last input to the NOR gate is connected to the  $Q_{n-1}$  stage, instead of the output of the  $Q_n$  stage, and if the output of the NOR is connected to a summing port, instead of the set input being connected at the last flip-flop. The resulting  $m$ -sequence will now contain an equal number of 1s and 0s.

The logic needed to implement the summing port is small. In most cases, it need consist of a half-adder or a few resistors only. Note from the table in (b) that the all-zero state is detected and used to generate a logic 1.

The same basic circuit can be used in the feed-forward mode to detect a sequence of  $n$  bits, too, as (c) proves. This method for checking the presence of a given sequence is of value when the error probability is low. During high-error bursts, however, the circuit's effi-

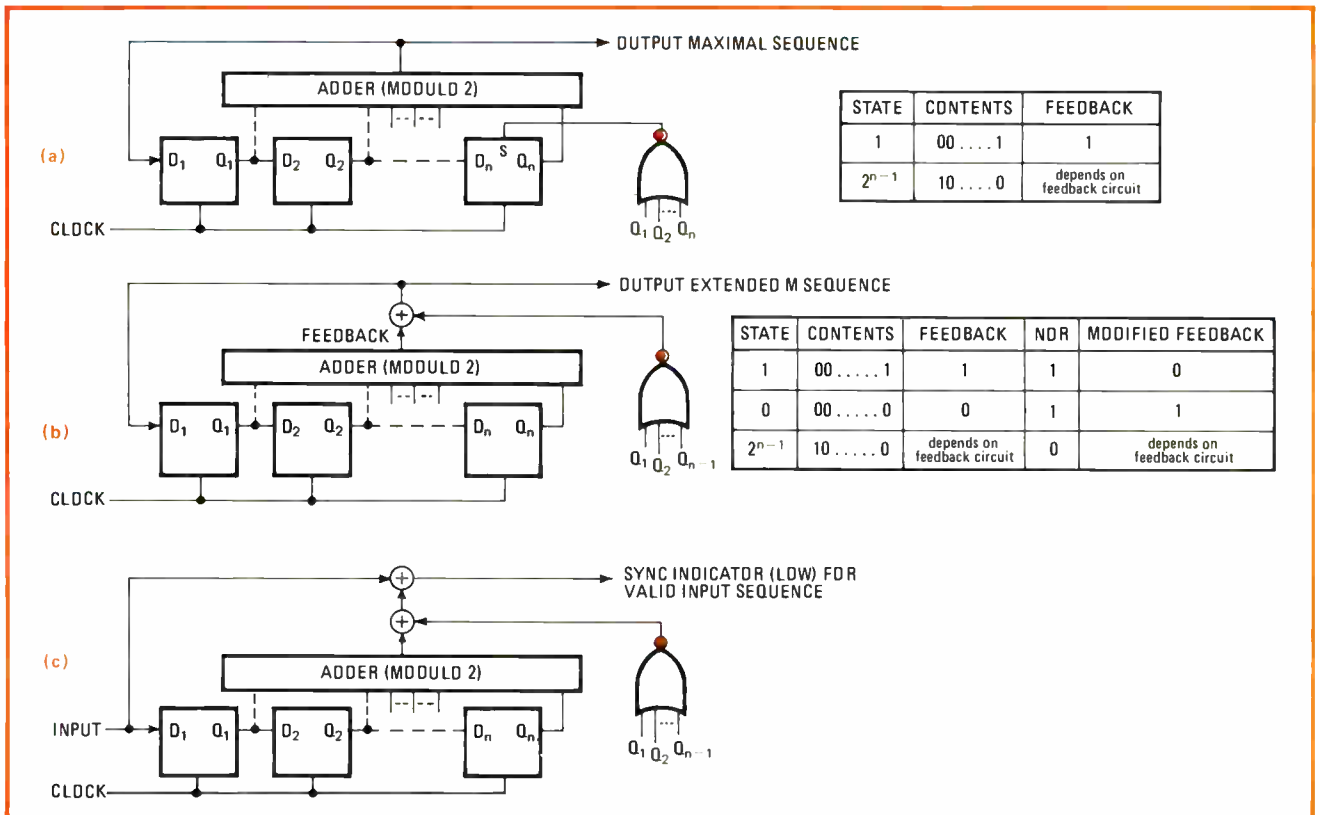

**Balanced states.** The usual  $n$ -stage, pseudo-random number generator cannot generate an equal number of 1s and 0s because it cannot cycle through the register's all-zero state (a). Modified circuit cycles through all  $2^n$  states (instead of the usual  $2^{n-1}$  states) and detects 0s (b). Circuit can be used in feed-forward mode to detect repeating sequences (c).



ciency is reduced because isolated, incorrect bits generate  $m+1$  parity errors when there are  $m$  taps driving a half (modulo 1) adder.

Note that the sequence-recognizer circuit in (c) does not require additional logic to prohibit the acceptance of the (false) all-zero data state. A standard sequence

checker will give a valid output when it is fed continually by 0s, because it would predict the next input to be a 0, once the register is filled. Thus, an additional  $n$ -input NOR gate and an exclusive-OR gate must be added to a standard feed-forward checker to reject an all-zero sequence within the data stream. □

## Optocoupler transmits pulse width accurately

by Tadeuz Goszczyński  
Industrial Institute of Automation and Measurements, Warsaw, Poland

Though optocouplers work fine in most pulse applications, shortcomings in their switching and temperature characteristics make them poor at such tasks as transmitting pulse-width modulated signals accurately. Adding an operational amplifier to the optocoupler circuit will improve its response time and reduce the effects of temperature on output voltage, enabling it to transmit a pulse width as small as 2 microseconds with an error of only 200 nanoseconds. If a second optocoupler is added to the circuit, temperature problems will be virtually eliminated.

An optocoupler is limited in its ability to transmit pulse width accurately because of two major factors: the response speed of the device is reduced by feedback currents that flow from the output port of the phototransistor to its base, and the current-transfer ratio is highly dependent on temperature. In either the emitter-follower or common-emitter configuration, an output voltage change produces the feedback current and an equal change across the collector-to-base capacitance. A certain time is required for the capacitor to charge to the voltage; this limits the response time and can cause errors in pulse-width transmission.

In addition, the switching times as well as the amplitude of the output pulse generated by this current source vary with temperature. All errors may be greatly reduced if the output voltage of the phototransistor is clamped to a near-zero level for any level of output current, in effect making its load resistance zero so that no feedback current is generated.

Tying a current-limiting resistor and an op amp to the output port of an MCT-26 optocoupler does the job, as shown in Fig. 1a. Two separate bidirectional feedback loops, comprising a diode in series with a 5.6-volt zener diode, are connected across the op amp. The 3.3-kilohm resistors supply sufficient bias to the zeners.

The op amp works as a zero-cross detector having essentially open-loop gain. Any signals emanating from the MCT-26 will be introduced to the LM301A op amp, causing it to saturate and switching on one of the two zeners in the feedback loop (depending on the signal polarity). The input voltage is thus forced to zero.

The switching speed of the optocoupler is high, being determined mainly by the op amp's slew rate of approxi-

mately 10 volts per microsecond. The circuit speed can thus be raised above the rated bandwidth of the optocoupler, assuming the MCT-26 equivalent load resistance is only a few ohms.

A small temperature error will still exist, because temperature variations will cause a current change in the MCT-26, and this will cause a change in the op amp's zero-crossing times. Replacing the 75-kilohm resistor with the phototransistor of another optocoupler, as shown in (b), will reduce the temperature error below

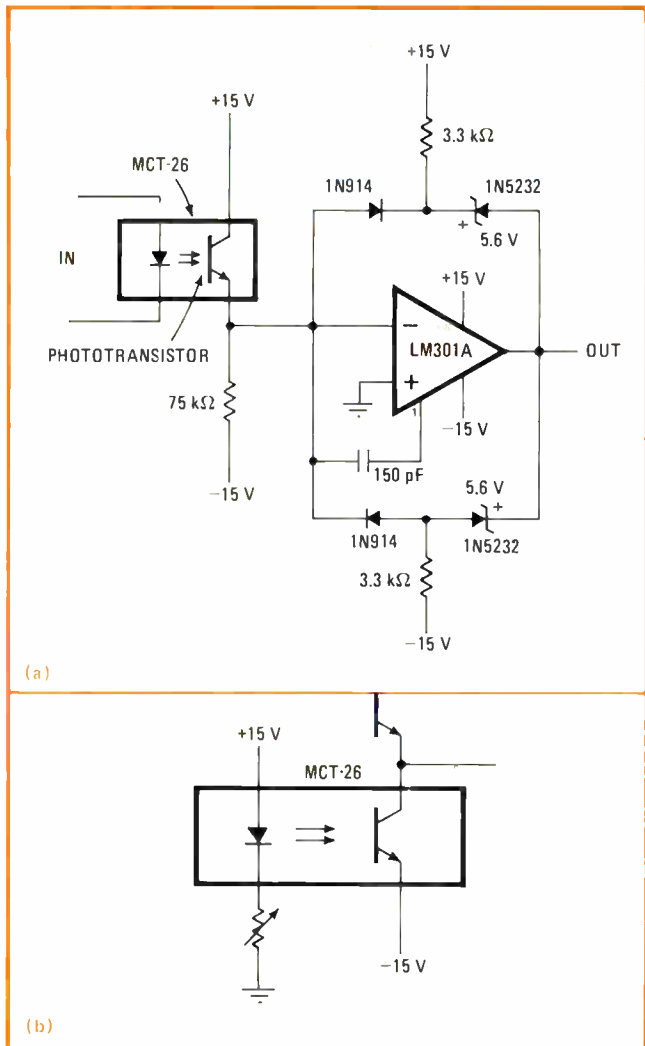

**Accurate transmission.** Phototransistor passes signals to output without pulse distortion. Two feedback loops with op amp work in zero-crossing detector (a) to reduce response time and prevent feedback currents that slow circuit speed, causing errors. Replacing a load resistor by second phototransistor (b) reduces temperature-generated errors by an order of magnitude.

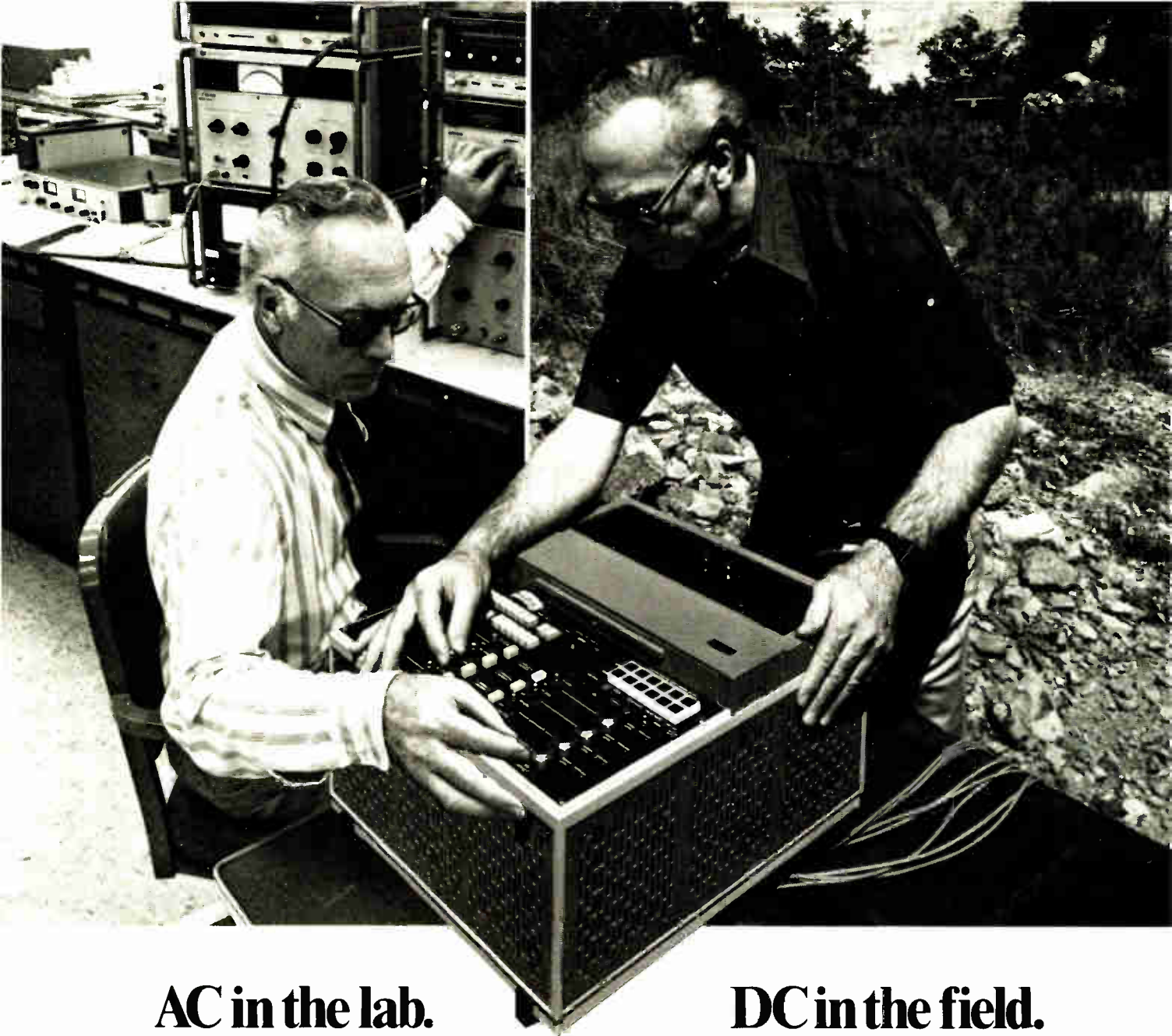

# AC in the lab. DC in the field. HP recorders do it with the flip of a switch.

Hewlett-Packard's instrumentation tape recorders have a simple switch that lets you change from AC to DC operation. That means the same high performance four channel or eight channel HP recorder used in the laboratory can also be used in a rugged field environment. Out there your HP recorder will operate from either a 12 or 28 volt DC power

source without an external inverter.

Recording is economical because you use inexpensive 1/4-inch tape. And these compact machines are designed to meet Hewlett-Packard's own tough environmental specifications.

Both machines have the same features including six tape speeds from 15/32 ips to 15 ips which give

you a 32:1 time base compression or expansion for flexibility and easy data analysis. Select direct recording from 50 Hz to 64 KHz with SNR up to 38 dB; FM recording from DC to 5 KHz with SNR up to 48 dB. Standard features include TTL remote control, a pushbutton built-in calibration source, tape/tach servo, flutter compensation and voice channel.

Start using one high performance recorder both in the lab and in the field. Make the switch to Hewlett-Packard. (3964A, four channels, priced from \$6300; \* 3868A, eight channels, priced from \$9200, \* OEM discounts available.)

\*Domestic USA price only.

**HEWLETT-PACKARD**, 16399 West Bernardo Drive, San Diego, CA 92127  
Please send me complete details on Hewlett-Packard  
Instrumentation Tape Recorders.

Name \_\_\_\_\_  
Company \_\_\_\_\_  
Address \_\_\_\_\_  
City \_\_\_\_\_  
State \_\_\_\_\_ Zip \_\_\_\_\_  
Application \_\_\_\_\_  
Telephone Number \_\_\_\_\_

**HEWLETT  PACKARD**

For assistance call: Washington (301) 948-6370 Chicago (312) 251-9800 Atlanta (404) 952-1500 Los Angeles (213) 877-1282

World Radio History

Circle 104 on reader service card

3 ns per °C. This ensures equal temperature-dependent voltage drops across both optocouplers, and with them connected as shown, the temperature-generated voltages will cancel. The op amp's temperature coefficient is

negligible in comparison and need not be considered. □

Designer's casebook is a regular feature in *Electronics*. We invite readers to submit original and unpublished circuit ideas and solutions to design problems. Explain briefly but thoroughly the circuit's operating principle and purpose. We'll pay \$50 for each item published.

## Timer IC circuit separates rep rate and duty cycle control

by Arturo Sancholuz  
Laboratorio Nacional de Hidraulica, Caracas, Venezuela

Combining both halves of a 556 dual timer with an operational amplifier in this simple circuit enables independent control of the output frequency and the duty cycle. The frequency is adjustable throughout the normal 10-hertz-to-10-kilohertz range of the 556, and the duty cycle is selectable from 1% to 99% of the total waveform period.

As shown in the figure, one half of the 556 ( $A_1$ ) is connected as an astable multivibrator, oscillating at a frequency given by  $f = 1.4 / (R_1 + R_2)C$ . This oscillator is the frequency-governing element in the circuit.

The negative-going edge of signal  $v_1$  periodically triggers timer  $A_2$ , which operates as a monostable multivibrator. An exponential ramp emanating from the threshold port of  $A_1$  drives  $A_2$  through the 531 op amp.

The duty cycle in this timer is determined not by

external resistance-capacitance elements, but by the voltage on the threshold port. The output of  $A_2$  will remain high if the threshold voltage stays below two thirds of the supply voltage,  $V_{cc}$ . This circuit can generate a dc offset voltage at the port to modify the threshold-switching time.

The voltage at the threshold port is determined by the two input voltages,  $v_2$  and  $v_3$ , at the summing junction. Thus:

$$v_4 = v_2 \left( \frac{R_5}{R_5 + R_6} \right) + v_3 \left( \frac{R_6}{R_5 + R_6} \right)$$

Voltage  $v_2$  is an exponential ramp resulting from charging C through resistances  $R_1$  and  $R_2$ . The boundaries of the signal, determined by the internal comparators of  $A_1$ , lie between  $1/3 V_{cc}$  and  $2/3 V_{cc}$ .

The 531 op amp is a buffer for the high-impedance  $A_2$  signal and prevents current from flowing into the timing port, which could charge C from  $V_{cc}$  through  $R_5$  and  $R_6$ . Dc voltage  $v_3$  can be varied from  $2/3 V_{cc}$  to  $V_{cc}$ . Thus it can be seen that  $R_3$  will determine how large a dc voltage is superimposed on  $v_2$ , thereby controlling the duty cycle. Since there are no feedback loops linking  $A_1$  and  $A_2$ , it is clear that frequency and duty cycle adjustments are independent. □

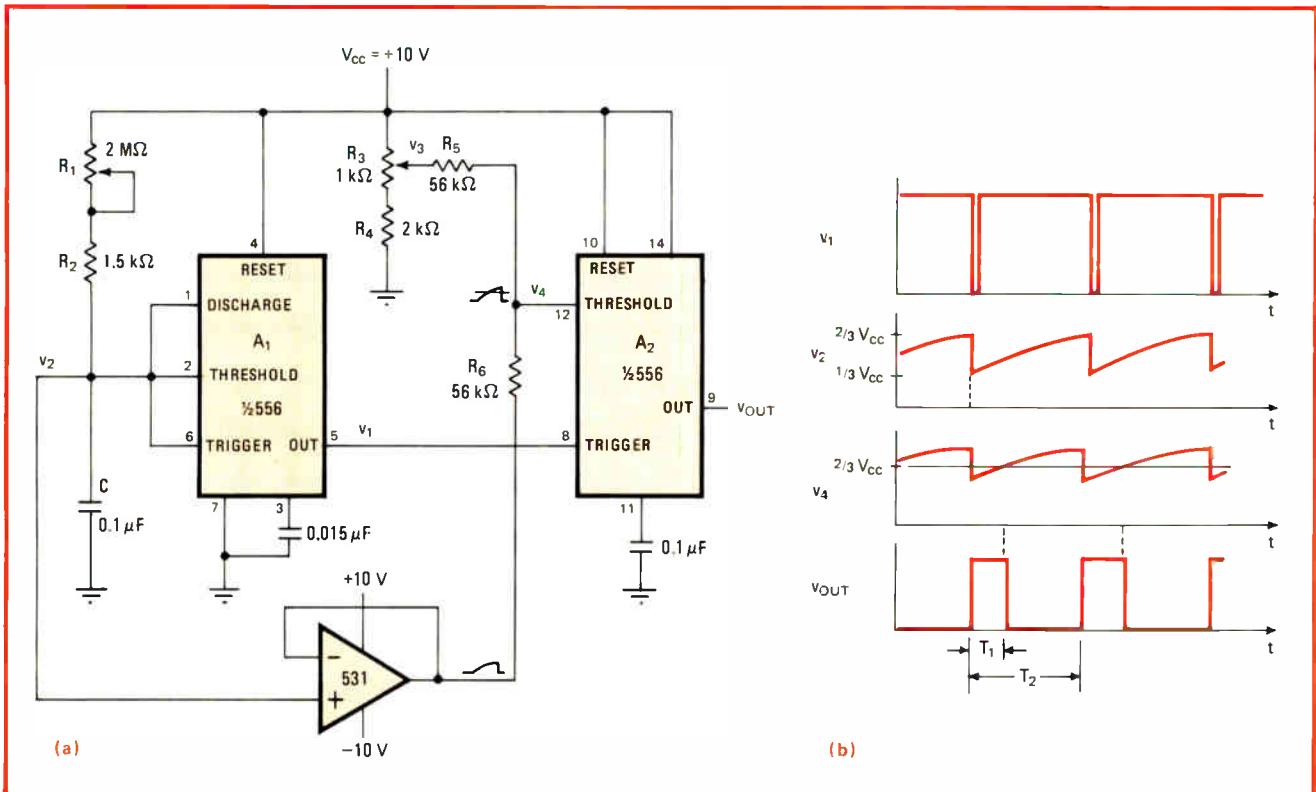

**No relation.**  $A_1$  runs at frequency set by  $R_1$ . But duty cycle is selected by  $R_3$ , which controls signal offset at threshold port of  $A_2$ . No feedback loops link  $A_1$  and  $A_2$ , thereby ensuring independent adjustment of rep rate and duty cycle. Timing diagram details operation.

# If you're this kind of systems OEM,

You're building complex turnkey projects.

You need more than "iron".

You know that your best buy is not a mixed bag of bottom-priced components, but a proved system, with all essential support, from a supplier who becomes your working partner.

# we're your kind of computer systems source.

We're different. Instead of selling you black boxes, we supply complete computer systems. We've been doing this for seven years.

We have a state-of-the-art line of standard processors, memories, I/O devices, terminals and other peripherals. Plus proved system operating software that speeds

Two Modcomp IV and four Modcomp II processors are the center of a new digital traffic control system for the city of Baltimore, engineered by TRW Inc. The TRW system has the capacity to control signals at 1200 key intersections in the city, and also provide surveillance of a five-mile section of the Jones Falls Expressway.

your application programming. Advanced network and transaction software. And we'll quote special hardware and software where needed.

You'll like our systems engineering help, because we understand system problems. And we don't love you and leave you, but supply full support — field service, documentation, personnel training, even sales support.

What you get from MODCOMP is a fully checked-out system, factory burned-in, ready to bring on-line quickly and efficiently.

Get the full MODCOMP OEM story, by asking for the brochure, "Power Tools For Building OEM Systems". Modular Computer Systems Inc., 1650 W. McNab Road, Fort Lauderdale, Fla. 33309. (305) 974-1380.

## **MODCOMP**

The systems store.

European Headquarters:

Export House, Woking,  
Surrey, England  
Phone: (04862) 71471

Circle 106 on reader service card

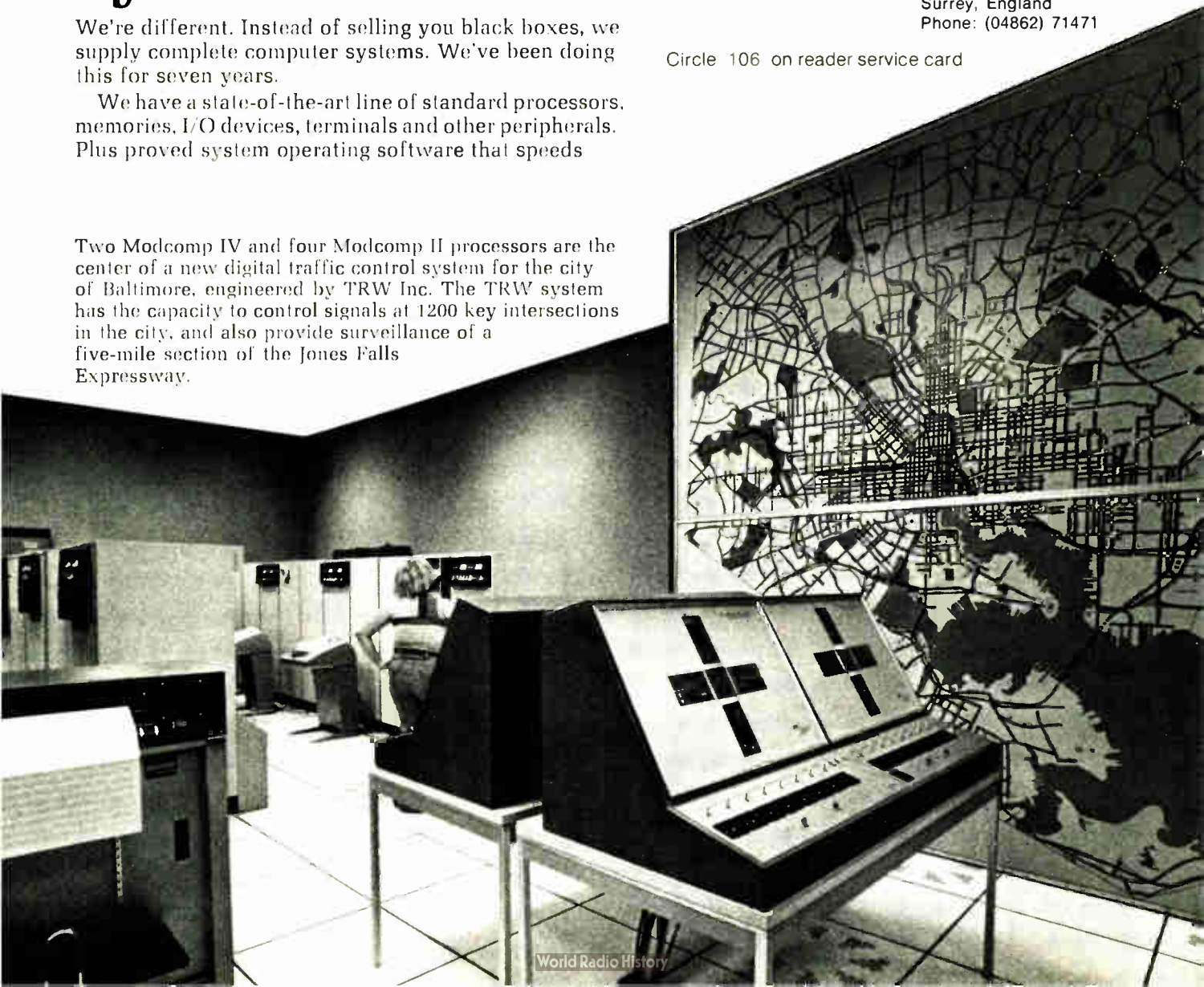

# Combining diagnosis and emulation yields fast fault-finding

Signature analysis and in-circuit emulation via microprocessor socket give test instrument powerful troubleshooting capabilities

by Laurence Badagliacca and Robert Catterton, *Millennium Systems Inc., Cupertino, Calif.*

□ The explosion of microprocessor-based equipment has proved a mixed blessing for many manufacturers. Replacing hard-wired logic with a microprocessor dramatically multiplies product features and provides a base for future product enhancements. But microprocessor-based products do not readily lend themselves to traditional test and maintenance techniques, primarily because most of today's test equipment is still in the pre-microprocessor era. What is really needed is an instrument as versatile and as intelligent as the products it must test.

A new instrument called the Microsystem Analyzer (Fig. 1) takes many of the techniques used to design new

products and adapts them to test and maintenance purposes. The key to the  $\mu$ SA's abilities is its use of the microprocessor socket in the system under test as a common testpoint. This socket is the focus for the system functions, and microprocessor development systems have taken advantage of this with in-circuit emulation. The  $\mu$ SA also uses in-circuit emulation to perform overall functional tests of system operation and adds a new diagnostic technique, recently introduced by Hewlett-Packard, called signature analysis [*Electronics*, March 3, p. 89]. The combination provides capabilities more powerful than either approach used alone (see Table 1).

Test techniques for digital equipment have, of course,

**1. Combination.** The Microsystem Analyzer combines in-circuit emulation with signature analysis to provide both functional testing and component fault isolation for microprocessor-based equipment.

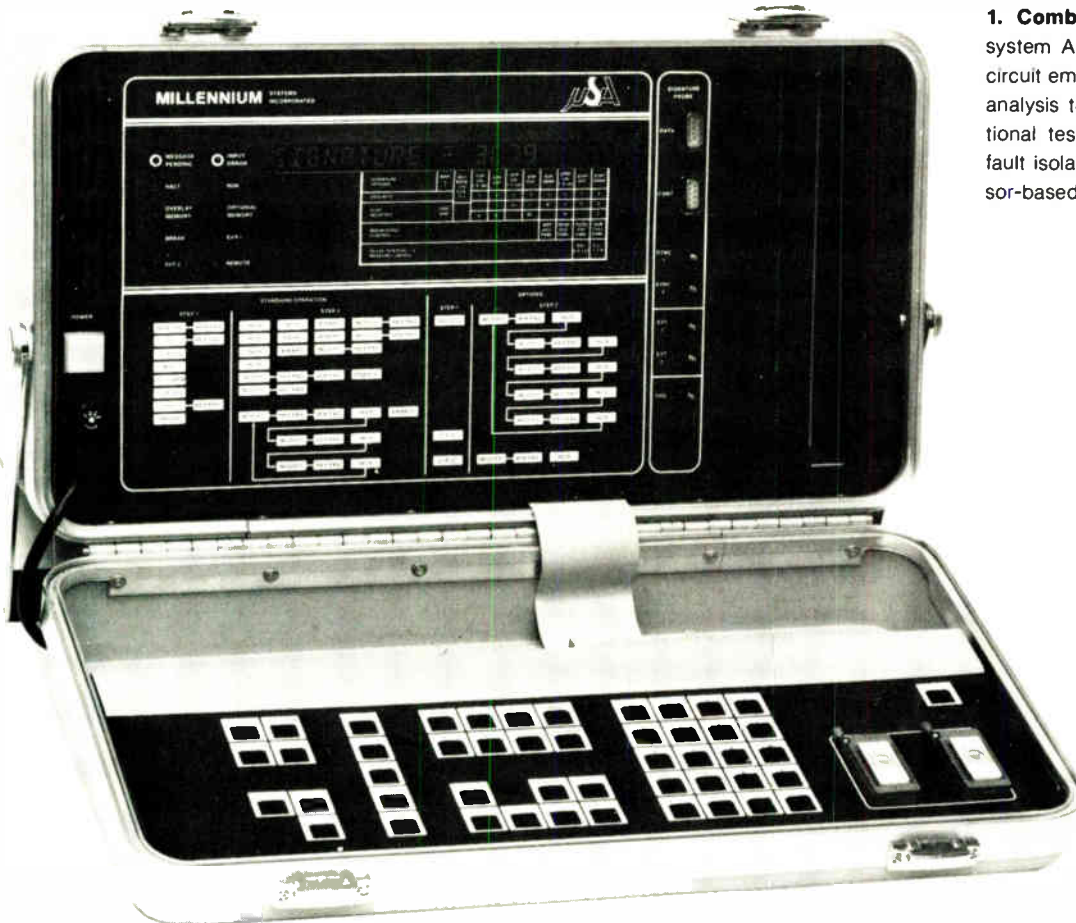

**TABLE 1: ADVANTAGES OF COMBINING IN-CIRCUIT EMULATION AND SIGNATURE ANALYSIS**

	Operates without built-in test source	System level diagnostics	Module fault isolation	Component fault isolation
In-circuit emulation and signature analysis	yes	yes	yes	yes
In-circuit emulators	yes	yes	no	no
Signature analysis	no	no	no	yes

been available for a long time. The new instrument can be put in perspective by being viewed in relation to these earlier techniques and their degree of applicability to microprocessor-based products:

- **Logic analysis.** The class of instruments called logic analyzers is generally used to passively monitor and store bit streams. Instrument manufacturers have tried to make the logic analyzers easier to use and in some cases have tailored the instruments specifically to microprocessor applications. However, analysis of bit streams and timing diagrams is often beyond the capabilities of repair personnel. Because of this, logic analysis is typically used by designers and has limited use in production testing or in maintenance.
- **Board testing.** Large computer-based board testers can use simulation techniques and can perform an intelligent analysis of output data to provide excellent fault diagnosis. They are particularly useful for production-line testing of long board runs. But because of their complexity, board testers are large and expensive instruments and are seldom found outside the factory.
- **Built-in self-testing.** A major advantage of the microprocessor is its self-testing capability. The tradeoff here is cost, particularly when the self-test involves adding function keys and display hardware to the equipment. Also, for self-testing to work, the kernel of the system (processor and memory) must remain operational.
- **In-circuit emulation.** Here, the instrument is attached to the system under test by an emulation cable plugged into the microprocessor socket, and when the failed system must be diagnosed, all of the test instrument resources—diagnostic programs, memory, and peripheral equipment—become available. This method is gaining popularity on the production line, where procedures can be standardized and where skilled personnel are available to take the results of the functional tests and perform component fault-isolation procedures.

### Functional testing

These four methods, although effective for certain tests, do not lend themselves to component fault isolation in the field. Consequently, the  $\mu$ SA combines in-circuit emulation, an effective functional test technique, with signature analysis, which because of its error-detection capabilities can perform the component fault isolation and is also easy to use. Table 1 shows the individual strengths of each of these approaches, as well as the

benefits to be derived from combining the two.

Functional testing combined with board replacement is the basis for many field maintenance programs. A functional test is typically based on a diagnostic program that exercises the major components of the system—the central processing unit generates outputs to memory, peripheral devices, and other input/output ports or an external bus—and then analyzes the results in order to isolate the failure.

The benefits of functional testing are significant when compared with trial-and-error board replacement: the faulty module is located much quicker, and only the bad module is replaced. These benefits can greatly reduce the number of boards floating in the repair cycle. But if module replacement is not practical, functional testing can at least limit the area within which the faulty component lies.

There is a growing trend, particularly in microprocessor products, to build a functional-testing capability into the system itself. Though this is an excellent use of the microprocessor's capability, it has its disadvantages. It increases the development effort and increases product cost, since it can require extra memory, displays, and input devices. Then, even the self-testing portion of the product can sometimes be faulty, which complicates maintenance.

However, in-circuit emulation requires only that the system clock be operational to accomplish functional tests. Table 2 compares built-in functional tests with the in-circuit emulation approach in its utilization of system resources.

### Component fault isolation

Besides performing functional tests, a field maintenance instrument should aid in component fault isolation. Although board replacement is generally the preferred technique for on-site repair, sometimes component fault isolation is necessary or desirable. Module replacement, for example, may be impossible because a replacement module may not be available, or it may be impractical. Many microprocessor systems consist of large boards, and even in multiboard systems the fault may exist in an area that is not modular or easily replaced. Many companies also wish to decentralize module repair centers to reduce the repair cycle, minimize inventory, and get the board back into the local inventory faster. The availability of a low-cost component fault-isolation instrument can make the decentralization economical.

Signature analysis provides the best and most cost-effective solution to fault isolation. It is straightforward and usable by a less experienced technician who need not even understand the system under test. He merely causes a defined stimulus pattern to be applied to the system and checks the correctness of the signature generated at a particular node.

On the negative side, signature analysis in its simplest form must be built into a product in the form of stimulus-generation firmware—a requirement that limits its usefulness. Typically, development costs and schedules, not to mention other design constraints, award maintenance considerations a lower priority. Also, design engi-

## How signature analysis works

To indicate its fault-free operation, a complex digital integrated circuit can be made to produce a few, easily verifiable digits. This "signature" is the basis for signature analysis, a technique for detecting faulty components in a failed digital system.

The assumption is that the system, if exercised with a complicated enough stimulus pattern, will produce a predictable and essentially unique serial stream of digital data at each of its nodes. But because the streams will each be hundreds or thousands of bits long, they must be compressed to make them recognizable to the human operator. Thus the two keys to signature analysis are data stream compression and network stimulation.

Data stream compression is done with polynomial code-generation technology, which has been widely used in digital error-detection and -correction techniques. It is

based on the use of serial shift registers with feedback, where the feedback makes the contents of the shift register a function of both prior and current data.

The data compression in the  $\mu$ SA provides a 16-bit compressed pattern or signature, yielding 65,536 possible individual signatures. The signature bits are displayed as four hexadecimal characters. The compression logic is designed to insure that the probability that two different bit streams will yield the same signature is vanishingly small (less than 0.002%).

The fundamental requirement of network stimulation is that it forces state changes at each node of the digital system. It can be done with firmware built into the product or with eternal stimuli. The more practical approach, and the method implemented in the  $\mu$ SA, is external network stimulation.

neers must be educated in the use of the technique. Even if signature analysis were instantly implemented, there would be a long lag before these new designs reached the field. Finally, it involves some increase in production cost, because of the small amount of additional hardware plus additional time required to test the signature analysis hardware.

The built-in approach to signature analysis also requires that some minimum amount (the kernel) of the system under test be operable. Also, some portion of the kernel, usually memory, has to be reserved to generate an appropriate stimulus for signature taking. Yet such built-in stimulus generation by itself is virtually incapable of isolating to the component level those faults that affect the kernel's performance through a feedback loop. A faulty component in a feedback loop causes all the other components in the loop to produce invalid signatures. Isolation of these faults therefore also requires provision, usually built in, for physically breaking the loop containing the fault.

Since functional testing is based upon feedback loops and component testing requires their absence, an instrument that uses both methods must be able to open and close loops selectively, depending upon the type of test to be performed. This is where the technique of in-circuit emulation really shines. Because the microprocessor is the common element in most such loops, control of the CPU allows them to be closed or opened selectively as the test requires.

### Enhanced signature analysis

A signature analysis system to which functional testing and in-circuit emulation have been added gains other important capabilities. In the case of a partial failure in a fairly complex product, a functional test can narrow down the source of an error enough for component testing to begin. Then, the feedback loops can be selectively opened, bit patterns generated, and signature analysis used for more precise fault isolation.

In the case of a completely inoperative system, the use of signature analysis without in-circuit emulation would require, first of all, that jumpers be built into the system to allow the isolation of the CPU and clock and to open feedback loops selectively. Then both the CPU and clock, after isolation, would have to be made operable and brought into a free-running state, as it were. Finally the diagnostic read-only memory, which contains the bit streams used in signature analysis, would have to be tested and made operable.

The addition of in-circuit emulation eliminates the need for jumpers, as well as the requirement that the CPU and diagnostic ROM be operable. One of the most important advantages of in-circuit emulation is that, being software-controlled, it eliminates the need for a fixed diagnostic ROM to generate the bit stream. The use of a fixed ROM means that only one general-purpose signature stream will be used, which cannot account for new conditions or changes that may arise during the product life. In-circuit emulation allows different signature streams to be used, depending on the type of error. Further, the signature start and stop operations can be done with bit patterns under program control.

The  $\mu$ SA's system architecture (Fig. 2) is similar to

**TABLE 2: IN-CIRCUIT EMULATION COMPARED TO BUILT-IN FUNCTIONAL TESTS**

Resource of system under test	Resources required for system to be testable	
	Built-in functional test	In-circuit emulation functional test
CRT/keyboard or other operator interface	yes	no
Diagnostic read-only memory	yes	no
System random-access and read-only memory	no	no
Central processing unit	yes	no
System input/output	partly yes	no
Address and data bus	yes	no
Control bus	yes	no
System clock	yes	yes

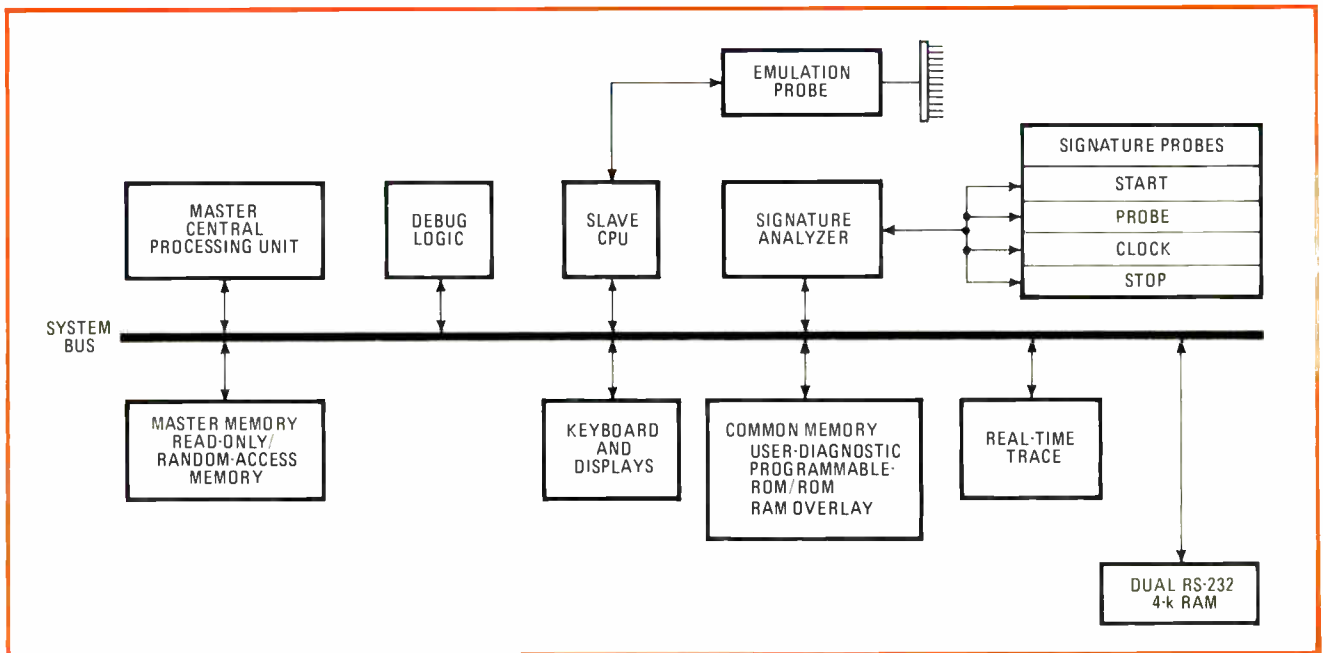

**2. Overall system.** The Microsystem Analyzer uses dual processors—master and slave—to allow easy adaptation to new microprocessors, since the slave processor need only be changed. Signature analyzer draws on common memory for its pattern of stimulus bits.

Millenium's Universal One development system, in which universality is achieved by dividing the system into two functional areas. Those functions that are related to operator interaction are controlled by the master CPU, and those functions that are related to the system under test are controlled by a second, or slave, CPU. This dual-system architecture enables the instrument to support new microprocessors with the addition of a new slave CPU card (at present the  $\mu$ SA supports the 8080A and 6800 CPUs).

### Servicing with intelligence

Diagnostic programs either for go/no-go testing or for signature stimulus are executed from a user ROM plugged into the instrument's front panel. Programs resident in user memory also can be executed. All normal in-circuit emulation functions are provided, such as memory display and modification, I/O port display and modification, real-time breakpoint and emulation, and real-time emulation of existing systems with display sampling.

Signatures can be taken with a hand-held probe and displayed as four hexadecimal digits. The signature period is determined by program start-stop addresses, by external start-stop events, or by counting clock pulses. The instrument detects unstable conditions and holds the last recorded stable signature. Clock and data phasing can be controlled to ensure repetitive signatures over a wide range of circuit variations.

When the instrument is used to service a microprocessor-based system, the microprocessor is removed and the emulation cable is plugged into its socket. Then the instrument's clock probe is connected to the system under test (note that the only part that must be working on the equipment is its clock). If the clock is not working, a pulse-width measurement capability helps in troubleshooting the clock circuits. Finally, the diagnostic

programmable ROMs, predesigned for the particular system under test, are plugged into the instrument, in sockets on the front panel.

The first section to be tested is the system microprocessor itself, since if the system checks out with the emulation cable plugged in, it can be assumed the microprocessor has failed. However, problems here are rare. The instrument next checks the PROMs, RAM, lights, and switches in the system under test and then does a serial I/O test by sending out a certain character and making a comparison when it returns.

With this procedure, the fault can be associated with a particular module, at which point signature analysis can take over to isolate the fault. The signature analysis bit stream is in the PROM, and the logic for the signature analysis is built into the instrument. The user then can begin probing the circuitry for signatures, following a troubleshooting tree.

### What lies ahead

The microprocessor, having opened up many new applications opportunities for the electronics industries, also has brought with it a need for a new class of development and servicing aids. The  $\mu$ SA is the leading edge of a class of instruments optimized for servicing microprocessor-based equipment. Future instruments of this type will extend not only the concept of flexible, universal microprocessor servicing, but also the use of a combination of such techniques as in-circuit emulation for top-down functional testing and signature analysis for component fault isolation.

Obvious areas for improvement are more sophisticated operating systems, software for diagnostic program creation, and more automatic servicing techniques. Other considerations for the next generation of instruments include local and remote storage media, telecommunications down-loading, and guided probing. □



□ Exactly how inaccurate will a change in temperature make an analog-to-digital or digital-to-analog converter? As designers are well aware, a 12-bit device may provide a much lower accuracy at its operating-temperature extremes, perhaps only to 9 or even 8 bits. But for lack of more precise knowledge, many play it safe (and expensive) and overspecify.

Yet it is fairly simple to determine a converter's absolute worst-case degradation from its various drift specifications. Considering these specifications separately and examining their basis will help to unravel the labyrinth of converter drift and show how to go about calculating the actual worst-case drift error for most devices.

Accuracy drift for a d-a converter or a successive-approximation a-d converter has three primary components: its gain, offset, and nonlinearity temperature coefficients. Instead of calling out the gain and offset drifts separately, some manufacturers specify a full-scale drift, which takes both into account. Another important specification in many applications is differential nonlinearity, which reflects the equality (or rather, the inequality) of the analog steps between adjacent digital codes. But, since this parameter is really describing only the distribution of the linearity error, its temperature coefficient does not contribute to the converter's worst-case accuracy drift.

### Examining the components of drift

The transfer function of a d-a converter will illustrate how the different kinds of drift degrade accuracy.

In a bipolar d-a converter, which produces both positive and negative analog voltages, offset drift changes all the output voltages by an equal amount, moving the entire transfer function up or down from the ideal in parallel to it (Fig. 1a). The drift of the converter's voltage reference is the main cause of this error—which may also be called the minus-full-scale drift, since it occurs even when all the input bits are logic 0 or off. In a unipolar unit, the offset drift is usually much smaller, being due mostly to drift in the offset voltage of the output operational amplifier and secondarily to leakage in the current switches.

Unlike offset drift, gain drift rotates the transfer function (Fig. 1b). In a bipolar unit it does so around minus full scale (all bits off), and in a unipolar unit it does so around zero (again all bits off). The gain drift affects each output voltage by the same percentage (not the same amount), tipping the transfer function at an angle to the ideal. In general, about 70% of this drift is caused by the drift of the converter's voltage reference.

Obviously, then, reference drift is a major contributor to total inaccuracy due to gain and offset drift. A positive temperature coefficient for the reference causes the transfer function to rotate about zero, as shown in Fig. 1c for a bipolar converter. Since the gain and bipolar offset drifts due to the reference will always be opposite in direction, the worst-case accuracy drift may be less than half the sum of the individual drift specifications. In a unipolar converter, the gain and offset drifts may well add together, but the unipolar offset drift is usually insignificant compared to the magnitude of the

# What designers should know about data-converter drift

---

Understanding the components of worst-case degradation can help in avoiding overspecification

---

by Paul Prazak

*Burr-Brown Research Corp., Tucson, Ariz.*

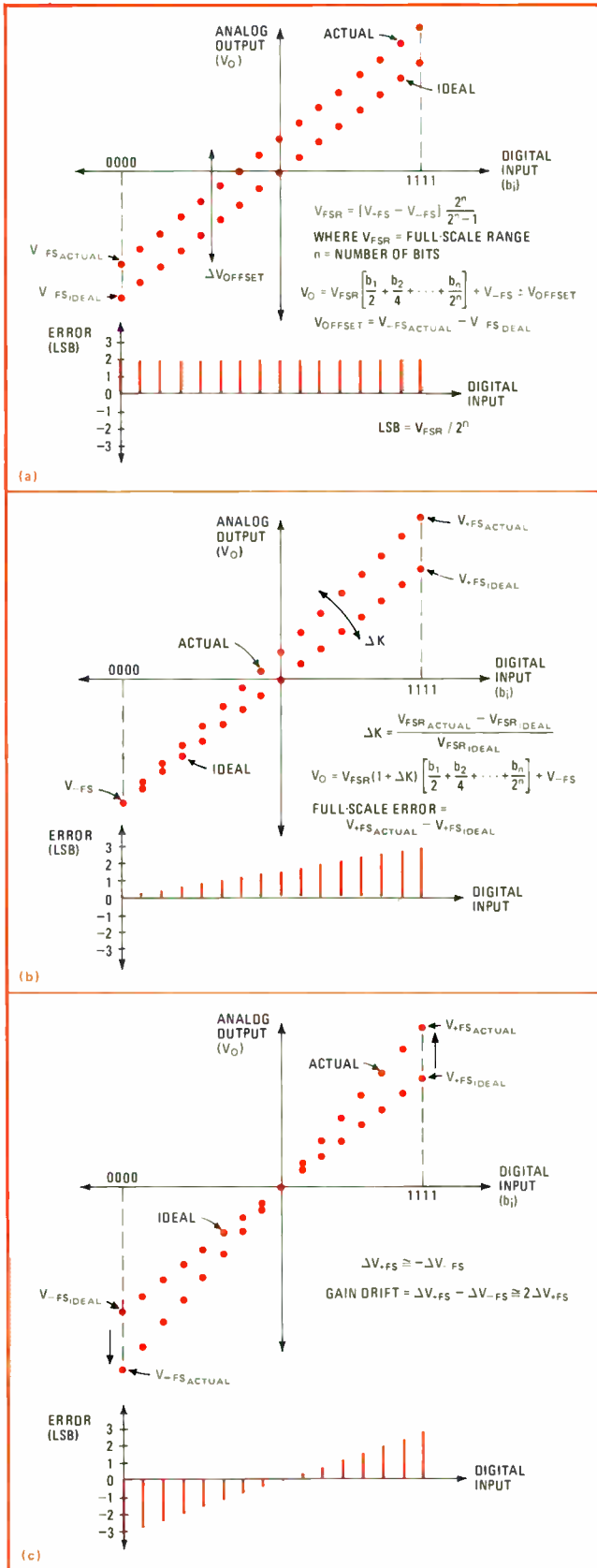

**1. Effects of drift.** For a bipolar d-a converter, offset drift (a) moves the unit's transfer function up or down, whereas gain drift (b) rotates it about digital zero. Both of these errors are chiefly due to reference drift (c), which causes a rotation about analog zero.

gain drift, so it is not so important a factor.

Full-scale drift describes the change in the output voltage when all the bits are on. For a unipolar converter, it is simply the sum of the offset and gain drifts. In contrast, for a bipolar converter, the full-scale drift is the sum of half the reference drift, the gain drift exclusive of the reference, and the offset drift exclusive of the reference, or unipolar offset drift.

### Poor tracking causes linearity drift

Finally, linearity drift reflects the shift in the analog output voltage from the straight line drawn between the output value when all the bits are off (minus full scale) and the output value when all the bits are on (plus full scale). This error is caused by the varying temperature coefficients of the ratio resistances of the converter's current-weighting (scaling) resistors, as well as the ratio drifts of the base-emitter voltages and betas of its transistor current switches.

Since the change in linearity with temperature depends on how closely various parameters track each other, and not on absolute parameter values, it is fairly easy to control with present-day hybrid and monolithic technologies. As a result, linearity drift is usually much smaller than either the gain or offset drift. Moreover, it is generally guaranteed to be within some maximum limit over the converter's full operating temperature range.

Another specification that is important in some applications is bipolar zero drift, which reflects the change in the output voltage of a bipolar converter at midscale, when only the most significant bit is on and all other bits are off. This drift error at zero is not affected by reference drift at all, but is caused mainly by poor tracking in the converter's scaling resistors and current switches. Therefore, it appears as a random variation about zero, and it has a worst-case magnitude equal to the offset drift exclusive of the reference plus half the gain drift exclusive of the reference.

To understand more fully how these drift errors are generated, consider the simplified schematic (Fig. 2) of a typical 12-bit bipolar d-a converter. Circuit operation is fairly simple. The reference current flows through reference transistor  $Q_c$ , producing a voltage drop across resistor  $R_c$ . Since the base of  $Q_c$  is connected to the bases of all the other transistor current switches, the same potential is also generated across resistors  $R_1$  through  $R_{12}$ . The multiple emitters of the transistors cause current density to be the same for each of these binarily weighted current sources, thereby providing good matching and tracking of the transistors'  $V_{BE}$  and  $\beta$ .

### Tracking errors tend to cancel

Now suppose that, because of temperature or aging, the value of every resistor on network  $RN_1$  increases by 1%. Since the reference current remains constant, the voltage across these resistors also increases by 1%, so the output current and the output voltage are unchanged. If, instead, the values of all the resistors on network  $RN_2$  increase by 1%, the reference current decreases by 1%, reducing the voltage across  $R_c$  by 1% and causing the output current to drop by 1%. However, since the value

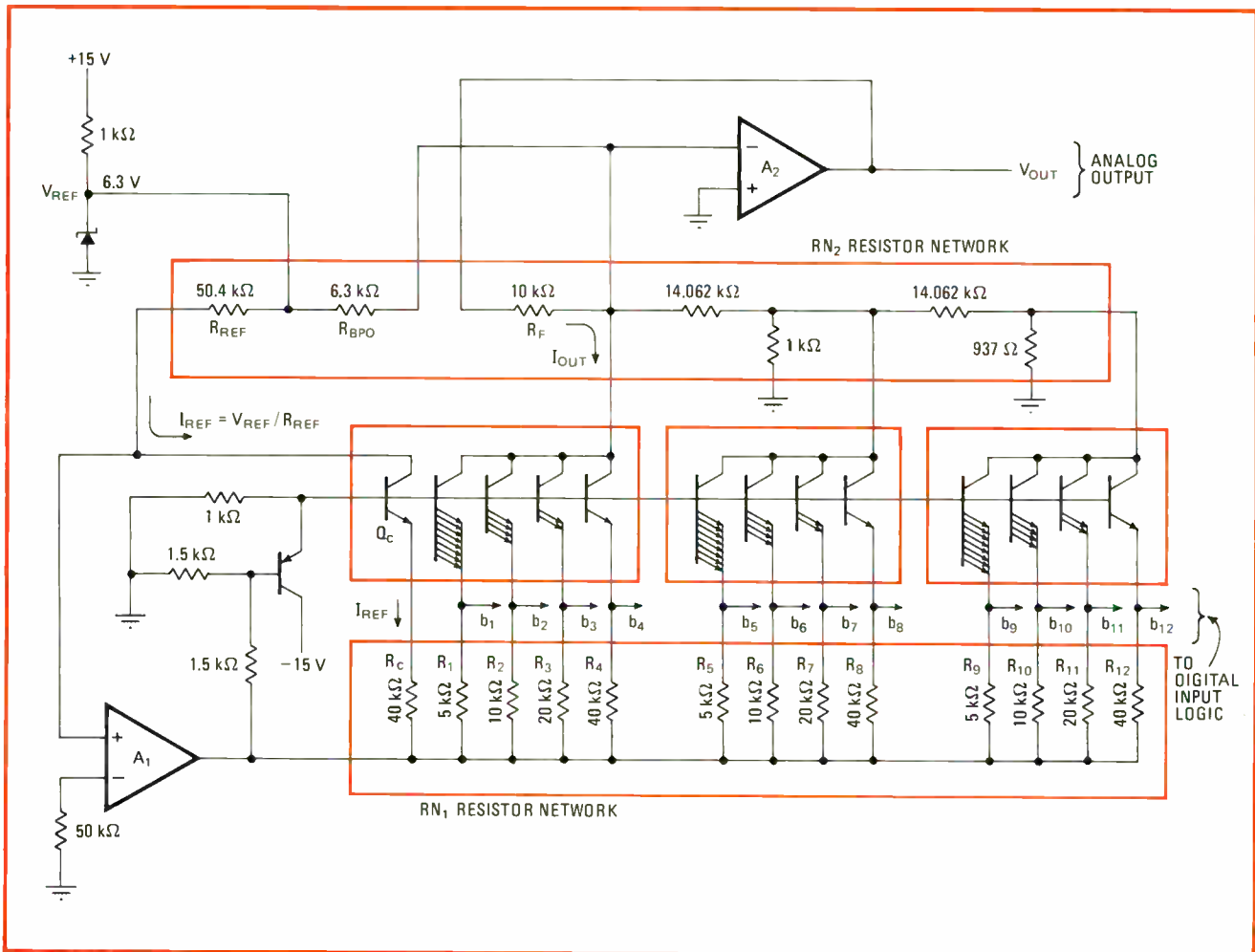

**2. Typical d-a circuit.** In general, the circuit design for a d-a converter largely compensates for tracking errors in the resistor networks and transistor current switches. By far the dominant error source is the drift of the zener diode that makes up the reference.

of the feedback resistor,  $R_F$ , is now 1% higher, the output voltage, which is equal to  $I_{OUT}R_F$ , does not change.

The converter compensates for variations in transistor  $V_{BE}$  and  $\beta$  in the same manner. Although the individual resistors on  $RN_1$  and  $RN_2$  may have temperature coefficients as high as  $\pm 50$  parts per million per degree Celsius, the tracking of these resistors, and therefore their contribution to drift in linearity and gain, is typically as little as 1 to 2 ppm/ $^{\circ}C$ . In fact, the only error sources for which the circuit does not compensate are the drifts in offset voltage and offset current of amplifiers  $A_1$  and  $A_2$ , as well as the drift of the zener reference diode. By far, the dominant error source is the drift of this zener, while the offsets of  $A_1$  contribute to the gain drift exclusive of the reference, and the offsets of  $A_2$  contribute to offset drift exclusive of the reference.

### The effect of reference drift

To evaluate the effect of variations in the reference voltage on the overall accuracy of the converter requires determining the variation in output voltage for a change in ambient temperature. A good first-order approximation is to assume that all other drift errors—those due to tracking errors and random variations—are zero.

Writing the node equation for the summing junction at the inverting input of amplifier  $A_2$  yields:

$$\frac{V_{OUT}}{R_F} + \frac{V_{REF}}{R_{BPO}} - \frac{V_{REF}}{R_{REF}} K \left[ \frac{b_1}{2} + \frac{b_2}{4} + \dots + \frac{b_n}{2^n} \right] = 0$$

where  $K$  is a gain constant, and  $b_1$  through  $b_n$  represent the digital bits, which are either 1 or 0, depending on whether a bit is on or off. This equation may be used to determine the output voltage for any digital input.

At minus full scale, with  $b_1 = b_2 = \dots = b_n = 0$ , the output voltage becomes:

$$V_{OUT} = V_{-FS} = - \left[ \frac{R_F}{R_{BPO}} \right] V_{REF}$$

At bipolar zero ( $b_1 = 1, b_2 = b_3 = \dots = b_n = 0$ ), the output voltage for an ideal converter is equal to zero:

$$V_{OUT} = V_{BPZ} = 0 = \left[ \frac{R_F}{2R_{REF}} K - \frac{R_F}{R_{BPO}} \right] V_{REF}$$

At plus full scale, with  $b_1 = b_2 = \dots = b_n = 1$ , the output voltage becomes:

$$V_{OUT} = V_{+FS} = \left[ \frac{R_F}{R_{REF}} K - \frac{R_F}{R_{BPO}} \right] V_{REF}$$

Solving the equation for  $V_{BPZ}$  for gain constant  $K$  yields:

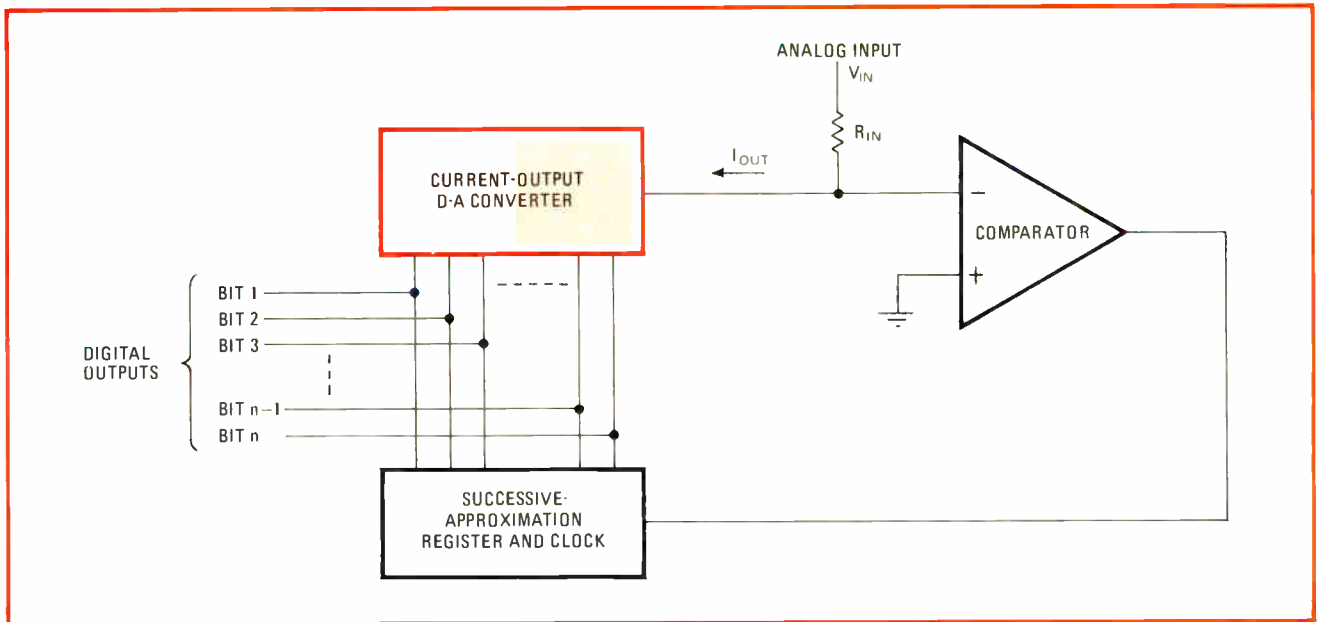

**3. A-d converter.** All of the relationships that apply to the drift errors in a d-a converter also hold for a successive-approximation a-d converter, since this component includes a current-output d-a converter as one of its circuit blocks, as shown here.

$$K = \frac{R_F}{R_{BPO}} \frac{2R_{REF}}{R_F} = \frac{2R_{REF}}{R_{BPO}}$$

Substituting this expression for K in the appropriate equations, the variation in output voltage for a change in the reference caused by temperature may be computed. At minus full scale, this drift is:

$$\frac{\Delta V_{-FS}}{\Delta T} = -\frac{R_F}{R_{BPO}} \frac{\Delta V_{REF}}{\Delta T}$$

where  $\Delta T$  is the change in ambient temperature. As mentioned previously, drift error at midscale is caused by tracking errors, not by variations in the reference, so:

$$\frac{\Delta V_{BPZ}}{\Delta T} = 0$$

At plus full scale, the change in the output becomes:

$$\frac{\Delta V_{+FS}}{\Delta T} = \frac{R_F}{R_{BPO}} \frac{\Delta V_{REF}}{\Delta T}$$

Therefore, the drift in the output voltage due to reference variations at minus full scale (or the bipolar offset drift) will be equal in magnitude but opposite in direction to that at plus full scale. Each of these drift errors amounts to half the reference drift. The gain drift due to reference variations may be written as:

$$(\Delta V_{+FS} - \Delta V_{-FS}) / \Delta T$$

which is equal to the reference drift. It should be noted that the gain and reference drifts are specified in ppm/°C, while the full-scale and offset drifts are in ppm of full-scale range (FSR) per °C.

### Computing the worst-case error

These results may now be used to find the worst-case total accuracy drift error for the typical converter of Fig. 2. Suppose the maximum temperature coefficient of the device's internal reference is  $\pm 20$  ppm/°C, resulting in a

gain drift of  $\pm 20$  ppm/°C, a plus-full-scale drift of  $\pm 10$  ppm of FSR/°C, and a bipolar offset drift of  $\pm 10$  ppm of FSR/°C. The maximum gain drift exclusive of the reference is  $\pm 10$  ppm/°C, and the offset drift exclusive of the reference is  $\pm 5$  ppm of FSR/°C.

The worst-case error occurs at plus full scale. To compute it, the errors due to the reference as well as those exclusive of the reference that are due to random variations must be taken into account. Therefore, the only contributors to the worst-case full-scale accuracy drift are the plus-full-scale drift due to the reference, and the random errors of the offset drift and the gain drift exclusive of the reference. Summing these together yields a worst-case full-scale accuracy drift of  $\pm 25$  ppm of FSR/°C or  $\pm 0.0025\%$  of FSR/°C.

The converter is a 12-bit device having a linearity error of  $\pm 1/2$  least significant bit, or  $\pm 0.01\%$ . Also, for its operating temperature range of 0°C to 70°C, the maximum excursion from room temperature (25°C) will be 45°C. Assuming that gain and offset errors are adjusted to zero at room temperature, the total accuracy error may be computed as the sum of the linearity error and the full-scale accuracy error:

$$\begin{aligned} \text{worst-case total accuracy error} &= (\text{linearity error}) \\ &\quad + (\text{full-scale accuracy error}) \\ &= (\pm 0.01\%) + (\pm 0.0025\%/^{\circ}\text{C})(45^{\circ}\text{C}) \\ &= \pm 0.12\% \end{aligned}$$

which is about 9-bit accuracy. The accuracy for many 12-bit d-a converters will typically be twice as good as this, with most devices providing 10-bit accuracy.

All of the drift relationships and causes examined in this article also apply to a successive-approximation a-d converter, which uses a d-a converter as one of its circuit blocks, as shown in Fig. 3. In the equations, simply substitute  $V_{IN}$  for  $V_{OUT}$  and  $R_{IN}$  for  $R_F$ . Also, in the a-d converter, comparator drift, rather than op-amp drift, contributes to the device's unipolar offset drift. □

# MIL/NASA QUALIFIED RECTIFIERS

WE HELPED WRITE THE "BOOK"!



## What's in a Number ?

For over a decade Military Specifications have been written around Semtech E.I.A. registered medium power rectifiers.

Many suppliers can provide parts with the same JAN, JANTX or JANTXV label. Although these devices may comply with the appropriate military specification, there can be significant differences in the design and manufacture that may affect the reliability; such as, different lead materials, pin materials, body materials, junction types and junction areas. Devices of one manufacturer are not necessarily the same as those of another, even though they are labeled with the same part number.

Semtech Corporation is one of the few manufacturers in the industry that has its own government approved Qualification Test Facilities equipped to perform tests that meet the requirements of Military and Space programs. A NASA approved Radiographic Inspection (X-Ray) facility rounds out the total capability of Semtech's environmental and test facilities.

We have earned the confidence of the Military establishment by supplying reliable devices to government specifications throughout our history.



## Military Specifications

### MIL-S-19500/2400

JAN, JANTX, JANTXV 1N645\*-1  
JAN, JANTX, JANTXV 1N647\*-1  
JAN, JANTX, JANTXV 1N649\*-1

### MIL-S-19500/279C (NAVY)

JAN, JANTX 1N3644\*  
JAN, JANTX 1N3645\*  
JAN, JANTX 1N3646\*  
JAN, JANTX 1N3647\*

### MIL-S-19500/286C

JAN, JANTX, JANTXV 1N4245  
JAN, JANTX, JANTXV 1N4246  
JAN, JANTX, JANTXV 1N4247  
JAN, JANTX, JANTXV 1N4248  
JAN, JANTX, JANTXV 1N4249

### MIL-S-19500/359B

JAN, JANTX, JANTXV 1N4942  
JAN, JANTX, JANTXV 1N4944  
JAN, JANTX, JANTXV 1N4946  
JAN, JANTX, JANTXV 1N4947  
JAN, JANTX, JANTXV 1N4948

### MIL-S-19500/411C

JAN, JANTX, JANTXV 1N5415  
JAN, JANTX, JANTXV 1N5416  
JAN, JANTX, JANTXV 1N5417  
JAN, JANTX, JANTXV 1N5418  
JAN, JANTX, JANTXV 1N5419

### MIL-S-19500/420A

JAN, JANTX, JANTXV 1N5550  
JAN, JANTX, JANTXV 1N5551  
JAN, JANTX, JANTXV 1N5552  
JAN, JANTX, JANTXV 1N5553  
JAN, JANTX, JANTXV 1N5554

### MIL-S-19500/427B

JAN, JANTX, JANTXV 1N5614  
JAN, JANTX, JANTXV 1N5616  
JAN, JANTX, JANTXV 1N5618  
JAN, JANTX, JANTXV 1N5620  
JAN, JANTX, JANTXV 1N5622

### MIL-S-19500/429B

JAN, JANTX, JANTXV 1N5615  
JAN, JANTX, JANTXV 1N5617  
JAN, JANTX, JANTXV 1N5619  
JAN, JANTX, JANTXV 1N5621  
JAN, JANTX, JANTXV 1N5623

\*Not E.I.A. registered by Semtech Corporation.

### MIL-S-19500/484(EL)

JAN, JANTX 1N5835  
JAN, JANTX 1N5836

### MIL-S-19500/503(EL)

JAN, JANTX, JANTXV 1N6073  
JAN, JANTX, JANTXV 1N6074  
JAN, JANTX, JANTXV 1N6075  
JAN, JANTX, JANTXV 1N6076  
JAN, JANTX, JANTXV 1N6077  
JAN, JANTX, JANTXV 1N6078  
JAN, JANTX, JANTXV 1N6079  
JAN, JANTX, JANTXV 1N6080  
JAN, JANTX, JANTXV 1N6081

## NEW! Transient Voltage Suppressors

### MIL-S-19500/516(EL)

JAN, JANTX, JANTXV 1N6102 thru 1N6137  
JAN, JANTX, JANTXV 1N6102A thru 1N6137A  
JAN, JANTX, JANTXV 1N6138 thru 1N6173  
JAN, JANTX, JANTXV 1N6138A thru 1N6173A

## NASA (MSFC) Approvals

85M01645 (NASA) S1N645S & S1N649S

85M03895 (NASA) S1N4245-1, S1N4247-1, S1N4249-1, S1N4942-1, S1N4946-1 & S1N4948-1

85M03896 (NASA) S1N5199, S1N5201, S1N5417-1 & S1N5419-1

## RELIABILITY COSTS LESS!

1975 NATIONAL SBA SUBCONTRACTOR OF THE YEAR



652 Mitchell Road, Newbury Park, California 91320  
(805) 498-2111 • (213) 628-5392 • TWX 910-336 1264

CHICAGO (312) 352 3227 • DALLAS (214) 234 6523  
DAYTON (513) 274 8356 • FLORIDA (305) 644 5404  
MARYLAND (301) 937 0070 • NEW JERSEY (201) 654 4884  
SAN FRANCISCO (415) 494 0113 • SEATTLE (206) 455 4807  
EUROPEAN SALES Bourns AG Zug, Switzerland (042) 232 242

## Simple go/no-go tester checks op amps

by S. J. Cahill and C. Stanfield  
Northern Ireland Polytechnic, Antrim, Northern Ireland

This simple tester will perform a go/no-go check of an operational amplifier by indicating if it is functioning normally, open, or short-circuited. The tester checks the op amp by driving its inverting port with an ac signal and comparing its output voltage state with the state that should exist if the amplifier is working properly. Although the test cannot check the op amp's linearity, it is a satisfactory and inexpensive way for determining the general electrical condition of the amplifier.

As shown in the figure, the inverting port of the op amp under test is driven by a 1-hertz oscillator configured around the 4093 Schmitt trigger. The op amp and

the oscillator drive the 4030 exclusive-OR gate, which is used as a phase detector. Both the 4030 and the 4093 are complementary-metal-oxide-semiconductor devices.

If the op amp is functioning normally, it will always invert the input signal, and the signals at points A and B will always be out of phase with respect to one another. This will cause point C to assume the high state at all times, and the green light-emitting-diode indicator will turn on.

If there is an open circuit anywhere within the internal signal paths of the op amp, points A and B will always be in phase, point C will be low, and the red LED will turn on. If the op amp's output is stuck at a fixed level, points A and B will alternate from an in-phase to an out-of-phase condition, and both LEDs will alternately flash at a 1-Hz rate. The red LED will light first if the op amp's output is stuck above ground; the green LED will light first if it is stuck below ground.

The circuit needs operating voltages of  $\pm 4.3$  volts. A 9-v battery and two zener diodes supply the voltages needed. □

**Op-amp test.** Op amps are checked for open and short circuits with this phase-detection circuit, which compares the amplifier's output state with the expected state. Oscillator using 4093 provides 1-Hz driving signal to op amp and 4030 phase detector. Illuminated red LED indicates bad op amp, green LED indicates good one. Alternating red and green shows op amp's output is stuck at fixed level.

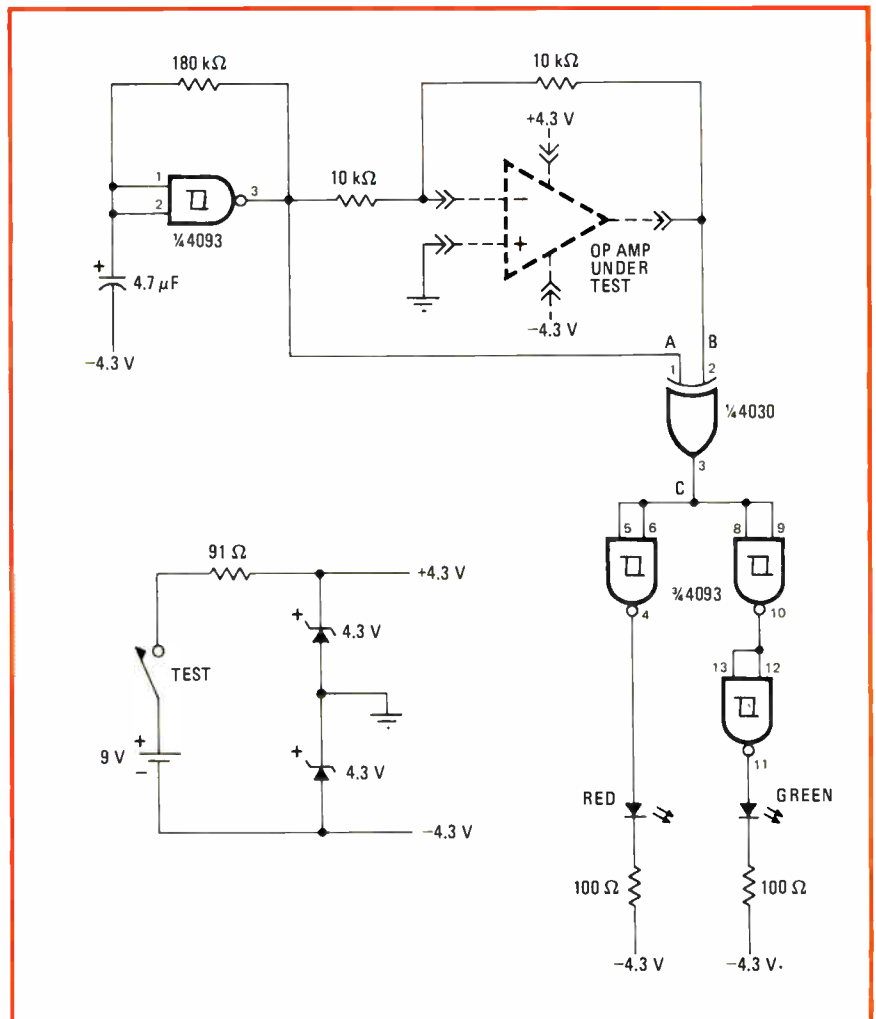

# One-shot and flip-flop add single-sweep option to scope

by M.C.W. Moerdijk  
N. V. Kema, Arnhem, the Netherlands

Oscilloscopes that have a Z axis, or intensity modulation, input can easily be modified for the single-sweep option if needed, provided the scope's sweep (time-base) signal is externally available. This inexpensive Z-axis blanking circuit has been used successfully with the popular Philips PM3210 oscilloscope and can be used with the older Dumont scopes as well.

As shown in the figure, the internal sweep signal is

connected to the time-base terminal of the circuit. The scope is placed in the external trigger mode and preset to a suitable triggering level.

Input (Y-axis) signals exceeding the trigger point initialize the internal sweep, and the signal is traced across the scope face. The negative edge of the ramp (X-axis) signal terminates the trace period, firing the 74121 one-shot multivibrator, which in turn resets the 7476 J-K flip-flop. The flip-flop drives the following comparator high, generating a signal to the scope's Z axis that blanks the trace before the time base can sweep again (if the input signal is above the set threshold).

Depressing the momentary-contact switch generates a negative-going pulse to the preset input of the flip-flop, thereby setting Q and resetting the Z-axis line. This reset scheme is most effective in applications where Y-axis signals trigger the ramp generator only occasionally,

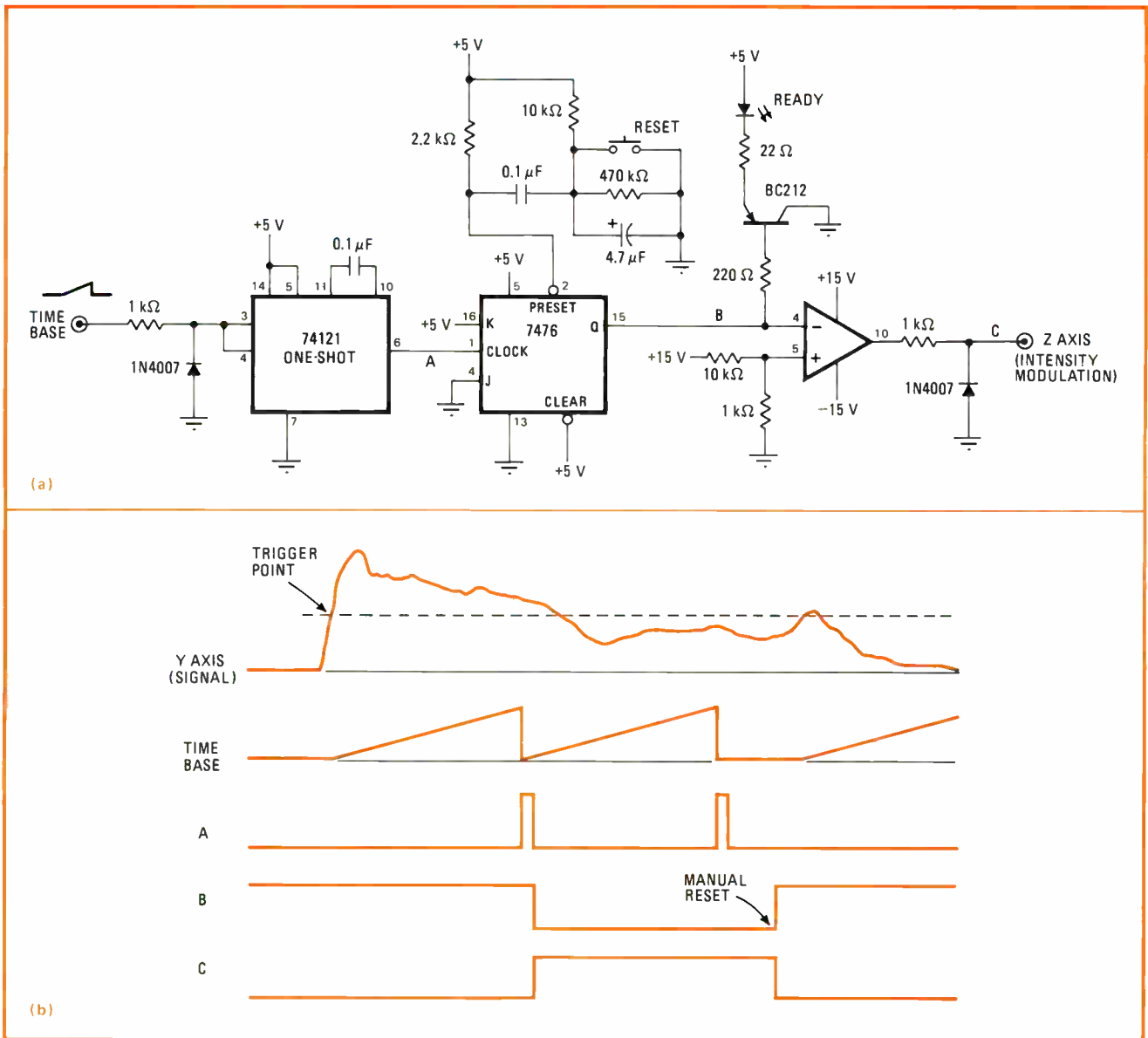

**One sweep per trigger.** Adding single-sweep option to Z-axis scope requires a one-shot, J-K flip-flop, and comparator, assuming that external time-base option is available. Trigger signal initiates ramp, and scope then displays signal for one cycle of the time base. Falling edge of ramp generates signal to Z axis, blanking trace until circuit is reset manually.

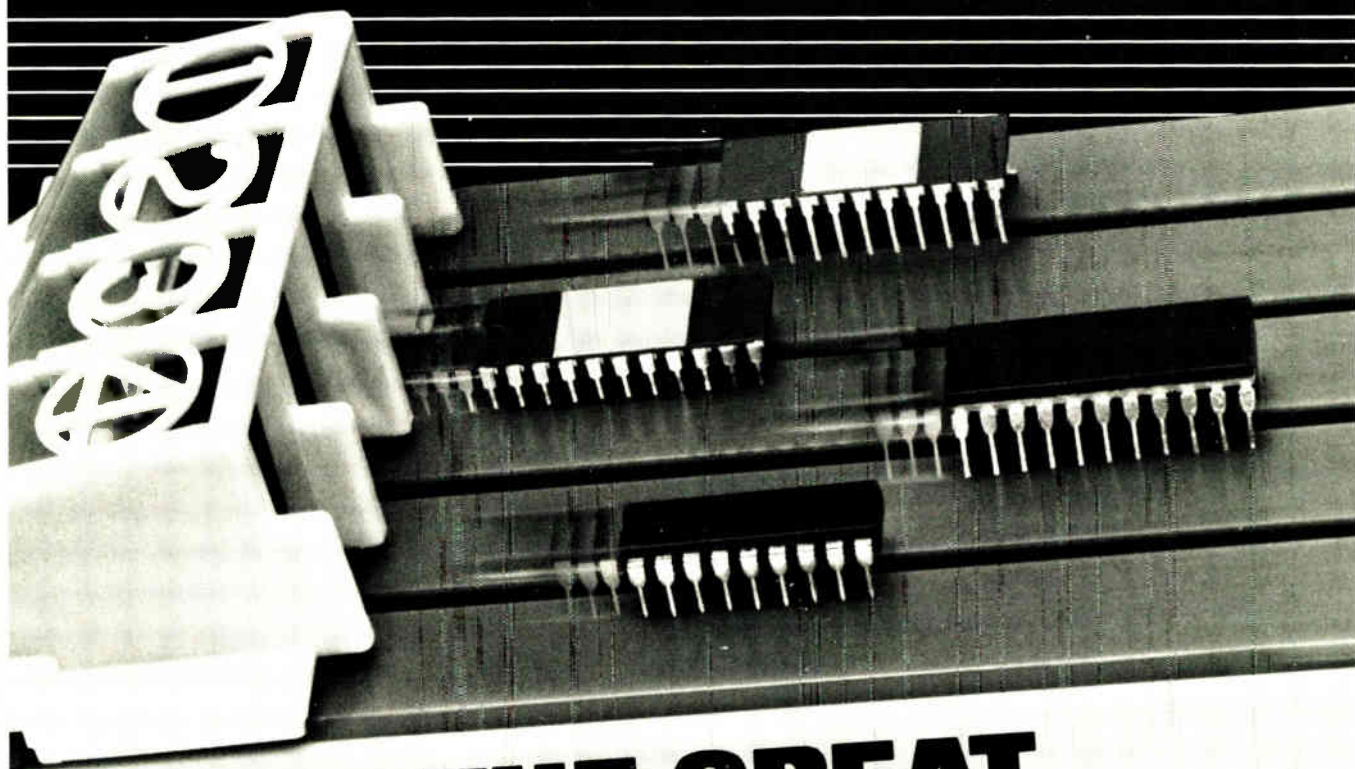

# THE GREAT 4K STATIC RAM RACE

In a world of claims and counter-claims, one thing is clear. EMM SEMI is still in the lead. Of course, we not only had a healthy head start, but we field a whole family of 4K static RAMs.

We *delivered* the industry's first 4K static RAM in 1975, a full year and a half before anyone else. We are now delivering 7 basic static RAM types with many versions

of each, and producing them at a greater monthly rate than our nearest competitors combined.

By now we have more 4K static RAMs operating in a wider range of customer equipment than anyone else in the semiconductor memory business — from 10 Megabyte IBM add-on memory systems to hobbyist microprocessor kits.

Whatever your application, from mass storage to telecommunications, from medical electronics to toys and games, chances are there's an EMM SEMI static RAM just right for you. Please call or write today for full details — and ask about our byte oriented RAMs, too.

**Memory at work** **EMM SEMI, Inc.**

a subsidiary of Electronic Memories & Magnetics Corporation • 3883 N. 28th Avenue, Phoenix, Arizona 85107 • (602) 263-0202

118 Circle 118 on reader service card

Electronics / November 10, 1977



even if the signals exceed the threshold point for a considerable length of time thereafter. When the trigger threshold is exceeded periodically, a partial sweep will often be generated—the result of initiating the manual

reset while the ramp generator is running. □

Engineer's notebook is a regular feature in *Electronics*. We invite readers to submit original design shortcuts, calculation aids, measurement and test techniques, and other ideas for saving engineering time or cost. We'll pay \$50 for each item published.

## Shunt diode extends linear range of LED

by R. W. Dawson

Bell Laboratories, Crawford Hill, Holmdel, N. J.

A standard diode in series with a resistor can be used to extend the linear operating range of a light-emitting diode, increasing its effectiveness as an intensity-modulated light source in an optical communications system.

In essence, the linear region of the LED's output

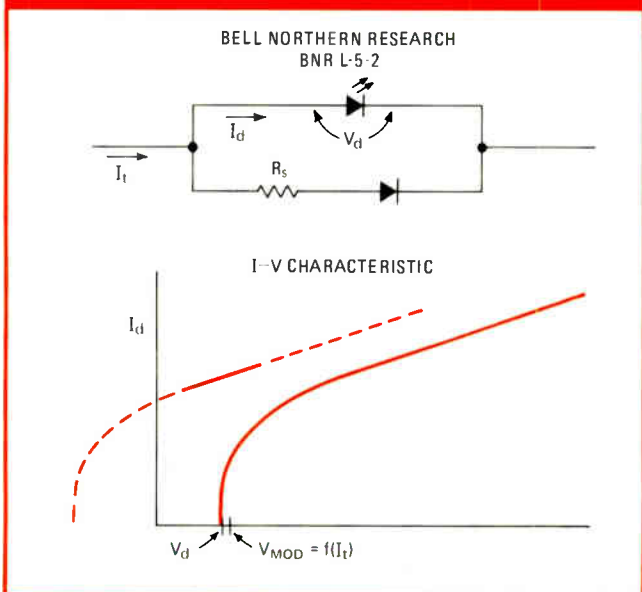
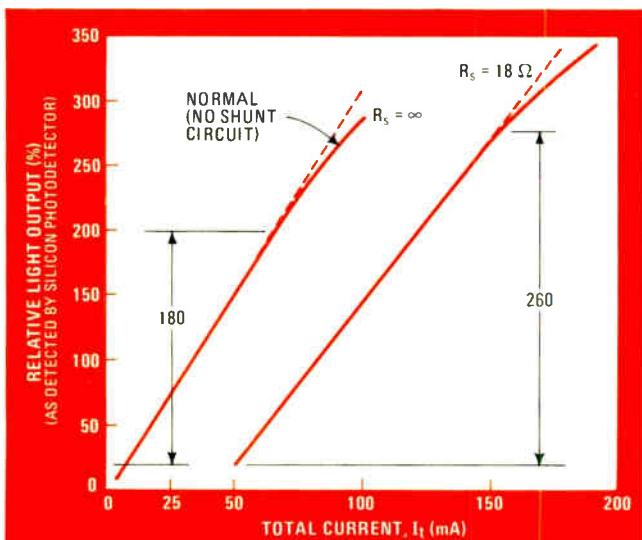

becomes responsive to the modulating signal, which can therefore be larger than when its influence is confined to a small segment of the LED's nonlinear region. Admittedly, the resistor-diode combination can draw considerable power, but a larger current source is often less expensive than an LED capable of greater output.

The LED on which the circuit is based is made of alternating layers of gallium aluminum arsenide and gallium arsenide. Also known as a double-heterostructure injection LED, it has an output characteristic that varies linearly for a current input of 20 to 65 milliamperes. To improve on that linearity, the diode-resistor network need only lower the LED's barrier potential, shifting the operating curve so as to bring the nonlinear knee point well below the minimum modulating signal. Thus, any diode will do, provided its barrier potential is lower than the LED's—that is, less than 1.5 to 2 volts.

The diode is connected in series with a current-limiting resistor, and the combination is connected across the LED. This acts to increase the relative optical output by 20% to 60%, depending on the diode used and the series resistance. The diode-resistor combination is normally selected to allow nearly all the current to pass through the shunt at low values and through the LED at high levels, but this ideal is not always attained.

In operation, the standard diode reaches its switch-on point before the LED reaches its barrier potential, so that the LED sees a low voltage across its terminal at low currents. This pre-biases the LED toward its conducting region, or in other words, shifts the entire current-voltage characteristics to the left, as shown in the lower part of the figure. As viewed by a given modulating signal, normally operating near the LED's knee, the curve is shifted from a nonlinear Q point to the linear portion, as shown.

Several types of standard diodes were tested as shunt diodes, including GaAs, silicon, and point-contact germanium devices. The one that did the most to improve the linear range of the GaAlAs-GaAs device was a germanium-alloy diode. (Other types of LEDs have slightly different current-voltage characteristics and might require a different type of shunt diode.)

The germanium alloy diode, together with a series resistance of 5 to 20 ohms and roughly three times the normal current input, increased the linearity of the LED used in this circuit by  $(260 - 180)/180$ , or 44%, as may be determined from the main figure. Use of a smaller series resistance would extend the range still further, but at the cost of raising the total drain current to about 300 milliamperes. □

**More linear.** The optical diode's linearity is improved when a standard diode-resistor combination is placed in shunt with it. This shifts the LED's I-V characteristics to left, as shown in lower part of figure. The percent improvement is found from the curves at top.

## **Wire chassis often beat solid-metal types hollow**

If the cost and weight of your solid-steel chassis is too high, how about switching to the welded-wire type? E. H. Titchener Co. of Binghamton, N. Y., can supply a holder for 2½-by-11-by-11-inch logic cards that uses ⅜-inch-diameter steel wire and 10 0.060-inch strip stampings and costs only \$2.50 per unit in large quantities. A large 11½-by-19-by-16-inch rack-mounted unit that is fabricated with the same technique is in the \$28 price range.

Minicomputer maker Digital Equipment Corp., Maynard, Mass., has already switched from solid metal to wire frame chassis for some of its machines. The DEC manufacturing engineers have found that **the approach slashes structural costs and weight, gives more efficient cooling and better accessibility**, and also reduces assembly time on the PDP-11/03 and 11/04 minicomputers.

## **Flexible-circuit jumpers come with built-in connections**

Short lengths of flexible printed-circuit cables are often used to connect parts of large electronic systems, since they eliminate wiring errors and can be folded to any shape. But they generally need connectors or pins added to them to mate them to the rest of the system. This additional hardware is unnecessary on flexible-circuit elements called sculptured cables from Advanced Circuit Technology of Merrimack, N. H. Made by a special chemical milling process, the new jumpers have 25-mil-wide, 10-mil-thick rigid copper fingers at their ends. These terminations may be made straight, staggered, at right angles to the cable length, and at any pitch, and they can be **either plugged into mating connectors or wave-soldered to printed-circuit boards**. The method adds to reliability, as well as eliminating the higher labor costs that are incurred with conventional types of flexible jumpers.

## **How to plot a neat frequency response curve**

You're measuring frequency response, and you would like to pick frequencies that will produce evenly spaced points when plotted along the horizontal axis of the semilogarithmic graph paper. How do you figure out which to pick? It's easy, says Glenn Darilek of Southwest Research Institute, San Antonio, Texas, if you use a calculator and if you recognize that **each value will be larger than the previous one by a factor of the nth root of 10**, where n is the number of points you have decided you want to plot per decade. For example, if you're plotting frequencies between 10 and 100 kHz and you want five points, you calculate the fifth root of 10, or 1.585, and the frequencies will then be 10, 15.85, 25.12, 39.82, 63.11, and 100 kHz.

## **40-pin carrier conserves 40-pin LSI packages**

The pins on a standard 40-pin LSI circuit package can easily get damaged or misaligned after you have plugged and unplugged it a few times from an integrated-circuit socket or socket panel. So Augat Inc. of Attleboro, Mass., has made a carrier with 40 much sturdier pins. **You plug the delicate package into it once and once only**. But the carrier-plus-package can be plugged and unplugged as often as you like without risk.

**Jerry Lyman**



# The Sinclair PDM35. A personal digital multimeter at only \$49.95

A digital multimeter used to mean an expensive, bulky piece of equipment.

The Sinclair PDM35 changes that. It's got all the functions and features you want in a digital multimeter, yet they're neatly packaged in a rugged but light pocket-size case, ready to go anywhere.

The Sinclair PDM35 gives you all the benefits of an ordinary digital multimeter – quick clear readings, high accuracy and resolution, high input impedance. Yet at \$49.95 it costs less than you'd expect to pay for an analog meter!

The Sinclair PDM35 is tailor made for anyone who needs to make rapid measurements. Development engineers, field service engineers, lab technicians, and computer specialists will find it ideal.

With its rugged construction and battery operation, the PDM35 is perfectly suited for hand work in the field, while its angled display and

optional AC power facility make it just as useful on the bench.

## Features of the PDM35

- 3½ digit resolution.
- Sharp, bright, easily read LED display, reading up to  $\pm 1.999$ .
- Automatic polarity selection.
- Resolution of 1 mV and 0.1 mA.
- Direct reading of semiconductor forward voltages at 5 different currents.
- Resistance measurement up to 20 M $\Omega$ .
- 1% of reading accuracy.

Operation from replaceable battery or AC adapter.  
Industry standard 10 M $\Omega$  input impedance.

## Technical Specification

**DC Volts (4 ranges)**  
Range: 1 mV to 1000 V.  
Accuracy of reading: 1.0%  $\pm$  1 count.  
Note: 10 M $\Omega$  input impedance.

**AC Volts (40 Hz-5 kHz)**  
Range: 1 V to 500 V. Accuracy of reading: 1.0%  $\pm$  2 counts.

**DC Current (6 ranges)**  
Range: 1 nA to 200 mA.

Accuracy of reading: 1.0%  $\pm$  1 count.  
Note: Max. resolution 0.1 nA.

**Resistance (5 ranges)**  
Range: 1 $\Omega$  to 20 M $\Omega$ .  
Accuracy of reading: 1.5%  $\pm$  1 count.  
Note: Also provides 5 junction-test ranges.

**Dimensions:** 6 in x 3 in x 1½ in.  
**Weight:** 6½ oz.

**Power supply:** 9 V battery or Sinclair AC adapter.

**Sockets:** Standard 4 mm for resilient plugs.

**Supplied with:** Leads, test prods, operating instructions, carrying wallet.

**Options:** AC adapter for 117 V 60 Hz power. De Luxe padded carrying wallet. 30kV high-voltage probe.

## The Sinclair credentials

Sinclair have pioneered a whole range of electronic world-firsts – from programmable pocket calculators to miniature TVs – holding a world-lead in innovative electronics. The PDM35 embodies six years' experience in digital multimeter design, in which time Sinclair have become one of the world's largest producers.

## Find out more!

You can see the PDM35 at any of the Sinclair distributors listed on this page. Or, if you'd like full details of operation and performance, and a complete distributor list, just send the coupon below. We'll send you all the facts by return.

The Sinclair PDM35 will make your life a lot easier – send the coupon today!

Send to: Sinclair Radionics Inc, Galleria, 115 East 57th Street, New York, N.Y. 10022, U.S.A.  
Please send me full illustrated details of the Sinclair PDM35 personal digital multimeter, without obligation.

Name.....  
Position.....  
Company.....  
Address.....

  
**sinclair**  
 World leaders in fingertip electronics

Sinclair Radionics Inc, Galleria, 115 East 57th Street, New York, N.Y. 10022, U.S.A.

See the PDM35 at: Carter McCormick & Peirce Inc., Farmington, Mich. 313 477 700; Crane & Egert Corp., Elmont, N.Y. 516 488 2100; F. L. W. Inc., Costa Mesa, California. 714 751 7512; International Standard Components, Los Altos, California. 415 941 2600; Osmann Instruments Inc., Syracuse, N.Y. 315 437 6666; Par Associates, Denver, Colorado. 303 355 2363; PVA Company, La Grange, Ill. 312 352 1037; Scientific Associates, Washington D.C. 703 573 8787; Southern Peripherals & Instruments Inc., Atlanta, Georgia. 404 455 3518.

# Multiwire<sup>®</sup>: Field modifiable.

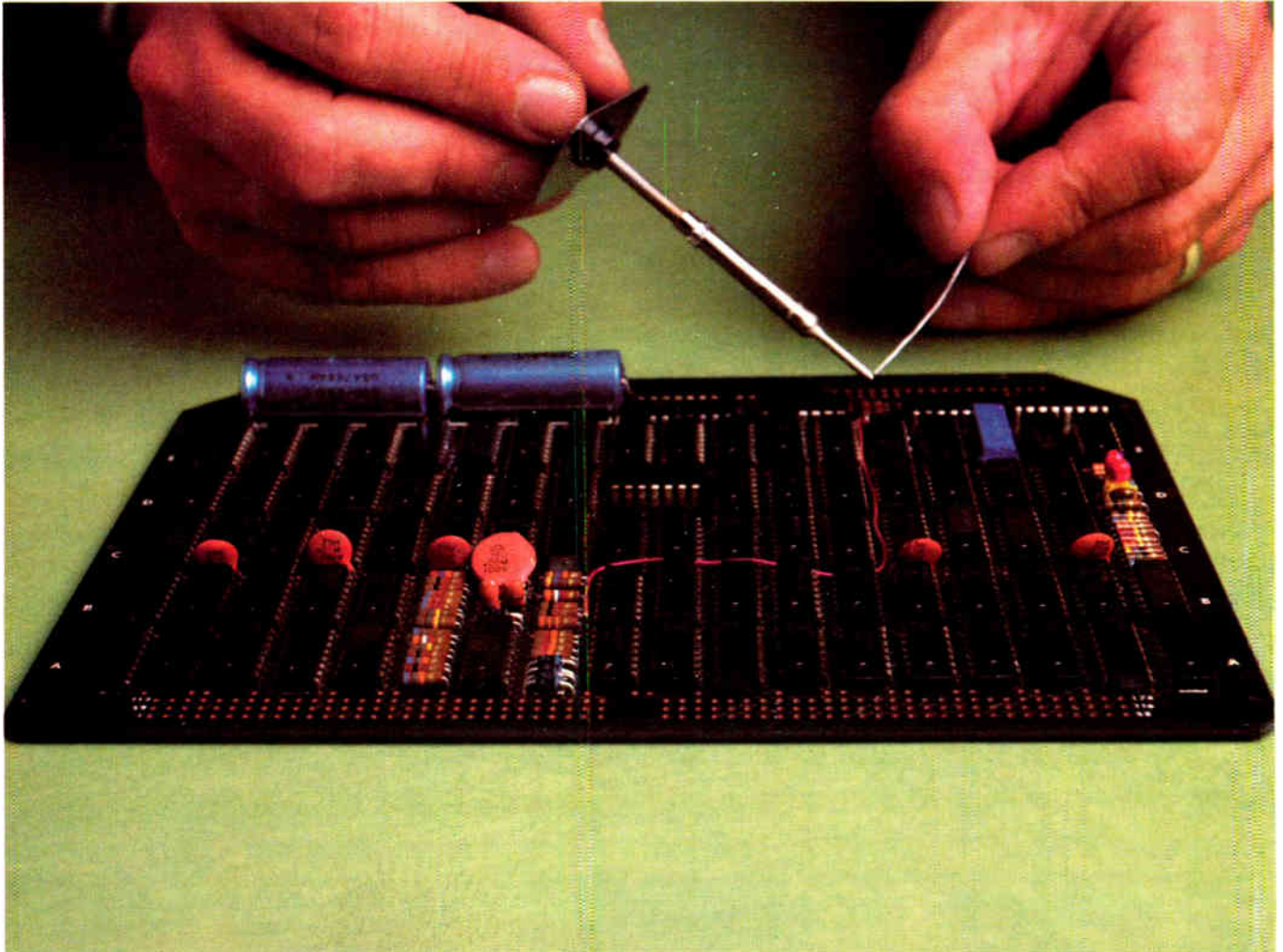

Of the many benefits offered by Multiwire, one of the most important is its simplicity of change and repair. Multiwire boards are normally easier to change after assembly or in the field than multilayer.

All wires are exposed in the typical Multiwire board. To make a change, use a blade to cut the conductor that you want to correct, and remove a portion of the wire to avoid bridging. Then, just solder in a jumper wire and

fasten down with epoxy or urethane.

Changes in Multiwire boards can easily be accomplished in minutes by field service technicians.

Multilayer changes, of course, are an entirely different story. Corrections are difficult at best and frequently impossible. As one engineer familiar with multilayer puts it: "Corrections . . . are something of a disaster."

With Multiwire, to replace a discrete or DIP that has failed, the component

# Multilayer: Field discardable.

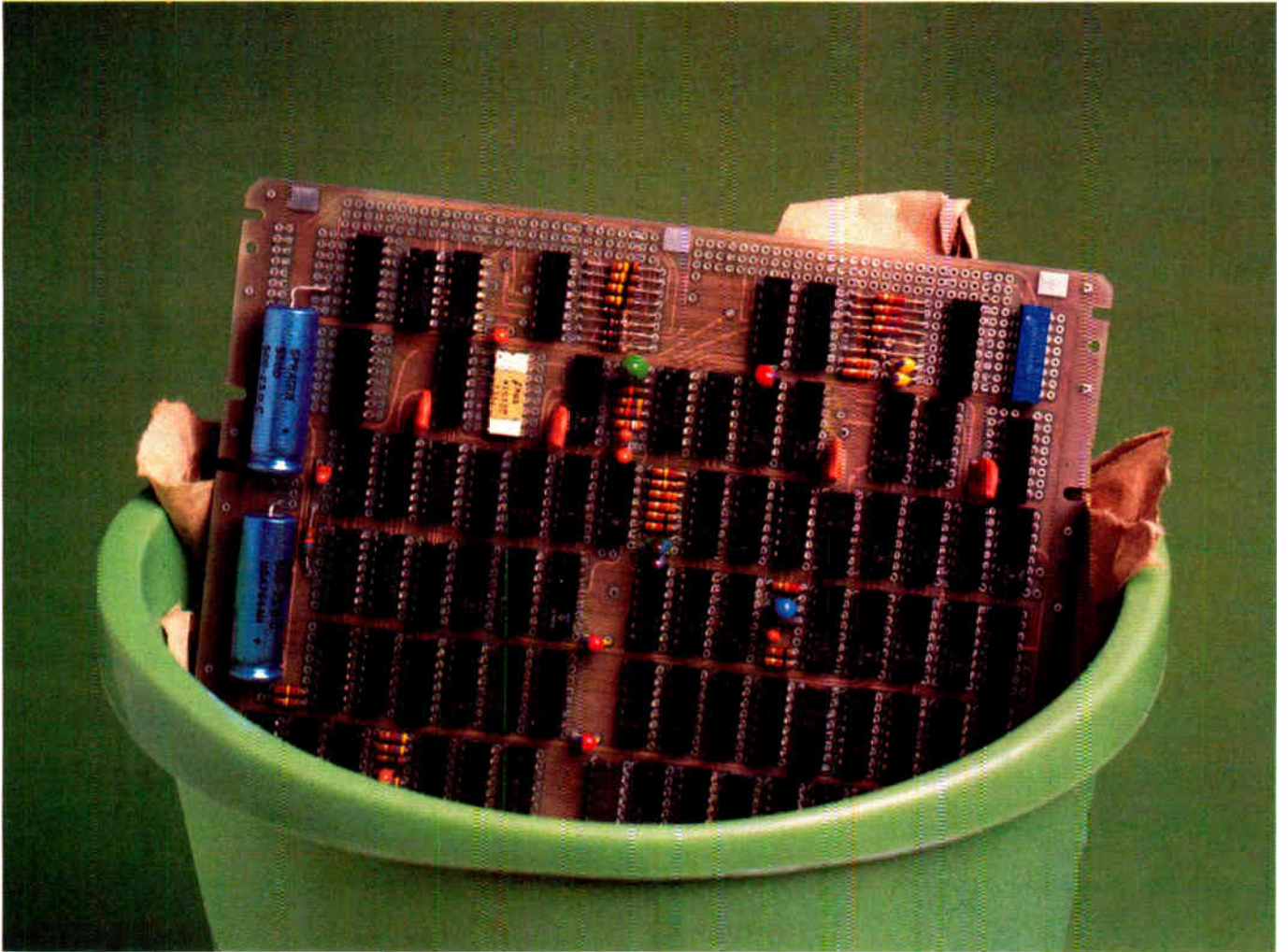

is simply unsoldered; the plated-through holes stand up just as well if not better than regular PC board holes. With multilayer, however, a soldering iron often lifts the board off the board, with many ensuing problems.

Of course, Multiwire will need fewer repairs to begin with. The Multiwire manufacturing method has far greater yield, usually better than 99% reliability at incoming inspection.

And now, consider some other key advantages of Multiwire: Shorter lead times. No artwork required except for basic ground planes and plug-in connections. Lower design and tooling costs. Much faster first-piece delivery.

To take advantage of Multiwire, all you supply us is an interconnection list from which we prepare the input data for our numerically controlled machines. Or you can prepare your

own input from our software. Since all of the logic is placed by N/C-controlled equipment made up from the wire running lists, changes in circuit design only require a change in your wire list.

For more information, write to Multiwire Marketing Department. Or call us at 516-448-1117. In New England, 603-889-0083. In California, 714-991-6030. For Texas, 214-234-2873.

## **Multiwire<sup>®</sup> from Photocircuits.**

Division of Kollmorgen Corporation, Glen Cove, New York 11542

# You Don't Have To Beg, Borrow Or Buy...



## Rent'em From GE

Short or long-term instrument rentals give you flexibility and economy.

GE has over 9,000 instruments available for immediate shipment: □ Tek Scopes □ Biddle Megger Insulation Testers □ H-P Signal Generators □ Honeywell Oscillographs □ Complete Data Systems □ Esterline Angus Recorders □ GE Chart Recorders □ Modems □ Communication Terminals ... all calibrated to the manufacturer's specs.

We have over 100 Sales/Service Centers,

and one of them is near you. In addition to maintaining our Rental Inventory, they can also repair and calibrate your own equipment.

Don't borrow someone else's GE Rental Catalog. **Call collect (518) 372-9900** or your nearest Sales/Service Center.

**Quick-rental<sup>®</sup>  
instruments**

**GENERAL**  **ELECTRIC**

**ALA.** BIRMINGHAM (215) 925-3104 • **ARIZ.** PHOENIX (602) 278-8515 or 8516, TUCSON (602) 294-3139 • **CAL.** LOS ANGELES (213) 642-5350, SAN FRANCISCO (415) 436-9260 • **COL.** DENVER (303) 371-1260 • **CONN.** SOUTHWINGTON (203) 621-4059 • **FLA.** JACKSONVILLE (904) 751-0610 • **GA.** ATLANTA (404) 457-5563 • **ILL.** CHICAGO (219) 933-4500 • **IND.** INDIANAPOLIS (317) 639-1565 • **KY.** LOUISVILLE (502) 452-3311 • **LA.** NEW ORLEANS (504) 367-6528 • **MD.** BALTIMORE (301) 332-4700 • **MASS.** BOSTON (617) 396-9600 Ext. 160, SPRINGFIELD (413) 781-1111 • **MICH.** DETROIT (313) 285-6700 Ext. 208 • **MINN.** MINNEAPOLIS (612) 522-4396 • **MO.** KANSAS CITY (816) 231-4377, ST. LOUIS (314) 965-7115 • **N.J.** CLIFTON (201) 471-6556 • **N.Y.** BUFFALO (716) 876-1200, SCHENECTADY (518) 385-2195 • **N.Y.C.** CLIFTON, N.J. (201) 471-6556 • **N.C.** CHARLOTTE (704) 525-0311 • **OH.** CINCINNATI (513) 874-8512, CLEVELAND (216) 523-6382, TOLEDO (419) 691-3501 • **OR.** PORTLAND (503) 221-5101 • **PA.** PHILADELPHIA (609) 424-4450, PITTSBURGH (412) 462-7400 • **TEX.** DALLAS (214) 357-7341, HOUSTON (713) 672-3570 • **VA.** RICHMOND (804) 232-6733 • **WASH.** SEATTLE (206) 854-0211 • **W.V.** CHARLESTON (304) 345-0920 • **WISC.** MILWAUKEE (414) 744-0110 • **PUERTO RICO** PONCE (809) 843-4225.

# Nodal tester handles semiconductors

Teradyne in-circuit unit adds that capability to node-to-node continuity and guarded-component testing of loaded circuit boards

by Lawrence Curran, Boston bureau manager

The L529 assembly inspection system for loaded circuit boards announced last month by Teradyne Inc. [*Electronics*, Oct. 27, p. 33] serves notice that the Boston company is going after the in-circuit board test market in a big way. To date, that market has been left mainly to Faultfinders Inc. and Zehntel Inc., but Jeff Hotchkiss, product manager for in-process test equipment at Teradyne, has set his sights on having a 25% market share by the end of next year.

The new unit is a prescreening unit for locating assembly and com-

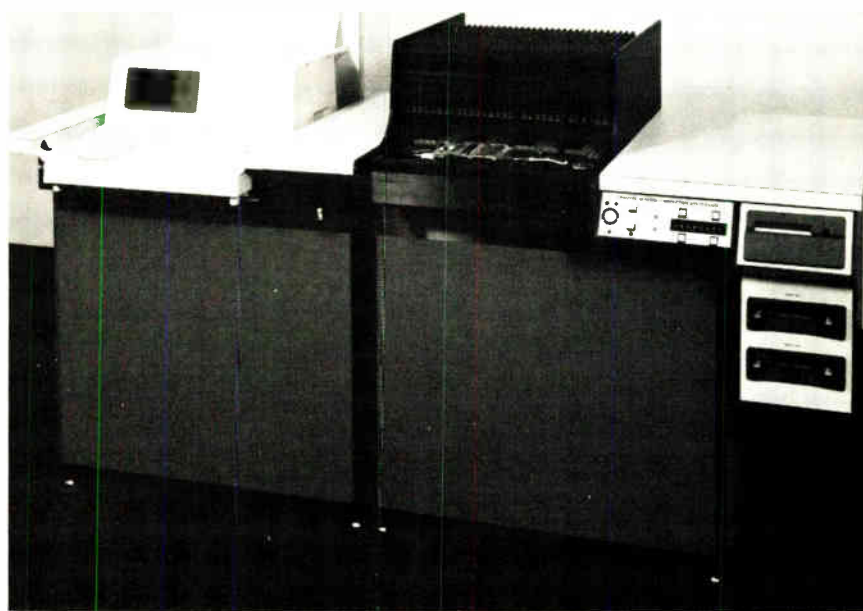
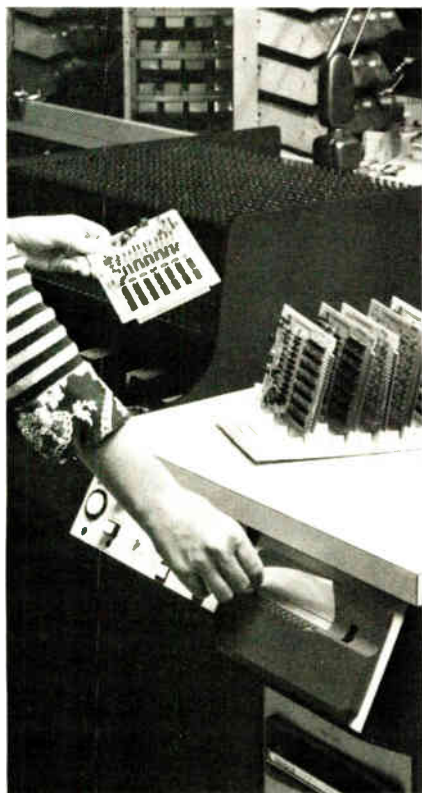

ponent faults on loaded analog, hybrid and digital circuit boards having as many as 700 nodes before they go to a functional tester, Hotchkiss says, and was designed with simplicity of programming as one of Teradyne's prime objectives. In order to reach that objective and still detect 60% to 90% of the faults on a board, Teradyne has come up with three simple types of tests that are incorporated into a microprocessor-controlled system.

The L529 performs node-to-node continuity tests to pinpoint shorts and opens on a board and node-to-node guarded-component tests for resistive and reactive components,

guarding out active semiconductor devices. These two types of tests are not new for in-circuit board testers, but, Hotchkiss maintains, the third test type—nodal testing of the semiconductor devices—employs an innovation not found in competitive machines.

In this test type, node-to-ground impedance tests are performed with all nodes taken to ground. Then each node is driven with 0.2 volt dc for the resistors, 0.2 v ac for capacitors and inductors, and +2.5 v and -2.5 v to exercise semiconductor junctions. Hotchkiss says that conventional in-circuit testers working on nodes that include a diode, for exam-

## New products

ple, would do a guarded-component type of test, "but if there's a semiconductor device nested in there, it can take a lot of programming to guard it out."

The three test types are put into a canned routine that cannot be easily tampered with, he says. The approach allows a junior technician to

program a complex board in a few hours. Even a test program for a fully loaded board with 700 nodes or test points can be developed in less than a day with the L529, which Hotchkiss says compares with one to three weeks for other in-circuit testers.

Three steps are included in pro-

gramming the system. The components are first defined for the system by being labeled with an R for a resistor, Q for transistor, X for a diode, and so on. Besides the label, the programmer also enters into the system the component class—resistive, reactive, semiconductor, integrated. This definition step tells the system which type of test to perform on each component.

The second programming step is entry of the node list—a simple interconnect list for the board, which the user develops as he builds up the test fixture for the board using a bed-of-nails kit that Teradyne provides. Finally, the programmer initiates the learn step, which establishes nominal values and tolerances for the board to be tested by entering a list of those values. The programmer uses figures obtained from about a dozen known good boards of the same type.

Programming is done on a console that has an interactive keyboard and cathode-ray-tube display. Besides the programming console, the L529 includes an operator's test station and board handler. The test station has a control panel, two tape drives, and a strip printer that generates diagnostic error messages. The board handler, first used on Teradyne's L429 shorts-detection system, uses weighted rods rather than the more conventional vacuum fixtures for applying the contact force for the board being tested.

Hotchkiss says that the L529 has tested in 10 seconds hybrid boards that previously required 45 s to a minute of test time. Hybrid boards contain both digital and analog components. He looks for the machine to boost by some 300% the productivity of the functional tester for which it prescreens.

Prices start at \$54,500 for testing boards with up to 100 nodes. Modules for increasing that to 700, in 100-node increments, are \$5,000 each, and the bed-of-nails test kits are about \$1,000 per board type. Delivery is 12 to 16 weeks.

Manufacturing Systems Division, Teradyne Inc., 183 Essex St., Boston, Mass. 02111. Call Jeff Hotchkiss at [617] 482-2700. [338]



There are scores of uses for Bud's new Contempo Series, the versatile mini-enclosures. Well engineered, solidly constructed, clean and contemporary. Four styles, 22 sizes in either woodgrain and eggshell, or black pebble and smooth gray finish. The Contempo Series, the newest idea for your ideas. From Bud! For literature, phone Bud toll free: (800) 321-1764; in Ohio, (800) 362-2265.

*Complete manufacturing facilities at two locations:*

**BUD**

**Bud Industries, Inc.**  
4605 East 355th Street  
Willoughby, Ohio 44094

**Bud West, Inc.**  
3838 North 36th Avenue  
Phoenix, Arizona 85019



# Need ROM retention and RAM alterability?



## Design in Nitron Non-Volatile Memories.

Our Metal Nitride Oxide Silicon NVM are fully reprogrammable in-circuit. They offer long-duration storage security without battery backup or "power-on" auxiliaries.

### HIGH DATA RETENTION

Data is secure for a minimum of 10,000 hours and can be read  $10^{10}$  times between refresh cycles.

### PROGRAM VERSATILITY

Nitron NVMs offer entire memory or word alterability. And it can all be done in-circuit a minimum of  $10^5$  times. Millisecond write times are ideal for applications in the human-response range.

### SYSTEM COMPATIBILITY

We built in on-chip decoding, and TTL and CMOS compatibility. Plus, Nitron NVMs can be reprogrammed without additional power supplies or power supply switching.

### PRODUCT AVAILABILITY

Nitron NVMs are available off-the-shelf for parallel data applications in 64x4 and 256x4 configurations;

and for serial data applications in 21x16, 16x18 and 1024x1 configurations. If you don't see what you need, tell us about it. We custom design NVMs, too.

Unique Nitron process puts silicon nitride and silicon dioxide layers between MOS gate and substrate. When voltage is applied, trapped charge offsets threshold voltage. Charge remains after voltage is removed.

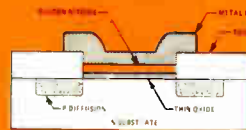

Need information fast? Call Nitron NVM Marketing at (408) 255-7550. Or fill in the coupon below for your NVM Fact Kit.

# NITRON

Mail to:  
NITRON NVM Marketing  
10420 Bubb Road  
Cupertino, CA 95014

TELL ME MORE!

I'm interested in (check box):

- 64x4 NC7040     21x16 NC7033  
 256x4 NC7050     16x18 NC7035  
 1024x1 NC7051     Complete NVM Fact Kit

Send to:

name & title

company

address

city

state

zip

E-8

# Intel delivers PDP-11 memory for people who can't afford to wait.

When you're in a hurry for more semiconductor memory for your PDP-11, call Intel. We deliver memory for the full PDP-11 line. And because we're the largest manufacturer of semiconductor memory in the world, delivery is when you want it.

Why wait? Since you've chosen the leader to supply your minicomputer, it makes sense to go to the leader for memory, too. That's us.

Intel memory systems save you more than time. Our in-1670 add-on memory for the PDP-11/70 is one example. It gives you four times the capacity in the same frame compared to the DEC MJ11-A core memory. And built in Error Correction Code (ECC) and Error Logging improve up-time and reduce maintenance time by automatically correcting and recording single-bit failures and detecting and recording double-bit errors.

For PDP-11 add-in memory go with our in-4711 plug in boards. You'll get memory that's even faster than DEC's. 16K words per hex-wide board. With or without parity. To further expand PDP-11 memory and reduce UNIBUS™ loading choose our in-4011 add-on. With memory management you can expand to 128K words in 16K increments. And since the in-4011 requires only one UNIBUS load, you get added system flexibility.

Get more memory for your LSI-11 and PDP-11/03 in less space with our in-1611 add-in memory. You get up to 32K words, in 8K increments, on a single, two-wide, board. That's up to eight times the memory you get with a DEC board.

When you can't afford to wait call us at 800-538-8476. In California and Canada, call 408-734-8102, x575. We'll save you time, and much more.

**intel delivers.**

Intel Memory Systems  
1302 N. Mathilda Avenue  
Sunnyvale, California 94086

I can't wait! Must have delivery in  5 Days  30 Days  \_\_\_\_\_ Days

Please call me at \_\_\_\_\_/\_\_\_\_\_ Ext. \_\_\_\_\_

Please send me information on semiconductor memory for the following:

LSI-11, PDP-11/03

PDP-11/04

PDP-11/05

PDP-11/34

PDP-11/35

PDP-11/40

PDP-11/45

PDP-11/55

PDP-11/70

Name/Title \_\_\_\_\_

Company \_\_\_\_\_ Mail Station \_\_\_\_\_

Address \_\_\_\_\_

City/State/Zip \_\_\_\_\_

UNIBUS is a trademark of Digital Equipment Corp. Maynard, Mass.

World Radio History  
Circle 130 on reader service card

**U.S. AND CANADA SALES OFFICES**

**ALABAMA**  
Col-Ins-Co  
Huntsville  
(205) 881-9512  
Glen White Assoc  
Huntsville  
205 883-9394

**ARIZONA**  
Intel Corp  
Phoenix  
(602) 242-7205  
BFA Corp  
Scottsdale  
(602) 994-5400

**CALIFORNIA**  
Intel Corp  
Santa Ana  
714 835-9642  
Intel Corp  
Sunnyvale  
(408) 738-3870  
Earle Assoc  
San Diego  
(714) 278-5441  
MAC-I  
Berkeley  
415 843-7625  
MAC-I  
Cupertino  
408 257-9880  
MAC-I  
Fountain Valley  
(714) 839-3341  
MAC-I  
Woodland Hills  
213 347 1374

**COLORADO**  
Intel Corp  
Denver  
303 373-4920  
BFA Corp  
Denver  
303 837 1247

**CONNECTICUT**  
Intel Corp  
Danbury  
203 792-8366

**FLORIDA**  
Intel Corp  
Ft. Lauderdale  
(305) 971 7200  
Intel Corp  
Orlando  
(305) 628-2393  
Col-Ins-Co  
Orlando  
305 423-7615

**GEORGIA**  
Col-Ins-Co  
Stone Mountain  
404 299-2138

**ILLINOIS**  
Intel Corp  
Oak Brook  
312 325-9510  
Data Electronics  
Chicago  
312-283-0300

**INDIANA**  
Data Electronics  
Indianapolis  
(317) 784-6360

**IOWA**  
Technical Repts Inc  
Cedar Rapids  
(319) 396-5662

**KANSAS**  
Technical Repts Inc  
Olathe  
(913) 782-1177

**LOUISIANA**  
Col-Ins Co  
Baton Rouge  
(504) 292-1755

**MARYLAND**  
Intel Corp  
Timonium  
(301) 252-7742  
Glen White Assoc  
Timonium  
(301) 252-7742  
Mesa Inc  
Rockville  
(301) 881-8430

**MASSACHUSETTS**  
Intel Corp  
Chelmsford  
(617) 256-4131  
Computer Marketing Inc  
Waltham  
(617) 890-1776

**MICHIGAN**  
Intel Corp  
Southfield  
(313) 353 0920  
Lowry and Assoc Inc  
Brighton  
(313) 227-7067

**MINNESOTA**  
Intel Corp  
Bloomington  
(612) 835 6722  
Data Electronics  
Minneapolis  
612 786-9666

**MISSOURI**  
Technical Repts Inc  
Hazelwood  
(314) 731-5200

**NEW JERSEY**  
Intel Corp  
Edison  
201 985 9100

**NEW MEXICO**  
BFA Corp  
Albuquerque  
(505) 292-1212  
BFA Corp  
Las Cruces  
(505) 523-0543

**NEW YORK**  
Intel Corp  
Hauppauge  
516 231-3300  
Intel Corp  
Rochester  
(716) 328-7340  
Intel Corp  
Poughkeepsie  
914 473-2303  
Measurement Tech Inc  
Great Neck  
516 482-3500  
T-Squared Inc  
Pittsford  
716 381-2551  
T-Squared Inc  
Syracuse  
(315) 463-8592

**NORTH CAROLINA**  
Col-Ins-Co  
Winston Salem  
(919) 748-0297  
Glen White Assoc  
Raleigh  
(919) 787 7016

**OHIO**  
Intel Corp  
Dayton  
513 890-9350  
Intel Corp  
Euclid  
216 289 0101  
Lowry and Assoc Inc  
Cleveland  
216 464 8113  
Lowry and Assoc Inc  
Dayton  
513 435 4795

**OREGON**  
ES Chase Co  
Portland  
503 620-9616

**PENNSYLVANIA**  
Intel Corp  
Ft. Washington  
215 542 9444  
Lowry and Assoc Inc  
Pittsburgh  
412 922-5110  
Q E D Electronics Inc  
Hatboro  
215 674-9600

**TENNESSEE**  
Glen White Assoc  
Germantown  
901 754-0483  
Glen White Assoc  
Johnson City  
615 928-0184

**TEXAS**  
Intel Corp  
Dallas  
214 241-9521  
Mycrosystems Mktg Inc  
Austin  
512 472-2492  
Mycrosystems Mktg Inc  
Dallas  
214 238-7157  
Mycrosystems Mktg Inc  
Houston  
713 783-2900

**UTAH**  
BFA Corp  
Salt Lake City  
801 466-6522

**VIRGINIA**  
Glen White Assoc  
Lynchburg  
804 384-6920

**WASHINGTON**  
ES Chase Co  
Seattle  
206 762-4824

**CANADA**  
Intel Semiconductor Corp  
of Canada  
Ottawa  
613 232-8576  
Multitek Inc  
Ottawa  
613 825-4553

**EUROPEAN MARKETING HEADQUARTERS BELGIUM**  
Intel International  
Brussels  
Tel: 02 660 30 10  
Telex 24814

**ORIENT MARKETING HEADQUARTERS JAPAN**  
Tokyo  
Tel: 03 426-9261  
Telex 781 28426

**New products**

Components

**Carbon networks replace discretes**

Off-the-shelf resistor net, aimed at display use, is priced under cermet

Equipment manufacturers are now accustomed to replacing multiple discrete resistors with thick-film cermet-resistor networks to pare assembly costs and save printed-circuit-board real estate. Yet many applications do not demand—and users should not have to pay for—the precise tolerances that cermet networks afford.

So Centralab Electronics has decided to develop a standard network line using the carbon system, which has been available up to now only on custom products. The devices will be tagged from 15% to 25% below their cermet equivalents. The Milwaukee-based division of Globe-Union Inc. is one of the few remaining firms that offers carbon-resistor networks as well as the most expensive high-

performance cermet versions.

The first part, now available in sample quantities, is a ceramic substrate with seven 200-ohm resistors screened on it in an isolated pattern. "It's designed to replace the discrete carbon-composition current-limiting resistors used with light-emitting-diode displays," says Dwayne A. MacDonald, marketing manager for the division's electronic controls group. "Displays don't require tight resistor tolerances, because the human eye can't detect slight variations in illumination," he explains.

Resistor tolerance for the seven devices is  $\pm 5\%$ , and each is rated at 0.15 watt. Temperature coefficient of resistance is  $-425$  parts per million per  $^{\circ}\text{C}$  maximum over an operating temperature range of  $-55^{\circ}\text{C}$  to  $105^{\circ}\text{C}$ . The 14-pin single in-line package, coated with a phenolic resin and measuring 1.6 by 0.425 by 0.2 inches thick, will sell for less than 15 cents in large quantities. In lots of 1,000 pieces, the network will cost 35 cents.

The network's specifications are better than those of carbon-composition resistors measured to MIL-R-11F, MacDonald points out, and the network is superior in moisture

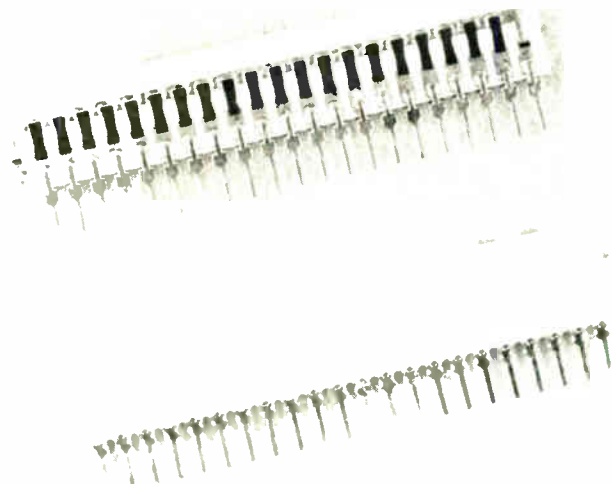

# LIMIT ONLY ONE PYROSCAN SYSTEM FOR EACH CUSTOMER



Pyroscan 100 system

Whether you have one or one hundred temperature sensors to monitor, the Newport Pyroscan System will do your job . . . and only one System is all you should need.

Pyroscan systems provide the flexibility and expandability to meet your present and future needs.

A Pyroscan 30 System is wired to accept three 10-channel cards while Pyroscan 100 is wired for ten cards. Just plug in the cards as your requirement changes, attach your sensors, and that's all there is to it.

Newport's building block approach allows you to start with a Scan Programmer and one 10 channel switch card (without cabling) for only \$380. Go to a full logging system and pay \$1480 for the first ten channels. A 30 channel system is only \$1810.

How about a ten channel switching card that is addressed by BCD code for only \$145?

A module change allows you to switch to a different thermocouple type.

Ask about Newport's Custom mod centers for your special application convenience. Send for the Pyroscan 8 page brochure. U.S. Prices only.

#### FEATURES:

- 20 thermocouple and 7 Platinum RTD ranges available
- First and last channel programming
- Resolution 1.0 or 0.1 degree C or F
- Manual/single/continuous scan
- System expansion made easy
- Variable dwell and scan rate
- Internal clock option
- Printed paper tape record
- Highly stable cold reference junction
- Linearized over sensor range
- Screw terminals for TC inputs
- Single or dual limit alarm options
- Easy to order
- Easy to obtain
- Easy to operate

## NEWPORT

Corporate Office  
630 East Young St  
Santa Ana, CA 92705  
Telephone: (714) 540-4914  
TWX 910-595-1787  
Cable: Newlab, Santa Ana  
CA 92705

Newport BV  
P.O. Box 7759  
Schiphol East  
The Netherlands  
Telephone: (20) 45-20-52  
Telex: 844-16347

Newport Laboratories GmbH  
6072 Dreieich  
Max-Planck-Strasse 13  
Postfach 102163  
German Federal Republic  
Phone: (06103) 64041/63042  
Telex: 417908 (NEWPT D)

Circle 132 on reader service card

## New products

resistance, temperature cycling, load life, and short-term overload tests. It is priced higher than seven discretes, which typically sell for about 1 cent each in large quantities, but that difference is often erased by its lower insertion cost, and networks also reduce procurement, inventory, inspection, and testing costs, MacDonald says.

Centralab plans other off-the-shelf carbon-resistor networks in the display area, varying the number of resistors per package, as well as resistor values. It is looking, too, for other products that might be standardized, such as multiple-divider or one-side common-resistor networks or commonly used RC networks.

Centralab Electronics Division of Globe-Union Inc., 5757 N. Green Bay Ave., Milwaukee, Wisc. 53201 [341]

## Solid-state relay operates from $-55^{\circ}$ to $110^{\circ}\text{C}$

Housed in a low-profile, hermetically sealed dual in-line package, the model 682-1 solid-state relay is a thick-film hybrid circuit designed to meet the requirements of MIL-R-28750/9. The optically coupled unit operates from  $-55^{\circ}\text{C}$  to  $110^{\circ}\text{C}$  and



handles input voltages from 3 to 16 volts dc, making it compatible with transistor-transistor and high-noise-immunity logic. Its output can handle 1 ampere at 250 v root mean

# The magazine you're reading now, could be your own.

Drop off the routing list. Get your own fresh, unclipped copy mailed to your home or office. Turn to the subscription card in the back of the magazine. If somebody has beat you to it, write: Electronics, P.O. Box 430, Hightstown, N.J. 08520.

# Recalibrate.

(Your thinking and your budget)

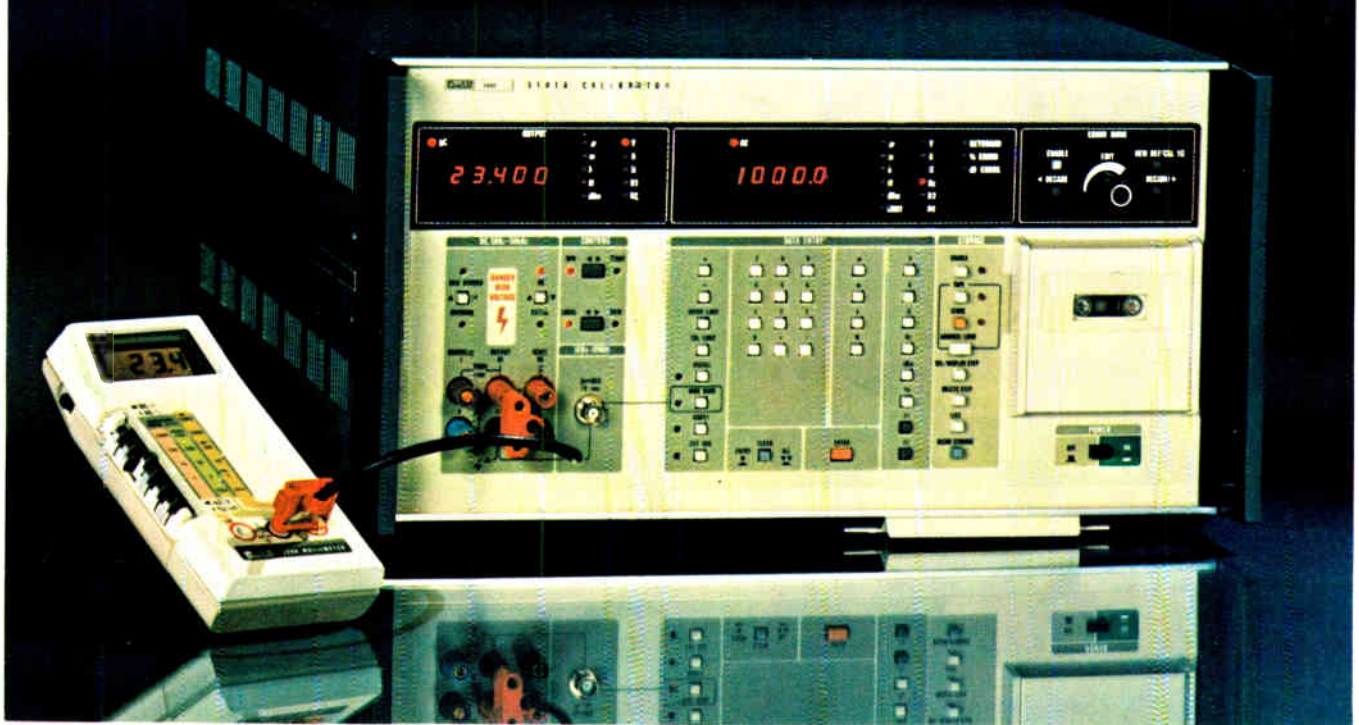

Our new 5100/5101A calibrators can calibrate VTVMs, VOMs, 3½-, 4½- and most 5½-digit DMMs around, in a fraction of the time it takes you now! (It's a cal lab in a box! All at an average price under \$9,000.)

For \$10,000 to \$15,000, you could invest in an intricate maze of instruments that takes a wizard to operate. Or, you could fill a room with computer-based hardware and expensive talent. About \$100,000 worth.

### The Fluke $\mu$ P-controlled alternative.

We've designed the new 5100A and 5101A for production test, QA and cal lab applications that need large system flexibility at a fraction of large system cost.

The heart of our new meter calibrators is a microprocessor that eliminates mechanical switches—the largest contributor to failure in conventional calibrators.

And, you can enter your tolerances in dB, volts or percent. The  $\mu$ F converts for you! For safety, store current or voltage limits and protect both your operator and the meter being calibrated.

Microprocessor control also facilitates scaling (for linearity checking), and makes your calibrator a *rangeless* instrument, always selecting the proper range for maximum resolution, *automatically!*

### Automation or economy? Fluke has both.

The 5100A is perfect for manual bench operation or integration into



your existing cal system to upgrade it to Fluke standards of calibration excellence. Priced at \$6,995\*, you save dollars but don't sacrifice accuracy or overall performance.

For perfection in automated calibration, you'll want the 5101A with its *mini-tape cassette reader*, a unique new feature that allows you to store up to 58 calibration settings, including limits and tolerances. Only \$8,995\*.

Both models have a friendly calculator-type keyboard. And, both have the RS232 or IEEE 488 system options you want for remote operation or hard-copy printouts of results.

Call (800) 426-0361, toll free. Ask for complete technical specs or the location of your local Fluke office or representative. Or, write: John Fluke Mfg. Co., Inc., P.O. Box 43210, Mountlake Terrace, WA 98043.

\*U.S. price only.

## Command Performance: Demand Fluke Calibrators.



2010-8001

For Literature circle 133  
For Demonstration circle 269

# Revolutionary cooling extrusion cuts size and cost in half.

Here is the first in a new series of unique cooling extrusions from Wakefield.

A totally different design concept called "High Fin Density" allows Extrusion 5113 to give the same cooling performance as devices needing nearly twice as much space.

And because of substantial material savings, the 5113 is half the price of the larger units—only \$1.10 per inch.

Until now, the space between fins of an extrusion could be no less than 1/4 the height of the fins. This limited the surface cooling area of the fins for any given size extrusion.

"High Fin Density" has changed all this by reducing the space between fins to as little as 1/10 their height. The result is a tremendous gain in cooling efficiency with 130 sq. in. of cooling surface per linear inch of extrusion.

Knowledgeable people say this is the most significant breakthrough in the history of cooling devices. But then, what would you expect from the leader? Write or call for full details.

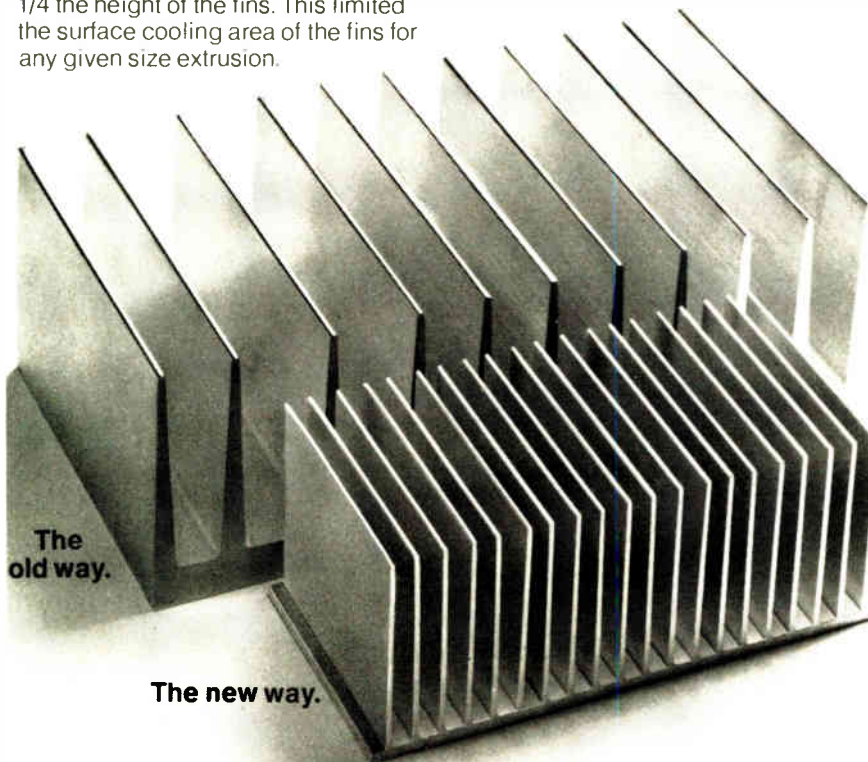

**WAKEFIELD ENGINEERING INC.**

77 AUDUBON ROAD WAKEFIELD, MA 01880 (617) 245-5900  
TWX 710-348-6713 AN EGG COMPANY

Circle 134 on reader service card

## New products

square. Zero-voltage turn-on minimizes electromagnetic interference. The relay sells for \$27.50 in 1,000-picce quantities.

Teledyne Relays, 3155 W. El Segundo Blvd., Hawthorne, Calif. 90250. Phone (213) 679-2205 [343]

### Carbon-film resistor

drifts only 200 ppm/°C

The GPR 5000X general-purpose resistor is a carbon-film component with a tolerance of 2% and a temperature coefficient of  $\pm 200$  parts per million per °C. Said to be price-

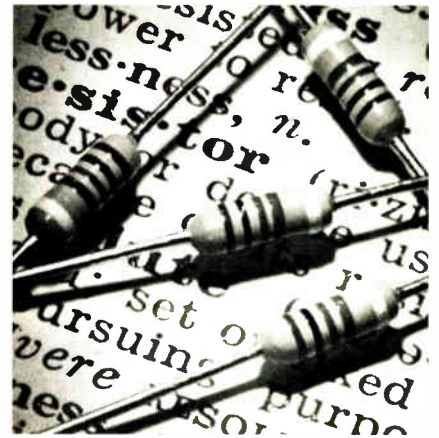

competitive with carbon-composition resistors, the GPR 5000X units are offered with resistance values from 10 ohms to 22 megohms. They have a maximum working-voltage rating of 350 volts and can dissipate 1/2 watt although they are housed in 1/4-w-sized packages.

Mepco/Electra Inc., Columbia Road, Morristown, N. J. 07960. Phone (201) 539-2000 [344]

### Metal-film resistors have tolerances to 0.05%

A line of precision metal-film resistors with values from 50 ohms to 250 kilohms is available with tolerances from 1% down to 0.05%. The first model in the new series is the 0.1-watt PTF 55, which has a diameter of 0.094 inch and a length of 0.260

## From Electronics Magazine Book Series. Zero-risk trial offer.



**Applying Microprocessors**  
2nd and 3rd generation technology. 26 detailed applications from data networks to video games. \$9.95

### Electronics Book Series

P.O. Box 669, Hightstown, N.J. 08520

Send me \_\_\_\_\_ copies of "Applying Microprocessors" at \$9.95 per copy. Discounts of 40% on orders of 10 or more copies. I must be fully satisfied or you will refund full payment if the book is returned after ten-day trial examination.

Payment enclosed  Bill firm  Bill me  
Charge to my credit card:  
 American Express  Diners Club  
 BankAmericard  Master Charge

Name \_\_\_\_\_ Title \_\_\_\_\_

Company \_\_\_\_\_

Street \_\_\_\_\_

City \_\_\_\_\_ State \_\_\_\_\_ Zip \_\_\_\_\_

Signature \_\_\_\_\_

Acc't No. \_\_\_\_\_

Date exp. \_\_\_\_\_

On Master Charge only, first numbers above name

# CHECK US.

We've been coming up with better instrumentation recorders for more than 40 years. And we're willing to put our reputation on the line. So check the boxes below for the type of recording equipment you need and send us this page. We'll send you some no-nonsense specs that will stand up to the toughest comparisons you care to make.

## VISICORDER OSCILLOGRAPHS

- Graphic data acquisition system (One to 32 channels, dc to 5000 Hz, choice of eight plug-in signal conditioning modules.)
- Linescan facsimile-type recorder (DC to 8 MHz; X, Y, Y', Z axis; high resolution, broad gray scale.)
- Recording oscilloscope (DC to 10 MHz; X, Y, Y', Z axis; up to one million in/sec writing speed.)
- Light-beam galvanometer recorders (DC to 25 kHz, up to 36 channels.)

## SIGNAL CONDITIONING

- Gage control units (Multi-excitation, calibration, balance, filtering, suppression, various gain ranges.)
- Thermocouple compensation unit (Calibration, suppression and span controls.)
- Amplifier/attenuator units (Differential, single ended, multi-bandwidth, various gain ranges.)

## MAGNETIC TAPE SYSTEMS

- Large-reel portable (DC to 2 MHz, 15-inch reels.)
- Small-reel portable (DC to 1 MHz, 10½-inch reels.)
- Laboratory systems (DC to 4 MHz, 16-inch reels.)

## SIGNAL ANALYZERS

- Correlation/probability analyzers
- Fourier transform analyzers
- Histogram recorders

## INDUSTRIAL TEST SYSTEMS

- Die casting test systems
- Welding test systems
- Data communications recording systems
- Air/oil circuit breaker analyzer system

## SPECIAL MILITARY PRODUCTS

- Digital cartridge tape recorder
- Shipboard analog tape recorder
- Airborne analog tape recorder
- Special applications recording oscillographs

To get a free catalog that describes all of our instrumentation recording systems, just circle the Reader Service Number.

## WE'LL SHOW YOU A BETTER WAY.

### Honeywell

Honeywell Test Instruments Division • MS-218 • Box 5227 • Denver, Colorado 80217

World Radio History

Circle 135 on reader service card





**faster, easier  
more accurate  
less expensive**

# METER CALIBRATION

**The Rotek PAMC-100  
Programmable, Automatic  
Calibration System**

A new relatively inexpensive system that can pay for itself in less than two years. Provides all these features . . .

- High accuracy (0.002% DC, 0.025% AC)
- Easy-to-use software
- Low initial & maintenance costs
- Hard copy test results
- Expandable, via IEEE 488 bus
- Extremely high calibration throughput
- Broad flexibility for future needs

Send for new, free brochure with all details & specifications.



**ROTEK** INSTRUMENT CORP. 220 GROVE STREET  
BOX 504,  
WALTHAM, MASS. 02154  
TEL. 617-899-4611

## New products

in. Additional units will follow early in 1978.

PTF resistors are expected to find wide application as matched sets or networks in a variety of applications (analog-to-digital and digital-to-analog converters, medical electronics, test equipment, etc.) in which the designer will be able to specify TCR tracking and initial tolerance ratios much tighter than the absolute requirements of each individual resistor. This is expected to allow cost savings approaching 50%.

The resistors are priced in the general range of 40 cents each in thousands. Normal delivery time is 8 to 10 weeks.

Dale Electronics Inc., Box 74, Norfolk, Neb. 68701. Phone (402) 371-0080 [345]

## TOPICS

### Components

**C. P. Clare & Co., Chicago, Ill.,** has increased the current-carrying capability of its series 203 solid-state relay from 0.75 to 1.5 amperes while raising the withstand voltage to 600 volts peak. The upgraded unit sells for \$7.20 in thousand-piece lots. . . . **The Intertechnical Group Inc., Irvington, N. Y.,** is offering a series of subminiature film dielectric capacitors no bigger than a TO-5 can. The units have polyester, metalized polyester, and polycarbonate film dielectrics with a thickness of about 0.002 millimeter. . . . **American Technical Ceramics, Huntington Station, N. Y.,** announces the QPL listing of its style CDR11 through -14 and CDR21 through -25 capacitors to MIL-C-55681/4 and -/5. The new qualification is in addition to the firm's present QPL listing on MIL-C-11272 for CY80 styles, which will be maintained. . . . **Struthers-Dunn Inc., Pitman, N. J.,** a major factor in the electromechanical relay marketplace, has entered the low-profile area with its 400 series. The single-pole units can handle up to 2 A, the multipole relays up to 1 A. All can be mounted on printed-circuit boards spaced 15 mm (19/32 inch) apart.



# CHALLENGE US.

Are you looking for a better way to monitor, condition, record or analyze data? Then challenge us. Describe your recording or signal analysis problem in the space below and send us this page. We'll get back to you with our recommendation.



**WE'LL SHOW YOU A BETTER WAY.**

**Honeywell**

Honeywell Test Instruments Division • MS-218 • Box 5227 • Denver, Colorado 80217

**About the only No Touch Controls we don't make  
you haven't asked for. Yet.**

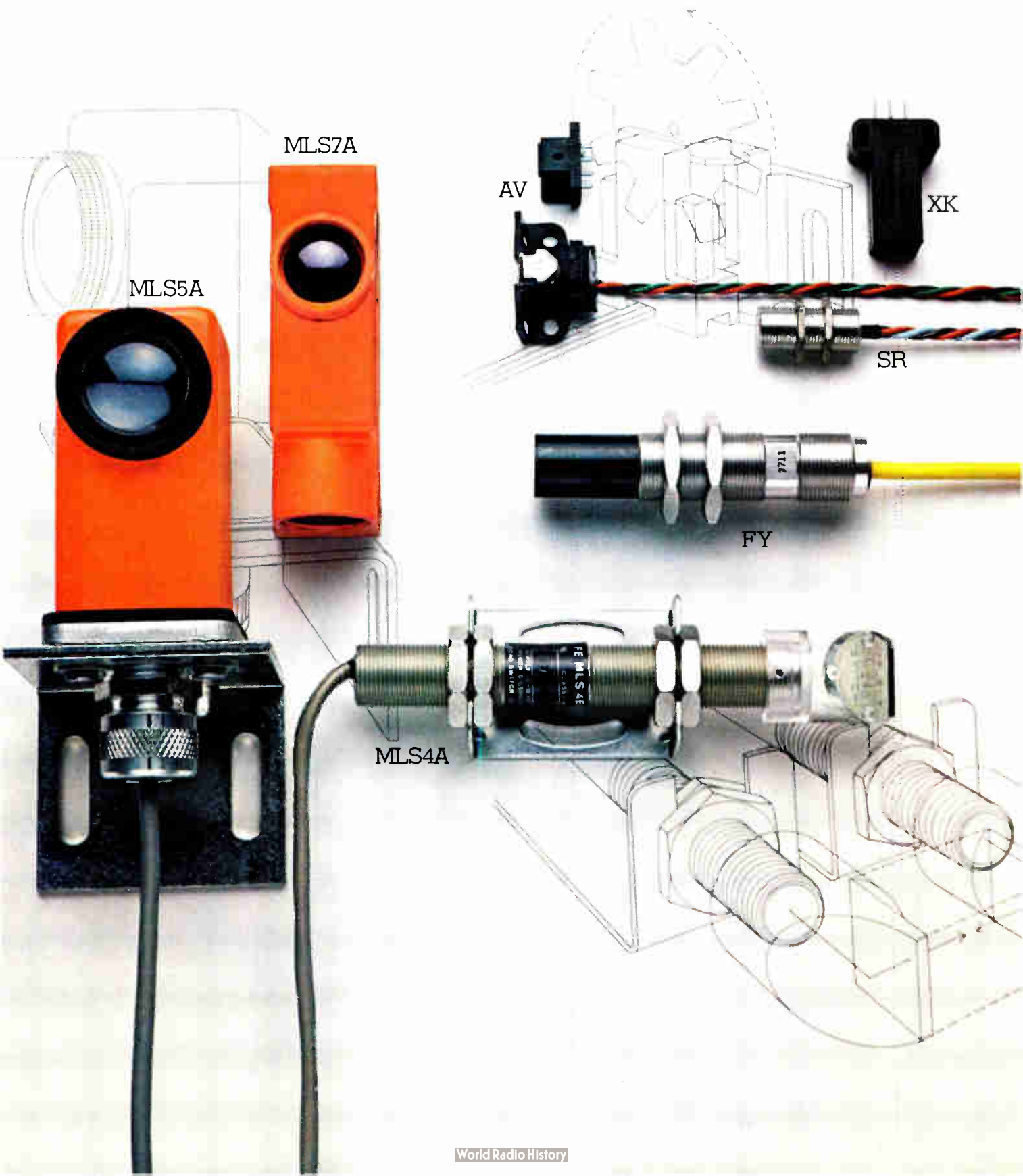

# are the ones

For years, MICRO SWITCH has been the leading maker of No Touch Controls.

That's because we're also leaders when it comes to listening to switching problems where mechanical devices just don't fill the bill. And then solving them with industry's broadest line of photoelectric and proximity controls.

For example, the ferrous-sensitive XK can detect metal targets of any thickness, either moving or stationary. There's also the vane-operated AV and the magnetically operated SR, both featuring dependable Hall-effect technology and high speed operation unaffected by dust and dirt.

You can also choose from a wide selection of solid state FYP proximity sensors designed to be directly compatible with programmable controllers and solid state logic. These self-contained controls have models ranging from 14 mm diameter to 76 mm.

For materials other than metals or where distances are too great for proximity switches, MICRO SWITCH offers a complete line of photoelectric controls.

At shorter distances, choose from MLS4A controls with a range of 8 feet or MLS7A controls that range up to 10 feet. Both are DC powered and use advanced integrated circuitry to increase reliability.

There are also models with much greater scanning ranges, like the high intensity MLS5A that ranges up to 250 feet in clean air and through dust, smog, steam and other pollutants at shorter distances.

Another model provides a scanning range up to 700 feet.

And whether you need proximity or photoelectric controls, you'll be getting solid state design that delivers long life. Which is what you've come to expect from the leading maker of No Touch Controls.

MICRO SWITCH will provide you with field engineers for application assistance and a network of authorized distributors for local availability. Write us for details or call 815/235-6600.

## MICRO SWITCH

FREEPORT, ILLINOIS 61032

DIVISION OF HONEYWELL

MICRO SWITCH products are available worldwide through Honeywell International.

## New products

### Semiconductors

## Dynamic RAM has dual latch modes

Intel 16-k memory line can operate with latched or unlatched outputs

Called third-generation 16-k dynamic random-access memories, Intel Corp.'s 2117 series combines the best features of the first commercially available 16,384-bit dynamic RAM, Intel's latched 2116, and the industry-standard Mostek unlatched 4116 with significant design improvements. What is more, it provides direct replacements for all types of first- and second-generation 16-k RAMs, says memory product manager, Bill Regitz.

The new chip design is based on the same process used to produce the 2116. This standard two-layer polysilicon n-channel metal-oxide-semiconductor technology has been used to produce 16-k RAMs and other high-density Intel memory components for nearly three years. It gives the 2117 the highest performance achieved to date in production 16-k RAMs.

The 2117-2 is specified with a maximum access time of 150 nanoseconds. The cycle time is specified at 320 ns, which is 55 ns faster than previous 16-k RAMs with the same access time.

Power dissipation and maximum

supply current have also been reduced. Current spiking, which generates system power-line noise, has been cut in half. Also, the 2117 provides the wide operating margins, a full  $\pm 10\%$  tolerance on all three power supplies (+12 and  $\pm 5$  volts), and transistor-transistor-logic compatibility with 300 millivolts of additional noise margin over competitive 16-k chips.

The 2117 replaces the latched 2116 as well as the unlatched 4116. However, the system designer has the option of using a new 2117 clock mode that provides the equivalent of a latched output.

One application of the new mode is hidden refresh. It holds the data output valid following a read access. As a result, a read cycle can be extended to a read and refresh cycle without affecting data validity.

The 2117 family is packaged in standard 16-pin dual in-line packages. It contains three speed selections: the 2117-2 with 150-ns maximum access, 320-ns read or write, and 375-ns read-modify-write cycle; the 2117-3 with 200-ns maximum access, 375-ns read or write, and 375-ns rmw cycle; and the 2117-4 with 250-ns, 410-ns, and 515-ns times, respectively. All timing characteristics are guaranteed over the  $\pm 10\%$  supply tolerance and an operating temperature range of 0°C to 70°C.

Maximum power dissipation of the 2117-3 is 465 milliwatts in active operation and 20 mw in standby. Maximum average operating current is 35 milliamperes. This figure drops to 1.5 mA when RAS and CAS, the





# There's another name for high-flying MIL-approved connectors. AMP

And there are more of them than ever before. Because now our externally-keyed 0.100" center line Box Connectors are approved to MIL-C-55302. And they are specified on F-16 and F-18 avionics systems. External keying eliminates the need to use contact positions. So you can make even higher density connections . . . up to 110 positions. And do it with all of the versatility our unique four-beam box contact design allows.

We've also added a new super-small member to the Box Connector family . . . the Mil-approved Mini-Box. It's available with up to 128 positions, has external keying and contacts on 0.050" center lines. It has all the high reliability advantages of our regular Box Connector design plus low insertion/withdrawal force and extra space savings. For more information, call (717) 564-0100, or write AMP Incorporated, Harrisburg, Pa. 17105.

Or take a look at our versatile, extremely rugged high-voltage Lead Assemblies and Receptacles. Meeting a wide range of military requirements, you'll find them in heads-up displays for tactical aircraft. They're fully shielded against RFI, and designed to withstand severe vibration, shock and handling. Integrally molded ends provide positive mating and a perfect seal. Accommodates up to 50 KVDC at altitude. And a wide choice of mounting and operational design is available. For more information, call (717) 367-1105, or write AMP Capatron Division, Elizabethtown, Pa. 17022.

AMP has a better way.

Circle 141 on reader service card

# AMP

INCORPORATED

Circle 140 on reader service card

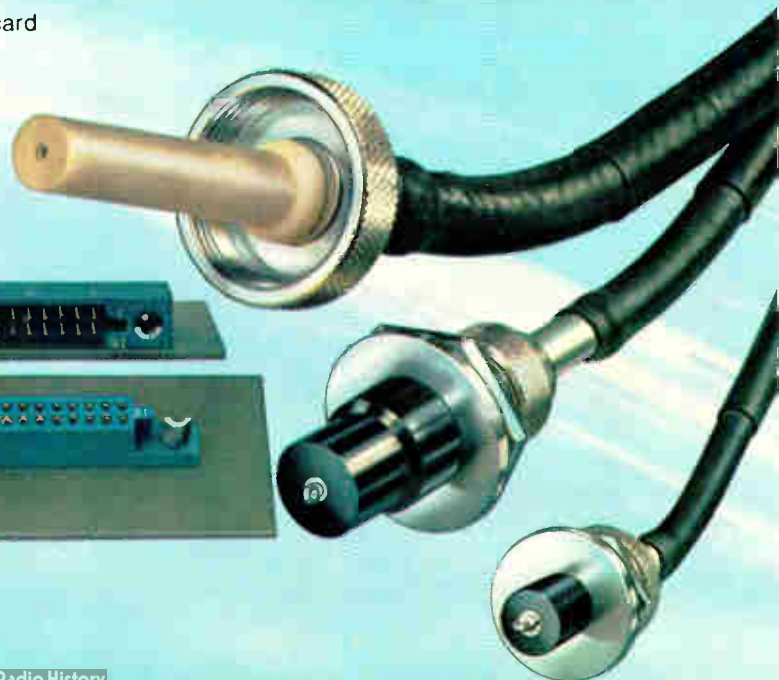
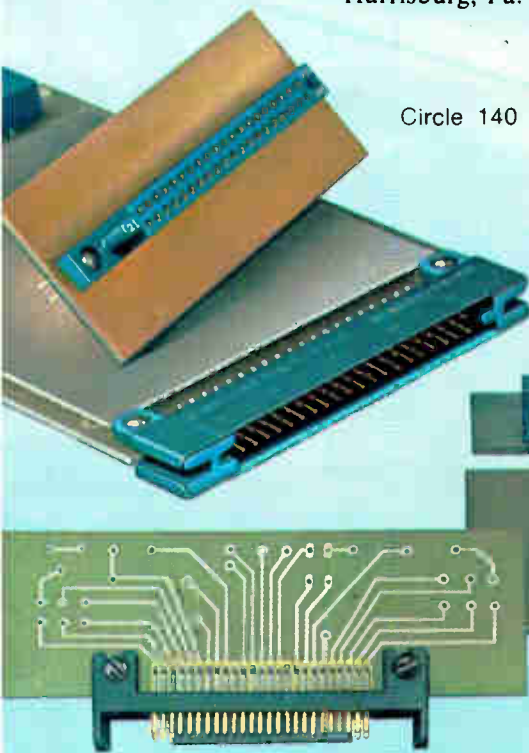

## AMP EUROPE

**Austria** — AMP Austria. Branch of AMP Deutschland GmbH. Markgraf-Ruediger Str. 6-8, 1150 Vienna. Phone: 924191/92

**Belgium** — AMP Belgium. Branch of AMP-Holland B.V., Rue de Brobant 62-66, Brussels. Phone: 322.17.55.17

**Finland** — AMP Finland OY Postilokera 3, 00401 Helsinki 40 Phone: 90/584122

**France** — AMP de France, 29 Choussée Jules-César. Boite Postale No. 39, 95301 Pontoise France. Phone: 030 82 20, 030 92 30

**Germany** — AMP Deutschland GmbH. Ampèrestrasse 7-11, 607 Longen, B. FFM., West Germany. Phone: (06103) 7091

**Great Britain** — AMP of Great Britain Limited, Terminal House, Stanmore, Middlesex, England. Phone: 01-954-2356

**Holland** — AMP Holland B.V., Papierstraat 2-4 5223 AW 's-Hertogenbosch, Holland. Phone: (073) 125221

**Italy** — AMP Italia S.p.A., Via Fratelli Cervi 15, 10093 Collegrino (Torino), Italy. Phone: 785-656

**Spain** — AMP Español, S.A., Apartado 5294. Pedro IV, 491, 495, Borcelona 5, Spain. Phone: 307-75-50

**Sweden** — AMP Scandinavio AB, Dotovägen 5, 17500 Jakobsberg, Sweden, Mailing Address: Fock S-175 20 JARFALLA 1, Sweden. Phone: 0758/10400

**Switzerland** — AMP AG, Holdenstrasse 11, 6006 Luzern, Switzerland. Phone: (414) 235421, 235422, 235423

## AMP NORTH AMERICA

**Canada** — AMP OF CANADA LTD., 20 Esno Park Drive, Markham, Ontario, Ph: 416-499-1251

**Mexico** — AMP de Mexico, S.A., Apartado Postal 179, Noucolpon de Juarez, Edo, de Mexico, Phone: Mexico City 576-41-55

**Puerto Rico** — AMP OF CANADA LTD., 677 Colé de Diego, Rio Piedras, Puerto Rico 00924, Phone: (809) 766-2346

**United States** — AMP Incorporated, Harrisburg, Pa. 17105, Phone: 717-564-0100

## AMP SOUTH AMERICA

**Argentina** — AMP S.A. Argentino 4 de Febrero, 76 Villa Zoglo — SAN MARTIN, Buenos Aires, Argentina, Phone: 752-4612

**Brazil** — AMP do Brasil Ltda., AV Comendador Martinelli 185, Lopo, Sao Paulo, Phone: 262-4353

## AMP PACIFIC

**Australia** — Australian AMP Pty. Limited, 155 Briens Road, Northmead, N.S.W. 2152 Australia, Mailing Address: P.O. Box 194, Boulkhom Hills, N.S.W. 2153 Aus. Ph: 630-7377

**Japan** — AMP (Japan), Ltd., No. 15-14, 7-Chome, Roppongi Minato-Ku, Tokyo, Japan, Ph: 404-7171

Products and services for many specialized industries are provided by the AMPLIVERSAL Division. In the United States, this division is known as AMP Special Industries.

For Amp products and services in other countries, write: AMP International Division, Harrisburg, PA 17105, USA.



Electronics/November 10, 1977

## New products

row- and column-address select inputs, are high.

All inputs have a 400-millivolt noise margin. Output drive is 4.1 mA when low and -5 mA when high (read cycles or hidden refresh cycles only).

The 2117 devices normally operate as unlatched-output RAMS, with conventional multiplexed address inputs, RAS and CAS. Strobe timings are not critical, allowing high performance to be maintained at the system level. On-chip latches are provided for address and data inputs. The output is three-state. All inputs, including clocks, and the output are TTL-compatible. The refresh interval is 2 milliseconds.

A new function—CAS-controlled output latching—increases the 2117's applications range. The CAS strobe may be used independently of the RAS strobe to keep the data output valid instead of allowing it to return to the high-impedance state. As a result, the 2117 can emulate latched-output RAM functions, including hidden refresh, which allows a refresh cycle to be performed without disturbing the data output state.

Minor changes in clock system timing are required to use this new mode. To emulate the normal latched-output operation of such RAMS as the 2104A and 2116, the 2117 clocks can be used as follows: hold the CAS clock low and allow the RAS clock to go high. This reduces power dissipation and keeps data output valid through an ensuing refresh cycle. The output returns to the normal high-impedance state when CAS goes high.

With the normally latched devices such as the 2116 and 2104A, hidden refresh is implemented by running a RAS-only refresh cycle after a RAS-CAS read cycle. With the 2117, RAS is clocked as before, but CAS is held low continuously, thus maintaining valid output data from the read cycle through the refresh cycle.

Prices in quantities of 100 and up are: 2117-2, \$55.00; 2117-3, \$41.00; and 2117-4, \$39.00. All selections in the family are supplied in ceramic packages. The company expects to

begin deliveries in OEM volumes in the fourth quarter.

Intel Corp., 3065 Bowers Ave., Santa Clara, Calif. 95051 [411]

## Three-stage fm amplifier includes detector, afc drive

The CA3089 intermediate-frequency amplifier-limiter for fm tuners and receivers is a monolithic circuit that includes three gain stages, with level detectors for each stage, a doubly balanced quadrature fm detector, and an audio amplifier. Among the other features that make the device suitable for use in fm stereo receivers are: delayed automatic-gain-control voltage for the radio-frequency amplifier, an automatic-frequency-control drive circuit, and an output signal that can drive a tuning meter and operate stereo-switching logic.

Pin- and function-compatible with the same-numbered part originally introduced by RCA, the CA3089 has a typical limiting sensitivity of 10

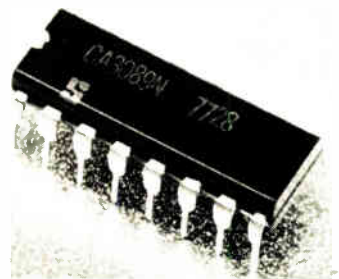

microvolts at -3 decibels and a typical recovered-audio level of 400 millivolts. Housed in a 16-pin plastic dual in-line package, it sells for \$1.90 in hundreds.

Signetics Corp., P. O. Box 9052, 811 East Arques Ave., Sunnyvale, Calif. 94086. [413]

## Audio power driver operates from ±40-V supplies

In a typical audio power amplifier, about 10 discrete transistors and diodes are used in the circuit that drives the power-output stage. The LM391 replaces these devices; its

AVX Distributors: Cramer Electronics / Elmar Electronics / Future Electronics / Jaco Electronics / Liberty Electronics / Texas Instrument Supply Company

Electronics/November 10, 1977

Circle 143 on reader service card 143

# WHEN YOU CAN'T AFFORD

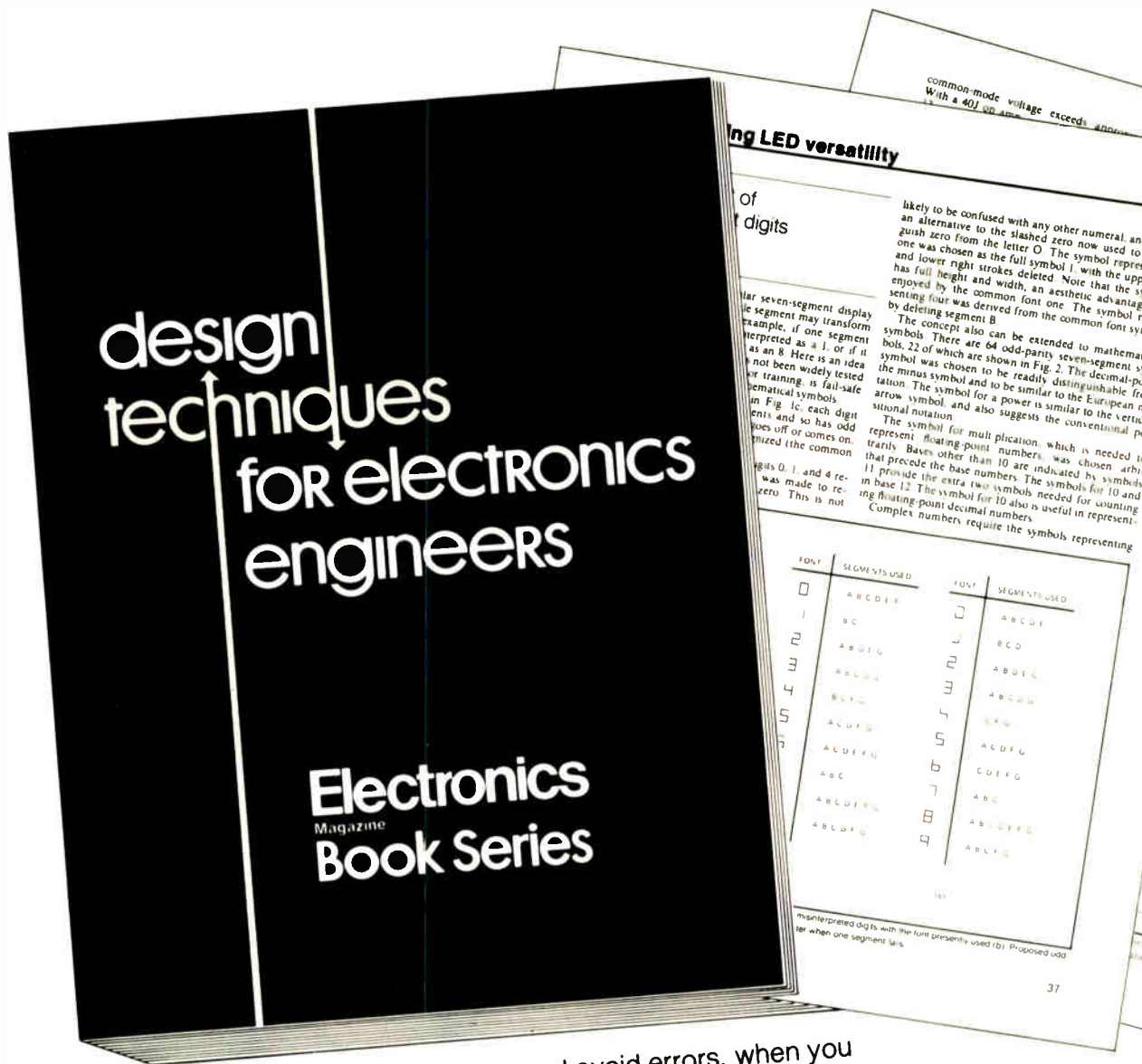

**Y**ou'll save time and money, and avoid errors, when you put this gold mine of design techniques on your desk. With almost 300 articles drawn from *Electronics Magazine's* popular feature, "Engineer's Notebook," this is an indispensable storehouse of solutions to a whole range of design problems you may encounter. You can rely on it for expert guidance at every point in the development of an engineering project — when you're making measurements . . . interpreting data . . . making calculations . . . choosing materials . . . controlling environment . . . laying out and purchasing components . . . and interconnecting components swiftly and accurately. No other reference available gives you the professional edge you get with this "must-have" sourcebook.

# TO RE-INVENT THE WHEEL...

Here's just a sampling of the vast range of useful information you'll have at your fingertips . . .

- How to use soluble masks to protect pc boards from solder.
- How to evaluate power dissipation in microcircuit design.
- How to hand-solder DIP circuits to save testing dollars.
- How to compare the power of C-MOS with TTL.
- How to really look at low-drift IC op amps.
- How to accurately trim closed resistor loops.
- How to drive LEDs directly from C-MOS logic outputs.
- How to convert coordinates and find SWRs graphically.
- How to compare coaxial-cable shielding effectiveness.
- How to calculate resistance for sum and difference networks.
- How to use a programmable calculator to analyze filter designs.
- How to compute response of RLC networks with a short program.
- How to eliminate stray signals in remotely gain-switched op amps.
- How to chart power losses for hybrid-combined amplifiers.
- How to reduce IC FET op-amp input bias currents.
- How to build timing circuits for noisy environments.
- How to approximate waveforms with exponential functions.
- How to increase an instruction set without increasing word length.
- How to extend the life of digital recording heads.
- How to add numeric readout to logic probe displays.
- How to pick the right film for better oscilloscope pictures.
- How to use a frequency counter to measure capacitance.
- How to evaluate high-energy pulse effects on materials.
- How to operate a logic gate as a flip-flop.
- How to choose the right detector for rf power measurements.
- How to measure the access time of bipolar read-only memories.
- How to test power supplies quickly and cheaply.
- How to get the most out of a digital multimeter.
- *And much, much more.*

Order today, and don't forget the other valuable books in the Electronics Books Series listed on the coupon below.

**Electronics Book Series**  
P. O. Box 669, Hightstown, N. J. 08520

## 1. Microprocessors

Send me \_\_\_\_\_ copies at \$8.95 per copy.

## 2. Applying Microprocessors

Send me \_\_\_\_\_ copies at \$9.95 per copy.

## 3. Large Scale Integration

Send me \_\_\_\_\_ copies at \$9.95 per copy.

## 4. Basics of Data Communications

Send me \_\_\_\_\_ copies at \$12.95 per copy.

## 5. Circuits for Electronics Engineers

Send me \_\_\_\_\_ copies at \$15.95 per copy.

## 6. Design Techniques

### for Electronics Engineers

Send me \_\_\_\_\_ copies at \$15.95 per copy.

Discounts of 40% on orders of 10 or more copies of each book.

If after my 10-day free-trial examination I am not fully satisfied, I understand that my full payment will be refunded.

- Payment enclosed     Bill firm     Bill me  
Charge to my credit card:  
 American Express     Diners Club  
 BankAmericard     Master Charge

Acc't No. \_\_\_\_\_ Date exp. \_\_\_\_\_

On Master Charge only, first numbers above name \_\_\_\_\_

Name \_\_\_\_\_ Title \_\_\_\_\_

Company \_\_\_\_\_

Street \_\_\_\_\_

City \_\_\_\_\_ State \_\_\_\_\_ Zip \_\_\_\_\_

**SIGNATURE** \_\_\_\_\_

**McGraw-Hill Electronics Book Series**

# RF Power Amplifiers?

## One unit may be all you'll ever need.



If you have the ENI Model 440LA ultra-wideband solid state power amplifier, all you need is a laboratory signal generator and you've got the ultimate in linear power for such applications as RFI/EMI testing, NMR/ENDOR, RF transmission, ultrasonics and more.

Capable of supplying more than 40 watts of RF power into any load impedance, the 440LA covers the frequency range of 150 kHz to 300 MHz.

We could mention unconditional stability, instantaneous failsafe provisions and absolute protection from overloads and transients, but that's what you expect from any ENI power amplifier, and the 440LA is no exception!

Our catalog contains complete specifications on the 440LA as well as the entire line of ENI amplifiers, and is available without obligation, of course.

For further information or a demonstration, contact ENI, 3000 Winton Road South, Rochester, New York 14623. Call 716-473-6900, or Telex 97-8283 ENI ROC.

# ENI

*The World's Leader  
in Power Amplifiers*

Circle 146 on reader service card

## New products

Data handling

### Graphics terminal has raster scan

Tektronix uses mapping to ease the mixing of characters and graphics

Tektronix Inc., long a maker of cathode-ray-tube displays, has embraced television-style raster scanning, which cannot be beat for flexibility in handling both characters and graphics. In contrast to high-resolution storage-refresh display terminals, the Beaverton, Ore., manufacturer's 4025 terminal produces images with patterns of dots. Also, Tektronix is taking a novel approach to dot-pattern storage: using what it calls virtual mapping, it references 112-dot cells of graphics memory to a list, rather than addressing each dot. This way characters and graphics can actually be interspersed on screen, and the entire image can

be scrolled up or down by users.

Herbert K. Quigley, marketing support manager of Tektronix's information display group, explains that the 4020 series, which comprises the 4025 and the alphanumeric-only 4024, serves different markets than the firm's storage-tube terminals. In the latter, the lines generated are actually stored by the CRT, but "for applications requiring a lot of alphanumeric data entry, and in some cases graphics capabilities, raster scan is best," Quigley says.

The major difference between the 4025 and the graphics terminals of other manufacturers, including Hewlett-Packard Co. [*Electronics*, July 7, p. 139] and Ramtek Corp. is the integration of the alphanumeric and graphics data. Since both data types are referenced by an 8-by-14-dot cell—which represents a character in the former and a dot pattern in the latter—a pointer moving through a list of cells as scanning occurs either gets characters from a read-only memory or graphics data from a random-access memory. The result is that the screen image,



**Electronics**/November 10, 1977



# Adaptable.

Kodak precision line film LP4 and LP7—line projection film on either a 4- or 7-mil base. It is designed for producing high-quality negatives of line originals. This tough Estar base film provides...

- high contrast
- wide latitude in exposure and development
- orthochromatic sensitivity
- matte level sufficient for quick and easy drawdown
- machine processing
- minimum pinhole tendency

It adapts to your needs and conditions. Can help cut waste and save money.



Our "Take a New Look" packet outlines all product details and performance charts for the Precision Line products. For your free copy, write Eastman Kodak Company, Dept. P04805, Rochester, N.Y. 14650.



## Kodak PRECISION LINE film LP4 and LP7

RESULTS COUNT



# 65 watts, 10 MHz-2.5 GHz



## New MCL power generators feature flexibility, high output, minimum distortion.

Main frames for 115 VAC and for 208/220/240 VAC operation. Six standard front panel plug-ins provide frequency range from 10 MHz to 2500 MHz with a minimum output of 65 watts. Two optional plug-in modules are available which produce 100 watts narrow-banded.

Single knob tuning for each plug-in provides exact frequency selection. Front panel, direct frequency readout is accurate to  $\pm 1$  percent.

Solid-state mainframe designed for minimum components, optimum reliability. Residual AM held to .1 percent, eliminating nearly all AM distortion in output waveform. Generates continuous or 1 KHz square wave pulsed output. External AM signal generator can be added with single plug-in connection. External pulse circuit is TTL compatible. Automatic VSWR protection.

Write or call for your 4-page power generator brochure: Tom Rys, MCL, Inc., 10 N. Beach, LaGrange, IL 60525. (312) 354-4350.



Circle 148 on reader service card

## 1977 Answer Book. It makes your job easier. \$25.

Who makes what? Over 4000 products, more than 5000 manufacturers with their local contracts and distributors, directory of trade names and catalogs, post-paid inquiry cards for 5-second ordering of current catalogs.

Electronics Buyers' Guide  
1221 Ave. of the Americas  
New York, N.Y. 10020

Yes, send me a copy of The Answer Book. I've enclosed \$25 (USA and Canada only, elsewhere send \$35). Full money back guarantee if returned within 10 days.

Name \_\_\_\_\_

Company \_\_\_\_\_

Street \_\_\_\_\_

City \_\_\_\_\_

State \_\_\_\_\_

Zip \_\_\_\_\_

Electronics  
BUYERS'  
GUIDE

## New products

though a mix of two data types, can be treated as one.

The user defines the screen area allotted for graphics, which can extend into buffer-memory storage beyond the screen limits—and therefore can be scrolled up or down. Once the graphics regions are declared in terms of character coordinates, the microprocessor-based 4025 sets up an array of 16-byte elements—14 bytes for the 112 dots per cell and 2 bytes for the cell's address.

The virtual-bit mapping uses memory efficiently, since only in the graphics regions must every picture element be represented by a bit in RAM; otherwise data comes from the ROM character generator. But the integration of the two data types is a far more important aspect than memory savings. "The integration works well for putting together reports, for example, where graphs and charts can be combined with text," says Jack Liskear, product marketing manager.

The disadvantage of virtual mapping lies in the manipulation of the graphs themselves. Other graphics terminals, which use a standard mapping, like HP's, can zoom and pan the images. Their one-to-one storage of picture elements in random-access memory, makes possible the direct implementation of algorithms for magnification, rotation, and translation.

The 4025, with its green P39 phosphor, displays 34 lines of 80 characters or 640 by 480 dots for graphics. Prices for the basic terminal start at \$3,595 with standard interfacing; polling options and interfacing to IBM 370 computers will be available.

Tektronix Inc., P. O. Box 500, Beaverton, Ore. 97077 [361]

Fixed-head disk drives offer special control features

Two hard-disk subsystems for sale to minicomputer end users employ a Winchester-type technology, which provides a head-loading area for

# Dialight Switches

A switch for all reasons.

**Reason 1:** Dialight offers three switch configurations to meet all your needs—*snap-action switches with silver contacts* for moderate-level applications, *snap-action switches*

*with gold contacts* for intermediate-level applications, and *wiping-action switches with gold contacts* for low-level applications. Each of these ranges is served by two switching actions—momentary (life: 750,000 operations) and alternate (life: 250,000 operations).

**Reason 2:** Dialight's snap-action and wiping-action switches come in a new modular design concept... a common switch body for either high or low current operation. All 554 series switches and matching indicators have the same rear-panel projection dimensions.

The snap-action switching mechanism guarantees a fast closing and opening rate. This insures that contact force and contact resistance

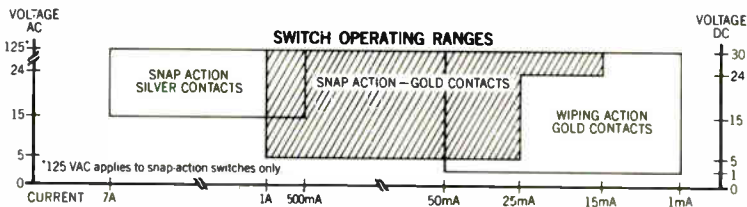

**Reason 3:** Dialight offers a wide variety of panel and snap-in bezel mounting switches with momentary and alternate action configurations in SPDT and DPDT

types. There are over 240 switch variations to choose from.

The 554 illuminated switch, designed for front of panel lamp replacement, gives you a choice of five different bezel sizes...

$\frac{3}{4}$ " x 1",  $\frac{5}{8}$ " x  $\frac{3}{4}$ ",  $\frac{3}{4}$ " square,  $\frac{5}{8}$ " square, and  $\frac{1}{2}$ " square. The first four sizes are also available with barriers. You also get a choice of six cap colors... white, blue, amber, red, green, and light yellow... four different underlying filter colors... red, green, amber, and blue and a variety of engraved or hot-stamped legends... over 300 cap styles... over 100,000 combinations.

There is also a variety of terminal connections... solder blade, quick connect, and for PC board insertions.

**Reason 4:** Dialight's 554 series is designed as a low cost switch with computer-grade quality.

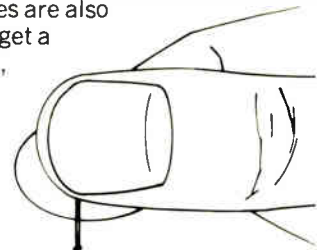
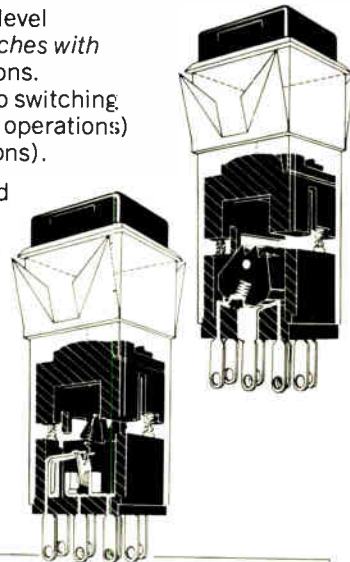

## PRODUCT SELECTOR GUIDE

SWITCHING ACTIONS	Snap-Silver contacts		Snap-Gold contacts		Wiping-Gold contacts	
	SPDT	DPDT	SPDT	DPDT	SPDT	DPDT
MOMENTARY	<input type="checkbox"/>	<input type="checkbox"/>	<input type="checkbox"/>	<input type="checkbox"/>	<input type="checkbox"/>	<input type="checkbox"/>
ALTERNATE	<input type="checkbox"/>	<input type="checkbox"/>	<input type="checkbox"/>	<input type="checkbox"/>	<input type="checkbox"/>	<input type="checkbox"/>
<b>OPTIONS</b>						
	PUSH BUTTON CAP SIZES					
	$\frac{1}{2}$ " Sq.	$\frac{5}{8}$ " Sq.	$\frac{5}{8}$ " x $\frac{3}{4}$ "	$\frac{3}{4}$ " Sq.	$\frac{3}{4}$ " x 1"	
BEZEL MOUNTING TO ACCOMMODATE	<input type="checkbox"/>	<input type="checkbox"/>	<input type="checkbox"/>	<input type="checkbox"/>	<input type="checkbox"/>	
BEZEL MOUNTING WITH BARRIERS TO ACCOMMODATE		<input type="checkbox"/>	<input type="checkbox"/>	<input type="checkbox"/>	<input type="checkbox"/>	
PANEL MOUNTING TO ACCOMMODATE	<input type="checkbox"/>	<input type="checkbox"/>	<input type="checkbox"/>	<input type="checkbox"/>	<input type="checkbox"/>	
MATCHING INDICATORS	<input type="checkbox"/>	<input type="checkbox"/>	<input type="checkbox"/>	<input type="checkbox"/>	<input type="checkbox"/>	

are independent of the switch's actuation speed.

In the wiping-action switch, the contacts are under constant pressure (A unique Dialight design). This insures long life with a minimum build-up of contact resistance.

*Both switch types are tease-proof.*



## DIALIGHT

A North American Philips Company  
203 Harrison Place, Brooklyn, N.Y. 11237  
(212) 497-7600

**Three ways to get a good CRT yoke**

**Call Syntronic**  
(312) 543-6444

**Write Syntronic**

**Use our Yoke Selection Guide**

It shows a simplified way to specify the best yoke for your CRT display. Our engineers have developed a unique concept—the yoke energy constant—as a way to estimate yoke inductance and current. From there, it's an easy step to specify a yoke "by the numbers". Try it. Call or write for your copy.\* See for yourself how Syntronic's years of experience can add up to getting a better yoke for your display.

**syntronic**

Syntronic Instruments, Inc.  
100 Industrial Road, Addison, IL 60101  
(312) 543-6444

\*Or see Pages 405 to 408 in EEM

## New products

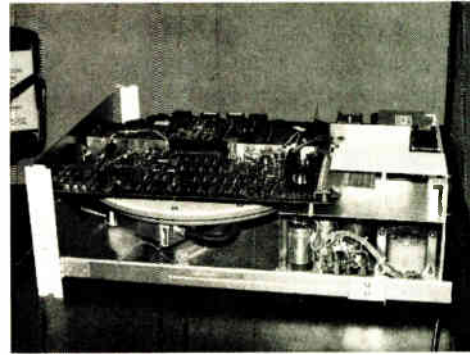

startup and shutdown, so the heads are always in contact with the disk. The head-per-track disk drives also offer special control features: error correction, channel-program operation, and configuration flexibility.

With the error-correction feature, the disk controller calculates a 32-bit error-checking code that is written on the disk after the data. It then recalculates the checkwords when the data is read and checks for errors. The technique allows the detection of single-burst errors up to 11 bits long in a 512-byte sector.

The channel-program operation or command-queuing feature allows the subsystem to receive commands from the data channel instead of from the programmed input/output control. This eliminates interruption of the central processing unit for as many as 16 of the blocks and increases the multiple-sector transfer-performance factor.

Configuration flexibility simply means that up to four of the drives can be daisy-chained together. Since the model 6063 has a capacity of 1 megabyte and the model 6064 can hold 2 megabytes, the user has a choice of 1 to 8 megabytes in 1-megabyte increments.

Both drives can transfer data at a rate of 910,000 bytes per second with an average access time of 10.12 milliseconds. They can be used with the Nova and Eclipse computers and are compatible with several of Data General's software packages. The 1-megabyte 6063 sells for \$9,900 with drive and controller, while the 6064 is priced at \$13,900. Add-on 1-megabyte drives go for \$7,900, and 2-megabyte units cost \$11,900. Delivery time will be 90 days, begin-

# Behind all these pretty faces...

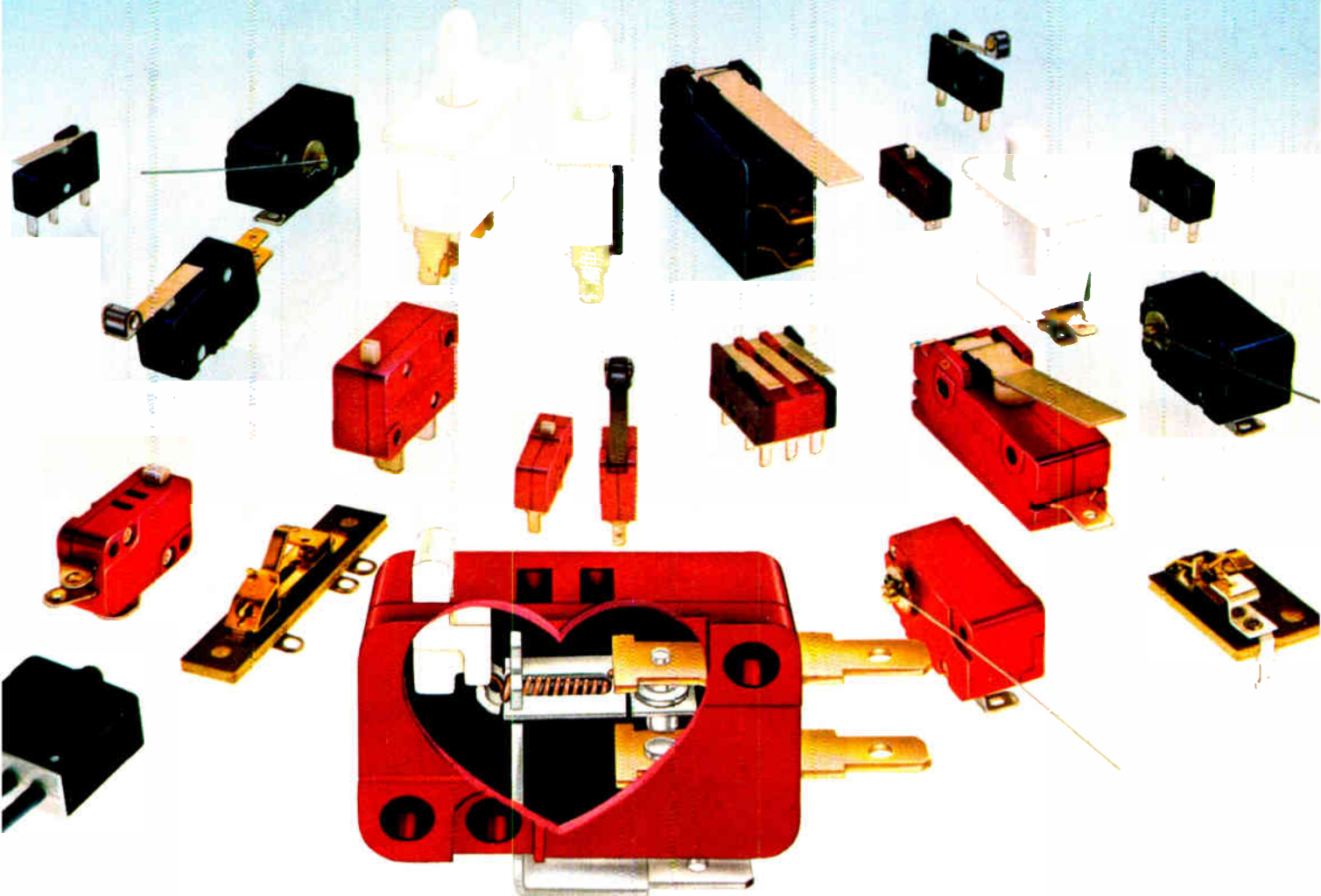

## beats a heart of coiled stainless steel.

No Cherry snap-action switch has ever died of a broken heart. Because there's a coil spring at the heart of every Cherry switch that expands and contracts again and again and never gets tired. Or breaks. Compare *that* to the stamped spring many switch builders use. The kind of spring that gets tired . . . and breaks. (Snap. Drat!)

This stainless steel coil spring mechanism not only insures long life, it provides large overtravel to make our switches quicker, easier to design-in and to install. Which is why more than 300 million of them have been designed-

in and installed. So far.

Cherry snap-action switches are available in gold crosspoint design for low energy switching. In general purpose, miniature and subminiature designs. In low torque. Light force. Open or enclosed. Panel mount pushbutton. And more.

For free catalog of all the Cherry switches, just circle the reader service number below. If you're in a hurry, our direct line number is 312/689-7702 . . . and we'll throw in a switch sample of your choice.



**CHERRY ELECTRICAL PRODUCTS CORP.**  
3608 Sunset Avenue, Waukegan, Illinois 60085

**SWITCHES and KEYBOARDS — Available locally from authorized distributors.**

# WE'VE GOT THE MERCURY REED RELAY YOU WANT...

## No matter how small a package you need.

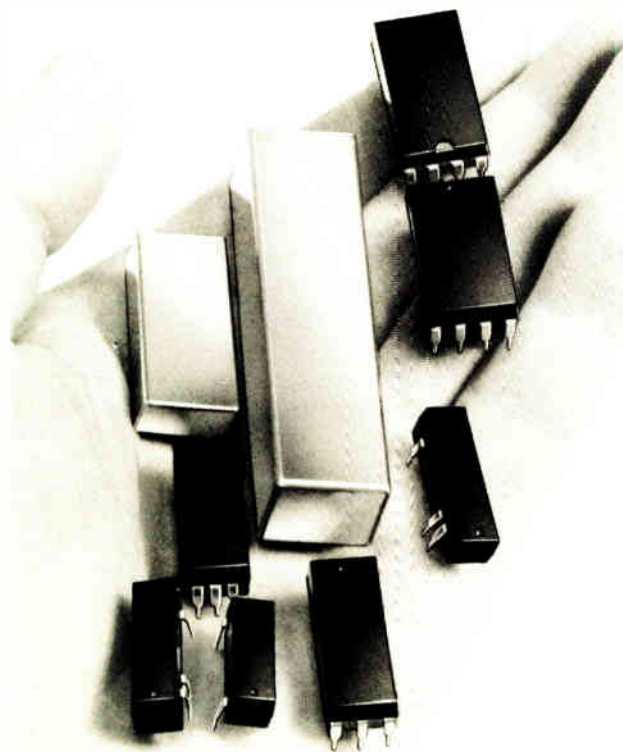

The handful of styles you see here represent the widest range of mercury wetted reed relays in the industry today. Over 115 different combinations of options and features to meet the most demanding requirements. All Gordos mercury reed relays feature: mercury wetted contacts; no-bounce switching; low and stable contact resistance and extremely high reliability over a long life. For high density packaging—our mini PCB models, the smallest in the business.

For complete specs send for free Bulletin RR409. Call or write GORDOS CORPORATION, 250 Glenwood Avenue, Bloomfield, N.J. 07003. Telephone (201) 743-6800  
TWX 710 994-4787.

**GORDOS**  
CORPORATION

ning in December of this year.

Data General Corp., Route 9, Southboro, Mass. 01803. Phone Dan Tanner at (617) 366-8911.[363]

Disk system for Tek 4051  
holds 0.5 megabytes

Designed for use with the Tektronix 4051 graphics system, a dual floppy-disk subsystem—the model 3200—provides more than half a megabyte of fast random-access storage for programs and data. Completely transparent to 4051 commands, the 3200 plugs into the 4051 read-only-memory port to get access to the operating system.

The 3200 uses a fast voice-coil head-positioning system to achieve an average access time of less than 0.167 second and a worst-case time of less than 0.333 s. Data is always transferred to the 4051 at the highest rate it can accept.

The model 3200 uses inexpensive IBM-compatible diskettes to store more than 250,000 bytes of data each. The industry-standard format allows the exchange of programs and data with users of many different computer systems.

In addition to all of the standard 4051 mass-storage commands, the 3200 has special commands that allow copying files from diskette to diskette, and saving and retrieving individual bytes and records in files, as well as merging files, and running diagnostics.

In singles, the 3200 sells for \$4,950. It is available immediately.

Second Source Industries, 735 Addison St., Berkeley, Calif. 94710 [364]



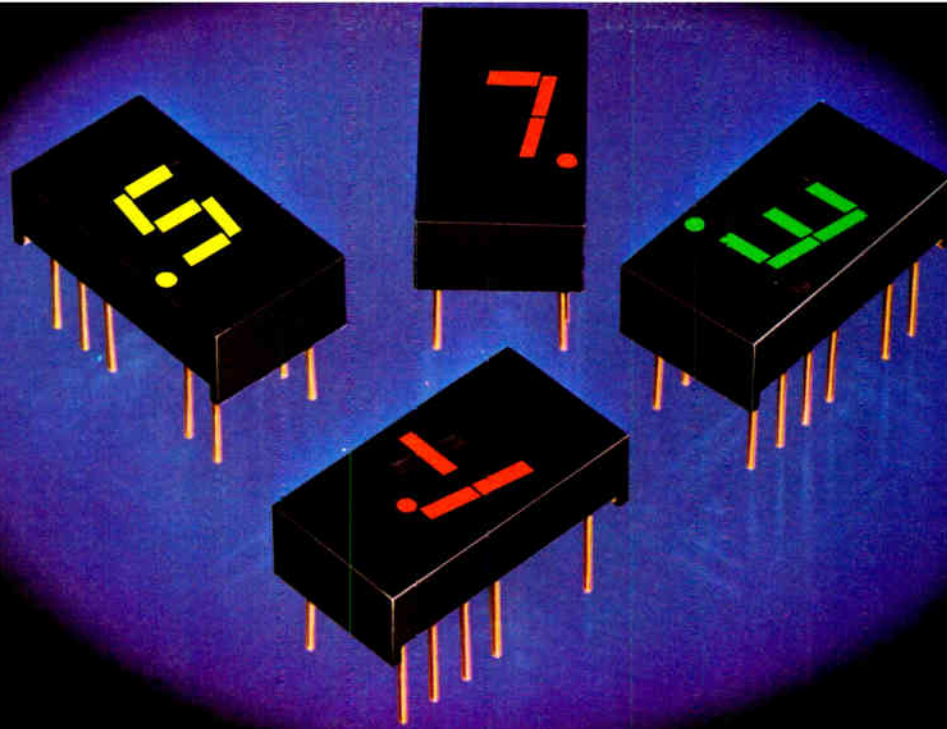

## OPTOELECTRONICS

# TI's .3" VLED displays: High contrast. Uniform color. Low cost.

Get more display for your money. Choose TI's .3" VLED seven-segment displays.

**You get color.** Easy-to-read red. Bright amber. Cool green. The right color for any application.



**You get top performance.** Excellent contrast. Wide, unrestricted viewing angle. Continuous uniform segments.

Segment-to-segment matching ratio is 1.5:1, and typical brightness is 500  $\mu$ cd.

For ease on your assembly line, all TI .3" displays are categorized by letter code for uniformity of luminous intensity.

**You get economy.** Compare the prices given in the table. They're less than those of other .3" contenders, making TI's displays an outstanding value for your money.

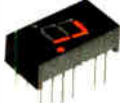
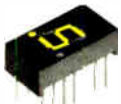
TI's .3" Color Seven-Segment VLED Display Family

		Price 100 Pcs.
	<b>Red</b>	
	TIL312 Left and Right Decimal, Common Anode	\$1.36
	TIL313 Right Decimal, Common Cathode	1.36
	<b>Amber</b>	
	TIL316 Left and Right Decimal, Common Anode	2.85
	TIL317 Right Decimal, Common Cathode	2.85
	<b>Green</b>	
	TIL314 Left and Right Decimal, Common Anode	2.85
	TIL315 Right Decimal, Common Cathode	2.85
	TIL328 Left Decimal, $\pm 1$ Overflow	2.85

## FREE

VLED data sheets for all TI optoelectronics products are available on request.

Applications Notes. A 32-page booklet on VLED applications including such topics as filter selection for VLEDs, display interface with the TMS 8080A system, VSWR indicator using VLEDs.

Texas Instruments Incorporated  
Inquiry Answering Service  
P. O. Box 5012, M/S 308  
Dallas, Texas 75222

- Please send me a copy of your new Optoelectronics Applications booklet.
- Please send me data sheets on the following products: \_\_\_\_\_

Name \_\_\_\_\_ Title \_\_\_\_\_  
Company \_\_\_\_\_  
Address \_\_\_\_\_  
City \_\_\_\_\_ State \_\_\_\_\_ Zip \_\_\_\_\_

TEXAS INSTRUMENTS  
INCORPORATED



Model 178

## Now... the next generation of bench DMMs!

Two New Keithley Models offer uncompromising performance and outstanding value.

- Accuracy 3½'s can't match: 0.04% + 1 digit on dc volts and ohms.
- Large, bright, 20,000-count LED display that's quick and easy to read.
- Convenient bench size that won't get "lost" yet doesn't crowd.
- Exceptional reliability.

Model 178 offers functions and ranges for most measurements: 100µV to 1200V dc, 100µV to 1000V ac, 0.1Ω to 20MΩ. At \$199\* it is a remarkable value!

Model 179 is a full-function, multi-feature model offering the same

advantages as the 178. Plus TRMS AC; 10µV Sensitivity; Hi and Lo Ohms; AC and DC Current.

Yet it's still half the price you'd expect. Only \$289\*!

Model 179



### Both models feature designed-in reliability.

Rugged circuits use a minimum of parts—high quality, off-the-shelf parts—carefully assembled and tested by Keithley (we've been making sensitive laboratory instrumentation for more than 30 years.)

Outstanding overload protection and rugged mechanical design keep both

units going even after severe abuse. One-year accuracy specifications minimize recalibration costs. Local assistance keeps downtime to a minimum should service ever be needed.

A battery option, user installable, gets you off "line" for critical measurements or for field use. Nine other accessories add versatility.

Keithley's 178 and 179 are designed, built and supported to provide continuous usability at the lowest total cost of ownership.

Need autoranging, more accuracy or sensitivity? See Keithley's complete line of DMMs.

For complete specifications and immediate delivery on the 178 and 179, call your local Keithley representative (see adjoining list). Or, call or write: Keithley Instruments, Inc., 28775 Aurora Road, Cleveland, Ohio 44139. (216) 248-0400. In Europe: D-800 München 70, Heighhofstrasse 5, West Germany. (089) 7144065.

# KEITHLEY

The measurement engineers.

\* U.S. domestic price only.



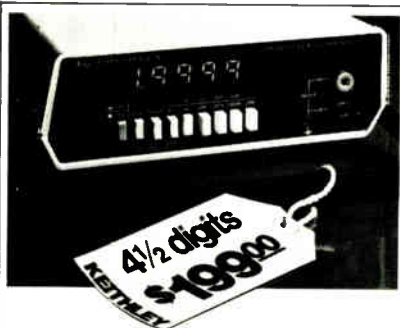

### To order your Keithley DMM:

**ALABAMA:** Huntsville, (205) 883-8660  
**ARIZONA:** Phoenix, (602) 944-9185  
**ARKANSAS:** (214) 231-9489 (Dallas, TX)  
**CALIFORNIA:** Los Angeles, (213) 836-6170  
 San Diego, (714) 226-0305  
 San Francisco (408) 257-8333  
**COLORADO:** Denver, (303) 795-0250  
**CONNECTICUT:** (800) 225-3409, Toll Free  
**DELAWARE:** (215) 657-0330 (Philadelphia, PA)  
**DISTRICT OF COLUMBIA:**  
 (703) 573-8787 (Arlington, VA)  
**FLORIDA:** Ft. Lauderdale, (305) 776-4800  
 Melbourne, (305) 723-0766  
 Orlando, (305) 425-5505  
 Pensacola, (904) 243-6424  
**GEORGIA:** Atlanta, (404) 939-1674  
**IDAHO:** (303) 795-0250 (Denver, CO)  
**ILLINOIS:** Chicago, (312) 585-5485  
**INDIANA:** Indianapolis, (317) 293-0696  
**IOWA:** Cedar Rapids, (319) 365-8071  
**KANSAS:** Kansas City, (913) 492-7020  
 Wichita, (316) 788-0621  
**KENTUCKY:** Lexington, (317) 293-0696  
 (Indianapolis, IN)  
 Louisville, (216) 729-2222 (Cleveland, OH)  
**LOUISIANA:** Baton Rouge, (504) 626-9701  
**MAINE:** (617) 944-6660 (Boston, MA)  
**MARYLAND:** Baltimore, (301) 321-1411  
 South, (703) 573-8787 (Arlington, VA)  
**MASSACHUSETTS:** Boston, (617) 944-6660  
**MICHIGAN:** Detroit, (313) 569-4497  
**MINNESOTA:** Minneapolis, (612) 559-1976  
**MISSISSIPPI:** (504) 626-9701 (Baton Rouge, LA)  
**MISSOURI:** St. Louis, (314) 426-7055  
**MONTANA:** (303) 795-0250 (Denver, CO)  
**NEBRASKA:** (913) 492-7020 (Kansas City, KS)  
**NEVADA:** (213) 836-6170 (Los Angeles, CA)  
**NEW HAMPSHIRE:** (617) 944-6660 (Boston, MA)  
**NEW JERSEY:** North, (201) 368-0123  
 South, (215) 657-0330 (Philadelphia, PA)  
**NEW MEXICO:** Albuquerque, (505) 255-2440  
**NEW YORK:** Metro New York, (201) 368-0123  
 Syracuse, (315) 454-9314 (Paramus, NJ)  
**NORTH CAROLINA:** Durham, (919) 682-2383  
**NORTH DAKOTA:** (612) 559-1976 (Minneapolis, MN)  
**OHIO:** Cleveland, (216) 729-2222  
 Dayton, (513) 434-8993  
**OKLAHOMA:** (214) 231-9489 (Dallas, TX)  
**OREGON:** Portland, (503) 297-2248  
**PENNSYLVANIA:** Philadelphia, (215) 657-0330  
 Pittsburgh, (216) 729-2222 (Cleveland, OH)  
**RHODE ISLAND:** (617) 944-6660 (Boston, MA)  
**SOUTH CAROLINA:** Columbia, (803) 798-3297  
**SOUTH DAKOTA:** (612) 559-1976 (Minneapolis, MN)  
**TENNESSEE:** Oak Ridge, (615) 482-5761  
**TEXAS:** Austin, (512) 451-7463  
 Dallas, (214) 231-9489, Houston, (713) 783-1492  
**UTAH:** (303) 795-0250 (Denver, CO)  
**VERMONT:** (617) 944-6660 (Boston, MA)  
**VIRGINIA:** Arlington, (703) 573-8787  
**WASHINGTON:** Bellevue, (206) 454-3400  
**WEST VIRGINIA:** (216) 729-2222 (Cleveland, OH)  
**WISCONSIN:** Milwaukee, (414) 464-5555  
**WYOMING:** (303) 795-0250 (Denver, CO)

### CANADA

**BRITISH COLUMBIA:** Vancouver, (604) 732-7317  
**MANITOBA:** Winnipeg, (204) 475-1732  
**ONTARIO:** Toronto, (416) 638-0218  
 Ottawa, (613) 521-8251  
**QUEBEC:** Montreal, (514) 735-4565

### EUROPE

**FRANCE:** Palaiseau, (01) 928-00-48  
**UNITED KINGDOM:** Reading, Berks.  
 (0734) 861287/88

**WEST GERMANY:** München, (089) 7144065

Or call Keithley's Toll Free  
 DMM Hot Line (800) 321-0560

**KEITHLEY**  
 The measurement engineers.

## New products

Subassemblies

# Dc-dc converters handle 12 watts

Twelve new models in converter line have single or dual outputs

Not content with stopping after its first venture into the dc-to-dc converter business [*Electronics*, June 23, p. 160], Computer Products Inc. is broadening its line with higher-powered offerings than their initial PM900 5- and 6-watt entries. The new line is designated PM800 and includes 12 models rated at 10 and 12 w.

Eight of the PM800 series are single-output units, with the other four having dual outputs. There are 5-volt and 12-v input units each offering single outputs of 5, 9, 12, and 15 v dc, and dual outputs of  $\pm 12$  and  $\pm 15$  v dc. Output currents for the converters range from  $\pm 412$  milliamperes for the dual-output versions to 2 amperes for the single-output units.

Thomas Pantelakis, project engineer who designed these and the earlier converters, says that the PM800 series "has all the advantages of the 5-watt units, but at a higher power. They incorporate essentially the same circuits, with larger parts to handle the higher power." The advantages he cites are the units' high efficiency, low ripple and noise on the outputs, and six-sided shielding from radiation.

Efficiency at full rated load is typically 65% and drops only to 60% with output loads as low as 10% of the rated output. Noise and ripple are 1 millivolt root mean square maximum and 50 mv peak-to-peak maximum at a bandwidth of 20 megahertz. Output current limiting and output short-circuit protection for shorts lasting up to eight hours are additional features, and all models in the PM800 line will automatically restart when a short circuit



is removed.

The converters measure 3.5 by 2.5 by 0.88 inches and are among the first offerings from Computer Products to come with substantial discounts for original equipment manufacturers. Single-quantity prices for the single-output models are \$86, dropping to \$52 in OEM quantities. The dual-output units are priced singly at \$92, or \$55 in OEM quantities. Delivery is from stock, or consult the company for large orders.

Computer Products Inc., 1400 N. W. 70th St., Fort Lauderdale, Fla. 33307. Phone Royal Orton at (305) 974-5500. [381]

## Low-cost peak detector works from $-55^{\circ}\text{C}$ to $125^{\circ}\text{C}$

The 4085SM analog peak detector is a hybrid device that operates over the temperature range from  $-55^{\circ}\text{C}$  to  $125^{\circ}\text{C}$ . The unit has an input-voltage range of  $\pm 10$  volts, a maximum  $25^{\circ}\text{C}$  droop rate of 0.06 millivolt per millisecond, and a small-quantity price of \$81. Dynamic errors are less than 0.01% for frequencies up to 500 hertz.

The detector tracks input signals and holds the peak value until it is reset or until a higher peak occurs. It also has a hold mode in which it ignores higher peaks. Maximum acquisition time is 200 microseconds, typical input offset is 2 millivolts (adjustable to zero), typical input offset drift is 50 microvolts/ $^{\circ}\text{C}$ , and input bias current is a maximum of



# HIGH TECHNOLOGY

*It takes three essential elements to successfully pioneer dreams into reality.*

*INITIATIVE . . . INTELLIGENCE . . .*

*A SENSE OF PURPOSE.*

Motorola, approaching its 50th Anniversary, has been able to successfully combine its pioneering spirit, the experience of a half Century of technological know-how, and its considerable resources into the pursuit of new and innovative technology for today's changing world.

Our engineers accept the challenge. . . . take the initiative. . . . and more often than not, soar to new heights in the creative application of down to earth high technology.

It's a big jump, but if you're ready to make it, we'll help you "SPREAD YOUR WINGS".

## **ELECTRICAL ENGINEERS:**

**Programmer/Analysts, Hardware - Software (TELEPHONE SWITCHING)**

## **MICROWAVE & SYSTEMS ENGINEERS**

**MOTOROLA . . . WE'RE THE PEOPLE WITH THE SOLID FOUNDATION  
. . . AND REALISTIC AMBITIONS.**

*Please send resume, including salary history, in confidence to:*



**MOTOROLA**

MOTOROLA INC.  
COMMUNICATIONS GROUP  
1301 East Algonquin Road  
Schaumburg, Illinois 60196

**New products**

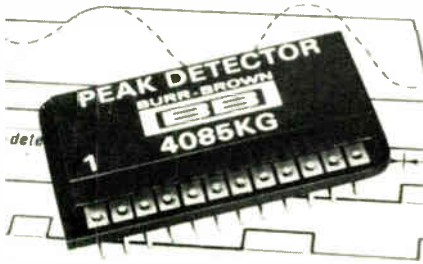

15 picoamperes, according to the firm.

Versions of the 4085 that operate over narrower temperature ranges are available at lower prices. The 4085KG works from 0°C to 70°C and sells for \$49 in single units, while the 4085BM, which is rated for operation from -25°C to 85°C, is priced at \$64.

Burr-Brown Research Corp., International Airport Industrial Park, Tucson, Ariz. 85734. Phone Joe Santen at (602) 294-1431 [383]

**Isolated v-f converter has 125-decibel CMRR**

Combining some of the best properties of isolation amplifiers and voltage-to-frequency converters, a device called the IVFC provides a minimum common-mode rejection ratio of 125 decibels, 4 kilovolts of input-output isolation, and inherently monotonic performance. The unit has a maximum nonlinearity of 0.01% (typically better than 0.005%) and has a maximum gain drift of 15 parts per million/°C. Maximum input offset drift is 1.5 microvolts/°C and maximum output offset drift is 20 μV/°C.

Completely encapsulated and



# The complete controller for IEEE 488 bus users.

IEEE 488 BUS

Talk/Listen

Control

- New S-D Model 3530 Instrumentation Controller is designed specifically for IEEE BUS applications!
- Controls any IEEE-488 compatible instrument!
- Universally accepted high-level language BASIC!
- Microcomputer system with 32k byte memory!
- RS232C/TTY current loop interface standard!
- Full 64 character ASCII keyboard!
- Highly legible CRT display!
- Convenient "load 'n go" keys!

For literature, contact Scientific Devices or Systron-Donner Data Products Division, 935 Detroit Avenue, Concord, CA 94518. Phone (415) 798-9900.

Circle 157 on reader service card

# If this magazine is worth your time, it's worth 54¢.

Drop off the routing list. Avoid the Perils of Passalong. Get your own fresh, unclipped copy mailed to your home or office. \$14 (54¢ per issue) for a one-year U.S. subscription. (\$16 in Canada.) Turn to the subscription card in the back of the magazine. If somebody beat you to it, write: Electronics, P.O. Box 430, Hightstown, N.J. 08520.

# PEEK-A-BUG.

Unintentionally



Free Catalog on  
Breadboarding Aids & More!

From the great socket-makers comes a world of universal designers, breadboxes, and every other microelectronic training aid you could ever use.

Inside these pages lies the simple road to circuit design, from solderless breadboarding to complete

design systems. And it's all for the asking. Send for our free 24 page "Bugworks®" catalog today!



**E&I INSTRUMENTS, INC.**  
61 First Street, Derby, Conn. 06418  
(203) 735-8774 Telex No. 96 3536

## Authorized Stocking Representatives

Los Angeles, Calif.  
(213) 328-9770  
San Francisco, Calif.  
(415) 961-2828  
Woodbridge, Conn.  
(203) 397-1461  
Denver, Colorado  
(303) 534-1356  
Orlando, Florida  
(305) 351-1841  
Chicago, Illinois  
(312) 956-8090  
Kansas City, Kansas  
(913) 649-8952

New York, N.Y.  
(201) 467-8585  
Syracuse, N.Y.  
(315) 699-2651  
Dayton, Ohio  
(513) 222-0011  
Philadelphia, Pa.  
(215) 723-8733  
Dallas, Texas  
(214) 328-5484  
Fairfax, Virginia  
(703) 273-1803  
Seattle, Washington  
(206) 938-4166

Canada  
Edmonton, Alberta  
(403) 455-4122  
Winnipeg, Manitoba  
(204) 774-6286  
or 772-9295  
Vancouver,  
British Columbia  
(604) 687-2621



TM

Circle 158 on reader service card

# If this magazine is worth your time, it's worth 54¢.

Drop off the routing list. Avoid the Perils of Passalong. Get your own fresh, unclipped copy mailed to your home or office. \$14 (54¢ per issue) for a one-year U.S. subscription. (\$16 in Canada.) Turn to the subscription card in the back of the magazine. If somebody beat you to it, write: Electronics, P.O. Box 430, Hightstown, N.J. 08520.

## New products

shielded in a module that measures 4 by 4 by 0.75 inches, the IVFC sells for \$195. Delivery time is two weeks. Dynamic Measurements Corp., 6 Lowell Ave., Winchester, Mass. 01890. Phone toll-free (800) 225-1151 [384]

## Unit combines outputs of synchro-digital converters

A digital combiner module, model MSC-36, combines the outputs of two synchro-to-digital converters to produce a single 19-bit digital output for two-speed synchro systems. Unlike some analog approaches to this technique, the digital combiner has no crossover stability problems. Its maximum translation error is 0.0013° (less than 5 seconds of arc). Housed in a module that measures 2

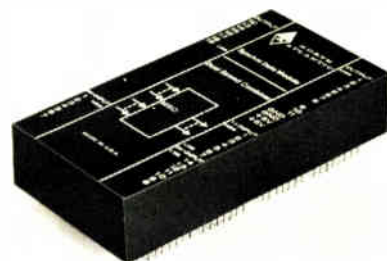

by 4 by 0.8 inches, the MSC-36 sells for \$325 and has a delivery time of two to six weeks.

North Atlantic Industries Inc., 200 Terminal Dr., Plainview, N. Y. 11803. Phone Ken Salz at (516) 681-8600 [386]

## Open-frame supplies power floppy-disk drives

Designed for incorporation into systems using the newer ac-powered floppy-disk drives, a line of open-frame power supplies includes three models. The 2BXFD is aimed at applications involving the Shugart Mini Floppy (or equivalent) drive. It puts out 12 volts dc at 0.9 ampere and 5 v dc at 0.5 A. In small quantities, it sells for \$46.95.

The 2PFD and 2QXFD supplies

# Who needs another source for solenoids?

You do if you want Potter & Brumfield quality, know-how, fast delivery.

## Traditional Quality

Imagine! The same great quality you've come to expect in P&B relays is now available in a new line of general purpose solenoids. Although solenoids from P&B may be a new idea to you, they're not exactly new products for us. We've manufactured them for years on a special order basis for specialized applications.

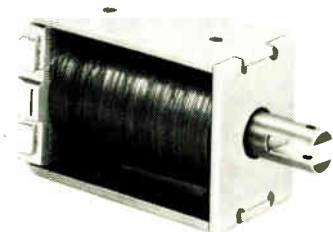

## Industry Standards

The Potter & Brumfield name gives new meaning to solenoid quality with our new S11 and S11L series. You can't buy more cost-effective solenoids for demanding photocopy machine, industrial control equipment, tape recorder, or machine tool applications.

The S11 and S11L are industry standard box frame, AC-DC solenoids which meet or exceed the performance of competitive units. We offer pull-on-operate or push-on-operate models with .187" quick connect terminations. Coil voltages are 6 to 24V DC and 24 to 120V AC for the S11, and 6 to 24V DC for the S11L. Coil powers from 8 watts continuous, up to 30 watts (S11L) intermittent duty. Coils rated Class A (105°C).



## Low Cost Performance

When low cost plus performance is important, our new C-frame S34 series is the only choice. The decision is especially easy when you have a volume application like appliances, vending machines, or valve actuators.

If a little more pull is needed, take a look at our S9 series. It, too, features low cost C-

frame construction, but provides a higher range of force characteristics for tougher jobs.

Coil powers are from 5 watts (S9: 6 watts) continuous duty to 10 watts intermittent duty. Standard voltages of 6, 12, 24 DC, and 24 and 120 AC are available. Terminations are standard .187" quick connects. Acetate yarn finished coils meet Class A (105°C) insulation requirements.

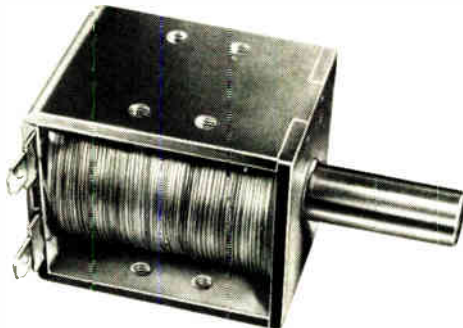

## Really Big Jobs

Some jobs call for muscle, and that's when our heavy duty solenoids really perform. Holding forces range up to 170 oz. continuous, and up to 200 oz. intermittent duty. That's power! All you need for a wide range of tough applications. And, it's available in our S4 and S4H series heavy duty solenoids. They pack more power in less space.

Coil voltages for the S4 and S4H are 6 to 24V AC and 6 to 220V DC. Standard terminations are .187" quick connect with optional wire leads or solder terminals. Varnish impregnated coils meet Class A (105°C) and Class E (130°C) insulation requirements.



## Engineering Help

When a standard won't do, you can rely on us to develop a finished product to solve your specialized application problem. We can call on our relay, switch, time delay relay, or control sub-assembly engineering to help deliver a solution.

Solenoid/switch combinations illustrate our broad capability in but one small way.

Solenoid actuated switch assemblies provide low cost control for garage doors, home appliances, heating and air-conditioning, or automated conveyor systems. Assemblies with one or two "M" style switches are available, with ratings to 10, 15 and 20 amps @ 125/250V AC, 1/2 HP. Solenoid coil voltages are 12 to 240V AC and 6 to 120V DC.

Where corrosive or dirty environments can be anticipated, our encapsulated solenoids really shine. Our Model S99 is designed to operate two-way diaphragm or piston type valves. Corrosion resistant materials handle water and dry or lubricated gases as well as air with ease. Hexagonal plunger design assures proper operation, even when handling water with particulate contaminants up to .02" diameter. Coil voltages are 6 to 120V AC and 6 to 24V DC. Standard mounting is by 3/4" x 20 UNEF 2A nut.

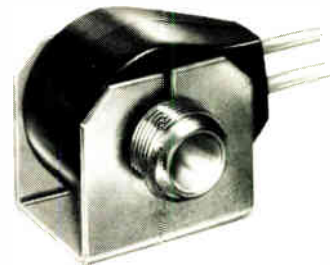

## Specials and Variations

Need a special or variation of a standard solenoid? P&B can help! Specify the solenoid you need and we can build it for you—special mountings, optional terminations, intermediate voltages, custom markings, and special plunger-end configurations. All engineered and built with P&B care and attention to quality.

For complete information and specifications, contact your P&B Sales Representative, or write or call Potter & Brumfield Division AMF Incorporated, Princeton, Indiana 47671. 812 386 1000.





## ELORG:

**ELECTRONIC COMPONENTS FROM THE U.S.S.R.**

Integrated Circuits · Solid-State Devices  
 Electronic Tubes · Various Evacuated  
 Electronic Devices and Discharge Tubes  
 Resistors · Capacitors · Ferrite Articles

**COMPLETE DEPENDABILITY  
 FULLY GUARANTEED.**

Because they have been put to severe tests in most diverse instrumentations and circuits.

Because they have been most thoroughly designed and elaborated.

Because they have been manufactured with every technological duty meticulously followed and watched.

Because they have been checked up by uncompromising Quality Control.

**ELORG embodies huge industrial and scientific potential of the U.S.S.R. in every field of radio-electronics.**

**ELORG displays**  
 electronic components

at the U.S.S.R. National Exhibition  
 in Los Angeles, November 9 to 29, 1977

**WELCOME!**



## New products



are for single and dual floppy-disk drives, respectively. The 2PFD is a triple-output unit that provides 24 v dc at 4.0 A, 5 v dc at 3.0 A, and 5 v dc at 0.6 A. Also a three-output supply, the 2QXFD puts out 24 v at 4 A, 5 v at 6 A, and -12 v at 1 A. The 2PFD sells for \$117.50, and the 2QXFD for \$134.95.

All outputs are fully adjustable and are regulated to within 0.15% against both line and load variations, with the exception of the two lowest-powered outputs (0.5 and 0.6 A), which are controlled by fixed monolithic regulators and have a total tolerance of  $\pm 3\%$ . Deliveries are from stock to two weeks.

Alpha Power Inc., 20536 Plummer St., Chatsworth, Calif. 91311. Phone Ken Lauchner at (213) 998-9873 [385]

### Dual output power supply uses recessed barrier strip

The model CM 2.15.100 power-supply module is a  $\pm 15$ -volt unit that can deliver up to 100 milliamperes from each output. What makes the supply unusual is its input/output connection scheme. Instead of pins, the module has a recessed barrier strip that both saves space and provides protection against breakage and accidental shorting of leads. Through holes and conventional molded-in threaded inserts give the user a choice of mounting methods. The supply is regulated to within 0.01% against line and load variations. It sells for \$55 in small quantities.

Calex Mfg. Co., 3305 Vincent Rd., Pleasant Hill, Calif. 94523. Phone Ron Kreps at (415) 932-3911 [387]

# We've Bridged the Gap



If GenRad's 1796 dynamic digital/analog board test system is too much machine for your application, and you need more performance than GenRad's 1795 digital tester normally provides, then you probably need GenRad's new 1799 Digital/Analog Test System. Our unmatched experience with board testing tells us that the 1799 is just the right system for many of today's applications.

A key feature of the 1799 is that it is an integrated system, which simply means it was **designed** as a hybrid tester. When you compare its performance with other hybrid testers on the market which are derived by adding analog capability (via IEEE-bus based instruments) to a

digital system, you'll find a world of difference.

Interface for the unit under test (UUT) is compatible with that of the 1795 and with the hybrid section of the 1796. Also, the fixed or programmable digital driver/sensors operate through a universal scanner which allows either digital or analog source and measure capability at each I/O pin.

For the complete story on the 1799 Digital/Analog Test System, request a copy of our new brochure.



**The difference in software is the difference in testers**



## GenRad

300 BAKER AVENUE, CONCORD, MASSACHUSETTS 01742 • ATLANTA 404 394-5380 • BOSTON 617 646 0550  
CHICAGO 312 884-6900 • DALLAS 214 234 3357 • DAYTON 513 294-1500 • LOS ANGELES 714 541-9830 • NEW YORK (NY) 212 964 2722  
IN/IL 201 791 8990 • SAN FRANCISCO 408 985-0662 • WASHINGTON DC 301 948-7071 • TORONTO 416 252-3395 • ZURICH (01) 55 24 20

# Some of these components will probably never The others will just come close.

The SR, XL, XK and AV are solid state position sensors featuring almost infinite life. All offer zero speed operation with some up to 100 KHz. ES current sensor utilizes Hall-effect IC and protects against damage from short circuits or overcurrent conditions.

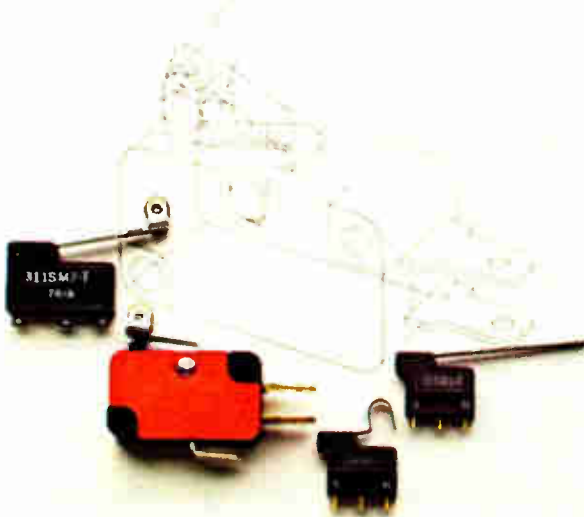

Snap-action V3, SM and SX switches offer wide variety of actuators, electrical capacity and termination.

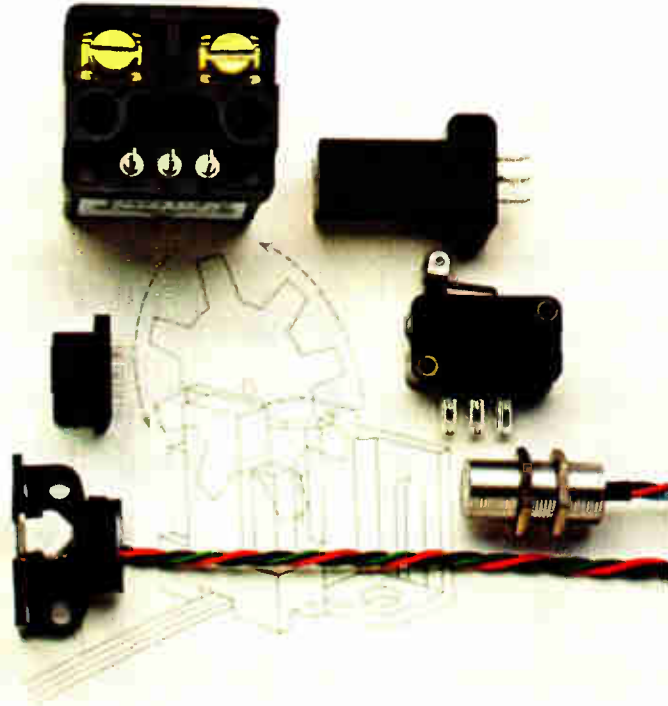

Mercury switches offer hermetic sealing, a variety of electrical capacity and broad temperature ranges at a low cost.



AML manual devices for low installed cost, electrical flexibility and attractive panel appearance. Series 8 miniature manual switches provide small size and wide variety of operators. DM offers inexpensive snap-in panel mount design.

Solid state keyboards provide high reliability no mechanical keyboard can offer. Panel sealed versions also available.





wear out.

The solid state keyboard, AML lighted push-buttons and sensors you see here will probably never wear out. Because they're all solid state.

Each is based on a Hall-effect integrated circuit. A circuit that's been tested through billions of operations without failing. And proven by performance in thousands of applications.

The precision electro-mechanical components you see here come close. Simply because of the careful way they're designed and put together.

Like the long-life versions of our snap-action 73, SM and SX precision switches. Available in a wide variety of sizes, electrical ratings, terminals, actuators, contact forms and operating characteristics — some tested to a mechanical life of over 10,000,000 operations.

MICRO SWITCH will provide you with field engineers for application assistance and a network of authorized distributors for local availability. Write us for details or call 815/235-6600.

And find out how you can get a component that goes on forever. Or at least comes very, very close.

**MICRO SWITCH**

FREEDPORT, ILLINOIS 61032

DIVISION OF HONEYWELL

MICRO SWITCH products are available worldwide through Honeywell International.

## New products

Instruments

### Logic analyzer plugs into scope

10-MHz, 32-channel unit takes up only one standard-sized slot

The latest logic analyzer in Scanoptik's LC series is a 10-megahertz, 32-channel unit that plugs into Tektronix 7000 series oscilloscopes. Unlike some other similar plug-ins, the LC-732 is only one module wide and has a digital delay feature built in. It can delay up to 65,000 clock pulses after being triggered, or it can hold off triggering until the specified address has come up a preset number of times. The trigger word can be the 16-bit address bus, the 8-bit data bus, or a combination of the two, for a 24-bit trigger word.

The LC-732 has a storage capacity of 64 32-bit words.

Included with the logic analyzer is an input cable assembly that contains a microprocessor personality board. This board has positions for interfacing the 732 with the 8080A, 6800, and Z80 microprocessors using a 40-pin clip-on connector. A general-purpose position on the board allows the user to configure the system for any other microprocessor or digital system. Priced at \$3,250, the analyzer has a delivery time of 60 days.

Scanoptik Inc., P. O. Box 1745, Rockville, Md. 20850. Phone Jerry Shumway at (301) 977-9660 [351]

### Impedance meter goes down to 0.3 mΩ full scale

The EMT 328 micro-impedance meter permits the measurement of very low impedances: it has 10 ranges from 0.3 milliohm full scale

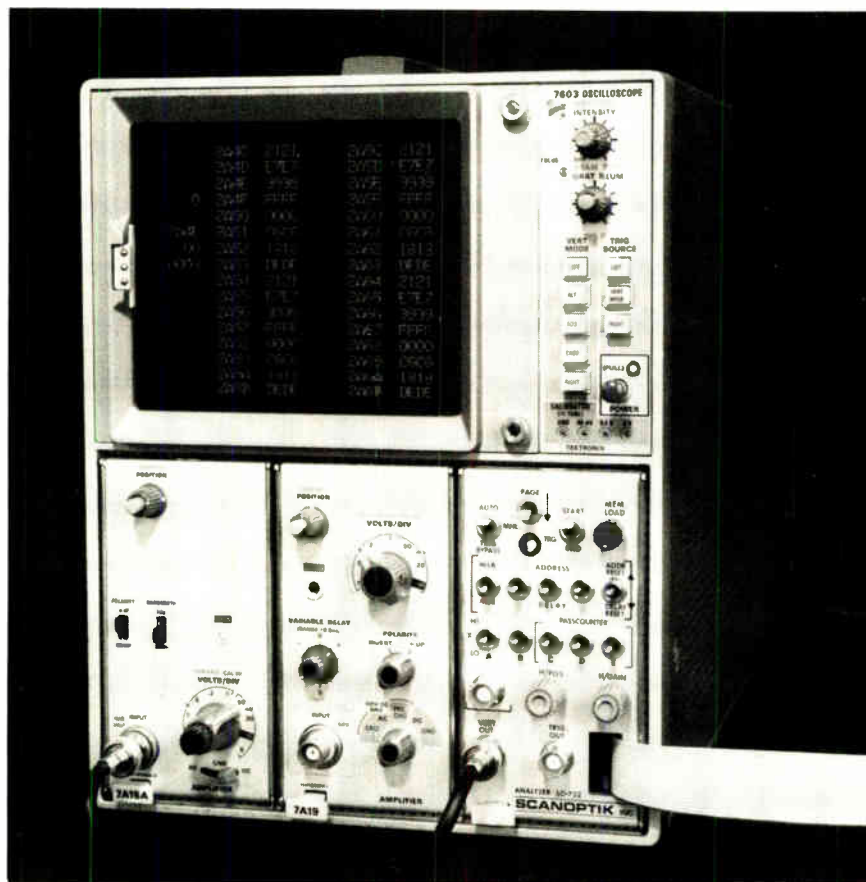

# FIXED & VARIABLE Ceramics FROM ERIE

LOOK TO ERIE FIRST FOR  
**CERAMIC  
TRIMMERS**



ACTUAL SIZE  
STYLE 513    STYLE 518    STYLE 538

- 1000 variations
- \$.30 to \$.75 in production quantities
- World's finest quality trimmers
- Other styles available

Write for catalog 500

## ERIE

ERIE TECHNOLOGICAL PRODUCTS, INC.  
Erie, Pennsylvania 16501  
814/453-5611

... AND STILL THE BEST BUY

**TUBULAR  
CERAMIC CAPACITORS**



Designed for  
Temperature Compensating and  
BY-PASS-COUPLING applications  
Complete line · High quality

**FEED-THRU  
CERAMIC CAPACITORS**

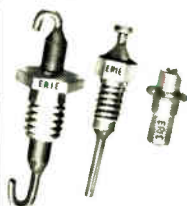

- For filtering and by-pass applications
- \$.05 to \$.30 in production quantities
- MIL Types

Write for catalog 0570

## ERIE

ERIE TECHNOLOGICAL PRODUCTS, INC.  
Erie, Pennsylvania 16501  
814/453-5611

### New products



to 10 ohms full scale. It can thus make meaningful measurements of impedances on the order of 0.1 mΩ. The instrument is especially well suited for measuring the internal resistances of batteries and storage cells and for determining contact resistances.

The unit also measures both the resistive and reactive parts of such complex impedances as those of very small inductors and very large capacitors. The actual values of inductance and capacitance are obtained from tables supplied with the instrument.

Two types of test leads are available: EMT 328L for small specimens and EMT 328M for large ones. Both are equipped with special clips that feed the test current through one set of contacts and measure the resultant voltage drop through another. The result is a measurement that is independent of contact resistance. The EMT 328 sells for \$1,291. It has a delivery time of four to six weeks.

Gotham Audio Corp., 741 Washington St., New York, N. Y. 10014. Phone Russ Hamm at (212) 741-7411 [353]

18-pound scope covers  
dc to 35 megahertz

The model 442 dual-trace oscilloscope is an 18-pound portable unit with a sensitivity of 2 millivolts per division and a bandwidth of 35 megahertz. Its dc coupling and bandwidth allow it to cover most digital troubleshooting applications.

Full X-Y capability allows channel 1 to be plotted vertically against

# CUSTOM HYBRIDS

Call Frank Albertson  
(714) 759-2411

Or send for new brochure:  
500 Superior Ave., Newport Beach, CA 92663

**HUGHES**

HUGHES AIRCRAFT COMPANY  
MICROELECTRONIC PRODUCTS DIVISION  
Circle 230 on reader service card

# CUSTOM BIPOLAR LSIs

Call Dennis Olson (714) 759-2411

Or send for new brochure:  
500 Superior Ave., Newport Beach, CA 92663

**HUGHES**

HUGHES AIRCRAFT COMPANY  
MICROELECTRONIC PRODUCTS DIVISION  
Circle 266 on reader service card

## The 1977 Answer Book. It makes your job easier. \$25.



- Over 4000 products.
- More than 5000 manufacturers with local sales offices, reps/and distributors.

- Directory of Catalogs with postpaid inquiry cards for 5-second ordering of current catalogs.

Electronics Buyers' Guide  
1221 Ave. of the Americas  
New York, N. Y. 10020

Yes, send me a copy of The Answer Book. I've enclosed \$25 (USA and Canada only, elsewhere send \$35). Full money back guarantee if returned within 10 days.

Name \_\_\_\_\_

Company \_\_\_\_\_

Street \_\_\_\_\_

City \_\_\_\_\_

State \_\_\_\_\_

Zip \_\_\_\_\_

# After you look at the specs, look how long they're guaranteed.

The accuracy specs for the Dana 5100 5½ digit multimeter are guaranteed for a full year. Not 90 days. Not 6 months. That means you only have to calibrate it once a year.

All other multimeters have to be calibrated an average of three times a year. At about \$75 a pop. Which makes their \$995 units a lot more expensive to own than the Dana 5100 at \$1145.\*

Instead of sitting in the shop for six weeks over the course of the year, the Dana 5100 will stay right where you are. Measuring AC, DC, Ohms and frequency

(yes, frequency too) with very high accuracy. Just like the specs say. For a year at a time.

When you look at it that way, one thing becomes obvious. The cost of owning a multimeter is a lot more important than the price.

Write Dana Laboratories, Inc., 2401 Campus Dr., Irvine, CA 92715 for all the specs. And take a good look. With specs that good, you'll be glad you only have to give it up once a year.

**DANA**

Others measure by us.



**Dana 5100.**

**Ask for a free demonstration  
before you consider anything less.**

For Product Demonstration circle 165 For Literature Only circle 232

# Introducing KERAMAX

and a new kind of performance—  
up to 3300°F in air

with KERAMAX  
LaCrO<sub>3</sub>  
elements.



KERAMAX high temperature furnaces and LaCrO<sub>3</sub> heating elements excel where others pale by delivering higher working temperatures in oxidizing atmospheres with stability, durability, simple operation and a lower cost/service life ratio.

KERAMAX developed by Nippon Kagaku Togyo Co., Ltd. provides a new level of performance at the highest working temperatures, whether for R&D, materials testing or production.

#### Furnace Applications

- Growing single crystals of (for example), ferrite for VTR heads • High temperature properties measuring • Ceramics sintering • Metal and slag heat treatment

#### KERAMAX LaCrO<sub>3</sub> Elements

- Longer service life at higher working temperatures in oxidizing atmospheres • Lower cost/service life ratio • Near zero resistance temperature coefficients at high temperatures; negligible electric resistance change due to aging • Excellent sensitivity and stability for precise temperature control; easy operation • Automatic control ease • Allows direct electricity supply at room temperature • Silicon carbide power units applicable for KERAMAX • Suitable for use as light source and electrodes

• Write or Telex for Complete Details

# Futek CORP.

Nishinura Bldg. 13-11, Nishi-Gotanda 1-Chome,  
Shinagawa-ku, Tokyo 141, Japan  
Phone: 03-494-0471 Telex: TOK 2467455

## New products



channel 2, with both input attenuators functioning. The scope's 150-millivolt external-trigger sensitivity allows it to trigger on transistor-transistor-logic levels even when a 10× probe must be used to reduce capacitive loading. The 442 sells for \$1,225, FOB Beaverton.

Tektronix Inc., P.O. Box 500, Beaverton, Ore. 97077 [354]

## TOPICS

### Instruments

**ECD Corp., Cambridge, Mass.,** has developed a tweezer-like chip probe for its hand-held 3½-digit capacitance meter. The new probe allows the battery-operated C-Meter to measure the capacitance of small chip capacitors. Designed for chips with terminal spacings from 0.02 to 0.30 inch, the probe sells for \$39. . . . **Ailtech, a Cutler-Hammer Co., Farmingdale, N. Y.,** has introduced several new options for its 707 and 727 spectrum analyzers. Among them: digital absolute power readout, remote tuning, switchable preselector, variable video filter, and selectable 100-hertz or 300-Hz intermediate-frequency filters. . . .

**GenRad Inc., Concord, Mass.,** is offering an instrument called the 2220 Bug Hound, which is said to greatly simplify the process of physically locating shorts, opens, bad integrated circuits, and other faults on printed-circuit boards. A key feature of the instrument is its current-tracing probe, which allows the user to follow currents along metalization tracks.

## Gas Sensing Semiconductor

# FIGARO TGS GAS SENSOR

quickly senses  
even small  
amount  
of gas.



#### Applications

1. Natural Gas-Leak Alarm
2. Propane Gas-Leak Alarm
3. Carbon Monoxide Detector
4. Automatic Fan Control
5. Fire Alarm (Detecting)
6. Combustible gases contained in smoke
7. Alcohol Detector (Detector for drunken driver)
8. Air Pollution Monitor

Please contact any of the addresses below directly for catalogs and price delivery information

### FIGARO ENGINEERING INC.

• Head Office: 3-7-3 Higashitoyonaka, Toyonaka City, Osaka, 560, JAPAN TELEX 05286155  
FIGARO J CABLE FIGARO TOYONAKA  
TEL (06) 849-2156

• North America: 3303 Harbor Boulevard, Suite D-8, Costa Mesa, California 92626, U.S.A.  
TELEX 678396 CABLE FIGARENGIN  
COSTAMESA TEL (714) 751-4103

Circle 231 on reader service card

## CUSTOM

# CRYSTAL FILTERS

Call Vic Gill (714) 759-2411

Or send for new brochure:  
500 Superior Ave., Newport Beach, CA 92663

## HUGHES

HUGHES AIRCRAFT COMPANY

MICROELECTRONIC PRODUCTS DIVISION

Circle 267 on reader service card

# STANDARD ELECTRONIC MODULES

Call Ed Skinner (714) 759-2411

Or send for new brochure:  
500 Superior Ave., Newport Beach, CA 92663

## HUGHES

HUGHES AIRCRAFT COMPANY

MICROELECTRONIC PRODUCTS DIVISION

Circle 233 on reader service card

# Fluke creates panel thermometers for people smart enough to look inside.

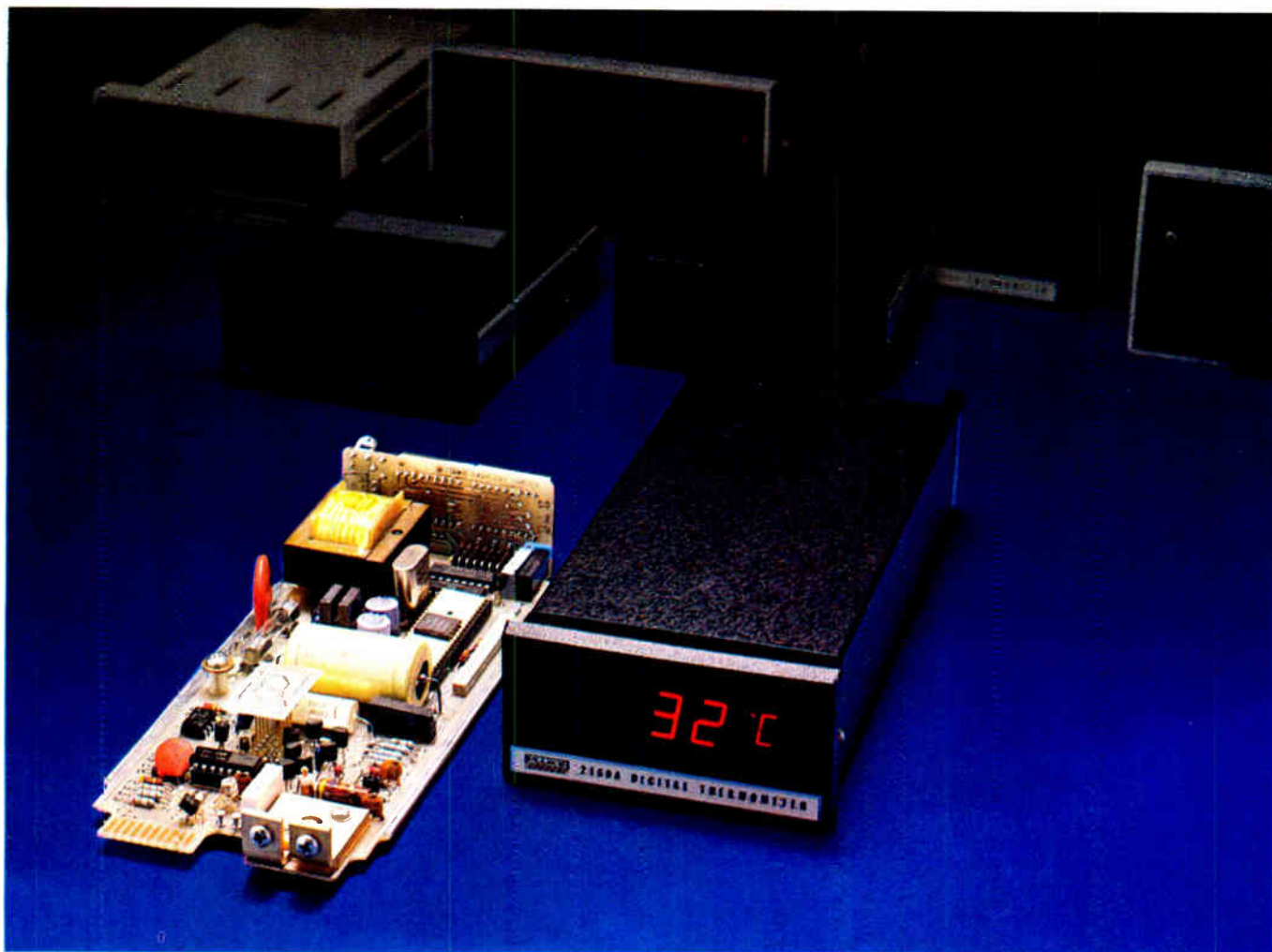

You have to know what's inside when all digital thermometers look alike on the outside.

Because there's only one line of panel mounted 1° or 0.2° digital thermometers with Fluke's recognized traditions of reliability, quality and technology.

Our 2160A and 2170A instruments.

For openers, our LSI design uses only 81 electronic parts. That's 50 parts fewer than the other recognized line. Fewer parts means greater reliability.

Then, our accuracy is so comprehensive, you'll find it difficult to compare with other digital thermometers. We give you specs that have meaning

in the real world. And no one else does that. We take operating time and ambient temperature into consideration. You get *Total Instrument Accuracy*, in °F or °C.

The 2160A is a front mounting, 4 digit thermometer that resolves 1°C or 1°F over the entire temperature range of any of eight thermocouple types (J, K, E, T, R, S, B, C). That's a temperature range of -200°C to +2327°C. The 2170A offers 0.2° resolution.

And these meters were designed for user convenience. You can mount, remove, calibrate, and select temperature scale (°F or °C) all from the front pan-

el. Options include isolated digital and analog outputs, a multi-point switch and a set point comparator.

And the price begins at only \$299.\* (OEM agreements available.)

All of this would seem to make one point: You can't judge a panel mounted digital thermometer by its cover.

Unless Fluke is on the outside.

For data out today dial our toll-free hotline, 800-426-0361. John Fluke Mfg. Co., Inc., P.O. Box 43210, Mountlake Terrace, WA 98043. Fluke (Nederland) B.V., P.O. Box 5053, Tilburg, The Netherlands. Phone: (013) 673-973 Telex: 52237.

\*U.S. price only.

**Accurate 1° digital thermometry for only \$299.**



Circle 234 for literature

World Radio History

Circle 167 for demonstration

# CUSTOM CRYSTAL OSCILLATORS

Call Vic Gill (714) 759-2411

Or send for new brochure:  
500 Superior Ave., Newport Beach, CA 92663

**HUGHES**

HUGHES AIRCRAFT COMPANY

MICROELECTRONIC PRODUCTS DIVISION

Circle 268 on reader service card

# CUSTOM HYBRIDS

Call Frank Albertson  
(714) 759-2411

Or send for new brochure:  
500 Superior Ave., Newport Beach, CA 92663

**HUGHES**

HUGHES AIRCRAFT COMPANY

MICROELECTRONIC PRODUCTS DIVISION

Circle 235 on reader service card

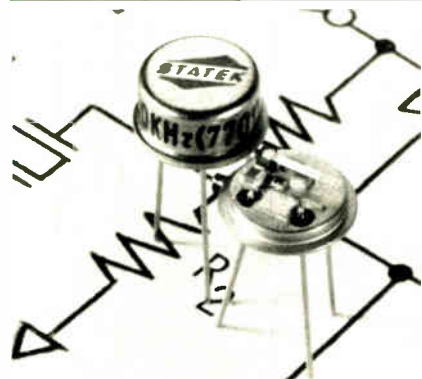

## CMOS Crystal Oscillators in low profile TO-5.

Frequency range is 10 kHz to 300 kHz (divided outputs to 1 kHz, low as one cycle per month available). Low milliamp current consumption. Accuracy  $\pm 0.01\%$ . Shock 1000 g. Hybrid thick and thin film chip and wire design is rugged and ideally suited for portable equipment. Details in Gold Book & EEM.



**CORPORATION**  
512 N. Main  
Orange, California 92658  
Telephone: (714) 639-7810  
TELEX 67-8394

## New products

Packaging & Production

### TV system eases wafer dicing

Split-field optical unit  
makes water alignment  
faster and less fatiguing

A split-field optical system with a television-screen display is designed to take much of the physiological and psychological fatigue out of high-precision wafer dicing. Offered as an option on M-1000 saws, the TV-1000 alignment system provides 100 $\times$  magnification on a 9-inch TV monitor. Its dual reticle, which is generated digitally, can be set to the exact width of the saw blade's kerf (the actual width of material sawed away by a particular blade). For ease in viewing, the reticles can be shown as either black or white images.

With the new system, first-pass alignment typically takes about 10 seconds. The second, perpendicular, cut can be aligned in about 5 seconds. An M-1000 dicing system fitted with a TV-1000 alignment

system sells for about \$3,000 more than one fitted with a standard microscope—approximately \$21,000 versus \$18,000. Delivery time is about six weeks.

Micro Automation Inc., 3170 Coronado Dr., Santa Clara, Calif. 95051. Phone (408) 988-2180 [391]

Pin-insertion machines  
ensure high reliability

A line of pin-insertion machines, which use shoulder pins to assemble hybrid substrates, produces mechanical attachments of extreme reliability. Each pin is staked very tightly to make the assemblies almost immune to shock and vibration. During staking, the top of the pin is expanded to

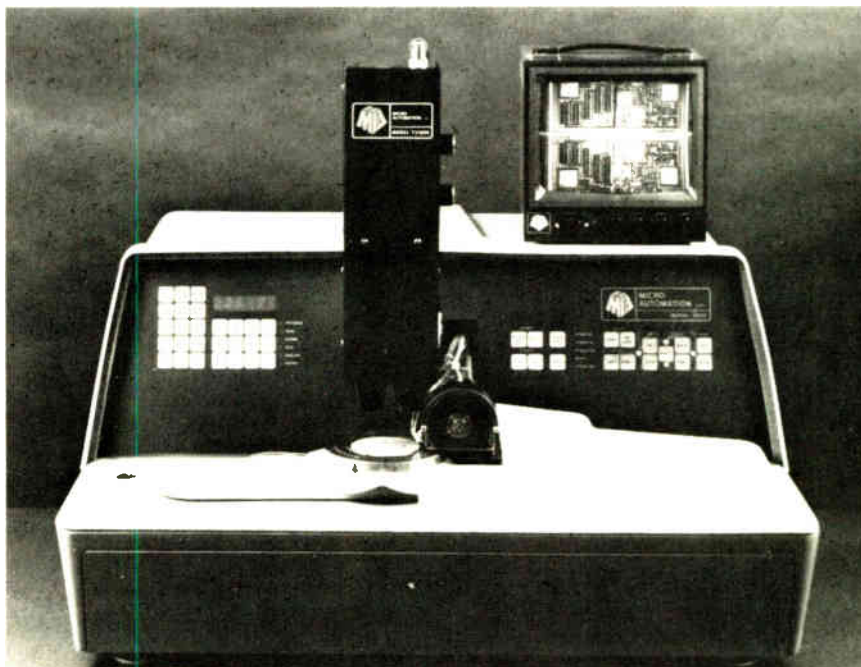
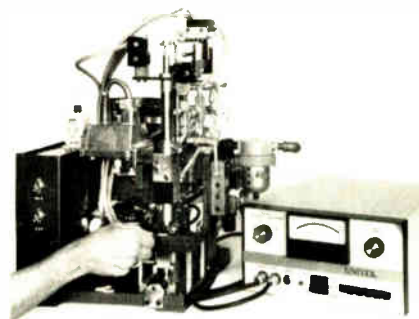

# PDP-11 users, let the computer experts help you play your hand



DEC\* computers are among the best ever. Everybody knows that. But even with DEC there is room for improvement. We took advantage of that fact and made the best ever even better. In the process, we've given you a chance to supercharge your present PDP-11\* instead of upgrading to the next computer. We've given you more time and improved your cash flow with the most complete line of sophisticated computer enhancements on the market today. They are available off the shelf. They are priced competitively. They install in minutes. They provide immediate results. And, in every instance, they outperform the competition. They should. We are the only *computer* people in the business. We are the only people really qualified to help you play out your hand and win.

Here are all the cards in our present deck: CACHE/34™, CACHE/40™ and CACHE/45™, a series of 2048-byte single-board buffer memories which increase processing speeds as much as 100% in the PDP-11/34, PDP-11/40 and PDP-11/45. SCAT/45™, an add-in memory which installs 128K of high-speed memory on the Fastbus\* of the PDP-11/45, PDP-11/50 and PDP-11/55. QUADRASYNC™, a quad interface board between the PDP-11 Unibus\* and 4 asynchronous serial communication channels which presents only one load to the Unibus. Current loop or EIA/RS-232 versions available. REBUS™, a dual-width board which supplies a repeating function without requiring space for an entire system unit. And UNIVERTER™, an adapter which converts the LSI\* bus to a Unibus structure and gives the LSI-11 access to a megabyte of memory.

There are more cards coming. In fact, we would like to build something especially for you. We'll tell you all about it when you write for details on our present line.

**Able**  
**the computer experts**

Write now. Able Computer Technology, Inc., 1616 South Lyon Street, Santa Ana, California. (714) 547-6236. TWX 910-595-1729.

\*DEC, LSI, UNIBUS, PDP and FASTBUS are registered trademarks of Digital Equipment Corporation.

Circle 169 on reader service card

THERE'S REALLY ONLY **ONE SOURCE** FOR COMPLETE, UP-TO-DATE, ANALYZED DATA ON THE RELIABILITY EXPERIENCE OF DISCRETE SEMICONDUCTOR DEVICES.



That's RAC Data Book

## TRANSISTOR/ DIODE DATA, 1977

- Failure rates, screens, stresses, failure modes and mechanisms
  - More than one billion part-hours
  - Over 250 pages—fully indexed
- Thousands of detail data entries; scores of data summaries on transistors, diodes, thyristors, and optoelectronics.
  - Order by catalogue no. DSR-2. \$50 per copy (\$60 non-U.S.)

**RAC**



**Reliability Analysis Center**

RADC/RBRAC • Griffiss AFB, NY 13441 • Tel. (315) 330-4151; Autovon: 587-4151

RAC is a DoD Information Analysis Center Operated by IIT Research Institute

Circle 170 on reader service card

### New products

approximately twice its original diameter. The result is good electrical reliability that eliminates the need for a solder reflow process or hand soldering.

Designated the model UD1/UDW-829, the machine consists of an automatic feed, an escapement mechanism, a transfer unit, and a pressure-sensitive staking head connected to a conventional dc welder power supply. Close control of the welding parameters and staking pressure permits reliable operation even on fragile 15-mil substrates with fine (16-mil) pins. The pin inserter sells for less than \$10,000. A variety of special indexing, feeding, and fixturing devices can be included at extra cost.

Cambridge Automatic Division, Eyelet Tool Co., 15 Erie Dr., Natick, Mass. 01760. Phone Dave Spencer at (617) 653-9002 [393]

### Unit bonds capacitor chips to tape-mounted lead frames

An automated bonder that produces either two or four bonds at a time has been designed to attach capacitor chips to microminiature lead frames mounted on 16-millimeter polyimide tape. Designated the model LF/C bonder, the unit employs a gold-to-gold thermocompression-bonding technique. While the lead frames are fed in on their tapes, the

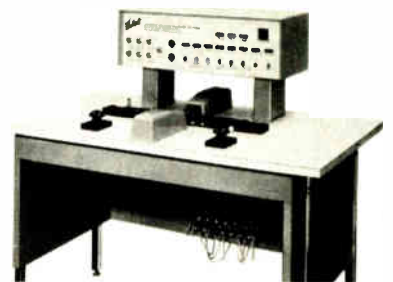

capacitors are positioned in stainless-steel boats that each hold about 10 to 20 chips. Available options include manual and automatic tape indexing, automatic chip indexing, capacitance checking, and optical inspection. The price, depending upon options, ranges from \$25,000

## Now measure AC and DC on any voltmeter with the NEW CURRENT GUN™ from F.W. Bell

The all-new Current Gun is a clamp-on instrument that lets you read AC and DC from 0 to 1 kHz and from 0 to 200A quickly, easily, safely — without breaking the connection. Use with any voltmeter... or get a reproduction of the wave form on a scope! Two ranges, 0 to 10A and 0 to 100A with 100% overrange. Only three controls: zero, range selector and press-to-read button.

**Less than \$200**

Accessories available to greatly expand ranges — higher and lower. Request complete specs today.

**Fw**

A Subsidiary of The Arnold Engineering Company



**BELL INC.**

4949 Freeway Drive East Columbus, Ohio 43229  
Phone (614) 888-7501 TWX 810-337-2851

170 Circle 236 on reader service card



# Help yourself, oem!

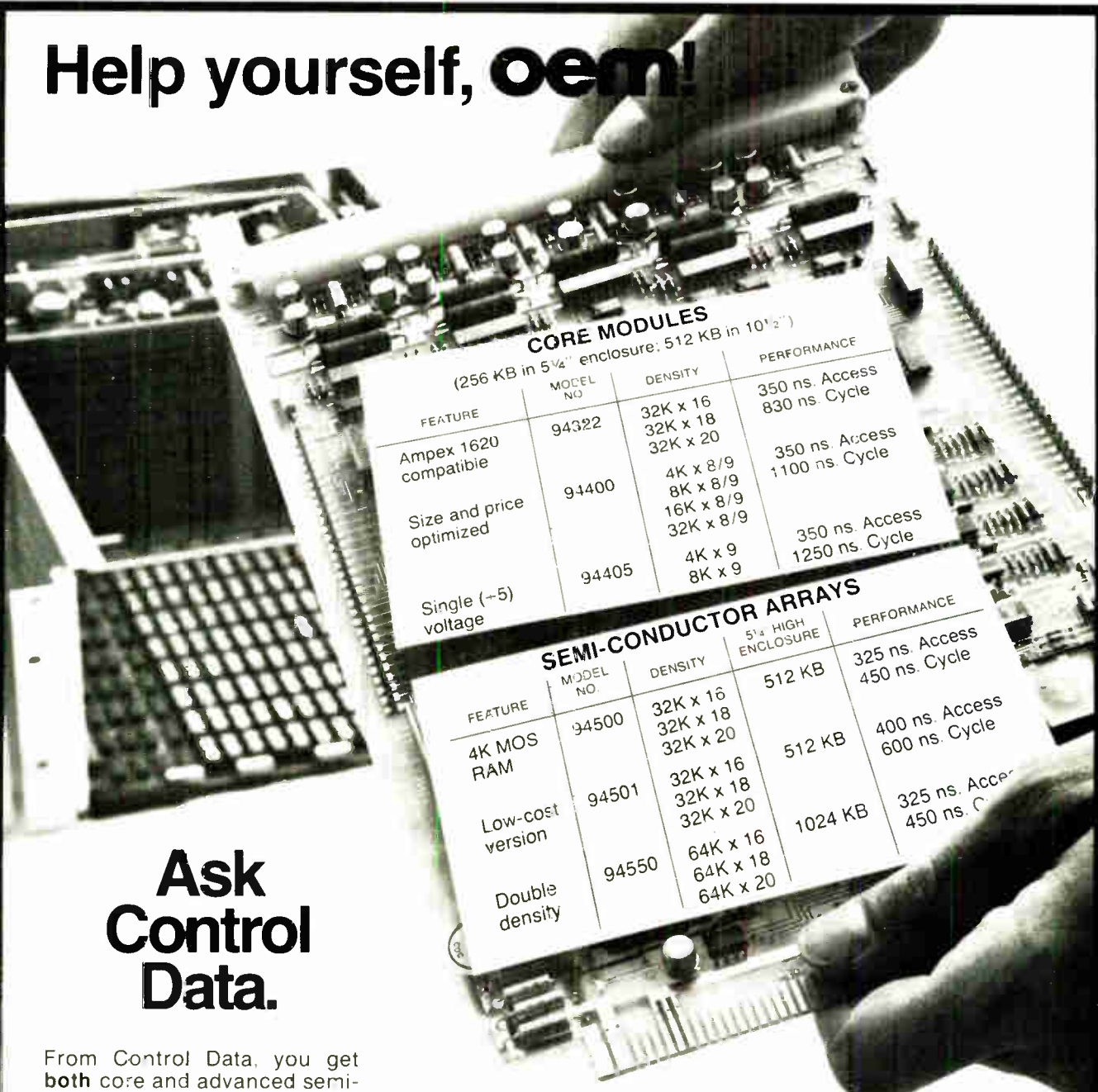

## Ask Control Data.

From Control Data, you get **both** core and advanced semi-conductor memory. You get "state of the art" in high density packaging techniques. (Example: the 94550 semi-conductor memory provides 1 megabyte in the 5 1/4" rack shown above!) You get **competitive pricing**, in custom or off-the-shelf standard configurations!

Also available:

**UNITEMP core.** In 13-mil and 18-mil sizes. UNITEMP is the temperature-independent magnetic ferrite core stable over the entire MT temperature range (0°-90° C).

**Enclosures.** For mounting core or semiconductor modules in standard EIA 19" racks.

Cabinets measure 5 1/4" or 10 1/2" high, 20" deep; cards mount horizontally. Self-contained cooling fans direct air horizontally across the modules. Both core and semi-conductor modules can be incorporated to a maximum of 1 megabyte.

CORE MODULES (256 KB in 5 1/4" enclosure: 512 KB in 10 1/2")			
FEATURE	MODEL NO.	DENSITY	PERFORMANCE
Ampex 1620 compatible	94322	32K x 16 32K x 18 32K x 20	350 ns. Access 830 ns. Cycle
Size and price optimized	94400	4K x 8/9 8K x 8/9 16K x 8/9 32K x 8/9	350 ns. Access 1100 ns. Cycle
Single (+5) voltage	94405	4K x 9 8K x 9	350 ns. Access 1250 ns. Cycle

SEMI-CONDUCTOR ARRAYS			
FEATURE	MODEL NO.	DENSITY	5 1/4" HIGH ENCLOSURE PERFORMANCE
4K MOS RAM	94500	32K x 16 32K x 18 32K x 20	512 KB 325 ns. Access 450 ns. Cycle
Low-cost version	94501	32K x 16 32K x 18 32K x 20	512 KB 400 ns. Access 600 ns. Cycle
Double density	94550	64K x 16 64K x 18 64K x 20	1024 KB 325 ns. Access 450 ns. Cycle

Phone (612) 830-5018 or write: Richard J. Koebler, OEM Marketing Manager, Computer Memory Manufacturing Division, #001 East Bloomington Freeway, Bloomington, Minnesota 55420. Please tell me more about your OEM Memories!

Ask our oem people

NAME \_\_\_\_\_ TITLE \_\_\_\_\_  
 COMPANY \_\_\_\_\_ ADDRESS \_\_\_\_\_  
 CITY \_\_\_\_\_ STATE \_\_\_\_\_ ZIP \_\_\_\_\_ PHONE \_\_\_\_\_

**GD** CONTROL DATA CORPORATION

# 5 YEAR WARRANTY ON CALEX POWER SUPPLIES



**CALEX MFG. CO., INC.**  
3355 Vincent Road  
Pleasant Hill, CA 94523  
Tel: (415) 932-3911  
Telex: 338 506

Circle 172 on reader service card

## ALCOSWITCH®

### MULTI-POSITION SLIDE SWITCHES FOR INDUSTRIAL APPLICATIONS

A most versatile switch family designed specifically for printed circuit applications featuring a unique wiping action to assume a low contact resistance—This is called our MSSA Series.

- 1,2,3, or 4 POLE OPTION
- CHOICE OF 3 or 4 POSITIONS
- VERTICAL PC OR RIGHT ANGLE MOUNTING
- GOLD OR SILVER PLATED CONTACTS AND TERMINALS
- PC LEVELLING TABS FOR ADDED STABILITY
- EPOXY SEALED TERMINALS
- QUALITY AT ECONOMY PRICES

Ask Customer Service for a sample and copy of our 76 page switch catalog.

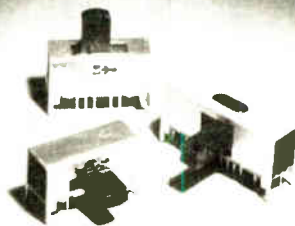

**ALCO** ELECTRONIC PRODUCTS, INC.  
1551 OSGOOD STREET NORTH ANDOVER, MA 01860 U.S.A.

Tel. (617) 685-4371 TWX: 711 342-0552

A SUBSIDIARY OF **AUGAT** INC.

172 Circle 239 on reader service card

## New products

to \$37,000. Delivery time is 14 to 16 weeks.

Wells Electronics Inc., Weltek Division, 1701 S. Main St., South Bend, Ind. 46623 [395]

2-inch LCDs mount easily on printed-circuit boards

A solderless, pinless connector for mounting 2-inch liquid-crystal displays to printed-circuit boards consists of a holder containing two Zebra conductive-elastomeric connectors and a bezel. The holder provides a 60-mil space under the LCD to accommodate a semiconductor circuit. A gas-tight connection is created when the holder

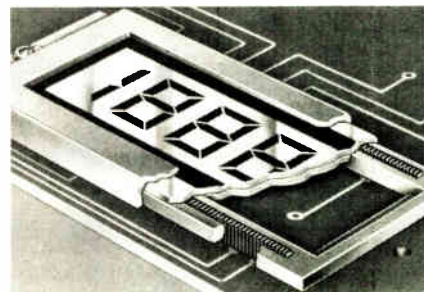

compresses the Zebra connector between the display and the pc board.

Prices for the entire assembly range from \$3.65 each in small quantities to 74 cents apiece in lots of 10,000. Delivery time is two to four weeks.

Technical Wire Products Inc., 129 Demody St., Cranford, N. J. 07016. Phone (201) 272-5500 [394]

Flexiprobe penetrates coatings on solder joints

A unpluggable piercing Flexiprobe is designed to penetrate almost any substance or residue on solder joints to yield accurate test readings on printed-circuit boards. The unit flexes on irregular surfaces, then realigns itself after contact with a test point.

Ostby and Barton Co., 487 Jefferson Blvd., Warwick, R. I. 02886. Phone (401) 739-7310 [396]

Electronics/November 10, 1977

# Proven problem solvers from Elco

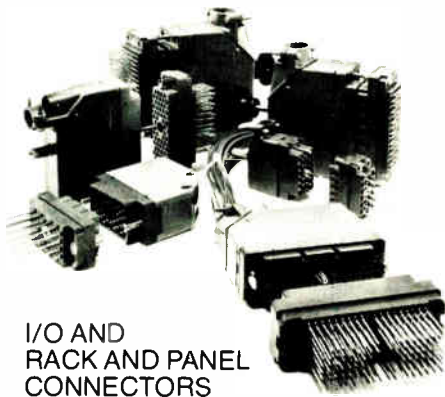

## I/O AND RACK AND PANEL CONNECTORS

Meets every i/o wire size requirement from 18 to 30 AWG. They feature easy mating/unmating and locking of mated connectors with a single jack screw operation. High-density contact spacings range from .100" to .150" grids, with 20 to 165 contacts with solder, crimp, wire wrap and other terminations. Lightweight aluminum covers are available for cosmetic appeal, wire clamping and strain relief. They utilize the Varicon™ contact which has a 25 year record of reliable service.

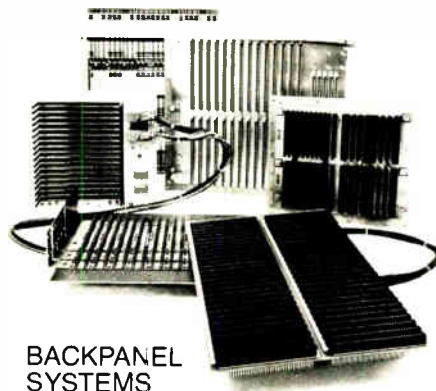

## BACKPANEL SYSTEMS

Are you looking for compact, ready-made backpanel interconnects for your daughter cards to reduce costs? Elco offers metal plate backpanels with pc connectors for automatic and hand wire wrapping which provide built-in ground and voltage interconnections. To further simplify your task and eliminate wire wrapping, Elco offers pc backpanels in two sided and multilayer configurations providing all ground, power and signal interconnections for mounted card edge or metal-to-metal connectors with contact spacings from .100" to .156". All backpanels are custom engineered to fit your exact needs in sizes accommodating as many as 20,000 contacts.

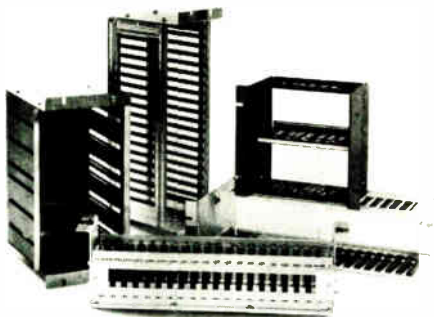

## PC CARD ENCLOSURES

The versatile Varipak® II card enclosures are constructed from standard components and will accommodate any number of cards and card sizes to meet your custom requirements. They come complete with guide plates, card guides, and connector mounting panels. Your local distributor offers immediate delivery on 64 standard models in 19" and 24" widths.

ELCO CORPORATION'S catalogs are available upon request for any of these products. In most cases, these products are immediately available from distributor stock. For custom products or engineering assistance, we'll be glad to help you. Just call us, Elco connects . . . worldwide!

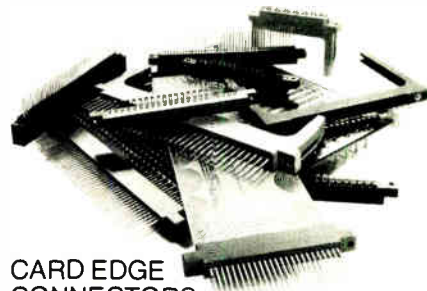

## CARD EDGE CONNECTORS

Elco has been the supplier of reliable card edge connectors for years. Now additional sizes in the standard line and a new line of wire-wrappable connectors with .156" centers are offered. All standard contact spacings from .100" to .156" for all termination techniques are available including, QPL, military qualifications to MIL-C-21097/21 and UL recognition. And they're immediately available from your local distributor.



## 2-PIECE METAL-TO-METAL PC CONNECTORS

For the user, who needs the most reliable card-to-card connection, end-to-end, at right angles or stacking connections, we offer the greatest variety of metal-to-metal contacts and connectors available anywhere. Expect off-the-shelf delivery from our distributors on most configurations that include .050" staggered, .100" to 200" spacing, 1 to 96 contacts, various termination styles, with or without card guides and hardware for most any application. Most are mil spec, QPL and UL recognized. Connections are made by our Varicon™ contact providing hermaphroditic, gas-tight joints with millions of operating hours proving their reliability.

Elco Corporation  
2250 Park Place  
El Segundo, Ca 90245  
TWX 910-325-6602 / 213 675-3311

**Elco Connects!**

**GW Elco Corporation**  
a Gulf + Western manufacturing company

Circle 173 on reader service card 173

# ELECTRONICS REPRINTS

No. of  
copies  
wanted

## New reprints

- \_\_\_ R-718 Display makers strive to refine their technologies 8 pp \$3.00
- \_\_\_ R-716 Special report—Japanese wave in semiconductor technology 24 pp \$3.00
- \_\_\_ R-714 Special report—active filter technology 6 pp \$3.00
- \_\_\_ R-713 Electron-beam lithography draws fine line 10 pp \$3.00
- \_\_\_ R-712 Special report—large-scale integration 16 pp \$3.00
- \_\_\_ R-710 Personal computers mean business 8 pp \$2.00
- \_\_\_ R-708 So you want to be a consultant 6 pp \$2.00

## Charts

- \_\_\_ R-516 Electronic symbols \$2.00
- \_\_\_ R-213 Electromagnetic spectrum (updated 1976) \$3.00
- \_\_\_ R-326 Optical spectrum (6-page report and chart) \$3.00

## Books

- \_\_\_ R-711 Circuits for electronics engineers: 306 circuits in 51 functional groups—Electronics Book Series \$15.95
- \_\_\_ R-704 Thermal design in electronics \$5.00
- \_\_\_ R-701 Applying microprocessors—Electronics Book Series \$9.95
- \_\_\_ R-608 Basics of Data Communications—Electronics Book Series \$12.95
- \_\_\_ R-602 Large Scale Integration—Electronics Book Series \$9.95
- \_\_\_ R-520 Microprocessors—Electronics Book Series \$8.95
- \_\_\_ R-011 Computer-aided Design 135 pp \$4.00
- \_\_\_ R-032 Active Filters 88 pp \$4.00

## Payment must accompany your order

Make check or money order payable to Electronics Reprints. All orders are shipped prepaid by parcel post. Allow two to three weeks for delivery. For additional information call (609) 448-1700 ext. 5494.

Mail your order to:

Janice Austin  
ELECTRONICS REPRINTS  
P.O. Box 669  
Hightstown, N.J. 08520

Back issues now available:

1960 to 1969, \$5.00 each  
1970 to 1973, \$3.00 each  
1974 to 1976, \$4.00 each

## New products

Microwaves

### Generator spans 10 to 15.5 GHz

K-band instrument delivers  
10 dBm, can be modulated  
internally or externally

A K-band signal generator delivers 10 dBm (10 milliwatts) of output power over the frequency range from 10.0 to 15.5 gigahertz. Designated the model 1819A, the instrument has a calibrated attenuator that provides precise output levels down to -90 dBm. Its applications include the testing of communications equipment, radars, and weapons systems.

Three types of modulation—frequency, square-wave, and pulse—can be produced using either the generator's built-in source or an external signal. The internal source provides modulation rates variable from 10 hertz to 10 kilohertz. Pulse widths can be set from 0.2 to 2,000 microseconds, and the pulsed rf

output can be delayed from 0.3 to 2,000  $\mu$ s, relative to the modulating pulse, for easy scope-monitoring. The 1819A also includes a 25-mw C-band signal source that provides similar capabilities from 5 to 7.75 GHz. It sells for \$7,750 and has a 30-day delivery time.

Polarad Electronic Instruments, 5 Delaware Dr., Lake Success, N. Y. 11040. Phone (516) 328-1100 [401]

Broadband oscillators  
are light in weight

A family of yttrium-iron-garnet-tuned oscillators includes five units that, among them, cover the frequency range from 2 to 18 gigahertz. The heaviest unit in the series, the AV-71211, weighs just 1 pound and puts out 7 dBm over 12 to 18 GHz. The lightest oscillator, the AV-7216, is a mere 6 ounces and delivers 8 dBm from 2 to 6 GHz. It has a calculated mean time between failures of 73,900 hours at 71°C case temperature; at 100°C the calculated MTBF is more than 46,000 hours under the most severe category (mis-

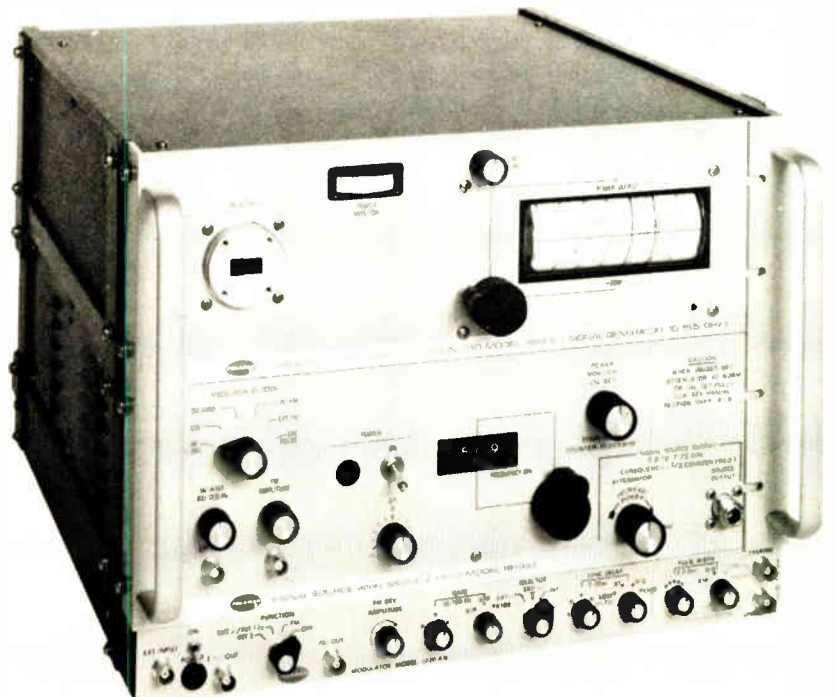

# When was the last time you saved money and got the counter you wanted?

A frequency counter should deliver all the performance you expected when you placed the order. If the counter is a B&K-PRECISION you'll be getting that plus something equally important—a price that you can easily afford.

B&K-PRECISION has engineered a line of full-feature frequency counters to suit most

applications. All have been conceived as cost-effective answers to frequency measurement needs in communications, lab, field and plant applications. Every B&K-PRECISION counter features: autoranging, liberal input overload protection, a minimum of 1Hz resolution, conservative specifications, and easy-to-read LED displays.

#### MODEL 1850

- 520MHz guaranteed
- Period measurement
- Reliability



#### MODEL 1801

- 40MHz guaranteed; 60MHz typical
- Reliable discrete TTL logic



#### MODEL 1827

- 30MHz guaranteed; 50MHz typical
- Compact size; portable

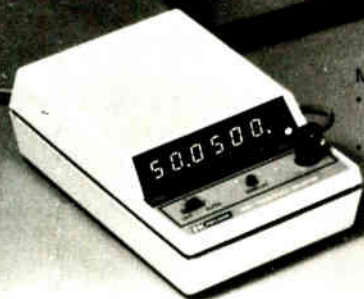

#### MODEL 1820

- 80MHz guaranteed; 100MHz typical
- Period, event and time measurements



At the top end of our line is the new Model 1850, very conservatively rated at 520MHz. Features include: TCXO time base...Period measurements from 5Hz to 1MHz...Leading zero suppression...Bright .43" LED display... Gate times from 10 ms to 10 seconds... \$450.

The 1820 Universal Counter is one of the most versatile counters available at any price. Frequency measurement typically extends beyond 100MHz...Period measurements from 5Hz to 1MHz... Period average, auto and manual positions... Elapsed time measurements to 9999.99 seconds (plus overflow)... Totalizes event counts to 999999 (plus overflow)... \$260.

At only \$120, the 1827 portable frequency counter is slightly larger than a pocket calculator. 30MHz guaranteed; 50MHz typical... Battery saver for all-day field use... Full range of optional accessories available.

The 1801 is a rugged frequency counter designed for production line and maintenance applications. Readings to 40MHz guaranteed; 60MHz typical... Easy to use and read...Wide range input eliminates the need for level adjustments... \$200.

Isn't it time you stopped sacrificing features and performance for price? See your local distributor for immediate delivery.

**B&K PRECISION** **DYNASCAN CORPORATION**

6460 W. Cortland Avenue, Chicago, IL 60635 312/889-9087

In Canada: Atlas Electronics, Ontario

International Sales: Empire Exporters, Inc., 270 Newtown Road, Plainville, L.I., NY 11803

World Radio History

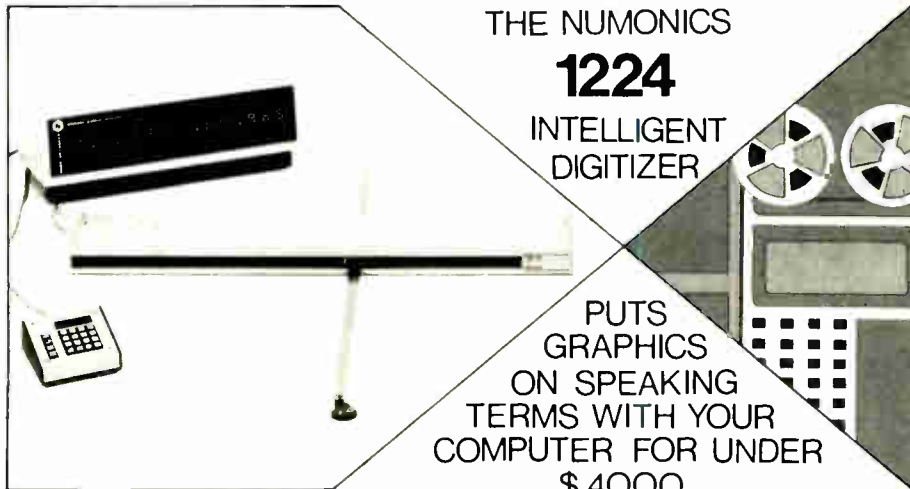

At last. An electronic graphics calculator that adds the program and memory power of a micro-computer and front-end digitizer. One easy-to-operate unit that's both portable and programmable for custom application and on-site use. Input data via the alpha numeric keyboard or the Electronic Digitizer itself. Data goes directly to the micro-processor for calculations, output to a 16-digit display and/or computer interface. And you've a choice of either character serial or EIA-RS232C output formats standard. Data batching, axis rotation, scaling, point-to-point area and length measurements. . .with the Numonics 1224's library of field changeable programs, we can put your computer on speaking terms with graphics. At less than \$4000. May we tailor one for you?

**NUMONICS** 418 Pierce St., Lansdale, Pa. 19446 (215) 362-2766  
Circle 176 on reader service card



- **Fast TurnAround**  
25 days from your design to prototype circuits
- **Low Cost**  
Save 80% over a fully custom design
- **Reduced Circuit Size**  
Multiple saving by reducing circuit size 90%
- **Proven Process**  
Standard CMOS assures high reliability and dependable delivery

**INTERNATIONAL  
MICROCIRCUITS, INC.**

3004 Lawrence Expwy., Santa Clara, Ca. 95050 (408) 735-9370

176 Circle 237 on reader service card

World Radio History

## New products



sile launch) of HDBK-217B.

With the exception of the Ku-band AV71211, all oscillators in the series include buffer amplifiers for increased power output and increased resistance to frequency pulling. They are fundamental transistor units built using thin-film gold-on-ceramic construction. Their packages are all hermetically sealed and filled with inert gas for enhanced reliability. Delivery times range from 30 to 120 days, according to the company.

Avantek Inc., 3175 Bowers Ave., Santa Clara, Calif. 95051. Phone William W. Berridge at (408) 249-0700 [403]

## Programmable field-intensity meter covers 11 to 18 GHz

The model NM-67 electromagnetic interference field-intensity meter is a self-contained, programmable, microwave receiver with spectrum-analyzer capability and tracking pre-selection. It covers the range from 1 to 18 gigahertz and is expandable up to 40 GHz.

The instrument's frequency and amplitude outputs are suitable for XY plotting and for conversion to digital form. Frequency readout is digital. Delivery of the meter is from stock.

Singer Instrumentation Division, 5340 Alla Rd., Los Angeles, Calif. 90066. Phone (213) 822-3061 [405]



Electronics/November 10, 1977

FROM  LAMBDA

# A COMPLETE LINE OF MONOLITHIC 1.5 AMP, 15W 4 VOLTS TO 30 VOLTS...FIXED & VARIABLE VOLTAGE REGULATORS

LAS 15U  
LAS 18U  
VARIABLE  
REGULATORS

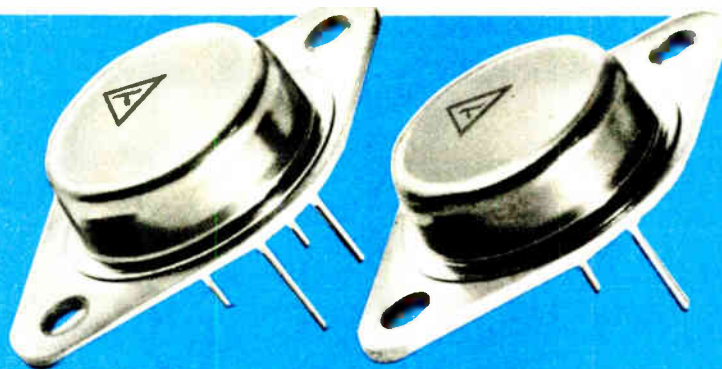

LAS 1500  
POSITIVE  
LAS 1800  
NEGATIVE  
FIXED  
REGULATORS

## BETTER THAN NATIONAL, BETTER THAN MOTOROLA

Compare these specifications of Lambda's 1.5 amp monolithic voltage regulator

PARAMETER	 LAMBDA		NATIONAL*				MOTOROLA*				UNITS
	LAS 1505 MIN	LAS 1805 MAX	LM 340 K 5 MIN	LM 320 K 5 MAX	LM 340 K 5 MIN	LM 320 K 5 MAX	MC7805 C K MIN	MC7905 C K MAX	MC7805 C K MIN	MC7905 C K MAX	
Input-Output Differential	2.4	2.1	Not Specified		Not Specified		Not Specified		Not Specified		Volts
Thermal resistance junction to case	3.0		3.0		4.0		3.0		4.0		°C/watts
Max operating junction temperature	+150		+150		+150		+150		+125		°C
Regulation Load @ 1.5A min	30		30		100		75		100		120 mV
Temperature Coefficient	0.03		0.03		Not Specified		Not Specified		Not Specified		%Vo/°C
Ripple Attenuation	58		59		Not Specified		Not Specified		Not Specified		dB

\* From Published Specifications

# △ LAMBDA LAS 1500 AND 1800 SERIES FIXED AND ADJUSTABLE MONOLITHIC VOLTAGE REGULATORS 4 TO 30VDC, 1.5A POS. AND -2 TO -30VDC, 1.5A NEG.



**The only monolithic voltage regulators in the industry  
performing 100% burn-in under load!  
Guaranteed to maximize and expand system reliability!**

Now available LAS 15U, LAS 18U adjustable monolithic voltage regulators

## OUTSTANDING FEATURES

- Guaranteed input-output differential— 2.4 volts pos. and 2.1 volts neg.
- Pin-for pin replacement for LM309, LM340, LM340A, LM320, MC7800, MC7900,  $\mu$ A7800 and  $\mu$ A7900 series regulators.
- Lower thermal resistance (more usable output power)— 3°C/W
- 4 to 30V output available (positive); -2 to -30 volt output available (negative)
- Guaranteed output noise voltage— 10 $\mu$ V/volt of output (1500 Series)
- Guaranteed load regulation at 1.5 amps— 30 mV
- Guaranteed line regulation at 1.0 amp— 100mV
- Guaranteed temperature coefficient— 0.03%  $V_o$  per °C
- Guaranteed ripple attenuation—58 db
- Internal short circuit and overload protection
- Thermal and safe area protection

## ORDERING INFORMATION

$V_o$ VOLTS	MODEL	$I_o$ AMPS	PRICE QTY.							
			1-24	25-49	50-99	100-249	250-499	500-999	1000-2499	2500-4999
4-30	LAS 15U	1.5	\$4.13	\$3.75	\$3.45	\$3.23	\$3.00	\$2.85	\$2.70	\$2.55
5	LAS 1505	1.5	2.75	2.50	2.30	2.15	2.00	2.00	1.90	1.80
6	LAS 1506	1.5	2.75	2.50	2.30	2.15	2.00	2.00	1.90	1.80
8	LAS 1508	1.5	2.75	2.50	2.30	2.15	2.00	2.00	1.90	1.80
10	LAS 1510	1.5	2.75	2.50	2.30	2.15	2.00	2.00	1.90	1.80
12	LAS 1512	1.5	2.75	2.50	2.30	2.15	2.00	2.00	1.90	1.80
15	LAS 1515	1.5	2.75	2.50	2.30	2.15	2.00	2.00	1.90	1.80
18	LAS 1518	1.5	2.75	2.50	2.30	2.15	2.00	2.00	1.90	1.80
20	LAS 1520	1.5	2.75	2.50	2.30	2.15	2.00	2.00	1.90	1.80
24	LAS 1524	1.5	2.75	2.50	2.30	2.15	2.00	2.00	1.90	1.80
28	LAS 1528	1.5	2.75	2.50	2.30	2.15	2.00	2.00	1.90	1.80
-30 to -2.6	LAS 18U	1.5	5.40	5.03	4.73	4.50	4.28	4.05	3.82	3.60
-2	LAS 1802	1.5	3.60	3.35	3.15	3.00	2.85	2.70	2.55	2.40
-5	LAS 1805	1.5	3.60	3.35	3.15	3.00	2.85	2.70	2.55	2.40
-5.2	LAS 18052	1.5	3.60	3.35	3.15	3.00	2.85	2.70	2.55	2.40
-6	LAS 1806	1.5	3.60	3.35	3.15	3.00	2.85	2.70	2.55	2.40
-8	LAS 1808	1.5	3.60	3.35	3.15	3.00	2.85	2.70	2.55	2.40
-10	LAS 1810	1.5	3.60	3.35	3.15	3.00	2.85	2.70	2.55	2.40
-12	LAS 1812	1.5	3.60	3.35	3.15	3.00	2.85	2.70	2.55	2.40
-15	LAS 1815	1.5	3.60	3.35	3.15	3.00	2.85	2.70	2.55	2.40
-18V	LAS 1818	1.5	3.60	3.35	3.15	3.00	2.85	2.70	2.55	2.40
-20V	LAS 1820	1.5	3.60	3.35	3.15	3.00	2.85	2.70	2.55	2.40
-24V	LAS 1824	1.5	3.60	3.35	3.15	3.00	2.85	2.70	2.55	2.40
-28V	LAS 1828	1.5	3.60	3.35	3.15	3.00	2.85	2.70	2.55	2.40



# Regulator Performance Specifications

## 1.5 amp positive regulators

The LAS 1500 Series of three-terminal voltage regulators are monolithic integrated circuits designed for use in applications requiring a well regulated fixed value positive output voltage for load current variations up to 1.5 amperes. The LAS 15U device is a 4-terminal adjustable positive-output voltage regulator. The LAS 1500 Series is available in fixed output voltage values ranging from +5V to +28V. The output voltage of the LAS 15U is adjustable from +4V to +30V. Both the LAS 1500 Series and the LAS 15U feature internal current limiting, thermal shutdown, and safe area protection for the series pass Darlington. A hermetically sealed steel TO 3 package is employed for high reliability, and low thermal resistance, when used with an appropriate heatsink.

PARAMETER	SYMBOL	TEST CONDITIONS			LAS 1500-1528 TEST LIMITS		LAS 15U TEST LIMITS		UNITS
		V <sub>IN</sub>	I <sub>o</sub>	T <sub>J</sub>	MIN	MAX	MIN	MAX	
Input Voltage	V <sub>IN</sub>		5mA	0-125°C	V <sub>O</sub> + 2.4V	35[40] <sup>(2)</sup>	V <sub>O</sub> + 2.4V <sup>(1)</sup>	35[40] <sup>(2)</sup>	volts
Output Voltage <sup>(3)</sup>	V <sub>O</sub>	V <sub>1</sub> to V <sub>2</sub>	5mA to 1.0A	25°C	.95IV <sub>O</sub> I <sup>(4)</sup>	1.05IV <sub>O</sub>	4 <sup>(4)</sup>	30	volts
Input Output Differential	V <sub>IN</sub> -V <sub>O</sub>		1.0A	0-125°C	2.4		2.4		volts
Output Current	I <sub>O</sub>	V <sub>1</sub>		25°C		1.5		1.5	amps
Standby Current	I <sub>Q</sub>	V <sub>1</sub>		25°C		10		10	mA
Standby Current Change with input <sup>(5)</sup>	ΔI <sub>Q</sub>	V <sub>1</sub> to V <sub>3</sub>	5mA	25°C		1.3		1.3	mA
Standby Current Change with Load	ΔI <sub>Q</sub>	V <sub>1</sub>	5mA to 1.5A	25°C		0.5		0.75	mA
Maximum Current Limit	I <sub>LIM</sub>	V <sub>1</sub>		0-125°C		2.8		2.8	amps
Short Circuit Current <sup>(7)</sup>	I <sub>SC</sub>	20V		0-125°C		1.8		1.8	amps
Short Circuit Current <sup>(8)</sup>	I <sub>SC</sub>	30V		0-125°C		0.8		0.8	amps
Power Dissipation <sup>(10)</sup>	P <sub>D</sub>					15		15	watts
Thermal Resistance									
Junction to-case	R <sub>θJC</sub>					3		3	°C per watt
Storage Temperature	T <sub>STG</sub>				-65	+150	-65	+150	°C
Maximum Operating Junction Temperature	T <sub>J</sub>				-55	+150	-55	+150	°C
Regulation - Load <sup>(9)</sup>	(R <sub>I</sub> G) <sub>L</sub>	V <sub>1</sub>	5mA to 1.5A	25°C		0.6		0.6	% V <sub>O</sub>
Regulation - Line <sup>(9)</sup>	(R <sub>I</sub> G) <sub>LN</sub>	V <sub>1</sub> to V <sub>3</sub>	0.1A	25°C		1.0		1.0	% V <sub>O</sub>
		V <sub>1</sub> to V <sub>3</sub>	0.5A	25°C		2.0		2.0	% V <sub>O</sub>
		V <sub>1</sub> to V <sub>2</sub>	1.0A	25°C		2.0		2.0	% V <sub>O</sub>
Temperature Coefficient	T <sub>C</sub>	V <sub>1</sub>	0.1A	0-125°C		0.03		0.03	% V <sub>O</sub> /°C
Output Noise Voltage <sup>(11)</sup>	V <sub>N</sub>	V <sub>1</sub>	0.1A	0-125°C		10		10	μVrms/V
Ripple Attenuation	R <sub>A</sub>	V <sub>1</sub>	1.0A	0-125°C	58 <sup>(12)</sup>		58 <sup>(12)</sup>		db
Control Voltage	V <sub>C</sub>	V <sub>1</sub> to V <sub>2</sub>	5mA	25°C			3.50	4.0	V

**Notes**

- (1) Minimum V<sub>IN</sub> = 6VDC
- (2) Values of 35V applies to V<sub>O</sub> of +4V to +12V. Values of 40V applies to V<sub>O</sub> of volts +15 to +30 volts.
- (3) V<sub>1</sub> = V<sub>O</sub> + 5V. V<sub>2</sub> = V<sub>O</sub> + 15V or the maximum input voltage whichever is less.
- (4) Nominal output voltages are specified under ordering information
- (5) V<sub>O</sub> = V<sub>C</sub> [1 +  $\frac{R_1}{R_2}$ ] R<sub>1</sub> = resistance from output to control. R<sub>2</sub> = resistance from control to common

- (6) For positive regulator V<sub>3</sub> = V<sub>O</sub> + 20V or the maximum input voltage whichever is less
- (7) Applies to those devices with IV<sub>O</sub> = 2V to 18V
- (8) Applies to those devices with IV<sub>O</sub> = 20V to 30V
- (9) Instantaneous regulation
- (10) Derate above T<sub>C</sub> = 105°C 333 mW per °C
- (11) Specified in μVrms/volt output. BW = 10HZ - 100K HZ
- (12) Ripple attenuation is specified for a 1 Vrms, 120 HZ input ripple. Ripple attenuation is a minimum of 58 db at 5 volts output and is 1 db less for each volt increase in output voltage

### FUNCTIONAL BLOCK DIAGRAM

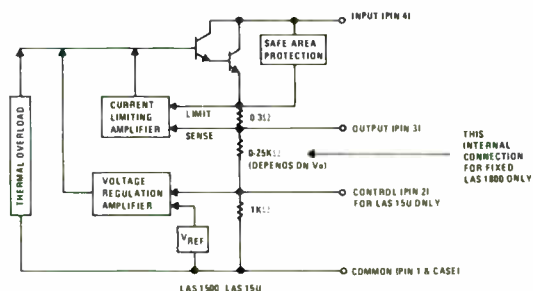

### OUTLINE DRAWING

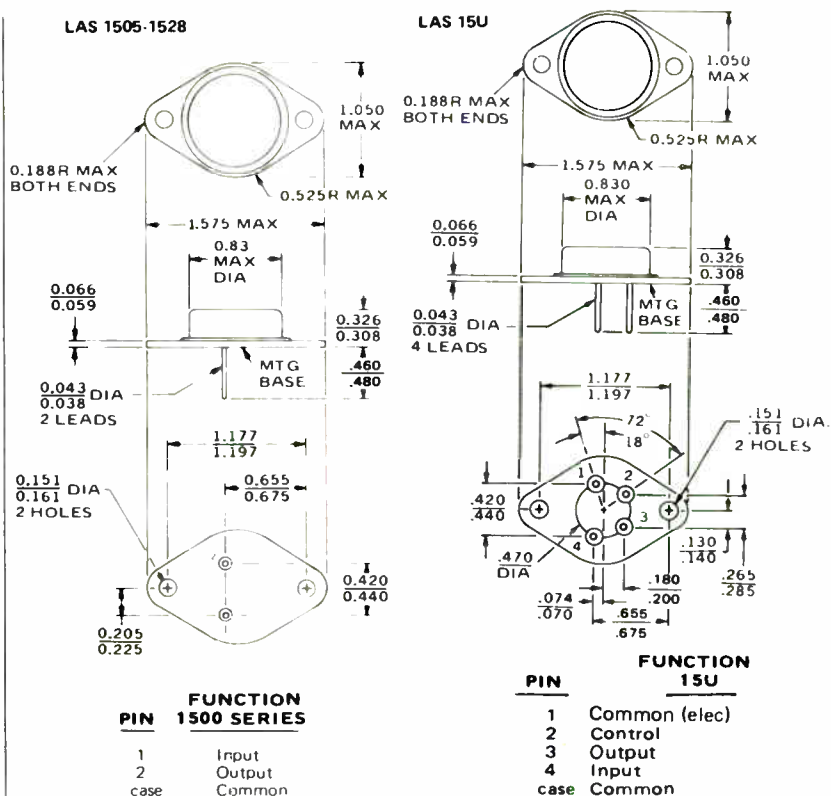

# LAS 1500, 15U SERIES

## Operational Data

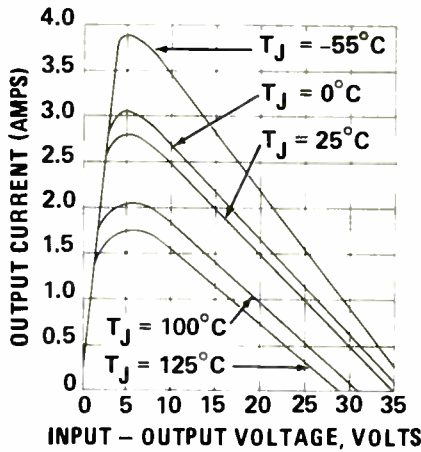

TYPICAL CURRENT LIMIT VS INPUT-OUTPUT VOLT. DIFF.

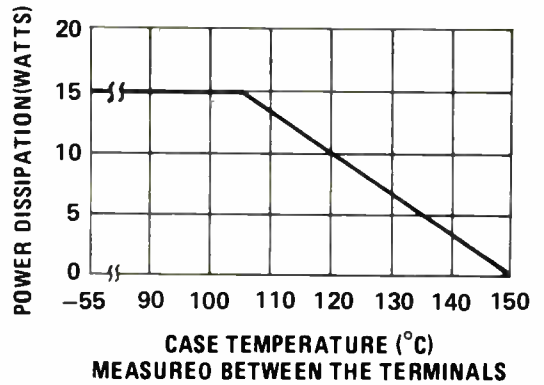

POWER DERATING

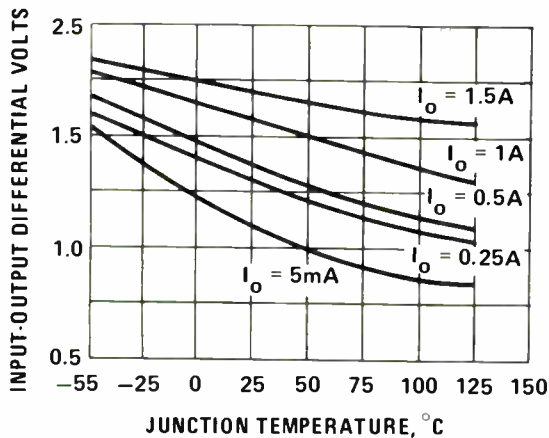

TYPICAL MINIMUM INPUT-OUTPUT DIFFERENTIAL VOLTAGE VS JUNCTION TEMPERATURE

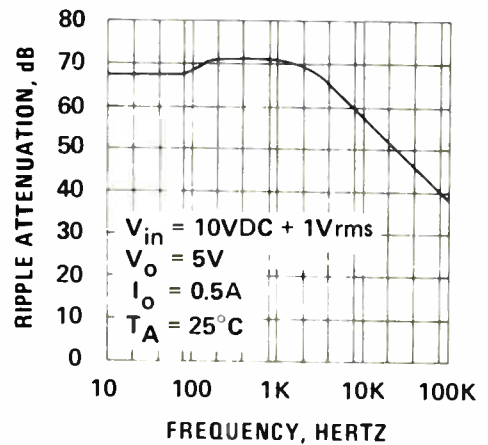

TYPICAL RIPPLE ATTENUATION VS FREQUENCY

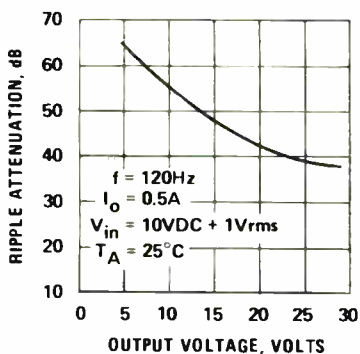

TYPICAL RIPPLE ATTENUATION VS OUTPUT VOLTAGE

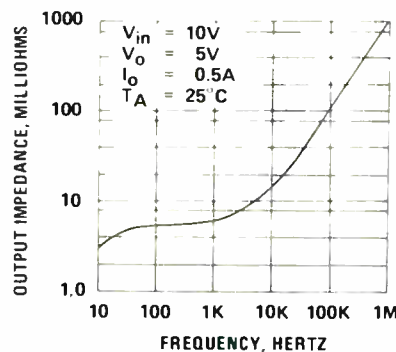

TYPICAL OUTPUT IMPEDANCE VS FREQUENCY

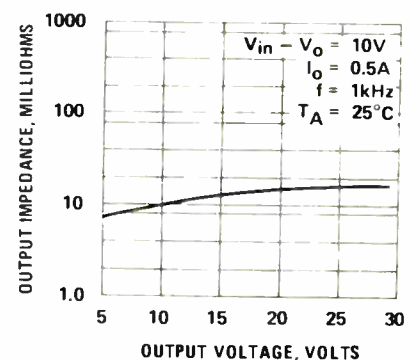

TYPICAL OUTPUT IMPEDANCE VS OUTPUT VOLTAGE

## Regulator Performance Specifications

### 1.5 amp negative regulators

The LAS 1800 series of three-terminal voltage regulators are monolithic integrated circuits designed for use in applications requiring a well-regulated fixed value negative output voltage for load current variations up to 1.5 amperes. The LAS 18U device is a 4-terminal adjustable negative-output voltage regulator. The LAS 1800 Series is available in fixed output voltage values ranging from -2V to -28V. The output voltage of the LAS 18U is adjustable from -2.6V to -30V. Both the LAS 1800 Series and the LAS 18U feature internal current limiting, thermal shutdown, and safe area protection for the series pass Darlington. A hermetically sealed steel TO 3 package is employed for high reliability, and low thermal resistance, when used with an appropriate heatsink.

PARAMETER	SYMBOL	TEST CONDITIONS			LAS 1802-1828 TEST LIMITS		LAS 18U TEST LIMITS		UNITS
		V <sub>IN</sub>	I <sub>o</sub>	T <sub>J</sub>	MIN	MAX	MIN	MAX	
Input Voltage	V <sub>IN</sub>	V <sub>1</sub>	5mA	0-125°C	-35[-40] <sup>(1)</sup>	V <sub>0</sub> = 2.1	-35[-40] <sup>(2)</sup>	V <sub>0</sub> = 2.1 <sup>(1)</sup>	volts
Output Voltage <sup>(3)</sup>	V <sub>0</sub>	V <sub>1</sub> to V <sub>2</sub>	5mA to 1.0A	25°C	-30	1.05 V <sub>0</sub>	-30	-2.6 <sup>(4)</sup>	volts
Input Output Differential	V <sub>IN</sub> - V <sub>0</sub>	V <sub>1</sub>	1.0A	0-125°C	2.1	1.05 V <sub>0</sub>	2.1	2.1	volts
Output Current	I <sub>o</sub>	V <sub>1</sub>	25°C	25°C	1.5	1.5	1.5	1.5	amps
Standby Current	I <sub>Q</sub>	V <sub>1</sub>	25°C	25°C	10	10	10	10	mA
Standby Current Change with input <sup>(5)</sup>	ΔI <sub>Q</sub>	V <sub>1</sub> to V <sub>2</sub>	5mA	25°C	1.3	1.3	1.3	1.3	mA
Standby Current Change with Load	ΔI <sub>Q</sub>	V <sub>1</sub>	5mA to 1.5A	25°C	0.5	0.5	0.75	0.75	mA
Maximum Current Limit	I <sub>LIM</sub>	V <sub>1</sub>	0-125°C	0-125°C	2.8	2.8	2.8	2.8	amps
Short-Circuit Current <sup>(7)</sup>	I <sub>SC</sub>	20V	0-125°C	0-125°C	1.8	1.8	1.8	1.8	amps
Short-Circuit Current <sup>(8)</sup>	I <sub>SC</sub>	30V	0-125°C	0-125°C	0.8	0.8	0.8	0.8	amps
Power Dissipation <sup>(9)</sup>	P <sub>D</sub>			0-125°C	15	15	15	15	watts
Thermal Resistance Junction to case	R <sub>θJC</sub>				3	3	3	3	°C per watt
Storage Temperature	T <sub>STG</sub>				-65	+150	-65	+150	°C
Maximum Operating Junction Temperature	T <sub>J</sub>				-55	+150	-55	+150	°C
Regulation - Load <sup>(6)</sup>	(R <sub>I</sub> G) <sub>L</sub>	V <sub>1</sub>	5mA to 1.5A	25°C	0.6	0.6	0.6	0.6	% V <sub>0</sub>
Regulation - Line <sup>(6)</sup>	(R <sub>I</sub> G) <sub>IN</sub>	V <sub>1</sub> to V <sub>2</sub>	0.1A	25°C	1.0	1.0	1.0	1.0	% V <sub>0</sub>
		V <sub>1</sub> to V <sub>2</sub>	0.5A	25°C	2.0	2.0	2.0	2.0	% V <sub>0</sub>
		V <sub>1</sub> to V <sub>2</sub>	1.0A	25°C	2.0	2.0	2.0	2.0	% V <sub>0</sub>
Temperature Coefficient	T <sub>C</sub>	V <sub>1</sub>	0.1A	0-125°C	0.03	0.03	0.03	0.03	% V <sub>0</sub> /°C
Output Noise Voltage <sup>(10)</sup>	V <sub>N</sub>	V <sub>1</sub>	0.1A	0-125°C	10	10	10	10	μVrms/V
Ripple Attenuation	R <sub>A</sub>	V <sub>1</sub>	1.0A	0-125°C	59 <sup>(11)</sup>	59 <sup>(11)</sup>	59 <sup>(11)</sup>	59 <sup>(11)</sup>	db
Control Voltage	V <sub>C</sub>	V <sub>1</sub> to V <sub>2</sub>	5mA	25°C			-2.6	-2.25	V

#### Notes

- (1) Maximum input voltage is -6 Volts
- (2) Values of 35V applies to V<sub>0</sub> of -2V to -12V. Values of 40V applies to V<sub>0</sub> of -15 to -30 volts.
- (3) V<sub>1</sub> = V<sub>0</sub> - 5V; V<sub>2</sub> = V<sub>0</sub> - 15V or the minimum value of input voltage whichever is smaller in magnitude.
- (4) Nominal output voltages are specified under ordering information
- (5)  $V_0 = V_C [1 + \frac{R_1}{R_2}]$  R<sub>1</sub> - resistance from output to control R<sub>2</sub> - resistance from control to common
- (6) For negative regulator V<sub>2</sub> = V<sub>0</sub> - 20V or the minimum value of input voltage whichever is smaller in magnitude.
- (7) Applies to those devices with |V<sub>0</sub>| = 2V to 18V
- (8) Applies to those devices with |V<sub>0</sub>| = 20V to 30V
- (9) Instantaneous regulation
- (10) Derate above T<sub>C</sub> = 105°C 333 mW per °C
- (11) Specified in μVrms/volt output. BW = 10HZ - 100K HZ
- (12) Ripple attenuation is specified for a 1 Vrms, 120 HZ input ripple. Ripple attenuation is a minimum of 59 db at -2 volts output and is 1 db less for each volt increase in output voltage

### FUNCTIONAL BLOCK DIAGRAM

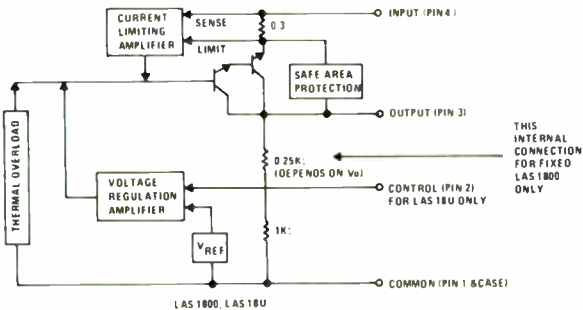

### OUTLINE DRAWING

#### LAS 1802-1828

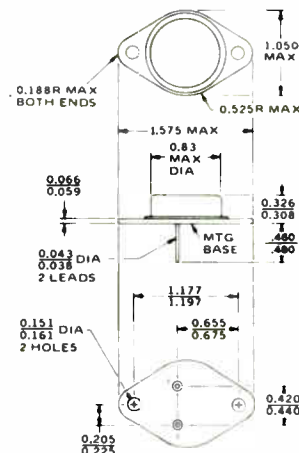

#### LAS 18U

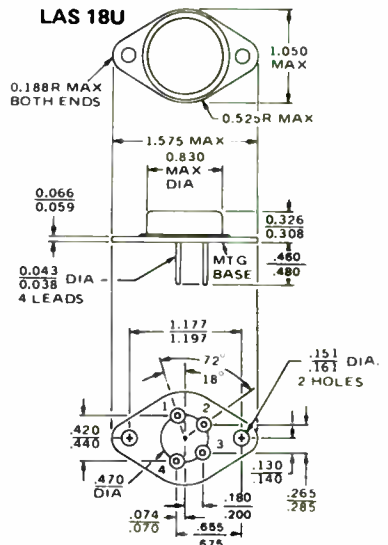

PIN	FUNCTION 1800 SERIES
1	Common
2	Output
Case	Input

PIN	FUNCTION 18U
1	Input (elect)
2	Output
3	Control
4	Common
Case	Input

# LAS 1800, 18U SERIES

## Operational Data

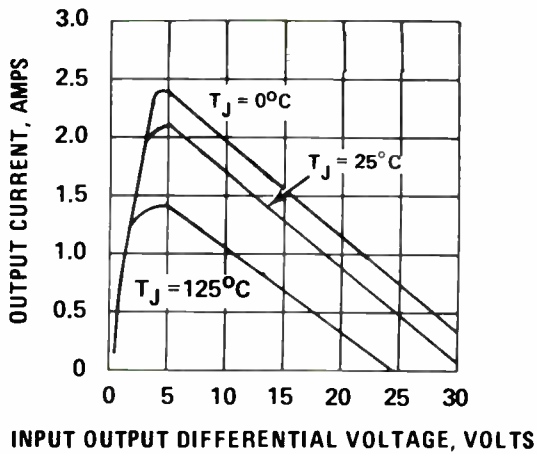

TYPICAL CURRENT LIMIT VS INPUT-OUTPUT VOLTAGE DIFFERENTIAL

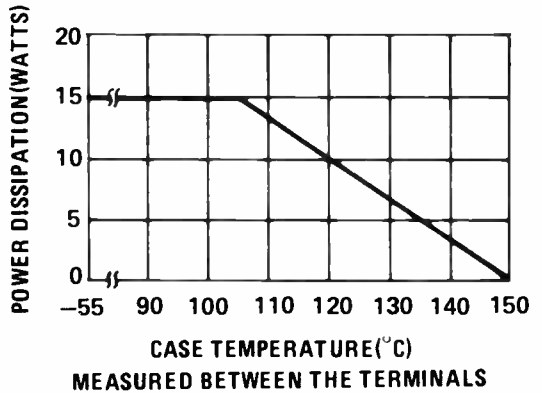

POWER DERATING

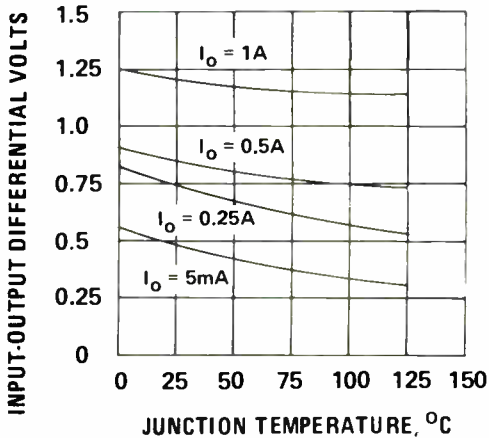

TYPICAL INPUT-OUTPUT DIFFERENTIAL VOLTAGE VS JUNCTION TEMPERATURE

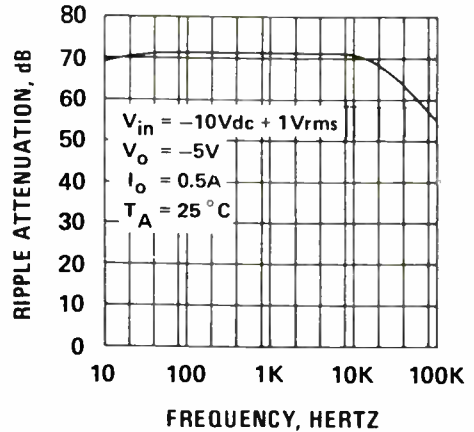

TYPICAL RIPPLE ATTENUATION VS FREQUENCY

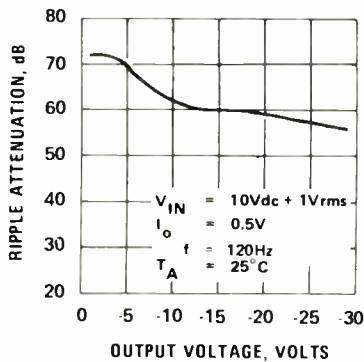

TYPICAL RIPPLE ATTENUATION VS OUTPUT VOLTAGE

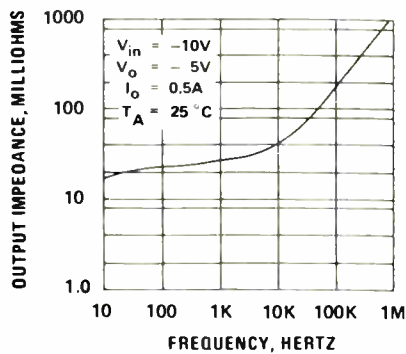

TYPICAL OUTPUT IMPEDANCE VS FREQUENCY

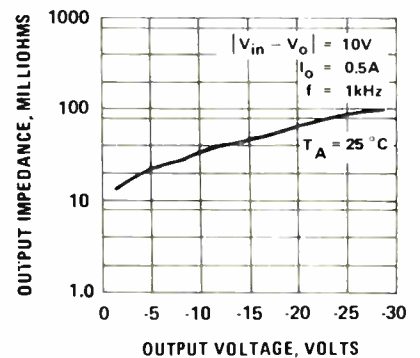

TYPICAL OUTPUT IMPEDANCE VS OUTPUT VOLTAGE

## Connection Diagrams

### POSITIVE REGULATOR LAS 1505-1528

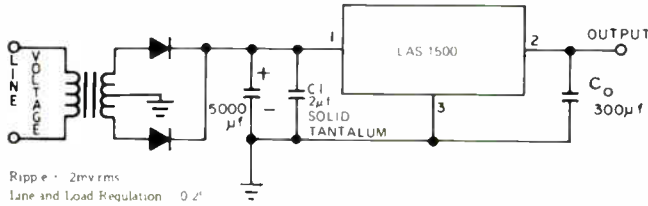

1.5 AMP POWER SUPPLY CIRCUIT

### NEGATIVE REGULATOR LAS 1802-1828

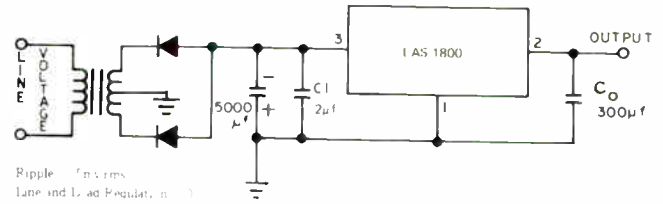

1.5 AMP POWER SUPPLY CIRCUIT

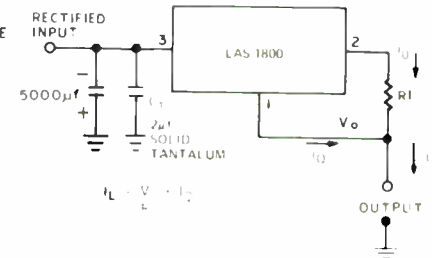
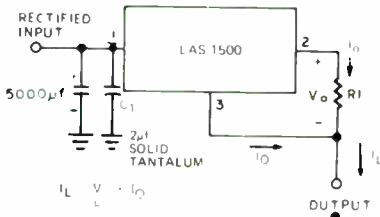
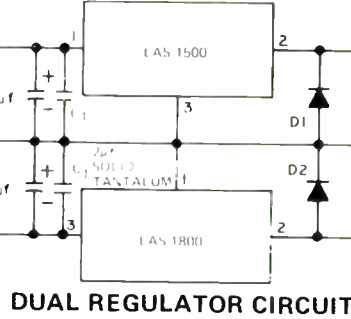

### LAS 15U

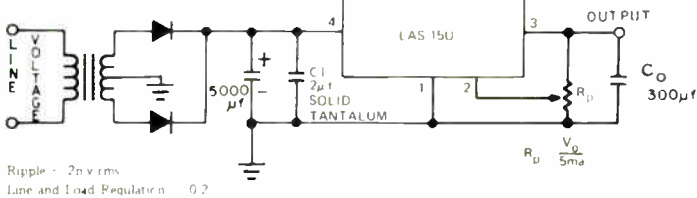

1.5 AMP ADJUSTABLE POWER SUPPLY

### LAS 18U

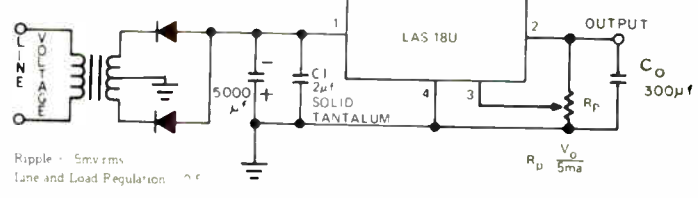

1.5 AMP ADJUSTABLE POWER SUPPLY

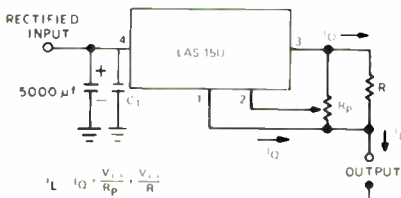
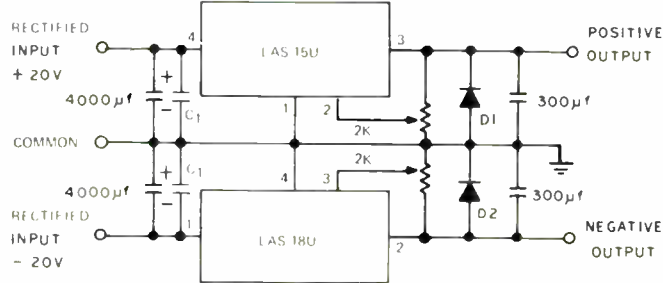

$$C_{IN} = 1000\mu\text{f}/\text{A}$$

$$C_{OUT} = 100\mu\text{f}/\text{A}$$

C1 TO BE PLACED AS CLOSE AS PRACTICAL TO DEVICE

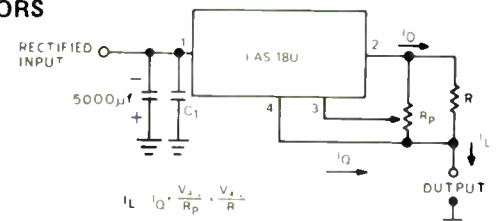



# PRODUCT FLOW CHART

## for Power Semiconductors

PROBED, PASSIVATED WAFERS	Each die is 100% high power visual class probed and electrically tested for all pertinent DC parameters. Rejects are inked.
SAW, BREAK, CLEAN DICE PRIOR TO ASSEMBLY	The 3" wafer is visually inspected prior to sawing. The wafer is grooved by use of a saw, and the dice are separated by fracture along the saw groove.
100% DIE VISUAL INSPECTIONS FOR METAL, CRACKS, OXIDE ALIGNMENT	Prior to package assembly, each die is subject to 100 power microscopic inspection to eliminate devices with visual defects that could cause failure in normal application.
DIE ATTACH AND 100% INSPECTION	Each die is attached to a JEDEC TO 3 package base using Sn/Pb/Ag soft solder. Each package and die is inspected for solder void and proper orientation.
WIRE BOND	Aluminum wires are ultrasonically bonded to both die and package terminals. Each bond is inspected and each wire pulled (Flick Test).
100% VISUAL INSPECTION	Prior to package sealing, each subassembly is subject to 50 power visual inspection to ensure device bond integrity, freedom from foreign material, and conformance to die visual standards. All devices are cleaned and baked for 14 hours.
CAP JEDEC TO 3 RESISTANCE WELD (STEEL) BRAZE SEAL (COPPER)	Lambda devices utilizing TO 3 packages are hermetically sealed in a JEDEC TO 3 package. Steel base packages are resistance welded. Copper base packages are braze sealed. Cold welding is not used.
LEAK TEST (GROSS)	Each device is gross leak tested by use of fluorocarbon bubble testing.
LEAK TEST (FINE)	A helium tracer gas leak test to $5 \times 10^{-8}$ is used to eliminate devices with defective seals. Testing is done to a 1.5 AQL. If parts fail they are 100% tested. (Min 50 devices/lot)
100% DC PARAMETRIC TEST, +25°C	All devices are electrically tested for conformance to +25°C DC parameters. Automatic test equipment assures proper testing.
100% SECOND BREAKDOWN TEST POWER DARLINGTONS AND SWITCHING TRANSISTORS	All power Darlington's are tested to conformance to the specified forward biased second breakdown current (I <sub>s</sub> /b). Non-destructive I <sub>s</sub> /b test techniques assure conformance to applicable safe operating area (SOA).
100% POWER CYCLE VOLTAGE REGULATORS	All devices are power cycled for 4 hours between case temperatures of 50°C and 100°C. Power dissipation during the heating cycle is approximately 5 watts resulting in approximately 40 cycles in 4 hours.
SAMPLE AC PARAMETERS 100% DC PARAMETRIC TEST, +25°C VOLTAGE REGULATORS	All devices are electrically retested for conformance to +25°C DC parameters.
SAMPLE AC PARAMETERS SAMPLE DC PARAMETRIC TEST AT +200°C POWER DARLINGTONS AND SWITCHING TRANSISTORS	Each production lot of power Darlington's is sample tested for conformance to all specified device DC parameters at T <sub>j</sub> = +200°C, including BV <sub>CE</sub> R and IC <sub>CE</sub> R. Testing of product at +200°C assures the utmost in device stability in a power Darlington were specified.
SELECT LIFE TEST SAMPLES CONDUCT LIFE TEST	Periodic tests are performed upon randomly selected device samples to assure product quality. Tests performed include solderability, temperature cycling, seal, moisture resistance, terminal strength, mechanical shock, vibration, acceleration, radiographic inspection, and power burn-in (thermal fatigue). Test results are available to qualified personnel upon request to Lambda.
FINISHED GOODS STOCK	

## Lambda staffed sales and service offices

<p><b>1</b></p> <p><b>MID-ATLANTIC REGION</b>          Melville, New York 11746          515 Broad Hollow Road          Tel 516 694 4200          TWX 510 224 6484</p> <p>Long Island, N.Y.; New York, N.Y.;          Northern New Jersey          Tel 216-694-4200</p> <p>Delaware; Eastern Pennsylvania;          Southern New Jersey          Tel 215 279 5644</p> <p>Maryland; Dist. of Columbia;          Northern Virginia          Tel 703 451 9340</p>	<p>Southern Virginia;          North &amp; South Carolina;          Alabama; Georgia;          Tennessee; Mississippi          Tel 704 542 1991</p> <p>Largo, Florida          Tel 813 596 5151</p> <p><b>2</b></p> <p><b>NORTH-EASTERN REGION</b>          Lexington, Massachusetts 02173          2 Militia Drive          Tel 617 861 8585          TWX 710 326 7558</p> <p>Rochester, New York          Tel 716 454 6770</p> <p>Poughkeepsie, New York          Tel 914 297 4800</p>	<p><b>3</b></p> <p><b>SOUTH-WESTERN REGION</b>          Dallas, Texas 75231          6950 Winchester          Tel 214 341 5130          TWX 910 861 9048</p> <p>Houston, Texas          Tel 713 464 6554</p> <p>Oklahoma          Tel Enterprise 2 183</p> <p><b>4</b></p> <p><b>MID-WESTERN REGION</b>          Arlington Heights, Ill. 60005          1420 East Oakton Street, Unit C          Tel 312 593 2550          TWX 910 721 2856</p> <p>Minneapolis, Minnesota          Tel 612 935 6194</p>	<p>Cleveland, Ohio,          Western Pennsylvania          Tel 216 585 7808</p> <p><b>5</b></p> <p><b>FAR-WESTERN REGION</b>          Carson, Calif 90746          20601 S. Annalee Ave.          Tel 213 531 8341          TWX 910 346 7649</p> <p>Denver, Colorado          Tel 303 779 9561</p> <p><b>6</b></p> <p><b>NORTH-WESTERN REGION</b>          Sunnyvale, California 94086          599 N. Milpitas Ave., Suite 210          Tel 408 738 2541          TWX 910 334 9143</p>	<p>For application information          call Chris Field at our Corpus          Christi Plant 512-883-6251</p> <p><b>POWER SEMICONDUCTORS          DESIGNED, DEVELOPED          AND MANUFACTURED BY</b></p> <div style="text-align: right;">    </div>
--	--	---	---	--

# We know your needs. Electronics Magazine Book Series. Zero-risk trial offer.

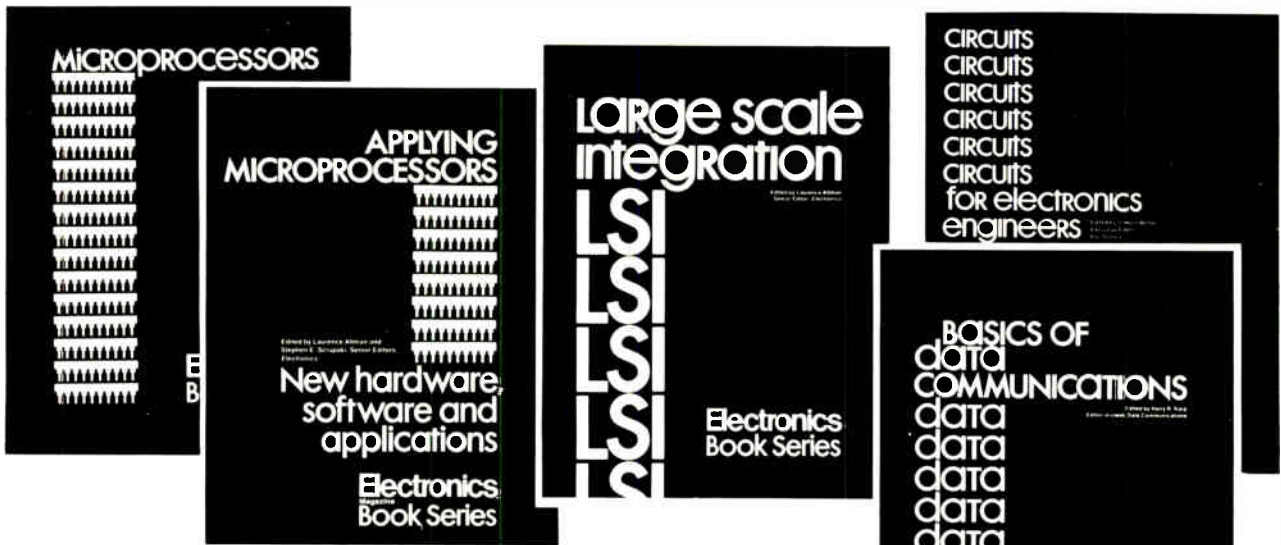

## 1. Microprocessors

What you must know about available microprocessor technology, devices, information, 4th printing. \$8.95

## 2. Applying Microprocessors

2nd and 3rd generation technology. 26 detailed applications from data networks to video games. \$9.95

## 3. Large Scale Integration

Covers the basic technology, new LSI devices, LSI testing procedures, plus system design and applications. \$9.95

## 4. Basics of Data Communications

Includes 47 articles from Data Communications magazine covering more than 11 key areas. \$12.95

## 5. Circuits for Electronics Engineers

Contains 306 circuits arranged by 51 functions from Amplifiers to Voltage Regulating Circuits. Saves design drudgery. \$15.95

### Electronics Book Series

McGraw-Hill Publications Company, Shoppenhangers Rd., Maidenhead, Berkshire SL62QL, England.



1. Send me \_\_\_\_\_ copies of "Microprocessors" at \$8.95 per copy.
2. Send me \_\_\_\_\_ copies of "Applying Microprocessors" at \$9.95 per copy.
3. Send me \_\_\_\_\_ copies of "Large Scale Integration" at \$9.95 per copy.
4. Send me \_\_\_\_\_ copies of "Basics of Data Communications" at \$12.95 per copy.
5. Send me \_\_\_\_\_ copies of "Circuits for Electronics Engineers" at \$15.95 per copy.

Discounts of 40% on orders of 10 or more copies.

I must be fully satisfied or you will refund full payment if the book is returned after ten-day trial examination.

Payment enclosed       Bill firm       Bill me

Charge to my credit card:

- American Express       Diners Club  
 BankAmericard       Master Charge

Acc't No. \_\_\_\_\_ Date exp. \_\_\_\_\_ Interbank No. \_\_\_\_\_

On Master Charge only, first numbers above name \_\_\_\_\_

Name \_\_\_\_\_ Title \_\_\_\_\_

Company \_\_\_\_\_

Street \_\_\_\_\_

City \_\_\_\_\_ State \_\_\_\_\_ Zip \_\_\_\_\_

Signature \_\_\_\_\_



## T-METER™ MEANS TOUGH

This digital thermometer is virtually indestructible... drop proof, shock proof, water proof, chemical proof, you name it. We have hurled it against stone walls, immersed it in boiling water for an hour, and submerged it for a week in a salt water fish tank without harming it. Its electronics are cast in silicon. Its teflon-coated probes and cables resist chemicals. It is so rugged that we confidently offer a 3 Year Full Warranty.

Tough, accurate, and versatile, spanning  $-100^{\circ}\text{C}$  to  $200^{\circ}\text{C}$  and  $-150^{\circ}\text{F}$  to  $400^{\circ}\text{F}$ , the T-Meter (with standard probe) achieves  $\pm 0.5^{\circ}\text{C}$  ( $\pm 0.9^{\circ}\text{F}$ ) accuracy over  $-55^{\circ}\text{C}$  to  $125^{\circ}\text{C}$  ( $-67^{\circ}\text{F}$  to  $257^{\circ}\text{F}$ ). Optional high accuracy probes for special applications achieve  $\pm 0.1^{\circ}\text{C}$  ( $\pm 0.15^{\circ}\text{F}$ ), covering

the MIL range in  $20^{\circ}\text{C}$  increments. You can supplement the standard 3' probe with lengths of 10', 25', and 100'. And you can special order lengths to 3,000'!

Tough as nails and nuisance-free, this fully guaranteed pocket-sized time-saver will cut your costs in a host of practical applications. Our reps stock T-Meters at \$239. Standard probe, \$25. General purpose high accuracy probe, \$30. Others available.

ECD CORP.  
196 Broadway  
Cambridge, MA 02139  
(617) 661-4400



SALES OFFICES: AL, Huntsville (205) 533-5896; AZ, Scottsdale (602) 947-7841; CA, Costa Mesa (714) 540-7160; CA, Sunnyvale (408) 733-8690; CO, Denver (303) 750-1222; FL, Winter Haven (813) 294-5815; GA, Chamblee (404) 457-7117; IL, Elk Grove Vill (312) 593-0282; IN, Indianapolis (317) 293-9827; MD, Silver Spring (301) 622-4200; MA, Wakefield (617) 245-5940; MN, Minneapolis (612) 781-1511; MO, Kansas City (816) 358-7272; So. NJ, Philadelphia (215) 674-9600; NM, Albuquerque (505) 299-7658; NY, Great Neck (516) 482-3500; (212) 895-7177; Syracuse (315) 446-0220; NC, Raleigh (919) 787-5818; OH, Centerville (513) 433-8171; TX, Houston (713) 688-9971; TX, Richardson (214) 231-2573.

Circle 188 on reader service card

World Radio History



## MONOLITHIC CRYSTAL FILTERS



### FIVE THINGS TO DO WITH VHF MONOLITHIC FILTERS ON A RAINY DAY

- 1) Make a paging receiver or other single-channel receiver, (models 2133F & 4171F).
- 2) Reduce IM and front-end overloading in a VHF mobile or base station receiver, (models 2131-33 VBP and 4131-33 VBB).
- 3) Make an up-conversion HF receiver or exciter (custom models).
- 4) Clean up the spectrum in your frequency synthesizer, (custom models).
- 5) Make a 900 MHz mobile receiver (Models 4371F & 2372F, 45 MHz first IF filters).

If one of these projects turns you on, or if you've got a project of your own, don't wait for a rainy day — turn us on right now. Just call or write. We offer a rain barrel full of monolithic crystal filters — from 5 MHz to 180 MHz, including over 60 stock models at 10.7 and 21.4 MHz.

### NEW KID ON THE BLOCK...

45 MHz is a popular first I-F for the new 900 MHz mobile radio band. We've got the filters for it — two poles (Model 2372F) and four poles (Model 4371F). And they're in stock. Just write or call for data sheets and quantity pricing.

# Pi

Piezo Technology Inc.

2525 Shader Road, Orlando, FL 32804  
(305) 298-2000

The standard in  
monolithic crystal filters.

Circle 189 on reader service card

## New products/materials

A blend of solvents formulated for removing rosin flux residues, including ionizable activators and organic contaminants, has a boiling range of 160°C to 170°C. The blend of polar and nonpolar solvents can be used for the vapor degreasing of printed-circuit boards as well as for cold tank dipping and ultrasonic cleaning. PC 81 is a nonflammable mixture that will normally not affect most electronic hardware and component markings.

Multicore Solders, Westbury, N. Y. 11590 [476]

Copper tape only 2 mils thick is available in strips or in thermo-compression-spliced form on reels. Intended for integrated-circuit interconnections, the tape will compete with copper-on-Mylar tapes, which are thicker and more expensive. The copper-only tape is more fragile than the composite material and will therefore need more careful handling.

Koltron Corp., 1380 Bordeaux Dr., Sunnyvale, Calif. 94086. Phone Franz Kolterer at (408) 734-0070 [477]

An epoxy casting material formulated for the encapsulation of small electronic assemblies, Tra-Cast 3103 is a solventless two-part system that mixes quickly to a smooth, low-viscosity liquid. The uncured fluid flows freely into and around fine windings and delicate circuitry. It will cure overnight at room temperature with very little heat production

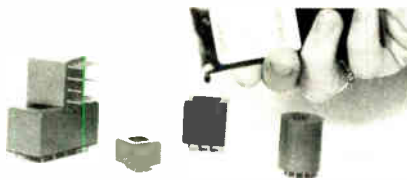

and shrinkage.

The cured material is a hard, opaque black solid with excellent resistance to water, weathering, petroleum fuels, and lubricants. It also has good resistance to electrical stress, mechanical impact, and thermal shock.

Tra-Con Inc., Resin Systems Division, 55 North St., Medford, Mass. 02155 [478]

## ECCOSHIELD® RF-SHIELDED CHAMBERS AND SHIELDING PRODUCTS



New folder describes types of chambers available and related shielding materials. ECCOSHIELD line includes rf-sealing, caulking, adhesive, lubricating products and conductive gaskets. Patented, self-sealing ECCOSHIELD MAS rf shielded door is also described.

Circle 240 on reader service card

## NEW PRESENTATION DIELECTRIC MATERIALS CHART

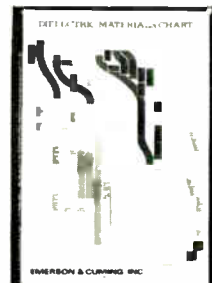

This colorful chart is a standard reference for electronic engineers. Shows Dielectric Constant ( $k'$ ) and Loss Tangent ( $\tan \delta$ ) for many E&C products and common materials plotted on 11" x 1 1/2" graph. For notebook or wall mounting.

Circle 241 on reader service card

## RTV SILICONES FEATURED IN NEW FOLDER



18 ECCOSHIELD RTV silicone compounds described in new well-illustrated folder. Pertinent data given in tabular charts on coatings, foams, sealants, adhesives, encapsulants thick section cure, mold-makers and alloys.

Circle 242 on reader service card



## EMERSON & CUMING, INC.

CANTON, MASSACHUSETTS 02021 U.S.A.

Manufacturing in: Canton, MA Northbrook, IL Gardena CA U.S.A.  
Scunthorpe ENGLAND Oevel BELGIUM and Fujiyama JAPAN  
Sales Offices in Principal Cities

# Technological Leadership for 3 Decades!

Ampex, headquartered on the San Francisco Peninsula, is the company that "invented" the magnetic recording industry.

The technology pioneered by Ampex over three decades has affected many aspects of our modern lifestyles, and has established Ampex as a leader in magnetic recording. Our continued effort in developing new technology has always been the key to our leadership. Right now our Advanced Technology, Data Products and Audio-Video Systems Divisions are embarking on several new programs. To insure the success of these programs we are seeking innovative graduate engineers with experience in the fields listed below.

Opportunities like this don't happen very often. But they're happening at Ampex now.

## Advanced Technology Division

- electron beam and optical recording
- magnetic recording
- tape or film handling
- servos
- high-bit rate digital circuit design
- optics
- signal analysis
- pattern recognition
- high frequency circuit
- communications theory

## Data Products Division

- circuit/systems design of very high-bit rate systems

- disk read/write systems and equalizing systems for tape recorders
- codes for magnetic recording
- precision servo systems for both linear positioners and rotating systems
- mechanical design of high precision systems in disk recorders and in longitudinal, helical and transverse scan tape recorders

## Audio-Video Systems Division

- analog videotape signal systems
- digital video signal processing
- servo systems
- videotape editing
- professional audio recorders
- head technology
- TV cameras

If you think you have something valuable to offer in any of these or closely related areas, and if you would like to join some of America's most talented engineers, please send your resume or a letter outlining your qualifications to: Ampex Corporation, ATTN: J.C. Puckett, Building 2, 2655 Bay Road, Redwood City, CA 94063. Or you can send us this coupon and we'll get back to you. We are an equal opportunity employer m/f.

**Manager Corporate Staffing  
AMPEX Corporation  
Building 2, 2655 Bay Road  
Redwood City, CA 94063**

Dept. 4

Name \_\_\_\_\_  
Address \_\_\_\_\_  
City, State, Zip \_\_\_\_\_  
Phone \_\_\_\_\_

Occupation \_\_\_\_\_  
Years of Experience \_\_\_\_\_  
Employer \_\_\_\_\_



## New literature

**Sensors.** The flexibility of lead-sulfide sensors and the detection capabilities of lead-selenide sensors are highlighted in two application notes. The one on lead-sulfide sensors provides information on electrical performance, configuration, packaging, and environmental-stress characteristics. The second application note provides the same information with an additional section on how to bias circuits. A third note discusses the packaging designs for silicon sensors. Infrared Industries Inc., Waltham, Mass. 02154. Circle reader service number 421.

**Temperature controls.** A 40-page booklet featuring more than 2,000 temperature controls provides technical data for electronic, electromechanical, indicating, and nonindicating models. Featured is a section on achieving better temperature control, including how to heat the system, selecting the temperature controller, and what affects control



accuracy. Operating information is provided. Fenwal Inc., 400 Main St., Ashland, Mass. [422]

**Safety standards.** The 12th edition of the standard for safety on industrial

control equipment, UL 508, covers the requirements for industrial-control devices. However, these requirements do not cover devices rated at more than 600 volts, such as electronic and static devices. Copies may be obtained at \$4.00 per copy. For \$10.00 you can receive this publication plus all revisions added while this standard is in effect. Underwriters Laboratories Inc., Attn: Publications Stock Dept., 333 Pfingsten Rd., Northbrook, Ill. 60062

**Noise elimination.** "Elimination of Noise in Low-Level Circuits," a 20-page bulletin, shows how to design low-level wide-bandwidth data systems that are noise-free down to and including the microvolt region. Included are recent developments in measurement technology, plus explanations of electrical noise sources, proper impedance matching, transducer characteristics, common-mode rejection, grounding methods, ca-

## Two New Refreshing Alternatives MEGRAPHIC 5000 & 7000 SERIES

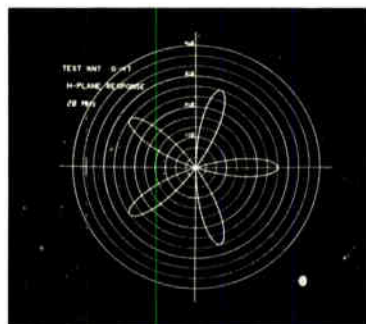
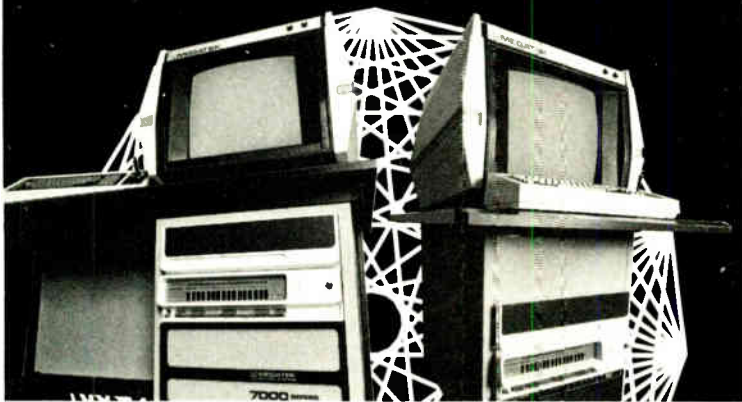

## Dollar For Dollar, The Best Performing, Most Powerful, Intelligent Graphics Systems

### DYNAMIC REFRESH

All MEGRAPHC Systems feature 100% vector refresh. Sharp, bright lines with 12 bits of screen resolution. Individual vectors or symbols can be erased, translated, rotated, or scaled in real-time. No need to blank the entire screen to change one, one hundred, one thousand, ten thousand, or more points!

Local minicomputer power eliminates the host or minimizes its support requirements.

### TEKTRONIX®\* COMPATIBLE

Our 5014 emulates all Tektronix® 4010/4014 \*\* Series storage terminals. MEGATEK's EDS™ adds powerful local edit capabilities, not available on a storage tube.

Easy to use, easy to pay for. Flexible, cost effective systems, backed by MEGATEK engineering and software support. PDP-11, DATA GENERAL, and OEM interfaces available. We listen to your problems and solve them with quality products.



**MEGATEK CORPORATION**  
The Refreshing Alternative™

1055 Shafter Street  
San Diego, California 92106 (714) 224-2721

\*TEKTRONIX® is a registered trademark of Tektronix, Inc., use of which in no way constitutes endorsement

# Industry's First 14-Bit A/D In a DIP

- Highest resolution A/D available in a DIP
- Fully specified from 0° to 70°C
- +1/2 LSB linearity error
- 0.04% accuracy
- Conversion time: 250  $\mu$ sec max
- Power consumption: 230 mW typical
- Adjustment free
- 24-pin hermetic DIP

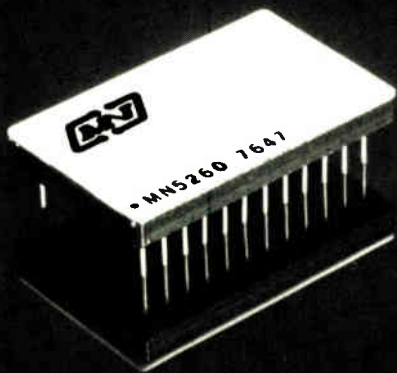

**MN 5260**  
**\$219.00\***

\* in 100 quantity



Micro Networks Corporation  
324 Clark Street, Worcester, MA 01606  
(617) 852-5400 TWX 710-340-0067

## New literature

bling systems, signal conditioning, and amplifier types. Marketing Services, Gould Inc., Instrument Systems Division, 3631 Perkins Ave., Cleveland, Ohio 44114 [426]

**Compounds.** Nearly 200 compounds and coordination compounds made from platinum, palladium, ruthenium, rhodium, iridium, osmium, and gold are listed in a 16-page catalog. The coordination compound section includes information on appearance and characteristics along with a suggested use for each. Matthey Bishop Inc., Malvern, Pa. 19355 [424]

**IR emitters and injection lasers.** A 24-page product guide provides data and outlines for infrared emitters and injection lasers. Included are ir-emitting diodes, single-diode injection lasers, stacked diode lasers, laser arrays, and optically coupled isolators. An applications section is featured with schematics of drive circuits for these devices. RCA Corp., Box 3200, Route 202, Somerville, N. J. 08876 [425]

**Planar gas-discharge displays.** A 16-page application note, "Screened Image Displays," discusses a variety of possible applications for designers of consumer, computer, and instrumentation displays. Four applications of screened image displays are detailed and diagramed. Specifications, matrices, standard numeric illustrations, and alphanumeric fonts will help those who wish to specify their own design. Beckman Instruments Inc., Information Displays Operations, 350 North Hayden Rd., Scottsdale, Ariz. 85257 [427]

**Temperature measurement.** The second edition of the "Temperature Measurement Handbook" contains more than 200 pages of temperature-measurement products. A 38-page data section provides temperature-millivolt tables for thermocouple calibrations in Celsius and Fahrenheit. New additions to the second edition include solid-state temperature controllers, digital thermometers, resistance temperature-detector

# ELECTRONICS REPRINTS

No. of  
copies  
wanted

## New reprints

- R-718 Display makers strive to refine their technologies 8 pp \$3.00
- R-716 Special report—Japanese wave in semiconductor technology 24 pp \$3.00
- R-714 Special report—active filter technology 6 pp \$3.00
- R-713 Electron-beam lithography draws fine line 10 pp \$3.00
- R-712 Special report—large-scale integration 16 pp \$3.00
- R-710 Personal computers mean business 8 pp \$2.00
- R-708 So you want to be a consultant 6 pp \$2.00

## Charts

- R-516 Electronic symbols \$2.00
- R-213 Electromagnetic spectrum (updated 1976) \$3.00
- R-326 Optical spectrum (6-page report and chart) \$3.00

## Books

- R-711 Circuits for electronics engineers: 306 circuits in 51 functional groups—Electronics Book Series \$15.95
- R-704 Thermal design in electronics \$5.00
- R-701 Applying microprocessors—Electronics Book Series \$9.95
- R-608 Basics of Data Communications—Electronics Book Series \$12.95
- R-602 Large Scale Integration—Electronics Book Series \$9.95
- R-520 Microprocessors—Electronics Book Series \$8.95
- R-011 Computer-aided Design 135 pp \$4.00
- R-032 Active Filters 88 pp \$4.00

## Payment must accompany your order

Make check or money order payable to Electronics Reprints. All orders are shipped prepaid by parcel post. Allow two to three weeks for delivery. For additional information call (609) 448-1700 ext. 5494.

Mail your order to:

Janice Austin  
ELECTRONICS REPRINTS  
P.O. Box 669  
Hightstown, N.J. 08520

Back issues now available:

1960 to 1969, \$5.00 each  
1970 to 1973, \$3.00 each  
1974 to 1976, \$4.00 each



## Sol-20. First it was THE SMALL COMPUTER. Now, it's THE SMALL COMPUTER SYSTEM.

A year ago, we introduced the Sol-20. It wasn't the first small computer. It was the first complete small computer with everything needed to get it up and on the air as it came from the factory. The keyboard, interfaces, extra memory, factory backup, and service notes were all there.

The results are in: Sol-20 is now the number one small computer in the world. Sols aren't the cheapest, just the most valuable.

We originally designed the Sol-20 as the heart of a complete computer system. So now to solve the problems of science, engineering, education, business management and control and manufacturing, we offer fixed price Sol systems in either kit or fully tested and assembled form. We offer language flexibility, Extended BASIC, ASSEMBLER, PILOT BASIC and FORTRAN

IV. We offer Helios II/PTDOS, an extraordinarily capable disk operating system. And remember, though we call these small or personal computer systems, they have more power per dollar than anything ever offered. They provide performance fully comparable and often superior to mini-computer systems costing tens of thousands of dollars more.

### What you get. What it costs.

Typical systems include Sol System I priced at \$1649 in kit form, \$2129 fully assembled and tested. Included are a Sol-20/8 with SOLOS personality module storing essential system software, an 8192 word memory, a 12" TV/video monitor, a cassette recorder with BASIC tape and a 1 necessary cables.

Sol System II has the same equipment with a larger capacity 16,384 word

memory. It sells for \$1883 in kit form; \$2283 fully assembled.

For even more demanding tasks, Sol System III features Sol-20/16 with SOLOS, 32,768 words of memory, the video monitor and the dual drive Helios II Disk Memory System with the PTDOS disk operating system and Extended DISK BASIC Diskette. Prices, \$4750 in kit form, \$5450 fully assembled and tested.

### More information.

For the most recent literature and a demonstration, see your dealer listed below. Or if more convenient, contact us directly. Please address Processor Technology Corporation, Box J, 7100 Johnson Industrial Drive, Pleasanton, CA 94566. Phone (415) 829-2600.

**Processor Technology**

AZ: Tempe (602)894-1129, Phoenix (602)942-7300, Tucson (602)327-4579. CA: Berkeley (415)845-6366, Costa Mesa (714)646-0221, Fresno (209)266-9566, Hayward (415)537-2983, Lawndale (213)371-2421, Orange (714)633-1222, Pasadena (213)684-3311, Sacramento (916)443-4944, San Francisco (415)431-0640, (415)421-8686, San Jose (408)377-4685, (408)226-8383, San Rafael (415)457-9311, Santa Clara (408)249-4221, Sunnyvale (408)735-7480, Tarzana (213)343-3919, Van Nuys (213)786-7411, Walnut Creek (415)933-6252, Westminster (714)894-9131. CO: Boulder (303)449-6233, Englewood (303)761-6232. FL: Fort Lauderdale (305)561-2983, Miami (305)264-2983, Tampa (813)879-4301. GA: Atlanta (404)455-0647. IL: Champaign (217)359-5883, Evanston (312)328-6800, Lombard (312)620-5808. IN: Bloomington (812)334-3607, Indianapolis (317)842-2983, (317)251-3139. IA: Davenport (319)386-3330. KY: Louisville (502)456-5242. MI: Ann Arbor (313)995-7616, Royal Oak (313)576-0900, Troy (313)362-0022. MN: Minneapolis (612)927-5601. NJ: Hoboken (201)420-1644, Iselin (201)283-0600. NY: Middle Island (516)732-4446, New York City (212)686-7923, White Plains (914)949-3282. NC: Raleigh (919)781-0003. OH: Columbus (614)486-7761, Dayton (513)296-1248. OR: Beaverton (503)644-2686, Eugene (503)484-1040, Portland (503)223-3496. RI: Warwick (401)738-4477. SC: Columbia (803)771-7824. TN: Kingsport (615)45-8081. TX: Arlington (817)469-1502, Houston (713)526-3456, (713)772-5257, Lubbock (806)797-1468, Richardson (214)231-1096. VA: McLean (703)821-8333, Reston (703)471-9330, Virginia Beach (804)340-1977. WA: Bellevue (206)746-0651, Seattle (206)524-4101. WI: Milwaukee (414)259-9140. WASHINGTON D.C. (203)362-2127. CANADA: Ottawa (613)236-7767, Toronto (416)484-9708, (416)482-8080, (416)598-0262; Vancouver (604)736-7474, (604)438-3282.

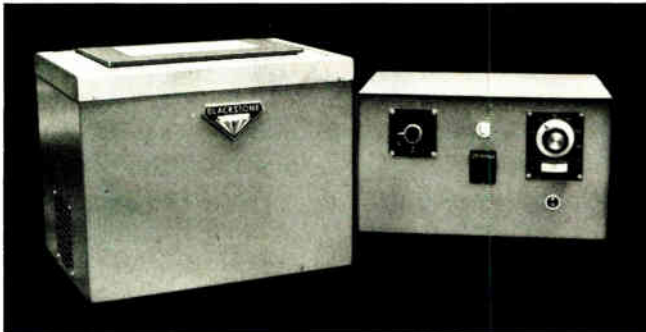

## New... Ultrasonic Solder System

**for Fluxless tinning of plated leads.**

Blackstone's new TP-6 Ultrasonic solder pot is ideal for production line tinning of gold, tin, nickel, solder and other plated leads...without flux. Check these outstanding features:

- Insulated, stainless steel pot; 4" x 8" x 1-1/2" deep.
- Totally activated pot volume permits multiple tinning of many components.
- Designed for use with 63/37, 60/40 and other electronic grade solders.
- Operation to 800°F solder temperature.

Send for complete descriptive literature.



**BLACKSTONE ULTRASONICS INC.**

1111 Allen Street, Jamestown, New York 14701  
Phone 716-665-2620 Telex 91-522

Circle 194 on reader service card

## New literature

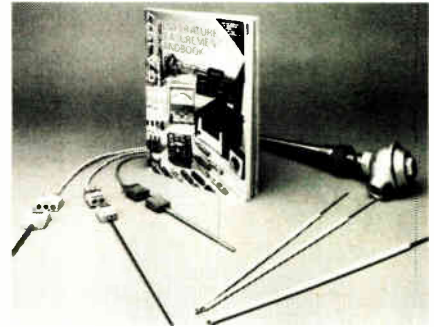

elements, and thin-film detectors. Omega Engineering Inc., Box 4047, Stamford, Conn. 06907 [430]

**System measurements.** How diagnostic and performance measurements on frequency-division multiplex basebands can be made more simple and quick using a spectrum analyzer and tracking generator is detailed in an application note from Marconi Instruments, Division of Marconi Electronics Inc., 100 Stonehurst Court, Northvale, N. J. 07647 [428]

**Ac and dc motors.** A list of thousands of ac and dc motors classified as induction, synchronous, and torque are covered in a 100-page catalog. Motors from 0.750 to 5.375 in. in outer diameter, with power outputs ranging from subfractional to 3 horsepower are described. IMC Marketing Division, 570 Main St., Westbury, N. Y. 11590 [429]

**Wiring products.** An illustrated brochure that unfolds into an 18-by-24-inch wall chart offers information on 36 different types of high-temperature insulated wire. It covers thermoplastic, asbestos, silicone rubber, and fluorocarbon materials on a variety of solid, stranded, and specially plated conductors. The guide is organized by increasing temperature service. Radix Wire Co., 26260 Lakeland Blvd., Cleveland, Ohio 44132 [432]

**Instruments.** Information for engineering personnel who wish to buy, rent, or lease electronic equipment is given in a 74-page catalog, which takes into consideration obsolescence and budget, capital, and mainte-



**25 AMP**  
50 to 1000 PRV

**.250**  
QUICK-CONNECTS

**FREE SAMPLE**

## RECTIFIER BRIDGES

PB Series! 300 Amp. surge. 1,500V RMS dielectric strength U.L. Component Recognition. Lots of features. Competitively priced. Write or use Inquiry Number for O.E.M. application card for free samples and condensed catalog of bridges.



Buy from the specialist

**electronic devices inc.**

21 GRAY OAKS AVE., YONKERS, N.Y. 10710  
(914) 965-4400, TWX 710 560-0021

For application information, call Toll Free: 800 431-1532

# Introducing the next generation of data acquisition systems.

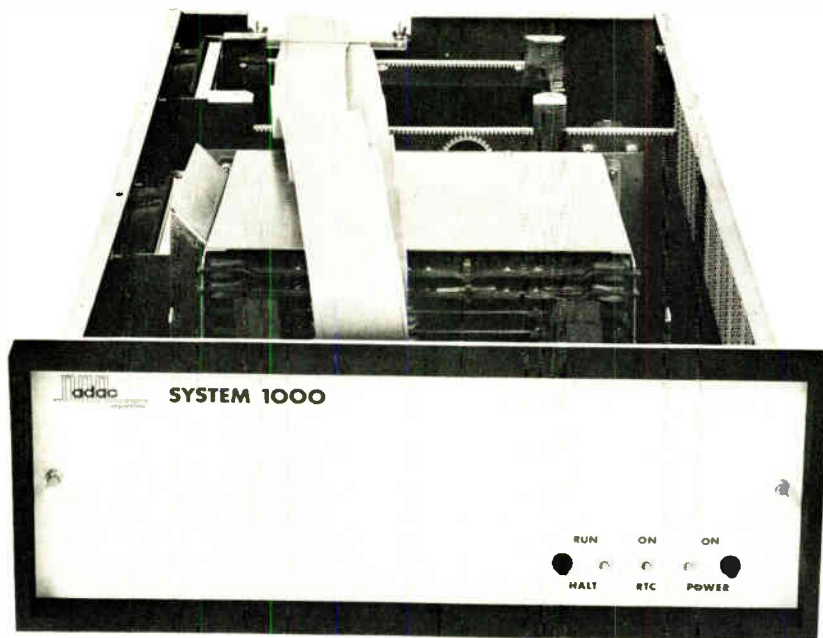

## The incredibly versatile Adac System 1000.

This remarkable system can operate in an almost unlimited range of applications. In its simplest form, the System 1000 can function as a low cost peripheral expander to the most popular minicomputers. When incorporating a DEC LSI-11 microcomputer, it can act as a stand-alone control system or as a remote intelligent terminal.

A single System 1000 can provide up to 700 high level analog input channels, or 128 analog low level input channels, or 700 digital I/O functions. For even greater capacity, a Model 1950 Bus repeater card allows additional 1000 Systems to accommodate as many analog or digital I/O modules as desired.

System 1000 in the stand-alone configuration comes with minimum memory of 4K RAM with up to 24K of additional memory possible in both RAM and ROM. The LSI-11 16 bit

resident computer can communicate with any of the extensive library of Adac analog and digital I/O modules or other LSI-11 compatible modules. Applications include digitizing outputs of thermocouples, strain gages, isolation amplifiers, LVDT, RTD, photomultipliers, potentiometers, optical scanners, or giving outputs to scopes, pen recorders and actuators.

And that's just the beginning. Adac digital I/O modules handle inputs from Digi-switches, shaft encoders, motor controls and relays with outputs to printers, cassettes, lamps, relays, solenoids . . . you name it.

So, when you need a  $\mu$ P based, or front end system with analog or digital I/O, take a look at the Adac System 1000.

Sales offices throughout the world.



15 CUMMINGS PARK • WOBURN • MASSACHUSETTS 01801 • TELEPHONE: (617) 935-6668 • TELEX: 949329

# 1977 Answer Book.

## It makes your job easier. \$25.

**"WHO MAKES WHAT?"**

**"WHAT COMPANIES MAKE THE PRODUCTS I NEED?"**  
(See alphabetical directory of 4000 products)

**"WHERE ARE THEIR NEAREST SALES OFFICES?"**

**"WHO ARE THEIR DISTRIBUTORS?"**

**"WHAT ARE THEIR LOCAL PHONE NUMBERS?"**  
(See alphabetical directory of over 5000 manufacturers)

**"HOW CAN I GET THEIR CURRENT CATALOGS FAST?"**  
(See directory of catalogs by product and by company, including catalog inquiry cards for 5-second ordering)

**"WHO MANUFACTURES THIS TRADE NAME?"**  
(See Directory of Trade Names)

Electronics Buyers' Guide  
1221 Avenue of the Americas  
New York, N.Y. 10020



Yes, send me a copy of Electronics Buyers' Guide. I've enclosed \$25 (USA and Canada only, elsewhere send \$35). Full money back guarantee if returned within 10 days.

Name \_\_\_\_\_

Company \_\_\_\_\_

Street \_\_\_\_\_

City \_\_\_\_\_ State \_\_\_\_\_ Zip \_\_\_\_\_

### New literature

nance requirements. Analyzers, frequency counters and timers, generators, oscilloscopes, and microprocessor design and test systems are detailed. A separate section discusses a system called "Inventory and Delivery Information in One Minute," which provides answers on the availability, price, and delivery of any instrument. United States Instrument Rentals Inc., 951 Industrial Rd., San Carlos, Calif. [431]

**Opto-isolators.** A 22-page handbook describes how to use opto-isolators effectively, including techniques for increasing speed, connecting circuits for use with transistor-transistor-logic devices, and circuit diagrams for various applications. Litronix Inc., 19000 Homestead Rd., Cupertino, Calif. 95014 [433]

**Instruments.** Articles on improving instrument transmission, reflection accuracy, and phase measurements are contained in a 57-page catalog. Technical data is provided for such instruments as solid-state sweep generators, and multiband, dual-band, and single-band plug-in sweep generators, with ranges from 100 kilohertz to 40 gigahertz. Diagrams and charts provide additional backup information. Wiltron Co., 825 East Middlefield Rd., Mountain View, Calif. 94043 [434]

**Telecommunications.** A 16-page handbook covering technical aspects and applications of modems, automatic dialers, and associated equipment, is a compilation of material from data-communications semi-



TELECOMMUNICATIONS FROM THE TERMINAL USERS VIEWPOINT



nars. Included are dozens of graphs and diagrams that illustrate the properties and operations of these properties. Vadic Corp., 505 East Middlefield Rd., Mountain View, Calif. 94043 [436]



# THE STANDARD FOR TACTICAL MICROWAVE LANDING SYSTEMS



Kearfott's AN/TPN-30 Scanning Beam Microwave Landing System for U.S. Marine Corps.

Kearfott's Microwave Landing System is completely self-contained scanning beam system that includes all the necessary airborne and ground equipment required to safely provide Category II approach and landing guidance for all types of aircraft—VTOL, STOL, and CTOL.

The AN/TPN-30 ground equipment and AN/ARN-128 airborne equipment constitute the most modern scanning beam landing system available today. It has been designed for and successfully tested to the most stringent environmental requirements of the U.S. Navy and U.S. Marine Corps. (MIL-E-16400 and MIL-E-5400).

The system features reliable performance which has been achieved by drastically reducing the complexity of the scanning antenna and by employing digital electronics throughout. All solid state, with full system BITE, the equipment has demonstrated that it will operate in excess of 2300 hours in adverse environmental conditions without experiencing a component failure.

For additional information write to: The Singer Company, Kearfott Division, 1150 McBride Ave., Little Falls, N.J. 07424.

## Ground System

- $\pm 20^\circ$  Azimuth
- $0-20^\circ$  Elevation
- 10-Minute Set Up
- Integral Alignment Sight and Levels
- Weight—115 pounds
- 200 watts at 115 Vac. 50-400 Hz or 24 volt Battery

## Airborne Subsystem

The airborne system provides the following information to the pilot:

- Air Selectable Glideslope  $3^\circ-12^\circ$
- Course Deviation—Localizer & Glideslope
- Range to Touchdown in  $1/100$ 's nmi, Rate Range in Knots
- Minimum Useable Glideslope
- Alert to an Obstacle Region
- Relative Vertical Position of Obstacle
- Ground Station Identification
- Automatic "Soft Course"
- Weight—23.2 lb, Volume 0.5 f<sup>3</sup>
- Power—95 watts

System Characteristics	Azimuth/Elevation	DME
Operational Frequencies	15.450 to 15.700 GHz	960 to 1213 MHz (TACAN Band)
Range	10nmi with 25mm of rain/hour	40nmi with 25mm of rain/hour
Data Rate	7.5 scans/second	30 second (track) 150/sec. acquisition
Number of Channels	20	252
Accuracy	0.2 Az, 0.1 EL	100 ft

# Kearfott

a division of The SINGER Company

# K·A·L Inc. Public Auction

**THURSDAY,  
November 17, 1977**  
BEGINNING AT 11:00 A.M. (CST)

ASSETS SURPLUS TO THE PRESENT OPERATION OF

## BOWMAR CANADA LIMITED

Moved for convenience of sale to: 8000 Bluffton Road • Fort Wayne, Indiana

**SEMICONDUCTOR PRODUCTION PROCESSING EQUIPMENT  
ALSO SUITABLE FOR LABORATORY RESEARCH AND DEVELOPMENT  
PREVIOUSLY USED FOR PROCESSING LIGHT EMITTING DIODES  
GALLIUM ARSENIDE - GALLIUM PHOSPHIDE TECHNOLOGIES  
MAJORITY PURCHASED NEW 1970 to 1975**

**Featuring:**

AMT MODEL AMG-500 EPITAXIAL REACTOR, w/  
LEPEL RF GENERATOR  
AMT SILICON OXIDE FILM DEPOSITION SYSTEM, w/  
LOAD STATION  
(5) VEECO MODEL 770 VACUUM SYSTEMS, w/  
MODEL VS-770 POWER SUPPLY  
(2) VARIAN AIR COOLED VACUUM SYSTEMS  
(2) CVC VACUUM SYSTEMS  
(7) BTU AND DIFFUSION TUBULAR MUFFEL  
FURNACES  
LFE PLASMA STRIPPERS — MICRO-TECH MASK  
ALIGNERS — WEST BOND BALL BONDER —  
KULICKE AND SOFFA ULTRASONIC BONDRERS —  
HEATH MONOCHROMATOR  
PHOTO-LITHOGRAPHIC MASK ALIGNER AND  
DEVELOPER

(27) CANADIAN CABINETS AND MICROVOID  
VERTICAL AND HORIZONTAL ENVIRONMENTAL  
CABINETS AND WET CHEMICAL BENCHES  
(9) PACIFIC WESTERN AND MICRO-TECH PROBERS  
BLACK & WEBSTER ELECTROSET COMPONENT  
BONDER  
(29) BAUSCH & LOMB, NIKON AND REICHERT  
PRECISION MICROSCOPES  
HEWLETT PACKARD DUAL TRACE OSCILLOSCOPE  
BECKMAN RATIO RECORDING  
SPECTROPHOTOMETER  
GCA INFRA-RED BELT FURNACE  
NORTON DICING AND SLICING SAW  
NEVAN PRECISION DIAMOND SAW  
GRACO AUTOMATIC INCAPSULATING SPRAY  
MACHINE  
PRECISION LABORATORY AND ELECTRONIC  
TESTING EQUIPMENT



AMT MODEL AMG-500 EPITAXIAL REACTOR, w/LEPEL RF GENERATOR



AMT SILICON OXIDE FILM DEPOSITION SYSTEM, w/LOAD STATION

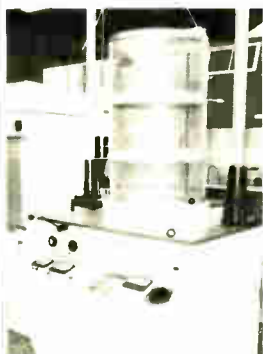

VEECO MODEL 770 VACUUM SYSTEM

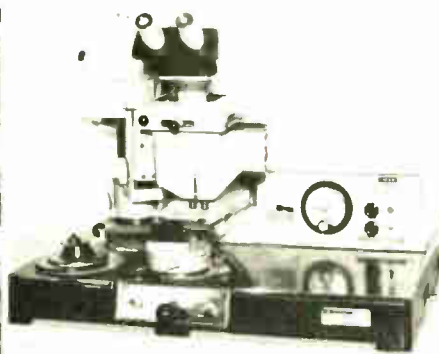

MICRO-TECH MASK ALIGNER



VIEW OF DIFFUSION TUBULAR MUFFEL FURNACES

IMMEDIATE DELIVERY  
NO APPROVAL NECESSARY

*(Deposit of 25% (Cash or Certified Check) required at time of sale)*

FOR FURTHER INFORMATION OR DESCRIPTIVE ILLUSTRATED BROCHURE TELEPHONE — WRITE — WIRE:

**INSPECTION:**  
Monday, Tuesday and Wednesday,  
November 14th, 15th and 16th,  
9:00 A.M. to 4:30 P.M. each day

# K·A·L Inc.

**AUCTIONEERS  
LIQUIDATORS  
APPRAISERS**

**NUMBER ONE to contact when contemplating a sale!**

Suite 903 • 999 West Big Beaver Road • Troy, Michigan 48084 • 313/362-0520

# 10 nsec. \$69.95

Meet CSC's LP-3. The multi-family logic probe that's as fast as a high-speed memory scope. At about 1/100th the price.

You won't want to be without this compact, enormously versatile test and troubleshooting tool that does the work of a level detector, pulse detector, pulse stretcher and memory probe. It gives you instant, positive indications of circuit conditions—capturing one-shot and low-rep-rate pulses (down to 10nsec) that are barely visible, even on a fast scope.

**Easy to use.** No sync, polarity or circuit loading to worry about: just set a switch to the proper logic family, connect two clip leads to the circuit's supply and touch the probe tip to the node under test. You get an instant picture of circuit conditions: Separate LED's indicate logic "1", logic "0" and all pulse transitions. To store single-shot and low-rep-rate pulses, simply set the PULSE/MEMORY switch to MEMORY.

At \$69.95, LP-3 simplifies testing, debugging and servicing all types of digital circuits, with pulses as fast as 10nsec. See your CSC dealer today. Or call 203-624-3103 (East Coast) or 415-421-8872 (West Coast) for the name of your local stocking distributor and a full-line catalog.

**Logic Family Switch**—TTL/DTL or CMOS matches Logic "1" and "0" levels; CMCS position also compatible with HTL, HiNIL and MOS logic.

**PULSE/MEMORY Switch & LED**—PULSE position detects and stretches pulses as narrow as 10 nanoseconds to 1/10 sec.; MEMORY stores single-shot and low-rep-rate events indefinitely; HI/LO LED's remain active.

**HI/LO LED's**—Display level (HI-logic "1", LO-logic "0") of signal activity.

**Interchangeable probe tips**—Straight tip supplied; optional alligator clip and insulated quick-connecting clip available. Optional input ground lead.

**Plug-in leads**—24" supplied, with alligator clips. Virtually any length leads may be connected via phono jack.

\*Manufacturer's Recommended Resale  
© 1977 Continental Specialties Corp.

## Specifications

Input impedance 500,000Ω.

Thresholds (switch selectable)	DTL/TTL	HTL/CMOS
logic 1 thresholds (HI-LED)	2.25V ± 10V	70% Vcc ± 10%
logic 0 thresholds (LO-LED)	0.80V ± 05V	30% Vcc ± 10%

Min. detectable pulse width 10nsec. guaranteed

**Pulse detector (PULSE LED)** in PULSE position of PULSE/MEMORY switch, 1/10-sec. pulse stretcher makes high-speed pulse train or single events (+ or - transitions) visible; in MEMORY position, first transition lights and latches LED

Operating temperature 0-50°C

Physical size (l x w x d)

5.8 x 1.0 x 0.7" (147 x 25.4 x 17.8mm)

Weight 3oz. (.085Kg)

Power leads removable 24" (610mm) with color-coded insulated clips; others available

Input protection overload, ± 25V continuous; 117 VAC for less than 10 sec.; reverse polarity, 50V

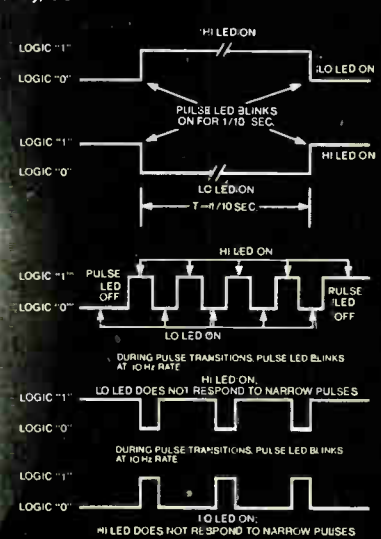
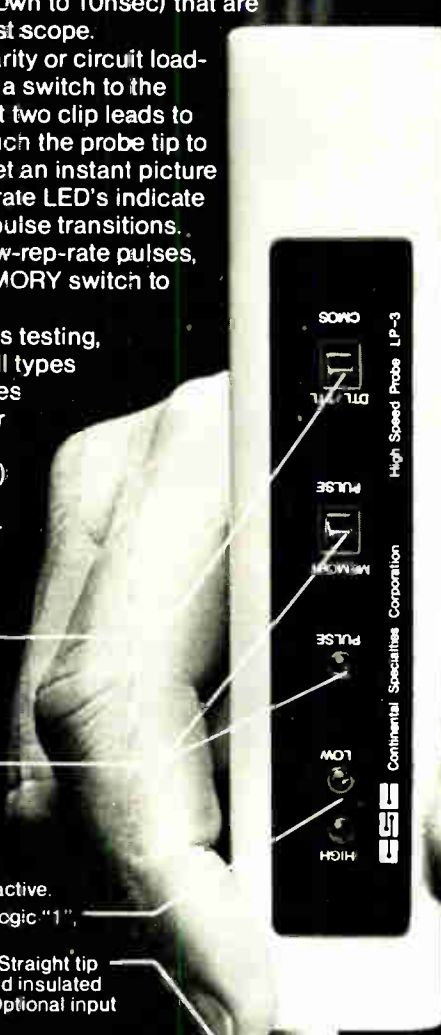

CONTINENTAL SPECIALTIES CORPORATION

44 Kendall Street, Box 1942; New Haven, CT 06509  
203-624-3103 TWX 710-465-1227  
West Coast: 351 California St., San Francisco, CA 94104  
415-421-8872 TWX 910-372-7992  
Great Britain: CSC UK LTD  
Spur Road, North Feltham Trading Estate,  
Feltham, Middlesex, England.  
01-890-8782 Int'l Telex 851-881-3669

Circle 199 on reader service card

NEW LP-3!

# Classified section FOR ENGINEERING/TECHNICAL EMPLOYMENT OPPORTUNITIES

## CLASSIFIED SALES REPRESENTATIVES

Atlanta	Jane Core	404/892-2868	Cleveland	Mac Huestis	216/781-7000	Houston	Mike Taylor	713/659-8381	Pittsburgh	Dean Genge	412/391-1314
Boston	Holt Buchanan	617/262-1160	Dallas	Mike Taylor	214/742-1747	Los Angeles	Sian Kassir	213/487-1160	San Francisco	M.E. Kenny	415/362-4600
Chicago	Bill Higgins	312/751-3733	Denver	Shirley Klotz	303/837-1010	New York	Larry Kelly	212/997-3594	Stamford	Holt Buchanan	203/359-2860
			Detroit	Mac Huestis	313/873-7410	Philadelphia	Dan Ferro	215/568-6161	XEROX 400 TELECOPIER		212/997-6800

## EAT•N Engineers

Positions Available In Our Modern Plant Located Within 30 Minutes Of Milwaukee, Wis. And 1 Hour Of Chicago, Il.

Eaton, a FORTUNE 150 Corporation, is seeking:

### \* Senior Project Inverter Design Engineer

Candidate must have 8-10 years experience in power electronics design/development with an emphasis on inverters. Must have proven achievements in inverter power circuit design and development. Some systems background desirable. BSEE Degree necessary. Must be capable of Senior Project Engineer responsibility in inverter design/development.

### \* Power Electronics Packaging Engineer

Candidate must have 5-8 years experience in high power electronics packaging. Should be capable of handling the thermo, mechanical and electrical aspects of high power electronics packaging. Must be capable of handling project engineering level responsibility in packaging high power industrial electronics.

Qualified candidates will receive an excellent starting salary commensurate with experience plus one of the finest company paid benefit programs.

Please Submit Resume With Salary History To Employee Relations Supervisor

**EATON Corporation**  
Industrial Drives Operation  
Kenosha Division  
3122 14th Ave.  
Kenosha, Wis 53140

An Equal Opportunity Employer M/F

# EAT•N

## SEMTECH CORPORATION

Expanding manufacturer of quality power rectifiers offers excellent opportunity for:

### MOS PROCESS ENGINEER PHOTORESIST

Participates in bringing into production a new generation of field effect power transistors.

Requires BS in Electronics or Physics plus a minimum of 3 years' experience in MOS wafer fabrication.

Salary commensurate with experience and ability. Excellent benefits including profit sharing.

Send resume with complete salary history to:

**SEMTECH CORPORATION**  
652 Mitchell Road  
Newbury Park, Calif. 91320

Equal Opportunity Employer M/F

## Broadcast Products Division

### ENGINEERING SECTION MANAGER

This is an opportunity to join Harris, a diversified, strongly growing electronics and communications company, noted for successful planning and management. Our Division is an expanding leader, active worldwide, in radio and television broadcast and related equipment.

A key technical management position in a major product line is currently available. This position represents an immediate career opportunity for personal growth and management development in a progressive division of Harris Corporation.

Position responsibilities include the direction of all activities related to commercial broadcast transmitter design. Support of existing products, new product conception and development, as well as direct supervision of design engineers is required.

Qualifications for this opportunity include BS/MSEE and a history of personal growth as exhibited by increasing levels of responsibility including design engineering, project engineering, and supervisory experience. Experience in the R. F. product area helpful but not essential.

We offer favorable career prospects in a growth environment, competitive salaries and excellent benefits, and relocation assistance to our desirable small, progressive city. Please direct resume in confidence, giving full pertinent details including salary progression, in confidence to: Mr. Lawrence E. Carlstone, Professional Employment Supervisor, Harris Corporation, Broadcast Products Division, Quincy, Illinois 62301.



**HARRIS**  
COMMUNICATIONS AND  
INFORMATION HANDLING

An Equal Opportunity Employer—Male and Female

# Engineers... are you pigeonholed?

We won't keep you pigeonholed in the same old assignment, year after year. After all, variety is the spice of a life's work. And we have a commitment to it. We make our living selling variety: command and control systems, complete air defense systems, radar systems, sonar systems, computer systems and much more. We're part of a company of 36,000 people, active in more than 550 major product areas in 80 technologies. Plenty of room for developing interests, plenty of room for growth.

Our Systems Division engineers enjoy technical diversity because of our program variety, and growth opportunities that we're steadily expanding. They benefit from the technically oriented management which put us on our strong growth curve. And they enjoy a good professional environment, where many of our people wear 10, 15, and 20 year service pins.

**Any more good news? Well, yes. We're hiring now.**

**For quick action, reach for your phone instead of your resume... call M. F. Duggins collect (714) 871-4080, Ext. 5410 between 8 A.M. and 4 P.M. Monday through Friday. Or send your resume to: Professional Employment—Ground Systems Group E, 1901 W. Malvern, Fullerton, CA 92634.**

U.S. citizenship required • Equal opportunity M/F/H/C employer

**HUGHES**

HUGHES AIRCRAFT COMPANY

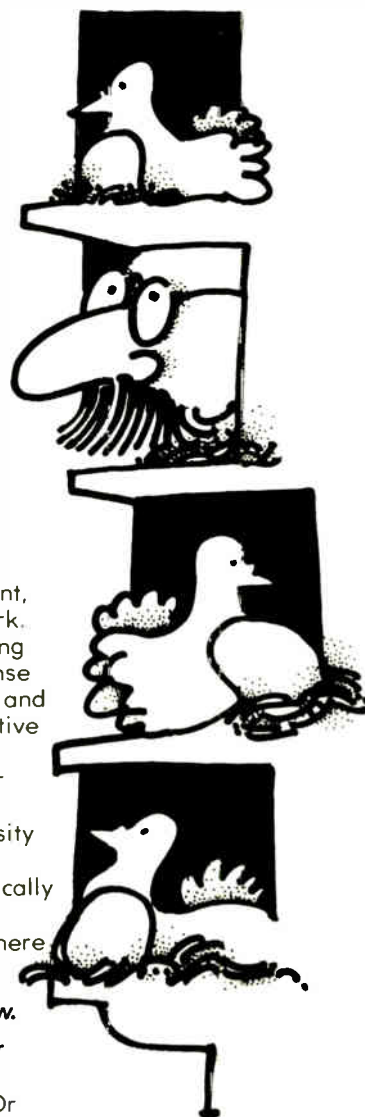

**Communications System Engineers.** Must understand hardware/software interaction signal processing, spread spectrum.

**Senior Systems Engineers.** Tactical, strategic system application of radar, sonar communications, electro-optical software, data processing and command and control technologies.

**Communication Analysts.** Lead/direct application of systems theory, applied math, estimation, probability to communication system problems.

**Data Processing and Software Analysts.** System level data processing architecture analysis, design, performance evaluation for multisensor systems.

**Display System Engineers.** Long term opportunity to lead display product definition/selection for military C&C Systems.

**Radar Systems Engineers.** Lead/direct radar system conceptual design/analysis. Integration of radar, weapon, command and control systems.

**Senior Air Defense Engineers.** BSEE, Math or Physics, project management experience in real-time hardware software systems.

**Hardware System Engineers.** Large scale data processing, peripheral display systems design, specification, integration checkout.

**Systems Analysts.** Systems Theory, applied math background. Variety of problems requiring modern analysis techniques.

# COMMUNICATION EXPERTS

## FORD SIGNALS A NEW CAREER

The Electrical and Electronics Division is gearing to meet the demands of the technological revolution in automatic communications systems. Ford Motor Company will continue as a leader in communication techniques and design. We are seeking an individual that can make immediate and significant contributions to our Advanced Entertainment Activity as a Principal Engineer.

### QUALIFICATIONS

- BSEE/MSEE preferred
- Proven Cost effective innovation record
- At least 5 years experience in high technology communications engineering, i.e., digital frequency synthesis, phase lock loops, active and solid state filters, and custom LSI (digital and linear) application.
- RF signal experience necessary, exposure to other electronic control devises is preferred.
- 1-2 years supervisory experience.

Ford Represents exciting opportunity for this individual. The position offers an excellent salary and is located near Dearborn, Michigan. Benefits include fully paid life, hospital and disability insurances, dental and retirement programs, and lease car privileges. An attractive savings and stock investment plan is also available.

Please reply in confidence to:



**Electrical & Electronics Division**

**Attn: Salaried Personnel  
P.O. Box 2053  
EEE Building—Room B-094  
Dearborn, Michigan 48121**

*An Equal Opportunity/ Affirmative Action Employer*

# FREE

## Your dream job

We hope you're happy in your current position, but there's always that ideal job you'd prefer if you knew about it.

That's why it makes sense to have your resume on file in the Electronics Manpower Register, a computerized data bank containing the qualifications of career-conscious ELECTRONICS readers just like yourself.

You'll benefit from nation-wide exposure to industry firms privileged to search the system, and since the computer never forgets, if you match up with their job requirements you'll be brought together in confidence.

To take advantage of this free service, mail your resume to the address below. We'll do the rest.

### **ELECTRONICS MANPOWER REGISTER**

**Post Office Box 900  
New York, N.Y.  
10020**

## Engineering- Software Professionals

# The New Era in Computer Controlled Telecommunications is Underway...

and that means exceptional career opportunity on the leading edge of a vast new technological frontier. GTE Automatic Electric is a world leader in this rapidly emerging new phase of one of the world's largest industries. You'll have the opportunity to advance your career in a highly professional environment . . . and working with concepts that are ahead of existing technology.

Highly visible, and promotable positions are available for software professionals who have above-average credentials in definition and design at advanced levels in the following areas:

- **Distributed Processing Architecture**
- **Computer Aided Design & Development**
- **AD/DA Systems Interface**
- **Top-down Systems Design**
- **Data Base Systems**
- **Real Time Systems**
- **Systems Diagnostics**
- **Signal Processing**
- **Stored Program Digital Systems**
- **Telecommunication switching and control systems (microprocessor or large CPU controlled)**
- **Large scale on-line systems management and executives**
- **Simulation**
- **Application Software**

If you have recent experience in one or more of these areas and a BS, MS, or PhD in Electrical Engineering, Computer Science, Math or the equivalent in technical qualification and accomplishment, we would like to tell you more about this major expansion in our long term research and development program. We are committed to maintaining our position of leadership in this exciting new field, and as a member of the GTE Family (ranked among the top R&D spenders in industry in 1976), can provide you with the support and resources to do the job.

For rapid contact,

# CALL COLLECT (312)681-7729

weekdays from 8 am to 5 pm cdt

Or forward your resume, including recent salary history to: Manager of Technical Employment,  
Dept. 471 A6

**GTE** **AUTOMATIC ELECTRIC  
LABORATORIES**

400 N. Wolf Road  
Northlake, IL 60164

An Equal Opportunity Employer M/F

# ENGINEERS

BURNS and ROE an internationally recognized leader in the engineering and construction of power plants is seeking proven professionals with a minimum of 3 years engineering experience in the following disciplines:

## MECHANICAL ELECTRICAL CIVIL

Our current projects require the expertise of engineers capable of contributing to our advanced technology while developing personally and professionally.

*We offer excellent compensation, including a fully-company paid benefits package.*

Forward resume including detailed work history and salary requirement in confidence to: Mr. R. B. TROUT  
550 Kinderkamack Road  
Oradell, N.J. 07649

*An Equal Opportunity Employer M/F*

**Burns  
and  
Roe**



## THE ANSUL COMPANY NEEDS AN ELECTRONICS DEVELOPMENT ENGINEER

Opportunity for degreed Electrical Engineer with several years experience in analog and digital design.

Responsibilities include: design and development of electronic peripheral circuits and devices for new automatic fire protection system, maintain, adapt and revise existing systems; act as advisory to our Manufacturing, Marketing and Quality Assurance people and coordinate contracts for product approvals with Underwriters Laboratories, Factory Mutual, etc.

You'll work at our world headquarters in Marinette, Wisc., an attractive small city on the shores of Green Bay. Here you'll find good schools (including a University Center), pleasant small city living and a rich variety of outdoor recreational activities. Ansul is a dynamic \$100 million international company producing fire protection equipment and specialty industrial chemicals.

Send resume and salary history to:

Eric R. Heiberg  
THE ANSUL COMPANY  
One Stanton Street  
Marinette, Wisconsin 54143



AN EQUAL OPPORTUNITY EMPLOYER M/F  
MINORITIES AND WOMEN ARE ENCOURAGED TO APPLY

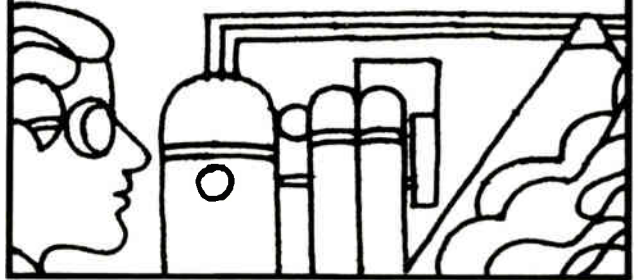

## SEMINAR INSTRUCTORS

Microprocessor-Minicomputers  
Management & Applications  
One to Five Day Sessions  
In U.S., Canada & Europe

Send resume & dates available to:

**SIR JOHN CO.**

Box 7143

Overland Park, Ks. 66207

(913) 649-8952

## NOTICE TO EMPLOYERS:

**Why  
we can recommend  
our readers  
for the top jobs**

The subscribers to this magazine have qualified professionally to receive it. They are also paid subscribers—interested enough in the technological content to have paid a minimum of \$14 for a subscription.

As subscribers to ELECTRONICS, our readers have told you several things about themselves. They are ambitious. They are interested in expanding their knowledge in specific areas of the technology. And they are sophisticated in their need for and use of business and technology information.

Our readers are now in senior engineering or engineering management, or they are on the road toward those levels. In either case, they are prime applicants for the top jobs in almost any area.

If you are interested in recruiting the best people in electronics, these pages are open to you for your recruitment advertising.

Our readers are not "job-hoppers". To interest them you will have to combine present reward with challenge and opportunity for future career advancement.

The cost of recruitment advertising on these pages is \$46 per advertising inch. For information call or write:

# Electronics

Post Office Box 900, New York, NY 10020  
Phone 212/997-2556

## RELIABILITY MAINTAINABILITY

Participate in Shipboard electronic systems acquisition management. Perform engineering evaluations, develop reliability, maintainability and test specifications. BSEE or equivalent with 5 years experience.

Please forward resumes to:

Mr. L. Orlando

**General Research  
Corporation  
(SWL DIVISION)**

Suite 700 Park Place  
7926 Jones Branch Drive  
McLean, Virginia 22101  
*Equal Opportunity Employer*

## TECHNICAL TRANSLATIONS

English/French by professional translator with over 10 years experience in electronic and electrical systems. Call or write:

**JEAN LOUIS AVRIL**  
5ter, rue des Bois  
92310 SEVRES FRANCE  
Tel: (1) 027.68.99

## FOR WESTERN ACTION

Free resume preparation and distribution to exceptional fee paid opportunities. Send experience and salary history to:

**The Wescott Agency**

Box 4428,  
Vancouver, WA 98662



# Software Development Engineer

## LSI/CAD

The position requires a person with substantial experience in the design of advanced LSI circuits, with knowledge of CAD systems. Specific experience should include design rule verification of LSI circuits, testing of digital LSI circuits or experience with development of manual or automated layout systems.

BSEE or equivalent experience necessary as well as experience in programming scientific applications.

Salary is open. Benefits include liberal insurance, educational support and profit sharing programs.

Send detailed resume and salary history to Mary Walhood, TEKTRONIX, INC., P.O. Box 500, E85, Beaverton, Oregon 97077.

An Equal Opportunity Employer M/F/H.

**Tektronix**  
COMMITTED TO EXCELLENCE

## WHERE DO YOU FIT?



In today's job market, that is. One way to see if you're in demand is to check the employment opportunities contained in ELEC-TRONICS' Classified Section.

Another way to get a reading is to place a blind (box number) Position Wanted ad there. The cost is low (only \$1.25 per line) and the results are often rewarding.

For more information call or write:

### ELECTRONICS

Post Office Box 900  
New York, N.Y. 10020  
Phone: 212/997-2556

## ELECTRONIC DESIGN ENGINEERS AND TECHNICIANS

Design and develop custom electronic control assemblies and solid state sensors for use in a broad line of industrial applications. Products utilize a wide range of analog and digital components including microprocessors in conjunction with electromechanical devices.

### Minimum Requirements:

**Engineers: BSEE Degree and 3 or more years' circuit design experience**

**Technicians: Associate Degree or equivalent and 5 or more years' industrial related experience.**

Salary commensurate with education and experience. P&B is an electronic & electromechanical manufacturer and offers an excellent benefit package, good working conditions and high growth rate. Please submit resume and salary requirement to:

**AMF INCORPORATED  
POTTER & BRUMFIELD DIVISION  
200 Richland Creek Drive—Princeton, Indiana  
47671**

Attn: Peggy A. Michas

*An Equal Opportunity Employer M/F*

## We're Looking For Exceptional Talent

We've openings for both hardware and software people, engineers and programmers capable of innovative multidisciplinary design. You will play key roles in developing our ambitious new digital business system, a pioneering effort with strong emphasis on human interface engineering. We offer you exposure to the entire range of current electronic technologies and expect you to be proficient in at least a few of the following disciplines:

- digital systems architecture
- network architecture & protocols
- common carrier interfacing
- logic system design
- circuit design
- language design
- hardware/software partitioning
- displays and keyboards
- A-D/D-A conversion
- signal processing
- RF transmission techniques
- data communication
- microprocessor design
- fault-tolerant design
- performance measurement

Our dynamic West Coast group is rapidly expanding and offers unusual opportunities for advancement. If you're ready for this kind of challenge, please send your resume to

**Burroughs Corporation**



Attention: Barbara Rausin, Dept. E-1027  
460 Sierra Madre Villa  
Pasadena, California 91109

*An Equal Opportunity Employer*

# SWITZERLAND

## Tele-control and Industrial Electronics

Increasing automation everywhere is continually opening up new fields of application for tele-control systems and industrial electronics. By expanding our range of products and systems we are aiming at strengthening our position on world markets. To reinforce our team of engineers we are looking for a

### Graduate Electrical Engineer

for the

### Development of Digital Equipment and Systems

### from the Initial Concept right through to Production

To name but a few typical applications; automation of networks for the distribution of electricity, water, gas and oil, automatic train control, industrial automation and process control.

Close contact with the practical aspects of applications enable our engineers to keep constantly abreast of technical developments, enabling them to gain experience in the use of microprocessors and to broaden their professional horizon by working intimately with software development groups, with the test laboratories, the sales and engineering groups.

Of course, applicants who already possess such experience will find a post offering excellent prospects for the future. But also those who have just graduated will also find an opportunity of working under expert leadership and becoming a member of a team with a varied field of activity. For advanced training it is possible to attend suitable external and internal courses. Applicants must have a good knowledge of German.

Swiss citizens or aliens with a class C permit are asked to submit their applications, quoting cipher 195/11/76, to Mr. Wehrl, Dept. PDE-A, BBC Brown, Boveri & Co., Ltd. CH-5401 Baden, Switzerland.

**BBC**  
BROWN BOVERI

**BBC Brown, Boveri & Company Ltd., CH-5401 Baden, Switzerland**

#### BUSINESS OPPORTUNITY

**How To Earn Money As A Consultant**  
(including specimen contracts) \$21  
Business Psychology Int'l 890/44  
National Press Bldg. Washington,  
D.C. 20045.



**Would  
you hire  
an engineer  
who  
couldn't  
understand  
this  
magazine?**

Of course not. ELECTRONICS is the technical publication for technical people. If they can't understand it, they can't receive it. That's why, when you're looking for qualified engineers, you should consider our Classified Section.

For only \$46.00 per inch your recruitment advertising will reach 46,000 pre-screened engineers—that's just \$1 per thousand!—as they're reading to combat job obsolescence, while they're thinking about their future and bettering themselves.

There's no charge for typesetting and free layout service is provided.

For more information call or write:

**ELECTRONICS**

Post Office Box 900  
New York, N.Y. 10020  
Phone: 212/997-2556

## PROJECT ENGINEERS

For a young and dynamic organization IN ISRAEL which extends its activity for consulting in industrial application of:

COMPUTER CONTROL PROJECTS  
PROCESS CONTROL SYSTEMS  
MICRO COMPUTER TECHNOLOGY

Duties include advising and leading junior engineers.

Qualifications include initiative to promote new and advanced projects in Israeli industry.

Preferred 5 years of industrial experience.

Write to

The Industrial Automation Institute  
Israel Institute Of Productivity  
4, Hennieta Szold St.  
P.O.B. 33010  
Tel-Aviv, Israel

We have been placing graduate ENGINEERS

in FEE-PAID positions THROUGHOUT THE U.S. since '59. Over 1,000 client companies. We are graduate engineers working full-time for you. Send resume & salary history today or request confidential application.

ATOMIC PERSONNEL, INC.

Suite L. 1518 Walnut St., Phila., Pa. 19102  
An Employment Agency  
For All Technical Fields

### POSITIONS VACANT

**Electronics Development Engineer**  
North Carolina firm seeking EDE. Minimum 8 yrs. experience with major machining manufacturer in the development of electronic controls for cigarette making and packing machines. College graduate. Preferably PE. 7½ hour work day. Salary \$18-25. 5K. Minimum travel. Excellent company benefits. Equal Opportunity Employer. Piedmont, North Carolina location. Send resume to Mrs. Beverly Wilson, Job Service, Box 82, Winston-Salem, North Carolina 27102.

**Georgia Tech Engineering Experiment Station**—Needs Electrical Engineers to perform defense systems analysis/operations research in client-oriented environment. Computer Modeling and electronic system simulation experience desired. MSEE/MSIE required. Send resume to Mr. R.P. Zimmer, Engineering Experiment Station, Georgia Institute of Technology, Atlanta, Georgia 30332. An Equal Opportunity Employer.

### EMPLOYMENT SERVICE

"How To Get A Job Overseas" 253 pages! Jam-Packed info. + Directory 300 firms \$5 Transworld, Box 90802-HR Los Angeles 90009.

**Engineers—discrete, personal,** reputable national fee paid placement serv. Murkett Assoc. Box 527, Montgomery, AL 36101.

# INSTRUMENTATION & CONTROL ENGINEERS BS-MSEE

## Principal Engineer

to lead a group of EE's having total responsibility for on-line instrumentation in film manufacture. Requires leadership qualities and approximately 10 years experience in electro-mechanical instrumentation. New England—to \$30,000.

## Senior Electronic Engineer

As project leader, will apply engineering and scientific principals and techniques to the design and development of microprocessor based systems and their application to process control. Requires minimum of 5-years related experience including digital logic design and firmware development. Upstate New York—to \$24,000.

## Electronic Product Engineer

involves the development of new analog-digital products from design stage to production. Includes product improvement, performance problem solving and deficiency correction. Requires at least one year in product design or manufacturing engineering with training in computer or microprocessor desirable. New England—to \$22,000.

If you are interested in these or related opportunities, please reply in confidence to:

**WETERRINGS & AGNEW**  
PROFESSIONAL PLACEMENT CONSULTANTS

475 MADISON AVE.  
ROCHESTER, N.Y. 14620 • TEL: 411-1888

## WHERE DO YOU FIT?

In today's job market, that is. One way to see if you're in demand is to check the employment opportunities contained in ELECTRONICS' Classified Section.

Another way to get a reading on your value is to place a blind (box number) Position Wanted ad there. The cost is low (only \$1.25 per line) and the results are often rewarding.

For more information call or write:

## ELECTRONICS

Post Office Box 900  
New York, N.Y. 10020  
Phone: 212/997-2556

# I'm my own boss.

# I work for Schlumberger.

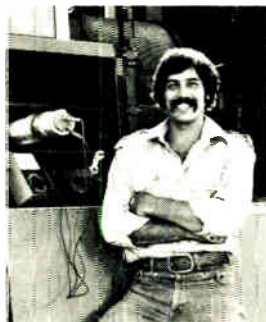

There's nothing routine about a career with Schlumberger. Just ask Larry Gulman who joined us a year ago.

"Working as a field engineer for Schlumberger is *everything* I thought it would be," says Larry. "I like to be outdoors. Work with my hands. And keep my own hours.

"I'm responsible for myself, my crew—and everything that happens on the job. It's really exciting to make things work out right.

"Some people aren't cut out for this. I takes a *special* person. I work long, hard hours—and sometimes it's tough to stay awake.

"But it's worth it. Because I'm satisfied

with myself and my work ...and you can't beat the money."

Ready for a challenge? Maybe this is for you. If you're fresh out of school with a degree in electrical engineering—or if you have no more than three years' work experience, let's talk. Just fill out the coupon and we'll tell you all about the career opportunities with Schlumberger.

Or call collect: (713) 928-4218. Openings are available in Louisiana, Texas and Oklahoma.

Schlumberger Well Services  
P.O. Box 2175  
Houston, Texas 77001

NAME \_\_\_\_\_  
ADDRESS \_\_\_\_\_  
CITY \_\_\_\_\_ STATE \_\_\_\_\_ ZIP \_\_\_\_\_  
SCHOOL \_\_\_\_\_  
DEGREE \_\_\_\_\_  
GRADUATION DATE \_\_\_\_\_ GPA \_\_\_\_\_



N

An Equal Opportunity  
Employer M F

## Job-seekers... be the first to know with McGraw-Hill's Advance Job Listings

By having our weekly ADVANCE JOB LISTINGS sent to your home every Monday you can be the first to know about openings both in and out of your field. AJL will enable you to contact anxious recruitment managers BEFORE their ads appear in upcoming issues of 21 McGraw-Hill publications. To receive a free sample copy, plus information about our low subscription rates, fill out and return the coupon below.

ADVANCE JOB LISTINGS / P.O. BOX 900 / NY 10020  
PLEASE SEND A SAMPLE COPY  
OF ADVANCE JOB LISTINGS TO

NAME \_\_\_\_\_ ADDRESS \_\_\_\_\_  
CITY \_\_\_\_\_ STATE / ZIP \_\_\_\_\_

Able Computer Technology	169	■ Data Precision	67	■ Gordoe Corp.	152
ADAC	195	■ Dialight	149	■ Gralex Industries	194
• Adret Electronique	52	Digital PDP	62-63	Harris Semiconductor	41
• AEG Telefunken	9E	‡ Dow Corning Resins & Chemicals	56A 56D	■ Hewlett-Packard	2nd C, 1, 10, 11, 58, 59, 82, 83, 86, 87, 104
■ Alco Electronic Products	172	• Ducati Elettrotecnica Microfared	12E	■ HI-G Incorporated	23-24
■ Allen-Bradley	24	Eastman Kodak Company, Graphics Markets Div.	147	• HI-G D'Italia	16E
AMF Potter & Brumfield	159	■ ECD Corp.	188	Honeywell TID	135, 137
American Microsystems Inc.	60-61	■ E & L Instruments	158	■ Hughes Aircraft	164, 166, 168
■ Amp, Inc.	140-141	Elco Corporation	173	Intel Memory Systems	130, 131
Ampex	190	‡ Electro Rent Corp.	54	Intel-Microcomputer Components	18-19
• Analog Devices	128	■ Electro Scientific Industries	75	■ Interface	213
Anseley (Thomas & Betts)	68	■ Electronic Applications Co.	213	International Microcircuits Inc.	176
• APEM	20E	■ Electronic Devices, Inc.	194	■ Ithaco, Inc.	6
AVX Corporation	143	■ Electronic Development Corp.	20	■ Johanson Manufacturing Corp.	38
■ F. W. Bell	170	EMM-Electronic Memories & Magnetics	118	KAL	198
CEC Division/Bell & Howell Company	213	Electronic Navigation Industries	146	Keithley Instruments	154-155
■ B & K Precision, Div. Dynascan Corp.	175	Elorg Electronorgtechnica	160	Kolmorgen Corp., Photocircuits Division	122-123
Blackstone Corp.-Ultrasonics Div.	214	■ Emerson & Cuming, Inc.	189	■ Krohn-Hite Corp.	5
■ Bourns, Inc.	4thc	English Electric Valve Co.	209	■ Lambda Electronics	177-186
‡ Bud Industries, Inc.	128	■ Erie Technological Products	164	Litronix	45
■ MGR/Bussmann Mfg. Co.	73	Essex Group Sub of United Tech	214	■* Matsuo Electric Co., Ltd.	10E
Calex Mfg., Inc.	172	Faultfinders, Inc.	71	Matsushita Electric Trading Company	121
• Carlo Erba SA	4E	Figaro Engineering, Inc.	166	MCL, Inc.	148
■ Centralab Electronics Division	3rd c.	‡ First Computer Corporation	52	Megatek Corporation	191
■ Cherry Electrical Products	151	■ John Fluke Mfg. Co., Inc.	167, 133, 21	■ Micro Networks	192
Computer Automation, Inc., Naked Mini Div.	78-79	Futek	166	■ Microswitch, Div. of Honeywell	138-139 162-163
■ Continental Specialties	199	■ General Electric-Instrument Rental Div.	126	■ Microwave Power Devices	142
Continental Rentals, Div. of Continental Resources	8	General Electric Miniature Lamp	16	■ Mini-Circuits Laboratory	28
■ Control Data Corporation	171	General Instrument, Microelectronics	17	3M Company	84-85
■ Dana Labs	165	■ GenRad	161, 9	Mitel Semiconductor, Inc.	42

# EEV Triodes are putting the heat on industry.



But not too much, or too little.

The wider the range, the closer you get to the exact power you need and EEV triodes for industrial r-f heating range from 1 kW upwards.

So, the better the result with EEV.

In glazed ceramics or glass, EEV triodes are conservatively rated and designed to give you long and reliable service.

If you need sound advice on which tube is right for your equipment, please get on the hot line to us at Chelmsford.

To: EEV, Chelmsford, Essex, CM1 2QU, England.  
Please send me details of EEV triodes for industrial r-f heating.

General information.  Please tick.

Or information for equipment type .....

Name \_\_\_\_\_

Position \_\_\_\_\_

Company \_\_\_\_\_

Address \_\_\_\_\_

Telephone \_\_\_\_\_ Telex \_\_\_\_\_

S5168/EWW

## EEV/M-OV

Members of GEC - turnover £2054 million



# ELECTRONICS REPRINTS

No. of  
copies  
wanted

## New reprints

- \_\_\_ R-718 Display makers strive to refine their technologies 8 pp \$3.00
- \_\_\_ R-716 Special report—Japanese wave in semiconductor technology 24 pp \$3.00
- \_\_\_ R-714 Special report—active filter technology 6 pp \$3.00
- \_\_\_ R-713 Electron-beam lithography draws fine line 10 pp \$3.00
- \_\_\_ R-712 Special report—large-scale integration 16 pp \$3.00
- \_\_\_ R-710 Personal computers mean business 8 pp \$2.00
- \_\_\_ R-708 So you want to be a consultant 6 pp \$2.00

## Charts

- \_\_\_ R-516 Electronic symbols \$2.00
- \_\_\_ R-213 Electromagnetic spectrum (updated 1976) \$3.00
- \_\_\_ R-326 Optical spectrum (6-page report and chart) \$3.00

## Books

- \_\_\_ R-711 Circuits for electronics engineers: 306 circuits in 51 functional groups—Electronics Book Series \$15.95
- \_\_\_ R-704 Thermal design in electronics \$5.00
- \_\_\_ R-701 Applying microprocessors—Electronics Book Series \$9.95
- \_\_\_ R-608 Basics of Data Communications—Electronics Book Series \$12.95
- \_\_\_ R-602 Large Scale Integration—Electronics Book Series \$9.95
- \_\_\_ R-520 Microprocessors—Electronics Book Series \$8.95
- \_\_\_ R-011 Computer-aided Design 135 pp \$4.00
- \_\_\_ R-032 Active Filters 88 pp \$4.00

## Payment must accompany your order

Make check or money order payable to Electronics Reprints. All orders are shipped prepaid by parcel post. Allow two to three weeks for delivery. For additional information call (609) 448-1700 ext. 5494.

Mail your order to:

Janice Austin  
ELECTRONICS REPRINTS  
P.O. Box 669  
Hightstown, N.J. 08520

Back issues now available:

1960 to 1969, \$5.00 each  
1970 to 1973, \$3.00 each  
1974 to 1976, \$4.00 each

Modular Computer Systems	106	• Siemens AG Munich	7E
Monolithic Memories	37	Signetics Corporation	27
Mostek Corp.	13	Sinclair Radionics Ltd. Minimeter	121
Motorola	156	Singer Kearfott	197
▪ National Semiconductor Corp.	33, 34	Sord Computer Systems, Inc.	40
▪ Newport Labs	132	Sprague Electric	51,70
Nikkei Electronics	203	▪ Statek Corp.	168
Nitron	129	Synertek	43
• North American Philips	20E	Syntronic Instruments, Inc.	150
Numonics	176	Syston-Donner, Data Products Div.	157
Optron, Inc.	14	▪ Tektronix	80-81
• Oscilloquartz	54	• Tektronix Datatek NV	17E
• Philips Industries	10-11	Teradyne, Inc.	64
▪ Philips TMI	46-47	Texas Instruments, Components	153
▪ Piezo Technology	189	Thick Film Systems, Inc.	174
Plessey Microcomputer Products	124-125	• Triplet Corporation	11E
• Plessey Semiconductor	2E-3E	• Trio Kenwood Corporation	57
▪ Precision Monolithics Inc.	15	▪ TRW LSI Products	122-123
Processor Technology	193	Wakefield Engr.	134
• R 2E	39	▪ Wavetek Indiana	88
RAC-Reliability Analysis Center	170	• Weston Schlumberger	15E
Ramtek	76-77	‡ Carl Zeiss, Inc.-Micro	39
RCA Electro-Optics	48	<b>Classified and employment advertising</b> F. J. Eberle, Manager 212-997-2557	
RCA Solid State	7	A.M.F. Incorporated	205
⚡ Rental Electronics, Inc.	57	The Ansul Company	204
• Rhone Poulenc-Chimie Fine	13E,211	Atomic Personnel Inc.	206
• Rohde & Schwarz	1E,21E,24E	B.S.C. Brown Bovier & Company	206
Rotek Instrument Corp.	136	Burns & Roe	204
Semtech Corporation	115	Burroughs Corporation	205
SEPA S.p.A.	126	Eaton Corporation	200
• Sfernice	18E	Ford Electrical & Electronics Division	202
		G.T.E. Automatic Electric Laboratories	203
		General Research	204
		Harris Broadcasting Prod	200
		Hughes Aircraft	201
		Jean Louis Avril	204
		Schlumberger	207
		Semtech Corporation	200
		Sir John Company	204
		Tektronix	205
		The Industrial Automation Institute	206
		Waterrings & Agnew	207
		The Wescott Agency	204
		For more information of complete product line see advertisement in the latest Electronics Buyers Guide	
		• Advertisers in Electronics International	
		‡ Advertisers in Electronics domestic edition	

# POLYIMIDE VS. EPOXY

**Kerimid®601**

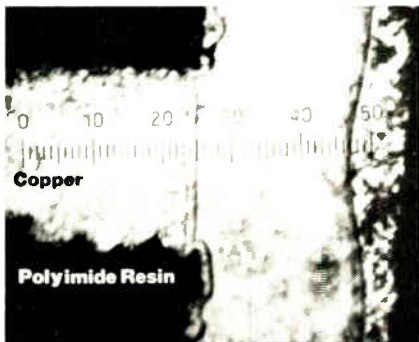

After drilling and soldering extreme magnification shows no resin smear or delamination interrupting circuitry.

**Epoxy**

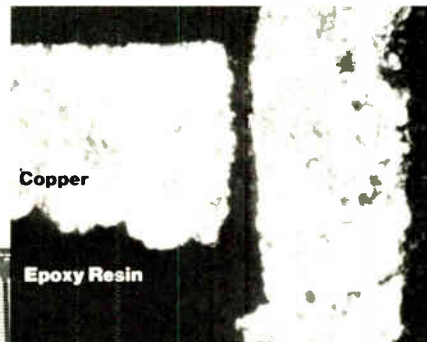

After drilling and soldering extreme magnification shows smear and delamination causing circuit malfunction.

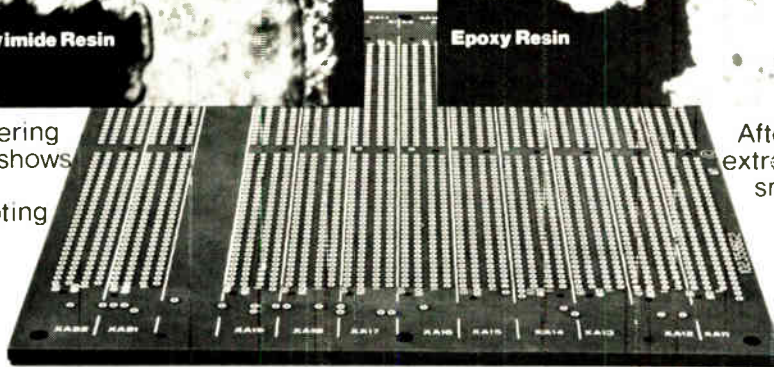

## Now approved for military use.\*

Kerimid 601 can significantly improve production yields by dramatically reducing smear and delamination. Which, when you consider the defective rate of epoxy boards, more than pays for the higher cost of Kerimid 601. Not to mention the gain it offers to your reputation for reliability in meeting promised delivery dates and in ultimate in-use functioning. In fact, one customer of ours hasn't rejected one circuit board due to smear or delamination in three years.

Kerimid 601 makes all this possible because it brings to circuit packaging the twin advantages of high heat resistance (4-500°F) and epoxy processability (355°F/200Psi). Additionally, void-free laminates offer improved characteristics over epoxies in z-dimensional stability and moisture resistance.

We think the combination of production and performance advantages offered by Kerimid 601 makes it well worth your investigation.

For more information, direct inquiries to: Rhodia Inc. Specialty Plastics Department, P.O. Box 125, Monmouth Junction, New Jersey 08852 (201) 846-7700.

Rhone-Poulenc, 22 Av. Montaigne, Paris-8e, France 256-4000.

**KERIMID® 601**   
A SUBSIDIARY OF RHÔNE-POULENC

\* MIL P-13949/10 Amendment 2; MIL P-55617 revision B; MIL G-55636 revision B.

# If this magazine is worth your time, it's worth 54¢.

Drop off the routing list. Avoid the Perils of Passalong. Get your own fresh, unclipped copy mailed to your home or office. \$14 (54¢ per issue) for a one-year U.S. subscription. (\$16 in Canada). Turn to the subscription card in the back of the magazine. If somebody beat you to it, write: Electronics, P.O. Box 430, Hightstown, N.J. 08520.

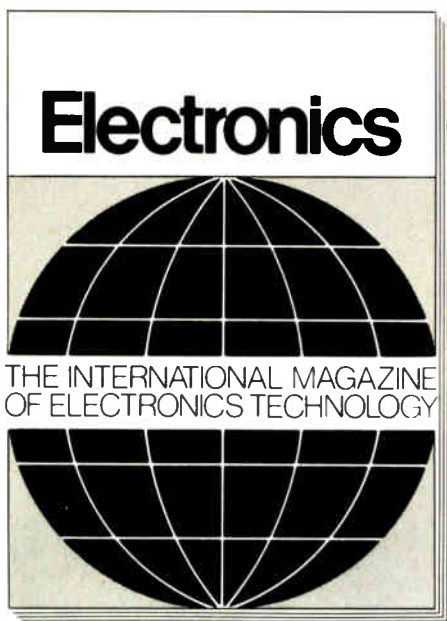

## Advertising Sales Staff

**Advertising sales manager:** Paul W. Reiss  
1221 Avenue of the Americas, New York, N.Y. 10020  
[212] 997-4371

**Atlanta, Ga. 30306:** Glen N. Dougherty  
100 Colony Square, 1175 Peachtree St., N.E.  
[404] 892-2868

**Boston, Mass. 02118:** Frank Mitchell  
607 Boylston St.  
[617] 262-1160

**Chicago, Ill. 60611**  
645 North Michigan Avenue  
Robert W. Bartlett [312] 751-3739  
Robert M. Denmead [312] 751-3738

**Cleveland, Ohio 44113:** William J. Boyle  
[716] 586-5040

**Dallas, Texas 75201:** John J. Uphues  
2001 Bryant Tower, Suite 1070  
[214] 742-1747

**Denver, Colo. 80203:** Harry B. Doyle, Jr.  
123 Speer Blvd. #400  
[303] 837-1010

**Detroit, Michigan 48202:** Robert W. Bartlett  
1400 Fisher Bldg.  
[313] 873-7410

**Houston, Texas 77002:** John J. Uphues  
601 Jefferson Street, Dresser Tower  
[713] 659-8381

**Los Angeles, Calif. 90010:** Robert J. Rielly  
Bradley K. Jones, 3200 Wilshire Blvd., South Tower  
[213] 487-1160

**Minneapolis, Minn. 55435:** Robert M. Denmead  
4015 W. 65th St.  
[312] 751-3738

**New York, N.Y. 10020**  
1221 Avenue of the Americas  
Michael J. Stoller [212] 997-3616  
Matthew T. Reseska [212] 997-3617

**Philadelphia, Pa. 19102:** Matthew T. Reseska  
Three Parkway  
[212] 997-3617

**Pittsburgh, Pa. 15222:** Matthew T. Reseska  
4 Gateway Center  
[212] 997-3617

**Rochester, N.Y. 14534:** William J. Boyle  
1175 Pittsford-Victor Rd., Pittsford, N.Y.  
[716] 586-5040

**San Francisco, Calif. 94111:** Don Harris  
Robert J. Rielly, 425 Battery Street,  
[415] 362-4600

**Paris:** Patrick Mouillard  
17 Rue-Georges Bizet, 75116 Paris, France  
Tel: 720-73-01

**Geneva:**  
1 rue du Temple, Geneva, Switzerland  
Tel: 32-35-63

**United Kingdom & Scandinavia:** Robert Ghey  
34 Dover Street, London W1  
Tel: 01-493-1451

**Scandinavia:** Andrew Karnig and Assoc.  
Kungsholmsgatan 10  
112 27 Stockholm, Sweden  
Tel: 08 51 68 70 Telex: 179 51

**Milan:** Luigi Rancati  
1 via Baracchini, Italy  
Phone 86-90-656

**Brussels:**  
23 Chaussee de Wavre  
Brussels 1040, Belgium  
Tel: 13-73-95

**Frankfurt/Main:** Fritz Krusebecker  
Liebigstrasse 27c, Germany  
Phone 72 01 81

**Tokyo:** Tatsumi Katagiri, McGraw-Hill  
Publications Overseas Corporation,  
Kasumigaseki Building 2-5, 3-chome,  
Kasumigaseki, Chiyoda-Ku, Tokyo, Japan  
[581] 9811

## Business Department

**Thomas M. Egan**  
Production Manager [212] 997-3140

**Carol Gallagher**  
Production Manager International  
[212] 997-2045

**Betty Preis**  
Production Manager Domestic  
[212] 997-2908

**Roberta Cummings**  
Production Assistant [212] 997-2044

**Frances Vallone**  
Reader Service Manager  
[212] 997-6057

## Electronics Buyers' Guide

**H.T. Howland**, General Manager  
[212] 997-6642

**Regina Hera**, Directory Manager  
[212] 997-2544

**Roberta Cummings** Production Manager  
[212] 997-2044

**Frances Vallone**, Reader Service Manager  
[212] 997-6057

## Classified and Employment Advertising

**Frank Eberle**, Manager  
[212] 997-2557



## A Breakthrough in Pressure Transducer Design

The highest performance requirements of a transducer can be met economically and efficiently with the use of the CEC® 1000 Sputtered Gage Pressure Transducer, the most consistently accurate, stable and reliable thin film transducer available. Obtainable in full scale pressure ranges from 15 to 10,000 psi, the CEC® 1000 also features an innovative double case isolation which insures against externally induced mounting stresses.

Manufactured in accordance with the program quality requirements of MIL-Q-9858A,

the CEC® 1000 provides combined linearity, hysteresis and non-repeatability of  $\pm 0.25\%$  of the full scale output. Advanced techniques in sputtered film deposition have created sensing elements which deliver performance stability of  $\pm 0.1\%$ , or better, for extended operation under the most severe environmental conditions.

The CEC® 1000 is capable of Total Error-Band Performance and long-term stability — far exceeding the performance of "average" transducers. Tell us your operational

parameters of your application. You may be surprised to hear of the Total Error-Band Performance attainable with the CEC® 1000.

 **BELL & HOWELL**  
**CEC DIVISION**

360 SIERRA MADRE VILLA  
PASADENA, CALIFORNIA 91109

CEC is a registered trademark of Bell & Howell

© Bell & Howell 1975

Circle 213 on reader service card

## Converting Force to mV's? That Takes an Interface...



...Interface, Inc., designer and builder of a full line of precision strain gage load cells for force measurement and test systems. This low range Minibeam cell offers a guaranteed error band of less than  $\pm 0.04\%$ , is thermally compensated to within 3 ppm/°F, yet is priced as low as \$160 in unit quantities. Like all Interface load cells, it's warranted for 2 years.

For specifications on 5 to 150 pound capacity Minibeams that operate in tension or compression—for details on load cells with capacities to 100 tons, contact Interface, Inc., 7401 E. Butherus Dr., Scottsdale, AZ 85260 USA. (602) 948-5555. Telex 668-394.



Low Profile



Sealed Super-Mini



Super-Mini

**interface**

ADVANCED FORCE MEASUREMENT

Circle 244 on reader service card

## 50 Million operations

With TTL loads,  
our new reed  
relay offers  
maximum contact  
resistance of 0.12 ohms,  
after more than  
50 million  
operations.  
And a contact  
resistance delta

of 0.01 ohms,  
maximum.  
Sticking and  
missed operations are es-  
sentially elim-  
inated.

Call or write for  
information  
on the RX-1.

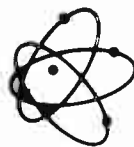

**EAC** Electronic  
Applications  
Company

4918 Santa Anita Ave., El Monte, CA 91734  
213/442-3212 TWX 910/587-3351

Circle 245 on reader service card 213

# DATELINE: MUNICH, LONDON, TOKYO, PARIS, MILAN, BUDAPEST, MELBOURNE, TEL AVIV, MOSCOW, BERNE, WARSAW, HONG KONG, OSLO, SAO PAULO, FRANKFURT, PRAGUE ...

Technological developments have never been contained by national boundaries. This is particularly true in electronics. To know what's going on in your profession, you have to know what's going on around the world.

Our editors are stationed around the world. Their assignment is international coverage of the electronics

technology—coverage you cannot get anywhere else.

In 1976, 38 per cent of the information contained in our editorial pages originated outside the U.S. We publish the only International Edition in the field. It is read by over 20,000 subscribers in 120 countries outside North America.

The U.S. one-year subscription price is 14 dollars. That's a bargain in any language. Please turn to the subscription card at the back of this magazine.



# DEPENDABLE

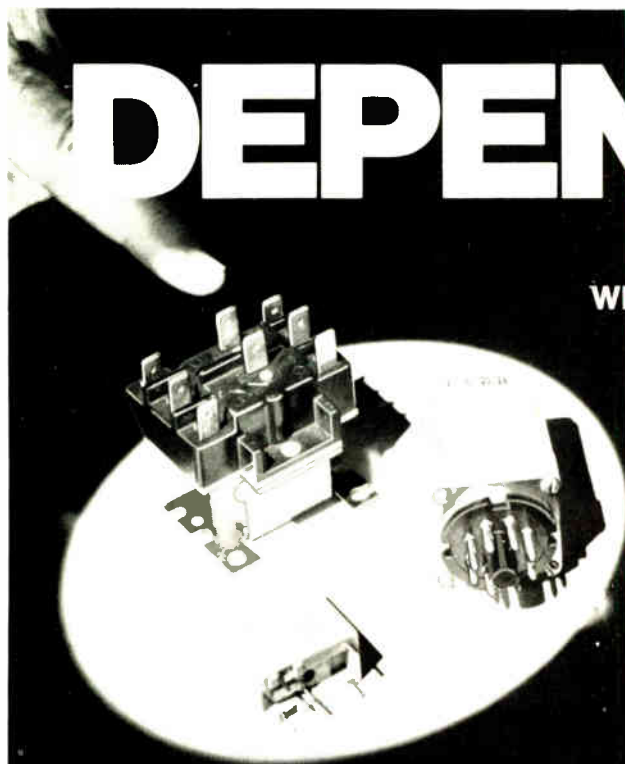

**Whether you're looking for a sensitive miniature D.C. relay or a versatile A.C. power contactor, rely on Essex/Stancor.**

Our relays and contactors are dependable! At Essex, we engineer for performance and doublecheck for quality. That's why you control it better when you control it with Essex. Essex/Stancor products are available off-the-shelf from electronic distributors everywhere. For more information, see your local distributor or write us for our free catalog:

**Essex/Stancor,**  
3501 W. Addison St.,  
Chicago, IL 60618, 313 / 643-7400.

**ESSEX GROUP**  Subsidiary of  
**UNITED TECHNOLOGIES.**

Now from Centralab . . .  
Pioneers in Thick Film  
Technology . . .

# LOW COST CERBON™ NETWORKS

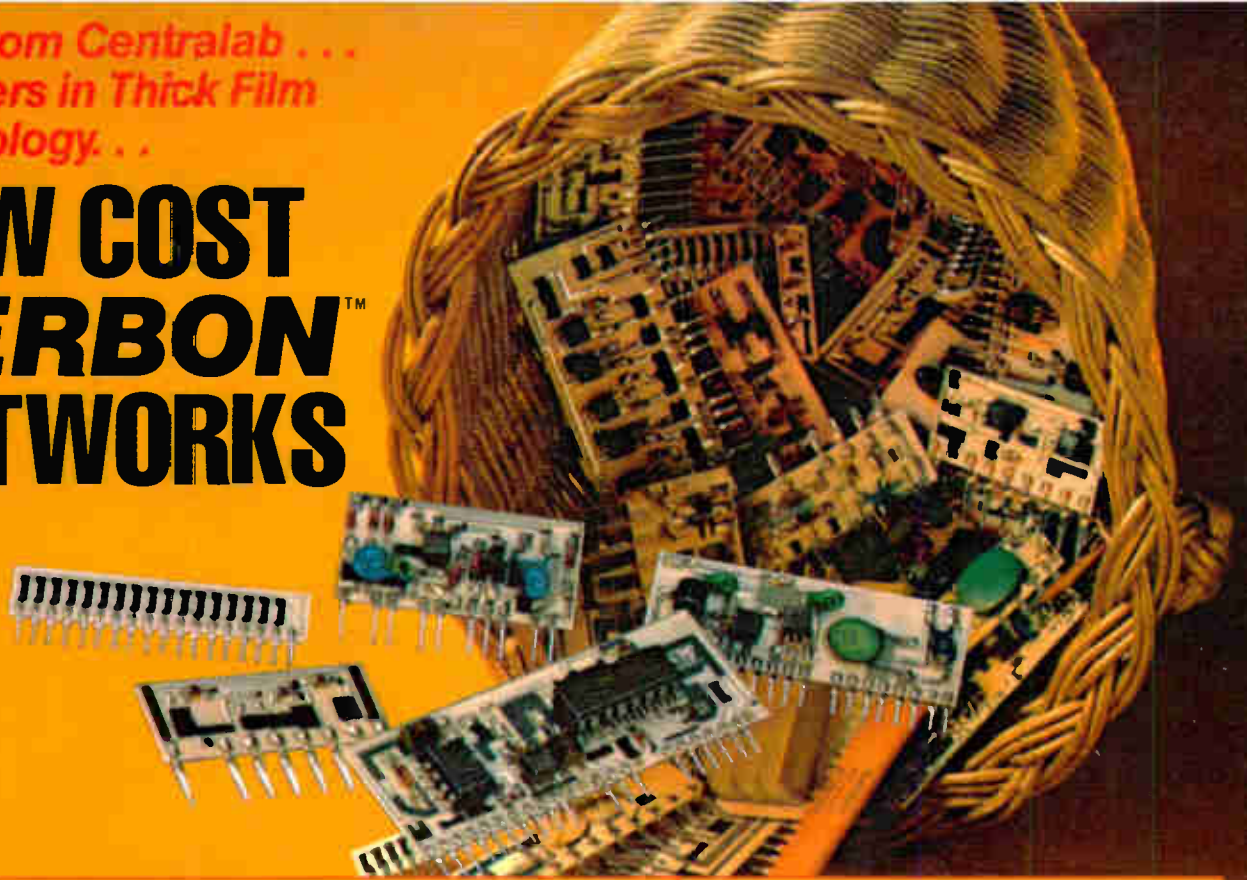

## Networks Save Money

Networks are in big-volume demand for one simple reason. Compared with discretely, they save. They save on assembly costs. They save PC board space. They save on inventory. They save on inspection and testing. They save on ratio matching. And they can save installation errors.

Centralab knows networks. We pioneered thick film networks back in 1945. Since then we've produced millions. In fact, we've delivered more than 200,000,000 units.

## Now, Save More With CERBON™

Centralab SIP thick film networks are now available with **CERBON™** — Centralab's patented resistor system. **CERBON** costs substantially less than cermet, yet it is measurably superior to carbon composition in critical areas. See chart below for some typical performance comparisons.

### Compare CERBON Resistors With Carbon Discretely

Typical 1/4 Watt Resistors

Measurement	Centralab <b>CERBON</b>	Carbon Composition (MIL-R-11F)
TCR (ppm/°C)	-250 @ -55°C -350 @ +105°C	±800 @ -55°C ±625 @ +105°C
Quantec Noise (0 db = 1μv/v)	-7 db max	0 to +10 db (not specified in MIL-R-11F)
Short Term Overload (%ΔR max.)	+0.1	±2.5

## Give a Little — Get a Lot!

If you've wanted to use networks to enjoy their many benefits, but couldn't justify the cost, consider this: **CERBON** meets or exceeds the performance requirements of over 85% of all resistor applications. So, if you can give a little on the precise tolerances of cermet — which you may not need — **CERBON** networks from Centralab can get you all the cost-saving benefits of networks — at a price you can afford.

## For More Information:

Whether your needs are for standard off-the-shelf SIP resistor or resistor/capacitor networks, or for custom hybrid designs, we will show you how you can save with **CERBON**. Talk to your Centralab Representative, or call (414) 228-2874, Centralab Circuit Product Sales.

*Products you need  
from people who care.*



**CENTRALAB**

ELECTRONIC DIVISION  
GLOBE-UNION INC.

5757 North Green Bay Avenue  
Milwaukee, Wisconsin 53201

Ceramic Capacitors • Filters • **Thick Film Circuits** • Switches • Potentiometers • Trimmer Resistors

Circle 901 on reader service card

# Another Colorful Innovation...

## Conductive Plastic Trimmers at Carbon Prices.

Just when you thought "low cost" also meant "low performance" along comes the dazzling new Bourns® Model 3355. Compare it to the CTS 201, Mepeco 46X or Piher PT15. Our revolutionary conductive plastic element vs. their carbon fact is we outperform them all. To prove it, we spec important characteristics such as CRV at 1% and a TC of 500 PPM/°C... the others don't. And only the 3355 has board-wash capability, a UL-94V-1 flammability rating and an optional choice of nine rotor colors. The standard blue is priced at just 11¢ each (100,000 pieces)... about what you'd expect to pay for the lower performance carbon types.

Send today for complete details on a colorful new way to design in superior performance for your cost effective needs — the Model 3355 Trimmer. Direct or through your local distributor.

TRIMPOT PRODUCTS DIVISION, BOURNS, INC., 1200 Columbia Ave., Riverside, CA 92507. Phone: 714 781-5050 — TWX: 910 332-1252.

### CATALOG SHEET SPECIFICATION COMPARISONS

CHARACTERISTIC	BOURNS 3355	CTS 201*	MEPCO 46X*	PIHER PT15*
Element	Conductive Plastic	Carbon	Carbon	Carbon
Temperature Coefficient	500 PPM/°C	No Spec	No Spec	1000 PPM/°C
Contact Resistance Variation	1.0% max.	No Spec	No Spec	No Spec
Power Rating	.25 W at 70°C	.25 W at 55°C	.25 W at 55°C	.25 W at 40°C
Flammability	UL-94V-1	No Spec	No Spec	UL-94
Board Wash Capability	Yes	No Spec	No Spec	No Spec

\*Source: CTS Series 201 Data Sheet, Mepeco Data Sheet ME1004, Piher Data Sheet F-2002 Rev 7/73



International Marketing Affiliates: European Headquarters — Switzerland 042/23 22 42 • Belgium 02/218 2005 • France 01/2039633 • Germany 0711/24 29 36 • Italy 02/32 56 88 • Netherlands 70/87 44 00 • United Kingdom 01/572 6531 • Norway 2/71 18 72 • Sweden 764/20 110 • Japan 075/921 9111 • Australia 02/55-0411 03/95-9566 • Israel 77 71 15/6/7

For Immediate Application — Circle 120  
For Future Application — Circle 220