

AUGUST 18, 1977

CAN SEMICONDUCTOR FIRMS STICK IT OUT IN DIGITAL WATCHES?/74

Memory-rich minicomputers close in on mainframes/69

Special report: the new generation of large-scale-integrated devices/91

97232

1970 N1231 CARAD NOV 77
MATT NEILL
2516 NE CLACKAMAS
PORTLAND OR

FOUR DOLLARS A MCGRAW-HILL PUBLICATION

Electronics®

**SQUEEZING MORE
PERFORMANCE OUT OF
TECHNOLOGY**

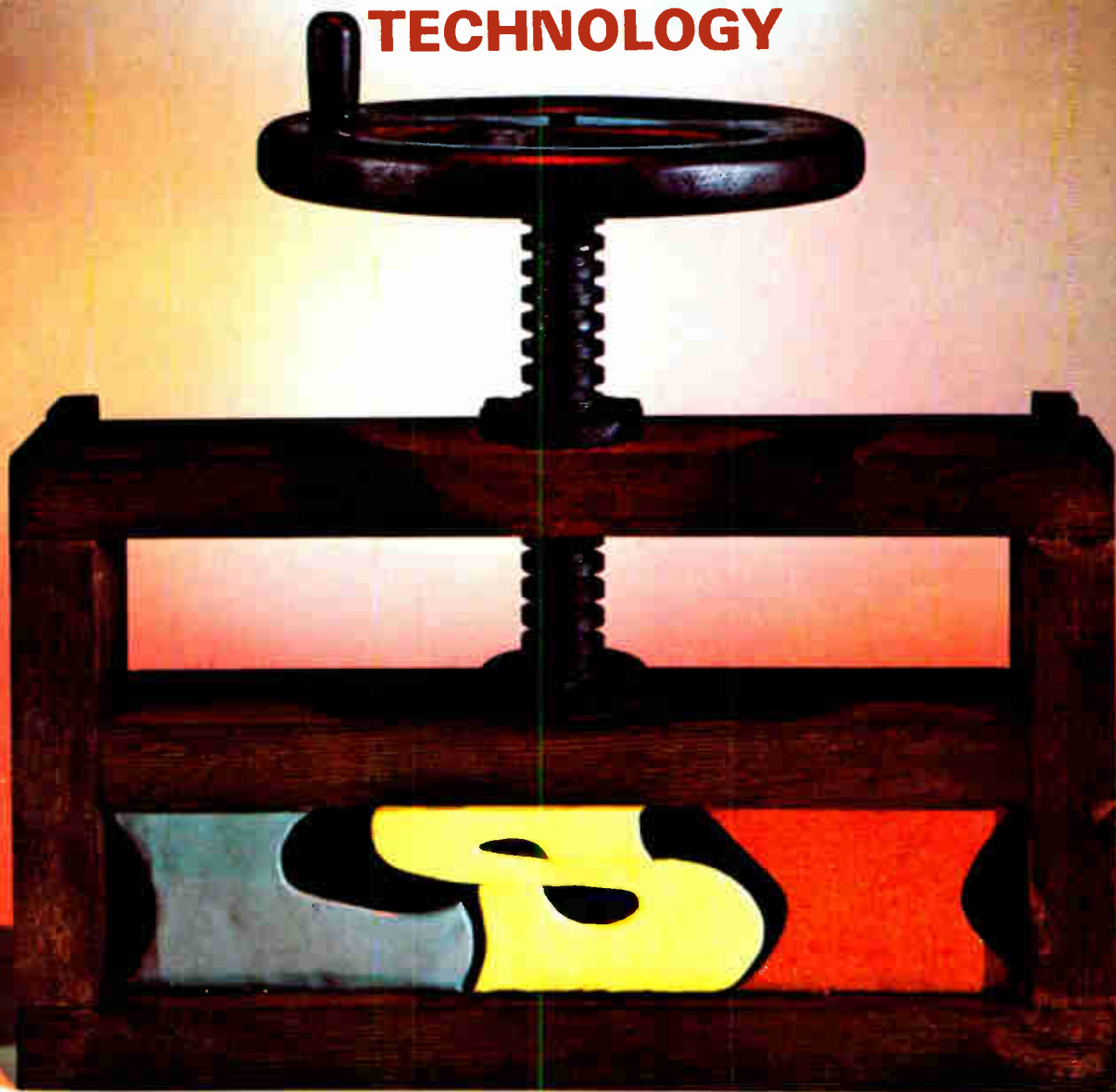

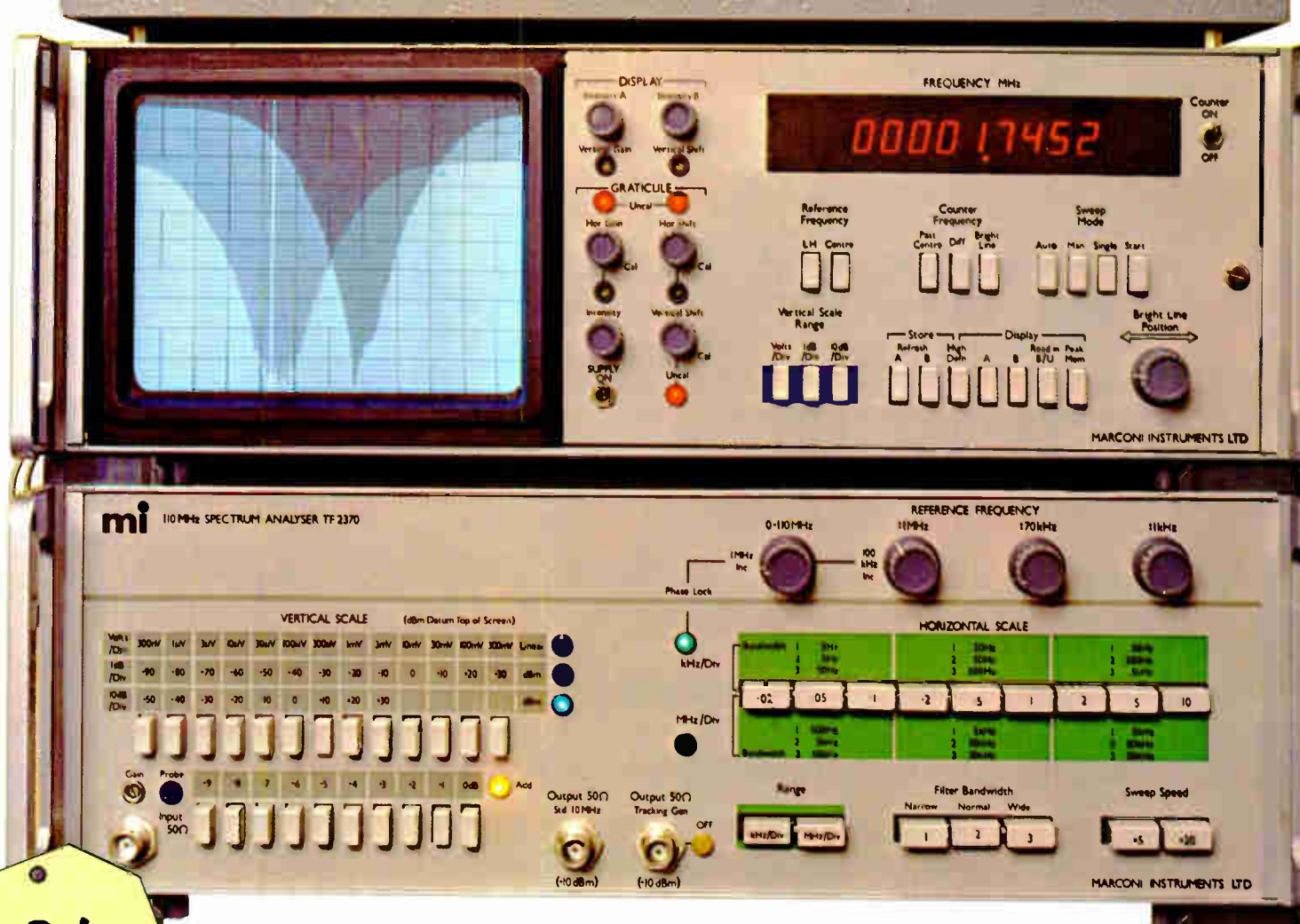

Price Reduced
 U. S. Price Only
\$13,795

We've always had unique features and better specs than our competition... now, in addition, OUR price is LOWER!

Save your skilled engineers for more important work with **mi** Model 2370 Spectrum Analyzer. Simplify complicated measurements such as *response, level, gain, signal purity, modulation* and many more. Forget everything you have heard about: spectrum analyzers. **mi** Model 2370 is unique. It employs advanced technology to make it as easy to operate as a multimeter. The facts speak for themselves.

- Flicker-free high brightness TV display (No more storage tubes to replace)
- Electronic graticule can pin point position of waveform display for rapid analysis and measurement.
- Choice of vertical scales: linear, 10dB/div for 100dB display, and 1dB/div for 0.1dB resolving power.
- Counter **automatically** displays center frequency, identifies the frequency corresponding to the manually

adjusted 'bright line cursor', or the difference frequency between the two. All to an accuracy of 2Hz.

- Integral synchronous signal source for measuring *networks, filters, amplifiers*, etc.
- For comparative measurements, memory storage can retain one display indefinitely, for simultaneous display with waveform from items under test.
- **Automatic** adjustment of amplifier gain to *optimize* noise performance.
- **Automatic** selection of *optimum* sweep speed.
- With the 5Hz filter, signals 100Hz from a response at 0dB can be measured to better than -70dB.

Such speed and accuracy must be seen to be believed, call us for an enlightening demonstration.

Circle 900 on reader service card **mi MARCONI INSTRUMENTS**
DIVISION OF MARCONI ELECTRONICS INC.

Behind all these pretty faces...

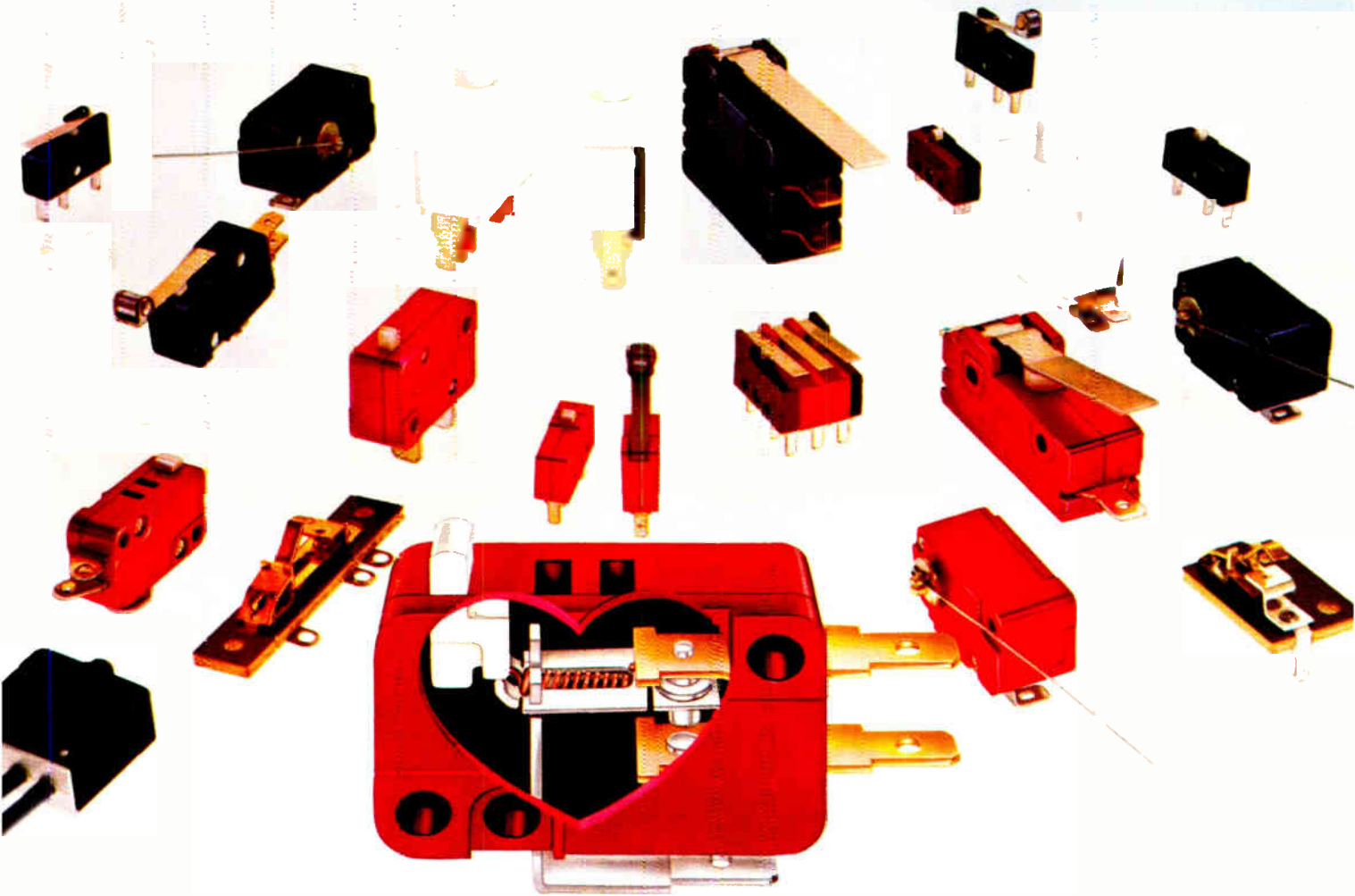

beats a heart of coiled stainless steel.

No Cherry snap-action switch has ever died of a broken heart. Because there's a coil spring at the heart of every Cherry switch that expands and contracts again and again and never gets tired. Or breaks. Compare *that* to the stamped spring many switch builders use. The kind of spring that gets tired . . . and breaks. (Snap. Drat!)

This stainless steel coil spring mechanism not only insures long life, it provides large overtravel to make our switches quicker, easier to design-in and to install. Which is why more than 300 million of them have been designed-

in and installed. So far.

Cherry snap-action switches are available in gold crosspoint design for low energy switching. In general purpose, miniature and subminiature designs. In low torque. Light force. Open or enclosed. Panel mount pushbutton. And more.

For free catalog of all the Cherry switches, just circle the reader service number below. If you're in a hurry, our direct line number is 312/689-7702 . . . and we'll throw in a switch sample of your choice.



CHERRY ELECTRICAL PRODUCTS CORP.
3608 Sunset Avenue, Waukegan, Illinois 60085

SWITCHES and KEYBOARDS – Available locally from authorized distributors.

Electronics/August 18, 1977

Circle 1 on reader service card 1

From the people who brought you IDIOM* United States Instrument Rentals introduces...

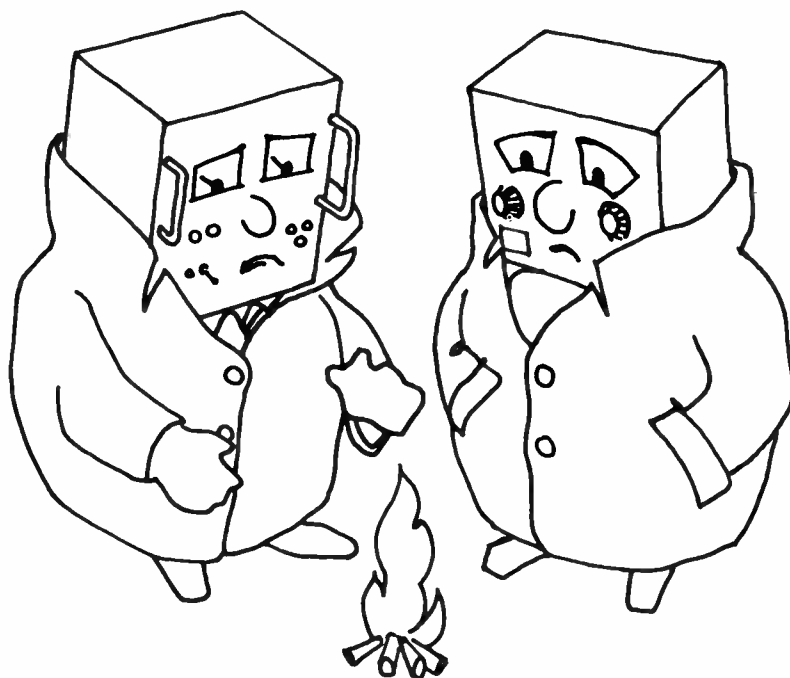

*Inventory Delivery Information in One Minute.

Unemployment Insurance (FOR TEST INSTRUMENTS)

Does it break your heart to see your test instruments just standing around idle while you're kept busy paying for them? Look around on your shelves . . . Are your test instruments not working to their full capacity because you don't need them all the time?

Well, U.S. Instrument Rentals believes that you shouldn't have to worry about paying *or* caring for instruments that are not working for you all the time. USIR feels that your valuable capital should be spent for equipment that can be employed all the time.

So, U.S. Instrument Rentals offers you Unemployment Insurance.

Unemployment Insurance means that by renting your test instruments from USIR only when you need them, you're protected against paying for idle equipment. You pay for our instruments *only* when they are working full-time for you. And when the job

is finished, you simply return the equipment to USIR until you need it again.

In addition, by renting from USIR, you're protected against those expensive calibration, maintenance and repair cost worries. We take care of all our instruments' needs.

And to insure that you get the equipment you need, USIR has thousands and thousands of instruments that are seeking gainful employment, giving you a better chance of finding the instrument that is just right for your needs.

So for a list of instruments you might like to employ and suggestions for solving your test equipment unemployment problems, send for our Unemployment Insurance Booklet . . . The USIR Rental Catalog. It's your best guide to full employment for test instruments.



Headquarters 951 Industrial Road San Carlos, CA 94070 (415) 592-9225



41 Electronics Review

INSTRUMENTS: Navy develops new calibration system, 41
AUTOMOTIVE: Motorola garners potentially huge Ford contract, 42
PERSONAL COMPUTERS: Radio Shack offers \$600 computer, 43
MEMORY: Fujitsu makes splash with 50-megabyte cartridge, 44
MILITARY: Army to get tactical satellite links, 46
SOLID STATE: National lowers bi-FET op amp offsets, 48
PACKAGING & PRODUCTION: Rigid assembly takes cannon launch, 50
NEWS BRIEFS: 52
MICROPROCESSORS: AMD adds more punch to its bit-slice family, 52

63 Electronics International

WEST GERMANY: Electronic navigator gives highway data, 65
FRANCE: Infrared detector aims at slashing costs, 66
JAPAN: Switching circuit makes TV whites whiter, 66

69 Probing the News

COMPUTERS: Memory-rich minis get aggressive, 69
CONSUMER: Games no longer need TV, 71
LCD startup problems bedevil watch manufacturers, 74
CAREERS: Boston program trains women, 76
ABROAD: Romania sails on through sea of Slavs, 81

91 Technical Articles

SPECIAL REPORT: Technologies squeeze more speed from LSI, 91
H-MOS scales traditional devices to higher performance level, 94
Grooves add dimension to V-MOS structure and performance, 100
Injection logic boosts bipolar performance while dropping cost, 107
DESIGNER'S CASEBOOK: Switch array includes priority encoder, 114
Ring counter synthesizes sinusoidal waveforms, 115
Darlington-switched relays link car and trailer signal lights, 116
COMPONENTS: Don't overlook resistor self-heating, 117
ENGINEER'S NOTEBOOK: 2 of 16 LEDs display 8-bit binary word, 120
Design checklist aids pc-board designers, 121

135 New Products

IN THE SPOTLIGHT: Spectrum analyzer eases operator's job, 135
Processors offer mainframe speeds, 138
COMPONENTS: Solid-state relays protected against transients, 140
DATA HANDLING: Cards link data and bus, 148
PACKAGING & PRODUCTION: Testers check out variety of boards, 162
MICROWAVE: Wideband mixer offers low conversion loss, 172
MATERIALS: Red phosphorus has cylindrical shape, 182

Departments

Publisher's letter, 4
Readers' comments, 6
News update, 8
Editorial, 12
People, 14
Meetings, 30
Electronics newsletter, 35
Washington newsletter, 59
Washington commentary, 60
International newsletter, 63
Engineer's newsletter, 124
New literature, 194
New books, 204

Services

Reprints available, 204
Employment opportunities, 208
Reader service card, 219

Highlights

Cover: New processes get more out of LSI, 91

Two metal-oxide-semiconductor processes and a bipolar technology promise a new generation of very large-scale-integrated chips. As the first devices made with them enter the marketplace, this special report analyzes the technologies.

■ The overview assesses these three approaches and two others: planar D-MOS and complementary-MOS on sapphire.

■ Following on page 94 is a review of the way H-MOS scales down the conventional n-channel silicon-gate structure to achieve higher performance levels.

■ Page 100 is the start of an explanation on how V grooves add a vertical dimension for denser MOS structures and improved MOS performance.

■ Beginning on page 107 is an examination of a bipolar Isoplanar injection-logic memory and a comparison of its performance with the most nearly equivalent MOS family.

The cover is by Tom and Ann Dalton.

LCDs strain some digital-watch makers, 74

A market shakeout could well be coming among the U. S. semiconductor firms manufacturing solid-state watches. The reason: introducing liquid-crystal-display watches during a profit squeeze on their light-emitting-diode models poses technical and financial problems for the companies.

And in the next issue . . .

A special report on components for analog data conversion . . . how to produce two pictures simultaneously on one television screen . . . inside a bipolar 16-bit micro-controller.

EDITOR-IN-CHIEF: Kemp Anderson

EXECUTIVE EDITOR: Samuel Weber

MANAGING EDITOR: Arthur Erikson,
International

SENIOR EDITORS: Laurence Altman,
Ray Connolly, Lawrence Curran,
John Johnsrud, H. Thomas Maguire,
Stephen E. Scrupski, Gerald M. Walker

ART DIRECTOR: Fred Sklenar

ASSOCIATE EDITORS: Howard Wolff,
Alfred Rosenblatt

DEPARTMENT EDITORS
Aerospace/Military: Ray Connolly
Circuit Design: Vincent Biancomano
Communications & Microwave:
Richard Gundlach
Components: Lucinda Mattera
Computers: Raymond P. Capece
Consumer: Gerald M. Walker
Instrumentation: Stephen E. Scrupski
New Products: H. Thomas Maguire,
Michael J. Riezenman
Packaging & Production: Jerry Lyman
Solid State: Laurence Altman

CHIEF COPY EDITOR: Margaret Eastman

COPY EDITORS: Ben Mason, Mike Robinson

ART: Charles D. Ciatto, *Associate Director*
Paula Piazza, *Assistant Director*

EDITORIAL SECRETARIES: Janet Noto,
Penny Rothman

EDITORIAL ASSISTANT: Marilyn B. Rosoff

FIELD EDITORS

Boston: Lawrence Curran (Mgr.), Pamela I even
Los Angeles: Larry Waller (Mgr.)
Midwest: Larry Armstrong (Mgr.)
New York: Bruce LeBoss (Mgr.)
San Francisco: Bernard Cole (Mgr.)
Judith Curtis
Washington: Ray Connolly (Mgr.)
Frankfurt: John Gosch
London: William F. Arnold
Paris: Arthur Erikson
Tokyo: Charles Cohen

McGraw-Hill WORLD NEWS

Editor: Michael Johnson
Brussels: James Smith
Milan: Andrew Heath
Moscow: Peter Hann
Paris: Andrew Lloyd
Stockholm: Robert Skole
Tokyo: Robert E. Lee

PUBLISHER: Dan McMillan

ADVERTISING SALES MANAGER:

Paul W. Reiss

MARKETING ADMINISTRATION MANAGER:

Wallis Clarke

CIRCULATION MANAGER: Karl Peterson

MARKETING SERVICES MANAGER:

Tomlinson Howland

RESEARCH MANAGER: Margery D. Sholes

In the never-ending parade of new chips, some stand out because they mark the commercial debuts of new semiconductor technologies. Three recent introductions of families of fast 1,024- and 4,096-bit random-access memories are just such events. They mark the availability of new metal-oxide-semiconductor and bipolar processes that boost the performance and capability of large-scale-integrated devices.

The three technologies are high-performance MOS, three-dimensional V-groove MOS, and bipolar Isoplanar injection logic. Solid State Editor Larry Altman was intrigued by discussions of these new processes at last winter's International Solid State Circuits Conference. The fruit of his interest is this issue's special report on LSI, which includes articles on H-MOS, V-MOS, and I³L.

In his overview (p. 91), Larry says that the three new processes, along with double-diffused MOS and complementary MOS on sapphire, will lead to very large-scale-integrated circuits of every kind. Each has its strengths and weaknesses, and Larry assesses them on those attributes.

Right now, the focus is on RAMs, where a battle is shaping up for the high-performance cache and buffer memory territory pretty much occupied by bipolar devices. Intel Corp.'s H-MOS static RAM and American Microsystems Inc.'s V-MOS static RAM bring MOS cost advantages into the fray. But Fairchild Camera and Instrument Corp.'s I³L dynamic RAM is a strong opponent, since it hikes bipolar performance while dropping costs to near MOS levels.

At Intel, scaling proved to be the key to obtaining bipolar speed with MOS technology. Starting on page

94, Richard Pashley and five members of his project team review scaling in general and H-MOS in particular. Since scaling theory was already known, the group concentrated on practical applications and related process technology. The 2115 1-k static RAM was a test bed to evaluate performance and evolved into the 2115A high-speed part. The 2147 4-k static RAM was the first H-MOS device developed from scratch.

In late 1976, AMI opted for its radically different V-groove technology. Spearheading the design effort were Fred Jenné, whose dissection of the process and cell structure begins on page 100, and T. J. Rodgers. The group demonstrated V-MOS scaling and built the 1-k and 4-k fast RAMs and a 16,384-bit read-only memory. "The technology can be scaled down in size and thus will be around for quite a while," says Jenné. "It's a dense means of implementing functions, the densest I know of."

The bipolar dynamic cell is central to Fairchild's I³L RAMs, and Wendell Sander, lead author of the rundown on the 4-k dynamic devices that begins on page 107, is inventor of the basic concept of that cell. Working under coauthors James Early, division vice president and director of research and development, and Thomas Longo, vice president and chief technological officer, Sander led a team that developed the 4-k RAM, as well as a forthcoming 16-k part that is pin-for-pin-compatible. Now they are working on a fully compatible 65,536-bit RAM.

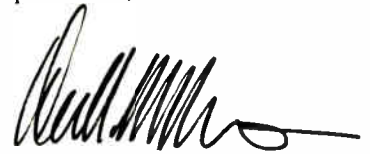

August 18, 1977 Volume 50, Number 17 95,651 copies of this issue printed

Published every other Thursday by McGraw-Hill, Inc. Founder: James H. McGraw 1860-1948. Publication office 1221 Avenue of the Americas, New York, N.Y. 10020. Telephone (212) 997-1221. Teletype 12-7950 TWX 710-581-4879. Cable address: MCGRAW HILL NEW YORK.

Executive, editorial, circulation and advertising addresses: Electronics, McGraw-Hill Building, 1221 Avenue of the Americas, New York, N.Y. 10020. Telephone (212) 997-1221. Teletype 12-7950 TWX 710-581-4879. Cable address: MCGRAW HILL NEW YORK.

Subscriptions limited to professional persons with active responsibility in electronics technology. No subscriptions accepted without complete identification of subscriber name, title or job function, company or organization, and product manufactured or services performed. Based on information supplied, the publisher reserves the right to reject non-qualified requests. Subscription rates: in the United States and possessions \$14.00 one year, \$35.00 three years; company addressed and company libraries \$20.00 one year, \$50.00 three years; APO/FPO addressed \$35.00 one year only; Canada and Mexico \$16.00 one year, \$40.00 three years; Europe \$40.00 one year, \$100.00 three years; Japan, Israel and Brazil \$65.00 one year, \$165 three years; Australia and New Zealand \$90.00 one year, \$240 three years, including air freight; all other countries \$45.00 one year, \$112.00 three years. Limited quota of subscriptions available at higher-than-basic rate for persons allied to field served. Check with publisher for these rates. Single copies: \$4.00. Please allow four to eight weeks for shipment.

Officers of McGraw-Hill Publications Company: Gordon L. Jones, President; Paul F. McPherson, Executive Vice-President; Group Vice-President Gene W. Simpson; Senior Vice-Presidents: Russell F. Anderson; David G. Jensen, Manufacturing; Ralph R. Schulz, Editorial; Vice-Presidents: Denis C. Beran, European Operations; James E. Boddort, Planning & Development; David P. Forsyth, Research; Douglas Greenwald, Economics; James E. Hackett, Controller; Robert L. Leyburn, Circulation; Edward E. Schirmer, Sales.

Officers of the Corporation: Harold W. McGraw, Jr., President, Chief Executive Officer, and Chairman of the Board; Robert N. Landes, Senior Vice President and Secretary; Ralph J. Webb, Treasurer.

Title registered in U.S. Patent Office; Copyright © 1977 by McGraw-Hill, Inc. All rights reserved. The contents of this publication may not be reproduced in whole or in part without the consent of copyright owner.

Subscribers: The publisher, upon written request to our New York office from any subscriber, agrees to refund that part of the subscription price applying to copies not yet mailed. Please send change-of-address notices or complaints to Fulfillment Manager; subscription orders to Circulation Manager, Electronics, at address below. Change-of-address notices should provide old as well as new address, including postal zip code number. If possible, attach address label from recent issue. Allow one month for change to become effective.

Postmaster: Please send form 3579 to Fulfillment Manager, Electronics, P.O. Box 430, Hightstown, N.J. 08520.



AT \$795.00 EVERYONE CAN HAVE HIS OWN NEW PHASEMETER

Krohn-Hite's new Model 6200 has the specs to meet many of your phase measuring applications at about 1/2 the cost of any other digital phasemeter (specs like 0.5° accuracy, ±180.0° continuous display, sine or square waveforms from 10 Hz to 1 MHz and input voltages from 0.1V to 120V rms.)

Think of all the circuit design, equipment calibration and component inspection areas where a low cost, easy-to-use digital phasemeter would pay for itself practically overnight!

Call or write today, at this price you can afford to put a 6200 to work for you.

**KH KROHN-HITE
CORPORATION**

Avon Industrial Park, Avon, Mass 02322 • (617) 580-1660

SALES OFFICES: ALA., Huntsville (205) 534-9771; ARIZ., Scottsdale (602) 994-5461; CAL., San Jose (408) 292-3220; Iriglewood (213) 674-6850; COL., Denver (303) 773-1218; CONN., W. Hartford (203) 525-7647; FLA., Orlando (305) 994-4401; GA., Atlanta (404) 451-1206; HAWAII, Honolulu (808) 941-1574; ILL., Arlington Hts. (312) 394-3380; IND., Ft. Wayne (219) 485-0845; KS., Overland Park (913) 384-2711; LA., Lafayette (318) 984-3516; MD., Baltimore (301) 321-1411; MASS., Wakefield (617) 245-5940; MI., Southfield (313) 569-4497; MINN., St. Paul (612) 645-5816; MO., St. Louis (314) 731-5400; N.M., Albuquerque (505) 251-2330; N.J., Cherry Hill (609) 482-0059; N.Y., Elmont (516) 488-2100, Rochester (716) 328-2230, Syracuse (315) 437-6646, Vestal (607) 785-9947; N.C., Burlington (919) 227-3539; OHIO, Chesterland (216) 721-2222, Dayton (513) 434-8993; OKLA., Tulsa (918) 299-2636; ORE., Portland (503) 297-2248; TEX., Dallas (214) 661-0410, Houston (713) 688-1431; VA., Falls Church (703) 573-8787; WA., Bellevue (206) 454-3400; CANADA, Montreal, Quebec (514) 341-7630, Ottawa, Ontario (613) 235-5121, Toronto, Ontario (416) 445-9900, Vancouver, British Columbia (604) 253-5555, Halifax, Nova Scotia (402) 454-8321, St. John's, Newfoundland (709) 726-2422.

Before you buy another filter, consider our moveable passband.

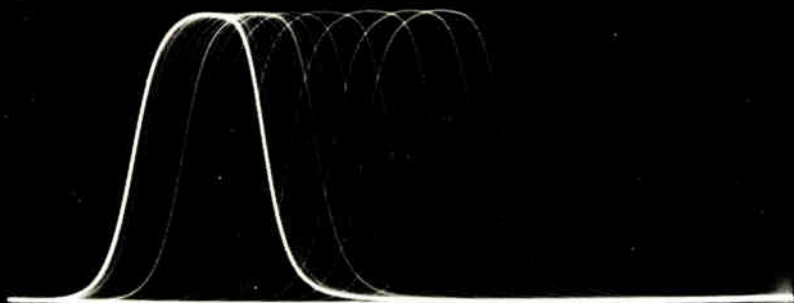

Our tunable bandpass filters provide two big benefits for anyone working in RF and microwave up to 4 GHz.

First, just one of our tunables replaces a whole drawer full of fixed bandpass filters. Less costly, more convenient, faster test set-ups.

Secondly, our tunables are calibrated directly—you get the center frequency you see on the dial—no interpolation or charts needed.

With over 50 standard versions in stock, we can supply a unit for frequencies as low as 48 MHz all the way up to 4 GHz. Each one covers a full octave, and comes with 3% or 5% 3 dB bandwidths. We even stock special purpose units for the

military band (210-420 MHz) and many telemetry bands (210-2310 MHz). And if one of those standards doesn't meet your needs, we'll be glad to quote on special designs for any lab or OEM situation.

Our new Filter Catalog gives complete data on all Telonic Tunable Filters as well as other

types we produce—tubulars, cavity, interdigital, comb-line—all the way to 12 GHz. If you wish a copy, write on your letterhead. If you need immediate information, call us

TOLL FREE (except CA) at 800-854-2436.

Telonic Altair, 2825 Laguna Canyon Road, Box 277, Laguna Beach, CA 92652, 714/494-9401 TWX 910-596-1320 Cable: TELENG Toll Free: (800) 854-2436

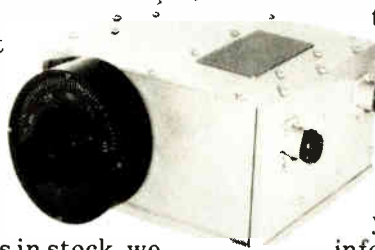

TelonicAltair 

Readers' comments

Inadvertently tuned out

To the Editor: Your article on earth stations [June 23, p. 91] left out Scientific-Atlanta as one of the major antenna suppliers. To date, we have supplied over 70% of the earth stations installed in the United States, as well as a number around the world.

John Feight
Scientific-Atlanta Inc.
Atlanta, Ga.

On target

To the Editor: As one who recently retired from the Marine Corps and who was then the officer in charge of the Capon project [a laser and battery pack mounted on a rifle, and a target consisting of four photodetectors], I would like to correct your statement that Capon does not help the inferior marksman [June 23, p. 96]. It does improve marksmanship by identifying early, before live firing, those trainees who need additional assistance. I have been informed that the troop leader in the Paris Island test of Capon was able to make correct early identification of four of the six Marines who did not qualify the following week on the known-distance live-fire range.

William A. Tate
Saint Petersburg, Fla.

Corrections

The current schematic of the transistor sensor for temperature-control circuits [Engineer's Notebook, June 23, p. 134] should show the noninverting port of the operational amplifier connected to ground instead of to -15 volts.

The value for R_3 of the resistor-controlled LC network that drives a tunable discriminator [Designer's Casebook, July 7, p. 104] is 10 kilohms. Any other value will not give the mark-and-space frequency pairs claimed.

In the caption for the photograph of liquid-crystal-display heaters [July 7, p. 99, Fig. 4.] the company should have been Photofabrication Technology Inc.

TRW power Schottkys.

Reliability at T_j of 125°C

International Exchange of Authenticated Electronic Component Performance Test Data

PRODUCT TESTED: TRW SD-51 Power Schottky Diode

TEST— High Temperature Reverse Bias

TEST CONDITION— $V_R = 30\text{ V}$ $T_C = 125^\circ\text{C}$

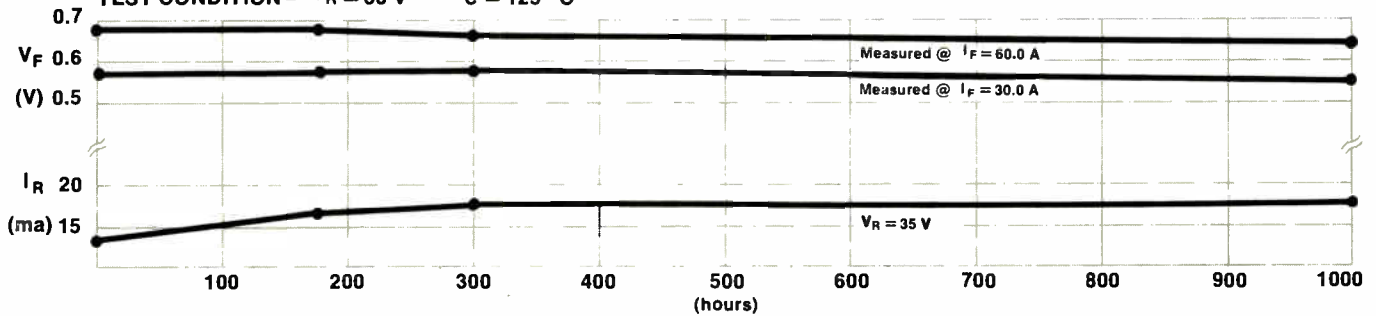

TEST—Endurance

TEST CONDITION— $I_F = 30\text{ A}$ $T_C = 125^\circ\text{C}$

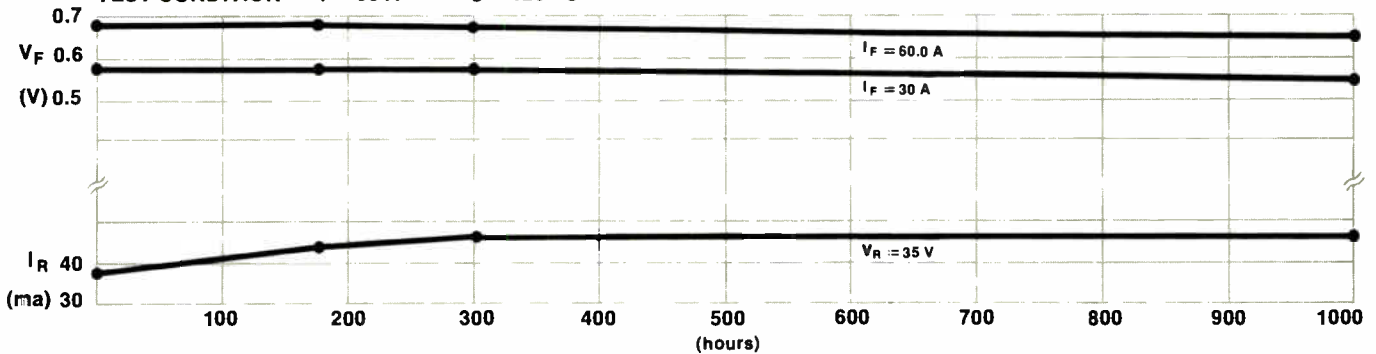

Proof of reliability? You bet. And proof of stability. You can rely on TRW Schottkys to keep on working as specified.

If you're into low voltage, high current power supplies, you owe it to your next design to test TRW's reliable SD-51, (in a DO5 package) the fastest switching diodes going! They're great little problem-solvers, they're drop-in, and they're very competitively priced.

What's more, they're JEDEC registered and available for immediate delivery.

If you're into lower currents (30 amps, 45 volts) check out our SD-41 in a DO4 package. For complete specs on either Schottky, use the coupon or call John Power at (213) 679-4561.

TRW Power Semiconductors

An Electronic Components Division of TRW, Inc.
14520 Aviation Boulevard, Lawndale, California 90260

Please send me data sheets on TRW's power Schottkys.

Please send sample.

Current requirement _____ amps.

NAME _____

COMPANY NAME _____

POSITION _____

ADDRESS _____

CITY _____

STATE _____

ZIP _____

E

TRW POWER SEMICONDUCTORS

ANOTHER PRODUCT OF A COMPANY CALLED TRW

WHO CARES?

...We do!

Our "instrument professionals" will make every effort to see that you rent the right test instrument for the job at hand. Too little won't do, and too much is too expensive.

Since 1962 we've cared about our customers. So we match tool to need, and guarantee performance . . . all at competitive prices.

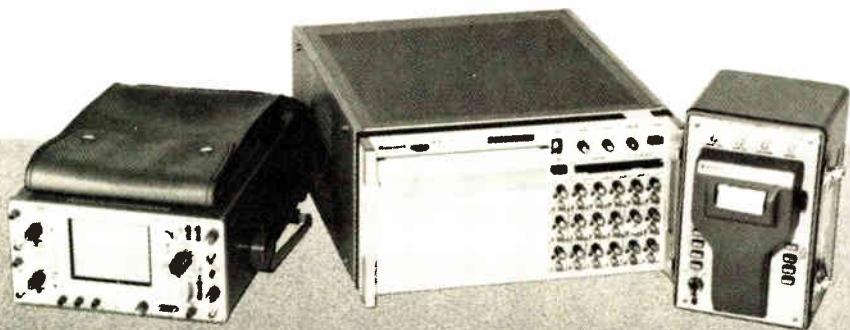

Call  Get our
FREE
Catalog

Continental Rentals

Div. Continental Resources, Inc.
175 Middlesex Turnpike, Bedford, MA 01730
(617) 275-0850

FOR IMMEDIATE RESPONSE CALL:
N.E. (617) 275-0850; L.I. (516) 752-1622;
NY, NJ (201) 654-6900; Gtr. Phila. (609) 234-5100;
Wash., D.C. area (301) 948-4310;
Mid West (312) 439-4700;
So. Central (214) 690-1706;
Costa Mesa, CA (714) 540-6566;
L.A., CA (213) 638-0454;
Santa Clara, CA (408) 735-8300.

Circle 8 on reader service card

News update

■ ECD Corp. of Cambridge, Mass., which earlier this year introduced a \$189 battery-operated digital thermometer [*Electronics*, Feb. 17, p. 148], says it has had to raise the price of the T-Meter because of a "supplier default of a key circuit component." The part is understood to be Motorola Semiconductor Products Group's MC1405, an analog processor subsystem for integrating analog-to-digital conversion.

The pocket-sized instrument, which can show temperature in either Fahrenheit or Centigrade—selectable by a switch—on its 0.6-inch-high liquid-crystal display, included a standard probe in its \$189 base price. Now, the T-Meter alone will cost \$239, effective immediately. The general-purpose probe will be an additional \$25 (a high-accuracy probe costs \$30).

The net \$75 increase to \$264 became necessary "when a supplier had difficulty producing a key circuit component to initial specifications," says ECD's marketing director Edward Costello. He neither confirms nor denies that Motorola's MC1405 was the part involved.

"The immediate high sales response to the T-Meter made it imperative to have readily available a high-volume supply of all components used to produce the device," Costello says. "We were compelled to redesign the circuitry using discrete components in order to assure the user the identical features and performance of the original design."

A spokesman for Motorola Semiconductor in Phoenix did not know whether it was his firm's MC1405, a complementary-metal-oxide-semiconductor part, that was involved in the T-Meter's difficulties. However, "we wouldn't ship a part that doesn't meet specifications," the spokesman notes. "If we have a part that can't meet spec, it doesn't get delivered."

The T-Meter measures temperature ranging from -100°C to 200°C and -150°F to 400°F . Accuracies are $\pm 0.5^{\circ}\text{C}$ or $\pm 0.9^{\circ}\text{F}$; with optional probes the specs are $\pm 0.1^{\circ}\text{C}$ or $\pm 0.15^{\circ}\text{F}$ over a selected 20° temperature range.

Bruce LeBoss

If you have one of these...

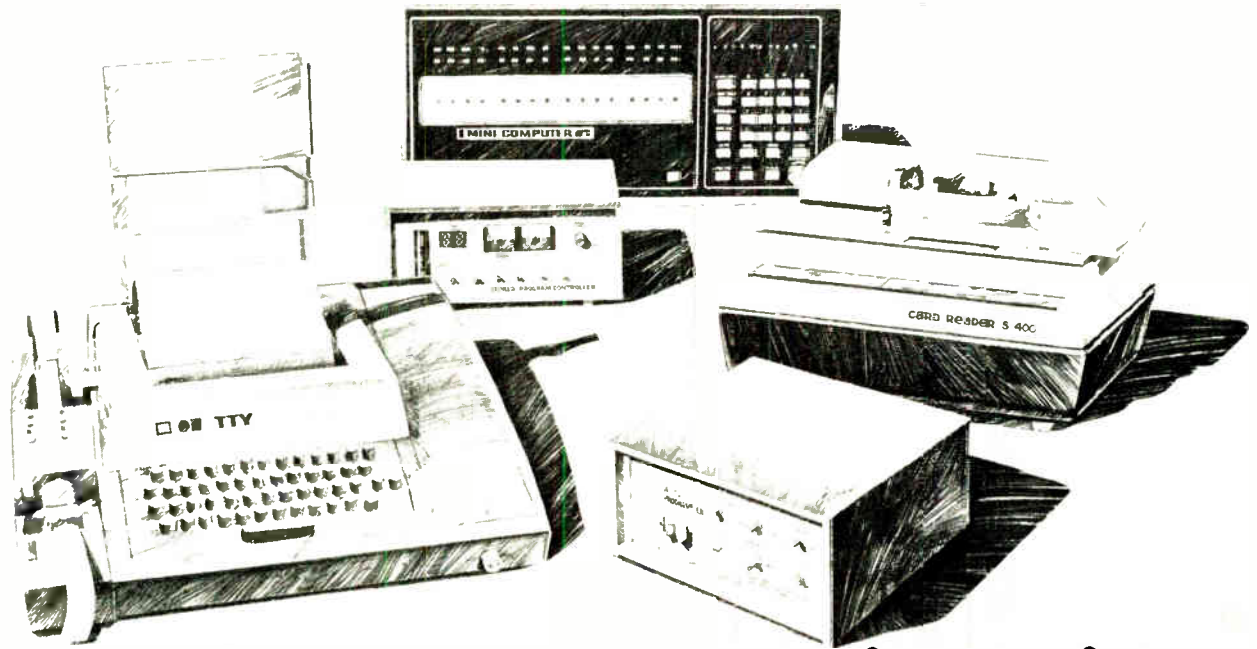

...you can start automatic testing with one of these.



Now you can get into automatic testing equipment (ATE) for well under \$10,000, total cost.

All you need is one of the units pictured, the new SPG-800 Synthesized Programmable Generator, and a little do-it-yourself effort. Just use one of the units pictured to store your test procedure program with simple instructions to command the SPG-800 (and any other programmable instruments you use) and you're off and running.

No more knob spinning. No more hooking up counters and scopes and voltmeters to your signal source. Now automatic testing is within reach of every manufacturer—along with the savings in time and labor it means.

And the Model SPG-800 is a modular instrument. So you can get started with just the basic unit for only \$3195. It is a combination programmable function generator operating in the 0.1Hz to 13MHz range and a programmable DC voltage source.

Now or later, add Interstate's low cost field-installable plug-in cards and you'll have a programmable synthesizer and pulse generator too—four programmable test instruments in one.

Interfacing the SPG-800 is easy, too. Use its basic ASCII interface or one of its (optional) plug-in cards for the IEEE bus, the RS-232C or 20 mil loop or parallel interface.

No matter what configuration you order, you'll find the SPG-800 easy to program and reliable in use. And the optional operator control panel—in English—is easily learned by non-technical personnel, so you can program it directly, the day you get it.

If you didn't think your company could afford ATE, it's time to re-think... write today for more information Or call us at (714) 772-2811 or (800) 854-3825 toll free.

The new SPG-800.

Please send me full information

Name _____ Title _____
 Company _____
 Address _____
 City _____ State _____ Zip _____
 Telephone Number _____

Interstate Electronics Corp.
 Department 7000
 P.O. Box 3117, Anaheim, CA 92803

INTERSTATE ELECTRONICS CORPORATION

SUBSIDIARY OF **ATO**

Circle 9 on reader service card

**How
to do three
things at the
same part:**

Advanced Micro Devices, Inc. • 901 Thompson Place, Sunnyvale, California 94086 • Telephone (408) 732-2400 •
Distributed nationally by Hamilton/Avnet, Cramer and Schweber Electronics and regionally by Arrow, Bell,
Century Electronics, Future Electronics and RAE Electronics.

If you want a great 8-bit D-type register with common clear, get our Am25LS273. If you want one with three-state outputs, get our terrific Am25LS374. If you're looking for a sensational common enable, you want our Am25LS377. However, if you'd be willing to settle for all three, read on.

Advanced Micro Devices announces the Am25LS2520 8-bit D-type register. With common clock enable. With common asynchronous clear. With three-state outputs. With MIL-STD-883 for free. And all in a super-convenient 22-pin DIP. Look:

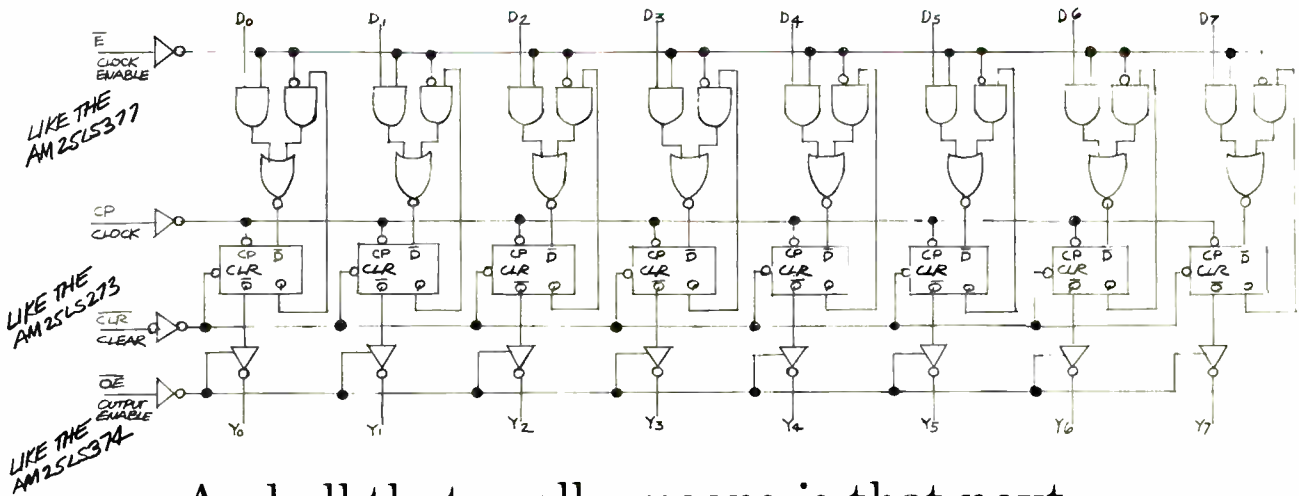

And all that really means is that next time you're thinking about registers, low-power Schottky and TI, you should also be thinking about AMD. Or calling. Or writing.

(After all, where else can you do three things at the same part?)

Advanced Micro Devices

Bipolar LSI. N-channel, silicon gate MOS. Low-power Schottky.
Multiple technologies. One product: excellence.



Circle 256 on reader service card

Technology isn't enough

Once again semiconductor companies are learning the painful lesson that technical know-how alone does not guarantee success in selling directly to the consumer. With a few notable exceptions, their attempts to penetrate the consumer market through vertical integration have met with disaster. After the debacle that took place in calculators over the last few years, one might reasonably have expected that prudence and good business planning would have replaced adventuresome exploitation and poor marketing efforts. But the growing casualty list in the digital-watch business shows that is not the case.

Some of the reasons advanced for the lack of success in consumer products include failure to establish brand identity, inability to plan for the seasonal nature of consumer buying, poor understanding of the distribution

and retailing aspects of the market, and sometimes just shoddy products.

What is particularly puzzling about the repeated mistakes made in consumer products is that the semiconductor firms who run into trouble are usually guilty of violating all the principles that have traditionally made them successful with original-equipment manufacturers: paying close attention to the customers' needs, furnishing support to customers and distributors, sensible pricing, and long-range planning geared to the long pull as opposed to a get-rich-quick philosophy.

Now programmable video games and their derivatives, personal computers, are shaping up as the next El Dorado for which venturesome semiconductor firms may go prospecting. Let us hope the lessons of the past will prevent another casualty list.

An opportunity for self-regulation

At the end of this month, the Joint Electron Device Engineering Council meeting in Chicago will get its first briefing on a new chemical process developed by 3M Co. This process could be used to tag JAN military semiconductors microscopically by manufacturer, type, model, and date of manufacture in a way that would effectively preclude their being later re-marked and sold as counterfeits [*Electronics*, July 21, p. 36].

But before 3M Co. undertakes to develop special codes for each JAN device maker and its products, it wants to know if there is sufficient volume within the industry for it to make the effort, and if industry is willing to adopt the process as standard in order for it to be effective. Those are answers Jedec should be able to provide.

But what concerns people like the Defense Logistics Agency's Richard Stimson, who is deep into the problem of semiconductor counterfeiting, is reports that some

semiconductor makers seem more concerned about the added costs of the new process and their legal obligation to perform it. What the agency wants is a simple means of guaranteeing product traceability through the supply chain back to the producer, and Stimson makes clear that his agency would prefer industry to come up with its own solution but adds that the Government is ready to come up with new regulations if it has to.

Stimson, it seems to us, has a point when he recalls "all the grumbling we have been hearing for years about Government overregulation." He asks: "What's become of taking pride in being able to guarantee the integrity of your product? Aren't they interested in protecting their good name?" In our opinion, the process deserves a full and fair hearing, as a demonstration to the Federal bureaucracy that industry can derive simple, cost-effective solutions to public problems without compulsion.

What we put in makes ours better

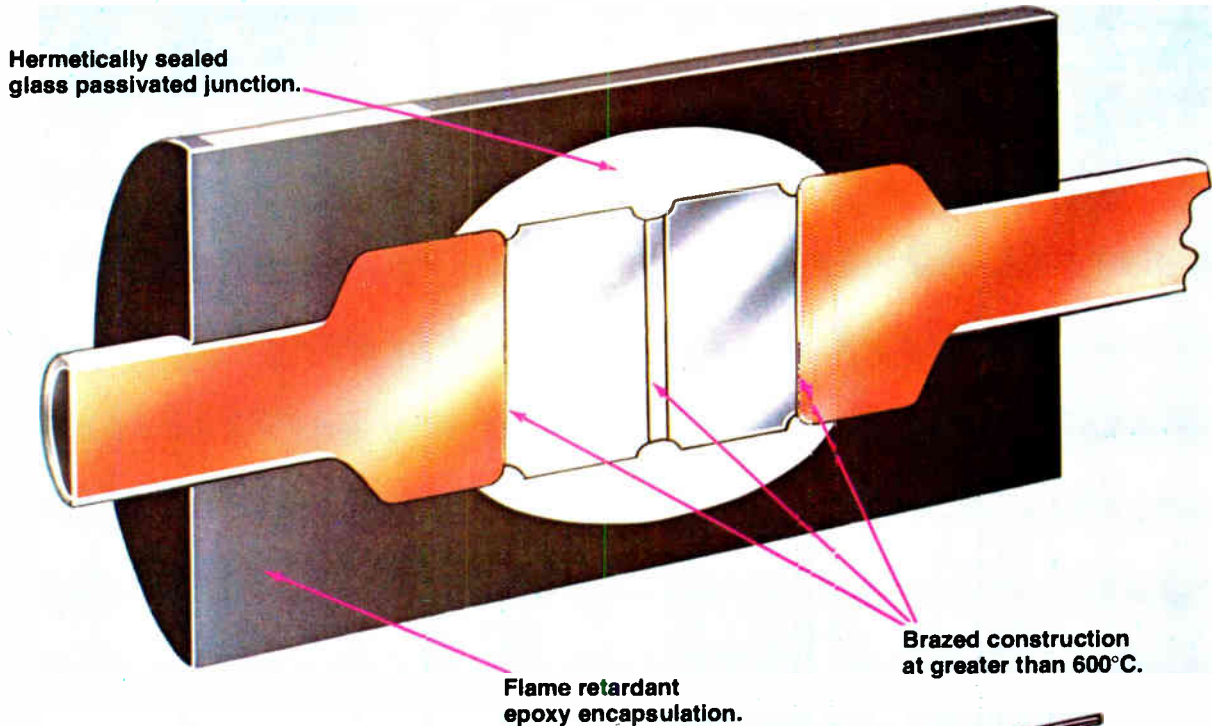

That's why
SUPERECTIFIERTM
we call it

No other rectifier manufacturer has gone as far as General Instrument in eliminating almost every potential cause for component failure.

First we eliminated failures caused by the stresses of automatic insertion and wave soldering, by metallurgically bonding—brazing both the junction and the leads at greater than 600°C. No soft solders. No pressure contacts. No environmentally-created intermittents.

Then we build in extra quality—exceeding military and environmental requirements by glass

passivating the junction with our patented glass compound. Then and only then, do we encapsulate with our UL Listed, flame retardant epoxy, to give you uniform size, clear marking and easy handling. And finally we put in our low, low price. So why pay more when you get it all in SUPERECTIFIER.

Call or write for our complete catalog today.

SUPERECTIFIER—
as good as if you designed it yourself.

GENERAL INSTRUMENT CORPORATION
DISCRETE SEMICONDUCTOR DIVISION
600 West John Street, Hicksville, New York 11802 (516) 733-3333

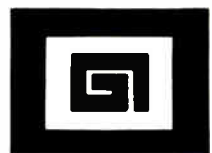

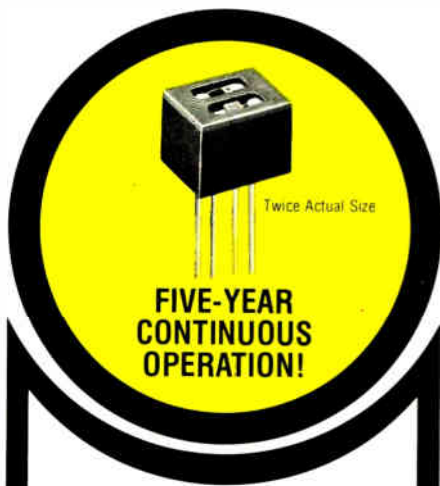

OPTRON REFLECTIVE TRANSDUCERS

NEW OPB 704 OFFERS
MAXIMUM RELIABILITY
IN A SINGLE
HERMETIC PACKAGE

OPTRON's new, low cost OPB 704 reflective transducer assures maximum reliability by combining a high efficiency solution grown LED with a silicon phototransistor in a single miniature hermetic package.

The hermetically sealed glass-metal-ceramic package offers extremely high reliability and stable performance at a cost competitive with that of plastic encapsulated devices. And, the OPB 704 has a usable continuous operating life of more than five years when operated at an average LED device current of 20 mA.

The OPB 704's phototransistor senses radiation from the LED only when a reflective object is within its field of view. With an LED input current of 50 mA, the output of the phototransistor is typically 0.5 mA when the unit is positioned 0.100 inch from a 90% reflective surface. With no reflective surface within the phototransistor's field of view, maximum output is 10 μ A with a LED input of 50 mA and V_{CE} of 5 volts.

Ideal applications for the OPB 704 reflective transducer include EOT/BOT sensing, mark sensing, detection of edge of paper or cards and proximity detection.

The OPB 704 and other low cost, high reliability OPTRON reflective transducers are immediately available. Custom designed versions for special applications are available on request.

Detailed information on the OPB 704 reflective transducer and other OPTRON optoelectronic products... chips, discrete components, limit switches, isolators and interrupter assemblies... is available from your nearest OPTRON sales representative or the factory direct.



OPTRON, INC.

1201 Tappan Circle
Carrollton Texas 75006, U.S.A.
TWX-910-860-5958
214/242-6571

People

Jordan Baruch: out to boost technology transfer's payoff

The problem with technology transfer in the U.S., contends Jordan Baruch, "is that it is like pushing on the end of a string," with the Government failing to get potential users pulling on the other end. As President Carter's new assistant secretary of commerce for science and technology, Baruch is eager to find more string pullers among industries like electronics. He hopes eventually to offer such incentives as greater tax relief for R&D and other forms of risk reduction still under study that will "foster development of technology in the public interest."

An electronics engineer by training, Baruch, 54, has his doctorate and undergraduate degrees from the Massachusetts Institute of Technology, and, most recently, held a pair of professorships at Dartmouth College where he taught both engineering and business administration courses. He also spent 20 years in industry—16 of them with Bolt, Beranek and Newman Inc., in Cambridge, Mass., specialists in acoustics and data processing.

Collaboration. He believes that accelerating technology transfer could help restore America's lead in consumer product technologies, a lead "that has gradually been eroded by offshore competition." While the U.S. "spends enormous amounts on R&D" oriented to specific programs with limited goals, Baruch points out that the country has never mounted a national effort to examine what he calls industrial homogeneity—exploring and encouraging collaborative programs among industries. The technology of one, like electronics, he believes, might be employed by another, like shoes, to enhance its competitive position. He would like the Government to encourage and fund such projects, though its role should be advisory rather than controlling, he says.

Baruch wants also to develop more reliable data to answer two related questions. One is what kind of technological innovations will lead to



More pull. Baruch favors special incentives that encourage technology transfer.

production of new U.S. goods for the U.S. consumer? And why do American manufacturers move things offshore for production?

Clearly, Baruch believes the answer to the second question goes beyond the issue of cheap labor, and he is organizing a study to determine it. Not only does the Department of Commerce need such data, says the assistant secretary, but manufacturers themselves need it "if they are to have the capability to manage rationally." He therefore expects industry will want to participate in the analysis and collaborate in developing innovative applications of technology within the country—as well as for export.

Richard Sawyer doesn't like to make service calls

Service manager Richard Sawyer is having a big impact on the way Beckman Instruments Inc.'s clinical instruments are designed. His goal: to make it easy for medical technicians with little training in electronics to repair their equipment.

"Service is an important part of an instrument's cost, especially in lower-priced instruments," points out Sawyer of the Clinical Instruments division of the Fullerton, Calif., firm. Fast-rising service costs

Tired of selecting 741's and 747's to get premium performance?

Specify our OP-02, OP-04, OP-14!

If your design requires premium 741 performance that right now can be met only by a costly and time consuming "selection game," the PMI OP-02 is for you.

A high performance general purpose Op Amp that really fills the gap between standard 741's and precision 725's, the OP-02 fits all 741 sockets. It's even better than the PMI SSS741! Input offset voltages are guaranteed better than the 725, but the speed of the 741 is retained. MIL STD 883 processing is available — level B right from stock.

Prices run higher than standard 741's, of course, but well below standard 725's. For a little bit extra you get **guaranteed** better performance across the board, low noise, low drift, low TCV_{OS} , low TCl_{OS} , and insensitivity to output load conditions. Check the specs.

Three steps to end your selection worries:

1. Get a complete OP-02 data sheet to compare to your selected 741 and 725 requirements.
2. Call your PMI distributor for a few OP-02's to convince yourself that PMI's specs are for real.
3. Specify the OP-02 as the **preferred** source. (You can still use the selected stuff as the second source.)

	Input Offset Voltage mV MAX		Input Offset Current nA MAX		Input Bias Current nA MAX	
	MIL	Comm.	MIL	Comm.	MIL	Comm.
Industry						
Standard 741	6.0	7.5	500	300	1500	800
PMI SSS741	3.0	7.5	10	50	100	200
PMI OP-02	1.0	3.0	5	10	50	100
Industry						
Standard 725	1.5	3.5	40	50	200	250
PMI SSS725	0.18	1.6	4	25	120	180

DUALS also available!

Standard	Superior Second Source	Premium Performance
747	SSS747	OP-04
1458/ 1558	SSS1458/ 1558	OP-14



Precision Monolithics Incorporated
1500 Space Park Drive, Santa Clara, CA 95050
(408) 246-9222. TWX 910-338-0528.
Cable MONO.

Circle 15 on reader service card

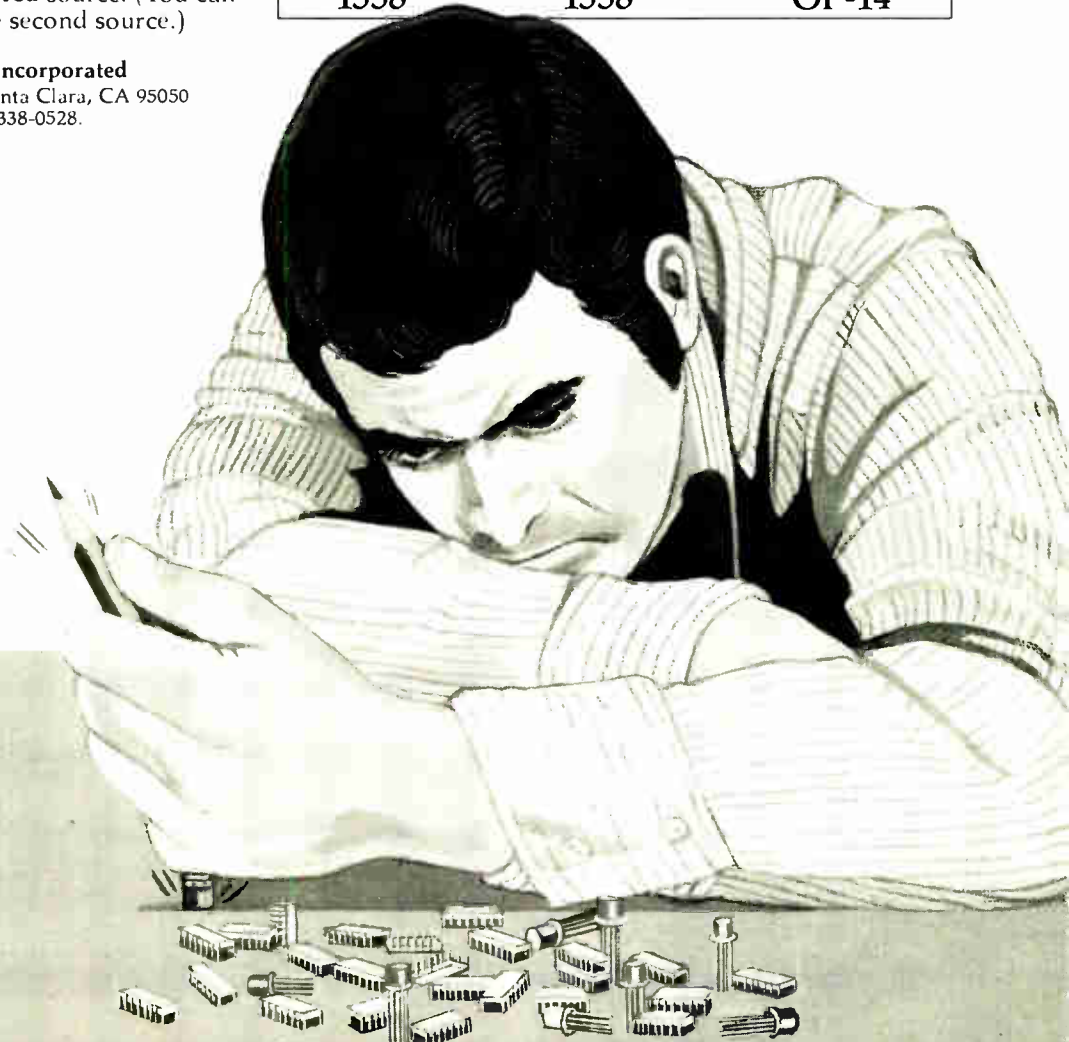

quality
makes
the difference
in...



NORTH ATLANTIC Phase Angle Voltmeters

with 48 hour burn-in

• High Reliability • Lab or ATE Use

Model 225 Digital PAV

- High Accuracy AC DVM
- 0.25° Phase Accuracy
- Direct and Automatic Display of Phase Angle
- AC Ratiometer Capability
- Autoranging and Reference AGC
- Remote Control and Digital Output Capability
- IEEE Interface (Optional)

Model 213 Analog PAV

- Direct Reading of — Total Voltage
Fundamental Voltage
Quadrature Voltage
Phase Angle
- 5% Bandwidth Without Adjustment
- Harmonic Rejection
- 10X Overload Capability
- $\pm 0.5^\circ$ Accuracy Option

CALL OR WRITE FOR
COMPLETE SPECIFICATIONS.



NORTH ATLANTIC
industries, inc.

200 TERMINAL DRIVE, PLAINVIEW, NEW YORK 11803
cable: noatlantic / twx: 510-221-1879 / phone: (516) 681-8600

People



At your service. Built-in voltmeters and diagnostic routines help Richard Sawyer's customers do the fault finding themselves.

will spell the end of sending servicemen to repair small instruments such as pH meters and tabletop centrifuges, he predicts, and he would like to cut the calls on bigger instruments as well. "If we don't come up with alternative service methods, mailing in the instrument will be the only affordable way to service it," he insists. "Either that, or throw-away instruments."

Built-ins. Illustrating Sawyer's approach to design is Beckman's just-introduced immunoassay analyzer [*Electronics*, Aug. 4, p. 31] which combines self-diagnostic capabilities with a built-in digital voltmeter and a probe—all made possible because Beckman designed its instrument around a microprocessor. Beckman has also installed a toll-free hotline so its staff can help customers through repair steps.

"But diagnosis by telephone starts on the design table," stresses Sawyer, who joined Beckman 16 years ago as a field service engineer. "So we're pushing ourselves into the original design of the instrument, as opposed to merely reacting to a product that was designed in a locked room."

Sawyer's division is taking the lead toward what he calls customer self-sufficiency. "The trend that's starting here will spread to our biomedical and industrial divisions," he predicts, "and I guarantee that other instrument companies will have to get on the bandwagon."

hp MEASUREMENT COMPUTATION **NEWS**

product advances from Hewlett-Packard

AUGUST 1977

100 MHz scope with unprecedented time-interval measuring accuracy

Here's a brand new concept in oscilloscopes. By incorporating a crystal controlled, time interval averaging counter with a 5-digit LED display into a 100 MHz delta time oscilloscope, the new HP 1743A offers major improvements in ease-of-use and accuracy. Nanosecond time intervals can easily be measured to 100 ps resolution, longer time intervals to 0.002 percent accuracy.

Additional features include:

1. Measurements of delta-time can now be made from the pulse that triggers the sweep, thus improving measurements of low rep rate or infrequently occurring pulses.
2. In the triggered delta-time mode, the 1743A automatically displays the time interval of interest without any "fine-tuning" by the operator.
3. With crystal timing you can use the sweep vernier to calibrate the CRT divisions for various measurements without uncalibrating the LED time readout.
4. Phase measurements on dual clocks or skew measurements between data channels are easily made between both channels. Three channel measurements can be made between the two vertical channels and on external trigger by using the third channel trigger view.

And there's much more. Check B on the HP Reply Card.

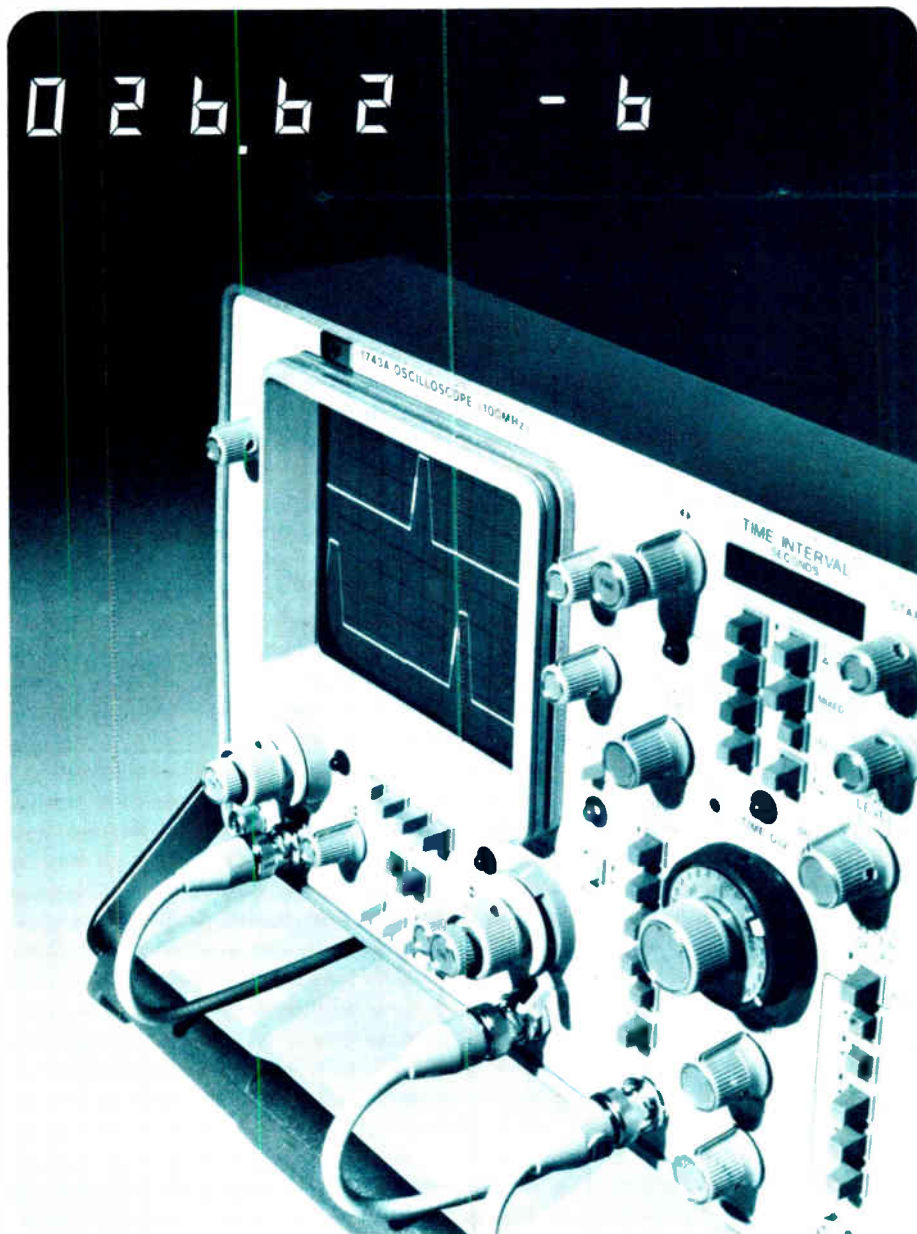

New dual-channel oscilloscope with third-channel trigger view and delta-time measurements also incorporates a 5-digit automatic time-interval averaging counter. Measurements are now 200 times more accurate than those using previous delta-time techniques.

New 2–18 GHz microwave pulser has 10 ns rise time

Modern high resolution radars and other microwave systems require fast risetime pulses for testing purposes. The HP 11720A Pulse Modulator provides pulses from 2-18 GHz with an 80 dB on-off ratio using a newly-designed PIN diode switch arrangement.



Now, signal generators can be upgraded to pulse modulation capability from 2 to 18 GHz with new fast pulse modulator.

An ideal input signal is the HP 8672A microwave synthesized signal generator or 8620C/86290A microwave sweep generator, both of which cover 2-18 GHz. Of course, any current microwave generator or source in use can be upgraded to provide high performance pulses by use of the 11720A Modulator. Sources with up to 100 mW output can be switched.

Rise/fall times are <math><10\text{ ns}</math> and internal delay is <math><70\text{ ns}</math>. Minimum pulse widths of <math><50\text{ ns}</math> are possible. This in-line switch has less than 10 dB insertion loss at 18 GHz (6 dB to 13 GHz). Input video is TTL compatible with >3V (on) and <math><0.5\text{ V}</math> (off), with a complement function provided.

For more details, check A on the HP Reply Card.

Complex signal analysis made very easy



HP's 5420A digital signal analyzer is the "smartest" commercially available instrument for low frequency signal analysis. Here it analyzes the read/write head positioning servo of a disc memory.

Once restricted to specialists, the time and frequency domain analysis of complex signals by Fourier transform and related techniques can now be done with far less understanding of the theory involved, and in a fraction of the time previously required.

Applications include characterizing the open loop gain of an operating control system, measuring close-in phase noise, and the study of vibration and noise in mechanical structures.

HP's 5420A new dual-channel analyzer offers capabilities not found even in instruments costing up to twice as much.

Dynamic range exceeds 75 dB and frequency resolution to 0.004 Hz can be achieved anywhere in the 25 kHz range. Measurements include: linear spectrum, auto and cross power spectrum and spectral density, transfer function, coherence, time average, auto and cross correlation, impulse response and amplitude histogram.

The 5420A is the easiest to use digital signal analyzer with a continuous, fully annotated, calibrated display. Dual x and y axis cursors provide data readout and measurement control. A CRT-displayed "menu" guides you through instrument set up, and the built-in digital tape cartridge can store up to 50 instrument set ups and 120 measurement results for later use.

Check G on the HP Reply Card.

New developments enhance RF network analysis

The HP 8505A RF Network Analyzer (0.5-1300 MHz) acquires significant new capabilities by virtue of two new developments:

1. The new HP 8501A Storage-Normalizer accessory brings digital storage of displays, normalization of system characteristics, CRT labeling plus measurement enhancement through signal averaging and resolution magnification.
2. Ability to phase-lock the 8505A to general-purpose reference sources such as the HP 8640 and 8660 signal generators. Phase-locking permits full characterization of narrowband devices such as crystal filters with reso-

lution and stability as high as 1 Hz.

The new 8501A Storage-Normalizer brings flicker-free displays which can be annotated with scale factors and frequency data. Signal averaging improves resolution in narrowband group delay measurements and where signal levels are low. The magnification feature permits resolution to be increased up to 10 times.

Using the HP Interface Bus and an HP computing controller, powerful graphics capability is available. Add test limit lines, or display and annotate program listings and instructions.

For additional technical information, check K on the HP Reply Card.

New storage-normalizer brings additional capabilities to HP 8505A network analyzer:

Storage and Averaging (photo A)—two traces, with and without averaging, are stored, to demonstrate improvement that averaging brings to group delay measurements of narrowband devices. **Normalization and Labelling** (photo B)—test device's response deviation from standard is displayed directly along with overall response of standard.

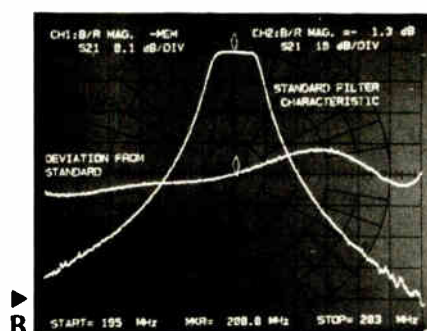
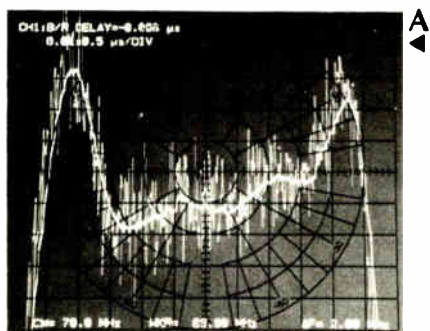

New microwave power measurement Application Note

One of the classic application notes from Hewlett-Packard was AN 64, *Microwave Power Measurement*. Now, a completely rewritten note AN-64-1 *Fundamentals of RF & Microwave Power Measurements* is available to bring all of the pertinent power measuring principles up-to-date.

AN 64-1 explores in detail three of the most popular power sensing techniques, thermocouple elements, thermistors, and diodes including a comparison of the advantages and disadvantages of the three methods. A comprehensive error analysis section follows with particular emphasis on mismatch considerations. Included also are some pulse power measurement considerations.

For your free copy, check N on the HP Reply Card.

How to configure your own automatic network analyzer

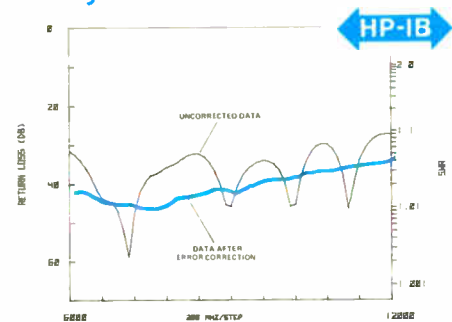

An economical method for semi-automatic, *error-corrected* microwave network measurements is described in Application Note 221. The HP-IB system uses the HP 8410 network analyzer and HP 9825A desktop computer, with 110 MHz to 18 GHz range.

Sources of error and the essentials of error correction are described. A sample 9825A program for calibration and measurement is listed along with annotations and flow charts. Results that demonstrated significant improvements in accuracy are presented.

If your work involves microwave measurements, be sure to send for your free copy. Check O on the HP Reply Card.

Continuous memory retains your programs and saves your data—even when you turn it off

Continuous memory makes it possible to add functions to those already preprogrammed into the HP-25C, ready at the touch of a key.

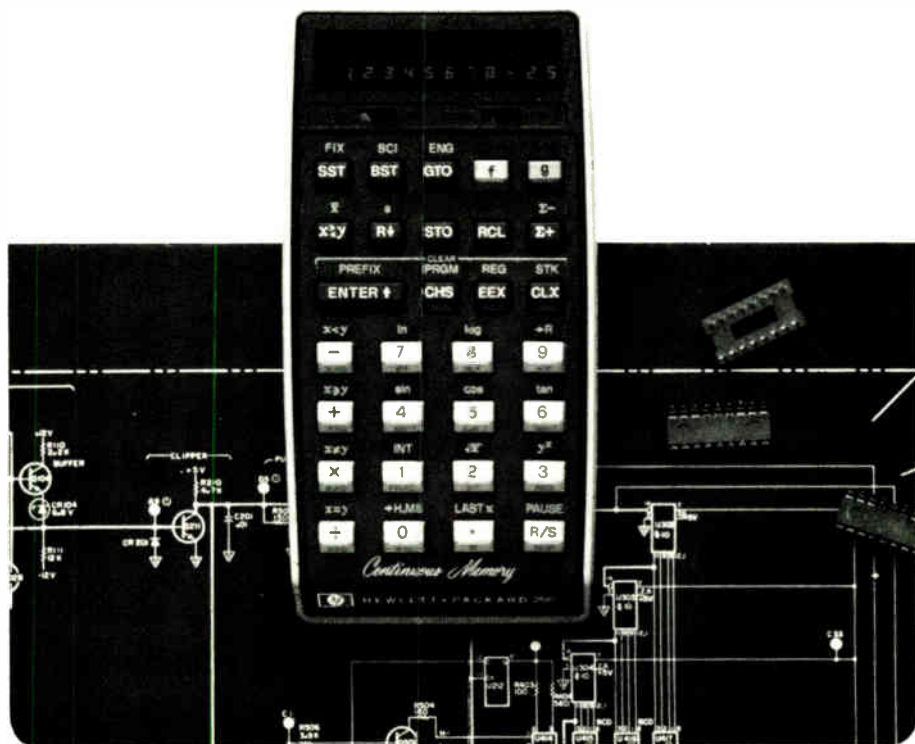

The continuous memory capability of the HP-25C scientific programmable pocket calculator can provide tremendous values in time-savings and convenience to any scientist, engineer or student who uses a few long programs repeatedly. The 25-C not only retains the last program you used, it also retains all data in the registers. And now, with a reduction in the price, you can save money too.

Continuous memory in the 25-C is the only feature not found in the popular HP-25. Otherwise, both calculators offer the same powerful capabilities.

- 49-step program memory plus 8 addressable registers
- BackStep and SingleStep keys let you review the entire memory one step at a time, in either direction

- Conditional branching allows you to test relationships between values
- Pause feature allows you to momentarily interrupt program execution and display the results of the X register for evaluation or recording
- Trig and log functions plus rectangular/polar conversions
- Statistical capabilities: summations, mean and standard deviations
- Three display modes: decimal, scientific or engineering notation
- All memories available for register arithmetic.

Either calculator is a good choice for your professional needs.

For more information, check C on the HP Reply Card.

Build your own automated system around an HP computing controller

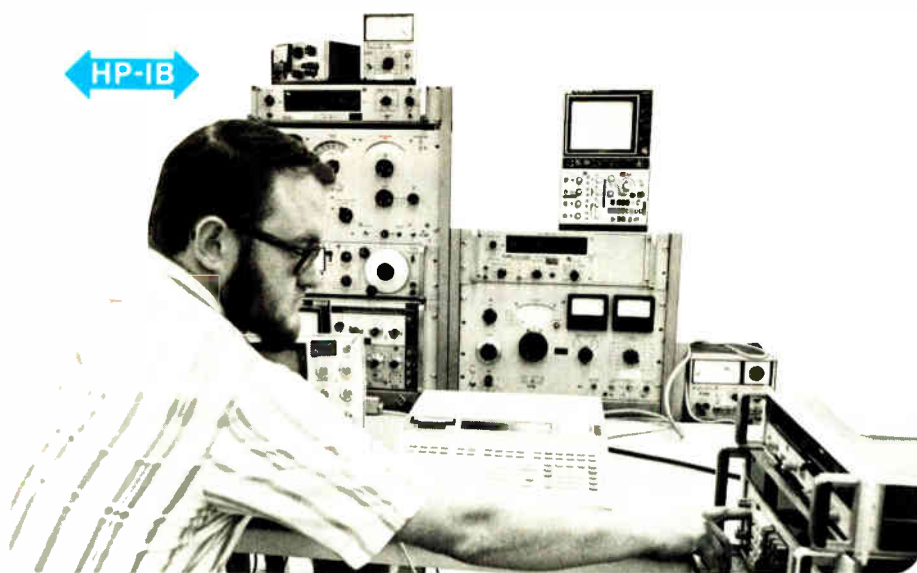

Shown above is an HP computing controller in a microwave test laboratory. The test limits can be set from the keyboard of the controller; the controller tests all parameters and makes NO-GO decisions. Data can be stored for later evaluation and analysis of quality control information.

A fast and inexpensive way to add data acquisition and analysis capability to your instruments is with HP computing controllers—the HP 9825A and 9815A. Each compact controller is a complete, one-package system with integrated keyboard, display, strip printer, easy-to-use language and tape storage. Interfacing the controller to your instrument is simple. Plug in the appropriate interface card, write a simple application program and your system is on its way up. Off-the-shelf interface cards and built-in software allow you to interface to BCD, 8 or 16 bit parallel, bit-serial and HP-IB (Hewlett-Packard Interface Bus)-compatible instruments.

HP 9825A controller

The HP 9825A computing controller provides minicomputer-like speed and capability. It features buffered I/O and live keyboard. A built-in 250k-byte tape cartridge with a 3k-byte-per-second transfer rate and 90-inch-per-second search rate allows quick storage and retrieval of data. Using the HP-IB, the 9825A can control as many

as 14 instruments and peripherals with each HP-IB Interface card. Up to three cards may be connected. The programming language (HPL), designed for scientists and engineers, is easy-to-learn and, in combination with the keyboard's eight editing keys, is easy-to-use.

HP 9815A controller

The HP 9815A computing controller with its 96k-byte tape cartridge can be anything from a simple data logger to a controller of a small automatic instrumentation system. Its 16-character alphanumeric thermal printer can be programmed to instruct the operator and provide labeled hard-copy results. Programming, for interfacing as well as data analysis, is fast and easy, using RPN. The AUTOSTART feature allows your program to begin executing automatically when the power is turned on.

For your copy of a brochure illustrating automatic test systems with integral desktop controllers, check M on the HP Reply Card.

Cut development costs when upgrading to a new desktop computer

For desktop calculator owners whose applications have outgrown their earlier HP 9800 series calculators, a simple way to move up to a more powerful data handling system is now offered.

The HP 98032A Interface Card allows accurate and swift transfer of data from the 9810A, 9820A, 9821A or 9830A/B to the newer 9825A and 9831A computing controllers. The same interface card also permits the direct transfer of data and programs used with the 9830A/B into the larger memory of an HP 9831A computing controller.

To perform the transfer, simply plug the interface card into your old calculator and connect the other end of the card to your new 9825A or the 9831A. In a fraction of the time it would take to manually re-enter the data or program, the interface card smoothly transfers it – unattended. In case an error is encountered in the transfer, an error message will be automatically recorded and prompt the user for a later correction.

For additional information on upgrading to an HP 9825A or an HP 9831A, check L on the HP Reply Card.



If your applications require larger storage and faster processing speeds than your earlier model desktop calculator can offer, consider upgrading to or adding a powerful new HP desktop computing controller. A new interface card will now enable you to transfer your data and/or programs simply, quickly, economically.

Distributed System/3000 brings remote computers within your reach

For the first time, it is now possible to interconnect Hewlett-Packard 3000 Series II Computer systems in distributed processing networks. DS/3000 consists of new software developed as an extension of Multi-Programming Executive II, the computer's basic operating system. MPE provides for multiple interactive and concurrent batch operations. It also brings an accounting structure and file security that provide protection against unauthorized use of local or remote HP 3000 systems and their data.

When existing 3000 Series II computers are networked with DS/3000, the user's investment in application software is protected. That software will require no change because the MPE operating system was designed to accommodate such future developments as networking.

DS/3000 cuts the cost and slashes the time and effort needed to get a useful distributed data-processing system up and running. You can sit down at a terminal and use the programs, files and data resident in any interconnected HP 3000. You don't need a special program to do it, either. Simply identify the computer you want to talk to and you're on-line.

With the same ease, you can shift programs and files from one HP 3000 to another. All that is needed to interact with a remote system is to add the word REMOTE to some commands. Remote files are as easily accessible as those stored locally. Only seven simple new commands need to be added to the HP 3000 repertoire to accomplish program-to-program communication among systems. Remote peripheral devices are also at your command. Operation at this high level without a massive investment in special programming is a breakthrough in distributed processing.

DS/3000's architecture is layered

DS/3000 has been implemented with a 'layered' architecture, so that user-created software will not become obsolete because of technological advances that may occur in communications.

Each layer to a large extent functions independently. In the future, network enhancements to DS/3000 could be

accomplished by providing a new software/hardware update to just one layer. This change would not affect either the structure or the usage of DS/3000 user commands and procedures.

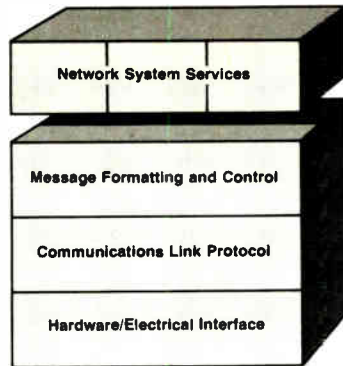

The layers. The first layer, the electrical interface to external modems, meets EIA RS 232C and CCITT standards. Systems can be linked over common carrier facilities at speeds up to 9600 bits per second or over hardwired lines at speeds up to 2.5 million bits per second.

The next layer is concerned with link protocol in a point-to-point configuration. It currently multileaves data bidirectionally over half or full duplex common carrier facilities, using IBM-

compatible Binary Synchronous Communication (BSC) protocol.

The third layer automatically handles conventions of message formatting and manages the flow of messages between systems.

The top (fourth) layer is the most exciting for it represents the set of full, high-level system services available to the user on DS/3000. These include sharing of resources, remote command processing, remote file access and program-to-program communication.

The HP 3000 Series II Computer

The all-round performance of the HP 3000 makes it an ideal departmental computer for solving a wide range of problems such as order processing, inventory control, cost accounting and materials requirement planning.

With its versatile executive software, the HP 3000 offers speed and power. The built-in flexibility of the HP 3000 will allow you to take advantage of technological developments in distributed data processing.

For more information, check D on the HP Reply Card.

Instantaneous information sharing between HP 3000 computers is now practical and economical. New software puts data and processing power of remote computers at your command—at your terminal. Just add the word "REMOTE" to the appropriate commands.

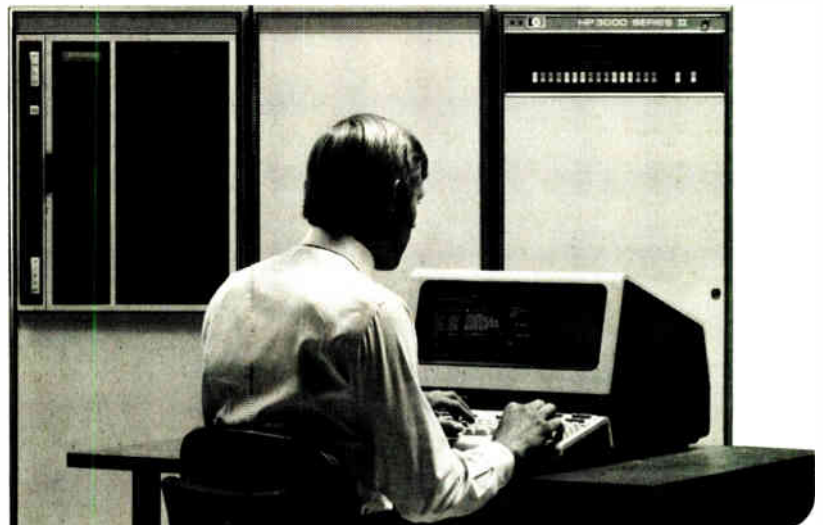

Microprocessor in new LCR automates a wide range of measurements



While the microprocessor in the new HP 4262A LCR meter automates and simplifies component measuring and testing, the arrangement of the instrument front panel keyboard switches assures maximum operating convenience and error-free operation.

This new Hewlett-Packard 4262A Digital LCR Meter is a 3-1/2 digit microprocessor-based instrument that meets today's requirements for measuring capacitance, resistance and inductance of components in the laboratory, on the production line and in quality assurance inspection.

Because the 4262A is microprocessor-based, it features automatic operation and internal self-test capability to insure the instrument is functioning properly. For example, the operator simply selects the function and loss parameters, one of three test frequencies and inserts the device to be measured. The LCR Meter does the rest—automatically selecting the proper range and equivalent circuit mode. Deviation measurements are also provided for very useful comparisons when measuring the range of small trimmer or variable capacitors.

Capacitance can be measured from

0.01 picofarads to 19.99 millifarads, inductance from 0.01 microhenries to 1999 henries and resistance from 1 milliohm to 19.99 megaohms. D and Q (loss) are also measured; D is measured from 0.001 to 19.9 and Q from 0.05 to 1000.

In addition to automatic measurement and wide range, the 4262A basic accuracy is 0.2 percent of reading. Measurement frequencies of 120 Hz, 1 kHz and 10 kHz are available. An HP-IB option allows the system-oriented user to easily interface the 4262A with a calculation controller or computer for increased speed, programmed measurements, automatic decision making and permanent hard copy records.

For more information, check F on the HP Reply Card.

A/D converter puts your analog voltages onto the HP Interface Bus

With the 59313A Analog to Digital Converter you can convert up to 4 channels of dc voltage sources to digital form for use in measurement or test systems structured around the Hewlett Packard Interface Bus (HP-IB). A particularly useful application is in adapting, to systems use, instruments whose outputs are dc voltages.

The 59313A was designed specifically for systems use. It can perform 200 conversions per second on a single input channel or 50 per second on each of four channels. Selectable rates are 5, 10, 20, 50, 100 or 200 samples per second and are accurate to $\pm 0.05\%$. Resolution is 0.05% (10 bits plus sign), and the dual slope A to D converter has a linearity better than 1/2 least significant bit (LSB) and 4.75 ms conversion time.

The four jumper-selected voltage ranges can be screw-driver adjusted to values of ± 1.0 to ± 1.3 , ± 2.5 to ± 3.5 , ± 5.0 to ± 7.0 , and ± 7.0 to ± 10.3 volts, so as to maintain maximum resolution with a variety of voltage sources. The input can take 30 volts rms without damage, and input impedance exceeds 1 megohm.

The binary output code is readily converted to decimal form, or other codes, with a computing controller on an HP-IB system.

For more information, check H on the HP Reply Card.



The HP 9825A computing controller programs the HP 59313A for versatile, four-channel A to D conversion on an HP-IB system.

Easier-to-read characters with new 16-segment display

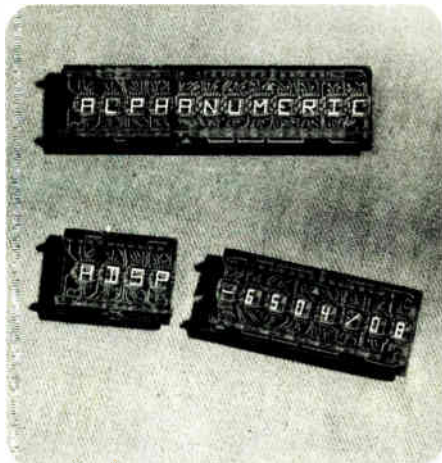

HP now offers a 16-segment font in a new display for applications requiring lower power usage with ease of readability.

The first 16-segment solid state LED alphanumeric displays from Hewlett-Packard are now available. They are designed for use in computer peripheral products, automotive instrument panels, calculators plus instruments and systems requiring low power con-

sumption in an easy-to-read display. Magnification of the LED by an integral lens enhances the character intensity while keeping the power use at a minimum, and results in a character size of 3.8 mm. In addition to the 16 segments, the display has a centered decimal point and colon. Drawing as little as 1.0 to 1.5 mA average current per segment, they are easily read at a distance of more than six feet.

The new HDSP-6504 and HDSP-6508 four- and eight-character offer complete 64-character ASCII set capability. Both dual-in-line packages can be stacked end-to-end for applications requiring additional characters.

More rugged than standard PC board/lens type display packages, the new HP devices are well suited for demanding in-field applications such as in computer-based mobile units.

For more information, check I on the HP Reply Card.

New low R_s beam lead PIN switches in just 2 ns



A new mesa process with glass backfilling is responsible for the performance of this new beam lead PIN. The mesa construction constrains the minority carriers thereby enhancing switching speed.

Representing a major improvement in beam lead PIN technology, the Hewlett-Packard HPND-4050 offers 1.3 ohms typical (1.7 max) series resistance at only 10 mA current. This low

resistance reduces power requirements and makes it ideal as a shunt switching element in stripline and microstrip circuits. The low current requirements make it suitable for use in portable, airborne or shipboard applications.

Reverse recovery time is typically 2 ns, which meets or exceeds switching time requirements for fast switches for high frequency modulator and attenuator component applications in EW systems. Capacitance of the HPND-4050 is 0.15 pF maximum and breakdown voltage is 30V minimum.

For more details, check E on the HP Reply Card.

HP offers wide choice of quality optoelectronic components



This new *Optoelectronics Designer's Catalog* contains detailed, up-to-date information on our complete optoelectronic product line. It is divided into five major product sections: solid state lamps, solid state displays, optocouplers, emitters, and PIN photodiodes.

Included in the 200 pages are product photographs, specifications, operating characteristics, and performance graphs.

For your copy, check Q on the HP Reply Card.

New Schottky Technical Note

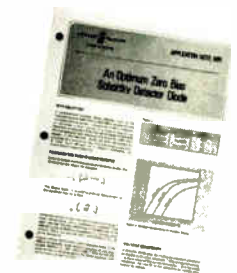

Application Note 969 addresses the theory behind a new line of Schottky detector diodes. Conventional Schottky detector diodes require a small amount of dc bias for low level detection to take place. Even though only a few microamperes are required, this is often difficult to supply. These new Schottky diodes (HSCH-3171 series) eliminate this need for dc bias and are more efficient as detectors compared with conventional Schottky detector diodes.

For your free copy of this application note, check P on the HP Reply Card.

New 50 MHz serial data generator produces 2048 bit data streams plus PRBS

Now the HP 8018A provides the answer to all your requirements for serial digital stimulus. The 8018A includes two data channels, each with 1,024 bits of digital memory. Both word length and the number of words may be selected to exactly match your application. Serializing the channels, you can generate data streams up to 2,048 bits in length, sufficient for even the most complex data requirements.

Pseudorandom pattern generation is also included. With preset sequences from 511 to over 1 million bits long, you can easily produce worst case testing patterns or simulate actual traffic in a data network. An innovative new technique even lets you interleave PRBS and programmed data words in a single stream, perfect for simulating preamble—data message—postamble patterns.

The 8018A's high performance output amplifier delivers clean 5 ns pulses with amplitudes up to 15V. A switchable 50-ohm source minimizes reflections under various load conditions, helping you maintain pulse integrity right up to your circuit or system under test. A full complement of cycle modes

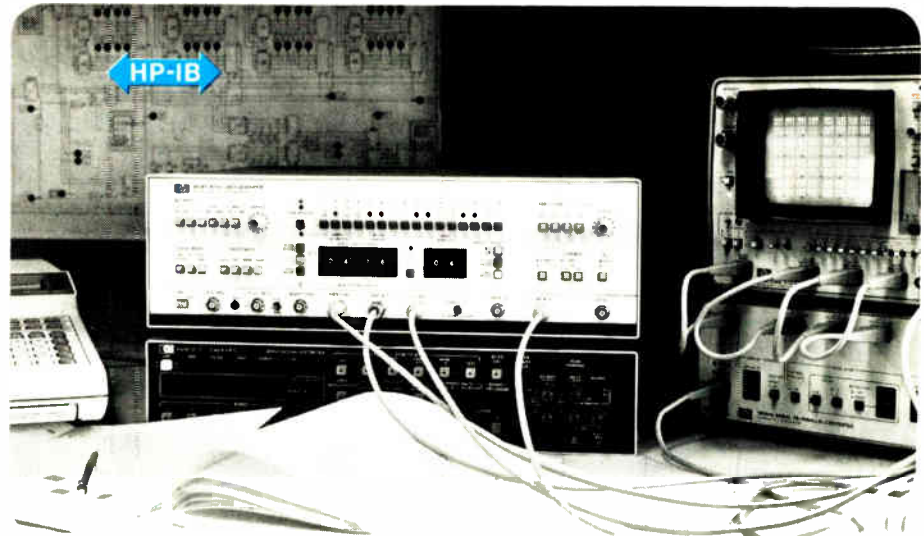

Suitable for bench and systems applications, the 8018A data generator is shown above. The logic analyzer displays the data pattern that has been generated for testing a serial digital interface. Both the data generator and the voltmeter are under programmed control using an HP desktop computer.

and trigger outputs simplifies synchronization with other instruments. An optional HP-IB programming interface enables you to rapidly load all 2,048 memory bits or integrate the 8018A's capabilities into automatic test systems.

This unmatched feature set has been

designed to shorten and simplify troubleshooting tasks wherever a source of serial data is required.

To find out more about this powerful new digital performer, check 1 on the HP Reply Card.

East-4 Choke Cherry Road, Rockville, MD 20850.

Ph. (301) 948-6370.

South-P.O. Box 10505, Atlanta, GA 30348.

Ph. (404) 434-4000.

Midwest-5201 Tollview Dr., Rolling Meadows, IL 60008.

Ph. (312) 255-9800.

West-3939 Lankershim Blvd., North Hollywood, CA

91604, Ph. (213) 877-1282.

Europe-7, rue du Bois-du-Lan, P.O. Box, CH-1217, Meyrin-2,

Geneva, Switzerland, Ph. (022) 41 54 00.

Japan-Yokogawa-Hewlett-Packard Ltd., Ohashi

Bldg., 1-59-1 Yoyogi, Shibuya-ku,

Tokyo 151, Ph. 03-370-2281/92.

HEWLETT  **PACKARD**

hp MEASUREMENT COMPUTATION news
product advances from Hewlett-Packard

July/August 1977

New product information from

HEWLETT-PACKARD

Editor: Iona M. Smith

Editorial Offices:

1507 Page Mill Road
Palo Alto, California, 94304 U.S.A.



It balances performance and cost where nylons and thermosets can't.

VALOX® thermoplastic polyester resins. From a performance/cost standpoint, VALOX resins consistently outperform nylons and thermosets.

They offer stable electrical properties even at higher temperatures and in moist environments.

VALOX resins have UL recognition of 140°C and heat deflection temperatures up to 420°F. Flame retardant grades are rated 94V-0 at 0.030 in.*

They exhibit excellent resistance to the broad range of solvents and chemicals typically encountered in electrical/electronic applications.

VALOX resins also offer outstanding moldability.

And Cost? VALOX resins cost less than nylons, and parts molded in VALOX resin can be more economical than thermoset parts through unique thin-wall design, scrapfree molding and short cycle times.

For more information on the performance/cost balance that VALOX resins offer, write for our new brochure: Section 300-04, General Electric Company, VALOX Products Section, One Plastics Avenue, Pittsfield, MA 01201.

*This rating is not intended to reflect hazards presented by this or any other material under actual fire conditions.

WHAT THE WORLD IS COMING TO: GE PLASTICS

VALOX® LEXAN® NORYL® GENAL®

GENERAL  ELECTRIC



Circle 27 on reader service card

Intel delivers Intellec® There's no shorter route

Intellec® is Intel's Microcomputer Development System that delivers in-depth support. And, in-depth support gets your microcomputer based products to market faster and easier.

Intellec is the only system that supports the entire line of Intel microcomputers. It's the only system with ICE In-Circuit

Emulation for the 8080, 8085, 8048 and Series 3000 microcomputers. And Intellec is the only development system with a resident high level language for microcomputer system programming.

We call that language PL/M. It has become the most widely used language for microcomputer programming and can cut months off your software devel-



in-depth support. from design to production.

opment cycle. And, because PL/M is resident in the Intellec system, you put an end to timeshare computer charges. You just can't get that kind of power and efficiency from any other system.

We've made Intellec easy to use. You communicate with the system in simple English-like statements. You can write application programs in small, manageable modules and link them together with other programs from the diskette library for loading into your microcomputer's PROM or EPROM memory.

To simplify hardware/software integration and system debugging, Intel's unique ICE modules give you a "diagnostic window" into the operation of your system. The ICE software system is the only one that lets you control, monitor and analyze all microcomputer functions using symbolic references for addresses



and data. And the new ICE-85™ provides expanded in-system emulation capability, extending the window to your entire microcomputer system.

You can count on Intel for in-depth support in other areas, too. Like user application assistance, complete documentation, training programs and design seminars worldwide, and a users' software library with over 275 programs and growing.

That kind of in-depth support is the reason more designers are using more Intel microcomputers and Intellec development systems than all others combined.

To find out how Intellec can get you on the road to faster and easier microcomputer development, contact your nearest Intel distributor or sales representative. For a local demonstration or a copy of the Intellec brochure, use the reader service card or contact us directly. Intel Corporation, 3065 Bowers Avenue, Santa Clara, California 95051. Telephone (408) 246-7501.

intel® delivers.

Circle 28 for technical information

Circle 29 for technical information and a demonstration

MILITARY
APPLICATIONS

A/D CONVERTERS

by

MSK

Accuracy

Speed

Size

Repairability

Military

Temp. Range
-55° C to +125° C

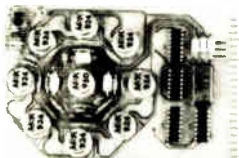

- 4 Bit/50 nSec; Low Cost
- Ideal for Radar Scan Converters
- Holds Absolute Accuracy Over Temperatures
- Tracks a 10 MHz Analog Input



- 9 Bit/200 nSec.
- < 2 Bit Drift Over Temperature
- Insensitive to Clock Frequency

For Further Information Call or Write
M.S. Kennedy Corp.
Pickard Drive, Syracuse, New York 13211
Tel. 315-455-7077

Meetings

Comcon Fall, IEEE, Mayflower Hotel, Washington, D. C., Sept. 6-9.

Fall meeting of Electronics Division of American Ceramic Society, ACS (Columbus, Ohio), Queen Elizabeth Hotel, Montreal, Quebec, Canada, Sept. 18-21.

Wescon 77, IEEE, Brooks Hall and Civic Auditorium, San Francisco, Sept. 19-21.

ESSCIRC 77—Third European Solid State Circuits Conference, IEEE et al., Ulm University, Ulm, West Germany, Sept. 20-23.

Eascon—Electronic and Aerospace Systems Convention, IEEE, Sheraton National Hotel, Arlington, Va., Sept. 25-28.

Communications Satellite Symposium, American Institute of Aeronautics & Astronautics (New York, N.Y.), Prague, Czechoslovakia, Sept. 25-Oct. 1.

International Electrical Electronics Conference & Exposition, IEEE, Automotive Building Exhibition Place, Toronto, Canada, Sept. 26-28.

Fourth International Conference on Computer Communication, International Council for Computer Communication (Washington, D. C.), Kyoto International Conference Hall, Kyoto, Japan, Sept. 26-29.

Thirteenth Electrical/Electronics Insulation Conference, IEEE et al., Palmer House Hotel, Chicago, Ill., Sept. 26-29.

Fifth Data Communications Symposium, IEEE and ACM, Snowbird, Utah, Sept. 27-29.

Advanced Techniques in Failure Analysis Symposium, IEEE, Marriott Hotel, Los Angeles International Airport, Sept. 27-29.

NMA/IMC Mid-Year Meeting, National Micrographics Association and International Micrographic Congress (Silver Spring, Md.),

Washington Hilton Hotel, Washington, D. C., Sept. 27-29.

Military Electronics Defence Expo '77, Industrial & Scientific Conference Management Inc. (Chicago), Rhein-Main-Halle, Wiesbaden, West Germany, Sept. 27-29.

International Conference on Thin- and Thick-Film Technology, IEEE, Congress Center, Augsburg, West Germany, Sept. 28-30.

Industry Applications Society Annual Meeting, IEEE, Marriott Hotel, Los Angeles, Oct. 2-4.

Euromicro—Third Symposium on Microprocessing and Microprogramming, IEEE et al., Free University, Amsterdam, the Netherlands, Oct. 3-6.

Nepcon '77 Central, Industrial & Scientific Conference Management Inc. (Chicago), O'Hare International Trade and Exposition Center, Chicago, Oct. 4-6.

Gidep—Government-Industry Data Exchange Program Conference, Gidep (c/o Dennis Starling, Datagraphix Inc., San Diego, Calif.), South Coast Plaza Hotel, Costa Mesa, Calif., Oct. 5-7.

Interkama 77—International Congress and Exhibition for Instrumentation and Automation, NOWEA (Düsseldorf, West Germany), Fairgrounds, Düsseldorf, Oct. 6-12.

Electrochemical Society, Electronics Division Symposium, The Electrochemical Society (Princeton, N. J.), Hyatt Regency Hotel, Atlanta, Ga., Oct. 9-14.

IntelCom 77—International Telecommunication Exposition, Horizon House International (Dedham, Mass.), Georgia World Congress Center, Atlanta, Oct. 10-15.

Tenth Convention of Electrical and Electronic Engineers in Israel, (c/o Daphna Knassim Ltd., New York, N. Y.), Tel Aviv, Oct. 10-13.

New from Centralab...

IMPS PUSHBUTTON SWITCHES

A new miniature modular building block system that offers microprocessor control designers more of what they need.

To meet the special digital and analog needs of today's μ P-based controls, Centralab offers design engineers a whole new system of modular pushbutton switch building blocks. We call it IMPS — Integrated Modular Panel System. IMPS saves PC board and panel area and simplifies front panel design, cuts assembly costs, reduces back-panel space requirements, and meets the digital-analog needs of μ P-based controls. Check these space saving, cost-cutting features.

Simplify front panel interface.

All IMPS switches regardless of function, are uniform in size, simplifying design and selection of front panel hardware. They have high volumetric efficiency, occupying .505" x .388" PC board area and require only .608" of space between PC board and front panel.



Cut assembly costs.

IMPS switches may be mounted on the front panel, and are designed for automatic wave soldering installation and PC board cleaning. Insert molded terminals prevent flux and solder wicking and contact contamination. Integral PC board stand-offs provide for efficient board cleaning.

Meet analog and digital needs.

IMPS switches are available with momentary, push-push and interlocking actions, with a long-life contact system that switches both digital and analog signals. To accommodate critical signal requirements, housings are high-insulation molded plastic with UL 94V-0 rating.

Available options.

Optional installations include ganged assemblies, front-panel mounting and wire-wrapping.



All IMPS pushbutton switches are built to Centralab's highest quality standards (see specifications at right). They're priced as low as 41 cents in 1,000 quantity. For full technical details, samples and quotation, call (515) 955-3770, or write to the address below.



CENTRALAB

Electronics Division

GLOBE UNION INC.

P.O. BOX 858

FORT DODGE, IOWA 50501

Built To Centralab Quality Specs.

IMPS Pushbutton Switches combine compact size, low cost and highest quality throughout.

- Silver or gold inlay wiping contacts for long-life and low-contact resistance.
- Less than 2 milliseconds contact bounce.
- SPST, SPDT, DPST, and DPDT switch contacts.
- Printed circuit, DIL socket or wire-wrap terminations available.
- 2.5 to 3.5 oz. actuation force (momentary).
- Choice of button interface — square or blade shaft (shown) — permits use of a variety of Centralab and industry standard buttons and keycaps.
- 10, 15, 20 or 25mm center-to-center spacing.

Circle 31 on reader service card

Forget our products.

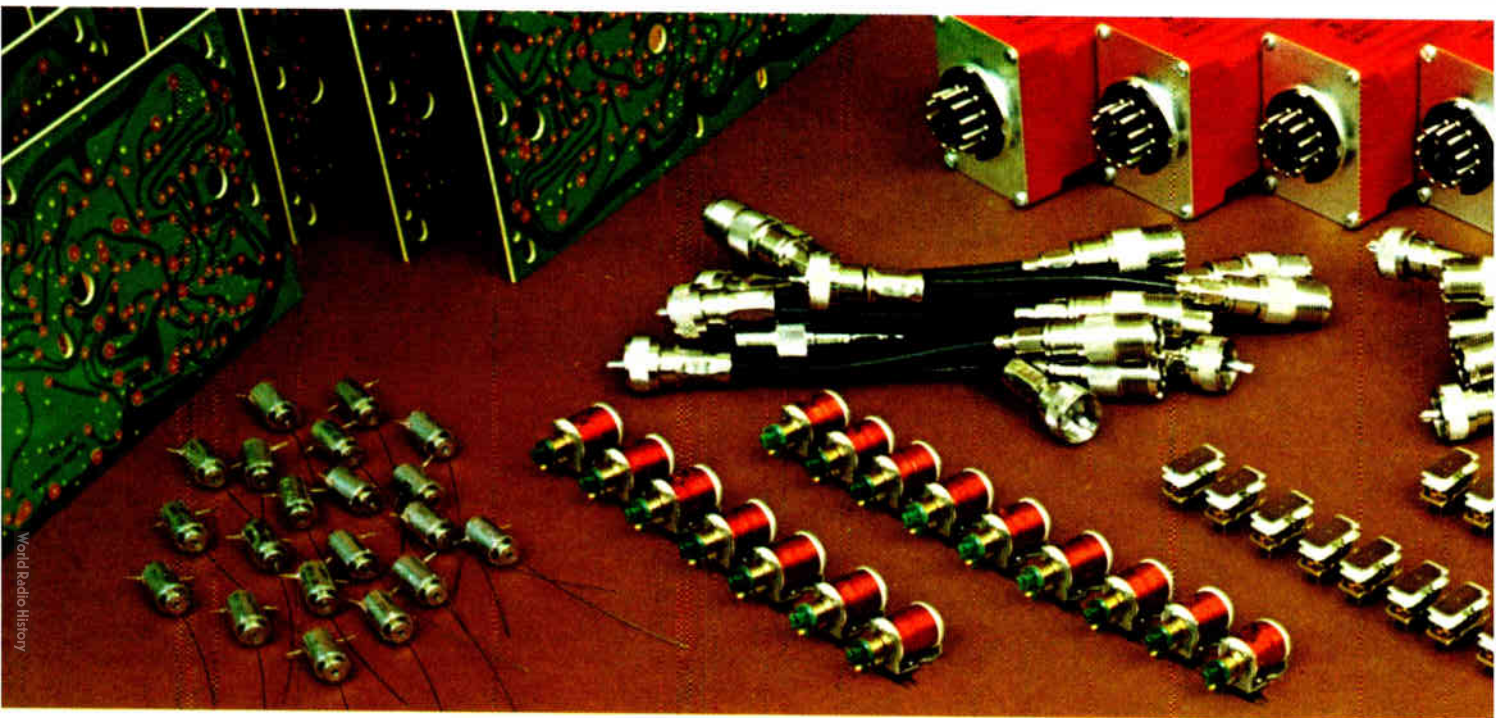

World Pacific History

Major manufacturers forget them all the time. Polaroid. DEC. Honeywell. Tandy. Foxboro. Ford. Bendix. Our products are easy to forget. Because, once installed, all of

Hi-G's quality products (transformers, solenoids, timers, printed circuit boards and others) do what they are meant to do. Keep right on working.

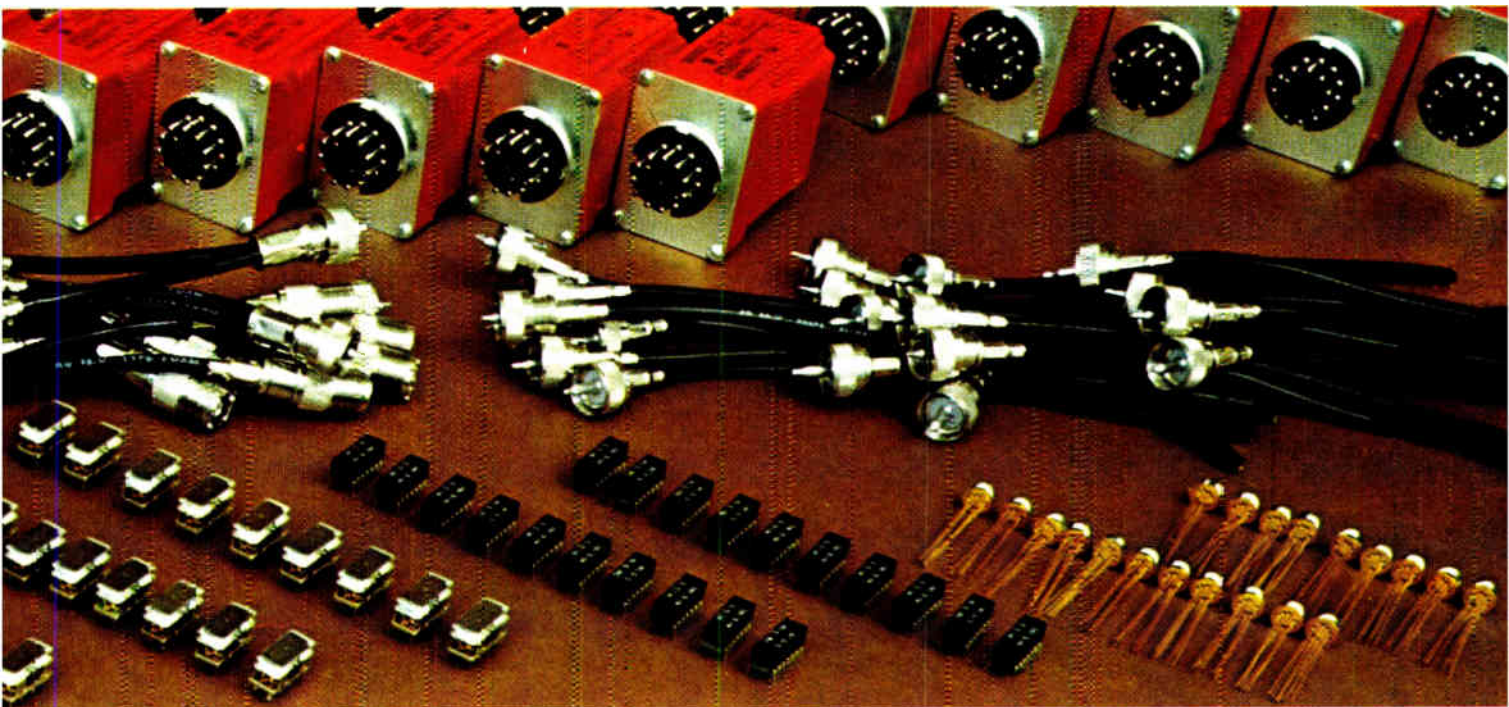

That's why Polaroid selected a Hi-G Magnetec solenoid to actuate the shutter on the SX-70 and the Pronto Land Cameras. Why Raytheon relies on the quality and performance of our Defiance printed circuit boards, counts on our prompt delivery at competitive prices. And why Hi-G commercial relays are on the job in scores of Foxboro control systems.

Our products work. And keep working. So it's fine with us if you forget them. Just remember our name. Hi-G Incorporated, 580 Spring Street, Windsor Locks, CT 06096.



Remember our name.

Whatever you need in an IC socket... **RN has 'em all!**

—and with “side wipe” reliability

PRODUCTION SOCKETS

NEW! ICL Series

26% lower profile—.150"
Ideal for high density, high volume configurations, provides maximum vibration resistance. Solder type, single leaf “side-wipe” contacts. 8 to 40 contacts.

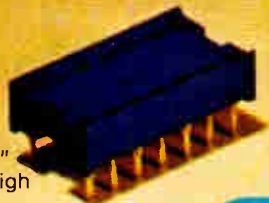

ICN Series high reliability general-purpose sockets. Low insertion force allows automatic IC insertion. In solder or wire-wrap. 6 to 64 contacts. Dual leaf “side-wipe” contacts.

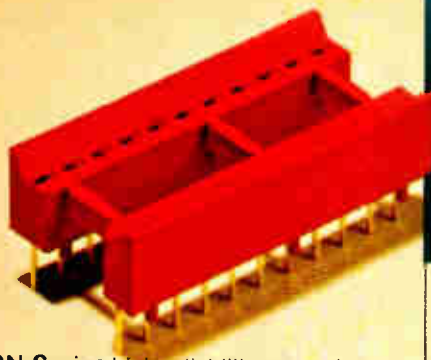

ICA Series

high reliability pin socket contacts. Low profile in solder or wire-wrap. 8 to 40 contacts.



WRITE TODAY
for New RN “Product Selection Guide”...



BURN-IN, TEST SOCKETS

TS Series

Very long contact life. Very low insertion force. Ideal for incoming inspection. With 14 to 40 contacts. Also strip sockets up to 21 positions.



RN HIGH RELIABILITY eliminates trouble. “Side-wipe” contacts make 100% greater surface contact with the wide, flat sides of your IC leads for positive electrical connection.

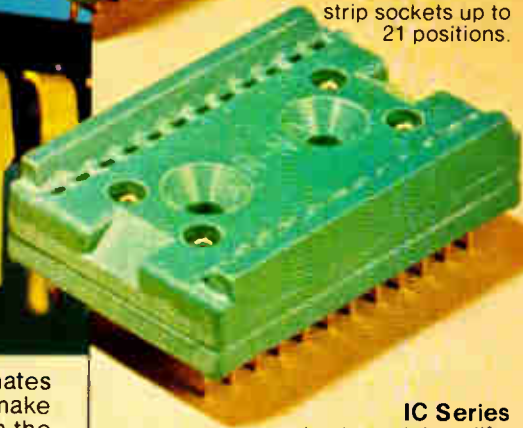

IC Series
moderate cost. Long life. Designed for general test and burn-in up to 350°C. With 14 to 40 contacts.

ICN/S2 Series

lowest cost burn-in socket available. Designed to accept IC extraction tool. With 8 to 40 contacts, with strip sockets up to 25 positions.

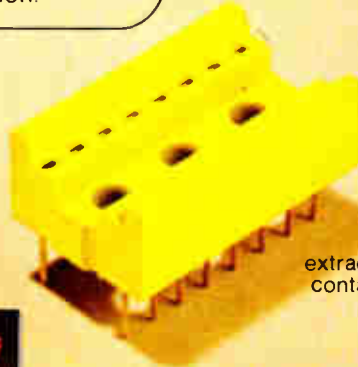

... and informative book “What to Look for in IC Interconnects.” Free from RN—the people who make more kinds of high reliability sockets than anyone.

RN ROBINSON NUGENT, INC.

ROBINSON-NUGENT, INC. • 800 East Eighth Street • New Albany, Indiana 47150 • Phone: (812) 945-0211

First hybrid 12-bit data-acquisition system due soon

Datel Systems Inc. next month will unveil the industry's first data-acquisition system to offer 12-bit resolution in one miniature metal package. The Canton, Mass., company's HDAS-16 and HDAS-8 thin-film hybrids are 16-channel single-ended or 8-channel differential units. Their combined acquisition-and-conversion time of 20 microseconds allows a 50-kHz throughput. At that speed, **"they'll probably be the fastest units on the market** of any kind that have a built-in instrumentation amplifier," says Eugene Zuch, product marketing manager for data-conversion products.

Also included in the units are a complementary-MOS multiplexer, sample-and-hold circuit, 10-v buffered reference, and the 12-bit a-to-d converter in a 62-pin metal can measuring 2.3 by 1.4 by 0.24 inches. Zuch says the much larger data-acquisition modules with which these will compete do not always include an instrumentation amplifier or have three-state outputs compatible with microprocessor buses, as do the Datel parts. Prices will range from \$295 to \$695, depending on operating temperature range.

Bipolar power transistor market target of Siliconix

Look for Siliconix Inc. to go after the \$5 million segment of the power transistor market now dominated by bipolar devices. The firm will announce next month the VN46AF series, a new group of power MOS field-effect transistors **fabricated with its v-MOS technology and housed in a TO-202 plastic package**. The new series will sell for under \$1 in lots of 100 and for about 50 cents in high volume. It features 2-milliampere continuous forward gate currents and drain source voltages ranging from 40 to 80 volts.

GI puts game for arcade play on one TV chip

Confounding industry skeptics, General Instrument Corp.'s Microelectronics Group in Hicksville, N.Y., is delivering an arcade-level tank battle game in a single television-game chip. The AY-3-8700 chip replaces the many boards of transistor-transistor logic and read-only memory found in arcade games of equivalent performance and **"is the beginning of a whole new type of dedicated video game,"** according to GI.

The game provides each of two players with a firing button and a video tank. The tank is completely steerable through 32 rotational angles and has three forward and three reverse speeds. Tank engine, gunfire, and explosion noises are audio outputs of the chip, while its video outputs include shells, shell bursts, and mines. For use with standard domestic TV receivers, the AY-3-8700 is available in a 28-pin dual in-line package at a base price of \$9.25 each in lots of 50,000.

System doubles battery life, Gould predicts

Gould Inc. is developing a new electrochemical system that should double battery life for electronic watches. The firm's St. Paul, Minn., Portable Battery division will start shipping an air-activated button-cell for hearing aids this fall, and versions for other consumer products — such as watches, calculators, and cameras — are probably not far behind.

Rather than using a metal oxide cathode to supply oxygen for the zinc anode, as in mercury and silver oxide batteries, **Gould relies on a catalyst that reacts with oxygen from the air**. The technique permits a larger zinc anode, doubling battery life in the hearing aid cell. A factory-installed seal keeps air out of the cell till the user removes it, prolonging shelf life.

Electronics newsletter

Monolithic 100-MHz converter costs \$30 to \$50

Advanced Micro Devices will begin shipping samples in the fourth quarter of what it calls a monolithic quantizer—an analog-to-digital converter that operates at video speeds. With its throughput rate of 100 megahertz, the 4-bit IC is intended for such applications as video-signal and radar processing. It is the follow-on to AMD's AM685 high-speed comparator and **contains the equivalent of 16 such devices** including decoding and a ladder network. An emitter-coupled-logic-type device, the AM6688 has two layers of metalization, three resistor technologies, three types of semiconductor materials, and three processing techniques. Priced at \$30 to \$50 each, the AM6688 will compete with devices costing as much as \$1,650.

50 Navy Tomcats to be converted to recon craft

Grumman Aerospace Corp. of Bethpage, N.Y., will modify about 50 of its Navy F-14 Tomcat fighter planes to accommodate a Tactical Air Reconnaissance Pod System (Tarps) to convert them into RF-14 reconnaissance aircraft. **They would replace the aging RF-8s and RA-5Cs** now in the fleet inventory.

The Tarps provides horizon-to-horizon coverage via the new KA-99 panoramic camera from Fairchild Camera and Instrument Corp.'s Imaging Systems division in Syosset, N. Y., and selectable forward oblique or vertical coverage with the KS-87B camera from Bourns Inc.'s CAI division in Barrington, Ill. Also in the Tarps is the AAD-5 passive infrared scanner from Honeywell Inc.'s Radiation Center in Lexington, Mass., that scans the ground area along the aircraft flight path and produces a high-resolution film record of the terrain's IR characteristics in a panoramic format. The Naval Air Development Center at Johnsville, Pa., is building prototype Tarps, which are expected to fly before year's end.

Motorola trades erasability for plastic package

Motorola will make an unusual tradeoff next month as it starts shipping samples of its MCM2708 erasable programmable read-only memory in a windowless plastic package. By giving up the ability to erase the part with ultraviolet light, which most customers don't use, **it can get rid of the expensive ceramic package with its quartz window.** That allows the firm's Austin, Texas, operation to price the 8,192-bit device—now simply a programmable ROM—at under \$10 in volume, or \$14.20 in 100-piece lots. And that's only two thirds the price of 2708 erasable programmable ROMs from the cheapest source, Texas Instruments, which recently lowered its price to \$21.50 (Motorola's ceramic 2708 is \$30.)

Addenda

Fiber-optic technology has progressed to the point at which "a market of at least \$1 billion seems assured within the next 10 years," according to International Resource Development Inc., a New Canaan, Conn., market research firm. The firm's projections indicate the market **will grow from only about \$10 million this year** to more than \$100 million in 1980 and climb past the \$1 billion mark by 1987. . . . Dionics Inc., a maker of silicon chips in Westbury, N. Y., will make its market debut next month with miniature silicon solar cells. The wire-bonded, oxide-passivated cells, called the PK series, will have **protected junctions and both contacts in the top surface** for assembly with conventional wire-bonding techniques. Priced from 20 cents in 1,000-piece orders, the cells are intended to charge batteries in electronic watches, portable instruments, calculators, radios, and hearing aids.



microNOVA keeps on trackin'.

Southern Railway has a long track record of being one of the most profitable rail systems in the country. To help stay on that track, they decided to increase the speed and flexibility of their online distributed communications network. So Southern Railway is now changing dumb terminals into intelligent ones throughout its rail system, using microNOVA microcomputers.

Southern Railway found that only the Data General microNOVA microcomputers could help them cut costs and keep track of some 75,000 freight cars moving over 10,500 miles of track, and do it the way Southern Railway wanted to. Controlling rolling inventory like that takes a lot of flexibility. And that's the big advantage Data General microNOVA microcompu-

ters bring to any application. Whether in a chip, on a board, or as a packaged system.

With the speed, flexibility and software of a minicomputer and the economies of microprocessor technology, microNOVA microcomputers let you do things your way. That's why they're setting track records in all kinds of applications.

Mail to: Data General, Westboro, MA 01581

- Send microNOVA technical literature.
 Send literature and have your sales representative call.

Name _____

Title _____

Company _____

Address _____ Tel. _____

City _____ State _____ Zip _____

NOVA is a registered trademark of Data General Corporation
 © Data General Corporation, 1977

Data General, Westboro, MA 01581, (617) 366-8911. Data General (Canada) Ltd., Ontario. Data General Europe, 15 Rue Le Sueur, Paris 75116, France, 50-006-06. Data General Australia, Melbourne (03) 82-1361. EM 818

Data General
 It's smart business.

World Radio History

Circle 37 on reader service card

For a whole range of capabilities

Ask CYBERNET[®] Services.

Get advanced programs that can cut time and costs, increase reliability in electronic design/analysis/testing. Easy-to-use through batch or interactive terminals. And available now with technical support just about anywhere in the U.S.

CIRCUIT ANALYSIS—SYSCAP II
SYSCAP simulates circuit design on an interactive terminal. And it's reliable enough to let you go from schematic to simulation to production without ever building a physical breadboard. Circuits are modeled as a system of nodes interconnected by circuit elements, driven by signal sources and power supplies. A data bank for conventional parts is built into the program. Special functions can be easily formulated in FORTRAN. A single, free-format, easy-to-use language enables you to submit the same circuit file with only minor alterations to any type of analysis — AC, DC, transient — in either mode — batch or interactive. SYSCAP is easy to learn, efficient, economical and completely supported.

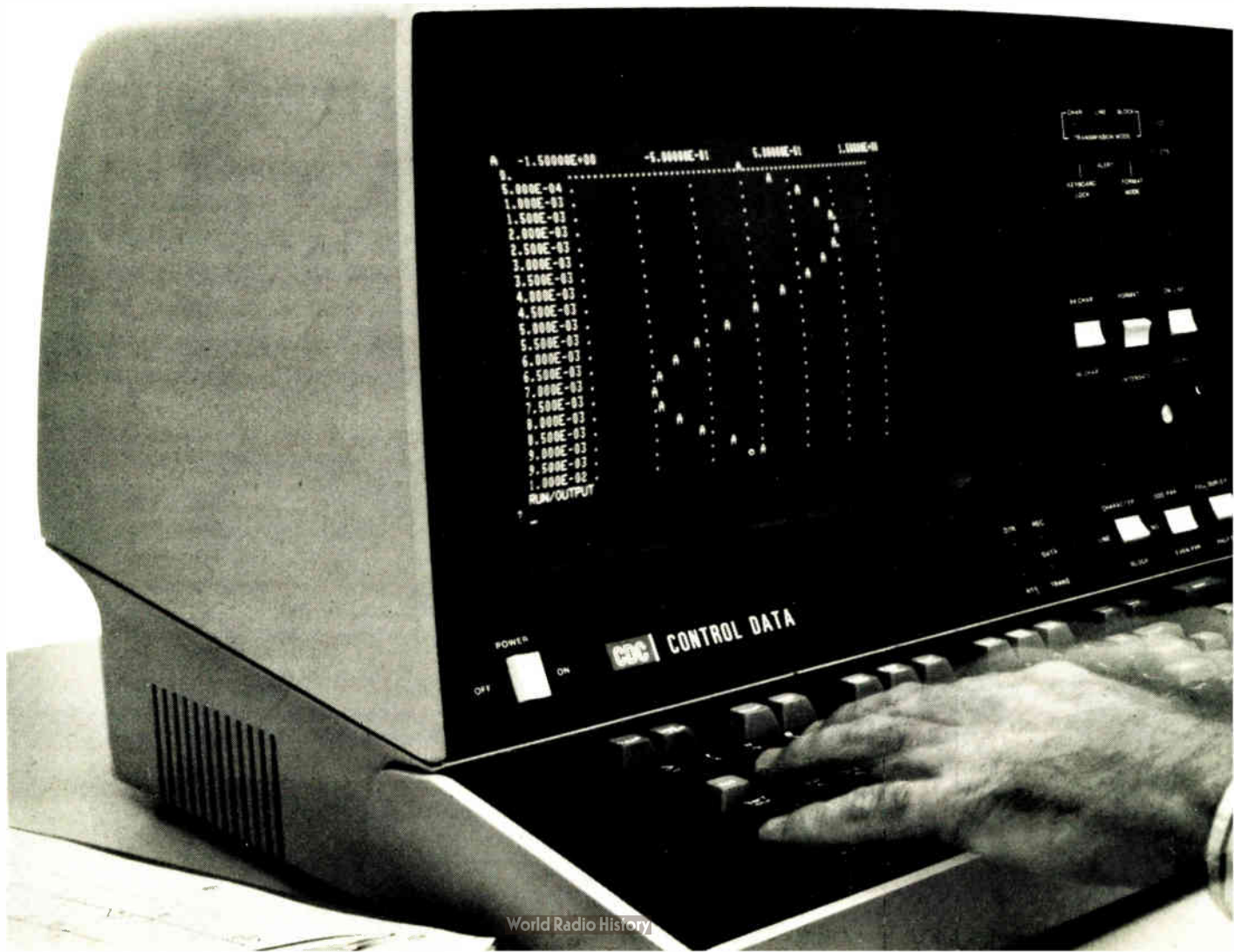

in computer-aided design...

CIRCUIT AND SYSTEM ANALYSIS — TESS

TESS is a flexible modeling tool which can be used not only in circuit design, but in combinational analysis (electromechanical, digital-analog, electro-optical)—virtually any system which can be represented by a set of coupled linear or non-linear differential equations. Data for approximately 1200 semiconductor devices is available with the program. A single input language makes it easy to use TESS's wide range of capabilities.

LOGIC SIMULATION/TEST GENERATION

CC-TEGAS3 enables you to perform the three fundamental functions required in digital logic simulation—design verification, fault simulation, and test generation—with a single input language. TEGAS can be used through either batch or interactive terminals. A stand-alone preprocessor allows you to check out and correct input before submitting it to analysis. Combining all three applications into one system makes it possible for the designer to file test patterns for subsequent use by a test engineer in fault detection tests.

MICROPROCESSOR PROGRAMMING — MICROLIB

MICROLIB is a library of assemblers and simulators for writing and verifying programs for the leading microprocessors and their second sources. It allows you to simply and easily evaluate chips for your particular requirements prior to purchase. And, programming is simpler and

easier using an assembler instead of machine language. Simulators let you verify the program by observing how well it works, how efficient it is, if there are any errors, and what output it generates at different points. With MICROLIB, you get fast turnaround, efficient programs, support when you need it, and a broad selection of microprocessor software—with no development or maintenance costs.

TECHNOLOGY SURVEY — TINA

TINA is a new service for CYBERNET users which allows you to quickly survey more than 10,000 abstracts from nearly 2000 scientific and technical journals via interactive terminal. The TINA service is concerned with innovations in electronics, telecommunications, computers, control, electrical power engineering and physics. TINA is a part of Control Data's TECHNOPEC™ Technology Exchange Service.

CYBERNET SERVICES TOTAL CAPABILITIES

CYBERNET Services offers a unique combination of comprehensive programs, computer power, technical support and a full selection of processing modes—for better, faster, more economical designs.

For information, call your nearby CYBERNET Service Center, circle the number below, or call our hotline, collect: 612/853-7600.

GD CONTROL DATA CORPORATION

Circle 39 on reader service card



Introducing the SMALLEST

BROADBAND MIXERS

in the world - 40 kHz - 2 GHz

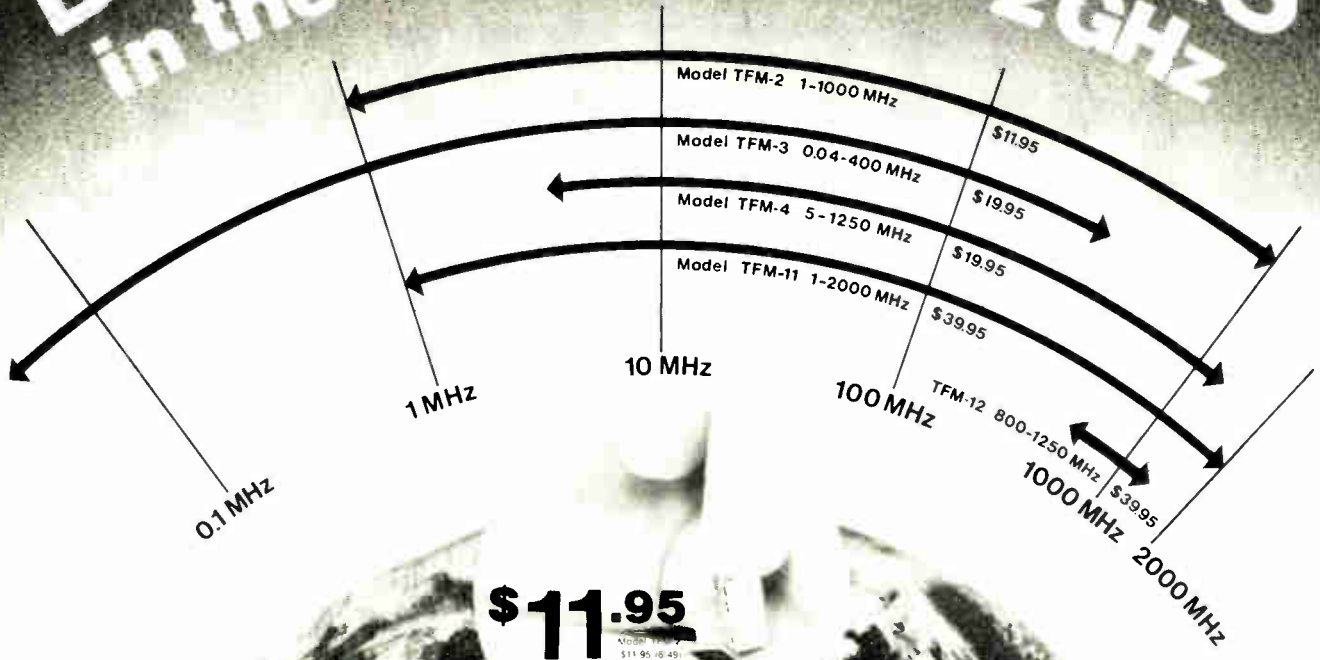

Our new designs increase your packaging density, and lower your costs. Specify Mini-Circuits' TFM series. This series of mixers is the smallest off-the-shelf Double-Balanced Mixers available today, cover the 40 kHz to 2 GHz range and offer isolation, high linearity and conversion loss of 6 dB. Each unit carries with it a 3-year guarantee by M.C.L. The TFM series is a system designed to rapidly become the new industry standard for high performance at lowest cost.

Model No.	LF	HF	Imp. Band Edge	Gain		Noise		Isolation		Conversion Loss		Quantity	Price							
				Typ	Max	Typ	Max	Typ	Min	Typ	Min			Typ	Min					
TFM-2	1-1000	1-1000	DC-1000	6.0	7.5	7.0	8.5	50	45	40	25	35	25	20	6-49	\$11.95				
TFM-3	0.04-400	0.04-400	DC-400	5.3	7.0	6.0	8.0	60	50	55	40	50	35	45	30	35	25	5-49	\$19.95	
TFM-4	5-1250	5-1250	DC-1250	6.0	7.5	7.5	8.5	50	45	45	40	40	30	35	25	30	25	20	5-49	\$19.95
TFM-11	1-2000	1-2000	5-600	7.0	8.5	7.5	9.0	50	45	45	40	35	25	27	20	25	20	1-24	\$39.95	
TFM-12	800-1250	800-1250	50-90	—	6.0	7.5	35	25	30	20	35	25	30	20	35	25	30	20	1-24	\$39.95

Signal: 1 dB compression level ± 1 dBm; Impedance: all ports 50 ohms; Total input power 50 mW; Total input current peak ± 0 mA; Operating and storage temperature -55°C to $+100^{\circ}\text{C}$; Fin temperature 510°F (10 sec).

Simple mounting options offer optimum circuit

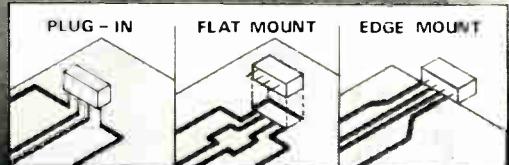

Use the TFM series to solve your tight space problems. Take advantage of the mounting versatility—plug it upright on a PC board or mount it sideways as a flatpack.

WE'VE GROWN

Customer acceptance of our products has been so overwhelming, we've been forced to move to larger facilities — THANKS.

International Representatives: AFRICA: Afira (PTY) Ltd, P.O. Box 9813, Johannesburg 2000, S. Africa. AUSTRALIA: General Electronic Services, 99 Alexander Street, New South Wales, Australia 2065. ENGLAND: Dale Electronics, Dale House, Wharf Road, Frimley Green, Camberley Surrey. EASTERN CANADA: B.D. Hummel, 2224 Maynard Avenue, Utica, NY 13502 (315) 736-9921. FRANCE: S.C.I.E. - D.I.M.E.S. 31 Rue George - Sand 91120 Palaiseau, France. GERMANY, AUSTRIA, SWITZERLAND: Industrial Electronics GMBH 6000 Frankfurt/Main Klüberstrasse 14 West Germany. INDIA: Gaekwar Enterprise, Kama Mahal, M.L. Dananjkar Marg, Bombay 400 028, India. ISRAEL: Vectronics Ltd, 69 Gordon Street, Tel Aviv, Israel. NETHERLANDS, BELGIUM, LUXEMBOURG: Coimes, Veldweg 11, Hattem, Holland. NORWAY: Datamatik AS, Ostensjøveien 62, Oslo 6, Norway. SINGAPORE & MALAYSIA: Electronics Trading Co. (PTE) Ltd, 87 Bukit Timah Road, Singapore 9, Malay Peninsula. SWEDEN: Intergrad Elektronik AB, Box 43, S-18251, Djursholm, Sweden.

U.S. Distributors: NORTHERN CALIFORNIA: Cain-White Co., Foothill Office Center, 105 Fremont Avenue, Los Altos, CA 94022 (415) 948-6533. SOUTHERN CALIFORNIA, ARIZONA: Crown Electronics, 11440 Collins Street, No. Hollywood, CA 91601 (213) 877-3550.



World's largest manufacturer of Double-Balanced Mixers

Mini-Circuits

MINI-CIRCUITS LABORATORY A Division of Spectrum Components Corp.

OUR NEW ADDRESS
AND PHONE NO. IS:

2625 EAST 14th STREET
BROOKLYN, NEW YORK 11235
(212) 769-0200

DOMESTIC TLX 125460 • INTERNATIONAL TELEX 620156

Navy has new way for calibration of test instruments

Mecca system uses controllers built around microprocessors to put instruments through paces, keep track of results

Within months, the U. S. Navy will be testing new commercial equipment that will permit calibrating its many different pieces of test instruments by relatively unskilled operators. Such equipment meets the Mecca concept of J. L. "Jerry" Hayes, technical director of the Navy's metrology engineering center: a virtually fool-proof calibration system that is also automated and portable.

"There are about 2.8 million test instruments in use by the military that have to be taken care of by someone who isn't an engineer, a para-engineer, or even a trained technician," says Hayes. Furthermore, proliferation of test equipment and supporting inventory is awesome—the Navy alone has 30,000 models numbering more than 1 million. It is at the point where the services cannot cope with the calibration load by bringing instruments to a central repair depot or to a field station, where 21 items of test equipment are required. Thus the need for Mecca, which simplifies the critical judgments a technician must make.

New instruments. Essentially, Mecca has two elements: a calibrator that puts out very accurate signal levels, and a controller that determines the sequence and level of signals applied to the unit under calibration. The signals are applied automatically, in response to a

stored program written for the particular model being calibrated. At the same time, the calibrator displays what the reading should be.

The operator compares the desired and the actual readings and adjusts the calibrator until the desired reading is obtained on the unit. The controller then calculates whether the amount of calibrator adjustment is within specifications. If not, the operator is given instructions to adjust specific variable components on the unit being calibrated.

Mecca (which stands for "modularly equipped and configured calibrators and analyzers") consists of a suitcased-sized controller and one calibrator for oscilloscopes and another for meters (see "Coming up: Mecca gear," p. 42). A Digital Equipment Corp. LSI-11 in the controller supplies the testing brainpower, interfacing with the operator through an Owens-Illinois Inc. 8-by-2 $\frac{3}{4}$ -inch plasma-display panel.

"The plasma display is necessary in helping untrained operators who

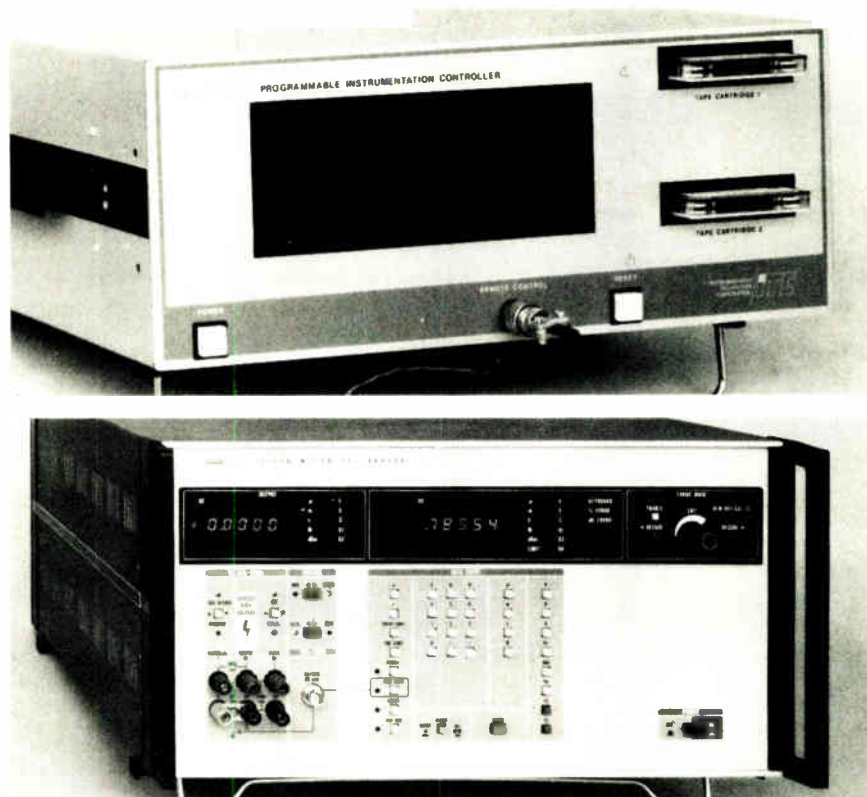

New models. Instruments being developed in conjunction with Navy's Mecca calibration system include programmable controller (top) from Instrumentation Technology and meter calibrator from John Fluke. Gas panel display on controller is shown in data-entry mode that allows operator to "key" in information by touching finger to screen.

Coming up: Mecca gear

At least a trio of instrument manufacturers are developing the new kinds of instruments needed for the Navy's Mecca system of automatic calibration, and they hope to sell them to industrial users as well. They are Instrumentation Technology Corp., a Northridge, Calif., designer of custom systems and a specialist in microprocessor applications, and the well-known instrumentation houses of John Fluke Manufacturing Co., Mountlake Terrace, Wash., and Tektronix Inc., Beaverton, Ore. They worked on the instruments mostly with their own funds and in close collaboration with the Navy metrology center in Pomona, Calif.

Already available is Instrumentation Technology's model 9601 precision instrument controller (p. 41). Selling for \$11,700, it incorporates the plasma panel display that also acts as an input keyboard for the user of the equipment.

Fluke is readying a pair of meter calibrators for introduction at the Wescon Show, Sept. 19-21, in San Francisco. Both models, the 5100A and the 5101A (p. 41) are built around the 6800 microprocessor. They will sell for \$6,495 and \$8,495, respectively, with the more expensive device containing a cassette unit that can be programmed. Tektronix is readying an oscilloscope calibrator, but a marketing official there says it is premature to set a price on it yet.

don't know how to use a keyboard," Hayes explains. The operator may simply select a routine by putting a finger on one of a number of options presented on the screen. The finger breaks a light beam from infrared diodes (arranged in a 4-by-16 array), and the processor identifies the precise point and starts the appropriate routine. Programs for each instrument model are on tape cassettes that plug into the controller. The display also presents step-by-step instructions for each calibration of an instrument.

Test results are stored on a blank cassette, for such purposes as deciding how long an instrument's calibration intervals must be and how much it drifts during use.

Hayes's metrology group in Pomona, Calif., writes the program cassettes. To date, it has completed those for testing several voltmeters and scopes, classes of instruments that make up 70% to 75% of the instrument population. The next step will be to move on to instruments representing lower calibration workloads.

The Navy will install the first Mecca units aboard several ships as soon as it gets them. Hayes already sees room for improvement, however. Weight of the controller and meter calibrator can stand improve-

ment, he thinks. The controller, now at 38 pounds, "should be closer to 25," and the meter unit, a bulky 60 lbs because of a precision ac-dc power supply, "is way too heavy." Next to come under Mecca, and requiring separate calibrators, will be signal generators, then frequency counters, followed by more complex analyzer gear, Hayes says. □

Automotive

Motorola nets Ford award

Enlarging its stake in the tantalizing automotive electronics business, Motorola Inc. has won a Ford Motor Co. design run-off aimed at selecting electronic engine controls on 1980 and later cars. This victory of its Automotive Products division follows its Integrated Circuits division's success in becoming top outside vendor for General Motors Corp.'s auto microprocessor programs [*Electronics*, Jan. 20, p. 31]. The awards may turn into the two largest orders in the history of the semiconductor business.

At Ford's Engine Control division in Dearborn, Mich., the Motorola design outdid entries from the Essex

group of United Technologies Corp., Tokyo Shibaura Electric Co. (Toshiba), and Ford's own Electrical and Electronics division, which had submitted designs from its two semiconductor vendors, Intel Corp. and Texas Instruments Inc. Ironically, Motorola had been excluded from bidding for EED's semiconductor business.

Custom micro. The Motorola approach reportedly uses a custom microcomputer tailored specifically to automotive applications. Called the 6700, the two-chip system mates an n-channel metal-oxide-semiconductor processor with an integrated-injection-logic input/output and analog-to-digital converter chip. Using an 8-bit data word and a 10-bit control word, it will handle spark timing, exhaust gas recirculation, and fuel management.

Ford's production volumes and timing are still unclear, resting largely on the vagaries of emission-control legislation. But insiders expect a minimum of a half-million modules in 1980 Ford cars as the Motorola design is phased in, and subsequent years should see the devices in all of Ford's annual output of more than 3 million vehicles.

Also uncertain is the size of Motorola's share of the business. Bidders were notified earlier this month that module production would be split, with 25% each going to Motorola and Essex, and 50% to EED. All vendors must copy the Motorola design, and Motorola must supply EED's semiconductor vendors with sufficient information to build the chips. The industry consensus, however, is that Essex will not be able to deliver competitively priced modules, and its share will likely be split between Motorola and EED. And Motorola's reliance on 1^2L as part of its design may hand EED's chip business over to TI because Intel has no 1^2L capability, unless EED uses Motorola as chip vendor.

Until the new module comes on stream in 1980, Ford will be trying out a couple of interim designs, primarily to gain on-the-road experience with electronic controls. It expects to ship some 30,000 cars

equipped with its 1978-model package, a spark-timing and exhaust-gas recirculation control built around nine custom integrated circuits, including a 12-bit processor. Module suppliers are Toshiba, Essex, and EED—all using Toshiba chips. But the Toshiba system will be repartitioned into six chips for Ford's 1979 requirements—possibly 100,000 to 150,000 modules. The 1979 module will also be used in 1980 cars until the Motorola module can be phased

in; TI will supply about 90% of the chips for the 1979 modules.

Also, Ford will ship about 30,000 1978 Pinto and Bobcat subcompacts equipped with an electronically controlled carburetor. The feedback control unit will be manufactured by EED and Motorola's Schaumburg, Ill., Automotive Products division, and will probably use the Mostek-designed 3870 one-chip microcomputer that Motorola recently decided to second-source. □

Personal computers

Radio Shack offers computer system with video display for only \$600

The world's largest retailer of electronics, the Radio Shack chain of more than 6,000 stores and outlets, has just entered the consumer-computer market. And it has done so not only with a microcomputer system that it designed itself, but with one that is the market's price leader—\$599.95 buys a 12-inch cathode-ray-tube display, keyboard, and cassette tape recorder.

Called the TRS-80, the microcomputer system is built around Zilog Corp.'s high-performance Z-80 microprocessor and comes with 4,096 bytes each of random-access and read-only memory. It is the easiest to set up and use of any microcomputer system now available. This is because its Basic assembler is already in ROM and does not need to be loaded into memory. All that is needed is for the separate units to be plugged together. Turned on, the computer system responds by saying "Ready." The user then types in simple Basic language statements either to create programs or to load the blackjack or backgammon programs supplied on the cassette that comes with the system.

"There's only one way a product like this can make it," says John Ratliff, assistant to the chief executive officer of Tandy Corp., Fort Worth, Texas, which owns Radio Shack. "We told the design engineers, 'Keep it simple. It's got to be

easy to understand.'" Radio Shack's own engineering staff handled the design (see "Radio Shack forms Tandy's backbone," p. 44).

Another prerequisite was flexibility. The first prototypes put everything—CRT, keyboard, and cassette—into one enclosure. "But we wanted a modular system that could be hooked up different ways and grow as easily as possible," explains Ratliff. "If a guy wants a bigger

CRT, for example, we want to be able to give it to him."

Elsewhere. Perhaps the nearest competitor—at least in price—to the TRS-80 is Commodore Business Machines Inc.'s PET microcomputer [*Electronics*, May 12, p. 36]. The Palo Alto, Calif., company made headlines when it said it would be selling its single-enclosure CRT-display machine for \$495. But the company's credibility suffered when it raised its price to \$595 [*Electronics*, June 23, p. 8]. Sam Bernstein, marketing vice president at Commodore, maintains it will begin shipping units in September at that price, but, according to one skeptical industry source, "so far it's all smoke."

Other microcomputer systems [*Electronics*, March 31, p. 89] are still far from being price-competitive with the TRS-80. Heath Co.'s recently introduced \$345 H8 microcomputer kit, like most of the Benton Harbor, Mich., firm's products, is directed more toward the hobbyist. Moreover, a video terminal is not included and costs an extra \$530.

The TRS-80 is designed with Radio Shack's own 48-line bus that allows peripherals to be daisy-



System. Radio Shack's \$600 TRS-80 microcomputer system consists of a 53-key keyboard containing a Zilog Z-80 microcomputer, 12-in. video display, data cassette recorder, and regulated power supply. The keyboard unit also sells separately for \$400.

Radio Shack forms Tandy's backbone

Not many realize the extent of Radio Shack's electronics design and manufacturing operations. For its fiscal year ending in June, Tandy Corp., the parent company, reported record sales of \$955 million. Radio Shack, headquartered with Tandy in Fort Worth, Texas, contributed more than 90% of this figure. Radio Shack manufactures 40% of what it sells, mostly under the Radio Shack and Realistic brands, in its more than 6,000 stores and outlets. These concentrate purely on electronics wares, including citizens' band radios, hi-fi equipment, and electronics parts. All together, Radio Shack employs about 5,000 people, with manufacturing spread over 20 locations in five countries. Moreover, it has a design engineering staff of 100. Though some of its design is done in Fort Worth, the largest group—45 engineers—is in Tokyo.

Another Tandy division, Allied Electronics Corp., an industrial-parts supplier, is being sold off to investors in New York. However, a new operation, Tandy Computers, will open retail stores specializing in the new Radio Shack computer and other hobby and small business systems. According to John Ratliff, general manager of the new operation, the first store will open in Fort Worth on October 1 and will carry such microcomputers as Apple Computer Co.'s Apple II, Processor Technology Corp.'s SOL 20, and IMS Associates Inc.'s IMSAI 8080.

chained together. "You don't need an expander to add on peripherals," says merchandising manager Don French. "Each one simply plugs into the back of any other peripheral. We designed our own bus so that each peripheral does its own interfacing, unlike the S-100 [hobbyists'] bus, which has the central processing unit doing the work." Radio Shack will make details of the bus available to enable users to interface peripherals of other makers easily. French also says he chose the Z-80 for its speed; its powerful instructions, which allow the Basic interpreter to fit into only 4-k bits of ROM; and its single 5-volt supply requirement.

Peripherals. Radio Shack is also planning to offer its own peripherals. One is a general-purpose expansion box that can be outfitted with additional memory—up to 62 kilobytes of RAM, which, with 12 kilobytes of additional internal ROM, will support extended Basic and provide such capabilities as graphics, double-precision calculation, and analog interfacing.

Among other peripheral products to be available later this year are a miniature-floppy-disk drive and a dot-matrix impact printer. The drive, which will store 90 kilobytes in a single-sided, single-density format, will be priced below those available

on today's market, asserts Ratliff, because "we'll be cutting corners and manufacturing them ourselves." The more-expensive printer will sell for less than \$1,000, he says. □

Memory

Fujitsu makes splash with 50-Mb cartridge

Fujitsu Ltd., the Japanese computer giant, has been treading water in the U. S. since 1973, when it began shipping disk drives to a single American customer. But earlier this month it made waves with a 50-megabyte disk drive in which the entire contents can be removed at the yank of a cartridge.

American makers do things differently. Their drives combine fixed and removable disks, and at most 15 megabytes are removable. The Americans need at least three disks to store the 50 megabytes; Fujitsu does it on two. Yet the comparable U. S. models cost as much as \$1,000 more than the \$3,900 of Fujitsu's new model M2201.

"People want 50 megabytes and to be able to remove all of it easily," maintains Saburo Adachi, manager of peripheral equipment in the engi-

neering liaison office of Fujitsu America Inc., Sunnyvale, Calif. "Transferring data to and from the fixed media takes too long and may introduce errors."

Fifty-megabyte disk configurations are relatively new to a marketplace until recently served by 5-to-10-megabyte drives. Diablo Systems Inc., the Hayward, Calif., subsidiary of Xerox Corp., announced its big cartridge-disk drive over a year ago, but delivery slipped to the middle of this year. Electronic Memories & Magnetics Corp. of San Jose, Calif., introduced its model 312 system only in June, and evaluation units are slated for November delivery. Both drives store from 25 to 75 megabytes of unformatted data on one removable and up to three fixed disks.

Wanted pair. These American competitors contend that the pairing of fixed and removable media in one drive is what is in demand. An accounts-receivable program or an inventory routine, for instance, are not usually removed from a small business system, but the data itself must often be removed and stored for security.

But Fujitsu is also looking to an expanding data-processing market and users who need more than just 50 megabytes of storage. So as separate units that complement the M2201, it is introducing two drives with nonremovable media—its M2253 moving-arm drive that stores 50 megabytes and its M2121 head-per-track drive with 3 megabytes. Therefore, says Adachi, "as systems



New drive. Fujitsu's rack-mounting model M2201 drive stores 50 megabytes in a two-disk front-loading cartridge.

The chip with the sensitive nose.

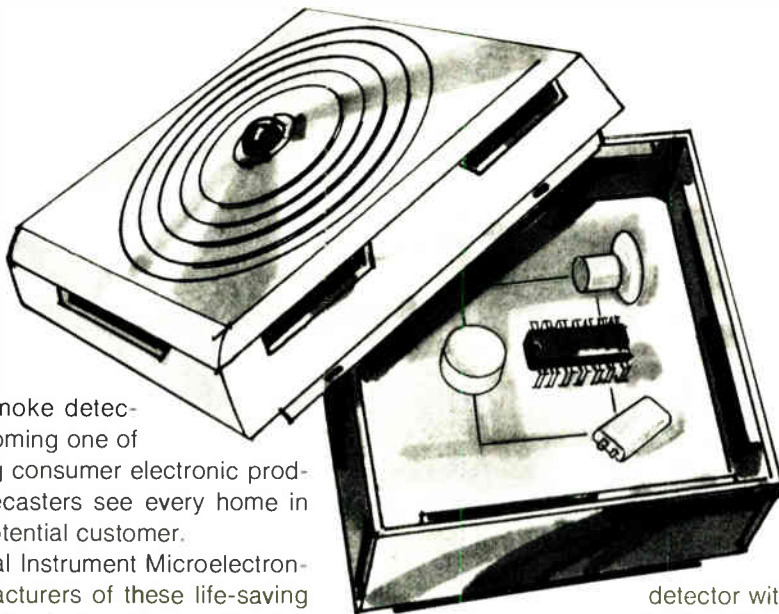

Early warning smoke detectors are fast becoming one of the hottest selling consumer electronic products. Market forecasters see every home in the world as a potential customer.

Now, General Instrument Microelectronics offers manufacturers of these life-saving devices a technological and cost-effective breakthrough that can help to develop the full market potential of the smoke alarm market. It's the new MEM 4962.

A single-chip LSI package, the MEM 4962 includes a FET input, detector, voltage comparator, oscillator, trigger, horn driver and C/MOS output. That's all the circuitry you need for a "sensitive nose" to detect combustion.

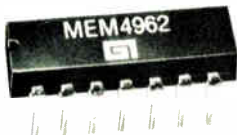

GI's new MEM 4962 replaces more than 30 discrete components now being used in conventional ionization smoke alarms. You know

what that can do for your inventory costs and assembly time.

Switch your product to GI microcircuit technology and you can offer your customers a competitive priced smoke

detector with super-sensitive reliability, long battery life, and audible reminder when battery power is too low for safety. All this from a single-chip package.

Whatever you manufacture — smoke detectors, microwave ovens, TV or stereo sets, TV games, calculators, organs, pianos, data and telecommunications equipment — chances are GI has the circuitry to help you be more competitive. Write today or call the leader in microcircuit technology — General Instrument Microelectronics, 600 West John Street, Hicksville, New York 11802, Telephone: (516) 733-3107.

We help you compete.

**GENERAL INSTRUMENT CORPORATION
MICROELECTRONICS**



expand, users can add fixed- or removable-disk storage at will."

Fujitsu's \$3,900 price for 50 megabytes (for quantities of 100 and up) derives partly from the use of a cartridge with only two disks, on which it records at higher densities than its competitors—6,135 bits per inch as against 4,700 b/in. or so. (It is generally agreed, however, that recording densities of most manufacturers will soon be up in the 6,000-b/in. ballpark.)

Fujitsu improves density further by storing data on three of the four sides and using only the fourth side for head-positioning information. EM&M requires one side of each disk for track information, and Diablo merges the information with its data. The Fujitsu drive, spinning its disks at 2,400 revolutions per minute, has

a transfer rate of 6.55 million bits per second. Track-to-track access is less than 6 milliseconds, slightly better than the others.

IBM inventory. The read/write heads and the linear-motor actuator that moves the heads in a straight path across the disk surface are the components most subject to wear. So Fujitsu selected them from the IBM 3330 inventory, which is reliable and available worldwide, Adachi points out. Shipments from Japan of the drives will begin in November. As for other equipment, Adachi says the future of Fujitsu in the U. S. original-equipment market depends on the success of the M2201 and its companions. A logical followup to these OEM products could be Fujitsu drives for the booming floppy-disk market. □

Military

RCA to begin producing new terminals for Army for tactical satellite communications

By the first-ever application of satellite technology to tactical communications, the U. S. Army plans to overcome some limitations in its existing equipment. Next month production will start of easy-to-erect ground stations that will communicate through the Defense Satellite Communications System.

Designed and being built by RCA Corp.'s Government Communications Systems division, Camden, N. J., the ground-mobile, super-high-frequency system will replace selected links at present serviced by radio-relay line-of-sight and tropo-scatter systems, and high-frequency single-sideband radio, says Peter Maresca, a deputy engineering development director in the U. S. Army Satellite Communications Agency at Fort Monmouth, N. J. The RCA stations will be used at commands from an entire theater

down to brigade level and will also provide links with air defense forces.

Maresca is enthusiastic about the

worldwide range of the satellite system, extending to all points that can "see" the satellites. No relay links are needed, a significant savings in both equipment and personnel, and the system need not be sited on prominent terrain features, he points out.

Immunity. Unlike hf systems, the satellite circuits are relatively immune to fading and other propagation problems. These occur when the hf signal, which characteristically bounces off the ionosphere to yield long ranges, may also skip great distances and leave areas without any coverage at all.

For \$37.7 million, the Army agency has ordered 31 terminals in three configurations, both for itself and the Air Force. They will be delivered for field trials by February 1979. Each can be transported by a work-horse 1¼-ton truck and set up in 20 minutes, says Daryl Hatfield, RCA's manager of transmission system sales. Each has a 500-watt transmitter and an 8-foot parabolic antenna that tracks the satellite automatically.

Eight AN/TSC-85(V)2 terminals for the Army will operate with up to 24 channels transmitting (in a 7.9-

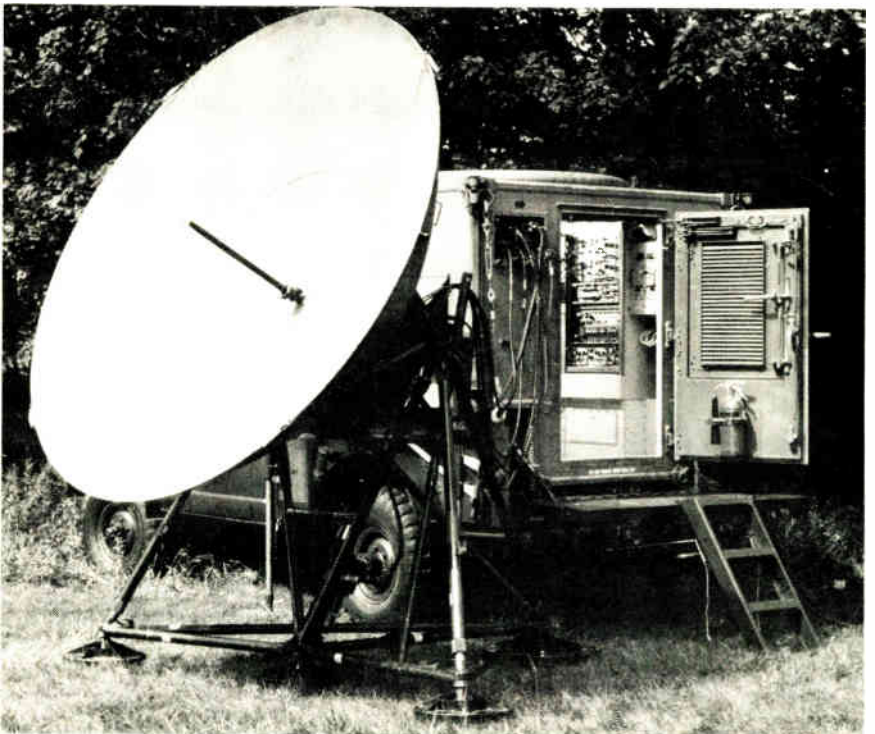

Satellite. Ground station with 8-foot antenna that RCA will start producing for the Army handles tactical communications via the Defense Satellite Communications System.

SORENSEN IS THE SOURCE: FOR RELIABLE OPEN- FRAME POWER SUPPLIES.

SOC, our new line of open-frame power supplies:

- Standard voltages and package sizes
- 115/208/230 Vac input standard
- Made in U.S.A. with quality components
- No overshoot with turn-on, turn-off or power failure
- Stocked for immediate delivery
- Conservatively designed and rated
- Low heat dissipation, high temperature stability
- One-year warranty, worldwide service organization
- UL recognized

Model No.	Series	Output (Vdc)**	Output Current (A dc)*			Price
			@ 40°C	@ 50°C	@ 60°C	
SOC 2-3	A	2	3.0	2.4	1.8	\$35
SOC 2-6	B	2	6.0	4.9	3.8	58
SOC 2-10	C	2	10.0	8.0	6.5	72
SOC 5-3	A	5	3.0	2.4	1.8	35
SOC 5-6	B	5	6.0	4.9	3.8	58
SOC 5-10	C	5	10.0	8.0	6.5	72
SOC 12-1.6	A	12	1.6	1.3	1.0	35
SOC 12-4.0	B	12	4.0	3.0	2.5	58
SOC 12-6.0	C	12	6.0	5.0	4.2	72
SOC 15-1.5	A	15	1.5	1.2	1.0	35
SOC 15-3.0	B	15	3.0	2.6	2.2	58
SOC 15-5.0	C	15	5.0	4.2	3.5	72
SOC 24-1.0	A	24	1.0	.75	.55	35
SOC 24-2.2	B	24	2.2	1.9	1.6	58
SOC 24-3.5	C	24	3.5	2.9	2.4	72
SOC 28-0.8	A	28	0.8	.64	.45	35
SOC 28-2.0	B	28	2.0	1.7	1.4	58
SOC 28-3.1	C	28	3.1	2.6	2.0	72

Common Specifications:

AC Input Power (VAC): 105-125, (190-226, 210-250 available by using taps on transformer.)

Frequency 50 to 63Hz. (Derate I_o 10% at 50Hz.)

Voltage Regulation (comb. line and load): $\pm 0.15\% + 6mV$ for 105 to 125 Vac and 100% load change.

Voltage Ripple and Noise: 1.5mVrms, 5mVpp.

Temperature Coefficient: 0.03%/°C.

Drift (24 hours): 0.2% after 1-hour warm-up.

Remote Sensing: 100mV maximum drop in each leg.

Operating Temperature: 0° to 60°C.

Storage Temperature: -20° to +85°C.

Overvoltage Protection: Available on all models except 2 volt. Specify by adding "VP" suffix to model number and add \$8 to unit price.

Current Foldback: Automatic, factory-set to approx. 14% of rated (40°C) output current.

Cooling: Convection.

Finish: Black anodize.

* Free-air rating — no external heatsink. ** $\pm 5\%$ adjustable.

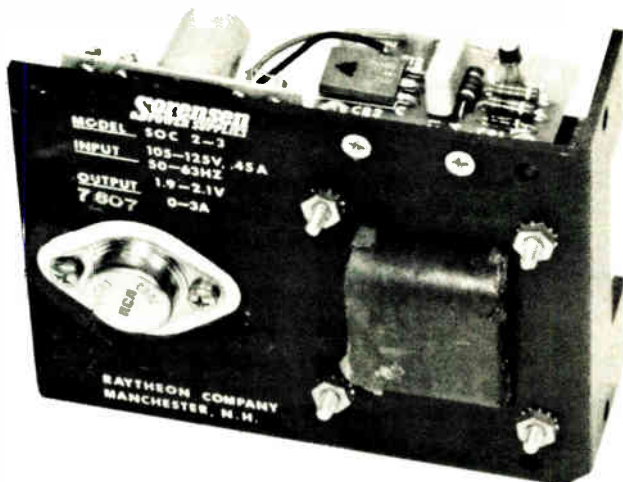

Call us for OEM discounts:
(603) 668-4500.

Sorensen
676 Island Pond Rd.,
Manchester, N.H. 03103.

SORENSEN
POWER SUPPLIES

A Raytheon Company

to-8.4-gigahertz band) and receiving (7.25 to 7.75 GHz) simultaneously to as many as four destinations. There are also 17 AN/TSC-93 terminals for communicating over anywhere from 6 to 24 channels between one point and another. The Air Force is also getting point-to-point units—six AN/TSC-94 terminals that will have from 6 to 96 channels.

The terminals use phase-shift keying as the modulation method, sending multichannel pulse-coded modulation data by standard PCM equipment. They are far different from the experimental tactical satellite communications (Tacsatcom) terminals developed for the Army in the late 1960s, says Hatfield. These earlier terminals were frequency-modulated, narrow-band systems for single-channel (voice) operation.

Unlike the new terminals, which have fully synthesized front-panel controls for changing frequencies quickly and accurately, the experimental stations used plug-in crystals that took a technician several hours to change. They also had antennas that had to be reoriented by hand as the satellite moved.

The new system uses thick-film microwave integrated circuits and other solid-state devices for all but the klystron in the output power amplifier. Eventually, the military could buy in the low hundreds of terminals, depending on how the tests turn out, the availability of funds, and just what the Army finally concludes the service's requirements will be, Hayes says. □

Solid state

National lowers bi-FET op-amp offsets

It looks like the fight for sales in the mixed-process operational amplifier marketplace is narrowing down to two frontrunners: on the whole, National Semiconductor Corp., the established leader, has the performance, but Texas Instruments Inc., the feisty challenger, has the price. Responding to the latest sally from

COMPARING BI-FET OPERATIONAL AMPLIFIERS								
Series	Type	Input offset voltage (mV)	Input bias current (nA)	Bandwidth (MHz)	Slew rate (V/μs)	Supply current (mA)	Price	
National	LF356	single	10	0.2	5	12	10	75 ¢
	LF351	single	10, 5, 2	0.2, 0.1	5	13	3.4, 2.8	39 ¢ – \$2.50
	LF353	dual	10, 5, 2	0.2, 0.1	5	13	3	90 ¢ – \$4.25
	LF347	quad	10, 5, 2	0.2, 0.1	5	13	3	\$1.25 – \$6.50
Texas Instruments	TL081	single	15, 6, 3	0.4	3	12	2.8	33 ¢ – \$1.66
	TL082	dual	15, 6, 3	0.4	3	12	2.8	61 ¢ – \$3.06
	TL084	quad	15, 6, 3	0.4	3	12	2.8	\$1.20 – \$5.99
	TL071	single	10, 6, 3	0.2	3	13	2.5	47 ¢ – \$2.33
	TL072	dual	10, 6, 3	0.2	3	13	2.5	80 ¢ – \$3.99
	TL074	quad	10, 6, 3	0.2	3	13	2.5	\$1.33 – \$6.65
	TL061	single	15, 6, 3	0.2	1	3.5	0.2	47 ¢ – \$2.33
	TL062	dual	15, 6, 3	0.2	1	3.5	0.2	80 ¢ – \$3.99
TL064	quad	15, 6, 3	0.2	1	3.5	0.2	\$1.33 – \$6.65	

TI [*Electronics*, Aug. 4, p. 33], National has unveiled a new process for putting junction-field-effect and bipolar transistors on the same chip.

Called bi-FET II, the National process achieves offset voltages as low as 2 millivolts by including on the op-amp chip a trimmable binary resistor network in series with the J-FET input stage. These diffused resistors are shunted by aluminum links, which can be opened selectively by being either blown with a high current or cut with a laser. This balances the current flow within the op amp so that errors cancel, thereby minimizing input offset voltage.

National's LF351 series, which it first announced in March, is a trimmed, blown-link bi-FET product—a fact the firm had not made public till now. Offset voltage in standard LF351 devices is held to 10 mv, and National is now also making available selected parts having an offset of 5 mv for 75 cents or an offset of 2 mv for \$2.50.

At this time, the company is also introducing two new series of laser-trimmed bi-FET II op amps—the LF353 family of duals and the LF347 family of quads. Like the LF351 devices, they provide an input offset voltage of 10, 5, or 2 mv. Price ranges from 90 cents to \$4.25 for the duals, and from \$1.25 to \$6.50 for the quads.

National's bi-FET II products will

most likely compete with TI's low-noise TL071 series, which is available in single, dual, and quad versions. As the table shows, offsets are comparable for the National and TI parts, but National's devices offer broader bandwidths at somewhat higher current drain. As a rule, TI's prices are lower, though—with one notable exception—the LF351 is only 39 cents compared to the 47 cents TI asks for its single TL071.

National also has in the works an advanced bi-FET II process that Jim Solomon, the manager of industrial linear IC development, believes will eventually make its new trimmed devices obsolete. With advanced bi-FET II, 90% of the yield has an offset of 2 mv or less, he says. "Moreover, 70% is at 1 mv and a significant percentage is at 0.5 mv." The advanced process is being used for a pair of single op amps, the LFT156/356 and the LFT156A/356A, currently being supplied as samples. Commercial versions are priced at \$10 for 0.5-mv offsets, \$7.50 for 1-mv offsets, and \$5 for 2-mv offsets.

As for TI, its general-purpose ultra-low-cost TL081 series (see table) should address most of the high-volume applications for op amps, asserts Delbert Whitaker, linear marketing manager, pointing out that "80% of the market can live with its 15-mv offset." Furthermore,

MICROCOMPUTER USERS.

Single Board Real Time Analog I/O Systems

...Widest Selection, Fast Turnaround, Lowest PRICES

Single Board Analog I/O Systems		DEC LSI-11				INTEL 80C-80 Series				COMPUTER AUTOMATION LSI 2 & 3				NATIONAL IMP & PACE		PCS Superpac		ZILOG MCB Series (Z-80)			
		DT1761	DT1762	DT1763	DT1764	DT1765	DT1761	DT1762	DT1763	DT1764	DT1765	DT1761	DT1762	DT1763	DT1764	DT1765	DT1761	DT1762	DT1763	DT1764	DT1765
Analog Inputs	16 channels	•	•	•	•	•	•	•	•	•	•	•	•	•	•	•	•	•	•	•	•
	32 channels	•	•	•	•	•	•	•	•	•	•	•	•	•	•	•	•	•	•	•	•
	64 channels	•	•	•	•	•	•	•	•	•	•	•	•	•	•	•	•	•	•	•	•
	10mV to 10V range	•	•	•	•	•	•	•	•	•	•	•	•	•	•	•	•	•	•	•	•
	0 to 10V, ±10V, ±5V ranges	•	•	•	•	•	•	•	•	•	•	•	•	•	•	•	•	•	•	•	•
Analog Outputs	1 to 5V (4 to 20mA) range	•	•	•	•	•	•	•	•	•	•	•	•	•	•	•	•	•	•	•	•
	8 bit resolution	•	•	•	•	•	•	•	•	•	•	•	•	•	•	•	•	•	•	•	•
	12 bit resolution	•	•	•	•	•	•	•	•	•	•	•	•	•	•	•	•	•	•	•	•
	2 channels	•	•	•	•	•	•	•	•	•	•	•	•	•	•	•	•	•	•	•	•
	4 channels	•	•	•	•	•	•	•	•	•	•	•	•	•	•	•	•	•	•	•	•
Features	8 channels	•	•	•	•	•	•	•	•	•	•	•	•	•	•	•	•	•	•	•	•
	0 to 10V, ±10V, ±5V ranges	•	•	•	•	•	•	•	•	•	•	•	•	•	•	•	•	•	•	•	•
	4 to 20mA range	•	•	•	•	•	•	•	•	•	•	•	•	•	•	•	•	•	•	•	•
	point plotting	•	•	•	•	•	•	•	•	•	•	•	•	•	•	•	•	•	•	•	•
	8 bit resolution	•	•	•	•	•	•	•	•	•	•	•	•	•	•	•	•	•	•	•	•
12 bit resolution	•	•	•	•	•	•	•	•	•	•	•	•	•	•	•	•	•	•	•	•	•
programmable gain	•	•	•	•	•	•	•	•	•	•	•	•	•	•	•	•	•	•	•	•	•
100KHz throughput	•	•	•	•	•	•	•	•	•	•	•	•	•	•	•	•	•	•	•	•	•
program I/O & interrupt	•	•	•	•	•	•	•	•	•	•	•	•	•	•	•	•	•	•	•	•	•
DMA interface	•	•	•	•	•	•	•	•	•	•	•	•	•	•	•	•	•	•	•	•	•
power required: +5V only	•	•	•	•	•	•	•	•	•	•	•	•	•	•	•	•	•	•	•	•	•

These single board systems provide the most cost effective and fastest way to get analog signals into and out of your micro-computer. Just plug in the board and hook-up your analog signals. Get a headstart on solving your system's problems without the headaches of designing an analog front end.

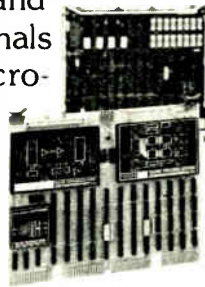

We've got the broadest selection of input and output capability—10mV to 10V or 4-20mA inputs, up to 64 channels on a single board, line amplified buffered D/A outputs, point plotting, or 4-20mA outputs—all at a cost that says you can't afford to do it yourself.

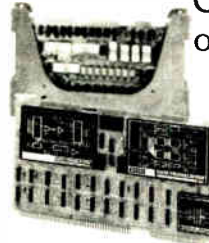

Concentrate on the software and other key system requirements... and let us take care of your analog problems. We've seen them all and solved them in these systems...no mysteries, no tweaking.

Prices are surprisingly low, with 8-bit models starting at \$295 and 12-bit models at \$395 both in OEM quantity.

Send for full technical data or call us.

DATA TRANSLATION INC

23 Strathmore Rd., Natick MA 01760
(617) 655-5300 Telex 94-8474

SALES OFFICES: AZ, Scottsdale 602-994-5400; CA, Cupertino 408-257-5131; CA, Santa Ana 714-540-3245; CO, Denver 303-837-1247; IA, Cedar Rapids 319-362-0503; KS, Prairie Village 913-649-4000; MD, Fulton 301-953-3724; MA, Natick 617-655-5300; MO, St. Louis 314-997-1515; NJ, Parlin 201-727-6454; NM, Albuquerque 505-292-1212; NM, Las Cruces 505-523-0601; NY, Rochester 716-334-2445; UT, Salt Lake City 801-466-6522; VA, Arlington 703-527-3262; WA, Bellevue 206-455-1246.

Capacitors FROM ERIE

COMPLETE SOURCE
FOR SUBMINIATURE

MONOBLOC CERAMIC CAPACITORS

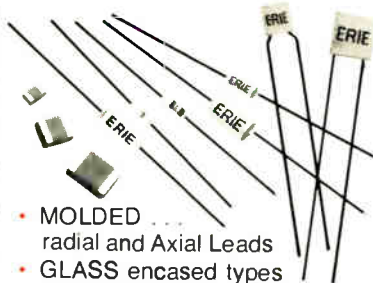

- MOLDED ... radial and Axial Leads
- GLASS encased types
- Ceramic Chips ... including new Ultra-High Q chips for RF applications

Write for new catalog E-8000R4

ERIE

ERIE TECHNOLOGICAL PRODUCTS, INC.
Erie, Pennsylvania 16501
814-453-5611

MINIATURE



CERAMIC CAPACITORS

- 21 Temperature Char.
- 1 pF to 7.5 pF capacitance range
- 50 to 500 Vdc ratings
- Jet-seal protective coating

Write for new catalog SC8100

ERIE

ERIE TECHNOLOGICAL PRODUCTS, INC.
Erie, Pennsylvania 16501
814-453-5611

Electronics review

sometime in the fourth quarter, TI will have a trimmed 0.5-mv part—the TL091—but its price has not yet been determined. □

Packaging & production

Rigid assembly takes cannon-launch g

Electronic assemblies used in cannon-launched ordnance must withstand terrific inertial forces, so they are usually completely potted in epoxy, which bears most of the shock. But epoxy encapsulation has its problems. For example, the high-temperature curing that the epoxy bricks must undergo may break leads and aggravate faulty wire bonds. To make matters worse, there is no chance to repair the finished assembly.

These problems are why engineers at the Orlando, Fla., division of Martin Marietta Aerospace are trying to eliminate the epoxy in the Copperhead projectile, which has begun test firings at White Sands

Missile Range, N. M. They are substituting an extremely rigid assembly to absorb the 9,000 g produced when Copperhead is fired from a 155-millimeter gun.

For use against tanks, artillery, and bunkers, Copperhead has a laser seeker and guidance system that locks on a target illuminated by an observer with a laser designator. The laser tracker is in the front of the projectile. Behind it is the receiver and guidance electronics. The warhead comes next, and, finally, fins that pop out for steering.

Three elements. The assembly, shown in the figure, has three principal kinds of elements: structural members, including a top and bottom bulkhead and "napkin rings" that act as shock absorbers; disk-shaped circuit boards containing the receiver and guidance electronics; and a Rigiflex motherboard that connects the laser-seeker head with the electronics section.

Starting with a cast-aluminum-bottomed bulkhead, Martin Marietta places structural layers atop a center column that traverses the length of the section and provides

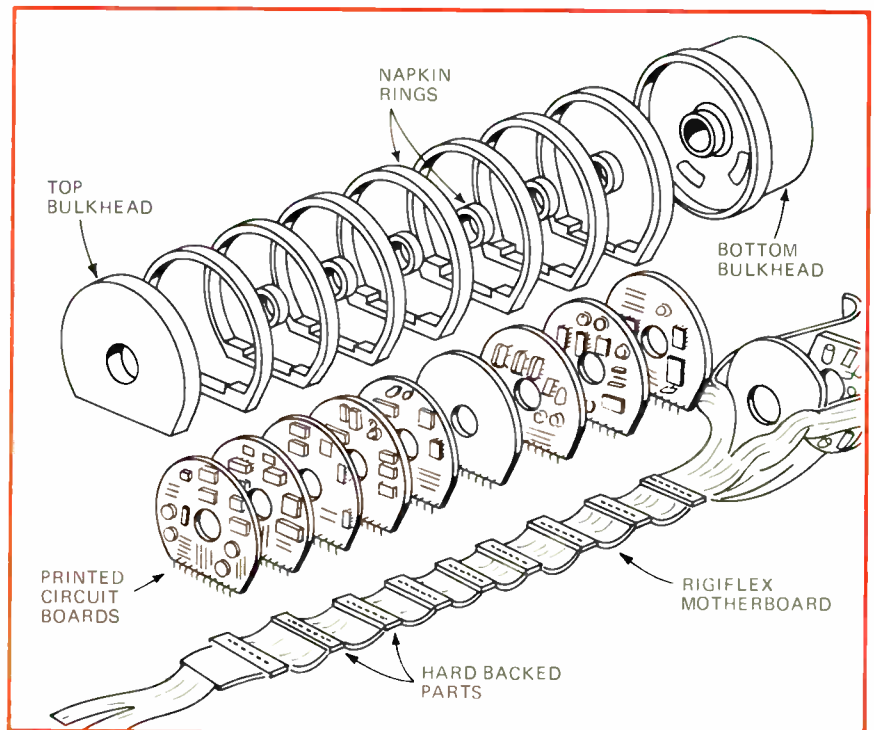

Protector. "Napkin rings" act as shock absorbers in rigid electronics assembly being designed by Martin Marietta Aerospace to withstand forces of a cannon launching.

Why fool around?

Our Snap-Lock makes your tough little connector decisions easy. It's the rugged, make-sure miniature circular connector to call for when you just don't want to fool around.

It has the right quality features: metal housing, high contact density, moisture-proof, can be pressure resistant and/or hermetically sealed.

And you can choose from enough sizes and options to make designing-in Snap-Lock as easy as it is dependable: 2 to 19 contacts, reversible, and crimp removable or soldered —

plus a variety of mounting styles, back shells and potting boots.

Positive, vibration-proof locking.

You can hear it snap into place. It won't shake loose. But release is easy with a squeeze of the metal ring.

Need a quick, pull-the-cable disconnect?

We have it: Pull-Lock. Friction holds the connector together, but a firm yank on the cable pulls it apart.

Details.

We have those, too, summed-up in our latest Snap-Lock catalog. Get your free copy.



O.K. Send me your latest Viking Snap-Lock miniature circular connector catalog.

MY APPLICATION: _____

NAME: _____

TITLE: _____

COMPANY: _____

ADDRESS: _____

CITY: _____ STATE: _____ ZIP: _____

 **Viking**
CONNECTORS

Viking Industries, Inc., 21001 Nordhoff Street, Chatsworth, CA, U.S.A. / (213) 341-4330

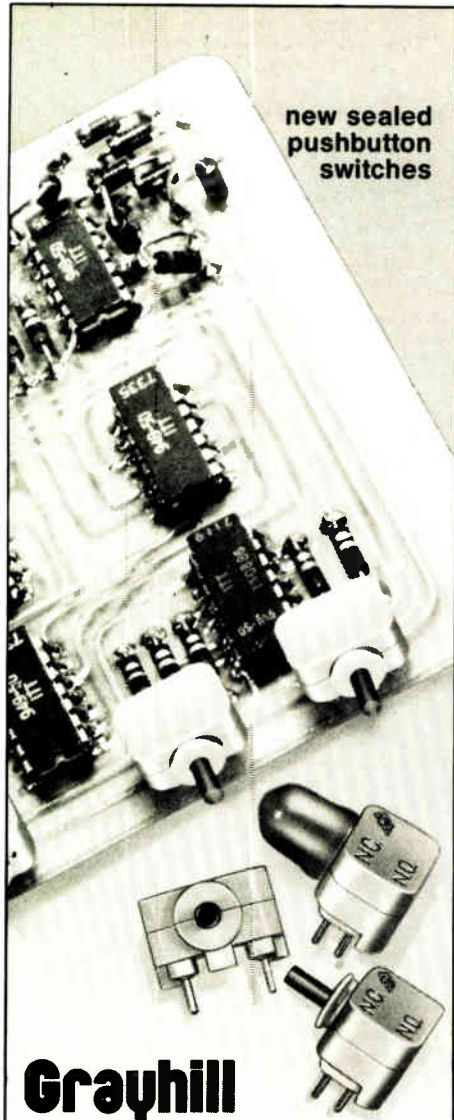

**new sealed
pushbutton
switches**

Grayhill ends contact contamination

**complete protection during
wave soldering and
PC board cleaning**

- terminals welded ultrasonically into switch body
- reusable protective cap seals switch plunger
- tripod stand-offs provide solvent flow area under switch

These economical pushbutton switches are ideal for 'on board' press-to-test or front panel applications. Occupying under 1/2" square, they provide momentary action, long life with low contact bounce and trifurcated gold plated contacts. Terminals are on .100" centers for easy prototype breadboarding and accommodation of board drilling equipment. Circuitry is SPDT (two circuit); operation from logic levels up to 1/4 amp.

The new switches (Series 39-251) are available from stock in prototype quantities and 5-7 weeks for production requirements. For complete information, write Grayhill for Bulletin 248 at 561 Hillgrove Avenue, La Grange, Illinois 60525, or phone (312) 354-1040.



Electronics review

News briefs

Transitron abandons semiconductors

Semiconductor pioneer Transitron Electronics Corp. is throwing in the towel. By October it will have closed its unprofitable Semiconductor division, which makes diodes, transistors, transistor-transistor logic, and linear integrated circuits. The Wakefield, Mass., firm will still make wire, cable, printed-circuit boards, and connectors.

NCR standardizes network architecture

NCR Corp. has taken a significant step toward unifying communications protocols—at least within its own product line—by establishing a set of guidelines under what it calls its distributed network architecture. The architecture covers link protocols, intranetwork disciplines, data-access methods, and other requisites of telecommunications. The DNA dictums will ease the implementation of distributed processing systems, message-switching systems, and large-scale retail and financial networking.

Seafarer declared safe, but . . .

The National Research Council has given the Navy's controversial Project Seafarer a clean bill of health on biological and environmental grounds, but says that the possibility of a shock hazard over its 4,000-square-mile grid is a matter of "serious concern." So the Navy says it plans to use the bulk of Seafarer's fiscal 1978 research-and-development budget of more than \$15 million to eliminate this and other hazards. GTE Sylvania Inc., Needham, Mass., is expected to get a new contract soon, project officials say.

Signetics, Philips, to second-source Intel microcomputers

Intel Corp., Santa Clara, Calif., has made Signetics Corp. of Sunnyvale, Calif., and N.V. Philips Gloeilampenfabrieken of Eindhoven, the Netherlands, second sources of its 8048 and 8035 microcomputers and related products. In return, Intel will have access to Philips' patents in metal-oxide-semiconductor integrated circuits.

some shock absorption. Next to the bulkhead are the inner and outer napkin rings. Next comes one of the disk-like circuit boards, with its components placed so that the rings, acting both as spacers and shock absorbers, fit flush against the board. There are eight of these ring-and-board layers.

The final board is followed by the top bulkhead, tightened in place by a top ring that puts a preload on the assembly. This compensates for a bounce-back force of 1,500 g that occurs in the opposite direction to, and following, the 9,000-g launch.

Each of the circuit boards supports only its own weight during launch, Classon says. The launch force is transmitted through the inner rings to the center column and through the outer rings to the electronics section's steel outer housing.

The bottom bulkhead takes the load from the steel housing on a shoulder designed for that purpose and also dissipates the forces traveling down the center column.

The Rigiflex motherboard extends through the electronics section. It is a flexible polyimide circuit with hard-backed points flow-soldered to the flats on the circuit boards. □

Microprocessors

AMD adds punch to bit-slice family

For fast processors with lots of throughput, the "king of the hill" is the bit-slice 2900 family of 4-bit bipolar microprocessor devices pioneered by Advanced Micro Devices

Revolutionary NEW 64-bit 15 MHz Digital Correlator.

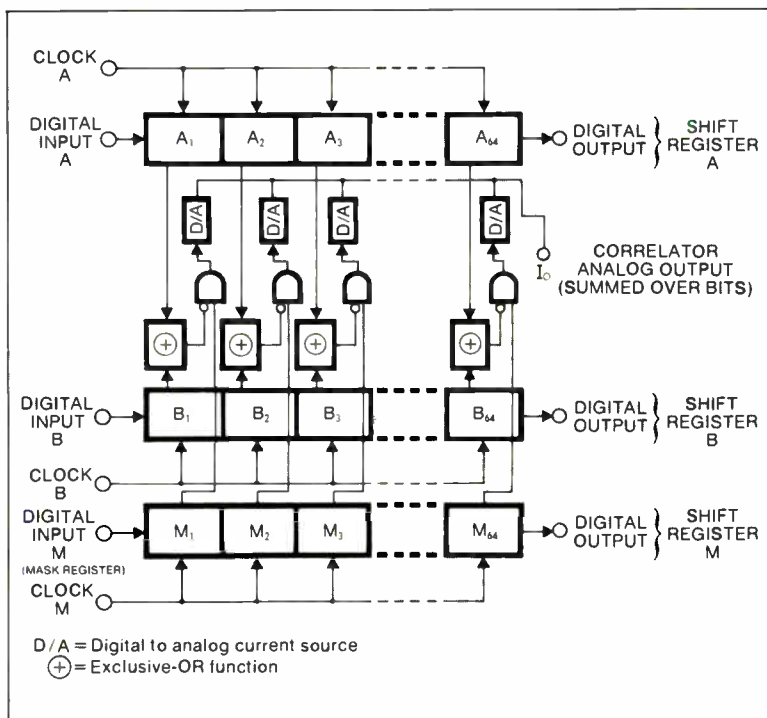

TDC-1004J

Features:

- 15 MHz correlator speed
- 30 MHz shift speed (static shift registers)
- Analog current output, proportional to degree of correlation between registers
- Mask register: Used to select "Don't Care" (no effect on correlation) bit positions if desired
- Monolithic, bipolar TTL
- 16 pin C DIP
- 0-70°C operation
- 200 mW power consumption
- Only \$150 each in 100's

Applications:

- Image comparison/recognition
- Bit/word synchronization
- Bit/word detection
- Error correction coding
- Pulse compression
- One's or zero's counter

The TRW TDC-1004J is a 64-bit digital correlator capable of operating at 15 MHz with analog correlation output. Digital parallel correlation is a signal processing technique used for bit synchronization, bit detection, error correction coding, pulse compression and other applications. Correlation takes place when two binary words are serially shifted into two independently clocked shift registers. The two words are continually compared bit-for-bit by exclusive-OR circuits.

Each exclusive-OR circuit controls a current source D/A. The current outputs of the D/A circuits are summed to produce the correlation function.

The mask register allows the user to selectively choose "no-compare" bit positions.

For detailed data, applications information and prices, contact your local TRW components sales office or call (213) 535-1831 or write TRW LSI Products, An Electronics Components Division of TRW, Inc., One Space Park, Redondo Beach, Calif. 90278.

Electronics/August 18, 1977

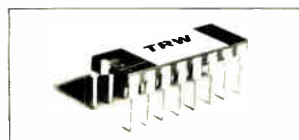

TRW LSI PRODUCTS

...from a company called TRW

Circle 53 on reader service card 53

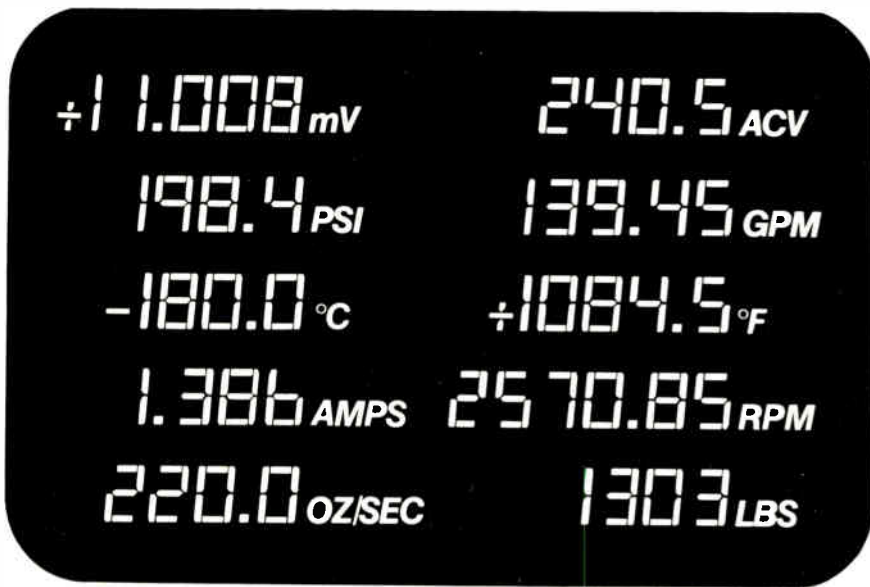

United Systems' Indicators Will:

- MEASURE voltage and current; ac, true rms or dc.
- CONVERT the output of any transducer/transmitter to display in engineering units.
- DISPLAY temperature (C or F) directly from thermocouple, RTD, or thermistor sensors.
- INTERFACE readily into your system by optional "single line enable" parallel BCD output.
- INDICATE when a predetermined limit is exceeded, through relay closure or logic level output from optional internal comparator alarm.

And with United Systems' exclusive adaptors these indicators change, in the field, to perform any measurement listed above and more!

For additional information contact your United Systems Representative or call the factory (513) 254-6251.



DigiTec. UNITED SYSTEMS CORPORATION

160 Woodley Road, Dayton, Ohio 45403
 (513) 254-2517, T.O. 8101-459-1728

United Systems Corp. Precision measurements to count on

LHC "Information only" circle 224

RHC "Demonstration only" circle 54

Electronics review

Inc. Its dominance is likely to continue with the still more capable AM 2903, to be introduced by AMD in the fourth quarter.

The new AM 2903 outdoes the 2901A bit-slice chip by including a special set of instructions in hardware. According to bipolar microprocessor manager John Springer, these make it easier to implement multiplication, division, normalization, and other functions for which designers of arithmetic-oriented computers needed external gates.

Two other chips from the Sunnyvale, Calif., semiconductor maker are intended to reduce parts count and also speed things up even more. One is the AM 2910, a 12-bit microprogram controller-sequencer that does the job of three of the older 4-bit 2909/2911 controllers. The second is the AM 2904, which replaces most of the 10 to 15 different small- and medium-scale-integrated devices used to tie the 2900 family together.

Fewer parts. According to Springer, a 16-bit minicomputer system built with the new parts could have 50 to 100 fewer integrated circuits. The basic microcycle time for the 2903 is about the same as that for the 2901A—200 to 250 nanoseconds. But the more tightly integrated architecture of a typical system using the new parts will reduce the total throughput time by at least 20%, he asserts.

Like the 2901A, the 2903 contains 16 internal working registers arranged in a two-address architecture. But unlike its predecessor, says Springer, the 2903 has the ability to expand the register file to any number of registers without using external devices. The 2903 also contains all the logic and interconnections necessary for nonrestoring, multiple-length division with correction of the quotient, which the 2901A cannot do. Also built into the 2903 is parity generation circuitry, for use in error detection and cyclic redundancy check code generation.

A typical system usually requires only two to three of the additional functions on the 2903. "But even this represents elimination of 20 to 30 external devices," Springer says. □

CCD MEMORY



**FAIRCHILD
ANNOUNCES
THE
GREATEST
BREAKTHROUGH
IN BULK
MEMORY
SINCE
THE DISC.**



FINALLY. BULK MEMORY WITHOUT THE BULK.

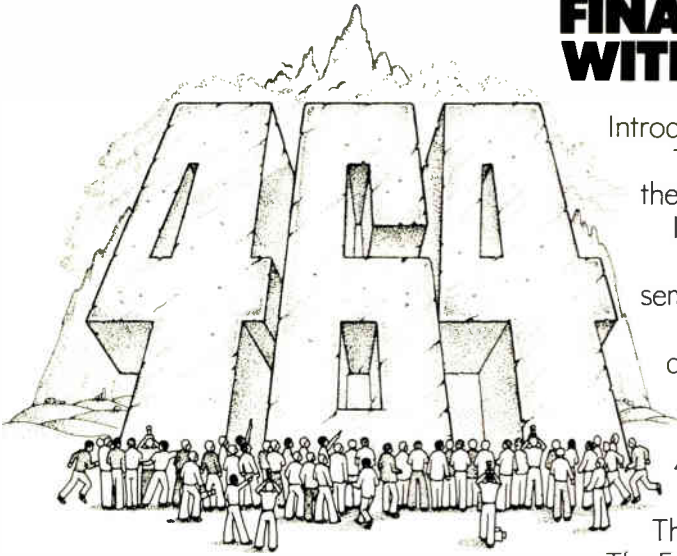

Introducing the Fairchild 64K F464.

The first semiconductor CCD memory designed for the bulk memory market.

It plugs the gap between MOS and magnetic memories.

It's as important to bulk memory systems as the semiconductor RAM was to core.

It's a higher-density, lower-cost alternative to discs and drums.

The fact is, the new F464 is the densest memory ever made. A compact die size of less than 40,000 mil² — not much larger than today's 16K RAMs.

All packaged neatly in a standard 0.3-inch 16-pin DIP.

This isn't a preview of coming attractions.

The Fairchild F464 is available right now. With a second source already signed up.

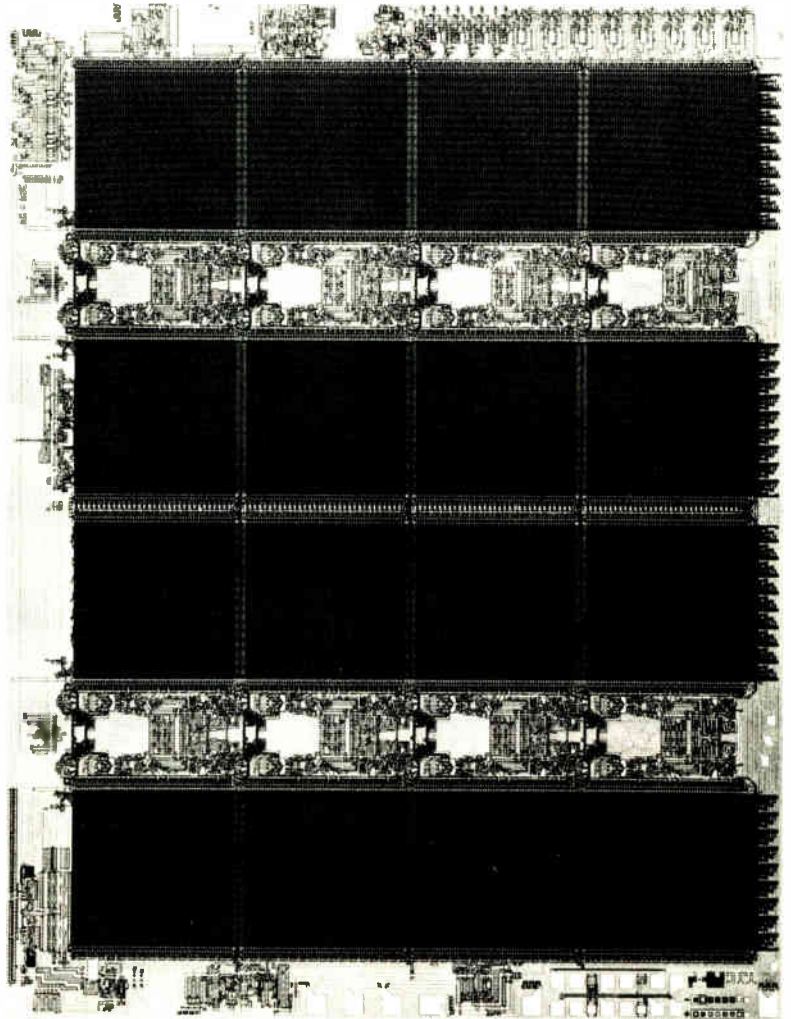

THE STUFF INDUSTRY STANDARDS ARE MADE OF.

There has never been a device like the new F464.

It's a 65,536 x 1-bit dynamic serial memory organized as 16 randomly accessible shift registers of 4096 bits each. The four address bits are decoded on-chip to select which one of these 16 shift registers is to be accessed. Control inputs include Write Enable and Chip Select. It requires standard power supplies of +12V and $\pm 5V$.

All inputs (except the clocks) are directly TTL compatible.

The two high-frequency and two low-frequency clock inputs are low capacitance 12V signals which can be easily generated with simple logic.

The data rate ranges from 1 MHz to 5 MHz. Since all 16 registers shift simultaneously, the average random access time (called latency) is only 410 μs at 5 MHz — a truly significant performance improvement over other bulk memory technologies! And, at the

same time, the power dissipation remains low: typically 3.5 μW /bit at 5 MHz, and 0.6 μW /bit during standby at 1 MHz.

These performance benefits make the F464 a natural for hybrid head-per-tracks and fixed-head discs, extended cache, and many other high-density memory applications.

LOW COST FROM DAY ONE.

The new F464 is three to four times less expensive than RAMs. It is also cost-competitive with all fixed-head and many movable-head discs. So there are no trade-offs between price and performance. The Fairchild F464 gives you the best of both.

We also give you excellent delivery. Fairchild has a plant in San Jose, California totally dedicated to VLSI technology and production.

FOLLOW THE LEADER.

Fairchild pioneered CCD technology. We introduced the world's first commercially available charge-coupled device in 1973. Today, we offer the world's broadest line of CCD products.

It stands to reason we'd be the ones to make CCD memories a reality.

For more information on the F464 (or our other CCD products), contact your Fairchild sales office or representative today. Or use the direct line at the bottom of this ad to reach our MOS/CCD Division. Fairchild Camera and Instrument Corporation, 464 Ellis Street, Mountain View, Calif. 94042. Tel: (415) 962-3941. TWX: 910-373-1227.

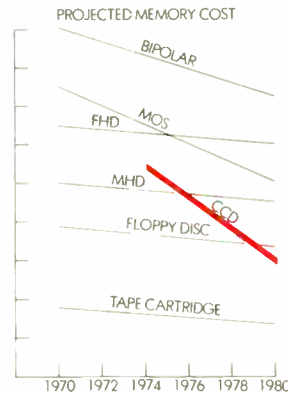
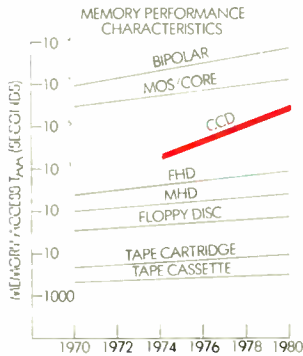

FAIRCHILD
CALL US ON IT.
(415) 962-3941

The Cube widens the gap...

In Power-Ferrite EC cores for switching power supply chokes

Now available from Ferroxcube are standardized gapped EC cores in four sizes: 35, 41, 52 and 70 mm. The gap lengths have been optimized to prevent saturation of the core due to a high DC field while simultaneously providing maximum impedance to the AC ripple current.

For worst case DC bias, two gapped cores should be used. Under less stringent conditions, one gapped and one ungapped core in combination may be used. The chart below shows the DC ampere-turns which can be supported for both 2-gapped and gapped/ungapped combinations that will not decrease incremental permeability more than 10%.

EC Core	2 Gapped Cores	1 Gapped + 1 Ungapped Core
35 mm	325 AT	200 AT
41 mm	370 AT	220 AT
52 mm	540 AT	330 AT
70 mm	860 AT	570 AT

For complete specifications on gapped EC cores, bobbins and hardware, call on The Cube.

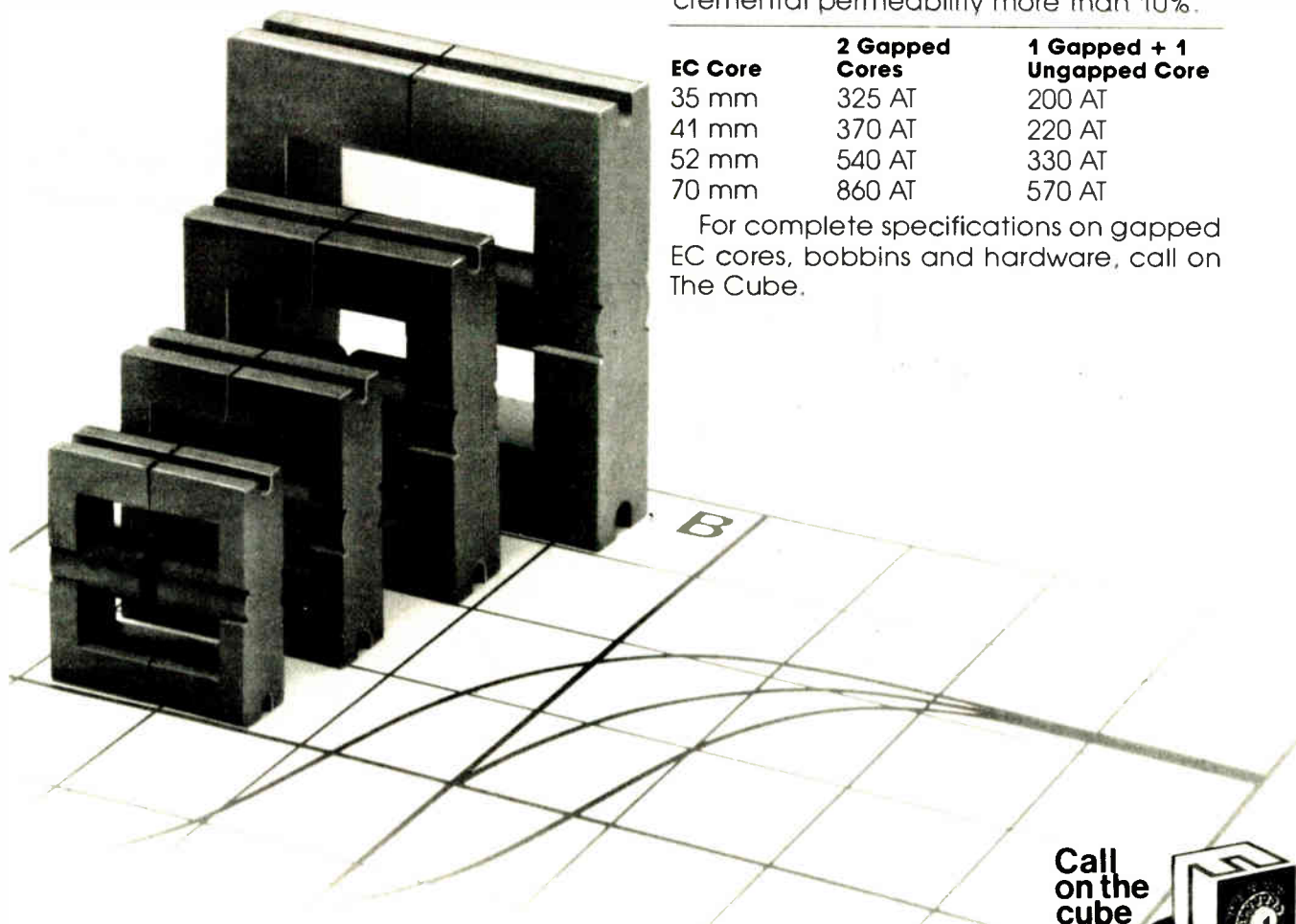

FERROXCUBE Division of Ampere Electronic Corporation,
Saugerties, New York 12477 (914) 246-2811
A North American Philips Company

Call
on the
cube

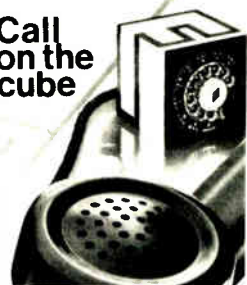

Washington newsletter

Jedec to start push for standards in microprocessors

Efforts to develop engineering standards for microprocessors are accelerating with the formation by Jedec—the Joint Electron Device Engineering Council—of a new committee that has scheduled an open meeting for Aug. 22 at Sunnyvale, Calif. Jedec is sponsored by the Electronic Industries Association and the National Electrical Manufacturers Association. “We finally have a responsive group of microprocessor producers,” says Rockwell International Corp.’s Gordon Smith, chairman of the JC-43 Committee on Microprocessors. “Now it is up to the users to help us do the things they’ve been asking for.” In addition to Rockwell, participants in the JC-43 May organization session, at which seven engineering task groups were formed, include: American Microsystems, GTE Automatic Electric Labs, Hitachi, Intel, Intersil, Lockheed, Mostek, Motorola, Texas Instruments, and Zilog.

Aerosat canceled by FAA after Congress drops funds

The \$100 million Aerosat communications satellite program to provide commercial transatlantic aeronautical services has been canceled by the Federal Aviation Administration. **Biggest loser is Comsat General Corp., which would have divided Aerosat’s estimated \$75 million costs** for the space segment with the European Space Agency and Canada in a 47-47-6 percentage split. The remaining ground facility costs would have been picked up by the participating countries. General Electric Co. was provisionally named contractor by the consortium it heads late last year, but had received no money pending congressional funding. Most of those funds were deleted from the fiscal 1978 budget by Congress, which substituted \$1 million instead for an in-house FAA feasibility study. As a result, Comsat General says it will write off \$5.3 million invested in studies.

NASA’s Rowe seen favored in race for EIA presidency

The Electronic Industries Association has narrowed its search for a new president to four candidates, and the search committee headed by Motorola’s William Weisz, EIA vice chairman, **expects to name its selection by Sept. 1.** Weisz could not be reached for comment on the reports. Candidates remaining for the top staff job are Herbert J. Rowe, NASA’s associate administrator for external affairs and reportedly the favorite; Peter F. McCloskey, president of the Computer and Business Equipment Manufacturers Association; and two EIA staff vice presidents—Raymond Johnson, general counsel, and John Sodolski of the communications division.

Awacs costs rise again; pricetag tops \$191 million a plane

Production costs of Awacs—the Air Force E-3A Advanced Warning and Control System—are up another 8% to over \$191 million per plane, **more than the proposed unit cost of the canceled B-1 bomber.** The Air Force Electronic Systems division at Hanscom Air Force Base, Mass., has boosted Boeing Co.’s contract for 10 planes to nearly \$1.92 billion with the award of another \$152.9 million. Aerospace executives in Washington attribute the higher price tag to the North Atlantic Treaty Organization’s rejection of Awacs this spring.

Boeing referred Awacs contract queries to the Air Force, which came up only with this classic response: “The increase in the face value represents the dollar amount necessary to fully fund the fiscal 1976 and 1977 production contract. This is over and above the amount the Government had obligated to Boeing to finalize the contract.”

Telecommunications competition: policy vs technology

With Congress recessed until after Labor Day, its committee staffs—which must continue to labor—are busy catching up on their reading. One of the busiest is the House Interstate and Foreign Commerce communications subcommittee. It is buried in responses from telecommunications interests to its 600-page report detailing congressional options in rewriting the 1934 Communications Act that could lead to a restructuring of the Federal Communications Commission. That legislative effort began with American Telephone & Telegraph Co.'s promoting the introduction of the so-called Consumer Communications Reform Act nearly two years ago. In one form or another, the legislation now has more than 100 congressional sponsors.

Most of the responses now in the hands of the House subcommittee run to 50 pages or more—AT&T's has 60—and contain extensive and unnecessary technical detail. That is a problem the subcommittee brought upon itself, of course, when it issued its April report. It, too, contained too much detail for congressional needs. Thus the subcommittee chaired by California Democrat Lionel Van Deerlin must try to make sense out of the many divergent and opposing views it has received. Where should it start?

Drowning in detail

It can make a very good beginning with a careful reading of the filing by the North American Telephone Association, a relatively small organization of terminal-equipment makers and distributors that compete with regulated telephone companies. NATA's position is that Congress should confine its consideration to issues of regulatory policy and leave questions of technology to the engineers in the FCC and industry. NATA's view is not engineering arrogance; it is simply a recognition that Congress should not allow "a welter of technical considerations to becloud the vital issues" in its coming debate on what constitutes good public policy.

In lieu of the subcommittee staff's detailed options and the responses they have provoked, NATA poses three "threshold questions" for Congress as it considers the new legislation: (1) is there anything wrong with the present division of labor between the Congress and the FCC in making telecommunications policy? (2) does Congress wish the FCC to continue to promulgate rules that help foster its broad policy objectives? (3) does Congress wish to reaffirm its overall policy of encouraging competition in the terminal-equipment industry, or does it seek to

substitute some form of regulated monopoly?

The questions are valid, if not the only ones Congress must address when it reconvenes. But they are questions fundamental to the future success or failure of independent telecommunications equipment makers in this country as they continue to challenge Western Electric Co. In asking them, NATA's members reflect their distress over "the insidious danger of letting the regulated industry—Bell—and not the regulator—the FCC—set the terms for congressional debate." That, NATA believes, is the danger the Van Deerlin subcommittee staff created in its options paper with the proposition that "the 'adverse impact of competition' debate becomes central only if Congress ultimately decides that it wishes to preserve current rate structure goals and methods."

The voters' fears

The angry NATA response to that premise is that its acceptance would leave legislators with nothing to decide since "AT&T has already foreclosed the issue." Preservation of existing rate structures and methods, the independent equipment makers contend, reflects the subcommittee staff's "wholesale acceptance" of AT&T's arguments. Chief among them is one that goes: pricing of competitive services will be driven down toward cost, requiring abandonment of cost-averaging in rate-making and eliminating the cross-subsidies that provides. Thus residential telephone costs will be driven up.

That conclusion frightens Congressmen because it frightens their constituents, who merely want their telephones to work at the lowest cost possible. AT&T does an effective job of convincing consumers that it alone can do that.

Changing that image—now held by most consumers, including Congressmen—is the most formidable challenge facing NATA's members and others in the telecommunications industry. AT&T's resources in money and personnel are unmatched. Its technology, too, is excellent, but it can be matched, even surpassed. Nevertheless, NATA is right to argue that the Van Deerlin subcommittee will make a serious mistake if it permits in-depth assessment of technical considerations to mask the policy issues before Congress. If Congress wants to encourage competition and thereby broaden the base of America's telecommunications industry, it should do so by changing the rules to give all comers an even break and then let the FCC enforce them.

Ray Connolly

At our plant, teams like this make sure reliable ICs arrive at your plant.

This typical 3" wafer photolithography production line employs sophisticated automated wafer-handling equipment. In a positively-vented clean-room environment, the specially-trained staff skillfully puts each wafer through photoresist coating, masking, exposure to ultraviolet light, developing, etching, and inspection, all with a high degree of productivity and product excellence.

At Sprague Electric's Semiconductor Division, we have accumulated over fifteen years of intensive experience in the manufacture of *innovative* semiconductor devices . . . devices making special contributions to technology . . . devices manufactured under the most exacting QAR program . . . devices that assure total customer satisfaction.

We have built the kind of operation it takes to produce semiconductors compatible with today's as well as tomorrow's requirements.

We proudly invite customers and prospects to tour our plant, the nation's finest semiconductor facility of its type. Here you will see the magnitude of effort that goes into properly designed and manufactured devices. You'll be pleasantly surprised!

Write or call George Tully or Bob Milewski to arrange a visit. You can reach them at the Semiconductor Division, Sprague Electric Co., 115 Northeast Cutoff, Worcester, Mass. 01606. Tel. 617/853-5000.



455 717R1

FOR FAST INFORMATION, CALL YOUR NEAREST SPRAGUE SALES OFFICE:

ALABAMA, Sprague Electric Co. 205 883-0520 • ARIZONA, Sprague Electric Co. 602 279-5435 • CALIFORNIA, Sprague Electric Co. 213 649-2600 Wm. J. Purdy Co. 415 347-7701 KCE Corp. 714/578-7640 • COLORADO, Wm. J. Purdy Co. 303 777-1411 • CONNECTICUT, Sprague Electric Co. 203 261-2551 • DIST. OF COLUMBIA, Sprague Electric Co. (Govt. sales only) 202 337-7820 • FLORIDA, Sprague Electric Co. 305 831-3636 • ILLINOIS, Sprague Electric Co. 312 678-2262 • INDIANA, Sprague Electric Co. 317 253-4247 • MASSACHUSETTS, Sprague Electric Co. 617/899-9100, Sprague Electric Co. 413-664-4411 • MICHIGAN, Sprague Electric Co. 517 787-3934 • MINNESOTA, HMR Inc. 612 926-8200 • MISSOURI, Sprague Electric Co. 314/781-2440 • NEW JERSEY, Sprague Electric Co. 201/696-8200, Sprague Electric Co. 609 795-2299, Trimble Sales Inc. 606 795-4200 • NEW MEXICO, Wm. J. Purdy Co. 505 266-7959 • NEW YORK, Sprague Electric Co. 516/549-4141, Wm. Rutt, Inc. 914/698-8600, Sprague Electric Co. 315 437-7311 Mar-Com Associates 315 437-2843 • NORTH CAROLINA, Electronic Marketing Associates, 819/722-5151 • OHIO, Electronic Salesmasters, Inc. 800 362-2616, Sprague Electric Co. 513 278-0781 • PENNSYLVANIA, Sprague Electric Co. 215 467-5252, Trimble Sales Inc. 215/922-2080 • TEXAS, Sprague Electric Co. 214 235-1256 • VERMONT, Ray Perron & Co. Inc. 617-762-8114 • VIRGINIA, Sprague Electric Co. 703 463-9151 • WASHINGTON, Sprague Electric Co. 206 632-7761 • CANADA (Ontario), Sprague Electric of Canada Ltd. 416 766-6123 • CANADA (Quebec), Sprague Electric of Canada Ltd. 514 663-9220



... and you thought we only make great capacitors.

**Need standard transformers, inductors,
electric wave filters and High Q Inductors
that are something special?**

TRW/UTC has a stock answer.



We have in continuous production the most complete line of standards for immediate delivery from the factory or an authorized distributor.

So our products get to you fast — when you need them.

But fast is not enough. All products that carry the TRW/UTC name have a quality background.

In engineering, all designs are fully laboratory proved before being released for production. In quality control, all incoming materials are subjected to exhausting test-

ing, and continuous surveillance.

In product testing, each individual transformer or filter is tested for performance at least three times during successive stages of manufacture.

The end result is a level of quality and reliability unmatched in the industry.

We're proud our products are available when you need them. But, we're even prouder of what we do to them before they reach the shelf.

TRW UTC TRANSFORMERS

ANOTHER PRODUCT OF A COMPANY CALLED TRW

F8 microprocessor controls operations in new TV set

West Germany's Blaupunkt-Werke GmbH is about to introduce a color television set that uses a Fairchild Semiconductor F8 microprocessor to control operating parameters—such as contrast, brightness, color saturation, and volume—according to stored data. **The F8 also turns on the set and switches it to different channels at times that the viewer has programmed into its memory as far as a year in advance.** The firm, a member of the Robert Bosch group, believes it is the first in Europe to use a microprocessor in this way. In the U. S., GTE Sylvania and Quasar use chips similarly. Blaupunkt is unveiling its PS19 at the Radio and Television Exhibition in West Berlin late this month.

British firm to supply subsystem for U.S. helicopters

Britain's Marconi-Elliott Avionic Systems Ltd. will supply Bell helicopters Textron, Fort Worth, Texas, with a digital air data subsystem for the U. S. Army's AH-1S Cobra attack helicopters. The contract, estimated by industry observers to be worth about \$10 million, calls for delivery of five prototype systems beginning February. It contains agreed options for as many as 507 production systems. **The 4.75-kilogram ADS gives the precise air speed and direction from hovering to full flight.** This information may be displayed or fed to the doppler navigation system or to the fire-control computer. The subsystem consists of an airspeed and direction sensor, a low-air-speed indicator, and an electronic processing unit built around an undisclosed military-hardened 16-bit microprocessor.

West Germany gets access to two U. S. data networks

West Germans now can use the services of U. S. data-bank operators. An agreement between RCA Global Communications Inc. and West German postal authorities **gives subscribers access to the American switched data networks Tymnet and Telenet** as of Aug. 1. A link to the two networks can be set up in direct-dial fashion by regular phone lines or by West Germany's Datex data network.

EMI sues Pfizer over Scanner patents

The originator of computerized axial tomography X-ray scanners, EMI Ltd. is suing a major competitor Pfizer Inc., claiming that the latter's Acta-Scanners infringe upon six EMI patents covering the basic technology. In the suit filed in Federal District Court, Wilmington, Del., the company says that it is negotiating with Pfizer for a licensing agreement. A spokesman for Pfizer, in New York, says, **"We do not believe EMI has a valid cause of action against Pfizer's scanners,"** which are marketed by the firm's Medical Systems Inc. subsidiary under license from Georgetown University.

\$940 video-tape recorder undercuts competitors in Japanese market

A two-hour video-tape recorder that Sanyo Electric Co. will begin selling in Japan on Sept. 1 for about \$940 signals a price break that should spread to the U. S., where the firm and Sears will be marketing the units in time for Christmas. **The Beta-format model is cheaper than any competing two-hour unit, including those of the Video Home System format.** It omits a one-hour recording feature but offers pause control and an electronic timer with a light-emitting-diode display that was an option on the preceding \$1,010 set. The Japanese price of competing VTRS is around \$1,000.

Intel delivers PDP-11 memory for people who can't afford to wait.

When you're in a hurry for more semiconductor memory for your PDP-11, call Intel. We deliver memory for the full PDP-11 line. And because we're the largest manufacturer of semiconductor memory in the world, delivery is when you want it.

Why wait? Since you've chosen the leader to supply your minicomputer, it makes sense to go to the leader for memory, too. That's us.

Intel memory systems save you more than time. Our in-1670 add-on memory for the PDP-11/70 is one example. It gives you four times the capacity in the same frame compared to the DEC MJ11-A core memory. And built in Error Correction Code (ECC) and Error Logging improve up-time and reduce maintenance time by automatically correcting and recording single-bit failures and detecting and recording double-bit errors.

For PDP-11 add-in memory go with our in-4711 plug in boards. You'll get memory that's even faster than DEC's. 16K words per hex-wide board. With or without parity. To further expand PDP-11 memory and reduce UNIBUS™ loading choose our in-4011 add-on. With memory management you can expand to 128K words in 16K increments. And since the in-4011 requires only one UNIBUS load, you get added system flexibility.

Get more memory for your LSI-11 and PDP-11/03 in less space with our in-1611 add-in memory. You get up to 32K words, in 8K increments, on a single, two-wide, board. That's up to eight times the memory you get with a DEC board.

When you can't afford to wait call us at 800-538-8476. In California and Canada, call 408-734-8102, x575. We'll save you time, and much more.

intel delivers.

Intel Memory Systems
1302 N. Mathilda Avenue
Sunnyvale, California 94086

I can't wait! Must have delivery in 5 Days 30 Days _____ Days

Please call me at _____/_____ Ext. _____

Please send me information on semiconductor memory for the following:

LSI-11, PDP-11/03

PDP-11/04

PDP-11/05

PDP-11/34

PDP-11/35

PDP-11/40

PDP-11/45

PDP-11/55

PDP-11/70

Name/Title _____

Company _____ Mail Station _____

Address _____

City/State/Zip _____

UNIBUS is a trademark of Digital Equipment Corp. Maynard, Mass.

World Radio History
Circle 64 on reader service card

Electronic navigator gives drivers highway guidance and information

Reducing the guesswork of driving on high-speed, crowded highways is the aim of a guidance and information system under development by the Robert Bosch subsidiary, Blaupunkt-Werke GmbH, and Volkswagenwerk AG. Through a dashboard display (see photograph), the system gives the driver information on routings, speed limits, passing zones, and the like. It also can warn him of traffic tieups and similar highway conditions.

Besides the in-car display, the essential parts of the system are a ferrite antenna somewhere on the car chassis; inductive loops, buried in the roadway, and accompanying electronics-packed roadside units; and control centers, each of which serves a number of roadside units.

Viable. The developers insist that the system is a down-to-earth project, one that the government wants to put into widespread operation. For example, reports of congestion ahead and guidance onto alternate routes would help improve the flow of traffic, an increasingly serious problem in West Germany where there is little room to build new highways. Further, with this and other crucial information visible at a glance, drivers can pay more attention to the traffic around them.

Called ALI—the acronym for the German words for automobile driver's guidance and information system—the system is undergoing trials at Blaupunkt's factory grounds in Hildesheim and at vw's sprawling test ground near the company's main plant in Wolfsburg. A test on a strip of autobahn is to follow some time within the next two years.

If a driver wants directional information, he keys a destination code into the dashboard unit. As the car passes over a buried loop, digital pulses representing the destination code are inductively coupled from the car antenna into the loop. The

pulses go to the roadside unit, which generates direction data and sends it back to the car, where it shows up as an arrow on the display. The data-exchange process is repeated at each loop, so new directions like an arrow pointing toward an exit can be generated.

Data transmission takes only 0.01 second. Appropriately programmed from the control center, the roadside unit can inform a driver about traffic tieups, fog, icy roads, and so on. It can even warn that he is driving too close to the car in front, by measuring the time interval between

successive passages over the loop. All panel indications are accompanied by an audible signal to catch the driver's attention.

Circuitry. The primary active components in the roadside unit are integrated circuits. They detect changes in loop inductivity, exchange data, filter pulses, and do some other jobs, too. Available microprocessors are too slow for some of the tasks, a Blaupunkt engineer says, but for analog-to-digital conversion, value comparison and averaging, and the like, a microprocessor is used. Target size for the

Turn here. The ALI system is warning of a traffic backup (Stau) ahead on the main road (the diamond shape) to Braunschweig, so the driver should take this exit (arrow). The figure (50) gives the permissible top speed in kilometers per hour on the alternate route.



units is 15 by 30 by 30 centimeters.

The dashboard units use integrated circuits, but Blaupunkt plans to replace them with a standard microprocessor. The firm expects the cost to be between \$85 and \$110 for display panel and electronics.

As for the other parts of ALI, experts at the Ministry of Transporta-

tion put the cost for a system covering autobahns and the major federal highways at between \$130 million and \$170 million. It could make use of inductive loops already present in many autobahn stretches to count vehicles, clock their speed, and determine traffic density [*Electronics*, April 1, 1976, p. 10E]. □

France

Infrared detector on wedge base aims at cost 10% that of other units

Even if Alex Argamakoff were not based in the Mediterranean resort of Cannes, systems developers interested in infrared devices would still beat a path to his door. He has developed a number of IR detectors over the years, and his latest development should increase traffic—since it probably will undercut the costs of conventional detectors by 90% [*Electronics*, International Newsletter, July 7].

The new unit from Arga Infrared Systems is a detector based on the Seebeck (thermocoupling) effect and combined with a preamplifier. Argamakoff is already talking with several European companies about licensing agreements.

The inventor believes that the time has come for much cheaper infrared technology. Large markets exist in medical applications, the military field, and environmental systems, he says. Apart from marketing considerations, the price break comes from the operational amplifier used as the preamp. It costs only about \$12.

Response. The important features of the new device are extremely low noise levels and a response time of between 5 and 15 milliseconds. Impedance is less than 100 ohms, compared to the 6 kilohms typical of other Seebeck IR detectors. Because impedance is low, there is very little current noise. Other Seebeck devices take 20 and 100 ms to respond because of their construction.

Unlike most Seebeck devices, the new detector does not have a flat substrate. It uses a wedge-shaped

base of insulating material onto which two thermoelectric materials in the form of strips are laid, overlapping at the apex to form a junction. The positive material is laid on one flank and the negative material on the other. The strips are deposited over a soluble substance along the top of the wedge. Then the soluble substance is dissolved, leaving a gap below the junction.

Because the thermocouple is thick, compared to those of other detectors, it has a higher thermoelectric coefficient, which increases its sensitivity

to IR. Also, the gap between the thermocouple and the wedge dissipates heat much faster than the membranes upon which the thermocouples of other detectors rest—thereby speeding up the thermoelectric reaction and thus the response time. Argamakoff says the overall effect is to increase sensitivity to IR to the point where one of his detectors can replace a conventional detector with 64 thermocouples.

The main advantage of the wedge shape is that much less internal heat is absorbed by the nonactive parts of the thermoelectric materials. Also, radiation falling on the sides of the wedge is deflected rather than absorbed. Hence, there is less of a tendency for absorbed heat to distort the readings of the detector.

Argamakoff has models of a medical radiation thermometer capable of measuring skin temperatures of 26° to 36°C with a thermal resolution of 0.02° in a 110-by-76-by-27-millimeter pack weighing 260 grams. The production price should be around \$120, he says. A medical thermometer for very small skin areas is also available, and a prototype of a thermograph has also been assembled. □

TVs offer whiter whites along with true colors

To provide color fidelity in television sets with a picture bright enough to watch in a normally illuminated room, Japan's Matsushita Electric Industrial Co. is introducing a new gamma switching circuit in two receivers. Since the strongly colored portions of the picture are less bright than the white portions, the circuit permits faithful reproduction of colors at lower color temperatures than necessary for the desirable brilliant white.

The circuit has a resistor in series with the cathode lead of each electron gun. Across the resistors for the blue and green guns are nonlinear shunts consisting of series combinations of a low-voltage zener diode and a resistor. The diodes respond to current flowing through the cathode resistors. They give precise color control because brightness is proportional to cathode current. Circuit operation becomes nonlinear above about 60 volts, as driving voltages rise to about 150 V necessary for the high color temperature of brilliant white.

When the diodes conduct, circuit constants increase the gain of green above that of red and the gain of blue above that of green. These constants are apportioned so that the brightness of green, to which the eye is most sensitive, approximates the brightness of present TVs. This feature maintains the same resolution, which can be degraded by high gain settings. Yet the relatively lower gain of red and the much higher gain of blue in the gamma circuit increase the peak white color temperature to the preferred level.

A companion circuit, to be introduced soon, is an integrated-circuit color decoder that incorporates nonlinear correction. The nonlinearity corrects the problems of color fidelity and resolution caused by adoption of primary-color phosphors that give the brighter picture demanded.

Introducing the new generation of programmable calculators...with revolutionary *Solid State Software*TM ...from Texas Instruments.



The world's most advanced programmables. Performance. Capability. Quality. Value.

5,000 program steps in a tiny, plug-in module. The TI Programmable 58 and TI Programmable 59 introduce a major technological advance in handheld programmable calculators — Solid State Software™. Each prerecorded program library contains up to 5,000 steps, providing significant additional program memory capability and programming flexibility.

The TI Programmable 58 and TI Programmable 59 offer the most

advanced features available. Anywhere. Use interchangeable Solid State Software™ modules, or enter programs you develop right from the keyboard. (The TI Programmable 59 also has magnetic card read/write capability.)

Both programmables feature computer-like power and versatility with subroutines, looping, flexible addressing, editing capabilities — and much more. And both can be quickly converted to

powerful alphanumeric printers with TI's optional PC-100A (see back page).

The Master Library software module, included with the TI Programmable 58 and 59, provides 25 prewritten programs in math, statistics, finance, and other application areas. Additional libraries are available from a selection of optional Solid State Software™ modules.

The TI Programmable 58.

The advanced key programmable calculator with plug-in Solid State Software™ libraries.

\$124.95*

The TI Programmable 59.

The super-powerful card programmable with Solid State Software™ libraries and magnetic cards.

\$299.95*



Solid State Software.TM

Plug-in library modules give you up to 5,000 additional program steps!

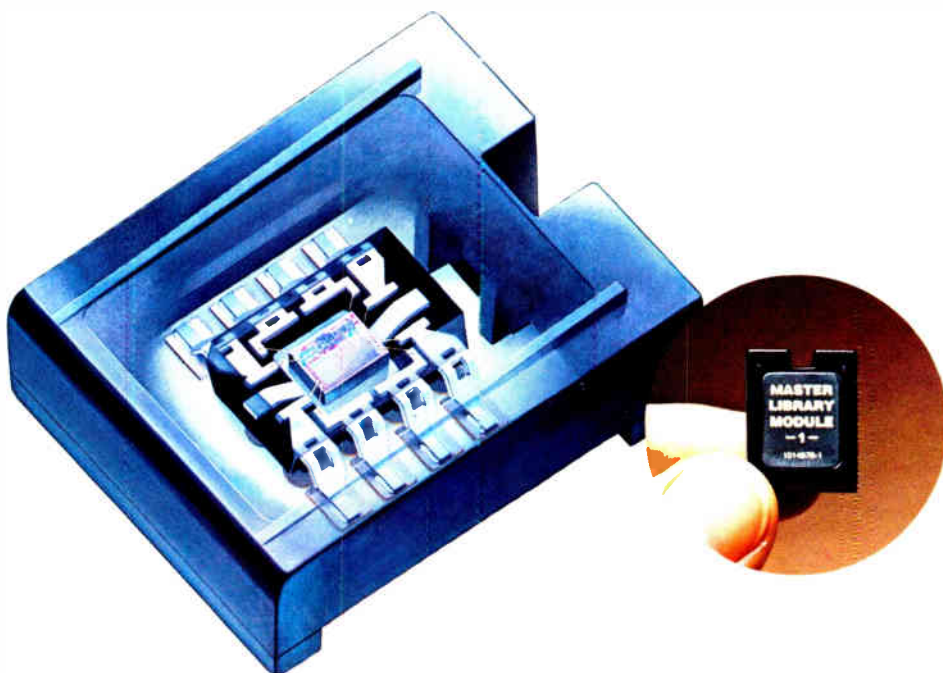

A new dimension in micro-memory technology.

TI's state-of-the-art Solid State SoftwareTM libraries combine the advantages of prewritten programs with the convenience of compact, easy-to-use, plug-in modules. Information that once required up to 25 magnetic cards can be contained in one small module. Simply insert the desired module and access a program in seconds, with just a few keystrokes. They bring the power of programming within easy reach, even if you have never programmed before. Use the 5,000-step module by itself. Or, use it as a base and call subroutines from your magnetic card or keyed-in program. You can also use your program as a base and call subroutines from the module. And much more.

Master Library.

The Master Library Solid State SoftwareTM module is included with the TI Programmable 58 and TI Programmable 59. A selection of 25 prewritten programs in mathematics, statistics,

finance, and other application areas, it provides the professional with a "tool kit" of preprogrammed solutions to a wide variety of problems.

Optional libraries.

Optional Solid State SoftwareTM plug-in libraries let you customize your TI Programmable 58 or TI Programmable 59 into a specialized problem solver. Choose from Statistics, Real Estate and Investment, Surveying, Aviation, Marine Navigation.

PPX-59 lets you share programs.

TI's Professional Program Exchange (PPX) makes hundreds of programs available to you. Programs developed, tested, and submitted by your professional peers. And, you can submit programs you develop for possible inclusion. Your yearly PPX-59 membership provides you with a source catalog, 3 free programs of your choice, a bi-monthly newsletter, and a member's guide and program submission forms.



Send for free 16-page brochure.

Want to know more? This 16-page color brochure is packed with information on TI's new handheld programmables. Contains detailed descriptions and specifications on these exciting calculators. For your free copy write to: Brochure Offer, Texas Instruments, P. O. Box 53, Lubbock, TX 79408.



Print alphanumerics. Plot data.

The PC-100A turns your TI Programmable 58 or 59 into a quiet, high-speed printing/plotting calculator.



\$199.95*

Simplifies program editing.

The PC-100A prints fast. Over 60 characters/second with its quiet thermal printer. So you get listings fast. Just push the LIST key for a printout of the entire program memory.

```

037 76 LBL
038 14 D
039 53 C
040 35 1%
041 65 X
042 61 GTO
043 15 E
044 76 LBL
045 11 A
046 58 FIN
047 09 09
048 88 DMS
049 42 STO
050 01 01
051 92 PTN
052 00 0
    
```

Program headings.

Printed headings for your programs provide easy reference and identification. You can even annotate data on printouts.

PORTFOLIO ANALYSIS

```

46.75 COST
3200. SHRS
85. MPGN
    
```

User prompting.

Use the alpha printing capability of the TI Programmable 58/59/PC-100A combination to enter prompting messages right in your program.

```

ENTER TEMPERATURE
76.3

ENTER PRESSURE
749.4
    
```

Data plotting.

The PC-100A allows you to input data from your TI Programmable 58 or 59 and plot curves and histograms. You can make a plot of data directly from the calculator keyboard or automatically from a program.

SINE CURVE PLOT
SAMPLED EVERY 30 DEG

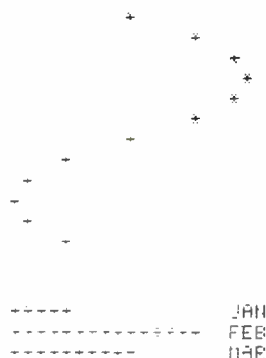

See each program step executed.

Push the TRACE key. Now every calculation that's performed in your program is printed. The full number and the operation.

*U.S. suggested retail price, may vary elsewhere.
All tape printouts shown approximately 60% of actual size

And other features.

List registers. Program labels. There's even a handy, built-in battery charger for your calculator's battery pack. Whether for school, technology, or business and finance, the uses for the PC-100A are limited only by your imagination.



Continuing revolutionary advances from Texas Instruments ...the leader in electronic technology.

When you judge the value of a high-technology product, it pays to look closely at the company behind the product. TI invented the original integrated circuit and the "calculator-on-a-chip" that ignited the calculator revolution.

As the world's leading producer of integrated circuits, TI holds the basic patent on the miniature calculator itself...and is a world leader in the production of electronic calculators. Performance. Capability. Quality. Value. TI.

TEXAS INSTRUMENTS
INCORPORATED
World Radio History

Print alphanumerics. Plot data.

The PC-100A turns your TI Programmable 58 or 59 into a quiet, high-speed printing/plotting calculator.



Simplifies program editing.

The PC-100A prints fast. Over 60 characters/second with its quiet thermal printer. So you get listings fast. Just push the LIST key for a printout of the entire program memory.

```

007 76 LBL
008 14 0
009 53 1
040 35 1.1
041 65 1
042 61 GTO
043 15 E
044 76 LBL
045 11 R
046 58 F11
047 09 09
048 58 DMS
049 42 STD
050 01 01
051 92 PTH
052 00 0
    
```

Program headings.

Printed headings for your programs provide easy reference and identification. You can even annotate data on printouts.

```

PORTFOLIO ANAL 000
48.75  COST
1000.00  SHRS
88.1  MFGN
    
```

User prompting.

Use the alpha printing capability of the TI Programmable 58/59/PC-100A combination to enter prompting messages right in your program.

```

ENTER TEMPERATURE
76.3
ENTER PRESSURE
749.3
    
```

Data plotting.

The PC-100A allows you to input data from your TI Programmable 58 or 59 and plot curves and histograms. You can make a plot of data directly from the calculator keyboard or automatically from a program.

SINE CURVE PLOT
SAMPLED EVERY 30 DEG

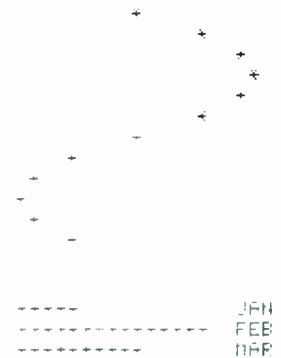

See each program step executed.

Push the TRACE key. Now every calculation that's performed in your program is printed. The full number and the operation.

*U.S. suggested retail price. May vary elsewhere.
All tape printouts shown approximately 60% of actual size.

And other features.

List registers. Program labels. There's even a handy, built-in battery charger for your calculator's battery pack. Whether for school, technology, or business and finance, the uses for the PC-100A are limited only by your imagination.



Continuing revolutionary advances from Texas Instruments ...the leader in electronic technology.

When you judge the value of a high-technology product, it pays to look closely at the company behind the product. TI invented the original integrated circuit and the "calculator-on-a-chip" that ignited the calculator revolution.

As the world's leading producer of integrated circuits, TI holds the basic patent on the miniature calculator itself...and is a world leader in the production of electronic calculators. Performance. Capability. Quality. Value. TI.

TEXAS INSTRUMENTS
INCORPORATED

The TI Programmable 58 and TI Programmable 59 present a significant new flexibility in program step/memory allocation. Flexible storage lets you vary the allocation between program steps and memory. The TI Programmable 58 provides up to 480 program steps or up to 60 memory registers:

PROGRAM STEPS		480
		400 10
		320 20
		240* 30*
		160 40
		80 50
60		MEMORIES

*Calculator in this configuration when turned on. May be changed from the keyboard or in a program.

The TI Programmable 59 provides up to 960 program steps or up to 100 memory registers:

PROGRAM STEPS		960
		880 10
		800 20
		720 30
		640 40
		560 50
		480* 60*
		400 70
		320 80
		240 90
160		100 MEMORIES

*Calculator in this configuration when turned on. May be changed from the keyboard or in a program.

These partitioning features allow you to tailor program step/memory resources to meet your requirements.

Plus, features to help you easily handle complex math problems. Both calculators utilize TI's AOS™ algebraic operating system, providing easy, straightforward problem entry. Powerful slide rule functions include logs, trig, and advanced statistics.

*U.S. suggested retail price. May vary elsewhere.

Personal Programming

A step by step guide to a whole new dimension in problem solving ease and power.



Step-by-step learning guide shows you how to get the most out of your TI Programmable 58 or 59.

Personal Programming replaces the traditional owner's manual and allows you to put your TI Programmable 58 or TI Programmable 59 to work more quickly. In a critical review by Ron Snyder of *The Washington Star*, it was described as a "new standard in writing owner's manuals.... You are swept away into what previously seemed to be a totally forbidden world and find yourself enjoying and understanding every moment of the trip."

In step-by-step fashion, *Personal Programming* takes you through a self-paced course, from simple techniques to advanced programming details. You'll learn how to put the programs in your Master Library Module to work immediately. How to teach the calculator to remember and execute your programs. And, how to use its power when programs aren't needed. A comprehensive selection of examples allows you to apply the power of programming to your particular personal or professional interests.

Prove to yourself how easy and effective programming can be with this easy to understand learning guide.

AOS™. Texas Instruments unique algebraic operating system makes the calculator part of the solution, not part of the problem.

What is AOS?

AOS is more than just algebraic entry. It's a *full* mathematical hierarchy coupled with multiple levels of parentheses. This means more pending operations, as well as easy left-to-right entry of expressions – both numbers and functions.

Mathematical hierarchy.

This is the universally recognized order of performing calculations. Functions first. Powers and roots. Multiplication or division. Then addition or subtraction. AOS performs calculations in this order automatically. But, you have the option to change the order whenever you wish by using the parentheses keys.

AOS *remembers* the numbers and functions in its pending operation stack. And processes them according to mathematical hierarchy. As more operations become pending, the stack fills up. As operations are completed, the stack empties into the display.

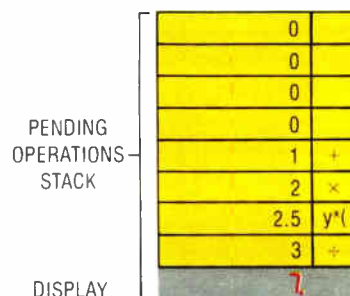

The case for AOS is strong.

That's why TI chose it. We think you'll prefer AOS. Because you begin using it immediately. There's no new language to learn. And, even if you are already conditioned to some other form of entry system, the added value and power of TI's programmable calculators with unique AOS is well worth the easy transition.

Compare the power and features of the TI Programmable 58 and 59 with any other programmable calculators available today.

	TI-58	TI-59		TI-58	TI-59
MEMORIES			Branch addressing types		
Program memory			Absolute	•	•
Maximum number of steps	480	960	Relative	•	•
Expandable	•	•	Indirect	•	•
Merging—fully merged	•	•	Label	•	•
semi merged*	•	•	Short form	•	•
Solid-state software			Label addressing		
Number of steps	5,000	5,000	User defined keys	10	10
Program down load into RAM	•	•	No. possible labels	72	72
Useable as subroutine to expand program memory size	•	•	User control keys		
Useable as separate program	•	•	NOP	•	•
			Clear Program	•	•
			Clear t register	•	•
			RST	•	•
			Program step/data memory repartition	•	•
Data memory			MAGNETIC I/O		
Maximum number of registers	60	100	Capacity per card—steps		480
Expandable	•	•	— registers		60
Addressing—absolute	•	•	Read/write program/data		•
—indirect	•	•	Autoload with override		•
—max. no. of index registers	60	100			
—short form	•	•	PRINTING		
—EXCH	•	•	Print alpha, plot, list labels	•**	•**
—increment/decrement registers	•	•	Print numerics, list, trace	•**	•**
PROGRAMMING			OPERATING SYSTEM		
Program edit—SST/BST, pause	•	•	Entry system	AOS	AOS
Program edit—insert/delete	•	•	No. of pending operations	8	8
			No. of sets of parentheses	9	9
			No. of stack registers	9	9
PROGRAM CONTROL			FUNCTIONS		
Conditional branching			Scientific, trig, DRG, pol/rect, DMS	•	•
Numeric comparisons			Integer, fraction, absolute value		
x=t, x<t, x>t, x=t, x<t, x>t, 0	•	•		•	•
x<0, x=0, x>0 (t register = 0)	•	•	Linear regression, trend line, correlation coefficient		
Independent comparison (t register)	•	•		•	•
Flags (Boolean comparison)			DISPLAY FORMAT		
Number of flags	10	10	VLED Characters	8+2, 10	8+2, 10
Set/reset flag, test flag	•	•	Scientific notation	•	•
Test on error (if error/if not error)	•	•	Engineering notation	•	•
Loop control			OPERATING CHARACTERISTICS		
Increment/decrement (branch on zero)	•	•	Internal digits	13	13
Increment/decrement (branch on not zero)	•	•			
No. of index registers (direct address)	10	10			
No. of index registers (indirect address)	60 max.	100 max.			
Unconditional—No. of levels of subroutine					
	6	6			

*Memory address, second functions and other key sequences

**With optional printer

FREE-Leisure Library.

When you buy a TI Programmable 58 or 59.

A \$35 value if you act now.

Leisure Library includes plug-in Solid State Software module, library manual, quick-reference guide, label cards, and library wallet. 19 fun programs: Football Predictor, Bowling Scorekeeper, Golf Handicapper, Bridge, Chess Rankings, Codebreaker, Black Jack, Acey Ducey, Craps, Mars Lander, Jive Turkey, Nim, Sea Battle, Quarterback, Photo I and II. For use in conjunction with the PC-100A there's Hangman, Memo Pad, Biorhythm, Computer Art.

Offer good from August 15 to October 31, 1977.



Fill out this coupon. Return it to TI with your serialized Customer Information Card (packed in the box), along with a copy of a dated proof of purchase showing the serial number. **IMPORTANT** Your envelope must be postmarked no later than October 31, 1977.

Texas Instruments Leisure Library Offer
P. O. Box 53, Lubbock, Texas 79408

Name

Address

City

State

Zip

Texas Instruments reserves the right to substitute software libraries of equal value based on availability. Please allow 30 days for delivery. Offer good in United States and Canada only. Offer void where prohibited by law.
SA9 IR9 CEB IEE9 E8

Solid State Software.™

Plug-in library modules give you up to 5,000 additional program steps!

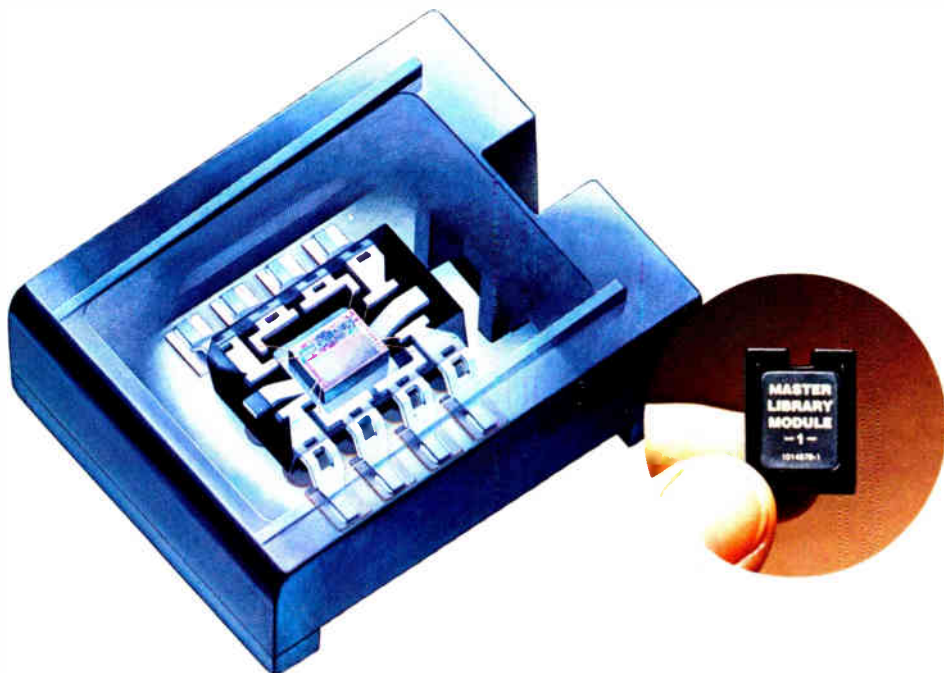

A new dimension in micro-memory technology.

TI's state-of-the-art Solid State Software™ libraries combine the advantages of prewritten programs with the convenience of compact, easy-to-use, plug-in modules. Information that once required up to 25 magnetic cards can be contained in one small module. Simply insert the desired module and access a program in seconds, with just a few keystrokes. They bring the power of programming within easy reach, even if you have never programmed before. Use the 5,000-step module by itself. Or, use it as a base and call subroutines from your magnetic card or keyed-in program. You can also use your program as a base and call subroutines from the module. And much more.

Master Library.

The Master Library Solid State Software™ module is included with the TI Programmable 58 and TI Programmable 59. A selection of 25 prewritten programs in mathematics, statistics,

finance, and other application areas, it provides the professional with a "tool kit" of preprogrammed solutions to a wide variety of problems.

Optional libraries.

Optional Solid State Software™ plug-in libraries let you customize your TI Programmable 58 or TI Programmable 59 into a specialized problem solver. Choose from Statistics, Real Estate and Investment, Surveying, Aviation, Marine Navigation.

PPX-59 lets you share programs.

TI's Professional Program Exchange (PPX) makes hundreds of programs available to you. Programs developed, tested, and submitted by your professional peers. And, you can submit programs you develop for possible inclusion. Your yearly PPX-59 membership provides you with a source catalog, 3 free programs of your choice, a bi-monthly newsletter, and a member's guide and program submission forms.



Send for free
16-page brochure.

Want to know more? This 16-page color brochure is packed with information on TI's new handheld programmables. Contains detailed descriptions and specifications on these exciting calculators. For your free copy write to: Brochure Offer, Texas Instruments, P. O. Box 53, Lubbock, TX 79408.

FREE
Solid State
Software™ offer.
See details
inside.

VARACTORS

5 10 20 30 40 50 60 70 80 90 100 110 115

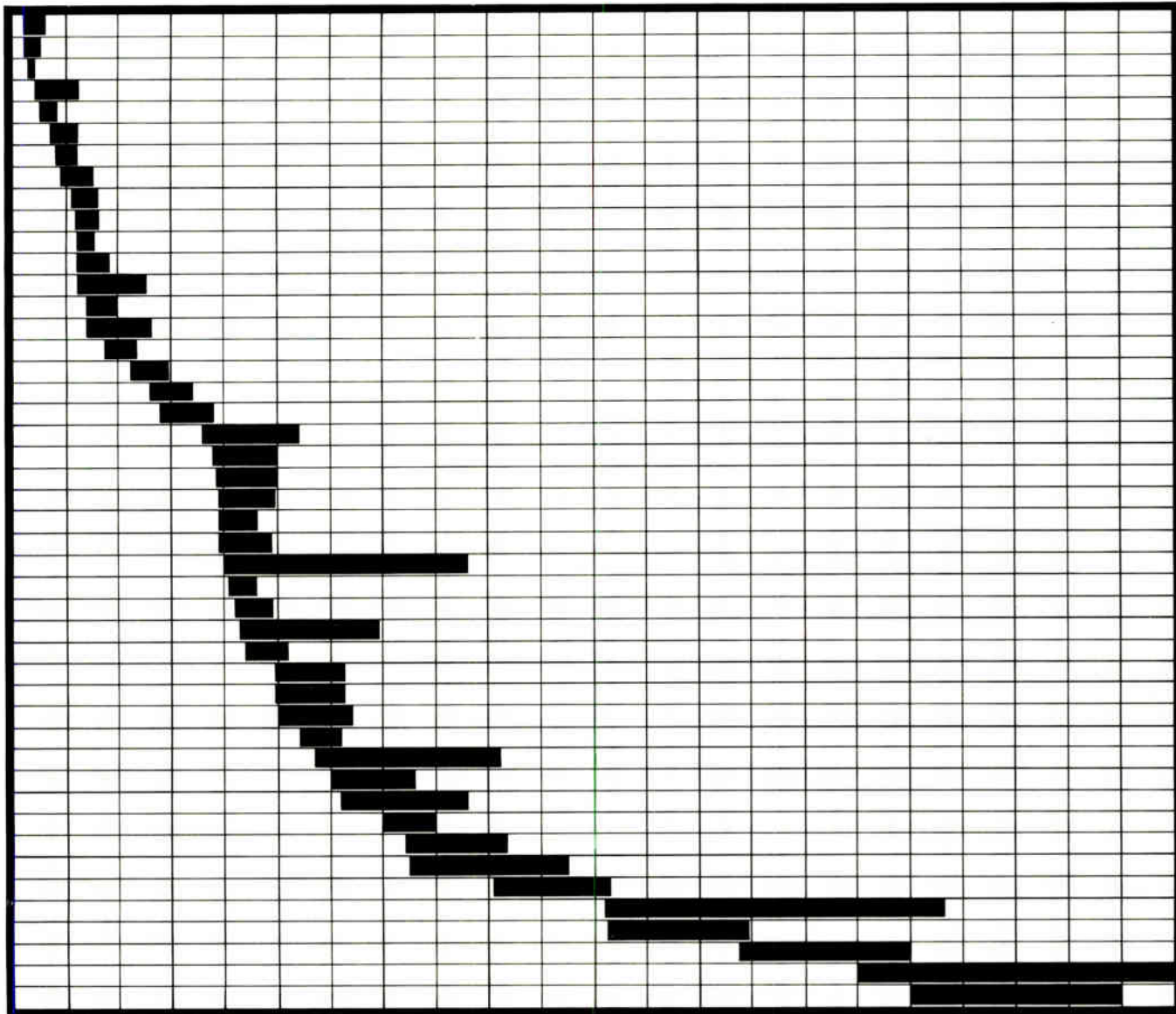

46 different ranges from 6.0 to 115 pF at 4V.

NPC offers from stock a line of Varactors that may be the broadest in the industry. Depending upon values, these devices are available in the most popular packages—DO-7, DO-35, DO-41, SOD-23 and TO-92. Matching can be guaranteed in sets of two, three and four.

Where Pricing is as Important as Technology



THOMSON-CSF
NPC
ELECTRONICS

NPC Varactors are manufactured by the epitaxial planar process and combine superior quality with excellent stabilization characteristics at high temperatures. They are available in varying capacitance ratios. Want more facts? Write NPC Electronics for Application Notes.

6660 Variel Avenue
 Canoga Park, California 91303 • (213) 887-1010
 Telex 69-8481 • TWX 910-494-1954

A Division of DuMont Electronics Corporation

ARIZONA G. S. Marshall (602) 968-6181 **CALIFORNIA** Brill Electronics (415) 834-5888; Intermark (714) 540-1322, (714) 279-5200, (408) 738-1111; G. S. Marshall (213) 999-5001, (714) 556-6400; Mouser Electronics (714) 449-2220; Rose Electronics (415) 692-5700; Semiconductor Concepts (213) 884-4560; Zeus Components (714) 990-1911 **COLORADO** Century Electronics (303) 424-1985 **FLORIDA** National Resistor Corp. (305) 792-2600; Zeus Components (305) 942-4312 **ILLINOIS** Advent Electronics (312) 297-6200; Bodelle/R-M Electronics (312) 323-9670; Edmar Electronics (312) 298-8580 **INDIANA** Advent Electronics (317) 297-4910; Ra-Dis-Co. (317) 637-5571 **IOWA** Advent Electronics (319) 363-0221 **MARYLAND** Pytronic Industries (301) 953-9650; Technico, Inc. (301) 461-2200 **MASSACHUSETTS** G. S. Marshall (617) 965-5115; Zeus Components (617) 273-0750 **MICHIGAN** Advent Electronics (313) 477-1650; R-M Electronics (616) 531-9300 **MINNESOTA** Joel Company (612) 545-5669; G. S. Marshall (612) 559-2211 **NEW JERSEY** General Radio Supply (609) 964-8560 **NEW MEXICO** Century Electronics (505) 292-2700 **NEW YORK** Kahgan Components (516) 538-2300; Zeus Components (914) 592-4120 **NORTH CAROLINA** Pytronic Industries (919) 782-6370; Resco (919) 832-2077 **OKLAHOMA** Component Specialties (918) 664-2820 **OREGON** Dunn Electronics (503) 285-0214 **PENNSYLVANIA** General Radio Supply (609) 964-8560; Pytronic Industries (215) 643-2850, (412) 276-6722 **SOUTH CAROLINA** Resco (919) 832-2077 **TEXAS** Component Specialties (512) 459-3307, (214) 357-6511, (713) 771-7237; Quality Components (214) 387-4949, (713) 789-9320 **UTAH** Century Electronics (801) 487-8551 **WASHINGTON** Zepher Electronics (206) 575-0922 **WISCONSIN** Taylor Electric (414) 241-4321

Quite frankly, we're going to be #1 in memory testing till the cows come home.



Four years of matching the memory industry breakthrough for breakthrough have made Teradyne the leader in memory testing.

We started back in 1973 with the J384, a dedicated memory test system. It tested RAMs and ROMs efficiently and economically. But things were changing fast.

1974 saw the advent of dynamic devices like the 4k 2107. And we added the M385 microprogrammable pattern

generator to keep pace.

In 1975 our answer to increasingly complex memory technology was a new system, the J387.

In 1976, when 16k and page-mode parts went into production, we responded with the H712 test deck.

Today, Teradyne has an installed base of well over 100 J380-series memory test systems working for more than

20 companies. At probe, at final test, and at incoming inspection. That's a larger dollar base than our two nearest competitors combined.

Four years of experience have made us the most capable source of memory test equipment in the world.

If you test semiconductor memories, call us today. You'll call us eventually. Because no matter where memory technology goes from here, Teradyne will be there.

TERADYNE

Semiconductor Test Division
Boston, Mass. - Chatsworth, Calif.

Memory-rich minis get aggressive

Dense memory chips create million-byte storage systems that equip minicomputers to undercut into mainframes

by Raymond P. Capece, Computers Editor

Minicomputers are pushing upward into mainframe territory, especially now that those breadbox-sized cabinets containing a million bytes or more of reliable semiconductor memory are catching on.

"Now the price tag is the only way to tell a small mainframe from a large mini," says Rowland H. Thomas, vice president of product marketing at Data General Corp. The Southboro, Mass., firm late last year introduced its C/330 minicomputer with half a million bytes of semiconductor memory for \$80,500.

Earlier advances in design in fact have long made the "mini" prefix a misnomer. Throughput has soared, thanks to use of sophisticated architecture and fast memory designs. Indeed, memory cycle times typically of 500 nanoseconds or less have made it not unusual for minicomputers to be compared head to head with an IBM System 370/158 in computing power.

Today, with the memory barrier giving way, "the only area where mainframes really beat big minis is in input/output capabilities," says Richard E. (Joe) Jones, vice president of product development at Interdata Inc. in Oceanport, N. J. Even that edge is being eroded, as more medium-speed I/O channels as well as high-speed direct-memory-access channels are added to minicomputers. Moreover, the minicomputer main memory is opening up to many more different modes of access, including special communications links and direct transfers for

controllers of fixed and moving-head disks.

The expansion of minicomputer memory is a tribute to the metal-oxide-semiconductor breakthrough in chip density, begun a few years back with the arrival of the 4,096-bit random-access-memory chip and rapidly accelerating today with the 16,384-bit chips. Their falling cost is ending the dominance of massive memories by cores, which owe any recent price cuts primarily to materials advances and seem unable to overcome their fundamental economic drawback: the expensive necessity of stringing them together by hand.

"There are machines to stuff chips

into boards and even to test them, but there just isn't a machine to build core memories," says Interdata's Jones. His company puts MOS memory in its 16-bit minicomputers but plans to continue using core in its 32-bit line, pending the easy availability of 16-k chips expected some time next year.

Some companies have not yet decided on the changeover. One is Systems Engineering Laboratories Inc. in Fort Lauderdale, Fla., which has just announced an addition to its 32-bit minicomputer line called the 32/75. At present it uses only core memory and says it has sold many systems in million-byte configurations. Abe Glatzner, director of sales

Light bytes. HP's Richard Anderson holds a 21MX minicomputer that conceals a million bytes of error-correcting memory.

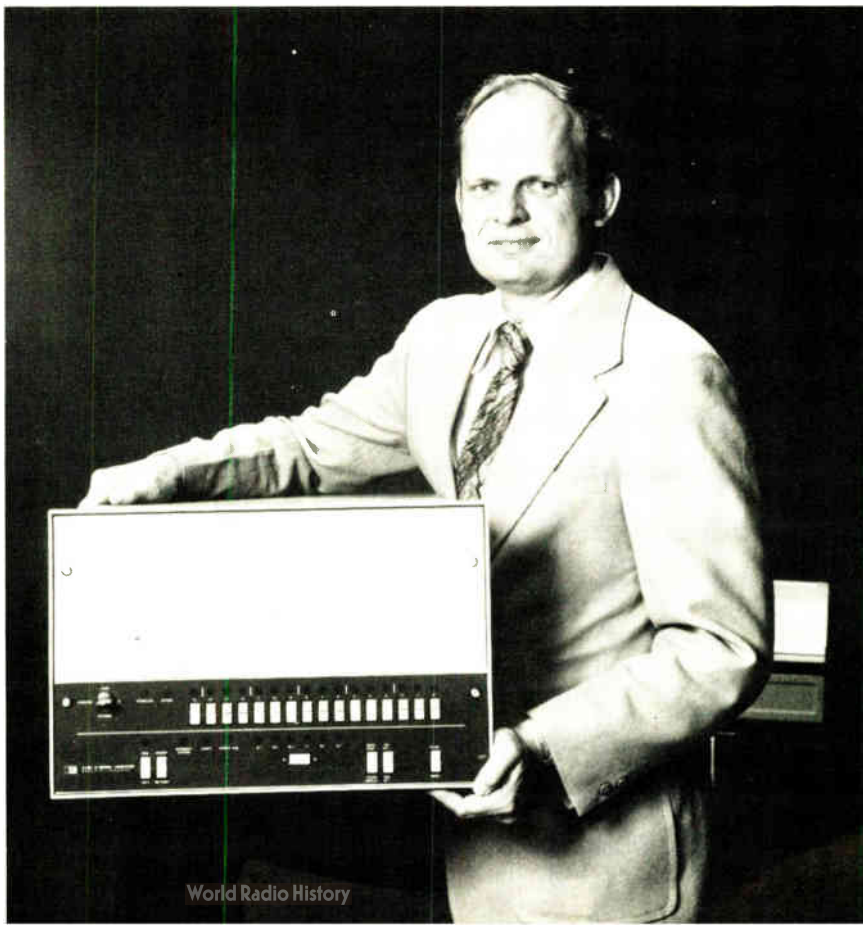

Probing the news

development, says, "Right now the price, performance, and reliability of core still beat RAMs. But the semiconductor curve is getting there, and we will definitely offer MOS memory as an option when it does."

Other minicomputer manufacturers think the time is already ripe. Last year, Prime Computer Inc. in Framingham, Mass., announced the first 256-kilobyte MOS memory board to use 16-k chips. The reported supplier of those chips was Intel Corp., though the memories that began delivery this year use chips mostly from Mostek Corp. Last month, Hewlett-Packard Co. introduced million-byte enhancements to its 21MX and 1000 lines of minicomputers [*Electronics*, July 21, p. 34] that also use Mostek's 16-k chips.

The 4-k chip, however, is basic to the MOS memory boards that Digital Equipment Corp. recently added as an option to its PDP 11/70 minicomputer. Somewhat similarly, General Automation Inc.'s 16/550 general-

purpose minicomputer, introduced in June, offers a half-megabyte of memory using 4-k chips, but in the form of 32,768-bit hybrid packages containing eight each. Lawrence A. Goshorn, chairman of the Anaheim, Calif., firm, says: "The hybrid packages are the best way for us to go right now. When the 16-k chips are ready, the packages can instantly be upgraded to 128 kilobits."

IBM Corp.'s Series/1 has a 128-k memory limit, upped from 65,536 bytes when 4-k random-access-memory chips were substituted for the earlier 2,048-bit chips. But since the machine has the potential for addressing up to 16 megabytes, it is almost certain that IBM will open that up to a half megabyte or 1 megabyte as the memory configurations adopt bigger RAMs.

Necessary. But who needs a million bytes of RAM? Lots of people, and for lots of reasons besides fast processing of a lot of data. "In distributed processing, where the environment is harsh and won't tolerate disk storage, you can now go to semiconductor memory," says Richard Anderson, general

manager of HP's Data Systems division in Cupertino, Calif. Other manufacturers indicate that many users are gluttons for memory.

Although the awesome parts counts and circuit densities of the enhanced semiconductor memories might seem a quality controller's nightmare, the addition of automatic error-correction circuits can make a million bytes more reliable than a standard 32-kilobyte system. Most manufacturers offer error correction, though sometimes only as an option. HP, according to Anderson, offers it as an option because the ceramic-packaged 16-k chips in its memory are in themselves pretty reliable.

The trend to increased minicomputer memory can be expected to continue. A recent study by Lee Walther, a computer consultant in Cupertino, Calif., reveals that 1976 saw worldwide shipment of 53,600 minicomputers with a total of 1.5 billion bytes of RAM—an average of 28 kilobytes per mini. Walther predicts that by 1981, with 121,000 minicomputers shipped, the total will be up to 7.7 billion bytes overall, or an average of 64 kilobytes. □

MINICOMPUTERS WITH APPROXIMATELY MILLION-BYTE CAPACITIES

Minicomputer	Price	Memory elements	Error correction	Word size (bits)	Memory width (bits)	Direct address capacity (8-bit bytes)	Physical memory limit (megabytes)	Memory cycle time (ns)		Comments
								Main	Cache	
Data General C / 330	\$80,500 with 0.5 megabyte	4,096-bit MOS RAM	+5 bits Hamming code	16 (variable)	16	64 kilobytes	1	400		<ul style="list-style-type: none"> variable instruction length handles many data types: decimal, binary, bit-string
DEC PDP 11 / 70	\$ 100,000 with 0.5 megabyte	4-k MOS RAM	+7 bits Hamming code	16	32	4 megabytes	4	300		<ul style="list-style-type: none"> multiprocessing 32-bit architecture core or MOS memory
Prime 500	~\$223,000 with 1 megabyte	16,384-bit MOS RAM	+6 bits Hamming code	16	16	64 kilobytes	8	280 average		<ul style="list-style-type: none"> virtual memory space up to 512 megabytes fast, floating-point hardware and business instruction set
								600	80 (2 kilobytes)	
Interdata 8 / 32	~ \$ 107,000 with 0.5 megabyte	core	—	32	32	1 megabyte	1	300		<ul style="list-style-type: none"> word lengths variable to 48 bits (instructions) and 32 bits (data)
								750	50 (2 by 64 bits)	
Hewlett-Packard HP3000	> \$154,000 with 0.5 megabyte (system)	4-k MOS RAM	+7 bits Hamming code	16	16	64 kilobytes	0.5	700 average		<ul style="list-style-type: none"> systems configured with disk, tape, and controllers multiple processing
Systems Engineering Laboratories 32 / 75	~ \$80,000 with 1 megabyte	core	—	32	32	0.5 megabyte	16	900		<ul style="list-style-type: none"> full 32-bit parallelism 600-ns memory available
Modular Computer System IV / 35	\$164,000 with 1 megabyte	core	—	32	32	1 megabyte	1	400		<ul style="list-style-type: none"> optional core memory available with high-speed interface extends limit to 4 megabytes
Hewlett-Packard HP 2113A	~ \$60,000 with 1 megabyte	16-k MOS RAM	+7 bits Hamming code	16	16	64 kilobytes	2	550		<ul style="list-style-type: none"> small, general-purpose ceramic-pack RAMs
General Automation 16 / 550	~ \$35,000 with ½ megabyte	32,768-bit hybrid RAM (4-k chips)	+7 bits modified Hamming code	16	32	64 kilobytes	1	300		<ul style="list-style-type: none"> multiprocessing shared cache-bus architecture
								1,000	120 (2 kilobytes)	

Consumer electronics

Electronic games no longer need TV

New breed of brain challengers is using microprocessors to add intelligent extra player that reacts to what happens and takes action

by Alfred Rosenblatt, Associate Editor

Soon video games will no longer be the only electronic games in town. A new ingredient—microprocessors—is being added to the cardboard and plastic that games manufacturers have traditionally relied on. The result is a bunch of intriguing new games that are either going into production or just beginning to show up on retailers' shelves.

The market in the battery-powered games could be huge. An important factor is how consumers react to price tags that reach above \$40. "We used to consider \$15 to \$18 the limit," says Edward Radding, marketing director at Parker Brothers Inc., Salem, Mass. "Then two years ago, air hockey broke \$40, and the limit is still in a state of flux. For the right products, there's always an exception."

Remarkable growth. As for the electronics, its value will be well below a game's retail price. But this year could see several million dollars worth of electronics go into the games, and next year this could at least triple, says Ed Hartnett, a product marketing manager for metal-oxide-semiconductor microprocessors at Texas Instrument Inc.'s MOS division, Houston. "It's got a fantastic growth rate," he concludes. TI supplies game electronics, based on its low-end TMS 0970 microprocessor, to at least two of the well-known games companies: Parker Bros. and Milton Bradley Co., Springfield, Mass. [*Electronics*, July 21, p. 26].

The game makers themselves are enthusiastic. "This is not a passing fancy," says Jim Houlihan, director of research and development at the \$200 million-a-year Milton Bradley.

"We see a big and permanent future in this area, and we'll have many more products next year. So far they've been quite successful, at least to the trade. As for the consumer, it's too soon to tell."

The types of games being developed vary greatly. Parker and Milton Bradley have thinking games in which strategy is important. For example, players of Parker's "Code Name: Sector" chase a submarine that moves under the control of a microcomputer. With Milton Bradley's "Battleship," opposing players strive to sink each other's secretly positioned flotilla of ships by "shooting" missiles at them. The microcomputer keeps track of where the missiles are aimed and what they hit, and it even triggers sounds of projectiles speeding to their targets and of bombs exploding.

Mattel Inc., Hawthorne, Calif., on the other hand, with help from Rockwell International's Microelectronics division in Anaheim, Calif., is bringing out action games. The size of hand-held calculators, they are miniature versions of electronic games found in penny arcades. For

each of these, Rockwell supplies its low-end PPS 4/1 microprocessor and has come up with a light-emitting-diode array that simulates movements of football players, missiles, and a racing car. In each game, the player pits control of a moving 40-by-10-mil bar against a constantly shifting pattern of obstacles controlled by the microcomputer, all generated in the LED display.

In the football game, for example, the player advances the "ball" left to right on the display, which is 2.75 inches wide and 1.55 in. high. His object is to maneuver the ball around tackler bars. One key advances the ball horizontally, two others move it up and down. After each play, a scoreboard key updates down, time, and yards to go, football's basic elements.

The other two games, "Auto Race" and "Missile Attack," have vertical LED displays on which the player guides his auto around obstacles or tries to shoot down the enemy's incoming intercontinental ballistic missiles.

The Mattel games also rely on a piezoelectric diaphragm to mark

Command post. In Parker's "Code Name: Sector," players enter moves through buttons on the control center. LED display spells out such details as ship speed and direction.

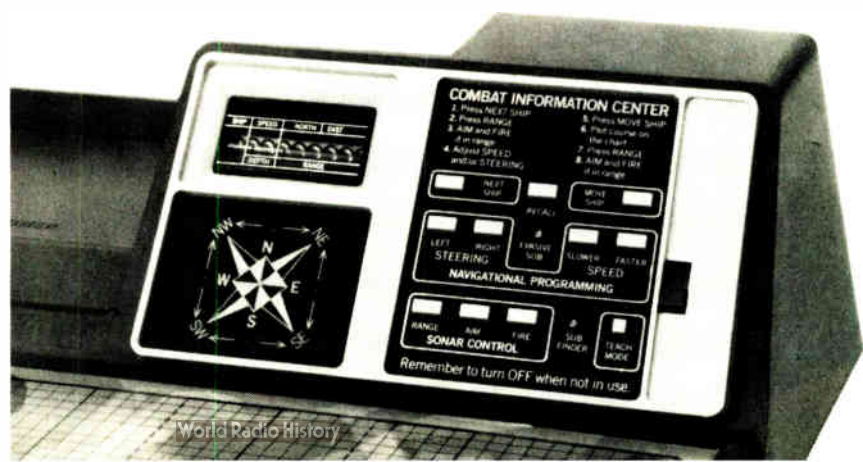

RF Power Amplifiers?

One unit may be all you'll ever need.



If you have the ENI Model 440LA ultra-wideband solid state power amplifier, all you need is a laboratory signal generator and you've got the ultimate in linear power for such applications as RFI/EMI testing, NMR/ENDOR, RF transmission, ultrasonics and more.

Capable of supplying more than 40 watts of RF power into any load impedance, the 440LA covers the frequency range of 150 kHz to 300 MHz.

We could mention unconditional stability, instantaneous failsafe provisions and absolute protection from overloads and transients, but that's what you expect from any ENI power amplifier, and the 440LA is no exception!

Our catalog contains complete specifications on the 440LA as well as the entire line of ENI amplifiers, and is available without obligation, of course.

For further information or a demonstration, contact ENI, 3000 Winton Road South, Rochester, New York 14623. Call 716-473-6900, or Telex 97-8283 ENI ROC.

ENI

The World's Leader
in Power Amplifiers

Probing the news

tackles and collisions, with buzzing sounds that last from milliseconds to seconds. Rockwell has a high regard for its LED display, which has as many as 27 separate light-emitting bars.

"Our display and microprocessor control give the feeling of continuity in movement that makes a game believable," asserts product application engineer Joseph Nissim. So unusual does Nissim believe the bars to be that he declines to reveal who is building the display for the Rockwell division.

Couldn't be done. The appeal the microprocessor has for the games people is perhaps summed up by Parker's manager of product development, Arthur P. Venditti: "We wanted to do a game that could not be done without a microcomputer—one with an intelligent extra player that reacts to what has happened and takes action. We also wanted a randomness to the action, an unpredictability that we can achieve with the microcomputer." Another factor games makers like to point out is that since the microprocessor controls the game and remembers all moves, it becomes a character builder: players cannot cheat.

Such requirements could have been implemented with discrete logic and memory packages, but only with the microprocessor did the price become low enough. By next year, for example, TI's TMS 0970 chip may reach \$2 in 100,000-piece quantities, says Hartnett of the company's MOS division.

Instructions for each game are stored in the microprocessor's read-only memory—a 1,024-bit unit in the case of Parker's TMS 0970. The chip's programmable logic array acts as a binary-coded-decimal-to-seven-segment decoder for driving LEDs that display numbers and some words. In addition, a random-access memory with 64 4-bit words stores changing data coming in on any of the chip's 19 input/output lines. The RAM stores the moves of the players as well as the moves of the microcomputer itself. In addition, the RAM holds a number that changes at the chip's 100-kilohertz-plus clock rate,



Grid game. In Mattel's football game, moves are made on matrix of LEDs. After each play, scoreboard is automatically updated.

and this number is used to trigger the random actions of the submarine game.

If there is a hard part to developing the game, it is making sure that the right instructions are stored in the ROM. In Parker's case, for example, months went by while the company checked out its game for "playability" by giving models to its employees to play with. Their comments were instrumental in developing the final set of rules that were written into the mask-programmable memory.

As for how the games makers got into electronics, the approaches varied. Milton Bradley began putting together its own electronics group about 18 months ago and now has both hardware and software designers, although it also has outside help.

Parker and Mattel are counting heavily, at least at present, on outside sources. Parker's Venditti liked TI in particular because the company could build almost all of the electronics for his game, including the microprocessor chip, LEDs, keyboard, and circuit board—"everything except the little red switch and the battery. We figured if they were responsible for every element, the quality would be high. And there was no way of passing the buck." □

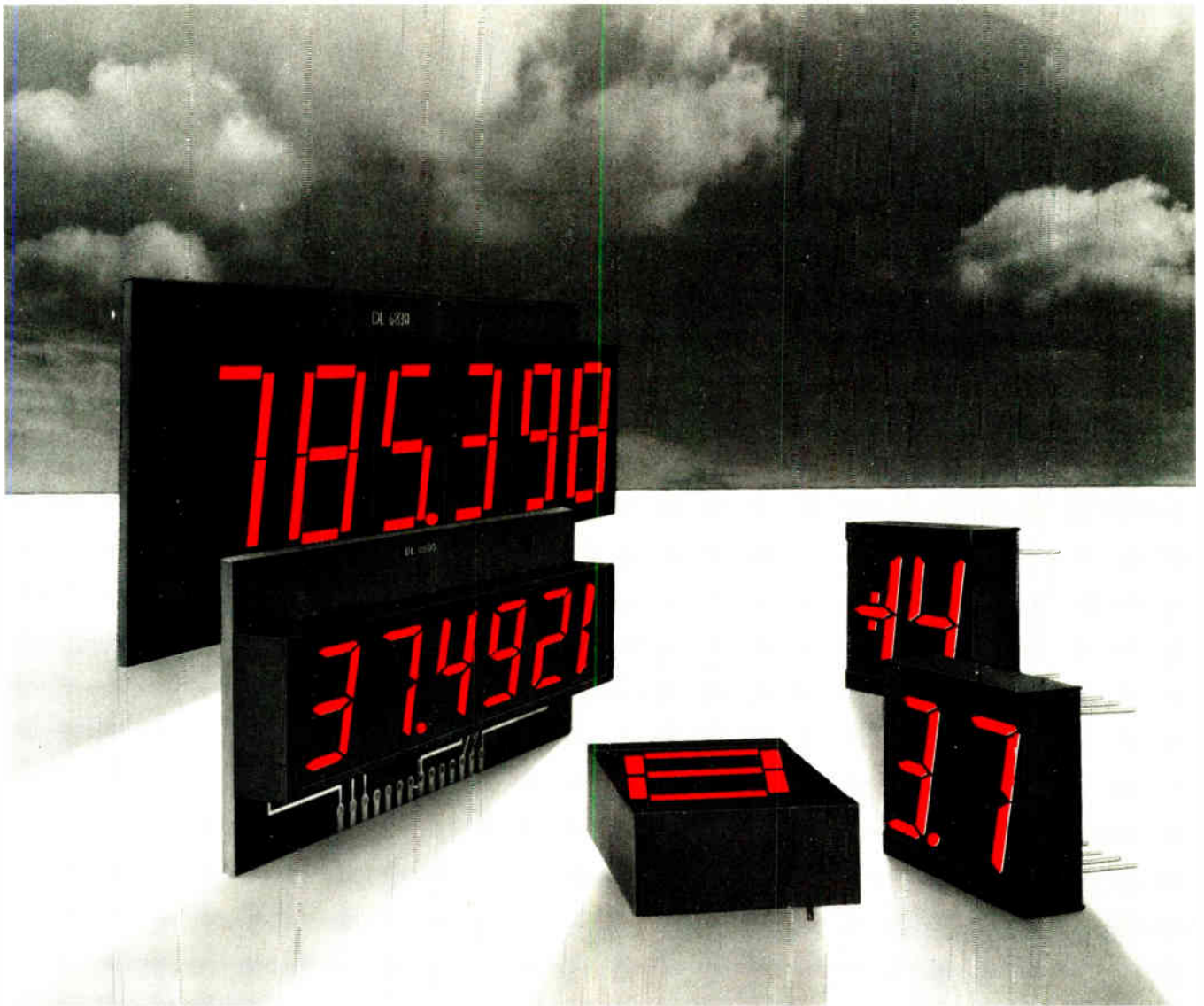

New technique saves 30% to 40% on big, bright, uniformly-lit LED digits.

Through computer-aided optical design, Litronix has developed a way to make top-quality LED digits using a low-cost manufacturing technique.

Our new 0.5" and 0.8" digits have unsurpassed eye appeal. They're bright. Every segment is uniformly illuminated throughout. And the digits are sharply defined.

You can't find better looking 0.5" or 0.8" LED digits at any price except for Litronix DL-700 series light-pipe displays. With the exception of light pipes, which can be seen clearly over an even wider viewing angle, our new displays are priced 30% to 40% lower than any others of the same size and comparable appearance.

You can get 0.5" and 0.8" digits in 1 or 2 digit DIPs and in 2 to 6 digit modules with PCB edge connectors.

Your product's display probably attracts far more attention than any other feature. Why not have the best!

Show me. Phone to arrange an appointment to show me your new displays illuminated. My number is _____.

Tell me more. Send complete data on 0.5" and 0.8" displays, DL-527, DL-827, etc.

NAME _____		TITLE _____
COMPANY _____		
ADDRESS _____		
CITY _____	ZIP _____	PHONE _____

Mail to Litronix, Dept. E, 19000 Homestead Road, Cupertino, CA 95014. Phone (408) 257-7910.

litronix

Consumer electronics

LCD startup bedevils watch firms

Market analysts foresee shakeout by end of the year, with TI, Fairchild, Timex, and Japanese firms surviving

by Gerald Walker, Consumer Editor

Bringing in new lines of liquid-crystal-display watches during a serious profit squeeze on their light-emitting-diode watches is putting a strain on the vertically integrated semiconductor watch companies, already beset by marketing difficulties. Their financial and technical problems might shake out at least one of the major competitors and open the way for an increased presence of the Japanese LCD watch-makers in the American market.

The basic technical problem for the U.S. firms is that they find the LCD too slow to multiplex—necessitating a 28-pin package for the standard four-digit watch, which increases production costs and failure rates. While Texas Instruments Inc., National Semiconductor Corp., and Fairchild Camera and Instrument Corp. were trying to establish the LED watch market, Japanese companies such as K. Hattori & Co. Ltd. (Seiko) and Casio Computer Co. concentrated on improving the liquid-crystal display. They learned how to multiplex it and now are in a good position to enter the U.S. midrange market, touting reliability and multiple features.

Survivors. By year-end, market analysts contend, the digital watch business will be narrowed down to three major U.S. contenders, plus the Japanese. The American firms are Texas Instruments, which has hewn to a carefully defined plan of capturing the low-end market, Fairchild, which is concentrating on expanding its distribution and service network, and Timex Corp., which struggled to get into the digital market but now seems to have its act together.



From east and west. TI prices its LCD watch models, above, from \$32.95 to \$48.95. Seiko prefers higher-priced market with watches like \$100 model at right.

National, left off the list, insists that it is in to stay now that it has overcome a yield problem with its watch chips. Litronix Inc. quit earlier this year, and American Microsystems Inc. got out in 1976.

Even the chosen few are having their problems. Ronald W. Shelly, manager of the Time Products division for TI, admits that until LCD assembly is as thoroughly automated as the LEDs, production costs will be higher. Right now, he estimates, over half of the LCD production line is automated. In addition, TI has had to buy complementary-metal-oxide-semiconductor chips, displays, and tritium back lights for its LCD line.

Timex, which has favored the LCD watch from the beginning, had two or three bad starts trying to get into digital watches. But since buying RCA's LCD facility and organizing an electronics division, the giant firm has begun to get on track. However,



it has avoided getting into a price war with its rival from Texas.

Distribution and brand name recognition are Fairchild's problems. "We have concentrated on building our distribution and customer service organization to strengthen our support of retailers," says Philip Conklin, director of watch marketing for Fairchild Consumer Products. "Right now we need to build confidence out there that Fairchild will be around." He adds that all the digital watch companies are suffering from a credibility gap

created by LED price wars and shakeouts.

While the Americans were carrying out their war of attrition in LEDs the Japanese bided their time. Seiko, the biggest Japanese watch company which has its own semiconductor facilities, stuck to its analog quartz-crystal line, then introduced some high-priced LCDs. It appeared too late for a good foothold in the U. S.

However, the firm's sales and profits in the U. S. were up last year and will increase again this year, according to Hideaki Moriya, president of Seiko Time Corp. (U. S.). While continuing to push its analog quartz watches, the company introduced a new line of LCDs priced to be competitive with the high end of the American semiconductor company models. (It has never favored the low end of the market.) Besides the 15 multifunction models priced at \$135 to almost \$300, the company intends to introduce a calculator watch before the end of the year.

Seiko poses a direct threat to Microma Inc., Intel Corp.'s digital watch subsidiary, which is also positioned in the mid-to-upper price range in LCDs. Microma's problem, say the market watchers, is that despite a greatly improved technical capability since Intel took over, the company has not established a strong enough brand name in its price category. This lack of consumer recognition makes it vulnerable to a firm like Seiko, which has the recognition and now the new line of multifeature LCDs.

However, the U. S. semiconductor firms are not necessarily doomed to fail in the digital watch business, says Kent Logan, research vice president at Goldman, Sachs and Co. He cites TI with an estimated \$30 million to \$35 million pretax income that the Dallas firm has generated in watches since entering the field.

"TI built up brand awareness with its calculators, and they've put in place the basic distribution network that was needed to reach watch outlets," he says. "By contrast, the people who have bailed out of the digital watch business, or those who are close to it, never really established brand recognition. Fairchild is gaining that awareness now, but it may be too little, too late."

1977 Answer Book.

It makes your job easier. \$25.



"WHO MAKES WHAT?"

"WHAT COMPANIES MAKE THE PRODUCTS I NEED?"
(See alphabetical directory of 4000 products)

"WHERE ARE THEIR NEAREST SALES OFFICES?"

"WHO ARE THEIR DISTRIBUTORS?"

"WHAT ARE THEIR LOCAL PHONE NUMBERS?"
(See alphabetical directory of over 5000 manufacturers)

"HOW CAN I GET THEIR CURRENT CATALOGS FAST?"
(See directory of catalogs by product and by company, including catalog inquiry cards for 5-second ordering)

"WHO MANUFACTURES THIS TRADE NAME?"
(See Directory of Trade Names)

Electronics Buyers' Guide
1221 Avenue of the Americas
New York, N.Y. 10020



Yes, send me a copy of Electronics Buyers' Guide. I've enclosed \$25 (USA and Canada only, elsewhere send \$35). Full money back guarantee if returned within 10 days.

Name

Company

Street

City State Zip

Careers

Program trains women technicians

Intensive campaign by Boston area organization impresses electronics firms, leads to good jobs for its graduates

by Pamela Leven, Boston bureau

Well aware of the difficulties women face going back to school for a technical education, Women's Enterprises of Boston Inc. has turned its attention to the electronics industries and is finding much success. "That's where the jobs are today," says Sharyn R. Bahn, director of programs for Women's Enterprises, a two-year-old nonprofit organization that specializes in helping women find training and jobs in nontraditional occupations.

In the last year, her organization has taught basic electronics to 44 women, and 31 of them have gotten jobs as technicians, including 15 from a June graduating class of 21. Now Bahn wants prospective employers—many of them were not at all enthusiastic about the little-known Women's Enterprises at the outset—to tell her precisely what they want the next class to study. Because of the apparent satisfaction at electronics companies that have hired graduates, Bahn is expecting more cooperation from the companies in helping shape the curriculum.

Last year she got in touch with Boston-area electronics companies, asking if employers would hire and train women. "We were told that was ridiculous. Companies don't have basic training programs; they always try to get other people to pay for that," she recalls. "So we decided to do our own."

The result was the Women in Electronics Program conducted last summer and repeated this spring by Wentworth Institute, a technical

college in Boston. To date, graduates have been snapped up by employers such as Xerox, Honeywell, Hewlett-Packard, GenRad, IBM, Savin Business Machines, and Unitrode. Average starting salary is \$167 a week.

Impressive. Moreover, employers are impressed with the women's abilities to handle their jobs as test technicians and field service representatives. Walter Pienkos, personnel manager at Hewlett-Packard Co.'s Waltham, Mass., division of the Medical Products group where two graduates are working, found the women "surprisingly well prepared." Richard Laws, manager of field engineers for Savin in Allston, Mass., notes that the women he hired picked up Savin's training program faster than most other trainees. "Women's Enterprises has become my prime source for women," he says.

The first program was an intensive eight-week course that ran five days a week, with three hours a day devoted to electronic theory and three hours of laboratory work. The curriculum covered the basic theory of ac and dc electricity, general science, and fundamentals of troub-

leshooting including linear and digital circuits.

In the second program, Women's Enterprises extended the course to 10 weeks by adding mechanical theory and lab work with Xerox-donated equipment. Bahn regards the training as very intensive and estimates that if it were run as a night course, it would take a year to complete.

The first class, a diverse group, consisted of 25 women aged 19 to 37, ranging from high school dropout to college graduate. Sixteen students were white; nine were black. Thirteen were heads of households, and 13 were on welfare.

"I really didn't think I could do it," recalls Connie Otero, 24, now a calibration technician at GenRad. "I was always afraid to do the nontraditional thing for women, but in this course we all helped each other and supported each other."

Bahn hopes to raise enough money from governmental and private grants to run the Women in Electronics Program twice a year. "If companies are interested in having women trained, they have to support a program like ours—it's a winner." □

Ironing it out. Boston's Bridget Kryszczuk learns to use soldering iron in special program to train women technicians.



World Radio History

**NATIONAL
REALLY
GETS THE
LED OUT.**

National Semiconductor, in case you didn't know it, is in the LED business. In a big way.

In fact, we make more different visible LED products than anybody else in the business.

Seventy-six, not counting variations in color.

That includes a full line of off-the-shelf multi-digit numeric displays, general purpose LED lamps, panel indicator lamps, and special feature lamps. Plus we have a full selection of LED segment drivers and digit drivers.

GOOD NUMBERS

All displays are multi-digit packages (0.3, 0.5, 0.7 inch high), pre-matched for brightness.



Packages, both dual and quad, are end stackable.

All units are PC board

mounted for low cost.

Our units are available common cathode or common anode, multiplexed or direct drive.

And if our standard products don't fit your needs, maybe we can whip up something special for you.

But another reason why we're making it big

in LEDs is that we're *pricing it small* in LEDs.

LOW NUMBERS

While most manufacturers are still into expensive single digit displays, we make only multi-digit ones.

The manufacturing efficiencies that result is what allows us to price our products so low.

Prices can vary, and competition can change prices, but this we can tell you: nobody beats our prices.

Nobody.

Check us and see.

PHONE NUMBERS

Where, you might ask (and we hope you do), can you find out more about these LEDs of ours?

Well, we just happen to have a list of our current distributors handy.

For the name, address and phone number of nearest distributor, call (408) 737-5142. Or you can write us.

National Semiconductor
2900 Semiconductor Drive,
Santa Clara, CA 95051

Gentlemen:

Get the LED out... please send me your new LED product catalog. I am

- | | |
|----------------------------------------------------------------------|------------------------------------------------|
| <input type="checkbox"/> Very interested | <input type="checkbox"/> Moderately interested |
| <input type="checkbox"/> Uninterested but I like filling out coupons | <input type="checkbox"/> Fretful |
| | <input type="checkbox"/> Vegetarian |

Name _____ Title _____

Company _____

Address _____

City _____ State _____ Zip _____

ONE OF THE FEW LAMPS WE DON'T MAKE.

Our lamps aren't this pretty. On the other hand, they don't cost \$40,000 apiece, either.

We make red lamps. Green lamps. Yellow lamps.

We make transparent lamps. Diffused lamps. We make size T1, and T1 $\frac{3}{4}$.

We make special lamps, like the NSL4944 constant current lamp with a current regulating integrated circuit that provides constant light output over a wide voltage range.

And we make lamps nobody else makes, like the NSL5072A Side View Lamp for applications where conventional end-viewing of the lamp is not possible.

In fact, if we can't come up with the lamp you're looking for, maybe you should get a Tiffany.

 **National Semiconductor**



From "The Lamps of Tiffany"
by Dr. Egon Neustadt,
Fairfield Press, N.Y.

Electronics abroad

Romania sails on through a sea of Slavs

Links with West are critical to boosting the development and production of consumer electronics and digital computers

by Arthur Erikson, Managing Editor, *International*

A land of Latins surrounded by a sea of Slavs is how many Romanians view their country, and that could explain the relatively independent stance Nicolae Ceausescu's government often takes in its dealings with countries outside the Comecon Bloc led by the Soviet Union.

For example, Romania has managed to obtain a "most-favored nation" rating in the United States, so that its electronic and other goods go through U. S. customs with levies as low as anyone's. The Romanian language has the same roots as French, a common ancestry that has fostered a sort of Latin link with some of France's electronics manufacturers. As for the computer technology so essential to the effort to industrialize the country in a hurry, Romania looked to the West for technology rather than join forces with the Comecon countries to develop the RJAD unified series of machines.

Nonetheless, Romania's economy moves mainly with the currents that prevail among the Slavs. The ruling Communist party, as elsewhere in the East European trading bloc, works up five-year plans for the country's industrial and agricultural growth. As part of the drive to turn the economy into an industrial one, the current plan, which covers the years 1976 through 1980, calls for annual growth between 9% and 10% for the output of the country's mills and factories. Tagged to grow around 12% yearly is the so-called machine-building industry, with output in electronics hardware scheduled to more than double. But it will not double across the board—radio-set production, for example, will



Exporter. Ion Linculescu is deputy director of Electronum, which is the state agency that handles electronics exports.

move up very slightly to roughly 1 million receivers a year, whereas computers and automation equipment could even triple. These goals still stand despite the problems created by the earthquakes that devastated parts of Bucharest, the capital, and its surroundings early this spring. One casualty then was the computer center at the Ministry of Transport and Communications, the country's biggest.

Conglomerates. The two electronics conglomerates charged with reaching these targets, both under the wing of the Ministry of the Machine-Building Industry, are Centrala Industriala pentru Electronica si Technica de Calcul (CIETC) and Centrala Industriala pentru Electrotehnica si Automatizari (CIETA). Broadly speaking, CIETA takes care of automation equip-

ment, telephone equipment, and medical electronics, while CIETC handles consumer electronics, computers, professional equipment, and components.

Consumer electronics is where the Romanians look strongest. Last year, Electronica and Technotron, the two consumer-electronics producers in CIETC's stable, turned out between 650,000 and 700,000 black-and-white television sets and nearly a million radios.

The sets are not going just to the home market, even though that is tagged to grow by about 50% by 1980. They are being sold, along with the radios, to mail-order houses in the United Kingdom and West Germany, and the Romanians have

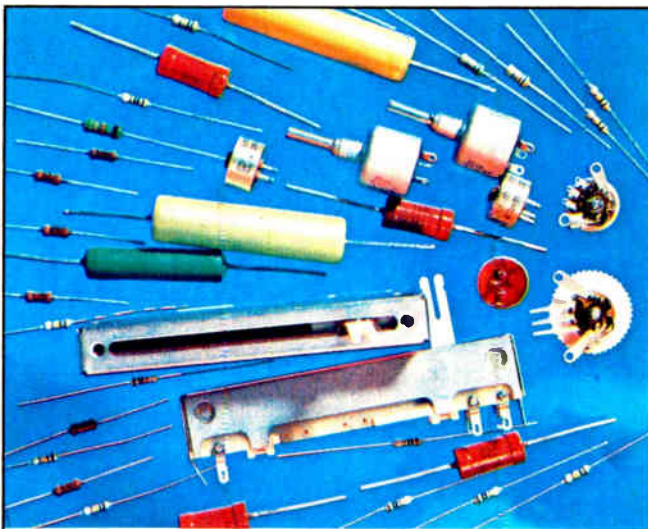

RELIABILITY IS ALWAYS THERE WITH ELORG RESISTORS

complying in full with MEC Standards
by dimensions, ratings and tolerances.

THE WIDE RANGE OF ABOVE 50 TYPES
OF FIXED AND VARIABLE WIRE AND NON-WIRE
RESISTORS including

- S2-33I Compact Metal-Film Resistors (0.25 W and 0.5 W dissipation, with maximum temperature factor of $500 \times 10^{-6} 1/^{\circ}\text{C}$). Packed in adhesive tape and bobbins. Color markings.
- VS-0.125b Carbon Resistors, with mean temperature factor of $1400 \times 10^{-6} 1/^{\circ}\text{C}$. Packed in adhesive tape and bobbins. Color markings.
- S5-5 Mini-Size Wire Resistors, with temperature factor of $1.15 \times 10^{-4} 1/^{\circ}\text{C}$.
- Thermoresistors.
- Photoresistors.
- Varistors.

DISPLAYED BY ELORG AT "WESCON-77"
INTERNATIONAL ELECTRONICS' EXHIBITION
IN SAN FRANCISCO,

September 19 to 21, 1977

Booth No 1062

WELCOME!



32/34 Smolenskaya-Sennaya
121200 Moscow
USSR
Tel. 251-39-46, Telex 7586

Probing the news

also lined up a U. S. outlet, Soundesign Inc. of Jersey City, N. J. "We became competitive in the U. S. after the 'most-favored nation' clause went into effect," explains Ion Linculescu, deputy director for Electronum, the state export agency for electronic products.

In addition, Electronum plans to market its portable all-solid-state TV sets in the U. S. Actually, these portables are not the most advanced ones from Romania. Electronum's line includes a 24-inch set with six linear-integrated circuits, plus an IC voltage regulator for the tuner.

There is a lot of foreign know-how underlying the output of semiconductors at IPRS, the 8,000-person components-producing group of CIETC. IPRS bought know-how for digital ICs from France's Thomson CSF in the early 1970s and added linears a couple of years ago. About six months ago, a diode facility set up with the help of Intermetall, the West German arm of ITT-Semiconductors, went on stream.

The linears for the TV sets come from IPRS, Linculescu says. But a French expert who is in close touch with Romanian semiconductor people strongly doubts that: they may be in pilot production, he says. Although a big semiconductor research center supports the production activities at IPRS, the Romanian claim that they have managed to get some digital and linear ICs into production on their own seems implausible to most outsiders.

French computer. In computers Western technology is again the mainstay. The machine now in production at CIETC's computer factory, Fabrica de Calculatoare Electronice (FCE) is a medium-sized computer called the Felix 256. Actually, it is a copy of the Iris 50 developed in the late 1960s by the French "national" computer company Compagnie Internationale pour l'Informatique (CII), since merged with Honeywell-Bull. Peripherals come from a CIETC outfit, Fabrica de Elemente Periferice (FEP), and from Romanian Control Data, a joint venture in which the U. S.'s Control Data Corp. has a 45% holding. □

NEC JUST MADE INTEL'S 8080A TWICE THE MICROPROCESSOR IT USED TO BE.

Introducing the μ PD8080AF.
From NEC Microcomputers.

Now you can get a microprocessor
that's absolutely identical to Intel's
8080A.

And we can prove it.

In three separate tests using
standard Intel programs, conducted
by three independent laboratories,
the μ PD8080AF was demonstrated
to be, both parametrically and func-
tionally, exactly the same as the
8080A. (The certified results of the
tests are available upon request).

Which means that now there's a
microprocessor that's pin for pin and
program compatible to the Intel 8080A.
And available in plastic or ceramic.

Of course, we continue to offer

our original μ PD8080A—a microproc-
essor with enhanced arithmetic capa-
bility and logical flags.

With either an μ PD8080AF or
 μ PD8080A comes our complete line
of standard peripheral chips. Plus
state-of-the-art support chips like the
8K Electrically Erasable PROM
(μ PD458), a Universal Synchronous
Receiver/Transmitter Data Commu-
nications Controller (μ PD379), a
450ns 32K ROM (μ PD2332) and a
Floppy Disc Controller (μ PD372)

that can control up to four IBM 3740-
compatible drives, and a complete
line of the most reliable memories
you can buy.

All backed up by applications sup-
port available nationwide.

The μ PD8080AF from us. And
the 8080A from them.

Even with a program, you won't
be able to tell them apart.

NEC Microcomputers, Inc., Five
Militia Drive, Lexington, MA 02173.
(617) 862-6410.

NEC microcomputers, inc.

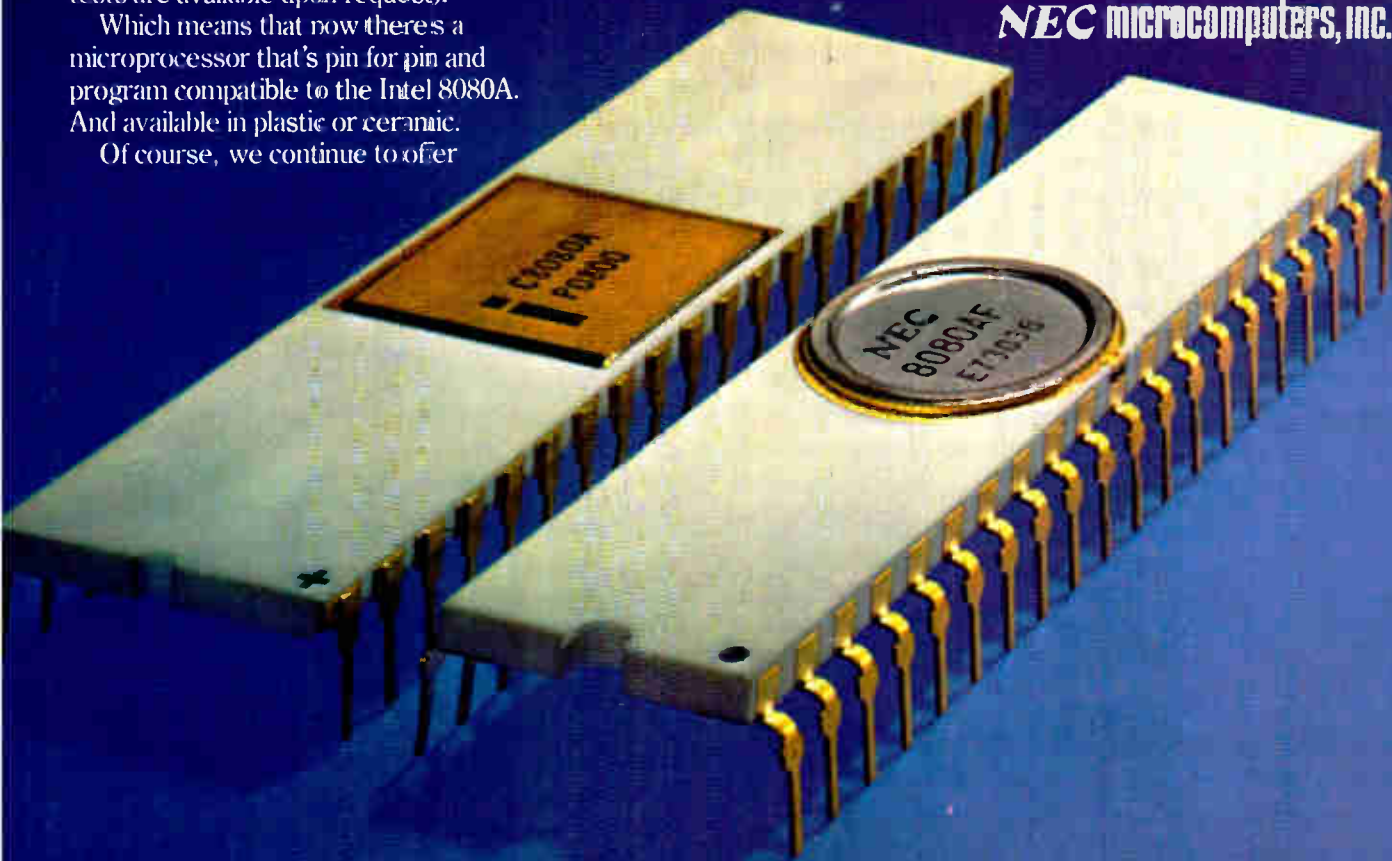

REPS: East—C&D Sales 301-295-4306, Contact Sales 617-273-1520, Harry Nash Assoc. 215-657-2213, Rome 516-249-0011, Tech-Mark 607-748-7475, 716-223-1252, 315-652-6229, Trionic Assoc. 516-466-2300; South—Perrott Assoc. 305-792-2211, 813-585-3327, 305-275-1132, 20th Century Mktg. 205-772-9237, Wolfs Sales Serv. Co. 919-781-0164; Midwest—Electronic Innovators 612-884-7471, W. Pat Fralia Co. 817-640-9107, 817-649-9981, 713-772-1572, Imtech 216-826-3400, 513-278-6507, K-A-W-F Eng. & Sales 816-763-5385, R.C. Nordstrom & Co. 313-559-7373, 516-429-8560, Technology Sales 512-436-3000; West—Cerco 714-560-9143, D/Z Assoc. 303-534-3643, Electronic Component Mktg. 714-879-9460, Summit Sales 602-994-4587, Trident Assoc. 408-734-8300, Tri-Tech 206-232-4993, 505-265-8409; Canada—R.F.Q. Ltd. 416-626-1445, 416-626-8324.

DISTRIBUTORS: ASI Electronics (Baltimore), Bell Ind. (Bellevue WA), Century Electronics (Albuquerque, Salt Lake City, Wheatridge CO), Diplomat (Cape Cod Falls MA, Clearwater FL, Elk Grove Village IL, Farmington MI, Minneapolis, Mt. Laurel NJ, Salt Lake City, St. Louis, Sunnyvale, Totowa NJ, Woodbury NY), Future Electronics (Montreal, Ottawa, Rexdale Canada), Harvey Electronics (Fairfield NJ, Lexington MA, Norwalk CT, Woodbury NY), Intermark Electronics (San Diego, Santa Ana, Sunnyvale), G.S. Marshall (Sunnyvale), Mirco Electronics (Phoenix), Resco (Raleigh), RIM Electronic (Kentwood MI, Madison Hgts. MI), Semicomp (Costa Mesa CA), Semiconductor Specialists (Burlington MA, Chicago, Dallas, Dayton, Farmington MI, Hazelwood MO, Indianapolis, Kansas City, Milwaukee, Minneapolis, Pittsburgh, Malton Canada), Sterling Electronics (Albuquerque, Dallas, Houston, New Orleans, Phoenix, San Diego, Seattle, Sun Valley CA, Watertown MA), Summit Distributors (Buffalo), Summit Electric (Rochester), Technico (Columbia MD, Fcanoke VA), Western Microtechnology Sales (Sunnyvale), Zeus Components (Elmsford NY).

Zilog introduces the first Z80 disk based microcomputer system.

The Z-80 MCS Microcomputer—designed to be the most advanced general purpose microcomputer available today. You get massive computing power at a price so low you'll find it most difficult to believe.



A bold new weapon is Zilog's breakthrough Microcomputer System.

It's a general purpose unit that gives users high performance at remarkably low cost—and it features all the reliability and low maintenance you have come to expect—and get—from Zilog.

Just for starters consider these Z-80 MCS system features.

- Full use of the powerful Z-80 CPU with its 158 instruction set, considered to be the most advanced in the industry.
- Main memory storage capacity of up to 64K bytes of RAM, PROM or EPROM. The standard basic system comes with 3K bytes PROM and 16K bytes of dynamic memory.
- Dual floppy disks with 600,000 bytes of storage.
- RS-232 or current loop serial interface for communication with a CRT or TTY. And room is available to add more.
- Two parallel I/O ports for simple interface to other peripherals, and more ports are available.

And a nine slot card cage, housed along with everything else in a heavy duty metal chassis, allows the Z-80 MCS the expansion capability and flexibility you need for design options. And you get a full complement of expansion cards. Read on.

Standard software ready for development.

With the MCS you get a PROM Based Monitor. A Macro Assembler, File Maintenance, Editor, Debug and Utility Routines are also part of the standard package.

Available options: BASIC. MCS/RIO with relocating assembler and linking loader. And coming soon a powerful repertoire of programs including MCS-COBOL and PLZ.

Needless to say complete documentation and system support comes along as part of the package.

Get unprecedented power thanks to the Z-80 MCS internal architecture.

Not only does it include all of the instructions of the preceding processors, but goes far beyond.

Memory Block moves. Up to 65K bytes can be moved at the rate of 8.4 microseconds per byte.

Memory Block searches. The entire memory of the system can be searched with a single instruction.

Block I/O operations. I/O transfers at rates of up to 125 kilobytes/second can be accomplished under software control.

Bit Handling. Any bit in any register or memory location can be set, tested or cleared with a single instruction.

Relative Jumps. Short, two-byte relative control transfers reduce program sizes. Three-byte absolute jumps provide access to any memory location.

Eight and sixteen bit arithmetic operations provide fast data and address calculations. BCD arithmetic and shifting is also supported.

Plug in these cards to further expand the Z-80 MCS's capabilities.

- **RMB:** contains 16K bytes of RAM consisting of 4K dynamic RAM devices.
- **IOB:** allows you to expand the system by four I/O ports per board.
- **SIB:** allows you to add 4 Serial RS-232 ports per card.
- **PMB:** contains 16 sockets for additional PROM Memory per board.

Circle 85 on reader service card

Configure the MCS the way you want it.

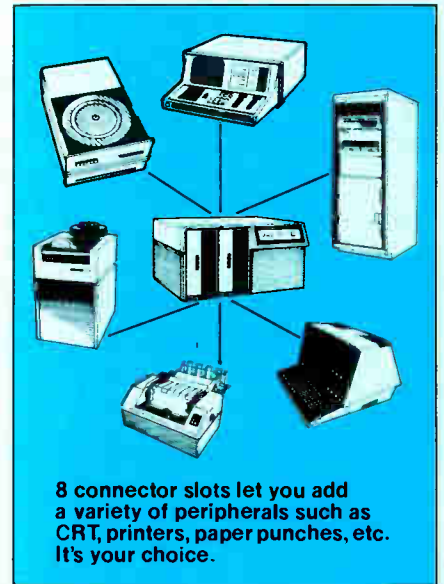

This is all a part of our pledge.

That pledge, to stay a generation ahead is further demonstrated by the new Zilog MCS. We urge you to learn more and a suitable brochure has been prepared. It can be yours, just write or call.



10460 Bubb Road, Cupertino, California 95014
(408) 446-4666/TWX 910-338-7621

EASTERN REGION: (617) 890-0640
MIDWESTERN REGION: (312) 885-8080
WESTERN REGION: (213) 540-7749
EUROPE (ENGLAND): (0628) 36131/2/3

AN AFFILIATE OF **EXON** ENTERPRISES, INC.

ANNOUNCING THE WORLD'S BROADEST LINE OF FIBER OPTIC CABLE.

THE FUTURE IS NOW.

If you're working in a field that uses connectors like the ones shown here, you now can be working with fiber optics. Because now there's Galite.[®]

The world's first line of optical communication cable that's broad enough to let you select exactly the right cable for your application. (Of course, your replacement optical connectors may look quite different from these old standards.)

So now you can bring the major advantages of optical communications to your product before it starts to look — and act — obsolete.

The world's broadest line of fiber optic cable begins with Galite 3000, which covers the biggest range of applications, and can be used up to 1100 feet. With its wide acceptance angle of light, it's the most efficient cable to couple, splice, and connect. And in most applications, it allows you to use proven, efficient, and durable LEDs, rather than the more fragile and temperature sensitive semiconductor lasers. But that's just the beginning.

We also offer, with varying light acceptance angles, Galite 1000, for use up to 150 feet. Galite 2000, for up to 250 feet. Galite 4000, for up to 3300 feet. Galite 5000, for beyond 3300 feet. And soon we'll be producing Galite 6000 and 7000 for even greater distances and wider bandwidths.

With this kind of choice, you can specify the exact characteristics for optimum performance in your application — strength, propagation efficiency, thermal compatibility, chemical resistance, weight — and cost.

What's behind this line of fiber optic cable nobody else can offer is a company with experience nobody else can match. We've pioneered in glass fiber optic products since 1959 and are now the world's largest manufacturer, with over 2 trillion feet shipped.

We also have the country's most integrated production facility where we do everything from formulating the glass to making complete systems including light sources, detectors, and connectors. So we can keep reliability up. And costs down.

Why not call, write, or circle the reader service number for our new information package, "Fiber Optics Now."

But don't put it off until tomorrow. Because tomorrow is already here.

Galileo Electro-Optics Corporation, Galileo Park, Sturbridge, Massachusetts 01518, 617-347-9191.

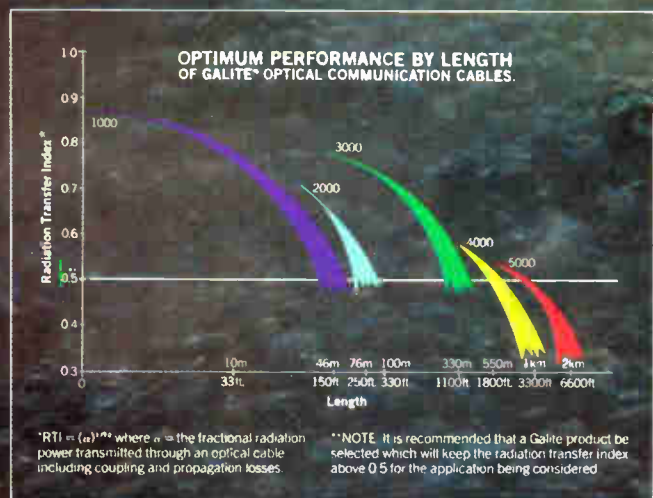



Galileo Electro-Optics Corp.

**THE FIRST COMPANY TO BRING FIBER OPTICS
OUT OF THE LAB AND INTO PRODUCTION.**

Circle 87 on reader service card



The quickest way to find a nurse is to ask an LSI-11 microcomputer.

When GTE Sylvania was looking to design the most advanced computerized hospital communications system in the market, they looked no further than our LSI-11.

The LSI-11 is the highest performance, most software-supported micro device you can buy.

Which is why some people think that the LSI-11 may be just a bit too much.

Yet for lots of applications — like Sylvania's — anything less than the LSI-11 isn't really enough.

GTE Sylvania's System Twenty-One is designed to handle all nurse/patient communications in a hospital through one central operator using a Sylvania-modified Digital VT52 CRT terminal as a Central Console. The idea behind it is to allow nurses more time for nursing by freeing them from handling calls, while making response to requests faster and more efficient.

The LSI-11 and its Dual Drive Floppy Disc are used to store

personal patient information, keep track of all patient requests, set priorities, locate nurses and aides, and generate hard copy reports of all system operations.

The reason Sylvania chose the LSI-11 was simple — they had to get to market fast. According to Project Manager Bill McClellan, "The LSI-11 saved us all the time it would have taken to design our own micro from chips. And to top it off, we got a nationwide service and spare parts network thrown into the bargain."

Since System Twenty-One had to be extremely easy to use, with the computer doing most of the work, software development was also an important issue.



Bill McClellan, Project Manager at GTE Sylvania, Waltham, MA.

Bill McClellan comments: "Thanks to the LSI-11's RT-11 operating system, we were able to do most application software in FORTRAN, instead of the assembly-level language other micros require. This made for faster, easier programming and far simpler debugging."

In addition, "When it came to interfacing the new computerized system to our existing Nurse Call equipment, the LSI-11's optional Serial I-O card made the job a snap."

To sum up, Bill McClellan told us: "The LSI-11 gave us the size and price of a micro, with the power, the software, and the backup of a full-blown OEM mini."

The customer is always right.

For 600 pages of solid technical information, plus our new brochure of microcomputer case histories, "Why Anything Less than the LSI-11 Wasn't Enough for Me," just call toll free 800-225-9220 (in Mass. 617-481-7400, ext. 5144), or write Digital Equipment Corporation, One Iron Way, Marlborough, MA 01752.

digital
COMPONENTS
GROUP

Wavetek's just put new life into the function/pulse generator business. Our Model 145 function generator not only doubles as a pulse generator, it does so without sacrificing any features.

The Model 145 is a 20 MHz function generator with sine, square, triangle, and DC output to 30V peak-to-peak.

Turn the function switch to pulse and you have a full-fledged pulse generator

with independent pulse width and delay control, plus single and dual pulse outputs. In addition to the 30V output, you get simultaneous ECL and TTL outputs.

Whether you use it as a pulse generator or a function generator, it offers triggering and gating manually or remotely, and external voltage control of frequency/period for frequency-shift keying and FM operation.

So if you've been coming down with a case of "should I buy a pulse or function generator-itis," the cure is obvious: Wavetek's Model 145. Just \$895. Circle our reader service number for details.

WAVETEK, P.O. Box 651,
San Diego, CA 92112.
Phone (714) 279-2200,
TWX 910-335-2007

WAVETEK®

**"Doctor, this
function
generator
has a
pulse!"**



Circle 90 on reader service card

World Radio History



Five technologies squeezing more performance from LSI chips

In race to entice the most users, speed and cost gaps narrow between metal-oxide-semiconductor and bipolar processes

by Laurence Altman, *Solid State Editor*

□ Semiconductor-device designers are up to their old tricks again. Using improved semiconductor processes, they are cooking up new generations of large-scale-integrated devices for computer and memory applications. These new chips will boost the performance and increase the capability of a broad range of data-processing, communications, instrumentation, and consumer products, while at the same time lowering the cost.

Not that getting more capability from semiconductor technology at lower costs is anything new in the industry—it has been a continuous process over the last 30 years. It is just that every two to three years new techniques, which are continuously maturing in the laboratory, reach the point where they are ready to spawn new and better integrated circuits (Fig. 1), which in turn foster some new generations of products and product

families—and even whole new areas of applications.

That time is here again with five new approaches vying for attention: a scaled-down silicon-gate metal-oxide-semiconductor process called H-MOS (for high-performance) by its principal proponent; an anisotropically etched, double-diffused MOS process called V-MOS; a planar double-diffused process called D-MOS; a complementary-MOS-on-sapphire process; and a bipolar process using integrated injection logic, or I²L. The proponents of each claim theirs is the best way of achieving higher speeds and densities at lower power dissipation on smaller chips costing less.

The term high-performance MOS—coined by Intel Corp., which was the first manufacturer to announce products using the technique—refers to an advanced MOS process under development in one form or another

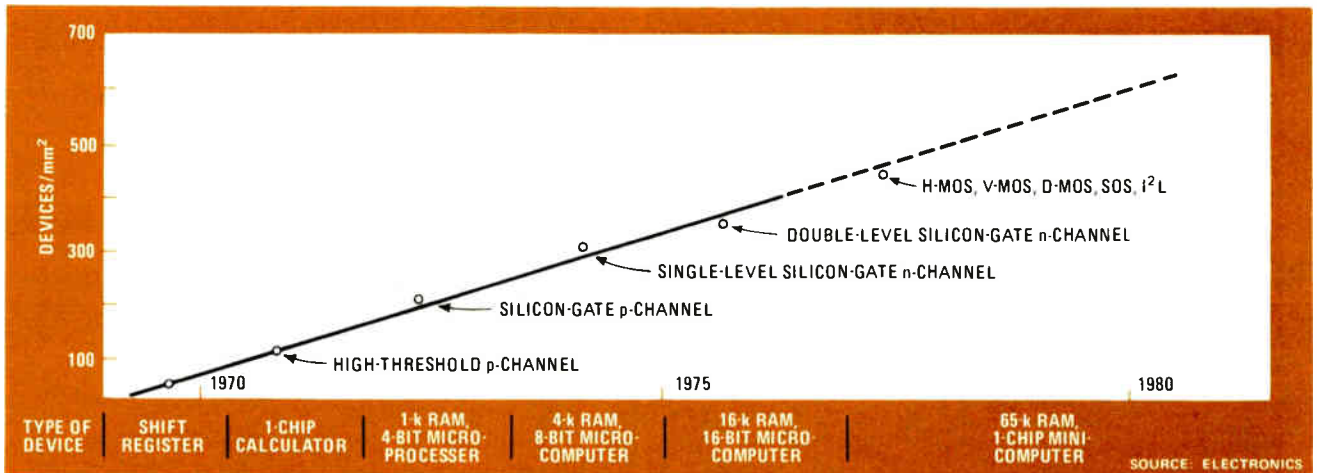

1. The march upwards. The drive for denser and more capable LSI circuits will continue unabated throughout the decade, as new technologies using improved metal-oxide-semiconductor and bipolar techniques move from the laboratory to the production line.

at most major semiconductor laboratories. It involves scaling down the dimensions and process parameters of standard silicon-gate MOS devices.

It is a basic law in semiconductor digital device theory that the smaller a circuit element is, the better it is: the faster, the denser, and the lower its power dissipation. So device scaling has been a part of the semiconductor industry from the start of integrated circuits. The scaling-down approach has become especially important during the MOS era—in 1969 lengths for p-channel devices were about 8 micrometers long; in today's H-MOS devices they are 4 μm .

H-MOS

By 1980, Intel designers predict, channel length will be 2 μm , yielding gates with speed-power products of about 0.15 picojoule. These devices will be 65,536- to 262,144-bit memories on chips measuring less than 40,000 square mils in area and operating in the 50-nanosecond range at 500 milliwatts, and 16- to 32-bit microcomputer chips containing a quarter of a million bits of program memory.

Another virtue of H-MOS is that it is potentially the cheapest way to get this performance, since it is a simple extension of standard silicon-gate structures. Also, it is directly applicable to a wide range of products, so that manufacturing experience should build quickly across the product line.

The big disadvantage of H-MOS is that, by relying on smaller device dimensions, it is dependent on a manufacturer's ability to build very finely patterned geometries. This requirement puts pressure on fabricating specialists to improve their processes, since smaller devices need thinner and purer oxides, better isolation methods, and better control of metalization and alignment.

Scaled-down devices must also prove their reliability, since the smaller they get, the more apt they are to follow non-ideal-device laws and be subject to second-order effects. Pushed beyond H-MOS design limits, these effects could result in unreliable operation.

Perhaps most important, scaled-down devices will require lower power-supply voltages, say 2 or 3 volts by 1980, to achieve their performance goals and still main-

tain reliability. The power-supply voltage now stands at a nice 5-v transistor-transistor-logic level; whether the computer industry will redesign its systems to the lower voltages remains to be seen.

V-MOS

A somewhat more speculative MOS approach to high performance, V-MOS has as its principal advocates for digital applications American Microsystems Inc. and more recently Texas Instruments Inc., which acquired the technique from AMI. It appears to offer the same high performance as H-MOS without the smaller channels that could cause trouble. But it is more speculative because it relies on two new techniques—a process modification and a structural change—that must be fed simultaneously into the production cycle.

The process modification is a complex double-diffusion profile in the channel region under the gate, which effectively reduces the channel length to a micrometer or so. The structural change—which gives the technique its name—is the V notch etched out of the silicon and containing the transistors on its face. The notch gives V-MOS devices their three-dimensional compact nature without needing tough-to-get short channels and other scaled-down parameters.

Two questions about the V-MOS technique must be answered. Can devices be built in high-volume production at competitive costs with other techniques? Will the process scale down for higher-performing devices?

Specialists at AMI say yes on both counts. They point out that V-MOS fabrication is not really much more demanding than straight silicon-gate fabrication—after the initial epitaxial wafer preparation. Thus, yields should be comparable to small-geometry silicon-gate devices. They say that V-MOS scales just as well as any other MOS technique, offering the same potential improvements in performance and density as the methods become available to build the required finer circuit patterns.

The two-dimensional MOS approach D-MOS uses a double-diffused self-aligned process to get short-channel performance without short channels. It is like V-MOS without the V. The Japanese get credit for introducing

this technology to the industry for digital LSI applications. They call it diffusion-self-aligned, or DSA, MOS.

While D-MOS does offer the prospect of high performance without straining photolithographic limits, it appears that its performance advantage over a conventionally scaled-down device may be too small to make it worthwhile paying for the cost of developing it. Japanese manufacturers are apparently still high on the technique—Mitsubishi Electric Corp., Tokyo Shibaura Electric Ltd. (Toshiba), and Nippon Electric Corp.—all have active D-MOS programs for high-speed memories and microprocessors. However, American semiconductor manufacturers appear to be less enthusiastic about D-MOS, at least until there is stronger indication that greater performance is in the offing.

SOS

Silicon on sapphire is still confined principally to two manufacturers of integrated circuits. RCA Corp., which has some complementary-MOS-on-sapphire static random-access memories on the market, is also building an SOS microprocessor for its commercially-available 1802 line, as well as a host of high-performance custom processor and other LSI components for the U. S. Army. Hewlett-Packard Co. is building a wide variety of custom SOS memories, microprocessors, and peripheral circuits for its own equipment.

Complementary-MOS on sapphire offers one of the best speed-power products of any technology (0.1 pJ now), especially for read-only memories, microprocessors, and other logic applications where the chips need not be pushed for all-out speed. Because of this, HP designers feel that the technique's dense, low-power configuration will give its equipment a performance advantage over those built with standard n-channel MOS. For them, that advantage far outweighs the SOS process-development costs and higher substrate-startup costs. Since the firm does not sell chips, straight cost-per-bit or cost-per-gate arguments do not hold. The crucial point is the value added in system performance and capability for an instrument and computer manufacturer like HP.

I²L

A bipolar LSI technology, integrated injection logic has already made inroads in important new applications in games and watches, in linear-digital chips for television tuning and control, and in data converters and custom logic for telephone exchanges. It is being tested in high-speed memories and microprocessors. Here 4,096-bit and 16,384-bit RAMs and 16-bit microprocessor families are beginning to compete with MOS devices for high-end data-processing designs.

The question for I²L designers building digital circuits is simple: can it offer a performance bonus over MOS at not too much added cost? It is in the premium-cost high-performance area that I²L and advanced MOS techniques such as H-MOS and V-MOS will clash head on. Certainly increasing MOS performance means adding process complexity that pushes production costs up. Thus, making MOS as high-performing as bipolar LSI may make it as expensive. If this is so, I²L has a bright future in the next generation of computer products. If not, it

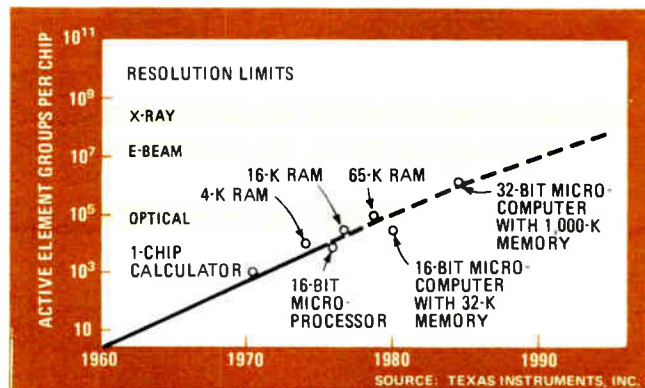

2. Powerful. VLSI techniques will yield chips containing whole complex computer functions, such as a 32-bit microcomputer and a 65-kilobit RAM, say TI planners. Electron-beam and X-ray photolithography, together with new processors, will do the job.

will remain a specialty technology suitable for dedicated applications.

Several new I²L static and dynamic RAMs are available, and others will soon be testing the water against the new MOS memories. Fairchild Camera and Instrument Corp., for example, has a working family of 4-k dynamic RAMs built with injection logic (they call their process I²L for Isoplanar I²L). These chips offer greater speed (90 to 120 ns) than the standard 150-ns 4027-type MOS 4-k dynamics at a modest price premium. The firm is also close to producing a 16-k I²L part with the same speed bonus and already has 65-k dynamic RAM designs on the drawing table.

Texas Instruments has developed a family of I²L 4-k static RAMs that will compete head on with the H-MOS and V-MOS 4-k statics for the new under-100-ns mainframe business, as well as serving as fast memory alternatives in microcomputer-based systems. The company also is pushing I²L memory designs into very-low-power areas for military applications.

In microprocessors, both firms have injection-logic entries: Fairchild, a minicomputer central processing unit and peripheral chip family, and TI, an I²L version of its 9900 microcomputer for military applications. Also, TI is planning a host of I²L peripherals for its new low-power Schottky-TTL chip family of bit-slice computers.

The crucial period

The next 18 months will determine which of the new very large-scale-integrated techniques will grab what portion of the higher-performing digital applications. If history is a guide, only one will win as the next generation mainline digital technology. As in the past, in any case, all this activity among semiconductor specialists means increased performance and lower costs for users of ICs. A straight-line increase in chip capability assures continued progress at the usual astonishing rate, as new fabricating methods (electron-beam and X-ray lithography) work into the arsenal of IC techniques (Fig. 2).

Of the three articles that follow, two offer detailed accounts of the H-MOS process of Intel and the V-MOS process as practiced by AMI engineers. The third shows how Fairchild's new RAMs, built with injection logic, are competing with today's dynamic MOS memories. □

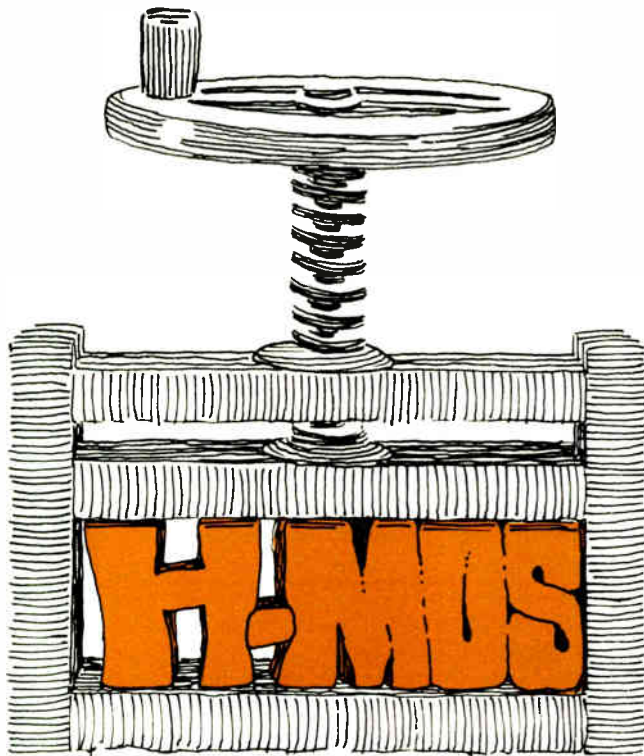

H-MOS scales traditional devices to higher performance level

by Richard Pashley, Kim Kokonnen, Edward Boleky, Robert Jecmen, Samuel Liu, and William Owen
Intel Corp., Santa Clara, Calif.

□ It has almost become a law of nature, the way metal-oxide-semiconductor devices double in density or performance every year. Over the last decade, MOS chips have gone from being low-density shift registers, gates, and flip-flops operating at millisecond speeds to being entire memories, microprocessors, and dedicated systems and subsystems packing tens of thousands of electronic functions into a single device that is capable of nanosecond operation.

Fueling this astonishing progress is the tremendous versatility of metal-oxide-semiconductor technology. Starting out as a high-threshold p-channel multiple-supply circuit technique capable at best of simple calculator and serial-storage functions, MOS moved to n-channel single- and double-layer structures that use a single 5-volt power supply to perform complex computer instructions in less than 100-ns cycles and static and dynamic memory operations in less than 50 ns—all at ever lower power dissipations.

Now MOS circuit technology stands at a still higher level. For the first time it can challenge the performance of bipolar circuits, while continuing to set new records in complexity and low cost. The techniques that have proved capable of achieving this breakthrough are various but share a crucial characteristic in that they all shorten the effective channel length, or drain-source spacing, of the fundamental MOS transistor.

Two approaches are possible. One relies on a double-diffused process: a depletion-mode device with a relatively long, 5-micrometer channel under the MOS gate is integrated in series with a 1- μm enhancement-mode channel, which is formed by the outdiffusion of boron through the self-aligned source-junction opening. The process is called D-MOS when the double-diffused structure has a planar configuration, but V-MOS when the structure has a vertical configuration, with the surface of the MOS transistor laid on the face of a V-shaped groove etched anisotropically into the silicon substrate. In either

case, the double-diffused structure requires new process technology and circuit structures that differ markedly from standard silicon-gate techniques.

The other approach relies on scaling down the size and parameters of MOS devices directly—in other words, device-scaling conventional n-channel silicon-gate structures. This is nothing new; right from the start MOS designers knew that by trimming down the size of their devices they could achieve higher speed, higher density, and lower power dissipation.

To achieve their new high-performance process called H-MOS, Intel has chosen the direct device-scaling method for two reasons. First, it evolves directly out of standard silicon-gate processing and so requires neither new device structures nor complex circuit schemes (either requirement would make yields and fabricating costs too unpredictable to guarantee their usefulness over a wide range of semiconductor products). Second, it fits in with the trend to smaller and smaller circuit patterns, as photolithographic methods grow more refined and electron-beam wafer-fabrication techniques stand ready to take over.

Further, double-diffused structures have a limited future. They may have been appropriate two to three years ago, when the industry was unable to build channels less than 5 or 6 μm long. But now that 4- μm (and soon 3- and 2- μm) channel lengths are possible, the need for new structures like D-MOS and V-MOS may simply be in the process of vanishing.

How to scale an MOS device

Figure 1 shows the cross section of a silicon-gate n-channel device, where L is the channel length, T_{OX} is the gate-oxide thickness, X_J is the junction depth, L_D is the lateral diffusion, and C_B is the substrate doping level. Now, first-order scaling theory says that the characteristics of an MOS device can be maintained and the desired operation assured if the parameters of the device are

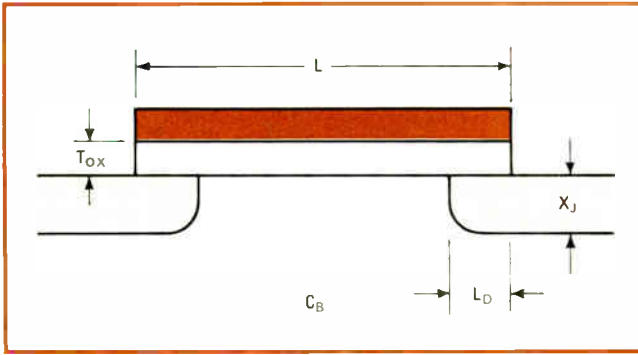

1. Scaling down. To reduce the size of an MOS device, all physical parameters must be scaled down proportionally. If the channel length L is shortened by $1/S$ where S is the scaling factor, then the oxide thickness, T_{ox} , the lateral underdiffusion, L_D , and the junction depth, X_J , must also be scaled down by $1/S$. Meanwhile, the substrate doping constant, C_B must be increased by S .

scaled as shown in Table 1. When S is the scaling factor and the channel length L is scaled by a factor of $1/S$, then the other device dimensions—the thicknesses of the gate oxide and the lateral underdiffusion, the device width and junction depth—must also be scaled $1/S$. Moreover, to maintain adequate threshold voltage and drain-source breakdown voltage, the scaling theory also states that the substrate doping concentration must be increased by S , while the supply voltage and current decrease by $1/S$.

The effect on performance

When this is done properly, the increase in the performance of the device is dramatic, as Table 1 also shows. The parasitic capacitance, gate delay, power dissipation, and power-delay product all improve markedly. Since the parasitic capacitance goes down roughly as the junction depth decreases, it too scales by $1/S$; this means that since gate delay is roughly proportional to parasitic capacitance, it is scaled by $1/S$ as well. Moreover, since the device's power dissipation is proportional to the supply voltage and current, it scales by the still stronger factor of $1/S^2$. Finally, the bottom line of all this is the power-delay product, or figure of merit, of the MOS device; and since it is the product of the gate delay and power dissipation, it is scaled down by a very significant factor of $1/S^3$. Thus, scaling the dimensions of an MOS device improves its performance by the cube of its scaling factor.

In short, by reducing the dimensions of a circuit, the MOS designer gains enormous leverage on its density and performance—a statement that happens also to describe a recurring event in MOS history. Table 2 places the move to H-MOS in this perspective. Notice the sharp reduction in circuit parameters that occurred between 1976 and 1977 when Intel went to H-MOS from standard n-channel silicon-gate processing. By reducing the channel length from 6 to $3.5 \mu\text{m}$ and decreasing the other parameters appropriately, it was possible to quarter the speed-power product. This improvement would have been even larger had the supply voltage been scaled as required by a first-order device-scaling theory, instead of being kept at the more acceptable 5-v system

TABLE 1: MOS DEVICE SCALING

Device/circuit parameter	Scaling factor
Device dimension, T_{ox}, L, L_D, W, X_J	$1/S$
Substrate doping, C_B	S
Supply voltage, V	$1/S$
Supply current, I	$1/S$
Parasitic capacitance, WL/T_{ox}	$1/S$
Gate delay, VC/I (τ)	$1/S$
Power dissipation, VI	$1/S^2$
Power-delay product	$1/S^3$

TABLE 2: EVOLUTION OF MOS DEVICE SCALING

Device/circuit parameter	Enhancement-mode n-MOS 1972	Depletion-mode n-MOS 1976	H-MOS 1977	MOS 1980
Channel length, L (μm)	6	6	3.5	2
Lateral diffusion, L_D (μm)	1.4	1.4	0.6	0.4
Junction depth, X_J (μm)	2.0	2.0	0.8	0.8
Gate-oxide thickness, T_{ox} (\AA)	1,200	1,200	700	400
Power supply voltage, V_{CC} (V)	4–15	4–8	3–7	2–4
Shortest gate delay, τ (ns)	12–15	4	1	0.5
Gate power, P_D (mW)	1.5	1	1	0.4
Speed-power product (pJ)	18	4	1	0.2

level. However, by 1980, as channel length shrinks to $2 \mu\text{m}$ and the supply voltage to 3 v, performance will improve even more dramatically, this time by a factor of five, to become altogether 20 times better than that of 1976 MOS devices.

An example of what device scaling means to the user of integrated circuits is given in Figs. 2 and 3, which chart the progress made over the years in static random-access memories. In 1972, the standard static MOS RAM was the 500-ns 2102, built with a $6\text{-}\mu\text{m}$ channel length and 1,200-angstrom gate-oxide thickness. Its resulting speed-power product was 18 picojoules. It occupied a silicon chip nearly 140 mils on a side and had a cell size of almost 8 square mils.

In 1974, the 2102 was redesigned around a depletion-load n-channel technology that shrank its die area by 15% and its access time to 200 ns. To this process oxide isolation and built-in substrate bias were added in 1976, to create the 2115 static RAM that accessed the same 1,024 bits in less than 70 ns. Today, the impact of device scaling is even more apparent with H-MOS, which fits the 2115 RAM (now called the 2115A) onto a chip slightly larger than 100 mils on a side, while improving access time typically to 25 ns.

More to come

Moreover, applied to a 4,096-bit static memory design, H-MOS results in a chip a little larger than the original 2102, yet pushes access times typically below 50 ns. Finally, as the MOS process evolves and scaling continues, a 16,384-bit fully static RAM will fit on a chip no larger than 200 mils on a side and offer system designers access times in the 50-ns range.

The high speed and high density of H-MOS are achieved through five major improvements in MOS technology, four of which are directly related to device

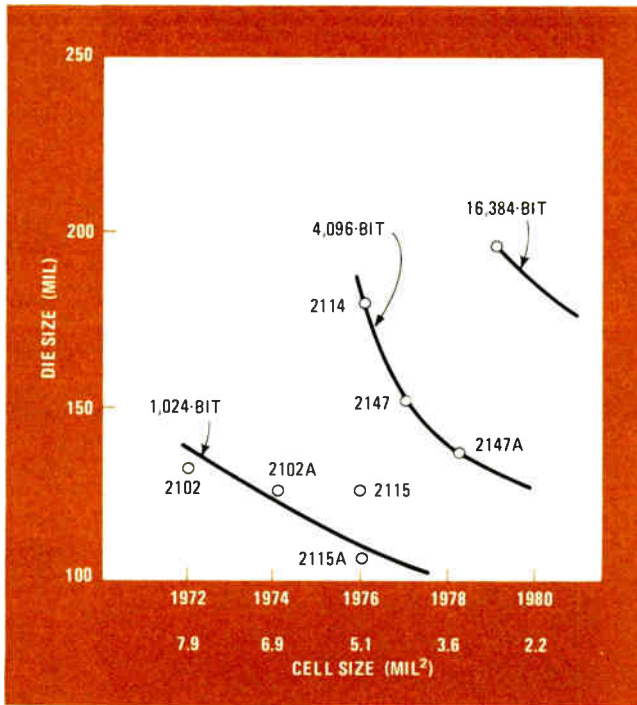

2. Better and better. Thanks to the vigorous development of n-channel silicon-gate MOS technology, static RAMs continually improve in density. In comparison with earlier processes, today's H-MOS increases device packing density by a factor of 4.

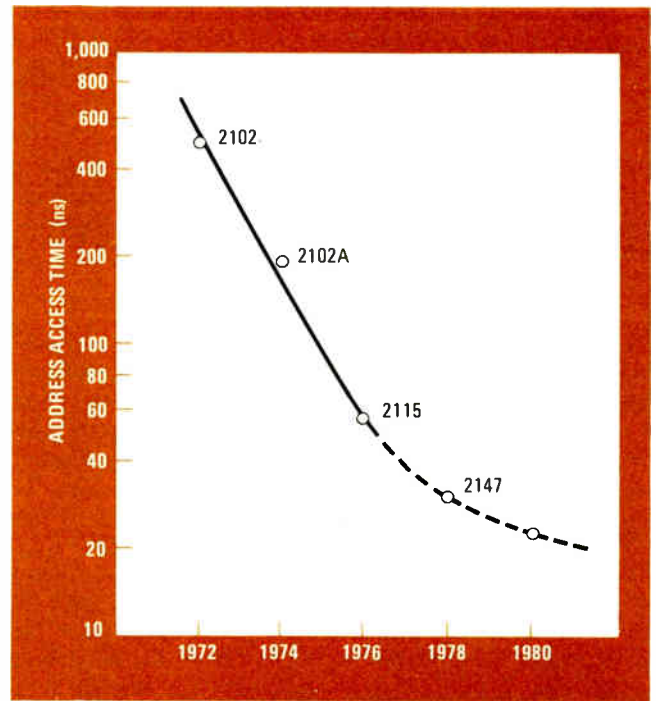

3. Faster, too. Process improvements and device scaling, as embodied in H-MOS, are also making MOS RAMs faster. In 1972, a typical 2102 1,024-bit static RAM had an access time of 600 ns; today's 2147 4,096-bit parts can be accessed typically in 45 ns.

scaling. A high-resistivity substrate is used, while device-scaling theory is applied to gate-oxide thickness, junction depth, gate length, and threshold-modifying ion implants.

The high-resistivity substrate made of 50-ohm-cm, p-type material is used to lower junction capacitance, reduce the substrate body effects that degrade performance, and increase the device's effective carrier mobility. All three factors result in faster, lower-power devices.

Scaling the H-MOS gate oxide down to 700 angstroms increases device gains and punch-through voltages and reduces body and short-channel effects, thereby increasing performance and reliability. The junction depth is scaled to approximately 0.75 μm by using slow-diffusing arsenic as the source-drain dopant. The shallowness of the junctions increases both speed, by reducing peripheral junction capacitance and gate-drain Miller capacitance, and density, by allowing smaller diffusion-to-diffusion spacing.

Scaling principles are also applied to the polysilicon-gate electrodes, which form the self-aligned source and drain diffusion regions. The narrow 3.5- μm polysilicon gates of H-MOS increase the device gain and still further increase circuit speed and density. Narrow gates, however, come at the expense of more severe photolithographic and etch control requirements, which are needed to avoid a wide variation in the electrical channel lengths of the device.

Finally, H-MOS threshold-voltage stability is maintained for both enhancement-mode and depletion-mode devices by using an ion-implanted channel region in conjunction with the high-resistivity substrate. This implant procedure controls threshold voltage with great

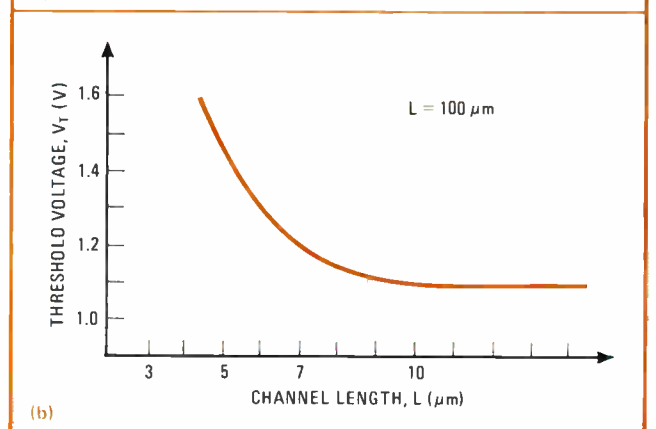
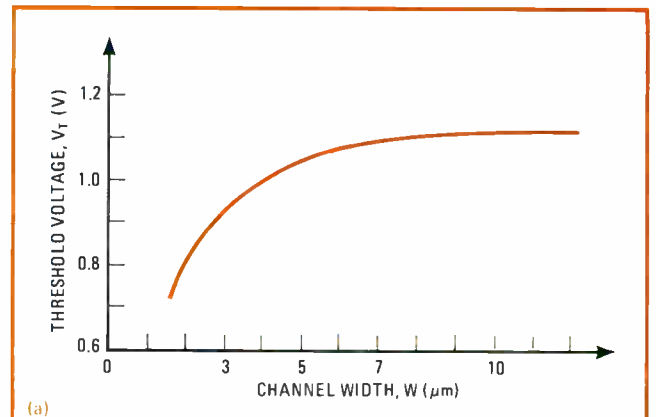

4. Maintaining that threshold. Decreasing channel length and width in small devices has a strong effect on threshold voltage. When the channel length goes below about 5 micrometers, V_t begins to decline (a); while for widths below 7 μm , V_t , begins to climb (b).

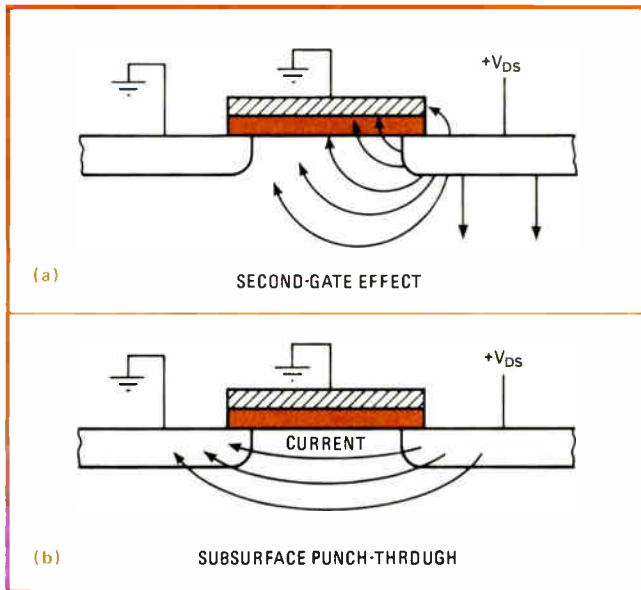

5. Second-order problems. Small devices are vulnerable to two second-order effects. One is the second-gate effect (a), where the electric field lines emanating from the drain junction end up on the oxide-silicon interface. The other is punch-through (b), which can be relieved by careful choice of the substrate impurity profile through ion implantation combined with a thin gate oxide.

precision and allows the MOS threshold voltage to be optimized independently of the substrate doping.

Happily, it proved possible to make all of these H-MOS technology advances within a relatively short time (about one year) without affecting the ability to manufacture devices at reasonable costs. H-MOS also is flexible enough to be applied over a broad range of circuit designs while maintaining its inherent high speed, small size, and low power. Unlike V-MOS and integrated injection logic, which require new circuit techniques to make them applicable to dynamic-memory and large-scale-integrated logic designs, H-MOS can be directly applied across the entire product spectrum.

Already the process has resulted in a family of static RAMs (the 1-k 2115A and 4-k 2147), which offer the industry the best speed-power performance of any memory. Moreover, work is under way on the application of H-MOS to a high-performance, 16-bit microprocessor family, a large variety of complex peripheral chips, 16-k and 65-k dynamic RAMs, high-density ready-only memories, and erasable programmable ROMs.

Its ability to be upgraded is a final and very important feature of H-MOS. Indeed, H-MOS is only the first step in that direction. As advances in photolithography occur, direct scaling can be applied to improve speed-power product and density even further.

Beyond first-order theory

As devices are shrunk, scaling theory says ideally they should maintain the same qualitative characteristics. But in reality, second-order phenomena become quite significant. Some of these phenomena affect the circuit design, while others relate to reliability, but all have to be considered and understood to assure that H-MOS is a useful and safe process. Basically, all of the second-order

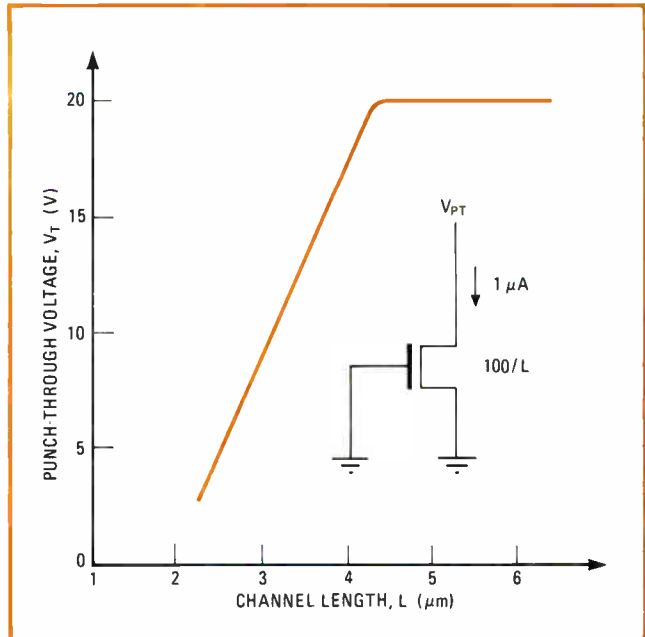

6. Guaranteeing punch-through. In short-channel MOS devices, the punch-through voltage falls to levels that could cause high leakage and circuit problems. The answer is to keep the channel length in the 4- μm region and to see that the gate oxide is thin.

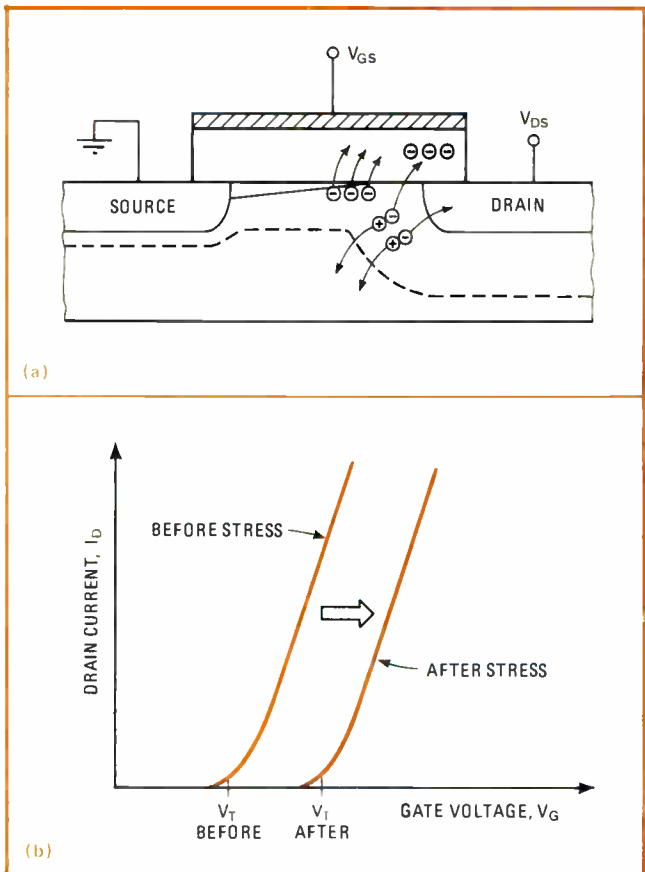

7. Effect of trapped electrons. So much charge can be trapped in the gate oxide of short-channel devices (a) that it may cause a permanent shift in the threshold voltage (b). This shift could cause a reliability problem in these devices, but it can be minimized by very careful oxide processing and by reducing the supply voltage.

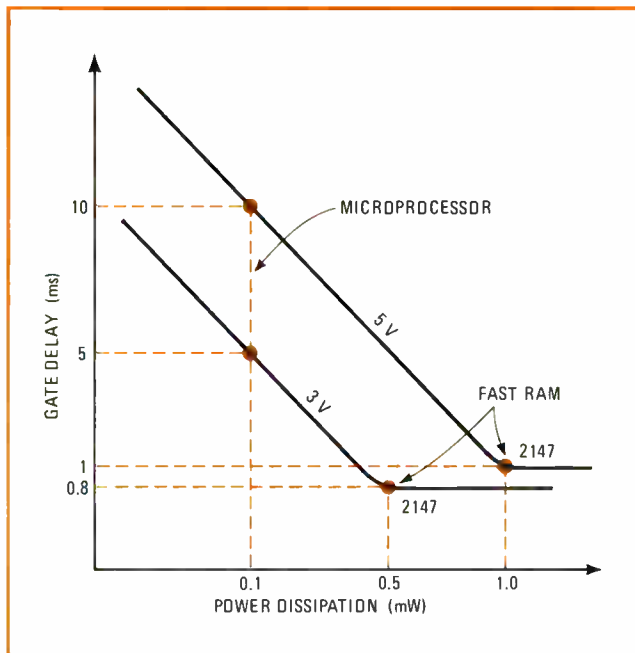

8. A change in supply voltage. Lowering the supply voltage from 5 to 3 V significantly enhances the speed and power dissipation of MOS circuits, especially scaled-down devices. The effect is most noticeable for microprocessors, where a 2-V reduction in supply voltage causes a doubling in performance.

effects arise for two reasons. First, as dimensions are shrunk while a constant (5-v) supply voltage is maintained, the average electric field is increased and this field activates many second-order effects. Second, the edges of a small device are so close together that the nonideal electric fields at these edges significantly affect its performance.

One second-order effect affects threshold voltage, which for the smallest geometries becomes a noticeable function of device size. As Fig. 4a shows, for the shortest channels, those less than $5\ \mu\text{m}$ long, the junction depletion regions around the source and drain tend to support part of the ionized impurity charge that the gate voltage would otherwise maintain, and this reduces the threshold voltage. On the other hand, for the narrowest channels (Fig. 4b), additional ionized charge created by the fringing electric fields near the device edges tends to increase the threshold voltage. These effects will make small devices somewhat more sensitive to process control.

Moreover, in short-channel devices, the isolation characteristics between source and drain could also affect operation. With the gate and source of an enhancement device grounded, the drain must be able to stand off a certain positive voltage and still maintain a nominal amount of leakage. In high-performance transistors, this leakage current may have several causes, but for H-MOS the limiting factor is the phenomenon called second-gate punch-through (Fig. 5). In it, the electric field lines emanating from the drain junction terminate at the oxide-silicon interface of the channel. There the drain acts as an unwanted second gate and inverts the channel from the back, making the device more sensitive to punch-through effects.

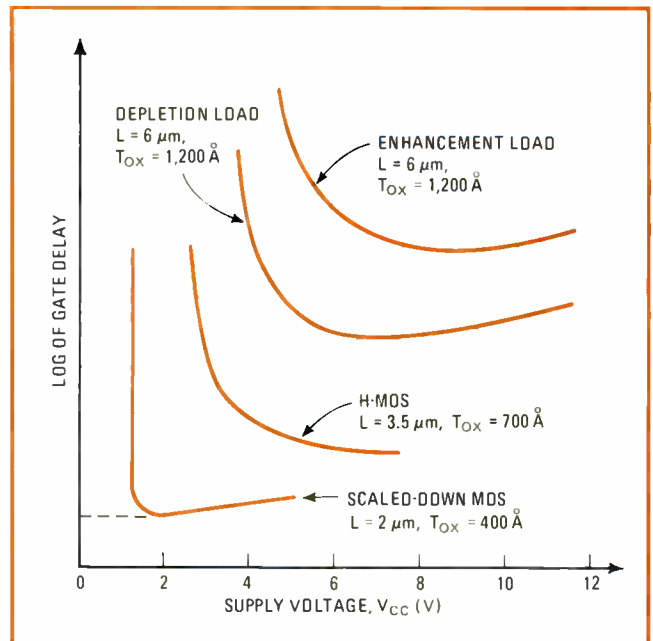

9. Benefiting performance. As MOS technology becomes better and devices smaller, the need for lower supply voltages becomes more urgent. For 2-micrometer channel lengths, a 3-V supply yields the best gate-delay performance and process reliability.

The problem for short-channel devices is that the punch-through voltage arising from this effect is a linear function of the channel length (Fig. 6). The shorter the channel, the lower the voltage causing punch-through and therefore the more susceptible is the device to leakage. In H-MOS however, this is overcome by maintaining a long enough channel length and reducing the oxide thickness, since a thinner oxide prevents unwanted inversions by capacitively coupling the surface potential more tightly to the grounded gate electrode. A second punch-through effect occurs, as shown in Fig. 4b, when the electric field from the drain reaches through to the source and forward-biases the junction, causing current to flow—it is similar to that in a bipolar transistor; but again this punch-through voltage, which is proportional to L^2 , is a limiting factor only for devices smaller than those that are being used at present in H-MOS designs.

Impact ionization

Another source of leakage is impact ionization, the effects of which are illustrated in Fig. 7a. At a very large drain voltage of around 20 v, the junctions avalanche for all channel lengths greater than about $4\ \mu\text{m}$. But even at the significantly lower (5-v) drain voltages of H-MOS, weak impact ionization can occur when current is flowing through the device channel. Activated by the high electric fields, impact ionization creates a population of electrons and holes with energies much higher than the normal channel electrons. The holes flow into the substrate and place a small load on the back-bias supply. Some of the electrons have enough energy to be injected into the gate oxide, as shown, where they can cause a gate current or be trapped. These trapped electrons cause a shift in the threshold voltage (Fig. 7b)—a

Where H-MOS excels

Three metal-oxide-semiconductor approaches to high performance are H-MOS, V-grooved MOS, and silicon on sapphire. As the accompanying table shows, the current versions of H-MOS and V-MOS both yield a speed-power product of about 1 picojoule.

V-MOS, in principle, has a slightly better packing density but pays for this compactness with a more complex process. Also, V-MOS yields an asymmetric device that must be used in one direction only, so that large-scale-integrated logic configurations are much more difficult to achieve than with H-MOS.

SOS, on the other hand, has the best speed-power product. But it requires a substrate five to seven times more costly and seems justified only for microprocessor applications, which do not require operation at the high-speed end of the speed-power curve.

The main advantage H-MOS has over V-MOS today is the fact that the scaling-down process moves it directly to higher performance and greater density at lower cost. The performance for 1980 scaled-down MOS (2-micrometer channels) is shown—it is about five times better than today's technology.

THREE MOS TECHNOLOGIES COMPARED

Parameter	H-MOS 1977	Scaled- down H-MOS 1980+	V-MOS 1977	SOS 1977
Layout density (gates/mm ²)	170	200	~220	150
Speed-power product (pJ)	1	0.2	~1	0.2
Gate delay (ns)	1	0.4	~1	0.5
Number of thin films	2	2	3	3
Number of implants	3	3	3	2

shift that could pose a reliability problem with channels less than 4 μm long.

Finally, there is the increase in interconnect capacitances induced by fringing fields. This parasitic effect occurs for some of the same reasons as the increase in threshold voltage associated with narrow channels—a narrow metal line over the large silicon ground plane has a larger effective area and therefore a larger parasitic capacitance from the fringing fields near its edges.

Happily, the only potential reliability problem brought out by the second-order theory—the trapping of injected electrons in the gate oxide—turns out not to affect H-MOS in its present form. True, trapped electrons tend to increase the threshold voltage, and an increase in threshold voltage could degrade circuit speed or totally stop it from functioning. But accelerated stress tests on H-MOS memory circuits reveal no signs of degradation [*Electronics*, Aug. 4, p. 103]. In fact, additional measurements on individual transistors, plus a physical model for electron injection, show that H-MOS devices will have a total threshold shift of less than 0.1 v after 10 years of continuous stress at worst-case conditions (at 0°C and a V_{DS} of 5.5 v). Careful processing of the gate oxide partly

accounts for these excellent results, for it minimizes the density of trapping sites for electrons. Moreover, it is worth noting that the gate oxides of these 5-v H-MOS devices are subjected to less stress than are the oxides of today's 12-v dynamic RAMs, since 5 v across an oxide 700 angstroms thick is less of an electric field than 12 v across the standard 1,000-angstrom oxides.

While the scaling down of devices as used in H-MOS for boosting MOS performance has a bright future, one condition must be met if its full potential is to be realized. That condition is a reduction in power supply voltage. Table 2 shows that if the technique is to work at all, the supply voltages for 1980 2- μm devices must be scaled down to the 2-to-4-v range. Since all supply voltages are now maintained at least at the 5-v TTL level, this lower supply-voltage requirement for future MOS devices must be accepted by integrated-circuit users.

There is, of course, an alternative for users who simply refuse to accept low system supply voltages. They could use converters to translate between the lower chip-voltage levels and the higher TTL input/output levels, or they could use two power supplies, one providing the chip's internal circuitry with 2 to 4 v and the second supplying 5 v to their I/O circuits. But either procedure is makeshift at best.

Key to the future: lower supply voltage

The fact is, a lower power supply voltage significantly increases the reliability of small-pattern devices, while at the same time increasing their performance remarkably. Reliability goes up because lower supply voltages entail greater tolerance to lower punch-through voltage and at the same time yield weaker electric fields in the channel region. This second effect reduces the risk that charge will be trapped in the gate oxide and alters the long-term stability of the device.

The increase in performance is even more striking. For RAMs and microprocessors (Fig. 8), the impact on the speed-power product would alone make it worth while going from a 5-v to a 3-v supply voltage. For RAMs, which operate at the saturation point of the speed-power curve, the lower power-supply voltage reduces power dissipation by about 60%, while maintaining the speed at the same high value. This reduced power dissipation becomes extremely important as the chip density goes up—65,536 bits and 262,144 bits—since it is generally agreed that for reliable operation power dissipation per package must be kept below a watt.

As for microprocessors, since they operate in a region that is well removed from the saturation point of the speed-power curve, they can take full advantage of a significant speed increase for a given power dissipation. A 3-v microprocessor chip, for example, will operate at twice the speed of a 5-v device.

How the supply voltage affects the various MOS processes that have evolved over the years is shown in Fig. 9, and again the desirability of lower voltages becomes evident. Indeed, for the 1980 scaled version of MOS devices—channel lengths of 2 μm and oxide thicknesses of 400 angstroms—a power supply of 2 to 4 v will give half the gate delay of today's H-MOS process operating at 5 v. □

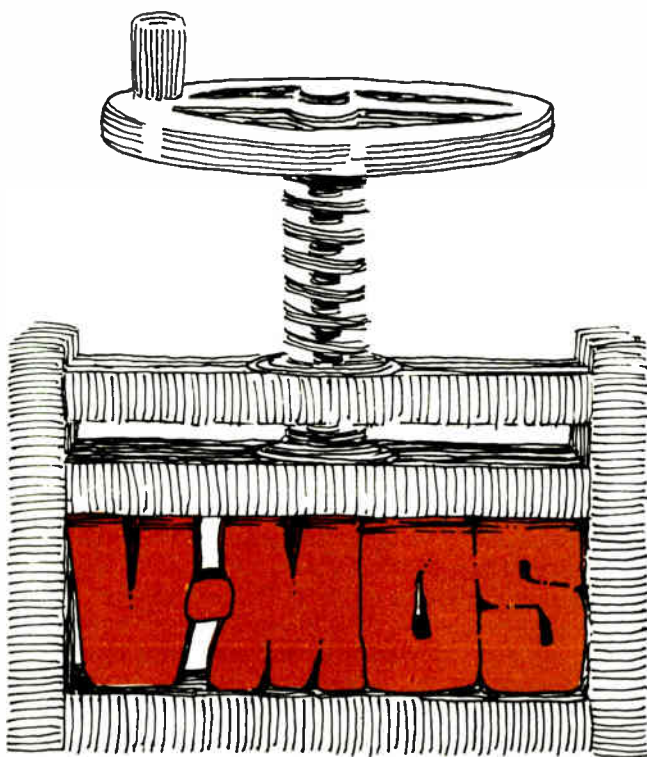

Grooves add new dimension to V-MOS structure and performance

by Fred B. Jenné,

American Microsystems Inc., Santa Clara, Calif.

□ Until now, metal-oxide-semiconductor transistors in large-scale-integrated circuits have been planar, or two-dimensional. v-MOS technology adds a vertical dimension, by forming devices with the source beneath the gate and drain rather than alongside them. This third degree of freedom makes v-MOS faster as well as denser than competing technologies like standard n-channel MOS and integrated injection logic.

These and other v-MOS advantages are already being reflected in a broad range of memory devices. For instance, there is a 4,096-bit static random-access-memory chip that is about half the size of a comparable n-MOS 4-k RAM and has an access time of less than 100 nanoseconds. A 16,384-bit erasable programmable ROM with a low, 15-volt programming voltage is in development, as is a 65,536-bit read-only memory with an access time of less than 300 ns. Moreover, a 65-k dynamic RAM appears achievable in the next two years.

The n-channel v-MOS transistor (Fig. 1) is formed along the slopes of the groove, which is anisotropically etched into the surface of a silicon wafer. Note that the n⁺ source, being below the n⁺ drain, occupies no surface area. Further, the n⁺ source region also serves as a ground plane, whereas other technologies need additional surface area for ground interconnections.

Compared with n-MOS, v-MOS technology saves about 40% in random-logic area because of the savings in source and ground areas, and also because, for a given ratio of load device to pull-down device, n-MOS requires a larger surface area. Compared with I²L, v-MOS is more dense because I²L has a base stripe width that must accommodate a concentric collector diffusion as well as a contact hole, whereas the v-MOS diffusion stripe must accommodate only a contact hole.

Figure 1 also shows that the active channel of the v-MOS structure is in the V-groove slope of the epitaxial layer. The epitaxial layer is nonuniformly doped; it consists of a p-type layer, less than 1 micrometer thick,

covered by a π (lightly doped p) layer about, 1 μm thick after processing.

Of the two, the p layer has the higher threshold and thus usually determines the overall transistor threshold and effective channel length over a wide region of operation. The π layer reduces the drain-to-source capacitance, prevents punch-through (where the depletion region extends through the p layer to the source), and also prevents drain-induced threshold reduction, a major problem in n-MOS devices as geometries are made smaller. (The effects in n-MOS can be reduced, but at the expense of increasing the channel doping, which increases capacitance, and thinning the gate oxide, which reduces yields.)

Channel width

Channel width determines drive current and transistor gain. In a v-MOS transistor, the channel width (W) is large because it extends completely around the V groove (again, see Fig. 1). This allows v-MOS to interface directly with systems requiring large current drives, such as large transistor-transistor-logic fanouts, light-emitting-diode displays, solenoids, and small motors, and thus results in simpler, lower-cost systems.

A drive current comparison can be made with TTL current-sinking output drivers of a v-MOS and an n-MOS product, both using rules of about 6 μm. The v-MOS driver is less than half the size of the n-MOS driver (45 square mils vs 94 mil²) but at the same time can sink 28 milliamperes or 0.6 mA/mil², while the n-MOS driver can sink 16 mA or 0.2 mA/mil². v-MOS in this comparison is thus three times as efficient as n-MOS.

Gain of the v-MOS transistor is superior, too. When short-channel devices are operating in electron velocity saturation, their gain, g_m, hits an upper limit, given by:

$$g_m = WCv_s$$

where W is the channel width, C is the channel capaci-

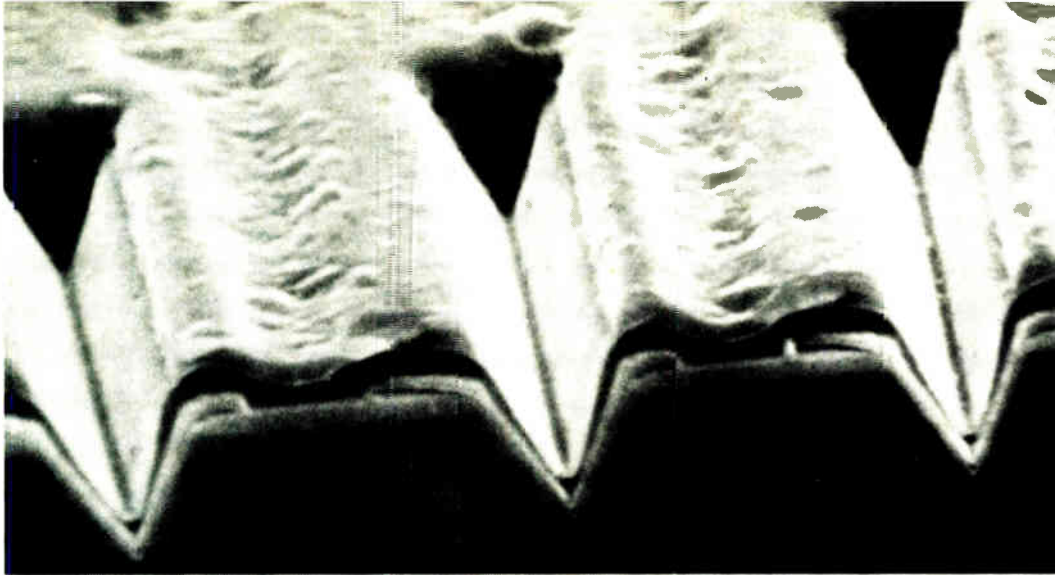

In the groove. A scanning electron microscope shows the V-grooves of the V-MOS process. MOS transistors are formed with the channels along the slopes of the groove, the sources in the substrate, and the drains on the surface.

tance per unit area, and V_s is the electron saturation velocity. For a given topological area of active gate region, the v-MOS transistor has a broader channel width than other n-MOS devices. Therefore its g_m is much greater, even when the small differences of saturation velocities are accounted for on (111) and (100) surfaces.

The v-MOS transistor also is essentially immune to hot-electron effects that are observed on short-channel n-MOS devices. In such devices, electrons in the drain region are injected and trapped at the gate-oxide silicon interface. When the transistor is reversed, this negative charge remains at what is now its source, affecting the source's control of the threshold voltage. To this effect, however, the v-MOS device is relatively insensitive, since its source region is shielded by its unique geometry. In addition, its highly doped p layer, which controls the threshold, is undisturbed.

Control of the v-MOS threshold, shown by data

collected over several months, varies ± 0.15 v with approximately a 1.0-v threshold. This included lots where the p-type dopant in the n^+ substrate was varied on purpose.

Scaling down

All n-MOS circuits can be scaled down in size to increase density and improve power-speed product, and the v-MOS transistor is no exception. Its channel width (W) may be considered to be the p-layer wraparound dimension of the V groove, and its channel length (L) the slanting drain-source distance. The device design equations show that, under the conditions discussed below, the aspect ratio (W/L) of the device will remain unchanged when scaled, as also will resistor values. Therefore, a v-MOS pull-down device and its resistor load will have the same impedance ratios and output levels.

All v-MOS parameters for the fast 1,024-bit RAM

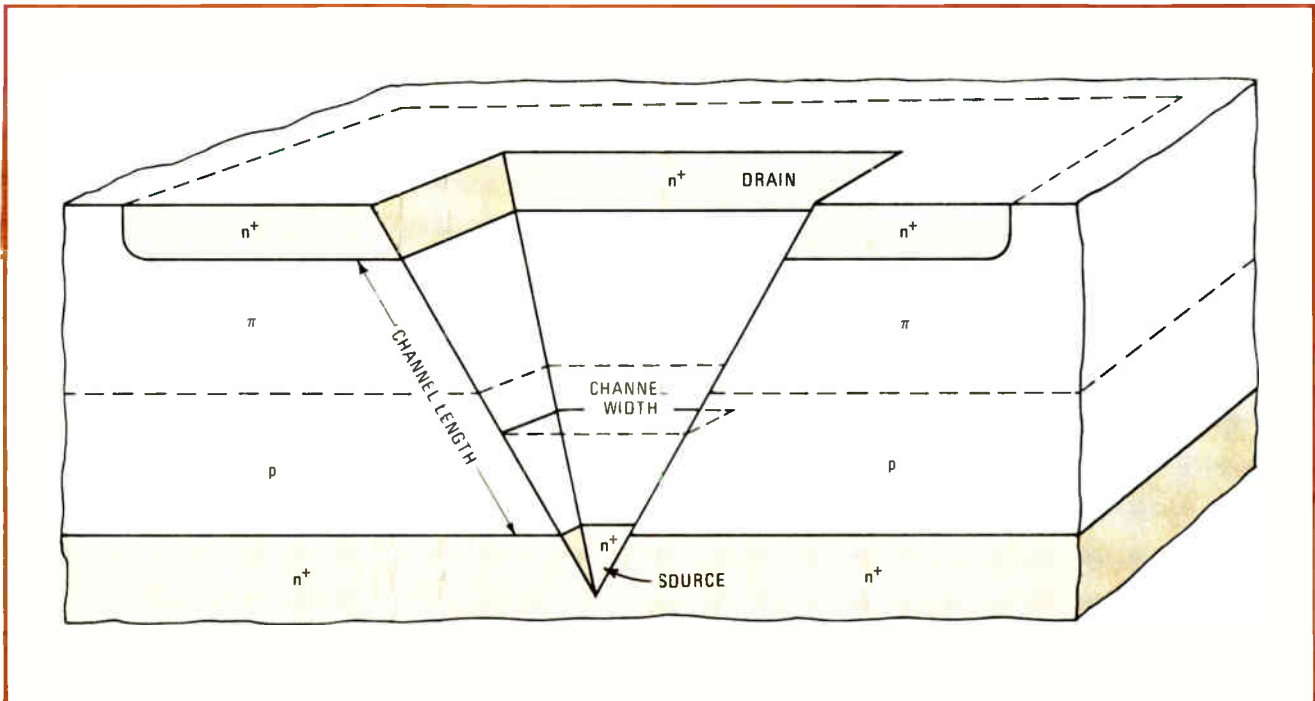

1. The V-MOS structure. A V-shaped groove is etched into the surface of the silicon down through all the n^+ and p layers, and the channel is formed on the slopes of the groove. To save surface area, the source is in the body of the silicon, beneath the drain.

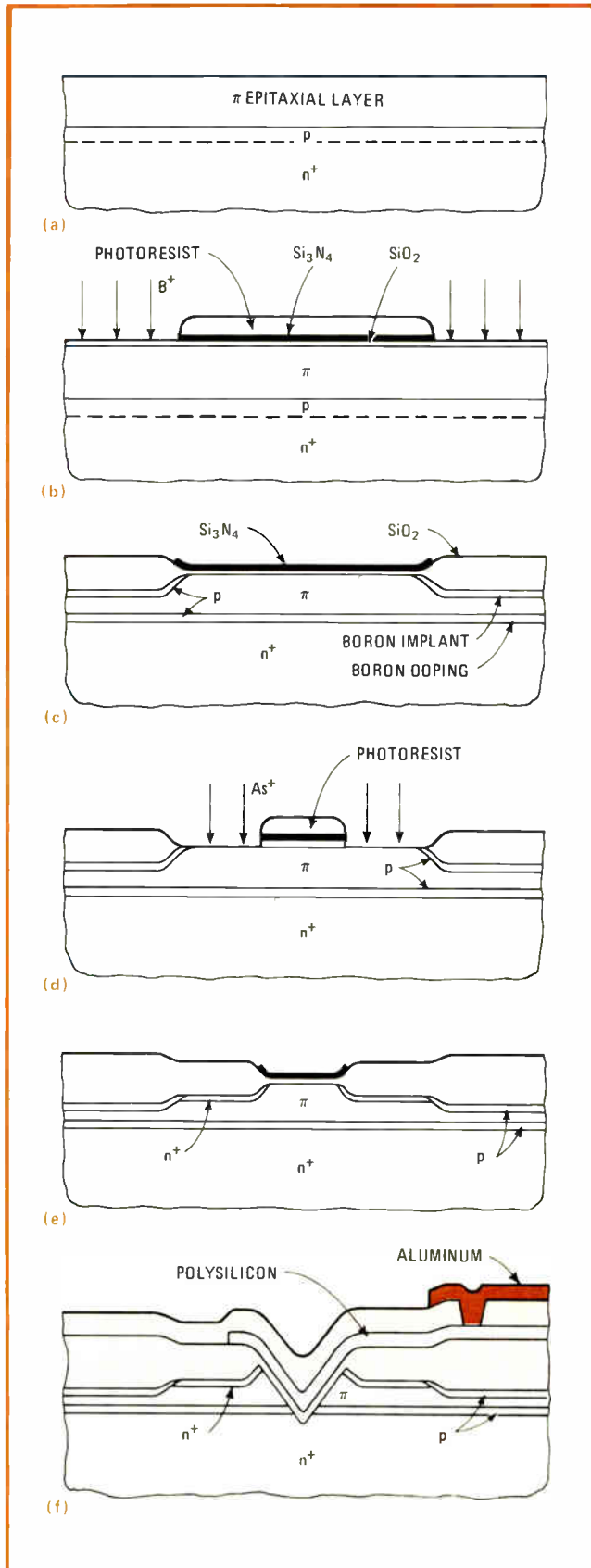

2. The V-MOS process. An n^+ substrate, which forms the source, is overlaid with a nonuniformly doped p layer, to which is added an n layer for the drain. Then a V-shaped groove is etched through the epitaxial layer, the exposed surface of which forms the channel.

described later are scaled by a factor of α , except for the gate-oxide thickness, channel doping level, and the 5-v supply, kept constant because of manufacturing and marketing constraints. In standard n-MOS scaling, these three variables must be changed to prevent punch-through breakdown and to control weak inversion currents. But v-MOS devices are immune to these problems because of their unique D-MOS-type doping profile.

The speed and power-speed product of a v-MOS circuit, under the above-mentioned constraints, are improved by a factor of α^2 because the area of the capacitors is reduced by that amount. If the constraints are removed and the three parameters mentioned above are scaled, then the power is reduced by α^2 and the power-speed product is improved by a factor of α^3 . In the case of delay, this first-order scaling has to be modified for both v-MOS and n-MOS because the junction capacitors do not scale quite as α^2 . The result is that the delay scales down somewhat less than that predicted by the first-order analysis.

Putting it together

The fabrication sequence of a v-MOS transistor is shown in Fig. 2. The process requires seven masking operations through the metal definition, one more than typical depletion-load n-MOS technology with polysilicon-to-diffusion contacts. However, two of the masks are noncritical in their alignment.

The v-MOS process begins with doping the surface of a heavily doped n^+ wafer with boron and then growing a π epitaxial layer about $3 \mu m$ thick on the substrate (Fig. 2a). The next step is the deposition of silicon dioxide and then silicon nitride, followed by removal of the nitride from those areas where a boron implant is next made (Fig. 2b). Thus two thin p layers are formed, the upper one from the boron implant and the lower one from the original boron doping. Next, a standard local-oxidation field oxide is grown (Fig. 2c). The remaining nitride is patterned again to open the areas to be doped n^+ , except for the areas to become v-MOS or n-MOS devices or resistors. The n^+ drain regions are formed by an arsenic ion implantation (Fig. 2d). Local oxidation is performed a second time to give a thick oxide over the diffused regions (Fig. 2e).

Finally, the V grooves are etched, the gate-oxide is grown, polysilicon is deposited, contacts are etched, and metal is deposited and defined (Fig. 2f).

Three types of devices

The devices created during this process are shown in Fig. 3. The v-MOS transistor is complemented by a floating planar n-MOS device and a resistor load. The thick oxide over the drain regions self-aligns the diffusions to the V -groove and n-MOS devices, minimizing overlap capacitance. The primary reason for using the resistor load is to save a mask. The resistor is identical to the n-MOS transistor except for the polysilicon gate, which serves as the resistor implant mask. The n-MOS enhancement implant does not require a mask and is performed on the wafer before polysilicon deposition, while the resistor implant is performed on the wafer after polysilicon definition. This technique eliminates the

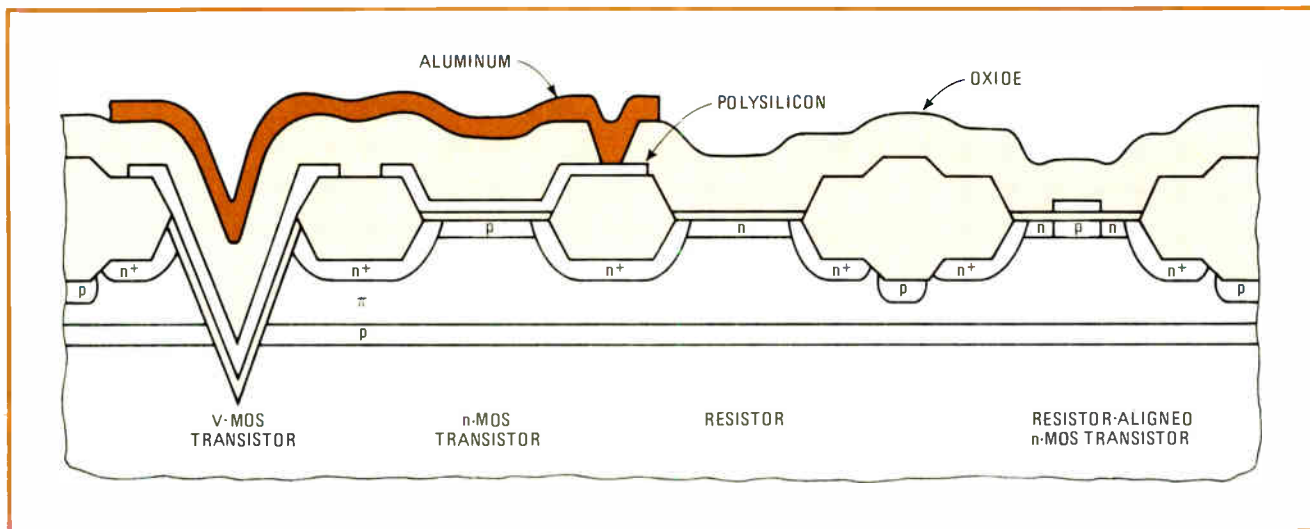

3. Multiple devices. Several types of devices can be formed during the V-MOS process: a V-MOS transistor, an n-MOS transistor, an n-channel resistor, and a resistor-aligned n-MOS transistor. The last is useful as the pass gate in a random-access memory cell.

depletion implant mask used in depletion n-MOS technology. Note that the process provides four unrestricted levels of interconnection: the ground plane, diffusions, polysilicon, and metal.

By combining the standard n-MOS device and the resistor, a second kind of n-MOS transistor, the resistor-aligned n-MOS transistor, can be fabricated, as also shown in Fig. 3. In this device, the polysilicon is defined in the device wells in the conventional manner, and the resistor implant serves as the drain and source. The device has minimal junction and overlap capacitances. In some applications, such as the pass gates in a six-transistor static-RAM cell, the advantage of low capacitance can outweigh the disadvantage of the higher series resistance of the resistor implant. This gives the v-MOS technology a full complement of devices with which to implement circuit functions optimally.

V-MOS static RAMs

A conventional six-transistor cell (Fig. 4) is used for the first 1,024-bit v-MOS static RAM (type 1401), which has a typical access time of 45 ns, has a power supply current of 120 mA, and can sink 20 mA at an output level of 0.45 v. To control the cell load currents and hence the power, this design employs a V_{GG} bias generator compensated for temperature and device parameter variations. Ion-implanted self-aligned transistors act as the pass gates from the latch to the bit lines.

Note that the width of the cell is determined by the two metal lines that run over the top of the cell. The small area is due to the absence of a top-side ground line (replaced by the v-MOS ground plane) and the fact that the V_{GG} polysilicon line can run on top of the n^+ diffused V_{DD} line, a feature that cannot be reproduced in standard n-MOS silicon-gate technology. The die size for the 1401 static RAM is 81 by 125 mils.

The 1401 RAM was scaled down in linear dimensions by a factor of $\alpha = 0.8$ to create the 1443 RAM, which was then scaled again by a factor of 0.8 and designated 1454 (Fig. 5). The smallest die has a cell area of only 1.25 square mils and an overall device density of 7,500

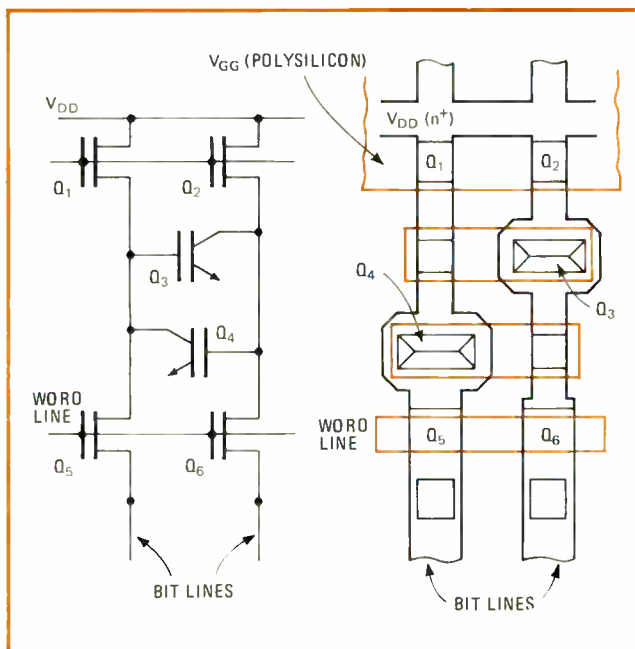

4. The static approach. The v-MOS static random-access memory uses a conventional six-transistor cell in which the two storage elements, Q_3 and Q_4 , are V-MOS devices and the pass devices are resistor-aligned n-channel MOS transistors.

devices in 4,356 mil², or 1.72 devices per square mil of die area. The access times for the RAMs are 46, 34, and 28 ns, respectively, with tight distributions due essentially to the high degree of control over the ion-implanted resistor loads. Another significant feature is that the 1443 (1.9 mil²/cell) yielded more net dice per wafer than the 1401, despite the tighter photolithographic dimensions.

On the basis of this experience, a small, fast 1,024-bit static RAM has been developed with a maximum access time of 45 ns (at 70°C) and a supply current of less than 95 mA with a die size of 5,600 mil². Based on the latest information, the same product in a scaled-down n-MOS part would be 10,500 mil² and the scaled-down bipolar

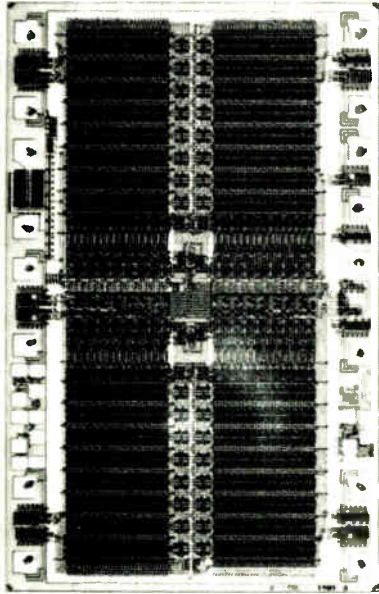

1401

DIE: $81 \times 125 = (100 \text{ MIL})^2$
 CELL SIZE: 30 MIL^2
 ACCESS TIME: $46.2 \cdot 16 \text{ ns}$

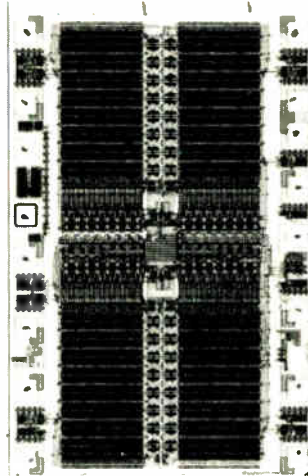

1443

DIE: $69 \times 100 = (83 \text{ MIL})^2$
 CELL SIZE: 1.96 MIL^2
 ACCESS TIME: $33.8 \cdot 1.5 \text{ ns}$

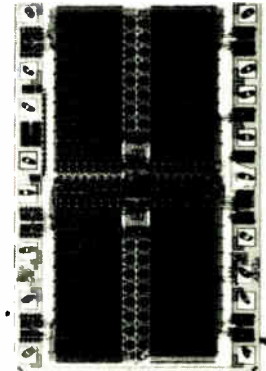

1454

DIE: $80 \times 55 = (66 \text{ MIL})^2$
 CELL SIZE: 1.25 MIL^2
 ACCESS TIME: $28.3 \cdot 0.9 \text{ ns}$

5. Scaling. Of these three 1,024-bit V-MOS static RAMs, the 1401 on the far left uses 5.5-micrometer design rules. A scaling factor of 0.8 gives the next in line, the 1443. A 4- μm rules, and the same 0.8 factor applied to the 1443 yields the 1454 with its 3.5- μm rules.

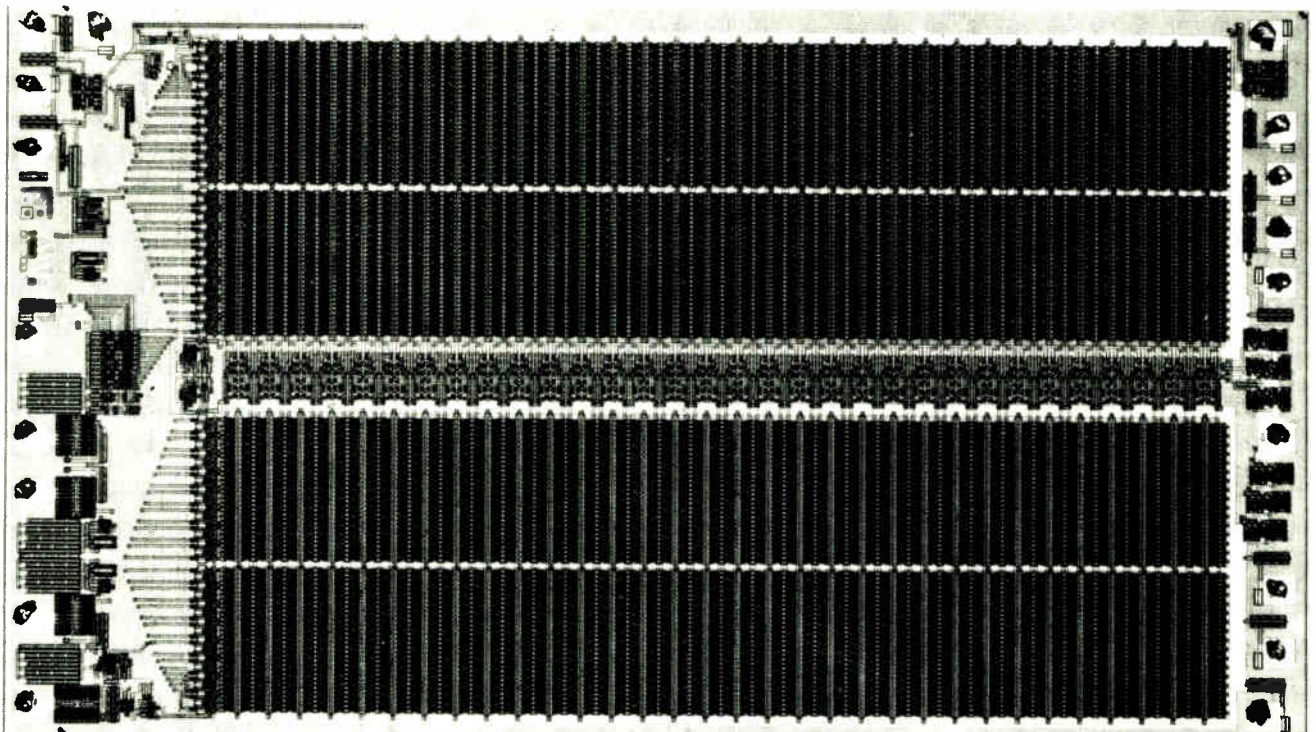

6. The 4-k static RAM. v-MOS technology has been used to produce a 4,096-bit static RAM on a die about half the size of corresponding n-MOS 4-k static RAMs. Access time is less than 100 nanoseconds, and supply current is about 100 milliamperes.

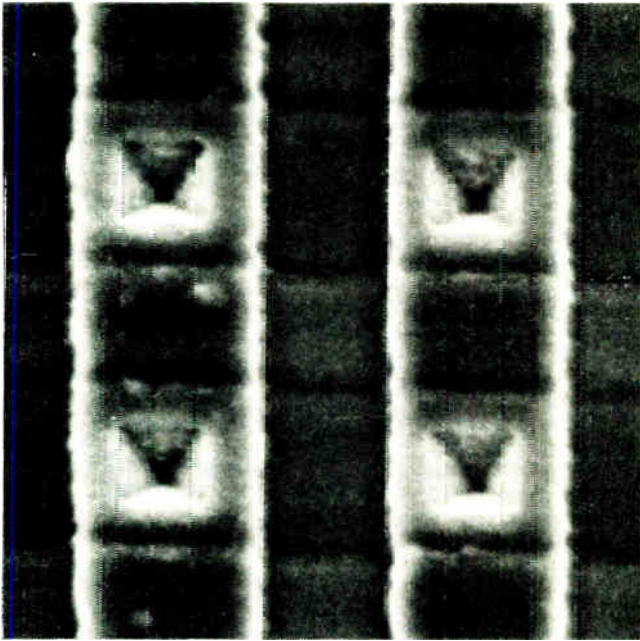

7. Memory cells. The fundamental V-MOS dynamic-RAM cell uses a V-MOS transistor. Each of the devices shown measures 15 micrometers on a side. This same cell structure, with modifications, is used for read-only memories and erasable programmable ROMs.

area would be 9,000 mil². This gives V-MOS technology a dramatic edge in density. Higher-speed and low-power versions will shortly follow the introduction of the 45-ns product.

Also in the V-MOS arsenal is a family of 4,096-bit static RAMs. The first 4-k product (Fig. 6) has an access time of less than 100 ns and a supply current of about 100 mA. The die size is only 13,795 mil², which makes it about half the size of n-MOS 4-k static RAMs. Soon to come will be a high-speed version in a 4-k-by-1-bit configuration. The power dissipation for these products will be less than 450 mw, and they will power down to about 80 mw.

A basic memory cell

For V-MOS memories other than static RAMs, the basic cell is the single-transistor structure shown in Fig. 7 (actually four memory locations in a V-MOS dynamic-RAM array). With modifications, this structure has been used to make ROM, erasable-programmable-ROM, and dynamic-RAM cells. The other elements are an address line and a data line, which with the storage site are the minimum requirements for a memory cell.

Since the surface features of V-MOS memory cells consist exclusively of word and bit lines with memory locations at their intersections, the cells can be packed as densely as the word lines and bit lines can be packed. Also, the fact that there are no contacts in any of the cell structures eliminates the yield-reducing mechanisms associated with contacts.

The first ROM products being introduced include a 65-k and a high-speed 16-k device. The 16-k ROM, designed for the most popular pinouts in a 2,048-by-8-bit organization, has an access time of 125 ns worst case at 70° C with a supply current of 150 mA maximum. Cell

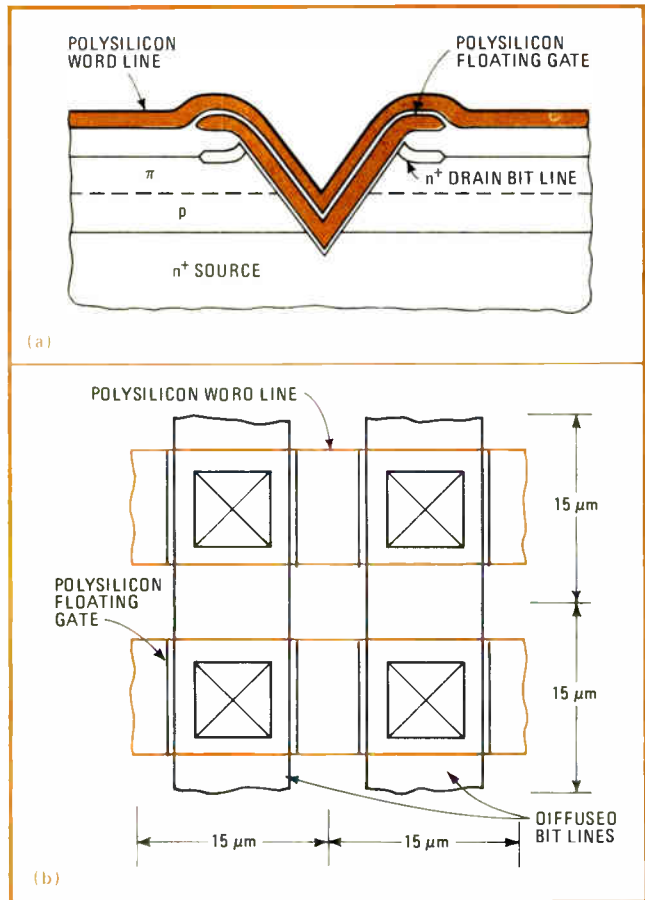

8. The erasable PROM. Adding a polysilicon floating gate to the V-MOS structure allows an erasable PROM to be built. Electrons injected from the drain through the oxide into the gate raise the threshold to prevent turn-on with 5 volts on the word line.

size is 12 μm on a side, or 0.22 mil², and die area is only 12,091 mil². A low-power version will also be available at 70 mA and 200 ns. A 65-k ROM product is coming, too, with an access time of less than 300 ns.

Adding a polysilicon floating gate to the ROM cell structure turns it into an erasable-programmable-ROM cell (Fig. 8). The device is programmed by the injection of hot electrons from the channel drain region through the oxide onto the floating polysilicon gate. The charge accumulates on the gate until the threshold is high enough to prevent the device from turning on when operated with 5 v on the word line. The device is erased by being exposed to ultraviolet light, which gives the stored electrons enough energy to discharge from the floating gate.

V-MOS erasable PROMs

The erasable-PROM cell programs to 6 v within 50 milliseconds with only 15 v on the gate. This low programming voltage has two attractions. First, it reduces the voltage stresses to the internal circuit that can degrade reliability. Second, valuable chip area is not taken up by the p⁺ channel stop required for a 26-v programming voltage.

This V-MOS device is being used for a 5-v-only high-performance 16-k erasable PROM now in development. It

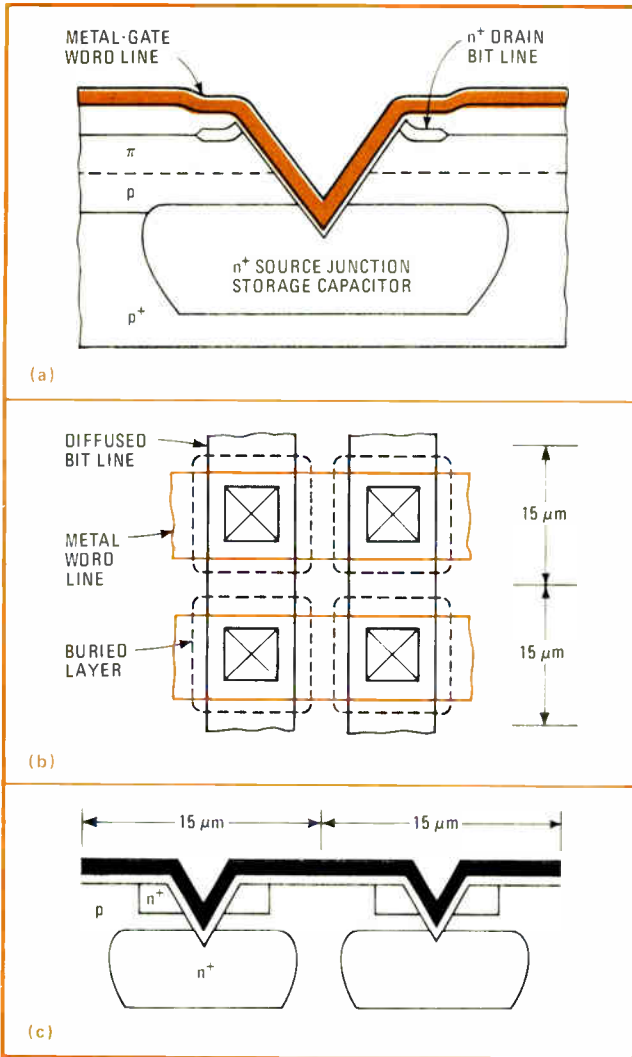

9. Dynamic RAM. To make a dynamic RAM with V-MOS, a buried source is used in the p^+ substrate. Note the use of a metal word line for low impedance and the absence of polysilicon interconnections. The layout (b) shows a four-transistor cell built with $6\text{-}\mu\text{m}$ rules.

is half the size of the cell for a new high-density dual-polysilicon erasable PROM where both use $6\text{-}\mu\text{m}$ rules, because the latter uses a surface-diffused ground bus, bit-line contacts, and p^+ channel stop area, none of which are required for the v-MOS cell.

V-MOS dynamic RAMs

The basic v-MOS memory structure again can be modified to make a dynamic-RAM cell. This structure (Fig. 9) is fabricated with a simple, low-cost, six-mask process. One advantage of this cell is that the storage element (buried source) lies directly below the pass gate, at the intersection of the word and bit lines. Also, the cell contains no contacts, and the word line is metal for low impedance (the process has only one level of metalization and does not require any polysilicon interconnect). Finally, the buried-source junction has six sides available for storing charge.

The storage characteristics of a v-MOS sense amplifier structure and the v-MOS dynamic-RAM cell have been measured. The test structure contains a dummy cell that

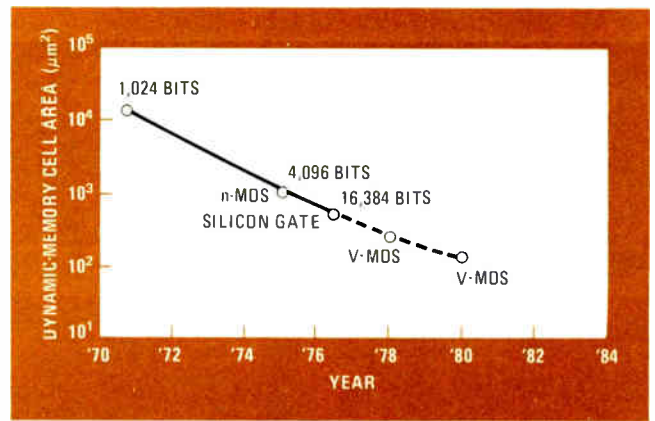

10. Progress. The use of V-MOS technology in dynamic RAMs significantly reduces memory-cell size, making 65,536-bit RAMs possible as soon as a cell area of about 100 micrometers square is reached—probably within the next two to three years.

is precharged to a reference voltage while data is written into the memory cell. Both 1 and 0 levels were tested with results that showed storage times of greater than 1 second at 100°C .

The v-MOS dynamic-RAM cell compares well with the conventional dual-polysilicon RAM cell. The dual-polysilicon cell stores its charge in the MOS capacitor on the surface, which consumes topological area, whereas the v-MOS dynamic-RAM storage element is transparent from this standpoint, since it is hidden below the surface under the bit line. The v-MOS cell area for $6\text{-}\mu\text{m}$ rules is less than half that of the dual-polysilicon cell using $5\text{-}\mu\text{m}$ rules. This allows very dense state-of-the-art memory-cell arrays to be fabricated.

Lots of storage space

Since all six sides of the buried junction are used to store charge, the v-MOS cell has a storage area of $360\ \mu\text{m}^2$, or $0.56\ \text{mil}^2$, and a cell area of only $0.35\ \text{mil}^2$. The storage capacitance per unit area is close to that of an 800-angstrom MOS capacitor. In contrast, the storage area for the dual-polysilicon cell is $0.24\ \text{mil}^2$ (assuming only storage across the oxide), just 30% of the 0.76-mil^2 cell area.

A projection of dynamic-RAM cell area is given in Fig. 10. As it indicates, the v-MOS dynamic-RAM floating-gate technology provides the densities required to build large arrays for the future, like the 65-k dynamic RAM that American Microsystems is planning.

Although so far applied to memory products, v-MOS achieves a circuit density that appears to offer random-logic circuits, too, a real cost advantage. Conceptually, the v-MOS density and speed offer a very attractive combination for microprocessors and microcomputers with greater on-board RAM and ROM or erasable-PROM capacity than has previously been attainable.

Thus v-MOS, a broad-based, high-performance, next-generation technology, will implement high-density logic at considerable area savings. v-MOS has been shown to be a powerful technology for static RAMs and because of its three-dimensional capabilities has an inherent ability to implement minimum-area ROM, erasable-PROM, and dynamic-RAM cell arrays. □

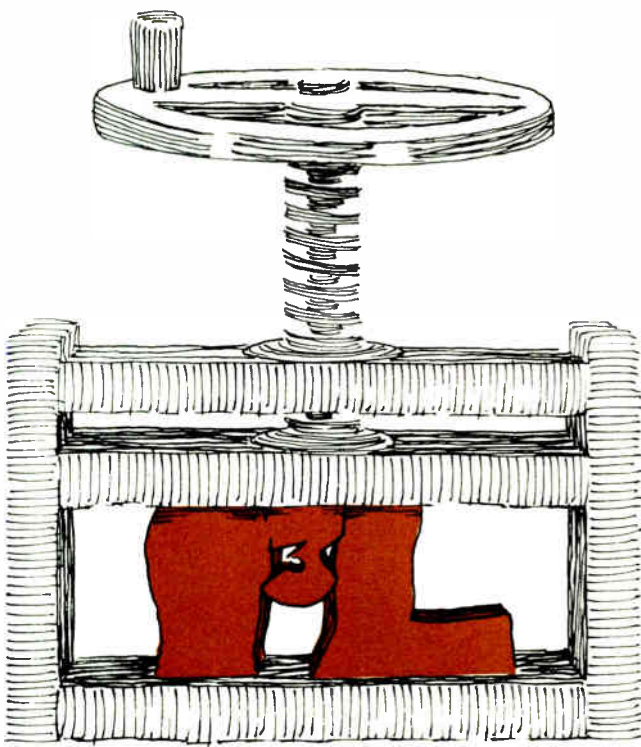

Injection logic boosts bipolar performance while dropping cost

by Wendell Sander, James Early, and Thomas Longo,
Fairchild Camera and Instrument Corp., Mountain View, Calif.

□ Doubting Thomases who argue that very large-scale integration spells real trouble for bipolar technology are ignoring integrated injection logic and its variant, Isoplanar-isolated I²L. Although invented less than five years ago, I³L is ready to fill an important role in VLSI circuitry, taking up where today's metal-oxide-semiconductor devices leave off.

Built with such techniques as Isoplanar isolation and walled emitters, I³L yields memory and logic circuits that are extremely dense (1 to 3 square mils) and very fast (less than 5-nanosecond delays). Yet the devices consume very little power (less than 1 nanowatt) and cost little more than MOS circuits.

For example, I³L 4,096-bit dynamic random-access memories, which are compatible with transistor-transistor

logic, typically operate at 90 ns and dissipate less than 500 milliwatts—or about two times better speed-power products than even the best 4-k MOS types. Moreover, 1,024-bit and 4-k I³L static RAMs will run at 50 ns on chips that are smaller than equivalent MOS types. Applied to logic, I³L produces microprocessors and peripheral integrated circuits can supply an entire 16-bit minicomputer central processing unit or a high-speed program sequencer on a single low-power chip—for the first time bringing bipolar performance to the computer designer at practically MOS costs.

Also, I³L techniques can be applied to a host of dedicated applications, such as game and watch chips, communication control-and-processing circuits, automobile engine controls, and so on, as well as to a host of

MEASURING MEMORY PERFORMANCE					
	4027 - 4	4027 - 3	4027 - 2	93481	93481A
Access time (ns)	250	200	150	120	100
Cycle time (ns)	375	375	320	280	240
Page access time (ns)	155	125	90	75	65
Page cycle time (ns)	275	215	160	75	65
	4027 (All)			93481 (All)	
Maximum power (at max cycle time) (mW)	462			450	
Maximum power (standby) (mW)	27			70	
Power supply (V)	+12; +5; -5 (10%)			+5 (5%)	
Chip selects	1			2	
Timing inputs	2			1	
Data latch	always			user-controlled	
Input capacitance (pF)	4 - 8 typical			2 typical	
Output drive low/high (mA)	3.2 / 5			16 / 5	
Chip size (mil ²)	14,500			11,700	
Refresh	64 lines; 2 ms			32 lines; 2 ms	

Merging transistors

Representing the most recent advances in Isoplanar injection logic, the I^3L dynamic bipolar memory cell shown schematically in (a) is a merged npn-pnp structure. The cross section of the cell illustrating the unique double-diffused pnp transistor used in the process is shown in (b). The simple surface topology required for the cells is illustrated in (c). The cell size is only 0.7 square mil for the 16,384-bit version.

The entire cell consists of a single transistor pair—npn and pnp—merged on silicon so that it occupies little more space than a single transistor. Moreover, it needs no space-consuming capacitors to store charge. Here the logic 1s and 0s are stored in the shared collector-base junction of the merged transistors.

Although the storage capacitor is quite small, on the order of 0.1 picofarad, the relatively high doping concentrations provide both high coupling capacitance and low leakage per unit area. In addition, the npn cell transistor provides a gain of $\beta = 70$ during readout, so that the effective coupling capacitance is about 7 pF and the signal available at the output is large enough to drive high-capacitance bit lines.

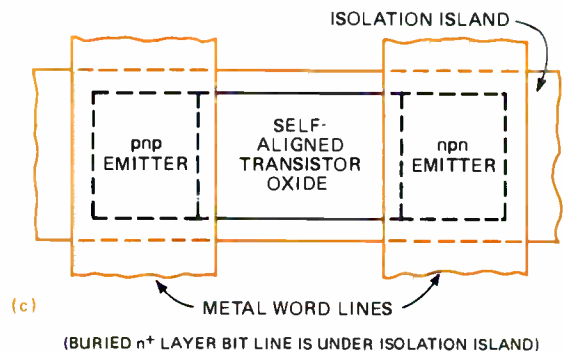
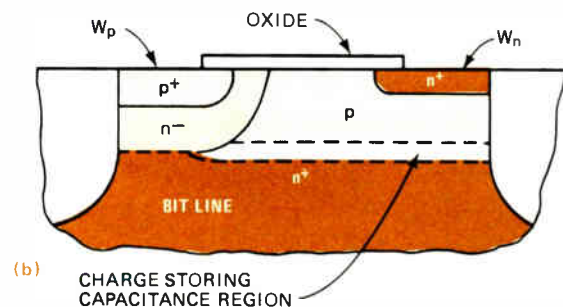
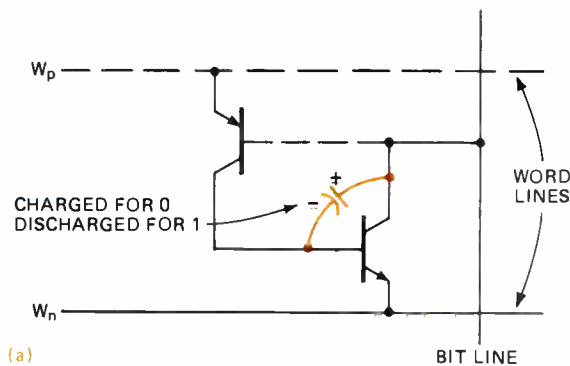

military applications. With their ability to run at a wide range of speed-power products, I^3L circuits are among the most versatile in the IC arsenal.

Perhaps the best example of the strength of injection-logic technology is the first 4-k bipolar dynamic RAM specifically designed for performance-oriented mainframe memory applications. It offers the designer of mainframe memories higher speed and flexibility than MOS equivalents at a cost he can manage. Although the memory costs more than the cheapest n-channel MOS RAM, its higher performance and compatibility with TTL more than offset that cost.

Main memory

This I^3L RAM takes up where MOS leaves off in access time. It also is more flexible, with a fast cycle time and page-mode operation. These features, along with operation from a single +5-volt $\pm 5\%$ supply, make it an attractive partner for 5-v microprocessors, as well as bit-slice bipolar processors.

What's more, these memory cells scale nicely. Thus, a 16,384-bit RAM fully pin-for-pin-compatible with the 4-k part is planned for this year, and a fully compatible 65,536-bit RAM is being readied for early 1979.

The new 4-k RAM employs single-layer metal and complementary npn/pnp I^3L technology [see *Electronics* Aug. 19, 1976, p. 99, for a complete description]. There are two versions, the 93481 and the 93481A. The faster A version features an access time of 100 ns, a page access time of 65 ns, and a cycle time of 240 ns. Maximum dissipation in standby is 70 mw; 450 mw active. The 101-by-116-mil chips, housed in a 16-pin package, operate at temperatures from 0° to 70° Celsius.

A look at how the 93481 series compares with the most nearly equivalent MOS series of RAMs is given by the table. Both parts are 4,096-by-1-bit, 16-pin, address-multiplexed, dynamic RAMs intended for low-cost, performance-oriented applications. The performance of the I^3L part starts where the 4027 leaves off; the cost of the slower 93481 model is equivalent to that of the fastest 4027 model. To compare systems, the row-to-column-address skew must be added to the full access times of the 93481, and \overline{CAS} skew must be added to the 4027 page-access time.

The 93481 is the first dynamic bipolar RAM, so the circuit and process technologies are very conservative to minimize risks. Higher-performance and lower-cost bipolar RAMs should be forthcoming. In fact, improved performance of both MOS and bipolar RAMs in 4-k, 16-k, and 65-k versions is expected over the next few years, but the relative performance of the two types of parts will remain about the same.

In main-memory access and cycle times, the 93481 performs beyond the MOS range. In applications where the 128-bit page mode is desirable, such as direct-memory-access block transfers, the cycle times are much faster, and timing requirements are simpler. Moreover, lower input capacitance and higher drive capability improve system performance.

Power dissipation comparisons must take into consideration the way the parts are used. The MOS part requires lower standby power, but the bipolar part dissi-

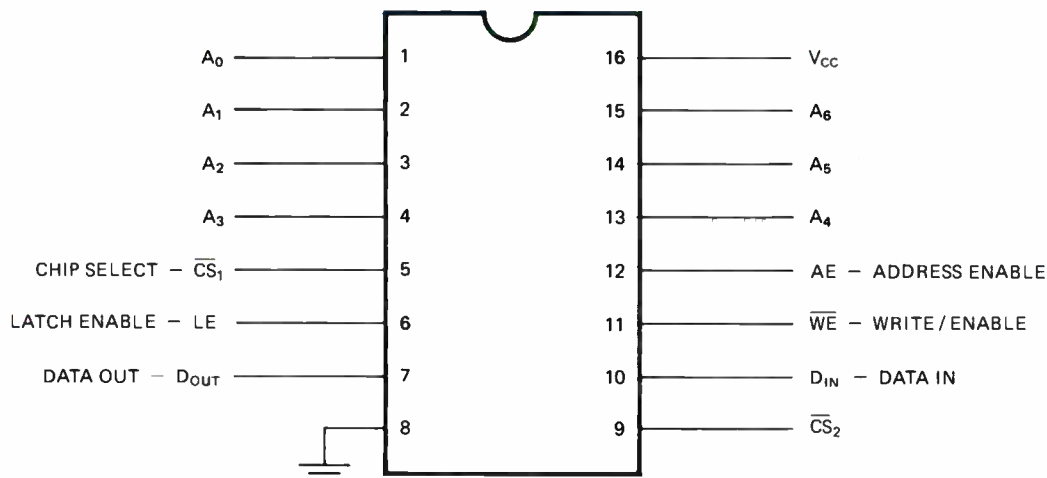

1. Pinout. The seven address pins (A_0 - A_6) in the 4-k and 16-k RAMs provide compatibility without loss of chip-select function. A single timing signal is used at AE; latch at LE is user controlled; data-out pin has high fanout. A single 5-V power supply is used.

pates less power at fast cycle times. If the 93481A were run at 320 ns—the fastest cycle time of the fastest, -2, model of the 4027—it would dissipate only 355 mW maximum, 107 mW less than the 4027-2.

The i^2L models are fully static except for the cells. Therefore they will dissipate more power than the 4027 while in standby operation, but they have fast page-cycle times. The 4027 versions use dynamic circuits throughout and therefore dissipate energy only when cycled, but have slower page cycle times because of the need for precharge of the access circuitry.

Since the 4027 is fully dynamic, power-supply transient currents are much higher than the 93481, which simply powers up and down with smaller dI/dt , even with a lower-voltage power supply. Low dI/dt with sharp thresholds minimizes noise problems. Moreover, the need for only a single +5-v power supply is a distinct advantage in systems that would otherwise require the extra power supplies for MOS circuits.

How they work

The 93481 4-k-by-1 RAM and the soon-to-be-introduced 93483 16-k-by-1 RAM are pin-for-pin-compatible (Fig. 1). Seven address pins are used for both versions. Address lines A_0 - A_4 define the row address for the 4-k part while lines A_0 - A_6 are used for the row address for the 16-k part. Thus, the only difference in addressing is to add multiplexing to pins A_5 and A_6 of the latter.

Another shared feature is the requirement for only a single timing signal, AE (address enable). The signal is used to power up the part and to latch the row address into the chip. Once this is accomplished, the RAM behaves like a true static part, with no further timing

being required for any of the standard read operations.

The need for only one power-supply voltage and a single timing signal frees additional pins for other uses on the device, such as two chip selects and control of the on-chip data latch.

How they run

The block diagram of Fig. 2 illustrates the internal structure of the 93481 memory chip. All inputs are low-power Schottky-TTL in terms of threshold and loading. The three-state, 16-milliampere drive permits a large number of loads on each output line and thus helps minimize system costs.

The seven address lines enter through a predecoder to provide the level shifting and amplification required for the on-chip decoding of words and bits. Common predecode circuits are used for both word and bit decoding to minimize on-chip interconnections. When the timing signal is activated to begin a cycle, the predecoders are powered up and the word decoder is activated to provide a select current to one of the 4-k part's 32 word-drive latch circuits. The timing circuit latches the address; the word line on the cell array is activated, and the 128-bit lines are then read into the bit circuits.

The timing circuit also latches the bit circuits so that they become 128 static-RAM cells. The address from the predecoders is now used to select one of the bits for read/write operations. At this point, the predecoder bit circuits, the bit decoder, and the input/output circuitry can be considered a 128-bit static RAM with 75-ns read-access and cycle times. The data output (D_{out}) of the bit circuits goes through the transparent data latch into the three-state buffer. The chip select is placed after the

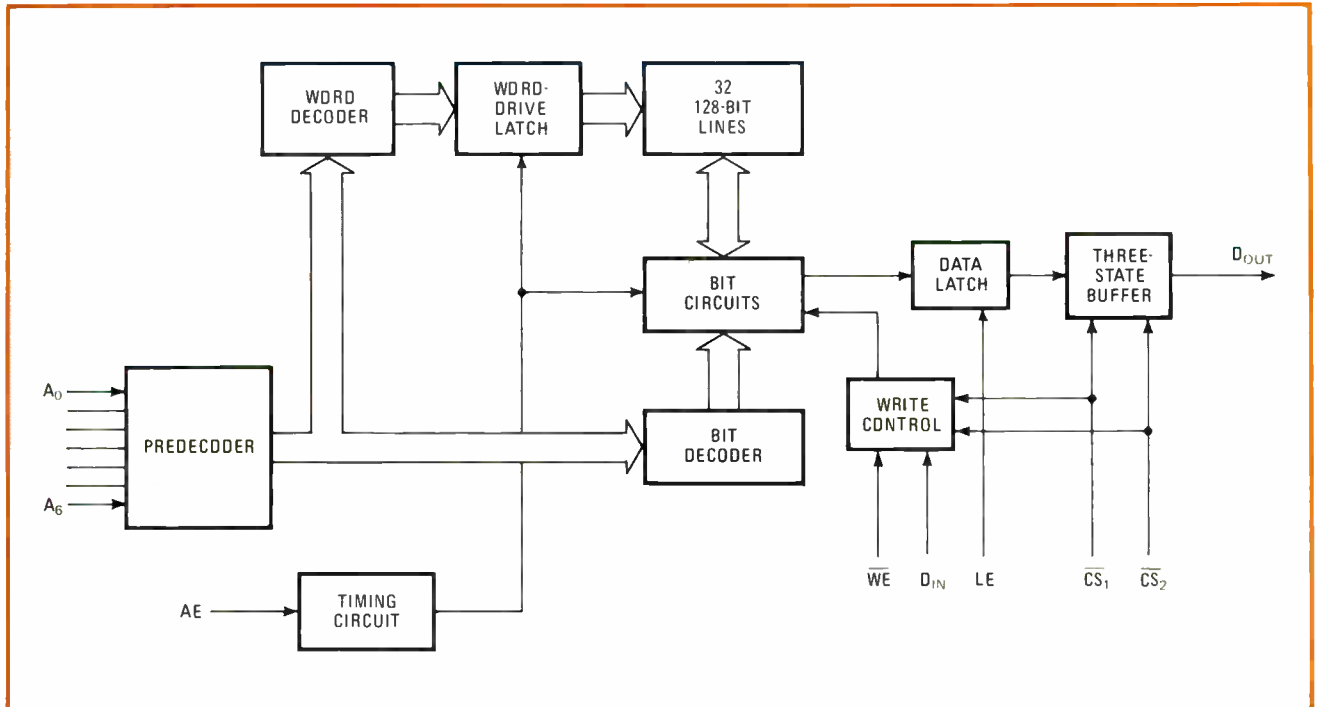

2. Blocking it out. With the internal memory array of the 4-k RAM arranged as 32 128-bit lines, only 32 lines need to be refreshed—yet 128 bits are available for page-mode operation. The shaded region forms a 128-bit static RAM for page-mode operation.

data latch operations so that data can be latched even on unselected chips for subsequent readout.

The timing of the write operation line is much like that of static RAM in that it requires a write-enable pulse to activate the write circuitry. What is unusual is that the data line is timed relative only to the trailing, or rising, edge of the WE pulse, rather than the usual scheme of timing it relative to the entire pulse. The 93481's scheme provides for better timing control and minimizes skew problems in write cycles.

Read timing

A read cycle for the RAMs is shown in Fig. 3. The 5-bit or 7-bit row address is held from T_{AS} to T_{AH} relative to AE . After T_{AH} , row address changes to column address, and the output is valid for a time, T_{CAA} , after the column address is stable. The on-chip data latch may be used to hold data over into the next cycle. A convenient way to do this is to tie the user-controlled LE to AE .

The timing for successive page cycles is detailed in Fig. 4. The data is available at a time, T_{CAA} , after the column address is stable. Then LE is activated and D_{out} is held. The column address is changed and a write cycle is performed at column address 2 while the data out from column address 1 is held. A read-modify-write would be performed if column address 2 were the same as column address 1. This procedure is just one of the many possible sequences that can be performed using the page-mode and data-latch features.

The i^2L technology used in the 93481 provides all the circuit capability of bipolar TTL circuits, so that fully compatible terminal characteristics are available. Isoplanar circuit technology produces exceptionally low input capacitance, permitting high speed with large fanout. As many as 32 inputs can be driven by low-power Schottky-

TTL circuits. The output of the 93481 memory chip is a 16-mA sink, three-state drive.

Figure 5 shows the effect of temperature on refresh time. It is significant that 60% of the devices tested could operate with a 2-millisecond refresh at a junction temperature, T_j , of 125°C (system ambient temperature of 100°C), and more than 45% would operate at 1-ms refresh times at 150°C (125°C ambient). Even at the higher temperature, the bipolar RAM, which requires refresh of 32 lines every 1 ms, is equivalent to the 4027, which requires refresh of 64 lines every 2 ms.

The bipolar junction is heavily doped to provide low leakage and high capacitance. With process refinements, a military version of the dynamic bipolar RAM is feasible.

Broad applications

The 93481 and 93483 devices have features that are attractive for both main memory applications and microprocessor applications. The high fanout and good noise immunity minimize system overhead. The single +5-v power-supply requirement makes it attractive to use with 5-v microprocessors such as the 6800, Z-80, and 8085. The single supply voltage, along with a page cycle time that permits 10-megahertz operation, is attractive for use with bit-slice bipolar processors such as the 9400, 2900, and 3000 series.

The fast page mode of these RAMs opens up new ways to use memory. To best understand these techniques, the 93481A should be viewed as a paging memory. The 4,096-by-1 memory now becomes a 128-by-1 static RAM with access and cycle times of 65 ns and with 32 pages of backing store, which may be transferred to and from the working store.

One application of this mode is for block transfer of data. Sequentially stored data can be loaded or read at

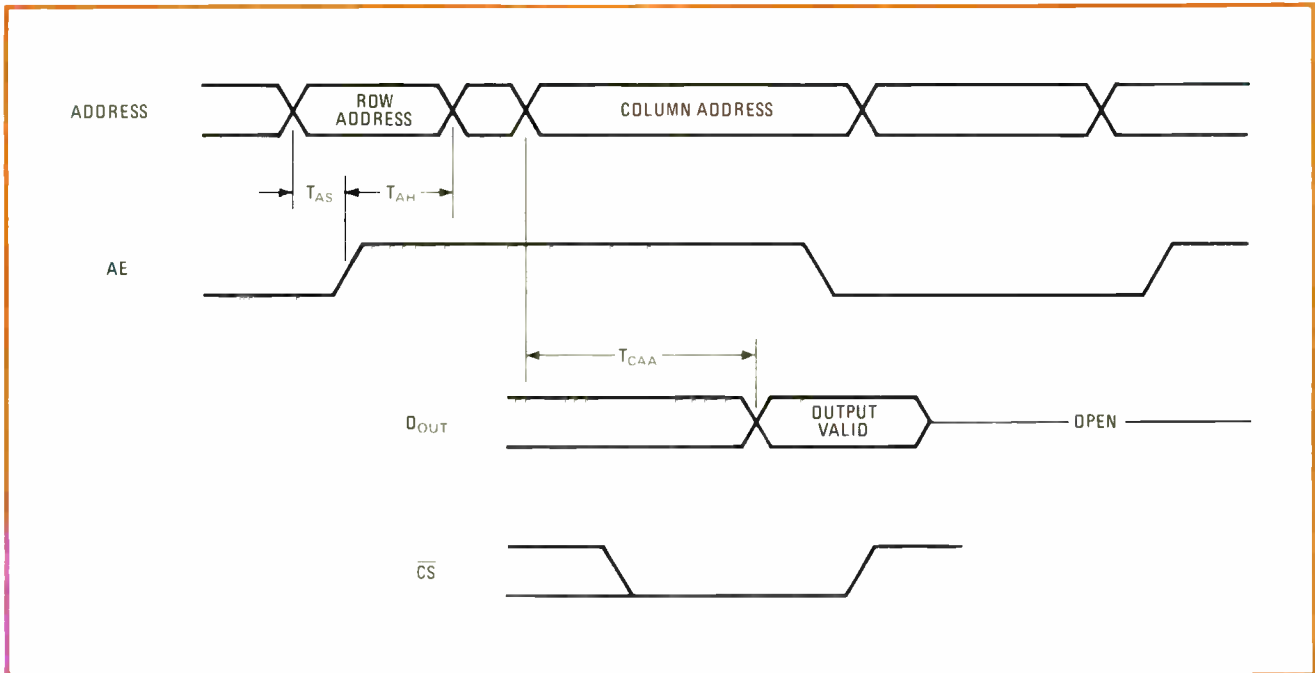

3. Full access cycle. The row address is first latched into the chip by the address-enable signal. Once this is done, the column address is put into the chip and the data then becomes valid at a time, T_{CAA} , after column addressing has stabilized.

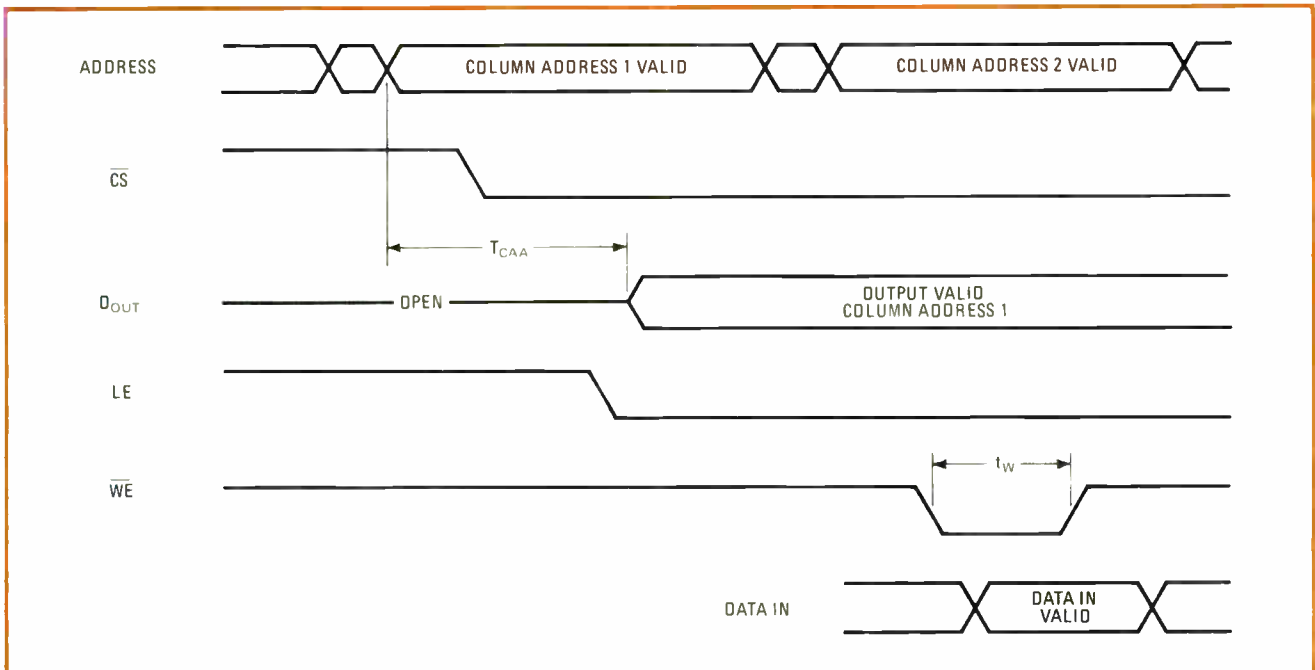

4. Page-mode timing. This operation boils down to a succession of different column-address cycles all done at the same row address. In this case, the address enable remains high and the page cycles behave as though the 128 columns were a static RAM.

the page cycle rate for fast data communications or support of fast peripherals such as raster displays. Since there is no need for sequential access to the page's data, the page could be the microcode store for a bipolar microprocessor.

Another application is vector storage in high-speed vector processing machines or dedicated APL machines. In fact, any system requiring rapid availability of a limited portion of RAM, such as a cache memory, can utilize this feature.

The paging memory of Fig. 6 has two 93481A RAMs on common data lines in a system. Each RAM contributes 128 bits to the rapidly addressable memory space. In addition, each contains a separate row-address register so that each can represent a different internal page. This feature provides a capability very similar to the requirements of a cache-based system, but with much faster repaging capability.

Modern LSI circuits are designed with computer-aided systems, and the resulting mask descriptions are avail-

Modular switch array includes priority encoder

by Thomas L. Sterling
Sigma Consultants Inc., Virginia Beach, Va.

The output ports of this momentary-contact switch array respond to the first command received, and the circuit locks out all subsequent commands, providing a time-sequence priority scheme often needed in industrial systems. The low-cost circuit prevents simultaneous switch depressions from spoiling system operation, and the modularized design technique employed makes it fairly simple to implement.

The structure for this switch array is shown in the figure. A number of single-pole, double-throw switches (SW_n) are individually interfaced through the same number of switch buffer modules (B_n) to a single set-reset flip-flop at the output of the last module. This flip-

flop generates a lock-out signal to ensure that only one module at any given time can be in the active state.

Each module contains its own SR flip-flop, a gated output driver with inhibit circuitry, and two AND gates. The flip-flop is configured to circumvent switch contact bounce and has its inputs connected to the normally open (NO) and normally closed (NC) contacts of each switch. The inverting output is combined with the M_i input signal through an AND gate to derive the M_o output. The noninverting output of the flip-flop is applied to the gated output driver. Each module is cascaded by connecting the M_o and A_o ports to the M_i and A_i ports of the next buffer.

Depressing any switch drives the \bar{P}_i output of its associated module low. The M_o and A_o ports of the last buffer module in the chain move low at this time, permitting generation of the LCK signal.

The inhibit gate in each module will prevent the output gate from going low, irrespective of the state of the input flip-flop, if the buffer module output, \bar{P}_i , is inactive. If the buffer module is active, the inhibit gate will be inactive, independently of the state of the LCK

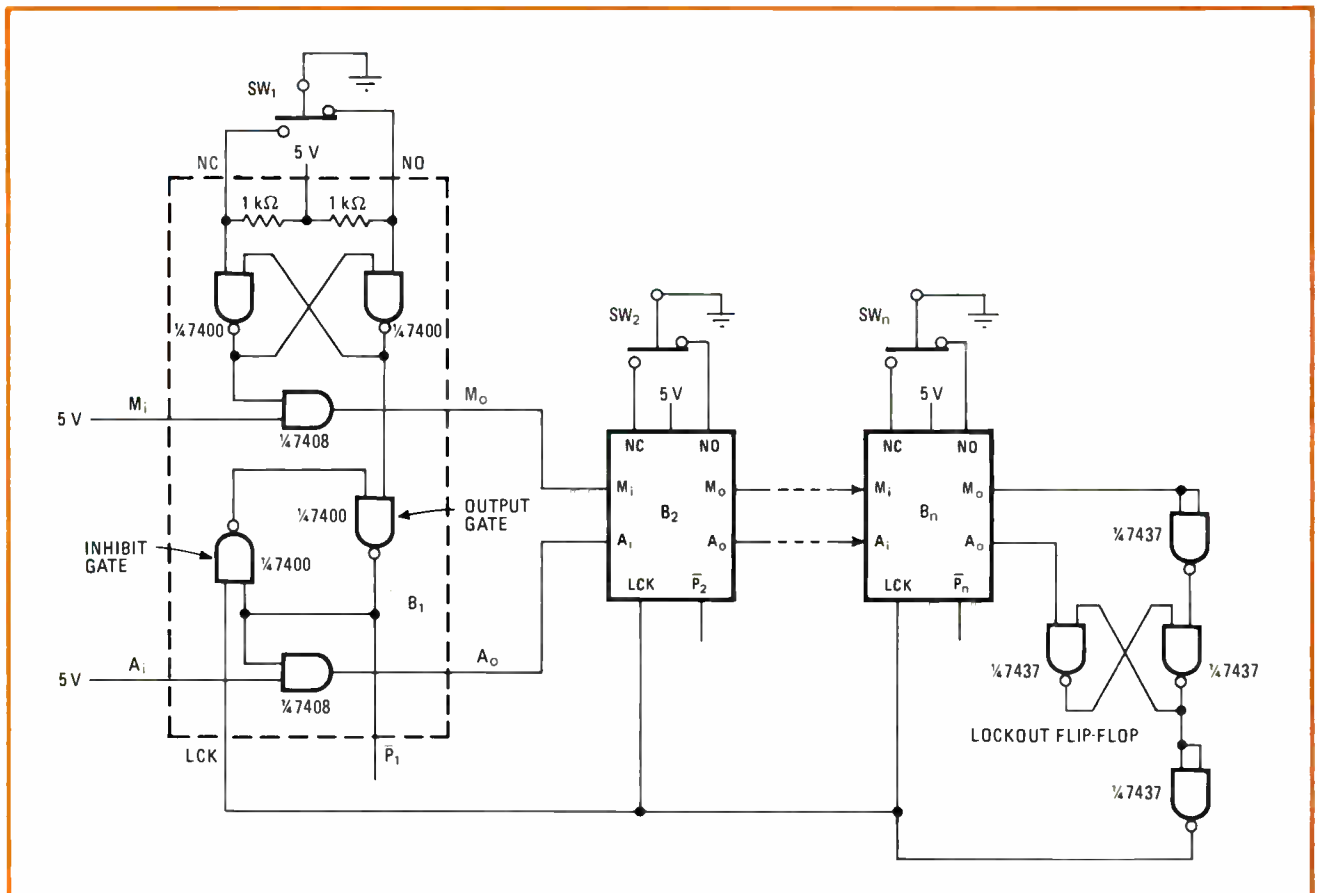

Priority encoding. First switch to close captures its output buffer. Circuit disables all other buffer output lines by generating a lockout (LCK) signal. Release of switch or switches automatically resets circuit. The truth table of the switch array is illustrated.

TRUTH TABLE FOR SWITCH ARRAY BUFFER

Time	SW ₁	SW ₂ ...	SW ₁ ...	SW _R ...	SW _{n-1}	SW _n	\bar{P}_1	\bar{P}_2 ...	\bar{P}_1 ...	\bar{P}_k ...	\bar{P}_{n-1}	\bar{P}_n	M _{on}	A _{on}	LCK
t ₀	0	0	0	0	0	0	1	1	1	1	1	1	1	1	0
t ₁	0	0	1	0	0	0	1	1	0	1	1	1	0	0	1
t ₂	0	0	1	1	0	0	1	1	0	1	1	1	0	0	1
t ₃	0	0	0	1	0	0	1	1	1	1	1	1	0	1	1
t ₄	0	0	0	0	0	0	1	1	1	1	1	1	1	1	0
t ₅	0	0	0	1	0	0	1	1	1	0	1	1	0	0	1
t ₆	0	0	0	0	0	0	1	1	1	1	1	1	1	1	0

output. The lockout flip-flop is not reset until the M_o signal at the last flip-flop moves high again. This occurs when the switch is released.

Once the switch first depressed is released, all module outputs become inactive, even if other switches were activated after a particular module had been set. Only

after all switches are released can one of the buffers become active again. The operation of the switch array is shown in the illustration.

This design can accommodate up to 30 switches. This limit on their number is set by the driving capability of the inverter driver of the lockout flip-flop. □

Ring counter synthesizes sinusoidal waveforms

by Timothy D. Jordan
Texas A & M University, College Station, Texas

A digital circuit composed of only two counters and a weighted resistor network is as good at producing sine and cosine waveforms as many quadrature oscillator

networks. Because matched components are not used, design considerations are radically simplified.

Use of the digital technique eliminates many components. The upper frequency limit of the oscillator is 250 kilohertz, and it is not affected by the frequency limitations of operational amplifiers, because no op amps are used. Tweaking the oscillator is not necessary, because no special circuitry is needed. And the sine and cosine waveforms are equal in magnitude at every frequency, because no integrating or differentiating circuits are used. It is even possible to transform the circuit into a digital-to-sine-wave converter with little modification, if

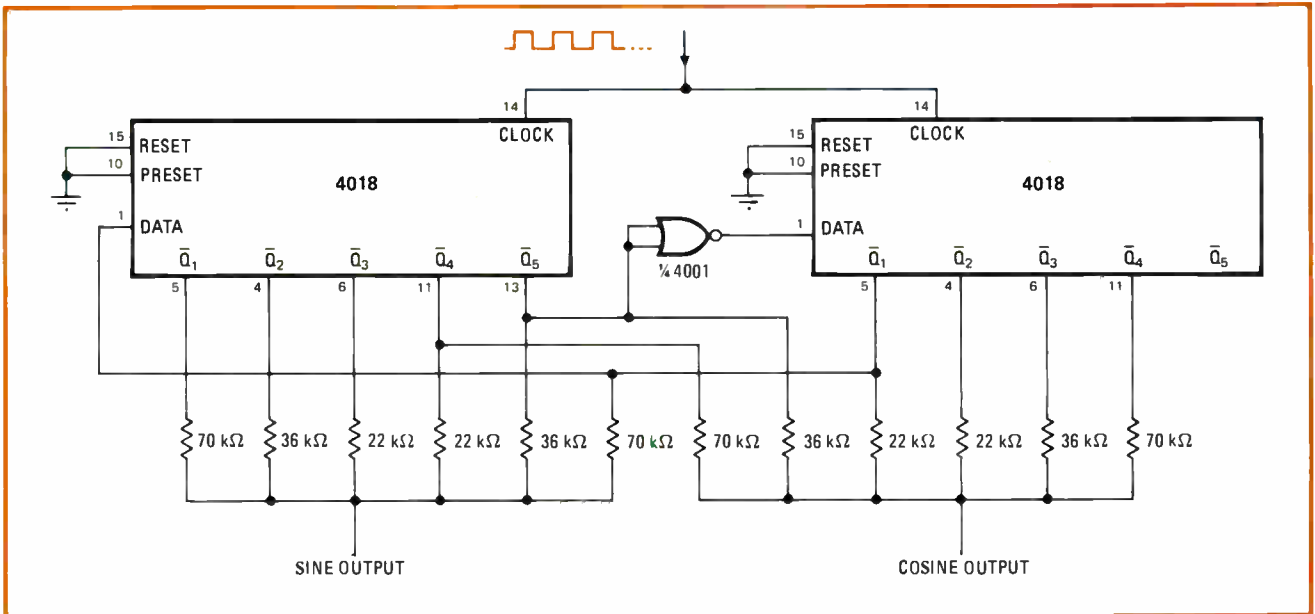

Digitized waves. Frequency dividers and weighted resistor network generate sine and cosine waveforms. The 4018 counters divide input frequency by 12. First counter provides 12-bit approximation of sine function. Second device lags by 90°, producing cosine waveform.

the counters' parallel input ports are used to accept binary signals.

As shown in the figure, two cascaded 4018 complementary-metal-oxide-semiconductor integrated circuits wired as a single ring counter are driven by the master clock. The 4018s divide the input frequency by 12. The digital clock advances the ring counter by one count on the positive clock transition, and each output port moves from the high to low state sequentially.

The resulting current through the weighted resistor network at the counter's output produces a 12-step

approximation of a sine wave. The output stages of the second 4018 produce a cosine wave, since it is delayed three clock periods, or one quarter of a cycle, with respect to the first counter.

The first appreciable harmonics to appear at the output are the 11th and 13th, and they may be filtered out with a passive resistance-capacitance filter. Identical filters should be used for each counter so that the phase shift introduced is equal for both output waveforms. The input frequency may be as high as 3 megahertz; above 1 MHz, no filtering is necessary. □

Darlington-switched relays link car and trailer signal lights

by M. E. Gilmore, and C. W. Snipes
Florence, Ala.

New cars with separate turn and brake signals—a safety feature—require a special circuit to properly drive the combination turn-and-brake lights on a trailer; otherwise, if the trailer lights are connected to the brake command, the turn signal will not work, and connecting the lights to the turn command will not yield a brake signal. But two relays and low-cost transistors will combine the signals onto a common bus again, ensuring that the trailer's lights respond to both commands.

As shown in the figure, the brake-command line is normally connected to the trailer lights through relays K_1 and K_2 during normal operation. However, a left- or right-turn command will turn on the respective Darlington amplifier, Q_1, Q_2 or Q_3, Q_4 , thus activating K_1 or K_2 . The turn signal is then routed to the lights.

Capacitors C_1 and C_2 charge to the peak amplitude of the turn signal, which flashes at one to two times per second. C_1 and C_2 should therefore be selected to hold the relay closed between these flash intervals (0.5 to 1.0 second), but no longer. If the capacitance is too large, the brake signal cannot immediately activate the trailer lights after the turn signal is canceled. Diodes D_1 and D_2 prevent capacitor discharge through the left or right turn-signal lines, respectively. □

Engineer's notebook is a regular feature in *Electronics*. We invite readers to submit original design shortcuts, calculation aids, measurement and test techniques, and other ideas for saving engineering time or cost. We'll pay \$50 for each item published.

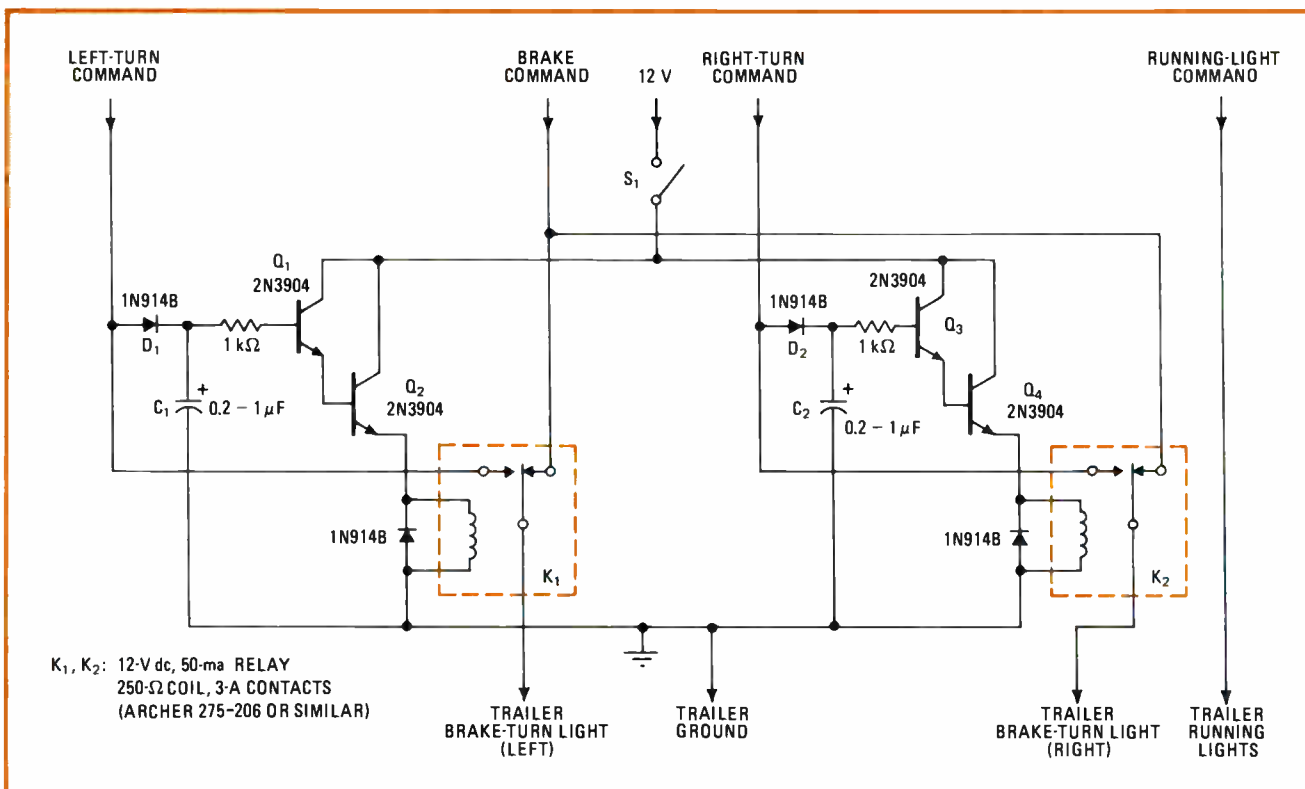

Auto-to-trailer interface. Relays multiplex brake and turn commands onto common bus line, permit control of brake-turn lights on trailer. Darlington amplifiers provide high command-line isolation and sufficient drive for the relays.

Don't overlook self-heating of resistors

by Gene Howell and Joe Winebarger*
TRW/IRC Resistors, Boone, N. C.

CONVERTING PARTS PER MILLION TO PERCENTAGE CHANGE	
ppm / °C	%ΔR / °C
1	0.0001
10	0.001
25	0.0025
50	0.005
100	0.01
200	0.02
500	0.05
1,000	0.1

□ Although most designers recognize the importance of accounting for the resistor temperature coefficient in critical applications, few are aware of the dual nature of this resistor characteristic—it is affected not only by the surrounding ambient environment but also by the power the resistor itself dissipates. This self-heating effect may cause a temperature rise large enough to change the resistance appreciably.

In general, resistor manufacturers express the temperature coefficient of resistance, popularly dubbed TCR, in parts per million per degree Celsius (ppm/°C):

$$\text{TCR}(\text{ppm}/^\circ\text{C}) = \frac{R_2 - R_1}{R_1(T_2 - T_1)} \times 10^6$$

where R_1 is the resistance at temperature T_1 , which is normally 25°C room ambient, and R_2 is the resistance at temperature T_2 , which may be a hot extreme of, say, 150°C or a cold extreme of, say, -55°C.

However, to properly assess its effect on a circuit, TCR should really be thought of as a percentage change in the resistor's value (%ΔR):

$$\text{TCR}(\% \Delta R / ^\circ\text{C}) = \frac{R_2 - R_1}{R_1(T_2 - T_1)} \times 100$$

As these equations show, to convert TCR from units of ppm/°C to units of %ΔR/°C is simple:

$$\text{TCR}(\text{ppm}/^\circ\text{C}) = \text{TCR}(\% \Delta R / ^\circ\text{C}) \times 10^4$$

The table lists several common values of resistor TCR expressed in ppm/°C and the corresponding %ΔR/°C.

Before finalizing a design, the engineer should calculate the maximum resistance change expected:

$$(\% \Delta R)_{\text{MAX}} = \text{TCR}(\% \Delta R / ^\circ\text{C}) \times (\Delta T)_{\text{MAX}}$$

where $(\Delta T)_{\text{MAX}}$ is the maximum temperature change

*Now with Telex Terminal Communications, Raleigh, N. C.

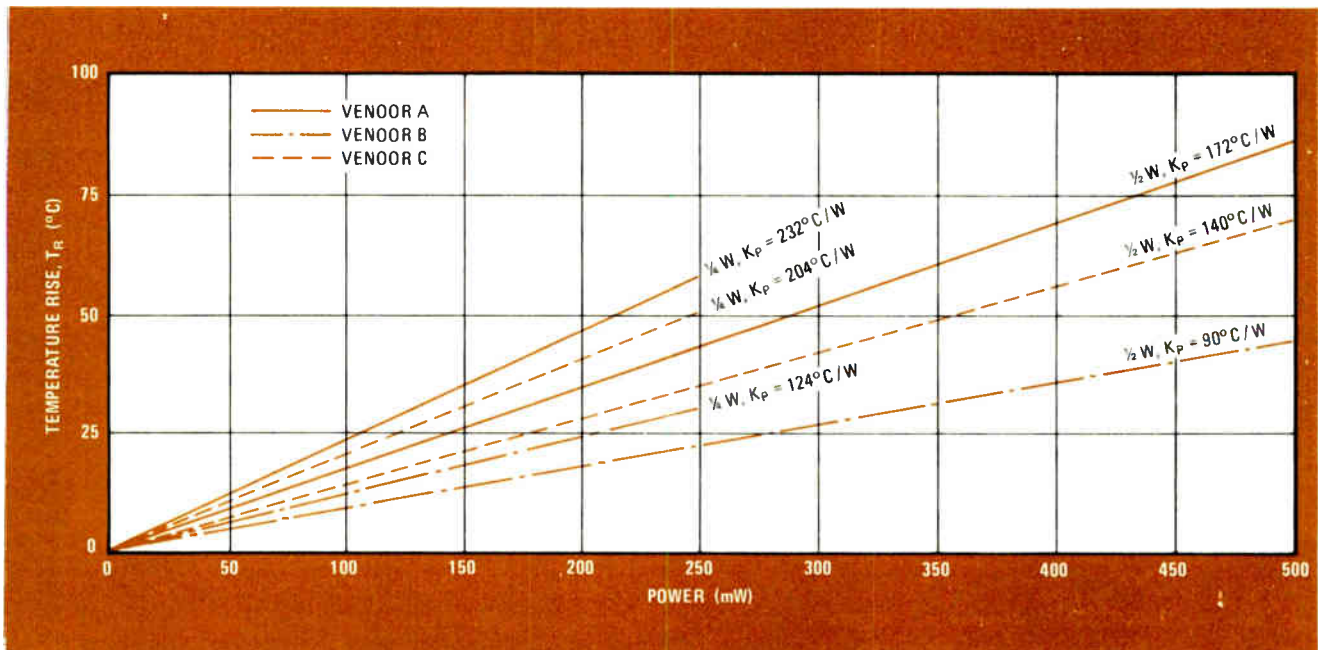

1. Because of self-heating. The power a resistor dissipates may cause its temperature to rise high enough to change the device's value appreciably. How much the temperature rises depends on the amount of power applied and the resistor's ability to transfer heat.

anticipated, reflecting the highest temperature of the environment itself plus the greatest heat rise caused by heat sources within the equipment. This resistance change, though, is associated only with temperature effects external to the resistor. In an actual circuit application, the power dissipated by the resistor may produce an additional temperature rise and therefore an additional change in the resistance.

The average temperature rise, T_R , caused by resistor self-heating may be written as:

$$T_R = K_P \times (\text{applied power})$$

where K_P is a constant, expressed in units of $^{\circ}\text{C}/\text{watt}$ and sometimes called the power coefficient. To be meaningful, this coefficient must reflect the average temperature rise of the resistive element.

Including the effect of self-heating

The key to a low power coefficient is a resistor built to provide good heat transfer, a property that depends on how the resistor is constructed. Figure 1 illustrates the variation in the power coefficient for metal-film resistors made by three different manufacturers. Temperature rise is lowest for devices produced by vendor B.

Taking both external and internal temperature effects into account, the worst-case resistance change becomes:

$$\% \Delta R = (T_A + T_R - 25^{\circ}\text{C}) \times \text{TCR} \quad (1)$$

where T_A is the highest ambient temperature of the environment, T_R the average resistor temperature rise caused by power dissipation, and TCR the resistor temperature coefficient expressed as a percentage. This equation sets the reference temperature at 25°C , but if the actual reference temperature is substantially different, the appropriate value should be substituted.

As a rule, when T_R is greater than T_A by 10% or more, it must be taken into consideration in the application. Generally, resistor self-heating may be significant if:

- Actual power dissipation is greater than the resistor's rated wattage by 10% or more.
- The power coefficient, K_P , is high.
- The resistor will be operating in a controlled ambient environment, making temperature T_A small.

The importance of accounting for self-heating can be

2. Nonlinear. A resistor's value may not change linearly with temperature (a). Moreover, resistor A meets its specified stability of $100 \text{ ppm}/^{\circ}\text{C}$ only at temperature extremes, while resistor B remains within specification over the full operating range (b).

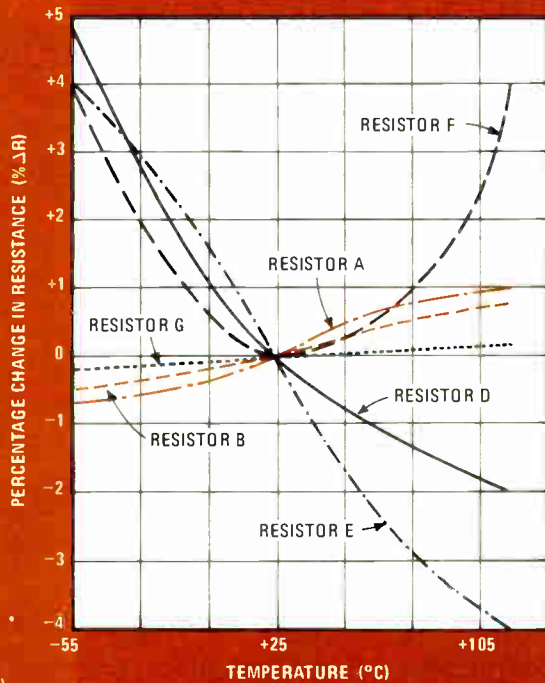

(a)

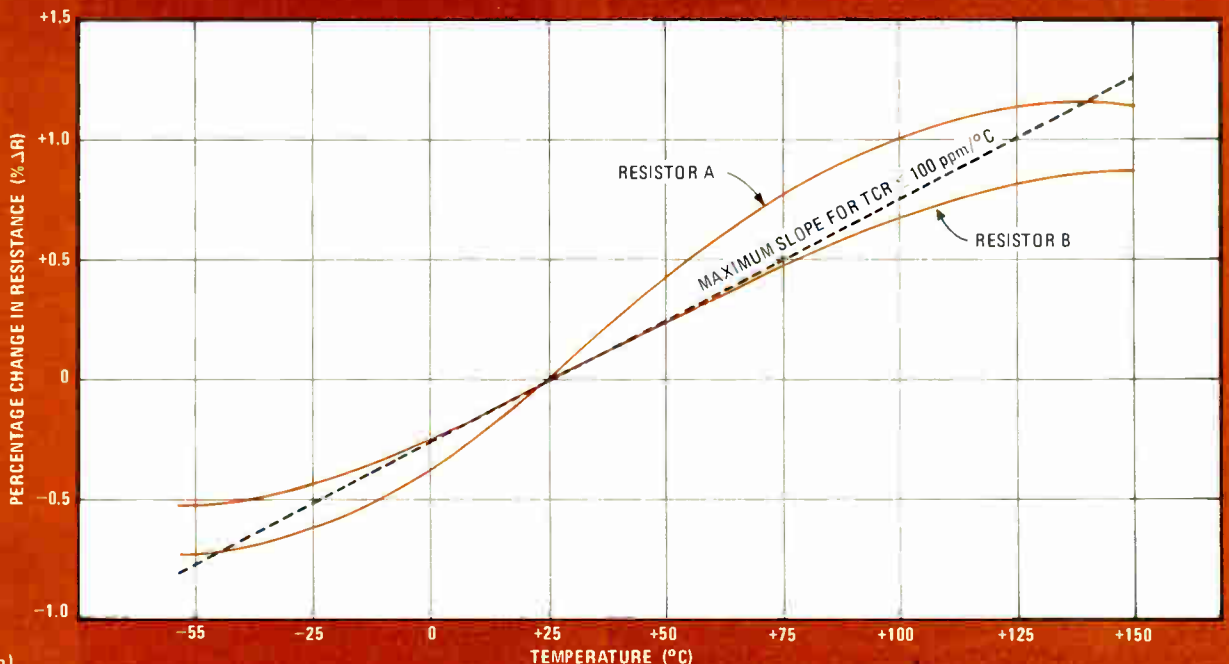

(b)

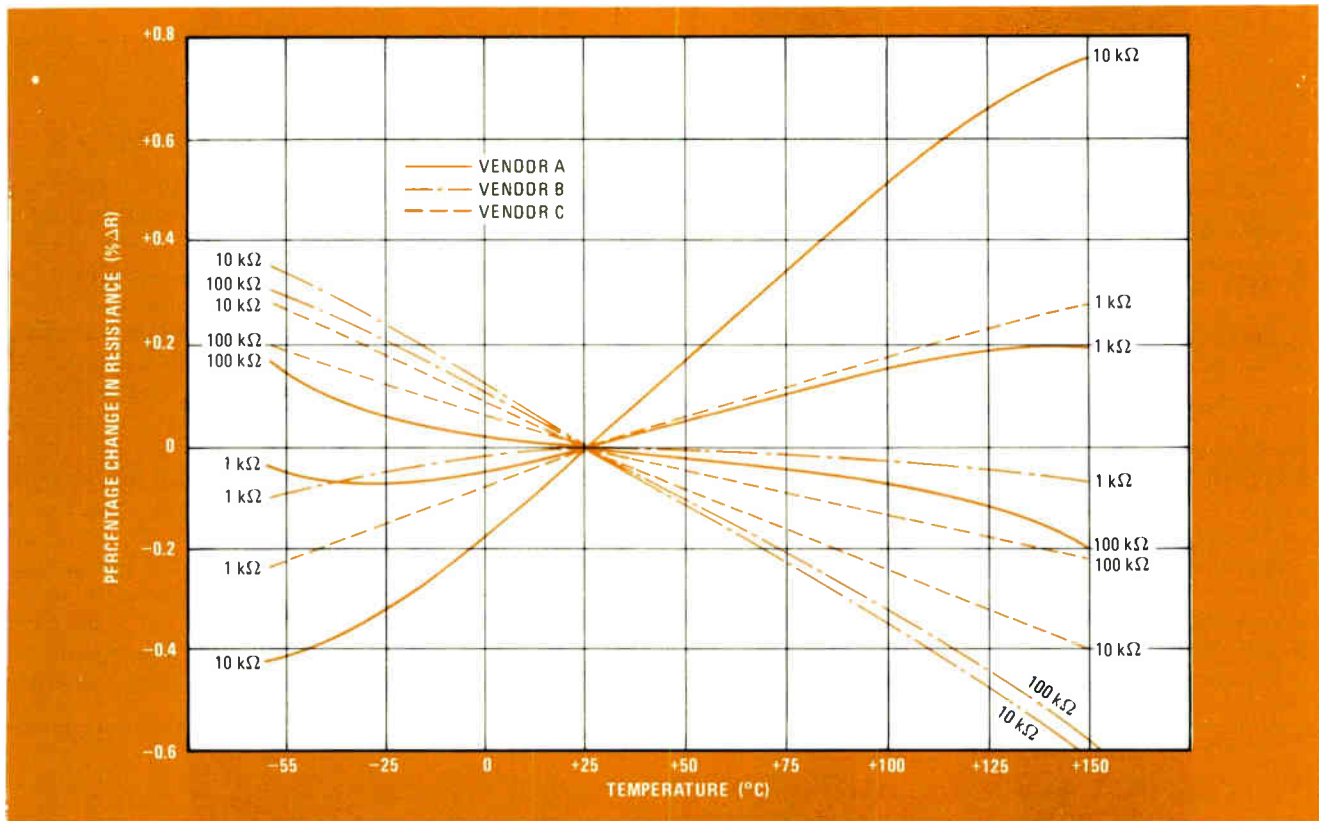

3. Same vendor, same shape. Resistors built by the same manufacturer tend to exhibit temperature characteristics with virtually identical shapes. This behavior tends to be independent of the nominal resistance value and the magnitude of the resistance change.

illustrated by an example. Suppose a ½-w resistor made by vendor B and having a TCR of 100 ppm/°C is to operate at its rated wattage in equipment where the maximum internal temperature is expected to be 60°C. What will be the worst-case resistance change when the equipment goes from an off condition at 25°C to an on condition at the maximum environmental temperature?

Equation 1 gives the answer readily. Since:

$$T_A = 60^\circ\text{C}$$

and from Fig. 1, for a ½-w unit made by vendor B and a power dissipation of 500 milliwatts:

$$T_R = 45^\circ\text{C}$$

and from the table:

$$\text{TCR} = 100 \text{ ppm}/^\circ\text{C} = 0.01\%/^\circ\text{C}$$

so that:

$$\% \Delta R = (60 + 45 - 25) \times 0.01 = 0.8\%$$

Therefore, if self-heating were neglected (by omitting T_R from the calculation), the maximum resistance change would be computed to be only 0.35%, which amounts to an error of 56%. Also, if a resistor from vendor A or vendor C were selected instead, the error would be even greater, as these devices have a higher power coefficient.

Furthermore, TCR does not necessarily remain constant with temperature, as has been assumed thus far. Quite the contrary, depending on resistor construction, TCR can be far from linear, as shown in Fig. 2a. Here, resistor G exhibits not only the best temperature

performance but also the most linear, while the behavior of resistor F is extremely nonlinear.

A closer look at the TCR characteristics of resistor A and resistor B (Fig. 2b) makes the importance of device construction even clearer. At temperatures of -55° or 150°C , which are common measurement points, the TCR of resistor A is better than 100 ppm/°C. However, from -40° to 140°C , the TCR exceeds 100 ppm/°C. On the other hand, resistor B, which has a similar TCR curve, meets the 100-ppm/°C specification over the entire temperature range of -55° to 150°C .

Look at operating region

Thus, a resistor's temperature stability depends on the slope of its TCR curve within the operating region, a fact that becomes particularly critical in applications where the resistor operates over only a narrow temperature spread. If the slope is significantly different from that at the vendor's measurement temperatures, the resistor will not behave as the designer expects.

Interestingly, the general shape of the TCR curve seems to remain basically the same for a given manufacturer, regardless of the magnitude of the TCR or the value of the resistor. Figure 3 illustrates this fact, showing the TCR characteristics of different-valued ¼-w metal-film resistors made by three vendors. The shape of the curves for those devices produced by a single manufacturer is nearly identical, whether the resistor's value is 1, 10, or 100 kilohms and no matter how much the resistance changes. Of course, an ideal TCR plot would be represented by a straight line. □

Two of 16 LEDs display 8-bit binary word

by Dennis Saputelli
SMS Co., San Francisco, Calif.

As a low-cost alternative to a numerical display, this binary-to-hexadecimal converter employs light-emitting diodes in an unusual manner. Only 2 LEDs out of a total of 16 light up at any one time to provide a unique indication of 1 out of a possible 256 states. The magnitude of the number may therefore be more quickly recognized from them than from a straight binary display, making it easier to spot trends in changing data.

The converter's operation is quite simple. An incoming

8-bit binary number is partitioned into two 4-bit words and presented to the input of the 74157 quad two-input multiplexer, as shown in the figure. A 50-to-60-hertz input clock moves high so that the 4 most significant bits of the number are selected. The strobe signal generated at the 7402 NOR gate moves low at this time, enabling the output lines of the 74154 4-to-16-line decoder, so that the hexadecimal equivalent of these bits is displayed. The clock then moves low, enabling selection and display of the 4 least significant bits.

Each LED must be distinguished from all the others so that the user is aware of its weight factor (16^0 or 16^1) in the hexadecimal system. All 8 bits of the word are sampled 60 times per second or so, which is fast enough to provide the appearance of a continuous glow in the most significant LED. Although the most significant bits are displayed at this rate, the least significant bits are displayed at only one quarter of this rate because of the

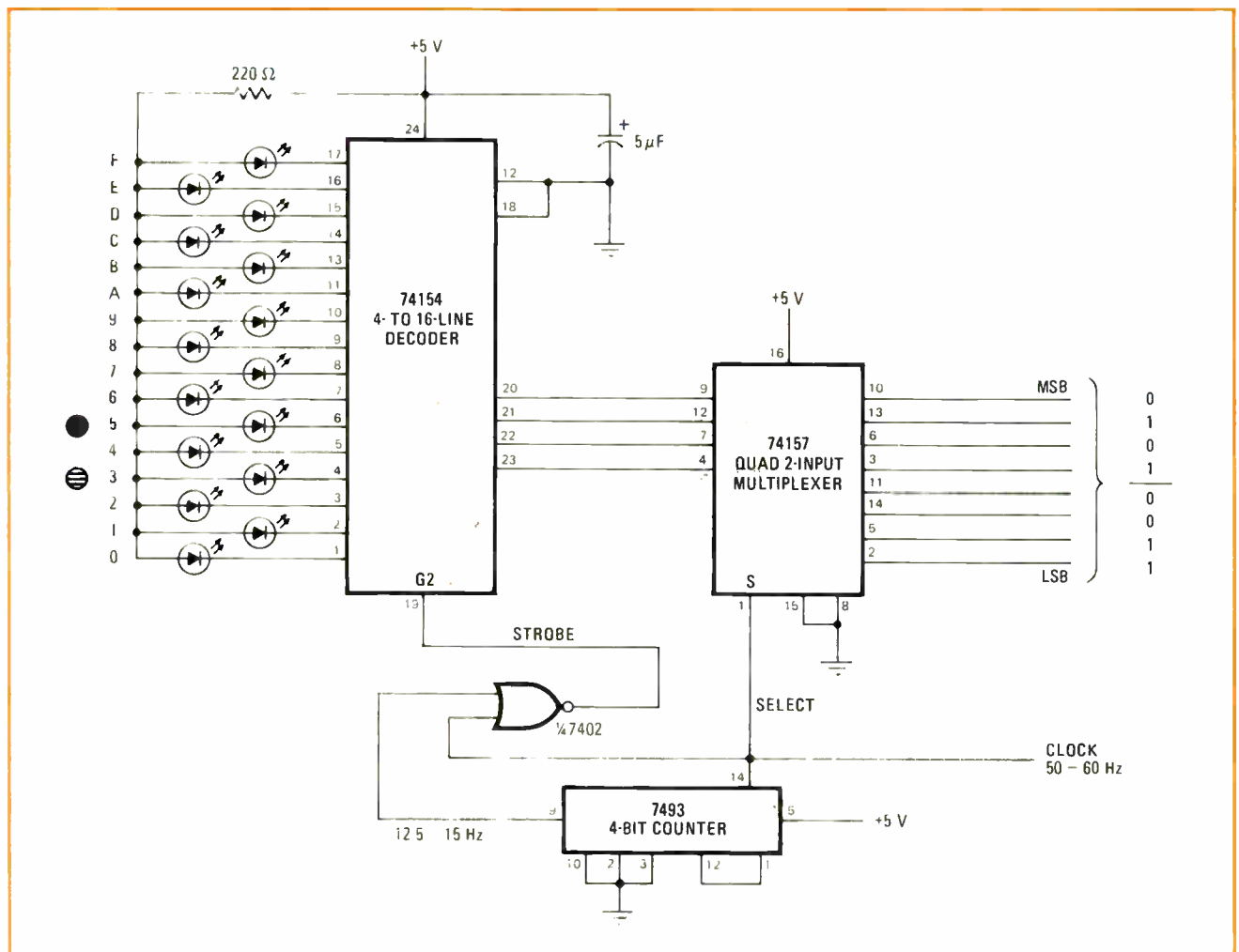

Binary conversion. Eight bit binary-to-hexadecimal converter uses standard ICs and very simple LED display. LED associated with most significant bit of word glows continuously, while flashing LED indicates value of least significant bit.

7493 divide-by-4 circuit driving the NOR gate. Note the example in the figure, which shows how the binary number 01010011 is converted to hex 53. The least significant LED, associated with the number 3, has a flicker rate of 15 Hz per second. This rate may be

reduced to 7 Hz if the NOR gate is driven by pin 8 of the 7493 instead of pin 9. □

Engineer's notebook is a regular feature in *Electronics*. We invite readers to submit original design shortcuts, calculation aids, measurement and test techniques, and other ideas for saving engineering time or cost. We'll pay \$50 for each item published.

Design checklist aids pc-board designers

by Robert J. Stetson
Storage Technology Inc., Aurora, Ill.

Invest the time for proper layout of your printed-circuit boards—it will reduce manufacturing costs and debugging time after production. Good design procedures not only will aid in providing a higher yield of working boards after etching, but they also can substantially

improve both reliability and operating characteristics.

The goal is easily achieved if the designer has a knowledge of board requirements, component-placement guidelines, and artwork considerations. What follows is a checklist covering these three vital areas.

The size and shape of the board, as well as its thickness, are important considerations in determining its cost. The board should be square or rectangular whenever possible—curved or oddly shaped boards should be avoided.

Exceptionally large boards may need special fixtures or etching vats to produce them; in some cases, two smaller boards may be more economical. Although the cost of connecting two boards can offset the savings

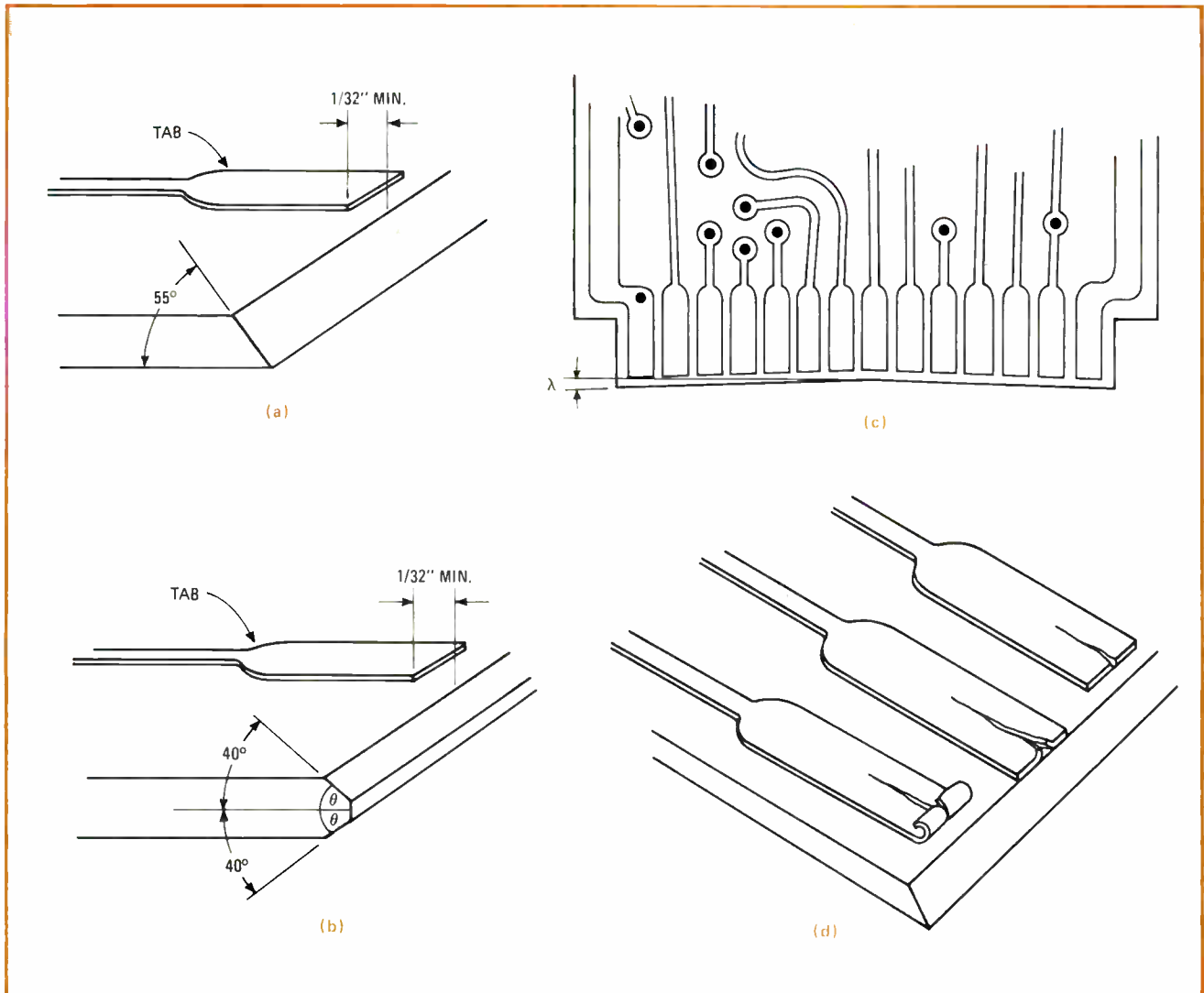

1. Connector considerations. Both single- (a) and double-sided boards (b) should be beveled to a specified angle. Another, but seldom used, bevel method is shown in (c). Poor design damages copper tabs (d). A properly gapped tab escapes destruction.

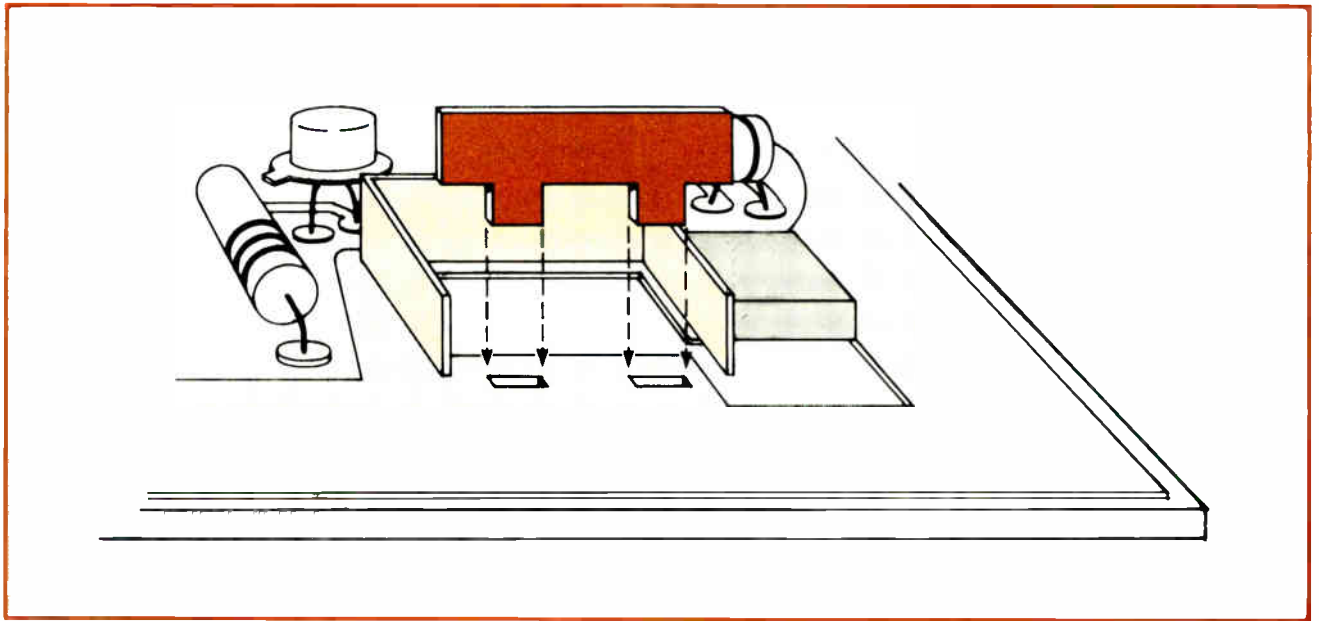

2. Shielding considerations. Metal vertical shielding plates are an effective but sometimes expensive solution for unwanted-coupling problems. This method is most efficient when used on double-sided boards in order to permit a shield connection to the ground bus.

expected with one board, it is often worth consideration.

Check that the board thickness is within specifications for any edge connector that may be used. The edge of the printed-circuit card should be beveled (Figs. 1a and 1b). There should be at least $\frac{1}{32}$ inch between the copper connector and the edge of the bevel or the tabs may be damaged by the connector pins after repeated use. Figure 1c shows an alternate method of fitting connector to board. Poor interfacing can lead to destruction of the tabs (Fig. 1d).

In laying out components on the board, consider the ventilation requirements of your particular circuit and its enclosure. Place high-wattage components to avoid interference with temperature-sensitive components or devices, such as the timing components on one-shot multivibrators. High-gain amplifiers should be placed away from any but the desired input-signal lines to avoid undesired coupling effects. Consider the use of vertical metal shielding plates connected to system ground (Fig. 2). The plates may be expensive, but they eliminate the offending signal.

When working with double-sided boards, try to maintain an even distribution of circuitry on both sides. Uneven distribution requires the board manufacturer to use "robber bars"—pieces of copper added to the low-density side of the board. These bars compensate for the difference in metal-surface area, which causes difficulties in etching during the plating operation. Robber bars are an added expense, which can be avoided if care is taken.

Avoid large areas of copper when designing a circuit board. During the wave-soldering operation, solder build-up will occur there. If large areas must be tolerated, use diamond or crosshatch (land) patterns spaced throughout the copper to eliminate the problem.

The elimination of dead tabs on the edge connector can save copper-plating costs. Also saved is the cost of the gold and nickel in those tabs.

Minimize the number of hole sizes. The fewer the number of different sizes, the less work to be done on the board.

The etch-resistant solder mask most times may be eliminated if the circuit patterns run in a direction parallel to the solder-wave process. This will reduce solder bridges between land areas and a number of other faults, provided the width of the land area is equal to the gap between the land areas, but no less than 0.025 in.

Establish uniform land widths that are as large as possible. It costs 20% more to produce a board with 0.012-in. land widths than 0.02-in. widths. Widths below 0.015 in. require dry-film printing for optimum results. This method is more costly than screen printing, and the yield is lower. Remember that the board will be produced with the processing techniques required to reproduce the thinnest land width on the board, just as though the entire board consisted of that particular width. That means more care, inspection, and a higher cost per unit.

Critical artwork should be 4 : 1 in scale to aid in the negative-making process. A scale of 2 : 1 may be used for most applications. This will permit the finished negative to be accurate to within 0.001 in.

An excellent technique for producing accurate double-sided artwork is to lay down the pads (connectors to individual components) and the edge connector on a clear Mylar drawing surface and to make two prints of the pattern on 0.007-in.-thick Mylar. The two copies should then be taped together and the conductor lines peculiar to either side drawn on their respective sides. This should result in an almost perfect match of the major land areas and connector pads. The technique is superior to the multicolor approach.

Try to give component identification and the polarity of the electrolytic capacitors and diodes on the circuit artwork. Their inclusion will eliminate an additional printing operation. □

WHY ARE MORE LEADING COMPANIES AND UNIVERSITIES BUYING DEC[®] FROM FIRST COMPUTER?

1. DISCOUNTS

Everyone can qualify for discounts, which range up to 20%. Special discount plans for qualified educational and OEM organizations are available.

2. DELIVERY

Prompt delivery of factory-fresh DEC[®] components and products is provided off-the-shelf. Plus, we also stock DEC 11V03[®], DECLAB[®] equivalent, and 11/03 Computing Systems, and can rapidly deliver both standard and customized systems.

3. SERVICE

Each customer and order is handled on a personalized basis. We can help you configure your system or select the proper component. Expedited delivery, rapid replies to information requests, and courteous treatment are assured.

4. CUSTOM CONFIGURATIONS

We will custom build systems to your specific requirements, with no resulting delays in delivery. We can package your system in a functional yet attractive desk, and provide additional memory, interfaces, terminals, and peripherals.

5. ADDED VALUE

Valuable software enhancements for each DEC 11V03[®], DECLAB[®] equivalent, or 11/03 Computing System delivered by First Computer are provided from our continually growing software library. Custom configurations are built to order, fully integrated, and tested prior to shipment.

6. WORLD-WIDE FIELD SERVICE

Because all of our systems are thoroughbred DEC[®], we can provide for on-site field service by DEC's own factory trained technicians world-wide.

7. WARRANTY

We provide the same warranty as DEC[®], plus, ask us about our priority exchange plan.

8. RENTAL/LEASING

We offer short-term rental or long-term leasing of complete systems. Ask about how these programs can help you meet your system acquisition and budget requirements.

WHAT THIS MEANS TO YOU

COMPLETE SYSTEMS

Standard or custom DEC 11V03[®], DECLAB[®] equivalent, or 11/03 Computing Systems with a \$1,000 savings and shipment in 30 to 60 days.

COMPONENTS

A complete stock of LSI-11[®] and 11/03[®] products for immediate delivery—at ATTRACTIVE DISCOUNTS.

Call FIRST first to find out how much money and time you can save. Call Don Berteau at (312) 920-1050.

FIRST COMPUTER CORPORATION

764 BURR OAK DRIVE, WESTMONT, ILLINOIS 60559

Call FIRST first



11/03 Computing Systems

® Registered trademark of Digital Equip. Corp., Maynard, Mass.



LSI-11[®] Components



DEC 11V03[®] Systems

Circle 123 on reader service card

SR-52 has two more hidden talents

Texas Instruments' SR-52 calculator has secrets other than those extra memory registers this page uncovered last year, observes Fredric N. Fish III of Tempe, Ariz. In the learn mode, he explains, the SR-52 has 100 different two-digit codes for programming a given operation. However, 16 of them are not normally used, and two of these—31 and 73—can be put to work for you. For example, when 31 is reached during program execution, the calculator automatically halts and goes into the learn mode. This capability can be **very useful as a prompt to enter a coding sequence such as a function subroutine.** The other code, 73, if it immediately follows a label, resets the program counter without affecting the flags. This comes in handy in a situation that would normally require the RSET key but needs to preserve the flag status.

How to make fast work of factorials

Computing factorials for statistical analyses can be time-consuming drudgery, especially if the number is rather large and your calculator doesn't offer a direct factorial operation. However, you can get your answer quite quickly in a single computation if you use **a neat approximation that is accurate to within 1%, even for factorials as large as 69!** (which, incidentally, is about the limit of any calculator's ability). The equation is simply: $n! = n^n e^{-n} (2\pi n)^{1/2}$. But it's best to break up the computation as: $n! = n^{n/2} e^{-n} n^{n/2} (2\pi n)^{1/2}$, so that the calculator need not deal directly with n^n —a number that can easily overload your machine's internal registers.

Ballot proposes changes to IEEE constitution

With all the hoopla about the multi-candidate races for the top posts in the Institute of Electrical and Electronics Engineers, don't overlook the vote for propositions to change the constitution. There will be at least three this year. The first, put on by the IEEE board of directors, would **advance the date at which nominating petitions need to be submitted.** The idea is to allow more time to put together the final ballots, as well as the statements and rebuttals of the various candidates. The second is a plan to reduce the number of regions from 10 to 7—6 for the U. S. and 1 for all foreign sections, thereby equalizing the voting power on the board of directors among U. S. regions with thousands of members and outside areas with fewer members. The third proposition is a rerun of one from last year that got a majority of "yea" votes, but not the two thirds necessary to pass. **This proposal would require that all increases in dues be put to a vote of the members.**

The truth about power-transistor hotspots

When large voltages or currents must be switched or amplified, designers often turn to power transistors. But, says the National Bureau of Standards, **the limits that traditionally characterize the safe operating areas of power transistors do not cope adequately with the phenomenon of thermal instability,** which can lead to destructive hot spots. So, the bureau is offering a free 28-minute videotape, "Safe Operating Area Limits for Power Transistors," which suggests improved methods for measuring and specifying transistor power limits for forward-biased operation. The presentation is available in color on 3/4-inch cassettes and in black and white on 1/2-in. reels. To borrow it, contact: Ms. Elaine C. Cohen, A-327 Technology Building, National Bureau of Standards, Washington, D.C. 20234. **Lucinda Mattera**

YOU CHOOSE THE WINNER

PROCESSOR	6/16	NOVA 3/4	PDP-11/04
Data Type Lengths (bits)	4 8 16	16	1,8,16
Instruction Word Length (bits)	16 32	16	16,32,48
General-Purpose Registers	16	4	8
Hardware Index Registers	15	2	8
Maximum Memory Available (KB)	64	64	56
Directly Addressable Memory(KB)	64	2	56
Automatic Interrupt Vectoring	Standard	N/A	Standard
Parity	Optional	Optional	N/A
Cycle Time (nanoseconds)	600	800	725

PRICE	6/16	NOVA 3/4	PDP-11/04
8KB Processor	\$2200	\$2600	N/A
16KB Processor	\$2800	\$3200	\$3795
32KB Processor	\$4000	\$4400	\$4995
Multiply/Divide Hardware	\$ 950	\$1400	\$1820

Interdata's 6/16 wins the battle of the specs.

Not only do we cost less than the Nova 3/4 and the PDP-11/04, we have more features. Just compare: 16 general purpose registers on the 6/16 to simplify programming and reduce fetches . . . only 4 in the Nova and 8 in the 11/04; 15 hardware index registers on the 6/16 against 2 for the Nova and 8 for the 11/04; 64 KB of directly addressable memory instead of just 2 KB for the Nova 3/4 and 56 KB for the PDP11/04.

What's more: all these hardware features enhance the nimble 6/16's performance. Its cycle time is only 600 nanoseconds, compared to 800 for the Nova and 725 for the 11/04.

Interdata's comprehensive software drives this powerful hardware full out. You get the field-proven OS/16 MT2, a real-time, multi-tasking operating system providing instantaneous response to events, while allowing the user to minimize memory by storing non-critical functions on disks. And the 6/16 can be programmed in your choice of FORTRAN, BASIC or MACRO CAL.

All this and save money too, as much as one-third less than a PDP-11/04 and substantially less on a Nova 3/4 . . . with OEM discounts saving even more.

Get the whole story. Just fill in the coupon or call (201) 229-4040.

Send me 1977 specs on your Model 6/16 E-8

NAME _____ TITLE _____

COMPANY _____

ADDRESS _____

CITY _____ STATE _____ ZIP _____

PHONE _____

 **INTERDATA®**

A UNIT OF
PERKIN-ELMER DATA SYSTEMS
Oceanport, New Jersey 07757, U.S.A.

INTRODUCING DELCO ELECTRONICS' MONOLITHIC OPERATIONAL AMPLIFIER

If you're now using discrete power output transistors, we've got an alternative that gives you design versatility.

It's the DA-101—Delco's Monolithic Operational Amplifier—with all the circuitry you need in one compact package.

The Monolithic Operational Amplifier (MOA) has two separate gain and power stages contained in a modified dual-in-line package.

The DA-101 operates from a 10- to 16-volt DC supply and can be used in an audio bridge configuration with floating speaker output, or as two separate amplifier-speaker systems.

The MOA means weight savings in more ways than one. Besides reducing the total number of components you need, the MOA has a copper mounting surface to assure ample heat transfer to the convectory. The tab negative or ground connection eliminates the need for mica insulation.

In fact, the design of one power megaphone showed a components weight savings of 65 per cent.

Our new MOA means added design application flexibility, too. In automotive and home entertainment systems, two-way communication systems, power megaphones, motor controls, various H switch applications, and more.

Another advantage of our Monolithic Operational Amplifier is its durability. It has integral protective circuitry for not only overvoltage, but

temperature, current conditions and shorted outputs as well.

And it can be mounted by either direct soldering to a printed circuit board or through the use of a suitable socket.

For more information, contact an authorized Delco distributor, your nearest Delco sales office, or return the coupon on the right.

ABSOLUTE MAXIMUM RATINGS

Supply Voltage	24V
Operating Voltage	16V
Peak Current	3A
Storage Temperature	-55°C to 150°C
Power Dissipation	22W

ELECTRICAL CHARACTERISTICS

	TYPICAL
V _{cc} = 14V dc	
I _{in} P _{out} = 0W	40mA
Differential Input Bias Current	0.80 μA
Open Loop Gain	90dB
Power Out @ 5% Distortion	
4Ω Bridge	6W
4Ω Non-bridge	3.5W

THERMAL CHARACTERISTICS

Thermal Resistance, R _{θjc} (Typical)	4°C/W
------------------------------------------------	-------

AUDIO BRIDGE CIRCUIT

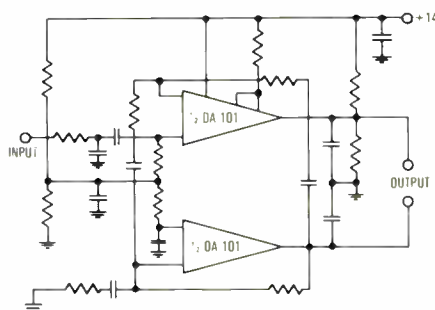

TWO SEPARATE AMPLIFIERS CIRCUIT

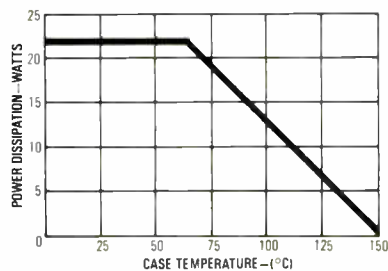
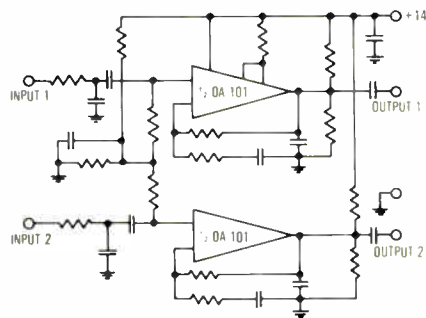

DIMENSIONS AND CONNECTIONS

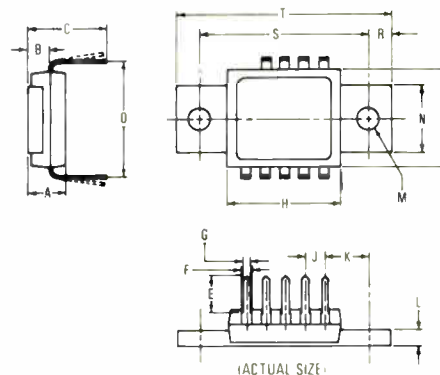

SYMBOL	INCHES		MILLIMETERS	
	MIN.	MAX.	MIN.	MAX.
A		270		5.59
B	127	133	3.27	3.38
C	423	443	10.746	11.254
D	628	637	15.95	16.05
E	215	225	5.463	5.717
F	044	048	1.13	1.21
G	015	019	0.39	0.47
H	644	650	16.37	16.52
J	095	105	2.413	2.667
K	275	285	6.983	7.237
L	086	096	2.183	2.437
M	1220	1280	3.100	3.250
N	369	379	9.373	9.627
P	539	549	13.693	13.947
R	120	130	3.053	3.307
S	955	965	24.253	24.507
T	199	1219	30.446	30.954

NOW AVAILABLE FROM THESE DISTRIBUTORS IN PRODUCTION QUANTITIES.

ALABAMA

HUNTSVILLE
Powell Electronics
(205) 539-2731

ARIZONA

PHOENIX
Sterling Electronics, Inc.
(602) 258-4531

CALIFORNIA

GARDENA
Bell Industries
Electronics Distributors Div.
(213) 321-5802

GOLETA
R.P.S. Electronics, Inc.
(805) 964-6823

LOS ANGELES
Kierulff Electronics, Inc.
(213) 725-0325

R.P.S. Electronics, Inc.
(213) 748-1271

PALO ALTO
Kierulff Electronics, Inc.
(415) 968-6292

SAN DIEGO
Kierulff Electronics, Inc.
(714) 278-2112

R.P.S. Electronics, Inc.
(714) 292-5611

SUNNYVALE
Bell Industries
(408) 734-8570

COLORADO

DENVER
Kierulff Electronics, Inc.
(303) 371-6500

CONNECTICUT

NORWALK
Harvey Electronics
(203) 853-1515

FLORIDA

CLEARWATER
Diplomat/Southland
(813) 443-4514

MIAMI SPRINGS
Powell Electronics/Florida
(305) 592-3260

ILLINOIS

ELK GROVE VILLAGE
Kierulff Electronics, Inc.
(312) 640-0200

SKOKIE
Bell Industries
Electronics Distributors Div.
(312) 282-5400

INDIANA

INDIANAPOLIS
Graham Electronics
Supply, Inc.
(317) 634-8202

MARYLAND

BALTIMORE
RESCO/Baltimore
(301) 823-0070

MASSACHUSETTS

BILLERICA
Kierulff Electronics, Inc.
(617) 935-5134
(617) 667-8331

NEWTON
The Greene-Shaw Co., Inc.
(617) 969-8900

MICHIGAN

LIVONIA
Pioneer/Michigan
(313) 525-1800

MINNESOTA

MINNEAPOLIS
Stark Electronics Supply Co.
(612) 332-1325

MISSOURI

KANSAS CITY
Walters Radio Supply, Inc.
(816) 531-7015

ST. LOUIS
LCOMP-St. Louis
(314) 291-6200

NEW JERSEY

CINNAMINSON
Wilshire Electronics/
Philadelphia
(609) 786-8990
(215) 627-1920

CLIFTON
Wilshire Electronics/
New Jersey
(201) 340-1900
(212) 244-8930

NEW MEXICO

ALBUQUERQUE
Sterling Electronics
(505) 345-6601

NEW YORK

BINGHAMTON
Harvey Electronics
(607) 748-8211

BUFFALO
Summit Distributors, Inc.
(716) 884-3450

FARMINGDALE
Wilshire Electronics/
Long Island
(516) 293-5775

FREEPORT
Milgray/New York
(516) 546-6000

WOODBURY
Harvey Electronics
(516) 921-8700
(212) 895-9260

OHIO

CINCINNATI
United Radio, Inc.
(513) 761-4030

CLEVELAND
Pattison Supply Co.
Industrial Electronics Div.
(216) 441-3000

DAYTON
Pioneer/Dayton
(513) 236-9900

OREGON

PORTLAND
Almac/Stroom Electronics
(503) 292-3534

PENNSYLVANIA

PHILADELPHIA
Almo Electronics
(215) 698-4000

PITTSBURGH
CAM/RPC Electronics
(412) 782-3770

SOUTH CAROLINA

COLUMBIA
Dixie Radio Supply Co., Inc.
(803) 779-5333

TEXAS

DALLAS
Sterling Electronics
(214) 357-9131

HOUSTON
Harrison Equipment
Co., Inc.
(713) 652-4700

Sterling Electronics
(713) 627-9800

WASHINGTON

SEATTLE
Almac/Stroom Electronics
(206) 763-2300

Kierulff Electronics, Inc.
(206) 575-4420

SPOKANE
Almac/Stroom Electronics
(509) 928-0679

IN CANADA:

Zentronics Ltd.
Toronto (416) 635-2822
Ottawa (613) 238-6411
Montreal (514) 735-5361

OVERSEAS: EUROPEAN INQUIRIES:

European Parts &
Accessories Marketing
Group
General Motors Continental
Plant 2, Noorderlaan,
Postbus 9
B-2030, Antwerp, Belgium

ALL OTHER OVERSEAS INQUIRIES:

General Motors Overseas
Operations
Parts & Accessories Dept.
767 Fifth Avenue
New York, N.Y. 10022
(212) 486-4412

DELCO ELECTRONICS REGIONAL SALES OFFICES

Charlotte, North Carolina
28209
4600 Park Road
(704) 371-5160
Van Nuys, California 91404
Box 2968
(213) 988-7550

GENERAL SALES OFFICE

700 E. Firmin, Kokomo,
Ind. 46901
(317) 459-2175



FOR MORE INFORMATION ABOUT
DELCO'S NEW MONOLITHIC
OPERATIONAL AMPLIFIER, MAIL
THIS COUPON TO:

Delco Electronics Division
General Motors Corporation
Marketing Services MS A-213
700 E. Firmin Street
Kokomo, Indiana 46901

NAME _____

TITLE _____

COMPANY _____

ADDRESS _____

CITY _____

STATE _____

ZIP _____

PHONE _____

**Delco
Electronics**



11

E-8/18

Great products.



1948



1955

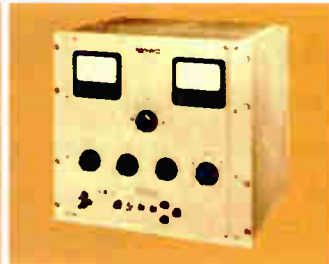

1959



1959



1959

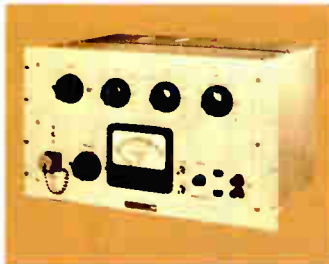

1960



1963



1963



1965

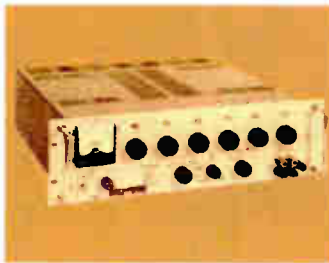

1965



1965



1965



1966

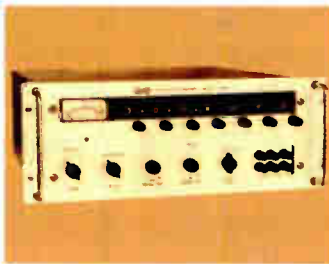

1966

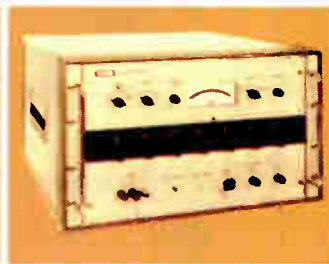

1967



1969



1971



1972



1974



1974



1975



1975



1976



1976

Great product, smaller.



You know Fluke for innovation in precision test and measurement instrumentation. For almost 30 years, we've anticipated the measurement problems that come with fast-changing technology.

And we've done it again. Introducing the new 8020A digital multimeter.

The 8020A DMM is built to the same high standards we've designed into its predecessors. The only difference is that the 8020A is smaller. And, of course, it costs a lot less.

You'll find the 8020A is the only DMM around with such impressive features for only \$169,* now and for

some time to come. Features that mean value and versatility, like 26 ranges and *seven* functions, including conductance (which measures leakage to $10^{10}\Omega$). And three-way overload protection. Hi-lo power ohms. And more.

In fact, the 8020A is 13 ozs. of pocketable benchtop instrument performance, in the Fluke tradition. Performance you can count on for up to 200 hours of continuous battery operation—thanks to its single, custom CMOS LSI chip and low-power 3½-digit LCD display.

Great performance, low cost: *that's* Fluke tradition. Where else can you

get a field reliable tool built to precision lab standards? Or, factory calibration that's NBS traceable, with 0.25% dc accuracy? And, of course, the Fluke 8020A has a full-year warranty including all specifications, with worldwide service backup.

The quickest way to get one is to call (800) 426-0361, toll-free. Give us your chargecard number and we'll ship one immediately. Or a "ten-pack" for only \$1521.* And we'll tell you the location of the closest Fluke office or distributor for a hands-on demonstration.

*U.S. Price Only

Command Performance: Demand Fluke.

FLUKE
®

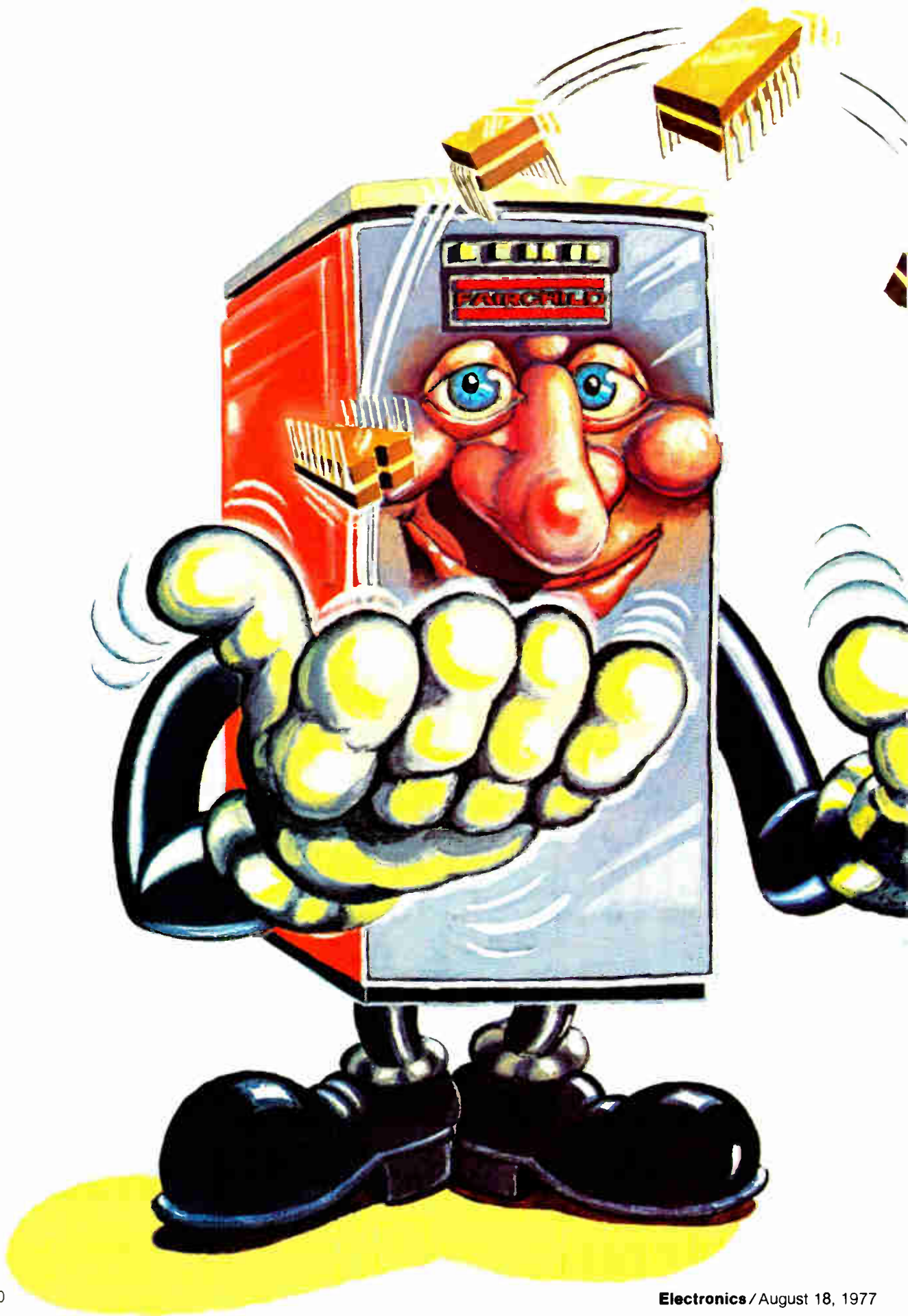

THERE'S ONLY ONE WAY TO TEST 16k RAMS— FOUR AT A TIME.

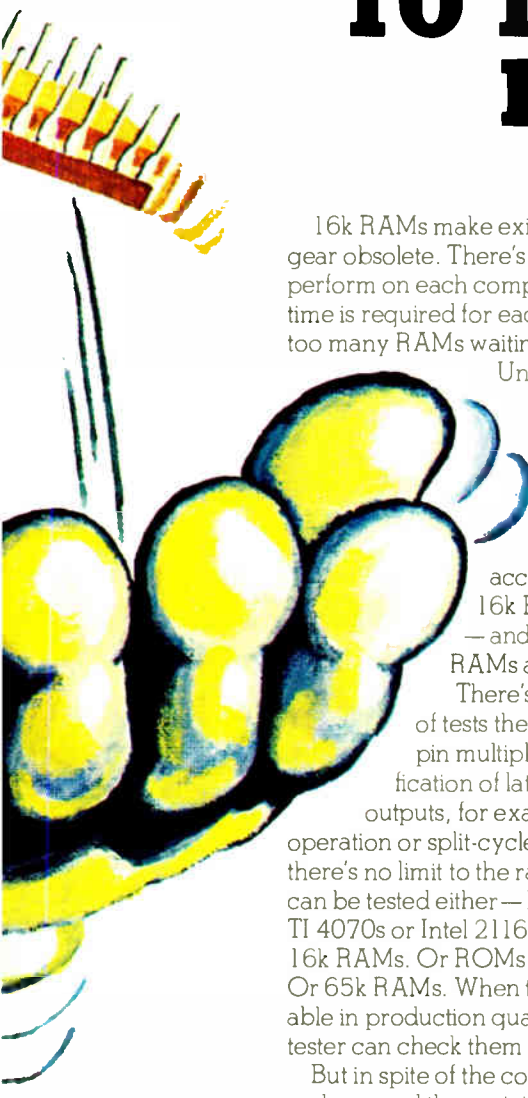
An illustration of a hand holding a RAM chip. The hand is rendered in a stylized, almost abstract manner with yellow and blue tones. The RAM chip is shown as a long, thin strip with many pins, held between the fingers of the hand.

16k RAMs make existing memory test gear obsolete. There's just too many tests to perform on each component, too much time is required for each test, and there are too many RAMs waiting to be checked out.

Until now.

With Xincor's Quad tester you can perform all the complex functional testing needed to thoroughly and accurately check out any 16k RAM on the market — and you can do it four RAMs at a time.

There's no limit to the range of tests the Quad can perform — pin multiplexing checks, verification of latched or unlatched outputs, for example. Or page-mode operation or split-cycle timing tests. And there's no limit to the range of devices that can be tested either — Mostek 4116s, TI 4070s or Intel 2116s to name just a few 16k RAMs. Or ROMs of any size up to 65k. Or 65k RAMs. When these become available in production quantities, the Quad tester can check them out four at a time too.

But in spite of the complex test procedures and the variety of devices that the Quad can handle, throughput rates are comparable to those associated with simpler, 4k-device testers. For large scale applications, up to four Quad testers can

be hooked together in parallel, giving you the power to check out 16 16k devices at one shot.

That's the good news.

Even better news is this. With the Quad's four-up parallel testing capability, per-socket costs come down — under \$35k. As a result, per component test costs come down too.

But the number of extras you get with a Quad tester goes up. As part of the Xincor III distributed automatic test system, the Quad tester can be used to store, analyze and process vast amounts of test data — schmoo plots for example, or wafer maps, or device-by-device, shift-by-shift yield/trend comparisons. You also get compiling and test-program editing capabilities.

And we do it all for you. We'll provide the software, and we'll put the system in. Then we'll assign an on-site team to run the Quad through its paces in conjunction with your engineering and production staffs to insure it does what it's supposed to do even under the most demanding industrial environments.

We'd like to show you a Quad tester, and we'd like to show you what it can do. Call or write us for more information.

The Quad tester: a four-taste of things to come from Xincor. Xincor Systems, Division of Fairchild Camera & Instrument Corp., 8944 Mason Avenue, Chatsworth, California 91311 (213) 341-5040 or TWX 910-494-2769.

FAIRCHILD

Allen-Bradley Variable Resistors:

We have what you need.

**Our distributors have
them when your
need is now.**



ALLEN-BRADLEY VARIABLE RESISTORS



Type J: $1\frac{1}{32}$ " diameter. Hot-molded carbon composition. 50 ohms to 5.0 megs. 2.25W at 70°C. 100M cycle rotational life. Single, dual, triple sections. SPST switch optional. Many other options. Publication 5200. **500 piece price \$1.27 (single).**



Type EJ: $1\frac{1}{32}$ " diameter. Hot-molded carbon composition. 50 ohms to 5.0 megs. 2.25W at 70°C. 1 MILLION cycle rotational life. Single and dual sections. Slip clutch optional. Many other options. Publication 5230. **500 piece price \$1.50 (single).**



Series 70: $\frac{5}{16}$ " square MOD POT.* Hot-molded composition, cermet, conductive plastic. 50 ohms to 10.0 megs. 100M cycle rotational life. Single, dual, triple sections. Switches optional. Many other options. Publication 5217. **500 piece price \$1.19 (single).**



Series 72: Case, bushing and shaft are non-metallic (for double insulation). Otherwise, same as Series 70. Singles and duals only. Publication 5217. **500 piece price \$0.90 (single).**



Series 73: A lower priced version of Series 70. Singles and duals only. Publication 5217. **500 piece price \$1.04 (single).**



Type G: $\frac{1}{2}$ " diameter. Hot-molded composition. 100 ohms to 5.0 megs. 0.5W at 70°C. 50M cycle rotational life. SPST switch optional. Many other options. Publication 5201. **500 piece price \$1.72.**



Type GD: Dual section version of Type G. Well suited for attenuator applications. Publications 5213 and 5221. **500 piece price \$3.67.**



Type W: A lower priced version of Type G. Publication 5212. **500 piece price \$1.19.**



Type WR: Radial lead version of Type W. SPST switch optional. Publication 5220. **500 piece price \$1.30.**



Type SP: $\frac{3}{8}$ " diameter. Cermet element. 50 ohms to 1.0 megs. 1.0W at 70°C. 25M cycle rotational life. Publication 5216. **500 piece price \$2.00.**



Type M: 10.0 MM (.394") cube. Conductive plastic element. 100 ohms to 1.0 megs. 25M cycle rotational life. Single and dual sections. Switches optional. Other options. Case, bushing and shaft are non-metallic. Publication 5239. **500 piece price \$2.12 (single).**

Quality in the best tradition.



ALLEN-BRADLEY

Milwaukee Wisconsin 53204

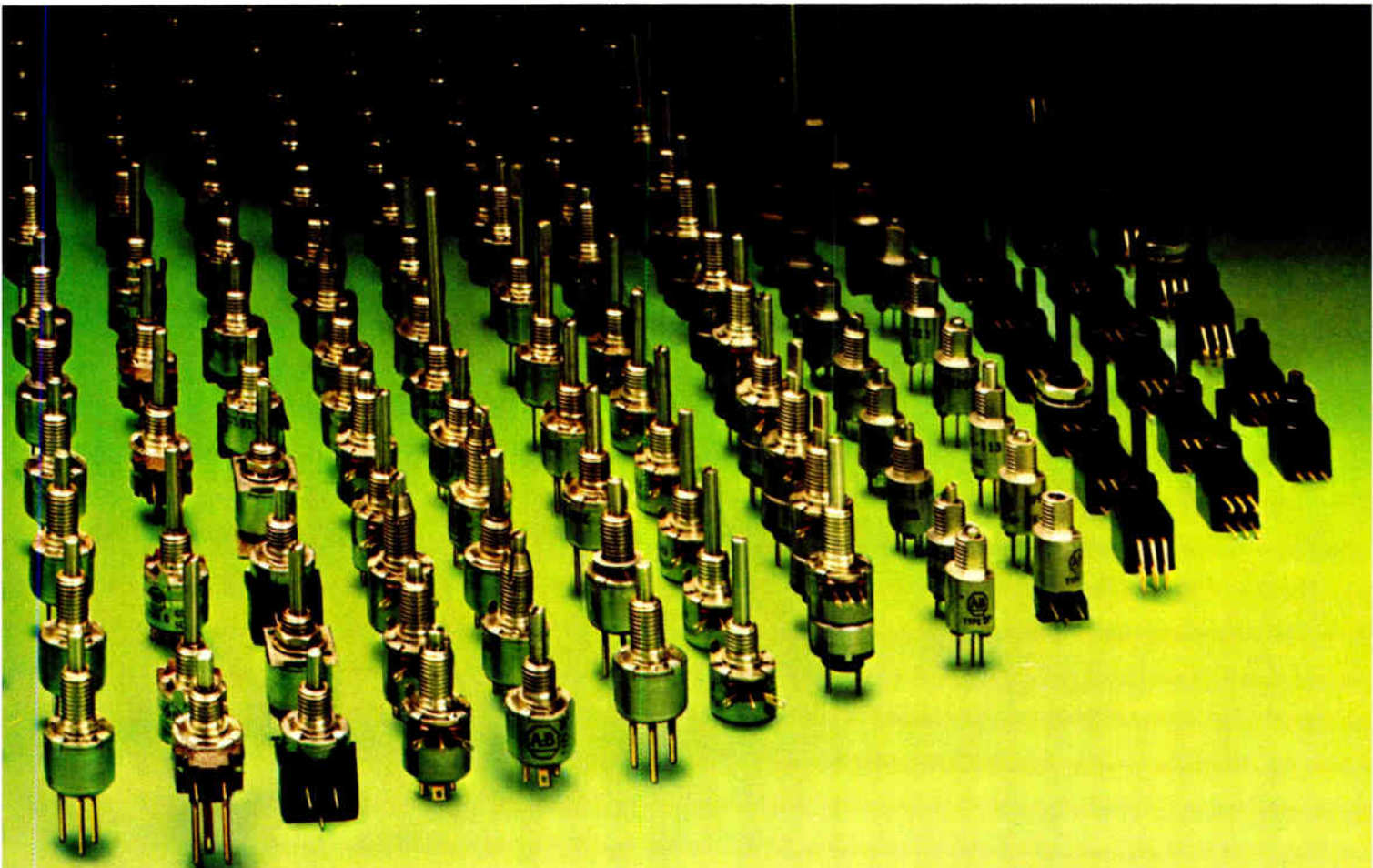

Circle 133 on reader service card



IF THE TELETYPE® MODEL 40 SYSTEM EVER MALFUNCTIONS, IT'S DESIGNED TO TELL YOU WHAT'S WRONG.

Even though we probably go to more trouble to insure uninterrupted reliability than anyone else, we're still realistic enough to admit that sometime something's going to go wrong.

So instead of burying our heads in the sand and pretending it won't, we've concentrated our efforts on what can be done to make downtime as short and painless as possible.

For starters, we gave the model 40 product line its own diagnostic capability. To tell you quickly what's wrong. Then, to make it easy to fix, we used a modular design concept. The result is an average mean-time-to-repair of only 3/4 hour.

We also made sure that when something does go wrong, you'll never be alone. We've got a nationwide service network standing behind every product with the Teletype name on it. We offer on-call repair service, maintenance contracts, and even an exchange repair service on components and parts.

The way we look at it, building something the best way humanly possible is only half our job. The other half is being ready for the unexpected.

For more information about the Teletype model 40 product line, write: Teletype, 5555 Touhy Ave., Skokie, IL 60076. Or call: 312/982-2000.



Teletype is a trademark and service mark registered in the United States Patent and Trademark Office.

Circle 134 on reader service card

Built-in diagnostics pinpoint trouble

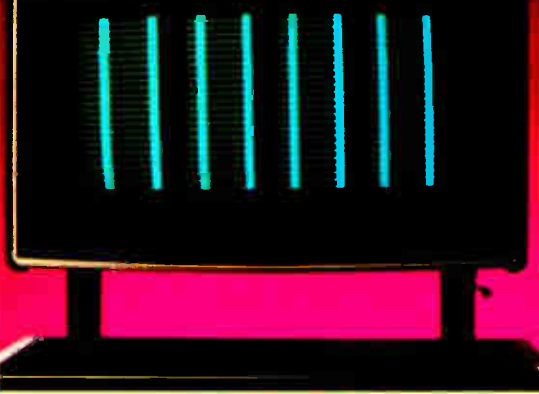

Average repairs take only 3/4 hour



Exchange repair of major assemblies

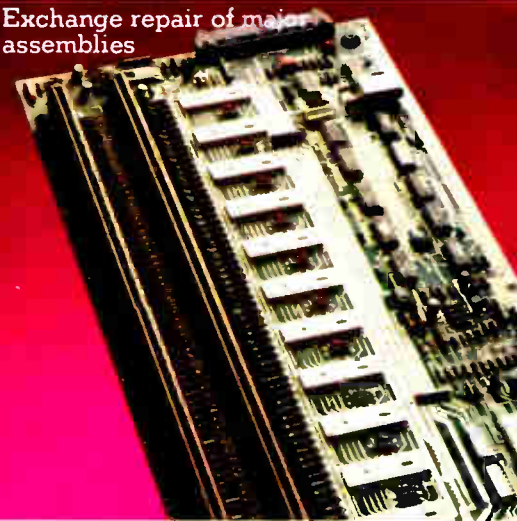

Nationwide service



Spectrum analyzer eases operator's job

Covering 100 hertz to 1.5 gigahertz, instrument uses three microprocessors for control of functions, automatic calculation of measurement results

by Stephen E. Scrupski, Instrumentation Editor

With three microprocessors to control nearly all functions, calculate results, and compute correction factors, Hewlett-Packard's HP-8568A takes much of the struggle out of spectrum analysis. Covering 100 hertz to 1.5 gigahertz, the analyzer even has a new high-stability method of phase-locking local oscillators.

All the 8568A's functions are set from its keyboard, although a single knob on the front panel can be used for continuous variations, and results are numerically displayed on the cathode-ray tube. An internal memory can store control settings in order to recall a particular display.

To identify points on a signal, there is a tunable marker that causes the signal amplitude and frequency

to be displayed on the CRT in number form with counter-type accuracy. A second marker allows relative measurements, displaying the difference in amplitude and frequency between the two markers—an advantage in modulation and distortion measurements. The second marker also can be set at a fixed harmonic or channel spacing from the first, so the operator can simply step frequencies to track higher-order harmonics or additional channels.

As for performance, the 8568A analyzer offers:

- A frequency-tuning accuracy that is within 150 Hz.
- A frequency stability that is essentially that of the 1-part-in-10⁹-per-day frequency reference.

- Resolution of 10 Hz across the entire band of 100 Hz to 1.5 GHz.
- Local-oscillator noise sidebands typically more than 80 decibels down 100 Hz away at 10-Hz resolution.
- Spurious-response-free dynamic range greater than 85 dB.
- Amplitude measurement range of -137 dBm to +30 dBm with ac- or dc-coupled inputs.
- Calibrated display range of 90 dB.
- Overall amplitude accuracy within ± 2.5 dB.

The improved stability, spectral purity, and accuracy all result from a new phase-locking system for the analyzer's local oscillators. In previous spectrum analyzers, several local oscillators were used. This led to difficulty in determining the exact

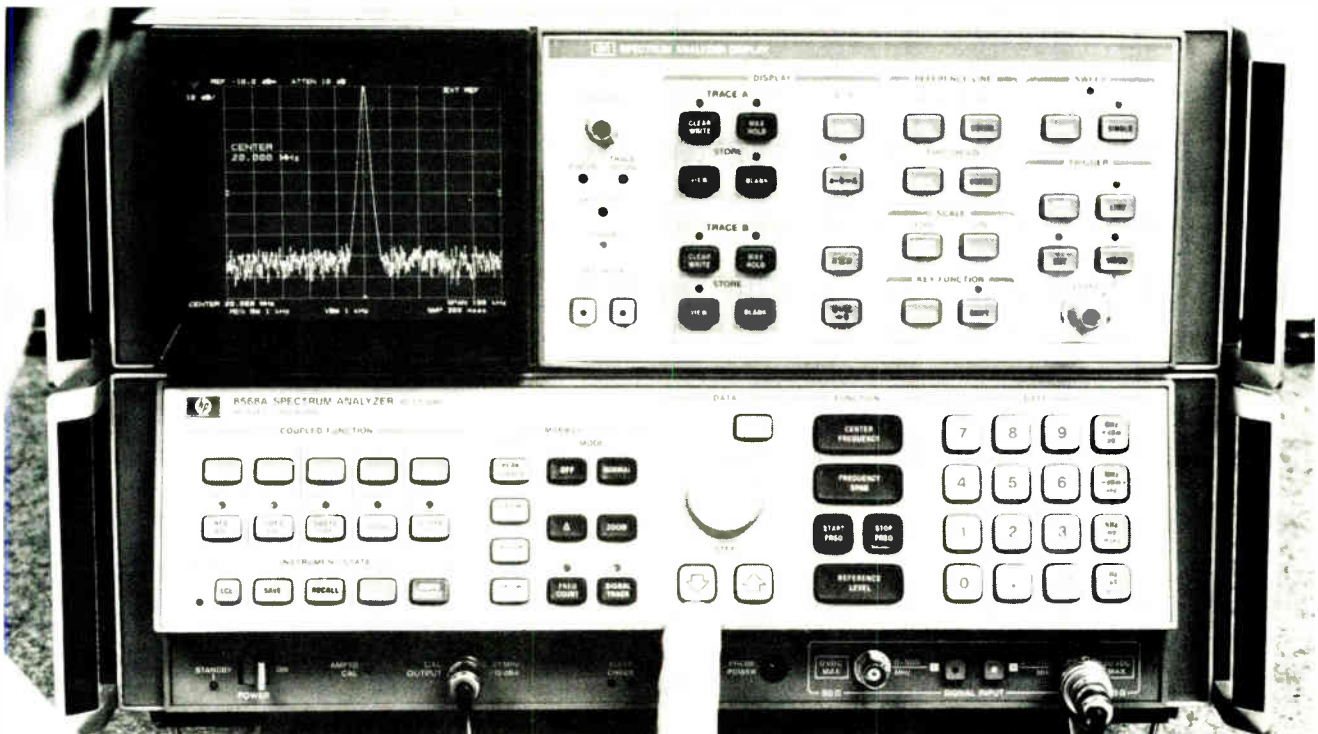

**You made us
Number One
in standard
enclosures.**

**Now,
we'd like to
make you
something
"special."**

Bud enclosures repeatedly score number one in brand preference studies. Why? Because you know what we're doing! That's why you've made us Number One. But what about special enclosures? No one comes close. Here's why.

You have options. We can build your special enclosure by modifying one of our 2700 standard enclosures. And by using existing dies and tooling, you save money!

However, if your enclosure design calls for more than modifying a standard, we'll help you design it, then build it.

Hundreds of firms have asked us to build special enclosures during the past 50 years. And why not! They know we're the Number One designer and manufacturer of enclosures. Standards. And specials.

You've got our number! Dial it now, toll free, if you want to talk about special enclosures. (800) 321-1764; in Ohio, (800) 362-2265.

**An extra
"special" offer!
Win a trip to the
next Super Bowl!**

Circle Bud's number on the reader service card and we'll mail you a brochure on our special fabrication service and an entry form for our Super Bowl Sweepstakes!

BUD

BUD INDUSTRIES, INC.
4605 East 355th Street
Willoughby, Ohio 44094

BUD WEST, INC.
3838 North 36th Avenue
Phoenix, Arizona 85019

New products

frequency to which the receiver is tuned, since each oscillator's frequency must be counted and then computations must be performed. Also, the oscillators' residual fm and phase noise was superimposed on the input signal so the system's resolution depended on the spectral purity of the worst oscillator. And since one or more of the local oscillators were swept, often over wide ranges, it was hard to achieve good spectral purity.

In the 8568A, however, a stable, spectrally pure, precise frequency comb is used to drive the local oscillators, and a comb line near the tuned frequency is converted into a pilot intermediate frequency and phase-locked to the reference frequency. The phase-locking voltage is then applied to the first local oscillator, and once the loop is locked, any inaccuracy, noise, or fm due to it is canceled. Thus, purity and accuracy are determined by the reference frequency alone.

Almost all functions and controls are activated by digital command, either from the operator via the front panel or remotely via the HP interface bus. The internal microcomputer, a hybrid processor initially developed for the HP-9825A desktop counter, interprets the commands and controls system operation. Another microprocessor serves as the interface to the HP interface bus. A third microprocessor controls the digital display storage using 1,024 bits of read-only memory and 4,096 bits of random-access memory to perform functions associated with the analog-to-digital conversion of video signals and the CRT trace.

The main memory bank for the spectrum analyzer consists of 14 kilowords of ROM and 1 kiloword of complementary-metal-oxide-semiconductor RAM. It stores control settings, error-correction data, and instructions that automatically set up the optimum combination of such functions as sweep time, resolution bandwidth, and video filtering to match operator changes in frequency span.

Price of the 8568A is \$27,800.

Hewlett-Packard Co., 1501 Page Mill Rd., Palo Alto, Calif. 94304 [338]

Gas Sensing Semiconductor

FIGARO TGS GAS SENSOR

quickly senses
even small
amount
of gas.

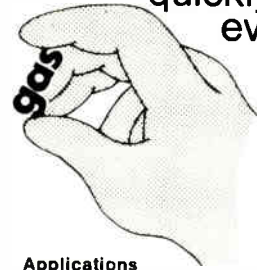

Applications

1. Natural Gas-Leak Alarm
2. Propane Gas-Leak Alarm
3. Carbon Monoxide Detector
4. Automatic Fan Control
5. Fire Alarm (Detecting combustible gases contained in smoke)
6. Alcohol Detector (Detector for drunken driver)
7. Air Pollution Monitor

Please contact any of the addresses below directly for catalogs and price details, information.

FIGARO ENGINEERING INC.

●Head Office: 3-7-3 Higashitoyonaka, Toyonaka City, Osaka, 560, JAPAN. TELEX 05286155 FIGARO J. CABLE FIGARO TOYONAKA. TEL (06) 849-2156

●North America: 3303 Harbor Boulevard, Suite D-8, Costa Mesa, California 92626, U.S.A. TELEX 678396 CABLE FIGARENGIN COSTAMESA. TEL (714) 751-4103
Circle 226 on reader service card

SOC FUSES
meet
World-wide standards



UL CSA SEMKO CB(CEE) MITI

- QUICK ACTING
- MEDIUM TIME DELAY
- TIME DELAY (slow-blow)

250V TIME DELAY

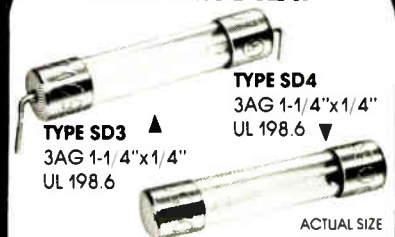

TYPE SD3
3AG 1-1/4"x1/4"
UL 198.6

TYPE SD4
3AG 1-1/4"x1/4"
UL 198.6

ACTUAL SIZE

FUSES ARE UL LISTED FILE NO. E39265 360C

Many other Fuses, Fuse holders and Fuse blocks are available — approved by UL, CSA and MITI

SANO
INDUSTRIAL CORPORATION

35-D Orville Dr., Bohemia, N.Y. 11716
TEL: (516) 567-5556 TWX: 510-228-7701

Overprotection can affect a CMOS switch for life.

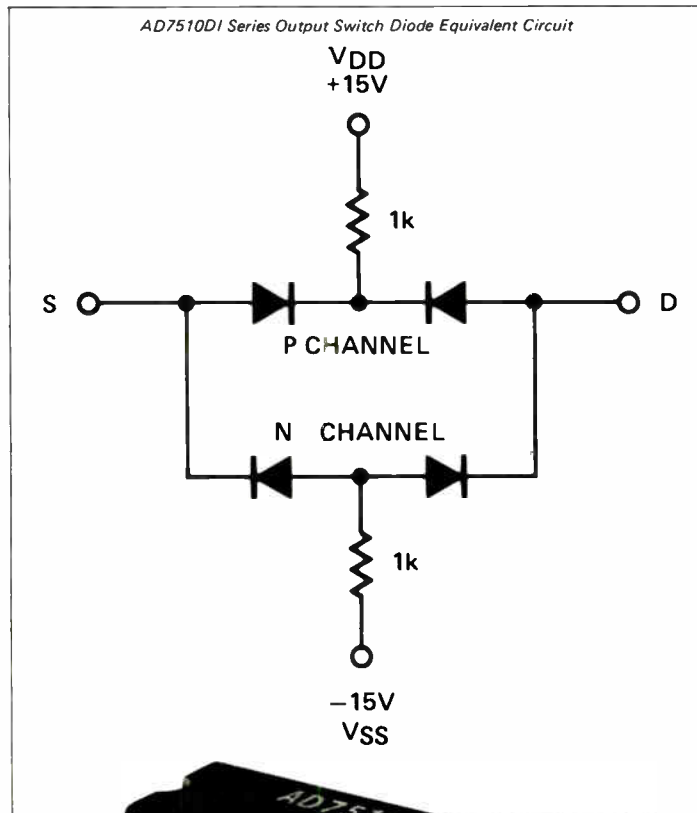

But not Analog Devices' AD7510 family of DI CMOS analog switches. They belong to a whole new generation. With positive overvoltage protection, but without any inhibition on performance.

We accomplished it through a unique design, utilizing "on-chip" resistors in series with the power supply. It provides as much as $\pm 25V$ overvoltage protection. But the resistors only switch in when an overvoltage condition occurs. So normal performance never suffers. And you get both the main assets of an analog switch: a low "ON" resistance of 75Ω and a low leakage current of $400pA$.

The equivalent circuit of the output switch element shows that, indeed, the $1k\Omega$ limiting resistors are in series with the back-gates of the P- and N-channel output devices — not in series with the signal path between the S and D terminals.

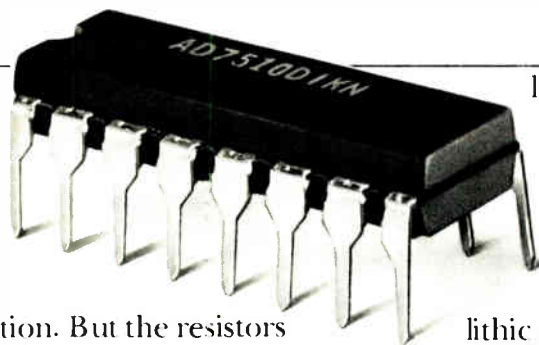

This design, combined with our dielectrically-isolated CMOS fabrication process, prevents latch-up. And allows TTL/CMOS direct interfacing.

We also included two other measures of security. Silicon nitride passivation to ensure long term stability and monolithic construction for reliability.

Now when it comes to protecting CMOS switches so they can survive in the real world, Analog Devices knows best. Write for our 8-page technical bulletin on the entire family of DI CMOS protected analog switches, to Analog Devices, the real company in precision measurement and control.

ANALOG DEVICES

The real CMOS switch company

Analog Devices, Inc., Box 280, Norwood, Massachusetts 02062, East Coast: (617) 329-4700, Midwest: (312) 894-3300, West Coast: (213) 595-1783, Texas: (214) 231-5094, Belgium: 03 38 27 07, Denmark: 97 95 99, England: 01 94 10 466, France: 686-7760, Germany: 089 53 03 19, Japan: 03 26 36 826, Holland: 076-879251, Switzerland: 022/319704 and representatives around the world.

Processors offer mainframe speeds

Array-type systems sell for minicomputer prices; bus-connecting subprocessors make it easy to handle radar, sonar, speech-analysis signals

by Lawrence Curran, Boston bureau manager

Digital processors for sonar and radar signal processing, speech analysis, image processing, and fast Fourier transformations are often not much more than black boxes added to a minicomputer to do the high-speed part of the job that the mini is not designed to do. But engineers at Stein Associates Inc., Waltham, Mass., have designed a family of high-speed array processors that can do the entire signal-processing job without the need for a background minicomputer—and the processors are said to work 10 to 15

times faster on typical instructions.

The AR-10 family, which can work with a minicomputer, has two kinds of subprocessors: a data-dependent section (DDS) and a pipelined arithmetic section (PAS). Allen Worters, Stein's hardware department manager, describes the DDS as an independent high-speed microinstruction-controlled subprocessor. It is designed to perform system control, input/output management, logic and arithmetic functions, and data testing. It can also do test and branch operations concurrent with

the performance of each instruction.

Worters says that an add instruction, often encountered in this kind of signal processing, is done in 135 nanoseconds by the DDS. A minicomputer with a typical 1-microsecond cycle time would require 3 μ s to execute the same instruction.

The PAS is also an independent microinstruction-controlled subprocessor. It contains two arithmetic elements for tasks involving repetitive multiplications, additions, and subtractions. Worters points out that the PAS contains "a large number of working registers—192—which is important for temporary storage associated with long algorithms such as transversal filters."

An optional feature of the family is the AR/Scan panel—a system console analyzer that both Worters and Ralph Jackson, senior applications engineer, say can be as important as the processors in applications where a lot of program development and debugging are required. The panel allows the operator to trap data, addresses, or other program parameters in any of the subprocessors as they occur, with the program running at full speed.

Prices for the AR-10 family range from \$28,000 to \$100,000. Jackson says a typical configuration, the AR-10/11, including one DDS, a single PAS with one arithmetic element, and minimum data memory but full instruction memory, will sell for \$56,000. Delivery time is six months, but that will drop to four months after Jan. 1, 1978.

Stein Associates Inc., a subsidiary of Adams-Russell Co., 280 Bear Hill Rd., Waltham, Mass. 02154. Phone Ralph Jackson at (617) 891-7400 [339]

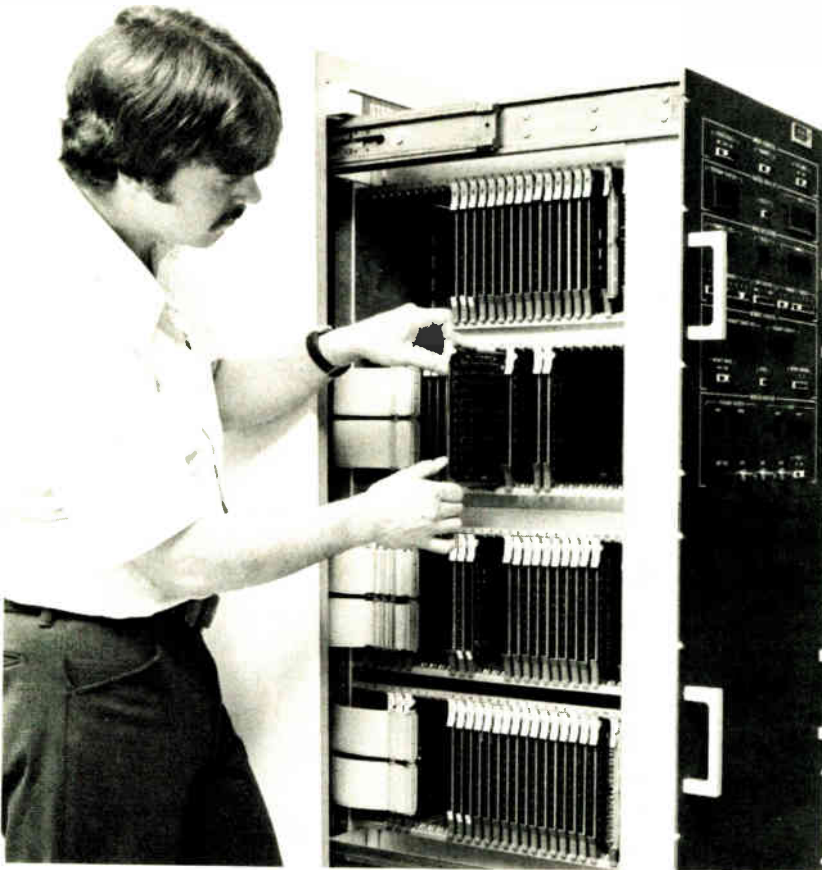

Get all the details.

For fast, accurate duplicates in one easy step, use Kodak precision line film LPD4 and LPD7—line projection duplicating film on either a 4- or 7-mil base.

This tough Estar base film provides...

- direct duplicating
- moderately high contrast

For contact-printing applications, all these features are provided with another product, Kodak precision line film LD4 and LD7—line duplicating.

When accurate duplicates are needed, consider Kodak precision line products.

- antihalation backing permitting exposure through film base
- orthochromatic sensitivity
- machine processing



Our "Take a New Look" packet outlines all product details and performance charts for the Precision Line products. For your free copy, write Eastman Kodak Company, Dept. P04804, Rochester, N.Y. 14650.

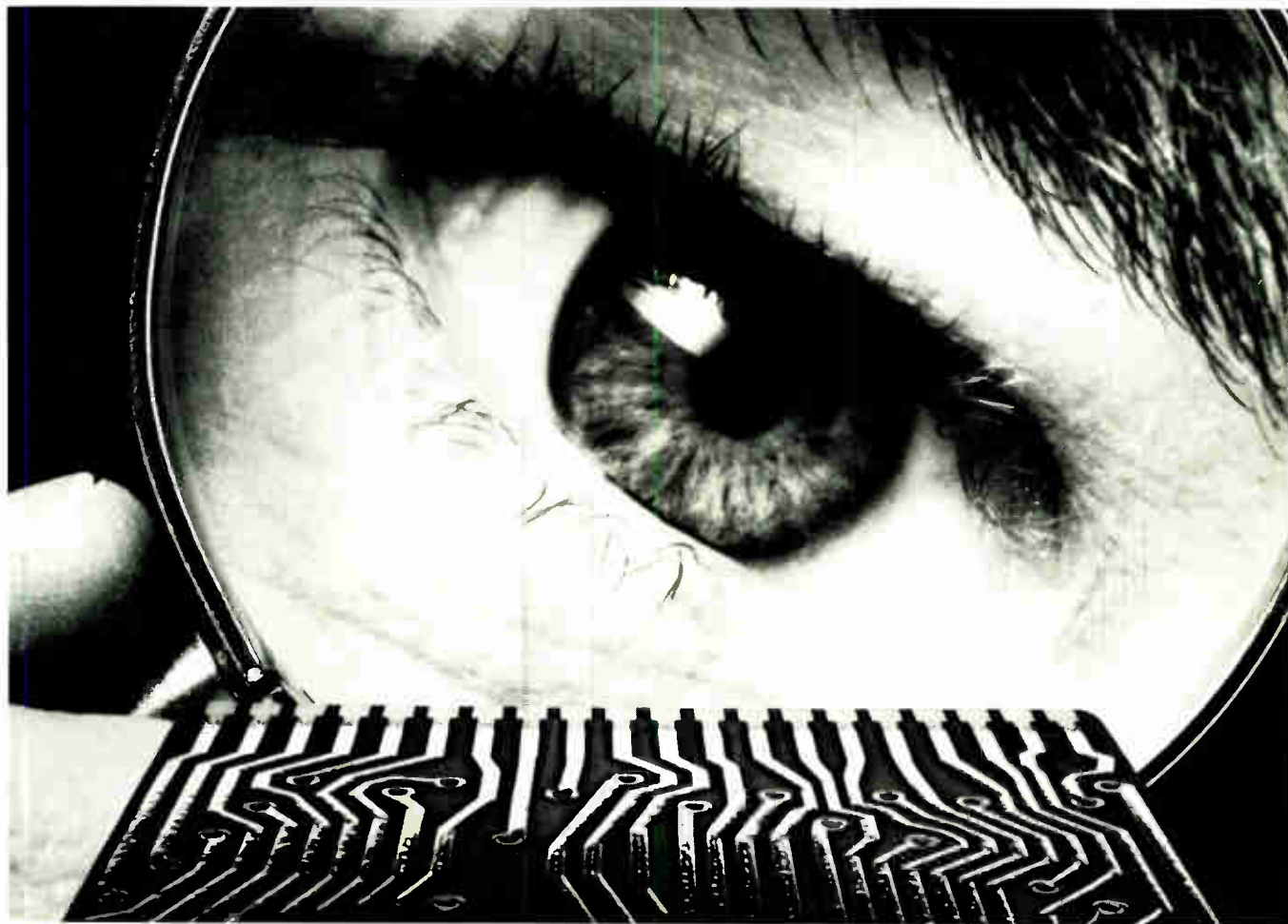

Kodak PRECISION LINE film LPD4 and LPD7

RESULTS COUNT



New products

Components

Relays protected against transients

Three snubber networks in each solid-state unit prevent false firings

Transients on the ac line can make solid-state relays fire, particularly when switching inductive loads. This false firing, according to Electronic Instrument and Specialty Corp., is virtually eliminated in its new family of optically isolated ac solid-state relays.

As a protection against transients, many solid-state relays have a single snubber network at their output—usually a simple RC circuit across the terminals of the output semiconductor device. In contrast, explains John Beigel, applications engineer, EI&S has designed three separate snubber networks into each of its new ac units “to desensitize those critical points in the circuit that lend themselves to false triggering.”

One network, he says, is the fairly standard resistor and capacitor connected across the output. The other two snubbers are down in the logic circuitry. One of these balances the

circuit to eliminate chatter—the undesirable half-cycle operation that can occur with inductive loads like motors. The third snubber, although also in the output stage, is close enough to the input to desensitize those parts in the output circuitry that are more subject to transients than the output triac.

Besides integral snubber protection, the new relays offer zero-voltage turn-on and inputs that are compatible with either transistor-transistor logic or metal-oxide-semiconductor logic. There are 24 separate models in the family, with current ratings of 3, 6, 10 or 25 amperes at output voltages of either 120 or 240 volts root-mean-square. The user may choose from three different control-voltage ranges: 3.5 to 15 v dc, 9 to 32 v dc, or 90 to 280 v ac.

Isolation between input and output is 10^9 ohms at a dielectric strength of 1,500 v rms. The units provide commutating dv/dt protection for loads with power factors as low as 0.4. At 25°C, their off-state dv/dt is a minimum of 400 v per microsecond, dropping to 200 v/ μ s at 85°C. At 60 hertz, turn-on response time is 8 milliseconds maximum, while turn-off response time is 10 ms maximum.

The relays are packaged in screw-terminal chassis-mountable housings, with quick-connect terminals or

terminal clamps optional. In quantities of 100, prices range from about \$13 to \$15 and are typically \$18 for single units. Delivery time is within three to six weeks.

Electronic Instrument and Specialty Corp., 42 Pleasant St., Stoneham, Mass. 02180. Phone (617) 438-5300 [341]

Cermet trimmer drifts less than 35 ppm/°C

Allen-Bradley's quarter-inch-diameter single-turn cermet Type A trimmer is fabricated with an ink that typically gives the trimmers a temperature coefficient of resistance of less than 35 parts per million per degree Celsius above 250 ohms. Available in many configurations including low-profile and reverse-rotation styles, the Type A is furnished with TO-5 or 0.100-inch-grid terminal spacings for top or side



adjustments. Standard values are between 10 ohms and 2 megohms with a 10% tolerance. Power rating is 0.5 watt at 85°C. End resistance is less than 2 ohms at both ends of rotation, and contact resistance is typically less than 1% or 1 ohm. All styles of Type A trimmers sell for 96 cents each when bought in thousand-piece quantities.

Allen-Bradley Co., 1201 South Second St., Milwaukee, Wis. 53204 [344]

Power relays stand only 0.413 inch high

Although capable of switching 8 amperes at 240 v ac or 24 v dc, type G2L relays are housed in low-profile packages that are 1.122 inches in length, 1.004 in. in width, and a

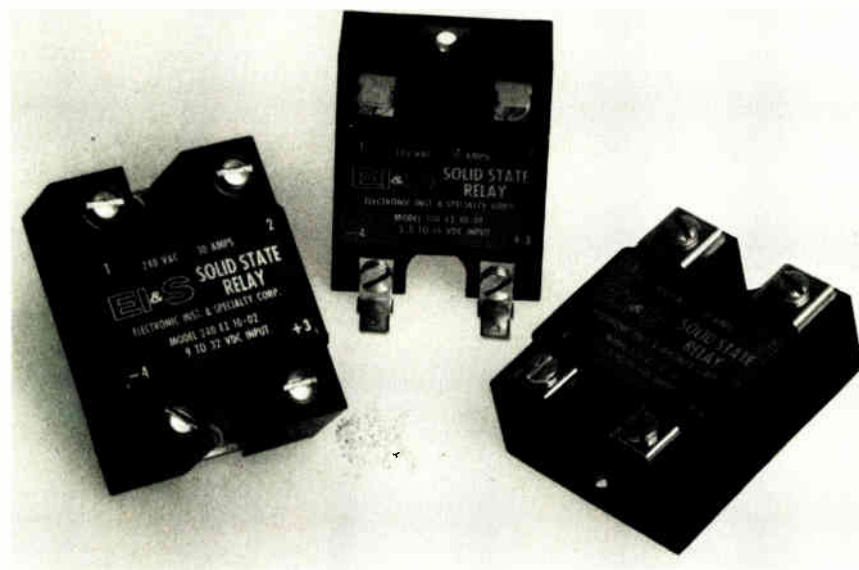

A digital F.R.A. with an exciting new feature.

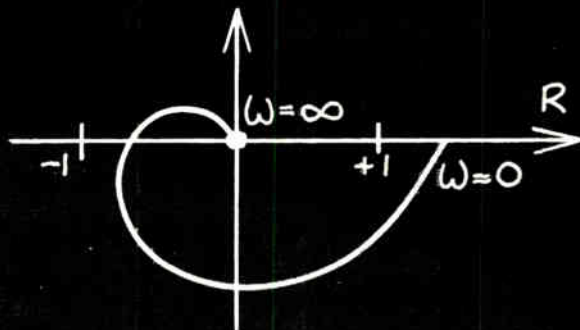

Simplicity.

EMI has taken the complexity out of digital F.R.A. operation. In fact, our SM2001A is so simple that, in effect, all the operating instructions are on the front panel, reducing test time from minutes to seconds.

But don't think that simplicity means a sacrifice in performance. The SM2001A has complete harmonic analysis capability, so it's a frequency response analyzer in the fullest sense. Innovative digital techniques ensure high stability, resolution and accuracy. And a range of custom-built accessories provides unique flexibility.

Accessories include facilities for frequency

extension, two-channel operation, plotter and computer interfaces. There are also modulator/demodulator and reference synchronizer units.

Frequency range is 0.00001 Hz to 999 Hz (up to 999 kHz with frequency extension).

The price is easy, too. The SM2001A costs far less than competitive equipment.

Contact EMI for complete information.

EMI Technology Inc., Instrumentation Division,
55 Kenosia Avenue, Danbury, CT 06810 (203) 744-3500,
TWX: 710-456-3068



EMI Technology Inc. Instrumentation Division
A member of the EMI Group International leaders in music, electronics and leisure

New products

mere 0.413 in. in height. They can thus be mounted on printed-circuit boards that are stacked on half-inch centers. For applications in which minimizing board area is more important than minimizing above-board height, the relays are offered in an upright configuration that lets them stand on end.

Six coil voltages from 3 v dc to 48 v dc are available. The coils will

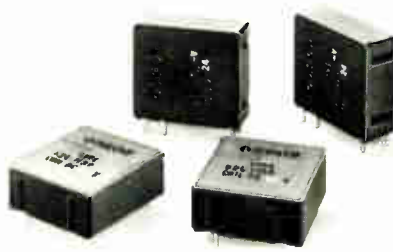

typically consume less than 520 milliwatts in continuous operation.

The relays have a maximum operate time of 6 milliseconds and a maximum release time of 4 ms. Minimum mechanical service life is 200 million operations. Offered with single-pole, single-throw contacts only, type G2L relays are priced from \$2.07 to \$3.95.

Omron Electronics Inc., Sears Tower, 233 South Wacker Dr., Chicago, Ill. 60606. Phone (312) 876-0800 [345]

We're showing off for Bendix.

Tiny LED lamps include current-limiting resistors

A line of subminiature light-emitting-diode lamps small enough to be mounted on 0.1-inch centers is supplied with both built-in current-limiting resistors and reverse protection diodes. Offered only in red, the

LEDs are made in two versions: model HLMP-6600 has a nominal forward current of 10 milliamperes at 5 volts while providing an axial luminous intensity of 2.4 millicandelas. Model HLMP-6620 draws 5 mA and puts out 0.6 mcd. Both models sell for 75 cents each in quantities up to 99.

Hewlett-Packard Co., 1501 Page Mill Rd., Palo Alto, Calif. 94304 [346]

Infrared LED output drops less than 10% in 10⁶ hours

Designed specifically for pulsed operation, two new infrared light-emitting diodes have an average drop in output power of less than 10% after 1 million hours of operation. This figure applies to 1-ampere pulses of

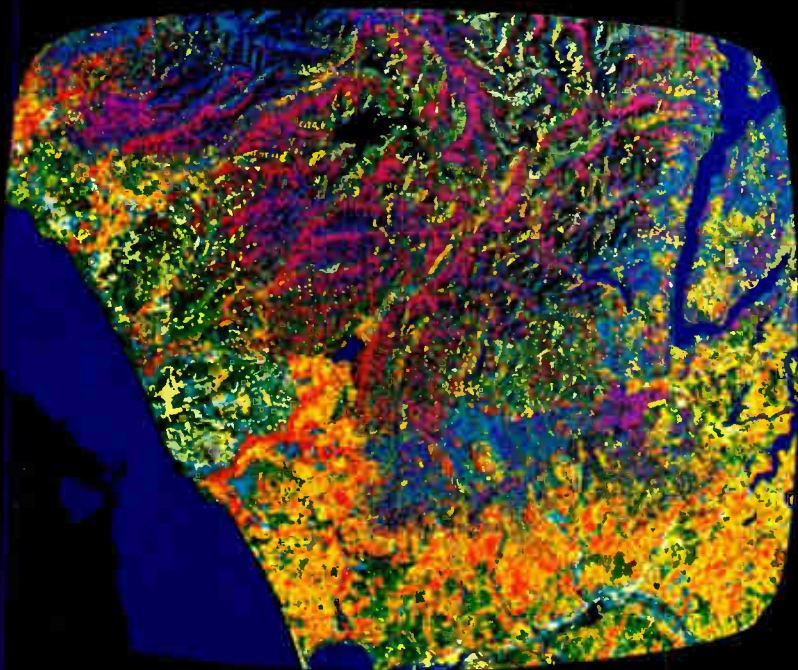

This display shows the Quinalt Indian Reservation in Washington state. 16 separate colors have been assigned for such categories as Burn Areas, Forest, Brush and Bare Land.

Bendix Aerospace Systems Division uses a Ramtek display generator to really show its colors. The Bendix Multispectral Data Analysis System (M-DAS) provides a clear, color-coded display for analysis of data from NASA's LANDSAT. And by using Ramtek's moving window display — or scroll — they're able to look at more data at one time than can be displayed on the still screen. Images of the same areas may also be correlated so that changes between past and present can be referenced.

Bendix is but one of a growing number of customers who are finding that Ramtek's modular graphics and imagery systems are giving them the expandability, flexibility and increased productivity they need. Besides the basic alphanumeric and imaging capability, Ramtek offers a wide variety of other functions including graphics — vectors, conics, plots, bar charts — pseudo color and grey scale translation.

Because the Ramtek RM 9000 family is totally controlled by a standard 8080 micro-processor, it is easy to develop and download your own control software.

To find out more about how Ramtek can show off for you, call or write: Ramtek Corporation, 585 North Mary Avenue, Sunnyvale, California 94086; (408) 735-8400.

ramtek
Our Experience Shows

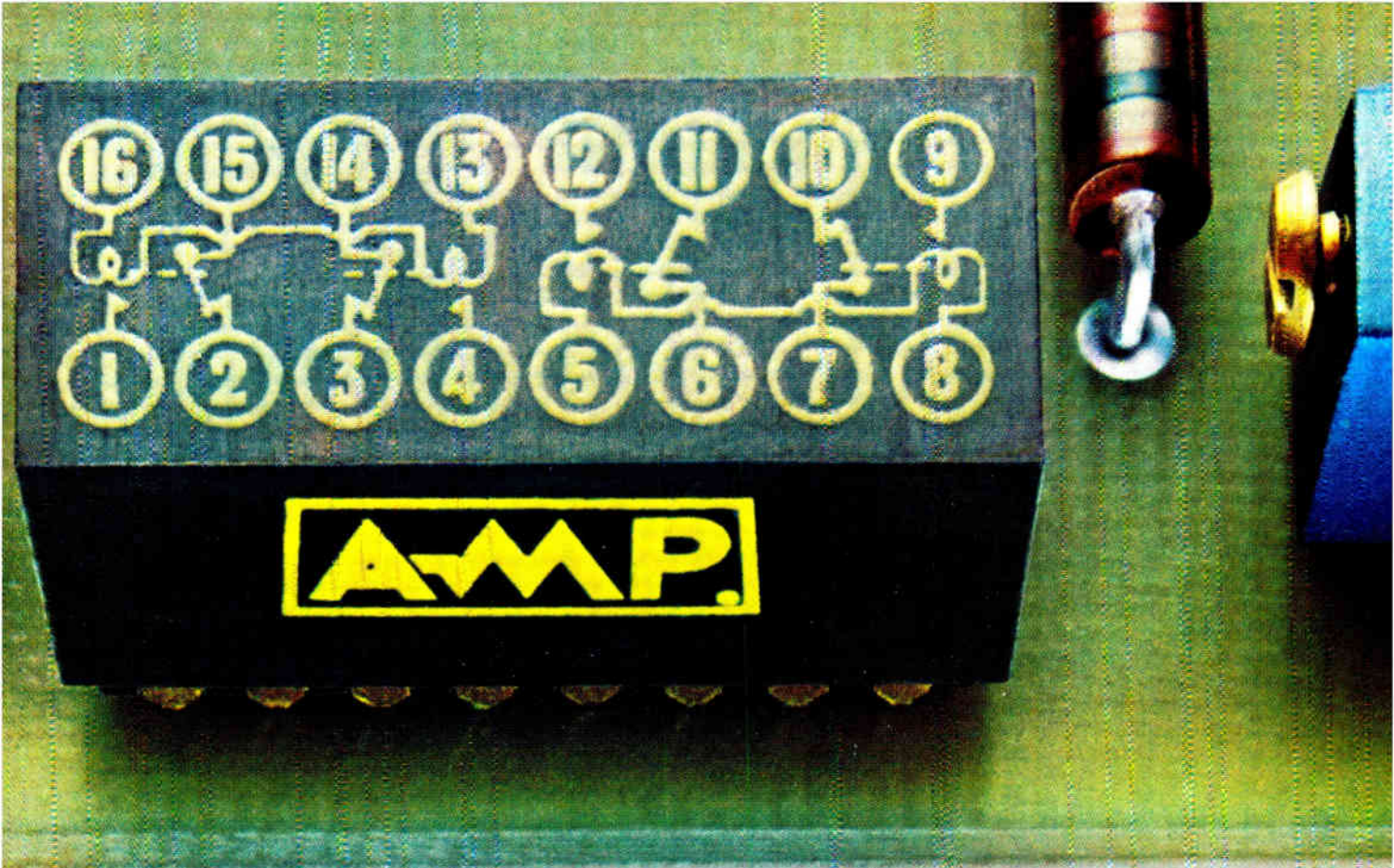

Function for function you still can't beat AMP's Dual-DIP relay for low level switching.

Its 16-lead, pluggable package contains two independent DPDT electromechanical relays. Providing a total of eight switching functions, with maximum operating time of only 5 ms. And maximum release time of just 4 ms.

Low-resistance, gold-plated contacts are ideal for "dry circuit" as well as general use.

AMP Dual-DIP relays can be "plugged" in with a variety of AMP standard or low-profile DIP headers, or standard or miniature spring-type receptacles, some posted, for automatic wiring. Or soldered directly to pc boards.

If you have a low-level switching application—and limited board space—the AMP Dual-DIP relay is your logical choice. Function-for-function.

For more information, call Customer Service at (717) 564-0100. Or write AMP Incorporated, Harrisburg, PA 17105.

AMP has a better way.

SEE US AT
INELTEC, BASEL

AMP
INCORPORATED

AMP is a trademark of AMP Incorporated.

Circle 144 on reader service card

World Radio History

AMP EUROPE

Austria — AMP Austria. Branch of AMP Deutschland GmbH. Markgraf-Ruediger Str. 6-8, 1150 Vienna. Phone: 924191/92

Belgium — AMP Belgium. Branch of AMP-Holland B.V., Rue de Brabant 62-66, Brussels. Phone: 322.17.55.17

Finland — AMP Finland OY. Pastilakera 3, 00401 Helsinki 40. Phone: 90/584122

France — AMP de France. 29 Chaussée Jules-César. Boite Postale No. 39. 95301 Pantaise France. Phone: 030 82 20, 030 92 30

Germany — AMP Deutschland GmbH. Ampèrestrasse 7-11, 607 Langen, B. FFM., West Germany. Phone: (06103) 7091

Great Britain — AMP of Great Britain Limited, Terminal House, Stanmore, Middlesex, England. Phone: 01-954-2356

Holland — AMP Holland B.V., Papierstraat 2-4 5223 AW 's-Hertogenbosch, Holland. Phone: (073) 125221

Italy — AMP Italia S.p.A., Via Fratelli Cervi 15, 10093 Callegna (Torino), Italy. Phone: 785-656

Spain — AMP Española, S.A., Apartada 5294. Pedro IV, 491, 495, Barcelona 5, Spain. Phone: 307-75-50

Sweden — AMP Scandinavia AB, Datavägen 5, 17500 Jakobsberg, Sweden, Mailing Address: Fack S-175 20 JARFALLA 1, Sweden. Phone: 0758/10400

Switzerland — AMP AG, Haldenstrasse 11, 6006 Luzern, Switzerland. Phone: (414) 235421, 235422, 235423

AMP NORTH AMERICA

Canada — AMP OF CANADA LTD., 20 Esna Park Drive, Markham, Ontario, Ph: 416-499-1251

Mexico — AMP de Mexico, S.A., Apartada Postal 179, Naucalpan de Juarez, Eda, de Mexico, Phone: Mexico City 576-41-55

Puerto Rico — AMP OF CANADA LTD., 677 Calé de Diego, Ría Piedras, Puerto Rico 00924, Phone: (809) 766-2346

United States — AMP Incorporated, Harrisburg, Pa. 17105, Phone: 717-564-0100

AMP SOUTH AMERICA

Argentina — AMP S.A. Argentina 4 de Febrero, 76 Villa Zagla — SAN MARTIN, Buenos Aires, Argentina, Phone: 752-4612

Brazil — AMP da Brasil Ltda., AV Camendador Martinelli 185, Lapa, Sao Paulo, Phone: 262-4353

AMP PACIFIC

Australia — Australian AMP Pty. Limited, 155 Briens Road, Northmead, N.S.W. 2152 Australia, Mailing Address: P.O. Box 194, Baulkham Hills, N.S.W. 2153 Aus. Ph: 630-7377

Japan — AMP (Japan), Ltd., Na. 15-14, 7-Chome, Rappangi Minato-Ku, Tokyo, Japan, Ph: 404-7171

Products and services for many specialized industries are provided by the AMPLIVERSAL Division. In the United States, this division is known as AMP Special Industries.

For Amp products and services in other countries, write: AMP International Division, Harrisburg, PA 17105, USA.

New products

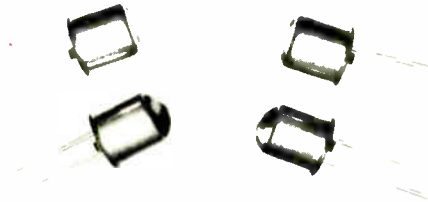

10-microsecond duration at a repetition rate of 10 pulses per second. Under these drive conditions, the OP 135 LED will deliver a peak power output of 20 milliwatts, while the OP 136 will produce 35 mw. Both units are housed in standard TO-18 packages and are offered with a choice of a lens or a flat window. In thousands, the OP 135 sells for \$1.44 and the OP 136 goes for \$1.74. Delivery is from stock.

Optron Inc., 1201 Tappan Circle, Carrollton, Texas 75006. Phone (214) 242-6571 [347]

Rectangular LED lamp puts out 4 millicandelas

A rectangular light-emitting diode with an illuminated area that measures 0.220 by 0.125 inch has a typical brightness of 4 millicandelas at a forward current of 20 milliamperes. Designated the MV57124, the lamp is fabricated of high-brightness red gallium arsenide phosphide on a gallium-phosphide substrate. Because of its size and shape, the lamp is expected to be especially useful as a backlight for illuminated legends

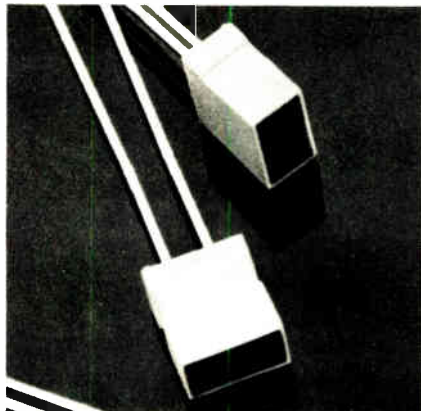

and as an element in bar graphs, sequential indicators, and similar arrays. The lamps sell for \$1.30 each in small quantities, \$1.05 each in hundreds, and 85 cents each in thousands. Delivery is from stock.

Monsanto Commercial Products Co., Electronics Division, 3400 Hillview Ave., Palo Alto, Calif. 94304. Phone (415) 493-3300 [348]

Rotary switches with plastic shafts cost as little as 60¢

Featuring plastic shafts for enhanced insulation from associated circuitry, extended struts for improved pc-board mounting stability, and threadless bushings, a new economy line of rotary switches has prices that start as low as 60 cents in production quantities. The switches are offered with up to 12 positions in both continuous-rotation and fixed-stop models. The silver-plated con-

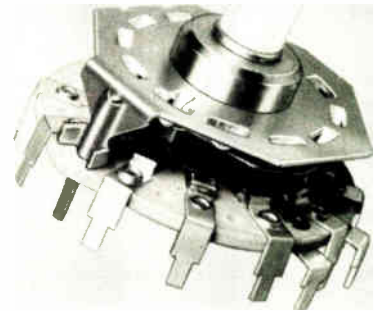

tacts are rated at 1.5 amperes at 28 volts dc and 0.23 A at 115 v ac. Minimum life is 25,000 cycles, and initial contact resistance is 3.5 milliohms. As an extra-cost option, a silver-alloy material can replace the plated brass contacts. Series 070 switches have application in high-volume games, antenna controls, toys, and alarm systems.

Centralab Electronics Division, Globe-Union Inc., P. O. Box 858, Highway 20 West, Fort Dodge, Iowa 50501. Phone (515) 955-8534 [343]



New products

Data handling

Cards link data and bus

Building-block system provides interface between instruments and computer

Smartening up data-acquisition and measuring systems sounds like a good idea to a lot of manufacturers who, by automating their test and quality-control facilities, could undoubtedly improve throughput and save money. But though the computers themselves are relatively inexpensive, the discouraging task of interfacing them, either by building a piece of hardware or by writing extensive software routines, often results in abandonment of the project while it is still on the drawing board. Now Computer Data Systems

Inc., a small company based in Morrison, Colo., is proposing to solve such interfacing problems with a low-cost building-block system that has a variety of user-selected plug-in cards for connecting just about anything to standard-protocol buses.

Among the various bus structures that the CDS box comprehends are the IEEE-488 standard, its predecessor, the ASCII 8-bit parallel bus, and the RS-232C serial-communication line. Input cards that fit into slots in the box enable it to take just about any signal—binary-coded-decimal, analog, or a signal from relay or switch contacts—and send the data to a controller or computer. Similarly, the controller can address output cards in the CDS box to command the output of contact closures and analog and digital signals.

The box itself is basically a card cage and power supply, with 10 slots that can accommodate input, output, and communications cards. CDS calls

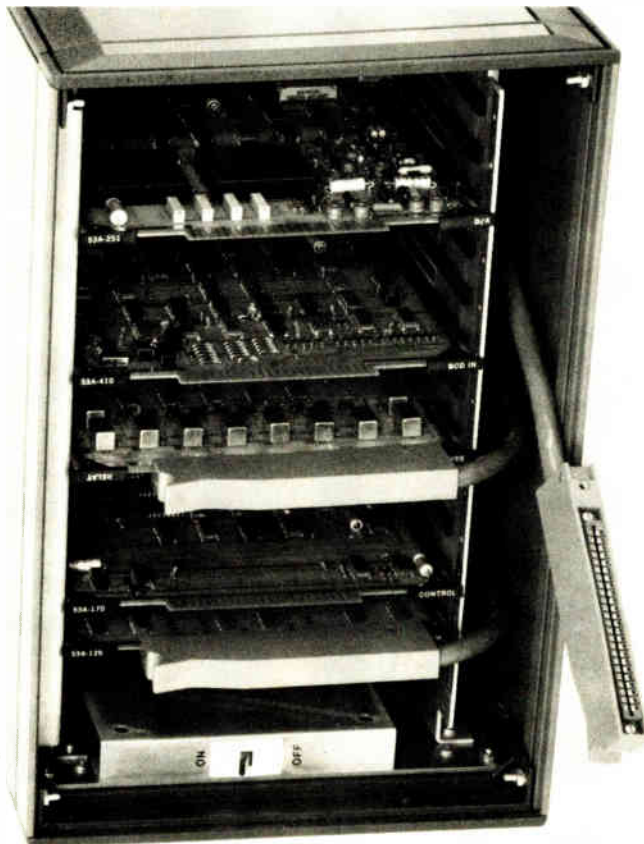

Monsanto

Products Are Available from These Distributors:

AVNET ELECTRONICS
CESCO ELECTRONICS
DIPLOMAT/ALTALAND
ELMAR ELECTRONICS
HAMILTON/AVNET
HAMMOND ELECTRONICS, INC.
HARRISON EQUIPMENT CO.
KIERULFF ELECTRONICS
LIBERTY ELECTRONICS
R.A.E. ELECTRONICS
SCHWEBER ELECTRONICS
SEMICONDUCTOR SPECIALISTS
SHERIDAN SALES

For technical assistance contact our representative in your area:

- A.P.J. Associates, Inc.**
Plymouth, MI. (313) 459-1200
- Beacon Electronic Associates**
Huntsville, AL. (205) 881-5031
Ft. Lauderdale, FL. (305) 971-7320
Maitland, FL. (305) 647-3498
Atlanta, GA. (404) 351-3654
Charlotte, NC. (704) 525-7412
Oak Ridge, TN. (615) 482-2409
Falls Church, VA. (703) 534-7200
- Bob Dean, Inc.**
Ithaca, NY. (607) 272-2187
- CMS Marketing**
Oreland, PA. (215) 885-5106
- Cantronics**
Downsview, Ont. Canada. (416) 661-2494
Montreal, Que. Canada. (514) 341-5207
- Comtronic Associates**
Melville, L.I., N.Y. (516) 249-0505
- CPS, Inc.**
Orange, CT. (203) 795-3515
- Datcom**
Waltham, MA. (617) 891-4600
- Harvey King, Inc.**
San Diego, CA. (714) 566-5252
- Ed Landa Company**
Los Angeles, CA. (213) 879-0770
- Lorenz Sales Inc.**
Cedar Rapids, IA. (319) 393-6912
- Midwest Marketing Associates**
Chagrin Falls, OH. (216) 247-4655
Dayton, OH. (513) 433-2511
- Mycrosystems Marketing**
Dallas, TX. (214) 238-7157
Houston, TX. (713) 783-2900
- Wm. J. Purdy Company**
Burlingame, CA. (415) 347-7701
Albuquerque, N.M. (505) 266-7959
- Spectrum Associates**
Phoenix, AZ. (602) 997-6324
- Straube Associates**
Denver, CO. (303) 426-0890
Salt Lake City, UT. (801) 943-5650
- Sumer, Inc.**
Rolling Meadows, IL. (312) 394-4900
Milwaukee, WI. (414) 259-9060
- Technical Associates, Inc.**
Eden Prairie, MN. (612) 944-3034
- Technical Representatives, Inc.**
Olathe, KS. (913) 782-1177
Hazelwood, MO. (314) 731-5200
- Valentine-Schillinger**
Greenwood, IN. (317) 888-2260
South Bend, IN. (219) 291-6258
- Waggoner-Ver Hill Associates**
Pittsburgh, PA. (412) 241-5202
- Western Technical Sales**
Portland, OR. (503) 297-1711
Bellevue, WA. (206) 641-3900

No one has ever seen a lamp like this. It's our bright, new, revolutionary rectangular LED

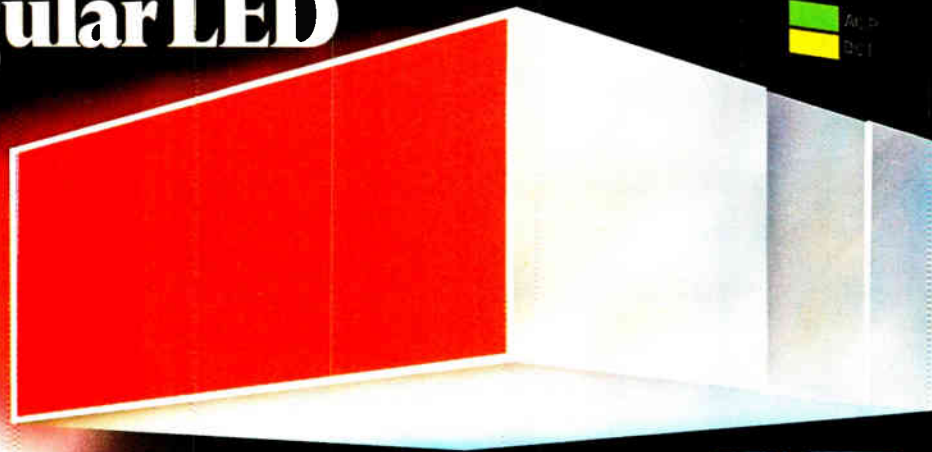

OUR "LEGEND LAMP" PUTS LIGHT UP FRONT, WHERE YOU NEED IT.

The MV57124 rectangular LED from Monsanto gathers light from a high brightness chip and focuses it on a flat front surface. The shape of the lamp and the uniform illumination across a large emitting area (.15" x .25") makes the "legend lamp" an exciting, aesthetically pleasing element in your modern industrial panel design. It's available now in high brightness red and will soon be available in other colors.

STACKABLE: SIDE-BY-SIDE, OR END-TO-END.

The unique design of the MV57124 utilizes a special plastic to house the LED assembly, so that

no light is emitted from the sides or edges of the unit. All of the light is concentrated on the viewed surface. This means that lamps can be stacked, side-by-side in an X or Y direction, without light interference between units.

4 MCD BRIGHT. UNIFORM.

The MV57124 "legend lamp" uses Monsanto's high efficiency red emitter. The carefully engineered package makes maximum use of that emitted light, minimizing unusable light. Light output is a very bright 4 millicandelas at

20 mA forward current. That's up to 3 times the output of other rectangular lamps. So you can use the MV57124 as a legend backlight, a panel indicator, or a bargraph meter.

ANOTHER PERFORMANCE PRODUCT FROM MONSANTO.

This unique new product is a development from the technology and experience that is Monsanto. Our history as being one of the first suppliers of LED's has led to the features and characteristics of the "legend lamp."

FREE SAMPLE.

Write today, on your company letterhead, for a free sample. We'll also send you full specifications on our new MV57124.

Monsanto Commercial Products Co., Electronics Division, 3400 Hillview Ave., Palo Alto, CA 94304. Telephone: (415) 493-3300.

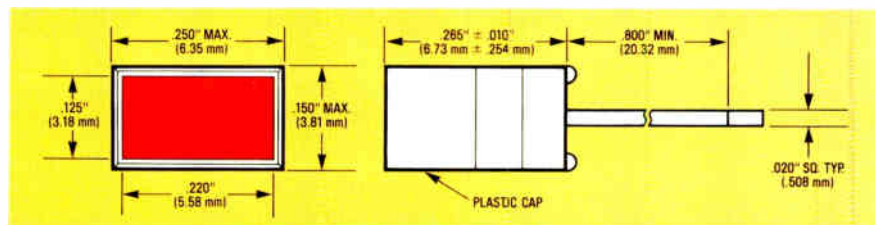

Monsanto:
the science
company.

World Radio History

Circle 149 on reader service card

New products

the equipment its 53A party line system. Says the company's president, W. S. Casey, "Each card performs a distinct function, and although up to 10 boxes with 10 cards in each may be hooked together, the controller speaks to any one card just by calling its number."

The novelty of the CDS system is how it calls its cards—each is addressed with ASCII characters. For example, the third card in the fourth box would be named 43. Instructions for the cards are equally simple. If it were, say, a hex digital-to-analog output card, which has six outputs, each with a range of ± 10 volts, the controller would first address the card by sending out (in 8-bit bytes) @43 and then it would give the output command, say, +3.14 V B. (The B refers to the second of six outputs labeled A through F.)

The CDS system also makes existing hookups between controller and instrument more flexible. Notably, the box overcomes the length limitation imposed on the IEEE bus standard, safely allowing interconnecting cables of up to 1,000 feet.

The IEEE-488 or Hewlett Packard Co.'s HP-IB restricts the bus length to 6 feet times the number of instruments, not to exceed 60 feet overall. When it was accepted, the standard worked well for bench-top instrumentation, but as the bus moved out into automated production and testing on the factory floor, its length limitation posed problems. A user of the CDS system, J. E. Maxwell, engineering manager at TRW/Colorado Electronics Inc., which manufactures Government communications equipment in Colorado Springs, explains his encounter with the IEEE bus: "We've used HP equipment outfitted with the HP-IB for many years, but as our facilities grew, we couldn't afford to have a computer or calculator at each test location. But by using the CDS box basically as an intelligent node, we can spread the automated testing over the factory floor and hook it all to a central controller."

The CDS box actually makes all instruments and equipment look like a teletypewriter to the controller,

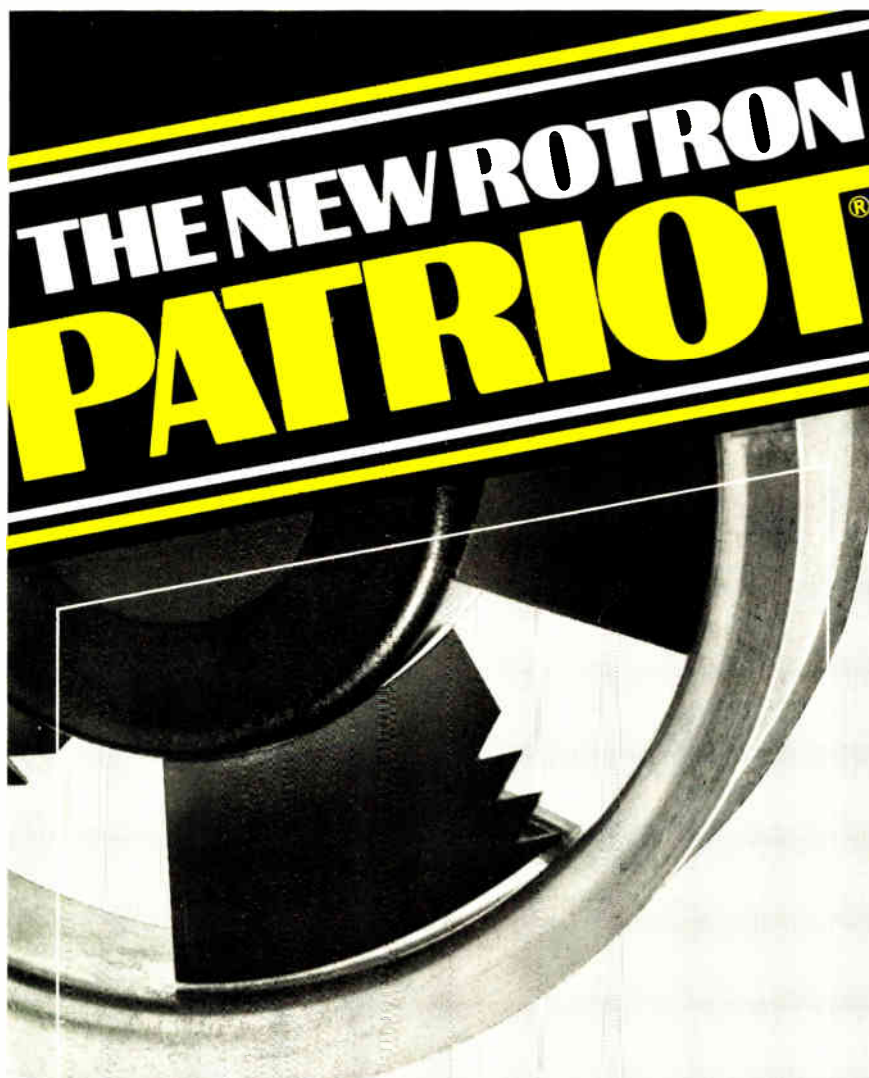

One more proof...

Rotron has a way with air

Here's the quietest, most powerful, rugged six inch fan on the market.

- 240 cfm at free delivery, 150 cfm at 0.35 inches H_2O
- With exclusive Feathered Edge™ blades for acoustical ratings as low as NC-47
- From the company that invented the precision air moving business, in 1949
- From the developers of more new and better products than the rest of the industry combined

And Rotron's skilled application engineers will help you get the most from the new Patriot or any Rotron product. Get the rest of the Rotron Patriot story. See what's in it for you. Write or call now.



ROTRON INC.
A subsidiary of EACO

Woodstock, N.Y. 12498 914 • 679-2401 TWX 510-247-9033
Garden City, Cal. 92541 • 714-898-1149 • Rotron B.V. Breda, N.-the-Netherlands Tel. (076)879311 Telex NL 54074

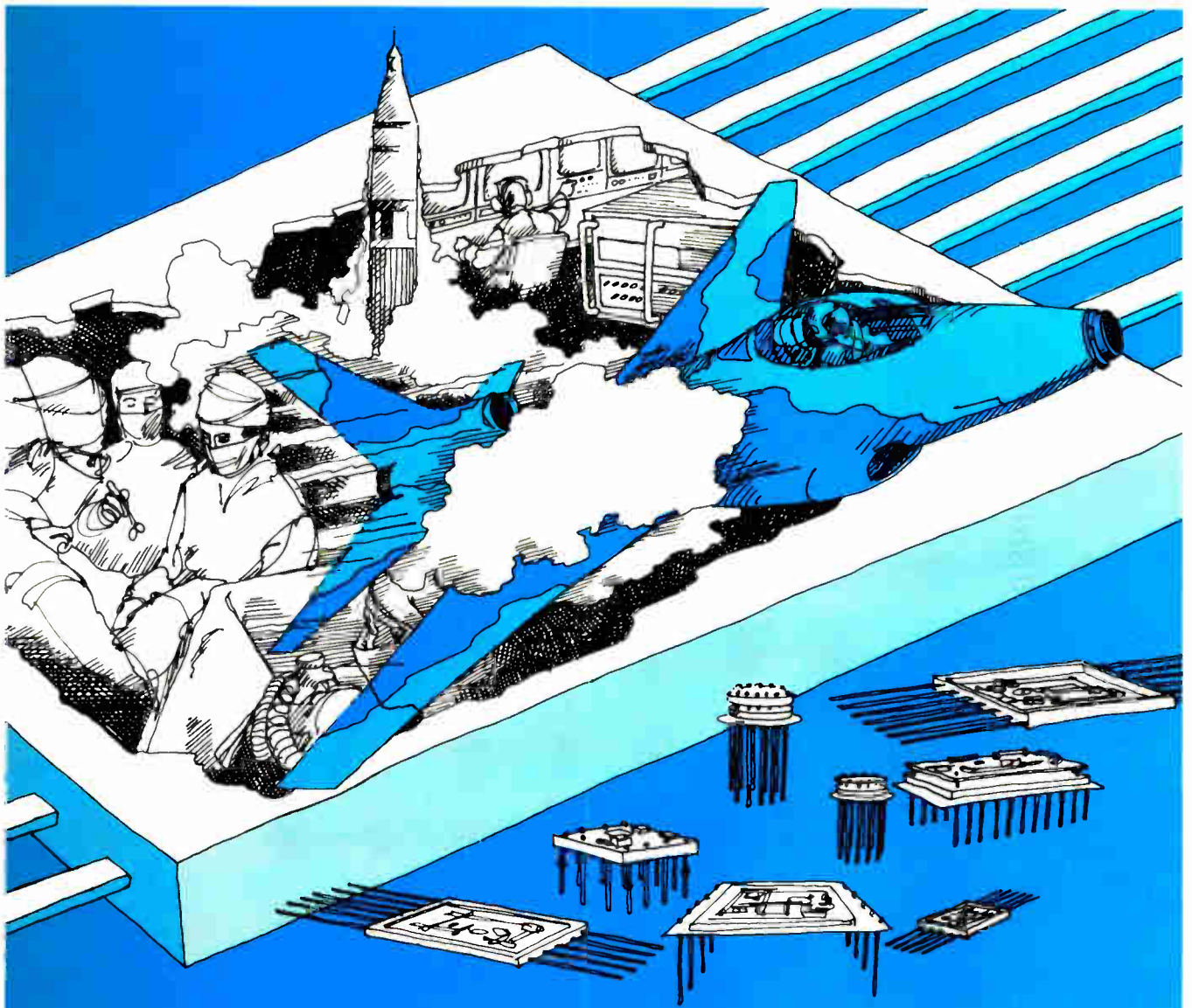

CTS puts a lot into hybrid circuits. And hybrid circuits into a lot!

Sixteen years experience in cermet circuitry and eleven in active hybrids add up to a lot of sophisticated capability. And it all goes into CTS hybrid circuits.

With that experience guiding our design activity, the CTS technical team can create an active hybrid circuit that meets your requirements, *whatever the application* . . .

At CTS, exacting standards beyond MIL STD 883 are a way of life used in the production of High Reliability im-

plantable grade Medical Electronics. The same exacting standards are used in all Hi Rel airborne and military applications and can benefit your applications.

This Hi Rel capability also complements and enhances the *known* CTS capability in commercial and industrial active hybrids and cermet resistor/trimmer networks.

CTS Microelectronics is dedicated to its single specialty: active & passive

hybrids. This dedication, based on the wealth of experience and capability already achieved, is your finest assurance that CTS is here to stay . . . in hybrid circuits.

Find out NOW how your Hybrid Circuit can benefit from CTS capability.

For full information contact
CTS MICROELECTRONICS, INC.,
Dept. X-00, 1201 Cumberland Avenue,
West Lafayette, Indiana 46906.
Phone (317) 463-2565.

CTS CORPORATION
ELKHART INDIANA
A world leader in cermet technology



STANDARD CUSTOMER CIRCUITS

- **Fast TurnAround**
25 days from your design to prototype circuits
- **Low Cost**
Save 80% over a fully custom design
- **Reduced Circuit Size**
Multiple saving by reducing circuit size 90%
- **Proven Process**
Standard CMOS assures high reliability and dependable delivery

INTERNATIONAL MICROCIRCUITS, INC.

3004 Lawrence Expwy., Santa Clara, Ca. 95050 (408) 735-9370

Circle 152 on reader service card

THE μ P MEMORY...\$75*



Model CM-600
Mini-Dek®

- For program loading, diagnostics, extended memory
- 1.6 megabits/200K Bytes, 2.4K Baud
- Includes all read/write and motion electronics
- Power 1Watt @ 5VDC, TTL I/O



11950 TWELFTH AVENUE SOUTH
BURNSVILLE, MINNESOTA 55337, (612) 890-5135

*1K Qty.
Avail. N. Amer. only.

152 Circle 230 on reader service card

New products

since it sends serial strings of 8-bit bytes. But its baud rate of 7,000 characters per second far exceeds that of teletypewriters.

The CDS family includes BCD input and output cards, a digital counter card, a clock card, and such special cards as one that fits into a slot in HP's 21MX minicomputer line and acts like a TTY driver. As CDS fills out its line of cards, it expects to meet the needs of all instruments and any controller. Says Casey, "With IEEE, ASCII-parallel, and RS-232C, there isn't a computer in the world that can't speak our language."

A typical system can range in price anywhere from \$4,000 to \$8,000, depending on the configuration and the number of cards used. Delivery time on the 53A ASCII party line system is eight weeks.

Computer Data Systems Inc., 186-58 Homestead, Morrison, Colo. 80465. Phone (303) 697-8014 [361]

Byte-oriented printers need no interfacing

Because of their byte-oriented format, daisywheel printers in the Sprint Micro 5 family can plug directly into the input/output channels of central processors—from microcomputers to mainframes—with no need for the special interfacing hardware and software required for many other character printers. Coupled with their serial communications capability, this is expected to make daisywheel printing mechanisms attractive to a wide range of terminal and system builders who have found it difficult to accommodate the 13-bit format of previous



Electronics/August 18, 1977

PROVEN PERFORMANCE CRYSTAL CLOCK OSCILLATORS



Motorola's K1100A leads the industry with a crystal clock oscillator that has a proven track record of more than two million units. That's right... over two million oscillators are in use by satisfied, repeat customers.

How versatile is the K1100A? With over 1200 frequencies already designed, and same-day shipment for standard stock frequencies of 4, 4.9152, 5, 10, and 20 MHz, you make the decision.

Oscillators are available from 250 kHz to 70 MHz, $\pm 0.01\%$ stability from 0°C to 70°C , TTL-compatible, and standard +5V dc input.

For full specifications and prices on the oscillator that design engineers trust, write Motorola, Component Products Department, 2553 N. Edginton, Franklin Park, Illinois 60131.

Or call (312) 451-1000, ext. 4183.

It's simple!
Motorola wants to be
your clock company.



MOTOROLA
Communications and Electronics Inc.

NOW measure AC, DC, and AC on DC CURRENT without breaking the circuit



Bell Model 1776 Digital Current Meter with non-contact, clamp-on probe does it!

Current measurements are faster, easier and safer. Utilizing Hall effect probes, the 1776 introduces practically no disturbance into the measured circuit. It can measure currents ranging from DC to 5 kHz.

- 3½-Digit Readout
- Peak—Read—Hold
- Three Current Ranges
1000A, 100A, 10A (Resolution to 10 mA)
- Fully Portable
Operates on 117VAC or rechargeable integral batteries.

Request complete information on this unique instrument for use in troubleshooting, R & D and maintenance.

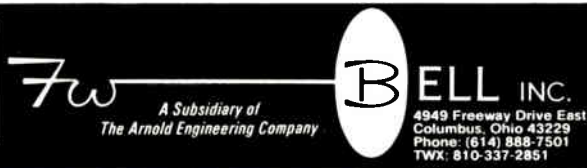

Circle 154 on reader service card



CUSTOM K SERIES MICA CAPACITORS

Maximum Energy in Compact Packages

The new K Series, developed for high reliability, is manufactured with mica paper dielectric impregnated with an epoxy formulation to produce a tough, long life capacitor.

KGR and KMR (wrap & fill), KER (fiberglass housed), and KEM (epoxy molded) models are available in solder type, threaded stud, or wire lead terminations. Mountings can be threaded studs, threaded inserts, or brackets.

Write for FREE K Series Techni Tip, and general Techni Tip including sample mica dielectric, to see how Custom Electronics can fill your requirements.

Send for FREE Product Brochure



CUSTOM Custom Electronics, Inc.
12 Browne Street, Oneonta, N.Y. 13820
Ph: (607) 432-3880 TWX: 510-241-8292

154 Circle 231 on reader service card

New products

types of daisywheel printer.

The microprocessor-based printers, which can read both serial and parallel data, offer the user 11 switch-selectable functions including control of baud rates, full- or half-duplex operation, selection of form length, automatic line feed, and operation of an optional serial communications interface. The Sprint Micro 5 is available in two versions: one prints 45 characters per second; the other, 55 c/s. The 45-c/s model sells for \$1,675 in quantities of 50 to 99 units, and \$1,495 in quantities of 500 and more.

Qume Corp., 2323 Industrial Parkway West, Hayward, Calif. 94545. Phone (415) 783-6100 [363]

CRT-display controller can be rack-mounted

In a departure from past configurations, Ann Arbor Terminals has introduced a series of controllers with cathode-ray-tube displays that allow rack mounting of the entire system for OEM and industrial use. The controllers are functionally complete subsystems that include power supplies, timing circuitry, memory, cursor control, and keyboards. Available display formats

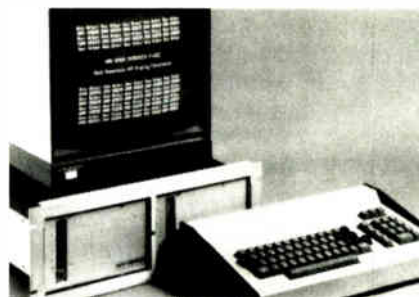

range from 8 lines of 32 characters to 24 lines of 80 characters. A multi-drop option, which allows 64 displays to be remotely addressed and written into over a single line, is also available. Prices begin at \$720 each for small quantities. Delivery time is eight weeks.

Ann Arbor Terminals Inc., 6107 Jackson Road, Ann Arbor, Mich. 48103. Phone Sarah J. Freeman at (313) 769-0926 [364]

Circle 155 on reader service card →

**FROM  LAMBDA
THE INDUSTRY'S BROADEST LINE
OF VOLTAGE REGULATORS**

**A COMPLETE LINE OF
MONOLITHIC 3 AMP, 30W
2.6 VOLTS TO 30 VOLTS... FIXED &
VARIABLE VOLTAGE
REGULATORS**

LAS 14U

**Voltage & current
adjustable — 3 amps**

LAS 1405 to
LAS 1415

**Fixed Voltage
5-15V — 3 amps**

BETTER THAN NATIONAL

Compare these specifications of Lambda's new 3 amp monolithic voltage regulator

PARAMETER	 LAMBDA		NATIONAL*		UNITS
	MIN	MAX	MIN	MAX	
Regulation-Load		30†		100	mV
Ripple Attenuation	60 (66)		Not Specified		dB
Temperature Coefficient		0.015	Not Specified		%Vo/°C
Output Noise Voltage (BW 10 Hz - 100 KHz)		10	Not Specified		μV rms/V
Thermal Resistance junction to case		2.25 (2.75)	Not Specified		°C per watt
Adjustable Voltage	Yes		No		—
Adjustable Current	Yes		No		—
Multiple Models	Yes		No		—
100% burn-in under-load	Yes		Unknown		—

*From Published Specifications †For 5V unit; specification for all units - 0.6% Vo () Values in parenthesis for LAS 14U

△ LAMBDA LAS 1400 SERIES FIXED AND ADJUSTABLE MONOLITHIC VOLTAGE REGULATORS 3.0A, 2.65 TO 30VDC



OUTSTANDING FEATURES

- Guaranteed input-output differential—2.5 volts
- Low thermal resistance (more usable output power)
- 2.65 to 30 volts available
- Internal short circuit and overload protection
- Guaranteed load regulation at 3.0 amp—30mV
- Guaranteed line regulation at 3.0 amp—50mV
- Guaranteed temperature coefficient .015% $V_o/^\circ C$
- Guaranteed ripple attenuation 60 db

FUNCTIONAL BLOCK DIAGRAM & OUTLINE DRAWING

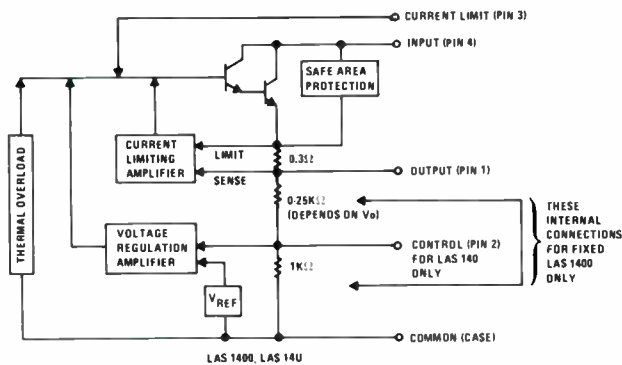

LAS-1400 Series Positive Voltage Regulator

LAS 1405-1415

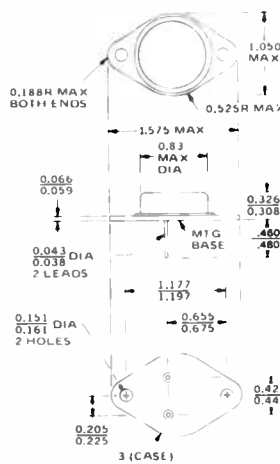

LAS 14U

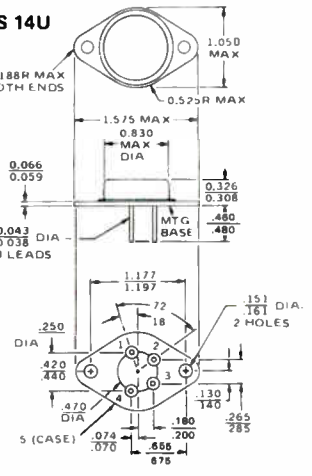

FUNCTION 1400 SERIES

PIN	FUNCTION
1	Input
2	Output
3 (case)	Common

FUNCTION 14U

PIN	FUNCTION
1	Output
2	Control
3	Compensation/Shutdown
4	Input
5 (case)	Common

V_o VOLTS	MODEL	PRICE LIST							
		Qty 1-24	Qty 25-49	Qty 50-99	Qty 100-249	Qty 250-499	Qty 500-999	Qty 1000-2499	Qty 2500-4999
2.65-30	LAS 14U	12.00	11.00	10.50	9.75	8.75	7.75	7.00	6.75
5	LAS 1405	8.50	7.50	7.00	6.75	5.72	5.05	4.45	4.10
6	LAS 1406	8.50	7.50	7.00	6.75	5.72	5.05	4.45	4.10
8	LAS 1408	8.50	7.50	7.00	6.75	5.72	5.05	4.45	4.10
10	LAS 1410	8.50	7.50	7.00	6.75	5.72	5.05	4.45	4.10
12	LAS 1412	8.50	7.50	7.00	6.75	5.72	5.05	4.45	4.10
15	LAS 1415	8.50	7.50	7.00	6.75	5.72	5.05	4.45	4.10

Regulator Performance Specifications

3.0 amp positive regulators

The LAS 1400 series of fixed-voltage, three-terminal positive voltage regulators are designed for applications requiring a well regulated output voltage for load currents up to 3 amperes. The monolithic construction of the integrated circuit permits the incorporation of current-limiting, thermal shutdown, and safe-area protection on the chip, providing protection for the series pass transistor under most operating conditions. A low-noise temperature-stable diode reference circuit is the key to the excellent temperature regulation of the circuit. A very low output impedance ensures excellent load regulation. A hermetically sealed TO 3 package is used for high reliability and low thermal resistance. The pin connections of the devices are the same as the LAS 1500 series, and μ A 7800/MC-7800 series thus allowing existing designs to be up-graded to 3 amperes without layout or wiring changes.

The LAS 14U 3 ampere, positive voltage regulator output voltage can be adjusted over the 2.65 V to 30 V ranges by the use of a single potentiometer. Output current of 3 amperes is available at any output voltage. External power transistors can be used to obtain much higher currents. Functions available at terminals are INPUT, OUTPUT, COMMON, CONTROL (inverting input of the error amplifier), and SHUTDOWN/COMPENSATION. The SHUTDOWN/COMPENSATION point enables the device to be shutdown externally and provides a point for additional compensation capacitance which could be required when the device is used as a driver for power transistors. This feature also enables the output current limit to be set externally to protect driven power transistors or to be set to a value lower than the internal current limit when the device is used as a stand-alone regulator. Protective features included in the monolithic integrated circuit are current-limiting, thermal shutdown, and series pass transistor safe-area protection. A low-noise, temperature-stable diode reference circuit is the key to the excellent temperature regulation of the circuit. A hermetically sealed 5-terminal TO 3 package is used for high reliability and low thermal resistance.

PARAMETER	SYMBOL	TEST CONDITIONS			LAS 1405-1415 TEST LIMITS		LAS 14U TEST LIMITS		UNITS
		V_{IN}	I_O	T_J	MIN	MAX	MIN	MAX	
Input Voltage	V_{IN}	—	5mA	0-125°C	$V_O + 2.5V$	35[40] ⁽¹⁾	$V_O + 25V$ ⁽¹⁾	35[40] ⁽¹⁾	volts
Output Voltage ⁽²⁾	V_O	V_1 to V_2	5mA to 3.0A	25°C	$.95 V_O $ ⁽³⁾	$1.05 V_O $	2.65 ⁽⁴⁾	30	volts
Input Output Differential	$V_{IN}-V_O$	—	1.0A	0-125°C	2.5	25	2.5	25	volts
Output Current	I_O	—	—	25°C	—	3.0	—	3.0	amps
Standby Current	I_Q	V_1	—	25°C	6.5	14	6.5	14.0	mA
Standby Current Change with input	ΔI_Q	V_1 to V_3	5mA	25°C	—	1.3	—	1.3	mA
Standby Current Change with Load	ΔI_Q	V_1	5mA to 3.0A	25°C	—	1.5	—	1.5	mA
Maximum Current Limit	I_{LIM}	V_1	—	25°C	—	4.5	—	4.5	amps
Short-Circuit Current	I_S	25V	—	25°C	—	2.0	—	2.0	amps
Power Dissipation ⁽⁵⁾	P_D	—	—	—	—	30	—	30	watts
Thermal Resistance	—	—	—	—	—	—	—	—	—
Junction to case	$R_{\theta JC}$	—	—	—	—	2.25	—	2.75	°C per watt
Storage Temperature	T_S	—	—	—	65	+150	-65	+150	°C
Maximum Operating Junction Temperature	T_J	—	—	—	-55	+150	-55	+150	°C
Regulation - Load ⁽⁵⁾ ⁽²⁾	(REG) L	V_1	5mA to 3.0A	25°C	—	0.6	—	0.6	% V_O
Regulation - Line ⁽⁵⁾ ⁽²⁾	(RI G) IN	V_1 to V_2	2.0A	25°C	—	1.0	—	1.0	% V_O
Temperature Coefficient	T_C	V_1	5mA	0-125°C	—	0.015	—	0.015	% V_O /°C
Output Noise Voltage ⁽⁷⁾	V_N	V_1	0.1A	0-125°C	—	10	—	10	μ Vrms/V
Ripple Attenuation	R_A	V_O 10V	2.0A	0-125°C	60 ⁽⁸⁾	—	66 ⁽⁹⁾	—	db
Control Voltage	V_C	V_1 to V_2	5mA	25°C	—	—	2.375	2.625	volts

Electronic shutdown is accomplished by sinking 5mA at 0.2V above ground on control pin (3).

Reference voltage is 2.5V.

⁽¹⁾ Values at 35V applies to $V_O = 5V$ to 12V. Values of 40V applies to V_O of +15 volts

⁽²⁾ $V_1 = V_O + 5V$ $V_2 = V_O + 15V$ $V_3 = V_O + 10V$

⁽³⁾ Nominal output voltages are specified under ordering information

⁽⁴⁾ $V_1 = V_C [1 + R_1] / R_2$ R_1 = resistance from output to control. R_2 = resistance from control to common

⁽⁵⁾ Instantaneous regulation average chip temperature changes must be accounted for separately

⁽⁶⁾ Derate above $T_C = 80^\circ C$ 444mW per °C for LAS 1405 1415. Derate above $T_C = 70^\circ C$ 364 mW per °C for LAS 14U

⁽⁷⁾ Specified in μ Vrms volt output. BW = 10HZ - 100K HZ

⁽⁸⁾ Ripple attenuation is specified for a 1 Vrms, 120 HZ input ripple. Ripple attenuation is a minimum of 60 db at 5 volts output and is 1 db less for each volt increase in output voltage

⁽⁹⁾ Ripple attenuation is specified for a 1 Vrms, 120 HZ input ripple. Ripple attenuation is a minimum of 66 db at 2 volts output and is 1 db less for each volt increase in output voltage

⁽¹⁰⁾ Minimum input voltage is 6V

Operational Data

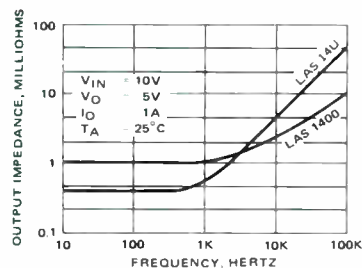

TYPICAL OUTPUT IMPEDANCE VS FREQUENCY

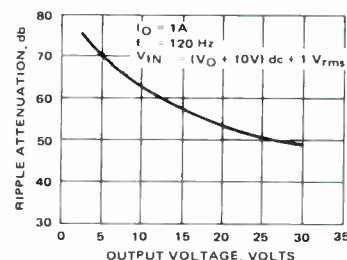

TYPICAL RIPPLE ATTENUATION VS OUTPUT VOLTAGE

Operational Data

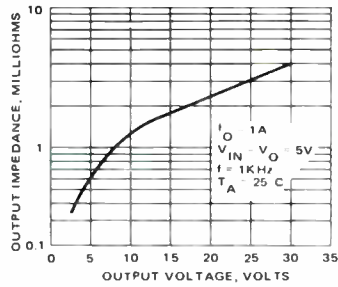

TYPICAL OUTPUT IMPEDANCE VS OUTPUT VOLTAGE

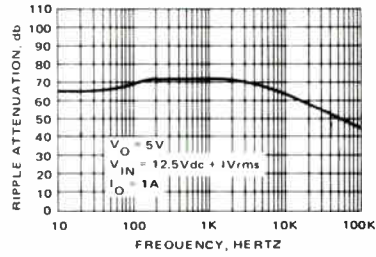

TYPICAL RIPPLE ATTENUATION VS FREQUENCY

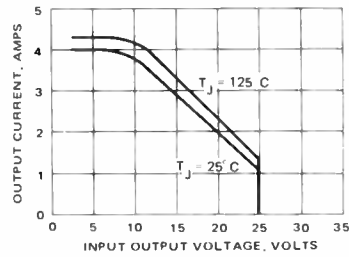

TYPICAL CURRENT LIMIT VS INPUT-OUTPUT VOLTAGE DIFFERENTIAL

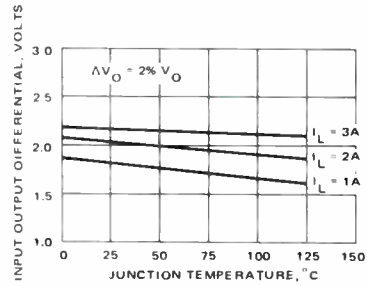

TYPICAL INPUT-OUTPUT DIFFERENTIAL VOLTAGE VS JUNCTION TEMPERATURE

Connection Diagrams

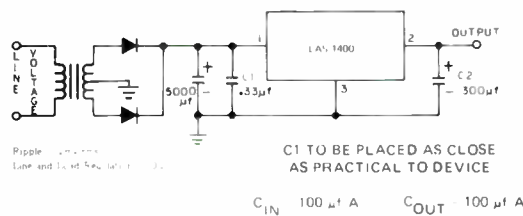

3.0 AMP POWER SUPPLY CIRCUIT

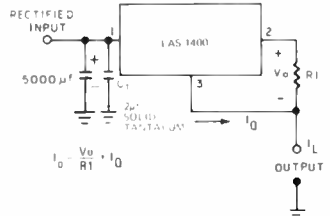

CURRENT REGULATOR CIRCUIT

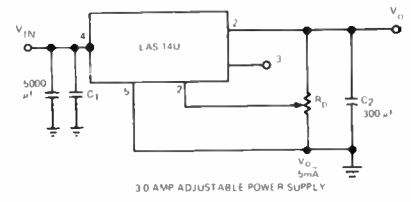

3.0 AMP ADJUSTABLE POWER SUPPLY

▲ Lambda staffed sales and service offices

1

MID-ATLANTIC REGION
Melville, New York 11746
515 Broad Hollow Road
Tel: 516-694-4200
TWX: 510-224-6484

Long Island, N.Y., New York, N.Y.,
Northern New Jersey
Tel: 516-694-4200

Delaware: Eastern Pennsylvania,
Southern New Jersey
Tel: 215-279-5644

Maryland, Dist. of Columbia,
Northern Virginia
Tel: 703-451-9340

Southern Virginia:
North & South Carolina,
Alabama, Georgia,
Tennessee, Mississippi
Tel: 704-542-1991

2

NORTH-EASTERN REGION
Lexington, Massachusetts 02173
2 Militia Drive
Tel: 617-861-8585
TWX: 710-326-7558

Rochester, New York
Tel: 716-454-6770

Poughkeepsie, New York
Tel: 914-297-4800

3

SOUTH-WESTERN REGION
Dallas, Texas 75231
6950 Winchester
Tel: 214-341-5130
TWX: 910-861-9048

Houston, Texas
Tel: 713-464-6554

Oklahoma
Tel: Enterprise 2-183
Largo, Florida
Tel: 813-596-5151

4

MID-WESTERN REGION
Arlington Heights, Ill. 60005
2420 East Oakton St. Unit Q
Tel: 312-593-7550
TWX: 310-222-2856

Minneapolis, Minnesota
Tel: 612-935-6194

Cleveland, Ohio,
Western Pennsylvania
Tel: 216-585-7808

5

FAR-WESTERN REGION
Carson, Calif. 90746
20601 S. Annaeae Ave.
Tel: 213-537-8341
TWX: 910-346-7649

Phoenix, Arizona
Tel: 602-996-1010

6

NORTH-WESTERN REGION
Sunnyvale, California 94086
599 N. Mathilda Ave. Suite 210
Tel: 408-738-2541
TWX: 910-339-9243

INTERNATIONAL

Lambda Electronics Corp. Export Dept.
515 Broad Hollow Road
Melville, N.Y. 11746
Tel: 516-694-4200
TWX: 510-224-6484
Cable: Lambdatron, Melville, N.Y.

ENGLAND

Lambda Electronics
Abbley Barn Road, Wycombe, Bucks
High Wycombe, Bucks, HP 11 1RW
Tel: High Wycombe 36386 7 B
TWX: 837153
Cable: VFEELAMHWYC

CANADA

Veeco Lambda Ltd
1000 Hymus Blvd
Pointe Claire, Quebec H9R 1E4
Tel: 514-697-6520
TWX: 610-422-3029

Veeco Lambda Ltd
P.O. Box 901, Postal Station K
Toronto, Ont. M4P 2G9
Tel: 416-486-0794

FRANCE

Lambda Electronique S.A.
Route de Griviers
91 Gometz le Chatel
Adresse Postale: BP 77 91403 Orsay
Tel: 012-1487

GERMANY

Lambda Netzgeräte GmbH
Lindenstrasse 93
D-7590 Achern 15
Tel: 078-41-5527
Telex: 752209 Lake D

ISRAEL

ISLAMBDA ELECTRONICS LTD
85 King Solomon St
Tel Aviv, Israel
Tel: 240-672
TWX: 03-2470 COIN ILI LAMBDA

JAPAN

Pan Electron Inc
1 Higashikata Machi, Midori Ku
Yokohama, Japan
Tel: 045-471-8811

LAMBDA MANUFACTURING PLANTS

Melville, N.Y.
Plant I: 515 Broad Hollow Rd.
Plant II: 1770 Walt Whitman Rd.
Reynosa, Mexico
Corpus Christi, Texas
121 International Dr

DESIGNED, DEVELOPED
AND MANUFACTURED BY



▲ LAMBDA

We know your needs. Electronics Magazine Book Series. Zero-risk trial offer.

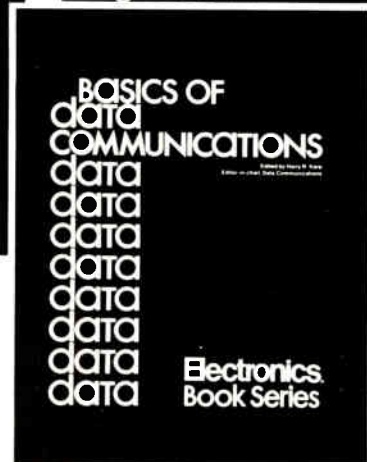
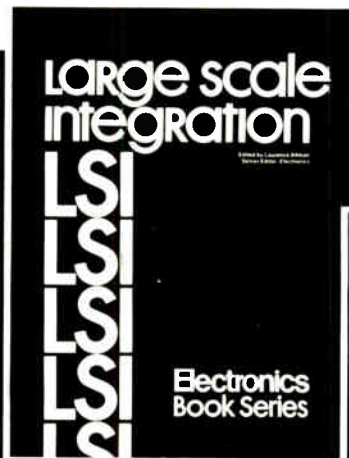

1. Microprocessors

What you must know about available microprocessor technology, devices, information, 4th printing. \$8.95

2. Applying Microprocessors

2nd and 3rd generation technology. 26 detailed applications from data networks to video games. \$9.95

3. Large Scale Integration

Covers the basic technology, new LSI devices, LSI testing procedures, plus system design and applications. \$9.95

4. Basics of Data Communications

Includes 47 articles from Data Communications magazine covering more than 11 key areas. \$12.95

5. Circuits for Electronics Engineers

Contains 306 circuits arranged by 51 functions from Amplifiers to Voltage Regulating Circuits. Saves design drudgery. \$15.95

Electronics Book Series

P.O. Box 669, Hightstown, N.J. 08520



1. Send me _____ copies of "Microprocessors" at \$8.95 per copy.
2. Send me _____ copies of "Applying Microprocessors" at \$9.95 per copy.
3. Send me _____ copies of "Large Scale Integration" at \$9.95 per copy.
4. Send me _____ copies of "Basics of Data Communications" at \$12.95 per copy.
5. Send me _____ copies of "Circuits for Electronics Engineers" at \$15.95 per copy.

D discounts of 40% on orders of 10 or more copies.

I must be fully satisfied or you will refund full payment if the book is returned after ten-day trial examination.

Payment enclosed Bill firm Bill me

Charge to my credit card:

- American Express Diners Club
 BankAmericard Master Charge

Acc't No. _____ Date exp. _____

On Master Charge only, first numbers above name _____

Name _____ Title _____

Company _____

Street _____

City _____ State _____ Zip _____

Signature _____

New products

Packaging & production

Testers check out variety of boards

Systems based on Intel microcomputer exercise most logic types used today

Users of printed-circuit-board testers have had to be content either with hardware-based systems that generate pseudo-random Gray-code fixed test-pattern sequences or with minicomputer-based software testers costing in excess of \$100,000 and using programmed patterns and responses.

Now Data Test Corp. of Concord, Calif., is offering an alternative that combines the advantages of both approaches with low cost—an automated board-testing family, the 5800 series, based on Intel Corp.'s powerful single-board microcomputer system, the SBC 80/20. First units in the series are the full-capability model 5800, priced at \$40,000 to \$60,000, depending on options; the model 5850, a test-only system, priced at \$30,000 to \$40,000; and the model 5810, a test-program development tool and test system designed to be used in conjunction

with the large 5800 system.

According to O. Douglas Greenwood, executive vice president of Data Test, the 5800, 5850 and 5810 combine two methods of pattern generation—fixed-pattern and programmed-pattern stimulus—and two methods of response evaluation—transitional redundancy check and programmed response—to test boards ranging from simple low-density types to complex high-density-logic configurations. The latter include microprocessors, peripheral interface adapters, read-only and random-access memories, and universal asynchronous receiver/transmitters.

Two types of bidirectional pin electronics are available with this series of testers. One is for transistor-transistor-logic and diode-transistor-logic (0 to +5-volt) levels with 64-pin grouping expandable to 256 pins in 32-pin groups (these levels are most common for the bulk of digital-logic circuits in use today). The other is for multilevel types (0 to +30 v), making it possible to test positive- and/or negative-zone logic families, such as emitter-coupled and metal-oxide-semiconductor logic.

The model 5800 includes a program-control console containing an alphanumeric display panel, a cathode-ray-tube display, keyboard status indicators, and system-command

elements. The 5810 is configured similarly except for the alphanumeric display panel. The 5850 is a test-only station and does not have a CRT for program development.

Testing speed on the 5850 and 5810 is 300 kilohertz for a single pin-execution (pattern/response); and 1 megahertz (one generator) and 500 kHz (both generators) for Gray code. On the model 5800, single-pin-execution rate is 200 kHz, with 400 kHz an optional feature. The time-interval-counter range is 50 nanoseconds to 3.2 milliseconds ± 50 ns in hardware on the models 5810 and 5850, extendable to 100 seconds through software. On the model 5800, the range is 100 ns to 500 microseconds ± 50 ns. Test programs are stored on floppy disks that have capacities of up to 250 kilobytes per disk. Memory capacity on the 5800 is 4 to 64 kilobytes, and 18 kilobytes is standard on the 5810 and 5850. This is expandable to 64 kilobytes.

Operating voltage is 115 volts ac $\pm 10\%$, at 50 to 60 hertz. A power level of about 900 watts is required on all models, depending on the load of the unit under test and power-supply options. All three models are available now.

Data Test Corp., 2450 Whitman Rd., Concord, Calif. 94518 [391]

PROM programmer

is easy to use

A slave-expandable PROM programming and emulating system called Smarty uses an 8-bit RCA complementary-metal-oxide-semiconductor microprocessor to greatly simplify its use. A set of five editing commands (find, delete, move, insert, and replace), for example, allows imperfect data to be loaded, corrected, and programmed. Similarly, once the machine has been set up to load a particular set of data into a particular type of programmable read-only memory, it runs completely automatically. Each PROM to be programmed is pretested to verify that erasure is complete or



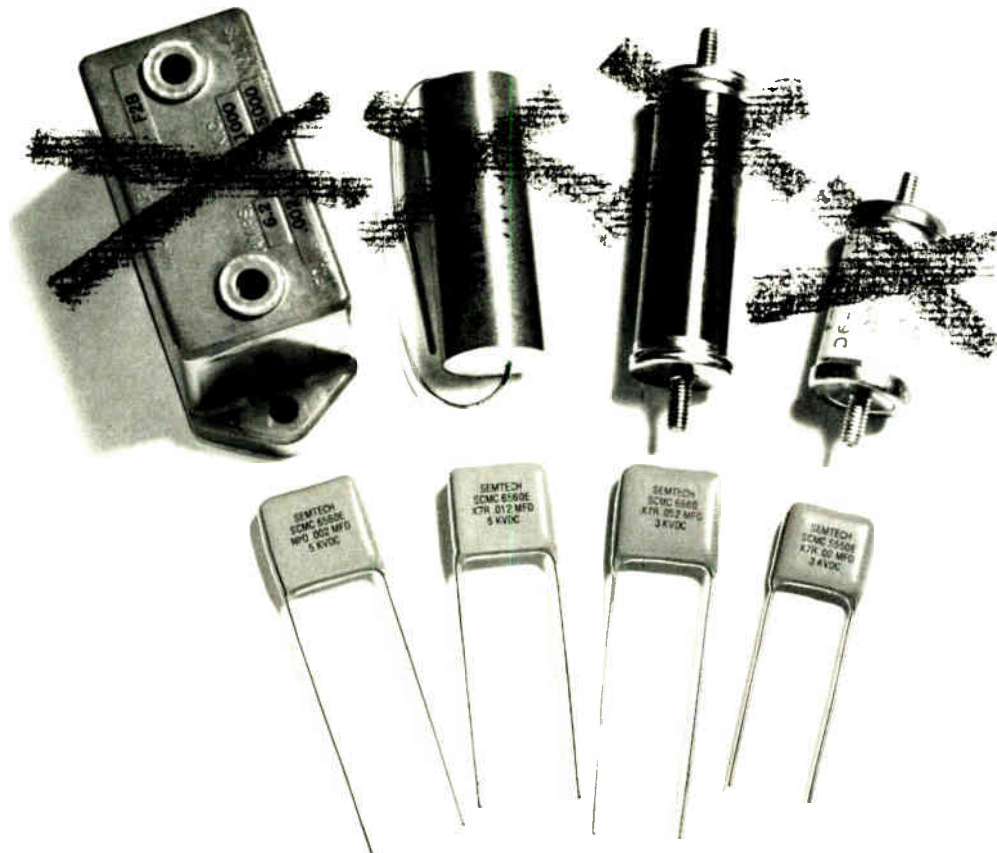

HIGH VOLTAGE MONOLITHIC CERAMIC CAPACITORS

Ideal for High Voltage High Density Power Supplies

We have a high density high voltage monolithic capacitor that meets present day equipment design criteria. Offering higher volumetric efficiencies and voltage stability over wider temperature ranges.

Higher Current Capabilities

In addition to high voltage the inherent design offers higher current carrying capabilities than previously available in ceramic monolithic capacitors of similar size.

"GOLD CAP" Radials

Construction: Monolithic radial leaded and dip coated
 Voltage: 1, 2, 3, 4 & 5 KV
 Capacitance: 18pF to .39 μ Fd.
 Dimensions: (Body) From .40"L x .35"H x .25"T to .80"L x .75"H x .35"T



"MONO" Chips

Construction: Monolithic with end terminations
 Voltage: 1, 2, 3, 4 & 5 KV
 Capacitance: 18pF to .39 μ Fd
 Dimensions: (Body) from .25"L x .20"W x .15"T to .65"L x .60"W x .25"T



Semtech capacitors are now available in quantity from stock at pricing low enough for use in commercial applications.

Contact your nearest Semtech office for our new High Voltage Capacitor Catalog.

Two Dielectric Types

Dielectric	NPO	X7R
Temperature Coefficient (T.C.)	Less than 30 ppm/°C; -55°C to +125°C	± 15% -55 to +125°C
Dissipation Factor (D.F.)	Less than .0015 (.15%) at 1 KHZ, 1 VAC, 25°C	2.5% max 1 KHZ 1 VAC, 25°C
Insulation Resistance (I.R.)	100K meg Ω or 1000 meg Ω microfarads, whichever is less (25°C, 500VDC)	100 K meg Ω or 1000 meg Ω microfarads, whichever is less (25°C, 500 VDC)
Aging	0	1% per decade
Dielectric Withstanding Voltage	1.2 Times Rated Voltage*, at 25°C	1.2 Times Rated Voltage*, at 25°C
Dimensional Tolerance	±.010 or ±5%, whichever is greater	±.010 or ±5%, whichever is greater

*Dielectric Withstanding Voltage Tests are conducted with charging current limited to 10 mA and the discharge current limited to 5 A

1975 NATIONAL SBA SUBCONTRACTOR OF THE YEAR



652 Mitchell Road, Newbury Park, California 91320
 (805) 498-2111 • (213) 628-5392 • TWX: 910-336-1264
 CHICAGO: (312) 352-3227 • DALLAS: (214) 234-6523
 FLORIDA: (305) 644-5404 • MARYLAND: (301) 937-0070
 NEW JERSEY: (201) 654-4884 • SAN FRANCISCO: (415) 494-0113
 EUROPEAN SALES: Bourns AG Zug, Switzerland (042) 232-242

Get the TM 990/100 μ P module from these distributors.

ALABAMA: Huntsville, Hall-Mark/Huntsville (205) 837-8700

ARIZONA: Phoenix, Kierulff Electronics (602) 243-4101 R V Weatherford (602) 272-7144, Tempe, G S Marshall (602) 968-6181

CALIFORNIA: Anaheim, R V Weatherford (714) 633-9633 **Canoga Park**, G S Marshall (213) 999-5001, **El Monte**, G S Marshall (213) 686-0141 **El Segundo**, TI Supply (213) 973-2571 **Glendale**, R V Weatherford (213) 849-3451, **Goleta**, RPS Inc (805) 964-6823 **Irvine**, Cramer/Los Angeles (714) 979-3000 (213) 771-8300 G S Marshall (714) 556-6400, **Los Angeles**, Kierulff Electronics (213) 685-5511, RPS, Inc (213) 748-1271, **Mountain View**, Time Electronics (408) 965-8000, **Palo Alto**, Kierulff Electronics (415) 968-6292 **Pomona**, R V Weatherford (714) 623-1261, **San Diego**, Cramer/San Diego (714) 565-1881 Kierulff Electronics (714) 278-2112 G S Marshall (714) 278-6350 **RPS Inc** (714) 292-5611 R V Weatherford (714) 278-7400, **Sunnyvale**, Cramer/San Francisco (408) 739-3011, G S Marshall (408) 732-1100 TI Supply (408) 732-5555, **Torrance**, Time Electronics (213) 320-0880 **Woodland Hills**, Semiconductor Concepts (213) 884-4560

COLORADO: Denver, Cramer/Denver (303) 758-2100 Kierulff Electronics (303) 371-6500 **Englewood**, R V Weatherford (303) 761-5432

CONNECTICUT: Hamden, Arrow Electronics (203) 248-3801 **North Haven**, Cramer/Connecticut (203) 239-5641, **Orange**, Milgray/Connecticut (203) 795-0714

FLORIDA: Clearwater, Diplomat/Southland (813) 443-4514 **Ft. Lauderdale**, Arrow Electronics (305) 776-7790, Hall-Mark/Miami (305) 971-9280, **Hollywood**, Cramer/Hollywood (305) 923-8181 **Orlando**, Cramer/Orlando (305) 894-1511, Hall-Mark/Orlando (305) 855-4020, **Winter Park**, Milgray Electronics (305) 647-5747

GEORGIA: Norcross, Cramer/Atlanta (404) 448-9050

ILLINOIS: Arlington Heights, TI Supply (312) 593-7660 **Elk Grove**, Hall-Mark/Chicago (312) 437-8800, Kierulff Electronics (312) 640-0200, **Chicago**, Newark Electronics (312) 638-4411, **Mt. Prospect**, Cramer/Chicago (312) 593-8230

INDIANA: Ft. Wayne, Ft Wayne Electronics (219) 423-3422 **Indianapolis**, Graham Electronics (317) 634-8202

IOWA: Cedar Rapids, Decco (319) 365-7551

KANSAS: Shawnee Mission, Hall-Mark/Kansas City (913) 888-4747

MASSACHUSETTS: Billerica, Kierulff Electronics (617) 667-8331 **Newton**, Cramer/Newton (617) 969-7700, **Waltham**, TI Supply (617) 890-0510, **Woburn**, Arrow Electronics (617) 933-8130

MARYLAND: Baltimore, Arrow Electronics (202) 737-1700, Hall-Mark/Baltimore (301) 796-9300, **Columbia**, Technico (301) 461-2200, **Gaithersburg**, Cramer/Washington (301) 948-0110, Kierulff Electronics (301) 948-0250, **Hyattsville**, Milgray/Washington (301) 459-2222

MICHIGAN: Detroit, Newark Electronics (313) 967-0600, **Wyoming**, Newark Electronics (616) 241-6681

MINNESOTA: Bloomington, Arrow Electronics (612) 888-5522 **Edina**, Cramer/Minnesota (612) 835-7811

MISSOURI: Earth City, Hall-Mark/St. Louis (314) 291-5350, **Kansas City**, LCOMP-Kansas City (816) 221-2400, **St. Louis**, LCOMP-St. Louis (314) 647-5505

NEW HAMPSHIRE: Manchester, Arrow Electronics (603) 668-6968

NEW JERSEY: Camden, General Radio Supply (609) 964-8560 **Cherry Hill**, Cramer/Pennsylvania (215) 923-5950, (609) 424-5993 **Milgray/Delaware Valley** (609) 424-1300 (215) 228-2000, **Clark**, TI Supply (201) 382-6400, **Clifton**, Wilshire Electronics (201) 340-1900, **Moonachie**, Cramer/New Jersey (201) 935-5600 **Moorestown**, Arrow Electronics (609) 235-1900 **Rutherford**, Kierulff Electronics (201) 935-2120 **Saddlebrook**, Arrow Electronics (201) 797-5800

NEW MEXICO: Albuquerque, Cramer/New Mexico (505) 265-5767

NEW YORK: East Syracuse, Cramer/Syracuse (315) 437-6671 **Endwell**, Wilshire Electronics (607) 754-1570 **Farmingdale**, Arrow Electronics (516) 694-6800, **Hicksville**, Kierulff Electronics (516) 433-5530, **Fishkill**, Arrow Electronics (914) 896-7530 **Freeport**, Milgray Electronics (516) 546-6000 (201) 432-4300 **Hauppauge**, Cramer/Long Island (516) 231-5600 Semiconductor Concepts (516) 273-1234, **Rochester**, Cramer/Rochester (716) 275-3000 **Rochester**, Radio Supply (716) 454-7800 **Wilshire Electronics** (716) 442-9560

NORTH CAROLINA: Raleigh, Hall-Mark/Raleigh (919) 832-4465 **Winston-Salem**, Cramer/Winston-Salem (919) 725-8711

OHIO: Cleveland, Arrow Electronics (216) 464-2000 Cramer/Cleveland (216) 248-8400 **Columbus**, Hall-Mark/Ohio (614) 846-1882, **Dayton**, ESCO Electronics (513) 226-1133 **Kettering**, Arrow Electronics (513) 253-9176

OKLAHOMA: Tulsa, Hall-Mark/Tulsa (918) 835-8458 TI Supply (918) 582-8272

PENNSYLVANIA: Huntingdon Valley, Hall-Mark/Philadelphia (215) 355-7300

TEXAS: Austin, Hall-Mark/Austin (512) 837-2814 **Dallas**, Hall-Mark/Dallas (214) 231-6111, TI Supply (214) 238-6821 **Houston**, Harrison Equipment (713) 652-4700 TI Supply (713) 776-6511, R V Weatherford (713) 688-7406

UTAH: Salt Lake City, Diplomat/Altalend (801) 486-7227 Standard Supply (801) 486-3371

VIRGINIA: Roanoke, Technico (703) 563-4975

WASHINGTON: Seattle, Almac/Strom Electronics (206) 763-2300 Cramer/Seattle (206) 575-0907, Kierulff Electronics (206) 575-4420

WISCONSIN: Oak Creek, Arrow Electronics (414) 764-6600 **West Allis**, Hall-Mark/Milwaukee (414) 476-1270

CANADA: Calgary, Cam Gard Supply (403) 287-0520, **Downsview**, CESCO Electronics (416) 661-0220 **Zenitronics** (416) 635-2822 **Edmonton**, Cam Gard Supply (403) 426-1805 **Hallifax**, Cam Gard Supply (902) 454-8581, **Kamloops**, Cam Gard Supply (604) 372-3338, **Moncton**, Cam Gard Supply (506) 855-2200, **Montreal**, CESCO Electronics (514) 735-5511, **Future Electronics** (514) 735-5775, **Zenitronics** (514) 735-5361, **Ottawa**, CESCO Electronics (613) 729-5118, **Future Electronics** (613) 232-7757, **Zenitronics** (613) 238-6411, **Quebec City**, CESCO Electronics (418) 524-4641, **Regina**, Cam Gard Supply (306) 525-1317, **Reddale**, Future Electronics (416) 677-7820, **Saskatoon**, Cam Gard Supply (306) 652-6424, **Vancouver**, Cam Gard Supply (604) 291-1441, **Winnipeg**, Cam Gard Supply (204) 786-8481

New products

that all links are good, then programmed and verified. The addresses of any bad cells are stored in a scratchpad memory to aid in quality-control analyses or to allow the use of PROMs with a few bad cells.

Perhaps more importantly, Smarty uses permanently connected slave units instead of plug-in personality modules. This eliminates both the connector problems and the time expenditure associated with chang-

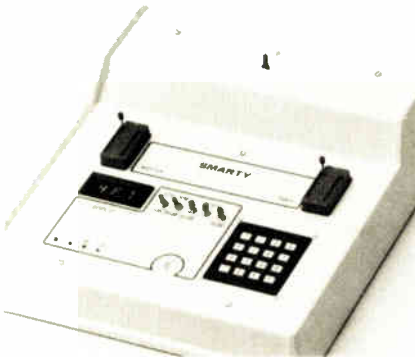

ing personality modules.

In its basic configuration, Smarty contains an 8-kilobyte data random-access memory, a 128-byte scratchpad RAM, parallel and serial data interfaces, a programmer for 2704 and 2708 PROMs, a hexadecimal keyboard, a hexadecimal display, and various indicators. Data can be entered from external devices, through the keyboard, or by reading an existing PROM or ROM through the master socket.

The basic Smarty sells for \$1,495 and has a delivery time of 30 days.

Sunrise Electronics, 228 North El Molino Ave., Pasadena, Calif. 91101. Phone Anna Erickson at (213) 963-8775 [392]

Substrate connectors

provide up to 81 contacts

A line of miniature connectors designed for use with ceramic substrates, glass-epoxy cards, and glass and plastic packages is available in standard sizes with 16, 40, 64, and 81 contacts. Designed for substrates with 0.0375-inch and 0.050-in. contact spacings, the connectors consist of a one-piece insulator in which the



beam-fork contacts are arranged in a row. Ceramic substrates 0.025 in. thick or glass-epoxy boards 0.031 in. thick can be connected by soldering, press-fitting, or a combination of press-fitting and reflow soldering.

The contacts are made of phosphor bronze and have a resistance of 10 milliohms maximum. Current rating is 1.8 amperes per contact for a temperature rise of 30°C. In large quantities, the microminiature substrate connectors sell for as little as 7 cents per contact.

Elco Corp., 2250 Park Place, El Segundo, Calif. 90245. Phone Pat Schofield at (213) 675-3311 [393]

Quad in-line sockets handle 48-pin devices

Designed to accept the Motorola Quill M10800 and Texas Instruments SN-74581 series of bipolar large-scale-integrated devices, a quad in-line socket can accommodate devices with up to 48 pins. Part number 860-48-CC-D is supplied with dip-solder terminals, while number 860-48-AA-D comes with

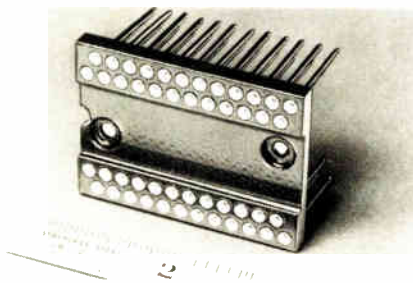

25-mil-square solderless wire-wrap terminals. Both types employ four-leaf beryllium-copper contacts for high retention. Prices range from \$1 to \$2.50, and delivery time varies from two to four weeks after the

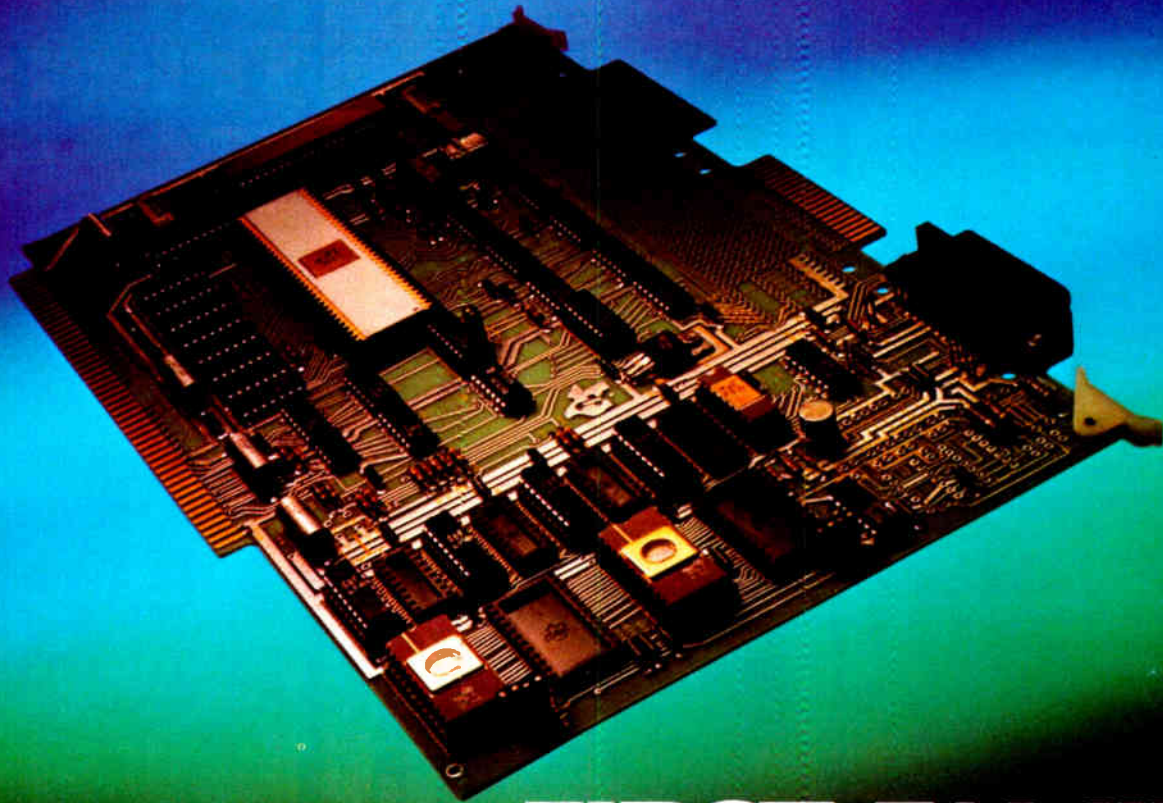

FIRST FAMILY

First low-cost, 16-bit μ P modules. For OEMs. From Texas Instruments.

The new TM 990 Series. Fastest, easiest way to get a microprocessor-based design to market. Ideal for μ P evaluation. And a cost-effective production alternative.

First in TI's new series: TM 990/100M. A TMS 9900 microprocessor, I/O circuits, 1K x 16-bit EPROM and 256 x 16-bit RAM on a single 7½" x 11" board. Pretested and ready to go.

The EPROM, which includes a self-contained software monitor (TIBUG™), is expandable to 4K x 16 bits. The RAM to 512 x 16 bits. Also on board: 16 lines of programmable parallel I/O, TTY current loop or RS 232 terminal interface. Two programmable interval tim-

ers; 15 external hardware interrupts. Plus a user prototyping area. All control, address and data lines are fully available to facilitate expansion to extremely large systems.

Leadership price

At a single unit price of \$450.00, the TM 990/100M is an economical means for checking out what TI's 9900 microprocessor can do. And at a 50-piece price of \$315.00, it is attractive for production runs.

More modules coming

A TMS 9980-based CPU module. A ROM/RAM memory expansion module. An I/O expansion module. A microterminal for data entry/

display. A line-by-line assembler in EPROM.

9900 First Family compatibility

The TM 990 Series modules are supported by the new advanced AMPL™ software development system. And are fully compatible with all members of TI's 9900 First Family. So you can move to the TMS 9900 components level. Or to TI's 990/4 microcomputer. Easily. Economically.

Order the TM 990/100M today from your TI distributor. Or for details, write Texas Instruments Incorporated, P.O. Box 1443, M/S 653, Houston, Texas 77001.



TEXAS INSTRUMENTS
INCORPORATED

Reed Low-Profile Keyswitches

FES-9 Series

Best choice today in meeting demanding keyboard applications!!

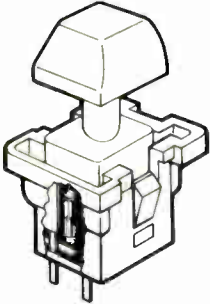

- Available in either "light touch" (snap-action) or "regular touch" models
- Choice of momentary or alternate action
- Wide range of keyface style and mounting (including sloped, stepped and sculptured)

FUJITSU LIMITED
Communications and Electronics

Circle 109 on reader service card

Reed Precision Switches

FPS-300 Series

Highest dependability of operation!!

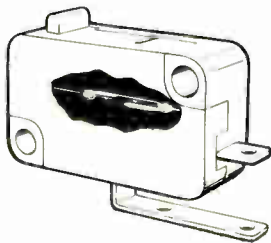

- Longer and more uniform service life for improved cost-performance
- 1 Form A or 1 Form B
- 30W DC contact rating available
- Wide choice of actuator with positive snap-action
- 10⁶ operations min.
- Wide range of ambient atmospheric conditions (-10°~60°C, -30°~70°C)

FUJITSU LIMITED
Communications and Electronics

* For contact information see page 170
Circle 168 on reader service card

New products

wafer damage because the only part that touches the wafer is a soft, thin monofilament. When the monofilament touches the wafer edge, it raises a low-mass shutter in an attached optical assembly and permits the light from a light-emitting diode to reach a photocell. The system thus combines mechanical delicacy with complete electrical isolation. Called the model 383, the detector is easy to adjust and repair; all the user must do is replace the monofilament occasionally.

Rucker and Kolls, 1305 Terra Bella Ave., Mountain View, Calif. 94042. Phone (415) 969-2369 [396]

Semiconductor-device tester is easy to program

An automatic parameter tester designed to measure various parameters of discrete semiconductor devices quickly and accurately can be pencil-programmed by means of a punched card. Designated the model PT-400, the tester can handle bipolar transistors, junction field-effect transistors, metal-oxide-semiconductor FETs, diodes, and resistors. Test results are displayed on a built-in digital panel meter, but provision has been made for connecting a data logger as well. A multiplexer option is available for use with multiple probes and probe cards, and a limit module is offered for go/no-go testing.

Automated Technology Inc., P. O. Box 2006, Santa Cruz, Calif. 95063 [398]

Platform connector mounts away from card edges

A new printed-circuit-board connector incorporates an elevated platform that allows it to be mounted anywhere on a pc board, even away from a card edge. Connectors in the injection-molded Term-acon series have contacts spaced on 0.156-inch centers and feature a minimum withdrawal force of 2.5 ounces. The contacts are rated at 2.5 amperes,

APPEAR SWITCHING REG. TOPS 700 LATEST.



A revolutionary development by Tohritsu offers you improved reliability as we utilized L.S.I. in the control circuit to be said complicated in order to reduce a great number of parts and also you are able to save the cost and the space.

Specifications

- Input A.C. 120V ± 15%
- Reg. line less than 0.2%
- Reg. load less than 1.0%
- Efficiency more than 70%
- Prot. over load and functions over current
- M.T.B.F. 100,000h
- Weight 2.1 lb
- Dimension 0.95(W) × 7.9(L) × 2.17(H) inch

Table

Model	Output voltage (V)	Output current (A)
TOPS700-4	4	15
TOPS700-5	5	15
TOPS700-6	6	12
TOPS700-9	9	8.5
TOPS700-12	12	5.5
TOPS700-15	15	5.5
TOPS700-18	18	3.5
TOPS700-24	24	3.5
TOPS700-28	28	3.0
TOPS700-36	36	1.8
TOPS700-48	48	1.8



Tohritsu Tsushin Kogyo Co., LTD.

Head Office 5-20-8, Nishigotanda,
Shinagawa-ku Tokyo, JAPAN

Looking for agent.

Circle 233 on reader service card



Lower system power with Mostek's Edge-Activated™ static RAMs.

Higher density, lower power, and simplified system design are the important advantages of Mostek's new Edge-Activated™ series of static RAMs. Implemented with a new Edge-Activated™ circuit design concept, the +5V-only family operates at faster speeds than traditional static circuits, but with much lower power dissipation and smaller chip area.

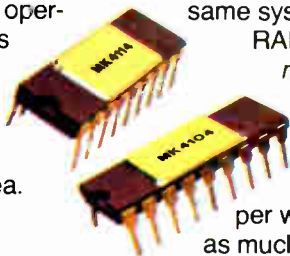

Lower Power Means Lower Costs.

A 16K × 9-bit storage matrix designed with Edge-Activated™ 4104's (4K × 1) or 4114's (1K × 4) dissipates less than 1 watt in the memory array. The same system with static-interface RAMs would dissipate *more than 18 watts.*

This means that power sub-system costs, which range from \$1.00 to \$1.50 per watt, can be reduced by as much as \$24.00 in a single storage matrix.

A battery back-up mode, where data retention is maintained at less than 0.3 μW per bit (typ.), offers even greater reduction of standby power.

Mostek High Performance RAMs

MK 4104-3* MK 4114-3*

Access Time	200 ns (max)
Cycle Time	310 ns (max)
Standby Power Dissipation	28 MW
Active Power Dissipation	<120 MW
Power Supply	+5V (± 10% tolerance)
Pin Configuration	Industry Standard 18 Pin

*Available in several speed/power ratings.

MOSTEK

Setting Industry Standards

1215 West Crosby Road • Carrollton, Texas 75006 • (214) 242-0444 • MOSTEK GmbH • West Germany • Telephone: (0711) 701096 • MOSTEK ASIA • Hong Kong • Telex: 8514EMKA HX

Circle 169 on reader service card

World Radio History

PC Board-Mount Reed Relays

FRL-640/710 Series

High dependability and solid performance reed relays for today's demanding switching requirements!!

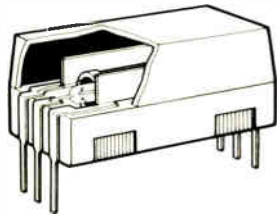

Wide reed relay lineup available for your requirements

FRL-640 Series	
Contact Form	1 Form A/B 2 Form A/B
Contact Rating	Type K 30W DC
	Type S 10W DC
Rated Coil Voltage	5 ~ 24V DC
Height	0.354"
Terminal Spacing	Dip terminal on 0.1" grid spacing

FRL-710 Series	
	Standard Dip Type Latching Dip Type
Contact Form	1 Form A Latching type 2 Form A
Contact Rating	4W DC
Rated Coil Voltage	5 ~ 12V DC
Height	0.20"
Terminal Spacing	Dip terminal on 0.1" grid spacing

FUJITSU LIMITED

Communications and Electronics

FUJITSU AMERICA INC./Los Angeles Office: 1251 West Redondo Beach Blvd., Suite 304, Gardena, CA 90247, U.S.A. Phone: 213-538-3397 TWX: 910 346 6724 **Chicago Office:** P.O. Box 694, Lake Forest, IL 60045, U.S.A. Phone: 312-295-2610 TWX: 910 651 2259

FUJITSU LIMITED/Components Group (Head Office): Syuwa Onarimon Bldg., 1-1, Shinbashi 6-chome, Minato-ku, Tokyo 105, Japan Phone: 03-457-2111 Cable: FUJITSULIMITED TOKYO Telex: 2424511 FT SIN J **London Office:** Norman House, 105/109 Strand, London W.C. 2, England Phone: 240 0461/0462 Telex: 51-22305

U.S./CANADIAN SALES REPRESENTATIVES:

Application Specialists, Inc.: 6806 Newbrook Ave., E. Syracuse, NY 13057 Phone: 315-437-2813 Telex: 937201 **Electrical Components, Inc.:** Box 172, Natick, MA 01760 Phone: 617-655-2225 Telex: 948437 **Swedelco, Inc.:** 65 Court St., White Plains, NY 10601 Phone: 914-946-1122 Telex: 13 1468 **Hughes Associates, Inc.:** 717 Pratt Ave., N.E., Box 33, Huntsville, AL 35801 Phone: 205-536-2127 **Bransky Sales:** 1279 Lincoln Ave., South Highland Park, IL 60035 Phone: 312-433-2375 **McFadden Sales, Inc.:** 4645 Executive Dr., Columbus, OH 43220 Phone: 614-459-1280 TWX: 810-482-1623 **Technical Representatives, Inc.:** 6515 E. 82nd St., Suite 110, Indianapolis, IN 46250 Phone: 317-849-6454 TWX: 810-260-1792 **Shonin, Inc.:** 1485 Bayshore Blvd., San Francisco, CA 94124 Phone: 415-467-8700 **Electronic Components International:** 450 Denison St., Markham, Ontario L3R 1B9, Canada Phone: 416-495-6202 Telex: 065-24011

Circle 170 on reader service card

New products

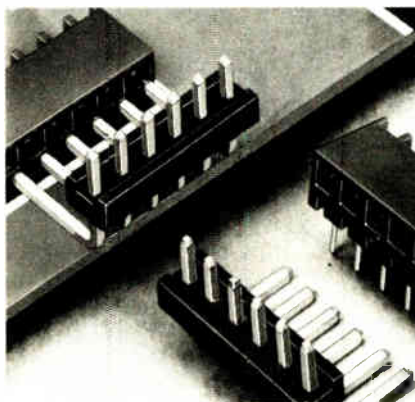

250 volts ac. Dielectric strength between adjacent terminals is 1,500 v. Delivery is from stock.

Methode Electronics Inc., Dept. PR, 1700 Hicks Road, Rolling Meadows, Ill. 60008. Phone (312) 392-3500 [397]

Automatic system inspects photomasks

An automatic inspection system for the photomasks used in semiconductor manufacture can examine 3- to 5-inch masks at a rate of about 2 square in. per minute or approximately five minutes for a 3-in. mask. The standard version of the model KLA-100 will detect defects as small as 50 microinches, while 25- μ m. capability is available as an option.

Because of its built-in microprocessor-based computer system, the KLA-100 has almost no need for operator intervention. One simply loads the mask into the machine and follows the instructions presented on the cathode-ray-tube display. After the inspection has been completed, the defects may be reviewed on the CRT and loaded onto a magnetic tape for defect location, repair, and reinspection at a later time.

KLA Instruments Corp., 2900 Corbin Drive, Santa Clara, Calif. 95051. Phone (408) 738-1441 [399]

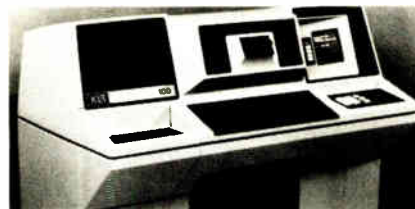

BUILDING BLOCKS FOR YOUR PRODUCTS!

GLASS EPOXY SILICONE POTTING AND COIL FORMS

- Molded
- Bonded
- Sandblasted
- Cut to size
- Holes and terminals

READY TO USE!

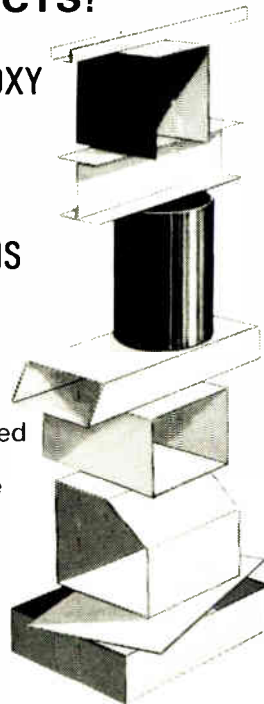

STEVENS TUBING CORP.
SUBSIDIARY OF STEVENS PRODUCTS, INC.
128 North Park St., East Orange, N.J. 07019
201-672-2140

Circle 234 on reader service card

PROFESSIONAL DISCOUNTS

Texas Instruments electronic calculator

TI-1750 LCD	\$19.95	SR-40	\$24.95
TI-2550 II	24.95	SR-51 II	49.95
Little Prof	12.95	TI-57 NEW	64.95
Dataman	22.50	TI-58 NEW	99.95
TI-5100	44.95	TI-59 NEW	249.95
TI-5015 NEW	65.00	PC 100A	147.00
TI-5050 M	84.95	Money Mgr	17.95
TI-5040 PD	95.00	Bus Analyst	29.95
TI-30 SP	17.95	All Libraries Available	



HEWLETT PACKARD

We are franchised H-P dealer All accessories at discount

HP-10 NEW	\$139.00	HP-27	\$140.00
HP-19C NEW	299.00	HP-29C NEW	159.00
HP-21	64.00	HP-80	235.00
HP-22	100.00	HP-67	360.00
HP-25	100.00	HP-91	275.00
HP-25C	128.00	HP-92	515.00
		HP-97	599.00

Also SCM, Olivetti, National Semiconductor, Casio, Canon, Corvus, APF, Sharp, Craig, Sanyo, Record-A-Call and more. ALL AT GREAT PRICES!

FAIRCHILD Programmable Video Game \$135.00 (2000 games possible)
Cartridges 17.95
Also Fairchild Watches!

WE WILL BEAT OR MEET ANY COMPETITORS' PRICE IF HE HAS MERCHANDISE ON HAND. All units shipped in original factory cartons with accessories according to manufacturers' specifications. In CA call (213) 370-5795 or CALL (800) 421-0367 (other than CA). Above prices are for cash only. Credit card prices differ. BankAmericard/Visa & Master Charge accepted. Send money order. Pers. ch. R2 wks to clear; in CA add 6% sales tax. Add \$3.50 min. shipping charges. WE SHIP AIR on request. Subject to availability. Send mail orders to DEPT.

2 locations in So California

tkenterprises
BETTER BUSINESS PRODUCTS

16611 Hawthorne Blvd., Lawndale, Ca. 90260
(213) 370-5795 (800) 421-0367

Circle 235 on reader service card

GRINNELL DISPLAYS:

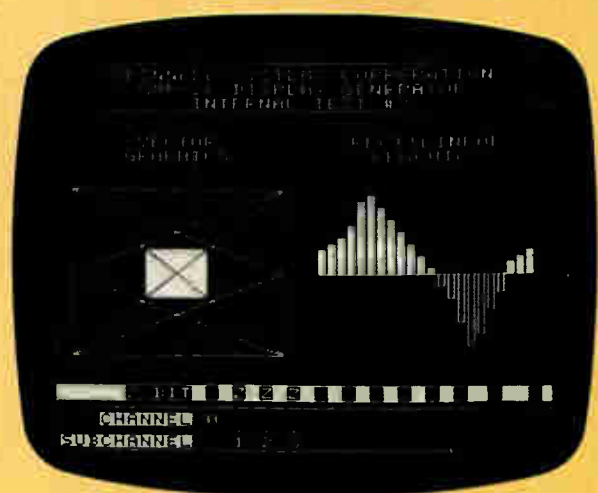
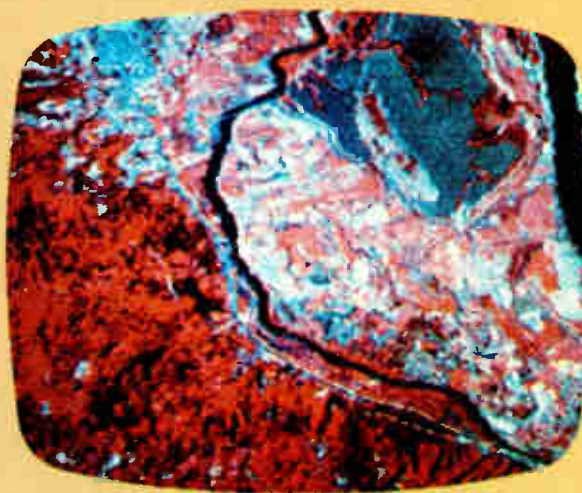
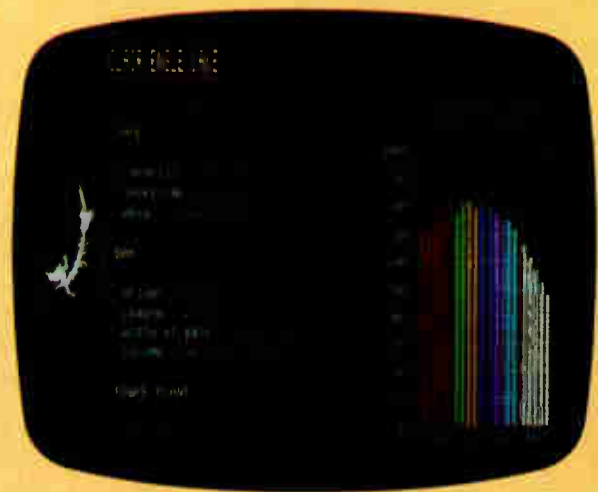
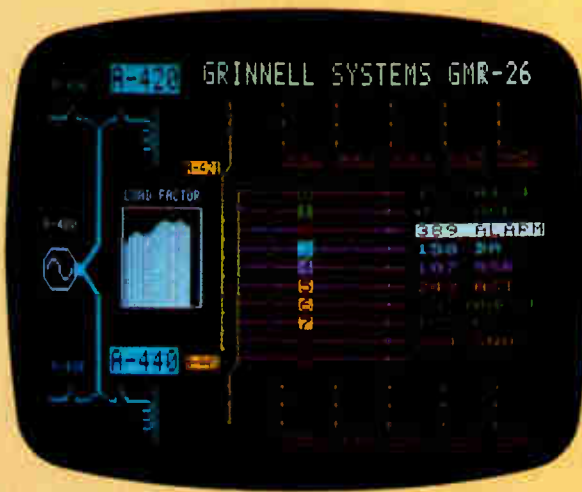

Complex color imaging . . . graphics . . . grey scale . . . basic black and white: our 100% solid state graphic television display systems can be matched to your computer display requirement, easily and economically.

And, they're intelligent. Powerful instruction sets minimize software overhead, simplify programming and eliminate the need for complex macro-instructions and

high order programming languages.

Further, every Grinnell system includes a standard computer interface, full alphanumeric and graphics, 4K MOS random access refresh memories and your choice of standard resolutions: 256 x 256, 256 x 512 or 512 x 512. Plug-compatible interfaces for most minicomputers are available, along with a large number of

operating options. All systems drive standard TV monitors.

So, before you make any decision about computer display systems, talk to the Grinnell experts. Our engineers have been in the display picture longer than most, and their experience shows. Complete operating systems start at \$5,700, and quantity discounts are available. For detailed specs and/or a quotation, call or write.

GRINNELL SYSTEMS

2986 Scott Boulevard, Santa Clara, California 95050 (408) 988-2100

Circle 171 on reader service card

World Radio History

Microwaves

Mixer offers low conversion loss

Isolation is kept high across unit's bandwidth from 2 to 12.4 gigahertz

A broadband double-balanced mixer holds conversion loss low yet keeps isolation high across its full operating bandwidth, while retaining a wide intermediate-frequency range. The new device, designated the HMXR-5001, is the first of its kind to be made by the Microwave Semiconductor division of Hewlett-Packard Co.

Bandwidth for the unit ranges from 2 to 12.4 gigahertz, although it is usable up to 18 GHz with only a slight sacrifice in performance. Its i-f band spans a 100:1 range, from 0.01 to 1 GHz. At frequencies up to 8 GHz, conversion loss is typically held

to 7.5 decibels, and to 8.5 dB up to 12.4 GHz. The device provides a typical isolation of 30 dB between its local-oscillator and radio-frequency ports.

Inside the hermetically sealed package of the HMXR-5001, HP is using Schottky-diode beam-lead quads, rather than the chip diodes found in most microwave mixers. In addition, HP builds the unit with small semirigid cables as transmission lines, instead of the stripline configurations common in other mixers.

The combination of sealed diode packages and semirigid transmission lines assures users that most of the important high-frequency signals remain confined within these components, says HP. It also permits the firm to use an epoxy foam to seal the package for increased ruggedness.

Among the applications for the HMXR-5001 are frequency conversions in electronic warfare systems, instrumentation, and measurement systems. Although it is specified for wideband operation, the unit may even be used in narrowband radar

and telecommunications applications.

At 25°C, total input power is 100 milliwatts maximum. Operating temperature range covers extremes of -65° to +125°C. To test its environmental capabilities, HP processes the mixer according to the requirements of MIL-STD-202E.

In quantities of one to nine, the HMXR-5001 is priced at \$325. It is available from stock.

Hewlett-Packard Co., 1501 Page Mill Rd., Palo Alto, Calif. 94304 [401]

4-GHz mixer-preamplifier features low gain ripple

Designed for use in the satellite communications band that extends from 3.7 to 4.2 gigahertz, the C62-1 mixer-preamplifier is noteworthy for its extremely flat response—gain ripple is less than 0.1 decibel over any 40-megahertz bandwidth. The

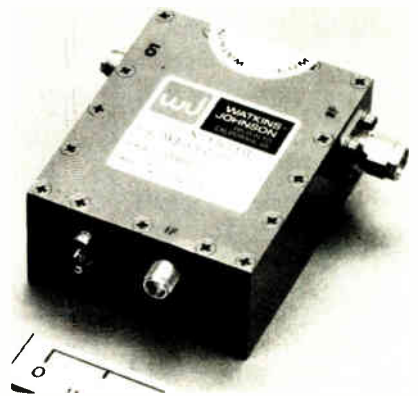

gain variation over the entire frequency range is typically less than 0.5 dB. Also, because of the unit's low VSWRs, isolators are not needed in most applications. The VSWRs are 1.25:1 on the local-oscillator and intermediate-frequency ports and 1.4:1 on the radio-frequency port.

The C62-1 provides 18.0 ± 0.5 dB of conversion gain and an overall noise figure of 10.0 to 10.5 dB with 10 dBm of LO drive. LO-to-rf port isolation is typically 40 dB. Minimum output power is -2 dBm; to obtain this, the unit requires 21 milliamperes at -15 v dc. In small

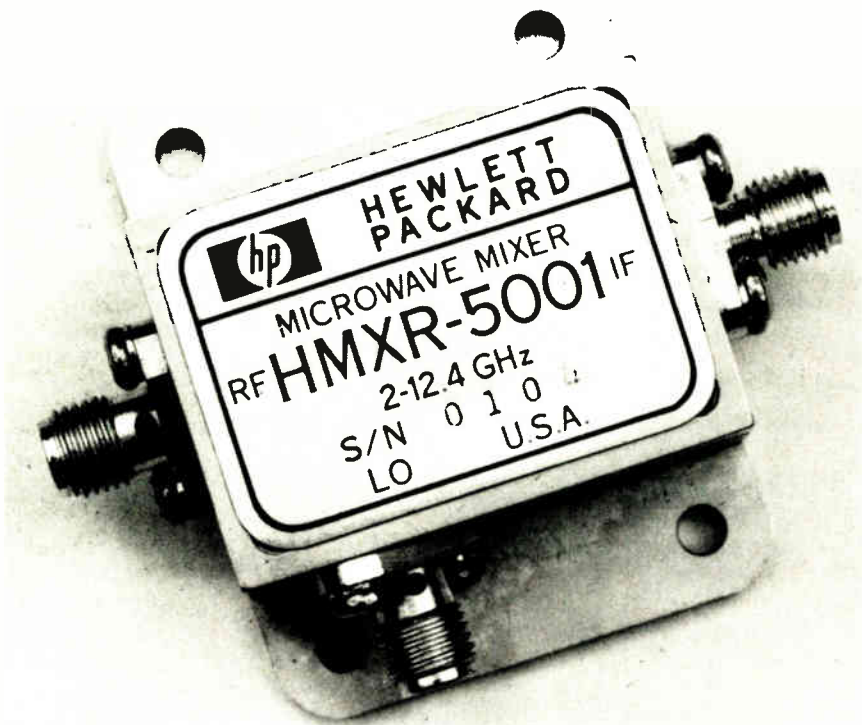

RIGHT ANGLE PC TOGGLES

Miniature toggle switches designed for PC applications. Gold plating over nickel on contacts and terminals is provided for efficiency in low-level applications and to facilitate soldering. Two styles; allowing a choice of vertical or horizontal toggle actuation. Short toggles, plain bushing or 3 or 4 pole types optionally available on special order.



MST-RA SERIES

Circle 237 on reader service card

MOMENTARY PUSHBUTTONS

Unique overtravel design allows a 3A-125VAC rating. Momentary types available as Normally Open or Normally Closed. Red or Black plunger or with replaceable buttons in a choice of five colors. One piece bushing and frame construction eliminates tear-off when mounted. Aluminum guards are available to enhance the appearance.



MSP SERIES

MPB SERIES

Circle 238 on reader service card

ALCO ELECTRONIC PRODUCTS, INC.

1541 OSBORN STREET NORTH ANDOVER, MA 01850 U.S.A.

Tel: (617) 685-4371 TWX: 710 42-0552

AUGAT

Circle 238 on reader service card

NEW for today's applications

Davies #1200 SERIES OF ELECTRONIC INSTRUMENT KNOBS

Molded of durable, thermo-setting materials, the versatile #1200 Series of Electronic Instrument Knobs is suitable for many applications including electrical appliances, electronic instruments and test equipment and consumer hi-fi components. 9 basic knobs in a variety of shapes and sizes with 5 round styles from 1/2" to 1 1/8", 3 pointer knobs and 1 skirted utility unit. Order them with or without brass inserts for set screw mountings, push-on spring mountings or knurled shaft mountings. Available lined or unlined, plain tops or decorative spun gold or spun silver inlays.

Request samples and prices from

Davies HARRY DAVIES MOLDING COMPANY

4920 W. Bloomingdale Avenue Chicago, ILL. 60639

Circle 236 on reader service card

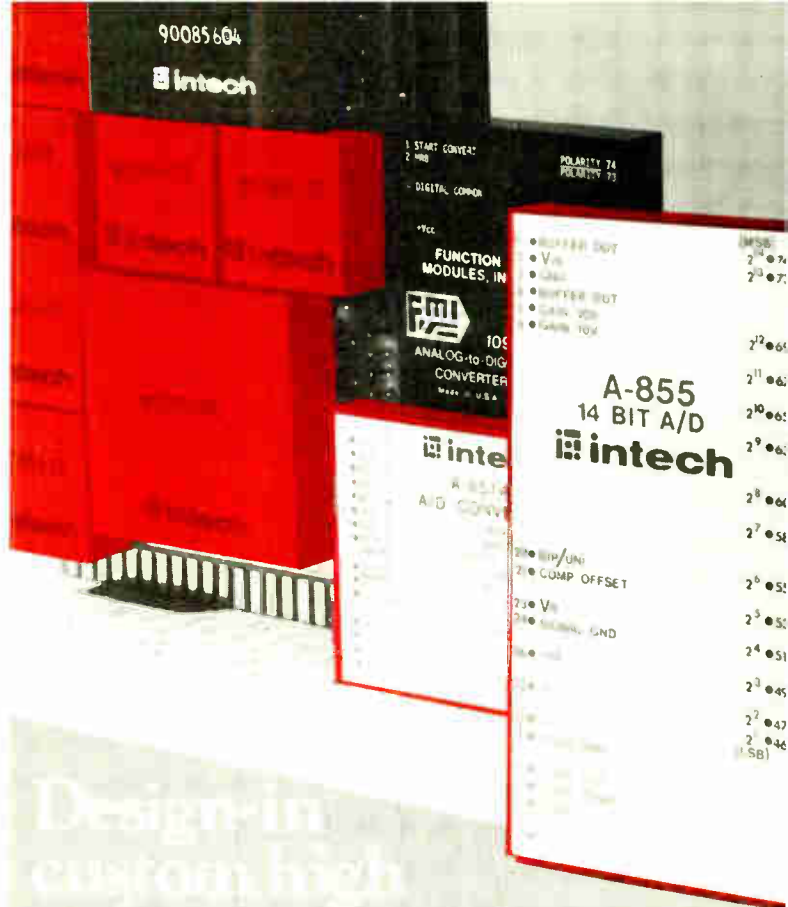

Whether you're looking for high resolution and/or high speed for commercial or military applications, there's a broad line of A/D "cost performers" that you should, and can, take a look at today. For example:

109 The versatile \$99.00 naked A/D with 16-bit or 5 1/2-digit resolution offers OEM flexibility in output configuration.

A-855-14 A 14-bit A/D with a conversion time of 25µs, gain t.c. of ±7 ppm/C at a new low price of \$295.00. A popular converter for medium to high speed computer-controlled data acquisition systems.

A-856-16 A 16-bit performer at less than 10µs, with sample and hold, is a veteran unit for high speed data acquisition systems, with large numbers of low level data points.

A-858-16 Our newest A/D offers 16-bit performance at 40µs and includes buffered input and byte-segmented tri-state outputs, all for \$425.00. Options include uni/bipolar inputs/outputs. Samples and Holds (settling times: 2µs to 10µs) and more.

The above listing is just a small sample of what Intech/FMI A/Ds can do to fit your design needs. We don't stop there either. There's a wide choice of high speed 8 and 12-bit A/Ds, also. Plus, Intech gives you design assistance and sample modules for testing that are available as fast as you ask. All units are tested through all parameters before delivery, burned-in, and guaranteed to be at spec or better.

Circle the reader service number below, or, call or write today, for more information on the Intech/FMI complete line of A/D converters.

intech/function modules

282 Brokaw Road, Santa Clara, California 95050
Phone (408) 244-0500 TWX: 910-338-0254

World Radio History

New products

quantities, the C62-1 sells for \$995. Small lots are available from stock. Large orders may take three weeks. Watkins-Johnson Co., 3333 Hillview Ave., Palo Alto, Calif. 94303. Phone (415) 493-4141 [407]

Double-balanced mixer works from 0.2 to 22 GHz

The model DBM-1800 double-balanced mixer is an extremely broadband device with a radio-frequency response that extends from 200 megahertz to 22 gigahertz and an intermediate-frequency response of 5 MHz to 7 GHz. The unit's extremely broad bandwidth makes it suitable for applications in wideband surveillance, high-speed data transmission, radar, microwave instrumentation, and the like. The DBM-1800 typically has a conversion loss

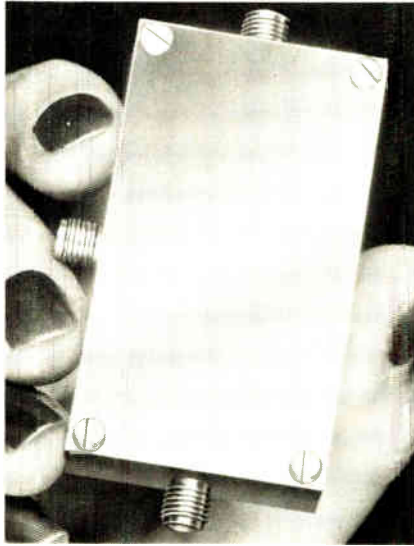

of 8 dB, isolation of 25 dB, and a VSWR below 3:1 over its entire frequency range. It measures 2.3 by 1.3 by 0.85 inches and is available in a hermetically sealed version. Priced at \$650 in quantities of one to nine

pieces, the mixer has a delivery time of eight weeks.

Vari-L Co., 3883 Monaco Parkway, Denver, Colo. 80207 [406]

Broadband step attenuators go up to 129 decibels

A line of miniature step attenuators, which provides as much as 129 decibels of attenuation, is available in both manual and motorized versions. The attenuators come in five standard frequency ranges with the broadest extending from dc to 18 gigahertz. The 50-ohm units are offered with a choice of eight standard rf-connector options including coaxial and waveguide types. They boast a switching life in excess of a million steps and a repeatability of better than 0.01 dB per drum up to 10 GHz. Maximum zero insertion

The Head-Start 16K ROM.

Beat the pack to your market.

Synertek's two-week turnaround on the SY2316B (Intel's 2316E), the SY2316A, or the SY4600 gives you the head start you need to beat the pack to the market.

If you want to lead, you have to get the quickest start.

Synertek gives you that quick start to 16K ROM production by maintaining a ROM inventory that needs only the last custom mask before





Peak-power meter covers 100 MHz to 12.4 GHz

loss and variation are held to low values on all models. For example, a single-drum 90-dB unit has a loss of less than 0.7 dB at 8 GHz, and the value rises only to 1.0 dB at 18 GHz.

All models in the series can dissipate an average power of 1 watt and can handle peak powers of 500 watts. They operate from -54°C to 55°C and can be stored at temperatures from -62°C to 85°C . Prices start at \$525; delivery is from stock to 45 days.

Weinschel Engineering Co., Gaithersburg, Md. Phone (301) 948-3434 [405]

The model 1018B peak-power meter, which covers the frequency range of 100 megahertz to 12.4 gigahertz, will measure the peak power of rf pulses as short as 200 nanoseconds, regardless of their shape. The unit can operate on single pulses or pulses in a train. Its fast detector, combined with a sample-and-hold circuit, provides an 80-ns measurement aperture with a variable trigger delay for profiling repetitive pulses. The digital instrument accommodates repetition rates as high as 1 MHz and amplitudes from -20 dBm to 10 dBm. In addition to measuring power, it can also measure the pulse width at any common power point such as 3 dB or 6 dB.

The basic 1018B sells for \$4,400.



For \$230 more its frequency range can be extended to 18 GHz. And for another \$800 it can be equipped with an IEEE-488 bus interface. Delivery takes 60 days.

Pacific Measurements Inc., 470 San Antonio Rd., Palo Alto, Calif. 94306. Phone (415) 494-2900 [404]

Tiny double-balanced mixer spans 17 GHz, weighs 0.3 oz

Although it weighs only a third of an ounce and measures only half an inch on each side, a new double-

delivery to you. Your data base (tapes, card, EPROMS, etc.) is used to generate verification media, test tapes, and the last mask in about a week. A few days later, we ship your ROMs.

Two weeks is the promise.

This whole technique of last mask programmability permits us to deliver your prototypes two weeks

after verification. This gives our customers great flexibility in adapting their hardware for new options, software changes or last-minute schedule changes. In your market and ours, the race belongs to the swift.

We're in the business of responding to reality. Today's reality is that everybody needs everything *yester-*

day. We can't quite do *that*, but we can give you an extra week or two of ROM lead time. It's up to you to convert it into time in the sun.

Call your local Synertek rep or distributor or call Larry Hester at the factory, 3050 Coronado Drive, Santa Clara, CA 95051. (408) 984-8900. TWX 910-338-0135.

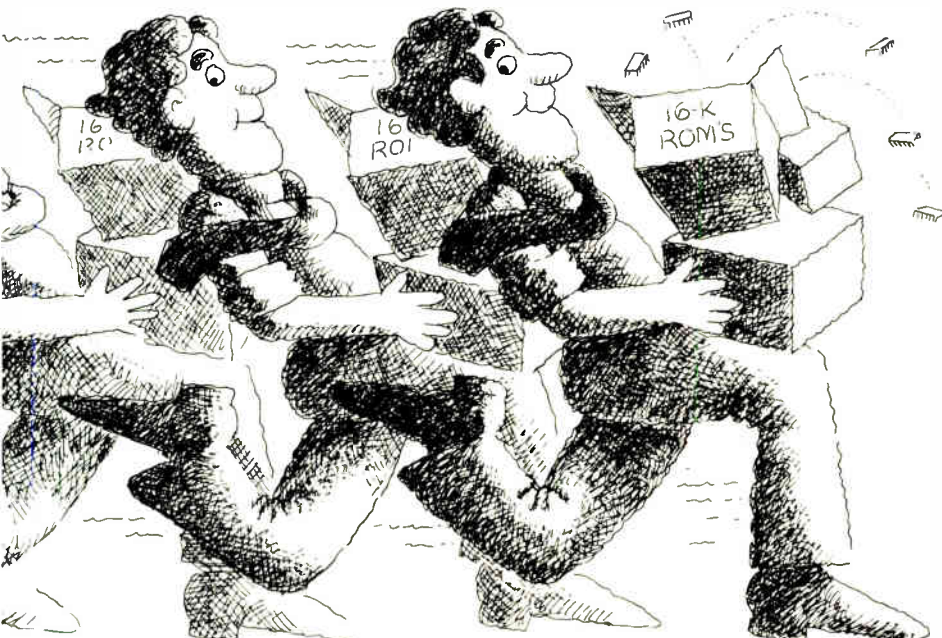

Synertek.
Solutions.
Not problems.

Circle 175 on reader service card

NEW—REVOLUTIONARY TOOL

SLIT-N-WRAP

WRAPS
INSULATED WIRE
FOUR TIMES FASTER

NO Prestripping
NO Precutting
Spool Fed Wire

Users say:

"Your P180 tool really does just what you said it would—We're very satisfied."

"We're shifting nearly all our wrapping over to Slit-N-Wrap."

The spooled wire passes thru the tool past a slitting edge next to the wrap post. A narrow longitudinal cut is made in the insulation where it passes the square post corner. The bared copper is indented by the sharp edge. (7 turns equal 28 contacts.) Insulation is slit where wrapped, but not between terminal posts when fed straight out of the tool.

Model P180 with two 100' spools of 28 gage wire \$24.50

Battery powered Model P180-4T includes charger and wire \$39.00

110V Model P180-4T \$39.00



view of unwrapped wire end .025 sq. post

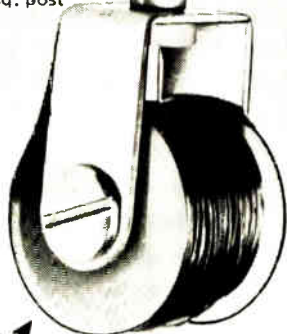

Vector

ELECTRONIC COMPANY
12460 Gladstone Avenue
Sylmar, CA 91342

If unavailable locally, factory order. Add \$2.00 shipping and handling charge.

California residents add 6% sales tax.

191076

New products

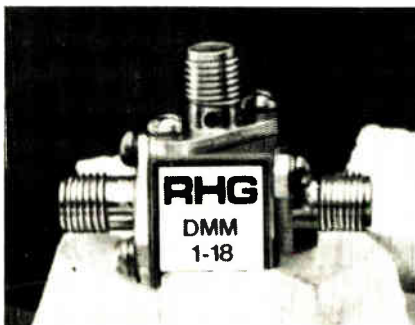

balanced mixer covers the frequency range of 1 to 18 gigahertz. Nick-named the sugar-cube mixer, the unit is particularly well suited for manpack and high-density applications. In addition, its light weight allows it to be supported by its connecting cables, which can simplify system packaging in any application.

Conversion loss for the model DMM1-18 is typically 7 decibels, with 8 dbm of local-oscillator power and an i-f response from dc to 350 megahertz. Priced at \$295, the ultraminiature mixer is available from stock.

Sales Department, RHG Electronics Laboratory Inc., 161 East Industry Court, Deer Park, N.Y. 11729. Phone (516) 242-1100 [403]

Ferrite isolator fits into microstrip circuits

The MA-7L933-S001 is a ferrite isolator designed with solder tabs so that it can be inserted directly into a microstrip circuit with no need for connectors or cables. Among the advantages of this approach are improved reliability and reduced

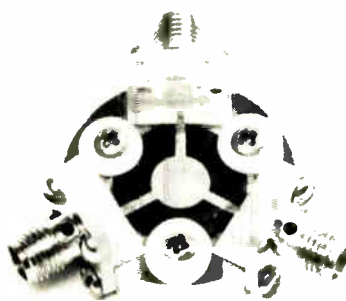

volume. Complete information on the isolator, which covers the frequency range from 5.855 to 6.425 gigahertz, is available from the manufacturer in Bulletin No. 1133.

Microwave Associates Inc., Burlington, Mass. Phone (617) 272-3000 [409]

Divide-by-8 counters dissipate little power

A line of divide-by-eight decade counters with upper operating frequencies as high as 1.2 gigahertz is noteworthy for its typical power dissipation of only 470 milliwatts. The monolithic devices are the 1.2-GHz model SP8677, the 1.1-GHz SP8676, and the 1.0-GHz SP8675. All three devices feature a self-biasing clock input, clock inhibit for direct gating, inputs compatible with ECL III, outputs compatible with ECL II, and an input dynamic range of 400 to 1,200 millivolts. In hundreds, the counters sell for \$32, \$36, and \$42 each in increasing order of upper-frequency limit. These units operate from 0°C to 70°C. More expensive counters are available for use from -30°C to 85°C.

Plessey Semiconductors, 1641 Kaiser Ave., Irvine, Calif. 92714. Phone Dennis Chant at (714) 540-9979 [408]

Two-gate GaAs FET operates up to X band

The NE463 dual-gate GaAs field-effect transistor can be applied in several different ways, depending upon how its two 1-micrometer gates are used. By adjusting the n-channel device's second gate, the NE463 provides up to 20 decibels of gain control up to X band. With the second gate grounded, the transistor is a cascode amplifier with a gain of 15 dB at 8 gigahertz. Chips are available from stock at \$90 each. Packaged devices sell for \$185 each in lots of 10 to 24.

California Eastern Laboratories Inc., One Edwards Court, Burlingame, Calif. 94010. Phone (415) 342-7744 [410]

The McGraw-Hill BETTER LIVING BOOK CLUB

MEMBERSHIP ORDER CARD

Please enroll me as a member and send me the two books indicated. I am to receive the bonus book at the introductory price of \$1.00 plus my first selection at the discounted price for members, plus tax, postage, and handling. If not completely satisfied, I may return the books within 10 days and request that my membership be cancelled. If I keep the books, I agree to take a minimum of three additional books of my own choosing during the next two years. I will receive the Club Bulletin 12 times a year. If I want to examine the featured selection, I need take no action. It will be shipped automatically. If, however, I want an alternate selection—or no book at all—I simply notify the Club by returning the

convenient card always enclosed. I will always have a minimum of 10 days in which to return the card, and you will credit my account fully, including postage, if this is not the case. Membership in the Club is continuous but cancellable by me at any time after the four-book purchase requirement has been filled. *This order subject to acceptance by McGraw-Hill. Orders from outside the continental U.S. must be prepaid. All prices subject to change without notice. Company, business, or institutional tax exemption status is not applicable to purchases made through individual Club memberships. Offer good for new members only.*

INDICATE BY NUMBER THE TWO BOOKS YOU WANT

Write Code No. of Bonus Book Here

Write Code No. of First Selection Here

SEND NO MONEY. SIMPLY MAIL THIS CARD TODAY AND WE WILL BILL YOU

Name _____

Street Address _____

City _____ State _____ Zip _____

EXTRA SAVINGS: Remit in full with your order, plus any local and state tax, and McGraw-Hill will pay all postage and handling charges.

L54023
Electronics

The McGraw-Hill BETTER LIVING BOOK CLUB

MEMBERSHIP ORDER CARD

Please enroll me as a member and send me the two books indicated. I am to receive the bonus book at the introductory price of \$1.00 plus my first selection at the discounted price for members, plus tax, postage, and handling. If not completely satisfied, I may return the books within 10 days and request that my membership be cancelled. If I keep the books, I agree to take a minimum of three additional books of my own choosing during the next two years. I will receive the Club Bulletin 12 times a year. If I want to examine the featured selection, I need take no action. It will be shipped automatically. If, however, I want an alternate selection—or no book at all—I simply notify the Club by returning the

convenient card always enclosed. I will always have a minimum of 10 days in which to return the card, and you will credit my account fully, including postage, if this is not the case. Membership in the Club is continuous but cancellable by me at any time after the four-book purchase requirement has been filled. *This order subject to acceptance by McGraw-Hill. Orders from outside the continental U.S. must be prepaid. All prices subject to change without notice. Company, business, or institutional tax exemption status is not applicable to purchases made through individual Club memberships. Offer good for new members only.*

INDICATE BY NUMBER THE TWO BOOKS YOU WANT

Write Code No. of Bonus Book Here

Write Code No. of First Selection Here

SEND NO MONEY. SIMPLY MAIL THIS CARD TODAY AND WE WILL BILL YOU

Name _____

Street Address _____

City _____ State _____ Zip _____

EXTRA SAVINGS: Remit in full with your order, plus any local and state tax, and McGraw-Hill will pay all postage and handling charges.

L54024
Electronics

FIRST CLASS
PERMIT NO. 42
Hightstown, N. J.

Business Reply Mail

No Postage Stamp Necessary if Mailed in the United States

Postage will be paid by

**The McGraw-Hill
Better Living Book Club**

P.O. Box 582
Hightstown, New Jersey 08520

FIRST CLASS
PERMIT NO. 42
Hightstown, N. J.

Business Reply Mail

No Postage Stamp Necessary if Mailed in the United States

Postage will be paid by

**The McGraw-Hill
Better Living Book Club**

P.O. Box 582
Hightstown, New Jersey 08520

Give your life a new dimension

Join The New McGraw-Hill **BETTER LIVING BOOK CLUB**
for all your non-professional needs.

WYMAN'S GARDENING ENCYCLOPEDIA

By Donald Wyman.
1,221 pp., 10,000 articles, 206 drawings,
170 photographs
771/995 Pub. Pr., \$19.95 Club Pr., \$15.95

A YEAR OF BEAUTY & HEALTH

By Beverly & Vidal Sassoon With Camille Duhe
288 pp., illus.
772/010 Pub. Pr., \$9.95 Club Pr., \$8.45

WINES OF THE WORLD

Edited by A.L. Simon.
720 pp., illus., 8"x11" format
574/081 Pub. Pr., \$20.00 Club Pr., \$14.95

WATERCOLOR

By John Pike.
224 pp., 8½"x11" format, 36 color plates
771/979 Pub. Pr., \$16.95 Club Pr., \$14.25

FROM JULIA CHILD'S KITCHEN

By Julia Child.
716 pp., photos and illus.
771/987 Pub. Pr., \$15.00 Club Pr., \$11.95

HOW TO CUT YOUR ENERGY BILLS

By Ronald Derven and Carol Nichols
132 pp., 200 illus.
769/370 Pub. Pr., \$12.00 Club Pr., \$9.95

AUTO REPAIR FOR DUMMIES

By Deanna Sclar, with Technical Advisor, Don Donesley.
360 pp., 280 illus.
558/701 Pub. Pr., \$12.95 Club Pr., \$9.95

HANDBOOK OF WEALTH MANAGEMENT

By Leo Barnes and Stephen Feldman
1,035 pp., with tables and charts
037/655 Pub. Pr., \$34.95 Club Pr., \$22.50

HAMMOND WORLD ATLAS

Collector's Edition. By Hammond, Inc.
352 pp., 442 maps, 134 flags and 47 photos in full color,
9½"x12½" format.
769/923 Pub. Pr., \$24.95 Club Pr., \$18.25

What McGraw-Hill's BETTER LIVING BOOK CLUB offers you . . .

- **GUIDANCE** on your personal and family financial planning and health matters.
- **ENRICHMENT** of your leisure time with photography, sports, music, plants, foods, travel, and MORE.
- **SKILLS AND RELAXATION** in do-it-yourself crafts, art, home building and repairs, and useful tinkering.
- **CONSUMER KNOW-HOW** to help you save money, energy, and time.
- **TOP-DRAWER CHOICES** from a variety of publishers.
- **ATTRACTIVE DISCOUNTS** combined with a no-risk guarantee, no fees, and no dues.



HOUSE PLANTS: How to Keep 'Em Fat and Happy

By Linda Finkle-Strauss
288 pp., with illus.
210/071 Pub. Pr., \$12.95 Club Pr., \$10.50

THE COMPLETE BOND BOOK

A Guide to All Types of Fixed-Income Securities
By David Darst.
366 pp., with sample forms and charts
173/907 Pub. Pr., \$14.35 Club Pr., \$10.75

THE AMATEUR PHOTOGRAPHER'S HANDBOOK

By A. Sussman.
8th Ed., 562 pp., 188 photos, 140 drawings
766/452 Pub. Pr., \$9.95 Club Pr., \$8.45

CHILD HEALTH ENCYCLOPEDIA

The Complete Guide for Parents
By The Boston Children's Medical Center and
Richard I. Feinbloom.
561 pp., 7½"x10-3/8" format.
768/579 Pub. Pr., \$15.00 Club Pr., \$11.95

THE COMPLETE BOOK OF HOME REMODELING

By Robert Scharff.
496 pp., illus.
551/677 Pub. Pr., \$14.95 Club Pr., \$10.95

THE OXFORD COMPANION TO SPORTS AND GAMES

By John Arlott.
1,143 pp., 400 photos, 200 drawings and diagrams.
767/076 Pub. Pr., \$29.95 Club Pr., \$22.50

PANCHO SEGURA'S CHAMPIONSHIP STRATEGY

How to Play Winning Tennis
By Pancho Segura with Gladys Heldman.
179 pp., illus., 8¼"x10¾" format
560/404 Pub. Pr., \$9.95 Club Pr., \$8.25

Select any one of these outstanding books
for only **\$1.00** as your bonus for joining. Values to \$34.95

VALUES UP TO \$34.95 WITH MAJOR DISCOUNTS ON ALL OTHER CLUB SELECTIONS. Your bonus book comes with the first selection, and you may choose both of them from the books described in this special introductory offer.

EXTRA SAVINGS. Remit in full with your order, plus any local and state tax, and McGraw-Hill will pay all postage and handling charges.

NO RISK GUARANTEE: If not completely satisfied return selections for full refund and membership cancellation.



The McGraw-Hill BETTER LIVING BOOK CLUB
P.O. Box 582, Hightstown, New Jersey 08520

Please enroll me as a member, and send me the two books indicated. I am to receive the bonus book at the special introductory price of \$1.00, plus my first selection at the discounted price for members, plus tax, postage, and handling. If not completely satisfied, I may return the books within 10 days and request that my membership be cancelled. If I keep the books, I agree to take a minimum of three additional books of my own choosing during the next two years at low Club prices. As a member, I am to receive free the Club Bulletin describing monthly selections and alternate choices. Whenever I want the next selection, I need take no action, for it will be shipped automatically. Whenever I want an alternate, or no book at all, I am to notify you in advance of selection shipment date on the convenient return card always provided. Company, business or Institutional tax exemption status is not applicable to purchases made through individual club memberships.

MEMBERSHIP ORDER FORM

Simply return this coupon today and we will bill you.
INDICATE BY NUMBER THE TWO BOOKS YOU WANT.

CODE # OF
\$1.00 BOOK

CODE # OF
1st SELECTION

Name _____

Address _____

City _____

State _____ Zip _____

This order subject to acceptance by McGraw-Hill. Orders from outside the continental U.S. must be prepaid. All prices subject to change without notice. Offer good for new members only

L54022



Желаете ли вы вступить в деловые контакты с Советским Союзом?

(Would you like to do business with the Soviet Union?)

Кто.

(Who): Business Week and V/O Vneshtorgreklama (the U. S. S. R. foreign trade advertising organization), who together made history on May 18, 1974, are going to do it again.

Что.

(What): A major publishing event called U. S. S. R. II. A special advertising section that will reach key Soviet business and government leaders. Soviet officials considered the first, historic special section in Business Week, "one of the most significant promotions directed to the Western world."

Где.

(Where): In Business Week/Industrial, a demographic edition targeted exclusively to key decision-makers in American business and industry—1.3 million readers.

Когда.

(When): The November 7, 1977 issue of Business Week. Four-color closes September 26. Two-color and black-and-white on October 3.

Почему.

(Why): Advertising participation in this historic insert permits American business to very positively demon-

strate to the appropriate Soviet officials economic interest in the U. S. S. R. and its market of over a quarter-of-a-billion people.

Reprints of the section will be distributed to Soviet officials in the U. S. S. R. and to the members of the U. S. Congress, the President, and the Cabinet. It will also be mailed to the Chief Executive Officers of the 1,000 largest U. S. corporations. These bonuses are on top of the regular Business Week/Industrial U. S. Circulation.

Как.

(How): Contact Earl S. Moore, Jr., Director of International Advertising, Business Week, 1221 Avenue of the Americas, New York, New York, 10020. (212) 997-6868.

Or your nearest Business Week office: **Atlanta** (404) 892-2868, **Boston** (617) 262-1160, **Chicago** (312) 751-3700, **Cleveland** (216) 781-7000, **Dallas** (214) 742-1747, **Denver** (303) 837-1010, **Detroit** (313) 873-7410, **Houston** (713) 659-8381, **Los Angeles** (213) 487-1160, **Minneapolis** (612) 332-7425, **New York** (212) 997-3598, **Philadelphia** (215) 568-6161, **Pittsburgh** (412) 391-1314, **Rochester** (716) 586-5040, **St. Louis** (314) 227-1600, **San Francisco** (415) 362-4600, **Stamford, Ct.** (203) 359-2860.

BusinessWeek

Лучшее рекламное агентство.

(The smart place to advertise.)





4000B 4001B 4001UB 4002B 4006AB 4007UB 4008B
 4009UB 4010B 4011B 4011UB 4012B 4013B 4014B
 4015B 4016B 4017AB 4018B 4019B 4020B 4021B
 4022AB 4023B 4024B 4025B 4026AB 4027B 4028B
 4029B 4030B
 4035B 4040B
 4043AB 4044AB
 4046B 4048B 4049UB 4050B 4051B 4052B 4053B
 4060B 4066B 4068B 4069UB 4070B 4071B 4072B
 4073B 4075B 4076B 4077B 4078B 4081B 4082B
 4085B 4086B 4093B 4094B 4160B 4161B 4162B
 4192B 4193B
 4412B 4416B
 4433AB 4441UB 4445B 4446B 4449UB 4494B 4428B
 4508B 4510B 4511B 4512B 4514B 4515B 4502B
 4518B 4520B 4522B 4526B 4527B 4528B 4516B
 4538B 4543B 4555B 4556B 4581B 4582B 4585B

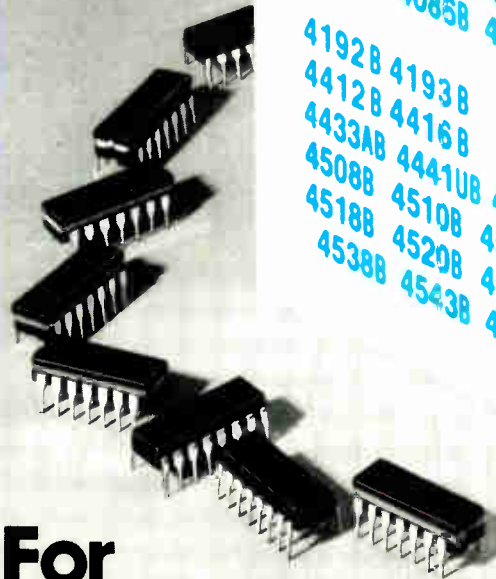

For B-Series CMOS take sides with the leader

Solid State Scientific has over 100 device types for your standard circuit requirements. We are a major supplier of the 4000, 4100, 4400 and 4500 families and our line includes all popular package configurations.

One indication of our commitment to leadership in the B-Series of CMOS circuits is our product development program. Recently, we have upgraded five devices (4016, 4020, 4040, 4060 and 4416) to meet or exceed the full electrical characteristics of the JEDEC Standard Spec-

ification. Five additional types (4006, 4017, 4022, 4043 and 4044) are now being upgraded and samples will be available shortly. In addition, eight new circuits (4048B, 4085B, 4086B, 4094B, 4174B, 4192B, 4193B and 4494B) are available for sampling and will shortly be moving into production.

We offer commercial grade devices, 883B Mil-Spec devices and a variety of low cost, industrial high reliability screening programs. Known as Solid Plus, these screening

programs can simplify incoming inspection at your plant and reduce problems caused by infant mortalities.

Write today for our new CMOS condensed catalog. In addition to our complete line of B-Series devices, it includes our standard memories and timekeeping circuits, plus details on the Solid Plus program. Solid State Scientific Inc., Montgomeryville, Pa., 18936. Phone: (215) 855-8400. TWX: 510-661-7267.



SOLID STATE SCIENTIFIC INC.
All sides of CMOS technology

New products

Materials

Phosphorus has cylindrical shape

High-purity red material eliminates dead space, allows bigger reactor charge

For producers of polycrystalline gallium phosphide, Phoenix Research Corp. has developed high-purity red phosphorus in cylindrical ingot form. This new configuration, which is 99.9999% pure, has a number of advantages over conventional chunks of phosphorus. For one thing, it allows a bigger reactor charge because it eliminates all the dead space associated with chunk phosphorus. Also, handling time and reactor turnaround time are reduced. Furthermore, contamination potential is cut because of the relatively small surface area of the cylindrical ingot.

The ingots are at present offered with a diameter of 45 millimeters and a guaranteed minimum density of 1.7 grams per cubic centimeter. Other sizes and weights can be provided, however. Evaluation samples are available immediately at 60 cents a gram.

Phoenix Research Corp., 8075 Alvarado Rd., La Mesa, Calif. 92041.

Acrylic adhesive cures within 6 minutes

A two-part acrylic adhesive that cures in 4 to 6 minutes at room temperature requires no weighing or mixing. To apply it, the user simply brushes, sprays, or rolls Part B onto the surfaces to be bonded and lets it dry for about 1 minute. Although

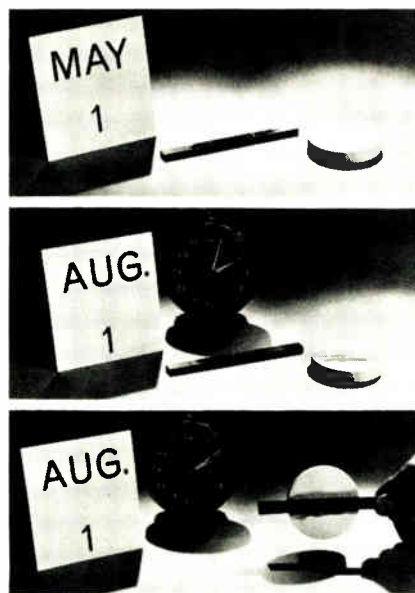

ready for bonding at that time, it will remain stable for three months.

When it is time to put the two surfaces together, Part A is applied to either surface, and the two surfaces are joined. Called Eccobond 300, the adhesive sells for \$4.75 a pound in small quantities. It is effective with, among other things, metals, plastics, glass, and ceramics. Curing takes only four to six minutes at room temperature.

Emerson & Cuming Inc., Canton, Mass. 02021. Phone (617) 828-3300 [476]

Silica-based mixture polishes silicon wafers

A silicon-wafer polish called Tizox 1300 is a silica-based colloidal formulation designed for use in both conventional and high-pressure wafer-polishing equipment. The material has a particle size of about 3 to 4 nanometers and can work with a variety of polishing pads.

Alliance Chemical Co., 200 Benton Rd., Penn Yan, N. Y. 14527 [477]

Solders offered with highly activated rosin flux

A highly activated rosin flux called Kester "88" is available in most of the company's solder alloys on 1- and 5-pound spools. Similar to the popular Kester "44," the new formulation is more highly activated and is therefore recommended for use with highly oxidized metals and with such problem metals as nickel. The flux is noncorrosive and nonconductive. For critical electronics applications, the residue can be removed with any of a variety of solvents, including aqueous rosin-residue remover.

Kester Solder Co., 4201 Wrightwood Ave., Chicago, Ill. 60639 [478]

Thick-film conductors adhere well to alumina and beryllia

Platinum-silver pastes in the 4570 series form thick-film conductors that adhere well to both alumina and

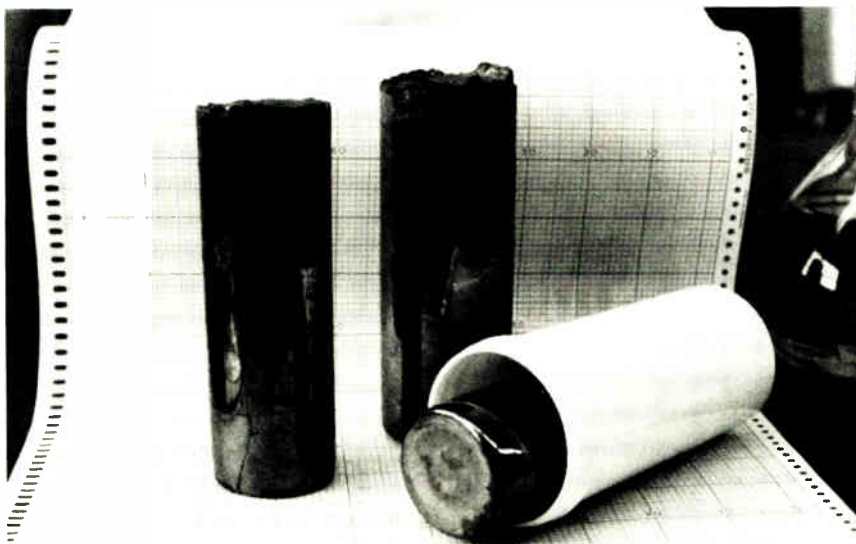

AUGAT MAKES IT EASY TO BUY THE BEST.

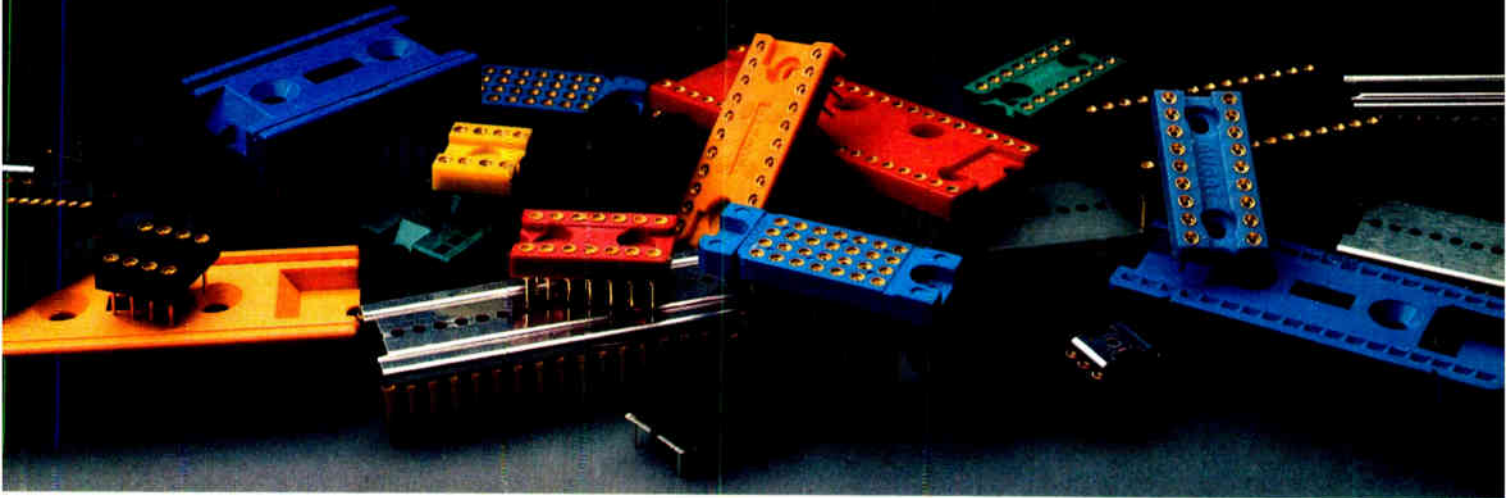

One of the biggest reasons Augat sockets outsell all others is that we make Augat sockets the easiest to buy. Augat offers IC sockets for off-the-shelf delivery from hundreds of worldwide distributor locations. So you have it easy when you buy the best. And here are some of the best you can buy.

Our Series 300 low-profile sockets excel over competitive types with their superior beryllium copper side-wipe contacts that handle all com-

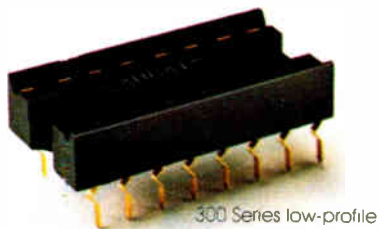

300 Series low-profile

ponent lead sizes with better retention and longer contact life. They are available in all sizes from 8 to 40 contacts.

Our 300 Series wire wrap sockets are the best buy in the industry today. Their special pir taper locks them in place without bonding or soldering, and

they're very attractively priced.

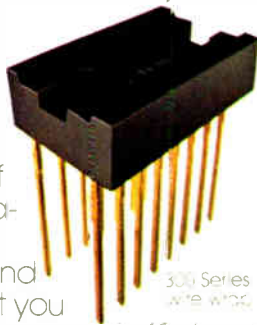

300 Series wire wrap

Our 500 Series sockets are the industry's "premium grade", the ones to use when high reliability and exceptional performance (at a reasonable price) are a must. They come in 12 sizes between 8 and 40 contacts.

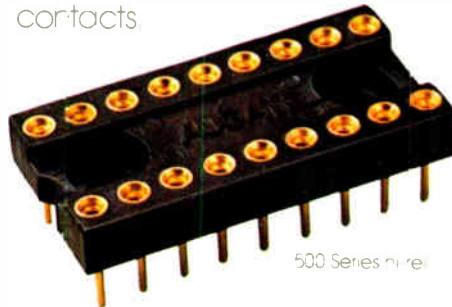

500 Series wire

Our 700 Series lead socket carrier is a new concept of growing popularity. The meta carrier holds the individual contacts in place through assembly and soldering, and is then removed. Advantages: improved airflow and complete topside accessibility for inspection and solder rework. Available in 14 sizes.

Beyond that, of course, is our

broad selection of standard profile and test sockets, LED sockets, and numerous accessories.

So the next sockets you buy, make them Augat. They're not only the best you can get, but getting them is a breeze... just about anywhere. Write us for a condensed socket selection guide with prices and a list of our distributors.

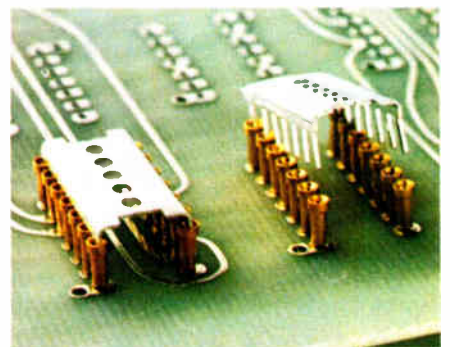

700 Series lead socket carrier

Augat, Inc., 33 Perry Avenue, P.O. Box 779, Attleboro, Mass. 02703 Tel. (617) 222-2202

AUGAT[®]

Augat interconnection products, Isotronics microcircuit packaging, and Alco subminiature switches

See at SICOB
STAND 3C 3308

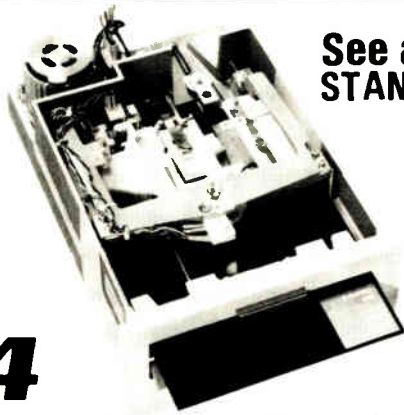

Our YD-174

2-Sided Single/Double Density Floppy Disk Drive Has a Lot Going for It.

We are talking about meaningful advantages.
The kind which spells higher profitability for OEM.

Manufactured by Y-E Data, Japan's OEM diskette drive market leader, the low-cost YD-174 provides a storage capacity of 0.56/ 1.2 M bytes. It's compatible with single-sided IBM 3740/System 32 drives, 2-sided IBM 3600/4964 drives and 2-sided double density IBM System 34 drive.

The YD-174 features a 2-sided head carriage assembly, standard ceramic R/W/tunnel erase head and flexured mounting arrangement. A simple/precise steel belt drive assures high reliability.

Contact C. Itoh for complete information on the YD-174 and entire Y-E Data product lineup.

Specifications

Capacity		Transfer rate	250/500K bits/sec
unformatted	0.8/1.6 M bytes/disk	Access time	
IBM format	0.56/1.2 M bytes/disk	track to track	4 ms
Recording density	3408/6816 BPI	settling	20 ms
Track density	48 TPI	Head Load Time	50 ms

- Also available. * Key to Floppy Data Entry System (IBM 3740 series compatible)
 * Termi-Pen (Codeless I/O terminal)
 * Program Loader Mini (Digital Signal to/from audio signal, loaded in audio cassette recorder)



Sole Exporter
 System & Business Machine Section (TOKKP)
C. ITOH & CO., LTD.
 C.P.O. Box 136 Tokyo 100-91 Japan
 Tel: 03-639-2910 / Telex: J22295 J22296

Manufacturer
Y-E Data Inc. Japan
 1-20-7, Suehiro Build.
 Kita-otsuka,
 Toshima-ku,
 Tokyo, Japan

Circle 184 on reader service card

New products

beryllia substrates. Initial adhesion is 25 pounds peel on 0.1-inch-square pads. After aging for 1,000 hours at 125°C, the strength drops only 5 lb.

Series 4570 paste may be conventionally screen-printed and fired at 875°C for 7 minutes. Containing 2% platinum, it sells for less than \$20 an ounce in production quantities.

Cermalloy, Cermet Division of Bala Electronics Corp., Union Hill Industrial Park, West Conshohocken, Pa. 19428. Phone (215) 825-6050 [479]

Silver-filled adhesive has low resistivity

A silver-filled adhesive designed especially for optoelectronic applications has a volume resistivity of about 0.2 milliohm-centimeter when cured for five minutes at 150°C. Called Ablebond 88-1, the conductive adhesive also performs well when cured at 80°C. It is a two-part system with a one-to-one mix ratio and a room-temperature pot life of six days. The soft, smooth paste, which can be applied by hand probe, automatic dispenser, screening, or printing, can be stored for at least a year at 25°C.

Ablestik Laboratories Inc., 833 West 182nd St., Gardena, Calif. 90248. Phone (213) 321-6252 [480]

Activated flux remains inert at room temperature

Although it provides a high level of chemical fluxing activity at soldering temperatures, Multicore 5381 leaves rosin and activator residues that remain chemically inert at room temperature. In particular, the residues do not create the potential corrosion and leakage problems generally associated with activated fluxes.

The mildly activated material has been formulated primarily for use as a foaming flux, but it can also be applied by wave, dip, brush, spray, or other means. It is on the QPL for MIL-F-14256D, type RMA, and

Electronics / August 18, 1977

1977 Answer Book. It makes your job easier. \$25.

Who makes what? Over 4000 products, more than 5000 manufacturers with their local contracts and distributors, directory of trade names and catalogs, post-paid inquiry cards for 5-second ordering of current catalogs.



Electronics Buyers' Guide
1221 Ave. of the Americas
New York, N.Y. 10020

Yes, send me a copy of The Answer Book. I've enclosed \$25 (USA and Canada only, elsewhere send \$35). Full money back guarantee if returned within 10 days.

Name _____
 Company _____
 Street _____
 City _____ State _____ Zip _____



Coming through...

with help getting your ideas off the ground

Whether you're thinking about new "black box" designs or better ways to work with wire, we can help get your ideas off the ground.

Involving Belden in the early stages of a project will almost always pay off in a cleaner, more economical package. It can also keep knotty—and costly—problems in compatibility, workability and availability from arising later.

We're coming through with extensive capabilities in problem solving and custom design. Plus thousands of high-quality wire, cable and cord products to draw from—including our new flat cable constructions.

Our know-how in the areas of insulation compound-

ing, shielding, innovative packaging, quality control and time/motion have resulted in some extraordinary savings for our customers.

Talk to a Belden specialist about your new black box ideas, processing and application problems—all your wiring needs. For fast answers to special problems, call our engineering "hot-line" number, 317-966-6681. You'll like the results.

Whether your needs can best be met through our nationwide team of electronic distributors or through a totally new cable design, we won't let you down. Belden Corporation, Electronic Division, P.O. Box 1327, Richmond, IN 47374; 317-966-6661.

8-4-7

BELDEN

Coming through...

with new ideas for moving electrical energy

© 1977 Belden Corporation

World Radio History

Circle 185 on reader service card

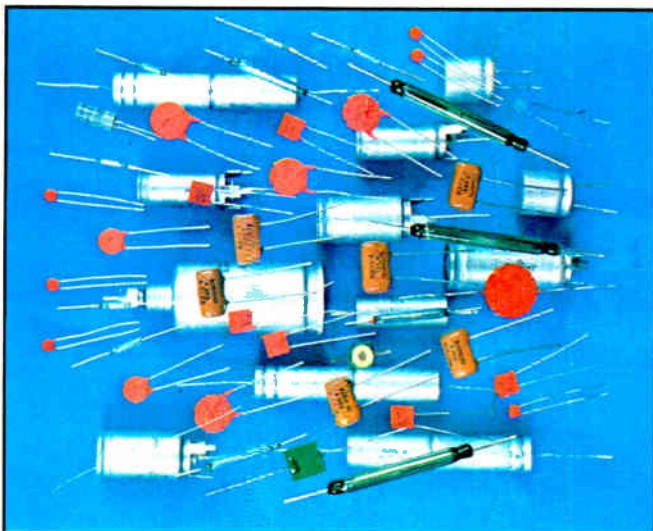

RELIABILITY IS ALWAYS THERE WITH ELORG CAPACITORS

complying in full with MEC Standards
by ratings, temperature factors and tolerances.

A BROAD CHOICE OF ABOVE 40 TYPES
including

- K10-78 Ceramic Capacitors (22 to 47,000 pf)
rated for voltages up to 50 V
- Electrolytic Capacitors
- Oxide-Semiconductor Capacitors
- Film-Capacitors

DISPLAYED BY ELORG AT "WESCON-77"
INTERNATIONAL ELECTRONICS' EXHIBITION
IN SAN FRANCISCO,

September 19 to 21, 1977

Booth No 1062

WELCOME!



32/34 Smolenskaya-Sennaya
121200 Moscow
USSR
Tel. 251-39-46, Telex 7586

New products



meets the stringent new silver-chromate paper test for halides.

Applications include meeting military and industrial specifications where an activated rosin flux is not acceptable and where cleaning of the final assembly is difficult or impossible. The flux is available in various-sized containers from pints to 55-gallon drums. Delivery is from stock. Multicore Solders, Westbury, N.Y. 11590 [372]

Acid cleaner for copper
acts quickly, rinses freely

Fast-acting acid cleaner 1118, which is designed to remove photoresist residues, light oxides, oils, fingerprints, and organic materials from copper surfaces, requires only 3 to 5 minutes to do its job. Used principally to prepare copper surfaces for electroplating, Cleaner 1118 is an acid aqueous solution with a pH of about 1.0. It is used at about 145°F. The free-rinsing material will typically clean 20,000 square feet of printed-circuit board per gallon of concentrate. It will not attack acid-resistant inks and photoresists. Shipley Co. Inc., 2300 Washington St., Newton, Mass. 02162. Phone (617) 969-5500 [374]

Copper-based adhesive
makes temporary contacts

Aremco-Coat 543 is a copper-based conductive adhesive that makes a good temporary contact for use in determining the volume resistivity of

The General Purpose **EXPLORER II**

New digital
oscilloscope for
low-frequency,
high precision
signal measurement.



EXPLORER II is an oscilloscope in every sense of the word— for use in the same way as other oscilloscopes. It has the same sweep controls, trigger controls and amplifier controls.

What makes it different is its precision and enormously improved waveform storage capability. EXPLORER II is a digital oscilloscope. Because of this and careful human engineering, a dozen old operating problems have just disappeared.

Great Storage: Storage occurs at the touch of a button. The captured waveform has the same quality as live waveforms — amazing quality. There is no trace fading or blooming. If you wish, you can tuck the waveform away, out of sight, for later recall and continue to use the oscilloscope for other things in the meantime. Storage at the touch of a button means more than saving operating steps. It means no blank screen before storage.

Automatic Persistence: The EXPLORER always displays the last signal waveform until the next signal occurs, even when signals occur only rarely. There are no adjustments or mode switching.

CRT Independence: No longer is accuracy dependent on the cathode-ray tube. True voltage and time numerics for any selected point end that problem. The numbers can show differences in both times and voltages, for two selected waveform points. Accuracies and resolution are an order of magnitude greater.

Write-through Storage: At the touch of a switch, both live and stored waveforms are shown superimposed. This is far better than split screen storage, which shows a stored waveform in one area of the screen and live waveforms in another. Write-through storage allows you to see changes as small as 0.025% while they are happening!

Dual Beam: EXPLORERS with two-channel plug ins are "dual beam". Both signals are accepted together. There is no need for alternate sweeps or chopped sweeps.

Cursor Triggering: It used to be that all you could see on a 'scope was the result of an event. With EXPLORER you can see what caused an event to happen. Move the vertical marker line to any desired position. In the cursor trigger mode, this will be time zero, the time the sweep trigger occurs. The trace shows you what happened before and after the trigger.

Easy Operation: It's as difficult to describe the "feel" of EXPLORER II as it is to describe the feel of a great sports car to someone who has only driven "soft" passenger cars. But once you've had an hour or two of familiarization and used this new digital 'scope you'll know. You'll never want to go back to anything else.

EXPLORER III

Identical to EXPLORER II, this unit incorporates an added module that contains a magnetic disk memory and a digital input/output port. To document waveforms for future reference, the diskette preserves the accuracy and resolution of the original. There is no compromise as with a photo document. For computation, the digital I/O allows interface to computers and calculators, also IEEE 488 interface.



See It Demonstrated. To really appreciate either of these new 'scopes you have to see them in action. For complete details, including descriptive brochures, send the reader service card or call Jim Bartosch at 608/271-3333.

**NICOLET
INSTRUMENT
CORPORATION**

5225 Verona Road
Madison, Wisconsin 53711
Telephone: 608/271-3333

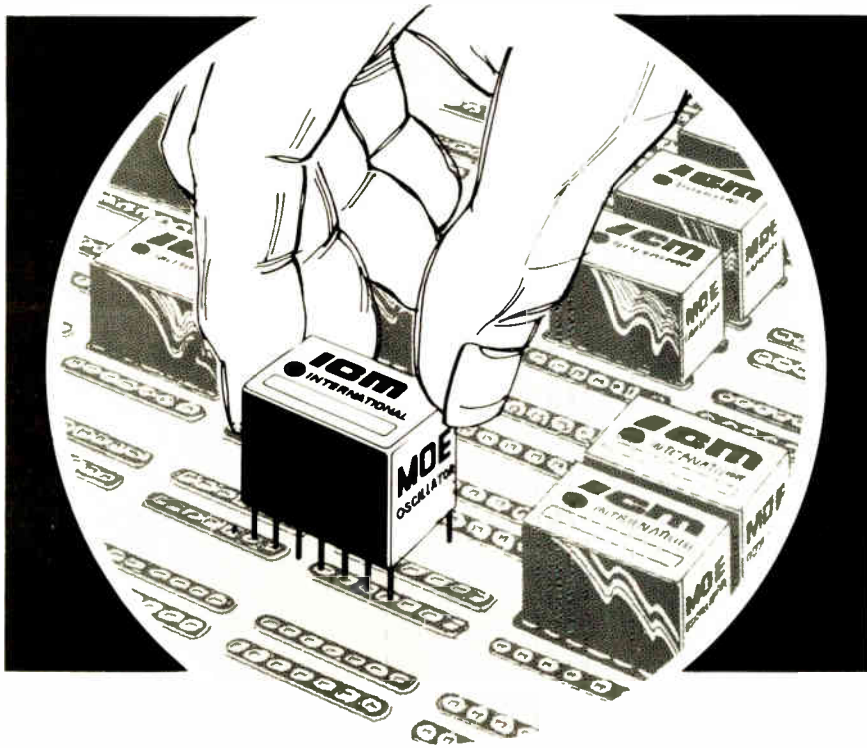

INTERNATIONAL'S
moe
**CRYSTAL OSCILLATOR
 ELEMENTS**

A Complete Controlled Signal Source from 6000 KHz to 60 MHz

The MOE series is designed for direct plug-in to a standard dip socket. The miniature oscillator element is a complete source, crystal controlled, in an integrated circuit 14 pin dual-in-line package with a height of 1/2 inch.

Oscillators are grouped by frequency and temperature stability thus giving the user a selection of the overall accuracy desired. Operating voltage 6 vdc. Output wave shape — non sine.

TYPE	CRYSTAL RANGE	OVERALL ACCURACY	25°C TOLERANCE	PRICE
MOE-5	6000KHz to 60MHz	+ .002% -10° to +60°C	Zero Trimmer	\$35.00
MOE-10	6000KHz to 60MHz	+ .0005% -10° to +60°C	Zero Trimmer	\$50.00

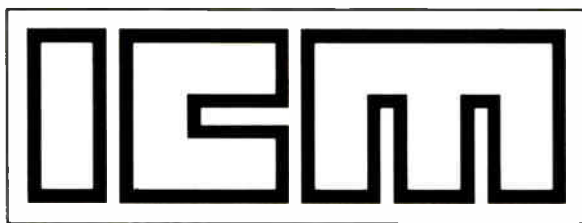

International Crystal Manufacturing Company, Inc.

10 North Lee, Oklahoma City, Oklahoma 73102

New products

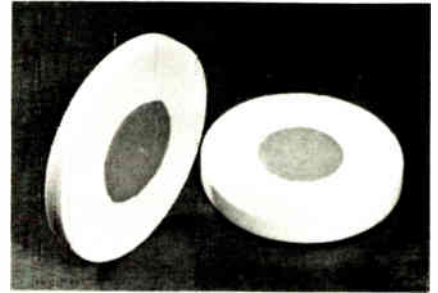

unknown materials. The adhesive adheres well to ceramics and glasses and will produce a temporary conductive bond after a simple air cure. (A permanent bond may be obtained by curing at 250°F.) The temporary bond may be removed by washing with hot water. Aremco-Coat 543 is available from stock at \$30 for a half pint and \$55 for one pint.

Aremco Products Inc., P. O. Box 429, Ossining, N.Y. 10562. Phone Herbert Schwartz at (914) 762-0685 [373]

RTV semiconductor paint is a pressure switch

A pressure-sensitive semiconductor paint that cures overnight at room temperature (or in 10 minutes at 200°F) has a resistivity that is strongly dependent upon applied pressure. A film of P/465 Pressistor compound only 5 mils thick and a quarter-inch in diameter has a no-load resistance in excess of 100 megohms. With a force of 1 pound applied to it, the film's resistance drops to less than 10 ohms. The resistance change is essentially reversible, but it has too much hysteresis to be the basis of a precision transducer.

The 6-volt material has applications that range from solid-state keyboards and intrusion alarms to musical instruments and slot-car controls. Large areas of the material, applied to an adequate heat sink, can be used to control small electric motors with no need for other components, such as amplifiers or thyristors.

One fluid ounce of P/465 Pressistor compound will make more than 300 0.25-in-diameter spots; so

WAFERTRAC. STILL STEAMING AHEAD!

Since GCA introduced the revolutionary WAFERTRAC™ a few months ago—the completely automatic, microprocessor-controlled wafer processing system, 9 out of 10 of the world's largest manufacturers of semiconductors have purchased their WAFERTRAC systems. Why?

WAFERTRAC provides higher yields in less facility space.

WAFERTRAC improves up-time and reliability to higher levels than ever before possible.

WAFERTRAC eliminates traditional 25-wafer group processing limits.

WAFERTRAC lets you design your own specific configuration, according to your firm's unique requirements.

WAFERTRAC.
The first practical application of the microprocessor to semiconductor processing, requiring only a single person in your processing loop ... and *then* only to load and unload carriers.

Don't be the last to get on board. WAFERTRAC's still steaming ahead... destination: greater profits!

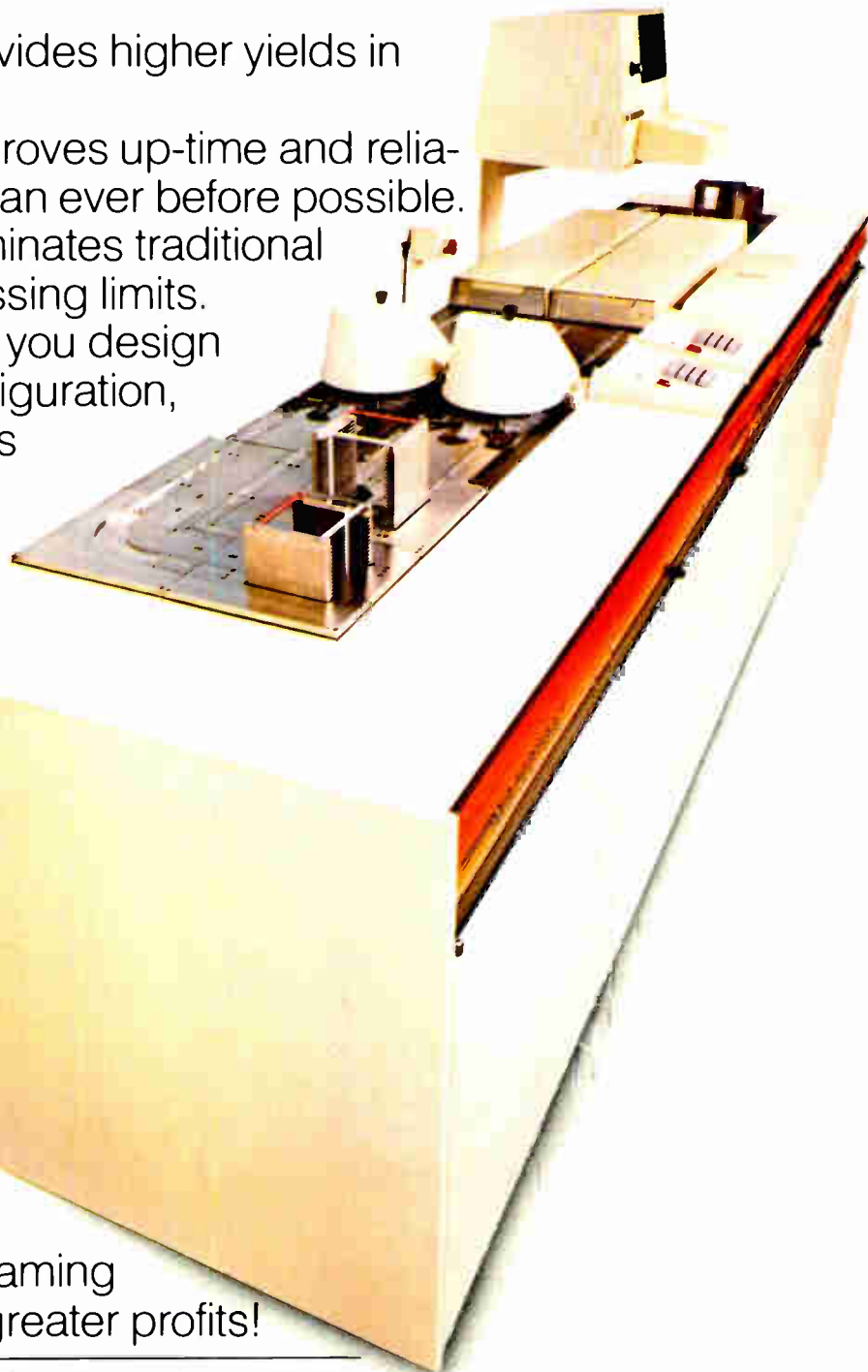

GCA/SUNNYVALE DIVISION ●●▲

PART OF THE GCA/IC SYSTEMS GROUP
1050 Kifer Road, Sunnyvale, Calif. 94068 TWX: 910-339-9211 (408) 732-5330



Relax

It's amazing how an easy mind enhances your hobbies

We're the easy mind people. TRW Capacitors. You can rely on us to choose the best raw materials.

Our X363 metallized polypropylene line is a perfect example. We spent several years making sure we had chosen precisely the right dielectric. And simultaneously making sure our technology was precisely right, too. The results were worth it!

The line features excellent electrical properties — high IR, low DF and dielectric absorption that's even better than polystyrene — to minimize offsets and errors in slope integrators and sample and hold circuitry.

The line features low dissipation factor (High Q) in a small package, for pulse, low level RF or filter applications. And it features high stability — for the long term shelf life and resistance to severe environments that's important for time base generators, integrators and filters. The specs are unique. And impressive. So are our engineering services. So relax and give us a call. Or write: TRW Capacitors, An Electronic Components Division of TRW, Inc., 301 West "O" St., Ogallala, Nebraska 69153 • Tel: (308) 284-3611.



TRW CAPACITORS
ANOTHER PRODUCT OF A COMPANY CALLED TRW

Circle 10 on Reader Service card

KEEP THE HORSE BEFORE THE CART!

You've probably known design engineers who are half-way through a project before they realize the power supply that could have come from a standard line must all of a sudden be a customized design. And you also know what that means in the way of extra costs. It's the old cart before the horse theory.

Call us when you are in the embryonic stages of your design and we'll work with you in your primary important stages. And not only will you like the fact that our standard lines will both fit your supply and keep you in budget... you'll like the idea of our already field-tested dependability.

Our power supplies are available for OEM computer, point of sale, EDP, bank telling and telecommunications use:

- Switching regulator and linear designs • 11 models — single/multi-output • Voltage ranges, from 2 to 30V • 50 current levels from .01 to 225 amps • Overcurrent/overvoltage protection • Filtering to meet world-wide EMI requirements • Designed and built to UL, CSA and European safety requirements.

Dependability. That's a word we define as quality and reliability. It's also what design engineers define as our reputation!

NCR

NCR POWER SYSTEMS DIVISION

formerly Scott Electronics

584 S. Lake Emma Road, P.O. Box 898
Lake Mary, Florida 32746

Telephone (305) 323-9250

Circle 241 on reader service card

New products

the small-quantity price of \$45 an ounce works out to 15 cents per device.

Innovation Labs., 1180 East Rubio St., Altadena, Calif. 91001 [377]

Fire-retardant thermoplastic resists arc tracking

Until now, if you needed a plastic material that combined the fire-retardant capabilities of Underwriters Laboratories standard 94 V-0 with resistance to arc tracking under high voltage, you were limited to such thermosetting materials as alkyds, diallyl phthalates, and thermoset polyesters. Valox 750 has changed that situation, however. The thermoplastic polyester combines the fire-retarding and arc-resisting properties of the thermosetting materials with high impact strength. Rated for continuous use at 140°C, Valox 750 has a tensile strength of 12,500 psi, a flexural strength of 19,500 psi, and a flexural modulus of 1,200,000 psi.

Valox Products Section, Plastics Division, General Electric Co., One Plastics Ave., Pittsfield, Mass. 01201 [375]

Solution speeds plating of metallic inks

An inexpensive solution that selectively promotes the electroless plating of metals onto copper and silver thick-film inks does not enhance plating onto ceramic substrates. Thus Promoter 144 permits sequential processing of thick-film circuits through a series of plating steps in a single vessel. Previous nonselective sensitizing agents ultimately made the carriers and plating vessels receptive to plating and commonly resulted in each carrier and vessel being restricted to one operation.

Promoter 144 causes uniform electroless plating even on isolated, noncontinuous metallized regions. It is thus useful for forming capacitors. Surface Technology Inc., Box 2027, Princeton, N. J. 08540. Phone (609) 452-2929 [376]

THE LOW PRICED DC/DC CONVERTERS... that out-perform the higher priced brands



ONE LOW PRICE: \$40.50 (1-249)

THE I/O RATINGS YOU NEED...

Input Voltage Vdc	Output Vdc @ mA	Model No.
5	±12V@±150mA	A5-12D150
12	±12V@±150mA	A12-12D150
5	±15V@±150mA	A5-15D150
12	±15V@±150mA	A12-15D150

QUALITY PERFORMANCE...

Regulation: 0.1% Line/Load
Efficiency: to 55%
I/O Isolation: 300Vdc Min.
MTBF: >100,000 Hrs.

Input...

Reflected Ripple: 1% Vin
Range: ±5%

Output...

Ripple & Noise: 20mV (typ)
Short Ckt. Protection: Yes

HERE'S THE PINOUT...



Order your newly designed A Series converters now. We've shaved cost — not quality. That's why SCL is the No. 1 SOURCE

Get Complete Information FAST!
Circle the number for our new 1977 FREE CATALOG.



SEMICONDUCTOR CIRCUITS, INC.
POWER SOURCES DIVISION

306 RIVER ST., HAVERHILL, MA 01830
TEL. (617) 373-9104, TWX. 710 347 0269

Circle 191 on reader service card 191

Smile Under Our Umbrella

MACHINE FAILURE LAWSUITS FIRE & SHOCK PRODUCT LIABILITY
FIRE & SHOCK LAWSUITS MACHINE FAILURE
***UL RECOGNITION**
1ST

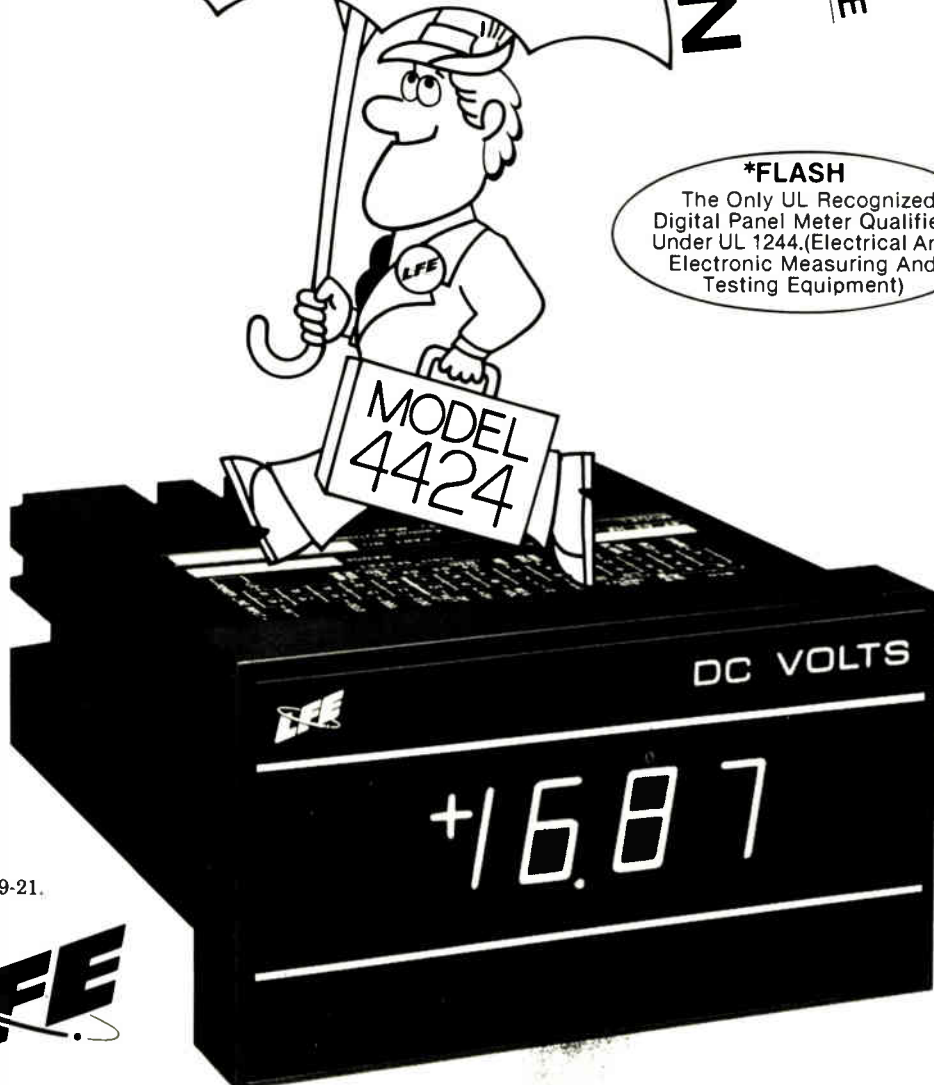

***FLASH**
The Only UL Recognized
Digital Panel Meter Qualified
Under UL 1244.(Electrical And
Electronic Measuring And
Testing Equipment)

Visit us at Wescon,
Booths 17-19,
San Francisco, Sept. 19-21.



For more information and a copy of our new digital catalog, write or call LFE Corporation, Process Control Division, 1601 Trapelo Road, Waltham, Mass. 02154 (617) 890-2000.

WE'RE LOOKING FOR LEAKS IN THE BOTTOM OF THE SEA.

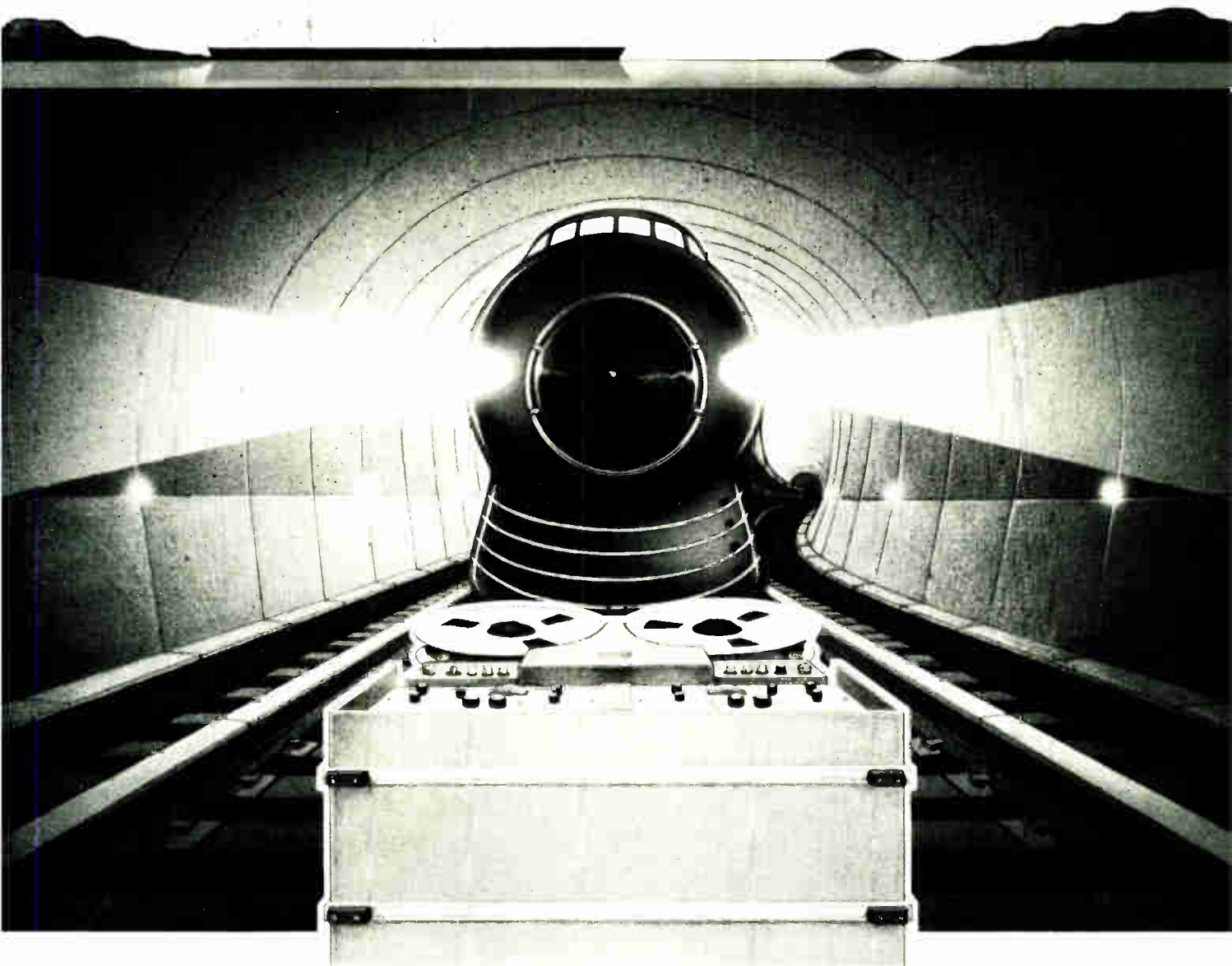

Almost 800 feet below the sea, crews are digging a 33-mile-long railroad tunnel to connect the Japanese islands of Honshu and Hokkaido. At that depth the water exerts tremendous pressure. So engineers continually probe the tunnel walls with ultrasound and rely on a Honeywell 5600 tape system to accurately record the echo-return signals. This critical data is then analyzed to pinpoint weak spots that could quickly become catastrophic leaks.

When you're responsible for one of the most

ambitious engineering projects ever attempted, you don't take chances. You choose a proven recorder like the 5600 that gives you up to 28 channels of exceptionally clean data, wideband or intermediateband.

If you need a tape system that can go just about anywhere, check our 5600 Series. For detailed information about these and other Honeywell instrumentation recorders, write or call: Darrell Petersen, Honeywell Test Instruments Division, Box 5227, Denver, CO 80217. (303) 771-4700.

WE'LL SHOW YOU A BETTER WAY.

Honeywell

World Radio History

Circle 193 on reader service card

Thin-Trim[®] capacitors



Tucked in the corner of this Pulsar Watch is a miniature capacitor which is used to trim the crystal. This Thin-Trim capacitor is one of our 9410 series, has an adjustment range of 7 to 45 pf., and is .200" x .200" x .050" thick. The Thin-Trim concept provides a variable device to replace fixed tuning techniques and cut-and-try methods of adjustment. Thin-Trim capacitors are available in a variety of lead configurations making them very easy to mount.

A smaller version of the 9410 is the 9402 series with a maximum capacitance value of 25 pf. These are perfect for applications in sub-miniature circuits such as ladies electronic wrist watches and phased array MIC's.

Johanson Manufacturing Corporation, Rockaway Valley Road., Boonton, N.J. 07005. Phone (201) 334-2676, TWX 710-987-8367.

MANUFACTURING CORPORATION
194 Circle 194 on reader service card

New literature

Microprocessors. A 20-page report, "All about Microprocessors," provides detailed specifications and guidelines for 66 microprocessor models. Specifications are given for packaging, architecture and performance, input/output control, and software. Guidelines to enable a user to select the correct microprocessor for his needs are included. To order this report at \$12.00 per copy, phone or write to Datapro Research Corp., 1805 Underwood Blvd., Delran, N. J. 08075. For further information, circle reader service number 421.

Phase-noise measurement. Application note 207 is a 16-page booklet that explains the theory and practice of phase-noise measurement in communication systems such as doppler radars, data-communications links, and multichannel receivers. The definition of phase noise, its effects on systems, and its relationship to frequency stability are covered. Also discussed are the theory and effects of frequency stability during phase-noise measurement, and a list of references is included. Inquiries Manager, Hewlett-Packard Co., 1501 Page Mill Rd., Palo Alto, Calif. 94304 [422]

Switches. Catalog 2100-77 is a comprehensive 76-page technical booklet about an extensive line of slide, toggle, rotary, dual in-line, and special switches. The switches are available in microminiature, miniature, and standard sizes, with ratings from 100 milliamperes to 15 amperes at 125 volts ac. Each switch type is listed, along with a dimensional diagram, photograph, chart, and specifications. A six-page selection guide is also included as an aid in finding the correct switch for a specific requirement. C-W Industries, 550 Davisville Rd. (P. O. Box 96), Warminster, Pa. 18974 [423]

Microcircuits. General Instrument's 1977 product guide lists more than 250 microcircuits, including metal-oxide-semiconductor, integrated-injection-logic, hybrid, and MOS field-effect-transistor types. The 12-page

reference is broken down into 24 product categories featuring circuits for calculators, clocks, radio, television, TV games, music appliances, telecommunications, and data communications. Microprocessors, read-only memories, and electrically alterable ROMs are also included. Functions, features, and packages for each microcircuit are described. General Instrument Corp., Microelectronics, 600 West John St., Hicksville, N. Y. 11802 [424]

Load cells. An eight-page illustrated catalog contains information on the 10 series, 30 series, and LFH-71 line of wafer-thin load cells, which weigh from 50 grams to 1,000 pounds. Cells for cable ends and weighing scales, and a new low-cost industrial load cell are described. Sensotec Inc., 1400 Holly Ave., Columbus, Ohio 43212 [425]

Electrical components. Switches, relays, and solenoids available from distributors nationwide are described in a 52-page catalog. Photographs, drawings, and specifications are provided for each component. Rotary switches are emphasized, but lever, slide, trim, push-button, keyboard, rocker, keylock, keyswitch and toggle types are also included. Oak Distributor Products (Form D-829), Oak Switch Division, Crystal Lake, Ill. 60014 [426]

Miniature connectors. Complete specifications on the series 1000, 2000, and 3000 miniature Term-Acon connectors are covered in a 16-page pamphlet. Described in detail are headers and connectors with pins on 0.100-inch, 0.156-in., or 0.200-in. centers for use in high-density circuits. Methode Electronics Inc., 1700 Hicks Rd., Dept. PR, Rolling Meadows, Ill. 60008 [427]

Ac power selection. Featured in the 1977-78 edition of the Invertron Selection Guide is the 830T programmable ac power controller with IEEE-488 bus compatibility. A two-page application note focuses on how to select an ac power source. Subjects include determination of



One company can cut keyboard costs. Even when their keyboards cost more.

The most expensive mistake you'll ever make selecting a keyboard could be spending too little. In the long run, that adds up to cutting corners, not costs.

So to make sure you get the keyboard that really meets your needs, MICRO SWITCH uses Value Engineering.

Through Value Engineering, we look at your particular product needs to design a cost-effective solution to your problems. That means designing a keyboard that interfaces with your total system and meets your needs. Precisely.

It also means we can often lower your total system cost. For example, we might be able to incorporate into a keyboard several levels of codes that you had been paying for separately. And at a much higher cost.

Or maybe customize

integrated circuits to provide you more logic for less money.

Besides giving you cost-efficiency, MICRO SWITCH keyboards out-feature practically every other in the industry.

You can choose LED or incandescent lighting. Tactile or linear feel. Sealed versions for military and industrial uses. Alternate or momentary action. Encoding techniques that'll meet any code requirement.

There are also wired-only assemblies or separate modules available. And you can pick from the industry's largest legend library.

Standard, solid state Hall-effect technology throughout the line delivers reliability no mechanical keyboard can offer. Plus, we back up every keyboard we make with a 1% Acceptable Quality Level and a two-year

warranty.

It all adds up to quality you can put your fingers on every time.

For more information, call 815/235-6600.

With MICRO SWITCH, you'll be paying for keyboards instead of mistakes.



MICRO SWITCH

FREEPORT, ILLINOIS 61032

A DIVISION OF HONEYWELL

MICRO SWITCH products are available worldwide through Honeywell International.

Circle 195 for Data.

1977 Answer Book. It makes your job easier. \$25.

"WHO MAKES WHAT?"

"WHAT COMPANIES MAKE THE PRODUCTS I NEED?"
(See alphabetical directory of 4000 products)

"WHERE ARE THEIR NEAREST SALES OFFICES?"

"WHO ARE THEIR DISTRIBUTORS?"

"WHAT ARE THEIR LOCAL PHONE NUMBERS?"
(See alphabetical directory of over 5000 manufacturers)

"HOW CAN I GET THEIR CURRENT CATALOGS FAST?"
(See directory of catalogs by product and by company, including catalog inquiry cards for 5-second ordering)

"WHO MANUFACTURES THIS TRADE NAME?"
(See Directory of Trade Names)

Electronics Buyers' Guide
1221 Avenue of the Americas
New York, N.Y. 10020



Yes, send me a copy of Electronics Buyers' Guide. I've enclosed \$25 (USA and Canada only, elsewhere send \$35). Full money back guarantee if returned within 10 days.

Name _____

Company _____

Street _____

City _____ State _____ Zip _____

New literature

Slaughter Co. at P. O. Box 1805, Ardmore, Okla. 73401 [432]

Reed relays. A 12-page catalog with data on more than 200 reed relays is now available from Electronic Instrument and Specialty Corp., 42 Pleasant St., Stoneham, Mass. 02180. The catalog provides data on the firm's entire reed relay line, along with exact-size photographs and ordering information. [433]

Optical waveguides. Specifications and general characteristics for four Corguide optical fibers are included in a six-page brochure put out by the Telecommunication Products Dept., Corning Glass Works, Corning, N. Y. 14830. Called "Corning Optical Waveguides For Lightwave Communication," the brochure lists standard waveguide characteristics: attenuation, bandwidth, numerical aperture, strength, and dimensions. It also describes coupling properties, shipping materials and dimensions, environmental properties, index profile, splicing loss, and temperature effects. A list of reference readings is also included. [434]

Synchro converters. A 30-page catalog describing synchro converters, displays, and encoders has been published by Computer Conversions Corp., 6 Dunton Ct., East Northport, N. Y. 11731. The catalog provides data on multispeed digital-to-synchro and synchro-to-digital converters and programmable solid-state limit switches. Digital-angle-conversion and metric-to-English conversion charts are also included. [435]

Safety standards. The newly amended "Catalog of Standards for Safety" of Underwriters Laboratories Inc. (UL) has been published, dated July 1977, and is now available. A quick and easy guide to UL's 387 published safety standards, the catalog is divided into two sections: Part I lists the standards by title and by number; Part II lists UL's proposed standards. Copies of the catalog may be obtained from Underwriters Laboratories Inc.,



Chemicals for a bold new world.

Optical waveguides. Thin film memory. Liquid crystal displays. Wherever today's breakthroughs are shaping tomorrow's world, you'll find EM Laboratories as a source for fine chemicals.

We manufacture chemicals for vacuum deposition, liquid crystal displays, fiber optics, crystal growth... dopants for electronics... that's just the start. And the R&D for tomorrow is bubbling in our labs.

Pure consistency in fine chemicals from EM Laboratories. Whatever you need to frame your future, we produce it. For a better world.

Pure Consistency...



EM Laboratories, Inc.

associate of

E. Merck, Darmstadt, Germany
500 Executive Boulevard
Elmsford, N.Y. 10523
(914) 592-4660

◆ Chemicals for electro optics ◆ Suprapur® ◆ Patinal®
◆ Aneron® ◆ Licristal® ◆ Selectipur®

Circle 199 on reader service card

SUPER MINIATURE

Neon Glow Lamps

Rated Voltage...AC 100V
 Rated Current...AC 0.3mA
 Total Flux...20mlm MIN.
 Starting Voltage...AC 75V MAX.
 External Resistance...150KΩ



NL-8S

ULTRA-HIGH BRIGHTNESS

Neon Glow Lamps

Rated Voltage...AC 100V
 Rated Current...AC 5mA
 Total Flux...500 mlm MIN.
 Starting Voltage...AC 85V MAX.
 External Resistance...8.2KΩ

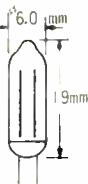

NE-2HU

CLEAR-GREEN

Fluorescent Glow Lamps

Rated Voltage...AC 100V
 Rated Current...AC 1.5mA
 Total Flux...90 mlm MIN.
 Starting Voltage...AC 75V MAX.
 External Resistance...27KΩ



NL-21G

● MAIN PRODUCT

NEON GLOW LAMP, XENON FLASH LAMP,
 RARE GAS, DISCHARGE LAMP,
 MINIATURE : BLACK-LIGHT, UV-LIGHT,
 FLUORESCENT COLOR-LIGHT

ELEVAM ELECTRONIC TUBE CO., LTD.

NO. 17-8 CHUO 2-CHOME OTA-KU, TOKYO JAPAN
 TELEPHONE : 03(774) 1231-5

EXPORT DIVISION : JAPAN NANOTRONIX CO., LTD.
 OTA-KU TOKYO, TELEPHONE. (03) 775-4811 TELEX 246-6583 JNANOX

Circle 200 on reader service card

Hewlett-Packard 9830 Users

You can now dimension, sort
and search any array that
will fit in your memory

With Infotek's Fast Basic III
ROM the 256 row-column limit
no longer exists!!!!

Infotek Systems

1400 N. BAXTER STREET • ANAHEIM, CALIF. 92806
 (714) 956-9300 • TWX 910-591-2711

200 Circle 243 on reader service card

Electronics Magazine Book Series. Zero-risk trial offer.

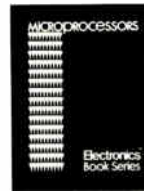

1. Microprocessors

What you must know about available microprocessor technology, devices, information, 4th printing. \$8.95

2. Applying Microprocessors

2nd and 3rd generation technology. 26 detailed applications from data networks to video games. \$9.95



3. Large Scale Integration

Covers the basic technology, new LSI devices, LSI testing procedures, plus system design and applications. \$9.95

4. Basics of Data Communications

Includes 47 articles from Data Communications magazine covering more than 11 key areas. \$12.95

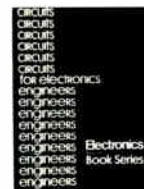
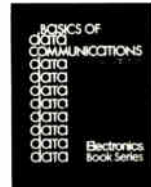

5. Circuits for Electronics Engineers

Contains 306 circuits arranged by 51 functions from Amplifiers to Voltage Regulating Circuits. Saves design drudgery. \$15.95

Electronics Book Series

P.O. Box 669, Hightstown, N.J. 08520



1. Send me _____ copies of "Microprocessors" at \$8.95 per copy.
2. Send me _____ copies of "Applying Microprocessors" at \$9.95 per copy.
3. Send me _____ copies of "Large Scale Integration" at \$9.95 per copy.
4. Send me _____ copies of "Basics of Data Communications" at \$12.95 per copy.
5. Send me _____ copies of "Circuits for Electronics Engineers" at \$15.95 per copy.

Discounts of 40% on orders of 10 or more copies.

I must be fully satisfied or you will refund full payment if the book is returned after ten-day trial examination.

Payment enclosed Bill firm Bill me

Charge to my credit card: BankAmericard
 American Express Diners Club Master Charge

Acc't No. _____ Date exp. _____ Interbank No. _____

On Master Charge only,
 first numbers above name _____

Name _____ Title _____

Company _____

Street _____

City _____ State _____ Zip _____

Signature _____

Electronics / August 18, 1977



13 years old, and already a has-been.

The crunch and thud of colliding bodies. The pain and anguish of broken bones and torn ligaments. The despair of permanent disability.

The tragedy of competitive sports is that so much emphasis is placed on winning, and so little on protecting the health of the participants.

McGraw-Hill, led by *The Physician and Sportsmedicine*, has been an outspoken advocate of improved equipment, better training and a more sensible approach to the physical and psychological effects of competition.

In a recent 3-article report on face protection for ice hockey players, *The Physician and Sportsmedicine* took a strong editorial stand on the need, backed it up with evidence on its practicality, and outlined various approaches to the design and manufacture of such equipment. "Violence in Sports" in the May, 1977 issue of the same magazine broadens the subject, promising impact in other media.

Thanks in part to our efforts, considerable progress is being made to improve sports safety. Another example of how McGraw-Hill magazines, by motivating business, professional and thought leaders, help bring about practical social action.

McGraw-Hill Publications Company, 1221 Avenue of the Americas, New York, N.Y. 10020.

McGraw-Hill Magazines



We help the doers get things done.

World Radio History

Polar super stars

Nichicon's Bi-Polar Series and Non-Polar Series of aluminum electrolytics are specifically designed for low-voltage AC circuits and reverse DC current. They're ideal for audio crossover networks as well as a wide variety of other applications. And since we manufacture two complete lines, we have the capacitor with the right performance characteristics for your design.



Free Catalog.

To receive complete catalog information and engineering samples, write to us on your company letterhead.



The pulse of the industry.

nichicon

NICHICON (AMERICA) CORPORATION
6435 N. Proesel Ave. • Chicago, IL 60645 • (312) 679-6530
Division of NICHICON CAPACITOR LTD., Kyoto, Japan

Circle 244 on reader service card

New literature

Attn: Publications Stock Dept., 333 Pfingsten Rd., Northbrook, Ill. 60062 [438]

Temperature controllers. LFE Corp. has just released a 32-page catalog that describes its line of temperature controllers, sensors, and accessory equipment. The catalog also features a comprehensive application guide to help the user select the right controller for his particular job. The application guide is also available as a wall chart. For a copy, write to LFE Corp., Process Control Division, 1601 Trapelo Rd., Waltham, Mass. 02154 [436]

Power supplies. A 14-page booklet from the Capatron Division of AMP, Elizabethtown, Pa. 17022, should prove valuable to anyone who makes or buys power supplies. With emphasis on high-voltage units, there are sections on making versus buying, determining whether you need a custom or standard package, how to specify high-voltage supplies, using oil as an insulator, and packaging high-voltage circuits. [437]

Science supplies. More than 6,000 items are described in the 228-page 1977 edition of the Markson Science Catalog. Included is information on pH meters and electrodes, ultraviolet spectrophotometer cells, glass and

Free!

Power advantage . . . economic advantage. Get full details on the energy future . . . new Gates rechargeable, sealed lead-acid batteries. Send today for our free, informative brochure containing exclusive battery features, application information, ratings and specifications. Find out what this new third-generation energy cell could mean to your design work.



Energy Cells
EXCLUSIVE FEATURES
APPLICATION INFORMATION
RATINGS & SPECIFICATIONS



Yes! I would like to know more about these new energy cells. Please send free information.

Name _____

Title _____

Company _____

Address _____

City, State, Zip _____

Mail to: George Sahl,
Gates Energy Products, Inc.
1050 S. Broadway, Denver CO 80217



E8

Where the energy future is now



plastic labware, lab safety equipment, and miscellaneous items such as calculators, drafting aids, and organizers of all kinds. For a copy, write to Markson Science Inc., Box 767, Del Mar, Calif. 92014 [439]

Dialight is your second source to C&K for miniature rockers and toggles...



Come to the people who've always been specialists in having more good ways to solve problems: Dialight. What we've done in indicator lights, illuminated switches, readouts and LEDs, we're doing now in miniature rockers and toggles.

This new Dialight family of switches, which comes in a full range of sizes is, we're proud to point out, all-American made.

When you consider all the configurations of styles, sizes, life and safety ratings, colors and mountings, you'll find there are literally hundreds of thousands of design combinations. Such a number of possibilities

can in itself be a problem, except that the new Dialight catalog is specifically designed to prevent confusion and help you quickly and easily find the most advantageous combination of features for your applications.

If you'd like to see what Dialight quality rockers and toggles can do for the looks, durability and economics of your products, contact us today for the Dialight "Meets Your Need" Book. Your free copy will include a list of stocking distributors in the U.S. and Canada.

DIALIGHT

A North American Philips Company

Dialight meets your needs.

Dialight, 203 Harrison Place, Brooklyn, N.Y. 11237 (212) 497-7600

Circle 203 on reader service card

Electronics advertisers

August 18, 1977

Advanced Micro Devices	10-11	EM Laboratories, Inc.	199	Litronix	73
■ Alco Electronic Products (Sub. of Augat)	173	■ EMI Technology	141	■ Marconi Instruments	2nd C
■ Allen-Bradley	132-133	■ Erie Technological Products	50	Better Living Book Club	177-179
■ Amp, Inc.	144-145	Fairchild (Semiconductor Oper. Div.)	55,56,57	■ Microswitch, Div. of Honeywell	195
Analog Devices	137	Fairchild Systems Technology	130-131	■ Mini-Circuits Laboratory	40
■ Augat, Inc.	183	‡ Ferroxcube Corp., Div. of North Amer. Philips	58	Monsanto Company	148-149
Belden Corporation	185	Figaro Engineering	136	Mostek Corp.	169
■ F. W. Bell, Inc.	154	‡ First Computer Corporation	123	■ Motorola Communications & Electronics	153
Biomation	197	■ John Fluke Mfg. Co., Inc.	128-129	• Murata Mfg. Co., Ltd.	151
■ Bourns, Inc.	4thC	Forth, Inc. Responsive Computing	196	• A/S Mycon	31
‡ Braemar Computer Devices, Inc.	152	Fujitsu Limited	166,168,170	■ National Semiconductor Corp.	77-80
■ Bud Industries, Inc.	136	‡ Galileo Electro-Optics Corporation	86-87	NCR Power Systems Division	191
• Burr Brown	11E	• Ganz Measuring Works	9E	‡ NEC Microcomputers	83
Business Week	180	Gates Energy Products, Inc.	202	Nichicon America Corp.	202
‡ Centralab Electronics Division	31	GCA Sunnyvale	189	■ Nicolet Instrument Corp. Oscilloscope Div.	187
■ Cherry Electrical Products	1	‡ General Electric Valox	27	Nippon Precision Circuits	196
■ C. Itoh & Co., Ltd.	184	■ General Instrument Corporation (Semiconductor)	13	■ North Atlantic Industries	16
■ Continental Rentals	8	■ Grayhill, Inc.	52	Nucleonic Products Co., Inc. Div. Thomson CSF	67
‡ Control Data Corp. (CDC Cybernet)	38-39	Grinnell Systems	171	Optron, Inc.	14
‡ CTS Corporation	151	■ Hewlett Packard, Electronic Prod. Group	17-26	• Oscilloquartz	2
■ Custom Electronics	154	■ HI-G Incorporated	32-33	• Philips Elcoma	14E
Data General Corp.	37	Honeywell, TID	193	■ Philips TMI	2E,3E,4E
Data I/O Corporation	113	Hutson Industries	166	Plessey Semiconductors	205
■ Data Precision	167	INFOTEK Systems	200	■ Precision Monolithics, Inc.	15
■ Data Translation (Datation)	19	Intech/Function Modules	173	Programmed Power, Inc.	217
Harry Davies Molding Co.	173	Intel Memory Systems	64	• Racal Thermionic Ltd.	12E,13E
Delco Electronics, Div. Gen. Motors	126-127	Intel-Microcomputer Components	28-29	Ramtek	142-143
■ Dialight Corp.	203	Interdata, Inc.	125	■ Robineon Nugent, Inc.	34
■ Digital Equipment Components	88-89	International Crystal Mfg. Co.	188	Rockwell Microelectronic Device Division	146-147
E. I. Dupont De Nemours & Co., Inc.	3rd C	International Microcircuits, Inc.	152	• Rohde & Schwarz	1E
‡ Eastman Kodak Co., Graphics Markets Div.	139	Interstate Electronics	9	Retron, Inc. (Commercial Prod. Div.)	150
Electronic Navigation Industries	72	■ Johanson Manufacturing Corp.	194	SAN-O Industrial Corp.	136
Electronics & Control Engineers Book Club	177,178,179	■ M. S. Kennedy Corp.	30	■ Semiconductor Circuits	191
Electronic Research Div. of Textron, Inc.	206	■ Krohn-Hite Corp.	5	Semtech Corporation	163
Elevam Electronic Tube Co., Ltd.	200	■ Lambda Electronics	155-160	• Siemens AG Munich	62
Elog Electronorgtecnica	82/186	■ Lansdale Transistor & Electronics, Inc.	9E	Solid State Scientific	181
		■ LFE Corp.	192		

Dialight is your second source to C&K for miniature rockers and toggles...



Come to the people who've always been specialists in having more good ways to solve problems: Dialight. What we've done in indicator lights, illuminated switches, readouts and LEDs, we're doing now in miniature rockers and toggles.

This new Dialight family of switches, which comes in a full range of sizes is, we're proud to point out, all-American made.

When you consider all the configurations of styles, sizes, life and safety ratings, colors and mountings, you'll find there are literally hundreds of thousands of design combinations. Such a number of possibilities

can in itself be a problem, except that the new Dialight catalog is specifically designed to prevent confusion and help you quickly and easily find the most advantageous combination of features for your applications.

If you'd like to see what Dialight quality rockers and toggles can do for the looks, durability and economics of your products, contact us today for the Dialight "Meets Your Need" Book. Your free copy will include a list of stocking distributors in the U.S. and Canada.

DIALIGHT
A North American Philips Company

Dialight meets your needs.

Dialight, 203 Harrison Place, Brooklyn, N.Y. 11237 (212) 497-7600

Circle 203 on reader service card

ELECTRONICS REPRINTS

No. of copies wanted

New reprints

- ___ R-718 Display makers strive to refine their technologies 8 pp \$3.00
- ___ R-716 Special report—Japanese wave in semiconductor technology 24 pp \$3.00
- ___ R-714 Special report—active filter technology 6 pp \$3.00
- ___ R-713 Electron-beam lithography draws fine line 10 pp \$3.00
- ___ R-712 Special report—large-scale integration 16 pp \$3.00
- ___ R-710 Personal computers mean business 8 pp \$2.00
- ___ R-708 So you want to be a consultant 6 pp \$2.00

Charts

- ___ R-516 Electronic symbols \$2.00
- ___ R-213 Electromagnetic spectrum (updated 1976) \$3.00
- ___ R-326 Optical spectrum (6-page report and chart) \$3.00

Books

- ___ R-711 Circuits for electronics engineers: 306 circuits in 51 functional groups—Electronics Book Series \$15.95
- ___ R-704 Thermal design in electronics \$5.00
- ___ R-701 Applying microprocessors—Electronics Book Series \$9.95
- ___ R-608 Basics of Data Communications—Electronics Book Series \$12.50
- ___ R-602 Large Scale Integration—Electronics Book Series \$9.95
- ___ R-520 Microprocessors—Electronics Book Series \$8.95
- ___ R-011 Computer-aided Design 135 pp \$4.00
- ___ R-032 Active Filters 88 pp \$4.00

Payment must accompany your order

Make check or money order payable to Electronics Reprints. All orders are shipped prepaid by parcel post. Allow two to three weeks for delivery. For additional information call (609) 448-1700 ext. 5494.

Mail your order to:

Janice Austin
ELECTRONICS REPRINTS
P.O. Box 669
Hightstown, N.J. 08520

Back issues now available:

1960 to 1969, \$5.00 each
1970 to 1973, \$3.00 each
1974 to 1976, \$4.00 each

New books

Digital Computer Circuits and Concepts, 2nd ed., Bill Deem, Kenneth Muchow, and Anthony Zeppa, Reston, 487 pp., \$15.95.

Introduction to Circuit Synthesis and Design, Gabor C. Temes and Jack W. LaPatra, McGraw-Hill, 598 pp., \$21.50.

Grounding and Shielding Techniques in Instrumentation, 2nd ed., Ralph Morrison, Wiley-Interscience, 146 pp., \$15.50.

Electronic Communications, Dennis Roddy and John Coolen, Reston, 706 pp., \$19.95.

Microprocessor Systems Design, Edwin E. Klingman, Prentice-Hall, 480 pp., \$19.95.

Microprocessor: Principles and Applications, A. C. Palit, Servonics (Calcutta, India), 203 pp., \$6.95.

A User's Handbook of Semiconductor Memories, Eugene R. Hnatek, Wiley-Interscience, 652 pp., \$29.50.

Device Electronics for Integrated Circuits, Richard S. Muller and Theodore I. Kamins, Wiley, 404 pp., \$21.95.

Basic Electronics: Theory and Practice, J. A. Wilson and Milton Kaufman, Gregg/McGraw-Hill, 528 pp., \$12.95 (paper).

Electronics: The Continuing Revolution, Philip H. Abelson and Allen L. Hammond, eds., American Association for the Advancement of Science (Washington, D. C.), 217 pp., \$12.95 (hardcover), \$4.95 (paper).

Electrical Noise: Fundamentals and Sources, Madhu S. Gupta, ed., IEEE Press, 359 pp., \$19.95 (hardcover), \$13.45 (paper).

Preparation and Properties of Solid State Materials, Vol. 3: III—V Alloys, Convective Instabilities, and Nucleation, William R. Wilcox and Robert A. Lefever, Marcel Dekker

Electronics Magazine Book Series. Zero-risk trial offer.

1. Microprocessors

What you must know about available microprocessor technology, devices, information. 4th printing. \$8.95



2. Applying Microprocessors

2nd and 3rd generation technology. 26 detailed applications from data networks to video games. \$9.95

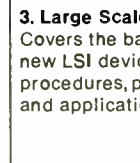

3. Large Scale Integration

Covers the basic technology, new LSI devices, LSI testing procedures, plus system design and applications. \$9.95

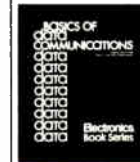

4. Basics of Data Communications

Includes 47 articles from Data Communications magazine covering more than 11 key areas. \$12.95.

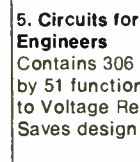

5. Circuits for Electronics Engineers

Contains 306 circuits arranged by 51 functions from Amplifiers to Voltage Regulating Circuits. Saves design drudgery. \$15.95

Electronics Book Series

P.O. Box 669, Hightstown, N.J. 08520

1. Send me ___ copies of "Microprocessors" at \$8.95 per copy.
2. Send me ___ copies of "Applying Microprocessors" at \$9.95 per copy.
3. Send me ___ copies of "Large Scale Integration" at \$9.95 per copy.
4. Send me ___ copies of "Basics of Data Communications" at \$12.50 per copy.
5. Send me ___ copies of "Circuits for Electronics Engineers" at \$15.95 per copy.

Discounts of 40% on orders of 10 or more copies.

I must be fully satisfied or you will refund full payment if the book is returned after ten-day trial examination.

Payment enclosed Bill firm Bill me

Charge to my credit card:

American Express Diners Club
 BankAmericard Master Charge

Acc't No. _____ Date exp. _____

Interbank No. _____

On Master Charge only, first numbers above name _____

Name _____ Title _____

Company _____

Street _____

City _____ State _____ Zip _____

Signature _____

Creeping up on daylight

We've just brought the integrated dc-to-daylight frequency synthesizer a couple of steps closer to reality.

The new Plessey IC's offer a quick and easy way to lower synthesizer costs while increasing loop response and channel spacing all the way from dc through the HF, VHF, UHF and TACAN bands.

Start with one of our IC prescalers. They feature input ports for VHF and UHF, self-biasing clock inputs, TTL/MOS-compatibility and variable input hysteresis for wideband operation.

Then add one of our two-modulus dividers. All of them provide low power consumption, low propagation delay and ECL-compatibility, and most of them are available in commercial and MIL-temp versions.

Finally, to make things even simpler, add the Plessey SP8760 control chip and phase lock your synthesizer to any crystal up to 10 MHz. All the stability you need with none of the usual headaches and hassle.

If it all sounds too good to be true, contact us today for details and application notes.

Once you've seen the data, you'll see the light.

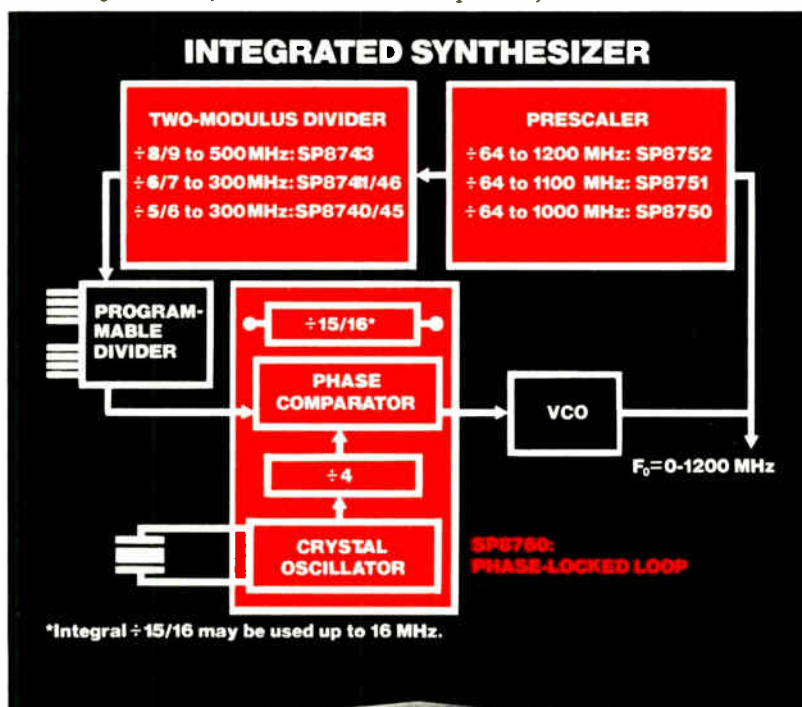

PLESSEY SEMICONDUCTORS

1641 Kaiser Avenue, Irvine, CA 92714
Tel. (714) 540-9979 TWX 910-595-1930
Represented world-wide

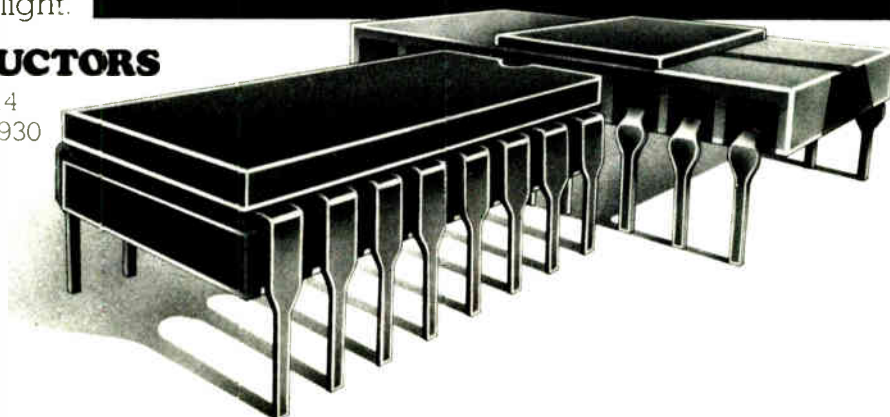

State-of-the-art brought down to earth

Fixed and programmable dividers □ Linear and digital communications circuits

Yes we make all of these...



Crystals, ovenized oscillators, TCXO's, VCXO's, and a hybrid crystal oscillator only .200" high in a frequency range of 2.5 KHz to 30 MHz.

No We don't want to brag about our capabilities, people, facilities, price or delivery...

Not Much

Call (913) 631-6700 or write P.O. Box 913, Shawnee Mission, Kansas 66201.

Electronic Research Operations
Speidel Division of Textron Inc.

Speidel **TEXTRON**

Circle 206 on reader service card

1977 Answer Book. It makes your job easier. \$25.

"WHO MAKES WHAT?"
"WHAT COMPANIES MAKE THE PRODUCTS I NEED?"
(See alphabetical directory of 4000 products)

"WHERE ARE THEIR NEAREST SALES OFFICES?"

"WHO ARE THEIR DISTRIBUTORS?"

"WHAT ARE THEIR LOCAL PHONE NUMBERS?"
(See alphabetical directory of over 5000 manufacturers)

"HOW CAN I GET THEIR CURRENT CATALOGS FAST?"
(See directory of catalogs by product and by company, including catalog inquiry cards for 5-second ordering)

"WHO MANUFACTURES THIS TRADE NAME?"
(See directory of trade names)

Electronics Buyers' Guide
1221 Avenue of the Americas, New York, N.Y. 10020

Yes, send me a copy of Electronics Buyers' Guide. I've enclosed \$25 (USA and Canada only, elsewhere send \$35). Full money back guarantee if returned within 10 days.

Name _____
Company _____
Street _____
City _____ State _____ Zip _____

New books

Inc. (New York), 264 pp., \$29.50.

Charge-Coupled Devices: Technology and Applications, Roger Melen and Dennis Buss, eds., IEEE Press, 414 pp., \$19.95 (hardcover), \$9.95 (paper).

Microprocessors: Fundamentals and Applications, Wen C. Lin, ed., IEEE Press, 334 pp., \$17.95 (hardcover), \$9.95 (paper).

Applying Microprocessors, Laurence Altman and Stephen E. Scrupski, eds., McGraw-Hill, 191 pp., \$15.

Advances in Cryogenic Engineering, Vol. 21, K. D. Timmerhaus and D. H. Weitzel, eds., Plenum Press, 549 pp., \$42.50.

Domestic Satellite: An FCC Giant Step toward Competitive Telecommunications Policy, Robert S. Magrant, Westview Press (Boulder, Colo.), 296 pp., \$20.

Advanced Electronic Troubleshooting, Derek Cameron, Reston, 325 pp., \$15.95.

Optimum Systems Control, 2nd ed., Andrew P. Sage and Chelsea C. White III, Prentice-Hall, 413 pp., \$22.50.

Hospital Instrumentation Care and Servicing for Critical Care Units, Robert B. Spooner, ed., Instrument Society of America (Pittsburgh, Pa.), 188 pp., \$9.50.

High Level Cobol Programming, Gerald M. Weinberg, Stephen E. Wright, Richard Kaufman, and Martin A. Goetz, Winthrop Publishers (Cambridge, Mass.), 252 pp., \$14.95.

Programming in Basic for Business, Bruce Bosworth and Harry L. Nagel, Science Research Associates (Chicago), 229 pp., \$7.95.

Database Processing: Fundamentals, Modeling, and Applications, David Kroenke, Science Research Associates, 408 pp., \$16.95.

Classified section FOR ENGINEERING/TECHNICAL EMPLOYMENT OPPORTUNITIES

CLASSIFIED SALES REPRESENTATIVES

Atlanta Joe Lane 404/892-2868
Boston Holt Buchanan 617/262-1160
Chicago Bill Higgins 312/751-3733

Cleveland Mac Huestis 216/781-7000
Dallas Mike Taylor 214/742-1747
Denver Shirley Klotz 303/837-1010
Detroit Mac Huestis 313/873-7470

Houston Mike Taylor 713/659-8381
Los Angeles Stan Kassin 213/487-1160
New York Larry Kelly 212/997-3594
Philadelphia Dan Ferro 215/568-6161

Pittsburgh Dean Genge 412/391-1314
San Francisco M.E. Kenny 415/362-4600
Stamford Holt Buchanan 203/359-2860
XEROX 400 TELECOPIER 212/997-6800

engineers

MAJOR NON-IMPACT PRINTER DEVELOPMENT

A growth opportunity for both non-impact and impact printer specialists

Computer Peripherals, Inc., the joint venture company of Control Data Corp., NCR Corp., and ICL, Ltd., has several key openings in a long term high technology program destined to make significant contributions to the state of the art. Impact printer specialists will also have opportunities to extend their expertise into the non-impact area.

NON-IMPACT DEVELOPMENT

MANAGER, INK JET TECHNOLOGY

You will be responsible for ink jet technology development for low speed non-impact printers, including direction of a staff of engineers, technicians, and design and drafting personnel. A BS degree plus a minimum of 10 years' related experience including project management, and low cost design engineering are required.

PRINCIPLE ENGINEERING SCIENTISTS

- Ink Jet Technology Selection, design & development of materials and processes
- Electrostatic Phenomena Extensive research in electrostatic deflection of ink droplets
- Fluid Mechanics Properties, flow, boundary, modeling and analysis of hydrodynamics

SENIOR ENGINEER, EPG

You will be a member of a technology team which will establish and provide design approaches for use in electrophotographic high speed printer products. Two to six years of EPG design and development experience with

specialization in EPG image development and fusing needed. BS degree in engineering or physical science or equivalent experience required.

MANAGER, MECHANICAL DEVELOPMENT

Leading the team responsible for development and application of mechanical aspects of ink jet technology, you will have a substantial annual budget, and a staff of approximately 10 engineers, technicians and support personnel. A BSME, MS preferred, plus a minimum of 10 years' related experience, including accountability for the design of a portion of a manufactured product are required. A background in low cost design and project management is also desirable.

PRINCIPAL SCIENTIST Electrophotographic printers

Lead a technology development team in establishing design approaches to new products. Ten years' EPG design and development experience with specialization in EPG image development and fusing required. A BS in engineering or physical science is also required.

IMPACT PRINTER DEVELOPMENT

MECHANICAL DEVELOPMENT ENGINEER

You will be responsible for the development of a new generation of band printers utilizing low cost innovative designs, in addition to responsibility for development of band printer paper stacker. Your background must involve the ability to direct a staff of approximately eighteen engineers, technicians and design and drafting personnel. Position requires BSME or the equivalent (MSME desirable) and a minimum of ten years' previous related experience including previous design

accountability for a portion of a manufactured product, experience in project management and low cost design.

MECHANICAL ENGINEERS

Mechanical production design background including mechanical processes as they apply to design, and value engineering techniques. Proven product development experience with expertise in mechanisms, structures, electromagnetics, electronic packaging/cooling, and value engineering. A BSME or the equivalent plus 4-6 years' related design and manufacturing experience.

ELECTRICAL (Electronics) ENGINEERS

A strong background in electronic circuit design including digital logic design, microprocessor design, and programming is required. We are looking for a BSEE or the equivalent with 3 years' design experience and the ability to direct engineering support personnel, design analog and digital circuits, AC power, and servo mechanisms.

These positions, both in the non-impact and impact areas, offer exceptional career potential, competitive salaries and excellent benefits. For confidential consideration, please forward your resume including salary requirements to:

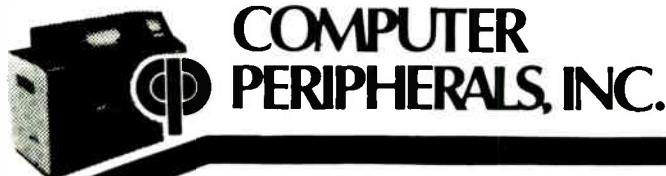

**COMPUTER
PERIPHERALS, INC.**

Mr. Bob Brown
1480 N. Rochester Rd.
Box
Rochester, Michigan 48063
1-313-651-8810

MANAGEMENT CONSULTANT MARKETING

We are an international, management consulting firm based in Chicago. Internal promotions together with continued growth have resulted in an unusual entry level opportunity for a promotable individual.

Qualified candidates will have an engineering degree, an MBA, high scholastic achievement and 2-5 years of experience in marketing, market research or closely related areas.

Send resume including salary history to:

P-5248, Electronics

Class. Adv. Dept., P.O. Box 900
N.Y., N.Y. 10020

We have been placing graduate ENGINEERS

in **FEE-PAID** positions
THROUGHOUT THE U.S. since
'59. Over 1,000 client companies.
We are graduate engineers working
full-time for you. Send resume
& salary history today or request
confidential application.

ATOMIC PERSONNEL, INC.
Suite L, 1518 Walnut St., Phila., Pa. 19102
An Employment Agency
For All Technical Fields

POSITIONS VACANT

Electronics Engineer to maintain scientific instruments used in chemical research. Experience with magnetic resonance and mini-computers preferred. Should have experience with R.F. and digital circuits. Recent graduate will be considered. Salary negotiable. Send resume to DR. G.L. Boshart, Department of Chemistry, The University of Chicago, 5735 S. Ellis Avenue, Chicago, IL 60637. An AA/EO Employer.

Georgia Tech Engineering Experiment Station needs Electrical Engineers to perform defense systems analysis/operations research in client-oriented environment. Computer Modeling and electronic system simulation experience desired. MSEE/MSIE required. Send resume to: MR. R.P. Zimmer, Engineering Experiment Station, Georgia Institute of Technology, Atlanta, Georgia 30332. An Equal Opportunity Employer.

Electronics/Communications Expert Small international electronic communication security equipment manufacturer has opening for communication expert with technical or engineering background in all aspects of telecommunications, audio and recording systems. Experienced in demonstrations and presentations. Capable of travel. N.Y. headquarters. Salary open. (212) 682-5915.

BUSINESS OPPORTUNITY

How to Earn Money As a Consultant (including specimen contracts) \$19. Business Psychology Int'l 890/44 Nat. Press Bldg., Washington, D.C. 20045.

BOEING

Software Specialists

The Boeing Company, in Seattle, Washington, is seeking computer professionals for a variety of important assignments on a wide range of systems including:

- Energy Management/Control Systems
- Military Command/Control Systems
- Military & Space Avionics Systems
- Surface Transportation Systems

Challenging opportunities exist in the following areas:

OPERATIONAL SOFTWARE DEVELOPMENT

- Design and develop software for simulators, operational systems, automatic test equipment and other special-purpose or realtime applications.

SOFTWARE/COMPUTING SYSTEM DESIGN AND ANALYSIS

- Analyze system hardware, software and operator requirements to support establishment of a system architecture.
- Perform systems analyses and trade studies to support design concepts, new business acquisition and proposal activities.

SOFTWARE AND COMPUTER SYSTEM TEST AND EVALUATION

- Design and develop hardware and software test concepts and environments to support operational software and computer systems test.
- Conduct software tests.

Candidates for these opportunities must have a BS degree or higher in Engineering or Computer Science and be a U.S. citizen.

Attractive salary, fringe benefits and moving allowances will be offered qualified candidates. And living is a pleasure in the unspoiled Northwest with its many recreational and sports activities and relaxed life-styles.

Look into these opportunities.

Send your résumé to The Boeing Company, P.O. Box 3707-LHK, Seattle, WA 98124.

An equal opportunity employer.

BOEING

Getting people together

POSITIONS WANTED

MS, EE (PE) \$25K/yr Microwaves, Antennas, Logic Design. Gene Pereda: 505-294-2935, New Mexico.

Will relocate. Engineering technician. 10 years experience in prototype design, assembly and troubleshooting. Worley, 1710 Arizona, Flint, MI 48506 (313) 785-2602.

EMPLOYMENT SERVICE

"How To Get A Job Overseas" 253 pages! Jam-Packed info. + Directory 300 firms \$5 Transworld, Box 90802-HR Los Angeles 90009.

Murkett Associates Qualified Reputable Management placement with national affiliates—fee paid. Box 527 Montgomery, AL 36101.

WHERE DO YOU FIT?

In today's job market, that is. One way to see if you're in demand is to check the employment opportunities contained in ELECTRONICS' Classified Section.

Another way to get a reading on your value is to place a blind (box number) Position Wanted ad there. The cost is low (only \$1.25 per line) and the results are often rewarding.

For more information call or write:

ELECTRONICS

Post Office Box 900
New York, N.Y. 10020
Phone: 212/997-2556

Engineers... are you pigeonholed?

We won't keep you pigeonholed in the same old assignment year after year. After all, variety is the spice of a life's work. And we have a commitment to it. We make our living selling variety: command and control systems, complete air defense systems, radar systems, sonar systems, computer systems and much more. We're part of a company of 36,000 people active in more than 550 major product areas in 80 technologies. Plenty of room for developing interests, plenty of room for growth.

Our Systems Division engineers enjoy technical diversity because of our program variety and growth opportunities that we're steadily expanding. They benefit from the technically oriented management which put us on our strong growth curve. And they enjoy a good professional environment where many of our people wear 10, 15, and 20 year service pins.

Any more good news? Well, yes. We're hiring now.

For quick action, reach for your phone instead of your resume... call Richard Navarro collect (714) 871-4080 Ext 2136 between 8 A.M. and 4 P.M. Monday through Friday. Or send your resume to: Professional Employment - Ground Systems Group E, 1901 W. Malvern, Fullerton, CA 92634

U.S. citizenship required • Equal opportunity, M.F. H. employer

HUGHES

HUGHES AIRCRAFT COMPANY



Communications System Engineers. Must understand hardware, software interaction, signal processing, spread spectrum.

Senior Systems Engineers. Tactical, strategic system application of radar, sonar, communications, electro-optical software, data processing and command and control technologies.

Communication Analysts. Lead/direct application of systems theory, applied math, estimation, probability to communication system problems.

Data Processing and Software Analysts. System level data processing architecture analysis, design, performance evaluation for multisensor systems.

Display System Engineers. Long term opportunity to lead display product definition/selection for military C&C Systems.

Radar Systems Engineers. Lead/direct radar system conceptual design/analysis. Integration of radar, weapon, command and control systems.

Senior Air Defense Engineers. BSEE, Math or Physics, project management experience in real time hardware/software systems.

Hardware System Engineers. Large scale data processing, peripheral, display systems design, specification, integration, checkout.

Systems Analysts. Systems Theory, applied math background. Variety of problems requiring modern analysis techniques.

ENGINEERS: NEW GROWTH MEANS NEW OPPORTUNITY!

New long-term growth at Litton Systems Amecom Division means fresh career opportunity for ambitious engineers who seek professional advancement.

Check out these immediate career openings at all levels:

SOFTWARE SYSTEMS ENGINEERS

- * Real-time hardware controller subsystems
- * Real-time systems processing
- * Assembly, Fortran, micro-code languages

RF ENGINEERS

- * Microwave communications and receiving systems
- * High Sensitivity DF Receivers
- * Solid state microwave component design

ANALOG AND DIGITAL PROCESSING ENGINEERS

- * LSI application
- * High speed data conversion
- * Power supplies

ELECTRONIC WARFARE SYSTEMS ENGINEERS

- * State of the Art ESM/ECM
- * Signal processing

TELECOMMUNICATIONS SYSTEM DESIGN ENGINEERS

- * Advanced digital subsystems including TDM
- * RF and analog subsystems including frequency synthesis and FDM techniques
- * Microprocessors and related real-time operating systems software
- * Voice switching systems

ELECTRONIC WARFARE PROCESSING HARDWARE

- * Microwave subsystem design
- * Circuit design—RF, video, analog, high speed A/D converters
- * EW digital subsystem design—signal sorting, microprocessors/microcontroller design, computer interfacing
- * Project engineering/design supervision

FIELD ENGINEERS

Openings for field engineers, domestic and foreign assignments in Electronic Warfare and/or Telecommunications.

U.S. CITIZENSHIP REQUIRED. All positions.

Litton Systems offers excellent compensation, benefits, growth opportunity, and a professional work environment. Please send your resume including salary history in confidence to:

J.J. FitzGerald

Amecom Division
LITTON SYSTEMS, INC.

5115 Calvert Road, College Park, Md. 20740

An Equal Opportunity Employer M/F



Litton



**MAKE YOUR
NEXT
MOVE A STEP
IN THE
RIGHT
DIRECTION**

The road to professional fulfillment can be a real jungle. We can help you find the right path. Our affiliation with

**National
Personnel
Associates®**

keeps us informed of opportunities in the ELECTRONICS industry from coast to coast as they occur. Together with over 175 associates, we offer our knowledge and expertise at no charge to you. Fees are company paid.

POWER SERVICES, INC.
DOD/I & C CONSULTANTS
Northgate Office Building
5861 Rivers Avenue
North Charleston,
South Carolina 29405
(803) 747-0955

JIM KING & ASSOCIATES
Electronics Division
438 Gulf Life Tower
Jacksonville, Florida 32207
(904) 398-7371

**ELLS PARK PERSONNEL
SERVICES**
5050 Excelsior Boulevard
Minneapolis, Minnesota 55416
(612) 927-4653

**BRENTWOOD PERSONNEL
ASSOCIATES**
1280 Route 46
Parsippany, New Jersey 07054
(201) 335-8700

WETERRINGS & AGNEW, INC.
425 Midtown Tower
Rochester, New York 14604
(716) 454-3888

AVAILABILITY, INC.
Engineering Consultants
1300 N. Westshore Blvd.
Tampa, Florida 33607
(813) 872-2631

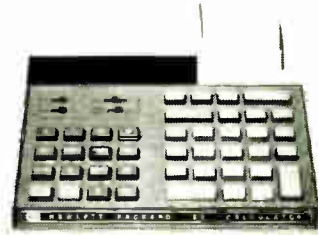
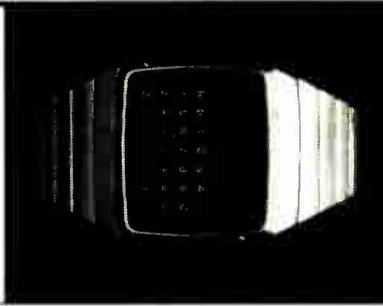
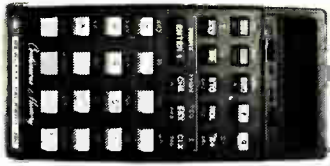

HP and YOU . . . in OREGON!

Hewlett-Packard's Corvallis Division, responsible for the development and manufacture of the most advanced personal calculator products, has challenging career opportunities in the Development and Component Departments.

Development Engineer/MTS

Experienced engineer to coordinate development of advanced technology for IC packaging and hybrid. Experience in IC processing (packaging) or hybrid development necessary. Requirements: BS/MSEE, BS/MSME.

Circuit Design Engineers

MOS Circuit Designers must be capable of carrying NMOS or CMOS from logic to finished parts. Requirements: BS/MSEE with at least 2 years' experience. Must have been responsible for at least 1 NMOS or CMOS design.

Product Marketing Engineer

Duties will be to implement distribution roll out of a new Hewlett-Packard product. You must manage the growth and maturity phases of the product life cycle. Requirements: We strongly prefer an MBA with electrical undergraduate degree.

IC Product Development Engineers

The individuals we are seeking will be responsible for the coordination of new chip development, device modeling and yield analysis and cost reduction engineering on production circuits. Requirements: BS/MSEE, Solid State Physics or related area; work experience in IC design or application is preferred.

Production Engineer

Duties include cost reduction, line support, production documentation, vendor liaison, product failure analysis. Requirements: BS/MS in Engineering preferred with 3 or more years' experience.

MOS Process Engineers

This opening in our LSI operation entails "hands-on" opportunities in the areas of diffusion and photomasking. The successful candidate will report to the process engineering manager with responsibility for medium volume production. Our commitment to engineering excellence provides ample opportunity for state-of-the-art process development. Requirements: BS/MSEE, ChemE with 1-4 years' experience desired.

Test System Support Engineer

The individual we select will be responsible for evaluating the LSI testing requirements for the Components Department, support of existing SENTRY test system, and coordination with chip designers on test programs. Requirements: BS/MSEE, CS or related area plus 3-5 years' experience in automated test equipment and/or IC circuit design.

Components Engineer

Responsibilities for this assignment will include process or packaging support engineering and/or yield/reliability analysis plus testing, as well as the development and coordination of new product introductions. Requirements: BS/MSEE, ChemE, Solid State Physics with related experience preferred.

Manufacturing Engineer

We are looking for an individual to support new product introduction and on-going fabrication of plastic and mechanical parts. Contribute to product design by consulting on manufacturability of fabricated parts; determine fabrication processes and arrange for tooling. Requirements: BSME or equivalent combination of education and experience; plastic tooling design desirable.

Electronic Tool Engineers

Design, debug and document test instrumentation and assembly machinery controls for subassemblies and components. Positions require strong background in digital. Requirements: BSEE or equivalent.

Semiconductor Tool Engineer

Responsibilities include tooling and machine design for manufacturing. Write specifications, do feasibility tests on major process machinery design and modification. Responsible for all shop drawings and documentation. Requirements: BSME or equivalent experience; design experience in vacuum and chemical handling equipment desirable.

Corvallis is situated in the beautiful Mid-Willamette Valley, 1 1/2 hours drive from the Oregon Coast, the Cascade Mountains and Portland, the beautiful City of Roses. Corvallis provides a university atmosphere with skiing, fishing, sailing and hiking in the picturesque nearby surroundings. The Pacific Northwest provides the opportunity to learn, explore and be challenged.

HP offers outstanding benefits, including flexible working hours, cash profit sharing and stock purchase program. Interested candidates should send resume in confidence to Mr. Y. Shimomura, 1000 N.E. Circle Blvd., Corvallis, Oregon 97330. An equal opportunity employer.

Corvallis Division

HEWLETT  PACKARD

Product Safety Engineer

Tests and evaluates measurement products to applicable UL and CSA standards. Recommends design changes consistent with intent of circuit to achieve compliance with standards. Writes reports describing construction and tests to testing agencies.

Position requires a BSEE or equivalent; a minimum of two years' design or test and evaluation experience and a good working knowledge of UL and CSA standards.

Tektronix, Inc., develops, manufactures and markets internationally recognized precision electronic measurement instruments, computer peripherals and related electronic instrumentation. Located near Portland, Oregon we are within a two hour drive of the Cascade Mountains and Ocean Beaches. The close-by nature playgrounds and the City of Portland provide a variety of recreational and cultural interests.

We offer a competitive salary, profit sharing and an outstanding benefits package.

Please send resume to: Mary Walhood, TEKTRONIX, INC., P.O. Box 500, E16, Beaverton, OR 97077.

An Equal Opportunity Employer M/F/H/C.

Tektronix®
COMMITTED TO EXCELLENCE

CAREERS IN

Printer Engineering

Computer Peripherals, Inc., the joint venture company of Control Data Corporation, NCR Corporation, and ICL, Ltd. is involved in an advanced technology development program.

MECHANICAL PROJECT ENGINEER

Outstanding growth opportunities exist in creative line printer development group for imaginative and creative project leader. Experience should include vibration, stress, structural, dynamic and thermal analysis of electro-mechanical equipment. Responsibilities will also include product definition and generation of product specification. Supervisory experience with engineers and technicians essential.

NON-IMPACT PRINTER SPECIALISTS

Our vigorous growth has created immediate opportunities in our Ink Jet and Electrophotographic programs for Program Managers, Project Engineers, and design and development specialists in a variety of disciplines. An advanced degree in engineering or physics or a Bachelor's degree with equivalent advanced experience is required, plus the creative ability to develop new directions in non-impact printer technology.

For both engineering positions above, BS required, MS preferred, plus 2-5 years relevant experience.

We offer competitive salaries and benefits and outstanding growth potential. Please send resume to:

Mr. Bob Brown



COMPUTER PERIPHERALS, INC.

1480 N. Rochester Road.
Box DTH-23
Rochester, Michigan 48063
1-313-651-8810

An Affirmative Action Employer

DATA COMMUNICATIONS

We are a rapidly growing international corporation with new, permanent openings in our Atlanta based Research & Development Division. We need Engineers with the following experience:

DESIGN ENGINEERS

BSEE or MSEE with minimum, 3 years' experience in (134-9600 band) data communications (hardware, software, modems, etc.).

APPLICATIONS ENGINEERS

BSEE or ICS with minimum, 3 years' experience in data communications. Must be familiar with widely used protocols in hardware.

This is an outstanding opportunity to make significant contributions and grow professionally and monetarily within a high technology growth industry.

Please send resume and salary history in confidence to:

**P.O. Box 1555
Atlanta, Georgia 30301
Att: Personnel Admin. Mgr.**

An Equal Opportunity Employer

WHERE DO YOU FIT?



In today's job market, that is. One way to see if you're in demand is to check the employment opportunities contained in ELECTRONICS' Classified Section.

Another way to get a reading is to place a blind (box number) Position Wanted ad there. The cost is low (only \$1.25 per line) and the results are often rewarding.

For more information call or write:

ELECTRONICS

Post Office Box 900
New York, N.Y. 10020
Phone: 212/997-2556



**Would
you hire
an engineer
who
couldn't
understand
this
magazine?**

Of course not. **ELECTRONICS** is the technical publication for technical people. If they can't understand it, they can't receive it. That's why, when you're looking for qualified engineers, you should consider our Classified Section.

For only \$46.00 per inch your recruitment advertising will reach 46,000 pre-screened engineers—that's just \$1 per thousand!—as they're reading to combat job obsolescence, while they're thinking about their future and bettering themselves.

There's no charge for type-setting and free layout service is provided.

For more information call or write:

ELECTRONICS

Post Office Box 900
New York, N.Y. 10020
Phone: 212/997-2556

**LSI APPLICATIONS ENGINEERS
CIRCUIT DESIGNERS
SENIOR LSI DESIGN ENGINEERS
TEST ENGINEERS**

There's no place like Florida

**...when you're in a growth career at the
ITT LSI Systems Support Center**

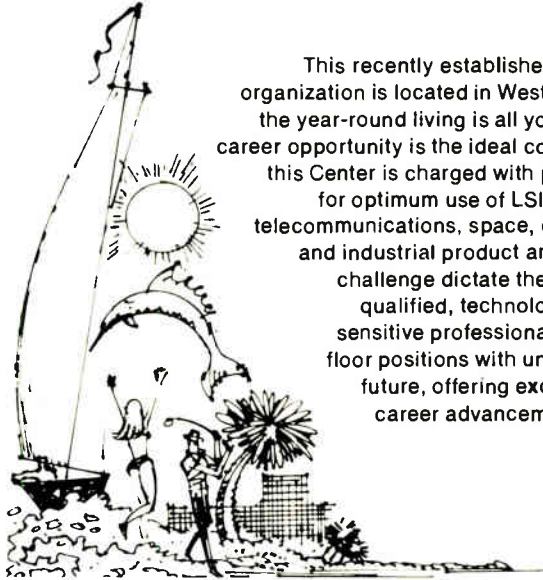

This recently established, corporate-funded organization is located in West Palm Beach, where the year-round living is all you could ask for. The career opportunity is the ideal complement, because this Center is charged with providing the means for optimum use of LSI in wide-ranging ITT telecommunications, space, defense, automotive and industrial product areas. This scope and challenge dictate the building of a highly qualified, technology oriented, system sensitive professional staff. True ground-floor positions with unusual reach into the future, offering excellent prospects for career advancement, are available to those who qualify.

LSI APPLICATIONS ENGINEERS

Direct interface with equipment division engineering personnel to identify and promote LSI design and application opportunity. Capable of assessing, analyzing, and coordinating the long range systems concept combining long range technology forecasting. Experience in telecommunications equipment highly desirable.

CIRCUIT DESIGNERS

Experienced designer in advanced LSI technologies. Responsible for design of complex LSI circuits in latest bipolar and MOS technologies. Requires BSEE and 2 years design experience using sophisticated computer-aided techniques.

SENIOR LSI DESIGN ENGINEERS

Responsible for custom LSI design using state-of-the-art MOS and bipolar techniques. Activities include feasibility studies, chip design, characterization and qualification studies. Requires MSEE and 4 years experience using sophisticated computer-aided design layout and analysis techniques.

SENIOR TEST ENGINEERS

Interface with ITT equipment and systems divisions in testing philosophy and testability for new applications. Generate and debug test and characterization programs for custom and standard LSI circuits. Requires BSEE and 4 years in product and test engineering. Sentry experience and knowledge of MIL-38510 qualification techniques preferred.

▶ **Positions available at lesser experience levels. Recent or pending college grads are also invited to inquire.**

Send resume with salary history in confidence to Mr. Jack W. Milligan, Director of Personnel, ITT LSI Systems Support Center, 3301 Electronics Way, West Palm Beach, Florida 33407.

**ITT LSI SYSTEMS
SUPPORT CENTER**

An Equal Opportunity Employer, M/F

Product Engineer

Monolithic/Hybrids

Openings exist for both junior and senior level monolithic (MOS and bipolar) and hybrid product engineers. You will assist component and instrument engineering groups in the development and transfer of IC's to IC Manufacturing. Provide product sustaining support to IC Manufacturing as required to meet commitments while achieving production quality, cost and yield goals.

Requires BSEE or equivalent professional experience plus a minimum of three years experience in MOS, bipolar, or hybrid product engineering.

In support of our development and manufacturing of precision electronic instrumentation, Tektronix designs and produces custom, in-house state-of-the-art MOS, bipolar and hybrid linear and digital IC's. Located near Portland, Oregon we are within a two hour drive of the Cascade Mountains and Ocean Beaches. The close-by nature playgrounds and the City of Portland provide a variety of recreational and cultural interests.

Salary is open. Benefits include educational support, insurance and profit sharing programs.

Send resume and salary history to Roy Epperson, TEKTRONIX, INC., P.O. Box 500, EM26, Beaverton, OR 97077.

An Equal Opportunity Employer M/F/H.

Tektronix
COMMITTED TO EXCELLENCE

ENGINEERING MANAGER

COMPUTER TERMINALS

Internationally recognized leader in the business machines, data processing industry, is seeking a manager with a strong technical background to manage an engineering activity developing display-based and printer-based computer terminals.

Candidate must have extensive knowledge and experience in processor architecture; display technology; printer technology; circuit design; logic design, and data communications. Knowledge of computer programming desirable.

An appropriate technical degree and 10 years of progressive engineering experience with demonstrated performance as an Engineering Manager is required.

This is a rare opportunity for a manager who is highly motivated toward new product development. Send resume including salary history, in confidence, to:

BOX P-5249

An Equal Opportunity Employer M/F

Semiconductor Device Physicist

As part of GTE Laboratories our Electronic Components Laboratory is responsible for research development and pilot fabrication of relevant future components. We are presently seeking a Semiconductor Device Physicist whose responsibilities will include the characterization and fabrication of various opto-electronics devices based primarily on III-V semiconducting materials.

The qualified candidate will have a PhD. in the area of semiconductor devices and materials with a strong background in experimental and theoretical characterization of p-n junction devices. A familiarity with thin film techniques and/or knowledge of liquid or vapor phase epitaxy is highly desirable.

Recognizing the unprecedented demand for top technical talent we offer an outstanding compensation and benefits package including a dental health plan. Our suburban Boston location is at the center of the Rte. 128 technical community and convenient to rural or urban living.

We invite you to submit your resume, including salary requirements, to Larry Schnicker, Personnel Supervisor, Dept. 818-E, GTE Laboratories, Inc., 40 Sylvan Road, Waltham, MA 02154.

GTE LABORATORIES
INCORPORATED

An equal opportunity employer, M/F.

NOTICE TO EMPLOYERS:

Why we can recommend our readers for the top jobs

The subscribers to this magazine have qualified professionally to receive it. They are also paid subscribers—interested enough in the technological content to have paid a minimum of \$14 for a subscription.

As subscribers to ELECTRONICS, our readers have told you several things about themselves. They are ambitious. They are interested in expanding their knowledge in specific areas of the technology. And they are sophisticated in their need for and use of business and technology information.

Our readers are now in senior engineering or engineering management, or they are on the road toward those levels. In either case, they are prime applicants for the top jobs in almost any area.

If you are interested in recruiting the best people in electronics, these pages are open to you for your recruitment advertising.

Our readers are not "job-hoppers". To interest them you will have to combine present reward with challenge and opportunity for future career advancement.

The cost of recruitment advertising on these pages is \$46 per advertising inch. For information call or write:

Electronics

Post Office Box 900, New York, NY 10020
Phone 212/997-2556

Digital Multimeter Design

You will be responsible for the complete design of digital multimeters. You will design circuits which include input switching networks, AC attenuators, AC to DC convertors, and analog-to-digital convertors and displays.

The successful candidate's background will include at least two years' analog design experience and familiarity with a combination of the above circuits.

Benefits include educational support, insurance and profit sharing.

Send detailed resume and salary history to Roy Epperson, TEKTRONIX, INC., P.O. Box 500, E23, Beaverton, OR 97077.

An Equal Opportunity Employer M/F/H/C.

Tektronix
COMMITTED TO EXCELLENCE

WHERE DO YOU FIT?



In today's job market, that is. One way to see if you're in demand is to check the employment opportunities contained in ELEC-TRONICS' Classified Section.

Another way to get a reading is to place a blind (box number) Position Wanted ad there. The cost is low (only \$1.25 per line) and the results are often rewarding.

For more information call or write:

ELECTRONICS

Post Office Box 900
New York, N.Y. 10020
Phone: 212/997-2556

ENGINEERS

AUTOMOTIVE ELECTRONICS

The continued growth and expansion of the Product Engineering Office of the Electrical and Electronics Division has created new positions for degreed engineers in our Advanced Electronic Controls Engineering Department. The requirements are for:

ELECTRONIC DESIGN ENGINEERS

Candidates must have 3-8 years of experience in digital hardware and software design, servo background and systems design experience. Transducer experience necessary for a few positions. Some analog experience helpful. BSEE/MSEE preferred.

ELECTROMECHANICAL ENGINEER

Candidate must have strong capability in both electronic and mechanical systems, servo controls background and transducer/actuator experience necessary. BSEE/MSME preferred.

ELECTRONIC PACKAGING DESIGN ENGINEER

Candidate will have had experience in design of electronic circuits packaging and in the packaging of electronic and electromechanical devices. Should have knowledge of plastic molding, metal stamping and manufacturing processes. BSEE or ME a must.

These positions will be located in our Dearborn, Michigan facilities they will offer excellent starting salaries and a comprehensive program of Employee benefits including fully paid medical, dental and life insurance plans, stock savings plan and a retirement program.

For immediate and confidential attention please send your resume to:



Electrical & Electronics Division
Attn: Salaried Personnel
P.O. Box 2053
Room B-160—EEE Building
Oakwood Blvd.
Dearborn, Michigan 48121

An Equal Opportunity Employer

Job-seekers... be the first to know with McGraw-Hill's Advance Job Listings

By having our weekly ADVANCE JOB LISTINGS sent to your home every Monday you can be the first to know about openings both in and out of your field. AJL will enable you to contact anxious recruitment managers BEFORE their ads appear in upcoming issues of 21 McGraw-Hill publications. To receive a free sample copy, plus information about our low subscription rates, fill out and return the coupon below.

ADVANCE JOB LISTINGS / P.O. BOX 900 / NY 10020
PLEASE SEND A SAMPLE COPY
OF ADVANCE JOB LISTINGS TO

NAME _____ ADDRESS _____
CITY _____ STATE/ZIP _____

Advanced Micro Devices	10-11	EM Laboratories, Inc.	199	Litronix	73
■ Alco Electronic Products (Sub. of Augat)	173	■ EMI Technology	141	■ Marconi Instruments	2nd C
■ Allen-Bredley	132-133	■ Erie Technological Products	50	Better Living Book Club	177-179
■ Amp, Inc.	144-145	Fairchild (Semiconductor Oper. Div.)	55.56.57	■ Microswitch, Div. of Honeywell	195
Analog Devices	137	Fairchild Systems Technology	130-131	■ Mini-Circuits Laboratory	40
■ Augat, Inc.	183	‡ Ferroxcube Corp., Div. of North Amer. Phillips	58	Monsanto Company	148-149
Belden Corporation	185	Figaro Engineering	136	Mostek Corp.	169
■ F. W. Bell, Inc.	154	‡ First Computer Corporation	123	■ Motorola Communications & Electronics	153
Blomation	197	■ John Fluke Mfg. Co., Inc.	128-129	• Murata Mfg. Co., Ltd.	151
■ Bourns, Inc.	4thC	Forth, Inc. Responsive Computing	196	• A/S Mycron	31
‡ Braemar Computer Devices, Inc.	152	Fujitsu Limited	166, 168, 170	■ National Semiconductor Corp.	77-80
■ Bud Industries, Inc.	136	‡ Galileo Electro-Optics Corporation	86-87	NCR Power Systems Division	191
• Burr Brown	11E	• Ganz Measuring Works	9E	‡ NEC Microcomputers	83
Business Week	180	Gates Energy Products, Inc.	202	Nichicon America Corp.	202
‡ Centralab Electronics Division	31	GCA Sunnyvale	189	■ Nicolet Instrument Corp. Oscilloscope Div.	187
■ Cherry Electrical Products	1	‡ General Electric Valox	27	Nippon Precision Circuits	196
■ C. Itoh & Co., Ltd.	184	■ General Instrument Corporation (Semiconductor)	13	■ North Atlantic Industries	16
■ Continental Rentals	8	■ Grayhill, Inc.	52	Nucleonic Products Co., Inc. Div. Thomson CSF	67
‡ Control Data Corp. (CDC Cybernet)	38-39	Grinnell Systems	171	Optron, Inc.	14
‡ CTS Corporation	151	■ Hewlett Packard, Electronic Prod. Group	17-26	• Oscilloquartz	2
■ Custom Electronics	154	■ HI-G Incorporated	32-33	• Philips Elcoma	14E
Data General Corp.	37	Honeywell, TID	193	• Philips TMI	2E, 3E, 4E
Data I/O Corporation	113	Hutson Industries	166	Plessey Semiconductors	205
■ Data Precision	167	INFOTEK Systems	200	■ Precision Monolithics, Inc.	15
■ Data Translation (Datation)	19	Intech/Function Modules	173	Programmed Power, Inc.	217
Harry Davies Molding Co.	173	Intel Memory Systems	64	• Racal Thermionic Ltd.	12E, 13E
Delco Electronics, Div. Gen. Motors	126-127	Intel-Microcomputer Components	28-29	Ramtek	142-143
■ Dialight Corp.	203	Interdata, Inc.	125	■ Robinson Nugent, Inc.	34
■ Digital Equipment Components	88-89	International Crystal Mfg. Co.	188	Rockwell Microelectronic Device Division	146-147
E. I. Dupont De Nemours & Co., Inc.	3rd C	International Microcircuits, Inc.	152	• Rohde & Schwarz	1E
‡ Eastman Kodak Co., Graphics Markets Div.	139	Interstate Electronics	9	Rotron, Inc. (Commercial Prod. Div.)	150
Electronic Navigation Industries	72	■ Johanson Manufacturing Corp.	194	SAN-O Industrial Corp.	136
Electronics & Control Engineers Book Club	177, 178, 179	■ M. S. Kennedy Corp.	30	■ Semiconductor Circuits	191
Electronic Research Div. of Textron, Inc.	206	■ Krohn-Hite Corp.	5	Semtech Corporation	163
Elevam Electronic Tube Co., Ltd.	200	■ Lambda Electronics	155-160	• Siemens AG Munich	62
Elorg Electronorgtecnica	82/186	■ Lansdale Transistor & Electronics, Inc.	9E	Solid State Scientific	181
		■ LFE Corp.	192		

Maybe TOKO Converters will convert you!?

We think so. Otherwise we would not have bought space in this publication. Below are some of the specifications of the new TOKO DC-DC converter Modules, F • M • K Series and E (floating type) Series. For complete details, please circle on the reader service card.

FMK-Series

- **1-Channel PLUS Output** Input, V_{in} : $+5V \pm 10\%$
Output, V_{out} : $+6V \pm 4\%$ to $+24V \pm 4\%$ for different types
Current, I_o : 7-13mA to 100-167mA, depending on type
Conversion Efficiency: 65-75%
- **1-Channel MINUS Output** Input: $+5V \pm 10\%$
Output, V_{out} : $-5V \pm 4\%$ to $-20V \pm 4\%$ for different types
Current, I_o : 7-13mA to 100-200mA depending on type
Conversion Efficiency: 55-75%
- **2-Channel PLUS MINUS Output** Input, V_{in} : $+5V \pm 10\%$
Output, V_{out} : $\pm 6V \pm 5\%$ to $\pm 20V \pm 5\%$ for different types
Current, I_o : $\pm 3-25mA$ to $\pm 12-84mA$ depending on type
Conversion Efficiency: 55-70%



E-Series (Floating Output)

- Input, V_{in} : $5V \pm 10\%$; $12V \pm 20\%$; $24V \pm 20\%$
Output, V_{out} : $5V \pm 6\%$; $12V \pm 5\%$; $24V \pm 5\%$,
 $\pm 12V \pm 6\%$ and $15V \pm 6\%$
Current, I_o : 150-300mA, 25-125mA,
15-60mA, $\pm 12 \pm 63mA$ and
 ± 10 to $\pm 50mA$
Rated Output, P_o : 1.5W
Conversion Efficiency: 60-65%
Regulation:
VS Input Current, ± 1.0 to $\pm 1.5\%$
VS Output Current, ± 4.0 to $\pm 8.0\%$



TOKO is known worldwide for precision electronic parts, highest quality and dependable performance. TOKO sales offices in the U.S.A., West Germany, United Kingdom, and Hong Kong. Eleven other offices and ten factories in Brazil, Korea, Taiwan, Hong Kong, Singapore, Malaysia and Malta.



Toko, Inc. Head Office
1-17, Higashiyukigaya, 2-chome, Ohta-ku, Tokyo 145 Japan Tel: Tokyo 727-1161
Toko America Inc.
350 Fifth Avenue, New York, N.Y. 10001 U.S.A. Tel: 212-736-0245~8
Toko America Inc. Chicago Branch
5520 West Touhy Avenue, Skokie Illinois 60076, U.S.A. Tel: 312-677-3640~43

- COILS FOR RADIO, TV & STEREO MPX ● COIL BLOCKS
- CERAMIC FILTERS ● MECHANICAL FILTERS ● TUNERS
- POLYVARICONS ● TOKO-SCHADOW MINIATURE
- PUSHBUTTON SWITCHES ● KEYBOARD SWITCHES
- WIRE MEMORY SYSTEM ● MICRO COMPUTERS
- TOKOM-80 ● IC MEMORY ● SEMICONDUCTORS
- PULSE TRANSFORMERS ● DELAY LINES
- DC-DC AC-DC CONVERTER MODULES

Circle 217 on reader service card

BROADER RANGE IN AN AWARD-WINNING DESIGN



75 KVA frequency converter/UPS

That's right. The IR-100 Award-winning series of advanced high-efficiency 400 Hz Frequency Converters/UPS systems has been broadened to include 50, 75, 100 & 125 KVA. These same power capacities are available in both 50 and 60 Hz UPS configurations.

And, PPD's broad capability in Power Line Disturbance Monitors, covering the 50-441 Hz range, offers unique parameters in power problem detection.

BRAND NEW is the unique Model 30 ENERGY MONITOR. It measures electrical energy usage, rate and demand, and compares to preset budget. Can be used in branch circuits too. Extremely useful for studying energy usage before installing expensive energy management systems.

Call or write today for more information on how Programmed Power's 50 to 125 KVA Frequency Converter/UPS and Monitoring Systems can fit your specific requirements.



Power Line Disturbance Monitor



Franklin Electric
Programmed Power Div.,
995 Benicia Ave., Sunnyvale, CA 94086, (408) 245-8900, Telex: 357405.

ELECTRONICS REPRINTS

No. of
copies
wanted

New reprints

- ___ R-718 Display makers strive to refine their technologies 8 pp \$3.00
- ___ R-716 Special report—Japanese wave in semiconductor technology 24 pp \$3.00
- ___ R-714 Special report—active filter technology 6 pp \$3.00
- ___ R-713 Electron-beam lithography draws fine line 10 pp \$3.00
- ___ R-712 Special report—large-scale integration 16 pp \$3.00
- ___ R-710 Personal computers mean business 8 pp \$2.00
- ___ R-708 So you want to be a consultant 6 pp \$2.00

Charts

- ___ R-516 Electronic symbols \$2.00
- ___ R-213 Electromagnetic spectrum (updated 1976) \$3.00
- ___ R-326 Optical spectrum (6-page report and chart) \$3.00

Books

- ___ R-711 Circuits for electronics engineers: 306 circuits in 51 functional groups—Electronics Book Series \$15.95
- ___ R-704 Thermal design in electronics \$5.00
- ___ R-701 Applying microprocessors—Electronics Book Series \$9.95
- ___ R-608 Basics of Data Communications—Electronics Book Series \$12.50
- ___ R-602 Large Scale Integration—Electronics Book Series \$9.95
- ___ R-520 Microprocessors—Electronics Book Series \$8.95
- ___ R-011 Computer-aided Design 135 pp \$4.00
- ___ R-032 Active Filters 88 pp \$4.00

Payment must accompany your order

Make check or money order payable to Electronics Reprints. All orders are shipped prepaid by parcel post. Allow two to three weeks for delivery. For additional information call (609) 448-1700 ext. 5494.

Mail your order to:

Janice Austin
ELECTRONICS REPRINTS
P.O. Box 669
Hightstown, N.J. 08520

Back issues now available:

1960 to 1969, \$5.00 each
1970 to 1973, \$3.00 each
1974 to 1976, \$4.00 each

Sorensen, Div. of Raytheon	47
Sprague Electric	61
Stevens Tubing Corp.	170
Synertek	174-175
• Teac Corporation	83
Teletype	134
■ Telonic Altair	6
Teradyne, Inc.	68
Texas Instr., Components	164-165
Texas Instruments, Calculator	66A-66F
T-K Enterprises	170
Tohritsu Tsushin Kogyo Co., Ltd.	168
Toko, Inc.	217
• Trio Kenwood Corporation	27
• Triplett Corporation	58
■ TRW Capacitors	190
■ TRW LSI Products	53
■ TRW Power Semiconductors	7
⊕ TRW/UTC Transformers	62
⊕ U. S. Instrument Rentals, Inc.	2
United Systems Corp., Sub. Monsanto	54
Vector Electronics	176
Viking Industries	51
• V/O Techmasheport	8E
Wavetek San Diego	90
• Weston Schlumberger	10E
• Yokogawa Electric Works	139
Zilog	84-85

Classified and employment advertising

F. J. Eberle, Manager 212-997-2557	
Atomic Personnel	207
Boeing Company	208
Computer Peripherals	207,212
Ford Motor Co.	215
G.T.E. Laboratories	214
Hughes Aircraft	209
Hewlett-Packard	211
ITT LSI Systems	213
Lanier Business Products	212
Litton Systems, Amcon Div.	210
National Personnel	210
Tektronix	212,214,215

- For more information of complete product line see advertisement in the latest Electronics Buyers Guide
- Advertisers in Electronics International
- ‡ Advertisers in Electronics domestic edition

Advertising Sales Staff

Advertising sales manager: Paul W. Reiss
1221 Avenue of the Americas, New York, N.Y. 10020
[212] 997-4371

Atlanta, Ga. 30309: Glen N. Dougherty
100 Colony Square, 1175 Peachtree St., N.E.
[404] 892-2868

Boston, Mass. 02116: Frank Mitchell
607 Boylston St.
[617] 262-1160

Chicago, Ill. 60611
645 North Michigan Avenue
Robert W. Bartlett [312] 751-3739
Robert M. Denmead [312] 751-3738

Cleveland, Ohio 44113: William J. Boyle
[716] 586-5040

Dallas, Texas 75201: John J. Uphues
2001 Bryant Tower, Suite 1070
[214] 742-1747

Denver, Colo. 80203: Harry B. Doyle, Jr.
123 Speer Blvd., #400
[303] 837-1010

Detroit, Michigan 48202: Robert W. Bartlett
1400 Fisher Bldg.
[313] 873-7410

Houston, Texas 77002: John J. Uphues
601 Jefferson Street, Dresser Tower
[713] 659-8381

Los Angeles, Calif. 90010: Robert J. Rielly
Bradley K. Jones, 3200 Wilshire Blvd., South Tower
[213] 487-1160

Minneapolis, Minn. 55435: Robert M. Denmead
[312] 751-3738

New York, N.Y. 10020
1221 Avenue of the Americas
Michael J. Stoller [212] 997-3616
Matthew T. Reseska [212] 997-3617

Philadelphia, Pa. 19102: Matthew T. Reseska
Three Parkway
[212] 997-3617

Pittsburgh, Pa. 15222: Matthew T. Reseska
4 Gateway Center
[212] 997-3617

Rochester, N.Y. 14534: William J. Boyle
1175 Pittsford-Victor Rd., Pittsford, N.Y.
[716] 586-5040

San Francisco, Calif. 94111: Don Farris
Robert J. Rielly, 425 Battery Street,
[415] 362-4600

Paris:
17 Rue-Georges Bizet, 75116 Paris, France
Tel: 720-73-01

Geneva:
1 rue du Temple, Geneva, Switzerland
Tel: 32-35-63

United Kingdom & Scandinavia: Robert Ghey
34 Dover Street, London W1
Tel: 01-493-1451

Scandinavia: Andrew Karnig and Assoc.
Kungsholmsgatan 10
112 27 Stockholm, Sweden
Tel: 08 51 68 70 Telex: 179 51

Milan: Luigi Rancati
1 via Baracchini, Italy
Phone 86-90-656

Brussels: Alain Offergeld
23 Chaussee de Wavre
Brussels 1040, Belgium
Tel: 13-73-95

Frankfurt/Main: Fritz Krusebecker
Liebigstrasse 27c, Germany
Phone 72 01 81

Tokyo: Tatsumi Katagiri, McGraw-Hill
Publications Overseas Corporation,
Kasumigaseki Building 2-5, 3-chome,
Kasumigaseki, Chiyoda-Ku, Tokyo, Japan
[581] 9811

Business Department

Thomas M. Egan
Production Manager [212] 997-3140

Carol Gallagher
Production Manager International
[212] 997-2045

Dorothy Carter
Production Manager Domestic
[212] 997-2908

Diane Arlotta
Production Assistant [212] 997-2044

Frances Vallone
Reader Service Manager
[212] 997-6057

Electronics Buyers' Guide

H.T. Howland, General Manager
[212] 997-6642

Regina Hers, Directory Manager
[212] 997-2544

Diane Arlotta, Production Manager
[212] 997-2044

Frances Vallone, Reader Service Manager
[212] 997-6057

Classified and Employment Advertising

Frank Eberle, Manager
[212] 997-2557

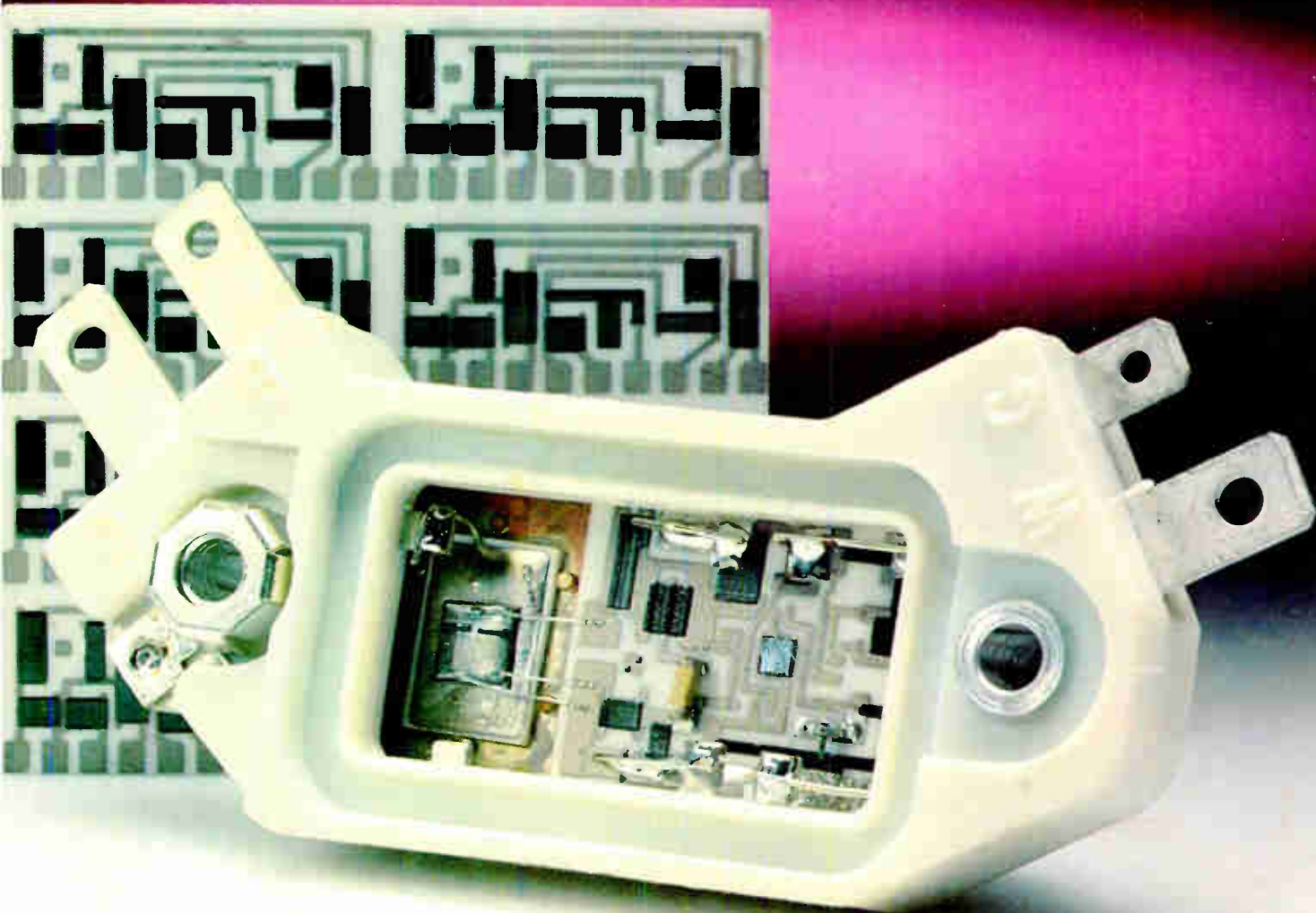

Lower your costs in high-volume microcircuit applications with Du Pont's new system of thick film materials.

To help cut your costs and raise your yields, Du Pont has developed a new system of cost-effective, compatible resistor and conductor materials for high-volume production.

With the new vehicle technology in our CERTI-FIRED[®] 4800-Series Resistors, you can get more consistent prints and reproducible resistance values, even with high-speed printers and long production runs. You get the same consistency if you print multiple

circuit patterns on one large substrate.

Our new Palladium/Silver Conductor 9843—compatible with the 4800-Series—uses the same new vehicle technology and offers the same processing advantages.

Altogether, it's a low-cost system that offers more of the quality and performance for which Du Pont is known. Palladium/Silver Conductor 9843 offers high adhesion and excellent soldering. The 4800-Series Resistors

offer tight laser trimming tolerances, excellent stability and TCR's less than 250ppm/°C. Both offer reproducible performance, lot-to-lot and substrate-to-substrate.

If you manufacture circuits or networks for any application, from consumer to military, Du Pont has a cost-effective system of thick film materials for you. Call 800-441-9475 toll-free. Or write Du Pont Company, Rm. 35639, Wilmington, DE 19898.

Electronic Materials Division



Electronics

World Radio History
Circle 901 on reader service card

The First Modular Precision Pot...

... 10 turn precision,
in a $\frac{5}{8}$ " square package.

Now custom design precision in your equipment! Bourns modular line of 10-turn wire-wound potentiometers offers virtually infinite selection of standard options, with specs that are unequaled in any other line of modular controls, potentiometers and switches.

SMALL SIZE—The $\frac{5}{8}$ " square design saves up to 35% of panel space compared to standard circular models. Position them closer or in an area simply not possible before now.

LOW ASSEMBLY COSTS—Easy and economical mounting on P.C. boards. Only Bourns offers a choice of P.C. pins or solder lugs!

MANY OPTIONS—Single shafts of $\frac{1}{8}$ " or $\frac{1}{4}$ " diameter are each available in 3 standard lengths, or choose dual concentric shaft options - all with plain or locking bushings. Specify to your application and gang up to two modules.

You'll find these smaller modular precision pots offer the same electrical specs as the larger circular types - such as independent linearity of only $\pm 0.25\%$.

"FEEL-APPEAL"—As with Bourns other styles of controls and switches, this precision line offers the same smooth, consistent feel. The low rotational torque is still only .3 to 2.0 oz. inch!

CALL TODAY—for complete information on this versatile off-the-shelf, modular constructed potentiometer. Find out how to custom design precision in your equipment at standard cost and leadtime.

MODULAR PRECISION... BEAUTIFUL!

TRIMPOT PRODUCTS DIVISION, BOURNS, INC., 1200 Columbia Avenue, Riverside, CA 92507, Telephone 714 781-5122—TWX 910 332-1252.



International Marketing Offices: European Headquarters — Switzerland 042/23 22 42 • Belgium 02/218 2005 • France 01/2039633 • Germany 0711/24 29 36 • Italy 02/32 56 88 • Netherlands 70/87 44 00 • United Kingdom 01/572 6531 • Norway 2/71 88 72 • Sweden 764/20 110 • Japan 075/921 9111 • Australia 02/55-0411 03/95-9566 • Israel 77 71 5/6/7

For Immediate Application — Circle 120
For Future Application — Circle 220