

APRIL 1, 1976

PREVIEW OF THE ELECTRONIC COMPONENTS CONFERENCE/96

Digital electronic TV tuner uses nonvolatile memory/86
What to look for in dc-to-dc converter power supplies/91

FOUR DOLLARS A MCGRAW-HILL PUBLICATION

Electronics®

**STILL PULLING
PERFORMANCE
SURPRISES**



1420 N. HILL ST. CAMAS, NOV 77
MATT NEILL
2516 NE CLACKAMAS
PORTLAND, OR

97232

The right DMM decision means
 1 μ V sensitivity, 0.03% accuracy,
 and a \$425* price.

Introducing HP's 3465A DMM.

Now you have a five-function DMM with the needed accuracy, sensitivity, and low cost to solve your bench or field service requirements. See how HP's 3465A Digital Multimeter combines capability, convenience, and confidence with low cost to bring you to the right decision.

Capability: Take a look at the front panel. It has all the functions and ranges you'd expect, and more. You get ohms, ac/dc volts, and ac/dc current. Extra resolution is obtained with a full-scale readout of 19999. Accuracy is $\pm 0.02\%$ of reading $\pm 0.01\%$ of range on dc, meeting the needs for most field or bench applications. The 10 mV dc range and 100 mV ac range provide performance typically found only in more expensive 5½-digit multimeters.

Convenience: The 3465A's functional design means easy rack and stack with other instruments in the lab, while its compactness and low power consumption result in a handy field-service instrument. It will operate from four different sources of power: 1) Four standard D-cell** batteries. 2) The ac line using an HP hand-held calculator charger. 3) The ac line using its own internal power supply. 4) Rechargeable Nickel Cadmium batteries.

Confidence: Fewer components and higher reliability are achieved through the use of a newly developed Tantalum-Nitride on Sapphire thin-film resistor. Easy calibration and improved performance are obtained with a new dual-slope integrator that uses a single reference supply. All these design features, plus input protection, give you the performance you'd expect from HP.

Cost: The standard 3465A costs \$500* and is equipped with an internal power supply, a battery recharging circuit, and Nickel-Cadmium batteries. If you don't need the rechargeable batteries, order Option 001 for \$480* and save \$20*. Order Option 002 for \$425* and save \$75* by powering the HP 3465A from dry-cell batteries. Also, Option 002 can operate from the ac line when using one of HP's Model 82002A chargers (supplied with most HP pocket calculators).

When you consider its capability, convenience, and cost, you can be confident that the 3465A is the right decision. Contact your local HP field sales engineer, or, write for more information.

*Domestic U.S.A. Price Only **U-2 Batteries in Europe

**HP DVM's...
 the right decision**



HEWLETT  PACKARD

Deals and service from 172 offices in 85 countries.
 HP's Payment Plans, Financing, Leasing, and Rentals

World Radio History
 Circle 100 on Reader Service Card

Is our new HP-91 an engineering work of art?

Or just a beautiful investment?

Time will tell. For the moment, let's just say it's an original. The first battery-operated (AC-DC), fully portable (40 oz.) printing scientific.

It performs all math, log and trig calculations.

The latter in radians, degrees or grads. It does hours/minutes/seconds arithmetic and conversions, rectangular/polar coordinate conversions, and more.

It performs many stat calculations.

Factorials, accumulations, 2-variable mean and standard deviations, linear estimates and regressions.

You can scarcely notice the 3-mode thermal printer.

One switch lets you decide to print everything, data entries and operations only, or nothing. For occasional printing, there's a PRINT x key.

The keyboard's buffered.

The printer catches virtually everything, no matter how fast you play the keys. (The number keys are set up just

like adding machine keys, by the way, so you can work them without looking.)

You can calculate up to five hours on battery power,

assuming you use the printer 20% of the time. And you can count on trouble-free performance.

You can print the contents of all registers:

the stack only (the HP-91 uses our RPN logic system with 4-register stack); the six stat registers only; or all 16 storage registers.

The 10-digit display glows like a firefly.

The characters stand almost twice as tall as those on our pocket models.

You get uncompromising design, assembly, support.

Three things that have made believers of the million+ people who own personal-sized HP calculators. Three things that might turn the HP-91 into an engineering work of art. Over time.

Meanwhile, at \$500.00* it's a beautiful investment.

800-538-7922

(in Calif. 800-662-9862).

The toll-free numbers to call for complete specs and a nearby dealer. Or send the coupon.

HEWLETT  PACKARD

Sales and service from 172 offices in 65 countries.
Dept. 214D, 19310 Pruneridge Avenue, Cupertino, CA 95014

616/05

Hewlett-Packard
19310 Pruneridge Avenue
Dept. 214 D
Cupertino, CA 95014

Please send me HP-91 specs and your magazine with buyer's guide.

Name _____

Company _____

Street _____

City _____

State _____ Zip _____

*Suggested retail price, excluding applicable state and local taxes - Continental U.S., Alaska & Hawaii.



Circle 1 on reader service card

THIS OEM ASKED US FOR A HEAD START.

Management Systems Technology in Chicago was in the market for a minicomputer and a disc. We said, "There's a better way."

Then, we introduced them to the Hewlett-Packard DISComputer concept.

Some vendors offer systems in which a disc, controller and mini-computer have been *put* together. In contrast, the elements of the HP DISComputer were *designed* together.

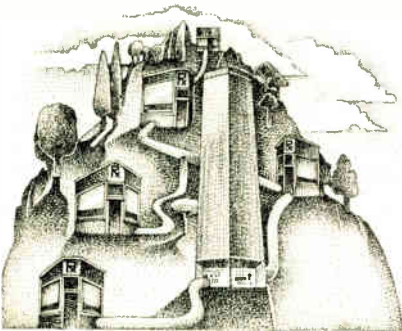

Management Systems Technology, Inc., builds a system that provides druggists real-time data on patient profiles and drug interactions, prints labels, handles billing and taxes. At its heart is a Hewlett-Packard DISComputer.

This means you don't get bogged down trying to optimize the performance of our hardware. Instead, you can jump ahead and put your efforts into developing your own systems.

You can also benefit from advanced HP software. RTE-III, the newest member of the RTE family, gives access to 64 partitions, up to 128K words of main memory, plus multiple languages and multi-programming.

At \$17,655*, the MX/65 DISComputer price/performance ratio is exceptional.

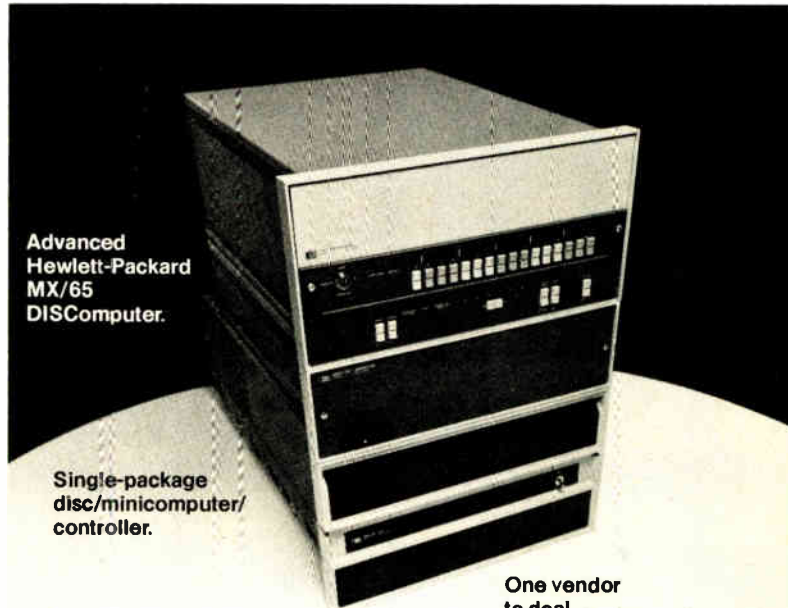

Advanced Hewlett-Packard MX/65 DISComputer.

Single-package disc/minicomputer/controller.

One vendor to deal with.

The further economies of dealing with a single vendor could help turn a head start into a winning performance any day of the week.

Just ask Management Systems Technology in Chicago.

THE HEWLETT-PACKARD MX/65 DISCOMPUTER AT A GLANCE

Minicomputer:	Controller:	Disc:
8K to 128K words. Solid state 4K RAM memory. Microprogrammable. Parity, EAU, floating point standard. Brownout-proof power supply. Optional Dynamic Mapping System.	Links to multiple CPU's. Combined seek/data transfer. Built-in error detection and correction. Automatic track switching. Data protect and recovery features.	25 msec average seek time. 15 Mbytes of storage, expandable to 120 Mbytes. Exceptional 937 Kbyte transfer rate. Operates over wide power and environment range.

*DOMESTIC USA OEM PRICES QUANTITY 50 WITH 32K MEMORY, 15 MBYTE DISC

NOW WHAT CAN WE DO FOR YOU?

HEWLETT  PACKARD

Sales and service from 172 offices in 65 countries.

22605 A Circle 2 on reader service card

1501 Page Mill Road Palo Alto, California 94304

World Radio History

29 Electronics Review

RELIABILITY: Moisture in ICs to get close check, 29
SECURITY: Automated baggage scanner uses gamma rays, 30
COMPUTERS: Wang line competes in business arena, 30
MEMORIES: Mostek 4-k device is high-performance RAM, 31
Core system has a special wiggle, 31
SOLID STATE: Motorola is adding M6800 hardware, 32
First of the dedicated 8-bit microprocessors arrive, 34
AUTOMOTIVE: Test program for spark advance is tough, 34
COMMUNICATIONS: Latest Picturephone has plasma display, 36
MILITARY: Seafarer tests may start next month, 36
Standard airborne computer set for October, 40
NEWS BRIEFS: 39

53 Electronics International

JAPAN: Electronic gear engraves images on plastic cards, 53
AROUND THE WORLD: 53

59 Probing the News

COMPONENTS: Spring brings optimism to Paris, 59
MICROPROCESSORS: European gold rush is on, 62
COMMUNICATIONS: IC houses eagerly eye phone market, 65
FCC 'naturalizes' foreign attachments, 66
YOU AND YOUR CAREER: Rivers charts IEEE campaign, 68

73 Technical Articles

SOLID STATE: New designs and processes improve MOS, 73
DESIGNER'S CASEBOOK: Low-pass filter rejects impulse signals, 82
FSK modem interfaces cassette and computer, 83
CONSUMER: Digital TV tuner uses LSI and nonvolatile memory, 86
COMPONENTS: Buy only needed quality in dc-to-dc modules, 91
Films dominate San Francisco components conference, 96
ENGINEER'S NOTEBOOK: Nomograph shows bandwidth for pulses, 102
Scope-triggered register freezes data for display, 103
Audio continuity tester indicates resistance values, *04

109 New Products

DESIGN ENGINEERS' COMPONENTS SHOW PREVIEW:
Standardized components simplify panel interface, 109
Toggle DIP switch offers side-access actuator, 110
Plastic connector terminates fiber-optic bundles, 113
Chip capacitors are adjustable from the top, 114
Logic-compatible DIP delay lines respond in 4 nanoseconds, 114
Leads of glass-encased capacitors are welded to chip, 115
Transformer ferrites minimize power losses, 116
IN THE SPOTLIGHT: Single-fiber optical cable is rugged, 118
Programming system takes on any microprocessor, 120
COMMUNICATIONS: Tone receivers meet Bell specifications, 123
SUBASSEMBLIES: Modular dc supplies have fixed outputs, 128
INDUSTRIAL: Power system protects against outages, 132

Departments

Publisher's letter, 4
Readers' comments, 6
News update, 8
Editorial, 12
People, 14
Meetings, 18
Electronics newsletter, 25
Washington newsletter, 47
Washington commentary, 48
International newsletter, 55
Engineer's newsletter, 106
New literature, 138

Highlights

Cover: MOS repeats its surprise performance, 73

Yet again, metal-oxide-semiconductor technology has done the unexpected—more than doubled in speed and more than quintupled in density, thanks to such process innovations as double silicon layers, V notches, double diffusion, and charge coupling.

Cover is by Art Director Fred Sklenar.

Europe is buying microprocessors, 62

The West European market in microprocessors is expected to hit \$150 million by 1980, up from \$10 million last year. Scrambling to pin down shares in that market are leading semiconductor houses in Germany, France, Holland, Italy, and the UK, as well as U.S. manufacturers operating usually through second sources.

Digital tuner remembers to turn on the TV, 86

A metal-oxide-semiconductor large-scale-integrated tuner, which handles 12 vhf and 70 uhf television channels with equal ease, is being equipped with a nonvolatile memory that can store an entire week's viewing times.

Films rate highest at components conference, 96

Speakers at the 26th Electronic Components Conference, scheduled to open in San Francisco on April 26, will be testifying to the versatility of thick- and thin-film technology. Optical devices, semiconductors, and organic materials will also get special treatment.

And in the next issue . . .

Special issue on microprocessors—who makes them, where to use them, and how to design with them, program, and test them.

EDITOR-IN-CHIEF: Kemp Anderson

EXECUTIVE EDITOR: Samuel Weber

MANAGING EDITOR: Arthur Erikson,
International

SENIOR EDITORS: Laurence Altman,
Ray Connolly, Lawrence Curran,
John Johnsrud, H. Thomas Maguire,
Stephen E. Scrupski

ART DIRECTOR: Fred Sklenar

ASSOCIATE EDITORS: Howard Wolff,
Gerald M. Walker, Alfred Rosenblatt

DEPARTMENT EDITORS

Aerospace/Military: Ray Connolly

Circuit Design: Don Blattner

Communications & Microwave:

Richard Gundlach

Components: Lucinda Mattera

Computers: Stephen E. Scrupski

Consumer: Gerald M. Walker

Industrial: Margaret A. Maas

Instrumentation: Andy Santoni

New Products: H. Thomas Maguire

Michael J. Riezenman

Packaging & Production: Jerry Lyman

Solid State: Laurence Altman

CHIEF COPY EDITOR: Margaret Eastman

COPY EDITORS: Everett C. Terry, Ben Mason

ART: Charles D. Ciatto, *Associate Director*

Patricia Cybulski, *Assistant Director*

EDITORIAL SECRETARIES: Janet Noto,

Julie Gorgoglione, Penny Roberts

FIELD EDITORS

Boston: Lawrence Curran (Mgr.), Pamela Leven

Los Angeles: Larry Waller (Mgr.)

Midwest: Larry Armstrong (Mgr.)

New York: Ron Schneiderman (Mgr.)

San Francisco: Bernard Cole (Mgr.)

Judith Curtis

Washington: Ray Connolly (Mgr.)

Frankfurt: John Gosch

London: William F. Arnold

Paris: Arthur Erikson

Tokyo: Charles Cohen

McGraw-Hill World News

Director: Ralph R. Schulz

Bonn: Robert Ingersoll

Brussels: James Smith

London: James Trotter

Madrid: Dom Curcio

Milan: Andrew Heath

Moscow: Peter Gall

Paris: Michael Johnson, Richard Shepherd

Stockholm: Robert Skole

Tokyo: Mike Mealey

PUBLISHER: Dan McMillan

DIRECTOR OF MARKETING: Pierre J. Braudé

MARKETING ADMINISTRATION MANAGER:

Wallis Clarke

CIRCULATION MANAGER: Nancy L. Merritt

MARKETING SERVICES MANAGER:

Tomlinson Howland

RESEARCH MANAGER: Margery D. Sholes

Robins are not the only harbingers of spring. In electronics, the beginning of spring coincides with the beginning of preparations for attending two important components shows.

So in this issue, our first of spring, we have put together a wide-ranging package of stories and features about the trends in components as the shows approach. On page 96, you'll find a five-page preview of what you can expect at the 26th Electronic Components Conference, which opens in San Francisco on April 26. The report, by our components editor, Lucinda Mattera, not only summarizes the highlights of the more than 70 technical papers being presented there, but fills in the background against which the papers must be viewed.

Then, on page 109, we continue the preview by presenting some of the more significant new products that will be shown at the companion Design Engineers' Electronic Components show. The new arrivals range from standardized components for panel interfaces to a plastic connector for fiber-optic bundles.

The opening of the Paris Components Show, which runs from April 5 to 10, is a good time to round up the components trend in Europe. After a rather dismal time there last year, components makers and marketers are feeling a lot more chirpy, according to the reports gathered by *Electronics'* European editors, who were assisted by Michael Johnson and Andrew Heath of McGraw-Hill World News. You'll find their story starting on page 59. Then, too, because microprocessors are looming so large in the designers' tool box,

we have a report on how the battle for Europe's microprocessor market is shaping up (see p. 62).

Les Penner, the author of the article on digital electronic tuning for television (p. 86), is something of a pioneer in metal-oxide-semiconductor technology, having joined General Instrument's MOS operations 10 years ago. Yet he was a stranger to the TV receiver when he headed the microelectronics design group that participated in GI's multi-division development of the digital tuner.

"Working with the Sickles group [GI's tuner division] was a revelation," Penner says. "I tended to think of consumer electronics as 'cheap and dirty,' a lesser quality product than other electronics instruments. In fact, TV-tuner reliability was harder to meet than some military products because of the TV-chassis environment. Picture-tube arcing is unique to TV sets, and making semiconductors survive arcing is a formidable task."

Although he is not certain where the next use of digital technology will be in the TV receiver, Penner is already looking at other applications of this type of tuner to automobile radios and citizens' band instruments.

"Being in MOS for 10 years is about as long as anybody in the field, but I don't feel like a pioneer," Penner observes. "I guess I've been too busy."



April 1, 1976 Volume 49, Number 6
91,548 copies of this issue printed

Published every other Thursday by McGraw-Hill, Inc. Founder James H. McGraw 1860-1948. Publication office 1221 Avenue of the Americas, N.Y., N.Y. 10020, second class postage paid at New York, N.Y. and additional mailing offices.

Executive, editorial circulation and advertising addresses: *Electronics*, McGraw-Hill Building, 1221 Avenue of the Americas, New York, N.Y. 10020. Telephone (212) 997-1221. Teletype 12-7960 TWX 710-581-4879. Cable address MCGRAWHILL NEW YORK.

Subscriptions limited to professional persons with active responsibility in electronics technology. Publisher reserves the right to reject non-qualified requests. No subscriptions accepted without complete identification of subscriber name, title, or job function, company or organization, and product manufactured or services performed. Subscription rates in the United States and possessions \$12.00 one year, \$30.00 three years. Canada and Mexico \$14.00 one year, \$32.00 three years, Europe \$35.00 one year, \$97.50 three years, Japan, Israel and Brazil \$60.00 per year, Australia and New Zealand \$60.00 per year including air freight, all other countries \$40.00 per year. Limited quota of subscriptions available at higher-than-basic rate for persons outside of field served, as follows: U.S. and possessions and Canada \$25.00 per year, Europe \$40.00, Japan, Israel and Brazil \$85.00, all other countries \$50.00. Single copies \$4.00. Please allow four to eight weeks for shipment.

Officers of McGraw-Hill Publications Company: Gordon L. Jones, President, Paul F. McPherson, Executive Vice President, J. Elton Tuohig, Executive Vice President-Administration, Gene W. Simpson, Group Vice President, Senior Vice Presidents: Ralph Blackburn, Circulation; John B. Hoglund, Controller; Ralph R. Schulz, Editorial; David G. Jensen, Manufacturing; Vice Presidents: James E. Bodoff, Planning & Development; Edward E. Schirmer, Marketing Administration.

Officers of the Corporation: Shelton Fisher, Chairman of the Board; Harold W. McGraw, Jr., President and Chief Executive Officer; Robert N. Landes, Senior Vice President and Secretary; Ralph J. Webb, Treasurer.

Title registered in U.S. Patent Office. Copyright ©1976 by McGraw-Hill, Inc. All rights reserved. The contents of this publication may not be reproduced in whole or in part without the consent of copyright owner.

Subscribers: The publisher, upon written request to our New York office from any subscriber, agrees to refund that part of the subscription price applying to copies not yet mailed. Please send change of address notices or complaints to Fulfillment Manager, subscription orders to Circulation Manager, *Electronics*, at address below. Change of address notices should provide old as well as new address, including postal zip code number. If possible, attach address label from recent issue. Allow one month for change to become effective.

Postmaster: Please send form 3579 to Fulfillment Manager, *Electronics*, P.O. Box 430, Hightstown, N.J. 08520.

A new digital phasemeter that's accurate to .05°?

.05° accuracy and .01° resolution
continuous precision measurement
from 0°-360.00°

no 0/360° ambiguity, right down
to readings as small as .01°

5 digit Sperry readout

accuracy unaffected by amplitude differences

frequency range 10Hz to 5MHz



Precisely.

and the best performance
at the best price,
only \$1995.—

for immediate action call
(617) 580-1660 or contact
your local KH representative,
listed below.

KH KROHN-HITE
CORPORATION

Avon Industrial Park, Avon, Mass. 02322 • (617) 580-1660, TWX 710-345-0831

SALES OFFICES: ALA., Huntsville (205) 534-9771; CAL., San Jose (408) 292-3220; Inglewood (213) 674-6850; CONN., Glastonbury (203) 633-0777; FLA., Orlando (305) 894-4401; GEO., Atlanta (404) 448-2365; HAWAII, Honolulu (808) 941-1574; ILL., Des Plaines (312) 298-3600; IND., Indianapolis (317) 244-2456; MD., Baltimore (301) 265-8144; MASS., Lexington (617) 861-8620; MINN., Minneapolis (612) 884-4336; MO., Kansas City (816) 454-5836; St. Louis (314) 423-1234; N.C., Burlington (919) 227-3639; N.J., Cherry Hill (609) 482-0058; N.Y., E. Syracuse (315) 437-6666; Rochester (716) 328-2230; Vestal (607) 785-9947; Elmont (516) 488-2100; OHIO, Chesterland (216) 729-2222; Dayton (513) 434-8993; ORE., Portland (503) 297-2248; VA., Falls Church (703) 573-8787; WASH., Bellevue (206) 454-3400; CANADA, Montreal, Quebec (514) 341-7630; Ottawa, Ontario (613) 235-5121; Toronto, Ontario (416) 445-9900; Vancouver, British Columbia (604) 253-5555; Halifax, Nova Scotia (902) 454-8321; St. John's, Newfoundland (709) 726-2422.

Thinking about custom hybrids? Collins has a lot to offer.

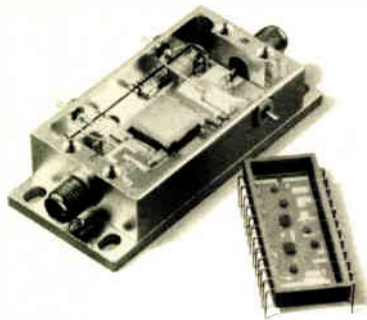

If you are considering hybrids, consider Collins. Our capabilities include:

For Conventional Hybrids:

- Thick Film
- Thin Film
- Laser Resistor Trim
- Low and High Density
- Multiple Packages
- Beam Lead

For RF Hybrids:

- Microstrip (UHF and Microwave)
- Up- and Down-Converters
- Power Amplifiers
- Low Noise Amplifiers (LNAs)
- Local Oscillators
- Integrated RF Systems

They are proven in Aerospace and Aviation Applications.

We meet MIL-STD-883/MIL-M-38510.

Our capabilities include Analog/Digital Auto Test at Temperature, Custom Design Implementation, and Design Specification.

Our production facilities are among the most advanced in the world. Collins has, in its more than 12 years of hybrid experience, built over 4,000 hybrid designs. They're all in our database. Our technical teams are eager to work with you.

Put us to your test.

For more information contact:
Hybrid Microelectronics Marketing,
Collins Radio Group,
Rockwell International,
Dallas, Texas 75207.
Tel. 214/690-5937.



**Rockwell
International**

...where science gets down to business

Circle 6 on reader service card

Readers' comments

Switch that protection

To the Editor: In my article, "Getting the most out of C-MOS devices for analog jobs" [Dec. 25, p. 69], the caption for Fig. 8 and the text describing the figure imply that, in the dielectric-isolated switch shown, the on resistance is purposely modulated with an analog signal level, affording some kind of protection. This is erroneous.

Actually, the purpose of the circuitry is to minimize the leakage current in the off state and to minimize the modulation of the on resistance in the on state when the input signals are within their normal analog signal range.

The dielectric-isolated switch is much less likely to fail catastrophically from brief input-voltage spikes than other complementary metal-oxide-semiconductor devices, since it will not latch up and will not go into avalanche.

But it could fail from prolonged high currents flowing through forward-biased junctions to the power lines under low-impedance over-voltage conditions.

Nor does capacitor N_2 in the circuit in Fig. 9 give protection. Its purpose, as with N_3 in Fig. 8, is to minimize modulation of on resistance. The protection is accomplished by resistor R_1 and transistors Q_5 and Q_6 .

Ernie Thibodeaux
Harris Semiconductor
Melbourne, Fla.

No restrictions on chip sale

To the Editor: In the article "Teletext decoder combines IC types" [International edition, Feb. 19, p. 10E], you gave the impression that Texas Instruments Ltd. would not sell the Schottky read-only memory and the serial-to-parallel converter chips to Teletext competitors.

If a decision is made to sell the Tifax chips individually, we would sell them to whoever wished to buy, irrespective of whether they were a competitor.

Geoff Shrank
Texas Instruments Ltd.
Bedford, England

Bugbook III:

A Blow for Microprocessor Independence.



For only **\$14.95**

Bugbooks are dedicated to the proposition that all men should be electronically independent and creative . . . that you should be able to conceive and execute your own circuit designs . . . that the Bugbooks will enable you to participate in one of the most exciting of all technological revolutions: the micro-electronics revolution.

Bugbooks I and II set forth the fundamental truths of digital circuitry. Bugbook IIa explores asynchronous serial interfacing of data transmission. But now there is a new one: Bugbook III. It expands and builds on the pioneering simplicity. It's a forthright approach to micro-computer/microprocessor use and design.

Bugbook III focuses on micro-processor system design, using an 8080 based system for micro-computer interfacing. Typical subjects: microcomputer programming and I/O; breadboarding the Micro-Designer™; clock cycles and timing loops; and more.

All practical. All clear in 592 pages, with a glossary of 200 microcomputer terms. And, most important of all, 60 self-teaching experiments designed to make you independent and creative.

Strike a blow for independence — your independence. Bugbook III is available now for \$14.95 from the people who are revolutionizing the way digital electronics is learned. Send your check or money order today.

"Postage paid only in the continental U.S."



E&I INSTRUMENTS, INC.
61 First St., Derby, Conn. 06418
Telephone (203) 735-8774

Circle 149 on reader service card

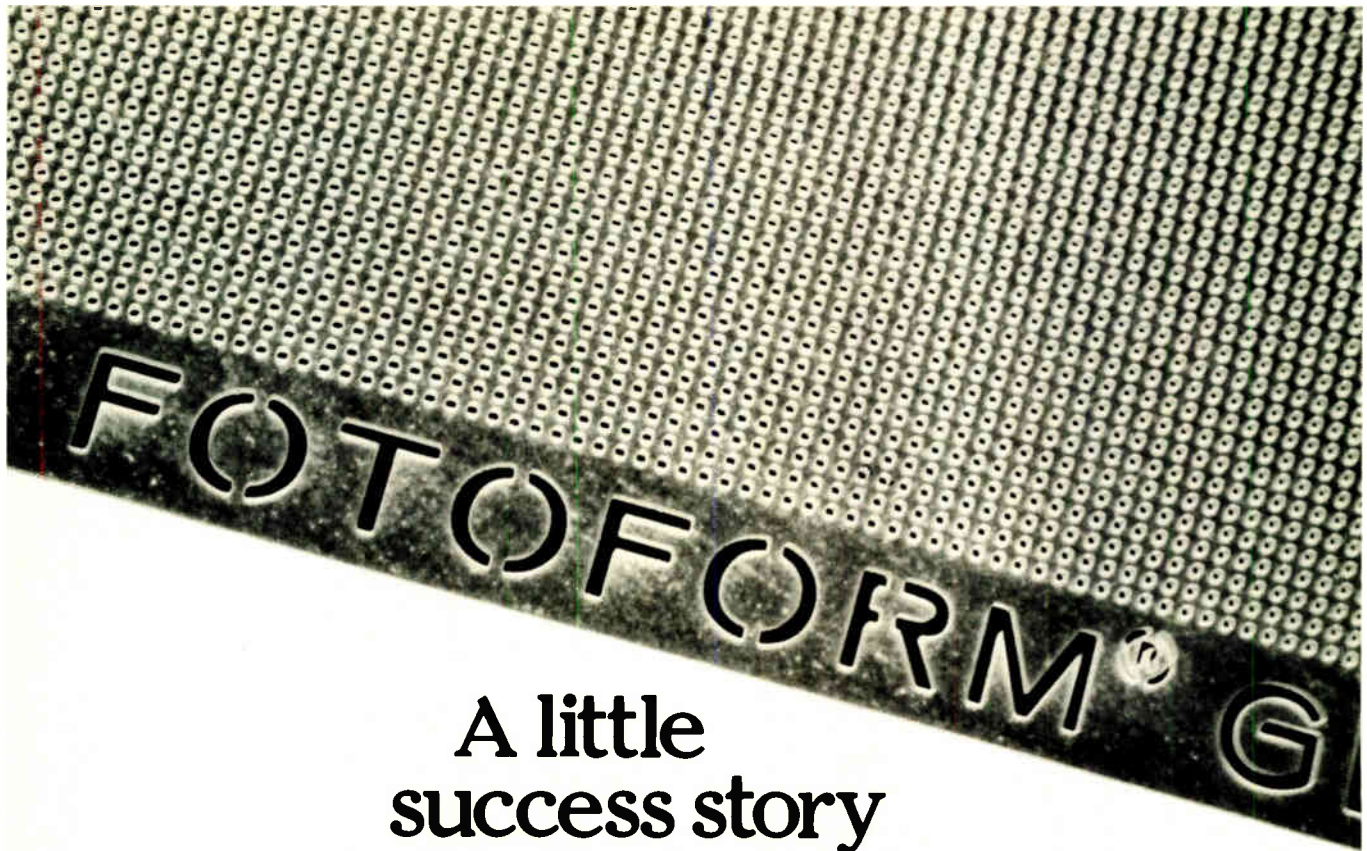

A little success story with holes in it...

Holes of almost any shape and size. Up to 10,000 holes per square inch, in pieces as thin as 0.10 inch. Holes, slots, and channels, as small as 0.005 inch. And with tolerances as close as ± 0.001 inch.

We're talking about Corning FOTOFORM® and FOTOCERAM® materials. Unique, photosensitive materials that can be precision-etched, machined, cut, milled, chamfered, ground, lapped, polished, sealed to glasses or ferrites. And even metalized.

The real beauty of FOTOFORM and FOTOCERAM materials is they offer you engineering flexibility—the flexibility to do it your way.

And at Corning, your way is the only way. That's why we developed FOTOFORM and FOTOCERAM materials. They may help you write your own success story. We'll help. We're the Fotoform Products Group, Corning Glass Works, Corning, New York.

You ought to get to know us better. Find out more about FOTOFORM and FOTOCERAM materials. Write, under your letterhead, for a free sample depicting the 1776 Bennington Flag and complete specifications to:

FOTOFORM Products Group Dept. E-46
Corning Glass Works, Corning, New York 14830
(607) 974-8583

CORNING
CORNING GLASS WORKS



Write for free sample today!

Get the scope you need-Now!

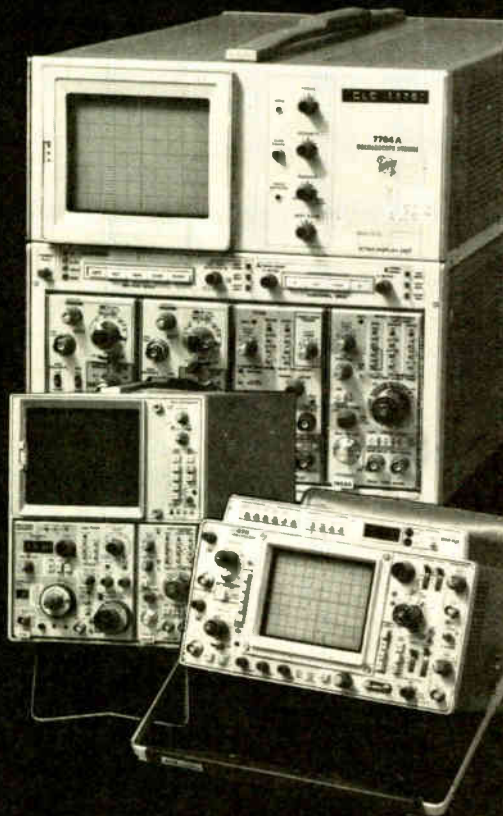

Our "Instrument Professionals" will tell you which scope will do the job best, at the lowest cost, make immediate delivery and guarantee performance.

Write or call for data on our other specialties: Instrument Leasing • Computer Peripherals • Equipment Sales • Instrument Service.

Circle 8 on reader service card

Call Get our FREE Catalog

Continental Rentals

Div. Continental Leasing Co., Inc.
175 Middlesex Turnpike, Bedford,
MA, 01730 (617) 275-0850

Metuchen NJ, (201) 549-8500; Rockville,
MD, (301) 881-7997; Dallas, TX, (214)
357-1779; Elk Grove IL, (312) 439-
4700; Costa Mesa, CA (714) 540-6566;
Santa Clara, CA, (408) 735-8300;
Los Angeles, CA, (213) 477-7521

News update

■ The analog technique used to compress or expand recorded speech in audio and audiovisual systems developed by Cambridge Research and Development Group, Westport, Conn., is catching on in a big way. Cambridge calls its method variable speech control [Aug. 22, 1974, p. 87]. It's a technique to get rid of both the Donald Duck effect when tapes are speeded up and the "growl" when the tape is slowed. Kenneth Sherman, a general partner in the company, emphasizes that Cambridge isn't a production house. "Our bag is licensing," he says, and the list of licensees now includes La Belle Industries, Oconomowac, Wis., Sony Corp., and National of Japan. Sanyo has also indicated it will become a licensee, according to Sherman; General Electric Co. has announced that it will use VSC in a tape recorder this year, he says, although GE isn't actually under license yet. National, says Sherman, has already introduced a system in Japan that sells for \$493, and La Belle Industries has prototypes of a single-cartridge VSC system that incorporates both 8-track sound and 16-millimeter film.

■ A television tuner incorporating a nonvolatile metal-nitride-oxide-semiconductor memory could be in American TV sets by midyear. The Omega tuner [May 15, 1975, p. 40], made by the F.W. Sickles division of General Instrument Corp., Chicopee, Mass., is in pilot production, according to Eli Cohen, vice president and general manager. "The system and technology are performing exactly as had been projected [see p. 86], and we're definitely in people's programs," Cohen says, although he won't say which set makers have designed Omega in.

Cohen doesn't expect production volume to be great this year, but is looking forward to brisk sales in the second and third production years, as set makers become more familiar with the unit. GI is making the MNOS memory, and has completed tooling for the LSI device, Cohen adds.

Deltron

Custom Power Supplies

have what you need

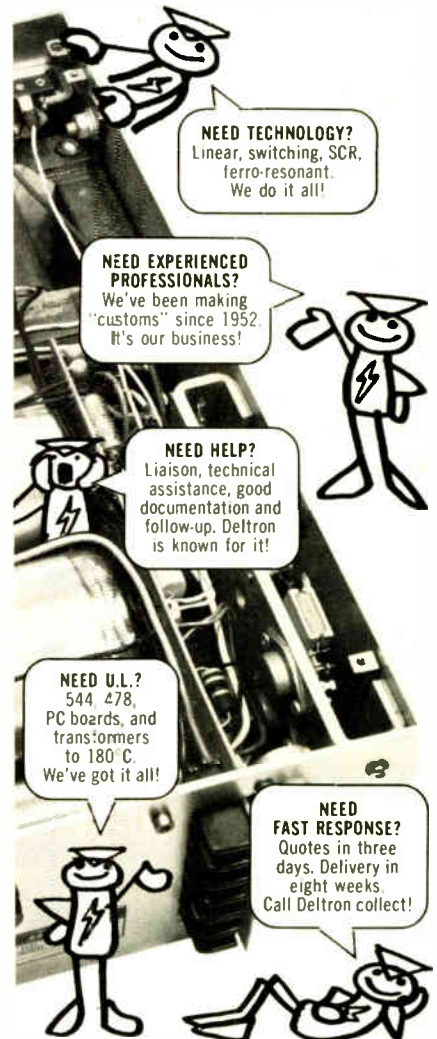

NEED TECHNOLOGY?
Linear, switching, SCR,
ferro-resonant.
We do it all!

NEED EXPERIENCED PROFESSIONALS?
We've been making "customs" since 1952. It's our business!

NEED HELP?
Liaison, technical assistance, good documentation and follow-up. Deltron is known for it!

NEED U.L.?
544 478, PC boards, and transformers to 180°C. We've got it all!

NEED FAST RESPONSE?
Quotes in three days. Delivery in eight weeks. Call Deltron collect!

Deltron's continuing R&D programs insure that your customs will be made using the latest technology, components, and manufacturing techniques. Our modern facilities include a U.L. printed circuit department. In-plant magnetics department. And a graphics and technical writing department.

Next time get what you need! Try Deltron. Call collect or write Deltron, Inc., Wissahickon Avenue, North Wales, Pa. 19454, Telephone: 215-699-9261, TWX 510-661-8061.

Deltron inc.

Circle 151 on reader service card

Now... Super RAM!

**Power cut 33% by 22-pin 4K RAM:
375 mW max at 200 ns access**

It's a pin-for-pin replacement for the old 22-pin boss — TMS-4060. But young SuperRAM cuts average power dissipation by 33% to 375 mW maximum when operating under worst-case conditions at 200 ns access.

The new EA 4122 delivers the same performance in the same sockets on the same PC boards built for TMS-4060s — but with far lower power drain. And it's available in the same three speeds as the TMS-4060 family:

1. EA4122-2 with 200 ns max. access, 400 ns min. read/write cycle, 375 mW max.
2. EA4122-1 with 250 ns max. access, 430 ns min. read/write cycle, 350 mW max.
3. EA4122 with 300 ns max. access, 470 ns min. read/write cycle, 325 mW max.

In case you don't require lower power dissipation, EA also offers devices specified identically to the TMS-4060, 4060-1 and 4060-2 as well as the Intel 2107B, 2107B-2, 2107B-4, and 2107B-6.

All these are available right now. Soon to come are military versions having an extended temperature range and meeting criteria of MIL-STD 883, Level B.

Phone now on toll-free WATS line for more information fast.

Electronic Arrays is the world's largest supplier of standard high-density ROMs. Now we're coming on strong with standard RAMs. First SuperRAM. Next a superior 16-pin 4K RAM and static RAMs for microprocessors. We're on our way to becoming the new preferred source for semiconductor memory devices.

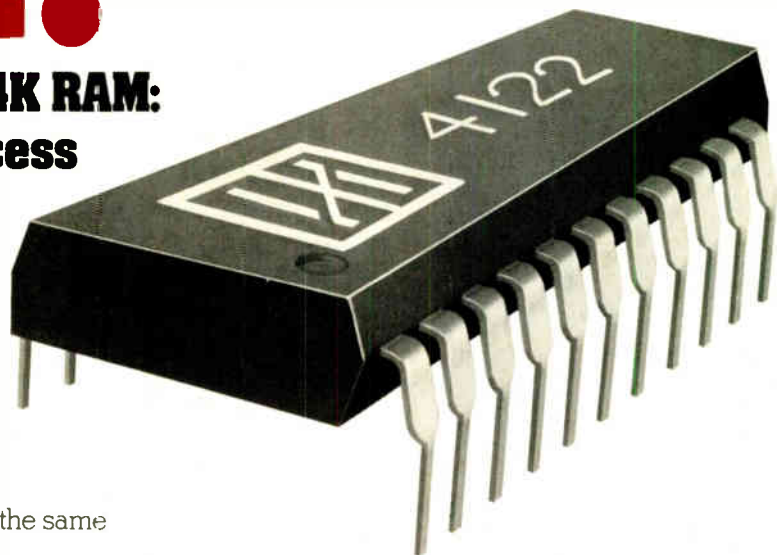

**electronic
arrays**

ELECTRONIC ARRAYS, INC., 550 E. Middlefield Rd., Mountain View, Calif. 94043/tel. (415) 964-4321/
TWX 910-379-6985/outside California use toll-free WATS (800) 227-9962/EAST, Cherry Hill, NJ (609)
795-5066/MID-AMERICA, St. Louis, MO (314) 378-6446/WEST, Huntington Beach, CA (714) 968-3775/
EUROPE, Amsterdam, The Netherlands, (20) 71-2560/FAR EAST, Tokyo, Japan (03) 403-9061.

Our curve was straight.

Advanced Micro Devices announces the 100-
piece price for the Am9080A and Am2901: \$21.00.
Just like we said.

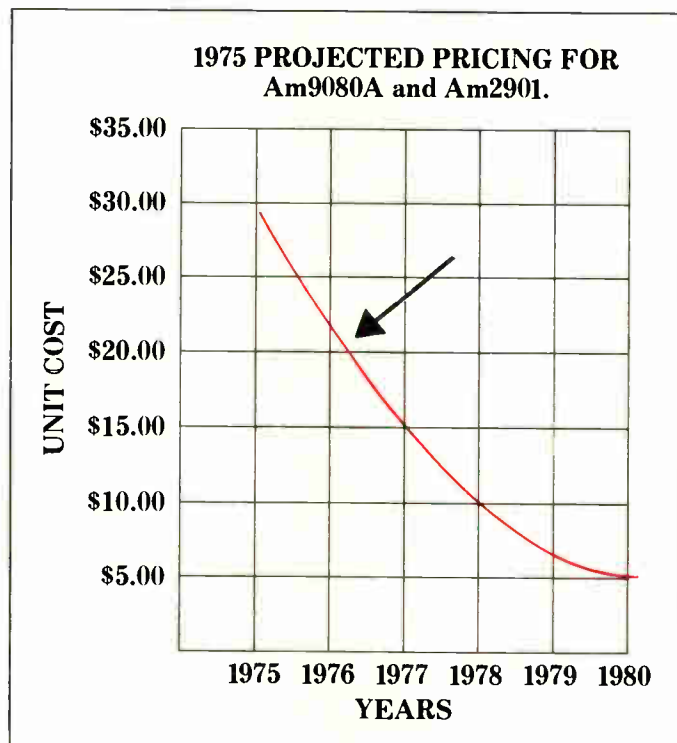

Last year, we predicted the price would be just over \$20.00. We even drew a curve. Now it's happened. And that's only the beginning. Look:

Am9080A. It's built with an advanced ion-implanted, n-channel, silicon-gate process that permits versions with speeds to 250 nanoseconds cycle time (one microsecond instruction time). Our low power (800mW maximum) gives you cooler running systems, less power drain and better reliability. The superior output drive (3.2mA @ 0.4V) gives increased design flexibility and improved margins.

Am2901. It's bipolar, for systems that rely on

high speed. It can do a 16-bit register-to-register add in just 145 nanoseconds. It has 16 working registers in a cycle-saving, two-address architecture, and is controlled by nine instruction lines that permit it to do almost anything you can think of.

Another thing. Advanced Micro Devices offers a full line of support circuits for either unit—support circuits that optimize your system, not compromise it.

Whether you can best use the MOS Am9080A or the bipolar Am2901, you can now do it for less. **\$21.00** in 100-piece quantities.

Just like the curve said.

Am9080A System Circuits

AMO Part Number	Description	Availability
CPU		
Am9080A/-2/-1/-4	Speeds to 250 nsec 0 to 70°C	In Dist Stock
Am9080A/-2	Speeds to 380 nsec -55 to +125°C	In Dist Stock
Static Read/Write Random Access Memories		
Am9101A/B/C/O	256 x 4 Speeds to 250 nsec	In Dist Stock
Am91L01A/B/C	256 x 4 Speeds to 300 nsec	In Dist Stock
Am9102A/B/C/O	1K x 1 Speeds to 250 nsec	In Dist Stock
Am91L02A/B/C	1K x 1 Speeds to 300 nsec	In Dist Stock
Am9111A/B/C/O	256 x 4 Speeds to 250 nsec	In Dist Stock
Am91L11A/B/C	256 x 4 Speeds to 300 nsec	In Dist Stock
Am9112A/B/C/O	256 x 4 Speeds to 250 nsec	In Dist Stock
Am91L12A/B/C	256 x 4 Speeds to 300 nsec	In Dist Stock
Am9130A/B/C/E	1024 x 4 Speeds to 200 nsec	In Dist Stock
Am9140A/B/C/E	4096 x 1 Speeds to 200 nsec	In Dist Stock
Dynamic Read/Write Random Access Memories		
Am9050C/O/E	4K x 1 Speeds to 200 nsec	In Dist Stock
Am9060C/O/E	4K x 1 Speeds to 200 nsec	In Dist Stock
Mask Programmable Read-Only Memories		
Am9208/B/C/O	1K x 8 Speeds to 250 nsec	Available Now
Am9214	512 x 8 mask programmed Speeds to 500 nsec	Available Now
Am9216B/C	2K x 8 mask programmed Speeds to 300 nsec	Available Now
Erasable Read-Only Memories		
Am9702	256 x 8 Speeds to 10 μsec	In Dist Stock
Am1702A	256 x 8 Speeds to 10 μsec	In Dist Stock
Am2708	1024 x 8 Speeds to 450 μsec	2nd Q 1976

AMO Part Number	Description	Availability
Processor System Support Circuits		
Am8212	8 bit I/O Port	In Dist Stock
Am8224	Clock Generator	In Dist Stock
Am8228	System Controller	2nd Q 1976
Am8216/26	Bus Transceiver	2nd Q 1976
Am25LS138	1 of 8 Decoder	In Dist Stock
Am9555	Programmable Peripheral Interface	2nd Q 1976
Am9551	Serial Communications Interface	2nd Q 1976
CPU 9080A=4E0 nsec -2=380 nsec -1=320 nsec -4=250 nsec Mem A=500 nsec B=400 nsec C=300 nsec D=250 nsec E=200 nsec		

Am2900 System Circuits

AMO Part Number	Description	Availability
Am2901	4-Bit Microprocessor Slice	In Dist Stock
Am2902	Carry Lookahead Chip	In Dist Stock
Am2905	4-Bit Transceiver For Open Collector Bus	In Dist Stock
Am2906	4 Bit Transceiver For Open Collector Bus With Parity Generator/Checker	In Dist Stock
Am2907	4 Bit Transceiver For Open Collector Bus With Single Data Input	In Dist Stock
Am2909	Microprogram Sequencer	In Dist Stock
Am2911	Minimicroprogram Sequencer	2nd Q 1976
Am2914	8-Level Priority Interrupt	3rd Q 1976
Am2915	4-Bit Transceiver For Three-State Bus	2nd Q 1976
Am2916	4 Bit Transceiver For Three-State Bus With Parity Generator/Checker	2nd Q 1976
Am2917	4 Bit Transceiver For Three State Bus With Single Data Input	2nd Q 1976
Am2918	1 By 2 Port Register	In Dist Stock
Am2919	Priority Interrupt Expander	2nd Q 1976
Am2950/51	256 Bit RAM Open Collector Or Three State	In Dist Stock
Am2952	1024-Bit RAM Open Collector	2nd Q 1976
Am2954/55	16-Word By 4-Bit Two Address Register Stack Open Collector or Three-State	2nd Q 1976
Am2970/71	256 By 4 PROM s With Open Collector or Three-State Outputs	In Dist Stock

Advanced Microprocessors



Advanced Micro Devices • 901 Thompson Place, Sunnyvale, California 94086 • Telephone (408) 732-2400

Distributed nationally by Hamilton/Avnet, Cramer and Schweber Electronics

Circle 254 on reader service card

Are manpower predictions of any value?

In the years immediately following Russia's launching of the first earth satellite, the future supply of engineers was a truly national concern. The big question then was whether there would be enough engineers to ensure that the United States regained its top technological position.

Helped in part by predictions that there would be a severe shortage of skilled manpower unless more students chose to enter engineering—and in part by the newfound glamour of the field—the enrollments at engineering schools rose and the engineer soon had one of the hottest careers going.

Things are, of course, vastly different now. The glamour has faded and so have many job opportunities. But, oddly enough, the predictions of engineering manpower shortages in the near or far future continue. The result, charge some observers, is an oversupply of engineers and an erosion of the quality of engineering as a career. Indeed, one study charges that the engineer-need predictions made by the Engineering Manpower Commission of the Engineers Joint Council, when compared with actual demand figures, were wrong 77% of the time from 1963 to 1974.

It is not surprising, therefore, that there have been increasingly vocal calls for a moratorium on the council's predictions, or at least a serious study of ways to change its

prediction process to take into account what really happened. Unfortunately, the growing concern among engineers over the effects of the consistently optimistic predictions apparently is not shared by the Engineering Manpower Commission.

Provided an opportunity at a recent meeting to take decisive action to suspend its manpower studies until it can prove out their accuracy, the EMC instead chose to continue business as usual while a committee studies the charges of inaccuracy recently brought to light. This move was taken despite the fact that the directors of the National Society of Professional Engineers, at their January meeting, went on record as doubting the credibility of the EMC projections.

Instead of ducking the issue—ensuring the accuracy of demand predictions that influence potential engineering students—EMC should analyze its projections. First, are the surveys accurate and unbiased? Second, is there a procedure for follow-up to find out if the actual job market matched the predictions? Third, is there any allowance made for refining the predictions based on present realities? Fourth, are overly optimistic projections harming the engineer's career?

If these questions are too hard to answer, then maybe more engineering groups should begin to question the Engineering Manpower Commission's actions.

The new package from the leader:

Precision Graphics at an alphanumerics price.

Not just graphing. Graphics from the graphics specialist. The key is information capacity. Tektronix' new 4006-1 offers far and away the highest output density of any terminal in its price range: 1024 X by 780 Y viewable points; 2590 alphanumeric on screen characters.

It's all you'd expect from the company serving all your graphic needs . . . priced competitively with most alphanumerics.

Immediately compatible with most mainframes. Thanks to proven interfaces. Time-tested software. Great new usable software packages. And expert maintenance anywhere in the world.

And rely on Tektronix to do it right. The 4006-1 is our biggest breakthrough towards making the power of graphics affordable for everyone. Just \$2995

for openers. Lease price \$150 per month on a two year lease, includes maintenance. Plus peripheral options like our 4631 Hard Copy Unit for up to four 4006-1's, with 8½"x11" copies, and 4923 Digital Cartridge Tape Recorder. And as fine a package of technical support as you'll find for any terminal anywhere.

Check it out: we're graphic leaders for some mighty good reasons. Your local Tektronix Sales Engineer can give you the whole story. Or write:

Tektronix, Inc.
Information Display Group
P.O. Box 500
Beaverton, Oregon 97077



Circle 13 on reader service card

\$2995.00



Graphics
\$150/mo



RF power

We've made the most of it... You can, too!!

All wrapped up in a neat little package, our Model 510L is an ultra-wideband RF power amplifier whose wide range of frequency coverage and power output provide the user with the ultimate in flexibility and versatility in a laboratory instrument. Easily mated with any signal generator, this completely solid state unit amplifies AM, FM, SSB, TV, pulse and other complex modulations with a minimum of distortion.

Constant forward power is continuously available regardless of the output load impedance match making the 510L ideal for driving highly reactive loads.

Unconditional stability and instantaneous fail-safe provisions in the unit provide absolute protection from damage due to transients and overloads.

This outstanding unit covers the frequency range of 1.7 to 500 MHz with a linear power output of more than 9.5 watts and there is no tuning.

For further information or a demonstration, contact ENI, 3000 Winton Road South, Rochester, New York 14623. Call 716-473-6900 or TELEX 97-8283 E N I ROC



ENI

The world's leader
in solid state power amplifiers

People

New team comes in at Electronic Associates

With a few tough years and several acquisitions and divestments behind it, Electronic Associates Inc., West Long Branch, N.J., is back on what it hopes is a profitable track and concentrating on building the machines it knows best—hybrid computers, which combine analog and



Hybrid vigor. Incoming Electronic Associates vice presidents Brown and Sanders see growth for hybrid computers.

digital processing techniques.

And it has two new vice presidents to help direct its specialty. Milton Sanders, who until recently was a corporate vice president of Conrac Corp., New York City, is vice president for marketing, and Robert N. Brown, is the new vice president for engineering. Before joining EAI, Brown held the same position at the Singer Co.'s Business Machines division in San Leandro, Calif.

Brown is no stranger to either analog or digital computers. After a Navy tour during World War II, he began his engineering career at Singer's Kearfott division working on an analog computer for the Navy. More recently, he was responsible for the development of digital-computer and peripheral lines at Singer.

One of the first problems that

Brown plans to start attacking is the pricing of his products. EAI's price-tags range from \$25,000 for desktop models to \$1 million for simulators. "Hybrid computers have a lot of versatility, but if their cost is out of line with a less efficient way of doing, for example, simulation, people will frequently take the lesser system and put in the additional manpower to do the job. So we're addressing ourselves to costs to make the product more attractive."

A second goal is to increase the life of the hardware. "There's a lot of our gear out there," says Brown. "But its life is perhaps near an end, not because it is worn out, but because it's not upgradable."

He particularly wants to apply new programable large-scale integrated devices. Besides taking advantage of their increasing power and decreasing cost, he believes they'll add to the common-

ality of parts in his company's products.

Sanders, who began his career in the early 1940s as a research engineer with the U.S. Naval Ordnance Laboratory, sees the market broadening for hybrid computers, particularly in process control and simulation systems. "Over the next five years, commercial simulation modeling will grow, mostly in the energy area where there are a lot of questions that must be answered without messing around with the actual system."

Cars are different vehicle
for Nortron's Pat Lynch

Patrick D. Lynch was one of the executives caught in the corporate wringer when Motorola Semicon-

Don't redraw. Restore.

Suddenly you need copies of that old battered drawing — the one with the dirt, creases, and yellowed background. You don't have to redraw to get a like-new second original. One fast, easy way is to have the old drawing reproduced on Kodagraph film or paper.

You'll be amazed at the results...the dense black lines, the clean background, the overall improved legibility—and at the time and money you save. For more information write: Eastman Kodak Company, Graphics Markets Division, Dept. R6822, Rochester, New York 14650.

Kodagraph films and papers Versatility in reprographics



Circle 15 on reader service card

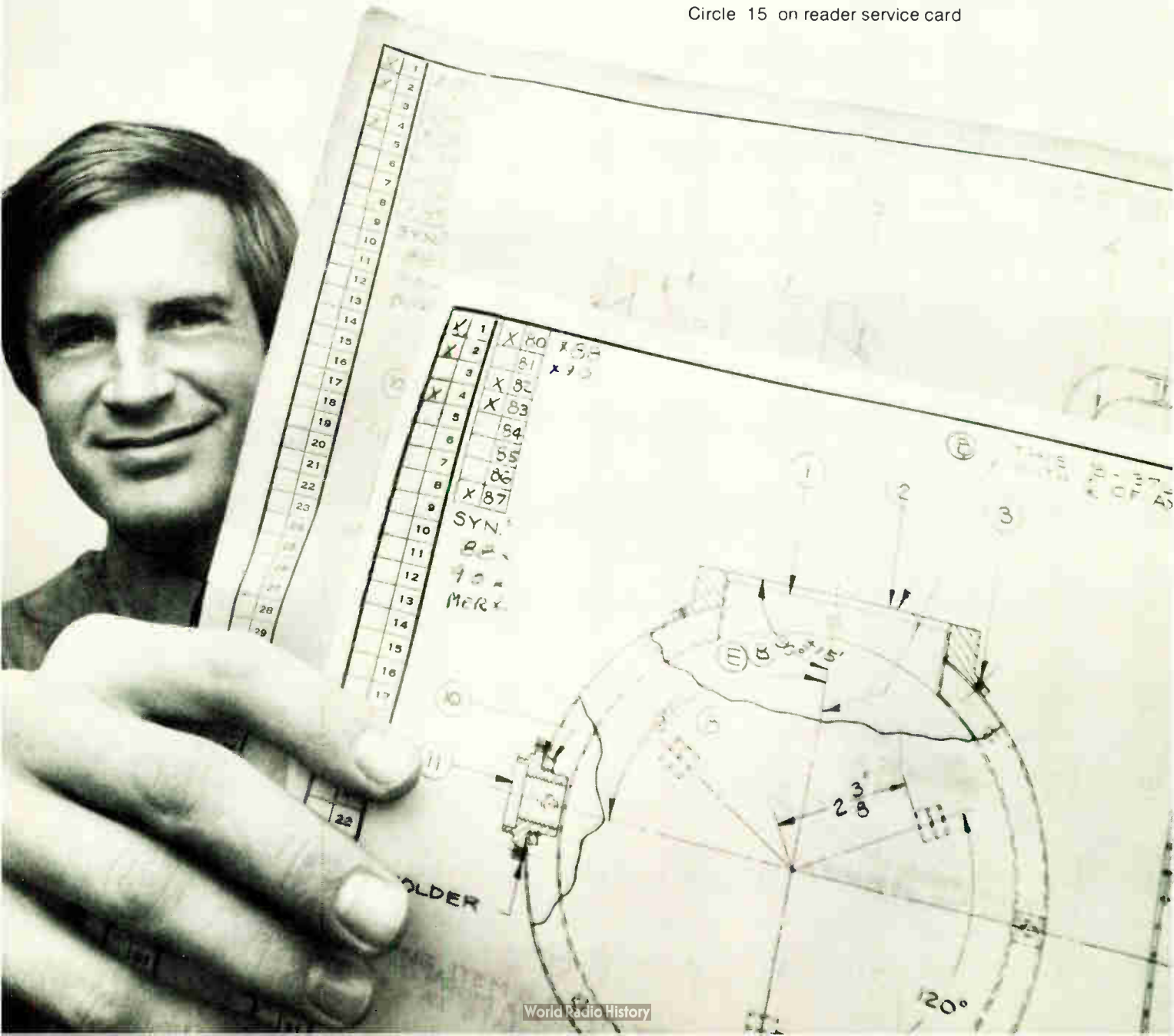

92 TO-

FROM THE COMPANY WHERE PRICING IS AS IMPORTANT AS

TECHNOLOGY NPC is expanding its Silicon Epoxy Transistor line and product—families listed below are available from stock. More to come!



PART NO.	DESCRIPTION	UNIT COST AT 1,000	PART NO.	DESCRIPTION	UNIT COST AT 1,000
2N3903/4	NPN General Purpose Amp/Switch, Cu Lead Frame	\$.11/.12	2N4400/01	NPN Medium Speed, Medium Current Switch, Cu Lead Frame	\$.13/.14
2N3905/6	PNP General Purpose Amp/Switch, Cu Lead Frame	.11/.12	2N4402/03	PNP Medium Speed, Medium Current Switch, Cu Lead Frame	.13/.14
2N4123/24	NPN General Purpose Amp, Cu Lead Frame	.10/.11	NPC2369	NPN High Speed, Low Current Switch, Cu Lead Frame	.15
2N4125/26	PNP General Purpose Amp, Cu Lead Frame	.10/.11			
2N5088/89	NPN Low Noise Amp, Cu Lead Frame	.14/.15			
2N5088/87	PNP Low Noise Amp, Cu Lead Frame	.14/.15			
2N5209/10	NPN Low Noise Amp, Cu Lead Frame	.14/.15			
NPCA20/21/22	NPN General Purpose Amp, Cu Lead Frame	.11			
NPCA70	PNP General Purpose Amp, Cu Lead Frame	.12			

WATCH THIS SPACE FOR IMPORTANT ANNOUNCEMENTS



6660 VARIEL AVENUE • CANOGA PARK, CALIFORNIA 91303
(213) 887-1010 • TELEX 69-8481 • TWX 910-494-1954

ductor Products division underwent a massive reorganization in mid-1975. Now he has surfaced again—but not at a semiconductor house.

The 42-year-old former vice president of Motorola's \$400-million-plus semiconductor operations in the U.S. [*Electronics*, May 15, 1975, p. 38], is now president and chief executive officer at Nortron Corp. The main product of this \$2-million-a-year, Sunnyvale, Calif., company is an electronic wheel balancer for automobiles.

While the company's product line may seem prosaic, its potential is anything but that, says Lynch. He sees the company as excellently positioned for expansion into sophisticated auto testers built around microprocessors and other semiconductor technology.

Expansion coming. Under Lynch's direction, the company plans to grow in a number of directions. First, using medium-scale integrated circuits and discrete electronics, the wheel-balancer line will grow from one general-purpose machine to three systems aimed at specific market segments. This will be followed by a second generation of balancers and aligners designed around a low-cost microprocessor.

"To anyone used to the semiconductor business, this would be a mundane marketplace," Lynch says. "But the numbers are far from mundane." With about 180,000 service stations and auto-service centers in the U.S., the potential market for sophisticated electronic wheel balancers and aligners is about \$22 million.

"As auto makers move toward sophisticated electronic control systems," says Lynch, "Nortron with its knowledge of both the auto and electronics industry, as well as auto servicing, is in a key position."

By the end of the company's fiscal year this June, sales will have quadrupled over last year. For next year, Lynch, who spent 15 years at Motorola and three at Texas Instruments, predicts at least another doubling. And he adds with a smile, "Another benefit of this job is that I can get my wheels balanced free." □

Here's a dependable, quick-delivery source
for Zero Defect

High Voltage Silicon Rectifiers

- MEETS STRINGENT ENVIRONMENTAL REQUIREMENTS.
- HIGH TRANSIENT VOLTAGE RATINGS.
- EXTREMELY LOW LEAKAGE.
- WORKING VOLTAGE RANGE . . . 200V. THROUGH 50KV.

If you're looking for on-time delivery of miniature and microminiature High Voltage Silicon Rectifiers, look no further than ERIE. You simply can't beat our zero defect rectifiers since these units were first designed for high reliability night vision, lunar and aerospace applications. Their small size makes ERIE rectifiers ideal for thick film substrates, miniature power supplies, airborne displays, CRT displays, color TV, microwave ovens and other industrial and commercial applications where small size, reliability and superior performance are critical. All ERIE High Voltage Silicon Rectifiers feature conservative voltage ratings, fast recovery time, fast turn-on time, wide operating temperature range, high transient voltage ratings, low reverse leakage and unsurpassed reliability.

ERIE also offers double sealed, miniature Full Wave Bridge Rectifiers perfect for P.C. use, with ratings up to 1000 volts per leg. So think ERIE for your High Voltage Silicon Rectifiers. Write TODAY for our new 24-page catalog High Voltage Components and Devices.



ERIE TECHNOLOGICAL PRODUCTS • Erie, Pennsylvania 16512

new SCR's

1.5 AMP IN A
MINIATURE
DIP



FEATURES:

HIGH di/dt AND dv/dt CAPABILITY

**SHORTED-EMITTER, CENTER GATE
GEOMETRY**

DENSE GLASS PASSIVATION

**2 DEVICES WILL FIT INTO A
STANDARD 14 PIN SOCKET**

COMPATIBLE WITH AUTOMATIC HANDLING

The new VCRC series of low-current SCR's are ideally suited for lighting, heating and cooling controls and ignition applications. The 4 pin, low-profile DIP is compatible with automatic testing, handling and inserting.

The VCRC series is available in 200V, 300V, 400V and 600V (V_{DRM} and V_{RRM}) ratings with 1.5 Amps [$I_{T(RMS)}$] and a peak surge current (I_{TSM}) of 100 Amps at 60 Hz.

DC gate-trigger current (I_{GT}) is 15 mA maximum at $T_C = 25^\circ C$. Critical dv/dt is 200 V/ μ sec (Typ.) and di/dt is 200 A/ μ sec. Holding current (I_{HO}) is 20 mA max.

**FOR COMPLETE INFORMATION CALL
MIKE HAWKINS, 214/272-4551**



Design us in . . . we'll stay there

VARO SEMICONDUCTOR, INC.

P.O. BOX 676, 1000 N. SHILOH, GARLAND, TEX. 75040 (214) 272-4551 TWX 910-860-5178

EUROPEAN OFFICE: UK: VARO SEMICONDUCTOR INTERNATIONAL, INC.
Deepdene House, Bellegrave Road, Welling, Kent, England DA163PY, 01-304-6519/0

Meetings

Acoustics, Speech, and Signal-Processing International Conference, IEEE, Marriott Hotel, Philadelphia, April 12-14.

Computer Software Engineering: Reliability, Management, and Design, IEEE, Barbizon Plaza Hotel, New York, April 20-22.

Reliability Physics International Symposium, IEEE, Caesars Palace, Las Vegas, April 20-22.

Eighth Annual Southeastern Symposium on System Theory, University of Tennessee and IEEE, Knoxville, Tenn., April 26-27.

Seventh Annual Pittsburgh Conference on Modeling and Simulation, IEEE, University of Pittsburgh School of Engineering, April 26-28.

Third FAA/Georgia Tech Workshop on Grounding of Electronic Systems, Federal Aviation Administration and Georgia Tech, Atlanta, April 26-28.

Electronic Components Conference, IEEE, Jack Tar Hotel, San Francisco, April 26-28.

Optical Computing International Conference, IEEE, Capri, Italy, April 27-29.

Circuits and Systems International Symposium, IEEE, Technical University, Munich, April 27-29.

Offshore Technology Conference, IEEE, Astrohall, Houston, Texas, May 3-6.

Carnahan Conference on Crime Countermeasures, IEEE, University of Kentucky, Lexington, May 5-7.

Industrial and Commercial Power Systems Conference, IEEE, Hyatt Regency Hotel, Los Angeles, May 10-13.

Electro 76—IEEE International Convention, IEEE, Hynes Auditorium and Sheraton-Boston Hotel, Boston, May 11-14.

National Workshop on Low-cost

BME™ Capacitors- Proven Reliability For Automotive Applications

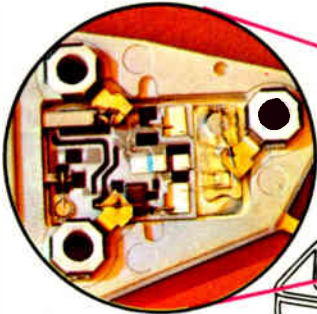

Voltage Regulators

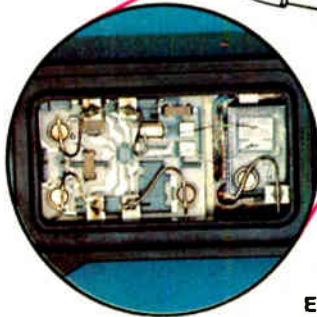

Electronic Ignition Systems

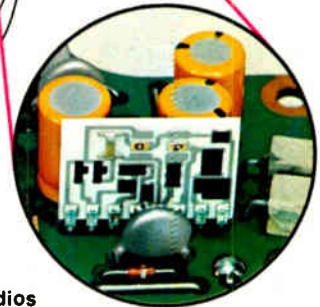

Radios

USCC/Centralab, the major supplier of monolithic ceramic capacitors to the largest manufacturers of automotive hybrid electronics.

The automotive environment can be considered the ultimate proving ground for component reliability. Under-the-hood systems provide a hostile environment where moisture, temperature extremes, shock and vibration are constant. It is a tremendous challenge to supply a component economical enough for an automotive application which can stand up to their rigorous specifications.

And Centralab is there, providing over 3.9 million BME-Chip™ Capacitors which are in 2.25 million domestic cars and light trucks. Over 11 billion unit life hours in ignition systems, voltage regulators and radios, without a single known failure. That's reliability!

Compare your requirements with those of the automotive industry. We're sure you'll choose BME™ Capacitors . . . reliability and availability at a low cost.

Please write on company letterhead for complete technical test reports.



USCC/CENTRALAB Electronics • GLOBE-UNION INC

4561 Colorado Boulevard • Los Angeles, Ca. 90039 • (213) 240-4880

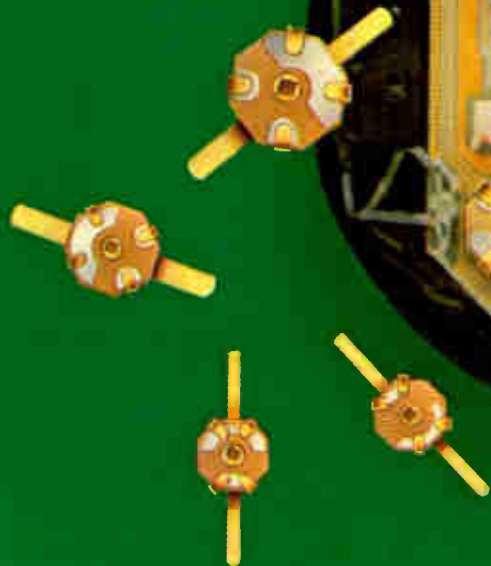

Thin-Trim capacitors

Tucked in the corner of this Pulsar Watch is a miniature capacitor which is used to trim the crystal. This Thin-Trim capacitor is one of our 9410 series, has an adjustable range of 7 to 45 pf, and is .200" x .200" x .050" thick.

The Thin-Trim concept provides a variable device to replace fixed tuning techniques and cut-and-try methods of adjustment. Thin-Trim capacitors are available in a variety of lead configurations making them easy to mount.

A smaller version of the 9410 is the 9402 series with a maximum capacitance value of 25 pf. These are perfect for applications in sub-miniature circuits such as ladies' electronic wrist watches and phased array MIC's.

Johanson Manufacturing Corporation
Rockaway Valley Road
Boonton, New Jersey 07005
(201) 334-2676 TWX 710-967-8367

Meetings

Polycrystalline Silicon Solar Cells, National Science Foundation and Energy Research & Development Administration, Southern Methodist University, Dallas, May 18-19.

Naecon Aerospace and Electronics Conference, IEEE, Dayton Convention Center, Dayton, Ohio, May 18-20.

Eighteenth Israel Annual Conference on Aviation and Astronautics, Technicon-Israel Institute of Technology, Haifa, Israel, May 19-20.

Third International Euromation Exhibition-Instrumentation and Automation in Industry, Belgian Institute of Automatic Control, Brussels International Fair, May 22-26.

Conference on Lasers and Electro-Optical Systems, IEEE, Town and Country Hotel, San Diego, May 25-26.

Semicon West '76, Semiconductor Equipment & Materials Institute (c/o Golden Gate Enterprises, Santa Clara, Calif.), San Mateo County Fairgrounds, Calif. May 25-27.

International Symposium on Multi-valued Logic, IEEE, Utah State University, Logan, Utah, May 25-28.

Trends and Applications in Micro and Mini Systems, IEEE, NBS, Gaithersburg, Md., May 27.

National Computer Conference, IEEE et al., New York Coliseum, June 7-10.

Hybrid Microcircuits Symposium, U.S. Army Electronics Command, Fort Monmouth, N.J., June 8-9.

Power Electronics Specialists Conference, IEEE, NASA Lewis Research Center, Cleveland, Ohio, June 8-10.

Electrical Insulation International Symposium, IEEE, Queen Elizabeth Hotel, Montreal, Ont., June 14-16.

**COSMAC ARCHITECTURE
HIGH SPEED**

CMOS FEATURES

DESIGN EASE

SUPPORT CIRCUITS

DEVELOPMENT AIDS

LOW PRICE

**Now for the first time:
this entire spectrum of
microprocessor benefits
in one package.**

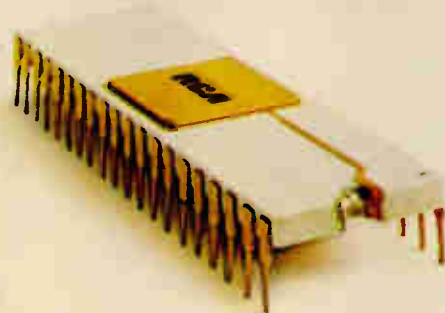

**The expanded
RCA Microprocessor Family.**

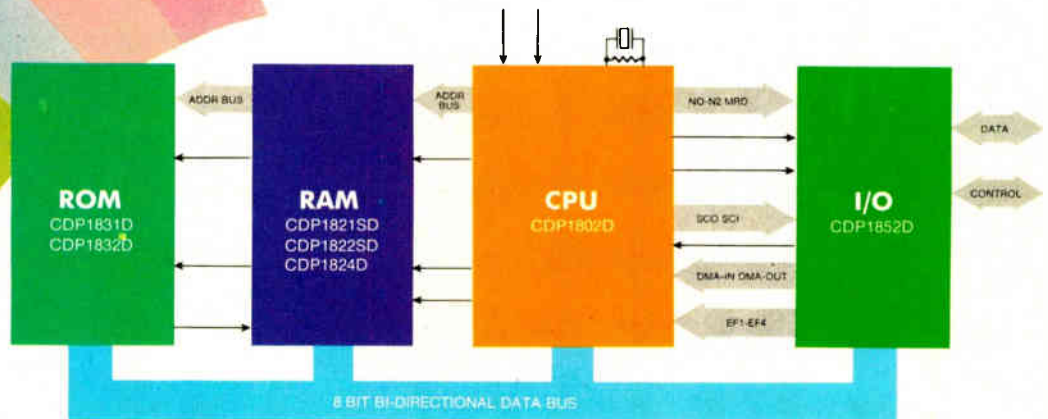

Your RCA 1800 payoff: a CMOS system, outstanding performance, unsurpassed cost effectiveness.

Now there's a new CPU in the RCA 1800 Series. The CDP1802: COSMAC on one chip. We believe and want to prove that this new 8-bit CPU, more than any other, fulfills the microprocessor promise of unprecedented system cost effectiveness and flexibility.

RCA supplies the whole system: CPU, ROM, RAM and I/O devices. Everything you need including complete design support. All from the first house in CMOS.

CMOS and low cost

CDP1802, like the original CDP1801, has the inherent CMOS tolerance to noise and power supply variations, and low power dissipation. But the 1802 is on a single, densely packed chip, made possible by a new RCA self-aligned silicon gate technology. CDP1802 is up to three times

faster: 2.5-3.75 microseconds for any instruction. And cost is way down: \$23.50 for the CDP1802 in 100 piece quantities.

In addition, we've further simplified control signals. And you get the single-chip benefits of simpler assembly and less design time, plus an expanded instruction set.

All this on top of other things you liked about the 1801. Especially its COSMAC architecture, simple yet powerful. Plus its easy learning and programming.

COSMAC architecture lowers memory costs

The big advantage is 1-byte instructions: less to store, less to fetch — which means less memory to buy. Simple subroutine calls can take just one byte.

Instructions need no addresses because the 16 internal general purpose registers act as pointers. You can point these registers at data areas or program areas. They can also be used to store data directly, reducing the need for RAM. One register even acts as a built-in DMA address generator—an RCA first.

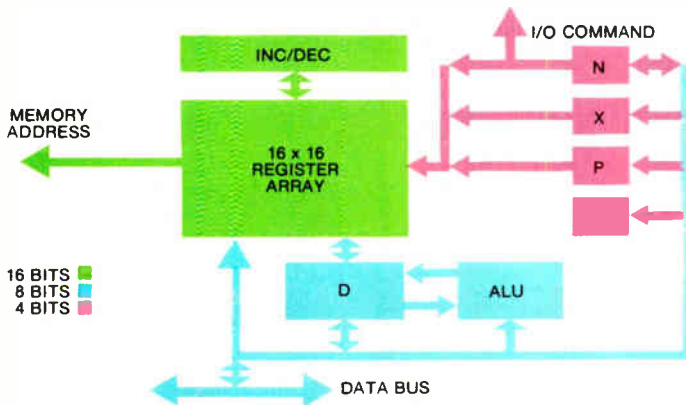

RCA offers ROMs and RAMs as standard support. But if you have reason to use memories from other manufacturers, you can use almost any industry standard in x1, x4 or x8 configurations.

I/O costs less, too

You'll find much of what you need in our line of standard I/O devices—some available now, many more in development. Or if you need special interfaces, design your own with our industry-leading CD4000 line of logic devices. If you want, we'll build a custom LSI I/O part for you. In any case, COSMAC architecture can greatly simplify your system design.

Result: system cost effectiveness

For all the reasons given, we challenge any other microprocessor to match the 1800's system cost effectiveness. Figure in, too, the other CMOS economies. One power supply. A single-phase clock, which can be implemented by an external crystal to work with the on-chip oscillator. Also consider the cooling and other equipment you *don't* have to buy because of CMOS low power dissipation and tolerance to noise, power-supply and temperature variations.

What about design time?

CMOS also makes it easy and inexpensive to assemble a prototype. Then, static logic makes your prototype easy to debug. Data exchange is carefully strobed. Everything about our 1800 Series helps make system design less time-consuming.

Use your 1801 programs

Any 1801 programs you may already have will run on the new 1802. So your program investment is safe. In fact, we offer a new emulation board that you can simply plug into COSMAC Development System to adapt it to the new CPU.

From RCA: a total system—all CMOS!

Available now:

- CDP1802D CPU
- CDP1821SD 1024x1 CMOS SOS RAM
- CDP1822SD 256x4 CMOS SOS RAM
- CDP1824D 32x8 CMOS RAM
- CDP1831D 512x8 CMOS ROM COSMAC Interface
- CDP1832D 512x8 CMOS ROM
- CDP1852D Byte I/O

Note: recommended operating range for above parts is 3 to 12 volts. They are also available in "C" versions (e.g. CDP1802CD) with recommended operating range of 4 to 6 volts.

In development:

- UART (Universal Asynchronous Receiver/Transmitter)
- MDU (Multiply-Divide Unit)
- 3- to 8-bit Latch-Decoder
- Bus Buffer Separator
- 128x8 RAM
- 1024x8 ROM
- Programmable Bit I/O part
- A/D Converter

Design support

- Microtutor (CDP18S011): a minimum computer for learning microprocessing.
- Evaluation Kit (CDP18S020): kit of parts including printed circuit board.
- COSMAC Development System with 1802 Emulator (CDP18S004) for easy breadboarding and resident software development. Includes chassis, power supply, simple control functions, CPU, RAM, byte I/O, terminal interface, utility routines, plus the capability of editing, assembling and debugging software programs.
- Floppy Disc for COSMAC Development System (CDP18S801).
- COSMAC Software Development Package (CDP18S910, CDP18S911): assembler, editor and simulator/debugger programs available on GE Time-Share or in Fortran IV for purchase.
- Manuals, seminars and application notes. Plus applications assistance by RCA engineers.

Consider RCA 1800 now

It all boils down to this: RCA offers cost and performance competitiveness with any other microprocessor—plus the special advantages of CMOS. And we're ready to prove it.

For more information, contact your local RCA Solid State distributor. Or RCA.

Write: RCA Solid State, Box 3200, Somerville, New Jersey 08876; Ste. Anne de Bellevue 810, Canada; Sunbury-on-Thames, U.K.; Fuji Bldg., Tokyo, Japan.

RCA

Hot-molded resistors provide low temperature coefficient and unmatched reliability.

The Resistance Temperature Coefficient of Allen-Bradley hot-molded fixed resistors is typically less than 200 PPM over the entire resistor range shown in the normal equipment operating temperature of +15°C to +75°C. Excellent RTC ratings have always been an Allen-Bradley benefit. And consistency of Allen-Bradley resistors means repeatable results and tight performance patterns. Allen-Bradley resistors offer the **lowest cost**—on the board—where it counts!

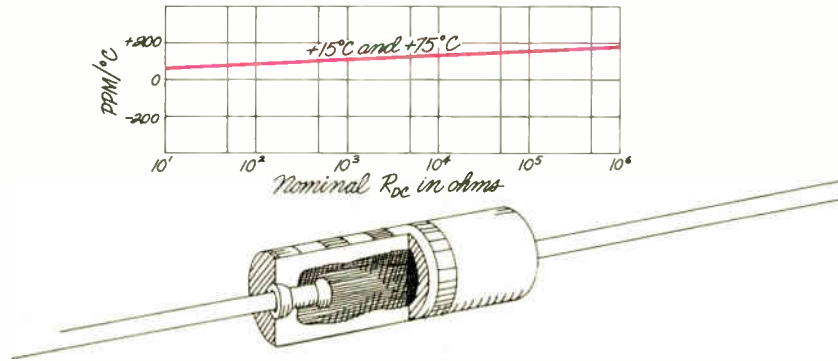

Reliability

is unsurpassed. Over 700 million unit test hours without a single failure.

No coatings

Insulation and resistance element integrally molded into one solid structure.

Pulse handling

characteristics offer outstanding protection against surges and transients.



Quality in the best tradition.



ALLEN-BRADLEY
Electronics Division
Milwaukee, Wisconsin 53204

New cable eases task of designing optical data links . . .

A new fiber-optic bundle cable from DuPont makes it possible for the first time for a designer to use standard cable bundles and associated hardware in a package approach to optical analog or digital data links. **Previously, the bundles were custom products.**

Called PFX, DuPont's seven-fiber, all-plastic cable can be used with standard fittings from several manufacturers, including Amphenol and AMP. Its attenuation is 470 decibels per kilometer at a wave-length of 656 micrometers—visible red—and it is easy to use, even in the field. The fiber is simply pushed into the connector with hardware that's supplied; then, excess fiber is trimmed with a razor blade, and the ends are polished with emery paper. DuPont claims splicing losses of 3 dB without any concern about fiber alignment. The PFX plastic cladding is very thin relative to the bundle, giving the cable a packing factor that passes 95% of the light.

. . . as ITT goes standard with fiber cables

Another significant step in the progress of optical fibers toward standardization has been taken by ITT's Electro-optical Products division. While the Roanoke, Va., division has been doing extensive work in the technology, it has been mostly on a contract basis with virtually no standardization of components. **Now, however, ITT has issued its first data sheets**—detailing a line of general-purpose plastic-clad silica fiber cables.

Included are two six-fiber heavy-duty versions, one with attenuation of 18 decibels per kilometer at 0.85 micrometer and 8 dB/km at 1.06 μm , the other 50 dB/km at 0.79 micron. The third, for light duty, has seven to 19 fibers. It is specified as 50 dB/km at 0.79 μm . Prices are \$6 to \$15 per meter.

AMD builds 1-microsecond version of 8080A

Using its ion-implanted depletion-load process, Advanced Micro Devices Inc. of Sunnyvale, Calif., has developed a 1-microsecond version of Intel's 8080A microprocessor, **probably the fastest instruction cycle time for an 8-bit n-MOS processor** achieved to date. Designated the 9080A-4, the part dissipates a maximum of only 1.1 watts. Intel's fastest part, the 8080A-1, has a 1.3- μs instruction time at 1.3 W maximum.

Production-line board tester coming from HP

Hewlett-Packard's Automatic Measurement division will announce **its first entry soon into the market for production-line printed-circuit board testers**. Called the DTS-70, the \$70,000 digital test system is capable of go/no-go testing and fault isolation of 250 MSI-type circuits in any logic family. Available with three test stations, costing \$10,000 each, the system also has a logic-simulation console that allows users to develop and debug test programs while the DTS-70 is at work on the production line. Control is provided in the form of an HP 2112 minicomputer with 32,000 words of memory.

Wind shear sensor sought

A request for proposals will be issued this summer by the Transportation Systems Center for a laser radar sensor to detect wind shear and wake-turbulence phenomena in the vicinity of airports. Wind shear—the sudden shift in wind direction **that can cause aircraft when landing to drop**

suddenly or overshoot the runway—causes crashes such as the one last year at New York's John F. Kennedy Airport. Wake turbulence is the trail of disturbed air created by an aircraft that can affect following planes. It also can be especially troublesome during landing.

TSC officials in Cambridge, Mass., are confident they can detect both phenomena at slant ranges up to 1,000 feet using a carbon-dioxide laser radar operating at 10.6 micrometers. Their confidence stems from data being gathered in tests sponsored by the Federal Aviation Administration using a Lockheed-built laser at Table Mountain, Colo. The request for proposals will seek both the laser radar and associated display.

Northrop delivers guidance system for Awacs

The first production navigation and guidance system for the Air Force's E-3A airborne warning and control system aircraft has been delivered. Northrop Corp.'s Electronics division is system integrator for prime contractor Boeing Corp., **under a \$4.7 million contract awarded last June to supply systems for six production aircraft.** Northrop has provided five pre-production navigation and guidance systems for the controversial Awacs craft, which has been a subject of dispute and has been in and out of the defense budget over the past decade. Its mission is to serve as an airborne command and control center, with the additional ability of detecting and tracking targets at long ranges.

As integrator for the E-3A equipment, Northrop has responsibility for a system consisting of its own Omega radio navigation set, a Delco Carousel IV inertial platform, and a Ryan doppler velocity sensor. Two of the five systems already delivered were for testing, and the remaining three will be converted to operating units. Current E-3A flight testing is taking place with production-configured avionics. Qualifications testing is expected to be completed this year.

Siemens establishes company to market medical gear in U.S.

West Germany's Siemens AG is expanding its medical-electronics bridgehead in the U.S. Only six months after starting a plant in Connecticut to produce X-ray equipment, Siemens is establishing a company in Union, N.J., to market hearing aids and infrared communications systems for schools to teach the deaf and partially deaf. Siemens expects a considerable increase in sales of these teaching systems, already being used by some German schools. **About 10% of the company's worldwide \$20 million a year in sales of hearing aids is exported to the U.S.**

Addenda

Look for Control Data Corp. to announce its entry into the computer-based education field within the next few weeks, **going commercial with its long-awaited system, Plato**, which is designed to meet many of the training needs of education, business, and government. . . . Japanese exports of **citizens' band transceivers to the U.S. climbed rapidly during 1975**, from 137,046 units in January to 692,498 in December, for a total of 3,759,333 for the year. The 1974 total was 1,317,602. . . . In an effort to improve its balance of payments deficit, Israel has negotiated several military contracts with U.S. firms stipulating that **10% to 15% of the hardware contain Israeli components.**

SURPRISE!

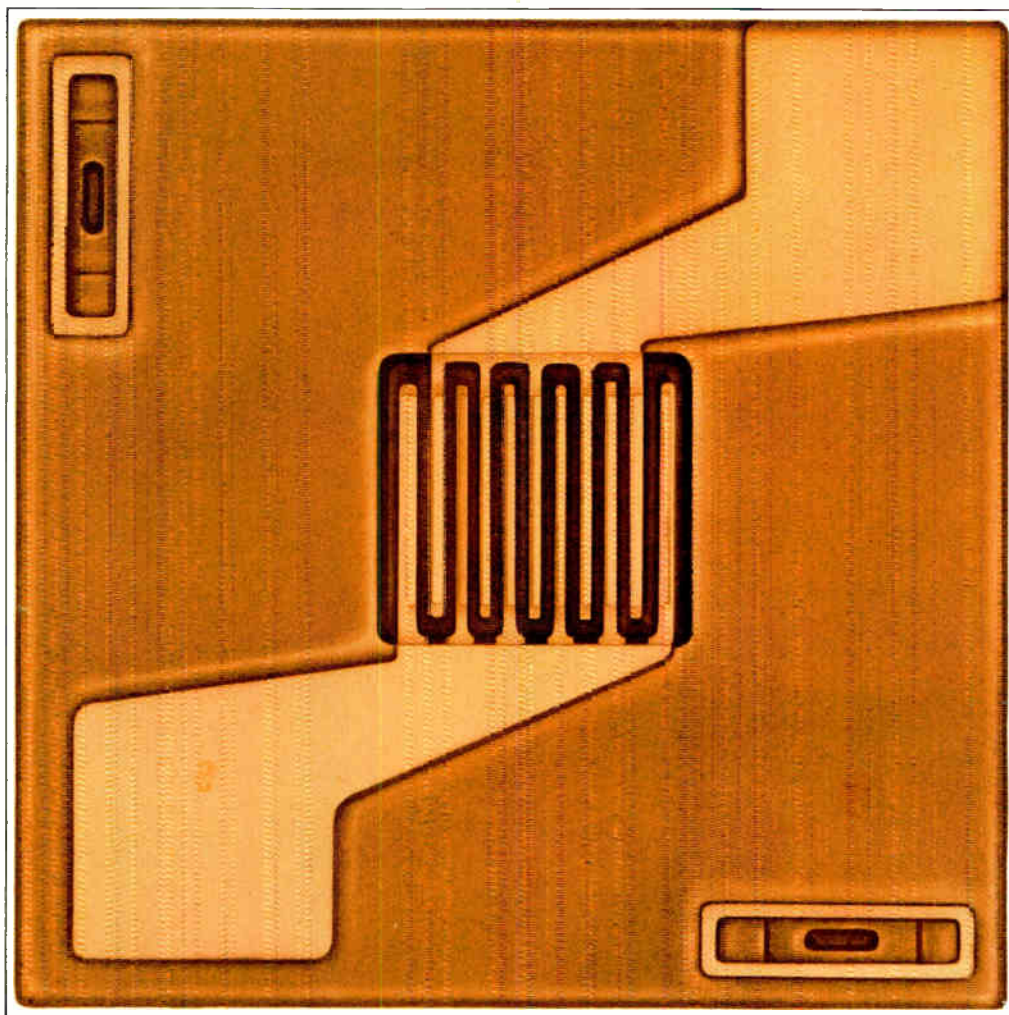

A Quiet Masterpiece: HP's New Low-Noise BiPolar Transistor.

Now HP offers you a new low-noise transistor with 2.7 dB typical (3.0 dB guaranteed) noise figure at 4 GHz. And you get 9 dB typical gain at the NF bias conditions. At 1.5 GHz typical NF is 1.5 dB with 15 dB associated gain.

We call it the HXTR-6101 and it's ideal for low-noise amplifiers in radar, telecommunications, avionics, ECM and satellite communications.

Price is \$150* in quantities of 1-9. *Domestic USA prices only.

For immediate delivery or more information contact any of our distributors or your local HP sales office. In the U.S. and Canada:

Bowtek Electronics Co., Ltd. • Hall-Mark Electronics •
Schweber Electronics • Wilshire Electronics •
Wyle Distribution Group (Liberty/Elmar) • Zentronics, Ltd.

HEWLETT  **PACKARD**

Sales and service from 172 offices in 65 countries.
15D1 Page Mill Road, Palo Alto, California 94304

01605

On the bench or in the field.

Model 1455. 4½ digit accuracy, stability, resolution. \$355.00 *

Here is a 4½ digit DMM that won't tie you down. It's Data Precision's Model 1455, the 4½ digit bench instrument that goes into the field with you.

The 1455 gives $\pm 0.02\%$ reading $\pm 0.01\%$ f.s., ± 1 digit basic accuracy for 6 months. A five function multimeter with large ½" high, 7 segment planar display and 100% overrange, it measures 100 μV to 1000 VDC, 100 μV to 500 VAC, 100 milliohms to 20 Megohms; AC and DC current 1 microamp to 2 amps, AC response, 30 Hz to 50kHz. These



are specs you'd expect from lab units costing twice as much. But the extraordinary 1455 gives you still more. With its built-in rechargeable NiCd battery, it is completely portable, meaning you can have this in-lab accuracy, anywhere you go.

The 1455 incorporates Tri-Phasic™ Conversion Cycle and our patented Isopolar™ Referencing, just two Data Precision

exclusives that enable us to offer you this kind of accuracy, flexibility and dependability for \$355.

For versatility and value you won't find anywhere else, carry off a Data Precision Model 1455. Or for the same specs and features in a unit designed for line use only, we offer our Model 1450 for only \$325.* They're both a lot of multimeter.

For complete information or a demonstration contact your local Data Precision representative or Data Precision Corporation, Audubon Road, Wakefield, MA. 01880, USA, (617) 246-1600. TELEX (0650) 949341.

*Price U.S.A.

Visit our Booths 2618, 2620 & 2622 at ELECTRO 76

Circle 28 on reader service card

 **DATA PRECISION**®
...years ahead



Reliability study checks moisture levels in ICs

Goal of Martin-Marietta tests is the determination of real need for hermetic packaging to stop leakage

Leakage in a hermetic package? For high-reliability integrated circuits that's been an industry-wide no-no, although some leakage always exists. But leakage may no longer be such a taboo. Now being launched is a series of experiments on the effects of moisture on integrated circuitry. By correlating leakage rates with moisture content, they may show that ICs can tolerate some leakage after all.

"Present industry-wide reliability standards for hermeticity have been established through experience, not scientific measurement," explains Saul Zatz, a staff engineer and the program's leader at the Martin-Marietta Aerospace's Orlando, Fla., division.

Martin-Marietta has developed a

technique for introducing a controlled leakage rate through micro-diameter holes, or microvents, into an otherwise hermetic package. The company includes a dew-point sensor in each IC package to measure the actual moisture.

In the process, for which a patent is pending, the company uses a laser to drill a 0.001-inch-diameter hole in the nickel cap of a standard metal-can package. Then, to smooth out irregularities, the hole is electropolished to remove unwanted metal from the periphery and electroplated with gold to prevent corrosion from closing it up. The plating reduces the hole diameter to between 0.0001 and 0.00001 in., which corresponds to a leakage rate of 10^{-4} to 10^{-8} atmosphere cubic centimeters per second.

Initially, Martin-Marietta will be "microventing" over 200 linear ICs for a 5,000-hour life test at 85°C and 85% relative humidity.

Linear devices. The ICs are 741-type operational amplifiers made sensitive to moisture by not being

passivated with glass. The op amps, in chip form, are attached to ceramic substrates on which special thick-film dew-point sensors made of gold are deposited. Finished substrates with both chip and dew-point sensor are encased in 24-pin metal dual in-line packages that are sealed by welding.

To measure the moisture level, the package is cooled down while a constant potential is maintained across the gap of the sensor. At the dew point, current increases abruptly, indicating moisture has condensed across the gap.

Periodically, Zatz and his group will interrupt the life test to determine how much moisture is in the packages and to check out the parts electrically. Besides trying to establish a scientific base for allowable leakage rates, the experiments will also explore how much moisture can be tolerated before failures occur and what failure modes are caused by moisture.

The tests are expected to be completed within the next 15 months.

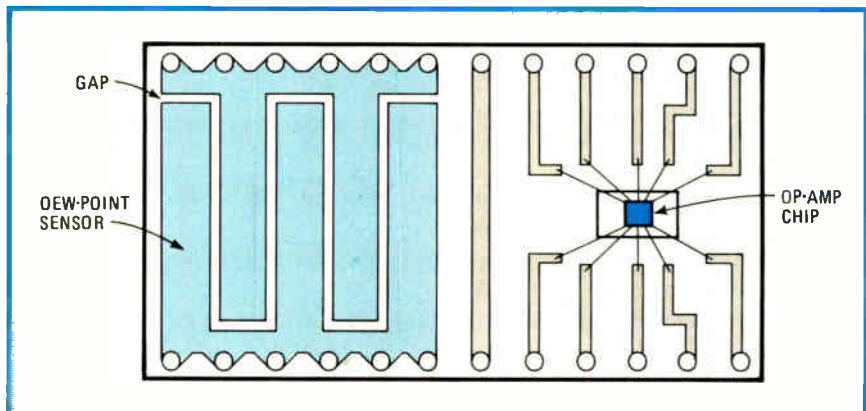
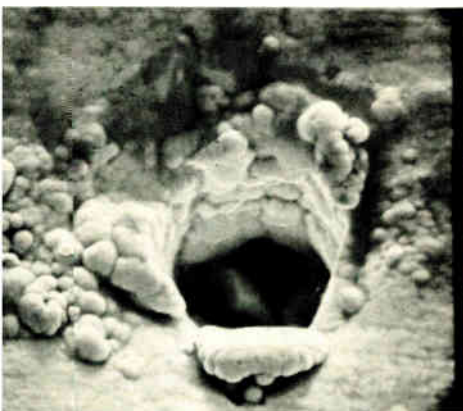

Hole in one. For Martin-Marietta tests, a 1-mil diameter hole is drilled with a laser in cap of a standard metal-can package (left) to form openings, after plating, between 10 and 100 microinches in diameter. Dew-point sensor in package is used to track moisture content.

Funds for the project are from the Advanced Research Projects Agency, with administration through the Semiconductor Technology Program of the National Bureau of Standards. □

Security

Baggage scanner uses gamma rays

The year-end bombing at New York's LaGuardia Airport that killed 11 persons has triggered a Federal Aviation Administration probe of gamma-ray systems to detect explosives and weapons.

The gamma-ray approach operates on the principle that explosives absorb more energy than surrounding material and can therefore attenuate a beam enough to set off an alarm. Its major advantage over conventional X-ray imaging systems, according to the FAA, is that does not have to be monitored by security personnel and is less subject to human error.

FAA administrator John L. McLucas says the agency is awarding \$194,000 to Westinghouse Electric Research Laboratories, Pittsburgh, for development of prototype systems for fast and effective automatic screening of checked as well as hand-carried baggage. Westinghouse Electric already is testing a prototype gamma-ray screening system for hand-carried luggage at the American Airlines gate at Washington's National Airport.

The Westinghouse system for screening checked baggage will be an advanced version of the demonstration model, says Arthur E. Anderson, manager for electronic systems at the Pittsburgh laboratories. "A system for screening checked baggage has a more difficult task because it must be designed primarily to detect bombs or explosives, rather than weapons," he explains, "and it must operate at faster speeds on larger pieces." Both systems are controlled by Digital Equipment

Corp. LSI-11 minicomputers. However, the checked-baggage system will employ a more sophisticated computer program to accommodate the higher speeds required.

Operation. In the hand-baggage demonstration system, the barium-133 gamma-ray sources are mounted in a special container designed to provide two shaped gamma-ray beams. As baggage is carried along on conveyors, the fan-shaped beams scan detector arrays on the opposite side of the belts each time they move 1 centimeter. The result is a vertical profile showing the reduction in radiation caused by items in the baggage. The minicomputer adjusts the system's electronic circuitry to compensate for differences in the characteristics of various types of baggage and calls for search of a bag when the beam attenuation drops below a predetermined level.

Masking the shape of a weapon or explosive is futile, because the

masking material provides even further attenuation of the beam, enhancing detection. What's more, the system is not easily fooled by how a weapon or explosive is positioned, Anderson says.

To minimize scattered radiation and bag exposure, the fireproof gamma-ray-source holder constricts the fan beam to the active detector area on each side of the conveyor, Westinghouse says. Radiation exposure per bag is less than 10% as much as single-pulse X-ray-imaging systems.

When the equipment is turned off, radiation ports close to shut off the gamma-ray beams. In another protective measure, the minicomputer monitors the detectors and warns of any deterioration in system performance, including the need for recalibration. The detector can be recalibrated automatically in about 20 seconds during slack periods with circuitry built into the equipment. □

Computers

Wang data-processing line competes in business arena

The other shoe has been dropped by Wang Laboratories Inc. in the company's push into the distributed business-data-processing market. The Tewksbury, Mass., firm, known for years primarily as a maker of scientific and engineering calculator products, last week unveiled a broad range of products that will put it squarely into competition with IBM, Tektronix, and Hewlett-Packard Co., among others, in distributed data processing.

Less than a year ago, Wang went to market with its three-computer WCS line, including processors with cassette, floppy-disk and hard-disk storage, the company's first entry into the small-systems market. To date, Wang has shipped or booked orders for some 1,700 of those systems. The latest machines go much further, however, especially to broaden the top of the line by offer-

ing Wang-developed microprocessor-based peripherals and two software packages for multi-user distributed data processing.

There are two new computers in the new line. One is the portable computer system (PCS), a 57-pound machine selling for \$5,400. It will compete head-on with the IBM 5100, says Wang's Carl Masi, director of product marketing. The PCS price includes a new processor in Wang's earlier-introduced 2200 series, 8,000 bytes of semiconductor random-access memory, and 42,500 bytes of read-only memory. The PCS includes a 9-inch CRT display, full alphanumeric keyboard, a tape cassette for program loading and storage, and controllers for a new printer and plotter. The random-access memory is expandable to 32,000 bytes.

The second new processor is in-

cluded in the 2200 series work station that might be laid out as a three-station multiprocessing system selling for \$41,000. It would include the 2200 central processing unit with a five-megabyte disk, 16,000 bytes of memory, a 200-character-per-second printer, a removable floppy disk for program loading, disk multiplexer, and three hard-disk work stations.

The other hardware entries in the Wang line are a 120 character-per-second printer and a drum plotter based on an Intel 8080A microprocessor. Both are priced at \$2,900, and both will eventually be sold to original-equipment manufacturers, says John Cunningham, senior vice president for North American operations. There are also two new communications controllers, and two software packages—a management-planning system, and Wang/CASH accounting package.

Cunningham admits that Wang is late getting into the distributed data-processing market, but he believes the company's substantial end-user support and service, its lower prices and broad use of Basic language, rather than a more complicated operating system, will quickly make Wang competitive in a range of systems prices from \$5,400 to about \$75,000. □

Memories

Mostek 4-k RAM is high-performance unit

Although all the news from memory makers seems to be about 16-kilobit RAMs, a new wave of 4,096-bit random-access memories—new designs aimed at high-performance appli-



In business. Wang Laboratories Inc. is aiming its new computer and peripheral line at business applications.

cations—is about to give a boost to the 4-k market. One such part, Mostek's 4027, also foreshadows the firm's design goals for its as-yet unannounced 16-k.

Mostek's first high-performance device is the 4027-3, which has a worst-case access time of 200 nanoseconds, making it the fastest 16-pin 4-k RAM to date. When in June it introduces the 4027-2, a mechanical-shrink version with 150-ns access times, it will have the smallest—104 by 140 mils. An even faster RAM is waiting in the wings. "We've left one slot open," says Derrell Coker, an applications engineer at the firm's Carrollton, Texas, headquarters. "We'll build the dash-1 part when the market says it needs it and when someone starts to second-source the others."

Unlike Mostek's first 4-k RAM, built with a complex double-level metal-silicon process, the 4027 relies on the industry's straight forward n-channel silicon-gate process, combined with ion-implanted depletion loads—the same process used for its interpretation of the 2102 1-k static RAM. The company will revert to a double-level process, this time two layers of polysilicon, for the 16-k part, the 4116.

Adoption. "The new features of the 4027, however, are being carried over into the 4116," Coker says.

"You might say we needed a 4-k RAM that could serve as a test vehicle for the 16-k." Improvements include more multiplexing, more operating modes, and simpler timing, than competing versions. In addition, the input levels have tripled the noise margin for operation with Schottky transistor-transistor logic, and a more powerful driver has been added at the output. Besides multiplexed addresses, Mostek is now multiplexing input buffers and row and column decoders and greatly reducing the active silicon area on the chip, as well as cutting input capacitance in half.

New operating modes include a page mode, handy for block transfers or direct-memory-access applications. Mostek has also added a row-address strobe-only refresh cycle that cuts the cycle power requirement to $\frac{2}{3}$ the normal operating power, while keeping data from the previous cycle valid.

Making the 16-k. For the 16-k version, Mostek has replaced the chip-select signal in the 4027 with the seventh address input and is using the double-poly silicon process. Company designers, who figure power dissipation can be kept to less than 600 milliwatts, are looking at an 18–20-mw maximum standby-power dissipation. Chip size is in the range of 125 by 230 mils, Coker says, and access time for the 4116-4 chip, to be sampled in June, will be 250 ns.

Another difference between the 16-k and 4-k RAMs is the former's lack of a latch on the three-state outputs. Without it, Coker says, the part is suited for common input/output operation, enabling the memory to be connected directly to most microprocessors' bidirectional data buses. □

Core system has a special wiggle

Two veterans in the core-memory business have developed an unusual electrically alterable read-only memory that achieves nondestructive

tive readout by only partially switching the cores.

Significantly, the memory can function not only as an electrically alterable ROM but also as a random-access memory, or any combination of the two. And it does not require the complex restore circuitry that is part of the usual destructive-readout core systems.

Bruce Kaufman, president, and Orville Moe, executive vice president, founded Controlex Corp. last year in Van Nuys, Calif., to build the memory for the digital industrial control market. Both have long experience in cores. Kaufman worked as an engineer for Litton Industries' Data Systems division and NCR Corp. and founded Memory Systems Inc. Moe was chief engineer for Litton's Memory Systems division, founded Computer Component Corp. and served as a consultant for major computer firms.

Reading a wiggle. The Controlex memory capitalizes on a transient phenomenon that occurs when a core is in one magnetized state and a "read" pulse that is insufficient to drive it to the other state is introduced. Ordinarily a conventional core system detects the difference between a logic 1 and 0 by sensing the presence or absence of an output pulse when a pulse sufficient to switch the core is applied to the read line.

When Controlex's read pulse comes along, the flux in the core will change along the hysteresis loop of the material. But because the pulse is too small, the core will revert to its original state of magnetization. However, the flux state of the core has changed, so that there is a relatively small, almost noise-like signal on the sense line—a "wiggle," as Kaufman calls it. "We read the wiggle," he says. Outputs are generated for all bits of any word line, and sense amplifiers shape it for processing.

Another fundamentally different approach is the configuration of two cores to each bit, compared to the usual one for one. Moe explains that they use two 18-mil cores—although one would do—to provide a signal

with higher electrical and magnetic symmetry, and better noise rejection.

Flexible nature. With the flexibility afforded by its nondestructive nature, the Controlex unit allows data to be selectively read and written at any random address without affecting any other parts of the memory. Therefore, it can operate as a nonvolatile RAM, or as any combination of RAM or ROM. Moreover, complementary-metal-oxide-semiconductor parts are used in the circuitry to keep power low.

Capacity of Controlex' first memory is 4,096 by 20 bits, but Kaufman says the size and organization is variable. The cycle time is about 1 microsecond, for either read or write, while access time is 750 ns. Power requirements average 12 watts, from supplies of ± 5 volts and ± 13 v dc. Drive current is in the 200-milliampere range, Kaufman says, which could be cut in half with further development.

The entire 4-k module is packaged on a single 8½-by-11-inch printed-circuit board. The high density of the core matrix (6,000 cores per in²) allows it to be placed just on part of one side.

Price for the memory will be \$1,000 to \$1,200 each, depending on the extent of the electronics that's required, Kaufman says. This makes it about twice the price of

semiconductor memories, he says, and only slightly more than ordinary core systems. Initial deliv-

Solid state

Motorola adding M6800 hardware

Much of Motorola's effort for the 6800 microprocessor has been tied up in software and firmware. Indeed, users have seen few significant hardware introductions since the 5-chip kit bowed early last year.

"That's about to change," says William Toon, microprocessor marketing manager at Motorola's LSI operations. New metal-oxide-semiconductor parts are now in pilot production at the Austin, Texas, wafer processing facility, and the recent decision to emphasize MOS over integrated injection logic has given the group added impetus [*Electronics*, March 4, p. 25].

Parts rush. Customers have been warned to expect a rush of new MOS and linear support circuits. Speed enhancement will come as soon as the firm changes to a depletion-mode process in late summer.

Price cuts on the MC6800 microprocessor, effective April 5, will chop the price from the earlier \$69 to \$29.95 in quantities of 50 to 99. That will put it into the same ballpark as Texas Instruments' aggressively priced TMS 8080. At the same time, price of the MC6860 low-speed modem will be reduced from \$24 to \$14 in lots of 100.

The first depletion-mode part, a 128-by-8-bit static random-access memory will be announced next week. It will also be the first of the family to be packaged in plastic—a move that signals the availability of the entire family in plastic packages by May, Toon says. The plastic parts should lead to further price reductions, but random-access memory, the MCM6810, will be sold at the same price as earlier ceramic versions because the new process has halved its access time. The series are scheduled for this month. □

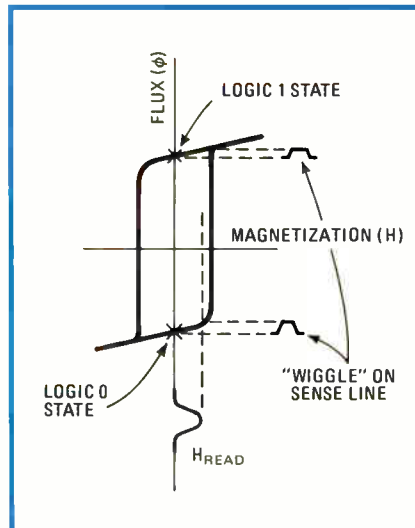

Special sense. Partial switching of cores produces a "wiggle" used for readout.

ANNOUNCING

**A 40 MHz function generator
you can phase lock,
am, fm, log or linear sweep, and more.**

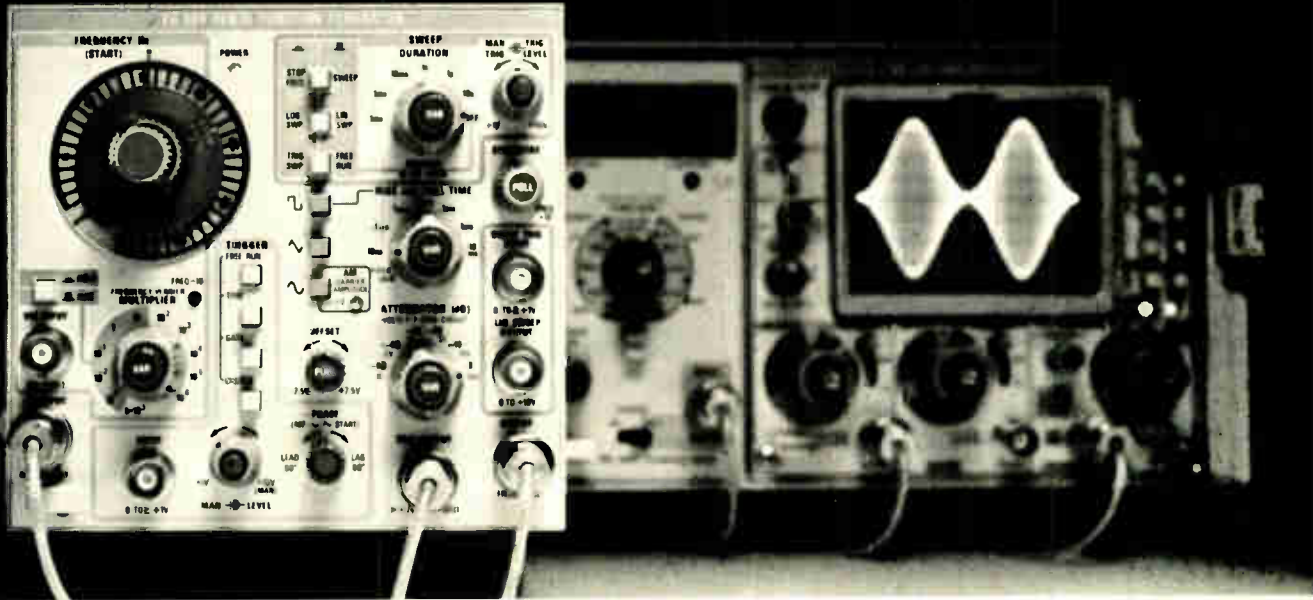

The TEKTRONIX FG 504

In its phase lock mode, the new FG 504 Function Generator will capture and track a periodic signal, such as a logic pulse or house standard frequency, letting you synchronize the generator's output or convert from one waveform to another. Its am input circuitry senses the presence of an applied modulating signal and reduces the output amplitude by one-half, allowing 100% upward modulation without adjusting the amplitude control. It can be frequency modulated, and it can be swept with its built-in logarithmic or linear sweep. Concentric knobs set the frequency start and stop points.

Frequency range: 0.001 Hz to 40 MHz • up to 6 ns rise/fall time • 3 basic waveforms • a wide range of pulse shaping with variable rise and fall and symmetry controls • up to 30 V p-p output • built-in attenuator • post-attenuator offset • external and manual trigger or gate.

In the phase lock, trigger, or gate modes, a phase control shifts the output of the FG 504, so that you can create setups such as a bi-phase clock. A capable instrument for driving logic circuits, the FG 504 is a "clean," 50 Ω source of pulses to less than 20 ns wide and up to 30 V p-p. Post-attenuator offset enables

For Technical Data circle 32 on Reader Service Card.
For Demonstration circle 33 on Reader Service Card.

use of the full ± 7.5 V offset range with small signals.

The FG 504 features independent push-button selection of many of its operating modes, so you are not limited to typical "either-or" decisions. Special modes of operation can be set up through independent or simultaneous use of such functions as AM, VCF (fm), SYMMETRY, VAR RISE and FALL, SWEEP, Waveform HOLD, and TRIGGER or GATE or PHASE LOCK.



Order FG 504T (\$1350) for a stand-alone instrument operable from 100-240 Vac, 48-440 Hz.

For example, the FG 504 may be operated as a free-running burst generator by using the LIN SWEEP OUTPUT to gate the main

generator. With the generator in the SWEEP mode but the START and STOP frequencies set the same, the actual sweep will be zero. Adjusting the trigger level controls the length of the burst. SWEEP DURATION controls the period between bursts.

A special range allows the audio engineer to sweep from 20 Hz to 20 kHz, or a single internal capacitor may be replaced to change the start and stop points.

And dynamic reaction of AGC, squelch, or amplitude-sensitive circuits such as Dolby systems are easy to test with the FG 504 in a square wave or pulse am mode that varies the output between two different levels.

Order FG 504 (\$1200) for a plug-in instrument that operates in any multi-compartment TM 500 mainframe power module.

For further information or a demonstration of the FG 504 and TM 500 Instrumentation, write or phone: Tektronix, Inc., P.O. Box 500, Beaverton, Oregon 97077, (503) 644-0161 ext. 5542. In Europe: Tektronix Limited, P.O. Box 36, St. Peter Port, Guernsey, Channel Islands. U.S. Sales: Prices FOB Beaverton, Oregon



TEKTRONIX®
Committed to
technical excellence

MCM6810AP—\$4.50 in lots of 100—will run 450 nanoseconds, and a 350-ns version will sell for \$4.95.

Communications parts. Also coming on April 5 are a synchronous serial-data adapter that will allow up to a 600-kilobit-per-second serial bit stream, and a 2,400-baud modulator that, when coupled with a digital-to-analog converter, modulates the digital bit stream for telephone transmissions. A third n-channel part, a 2,400-baud demodulator, is expected in the fourth quarter.

In linear devices, Motorola recently introduced the MC6880, a quad three-state bidirectional line-driver/receiver and has begun supplying samples of a triple bus switch in three versions. These are three single-throw, double-throw switches with a center-off position for multiplexed microprocessor systems that need to switch either a common bus or a common memory. Also in the works is a priority-interrupt controller that allows up to eight interrupts with direct vectoring to subroutines.

By the end of the year, Toon says, Motorola will also offer several more memories, including a 1,024-by-4-bit static RAM, and a 1,024-by-8-bit erasable read-only memory. □

Stripped-down 8-bit microprocessors bow

With the opening up of mass markets for dedicated microprocessors, semiconductor houses are moving to reduce parts count, simplify the instruction sets and cut the systems assembly costs. It's already begun in the four-bit world [*Electronics*, Feb. 10, p. 132] and now makers of eight-bit machines are getting into the act.

The first of these low-cost, minimum-chip eight-bit devices will come from Electronic Arrays Inc., Sunnyvale, Calif. What's more, Intel Corp. is readying a stripped-down, redesigned version of its 8080—called the 8048 [*Electronics*, Feb. 5, p. 25]. And Motorola is reported to be in development on an eight-bit n-MOS processor that also will contain RAM, ROM, and input/output

circuitry on a single chip.

Dense. Designated the EA9002, Electronic Arrays' 28-pin n-channel MOS unit is a single 5-volt supply, depletion-load device, containing the equivalent of more than 10,000 transistors on a 200-by-201-mil chip. Intel's three-power-supply 8080, by comparison, contains 4,500 on a 192-by-192-mil chip.

Besides a 12-bit program-address counter, a seven-level 12-bit subroutine-address stack, an eight-bit ALU, eight general purpose eight-bit registers, eight four-bit page registers, a 12-bit parallel bus driver and three-state eight-bit parallel bidirectional data bus, the 9002—like the Motorola and Intel one-chip versions—contains 512 bits of scratch memory. But unlike those devices, a minimum 9002 system requires an 8-k ROM and two MSI devices for parallel input/output ports.

"The emphasis in our design was on simplicity," says William Wickes, manager of microprocessor development at EA, "and on a machine totally dedicated to the low-end microcontroller market." Key to this concept is a clearly defined and unambiguous instruction set, he says, so the 55 instructions provide complete control capability.

Timing for each instruction is straightforward and consistent. "Every cycle is the same, whether it's an internal operation or a data transfer," says Wickes. "All peripherals are treated as memory locations, so instructions or data can be obtained from any external device."

Available in sample quantities now, Wickes says, the 9002 will be in production by mid-year. Additional members of the family will be available by year-end. □

Automotive

Test program tough for spark advance

Asserting that its new analog "lean-burn" spark-control computer is one of the most sophisticated assemblies

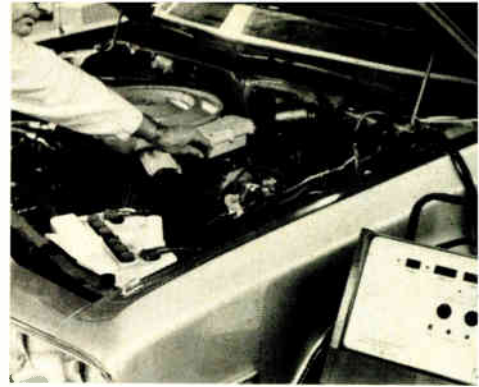

Lean design. Chrysler dealers will use microprocessor controlled diagnostic system.

on a production car, Chrysler Corp.'s Huntsville Electronics division has set up an assembly line test program that would be the envy of any aerospace operation.

"When Chrysler Huntsville was a space and defense contractor, we didn't have as much testing under computer control with real-time information available to us as we do now with the spark-control computer," says John Webster, manager of electronic-product development there.

Besides testing each unit, the system sends information from the assembly-line test heads to a minicomputer with a disk memory that spews up complete quality-control reports for each work shift. Using this real-time system, engineers can pinpoint excessive components failures or production snags fast.

Simultaneously, the Huntsville division has begun production of a lean-burn system analyzer for use by auto dealers for testing the units in the field. During the 1976 model year, Huntsville will produce about 109,000 lean-burn spark-control computers for the 400-cubic-inch, four-barrel engine [*Electronics*, April 3, 1975, p. 38].

Better burn. The system, after evaluating such parameters as engine speed, temperature, and cylinder vacuum, advances or retards the spark to ensure the efficient burning of fuel at the leanest setting of the carburetor. This adjustment minimizes emissions so that they comply with Government standards without the use of catalytic converters.

Each spark-control computer contains more than 200 parts. The key electronic components are quad operational amplifiers supplied by RCA, Texas Instruments, and National Semiconductor. During as-

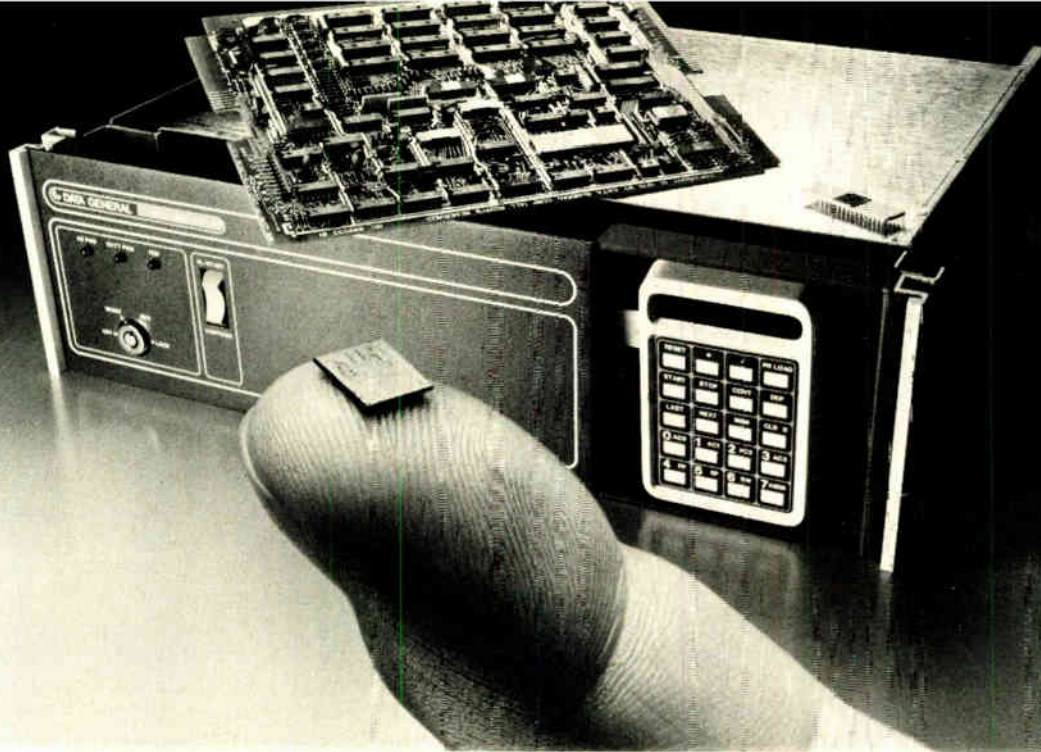

Announcing a giant reduction in the Nova line.

You're looking at a whole new family of NOVA[®] computers. microNOVA. A microprocessor chip, a microcomputer board and a complete MOS mini-computer. All based on the little thing on the tip of the finger.

mN601. The microNOVA CPU.

It's a full-blown, 16-bit NOVA computer. Manufactured by Data General. And fully supported by NOVA software.

And it's not a NOVA computer in name only. This chip has all the NOVA registers, internal data paths and computational elements. The NOVA multifunction instruction set. The NOVA multiple addressing modes. And the NOVA 3 hardware stacking. Plus things that used to be NOVA options: multiply/divide, real-time clock and power fail/auto restart. All standard at no additional cost.

The difference is, all that NOVA has been reduced to a single chip that measures only 225 mils by 244 mils.

Which was no small accomplishment.

For those who need more than a chip, there's the microNOVA computer-on-a-board. A complete, fully-buffered microcomputer that comes with 2K or 4K words of RAM on a single 7½" by 9½" board. You can add on more RAM in either 4K or

8K increments, or PROM boards with up to 4K words. Plus terminal interfaces, general purpose interfacing boards, card frame, power supply and PROM burner.

And for those who need more than a board, there's a fully-packaged 4K word MOS microNOVA mini. It comes with power supply and turnkey console. In 9 and 18 slot versions. Into which you can place as much as 32K words of RAM or PROM. And still have plenty of room left over for I/O.

There's even a microNOVA system specifically for program development. A complete system, with dual diskette drive, terminal and our RDOS-compatible Disc Operating System. Or you can use a Nova 3 system with RDOS. The best development software you can get.

And no matter which microNOVA product you get, you get to use NOVA software like FORTRAN IV. Software that's in use in over 20,000 installations all over the world. So you know it's going to work right the day you get it.

Want to know something else?

Call our toll free number.
800-225-9497.

microNOVA

Nova is a registered trademark of Data General Corporation.

DataGeneral

Circle 35 on reader service card

• Data General, Route 9, Southboro, Mass. 01772 (617) 485-9100. Data General (Canada) Ltd., Ontario.
Data General Europe, 15 Rue Le Sueur, Paris 75116, France. Data General Australia, Melbourne (03) 82-1361/Sydney (02) 908-1366.

Electronics review

sembly, the computers are tested five different times on the line, and twice after completion. The most stringent test is a 10-hour temperature-cycling that checks performance of each unit through to 185° F.

The entire test operation is controlled by three minicomputers—two General Automation 16/45 models on the production floor and one General Automation SPC 16/66 monitoring the whole show from the engineering department.

One of the production-floor minicomputers, coupled to a video display, handles the three assembly tests, which include measurements before and after automated laser trimming of resistor networks. This machine, which checks laser-trimmer status, as well, records the number of hours the laser lamp burns. In all, a production supervisor can call up from this station some 50 test reports on virtually every component. A second production-floor minicomputer tracks tests performed on finished assemblies.

Dealer aid. Built around a Motorola 6800 microprocessor, the dealer diagnostic unit costs about \$700. It tests the entire operation of the lean-burn system via a set of programmed procedures. A mechanic has to follow only 12 instructions printed on the front of the unit and read results from three light-emitting-diode display windows. Two windows show performance readings, and the third shows a diagnostic code number if a part fails.

A major advantage of the 6800 microprocessor in this equipment, according to Chrysler, is that the program and the test parameters can be changed as newer lean-burn systems come out. □

Communications

Bell's visual terminal uses plasma display

Despite their troubles with Picturephone, the thinkers at AT&T haven't given up on two-way visual commu-

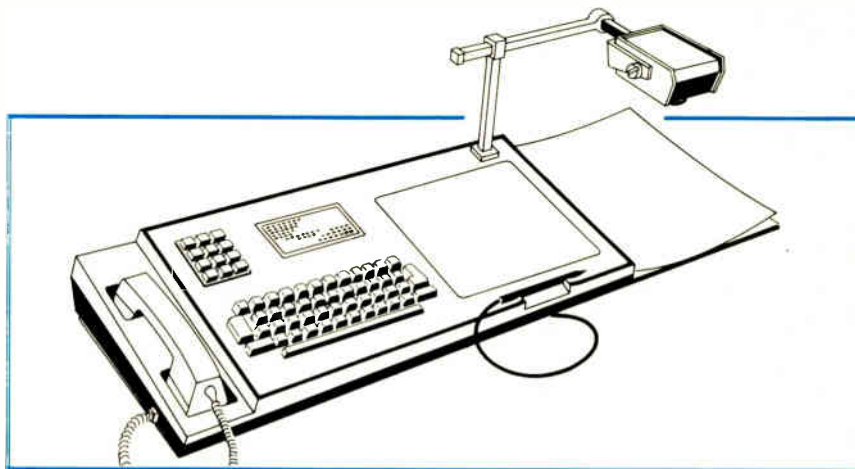

New image. Latest lab version of Picturephone sports alphanumeric keyboard, plasma screen, light pen, and solid-state camera. Output hooks into hard-copy printer.

nications. They're merely revising their approach—from emphasis on the speaker's image to terminals designed to send and receive local and computer-generated alphanumeric and graphic data.

To do this, Bell Laboratories researchers Ralph C. Brainard and Thomas P. Sosnowski in Holmdel, N.J., are developing a visual communications terminal around a microprocessor. It has a flat-screen ac plasma-display panel, television camera, telephone data set, keyboard, and a light pen for the interchange of sketches, text, and continuous-tone pictures. Equally important, the experimental terminal uses the existing switched telephone network; Picturephone requires special broadband lines.

Sosnowski says the microcomputer, based on Intel Corp.'s 8080 microprocessor, also contains 8 kilobytes of programable read-only memory and 8 kilobytes of random-access memory for programing flexibility and experimentation. The plasma display panel, 8 inches by 8 inches, contains over a quarter of a million discrete light points or sites arranged in a 512-by-512 matrix-addressed array. Produced for Bell Labs by Owens Illinois Corp., the display has inherent memory and is bilevel; that is, a site is either on or off with no provision for intensity modification.

With the present system, an image is picked up by the camera and displayed in 8 seconds. "The display architecture is such that a minimum of 5 seconds is required to illuminate the entire panel," says

Brainard. The overriding constraint is the time required to send a quarter of a million bits of picture information (one bit per picture element) to a remote telephone over the phone network. Brainard believes this will be acceptable to many users who would want to take their time studying data.

The computer can control the display in several ways. Fundamentally, all that is required by the panel is an 18-bit address (9 bits each for X and Y) and a code to write or erase the site. The keyboard is used for alphanumeric input as well as control ASCII-coded characters, as well as pictures, can be transmitted between terminals. This would permit access to interactive computer systems, for example. □

Military

Seafarer tests may start next month

Despite uncertainty about where Project Seafarer's transmitter and huge transmitting antenna grid will be located, the Navy may begin tests next month that would mark the first use of the extremely-low-frequency (elf) band for communications. Seafarer is the new name for the former Project Sanguine [*Electronics*, Oct. 2, 1975, p. 41], the Navy's attempt at an elf communications system that would permit continuous communications with deeply submerged submarines without exposing them to detection. The

The Pronto Challenge:

we ship your transformers in 48 hours, or you get this

Polaroid "Pronto"
free*

Either way, you win.

Because when we say 48-hour shipment, we mean business. We guarantee your prototype (1-4 pc.) order to be shipped in 48 hours. We did it for over 8000 different orders last year, and we can do it for you. Many orders were for quantities in the 100's. That's the PRONTO promise: instant service or you get the new instant-picture Pronto camera free.

Why are we so sure our PRONTO program can't miss? Simple. We back it up with the most complete and diversified line of first-quality transformers in the business. The thing is, speed is just one criterion for Signal's success; what really puts us ahead are the performance and price advantages our innovative engineering assures.

Case in point: the 50% savings in weight and size and cost that make our 241 series of small

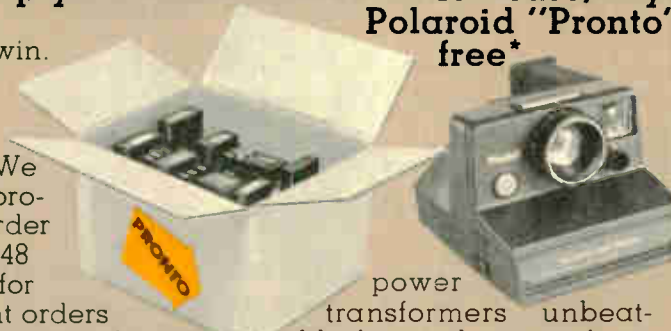

power transformers unbeatable for applications from 2.4 to 60 VA. Here, we not only used bobbin instead of layer winding to save 40-50% in winding space, we developed a special "split" bobbin to eliminate inter-winding insulation and crossover of primary and secondary leads. What's more, we made the core of grain-oriented steel instead of ordinary silicon steels—resulting in a 40% reduction in required turns, and still more weight/cost savings for you.

That's the kind of professionalism Signal is known for.

You'll see it in the unsurpassed

scope of our miniature PC power transformer line. In such Signal exclusives as flat plug-ins with 6 VA ratings in a package only 0.85 inches high. And in the most extensive line of rectifier power transformers and chokes. Add to that our dual

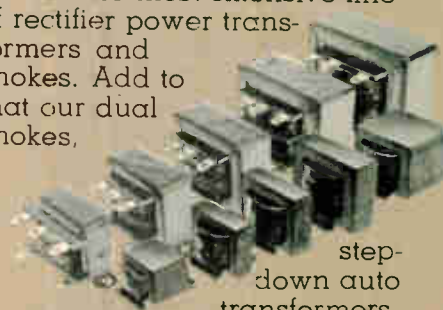

step-down auto transformers, heavy duty transformers and industrial grade step-up or step-down power isolation transformers... and you'll see why we're ready to take on anyone in the field.

But don't take our word for it; take us up on our PRONTO challenge, and see for yourself what Signal professionalism is all about. Write or call for latest catalog and price schedule (for quick data, check EEM):

Signal Transformer Co., Inc., 1 Junius St., Brooklyn, N.Y. 11212
Tel. (212) 498-5111;
Telex 12-5709.



signal

TRANSFORMER

Circle 37 on reader service card

*The Polaroid PRONTO™ XL Film camera comes complete with carrying case and tripod mount adapter. Suggested retail value \$79.95.

SCIENCE/SCOPE

The first recipient of Sweden's new L M Ericsson International Prize for "an especially important scientific or technological contribution to telecommunications engineering" will be Harold Rosen of Hughes. King Carl XVI Gustaf will award the prize of 100,000 kronor to Dr. Rosen on May 5 "for his foresightedness -- against an originally contrary current opinion -- in proposing the introduction of geostationary communications satellites, and for his eminent scientific and technological contributions to their development, design, and operation."

The first scanning optical microscope that will inspect large-scale integrated circuits while they are being operated has been developed by Hughes. It has demonstrated its ability to detect, localize, and identify flaws in complex devices. Unlike other scanning microscopes, which scan only one logic state at a time, the Hughes microscope will effectively superimpose many logic states at one time to "characterize" or inspect the microcircuit. The completely non-destructive instrument scans with a modulated laser and was specifically designed under sponsorship of NASA's Marshall Space Flight Center to meet the high throughput requirements of manufacturers of high reliability microcircuits.

A Roland missile intercepted a jet drone at White Sands Missile Range, N.M., recently, as the U.S. Army began testing two West German-built Roland all-weather short-range air defense systems. Roland, first major foreign-designed weapon system selected for deployment with U.S. forces, protects battlefield troops and equipment and high-value rear-area emplacements against high-speed, low-level air attack. Hughes is prime contractor to the Army Missile Command for the U.S. Roland program.

Hughes needs systems-level engineers. Sonar Systems: design and develop surface and subsurface ASW tactical and surveillance sonar systems for Underseas Systems Laboratory....Communications Systems: define architecture and signal processing concepts for next-generation TDMA communications systems. Requirements: BS or higher degree, U.S. citizenship. Please send resume to: Engineering Employment, Hughes Aircraft Company, P.O. Box 3310, Fullerton, CA 92634. An equal opportunity employer.

New products from Hughes include a CMOS/LSI digital frequency synthesizer that provides up to 1,021 output frequencies from a single crystal; it is designed to increase the performance and reduce the cost of industrial, military, and citizens' band communications equipment; circuit contains an adder for transmit/receive frequency offset adjustment....an X-band traveling-wave tube for military satellite communications earth terminals; using modulation anode control techniques, it operates efficiently at 600 and 1200 watts -- highest power to date for a PPM-focused, X-band CW, air-cooled TWT -- and is available as a component or in a power supply package.

Creating a new world with electronics



Electronics review

uncertainty about the site (see "Seafarer sites and schedule," p. 40) stems from environmentalist concern over impact of elf transmissions on wild life, even though the Navy has presented substantial data showing them to be harmless.

First shipments. GTE Sylvania next month will ship the first elf receiver scheduled for fleet testing under terms of a \$3.9 million contract that's part of Seafarer's propagation-validation study. In all, Sylvania's Communication Systems division, Needham Heights, Mass., is to deliver 15 receivers. Along with associated test equipment, 13 of these will be used "to determine the signal-to-noise ratio of the elf signal when we get the receivers at sea," says George L. Downs, Sylvania's manager of elf operations. "We want to get operational experience

because we're pioneering in elf."

The band between 72 and 80 hertz was chosen for Seafarer because it suffers little from atmospheric attenuation and penetrates sea water about 10 times more effectively than the very low frequencies now used for communications with submarines. A submarine must not only slow down to receive vlf signals, but also trail an antenna uncomfortably close to the surface. With the elf transmissions the antennas can remain hundreds of feet below the surface.

There's nothing exotic about the elf receivers, says David A. Boots, Sylvania's technical director for the Seafarer program. They will be mainly digital, using transistor-transistor logic, and have analog amplifiers and filters. The transmissions are buried in noise, Boots points

News briefs

Motorola, MOS Technology settle patent suit

MOS Technology Inc. of Norristown, Pa. has agreed to withdraw its MCS6501 microprocessor from the market and to pay Motorola Inc. \$200,000 in damages as part of the settlement in the patent-infringement and unfair-competition litigation between the two companies. In addition, MOS Technology and eight former Motorola employees have given back, under court order documents that Motorola contends are confidential.

Although MOS Technology is dropping the MCS6501, which was pin-compatible with Motorola's MC6800, it will continue to produce and market five microprocessors in its 6500 family, which are not pin-compatible with Motorola's MC6800. Furthermore, both companies have agreed to a cross license relating to patents in the microprocessor field.

Cox steps down at Intersil

After 14 years in the electronics business, Intersil president Marshall Cox says that he is stepping aside to decide what to do with the next 14. The 40-year-old Cox announced his resignation, which is effective April 1, last week. No successor has been picked, and a company spokesman estimates the replacement process, which Cox will participate in, may take up to two months. Cox will remain a consultant to Intersil and will retain his equity in the company.

Bell Labs executives move up

Ian M. Ross, Bell Telephone Laboratories' vice president of network planning and customer services since 1973, has been named executive vice president of Bell Labs, succeeding Morris Tanenbaum, now vice president for engineering and network service at American Telephone & Telegraph Co. [*Electronics*, Feb. 19, p. 84]. Also, Solomon J. Buchsbaum, executive director, transmission systems, succeeds Ross at Bell Labs.

Nigeria buys \$150 million Westinghouse balloon-borne system

The Federal Republic of Nigeria has awarded a contract for close to \$150 million for a balloon-borne telecommunications and fm television and radio broadcasting system to TCOM Corp., Columbia, Md., a subsidiary of Westinghouse Electric Corp.

For microelectronic circuits and systems

Call Hughes (714) 548-0671



Hybrid Microcircuits—both thick film and thin film



Communications Products: crystal filters and crystal oscillators



Bipolar LSI Cell Arrays—interconnection of MSI functions



Microelectronic Systems for remote communications/control

We've been solving tough problems in micro electronic circuits and systems for years. Designing, manufacturing, testing—all within one organization specializing in microelectronics technology. That's why you can call on us for answers you need in a hurry—on specs, specials, prices and delivery. For product literature, write 500 Superior Ave., New Port Beach, CA 92663.

HUGHES

HUGHES AIRCRAFT COMPANY

Grayhill brings all PC terminals out one side



switches from logic levels up to ¼ amp

- ½ inch switches with 10 or 12 positions—1 or 2 poles per deck —1 to 12 decks.
- Designed for wave-soldering process—resists flux contamination
- Enclosed construction at price levels as low as or lower than open wafer switches.

Here's a new Grayhill miniature switch specifically designed for the small loads—and the specialized mounting techniques—of low voltage circuitry. Probably the smallest switch you can find with all PC terminals in the same plane, the switch is surprisingly small in the price dimension too... for enclosed construction and Grayhill quality. For more information on this new member of the Grayhill Series 71 family, write for Bulletin #236... and consult EEM for information on other Grayhill switches.



661 Hillgrove Avenue • LaGrange, Illinois 60525
(312) 354-1040

Electronics review

Seafarer sites and schedule

The Navy and GTE Sylvania still have a long way to go before Seafarer gets afloat, even if fleet tests turn up no extremely-low-frequency propagation problems. For one thing, sites in Nevada and New Mexico [*Electronics*, Oct. 2, 1975, p. 41] are not as desirable as the upper Michigan peninsula. The Navy first became interested in Michigan for Project Sanguine, as it was then called, in 1972 and still prefers it, claiming some \$300 million could be saved by locating the transmission complex there.

But depending on the outcome of the Navy's investigation of the environmental impact of such a grid on upper Michigan, that state may rule itself out of consideration. The National Academy of Sciences, at the Navy's request, will produce an interim report in August covering the biological and ecological implications of Seafarer. And this report will be factored into the environmental impact statement the Navy must deliver the following May.

The Defense Department anticipates making a site selection next April. Actual construction will begin in May 1979 if the program is approved more than 20 years after the concept originated in 1958. Meanwhile, Seafarer watchers are also awaiting Senate Armed Services Committee action on a fiscal 1977 request for funds to start still another proposed elf research effort. It's called Pisces, for Pacific Intertie Strategic Communication ELF System, and would use an existing 851-mile power line from Dalles Dam, Ore., to Los Angeles as a test antenna.

out, and the propagation-validation system "will measure how well the signal gets to the submarine."

Reeling. The sub's antenna, an insulated wire ¾ inch in diameter, is reeled out several hundred feet so it is as far as practical from the vessel's own electrical noise. The elf signal sensed by uninsulated electrodes fitted to the wire, is boosted 80 decibels by a preamplifier.

Both analog and digital filters are used in an analog-to-digital converter stage to further isolate the signal from the noise. High-pass and low-pass filters get rid of those portions of the signal above 80 Hz and below 72 Hz, while notch filters cancel out any 50–60-Hz noise from the sub's electrical system. Another filter handles the sea water's spreading of high-energy noise spikes.

The superficial band-spreading, applied to the transmitted signal to simulate the anti-jamming techniques that an operational Seafarer system would use, can be eliminated. A cartridge recorder and AN/UYK-20 computer for digital processing are part of the validation system, too. The recorder collects such data as noise levels, highest interference signals detected, and the phase of received signals. Ultimately, the transmitted message is printed on a teletypewriter. □

Standard computer set for October

After a slippage of one month and a change in project leadership, the Naval Air Systems Command is calling for quotes on the first 70 preproduction models of its standard airborne computer, the AN/AYK-14(V). Selection of a winner from among the seven expected bidders has also slipped by two months to October, say sources close to the program.

The delays follow a dispute between the Naval Stacom project office and the office of H. Tyler Marcy, assistant secretary of the Navy for research and development. At issue, Navair sources report, was the insistence of Marcy's organization that AN/AYK-14(V) bidders effectively benchmark their systems against Sperry Univac's AN/UYK-20, which is already in the Navy inventory. Stacom program manager Ronald S. Entner reportedly opposed the requirement and was replaced by Navair's Thomas Smith. Entner, still in the Navair branch, did not respond to queries about his removal, while Smith said, "I prefer not to say anything about it."

The Stacom program is now re-

They chose Motorola's M6800 Family to handle tough systems jobs



TEKTRONIX

Tektronix designers were given the challenge of developing a reasonably priced, locally controlled, compact computing system combining convenient storage, large-screen graphic display, and a general purpose interface bus. All goals were achieved with the 4051 BASIC Graphic Computing System. Tektronix chose the MC6800 for the central processing unit.

FASFAX

FasFax was looking for the way to package their P.O.S. system more compactly with a smaller power supply and fewer devices, yet increase system capability. They found Motorola's M6800 Family just what was needed to produce "STANLEY." They're satisfied it's the most cost effective, most adaptable, P.O.S. system now in the restaurant business, and the MC6800 controls up to six units.



CODEX

Implementation of Codex Corporation's 6000 Series Intelligent Network Processors required a microprocessor to perform network management and centralized control, terminal intermix, data compression, and several additional functions in a uniquely executed multiprocessor architecture. Codex elected to use the M6800 Family for its microprocessor performance and its compatible I/O, ROM, and RAM.



MOTOROLA M6800
Benchmark family for microcomputer systems.

Positions, everyone. New HV interconnections.

With three multiposition high-voltage interconnections added to the LGH line, our military and commercial coverage is broader than ever.

The new 7-position circular connector is designed specifically for electronic warfare use. Yet, this one design is so universally effective it's filling the connection gaps in a number of other critical military electronics applications.

And consider the 60-position quick disconnect. It's an interconnection first. Compact, lightweight, field-installable, for high or low voltage, here's a technological development so advanced it's being used in helmet-mounted sites and displays.

For medical electronics, lasers, industrial machines, and the like . . . the 7-position commercial circular connector. Deeply recessed contacts, built-in strain relief. There's nothing else like it.

No matter what position your product is in, we have the HV interconnections in the positions and configurations you need. For data, contact AMP Incorporated, Capitron Division, Elizabethtown, PA 17022, (717) 367-1105.



AMP
INCORPORATED

Electronics review

garded as more than a mere gap-filler pending the availability of the All-Applications Digital Computer [*Electronics*, Dec. 25, 1975, p. 52]. Transferred to the Naval Material Command from Navair earlier this year, AADC is still at the research and development stage and years from procurement.

Meanwhile, Stacom is being pushed for use in the Navy's new F-18 fighter and the antisubmarine-warfare helicopter program known Lamps—for Light Airborne Multipurpose System. And in its request quotations on the AN/AYK-14(V), Navair says that beyond the first 70 preproduction models, vendors can expect fixed-price incentive options in fiscal 1978 and 1979 for "various step-ladder quantities [of] from 30 to 720" systems. If the Navy buys the 800 F-18 fighters it says it wants, procurement will run to at least 1,600 machines in view of plans to install two on each aircraft [*Electronics*, Nov. 13, 1975, p. 32].

In addition to Sperry Univac, companies ready to respond to the June 1 bid deadline include Control Data Corp., General Motors' Delco Electronics division, International Business Machines Corp., Lear Siegler Inc., Teledyne Ryan Aeronautical, Westinghouse Electric Corp., and probably Rolm Corp.

What troubles some contenders is the Navy's requirement that any off-the-shelf systems being bid must use "new microprogramming techniques to emulate the AN/UYK-20 Government-furnished support software." As part of the evaluation, the Navy says, each competitor will be required to perform "an equipment demonstration by execution of an AN/UYK-20 object code" limited to the system's instruction set.

Software. Anxious to get the AN/AYK-14(V) on board the F-18, the Navy chose to specify the existing software of the AN/UYK-20, rather than the variant CMS-2 higher-order language identified earlier by Entner, sources said. Entner had also proposed that Stacom's support software be Fortran. He believed that it offered ease of handling and system logistics. □

NATIONAL ANTHEM

A Review of New Products and Literature

ALL THE NEWS THAT FITS

from National Semiconductor

WOW! 12-Bit Binary and 3-Digit BCD DACs

Brand new from National . . . a family of precision, low-cost, digital-to-analog converters for a wide range of industrial and military applications. Our DA1200 Series is self-contained in a 24-pin DIP (molded or hermetic); just turn them on and they're ready to go to work for you.

General features of the new DACs include both current- and voltage-mode outputs (0-2 mA, 0-10 V, ± 10 V); $\pm 1/2$ LSB (binary), $\pm 1/2$ LSD (BCD) linearity; 1.5- μ s current-mode, 2.5- μ s voltage-mode settling times; precision, buffered, internal references (10.240 V binary, 10.000 V BCD); standard power supplies (± 15 V, +5 V); TTL/CMOS-compatible, complementary binary or BCD input-logic formats; and expandability to 14 or 16 bits.

The DA1200/DA1201 are the 12-bit binary devices; the DA1202/DA1203 are the 3-digit BCD devices. Terrific specs, terrific parts. Ask for the data sheet and you'll see what we mean. #

TELEPHONE RELAY DRIVERS



Our high-voltage/high-current positive and negative voltage relay drivers have many features that make them nearly ideal devices. For example, we specify output leakage, over temperature, at an output of ± 54 V (the polarity depends on the device). Again, we specify over temperature and at 5 mA, the minimum output breakdown; there's even an internal reference, which doesn't allow the output breakdown latching you'll find in all other

LM117-Series Regulators Adjust to Your Needs

Announcing the one and only three-terminal adjustable voltage regulator on the market today! To change an output voltage, change a resistor value. Our LM117/217/317 regulators are exceptionally easy to apply, easy to mount (TO-3, TO-5, and TO-220 packages), and feature line and load regulations better than those of fixed regulators.

Look at these specs:

- Output adjusts from +1.2 to +37 V
- Guaranteed 1.5-A output current
- Line regulation, 0.01%/V, typ.
- Load regulation, 0.1 %, typ.
- Ripple rejection, 80 dB, typ.

And the chip includes full overload protection—current limiting, thermal overload, and safe-operating-area circuitry—which remains functional even when the adjustment terminal is disconnected. Even high-voltage supplies may be regulated because the chip floats; don't exceed a 40-V output-input differential and you stay in business.



So . . . ECL users, TTL users, supply didders (optimize, optimize!) . . . let purchasing stock *one* part—the LM117—and everyone will come up smiling. #

Our LM148: The Only True Quad-741 You Can Buy

Yep, we've gone and done it and, in this case, more is definitely better. Our LM148 Series is a true quad-741. It consists of four independent and well-isolated (120 dB), high gain, compensated op amps, and provides functional characteristics identical to

relay drivers, and which generally eliminates the usual need for external, inductive-transient protection; yet the output transistor is still *fully* protected.

TTL/DTL/CMOS compatibility; high-impedance pnp inputs; low power dissipation (typ., 90 mW with both outputs on); high output-voltage breakdown (typ., ± 65 V); high output current (300 mA, max.) . . . all these and more make our DS3686 (positive) and DS3687 (negative) voltage relay drivers ideal in telephone relay applications. Check them out for yourself; see what you've been missing. #

those of the 741. Yet the LM148's total supply current (2.4 mA, typ.) is less than that of a single 741; and input offset and bias currents are very much less (typ., 4 nA and 30 nA respectively) than those of a 741. Input offset voltage of the LM148 is 1 mV (typ.); all inputs and outputs are overload protected; and it's pin-compatible with the LM124.

The gain-bandwidth product of the LM148 is 1 MHz at unity gain; the other member of the family, the LM149, is a decompensated, wideband amp—4 MHz for $A_{v(\min)} = 5$. Stability? Super; 60° phase margin for both parts at the gain figures just mentioned.

To sum up: the LM148 and LM149 quads are just what you've been waiting for. Multiple-741 and 1558-type amplifier applications cry out for this part. Wherever you need matched amps or a high packing density, the LM148/LM149 will do the job; where before you had to settle for one or the other, now you get both. That's a little like having your cake and eating it too. Really. #

A Review of New Products and Literature from National Semiconductor

New Bipolar PROMs Ideal for High-Speed Systems

Our new 1024-bit PROMs are Schottky clamped; and this means high speed—a 30-ns (max.) enable-to-output delay and a 50-ns (max.) address-to-output delay into 30 pF across 300Ω. Organized as 256 4-bit words, the memories feature pnp inputs to reduce input loading, and two memory-enable inputs to control the output states.

When both enable inputs are at logic zero, the outputs present the selected

word; if either or both of the enable inputs are at logic one, all four outputs go to their high-impedance (off) state.

The memories are available in a Tri-State® version as the DM54S287/DM74S287, and in an open-collector version as the DM54S387/DM74S387. Both versions are available as either ROMs or PROMs, and are packaged in 16-pin molded and cavity DIPs.

≠

Fast Access Featured in Tri-State®, Si-Gate CMOS RAMS

National's first silicon-gate CMOS RAMs are here. Ideal in microprocessor, minicomputer, and mainframe memory applications, these Tri-State® memories are very-low-power devices with high performance: access times are only 250 ns, maximum. Intended for operation from a single +5-V supply, the memories retain their data at $V_{CC} = 2$ V. All inputs and outputs are TTL compatible; data outputs are of the same polarity as the inputs; and on-chip registers are provided.

The MM54C920/MM74C920 (22-pin DIP) and MM54C921/MM74C921 (18-pin DIP) are organized as 256 4-bit words; the MM54C929/MM74C929 (16 pins) and MM54C930/MM74C930 (18 pins), intended for larger systems, have a 1024 x 1 organization. ≠

qualified on MIL-S-19500/195 (2N2608), /375 (2N3823), /431 (2N4091 series), and /476 (2N5114 series).

All this shouldn't surprise you. After all, we've had, for many years, a fine reputation for MIL-M-38510 parts. We're simply expanding. So whatever your REL FET needs, consider National to be your prime source. Tie in with the leader. ≠

Clock Modules



JUST WHAT THE DOCTOR ORDERED FOR A REALLY GOOD 'MOVEMENT'

National's MA1002 Series electronic clock modules get it all together for you on a single PC board; a MOS/LSI clock circuit; a bright, 4-digit, 0.5-inch LED display (hours, minutes, and blinking colon for seconds); and all necessary discrete components. All you add are a transformer, switches, and an ear-phone alarm-output to form a complete, pre-tested movement that's ideal for desk clocks, alarm clocks, clock-radios, TV or stereo clocks, instrument panel clocks, etc.

Features of the MA1002 Series include a 12- or 24-hour format; 50- or 60-Hz operation with power-fail indication; brightness control; sleep and snooze timers; alarm-on and PM indicators; and fast and slow set controls. Additionally, direct (non-multiplexed) LED drive eliminates RFI, and the module's size—0.93-inch max. thickness x 1.375 H x 3.05 W—allows the finished clock a very compact design. ≠

NSC's REL FETs: Now You Know Where to Go

National is now a REL FET supplier, a simple fact that many of you will be happy to know. We've received qualification on MIL-S-19500/428 for the JAN/JANTX/JANTXV 2N4416A, a part that's been very difficult to get ('til now).

You'll also like to know that we're qualified on MIL-S-19500/385 for the JAN/JANTX 2N4856 through 2N4861—the most popular JAN FETs in today's marketplace—and will soon be



CMOS-Compatible Interface Components

We designed our DS3631/32/33/34 Series of dual peripheral drivers to be a universal set of interface components for CMOS circuits. This means that each circuit has CMOS-compatible inputs (high-impedance pnp transistors); high-voltage outputs (minimum breakdown, 56 V at 250 μA); high-current operation (300 mA, max.) at low internal V_{CC} current levels, with base drive for the output transistor derived from the load proportionate to the needed loading—essential to reduce the load on the CMOS logic

supply; and low V_{CC} dissipation (28 mW, both outputs on at 5 V). An additional bonus is that this family of peripheral drivers is also TTL-compatible at $V_{CC} = 5$ V.

Note, too that we've made the pinouts the same as those of our very popular DS75451, DS75461, and DS3611 parts. All of which means that with our DS3631 Series you can directly convert your present systems to our MM74C CMOS family, and end up with a terrific saving of power. ≠

A Spinning Wheel Doth a Tachometer Need

While originally designed for vehicle tachometer applications, our new monolithic frequency-to-voltage converters turn out to have a wide number of uses. Besides tachometer-related applications in vehicle engines and motors in general—over/under speed sensing and control, speed switches, cruise controls, and automotive door lock, clutch and horn controls—our LM2907/17 ICs make dandy touch and sound switches, capacitance meters, and delay switches (it's not magic; to see how it's done, see the data sheet).

These circuits use the charge pump technique and offer frequency doubling for low-ripple and full-input protection. The load (to 50 mA) may be ground- or supply-referenced. Versions available offer single-ended or differential tach inputs, with or without an on-chip Zener regulator.

The transfer function of the circuits is easy to use: $V_{out} = f_{in} V_{CC} RC$, where R and C are external to the chip; linearity is 0.3% typ., $\pm 1\%$ worst case. New, interesting, and unique, our LM2907/17 will definitely make your life easier. ☞

CLOCK CIRCUITS: Night and Day, These are the Ones

These MOS ICs provide all the logic needed to build many types of digital clocks and timers, notably desk and auto clocks, alarms, clock-radios, stop-watches, timers for industrial, photographic and appliance uses, sequential controllers, etc. The circuits have four display modes—time, seconds, alarm, sleep—and interface directly to LED displays.

The timekeeping function operates from either a 50-Hz or a 60-Hz input, and a power fail/return indication is provided. Outputs consist of display drive signals, a 59-minute presettable sleep timer (which can be used to turn off a radio), and a nine-minute snooze alarm. The display format is either 12 hours (with leading-zero blanking and AM/PM indicator) or 24 hours. These circuits, designated MM5384/5/6/7, operate from a single, unregulated supply (either 8-26 V or 18-26 V), and are packaged in 40-lead DIPs.

APPLICATIONS CORNER Low-Voltage Reference Sources

We've had a number of inquiries from readers asking us how to use a three-terminal regulator as a low-voltage reference source, and how to make that source bipolar.

Our answer to these questions is that three-terminal regulators can be used in such a way, but to produce a lower-than-nominal regulator output requires a rather cumbersome amount of external circuitry.

A far better method makes use of our recently-announced LM117, a three-terminal regulator with an output that is adjustable from 1.2 V to 37 V (story on Page 1). Its use as a low-voltage reference source is shown in Figure 1.

By connecting the 'Set V' pot to a negative reference in Figure 1 becomes the bipolar source of Figure 2. Pre-loading the output to a negative voltage is necessary because the LM117 is a positive-output regulator and cannot sink current.

Still another scheme—this one taken from our LM199 data sheet and shown here as Figure 3—uses the LM199 temperature-stabilized Zener in combination with an LM108A op amp to provide output voltages to ± 6.9 V. ☞

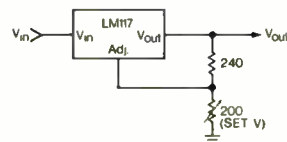

Figure 1. 1.5V to 2.0V Reference

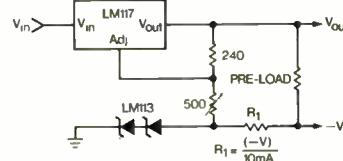

Figure 2. -2.4V to +2.7V Reference

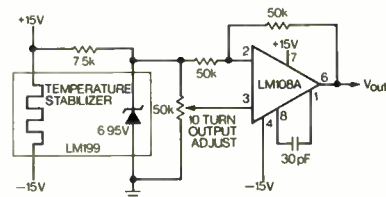

Figure 3. -6.9V to +6.9V Bipolar Reference

MM74C908/918: OLDIES BUT GOODIES

We'd like to remind you about some very popular parts we've been making. They are the MM74C908/918; CMOS, dual, high-voltage drivers that are super parts now being offered at lowered prices.

The MM74C908/918 differ only in power dissipation. At a 70°C ambient, maximum dissipation for the 908 ($\theta_{JA} = 110^\circ\text{C/W}$, max.) is 0.7 W, while the 918 ($\theta_{JA} = 55^\circ\text{C/W}$, max.) will handle 1.4 W. Both parts feature a supply range of 3 to 18 V; a low output on-



Two other 'super clock' circuits, the MM5382 and MM5383, are due very shortly. These displays feature a month-day calendar display and a unique power-failure indication: if there is a momentary ac power failure the word 'OFF' is flashed at a 2-Hz rate until the time is reset. The MM5382 operates in the 12-hour mode (and has a PM indicator); the MM5383 operates in the 24-hour mode. ☞

resistance of 8Ω (typ.); they can withstand 30 V in the off state; they will source 250 mA (min.) at $V_{OUT} = V_{CC} - 3$ V, $T_J = +65^\circ\text{C}$; and have proved invaluable when interfacing normal CMOS voltage levels to relays, regulators, lamps, etc. ☞



NEW TRI-STATE® OCTAL BUFFERS Use Low-Power Schottky Technology

Four new Tri-State® octal buffer ICs that employ low-power Schottky technology are now available in quantity from NSC. The DM81LS95/96/97/98 provide eight, two-input buffers in a single package. One of the two inputs is a control line that gates the output into the high-impedance state, while the other input passes the data through the buffer. Typically, power consumption is less than 80 mW per package with propagation delays less than 13 ns.

The DM81LS95 and 97 present true data at their outputs; the DM81LS96 and 98 invert the data. The DM81LS95 and 96 have eight common Tri-State enable lines, accessed through a two-input NOR gate. The DM81LS97 and 98 have two groups of four buffers each, each enabled by its own common line. Both commercial- and military-grade versions are available from stock.

✽



A MICROPROCESSOR HANDBOOK FOR LOGIC DESIGNERS

We've just published a new book. It's called *A Logic Designer's Guide to Program Equivalents of TTL Functions*, and it's intended to help system designers make the transition from design in hardware to design in software.

While written primarily for current and potential PACE users (PACE is National's single-chip, 8/16-bit microprocessor), much of the text will be useful to anyone unfamiliar with microprocessors and software in general.

The handbook begins with the basics of microprocessing and software, then explains, in detail, the PACE instruction set and its use. More than two dozen simulations are described from both the hardware and software points of view. These simulations range from simple logic (AND gates, etc.) to complex subsystems (digital servo, digital tach, etc.), and are written in language familiar to TTL designers. A series of appendices—a glossary, a description of the hexadecimal number system, powers of two, and many more—concludes the handbook.

A Logic Designer's Guide to Program Equivalents of TTL Functions will be a unique and useful addition to any bookshelf of modern technology. The handbook costs \$5.00, and may be ordered directly from National. ✽



VIP CARD

Complete card and mail to
NATIONAL SEMICONDUCTOR
Attn: Marketing Services
2900 Semiconductor Drive
Santa Clara, CA 95051

INDEX

Please send me the literature that I have checked:

- | | |
|---|---|
| <input type="checkbox"/> LM117 Regulator, Page A, Col. 2 | <input type="checkbox"/> JANTX FETs, Page B, Col. 2 |
| <input type="checkbox"/> DA1200 Series DACs, Page A, Col. 1 | <input type="checkbox"/> DS3631/2/3/4 Drivers, Page B, Col. 2 |
| <input type="checkbox"/> LM148/9 Quad Op Amps, Page A, Col. 2 | <input type="checkbox"/> LM2907/17 Tachs, Page C, Col. 1 |
| <input type="checkbox"/> DS3686/7 Relay Drivers, Page A, Col. 1 | <input type="checkbox"/> MM5384/5/6/7 Clocks, Page C, Col. 1 |
| <input type="checkbox"/> DM74S287/387 PROMs, Page B, Col. 1 | <input type="checkbox"/> MM74C908/18 Drivers, Page C, Col. 2 |
| <input type="checkbox"/> MM74C920/21/29/30 RAMs, Page B, Col. 3 | <input type="checkbox"/> DM81LS95/6/7/8 Buffers, Page D, Col. 1 |
| <input type="checkbox"/> MA1002 Clock Modules, Page B, Col. 1 | |

A Compendium of Recently-Issued Literature (i.e., stuff to file)

- | | |
|--|---|
| <input type="checkbox"/> AN-141 Designing with the IMP Chip Set | <input type="checkbox"/> DB-4 Driving Burroughs' Bar Graph Display |
| <input type="checkbox"/> AN-152 Communications Interfaces for the IMP-16 | <input type="checkbox"/> μSpec 3 Floppy Disc Operating System (and CRT Interface) |
| <input type="checkbox"/> AN-153 Constant-Current LED | <input type="checkbox"/> μSpec 14 IMP-16 Utility Programs |

Your End Product or Application: _____

Have Salesman Call YES NO E-4/1/76

Please print clearly; this information will be used for our mailing list.

NAME _____ TITLE _____

COMPANY _____

ADDRESS _____

CITY _____ STATE _____ ZIP _____

Washington newsletter

Components trade balance down 14% in 1975, U.S. says

The U.S. trade balance for electronic components **dropped 14.1% to \$827.2 million during the 1975 recession**, according to new Commerce Department figures. Exports fell 12.3% from the 1974 level to \$1.99 billion, while imports declined 11.1% to \$1.16 billion. Semiconductors, which accounted for 69% of component imports and 53% of exports, generated a favorable trade balance of nearly \$251 million, up 12.4% for the year. Semiconductor exports totaling \$1.05 billion were off 15.6%, while imports fell 16.5% to nearly \$803 million.

The \$317 million negative trade balance in integrated circuits rose 10.4% from 1974, Commerce said, reflecting increased imports from American-owned offshore manufacturing facilities. Imports from Malaysia, for example—almost entirely ICs—climbed 28.5% to \$163.2 million, compared to exports of \$134.6 million. Japan produced the biggest deficit for the U.S., \$52.1 million, by exporting \$161.2 million of components to the U.S., while importing only \$109.1 million.

Marisat malfunction could cost Hughes incentive payments

Although the Navy is already beginning ship-to-shore service on the uhf wideband and two narrow-band channels it has leased on the first Marisat maritime communications satellite, neither Comsat General Corp., the system's majority owner and manager, nor Hughes Aircraft Co., spacecraft builder, has been able **to get the Atlantic Ocean satellite's C- and L-band commercial channels working properly**. Although tests to correct the malfunction are continuing at Hughes, the contractor stands to lose incentive payments on the program if the commercial circuits cannot be repaired, Comsat General officials indicate.

Adoption of UPC scanner systems suffers setback

Automation of the nation's supermarket checkout procedure with the laser-scanner Universal Product Code has suffered a severe setback. A supermarket industry committee has called for continued price marking of each item, **a practice that the UPC bar code and electronic checkout scanning systems would have eliminated**. "Elimination of item-by-item pricing in favor of shelf pricing was the economic key to getting stores to adopt electronic scanning," one food-industry technology specialist explained. "If item-by-item pricing must be continued, then you can forget about UPC."

Addenda

Electronics manufacturers with offshore assembly operations are mounting **strong opposition to another effort to repeal Items 806.30 and 807** of the U.S. Tariff Schedules. Both the Electronic Industries Association and Wema have testified against legislation that would repeal USTS provisions permitting importation of hardware assembled abroad with duty paid only on the value added. . . . The Navy has named General Dynamics Corp.'s Convair division **to develop its Tomahawk submarine-launched cruise missile for \$34.8 million**. . . . The Air Force has awarded two six-month contracts **for competitive study and preliminary design of the airborne electronic countermeasure system** known as PELSS—for precision emitter location strike system. Boeing Aerospace, teamed with Hughes Aircraft, McDonnell Douglas, and RCA, got \$3.9 million, while Lockheed Missiles & Space Co., teamed with IBM Corp. and E-Systems Inc., received \$3.6 million.

The unresolved issues in interconnection

When the Federal Communications Commission acted in March to drop the last barrier to interconnection of customer-owned terminals to the nation's telephone network, terminal makers were not surprised. Like a pregnant elephant, the FCC had been carrying the issue around for years. It labored long over the delivery, issuing its first ruling last fall when it favored interconnection of data modems and ancillary equipment that qualified under a new certification and registration program. Now the FCC has extended interconnection rights to the last and by far the largest categories of terminals—private-branch-exchange switchboards, main telephones, and multi-line key telephones.

But despite months of intellectual preparation, telecommunications-equipment makers were not altogether ready for the FCC's delivery of its opinion when it came. Emotions ran high for good reason. The FCC decision opens up an interconnect market that generated product sales of \$4.2 billion for Western Electric Co. alone in 1974. The American Telephone & Telegraph Co. manufacturing arm controlled about 80% of the Bell System market that year, limiting other manufacturers to sales of about \$900 million. The North American Telephone Association, which represents makers of interconnect hardware, calls the latest FCC action "the most significant and definitive since the commission's Carterfone decision in 1968."

Winning the war

But interconnection is not yet a *fait accompli*. The nation's telephone companies do not intend to surrender control over their equipment market easily. The U.S. Independent Telephone Association is challenging the FCC ruling in a Federal appeals court, while AT&T reads the decision as one more weapon with which to get Congress to rewrite the 1934 Communications Act to restore its monopoly position.

Though Congress has been unresponsive so far to the pleading of the telephone companies, terminal-equipment makers should not take interconnection for granted. Beyond the efforts of NATA, lobbying against the AT&T "reform" bill will have to be largely on a company-by-company basis since the Electronic Industries Association's Communications division is hamstrung by having AT&T as a member.

Those who favor a competitive interconnect

market would do well not to let themselves be trapped into responding to issues defined only by the telephone companies. In its fight against competition in terminals, AT&T can be expected to use much the same language as it used against competition in services. AT&T believes telephone companies are being placed in the posture "of Gulliver among the Lilliputians. Some of their most profitable business is being taken from them, and they are not allowed to respond." Eugene V. Rostow, now a Yale law professor and AT&T consultant, told Congress that "this is an absurdity which would give the nation the worst of both worlds. It is not a policy of competition, but of its opposite—market-sharing, restrictive rules, cartelization, and mercantilism."

Despite Professor Rostow's distinguished prior service as chairman of the President's Task Force on Communications Policy a decade ago, his melodramatic characterization of the issues is wide of the mark. As the president he served might have put it, "That dog won't hunt."

Defining the issue

The issue fundamental to free interconnection and competitive specialized services is whether the *de facto* monopoly of AT&T and the independents in the market for basic telephone service should be extended automatically to each new telecommunications service as it is developed. The answer to that question must be no. AT&T cannot possibly respond to every specialized need, be permitted to control every specialized market that comes along. The interconnection of new, special-purpose terminals to the telephone network can be expected to supplement, rather than supplant, the basic services now available from common carriers. And any telephone company that wants to compete in these new submarkets should be permitted to do so at prices that at least cover their true costs.

But as the Gulliver of the world's telecommunications industry, AT&T should not be permitted to abuse its power by destroying its Lilliputian competitors at the start. Telecommunications technology is moving faster than AT&T can economically employ it. Therefore, interconnection must be permitted to flourish if the U.S. is to maintain its position as an innovator and leader in the world telecommunications market.

—Ray Connolly

NOW! SINGLE IN-LINE RESISTOR NETWORKS WITH IMPROVED PERFORMANCE

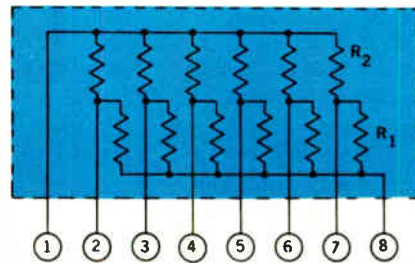
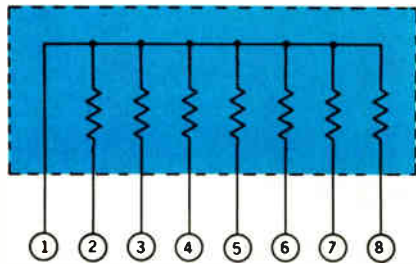

BOARDABLE AND AFFORDABLE

Low Cost and **High Density Configuration** are only two of the features of Sprague Type 216C Metanet® Resistor Networks. Now, you can also enjoy the benefits of improved power dissipation, better temperature coefficient of resistance, and closer standard resistance tolerance.

Save Board Space. Single in-line design permits vertical installation, which allows more units to be seated in less space. This mounting style also results in improved high-frequency performance and significant in-place cost reduction.

Better TCR. Typical temperature coefficient of resistance is within ± 200 ppm/°C, cutting previous allowable limit almost in half.

Up-graded Power Dissipation. Individual terminating, pull-up/pull-down, and interface networks are capable of dissipating 250 mW per resistor at 70°C, an increase of 100% over previous designs.

Closer Resistance Tolerance. Standard resistance tolerance for each resistor is $\pm 2\%$, with other tolerances between $\pm 1\%$ and $\pm 5\%$ available on special order.

Proven Product Line. Sprague has more than fifteen years of experience in the development and manufacture of precision thick-film resistor networks, which include individual terminating, pull-up/pull-down, interface, and dual terminating designs.

*For complete technical data, write for Engineering Bulletin 7041A to:
Technical Literature Service, Sprague Electric Co.,
35 Marshall Street, North Adams, Mass. 01247.*



THE BROAD-LINE PRODUCER OF ELECTRONIC PARTS

AMS clobbers TI's 4K in Read/Modify/Write.

We give you 80 ns t_{mod} vs 20 in 22 pins;
100 vs 20 in 18 pins.

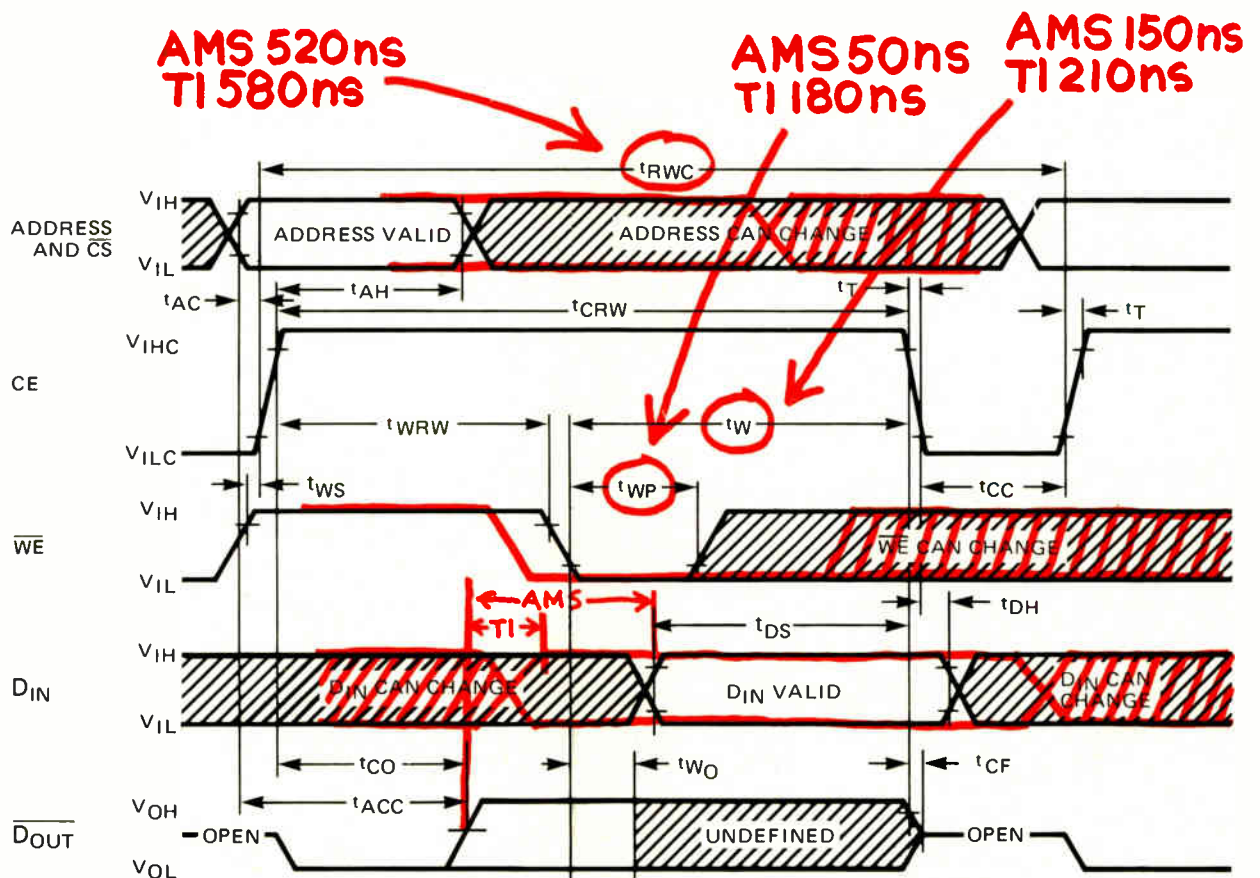

The excessively short system modify time for TI's 4060 stems from the fact that the \overline{WE} line must go low 60 ns earlier than our 7280. TI's Data In must be stable when \overline{WE} goes low, while ours only requires that Data In be stable 150 ns prior to CE going low, a clear advantage of 60 ns for the 7280, 80 ns for the 7270.

No compromises.

If you've built your cards around that minimal modify time, it's time for a whole new shuffle. No trade-offs, no latches, no hitches. Compare the specs, and write or call collect for further information or immediate requirements.

No lack of sources.

The masks for our 22 pin 7280 and 18 pin 7270 are currently in production at National, too. Not only spec compatible, but mask-for-mask. You'll never be caught in a production/supply bind.

One of the largest RAM suppliers in the world.

We have shipped more than eleven million RAMs. In ceramic and plastic DIPs, in custom and standard card assemblies; in subsystems with or without power supplies; and in large scale memory systems. We're the largest independent add-on memory supplier in the world; and that RAM experience is ready to work for you.

Pick a spec.

These are only highlights, but you can readily see how TI ends up in the red.

	22 pins		18 pins	
	AMS 7280	TI 4060-2†	AMS 7270	TI 4050††
t_{AH} Address & CS Hold Time	50	150	50	150
t_{WP} \overline{WE} Pulse Width Time	50	180	50	180
t_W \overline{WE} -to-CE OFF Time	150	210	200	210
t_{DH} D_{IN} Hold Time	0	40	0	40
t_{DS} D_{IN} -to-CE OFF Set Up Time	150	210*	150	210*
min RMW cycle	520	580	580	600
t_{mod} @ min cycle	20	20	80	20
t_{mod} @ TI's min cycle (580 ns)	80	20	(600 ns) 100	20

*data must be valid on \overline{WE} going low
†pin-for-pin compatible
††not pin-for-pin compatible

Pick a winner.

The 7280 or 7270 from Advanced Memory Systems. With the devices you need, in production quantities, and with the experience to support you in performance, reliability, delivery and pricing.

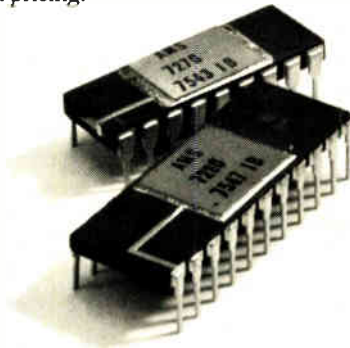

4K OK

AMS 7280 22 pin

4096 X 1 NMOS Dynamic RAM
Max Access 200 ns
Min Cycle 400 ns
Single High-Level Chip Enable
TTL Compatible
 P_{diss} 480mW typ
Capacitive inputs
On-Chip Address Registers
Pin-for-pin with TI 4060
Ceramic DIP

AMS 7270 18 pin

Same as 7280 with
Special Tri-Share Port*

*Tri-Share is a registered trademark of National Semiconductor Corporation.

Intel delivers if you have power to burn and a fistful of capacitors.

Intel's 2107B consumes one third more power during a read or write cycle than our 7280. It's even worse during read/modify/write. Note the chart of I_{DD} Avg. to your right.

To observe the glitch in the far right graph, hang a probe on an address line of an Intel 2107B board. Watch it shoot above 0.6 Volts. And watch it go away with 7280s.

Supply noise? You can silence Intel with a fistful of capacitors. Or, more simply, you can replace the 2107Bs with our 7280s. No power problem. No clock watching. No trade offs. No kidding.

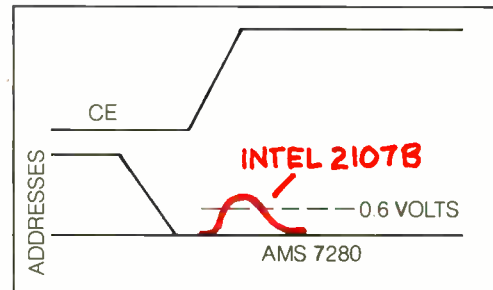
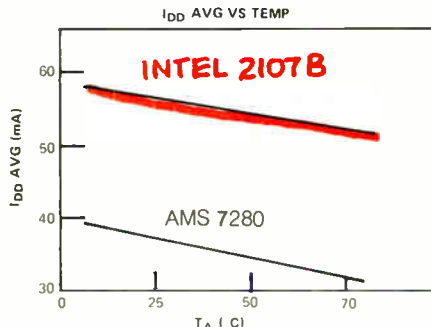

AMS Advanced Memory Systems.
Memories with a future.

1275 Hammerwood Avenue, Sunnyvale, California 94086

In stock at Weatherford, all locations.

Sunnyvale, California
(408) 734-4330

Boston, Massachusetts
(617) 259-0050

Chicago, Illinois
(312) 529-1474

London, England
01 542 4690 Telex: 928139 CANFOR G

Buss Fuses Specialize Too!

WITH A COMPLETE LINE OF CIRCUIT PROTECTION DEVICES AND MOUNTINGS TO MEET MILITARY SPECIFICATIONS*

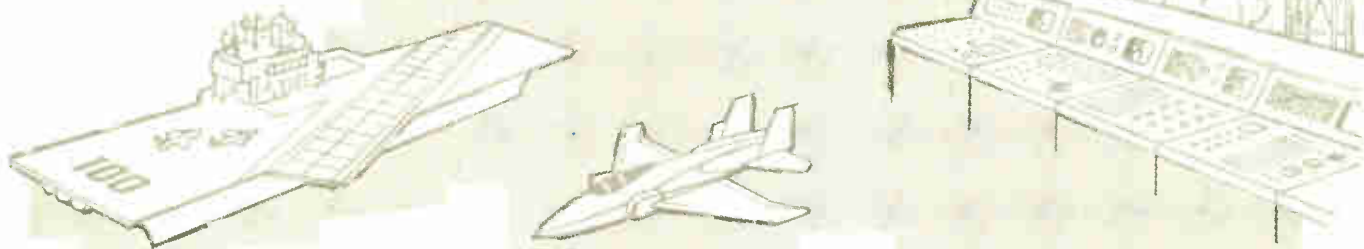

FHN55W

FHL10U

FHN20G

FHL17G1

FHN42W

FM01

F02A

F02B

F01A

F09B

F09A

F77A

FH21AM

FC21AN

Whatever your military requirement calls for in the way of electronic circuit protection — BUSS offers an extremely broad line of product capabilities — time-delay or quick-acting fuses — instrument type fuses — fuse blocks — fuse clips — extractor post type, open fuse indicating and non-indicating fuse-holders, plus aircraft limiters and limiter blocks. All precision engineered and tested to meet rigid military specifications.

For the full list of BUSS circuit protection products listed under MIL Specs, ask for BUSS Form MIL — See for yourself.

***Military Specifications**

- MIL-F-15160C
- MIL-F-15160E
- MIL-F-19207B
- MIL-F-21346A
- MIL-F-23419B
- MIL-F-5372C
- MIL-F-5373C



BUSSMANN MANUFACTURING
a McGraw-Edison Company Division
St. Louis, Missouri 63107



Japanese system scribes images from TV camera into identification cards

An electronic engraver for quick production of pictures on identification cards combines the principles of electronic photoengraving and photography. The subject is photographed by a vidicon camera, and the image is scribed on the card by an electronic scanning process. The so-called portrait-engraving processor was developed by Matsushita Research Institute Tokyo Inc. with the aid of Dai Nippon Printing Co., which has patented the plastic cards in Japan and the U.S.

The system is much faster than photographic reproduction. Because the cards are not laminated, magnetic-tape stripes can't be erased by heating them above the curie point. And since the image is an intrinsic part of the card base, it cannot be changed, nor can a new one be pasted in. Although color photography is impossible with the system, any convenient dark color can be used. The white part of the card can also be printed or engraved.

Storage of the image in digital memory as a single TV frame also makes possible other applications. It can be read out at any clock rate below 1.5 megahertz, including slow-speed transmission over telephone lines. A similar unit at the other end can display the image on a monitor or engrave a card.

Engraving. The processor consists of a standard black-and-white TV camera with video monitor, a control-and-memory unit, and an engraving unit. When the camera picks up the image and displays it on the monitor, the operator presses a button to send the video signal to a digital memory.

In the engraver, the identification card is clamped to a table that scans the diamond cutting stylus from top to bottom, with a horizontal displacement between parallel scans spaced to engrave five lines per millimeter. The stylus cuts grooves of

varying depths on a rectangle of 17 by 21 millimeters in black or a dark color on the white plastic card.

An overscan of 20 by 24 mm prevents a dark border from appearing if the photo registration is imperfect. Light shades and white are obtained by increasing the depth of the cuts.

Automatic circuits compare signal levels over the facial region and adjust them so that the facial highlight is set at the lightest density and the darkest color is set at the darkest. The stylus reproduces 16 shades, which are adequate for positive

identification. Each picture element requires 4 bits of memory for the 16 density levels. The memory capacity of 48 kilobits is obtained by connecting in series four loops of 12 1-kilobit shift registers. The memory produces with 4-bit precision the 12,000 picture elements needed.

The picture elements are stored in horizontal lines for the video monitor, but a buffer memory stores the signal vertically to drive the stylus. The 4 bits representing one picture element are read out in parallel during a single clock cycle. □

Around the world

Plessey makes bipolar logic for blg controllers

Plessey Semiconductors is about to introduce a new bipolar-logic series of circuits specially designed to replace, almost on a plug-in basis, the complementary-MOS circuits and their interfaces in industrial controllers. The SP530 family can also replace the discrete logic in digital control systems in high-noise, high-voltage environments, but it does not directly drive large machinery. The five chips can handle crude direct-current power supplies of 30 to 60 volts, tolerate line surges up to 80 V, and have breakdown voltages up to an unusually high 90 V, the firm claims. And the chips can put out from 35 to 75 milliamperes, enough to directly drive ordinary industrial switches, unlike C-MOS circuits, which typically yield 5 to 10 mA.

Because the SP530 needs few additional components, its reliability is high. These chips, together with a microprocessor and Plessey's new SL 1200 series of extremely low-noise amplifiers, could be developed into a complete electronic monitoring and control system for automobiles.

System prevents traffic congestion on autobahn

West Germany's first computerized traffic-control system for the open road is being tested in the Rhein-Main region on all autobahns—those multilane freeways that resemble interstate superhighways in the U.S. A process computer from Siemens AG evaluates detector-derived traffic data and determines alternate autobahn routes when a particular section is jammed. Alternate routes are flashed by an attendant to remotely controllable road signs so that drivers are guided around sections slowed by heavy traffic.

The trial area, about 30 miles in diameter, is in the Frankfurt-Darmstadt-Wiesbaden triangle, where autobahn traffic from all over Germany and other parts of Europe converges. The system consists of the signs at and near the autobahn interchanges, about 600 strategically spotted inductive-loop detectors, a number of data-transmission links and the Siemens VSR 16030 computer, installed in a roadside control center.

The detectors, which are embedded in the road surface, count the vehicles, determine their speed, and ascertain whether they are trucks or passenger cars. The type of vehicle is considered when rerouting traffic on alternate routes with hills. The computer processes the detector data and displays the number, density, and speed of vehicles at the interchanges.

**You can buy
this signal generator
for a 3-month job,
and then let it
gather dust.**

**You can rent
this signal generator
for a 3-month job,
and return it
when you're done.**

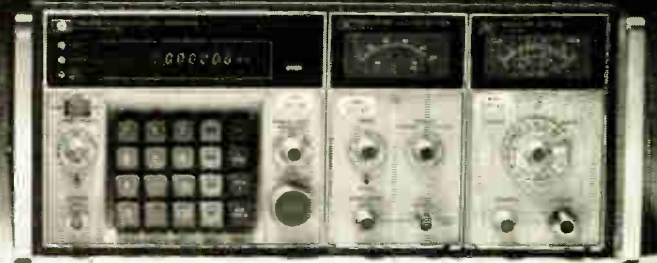

When you buy electronic test equipment for a short-term project, you're stuck with the equipment after the project is completed. Maybe it'll sit around gathering dust and costing you money. Or maybe you could sell it at a loss.

Or maybe, you should have rented it from REI.

When you rent equipment from us, you keep it only as long as you need it. When you're through with it, you send it back. Since you pay only for the time you have your instruments, you never have to spend your money on idle equipment. Short-term needs are just one reason for renting. Immediate delivery is another. Because we maintain over \$10 million in inventory in fully stocked instant inventory centers around the country, you can get delivery within hours.

REI stocks over 8,000 fully checked-out test instruments. And they're ready whenever you are. For the full story on renting as well as our low prices, send in the coupon for prompt delivery of our free illustrated catalog. Or call us now for your immediate requirements.

Rental Electronics, Inc.,
99 Hartwell Avenue, Lexington, Mass. 02173.
Please send me your free instrument rental catalog:

Name _____ Title _____

Company _____

Address _____

City _____ State _____ Zip _____

Tel. Number _____

Rental Electronics, Inc. 

A DEPSICO LEASING COMPANY

Burlington, MA (617) 273-2770 • Gaithersburg, MD (301) 948-0626 • Oakland, NJ (201) 337-3757 • Ft. Lauderdale, FL (305) 771-3500
Des Plaines, IL (312) 827-6670 • Dallas, TX (214) 661-8082 • Mountain View, CA (415) 968-8845 • Anaheim, CA (714) 879-0561
Rexdale, Ontario (PLC Leasing Ltd.) (416) 677-7513

"See us at booth #2702 at Electro 76 May 11-14.
The Bicentennial IEEE Show in Boston"

World Radio History

Circle 54 on reader service card

Toshiba seeks to slash solar-cell costs by 99%

Japan's Toshiba hopes to slash costs of silicon solar cells by 99% to 50 cents a watt by its new method of vertically pulling ribbons of a silicon melt in a crucible. In the laboratory research, being subsidized as part of the Japanese government's Sunshine project, ribbons 300 micrometers thick, 30 millimeters wide, and 800 mm long have been pulled. Measured efficiency is 9%. However, by refining the controls, Toshiba hopes to get the thickness down to 100 μm . Thin ribbons and high rates of growth both contribute to low prices.

To control and minimize the ribbon's thickness, Toshiba tapers to knife edges the tops of the two inner sides of two vertical carbon plates through which the silicon is pulled. The ribbon grows straight upward through these sharp inside edges. Tyco Mobile in the U.S. also controls ribbon width by means of the top edges of two carbon plates, but the top edges are square. When the ribbon emerges, it wets the tops of the plates and grows straight upward from the outside edges, adding both plate widths to the thickness.

Bosch licenses two U.S. firms to make helical-scan VTR

West Germany's Robert Bosch GmbH has licensed RCA Corp. and International Video Corp. in the U.S. to market and manufacture the BCN-format helical-scan broadcast video-tape recorder. Developed by Bosch's Television division, the BCN equipment directly records color video signals of broadcast quality on 1-inch tape. **The equipment, only about one third the size and weight of conventional quadriplex systems, requires only a third as much current and tape.**

The licensing of the two U.S. firms closely follows a Bosch-Philips agreement to jointly promote the BCN system and to combine their engineering and manufacturing capabilities to develop it further. The PAL/Secam version of the BCN system was introduced by Bosch at the Montreux Television symposium 1975. In the meantime, the NTSC version was recently shown to the broadcasting industry at the NAB convention.

UK firm enlarges customer base in Singer buy . . .

International Computers Ltd. is increasing its customer base by more than a third with its \$2 million down payment for the overseas business of the Singer Business Machines division. The complex deal will boost ICL's overseas business by 50% and add to its 3,400 customers another 1,300 in Europe, Latin America, South Africa, and Australia.

ICL, which is to pay only for the inventory and spares it wants during the next four years, **also has the option of marketing and possibly manufacturing Singer's System-10 small business computers, model 1500 intelligent terminals, and point-of-sale equipment.** ICL is also joining the Control Data Corp. British subsidiary to form a computer-peripherals company. In the U.S. and Canada, TRW Inc. is taking over customer support for Singer's point-of-sale and System-10 equipment.

. . . and launches new medium computer

Filling a gap in its successful 2900 computer series, Britains' International Computers Ltd., is introducing the modular 2960 medium-scale system, intended for government, university, and branch-business accounting applications. The 2960, built with the "new range" architecture of the larger two-year-old 2970 and 2980, **has a main-store capacity of 512,000 to 3 million bytes and a store-block cycle time of 900 nanoseconds.** The

2960, priced at \$1 million to \$2.3 million, uses Schottky transistor-transistor logic in the central processor, instead of the faster emitter-coupled logic used in the 2970 and 2980.

Asahi Glass to sell National products

Asahi Glass Co., Japan's leading maker of television-picture-tube bulbs, has been selected as nonexclusive agent here for National Semiconductor Corp. products from the U.S. Asahi formerly represented Signetics, but when Philips of the Netherlands bought that U.S. semiconductor maker, it decided to market Signetics products directly. To service National, Asahi plans to add to its staff of experienced semiconductor salesmen.

The Japanese company will also carry notes for the small firms that have been selling National products but don't have the resources to cope with the common Japanese practice of stretching out payment for as long as four months.

Swedish firm split in try to regain profitability

The state-owned Swedish electronics manufacturer, Sonab, which lost about \$10 million last year, is being reorganized into four independently managed companies in an attempt to regain profitability. One of the new companies will make personal paging systems; another, entertainment audio equipment; the third, mobile-radio systems, and the fourth will subcontract work from the other three, as well as outside jobs.

Stig Carlsson, developer of the omnidirectional stereo speaker system that Sonab was originally created to produce, is negotiating with other electronics firms interested in producing his speaker. However, Sonab has exclusive rights to the speaker through Oct. 1, 1979. **Despite its production of what many enthusiasts claim is one of the world's best speakers, Sonab's hi-fi sales have dropped in the past two years, while the Swedish market has nearly doubled.** Carlsson charges Sonab management with wasting millions of kroner. After a feud involving unions, management, and the state holding company, Sonab managing director Staffan Haakanson has resigned.

Italian navy tries fiber-optic system for transmissions

The Italian navy has started to take a serious look at fiber-optic data-transmission systems for warships. The navy expects to have an experimental system working ashore by the end of the year. **Initially it will be operated at a slowish 35 kilohertz, then will be stepped up to 100 kHz.** The system, which will give two terminals direct access to a minicomputer memory, is scheduled to get sea trials toward mid-1977. CGE-FIAR is handling the electronics, and FACE Standard, an ITT affiliate, the optical link.

Telefunken to show digital TV tuner

West Germany's AEG-Telefunken is about to introduce a digital television-program memory that can be preprogrammed to store as many as 16 different TV channel numbers. The DSP 190, built around a phase-locked loop, will be shown at the Hanover Fair, April 28 to May 6, and be available thereafter. **For high accuracy and stability of the tuned frequencies, the PLL compares the frequency of the tuner oscillator with that of a quartz oscillator.** A channel is preselected by setting the switch to the desired channel number and pushing a "store" button.

**One of these
OEM computers is new.
The other is newer.**

**One is powerful.
The other is more than
twice as powerful.**

**One is Digital's PDP-11/04.
The other is....**



Digital's PDP-11/34.

The new and perfect match is made.

To any OEM who couldn't expand his computerized product line because even little changes implied big costs, Digital announces an engineering breakthrough.

The Twin Minis are here.

As alike as two peas in a pod on the outside. But on the inside they're as full of new and different possibilities as anything we've ever offered.

You already know the 11/04 — or do you?

The 11/04 arrived on the

scene only a short time ago and its simplicity of design was immediately recognized as an important OEM advancement. With its virtual programmer's console, its unique self-test feature, MOS memory, and direct memory accessing, it moved our low-end computer to a new high in performance and a new low in cost — simultaneously. And yet now, just a few months later, it's even better.

11/04 can now manage 28K of core or 28K of MOS memory.

Think of the flexibility. Even at the low low-end you can tailor the package and the price to the prospect. You can sell lower initially, and with plenty of expansion room offer your customers a small computer today with a big future tomorrow.

Now enter 11/34. The perfect twin. The greater among equals.

The 11/34 comes in the exact same sizes as the 11/04. 5¼" x 19" x 25". Or 10½" x 19" x 25". It's the same color, has the same number

PDP-11/34

Price: From \$6,318*

Word Length: 16 bits, plus byte parity

DMA Rate: 1.4M words/sec

UNIBUS™ Rate: 2.5M words/sec

Addressing Space: 128K words

Memory:

16K, 32K, 48K, 64K, 80K, 96K, 112K, 124K words MOS memory

16K, 32K, 48K, 64K, 80K, 96K, 112K, 124K words core memory

Contains Standard PDP-11/04 — 11/34 Features:

Direct Memory Access

Vectored Automatic Priority

Interrupt

Virtual Programmer's Console

ROM Diagnostics

Power-Fail/Restart

UNIBUS™ architecture

More Than 400 Instructions

Operating Systems: RT-11, RSX-11M, RSX-11S

Physical: 5¼" x 19" wide x 25" deep

10½" x 19" wide x 25" deep

Plus Standard PDP-11/34 Features:

Operating System: RSTS/E

Memory Management & Protection

Extended Instruction Set

Hardware Multiply & Divide

Mixed Core/MOS Memory



*91 Quantity OEM Prices

Prices apply to U.S.A. and Canada only

World Radio History

of buttons, identical back plates, cord position and shape. The difference can't be seen.

The fact is the difference is easy to say and hard to believe: the 11/34 is 2½ times more powerful.

It starts with a high-performance CPU, the money-saving virtual programmer's console, the automatic self-testing diagnostic designed into its micro-code and bootstrap ROM, and 16K words of parity core or MOS memory.

From there it gets bigger but never slower. The 11/34's memory management and extended instruction set give you up to 124K words of memory. Without loss of throughput speed. And all of this for less than \$6,318.*

Picking up precisely where the 11/04 leaves off, the 11/34 can carry your product line in carefully calculated steps to new performance highs and into sales opportunities you've never had before.

Any system using an 11/04 today can use an 11/34 tomorrow.

The 11/34 and 11/04 have identical UNIBUS™ architecture, and both take their commands from totally compatible operating software and instruction sets. They use the same spare parts, and drive exactly the same peripherals. The only difference is the CPU. The compatibility is literally years ahead of its time.

To get an idea of what this compatibility might mean to your business, turn the page.

PDP-11/04

Price: From \$2,581*
Word Length: 16 bits
DMA Rate: 1.4M words/sec
UNIBUS™ Rate: 2.5M words/sec
Addressing Space: 32K words
Memory:
8K, 16K, 28K words MOS
memory
8K, 16K, 28K words core
memory

Contains Standard PDP-11/04 –
11/34 Features:
Direct Memory Access
Vectored Automatic Priority
Interrupt
Virtual Programmer's
Console
ROM diagnostics
Power-Fail/Restart
UNIBUS™ Architecture
More Than 400 Instructions
Operating Systems: RT-11, RSX-
11M, RSX-11S
Physical: 5¼" x 19" wide x 25" deep
10½" x 19" wide x 25" deep

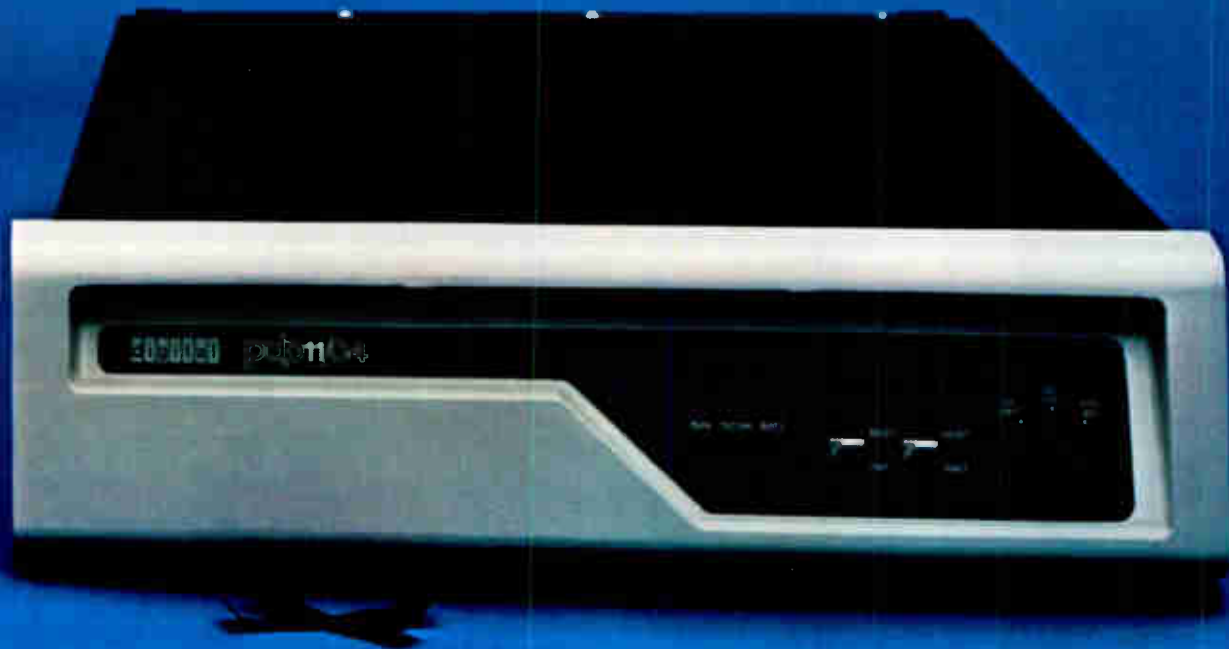

The 11/04 and the 11/34. The Twin Minis that cut the cost of change.

Yesterday small changes in an OEM system made big dents in OEM profits. Starting today you can make changes big or small and make money on every one of them.

Because at last you can completely upgrade a system in as many as 22 different steps without redesigning it in the slightest.

All your design costs, manufacturing costs, inventory control costs, software costs, spare parts costs, training costs, retraining costs and service costs will be cut. Dramatically.

Instead you can begin to look at pin-point packaging, expanded markets for your products, new trade-up opportunities and new applications.

The Twin Minis from Digital. There's never been anything just like them.

For more information on the PDP-11/34 and 11/04, fill out the coupon below, or write to Digital Equipment Corporation, PK3/M28,

Maynard, MA 01754. (617) 897-5111. European headquarters: 81 route de l'Aire, 1211 Geneva 26. Tel: 42 79 50. Digital Equipment of Canada Ltd.

digital

50,000 Computers Saving Managers Millions.



Gentlemen:

I want to know more about the new Twin Minis.

- Please send your brochure, "Introducing the PDP-11/04 and PDP-11/34. Two Sure Ways to Reduce Your System Costs."
 My need is more immediate. Please have a salesman call.

Name _____ Title _____





Company _____ Telephone _____

Address _____

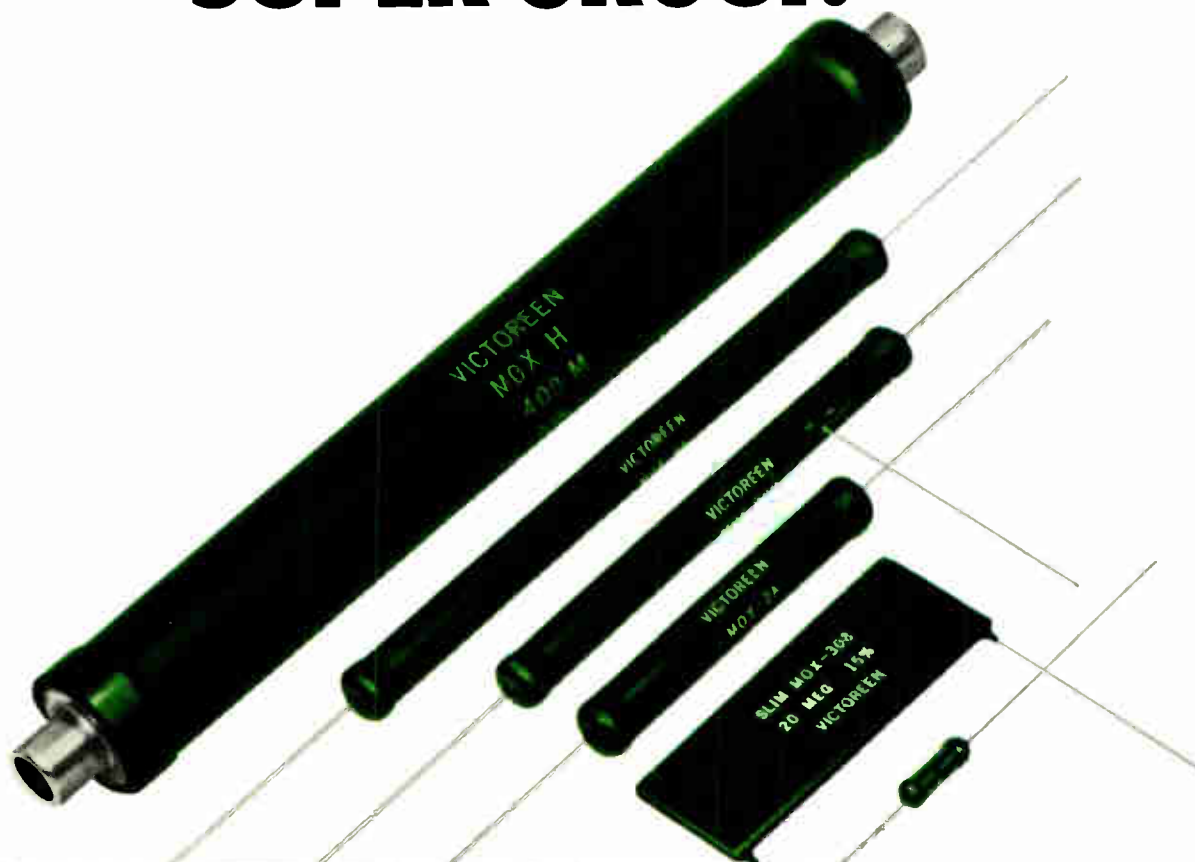
City _____ State _____ Zip _____

THE HIGH VOLTAGE SUPER GROUP.



Type	Resistance Range	Power Rating At 70 C	Max Operating Volts	Temp. Coef. Rating (-55 C to +125 C)	Maximum Dimensions (Inches)
Slim-Mox 	1 M Ω to 5000 M Ω	5W	18,000 V	± 250 ppm	Length 2.08 Height .84 Thickness .860
Mini-Mox 	100 k Ω to 10,000 M Ω	.25 W to 1.4 W	1000 V to 5000 V	± 100 ppm to ± 1000 ppm	Length .470 to 1.310 Dia. .140 or .165
Divider-Mox 	4.5 M Ω to 2000 M Ω	1.5 W to 6.0 W	7.5 kV to 30kV	± 100 ppm to ± 1000 ppm overall TCR Tracking ± 25 ppm	Length 2.2 to 5.2 Dia. .345
Maxi-Mox 	10 k Ω to 5000 M Ω	1.5 W to 12.5 W	7.5 kV to 37.5 kV	± 100 ppm to ± 500 ppm	Length 1.122 to 5.2 Dia. .310 or .345
Power-Mox 	20 k Ω to 7000 M Ω	22.5 W to 45 W	20 kV to 45 kV	± 100 ppm to ± 300 ppm	Length 3.96 to 6.96 Dia. .89

MOX resistors from Victoreen. The high voltage experts.

What's your problem? Space? Economy? Stability? Better tolerance? Here's one solution to all of the above. The Victoreen MOX high voltage resistor line.

From Mini-MOX to Power-MOX, you'll find that the people at Victoreen know how to make you happy. We know how to give you resistor performance that allows more design flexibility. And product reliability.

MOX resistors are the high voltage designer's solution to problems caused by other resistors.

The tougher your high voltage resistor requirements, the more you need our advanced, reliable MOX magic.

Send for complete technical data. Write: Victoreen Instrument Division



10101
Woodland
Avenue,
Cleveland,
Ohio 44104

SG SELLER-GLOBE CORPORATION

THE J325 IC TEST SYSTEM. THERE'S A SPECIAL PREMIUM IN EACH ONE.

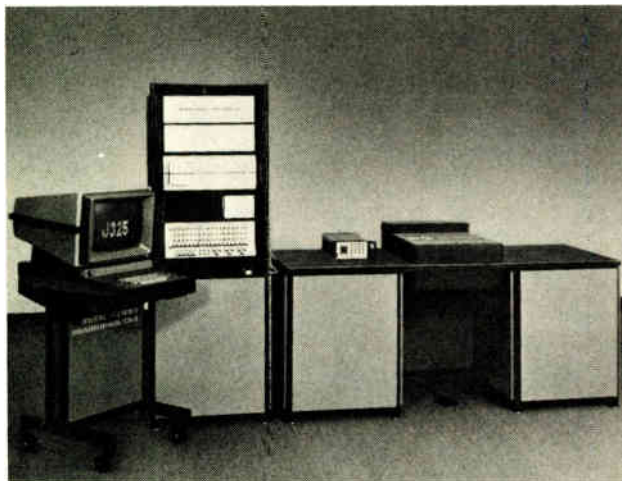

The premium is productivity.

To squeeze every last bit out of the J325 digital IC test system, we combined a single mainframe with two optimized test stations, one for ECL, TTL, and DTL, the other for CMOS and static MOS.

The CMOS/MOS station gives you low current and differential voltage measurements, programmable clock phases, and comparator strobe delays. The ECL/TTL station provides solid-state switching, low noise, one millivolt resolution, and subnanosecond time measurements with the optional S357 add-on. The system can handle up to four of these stations in

whatever combination is most productive for you.

The J325 really shines on the production line, but it also delivers excellent service in incoming inspection, device evaluation, and QC. To help make your operation even more productive, the system feeds back Schmo plots, distribution analyses, summary sheets, wafer maps, and full datalogging of all tests.

We back up the J325's productivity with our unique 10-year circuit module warranty and a global service program supported by local parts stocking centers. We also provide all software, interfaces to probers and handlers, and ongoing applications support.

System design will always be a question of trade-offs. At Teradyne, we'll always take the alternatives that give our systems the greatest productivity. And we'll continue to build them in a way that guarantees they'll remain productive for as long as they're needed. Productivity is something you can't have too much of.

Teradyne. 183 Essex Street, Boston, Massachusetts 02111.
In Europe: Teradyne, Ltd., Clive House, Weybridge, Surrey, England.

WE SELL PRODUCTIVITY.

TERADYNE

CHICAGO (312) 298-8610 / DALLAS (214) 231-5384 / NEW ENGLAND (617) 458-1256 / NEW YORK (201) 334-9770
SUNNYVALE (408) 732-8770 / LONDON (0932) 51431 / PARIS 073 16 98 / ROME 59 47 62 / MUNICH (089) 33 50 61 / TOKYO (03) 406-4021

Spring: Paris show and optimism

Signs of upturn are budding all over Europe's components business as consumer sector blooms; but recovery in other areas is still delaying

The atmosphere last year at the annual Paris Components Show was something like a wake. Any gaiety there merely glossed over the dismay about dear, departed order backlogs. But this year's show figures to be more like a coming-out party because the signs point to an upturn for the components business in West Europe.

To be sure, marketing men from the 1,000-odd companies with booths at the show (April 5 to 10) won't be chorusing "happy days are here again" as they troop into the exposition halls at the Porte de Versailles. But color-TV sales have perked up, and set makers are buying more components. That's enough to start turning the market around, since the consumer area is a kingpin in Western Europe.

Better yet, the upturn so far has been strongest in West Germany, the pace-setting economy in the nine-nation European Economic Community. Almost all German marketing managers agree that their home components industry is on the rebound, and some foresee a stronger boom than the one in 1973-74.

Semiconductor suppliers suffered worst during the slump but are surfacing fastest now. Erich Gelder, marketing manager for integrated circuits at Siemens AG, notes that bookings have been running much higher than billings during the past few months. "The volume of incoming orders is beyond our expectations and signals a real upswing," agrees Gerhard Liebscher of Intermetall GmbH, part of the ITT Semi-

conductor group. Fritz G. Hoehne, manager for world semiconductor sales at AEG-Telefunken, reports that bookings for his firm are heavy, too.

"It is primarily color TV, but also radio and hi-fi, that's providing the push," comments Hoehne. Production of color sets this year will hit 2.6 million units, predicts the electrical-electronics industries trade association ZVEI. That's up substantially from last year's estimated 2.1 million. With set builders' prospects like that, Hoehne is looking for a rise of something between 15% and 17% for semiconductor sales in Germany. Consumer analog circuits and ICs for remote controls are in for a big lift, so much so that users are now getting nervous about deliveries. Optoelectronics devices are profiting, too, since they're turning up in dials and in remote TV sound systems.

Turn from entertainment electronics, though, and the outlook dims fast. Orders from the industrial sector are "still unsatisfactory," Liebscher, Hoehne, and Gelder agree. "But it's showing signs of re-

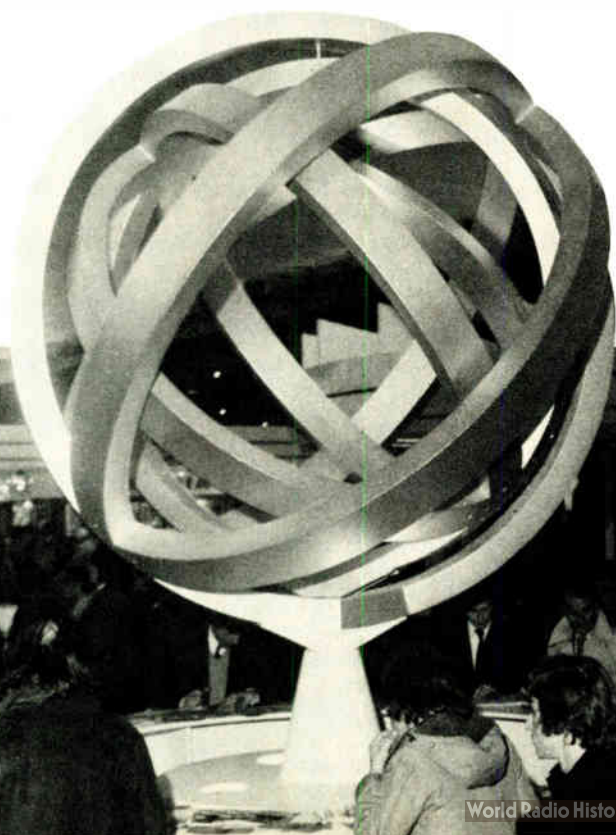

The only thing more reliable than these solid state sensors is the company behind them.

MAGNETICALLY OPERATED 103 SR MONITORS AND CONTROLS OPERATION OF CONVEYOR SYSTEMS IN REMOTE AREAS.

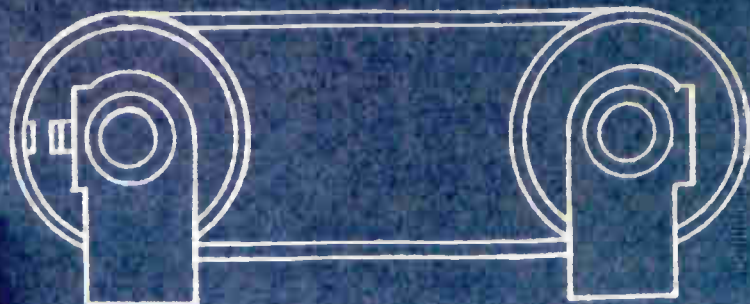

THE XK PROXIMITY SENSOR IN COMPUTER TAPE TRANSPORTS REVERSES TAPE REELS BY SENSING FERROUS FOIL AT END OF TAPE.

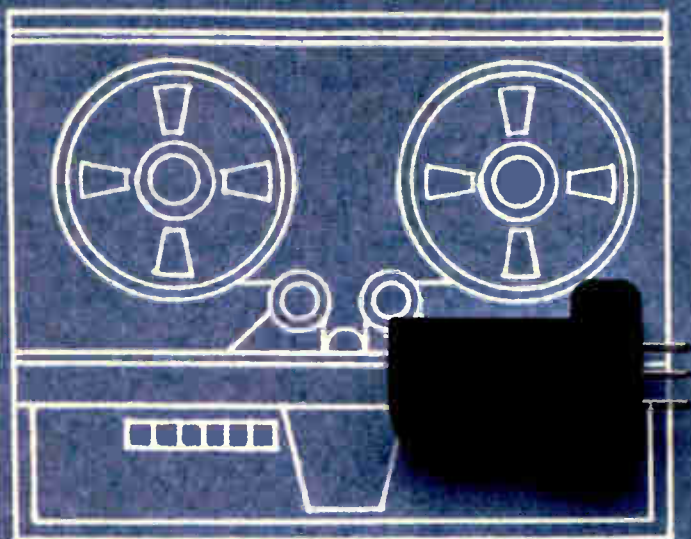

VANE OPERATED AV POSITION SENSOR INSURES THAT ELECTRONIC SEWING MACHINES WILL REMAIN IN THE SELECTED MODE.

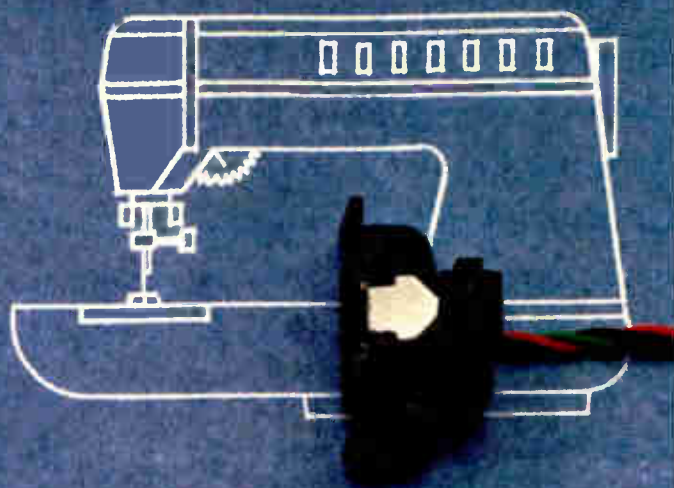

XL MECHANICALLY OPERATED SOLID STATE SWITCH USED IN MANY LIMITING FUNCTIONS ON COMPUTER PRINTERS AS IN THE CARRIAGE RETURN, PAPER SUPPLY, ETC.

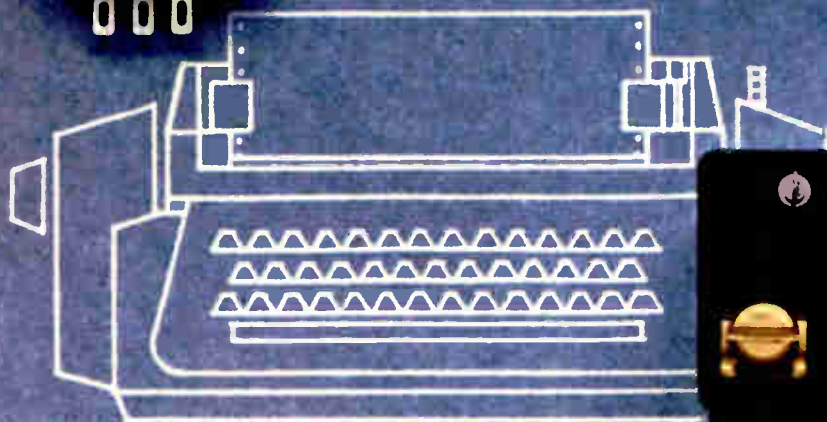

ES HALL EFFECT CURRENT SENSORS USED IN PRINTERS TO PREVENT CURRENT SURGE FROM DAMAGING EQUIPMENT.



who knows more about solid state switching technology than the company that pioneered the solid state keyboard in 1968?

That's why so many designers want the MICRO SWITCH name on their solid state sensors.

MICRO SWITCH makes a wide variety of maintenance-free solid state sensors. Proximity sensors. Current sensors. Mechanically and vane operated sensors.

Choose between 5 VDC or 16 VDC with a built-in voltage regulator. All offer zero speed operation with some up to 100 rpm. And all offer broad temperature operating ranges of -40° to +150°C. Each one is ruggedly constructed for long life. The Hall effect IC has been performance-tested through billions of operations without failure.

And what MICRO SWITCH solid state sensors don't do is just as important as what they do. There's "no touch" operation. There's no contact bounce. Most are unaffected by dust and dirt.

You'll find them in everything from medical to computer equipment. From tachometers to home appliances. But that's only natural.

MICRO SWITCH has been a leader in its field since we introduced the first snap-action switch in 1932. We've established a reputation for dependability, not only in our products, but in our service. But don't take our word for it. Just ask someone who's used a MICRO SWITCH product.

If you believe there's more reliability than solid state construction, choose MICRO SWITCH. You'll get all the advantages of solid state design, and all the advantages of MICRO SWITCH technology and experience.

For more information, call your nearest MICRO SWITCH Branch Office or Authorized Distributor.

MICRO SWITCH

FREEMONT, ILLINOIS 61032
DIVISION OF HONEYWELL

MICRO SWITCH products are available worldwide through Honeywell International.

Circle 61 for Data;
89 for Salesman call.

Probing the news

covery," says Siemens' Gelder. For his part, Intermetall's Liebscher, who says the auto industry is also a plus factor, is hoping for an improvement during the second half for things like transistor-transistor logic and power semiconductors.

France's changes. Much the same outlook prevails in France, only a little less so. "We can say we have the feeling—but not the certainty—that there's been a new departure," says Pierre Mestre, who heads Thomson-CSF's components group.

For Thomson-CSF, France's largest components maker, and for most other producers as well, a new departure means an upswing after a very bad 1975. Mestre's group, for example, saw its sales dip 4% to roughly \$310 million and its profits turn to losses. (Other components-producing units in the Thomson-Brandt group—mainly for TV tubes, ferrites, relays, and transformers—did roughly \$150 million last year, so that overall the parent group was up slightly for the year in current francs, down slightly when inflation is figured in). As Mestre put it, "1975 is a bad memory that we'd like to forget." To exorcise the memory, the components group has budgeted a 15% sales rise this year.

Last year left a bitter taste in the corporate mouth at RTC-La Radiotechnique-Compélec, too. RTC, a Philips group company that ranks second in France among components makers, saw its sales slide 8.5% to roughly \$260 million.

As in Germany, the most cited signal that an up cycle has started is the strong performance of the color-TV market. At the Fédération des Industries Electriques et Electroniques, forecasters now put their estimate for color-set sale at around 950,000 sets, up a gaudy 100,000 sets from last year. Says an FIE official, "We registered a spurt starting the end of August, and we've stayed at a high level ever since."

But again as in Germany, other sectors are labelled "remain to be seen." Now that the Honeywell-Bull-CII fracas has been resolved, the computer sector should liven up. But the massive switching orders ex-

pected from the government-run phone network are still tied up in politics; the business that will eventually come from them seems unlikely to filter down to components makers much before late this year. As for the industrial sector, "We're paying for the lack of investment by industry in 1975," observes Daniel Ameline, head of RTC's Semiconductor division.

UK further away. As yet, there's hardly a wisp of smoke to signal that the fires of the British economy have been rekindled. But there's conviction in some quarters that something might start happening late this year. K.G. Corfield, deputy chairman and managing director of the ITT-owned Standard Telephones and Cables, for example, predicts a distinct upswing for the British economy in late 1976, then a takeoff in 1977 paced by consumer durables, entertainment electronics, and light industrial machinery.

A more cautious view is held by Ken Bradshaw, sales director, Plessey Semiconductors. The market is "still soft," in his view, with no chance of any basic growth "before the third or fourth quarter this year." Although there are signs here and there of an upturn, Bradshaw's "not sure whether it's salesmanship or buoyancy in the market *per se*."

Unsunny Italy. Until the crisis of the lira escalated into outright panic in mid-March, Italian component makers thought they had a real pickup going for them. Now that the value of the lira has plummeted some 30% and the government has patched together a package of restraints to cool the feverish economy, nobody's quite sure.

Just before things went from bad to worse, Enrico Villa, planning manager for the Italian semiconductor house SGS-ATES, happily reported that "for five months now the number of incoming orders has been about 20% higher than shipments." At the beginning, there was some doubt over how much of this was because of real growth and how much merely the result of stock-rebuilding. "Now we know for sure that color-TV consumption is actually going up," he said. □

Contributing to this article were William F. Arnold, John Gosch, and Andrew Heath. It was written by Arthur Erikson.

Microprocessors

European gold rush under way

Local semiconductor houses want piece of market pegged at \$150 million by 1980, while American makers rush to line up second-source deals

by Arthur Erikson, Managing Editor, International

Western Europe is a far cry from the Klondike, but all the same there's a gold rush of sorts on there among American and European microprocessor makers.

The lode they're after is formidable, indeed. Last year's sales of microprocessor chips—central processing units, memories, input/output controllers, and the like—ran something like \$10 million. At least that's the opinion of four of the heavyweights in the market. The figure will bounce up above \$20 million this year, they expect. By 1980, \$150 million looks likely, and by the mid-eighties the market should top \$750 million a year, perhaps by a lot if European entertainment-electronics producers take to microprocessors as fast as semiconductor suppliers hope they will.

Even so, the band of prospectors is so large that not everyone can

count on striking gold. So far, Intel Corp., as in the U.S., has staked out the largest claim in Western Europe, and the list of would-be claim jumpers adds up to the roster of all of Intel's major American competitors. The scramble for market shares figures to be even more hectic there than here. Lured by the burgeoning market, Europe's semiconductor houses are getting into microprocessors fast, either with their own designs or with second-source chips. At the April 5-10 Paris Components Show, for example, the Philips group, Siemens AG, AEG-Telefunken, SGS-ATES, and Thomson-CSF's Sescosem division will all have microprocessors to talk about.

Siemens has set its sights the highest. Erich Gelder, marketing manager for integrated circuits, believes the company can nail down half its West German home market

by 1980 and win "adequate" shares in other West European countries, enough to have between 20% and 25% overall.

To score that high, Siemens will field technology from both sides of the Atlantic. It has signed a contract with Intel that calls for cooperation in both microprocessor hardware and software, with second-sourcing both ways. So Siemens now offers its versions of Intel's standards—4004/4040, the 8080, and the 3002—and one of its own, the 4-bit SAB 4080. "In addition to a complete program of standard circuits, our aim is to have an array of applications-oriented devices of our own design, complete with input/output circuits," Gelder points out. Siemens has also thought about software and has gone to market with an entire programing station.

Philips Gloeilampenfabrieken, too, is convinced it can propel its wholly owned U.S. semiconductor house, Signetics Corp., into a strong market position. Far and away the largest Europe-based electronics group, with total sales of over \$10 billion last year, the Dutch firm has a components-sales force that blankets Europe. That, plus an inside shot at a big captive market, gives Signetics considerable market muscle. "As these new salesmen get trained, I think we will dominate the European market," enthuses George Rigg, Signetics' microprocessor manager in the U.S.

Back in Eindhoven, at Philips headquarters, the optimism is more muted. Kurt Noach, marketing manager for microprocessors at the Elcoma division, sees a chance for Signetics to skyrocket from next to

Think soft. Siemens, in addition to second-sourcing Intel and offering its own processor, is going to try the European market with this complete microprocessor programing station.



If reliability's giving you a devil of a time, Thermopad power will keep the gremlins out

THERMAL EXPANSION SPOOK

An uncoordinated, disoriented monster who makes things come apart at the seams when the heat's on, and off, particularly above 75 C. Thwarted by closely matched coefficients of expansion in all Thermopad II dice, solder, leads, headers and encapsulant.

HERMETICITY HOOLIGAN

Dirty, ragged contaminator whose instant touch condemns exposed collector-base junctions to fates worse than death: excessive leakages, weak knees, jitters and snapbacks. Stopped before he starts by instant application of super-reliable Motorola glass.

UNSAFE OPERATING OGRE

Laughing, elusive fiend who strikes terror, and holes, in the best-armed calculations of designers. Never totally vanquished but best defined and held at bay through 100% testing of Thermopad II capabilities under actual operating conditions.

SOFT SOLDER DICKENS

A lazy, lead-footed hypocrite who promises stress-relief between die and header but invariably hardens his heart against it causing total thermal characteristic decay. Banished forever by Thermopad II proprietary gold eutectic hard solder bonding.

FICKLE WIREBOND FURY

Likes to team with the Dickens to strain wires or drive wedges between base-emitter lead connections during power cycling. Creates discontinuity and doubt in performance. Exorcised by fatigue-resistant Mg-Al wires.

FOGGY-HEADED HARRY

Creeps in on little cat feet through unnoticed cracks and crevices splashing open disorder all over the place. Hung out to dry by proprietary Thermopad II 5021 compound and high-pressure mold equipment.

HOT-TEMPERATED TROLL

#1 rabble rouser, incites other imps to riot, normally preys on individuals with no internal fortitude, stressing them beyond limits of endurance. Stopped cold by total engineering behind Thermopad® II construction and testing.

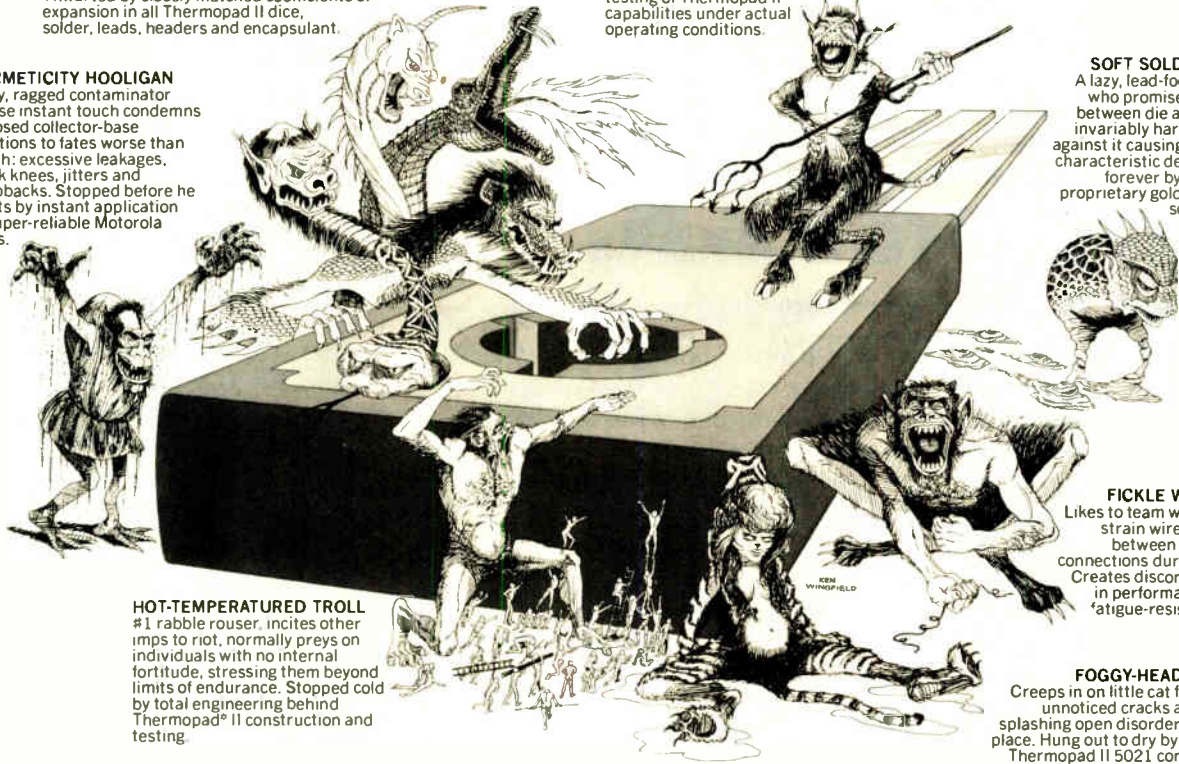

Motorola's got a lot more reliability going for you in plastic power than any other manufacturer. Find out in a new engineering bulletin from your authorized distributor, your nearest field sales rep, or Box 20912, Phoenix 85036. We won't fail you.

Hallelujah.

*Trademark Motorola Inc.

 **MOTOROLA POWER PRODUCTS**

SUPERPOWER

unlimited

Electronics/April 1, 1976

Circle 63 on reader service card 63

pulse-code-modulation voice coder/decoder (codec) system now

C-MOS. Although details are sketchy, Signetics Corp. is considering a

rays, rather than the traditional resistive arrays.

Electronics/April 1, 1976

65

in the top three with Intel and Motorola.”

With that in mind, Philine has

will use a smaller chip and provide a faster instruction time—1.5 microseconds instead of the 2.4 μ s of its

There's
still
nothing
like
them.

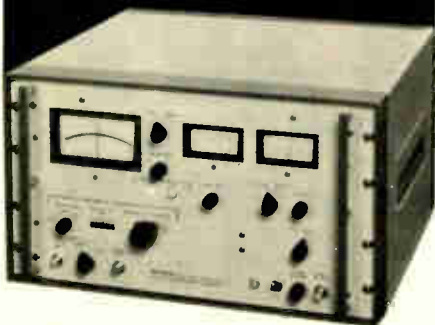

The PRD 915-B Attenuation Calibrator has long been in a class by itself.

It measures up to 110 dB in a single step, and achieves an accuracy of ± 0.03 dB/10 dB with only -80 dBm input power. It's *the* lab/production line instrument for attenuator calibration, extreme VSWR measurements, noise measurements, and sensitive detection in reflectometers, plasma diagnostics, etc.



The PRD 819-A Klystron Power Supply saves a jumble of power supplies, meters, and haywire connections. It provides universal operating potentials and modulation capabilities for low and medium power microwave and millimeter klystrons to 3,600 volts and 100 milliamperes.

Looking for quality microwave components? Ask for our new RF and microwave product catalog. Call (516) 334-7810. Or write: Harris Corporation, PRD Electronics Division, 1200 Prospect Avenue, Westbury, L.I., N.Y. 11590.



Communications

Courts get FCC ruling

Common carriers to appeal decision that phones may be hooked to network without protective devices

by Ray Connolly, Washington bureau manager

A counterattack is forming against the Federal Communications Commission's decision to remove the last barriers to so-called foreign attachments for the telephone network. For that reason, independent telephone-terminal makers are proceeding slowly with marketing plans.

On one front, the U.S. Independent Telephone Association, made up of carriers not affiliated with the Bell System, has promised to appeal the decision in the Federal courts. And on another, AT&T chairman John D. deButts warns that AT&T would "call public attention to the fact that quality and cost of telephone service for millions of Americans will be adversely affected by this decision."

The North American Telephone Association, representing independent terminal-equipment vendors,

was predictably pleased with the ruling. NATA has estimated that competition in terminal interconnection could lead to a 50% penetration of the Bell System's market by 1980 and reduce AT&T's capital costs by \$600 million to \$800 million a year over the next five years [*Electronics*, Nov. 27, 1975, p. 40].

The FCC's 5-2 decision effectively broadens one made in November, which also is being appealed in court by Usita. The latest decision will permit interconnection of approved PBX switchboards, main stations, and key-switching telephones directly to the telephone network without protective interface devices. The decision on interconnect Docket 19528 ran counter to earlier recommendations from a Federal-state joint board of regulators. But it was not unexpected in view of last

Listening. Sellers of telephone equipment, such as this Manhattan store, would benefit from the FCC decision permitting interconnection of PBX, main station, and key phones.

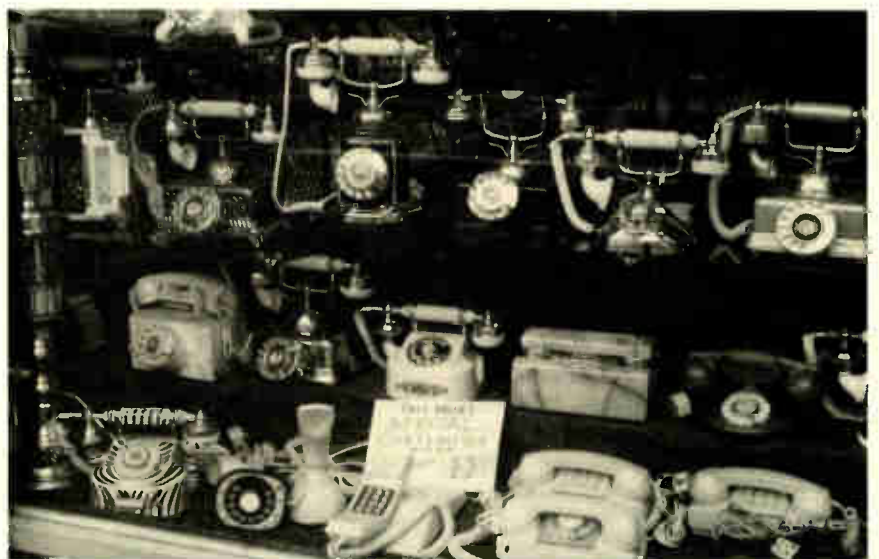

November's ruling that favored direct interconnection of data modems and ancillary terminal equipment the FCC approves under a new equipment-registration program [*Electronics*, Nov. 13, 1975, p. 38].

Exemptions. Party-line and pay telephones are exempted from direct interconnection, the FCC said, but registered data modems and ancillary devices may be interconnected after May 1, and registered PBX and key systems may be interconnected after Aug. 1. But, even if the Usita appeal of the initial November interconnect ruling is reopened to permit inclusion of the latest decision on PBXs and key systems, a decision is not expected before that date.

And while the FCC action elicited a minority dissent from commissioner Benjamin L. Hooks, the decision was strongly supported by John Eger, acting director of the White House Office of Telecommunications Policy.

AT&T's deButts not only promised to take his case to the public—an apparent allusion to the company's effort to gain congressional support for legislation to limit competition [*Electronics*, March 18, p. 60]—but the company has warned that the cost of service will increase. AT&T has previously suggested that residential-service charges could soar as much as 75%.

Although prices for phones vary widely across the country, in New York City, the basic charge for a residential phone is \$7.34 a month and extensions cost about \$1 a month each. A business phone there costs \$12.29.

AT&T and other carriers will be obliged to participate in the equipment registration plan, but the FCC has eased the burden of registration on carriers by exempting all items of equipment except PBXs and key telephones already connected by May 1. These may continue to be connected through Jan. 1, 1977, "and may remain connected for life, without registration, unless subsequently modified." All PBX and key telephones of the type connected by Aug. 1, the FCC said, may continue to be connected through Jan. 1, 1977, also under the same conditions. □

This is an echo chamber?



Yes, and much more! It is the first N-channel Bucket Brigade Device designed with the audio engineer in mind. The **SAD-1024 Serial Analog Delay** will provide reverberation, echo, tremolo, vibrato and chorus effects in electronic organs and musical instruments. It will equalize speaker systems in an auditorium, or can be used in speech compression or voice scrambling systems. The SAD-1024, which contains two independent sections of 512 analog storage elements will accomplish all of these with a signal-to-noise ratio in excess of 75 dB. The two sections may be used independently or they may be connected in sequence to provide 1024 clock periods of delay. The delay provided by the device can be continuously varied by the clock rate from less than one millisecond to more than one second.

Other performance characteristics include: Signal bandwidth from 0 to 200 KHz, less than 1% total harmonic distortion, 0 dB insertion loss, and less than 5 mW power requirements from a single 15V power supply.

You get all of these features for less than 1¢ per storage element in OEM quantities.

We also offer a complete circuit card to help you evaluate this exciting new device. Other devices for applications such as time base correction in the video bandwidth are also available.

There are over 70 salesmen and 16 distributors to serve you worldwide.

RETICON®

910 Benicia Avenue
Sunnyvale, California 94086
(408) 738-4266 • TWX: 910-339-9343

THE DETECTORS

Tough infrared measurement problems are no match for The Detectors . . . Sensors' rugged, reliable, low cost thermopile detectors.

Whatever your application . . . from temperature monitoring, spectrophotometry or pollution monitoring to intrusion and fire detection, horizon sensing instrumentation or laser power measurement, The Detectors are ready to help you solve it.

One of The Detectors has the precise combination of high D*, convenient resistance range, excellent responsivity, fast time constant and broad spectral response for your specific application.

Learn about the entire Sensors' line of thin film thermopile detectors. Ask for the free brochure now.

 **sensors, inc.**
3908 VARSITY DRIVE
ANN ARBOR, MI 48104
TEL: (313) 973-1400

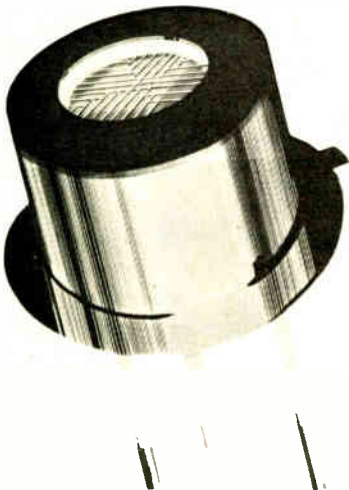

68 Circle 68 on reader service card

Probing the news

You and your career

Rivers charts campaign for IEEE presidency

Board member seeks place on ballot utilizing flow chart showing 'everybody else twists knobs of engineer's career'

by Gerald M. Walker, Associate Editor

Presidential candidates can determine their positions on the issues in a number of ways. They take polls, talk to leaders, or just evolve views over the years. But Robert A. Rivers, who is seeking a spot on the IEEE ballot by petition, has a unique approach to delineating his campaign platform: a systems approach.

Rivers, the 53-year-old president of Aircom Inc. of Union, N.H., is joining Robert Saunders of the University of California, the nominee of the institute's board of directors, and Irwin Feerst, the perennial petition candidate, in this year's race for the presidency. The basis of his platform is a complex flow chart covering a 22-by-30-inch sheet of graph paper that he describes as a representation of the engineer's career development. The chart has enabled Rivers, a member of the IEEE board representing Division 4 and a member of the IEEE's manpower commission, to pick what he sees as the institute's weaknesses.

The chart shows all the governmental, industrial, and academic in-

fluences on this environment. Rivers took some three years to develop his analysis. "This chart essentially shows that we have a system operating in which the engineer is performing his services, but everybody else is twisting the knobs of the engineer's career," he says.

Influence sought. Rivers contends that the institute can become an influential force on the career environment. He has identified 67 goals in seven categories—27 of them under the heading of a lifetime career with adequate compensation.

A strong believer in the systems approach to any problem, Rivers has outlined in matrix form the various segments of the institute that must participate in implementing these goals. For example, the goal of eliminating age discrimination in engineering employment includes participation by staff and member committees in public rela-

In his hands. Robert A. Rivers holds flow chart, three years in the making, with which he illustrates EE's career development.





If you're thinking about integrated circuits for communications products, you should be thinking about Micro Power Systems.

Micro Power Systems is one of America's leading producers of custom integrated circuits. Our business is helping original equipment manufacturers exploit the advanced semiconductor technologies to improve performance and reduce costs.

During the past five years, we have helped design and produce numerous proprietary LSI circuits for our customers in the fields of digital time-keeping, instrumentation,

medical electronics, and communications.

We now possess a unique capability for development and production of specialized ICs for use in communications equipment. If you have an interest in any of the following circuits, or related devices, we urge you to contact us immediately:

- Digital and phase-lock loop frequency synthesizers
- Integrated audio and transmit circuits

- Completely integrated CB radio receivers
- Integrated scanning monitor circuits
- Pocket pager RF and decoder ICs

Our knowledge of the custom LSI approach can help you to evaluate its potential benefits in your own terms. If your need is immediate, we invite you to contact Bob Sabo or Rich Koury at (408) 247-5350.

We sell more than circuits. We sell solutions.



3100 Alfred Street, Santa Clara, California 95050

CHECK DIGITAL IC'S FASTER THAN A SCOPE, SAFER THAN A VOLTMETER

You're looking at the most convenient and efficient way developed to check digital IC's: CSC's Logic Monitor. It speeds digital design and testing by accurately and automatically displaying static and dynamic logic states of DTL, TTL, HTL and CMOS DIP IC's. All in a compact, self-contained 16-pin circuit-powered unit.

Use it to effortlessly trace signals through counters, shift registers, gating networks, flip-flops, decoders... even entire systems made up of mixed logic families. It's a great way to cut minutes, even hours all along the line from design through debugging.

Nothing could be simpler: just clip it over any DIP IC up to 16 pins, and the Logic Monitor does the rest. Precision plastic guides and unique flexible web insure positive connections between non-corrosive nickel-silver contacts and IC leads. Each contact connects to a single "bit" detector with high-intensity LED readout, activated when the applied voltage exceeds a fixed 2V threshold. Logic "1" (high voltage) turns LED on; Logic "0" (low voltage or open circuit) keeps LED off. A power-seeking gate network automatically locates supply leads and feeds them

to the Logic Monitor's internal circuitry.

Very clever. Very portable. Very effective. And very reasonable, at \$84.95*. See the Logic Monitor at your CSC dealer, or write for our catalog and distributor list.



CONTINENTAL SPECIALTIES CORPORATION



EASY DOES IT

44 Kendall Street, Box 1942
New Haven, CT 06509 • 203-624-3103 TWX: 710-465-1227
West Coast Office: Box 7809, San Francisco, CA
94119 • 415-421-8872 TWX: 910-372-7992
Canada: Len Finkler Ltd., Ontario

© 1976, Continental Specialties Corp.

*Manufacturer's suggested price. Prices and specifications subject to change without notice.

70 Circle 70 on reader service card

Probing the news

tions, administrative liaison, legislative liaison, employment practices, manpower, ethics, placement, license and certification, accreditation, education, publications, member contact, technical forecasts, and survey activities.

As impressive as the career-environment chart and the goal matrix may be, do they reflect the members' needs? "Each member has different needs," Rivers remarks. "So far the institute has been in a 'survey mode:' it polls the members to find out the problems and then tries to act on the results of the poll.

"In the 'leadership mode' that I propose to follow, the candidate for office suggests what the problems are and what the solutions are, then sees if the members want to endorse those solutions."

Issues defined. Among the most important issues is age discrimination, which definitely affects the EE's lifetime career. Rivers states flatly that the "nice guy" approach to industry—that is, friendly persuasion to try to change company policies—is not good enough.

"If you want to control the environment under which people practice engineering so it can operate in a long-term mode, there are several ways of going about it," he says. "One of the ways is to make changes in the statutes, so that companies are in equal competitive position with regard to long-term employment practices.

"Another way is to identify employers that already use employees in a long-term mode and make it easier for them to get the best engineers. The companies on the other end of the scale should be deprived of engineering services and not be able to produce a product. A third way is to support test cases of age discrimination."

Another hot issue is the control of the quality and quantity of engineering graduates. Says Rivers, "Anything that destroys the lifetime-career concept is against the best interests of engineers. Many schools have short-term interests—enrollments—when we are concerned with long-term problems." □

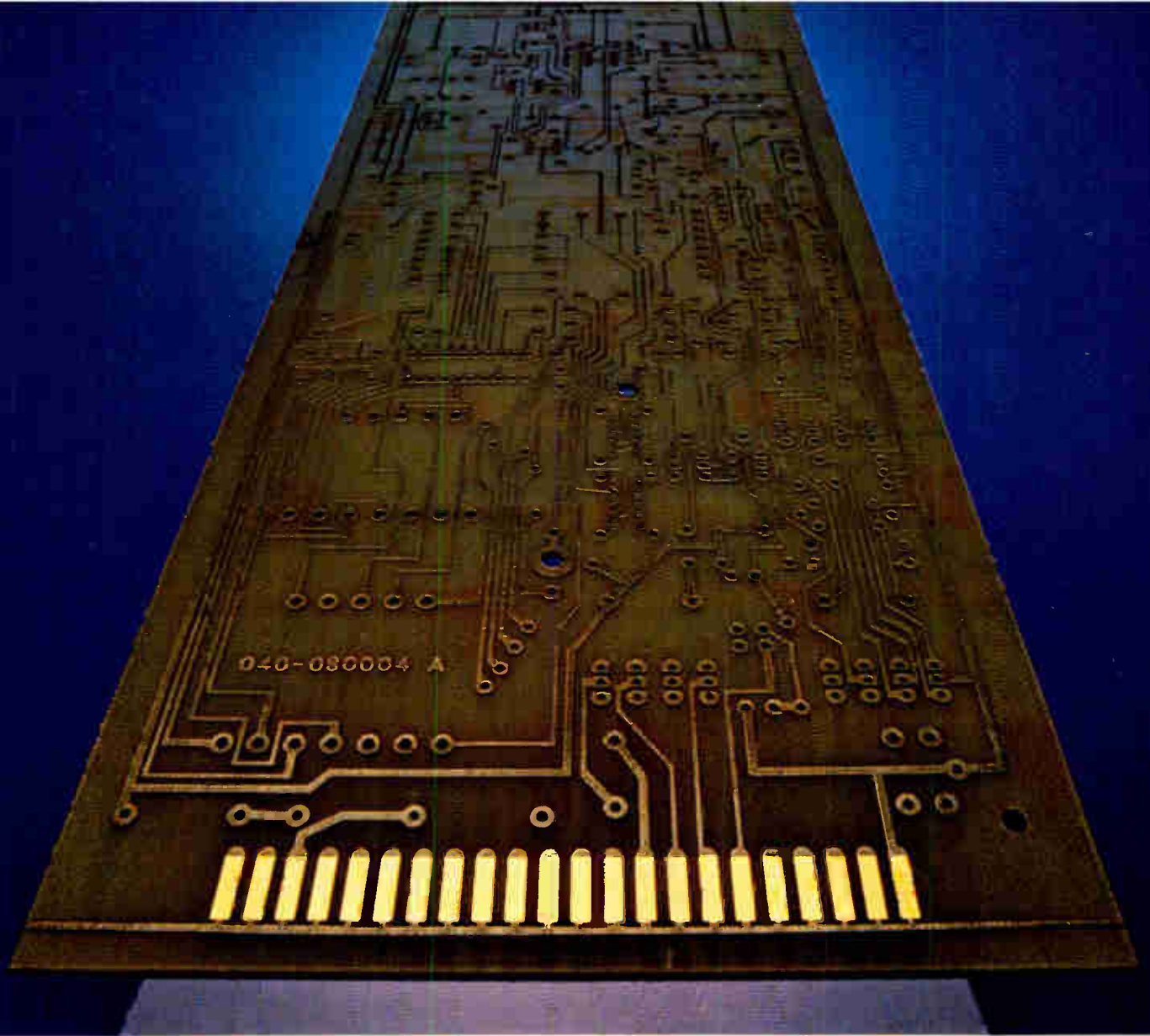

How much gold can new RISTON* Phototape save you?

Perhaps, quite a bit. We call RISTON Phototape "the gold-saver" because it eliminates wasteful plating of busbars and robber's edges. And that means less gold for the reclaiming process.

RISTON Phototape also makes more sense, since it uses the same equipment as your RISTON dry-film process. With a minor modification of your RISTON HRL-24 Laminator, you

can increase productivity and reduce the operating cost of your yellow room.

Ask your RISTON Technical Representative to show you just how much gold you can save with RISTON Phototape. And you'll get an obvious bonus in high-quality board work with the sharpest lines of demarcation.

RISTON Phototape—another innovation from Du Pont—brings the accuracy of dry-film photo-imaging to

your plating operation. It's part of Du Pont's commitment to bring increased productivity and higher-reliability to your board-making systems.

Call your Du Pont RISTON Technical Representative today. Or write: Du Pont Company, Room 25007, Wilmington, Delaware 19898.

*Registered U.S. Pat. & Tm. Off. for Du Pont's processable dry film photoresist system.

RISTON Division



Electronics
World Radio History

Circle 71 on reader service card

Are you using your \$20,000 mainframe set-up wisely? If you're using it to sweep anywhere in the 1 MHz to 1.4 GHz range, then you know it's only doing a fraction of the job you bought it for.

But think about this: if you used a Wavetek Model 2001

Sweep/Signal Generator instead of a plug-in to work below S-Band, your mainframe would be free for other high frequency testing at the same time.

Besides its range of 1 MHz to 1.4 GHz,

the Model 2001 has an output of 10mW that's flat to within 0.5dB. This solid-state designed unit features excellent linearity and low spurious content. Plus, the 2001 is programmable—with remote control of center frequency, bandwidth and output level over the

20dB range of its PIN diode attenuator. Not to mention its start/stop mode of operation, (in addition to Δf), or its flexible birdy by-pass marker system.

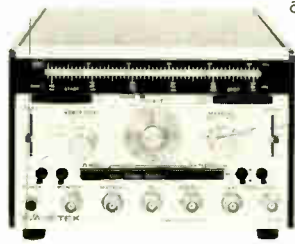

Now let's get down to prices. An equivalent low-frequency sweep plug-in will run you at least \$2,200. And it'll tie up your mainframe while you're using it.

On the other hand, you can get a Model 2001 for just \$1,850.* And untie your mainframe at the same time. It's like having your cake and eating it, too. WAVETEK Indiana, Inc. P.O. Box 190, Beech Grove, Indiana 46107. Phone (317) 783-3221. TWX 810-341-3226

*US domestic price only

WAVETEK®

Circle 72 on reader service card

Don't tie up your microwave mainframe.

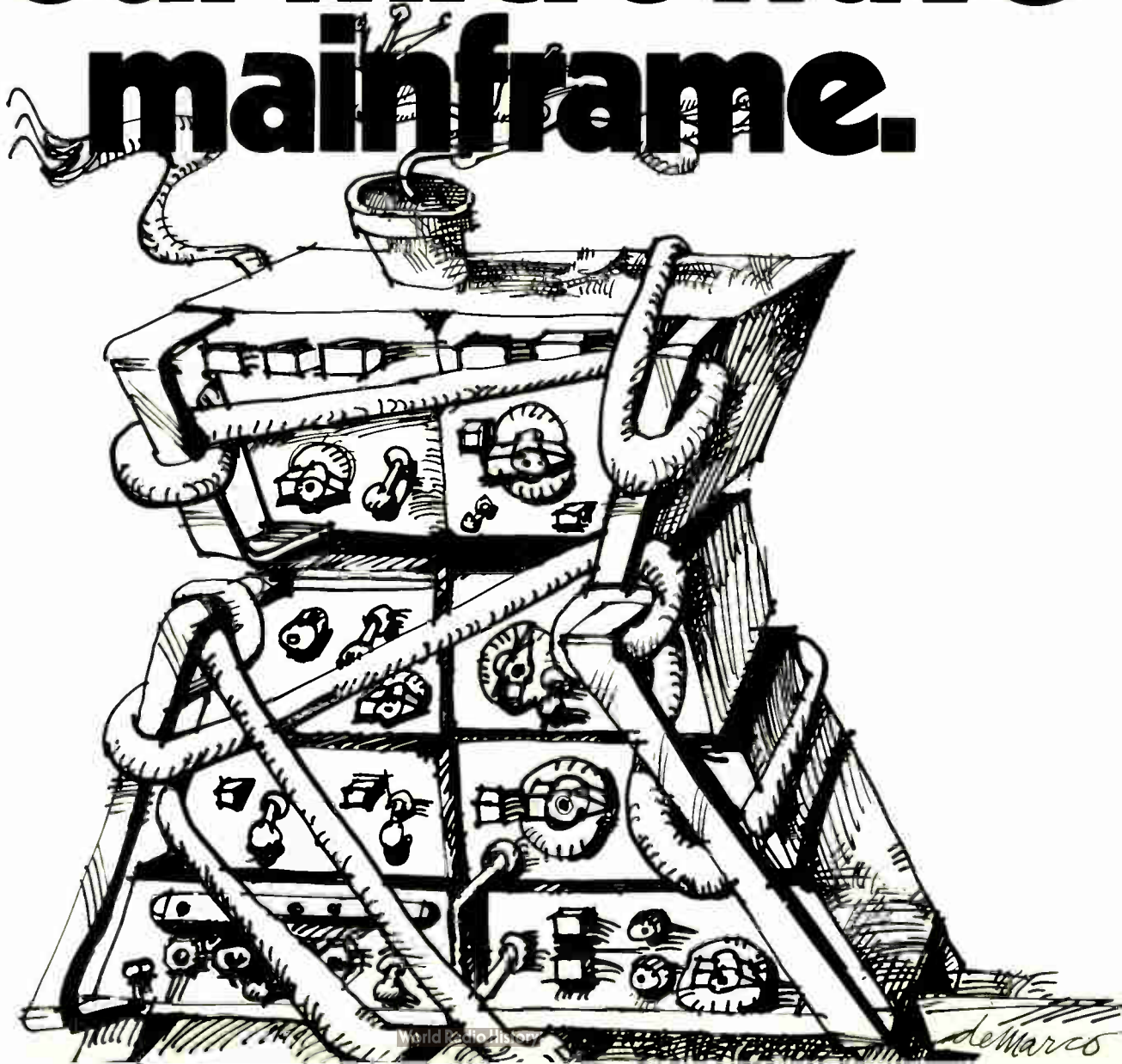

Advances in designs and new processes yield surprising performance

by Laurence Altman,
Solid State Editor



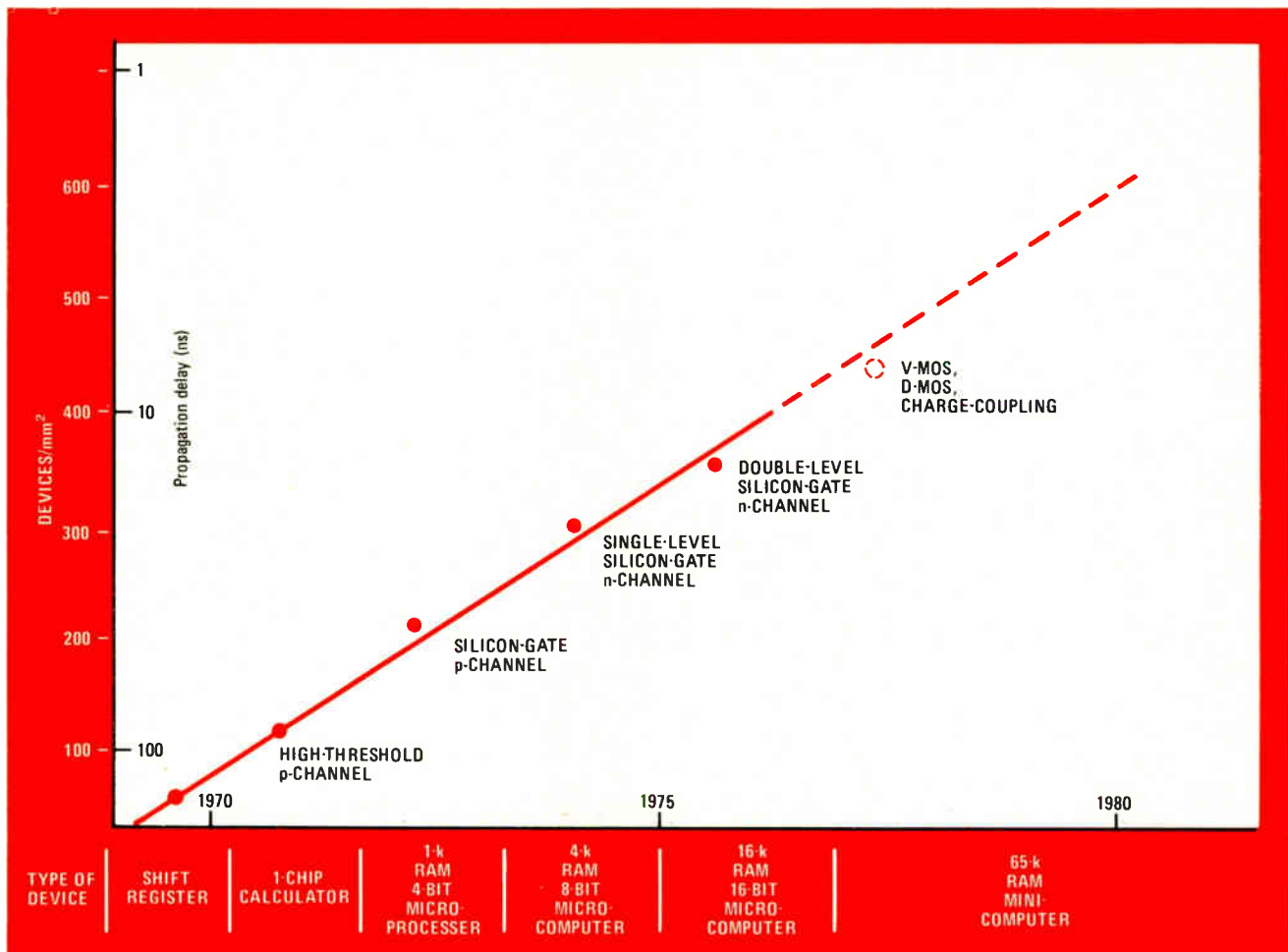

1. MOS marches on. Thanks to new inventions, MOS technology has moved up in seven years from a shift-register technique to a powerful random-access-memory and microcomputer technology. The latest tricks: double-level polysilicon, D-MOS, V-MOS and charge-coupling

□ MOS keeps popping up with new surprises. Each time metal-oxide-semiconductor technology seems to stall, designers invent new methods to carry it to higher performance levels. Now, they are calling on such techniques as double polysilicon, V notch, double diffusion, and charge coupling, to move it still higher—two to three times greater speed, five- and tenfold increases in density. These designs threaten to steam-roll over bipolar large-scale integrated-circuit designs, to make MOS the dominant digital technology.

The track record (Fig. 1) is replete with examples of this recurrent invigoration. When the high-threshold p-channel techniques developed for the single-chip hand-held calculator proved to be too slow for use in memory, designers developed a low-threshold process that brought the first 1,024-bit random-access memory and ushered in the era of programmable logic with the first 4-bit microprocessor.

When this p-channel process proved too unwieldy for denser memories, designers turned to faster and smaller n-channel structures that brought the first 4,096-bit RAMs and general-purpose 8-bit microcomputers.

Then to boost performance further, designers invented the depletion-mode technique, bringing forth MOS memories with access times of less than 100 nanoseconds and microprocessor chips capable of handling

8- and 16-bit word lengths at throughput speeds below 1 microsecond.

Now the new techniques are producing another round of devices (Table 1). In essence, the double-polysilicon process and charge-coupled designs are straight-line extensions of the existing silicon-gate n-channel technology. V-MOS and D-MOS, on the other hand, are significant departures from the standard technology.

Double poly is the process that achieves two-level memory structures in most 16,386-bit RAM designs [*Electronics*, Feb. 19, p. 116]. With two separate polysilicon levels for transistor and capacitor, designers can gain access to either of the cell's circuit elements independently. The technique cuts cell areas in half and makes possible single-chip 16-k memory arrays no larger than today's 4-k arrays.

Although some memory manufacturers, such as Texas Instruments, will introduce their first 16-k chips without double-polysilicon structures, most are convinced that it represents the best long-run approach. Since it is a direct extension of the n-channel process used in 4-k products, the process should move into production quickly and dominate mainframe-memory technology for several years.

Moreover, it sets the stage for even denser memory chips. Since the storage capacitor is essentially a bulk

silicon region and not a semiconductor junction, the two-level cell establishes the principle of nonjunction storage that surely will be required for the next RAM level, the 65,536-bit chip.

Logic designers are looking at a similar process, but for them its benefits are not quite as apparent. Although manufacturers are not talking much, apparently the trick is to let each polysilicon layer address an independent gate, so that two levels of logic can be accommodated on the chip. The independent polysilicon conductors in effect serve as a two-level interconnection system that could halve the area needed for random-logic and microprocessor layouts.

V-MOS is an adaption of the technique first used in the early 1970s to increase the density of bipolar circuit elements. A V-notch allows access to a substrate-level MOS source element, while the drain and gate structures are formed on the bias of the notch.

The vertical arrangement of these active elements permits extremely compact logic and memory. Moreover, since the structures are characterized by 1-micrometer dimensions, they significantly reduce parasitic losses and power dissipation. American Microsystems Inc. already has applied the process to a 16-k read-only memory with 200-ns access time [*Electronics*, Feb. 19, 1976, p. 105], while device designers at Electronic Arrays are working on V-notch ROMs, RAMs, and microprocessors.

The technique is also high on the list of next-generation approaches at Intel, Texas Instruments, and Motorola, where designs for 16-k and 32-k ROMs, 8- and 16-bit enhanced microprocessors, and 4-k static RAMs are under way.

Whether the notch technology, which presents a difficult topography for conventional oxide methods to

cover, will prove amenable to volume production has yet to be determined. Moreover, it requires at least one more fabricating step than standard n-channel silicon-gate process. The increased cost could offset its performance advantages to some degree, at least in the early stages of development.

D-MOS, like the notch technique, results in very small, high-performing structures without scaling their dimensions down to the micrometer level—an achievement physically beyond the capability of present photolithography. D-MOS structures do it with a double-diffused doping profile in the gate region that reduces the effective channel length to 1 micrometer or so. Since speed goes up as size goes down, the technique permits a discrete transistor to operate in the gigahertz region and transistors in large-scale-integrated circuits to operate in the 1–5-ns region.

Signetics pioneered the D-MOS approach in discrete field-effect-transistor devices and now has several low-noise FET-input amplifier products as well as discrete high-frequency transistors. The firm also has used the technique to build an 8-by-8-element crosspoint switch for telecommunication systems that is capable of more than 100 decibels of crosstalk isolation [*Electronics*, Feb. 19, p. 105].

Several Japanese manufacturers have strong D-MOS development programs in integrated circuits for memory and microprocessors. For example, researchers at Nippon Electric Co. have built a 4-bit arithmetic/logic unit that operates with less than 3-ns propagation delays.

The double-diffused technique also has been used to build power FETs. Siliconix, for example, has built a 2-ampere device and has designs for devices handling currents of 20 A and up, pointing to the time when the

TABLE 1: PROGRESS IN LSI TECHNOLOGY

	1970	1975		1977		1980	
Memory type	256-bit static	1,024-bit static	4,046-bit dynamic	4,096-bit static	16,384-bit dynamic	16,384-bit static	65,536-bit dynamic
Speed	1 μ s	150 ns	250 ns	150 ns	200 ns	100 ns	200 ns
Process	p-channel	n-channel C-MOS	n-channel single-level C-MOS I^2L		n-channel double-level	n-channel V-MOS D-MOS C-MOS I^2L	n-channel V-MOS D-MOS CCD
Microprocessor type	4-bit serial	8 to 16-bit parallel	4-bit slice parallel			16 to 32-bit parallel (active RAM control)	16-bit parallel (active RAM control)
Cycle time	50 μ s	2 μ s	1 μ s			200 ns	100 ns
Process	p-channel	n-channel C-MOS	I^2L			V-MOS D-MOS	I^2L

TABLE 2: MAJOR LSI TECHNOLOGIES (1976)

Technology	Propagation delay (ns)	Power-delay product (pJ)	Density		Chip size (mm ²)
			(Devices/mm ²)	(Gates/mm ²)	
High-threshold p-channel metal gate	80	450	150	50	7 x 7
p-channel silicon-gate	30	145	270	90	6.5 x 6.5
n-channel silicon gate	15	45	285	95	6 x 6
n-channel silicon gate depletion-load	12	38	320	107	6 x 6
n-channel double-polysilicon	10	35	525	175	6 x 6
Silicon-gate C-MOS	10	0.5	220	45	5.5 x 5.5
V-MOS D-MOS	5	20	600	225	—
SOS / C-MOS	2 - 5	0.1	650	275	5 x 5
I ² L (double level)	5 - 50	0.01 - 1	500	150	5.5

bipolar Darlington transistor pair may get a run for its money from MOS techniques.

As Table 2 indicates, the best of today's silicon-gate approaches is the double-polysilicon technique, which has a propagation delay almost equal to standard transistor-transistor logic and a power-delay product that's three times better. Its density easily exceeds that of any other standard n- or p-channel technique, rivaling those obtainable with v- and D-MOS.

Best of both

The big advantage for the notch and double-diffused processes is, of course, increased speed at double-poly densities, thus offering the best of both worlds. In fact, both approaches offer potential speed in the range of Schottky TTL, with a concomitant tenfold increase in density.

These two techniques are as fast and as dense as integrated injection logic. But I²L has a power-delay product 50 times better than any technique except silicon-gate complementary MOS and C-MOS on sapphire.

On paper, C-MOS on sapphire and injection logic finish in a dead heat with the best combination of speed, power dissipation, and density. But that's on paper. In a circuit, most manufacturers still feel that the single-channel MOS advantages of low cost and proven high-yield production continue to make up for the lag in performance, at least for present mainstream memory and microprocessor applications. (Notable exceptions are RCA and Intersil, who have commercially available C-MOS microprocessors.)

Charge coupling is based on principles used in optical imagers and serial memory devices. By combining storage and transfer into a single gate region, it reduces a RAM cell to the size of a single silicon gate, about 100 square micrometers. That's four times smaller than double-poly 16-k cells and small enough for 65-k de-

signs. Most memory suppliers are developing charge-coupled devices, with Texas Instruments providing a glimpse of some of its work [*Electronics*, Dec. 25, p. 30].

From what has been disclosed, many observers see the company's technique as elegant in principle but somewhat speculative, since the switching mechanism of the resulting structure depends on the transfer of charge between two very closely spaced storage regions. This would be difficult to control over large arrays. Moreover, logic swings in the cell disclosed are very low—1 milliampere or so—which would be difficult for present sense amplifiers to detect reliably.

Nevertheless, the problems are not insurmountable, and veteran observers feel that TI, as well as Intel, Fairchild, RCA, and others with proven CCD capability, are seriously exploring charge coupling for 65-k designs.

Making them work for memory

Device manufacturers are at different stages in applying these new techniques to memory, where high-volume production requirements make it the perfect place to prove a new technology. The double-poly process already has entered production for 16-k RAMs at several manufacturers [*Electronics*, Dec. 25, p. 29].

The schematic in Fig. 2 is from an Intel design, but it's typical of the two-level structures being developed throughout the industry. It saves space by placing the storage capacitor, which stores the charge corresponding to a logic state, directly under the cell's single switching transistor.

One polysilicon layer is the transistor's gate contact and interconnection while the other is the storage capacitor. In 4-k designs, transistor and capacitor had to be placed side by side. The single polysilicon layer acted as the gate interconnection as well as acting as the storage capacitor.

Since capacitor and transistor are about the

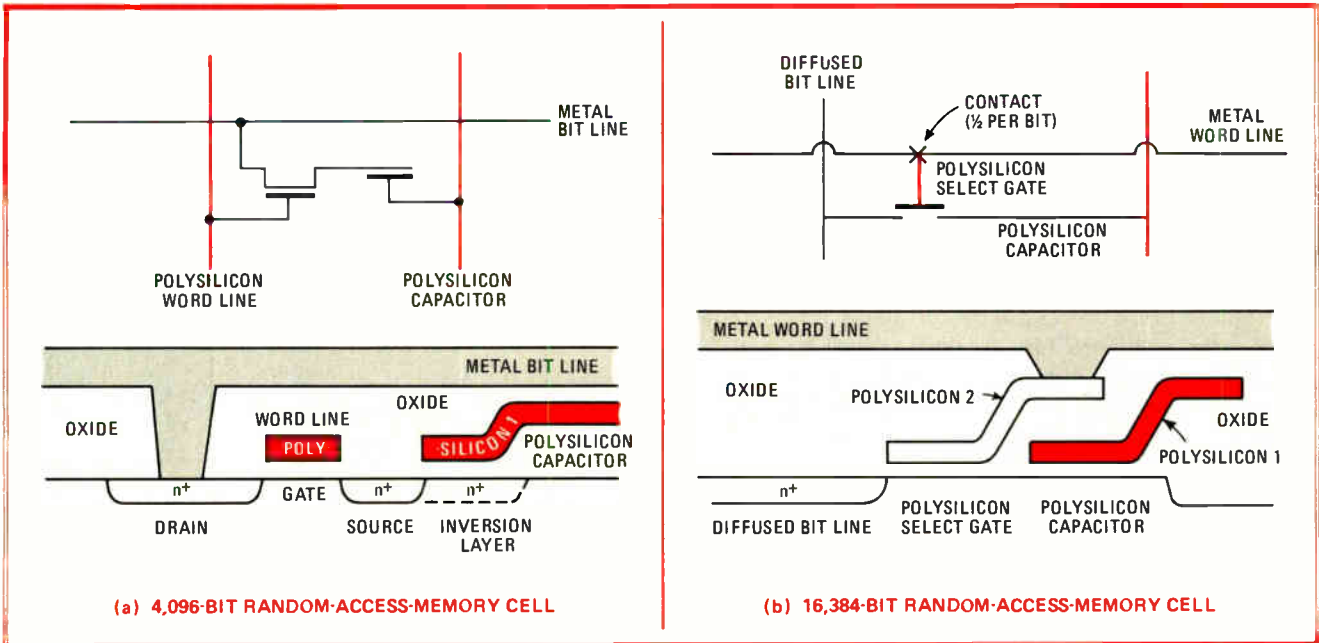

2. Two is better. Designers of 16-k RAMs went to double polysilicon levels to shrink cell sizes. In the 4-k RAM (left) one poly level made access to both transistor and storage capacitor, which were side by side. In this Intel double-level cell, two stacked lines are used.

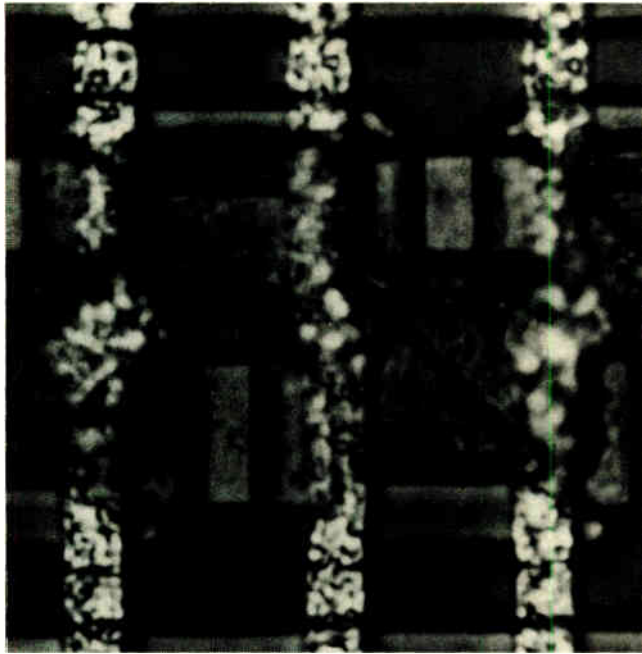

3. Small cell, large memory. This Mostek 16-k cell, which is built with a two-level polysilicon technique, shrinks cell to near $400 \mu\text{m}^2$, or less than one-half the size of 4-k RAM cells. Performance is enhanced because of lower parasitic capacitance.

same size, the two-level 16-k structure occupies about half as much silicon surface of the spread-out, 4-k one-level structure. Moreover, it operates more efficiently, because a diffused polysilicon bit-sense line has lower parasitics than the deposited metal line in 4-k designs.

The design adds up to a cell, such as the one from Mostek shown in Fig. 3, that occupies about $400 \mu\text{m}^2$ compared to 4-k cell designs typically occupying 800 to $1,000 \mu\text{m}^2$.

While the double-poly process is making 16-k RAMS

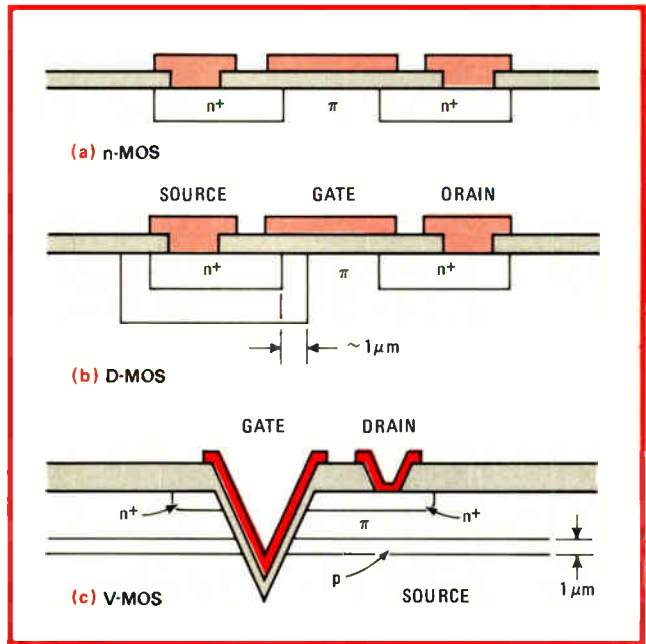

4. D-MOS, V-MOS. Double-diffused and V-notch techniques increase performance by effectively decreasing the channel lengths to 1 micrometer. D-MOS does it with a p-diffusion in the channel; V-MOS does it with a notch to access a common source.

possible, V-MOS is extending the range of ready-only-memory design, and D-MOS is boosting the speed of large-function LSI logic design. Cross sections of standard n-channel, double-diffused, and notched devices are shown in Fig. 4. In the standard structure, present photolithographic procedures must be stretched to their utmost to yield the short channels for today's products. The existing practical minimum dimensions are 4 or 5 μm especially when making big large-scale-integrated chips, where narrow lines and spaces would reduce the

yields from production lines to a quite drastic degree.

But in both double-diffusion and notch processes, narrower lines and shorter channels (hence faster, smaller devices) are produced by diffusion or implantation, rather than by squeezing photomasking limits. In D-MOS, a second lightly doped p diffusion, called a pi region, together with a heavily doped p region, are made in the channel, so that lengths can be controlled down to 1 μm .

With V-MOS, an n^+ substrate essentially is the common source for all devices, and a p layer 1 μm thick determines the effective channel depth in the saturated regions. This dimension, which corresponds to the length of n channels, can be more easily controlled than in the D-MOS process. Moreover, a pi region lowers the drain capacitance and increases the drain breakdown, so that reliable devices that have a 25-volt breakdown are being produced.

And because the source is controlled from above via the groove (Fig. 5), V-notch gate geometry is highly efficient. A typical device has a channel width of 25 μm , and yet its gate area is only 10 μm by 10 μm .

Designed by American Microsystems Inc. into a read-only memory (Fig. 6), the V-notch process produces a 16,384-bit, 5-volt static device that fits on a chip less than 17,000 mil^2 , compared to present n-channel ROM chips larger than 22,000 mil^2 . Moreover, the device's speed is at least doubled: the worst-case access time is put at 200 ns.

The process requires an extra mask for the V grooves, over the six in the depletion-load n-channel process. It can handle all the necessary circuit elements used in

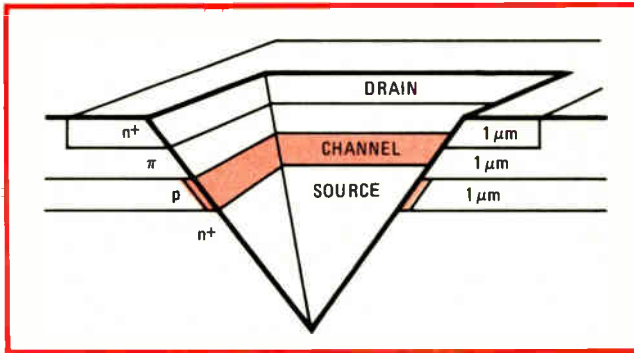

5. Getting in control. In this V-MOS structure from AMI, the source is controlled from above via a groove. This makes the device extremely small. In a 16-k ROM design, it has a gate area of only 100 μm^2 , while the channel width is 25 μm .

memory design: the high-performance V-MOS transistor itself, a planar enhancement n-channel transistor, and ion-implanted load resistors. AMI's designers chose resistors as load elements, instead of depletion-load devices, because they have lower temperature dependence and better worst-case power-delay characteristics.

The V-notch process also is being applied to design of random-access memories throughout the industry, although the work is still in the early stages and manufacturers won't tip their hands. The most serious problem is the difficulty in controlling each memory cell independently and randomly, since they share a common source element lying on the substrate.

Nevertheless, the V-MOS process could make a great RAM compared to today's double-poly n-channel designs (Table 3). At first, a cell wouldn't be much smaller or result in a higher level of chip integration than do the best 16-k double-poly designs, but its 50-ns speed makes it a strong contender.

Whether V-MOS makes it as a RAM technology depends on what happens to the more established silicon-gate technology. The evolution to two-level structures suggests there's some life left in the old game yet, especially since there's not much production history with dense random-access memories for the notch process. (This also is true of I^2L —potentially as attractive for logic and memories, as Table 3 shows.) The results such manufacturers as AMI and Electronic Arrays achieve with devices now under development will go a long way toward determining just where the notch process fits into the spectrum of memory products.

In its competition with injection logic, much will depend upon the relative complexity of the processes. As Table 4 shows, there is considerable similarity. However, where V-MOS requires a gate diffusion, I^2L requires a Schottky diffusion, which generally is considered more difficult to achieve.

The moving target

Many designers of one-transistor cells are convinced the double-poly process will run out of gas short of the 100-200- μm^2 sizes needed for the 65-k RAM. But that may not be the end of the road for silicon-gate technology, because it can be applied to charge-coupled cell designs as Texas Instruments has done with its random-access cell disclosed in December. That experimental cell has the potential for achieving the 65-k size.

Unlike the single-transistor cells of 4-k and 16-k RAMs, charge-coupled cells have no transistors as such

TABLE 3: RAM TECHNOLOGY

	Two-poly n-MOS (1976)	V-MOS (1977)	I^2L (1976)	
Cell size (mm^2)	400	400	800	450
Power (W/bit)	0.1	0.05	0.05	0.05
Speed (ns)	150	50	50	75
Speed power (pJ)	15	2.5	2.5	1.5
Power supply (V)	+12, -5	+5	+5	+5
Refresh	dynamic	dynamic	static	dynamic

SOURCE: ELECTRONIC ARRAYS

TABLE 4: PROCESS STEPS IN DEVICE FABRICATION

V-MOS	I^2L
1. Source diffusion (n-type)	1. Emitter diffusion (n-type)
2. Epitaxial layer (p-type)	2. Epitaxial layer (n-type)
3. Drain diffusion (n-type)	3. Base and injector diffusion (p-type)
4. Deep etch	4. Collector etch
5. Gate	5. Schottky formation
6. Contacts	6. Contacts
7. Metal	7. Metal

SOURCE: ELECTRONIC ARRAYS

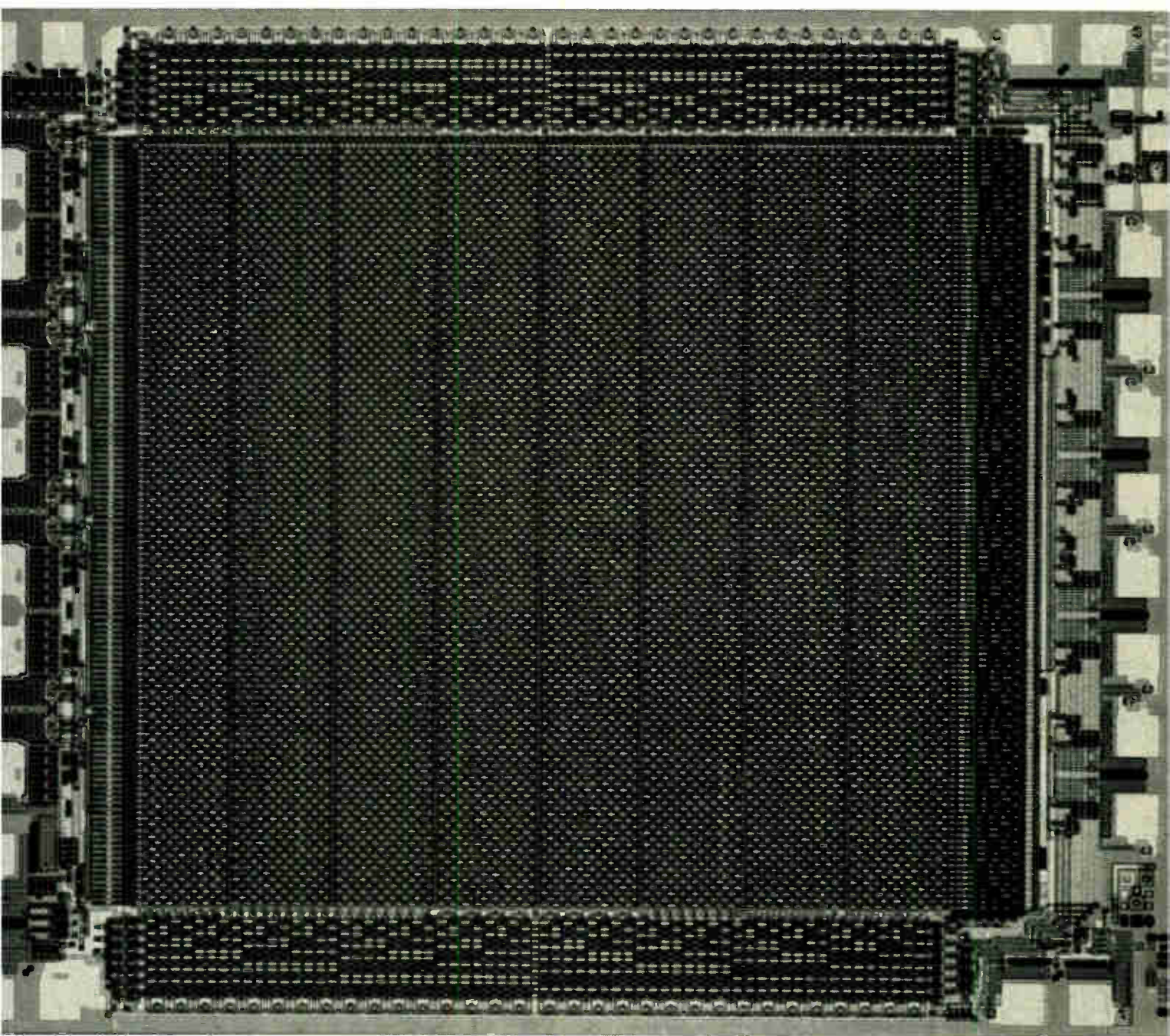

6. The V-MOS RAM. This 16-k read-only memory fits on a chip less than 17,000 mil², or one-fourth less than n-channel devices. Moreover, device speed is doubled to 200-ns access time. Fabrication requires an extra mask for the grooves over the sink in the n-channel process.

(Fig. 7). Charge coupling stores data in switchable capacitor regions implanted beneath a CCD gate. An entire memory cell is no larger than a gate, which can measure less than 200 μm^2 , even with today's standard fabrication rules.

With this compact cell, CCD operation can be as fast as single-transistor cells. Moreover, combining the storage and transfer gates into a single gate region eliminates laying out two separate gate regions, which the double-poly cells have. The simplified cell structure has much more room for charge storage.

Even more chip space is saved because there are only

two access lines per cell—one to the storage or word line for writing, the other to a sense line for reading. Today's RAM cells need an additional line as a transfer gate.

The lower level of the storage region is achieved by a p-type implant into the silicon at a depth of several thousand angstroms, while the upper level is achieved by a shallow n-type implant. Once data is stored in one of the levels, all that's needed to sense a bit is to remove the potential on the gate and allow the charge to transfer to the adjoining n⁺ region connected to the sense line.

To write a 1 into the storage region, the bit-line volt-

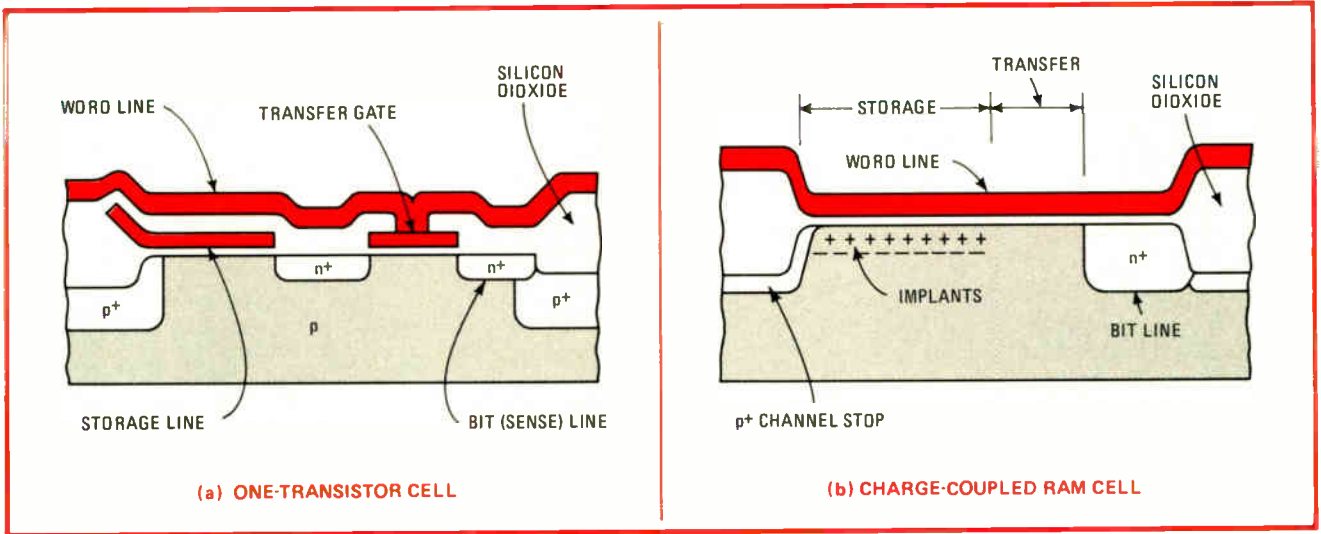

7. Charge coupling. In RAM designs, charge coupling allows the switching and storage structures to be about the size of a single MOS gate, compared to the spread-out design of a single-transistor n-channel cell. This 1T1 design uses a double implanted storage region.

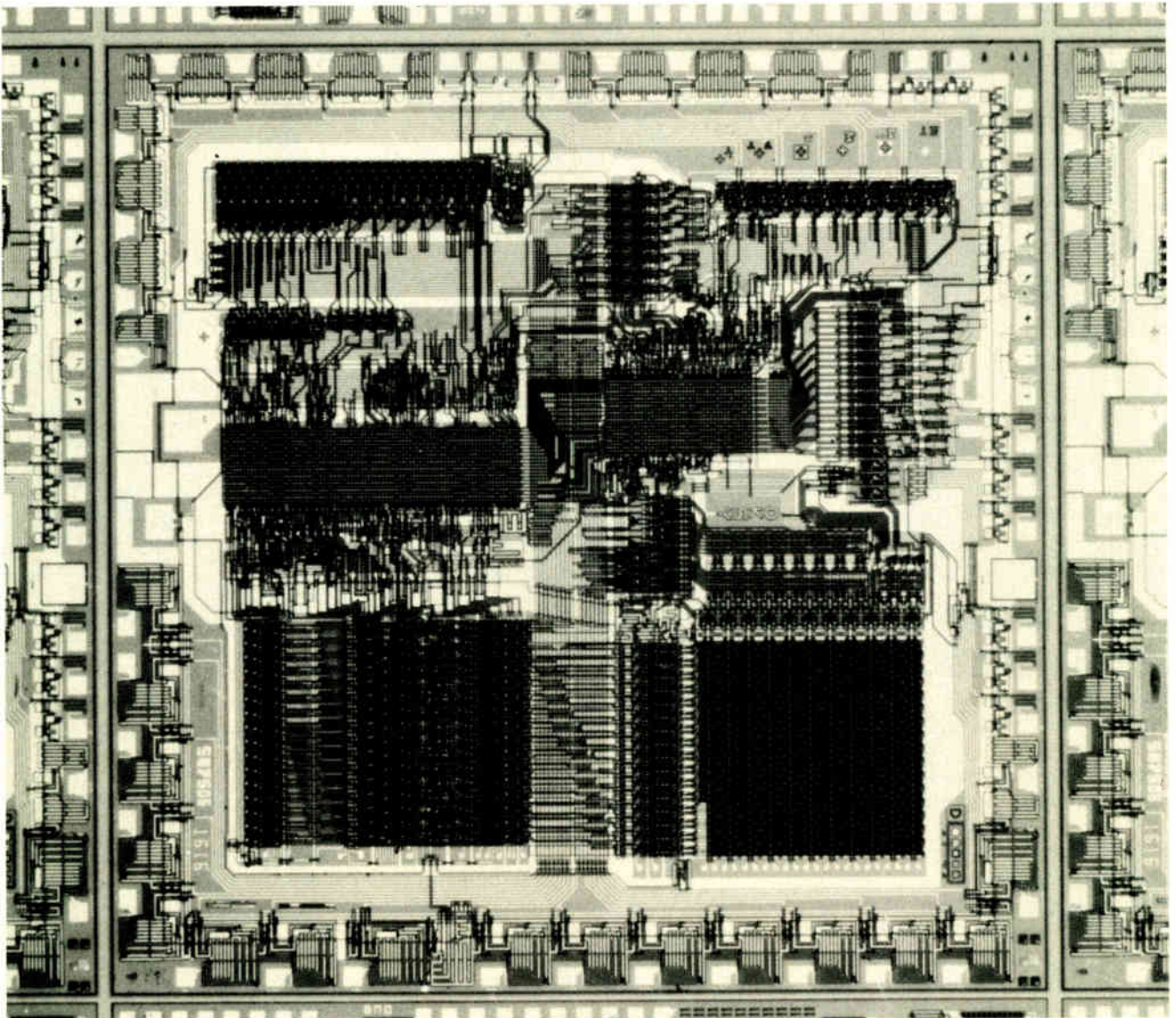

8. Better gates. Toshiba's gate-oxidation method simplifies n-channel processing so that a single mask step serves both transistor gate and field regions. Their 16-bit microprocessor has a cycle time of 300 ns and can handle 117 basic instructions.

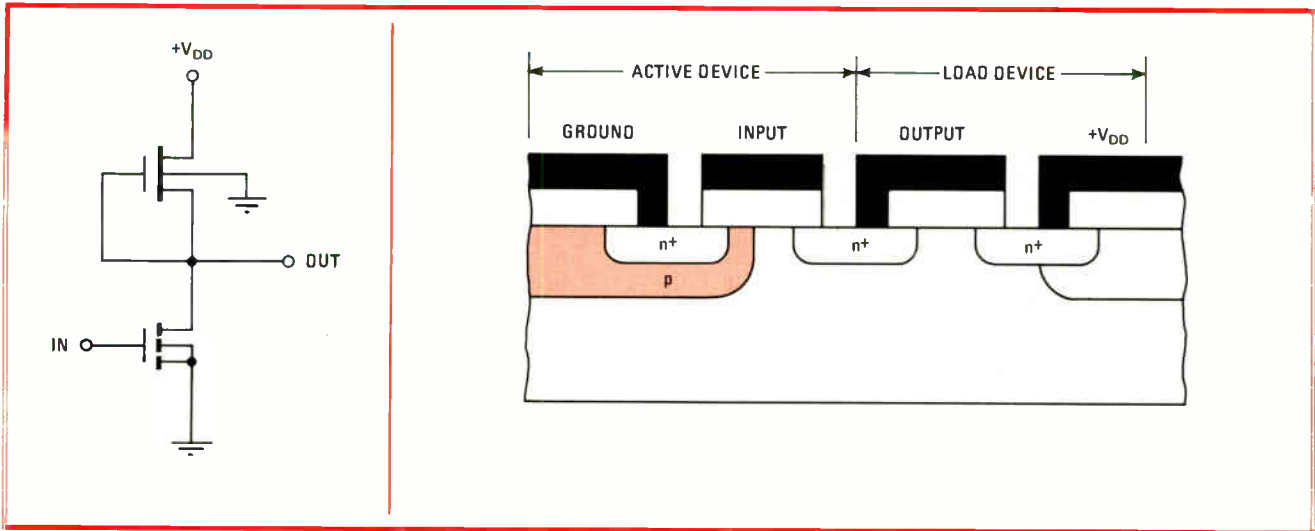

9. D-MOS logic. This D-MOS inverter design, using depletion loads, results in a compact structure that boosts performance almost five times over n-channel designs. Fully loaded gates operate in the 1-to-5-ns region at densities of about 141 gates per mm².

age is lowered to ground or near-ground. This allows electrons to flow into a potential well that fills the region. To write a 0, the bit-line voltage is set high, and no charge enters the storage region. To achieve the store mode, the word line is turned off to complete the write operation and isolate the storage cell from the bit line.

Reading is done in the store mode with the gate voltage off and the potential well still present to store charge. When the word-line gate voltage is turned on, the surface potential in the transfer region becomes more positive than in the storage region, so that charge can flow between the bit line and the storage region. Any charge present in the storage cell is dumped onto the bit line and sensed.

Logic, too

Several Japanese manufacturers are working with new MOS structures in logic designs for microprocessor applications. A particularly promising approach is Toshiba's gate-oxidation method [*Electronics*, Nov. 27, 1975, p. 99], which boils down to increasing the oxide impurity concentration during gate diffusion when making n-channel transistors.

Simpler n-channel designs result, which are faster and dissipate less power. One mask produces the self-aligning transistors and the field regions between them. It takes two masks to get both of these elements in conventional processing.

Since the gates are more efficient, they operate with propagation delays well below 5 ns, even in complex logic configurations, such as a 21-stage 4-fanout ring oscillator. Toshiba engineers are using the method in a 16-bit microprocessor chip (Fig. 8) that achieves minicomputer performance. Capable of cycle times of 300 ns (compared to 2 microseconds for regular n-channel designs), it has 16 general-purpose registers, 15 index registers, and a set of 117 basic instructions. It can handle data in lengths of 1, 8, 16, and 32 bits and has 225 input and output ports, plus two direct memory access ports.

This 42-pin part was developed for a custom computer project but may be unbundled for the general

markets. It can address a full 64-k bytes of external RAMs, enough for most minicomputer designs.

At Nippon Electric, device designers are taking a venturesome approach with a depletion-load D-MOS technique that could outperform most standard silicon-gate approaches. With logic elements operating unloaded at 1-ns propagation delays (faster than emitter-coupled logic), Nippon engineers have built a 4-bit arithmetic/logic chip whose 113 fully-loaded NOR gates typically run at less than 3 ns at 2 v.

At these speeds, power dissipation is still only 0.71 milliwatt with a power delay product of 2 picojoules. A typical density, in Nippon's inverter design (Fig. 9), is 141 gates per square millimeter using conventional 5-micrometer design rules. And that's ECL speed at MOS densities.

An interesting D-MOS application with both logic and power-train capability is Signetics' crosspoint switch for telecommunications applications. The double-diffused approach lets designers integrate on a single chip an 8-by-2 crosspoint array that before had required many discrete devices.

The technique produces an excellent switch because, unlike standard n-channel silicon-gate transistors, the device has a small on resistance and considerably lower parasitic capacitance. The result is a switching network whose interchannel crosstalk isolation is greater than -105 decibels, and whose insertion loss is extremely low.

With logic or memory, the big question is what will it cost to build? Both the v-MOS and D-MOS processes are more complicated than straight polysilicon-gate processes—single or double—and are easily as complex to build as injection logic in its highest-performing Schottky form.

Although CCD is an extension of the conventional silicon-gate process, its storage and transfer of charges in the same region may require extraordinarily precise fabrication to avoid unreliable operation. The next year will tell for these four new techniques, as manufacturers try to get some prototype-design and production experience under their belts. □

Nonlinear low-pass filter rejects impulse signals

by Barrie Gilbert

Analog Devices Semiconductor, Wilmington, Mass.

A circuit that rejects impulse signals but passes low-slew-rate signals without attenuation or phase shift can be made by connecting a capacitor to the compensation terminal of an operational amplifier. This nonlinear low-pass filtering is useful in the reduction of noise (particularly impulse noise) and in the control of glide rate between notes in electronic music equipment.

Figure 1 shows the basic configuration required of the op amp. It must have a compensation node into which it drives a stable current, I , during slewing. For optimum performance, this current should have the same magnitude in either slew direction. An external capacitor tied to the node then limits the slew rate to any value below the maximum specified for the particular op amp, because V_{out} is the voltage across the capacitor, and therefore

$$dV_{out}/dt = I/C$$

Not all op amps have the necessary configuration,

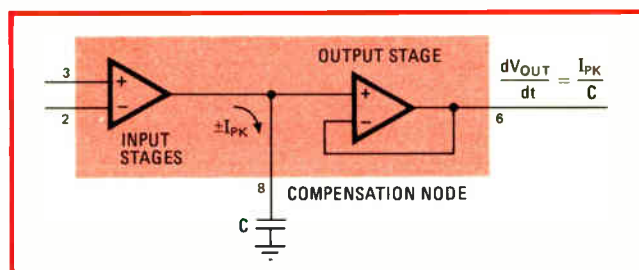

1. Nonlinear filter. An operational amplifier that has a compensation terminal with a well-controlled peak current, such as the AD504 or AD507, becomes a nonlinear low-pass filter when a capacitor is connected as shown. Because the slew rate of this circuit is limited, impulse signals and noise are strongly attenuated while low-slew-rate signals are passed without a change of amplitude or phase.

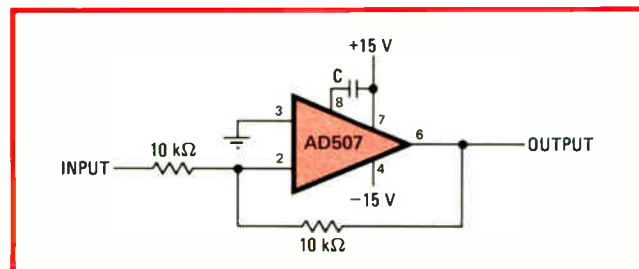

2. How to do it. The actual working circuit for the nonlinear low-pass filter shown here has the performance illustrated by wave forms in Fig. 3. Capacitor C has various values, depending on application.

and of those that do, only a few have a sufficiently well-controlled value for the peak current from the compensation node, I_{pk} . The AD507 is ideally suited to this application, having an I_{pk} that varies little from device to device or with temperature or supply-voltage variations. Its nominal value of ± 200 microamperes, which may be either measured or calculated from the compensated slew rate, gives a slew-rate of 1 volt per microsecond for a C of 200 picofarads, and reliable accuracy up to slew-rates of $10 \text{ V}/\mu\text{s}$.

Figure 2 shows a unity-gain inverting amplifier using the AD507; with $C = 0.01$ microfarad the slew-rate is $0.02 \text{ V}/\mu\text{s}$. The response to a ± 10 -V square wave, shown in Fig. 3a, demonstrates this slew rate. Notice that C provides adequate loop stabilization, so the capacitor normally connected from pin 6 to pin 8 may be omitted. The small-signal response of this filter is determined by C , but is much higher than the full-power response; for the capacitor shown the figures are 20 kilohertz to -3 decibels (signal level of $\pm 100 \text{ mV}$), and 320 hertz for $\pm 10 \text{ V}$, respectively. Gains other than unity may be achieved simply by altering the ratio R_2/R_1 , and the amplifier may be used equally well in the noninverting mode. The slew-rate is unaffected by the absolute value of the resistors, the gain, or the mode.

The usefulness of the filter can be judged by the other wave forms in Fig. 3. In Fig. 3b a $40\text{-}\mu\text{s}$ pulse of 10-V amplitude is shown in the top trace, and the output from the nonlinear filter with $C = 0.008 \mu\text{F}$ is shown in the center trace, which for clarity has been inverted and expanded vertically. The nonlinear op-amp filter has reduced the pulse to a 1-V triangle lasting $80 \mu\text{s}$. For comparison, the response of a single-pole linear filter having a time-constant of $400 \mu\text{s}$ is shown in the lower trace. Although the amplitude has been reduced to 1 V , a tail in the response extends beyond 1 millisecond.

The capacity to reject impulse signals while passing signals of low slew rate with neither attenuation nor phase error is shown more clearly by the wave forms in Fig. 3c. Here the input is a 1-kHz sine wave of 1-V amplitude, on top of which rides a $40\text{-}\mu\text{s}$ pulse of amplitude 3.5 V representing a noise spike. The center trace is the output of the nonlinear filter and shows that the pulse has been almost eliminated while the wave form of the sine wave is preserved.

In contrast, the linear low-pass filter (again a single $400\text{-}\mu\text{s}$ RC network) more than halves the sine-wave amplitude and introduces about 60° of phase lag. Furthermore, the pulse is stretched and actually distorts the wave form, as the lower trace demonstrates.

Nonlinear filters may also be used to reduce the Gaussian noise content of a signal, since it contains occasional high peaks (there is a 0.37% probability that the amplitude exceeds three times the rms value). Fig. 3d illustrates this. Again the input is a 1-kHz sine wave with an amplitude of 1 V , to which has been added 1 V rms of white noise. The output shows an undistorted

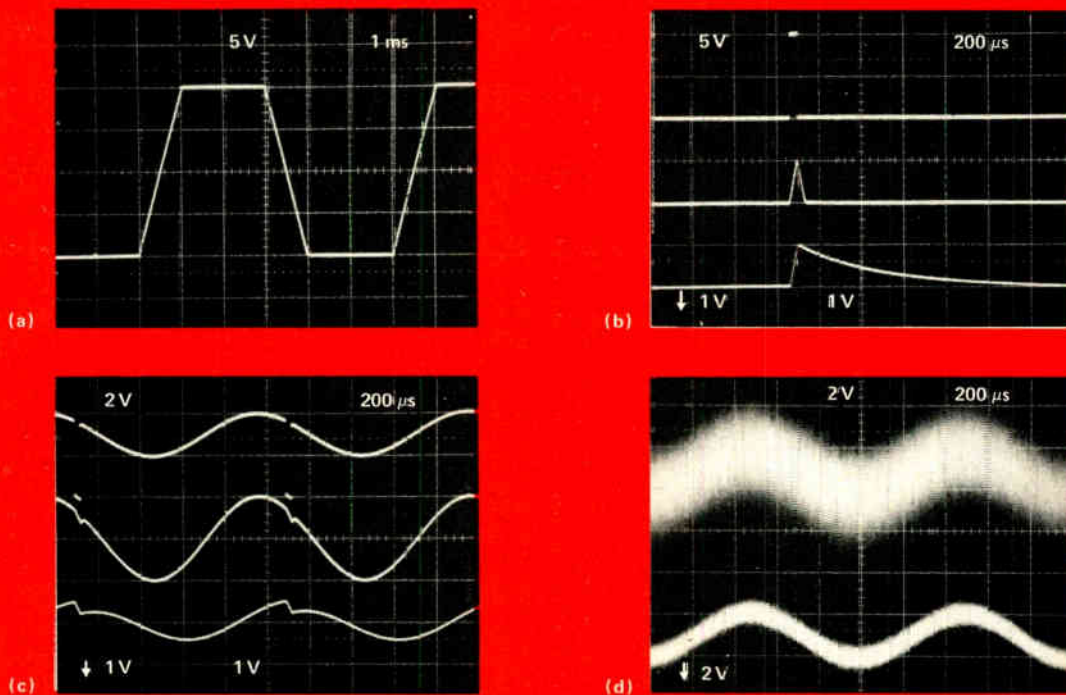

3. Get the picture? Performance of nonlinear low-pass filter is shown and compared with that of a linear low-pass (RC) filter. In (a) the input signal is a square wave; with $C = 0.01 \mu\text{F}$, the circuit slews the output at 20 V/ms . Both (b) and (c) show impulse inputs, response of nonlinear filter with $C = 0.008 \mu\text{F}$ and response of a linear low-pass (RC) filter. Noise reduction is demonstrated in (d).

sine wave, with only 0.3-v rms noise. Subjectively (if this were an audio signal) the improvement is slight, and more care is needed in selecting the optimum slew rate to effectively reduce white noise.

Unlike in linear filters, no change in response results from cascading stages of equal gain and slew rate. Also, if stages of different gain or slew rate are used, the one having the lowest slew rate is in the driver's seat. A high-pass nonlinear filter can easily be made by sub-

tracting the low-pass signal from the direct input. In fact, the voltage at the summing node of the op amp in Fig. 2 is the high-pass function of the input.

Bandpass filters also can be constructed, by cascading a low-pass section with a high-pass section. When these have the same slew-rate the center frequency of the bandpass filter is inversely proportional to input amplitude. The practical value of the high-pass and bandpass nonlinear filters has not been established. □

FSK modem interfaces cassette and computer

by John I. Compton
Wenner-Gren Laboratory, University of Kentucky, Lexington, Ky.

Serial data from a teleprinter or serial output from a computer can be recorded and played back from cassette tape with the frequency-shift-keyed modulator/demodulator described here. The circuit may also be used as a half-duplex modulator/demodulator to store data or read it out over a telephone line. The system is crystal-controlled, operates at standard FSK frequencies, and needs no adjustment. It can be operated from 5 to 15 volts and costs less than \$15 to build.

The block diagram in Fig. 1 shows the principle of

the modem circuit, and details are given in Fig. 2.

What happens is this. A 14-stage 4020 C-MOS counter is reset to zero when one of two diode arrays, selected by the serial input, decodes a count of 424 for a logical 1 and 464 for a logical 0. In this manner the output frequencies, at Q_9 , will be the clock frequency of 950 kilohertz divided by 424 and 464, or 2,240 and 2,047 hertz, respectively. This gives 2,240 Hz for a logic 1 and 2,047 Hz for a logic 0. The resulting square wave is filtered and ac-coupled to the auxiliary input of the recorder. The 4013 D latch on the counter reset prevents false resets that might otherwise be caused by ripple outputs between leading edges of the clock.

Record and play do not occur at the same time, so that the same C-MOS counter can be used in both the modulator and the discriminator. When retrieving data, the recorder's "ear" output is ac-coupled, amplified, and Schmitt-triggered by two Norton amplifiers (National LM3900), and finally shaped by a 4013 D latch. The re-

Don't stop traffic to measure frequency.

Using an EIP microwave counter, you can easily test high-density communications links without removing them from service. Here's why.

Many communication applications require measurement of a frequency modulated (FM) carrier. A counter's ability to measure such a signal is determined by its FM tolerance, the maximum deviation it can tolerate at a given modulation rate.

EIP microwave counters use Autohet[®] technology to completely eliminate such a problem. They will measure the center or carrier frequency in the presence of 40-MHz peak-to-peak modulation, worst case. In the best case, an EIP counter can measure with as much as 200-MHz peak-to-peak deviation, an obvious advantage to any communication system manufacturer or end user.

And if you have an electronic warfare application, an EIP microwave counter lets you test vital EW/ECM circuits in-service too.

PC board and module exchange program means quick, reliable service.

EIP offers an assembly exchange program to minimize down time. If your system should ever fail anywhere in the United States, give us a call. We'll help you track down the problem by phone, and ship you a replacement plug-in board or an entire pre-aligned microwave converter section the same day. For systems in Europe, we have a complete service facility in Brussels.

We've got an applications note explaining in greater detail the advantages of using an EIP microwave counter for in-service communications equipment testing.

Write for your copy. We'll also send you information on our microwave counters, all constructed using the Autohet[®] principle.

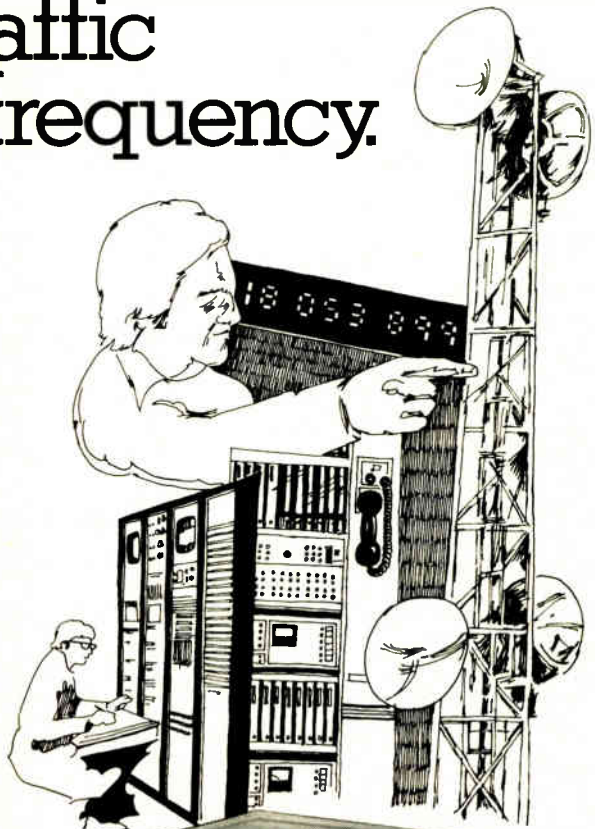

The EIP 351D, 20 Hz to 18 GHz. The EIP line also includes the 350D, 20 Hz to 12.4 GHz; the 331, 825 MHz to 18 GHz, and the E01-350D or -351D designed to MIL-T-21200 environmental specifications.

All EIP counters are constructed using printed circuit boards mounted vertically for easy test point access and servicing. The entire microwave section can be taken out and replaced in a few minutes by unplugging 4 cables and removing 6 screws.

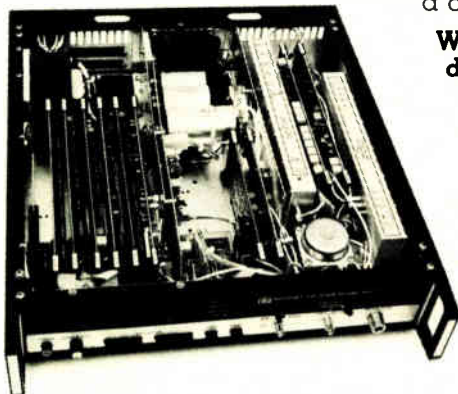

EIP, Inc.
3230 Scott Boulevard
Santa Clara, CA 95051
Telephone (408) 244-7975

sulting wave form is used for clocking a toggle flip-flop.

The output of the flip-flop stays high for a time equal to one cycle of the recorded data and, with the mode switch in the play position, allows the counter to count

system clock pulses for one input period. Then, when the counter has counted a period longer than 472 microseconds, or a frequency of below 2,120 Hz, a three-diode array (decode 448) has an output of 1 and as a result the C-MOS NAND latch is set. At the end of the input period the output latch is set and a logical 1 will appear on the \bar{Q} output line. If the input frequency is higher than 2,120 hertz, the latch does not set, and a logic 1 will appear on the output line. The serial output, which is valid during record and play, provides automatic echo for teletypewriter use. However, the FSK output is valid only while in record mode.

This circuit has recorded and played back an 18,000-character (30-minute) test tape at 110 baud without a single error. A baud rate of 300 can be used with good-quality tape. The recorder can be low quality, however, because this frequency shift allows a 5% tape speed variation without error. Even greater speed variation can be allowed if the frequency shift is larger. □

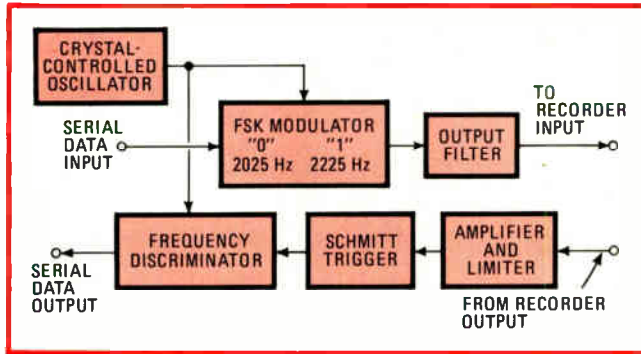

1. Taping the digits. Modem circuit converts serial digital data to FSK signal for cheap storage on cassette tape, and also converts the taped signal back to digital form for re-entry into a computer or other digital system. The FSK signal can be sent over telephone lines. This circuit can handle a baud rate of 300 without difficulty.

Designer's casebook is a regular feature in Electronics. We invite readers to submit original and unpublished circuit ideas and solutions to design problems. Explain briefly but thoroughly the circuit's operating principle and purpose. We'll pay \$50 for each item published.

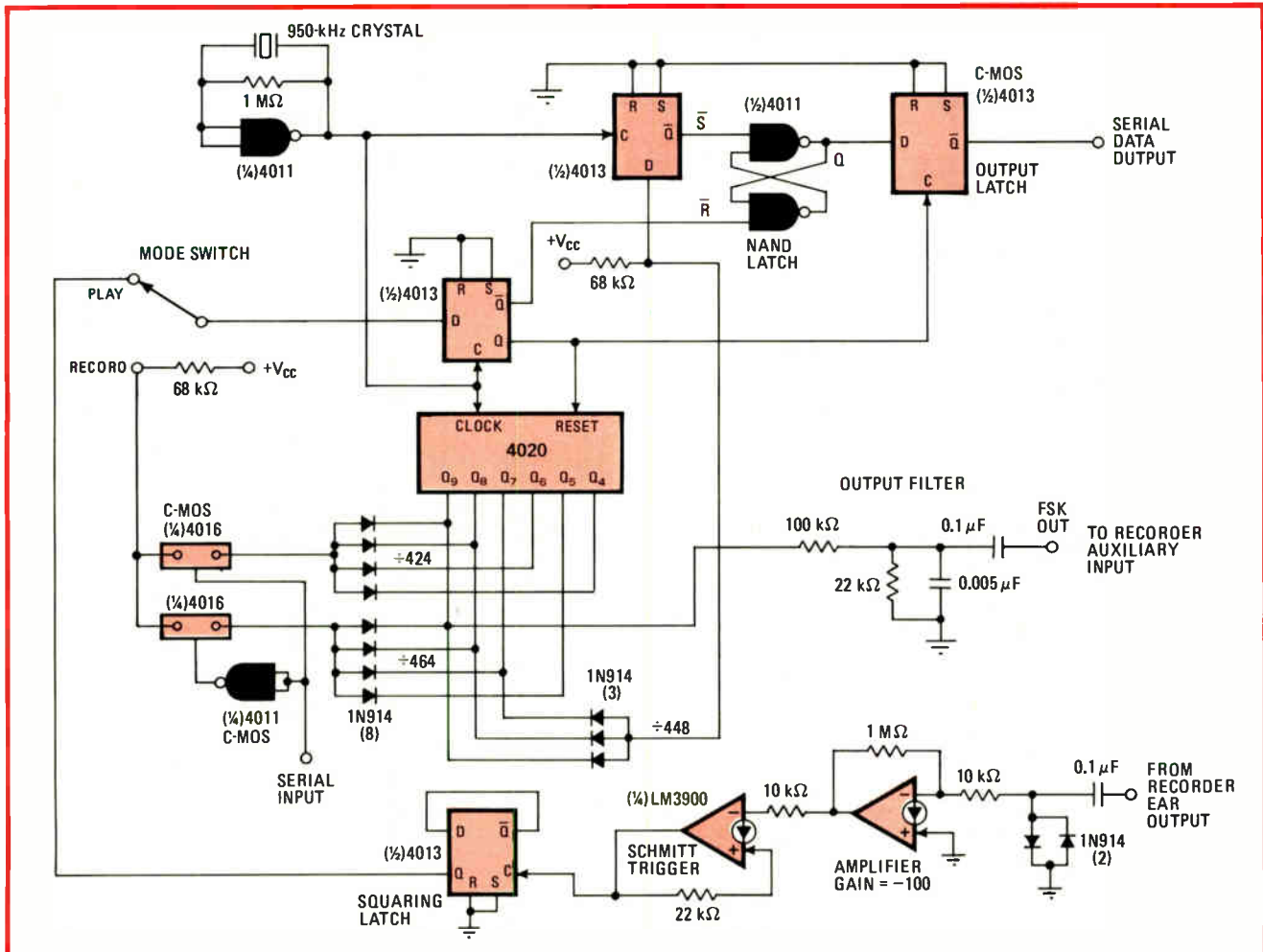

2. How to modem. The heart of this circuit is the 4020 14-bit C-MOS counter. In the record (modulate) mode, the counter divides the 950-kHz crystal frequency by 424 to put out 2,240 Hz when the input digit is a logic 1, and divides by 464 to put out 2,047 Hz when the input is logic 0. In the playback (demodulate) mode, the 4020 determines the incoming frequency by counting clock pulses during one period; a long count, corresponding to the lower frequency, signals a logic 0, and a short count yields a logic 1. All C-MOS components are available from several manufacturers. Other crystal frequencies in the range 0.5–4 MHz can be used if diode code is changed to decode the proper count.

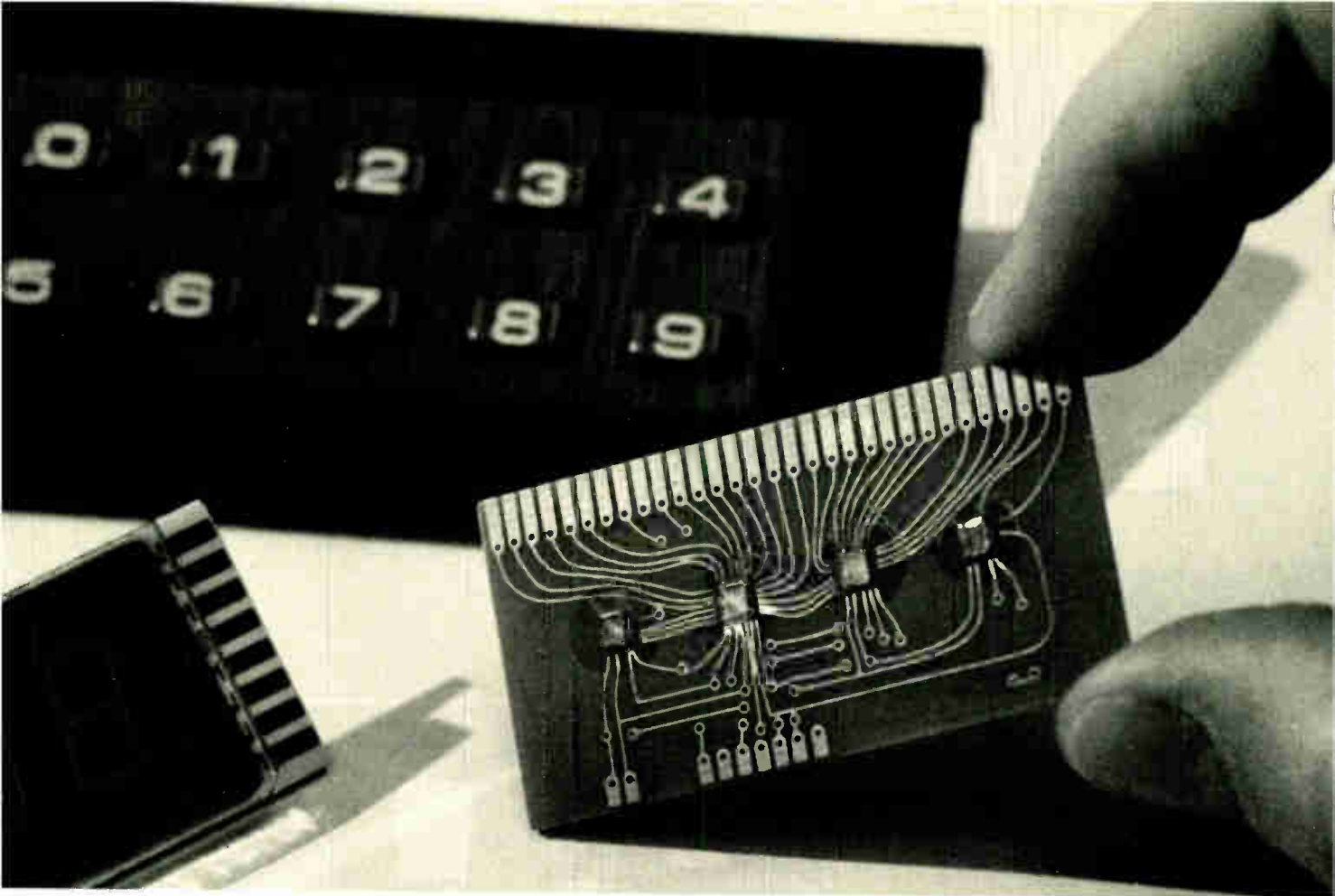

Digital television tuner uses MOS LSI and nonvolatile memory

by Lester Penner, *General Instrument Corp., Hicksville, N. Y.*

□ The phenomenal capabilities of digital technology are coming to the rescue of television-set manufacturers. The tuning of TV receivers electromechanically has been pushed to its practical limits in efforts to make ultrahigh-frequency channels tunable as easily as very-high-frequency channels. That tuning requirement has been mandated by the Federal Communications Commission. Fortunately, the versatile electronic tuner can not only handle this requirement with ease, it can accommodate a number of added frills at minimal cost.

One of the latest digital tuners is the Omega (Fig. 1). The Omega combines low-cost performance and reliability of large-scale-integrated MOS digital circuits with the analog technology of the varactor tuner and television itself. The system also capitalizes on the nonvolatile capabilities and economy of the metal-nitride-oxide-silicon (MOS) electrically alterable read-only memory. As an indication of mix of technologies involved, the design team included representatives of General Instrument's semiconductor components, television-tuner, microelectronics, and keyboard divisions.

Not only can the electronic control accurately tune in

the 12 very-high-frequency channels and 70 ultrahigh-frequency channels, but a character generator can easily be added to display the channel number on the screen. In addition, a clock chip can be added to display the time on the screen. The smaller size of the electronic tuner offers the designer more versatility in using various types of push buttons and readouts while at the same time reducing the size of the TV cabinet.

And, although it's still on the drawing board, the programmable nonvolatile memory will enable the viewer to preprogram an entire week's viewing. In addition to being smaller and more versatile than electromechanical tuners, electronic controls, benefiting from MOS-LSI technology, are much more reliable. Yet, they are only slightly more expensive.

Even with only the 12 vhf channels to cope with, the electromechanical tuner's detent operation is susceptible to failure because of loose or dirty contacts. Reliability is jeopardized when the electromechanical control is designed to tune the uhf channels as well.

To help alleviate the problem for electromechanical tuners, the FCC has made two concessions—reducing to

1. Digital dexterity. The Omega digital tuner, shown with a seven-segment digital display and a keyboard that might be used on a TV set, is only slightly more expensive than the detent tuner.

six the number of uhf channels that must be programed into a tuner at one time and reducing the maximum deviation from the optimum frequency on any channel to ± 1 megahertz.

Although the detent tuners most manufacturers supply can fine-tune the vhf channels, that degree of flexibility can't be carried over to the uhf channels except with a cumbersome, complex device. Thus, the FCC has started manufacturers scurrying to adopt the electronic tuner, which can easily fine-tune all the channels.

The varactor tuner shows the way

Omega is not the first system to take advantage of the varactor tuner, an analog semiconductor device in which the capacitance varies with the applied voltage. Two other systems have showed promise, but proved to have shortcomings—higher costs among them. These techniques are the use of the varactor with a potentiometer array and with the phase-locked loop.

To date, the varactor is most commonly used with the potentiometer array (Fig. 2). In this arrangement, a group of potentiometers, usually 20, is connected between a stable voltage supply and ground. Each potentiometer can be adjusted to a voltage that tunes the set to one of the local channels. Some form of selector, such as solid-state switch, routes the voltage from one of the potentiometers to the tuner.

The selector may be push buttons, touch buttons, a rotary knob, or a slide lever. If a momentary button is used, flip-flop storage is included in the solid-state switch. Also, the bands must be changed, either by slide switches or by tabs inserted in the switches to indicate the channel numbers programed into each position. However, either way, someone must adjust each potentiometer for optimum tuning of all local channels.

The costs of stable potentiometers and elaborate mechanical assemblies are drawbacks, regardless of the method chosen to change channels. Slide switches lack precision in tuning, and the alternative, insertion of tabs, is inconvenient.

The other common type of electronic tuning is the phase-locked loop (Fig. 3). In this technique, the fixed frequency of a crystal-controlled oscillator is divided down to a stable reference frequency and compared against a variable voltage-controlled oscillator. The VCO frequency output, f_1 , from the varactor tuner is amplified enough to drive a high-frequency digital counter. The prescaler divides f_1 by a fixed number, M , and the resulting frequency, f_2 , is then divided by a variable counter that divides by a value N , determined by the modules

of the variable counter and the value of its initial preset.

The output of the variable counter is a frequency, f_3 , equal to f_1/MN . This frequency, in turn, is forced by the servo loop to equal f_r by putting both through a phase detector and using the output-error signal to change the frequency, f_1 , of the tuner oscillator in a direction to reduce the error between f_3 and f_r to zero. Since a subharmonic of the varactor-controlled oscillator is phase-locked to a subharmonic of the crystal oscillator, the varactor tuner will exhibit the stability of the crystal oscillator, but at some different frequency.

Channels are selected by changing the value of N to get the desired frequency, f_r , which is f_1/MN . The

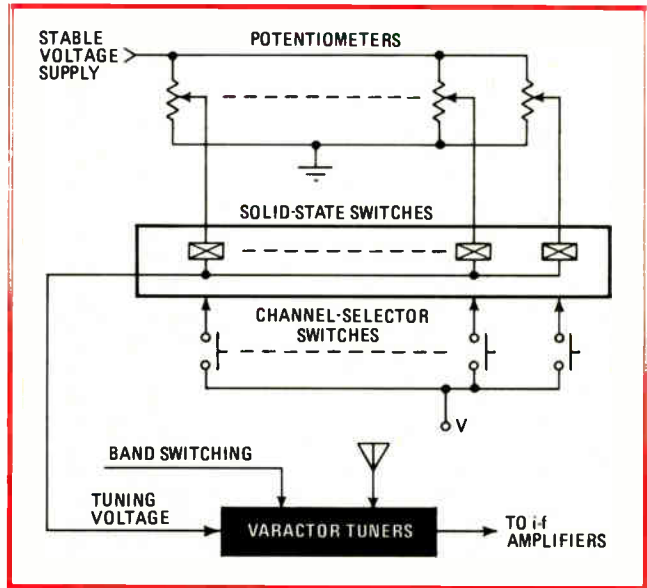

2. Varactor gone to pot. Until recently, the varactor tuners used for TV receivers have usually included about 20 potentiometers that could be adjusted to a voltage that tuned the set to one of the local channels. This approach has worked in the early electronic tuners, but it requires stable potentiometers, which can be costly.

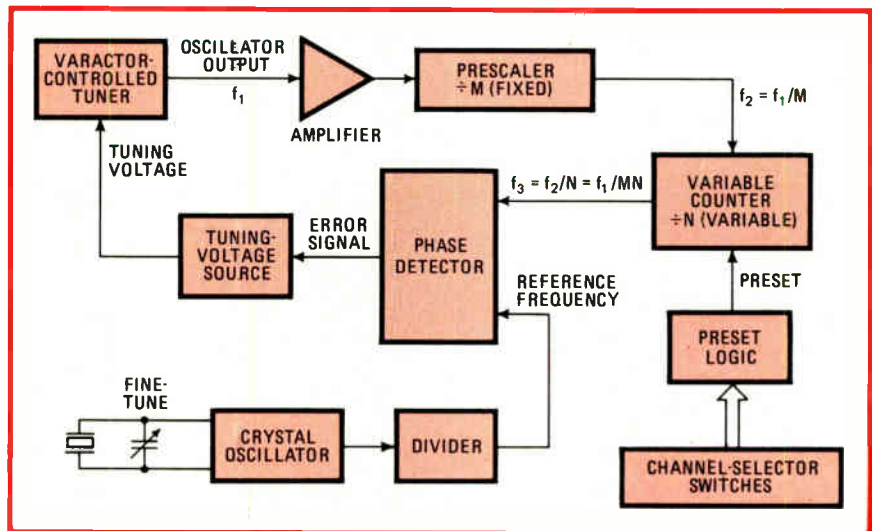

3. Going through a phase. A newer electronic tuner has a phase-locked loop to ensure a stable reference frequency divided down from a crystal-controlled oscillator. Phase detector measures error between reference and preset frequency f_3 ; error signal is used to adjust varactor tuning voltage. Again, cost is a problem with PLL-based tuners.

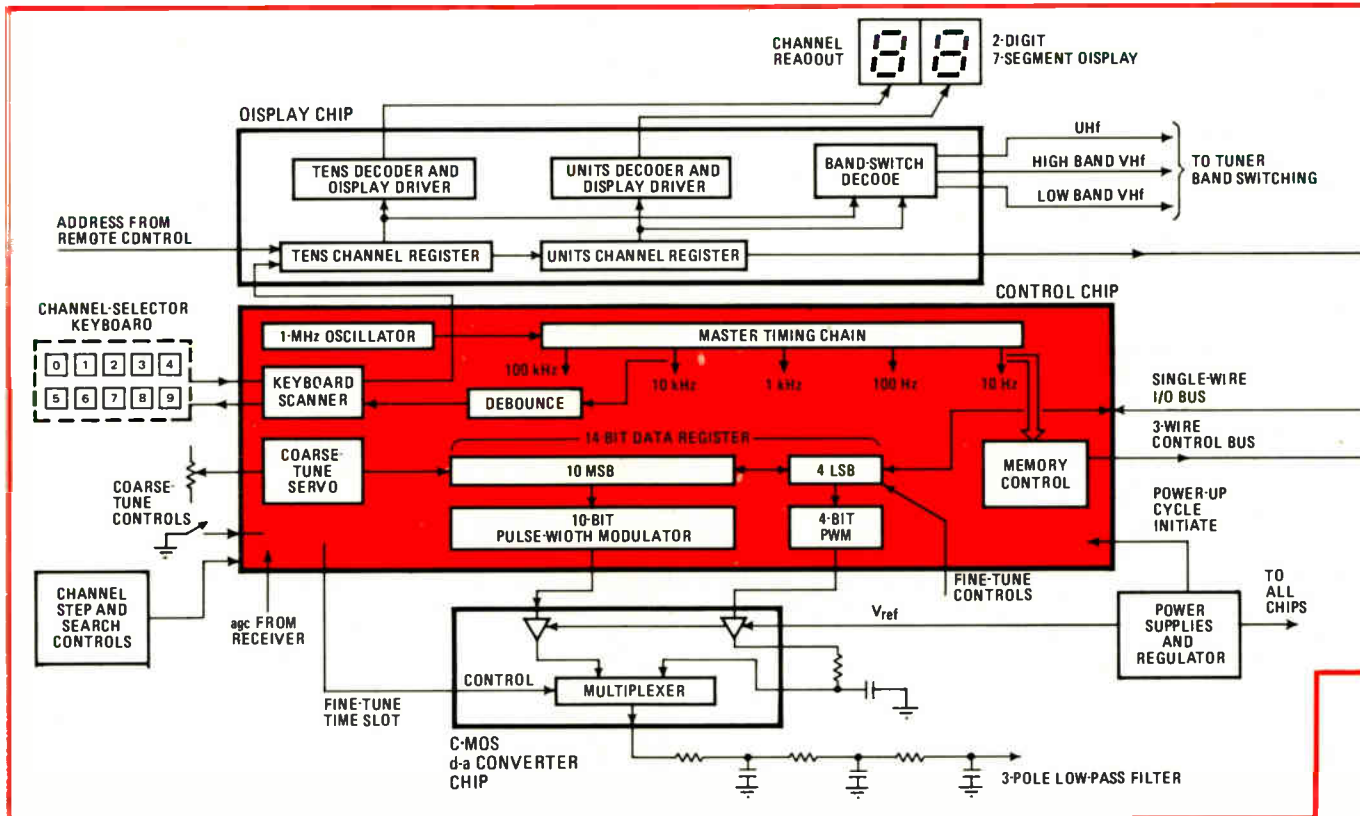

viewer operates a channel-selector switch that causes the preset logic, which may contain a read-only memory, to select a preset count-down starting point that will provide the correct value of N to tune the varactor tuner to the selected channel. The values of f_1 , M , and the range of N are all engineered to give the desired range and resolution to the tuning system. A channel can be fine-tuned by causing small shifts in the crystal-oscillator frequency, but this adjustment is not independent for every channel.

The phase-locked-loop technique is limited because the prescaler must operate at 900-megahertz input frequency, which is near the upper limit of commercially available ICs. What's more, the amplifier used to raise the low level of the tuner oscillator to drive the digital prescaler may be costly.

Omega changes the approach

The Omega all-electronic tuning system fulfills these design objectives:

- It provides an electronic memory in addition to all the best features available on mechanical tuners.
- Its nonvolatile MNOS memory eliminates the need to keep a power source operating, and its production cost is low. These two factors help keep the tuner competitive in the cost-conscious color-TV industry.
- It uses low-speed MOS-LSI digital techniques to achieve low cost, yet is compatible with LSI innovations such as on-screen channel and digital-clock displays.
- It provides the push-button inputs and digital readouts that have become so well accepted with calculators and electronic clocks and watches.
- It accommodates a variety of available varactor

tuners, push-button selectors, display readouts, and remote-control systems.

- It accommodates the differing channel allocations found all over the world, as well as the special requirements of conversion to cable television.
- It eliminates the need for any initial setup by the customer while allowing independent fine-tuning of all 82 channels.

Cognizant of the limitations of earlier tuning systems, Omega designers built this system around four custom LSI chips fabricated with three MOS technologies. The control and display chips are fabricated with n-channel metal-gate ion-implant technology, the digital-to-analog converter chip is complementary-MOS, and the Earom is metal-nitride-oxide silicon.

The n-channel technology was selected for the control and display chips primarily to meet the low cost-to-performance ratio necessary for a TV tuner. The control chip (Fig. 4), which performs the timing and logic functions, contains all the circuitry necessary for interpreting input from the channel-selector buttons and mode controls. It includes some digital circuitry of the digital-to-analog converter and produces all the timing and control signals for tie-in with the other LSI chips.

In operation, the control chip scans the keys and switches at a 10-kHz rate until it senses a closure. A debounce circuit reconfirms the closure 10 milliseconds later. A switch closure might command one of several functions: two-digit random channel selection, channel stepping (by units or tens), coarse-tune, fine-tune, or search. In addition to switch closure, the control chip accommodates a signal input from a remote-control receiver, a power-up signal from a power supply to trigger

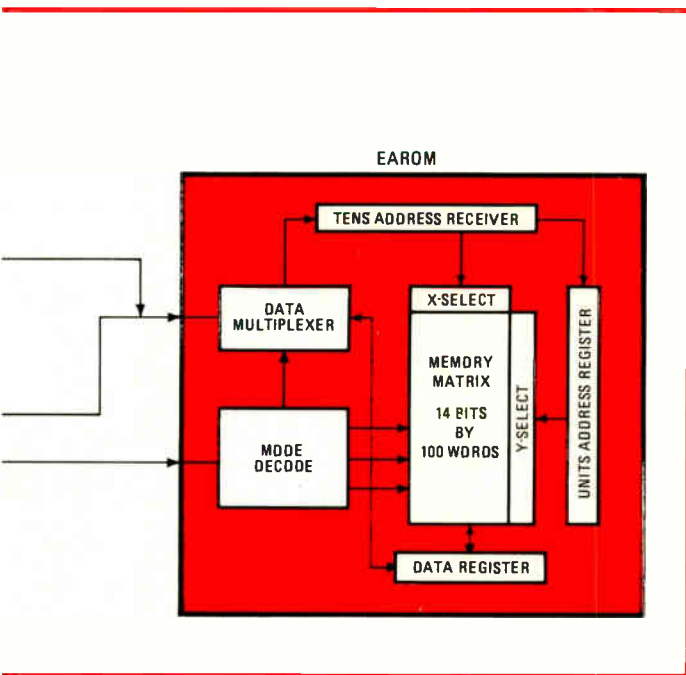

4. Omega, the tuner. This digital tuner system includes an n-channel MOS control chip, an n-channel MOS display chip, a complementary-MOS d-a converter chip, and an MNOS electrically alterable read-only-memory chip, which has a capacity of 100 14-bit words. Control chip interfaces with Earom through a single-wire I/O bus.

the last channel viewed, and an automatic-gain-control signal to terminate the search mode.

The display chip, which accepts the encoded keyboard entries from the control chip, performs the display decoding and driving, as well as the tuner-band switching. When the viewer selects a channel, the corresponding data word is retrieved from memory and held in the control chip. The data is converted from digital to analog form, and the resulting voltage is applied to the varactor tuner.

The fine-tune control can be either a double-throw switch with a center neutral position or a pair of push buttons. Using these switches, the viewer can fine-tune up or down until satisfied with the picture. This procedure actually increments or decrements the data register in the control chip. When the viewer releases the switch, the modified word is reloaded into the Earom so that any time that channel is selected, the word corresponding to the most recent adjustment is retrieved.

Each digit of the channel-number entry is encoded and sent to the display chip, where it is stored and decoded both for a seven-segment display and for band-switching. This channel number is also used as a two-digit address (0, 2 through 9, 9) for the Earom to locate the corresponding memory line. The address is sent serially to the Earom on a single-wire bidirectional bus.

Memory is slow but sure

The Earom, made by a technology licensed by NCR Corp., has a capacity of 100 14-bit words. The memory stores binary equivalents of the analog voltages for 82 channels, as well as the two digits of the channel being viewed when the receiver is switched off. An additional

16 memory locations can accommodate special frequency allocations that might be required in cable-TV.

The Earom (Fig. 5) was designed not so much for high speed as for low cost. Both write and erase take 20 milliseconds. Since memory-access time for this application may be slow, all address and data transfers are serial—a single bidirectional terminal is used to transfer both data and address to and from the memory.

Using a 3-bit parallel code to command the memory into one of its seven operating modes—input address, input data, output data, erase, write, read, and stand by—achieves another economy. In fact, the entire memory in its inexpensive package has only seven pins.

In operation, it's necessary to erase a word location to all 0s before a new word is written because the write procedure only writes 1s. This type of memory has certain theoretical storage limitations, such as storage time of 10 years between refreshes, 1 billion reads between writes, and 1 million erase/write cycles per word. However, in the manual Omega system, these are not practical limitations.

In the 100 words of memory, designated 0, 0 to 9, 9, each address is used to store the channel-voltage data corresponding to the same two-digit channel number. The single digit channels use location 0, 2 through 0, 9. Locations 0, 0 and 0, 1, which do not have corresponding channel numbers, are used for a special purpose. When a two-digit channel number is selected, that channel number is first stored in the 0, 0 and 0, 1 locations, one digit in each. Thus, when power to the set is turned off, the last channel viewed is always retained in these two locations.

When the viewer turns on the receiver, an automatic sequence, like the mechanical memory of a rotary-type selector, begins to retrieve that channel number and retune the set to the last channel setting.

In addition to the random channel selection possible with a two-digit entry, the channel number can be incremented up and down in units or tens. This form of control is useful when interfacing with remote-control systems. However, fully encoded random channel selection by remote control can be shifted into the control chip through terminals provided.

The d-a converter uses a low-pass filter along with the C-MOS device between the control chip and the low-pass

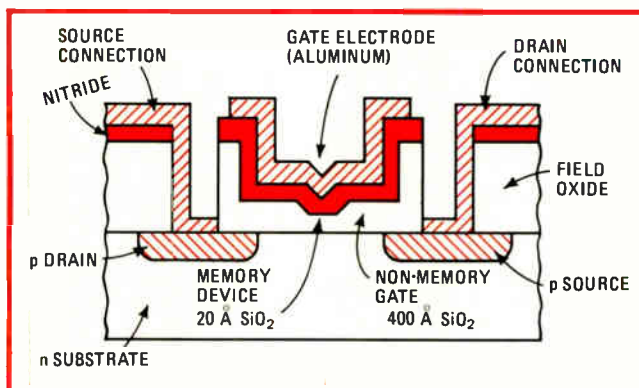

Inside Earom. In the MNOS memory transistor, voltage applied to the gate causes tunnelling through the gate oxide, 20 angstroms thick, which is the basis for nonvolatile data retention.

filter to achieve the precise, stable amplitudes required at the input to the filter. C-MOS technology provides the best way of time-gating the precise reference voltage into the filter to give a tuning voltage that suffers minimal error from variations in components.

The d-a converter had to be inexpensive, as well as highly accurate. Fortunately, the speed of conversion was not a major factor, since settling times of 100 or 200 ms when changing channels would be barely noticeable. The converter that was selected modulates the duty factor of a constant-frequency pulse train proportionally to the digital input and then filters out the average dc component of that train and uses it as the voltage input to the varactor.

D-a converter is precise

The basic converter accepts and holds the 14-bit word in the data-holding register while a counter of the same bit length is stepped by a clock of frequency f_c . The parallel outputs of the data-holding register and the counter are continuously compared. The output of the comparator is 1, so long as the count in counter B is less than that in data register A. When B exceeds A, the comparator switches to 0 until the count of B overflows, and then it begins again.

The output from the comparator, which has a period of 2^n counts, remains at 1 for a time proportional to the input value. Derived as it is from a digital LSI circuit, this signal's duty factor is precisely defined but not its amplitude. The converter must now control a solid-state switch that can increase amplitude and maintain the precise level. Because a high-voltage C-MOS device provides the best control, a special circuit and process modification was developed to perform this function.

A simple RC filter averages the area under the C-MOS-output waveform and extracts a dc component within the range of 0 v to V_{ref} for duty factors between 0% and 100%. With a V_{ref} of 28 v, the full range of most varactor diodes can be driven directly from the filter without need for amplification.

The stability and accuracy of the filter output depend primarily on V_{ref} and the duty factor. The clock frequency and the values of R and C have only secondary effects on the analog output.

The cutoff point of the low-pass filter is a compromise between the amount of ripple left in the analog output and the sluggishness in response to a change in duty factor (a channel change). A 14-bit word was needed in the system to achieve the necessary resolution. But, since it was also desirable to keep the clock frequency below 1 MHz to minimize chip yield even with a multipole filter, such a slow period could not be filtered adequately to maintain a reasonable response time.

To overcome this problem, the converter was modified (Fig. 6) to operate only on the 10 most significant bits of the 14-bit word, as described above, while the four least significant bits are made to generate a variable-amplitude pulse that is multiplexed into the filter. A pulse 1 μ s wide, which could take on 16 possible amplitudes, multiplies the resolution of the basic 10-bit pulse-width-modulated wave form by 16 while only adding 1 μ s to the total period.

The amplitude of the pulse representing the four least significant bits is again generated by a pulse-width modulator and low-pass filter to make it relatively insensitive to component variation. Still maintaining a clock frequency of 1 MHz, the converter has a resolution of one part in 16,384 while limiting the variable duty factor period of 1,025 μ s. A simple three-pole filter reduces the ripple below the noticeable level and maintains an adequate response to channel changes.

For coarse-tuning, a rotary control is desirable so that its position can be calibrated to show a rough indication of channel number. A servo loop is built into the chip to cause the variable pulse width of the d-a converter to track the pulse width of a monostable multivibrator controlled by a coarse-tune potentiometer. Because the d-a pulse width is varied through incrementation of the data register, the digital value in this register also tracks the potentiometer position. When the push switch on the coarse-tune control is released, the memory is updated with the new digital word.

In the search mode of channel selection, depressing a switch button causes the system to select each channel in sequence. When a signal from the receiver indicates that a program is present on that channel, the sequencing stops. The effect is to scan through the channels, stopping at each active signal. □

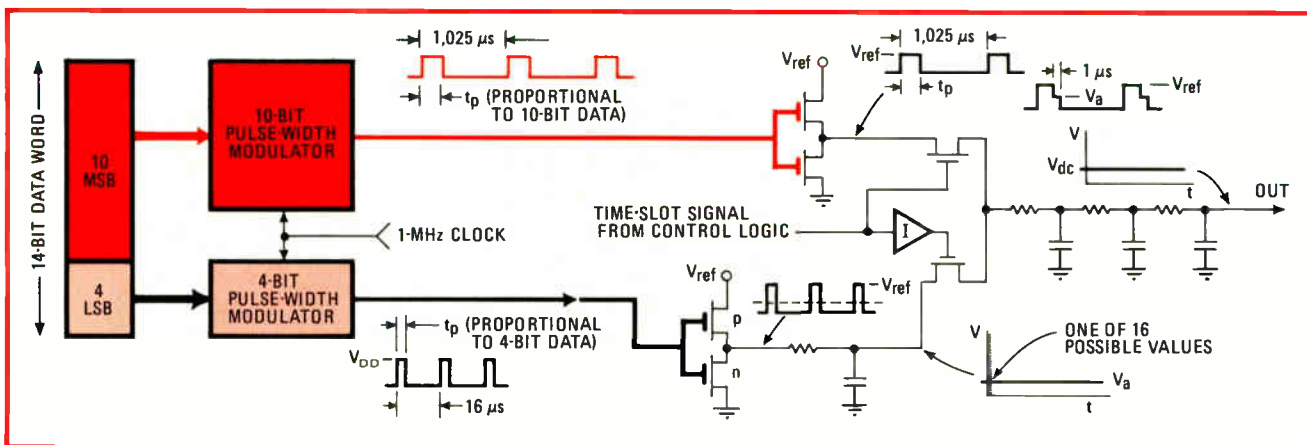

6. Most significant. To keep clock frequency below 1 MHz but filter it adequately, converter operates separately on the 10 most significant bits of 14-bit word, while four least significant bits, operating on a different track, are made to generate a variable-amplitude pulse.

Don't pay for more performance than you need in dc-to-dc converter modules

by Daniel T. Sheehan, Stevens-Arnold Inc., South Boston, Mass.

□ Nowadays, the small, board-mountable, encapsulated module is the most widely used type of dc-to-dc converter, but selecting the right one for a given application is no easy matter. The potential user must be familiar not just with the specifications but with their interrelationships. Otherwise, he or she will be paying for unneeded performance in such parameters as noise, temperature and the related power-transfer efficiency, and input conditions.

Dc-to-dc converters, as a convenient means for shifting from one voltage level to another, were used primarily in portable standby power supplies for many years. With the development of modular converters came new uses in uninterruptible power supplies. But the modules also acquired a whole new function: as isolators for eliminating ground loops and noise problems in analog and digital systems.

There is a wide selection of modules available for powering logic devices and operational amplifiers, at prices much lower than they used to be. They always use some form of switching, although there are only two basic types of popular conversion schemes—the push-pull saturable-transformer circuit (Fig. 1a) and the switching regulator (Fig. 1b).

Making the conversion

The push-pull dc-dc converter is actually a free-running oscillator that produces an unregulated square-wave output. The dc input is chopped into complementary square waves, passed through a transformer, then rectified and filtered.

During each cycle, the transistors are driven between cutoff and saturation through the positive-feedback windings of the transformer primary. For half a cycle, the voltage across the transformer primary stays constant, as the magnetizing flux steadily increases. When the transformer core saturates, the magnetizing current rises suddenly to its peak value, the rate of rise of the magnetizing flux decays to zero, and the voltage across the primary winding collapses. This removes the base drive to the saturated transistor, turning it off.

In the switching regulator, the transistor is driven on and off through its base terminal by a pulse train whose duty cycle is modulated. The catching diode, which provides a continuous path for the inductor current when the transistor is off, limits excursions at the collector ter-

minal. The output V_{OUT} of the LC filter is the average value of the switched waveform V_C . If the voltage drop across the transistor and the inductor are ignored, then:

$$V_{OUT} = (t_{ON}/T)V_{IN}$$

which is independent of the load current. Here, T is the total period of the switched waveform and t_{ON} is the on-time of this period. With the switching regulator, large changes in input voltage can be accommodated by varying the duty cycle of the switched waveform.

Of these two dc-dc conversion techniques, the push-pull circuit is the more widely used because it offers inherent transformer isolation. Although its output is

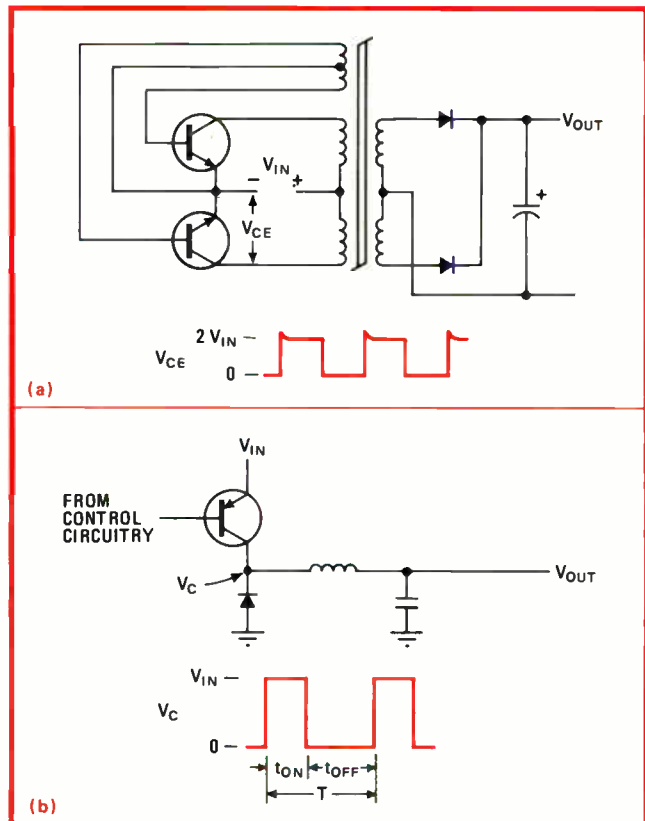

1. Dc-dc conversion techniques. The push-pull saturable-transformer converter (a) chops up dc input into a complementary square wave that is then rectified and filtered. In the switching regulator (b), duty-cycle-modulated pulses are transmitted through a transistor.

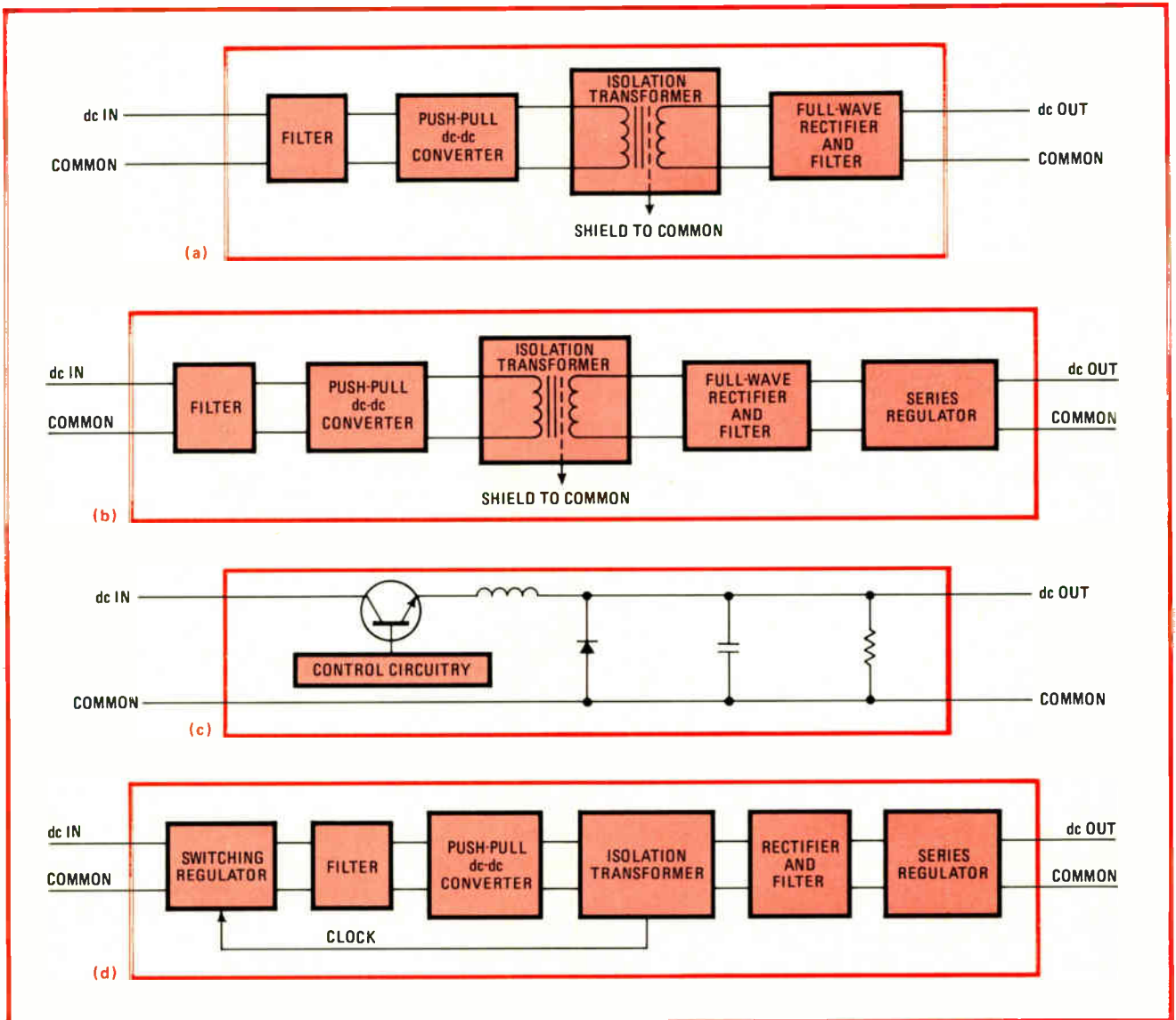

2. Classes of modules. There are four basic types of commercial dc-dc converter modules—isolated unregulated (a), isolated series-regulated (b), nonisolated switching-regulated (c), and isolated switching-regulated combination (d) for extending input range.

poorly regulated—to only about 10% at best—it can provide excellent line and load regulation of down to 0.01% when it is followed by a series-pass regulator.

The switching regulator is not isolated, but it provides line and load regulation of down to 0.1% without extensive additional circuitry. Its ability to operate over a wide range of input voltage and its high power-transfer efficiency also are advantages. Since it's noisy, though, the switching regulator may require filters at its input and output. Load-recovery time is very slow—usually longer than 1 millisecond—while switching frequency is sensitive to reactive loads.

Because it contains no transformer and often no filters, the switching regulator tends to be less expensive than the push-pull converter, particularly at high power levels. Generally, the switching regulator is the more economical of the two circuits for power outputs of 50 watts or more.

The two standard forms of dc-dc conversion circuits appear in four types of commercially available modules

(Fig. 2). Two types have the push-pull circuit, one has the switching regulator, and the fourth has both. For the most part, each type can produce a single positive output for powering logic devices or a dual output (positive and negative) for supplying op amps.

Classifying commercial modules

The module of Fig. 2a is an isolated, unregulated device. It uses the push-pull circuit followed by an isolation transformer, which can be used to step up or step down the voltage and to invert it. Adding a series-regulator output stage to this module produces the well-regulated low-noise isolated converter of Fig. 2b.

The nonisolated regulated module (Fig. 2c) is simply the switching-regulator conversion circuit. To obtain isolation and the ability to operate over a wide input range, the switching regulator and the series-regulated push-pull converter can be combined (Fig. 2d). Such a module can accept inputs from 6 to 60 volts.

Circuit designers are aware that there are tradeoffs

involved in the performance characteristics of any component or device. But it is an oversimplification to say it boils down to cost versus performance—the tradeoffs are often between the performance characteristics themselves, because they influence one another.

For example, with dc-to-dc converters, increases in the surface temperature of the package are influenced by such factors as the size of the module, the amount of package power that must be dissipated (which, in turn, depends on the efficiency), and the rate at which the package can dissipate heat (which is determined by the package's thermal resistance.)

And surface-temperature rise is only one of a number of thermal factors that figure in the performance of converter modules. In fact, noise, temperature, efficiency, and input conditions are the chief determinants of module performance.

Many parameters are interdependent

Noise is influenced by converter switching-spikes, package and transformer shielding, circuit layout, and the design of the transformer, filter, and regulator sections. Converters are subject to reflected input ripple current, common-mode noise current, and output noise voltage.

Sometimes called spike-feedback current, reflected input ripple current is caused by spikes generated by the converter's power switches. If they are reflected back into the voltage source, they may falsely trigger other circuitry (such as flip-flops, gates, and counters) being supplied by the same source.

A converter module should contain a filter between its conversion circuitry and its input pins that reduces the reflected spikes by a factor of 10 or more.

Common-mode noise current consists of nanosecond-long current spikes generated by an isolated module between its input and output common terminals. Its magnitude is proportional to the converter's power rating and voltage-transfer ratios.

Common-mode noise is the least understood noise parameter and can cause mysterious systems problems.

For example, excessive noise of this type on the output common line can saturate a differential op amp that is nowhere close to approaching its true differential-input limitations.

If the transformer is not properly designed and shielded or if there are excessive leakage paths paralleling the transformer, the module's common-mode noise will be high. Moreover, if the transformer is poorly designed, the converter's isolation will be affected, and some high-frequency noise at the input may be transferred into the output common as common-mode noise current.

Output noise voltage (often called simply "ripple") is the ac component of the dc output voltage. It is specified as either a peak-to-peak or a root-mean-square value. Ripple voltage affects different systems to a different extent.

For instance, a narrow-band circuit may not be able to cope with more than a millivolt of true-rms noise, yet it may tolerate a short 10-mv pk-pk switching spike lasting 50 or 100 nanoseconds. Just the opposite may be true for a wideband high-accuracy circuit. On the whole, it is difficult to correlate sinusoidal behavior with switching spikes, so the user should make hardware measurements to determine a system's sensitivity to output noise voltage.

The converter's noise bandwidth, at 20 megahertz minimum, should be specified as either a pk-pk value or true rms value. If some other noise callout is used, such as an average rms value, the designer may be suitably impressed by the low number—until he tries to make a wideband true-power noise-measurement correlation. With dc-dc converters, true noise measurements require high-frequency pulse techniques, as well as appropriate terminations and ground planes.

Switching-frequency considerations

Most dc-dc converters operate at inaudible switching frequencies of 20 kilohertz or higher. Some switch at audible frequencies below 20 kHz for better power-transfer efficiency. In either case, there may be radiated ef-

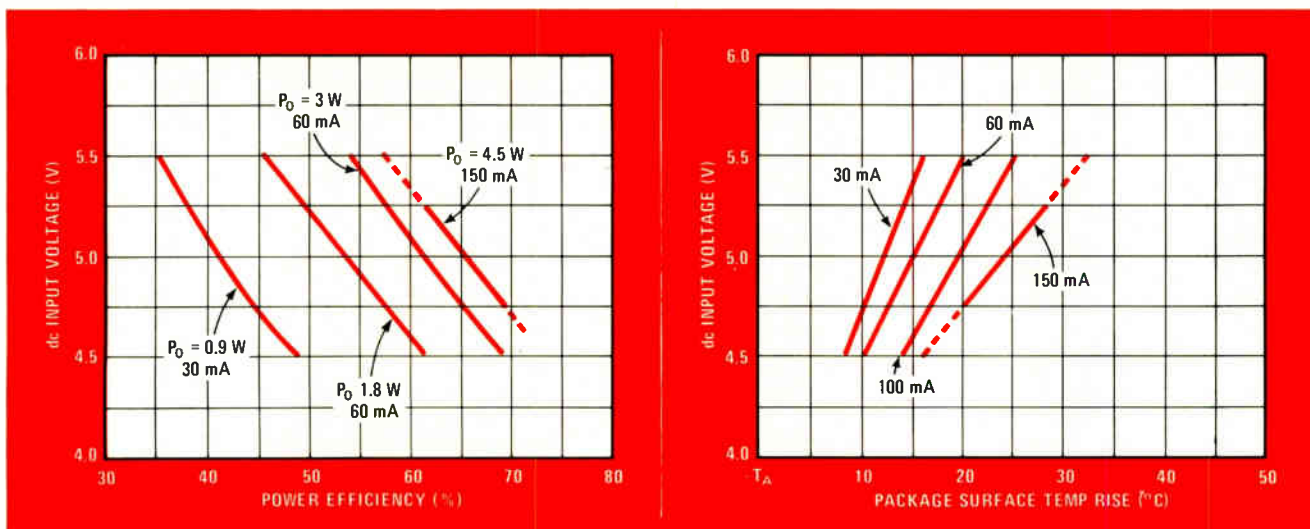

3. Typical characteristics. Since the power dissipated by converter package is the difference between input and output powers, surface-temperature rise and power efficiency are related to each other, as illustrated by these curves for a standard commercial module.

PERFORMANCE RANGE OF POPULAR MODULAR DC-DC CONVERTERS

Type of converter	Output voltage (V)	Power ratings			Input voltage (V)	Regulation		Output noise voltage	Isolation voltage (V)	Unit price range	Notes
		Output (W)	Efficiency (%)	Density (W/in. ³)		Line (%)	Load (%)				
Unregulated, isolated	± 15	1 - 6	50 - 85	1.4 - 8	5 nom, -1.5, +3	none	10 - 100	30 mV pk-pk 50 mV rms	50 - 600	\$31 - \$49	filtered, raw dc output
Series-regulated, isolated	+ 5	3 - 6	40 - 70	0.73 - 3.3	12 nom, ± 2	0.02 - 0.1	0.02 - 0.3	30 - 150 mV pk-pk	300 - 500	\$69 - \$89	12-μs load recovery time
	+ 5	10 - 25	62	1.4 - 1.7	12 nom, ± 2	0.2	0.2	40 mV pk-pk	500	\$99 - \$160	external heat sink required
	± 15	1 - 4.5	40 - 65	0.6 - 3	5 nom, ± 0.25 - ± 0.5	0.01 - 0.3	0.01 - 0.1	7 - 150 mV pk-pk	300 - 500	\$39 - \$80	25-μs load recovery time
	± 15	10 - 25	55 - 65	1.3 - 1.7	5 nom, ± 0.5	0.02 - 0.1	0.02 - 0.1	40 mV pk-pk, 1 mV true rms	300 - 500	\$99 - \$165	external heat sink required
Switching-regulated, nonisolated	+ 5	5 - 10	70	1.4 - 2.8	12 nom, -3, +4	0.1	0.1	5 mV rms	none	\$31 - \$41	1-ms load recovery time
	± 15	30 - 60	85	4.3 - 8.5	19 - 28	0.1	0.1	5 mV rms	none	\$65	1-ms load recovery time

fects of electromagnetic and radio-frequency interference on other circuit components. For adequate containment of noise caused by switching, the converter should include multiple transformer and package shielding, as well as an input filter that minimizes reflected input ripple current.

If the converter does operate below 20 kHz, it should be monitored through its load conditions with an oscilloscope to assure that there is no extreme electrical or mechanical resonance point. Such a resonant condition may set up vibrations in other components that may be capable of converting them into large, intolerable noise signals. Locating the source of these signals can prove to be very difficult, because the noise occurs "all over the place."

Converter switching frequency also should be taken into consideration when noise measurements are made. A converter switching at 5 kHz will not exhibit the same amplitude of wideband noise that it does when operating at 20 or 30 kHz. Noise-measurement bandwidths should allow for such differences.

Relating thermal and power parameters

The thermal performance of a dc-dc converter module is influenced by a number of factors, such as power-transfer efficiency, package-surface-temperature rise, operating temperature range, external heat-sinking requirements, and output short-circuit protection.

So the user should carefully examine all thermal parameters for both operating and fault modes. For the

operating mode, these include surface temperature rise, derating requirements, and external cooling and heat-sinking requirements. For the fault mode, they include the conditions under which the output is protected against shorts, how long and at what temperature the output can be shorted, and the worst-case input fault-mode current.

To provide reliable operation, converters generally require extremely conservative design. For example, in the full rated operating mode, a reliable and safe converter may well consist of components operating at half or less of their limits. Such a design is necessary if the converter is to survive a long-term fault condition (say, an eight-hour output short at its upper temperature extreme and a high line-condition) and if the converter's package surface-temperature-coefficient is to be held to a reasonable level, without power derating or any external heat sinking.

Surface-temperature rise, which should be specified for the hottest point on the case, is a measure of the temperature increase (above ambient) of the module's surface for each watt dissipated in the package. It is commonly specified in degrees celsius per package-watt dissipated. The power dissipation of the package is actually the difference between input power and output powers:

$$P_P = P_{IN} - P_{OUT}$$

Power-transfer efficiency, the ratio of output power to input power, expressed in percentage, is yet another im-

portant characteristic of dc-dc converters. In portable equipment applications, it directly influences how long the batteries may be expected to last. Also, it tells the user how much power the converter's package will be dissipating, and it is linked with the device's surface-temperature rise.

Converter data sheets usually include graphs that help the designer determine power efficiency and surface-temperature rise over a wide range of input and output conditions. Figure 3 shows typical graphs for a commercial converter module. For example, for an input voltage of 5 v and an output power of 4.5 watts at 150 milliamperes, the power efficiency is 65% and the surface-temperature rise is 24°C.

Looking over input conditions

Generally, an isolated series-regulated dc-dc converter operates over a fairly narrow input range. To circumvent this limitation, the user can, of course, pay a premium to the converter manufacturer for a special unit. However, if he is able to compromise a bit on output power, he may be able to use a standard model over a wider input swing.

For instance, suppose a converter puts out 15 v at 150 mA and operates over an input range of 5 ± 0.25 v. If the output rating is reduced to 15 v at 120 mA, then the input range may be extended to 5 ± 0.5 v.

Input voltage swing can also be broadened by adding a nonisolated switching regulator between the voltage source and an isolated regulated converter.

It is essential for a dc-dc converter to receive the continuous input current it requires, so that it can operate at rated efficiency and output power. This means that the cross section of the printed-circuit conductors to the device's input pins should be big enough to permit adequate current flow.

Also, if separate sense leads for monitoring and adjusting the input voltage level are used, they should be right at the device's input pins. With such direct sense leads, the IR drop of the input power wiring will not reduce the effective input voltage the converter sees. If the required input current is not specified on the data sheet, it can be computed from:

$$I_{IN} = (V_{OUT} \times I_{OUT}) / (V_{IN} \times P_{EFF} \times 10^{-2})$$

where P_{EFF} is the power efficiency expressed in percentage. (It is usually also helpful to know the converter's no-load and full-load input currents.)

Another important input consideration is start-up after an output fault condition has been removed. A well-designed converter should restart at an input level far below its nominal requirement and operate even if its regulator section has dropped out.

Current foldback, in which the output current is reduced to two thirds of its full rated value during an output short circuit, is a common protective technique. Although it does reduce package dissipation during a fault condition, it sometimes prevents the output from returning to its normal level, even after the short has been removed. In this latchdown state, the converter simply will not recover automatically.

Also, current-foldback circuits can produce fault-

mode oscillation problems. Constant-current techniques seem to be a better alternative for avoiding latchdown problems, provided that the converter has an appropriate thermal design.

Even after the output short has been removed, some converters remain fully or partially latched down, and their input must be turned off and back on again before they recover. Other converters will not restart after an input power interruption, as long as their output is still shorted. And even if the converter does normally recover after a power interruption, large-value capacitors, distributed throughout the circuitry that the converter supplies, can inhibit startup.

So an important consideration in choosing a module is the type of fault recovery needed. Moreover, the converter should be able to restart even though a small reverse current is being fed back through the system and injected into its output—which is not an unusual system condition at all.

Of course, reliability is also a major factor in selecting a module. Since many dc-to-dc converter manufacturers burn in their units before shipment, reliability generally is good. As a rule, though, users should look for units with a mean time before failure of 75,000 hours or longer.

Selecting a commercial converter.

The user should always try to select the off-the-shelf module that most closely matches needs, without paying for performance not essential to the application. The table shows the range of performance available from standard dc-to-dc converter modules.

Sometimes, additional savings can be realized by having the vendor eliminate extraneous features. For example, output fault protection may not be essential, or the ability to operate at such typical high temperatures as 71°C or 85°C may be unnecessary.

The type of converter more or less determines regulation performance. An inexpensive switching-regulated module can provide both high efficiency and fairly good regulation in applications where isolation, low noise, and fast load recovery are not required. If low noise or isolation is a must, then a transformer-isolated series-regulated converter is the answer.

Of the more popular modules, many single-output 5-v devices operate from a nominal input voltage of 12 v, whereas most ± 15 -v dual-output units require a 5-v nominal input. An exception is the high-power dual-output switching-regulated converter, which can accommodate inputs of 19–28 v. It also provides the highest power-transfer efficiency, usually as high as 85%, and the greatest power density, up to 8.5 W per cubic inch. On the other hand, the best noise performance is obtained from the dual-output isolated series-regulated units. As a rule, isolated converter modules can provide up to 500 v or so of isolation between input and output. □

Bibliography

Dan Sheehan, "Determine Noise of dc-dc Converters," *Electronic Design*, Sept. 27, 1973, pp. 100–102.

R.J. Widlar, "Designing Switching Regulators," *Applications Manual*, Application Note AN-2, National Semiconductor Corp., Santa Clara, Calif.

"Dc Power Supply Handbook," Application Note 90A, Hewlett-Packard Co., Palo Alto, Calif.

Paul Birman, "Power Supply Handbook," No. 146-1131, Kepco Inc., Flushing, N.Y.

Films dominate components conference

by Lucinda Mattera, *Components Editor*

The San Francisco gathering will also, for the first time, allot separate sessions to semiconductors, optical devices, and organic materials

□ Thin- and thick-film technologies are extending their sway and influencing all kinds of components, active as well as passive. That will be abundantly clear at the 26th Electronic Components Conference, which opens in San Francisco on April 26.

Audiences at the dozen technical sessions will hear about:

- A gas-discharge display so simple that it could be made very large—basically it's no more than a pattern of conductive thick film screened onto a glass base.
- New versions of passive components, such as an electronically tunable thin-film inductor, a thick-film automotive thermocouple, and thin-film resistor networks that push thermal printing heads to a high level of resolution.
- High-performance hybrid circuits, including an active

digitally programmable filter that uses both thin and thick films, plus a thin-film LC delay line that's fast enough for the likes of emitter-coupled logic.

Also spotlighted will be: cleverer techniques for splicing and terminating fiber-optic bundles for data transmission, methods for protecting MOS chips against damage from electrostatic discharge, and improved silicones for encapsulating optoelectronic devices and beam-lead integrated circuits.

Altogether some 71 papers will blanket all major component areas—passive, active, electromechanical, optical. That kind of coverage certainly backs up the claim of program chairman John H. Powers, Jr., that the conference is still the most broadly based of all the electronic components meetings. Powers is with IBM System Products division in Hopewell Junction, N.Y.

In other ways, though, the conference is breaking with tradition. For the first time in 15 years, it will be held on the West Coast and not in Washington, D.C. In another break with precedent, the organizers are willing to register attendees for just one day, instead of the formerly obligatory three days, because they want to attract both local attendees and visitors to the companion exhibition, Design Engineers' Electronic Components show. (For a preview of new products to be introduced at the show, turn to p. 109.) Also without precedent is the fact that optical components, semiconductors, and organic materials are each getting a session of its own.

The two new component sessions

By giving optical components equal time, the conference is intentionally granting them the same status as other classes of components, says Powers. The innovation collects developments in displays, light-emitting diodes, and fiber optics under one banner.

Large-area gas-discharge displays have been a contradiction in terms. But now Beckman Instruments Inc., Helipot division, Fullerton, Calif., has developed a screened planar technology for making low-cost large-area displays that can show hundreds of characters—both alphanumeric and special symbols. The displays sandwich the gas between a glass panel and a substrate on which a conductive thick-film pattern is screened.

High-brightness LEDs can now be fabricated several at a time on the same substrate, report researchers at Monsanto Commercial Products Co., Electronics division, Palo Alto, Calif., and many character sizes are possible. Until now, very bright LEDs have usually been discrete devices.

In fiber optics, the impulse to growth comes mainly from data communications. Both AMP Inc. of Harrisburg, Pa., and ITT Cannon Electric of Santa Ana, Calif., will be presenting papers on improved methods for splicing and connecting high-density bundles of fibers for data transmission. In each case, new adhesive and polishing techniques minimize the chances of fibers breaking during connection. Also, as shown in Fig. 1, AMP is proposing a circular plastic termination with a tapered bushing that compresses the fiber bundle for the best fit. It is intended for medium- and high-loss cables. A third company, Meret Inc. of Santa Monica, Calif., will describe transmitter and receiver modules

for sending data over the fiber-optic lines at very high speeds.

Semiconductors, too, have achieved a session of their own. Here, because of the ever-expanding use of integrated circuits, their reliability comes in for attention. To underscore that point, chairman Don Carmean of Hewlett-Packard Co., Palo Alto, Calif., notes that more than 50% of the components in an instrument nowadays are ICs.

MOS devices and thyristors both have their vulnerabilities. IBM Corp., System Communications division, Manassas, Va., is therefore reporting on a hybrid circuit that protects a large-scale-integrated MOS device against its perennial enemy—electrostatic discharge. The hybrid device is placed inside the MOS package, and to extend protection up to 6,000 volts and beyond, IBM recommends plating a spark gap on the outside of the package. General Electric Co., Static Power Component Operation, Collingdale, Pa., is concerned about thyristors with unequal recovery times and the danger of destroying the devices when connecting them in series. The firm will discuss the method it has developed for non-destructive series connection.

In a second paper, this time on Josephson tunneling logic, IBM, Thomas J. Watson Research Center, Yorktown Heights, N.Y., analyzes what electrical characteristics are best for the interconnection systems of such logic. These logic circuits (Fig. 2) must operate at cryogenic temperatures, near absolute zero, but there they offer the advantages of high speed, high density, and low power.

In another first for the conference, microwave semiconductors will be discussed. The topics are the design of microwave power transistors and the characterization of Ka-band impatt diodes.

Passives shrink—but not in importance

Unlike their active counterparts, passive components have long been a mainstay of the conference and are represented by two strong technical sessions, one of them devoted exclusively to ceramic and film capacitors. "Almost all efforts nowadays are directed toward miniaturizing components," observes John J. Bohrer, who is chairing the general session on passive devices and is with the Electronics Components Group of TRW/IRC in Philadelphia.

For example, a miniature thin-film tantalum-nitride resistor network, to be described by TRW Network Operations, Burlington, Iowa, has impressive power dissipation for its size—a tiny resistor measuring only 0.075 by 0.075 mil can handle up to 0.4 watt at 70° C. Intended for terminating logic lines in computers, it's packaged in a three-lead epoxy housing.

Obtaining inductance with IC techniques has been a long-standing problem. However, an IC-compatible miniature thin-film inductor, proposed by Egypt's Ain Shams University, can be tuned electronically. By evaporating a permalloy thin film onto a substrate, researchers there have built experimental devices with inductances of 4.5 microhenries in an area of only 0.5 by 0.5 centimeter. At 15 megahertz, quality factor is 65.

Miniaturization is also making new demands on elec-

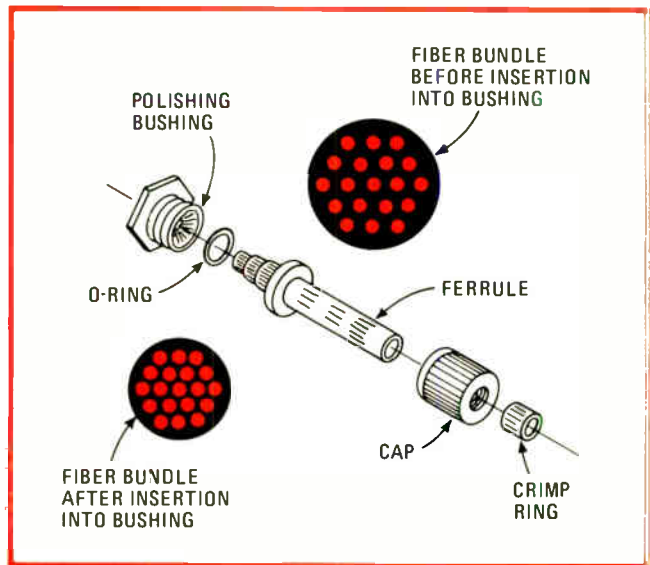

1. Terminating fiber optics. Plastic connector from AMP has tapered bushing that squeezes fiber bundle for optimum fit without overstressing it. The technique is intended for terminating jacketed high-density fiber-optic bundles being used for data transmission.

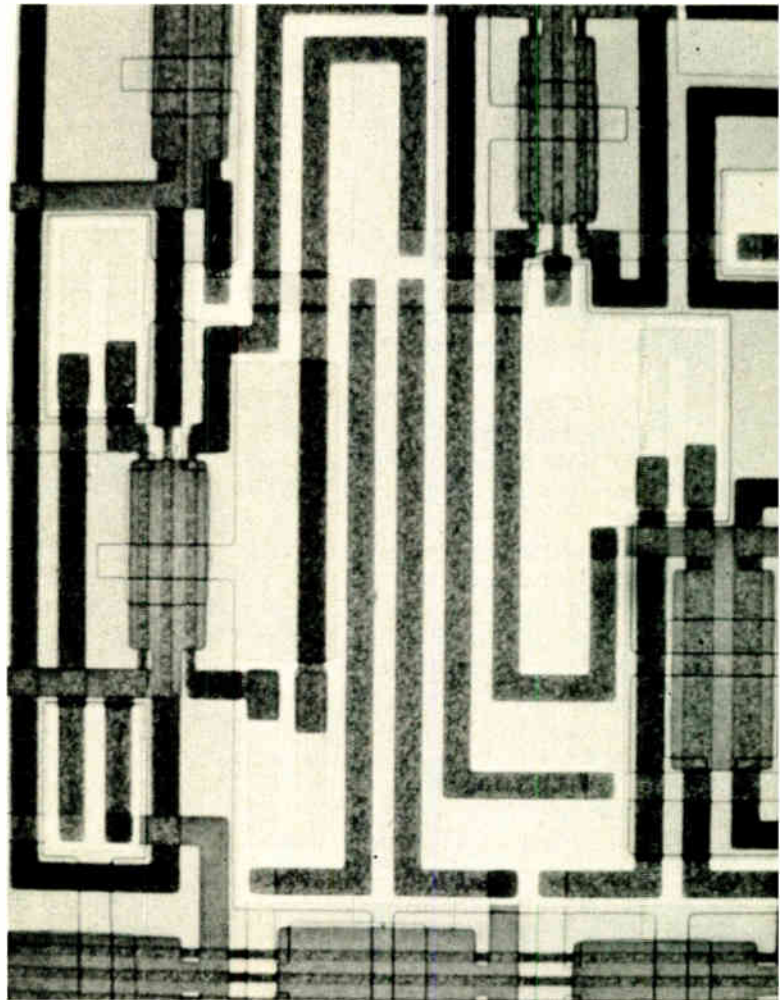

2. At absolute zero. Besides high density, Josephson tunneling logic offers fast operating speeds and low power levels—but at cryogenic temperatures. IBM has investigated the electrical characteristics of interconnection systems for these semiconductors.

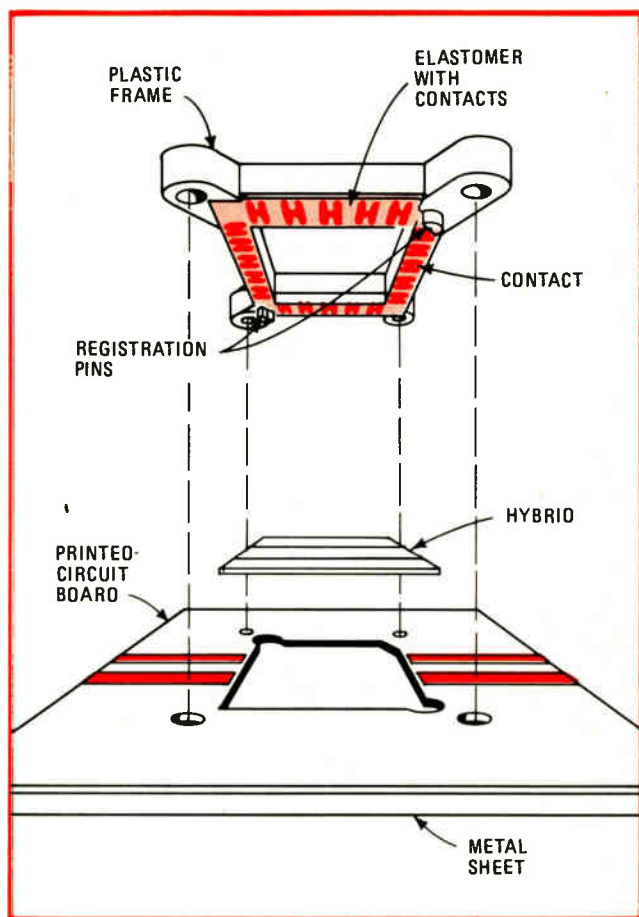

3. Hybrid Interface. Connector developed by Tektronix eliminates need for impedance matching when hybrid is interfaced with printed-circuit board. The H-shaped metal contacts, which are flexible foil-like conductors, are backed up by an elastomer.

trolytic capacitors, and Japan's Fujitsu has developed an etching method for forming aluminum electrolytics that adds dramatically to their capacitance. The process increases their effective dielectric surface by a factor of 150.

New low-cost metalization systems for multilayer ceramic capacitors are getting attention in the capacitors-only session, notes its chairman, Raj. B. Amin, from San Fernando Electric Manufacturing Co., San Fernando, Calif. Until recently, the electrode system for these capacitors used so much in the way of precious metals that it contributed heavily to their cost, says Amin. "For certain multilayer units, the electrode cost was as much as 50% of the total," he observes.

On this subject, USCC/Centralab, Electronics division, Globe-Union Inc., Los Angeles, describes a nickel electrode system that can cut device cost to as little as half that of precious-metal ceramic capacitors. The tradeoff is somewhat different electrical properties from those of the precious-metal units.

Other papers in this session will examine: methods for attaching ceramic chip capacitors, designing with high-frequency ceramic chips, low-inductance film capacitors, and spurious signal generation in plastic-film capacitors.

Connectors and contacts share the session chaired by Robert H. Van Horn of Bell Telephone Laboratories, Columbus, Ohio. His aim, he says, is "to develop an in-depth understanding [of the ability] of the connector structure to do its job over a long period of time."

Understanding the connection

Supporting this theme are two papers from Bell Labs. One, from the facility in Whippany, N.J., concerns crimp terminations for dry-circuit applications. Apparently, the crimp that gives the best electrical performance is usually deeper than the one required for greatest mechanical strength. A deeper crimp can therefore improve electrical performance yet still be strong enough mechanically.

The second Bell paper, from the laboratory in Columbus, Ohio, investigates three new metal systems for preventing dry-reed sealed contacts from sticking together. In most existing contact systems, a gold or gold-alloy layer plated over the reeds, plus extra circuitry, helps the contacts to reopen. Three proposed noble-metal systems—soft diffused gold or ruthenium or rhodium—cut overall costs by doing the job without the aid of any circuitry.

Another interesting connector development is being reported on by Tektronix Inc. of Beaverton, Ore. The company has a connector, called Hypcon, for interfacing a hybrid with a printed-circuit board. The device consists of a flexible metal conductor, almost a foil actually, backed up by an elastomer. As shown in Fig. 3, it goes around the periphery of the hybrid, interfacing the circuit with the pc board and eliminating the need for impedance matching.

Films get better ratings

Because of the sustained growth of hybrid circuits over the last few years, thick and thin films have been flourishing. "Both technologies are maturing, so that old problems are being solved," says Robert W. Berry, chairman for the session on thick and thin films, who is with Bell Telephone Labs, Allentown, Pa. Two related sessions cover hybrid circuit applications and technology.

In thick films, resistor voltage limits are being raised and conductor costs are coming down. For thick-film resistors, E.I. DuPont deNemours & Co., Electronic Materials division, Wilmington, Del., has a new high-voltage-stable material that can withstand transient voltage gradients of 75 kilovolts per inch with only negligible change in resistivity. In thick-film conductors, Motorola Communications division, Plantation, Fla., has found that platinum-silver can be substituted for palladium-silver, the popular alloy at present. Although platinum is more expensive than palladium, less platinum is needed, so that overall cost is lower.

A rather novel use of thick film, to be described by Engelhard Industries division, Engelhard Minerals and Chemicals Corp., Edison, N.J., is a thermocouple for automotive and similar sensing applications. Ordinary thermocouples are two-wire structures, and the new device is like them—it consists of two different thick-film materials, palladium-platinum and gold-palladium. It

TEMPERATURE (°C)	OUTPUT (mV)
0	0
100	3.6
200	7.6
300	11.9
400	16.4
500	20.9
600	25.3
700	29.7
800	33.8

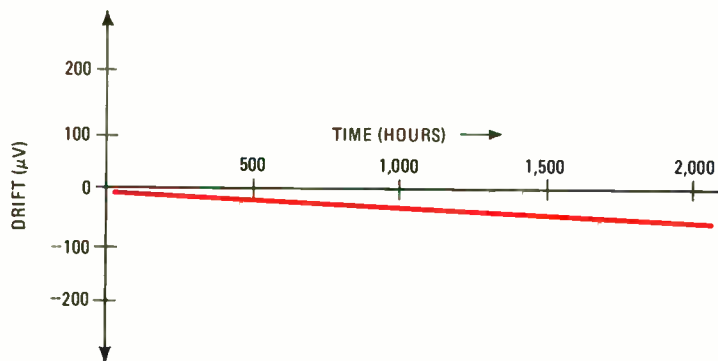

4. Thermocouple performance. Thick-film thermocouple made by Engelhard Industries produces an output of about 34 millivolts at 800°C, as indicated in table. Stability plot shows output drift is only 50 microvolts or so after 2,000 hours of operation.

can sense temperatures over the range of 0°C to 800°C to within an accuracy of $\pm 1\%$ (Fig. 4).

Another unique structure—this time a thin-film device—is a tantalum-nitride resistor network for use in high resolution thermal printing heads. Developed by Japan's OKI Electric Co., it permits a printout resolution of 5.3 dots per millimeter. Altogether, there are 512 resistors to a line (or row) over a head length of 96 millimeters.

The intent of the session on hybrid applications is to illustrate state-of-the-art circuit developments by presenting specific applications examples according to chairman Richard A. Rikoski from the Illinois Institute of Technology in Chicago. For example, Motorola Communications division, Fort Lauderdale, Fla., has developed a switchable active bandpass filter made with both thick and thin films and a custom linear IC. A digitally programable state-variable filter, it can produce any one of 12 different frequency responses.

From Japan's Susumu Industrial Co. comes the first LC delay line to be compatible with high-speed circuits like emitter-coupled logic. In essence, the delay line is a distributed LC network, made up of inductors formed by etching a copper plate and thin-film capacitors deposited by plasma polymerization. Conventional delay lines, consisting of discrete capacitors and wirewound inductors, respond too slowly and distort waveforms too much for use with high-speed logic. Response time of this film hybrid, however, is 1.5 nanoseconds to a 1-ns pulse, and waveform distortion is only about 10%.

The session on hybrid technology will emphasize new processing techniques for thick- and thin-film hybrids, notes chairman Mauro Walker from Motorola Communications division in Fort Lauderdale, Fla. Zenith Radio Corp., Elk Grove Village, Ill., reports on a technique for fabricating glass-passivated thick-film capacitors that overcomes the yield and reliability problems that plagued earlier attempts to produce the devices in volume. Zenith perfected the technique for a television varactor tuner in which thick-film capacitors and thick-film resistors are screened onto the same substrate (Fig. 5). Similarly, Honeywell Inc., Aerospace division, St. Petersburg, Fla., has developed an efficient method for attaching active elements in complex circuits, which

also tend to be subject to poor yields and excessive repairs.

Also in this session, Hughes Aircraft Co., Culver City, Calif., will describe a major step in hybrid development—taking hybrids up to the module level. As indicated in Fig. 6, these so-called large-area hybrids can contain both discrete and chip components, both thick- and thin-film hybrids and even multilayer thick-film interconnections. Hughes, which has built hybrid modules as large as 4 by 4 inches, can also hermetically seal selected areas of the substrate by means of a repairable process.

The fine art of fabrication

In the session on manufacturing technology, Bendix Corp., Kansas City, Mo., will present two related papers on improved techniques for processing two-layer thin-film circuits—specifically, those made up of a tantalum-nitride resistor system and a chromium-gold conductor

5. For TV tuner. Zenith Radio Corp. puts thick-film resistors, as well as glass-passivated thick-film capacitors, on the same alumina substrate for a television varactor tuner. Here, black rectangular areas are resistors, while dark gray areas are capacitors and crossovers.

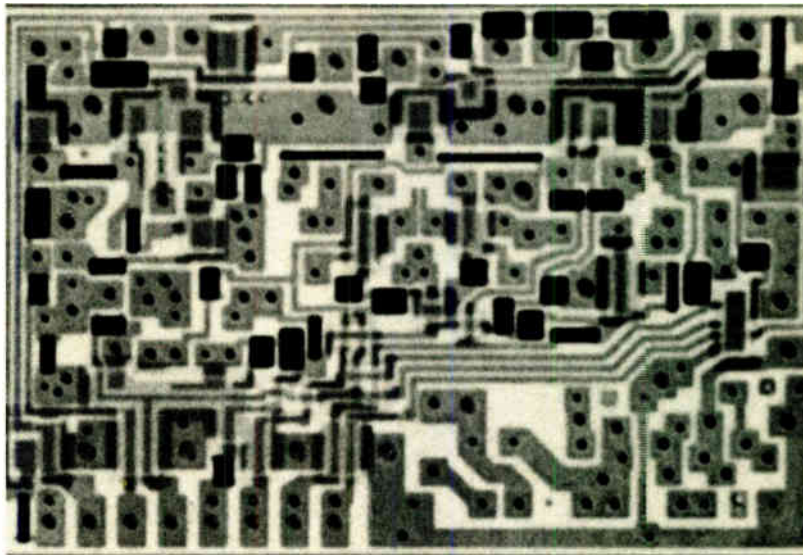

6. Next step in hybrids. Large-area hybrid from Hughes can include conventional thick- and thin-film hybrids, in addition to discrete and chip components. Selective areas of the substrate can even be hermetically sealed. Circuits as large as 4 by 4 inches have been built.

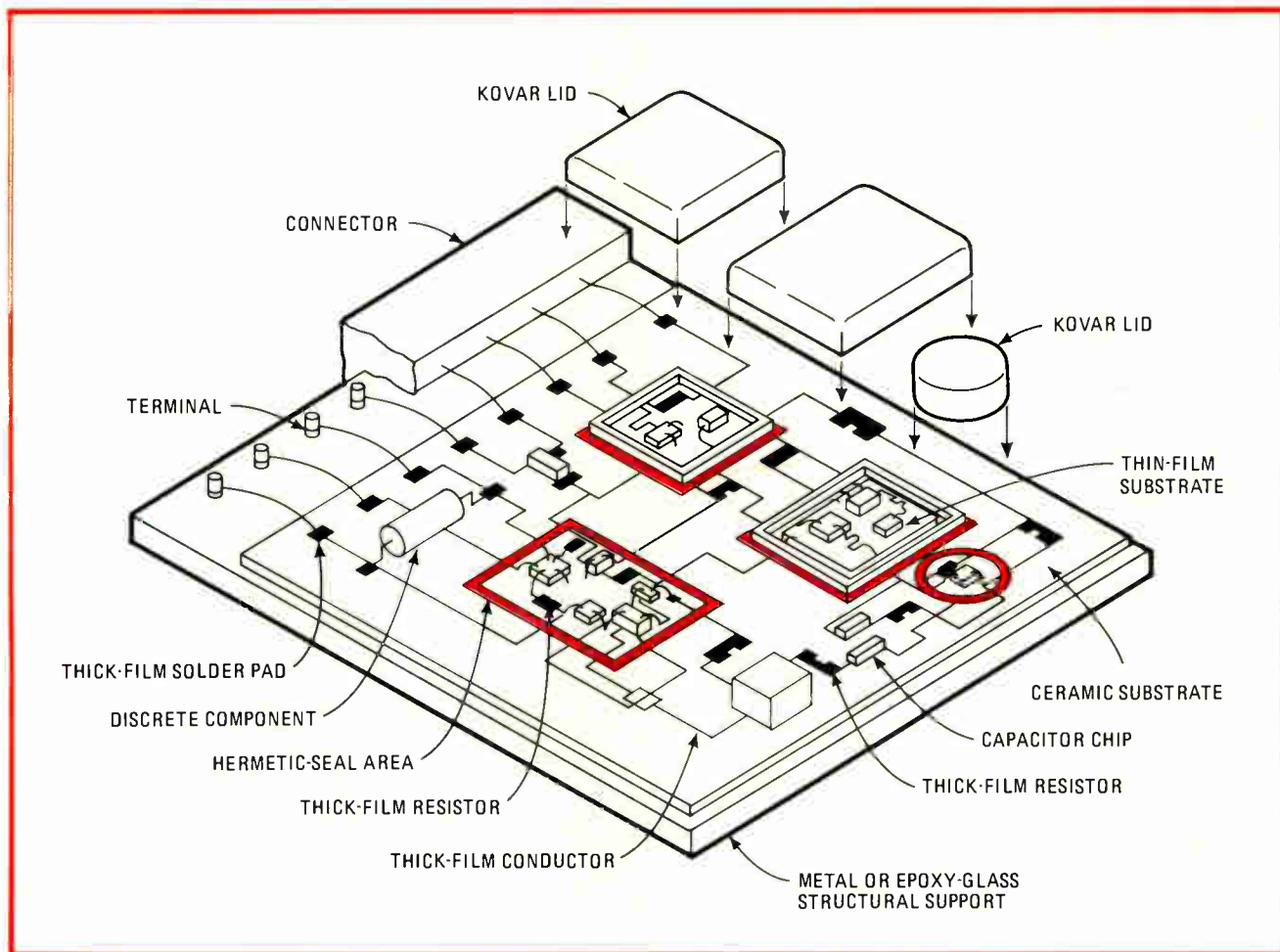

system. One paper describes a rotating system for vacuum-depositing both conducting layers, plus their interconnects, in a single pumpdown. The other deals with a dry-film photolithographic process for obtaining the resistor patterns on both sides of the substrate simultaneously. Two "dry" sheets of photoresist are laminated to each side of the substrate. "Wet" methods require separate steps.

Another thin-film advance in manufacturing technology—an electroplating technique for depositing a thin film of gold—will be disclosed by Bell Telephone Labs and Western Electric in Allentown, Pa. Developed especially for circuits going into plastic dual in-line packages, the electroplating is done at a very high current density, to reduce the gold's hardness and improve its bondability.

A separate session on wire bonding covers parallel-gap (resistance) welding of gold ribbon to thick films, the influence of lead-frame thickness on the mechanical properties of the thermocompression bond, and the effect of nonmetallic constituents in fired thick-film gold metallization on thermocompression bonding.

Next to last, but not least, the session on reliability offers at least two noteworthy papers. Rome Air Development Center, Griffiss Air Force Base, N.Y., will re-

view several year's worth of data on how moisture affects microcircuits. The report investigates how much moisture microcircuits can withstand before failing, as well as the degree of moisture that produces certain failure modes. Another paper, to be given by Westinghouse Electric Corp., Defense and Electronic Systems Center, Baltimore, Md., describes practical procedures for discovering excessive adhesive degradation in thick-film gold-alloy solder systems.

Finally, ways to improve component reliability are also the thrust of the third new session—the one on organic materials. They're useful mainly in hybrid circuits, for bonding chips to substrates, sealing packages, and encapsulating circuits. summarizes chairman Isaac H. Pratt, Integrated Electronics division, U.S. Army Electronics Command, Fort Monmouth, N.J.

A new silicone epoxy from Dow Corning Corp., Midland, Mich., promises better reliability for molded plastic hybrid packages. Likewise, a silicone encapsulation system, developed by Honeywell Inc., St. Louis Park, Minn., can extend the life of optoelectronic devices in harsh environments. And to give Bell Labs from Allentown, Pa., the last word, its paper at this session will describe a special silicone encapsulant for beam-lead chips. □

THE MATCHMAKER

Telefile introduces the only disk system flexible enough to match any minicomputer with any of the hot, new 3330-type drives. Big disk storage at a mini price.

Telefile now has available the most flexible large capacity disk system for minicomputers on the market today. The Matchmaker. It comes two ways:

As a disk system for users (DS-16-C) where we match your minicomputer with any of the latest 3330-type technology drives you want. Telefile supplies the complete package.

As an OEM disk controller. You can order just controllers alone (DC-16-C) and mix and match minicomputers and drives to satisfy your customer's whims and storage requirements.

Either way, disk system or controllers alone, you are assured of flexibility, performance features, and price no one else can match.

Each system stores up to 1.2 billion bytes.

You can match just the right drives to meet your storage capacity needs all the way from 13.3 million to 1.2 billion bytes per controller. Each DC-16-C Matchmaker controller handles up to four drives. Minicomputers never had it so good.

Choose any of the latest drives.

You've seen them announced one-by-one and they're coming on strong. CalComp's Trident. Control Data's Storage Module. Diablo's 400 Series. The Ampex 9000's and Memorex 677's. Each builds upon IBM 3330 technology, which means higher storage densities and new circuitry for superior reliability.

To switch drives, simply change one controller circuit board. We've timed it at 63 seconds flat!

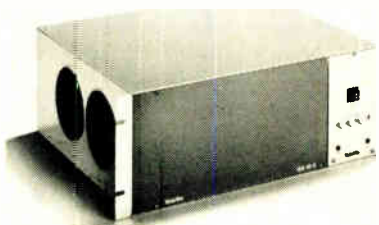

Compatible interfaces to eleven minicomputers.

We're designing a complete line of compatible interface boards to match up to many minis: Data General, DEC, Interdata, Keronix, D.C.C., Microdata, Honeywell, Lockheed, H-P, Varian, and Cincinnati Milacron. Simply fit our tailor-made computer interface module inside your computer chassis and you're in business. If you have another type mini, we'd be glad to design one for you.

Or you can design your own interface.

Your designers may want a piece of the action. Our general interface board makes it easy. Your board will tie in directly, bringing big disk storage to any 16-bit minicomputer.

A controller so small you can even hide it.

The Matchmaker is our smallest controller yet. It is totally self-contained right down to its power supply and cooling system. It's small enough to tuck away in a drive housing or in a rack above, below, or even behind the computer. Out of sight.

We'll even make you a faceplate.

If you want to show the Matchmaker off, we'll make a bezel to match your computer panel. Private label it and call it yours. There's no end to the flexibility.

Easy "front door" maintenance.

Five circuit boards slip right in from the front of the DC-16-C Matchmaker. A disk interface board, a general interface board, a command/timing board, a memory/address board, and an optional maintenance board for offline disk pack formatting and test exercising.

Unmatched features

- Contains 512-byte buffer for data rate matching
- Variable data search and read
- Block transfer of data up to mini-addressing capacity
- Offset positioning and data strobe controls
- Write protection to the sector level
- Sequential or staggered sector addressing
- Defective track relocation and alternate track addressing
- Overlapping seek capability
- Multi-sector operations across head and cylinder boundaries

We wrote the book on disk controllers, and you can get it free.

For years, we've helped minicomputer users grow their disk capacities. Now our Matchmaker system is a quantum leap forward. A new in-depth, hot-off-the-presses Matchmaker technical manual gives you all the facts. Write for it. Prove to yourself that this is one disk controller no one else can match.

Telefile

Turning minis into maxis with moxie



Please send me your Matchmaker book. I'm interested ___ now ___ later (more than six months from now).

NAME _____

TITLE _____

PHONE _____

ORGANIZATION _____

ADDRESS _____

CITY _____

STATE _____ ZIP _____

Telefile Computer Products, Inc.
17131 Daimler Street, Irvine, CA 92714
Free ph. (800) 854-3128, In Ca. (714) 557-6660
Telex 68-5660 TELEFILE IRIN

Nomograph shows bandwidth for specified pulse shape

by Franc E. Noel and James S. Kolodzey
IBM Corp., Poughkeepsie, N. Y.

In a digital communications system, the bandwidth of the transmission channel determines the sharpness of a received pulse. For a communication channel where the received pulses may be treated as gaussian wave shapes, the system bandwidth required for a specified pulse shape is:

$$F = (2/\pi T)[2 \ln(1/P)]^{1/2}$$

where, as in Fig. 2, T is the width of the time slot, P is the normalized height of the gaussian pulse at the ends of the time slot, and F is the 2σ bandwidth of the channel, where σ is the standard deviation of the pulse. The bandwidth that is given by this expression contains 95.45% of the pulse power.

The choice of the 2σ point is an arbitrary decision based on the fact that the frequency spectrum of the gaussian pulse is down 8.7 decibels at this point. Therefore, a linear system with a bandpass flat to this point provides a reasonable reproduction of the time-domain pulse.

The bandwidth required to pass a particular pulse is

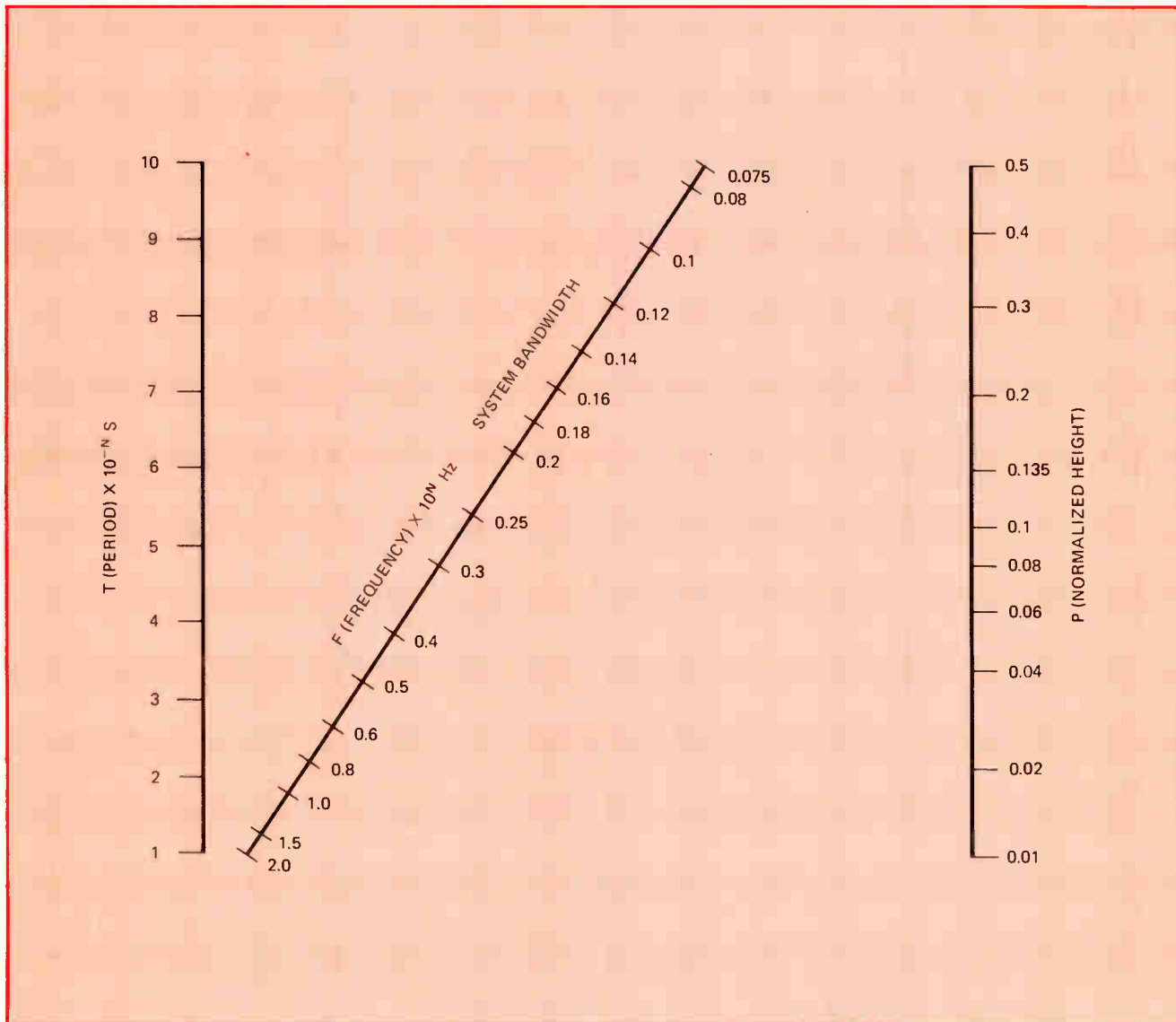

1. **How wide the band?** This nomograph shows the bandwidth F that contains over 95% of the energy in the spectrum of a gaussian pulse, where the duration of the pulse is T and the normalized amplitude of its end points is P (as shown in Fig. 2).

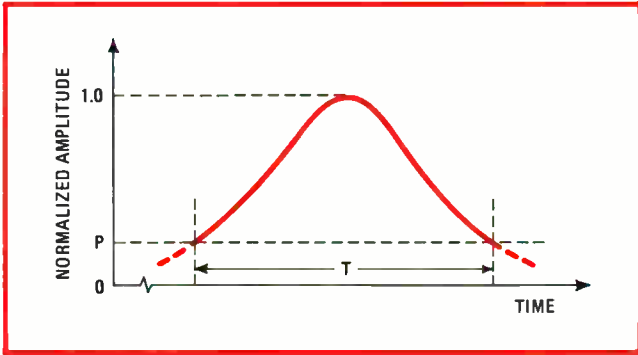

2. Pulse parameters. Time-domain representation of gaussian pulse shows normalized amplitude P at edges of time slot T . A low value for P gives low spillover into next slot, and therefore low error rate, but requires large bandwidth in transmission system.

given by the nomograph in Fig. 1. The values of the time slot, T , and normalized amplitude desired at the ends, P , are connected with a straight edge to determine the frequency axis crossover. For example, a time pulse that is down to $1/e^2$, or 0.135, at the edges of a 12.5-nanosecond time slot can be passed with a system bandwidth of 102 megahertz. □

Scope-triggered register freezes data for display

by Matthew L. Fichtenbaum
General Radio Co., Concord, Mass.

As an aid in logic analysis and program debugging, a standard delaying-sweep oscilloscope, such as the Tektronix 465 or 475, may be augmented with some logic circuitry, to capture and display the data present on a data bus.

The two time bases of the scope perform trigger and trigger-delay functions, the delayed trigger clocks a reg-

ister to store the data, and light-emitting diodes display the stored levels. The data is not displayed on the face of the scope, which merely shows the timing of operations including a visual indication of the point at which the data state is stored for display by the LEDs.

The scope is operated in a repetitive or nonrepetitive mode, as appropriate. Generally the technique is used to study a repetitive process such as a program loop.

The figure shows a register of two 74175 quad D flip-flops, used to "freeze" the state of a multibit bus, such as a microprocessor's data bus, for examination. The scope trace is triggered by some major timing signal in the program, e.g., an input or output pulse, and its length corresponds to the program's duration.

The scope is operated in its A-intensified-by-B mode. Using the delay-time control of the scope, the bright-

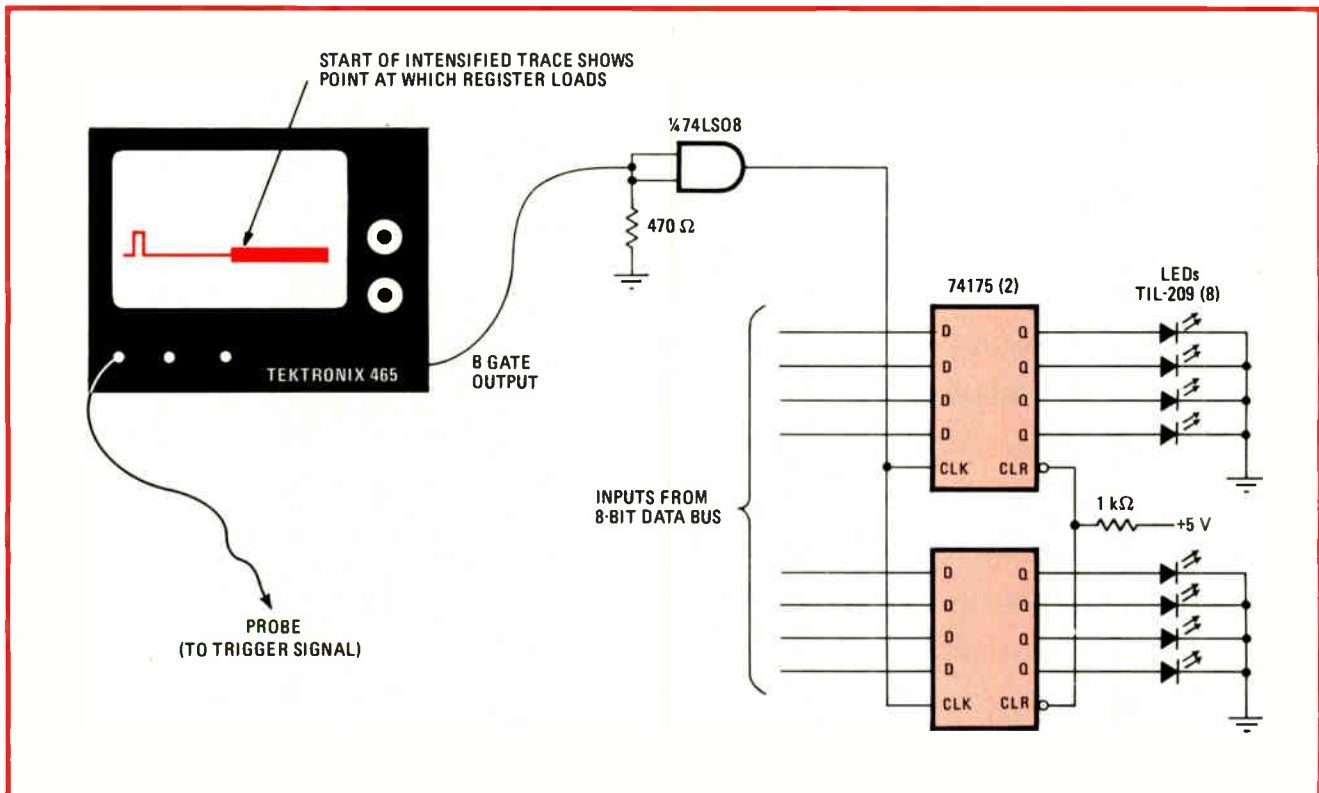

Rudimentary logic analyzer. A lit light-emitting diode shows a logic 1 on the microprocessor data bus and a dark LED shows a logic 0—both at the moment that is determined by the setting of the delay-time knob on the oscilloscope. Scope trace indicates duration of program loop; the trace becomes brighter at the point where the data sample is loaded into the register to light the LEDs.

ened area of the trace that represents the delayed sweep is positioned to begin at the time point of interest.

When the B gate output goes high at the start of the delayed sweep interval, it loads and latches the register, which allows the LEDs to display the data levels that were on the bus at the instant of loading. As the delay time is advanced, the display lights show successive data values.

A 74LS08 AND gate is used as a buffer between the

scope and the clock terminals of the quad D flip-flops.

The register, which in this example is eight bits wide, should be as wide as the bus being examined. The ordered array of LED's is easier to interpret as a number than multiple scope traces, and the storage of the register makes it possible to examine nonrepetitive events.

If desired, the LEDs may be replaced by decoders and numeric readouts to present a binary-coded-decimal, octal, or hexadecimal interpretation of the data. □

Audio continuity tester indicates resistance values

by Calvin R. Graf,
San Antonio, Texas

A continuity tester built around a 555 timer audibly and visually indicates a wide range of resistance values. The unit, which can be assembled for less than \$10, is especially handy for testing devices without having to glance from test probe to meter and back again. However, by merely changing the value of one resistor, the tester can function as a multivibrator.

The meter can indicate by tones over a loudspeaker or a headset forward and reverse continuity conditions from 0 to more than 30 megohms for such devices as resistors, diodes, transistors, capacitors, and light-emitting diodes. In addition to the audio output, a LED serves as a pilot light and flashes when the output frequency falls below 10 to 12 pulses per second. The output is a square wave, and an audio pulse sounds each time the LED is turned on or off.

The tester can also determine the charges stored in mercury and nickel-cadmium battery cells. A full charge of 1.2 to 1.4 volts will either not sound at all or sound in only one direction, depending on the probe's polarity. However, a partially discharged cell with a potential of 0.9 V or less will create a sound in either direction because the audio frequency depends on the resistance of the cell in either direction. For the value of

resistors used an on-to-off duty cycle of about 60% is obtained. The circuit draws about 7 milliamperes from a standard 9-v battery.

The schematic shows where unknown resistor R_x is connected into the multivibrator circuit. The unknown can have any resistance value from zero ohms to more than 30 megohms. At 0 ohm, which is a short circuit across the test probes, the audio output frequency is about 7,000 pulses per second. This frequency sounds like a tone (sine wave) to the ear. At 30 megohms, the frequency from the speaker is about 1 pulse per second.

Very low current flows through the test probes. When R_x is 0 ohm, the current level through the probes is about 270 microamperes, and when R_x is 1 megohm, the current is about 9 μ A.

The 555 timer is operated in the astable-oscillator mode. The free-running frequency and duty cycle are both accurately controlled with three external resistors and one capacitor. The external capacitor, C, charges through R_1 , R_2 , and R_x , but it discharges only through R_2 and R_x . R_2 limits the upper frequency of oscillation to about 7,000 pulses per second when R_x is 0 ohm; otherwise, the frequency would be out of the upper range of hearing (higher than 18,000 pulses per second). The lower frequency limit of approximately 1 pulse per second is set by the value of R_x when it is above 20 megohms.

Resistor R_3 limits the current drawn through the output circuit. A value of 1 kilohm provides adequate audio volume. □

Sounding off. Low-current audio continuity tester indicates unknown resistance value by the frequency of audio tone. A high tone indicates a low resistance, and a tone of a few pulses per second indicates a resistance as high as 30 megohms.

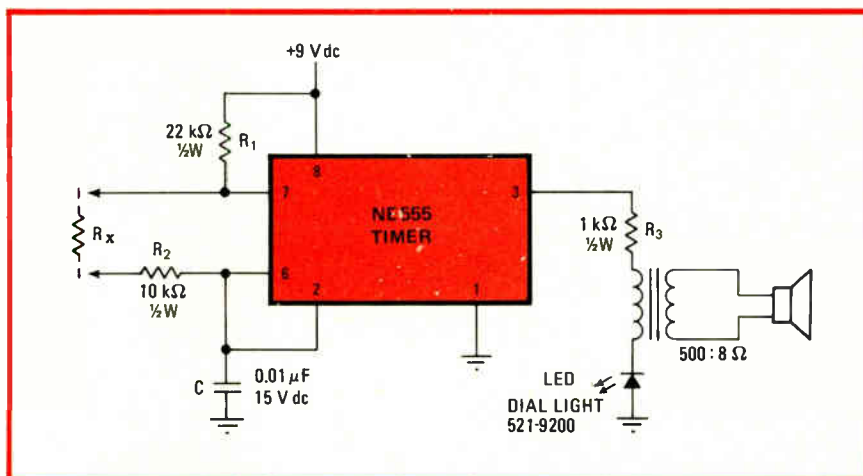

Engineer's Notebook is a regular feature in Electronics. We invite readers to submit original design shortcuts, calculation aids, measurement and test techniques, and other ideas for saving engineering time or cost. We'll pay \$50 for each item published.

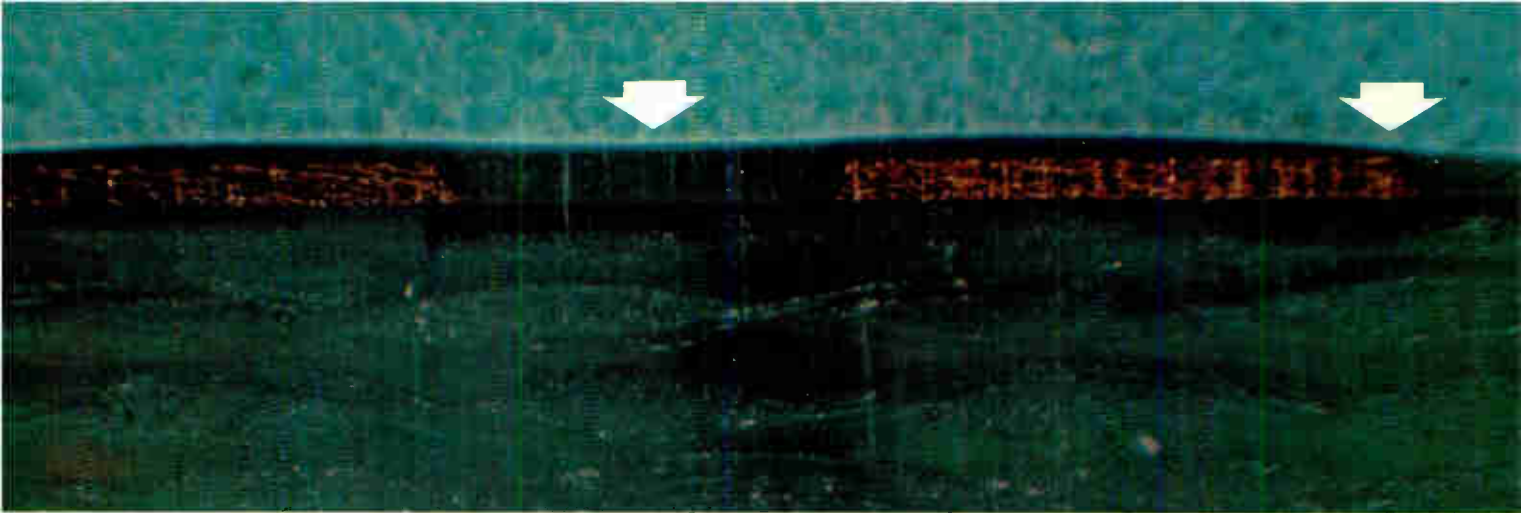

When spray or dip coatings fail...

Parylene works.



You are looking at magnified cross-sectional views of copper conductors on a circuit board . . . and why parylene protection brings the highest reliability to electronic circuitry.

The spray-applied urethane coating (top photo) bridges the channel between conductors, and offers scant protection at the edges. Urethane, silicone, epoxy . . . liquid coatings are uneven, and can produce potential failure points.

Parylene forms a thin and even coating, whatever the configuration, however complicated or delicate or densely populated. Without bridging. Without pinholes, voids, bubbles. We call it a conformal coating. From conformality comes reliability.

Parylene conformal coatings can be applied in precisely controlled thicknesses from 0.002 to 3 mils. *In one step.*

Parylene is applied at *room temperature*. No heat, no melting, no cure. No coating shrinkage. In other words, no discomfort for delicate components.

Parylene provides better barrier protection than urethanes, silicones or epoxies. It is extremely resistant to chemical attack,

exceptionally low in trace metal contamination, and compatible with all electronic solvents. Dielectrics are excellent.

Parylene has qualified under the stringent requirements of MIL-I-46058C; it does so with a 0.6 mil coating—parylene excels in the micro-electronic virtue of thinness.

Parylene conformal coatings have shown excellent cost effectiveness in many applications. On delicate, sophisticated and complex circuitry, in hybrid circuits and components, they may be the most cost effective answer for long term reliability.

Union Carbide invented the parylene system. The method is gas phase deposition, which is the only route to the reliability of conformal protection. Various patents apply; commercial use of the patented technology is licensed.

You can get complete information on parylene by writing for our 16-page brochure: Union Carbide Corp., 270 Park Ave., Dept. RB36, New York, N.Y. 10017. Further investigation will no doubt indicate a trial run, which we can perform at reasonable cost. If you would like to discuss that or any other related matters, please call Bill Loeb at (212) 551-6071.



Industry reaches agreement on C-MOS specs

For years, selecting C-MOS products from more than one source has been very treacherous. Incredibly, there were no standards for specifying or even numbering the part types. **An ordinary C-MOS gate from one manufacturer might not have been comparable to or even compatible with a C-MOS gate made by a different manufacturer—that is, until now.** C-MOS marketing and engineering representatives from Fairchild, Harris Semiconductor, Motorola, RCA, National, and Solid State Scientific met in Austin, Texas, in January. The imminent result: industry standards on the C-MOS “B” series and an industry-wide numbering system.

How to find out what happens inside a microprocessor

Microprocessors may simplify the job of designing complex logic—but they also complicate the job of testing by making those helpful, well-worked-out logic breadboards unnecessary. The problem has not gone unnoticed. **One of the best sources of information now available on choosing logic testers for microprocessor-based systems is the “Omnicomp Handbook of Logic Circuit Testing.”** The four volumes cover in-circuit test techniques, economics, vendor analysis, and the complete brochures and data sheets for all currently available equipment. The set costs \$295 from Omnicomp Inc., 7101 N. Twelfth Place, Phoenix, Ariz. 85020.

IC regulators, too, can split dc

There's no need to fuss over designing a dual-output power supply for, say, operational amplifiers, if you have some of those inexpensive three-terminal IC voltage regulators around. You can split a dc voltage either symmetrically or asymmetrically using only positive regulators, says Russ Weltmer, a staff electronics engineer at McDonnell Aircraft Co., St. Louis, Mo.

To build the supply, connect a full-wave rectifier bridge across the secondary of a center-tapped transformer. Next, run a large-value (say, 3,500-microfarad) electrolytic from one midpoint of the bridge to the center tap, and run a second (same value) electrolytic from the center tap to the other bridge midpoint. Then, simply connect a pair of regulators across the electrolytics. **The positive dc voltage is obtained from the output terminal of one regulator,** the negative dc voltage from the ground terminal of the other regulator, and the common line by tying together the ground terminal of the positive-dc regulator and the output terminal of the negative-dc regulator.

Off the shelf of the IEEE press

If you're interested in computer communications, nonlinear networks, frequency synthesis, automatic test equipment, computer-aided filter design or digital signal processing—they're **all new titles in this year's IEEE Press catalog.** Of the 22 books now in print, 20 are from the IEEE Press Selected Reprint Series. For a free catalog, write to IEEE Press, M. A. Walker, 345 47th St., New York, N.Y. 10017. —Laurence Altman

our card-edge connectors have a special edge.

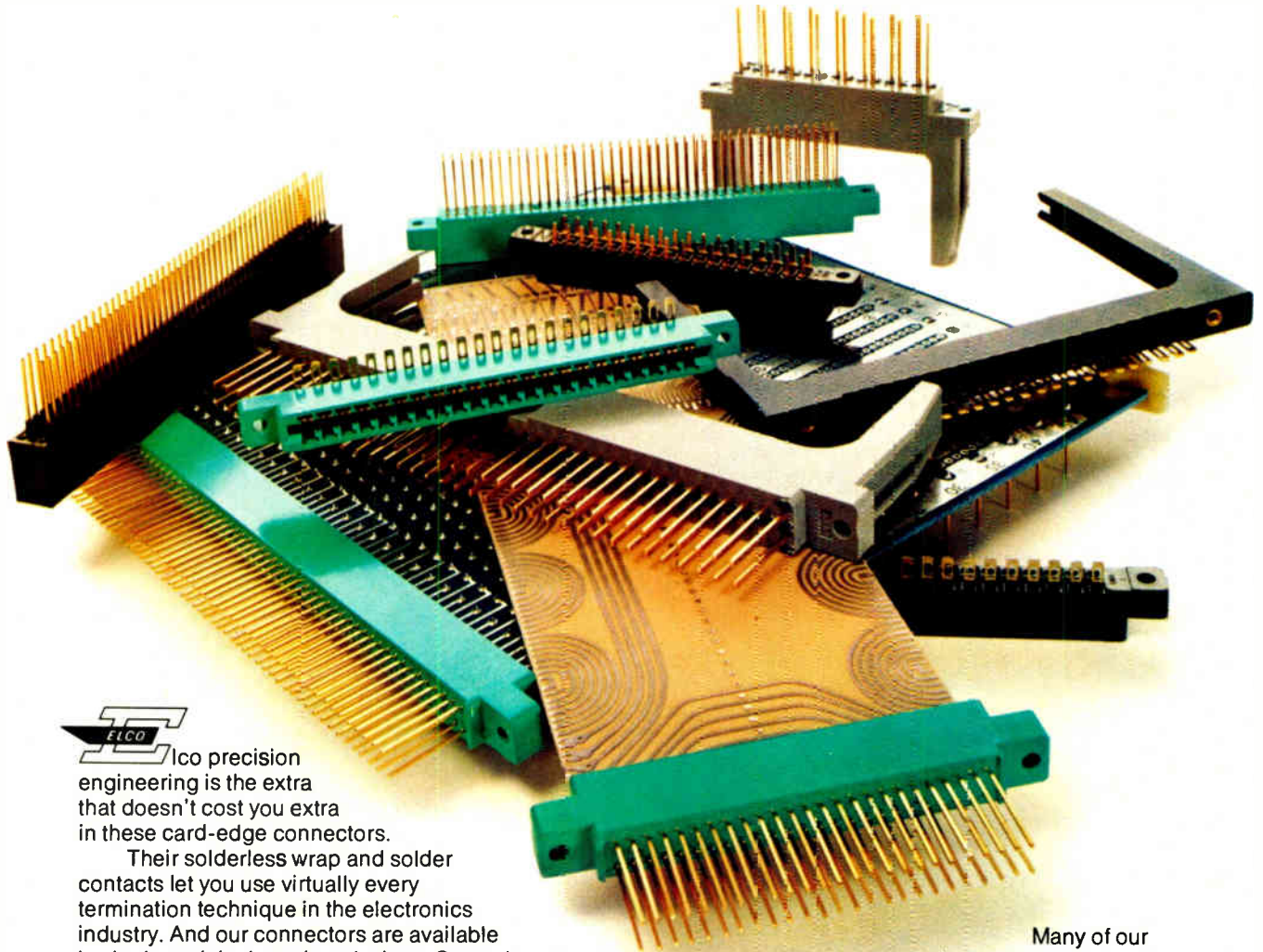

Elco precision engineering is the extra that doesn't cost you extra in these card-edge connectors.

Their solderless wrap and solder contacts let you use virtually every termination technique in the electronics industry. And our connectors are available in single and dual-readout designs. Several even have extended card guides. This makes P.C. card insertion a snap — and serious vibration effects a thing of the past.

And do they deliver when it comes to a variety of sizes and contact spacing! Elco card-edge connectors have from 4 to 100 contacts or more, with spacings of .100", .125", .150", .156" and .200". You can get any number of configurations ranging from receptacles with cantilever or single beam, to bellows-type contacts. And they're all cost-effective.

Many of our connectors are included on the Military Qualified Products List (QPL) and meet MIL-C-21097. So get that special edge — and get it fast. Contact us. We'll respond quickly with precision standard or specially engineered card-edge connectors to meet your needs.

"GREAT CONNECTIONS . . . WORLDWIDE"

Elco Corporation
2250 Park Place, El Segundo, Ca. 90245
213-675-3311 / TWX 910-325-6602



Elco Corporation

A GULF + WESTERN MANUFACTURING COMPANY

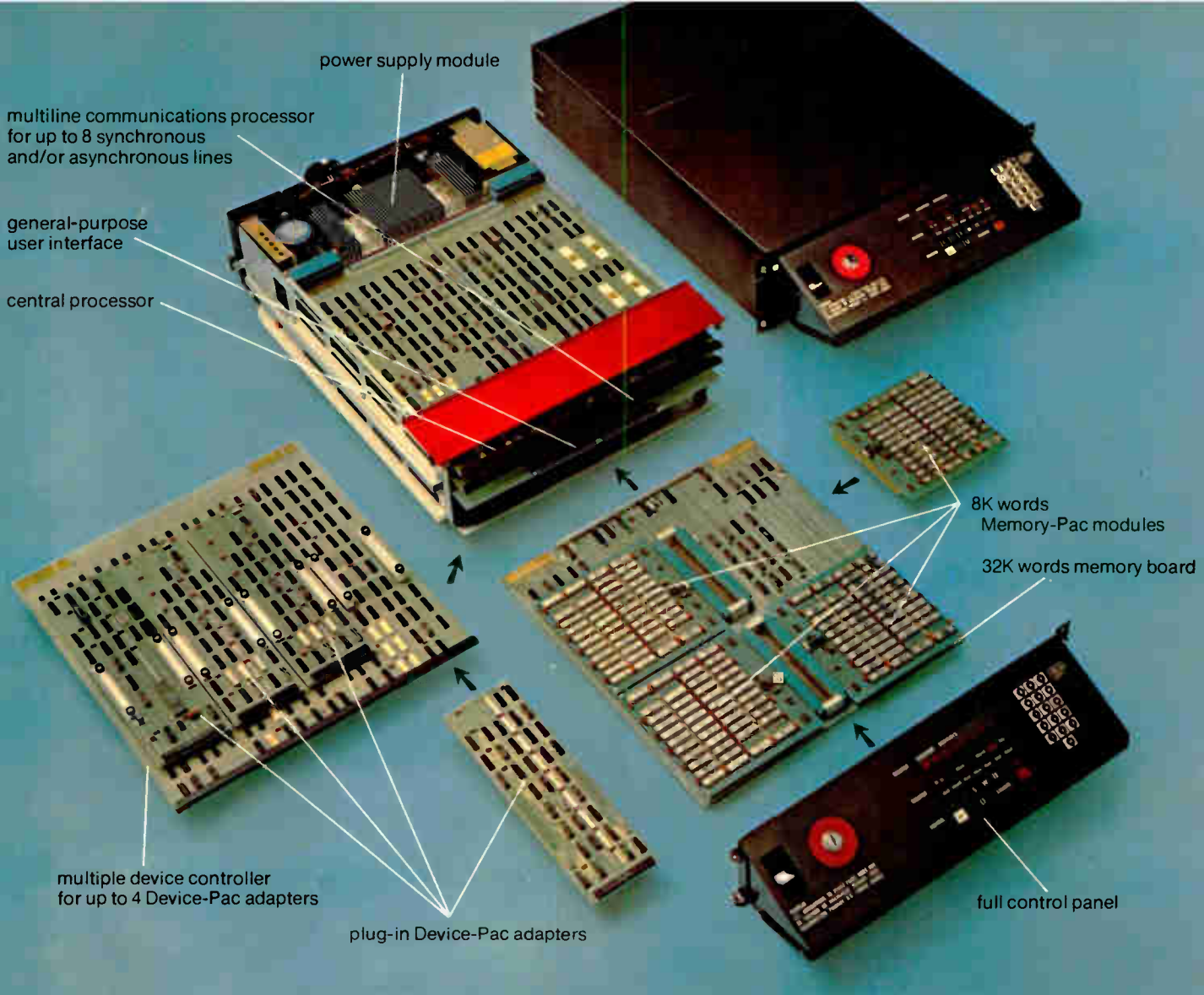

Shown is the compact, rack-mountable Model 6/36 designed for OEM and system builder applications. The 5 1/2-inch high cabinet houses the central processor, 64K words of memory, a controller for up to four peripherals, and a communications processor which accommodates eight full duplex lines.

The inside story on Honeywell's new mini.

Honeywell's Level 6 minicomputer family offers OEM's and system builders the best of two worlds: A fully open-ended architecture that makes provisions for future developments in technology. And a unique modular packaging design that offers outstanding configurability and serviceability.

Open-ended architecture

- High-performance bit, byte, word and multiword addressing is standard.
- Each 15" x 16" board (central processor, communications processor, mass storage controller, multiple device controller) has its own micro-

processor for more efficient I/O.

- The Megabus™ supports 24 memory address bits, or 8 million directly addressable words.
- Megabus address and data paths are dedicated for bus cycle efficiency, and contention delays are eliminated by distributed control.

Advanced packaging

- The Megabus allows easy configuration by means of unrestricted positioning and addition of boards and modules.
- Modules plug into the 15" x 16" boards for maximum functional density and configurability.

- Hardware self-diagnosis simplifies servicing.

We'd like to tell you a lot more. Circle the reader service card. Or write us about your application plans. Honeywell Information Systems, 200 Smith Street, MS 487, Waltham, Mass. 02154.

The Other Computer Company:
Honeywell

™Trademark of Honeywell Information Systems

Circle 108 on reader service card

World Radio History



Components show to highlight easy-to-use devices

Moving west for the first time, the Design Engineers' Electronic Components (DEEC) show will be held at the Jack Tar Hotel, San Francisco, April 26 to 28 (see p. 96). The exhibits will stress user convenience and reliability. Here are some of the more significant products to be introduced.

Standardized components simplify panel interface

Interfacing front panels to mother boards has always been a troublesome and expensive problem for the equipment designer. The lack of standardized components has caused him to intermix first-, second-, and third-generation devices, and to use mounting blocks and secondary printed-circuit cards, as well as different mounting techniques. In a complex oscilloscope, for example, as much as 20% of the total cost may be tied up in the panel interface.

Centralab Electronics division is now proposing that front-panel components be standardized as to type of mounting and device height, making it possible to mount all components on a single pc board that is 0.6 inch behind the front panel. The company, which is kicking off its campaign with a family of push-button switches, plans to supplement the system with both slide and rotary potentiometers and switches, displays, indicator lights, and perhaps even toggle, thumb-wheel, and rocker switches.

"All components will plug into a single board, which can be flow-soldered and mounted 0.6 in. behind the front panel," says Dwayne MacDonald, marketing manager for the firm's electronic-controls group. "There's no need for extra hold-down features—everything is mounted on and supported by the pc board. The panel serves only as

an esthetic cover," he points out.

The Milwaukee-based subsidiary of Globe-Union Inc. calls its design IMPS, for integrated modular panel system. The IMPS push-button switch, to be shown for the first time at DEEC, is now available in sample quantities. It can be configured as a momentary push-push or interlock switch.

"With the trend to smart instruments, most switches will be used in keyboard configurations," observes MacDonald. Therefore, momentary-action versions of the spdt switch are designed to key-switch specifications. Total plunger travel is 0.140 in., a peak activation force is

2.5 to 3.5 ounces, and life is guaranteed for at least a million cycles. Dpdt versions have a different contact arrangement, which requires a higher activation force, and they are rated for 100,000 cycles.

The switches have square pins that can be wire-wrapped. Terminal spacing is the same as standard dual in-line packages for pc-board mounting and wave-soldering—the 0.025-in. square pins are spaced on 0.1-in. centers in rows 0.3 in. apart. Terminals are insert-molded to prevent "wicking" of contaminants into the switch when being soldered.

Price for the switches in production volume, which will be available

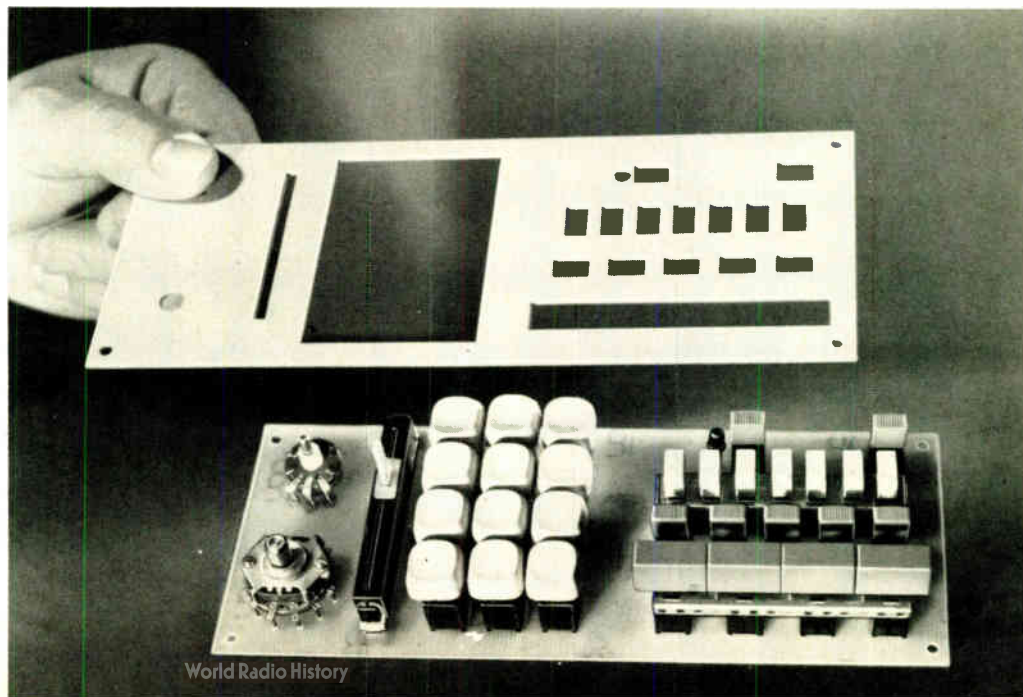

New products

in June, will be less than 25 cents each. They are molded from a non-flammable glass-filled polyester, and a standard ganged bracket assembly holds a maximum of 12 switch modules. Maximum contact resistance is 25 milliohms, and contact bounce is less than 2 milliseconds, according to the company.

Earlier this year, Centralab intro-

duced a microminiature rotary switch and the 700-series slide potentiometer, both of which will work in the IMPS. Also, the company is changing the terminals of its conventional 1-in.-diameter rotary switch to get the 0.1-in. standoff height, and is modifying its line of 5/8-in. industrial potentiometers. IMPS configurations of these modi-

fied products will be available in July or August.

By the end of the year, the firm will have two new rotary switches—a conventional open-range index type and an index assembly with integral lighted display.

Centralab Electronics Division, Globe-Union Inc., 5757 North Green Bay Ave., Milwaukee, Wis. 53201 [351]

Toggle DIP switch gets new look

Toggle or rocker switches in miniature dual in-line packages are among the fastest-growing segments of the electromechanical-switch market. Now, Grayhill Inc. has developed a new twist for these DIP devices—moving the actuators from the top of the housing to the side. Called the piano DIP, this side-access switch (below, right) retains the same spring-loaded, wiping, sliding-ball contact system that the company uses in its top-access models.

Unlike other DIP switches on the market, if this version is mounted near the edge of a printed-circuit board, the toggles can be adjusted without uncracking the card. Moreover, the programed setup is visible from the edge of the card.

Grayhill has tooled the part with seven independent single-pole, single-throw programming switches, with actuators that are miniature toggles, instead of slides or rockers. Terminal spacing is on standard 14-pin DIP centers, and the 0.780-by-0.380-inch package stands 0.305 in. above the board.

DIP switches have found broad application in the computer and telecommunications industries as logic switches on multifunction boards. At logic levels, the gold-plated contact system is rated at 50,000 operations per station. At higher loads, life expectancy is 35,000 operations at 50 milliamperes and 30 volts, or 25,000 operations at 125 mA and 30 v dc.

The first volume shipment is scheduled for mid-April. In quantities of 100 to 499, the piano DIP is priced at \$3.50 each.

Also at DEEC, Grayhill will introduce what is possibly the smallest 16-position rotary switch—a fully enclosed unit that measures only 0.562 inch in diameter and 0.617 in. behind the panel. The new 51 series switch is significantly smaller than its predecessor, which has a diameter of 1.125 in.

Aimed at the communications, instrumentation and computer markets, this miniature switch is available with shaft and panel seals, or as an unsealed model. It has solder-lug terminals and is rated at 50 mA at 120 v ac. A gold-plated contact sys-

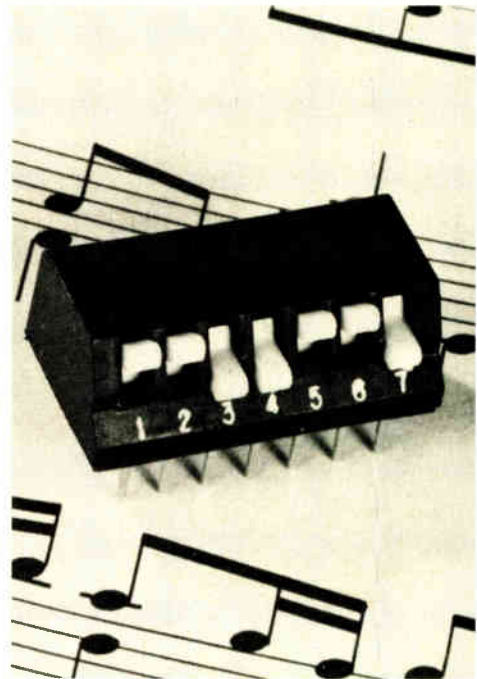

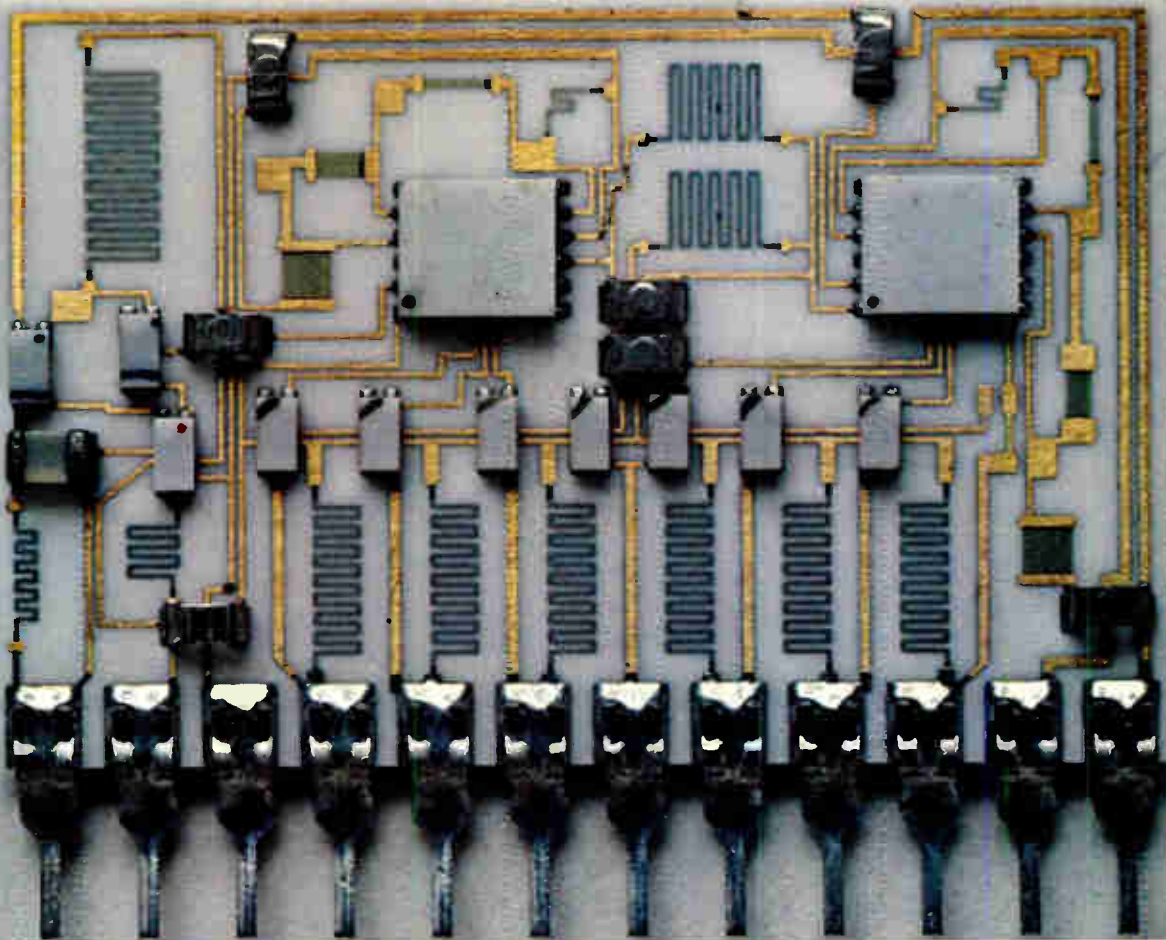

In this complicated world, you can't afford to be without us.

Introducing the GR 2230. The first computer-controlled network and module tester for under \$20,000.

These days, multi-leaded networks and modules have become so complex, you simply can't get away with sample testing.

Yet in-house or calculator-based test systems are just too slow. And the computer-controlled ones cost an arm and a leg.

But now there's the GR 2230.

At the heart of this compact bench-top system is a small but powerful micro-computer. To give you computer-controlled speed, accuracy and flexibility. All starting at just \$15,000.

The 2230 will test networks, modules, and low-frequency passive circuits at speeds up to 80 tests per second, measuring to specified limits the performance of each circuit component.

It can be programmed by just about anyone, thanks to its unique English-language macro-instruction keyboard. Programs are then automatically stored on magnetic cards for easy retrieval.

In addition, the system will continuously print out all test data and can be easily interfaced to virtually any device handler.

The new GR 2230. A computer-controlled tester you can afford. Now that you can't afford to be without a computer-controlled tester.

GenRad, Inc. (formerly General Radio). Test Systems Division, 300 Baker Avenue, Concord, Mass. 01742. 617-369-8770.



GenRad

The difference in software is the difference in testers.

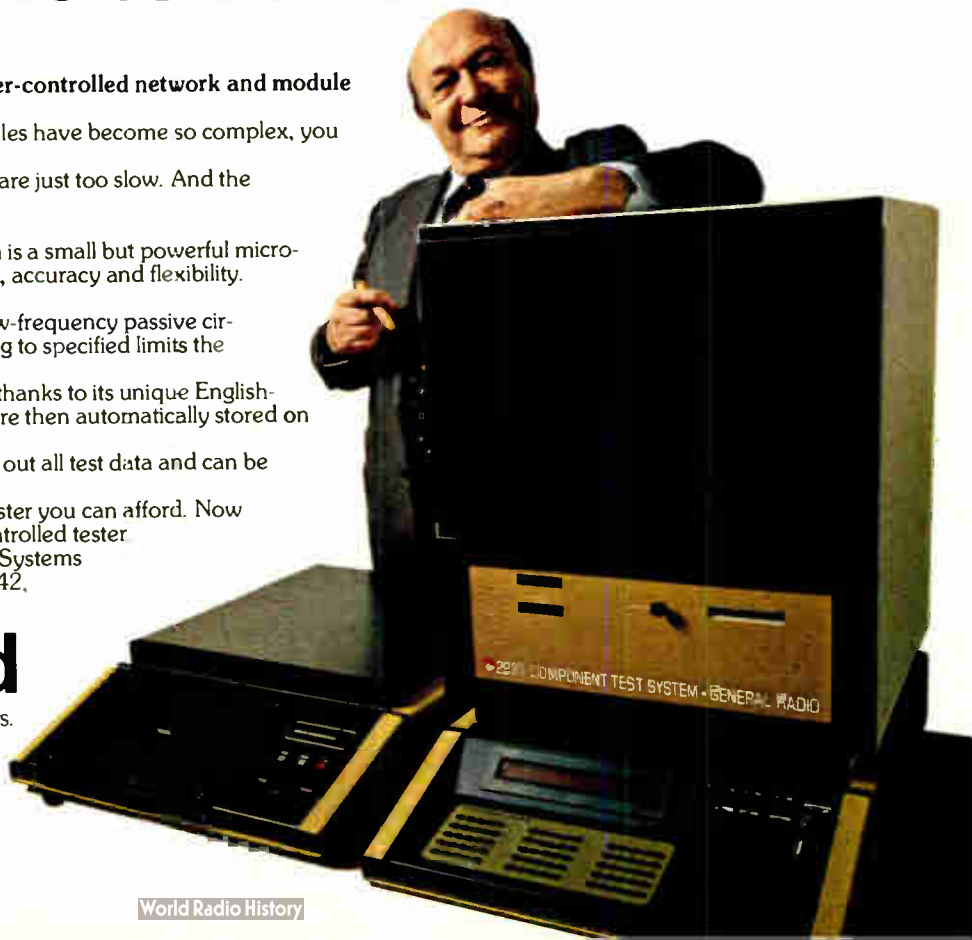

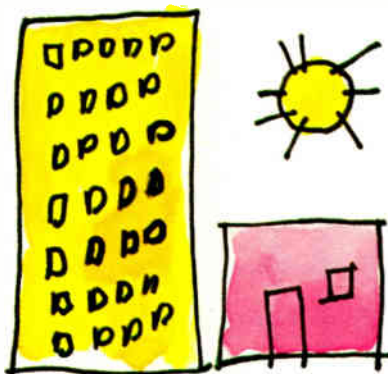

THE IMPORTANCE OF BEING LARGE AND SMALL

Large companies have the resources. Financial stability. Purchasing clout. Product depth. Optimum inventories. Blanket distribution. Close technical help. Engineering reserve. After sale service. And the luxury to chase far-flung ideas back to reality. Superior Electric is a large company.

Small companies have the flexibility. Quick customer response. Working one-on-one. Opening early, staying late. The motivation to meet emergency deadlines. Turning off-the-shelf standards into one-of-a-kind specials. The absence of bureaucracy. And the tenacity of entrepreneurs. Superior Electric is a small company.

Superior Electric. Controlling the motions in manufacturing with *SLO-SYN*[®] numerical controls. From

economical 2-axis to contouring 4-axis models. Open or closed loop.

Program storage, memory files, tool length and diameter compensation — you choose the options. And with *SLO-SYN* motors and drives. The entire range of *SLO-SYN* synchronous and stepping motors. Matched translator and preset indexer drives. Rotary and positioning tables.

For information on Superior motion systems, write the large and small company:
The Superior Electric Company, 383 Middle Street, Bristol, Connecticut 06010.
Or call 203/582-9561.



Superior Electric

We live up to our name.

New products

tem ensures low contact resistance over the rated life of 25,000 cycles or 750,000 operations.

While the unit is designed to do tap switching, it can be coded by the user to give hexadecimal outputs. It is available in single-pole contacts (2 to 16 positions) and double-pole contacts (2 to 8 positions). In quantities of 100 to 499, the single-pole

version is priced at \$6 each; the double-pole type, for \$7.25. Samples are available now, and production quantities of the rotary switch will be ready after July 1, the company says.

Grayhill Inc., 561 Hillgrove La., LaGrange, Ill. 60525. For information on the piano DIP, circle No. 352 on the reader service card; for the rotary switches, No. 353.

Connector terminates optical cable

Though fiber optics hold the promise of data transmission at very high speeds over cabled lines, terminating and splicing the fiber-optic bundles is still difficult. However, AMP Inc. is now offering a circular plastic connector that simplifies terminating high-density bundles in medium- or high-loss cables. The new connector, which is billed as a universal end termination, minimizes fiber breakage and eliminates scoring of the bundle face during polishing.

The unit is constructed of a lightweight nonconductive thermoplastic, and its molded design is suitable for economical mass production techniques, says AMP. Termination is accomplished with a crimping tool, so that the epoxy normally needed for plastic fibers is unnecessary.

A plastic ferrule makes it easy to insert bundles with varying diameters. The ferrule's tapered end compresses the bundle to achieve a good

packing fraction of the fibers. Moreover, the screw thread of the cap permits continuous adjustment of the connection.

At DEEC, the firm is also showing for the first time a line of card-edge connectors (below) that eliminate the need for conventional insulating plastic housings. Designated the Laminar family, they rely on two strips of insulating film for their structural and dielectric strength. This flame-retardant film, which connects the strip of contacts, can be cut to length with hand tools.

Laminar connectors are designed to interconnect parallel-mounted printed-circuit boards. A compliant center section lets them accommodate even irregular boards.

Tin-plated contacts, rated at 3 amperes with a 30-milliohm maximum termination resistance, engage both sides of a board at the same time. At 500 volts dc, insulation resistance is 5,000 megohms.

Presently, Laminar units are

The Designer's Design Handbook

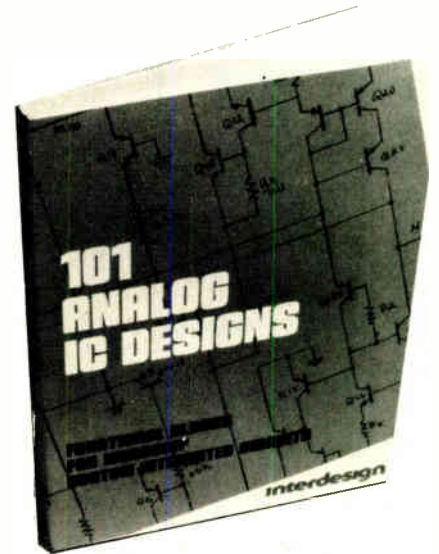

At last, you can get a great selection of 101 standard circuits for commonly needed custom IC designs in one compact handbook. You get 124 pages full of new and clever circuit diagrams and ideas that have been tried and tested to insure optimum performance. Best of all, these circuits are available in Monochip form.

This is a designer's design handbook you won't want to miss. All it takes is \$3.00 to cover nasty old handling and postage costs. Then you have perhaps the smartest collection of new IC design tricks in the industry.

Interdesign

1255 REAMWOOD AVE.
SUNNYVALE, CA. 94086

Send me your book "101 Analog IC Designs." I have enclosed my check for \$3.00 (prepaid only).

Name _____
Title _____
Company _____
Address _____
City _____
State _____ Zip _____

Send to: **INTERDESIGN, INC.**
1255 REAMWOOD AVENUE
SUNNYVALE, CA 94086

DM-05-376

113

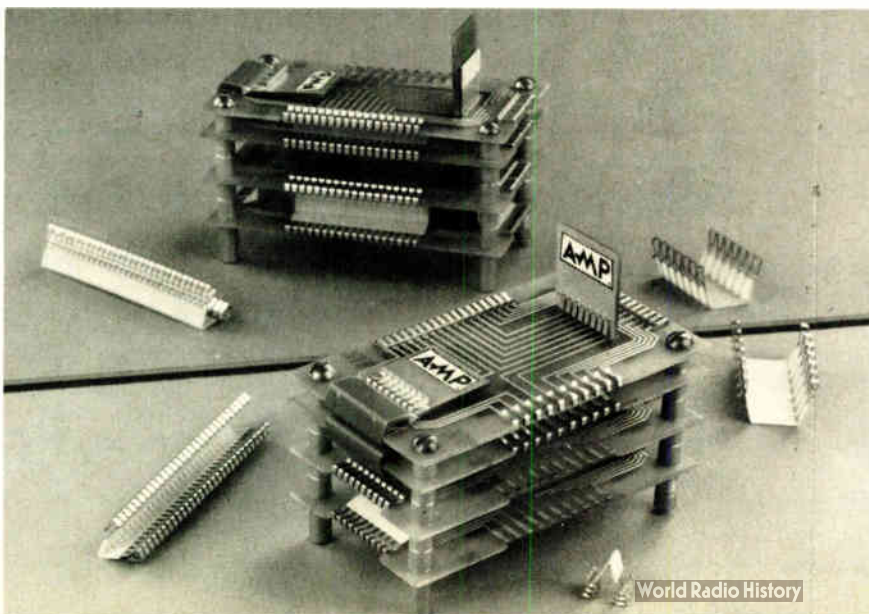

TIME & FREQUENCY....



If these words are important to you then you should know more about Spectracom Corporation. We specialize in **TIME** and **FREQUENCY**, and produce test equipment that leads the industry.

For instance, our **WWVB RECEIVERS** are the finest available. Priced from about \$700 to \$2500, they all have features and performance found only in competitive equipment costing \$5,000 to \$10,000. And some of these features, such as positive go/no-go front panel phase lock indication, are available only from Spectracom. For the first time, you can install a receiver and immediately know beyond doubt that it is working, receiving a strong enough signal, and giving correct frequency calibration and time code information! The green "go" light will be on steadily, because our receivers work well under poor signal-to-noise conditions where other won't!

Another example is our **FREQUENCY DISTRIBUTION SYSTEM**, also the finest on the market. You don't need a separate cable for each remote station. You install our system by running one coaxial cable past each remote station in turn, similar to a cable TV system. Buffered line taps at each station give you the standard frequency you need there. If you want to add a station somewhere along the line, just cut the cable and insert another line tap for the desired frequency! Up to 25 stations can be driven from one base station that costs about \$650, and the cost is even less if you buy the system built into one of our VLF Receivers!

Our **FREQUENCY STANDARDS** can also be furnished with the Distribution Amplifier built in. We also have a Frequency Standard that is furnished as part of a WWVB Receiver, tracked continuously against the NBS standard frequency.

So you see, we have good reasons to be proud of our products. And the people who buy them and use them are proud of them too. For the highest quality and performance you can buy in Time and Frequency test equipment, or for special communications test equipment, call your Spectracom sales engineer.

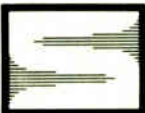

SPECTRACOM CORP.
87 WEDGEWOOD DR
PENFIELD, NY 14526
PHONE 716-381-4827

New products

available with 1 to 50 contact positions on 0.1-inch centers, for connecting 0.062-in.-thick boards when board-to-board spacing is 0.25 or 0.295 in.

AMP Inc., Harrisburg, Pa. 17105. Phone (717) 564-0101. For information on the fiber-optic connector, circle No. 354 on the reader service card; for the card-edge connectors, No. 355.

IC capacitors adjustable at top

Not too long ago, ceramic chip capacitors were only available as fixed-value devices. But with the introduction of Vitramon's Vee Cal family [*Electronics*, Jan. 9, 1975, p. 125], chip capacitors became devices whose value could be varied either up or down from a nominal level. To make it easier for the user to adjust them, the company is now moving the adjustment points from the side of the chip up to the upper surface, making them more accessible and more readily visible.

As with their earlier counterparts, adjustment does not affect the integrity and stability of the VC2A versions of the Vee Cal family, claims

Vitramon. Nominal capacitance values range from 1 to 55 picofarads, and the eight adjustment increments are in 0.5-pF steps. Each chip is 0.12-inch long, 0.1-in. wide, and 0.03-in. high.

Additionally, Vitramon is introducing at DEEC a line of NPO radial-lead ceramic capacitors that provides value tolerances as tight as $\pm 0.25\%$. The new VK series devices cover the capacitance range from 10 pF to 0.51 microfarad.

Vitramon North America, Div. of Vitramon Inc., Box 544, Bridgeport, Conn. 06601. For information on the chip capacitors, circle No. 356 on the reader service card; for the radial-lead units, No. 357.

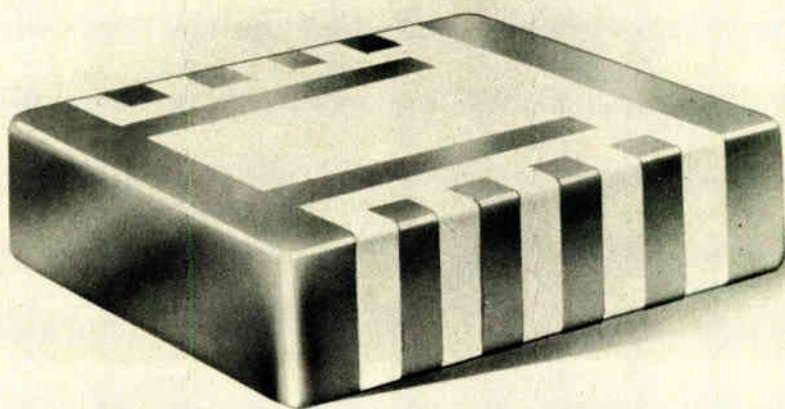

Delay lines respond in 4 ns

Besides being accurate to within $\pm 5\%$ or better, the series DDU-5 digital delay lines from Data Delay Devices offer a typical rise time of only 4 nanoseconds. The units, which are compatible with both transistor-transistor logic and diode-transistor logic, do not require any

outboarded components. Moreover, they provide 10 equally spaced taps in a 16-pin dual in-line package.

Ten different models are available, with total delay time ranging from 100 to 2,000 ns and a delay-per-tap of 10 to 200 ns. Standard operating temperature range is 0°C

to 70°C, and temperature coefficient is 100 ppm/°C.

The devices can operate from a supply voltage of 4.5–5.5 v dc. Maximum input current is 50 microamperes for logic 1, –2 milliamperes for logic 0. Output voltage is 2.5 v minimum for logic 1, 0.5 v maximum for logic 0. Maximum fanout is 20 per tap for a logic-1 output, 10 per tap for a logic-0 output.

Each 16-pin DIP measures 1.57 inches long, 0.53 in. wide, and 0.28 in. high (excluding pins). An optional extended temperature range of –55°C to +125°C is available on request.

Data Delay Devices, 253 Crooks Ave., Clifton, N.J. 07011. Phone (201) 772-1106 (358).

Glass capacitors

Glass-encased ceramic capacitors that qualify to the level M reliability of MIL-C-39014 are available from San Fernando Electric Manufacturing Co. The series CKR11 units are the first glass capacitors to meet the level M failure rate of 1% per 1,000 hours, says a company spokesman—all previous level M capacitors were molded devices.

The new capacitors are hermetically sealed structures, in which the radial leads are welded to the ceramic chip. Because of the glass case, lead attachment can be inspected visually. In molded devices, lead attachments are not visible.

Besides being suitable for handling by automatic insertion equipment, the glass devices offer rugged construction. They can withstand many temperature cycles between –55°C and +125°C, as well as such high pressures as 10,000 pounds per square inch, without degradation.

Two different working voltage ratings—50 or 100 volts dc—are available in a body size of 0.16 in. long by 0.09 in. in diameter. Capacitance range for the 50-v units is 5,600–10,000 picofarads, with a tolerance of ±10% or ±20%. The 100-v units cover the range of 10–4,700 pF.

San Fernando expects to sell its

Why invest in a test handler for each package* when one Sym-Tek System handles them all?

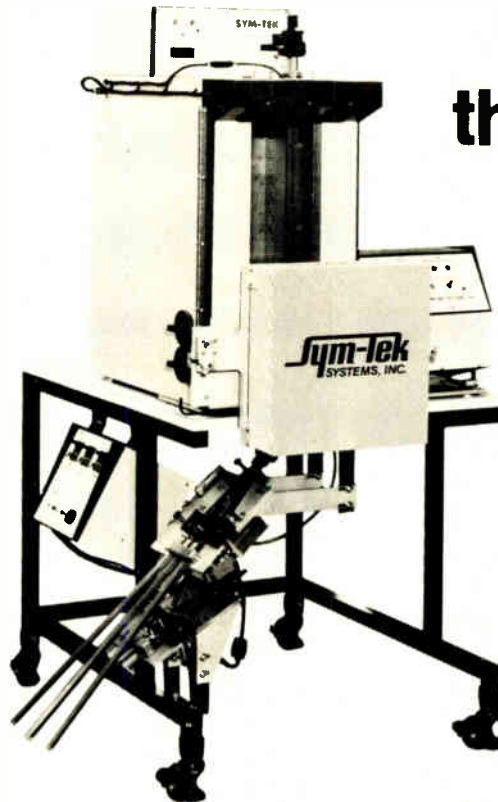

SYM-TEK builds complete systems for most semiconductor devices.

Versatile modular design maximizes flexibility.

You can change modules in less than 15 minutes.

Ambient and environmental testing –73°C to +150°C.

For detailed information about automatic testing applications, please call or write:

Sym-Tek
SYSTEMS, INC.

4140 Morena Blvd. San Diego, CA 92117
(714) 270-7600



*These and many more.

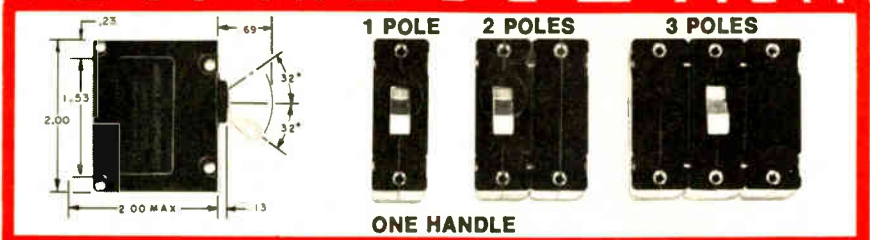

ONE HANDLE

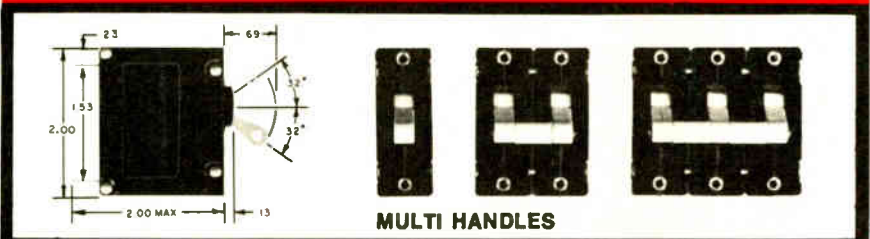

MULTI HANDLES

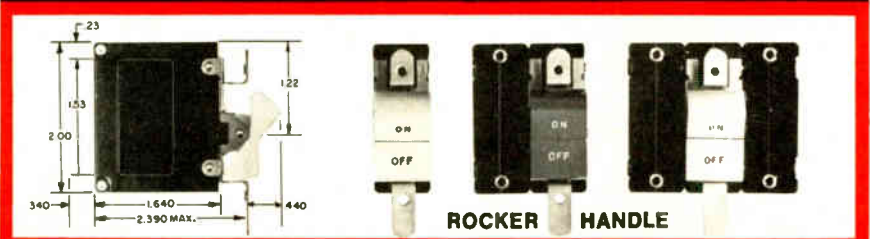

ROCKER HANDLE

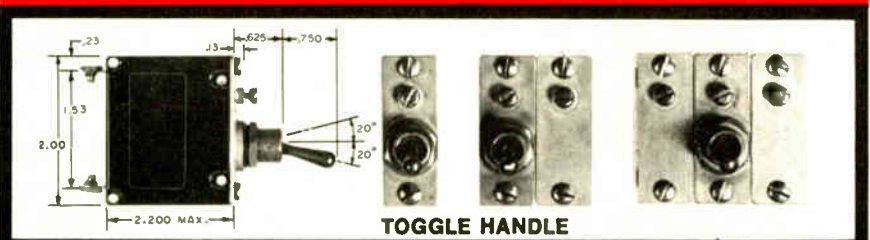

TOGGLE HANDLE



THUMBWHEEL

Airpax UPG Series Magnetic Circuit Protectors Offers 'em all!

Although originally designed for industrial, military (QPL to MIL-C-55629), and marine applications, UPG protectors are suitable for use in any situation where low cost precision operation is required. They are also available in 4 pole models (not shown).

Current ratings: 20 milliamperes to 30 amperes at voltages to 65V dc and 250V ac, 60 or 400Hz.

AIRPAX™

**AIRPAX ELECTRONICS
CAMBRIDGE DIVISION**
Cambridge, Maryland 21613 / Phone (301) 228-4600
Circuit Breakers, Switches,
Glass/Ceramic-to-Metal Seals
Other Airpax Divisions:
CONTROLS DIVISION, Ft. Lauderdale, Fla.
Instruments for Industry
AMERICAN DATA, Huntsville, Alabama
TV Products

New products

new glass capacitors for less than the price charged for equivalent molded devices. Delivery of the capacitors is from stock.

San Fernando Electric Manufacturing Co.,
1501 First St., San Fernando, Calif. 91341
Phone (213) 365-9411 [359]

Low-loss ferrites

Switching-regulated power supplies are smaller, as well as more efficient, than their series-regulated counterparts, and for very high power outputs, they tend to be considerably less expensive, too. Now, new transformer ferrites from Japan's TDK Electronics Co. promise to improve their efficiency still further. Intended for the transformers used in dc switching-regulated supplies, series H7C1 ferrites can reduce power losses by approximately 10% to 15%.

The low-loss ferrites exhibit a fairly high magnetic-flux density. They are free of the usual high-frequency-response flaws found in conventional magnetic alloys like silicon steel plate. Furthermore, at high frequencies and high levels of magnetic flux density, core loss is quite low, so that the temperature of the core rises very little. As a result, transformers built with H7C1 ferrites can develop high outputs at high efficiencies.

For filters operating at frequencies of 100 to 500 kilohertz, the firm has another new ferrite family, the H6K series. These units are low-loss filter ferrites that feature good stability over both time and temperature. Since the relative-loss coefficient of the devices is low, they are suitable for realizing miniature coils with very high Q values.

Both of these new ferrite families are available from MH & W International Corp. Prices are expected to be competitive with existing products, the company says.

MH & W International Corp., 280 Midland Ave., Saddle Brook, N.J. 07662. Phone (201) 791-6277. For information on the H7C1 series, circle No. 360 on the reader service card; for the H6K series, No. 361.

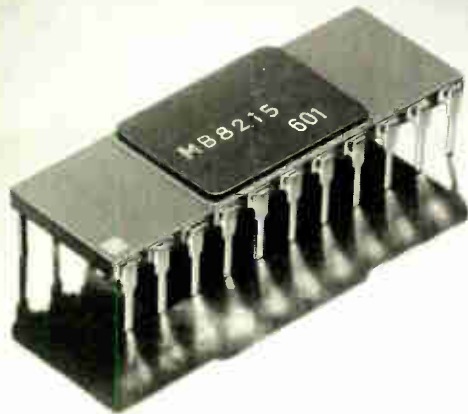

4096 x 1 bit
70ns typ. access time
(100ns max. access time)
TTL compatible inputs
Differential/OR-tie outputs
Single-phase/hi-level clock
500mW typ. power dissipation
+12/+7V/-5.2V supplies
22-pin DIP ceramic package

FUJITSU SEMICONDUCTORS

MOS MEMORY 4K Dynamic RAM MB 8215

When it comes to semiconductor memories, performance is the name of the game. And when it comes to 4K RAMs, the name of the game is the new Fujitsu MB 8215 N-channel silicon gate dynamic MOS 4K RAM. It's the *first* 4K to offer a typical access time of 70ns and power dissipation as low as 500mW/chip.

Bipolar comparable speed

The adaptation of N-channel silicon gate construction provides the key to obtaining bipolar-like speeds. The MB 8215 features a typical access time of only 70ns (100ns max.) and a minimum cycle time of 220ns guaranteed over 0 to 70°C. With this kind of speed, it's easy to see why the MB 8215 is fully capable of handling memory applications which, up to now, have been limited to more costly bipolar devices.

Low power consumption

The Fujitsu MB 8215 also gives you reduced power requirements for saving on power. The device has a typical dissipation of 500mW/chip (less than 0.15mW/bit), which adds up to a substantial improvement of the speed-power product.

Perfect for main memory applications

The MB 8215 is ideal for computer main memory (or similarly demanding) applications. Its 22-pin DIP design eliminates the need for address multiplexing and related timing headaches. All inputs, with the exception of the single-phase hi-level clock, are fully TTL compatible for simplified interfacing. And, Fujitsu supplies compatible bipolar linear sense amplifiers that permit the same fast access time.

Proven reliability and available now

The MB 8215 4K RAM is built by

Fujitsu, a maker with proven reliability in the field of semiconductors. Stringent production standards, proven in-field performance, the most advanced processes, the capability to meet your requirements, and a price that's fully competitive—these and more add up to Fujitsu quality and Fujitsu service.

So, contact Fujitsu now for the MB 8215, or any of your MOS memory requirements. Availability is NOW! Write or call for more information to Fujitsu California, Inc., Laboratory Division, 1280 East Arques Ave., Sunnyvale, California 94086, phone: 408-735-0735 telex: 346393.

FUJITSU LIMITED

Communications and Electronics
Marunouchi, Tokyo, Japan

One-fiber optical cable is rugged

High tensile strength and low cost make single-fiber waveguide attractive for communications bandwidths up to 20 megahertz

by Richard Gundlach, Communications and Microwave Editor

Low-loss fiber-optic waveguides are coming closer to being competitive with conventional transmission media—wire and coaxial cable. A step in that direction has been taken by Fiber Communications Inc., which has developed a single-fiber cable, called Fiberguide, that offers high tensile strength and cost-effectiveness for bandwidth requirements that extend as high as 20 megahertz.

Fiber-optic waveguides are particularly attractive in communications applications, such as computer control of machinery and remote sensing in electrically noisy environments where electromagnetic interference is a severe problem.

Not widely used. So far, however, fibers have not been used widely for several reasons: their high cost when placed in a fairly rugged cable, their limited availability, and the fact that they have often been fragile and difficult to handle even after being placed in a cable.

And up to now, cabled fibers have been available only in fiber bundles or cables containing six separate fiber channels in one sheath. This reduced cost-effectiveness, since all the fibers in the cable might never be used. In fact, for most applications a single fiber would suffice. Moreover, most multiple-fiber cables are about ½ inch in diameter, larger than was expected for optical transmission. Also, Fiber Communications says, only moderate-strength cables with minimum bending radius have been available.

The new Fiberguide is a single-fiber waveguide encased in a ruggedized sheath with an outside

diameter of 80 mils. It offers exceptionally high tensile strength—about 475 pounds, almost four times the strength of previously available cables. But it is the combination of small size and high tensile strength of Fiberguide cables that makes possible reduced installation costs. They can be pulled through ducts

are perfect for the plastic jacket, or even fingernails will do the job. And since all segments of the cable are concentric, all alignment can be done from the outside of the cable rather than working from the small fiber.

Several features of the Fiberguide cable point to its usefulness. The fiber waveguide itself is all glass. It consists of a glass core surrounded by a cladding of glass with a slightly lower refractive index. The use of an all-glass waveguide, instead of plastic cladding around a fused-silica core, helps prevent degradation of the cable's transmission characteristics in humid or underwater environments.

The step-index cable has a 0.16 numerical aperture, attenuation is below 40 decibels per kilometer, with a typical value of 25 dB/km. The cable has a recommended bending radius of 2.5 inches, comparable to large-bandwidth coax cables but it can accommodate tighter bends.

Severe tests. The cable has been extensively tested in salt water without showing any degradation. It's been put through more than 1 million cycles of flexure test under 200-pound loads with no adverse effects, the company says.

The price of Fiberguide cable is \$3 per meter (less than \$1 per foot) when purchased in lengths of 500 meters. Standard lengths of 200 and 500 meters are generally available, and lengths over 500 meters can be obtained upon special order. Lengths of 1 kilometer have already been manufactured.

Fiber Communications, Inc., Orange, N.J. 07050 [339]

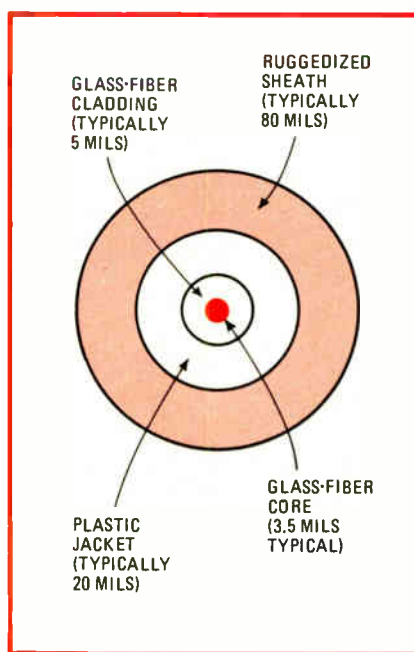

Cross section. Ruggedized sheath assures high tensile strength. All materials are dielectric, so equipment linked by the optical cable is electrically isolated.

more easily and for greater distances without any need for splices.

Further, the cable weighs only 1.5 pounds per thousand feet and can be easily stripped without specialized tools to gain access to the fiber. An ordinary pair of diagonal cutters can be used to strip and peel the outer sheath. Thermal wire strippers

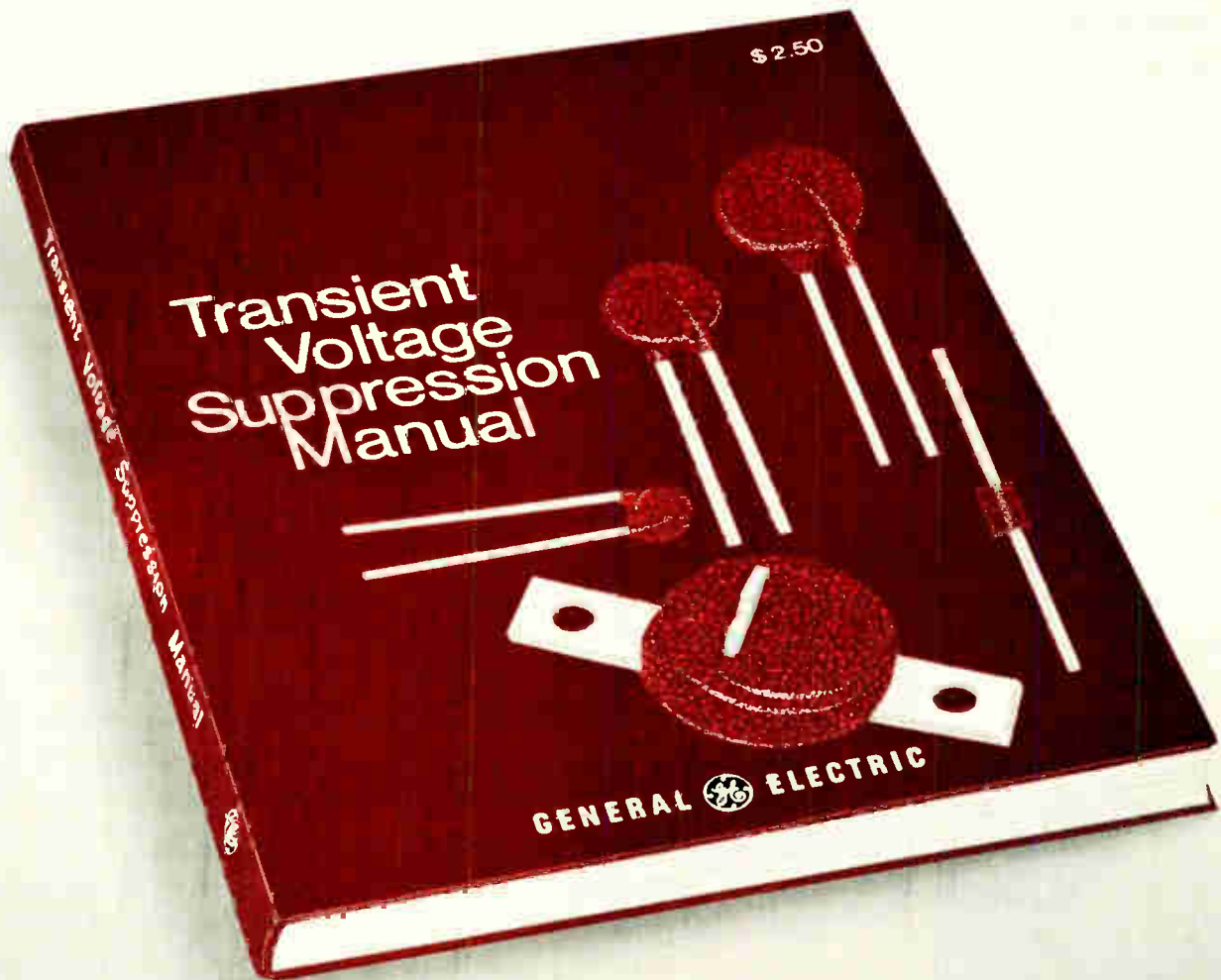

From General Electric New Transient Protection Manual

New 112 page manual combines in one publication theory, knowledge and experience relating to transient cause, detection and protection accumulated by General Electric scientists and engineers...includes a comprehensive selection guide and product specification sheets for determining the optimum GE-MOV® Varistor.

Copies are available from any authorized GE distributor, GE OEM Electronic Components Sales Office, or by sending \$2.50 plus applicable tax to General Electric, Semiconductor Products Department, Electronics Park, Bldg. 7-49, Syracuse, New York 13201.

GENERAL  ELECTRIC

Programer takes on any CPU chip

System is adaptable to any microprocessor; package includes keyboard and CRT display, permits interactive program-writing

by Stephen E. Scrupski, Computers Editor

Writing programs for microprocessors is a difficult enough task for a programmer without his having to worry about the extra time involved in loading paper tape and whether his program will fit in the available memory space. With this philosophy in mind, Tranti Systems Inc., North Billerica, Mass., has developed a system that it says is easy to use and is adaptable to any microprocessor on the market.

The system, called the μ Scope model 8000 programing system, consists of the following, all in one package: alphabetic keyboard, 10-key numeric pad and extra control keys, cathode-ray-tube display, a small alphabetic printer, a magnetic-tape cartridge, and an expandable memory that provides up to 57 kilobytes of user space. The software package is in a read-only memory and consists of three parts: monitor, editor, and assembler. Unlike off-line assemblers, which perform the assembly after the program is fully written, Tranti's system assembles the program as it is entered.

Thus, as the programmer writes his instructions using the mnemonics of the assembly language for the particular microprocessor involved, each instruction, which, of course has a one-to-one correspondence to a machine code, is translated to a stored list and the object code stored in random-access memory. The CRT displays the program as it is entered.

The model 8000 system is

built around the Intel 8080A, and the programmer can run his programs after they have been entered, edited, and assembled on the internal central processing unit. If he is using another CPU, he needs only a different dictionary of translations of assembly language to object code, which can be entered into a RAM via the magnetic tape cartridge. To run this program for another processor other than the 8080A, he must add an alternate CPU board, or bus the system memory out to his equipment.

Since the assembler is designed to convert user entries into object codes, the only additional memory required is for labels. Typically, object code and labels will consume equal amounts of memory space, resulting in 50% efficiency of memory use. Thus, a user can generate 2

kilobytes of object code with only 4 kilobytes available in user memory. Tranti says this 50% assembler efficiency is approximately 10 times better than conventional programming methods.

It gives the programmer the ability to write extensive programs without running short of memory. Also, it completely eliminates the time-consuming need to shuffle and reshuffle paper tapes.

The system's monitor program reads, writes, and verifies magnetic tapes, copies and compares blocks of memory, allows direct entry or modification of any memory location, and has the capability for multiple traps or breakpoints in the program. Control keys are provided to set address, examine, backspace, clear, deposit, and run.

The editor allows the user to set program address, increment address, decrement address, label, list, move, assemble, and disassemble programs. With the printer, the programmer can selectively list portions of the program or the entire program.

The system grew out of the company's own work on cash registers intended for fast-food chain restaurants, according to president Frank Trantanella. The μ Scope has been used within Tranti for more than six months. Price of the system is \$6,995. It will be ready in June, and delivery time will be 30 days.

Tranti Systems Inc., 1 Chelmsford Rd., N. Billerica, Mass. 01862. [340]





Now our expandable line offers DC to 4 million bits per second!

We offer PCM capability, in addition to Direct and FM electronics, in three of our recorder/reproducers. There's the 7 to 14 channel Sabre III and the 28/32 channel Sabre V, both IR-G all-band portable recorders; and the Sabre IV, a 7 to 48 channel laboratory recorder/reproducer.

In addition our line includes the new Sabre VI which offers superior performance plus ultra-portability, and the Tandberg TIR-115, a 4-channel, FM, 25-pound system.

Those basic five recorders are actually an almost unlimited line because each is designed and built to adapt to an amazing variety of functions. Just tell us what you want one to do!

For information write: Sangamo Electric Company, Data Systems Division, P.O. Box 3347, Springfield, Illinois 62714. Area Code 217, 544-6411. Telex 406-461. Sales and service representatives worldwide.

SANGAMO RECORDERS
THE INNOVATORS IN TAPE INSTRUMENTATION

DigiTec creates a 'counter' revolution... with two new revolutionary 'counter' features.



1. **OPTI-RANGING:** DigiTec's exclusive display technique is an improved auto-ranging that actually organizes the data before you see it. With Opti-ranging, there is no need for lights or indicators to indicate MHz, kHz or Hz since the display position is fixed regardless of the time base (resolution) selected.

All our Opti-ranging counters are augmented by a standard LED display of 9 full digits that shows your complete measurement.

2. **INPUT SHUTDOWN:** Another DigiTec exclusive, prevents the display of erratic or erroneous data. Based on the input sensitivity of each instrument, this system shuts down the display if the incoming signal drops below a reliable measurement level. A single zero is displayed to indicate such a condition while preserving maximum measurement confidence.

COMPARE BEFORE YOU BUY!

These counters are not partial-function. All our **UNIVERSAL COUNTERS** feature two separate channels for complete time interval measurements. Each channel has a separate set of input controls, including slope, waveform and attenuators for extra precision.

Every counter is housed in a rugged diecast and extruded aluminum case for lightweight convenience and total protection.

8500A Series Universal Counter/Timers

consist of 4 models for measurements from 5Hz thru 1GHz

Start at **\$725.**

8700A Series Frequency Counters

consist of 3 models for measurements from 5Hz thru 1GHz

Start at **\$625.**

We also offer 15 other counters from which to choose.

DigiTec

UNITED SYSTEMS CORPORATION

918 Woodley Road • Dayton, Ohio 45403 • Ph: (513) 254-6251 • TWX: (810) 459-1728

These instruments available under GSA Contract GS-OOS-27741

"Information only" circle 122 on readers service card

"Demonstration only" circle 123 on readers service card

New products

Communications

Tone receivers meet Bell specs

Hybrid modules are offered individually or as subsystems on pc boards

Bell's Touch-Tone telephone signaling involves the transmission of pairs of tones to represent the dialed numbers. Series 883 hybrid tone-receiver products are designed to receive these tone pairs and decode them. Available as individual modules and as pretested subassemblies mounted on printed-circuit cards, the series includes the model 883-1 dial-tone reject filter, the 883-2 low-band filter, the 883-3 high-band filter, the 883-4 dual limiter, the 883-5 quad tone detector, and eight band-pass filters (883-6 through -16). The hybrid circuits all meet Bell System requirements for use in central-office equipment manufactured by Western Electric.

Two additional products are the 883-107 and 883-108 tone-decoder subsystems. These are assemblies of series 883 hybrid modules, together with other components, mounted on a pc card. The 883-107 is designed to decode the four-by-three tone matrix (two-of-seven code) put out by standard Touch-Tone telephones. The 883-108 can handle the full Touch-Tone four-by-four matrix (two-of-eight code). In addition to the hybrid modules, the subassemblies include an input

transformer, coupling capacitors, bypass capacitors, timing and reference capacitors, and a pair of zener diodes.

Because it uses a limiter approach rather than automatic-gain control, series 883 equipment can decode tone-burst repetition rates as high as 25 bursts per second without degrading key parameters.

Unit-quantity pricing on the hybrid modules is as follows: the 883-1 through 883-4 sell for \$22, \$18.50, \$19.60, and \$12.75 respectively. The 883-5, two of which are required for a complete tone decoder, sells for \$25.25. The 883-6 through 883-16, of which seven or eight are required, sell for \$10.25. The 883-107 subassembly is priced at \$288.90, while the 883-108 goes for \$300.75. Beckman Instruments Inc., Technical Information Section, Helipot Division, 2500 Harbor Blvd., Fullerton, Calif. 92634 [401]

Portable level generator has very flat response

Designed primarily to provide the extremely stable tones needed to test frequency-division-multiplexed carrier systems, the model AT-607 level generator is portable. Its out-

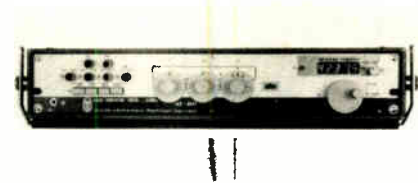

put power varies less than 0.12 decibel from its value at 10 kilohertz over the frequency range from 200 hertz to 4.5 megahertz. This flatness and all other specifications become valid over the generator's rated temperature, line-voltage, and line-frequency ranges immediately after turn-on.

The instrument has an output power range from 0 dBm down to -70 dBm, switchable in calibrated steps of 10 dB and 1 dB. In addition, the level can be varied continuously over a 1.2-dB range. Frequency resolution is 10 Hz, and the maximum

frequency error is less than 30 Hz, the company says.

The large five-digit incandescent frequency numerals can be read even in direct sunlight.

In addition to its main 75-ohm coaxial output, the AT-607 has three balanced outputs: 124 ohms, 135 ohms, and 600 ohms. All four outputs are compatible with standard Western Electric and equivalent plugs.

The level generator can be combined with the manufacturer's recently announced model AT-608 selective and wideband level meter [*Electronics*, Jan. 22, p. 129] to form a frequency-response measuring system. When coupled, the two instruments operate synchronously so that it is necessary merely to tune the receiver and the generator automatically tracks it.

The level generator, which weighs about 20 pounds, sells for \$2,775. W & G Instruments Inc., 119 Naylor Ave., Livingston, N. J. 07039. Phone Ken Chipman at (201) 994-0854 [403]

Citizens' band SSB filter is extremely stable

A single-sideband mechanical filter designed for the citizens' band radio market will typically shift a maximum of 35 hertz over the temperature range from -30°C to 50°C. Designated the model P/N 526-9897-010, the filter is an upper-sideband device for an i-f of 455 kilohertz. Either end of the filter may be used as the input or output, but only one end is balanced. Both ends should be terminated in an impedance of 2,700 ohms shunted by 360 picofarads. Custom-made ferrite transducers keep the insertion loss low. The result is a very stable filter. The P/N 526-9897-010 sells for \$11 each

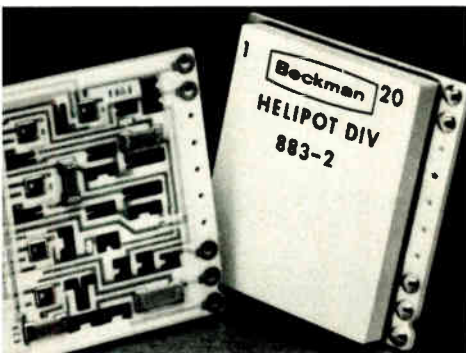
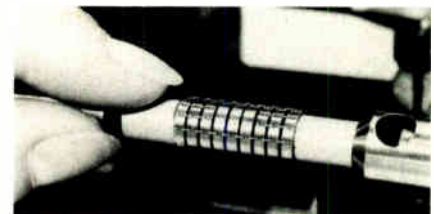

New products

when it is ordered in lots of 5,000.

Collins Radio Group, Rockwell International, 4311 Jamboree Rd., Newport Beach, Calif. 92663. Phone Jim Campbell at (714) 833-4632 [405]

Broadband multicoupler can handle a kilowatt

Covering the frequency range from 20 to 80 megahertz, the model PM1777 four-port multicoupler is capable of combining or splitting power levels as high as 1 kilowatt over an ambient temperature range of -50°C to 90°C . The latest addition to a family of 1-kw multicou-

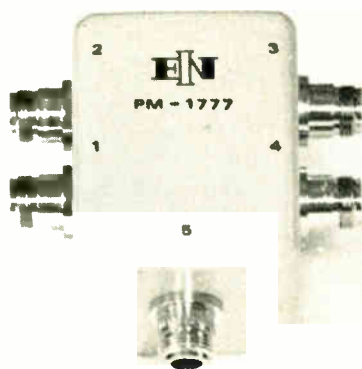

plers, the PM1777 has a maximum insertion loss of only 0.2 dB, a maximum VSWR of 1.25, and a minimum isolation of 22 dB. The entire coupler is immersed in a silicone-oil bath and heat-sunk to its hermetic brass case. For high-power operation, the case should be mounted to a good heat sink. The multicoupler sells for \$349 in quantities of one to four and for \$295 for five to 49. Delivery time is 30 days.

Electronic Navigation Industries Inc., 3000 Winton Rd. South, Rochester, N. Y. 14623. Phone L. M. Salmen at (716) 473-6900 [406]

Spectrum analyzer spans 25 megahertz

Useful for both routine monitoring and troubleshooting of frequency-division-multiplexed communications systems, the model 236 spectrum analyzer spans the range from 100 hertz to 25 megahertz. The unit's 100-Hz resolution makes it suitable for baseband work as well as for the analysis of i-f and rf signals. The model 236, priced at \$3,800, has a dynamic range of 60 decibels and sensitivity of -105 dbm. It is offered with an input im-

pedance of either 50 or 75 ohms. A high-impedance probe adds \$155 to the basic price. Delivery time is 30 days.

Nelson-Ross Electronics, 5 Delaware Dr., Lake Success, N. Y. 11040. Phone (516) 328-1100 [404]

Equalized multi-modem operates at 4,800 b/s

Intended for multipoint polled operation, the 48/Multi data modem is an eight-phase differentially coherent unit that requires no operator intervention at the distant station. Able to operate at 4,800 bits per second over unconditioned lines, the modem has a built-in



equalizer that needs adjustment only when the unit is installed. An integral signal-quality meter makes an oscilloscope unnecessary for equalizer adjustment. The 48/Multi

FREE



MICROWAVE CAPABILITY GUIDE

For complete information on General Electric's line of microwave tubes and devices, use the Reader Service Card to order Condensed Catalog . . . or contact:
Microwave and Imaging Devices Products Section,
General Electric Company,
316 E. Ninth Street,
Owensboro, Kentucky 42301.
(502) 683-2401.



GENERAL ELECTRIC

The Right Tape Perforators From REMEX Give More Punch For The Money

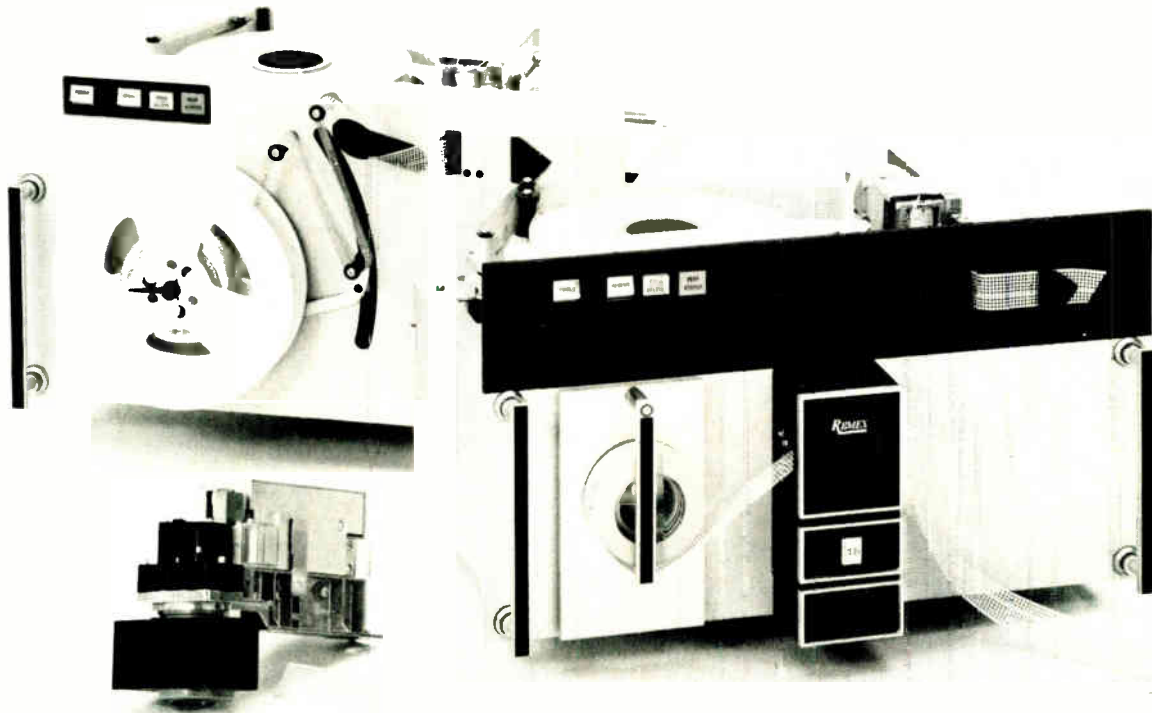

6120 cps punched tape perforators and combos are now available for the same price you've been paying for low speed punch units.

The REMEX 6120 series includes the right perforator configuration for minicomputer, NC, test and phototypesetting applications:

a perforator/spooler system, rack mountable or desk top, for high volume data tape preparation.

a perforator/reader "combo" — a REMEX exclusive — combining the high speed punch with a 300 cps reader for program preparation, load and edit.

a high speed punch mechanism for OEM system integration sized 1/3 smaller than other high speed perforators.

All 6120 perforators have motor driven tape feed and sprocket drive design giving longitudinal registration within $\pm .015''$ in 5" of tape. No registration adjustments are required for the life of the product.

Life expectancy of the perforator mechanism is greater than 700 rolls of paper tape and can be further extended by use of an optional carbide punch block.

To satisfy all application requirements, 6120 perforators will punch paper or mylar tape of 5-8 levels for roll or fanfold, bidirectionally. A six level advance feed typesetter version is available.

Call or write for information on the REMEX RPS 6120 Perforator System, the RAB 6120 Combo and the RPM 6120 Punch Mechanism — the **right** perforators for your application.

REMEX[®]



**Peripheral
Products**

Ex-Cell-O Corporation

1733 E. Alton Street, P.O. Box C19533, Irvine, California 92713
(714) 557-6860, TWX (910) 595-1715. In Europe and the U.K.: SpA, Microtecnica
Via Madama Christina 147, Torino, Italy 10126.

Circle 125 on reader service card

OFF-THE-SHELF KEYBOARDS?



This telephone keyboard is, and the others might as well be.

The key legend that makes one



keyboard different from another costs next to nothing. Prototyping?

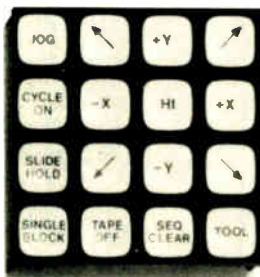

The Chomerics approach makes small quantities of custom keyboards practical.



Special encoding? No problem.
Tight schedule? You've come to the right place. Application: Communications? Lab instruments? Computers? whatever

— Key in to the leader. **CHOMERICS**

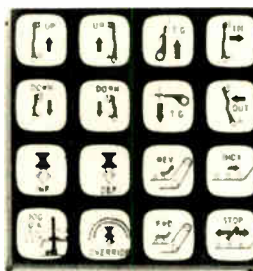

77 Dragon Court
Woburn, Ma. 01801
(617) 935-4850

New products

sells for \$2,395—more than \$1,000 less than its predecessor. Delivery time is 30 days.

Penril Corp., 5520 Randolph Rd., Rockville, Md. 20852. Phone Bill Myers at (301) 881-8151 [407]

16-channel multiplexer is microprocessor-controlled

A microprocessor-based multiplexer, the model M1308, accommodates up to 16 asynchronous or eight synchronous data channels, or a combination of both. A complete basic 16-channel, point-to-point multiplexing network sells for less than \$8,000. The multiplexer can operate at rates up to 9,600 bits per second over a single voice-grade telephone line. The unit's programmable microprocessor allows it to handle a wide mix of remote-job-entry terminals, synchronous CRT controllers, and interactive asynchronous terminals. The price of a model M1308 multiplexer ranges from \$1,800 to \$2,250.

Computer Transmission Corp., 2352 Utah Ave., El Segundo, Calif. 90245. Phone (213) 973-2222 [408]

TOPICS

Communications

Solid-State Communications Inc., Hayward, Calif., has acquired a line of dc remote-control products from **Alpha Electronic Services Inc., Stanton, Calif.** The line includes the AR-7 remote-control unit, and the XR-4 extended local-control unit.

Syntech Corp., Rockville, Md., has developed an automatic control device, the ADRS, that allows its modems operating on the dial network to adapt themselves to a variety of other modems.

Penril Corp., Rockville, Md., and **Tektronix Inc., Beaverton, Ore.**, have entered into an agreement whereby Penril will provide Tektronix with modems for display terminals.

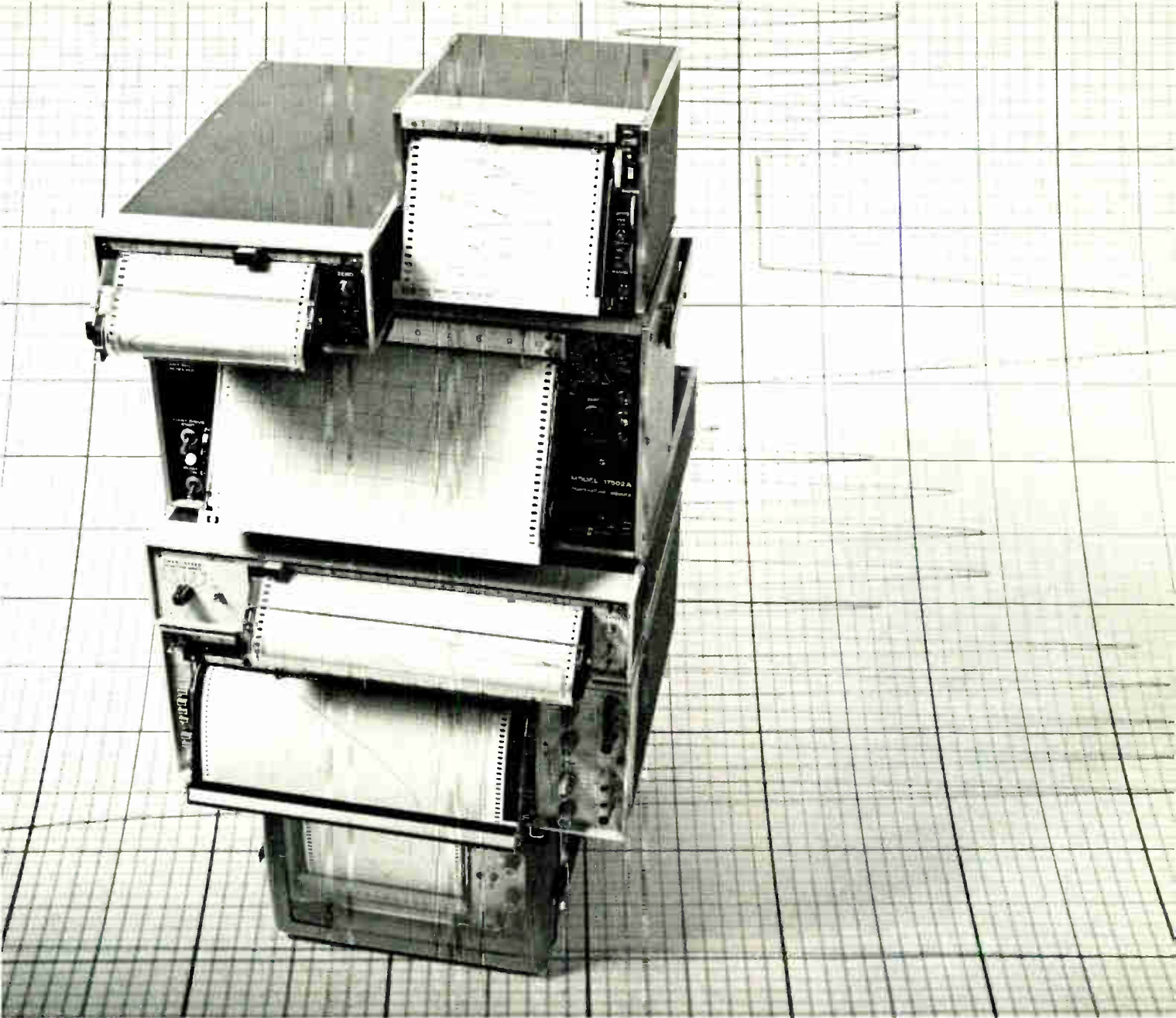

We've built these strip chart recorders as if your job depended on them. (no matter what your line of work)

Whether your line is lab work, field research requiring battery operated recorders, or you are an OEM, we have just the strip chart recorder you need.

You'll find everything from compact dedicated OEM machines, to high performance lab recorders with a variety of plug-in signal conditioners. Offering capabilities such as 100 μ V up to 10 scales of calibrated zero offset and direct measurements of temperatures from thermocouples. In addition, some very choice options like event markers, limit switches, and TTL remote control are available.

We are really proud of our writing systems. All the capability in the world isn't worth a thing if you can't get it down

on paper with a crisp, clear, accurate trace. HP's one and two pen recorders give you a choice of time proven capillary ink writing or the convenience of snap-in, snap-out disposable ink pens.

But if you're looking for an alternative to ink writing, our thermal writing, available on the 7130 series recorders, is the perfect option. Especially for reliable long-term unattended operation. The pen tip won't broaden with use, and the tip temperature is compensated for ambient temperature changes to insure consistent line quality in varying environmental conditions. Independent front panel intensity adjustments are included.

The thermal styli have been carefully insulated and a safety interlock shuts off

pen power when the chart magazine is removed, so when you buy thermal writing from HP, you don't get burned.

For OEM applications, a number of our recorders have been designed specifically for you, and are not simply scaled-down versions of lab models. And all models have built-in OEM discounts available.

HP strip chart recorders. Built for times when a thin line separates success from failure.

11603

HEWLETT  **PACKARD**

Sales and service from 172 offices in 65 countries.
11000 Page Mill Road, Foster City, California 94024

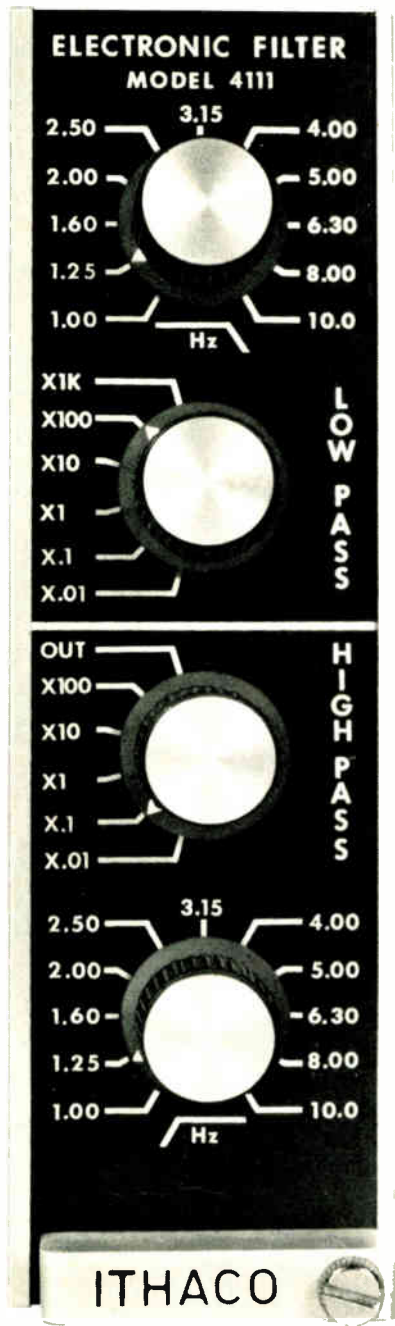

The predictable filter.

Get $\pm 1\%$ gain, $\pm 1\%$ frequency and $\pm 2^\circ$ phase accuracy. 24 dB/octave. From .01 Hz to 1 MHz. With tenth decade step switch positions for repeatability. Available as shown or dual low-pass. For information on electronic filters, AC instrumentation amplifiers, dynamic strain gage amplifiers, and auto-gain amplifiers, contact: Ithaco, Box 818-MD3, Ithaca, N.Y. 14850. 607/272-7640.

ITHACO

New products

Subassemblies

Dc-dc converter puts out 120 W

Compact modules use high-efficiency power-transfer circuit

Power supplies are often the limiting factor in miniaturization of equipment. That's why small units that are high in power density take on special significance.

Housed in compact modules measuring only 4 by 6 by $2\frac{1}{4}$ inches, a line of dc-dc converters from Etatech provide up to 120 watts of output power at voltages from 5 to 48 v dc. The new units employ a high-efficiency power-transfer circuit called Univerter, and all have a power density of 2 w per cubic inch.

There are six converter models in all, with nominal outputs of 5, 12, 15, 28, 30, or 48 v dc. Output current is 20 amperes for the 5-v model, 4 A for the 30-v model, and 2.6 A for the 48-v model. Minimum efficiency ranges from 71 to 80%, over an input line range of 26 ± 6 v dc to 44 ± 10 v dc.

The converters are primarily intended for use in battery-operated standby power supplies for high-reliability avionics and ground-support and communications gear.

Combined line and load regulation is 0.4%, while peak-to-peak output ripple is 100 millivolts max-



imum from all sources. All units include remote error-sensing, as well as protection from output short circuits, output overloads, input over-voltages, and reverse input polarity. Recovery time from transients is 250 microseconds; filters and noise-cancellation circuitry reduce noise.

In 100-unit quantities, price is \$295 each for most models. Delivery time is four to six weeks.

Etatech Inc., 187-M West Orangethorpe Ave., Placentia, Calif. 92670. Phone (714) 996-0981 [382]

16-bit hybrid d-a converter has reference and op amp

The model MN3300 16-bit digital-to-analog converter, a hybrid device, comes complete with an internal reference and an output op amp and is housed in a 24-pin hermetic dual in-line package. Having the output op amp inside the package eliminates contact-resistance and



grounding problems that could degrade the unit's accuracy and linearity. Maximum nonlinearity is specified as less than half a least significant bit over the operating temperature range from 0°C to 70°C . Four laser-trimmed analog voltage ranges are user-selectable by external pin connection. They are: 0 to -5 volts, 0 to -10 v, 0 to +5 v, and 0 to +10 v. The negative ranges use true binary-coded-decimal inputs, while the positive ranges use complementary BCD. The MN3300 consumes a maximum of 420 milliwatts and has a maximum settling time of 35 microseconds. It can be driven by either C-MOS or TTL levels. Typical applications include weighing systems, thumb-wheel interfacing, and process controls. The converter sells for \$149 in small quantities, drop-

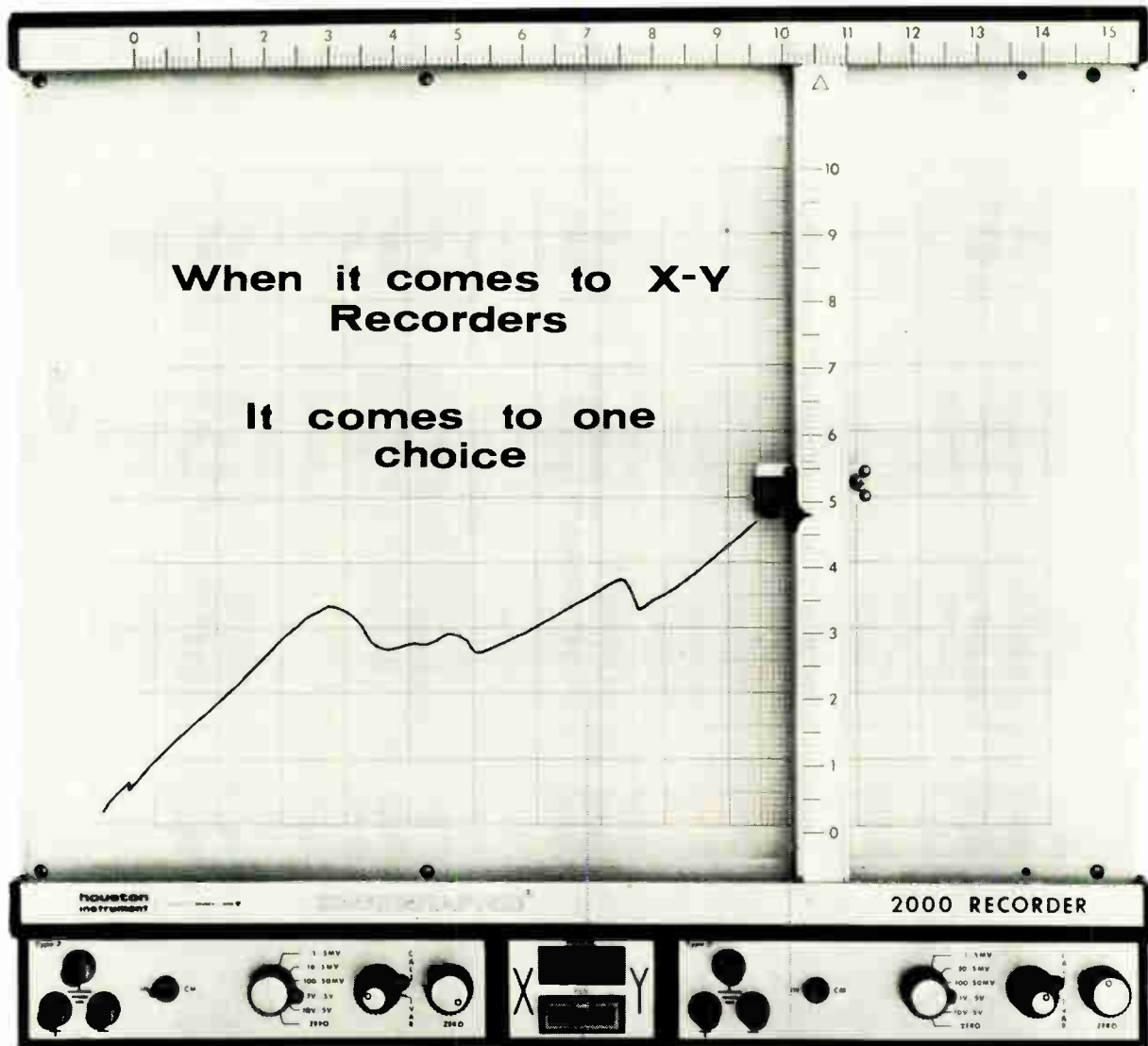

**When it comes to X-Y
Recorders**

**It comes to one
choice**

BEST VALUE - MOST FLEXIBILITY

This versatile 11" x 17" recorder is adaptable for laboratory or field, production or process, OEM (with or without modules) or dedicated applications in either bench or rack mounted. Inch/centimeter scaling by front panel switch.

Differential input is potentiometric with no less than 2 megohms slewing resistance. High common mode rejection. Acceleration, slewing speed, phasing and damping of X and Y axes drives are matched for

minimum error under dynamic conditions. Amplifiers are interchangeable as are input modules.

Overall accuracy $\pm 0.2\%$. Linearity $\pm 0.1\%$ full scale. Repeatability $\pm 0.1\%$ full scale. Resetability $\pm 0.05\%$ full scale. Overshoot is less than 1%. Basic sensitivity 1 mv/inch (0.5 mv/cm). Zero is fixed or can be remotely controlled. Local or remote control electric pen lift. Dozens of selections for input modules.

OEM discounts available.

Need more information? Call or write:

**houston
instrument**

DIVISION OF **BAUSCH & LOMB** 

ONE HOUSTON SQUARE (at 8500 Cameron Road) AUSTIN, TEXAS 78753

(512) 837-2820

TWX 910-874-2022

cable HOINCO

TELECOPIER

EUROPEAN OFFICE

Rochesterlaan 6 8240 Gistel Belgium

Phone 059/277445 Telex Bausch 81399

"the recorder company"

® A registered trademark of Houston Instrument.

New products

ping to \$119 each in hundreds.

Micro Networks Corp., 324 Clark St., Worcester, Mass. 01606. Phone (617) 852-5400 [383]

Modular dc supplies have fixed outputs

A family of modular dc power supplies from Semiconductor Circuits is directly interchangeable with equivalent series LZ made by Lambda.

These new supplies, also called the LZ series, can operate over a temperature range of -25°C to $+71^{\circ}\text{C}$ with no power derating. Furthermore, they are packaged in 2.5-by-3.5-inch cases, having heights of 0.875 to 1.56 in. The Lambda units, however, have adjustable outputs, whereas Semiconductor Cir-

cuits' supplies are fixed-output devices.

At this time, there are eight models from which to choose. All models can accommodate inputs of 105-125 volts ac at 50-440 hertz. The fixed output can be 5 v dc at 1 or 2 amperes, or ± 12 or ± 15 v dc at ± 100 , ± 200 , or ± 300 milliamperes. Output



protection against short circuits is standard, and output ripple and noise is held to 1 millivolt root-mean-square.

Under high-line and full-load conditions, efficiency ranges from 47% for the 5-v models to 55% for the dual-output models. Line and load regulation is 0.5% for all the single-output units, 0.2% for most of the dual-output ones.

Moreover, to aid heat removal, the supplies have plastic cases made from a thermally conductive epoxy. At 25°C , their mean time before failure is specified as 150,000 hours, the company says.

Single-unit prices range from \$38.95 to \$84.95, depending on the model, and delivery is from stock to within two weeks.

Semiconductor Circuits Inc., 306 River St., Haverhill, Mass. 01830. Phone (617) 373-9104 [391]

We tailor TWTs

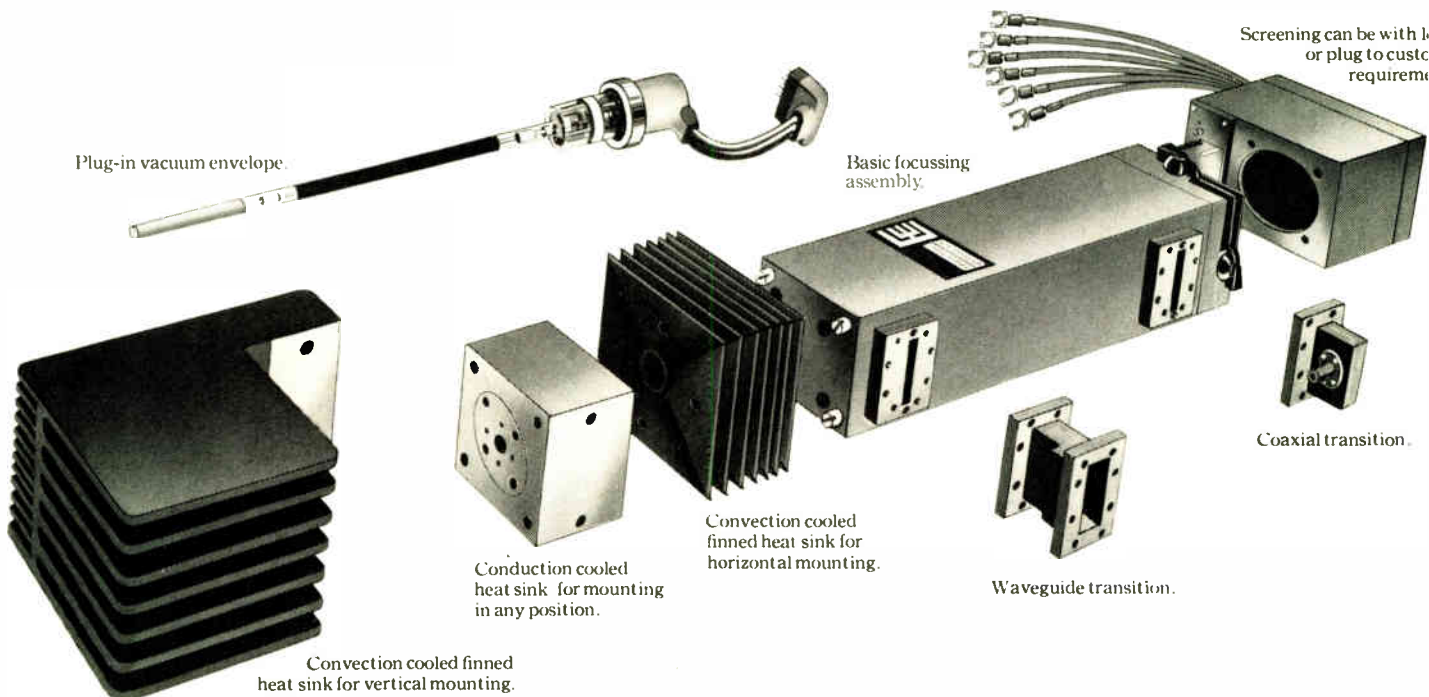

Triple-output power supply operates from 6.5 to 40 V dc

Able to accept input voltages over the range from 6.5 to 40 V dc, the WC series battery stretcher provides outputs of ± 5 V dc at 2 amperes and ± 15 V dc at 165 milliamperes. The 15-watt supply requires only free-air convection cooling for ambient tem-



peratures from -25°C to 71°C . An 8-w companion converter is similar to the 15-w unit except that it supplies only 1 A at 5 V and 100 mA at ± 15 V. For both supplies, the 5-V output is not isolated from the input, but the 15-V outputs are isolated from both the input and the 5-V output. Regulation on the 5-V output is typically within 0.5%, and regulation on the tracking 15-V outputs is typically within 0.01%. These parameters, and all others, change very little over the full range of input voltage; for instance, the efficiency rises from 68% to 73% as the input voltage drops from 40 V to 6.5 V. In small quantities, the 15-w supply sells for \$114 and the 8-w version is priced at \$99. Delivery of production quantities takes from four to six weeks.

Stevens-Arnold Inc., 7 Elkins St., South Boston, Mass. 02127. Phone (617) 268-1170 [384]

Log converter stays within 0.5% over four decades

A temperature-compensated, dc-coupled log ratio module maintains log conformity to within 0.5% over the four decades of input current from 10 nanoamperes to 100 microamperes. When operated over its full six-decade range, from 1 nA to 1 milliamperere, the unit still holds log conformity within 1%. And unlike earlier designs, the model 757 does not restrict the relative magnitude of the two signal inputs, which may be either currents or voltages. Offered in two versions—one for positive inputs, the other for negative—the 757 sells for \$69 in small quantities. Delivery is from stock.

Analog Devices Inc., P.O. Box 280, Norwood, Mass. 02062. Phone Lowell Wickersham at (617) 329-4700 [385]

fast at EEV.

Convection cooled finned heat sink for vertical mounting.

Convection cooled finned heat sink for horizontal mounting.

Package.

Conduction cooled heat sink for mounting in any position.

Coaxial transition.

Waveguide transition.

EEV make travelling wave tubes on a modular 'building block' system.

So you get exactly the tubes you want from EEV, and you get them quickly.

Our production capability has now expanded into new and much larger premises.

You can depend on EEV for fast service for TWT's covering all civil and military communications bands.

Send us your spec or write for data sheets.

EEV and M-OV know how.

THE M-O VALVE CO LTD, Hammersmith, London, England W6 7PE Tel 01-603 3431 Telex 23435 Grams Thermionic London
ENGLISH ELECTRIC VALVE CO LTD Chelmsford, Essex, England CM1 2OU Tel 0245 61777 Telex 99103 Grams Enelectico Chelmsford

Genalex 

For bonding metal- to-metal- to-glass- to-glass-to- plastics- to-plastics- to-rubber-to- rubber-to- metal-to-etc- to-etc.

One drop goes a long way in fastening almost anything to almost anything.

Eastman 910[®] adhesive bonds fast, too. Almost instantaneously. With only contact pressure.

Tensile strength? Up to 5000 psi at room temperature.

New Eastman 910 MHT and THT/Grades hold when the heat's on. Even over 400° F.

For further data and technical literature, write: Eastman Chemical Products, Inc., Kingsport, Tennessee 37662.



New products

Industrial

System protects against outages

Uninterruptible power equipment restores voltage to within 5% in 50 ms

As power loss becomes a critical factor in more and more computer-based equipment, there's a rapidly growing demand for power systems that provide protection against outages.

With that in mind, Topaz Electronics of San Diego, Calif., is introducing a line of uninterruptible power systems. Standard models are available in ratings of 3, 5, 10 and 15 kilovolt-amperes. The Topaz systems, called the 81000 series, consist of isolation transformer, rectifier, battery bank, static inverter and transfer switch. When ac power is normal, the transformer eliminates line transients, the output is converted to dc by the rectifier, and then the static inverter reconverts it back into ac. The battery charger maintains the battery bank in a fully charged state. If the ac voltage falls more than 15% below nominal, a silicon controlled rectifier connects the battery bank to the inverter input, so that no discontinuity results. When ac power is restored, the SCR

turns off the battery charger.

Minimum efficiencies for the rectifier, charger, and inverter are said by the company to be 90%, 85% and 85% respectively. The incorporation of separate battery charger and rectifier modules improves the input power factor, resulting in lower operating costs and reduced heat losses. The company claims output voltage variations do not exceed 10% of the steady-state value for step-load changes of 50%. Output voltage recovers to within 5% in 50 milliseconds.

A major feature of the 81000 series, Topaz says, is a status monitor and control panel for continuously displaying operational functions. The Topaz units are designed for a 20-year life, with company calculation indicating a mean-time-between-failures in excess of 20,000 hours. Options include a static transfer switch, an audible alarm and acknowledgement switch, output frequency meter, and battery ammeter. The new line is constructed in NEMA type 2 front-access cabinets. Topaz also manufactures a complete line of uninterruptible power systems in rack-mounted packages, with ratings from 500 voltamperes through 10 kVA, single phase.

Prices start at \$5,000 for the 3-kVA model. Delivery time is one to four weeks.

Topaz Electronics, 3855 Ruffin Rd., San Diego, Calif., 92123. Phone Richard Wheelock at (714) 279-0111 [371]

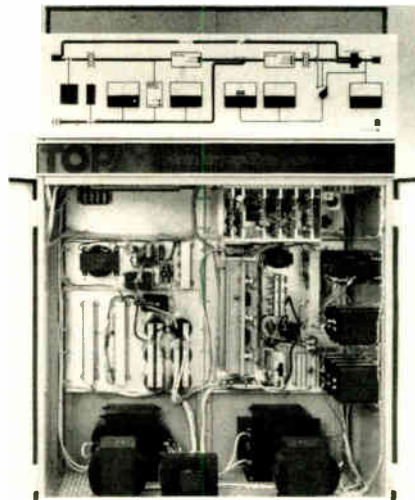

Ultrasonic liquid level sensor wraps around pipe

Using a nonhazardous, low-energy ultrasonic signal for detection of liquids, the Sensall model 621S level sensor has a pair of small encapsulated transducers that are curved to fit around a tube, pipe or vessel. There are three versions, which wrap around 1/2-inch, 3/8-inch, and 3/4-inch diameters. Other sizes may be specified as options. In operation, a remote control unit generates an electrical signal that is converted to

Stay current with small lamp data from General Electric. It's free.

**Check these 6 halogen cycle lamps
GE has added to its low-voltage line.**

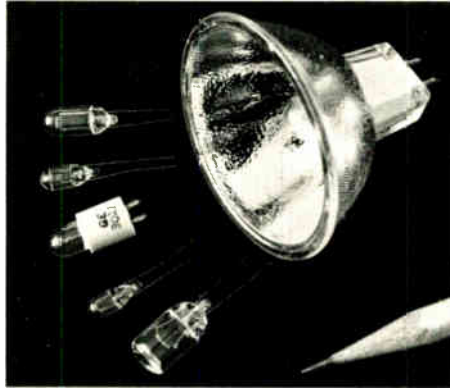

General Electric now offers over 27 halogen cycle lamps that pack high light output in small packages. (In addition, GE offers 8 sealed beam halogen lamps primarily for aircraft applications.) Bulb diameters range from $\frac{3}{16}$ " to $\frac{1}{2}$ ". Lengths from .520" to 2.25". Voltages from 3.5 to 28. O.V. And candlepower from 2.15 cd up to 250 cd.

They're ideal for you if you're designing applications such as optical systems, instrumentation, illuminators, fiber optics, card readers, displays and aircraft navigation. A variety of terminals are offered.

For updated technical information circle the number below or write GE for Bulletin #3-5357.

**These GE wedge base miniature lamps offer
you savings in time, money and space.**

These lamps are ideal for applications such as indicators, markers and general illumination where space is at a premium. Their wedge-based construction makes them easy to insert and remove. They don't require bulky, complicated sockets. And because the filament is always positioned the same in relation to the base, you get consistent illumination from lamp to lamp.



You can choose from over 25 types of GE wedge base lamps. Voltages range from 6.3 V to 28 V. Candlepower from 0.03 to 12 cd. Bulb sizes range from subminiature at 6mm to a heavy-duty bulb at 15mm.

To send for updated wedge base lamp technical information, circle number below or write GE for Bulletin #3-5259.

**These three free GE catalogs include
important data changes that could affect
your present design. Send for yours today.**



#3-5169

June '75 Miniature lamp catalog features 40 pages and 500 data changes for complete 500-lamp line.



#3-6252R1

Feb. '75 Sub-miniature lamp catalog features 24 pages and 91 changes for more than 210 lamps.



#3-6254R

Dec. '74 Glow Lamp catalog features 8 pages and 50 changes for 83 Glow Lamp Indicator and Circuit Component lamps.

For up-to-date technical information on any of these items write: General Electric Company, Miniature Lamp Products Department #3382-M, Nela Park, Cleveland, Ohio 44112.

GENERAL  ELECTRIC



an ultrasonic signal at the transducer. The ultrasonic signal passes through the wall of a pipe or vessel to the opposite transducer only when liquid is in the signal path. It then closes the electrical circuit, activating a relay in the control unit.

National Sonics Division, Envirotech Corp.,
250 Marcus Blvd, Hauppauge, N.Y. 11787.
Phone Nicholas Poulis at (516) 273-6600
[373]

**Omnidirectional switch
has alarm applications**

A conically shaped switch, called the EMSC-1, is normally open but closes contact when the device is tilted the prescribed number of degrees in any direction from the ver-



Disc has made it easy for the OEM using optical encoders in small quantities to realize costs in the same low range as the big users—like under \$100.00.

We've maintained the same high order of resolution, accuracy, and reliability found in our more expensive units for this new EC series. "EC," obviously, is our economy model, but it could also stand for exceptional capabilities. Here's what you get for your \$99 (much less in quantity):

- LED source
- 20 to 1024 pulses / revolution
- Differential electronics
- Square wave output
- ± 2.5 minutes accuracy
- Solar cell light sensors
- Instrument bearings
- 1/4" shaft for interfacing

Translated into benefits, these features mean the Disc EC ROTASWITCH® Encoder gives you superior performance, a long service life, and a unit cost you just can't touch.

That's the model EC 81. It has a single channel output. If you need dual channel, we also offer the EC 82 at \$125.00 in single quantities. It too plummets to well under \$100.00 in quantity.

A new spec sheet is just off the press—write or call for your copy. Immediate questions can be answered by calling 714 / 979-5300.

Disc Instruments, Inc., 102 East Baker Street, Costa Mesa, CA 92626.



THE PRICE OF OPTICAL ENCODERS JUST PLUMMETED.

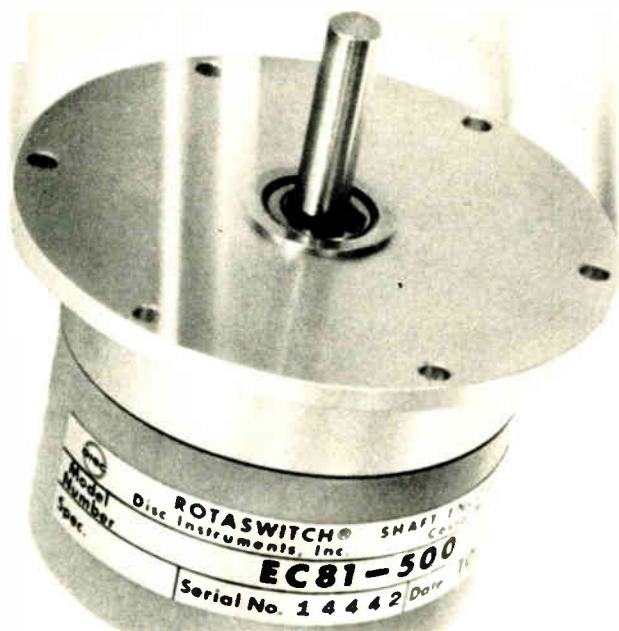

New products

tical. This is accomplished through use of a halo-shaped electrode and a bridging mercury pool that contacts a part of the halo at the same angular displacement, regardless of its direction. Suitable for applications in positioning, as a detector and in alarm systems, the switch is only 0.7 inch high and 0.4 in. in diameter. It is rated at 1 ampere at 115 v ac and 30 v dc.

Mack Electric Devices Inc., Wyncote, Pa. 19095. Phone Ken McKinney at (215) 884-8123 [377]

IR photoelectric devices can see around corners

A through-scan infrared photoelectric device for industrial and commercial environments can operate in almost all kinds of light and even see around corners, thanks to its optional right-angle beam-deflectors. The fully threaded, modulated light source, the MLS4A, is fully compatible with logic-level circuitry and requires no additional amplification for the 120-milliamper output to drive a relay directly. For barely accessible places, parallel positioning of the integrated-circuit units is also possible. The two-unit MLS4A works at speeds up to 125 operations per second and has an input voltage of 12-16 v dc. Both the emitter and receiver are potted in a vibration-resistant, 3/8-inch-diameter aluminum package. Price is about \$120.

Micro Switch, Division of Honeywell, 11 W. Spring St., Freeport, Ill. [374]

Rotary limit switches are programmable

Designed to replace electromechanical cam-operated switches, the series DLS103 line of programmable solid-state limit switches consists of a rotary electromagnetic transducer connected through a six-wire cable to a digital programming unit. Used for control of repetitive or sequential operations, the switches can be

High performance you can really see.

Look to Motorola CRT modules for sharper, brighter displays.

Motorola's 12 and 15 inch CRT modules deliver! 80 sharp characters by 24 lines, with a 7x9 dot matrix display. Video response to 22MHz. Horizontal scan frequency up to 19KHz. TTL separate sync or composite video input. And all at a lower cost than you may now be paying for CRT's with lower performance.

Other screen sizes are 5, 9, 19 and 23 inches. All are optimized for data display applications. All are adaptable for U.S. or European operation. All circuitry is completely solid state. In fact, up to 99% of the module circuitry comes on easily removed printed circuit boards . . . for quick and easy maintenance.

Readable. Economical. Versatile. Serviceable. Why not look us over? Send today for our free Design Kit with complete specs and application notes.



MOTOROLA Data Products

Domestic 455 East North Avenue
Coral Stream, Illinois 60187
312-690-1400 TWX: 910-252-4404

International Airport Center
4250 Veterans Memorial Hwy.
Halbrook, L.I., NY 11741 U.S.A.
516-588-4700 TWX: 510-228-1096

Circle 135 on reader service card

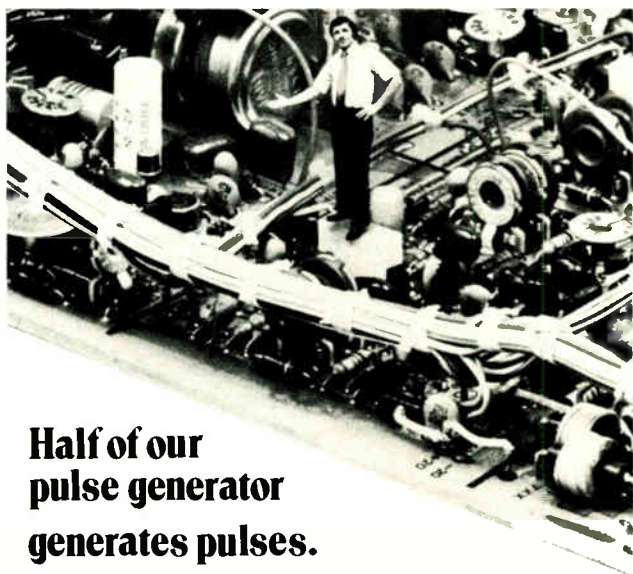

Half of our
pulse generator
generates pulses.

We'd like you to know what the other half is for. Interstate has just produced a handy Applications Report that tells you how to get the most out of your pulse generator. Our SERIES 20 Pulse Generators, featuring rep rates to 50 MHz, 3.5 ns rise/fall times, and 10 V output into 50 ohms, are detailed and cross-compared, and applications notes reveal methods and techniques for imaginative pulse problem-solving. For your free copy, write to:

INTERSTATE
ELECTRONICS CORPORATION
Subsidiary of A-T-O Inc.

P.O. Box 3117, Anaheim, California 92803 • (714) 549-8282
TWX U.S.A. 910-591-1197 TELEX 655443 & 655419

Circle 155 on reader service card

Solar photovoltaic— greater output now at lower cost!

*Fuel and Maintenance Free
Long Term Reliability for All
mW to KW Applications!*

Unlimited, clean, dependable electric power wherever you need it. Life cycle cost lower than primary batteries and fuel operated generators. Thousands of Solarex panels and systems in use throughout the world.

1335 Piccard Drive/Rockville, Md. 20850
301-948-0202/TWX: 710-828-9709/Cable: SOLAREX



SOLAREX CORPORATION
 CELLS PANELS
 SYSTEMS

All sizes
to 4" diameter
Chevron™
cells (shown)

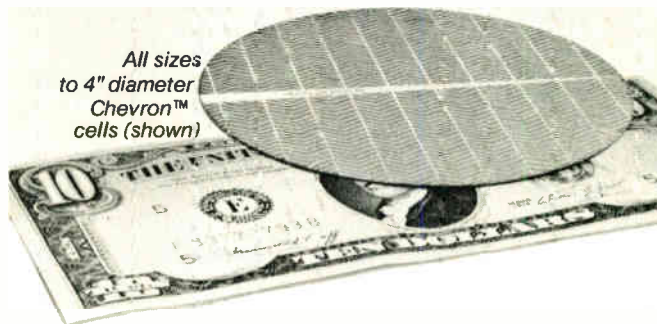

Circle 156 on reader service card 135

PINPOINT HEAT

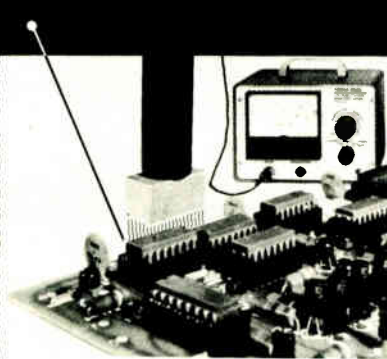

Heat any I. C. or semiconductor component to its rated temperature with a heat probe. Accuracy $\pm 1/2^\circ\text{C}$. Or check the component's temperature with a thermocouple probe. Accuracy $\pm 1^\circ\text{C}$. Model 810 Thermo-Probe does both. Reads out directly in $^\circ\text{C}$ and $^\circ\text{F}$ on a large $4\frac{1}{2}$ -inch meter.

PRICE \$272.50 F.O.B. South Laguna

Models with other temperature ranges available. For details write to:

MTI MICRO-TECHNICAL INDUSTRIES

P.O. Box 287 South Laguna, CA 92677

714-545-3734 • TWX 910-587-3425 MICRO OHM ELM

Circle 136 on reader service card

Gas Sensing Semiconductor

FIGARO GAS SENSOR

TGS quickly senses even small amount of gas.

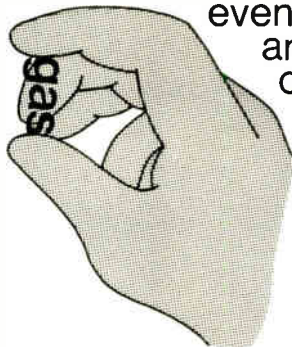

New Models, some with highly sensitive CO sensor, now on the market.

Please contact the address below directly for catalogs and price/delivery information.

FIGARO ENGINEERING INC.

3-7-3, Higashitoyonaka, Toyonaka City, Osaka 560.

Japan/Tel: (06) 849-2156

Cable: FIGARO TOYONAKA/Telex: 05286155 FIGARO J

Circle 157 on reader service card

New products

remotely set while in operation at anywhere from 1° to 359° with an accuracy, resolution and repeatability of 1° . Up to 16 single, or eight dual, limit setpoints are available with logic or relay outputs. Unit prices start at \$550, and delivery time is stock to four weeks.

C & A Products Inc., 37-12 58th St., Woodside, N.Y. 11377. Phone (212) 779-4303 [375]

Preset counters control production systems

Built particularly for automatic production operations where predetermined quantities must be delivered, the series 7694 preset counter acts as a solid-state digital control device. Applications include production piece counting and control, spooling and converting operations, batching and packaging, blending, mixing, and liquid flow control. The predetermined counter precisely controls production according to the quantity preset on its batch switches. When used with the Veeder-Root 7690 remote ticket printer, progression of the batch quantity can be monitored on the printer's front panel, and multiple-copy tickets can be printed for production records. One feature of the 7694 is its programmable input circuit. Adjustments can be made to accept input signals from switches, transistor-transistor logic, pulse transmitters, and photoelectric relays.

Veeder-Root, 70 Sargeant St., Hartford, Conn. 06102 [379]



use Super-strip™ for all circuit sizes ...it's a complete mini breadboard... it's a capacity growth module for large-scale breadboards, too.

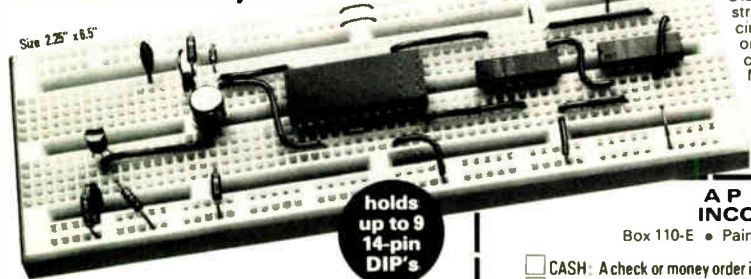

Start with one Super-strip for small-size circuits... add more only when expanded capacity is needed. Mounts quickly on boards up to $1/8$ " thick.

holds up to 9 14-pin DIP's

ALL IN ONE SUPER-STRIP — you get an integral 8-bus distribution system plus room for lots of components in a matrix of 840 solderless, plug-in tie points.

Super-strip is the world's greatest "quick-change artist" for building, testing and modifying experimental circuits. No lost time doing tedious soldering — just plug in virtually any DIPs and discrete where you want them and interconnect with any solid wires up to #20. Then change anything in your circuit at will. Just unplug, move, plug in again — undamaged — where desired. Reuse everything, every time.

Buses may be used for voltage, ground, reset lines, clock lines, shift command, etc. Link buses together when grouping several Super-strips to form large-scale breadboards.

CALL YOUR A P DISTRIBUTOR TODAY

If no distributor in your area, call the factory or mail the convenient order form at right.



A P PRODUCTS INCORPORATED

Box 110-E • Painesville, OH 44077

216/354-2101 • Dealer inquiries invited

A P PRODUCTS INCORPORATED

Box 110-E • Painesville, OH 44077

- CASH: A check or money order is enclosed.
 P.O.: (Attach coupon). F.O.B. factory; Net 30.
 Charge B.A. Charge M.C.

ACCOUNT NUMBER

SEND ABOVE NAME TO (CIRCLE THREE)

SIGNATURE

PRINT NAME

ADDRESS

CITY STATE ZIP

Quantity	Part Number	\$ Each	\$ Total
	923252 (nickel-silver terminals)	\$17.00	
	923748 (gold-plated terminals)	\$18.90	

SHIPPING/HANDLING

Up to \$10.00 \$1.00
 10.01 to 25.00 1.50
 25.01 to 50.00 2.00
 50.01 to 100.00 2.50
 100.01 to 200.00 3.00

Merchandise Total

Sales Tax (OH & CA)

Shipping (see chart)

Total Amount Enclosed

All orders subject to acceptance at factory

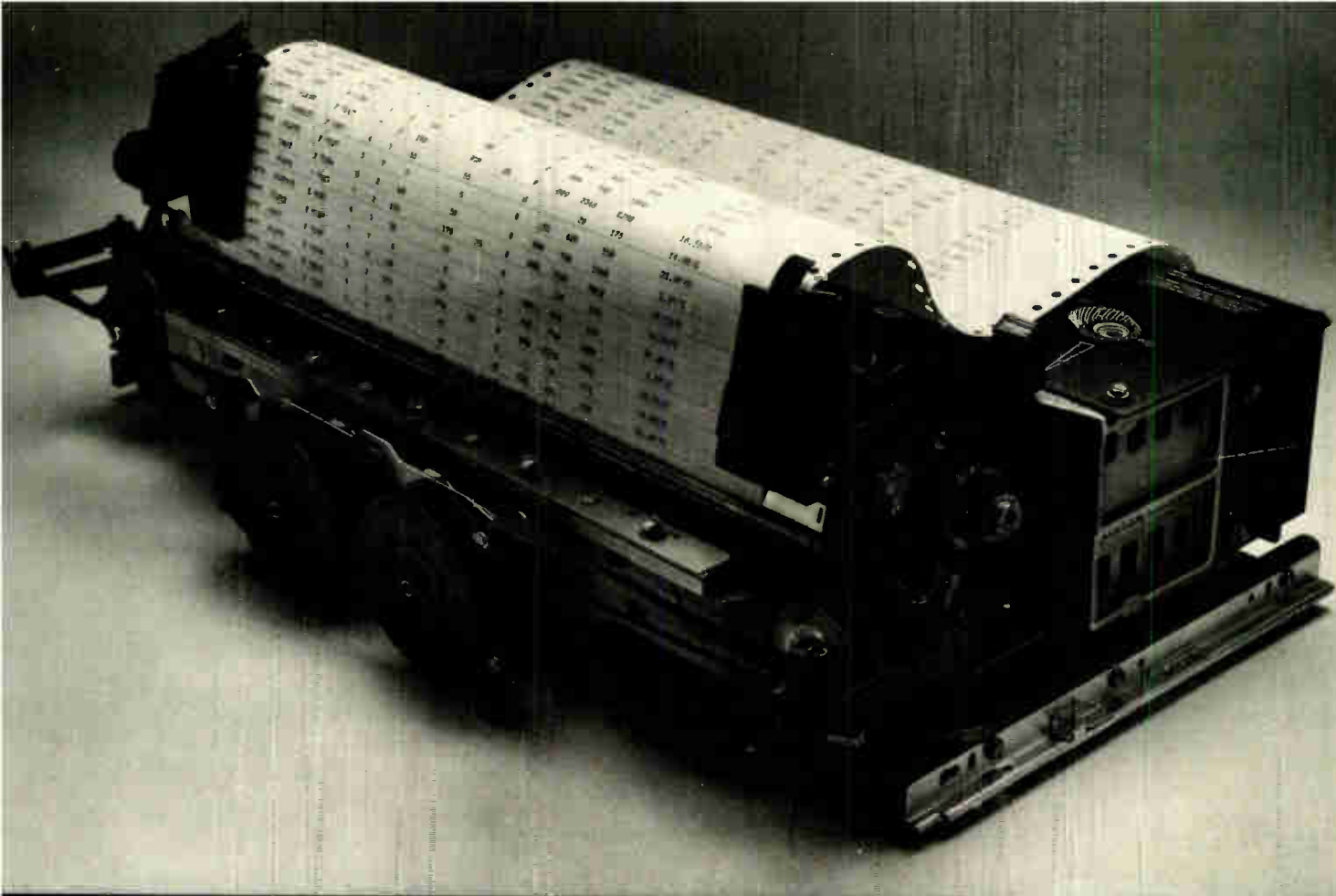

132 columns. Over 300 lines per minute. Under \$2000*.

In printers, it's not just a question of how much they cost, but one of how much you get for your money. And on a price/performance basis, nothing even comes close to the Teletype® model 40 OEM printer.

Besides getting a 132-column, heavy-duty impact printer that delivers over 300 lpm for less than \$2000, you also get a printer with outstanding flexibility and reliability.

The big reason behind the model 40's price/performance advantage over the competition is our unique design. Even though it operates at speeds over 300 lpm, wear and tear is less than you'd find in a conventional printer operating at a much slower speed. Fewer moving parts and solid-state components add up to increased reliability and reduced maintenance.

We'd be ahead if we just stopped there, but the model 40 also offers you a number of other features. Like a choice of character sets, operator-adjustable form width and form length, parity error indication, and a built-in self-test feature, just to name a few.

For complete information, please contact our Sales Headquarters at: 5555 Touhy Ave., Skokie, Ill. 60076. Or call Terminal Central at: (312) 982-2000.



The Teletype model 40 OEM printer. Nothing even comes close.

Teletype is a trademark and service mark registered in the United States Patent and Trademark Office.
*80-column-version available for under \$1400.

Circle 137 on reader service card

New literature

Circuit design wall chart. A technical wall chart containing data, graphs, circuits, and formulas often used in the design of analog circuitry is offered by Intronic Inc., 57 Chapel St., Newton, Mass. 02158. The chart includes a circuit for the computation of vector phase and magnitude, tables and curves showing thermal noise in resistors, and Fourier spectra and crest factors of common waveforms. Circle reader service number 421.



Camac standard. IEEE Std 583-1975 is an internationally accepted instrumentation interface standard for Computer Automated Measure-

ment and Control (Camac). The standard deals with both mechanical and electrical quantities. Camac systems can be connected to digital data systems built in accordance with IEEE Std 488-1975 by means of an interfacing module. Copies of the Camac standard are available from the Institute of Electrical and Electronics Engineers, 345 East 47 St., New York, N. Y. 10017. The price of IEEE Std 583-1975 is \$10 per copy, post paid; IEEE members may

THE SPECTRUM ANALYSIS

Select normal or variable persistence display, choose economy or high-resolution IF module. Then pick or change your frequency range by simply plugging in the appropriate tuning module.

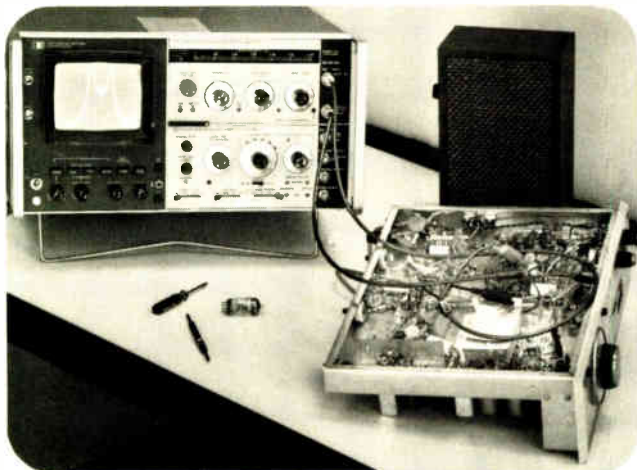

20 Hz to 300 kHz

The 8556A tuner covers 20 Hz to 300 kHz and comes with a built-in tracking generator. It's calibrated for measurements in both 50 and 600 ohm systems, with accuracies better than ± 1 dB.

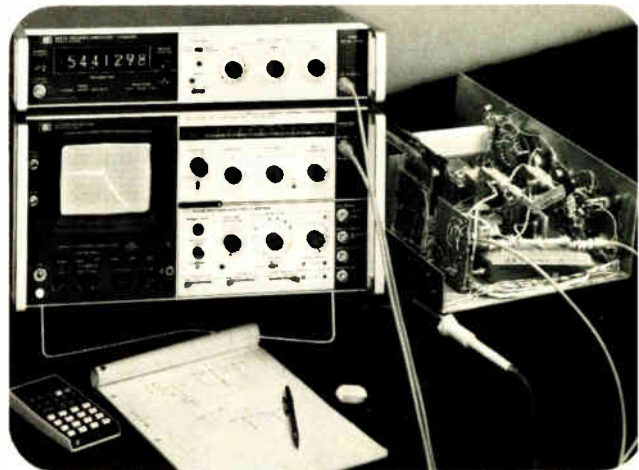

1 kHz to 110 MHz

The 8553B takes you from 1 kHz to 110 MHz with -140 dBm sensitivity. Signals can be measured with $\pm 1\frac{1}{4}$ dB accuracy. Choose the companion tracking generator/counter for wide dynamic range swept frequency measurements and precise frequency counting.

No matter what range you're working in, you need reliable unambiguous answers. HP's spectrum analyzers give you accurate measurements over wide, distortion-free dynamic ranges, time after time. Easy operation too, with front panel markings that really help reduce the possibility of operator error.

But there's much more. Call your nearby HP field engineer or write for the full story on HP's spectrum analyzer spectrum'.

order a single copy of the publication for \$7.50.

Measuring noise. A 16-page brochure from Ailtech, 19535 E. Walnut Dr., City of Industry, Calif. 91748, includes an introduction to noise-figure measurement, a page of useful formulas, including a nomograph for finding noise figure or effective input noise temperature, and catalog data on the Ailtech line of noise-figure measuring equipment.

Some of the equipment spans the range from 10 MHz to 40 GHz. [423]

Speed-sensing switches. A line of zero-speed and speed-sensing switches along with a series of rotary-motion detectors is described in a new product brochure put out by Autotech Corp., 859 Westgate Ave., Addison, Ill. 60101 [424]

Power supplies. Catalog 1976-1977 covers laboratory benchtop power

supplies with single, double, and triple outputs; miniature supplies in both pc-board and chassis-mounting versions; and rack-mounting high-current supplies. Also included are general-purpose, plug-in, premium-performance, narrow-profile, and unregulated units. The catalog can be obtained from Acopian Corp., Easton, Pa. 18042 [425]

Indicator lamps. A 15-page catalog from Solico, 530 Oakwood Ave.,

SPECTRUM

The HP 140 family covers it.
Precisely. Conveniently.
Completely.
From 20 Hz to 40 GHz.

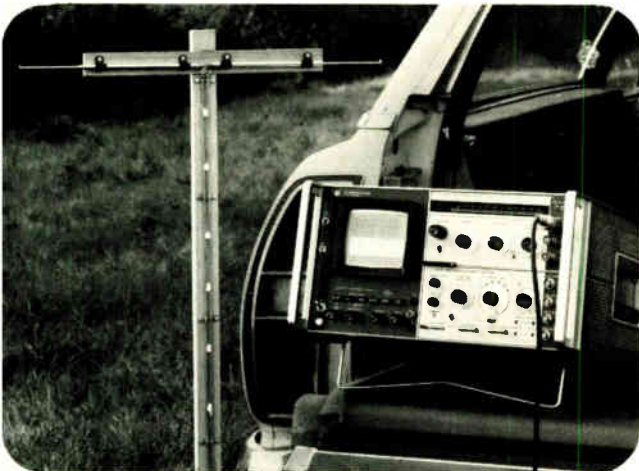

100 kHz to 1250 MHz

Use the 8554B tuning section to cover the 100 kHz to 1250 MHz range. Measure with $\pm 1\frac{3}{4}$ dB accuracy. Its companion tracking generator (500 kHz to 1300 MHz) also works with the 8555A tuning section.

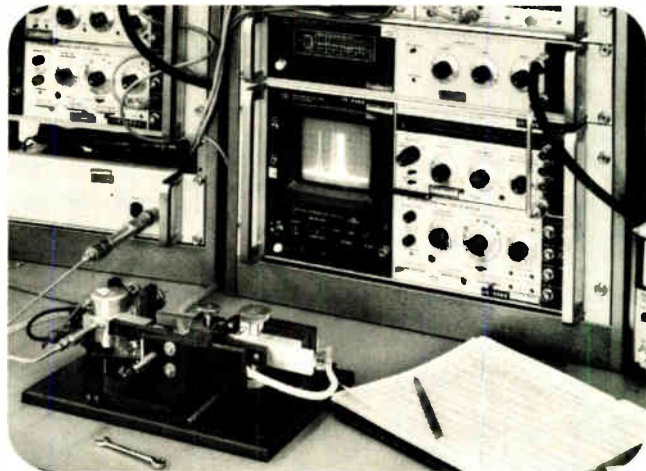

10 MHz to 40 GHz

For 10 MHz to 40 GHz, choose the 8555A. Its internal mixer covers to 18 GHz, accessory mixer for 18-40 GHz. Maximum resolution is 100 Hz. Measure with $\pm 1\frac{3}{4}$ dB accuracy to 6 GHz, $\pm 2\frac{3}{4}$ dB to 18 GHz. For wide scans free from unwanted response between 10 MHz and 18 GHz, add the automatic preselector.

HEWLETT  PACKARD

Sales and service from 172 offices in 65 countries.
1501 Page Mill Road, Palo Alto, California 94304

45509

Today, it makes more sense than ever to test the big 3 against it.



MATSUO DIPPED TANTALUM CAPACITORS

1. ✓ **Matsuo builds them better & pretests longer** Matsuo builds on lead frames — the quality mode of construction. Then pretests for 48 hours at full voltage.
2. ✓ **Matsuo has lowest failure rate** Our standard failure rate is only 2% per 1,000 hours — 60% confidence level. Selected units at 1% per 1,000 hours. What we deliver, delivers!
3. ✓ **Matsuo provides better leakage control** Our standard units are .01XCV. Selected capacitors are .001XCV. Ten times better when you need it.
4. ✓ **Matsuo saves costly assembly time** Matsuo lead spacing is fixed — always the same to fit assembly board quickly, easily. Positive leads are longer — touch tells assembler, eliminates examining. Leads are square — "bite" corners so Dip stands upright even during soldering. Each feature saves you costly assembly minutes.
5. ✓ **Matsuo prices are competitive and then some** All the features, all the quality are yours at unbeatable prices. Test us here, too!

Other Matsuo Capacitors:
Type 242 Molded Tantalum, Type 262 Chip Tantalum.

These days with Dipped Tantalum Capacitors readily available, shouldn't you be sure you're getting the most for your money. All we ask is that you test Matsuo Dips against the one you're using. And that, we think, says more about the way we build our Dips than anything else!

For engineering samples, literature, prices, write or call

MATSUO ELECTRONICS

831 SO. DOUGLAS ST., EL SEGUNDO, CA 90245 / (213) 679-0379

New literature

West Hartford, Conn. 06110, gives details of the company's line of incandescent, glow, and LED pilot and indicator lamps. The booklet also contains a discussion of the physical characteristics of glow lamps and a glossary of technical terms. [426]

Semiconductor chips. A broad line of discrete transistor, diode, and zener-diode chips is described in catalog CN-164D, which also supplies information on Sprague's Oxsil MOS capacitor chips, which are used in thin-film hybrid circuits. Copies of the catalog may be obtained from Technical Literature Service, Sprague Electric Co., 35 Marshall St., North Adams, Mass. 01247 [427]

Interconnection devices. Specifications of terminal strips, tube and transistor sockets, plugs, receptacles, wire-grip terminal board assemblies, and similar electromechanical interconnection devices are outlined in a 28-page catalog put out by Malco, a Microdot Co., 12 Progress Dr.,



electro mechanical
assemblies

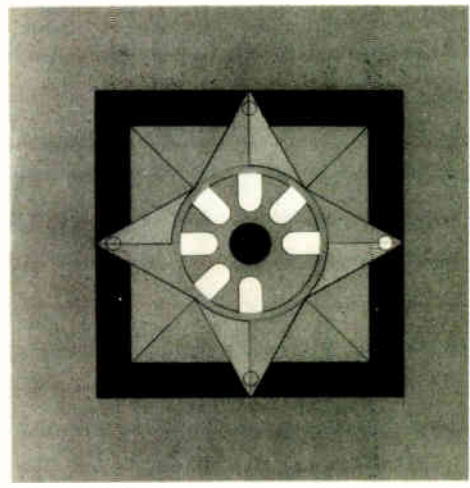

Montgomeryville, Pa. 18936. Ask for Electro Mechanical Assemblies catalog #801-1. [428]

Hard to find. Electronic and optical items ranging from resistors and prisms to digital telephone dialers

CHANGING YOUR ADDRESS?

Please take the following steps to ensure continuing, prompt receipt of your Electronics subscription. Allow 4 weeks advance notice.

1 Remove your current mailing label from the cover and attach where indicated below.



2 Fill in new address as follows (please print):

NAME _____
 COMPANY _____
 ADDRESS _____
 CITY _____ STATE _____ ZIP _____

3 Mail this entire form to:

Electronics, McGraw-Hill Inc. Subscription Dept.
 P.O. Box 514, Hightstown, N.J. 08520

RECTIFIER BRIDGES



**NEW 10 AMP
 SMALL SIZE, LOW COST**

Just tell us your OEM application for these great, new, low cost, small size, 10 ampere, single phase, full-wave bridges and we will send you free samples for evaluation. 50, 100, 200, 400, 600 and 800 PRV. Heat sink or chassis mounting. If you would rather have samples of some of the many other items in our extensive bridge and diode lines let us know. We will try to get them to you. Company letterhead, please.

Buy from the specialist.



edi electronic devices inc.

21 GRAY OAKS AVE., YONKERS, N.Y. 10710
 (914) 965-4400, TWX 710 560-0021

Circle 159 on reader service card

Processing analog signals?

Use the Panasonic 512-stage BBD for 25.6 m/sec. delay with wide frequency range and excellent S/N ratio of 70 dB.

The Panasonic MN 3001 contains two BBDs with independent input, output and clock terminals. Uses a common power supply. Pair of output terminals allows the clock component to be cancelled.

The BBD MN 3001 gives you wide frequency response. Up to 0.3 x fcp. Clock frequency range from 10 kHz to 800 kHz. S/N ratio of 70 dB.

Use the Panasonic MN 3001 BBD for variable speed control in tape recorders, tremolo and vibrato effects for musical instruments, plus telephone time compression and voice scrambling. Any place you design to process analog signals.

Panasonic[®]
 just slightly ahead of our time

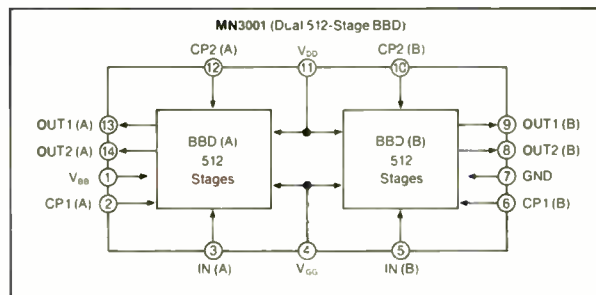

For free data on all our BBDs, mail to:

Panasonic Electronic Components
 One Panasonic Way, Secaucus, N.J. 07094.

Name _____

Title _____

Company _____

City _____ State _____ Zip _____

RF PACKAGES — MICROWAVE SYSTEMS

AUTOTRACK ANTENNA SCR-584 RADAR SYSTEM

360 deg AZ 210 deg EL. 1 mil. accuracy. Missile vel. accel. and slew rates. Amplidyne control. Handle up to 20 ft. dish. Compl. control chassis. ALSO in stock 10 cm. van mounted rad. system. Conical scan. PPI, 6 ft. dish. 300 pg. instr. bk. on radar \$25



RF SOURCES

CW: 300-535KHz 500W; 2-30MHz 3KW; 4-21MHz 40KW; 24-350MHz. 100W; 385-585MHz 1KW; 750-985MHz 10KW; 95-8.8GHz 150W; 1-1.5GHz 110W; 1.7-2.4GHz 10KW; 4.4-5GHz 1KW; 8.8-11GHz 200W. Many more.

UHF: 1 Megawatt 210-225MHz 5μsec 180 PPS; 14KW 400-420MHz .002DC; 1KW 400-700MHz .002DC.

L BAND: 1KW 1-1.5GHz .1DC; 500KW 1.2-1.35GHz 2μsec 400PPS. Many more. Phone or write.

S BAND: 1KW 2.4-2.6GHz .75μsec 1200PPS; 250KW 2.7-3.1GHz .8μsec 1600PPS; 500KW 2.7-3.1GHz .8μsec 1600PPS; 1 Megawatt 2.7-2.9GHz .1μsec 1200PPS; 5 Megawatts 2.75-2.85GHz 2.5μsec 400PPS.

C BAND: 225KW 6275-6575MHz .4μsec 680PPS; 250KW 5.4-5.8GHz .5μsec 680PPS; 1 Megawatt 6GHz .1μsec 1000PPS. Many more. Phone or write.

X BAND: 100W 9.2-9.5GHz .5μsec 1000PPS; 1 KW 8.9-9.4GHz .001DC; 65KW 8.5-9.6GHz .001DC; 250KW 8.5-9.6GHz .001DC; 400KW 9.1 GHz 1.8μsec 450PPS. Many more. Phone or write.

Ku-K BAND: 50KW 16.4-16.6GHz .001DC; 135KW 15.5-17.5GHz .0006DC; 40KW 24GHz .0007DC; 40KW 35GHz .0004DC. Many more. Phone or write.

PULSE MODULATORS + H.V.P.S.

245 KW LINE Output 16 KV 16 A. .25 μs 4000 PPS.
405 KW FLOATING DECK Output 20 KV 20 A 1 μs to 10 millisecond pulse.

500 KW LINE Output 22 KV 28 A. 4/1.75/2.25 μs 2500/550/300 PPS.

1 MW HARDTUB MIT MODEL 9 Output 25 KV at 40 A. .25 μs .002 D.C.

2.0 MW LINE 30 KV 70 A. 1/2 μs 600/300 PPS.
3 MW LINE Output 39 KV 75 A. .25/1 μs 500 PPS.

10 MW LINE 76 KV 135 A. 2.5 μs 350 PPS.
17 MW LINE 17 KV 1000 A. 2.5 μs 150-2000 PPS.

SEND FOR FREE 20 PG. CATALOG

AN/MPS-19 S Band Tracker

Pwr: 500 KW. Range: 100 miles. Display: PPI and "A" scopes. 8' dish. Heilhut mounted.

RADAR SYSTEMS

K BAND MONOPULSE 40KW E-34
KU BAND SEARCH 135KW B-58
X BAND MISSILE CONTROL NIKE AJAX/HERC
X BAND HI-RES. MONOPULSE TRACKER
X BAND FIRE CONTROL 250KW M-33
X BAND WEATHER/SEARCH 250KW AN/CPS-9
X BAND AIRBORNE TRACKER 50KW B-47
X BAND MOBILE TRACKER 40KW AN/MPQ-29
X BAND WEATHER/SEARCH 40KW AN/SPN-5
X BAND ANTI-INTRUSION 7 KW AN/TPS-21
X BAND ANTI-INTRUSION CW DOPPLER AN/PPS-9/12
X BAND TRANSPONDER 100W AN/DPN-62
C BAND HGT. FDR. 5MW FPS-26; 1MW TPS-37
C BAND SEARCH 285KW AN/SPS-5B/D
C BAND HEIGHT FINDER 5MW AN/FPS-6
S BAND SEARCH COHERENT 1MW AN/FPS-18
S BAND ACQUISITION 1MW NIKE AJAX/HERC
S BAND TRACKER 10' DISH 500KW AN/MPQ-18
S BAND MORTAR LOCATOR 250KW AN/MPQ-10A
S BAND TRACKER 250KW AN/MPS-9
L BAND SEARCH 40' ANTENNA 500KW AN/FPS-75
L BAND SEARCH 500KW AN/TPS-1D/GSS-1
UHF SEARCH 1MW TPS-28

DRONE CONTROL SYSTEMS

UHF COMMAND SYSTEM AN/URW-14
X BAND DATA LINK AN/UPW-1
X BAND TRACKER AN/MPQ-29
X BAND TRACKER AN/MSQ-51

60 FT. DISH

Complete with Az-El pedestal, ready for installation. Immed. delivery. Write or call.

SPARE PARTS IN STOCK

Nike Ajax, Nike Hercules, M-33, MPS-19, TPS-1D, TPS-10D, TPS-n, SPSS, SCR-584, HIPAR. Many more, write



**Radio
Research
Instrument
Co., Inc.**

3 QUINCY ST. NORWALK, CONN 06850
(203) 853-2600

Circle 213 on reader service card

New literature

and photo reproduction lenses are listed in a catalog of unusual items published by Electro Science Mart, 119 Foster St., Peabody, Mass. 01960 [429]

Phase measurement. A 28-page illustrated publication entitled Applications Handbook of Precision Phase Measurement is available for \$2.75 from Dranetz Engineering Laboratories Inc., 2385 South Clinton Ave., Plainfield, N.J. 07080. The handbook begins with two introductory sections, one on how today's phase meters work and the second on why phase measurement may often be preferable to gain or bridge measurements. The third section discusses and illustrates various types of measurement in device work.

Signal sources. Circuit techniques for optimizing the performance of various types of phase-locked sources are described in a 12-page applications bulletin, "Recent Advances in Solid-State Phase-Locked Microwave Signal Sources." The bulletin first describes six types of sources and the principal reasons for employing the phase-locked technique. Then comes a section on the theory of operation, and the final section is devoted chiefly to methods and devices for improving the performance of phase-locked signal sources. The bulletin is available from Communication Techniques Inc., 1279 Route 46, Parsippany, N.J. 07054 [430]

Vacuum coating. The first in a series of application notes on coating is available from Varian Palo Alto Vacuum Division, 611 Hansen Way, Palo Alto, Calif. 94303. The eight-page bulletin describes details of the deposition of aluminum silicon alloy with high-rate S-Gun sputtering sources. The recipe for a typical metalization process is defined and microphotographs showing step coverage are reproduced. The bulletin deals with application of coating techniques to silicon-gate MOS and silicon-gate nitride MOS devices [431]

FOR SALE

"MICRO 68" \$460.

AMI S6800 COMPUTER; HEX KYBD
6 DIGIT DISPL; ASSEMBLED; FREE DATA

ECONOMY KITS MINUS PWR. SUPP. & CASE

TVT-II \$112.75
VIDEO DISP. W/2K MEM. (NO KYBD)

SCREEN READ \$11.65
PLUGS INTO VIDEO DISPLAY

MANUAL CURSOR \$9.50
PLUGS INTO VIDEO DISPLAY

CASSETTE \$28.50
INTERFACE; 2-RECORDER, PULSE MOD.

POCKET \$39.75
DATA TERMINAL; 16-TONE GEN.

CLOCK-CAL. \$38.75
6-DIGIT, CT7001 (W/PWR. SUPPLY)

FREE CAT; NEXT: 4½ DIGIT DVM

ELECTRIC DISCOUNT SALES

138 N. 81st ST,
MESA, AZ. 85207

NOTE: NEW McGraw-Hill EQUIPMENT BULLETIN

The used, surplus, and rebuilt equipment ads in this Classified Advertising Section will also appear, at no extra cost, in the McGraw-Hill Equipment Bulletin.

This new free monthly reprint will reach an additional audience of qualified cost-conscious readers (who have requested it) in fields served by 27 other McGraw-Hill publications.

To find out how you can benefit from this bonus readership when you have items for sale, lease, or rent—contact the Classified Advertising representative in the McGraw-Hill regional office nearest you, or write to:

McGraw-Hill EQUIPMENT BULLETIN

P.O. Box 900
New York, NY 10020



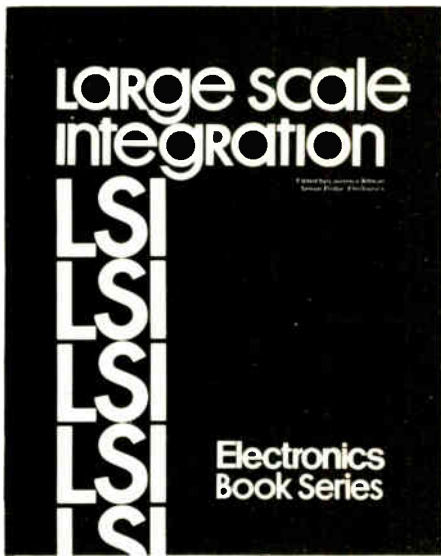

The Electronics Book Series offers you a handbook on the current and revolutionary impact of LSI on digital design. This 220-page book presents a unique opportunity for circuit designers, systems designers, and engineering managers and supervisors to bring their expertise into line with today's LSI design requirements.

Electronics Book Series
 PO Box 669, Hightstown, N.J. 08520

Send me _____ copies of "Large Scale Integration" at \$9.95 per copy.
 I must be fully satisfied or you will refund full payment if the books are returned after ten day trial examination.

Payment enclosed Bill firm Bill me
Credit Cards Charge My Book To

American Express Master Charge
 Diners Club BankAmericard

Acct. No. _____
 Date Card Expires _____
 Interbank No. _____
 1st No's. above name on Mastercard only.

Name _____
 Title _____
 Company _____
 Street _____
 City _____
 State _____ Zip _____
 Signature _____

Electronics IS THE SOURCE FOR BOOKS, TOO



Four C&K Switch Catalogs for the price of none...

In the photo, the top two catalogs give you 30 pages of complete specifications including options and ordering information for these great C&K switches: *Subminiature toggle, illuminated rocker, and lever handle; subminiature and micro-miniature momentary pushbuttons; and thumbwheel switches.*



And the other two catalogs list brand new C&K switches just off the design board: a miniature *9201 DPDT Power Switch* to meet international specifications; a subminiature *1101 SPDT Slide Switch*; a subminiature *8161/8168 SPDT Alternate Action Switch*; and 7 new termination styles for the SPDT 8125 and DPDT 8225 series of subminiature Momentary Snap-acting Pushbutton Switches. Call or write for all four of these switch catalogs now!

Free Engineering Samples On Request.

C&K Components, Inc.

103 Morse Street, Watertown, MA 02172
 Tel: (617) 926-0800 TWX: 710 327 0460 TELEX: 92 2546

C&K ELECTRONICS (AUST.) PTY., LTD., Merrylands, Australia
 C&K BENELUX, Mechelen, Belgium
 C&K COMPOSANTS S.A., Paris, France
 C&K ITALY, Milano, Italy
 C&K GERMANY GMBH, Munchen, West Germany

Visit C&K at IEEE Boston Show, Booth 1627 and Nepcon '76 East, Booth 4737

ANNOUNCING

A new modular super op-amp!

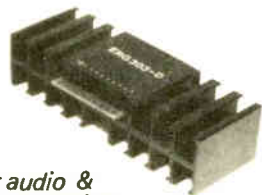

for audio & servo motor applications

THE **ERG 303D**
TRANSCONDUCTANCE
POWER DRIVER

HIGH power
25 Watts into 8 ohms
100-300+ driving
output pairs

LOW distortion
0.01% harmonic at 15 Watts
R.M.S. 0.02% typ. at
100 Watts

VERY LOW price
\$33.50 qty. 1-9
29.95 qty. 10-99

Electronics Research Group, Inc.
134 Mt. Auburn Street
Cambridge, MA 02138
tel. 617-661-9383

↑ THE SIZE OF THIS AD



↓ THE ERG 303D IS

Circle 160 on reader service card

ADVERTISE • CONTROL
IDENTIFY • DECORATE
COMMUNICATE • INSTRUCT
WITH

DECALS

SCREEN PRINTED
PRESSURE SENSITIVE VINYL,
MYLAR, AND WOOD GRAINS

Apply to Steel, Aluminum,
Glass, Plastic, Wood, Concrete,
Paper, Etc.

WRITE FOR INFORMATION

**Gillespie
Decals, Inc.**

P.O. Box 4146 - E
PORTLAND, OREGON
97208



Phone 800-547-6841
or 638-6831 (Oregon Only)

Electronics advertisers

April 1, 1976

° Adelsy	43	General Electric Tube Products Dept.	124
Advanced Memory System	50,51	■ General Radio	111
Advanced Micro Devices	10,11	Gillespie Decals	144
■ Airpax Electronics	116	■ Grayhill Inc.	40
Allen Bradley Company	24	Harris Corporation/PRD Electronics Division	66
■ AMP Incorporated	42	■ Hewlett-Packard	1,2,2nd C,27,127,138,139
■ AP Products Incorporated	136	° Hi G D'Italia	14E
■ Bourns Inc.	4th C	Honeywell Information Systems	108
° Burr Brown Research Inc.	31E	Houston Instruments	129
‡ Busman Mfg. Division of McGraw Edison Co.	52	Hughes Aircraft Company	38 & 39
Carborundum Company	3rd C	° I.M.T. Tel Aviv, Israel	25E
Chomerics Inc.	126	° Integrated Computer Systems	45
■ C&K Components	143	‡ Interdesign	113
■ Collins Radio Hybrid Circuits Division of Rockwell International	6	■ Interstate Electronics Corp.	135
Continental Rentals	8	° Italtel Siemens	15E
■ Continental Specialties Corporation	70	■ Ithaco, Inc.	128
‡ Corning Materials Division	7	Johanson Mfg. Corp.	20
■ Custom Electronics Inc.	145	Krohn Hite Corporation	5
■ Dana Laboratories	64	° Lemo S.A.	18E
Data General Corporation	35	° Logabax	54
■ Data Precision	28	° Magneti Marelli	19E
Deltron	8	Matsuo Electronics of America	140
‡ Digital Equipment Corporation (OEM)	56A-D	Micro Power Systems	69
Disc Instruments	134	Micro Switch Division of Honeywell	60,61
Dupont Riston	71	■ Micro Technical Industries	136
Eastman Chemical Products Inc.	132	Miller Stephenson Chemical Inc.	147
‡ Eastman Kodak Company Graphics Division	15	Motorola Data Products	135
E.I.P. Inc.	84	Motorola Semiconductor Products Inc.	41,63
■ E&L Instruments Inc.	6	Mueller Electric Co.	147
ELCO	107	‡ National Semiconductor Corporation	43-46
Electro 76	148	° National Semiconductor GmbH	46
Electrol	16E	Nucleonic Products Co. Inc.	16
Electronic Arrays	9	° Oscilloquartz	20E
■ Electronic Devices Inc.	141	■ Panasonic	141
Electronic Discount Sales	142	■ Powermate	145
Electronic Navigation Industries	14	° Procond S.p.A.	15
English Electric Valve Company Ltd.	130,131	RCA Solid State Division	21-23
■ Erie Technological Products Co. Inc.	17	‡ Rental Electronics Inc.	54
Esterline Angus Instrument Corporation	147	Reticon Corporation	67
° Feme	10E	° Rifa	37,2E,3E
Figaro Engineering Inc.	136	° Rohde & Schwarz	1E
° Fort Electronique	28E	° Salon Mesucora	20E
‡ Fujitsu Ltd.	117	Sangamo Electric Co.	121
■ General Electric Co. Miniature Lamp Division	133	° Schlumberger SOMV	30E
General Electric Semiconductor Products Dept.	119	° S.E.C.I. Divisione Cristalli Liquidi	29E
		° Secme	32E
		° Sedeme	26E

* S.E.E.M.	27E
* Selmart	6E
■ Sensors Inc.	68
* Sescosem	4E,5E
* Sfernice	11E,12E,13E
* Siemens AG, Karlsruhe	52
‡ Signal Processing	120A & B
‡ Signal Transformer	37
* Sime Brondi	117
* Sodeco	17E
Solarex Corporation	135
Spectrotherm Corp.	114
■ Sprague Electric Company	49
■ Superior Electric Company	112
SYM-Tek Systems Inc.	115
■ Tektronix Inc.	13,33
Telefile	101
Teletype	137
Teradyne Inc.	58
* Thomson CSF	7
* Tokyo Sokuhan Co. Ltd.	113
■ Union Carbide Corporation	105
United Systems Corp. a Sub of Monsanto Co.	122
■ U.S. Capacitor Corporation	19
Varo Semiconductor Inc.	18
Victoreen Instrument Division	57
■ Wavetek Indiana	72
XLO-REMEX	125

■ For more information of complete product line see advertisement in the latest Electronics Buyers Guide
 * Advertiser in Electronics International
 ‡ Advertiser in Electronics domestic edition

Classified & Employment Advertising
 F. J. Eberle, Manager 212-997-2557

■ For more information of complete product line see advertisement in the latest Electronics Buyers Guide
 * Advertiser in Electronics International
 ‡ Advertiser in Electronics domestic edition

33% more power to the people.

Power/Mate presents Econo/Mate II.

The open frame power supply.

Now Power/Mate brings you 33% more power in the same package size with the second generation of our Econo/Mate series.

The size is the same, the basic components are the same for easy interchangeability. But that's where the similarity ends.

Econo/Mate II adds features like dual AC primary and a plug-in IC regulator for improved regulation.

And Econo/Mate II is tough. Computer design, quality control, and Power/Mate's experience helps insure 100,000 hr. MTBF even at this higher power output.

But for all its features, Econo/Mate II is still, most of all, economical.

We wouldn't call it Econo/Mate if it wasn't.

Econo/Mate II is in stock, ready for delivery. Send for our free brochure.

Prices start at \$19.95.

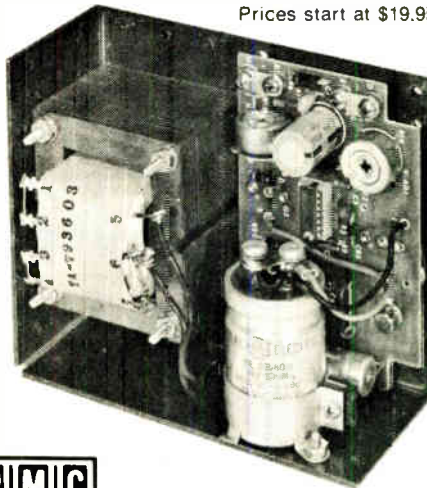

POWER/MATE CORP.

World's largest manufacturer of quality power supplies

514 South River Street/Hackensack, N.J. 07601/Phone (201) 343-6294 TWX 710-990-5023

Circle 161 on reader service card

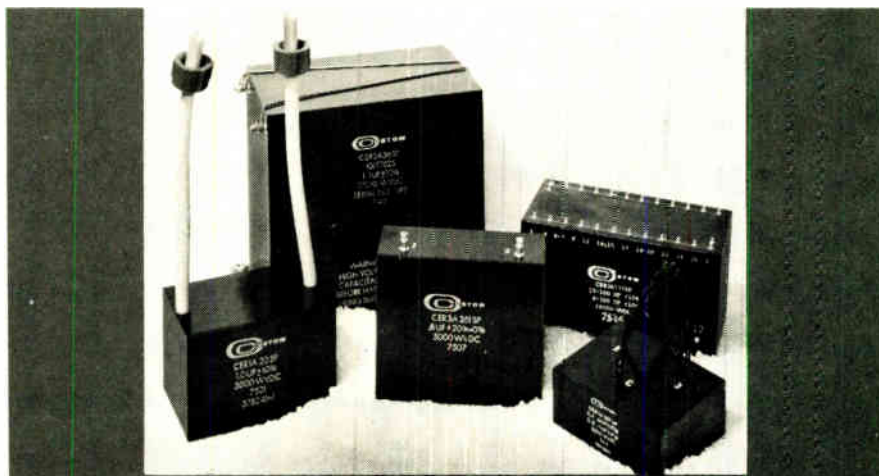

CUSTOM MICA CAPACITORS

for Selected Environmental Parameters and Specialized Mounting Arrangements

CER type mica capacitors are housed in an epoxy-glass laminated tube, and potted with an epoxy compound under high vacuum, producing a void free capacitor capable of operation in more severe environments than tape wrapped types.

The CER type is available in a large selection of terminations and mounting hardware, including wire leads, threaded studs, ribbon leads, threaded inserts and turret terminals.

Designers . . . Look:

- High temperature applications to 260°C
- No oil to leak
- High Corona Resistance
- Low Δ capacitance vs temperature

To see how Custom Electronics can fill your requirements, write for FREE descriptive CER Techni Tip, and general Techni Tip including sample of mica dielectric.

Send for FREE Product Brochures

CUSTOM ELECTRONICS, Inc.

12 Browne Street, Oneonta, N.Y. 13320

PH: (607) 432-3860 TWX: 510-241-8292



Classified section

FOR EMPLOYMENT AND SALES OPPORTUNITIES

RATES \$46 per advertising inch (1/4") Commissionable

SIZES 1/4" to 10" deep in widths of one column (1 1/4"), two (3 1/4"), three (5 1/4"), and four (7")

CLOSING Two weeks prior to mailing

MAILING One week prior to issue date

ISSUE DATE Every other Thursday

AD ORDERS/BOX NUMBER ANSWERS

Send to Electronics, Post Office Box 900, New York, N.Y. 10020

EMPLOYMENT SERVICE

Electronics' Industry Newsletter tells you which firms have current employment opportunities, in the field of Electronics, for all types of Engineers, Sales Representatives, Technicians, Executives, Computer Personnel and others. Latest product information is also reported. For information write: Electronics' Industry Newsletter, Dept. 304A, 23573 Prospect Avenue, Farmington, MI 48024.

POSITION VACANT

Graduate Assistantships in Physics can begin during any quarter. Write: Dr. R. Madey, Kent State University, Kent, OH 44242.

POSITION VACANT

Design, Production, Instrumentation, Communication Engineers and Managers. All fees paid. Career opportunities now exist with our microelectronics, analytical, telecommunications and electronic manufacturing companies. Salaries open. Call or send resume to James Franklin and Associates, Inc. 502 Earth City Plaza, Suite 120 Earth City, Mo. 63045 (St. Louis) Phone: (314) 291-6880. Specialists in Engineering Search and Placement.

Position Available—Need BS Eng. + U.S. exper. in engineering or technical sales. Fee paid by employer. Over 1,000 U.S. client co's. Est. 1959. Send resume & present salary. Atomic Personnel, Inc., Box L, 1518 Walnut, Phila, PA 19102.

RESUMES

Resumes—Complete instructions and examples; \$4.. Consultants. Dept. 40-E, 8 Golfview Dr., Dumont, NJ 07628.

NOW IS THE TIME ... TO HIRE A STUDENT THIS SUMMER.

First, it's later than you think, with schools closing on different semester schedules, and students torn between lining-up "sure" jobs now or gambling that something in their chosen field will come along later.

Second, and most important, it's in our industry's best interest to encourage and hold its life-blood by providing practical experience in their future profession.

And, since there'll always be more applicants than openings, you'll be able to select the cream of the crop, then evaluate them with an eye towards hiring, when

as coveted graduates, the job market might well be in their favor.

Because we believe this program is of mutual benefit to both employer and employee alike, we again offer our services as a clearing-house.

Just fill out and return the coupon below, and we'll include your organization in a free listing to be sent to Placement Directors and Department Heads at leading colleges and universities across the nation. They'll post it, and the students will contact you directly.

Free summer help listing

MAIL TO: ELECTRONICS/POST OFFICE BOX 900/NEW YORK/NY 10020

NAME/TITLE: (of individual to be contacted)

ADDRESS: (Mailing address of your personnel office)

ORGANIZATION: (Firm, Company, Government Agency or Institution)

TYPE AND NUMBER OF STUDENTS SOUGHT: Electronics Avionics

Technician Other: (Draftsman, etc.)



4/1/76

Advertising Sales Staff

Pierre J. Braudé New York [212] 997-3468
Paris Tel: 720-73-01
Director of Marketing

Atlanta, Ga. 30309

100 Colony Square, 1175 Peachtree St., N.E.
[404] 892-2868

Boston, Mass. 02116: James R. Pierce
607 Boylston St. [617] 262-1160

Chicago, Ill. 60611:

645 North Michigan Avenue
Robert W. Bartlett (312) 751-3739
Robert M. Denmead (312) 751-3738

Cleveland, Ohio 44113: William J. Boyle
[716] 586-5040

Dallas, Texas 75201:

2001 Bryant Tower, Suite 1070
[214] 742-1747

Denver, Colo. 80203: Harry B. Doyle, Jr.
123 Speer Blvd. # 400
[303] 837-1010

Detroit, Michigan 48202: Robert W. Bartlett
1400 Fisher Bldg.
[313] 873-7410

Houston, Texas 77002:

Paul Reiss
601 Jefferson Street, Dresser Tower [713] CA 4-8381

Los Angeles, Calif. 90010: Robert J. Rielly
Bradley K. Jones, 3200 Wilshire Blvd., South Tower
[213] 487-1160

New York, N.Y. 10020

1221 Avenue of the Americas
Warren H. Gardner [212] 997-3617
Michael J. Stoller [212] 997-3616

Philadelphia, Pa. 19102:

Warren H. Gardner
Three Parkway,
[212] 997-3617

Pittsburgh, Pa. 15222:

Warren H. Gardner
4 Gateway Center, [212] 997-3617

Rochester, N.Y. 14534:

William J. Boyle
9 Greylock Ridge, Pittsford, N.Y.
[716] 586-5040

San Francisco, Calif. 94111:

Don Farris
Robert J. Rielly, 425 Battery Street,
[415] 362-4600

Paris:

Alain Offergeld
17 Rue-Georges Bizet, 75 Paris 16, France
Tel: 720-73-01

Geneva:

Alain Offergeld
1 rue du Temple, Geneva, Switzerland
Tel: 32-35-63

United Kingdom:

Robert Ghey
Tel: 01-493-1451, 34 Dover Street, London W1

Milan:

Luigi Rancati
1 via Baracchini, Italy Phone 86-90-656

Brussels:

Alain Offergeld
23 Chaussee de Wavre
Brussels 1040, Belgium
Tel: 13-73-95

Frankfurt/Main:

Fritz Krusebecker
Liebigstrasse 27c, Germany
Phone 72 01 81

Tokyo:

Tatsumi Katagiri, McGraw-Hill
Publications Overseas Corporation,
Kasumigaseki Building 2-5, 3-chome,
Kasumigaseki, Chiyoda-Ku, Tokyo, Japan
[581] 9811

Australasia:

Warren E. Ball, IPO Box 5106,
Tokyo, Japan

Business Department

Thomas M. Egan,

Production Manager [212] 997-3140

Carol Gallagher

Production Manager International [212]
997-2045

Dorothy Carter, Production Manager Domestic
[212] 997-2908

Frances Vallone, Reader Service Manager
[212] 997-6057

Electronics Buyers' Guide

George F. Werner, Associate Publisher
[212] 997-3139

Regina Hera, Directory Manager
[212] 997-2544

GREAT MOMENTS

..... in electrical history

..... our day of fame in the laundry room, when one of our employees doffed his socks, paired them with a copper Mueller Mini-gator Clip, sent the mates through washer, through dryer, into his drawer, and divorced them only when ready to don them again. Spared the matchmaking, his wife now has the whole family do it with everything worn in pairs! Electrical or not, can you match this creative connectivity with your Mueller Clips?



At Jobbers everywhere.

Write factory for FREE sample clips and catalog.

Mueller Electric Co.

1582 H East 31st Street • Cleveland, Ohio 44114

Circle 162 on reader service card

Battery Miniservo[®] recorder only \$725

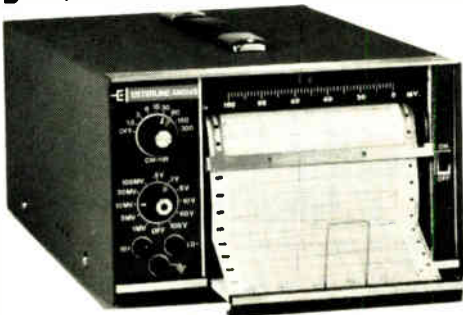

72-hour delivery

For field or remote applications. Input spans are 1, 5, 10, 50, 100, and 500 mVDC and 1, 5, 10, 50, and 100 VDC, with $\pm 100\%$ zero adjust. Eight chart speeds from 1.5 to 300 cm/hr. 10 cm wide, Z-fold chart. The rugged Miniservo recorder is powered by internal 12V 8-hour rechargeable battery, or from external battery, or plugged into line power. Replaceable throwaway pen/ink cartridge. For fast delivery, order stock number S22243. Call Larna, 317/244-7611. For more information, write Esterline Angus instrument Corporation, Box 24000, Indianapolis, Indiana 46224.



Circle 163 on reader service card

Facilitates Compliance with OSHA STANDARDS...

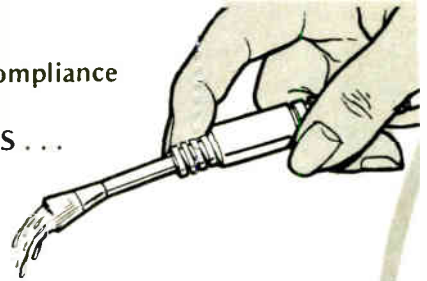

FREON[®] Means Safe Cleaning

SAFE FOR YOUR PRODUCT... YOUR EQUIPMENT AND YOU.
(LOW TOXICITY - TLV 1000 ppm)

FREON efficiency plus aerosol convenience. "FREON" TF cleans without damage to most metals, plastics or elastomers. No need to disassemble components. Removes dirt, dust, oil and is non-conductive. Ideal for cleaning electronic assemblies, PC boards, switches and relays. Low order of toxicity. Non-flammable. Available in quarts, gallons and 5 gallons - "FREON" TF, TA, TE, TMC, TES, T-E 35, T-P35.

Fed. Spec. BB-F-671-A/Fed. Spec. BB-C-00310A/Mil-C-81302B Type II-A KS-20406/Fed. Stock No. 6850-105-3084/Propellant BB-F-1421/Pkg. Spec. 2P Fed. Reg. 49.

FREON is Du Pont's registered trademark for its fluorocarbon compounds.



SEND FOR TRIAL UNIT

"One-Product Trial Unit" -

- MS-180 "FREON" TF Solvent - 16 oz.

"Two-Product Trial Unit" -

- MS-180 "FREON" TF Solvent - 16 oz.
- MS-226 "Cobra" Extension Hose and Brush.



miller-stephenson chemical co., inc.

Danbury, Connecticut 06810 (203) 743-4447

- Enclosed is \$2.00, send "One-Product Trial Unit".
- Enclosed is \$5.00, send "Two-Product Trial Unit".
- Please send FREE literature and prices.

Intended Use

Name Dept./Title

Company

Address

CHICAGO • LOS ANGELES • TORONTO Dist in ITALY • GERMANY • FRANCE
• GREAT BRITAIN • SWITZERLAND • LEBANON • SPAIN • NETHERLANDS E-4U

Circle 147 on reader service card 147

On May 11 Boston becomes the electronics capital of the world!

That's the day 25,000 "delegates" will gather for the opening of ELECTRO/76, the new IEEE international electronics convention in Bicentennial Boston.

Just about everything new and significant in electronics will be there — more than 500 hands-on product and systems demonstrations; more than 130 hours of solid, useful professional programming.

It's All Live and Direct

Everything at ELECTRO/76 is up-front and in-person. More than 300 leadership companies presenting the newest high-technology hardware, from micro-processors to "smart" instruments, and from raw materials to complete systems. ELECTRO/76 is the biggest all-electronics event in the eastern United States in many years.

All exhibit space in Hynes Auditorium has been sold out for months, and world-wide electronics industry attention is clearly focused on beautiful, springtime Boston.

Programming by Objective

35 half-day professional program sessions have been selected and refined from more than 100 proposals, by a committee of leaders in electronics technology.

This program is designed for immediate impact — direct usefulness to pro-



professionals in their job assignments with strong emphasis on new-technology applications.

All sessions will be held in ballrooms of the Sheraton-Boston Hotel, immediately adjacent to the Hynes Auditorium exposition halls.

A single low registration fee gives you all four days of ELECTRO/76 — 500 exhibits, strong sessions, and a fine technical film program. All this, and Bicentennial Boston, too!

A Very Special Event

ELECTRO/76 is a brand-new, all-industry activity. It combines the best of the Nerem and IEEE Show traditions — and adds much more.

Examples: Fully illustrated and complete session manuscripts will be

available on-the-spot; audio tapes of most sessions will be available within a couple of hours. Visitor registration is computerized — it's quick, silent, and it gives each visitor an embossed Inquiry Badge for use in requesting technical literature.

There's an exclusive special exhibit of "famous firsts" in electronics — historically significant devices and systems. And a continuous showing of award-winning technical and scientific films.

Suburban Bostonians can use our special "Mass Pike-128 Flyer" — a continuous bus system from either of two free-parking lots, direct to ELECTRO/76. (\$1 round-trip.) Air and rail transportation to Boston from other eastern cities is frequent and plentiful.

ELECTRO/76 is for you!

If you are reading this ad in this magazine, ELECTRO/76 is for you!

If you design, develop, test, measure, fabricate, inspect, assemble, package, or use electronics, ELECTRO/76 is a very important week for you.

Registration for ELECTRO/76 — for all of it — is just \$6 for IEEE members, \$9 for non-members. You'll find that's a very modest price to pay for the dozens of new ideas you'll discover for yourself. Make your plans now to join the leaders in Boston — and take home some great ideas!

Electro76

The IEEE Convention in Bicentennial Boston May 11-14
Hynes Auditorium and the Sheraton-Boston

For further information: ELECTRO/76 31 Channing Street, Newton, Massachusetts 02158 (617)527-6944

Reliability at 300° C is not the only reason Babcock Electronics uses Ekkcel™

Designing for reliability means considering the extremes. Relays designed for ambient temperatures of 125° C (256° F) see much higher internal temperatures when in operation at this extreme. So components like arc cages, bobbins, and shield insulators have to be able to take the higher temperatures.

Babcock Electronics found ceramic too fragile to withstand the vibration and shock. Other high temperature plastics tend to outgas at the operating temperatures which caused contact resistance problems.

Ekkcel injection molding resins were the perfect answer. Our high temperature reliability at a continuous 300° C (572° F) is unmatched. And our radiation resistance is 10¹⁰ rads.

We'd like to work with you on similar high temperature applications. We can help you give your electronic components all the reliability you can get.

Carborundum Plastics, Inc.
Ekkcel Division
5785 Peachtree Industrial Blvd.
Atlanta, Georgia 30341
(404) 455-6127

CARBORUNDUM



Circle 901 on reader service card

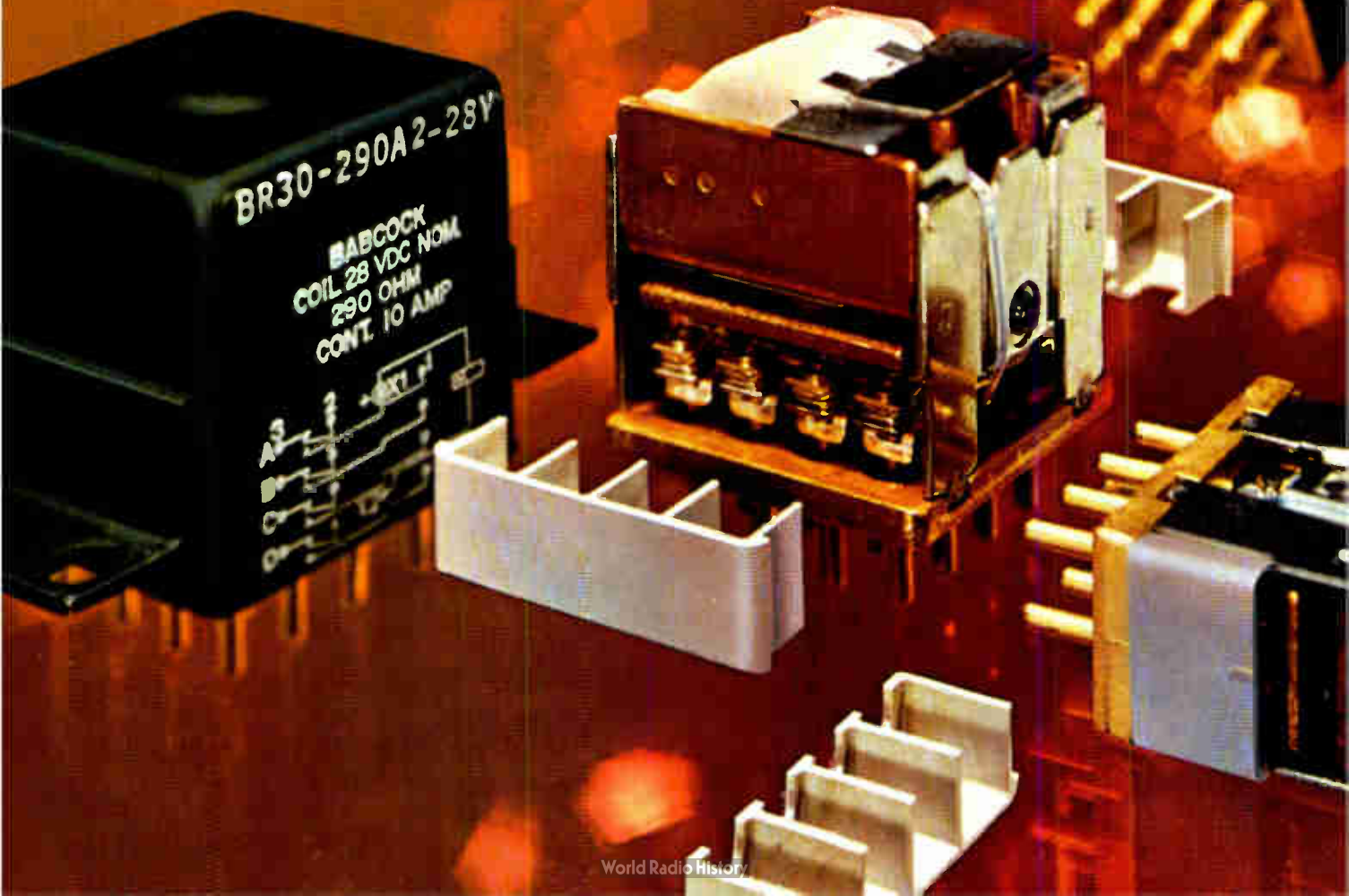

So good... you can actually feel the difference!

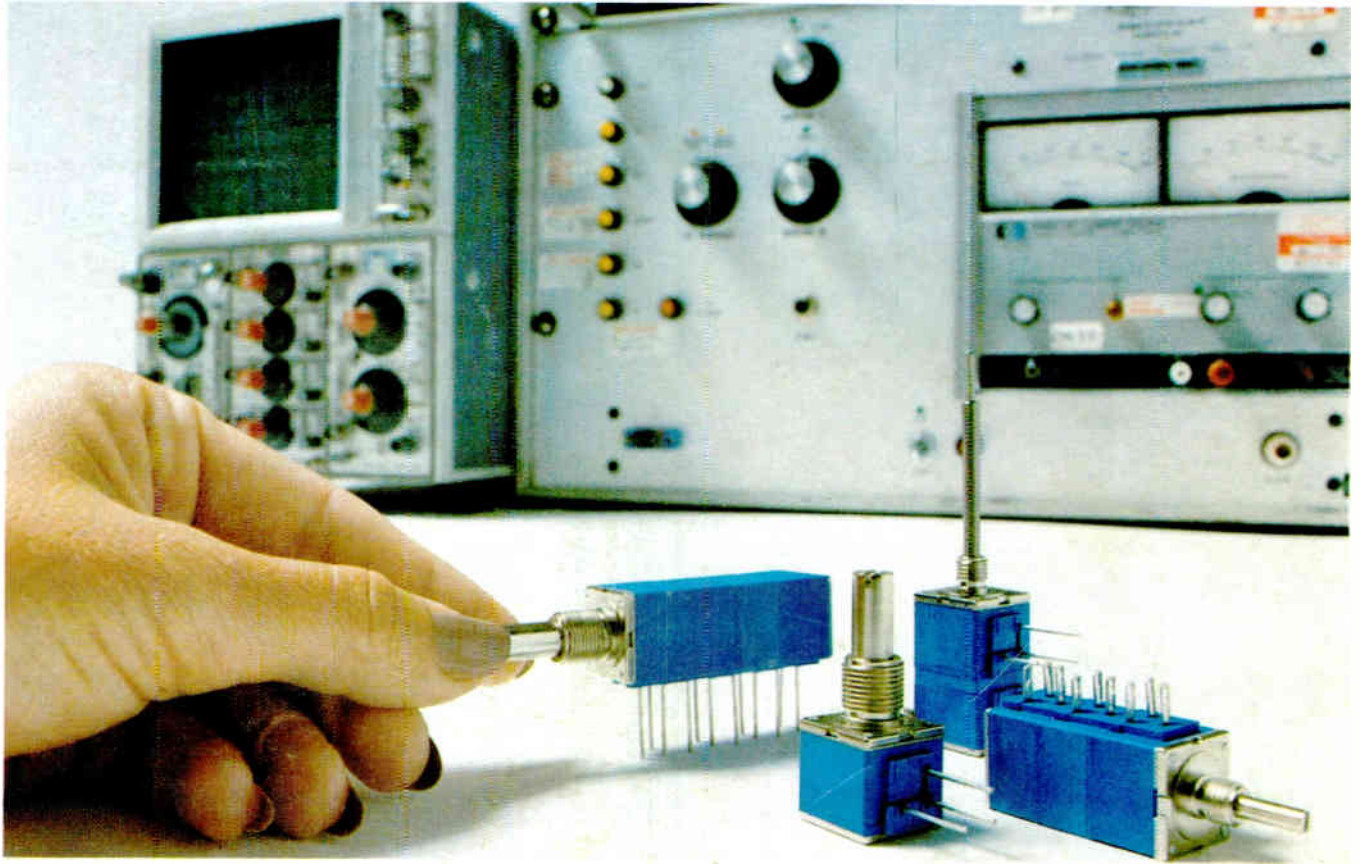

BOURNS announces an ADVANCED building-block potentiometer...

... with a velvety smooth control feel that will enhance the quality image of your equipment. It's BOURNS® new Model 80 Building-Block potentiometer.

The Model 80 incorporates a unique new shaft torque control device which enables us to produce an advanced modular potentiometer with a smooth, consistent high quality "feel" ... regardless of the number of modules ganged on a single shaft (shaft torque only .3 to 2.0 oz.-in.).

MODULAR VERSATILITY, FACTORY ASSEMBLY

Bourns modular concept combines the design versatility of advanced building-

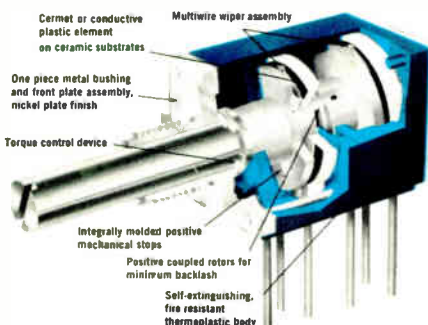

block construction ... with factory assembled reliability and quality control. All Model 80 potentiometers are built to your "prescription" by full-time production personnel, under the supervision and control of the industry's most respected quality assurance organization. High-volume assembly techniques, plus mass-produced modular components stock means fast delivery ... at competitive prices.

CERMET OR CONDUCTIVE PLASTIC

Bourns Model 80 is available with either cermet or conductive plastic elements in virtually all linear and non-linear tapers. Element types may be mixed in multiple section units. **INDEPENDENT LINEARITY IS $\pm 5\%$** ... offering more precise phasing of potentiometer output to panel calibration.

SUPER SETABILITY

A multifinger wiper and precise resistive ink formulations provide tight 1% CRV in both cermet and conductive plastic elements. This - combined with a smooth, no backlash feel - makes for easy, accurate operator settings.

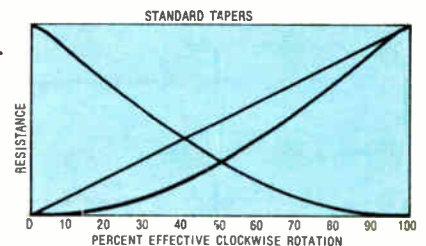

NO SHARP KNEE ON TAPERS

Model 80 audio tapers provide a smooth "knee", which allows improved setability within the crossover area on both cermet and conductive plastic.



FREE SAMPLES

Write on your company letterhead and tell us about your application. We'll send you the Model 80 that best suits your needs.



TRIMPOT PRODUCTS DIVISION
 1200 COLUMBIA AVENUE, RIVERSIDE, CALIFORNIA 92507
 PHONE 714 684-1700 TWX 910 332-1252 CABLE BOURNSINC