

NOVEMBER 14, 1974

Analog signal processing with charge-transfer devices/113
Technology update: integrated temperature transducers/130
Modeling the bipolar transistor, Part 3/137

FOUR DOLLARS A MCGRAW-HILL PUBLICATION

Electronics®



**UNIVERSAL
INTERFACE
LINKS
INSTRUMENTS
IN SYSTEMS**

1420 KAS910 UBEAR NOV73
E KLASSEN
910 DUBLIN ST
NEW WESTMINSTER BC CAN

Dialight sees a need:

(Need: The widest choice for your every application.)



513 SERIES With bezel for snap-in panel mounting. Alternate, momentary contacts with ratings to 5 amps, N.O., N.C. and two circuit (one N.O., one N.C.). Low level switches also available. Round, square and rectangular bezels in four colors; caps from 1/2" to 1 1/2" in more than 12 colors. Illuminated caps with or without legends. **UL listed.**



513 SERIES Same as above, but without bezel. For panel or sub-panel mounting. All switch contacts are gold plated for high reliability. Totally enclosed within anodized aluminum housing. Low level and D.P.D.T. snap action and contactless solid state switches also available. **UL listed.**



913 SERIES Miniature size, mount in 3/8" hole. Red, green or yellow LED operates from 5VDC; Neon operates from 125 VAC. Momentary action. Choice of S.P.S.T. double break, N.O., N.C. or two circuits (one N.O., one N.C.). Life: 1,000,000 operations.

922 SERIES Incandescent lighted, operates from 5 to 28V. Miniature size, mount in 3/8" clearance hole. Life: 1,000,000 operations (bottom switch).



545 SERIES Low priced thumbwheel switches available in standard and miniature sizes with BCD or decimal format. Positive detents for easy action. Miniature switch snaps together, no tools or hardware needed, on 3/4" centers. Gold bifurcated contacts assure high reliability. Rugged design allows operation from -25°C to +85°C. Modern low profile—recessed on panel face to eliminate accidental activation.



PUSH BUTTON CAPS Round, square and rectangular shapes in wide variety of sizes and colors. With hot stamped, engraved or film legends.



Dialight, the company with the widest choice in switches, LEDs, indicator lights and readouts, looks for needs . . . your needs . . . and then they develop solutions for your every application. No other company offers you one-stop shopping in all these product areas. And no other company

has more experience in the visual display field. Dialight helps you do more with these products than any other company in the business, because we are specialists that have done more with them. Talk to the specialists at Dialight first. You won't have to talk to anyone else. Send for your free new copy of Dialight's brochure on illuminated push button switches and matching indicator lights. Write today.

DIALIGHT

Dialight, A North American Philips Company
203 Harrison Place, Brooklyn, N. Y. 11237
(212) 497-7600

See Dialight.



**There's
something
very special
about this line
of HP XY recorders...**

**the newest addition
is the fastest most sensitive machine
we've ever built.**

HP's line of XY recorders is designed to let you choose the right machine with the right options to do the right kind of job for your lab. First: a basic one-pen workhorse. Then, a fast high-performance version. And a two-pen model that doesn't sacrifice speed.

Now, HP introduces a very special combination of acceleration and sensitivity: The Model 7047A.

This is an outstanding XY recorder, the top of the line. Sensitivity of 50 $\mu\text{V}/\text{in}$.

Acceleration in the Y axis of 3000 in/sec^2 and 2000 in/sec^2 in the X axis. With fully guarded input and 130db common mode rejection.

To meet the demands of the most exacting lab work, the 7047A gives you a switchable input filter, 11 scales of calibrated offset, internal time base and TTL remote control. All as standard equipment.

And like all recorders in the line, the 7047A is built on a strong die-cast aluminum mainframe. Inside, there are no

complicated slip clutches, just tough, continuous duty servo motors that can be driven offscale independently without damage.

This is the best of the best XY recorders ever offered by Hewlett-Packard. Prices start at \$2,850 (domestic USA price only). For complete details on the new 7047A and the other recorders in the HP line, see your HP field representative or write Hewlett-Packard, 1501 Page Mill Road, Palo Alto, California 94304.

13408

HEWLETT  PACKARD

Sales and service from 172 offices in 65 countries.
1501 Page Mill Road, Palo Alto, California 94304

World Radio History

Circle 1 on reader service card

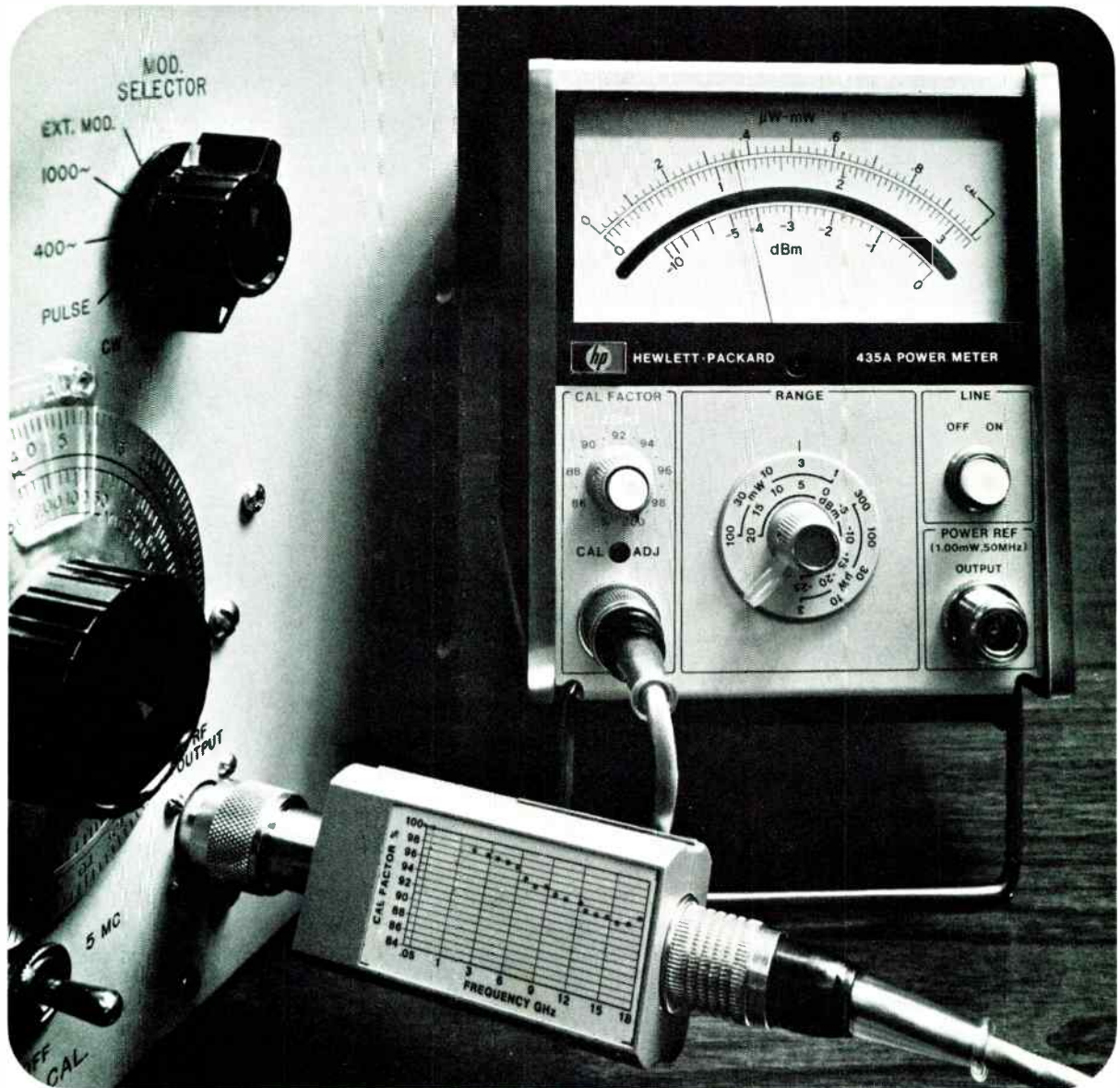

It takes more than an accurate meter to make accurate power measurements. It takes a sensor with low SWR.

And this is just what you get with the HP 435A Power Meter and its associated thermocouple power sensor. The HP 8481A Sensor's SWR is typically one-half that of other mounts. Specs are <math><1.2</math> to 12.4 GHz and <math><1.3</math> to 18 GHz.

The resulting reduction in mismatch error means overall measurement accuracy is substantially higher. Up to now, overall inaccuracies could be as high as 10-20% with high SWR mounts.

The 435A/8481A combination also gives you:

- **Broad Frequency Coverage:** Work from 10 MHz to 18 GHz without change of setup.
- **Wide Dynamic Range:** Measure from 0.3 μ W to 100 mW (-35 to +20 dBm) with just one sensor.
- **Built-in Power Reference:** Verify meter/sensor calibration at any time for added confidence in your measurements.

Now available:

- **Three New Precision Sensors:** For lower RF (100 KHz to 4.2 GHz); for 75 ohm systems; and for higher power: 3 mW to 3 W (10 MHz to 18 GHz).

Price: 435A Power Meter \$750; 8481A Sensor \$400.
Domestic USA prices only.

For complete information, call your HP field engineer or write.

HEWLETT  PACKARD

Sales and service from 172 offices in 65 countries.
1501 Page Mill Road, Palo Alto, California 94304

04407A

29 Electronics Review

SOLID STATE: TI readies family of microprocessor parts, 29
Four-kilobit RAMs run faster, get smaller, 30
MEDICAL: Device fitted on ear measures oxygen in blood, 31
MATERIALS: Liquid-crystal layer reveals IC design faults, 32
INDUSTRIAL: Microchips meet resistance at instrument show, 34
COMMUNICATIONS: Digital microwave test set by Bell System, 36
Scientific-Atlanta takes awards for Marisat hardware, 38
BUSINESS: Few bright spots in 1975 U.S. sales forecast, 38
PACKAGING & PRODUCTION: Mask makers staying with experience, 40
INDEX OF ACTIVITY: 42
SOLID STATE: C-MOS memories overcome volatility, 42
GOVERNMENT: Justice Dept. files pre-trial brief versus IBM, 44

52 Electronics International

GREAT BRITAIN: ICL introduces two computers in new range, 52
JAPAN: Fast n-MOS imager needs no clock, 52
AROUND THE WORLD: 53

67 Probing the News

COMMUNICATIONS: IBM envisions individual ground stations, 67
PRODUCTION: Motorola automates epitaxial operation, 69
COMMUNICATIONS: Facsimile picks up speed, 75
THE ECONOMY: Tight money squeezes companies, 78
MANUFACTURING: Semiconductor makers delay expansion, 82

95 Technical Articles

INSTRUMENTS: Standard interface simplifies system design, 95
SOLID STATE: CTDs filter complex communications signals, 113
DESIGNER'S CASEBOOK: Op amp compares bipolar voltages, 123
Regulating voltage with just one quad IC and one supply, 125
As clipper, IC comparator is improved by feedback, 126
TECHNOLOGY UPDATE: Integrated temperature transducers, 130
CIRCUIT DESIGN: Part 3, Modeling the bipolar transistor, 139
Getting inside a peak detector to make it do its job, 145
ENGINEER'S NOTEBOOK: Microprocessor ROMs can test selves, 153
Scanning only bright spots generates CRT characters fast, 155
Low-frequency discriminator utilizes analog delay, 156

167 New Products

IN THE SPOTLIGHT: 4-bit controller system is upgraded, 167
INSTRUMENTS: Logic probe tells you more, 170
DATA HANDLING: Plug-in board holds data-acquisition system, 178
PACKAGING & PRODUCTION: PROM programmer handles 16-k bits, 186
SUBASSEMBLIES: 12-bit a-d converter offers good linearity, 198
MICROWAVE: Transistor built for Tacan/DME band, 208
SEMICONDUCTORS: ECL transceiver is also a driver, 219
MATERIALS: 228

Departments

Publisher's letter, 4
Readers comment, 6
40 years ago, 8
People, 14
Meetings, 20
Electronics newsletter, 25
News update, 46
Washington newsletter, 49
Washington commentary, 50
International newsletter, 55
Engineer's newsletter, 160
New literature, 235
New books, 245

Highlights

Cover: Standard bus links assorted instruments, 95

International agreement on a standard instrument interface will make it much easier to build systems out of instruments made by different companies in different countries. This two-part article describes the proposed bus system from the viewpoints of the system designer and the instrument designer.

Opposition to IBM's satellite proposal grows, 67

Fear of yet another U.S. communications monopoly has both Government agencies and private industry lining up against IBM's proposed entry into satellite communications.

Charge-transfer devices make analog filters, 113

The complex filters, delay lines, and multiplexers required by today's large communications systems can be built out of charge-transfer devices—chips that bring analog-signal processing the high-performance, low-cost advantages of MOS technology.

Modeling the bipolar transistor, Part 3, 145

A computer-aided-design program needs values for many bipolar-transistor parameters before it can utilize the second-level nonlinear Ebers-Moll model described in Part 2 of this series. The third and last article describes how to measure the parameters.

And in the next issue . . .

Special report on the electronics industries in Japan . . . matching readouts and temperature transducers.

EDITOR-IN-CHIEF: Kemp Anderson

EXECUTIVE EDITOR: Samuel Weber

MANAGING EDITORS: Lawrence Curran, *News*;
Arthur Erikson, *International*

SENIOR EDITORS: John Johnsrud,
H. Thomas Maguire, Laurence Altman,
Ray Connolly, Stephen E. Scrupski

ART DIRECTOR: Fred Sklenar

ASSOCIATE EDITORS: Howard Wolff,
Gerald M. Walker, Alfred Rosenblatt

DEPARTMENT EDITORS
Aerospace/Military: Ray Connolly
Circuit Design: Wallace B. Riley
Communications & Microwave:
Stephen E. Scrupski
Components: Lucinda Mattered
Computers: Wallace B. Riley
Consumer: Gerald M. Walker
Industrial: Margaret A. Maas
Instrumentation: Andy Santoni
New Products: H. Thomas Maguire,
Michael J. Riezenman
Solid State: Laurence Altman

COPY EDITORS: Margaret Eastman,
Everett C. Terry, Bill Dunne

ART: Charles D. Ciatto, *Associate Director*
Patricia Cybulski, *Assistant Director*

PRODUCTION EDITOR: Arthur C. Miller

EDITORIAL SECRETARIES: Janet Noto,
Julie Gorgoglione, Penny Roberts

FIELD EDITORS

Boston: Gail Farrell
Los Angeles: Paul Franson (Mgr.)
Midwest: Larry Armstrong (Mgr.)
New York: Ron Schneiderman (Mgr.)
San Francisco: Bernard Cole (Mgr.)
Judith Curtis
Washington: Ray Connolly (Mgr.)
Larry Marion
Frankfurt: John Gosch
London: William F. Arnold
Paris: Arthur Erikson
Tokyo: Charles Cohen

McGRAW-HILL WORLD NEWS

Director: Ralph R. Schulz
Bonn: Robert Ingersoll
Brussels: James Smith
London: Marvin Petal
Madrid: Dom Curcio
Milan: Peter Hoffmann, Andrew Heath
Moscow: Peter Gall
Paris: Michael Johnson, Richard Shepherd
Stockholm: Robert Skole
Tokyo: Mike Mealey

PUBLISHER: Dan McMillan

DIRECTOR OF MARKETING: Pierre J. Braudé

ADVERTISING SALES SERVICE MANAGER:
Wallis Clarke

BUSINESS MANAGER: Stephen R. Weiss

CIRCULATION MANAGER: Nancy L. Merritt

MARKETING SERVICES MANAGER:

Tomlinson Howland

RESEARCH MANAGER: Margery D. Sholes

Standardization is an important milestone along the road called technological progress. And right now, impacted by the rising demand for automated instrumentation systems, the world's instruments makers are getting together on an international standard for interface design. The result: a faster and cheaper route to creating complex instrumentation systems.

You'll find a complete description of the interface standard and a detailed presentation on what it will mean to designers in the 12-page article that starts on page 95.

The article was written by David W. Ricci and Gerald E. Nelson of Hewlett-Packard Co., which initiated the interface standard proposal. Supported by other makers, the proposal was accepted recently at the Bucharest meeting of the International Electrotechnical Commission and referred to national standards agencies for final action.

The proposal's impact on instrument system design can be gauged by the territory it covers—the data bus's physical connector, the roles of the interconnecting bus wires, and the logic conventions, format, and timing of control and data signals. Also covered, as the article points out, are "other factors necessary in a communications link that will be capable of interconnecting instruments and peripherals—computers, voltmeters, card readers—made any place in the world."

Actually, our interface article is two stories in one. The first part is for the system engineer and covers the capabilities and limitations of the standard when it comes to system design. The second part, aimed at the instrument designer, homes in

on how the interface approach can be applied to the design of instruments themselves.

The state of the economy—at home, as well as around the world—is not exactly rosy. Along with other industries, electronics is feeling the pinch of inflation, high interest rates, and slackening of demand. To keep you abreast of what's happening to the business of electronics, we've put together an illuminating pair of Probing the News stories.

On page 78, you'll find the results of a survey we have just completed on a key short-term economic indicator—money. The conclusion: accounts receivable are still too high as customers put off paying their bills. There is a severe money squeeze, due largely to the high cost of borrowing, and the emphasis at more and more companies is on strict "asset" control, especially of inventories.

Then, on page 82, you can read about an important long-term indicator—expansion plans. In the view of many semiconductor companies, "the world next year will be flat." That view has triggered the delay or abandonment of a host of plant-expansion projects by U.S. companies, both here and abroad. But the picture is not altogether clearcut for this yeasty segment of the electronics field, because some companies are pressing ahead with plant expansions, despite the generally grey world economic picture.



November 14, 1974 Volume 47, Number 23
94,465 copies of this issue printed

Published every other Thursday by McGraw-Hill, Inc. Founder: James H. McGraw 1860-1948. Publication office 1221 Avenue of the Americas, N.Y., N.Y. 10020; second class postage paid at New York, N.Y., and additional mailing offices.
Executive, editorial, circulation and advertising addresses: Electronics, McGraw-Hill Building, 1221 Avenue of the Americas, New York, N.Y. 10020. Telephone (212) 997-1221. Teletype TWX N.Y. 710-581-5234. Cable address: MCGRAW HILL N.Y.

Subscriptions limited to persons with active, professional, functional responsibility in electronics technology. Publisher reserves the right to reject non-qualified requests. No subscriptions accepted without complete identification of subscriber name, title, or job function, company or organization, including product manufactured or services performed. Subscription rates: qualified subscribers in the United States and possessions, Canada, and Mexico \$12.00 one year, \$24.00 three years; all other countries \$25.00 per year, except Japan and Israel \$50.00 per year, Brazil \$40.00 per year, Australia and New Zealand \$60.00 per year, including air freight. Limited quota of subscriptions available at higher-than-basic rate for persons outside of field served, as follows: U.S. and possessions and Canada, \$25.00 one year; all other countries \$50.00. Single copies: \$4.00.

Officers of the McGraw-Hill Publications Company: John R. Emery, President, J. Elton Tuohig, Executive Vice President-Administration; Gene W. Simpson, Group Publisher-Vice President; Senior Vice Presidents: Ralph Blackburn, Circulation, Walter A. Stanbury, Editorial; John D. Hoglund, Controller; David G. Jensen, Manufacturing; Gordon L. Jones, Marketing; Jerome D. Luntz, Planning & Development.

Officers of the Corporation: Shelton Fisher, Chairman of the Board and Chief Executive Officer; Harold W. McGraw, Jr., President and Chief Operating Officer; Wallace F. Trendy, Group President, McGraw-Hill Publications Company and McGraw-Hill Information Systems Company; Robert N. Landes, Senior Vice President and Secretary; Ralph J. Webb, Treasurer.

Title registered in U.S. Patent Office. Copyright ©1974 by McGraw-Hill, Inc. All rights reserved. The contents of this publication may not be reproduced in whole or in part without the consent of copyright owner.

Subscribers: The publisher, upon written request to our New York office from any subscriber, agrees to refund that part of the subscription price applying to copies not yet mailed. Please send change of address notices or complaints to Fulfillment Manager; subscription orders to Circulation Manager. Electronics, at address below. Changing of address notices should provide old as well as new address, including postal zip code number. If possible, attach address label from recent issue. Allow one month for change to become effective.

Postmaster: Please send form 3579 to Fulfillment Manager, Electronics, P.O. Box 430, Hightstown, N.J. 08520

A new digital phasemeter that's accurate to .05°?

.05° accuracy and .01° resolution
continuous precision measurement
from 0°–360.00°

no 0/360° ambiguity, right down
to readings as small as .01°

5 digit Sperry readout

accuracy unaffected by amplitude differences

frequency range 10Hz to 5MHz



Precisely.

and the best performance
at the best price,
only \$1995.—

for immediate action call
(617) 491-3211, TWX 710
320 6583, or contact your
local KH representative,
listed below.

**KH KROHN-HITE
CORPORATION**
580 Massachusetts Avenue, Cambridge, Massachusetts 02139

SALES OFFICES: ALA, Huntsville (205) 534-9771; ARIZ., Scottsdale (602) 947-7841; CAL., San Jose (408) 292-3220, Inglewood (213) 674-6850; COLO., Denver (303) 934-5505; CONN., Glastonbury (203) 633-0777; FLA., Orlando (305) 894-4401; HAWAII, Honolulu (808) 941-1574; ILL., Des Plaines (312) 298-3600; IND., Indianapolis (317) 244-2456; MASS., Lexington (617) 861-8620; MICH., Detroit (313) 526-8800; MINN., Minneapolis (612) 884-4336; MO., St. Louis (314) 423-1234; N.C., Burlington (919) 227-3639; N.J., Haddonfield (609) 795-1700; N.M., Albuquerque (505) 299-7658; N.Y., E. Syracuse (315) 437-6666, Rochester (716) 328-2230, Vestal (607) 785-9947, Elmont (516) 488-2100; OHIO, Cleveland (216) 261-5440, Dayton (513) 426-5551; PA., Pittsburgh (412) 371-9449; TEX., Houston (713) 688-9971, Richardson (214) 231-2573; VA., Alexandria (703) 354-1222; WASH., Seattle (206) 624-9020; CANADA, Montreal, Quebec (514) 636-0525, Toronto, Ontario (416) 444-9111, Stittsville, Ontario (513) 836-4411, Vancouver, British Columbia (604) 688-2619.

Cool as a
cucumber

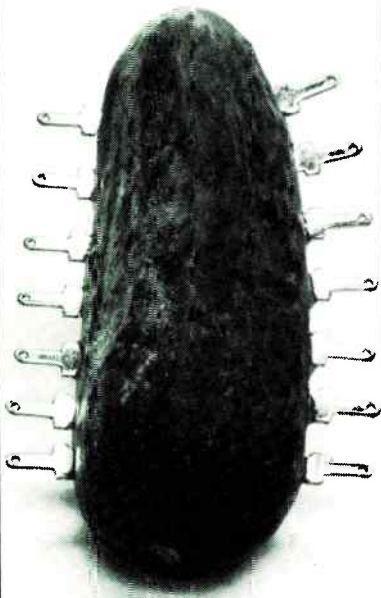

**Temperature
sensitive
hybrids
welded with
Raytheon
DC Welders.**

Rectangular or round—weld them fast—and cool—with a Raytheon DC welder... from the widest power range of models available. For more data or a free evaluation of your welding needs—call Tom Daley or Keith Nutter, Raytheon Company, Production Equipment Department, 676 Island Pond Road, Manchester, N.H. 03103. (603) 668-1600.



Readers comment

Storing vested interest?

To the Editor: A real measure of the effectiveness of a computer is the number of bits of stored program required to accomplish a given operation. Considering the instruction sets of most of the available microprocessors, one wonders if the designers of these sets had a vested interest in maximizing the required storage, instead of minimizing it.

One class of instructions in which the design approach can result in a differential factor of two or more in required storage is that of conditional tests. On one side, we see the skip instructions, which usually require another instruction to complete the operation, and on the other side, we have branch instructions, which are self-contained.

Speaking from experience with both approaches, I believe that the conditional-skip approach typically needs at least twice as many bits of storage to do anything useful as does the jump approach. Furthermore, programing with explicit jump instructions is conceptually easier and less error-prone, a very real consideration, since software accounts for so much of the computing dollar.

I hope manufacturers of the next generation of microprocessors adopt jumps instead of skips; they are more efficient.

Ernest Stiltner
Boulder, Colo.

Providing a decimal output

To the Editor: Re Jack Lambert's article, "Providing a decimal output for a calculator chip" [Electronics, Aug. 8, p. 105], I believe that if segment inputs a, d, e, f (d instead of b) were used, Mr. Lambert would find that the only redundancy is on 0 and 8, which still requires the g segment input to resolve. However, 3 and 7 are now unique (as well as others). Thus, one inverter and two NAND gates may be eliminated.

Robert L. LaFara
Naval Avionics Facility
Indianapolis, Ind.

■ **The author replies:** *You are indeed correct, and your selection of segments will simplify the design since it*

freed two NAND gates, one of which can be used as an inverter so that only two packs are needed for the converter.

To elaborate on the published article, however, it was my desire to have the output dark when there was no input to the demultiplexer. For the segment selection a, d, e, f and g, any unexcited numeral will, when converted, indicate decimal one. Thus a readout with leading zeros suppressed will display leading 1s. For my purpose it was worth the extra hardware to eliminate this.

Arithmetic is simple

To the Editor: In your New products section [Electronics, Sept. 19, p. 156] it is written that National Semiconductor's LM3611 series peripheral drivers each contains a pair of TTL gates driving 300 milliamperes and 80-volt-output power transistors—"said to be double the voltage capability of other monolithic peripheral drivers."

Simple arithmetic shows that the 80-volt capability of the National LM3611 is not twice the 100-volt minimum rating of the Sprague Series 500 monolithic power drivers, which have been on the market for some four years!

The National Series 3611 is intended for relays, lamps, solenoids, etc., and this is exactly the type of interface provided by the Sprague power drivers. Also, our relay driver versions incorporate integral suppression diodes for use with inductive loads.

Paul R. Emerald
Sprague Electric Co.
Worcester, Mass.

Faster than stated

To the Editor: In the News update section [Electronics, Sept. 5, p. 42], the author said the IBM Word Processing System (referring to our magnetic media typewriters) typed at a speed of 11 characters per second. In fact, all these IBM typewriters operate at a speed of approximately 15 c/s.

Fred Steinberg
IBM Corp.
Franklin Lakes, N.J.

A linear gold mine in Silicon Valley

All is not gold that glitters in some linear IC cost/performance claims. At Teledyne's big plant in Silicon Valley we produce only the genuine nuggets—the linears that have passed the test of time.

Teledyne keeps cost low by concentrating on volume production of the most universally applicable types of linears. And you know performance is high because these have proved their worth in thousands of system designs.

Some are extra fine. For example, our 141 op amp gives better slew rate, input bias and offset current performance than does a 107. Likewise, our 142 outperforms the 101A in most applications. And if you don't need the high performance of a 108, our 142 will do the job just fine—at a lot lower price.

And don't worry about your committed system designs caving in. We support your needs with linears stocked in all the popular packages, with unpackaged chips—and with military-grade parts processed to MIL-STD-883

SILICON VALLEY'S BEST LINEARS

Operational Amplifiers

101A/201A/301A	709/709C
107/207/307	741/741C
108/208/308	141/241/341*
108A/208A/308A	142/242/342*
747/747C	2740*
748/748C	1558/1458/1458C

Dual Timers

D555

Voltage Regulators

104/204/304
105/205/305/305A
376
723/723C
823*
829/829C*
830/830C*

Transistor Arrays

861*

Voltage Comparators

710/710C
711/711C
111/311
3302
139, 239/339

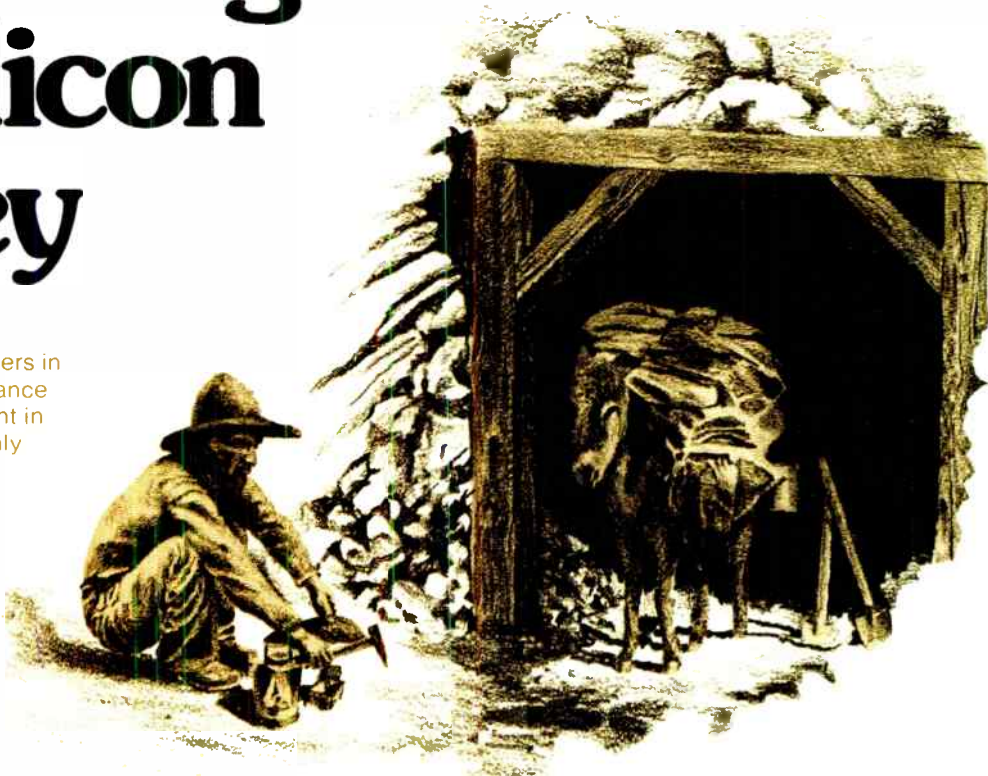

*Teledyne proprietary linears

Best of all, you don't have to go prospecting for our linears. You'll find them all at Teledyne distributors. And if you need factory volume and pricing, call a Teledyne rep or come straight to our linear gold mine in Silicon Valley. Either way, you'll strike it rich.

 **TELEDYNE**
SEMICONDUCTOR

1300 Terra Bella Avenue Mountain View, California 94043
(415) 968-9241 TWX: 910-379-6494 Telex: 34-8416

Electronics/November 14, 1974

Circle 7 on reader service card 7

Solid Tantalums for Solid Performance

40 years ago

From the pages of Electronics, November, 1934

The home radio printing-press

Broadcasting had scarcely got started, before radio men began asking themselves what other use or uses could be made of the radio waves to furnish other services to the home. And now, after some years of experimentation, we seem to be entering upon a new period of visual broadcasting, when it will be possible to scatter across the countryside, to homes in cities and hamlets, printed pages and pictures, delivered with the speed of light.

Thus "the radio printing press in the home," may soon be a reality, paralleling the commercial use already made of the same facsimile methods by the great newspaper and communication groups.

Home facsimile systems [being developed include]:

- Otho Fulton's Fultograph
Sepia-colored solid and half-tone images recorded by a stylus on moistened, chemically treated paper by electrolytic action. One sheet (8½ by 11 inches) printed at a time, one sheet in six minutes, with automatic reloading. Detail: 60 lines to the inch. Probable retail cost \$50. Operates from modern radio receiver. Suitable for reproduction of text, cartoon, and half-tone images comparable in quality and appearance with rotogravure.

- J.V.L. Hogan's Radio Pen
Black-and-white images recorded in ink by magnetic pen on a continuous roll of paper, image three inches wide. Detail: 60 lines per inch. Probable retail cost: \$35. Operates on output of any modern receiver. Suitable for reproduction of cartoon and type at a rate of 40 words per minute.

- C.J. Young's Lawnmower
Black-and-white or half-tone images recorded from carbon paper on continuous roll of paper, 8½ inches wide, by a helix-and-bar system. Detail: 100 lines per inch. Suitable for continuous reproduction of text, cartoons, and half-tone images at a rate of 100 words per minute. System being developed by RCA Victor Company.

MOLDED, PLASTIC-ENCASED ECONOLINE™ TANTALEX® CAPACITORS

Type 198D Economically priced. Flame-retardant case has flattened section and polarity indicator for easy-to-read marking and error-free insertion. High volume production-oriented design for efficient assembly. Molded straight-wall case eliminates cracking as well as soldering problems associated with epoxy rundown.



ASK FOR BULLETIN 3546

INFORMATION RETRIEVAL NUMBER 29

EPOXY-DIPPED TANTALEX® CAPACITORS

Type 196D Low-cost capacitors that utilize high-quality tantalum pellet construction. Dipped coating is hard insulating resin highly resistant to moisture and mechanical damage. Designed for printed circuit board applications. Wide range of capacitance values with voltage ratings from 4 to 50 VDC.



ASK FOR BULLETIN 3545B

INFORMATION RETRIEVAL NUMBER 30

HERMETICALLY-SEALED METAL-ENCASED TANTALEX® TUBULAR CAPACITORS

Type 150D Polarized units offer high capacitance, long life, low leakage current, low dissipation factor, and high stability. Also available to Spec. MIL-C-39003 as CSR09, CSR13, and CSR23.

Type 151D Non-polarized capacitors with the same outstanding characteristics as Type 150D units. Also available to Spec. MIL-C-39003 as CSR91.



ASK FOR BULLETINS 3520G, 3520.2A, 3521B, 3521.7

INFORMATION RETRIEVAL NUMBER 31

MOLDED DOMINO® TANTALEX® CAPACITORS

Type 193D For hybrid circuit and low-profile printed circuit board applications. Offer superior mechanical protection as well as excellent stability in severe operating and storage environments. Can be attached to substrates or circuit boards by conventional methods.



ASK FOR BULLETIN 3532A

INFORMATION RETRIEVAL NUMBER 32

ULTRA-MINIATURE TANTALEX® CAPACITORS FOR MINIATURE CIRCUITS

Types 182D and 183D Cylindrical-shaped Type 182D and rectangular-shaped Type 183D capacitors, ideal for subminiature assemblies requiring the ultimate in component density, offer high volumetric efficiency. Housed in polyester-film sleeving with epoxy resin end seals, ensuring excellent moisture resistance.



ASK FOR BULLETIN 3517

INFORMATION RETRIEVAL NUMBER 34

MINIATURE RED TOP® TANTALEX® TUBULAR CAPACITORS

Type 162D Capacitors in resin-sealed cases offer excellent stability. For use on printed wiring boards, in packaged circuit modules, and in applications where space is at a premium. Priced competitively with axial lead molded case units. Available on reels, with taped leads, for automatic machine insertion on PC boards.



ASK FOR BULLETIN 3536B

INFORMATION RETRIEVAL NUMBER 36

For complete technical data on any of these Sprague solid tantalum capacitor types, write for the applicable Engineering Bulletin(s) to Technical Literature Service, Sprague Electric Company, Marshall Street, North Adams, Mass. 01247.



The counter specialists have done it again!



New S-D family makes buying decisions easy. 5 MHz to 512 MHz.

Whether you need a simple frequency counter, a complete universal counter-timer, or a quality communications counter, Systron-Donner has it... at a sensible price and with features nobody else has.

1. **Low cost frequency counter.** Model 6202A is a simple, straightforward and reliable workhorse for frequency counting to 5 MHz. Especially suited for industry and education. Price only \$435.

2. **Complete universal counter-timer.** S-D's 50 MHz Model 6250A offers all universal functions along with such standard features as trigger levels, pre-set positions, 2 independent inputs, automatic and manual resolution, and 8 digits. Price \$740.

3. **great communications trio.** S-D gives you a choice of three frequency counters, all with 8 digits, tone measurement and sensitivity control to reject noisy signals. Options include 5 oscillators to $5 \times 10^{-10}/24$ hr. and an internal battery pack. Model 6220A is a 50 MHz unit upgradable to 180 MHz or 512 MHz. Price \$650. Model 6251 covers to 180 MHz. Price \$985. Model 6252 (shown) measures to 512 MHz. Price \$1195. Relay overload protection and metered input are standard on the 6251 and 6252.

For immediate details contact your Scientific Devices office or Systron-Donner at 1 Systron Drive, Concord, CA 94518. Phone (415) 676-5000.



Circle 9 on reader service card

Q. what's new from the specialists in waveform analysis?



A. a systems measurement center that makes 3,000 measurements/sec!

Model 780 measures single transient to 100 MHz signals • Measures time from 0.1 ns to 10 s
Measures voltage with bandwidth from D.C. to 300 MHz • Calculator or computer compatible • ASCII buss programming.

For information on Systron-Donner waveform analysis instruments call your Scientific Devices office or Systron-Donner at 1 Systron Drive, Concord, CA 94518. Phone (415) 676-5000.



In bipolar PROM fuses can stand the

Time has proved that Intel's polysilicon fused, electrically Schottky programmable ROMs are the most reliable bipolar PROMs made. Our polysilicon fuses show absolutely no regrowth or opening — not in systems in the field, not even after billions of fuse hours of high tem-

INTEL ADDS 4K PROMS TO THE 3601 FAMILY			
SIZE	PART NUMBER	WORST CASE ACCESS TIME	IN STOCK
1K (256X4)	3601	70 ns	NOW
	3601-1	50 ns	NOW
	3601M	90 ns	NOW
2K (512X4)	3602	70 ns	1Q, 1975
	3622	70 ns	1Q, 1975
4K (512X8)	3604	70 ns	NOW
	3604-6	90 ns	NOW
	3624	70 ns	1Q, 1975

perature reverse bias at 125°C. Nor have any failed in 1.2 billion hours of operating system life tests at 85°C.

Today, the industry's highest density, highest performance PROMs have polysilicon fuse reliability. Intel's new 3604 is the first 4K design in real production. It dissipates only 60 μ W/bit with the 3604-6 low stand-by power option. Yet 70 ns is guaranteed from 0-75°C, not just at 25°C. The new 2K and 4K designs offer three-state output options — 3622 and 3624. And the 3601-1, at 50 ns worst case access, is the world's fastest PROM. The ultimate in military PROMs



is the 3601M, with maximum access time of 90 ns from -55 to +125°C.

These PROMs all program easily, in less than a second, with high programming yields, using any of several standard programmers. Intel distributors do it FREE. Or, buy 10,000-up and we'll provide the programmer. Most important, when a polysilicon fuse is blown, it

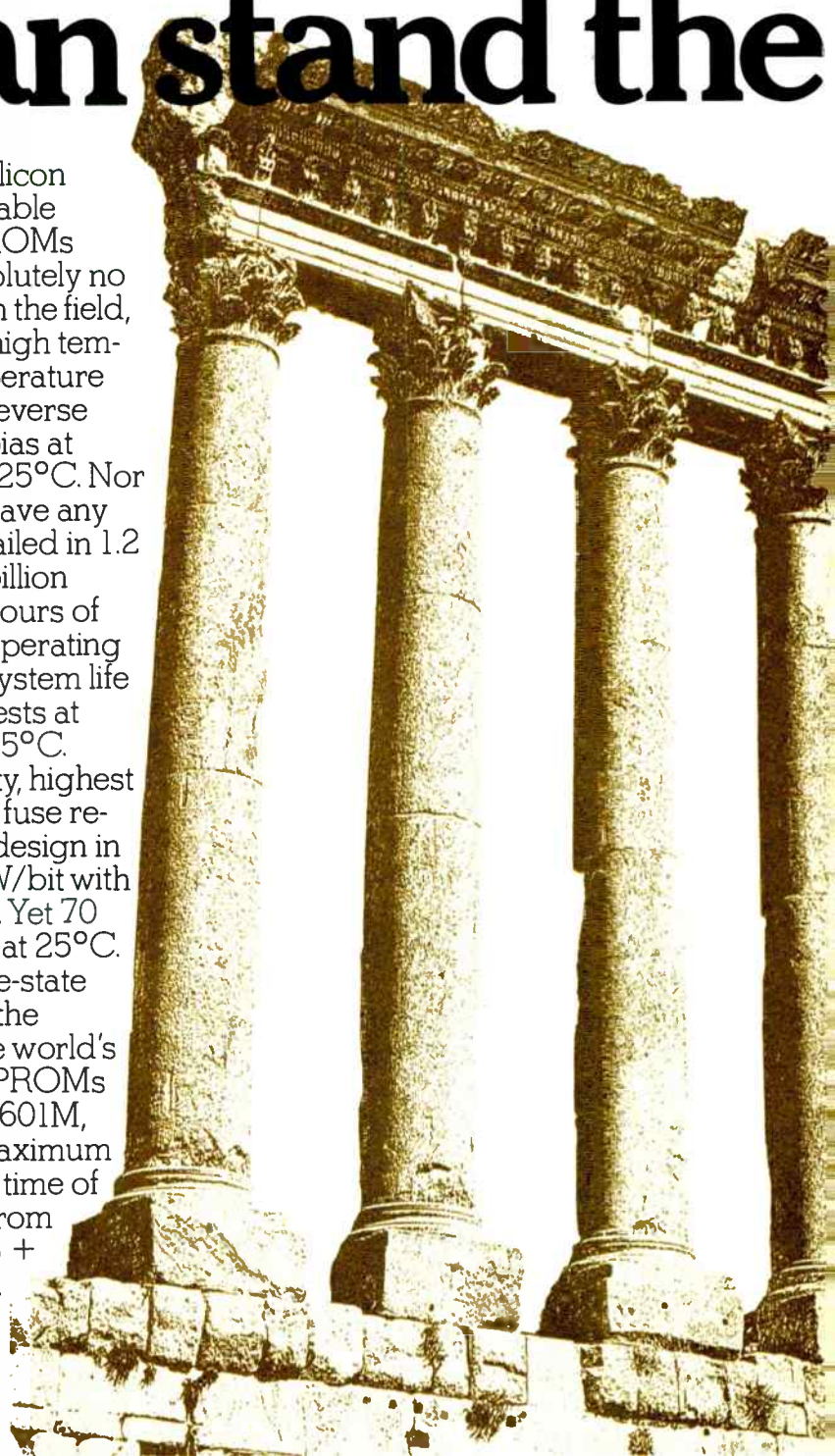

*IEEE 12th Annual Proceedings on Reliability Physics 1974; Joseph Brauer, "Military Microcircuit Packaging" The Electronic Engineer, July, 1972.

Ms, only polysilicon test of time.

oxidizes completely. There is no conductive residue to short other parts of the circuit. In contrast, blown nichrome does produce conductive residue. Moreover, nichrome can regrow, and moisture can cause unblown nichrome fuses to open over time. No wonder experts question the reliability of nichrome fused PROMs*

The very structure of an Intel PROM is inherently more reliable. You'll find no dissimilar metals, as you do in nichrome-aluminum interfaces, in our bipolar PROMs. The fuses are semiconductor material. And polysilicon is classically simple compared to blown junctions. Blown junctions miss the target, being complex, difficult to fabricate and requiring tight programming control. They also require high current programming pulses that may blow the wrong junction.

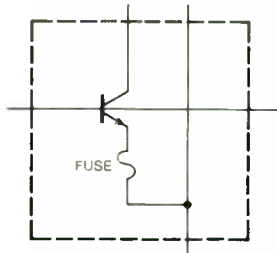

CELL SCHEMATIC

technology, also used for our compatible metal mask ROMs.

Write Intel for a PROM application note. It shows how to add this monumental reliability to your system at low cost.

Intel Corporation, 3065 Bowers Avenue, Santa Clara, California 95051. (408) 246-7501. Free programming from your ASCII paper tape or master PROMs at Almac/Stroum, Cramer, Hamilton/Avnet, Sheridan Sales, Industrial Components, and L. A. Varah.

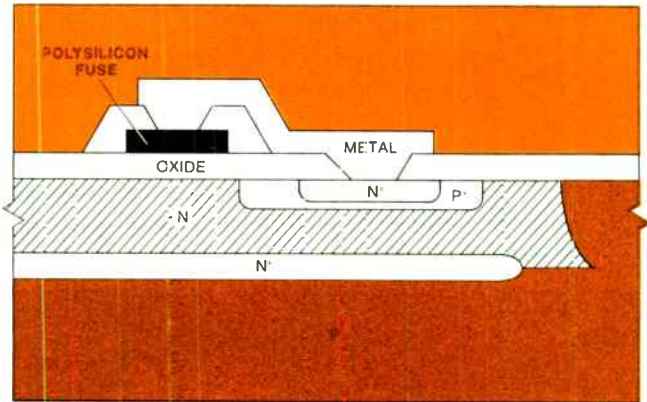

intel® delivers.

Announcing the Battery Status Indicator— a new LED/IC combination

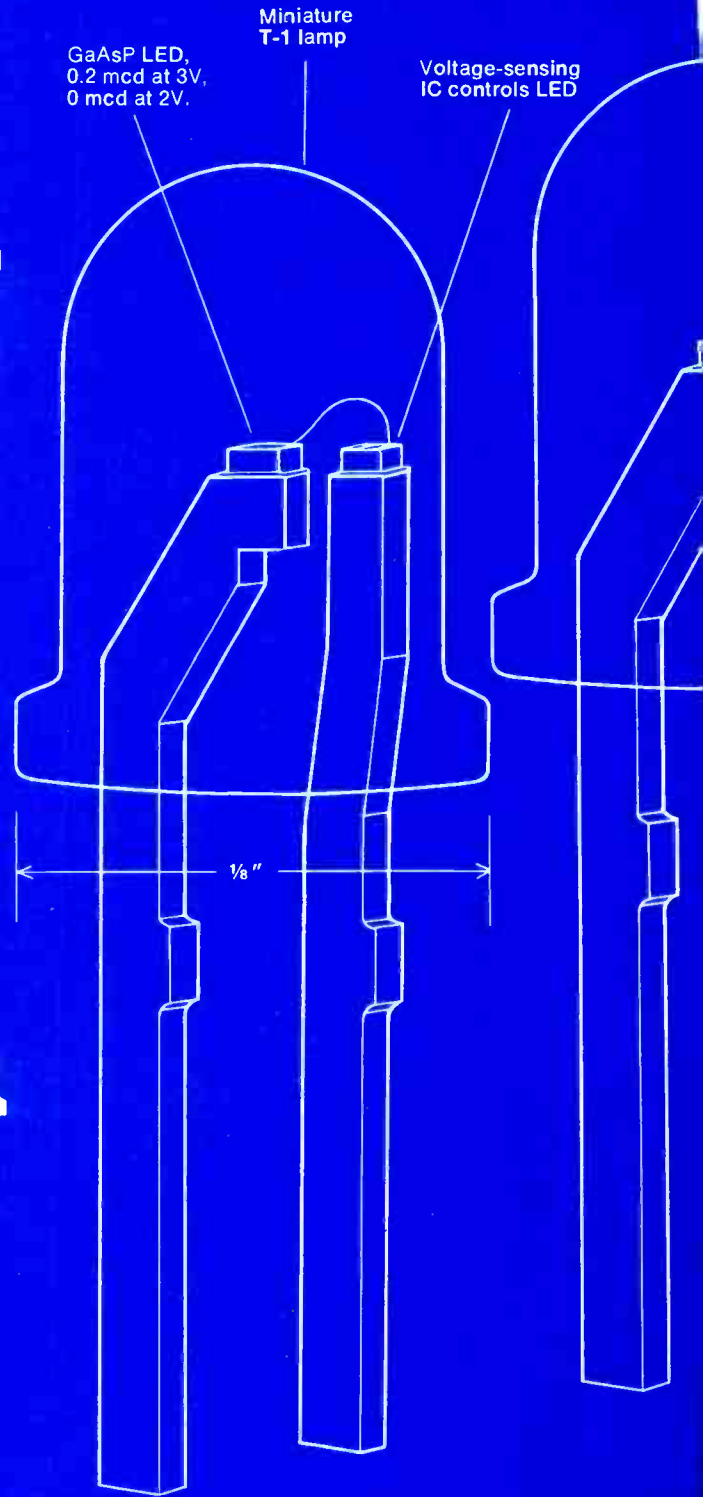

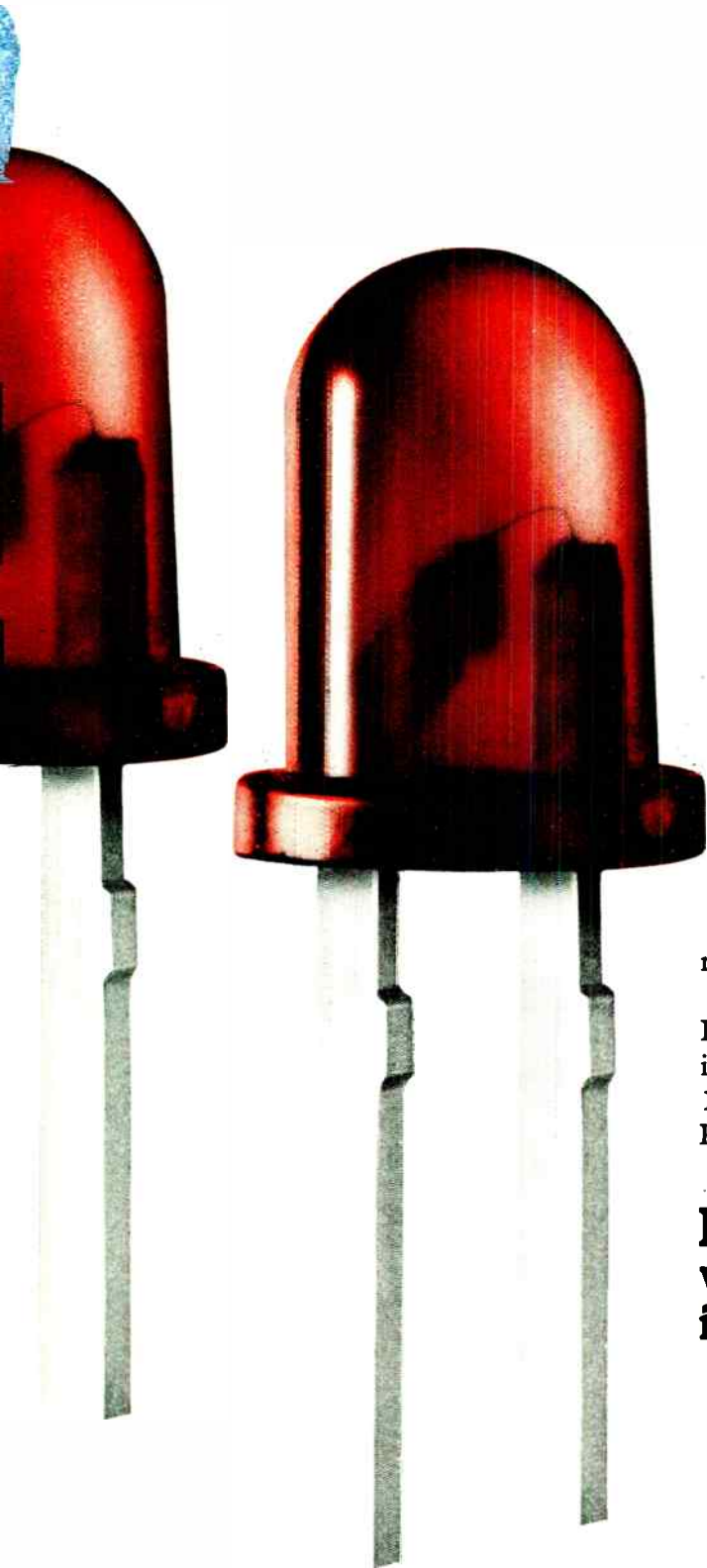

Dead batteries! Everyone hates 'em. And most battery powered equipment—cameras, tape recorders, calculators—don't warn you until it's too late.

Now Litronix—the world's largest manufacturer of LEDs—introduces the RLC-400 Battery Status Indicator. It's a red GaAsP warning light and voltage-sensing IC combined in one little T-1 lamp package. The light is on at 3V, off at 2V.

One of the nation's most prominent camera manufacturers uses it. Any battery-powered device that uses it may acquire an important competitive advantage at low cost.

The Litronix Battery Status Indicator will cost you only 60¢ in quantities of 1000. And you keep production costs down because you don't have to test, assemble and inventory several components.

If you need a warning light that goes on and off at different voltages, get in touch with us. We may be able to help you.

You can get a free sample of the Battery Status Indicator by writing us on your company letterhead. Or if you want more information quick, contact Litronix, 19000 Homestead Road, Cupertino, California 95014. Phone 408-257-7910. TWX 910-338-0022.

**No wonder
we're No.1
in LEDs**

litronix

a little A-300 goes a long way.



In high frequency transmission. RF power generation for industrial and research processes. RFI/EMI and general laboratory applications, too.

The Model A-300 is a totally solid state power amplifier, covering the frequency range of 0.3 to 35MHz with a gain of 55dB. Capable of delivering 300 watts of linear Class A power and up to 500 watts in the CW and pulse mode, the A-300 is the ultimate in reliability.

Although the unit is perfectly matched to a 50 ohm load, it will deliver its full output power to any load (from an open to a short circuit) without oscillation or damage.

Complete with power supply, RF output meter and rack mount, the A-300 weighs a mere 89 pounds and operates from ordinary single phase power.

High power portability goes a long way for \$5350.

For further information or a demonstration, contact ENI, 3000 Winton Road South, Rochester, New York 14623. Call 716-473-6900 or TELEX 97-8283 E N I ROC

ENI

The World's Leader
in Solid State
Power Amplifiers

People

Schulke moves to manage IEEE



New. Maj. Gen. H.A. Schulke, Jr., right, will take over next year as IEEE's general manager.

During his rise to the directorship of communications-electronics for the U.S. Joint Chiefs of Staff, Maj. Gen. Herbert A. Schulke, Jr., gave new meaning to the Gilbert and Sullivan line that "he is the very model of a modern major general."

"Judd" Schulke is a specialist who supplemented his 1946 bachelor of science from West Point with a doctorate in electrical engineering from the University of Illinois. And on Jan. 1, 1975, when he leaves the Army to succeed the retiring Donald G. Fink as general manager of the Institute of Electrical and Electronics Engineers, Dr. Schulke—"I prefer doctor to general," he says quietly—looks forward to becoming a model modern manager. Considering the JCS management responsibilities he has mastered, he should not find the transition difficult.

"I consider this the greatest opportunity of my life," says Schulke, 51, of his new job, one whose title is due to be broadened soon to that of executive director. As an IEEE Fellow and a lifetime engineer, he sees new opportunities for the Institute in offering its members programs in continuing education, development of professional standards, better information on engineering salary

scales, better industry employment statistics through updated Government job-identification codes, and implementation of a new pension plan that will prevent engineers from losing benefits each time they change jobs.

Traveller. Work on those last two categories is expected to bring Schulke to Washington more frequently than his predecessor. And the IEEE clearly sees the JCS communications chief's special knowledge of the Federal bureaucracy as a distinct asset in getting increased Government cooperation.

Schulke may also receive interesting feedback from his oldest son, Lt. Herbert A. Schulke III, who is creating a tradition for the fam-

ily by commanding a communications outfit at an army post in the South. The younger Schulke is very likely to be using hardware there that was earlier approved by his father as chief program planner for the deputy director of defense research and engineering.

Curry gears Monolithic to n-channel MOS

After giving up on metal oxide semiconductors about a year ago to concentrate on bipolar memories, Monolithic Memories Inc. has again changed its course. And if the Sunnyvale, Calif., semiconductor manufacturer meets its goal of shipping

Reentry. Joe Curry's experience makes n-channel MOS processing seem easy.



Join 'em... the growing crowd using MOSTEK's 16-pin 4K RAM!

The crowd of MOSTEK's 4K RAM users continues to grow. Why this preference for MOSTEK's 16-pin MK4096 over 22-pin alternates? Let's review a few of the reasons:

MOSTEK saves you memory board space. You can pack over twice the memory in the same board space as the 22-pin designer, without increasing power dissipation. The result is a more compact and efficient system.

MOSTEK leads in 4K performance. Check the comparative performance table for proof!

MOSTEK gives you direct compatibility with TTL, DTL, ECL and CMOS. The MK4096 will interface

directly with these popular logic families *without* the special high-voltage clock drivers required by 22-pin RAMs. Fewer address drivers are required also.

COMPARATIVE PERFORMANCE—16-PIN VS 22-PIN RAMs

PARAMETER	MOSTEK	2107	4030
Power Diss.	375 mW	425 mW	690 mW
Input Levels			
Input 0 (Max)	0.8	0.8	0.6
Input 1 (Min)	2.4	3.0	2.2
Output Levels			
Output 0 (Max)	0.4 at 2 mA	0.45 at 1.8 mA	0.4 at 3.2 mA
Output 1 (Min)	2.4 at 5 mA	2.4 at 100 μ A	2.4 at 2 mA
Access Time	300 ns	300 ns	300 ns
Read Cycle Time	425 ns	500 ns	470 ns
Write Cycle Time	425 ns	700 ns	470 ns
Output Data Hold Time	260 ns	40 ns	30 ns
Clock Characteristics	2 TTL Clocks 7 pF	One 12V Clock 21 pF	One 12V Clock 27 pF

MOSTEK's 4K RAM is easy to use. You can use readily available automatic handlers both for incoming test operations and in circuit board assembly. Not so with 22-pin versions!

Want still more reasons to join the MOSTEK 4K RAM team? Then contact MOSTEK at 1215 West Crosby Road, Carrollton, Texas 75006, (214) 242-0444—or your local MOSTEK distributor or representative. In Europe contact MOSTEK GmbH, TALSTR 172, 7024 Bernhausen, West Germany, Tel. (0711) 70 10 96.

MOSTEK

Circle 15 on reader service card

MOSTEK moves forward...in memories.

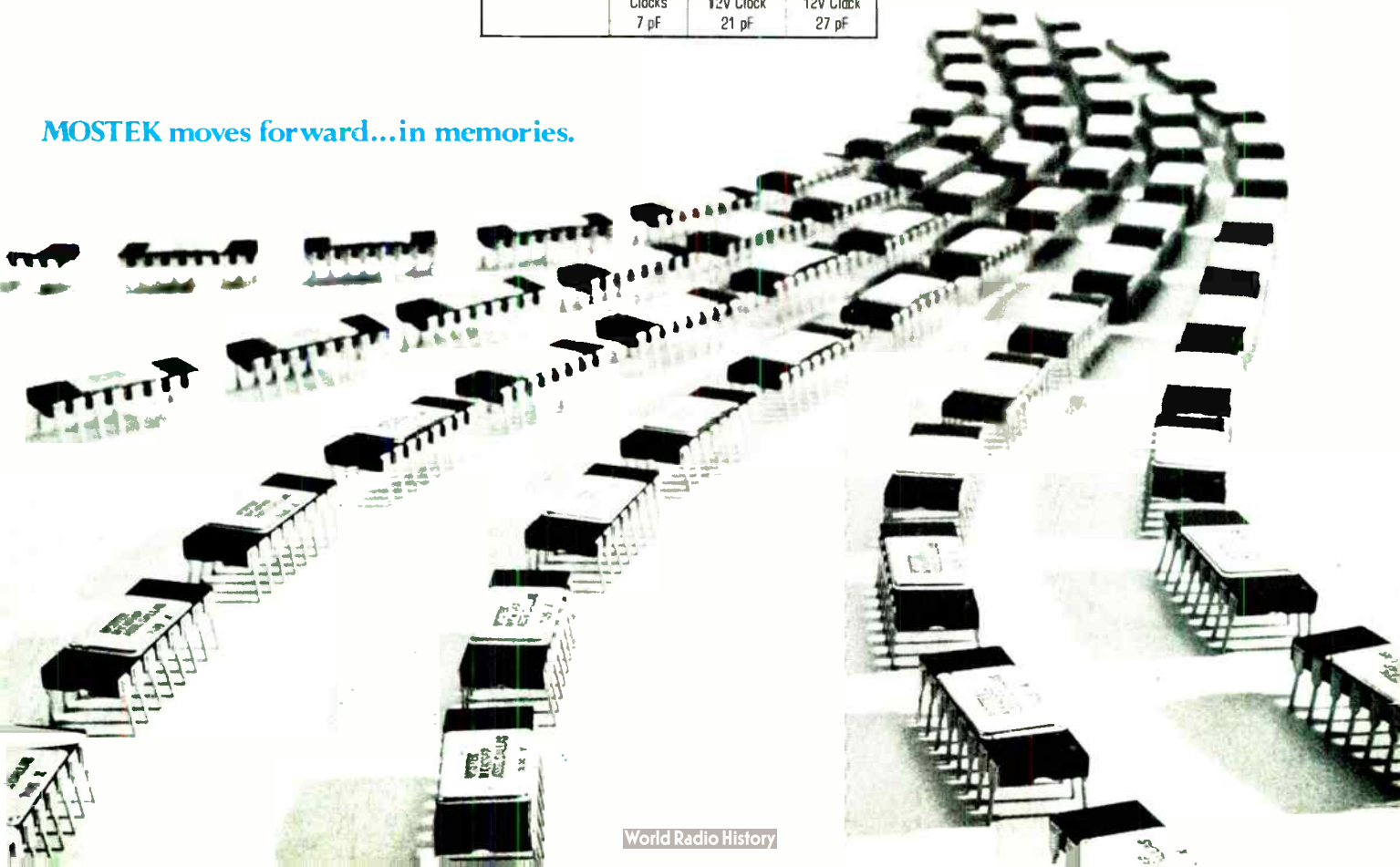

What You Should Know About...

Miniature High Voltage Resistors

new Mini-Mox resistors offer 100 ppm TCR plus low noise characteristics

If you are responsible for design of high-voltage, highly-stable miniaturized electronic networks and equipment, the new Mini-MOX resistor can be a life saver. Mini-MOX resistors have all the ingredients you need to cook-up new designs for ultra-critical applications. For instance, Mini-MOX resistors are a fraction the size of conventional types; they meet or exceed MIL-R-10509-F for environmental parameters . . . 100 ppm or less; stability better than $\pm 2\%$ for 2,000 hours at full load; low-voltage coefficient less than 5 ppm/volt, measured between 100 volts and

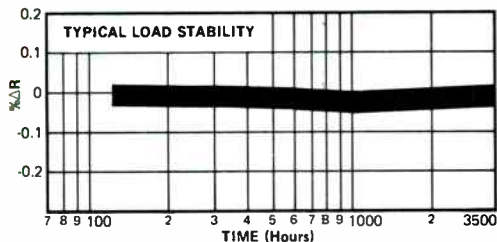
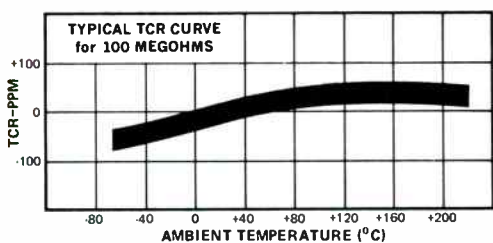

Model	Resistance	Rating @70°C	*Max. Dper. Volts	Length Inches	Diameter Inches
MOX-400	1-2500 megs	.25W	1000V	.420	.130
MOX-750	1-5000 megs	.50W	2000V	.790	.130
MOX-1125	1-10,000 megs	1.00W	5000V	1.175	.130

in addition, typical quantech noise at 20 megohms is less than 0.5 microvolt/volt.

All these characteristics combine to provide extremely-rugged and highly-stable resistor configurations that are virtually immune to environmental extremes. Available off-the-shelf in a wide range of resistance values, Mini-MOX resistors are ideally-suited for high-voltage applications where long-term stability and power-to-size ratios are critical.

Write for complete Technical Data Sheet on Mini-MOX Resistors: Victoreen Instrument Div. of VLN Corp., 10101 Woodland Avenue, Cleveland, Ohio 44104. Telephone: 216/795-8200



Expertise in high voltage

DMA 557

People

new MOS devices early in the second quarter of 1975, it will be Joseph Curry who helps pull it off.

Curry, an up-and-coming and aggressive 30-year-old specialist in process technology, has impressive credentials. Besides holding a bachelor's degree in electron physics and a doctorate in metallurgy and materials science, Curry spent three and a half years at the prestigious Bell Laboratories, where he became head of digital development at the Allentown, Pa. facility.

Following this, he put in two years at Electronic Arrays Inc., Mountain View, Calif., where, as director of process technology, he was instrumental in moving that company's n-channel, silicon-gate MOS process from pilot to production line. It's just this kind of process that Monolithic Memories hopes to get onstream. Very likely, the company has been influenced by forecasts that MOS alone of the semiconductor technologies will show any growth in the years ahead [*Electronics*, Oct. 31, p. 27].

Repeat. Curry is sure he can do the same for Monolithic Memories as he did for Electronic Arrays—and in much less than the year to 18 months it normally takes to set up such an operation. "All it takes is knowing what you are doing and where you are going, as well as a corporate commitment to get there," he says. "And we've got all three ingredients."

Monolithic Memories is concentrating on "high-performance memories of 1 kilobit and up," he continues. The first product, a 1,024-bit n-channel silicon-gate random-access memory, is nearing the pilot-line stage after only a three-month effort that began shortly after Curry joined the company last August. A 40,000-square-foot production-line facility devoted to n-channel MOS will be completed in February 1975. The move from pilot line into production should happen shortly after.

Curry hasn't the slightest doubt that he will put his company into the MOS marketplace on schedule. "If I weren't confident that we could do it," he says, "I wouldn't have tried in the first place."

EMI FILTER CAPITAL OF THE WORLD

**FROM CERAMIC POWDER TO MIL-APPROVED TEST LAB...
ERIE HAS IT ALL, UNDER ONE ROOF**

Only one company can deliver your total EMI Ceramic Filter needs... ERIE. We've been applying sophisticated ceramic and related technologies to developing superior filters for 35 years. Today ERIE has, by far, the broadest line of subminiature EMI Filters in the world. From tiny high frequency filters to broad band filters to custom filter assemblies, ERIE offers the ultimate in quality. And you get single-source responsibility too, for we build the complete filter in a plant devoted exclusively to the design and manufacture of EMI Filters. So come to ERIE for your filter needs. We'll put a team to work on your particular application. Aerospace. Communications. Avionics. Industrial Equipment. Whatever the market, we can help eliminate electromagnetic "noise" and emissions. In the meantime, write for our complete catalog... EMI Filters or call 613/392-2581.

ERIE TECHNOLOGICAL PRODUCTS, INC.

Erie, Pennsylvania 16512

Circle 17 on reader service card

ERIE





**Your problem is data input and storage.
The answer is ready to ship.**

**The TU60 cassette mag tape recorder.
Proven. Reliable.
Priced at \$1600 in quantities of a hundred.**

Maybe you're storing numerical control data, communications messages, or data logged from instruments.

Maybe you're involved with program development, file searching, or remote control storage.

Or maybe you want to store your data in small, rugged, portable packages.

The TU60 cassette mag tape recorder is the answer.

We designed the TU60 specially for accuracy and reliability.

The mechanics are simple and sturdy: the TU60 is tough. Its extra-heavy 1 mil tape resists stretching and edge wear; it's spec'd at 1000 passes, with a typical life of 6000. Reel-to-reel drive and servo-controlled motors give smooth, easy starts and stops, with no capstans, pulleys or pinch rollers that could damage tape.

Power variation or mechanical difficulty won't cause mistakes either: the read electronics adapt to tape speed. Each data record is terminated with 16 bits of cyclic redundancy checking. The machine reads even very low data levels, yet rides right over any noise between the data blocks. Other error reducing features include automatic leader detection and single-track low-density recording.

With an error rate ten times lower than that of most other systems, the TU60 is a machine you can count on.

Maintenance is rarely necessary. When it is, it's no problem. The top flips open, everything is acces-

sible, and the two main modules can be replaced in minutes.

The TU60 is easy to interface to any major minicomputer — if you want, we'll even design and manufacture the interface for you.

And compared to paper tape, the TU60 is easier to handle, less messy, and a lot more versatile. (Ever try to erase a hole?)

Look at the price: \$1600 each in quantities of a hundred. Low? Low.

So pick up the phone and dial 800-225-9480. Toll-free from 8:30 AM to 5:00 PM Eastern time.

(US only. Massachusetts residents, please dial (617) 481-7400, extension 6653.)

We're the Components Group of Digital Equipment Corporation, One Iron Way, Marlborough, Massachusetts 01752.

In Canada: Digital Equipment of Canada Limited, P.O. Box 11500, Ottawa, Ontario, K2H8K8. (613) 592-5111; extension 154.

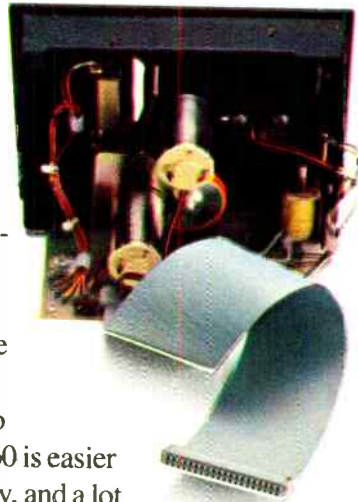

digital
COMPONENTS
GROUP

**Unbundling the world's most
popular minicomputer systems.**

Circle 19 on reader service card

FLAT INTERCONNECTS YOUR COMPLETE SOURCE

Ribbon Cable / IC Interconnects / Custom Harnesses

You're sold on flat cable, now buy it at its best. Precise, compact cable packages to fit your specifications perfectly, computer-loomed for unmatched versatility by Woven Electronics.

Handling ease of independent non-bonded leads speeds production, cuts cost, while technical characteristics outrank other flat cable forms.

Make Woven your source for jumpers, continuous rolls, special harnesses, all your interconnect needs.

WOVEN ELECTRONICS

P.O. Box 189 Mauldin, South Carolina 29622
803/963-5131

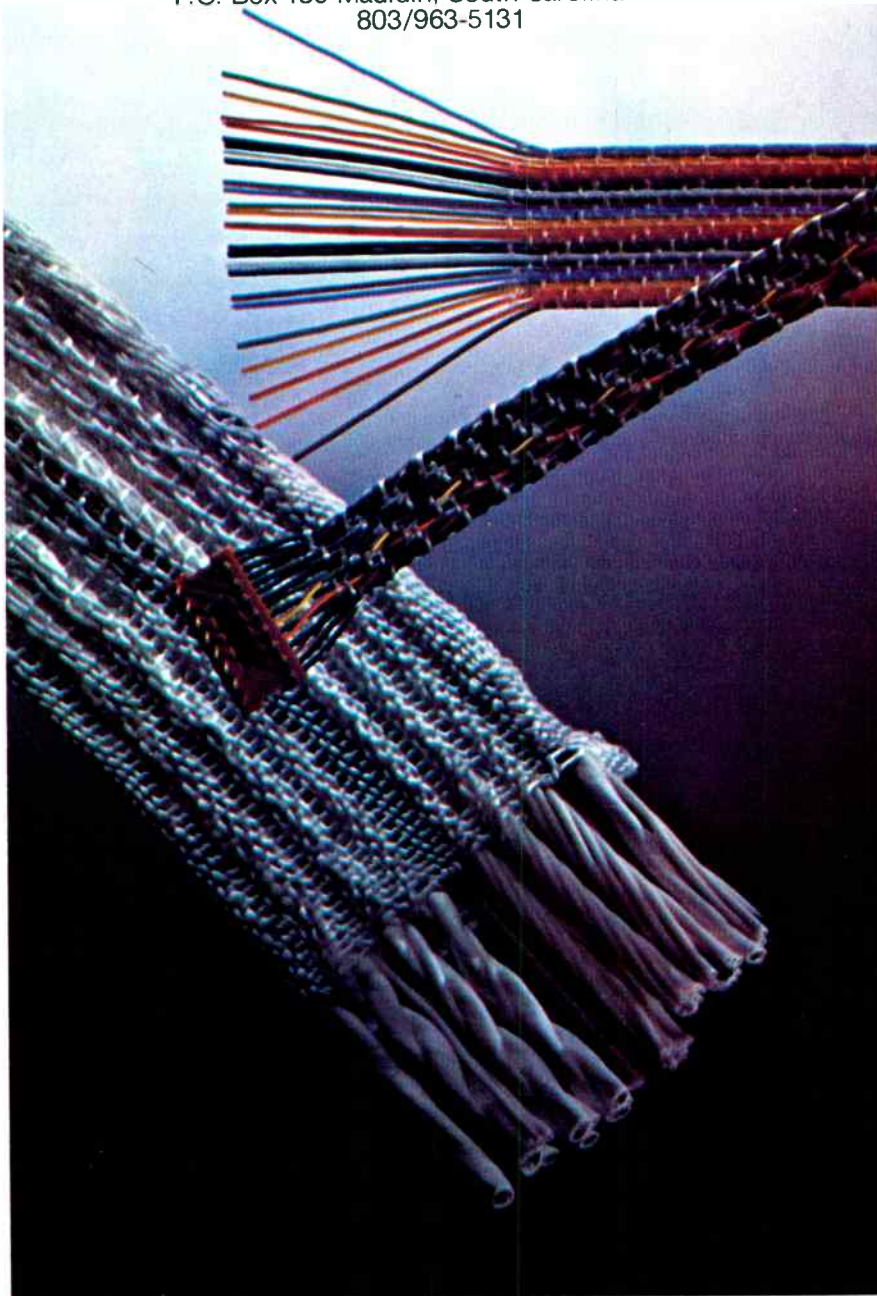

Meetings

International Semiconductor Laser Conference, IEEE, Atlanta Inn, Atlanta, Ga., Nov. 18-20.

Communications Transmission Seminar on Wideband Analog Cable Systems, IEEE and Princeton University, Engineering Quadrangle, Princeton, N.J., Nov. 19.

Specialist Conference on Technology of Electroluminescent Diodes, IEEE, Atlanta Inn, Atlanta, Ga., Nov. 20-21.

Electronica '74—International Fair on Components and Production Equipment, Munich Fair Co., Munich, Germany, Nov. 21-27.

Sixth International Congress on Microelectronics, IEEE et al., Congress Hall and Fairgrounds, Munich, Germany, Nov. 25-27.

First National Microprocessor Conference, Arthur D. Little Inc., Sheraton-Boston Hotel, Boston, Dec. 2-3.

National Telecommunications Conference, IEEE, Sheraton Inn, Harbor Island, San Diego, Calif., Dec. 2-4.

Eighth Asilomar Conference on Circuits, Systems, and Computers, Naval Postgraduate School (Monterey, Calif.), IEEE, et al., Asilomar Hotel and Conference Grounds, Pacific Grove, Calif., Dec. 3-5.

International Colloquium on Complex Integrated Circuits, Fédération Nationale des Industries Electroniques (Paris, France), Paris, Dec. 3-6.

Twentieth Annual Conference on Magnetism and Magnetic Materials, IEEE and AIP, Jack Tar Hotel, San Francisco, Calif., Dec. 3-6.

International Electron Devices Meeting, IEEE, Washington Hilton Hotel, Washington, D.C., Dec. 9-11.

ICMB 74, International Conference on Magnetic Bubbles, IEEE, APS, and IBM Corp., IBM Research Laboratory, San Jose, Calif., Dec. 9-11.

SOLID ROCK

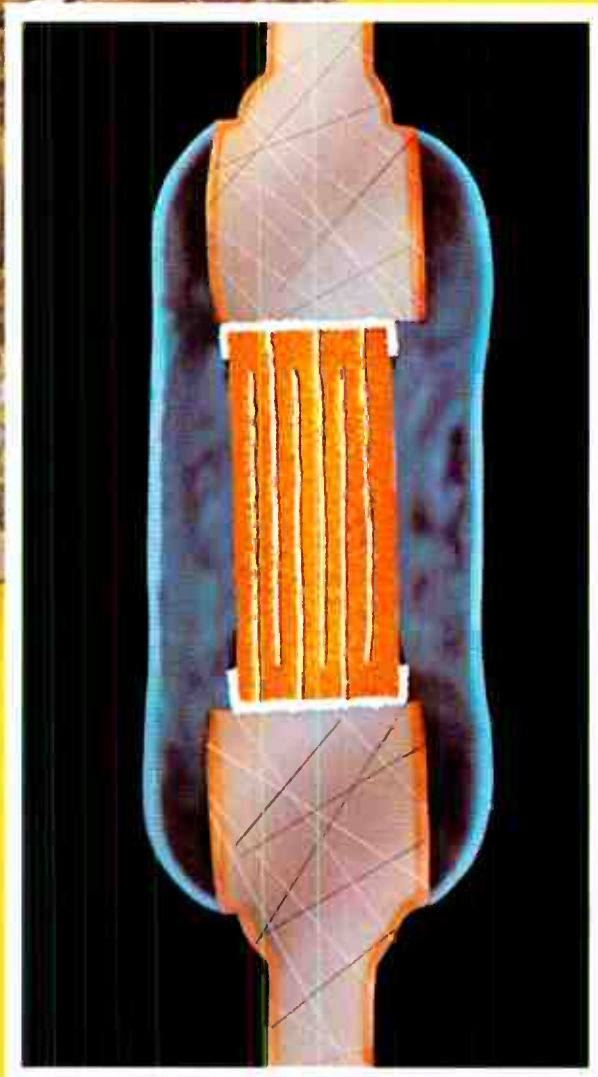

ROCK SOLID

The most solid, stable glass-sealed ceramic capacitors around. Processed with unique and proprietary techniques (patents pending). That's what makes GTI/Tensor's glass-sealed ceramic capacitors as solid and tough as a rock. Results:

- **No point contact resistance**
- **50% lower ESR**
- **Dielectric stability**
- **Higher insulation resistance**
- **Greater volumetric efficiency**
- **Smaller size (resulting in greater component density on the board)**

Body characteristics available: NPO (COG), X7R (BX) and Z5U (GP).

GTI/Tensor tapes and reels your order for automatic insertion.

For hard facts and rock-solid deliveries, write or call us or one of our representatives; while you're at it ask for our new catalogs on Glass Sealed Ceramic Capacitors and Monolithic Chip Capacitors.

 **tensor**
electronics, inc.
A SUBSIDIARY OF GTI CORPORATION

11558 Sorrento Valley Road
San Diego, California 92121
(714) 453-7262 Telex: 69-5056

Circle 21 on reader service card



New solderless
Micro Pierce™ Connector.

Amphenol connector system

Choose from the most widely accepted solder-type connectors available or from the *newest* solderless connectors on the market. Either way the Blue Ribbon® connector family gives you proven reliability.

More than 250 million Micro Ribbon

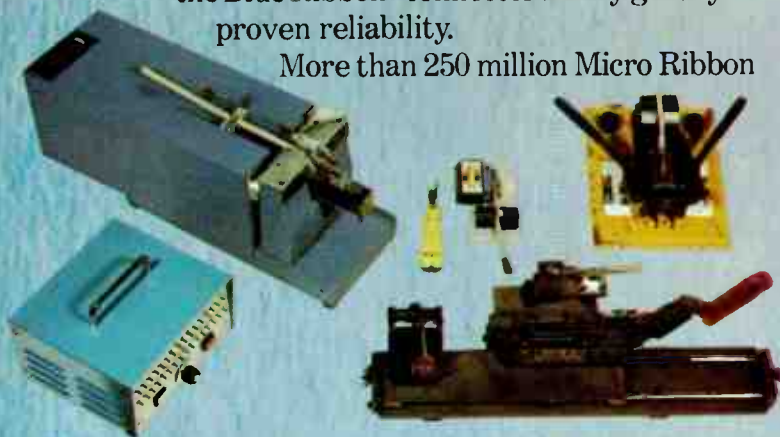

solder-type connectors have been put into telephone industry service since 1957. And we've never had a single reported connector failure. That's proven reliability.

Amphenol's new Micro Pierce solderless connectors offer the same quality and reliability plus important extras. Like cost savings, convenience and speed. You can now terminate cables in the field to the exact lengths you need. Save thousands of dollars in cable costs alone. Save on termination costs, too. Terminate a 25-pair connector in the field in less than 5 minutes with our field termination tool kit. Or less than 4 minutes with our semi-automatic tool. Factory or central office termination takes only 2



Proven solder-type
Micro Ribbon® Connector.

Blue Ribbon® gives you the choice.

minutes with the new automatic termination machine.

You also get individual conductor strain relief to prevent "opens" caused by cable flexing.

Micro Pierce solderless connectors are completely intermateable and intermountable with the millions of Micro Ribbon solder-type connectors and bridging adapters already in service.

And the price is no higher. So your choice is simple. Use the one that best fits

your individual needs.

Both use the same standard Blue Ribbon hardware and accessories. And both have telephone industry acceptance plus second source availability.

Get the whole package from Amphenol. Connectors, termination equipment, hardware and accessories. Whether you buy cable assemblies from an outside supplier or make them yourself, you can't get a lower installed cost.

Call for details, a demonstration and samples for evaluation. Or, write for new catalog. Amphenol Industrial Division, Bunker Ramo Corporation, 1830 S. 54th Avenue, Chicago, Ill. 60650. (312) 242-1000.



**BUNKER
RAMO**

AMPHENOL

Circle 23 on reader service card

There's only one cermet film resistor with enough design improvements to set a new standard of quality.

Ultra thick solder coated wire leads are both weldable and solderable.

Capless design does away with problems associated with end cap construction.

Conformal coating provides outstanding insulation properties.

Alumina core is physically and thermally strong to resist fractures.

Crisp, clear, dual markings for easy identification.

We blended our extensive fixed resistor knowhow with 15 years of cermet experience to produce an outstanding cermet film resistor. And we've developed unique manufacturing techniques that let us provide consistent quality.

Available in preferred resistance values (E96 Series) from 10 ohm to 1 meg; higher values available on special order. 1/4 watt at 70°C; 1/8 watt at 125°C; 1% tolerance; 100 PPM. Size 0.250 L. by 0.090 D.

Available in tape reels if you prefer.

Approved to MIL-R-10509 for Style RN55, Characteristic D. Write Allen-Bradley Electronics Division, 1201 South Second Street, Milwaukee, Wisconsin 53204 for complete technical details on Type CC. International Division, Milwaukee, Wisconsin 53204. Canada: Allen-Bradley Canada Limited, Cambridge, Ontario. United Kingdom: Allen-Bradley Electronics, Limited, Jarrow, County Durham NE32 3EN.

If you're really serious about cost, be serious about quality.

Circle 24 on reader service card



ALLEN-BRADLEY

Milwaukee Wisconsin 53204

World Radio History

EC69

Problems seen in TI watch works

Texas Instruments' decision to postpone its entry into the consumer digital watch market was due at least partly to problems with the watch itself, say well placed sources [*Electronics*, Oct. 31, p. 29]. Those sources mention **exposed wire bonds, low-capacity batteries, and a faulty rotary switch for making time settings** as the defects. They also feel that the problems may force the semiconductor giant to take another look at its plans to enter the market initially through sales of its digital modules to traditional watchmakers for use in their models.

Carlson ousted as head of Rockwell Microelectronics

R.S. "Sam" Carlson has been eased out as president of the Microelectronics Group at Rockwell International's Electronics Operations. His replacement is Don A. Mitchell. The move comes as **the company is experiencing heavy setbacks in MOS-chip production.**

Under Carlson, who has headed Rockwell's MOS activities since they achieved division status in 1969 [*Electronics*, April 14, 1969, p. 33], **sales have grown from \$20 million in 1970 to \$180 million this year.** Under him, the group produced the first commercial MOS calculator (for Japan's Sharp), and expanded into finished calculators—including, this year, a line carrying the Rockwell name.

Carlson will become vice president and assistant to Donn L. Williams, president of the Electronics Operations. Mitchell retains the title of executive vice president in control of microelectronic (MOS) devices, products (calculators), business equipment (the former Unicom Systems), and Britain's Sum-Locke Anita.

RCA pushes SOS despite skepticism

RCA is moving steadfastly ahead with its silicon-on-sapphire IC program, despite growing skepticism by competitors of SOS' worth. Such semiconductor manufacturers as Texas Instruments, Intel, and National Semiconductor **doubt that the cost of developing SOS devices is worth their advantages** over devices made by established technologies.

RCA is introducing a host of new standard C-MOS circuits on sapphire substrates that are aimed at both digital processing and timekeeping functions. A 4-megahertz timing circuit for analog electronic watches is now ready for sampling. Because the circuit runs at higher frequencies than today's standard 32-MHz circuits, it can be driven by a smaller, cheaper 4-MHz crystal. A digital-readout SOS circuit will follow. Planned for first-quarter introduction is a 1,024-bit C-MOS-on-sapphire RAM (see p. 42) aimed at high-speed buffer and cache-memory systems for computers. In addition, selected standard circuits from the company's large 4000 family **will be produced on sapphire to boost their performance into the mainstream of data-processing applications.** Among these are SOS versions of the 4017 decade counter/divider, the 4040 12-stage binary ripple counter, the 4066 quad bilateral switch, and the 4518 synchronous dual BCD counter.

Signetics offers field-programable logic arrays

The future of programable logic arrays has been greatly enhanced by a **field-programable device developed by Signetics.** Until now most PLAs, which many designers predict will become the next generation of control circuits for microprocessors, have been mask-programable

only. The Signetics design is programmed by applying current to "blow" nichrome lines in the desired program configuration, much in the manner of programmable read-only memories. The PLA will have 16 inputs, 8 outputs, and an access time of 50 nanoseconds. It is scheduled to be introduced in the second quarter.

First zener IC due from National

After more than two years of development, National Semiconductor of Santa Clara, Calif., has come up with an integrated voltage reference on a chip, **the first zener function ever made in IC form.** Planned for the first quarter, the part is specified at 0.1 ppm per degree centigrade drift; a long-term stability of 100 ppm (or 0.01%); a dynamic impedance of 1 ohm (compared to 15 ohms ordinarily); and a current drain of 200 microamperes. **It will be the first in a family** of zener-type ICs to be introduced over the next year.

N.Y. convention hall to get integrated communications

Goldmark Communications Corp. has landed the initial contract to study telecommunications needs for the proposed \$200 million New York City Convention Center. If the complex is built, over the objections of neighborhood groups, **Goldmark Communications could eventually be responsible for designing, purchasing, and installing a complete communications network.** The system would include management information, security and safety, teleconferencing, TV broadcasting, possibly through satellites, and audio-visual systems.

SMS to build microcomputer

Scientific Micro Systems of Mountain View, Calif., formerly Signetics Memory Systems, is re-emerging after two years in the doldrums and an infusion of new capital from its parent company, Corning Glass Works—**this time as a microcomputer house.** By year-end, SMS will make available a proprietary "MicroController" that will be a complete microcomputer system incorporating an in-house-developed bipolar Schottky microprocessor with a cycle time of 300 nanoseconds. Combined with unique system architecture, the SMS microcomputer will allow control sequences to be executed up to 100 times faster than many currently available microprocessor systems.

Low power featured by field-effect LC display

Field-effect liquid-crystal displays with direct-current time-shared multiplex drive have been developed for digital multimeters and panel meters by Shinshu Seiki Co., a manufacturer of watches and printers. The company, which will start sales by year-end, hopes to take business away from light-emitting diode and fluorescent tubes **because the new dynamic displays reduce power requirements by an order of magnitude.**

Addenda

TI says more layoffs will follow the 2,250 in Taiwan and Singapore. Some 490 also were furloughed at U.S. and other operations, **and another 2,500 to 3,000 will be laid off in the fourth quarter.** . . . At the same time, Motorola Semiconductor is laying off 3,000, including 2,000 in Phoenix. . . Electronics firms plan to **increase capital spending by 8%** next year, but cut back 1% in 1976, according to the latest McGraw-Hill capital-spending survey.

Perfect for power supply design.

Unitrode's new ESP Power Switch provides the power transistor and catch diode functions required in switching regulator applications. One convenient package delivers the extra *Efficiency, Speed, and Power* needed to improve response time over regulating components commonly used in power supplies...and at no extra cost.

Unitrode selects and matches its exclusive ESP high speed rectifiers and power transistors to produce a single, plug-in TO-66 package...saving hours of design time.

This new ESP power switch operates with more than 80% efficiency. That's at least 15% better than most switching regulator circuits. Switching rates can be increased from the normal 10-20 KHz to 50 and even 100 KHz. And the ESP power switch can be driven by any IC regulator with no external biasing required.

Since no diode recovery spike is generated, there's less noise and RFI. Circuit designers can use a smaller LC filter, further reducing total power supply size, weight and cost.

For detailed specifications and performance characteristics on both 5A and 15A units, send for our ESP Power Circuit literature. Or, for faster action call Ernie Crocker at (617) 926-0404.



New Unitrode ESP Switching Regulator Power Switch

**Available
off the shelf**

Type	Max. Output Current I_1	Max. Input Voltage V_{1-2}	Typical Efficiency η^*	Typical Rise Time t_{rv}^*	Typical Fall Time t_{fv}^*
POSITIVE OUTPUT					
PIC600 PIC601	5A	60V 80V	85% @ 2A	30nSec	50nSec
PIC625 PIC626	15A	60V 80V	82% @ 10A	45nSec	70nSec
NEGATIVE OUTPUT					
PIC610 PIC611	-5A	-60V -80V	85% @ -2A	40nSec	50nSec
PIC635 PIC636	-15A	-60V -80V	82% @ -10A	50nSec	65nSec

*Measured with $V_{in} = 25V$, $V_{out} = 5V$, $f = 20$ KHz, Input pulse width = 0μ Sec
See Electronics Buyers' Guide Semiconductors Section for more complete product listing.

Circle 27 on reader service card

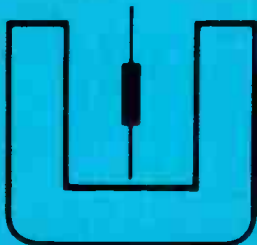

UNITRODE

58C PLEASANT STREET, WATERTOWN, MA 02172

World Radio History

Cut your design costs

with our optimized 27 dB gain combined
units for FM broadcasting

TH 361
+ TH 18106 cavity
for **10 kW**

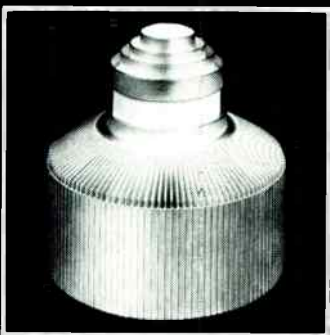

TH 298
+ TH 18104 cavity
for **3 kW**



two unparalleled solutions with
Pyrobloc[®] grid tetrodes



THOMSON-CSF

Circle 28 on reader service card

THOMSON-CSF ELECTRON TUBES, INC / 750 BLOOMFIELD AVENUE CLIFTON NJ 07015 / TEL. (201) 779 1004 / TWX : 710 989 7140

France - THOMSON-CSF Groupement Tubes Electroniques / 8, rue Chasseloup-Laubat / 75737 PARIS CEDEX 15 / Tel. (1) 566 70 04

Germany - THOMSON-CSF Elektronenröhren GmbH / Am Leonhardsbrunn 10 / 6 FRANKFURT/MAIN / Tel. (0611) 70 20 99

Italy - THOMSON-CSF Tubi Elettronici SRL / Viale degli Ammiragli 71 / ROMA / Tel. (6) 38 14 58

Japan - THOMSON-CSF Japan K.K. / Kyosho Building / 1-9-3, Hirakawa-cho / Chiyoda-ku / TOKYO 〒102 / Tel. (03) 264 6341

Sweden - THOMSON-CSF Elektronrör AB / Box 27080 / S 10251 STOCKHOLM 27 / Tel. (08) 22 58 15

United Kingdom - THOMSON-CSF Electronic Tubes Ltd / Bilton House / Uxbridge Road / Ealing / LONDON W 5 2TT / Tel. (01) 579 55 11 / Telex 26 659

World Radio History

TI readies family of bipolar parts aimed at processor designs

Dallas company draws bead on TTL computer, peripheral customers with new family of fast Schottky components

The wraps are off the long-awaited decision on how Texas Instruments will enter the growing micro-processor business. The company will go after the computer and peripheral market—heretofore served by TI's own transistor-transistor logic—with a family of LSI bipolar processor products that include both integrated injection logic and compatible Schottky TTL devices.

This family of medium- and high-performing circuits will be aimed squarely at TI's present digital bipolar TTL customers—the mini-computer and peripheral manufacturers who make up the bulk of the company's standard 54/74 TTL and Schottky TTL product sales. This is in sharp contrast to most micro-processor suppliers, who generally have pitched their n- and p-MOS devices at an emerging, new controller market that hitherto had no pro-

grammable computer capability.

TI has already been quietly introducing some of its bipolar processor parts to principal customers as extensions to the TI Schottky family. Formal introduction is scheduled for 1st quarter 1975. Among these processor-oriented products are byte-organized PROMs, first-in first-out buffer memories, bipolar RAMs, byte-sized input/output ports, high-speed 8-bit shift registers, counters,

But since the new Schottky parts, which can operate at speeds as high as 70 to 100 megahertz, are clearly capable of more performance than is needed for either an n-channel or I^2L central processor, there's no reason to believe that TI won't eventually be offering a full-performance Schottky TTL central processor, such as the kind already being offered by makers such as Intel, Monolithic Memories, and others.

Significantly, no accompanying software package is being contemplated in TI's processor program. Again, unlike other micro-processor manufacturers, TI is clearly aiming its processor program at the established computer customer in an industry that already has a high level of software development.

Shunning the new n-channel controller business and leap-

frogging into the performance range that competes with its own TTL dominance was apparently a tough corporate decision for TI to make. But planners had determined that because standard TTL had reached the decline point in the product life-cycle, it would gradually give way to the newer, more cost-effective, pro-

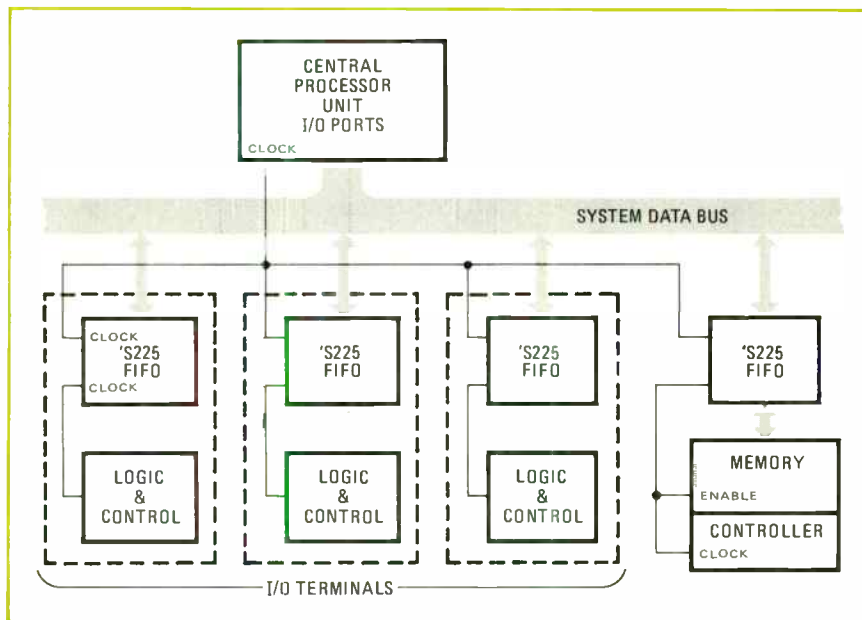

Example. TI's new LSI Schottky technology is likely to be applied in first-in first-out memory device of 400-gate complexity for remote terminal or memory interface.

and octal bus drivers.

Star. As for the processor itself, it's no secret that TI is close to an LSI device built with integrated injection logic that promises two to five times higher performance than today's n-channel microprocessors, and that's destined to play the central role in TI's new Schottky LSI family.

gramable LSI designs.

And although this replacement is not expected to occur overnight, they want to have their own LSI circuits when it happens. As Charles Clough, vice president of marketing, puts it: "This is an innovative business. If you don't innovate, someone will innovate for you."

But the company has not launched its expensive developmental enterprise simply to replace itself in old designs. Instead, it is looking to expand the market as it did with conventional TTL products.

"True, by leapfrogging n-channel designs," says M. Douglas Rankin, market manager, digital circuits, "we are going straight to the heart of existing computer designs—our traditional TTL users in the medium- and high-performing minicomputer and peripheral market. But with our new LSI programable family we'll let these manufacturers emulate their own machines with upgraded LSI bipolar designs at lower LSI prices."

TI's hope is that these manufacturers will, using existing software, be able to penetrate new low-cost markets with higher-performing systems. Says Rankin, "With a general-purpose bipolar LSI processor family, they can compete even in the low-end n-channel controller market as well as enlarge their share of the minicomputer market." □

4-kilobit RAMs get smaller, run faster

Now that certain semiconductor memory suppliers have developed their processes to manufacture 4,096-bit random-access memories, they are gearing up for large-scale production in 1975 with significantly faster and smaller parts. For example, Intel Corp., Santa Clara, Calif., in a surprise move, has developed its higher-speed "B" version with a single-transistor cell structure, similar in concept to the structure used in Texas Instruments' TMS4030 RAM.

The technique offers Intel a significantly smaller die size (about 16,000 mil²) than its current 2107A part, as well as a maximum access time of about 200 nanoseconds, a third faster than the 2107A. The new product, which Mike Markkula, North American marketing manager, says will be available in December, is clearly what industry observers have in mind when they predict the death of core memories. Markkula predicts that a high-speed random-access-memory that sells at only 0.1 cent per bit is around the corner.

Concurrently a 22-pin 4-kilobit

RAM is also going through design iterations at Texas Instruments, Dallas, increasing speed and reducing die sizes. For early 1975 introduction, the 200-ns part is built with an optimized one-transistor cell structure that reduces chip space by an undisclosed but considerable amount.

Ed Huber, marketing manager for the product, says that significant reduction in chip area can also be achieved by tightening the design of the chip's peripheral circuitry, which now occupies almost half the chip. This means smaller, more efficient clocks, sense amplifiers, and buffers in the foreseeable future.

Dean Toombs, technology manager at TI, estimates that a 16-kilobit n-channel RAM with an optimized capacitance-type single-transistor cell design, such as TI uses in its present 4-kilobit RAM, is technically possible as early as 1976 on die sizes not significantly larger than TI's present product.

And in Carrollton, Texas, Mostek Corp.'s third iteration of its 16-pin MK4096-P is 127 by 148 mils—only about 80% the size of the original chip. The new version, dubbed the MK4096-6, will be phased into production in the second quarter of 1975, and the company will have selected units operating at an access time of 200 nanoseconds. Mostek, says Dave West, director of marketing, is also close to an alternate-source agreement with a third semiconductor manufacturer. Fairchild Semiconductor is the original second source.

Motorola's Durrell Hillis, manager of p-MOS and n-MOS marketing, claims the latest version of its MCM 6605 has brought "a dramatic yield improvement" with its size of 144 by 166 mils. He adds that some 40% of the smaller dice are operating at 210 ns and the remainder at 300 ns. Hillis is counting on the new memory to crack the large-mainframe market, which he says won't consume significant quantities of the parts until late next year. He says the 4-kilobit-RAM business is "still a real horse race."

Meanwhile, in Santa Clara, Calif.,

What's in TI's new LSI processor family

Along with the Schottky and integrated injection logic bipolar microprocessors that Texas Instruments is planning to produce, the company is offering an expanded family of processor-oriented parts. Many already have been identified and scheduled for first-quarter 1975 entry. Among them are:

- A 45-nanosecond 2,048-bit Schottky TTL programable read-only memory arranged in a 256-word-by-8-bit format for microprocessor designs.
- A 400-gate 20-MHz first-in first-out Schottky memory in a 50%-space-saving 20-pin package that's oriented in a 16-word-by-5-bit processor format for high-speed bipolar processor systems.
- New small bipolar memories built with an inverted (injection-like) array that reduces the cost of bipolar memory design (the first is a 42-ns 256-bit RAM, to be followed by 1,024-bit inverted-cell random-access-memory types).
- Octal latches and multiplexers capable of serving 8-bit input/output ports with 6-ns data throughput.
- 70-MHz 8-bit shift registers for buffer and memory-interrupt data-storage duty.
- 100-MHz 4-bit asynchronous counters.
- Octal bus-drivers capable of managing 8-bit bus systems.

Motorola second-sourcer American Microsystems Inc. is also beating the drum for its smaller chip—identical in size to the Motorola part. But Norman Grannis, AMI vice president and general manager for standard products, says the device will be faster than 210 ns. Even though AMI isn't in volume production, Grannis points to a substantial yield improvement since September, and emphasizes that the company's experience in silicon-gate MOS production will make AMI a contender in the 1975 4-kilobit-RAM derby. He believes demand will top 6 million units next year, and adds that if the major suppliers all make their production milestones, 8 million units could be shipped. □

Medical electronics

Device measures blood oxygen

A number of situations require a doctor to know the ratio of oxygenated hemoglobin to total hemoglobin in a patient's blood: to determine whether the oxygen level is too low, to monitor the effects of exercise, and to control oxygen therapy.

Ordinarily, the doctor takes a blood sample from an artery and sends it to a lab for analysis, a time-consuming procedure that does not allow for continuous readings. But Hewlett-Packard's Medical Electronics division in Waltham, Mass., has developed a device that can give quick and continuous oxygen-saturation readings without a blood sample. Called the model 47201 earprobe oximeter, it analyzes the absorption of light transmitted through the pinna, or top part of the ear, to determine saturation.

The light is generated by a quartz iodine lamp, and passed through a fiber-optic cable to a device that fits over the ear. It is transmitted through the ear, which absorbs some of it, and the rest is sent by another cable to the oximeter. There, a wheel of thin-film interference fil-



Tester. By measuring light transmission through the ear, earprobe oximeter from Hewlett-Packard automatically reads out the amount of oxygen present in the blood hemoglobin.

ters breaks the light into eight wavelengths, in the red and infrared regions, between 650 and 1,050 nanometers in 50-nm increments, excluding 950 nm, a wavelength found not to contribute much to the final result. Eight wavelengths are used to minimize the effects of other optically interfering substances in the ear such as pigment, cartilage, and hair follicles. The absorbance spectrum of hemoglobin, which goes up as wavelength increases, and of oxyhemoglobin, which goes down as wavelength increases, can then be determined.

Volunteers of all races and ages and both sexes were tested, to determine the coefficients of absorbance that provide the best fit of oximeter readings to base-line oxygen satura-

tions determined by an arterial blood tap. These coefficients are stored in a 1,024-bit field-programmable read-only memory and used in a set of simultaneous equations for handling the total absorbance expected for each wavelength.

Once analyzed by the filter, the light is converted to current by a silicon photodetector, gain is added with a current-to-voltage converter, and a triple-slope analog-to-digital converter synchronized with the filter converts the voltage to a 16-bit digital word. A 1,024-bit PROM averager removes noise, and then the signal goes to a digital processor with 1,024 bits of ROM for program storage where equations to determine saturation are done. The result is converted to binary-coded-deci-

mal (BCD) form and sent to a 2½-digit LED display on the front panel. Alternatively, it can be converted to an analog signal for remote recording or display.

While Hewlett-Packard claims an accuracy ranging to within $\pm 1\%$ in the 99-to-100% saturation range and to within $\pm 2.6\%$ in the 60-to-70% saturation range, in tests there has been only a 0.25% variation among five units. And results are available quickly; readings settle 20 seconds after the earpiece is in place, and a change in saturation level can be detected in as little as 1.6 seconds.

The oximeter is quite simple to operate. When power is first turned on, the operator pushes a "STD," or standardization, button, which causes the oximeter to store the light-intensity levels of each wavelength at the open, unattached earpiece. Once the values are stored, the earpiece is attached to the patient, and saturation levels are displayed continuously. Two sets of thumbwheel switches can be used to

set high and low saturation values, and an alarm sounds if the reading departs from these values.

Pushing a "test" button tests the CPU by generating a simulated saturation level, one that depends on the coefficient set individually calculated for each unit. If the earpiece is detached or if there is not enough blood to make an accurate measurement, an "off ear" signal lights. Other conditions such as "instrument inoperative," "ear probe temperature," and "standardization required" are also displayed.

The oximeter does have a drawback. It is limited to use with patients who have good arterial circulation, so if blood flow to the ear is impaired it cannot be used. But H-P figures there is a fairly sizeable market, since in the U.S. alone there are an estimated 1,600 pulmonary-function labs and 3,000 respiratory-therapy centers. H-P feels the \$8,200 price will be no drawback because a single unit can be used to serve many patients. □

Materials

Thin liquid-crystal coating reveals design faults in integrated circuits

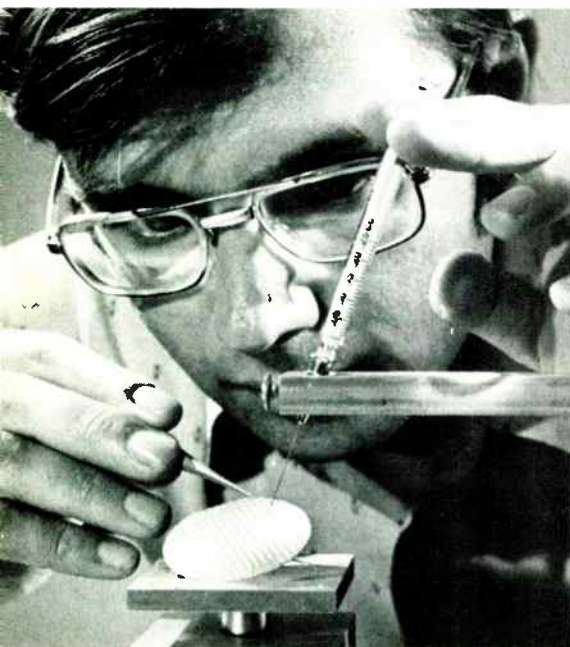

Conventional test equipment can determine whether an IC is functioning properly, but these tests may be of little value in determining exactly why and where an IC has failed. To solve this problem, scientists at the RCA Physical Electronics Research Laboratory in Princeton, N.J., say they have developed a nondestructive technique that enables both the electric fields and temperature distributions at the surface of an operating IC to be viewed through conventional optical microscopes.

The method, which involves applying a thin liquid-crystal layer to the surface of the bare device, en-

Telltale. RCA's Donald J. Channin adds liquid-crystal material to IC wafer surface. Circuit faults show up when operating devices are viewed under a microscope.

ables observers to watch electrons flow through an IC, and they can pinpoint defects by observing where the electron flow is interrupted.

Engineers at RCA's Solid State division, Somerville, N.J., used the liquid-crystal technique to locate the exact point of design and fabrication failures, as well as to uncover other faults in ICs being manufactured or under design tests. The process, say its developers, Donald J. Channin and Gerald E. Nostrand, can be used for complementary-MOS, bipolar and other IC types.

Liquid-crystal material has been used in the past for detecting grosser flaws in ICs. For example, the British Royal Radar Establishment has used the material to detect pin holes [*Electronics*, Feb. 28, 1972, p. 6E].

In the RCA technique, a surface-wetting agent, or surfactant, is first placed on the device, followed by a drop of nematic liquid-crystal material. A glass cover plate is then placed over the liquid, much like a contact lens on an eyeball. The surfactant causes all the rod-like molecules in the liquid crystal to align in the same direction. However, when electrons travel through the IC, the electrical field they create rotates adjacent liquid-crystal molecules, thus changing the index of refraction of the liquid.

Viewing. The IC, which is placed in a conventional metallurgical microscope, is illuminated by light passed through a set of polarizers arranged so that normally none of the light reaches the microscope's eyepiece. However, when the IC is operating, the changes in refractive index caused by the electrons' electrical fields allow light to pass through the polarizers and, in effect, give the viewer a "live" picture of the pulses or signals flowing in the IC, Channin explains.

He also says the technique pinpoints mask defects and metalization failures. In addition, so-called "hot spots" caused, for example, by shorts, change the liquid from its crystalline state to an isotropic one. This shows up as bright spots under a microscope.

Channin says the technique is

THE 741 OP AMP FOR TIGHTWADS.

If you're watching your dollars these days (and who isn't?) here's some neat news.

National's 741 op amp (the LM741) is just as good or better than anyone else's 741, but it costs a bunch less.

It costs less 'cause it's smaller. We've managed to get it on a die 40% smaller than other 741 amps.

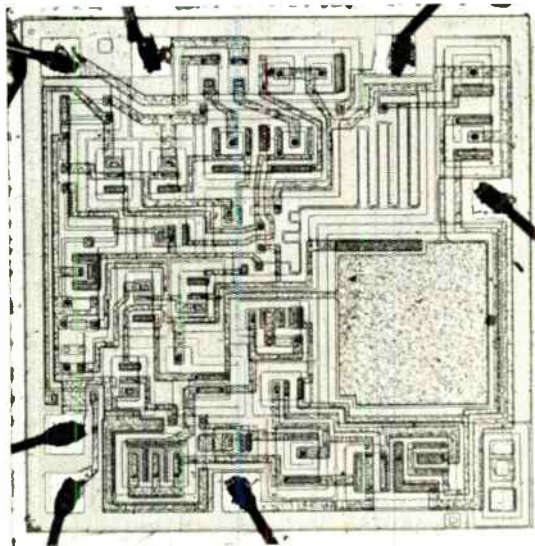
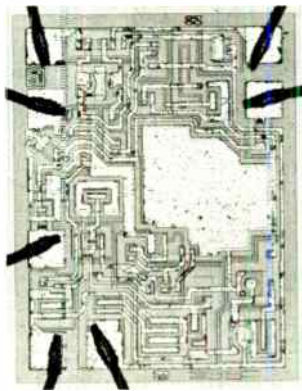

Us

Them

That's an example of the kind of technology leadership that we've been displaying for some time now in the linear field.

And that's a pretty good example of something else about us and the linear field.

We're cheap.

When it comes to pricing, National can be the most competitive semiconductor outfit around.

We figure that technology made us the linear leaders...and our price/performance capability will keep us there.

To pursue the possibilities further write National Semiconductor Corporation, 2900 Semiconductor Drive, Santa Clara, California 95051 or call (408) 732-5000.

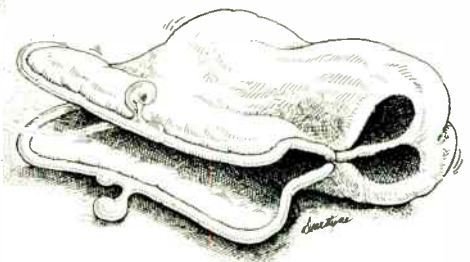

National

useful in examining ICs undergoing life testing and in investigating other subtle problems. He says an IC can be examined with or without load, to determine, for example, what the load does to the device's timing. ICs can be examined at various speeds and at normal operating voltages—from 8 to 10 v for C-MOS circuits to as low as 2 or 3 v for bipolars.

Advantages. Channin says that earlier research indicates that operating circuits can be observed satisfactorily through a scanning-electron microscope, but the equipment is expensive. Also, he says "infrared microscopy appears to require higher current density for a visual effect than does the liquid-crystal technique. And observation time on scanning-electron microscopy is sometimes limited by surface-charge accumulations on the circuit." In contrast, he says the liquid-crystal process requires only conventional microscopes and electronics of the types that are generally used in IC-development laboratories.

In addition, the time required to conduct electron-microscopy tests is relatively long, but 30 to 50 ICs can be prepared in about an hour with the new process, Channin points out. Future development of the technique, he says, will be directed toward increasing sensitivity by using a variety of liquid crystals. □

Industrial

Microchips meet buyer resistance

Microprocessors were a hard sell at the recent Instrument Society of America conference and exhibit in New York, but few were buying.

Manufacturers of measurement and control equipment at the annual event substantially agreed that microprocessors will wind up in their equipment—particularly in data-acquisition systems and programable controllers. However, most of them aren't quite ready to



Users. Robert O. Wilson, right, head of FX Systems, says he's a year away from using microprocessors. Robert H. Rech, left, general manager of Struthers-Dunn's Systems division, likes them when large orders need different configurations.



buy the new chip sets.

Applications engineering takes time, the potential customers insist, and they want to evaluate competitive products, including those that have been announced but are not yet available for delivery. Several readily admit to window-shopping—they are interested, and they're looking, but they won't buy until the price drops.

At the same time, some systems manufacturers are disturbed about the prospect that microprocessors will be marketed much like certain products in the computer industry, which are announced well in advance of their actual availability. This practice could even slow the adoption of microprocessors in their hardware, they contend.

Monday look. Microprocessors, says Robert O. Wilson, president of FX Systems Corp., Saugerties, N.Y., are "something we look at every Monday morning. We're keeping up with all the developments and looking forward to using them, but they're still not economical for our products."

Wilson says he can replace all but four of the 13 function cards in his Series 1 programable data-acquisition system, but will hold off for

about a year, when he expects the price to fall significantly. He'll hold off even longer on using microprocessors in programable controllers, he adds, because "they don't have the horsepower yet."

Allen-Bradley Co., Cleveland, uses a microprocessor in one of its programable controllers to decode binary information for generating graphics, but not for control functions. "We evaluated a number of microprocessors before we went with one," says an Allen-Bradley systems engineer, "but as for controls, we'll probably stick with core memory for a while just because it's reliable and low-cost. We'll get there, but we're not going to dive in [to microprocessors], I'll tell you that."

The systems division of Struthers-Dunn Inc., Bettendorf, Iowa, uses microprocessors only when building a large number of systems in different configurations. "We program for each job," says Robert H. Rech, general manager. "But in all jobs, we've had the customer pay for the programing," which he describes as difficult and time-consuming.

Another firm, Modicon Inc., which bills itself as "the programable controller company," recently

1975 CERAMIC CAPS...NOW

MONO-KAP™. MONO-GLASS. Radial. Axial. USCC/Centralab has taken the lead for '75. You can be confident now of short delivery, plentiful supply and competitive pricing on reliable ceramic capacitors from the leader in monolithic technology.

DISCRETE ASSEMBLY

MONO-KAP™ radial-leaded epoxy coated capacitors are reliable performers; they're rugged enough to work in MIL environments. 4.7pF to 10Mfd., 50 to 200 WVDC in a variety of dielectrics and case sizes. Immediate delivery from stock; large volume production orders in *eight weeks* . . . and price competitive.

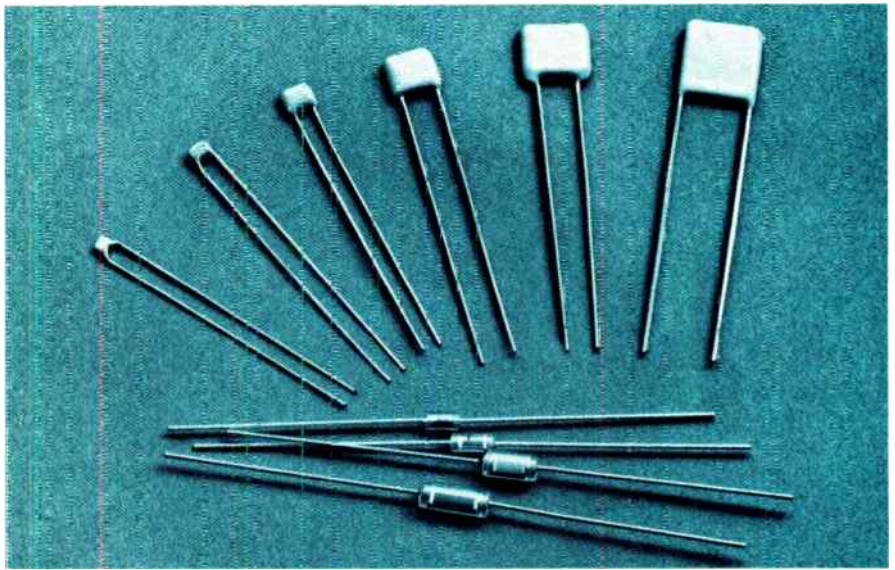

AUTOMATIC HIGH VOLUME INSERTION

MONO-GLASS axials are glass encapsulated, designed for automatic

PCB insertion; furnished reel-packed for high volume applications. They're available in 50 and 100 WVDC from .01 to 1.0Mfd.; three dielectrics: COG, X7R and Y5V.

Our basic materials research gives you the best in monolithic technology; our productivity engineering guarantees competitive prices and best delivery.

You can design confidently with USCC in 1975 for: calculators, computers, business machines, communications or any volume application using discrete or automatic assembly.

Some manufacturers are still solving problems; we can produce 25 million pieces per month and we're still expanding; at USCC we've got 1975's

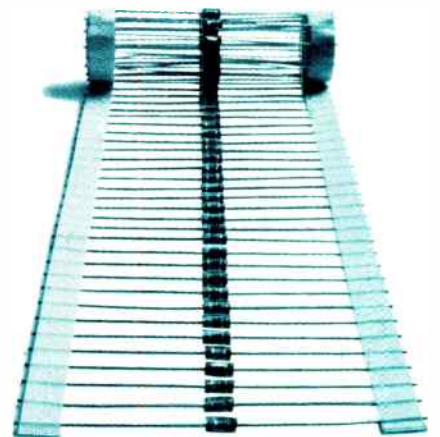

capacitors NOW. Write or call for large quantity quotations or evaluation samples.

Remember, USCC/Centralab.



USCC/Centralab

Electronics Division • Gibbe-Union, Inc.

2151 North Lincoln Street • Eureka, California 91504

(213) 843-4222 • TWX: 910-498-2222



introduced a system using microprocessors to handle 23 data-transfer functions. "I'm getting more speed, and that means I can add more functions," says Fred U. Henderson Jr., regional manager. "It may even give us a cost-reduction in terms of what we can do in control functions. But we really won't know until we get into it."

Mark Levi, director of National Semiconductor Corp.'s Microprocessor group, says his company has designated measurement and control as one of the three prime markets for its microprocessors, along with communications and terminals. "We're telling the end user that he should be talking with his vendor about the flexibility that microprocessors can provide."



But Levi admits that equipment makers' investment in existing products is something National and other chip suppliers will have to contend with, at least for a while. "In the late 1970s, we'll see dedicated microprocessor systems," concludes Levi. "It makes the 'smart' instrument a reality." □

Communications

Digital microwave test set by Bell

The Bell System will soon start testing its first digital microwave system, the DR-18, for transmitting over relatively short distances in metropolitan areas. The announcement follows hard on the heels of the Federal Communications Commission's release of operating parameters for digital microwave signals [*Electronics*, Oct. 3, p. 63]. Commercial service is planned to begin early in 1976.

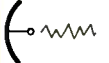
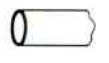
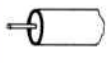
The DR-18, which will operate with the longer-distance WT4 and T4 systems now also undergoing field trials, will be installed over a 9.7-mile link spanning the Hudson River between Nyack, N.Y., and White Plains, N.Y. The DR-18 operates at 274 megabits per second,

BELL SYSTEM DIGITAL TRANSMISSION SYSTEMS				
System	Transmission medium	Bit rate (megabits per second)	Number of 2-way voice channels	Date introduced
 DR-18	17.7 - 19.7 GHz Radio	274.176 (DS-4)*	28,224	In development
 WT4	40 - 110 GHz Circular waveguide	274.176 (DS-4)*	250,000	In development
 T4	Coaxial cable	274.176 (DS-4)*	4,032	In development
 T2	"Locap" twisted pair	6.312 (DS-2)	96	1972
 T1	Twisted pair	1.544 (DS-1)	24	1962

*The Bell System refers to its hierarchy of digital-signal-bit rates as DS levels. DS-1 is the lowest and slowest level - 1.544 Mb/s. Four DS-1s make up a DS-2. DS-3 - 44.736 Mb/s - is an intermediate multiplexing level and is not presently used for transmission. DS-4 now has the highest speed level - 274.176 Mb/s.

the same bit rate as both of the longer-range systems which carry both voice and data signals. The new DR-18 digital microwave system can be used to feed both the WT4 millimeter-waveguide and the T4 coaxial-cable systems.

The DR-18 tops off a hierarchy of Bell digital systems that use a variety of transmission modes tailored to different bit rates (see chart). Included are twisted-wire pairs, circular millimeter waveguides, coaxial cables, and digitally modulated microwave links. Now that the FCC rules have been issued after several years of study, other manufacturers will probably soon begin marketing microwave systems using digital modulation techniques for telephone companies and private industrial users.

Big band. The DR-18 is the Bell System's first move into the common-carrier band that lies between 17.7 and 19.7 GHz. The 2-GHz band is split into two halves, separated by a guard band about 200 megahertz wide. Four frequencies are used in each half-band, and by transmitting cross-polarized signals, the capacity of each band is doubled so that each half of the band handles eight 220-MHz channels. Each repeater station

has 16 receiver-transmitter pairs—seven for each direction and one pair in reserve.

Repeater spacing for the DR-18 is determined primarily by the attenuation caused by rain. Repeaters installed in the microwave systems operating at the lower common-carrier frequencies of 4 and 6 GHz are normally spaced at intervals of 25 to 30 miles, a distance that is limited primarily by the curvature of the earth. But at the higher frequencies, rain attenuates signals by as much as 10 decibels per kilometer, and to maintain a 40-dB maximum path loss during heavy rain, repeaters are spaced much closer together—only about 2.5 miles apart.

Transmitters and receivers use solid-state components. Impatt diodes that serve as local oscillators in the receivers are also used for the main transmitting elements. These elements radiate about 200 milliwatts from antenna dishes 32 inches in diameter.

One possible use of the system will be to assemble six groups of 28 T1 pulse-code-modulated channels for transmission between cities. To do this, 28 T1 channels would be multiplexed in one step and then six of these would be combined to

Dickson has a big new name: Siemens

Dickson Electronics Corporation has merged with Siemens Corporation as the Siemens Components Group. This means that Dickson Zener diodes, TC Zeners, tantalum capacitors and Dickson microelectronic products will now carry the Siemens brand, along with such quality products as Siemens capacitors, diodes, ferrites, flash tubes, surge voltage protectors, relays, switches, electro-optic products, microwave components and other semiconductors. Headquartered in Scottsdale, Arizona, the Components Group will provide local service through an existing organization of Group sales offices,

For the phone number of your Siemens Components Group sales office, PHONE TOLL FREE 800-645-9200 (in New York call collect 516-294-0990).

Call us, today, But call us Siemens.

Siemens Corporation
Components Group

World Radio History P.O. Box 1390, Scottsdale, Arizona 85252
(602) 947-2231 TWX 910-950-1292 Telex 667-406

make up one DR-18 channel, carrying 4,032 two-way voice conversations. □

Scientific-Atlanta takes Marisat

When Scientific-Atlanta Inc. in late October was awarded a Comsat General Corp. contract for 200 below-deck terminals for use with the Maritime Communications Satellite, the Georgia company appeared to have locked up the Marisat merchant-ship terminal business. The contract follows closely on another the company received for the above-deck equipment package from Comsat the Marisat consortium leader [*Electronics*, Oct. 3, p. 95].

But the awards have angered some competition. What upsets them is Comsat General's refusal "for competitive reasons" to disclose contract price for the shipboard package. Scientific-Atlanta's Peter M. Pifer, Electro-Systems division manager, says only that single-terminal cost for a merchant ship is "less than \$60,000." But Washington-based Comsat General refuses to discuss price on the ground that "we don't want someone figuring out unit costs so they can build a cheaper package to sell" to ship operators.

Market. At stake is the market described by Pifer as serving "80% of all the ships at sea" in the Atlantic and Pacific oceans when the two planned Marisats become operational. Comsat General now says the 1975 launch of the first satellite has slipped again from the first quarter to the end of the second because of difficulties over launch logistics. Allowing 60 days for system test, this first Marisat may not be operating until the end of August.

The second launch is expected to follow within three months. Scientific-Atlanta's commercial terminal interests would best be served if the U.S. Navy, principal user the first two years, opts for satellite placement over the Atlantic. Reason: the

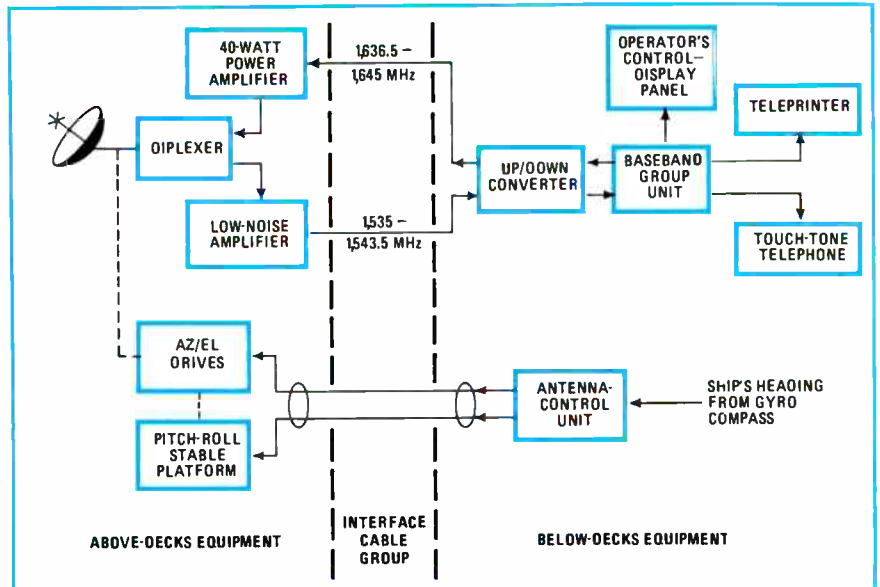

System. Complete shipboard Marisat terminal is being supplied for Comsat General by Scientific-Atlanta. Four-foot parabolic dish antenna took three years to design.

company has licensed Far East manufacturing and marketing rights of its terminals to Japan's Nippon Electric Co., a major earth-station supplier in its own right. With an Atlantic Ocean satellite, Scientific-Atlanta would sell more systems of its own.

To provide real-time service for the four-function system—telephone fm voice service, teleprinter, facsimile, and digital data transmission—and do it at "a viable price," Pifer notes that antenna control and the teleprinter, telephone and display panel have been integrated into a single console smaller than an office desk. The console control box, Pifer adds, contains a microprocessor for automatic frequency shifting within the system's operating bandwidth. The system uses a TDM/TDMA phase-shift-key carrier system for control, signalling and teleprinting. A single-channel-per-carrier multiplexed fm signal is employed for voice. An up/down converter interfaces at L-band with two above-deck amplifiers—a 40-watt unit for transmission and a low-noise package on the receiving end (see diagram).

Toughest part of the shipboard system design was the 4-foot-diameter parabolic antenna above deck, Pifer says. "We've been working on it for three years."

To solve antenna-design problems, a computer model simulated ship and satellite motion and calculated optimum beam-pointing systems and cost tradeoffs. A four-axis slave-pointing method was selected, which gives the 10°-beamwidth antenna a pointing accuracy of better than $\pm 2^\circ$, Pifer says. The four-axis gimbal package can be mounted on deck or on a ship's mast, he says. Gearless servo drives are used in all four axes, and slip rings or rotary joints are not used at all. □

Business

Few bright spots in 1975 sales forecast

With few exceptions, any gains next year in shipments of electronic equipment are not expected to match inflation rates, according to figures released early this month by the U.S. Department of Commerce. The only bright spots are soaring shipments of electronic calculators and accounting machines, expected to expand by 65% through 1975, to rise to \$3 billion from this year's \$1.81 billion, and to maintain the growth rate set a year ago.

Shipments of computers and re-

This Christmas, ask for a gift for a lifetime.



lated products, however, have been projected to rise only 14% to \$10.3 billion in 1975—only slightly above the current rate of inflation in the U.S., and down from the 20% growth reflected in this year's estimate of \$9 billion.

Integrated-circuit shipments are forecast to rise 15% next year to \$1.77 billion following a 20% increase to \$1.54 billion this year from last. The performance of ICs is well above that for components overall.

Instruments present a mixed sales picture next year, the Commerce forecast shows. Engineering and scientific instruments—about half of which are used for aeronautical, nautical, and navigational applications—are expected to show a 13% increase in shipments this year, to \$1.4 billion, and then climb another 10% to \$1.5 billion in 1975.

Within this category, however, laser instrumentation is expected to rise by 26% to \$118 million in 1974, and then expand another 22% to \$144 million next year.

Electrical test and measurement instrument shipments are expected to jump 22% this year to \$1.96 billion—including \$425 million in exports—but then grow by no more than 13% in 1975 to \$2.23 billion, of which \$540 million will be exported. Profit margins, however, have been eroded by materials price increases and shortages as vigorous competition has held down instrument price increases.

No inflation? But the really bad news for the electronics industries contained in the 1975 edition of the "U.S. Industrial Outlook," published by the Domestic and International Business Administration, is that the dollar value of 1975 components shipments will rise only 8% next year to \$9.9 billion. This is less than the rise caused by inflation—a crucial consideration not given official recognition in the 432-page Federal document—and down from 1974's estimated growth of 10% to \$9.2 billion.

An even lower level of growth—6%—is reflected for the broad category of "Commercial, Industrial, and Government Electronic Sys-

tems and Equipment" in which Commerce deals largely with Federal buys of communications equipment. Shipments for these products are predicted to reach \$8.67 billion this year, up 3% from 1973, and then rise to \$9.2 billion next year. Omitted from these figures is consideration of the value of electronics procured by the military.

Decline. Consumer-electronic products are expected to register a 6% drop in domestic shipments this year to \$3.58 billion, although Commerce optimistically forecasts a small 3% rise to \$3.7 billion in 1975. Imports of consumer electronics this year are forecast to drop 7% to \$2.1 billion before rebounding to register a 14% increase in 1975 to \$2.4 billion, according to the study.

In its discussion of the outlook for domestically produced consumer electronics, Commerce puts the value of industry shipments in 1980 at \$5.2 billion, a 2.6% gain based on the industry's compounded rate of annual growth. Total value of all U.S. industry shipments and services in 1975 is expected to reach \$27.18 billion, up 5% from this year's level of \$25.76 billion.

For 1980, Commerce predicts that U.S. industry shipments will reach \$35.33 billion, reflecting a 5.5% compounded annual growth rate. The equipment segment is to reach \$16 billion in this period, based on an 8.9% annual growth rate. Components will account for \$12.6 billion of the total, growing 3.3% per year, while R&D outlays will reach \$830 million by 1980, up from \$570 million in 1975. □

Packaging & production

Mask makers stay with experience

Semiconductor manufacturers have been getting by for years with tried and true (usually) photolithographic techniques, using ultraviolet light to define patterns on a wafer's surface. And things are likely to stay that

way for some time to come.

"To read the literature, one would think that photolithography is being outmoded," scoffs Aubrey C. Tobey, who is director of marketing for GCA/David W. Mann Co., Burlington, Mass., a production-equipment manufacturer. "Within the next several years," he asserts, "photolithography will not be replaced by electrolithography or X-ray lithography. Rather these will augment the capabilities of semiconductor houses."

Economics. Tobey contends that for most of the circuits being built today, photolithography will continue to be used because the technology is economical, the problems are well-defined and its limitations are well-known. "In only a very few instances must electron-beam technology be used. In other instances, there will be a combination of electrolithography and photolithography where the electron beam process will create the 10× master pattern and the photorepeater will make the final mask." Such combinations could be useful in extremely dense devices for memories or for gigahertz communications.

Despite certain difficulties with the electron-beam technique—it is, for example, strongly affected by electromagnetic fields—Tobey says, "there can be little question but that electron-beam systems or electrolithography will be a major workhorse for the manufacturers of circuits with geometries of a micron or less. Also it will be used as a pattern-generation system for irregularly shaped patterns and for defect-free master patterns."

Bell Laboratories in particular has been working diligently with the newer lithographic technologies—proximity printing, electron-beam lithography and, to some extent, X-ray lithography.

Proximity printing, in which the mask is close to but not touching the wafer, has not caught on very rapidly, according to John D. Cuthbert, supervisor of Bell Labs' Photolithography group, Allentown, Pa. One of the reasons for this, he says, is that the early proximity printers

A Hewlett-Packard pocket calculator is a gift for a lifetime.

The HP-35 Electronic Slide Rule.

Performs *all* basic arithmetic, trig and log calculations automatically. Has an Addressable Memory, displays 10 digits in fixed decimal or scientific notation, automatically positions decimal point throughout its 200-decade range. Cost, \$225*.

The HP-45 Advanced Scientific.

Performs 44 scientific functions including vector arithmetic, rectangular to polar conversion, mean and standard deviation. Has 9 Addressable Memories. At \$325, it's *the* pre-programmed calculator for *all* scientists, engineers and students of science and engineering.

The HP-65 Fully Programmable.

The world's only fully programmable pocket calculator. You can write, edit and record programs up to 100-steps long. You can take advantage of HP pre-recorded programs, so you gain the speed/accuracy benefits of programming without writing your own. Performs 51 pre-programmed functions. Cost, \$795*.

The HP-70 Business.

Performs all sorts of general business, interest, financial management, lending, borrowing and saving calculations—precisely, quickly, easily. A Financial Memory Bank lets you enter numbers in any order and change them anytime. Has 2 Addressable Memories and a very affordable price, \$275*.

The HP-80 Financial.

Performs virtually *all* time/money calculations in seconds. Has a 200-year calendar, an Addressable Memory. Lets you make new kinds of management calculations that enable you to make better decisions. Cost, \$395*.

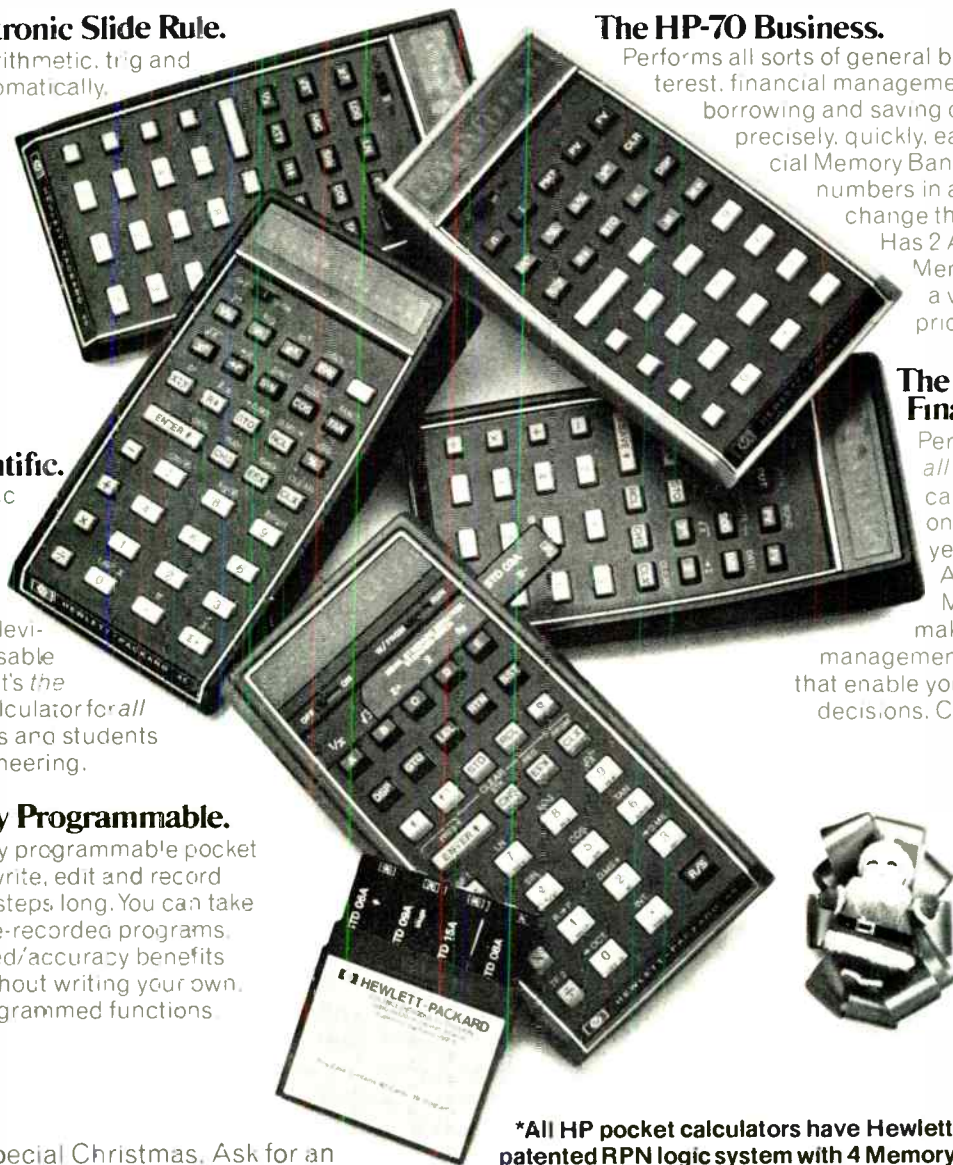

Make this a special Christmas. Ask for an instrument crafted to last your working lifetime and designed to solve the problems you can expect to encounter throughout that lifetime.

Circle the HP pocket calculator that's right for you, then slip this ad to you-know-who. They can call us toll-free at (800) 538-7922 (In Calif. call (800) 662-9862) for the name, address and telephone number of a nearby HP dealer.

***All HP pocket calculators have Hewlett-Packard's patented RPN logic system with 4 Memory Stack and carry a one year warranty on parts and labor. Prices exclude state and local taxes.**

HEWLETT  PACKARD

Sales and service from 172 offices in 65 countries
Dept. 214M, 19310 Pruneridge Ave., Cupertino, CA 95014

Electronics review

were unable to reduce diffraction effects to a tolerable level. The result was unpredictable line widths and feature shapes.

Cuthbert reports steady progress toward overcoming these problems, however. After studying proximity printing techniques over the past six months, he says, "we are now fairly confident that it can play a role in the manufacture of our LSI circuits."

Also reported working on a proximity system, but for the commercial market, is the Photo-Lith-

ographic Products division, Kulicke & Soffa Industries, Horsham, Pa.

Bell Labs' Cuthbert also found that proximity masks degrade at a rate of about 1/16th that of contact-printed masks. The studies were done with a gap between mask and substrate of 10 micrometers on metal-oxide semiconductor devices.

This degradation rate, according to Cuthbert, implies that at least 60 prints should be attainable from a mask in proximity printing before it is discarded. For devices within its

resolution capabilities, proximity printing can play a significant role in chip production, he says. He concludes that, "the obvious route to go is towards reduced wavelengths, with X-ray lithography the ultimate extension of this route." □

Solid state

C-MOS memories overcome volatility

At least three semiconductor manufacturers are nearing introduction of 1,024-bit static complementary-MOS memory devices that will go a long way toward defeating that nemesis of semiconductor memories in many applications—volatility. Intel Corp.'s entry will be unveiled next month, and several fast versions from Intersil Inc., as well as a C-MOS-on-sapphire part from RCA, are expected early next year. Not to be left behind, Inselek, Inc., Rockwell International, and Harris Semiconductor are also known to be developing 1-kilobit C-MOS RAMs, as is AMI.

Semiconductor memories lose stored data when power is removed. This means an auxiliary store must be available so the data can be restored before operation can be resumed after a power down. A non-volatile auxiliary store such as a core memory, however, consumes a lot of power—a deterrent to its use in electronic cash registers, many minicomputer-based systems, and other applications in which power must be conserved.

Hero. Enter C-MOS with its negligible standby power dissipation. It's an ideal solution to the volatility problem because very little power is consumed when the memory system is not operating (in standby), and a simple low-power battery backup can assure the memory is never lost. What's more, C-MOS is a static-memory design requiring no refresh clocks and only a single simple-to-use power supply.

Mike Markkula, Intel's North American marketing manager, says

Electronics Index of Activity

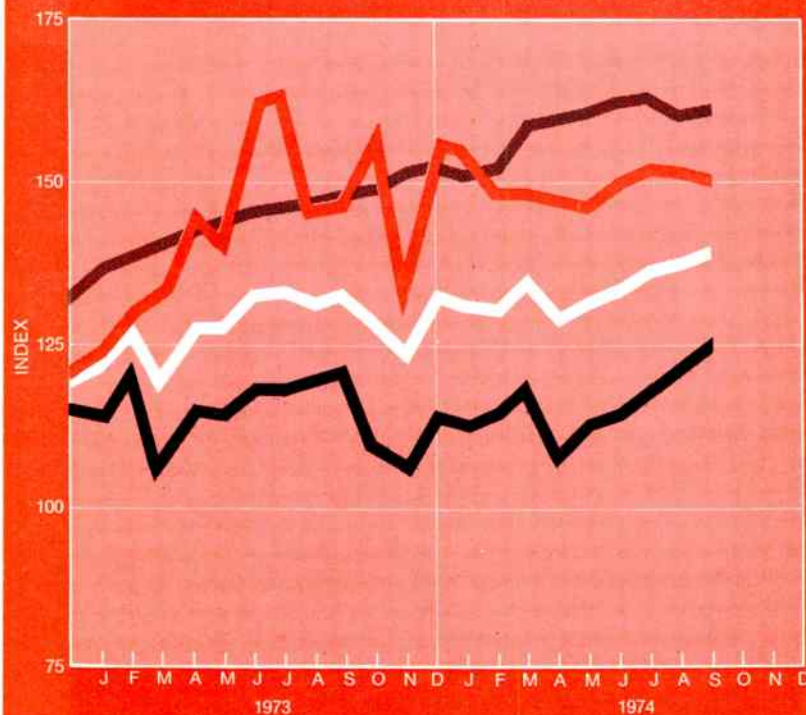

Segment of Industry	Sept. '74	Aug. '74*	Sept. '73
Industrial-commercial electronics	161.7	160.6	148.7
Consumer electronics	150.5	151.9	158.8
Defense electronics	125.7	121.9	109.9
Total industry	140.6	136.5	129.9

The total industry index, up 1.5% in September from the previous month, was a healthy 8.2% higher than September 1973's 129.9. Defense electronics climbed the most—3.1%—to 14.4% above last year's level. And industrial-commercial electronics inched up 0.7% to 8.7% ahead of last year's level. The consumer sector fell, however—down almost 1% from August's level and 5.2% below that of September 1973.

Indexes chart pace of production volume for total industry and each segment. The base period, equal to 100, is the average of 1965 monthly output for each of the three parts of the industry. Index numbers are expressed as a percentage of the base period. Data is seasonally adjusted.

*Revised

Another technical knockout

the first plastic, low-noise GHz transistor

Look out, expensive metal and ceramic types — here comes the MRF901 in a microwave plastic package: a 1 GHz small-signal device with 2 dB NF at an applications-unlimited price!

The die is fabricated using unique arsenic-ion-implant process technology to gain higher performance for state-of-the-art designs — and it's available in metal-ceramic packages for high reliability applications.

Now you can improve communication system performance by gaining low-cost dB's in receiver sensitivity.

And... increase receiver

range with an MRF901 in front of your diode mixer for a 3-5 dB improvement in front end NF at UHF.

And... build a better 900 MHz front end for less \$.

And... design low-cost, HF pre-selectors for counters up to 1500 MHz.

And... achieve low-noise at high current (up to 20 mA) for low-distortion, UHF/VHF MATV amplifiers.

And... do it for a unit price of just \$9.00.

It's available now from an RF supplier who believes OEM needs are first priority. See your distributor. Design it in. Be first with the first...

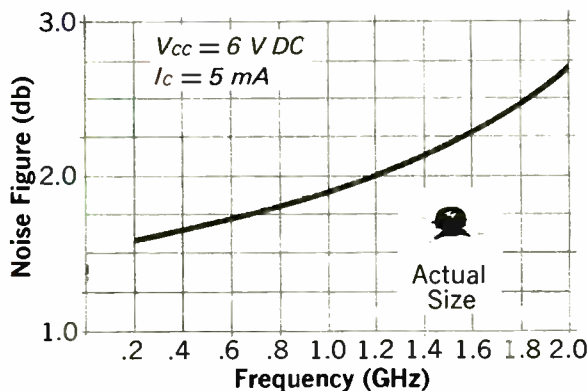

heavyweight
from Motorola, the RF producer.

MONOLITHIC CRYSTAL FILTERS

the
State
of the
Art

TELLING vs. SELLING

The purpose of this column is to disseminate information. Or, to be absolutely honest, to sell by informing. As a responsible engineering or procurement person, you're quite capable of making your own decisions, given the facts. So that's what we give you. We think that the more facts about monolithic crystal filters we present, the more likely you are to buy ours. That's our "let the buyer be aware" theory.

ON SPECIFICATIONS

Writing a component specification is a lot like writing a legal contract. Both can be precise and complete, or vague and ambiguous. Or misleading.

In specifying monolithic crystal filters, one simple method—the boundary method—guarantees desired selectivity—precisely, under specified conditions, without ambiguity. That's why all of PTI's standard specifications are boundary specs. While other methods of specification may make the filter appear in a more favorable light, we feel that this kind of "specmanship" is not in your best interest and hence not in ours.

And boundary specifications—since they are usually intimately related to system requirements—represent a "natural" for the equipment designer preparing a filter spec. One pitfall: in writing boundary specs don't try to include filter manufacturing tolerances. We'll take care of that. Specifying selectivity is only one part of the story. If you need guidance in any aspect of writing specifications for monolithic crystal filters, we may be able to help.

Pti

Piezo Technology Inc.

2400 Diversified Way Orlando, Florida 32804
305.425.1574

The Standard in monolithic crystal filters.

Electronics review

the Santa Clara, Calif.-based company's 1-k RAM (the 5101) will be produced in the 256-word-by-4-bit organization that's growing in popularity for microprocessor-based systems. Operating from a single +5-volt power supply, the silicon-gate

C-MOS device has a respectable 450-nanosecond access time. Its extremely low standby power rating of 0.15 microampere per bit makes the part desirable for low-power applications where battery backup or nonvolatility is required.

U. S. demands new structure to break IBM's 'monopoly'

After six years of legal sparring, the U.S. Department of Justice has at last declared that a major restructuring of International Business Machines Corp. is the only way to break its "monopoly power" and restore competition in the computer industry.

In a stunning 349-page pretrial brief filed early this month with the U.S. District Court in New York, Justice spells out in detail the basis for its charges of monopoly and provides a road map of how it intends to develop its case in court. Although many of the antitrust allegations against IBM have been widely discussed within the data-processing community, the pretrial brief is the first formal documentation by the Government.

Next year. Judge David N. Edelstein is expected to begin hearing the Government's antitrust suit early next year. After six years of preparation since the charges of violating the Sherman Antitrust Act were brought against IBM, the trial is expected to be "a long one, even by antitrust standards," according to the Government brief, "in part because IBM's power base in the relevant markets is very broad, touching a very large percentage of the commercial establishments that are the heart of U.S. commerce and industry."

Justice disclosed that evidence used to prove allegations of an IBM monopoly "will be largely reflected in IBM's own documents, culled from millions that have been examined" by U.S. attorneys during the years of preparation.

Specifics. "The markets that IBM has monopolized," says the Government, include not only the sys-

tems market, but the peripheral equipment and terminal markets, as well. Using IBM documents and those of other manufacturers, Justice says IBM estimated in 1968 it had nearly \$40.8 billion or 68.2% of the \$59.8 billion value of the commercial computer installations.

In September, 1972, Sperry Rand Corp. calculated that IBM had a \$22.7 billion slice of the \$31.9 billion in U.S. installations plus \$10.5 billion of the nearly \$15.7 billion worth of computers in the rest of the world. Sperry's Univac division estimated that by 1977, IBM would have \$36.2 billion of the \$50.7 billion U.S. market plus \$22.4 billion of the \$33.6 billion foreign market, excluding the Soviet Union and Communist-Bloc nations.

A 1971 Honeywell document also subpoenaed by Justice credits IBM with 72% of the market, ranking Univac next with 8.3%, Honeywell 8%, Burroughs 4.5%, Control Data Corp. 3.4% and NCR, 1.9%. Another internal IBM report estimated its share of the market for machines with capabilities ranging from the system/360-20 class through 360-67 held at 73% from 1970 through 1973 after gradually slipping from a high of 84% in 1965 to 75% in 1969.

Fatal. The pretrial brief cites in detail "the demise of GE" and "the demise of RCA" as examples of IBM's power to exclude even well-financed competition from the market, in part because IBM's massive resources were enhanced by a huge cash flow from equipment rentals. The document also details "IBM's ability to set de facto industry standards" and its "predatory conduct" in controlling the peripherals market.

Efficiency Experts

Markkula points out that the device is another of Intel's growing family of static MOS RAMs, the others being in the n-channel 2100 series. The C-MOS RAM can be interchanged with any member of the 2100 series.

Intersil's C-MOS RAM, also a silicon-gate structure, will be organized in the more traditional 1,024-word-by-1-bit format, but Joseph Rizzi, vice president for digital and C-MOS operations, says that a 256-by-4-format will come later. Although Intersil's standard part (the IM6508) is specified at 600 ns maximum at 5 v, it typically can be accessed at 300 ns. Further, Rizzi points out that at 10 v the part can be pushed as fast as 80 ns. The company plans to select a 10-v, 100-ns part for customers who need the speed and are willing to live with the higher power.

Rizzi sees the RAM as part of a family of C-MOS microcomputer circuits now under development, among them a 12-bit microprocessor chip, 12-bit-compatible interface circuits, 256-bit synchronous and asynchronous RAMs, and a C-MOS universal asynchronous receiver-transmitter capable of gigahertz operation, as well as a C-MOS first-in first-out memory and buffers for modem-based systems.

RCA will have samples of its 1-kilobit C-MOS-on-sapphire RAM in February and production quantities in the third quarter of 1975. The part, which also operates from a single power supply, is specified at a speedy 125-ns access at 10 v and a cycle time of only 130 ns. Operating power is 15 milliwatts at 1 megahertz.

RCA is also developing a 1-kilobit C-MOS RAM in which standard silicon-gate technology cuts the size of each cell to a small 134 by 168 mils. As a result, each high-density, six-transistor memory cell occupies only 13.4 mil², and packing density is almost five times better than that of present commercially available C-MOS memories. The memory, which will operate from supply voltages of 5 to 15 v, has a 500-ns access time and standby power consumption of less than 10 μ A per chip. □

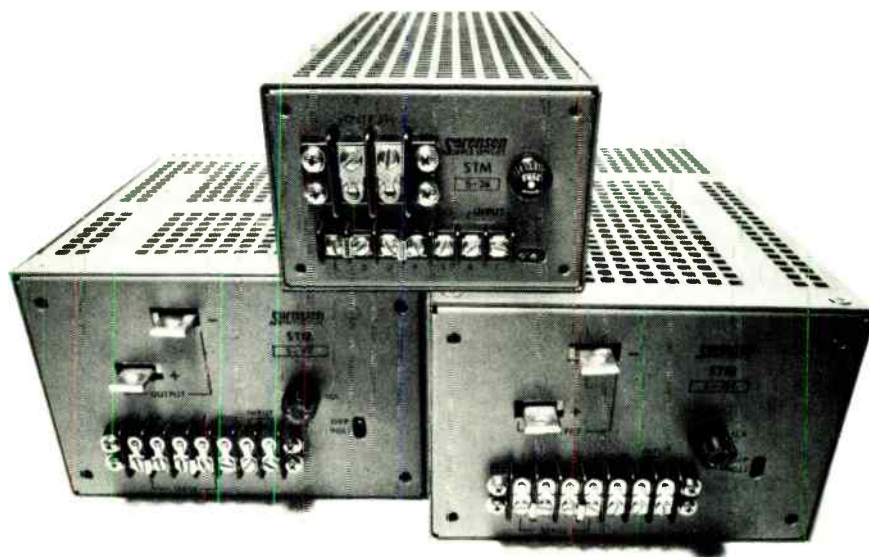

Built to save energy — modular STM switching-transistor power supplies from Sorensen. Exceptional power density and efficiency. Up to 1.5 watts per cu. in., and up to 75% efficiency in half the space of comparable competitive units. 40 models offer outputs from 72 to 780 watts (3 to 56 volts) — all with these features: cool running . . . excellent performance characteristics . . . built-in overvoltage protection . . . quiet operation . . . adjustable current limiting. For complete data, contact the Marketing Manager at Sorensen Company, a unit of Raytheon Company, Manchester, N.H. (603) 668-4500.

Representative Specifications — STM

Regulation (comb. line & load)	0.05%		
Ripple (PAR)	rms: 3 to 10 mv p-p: 30 mv typ., 50 mv worst case		
Module Sizes & Prices	Module	Size	Price
	III	5.12" x 3.31" x 9.50"	\$240-270
	IIIA	5.12" x 3.31" x 14"	\$300-330
	IVA	7.5" x 4.94" x 10.5"	\$475-495
	VI	7.5" x 4.94" x 14"	\$600-650

Sorensen
POWER SUPPLIES

News update

Closed-flux-memory test results coming soon What's potentially as fast as a bipolar semiconductor memory, and is smaller, more reliable, and uses less power than any other type of memory? The answer, the Ampex Corp. intends to prove, is the closed-flux memory. Results are due soon of tests conducted by the Ampex Corp. under contracts from the Naval Air Development Center at Warminster, Pa. [Nov. 22, 1973, p. 65] The idea was to determine if the promise of closed-flux memory devices could be fulfilled: inexpensive mass production through batch-fabricated metalizing, etching, and plating. The result would be memories that are planar counterparts of plated-wire memories, with each basic plane only 3 inches square and capable of storing 4,096 computer words. Ampex set up a pilot plant at its research and advanced technology division in Redwood City, Calif., with a capacity of 500 planes a year. The Navy, which put up \$500,000 for the pilot operation, was to receive last summer 50 fully tested planes and a statistical study of yields. Now, an Ampex spokesman says results on yields and feasibility aren't ready yet, but should be by the end of the year.

Industry, U.S. talking about laser goggles A year ago the Bureau of Radiological Health asked the electronics industries for comments and data to help set safety standards for laser protective eyewear [Nov. 22, 1973, p. 36]. The bureau at the time said that it hoped to work out "as soon as possible" criteria for selling and using goggles with manufacturers and other affected groups. Well, laser users, you're pretty much on your own because negotiations between the bureau and industry are still going on, says the bureau. Where or when it will all end is anybody's guess. But what might evolve prior to any joint mandated U.S. standard, says one bureau official, is a set of voluntary standards put together by the goggle makers themselves. Meanwhile, the danger that started the whole thing—bureau lab tests showing that some goggles may melt, lose their color, bubble, or even shatter when exposed to sufficiently high laser power—presumably is still a threat.

\$75 home video player promised in 15 months Can a home video player made of \$75 worth of off-the-shelf parts make it in the steely-eyed world of consumer electronics? Tune in again in about 15 months, says Peter G. Wohlmüt, and you'll see. Wohlmüt is president of a Sunnyvale, Calif., firm called i/o Metrics Corp. that said last year it had used the parts, and a 25-watt bulb, to build its system [Nov. 22, 1973, p. 39]. At the time, Wohlmüt envisioned applications in audio-visual,

mass-memory, and industrial-control markets as well as home video. Now Wohlmüt says that his company will come out with the machine in 15 months and that it will be marketed in a joint venture with what he says is a major firm in the TV industry. Meanwhile, says Wohlmüt, i/o Metrics has put prototypes of its player in children's hands and at airline baggage check-in points to test its durability; it has reduced the size of the bulb to 10 W; and has gotten production cost down to the \$50-to-\$75 range. What's more, says the company president, an automatic file-retrieval system will be in production in six months. Price will depend on configurations used, but will be under \$8,000. The system, for banks, real-estate firms, and law-enforcement agencies, will handle up to 36,000 frames on one disk, can be randomly accessed, and can be built to interface with any computer.

Coast Guard arrays still on station in tests The U.S. Coast Guard would like the sun to power its untended buoys and shore aids. With that in mind, the service has placed solar-cell-powered buoys in selected waters and at shore facilities. If the test program proves to be successful, says the Coast Guard, it will buy such solar-cell units for at least some of its total of 14,000 untended buoys and shore points [Nov. 8, 1973, p. 34]. The test is still going on—it will likely last two to three years—and the focus at the moment is the ratio between battery and array size. In all, 73 arrays are bobbing around on the ocean or are sitting atop buildings: 53 are in place at the R&D center in Groton, Conn.; nine are on a "small-buoy farm on Long Island Sound;" six are in Los Angeles at the plants of their suppliers, Centralab and Heliotek; and one is on an oil rig on the Gulf of Mexico.

Engineering academy stays in science body An unhappy National Academy of Engineering first threatened to leave the National Academy of Sciences [April 12, 1973, p. 36], then decided to try to work out a plan designed to keep it within the body [Nov. 8, 1973, p. 49]. The plan was worked out, submitted to the members of both groups, and approved. The result is that the science academy is in charge with resulting limits on the engineering body's autonomy. It now functions as one of four entities under the National Research Council dominated by the science academy. Also, its executive committee serves on the council and its president is vice chairman of the council's governing board. But the rub is that the engineering group can inaugurate only preliminary studies on its own—full-blown studies must be presented to the 11-member council, seven of whom are from the National Academy of Sciences. —Howard Wolff

Intended to bring *Electronics* readers up to date on news stories of the past months.

New, Improved and Free!

Cut out the coupon and send it in for your **FREE** Graphic Controls Electrostatic Recording Chart sample. Not just a snippet of paper . . . but a full roll sample of the newest finest quality electrostatic paper on the market. Put it into your **GOULD, VARIAN or VERSATEC** recorder for your own in-use test.

If you like what you see—and we're betting you will—the rest is easy. Easy for you

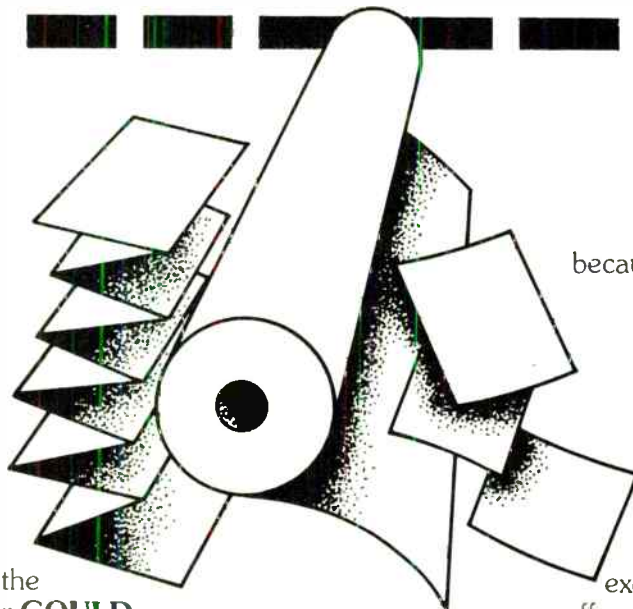

because you'll be dealing with one source of supply for paper and toners, with a nationwide distribution system. Always ready to deliver what you want when you want it, from inventory. In addition to our standard rolls and fanfold packs (with exclusive page numbering), we offer preprinted formats in any color or configuration that you want.

Fill out and mail the coupon today. Or call Ray Newstead, our Industrial Marketing Manager. Phone: (716) 853-7500, Ext. 352.

I'D LIKE TO TEST a FREE sample of your electrostatic paper in the following recording equipment:

GOULD, Chart No. _____ **VARIAN**, Chart No. _____ **VERSATEC**, Chart No. _____

Estimated Annual Chart Usage _____

Name _____ Title _____

Company _____

Address _____

City _____ State _____ Zip _____

Phone _____



RECORDING CHART DIVISION
GRAPHIC CONTROLS CORPORATION
189 VAN RENSSELAER STREET, BUFFALO, NEW YORK 14210

Clean up your act!

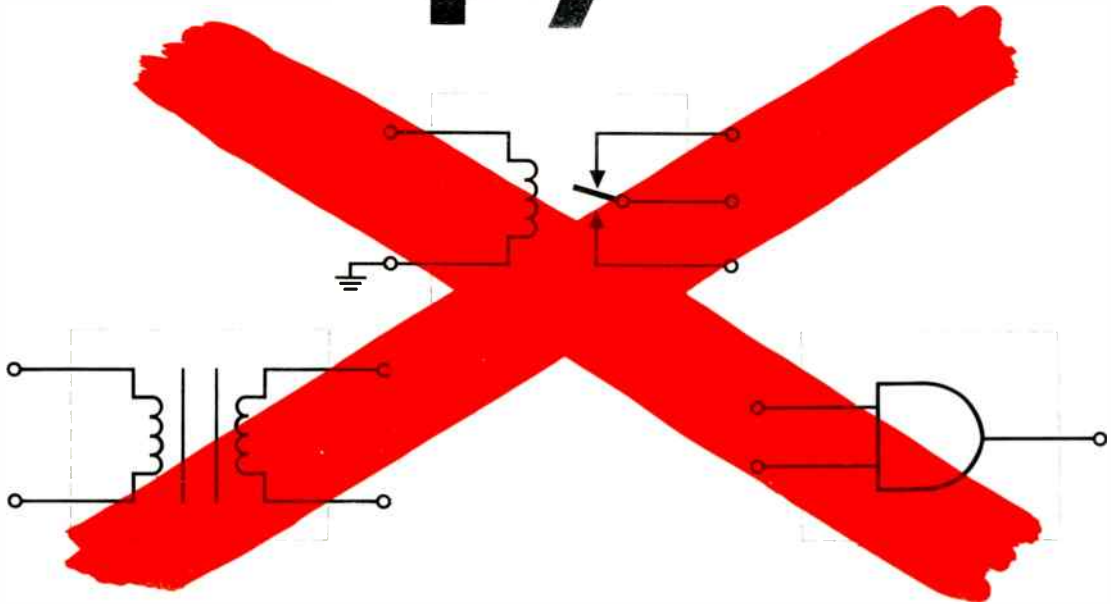

Opto-isolate your critical circuits with Monsanto's MCT2's.

Here's a cost-effective way to get top signal transfer (50% CTR for MCT2's, 250% for MCA 230's), yet isolate critical components against transients of 1.5 to 2.5kV: Put an opto-isolator in the circuit. Switching speeds range from 150kHz (MCT2) to 10kHz (MCA230). Millions of them are in daily use in industrial controls, telephone interfaces, computer mainframes and peripherals. Cleaning the noise out of critical paths.

System interface problems?

We've put together App Notes on sixteen of the thorniest design problems that O/I's can help solve. Includes:

- Input drive circuits.
- Solid-state 125 MA relay.
- Low-cost AC relay.
- O/I's in linear coupling.



- Gated amplifier functions.
- Phone line coupler isolator.
- Logic isolation, line receiver.
- Interfacing Darlington O/I's to TTL logic . . . and more!

We'll be glad to send you a copy of this 64-page applications book. Simply ask for it on your letterhead. And give us an idea of your application, will you please?

And now . . . more!

We've increased our production of these widely accepted components during the past six months and can now deliver the quantities you specify when you need them. Call your Monsanto distributor or **Monsanto Commercial Products Company**, Electronics Division, 3400 Hillview Avenue, Palo Alto, CA. 94304. Phone: (415) 493-3300

Putting innovation to work.

Monsanto

FAA wants \$96 million for R&D in fiscal 1976 . . .

Two big-ticket prototype procurements could help boost the Federal Aviation Administration's fiscal 1976 research and development funding by two-thirds from the current \$58 million. The agency has asked the White House Office of Management and Budget to approve an R&D budget of more than \$96 million, a figure that **includes \$19 million for prototype of microwave landing systems and \$11 million for prototypes of the discrete address beacon system** [*Electronics*, Oct. 31, p. 31 and p. 41].

The much-debated flight-service-station proposal, for the purchase of hundreds of keyboard terminals to enable rural pilots to submit their flight plans, continues to be advocated and would cost \$6.3 million. **Enhancement of air-traffic controllers' existing visual displays is put at \$7.6 million**, and about \$3.5 million is allotted to communications research, which an industry source says may mean a "rebirth" of the electronic voice switch project [*Electronics*, Aug. 22, p. 49].

. . . and makes unwelcome change in MLS requirements

The Federal Aviation Administration's **proposal to change one of the ground rules for its microwave landing system program has upset competitors for the potential \$1.5 billion market**, according to industry and agency officials. The agency wants the present frequency-division-multiplex format abandoned and a **time-reference-signal format adopted in the scanning-beam approach to MLS**—the rival approach uses doppler scan [*Electronics*, Oct. 31, p. 51]. FAA staffers say their decision is based on a comparison of the costs, complexity and reliability of the two formats.

ITT Gilfillan and Hazeltine Corp., doppler-scan proponents, are said by officials to be worried about the change, and **ITT reportedly has already protested informally to the FAA**. Bendix Corp. and Texas Instruments, with a total of \$12 million between them in FAA funding, have already tested FDM scanning-beam versions of MLS.

U.S. trade deficit falls to \$235 million in first 1974 half

The U.S. trade deficit in communications and electronics dropped 48% to \$235 million in the first six months of 1974 compared with a \$459 million deficit in the same 1973 period, according to the Commerce Department. **Exports jumped 48% to \$1.82 billion, offsetting a 22% rise in imports to more than \$2 billion**. Consumer electronics imports continue to dominate the deficit, accounting for \$894 million in red ink in the half, of which \$589 million represents Japanese products. Although imports from Japan dropped 12% from a year ago, sharp rises in Korea and Taiwan shipments more than offset the decline.

Other significant trends: **telephone and telegraph equipment exports rose to \$81 million in the half, cutting the trade deficit to \$4 million from \$10 million a year ago**. Military, industrial, and commercial equipment exports jumped 58% to \$380 million, boosting the favorable U.S. balance to \$147 million in the half—nearly equal that for all of 1973. Component exports, more than half of them semiconductors, rose to \$1.15 billion, producing a \$493 million positive balance. However, imports of integrated circuit continue to climb, generating a first-half negative balance of \$138 million, nearly equal that for all of 1973.

IBM's challenge in communications

A proposal that could ultimately lead to a significant restructuring of the U.S. communications business is scheduled for oral argument on Monday, Nov. 25, 1974, before the Federal Communications Commission. It is the joint proposal of International Business Machines Corp. and Comsat General Corp. to restructure CML Satellite Corp. in a way that would give IBM a controlling 55% interest and thereby mark the entry of the world's largest computer maker into the business of communications services (see p. 67).

The FCC has now assigned the petition a docket number—20221—which suggests that the proceeding is likely to be a prolonged one, especially in view of what the commission calls the “voluminous comments, replies and responsive pleadings” that have been filed. Most of these, including those of the Department of Justice and the Federal Trade Commission, are opposed to letting IBM into the domestic satellite business in a joint venture with Comsat General. FCC approval is necessary, of course, since its domsat ruling of December 1972 ordered that Comsat General not increase its interest in CML beyond the 33% it now holds.

The arguments

Key arguments being raised against IBM's entry—and the company's responses—are worth examining. In summary, they are that

- IBM would not compete head on in the market with customer AT&T: “unfounded” and “absurd,” says IBM, contending that if it were “concerned about its role as a supplier” to AT&T, it would not be before the FCC seeking to compete in the first place.
- IBM and AT&T would divide between them the data and voice markets, thereby substituting a duopoly for AT&T's monopoly: “ridiculous from an economic standpoint,” says IBM, “because the market is simply not capable of division.” A successful domsat operation must offer a full spectrum of service, and “there is no way it can succeed without voice.”
- Discriminatory CML interfaces would favor IBM products: wrong because “IBM's competitors will be watching it closely.”
- IBM's entry would be anticompetitive for the data-processing industry: “unwarranted,” IBM claims, since CML's plans “will necessarily provide new communications services” for all EDP users and thereby “stimulate further development” of the data-processing industry overall.
- Permitting IBM's entry would encourage other anti-competitive vertical integration:

what about RCA? asks IBM in effect. RCA was not denied entry despite its vertical integration, combining interests in communications-equipment manufacturing and network TV broadcasting. IBM quite cleverly quotes the Justice Department's 1971 opinion when the anticompetitive threat of RCA's entry was first raised: “Although . . . there may well be competitive dangers in authorizing suppliers or users to construct and own satellite systems, we affirm . . . that such dangers are outweighed by the competitive benefits of permitting such entry”.

Word-eating time

Turning the words of Justice as well as the FCC's own domsat ruling against the Government may prove IBM's strongest argument. Partner Comsat General, too, has been quick to remind the commission that its 1972 judgment was that “if we adhere too strictly to conventional standards in this unconventional situation, such as requiring a persuasive showing by new entrants that competition is reasonably feasible . . . most such new applicants may in effect be denied any opportunity to demonstrate the merits of their proposals at their own risk and without potential danger to existing services—thereby depriving the public of the potential benefits to be derived from diverse approaches by multiple entrants.”

That argument's screw is being turned also by CML, which contends its restructuring would give it “unique qualifications” to innovate. If the FCC now excludes it, the company believes that “would leave the public with the lower grade of performance which others are now capable of offering—a sacrifice the competitors would have the public make in order to protect their weaker capacities to compete.”

Now that the battle is certainly joined, no one should be misled by the arguments of IBM, CML, and Comsat General, however good, that would limit the issue to a skirmish around strict legalities. The FCC's failure in 1972 to consider the possibility and impact of IBM's entry into satellite communications should not be held against the commission—it was never meant to forecast the future, and in the end, IBM may indeed turn out to be the only company with the resources to challenge AT&T effectively. But there is far more at stake here than the interests of AT&T and IBM. The commission has a responsibility towards all parties and must not allow itself to be hustled into making a quickie decision on a single legal point before hearing all sides.

—Ray Connolly

NEED A 1/4" x 1-1/4" TIME-DELAY FUSE OR QUICK-ACTING FUSE?

BUSS HAS IT!

Time-current characteristics of FUSETRON® dual-element time-delay fuses

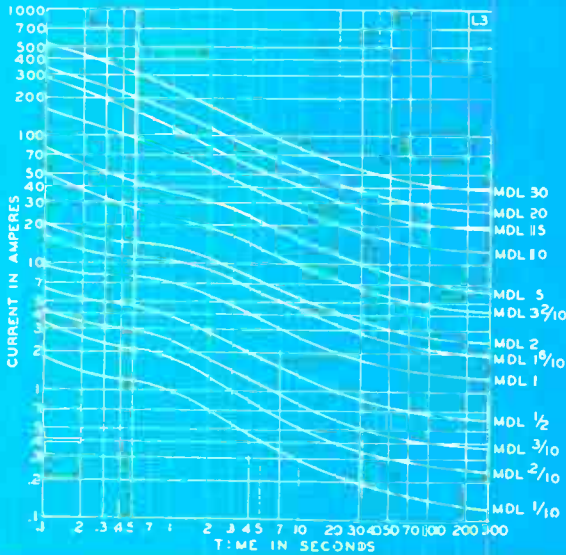

Time-current characteristics of BUSS® fast-acting fuses

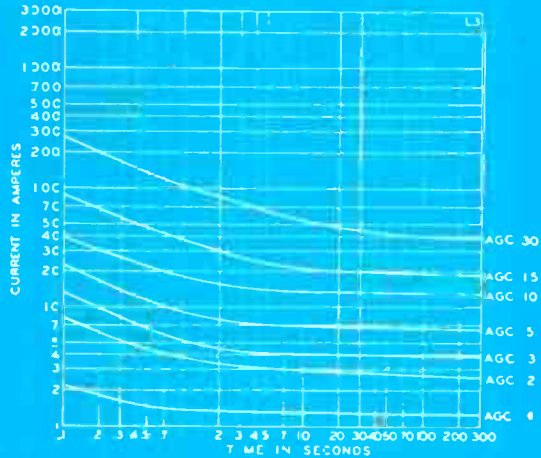

FUSETRON® dual-element fuses

Time-delay characteristics avoid nuisance openings from starting currents or surges—yet, give full protection from short-circuits or dangerous overloads.

Voltage	Symbol	Amperes
250 or less	MDL	1/100, 1/32, 1/16, 1/10, 1/8, 15/100, 175/1000, 3/16, 2/10, 1/4, 3/10, 3/8, 4/10, 1/2, 6/10, 7/10, 3/4, 8/10 or 1
250 or less	MDX	1-1/4, 1-1/2, 1-6/10, 1-8/10 or 2
125 or less	MDL	1-2/10, 1-1/4, 1-1/2, 1-6/10, 2, 2-1/2, or 2-8/10
125 or less	MDX	3, 3-2/10, 4, 5, 6-1/4 or 7
32 or less	MDL	3, 3-2/10, 4, 5, 6-1/4, 8, 10, 15, 20, 25 or 30



BUSS® fast-acting fuses

Fast-acting characteristics provide the instantaneous high speed opening necessary to protect sensitive instruments or delicate apparatus.

Voltage	Symbol	Amperes
250 or less	AGC	1/500, 1/200, 1/100, 1/32, 1/16, 1/10, 1/8, 15/100, 175/1000, 3/16, 2/10, 1/4, 3/10, 3/8, 45/100, 1/2, 6/10, 3/4, 1, 1-1/4, 1-1/2, 1-6/10, 2
250 or less	MGB	1/16 or 1/8
MBW & MBB fuses now called AGC.		
250 or less	AGC	2-1/2, 3
250 or less	MTH	4, 5 or 6
For 250 volt fuses above 6 amperes—See ABC fuses.		
125 or less	GLH	7, 8 or 10
32 or less	AGC	4, 5, 6, 7, 7-1/2, 8, 10, 15, 20, 25 or 30

For a complete selection of BUSS fuses and fuseholders ask for bulletin SFB.



BUSS In the Line Fuseholders

HXP Fuseholder

BUSS Panel Mounted Fuseholders Lamp Indicating

BUSS HGB C Fuseholder Military Type FHL11U

BUSS Space Saver Panel Mounted Fuseholders

BUSS HWR Shielded Panel Mounted Fuseholders

BUSS Snap Lock Rear Panel Mounted Fuseholders

BUSS Panel Mounted Fuseholder

Fuse Blocks For 1/4 x 1/4 Inch Fuses No. 4408 2 pole



BUSSMAN MANUFACTURING
a McGraw-Edison Company Division
St. Louis, Missouri 63107



ICL introduces two computers in new series for communications-oriented applications

International Computers Ltd. claims to have started with needs of the intended user and worked backwards to design its new range of computers. The 2900 series was designed first for the types of jobs it might do, and the software was developed to support those jobs. The hardware was then designed to support the software, so that the machine architecture is technology-independent, the company says.

The 2900 series, based on modified Motorola MECL technology, will continue to compete in international markets in the 1980s. Five and a half years in design, the family is slotted for medium-scale number-crunching, as well as communications and scientific uses.

Markets. Introduced last month were the 2970 and the larger 2980. A single 2980 processor, the company claims, is equivalent to IBM's System/370-168 in raw power. Priced at about \$5 million, the 2980 will "have particular usefulness for communications." Prime market targets will be universities and insurance companies, a spokesman says. The 2970 will sell for about \$2.5 million in a typical configuration.

The new range won't be sold abroad the first year because the company is filling orders totalling about \$50 million from UK government agencies and large retailers, among others. The government, a 10.5% owner in the ICL amalgamation, has contributed about \$100 million toward the development, which cost about \$400 million, ICL says. The company seems prepared to introduce other models if any gaps are found in the market between the 2980, the 2970, and the small 2903, introduced 18 months ago. Although not technically part of the series, \$150,000 little step-brother has been sold to 750 customers, most of them overseas.

The basic 2980 has a main store of 2 million bytes, in steps of 256 kilobytes, expandable to four store modules of 2 million bytes per module. Memory speed is 600 nanoseconds for 16 bytes. Instantaneous throughput rates range from 27 megabytes per second for the machine's store-multiple-access controller (SMAC) to 4 megabytes per second for the internal trunk lines. The smaller 2970 comes with 768 kilobytes of main storage, expandable to 6 million bytes. Memory speeds are 500 nanoseconds for eight bytes, or two eight-bit words, and 16 megabytes per second for the SMAC.

The new range provides virtual-machine processing, virtual memory, a high degree of modularity, use of high-level machine languages, and an "organic" data-management system that enables a customer to go from input/output stages to the data base "without changing his mode of behavior."

Moreover, the new range is compatible with other ICL machines and peripherals, as well as IBM equipment on the data-interchange level. The 2900s are not IBM-compatible on the order-code level, and the two computers cannot operate together in an integral system.

Autonomy. Virtual-machine processing, explains William Talbot, director of hardware development, means that "the machine is so segmented that the user appears to have it all to himself." Each module functions autonomously and in parallel with other modules, the company says. Modules include the high-speed order-code processors, the store-access controllers, which free the order-code processors from handling main-store access by peripherals, and the main-storage units. All main-storage units are independent or can be accessed simultaneously through the SMAC.

ICL's architecture exploits two ad-

ditional processing concepts—pipelining and slave stores. Borrowed from the larger 1900 series, pipelining is the simultaneous execution of several instructions. Each computer instruction is broken into a number of logically separate operations so that corresponding sections of the hardware logic can handle the instructions. By the use of hardware interlocks, several instructions can be processed simultaneously, even though they are at different stages of execution.

To support pipelining, slave stores ensure that the machine's pipeline gets quick access to the instructions and operands. Compared with traditional general-purpose cache memories, slave stores considerably shorten access time to operands, the company claims. Quick access is achieved by stack processing, which allows rapid identification of operands and enables rapid controlled switching of software procedures. The architecture distinguishes between the types of information the machine is handling so that there are separate slave stores for different types of information, he says. □

Japan

Fast n-MOS imager needs no clock

A solid-state imager with an unclocked shift-register scanner, developed at Central Research Laboratory of Hitachi Ltd., greatly decreases spike noise and operates faster than those with clocked registers. This experimental device has 670 picture elements.

The device uses p-MOS technology because n-MOS devices tend to leak. Each stage of the shift register,

which gates one picture element, consists of two cascaded inverter stages and one transfer gate. Direct-current voltages are applied to the load-transistor drain, V_{DD} , load-transistor gate, V_{GG} , and to the gate electrode of the transfer gate, V_{TG} .

The output of the second inverter in each stage is connected to the gate of a transfer gate between the picture-element photodiode associated with that stage and a common video-output line. A battery and a load resistor are also connected between the video line and ground. The load resistor, rated at 100 ohms, gives a resistance-capacitance product of 7 to 12 megahertz.

Propagation. A short negative-going pulse is applied to the input stage, and this pulse propagates through the register, turning on the transfer gates connected to the video-output line, one after the other. The photodiodes are thus successively sampled, and the video signal flows in the output circuit.

During operation, the output of each inverter pair is a pulse with the same polarity as the input pulse, which has, in effect, been inverted twice. But the negative-going leading edge of the output pulse has a speed only about 1/15th that of the positive-going trailing edge. This is caused by the large ratio of transconductance, G_M , between the driver and the load, which is necessary for proper operation of the inverter. Delay is a function of transconductance ratio, circuit capacitance, and voltage of the MOS-transistor threshold.

The second stage of the shift register does not start to turn on until the output of the first stage exceeds the threshold voltage of the input driver of the second stage. In that way, the speed of the negative-going output pulse of each stage and the threshold voltage of the following stage control the rate the input pulse propagates through the shift register. The transfer gate between the stages also has a small effect.

Speed. Scanning speed of the device is about 12 MHz when 12 volts of direct current is applied to all three power-supply lines. By vary-

Around the world

'Cold' IC doping is cheap and easy

A researcher at the Max Planck Institute for Physics and Astrophysics in Munich has developed an electrochemical method of doping semiconductor crystals at room temperatures that's simpler and less costly than diffusion or ion-implantation techniques. Jovan Antula, a graduate of the Technical University of Belgrade, Yugoslavia, has fabricated functional laboratory-type pn junctions in silicon materials. The material to be doped is subjected to an electrolyte containing positive ions as dopants. Then, under the influence of an electrical field, the ions are gradually drawn into the material's surface. In this way, the electrical characteristics of semiconductors can be altered over a wide range to produce pn junctions.

Digitizing improves hybrid computer

Designers can combine the speed of an analog computer with the accuracy of a digital processor, but the resulting hybrid computer often suffers from three problems—difficult interfacing, complex programming, and different maintenance and operating specifications for the two machines. At the Computer Systems and Technology Conference of the Institute of Electrical Engineers, however, a University of Surrey team described a way to solve the problems—they digitized the analog part of a hybrid. The team has built an experimental machine and has funds to build another.

Two firms develop dial-a-bus systems

Aerospace firms Messerschmitt-Bölkow-Blohm GmbH and Dornier Systems GmbH are making feasibility studies of a dial-a-bus systems that differ somewhat from U.S. and other configurations. Both companies are well along in developing slightly differing concepts of enabling passengers to summon buses from terminal-equipped stops by selecting destinations and depositing fares. Dornier's system is intended primarily for rural districts, and MBB's is aimed at thinly populated urban areas where regular bus service often tends to be inadequate. West Germany's Ministry for Research and Technology is contributing \$1.4 million to the program.

ing the voltage applied to the gate of the inverter load transistors from about 8 v to 20 v, the scanning rate can be varied from less than 10 MHz to about 35 MHz. A much smaller change in scanning rate can be obtained by varying the voltage on the transfer gates between inverter pairs, and this voltage can be used for vernier control.

Threshold voltage of the inverter transistors has a large effect on scanning speed—a 1-v change in threshold causes about a 20% change in scanning rate. Hitachi engineers say they can hold threshold voltage to within 0.1 v, which limits variations in scanning speed to 2%.

The scanning rate varies about 20% between temperatures of 25°C and 75°C, which is reduced by a control circuit on the chip. The period between the output of the last stage of the register and the next

start pulse is measured and converted into a voltage, which is applied as a correction to the inverter-load transistor-gate voltage line, V_{GG} , to correct the scanning rate.

Overlap. Because the propagation delay between stages is shorter than the width of the pulse propagated through the register, the pulses applied to the transfer gates connected to the video-output line overlap. This could cause superposition of the output signals of several picture elements if the charge time of the photodiodes were not shorter than the propagation time. The experimental device has no superposition of picture elements for scanning rates below 10 MHz.

Output waveforms of the experimental device show no spike noise, and the signal-to-noise ratio is about 25 to 30 decibels, even without noise-elimination processing. □

Here are two of the world's best oscilloscopes.



Hewlett-Packard 1707B

Tektronix 465

Here's why you shouldn't own either one.

You can lease one for as little as \$45 per month.

We can give you immediate delivery on either the Hewlett-Packard 1707B or the Tektronix 465, in quantity.

The Hewlett-Packard scope lease is \$45 per month for 36 months. The Tektronix 465 is \$50 per month for 36 months.

Anyway you choose, leasing is the best thing that ever happened to a tight capital equipment budget. You pay for your scope as you use it ... and you pay for it out of the profits it generates.

Call your closest Instant Inventory Center and ask us about short term rentals, delivery, and other lease terms for scopes or any other electronic equipment you need, up to and including minicomputers.



Anaheim, California (714) 879-0561
Dallas, Texas (214) 661-8082
Fort Lauderdale, Florida (305) 771-3500
Gaithersburg, Maryland (301) 948-0620
Burlington, Massachusetts (617) 273-2770
Mountain View, California (415) 968-8845
Oakland, New Jersey (201) 337-3757
Rexdale (Toronto) Ont., Canada (416) 677-7513
Des Plaines, Illinois (312) 827-6670

Rental Electronics, Inc.

A **PEPSICO** leasing company.

Components firms in Germany lay off workers in slump

Some of West Germany's components makers, faced with prospects of a flat or possibly declining semiconductor market next year, have started to retrench. **Texas Instruments GmbH has decided to shut down its Ingolstadt facilities in Bavaria by the end of this year, which will idle 350 workers engaged primarily in producing small-signal transistors.** TI will also throttle production of integrated circuits at its main West German plant in Freising by not replacing workers lost through attrition.

Other semiconductor producers are getting increasingly jittery over the slackening demand for components. Fritz G. Höhne, manager for worldwide semiconductor marketing at AEG-Telefunken, says, "We hope that the chalice [of hemlock] will pass by." Erich Gelden at Siemens AG in Munich, says "In times like these, it's no use hanging on to excess capacity." **Philips Gloeilampenfabrieken, Europe's largest components maker, has decided to cut the length of work weeks in West Germany, Belgium, and the UK because "in the third quarter of 1974, the increase in Philips' sales volume was lower than expected,"** says the management board. Similar measures, the firm says, will shortly become necessary also in the Netherlands, Philips' home base. **The hardest-hit facility in West Germany is the Philips subsidiary Valvo GmbH in Hamburg, where 620 people—20% of work force—in the tube and semiconductor plants have had their work hours reduced.**

Soviets weigh Stansaab, Univac bids for ATC gear

The Sperry Rand Corp. Univac division and Stansaab of Sweden are finalists in the competition for an order from the Soviet Union of air-traffic-control equipment, valued at an estimated \$75 million, says a Univac official. **Other companies, including Lockheed, Marconi, and Plessey, are reported to have dropped out after hard bargaining with the Soviets, who are said to be only "weeks away" from a decision.** Univac submitted a final bid after the Soviets reportedly pressured the U.S. firm by leaking information that Stansaab was on the verge of getting the contract. "That's the hard-as-nails bargaining style of the Russians," observed an industry official.

French score hits in armaments sales to foreign navies

French manufacturers of naval armaments have been filling their order books this year. At a late-October exposition of naval weapons aimed at boosting sales to foreign navies, the French defense ministry's weapons-sales agency, the Délégation Ministérielle pour l'Armement (DME) reports that **orders for ships and equipment during the first half of 1974 reached about \$210 million, roughly triple the comparable figures for the past four years.** The surge in orders won't affect deliveries much before 1977. **DME estimates this year's deliveries of naval vessels at about \$63 million and practically the same for 1975.**

Optical fiber may cut transmission losses for British

Production of such components as parametric amplifiers, modulators, and isolators inside of optical waveguides is likely through use of a single-crystal optical fiber developed by the British Post Office's Research department. **This compact configuration would increase efficiency of fiber-optic transmissions because it would dispense with exter-**

nal planar coupling, which induces losses, and could stimulate development of all-optical repeaters for fiber-optic communications.

The BPO experimental fiber has a core of nonlinear optical-crystal meta-nitroaniline. Hollow optical fibers, having internal diameters of less than 20 micrometers, are pulled from lanthanide-flint optical glass and filled with the molten meta-nitroaniline. Controlled cooling produces a single-crystal meta-nitroaniline-fiber core. The process automatically aligns the principal axes of the crystal core with the geometric axes of the glass cladding. **The BPO is developing low-frequency electro-optic modulators for use with the fibers.**

Spain defers try to create joint computer company

Spain's deepening political turmoil has hit Instituto Nacional de Industria (INI), the government industrial holding agency, which is **deferring the launching of major electronics projects until the Spanish government is reorganized.** Fernandez Ordonez, working in tandem with Barrera de Irimo, economic vice premier, was to have decided on the formation of a government-dominated computer company by INI and a foreign partner, but both men have now resigned. **Japan's Fujitsu appeared to be the favorite for the foreign-held minority interest in the venture, but Nixdorf of Germany was reported to have been still in the running.**

Japanese to export \$165 LCD digital quartz wristwatch

A digital quartz wristwatch with a liquid-crystal display, to go on sale Dec. 5 in Japan at about \$165, will be by a wide margin Japan's lowest-priced digital watch. Orient Watch Co., which teamed with Sharp Corp. to produce the watch, says it will also export it to 60 countries around the world where its more conventional watches are sold. Sharp produces the watch insides, and Orient produces the jewelry. **The initial production rate is said to be 10,000 units a month, to be increased to 20,000 next spring and 50,000 by the end of new year.**

The watch differs from many others in using single chip for all functions, including a 32-kilohertz oscillator, divider, and display driver. Circuits for the first two functions operate from 1.55-volt power supply, and those for third function operate from a stepped-up 4.5-v power supply. The package for the device and wiring substrate are integrated to form a sort of hybrid circuit. **The field-effect display has three and a half digits, and a comma between them winks out the seconds.**

British to test data-transmission, message services

The British Post Office is planning to start several projects in data transmission that will lead to a pilot circuit-switched service by the end of the decade. **Two-phase trials for the private-line, or exclusive end-to-end, service are to begin in 1976,** but the BPO says that demand for a national switched service appears to be less than originally thought when the plans were announced in 1971.

Nevertheless, next fall, the BPO intends to open an experimental packet-switched public service for individually routed messages through a London exchange, followed soon by exchanges in Manchester and Glasgow. Also in 1975, the BPO plans service based on time-division techniques that will give the UK access to circuit-switched asynchronous transmission systems now being introduced in Europe.

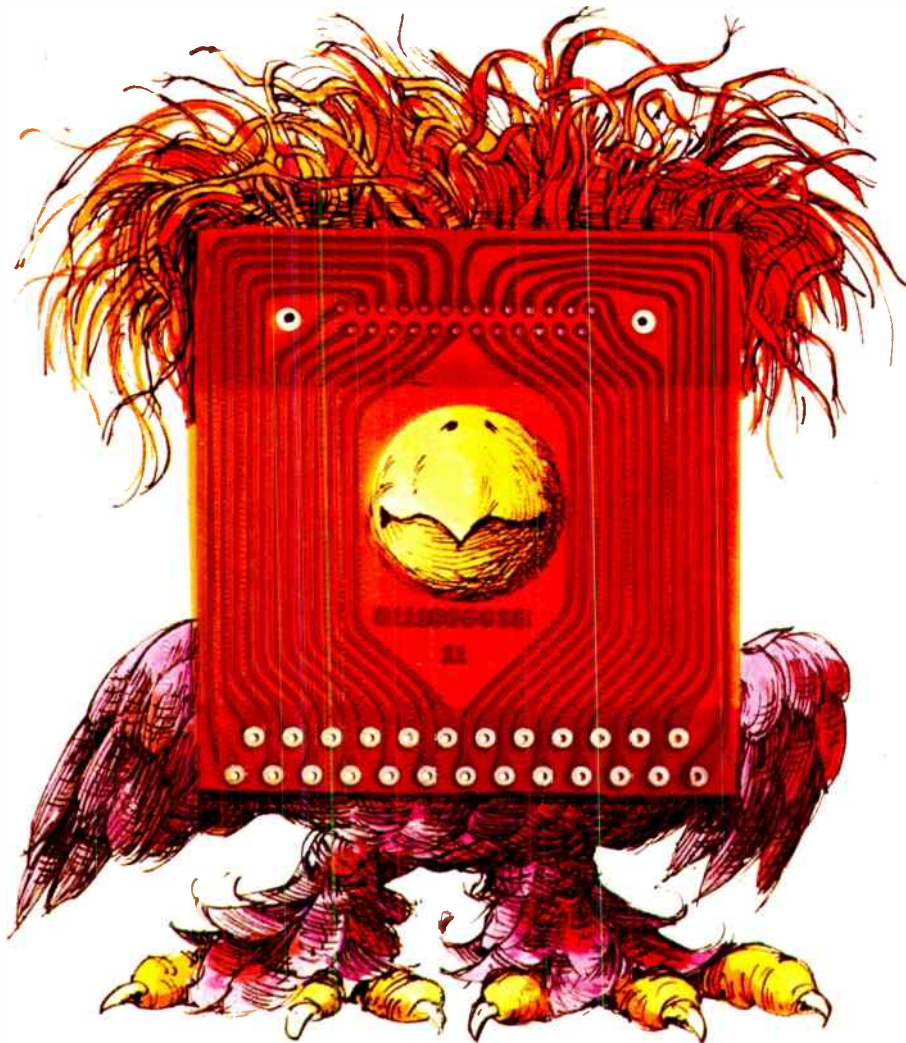

The Great Tufted Single Sided Strain Relief Conductor.

(Very rare. Only 400 in existence.)

To an ornithologist, maybe single sided strain relief conductors aren't much of a turn on. But if you're an engineer wrestling with a next to impossible design problem involving limited space, circuitry needs on several planes, and low volume restrictions, then single sided strain relief conductors are not for the birds—they may be your answer.

Flexcircuits, like the small volume one you see here (we built only 400), get the same Sheldahl engineering attention, 100% quality control and on-time delivery as high volume orders. We don't think our customers come in different sizes. They come with different *needs*.

For short runs of flexcircuits we offer the same capabilities as for high volume production: single or double-sided circuits, plated through holes, reflow coated circuits, solder-plated conductors, solder-fused pads, film or epoxy covered coated circuits, back bared pads and flexcircuit/hardboard hybrids.

So whether it's a new product, design change, or a prototype to help start an idea toward reality, consider flexcircuit technology and quality. It's been the answer for many companies—large and small—and could be just the answer you've been looking for.

Call Sheldahl and find out.

(Flexcircuit watcher? To get an 11 x 14 reprint of the above bird, suitable for framing, just write on your letterhead.)



Sheldahl

Electrical Products Division
Northfield, Minnesota 55057
Phone: (507) 645-5633

GENERAL ELECTRIC ROTRON
PAMOTOR BODINE
ROBBINS & MEYERS AMPHENOL
IMC INDIANA GENERAL

Need another prime* source?...

** If we've missed any, we apologize*

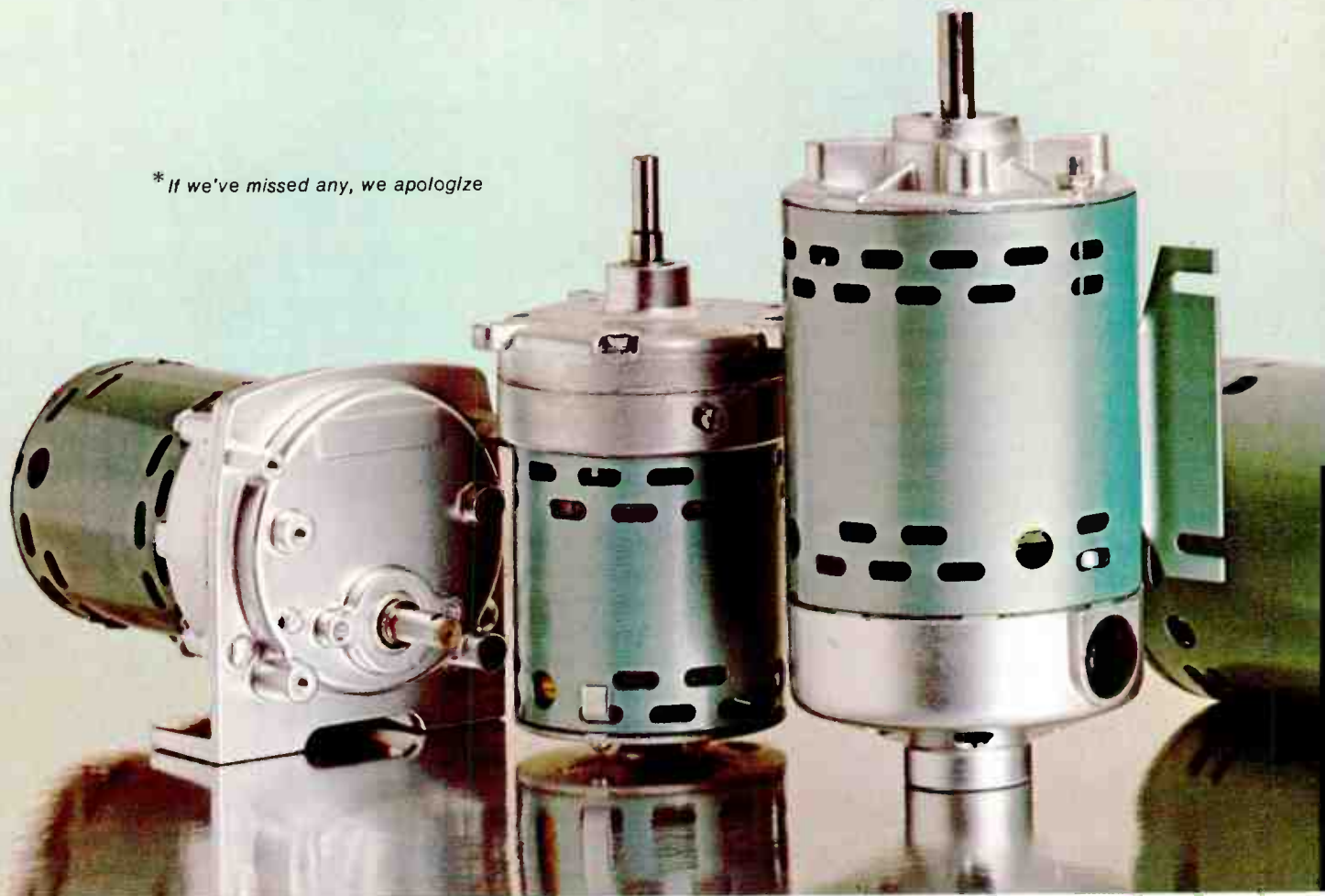

For fast help on INDUCTION MOTORS
call Bill Samaras (815) 889-4105

For assistance on UNIVERSAL/DC MOTORS
call Art Grau (815) 889-4107

Circle Card No. 58 for data on FHP MOTORS/GEARMOTORS

World Radio History

**If you need UNIVERSAL/DC . . .
INDUCTION . . . SHADED POLE
FHP motors, gearmotors, fans
or blowers—Call Howard now.**

When price, quality and delivery are *prime* considerations—look into what Howard can offer you. Today, because of greatly expanded facilities, you (just as many other major firms) can depend on Howard as a *prime* source for more of your FHP motor, fan and blower needs. Geared to work closely with O.E.M. customers, Howard can meet your particular design requirements.

Prototypes and production models can be developed to your specifications.

And delivery is much earlier than you'd expect! With the broadest line of FHP motors, gearmotors, fans and blowers in the industry—Howard is large enough to insure dependable service, small enough to respond to your individual needs. Our customer service representatives and phone numbers are listed below.

*For another reliable prime source
call Howard now!*

Call

HOWARD

HOWARD INDUSTRIES / Division of MSL Industries, Inc.
One North Dixie Highway, Milford, Illinois 60953

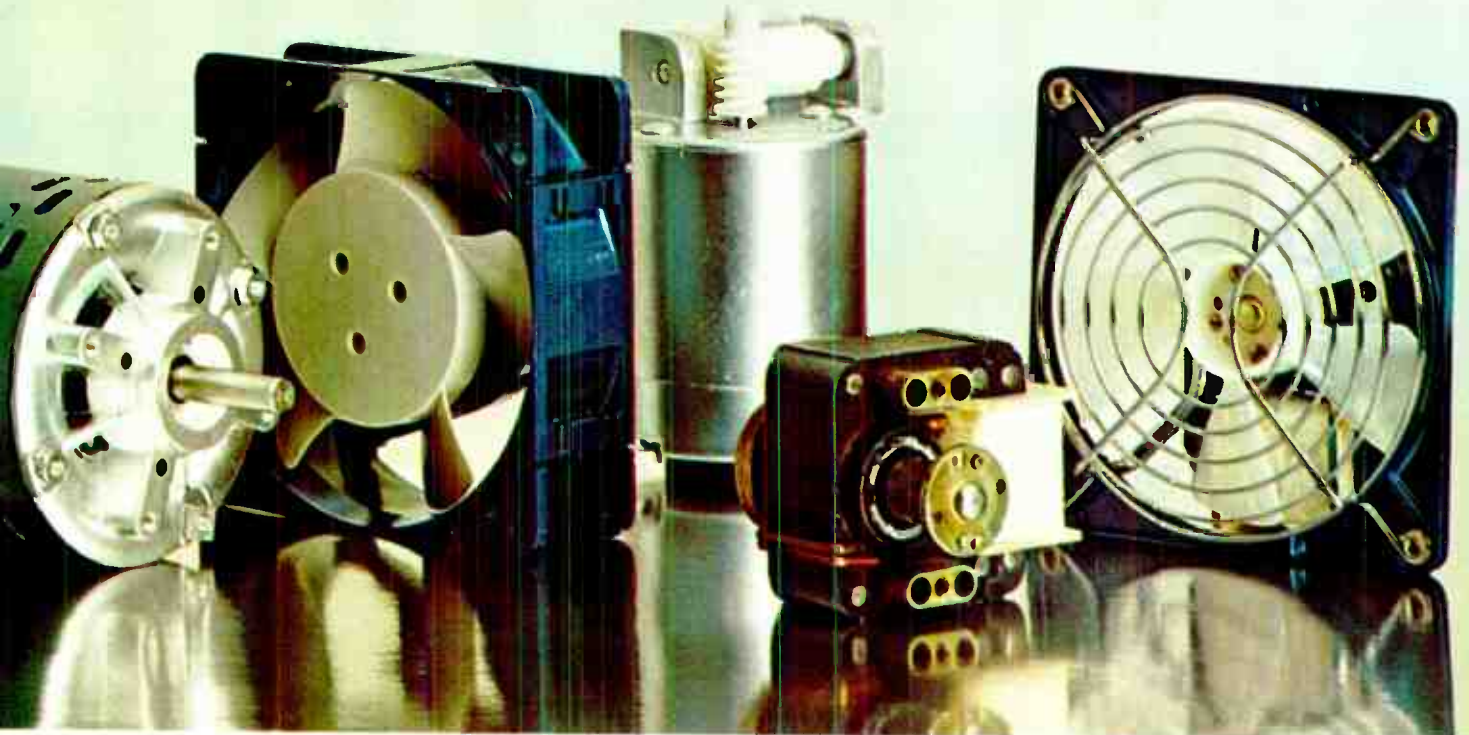

If you need SHADED POLE MOTORS—FANS, BLOWERS
call Larry Taylor (815) 889-4106

Circle Card No. 59 for data on FANS/BLOWERS

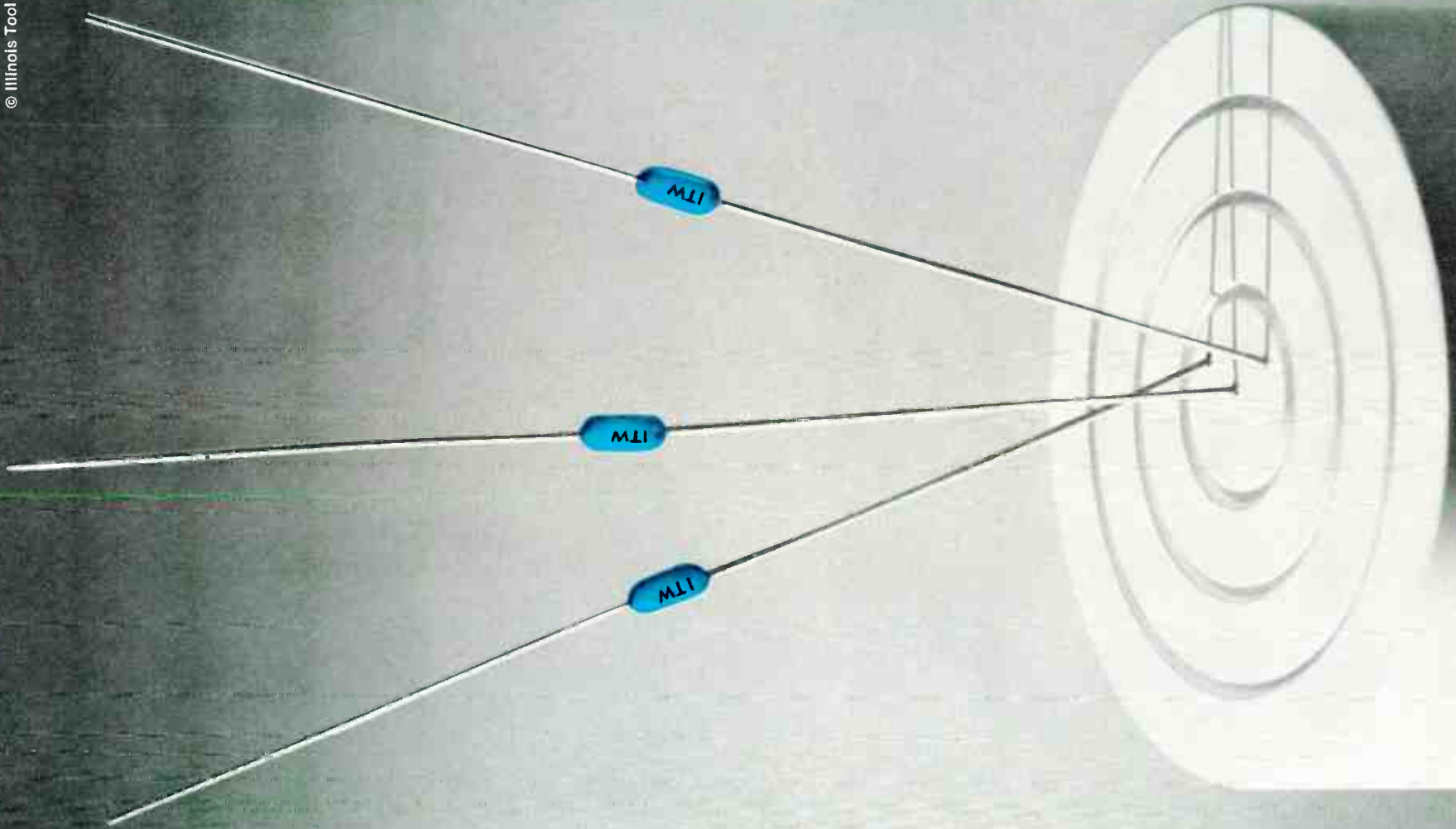

The Winner!

New EMCON[®] BLUE DART[™] Drip-free Ceramic Capacitors hit the mark.

Call it a breakthrough. Because that's what our new line of Blue Dart Ceramic Capacitors is. A breakthrough in axial-leaded, dipped-type capacitor technology.

Here's a conformally-coated capacitor that finally eliminates drippdown or "pants leg" . . . a problem that results in broken seals when leads are bent. We solved it with tighter meniscus control. So, when you bend the leads of a Blue Dart capacitor, seal breakage is very unlikely.

Our breakthrough also brings you a stronger lead attachment (probably the strongest) and total dimensional

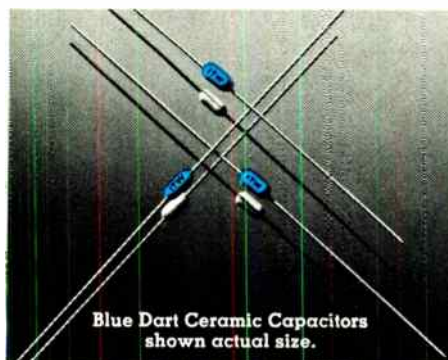

uniformity. That makes Blue Dart capacitors ideal for automatic insertion equipment.

No, you don't sacrifice low cost for these important advantages. Fact is, Blue Dart capacitors may well cost less than you're now paying for ordinary ceramic capacitors. You can order new Blue Dart Ceramic Capacitors in two sizes, covering a capacitance range of 10pf. to 12mf.

Choice of three styles: general purpose, X7R and COG (NPO). General purpose units are rated at 25, 50 and 100 WVDC. X7R and COG (NPO) are rated at 50, 100 and 200 WVDC.

If you are using, or are planning to use, automatic insertion, reel-taped sample parts are available upon request. For complete information, write: EMCON, Division Illinois Tool Works Inc., 11620 Sorrento Valley Road, San Diego, California 92121. Or phone (714) 459-4355, TWX 910-332-1130.



EMCON[®]
A DIVISION OF ILLINOIS TOOL WORKS INC.

The Innovative Electronic Groups of ITW . . . EMCON•PAKTRON•LICON

Circle 61 on reader service card

Only TRW/IRC offers you complete resistor choice.



You get exactly the resistor you need for your application.

No compromises. No "favorites." Just quality.

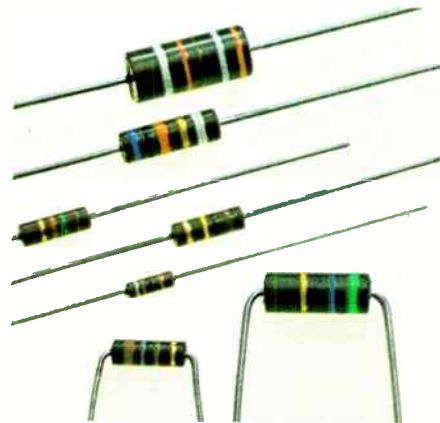

Carbon comp.

Billions used in consumer, industrial, military applications. TRW/IRC carbon comp. capability ranges from standard commercial types through established reliability RCR's, to ultra-high range (10^{11} ohms). Where you're using carbon comp.'s in automated assembly, TRW/IRC packaging options can help cut the cost of interfacing with your machines. Card packs, lead tape reels, cut and formed leads... we'll be glad to explore the potential economies with you.

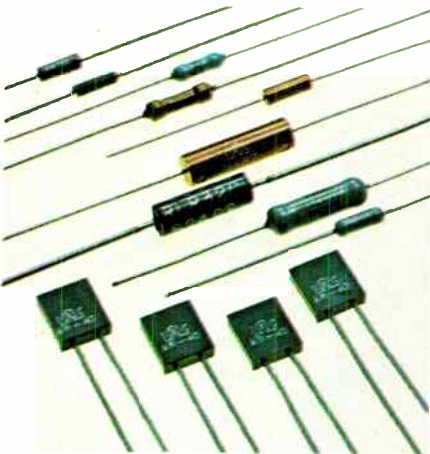

Metal Film

TRW/IRC has brought the state of the art in thin-film to a performance level equaling high-stability wirewounds. Capabilities include resistors with tolerances to $\pm 0.01\%$ and ± 3 PPM T.C. ... high-rel units... precision subminiatures... and, of course

the popular RN's. You can also look at alloy films offering high-temperature and high-voltage capability at low cost.

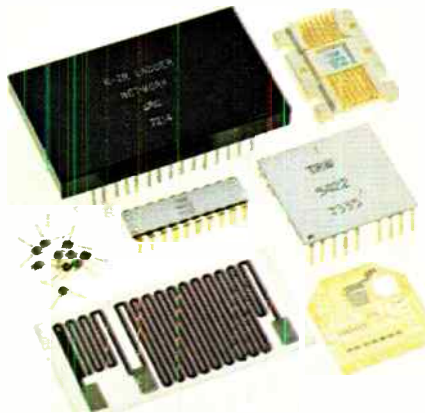

Resistive Networks

Advanced resistor technology here. These IC compatible, precision tantalum-film circuits provide inherent low noise, excellent stability, and hermetic performance without hermetic cost. Tolerances from 5% to 0.05% available in custom designs. TRW/IRC also offers the industry's most complete line of discrete fixed resistors.



Wirewound

The line starts with molded wirewound resistors—"space-savers" that bridge the cost-performance gap between composition resistors and precision wirewounds. It proceeds to standard, non-insulated types

for appliance/automotive use... to precision subminiatures offering high power density... to low cost fusible, flameproof units for consumer and industrial applications... to tubular and flat power wirewounds with ratings to 250 W.

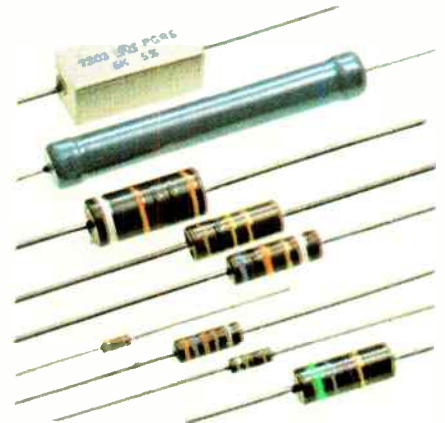

Metal Glaze™

This is TRW/IRC's thick-film technology—for all types of low power resistor applications. Metal Glaze is widely accepted for its built-in power handling reliability, resistance range, and cost effectiveness. Numerous standard and special designs—precision, semi-precision, flameproof, high-rel, high-voltage.

All types...all technologies... one source

To wrap it up, TRW/IRC offers you the most complete line of fixed resistors in the business, with many of the popular types available from one source—your local TRW/IRC distributor. Having a direct pipeline to each of our plants, he can give you fast delivery.

Contact your local TRW sales office for application assistance, custom designs, and special engineering help when you need it. TRW/IRC Resistors, an Electronic Components Division of TRW, Inc. Plants at Boone, N.C., Burlington, Iowa, and Philadelphia, Pa. Write TRW/IRC Resistors, 401 N. Broad St., Philadelphia, Pa. 19108. Or call (215) 923-8230.

TRW[®] IRC RESISTORS

Circle 63 on reader service card



Introducing Eclipse.
Suddenly a lot of computers don't look so bright.

The most expensive part of a computer isn't the computer anymore.

It's the people who work with it.

So Data General is introducing a family of medium scale computers that cut down on the work people have to do.

Eclipse.

You won't have to clean up the mistakes this computer makes. Eclipse has automatic memory error correction.

You won't have to rewrite complicated instructions every time you need them. Eclipse's microprogrammed architecture includes a comprehensive new set of instructions so powerful they do the work of entire subroutines.

You won't have to lose speed doing special subroutines with software. Eclipse has a Writeable Control Storage Unit that lets you keep them in the hardware.

You won't have to use assembly language to make your programs go fast. Eclipse is so fast it can run high level languages at assembly language speeds. (It has a bipolar memory cache that makes semiconductor memory a lot faster. Plus core and semiconductor memory interleaving for even more speed. And the fastest Floating Point Processor in the industry.)

And even though Eclipse is a brand new computer, you won't have to write a lot of systems software or jury-rig your peripherals. Eclipse is upwards compatible with the Nova line. So all the software and peripherals we've already made can go right to work on the Eclipse.

Write for our brochure. And see how bright an Eclipse can be.

Data General

The computer company you can understand.

• Data General Corporation, Southboro, Massachusetts 01772, (617) 485-9100. Data Gen of Canada Ltd., Hull, Quebec, J8Y3S6. Data General Europe, 116 Rue de la Tour, Paris 75016 France. Data General Australia, Melbourne (03) 82-1361/Sydney (02) 908-1366.

Circle 65 on reader service card

The programmable laser trimmer for people who never thought they could afford one.



The Teradyne W233 Unitrimmer. The first programmable laser trimmer with a trimmed-down price.

The Unitrimmer is designed for people who trim only one or two resistors at a time, do development work or multiple trims in low-volume applications.

And it's from Teradyne — the company that makes the finest computer-controlled laser trimming system in the business — the W311.

The Unitrimmer lets you program two trims at a time by setting front panel digit switches. It can also be programmed electrically to interface with other systems. The trims can be on the same resistor, or one each on two resistors. Additional trims can be handled in multiple passes.

Length and direction, resistance or voltage, Q-switch rate, bite size, and trim speed are all programmable. A single joy-stick lets you position the start-trim point in seconds.

The laser, optics, beam positioner, and parts handler are all identical to those on the W311. So you get galvanometer-controlled beam positioning for unmatched speed, resolution, and reliability; a clear view of work in process via TV monitor or microscope; your choice of in-line, rotary, or step-and-repeat feed. And if you ever want to upgrade to computer-controlled trimming, the Unitrimmer can be field-expanded into a W311.

Best of all, since the Unitrimmer doesn't need a computer, mag tape unit, software, etc., you can get one for less than half the price of a computer-controlled system.

The Teradyne W233 Unitrimmer. Programmable laser trimming.

At a trimmed-down price.

Write Teradyne: 183 Essex Street, Boston, Mass. 02111. In Europe: Teradyne Ltd., 12 Queens Road, Weybridge, Surrey, England.

TERADYNE

W233

CHICAGO (312) 298-8610/DALLAS (214) 231-5384/NEW ENGLAND (617) 458-1256/NEW YORK (201) 334-9770/SUNNYVALE (408) 732-8770
LONDON (0932) 51431/PARIS 265 72 62/ROME 59 47 62/MUNICH (089) 33 50 61/TOKYO (03) 406-4021

Probing the news

Analysis of technology and business developments

IBM plan: individual earth stations

Computer giant's attempt to gain control of CML Satellite Corp. stirs strong opposition, with FCC ruling seen by early 1975

by Ray Connolly, Washington bureau manager

Visualize a domestic communications system served by a satellite launched by a company controlled by International Business Machines Corp. To IBM's potential competitors, the system's most terrifying characteristic would be creation of another U.S. communications monopoly, and they are urging the Federal Communications Commission never to let that satellite get off the ground.

The FCC would first have to approve its joint petition with Comsat General Corp. to restructure CML Satellite Corp. to give the giant computer company a 55% share [*Electronics*, July 11, p. 26].

IBM so far has said little about the system it proposes to launch. But the little the computer company has said lately to the FCC about its plans has some commission staffers wanting to know more before a recommendation is made to the full commission by year's end.

A restructured CML's satellite system "will be different from the first-generation systems proposed by the other entrants," IBM acknowledges. CML goes somewhat further: its "ultimate system will be a digital satellite transmission system for integrated voice, image, and data service, including high-speed data transmission on a multipoint-network basis, utilizing the higher transmit/receive frequencies and heavily dependent on numerous single-customer-dedicated as well as some multiple-user earth stations."

Test plan. The companies have been unwilling to go beyond that, except for IBM's admission that it is busy acquiring "more expertise about the relationship of data pro-

cessing and satellite communications." To get it, the company says, it will ask the FCC for construction permits "within a few months" to build "two or three" earth-station transceivers at as many IBM sites. Its goal is to further explore and develop techniques and hardware for "flexible and efficient use of full transponders" using the company's internal voice and data communications. It's believed that IBM will use Comsat's Intelsats for the test, although Westar and Canada's Anik I are available.

"For several years we have been studying satellite-communications technology," IBM concedes. The first

disclosure of that interest, however, came long before the latest statement before the FCC. Internal IBM documents, subpoenaed by Telex Corp. in its successful antitrust suit now in appeal, show that in 1970 the company established a communications task force on the premise that "our strategy must be to provide a total system." From the hints it has given the FCC, IBM's system apparently would be total.

Reactions. Despite this, the company with the most at stake in a competition with an IBM-controlled CML—American Telephone & Telegraph Co.—is playing it decidedly cool. This contrasts markedly with

Carnation. That was code name for this IBM model 3750 PABX, made and now marketed in France. Computer Industry Association says IBM plans "Carnation-to-satellite transmission."



its determined opposition to terrestrial competition from such infant specialized carriers as Data Transmission Co. and MCI Communications Corp. Of course, MCI, one of the sellers in the CML deal, along with Lockheed Aircraft, is silent on the proposal. But Datran and numerous others strongly oppose approval of the IBM-Comsat general linkup (see "The defensive team," p. 68).

AT&T says it "has no objection to the proposed change in ownership" of CML. But it reserves the right "to address the public-interest questions" it expects will be raised when CML files formal applications with the FCC "setting forth its actual satellite plans." That carefully structured AT&T reaction drew wry chuckles from communications lawyers in the nation's capital.

"AT&T knows exactly what it is about, of course," explains one of them. "It wants IBM's entry into the communications business approved so it can get the commission to let it into the data-processing-services business. If it can get FCC to turn around on that, *then* Bell probably will fight to limit what IBM can do."

That course of action is in fact suggested in AT&T's brief comments to the FCC, in which the company

foresees later questions asking "whether the public interest would be served by permitting IBM indirectly to engage in both common-carrier satellite and data-processing activities" while restricting AT&T. AT&T appears to have charted its course precisely, responding only to the single question asked now by Comsat General and IBM—will the FCC, while reserving action on specific service plans still under company study, make the "threshold decision" that will let the two of them restructure CML?

In a capital made conspiracy-conscious by Watergate, the Computer Industry Association's assessment of IBM's strategy is the most intriguing. "Quite simply, this may amount to a careful attempt to monopolize the market for information-handling services and hardware by obtaining a total systems lock" in both areas, charges the association.

On the rooftop. Prior to CML's recent statement that its "ultimate system" will depend heavily on individual customer earth stations—its most significant disclosure thus far—the computer association's forecast that one component of an IBM/CML end-to-end system would be a "rooftop antenna for direct Carnation-to-satellite transmission" costing between \$1,200 and \$1,600.

Carnation was the IBM code name for its model 3750 automated pri-

vate exchange equipment (PABX) that is being made and successfully marketed by IBM in France, widely regarded as a test market for later introduction to the U.S. [*Electronics*, Nov. 8, 1973, p. 68]. The association says Telex documents show a U.S. version would add such features as "direct dialing, tie lines, data access, signaling, 60-cycle power, call directors, satellite connection, automatic overflow routing," and possible encryption capability for privacy.

The threatened competitors recall, as does the association, the IBM communications task-force report of May 1972 calling for formation of an Information Systems division that would "keep options open based on 3750 success and future developments in CATV, satellite communications, etc. Strategy would support both voice and data applications—focus on data/word entry in office environment." IBM management reportedly rejected the new-division idea on the ground that it could lead to "fragmentation of market requirements for communications products."

What IBM proposes now is creation of a wholly owned subsidiary, IBM/S, with separate accounting, officers, equipment, and facilities to handle its controlling interest in CML. Moreover, it argues it "has no desire for a permanent position as a majority owner" in CML, but plans at some unspecified date to make available, along with Comsat General, "a substantial number of shares of CML common stock to other investors after CML has gained operational experience."

Should these and other arguments of IBM, Comsat General, and CML fail to convince the FCC staff study being directed by the Common Carrier Bureau's Ruth Reel, they may be sufficient to get the commissioners themselves to rule favorably on the "threshold decision" on IBM's eligibility that the companies want. That could come near the beginning of the new year.

But even if that action and all of CML's later service and tariff filings go smoothly for the petitioners—an unlikely prospect—the companies themselves believe it will be 1979 before a reorganized CML is operational. □

The defensive line-up

IBM's wish to buy the controlling interest in CML Satellite Corp. is not going unopposed after all. Trustbusters in the Department of Justice, after expressing disinterest in July, came out in opposition in October. So did the Federal Trade Commission, which shares antitrust authority with the Justice Department.

Both warned the FCC that it might be creating a new U.S. communications monopoly by letting IBM and Comsat subsidiaries join forces. The Justice Department called for FCC deferral of the plan at least until significant competitive questions are resolved; the FTC called for denial since it has "no information which would lead us to conclude that other potential applicants in these fields could possibly match the combined expertise, resources, or access to customers" of IBM and Comsat, "and therefore we think none is likely to try."

Domsat applicants opposed in varying degrees to IBM's entry include: American Satellite Corp. and its parent Fairchild Industries Inc.; Data Transmission Co.; ITT World Communications Inc.; RCA Global Communications Inc. and RCA Alaska Communications Inc.; Southern Pacific Communications Co., and Western Union. Electronics companies opposed include computer-maker Sperry Rand Corp., and CRT terminal maker Sanders Associates Inc., which recently disclosed plans to sue IBM for allegedly monopolistic marketing practices.

Manufacturing

Automating the epitaxial process

Effort at Motorola Semiconductor will produce 25,000 wafers weekly, with only 12 workers a day needed instead of 50 now on the job

by Paul Franson, Los Angeles bureau manager

Automated production is considered by many major semiconductor makers as the way to deal with expected offshore labor restrictions and to increase productivity without adding personnel. One important effort is at Motorola Inc.'s Semiconductor Products division in Phoenix, where a long-term program to automate epitaxial growth on wafers is nearing fruition.

The three-year-old program, a joint effort of Motorola and the Air

Force Manufacturing Technology division at Wright Patterson Air Force Base in Ohio, has many implications beyond labor savings. The long-term commitment by Motorola is one that few semiconductor firms can afford, but automation on this scale by the giants in the industry may increase their domination of the market.

The Motorola system, which was developed under the direction of Bernard van Pul of the epitaxial

products group, will eventually produce 25,000 finished 3-inch wafers a week—one every 12 seconds. Only 12 workers a day in two shifts will be required in contrast to the 50 now needed.

After the computer-controlled system accepts Motorola-developed cartridges holding 50 wafers, the op-

. . . **And it comes out here.** Here's Motorola's automated epitaxial production line, developed jointly with the Air Force.

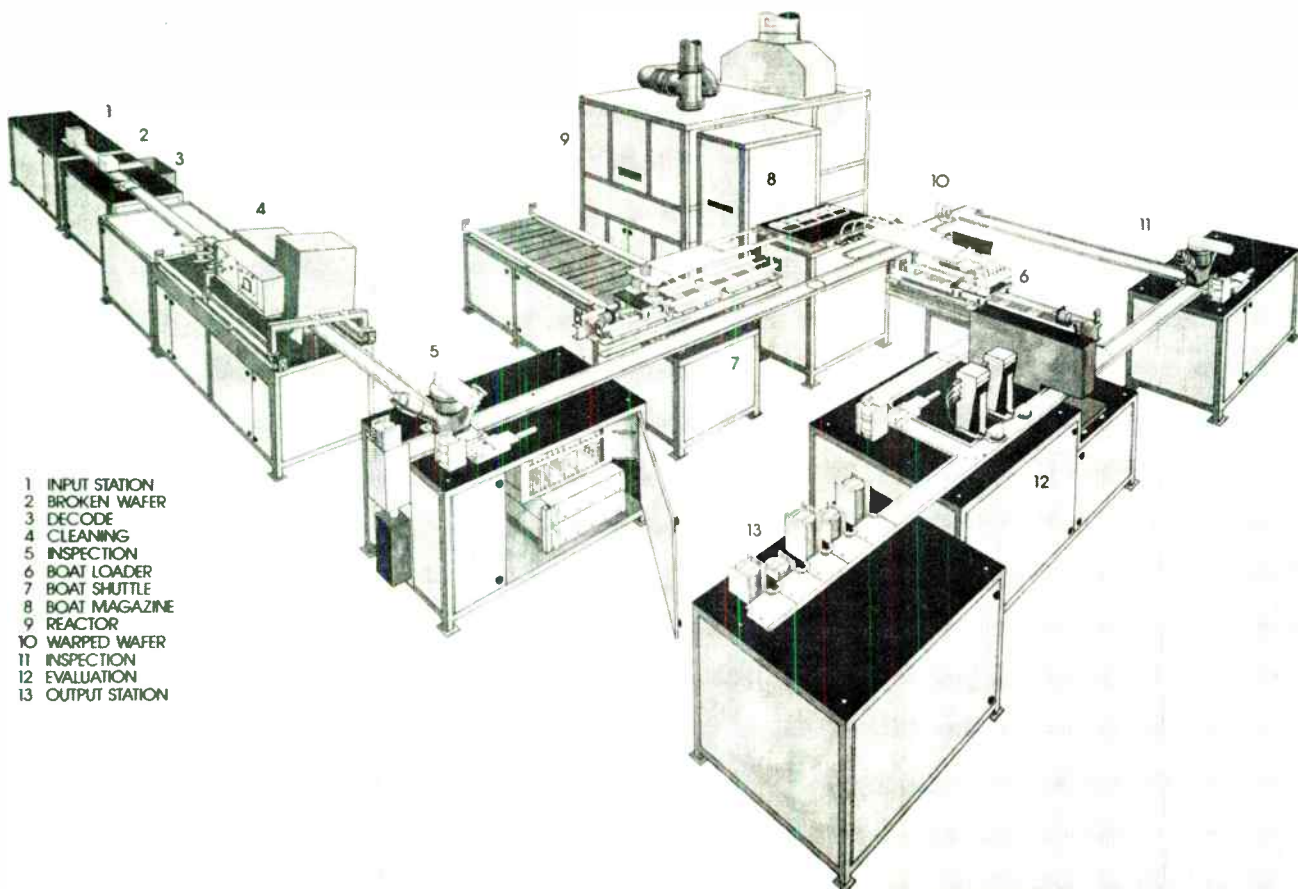

Probing the news

eration is completely automatic. The wafers move through cleaning, inspection, epitaxial growth, more inspection, and binning into desired categories.

James H. Williams, manager of automation and instrumentation for epitaxial products, says a Control Data Corp. 1700 medium-scale computer was chosen to control the system partly because of experience gained using another CDC 1700 that controls a separate epitaxial facility. The two systems may be integrated eventually. The reactor on the epitaxial production line is not computer-controlled, but growth is automated as part of the system. There's also a system to check epitaxial thickness and resistivity.

Each section of the system was developed separately. Epitaxial-products manager Don M. Jackson Jr. says, "We didn't try to bring it all up at once. That's probably more than we could handle." He adds that the company tried to buy parts for the system, but nothing suitable was available, so that everything is custom-made—including the epitaxial reactor—except for a highly modified dry-plasma-wafer cleaner from LFE Corp.

Jackson says that he doesn't expect this type of automated equipment to be available from companies in the business. "Not many people in the world need this level of complexity." Motorola's central epitaxy facility produces all the epitaxial wafers needed worldwide for its IC operations. Other semiconductor companies typically split the operation among separate production lines, even in a single location—so Motorola can take advantage of much greater economies of scale. The firm does not expect to sell systems to others, but will use subsystems, such as automated inspection, in other parts of the company.

At present, the line is limited by the capacity of the epitaxial reactor, but Jackson expects it to handle a significant part of Motorola's production by the end of 1975. Additional reactors can be added simply by extending the track of the forklift boat-loader.

1. Start. Three-inch wafers are fed from cartridge in foreground onto track. Air bearing system suspends and moves them; vacuum inlets stop them. Instrument just beyond cartridge reads binary coded number scribed earlier on back of wafer by a laser. In background is Bernard van Pul, who directed development of the system.

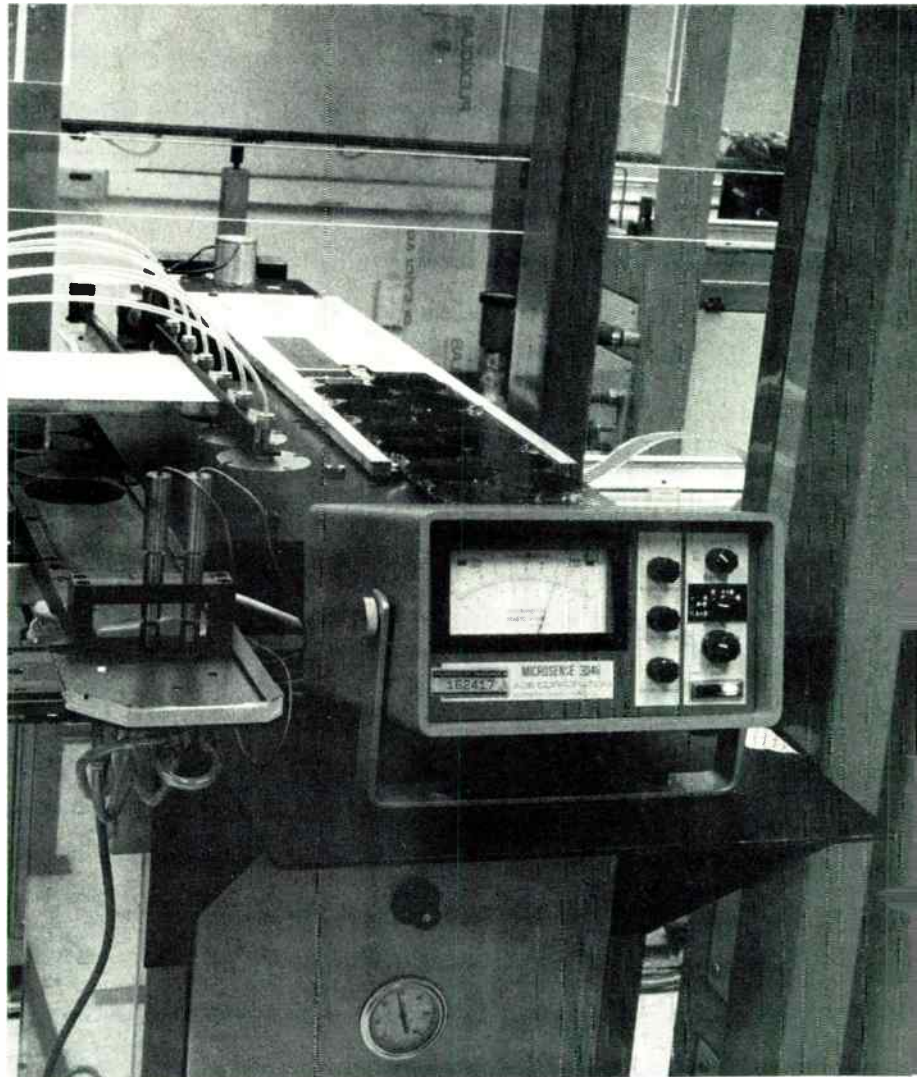

4. Boat. Wafers are queued, then picked up and placed on boat (behind instrument). They are lifted by Bernoulli jets rather than vacuum to prevent contamination. The boat is then lifted by fork lift beyond it and inserted into the epitaxial reactor. Emerging, wafers are placed aboard track at left and moved forward. Two sensors at elbow check for warpage, after which the good wafers turn left and bad ones simply continue over end into a waste bin, since warped wafers are useless. The instrument in foreground is the electronics package for the vertical warpage sensors. The next stop, shown on the page opposite, is the epitaxial reactor—in this case, an experimental model using tungsten bulbs.

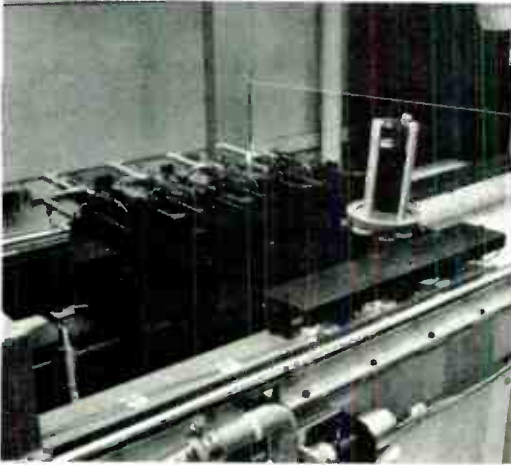

2. Cleaner. At this station, left, wafers are loaded in carriage. Modified LFE plasma cleaner then moves over the carriage to clean the wafers. LFE system is only commercial equipment in the entire Motorola epitaxial setup.

3. Inspection. From cleaner, wafers move individually to inspection, right. Defects reflect bright light to phototransistor sensors; defect data is recorded to help monitor cleaning operation. Defective wafers go back to cleaner, good ones move to next step.

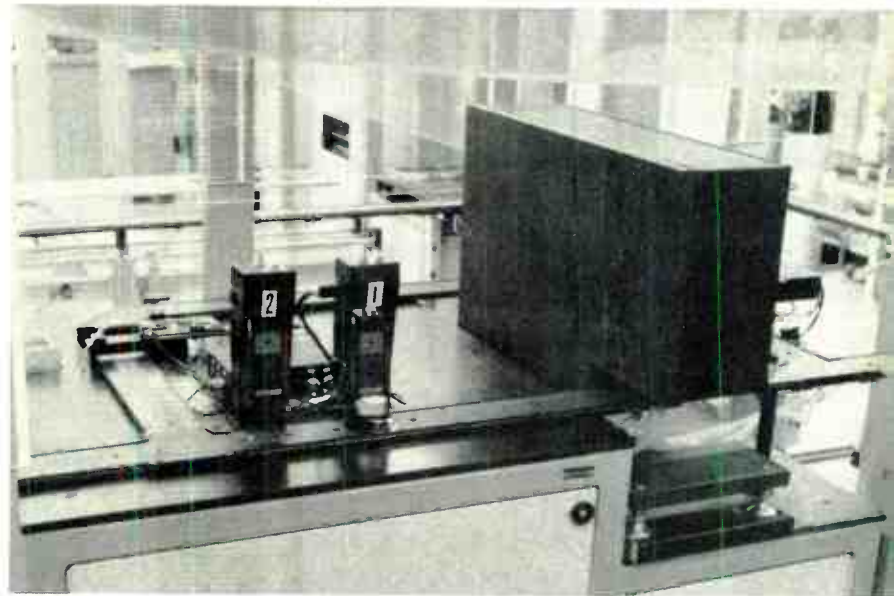
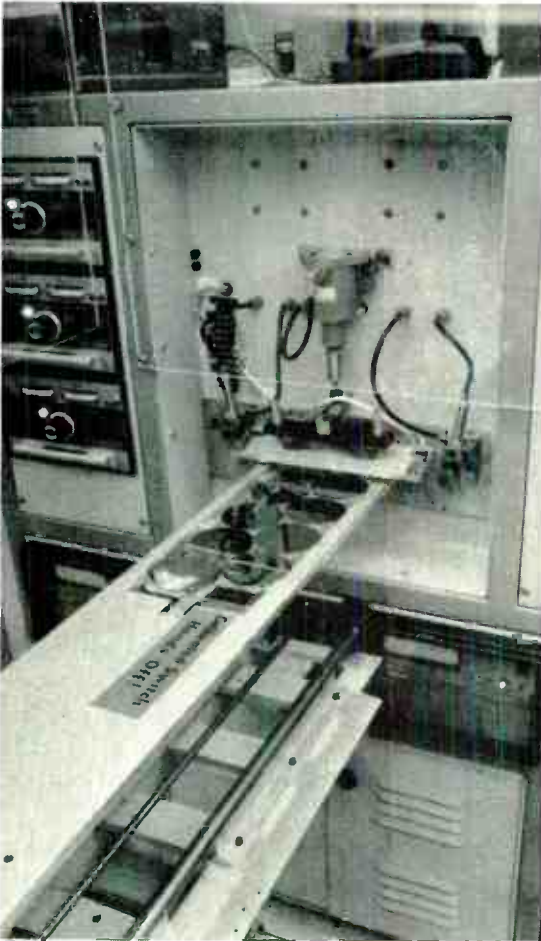
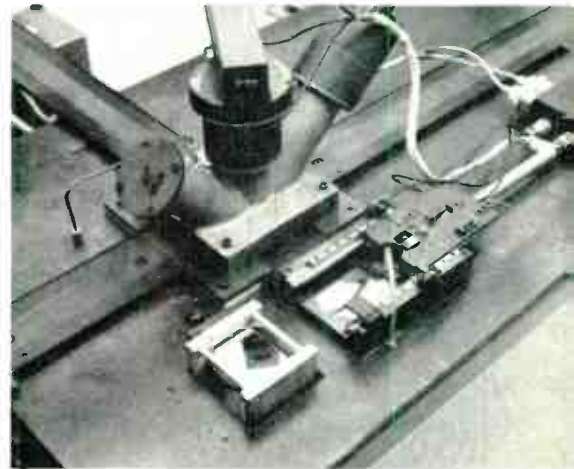

6. Tests. After leaving the warp detector, the wafers are visually inspected again. They then pass to stations that check the thickness and resistivity of the epitaxial layer. The units on left are four contact resistivity probes; at right is rapid-scan Michelson interferometer that checks thickness.

5. Reactor. The forklift inserts the boat into the epitaxial reactor. In production, any number of reactors can be loaded and unloaded by the forklift simply by extending the track, but Motorola expects that larger capacity models will become available within the next year—an arrangement that is better than the use of many small reactors.

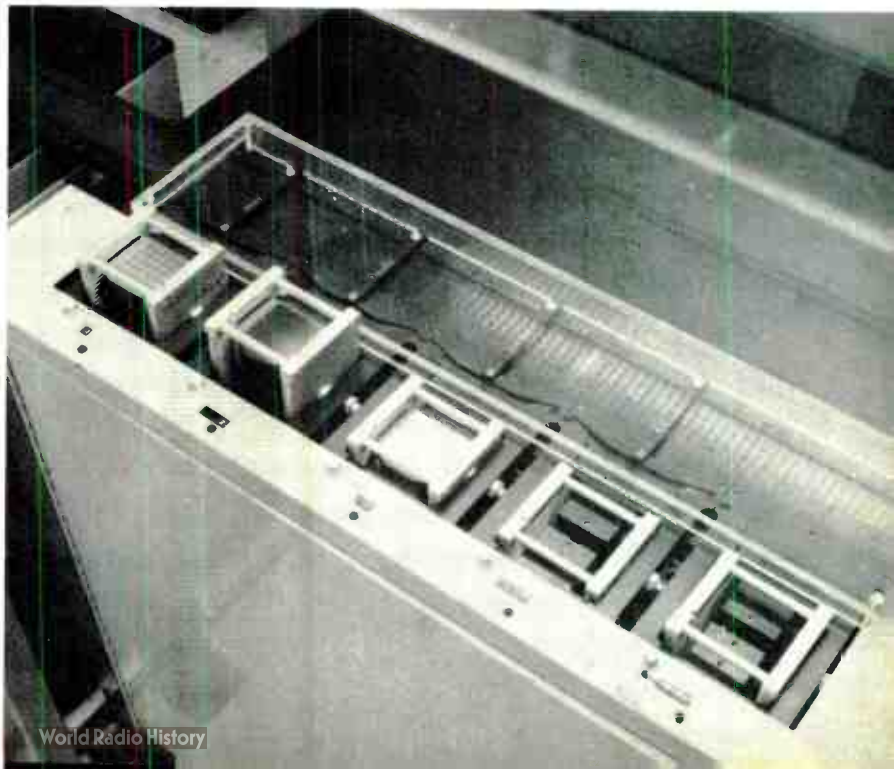

7. Stacked up. The final stop on the automated Motorola line is for separation into one of five bins. This is especially valuable, for though the system yields much higher uniformity among wafers than manual epitaxial production lines, wafers that do not meet specifications for certain applications still can be quite suitable for others.

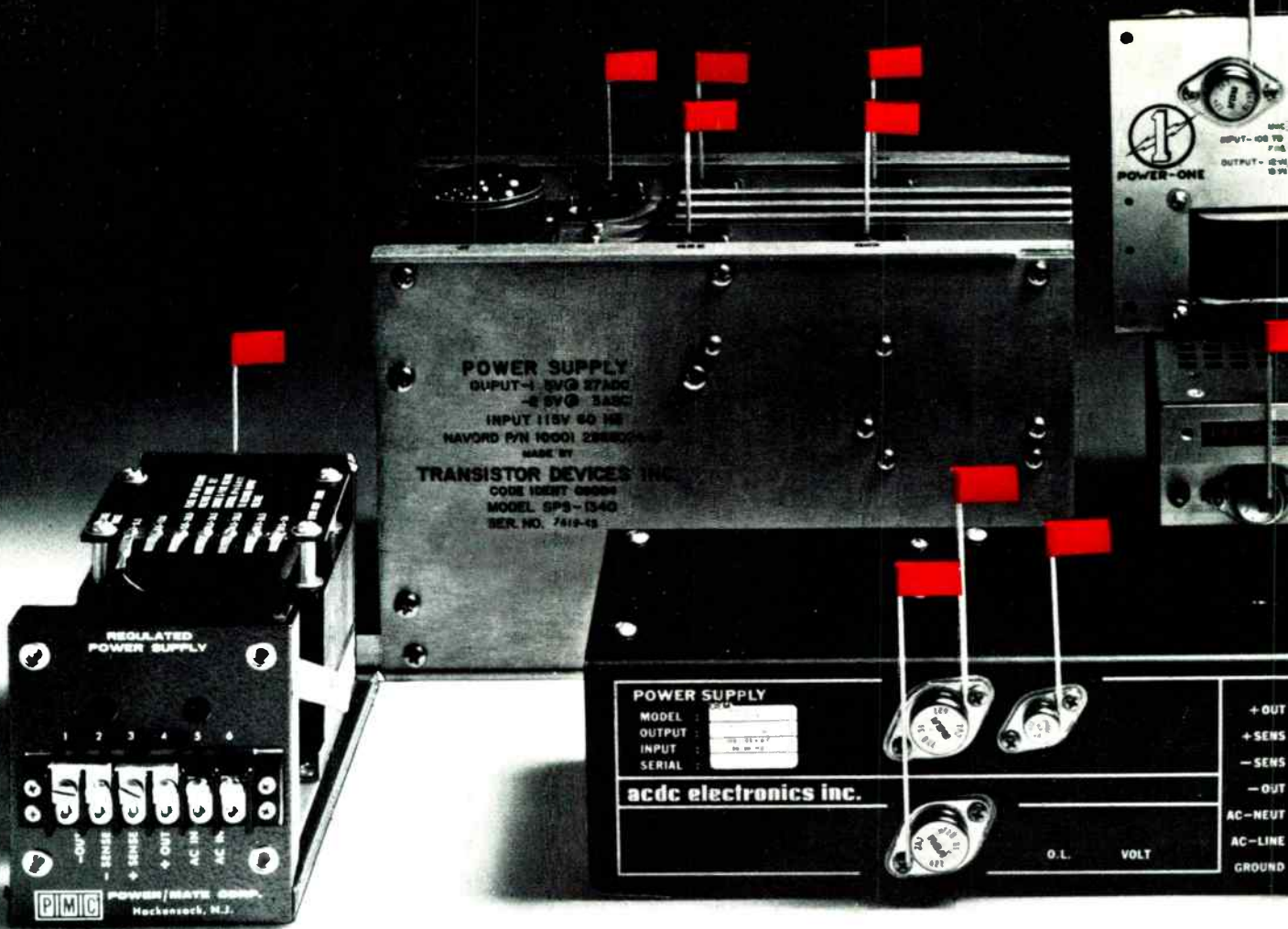

**Why companies who supply power
will tell you that
"RCA" and "Power Transistors" are
practically synonymous.**

 = RCA power transistors

Power/Mote Corp. • Transistor Devices Inc. • ACDC Electronics Inc. • Power-One, Inc. • Power-Pac Inc. • Hewlett-Packard • Powertec, Inc. • Techpower, Inc.

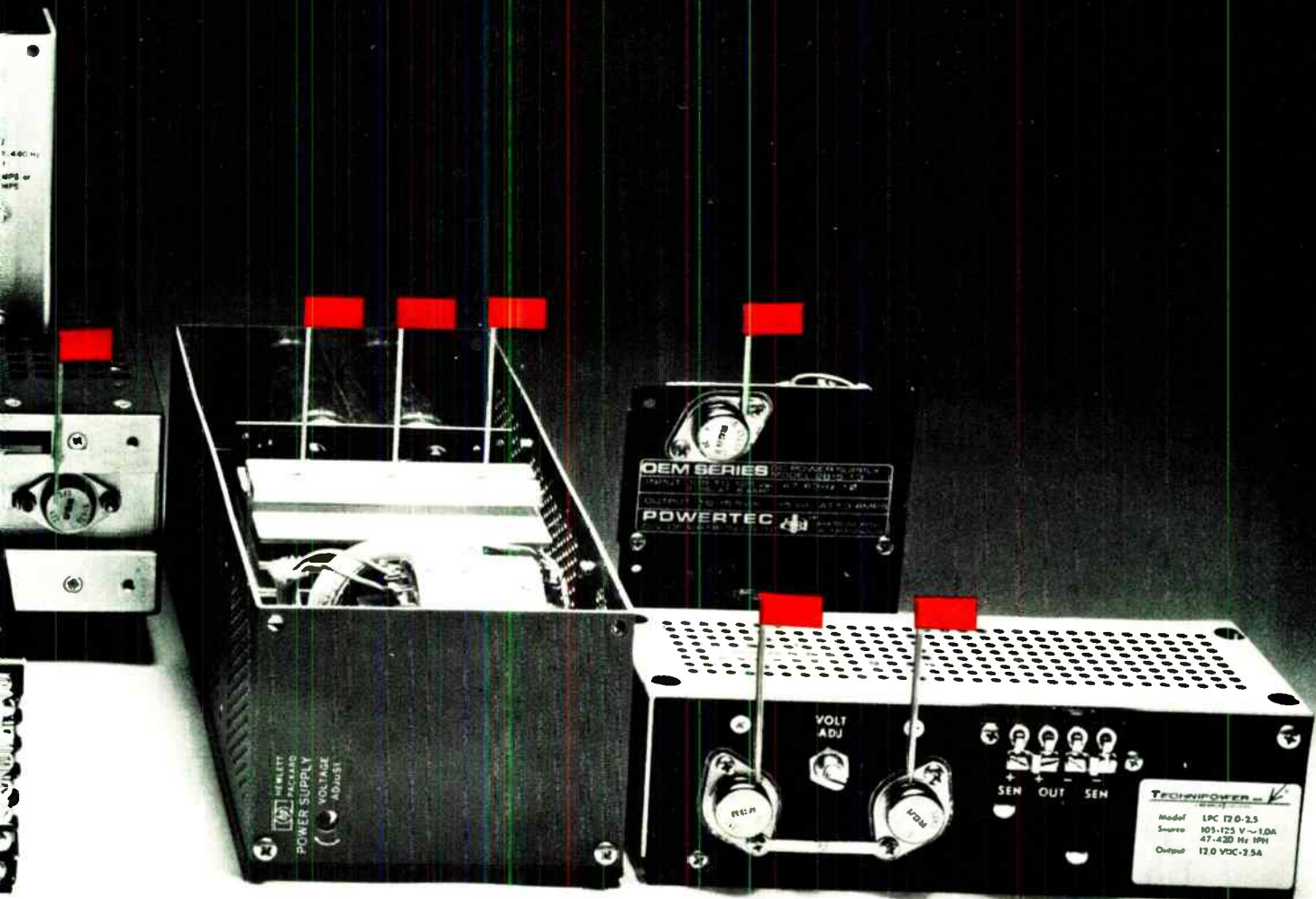

One reason is our product.

But an even bigger reason is what we know about our product and its applications.

We've made it our business, for instance, to understand power supplies so we can properly specify the requirements of the power transistors that go into them.

Where necessary, we've done power supply development work. We've studied the transient and stress conditions to which power transistors are subjected—and produced a line of hometaxial transistors to cope with them. We've developed characterization and rating systems to help assure

that our products perform as designed; built in extra ruggedness to help increase reliability; implemented a real-time process and quality control system in manufacturing.

That's why the companies whose power supplies are pictured above use RCA power transistors.

Low power devices up to 4 watts packaged in plastic and hermetic TO-5's and TO-18's with heat sink. A high-frequency epitaxial family that meets non-critical, high energy requirements up to and beyond 20kHz. Transistors that are tailor-made for high-speed switching up to and above 50kHz. Darlingtons

with gains of 1,000 at 5 amps and 100 at 10 amps in hermetic and VERSAWATT packages. High voltage pi-nu structure transistors, that provide inherently better current capability than conventional triple-diffused devices.

All of which has resulted in products that power people rely on. If your industry is one that supplies power, you should know more about RCA. Write RCA Solid State, Box 3200, Somerville, N.J. 08876. Phone (201) 722-3200, Extension 2129.

Better still, call your local RCA Solid State distributor for off-the-shelf deliveries.

RCA Solid State
A power house in transistors

Six things our salesmen are doing to ease the energy crisis.

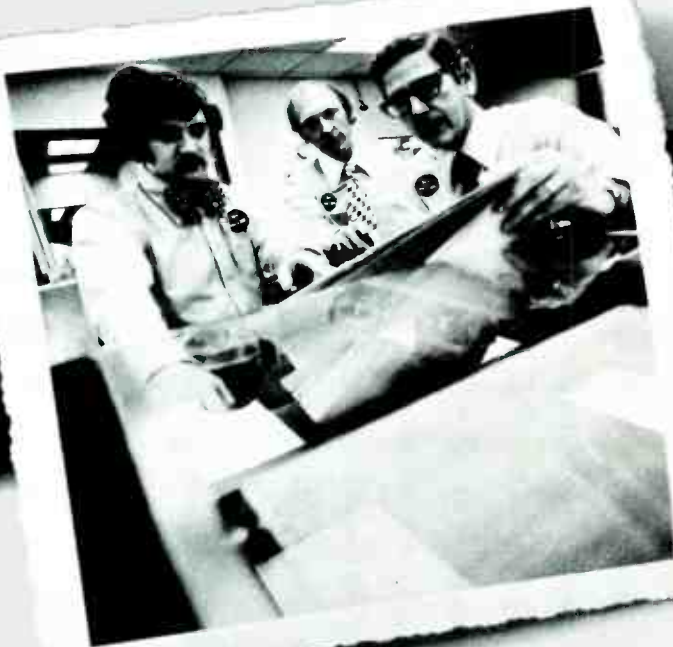

We know we can't eliminate wire and cable supply shortages overnight.

But everyone at Brand-Rex is committed to providing the best service we can — not least of all our salesmen.

Here are a few things they're doing to help — with an assist from our Marketing people.

1. Working closely with customers to project annual needs so we can make long-range commitments with our vendors. That gives us a better chance to get the continuing and on-time supply of materials necessary to meet your requirements.

2. Keeping tabs on hard-to-obtain or over-committed materials so Product Engineering can be alerted to find acceptable alternates.

3. Helping customers to lower costs and conserve raw materials through the use of smaller gauges and thinner insulation walls. Without sacrificing performance.

4. Reviewing daily computer printouts of orders behind schedule to get immediate corrective action under way, or where this is impossible, advising customers of the delay.

5. Making expediting calls on vendors in an attempt to keep vital supplies flowing.

6. Helping the Marketing Department to keep in closer touch with conditions and trends in the industries we serve.

None of these steps will end the energy crisis by itself.

But add them up, and they can make a difference in our ability to serve our customers.

Frankly, we hope the "Yes We Can" attitude of our sales people becomes contagious. It's already spread throughout Brand-Rex, helped by strong management commitment. We think you'll see results in a very short time. And if it becomes standard practice throughout the industry, so much the better.

Because if we all do everything we can, we'll all be better off.

Brand-Rex

Willimantic, Conn. 06226

**Yes
we can.**

Circle 74 on reader service card



Probing the news

Communications

Fax speeds up

New technology, in the form of laser-based systems, and other techniques could give industry long-awaited impetus

by Ron Schneiderman, New York bureau manager

"If we can go along with the old premise that technology influences growth," says a facsimile transceiver marketing executive, "then the fax market is in for some long-awaited growth."

Facsimile manufacturers have prophesied such great things of themselves for so long that little attention has been paid even to the few that command over half the market. Not surprisingly, they're

still prophesying, but now that they have new high-speed terminals, designed primarily to cut transmission costs and improve reliability, fax may finally snap out of its years-old reputation as one of the more somnolent of the electronics industries' sleeping giants.

"The fax market," says Howard M. Anderson, a fax consultant and market researcher, "is getting more competitive as new entries raise the

Quick study. Rapifax 100 machine can send letter-sized page in 35 seconds. It uses Rockwell MOS LSI modem and an electrostatic printing technique.

stakes by increasing the technological kitty." Xerox Corp. which is about to announce its first sub-three-minute system [*Electronics*, Oct. 3, p. 39], continues to dominate the field. But others, such as Faxon Communications Corp., the Electronic Associates Inc.-Comfax Communications Corp. partnership, and Rapifax Corp., a spinoff of the old CBS-Dacom-Savin venture, are also pushing new high-speed models. In addition, stalwarts like Minnesota Mining & Manufacturing Co. (3M), Graphic Sciences Inc., Stewart-Warner Corp., and Visual Sciences Inc. are busily developing their own high-speed fax transceivers, aiming for late 1975 or early 1976 introductions.

Xerox is expected to announce its new model within the next few months. The laser-based two-minute system was field-tested a year ago at the Los Angeles Times, but the test was halted for additional debugging. Although faster terminals are already on the market, the Xerox unit will be the first high-speed system available backed by a major national sales and service force.

Some pluses. The laser approach to facsimile has several advantages over the more conventional electrostatic, electrolytic, or even stabilization paper reproduction system. Among them are low noise, potential low cost, and the elimination of relatively expensive silver-halide film as a recording medium. In addition, says Philip Vokrot, manager of laser market planning at the RCA Industrial Tube division, Lancaster, Pa., new helium-cadmium lasers should be able to record on inexpensive papers more quickly and with better resolution than most existing fax recording techniques.

Laser-based fax is also drumming up new interest in the medium among military communicators. Litton Industries' Datalog division at Melville, N. Y., which has a proprietary data-redundancy-reduction technique for high-speed fax transmissions, is developing an all-ser-

Probing the news

vice portable system. It will use a laser light source with digital encoding to transmit documents, fingerprints, weather charts, and photos of satellite cloud cover within 30 seconds. Edgar L. Moore, Datalog president, says the \$1.3 million contract to develop and deliver four of the systems is part of a Defense Department effort to standardize tri-service tactical communications. The new system, adds Moore, will improve on previous data-reduction systems that compress printed material into digital pulse groups for selective transmission, and will be designed to transmit and receive up to 32 kilobits of data per second.

Speed is important since a leading end-user objection to fax has been transmission costs. Now, with one- and two-minute terminals available, fax sellers feel they are operating from a stronger marketing position. The new terminals come with a higher price tag—up to \$350 per month lease compared with an average \$76 for conventional equipment—but they're being aimed, at least initially, at large-volume users who can justify the rates yet still save money.

For example, John R. Hopf, Rapifax' marketing program manager, says that the Boeing Co. uses about 50 Rapifax 100 machines to

transmit some 10,000 pages monthly to its vendors. By substituting high-speed fax for its older four- and six-minute machines, Boeing estimates, monthly savings between Seattle and two locations in California alone amount to \$20,000.

Rapifax is using a custom Rockwell International Corp.-designed MOS LSI modem capable of speeds of 4,800 and 2,400 bits per second in its 100 series transceivers. Able to send a letter-sized document in 35 seconds, the Rapifax uses an electrostatic printing technique with a stationary multi-stylus printer.

Electronic Associates has been making its high-speed Fax 1 since last December under a license from Comfax, which developed the digital data-compression techniques used in the system. The Fax 1 leases for \$335 per month, including service, or sells for \$9,800 without modems. So far, EAI has leased 50 Fax 1 machines and sold two to Net Com Corp., the communications organization serving New York's World Trade Center.

Acquisition. In Danbury, Conn., Graphic Sciences expects to have its sub-three-minute fax available by early next year. What's more, Burroughs Corp. has reached an agreement in principle to acquire the company for stock worth \$30 million. From Graphic Sciences' standpoint, the acquisition would give the fax maker a built-in national sales and service organization.

In Minneapolis, meanwhile, 3M has been working with a fiber-optic light source in the development of a high-speed fax terminal that isn't expected to go to market before 1976. However, Visual Sciences Inc., under a long-term contractual arrangement with Matsushita Graphic Sciences Inc., a jointly owned company, buys co-developed facsimile transceivers from Matsushita Graphic Communications Systems and sells them to 3M and Plessey Co. for marketing.

Next year. At the moment, none of these companies has a high-speed fax, although James McCarthy, Visual's sales vice president, says a two-to-three-minute model will be available to both 3M and Plessey early next year. This will be an analog system with an integral modem, but will not compress data. Visual does have a prototype sub-one-minute model that operates in both digital and analog modes and compresses data to eliminate white space during transmissions, but McCarthy says he hesitates to guess when it will be available to 3M and Plessey to bring to market.

Faxon, White Plains, N. Y., which has been working on its Faxon 811 for close to five years, will introduce it within the next few months, according to John Ransom, president. The 811's scanning and recording system uses a flying-spot CRT as its light source. Neither the original document nor the copy moves during transmission with the 811, says Ransom. Also, unlike some data-compression machines, which read everything but eliminate the white spaces during transmission, the 811's skips the white areas and neither reads nor transmits them. Ransom says Faxon has just been awarded a patent on the system.

Helping to stir up interest in fax, meanwhile, is a recent flurry of market studies—from The Yankee Group and Arthur D. Little Inc., both in Cambridge, Mass., and International Resources Development Corp., New Canaan, Conn. Also, a major effort is expected from Stanford Research Institute, Palo Alto, Calif. SRI published a fax report in May 1972 at \$7,500. Its latest study, due in May 1975, has already been priced at \$12,500. □

Wanted: 65,000 terminals

Anyone interested in selling 65,000 facsimile terminals to a single customer? That's quite a deal, considering that there are about 130,000 facsimile transceivers in use in the United States today, but Harvey R. Berke, McGraw-Hill Information Systems Co.'s senior vice-president for manufacturing, says he would be willing to boost that figure by 50%—if he could find the right terminal.

For openers, says Berke, it would have to be a low-cost unit, but not necessarily very fast since all transmissions would take place between 11 p.m. and 8 a.m., when rates are lowest and traffic lightest. The system would also require a selection code and must transmit in a broadcast mode to multiple fax receivers simultaneously. The terminals would be in the offices of subscribers to McGraw-Hill's F. W. Dodge construction-business reports. "I want next-day delivery and I don't need two-way fax since I just want to send, not receive."

What prompted his interest in fax, says the McGraw-Hill executive, is the rising cost and irregularity of postal service throughout the country. Berke adds that when he finds the right terminal, he'll probably go for a five-year contract with the supplier. "I have talked with a number of communications [equipment] companies and some of them are interested."

Positions Wanted

QUAD OP AMP WITH COMPLETE SPEC BACKGROUND SEEKS AMPLIFIER GAIN FUNCTION

You'll find it difficult to top the qualifications of the new MC3403 quad differential input op amp. Its resume includes 38 different parameters with 26 of these sporting min and/or max values. So now you don't have to put up with the uncertainties of the common "typical" spec.

The new quad although electrically similar to the industry standard 741 boasts several advantages over such standard op amps. For instance, the MC3403 can operate at single supply voltages starting at 3.0 V and going all the way up to 36 V with about one-fifth the quiescent power supply currents of the MC1741 (per amplifier). Or choose split supply. Either way, you can design confidently with the MC3403 as performance min/max is specified for both.

Also, we've reduced crossover distortion to a mere 1% (typ) using a class AB output stage.

Price? Quoted at \$2.60 (100-up). But that's only the surface of the savings. In most cases, each MC3403 can replace four industry standard 741's. That affords you much greater economy than the already low price implies.

So interview the MC3403 quad op amp today. Use the coupon below or the reader service number to retrieve the comprehensive MC3403 data sheet.

Circle 76 on reader service card

FREE LINEAR "THEM-TO-US" CROSS REFERENCE

We'd like to familiarize you not only with the MC3403 quad op amp but with all the linear "professionals" from Motorola. So we're offering a new "Linear IC Cross Reference" which tells you at a glance what Motorola linear IC to use in place of whoever else's you were thinking of using!

As far as we know, it's the most complete linear IC cross reference in the industry today. Fast and easy to use. Handy, fileable format. Free for the asking.

If you have anything to do with linear ICs, you should have Motorola's "Linear IC Cross Reference". Send for it today via coupon or reader service number.

From quad op amps to interface, we'll handle your linear IC job.

Circle 77 on reader service card

HIRE MOTOROLA LINEAR TODAY



MOTOROLA LINEAR
—practical innovations for systems design!

Snip Out and Attach to Company Letterhead.

Show me your qualifications:

Send: _____ MC3403 quad op amp data sheet

_____ Motorola Linear Cross Reference Guide

Name _____

Title _____

Mail Drop _____

Mail to: Motorola "Quad"
P. O. Box 20912
Phoenix, Arizona 85036

The economy

Tight money means tight belts

Electronics firms are pressuring slow-paying customers, keeping inventories down, furloughing workers—all to avoid borrowing

by Howard Wolff, Associate Editor

Money is tight. Electronics executives across the country are fretting about mounting accounts receivable as customers put off paying their suppliers for 90 or 120 days, instead of the more customary 60 days, simply to avoid borrowing money. The situation has become one in which, as one company official puts it, "We find more customers deciding to pay late and, in effect, running their business with our money. This puts us in the position of having to put more pressure on them without actually driving them away."

Not only are electronics suppliers facing the slow-pay problem, but they too must strive to finance operations out of earnings rather than go to the money market because high interest rates prevent profit on borrowed money. They are also tightening up on inventories, deliveries, and, generally as a last resort, closing portions of their facilities and laying off work force.

"We're all caught in the same

squeeze," says one company official. "The idea is to avoid borrowing money except as a last resort, so we're being very careful to tie up as little cash as possible in inventory, production, or capital improvements. And with interest rates showing no real sign of dropping rapidly, it looks as though we'll be treading carefully for a while."

A spot check of electronics firms reveals agreement that the major soft spot is accounts receivable. The Electronics Components divisions of TRW Inc. in Los Angeles, which makes resistors, capacitors, connectors, and semiconductors, pins the blame for today's poor cash flow squarely on slow payments from customers.

"The key thing is asset control," says James E. Gwyn, manager of market research and analysis. TRW has a corporate official, as well as task forces at the division levels, constantly watching and forecasting inventory levels and receivables so

that a healthy balance can be maintained between the two. Also, "We are making an aggressive effort to collect," says Gwyn, while attempting to increase productivity with the current TRW work force so that the company can utilize its inventory of materials more effectively.

Another component supplier, Allen-Bradley Co. of Milwaukee, a major resistor house, says it's buying less in the way of raw materials and other goods used in manufacturing. The company also is keeping a sharp eye on inventory levels—its own as well as those of its customers. As soon as business slows, the company does a study to determine how immediately to cut expenses and what additional steps must be taken if the situation continues to worsen. The system seems to be working, since there have been no layoffs at Allen-Bradley during the current slump, though there have been personnel shifts due to reorganization.

Computer Automation Inc. of Irvine, Calif., a minicomputer maker, finds itself forced to put pressure on accounts receivable. "We're delaying shipments to those with heavy accounts payable which have gone on for some period of time," says David Methvin, president, adding that his company is trying to get all its customers on a 60-day payment schedule.

But the company says it's not delaying payments to its own suppliers while financing operations out of cash flow or earnings.

"A lot of companies typically pay in 90 to 120 days. That's not necessarily due to tight money, it's probably the way they've done it all the

The revenge list

Most electronics companies, asked what they are doing to get customers to pay bills faster, talk about aggressive collection programs. Those programs can take many forms, ranging from phone calls to curtailment of deliveries.

One company, which must go unnamed, is in the unique position of being both a supplier and a customer to the same manufacturers. So what it does, simply, is withhold its own payments from slow-paying customers. The result is a kind of revenge list of those vendors that are also on the receivables list—to keep the books in order, checks are made out but not forwarded. The total of such withheld checks recently was in five figures involving four companies—several of them among the best known in the electronics industries. And in still another category are late-paying vendor-customers for whom checks have not been made out at all.

It's too early to tell how such a program works, although not many firms find themselves in the vendor-buyer position. Still, the company withholding the checks has also had to lay off 10% of its work force.

Centralab perspectives

FOR USERS OF ELECTRONIC COMPONENTS



CENTRALAB
Electronics Division
GLOBE-UNION INC.
5757 NORTH GREEN BAY AVENUE
MILWAUKEE, WISCONSIN 53201

To get the latest generation component, engineers are saying Selectashaft®—before they say rotary switch.

Distributor assembly of this mechanically superior rotary switch gives them instant delivery on over 100,000 custom assemblies and eliminates secondary modification costs.

If you're specifying or buying rotary switches, your Centralab Selectashaft Distributor would like to let you compare this totally new switch with any old style switch. One sample is all you'll need to see how it can meet custom specifications yet save from 3% to 17% on total cost, depending on switch type and quantity.

Selectashaft is the first name for rotary switch. Electrically equivalent to our famous PA-Series switches, it's the latest generation component. Mechanically superior to any old style rotary, it gives you adjustable torque, better feel and longer life. It uses a new dual ball, side-thrust index, and incorporates an adjustable stop ring instead of the old style stop tabs. There are no modification problems—no bare metal to rust or corrode, no scrap, no loss of warranty and no secondary modification cost. You get everything you need—exact shaft length, end detail and shaft flat angle without modification. And, when you consider the cost savings, the reasons to say Selectashaft—before you say rotary switch—are clear. Ask for a sample and see.



THIS CATALOG, available from your Distributor, gives complete specs, dimensional drawings, circuit diagrams and easy ordering instructions. Ask for it. You'll find the answers to your design and delivery problems.

THE SELECTASHAFT SYSTEM consists of preassembled standard rotary switches and a series of individual exact shafts. Factory trained Distributors, using specially designed equipment, assemble these parts to meet custom requirements. You choose from three shaft styles—.250" plain round, .218" and .156" flat. There are 24 shaft lengths, .687" to 2.375" and 24 shaft flat angles in 15° increments. You select from 92 subminiature and miniature switches—1", 1.325" and 1.500" diameters; diallyl phthalate, phenolic or ceramic sections. You have your choice of knobs, dial plates, index assemblies and hardware. You get the design freedom of over 100,000 possible custom switch combinations.

ASK FOR SELECTASHAFT ROTARY SWITCHES AT THESE CENTRALAB DISTRIBUTORS:

CALIFORNIA

Abacus Electronics
Mountain View 94040
415/961-1500

Elmar Electronics Inc.
Mountain View 94041
415/961-3611

Kierulff Electronics Inc.
Los Angeles 90022
213/685-5511

COLORADO

Acacia Sales, Inc.
Lakewood 80215
303/232-2882

FLORIDA

Electronic Equipment Co.
Miami 33142
305/871-3500

Hammond Electronics
Orlando 32802
305/241-6601

INDIANA

Radio Distributing Co., Inc.
South Bend 46624
219/287-2911

Ra-Dis-Co, Inc.
Indianapolis 46202
317/637-5571

KANSAS

Radio Supply Co., Inc.
Wichita 67211
316/267-5214

MASSACHUSETTS

Wilshire Electronics/N.E.
Cambridge 02138
617/491-3300

MICHIGAN

RS Electronics
Detroit 48227
313/491-1012

MINNESOTA

Gopher Electronics Co.
St. Paul 55113
612/645-0241

NEW YORK

Peerless Radio Corp.
Lynbrook, L.I. 11563
516/593-2121

Summit Distributors
Buffalo 14202
716/884-3450

NORTH CAROLINA

Kirkman Electronics
Winston-Salem 27108
919/724-0541

OHIO

Esco, Incorporated
Dayton 45403
513/226-1133

Pioneer-Standard Electronics
Cleveland 44105
216/587-3600

Stotts-Friedman Company
Dayton 45402
513/224-1111

PENNSYLVANIA

Cameradio Electronics
Pittsburgh 15222
412/288-2600

Herbach & Rademan, Inc.
Philadelphia 19134
215/426-1700

Philadelphia Electronics Inc.
Philadelphia 19107
215/568-7444

TEXAS

Harrison Equipment Inc.
Houston 77004
713/224-9131

Texas Instruments Supply
Dallas 75235
214/238-6811

Southwest Electronics Inc.
Stafford 77477
713/494-6021

WASHINGTON

Almac/Stroum Electronics
Seattle 98108
206/763-2300

Probing the news

time. But now, Computer Automation, like everyone else, is saying that's a no-no," explains Methvin. The company also reduced its bank indebtedness during the first quarter of its fiscal year to \$3 million from \$4 million and "anticipates doing more of that during the second. The cost of money is just too expensive," says Methvin. To keep from borrowing, Computer Automation is also trying to keep its inventory down. As a result, says Methvin, the company is "slowing shipments to customers to some extent; by and large, however, the customers seem to be responding well. Everybody understands the problem." As for layoffs, the company says there were two in August and September, totaling 60 people. Twenty more left through attrition and for other reasons.

Across the country in Maynard, Mass., another mini maker, Digital Equipment Corp., wound up its fiscal year on June 30 with \$144 million in accounts receivable on the books. Although George Chamberlain, assistant treasurer, won't say how much is outstanding now, he did say that compared to a year ago, payments are coming in quicker: an average of 96 days vs 112 days.

DEC finds itself in a good position overall. Its assets at year end were \$324 million, including \$38 million in cash, while its liabilities were only \$85.5 million. The result is that it can afford to be generous with slow-paying customers. Chamberlain says that DEC often will sit down with a customer and work out a program for extended payment that is suitable for both parties. While it has cut off shipments to late payers, such instances are relatively rare. As for paying its own suppliers, Chamberlain says that DEC pays twice a month as well as taking any discounts that are offered. And the company apparently isn't having too much trouble with borrowing; Chamberlain says DEC will need additional outside capital for the next fiscal year and that the money is available.

National Semiconductor Corp.'s attitude on borrowing is that it

"would be willing to borrow even at these awful rates if we needed it for future growth," says John Hughes, finance vice president. But National finds that the current business climate discourages expansion (see p. 82). "We don't need to expand, but we do need to cut costs," says Hughes.

The Santa Clara, Calif., firm also sees more and more customers delaying payments and resisting collection efforts. National has taken to reminding customers more aggressively—over the phone—that they're late.

One Eastern instrument maker, Leeds & Northrop Co. of North Wales, Pa., has had to borrow money. David T. Kimball, president, says the company is in the final phases of negotiations for a \$15 million loan with a group of life-insurance companies. Availability of the additional capital, he says, will permit Leeds & Northrop to reduce its bank loans and also to support its growth during a period of strong business activity. But the cost of the money is high, notes Kimball, and the "challenge is to pull in our belts to cover the costs and still deliver our earnings."

Another East Coast company, semiconductor maker MOS Technology Inc. of Norristown, Pa., repeats the litany of receivables and collections. Donald L. McLaughlin, engineering vice president, says, "We are well matched in our ability to sell what we can make, but a glitch in the system is the customer who wants our product and may even order it but can't pay his bills within a reasonable time." This, says McLaughlin, "is an increasing problem, but we have an aggressive program to collect receivables and enforce it regularly because we have to."

What about the future? Methvin of Computer Automation takes an optimistic view of what's coming up. "There's business out there," he says, "and we're going to be in a good position to go out and get it." While a high-ranking official at another company seconds the motion, he is a bit less cheerfully optimistic. "What we need," he says, "is a Federal economic policy with teeth in it." □

SCANBE DISTRIBUTORS

WESTERN

- Aimac/Stroum**, Seattle, WA
(206) 763-2300
- Aimac/Stroum**, Portland, OR
(503) 292-3534
- Electronic Parts**, Denver, CO
(303) 744-1992
- Moltronics of Arizona**, Phoenix, AZ
(602) 272-7951
- Moltronics**, San Diego, CA
(714) 278-5020
- Moltronics**, Santa Clara, CA
(408) 244-7600
- Moltronics**, South Gate, CA
(213) 773-6521
- Rose Electronics**, Burlingame, CA
(415) 697-0224

EASTERN

- Car-Lac**, Bohemia, NY
(516) 567-4200
- Garden State Electronics**, Roselle, NJ
(201) 241-9000
- Pyttronics**, Montgomeryville, PA
(215) 643-2850
- QPL Electronics**, Waltham, MA
(617) 891-0460
- Summit Distributors**, Buffalo, NY
(716) 884-3450
- Summit Distributors**, Rochester, NY
(716) 334-8110
- Time Electronics**, Woburn, MA
(617) 935-8080
- Treeko Sales**, Beltsville, MD
(301) 937-8260

CENTRAL

- Hall-Mark Electronics**, Elk Grove Village, IL
(312) 437-8800
- Hall-Mark Electronics**, Houston, TX
(713) 781-6100
- Hughes-Peters, Inc.**, Columbus, OH
(614) 294-5351
- Hughes-Peters, Inc.**, Cincinnati, OH
(513) 351-2000
- Industrial Components**, Minneapolis, MN
(612) 831-2666
- Marsh Radio Supply**, West Allis, WI
(414) 545-6500
- Olive Electronics**, St. Louis, MO
(314) 863-7800
- Pioneer-Cleveland**, Cleveland, OH
(216) 587-3600
- Pioneer/Michigan**, Livonia, MI
(313) 525-1800
- Specialized Products**, Dallas, TX
(214) 358-4663

SOUTHERN

- Hall-Mark Electronics**, Orlando, FL
(305) 855-4020
- Powell Electronics**, Huntsville, AL
(205) 539-2731

SCANBE MANUFACTURING CORP.
3445 Fletcher Av. / El Monte, CA 91731
(213) 579-2300 / TWX: (910) 587-3437

All sockets look alike, but.....

While some socket manufacturers include some of the features and advantages of a Scanbe socket some of the time, no manufacturer can include all the features all of the time...except us.

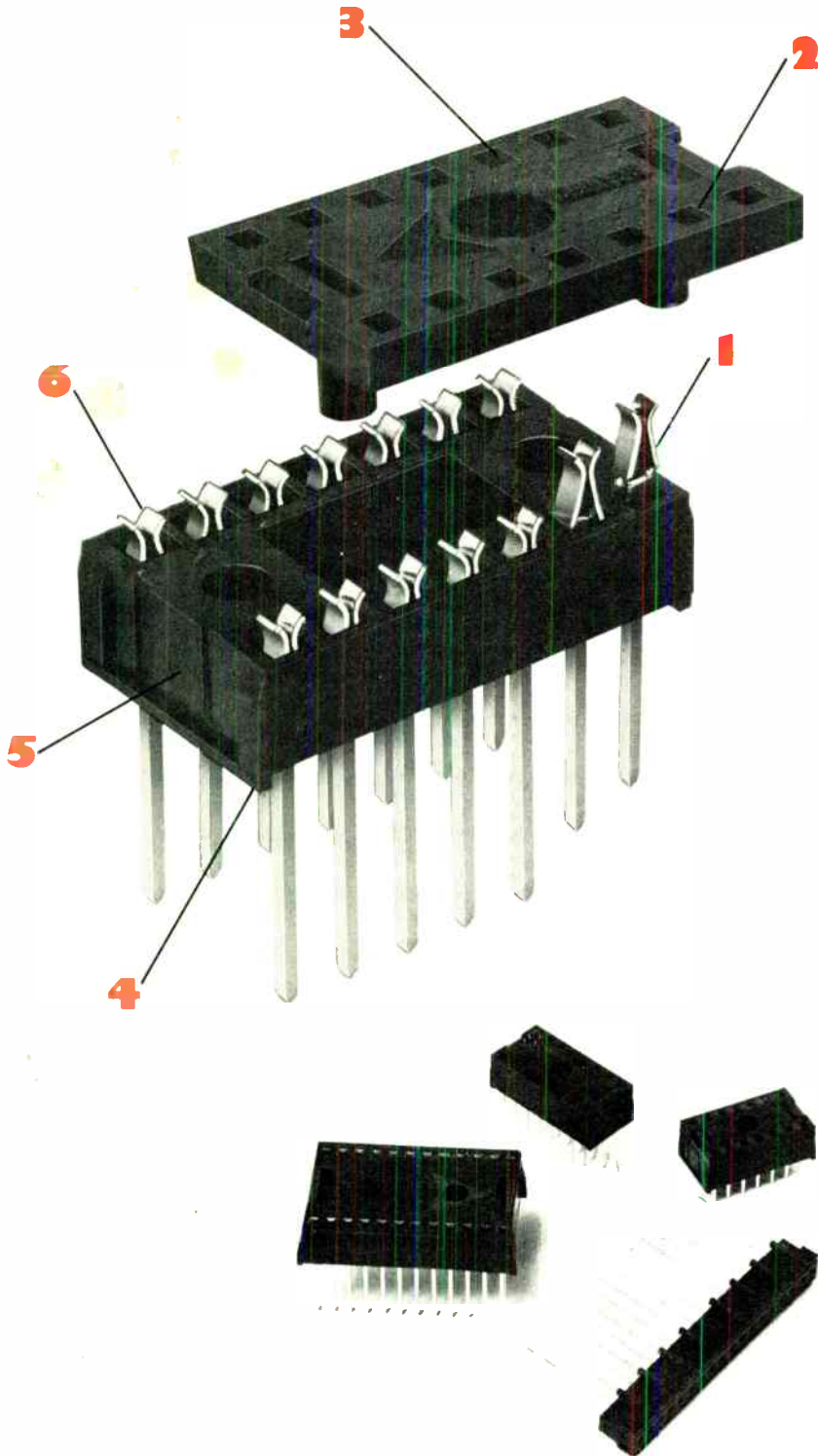

1 EDGE GRIPPING CONTACTS

provide greater contact pressure.

2 CLOSED ENTRY DESIGN

accurately guides I.C. leads into contacts.

3 TAPERED ENTRY CHANNELS

insure that I.C. leads enter contacts in perfect alignment.

4 SOLDER RELIEF

keeps solder from wicking into contacts.

5 PRECISION MOLDED

cap and body assures accurately positioned and aligned pins.

6 MATERIAL

U.L. approved glass filled nylon with gold over nickel or tin contacts.

Scanbe produces 14, 16 and 24 pin Sockets...11, 12, 14, 18 and 20 pin Pin Strips...and Scanbe includes all the features all the time.

Give us a call or write today for our latest Socket information. You'll be glad you did.

Scanbe Manufacturing Corp.
3445 Fletcher Avenue
El Monte, California 91731
Tel: (213) 579-2300

SCANBE
CANOGA INDUSTRIES

PHILIPS



Philips PM5771, a pulse generator with < 2.4 nsec risetime designed for TTL/ECL work

Rugged enough and simple enough for industrial use. Pushbutton controls simplify selection of operating modes. Fast, easy calibration minimizes down time. Can be stacked for true dual-channel operation. Priced at \$ 1440

- Rise and fall times adjustable to < 2.4 nsec. Permits ECL tests at rated conditions.
- Internal triggering to 100 MHz; external to 50 MHz.
- Amplitude from 80 mV to 10V in 50 ohms; baseline offset to $\pm 5V$.
- Single, double pulses. Gated, continuous, or single shot.
- Output positive or negative, normal or inverted.
- Jitter less than 50 psec.
- Pulse width and delay from 5 nsec to 100 msec.
- Duty cycle nearly 100% with inverted output.

SPECIAL APPLICATIONS
INFORMATION 'HOT LINE'
DIAL TOLL FREE NUMBER
(800) 645-3043
NEW YORK STATE, CALL
COLLECT (516) 921-8880

Philips Test & Measuring Instruments, Inc.
A NORTH AMERICAN PHILIPS COMPANY

Probing the news

Manufacturing

Semiconductor makers delay expansion

Downturn in business causes companies to take second look at plans for new plants in this country and abroad

So far as semiconductor marketers can see, the world next year will be flat, what with WEMA and others predicting almost no rise in 1975 sales figures [Electronics, Oct. 31, p. 27]. That, coupled with the generally gray world economic outlook, has had the effect of delaying or curtailing some manufacturers' plans for plant expansion.

In the words of Robert Noyce, president of Intel Corp., "The whole output needed is not as great as before." His Santa Clara, Calif., firm has canceled the study phase of two construction projects: one that included an overseas assembly operation and another that was to have added testing facilities in the Bay Area. The two plants would have increased Intel's capacity by 20%, says Noyce, though final decision on whether to proceed won't be made

until the beginning of next year.

A bipolar facility that Advanced Micro Devices Inc. had planned for the first quarter of 1975 in half of a new 116,000-square-foot building in Santa Clara won't be installed after all. "We don't need the capacity of the second half of the building," says a company official, "because of the downturn." AMD also has put off a 40,000-ft² addition to its Malaysian plant.

Deep in the heart of Texas, there is also some constriction. Texas Instruments Inc.'s policy is to lease space as requirements grow, then build. Decisions to lease are controlled by market conditions and require a shorter lead time than decisions to build. For this reason, many determinations do not have to be made at this time. However, it's interesting to note that TI's second-



Headquarters. This is Advanced Micro Devices Inc. in Sunnyvale, Calif. The company has decided it won't need a bipolar facility scheduled to go into half of another building in nearby Santa Clara.

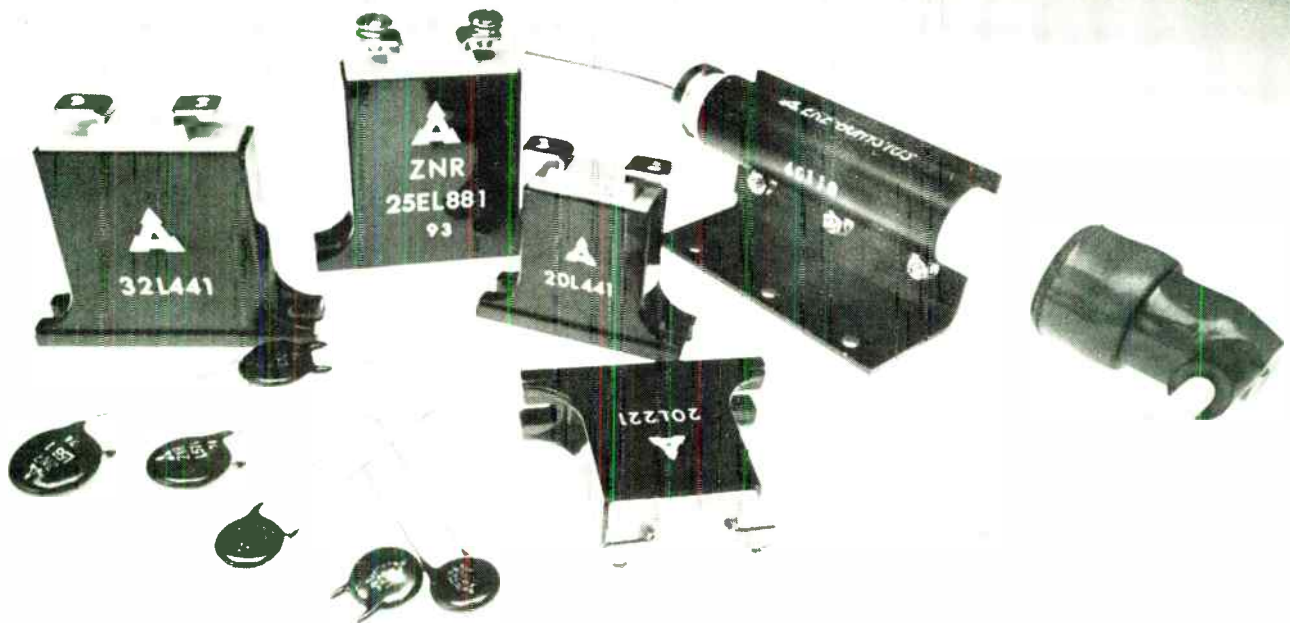

Three basic reasons to specify Panasonic ZNR's.

1. Panasonic ZNR's greater nonlinearity coefficient gives your design unique protection against repeated high-voltage surges. ZNR's extremely fast response time is in the order of 40 nano-seconds. Unlike the zener diode, ZNR clamps and shunts energy. ZNR's protect your circuit by limiting both surge and pulse voltages from either transients or lightning. ZNR's maintain circuit integrity by preventing reverse leakage and stabilizing DC currents.

2. Panasonic ZNR's come in a wide range of ratings to match your design. Disc-type ZNR's range from 33V to 1800V at 1MA. They give you superior voltage stabilization and surge absorption for semiconductor circuits. In higher voltages, stacked-type ZNR's range from 6KV to 26KV. Ideal for voltage stabilization of high-voltage power supplies and inputs to CRT's.

3. Panasonic ZNR's have a bilateral and symmetrical VI characteristic curve. This gives your circuit clamping protection in either direction.

Superior surge protection. Wide range of voltage ratings to match your design requirements. Clamping protection in either direction. Consider the Panasonic ZNR for your next circuit design or system.

All are readily available. All at a reasonable price. All made with the kind of quality that delivers high performance. It's what you expect from Panasonic. For more information on Panasonic's ZNR's, fill out the coupon.

Matsushita Electric Corp. of America, E-2
Industrial Division, 200 Park Avenue, N.Y., N.Y. 10017

- Please send ZNR literature.
 Please have representative call.

Name _____

Title _____

Company _____

Address _____

City _____ State _____ Zip _____

Panasonic Electronic Components
our technology is all around you

Circle 83 on reader service card

Probing the news

quarter report put 1974's capital expenditures at no more than \$175 million, whereas its earlier estimate was \$190 million. But TI does have some construction plans, and is completing four buildings in Texas—multipurpose structures in Houston, Austin, Sherman, and

Lubbock—for the manufacture of components, calculators, circuit boards, and systems. The Houston and Sherman facilities are more than 100,000 ft² apiece; Austin will total less than that, and Lubbock will come to 385,000 ft².

The word at Mostek Corp. in Carrollton, Texas, is "delay." Robert B. Palmer, engineering, vice president, says, "We don't expect to need any

additional production space before the second quarter of 1975. We don't see any need for real aggressive growth." Late last year, Mostek bought a group of buildings from Avco Corp. in Lowell, Mass., with the intention of building n-channel metal-oxide-semiconductor parts there in 100,000 ft² that CBS Laboratories had originally built for semiconductor processing. Mostek wanted to start the move into the Lowell plant by the fourth quarter of this year.

However, now that the market for calculator chips is weakening, Mostek has replaced those parts in its Carrollton facility with 4,096-bit random-access memories; n-channel memories are manufactured in a Worcester, Mass., facility totaling 8,000 ft² leased from Sprague Electric Corp., which owns 42% of Mostek. "I don't see a need now to go into the Lowell facility as rapidly as we had originally planned," sums up Palmer.

Broad lines. There are several exceptions among the semiconductor manufacturers, notably National Semiconductor Inc. and Motorola Inc.'s Semiconductor Products division. That's not too surprising when one considers what these two companies have in common—broad product lines where slumps in sales of some parts can be made up by the rest of the line.

A spokesman for National says it has completed its 150,000-ft² plant in West Jordan, near Salt Lake City, Utah. That plant will house an MOS wafer-fabrication facility, plus an assembly area for National's Novus calculators. The company says the new West Jordan facility was scheduled to go on line this month.

At Motorola, building plans have remained unchanged because the semiconductor operation is strong in discrete and linear circuits, but not a major factor in transistor-transistor logic and MOS, which have been hit the hardest. A spokesman says, "We have speeded up our building in certain areas, or slowed down as the result of availability of materials, but haven't made any major changes." This applies to facilities in Austin, Texas; Tempe, Ariz.; and Kuala Lumpur, Malaysia. In fact,

PLASMAC™

A *New* DISPLAY OPPORTUNITY



Custom Design Capability Allows Significant Cost Reductions

- Unlimited combinations of fixed messages, numeric and alphanumeric characters in a single panel.
- Minimized drive requirements with internal bussing and multiplexing.
- Large panels with Large Characters.
- High Brightness with Uniformity.
- Superior Readability.
- Low Power Consumption.

Call or write for full details



NATIONAL ELECTRONICS
a varian division
geneva, illinois 60134 (312) 232-4300

the Austin MOS plant, now in early operation, may even be ahead of schedule due to the availability of certain capital equipment. However, engineering and marketing personnel won't move until 1975.

The manufacturers of processing equipment also are beginning to feel the semiconductor pinch. According to Robert F. Graham, director of corporate planning at Applied Materials Technology Inc. in Santa Clara, "Business will be flat to down, which means the semiconductor business will be flat to up 10%" through the rest of the year. "We're more sensitive as an economic indicator than the semiconductor companies," he explains.

Applied Materials is "not booking at the rate we'd like," says Graham, but adds that "some customers say they will continue capital spending next year." The company's business has risen in the last few months, primarily because of increased overseas sales, says Graham. Based on orders in hand and customer inquiries, Graham predicts a better year in 1975—that's why "we have to start running before they get going again," he says. So Applied Materials is moving into a new 80,000-ft² building later this year, increasing total area by 14%.

Lower rate. At the Cobilt division of Computervision Corp., Sunnyvale, Calif., Peter Wolken, marketing vice president, says, "Customers are not buying at the rate they did at the beginning of the year." Wolken also sees "a tendency for more emphasis on automated equipment." Business has leveled off in every sector, the official says, predicting the industry "will remain flat until the middle of next year when [semiconductor companies] will pick up on their expansion plans." Cobilt is acting on this belief, planning to move into a new 84,000-ft² plant that will double present capacity.

As for his business generally, says Wolken, there's no doubt that it has been affected by the conditions in the semiconductor industry. However, the Cobilt executive is optimistic, as anyone who deals with semiconductor makers must be. "Our business is really young," he says, "and it's growing fast." □

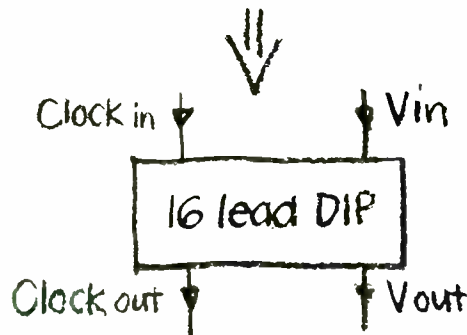
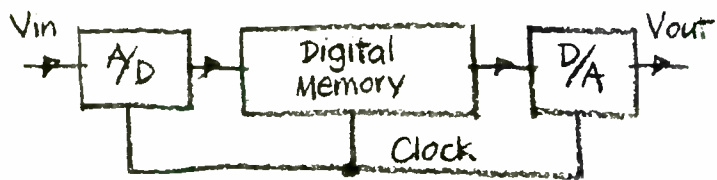

Analog Memory

70 DB S/N

Sample rate: 12 MHz

1 μsec - 40 msec delay

IN PRODUCTION!

Reticon Corporation, a pioneer in solid state image sensing, has now applied its technological leadership to the field of analog memories.

These devices are large scale integrated circuits which sequentially time sample an analog input signal and store each sample as an analog voltage level on one of a series of storage capacitors. The stored samples are then read-out in sequence to reconstruct the original input signal with a new time base. Several device types are available from inventory with up to 128 elements of storage.

Applications include time base correction (expansion or compression), tapped delay lines, correlation, digital filtering, real time Fourier transforms, chirp radars and many others.

Write or call for further information including detailed peripheral circuits.

There are over 60 salesmen and 14 distributors to serve you worldwide.

RETICON®

910 Benicia Avenue,
Sunnyvale, California 94086
Phone: (408) RET-ICON TWX: 910-339-9343

“Think Hz for a

“A different point of view . . . that’s often the key to a problem solution. And that’s just what HP analyzers give you. A look at your problems in the frequency domain instead of the time domain.”

“HP high-frequency analyzers have a solid reputation for providing RF and microwave designers with accurate frequency-domain measurements. But what about analyzers to help engineers with low-frequency problems?”

“I’d like to tell you about HP’s broad line of low-frequency analyzers that can solve some of your tough measurement problems. Problems such as making low-level measurements in

the presence of noise, analyzing frequency components of a signal, determining the transfer function of a network, or making distortion measurements on analog circuits.”

“Take the narrow view. HP’s 3581A wave analyzer lets you home-in on a specific frequency for amplitude measurements. Look at a signal through a 3 Hz bandwidth. Monitor low-level signals to 30 nV over a 15 Hz to 50 kHz range. This ability to measure low-level signals in the presence of noise simplifies transducer signal monitoring. Helps you isolate ground-loop problems.”

“Look for a broad picture. Spec-

trum analyzers display your waveform’s Fourier components on a CRT. That’s an easy way to see your signal and its component relationships. It’s also an ideal way to characterize mechanical devices that have unique spectral ‘signatures.’”

“HP’s 3580A spectrum analyzer gives you a 5 Hz to 50 kHz range and the sensitivity to operate directly from the lowest level transducer outputs. Its digital memory lets you store traces for accurate comparison of two signals. And a narrow 1 Hz bandwidth allows you to resolve 60 Hz sidebands.”

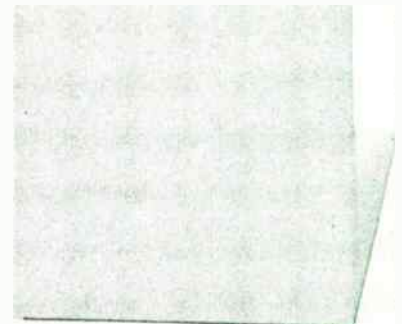
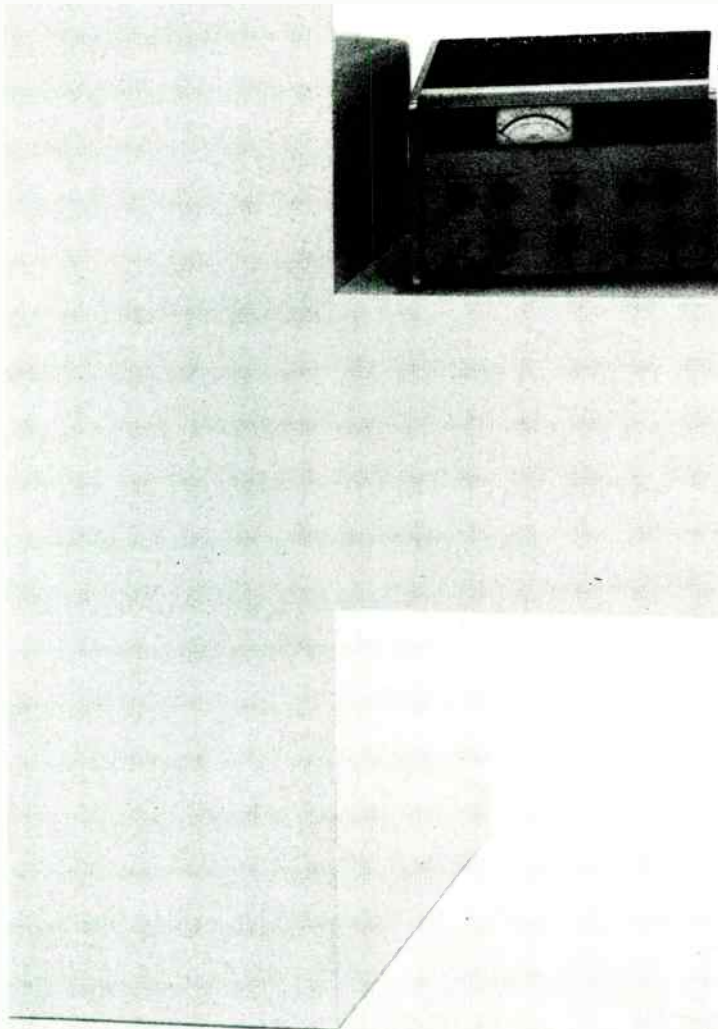
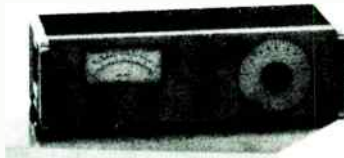

different view™

"There's also an in-depth view provided by HP's network analyzers. These dual-channel analyzers provide amplitude and phase measurements as a function of frequency. This simplifies transfer-function measurements, speeds the location of poles on a Bode plot, and accurately determines resonant frequencies and phase margins in circuit design."

"Our broadband 3575A gain-phase meter gives you a range of 1 Hz to 13 MHz and lets you select your own signal source to do low-cost network analysis."

"For high-accuracy network analysis, plus optional group delay and offset determinations to 13 MHz, HP's high-performance 3040 analyzer is the answer. By adding the computational power of a calculator

to either the 3575 or 3040 analyzers you can view the results of 108 tests in less than 20 seconds...and with greater precision."

"And there's a reciprocal view. HP's distortion analyzers give you the reciprocal function of a wave analyzer. By rejecting the fundamental and monitoring the remaining harmonic and spurious components, distortion is measured and displayed on a meter. Our 331A to 334A series provides a wide range of 5 Hz to 65 MHz.

And automatic nulling speeds the measurement of total harmonic distortion."

"So think hertz and get a different view...in design, in manufacturing, and in servicing. Think hertz and get a different view of everything from electronic components and networks to mechanical devices and systems. Think hertz for a different view and look to HP for help in applying analyzers to your measurement problems."

"You're local HP field engineer will be happy to give you additional details on our broad line of analyzers that operate from 1 Hz into the GHz range. Give him a call today."

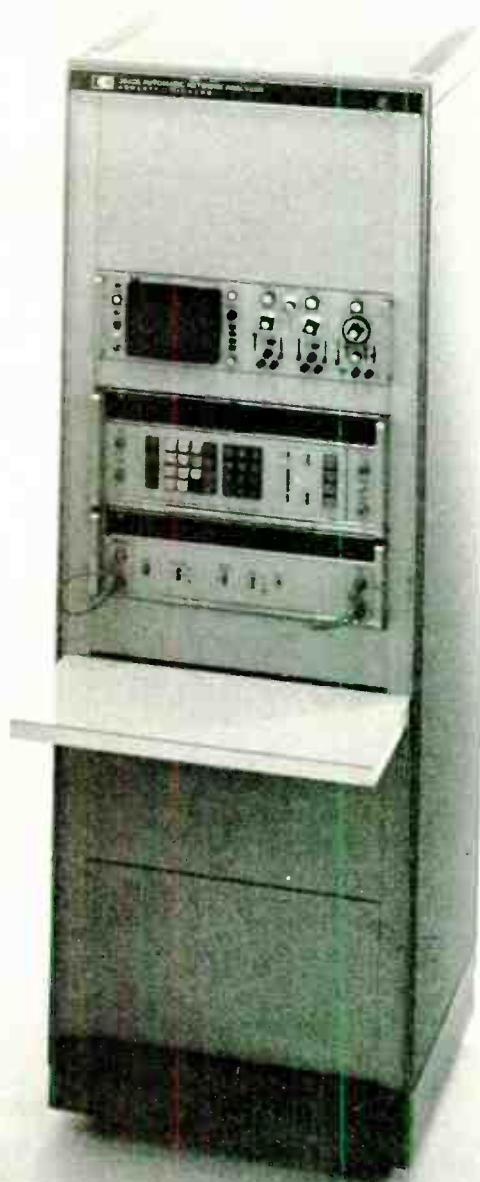
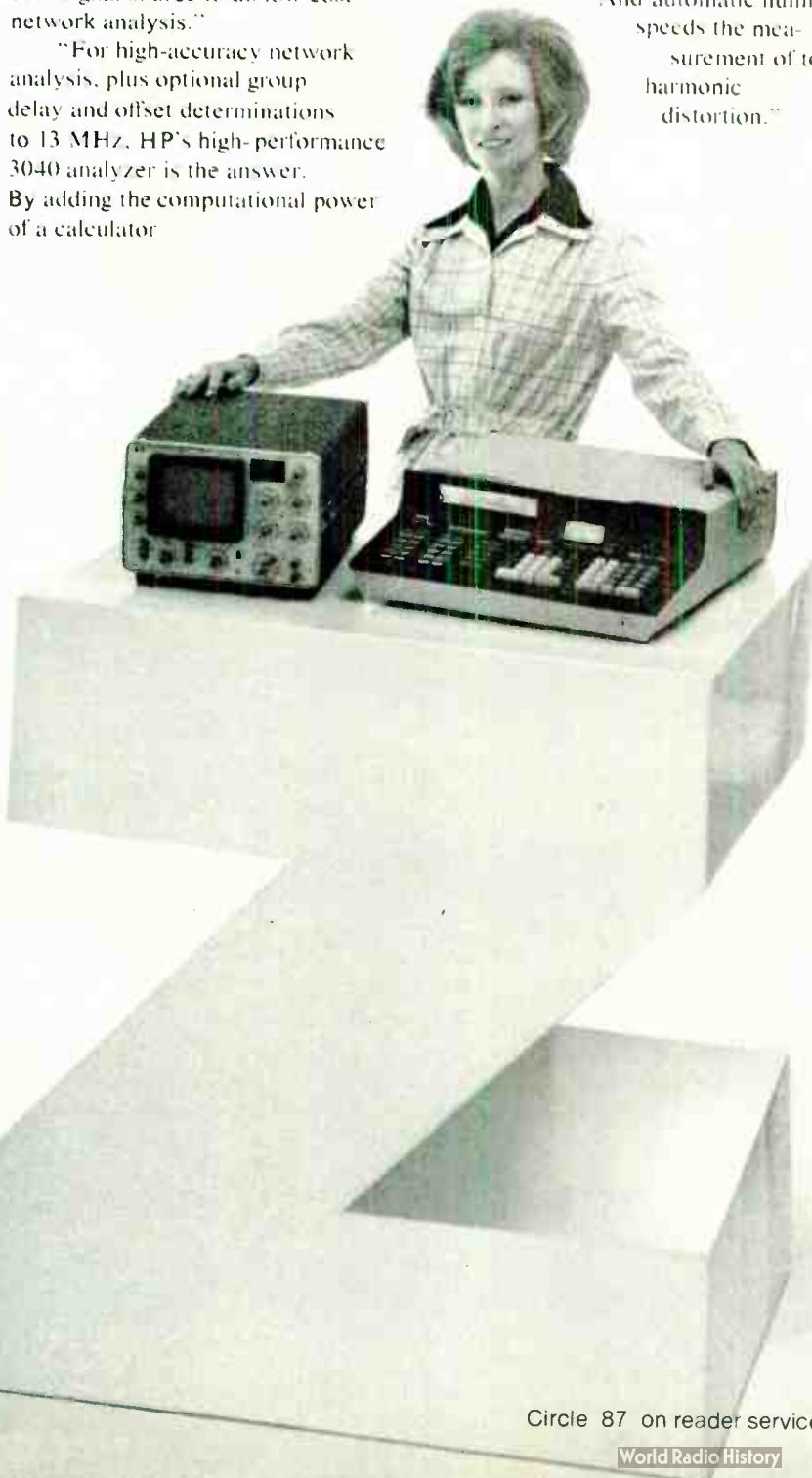

Measurement with a different view

HEWLETT  PACKARD

Circle 87 on reader service card

Sales and service from 172 offices in 65 countries.
1515 Page Mill Road, Palo Alto, California 94304

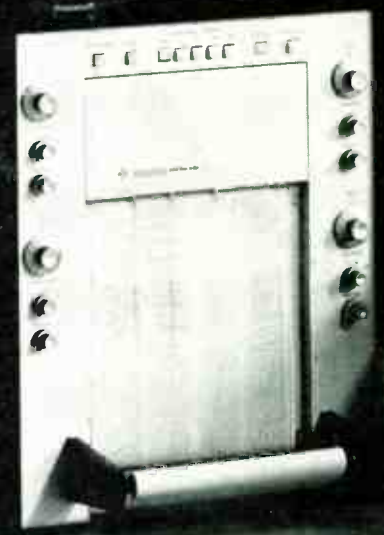
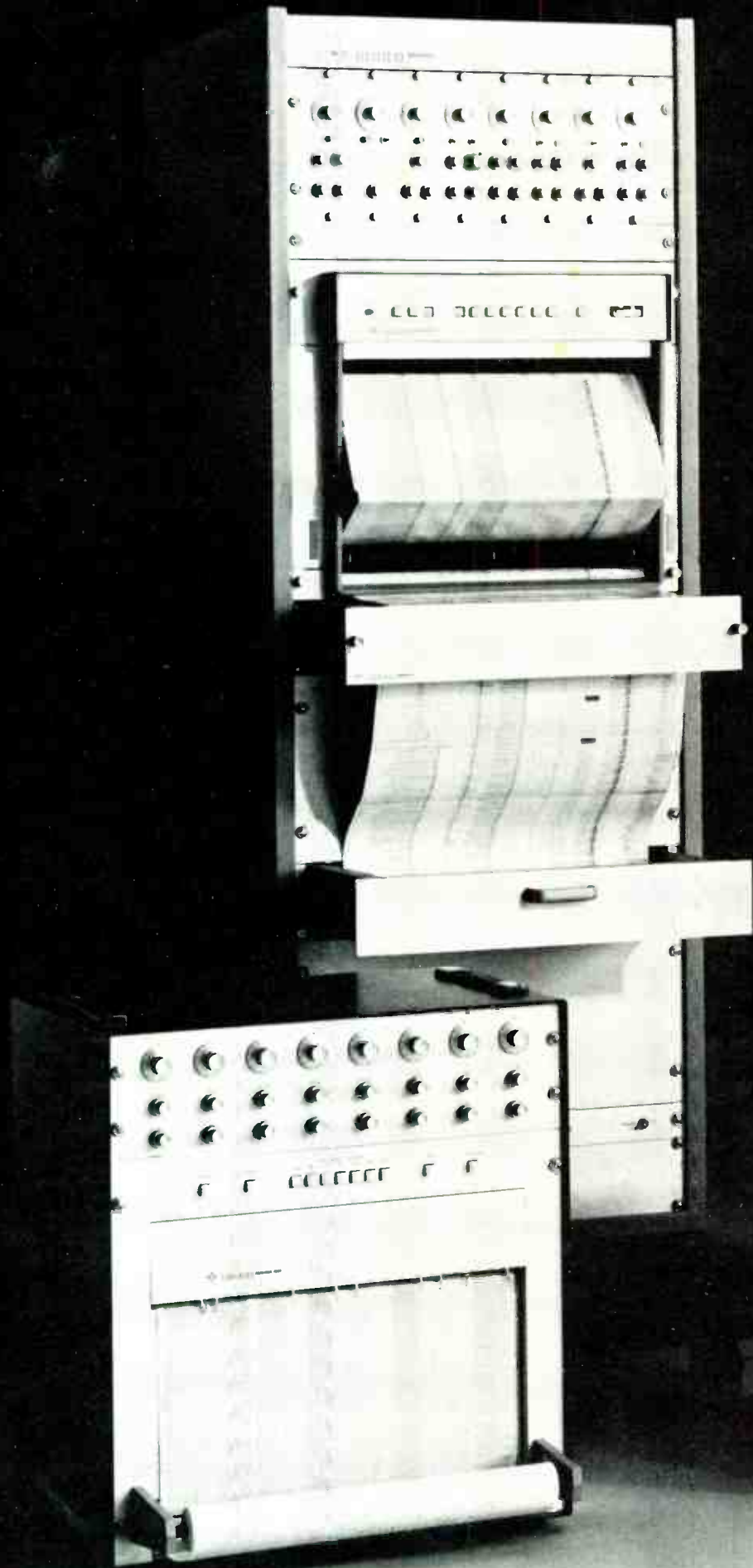

Six good reasons why Brush recording systems are your best buy.

1. Brush has the broadest line in the industry.

We make a recorder/signal conditioner to meet just about any industrial or scientific application.

Choose from 1 to 8 channel direct writing recorders with or without built-in preamps; full scale frequency responses from 35 Hz to 55 Hz; 40 mm, 80 mm and 4½" wide channels; portable and rack mounted models.

2. Brush guarantees better than 99.5% linearity.

There are two reasons why we can guarantee such a high degree of accuracy. First, our Metrisite non-contact servo-loop feedback device. Second, our recorders have a rectilinear presentation which eliminates geometric errors.

3. The Brush pressurized inking system gives you the highest quality traces.

For twelve years, Brush traces have been the standard of the industry. Our pressurized inking system writes dry. It eliminates smudges, smears, skips and puddles. The record you get is crisp, clear and permanent.

4. Brush recording systems give you trouble-free operation.

All of our instruments require minimal maintenance. For example, our disposable ink supply usually lasts more than a year. And all of our electronics are solid state.

5. A Brush system is easy to operate.

All of our systems are self-calibrating. Controls are conveniently placed to give you maximum flexibility. Chart

paper can be replaced in seconds. Switching signal conditioners is a snap.

6. Brush is a single source for everything you need.

We offer custom financing and leasing plans. Our installation, training, and maintenance programs are geared to your needs. And our warranty and replacement parts packages are two of the best in the industry.

If you'd like to find out more contact your nearest Gould Sales Engineer or Representative. Or write for detailed performance information and specifications. Gould Inc., Instrument Systems Division, 3631 Perkins Avenue, Cleveland, Ohio 44114. Or Kouterveldstraat Z/N, B 1920 Diegem, Belgium.

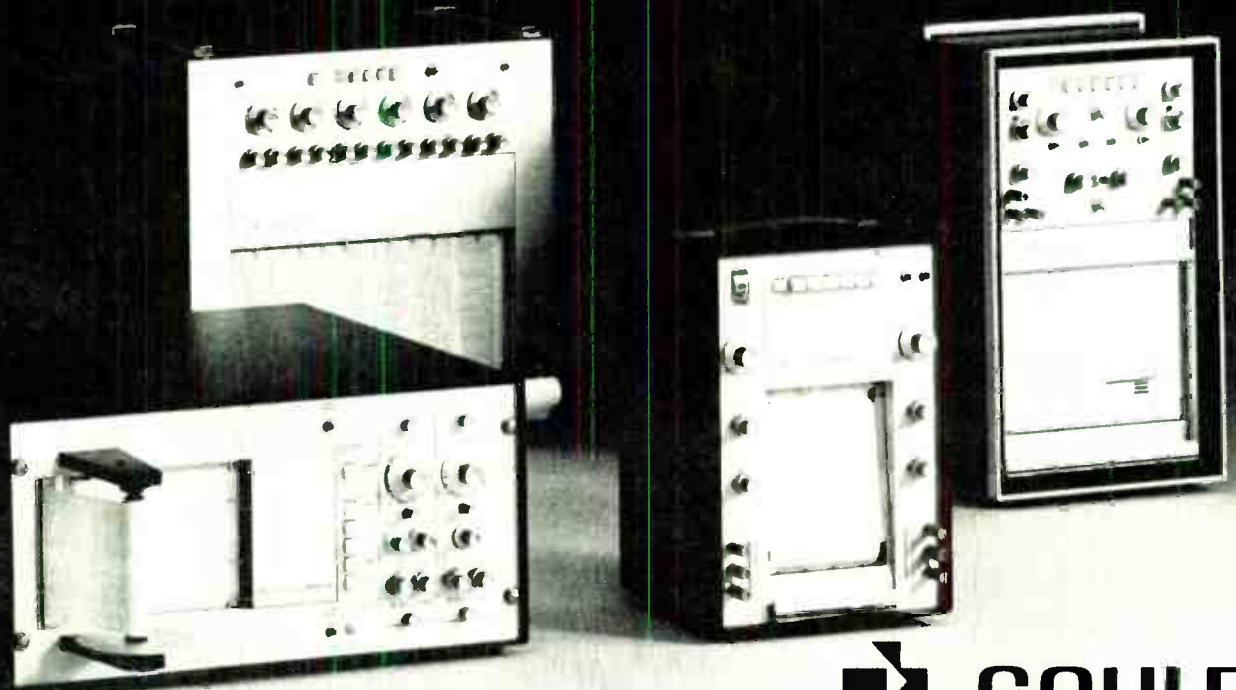

 **GOULD**

Circle 89 on reader service card

MOS ANOTHER FIRST!!!!

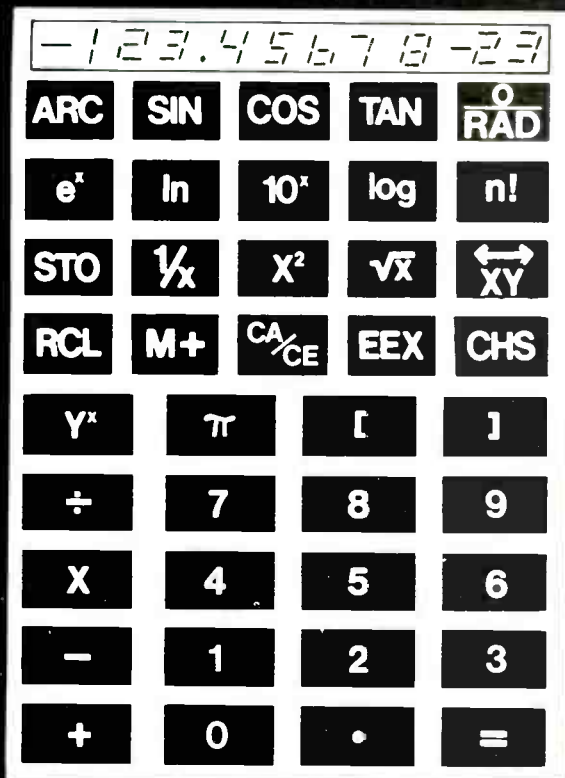
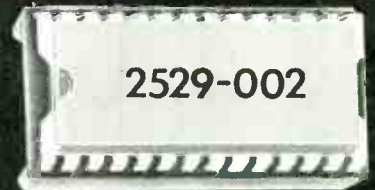

HEADQUARTERS
Applications Mgr.: Mr. Julius Hertsd
MOS Technology, Inc., Norristown, Pa. 19401

CENTRAL REGION
MOS Technology, Inc., 838 S. Des Plaines S
Chicago, Illinois 60607 (312) 922-0288

EASTERN REGION
Mr. William Whitehead, Suite 307
88 Sunnyside Blvd., Plainview, N.Y. 11803 (506) 822-4244

WESTERN REGION
MOS Technology, Inc., 2172 Dupont Dr., Suite 22
Patio Bldg., Newport Beach, Calif. 92660 (714) 833-1666

a proud affiliate of **ALLEN-BRADLEY**

The First Single Chip Scientific Calculator Arrays

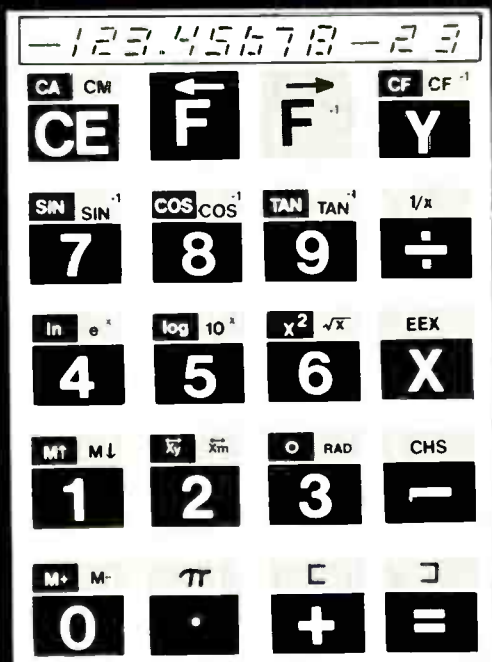

With...

- FULL SCIENTIFIC FUNCTIONS
- ALGEBRAIC ENTRY
- TWO PARENTHESIS LEVELS
- FULL SCIENTIFIC NOTATION
- 12 DIGIT DISPLAY (S,8,S,2)
- FULL FEATURE MEMORY

And

- REDUCED POWER
- DIRECT SEGMENT DRIVE
- NO EXTERNAL COMPONENTS

- FOR
- POWER-ON-CLEAR
 - CLOCKS
 - DISPLAY CUTOFF

- ONE 28 PIN DIP

WE'VE TURNED
A TECHNOLOGY
INTO A COMPANY



MOS TECHNOLOGY, INC.
VALLEY FORGE CORPORATE CENTER, NORRISTOWN, PA. 19401 (215) 666-7950

What price Zeiss?

The small Epi-Microscope is the best buy anywhere...

... and, for the other five microscopes shown here, too, the price depends entirely on your needs. Whether production line, industrial research, or quality control, Zeiss quality and features always add up to true economy. Zeiss microscopes do more now, can be expanded to do more later, never become obsolete. The Zeiss range of optics and accessories is unequaled.

1. Epi-Microscope. A small and versatile upright incident-light microscope for production, QC and R/D. Rugged and sturdy. Can be mounted on various stands, or attached to machinery in the shop. Switches instantly from brightfield (for regular surface examination) to darkfield (to detect scratches, dirt, small de-

fects). Nomarski interference contrast makes minutest elevation differences stand out. Accepts cameras and TV attachments. Best buy on the market. **Reader service number 90.**

2. Standard KK-08—the Semi-Conductor Microscope. Features Epi-Nomarski optics at production-line cost. Makes it easy to spot pinholes, stacking faults, alignment errors, etching problems, bonding defects, mechanical damages, and many minute irregularities not detectable with any other light microscope technique. 3 x 3" stage with stainless steel plate makes loading and unloading rapid and easy. Can be expanded for research with wide range of accessories, also for photomicrography. **Reader service number 91.**

3. Invertoscope M. The smallest, most compact metallographic microscope. Ideal for fast, routine examinations. Yet has great optical features found in our larger microscopes. Excellent for brightfield and microscopy in polarized light and Nomarski interference contrast, even with Glarex projection screen. Great stability, low price. **Reader service number 92.**

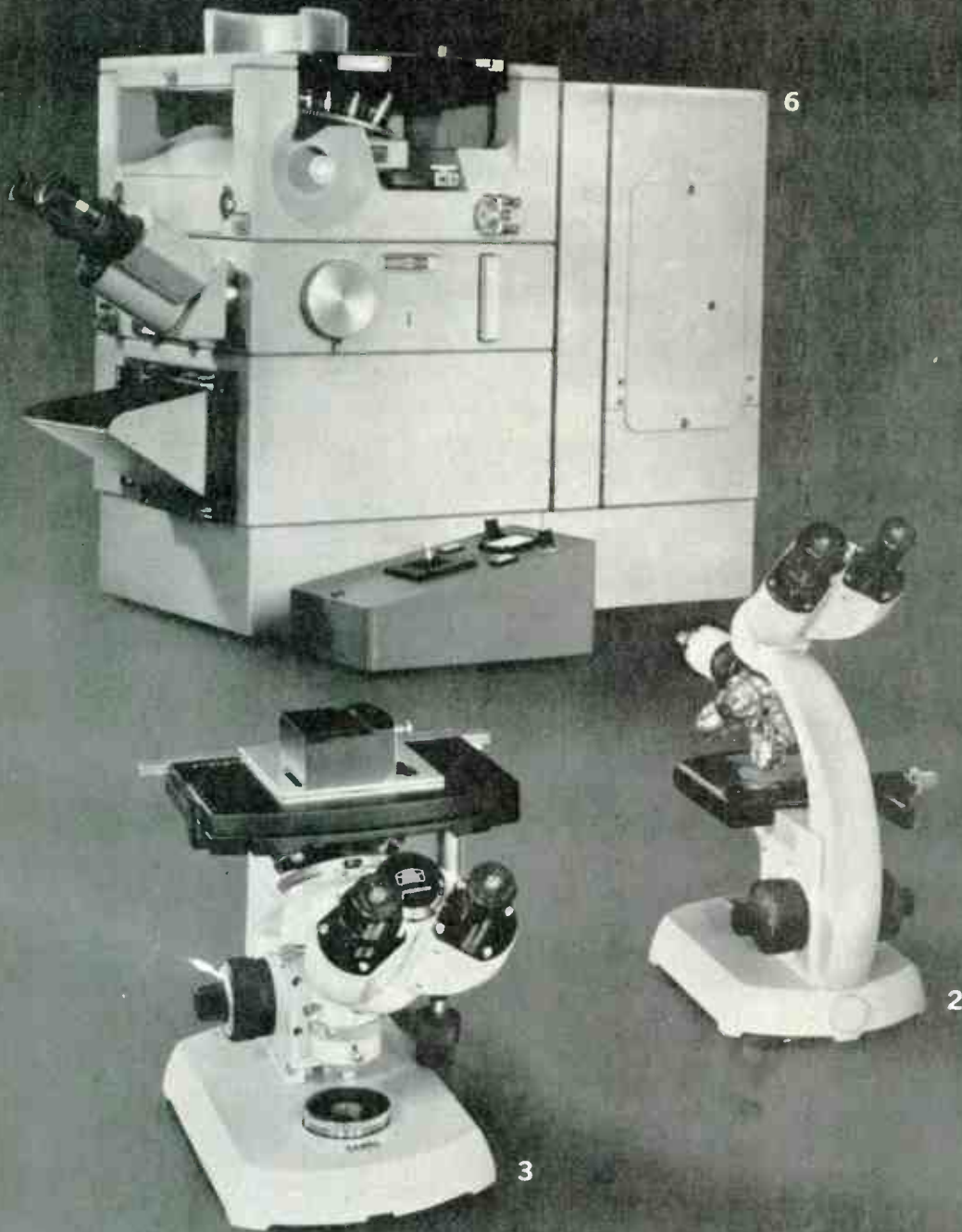

4. Universal Microscope. Recognized as the most universal microscope. With fully interchangeable optics and components for all microscope techniques in reflected and transmitted light, including UV. Accepts all accessories and camera formats, including TV and projection screen. With automatic scanning stage, ideal for photometry and quantitative stereometric image analysis. **Reader service number 93.**

5. Ultraphot IIIB with fully integrated, fully automatic camera systems for 4 x 5" and 35mm, and correct exposure reading from the center of the image field. For all microscope techniques in transmitted and reflected light. Continuous magnification from 2.5x to the limits of light microscopy. Holds 3 lamp housings simultaneously; the flip of a lever selects the illumination source and mode. Ideal for grain-size determinations by either micrometer eyepieces or projector. **Reader service number 94.**

6. Axiomat—a revolutionary modular microscope system. The finest, most stable metallograph ever made. Newly com-

puted optics, topped by a new Epiplanapochromat 125/1.6 with highest resolution ever achieved. Extreme widefield, and built-in zoom system for easy magnification change to the limits of light microscopy. All standard ASTM magnifications. Exceptionally large stage (8 x 17"). Stages remain stationary for utmost stability while focusing is done by moving the objectives — also remote-controlled. Two fully integrated, fully automatic camera systems. Quantitative image analysis by photometer or TV. Modular concept permits different assembly of modules, also for upright microscopy. **Reader service number 95.**

For details write Carl Zeiss Inc., 444 5th Avenue, New York, N. Y. 10018. Or phone (212) 736-6070.

In Canada: 45 Valleybrook Drive, Don Mills, Ont., M3B 2S6. Or phone (416) 449-4660.

Nationwide service

BRANCH OFFICES: BOSTON, CHICAGO, COLUMBUS, HOUSTON, LOS ANGELES, SAN FRANCISCO, WASHINGTON, D. C.

ZEISS
THE GREAT NAME IN OPTICS

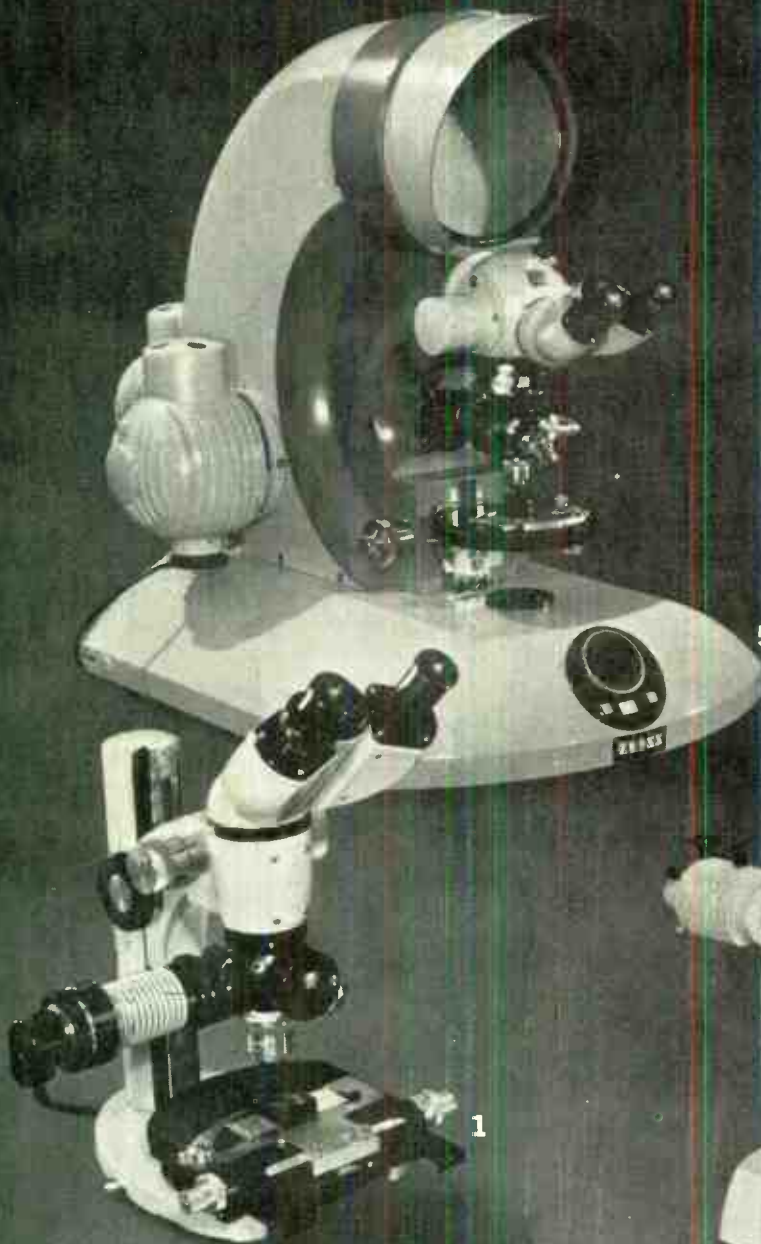

1

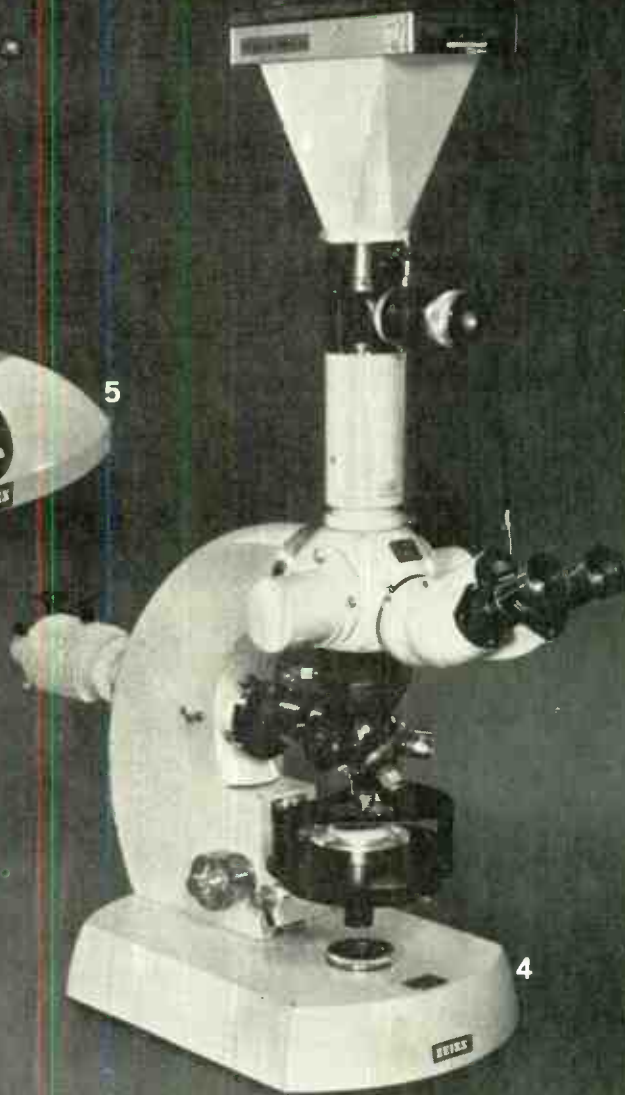

4

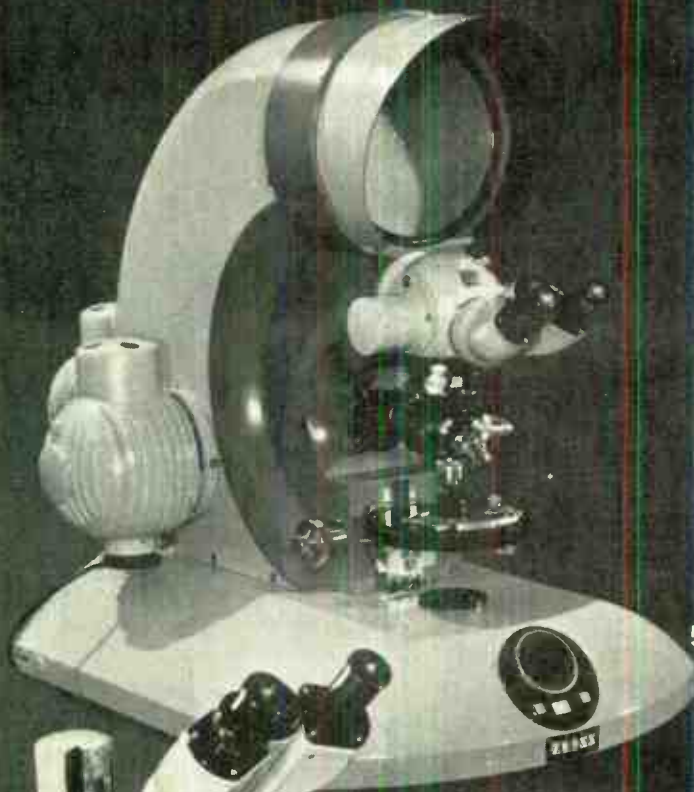

5

Calma presents Norman's latest napkin masterpiece.

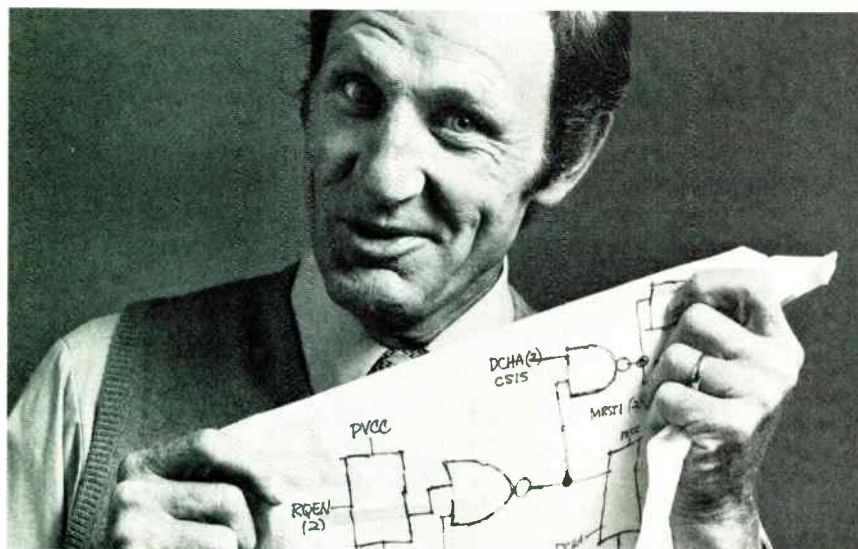

A report on circuit art production. Norman is a conceptual genius. A little sloppy perhaps, but a genius nonetheless. His greatest idea was conceived halfway through an anchovie and pepperoni pizza at Bruno's last Wednesday. After lunch, a young lady earning \$8400 per year turned Norman's napkin into flawless circuit art in just 54 minutes. She did it on a Calma interactive graphics system. She did it one hundred times faster than a speeding draftsman, about twice as fast as she could on any other system. The Calma system checked her accuracy, drew all the lines and symbols automatically, relieved her of the drudge work.



Changes made lightning fast. While eating pretzels two days later, Norman had a brain-

storm. A way to get even hotter performance out of the same circuit concept. Presto. In microseconds, the original design was retrieved from storage and displayed on the CRT at Norman's own interactive work station. In about three minutes Norman himself modified the original. Electronically. Just that fast the company benefited from his fertile mind with a totally new and competitive circuit. Incidentally, up to six work stations can be included in one system with no degradation of performance.

The fast generation. Where Calma really makes tracks is the transition from art to production. Each Calma system drives up to three high speed plotters in the background mode. All operate at full rated speeds, never interfering with design

or drafting at the system's six work stations. The secret of Calma's non-stop productivity is that no function ever interferes with another.

Reliable sophistication! For all its sophistication a Calma system is incredibly reliable. More than 100 have been installed and almost all were up and operating the day they were delivered. Learn how this powerful computer-based graphics system can speed your circuits from conception to production. For literature or to arrange a demonstration, phone or write Calma Company,

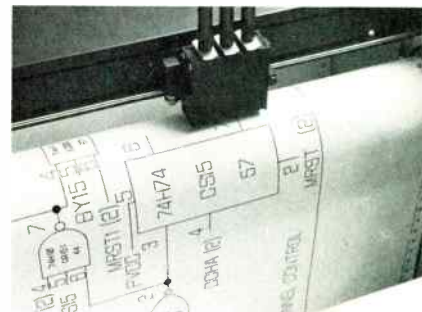

Corporate Marketing Headquarters, 1930 Isaac Newton Square East, Reston, Virginia 20090. Phone (703) 471-1450. European Marketing Headquarters, P.O. Box 6, Marlborough, Wiltshire, SN8 4EW, England. Phone 067286 (Lockeridge) 658.

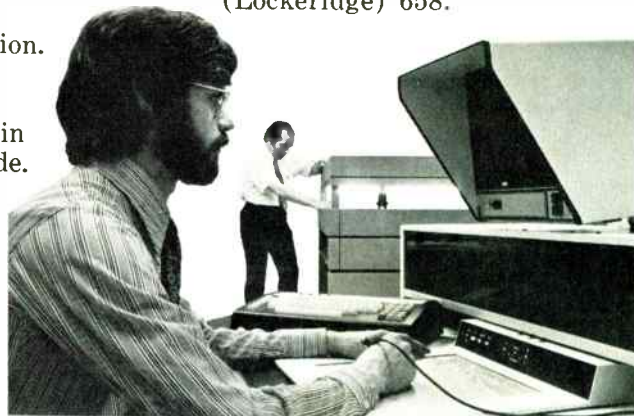

Calma Interactive Graphics Systems.

Standard instrument interface simplifies system design

Instruments made by any company anywhere in the world will be easy to link up into systems when all the elements conform to an international standard on interface circuitry and bus interconnection

by David W. Ricci and Gerald E. Nelson, Hewlett-Packard Co., Santa Clara Division, Calif., and Loveland Division, Colo.

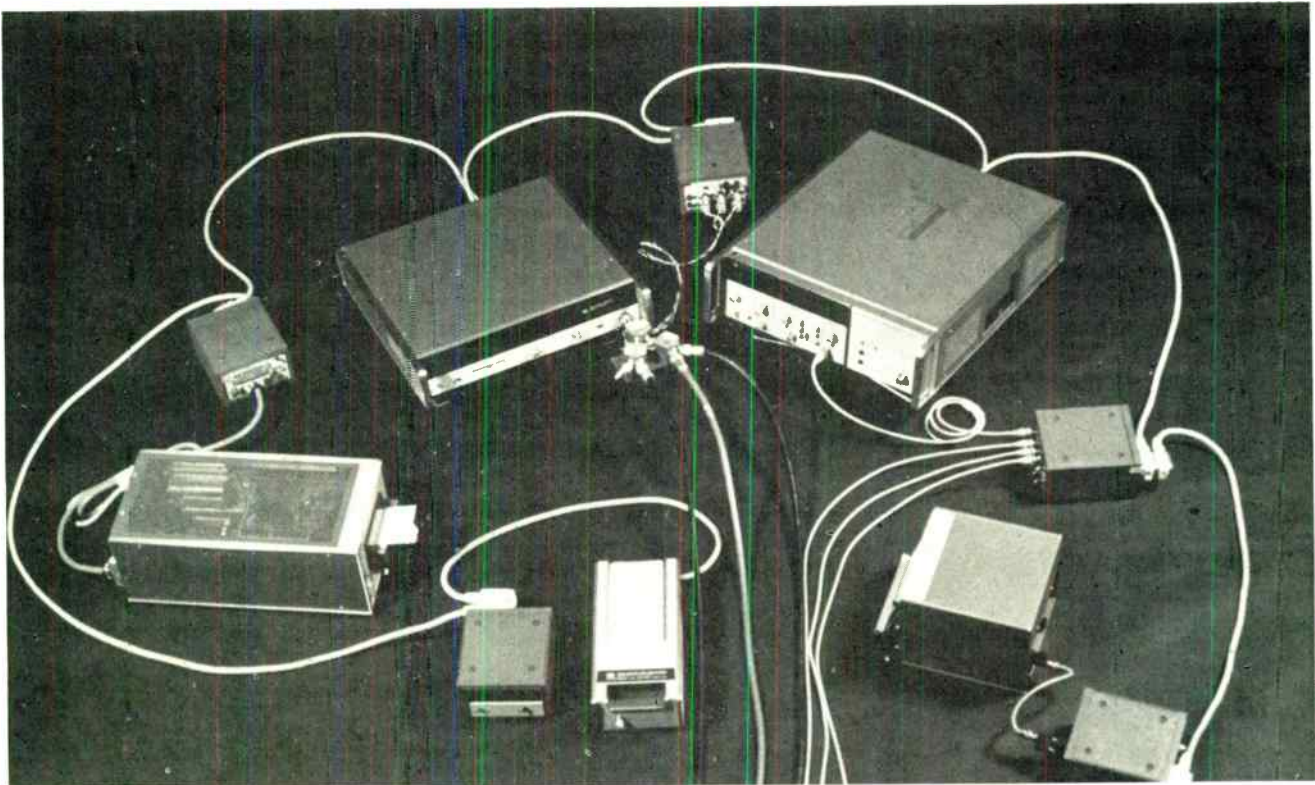

Once the international standard for an instrument interface is agreed on, it will become quicker and more economical to construct automated instrumentation systems. Until now, sophisticated, cost-effective instruments have been readily available—but their generally incompatible inputs and outputs have forced the system designer to put a lot of effort into interface design. A standard interface is the rational solution, and for once the rational solution is being attempted.

The International Electrotechnical Commission recently met in Bucharest, Romania [*Electronics*, Sept. 19, p. 67], to discuss just such a standard. The proposal before the IEC's Technical Committee 66 was an instrument bus standard initiated by Hewlett-Packard Co., Palo Alto, Calif., and supported by many other instrument makers. The document defines the bus's physical connector, the roles of the

interconnecting bus wires, the logic conventions, format, and timing of control and data signals, plus the other factors necessary in a communications link that will be capable of interconnecting instruments and peripherals—computers, voltmeters, card readers—made any place in the world.

The IEC technical committee voted to accept the draft standard for ballot by the Commission's member nations, but further changes, if any, should be minor. Final adoption is now about a year off [*Electronics*, Oct. 3, p. 56].

Details of the standard are presented here in a two-part article. The first part is aimed at the system designer, to help him make the most of the interface by understanding its capabilities and limitations. The second part covers the interface from the instrument designer's viewpoint and includes examples of how to use it in instruments.

Part 1: The standard interface and system design

□ Building an automated system of instruments already equipped with standard interface circuitry is almost a matter of plugging them into a standard data bus—but not quite. In the case of the Hewlett-Packard interface, which soon may become the international standard, the system designer needs to know how the data bus is used to transfer commands and data between the attached instruments and why some methods of data coding are more useful than others. He also needs to be aware of the constraints that exist on the length of bus cables and the number of instruments that may be connected to it. In short, an understanding of the HP standard interface helps in configuring a system around it.

Figure 1 diagrams the basic interface structure. A set of 16 signal lines interconnects a number of instruments, each of which fulfills at least one interface function or role, depending on the interface capabilities designed into its circuitry.

At any one time, any particular instrument connected to the bus may be either idle, simply monitoring the activity on the bus, or it may be functioning as a talker or listener or controller. As a talker, it sends data over the bus to a listener or listeners. As a listener, it receives such data. As a controller, it directs the flow of data on the bus, mainly by designating which instruments are to send data and which are to receive data. An instrument may be equipped to serve in more than one of these interface roles, depending on the kind of system expected to be built around it.

A minimum system need not contain a controller but may consist of just one talker and one listener—a counter and a printer, for example—provided that the two instruments have the interface options that allow a

local control to assign them their interface functions. Otherwise, a system must include a controller to designate talkers and listeners. A typical system might include one element with a talker, listener and controller interface, such as a calculator or computer, and a variety of other elements that may be talkers or listeners or both, such as tape readers, signal generators, or digital voltmeters.

All of the active circuitry equipping an instrument to talk or listen or control and simply to monitor the bus is contained within that instrument. The interconnecting bus is entirely passive. Circuitry and bus together make up the interface.

The bus itself consists of 16 signal lines, grouped functionally into three component buses. The data bus (eight lines) is used to transfer data in bit-parallel, byte-serial form from talkers to listeners; it also transfers certain commands from the controller to subordinate instruments. The transfer bus (three lines) is used for the handshaking process, by which a talker or controller can synchronize its readiness to transmit data with the listener's readiness to receive data. The general interface management bus (five lines), as its name suggests, is principally used by the controller.

The operation of the interface is generally controlled by the one member of the instrumentation system that's equipped to act as controller. It uses a group of commands, referred to as interface messages, to direct the other instruments on the bus in carrying out their functions of talking and listening.

The controller has two ways of sending interface messages. Multiline messages, which cannot exist concurrently with other multiline messages, are sent over

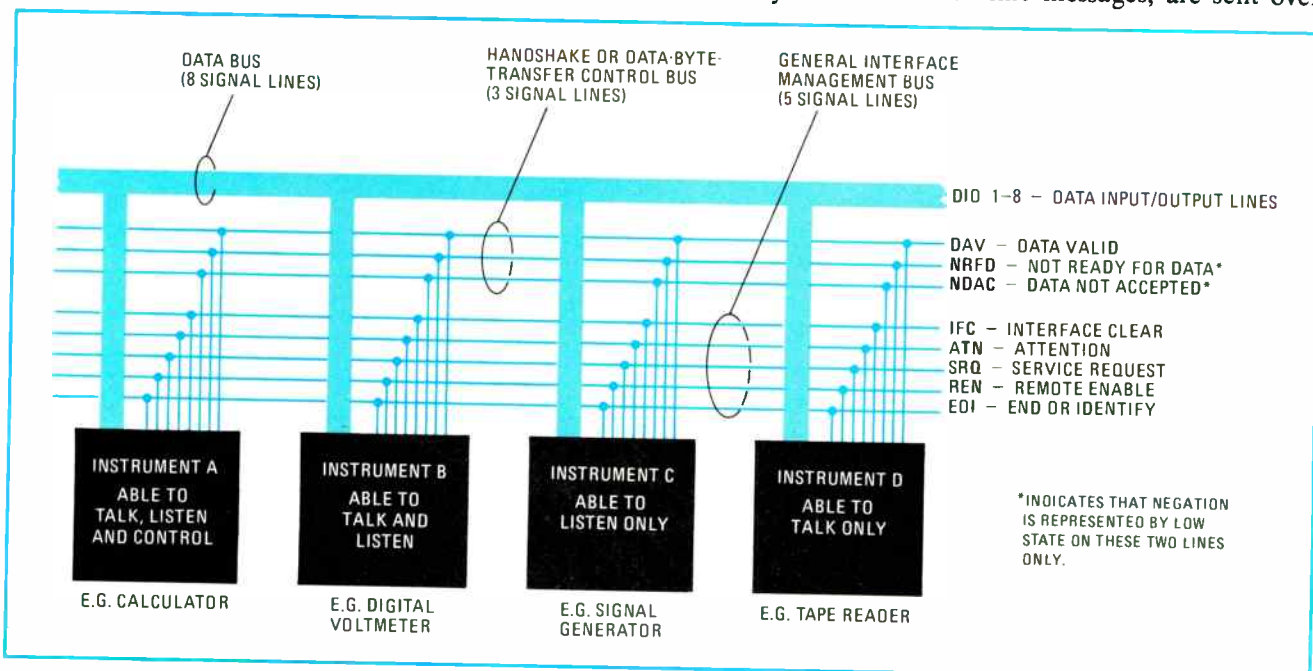

1. Data bus. The Hewlett-Packard bus uses a 16-line cable to quickly link up any instruments equipped with appropriate interface circuitry into a system. Data transfer is byte-serial, bit-parallel at rates as high as 1 megabit per second.

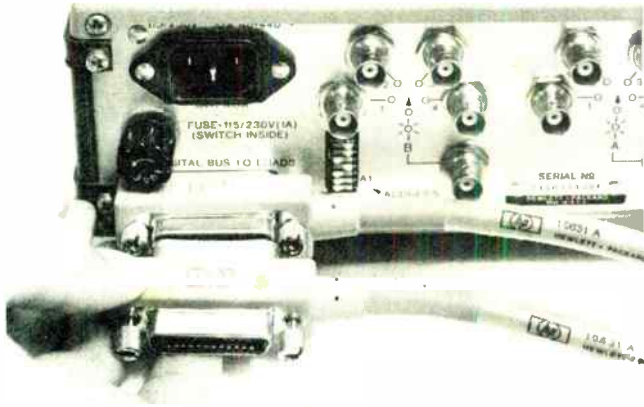

2. Connector. Cables used with the interface system have dual male-female connectors at each end so that they can be stacked, thus allowing more than one cable to be attached to any instrument. This permits either star or daisy-chain configurations.

the eight data lines and the three transfer-bus lines. Uniline messages are transferred over the five individual lines of the management bus.

The commands serve several different purposes:

- Addresses, or talk and listen commands, select the instruments that will transmit and accept data. They are all multiline messages.
- Universal commands cause every instrument equipped to do so to perform a specific interface operation. They include multiline messages and three uniline commands, interface clear (IFC), remote enable (REN), and attention (ATN).
- Addressed commands are similar to universal commands, except that they affect only those devices that are addressed and are all multiline commands. An instrument responds to an addressed command, however, only after an address has already told it to be a talker or listener.
- Secondary commands are multiline messages that are always used in series with an address, universal command, or addressed command (also referred to as primary commands) to form a longer version of each. Thus they extend the code space when necessary.

To address an instrument, the controller uses seven of the eight data-bus lines. This allows instruments using the Ascii 7-bit code to act as controllers. As shown in Table 1, five data bits are available for addresses, so a total of 31 addresses is available in one byte. If all secondary commands are used to extend this into a two-

byte addressing capability, 961 addresses become available (31 addresses in the second byte for each of the 31 in the first byte).

Addressing details

A talk address selects one instrument to send data and disables all the others with talker circuitry from sending data. That is, sending a talk address selects one and only one instrument to transmit on the data bus, preventing data errors due to wire OR'ing on the data bus. A listen address selects one instrument to receive data, but does not affect the others—they remain as they were, addressed or unaddressed. Thus, several instruments may listen at the same time. Sending a talk address does not affect listeners or vice versa.

Also shown in Table 1 are two other commands associated with the addressing process—the untalk and unlisten commands. They are called “un” commands because they perform exactly the opposite function of an address; that is, they disable an instrument from sending or receiving data. The unlisten command is used whenever a new listener or group of listeners is to be selected in order to disable all the previously selected listeners. The untalk command disables all previously selected talkers. In fact, the untalk command is merely a talk address using an address number to which no instrument may be assigned, and instruments make no distinction between an untalk command and a talk address to a different device.

During the configuration of a system, each device must be assigned one or more addresses unique to it. However, two listeners may have the same address if they are always to receive the same data. An instrument is assigned its address by some convenient means such as switches on the rear panel or jumper wires on a printed-circuit board. Typically, there are five switches or jumpers to be set which specify the five bits of the talk or listen address (or both if the instrument is both a talker and a listener). The particular value of the address is the system designer's choice. In the case of instruments using more than one talk and/or listen address, only four bits of the address may be settable.

The actual bus

Instruments are connected into a system with a special piggyback cable (Fig. 2) which has a single male-and-female connector at either end and a lockscrew mechanism which allows one cable to be stacked on top of another and secured. This arrangement allows the user to assemble a system in any configuration he wishes—a line or a star or any combination that's convenient in terms of the space available. (Although the connectors are in theory infinitely stackable, in practice

Closing the loop

The authors will both be available on Nov. 26 and 27 to answer any questions readers may want to ask about their article. Call either David Ricci in California at (408) 246-4300, ext. 2192, or Gerald Nelson in Colorado at (303) 667-5000, ext. 2158, in office hours.

TABLE 1: COMMAND AND ADDRESS CODES

Code Form							Meaning
X	0	0	A ₅	A ₄	A ₃	A ₂ A ₁	Universal Commands
X	0	1	A ₅	A ₄	A ₃	A ₂ A ₁	Listen Addresses
X	0	1	1	1	1	1	Unlisten Command
X	1	0	A ₅	A ₄	A ₃	A ₂ A ₁	Talk Addresses
X	1	0	1	1	1	1	Untalk Command
X	1	1	A ₅	A ₄	A ₃	A ₂ A ₁	Secondary Commands
X	1	1	1	1	1	1	Ignored

Code used when attention (ATN) is true (low)

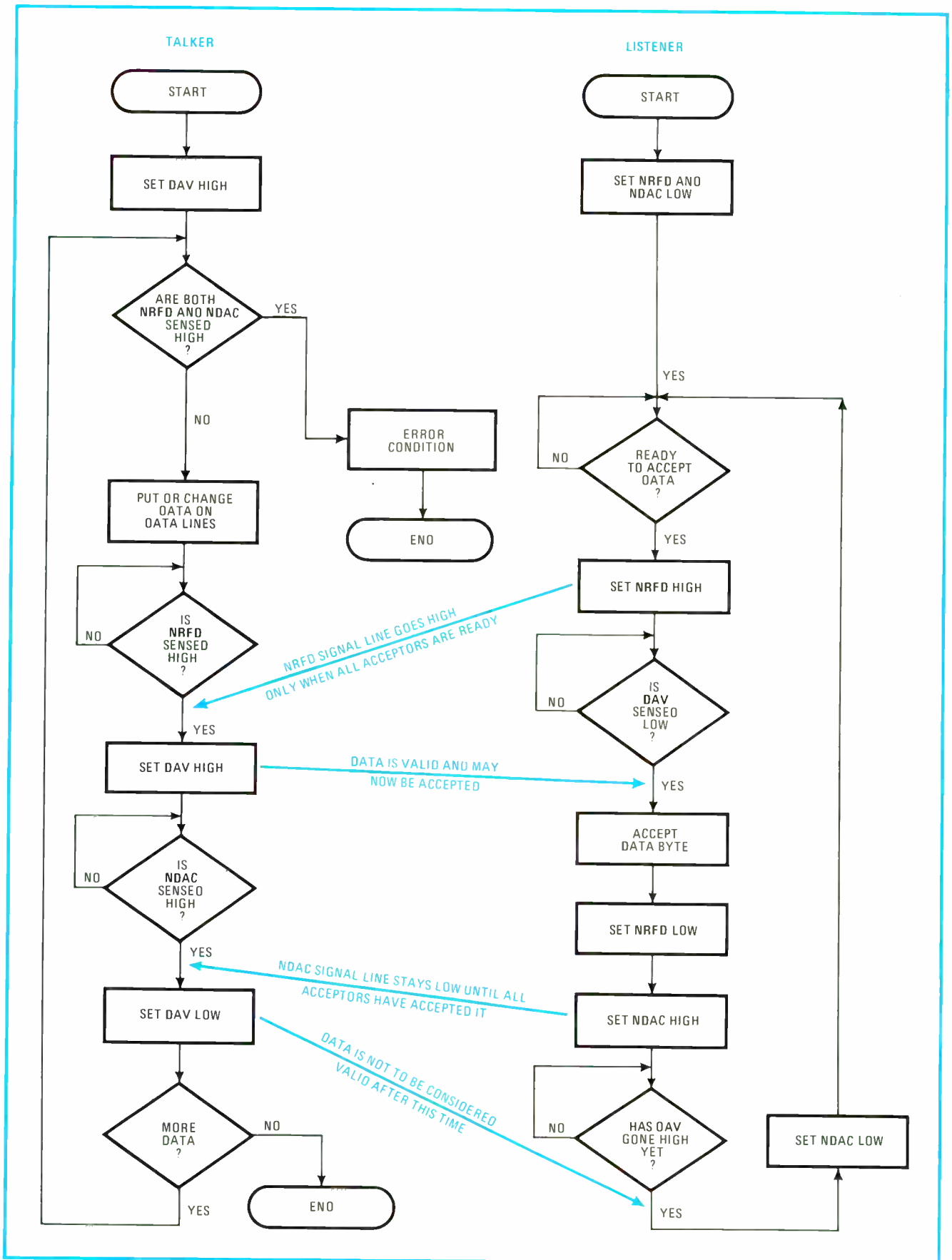

3. Handshake. To ensure that data is properly transferred, this handshaking procedure must be performed every time a talker sends data to a listener or listeners. The DAV line is controlled by the talker, NRFD and NDAC by the listeners.

TABLE 2: HOW TO USE ASCII IN CODING INTERFACE COMMANDS

Recommended	To be avoided
The upper-case alphabet: A - Z	The lower-case alphabet: a - z (some controllers cannot generate or display these)
The digits: 0 - 9	
Common punctuation, used for their standard meanings: (+) (-) (.) (,) (.)	Punctuation used by computer languages for syntax control: (") (space) (_)
End of record: (CR) (LF) (carriage return and line feed)	Most nonprinting characters: ECT hangs up telephones; (NUL), (DEL) mean no information; (BEL) rings a bell; (SO), (ESC) alter the meanings of subsequent bytes; (X 11 11111) is sometimes used as a "rub-out" code.

only two to four are actually stacked to avoid creating a cantilevered structure that may damage a panel.)

Electrical considerations limit the total number of instruments to 15 and the maximum length of cable to 20 meters, although both of these limitations can be overcome by extender or terminal units (to be discussed in Part 2). The fact that the cable terminations are distributed (each device contains a termination) imposes another restriction—the maximum length of cable for any given configuration is two meters times the number of devices up to the maximum of 20 meters. This restriction only applies to the maximum length of cable, not to how it is distributed between the devices.

Data transfer and data rates

When a talker sends a listener data over the data bus, they coordinate their activities by a handshaking process, which is carried out over the three-line transfer bus. As a result, the rate at which data is transferred is determined only by the characteristics of the instruments involved. Moreover, several instruments can listen to the same data simultaneously.

There are essentially four phases to the data transfer cycle: the talker or source generates a new data byte; the states of the data bus's signal lines settle; the listener or acceptor instrument accepts the data (i.e., no longer requires it to be held on the data bus), and the acceptor becomes ready for the next byte. Figure 3 is a flow chart detailing the handshake process.

The time taken to generate data is determined by the characteristics of the source, and the times taken to accept data and to become ready for more depend on the acceptor's characteristics. The data settling time is determined by the characteristics of the transmission system (the drivers, receivers and terminations in the instruments, and the bus cable).

Between them, therefore, the source, acceptor, and transmission system set the upper limit for the data rate at which a bus system will operate. Note that acceptors can be designed to store data for a while, to permit the data-generation and data-settling times to overlap with the acceptor's ready-for-data time and thus increase the bus's data rate.

By careful design and configuration, a rate of 1 megabyte per second can be achieved on a burst basis.

The logic levels employed on the bus's signal lines are TTL levels (high at or above 2.4 volts, low at or below 0.8 v). Driver and receiver circuits must, therefore, be TTL or TTL-compatible devices. The driver circuits are open-collector types capable of sinking 48 milliamperes at 0.4 v. Three-state drivers may be employed on some of the signal lines to increase the speed of data transfers. The receiver circuits may be standard TTL gates or inverters, or equivalent. For higher noise immunity, Schmitt trigger-type gates or inverters are better.

Each signal line is terminated within each instrument with a 3-kilohm resistor to +5 v and a 6.2-kilohm resistor to logic common. Distributing the terminations among all the instruments (rather than having a lumped termination) is a compromise between an ideal design for a transmission-line termination and the desire to minimize the job of configuring a system (i.e., by not restricting the interconnection scheme or requiring an external load device).

Data coding

The only functional restriction on data transfer between a talker and listener imposed by the bus is that it must consist of a sequence of 8-bit bytes. Even though the interface imposes no restrictions on information coding, conventions obviously must exist between the talker and listener, and the system designer is free to choose whichever he prefers.

Still, he should bear in mind that the computers and calculators used as controllers in many systems have established coding and format conventions built into their software. If he can use these conventions, his task will be much easier than if he makes the machines generate and accept arbitrary coding.

The two most common of these conventions are Ascii coding of information bytes and Fortran-style number representations (formatted and free field). Though both of these are subject to ANSI (American National Standards Institute) standards, the American National Code for Information Interchange (Ascii) conforms to the ISO 7-bit code used internationally. In fact, though the kind of bus now proposed as the international standard can be used with other codes, it has used Ascii so often that it became commonly known as the "Ascii bus."

It still is very useful to implement instrument program codes and numeric data with Ascii, where possible, because of the ease with which most controllers read and write Ascii strings and numbers. However, a further restriction to a subset of these codes is also highly desirable, because certain codes have special meanings in these controllers and their software. Table 2 gives recommendations on code use.

Number representations

Note that a measurement instrument that reads out numbers with the least significant digit first causes severe headaches for the system programmer. He must read the data as individual bytes and rearrange them to reconstruct the number. On the other hand, a simple read statement in the controller's language is all that's neces-

sary if the meter puts out its data in a form acceptable to standard software. This form for numbers is largely identical to the conventional way numbers are written. Examples are [12976], [-42.67], [+1.00298 E-04]. Multiple values should be delimited by commas, and the

most convenient end-of-record indication is [CR][LF].

If numeric data must be mixed with alpha status information, the alpha characters can generally be made to precede the number and either be read as a string of binary bytes or optionally skipped. □

Part 2: The standard interface and instrument design

□ While the system designer has merely to understand how the standard interface works, the instrument designer has to be able to build part of the standard interface into a piece of equipment. He therefore needs to specify how an instrument must behave if it's to be classified as conforming to the standard.

Writing a specification for this interface, however, presents a significant challenge. The requirements must be explicit enough to ensure compatibility yet flexible enough to allow the designer to tailor an instrument to his particular needs. To achieve this goal, the specifica-

tion is written in terms of *interface functions* (as distinct from instrument functions), *messages* to and from the interface functions, and *state diagrams* describing the behavior of each of these functions (Figs. 3 and 4).

Interface functions and messages

Figure 4 shows how to conceptualize the interface functions and the messages.

Each instrument contains a set of driver and receiver circuits that serve as the electrical interface between the bus signal lines and the instrument's internal logic. To

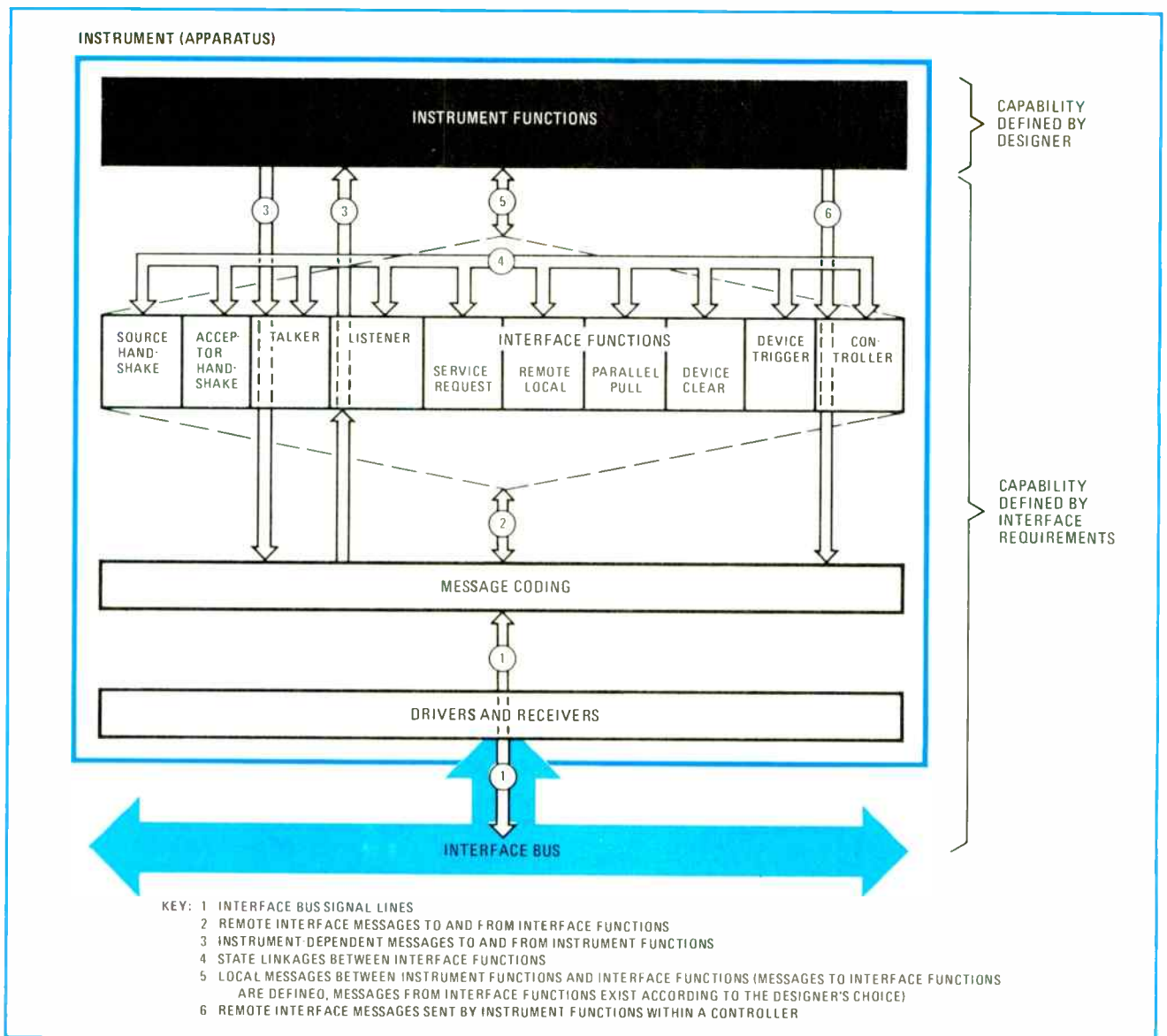

4. Partition. Instrument designs can be conceptualized as being partitioned into two areas: instrument functions and interface functions. But this division does not necessarily imply two separate physical layouts within the instrument.

leave the designer free to decide what kind of logic to use for an instrument, the instrument's functions are distinguished conceptually from the interface functions and are independent of the needs of the data bus. The interface functions ensure that the instrument behaves correctly with respect to the bus signal lines and are constrained by the needs of the standard interface.

Note that this theoretical separation between the functions of interface and instrument need not imply that they are also physically separated. The aim is simply to make it easy to analyze each of the interface requirements in relation to the instrument's requirements.

Communication between the instrument, its interface functions, and the bus signal lines is described in terms of messages. Actually, every such message is coded into particular electrical states (high and low voltage levels) of the bus signal lines. But in writing a specification, it would be tedious to have to describe exact electrical values of the bus lines for each message, so instead the messages are treated simply as binary functions with values of true or false.

The total capabilities of the interface are grouped into 10 interface functions—five basic functions and five supplementary functions (Tables 3a and 3b).

The basic functions are the ones that appear most frequently in most systems. Almost all instruments will contain either a talker or a listener function or both. Although only a few will incorporate the controller function, an instrument with controller capabilities will almost always be included in a system, and in certain cases multiple controllers can be utilized. The source and acceptor handshake functions are always used in conjunction with the talker, listener and controller.

In Table 3b, the service request function must always be used in conjunction with a talker function, since the instrument has to identify itself as the source of a service request during a serial poll. The parallel poll function differs from serial polling in being initiated by the controller rather than requested by the instrument.

State diagrams are used to describe the sequence of states the interface goes through as it fulfills a particular function in relation to the instrument and the data bus. Two examples are given in Fig. 5.

How to select interface functions

In selecting interface functions, the instrument designer has two degrees of freedom: which functions to choose, and which capabilities of each to choose.

The interface functions are selected by being matched with the instrument's requirements. All the combinations allowed are compatible with each other. That is, a given set of interface functions is guaranteed always to work with other, appropriately equipped, instruments in the sense that the set will not limit the other instruments' operation. Thus, the only mistake a designer can make is omitting a function required for his instrument or the system designers' applications for his instrument.

Once the interface functions are selected, a second set of choices can be made. The various combinations of capabilities that form subsets of each function allow certain capabilities to be omitted if they are not relevant to the instrument's needs. Again, the omission of a ca-

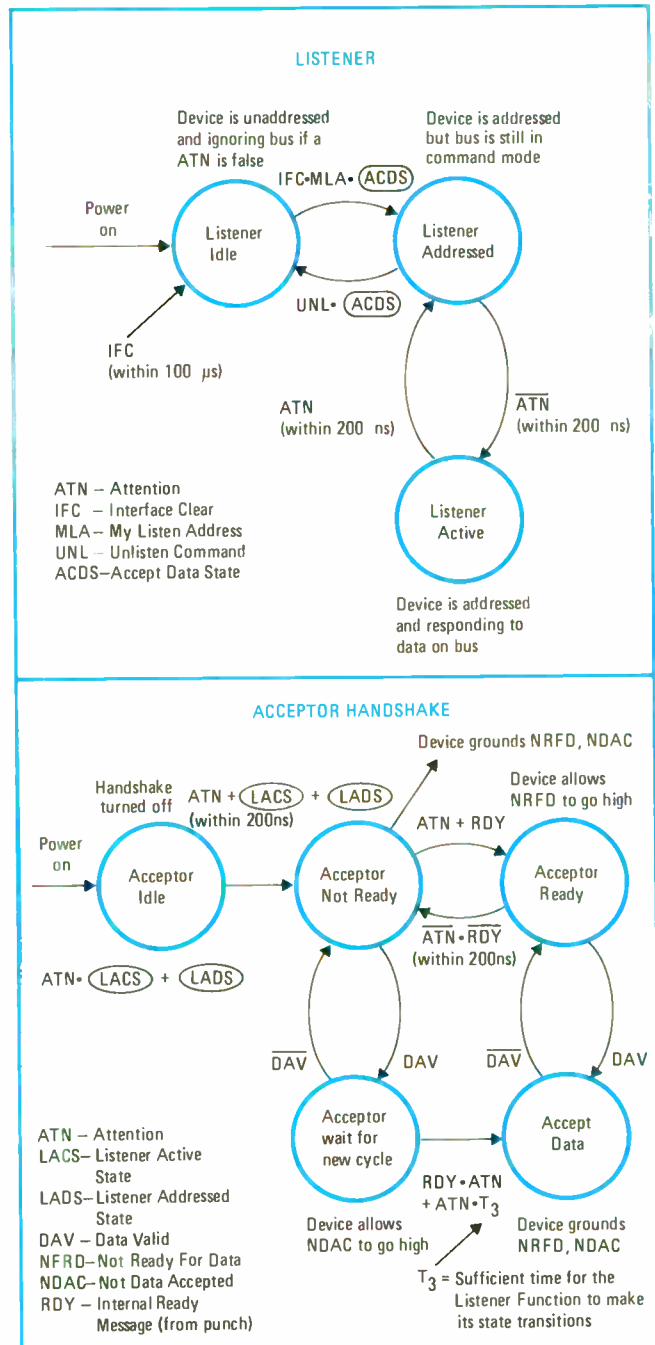

5. States. One way of looking at an instrument's interaction with the data bus is to use state diagrams like the two shown here for any listener tied to the bus (above) and for a listener in the process of receiving data and handshaking with a talker (below).

ability does not limit the operation of the over-all system, just the particular instrument.

Four interface design steps

However, selecting the proper group of interface functions and capabilities is only the second step in designing an interface. The first and crucial step is to generate a detailed list of objectives for the remote input/output behavior of the instrument for which the interface is being designed.

These objectives, plus the interface functions chosen

TABLE 3A: BASIC INTERFACE FUNCTIONS

Function	Description
TALKER	
Basic Talker	To let an instrument send data to another instrument.
Talk Only	To let an instrument operate in a system without a controller.
Unaddress if my listen address (MLA)	To prevent an instrument capable of functioning as both a talker and a listener from talking to itself.
Extended Talker (TE)	Same as talker function with added addressing capability.
Serial Poll	To send a "status byte" to the controller and identify itself as the source of a service request.
LISTENER	
Basic Listener	To let an instrument receive data from another instrument.
Listen Only	To let an instrument operate in a system without a controller.
Unaddress if my talk address (MTA)	To prevent an instrument capable of functioning as both talker and listener from listening to itself.
Extended Listener (LE)	Same as listener function with added addressing capability.
SOURCE HANDSHAKE	To synchronize the transmission of information on the data bus by the talker when sending instrument-generated data and by the controller when sending interface messages.
ACCEPTOR HANDSHAKE	To synchronize the receipt of information on the data bus for all interface functions when receiving interface messages and for the listener function when receiving instrument-generated data.
CONTROLLER	
System Controller	To let an instrument send the interface clear (IFC) or remote enable (REN) messages.
Send Interface Clear (IFC)	To let a system controller take charge from another controller and/or initialize the bus.
Send Remote Enable (REN)	To let a system controller enable instruments to switch to remote control.
Respond to Service Requests (SRQ)	To let a controller respond to service requests.
Send Interface Messages	To let the controller send multiline interface messages
Receive Control	To let the controller accept control on the bus from another controller.
Pass Control	To let the controller pass control of the bus to another controller.
Parallel Poll	To let the control execute a parallel poll.
Take Control Synchronously	To let the controller take control of the bus without destroying a data transmission in progress.

to implement them, plus the rules in the interface standard applying to those functions, form the basis of the interface design. They must be detailed enough to spell out exactly the behavior of every wire on both the bus side of the interface and the instrument side.

The third step is to choose a method of logic implementation that fits one's knowledge, economic considerations, and so forth. This part of the procedure is the subject of an entire science and will necessarily be passed over rather lightly in this article, although it is undeniably the most difficult part of the design.

The fourth and final step is to verify hardware performance. If the interface is part of a very general-purpose piece of equipment, like a measuring instrument, calculator, or data peripheral, it is virtually impossible to check its performance in the same system configuration as the customer's. (The number of different system configurations is large and in all likelihood, some of the pieces of some of those systems are not invented yet.) It is very important, therefore, to check very thoroughly that the interface standard rules are adhered to.

Some examples of this design procedure follow. Each involves a different set of interface functions and illustrates a different combination of principles, but they are not completely detailed and do not necessarily represent designs now in development or production.

The first example, a paper-tape-punch interface, will be carried all the way to the schematic level. The other examples—interfaces for a digital voltmeter and a programmable calculator, plus a serial terminal unit—will be carried only through the definition phase.

Interface for a paper-tape punch

Though this is a specific type of data peripheral, its list of objectives fits many other instruments—in fact, all those that take digital information from a remote input and convert it into some other form. Printers, programmable power supplies, function generators, X-Y plotters, scanners, and programmable attenuators all do this.

A block diagram for the tape-punch interface is given in Fig. 6. As for its objectives, it must be able to:

- Be told by the controller of the bus when and when not to punch received data.
- When told to punch, take data bytes from the bus and pass them to the punch data-input lines.
- Provide a punch-initiate signal to command the punch circuits to punch the data byte onto the tape.
- Accept a punch-ready signal from the punch and use it to control the timing of bytes received from the bus (to ensure the data remains stable while punching and notify the data source when ready for the next byte).
- Not punch data received in the bus command mode, and handshake as fast as possible to avoid slowing the bus down unnecessarily.

The most obvious interface function required is the listener function. This is needed to satisfy the first objective. The listener function is the one that basically remembers whether the instrument is addressed to listen or not. Of the subset of four capabilities, only the basic listener capability is needed here.

The only other interface function required for the punch is the acceptor handshake function. This function

meets the third objective by indicating when the bus data is valid. It also allows control of byte timing for the fourth objective. Actually, the bus standard requires the acceptor handshake to be included in any interface having a listener function.

The standard rules for these two interface functions are most easily shown by means of state diagrams. The listener function is provided by a flip-flop that is set when the punch's listen address is received and cleared when the unlisten command or interface clear is received. In Fig. 5a, the set states are listener addressed and listener active, with the condition of attention on the bus distinguishing between the two states on the diagram. The cleared state is listener idle.

The acceptor handshake is also provided by one flip-flop plus some gating. In Fig. 5b, if attention is false and the listen flip-flop is not set, the handshake must be idle. The two not-ready states (acceptor not ready and acceptor wait for new cycle) can be one state of the handshake flip-flop, data valid being used to distinguish the wait-for-new-cycle from the not-ready state. The two ready states (acceptor ready and accept data) similarly can be the other state of the handshake flip-flop.

Because of the simplicity of this interface, standard TTL ICs were chosen to implement it. The complete schematic is shown in Fig. 7.

Interface for a DVM

Digital voltmeters represent the very large class of devices that must both listen and talk on the bus. Other measuring instruments that belong to this class include timers or clocks that must be set as well as read remotely, and terminals having both keyboard and display. The DVM interface must be able to:

- Provide two alternate means of controlling the voltmeter's program information—front-panel controls or remote commands.
- When in remote control and addressed, respond to program commands from the bus and pass them on to the voltmeter's control logic (range, function, etc.).
- Accept either a universal command from the bus or a normal program command to initiate a reading.
- Send measurement results and program status data to the bus when addressed to do so by the controller.
- Operate in a controller-less system with a printer or tape punch by being configured to talk without requiring an address.
- Asynchronously request the bus controller's attention for either of two reasons—programs not understood, or measurement complete—and, when polled by the controller, indicate to it which was the reason.

The first of these objectives is completely met by the remote local function in the bus standard. A subset of this function with no local lockout capability could be used for simplification, but full capability is preferable, especially with little foreknowledge of system usage.

The listener and acceptor handshake functions are needed for the second objective. The designer of a talker-listener combination such as a DVM might want to add the "unlisten if my talk address" capability.

For the third objective, the device trigger interface function should be included to allow response to the

TABLE 3B
SUPPLEMENTARY INTERFACE FUNCTIONS

Function	Description
SERVICE REQUEST	To let an instrument indicate to the controller that some event has occurred and request it to take some specific action asynchronously with respect to other bus operations (one SRQ function is required for each independent reason for requesting service).
REMOTE-LOCAL Basic Remote-Local	To let the control of the instrument be switched between its local (manual) controls and remote control (programming codes received while addressed as a listener).
Local Lock Out	To let the local control "return to local" be disabled.
PARALLEL POLL Basic Parallel Poll	To let instruments return one-bit status to the controller. Up to eight instruments may respond simultaneously. More than one instrument may respond on the same status line so that logical operations (AND, OR) may be performed on a group of instruments.
Parallel Poll Configure	To let the instrument be configured by the controller.
DEVICE CLEAR Basic Device Clear	To provide a means by which an instrument (device) may be initialized to a predefined state. All instruments are cleared concurrently.
Selective Device Clear	To clear individual instruments (devices) selectively.
DEVICE TRIGGER	To let instruments (devices), either singly or in a group, be triggered, or some action be started.

universal command, GET (group execute trigger). GET has the obvious meaning of "take a reading". The normal program command to take a reading can be brought in the same way as range and function information, under control of the listener function.

The talker function is required for data output to fulfill the fourth objective of the DVM interface. It is probably appropriate to include all the capabilities of the talker function (except perhaps the extended talker). Serial poll will be necessary to be able to indicate reasons for requesting service via a status byte to meet the last objective.

Talk-only mode is the means of achieving the second-last objective. Unaddress-if-my-listen-address is a possible inclusion, providing the controller with a minor saving in software by not requiring an unlisten com-

mand to be sent between programming the DVM and accepting its data. Moreover, since the DVM is a talker, it also requires the source handshake function.

Finally, the service request function is required, since, to meet the last objective, the DVM must be able to request asynchronous attention. Normally, an instrument having two reasons for requesting service would need two service request functions, but in this case the reasons are not independent. The DVM probably cannot take a reading and then request service if its program was not understood. Conversely, if the DVM is requesting service to indicate a measurement is complete, it is probably not working on program data or it is receiving erroneous program data.

In general, to minimize hardware logic costs in an instrument, it's best to consider the design as a unified whole (rather than assume hardware partitions from the start) and to make the circuitry operate time-serially (as far as is consistent with speed requirements). Application of these two principles maximizes the opportunity to share logic hardware among many tasks, though it may increase trouble-shooting time. It also enables the designer to take more advantage of available or custom LSI and MSI circuits.

This approach suggests that minimum cost to the customer would result from combining the interface functions described above with the voltmeter's functions (analog-to-digital conversion, program interpretation, etc.) and do one logic design for them all.

A calculator interface

A programmable calculator is representative of controllers of medium complexity. Modern calculators are powerful enough to replace minicomputers yet inexpensive and simple enough to use to replace paper-tape readers in many system control applications.

Let's suppose that this particular calculator is characterized by having a complete algebraic language (Basic, for example) and no interrupt capability (the calculator can execute only one program statement at a time). Moreover, it must be in control of the system it is interfaced to. There is no convenient way to treat the machine as a number-crunching peripheral to something else, or to wake it up and make it accept and execute programs from the I/O port.

The interface to be designed in this example is the combination of an I/O card, to handle specifics of communication between the bus and the calculator's internal I/O structure, and a "firmware" driver (software encoded into read-only memory), to handle special protocols and details relating to bus operation.

The calculator interface must be able to:

- Send data to instruments on the bus (numeric data and program data). This data could be binary bytes, Ascii-coded numbers, or Ascii strings.
- Receive similar data from the instruments on the bus.
- Send addresses and universal commands to the bus so as to control information flow.
- Control remote local functions in other instruments.
- Test the status of the service request line at any time, allowing software branching to service routines in lieu of true interrupt capability.

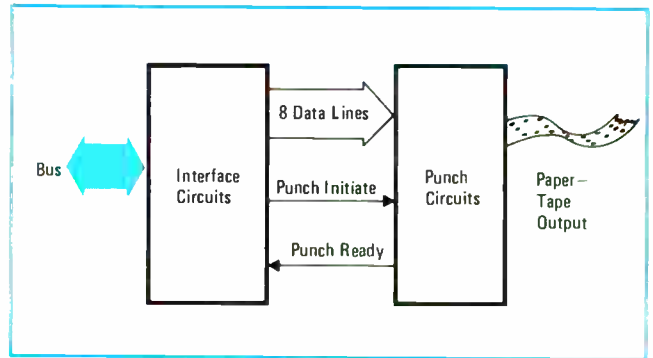

6. **Punch.** As shown by its block diagram, a tape punch can be partitioned into the punch circuits that will enable it to perform its functions as an instrument and the interface circuits that are necessary to connect it to the data bus.

- Take charge of and initialize the bus at any time, so that erroneous operations can be halted and a program be run from a known initial condition for the system.

The first of these objectives is met by the talker and source handshake functions. Even though the calculator is a controller, it is worth reemphasizing that the sending of instrument-generated data with attention false on the bus is done only by controllers, never by talkers. The capabilities of talk only and unaddress on my lister address are not necessary for this type of instrument.

The second calculator-interface objective is realized by including listener and acceptor handshake functions. The listener function has one additional capability when combined with a controller; the calculator can, if it wishes, tell the listener function to listen or unlisten internally, without sending those commands to the bus.

The next three objectives are implemented by various capabilities of the controller function—send interface messages, send remote enable, and respond to service requests, respectively. The send remote enable capability also requires the system controller function.

For convenience, the calculator could also include the "send interface clear and take charge" capability to allow bus initialization by pulling one line. But the last objective can also be implemented by the "send interface messages" capability since by sending attention true, all instruments must listen to the calculator.

A serial terminal unit

Sometimes it is necessary to extend instrument-system interconnection length beyond the 20 meters provided by the bus. For instance, monitoring or test subsystems might have to be scattered throughout a manufacturing plant, so that a group of instruments might need to be several hundred feet from their controller. The technique that best meets this need is a totally serial transmission. This minimizes the cost and bulk of interconnection cables and makes it possible to transmit the information by telephone.

Use of a terminal unit can supply the designer with the advantages, where appropriate, of having two distinctly different interfaces. In this example, by designing a bus-to-serial interface, he could preserve the party-line communication and standardized instrument input/output of the bus yet still allow easy communi-

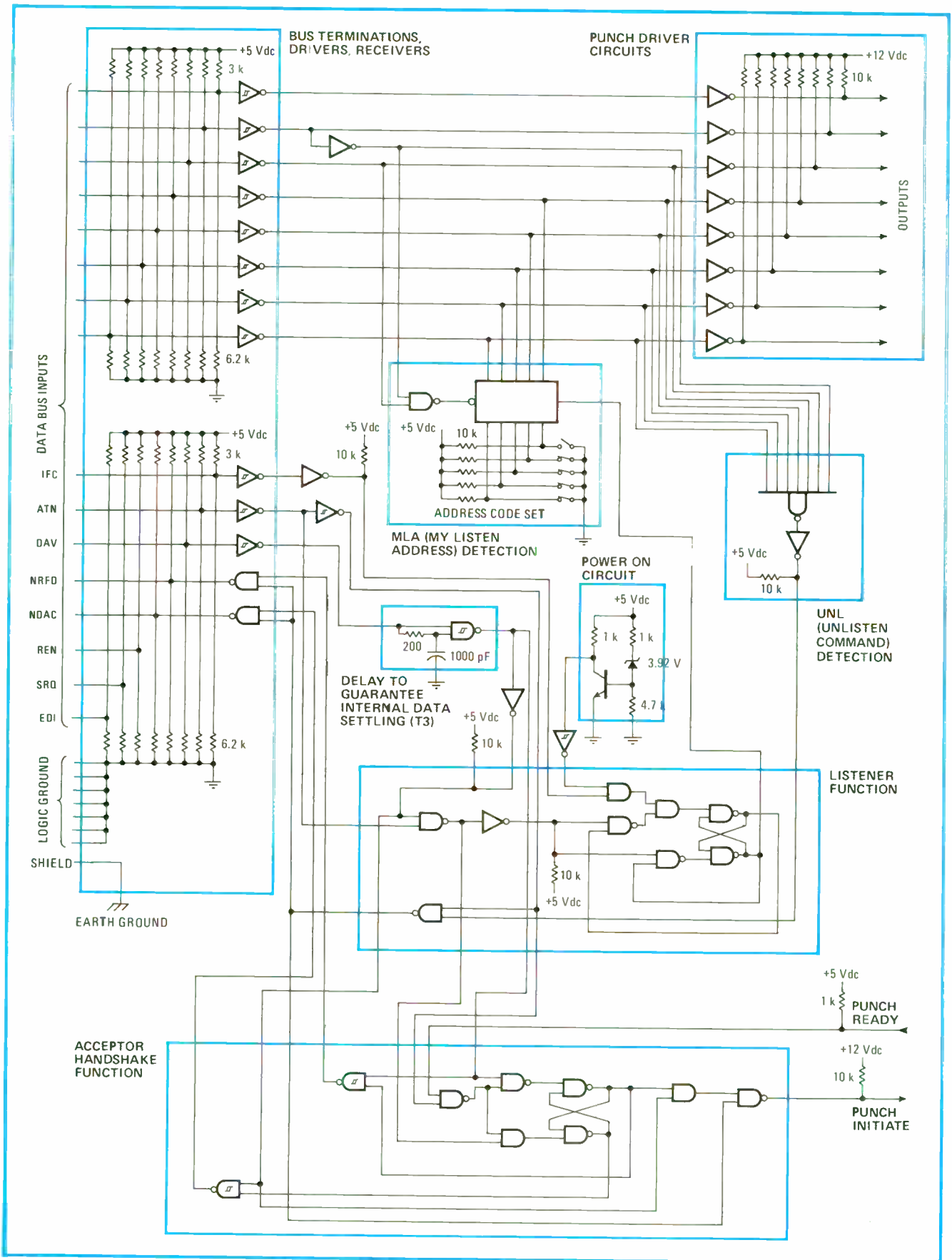

7. Design. Because of the simplicity of a tape-punch interface, standard TTL integrated circuits were chosen to implement the design. The class of devices that take digital data and convert it to some other form may make use of similar circuitry.

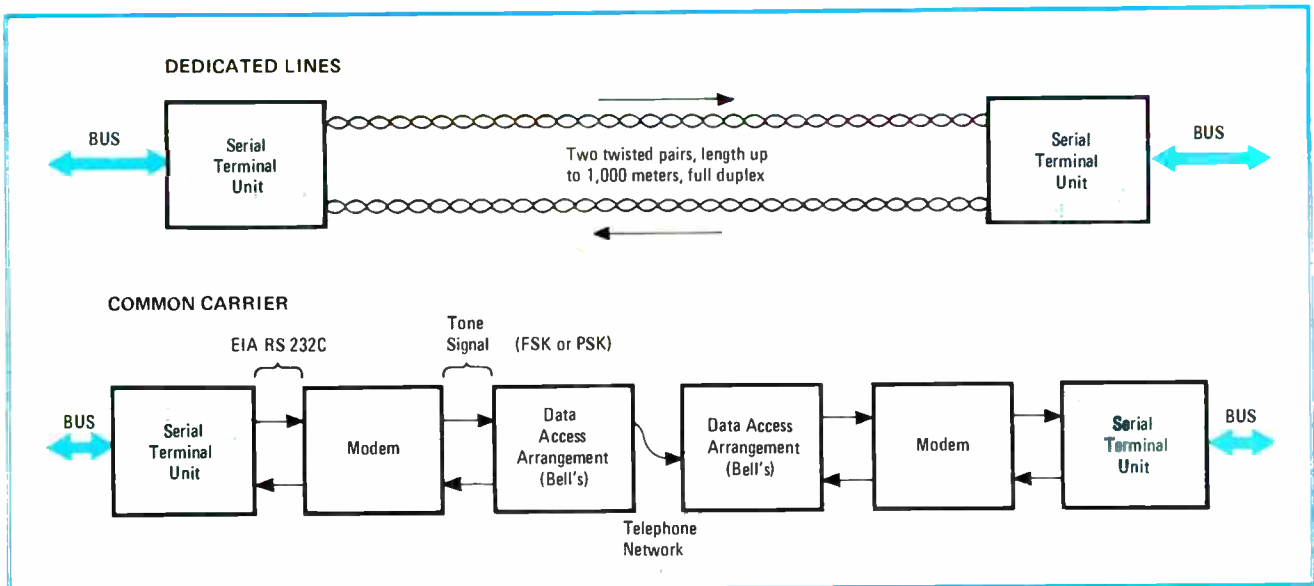

8. Extension. Serial terminal units may be used to extend the length of the data bus, either through dedicated lines or by common carrier. The units lower the cost of transmission by taking parallel data from the bus and converting it to serial form.

communications among instruments that may be separated by anything from a thousand feet to thousands of miles.

A serial terminal unit must be able to:

- Be used in two system modes (as in Fig. 8).
- Convert bus information on 16 lines into 8-bit serial words as efficiently as possible.
- Minimize software problems by acting in as “transparent” a fashion as possible. A controller on one end of the phone should be able to converse with an instrument at the other end exactly as if instrument and controller were on the same bus in the same room.
- Control an automatic dialer to allow communication to be established over the telephone network without a human at each end. (The information for the dialer will come from a bus talker.)
- Take into account the fact that modems used for voice-grade line communications greatly restrict the data rate achievable on the bus (details below).
- Provide a service request to the controller from either end for these five conditions: parity error in serial; handshake error (handshake overrun at receiver serial terminal unit when in on-line mode); line disconnect; and (if used with a dialer) busy, and call complete.

To elaborate on the fifth objective, these modems operate at 10, 30, and less commonly 120 bytes/second. Faster speeds can be achieved over dedicated private or leased lines, but require synchronous operation. If a complete asynchronous handshake is required by the system, data rates are at least halved again because a byte would have to be transmitted in each direction sequentially to insure a correct handshake cycle. Fortunately, most instrument and controller responses are rapid enough, compared to the above data rates, to allow information to be transmitted “open loop” without overrunning the receiving device handshake.

To allow bus systems to operate efficiently with these terminal units, the units must be provided with three modes of operation—off-line, on-line and handshake—all of which must be programmable from a controller.

The off-line mode allows the controller to communicate with the bus devices at its end of the phone line at rapid bus speeds when information does not have to be exchanged with the remote part of the bus system. The on-line is an open-loop mode used when device responses are rapid enough for the byte rate of the modem not to overrun them. The handshake is a closed-loop mode that allows full asynchronous operation by having the receiving terminal unit re-transmit a byte to the sender as soon as the data is accepted.

What interface functions will meet these objectives? The transmitting terminal unit will operate by accepting data from the bus, using the acceptor handshake function, and transmitting the data bytes serially to the other end. Any changes in state of the five management bus lines (attention, remote enable, service request, end or identify, and interface clear) will cause a “cycle steal.” the transmitter will sense those changes and generate a two-character code sequence over the serial link. This sequence is decoded by the receiving terminal unit which drives the management bus at its end.

The prerogative of driving the three management bus lines called remote enable, attention, and interface normally belongs exclusively to the controller function when in active control. In this special instance, however, the terminal unit will drive those lines from instructions received by the system’s active controller, but only on the bus side having no active controller of its own. In the strictest sense, the terminal unit has a controller function that from the bus’s viewpoint behaves indistinguishably from a standard controller function. Functionally, however, the unit is only operating to keep the management bus lines in the same condition at both ends of the serial link.

The serial terminal unit does require these interface functions of its own: the source handshake, the acceptor handshake, the talker function (for responding to serial poll), and five service request functions (i.e., five independent reasons for requesting service). □

Missing some test data?

Are you missing some test data because you don't have an instrument that can capture it . . . or one that can adequately read it out?

The missing link may well be a Nicolet 1090 digital oscilloscope.



There are many good laboratory measuring instruments that suffer either from lack of adequate speed or from their inability to retain a signal for detailed analysis. For instance, an X-Y recorder may not react quickly enough to record all the transitions in your signal of interest. By the same token a voltmeter or analog oscilloscope typically makes only a fleeting readout. Even those instruments that have the ability to hold a reading usually cannot read it out as a permanent record, nor can they present it for more detailed analysis.

This is one area where the 1090 really shines. You can record two waveforms simultaneously, and display up to four waveforms simultaneously for easy comparison. Since waveforms are stored digitally you may retain them until you wish to store new information.

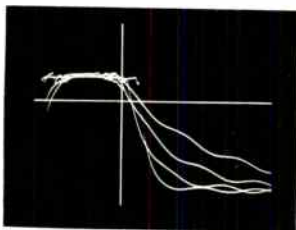

The 1090 offers numerical readout of any selected data point. Selection is made with an easily moved cursor. Wherever the vertical cursor intercepts the waveform the alphanumeric readout on the CRT displays time from trigger and voltage

recorded at that point in time. Both values are calculated by the 1090 so that the CRT alphanumeric are in actual time and voltage. (You don't have to multiply a number times a switch setting.)

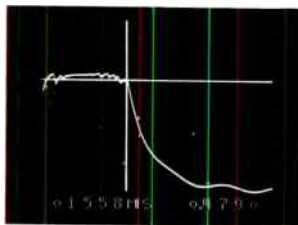

So you can closely inspect any particularly interesting portion of your signal the 1090 offers expansion of the stored waveform up to 64 times on both X and Y axes revealing selected detail of the 4096 x 12-bit word memory.

The 1090 also offers mid-signal trigger capability so you can "look backwards" in time as well as forward from the trigger. This feature permits you to inspect the events leading up to, and following, a trigger.

Besides being much easier to use than an analog 'scope, the digital 1090 also offers hardwired interface to magnetic



Phone or write for details on the 1090 and its plug-ins and how they might apply to your measurement needs in the frequency range of d.c. to 1 MHz.

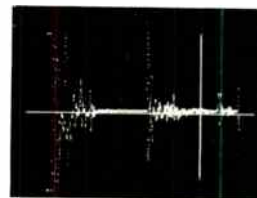

A. An unexpanded view of a signal from an accelerometer. Vertical marker shows center of region which will be shown when display is expanded

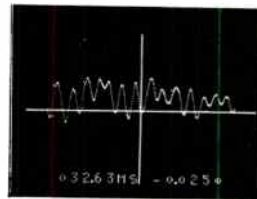

B. Fig. A with X and Y scale magnification of 8.

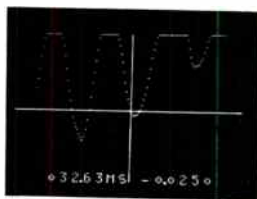

C. Fig. A with X and Y scale magnification of 32.

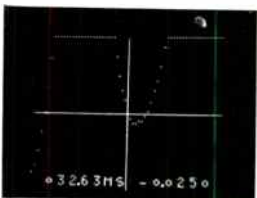

D. Fig. A with X and Y scale magnification of 64.

tape recorders, programmable calculators, and X-Y recorders. Some customers have interfaced it to a minicomputer.

Waveforms previously stored on digital magnetic tape may be recalled from your tape library and examined using the 1090's expansion and comparison features.

NICOLET INSTRUMENT CORPORATION

5225 Verona Road
Madison, Wisconsin 53711
Telephone: 608/271-3333

**Announcing
the 120-
nanosecond
1103 with
a 7-day
access time!**

We took the most popular 1K semiconductor RAM ever built and made it smaller and faster.

The result is the S1103-X. At 120 nanoseconds, it's the fastest member of the world's quickest 1103 family.

And it has another feature that's unique to our RAMs: guaranteed 7-day delivery! Within a week, you can start putting more speed into your systems.

Guaranteed quantity, too!

Our production lines in Santa Clara and Pocatello are turning out 1103 circuits so fast that we can ship any number you need. This year, we have already produced millions of them.

And our whole 1103 RAM family has several unique characteristics that are worth remembering.

If your system has trouble with pattern sensitivity like the Bodio effect, our circuit will eliminate it. It automatically solves t_{cw} problems, too, which gives you more flexibility in systems design.

And having the largest and most experienced RAM testing capacity in the industry, we cut down your incoming test problems.

Our spectacular specs!

In addition to the super-fast S1103-X, there are three RAMs in this AMI line—the S1103, S146 and S1103-1. The difference between them is speed. They

have access times of 300/205/150 ns respectively and fast cycle times of 580/390/360 ns.

Other memorable features of our 1103 family are:

- Full internal decoding
- Or tie capability
- Chip enable for low power distribution
- Simple memory expansion
- Input protection against static charge
- 2 msec refresh period
- 18 pin plastic or ceramic dual-in-line package

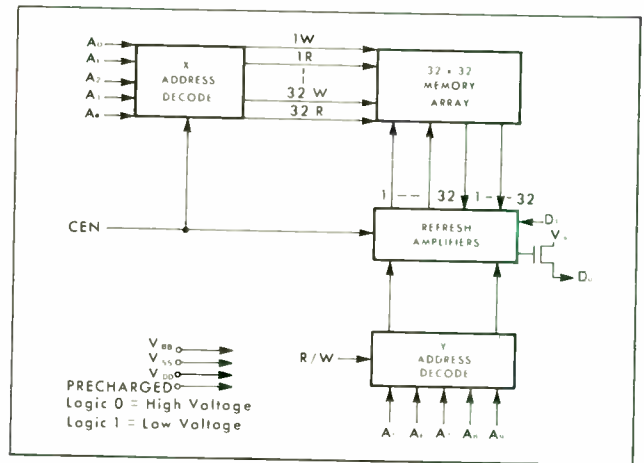

S1103-X Block Diagram

Call now for immediate delivery!

For fastest possible access to our 1103 RAMs, call or write Frank Rittiman, AMI, 3800 Homestead Road, Santa Clara, CA 95051. Phone (408) 255-3651. Or get your distributor to truck some over. He's got all you can handle.

More good news from AMI

AMERICAN MICROSYSTEMS, INC.

**OUR POWER
SEMICONDUCTORS
ARE SO GOOD
WE USE THEM OURSELVES.**

20,000 TIMES A DAY.



That's the rate at which Delco Electronics supplies a variety of products for GM cars.

Under one roof we design and manufacture complete systems, including the power semiconductors that help make those systems work. This can mean a lot to you. Here's why:

We know the requirements and standards that must be met to produce over 20,000 systems a day. We know what it means to deliver on time, to meet our own production schedules. And we know the importance of component quality in assuring reliability of the end product.

Our semiconductor devices are used

in the Delco AM radios, AM/FM radios and stereo tape systems we produce for GM cars. They are also used in the GM High Energy Ignition systems, I.C. voltage regulators, alternators, and in the combination front seat/shoulder belt interlock systems you find in all the 1975 GM cars.

And all the capabilities that go into Delco semiconductors can work for you, too.

There are select distributors with stock on hand strategically located coast to coast. For the distributor nearest you, phone

your closest Delco Electronic regional sales office: Kokomo, Ind. (317) 459-2175, Van Nuys, Calif. (213) 988-7550, Union, N.J. (201) 687-3770.

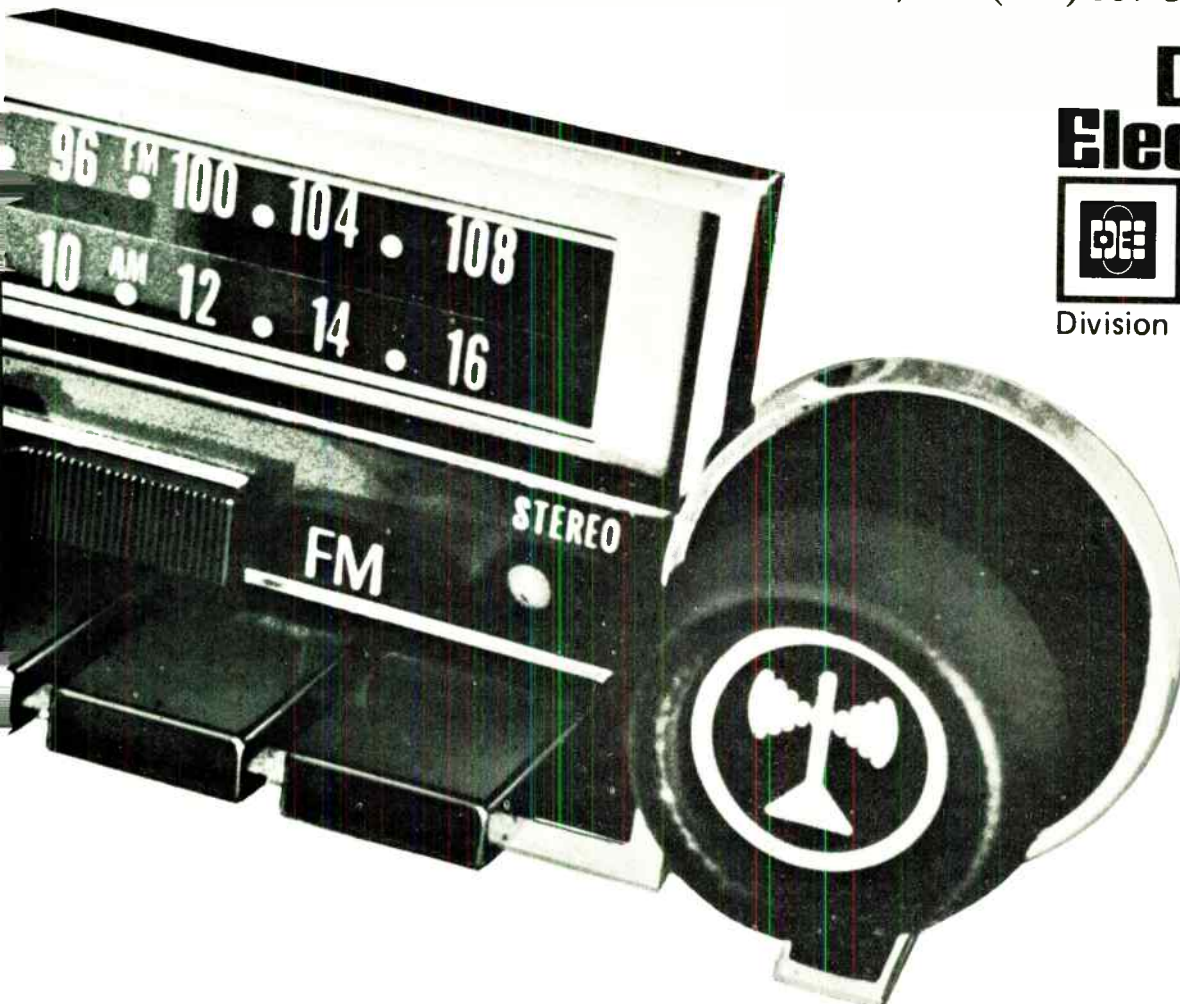
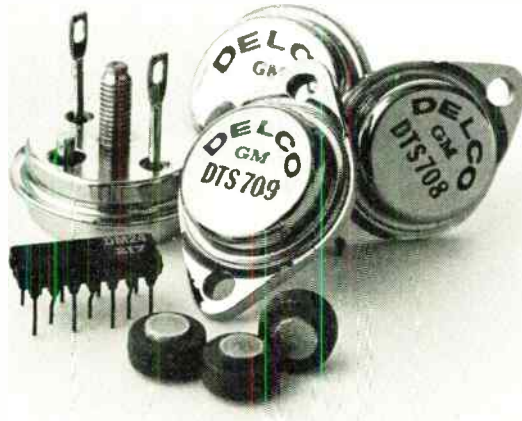

Delco Electronics



Division of General Motors

INTERDATA ANNOUNCES THE INDUSTRY'S FIRST \$3200 MINICOMPUTER TO CHALLENGE THE NOVA.

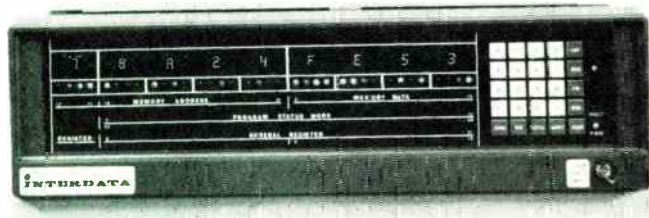

PDP-11 performance at a Nova 2 price.

Minicomputer myths you can live without:

1. There is no such thing as a high-performance, low-cost minicomputer. 2. You have to choose between two extremes – pay a ton for a machine like the PDP-11 and save on software costs, or buy a cheapie like the Nova 2 and pay the price later.

All wrong. Because now there's the Interdata 7/16 – an extremely flexible 16-bit OEM minicomputer that combines the best of both worlds.

It's easier to program than the PDP-11 because it has 16 hardware registers, up to 64K bytes of directly addressable main memory, 255 I/O interrupts with automatic vectoring to service routines and a comprehensive set of more than 100 instructions. That's a lot of muscle.

It's completely modular in design – plug-in options can be installed in the field to meet your specific application requirements.

Options like multiply/divide, programmers' console with hexadecimal display, power fail/auto restart, memory protect and a high-speed Arithmetic Logic Unit that includes floating point hardware. In fact, you can expand the low-cost 7/16 all the way up to the 32-bit Interdata 7/32.

Yet it costs as little as \$3200. Just like the machines that give you the barest minimum. And quantity discounts can reduce that low price by as much as 40%.

Performance	7/16	Nova 2/4	PDP-11/05
Data word length (bits)	4, 8, 16	16	1, 8, 16
Instruction word length (bits)	16, 32	16	16, 32, 48
General-purpose registers	16	4	8
Hardware index registers	15	2	8
Maximum memory available (K-bytes)	64	64	64
Directly addressable memory (K-bytes)	64	2	64
Automatic interrupt vectoring	Standard	Not available	Standard
Parity	Optional	Not available	Special order
Cycle time (usec.)	1.0 or 0.75	1.0 or 0.8	0.9
Available I/O slots	4	2	2

Price	7/16	Nova 2/4	PDP-11/05
8 KB processor	\$3,200	\$3,200	\$4,795
16 KB processor	3,700	3,700	6,495
32 KB processor	5,300	5,300	10,895
Multiply/Divide option	\$950	\$1,600	\$1,800
Floating Point option	\$4,900	\$4,000 plus \$1,000 for 2/10 configuration	Not available

Source: Data General Price List, Copyright 1973, and addendum dated 5/15/73. Nova 2/4 bulletin 012-000060, 1973. DEC OEM & Product Services Catalog, 1972. Auerbach Minicomputer Characteristic Digest, June, 1973. "How to use Nova Computers", 1973.

So you no longer have to make the painful choice between good performance and good price. Or between hardware economy and software efficiency. Now you have a minicomputer that gives you both.

The Interdata 7/16.

We put our muscle where their myth is.

INTERDATA®

2 Crescent Place, Oceanport, New Jersey 07757 (201) 229-4040.
 Boston – (617) 890-0557. Washington – (703) 525-4806. Philadelphia – (215) 436-5579.
 Orlando – (305) 851-6962. Chicago – (312) 437-5120. Detroit – (313) 356-5515.
 Dayton – (513) 434-4193. Kansas City – (913) 384-1606. Houston – (713) 783-3060.
 Dallas – (214) 238-9656. Denver – (303) 758-0474. Los Angeles – (213) 640-0451.
 Phoenix – (602) 968-2477. San Diego – (714) 565-0602. San Francisco – (415) 969-1180.
 Seattle – (206) 455-0680. Toronto – (416) 677-8990. Tokyo – (270) 7711.
 Sydney – 439-8400. London – Uxbridge 52441. Munich – 0811-8543887.

Charge-transfer devices filter complex communications signals

CTDs combine the simplicity, high speed, and low power requirements of analog filters with the stability and programability of digital systems without the need for large, expensive computer installations

by J. J. Tiemann, W. E. Engeler, R. D. Baertsch, and D. M. Brown, *General Electric Co., Schenectady, N. Y.*

□ Designers of large communications systems—both military and commercial—have found a new tool for their increasingly complex filtering jobs. This is the charge-transfer device (CTD), also called the charge-coupled device (CCD), which had been considered by many to be useful only for memories and imaging.

These CTDs are providing designers with a new way to apply the formidable capabilities of MOS integrated-circuit techniques to analog-signal processing. The result is a happy combination of high performance and low cost not previously attainable by other means. Communications gear being developed is using CTDs for delay lines and multiplexers, as well as for matched filters and Hilbert and Fourier-transform processors.

Although the earliest devices could only perform the specific function for which they were designed, recently developed structures permit the filter function to be programmed by electrical means so that it can perform several filter functions. This device, which makes use of a "sloshing" charge-transfer method, has been built into a successful experimental correlator chip (Fig. 1) that holds 32 analog samples and 32 binary tap weights.

In each clock cycle, this chip computes the sum of the products of the analog samples and the binary tap weights, then shifts them one position. Thus, a 32-point correlation can be computed in only 32 clock periods.

For computing correlations, a combination of several of these correlator chips with a microprocessor can out-

perform even a large general-purpose computer. For typical signal-processing tasks, CTDs provide flexibility and precision previously attainable only by digital methods without the cost of the computer and the associated equipment, and they can implement these highly complex filters with the simplicity and low power demands of analog methods. True, charge-transfer losses limit the length of the impulse response that can be implemented with serial transfer devices, but the present state of the art is adequate for a wide class of applications.

The art of signal processing

The time-honored approach to signal processing has been to interconnect a number of discrete passive and active filtering devices—RC and LC passive networks, and operational amplifiers—to form filters with a desired frequency response.

The main advantage of analog filters is that they consume negligible power, especially if passive components are used, and can operate at frequencies as high as their active components, if any, will permit.

If accurate frequency characteristics are to be achieved, however, the component values must be precisely determined, and they cannot be permitted to change with temperature or drift in time.

In addition to the cost problem associated with needed component precision, the analog approach also requires a separate device for each filter in a system. Thus, in applications where a large number of filter operations need to be performed on the input signal, a prohibitive number of filters may be required. To solve these problems, designers turned to the digital computer to process the analog signals, which were sampled and digitized before processing.

The advent of the fast Fourier transform algorithm¹ gave the digital approach a tremendous boost, and as the cost and performance of digital hardware improved, digital signal processing became increasingly attractive. Generally speaking, the digital approach entails a rather high minimum cost, and the hardware involved consumes a relatively large amount of power and space.

The digital approach is economically attractive when several thousand filters must be implemented. This is because a single central processing unit can implement essentially any number of different filters, which de-

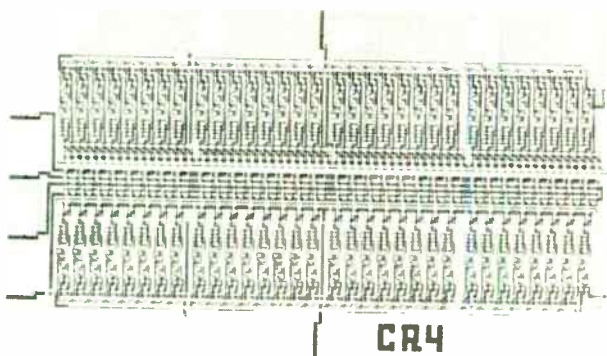

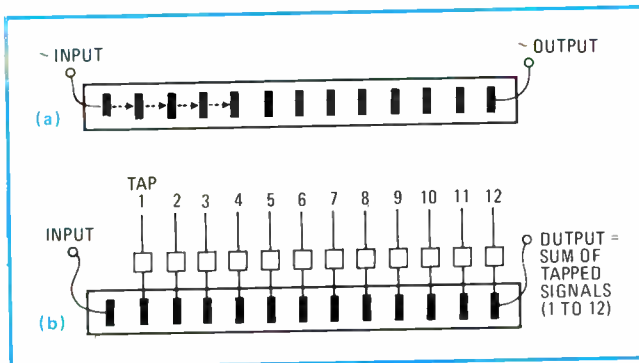

2. The basic delay line. A simple charge-transfer device (a) acts as a delay line when a signal is passed along from element to element and detected at the output. For signal processing, the a weighted signal is collected along the way (b) to form a summed output corresponding to a particular analog-signal transformation.

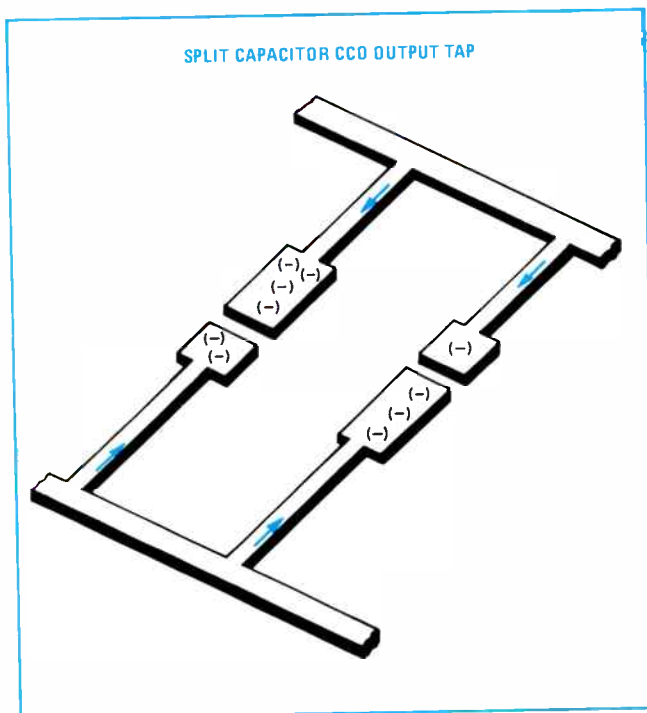

3. Weighty. The correct weighted output at each tap can be obtained by simply splitting the electrode at that position so that a fixed quantity of signal is detected. Summing all such taps produces the desired signal transformation.

creates the cost per filter as the number increases. The digital approach is also preferred when low-frequency responses are needed because of the stability problems of the analog methods or the sheer size of the components—it increases with decreasing frequency—may make the analog implementation impractical.

Enter the CTD

Digital filters achieve high accuracy and stability, and highly complex filters can be implemented with the same hardware used for simple ones. The disadvantage is many operations are required to compute each output point. This requires that the computer operate at much higher speed than the bandwidth of the signal, limiting the bandwidth that may be obtained with digital tech-

niques. In addition, the minimum cost of a digital signal processor may be too high for many applications.

The charge-transfer device combines the simplicity and low power requirements of analog filtering techniques with the complex filter-handling properties of digital methods. The conventional CTD (Fig. 2a) is serially organized, and the charge packets, consisting of successive samples of the input signal, are physically moved from cell to cell along a linear array.

This structure can obviously function as a delay line if the charge packets are recovered at the end of the line. The delay is simply the clock-transfer rate times the number of transfers or CTD elements. This is a useful function in signal processing, but CTDs are even more powerful than simple delay lines because they can have multiplicative output taps (Fig. 2b) at every stage. If these outputs are appropriately summed during each period, a transversal filter can be implemented.

This property of CTDs can produce a signal of a magnitude corresponding to the summed series of output signals of fixed magnitudes. This summing can provide complex analog-signal transforms because a network of linear components obeys a linear differential equation in which the magnitudes of the constant coefficients are also precisely the sums of series of fixed weighted values. This equation can be converted to a simple algebraic equation by use of the Laplace transform. This equation, which is characterized by the locations of poles and zeroes in the complex frequency plane, determines the frequency response of the filter.

It is quite easy to implement signal-processing functions with transversal filters. Since the tap-weight function along the delay line corresponds exactly to the impulse response of the filter, only the impulse response of the required filter is needed. Because the impulse response of a filter and its frequency response are related by the Fourier transform, one can easily translate a desired frequency response to a set of tap weights.

The output from all the taps on a CTD transversal filter (Fig. 3) can be summed by splitting the clock electrodes for each stage into two portions corresponding to the desired tap weight and connecting these portions to two separate clock drivers.² Since the total loading on the clock drivers is proportional to the total amount of charge being transferred, the loadings on these two clock drivers can form an output signal that is the sum of the charges in the packets times their respective tap weights. Thus, CTDs can implement the convolution of a fixed set of tap weights and a set of signal samples; they can therefore simply implement the difference equations employed by a digital signal processor.

However, because signal output depends on a fixed tap weight that is built into the device geometry, a new device is required for each new filter. Thus, a prohibitive number of devices are needed in applications where a large number of separate processes are performed on the input signal, as in spectrum analysis, character recognition, or aperture synthesis. For these applications, a great cost advantage would be achieved if it were possible to implement a variety of filters by reprogramming a single hardware element.

A new CTD structure (Fig. 4) provides this program-

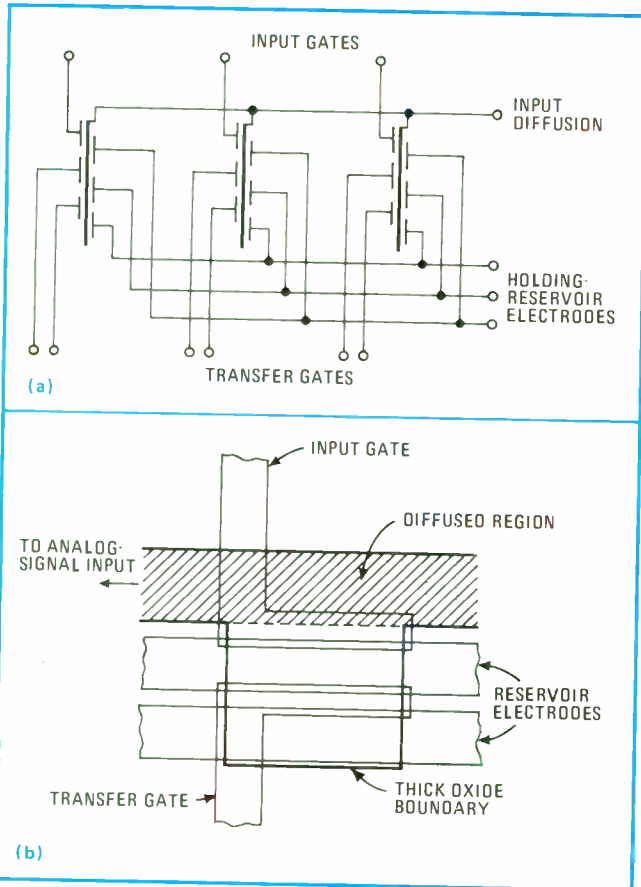

4. New method. In the CTD method of signal processing, the analog signal is connected to input diffusions (a) that are connected to all the charge-transfer cells, where they slosh back and forth until the desired output is achieved at that cell. A detail of the basic cell in a charge-sloshing structure is shown in (b).

ing capability, along with the low power and high-speed advantages of analog methods. The architecture of the conventional serial CCD has been changed to take advantage of the mechanism of charge transfer. In the new device, the charge packets representing the samples of the input signal are not clocked along from cell to cell as in Fig. 2; instead, each is inserted into its own charge-storage region, where it stays until replaced.

Readout is accomplished by transferring the charge back and forth between electrodes within this storage region and deriving an output signal by means of the ac coupling, produced when the charge "sloshes" under an output electrode. These output electrodes serve all cells in the system, and cells are summed in the same manner as in the split-capacitor structure.

This organization has the advantage that charge-transfer losses are not cumulative, which permits coherent processing of several thousand samples at one time. But the derivation of a multiplicative tap weight, which was convenient when the charge packets moved from cell to cell, now becomes a problem. This is solved in the new structure by providing two separate output regions for each storage cell and by controlling the direction of charge transfer during readout. Since each charge packet can be read out on either of the two output electrodes, tap weights of ± 1 are obtained.

Although limitation to only two tap-weight values may seem to be a serious problem, it can be overcome by using additional binary correlators. Suppose, for example, that the analog signal is fed in parallel to a number of correlator chips and that the first is assigned a weight of ± 1 , the second, a weight of $\pm 1/2$, and so on in descending powers of two. These tap weights could be set either by combining the outputs of identical correlators with a resistor ladder, or a family of devices having reservoir areas that correspond to the desired weights could be used. A combination of these two methods could also be employed.

If the outputs of these separate correlators are summed, every signal sample can be assigned an arbitrary weight corresponding to the binary number whose digits are sent to each of the correlators. Usually, four to eight binary correlators are required to achieve a tap-weight resolution appropriate for typical applications.

The schematic in Fig. 4a shows the simplest version of this basic architecture, and Fig. 4b shows the layout of a single cell. The analog input is connected to the input diffusions of all the charge-transfer cells, and control circuits sequentially gate each time sample of the input signal to the selected cell. Once the charge is loaded into a cell, it remains there for repeated cycles, sloshing back and forth between storage reservoirs under the control of the clock voltage and transfer gates.

How this is accomplished is shown in a plan view of the charge-transfer cells (Fig. 5a), and the cell detail is shown in Fig. 5b. After each charge sample enters the cell, it is transferred to a holding reservoir, where it is held until readout is desired. Readout of each of the charge samples is independently controlled by the voltage on the transfer gate of the cell. If the gate voltage is sufficiently above the threshold, the charge is transferred, and a signal proportional to the magnitude of the charge is induced in the output circuit. But if the voltage is below threshold, transfer is prevented, and no output is induced.

Since the clock electrodes overlie all of the cells, the total output signal is proportional to the total charge contained in all the cells involved in the transfer; that is, all the cells in the system are summed. This summation can be extended over more than one chip simply by connecting the corresponding electrodes of the individual chips together. The cycle can be repeated as often as desired until the signal charge is replaced by a new sample or has been rendered inaccurate by thermal leakage to the extent that it must be refreshed. The input gate is then reopened, and a new signal is inserted. Since the signal charge is returned at the end of each cycle to the location from which it started, any charge that was left behind in the transfer operation is later added to the transferred portion. Therefore, charge-transfer losses are not cumulative in this structure.

Building a correlator

One signal-processing application that can be conveniently realized by charge-sloshing is a polarity-coincidence correlator (Fig. 6). A binary reference word controls the polarity of the tap weight of a given charge sample, and the reference word shifts one position after

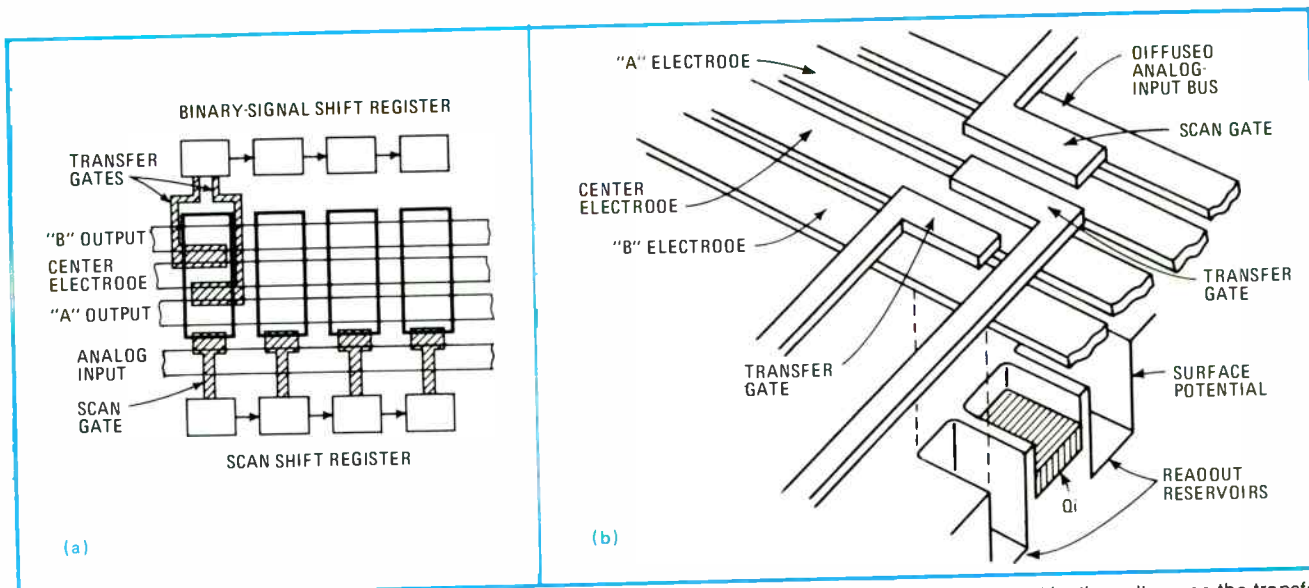

5. Making a transfer. In a charge-transfer device, readout of each charge sample is independently controlled by the voltage on the transfer gate of the cell. Readout is achieved when the gate voltage is sufficiently above a fixed threshold and when a signal proportional to the magnitude of the charge is induced by means of ac coupling in either "A" or "B" output circuit.

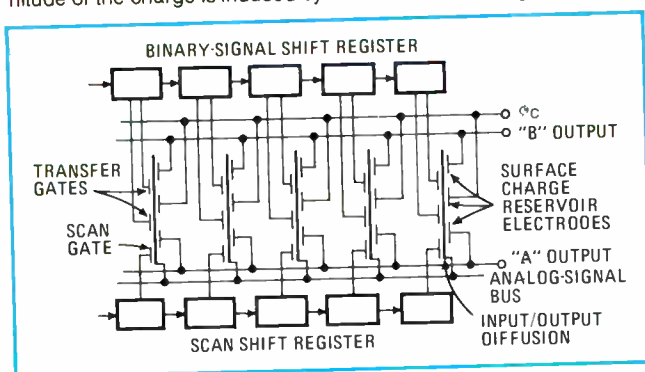

6. Correlator. In the CTD correlator chip, a binary reference word controls the polarity of the tap weight of a given charge sample. Two transfer gates control the direction of charge transfer. Charge samples assigned a positive weight are transferred toward one output line, while negative-weight samples go toward the other one.

each readout. Two output electrodes are used, and the sample charge is held under a third electrode between them. Two transfer gates are present to control the direction of charge transfer. Charge samples to be assigned a positive weight are transferred toward one output line, while those requiring a negative weight are transferred toward the other output. The operation of this device is similar to the basic structure, except for the presence of the extra reservoir electrode and transfer gate in the correlator.

A charge may be inserted in each cell by the action of the input gate as before; however, the charge is always returned to the central reservoir before the readout portion of the cycle. From the central reservoir, the charge is transferred under the control of the transfer gate to either of the outer reservoirs. Tap weights of ± 1 are formed by subtracting the signals that appear on the two output lines.

The experimental correlator, which holds 32 analog samples and 32 binary control signals, can be operated at speeds as high as 3 megahertz, and demonstrated

tap-weight accuracy is within $\pm 1\%$. The photomicrograph (Fig. 1) shows the device layout and geometry.

There are two ways to view the development of this type of correlator chip. It can be considered either as a programmable transversal filter or as a peripheral device capable of performing hundreds of thousands of multiply-add operations per microsecond.

Implications and applications

As a programmable transversal filter, many signal-processing applications are suggested. The most familiar—bandpass filtering, matched filtering and spectrum analysis—can be implemented with a CTD device having fixed tap weights, but when turnaround time or low volume makes the design of a special chip unattractive, a universal programmable device is advantageous. Applications in which programmability is necessary include automatic equalizers for modems, secure communications systems in which the signaling waveforms must be changed from time to time, and multiplexed systems.

The viewpoint that the correlator is simply a high-speed multiply-add peripheral to a computer is in many ways more intriguing. The combination of a small microprocessor and a peripheral correlator can outperform even the largest general-purpose number-cruncher. Specifically, a correlator subsystem containing 128 of the modules described above, together with the necessary drivers and readout circuits, can accomplish several thousand 8-bit multiply-add operations per microsecond—all under program control. Thus, operations such as matrix inversion and tomographic reconstruction, which require large number of multiply-add operations, but which are not usually regarded as signal-processing problems, are among the applications ahead for this new analog-digital approach. □

REFERENCES

1. Cooley, J. W., and Tukey, J. W., "An Algorithm for the Machine Calculation of Complex Fourier Series," *Mathematics of Computation*, 1965.
2. Sangster, F. L. J., "The Bucket Brigade Delay Line, a Shift Register for Analog Signals," *Philips Technical Review* 31, pp. 97-100, 1970

When it comes to precision p.c. board drilling it's **Excellon vs. Excellon.**

When it comes to p.c. drilling systems, nobody can compete with Excellon. That's why the leaders in the electronics industry look to Excellon equipment for unparalleled quality. They also enjoy the service. The innovations. The dependability.

Here is a short-form roster of Excellon equipment.



Mark III. Unequaled for high production, high utilization.

The most advanced p.c. drilling system in the industry today, the Mark III is an 8-spindle, granite-framed automatic drilling system. It has its own minicomputer, plus tape and typewriter output. Drill hit rates up to 200/min., high-quality holes on 1/4" movement with 3-high stacks and 0.002 chip load. Spindle motor speeds: 15,000 - 45,000, 15,000 - 60,000 rpm liquid-cooled, frequency-controlled motors; 30,000 - 80,000 rpm air-bearing, frequency-controlled motors.



XL-2. The ultimate in versatility for medium to high production.

Many of the features of the magnificent Mark III are on the XL-2. But not quite as many options. The XL-2, with 1-, 2-, 3-spindle configurations, is a computer-controlled p.c. board drilling system. Designed primarily for automatic operation, the XL-2 operation modes can also be semi-automatic, single block and manual feed.

A Programming option is available for the XL-2 which allows the machine to be used in a tape preparation mode of operation... performing both programming and drilling functions.

Drill hit rates up to 300/min. with 3 stacks. Spindle motor speeds: 20,000 - 60,000 with Excellon Quiet-Drill Model 700 Liquid-cooled & variable speed

QUAD-DRILL™ 1218. For short-to-medium runs.

This quality Excellon 4-spindle drilling machine mass produces holes with minimum tooling investment. Takes four stacks of 12.5" x 18.5" boards. Features an adjustable, semi-automatic drilling cycle by a template-following stylus. Hit rate to 55/min. Highly accurate, dimensionally stable granite working surface.

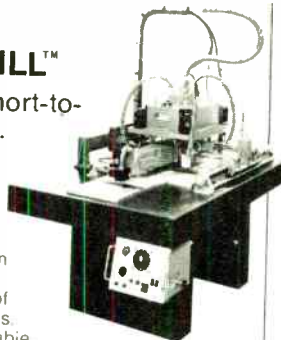

UNI-DRILL™. For prototype/short-run drilling.

This single-spindle drill takes a stack of boards, pinned to either template or negative. Drill cycles upward from below when conical stylus centers in template or, with negative, centers in optional projection scope. Production rates of more than 250,000 holes/day.

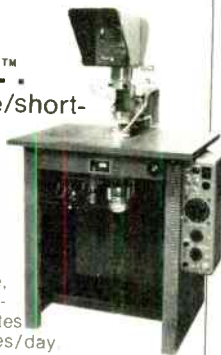

OPIC II™. Optical Programming Inspection Center.

Makes extremely accurate punched-tape programs directly from circuit art, negative or etched board, up to 1300 positions/hr. Master is centered in 10x projection scope and triggered. Encoding is to word address or fixed sequential format; optional unit adds other formats, permitting OPIC II to program any Excellon drilling machine and almost all others operating today.

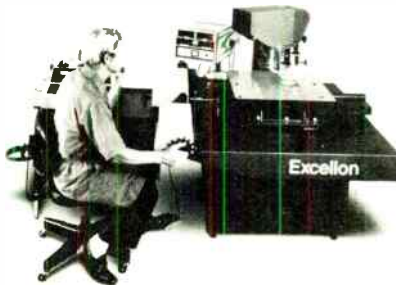

GALE Wave soldering systems.

Excellon's family of quality equipment for the p.c. board industry now includes the Gale systems. Featuring the unique oil intermix design (U.S. Pat. No. 3,589,590), Gale is the only wave soldering system with a single infinitely variable, stepless control dial to adjust both wave height and oil intermix ratios.

Available in 8", 11", 16" and 18" board width capacity. Conveyor permits optional pallet or palletless operation, single or double row. Excellon's Gale systems offer maximum flexibility, economy, ruggedness and quality output... featuring solid state control centers, electrostatic smoke eliminators, and efficient, reliable solder wave generators.

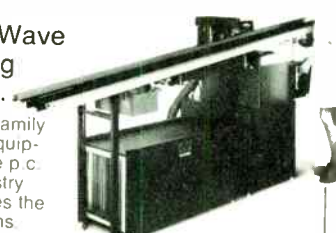

Other products distributed worldwide exclusively by Excellon.

The Barnaby pin routers.

Manual pneumatic (Model 103) spindle lift pin router for internal and external routing of p.c. boards. Belt-driven (Model 104) offers quiet, long-life operation.



Model 202A

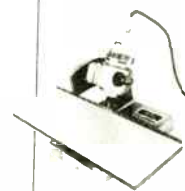

Model 104

Model 103

Beveler. High speed downward cut... no delamination or burrs. 1/4-hp, 22,000 rpm spindle with carbide tools.

Model 901

Slotter. Cuts single or multiple slots in p.c. board edges. Fast, accurate and repeatable to 1" max. depth.



"Stackmaster."

Stacks, positions, drills and pins p.c. boards in complete make-ready operation for all Excellon drilling machines.

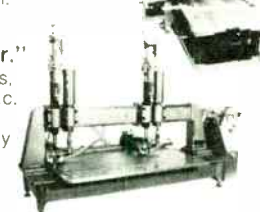

For full details on the quality Excellon line, write or call Dick Hogan, VP/Sales.

Excellon Automation

A Division of Excellon Industries
23915 Garnier Street
Torrance, California 90509
Phone: (213) 325-8000



Telex: 67.45.62 Cable: Excellon Torrance

Excellon Sales and Service in ENGLAND • FRANCE • W. GER. MANY • HOLLAND • AUSTRALIA • INDIA • TAIWAN • JAPAN

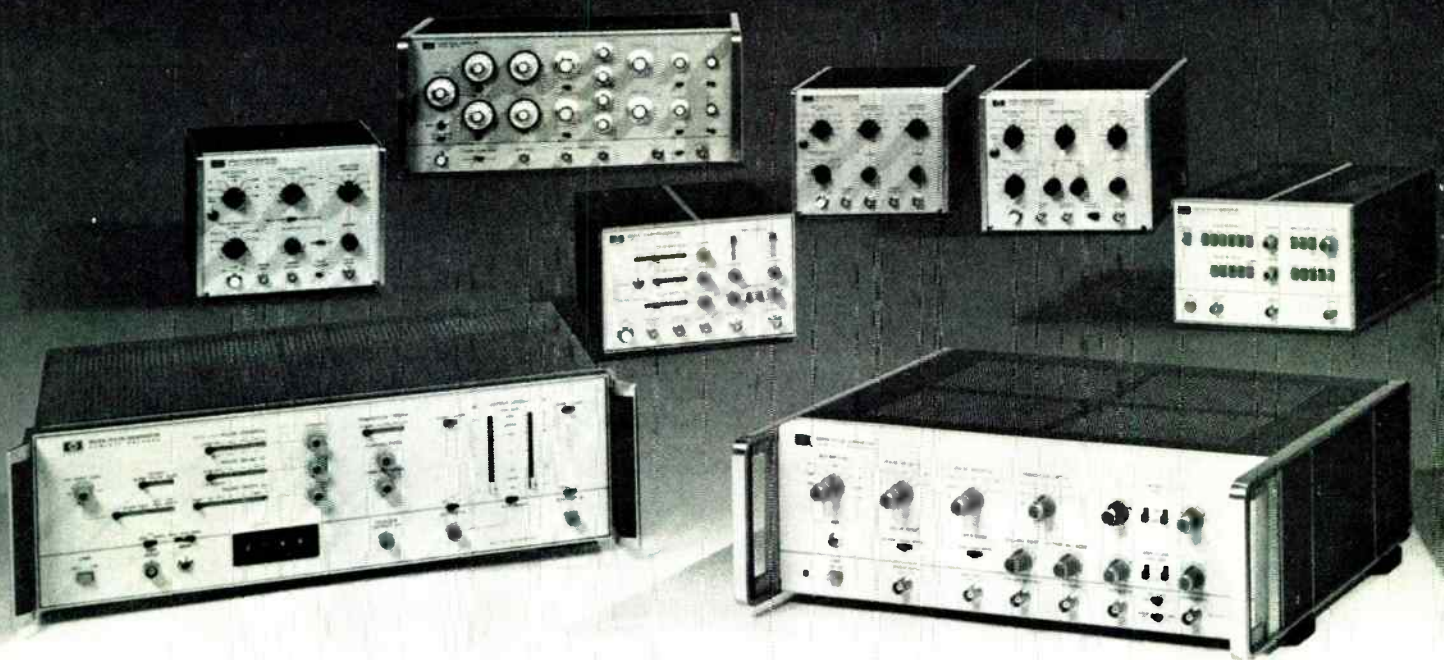

MOS·CMOS, TTL·HTL, HP pulser solutions for

Before you choose your next pulse generator, look into THE broad line... from HP. We'll give you a choice of several instruments for your particular logic family... whether it's high-speed bipolar, MOS, high-threshold, or general-purpose bipolar logic.

Need to test above 200 MHz? Our newest pulse generator gives you a rep rate to 250 MHz for testing high-speed bipolar logic at operational frequency limits. And its UNMATCHED variable transition time down to 1 nsec lets you meet manufacturers' conditions for propagation-delay

tests... or degrade transition times for worst-case testing.

Maybe you need high output levels for MOS. We have instruments with outputs up to 16V (30V swing on dual outputs) and rep rates to 50 MHz for the most advanced MOS circuits. Other units handle lower rep rates with outputs to 100V.

TTL?... HTL? We offer a variety of instruments with single or dual outputs, selectable output impedance levels, fixed or variable transition times and pulse-burst options.

We even have a plug-in series that lets you



ECL·S/TTL... your IC problems

put together your own logic-testing system to include programming, word generation, pseudorandom sequences, multiphase clock generation, and more.

In this family, there's a pulse generator to satisfy your particular testing requirements. And you'll find human-engineered instruments to simplify your setups and reduce testing errors.

So if you're thinking digital testing, find out what HP has to offer. Give your local HP field sales engineer a call today. Or, write for a free copy of our new pulse generator brochure.



Sales and service from 172 offices in 65 countries
1501 Page Mill Road Palo Alto, California 94304

Circle 119 on reader service card

To measure lower distortion than ever before

-- just push a button

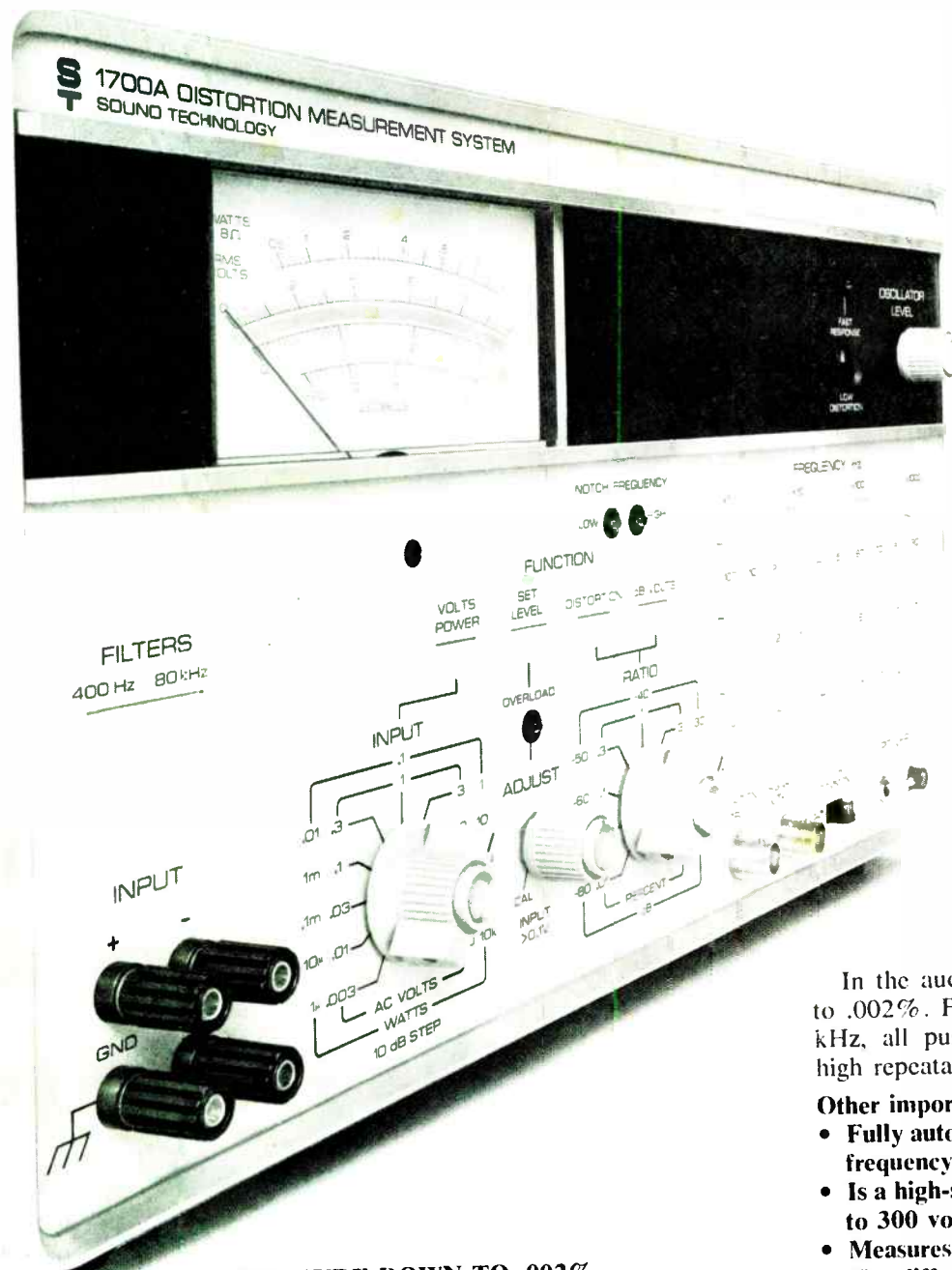

MEASURE DOWN TO .002%

Here is an important new system for measuring distortion.

This new Sound Tech 1700A is both an ultra-low-distortion signal source and a total harmonic distortion analyzer.

It's an instrument that's fast and easy to use. You can make a measurement in 5 seconds — because both source and measuring circuits are tuned by the same pushbuttons. Even non-technical production personnel can measure with it. And that can save a lot of test dollars in the plant and lab.

AUTOMATIC NULLING

In the audio range you can typically measure down to .002%. Full frequency range is from 10 Hz to 110 kHz, all pushbutton-controlled for fast selection and high repeatability.

Other important features:

- Fully automatic nulling — just push a button for frequency at which you want the measurement.
- Is a high-sensitivity AC voltmeter — 30 microvolts to 300 volts.
- Measures signal ratios up to 100 dB.
- Has differential input.
- Reads power in 8-ohm loads.

ECONOMICAL

The 1700A truly saves on initial outlay, too. It's only \$1625 (other models only \$1340). That's less than the cost of much lower performance oscillators and distortion analyzers.

MAKE PROFIT HAPPEN — CALL NOW

So don't get caught short. Make profit happen. Call Larry Maguire or Bob Andersen and get full performance data on this important new development.



SOUND TECHNOLOGY

1400 OELL AVENUE
CAMPBELL, CALIFORNIA 95008
(408) 378-6540

DEVELOPERS OF THE INDUSTRY-STANDARD 1000A STEREO ALIGNMENT GENERATOR AND 1400A ULTRA-LOW-DISTORTION OSCILLATOR

Circle 120 on reader service card

World Radio History

Analog gate and zener diode give 70-dB isolation at 80 MHz

by Roland J. Turner,
General Electric Co., King of Prussia, Pa.

When conventional double-balanced Schottky diode mixers are used as analog signal gates, they have two serious limitations: the "off" impedance of a series diode offers a switch isolation of less than 40 decibels, and the peak radio-frequency input signal cannot exceed the series diode's forward blocking voltage—500 millivolts at room temperature, but falling to 300 mV at higher temperatures. An rf analog gate with both larger signal-handling capability and higher "off" isolation would be very useful, for example, in a pair of switches controlling a transmitter and receiver that share a common antenna.

The analog gate shown in the diagram achieves an "off" isolation of as much as 70 dB at 80 megahertz without using matched diodes. When +30 milliamperes is supplied to the gate, it turns on shunt diodes D_1 and

D_2 , while the series diodes D_3 and D_4 are reverse-biased by a voltage equal to the zener voltage at D_5 minus the positive swing of the input signal. With the gate biased off in this way, variable capacitor C_1 is trimmed, so that out-of-phase signals cancel signal leakage through the gate.

With a 6-v zener diode, this circuit isolates input signals of as much as 10 v peak to peak—whereas the mixer gate cannot handle even 1 v without letting the signal break through.

On the other hand, when the current is -30 mA, diodes D_3 and D_4 are forward-biased and the shunt diodes D_1 and D_2 become reverse-biased. The Schottky diodes have a dynamic impedance of 10 ohms, which is much less than the typical antenna impedance as seen from this gate (about 200 ohms). Thus the input signal passes through the gate with an insertion loss of less than 0.50 dB.

The gate's on-off status is controlled by the current source shown at the bottom of the diagram. When the control signal is at 12 v, the pnp transistor on the left is turned on, supplying +60 mA—half to the gate to turn it off, and half to the npn current sink on the right. But when the control signal rises to 15 v, the pnp transistor is cut off and the npn device, which stays on, reverses

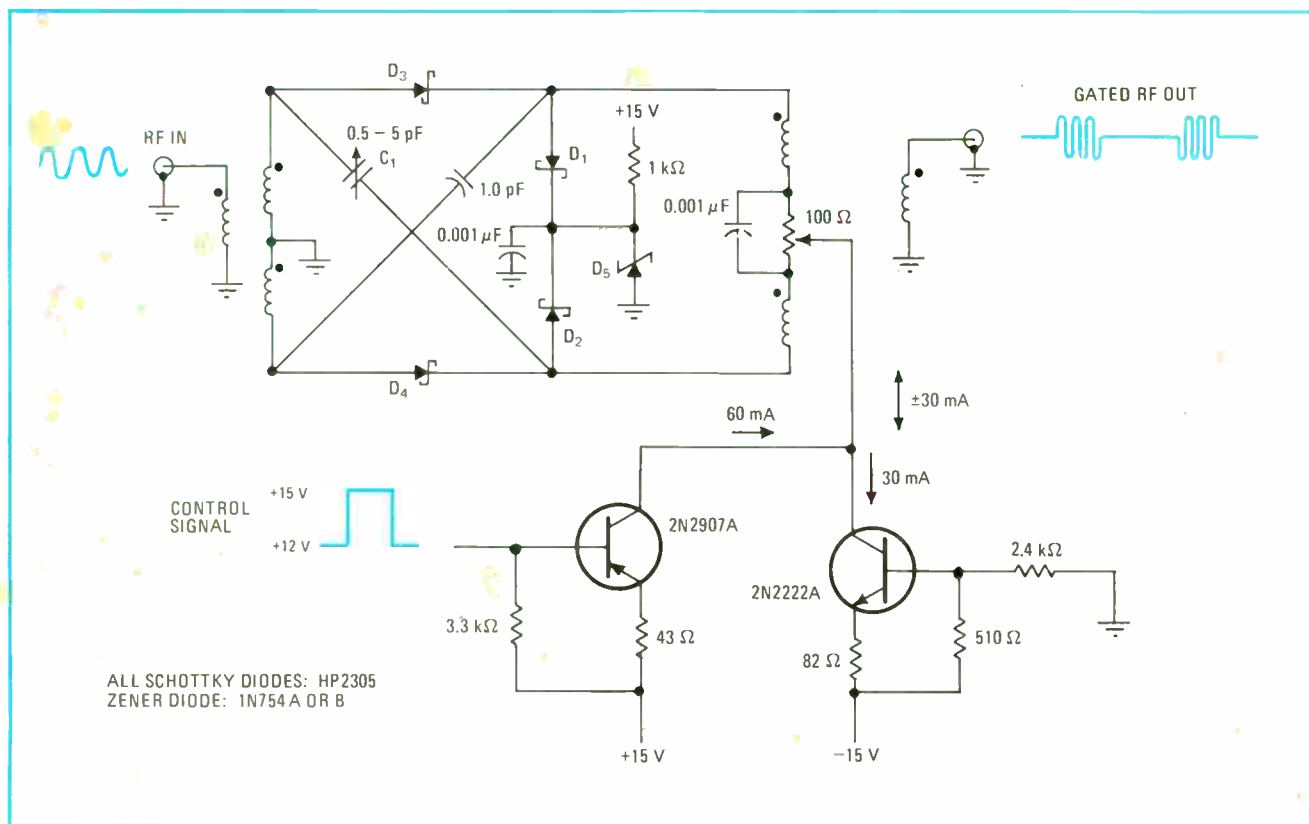

High Isolation. Control signal (lower left) turns on pnp transistor, providing +30 mA to gate circuit at top, to turn it off and block passage of rf signal to antenna. When control is up, npn device takes over, drawing -30 mA from gate and turning it on. Zener voltage minus positive swing of input signal establishes reverse bias on series diodes, achieving isolation of as much as 70 dB at 80 MHz.

The case for Liquid Crystal Displays

Dynamic Scattering or Field Effect

Liquid Crystal Displays; light emitting diodes; incandescent and fluorescent displays and "Nixie" tubes are becoming solidly established in circuit design as the trend to digital readout continues. The design engineer faces an unusually formidable task in determining the type of display most suitable and practical for his product. We make liquid crystal displays — dynamic scattering and field effect.

The display of the future? Our displays are as sandwiches of two glass plates, spaced typically about .0005" apart with a nematic liquid crystal solution between them and hermetically sealed at the perimeters.

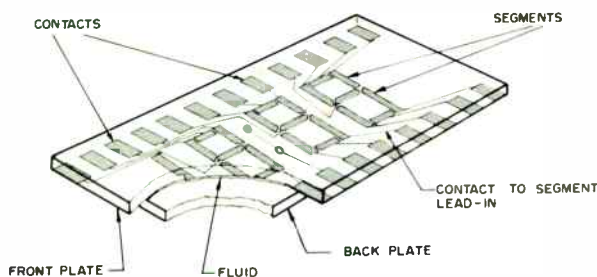

How they work. When the liquid is not electrically excited, its long cigar-shaped molecules are parallel to one another in a position perpendicular to the plates. The liquid appears transparent. When an electric current is applied, ion activity of the molecules leads to turbulence causing the liquid to scatter incident light. Depending on the type of nematic liquid used, either a dynamic scattering or field effect display results.

Dynamic scattering. We use a nematic liquid crystal solution in our dynamic scattering displays. This nematic liquid crystal is conductive, has negative dielectric anisotropy, and is oriented in either a homeotropic or homogeneous alignment. In either case the liquid is clear in the absence of an electric field. When an electric field is induced, the molecules scatter, giving the visual effect of a frosted piece of glass.

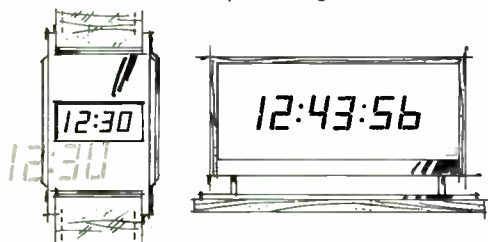

Field effect. These displays also utilize a nematic liquid crystal but with a different molecular orientation. The molecules are arranged in a helical stack, like a spiral staircase. The liquid is also sandwiched between two polarizers which are at right angles with each other. When current is applied the molecules rotate 90° so that they become perpendicular to the front polarizer. Light that passes through them is not rotated and therefore is absorbed by the rear polarizer. The result is a dark image on a light background. The image also can be reversed — light on dark.

Producing an image — digital or other — simply requires a conductive surface the shape of the desired image on the front glass plate. Current flowing from the conductive image through the liquid crystal to the common ground back plate causes the liquid to change from clear to a frosted appearance in the current-carrying areas.

The images almost always are in the form of seven segments formed on the front glass with transparent oxide and each with its own electrical lead. Energizing the proper segments produces the desired numerals. Lead-ins connect the segments to external contacts on the sandwich (display).

Consider the advantages. Liquid crystal displays have a number of distinct advantages. Simplicity is the reason for several of these. The elements are few and passive — very little can go wrong with an LCD and this means reliability and long life. Simplicity means low cost too — lower than that of most similar displays. Packaging costs are low because LCD's can be driven directly by MOS and C/MOS circuits. Very narrow character widths are possible and still provide a good viewing angle — 60 degrees in many cases.

Low power consumption makes LCD's a logical choice where power limitations rule other displays out. They do not generate light as do other displays so use no power for that purpose. Watch type field effect LCD's use only 3μW, for example with all segments energized at 7 Volts.

LCD's offer the greatest flexibility of any display type. Several standard displays, dynamic scattering or field effect, are immediately available from Hamlin's stock. Special displays with virtually any type of image can be produced with surprisingly low preparation or "tooling" cost. Because of the LCD's simplicity, lead time on specials is only a matter of weeks.

DYNAMIC SCATTERING

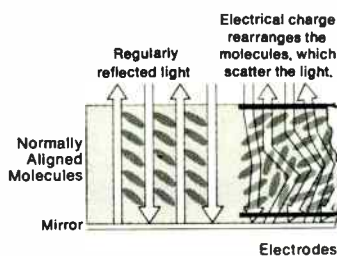

FIELD EFFECT

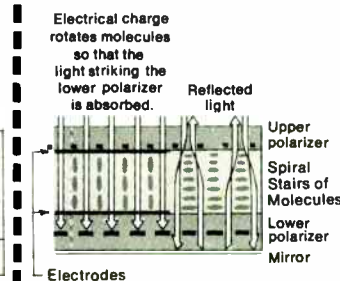

A few limitations. LCD's have limitations too. Operating temperature range is one. Liquid crystals slow down and may even cease to function at temperatures below 0°C. Above 50-60°C, crystals go into solution and will not function properly. But extremes do not damage LCD's. Once the temperature returns to normal, operation is automatically resumed.

LCD's are somewhat difficult to read under low ambient light conditions. (Side or back lighting can remedy this.) Visibility under medium to high ambient light conditions is excellent.

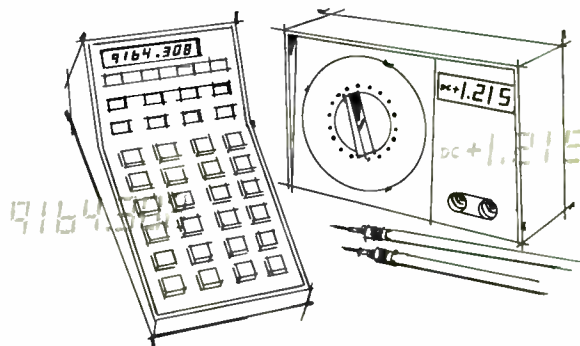

Conclusion. In the majority of display applications, MOS and C/MOS compatibility, reliability, flexibility and low power requirements are important considerations. No other display can match the liquid crystal display on these jobs. They could be the display of the future.

And that's the case for the LCD. For specifications, and application data, write Hamlin, Inc., Lake Mills, WI 53551 • 414/648-2361. Or dial toll-free 800-645-9200 for name of nearest representative. (Evaluation samples are available at moderate cost.)

HAMLIN
INCORPORATED

the current passing through the gate connection.

Both input and output transformers are conventional components, with bifilar 1:1:1 windings on Indiana General Q-3 core material. The center tap of the input transformer is grounded, while that of the output is

split. At this point an RC network collects the -30-mA current when the gate is on. Because the two shunt diodes may have different voltage drops, the resistance is a potentiometer that can be adjusted to eliminate any dc bias at the output. □

Single op amp compares bipolar voltage magnitudes

by F.N. Trofimenkoff and R.E. Smallwood
University of Calgary, Alta., Canada

The operational-amplifier bridge circuit shown in Fig. 1 is a window comparator for bipolar signals. It indicates when the magnitude of the input signal exceeds a preset value. Selection of resistor values sets positive and negative trigger levels independently, so that the trip levels for the two polarities need not be the same.

To analyze the circuit, first ignore the output clamping diode. The input diodes isolate one of the two signal paths, depending on the polarity of e_i . For e_i positive:

$$e_o = -(e_i - e_d)(R_2/R_1) - e_r(R_2/R_3)$$

where e_d is the voltage drop across the diode when it conducts. For e_i negative:

$$e_o = (e_i + e_d) \frac{[1 + (R_2/R_3) + (R_2/R_6)]}{[1 + (R_4/R_5)]} - e_r(R_2/R_3)$$

The switch-over points are defined by setting $e_o = 0$ in each of these expressions. For e_i positive:

$$(e_i - e_d) = e_r(R_1/R_3) \quad (1)$$

and for e_i negative:

$$(e_i + e_d) = \frac{-e_r[1 + (R_4/R_5)]}{[1 + (R_3/R_2) + (R_3/R_6)]} \quad (2)$$

If the positive and negative trip levels must have the same magnitude, then the coefficients of e_r in equations (1) and (2) are equal. The equality reduces to:

$$[1 + (R_3/R_2) + (R_3/R_6)] = [1 + (R_4/R_5)](R_3/R_1) \quad (3)$$

If the switching levels are different, equations (1) and (2) must be used to determine the resistor ratios. But regardless of the levels, R_2 is very large and may even be infinite—that is, the circuit may have an open-loop configuration—to provide the maximum gain and thereby produce a sharp transition between the output states at the switch-over points.

The circuit may be simplified if, for example, the reference voltage is greater than the desired switch-over point. In that case, $R_4 = 0$. If it is less, then R_6 is omitted from the circuit. For symmetrical switching, making $R_4 + R_5$ approximately the same as R_1 equalizes the diode currents, thus more nearly matching the diode forward voltage drops.

If now the output clamp is taken into account, it keeps the lower level of the output from going more than very slightly negative, as shown in Fig. 2. The complement of this transfer function is obtained by changing the polarities of the input diodes and the reference voltage.

As a design example, suppose ± 10.0 -volt switch-over points are required, and $e_r = 15$ v. Assume $e_d = 0.5$ v, and use 11 kilohms for R_1 and an open circuit for R_2 . Equations (1) and (3) show that $R_3 = 17.4$ kilohms, $R_4 = 0$, $R_5 = 11$ kilohms, and $R_6 = 29.9$ kilohms. Building the circuit with these component values results in measured switch-over points of -10.12 and +10.15 v. The actual switching is completed during a change in

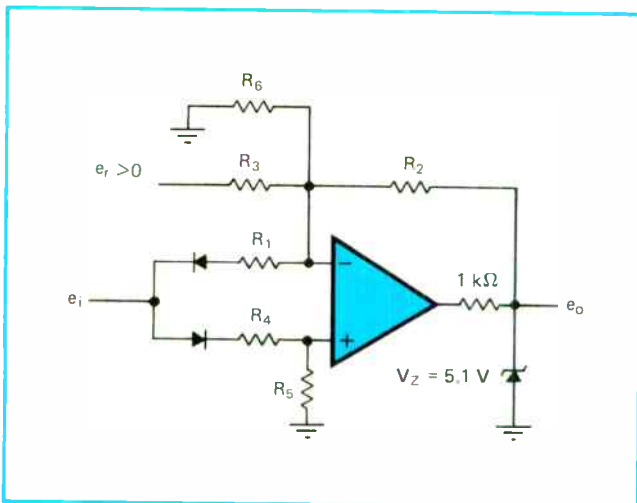

1. Comparator. Amplifier output is low when the input is between two levels set by choice of resistances, and high when outside these levels. The two trigger levels are independent.

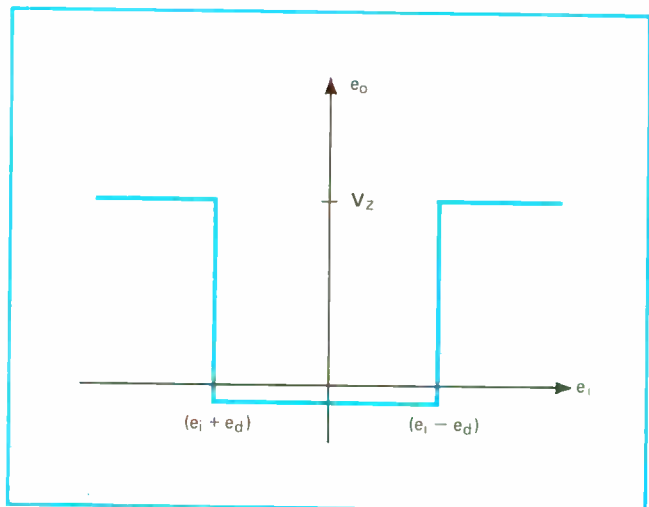

2. Transfer function. Output clamp keeps low level only a fraction of a volt below ground. The complementary function is obtainable by inverting the two input diodes and the reference voltage.

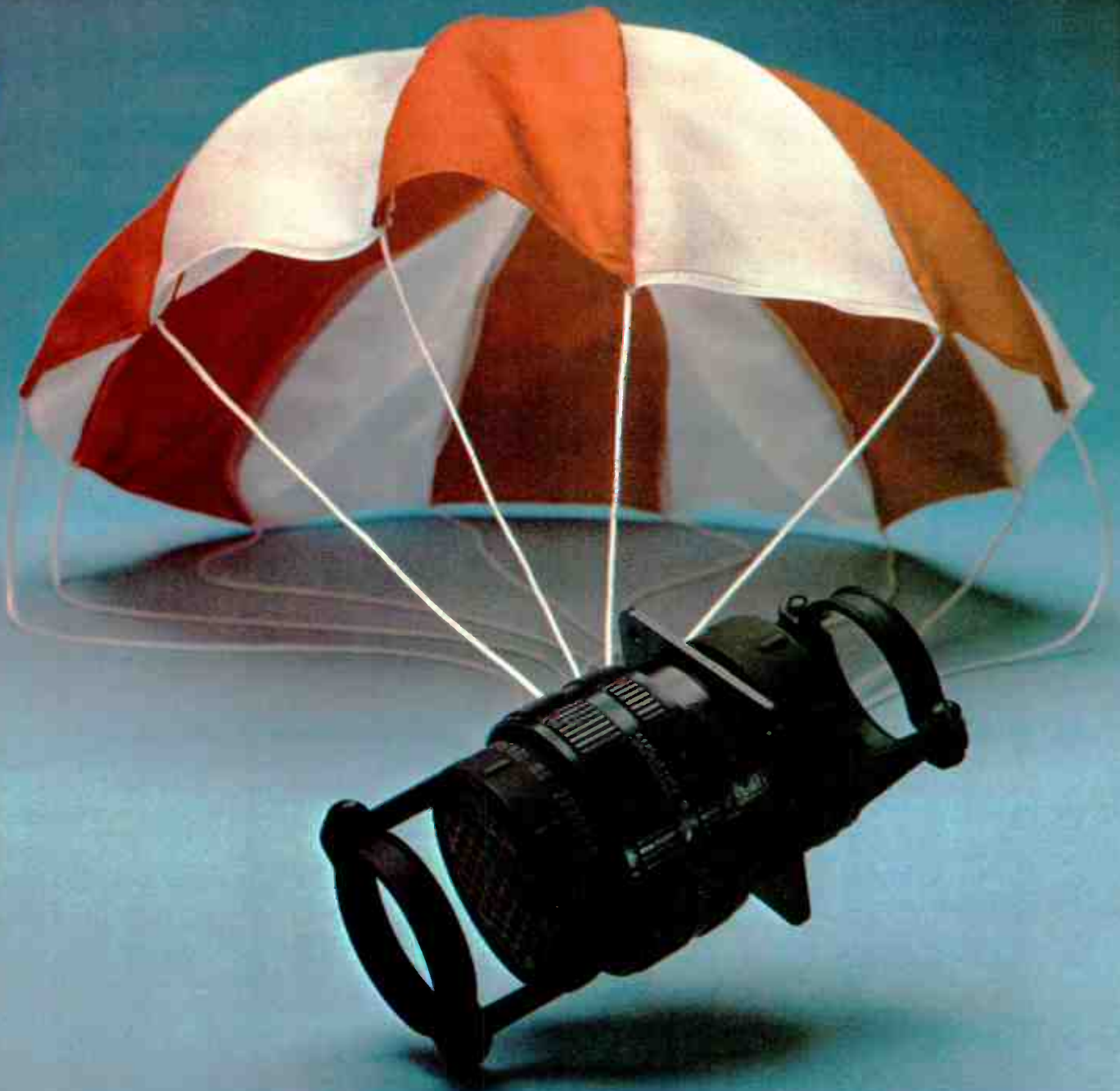

Our finest performer has come down to earth.

"AMPHENOL 48." Proven through more than 15 years of environmentally tough aircraft and aerospace applications, Amphenol's 48 Series connectors have come down to earth for use in communications, electric utility, automotive, rapid transit and construction applications. Ready availability with a wide choice of configurations and styles is the reason why.

48 Series connectors stand up to environmental assaults that put other connectors out of operation, like temperature extremes, physical shock, vibration, moisture and corrosion. They're your best buy for both standard and environmentally-demanding commercial and industrial applications.

Choose from standard power to coax contacts with semi-automatic, automatic crimp terminations.

Quick-disconnect bayonet or vibration-proof threaded coupling connectors are available in 30 different insert arrangements. Our 48 Series gives you the industry's broadest selection of environment-resistant connectors.

They're available from stock or from any one of more than 60 Amphenol distributors nationwide. Get them in a choice of finishes to dress up your product design.

Call or write Wayne Zimmerman for full information on the 48 Series connectors. The high-reliability, aerospace-quality connectors that make a lot of sense in tough, down-to-earth applications.

Amphenol Connector Division, Bunker Ramo Corp.
2801 South 25th Avenue.

Broadview, Illinois 60153. (312) 345-9000.

BUNKER RAMO **AMPHENOL**

To contact the Amphenol Sales Offices in your area, dial our hotline number toll free 800 645-9200 (In New York State dial collect 516 294-0990).

Circle 124 on reader service card

World Radio History

the input of less than a millivolt, because the amplifier gain is high and the open-loop configuration is used.

This simple circuit has some disadvantages. Among these are the forward voltage drops of the input diodes, which are significant. Consequently, the circuit cannot be operated near $e_i = 0$. These voltage drops can be minimized with germanium or hot-carrier diodes.

Another disadvantage is that the switch-over points are temperature-sensitive, because the diode forward drops have a temperature coefficient. Finally, the speed of the circuit depends on the type of operational amplifier and on the clamping scheme. Using a comparator in place of the operational amplifier permits somewhat faster switching. □

Regulating voltage with just one quad IC and one supply

by R. A. Koehler
York University, Toronto, Canada

Full-range, high-performance power supplies are often bulky and expensive because they require two independent voltage sources—one main and one reference—with associated rectifiers, filter capacitors, and reference regulator circuitry.

But only one unregulated source of about 26 volts dc and one ground-sensing quad operational amplifier are necessary in a regulated power supply that provides 1 ampere at 0 to 20 v with foldback current-limiting and overload indication. It achieves line and load regulation within $\pm 0.02\%$ over the full range of load conditions, even when the input voltage varies between 24 and 28 v dc. When the regulator is quiescent, its current require-

ment amounts to less than 10 milliamperes.

Amplifier A_1 is a self-biased, constant-current amplifier that provides a stable reference voltage [Electronics, March 13, 1972, p. 74]. Its output, V_1 , depends on the breakdown voltage V_z of the zener diode, D_1 :

$$V_1 = V_z [1 + (R_1/R_2)]$$

It is approximately 9.1 v for the values shown in the diagram. The potentiometers R_3 and R_4 bring V_1 down to a desired value V_2 , which is amplified by A_2 and the Darlington output stage to the output level:

$$V_{out} = V_2(R_5 + R_6)/R_6$$

With R_4 at its maximum-voltage position, variable resistor R_3 sets the voltage at exactly 20 v; thereafter, R_4 varies the output voltage over its full range. The output stage gain is 2.5 for the values shown.

Amplifier A_3 monitors the regulator's output current under varying loads. It compares the voltage across R_7 (a very small resistance) with the drop across diode D_2 . Whenever the former is greater than the latter, the output of A_3 drops, biasing diode D_3 for-

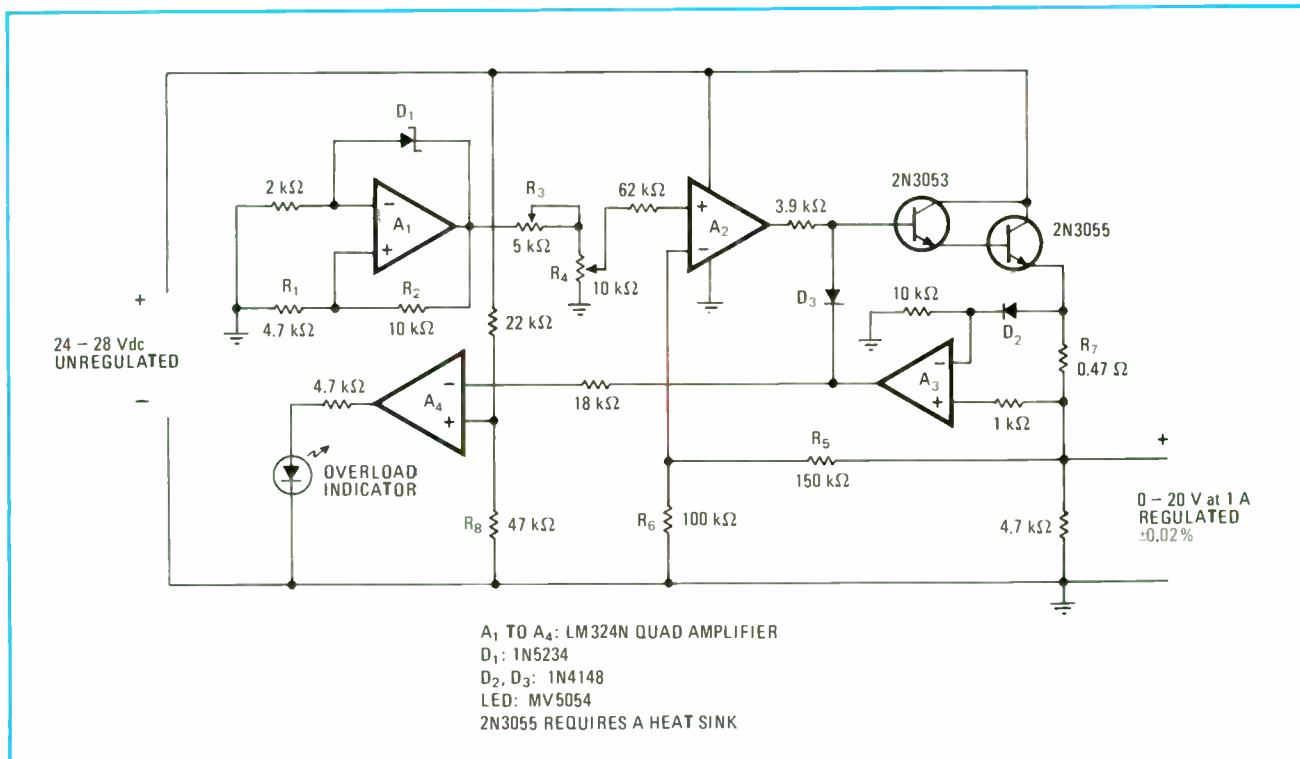

Op amp regulator. An unregulated 26-volt source becomes a 1-ampere 0-to-20-V supply regulated to within $\pm 0.02\%$ by a simple quad operational amplifier. Input can vary between 24 V and 28 V, and quiescent current is less than 10 mA. A light-emitting diode gives an overload indication, the level of which depends on the value of resistor R_8 . Single power Darlington can replace the two transistors.

Our 31 Programmable Calculator.

Computer capabilities right at your desk.

The 31 rivals the mini for pure problem-solving power. But no mini can match the 31 for ease of use and low-cost operation. Its expandable memory (up to 8192 program steps or 1010 data registers) auxiliary plug-in mag tape, and optional flexible disc provide storage traditionally reserved for mini applications.

The 35 built-in functions and 24 user-definable keys let you tackle complex variables with natural math. No computer languages to learn. And no computer price either: just \$3550, including silent alphanumeric printer.

Use the 31 with other data tools. We have three new interfaces (like the 154 RS-232-C shown) that work with most instrumentation and I/O devices on the market. Then there's our Tektronix peripherals you can interface with. Like our digital plotter, graphic terminals. And software packages you add as you need.

But there's still more to the story on the 31. More interfaces, more peripherals, more power. And information on OEM and quantity discounts. Get it by calling your local Tektronix sales engineer. Or write us.

Tektronix, Inc.
Information Display Division
P.O. Box 500
Beaverton, Oregon 97077

Our programmable calculators. Natural. Powerful. Significantly less expensive.



Circle 126 on reader service card



ward; thus it reduces the output voltage by removing the drive to the Darlington stage. If the load continues to increase, the output of A_3 becomes low enough to indicate, through amplifier A_4 , and a light-emitting diode, an overload condition. The circuit's overload threshold

may be changed, if desired, by changing the value of resistor R_8 .

The output transistors may be replaced by a single power Darlington, such as 2N6050, to reduce the package count from three to two. □

As clipper, IC comparator is improved by feedback

by Arthur D. Delagrange,
Naval Surface Weapons Center, Silver Spring, Md.

When used as clippers, modern integrated-circuit comparators are generally limited by input offset, not gain. To assure that the output will switch in a conventional circuit (Fig. 1), the peak input voltage must be greater than the differential current offset multiplied by the bias resistor value and added to the differential voltage offset.

A smaller peak input voltage can be used, however, if dc negative feedback is added to the negative input at pin 3, as shown in Fig. 2. The input offset is effectively reduced by the gain of the comparator as the circuit seeks its own bias point, just as operational-amplifier circuits do. The output is symmetrical, even for input levels near or below the comparator input offset.

Substituting a current-limiting diode for the pullup resistor further improves output symmetry. The Schottky diode provides a charging path for the low-pass capacitor to minimize startup time. If startup time is not a problem, the Schottky diode may be replaced by an ordinary diode or eliminated altogether. To prevent the ac signal from feeding back and reducing sensitivity, the feedback RC time constant must be an order of magnitude longer than the signal period times the gain. A multiple-stage RC network cannot be used because it would introduce additional phase shift that might cause the circuit to oscillate.

As shown, the circuit does not work well with an unsymmetrical rectangular pulse-train input. For this special case, the voltage divider ratio must be the same as the input symmetry ratio. This technique can also be used to give an unsymmetrical output for a symmetrical input (except square wave) if desired.

Input and output waveforms are shown in Fig. 3 for a sine wave input at a frequency of 1 kilohertz and an amplitude of 100 microvolts root-mean-square. Since the difference between input and output levels is about 90 dB, circuit arrangements that create parasitics must be carefully avoided. To obtain the waveforms of Fig. 3, a 50-ohm source was used, the output was loaded only by an oscilloscope, and power came from a well-regulated supply with a 1-microfarad ceramic bypass capacitor at the comparator. □

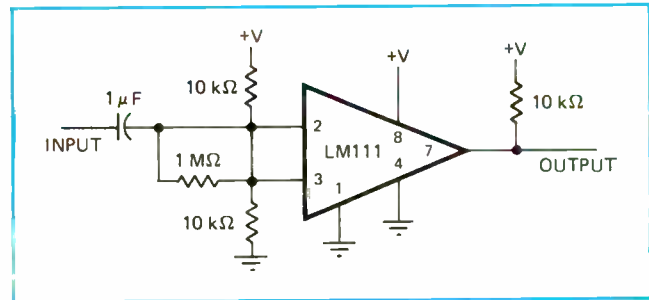

1. Conventional. Input offset limits the utility of the comparator when used as a clipper; it won't work with very small signals.

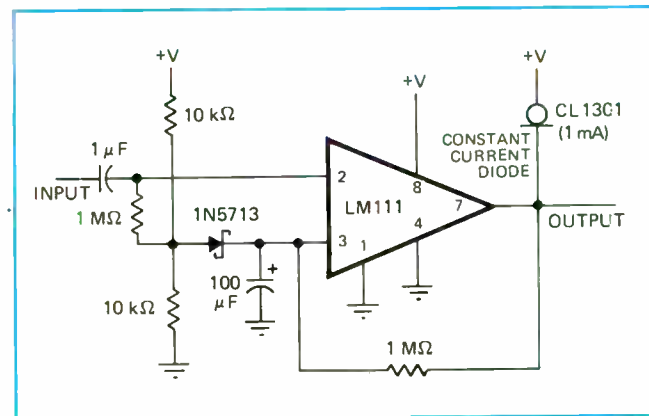

2. Improvement. Adding dc negative feedback reduces input offset, produces symmetrical output if input divider has 50:50 ratio.

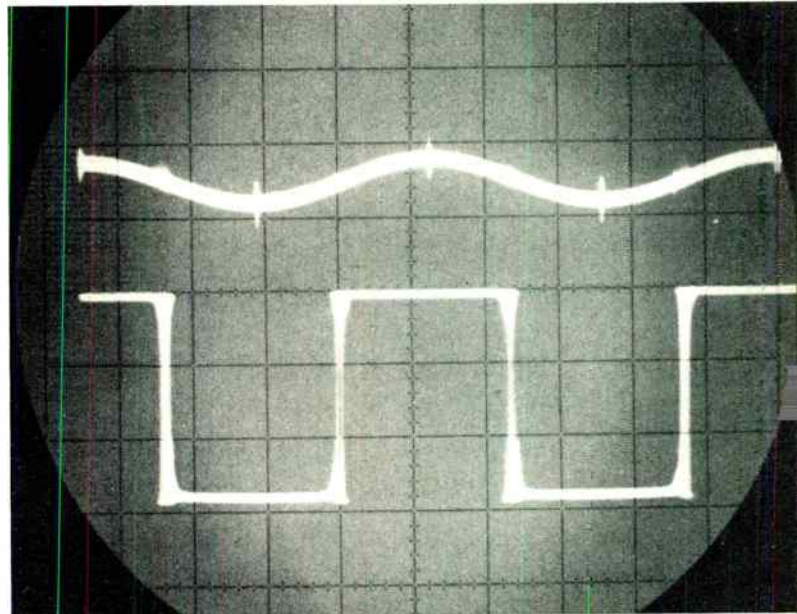

3. Result. In this trace, the horizontal scale is 200 microseconds per division. Vertical scales are 500 microvolts per division for input (top), and 5 volts per division for output.

Designer's casebook is a regular feature in Electronics. We invite readers to submit original and unpublished circuit ideas and solutions to design problems. Explain briefly but thoroughly the circuit's operating principle and purpose. We'll pay \$50 for each item published.



HP's Family Planning Means A DVM To Match Your Budget And Your Needs.

An HP DVM Built For Your Needs . . . all the way from troubleshooting in the field to complex systems in the plant. Whether you need a general-purpose instrument or one dedicated to a specific task such as measuring true RMS, we can supply it. With our modular and plug-on approach we can even combine general-purpose and specialized functions. HP's innovation and advanced technology are on your side to help solve your measurement problems. Look at the capability you can obtain in just five instruments from our broad product line.

Low-cost 970A Probe Multimeter packs a lot of performance in a seven-ounce package. Probably the easiest-to-operate

probe multimeter ever made,

this 3½-digit instrument

has only two selectors: one

for choosing DC V, AC V or ohms, the other for inverting the LED readout. With

AUTO ranging, AUTO polarity and AUTO

zero you only have to touch the probe to your test point to take a reading. And it's overload-

protected. Powered by a nickel-cadmium battery, this one is completely portable. Use it

in the lab or pocket it and take it with you in the

field. It's designed to simplify your measurement tasks from start to finish. You can operate it single-handed, right side up or upside down. The inverting switch lets you read the display either way. And you read it right at the test point. At just \$310* the 970A probe multimeter is a real bargain.

Self-Test 3490A makes double use of its internal ICs to bring you HP's "Self-Test" capability without extra cost. The basic 5-digit 3490, ready to measure AC, DC and ohms, sells for only \$1,785*. At low added cost you can have isolated BCD output and remote control or the versatile General Purpose Interface Bus for systems applications. Compare the 3490A with any other multimeter in its class and you'll find an unusual blend of features and performance for the money.

Snap-On 3470 Series lets you custom-build your own measurement system. Starting with a 4½- or 5½-digit LED display unit, you add only those modules you need. Get 4½-digit DC only for \$530*, or 5½-digit DCV/DCA/Ohms for

\$1,200*. Add a battery pack for \$220*, BCD output for \$189* or an HP "Self-Test" accessory for only \$50*. With this series you don't have to worry about obsolescence.

Multi-Mode 3450B lets you add up to 12 modes of high-accuracy measurement capability to your automated system. You can have true RMS, 4-terminal ohms and the unique limit test in addition to the usual functions. The 3450 is both fast and accurate. You get 15 readings/sec. and DC accuracy to ±(0.008% of reading + 0.002% of range). Prices start at \$3,785* for the 5-digit DC volts and Ratio model, go to \$6,616* for total 12-mode capability.

Speed Star 3480C/D is systems oriented, but fine for the bench as well. This 4-digit, ±0.01% unit in DC delivers a fast 1,000 reading/sec. Get the exact capability you need by selecting plug-ins. For example, you can have DC, ohms and true RMS AC for \$3,370* (isolated BCD output and remote control are low-cost options). Sample and hold option lets you take peak readings or do transient analysis.

HP's family of DVM's also includes high-performance AC V, DC A and ohms (Model 3469B at \$760*), resolution of 1 PPM (Model 3462A at \$5,835*), true RMS to 100 MHz (Model 3403C from \$1,895*) and for systems use, the 2402A with outstanding noise rejection at high measurement speeds from \$8,000*. No matter what your measurement needs, check HP for a solution to your problem. For more information on how HP's DVM family can help you, contact your local HP field engineer or fill out the coupon below and mail it in.

For helpful information on DVM measurement techniques, send for our 72-page application note AN-158 entitled "Selecting the Right DVM."

*Domestic U.S.A. prices.

HEWLETT  PACKARD

Sales and service from 172 offices in 65 countries
*501 Page Mill Road, Palo Alto, California 94306

I'm interested in your DVM line. Please send me:

- More information on the 970A Probe Multimeter.
- More information on the DVM family.
- Application Note 158 "Selecting the Right DVM."

Name _____ Dept. _____

Company _____

Street _____

City _____ State _____ Zip _____

Mail coupon to:
Hewlett-Packard, 1501 Page Mill Road, Palo Alto, California 94306

E11/14/74

Integrated temperature transducers

Within their limited temperature range, new ICs are cheap and easy to use because they have large linear outputs

by Michael J. Riezenman, *Industrial Editor*

□ The electrical temperature transducer, characterized for many years by slow, evolutionary development, has at last entered the semiconductor age. During all this time, there has been no serious competitor to these sensors—thermocouples, resistance-temperature devices (RTD)s, and thermistors.

Despite their newness and relatively limited temperature range of -100 to $+150^{\circ}\text{C}$ at best, the new silicon devices are creating a good deal of interest because of their large and linear outputs—typically 10 millivolts per degree Celsius. The new transducers are cheap and easy to use because of these two attributes, which eliminate the need for signal-conditioning amplifiers, cold-junction compensators, and other accessories.

Further, such highly integrated units as the LX5600/LX5700 from National Semiconductor Corp., Santa Clara, Calif., include output operational amplifiers. When an externally set voltage is applied to one of its inputs, this transducer acts as an adjustable temperature-sensitive switch.

The key to temperature measurement by semiconductors is the exploitation of the temperature sensitivity of a transistor's base-emitter voltage. Although the effect is well-known, difficulties arise when it comes to

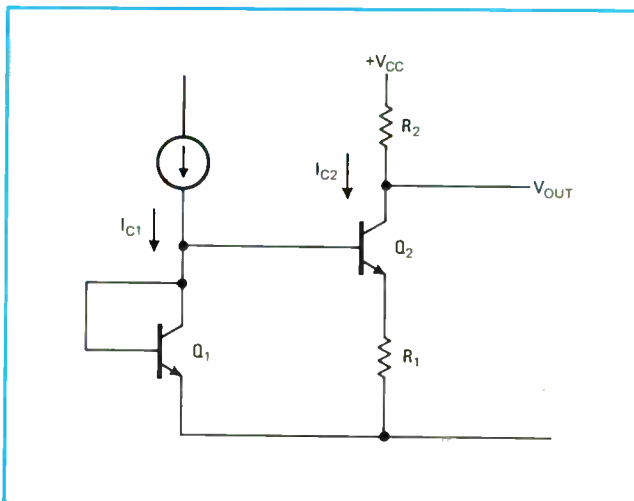

1. Measuring temperature. So long as Q_1 and Q_2 are a matched pair and I_{C1} and I_{C2} are not equal, the difference in the base-emitter drops across R_1 is proportional to the absolute temperature.

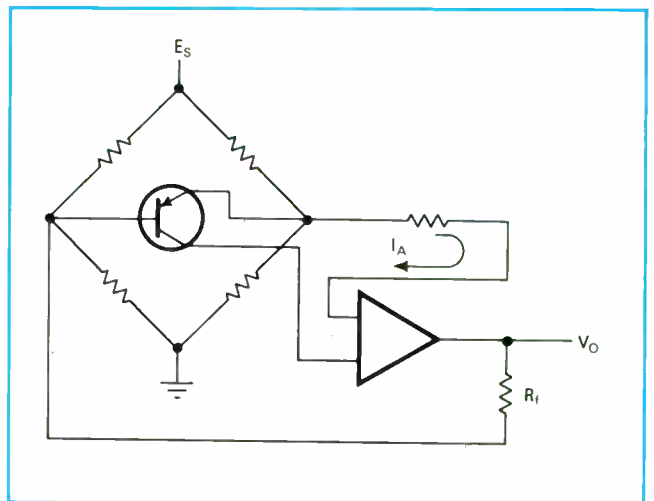

2. Feedback. Bridge circuit operates sensing transistor (a selected 2N2484) at a constant current so that its V_{BE} is a linear function of absolute temperature. Op amp is usually an LM-308.

actually using this phenomenon as the basis for a thermometer. The main problem is that it is difficult to control the V_{BE} of any transistor with sufficient precision to make a useful measuring device. The V_{BE} can vary as much as ± 100 millivolts over a single production run. Nevertheless, both National Semiconductor and Relco Products Inc., Denver, Colo., have successfully exploited the phenomenon, and they did it in completely different ways.

A hot idea

National's solution is to measure the difference in base-emitter voltages of two matched transistors operating at different collector currents. This quantity is directly proportional to the absolute temperature of the transistors and to the natural logarithm of the ratio of their collector currents. In the simplified temperature-sensing circuit of Fig. 1, it can be shown that if Q_1 and Q_2 are matched transistors, and if they are operated at different collector currents, then the difference in base-emitter voltage appearing across R_1 will be given by

$$\Delta V_{BE} = (kT/q) \ln(I_{C1}/I_{C2})$$

where k is Boltzmann's constant, T is the absolute tem-

perature, and q is the electronic charge.

If the transistors' betas are high enough and the ratio of the collector currents is kept constant—two relatively easy tasks in the fabrication of modern monolithic circuitry—then the voltage across R_2 is proportional to the absolute temperature, and an appropriate choice of R_2 can provide a readout directly in the Kelvin scale.

Constant current

Relco uses a bridge-type feedback circuit to keep the sensing transistor's emitter current constant (Fig. 2). Since it can be shown that operating a transistor at a constant current makes its V_{BE} a linear function of temperature, the illustrated feedback circuit constitutes a linear temperature-to-voltage transducer.

To avoid self-heating problems, which would compromise the maximum error of 0.1°C , Relco builds its transducer out of discrete components, rather than integrating the entire circuit onto a single chip. As a result, it is easy to compensate for variations in V_{BE} between various transistors by simply choosing the correct value of R_f , the feedback resistor. Alternatively, R_f can be made variable, allowing the sensitivity of the transducer to be changed by the user. In this fashion,

CHARACTERISTICS OF TEMPERATURE TRANSDUCERS

PARAMETER	THERMISTOR	RESISTANCE-TEMPERATURE DEVICE	THERMOCOUPLE	SILICON TEMPERATURE TRANSDUCER
Sensitivity/ $^\circ\text{C}$	-4 %	+0.4 %	+60 μV	+10 mV to +200 nV
Linearity	Highly exponential	Very linear	Somewhat nonlinear	Very linear
Room-temperature resistance range	5 Ω to 20 M Ω	10 Ω to 1 k Ω	N/A	N/A
Sensitivity to changes in ambient temperature	No effect	No effect	Needs cold-junction compensation	No effect
Minimum temperature	Liquid-oxygen temperatures	Liquid-oxygen temperatures	Liquid-oxygen temperatures	-100 $^\circ\text{C}$
Maximum temperature	300 $^\circ\text{C}$	750 $^\circ\text{C}$	3,000 $^\circ\text{C}$	+150 $^\circ\text{C}$
Minimum size	0.005 in. dia beads	Small coil	Small wire (smallest)	TO-5 or TO-46 transistor package
Room-temperature error	Typically ± 20 %	Usually wound to $\pm 0.25^\circ\text{C}$	About 2 $^\circ\text{C}$	8 $^\circ\text{C}$ to 0.1 $^\circ\text{C}$
Cost	S 5	S 25	S 2	S 3 to S 30

sensitivities from less than 10 mv/°C to more than 200 mv/°C can be obtained.

Choosing a transducer

Where do the new semiconductor devices fit into the grand scheme of temperature measurement? As the table indicates, right in the middle. They're no good for extremely high or low temperatures. They're not the most accurate devices available. And they're not the smallest or fastest-responding transducers. But as the applications chart shows, their low cost and ease of use make them ideal for a large number of applications in the middle.

If low price is the main consideration, cheap thermocouples are available for temperatures as high as about 1,200°C. Above that, more-expensive platinum and tungsten units must be used. If accuracy is most important, the RTD is the way to go. Although usually wound to an error tolerance of ±0.25°C, the RTD will normally

drift less than 0.05°C over a long period and hence can be calibrated to much greater accuracy. It is obvious that since the increased accuracy requires greater care and time in calibration, it comes at an increased price.

Nearly anything except a semiconductor transducer can be used at cryogenic temperatures, while nothing but a tungsten-based thermocouple can withstand temperatures above about 2,000°C. The thermistor, while highly nonlinear, is extremely small, rugged, and sensitive. Furthermore, although not as stable as an RTD, a properly used thermistor will actually improve with age. Thermistors, of course, are also useful as temperature-compensating devices in all kinds of electronic circuitry.

Finally, if an extremely small device is needed, if the fastest possible response is essential, or if it is necessary to locate the transducer far from the rest of the measuring circuitry, the thermocouple again is the best choice. □

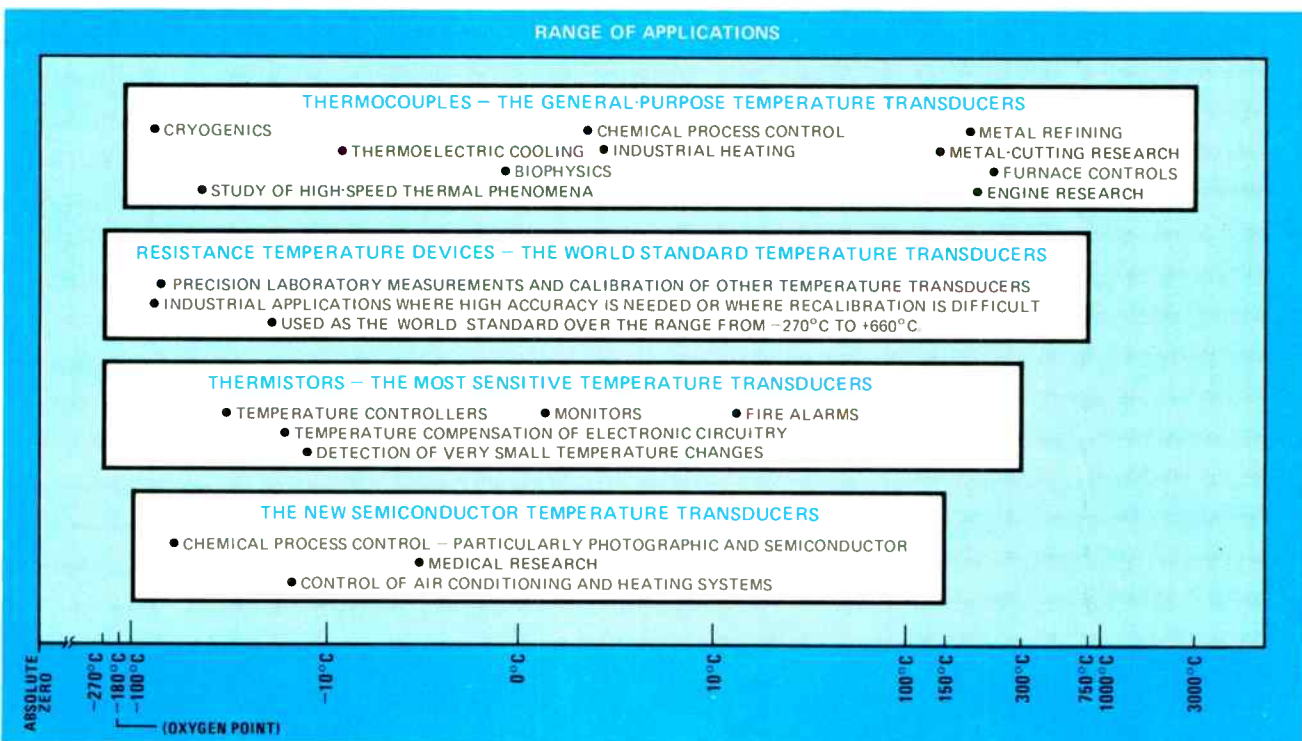

**JUST
HOW GOOD
IS THE
TELETYPE[®]
MODEL 40?**



We think our data terminal system is so good nothing even comes close.

In fact, we believe the Teletype® model 40 system is so good it'll change the way business looks at data. We're that sure it's that good.

Here's why:

It's a complete, versatile, reliable terminal system delivering maximum efficiency in a wide range of applications. From message communications to computer input/output on switched network or private-line systems. Right now, the model 40 system is being used by airlines, news services, brokerage firms, manufacturers, law enforcement agencies and time-sharing services.

Significant features of the system are speed, ease of data preparation and editing, compactness and extremely low maintenance. And since the model 40 is completely modular, you can forget about obsolescence.

It's designed to grow as your needs grow.

Data is presented with extreme clarity on the big, 13-inch screen. Characters are 35 percent larger than standard print size and are formed on a 7 x 9 dot matrix. Screen capacity is 24 lines of 80 characters each for a total of 1,920.

Teletype's exclusive solid-state design makes the model 40's fast (up to 2400 wpm), heavy-duty impact printer the most cost-effective unit on the market. Its simplicity of design makes it one of the most reliable printers we've ever made. And after more than 60 years experience building printers that set the standards for reliability, that's saying something.

It took a total corporate commitment to come up with something as good as the model 40. For example, we had to develop and manufacture our own MCS. It didn't come easy, but we think it's worth it. Because the solid-state components throughout the system deliver exceptionally high reliability.

And the self-diagnostic circuitry and design modularity significantly reduce downtime and maintenance costs.

Operator comfort and efficiency are increased by human-engineering efforts like a brightness control and screen tilt, plus a glare-reducing display tube and an easy to operate keyboard.

The Teletype model 40 data terminal system.

It's every bit as good as you've heard.

And probably even better.



The Teletype model 40 system.



Keyboard Display (KD)

Keyboard Display Printer (KDP)

RO Printer

The Teletype model 40 is so good it's worth looking into.

Listed below are some of the general specifications of the model 40 system.

Display

- 5¼" x 11¼" viewing area on a 13" display tube.
- High resolution 7 x 9 dot matrix character presentation.
- 127 characters of ASCII code displayed (all except backspace).
- 1,920 character screen capacity composed of 24 lines of 80 characters per line.
- Anti-glare screen, brightness control plus tube tilt.
- Constant image cursor—when cursor is positioned over a character, character becomes a negative image.
- Refresh rate: 60 frames/second.

Operator Console

- Standard keyboard generates 127 ASCII characters.
- Six cursor positioning controls; Home, Return, Left, Right, Up and Down.
- Five data editing controls; Clear, Character Insert, Character Delete, Line Insert and Line Delete.
- Basic terminal controls; Send, Receive, Local.

Optional Page Printer

- Impact printer provides hard copy of data stored in the display memory, or of data received directly from the communication line.
- Printing speed is over 300 lines per minute (monospace), or 220 lines per minute (full upper and lower case).

Optional Features

- Expanded memory, scrolling, protected format, highlight, tabulation, form send. Plus more.

Technical Information

- Speed: serial interface; 105 or 120 cps. Code: 1968 USASCII.
- Method: transmission is serial by bit and character with low order bit transmitted first.
- Synchronization: asynchronous; 1 start bit, 7 information bits, 1 parity bit, 1 stop bit.
- Communication line: switched network at 105 or 120 cps.
- Bell System Data Sets 202C, 202R or equivalents. Other speeds optional.
- Interface: serial—EIA RS-232C. Mode: half duplex.
- Error control: optional vertical parity detection on received data (substitute character printed for errored characters). Keyboard generates even vertical parity.
- Power requirements: 117V AC ± 10%; 50-60 Hz.
- Operating environment: + 40° to 110° F, 2% to 95% humidity.

For complete technical data, please contact our Sales Headquarters at 5555 Touhy Avenue, Skokie, Illinois 60076. Or call TERMINAL CENTRAL at (312) 982-2000.

Teletype is a trademark registered in the United States Patent Office



Circle 136 on reader service card

Part 3

MODELING the bipolar transistor

The best way to determine any of the 12 parameters for the second-level Ebers-Moll model is to duplicate, as nearly as possible, the operating conditions under which the analysis is to be run

by Ian Getreu, Tektronix, Inc., Beaverton, Ore.

□ To specify the second-level nonlinear Ebers-Moll model for the bipolar transistor, 12 parameters must be measured, in addition to the five parameters needed for the first-level Ebers-Moll model. Besides a curve tracer and a thermometer, which is the minimal test equipment for measuring the first-level parameters, the second-level parameters require at least a capacitance bridge, a pulse generator, a high-speed oscilloscope, and a small-signal measurement system such as an S-parameter setup. Needless to say, the inevitable power supply is also required.

As for the measurement methods described in Part 1 for the first-level parameters, the methods suggested here for obtaining the second-level parameters are not necessarily the only possible ones, nor are they necessarily the best ones. Rather, they represent viable methods to getting accurate results for a computer analysis.

Reviewing the parameters

Briefly, the five first-level parameters are:

- β_F , the forward common-emitter large-signal current gain,
- β_R , inverse common-emitter large-signal current gain,
- I_S , the saturation current,
- T_{nom} , the temperature at which the parameters are

This three-part series explains how to model the bipolar transistor systematically and how to measure the model parameters. Part 1 appeared in the Sept. 19 issue, and Part 2 in the Oct. 31 issue.

obtained, and

- E_G , the energy gap of the transistor's semiconductor material.

The additional 12 parameters for the second-level model are:

- r_E , the emitter ohmic resistance,
- r_B , the base ohmic resistance,
- r_C , the collector ohmic resistance,
- C_{JE0} , the emitter-base junction capacitance at $V_{B-E} = 0$,
- C_{JC0} , the collector-base junction capacitance at $V_{B-C} = 0$,
- ϕ_E , the emitter-base barrier potential,
- ϕ_C , the collector-base barrier potential,
- m_E , the emitter-base capacitance gradient factor,
- m_C , the collector-base capacitance gradient factor,
- τ_F , the total forward transit time, which can be computed from the transistor's unity-gain bandwidth, f_T ,
- τ_R , the total reverse transit time, which can be calculated from the saturation time constant, τ_{SAT} , and
- C_{SUB} , the constant substrate capacitance.

Parameter r_E is the constant that models the resistance between the transistor's active emitter region and its emitter terminal. Typically, r_E is approximately 1 ohm. Its value can be obtained directly from a curve tracer by observing base current as a function of collector-emitter voltage when the transistor's collector is open-circuited¹.

The slope of the resulting curve, which is shown in Fig. 1, is approximately the reciprocal of r_E . The low-

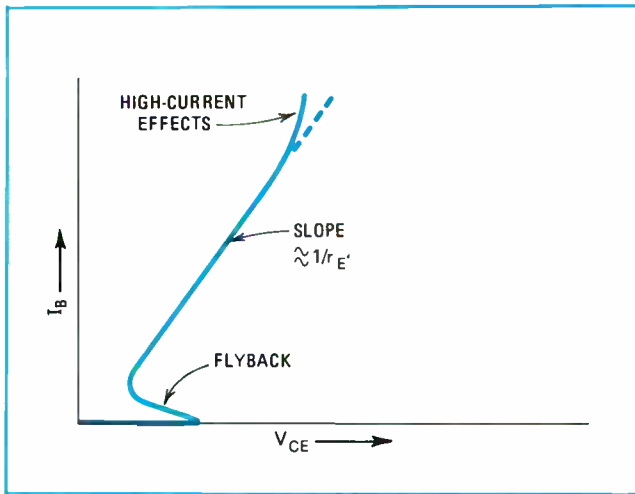

1. Emitter resistance. Constant value of emitter resistance (r_E) is obtained from a display of base current (I_B) as a function of collector-emitter voltage (V_{CE}). The r_E value, typically around 1 ohm, is the inverse slope of this display at low currents.

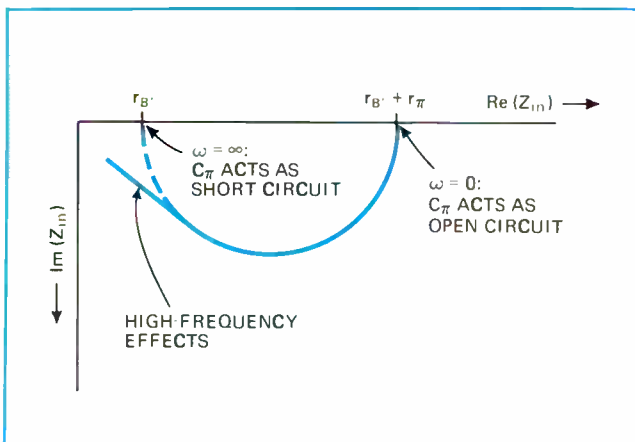

2. For small-signal analyses. The base resistance (r_B) of the second-level linear hybrid-model can be determined from a complex-impedance plot. As the signal frequency is varied, the real and imaginary parts of the input impedance of the base-emitter junction are measured. The intercepts of the resulting semicircle with the real axis yield the r_B value, which can vary from ohms to kilohms.

current flyback effect is caused by the decrease of the inverse beta at low currents. (Sometimes the flyback effect is difficult to observe.) The slope of the curve should be determined as close as possible to the flyback region, and not at high current levels. At high currents, the trace of I_B vs V_{CE} departs from a straight line.

Measuring base resistance

Parameter r_B models the resistance between the transistor's active base region and its base terminal. Its value usually ranges from approximately 10 ohms (for microwave devices) to several kilohms.

Traditionally, r_B is a difficult parameter to measure, because it is modeled as a lumped constant resistance, although it is actually a distributed variable resistance. As a result, the value obtained for r_B strongly depends on the measurement technique used, as well as the transistor's operating conditions. Because of this, r_B should

be determined by the method that is closest to the operating condition being analyzed. Therefore, several measurement techniques are presented here.

If r_B is being measured to ascertain its effect on the noise performance, the noise measurement technique should be used. Similarly, if the transistor is to be used in a switching application, the pulse measurement technique may provide the most appropriate value. For small-signal analyses, the impedance-circle method, which involves the most work, is the most accurate way. The phase-cancellation technique is a considerably simpler version of the impedance-circle approach, but it can only be used at one collector current—a current that normally is low and not under the control of the person making the measurement.

For dc analyses, it may be possible to obtain r_B from a plot of $\ln(I_C)$ and $\ln(I_B)$ vs V_{BE} . However, since this procedure involves subtracting two large numbers, substantial errors can be introduced. In fact, it is not uncommon to obtain negative values for r_B with this method.

Impedance-circle methods

The impedance-circle technique for measuring r_B is applicable for the small-signal linear hybrid- π transistor model. As the signal frequency is varied with the ac collector voltage kept at zero, the input impedance looking into the base-emitter junction is plotted on the complex-impedance plane.

The locus of points forms a semicircle, as shown in Fig. 2. The right intercept of the semicircle with the real axis occurs at zero frequency (dc). The impedance value at this point (for zero r_E) is the sum of base resistance r_B and resistance r_π (because capacitance C_π acts as an open circuit). The impedance value of the left intercept, which occurs at infinite frequency (for zero r_E) is r_B alone (because C_π now acts as a short circuit). Since r_E is, in fact, nonzero, the left intercept will be the sum of r_B and r_E , and the right intercept will be the sum of r_B and $(1 + \beta_F)r_E$.

The accuracy of this measurement depends on the value of the collector current. At a low collector current, the value of r_π will be large, resulting in a large semicircle. When the collector current is high, the value of r_π will be small, giving a small semicircle and permitting the left intercept to be determined more accurately.

For high frequencies, the linear hybrid- π model does not provide good accuracy. The distributed nature of the transistor and such parasitic elements as lead capacitance cause the measured points to deviate from the predicted semicircle. When this happens, the semicircle construction is based on the measured points obtained at low frequencies.

The test instrument needed for the impedance-circle measurement is either: an RX meter, for example, the Boonton model 250A and an appropriate test jig; or a variable-frequency admittance bridge, like the Wayne-Kerr model 801B; or an s-parameter setup, such as the General Radio model 1710 network analyzer. If the latter is used, the measured data, which must be converted into input impedance, must be taken at low frequencies so that the semicircle can be fitted.

For the phase-cancellation technique², the transistor is connected in its common-base configuration. Then, an admittance bridge, such as the Wayne-Kerr model 8018, is used to measure the real and imaginary parts of the device's input impedance across its base-emitter junction. At a frequency between $f_T/3$ and f_T/β , the collector current is varied until the reactive part of the input impedance goes to zero. The sum of resistances r_E and r_B can then be computed from:

$$r_E + r_B = 1/g_m = kT/qI_C$$

where g_m is the transistor's transconductance, k is Boltzman's constant, T is temperature, and q is electron charge. The phase-cancellation technique cannot be used with devices that have low beta values (such as lateral pnp transistors).

The test circuit for the pulse measurement technique³ is shown in Fig. 3. A current pulse, which is applied to the base of the transistor through a fast switching diode, causes the device to turn off. The voltage across resistance r_B now instantaneously drops to zero, while the base-emitter capacitance keeps the internal junction potential constant. Resistance r_B can then be determined from the display on a dual-channel oscilloscope:

$$r_B = \Delta V/I_{B1}$$

This technique does not necessarily work well for all transistors. When the external component of the base resistance is small with respect to the internal component, the ΔV drop is not readily observable. Other useful information can be obtained from this technique. When the oscilloscope time-per-division scale is reduced to the point where ΔV no longer appears to be vertical, the simple constant-value model for r_B is no longer valid, giving some indication of the switching

times at which the constant representation of r_B is inadequate.²

The equipment required for the pulse measurement technique includes: a pulse generator, a current probe such as the Tektronix model P6042 or model CT-1, and a dual-channel oscilloscope like the Tektronix 500 series or 7000 series. If biasing resistors R_B and R_L and supply voltage V_{CC} are chosen so that the transistor is saturated, greater sensitivity can be obtained from the current probe. However, the value of r_B can be significantly different from that obtained when the transistor is in its normal active region. For a high-frequency transistor, the capacitive loading of the oscilloscope at the base can affect the accuracy of the pulse measurement. For such a device, a time-domain reflectometry system can be used to determine r_B by the same principle.

The use of noise measurements presents a number of problems to anyone unfamiliar with noise work and probably should not be attempted by a beginner. These methods require using not only very-high-gain amplifiers whose gain is stable with time, but also extensive shielding to prevent excessive rf interference and 60-hertz pickup. Furthermore, the equipment for making noise measurements is fairly expensive.

Once a noise measurement system is set up, resistance r_B can be evaluated quite conveniently. The transistor is inserted into the apparatus, and a single meter reading allows fast estimation of r_B . If the flicker noise is assumed to be negligible, then:

$$r_B = [(\overline{v_i^2})/(4kT)(\Delta f)] - (1/2g_m)$$

where quantity Δf is the bandwidth of the measurement, quantity $(1/2g_m)$ is calculated from the known collector current, and quantity $(\overline{v_i^2})$ is the transistor's

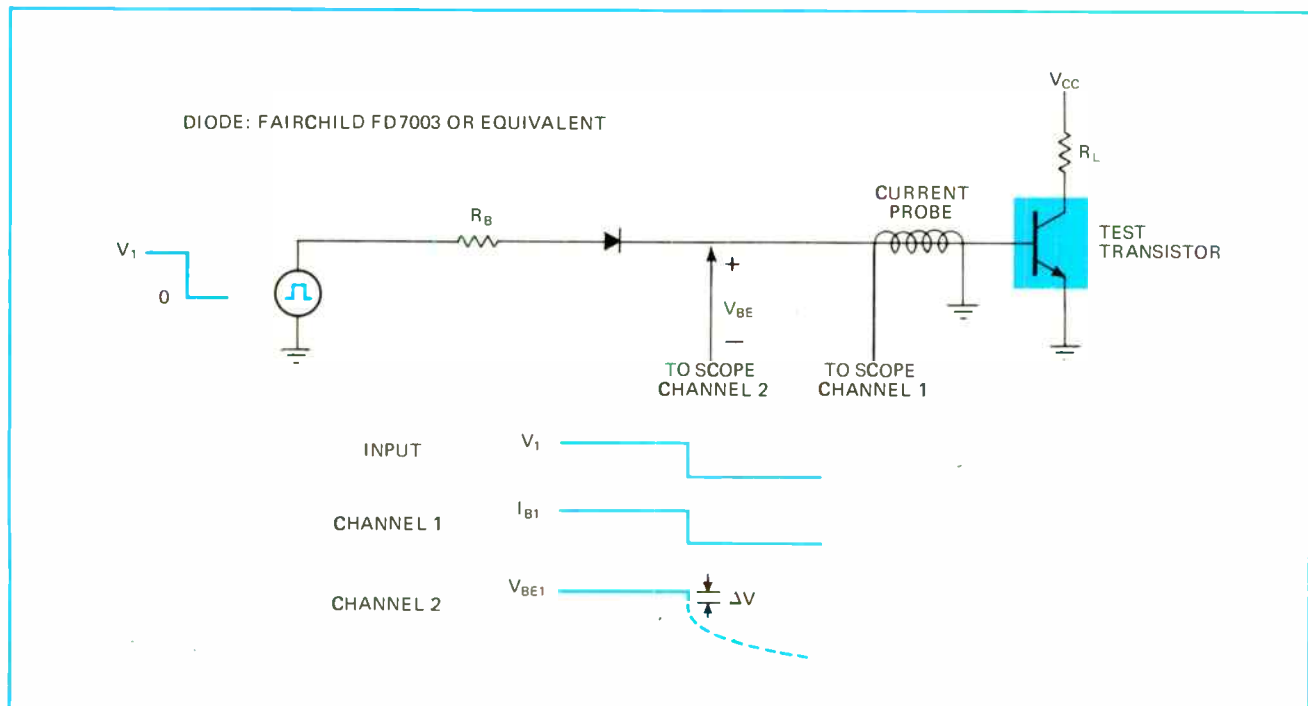

3. For switching applications. This pulse measurement scheme is best for determining base resistance r_B when the transistor is to be used as a switching device. The voltage drop (ΔV) across r_B is observed as the transistor turns off. Then: $r_B = \Delta V/I_{B1}$.

equivalent input mean-square noise voltage, the magnitude of which is determined from:

$$\overline{(v_i^2)} = \overline{(v_o^2)}/G^2$$

where $\overline{(v_o^2)}$, which must be measured on a true-rms-reading voltmeter, is the output mean-square noise voltage measured with the test system, and G is the voltage gain from the test-device input to the system output. This measurement is performed with an ac short circuit

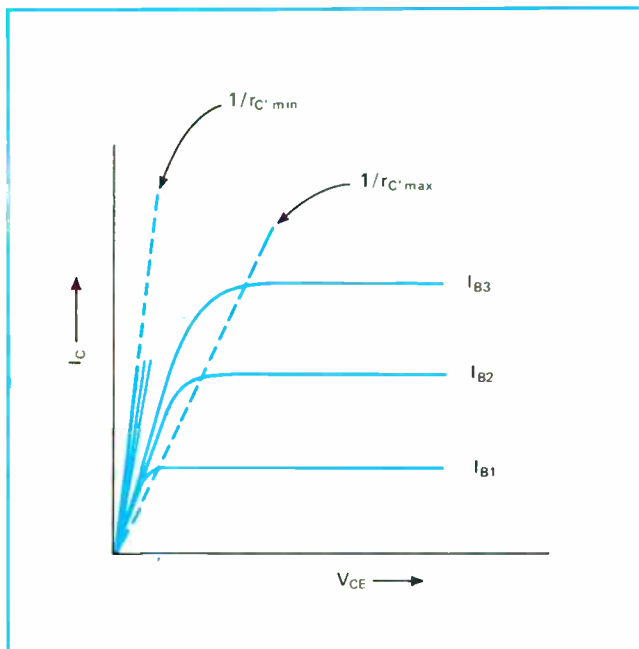

4. Collector resistance. The value of resistance r_c can range from a few ohms to hundreds of ohms. It is measured by displaying the collector characteristics. In the normal active region, r_c is the inverse slope of the dashed line ($1/r_{c\max}$) through the knees of the curves. When the transistor is saturated, the value of r_c increases. Its upper limit is noted here by the other dashed line ($1/r_{c\min}$).

between the transistor's base and emitter.

Parameter r_c models the resistance between the transistor's active collector region and its collector terminal. This resistance actually varies with current level, but for the second-level model, it is considered to be constant. The value of r_c can vary significantly from device to device—from a few ohms for discrete and deep-collector integrated devices to hundreds of ohms for standard integrated devices.

The biggest problem in measuring r_c is not how to measure it, but which value to use for the model. Therefore, the selection of the r_c value depends strongly on how the transistor is being employed or which aspect of device behavior needs to be modeled accurately.

Determining collector resistance

Resistance r_c can be determined from a curve-tracer display of the transistor's collector characteristics. In the typical characteristics drawn in Fig. 4, the two limiting values of r_c are noted by the dashed lines. One of the dashed lines ($1/r_{c\max}$) is drawn through the knee of each curve, where the curve departs from the straight-line approximation of the normal active region. The inverse of this line's slope is the ohmic collector resistance when the transistor is in its normal active mode and is not saturated.⁴

If the transistor is strongly saturated, the inverse of the slope of the other dashed line ($1/r_{c\min}$) provides the appropriate value of r_c . However, when this slope is used to find r_c , a correction factor must be subtracted from the value obtained for r_c . This factor is:

$$r_{E'} + (kT/q) \left[\frac{1}{(\beta_F I_B - I_C)} + \frac{1}{((1 + \beta_R) I_B + I_C)} \right]$$

When the transistor is to be modeled accurately in both its saturation and normal active regions, an appropriate compromise should be made. Since the r_c value is used in some computer programs to determine transit

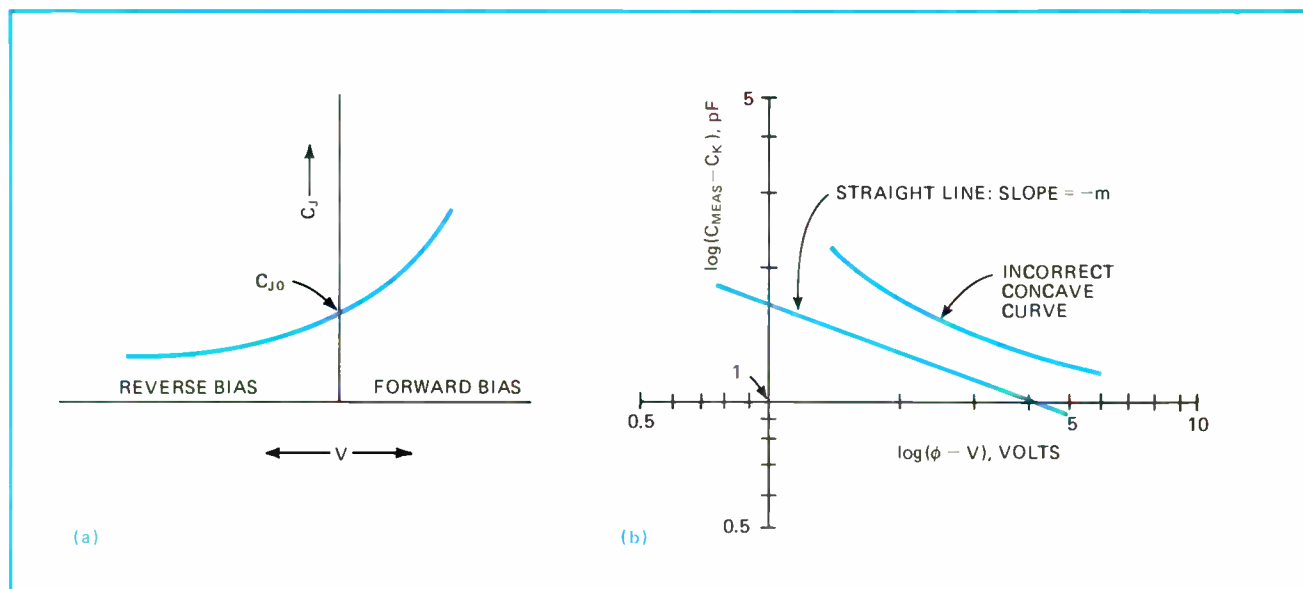

5. Junction capacitances. Both the emitter-base and collector-base junction capacitances (C_j) are a function of their respective junction voltage (V), as shown in (a). These two capacitances can be measured with a bridge, but the extra capacitance (C_K), mainly caused by pin, stray, and pad capacitances, must be accounted for. A graphical method for reducing the measured capacitance (C_{MEAS}) is given in (b).

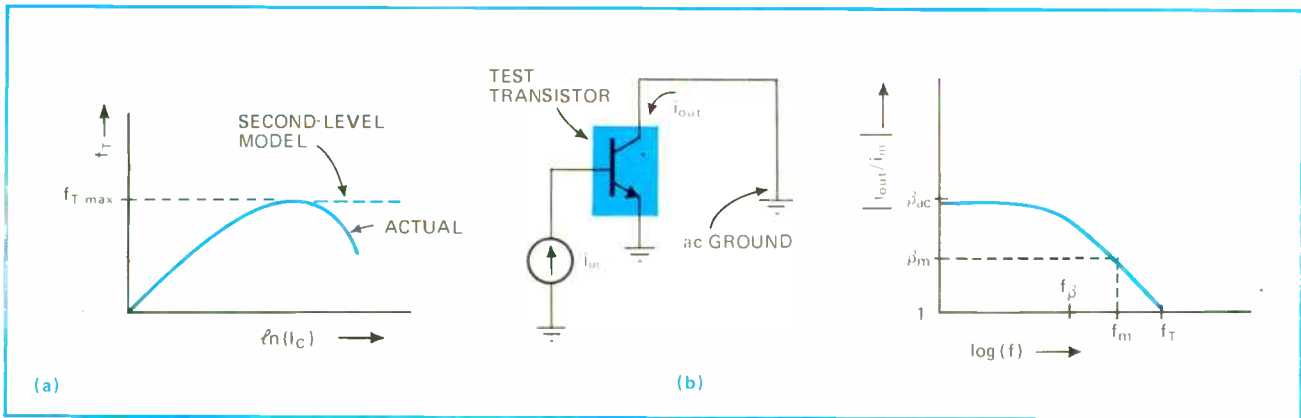

6. Unity-gain bandwidth. Parameter f_T , the unity-gain bandwidth, is a function of collector current, as shown in (a). At a given current level, it can be determined from a measurement of the small-signal short-circuit current gain (β_m) at any frequency (f_m) between $3f_\beta$ and $f_T/3$, where f_β is the transistor's 3-dB frequency at the device's low-frequency current gain (β_{ac}). Bandwidth f_T is the product of the measured gain and frequency values: $f_T = \beta_m \times f_m$, or $f_T = \beta_{ac} \times f_\beta$. A simplified measurement setup is illustrated in (b).

time τ_F from bandwidth f_T , it may be advisable to specify τ_F directly (if possible) whenever the r_C value for the normal active region is not used.

Evaluating the junction capacitances

Junction capacitances C_{JE} and C_{JC} require three parameters each— C_{J0} , ϕ , and m —to model the junction capacitance caused by the fixed charge in the two junction depletion regions. When the appropriate junction voltage (V) is less than or equal to $\phi/2$, each junction capacitance can be described by⁵:

$$C_J(V) = C_{J0}/[1 - (V/\phi)]^m$$

For the emitter-base junction, the subscript E is added. For example, junction capacitance C_{JE} is a function of the internal base-emitter voltage (V_{BE}), and the parameters are C_{JE0} , ϕ_E , and m_E . Similarly, for the collector-base junction, $C_{JC}(V_{BC})$ is expressed in terms of C_{JC0} , ϕ_C , and m_C .

Typically, C_J varies with V as shown in Fig. 5a, provided that V is less than or equal to $\phi/2$. Capacitance C_{J0} varies from device to device, but it is typically on the order of 0.3 picofarad per square mil of junction area; barrier potential ϕ is usually around 0.5 to 0.7 volt; and gradient factor m lies between 0.333 and 0.5, depending on whether the junction is graded or abrupt, respectively.

Either junction capacitance can be obtained as a function of voltage by means of a capacitance bridge such as the Boonton model 75. The two junction contacts are connected to the bridge, and the third contact is left open. For example, for C_{JE} , the emitter and base leads are connected to the bridge, and the collector contact is left open. The measurement frequency is normally low enough so that the ohmic resistances have a negligible effect.

A complicating factor is the extra capacitance (C_K) caused mainly by pin capacitance, stray capacitance, and pad capacitance. This extra capacitance is normally assumed to be constant. The capacitance that is measured by the bridge is:

$$C_{MEAS} = [C_{J0}/[1 - (V/\phi)]^m] + C_K$$

Capacitance C_K can be determined in four ways: by an estimate (taken to be approximately 0.4 to 0.7 pF), by a measurement with a dummy can, by a computer parameter optimization, or by graphical techniques.

The dummy-can technique is the most accurate method. It requires an identical device can having its metal runs disconnected at the device. This dummy package can either be used to zero the capacitance bridge, or its capacitance can be measured separately and the measured value subtracted from the bridge measurement.

The use of an optimization algorithm on a computer or calculator is fast and convenient once the algorithm is written and tested. However, as with the graphical techniques, the solution is often not unique, and several sets of solutions can be obtained, depending on the initial estimates and the methods used. Since parameters C_{J0} , ϕ , and m are required only to recreate the junction capacitance, any set of positive values for these parameters is acceptable.

One method of reducing the data by graphical means is to first make an initial guess for ϕ and C_K . The resultant value of $(C_{MEAS} - C_K)$ is then plotted as a function of $(\phi - V)$ on log-log graph paper. If a straight line having a slope of -0.5 to -0.333 is obtained, the values chosen for the parameters are assumed to be correct. If the plotted line is not straight, a second guess is made for C_K and/or ϕ , and the log-log plot is done again. This process is repeated until the appropriate straight line is obtained, as in Fig. 5b. Since the slope of the straight line is equal to $-m$, the values of ϕ , m , C_K , and C_{J0} can be determined from this plot. If the curve is concave, decrease ϕ and/or increase C_K .

Obtaining unity-gain bandwidth

Parameter f_T , which is the transistor's unity-gain bandwidth, represents the frequency at which the common-emitter zero-load small-signal current gain becomes equal to one. This parameter varies with the operating point, as well as from device to device. A typical variation of f_T with $\ln(I_C)$ is sketched in Fig. 6a. For discrete devices and integrated npn transistors, the peak f_T is generally on the order of 600 megahertz to 2 gi-

gahertz. For integrated pnp transistors, the peak f_T is usually 10 MHz for a substrate pnp device and 1 MHz for a lateral pnp device.

Primarily, f_T is measured to determine the forward transit time, τ_F which, in turn, is needed to compute the transistor's emitter diffusion capacitance. In some computer programs, the user has the option of either entering τ_F directly or f_T (with appropriate operating-point data). In the latter case, the program converts the f_T data to τ_F . Otherwise, the conversion to τ_F must be performed by the user.

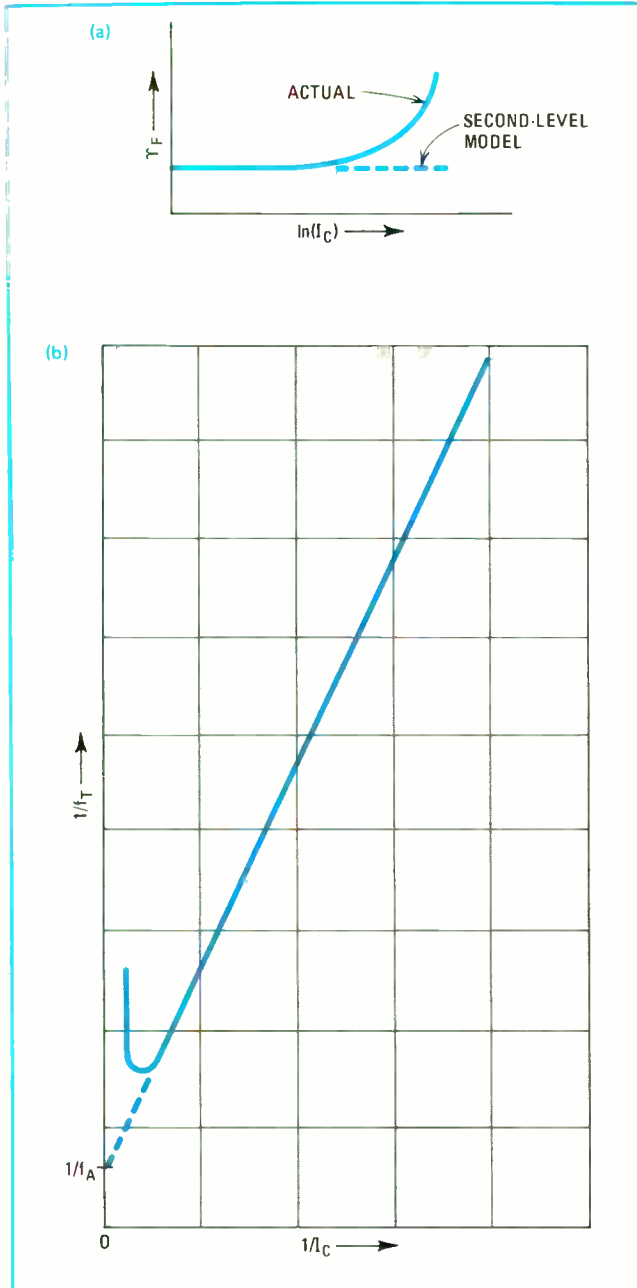

7. Forward transit time. For the second-level Ebers-Moll model, the total forward transit time, τ_F , is assumed to be constant, although it does vary with collector current, as indicated in (a). Generally, τ_F is computed from the measured value of the unity-gain bandwidth, f_T . But if there is no quasi-constant f_T region, an appropriate f_T value can be found graphically from a plot (b) of $1/f_T$ vs $1/I_C$.

The unity-gain bandwidth can be measured on: an f_T meter (such as the Dynatran f_T meter); or an S-parameter measurement system (a relatively simple algorithm can be written to convert the S-parameter data to f_T); or with a small-signal measurement setup.

A simplified small-signal measurement circuit is drawn in Fig. 6b. A power supply is required, in addition to a small-signal source and detector, for example, a vector voltmeter, or an oscillator and an oscilloscope. The ac beta (β_{ac}) and the 3-dB frequency (f_β) are then measured at the desired bias point. Bandwidth f_T is the product of these two measured values⁵:

$$f_T = \beta_{ac} \times f_\beta$$

Alternatively, two other beta and frequency values can be measured to determine f_T . For example, at a frequency (f_m) between $3f_\beta$ and $f_T/3$, the beta value (β_m) at that frequency is measured. Then:

$$f_T = \beta_m \times f_m$$

If the ac ground required for measuring f_T is not perfect—that is, there is a finite ac load resistance (R_{load})—a corrected value of f_T must be computed:

$$f_{Tcorrected} = \frac{1}{(1/f_{Tmeasured}) - 2\pi C_{JC}R_{load}}$$

Parameter τ_F , the total forward transit time, is used for modeling the excess charge stored in the transistor when its emitter-base junction is forward-biased and $V_{BC} = 0$. Typically, τ_F varies with $\ln(I_C)$ as shown in Fig. 7a, but for the second-level mode, τ_F is assumed to be constant. Generally, values of τ_F range from 0.3 nanosecond for a device with an f_T of 600 MHz to 80 picoseconds for an f_T of 2 GHz.

Because τ_F and f_T are related to each other, they influence each other. The drop in f_T at high currents is caused by the increase in τ_F at high currents. However, the drop in f_T at low currents is caused by junction capacitances C_{JE} and C_{JC} . Since these two capacitances are modeled separately, the drop in f_T at low currents is inherently included in the second-level model.

In the region where f_T is constant, τ_F is given by:

$$\tau_F = (1/2\pi f_{Tmax}) - C_{JC}r_C$$

where f_{Tmax} is the peak value of f_T . When there is no constant f_T region, τ_F is obtained by plotting $1/f_T$ as a function of $1/I_C$, as shown in Fig. 7b. The resultant curve can then be extrapolated to obtain τ_F . The intercept (noted here by $1/f_A$) of the extrapolated straight line at $1/I_C = 0$ is related to τ_F by:

$$\tau_F = [(1/f_A)/2\pi] - C_{JC}(V_{BC})r_C$$

Parameter τ_R , the total reverse transit time, is used for modeling the excess charge stored in the transistor when its collector-base junction is forward-biased and $V_{BE} = 0$. Typically, τ_R ranges from 1 to 20 ns. This parameter is needed to calculate the transistor's collector diffusion capacitance. If the inverse beta, β_R , is significantly greater than one, the value of τ_R can be obtained in the same way that τ_F is found, but with the transistor's emitter and collector terminals interchanged.

In most cases, however, β_R is less than or just greater

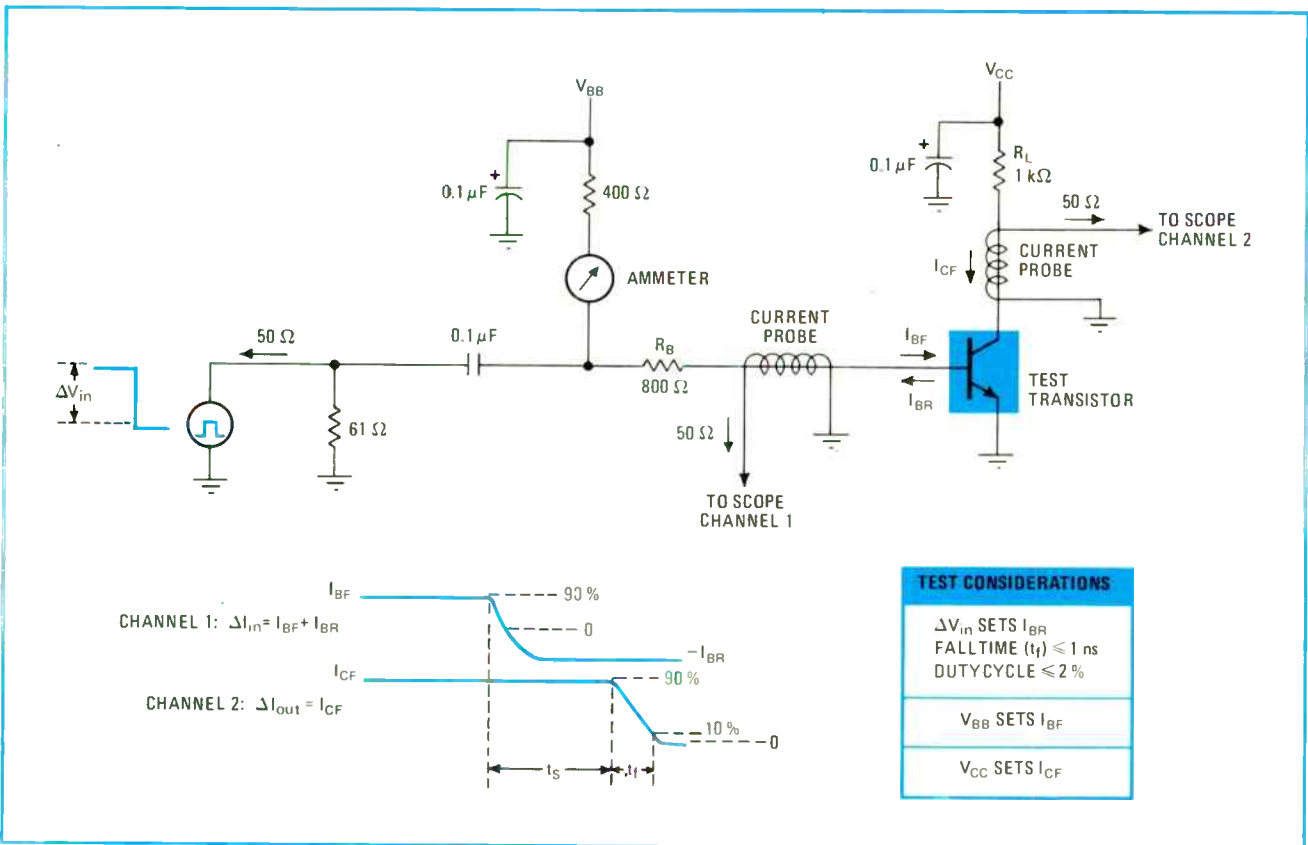

8. Reverse transit time. Parameter τ_R , which is the transistor's total reverse transit time, is used to determine the collector diffusion capacitance. Generally, τ_R is not measured directly. Instead, the transistor's saturation delay time constant, τ_{SAT} , which is related to τ_R , is found. But, τ_{SAT} is also not usually measured directly, and another parameter, t_{SAT} , the transistor's saturation delay time, is evaluated with the test circuit shown here. Delay time t_{SAT} is marked off between the 90% points of the base and collector currents.

than unity, and a different measurement technique must be used. The simplest method of obtaining τ_R is to compute it from the measured value of τ_{SAT} , the saturation delay time constant. These two parameters are related by:

$$\tau_R = \left[\frac{1 - \alpha_F \alpha_R}{\alpha_R} \right] \tau_{SAT} - \frac{\alpha_F \tau_F}{\alpha_R}$$

where α_F is the forward common-base large-signal current gain, and α_R is the reverse common-base large-signal current gain. In some computer programs, this calculation is performed internally, and τ_{SAT} is the parameter that is specified.

The saturation time delays

The saturation delay time constant, τ_{SAT} , determines how long it takes for the transistor to come out of saturation. Typical values for τ_{SAT} range from 2 to 40 ns. This parameter is determined through a simple measurement of the transistor's saturation delay time, t_{SAT} .

The test circuit for measuring t_{SAT} is shown in Fig. 8. The saturation time constant, τ_{SAT} , is related to the saturation delay time, t_{SAT} , by:

$$t_{SAT} = \tau_{SAT} \ln \left[\frac{I_{BF} + I_{BR}}{(I_{CF}/\beta_F) + I_{BR}} \right]$$

where I_{BF} is the forward base current, I_{BR} is the reverse base current, and I_{CF} is the forward collector current.

The equipment required for this measurement includes: a fast pulse generator; two current probes, such as the Tektronix CT-1; and a fast oscilloscope, for instance, the Tektronix 500 or 7000 series with a dual-trace plug-in. Additionally a 90-ns 50-ohm delay line may be needed for pretriggering purposes.

Parameter C_{SUB} is the epitaxial layer-substrate capacitance that is important mainly for integrated npn transistors and lateral pnp transistors⁴. For npn devices, it is represented as a constant capacitance, typically of 1 to 2 pF, from the collector terminal to ground. Ideally, C_{SUB} should be modeled by a junction capacitance distributed across r_C , and expressed as a function of the epitaxial layer-substrate voltage.

Capacitance C_{SUB} can be measured directly on a capacitance bridge, such as the Boonton model 75, at the bias voltage to be used in the analysis. If the bias voltage will change drastically, an averaging process should be used, or a separate reverse-biased diode may be added to model the varying substrate capacitance. □

REFERENCES

1. B. Kulke and S.L. Miller, "Accurate Measurement of Emitter and Collector Series Resistances in Transistors," IRE Proceedings (Lett.), Vol. 45, p. 90, 1957.
2. W.M.C. Sansen and R.G. Meyer, "Characterization and Measurement of the Base and Emitter Resistances of Bipolar Transistors," IEEE Journal of Solid-State Circuits, Vol. SC-7, pp. 492-498, 1972.
3. P. Spiegel, "Transistor Base Resistance and Its Effect on High-Speed Switching," Solid State Design, December, 1965, pp. 15-18.
4. L.A. Hahn, "The Effect of Collector Resistance Upon the High Current Capability of npn Transistors," IEEE Transactions for Electron Devices, Vol. ED-16, pp. 654-656, 1969.
5. A.B. Phillips, "Transistor Engineering," McGraw-Hill, 1962.

IF WE CAN'T MAKE YOUR MINICOMPUTER SYSTEM DO MORE WORK FOR LESS MONEY, NOBODY CAN.

When we introduced the SPC-16, we promised it would be the world's most powerful, versatile, cost-effective family of minicomputers.

It was. It still is.

The SPC-16 isn't the lowest priced hardware you can buy. But it will give you the lowest cost solution.

Through advanced systems architecture, simplified interfacing and a powerful instruction repertoire, the SPC-16 allows you to minimize programming, interfacing and memory costs no matter what size your system is.

Six mighty minis.

The SPC-16 family consists of six minicomputers offering a choice of three memory cycle times (800ns, 960ns and 1440ns), memory expansion to 128K using efficient 16K boards, and two different packaging configurations.

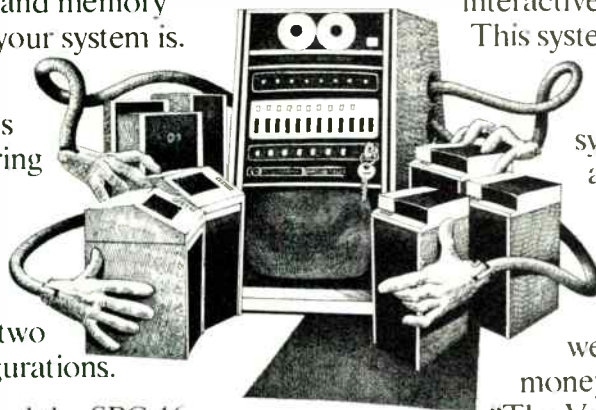

If you build a system around the SPC-16, it will do more work for less money than any other system you could build.

And that translates into more profits.

We know it for a fact. In the past few years, we helped a lot of OEMs get the edge on their competition by designing our product into their products. We helped a lot of end users solve a lot of tough, tight-budget applications. And, we produced some cost-effective systems of our own.

Two hard working systems.

Take RTOS II for example. It's a multi-programming system offering real-time event driven foreground processing concurrent with background job development and computation.

You couldn't buy a better price/performance solution for applications such as process control, data acquisition, laboratory research, material handling, communications or overall manufacturing automation.

We also built a powerful disk-based general purpose system around the SPC-16. DBOS II lets you do more computation with less memory, in far less time, at a lower price than any system on the market. It offers both scientific and commercial languages and a combination of interactive and batch operation.

This system is perfect for service centers, research and development groups and system house dedicated applications.

That's the short form.

To really appreciate how much power we can deliver for your money, write for our book

"The Value of Power." It will give you the facts to back up our claim: If General Automation can't make your system do more work for less money, nobody can.

Write General Automation, 1055 South East Street, Anaheim, California 92805. Or call (714) 778-4800. In Europe, write General Automation, S.A., 24 rue du Sergent Bauchat, 75012 Paris, France. Telephone (1) 346/7973. In Canada, write G.A. Computer Ltd., 880 Lady Ellen Place, Ottawa K1Z5L9, Ontario. Telephone (613) 725-3626.

POWERFUL MINICOMPUTERS BY GENERAL AUTOMATION

Getting inside a peak detector to make it do the job

Definition of signal acquisition time is usual starting point for meeting particular needs; control of overshoot, parasitic drain, other problems, depends on care in parts selection

by Jerald Graeme, *Burr-Brown Research Corp., Tucson, Ariz.*

□ As valuable as peak detectors are in measuring non-periodic signals—a chore not amenable to root-mean-square instruments—certain design characteristics ought to be understood by the user before he tries to tailor a peak detector for his particular requirements. It might also be useful to look at the most common design variations and their applications.

Basically, a peak detector has a sample mode and a hold mode, with the mode determined by the signal being monitored. As the signal rises, it is tracked by the circuit in the sample mode. As it falls, the peak detector preserves the maximum voltage information in the hold mode. Unless forced higher by a larger input signal, or until deliberately reset to zero, the voltage is maintained at the peak detector output. A peak detector thus delivers a dc output equal to the maximum amplitude of the signal being monitored. Figure 1 illustrates the basic peak detector circuit (left) and the way it operates (right).

Because of the gating of diodes D_1 and D_2 the detector output e_o can only rise with the input. It cannot decrease. If the input e_i rises above a previously stored voltage (on capacitor C_H), the op amp senses the rise and responds with a positive output swing. The rising voltage has the effect of forward biasing D_1 and thereby

connects the op amp in the mode of a voltage follower to drive the holding capacitor C_H ; the capacitor voltage follows the input signal. When e_i decreases, the amplifier output swings negative. As diode D_1 becomes reverse-biased, it blocks capacitor discharge current, so the capacitor voltage remains at its previous (maximum) level. Diode D_2 clamps the amplifier output at a level equal to the diode forward voltage drop below ground, rather than permit the output to swing to its negative saturation level. This confines the voltage swing, reducing the time required for return to the sample mode. The phase compensation capacitor (C_p in Fig. 1) is connected so as to reduce the acquisition time, i.e., the time required for a sample/hold circuit to acquire a new value of input signal. The amplifier drives the phase compensation only when the diode D_1 is forward biased. Until D_1 conducts, op amp slew speed is faster, so that acquisition time is lower.

A reset switch, usually a relay or field-effect transistor, can be used to discharge C_H before a new measurement cycle. A FET is simpler, but can introduce leakage and offset errors. A shunt resistor can be employed instead of a reset switch, and is particularly appropriate if the signal is repetitive. The shunt resistor should be chosen carefully, so that its resistance will prevent signifi-

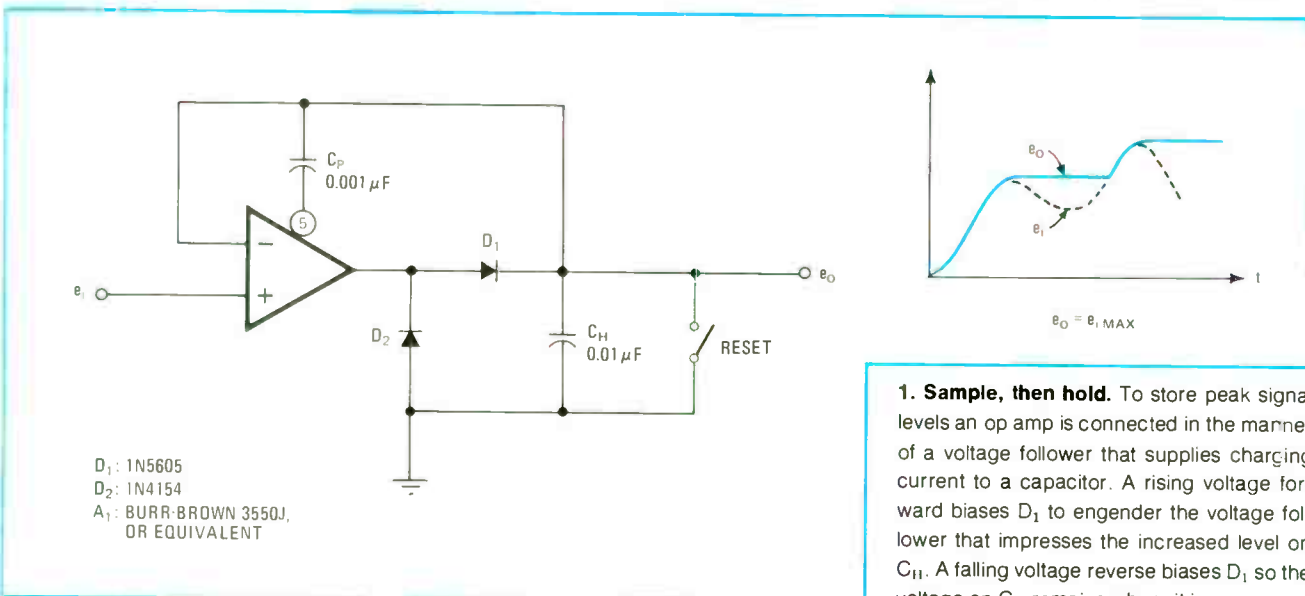

1. Sample, then hold. To store peak signal levels an op amp is connected in the manner of a voltage follower that supplies charging current to a capacitor. A rising voltage forward biases D_1 to engender the voltage follower that impresses the increased level on C_H . A falling voltage reverse biases D_1 so the voltage on C_H remains where it is.

2. An Improvement. Two FETs provide temperature compensated buffering at the output of the peak detector. Output current no longer drains the holding capacitor C_H . Offset shift in the buffer FET Q_1 is compensated by biasing it with a matching FET Q_2 and by enclosing Q_1 in the feedback loop.

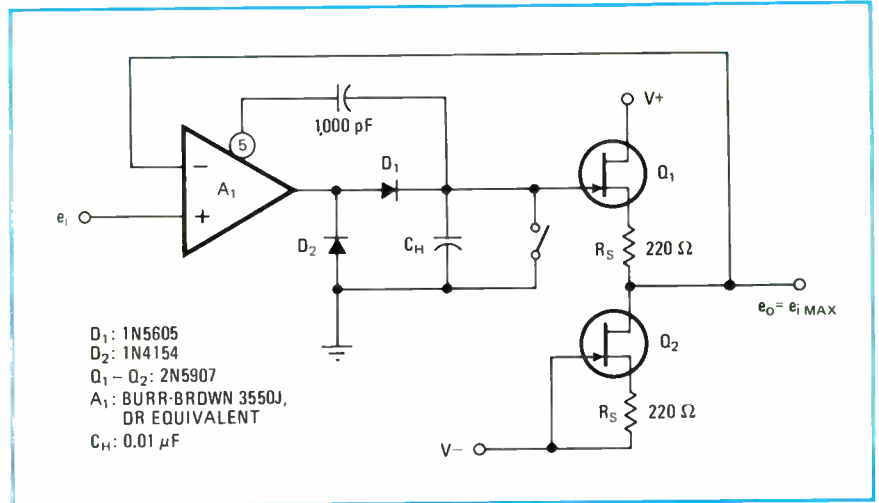

cant discharge between repetitive signal peaks, but will discharge the capacitor in the absence of signal.

Errors and causes

When peak detectors are inaccurate, it's usually because of faults occurring when the circuit is switching to the hold mode. Overshoot in the op amp, diode-switching time, and parasitic drain on the holding capacitor C_H are frequent causes of error.

Overshoot in particular can cause potentially large errors. To avoid this, it is necessary to overdamp the amplifier through phase compensation. Internally phase-compensated op amps are, for this reason, seldom suitable because they are too often underdamped. A provision for external phase compensation is therefore preferable. To determine the necessary phase compensation, it helps to observe the square-wave response of the circuit. But since the peak detector normally responds only to the first peak of the square wave, the detector diode D_1 must temporarily be shorted. Phase-compensation elements are then added to remove overshoot. With large storage capacitors, phase compensation can be further enhanced by inserting a small decoupling resistor in series with the amplifier output.

Droop—the decay of output voltage caused by parasitic current drain on C_H —can be traced to excess op amp input current, or leakages through diode D_1 and the reset switch, or dielectric absorption of the capacitor and any output load current.

Input current can be reduced by using a FET op amp that maintains its high input impedance even under overload. Input overload voltage, in the hold mode of an op amp, is equal to the difference between the input signal and the voltage stored on C_H . Many op amps exhibit low input impedance in the hold mode because of shunting input-protection diode clamps.

Droop caused by leakage can be minimized through careful selection of diode D_1 and the reset switch, and by leakage decoupling techniques. Another avenue for leakage, dielectric absorption, can be minimized by using teflon or polystyrene capacitors.

Obviously, the time required to switch between the hold and the sample mode is critical. If the transition is

longer than the duration of a peak, the oncoming new peak value won't be captured. Transition time is the major limitation on acquisition time. Peak detector design, in fact, usually begins with a definition of the required acquisition time.

Designing the peak detector

Beginning with the holding capacitor, selection takes into account the permissible droop rate (d) in volts/second caused by a net parasitic drain current (I_p). The holding capacitor must have a value

$$C_H = I_p/d$$

To charge C_H within an acquisition time of T_a , an op amp must be chosen for settling time that's fast enough and an output current large enough. Settling time must be no longer than T_a when the amplifier is phase-compensated for zero overshoot with a capacitive load equal to C_H . Also, the amplifier output current (I_o) must charge the capacitor to a peak voltage (E_p) in less than the acquisition time. Typically, this requires that

$$I_o = 2C_H E_p / T_a$$

The factor of two in this expression arbitrarily allots one-half the acquisition time for charging C_H and the other half for final settling. Following this approach, the components of Fig. 1 were selected for a droop rate of 10 millivolts per second under a parasitic drain of 100 picoamperes, and for a 15 microsecond acquisition time to within 0.1% of a 10-volt peak. Most loads connected to the output of the peak detector in Fig. 1 cause significant droop because the capacitor must supply the load current in the hold mode. What's needed to overcome this condition is output buffering.

Output buffers

Adding two FETs to the circuit as shown in Fig. 2 is a simple buffer arrangement. This replaces the output load current drain on the capacitor with the small gate leakage at Q_1 . The capacitor no longer provides the amplifier input current; it is now supplied by the buffer. Thus, a bipolar input, rather than a FET input op amp, can be used for the sake of economy. What's more, no sample-mode error is added by the offset voltage and

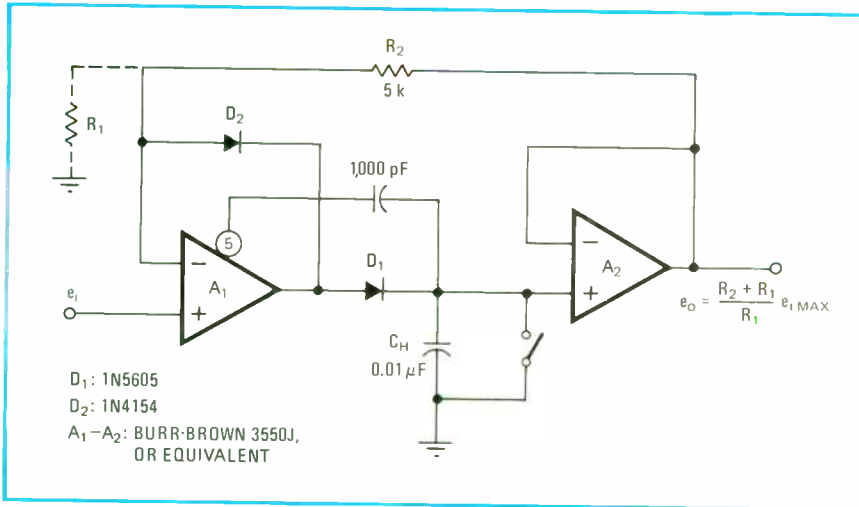

3. Less error. Improved output buffering, and peak detection gain greater than unity are achieved with an output voltage follower. The voltage follower replaces the FET buffer stage of the previous circuit, further reducing buffer error.

output resistance of this buffer. In the sample mode, feedback adjusts the capacitor voltage to counteract the buffer errors. In the hold mode, however, this error-correcting feedback is disabled because diode D_1 no longer conducts, so any change in buffer offset or loading will create an uncompensated error. Accuracy then becomes dependent on stable FET temperatures and constant loading. The output resistance is $R_s + 1/g_{fs}$, where g_{fs} is the transconductance.

Some temperature variation can be tolerated because the bias shown is temperature compensated. Although Q_1 is essentially in a source-follower circuit, offset and drift are small because the source-follower is biased by the matching FET current source Q_2 which tends to cancel any gate-source voltage shift in Q_1 . The voltage drop across Q_1 is held by Q_2 to about the gate-source voltage of Q_2 as long as the output current remains small. If the two FETs have the same source current level, the gate-source voltage of Q_1 is nearly equal in magnitude and opposite in sign to the voltage developed on its source resistor. Offset shift and drift tend to cancel, therefore, as long as output current is small.

Better output buffering can be achieved with an op amp that is voltage-follower-connected. Direct connection of a voltage follower to the circuit of Fig. 1 does, of course, add another set of offset-voltage, input-bias current and gain errors to the peak detector. To avoid this possible additional error, the follower is connected within the feedback loop as is the case for buffer Q_1 in Fig. 2. The result is the common peak detector circuit in Fig. 3. Here the buffer is within the feedback loop, so its offset and gain errors are nullified. Again no input current flows to the input amp from the storage capacitor, so input current from only one amplifier, A_2 , loads the capacitor. Thus, peak-detector error is not increased by the added voltage for the buffer because it is connected within the sample mode feedback loop. For the component values shown, droop is 10 mV/s and acquisition time is 20 Ms.

To ensure that the added buffer does not increase error, special care must be taken with phase compensation. The op amps and phase compensation both must be selected to ensure that buffer A_2 is significantly faster than input amplifier A_1 . For if A_1 were to charge the ca-

pacitor faster than the buffer A_2 could follow, a feedback delay would be introduced that would cause capacitor C_H to overcharge. The designer can avoid this by selecting phase compensation for A_1 that eliminates peak detector overshoot. As before, this selection is made with a square-wave input signal and with detector diode D_1 shorted to permit repetitive circuit response.

Adding gain

The configuration in Fig. 3 can be used for designing a peak detector with gain greater than unity. Gain is developed by adding a resistor (R_1) across the input of the basic circuit. Thus, in a sample mode, the circuit behaves as a noninverting amplifier with a gain of $R_2 + R_1/R_1$. Since the capacitor voltage at the input of amplifier A_2 equals the output voltage, the voltage will be an amplified equivalent of the peak input level.

To detect the magnitude of a negative peak, or the minima of bipolar signals, diodes D_1 and D_2 in the circuits described above can be reversed. Or the input signal can be connected to R_1 rather than the noninverting input of A_1 as in Fig. 3. Since this connects A_1 as an inverting amplifier, it can be used with most high-speed inverting-only op amps. Fast response is valuable to contrast switching time limitations faced by A_1 . If in addition to the change in input signal the diodes are reversed, the circuit again detects positive peaks and a fast, inverting-only op amp can still be used.

To minimize droop caused by the buffer amplifier input bias current, it is also sometimes desirable to use an inverting-only high speed amplifier, or a chopper-stabilized varactor amplifier. They all exhibit very low input bias current and low associated thermal drift. They can be used by connecting the holding capacitor in the feedback path of the output buffer, as in Fig. 4. Circuit operation is much like that of the circuit of Fig 3, and a detector gain greater than unity can again be attained by adding R_1 and R_2 .

When the input signal rises above that which is fed back at the junction of R_1 and R_2 , the output of A_1 swings negative. This forward biases diode D_1 and charges C_H . The output voltage (e_o) rises until the signal which is fed back matches the input signal. When the input signal begins to decrease, the output of A_1 at-

tempts to swing positive but is clamped by diode D_2 . Since diode D_1 disconnects C_H from positive signals, C_H holds the output voltage at the highest previous level.

Note that feedback is returned to the noninverting rather than the inverting input of A_1 , as there is now a phase inversion through A_2 . With the components shown, the circuit will acquire a 10V peak in 30 μ s; droop will be about 20 mV/s.

Specialized peak detectors

Simple modifications of the basic peak detector can easily solve specialized measurement problems. A peak-to-peak detector, for example, is well suited to measure bipolar, nonrepetitive signals, such as noise and ac signals having dc offsets. As long as the offset is smaller than the signal, a peak-to-peak detector rejects the offset component without resorting to coupling capacitors. This avoids the measurement delay normally imposed by coupling capacitor charging, a delay which is often the speed limiting factor in automated testing.

One way to form a peak-to-peak detector is to combine separate positive and negative peak detectors built similarly to Fig. 3. But four op amps would be required. Worse, the output would have to be measured differentially between the separate detector outputs, unless a fifth op amp were used as a difference amplifier to restore ground reference.

What's called for is a circuit with a ground referenced output, fewer op amps, and inherent droop compensation. Such a circuit, essentially a combination of the simple peak detector of Fig. 1 with that of Fig. 4, is shown in Fig. 5. It requires three op amps.

The portion of the circuit derived from Fig. 1 is the positive peak detector formed with A_2 , D_1 , D_2 , and C_1 . Although the input level to this detector is halved by the R_1 divider network, the output from C_1 is boosted by compensating gain in A_3 so that the overall gain is unity. In addition, A_3 combines with A_1 and, together with their feedback elements, form an inverting, negative peak detector similar to Fig. 4.

Here the output of the positive peak detector serves as the ground reference for the negative peak detector. Due to this choice of reference, A_3 adds the amplified output of the positive peak detector to that of the inverting negative peak detector. This sum is the peak-to-peak value of the input signal. The R_1 divider circuit

provides for referencing one detector to the other. The circuit is significantly more accurate than the earlier circuits because holding capacitors C_1 and C_2 are connected to both inputs of A_3 ; the input bias currents, which would otherwise create droop effects, are counteracting. Moreover, if the designer selects capacitor values carefully, the droop on C_1 caused by the input currents flowing to A_1 and A_2 can also be counteracted. If the three op amps have similar input bias currents, then the design center for droop compensation is $C_1 = 3C_2$.

Even better droop compensation can be achieved by experimentally adding capacitance to C_1 or C_2 . Otherwise, the accuracy limitations of the peak-to-peak detector are identical with the errors of the individual peak detectors described for Fig. 1 and 4. In fact, the error values of these basic peak detectors can be summed to find the errors of the composite peak-to-peak circuit if the effects of the R_1 and R_2 divider networks are accounted for. It should be noted, however, that as a result of the R_1 divider, the input offset voltage of A_2 will be doubled, causing twice the error. The R_2 divider multiplies the offset voltage of A_3 by two, and the associated increase in closed loop gain doubles the gain error of A_3 .

Operating speed is still limited primarily by mode switching times, but if R_2 is too large, the charging rate of C_2 will lengthen the acquisition time significantly. As with previous circuits, A_1 and A_2 must retain high input impedance during overload to avoid excessive drain on C_1 when either or both op amps are in a hold mode. Also, both A_1 and A_2 must be phase compensated for zero overshoot.

Absolute magnitudes

Another common peak-detector application is to detect the maximum excursion of a signal from a set point, such as the deviation of a process control monitor. Such deviations are often both positive and negative, and the two polarities cannot be monitored by one simple peak detector. An effective way to handle this, as shown in Fig. 6, is to combine a common positive peak detector and an inverting negative peak detector, and connect them to the same storage capacitor C_H and output buffer A_2 . Together, A_1 and A_3 perform as a positive peak detector similar to the circuit in Fig. 3. Positive peaks above the voltage across the capacitor will cause the

4. Other op amps. The benefits of some inverting-only op amps can be utilized if feedback is rearranged to use an inverting output buffer. This permits use of many feed forward and chopper-stabilized amplifiers. Also, the large capacitive loading effect of holding capacitor C_H is not transferred from A_1 to A_2 , and minimizes droop.

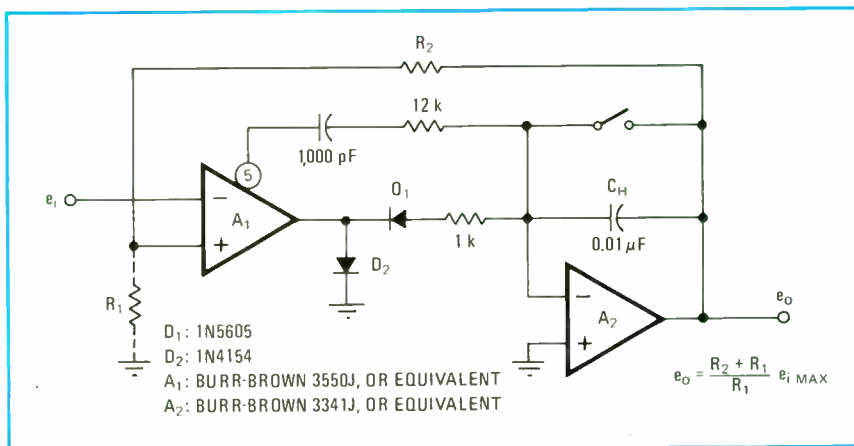

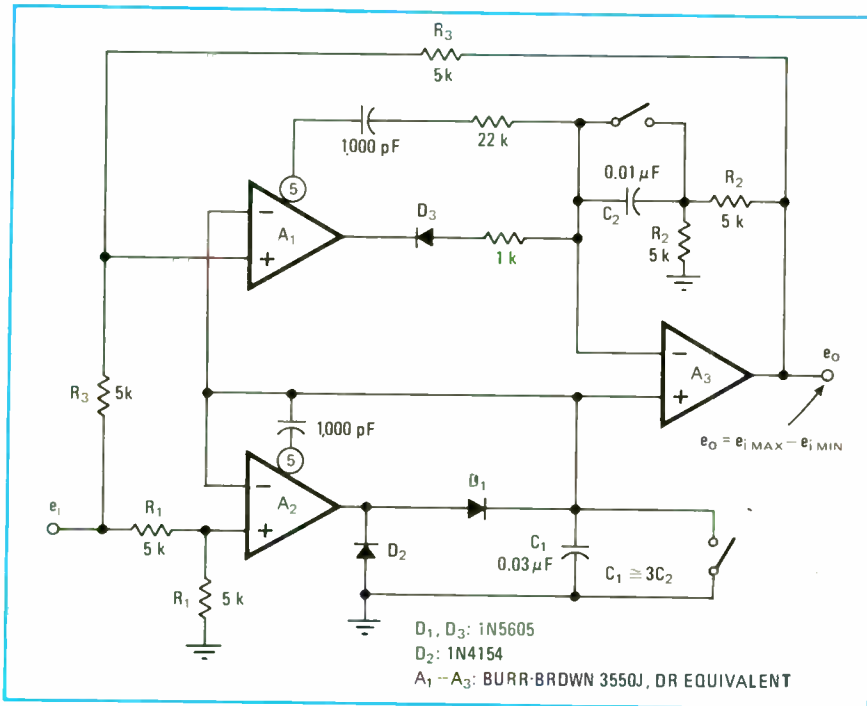

5. Peak-to-peak. A simplified peak-to-peak detector is formed by combining two simple peak detectors. A positive peak detector is formed by A_2 and A_3 , and a negative peak detector by A_1 and A_3 . Op amp A_3 sums the peaks, positive and negative.

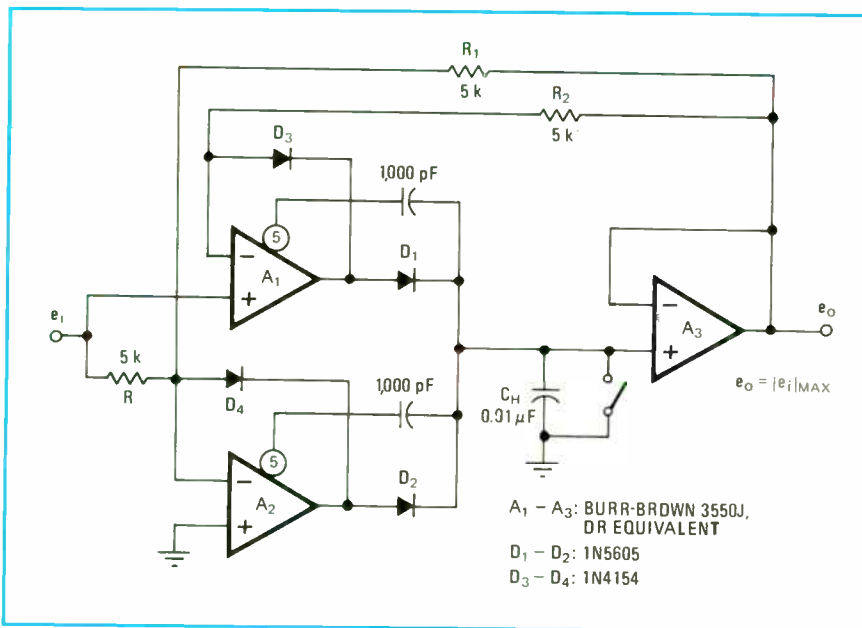

6. Absolute magnitude. A magnitude peak detector is put together in the fairly simplified combination of a positive peak detector and an inverting negative peak detector. A_1 and A_3 form the positive peak detector, A_2 and A_3 form the negative peak detector. The largest peak, either positive or negative, appears as output e_o .

output of A_1 to swing positive and increase the capacitor voltage to the higher input level. For negative signal excursions, A_2 and A_3 perform as an inverting negative peak detector. If the magnitude of a negative excursion exceeds the voltage stored, the R_1 feedback network will drive the inverting input of A_2 negative. This causes the output of A_1 to swing positive to charge the capacitor until $e_o = -e_i$ and the inverting input of A_1 is driven via resistor R_2 until A_1 's two inputs are equal.

Both positive and negative peaks charge holding capacitor C_H positive, so the detector output is independent of the polarities of the signal peaks. Accuracy and speed limitations are similar to those discussed for the detector in Fig. 3, plus those of a common inverter added by A_2 , and any overshoot error.

The magnitude peak detector of Fig. 6 can be modified to deliver a gain greater than unity by altering both the positive and negative detector feedback paths. To increase positive detector gain a resistor may be shunted to ground from the inverting input of A_1 as shown in Fig. 3. A similar gain increase for the negative detector is developed by making feedback resistor R_1 in Fig. 6 greater than R , just as is done for an inverting op amp with gain greater than unity. □

BIBLIOGRAPHY:

1. G. Tobey, J. Graeme, L. Huelsman, *Operational Amplifiers—Design and Applications*, McGraw-Hill, 1971
2. J. Graeme, *Applications of Operational Amplifiers—Third Generation Techniques*, McGraw-Hill, 1973.
3. J. Graeme, *Peak Detector Advances Increase Measurement Accuracy, Bandwidth*, EDN, Sept. 5, 1974, p. 73

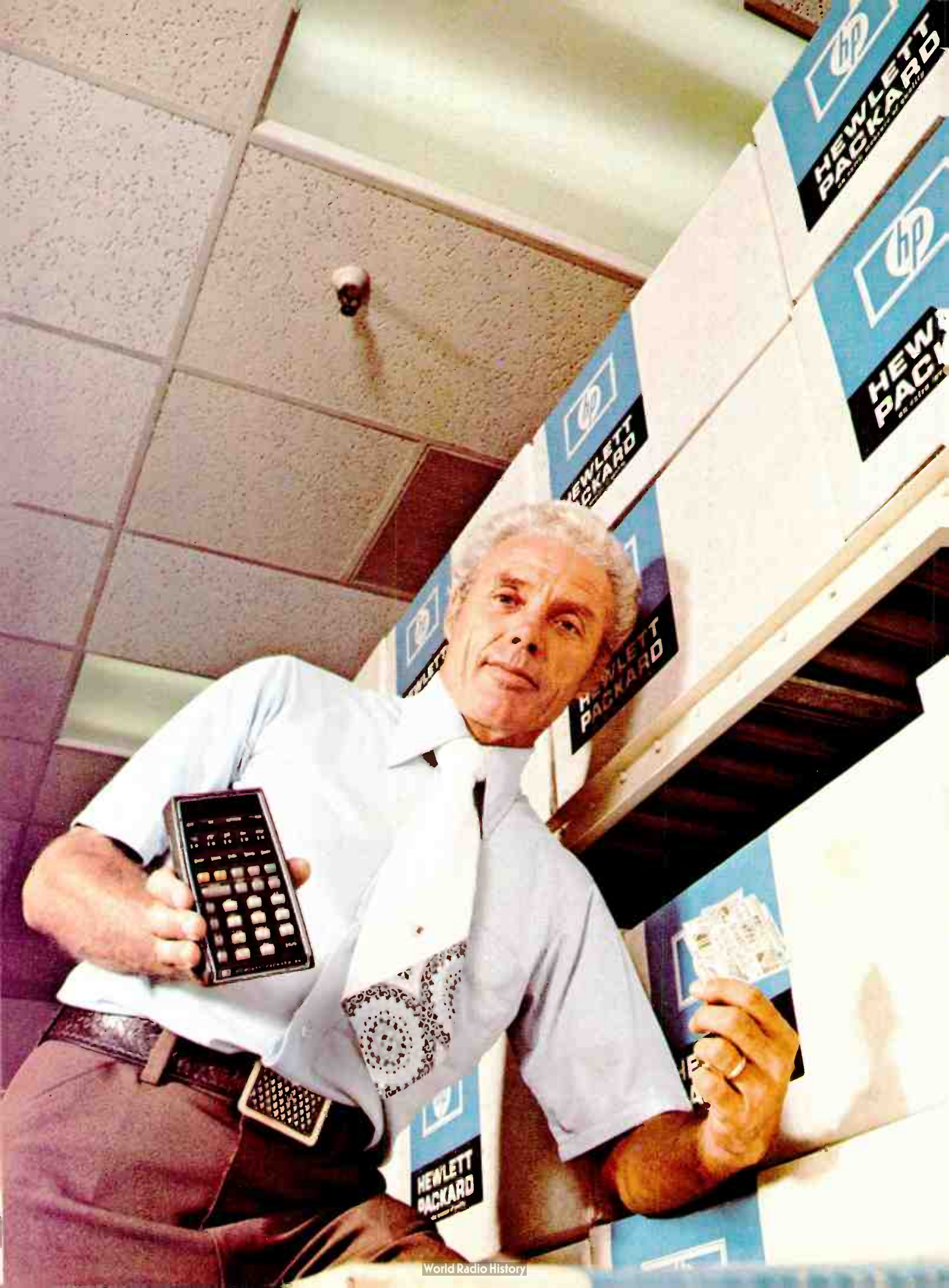

"My records prove it. Photocircuits shipped us over 1/2 million PCBs for calculators. Less than 1% were rejected."

Tom Miller, Production Control Supervisor, Hewlett-Packard

"I supervised in-house production of printed circuitry for Hewlett-Packard. When the demand for our pocket-sized calculators taxed our own capacity for making printed circuit boards, I had to look outside the company.

"The scientific and business calculators Hewlett-Packard makes have infinitely more functions than the typical 'house-wife' variety. And we have sold over one-half million of them. So we needed large volumes of quality boards for logic and battery charger applications.

"Photocircuits' reputation for quality was confirmed by my first visit.

"I've been in this business since 1955, so I knew of Photocircuits even before we made a facilities check. What I had heard proved to be true. Their overall efficiency was evident and everyone seemed to know what they were doing.

"We had no qualms about dealing with an East Coast house either. They were only a short 5 hours away by plane. And seconds away by WATS line. In fact, when we asked for price quotes, they got back to us within ten days. And that

included mailing time.

"Their price was lower and they delivered what they promised.

"Long Island labor costs are comparable to the West Coast, but Photocircuits still managed to beat local prices. To me, that's another indication of overall efficiency.

"And even though we hit them at the same time as everyone else, Photocircuits guaranteed they would deliver a certain number of boards every week. They kept that promise.

"Quality-wise, they were the best boards I've seen in twenty years.

"We have some very stringent standards at Hewlett-Packard. Not only do we expect operational quality, but esthetics as well. If a customer tears the cover off one of our products, we want our components to look good.

"In both cases, performance and looks, Photocircuits was outstanding. Over half a million boards have been delivered. Less than 1% have been rejected for any reason whatsoever.

"What more is there to say?"

Photocircuits

Division of Kollmorgen Corporation, Glen Cove, New York 11542 (516) 448-1000

Printed circuitry for mass-produced electronics

Pretrigger recording

The Biomation demonstration

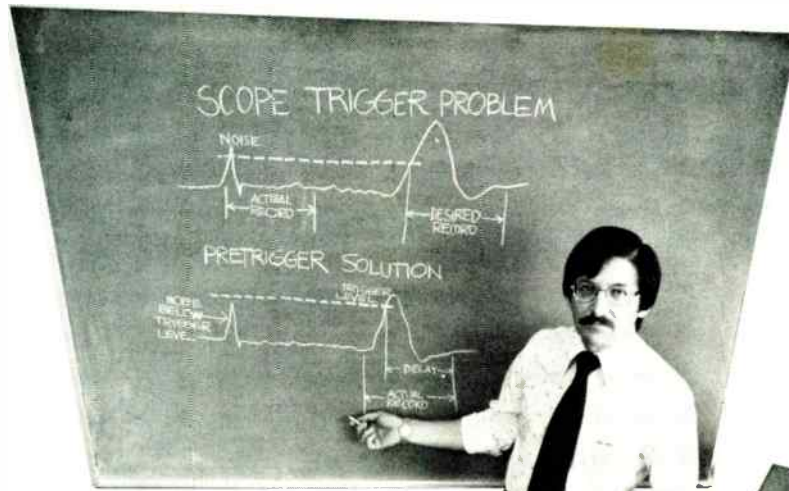

Pretrigger recording is a simple concept. And it is the most powerful recording method for short-lived signals. But Roy Tottingham, Biomation Product Manager, has found that almost no one grasps its usefulness until shown a demonstration. So here's his demo.

"Let's start with the familiar, then move to the unfamiliar. You work with scopes now, right?"

"Right."

"Good. And scopes do a fine job catching repetitive signals for analysis."

"No sweat. But my signal is a unique waveform—once per test shot."

"Exactly—A classic job for one of our waveform recorders with pretrigger recording—this Model 8100, for instance. Its 25 MHz bandwidth is ideal for a wide range of waveforms. Let's connect your signal and I'll show you why."

"O.K."

"Set the input coupling and sensitivity and select the timebase for the signals' duration. Next choose the trigger coupling, polarity and internal source."

"Say, that's just like a scope setup."

"You're right! But if this was a typical scope/camera or storage scope capture, we would now face what I call the trigger level dilemma."

"What's that?"

"Set the trigger level low and we risk triggering on noise or signal echoes. Or set the level high and the scope loses most of the leading edge. Here, like this upper trace on the chalkboard."

"Arrgh! That gets me where I live! I tried solving that problem with a special trigger detector and trigger path to externally trigger my scope, but that was a pain to set up and only worked about half the time."

"M-hmm, twice the cost and half the reliability... nobody wins."



"You mean... this Biomation box gets around all that hassle?"

"With the waveform recorder in pretrigger mode, we can't miss. Let's set the 8100's trigger level high and its trigger delay to about 80% of the record length. Now I'll reset the trigger circuit and you can trip your test anytime you want!"

"O.K. Here goes."

"And there you have it!—on the CRT monitor output of the 8100!"

"Wow! Look at that leading edge trigger point! 20% from the left end of the trace. What do you have in that 8100? A superfast disc or tape loop?"

"No way! The 8100, like all of our waveform recorders, uses a superfast A/D converter and semiconductor memory for recording."

"But how does that give me pretrigger data?"

"In pretrigger mode, the delayed trigger is used to stop recording, not start it. So the memory can be continually updated with the newest data from the A/D—in real time—until the trigger is detected. Then it's stopped after the trigger delay. Here, I'll illustrate this effect on the board. The stored signal is then repetitively reproduced through a D/A for display on a scope or CRT as you see here. Or you can output it slowly onto a chart recorder."

"Hey! That's a clean deal! Does it have digital output too?"

"Of course, and we also have models with digital input for recording digital signals. One of our units is sure to fit your need."

So there's the demo. Now if you want data sheets or applications ideas, drop us a line, Biomation, 10411 Bubb Road, Cupertino, CA 95014. (408) 255-9500.

biomation

ROMs in microprocessors can test themselves

by John B. Peatman,* David G. Dack, and David A. Warren, Hewlett-Packard Ltd., South Queensferry, Scotland

Read-only memories that contain the programs and constants needed in a microprocessor-based system can be given self-test capability by reserving one word of the ROM for a bit-for-bit parity check on all the other words. The approach can detect any of several possible ROM malfunctions.

As illustrated in the diagram, the check word can be, but need not be, the last word in the memory. Each of its bits is selected to force an odd number of 1s (odd parity) in the corresponding column of the ROM. Even parity won't work.

To check the contents of the ROM, the microprocessor reads out every word in the ROM and performs a cumulative parity check—an exclusive-OR operation on each bit. At the end, the result should be a 1 in every bit position of the accumulating register.

If the specific microprocessor's instruction set doesn't include an exclusive-OR instruction, it can execute the equivalent operation in a subroutine.

This self-test always detects single errors, whole-word errors, data output lines stuck at 1 or 0, and address input lines stuck at 1 or 0. It sometimes detects address lines short-circuited to each other, output lines short-circuited to each other, and multiple random errors. Each of these has its own effect on the test.

Single errors occur at random as a result of flaws in the chip, or occasionally when a bit in a programmable ROM reverts to its unprogrammed state—unlikely in recent versions of programmable ROMs. Any single error changes the parity of its column from odd to even.

Multiple errors in a single word change the parity of every column involved. They occur only rarely.

If a data output line is stuck at 1 or 0, there may be a short circuit to ground or to a power line from wiring connected to that output, or the output driver circuit may be dead. Since most ROMs have a total capacity equal to a power of 2, the number of words is even, and the stuck output line looks like an even number of 1s or an even number of 0s—thus creating an even parity. (This is one reason why even parity in the check word won't work.)

If an address input line is stuck at 1 or 0, it may similarly indicate a short circuit somewhere in or near the ROM, or a dead bit position in the address input buffer. This fault renders exactly half of the words inaccessible; an attempt to read all the words in the memory will read the other half twice, necessarily generating even

parity. (Even if a user perversely loads a whole ROM with two identical groups of words, contents of the one location reserved for a check word must necessarily be different from its image in the other half of the memory.) Likewise, if two address lines are stuck, a sweep of the ROM reads one quarter of the words four times, again giving even parity.

Of the kinds of fault detected with uncertainty, short circuits in address and data lines can occur either on the chip or in associated wiring. A short circuit between two address lines causes the lines always to have the same logic state. They correctly address one quarter of the words in the ROM when they both should be 0, and another quarter when they both should be 1; but when they are supposed to be different, for access to the remaining half of the ROM, they address one of the same-state quarters instead. Which quarter is addressed depends on the circuit family and the definition of the 1 and 0 states; in some cases a short-circuited 0 pulls a 1 down, while in others a 1 pulls a 0 up. This may or may not cause a parity error; if the inaccessible words themselves have even parity in all columns, the remaining words generate odd parity and thus don't upset the check-word parity. Assuming the distribution of 1s and 0s in the ROM to be random—an assumption that's not necessarily justified—the probability of an error in any one column is 0.5, and the probability of an error somewhere in n columns is $1 - (0.5)^n$. If $n = 8$, this probability is 0.996, which is close to certainty.

If two output lines are short-circuited, those two lines always present the same bit pair, either 00 or 11, regard-

ROM ADDRESS	ROM CONTENTS			
0 0 0	1	0	1	0
0 0 1	0	1	1	0
0 1 0	0	1	0	1
0 1 1	1	1	1	0
1 0 0	0	1	1	0
1 0 1	1	0	1	1
1 1 0	0	0	0	0
1 1 1	0	1	0	1
	1	1	1	1

← CHECK WORD

← PARITY

Self test. Reserving one location in a read-only memory for a check word enables a variety of faults in the ROM to be detected.

*Now at Georgia Institute of Technology, Atlanta, Ga.

Move up in performance, or down in price.



If you've been sacrificing oscilloscope specs for price, now you can move up in performance. Or, if you're used to high performance, you can keep it and pay less. Because HP's new 1720A has the specs you want at just \$3,400.* In fact, for less than the price of its nearest competitor, you can get the 1720A and still have money left over to buy an HP model 45 calculator, and a 970A probe digital multimeter.

This scope's 275 MHz bandwidth spec holds over the entire viewing area... on all deflection ranges... in both input impedance modes... whether the amplitude vernier is used or not... from 0 to 55°C.

Stable triggering lets you change

position, vernier, and polarity controls without losing sync. It triggers on low-level signals, yet refuses to double trigger on noise. And it triggers well beyond its bandwidth—often to 400 MHz or above.

Fast linear sweeps and a wide 10 cm screen give you high resolution for accurate high-speed digital timing measurements. Flood guns provide a display that's easy to view and photograph. And the logical layout of color-coded controls make this new high-speed scope a pleasure to operate.

Custom ICs and improved packaging provide a new dimension of simplicity in calibration and servicing (internal adjustments have been cut

about in half compared to other scopes in its class). And a lower component count means higher reliability—over 3,500 hours MTBF.

Any way you look at it—comparing features, or figuring cost of ownership—the 1720A gives you exceptional scope value. So move up in performance... or down in price, with HP's high-performance 1720A. Just contact your local HP field engineer. He'll also give you details on our new 200 MHz 1710B, at just \$2,625,* for field-service applications.

* Domestic USA prices only.

084/8

HEWLETT  PACKARD

Sales and service from 172 offices in 65 countries.
195 Page Mill Road, Palo Alto, California 94306

Circle 154 on reader service card

less of the true contents of the addressed word. Which pair is presented again depends on the circuit family and the logic state definition. With a random distribution of 1s and 0s, half the words will present an incorrect bit in one column or the other.

For multiple random errors in the ROM, even parity

results if any column has an odd number of errors.

The self-test is intended to be performed on individual ROM chips, each with its own check word, even if the system contains multiple chips. This pins down the location of detected errors to particular chips, which a single check word over a whole system can't do. □

Scanning only bright spots generates CRT characters fast

by P.V.H.M.L. Narasimham
Indian Institute of Technology, Kanpur, India

Generating dot-matrix characters on cathode-ray-tube screens wastes more than 50% of display time when, as is usually the case, the beam scans every point of the dot matrix, whether bright or dark. But if the beam scans only the bright spots of the matrix for each character, the flicker-free display capacity of the CRT is more than doubled, with no increase in bandwidth and without substantially increasing the memory and control logic requirements.

In the conventional approach, the entire 5-by-7 dot matrix is generated from a read-only memory that stores 35 bits per character, or a total of 2,240 bits for the standard Ascii font of 64 characters. This approach requires a bandwidth in the associated circuits of about 2 megahertz, well within the 2.5 MHz maximum of television-type CRTs.

1. Common spots. Many alphanumeric characters generated within a 5-by-7-dot matrix overlap at certain matrix points, which can therefore share memory space. At bottom left, overlapping representations of B, D, and F are shown.

2. Coordinates. Every point in a 5-by-7 matrix can be represented by a two-digit number (bottom middle) that designates the row and column of that point.

3. Seven characters. The eight coordinates in color (right) are common to B, C, D, E, F, the letter O, and the numeral 0. Other listed coordinates are the remainder for these characters when the control logic enters and leaves the list as shown.

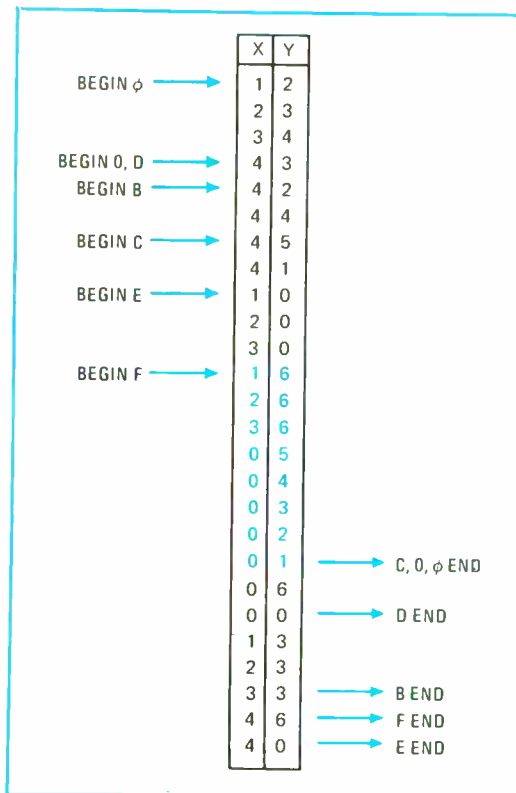
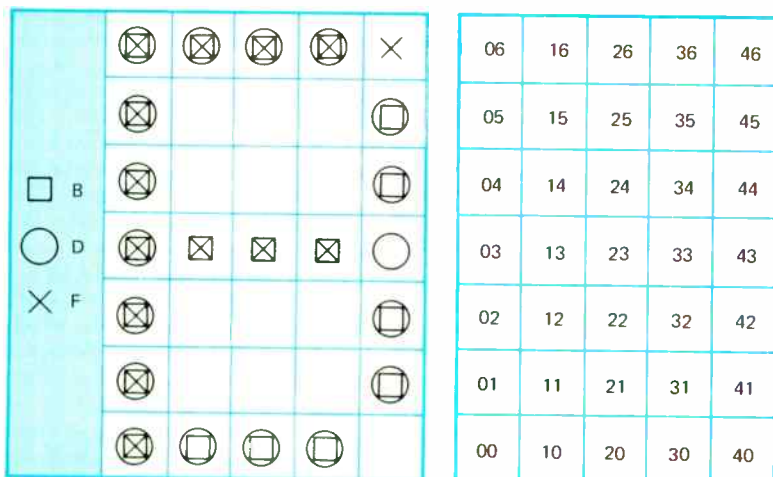

Providing that the refresh rate and bandwidth are fixed, reducing the number of dots per character has the effect of proportionately increasing the number of characters per frame without introducing flicker. One way to reduce the number of dots per character is to scan only the bright spots.

To scan the bright spots directly, a position code must be supplied for every bright spot. For the dot matrix's 35 possible positions, the position code must have six bits, which can be divided into two three-bit fields for row and column codes, corresponding to the three-bit counters in the point-to-point scanning method. If this six-bit code were stored independently for each character in a font of 64, which contains about 800 bright spots, it would require a ROM of 4,800 bits. But the order of scanning the bright spots is immaterial; exploiting this fact facilitates packing bright-spot data in fewer than 2,400 bits—a slightly larger number of bits but a much faster scan.

Several bright spots are common to many characters, which therefore can share common storage. These characters can be grouped; one such group, for example, is B, C, D, E, F, the letter O, and the numeral 0 (printed here with a slash, as computer output printers often show it, because the standard dot-matrix representation

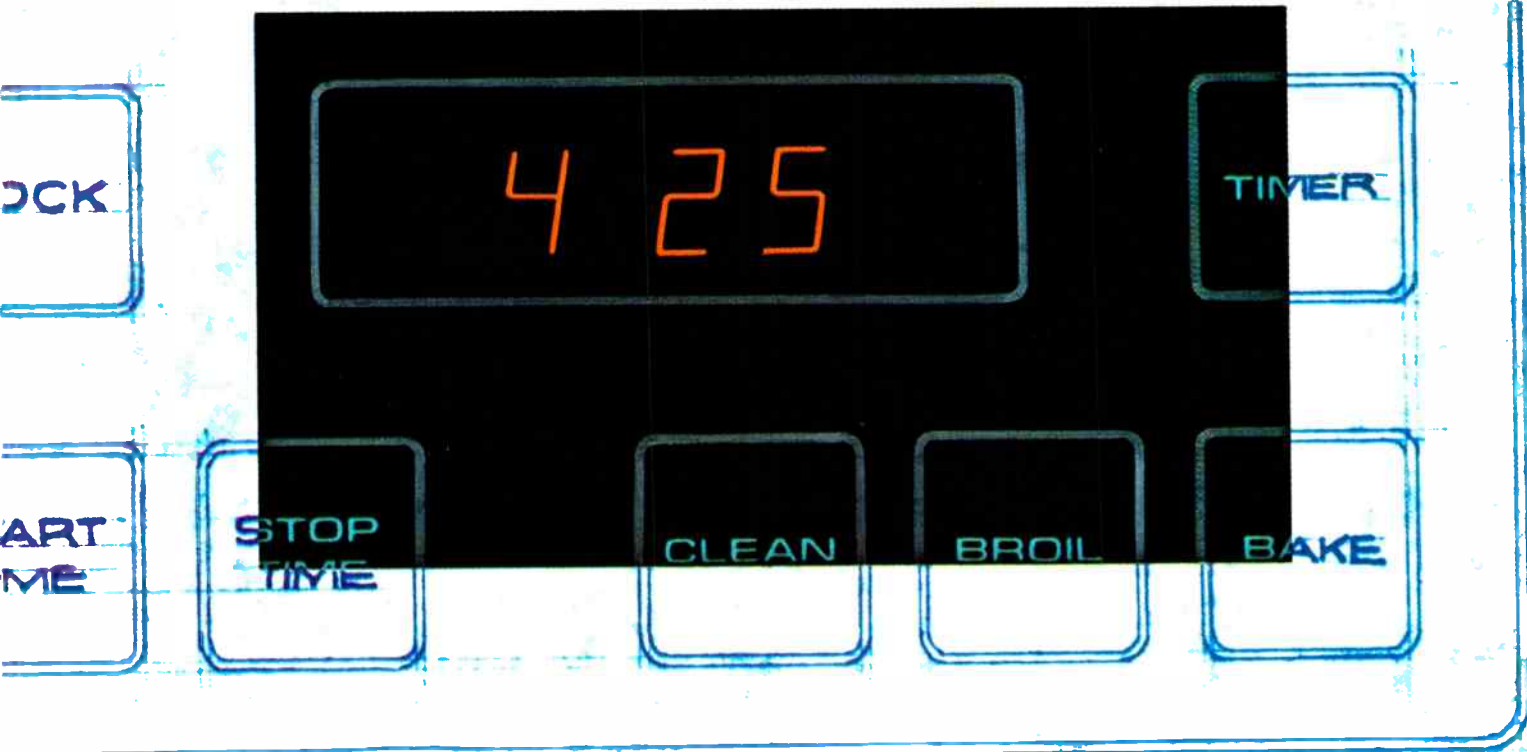

OVEN CONTROLS

OVEN CLEANING: LATCH DOOR THEN TOUCH CLEAN

ROTISSERIE SET AT 375

BROIL VALUES RARE MEDIUM WELL
1 . . . 2 . . . 3 . . . 4 . . . 5

Better looking Beckman Displays are ideal for modern appliances



Beckman Displays are finding their way into hundreds of new designs. A major appliance manufacturer has incorporated Beckman Displays in the control panel of an advanced new range and oven.

Two major brands of television sets use Beckman Displays in their tuners for channel call-outs. And, of course, Beckman Displays have been selected for a wide variety of technical instruments.

There are many reasons why Beckman Displays are chosen

for these applications. First, of course, is the appearance of the displays — they look better. Crisp, clear, unbroken numerals that are easy to read. A neon orange color (red is available with filters) that's pleasing to the eye and bright enough (210 foot lamberts) to be read even in direct sunlight.

Add to this the low cost (less than \$1 per digit in large OEM quantities), the ease of application, the reliability, and you have the ideal display for today's appliance designs. See for yourself. Compare Beckman 1/3" and 1/2" Displays side-by-side with LED's or any other display. You'll choose Beckman because they look better, are better.

For the telephone number of your Beckman/Helipot sales office, or the name of your Beckman stocking distributor, call toll free (800) 437-4677. Or write, Beckman Instruments Inc., Information Displays Operations, P.O. Box 3579, Scottsdale, Arizona 85257.

Beckman

HELIPOT DIVISION
INFORMATION DISPLAYS OPERATIONS

Circle 156 on reader service card

There's more eye appeal in Beckman Displays!

World Radio History

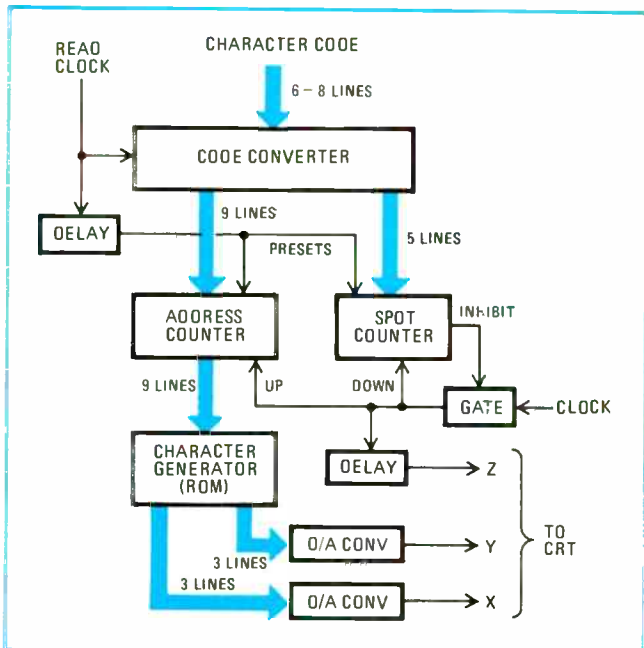

4. Character generator. This logic produces beam deflection and blanking information for a CRT to generate alphanumeric characters without wasting time at matrix points that remain dark.

also has a slash to distinguish \emptyset from O). All of these seven characters have bright spots in the middle three of the top row of five, and in all but the top and bottom of the left-most column of seven. Commonality for B, D, and F is illustrated in Fig. 1.

The coordinates of the 5-by-7 dot matrix can be represented by a two-digit number representing the X and Y coordinates, respectively (Fig. 2). A list of these coordinates, in any order, can be scanned to obtain the common parts of many characters; and often the non-common parts can be represented by other lists appended above or below the common list. For example, the list of eight coordinates at the center of Fig. 3 represents all the common points of the group of seven char-

acters mentioned previously. The other coordinates in that list represent every bright spot of all seven characters when scanning begins and ends at the points shown. The spots need not be scanned in sequence.

In general, such close packing isn't possible for all characters; but the standard Ascii font can be represented by as few as 380 coordinate pairs of six bits each, overlapping for points common to many characters. This list may be reduced still further by about 10 locations by carefully matching patterns. Space does not permit the entire list to be reproduced here.

Character generation from this overlapped memory requires a starting address, the number of bright spots per character and control logic (Fig. 4). The list's words call for a nine-bit starting address code, which points to the location just before the actual starting address. In this font, the maximum number of bright spots for one character is 20 (for B, @, and #), requiring another five bits. This 14-bit character-generating code requires a converter driven by the character code, which is seven bits in Ascii, six or eight bits in certain other codes. This converter's output presets two counters; clock pulses increment the nine-bit address counter and decrement the five-bit spot counter. When the latter reaches 0, the preset number of steps have been applied to the address counter, producing that many bright-spot coordinates of the character. Each clock pulse, delayed, also unblanks the CRT beam to produce a bright spot on the screen after the beam has moved to the position specified by the coordinates.

The character generator for the new method doesn't differ appreciably in cost from the conventional type, especially in view of the shrinking costs of MOS memories. The two- to three-fold increase in the flicker-free display capacity warrants pattern matching to pack bright-spot data as densely as possible. For the 5-by-7 matrix on the average, 35% to 40% of the dots are bright, but for larger matrixes, the percentage drops—to perhaps 20% for 16-by-16 and larger—and the increased capacity of the new method becomes more apparent. □

Low-frequency discriminator utilizes analog delay

by Satoru Tanaka and William L. Brown,
Reticon Corp., Mountain View, Calif.

Low-frequency discriminators, which translate frequency-modulated signals having center frequencies from a few hundred to a few thousand hertz into direct analog signals, are vital components in equipment such as doppler tracking systems and servo motor control systems. But they have been cumbersome because of the requirement for very large inductors and capacitors. That no longer need be true, however, with the advent of the discrete time analog delay.

The approach employed here (Fig. 1) is a low-fre-

quency equivalent of a technique that is common at much higher frequencies. The amplitude of the incoming signal is clipped by the limiter, becoming, in essence, a square wave. The square wave is then split in two; one signal goes directly to one input of a four-quadrant multiplier; the other is first delayed, then applied to the other input of the multiplier. The output voltage of the multiplier is inversely proportional to the

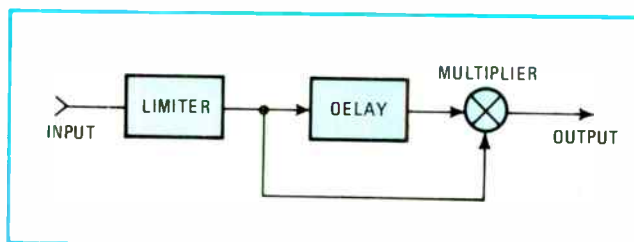

1. Principle. Clipped input, multiplied by a delayed form of itself, produces an averaged output proportional to input frequency.

TRW connects with Celanex. At 1/3 the cost of DAP

Based on a very thorough material comparison, Cinch Division of TRW Electronic Components now molds these printed circuit edge connectors, shown below, in flame-retardant Celanex SE-O—replacing DAP and glass-filled phenolics. Why? Celanex cuts molded insulator costs by a whopping ⅓. And insulator properties in Celanex are equivalent or better.

Fact is, for electrical/electronic connectors, glass-filled Celanex thermoplastic polyester combines all the advantages of DAP and phenolics. With none of their disadvantages.

Celanex is faster cycling than all thermosets. By far. Easier to mold in thin-walled sections. And Celanex scrap can be re-ground and reused. Another cost-saving.

Celanex is rigid, for support of the printed circuit board. It will withstand severe shocks to thin-wall parts. It's dimensionally and electrically stable at elevated temperature and humidity. And it resists strong chemical solvents and cleaning solutions.

Maybe Celanex has so much going for it because Celanex was the first to market a thermoplastic polyester. We have more ex-



perience and far greater depth of data to offer you. It's yours for the asking. Celanese Plastics Company, Dept. X-602, 550 Broad Street, Newark, New Jersey 07102.

Celanese Plastics Company is a division of Celanese Corporation. Canadian Affiliate: Celanese Resources, Ltd. Export: Amcel Co., Inc., and Pan Amcel Co., Inc., 122 Fifth Ave., New York 10036.

Celanex: the original thermoplastic polyester

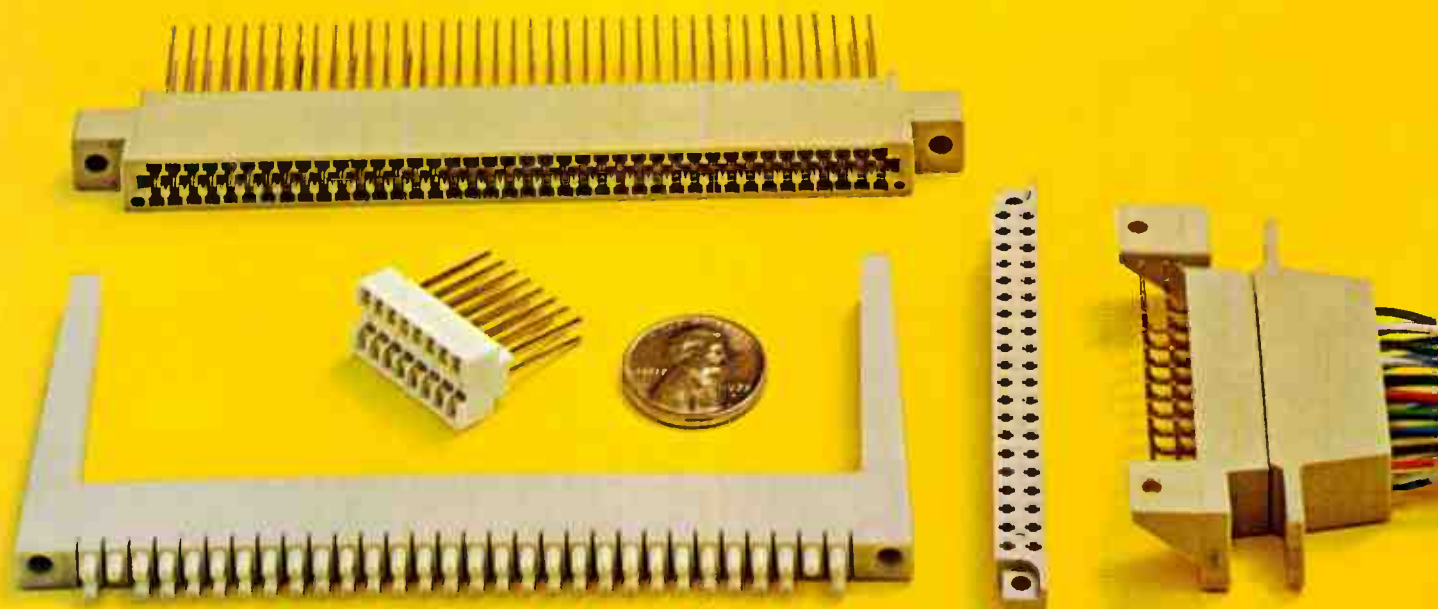

Molder: Woodland Engineering Company, Libertyville, Illinois

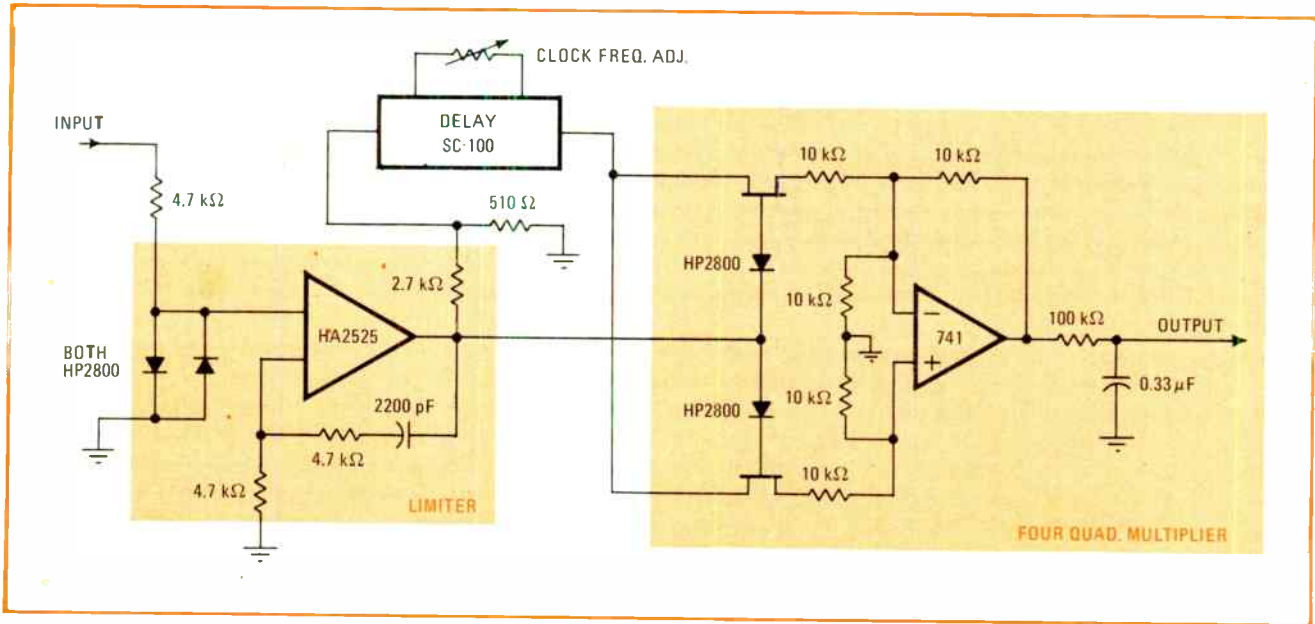

2. Implementation. Discriminator circuit is based on principle of clipping, delaying and multiplying, as shown in Fig. 1.

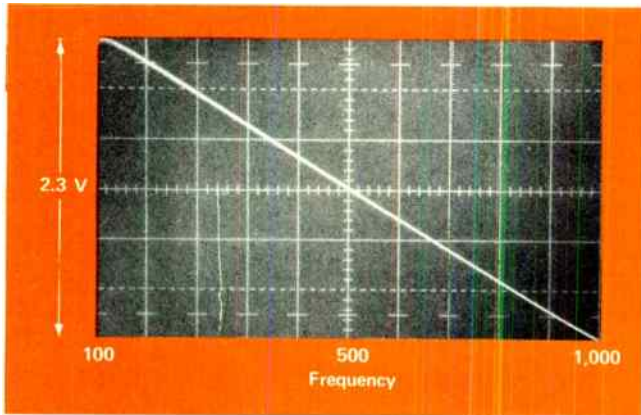

3. Result. Output voltage decreases linearly with swept frequency.

phase difference of the two signals. But since the time delay is fixed, the change of phase imposed by the delay line is directly proportional to the frequency; therefore, when the phases are compared in the multiplier, the output is inversely proportional to the frequency.

The delay line, one of the two key elements of the circuit, is a monolithic integrated circuit: Reticon Corp.'s SAD-100, fabricated with MOS silicon-gate technology and packaged in a 16-lead dual in-line package. The SAD-100 is essentially an array of 100 sample-and-hold circuits. It stores analog information sequentially in an array of 100 storage capacitors. Each capacitor has two multiplex switches—one for reading a sample of data onto the storage capacitor, and one for transferring the stored data from the storage capacitor to the output. A dynamic shift register operating as a ring counter sequentially activates the two multiplex switches. As the n th capacitor acquires a new data sample, the data which was stored 100 clock pulses earlier on the $(n + 1)$ th capacitor is transferred to the output. No data is transferred from cell to cell within the array, as is done with charge transfer devices, in which the multiple transfer can cause signal degradation.

The total delay range of the SAD-100 is from 700 nanoseconds to 50 milliseconds; it is controlled by its sampling frequency. Its delay-to-rise-time ratio is 98, its video bandwidth exceeds 5 megahertz, and under certain conditions its signal-to-noise ratio is greater than 65 dB. The SAD-100 is obtainable separately, or as a component in a network, designated the SC-100, which includes clocking and signal extraction circuits.

The four-quadrant multiplier, as a phase comparator, is used in the conventional way. Its two input values are $+1$ and -1 ; it multiplies the two signals to obtain one of four products: $+1 \times +1$, $+1 \times -1$, $-1 \times +1$, and -1×-1 . If two square waves that switch between $+1$ and -1 with identical frequency and phase are continuously multiplied, the product would be $+1$ at all times. Likewise, if the signals' phases are 180° apart, the product is -1 at all times. Thus, if the phase is continuously shifted between 0 and 180° , the average output is somewhere between these extremes, proportional to the phase. If the amplitude is some value other than unity, a corresponding constant factor is included.

In the actual circuit (Fig. 2), the time delay depends on the clocking frequency, which is continuously variable from 3 kilohertz to 10 MHz. For this discriminator the clock was set to produce a delay of approximately 500 microseconds, which shifts the phase of a 1,000-hertz signal by 180° . Lower frequencies down to 100 Hz are shifted proportionally. This circuit's linearity over a range of 10:1 is better than 99%; its maximum frequency can be shifted as high as 100 kHz by adjusting a single resistor. No tuned circuits, bulky coils, or capacitors have to be changed.

Figure 3 is a photograph of the output voltage as the frequency is swept from 100 Hz to 1,000 Hz. The output does not change noticeably as the input to the limiter is varied between 0.5 v and 30 v peak-to-peak. □

Engineer's Notebook is a regular feature in Electronics. We invite readers to submit original design shortcuts, calculation aids, measurement and test techniques, and other ideas for saving engineering time or cost. We'll pay \$50 for each item published.

**See for yourself
how efficient this
dc-dc converter is**

The way to build a high-efficiency dc-to-dc converter is to use a switching converter based on one of its ferrite toroids, according to Ferroxcube Corp. And to prove that's not a biased opinion, the company says it will give all comers a small design kit containing a ferrite toroidal core and a detailed diagram for the construction of a 12-to-150-volt, 4-watt converter with an efficiency better than 80%. Write to John Turnbull, Ferroxcube Corp., P.O. Box 359, Saugerties, N.Y., 12477.

**Top people
to teach about
information displays**

We recently heard about a series of seminars on information displays that are headed up by some of the top people in the field. All the meetings will be held in New York City, but you'll have to contact I.F. Chang, at IBM's Thomas J. Watson Research Center, Yorktown Heights, N.Y., 10598, (914) 945-1234 or 945-2041, to find out the exact location for each meeting. The next one, set for Dec. 4, covers integrated thin-film devices and circuits for information displays, and it's being given by T.P. Brody of Westinghouse Laboratories. On Jan. 22, Lucien Bieberman of the Institute for Defense Analysis will cover camera-type imaging tubes and systems. Future meetings will cover electroluminescent thin-film displays, multiplexed airborne display systems, and human factors in displays. All the meetings begin at 7:30 p.m.

**Converting
semilog decades**

If you already know this, raise your hand. Semilog graph paper, though it's calibrated in decades of 1.0, can be easily converted to span a new set of decades by multiplying the log values by a constant. Thus, if you want to display a plot of audio response covering, say, 20 Hz to 20 kHz, don't reach for the four-cycle semilog paper; three-cycle paper will do the job. Simply multiply the abscissa values by 20, and you'll have a much neater, more precise display of your data. You can thank Glenn Darilek, Southwest Research Institute, Dallas, for this one.

**Putting the heat
on a transistor
without an oven**

To remedy drift in a transistor that's subject to large variations in ambient temperatures, you can put it in an oven, but that's an expensive, bulky proposition, observes Brother Thomas McGahee of the Salesian Center in Columbus, Ohio. A dual transistor is better, he says, if one of the transistors is strongly biased on with a resistor between its collector and base, so that its mate on the same chip heats up. Usually only a few milliamperes are enough to heat it. The transistor can then be freely connected in the circuit of your choice.

**Modulation basics
available
on video tape**

Pass this one on to your company's training supervisor: Hewlett-Packard is offering the first of three video-tape programs on modulation fundamentals, aimed at students and technicians. "Amplitude modulation" covers single- and double-sideband, suppressed-carrier, and vestigial-sideband modulation. Soon to come are tapes that explain angular modulation (fm and pm) and pulse modulation and multiplexing techniques. The a-m tape, available from HP at 1501 Page Mill Rd., Palo Alto, Calif., 94304, is in 1/2-inch reel-to-reel or 3/4-inch video-cassette formats. Cost is \$140.00 per tape.

These ideas for cooling board-mounted semis could improve your circuit's performance

Thermal management is a highly versatile and valuable circuit design tool that can be used to increase semiconductor power, increase circuit density (or reduce the number of semiconductors), improve switching

and temperature-related rise and fall characteristics, increase small signal gain and DC beta, match operating characteristics of two or more devices, improve reliability and cut costs. Here are some ways circuit de-

signers have used IERC heat sinks/dissipators to beat printed circuit board-mounted semiconductor heat problems in order to improve their circuits, ideas that may be of help to you.

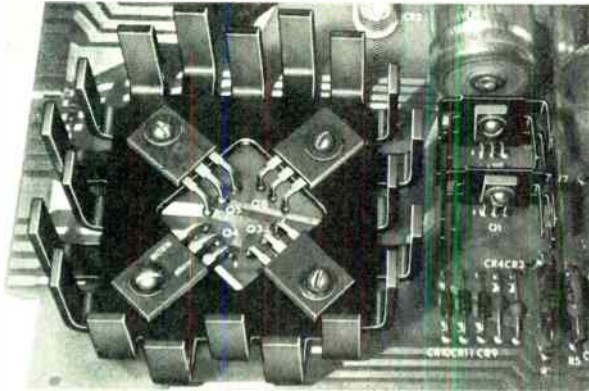

Four times the power from four power plastics took just one IERC dissipator. Bare transistors were capable of only 2 watts with 102°C substrate rise above ambient so designer used modified HP3 dissipator and got 8 watts from each at the same temperature rise. Or you could improve transistor life — roughly 7 times — by operating the devices at 2 watts and letting the same dissipator keep the substrate temperature rise to 32°.

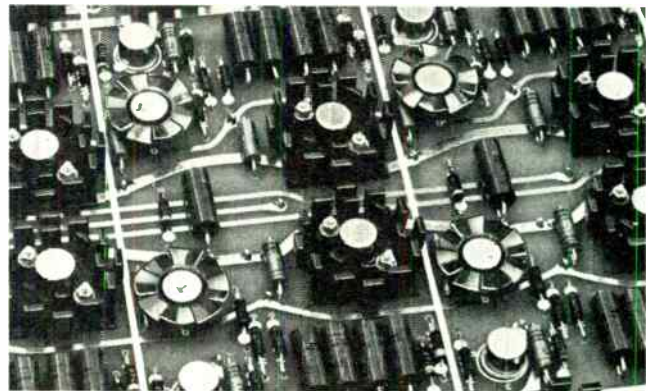

Temperature matching at varying power levels is easy with the wide variety of IERC dissipators. On this board problem was to keep TO-5s at approximately equal case temperatures although some were operated at 2.2 watts and others at 1 watt. Press-on Fan Tops costing pennies kept 1 watters at 55°C case rise above ambient while LP dissipators held 2.2-watt devices at nearly identical case temperatures. IERC Insulube® coating permits mounting LPs directly on printed circuit lines.

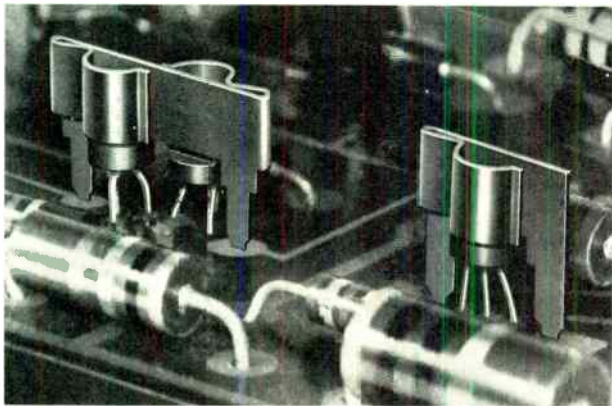

Dissipators protect circuit — Designer of this TV circuit made sure dissipators would stay when D-case devices needed replacing. He designed dissipators as a part of the circuit, making it impossible to fire the circuit without them. In addition to this circuit protection the dual "Universals" gave him some other benefits: excellent retention in shock/vibration environments, good heat sinking during solder operations, and they cost just pennies.

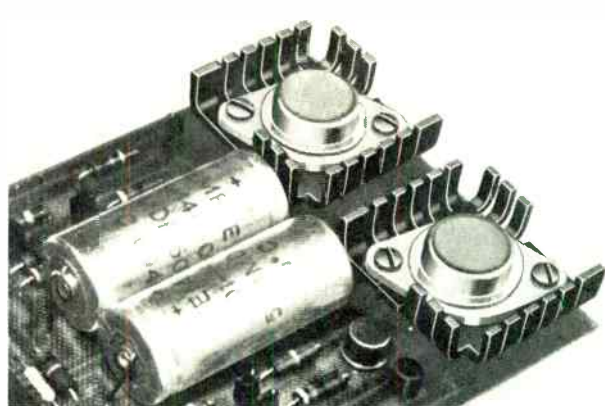

Lower cost per unit was result of replacing four TO-3s used in this 10-watt power supply with two TO-3s in UP3 dissipators. Dissipators allow two TO-3s to operate at 5 watts each with same 65°C case rise above ambient as four devices operated at 2.5 watts each. Low profile dissipators plus TO-3s were assembled in less space allotted to four transistors. New design saved money, improved reliability and eliminated troublesome charring of G-10 board.



For more information

on heat sinks and dissipators for milliwatts to kilowatts, send for the IERC Short Form Catalog today. It covers the most complete line of thermal problem solving devices available anywhere.

IERC



Heat Sinks/Dissipators

INTERNATIONAL ELECTRONIC RESEARCH CORPORATION / A SUBSIDIARY OF DYNAMICS CORPORATION OF AMERICA / 135 WEST MAGNOLIA AVENUE, BURBANK, CALIFORNIA 91502

the monochip:®

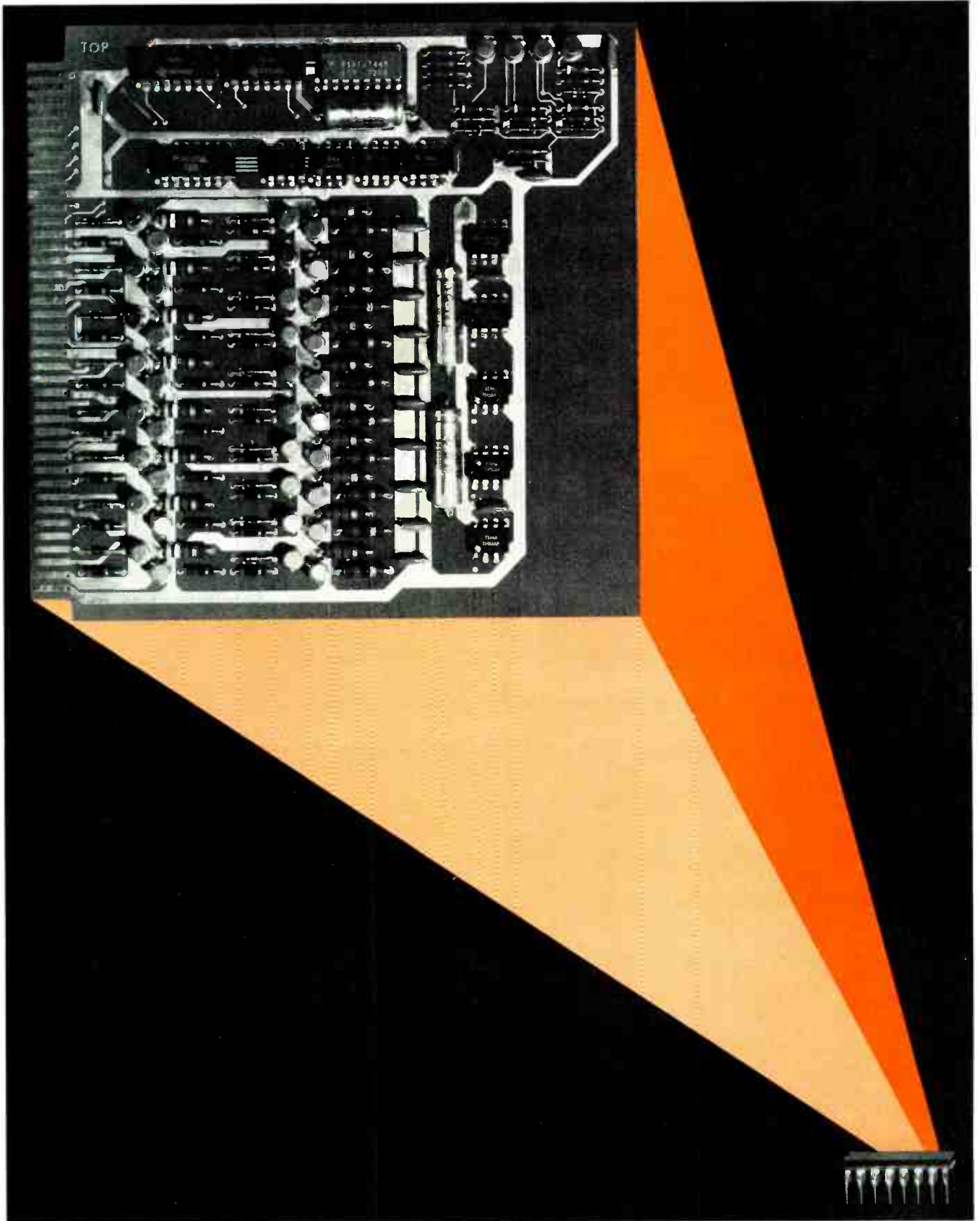

puts your PC board on one chip for \$1,800

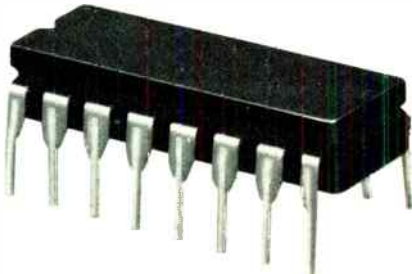

It's a remarkable concept.

A do-it-yourself monolithic IC chip. And it works just like the Erector Set you had as a kid.

We have three basic IC chips carrying up to 300 bipolar components—but none are interconnected yet. You tell us which components you want connected and we perform the integration.

You start by breadboarding your circuit using our \$39 design kit. It contains discrettes corresponding to the components on our Monochips plus a complete design handbook.

Then you select one of three Monochips that best fits your design.

Finally, we do the integration for you on the chip by making a mask that connects only those components you want to activate.

In three weeks you have your initial 50 custom IC's.

And for under \$2,000.

The Monochip fills the bill for products that don't call for LSI technology or ultra-high production runs. It is most economical in production runs of 1,000 to 100,000.

Any manufacturer of instrumentation will be interested, for example. (Imagine squeezing a \$30 PC board on a \$3 chip. Or an \$80 hybrid on a \$6 chip!)

The Monochip is also ideal for the first stages of product design. You can do the development right on the chip.

If you don't want to spend \$40,000 and a whole year to get your custom IC, send for our new brochure on Monochip design. See how simple it is to design your own monolithic IC's.

Your note on a company letterhead will also get a free subscription to our quarterly publication on chip design—the "Monochip Technical Journal."

But don't dilly-dally. Your competitor is also reading this ad.

Interdesign, 1255 Reamwood Ave., Sunnyvale, Calif. 94086. Phone (408) 734-8666.

Interdesign™

Honeywell Test Instruments Division sells solutions—and services every problem-solving oscillograph, magnetic tape recorder/reproducer, signal analyzer and biomedical system it sells.

You can rely 100% on the integrity of Honeywell test instruments and systems at start-up, and you can enjoy complete confidence in our follow-up service throughout the equipment's life. You can choose from a variety of service programs including preventive maintenance, calibration and repair on a periodic or as-needed basis, in your

facility or in one of our 30 nationwide metrology centers.

This same high standard of responsive service is available for instrumentation manufactured by other companies. Our skilled specialists are available to service all types of electronic test and measurement instruments from biomedical instrumentation to automotive test equipment.

For more details on our service programs, call Dick Janes (301) 267-0600 or write: Honeywell Test Instruments Division, Dept. 218-A, P.O. Box 5227, Denver, CO 80217 for our latest service brochure.



Honey

TEST INSTRUMENTS DIVISION

World Radio History



WAVE

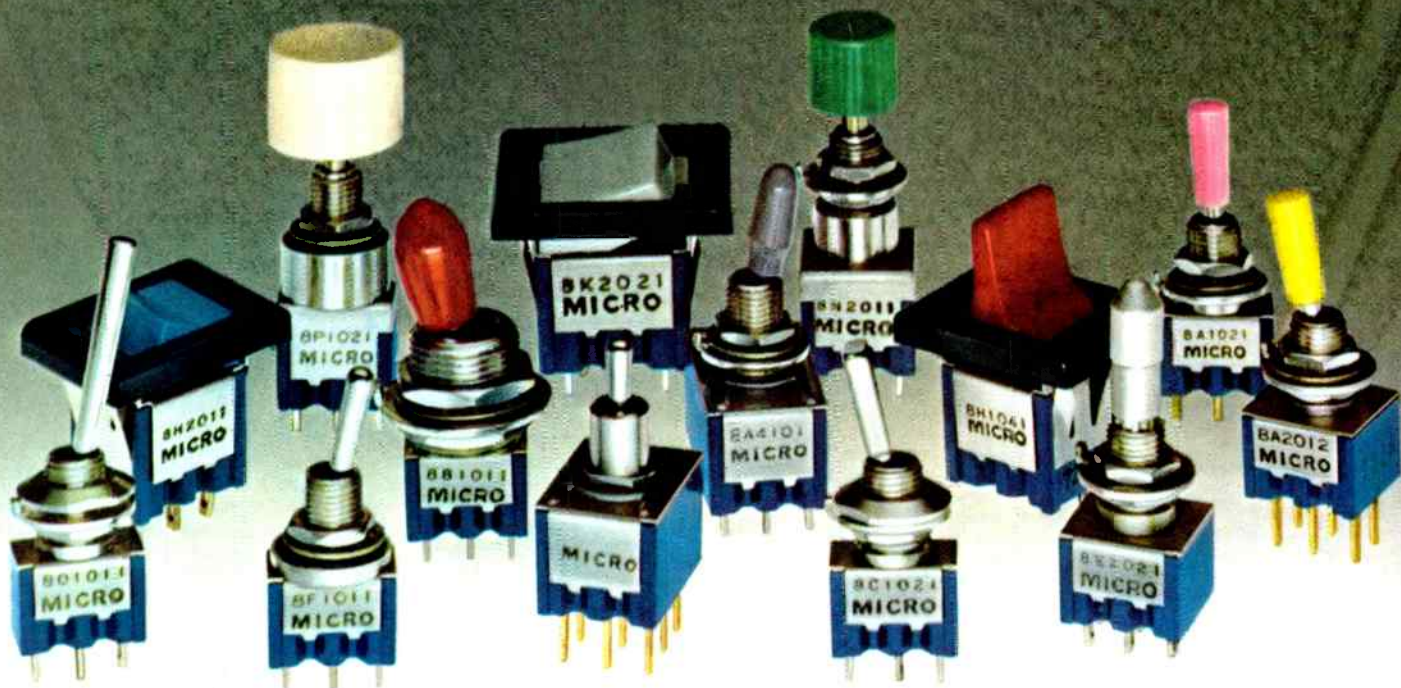

They look like miniature manual switches. But they're really just responses.

Every one of the miniature manual switches in the MICRO SWITCH Series 8 line is the direct result of a design need.

And, because design needs change continually, so do the miniature manuals we offer.

In the last year alone, we've added hundreds.

So you can choose from toggles, paddles, rockers—lighted and unlighted—and pushbuttons. With terminal variations that include solder, quick-connect, PC board and wire wrap.

They're all U.L. listed at 6 amps, 125VAC. With low energy versions available in every design.

And they all come with standard features like traditional MICRO SWITCH quality. Including inspection to a one percent Acceptable Quality Level. And nationwide, off-the-shelf availability, so there's no waiting.

They're also available with new features, like panel and bushing-sealed pushbuttons and toggles. A non-threaded bushing on PC mounted toggles. And colored sleeves for the 15/32-inch diameter bushing toggles.

If you'd like more information on the MICRO SWITCH Series 8 miniature manual switches, call, toll-free, 800/645-9200 (in N. Y., call 516/294-0990, collect) for the location and phone number of your nearest MICRO SWITCH Branch Office or Authorized Distributor.

Find out why you need only one source for the right miniature manual switch, at the right price, at the right time.

And how that source will work with you, just in case it doesn't make exactly what you need. Yet.

MICRO SWITCH products are available worldwide through Honeywell International.

MICRO SWITCH

FREEPORT, ILLINOIS 61032

A DIVISION OF HONEYWELL

Circle 166 on reader service card

4-bit controller system upgraded

Intel's improved 24-pin microprocessor is heart of updated microcomputer; versatile CPU to launch new wave of automatic, programable equipment

by Bernard Cole, San Francisco bureau manager

A little more than two years ago, Intel Corp. introduced the industry's first microprocessor, the 4004. Incorporated within what the company called its MCS-4 microcomputer system, the 4-bit processor launched a wave of successful attempts to incorporate more "intelligence" into a wide range of products, from traffic lights and oscilloscopes to point-of-sale and data-communications terminals.

Now the company is in volume production with an updated 4-bit microprocessor, the 4040. As the heart of its new MCS-40 microcomputer system, Intel expects the new 24-pin microprocessor to launch still another wave of low-cost intelligent microcomputer-based product developments.

Low power. The new family features automatic interrupt processing, a large set of instructions (60), single-step operation, CPU standby at low power, and other advanced capabilities not previously available in minimum-cost, 4-bit microcomputer systems. In addition, it operates at relatively high speed, with a clock rate of 1 megahertz.

According to Howard Raphael, Intel's MCS-40 product manager, the 4040-based system can be purchased in OEM quantities at between \$20 and \$100 each, depending on configuration. Because of its relatively low cost, he says, the 4040 makes it economically more feasible to automate and make programable a variety of products as diverse as vending machines, point-of-sale equipment, business machines, industrial controls, and instruments.

In addition, he says, the MCS-40 makes practical the use of multiple-

microcomputer distributed-intelligence networks in large systems. In such systems, the MCS-40 would be used for diagnostics, custom-forms control, control of keyboards, displays and printers, control-panel simplification, control of large processors, and such preprocessing functions as calibration, curve-fitting, code conversions, and data-formatting. It can also be used for local processing and automatic control of remote intelligent terminals or other peripherals.

Like its famous predecessor, the 4040 is a single-chip silicon-gate p-channel MOS device. It retains the basic 4-bit parallel-data-bus structure and the basic arithmetic-and-logic-unit design of the 4004. However, speed and flexibility have been greatly increased.

The clock rate has been increased by one third to 1 megahertz in the 4040, and a large group of logic enhancements has been added to the basic design—features never available before in single-chip 4-bit units. For example, says Raphael, the 4040's standard instruction set of 60 is very large for a 4-bit micro-

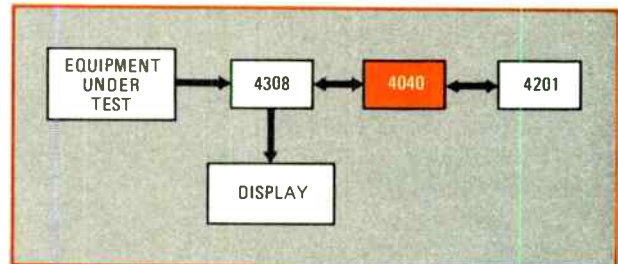
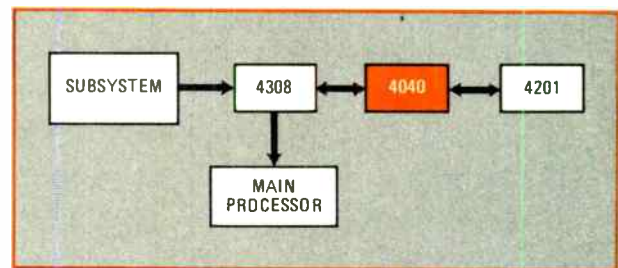
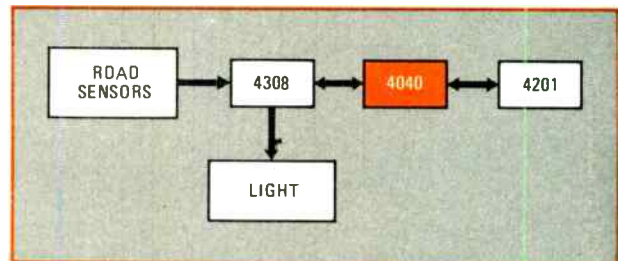

Applications. The 4040, with the 4308 ROM and the 4201 clock generator, could form a "smart" traffic controller (top), a preprocessor (middle), or a portable troubleshooter.

processor and provides for vectored interrupt, logic halt, bank switching, and additional logic operations (AND/OR). The 60 instructions include the 4004's 46 instructions as a subset and 14 new ones. The new instructions make the 4040 easier to program for complex operations, Raphael says, by minimizing instructions and improving throughput.

Interrupt control allows the CPU to automatically switch from one

immediate prototype delivery on Grayhill rotary switches



Adjustable stop switches off-the-shelf with the form-fit-function characteristics you need

- Simple pin adjustment provides the right number of positions per pole
- Over 100,000 possible combinations
- Available now from your local Grayhill distributor

Here's the fast route to rotary switches for prototypes or small production runs. Grayhill Adjustable Stop switches, available from your local Grayhill distributor, cut procurement lead time. You no longer need to wait for even small quantities to be built to order. The Adjustable Stop feature is available in one-inch and half-inch diameter, single deck and multi-deck versions. Your distributor can supply 1-and 2-deck Adjustable Stop switches from stock (one or two poles per deck) and can quickly secure other variations from factory stock. Write for complete literature.



561 Hillgrove Avenue • LaGrange, Illinois 60525
(312) 354-1040

New products

operating procedure or mode to another upon receipt of an interrupt-control signal from external logic. During the interrupt, the data required to resume the interrupted operation can be saved on the CPU chip. Bank switching allows rapid changes of operating modes and instruction routines. For example, says Raphael, the standard routines for a product line might be stored in one ROM and those used for specialized models in another ROM or PROM. Likewise, one set of registers (and/or ROM) might be used for normal operations and a second set for interrupt operations.

Nesting. The 4040 CPU's total storage capacity has been doubled, with an 8-by-12-bit address register stack array permitting up to seven levels of subroutines to be nested (compared with the 4004's three levels), and providing a fully incrementable program counter. This allows more complex programs to be stored economically in ROM. Also, there are now 24 index registers, rather than 16.

Bank switchings, says Raphael, doubles direct-access ROM capacity and I/O capacity. Two arrays can now be used, providing 32 pages and 32 ports. Various ROMs and I/O devices can be mixed in these arrays to extend capabilities.

Some new devices supporting the 4040 CPU in the MCS-40 include:

- The 4201 clock generator, which allows single-step operation under software or hardware control. Push buttons or toggle switches can be attached to the 4201 to single-step the 4040 or operate it in a stop-run mode. The 4201 is a C-MOS device which can drive a full MCS-40 system with a two-phase buffered MOS clock as well as generate a two-phase TTL-level clock for use by ancillary devices.
- The 4289 standard memory interface, which replaces the 4008/4009 interface circuit set used with the 4004. Major enhancements include reading and writing of program memory, internal timing changes that allow devices with long access times to be utilized, a separate supply input for use with TTL-compat-

ible n-channel MOS devices, and a separate device-reset feature.

- The 4308 metal-mask ROM, which serves as the basic program memory element of most MCS-40 system configurations. The 8-kilobit ROM section stores 1,024 8-bit words organized as four 256-byte pages. It also has four I/O ports, which consist of 16 lines organized as four independent 4-bit ports.

- Three general-purpose I/O arrays for use on ROM or RAM lines in control and data-communications applications with devices such as printers and keyboards.

Other support devices include 4040-oriented versions of some of Intel's standard memory products, such as the 4001 metal-mask ROM used as a 256-bit program memory page, plus an independent 4-bit I/O port; the 4316 metal-mask 2,048-by-8 ROM; the 4702A erasable 2-k PROM; the 4002 RAM (320 bits and I/O); the 4101 static 256-by-4 RAM; and the 4003 shift register.

Variety of uses. Raphael says that most of the MCS-40 configurations purchased in OEM quantities will fall into the following price/application ranges:

- \$29.95 for small-system automation, preprocessing and diagnostics. A typical configuration would include the 4040 CPU, the 4201 clock generator, and the 4308 ROM.
 - \$39.95 for stand-alone use as data processors and controllers in relatively complex products and for large-system, distributed-intelligence applications. A typical configuration here would be the 4040, 4201, 4308 and—for read-write and extra I/O capabilities—the 4002 RAM and 4003 shift register.
 - \$40 to \$50 for applications requiring larger program memory capacities or other expansions. A typical assortment is the 4040, 4201, 4002, and two 4308 ROMs.
 - Small-volume systems for such applications as prototype equipment development, small-quantity products, and one-of-a-kind applications. Such systems can be purchased singly for about \$100.
- Intel Corp., 3065 Bowers Ave., Santa Clara, Calif. 95051 [338]

**This
Green
Light
Says,**

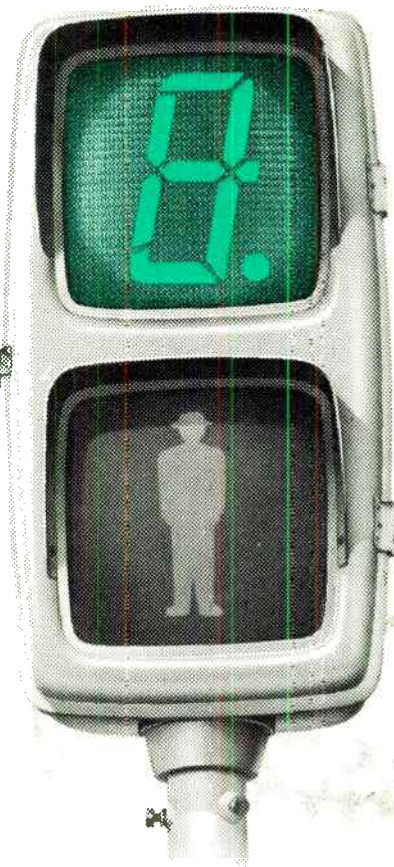

**“Go ahead
with
slim trim
display
equipment
ideas.”**



Multi-Digit Display with nine, eleven or thirteen digits. Or the FG type Multi-Digit Display with nine or twelve digits.

Go ahead because Ise lights your way to smaller, snappier equipment with a new wafer-thin multi-digit display. Then in addition to lighting the way, gives you a choice of two displays to work with. The DP-AS

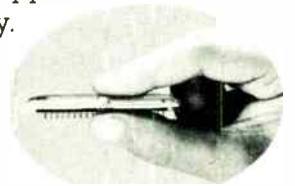

Digits on <FG> models measure a mini 5 mm high to help you be as small in your thinking as you want. Both new displays are glass-enclosed all around. And have easy-mounting pin connectors. But mounting isn't the only thing that comes easy with these trimmed-down displays. Reading the indication they give comes easy, also. Because Ise keeps with the past. Gives these new multi-displays the same eye-easy green glow and planer construction that make their forerunners so popular. In addition, they also give you low-voltage advantages for direct LSI drive.



If you've been holding back on a headful of ideas simply because the right multi-digit display wasn't available, it's time to stop.

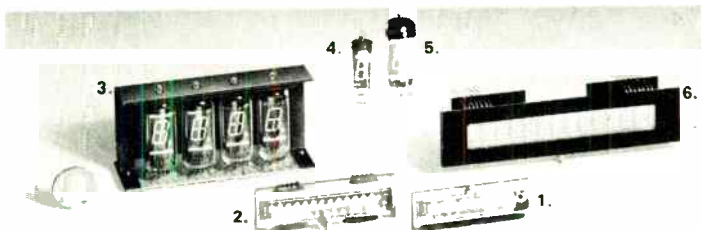

1. FG95A (NEW)
2. FG125A2 (NEW)
3. DMCL12H
4. DG12H1
5. DG19E1
6. DP128AS (NEW)

The Brighter Side of Electronics



Creator of Fluorescent Digital Display:

ISE ELECTRONICS CORP. P.O. Box 46 Ise-city, Mie Pref., Japan
Tel: (05963) 5-2121 Telex: 4969523

International Sales Div.:

ISE INTERNATIONAL CORP. 2-7-7, Higashi-Shinbashi, Minato-ku, Tokyo, Japan
Tel: 433-6616~9 Telex: J26546 Cables: "ISEWORLDREP" TOKYO

Sales & Technical Office:

ISE CORP. OF AMERICA 1472 West 178th Street, Gardena, Calif., 90248 U.S.A.
Tel: (213) 532-0470 Telex: 230674910

Representative: Paris, Munich, Amsterdam, Stockholm, Vienna, Milan, Bombay, Hong Kong, Taipei.

Instruments**Logic probe tells you more**

Indicator lamp near tip lights when gate-voltage or logic levels are wrong

Logic probes are valuable aids in troubleshooting digital systems, both on the production line and in the field. Their simple high/low logic indications are often all that is needed to track down a trouble spot.

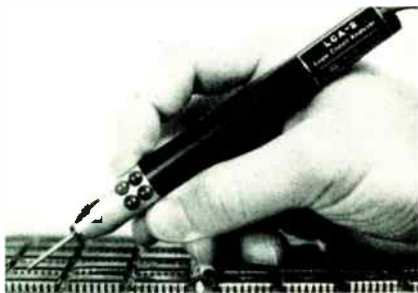

But sometimes a little more information is necessary. Logic systems sometimes fail or, worse yet, fail intermittently because gate-voltage levels are not quite right—ground is a little too high or a little too low.

The LCA-2 logic-circuit analyzer from Hunnicutt Digital Electronics, designed for testing 5-volt logic systems, is said to provide this test data. An indicator lamp responds to the quality of a logic level under test by operating whenever the voltage is between 0.8 and 2.1 v, when the point under test has high impedance or is open, or when a train of pulses have long rise or fall times. The lamp also lights when the logic levels of a pulse train are not within accepted ranges.

The quality indicator, a yellow lamp, is mounted near the probe tip in a cluster with three other lamps: green indicates a logic low (zero to 1.4 v), red indicates a logic high (1.4 v to V_{CC}), and blue indicates a transition between logic levels, as with pulses or pulse trains.

The LCA-2 is an improved version of an earlier logic probe Hunnicutt has been supplying exclusively to the U. S. Postal Service. Field experience with the earlier probe convinced Hunnicutt to make a few design changes, such as shifting the indicator lamps' positions from the heel end of the instrument closer to the probe tip, where they are easily monitored. The older probe also had a fused input, and replacing the small-value fuse was often a problem. Input of the LCA-2, which has no fuse, can be connected to 200 v ac or dc for as long as a minute or 125 v ac or dc continuously without damage.

The power-supply input to the LCA-2 is protected against polarity reversal, and the all-metal anodized aluminum body is nonconducting to prevent shorting out leads in the equipment under test. Probe tip, clip-on hook, and pin-socket input connectors are standard, as is a coaxial power cord and BNC power connector. Other power connectors are no-cost options.

The LCA-2 is priced at \$69.50 in lots of fewer than 10. Delivery is from stock to two weeks.

Hunnicutt Digital Electronics, 2800 Shamrock Ave., Fort Worth, Texas 76107 [351]

120-volt meter mounts in standard panel cutout

While no formal standards exist for the mechanical layout of digital panel meters (DPM), there are two de facto standards for panel meter packages—one for 5-volt powered units and one for line-voltage-operated models. Analog Devices' design

for 5-v DPMS has gained recognition as a standard, but until now the firm did not offer 120-v meters that could be mounted in a panel cutout that is the industry norm.

The AD2008, a 4½ digit, ac-line-powered DPM using 0.55-inch-high Beckman gas-discharge displays, is housed in a 4.18-by-1.93-by-5.10-inch case designed to fit the standard 1.68-by-3.93-inch ac-powered DPM panel cutout.

Slipping the DPM into a cutout, snapping a nylon mounting block into each side of the case, and tightening two screws on the instrument's rear plate is all that's required to install the AD2008. Such a simple mechanical design isn't simple to develop, though; choosing the right dimensions and materials took Analog Devices' engineers almost a year—just about as long as the electrical design required.

That electrical design includes dual-slope conversion. The AD2008 measures bipolar voltages over a full-scale range of ± 1.9999 v with an accuracy to within 0.005% of reading, ± 50 microvolts, ± 1 digit. Dual-slope conversion also permits ratiometric operation—the DPM can measure the ratio of two input voltages, not just absolute measurements referred to system ground.

In its ratiometric version (a no-cost option), the DPM accepts external reference voltages over the range of 600 millivolts to 1.3 v, at full specified accuracy.

The AD2008 uses MOS logic (a standard Mostek 5007 chip), which yields 4-watt power dissipation. Internal circuitry converts the LSI chip's multiplexed data output to either full-parallel, latched BCD for 4½ digits, polarity, and overload, or a pulse-train output, which can be counted external to the DPM. Either data output is compatible with DTL, TTL, C-MOS, or p-MOS.

The AD2008 joins Analog Devices' line of 5-v-powered DPMS, which includes 2½-, 3½-, and 4½-digit units with LED, Numitron, or Beckman displays, and a 3½-digit ac-powered unit with Beckman displays.

The 2008 is priced at \$295 in un-



ECL design just became a three-layer piece of cake.

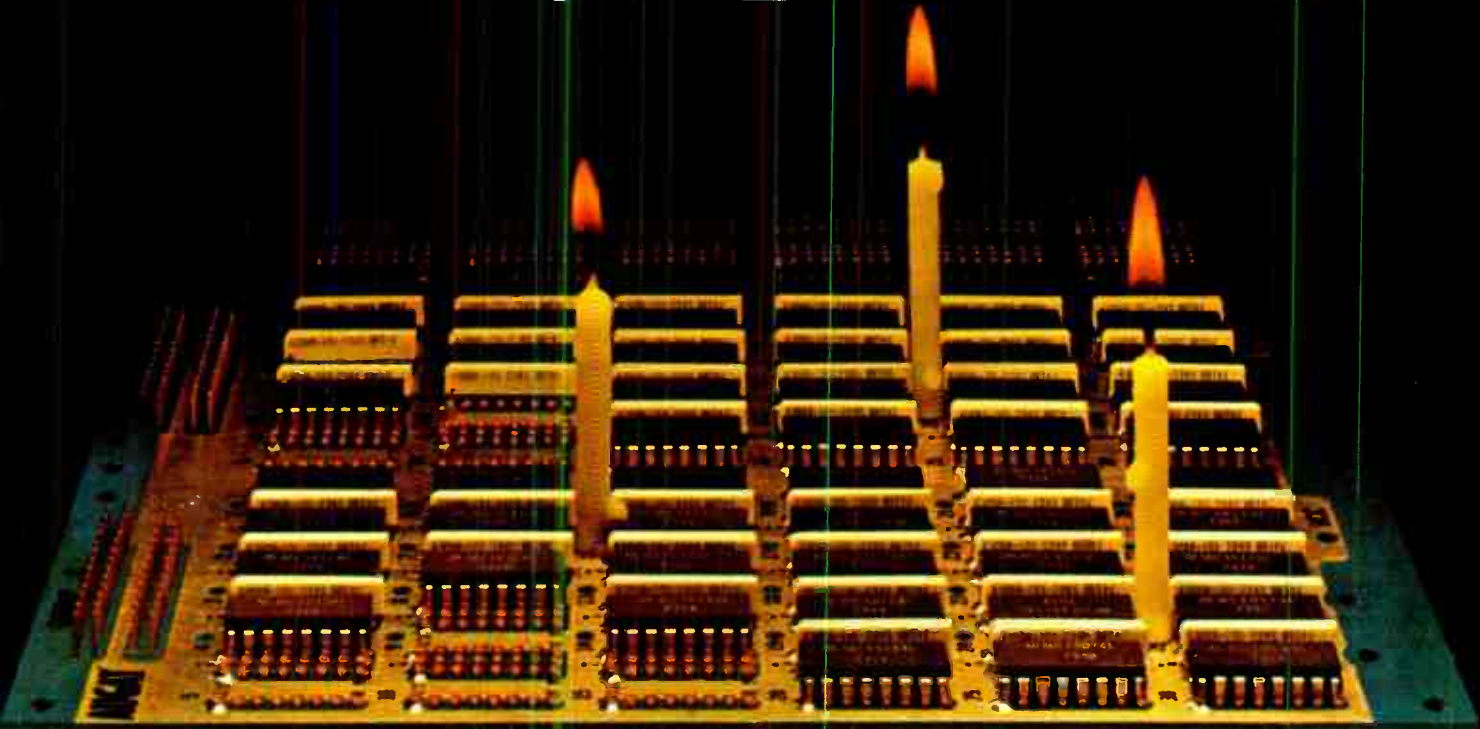

Augat ECL Board with 2 volt bus for terminating single in-line package (SIP) resistor network.

Compared to methods of the past, the Augat series of socket, Wire-Wrap® ECL boards makes ECL design a piece of cake. Even for circuits in the 125 to 500+ MHz range. They can save you 90 percent or more in breadboarding and prototyping time. Tens of thousands of dollars in start-up costs. And many costly hours in field maintainability. With this proven advance in three-layer interconnection technology you don't have to design in controlled impedance interconnections, mess around with transmission lines, or commit power connections for different ECL logic modules. All of which frees you to concentrate on the partitioning of logic functions and the preparation of a wiring list.

And unlike a multi-layer P.C. board, there is no loss in planar density. Two 16-pin ECL and associated pull down and decoupling components fit into one square inch on every Augat ECL board.

The nice thing, too, is that Augat ECL boards are standard catalog items available in any quantity at any time from Augat distributors around the world. You can contact them directly or write Augat, Inc., 33 Perry Avenue, Attleboro, Mass. 02703. Tel. 617-222-2202. TWX 710-391-0644.

AUGAT®

Registered TM of Candner-Denwer Company

Circle 171 on reader service card



Now there is a choice.

DuPont calls their trichlorotrifluoroethane "FREON" TF. We call ours "BLACO-TRON" TF. So now you have a choice.

That's why BLACO-TRON precision cleaning solvent cleans the same as FREON: Their chemical formulas are identical.

If they're identical, why should you try BLACO-TRON? Service. The

service you get only from Baron-Blakeslee—for 38 years the accepted leader in advanced design precision cleaning equipment and the solvents to go in them.

Many types of BLACO-TRON are available for immediate delivery.

BLACO-TRON
FLUORINATED SOLVENTS—NOW THERE IS A CHOICE

NEW

**Precision
Cleaning
Solvent**

REFERENCE GUIDE

Covers the full line of BLACO-TRON fluorinated solvents—with complete specifications on each solvent.

WRITE FOR YOUR COPY TODAY.



Baron-Blakeslee

1620 South Laramie Ave., Chicago, Ill. 60650—Offices in All Principal Cities.

*FREON is DuPont's registered trademark for its fluorocarbon cleaning agents.

**BLACO-TRON is Baron-Blakeslee's registered trademark for its fluorocarbon cleaning agents.

Circle 172 on readerservice card

World Radio History



Now there is a choice.

BLACON
Baron-Blakeslee

Call your nearest Baron-Blakeslee "BLACO" SERVICE CENTER for prompt Solvent Service

New England

General Chemical Corp., Boston, Mass.
(617) 872-1202
The Hubbard-Hall Chemical Co.
Waterbury, Connecticut
(203) 756-5521

Metro New York City, Northern New Jersey, Long Island

Baron-Blakeslee, Garden City, N.Y.
(212) LE9-8680
(201) 687-7383
(516) 747-8460

South New Jersey, Eastern Pennsylvania, Maryland, Delaware

Tri-State Chemicals, Inc.
Blackwood, N.J. (Philadelphia)
(215) LO3-5071

Southeastern United States

MORELAND CHEMICAL CO. INC.
Spartanburg, S.C.
(803) 583-8481
Greenville, S.C.
(803) 242-3727
Florence, S.C.
(803) 662-5246
Augusta, Ga.
(404) 722-3751
Atlanta, Ga.
(404) 457-4485
Kingsport, Tenn.
(615) 247-7149
Chattanooga, Tenn.
(615) 894-8700
Charlotte, N.C.
(704) 392-4301
Greensboro, N.C.
(919) 292-0624
Tampa, Fla.
(813) 685-5874

Upstate New York, Northwest Pennsylvania

Inland Chemical Corp., Syracuse, N.Y.
(800) 348-4661

Indiana, Ohio, Michigan

Inland Chemical Corp.
Ft. Wayne, Indiana
(800) 552-4605
Inland Chemical Corp., Toledo, Ohio
(800) 348-3621
Inland Chemical Corp.
South Bend, Indiana
(800) 552-4605
Inland Chemical Corp., Cleveland, Ohio
(800) 348-3621
Inland Chemical Corp., Lima, Ohio
(800) 348-3621

Illinois, Wisconsin, Minnesota, Iowa, Missouri, Nebraska

Baron-Blakeslee, Chicago, Illinois
(312) 656-7300
Baron-Blakeslee, Milwaukee, Wisc.
(414) 762-6850

No. California, Nevada

Baron-Blakeslee, San Francisco, Calif.
(415) 591-8237

Oregon, Washington

Baron-Blakeslee, Portland, Oregon
(503) 252-3468

Southern California, Arizona

Baron-Blakeslee, Los Angeles, Calif.
(213) 532-0730

San Diego Area

Baron-Blakeslee, San Diego, Calif.
(714) 295-0041

New products

der-10 quantities, \$195 in hundred-lots. Versions are available for 50 or 60 Hz, 100, 115, 220, or 240 v.

Analog Devices, Inc., Route 1 Industrial Park, Norwood, Mass. 02062 [352]

Vinyl-chloride detector

measures 50 parts in 10⁹

An analytical instrument system can measure levels of exposure to vinyl chloride as low as 50 parts per billion, well below the 1 part per million standard proposed by the Occupational Safety and Health Administration. It has four elements: a small sample-collector column, a connecting sample pump, a flasher assembly, and a gas chro-

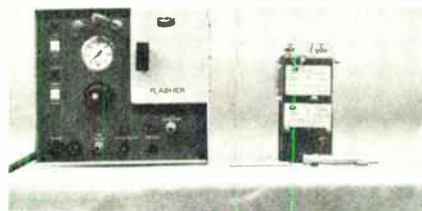

matograph. A worker wears only the first two items—the collector column on his collar, and the sample pump on his belt. After a period of time, the collector column is detached and placed in the flasher assembly, which is connected to the chromatograph. The flasher assembly heats the column and causes the collected sample to be passed through the chromatograph where it is analyzed in a matter of minutes.

Bendix Process Instruments Division, P. O. Drawer 477, Ronceverte, W. Va. 24970 [353]

Bandpass filter retrieves

low-amplitude signals

Suitable for such applications as the isolation of frequency components in complex sound and vibration signals, the retrieval of low-amplitude signals buried in noise, and the accurate measurement of rotational speeds in high-speed equipment, a



bandpass filter/amplifier combines the functions of a tunable bandpass filter, an ac-coupled amplifier, and a sine-wave oscillator. Covering the range from 3 Hz to 35 kHz, the AF501 is a plug-in unit for the Tektronix TM-500 line of modular instrumentation. Price is \$395; delivery is from stock.

Tektronix Inc., P. O. Box 500 A, Beaverton, Ore. 97077 [354]

Low-cost logic analyzer

has 10-MHz sampling rate

Meant to be used with an oscilloscope with a bandwidth of at least 300 kHz, the DSR-505 digital signal recorder is a dual-channel logic analyzer that can acquire and store up to 480 points per channel. Like

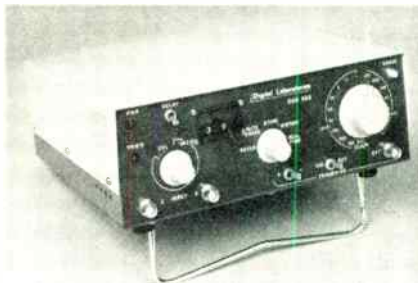

more expensive analyzers, the DSR-505 has adjustable "0" and "1" thresholds, can operate from its internal crystal-controlled clock or from an external timing signal, has a 10-MHz maximum sampling rate,

Not just another step-and repeat photomasker--but the world's only Lasometric* system operating on air-bearings-- for the ultimate in speed, precision, and reliability!

Fastest System Available—(1) Stage speeds up to 1-inch per second, no deadheading mode—exposures made in both directions. (2) 5 flashes per second on emulsion, 1 second maximum on photoresist, producing a 3-inch photomaster on emulsion with an array of 200-mil chips in less than 1 minute, and on photoresist in less than 8 minutes.

Lasometric Precision—Precision non-contact stage positioning and system control achieved by use of the HP laser interferometer system and the HP2100 Series controller, providing positional precision of ± 10 microinches, absolute accuracy of less than ± 15 microinches, and minimum programmable resolution of 10 microinches.

Non-degradable Accuracy—Non-contact laser interferometer system and frictionless, wear-free air-bearing stages together provide maximum control of stage speed

and positioning and ensure constant reliability over the life of the system.

Customer-Oriented Features—English or metric operation by software command; your choice of 1 to 4 barrels, e-line or h-line cameras with either 10X or 5X reduction, all with exclusive Electromask floating focus for the ultimate in resolution and image size control.

For more information on the world's only Lasometric* step-and-repeat system, use the reader service number or call and ask for your copy of the Electromask Image Repeater* brochure.

*Trademarks of Electromask, Inc.

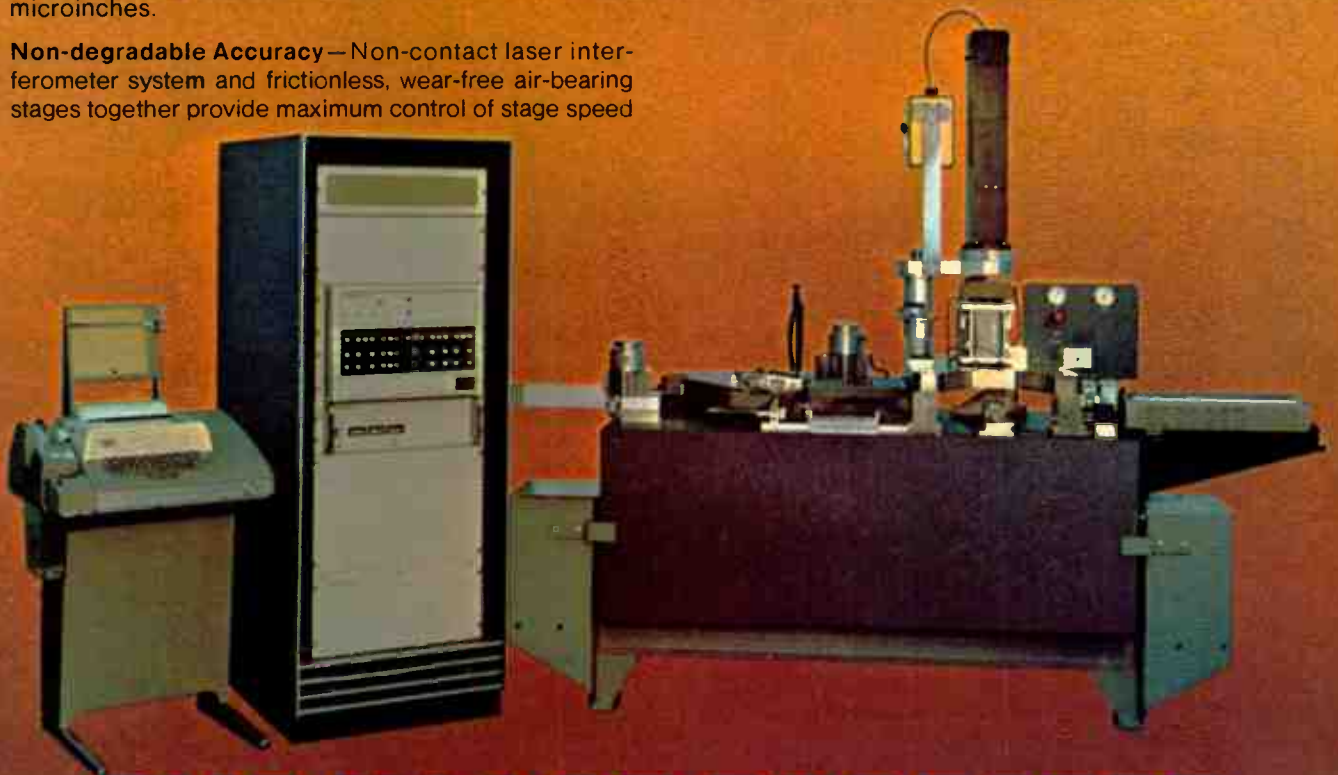

**THE IMAGE REPEATER
THE IMAGE REPEATER
THE IMAGE REPEATER**



ELECTROMASK, INC.

A subsidiary of TRE Corporation, 6109 De Soto Ave., Woodland Hills, Calif. 91364, Phone: (213) 884-5050, Telex 67-7143

Circle 174 on reader service card

New products

and has a delayed-trigger mode of operation that allows the viewing of signals that precede the trigger. Price of the instrument is \$975; delivery is from stock.

Digital Laboratories, 377 Putnam Ave., Cambridge, Mass. 02139 [355]

United Systems unveils line of counter/timers

The 8500 series of universal counter/timers consists of four instruments that cover frequency ranges of 50, 150, 550, and 1,000 MHz. All four instruments can measure frequency, period, multiple-period average, time interval, frequency ratio, and number of events. Each unit has a nine-digit amber LED display (the Monsanto MAN-



82) and offers autoranging for both frequency and period measurements. Prices for the counter/timers, in increasing order of maximum frequency, are \$650, \$750, \$995, and \$1,295. Parallel BCD output is available as an extra-cost option. Delivery is from stock.

United Systems Corp., 918 Woodley Rd., Dayton, Ohio 45403 [356]

Angle indicators can resolve 0.1 degree

Two solid-state angle indicators have resolutions of 0.1°. The model CUO 9628 043, which accepts synchro inputs, and the model CUO 9628 045, which accepts resolver inputs, both employ LED displays and the half-wave integration method for converting the input data into digital form. Resolver or synchro-



puts from 5 to 120 volts and from 50 to 1,000 hertz can be handled directly. The standard display ranges from 000.0 to 359.9°. Other special scales, such as $\pm 180^\circ$, are also available, as are BCD, binary or dc outputs.

Kearfott Division, The Singer Co., 1150 McBride Ave., Little Falls, N. J. 07424 [357]

Hand-held logic analyzer stores, displays 32 bits

Able to handle data rates as high as 20 MHz, the model 0617B logic analyzer can be easily held in one hand. An array of 32 light-emitting diodes, arranged in two rows of 16 each, displays the data collected and stored by the analyzer. Like other logic scopes, the 0617B can display data that both precedes and follows the trigger signal. A series of switches allows the viewed data to be delayed, in increments of 10



clock cycles, up to 2,550 clock cycles from the time the trigger signal is received. Price of the instrument, in quantities of one to four, is \$475. Delivery time is two to four weeks.

CPSR Instruments Inc., P. O. Box 195, Bluebell, Pa. 19422 [358]

Obsolete Hand Loading (and high prices)

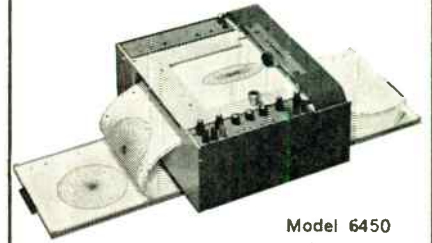

Model 6450
\$2150.

Continuous Chart Supply

X-Y Recording

- Bi-directional Chart Movement
- Z-Fold Paper
- 8½" x 11" Recording Surface (tears out for file use)
- Local or remote control of recording mechanism and pen lift
- English/Metric Scale
- 15 in./sec. slewing speed
- 18 calibrated voltage ranges for each axis—continuously variable in between
- $\pm .2\%$ Accuracy
- $\pm .1\%$ Repeatability

Model 6452, X-Y-Y' (two pen)—\$2950.

houston instrument | THE RECORDER COMPANY

ONE HOUSTON SQUARE (at 8500 Cameron Road)
AUSTIN, TEXAS 78753 (512) 837-2820
TWX 910-874-2022 cable HOINCO

EUROPEAN OFFICE:
Rochesterlaan 6 8240 Gistel Belgium
Phone 059/27445 Telex Bausch 19399

**If you are
serious about
solving EMI
problems...**

**...this
Designer's
Kit is FREE!**



If not...

**...it'll
cost you
\$35.00**



New Designer's Kit on EMI Filters and Systems Engineering Services.



These Kits are in production now . . . and quantities will be limited.

To reserve your EMI/EMC Designer's Kit #2...write, on your letterhead to Marketing Communications, Cornell-Dubilier Electronics, 155 Avenue L, Newark, NJ 07101 or call (201) 589-7500, extension 480.

This is the most comprehensive package of helpful, useful, and practical information concerning Electro-Magnetic Interference ever offered! To the serious designer, it's free . . . on letterhead request only . . . and for a limited time.

This is what it contains:

- Reactance Slide Rule
- 44 page EMC Solutions brochure
- All Purpose Filter Catalog
- Useful Engineering Data Product Sheets
- Government Interference Restrictions brochure
- Article Library . . . containing reprints of recent technical articles from major publications
- Application Engineering Questionnaire
- And More

CDE **CORNELL-
DUBILIER**

155 Avenue L, Newark, N. J. 07101

CDE — The People to People Company
— the mark of quality is on everything we make.



Circle 176 on reader service card

World Radio History

324 (CDE)

one way...

or the other

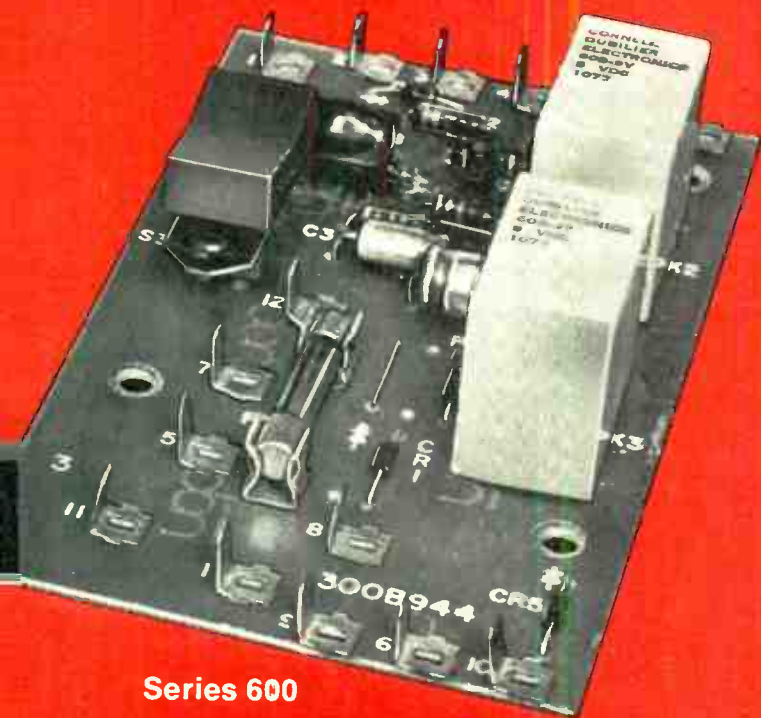

Series 600

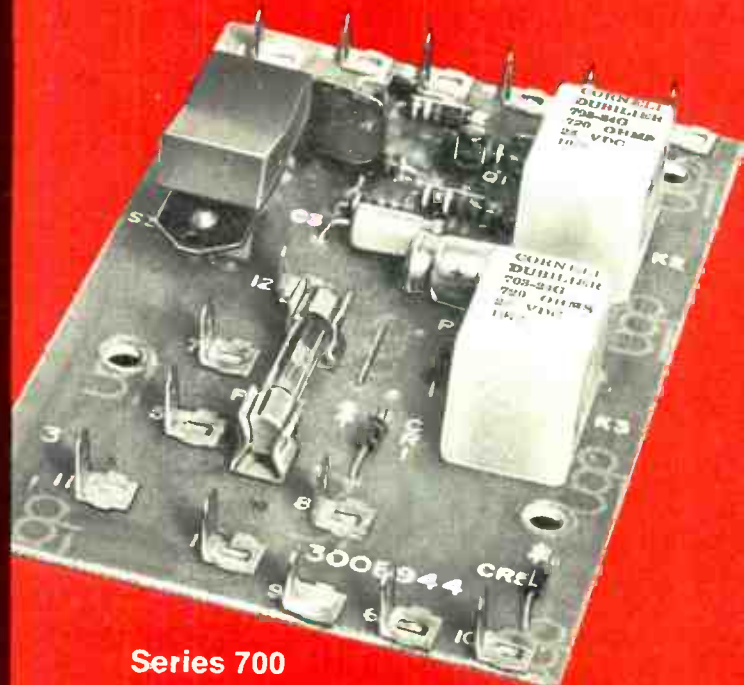

Series 700

CDE Solves Your "Cost Crisis" Problem in Relay Switching!



This 130 page Component Selector Guide presents in detail all CDE products... from ceramic to electrolytic capacitors... from mica to paper capacitors... from Relays to EMI Filters.

LETTERHEAD REQUEST ONLY!!!

Here are two CDE relays that give you miniaturization, proven reliability, outstanding performance . . . all at an unbelievable low cost. Both series are stocked in depth for immediate delivery . . . in a variety of standard coil voltages. Check the specs below. If either the 600 Series or the 700 Series can't help solve your spec/price problem . . . we'll make a special for you, and we'll keep the cost competitive. In fact, if your needs include any type of miniature relay, general purpose relay, bi-stable relay or time delay relay . . . contact CDE.

	Series 600	Series 700
SIZE:		
Chassis Space	1.22" X 0.77"	0.97" X 0.67"
Height	1.20"	0.79"
CONTACTS:		
	SPDT or DPDT	SPDT
	UL listed from 2 amp resistive to 480VA, 240VC, Pilot Duty	Up to 5 amps resistive
		Designed to meet UL specs.
DC SENSITIVITY:	60 MW DC min.	450 MW DC min.
AC:	SPDT available	Not available.
PRICE:	Typically about \$1.	Usually 20% less for similar switching specs.



150 Avenue L, Newark, N. J. 07101

For detailed spec. sheet, circle Reader Service Number listed below!

CDE — The People to People Company
— the mark of quality is on everything we make.



Circle 177 on reader service card

323 (CDE)

New products

Data handling

Plug-in boards acquire data

Systems for PDP-11 and -8E include a-d converters, multiplexers, sample-holds

ADAC Corp., a new company in Woburn, Mass., specializes in data-acquisition systems that can fit into a slot on a minicomputer's mainframe. Since Digital Equipment Corp.'s PDP-8E and PDP-11 minicomputers have wide acceptance for data-acquisition applications, ADAC's initial products have been designed to work with them. The model 600-11 is a complete data-acquisition system on a single 8.5-inch by 15-inch board, which is compatible with the PDP-11 line, while for the PDP-8E line there are three new products: the model 600-8E data-acquisition system, the model 600-ED stand-alone digital-to-analog converter system, and the model 600-ES sample-and-hold system. All four products can operate at speeds as high as 100 kilohertz, and offer 12-bit resolution.

The 600-11 contains an analog-to-digital converter, a sample-and-hold amplifier, and a 16-channel multiplexer that can be expanded to 64 channels. The unit needs no external power supplies—it takes 5 volts from the computer, and converts it to ± 15 v with a dc-to-dc converter. A program interrupt interface is in-

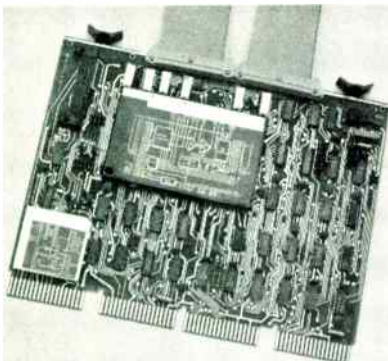

cluded with the system. A cable connects the board to the rear panel of the computer for input/output connections. Depending upon the number of channels, the 600-11 costs from \$1,800 to \$2,370.

Extra-cost options for the 600-11 include a programmable-gain amplifier, and one or two 12-bit digital-to-analog converters for driving oscilloscopes, strip-chart recorders, and other analog instrumentation. All options available from the company fit on the 600-11 board.

The model 600-8E is identical to the 600-11 except for size; because it is meant to work with a PDP-8E, the system is laid out on a 8.5-in. by 10-in. printed-circuit board. Prices for this unit range from \$1,900 for the 16-channel version up to \$2,280 for 64 channels.

Instead of having d-a converters available as on-board options for the 600-8E, ADAC has chosen to make them available as a separate stand-alone product—the 600-8ED. The 600-8ED can have from one to four d-a converters, and can operate independently of the 600-8E. Prices for the 600-8ED range from \$650 to \$1,350.

Similarly, the 600-8ES can contain from two to four sample-and-hold amplifiers, and ranges in price from \$950 to \$1,350.

Delivery time for all units is eight weeks.

ADAC Corp., 29B Cummings Park, Woburn, Mass. 01801 [361]

Fabri-Tek has solid-state memory for PDP-11/45

Fabri-Tek Inc. has announced its first semiconductor memory product—a high-speed buffer memory for the PDP-11/45 minicomputer. Designed to increase the effective speed of the computer's main memory, the model 4511 memory buffer is claimed to save as much as 50% of the processing time in customer installations. It uses bipolar technology to achieve speeds compatible with a 300-nanosecond central-processing-unit cycle time. Ca-

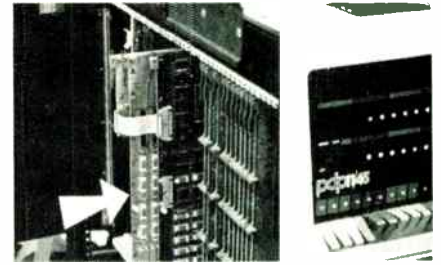

capacity is 512 words by 16 bits. Price, with 8-k words of model 11 core memory, is \$11,810. Delivery time is 45 days.

Fabri-Tek, Inc., 5901 South County Rd. 18, Minneapolis, Minn. 55436 [363]

Printec interface is buffered, pollable

An interface for the Printec-100 serial-impact printer allows the printer to be used in a multidrop, polled system. This capability is

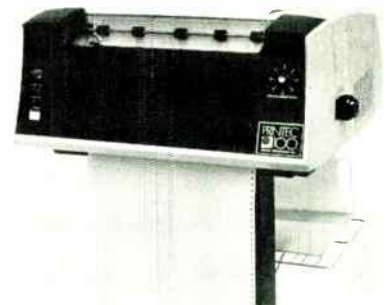

valuable in systems that combine CRT terminals and printers on one line. Since the interface contains a 1,024-character buffer, a Printec-100 can be printing a message while other terminals are being serviced by the computer. Price of the interface, complete with a Printec-100, is \$4,650.

Printer Technology, Inc., Sixth Rd., Woburn Industrial Park, Woburn, Mass. 01801 [364]

Multiplexer available for Tektronix hard-copy unit

A four-channel multiplexer enables the Tektronix 4632 video hard-copy unit to make facsimile copies from

New from Cinch: compact, easy interconnection

for
switching and
test panels,
programming
boards,
and other
patch cord
systems

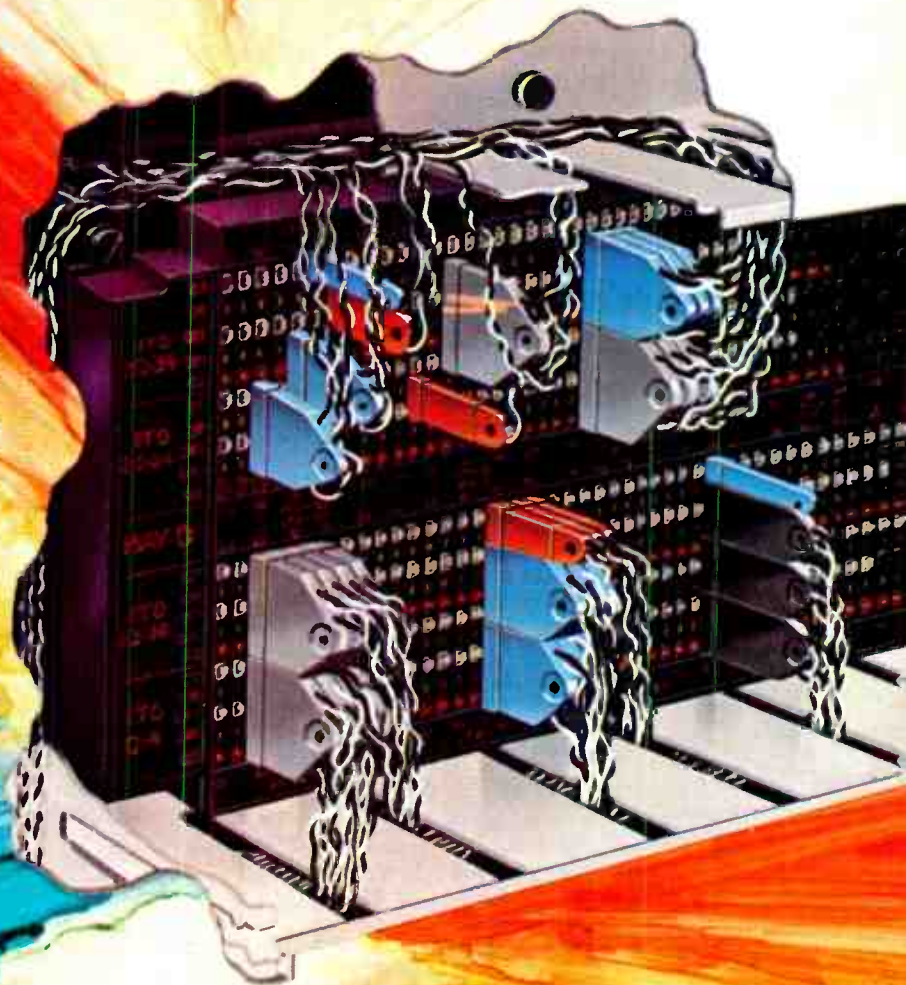

Originally developed and successfully used for telecommunications applications, this Cinch CCB circuit concentration system may now be the answer to *your* complex interconnection problems.

One side of the panel assembly is wirewrappable, for automatic, semi-automatic or hand wiring. The other side accepts polarized, positive detent, single through six-pin, color-coded patch cord plugs for rapid circuit changes.

Color coded panels have raised, high-visibility, replaceable marker strips. Contacts are on 0.200" centers and individual contact modules can be replaced in seconds. The compact CCB system is remarkably easy to install, modify and maintain.

For detailed information call TRW/Cinch Connectors at (312) 439-8800 or write TRW/Cinch Connectors, an Electronic Components Division of TRW Inc., 1501 Morse Ave., Elk Grove Village, Ill. 60007.

CM-7310

TRW CINCH CONNECTORS

Circle 179 on reader service card

New and improved General Electric lamps provide for increased design flexibility.

Two new sub-miniature halogen cycle lamps ideal for miniaturization.

These new T-2, 6.3V, 2.1 amps, 75 hour GE halogen cycle lamps are the smallest of their type (.265") and set industry standards for size and light output (16-20 candlepower). They are perfect for miniaturization of equipment such as reflectors, housings and optical systems. They also save on overall cost of equipment and are less than half the cost of the #1973 quartz lamp they replace.

Two terminal configurations are available. #3026 (20 candlepower) has wire terminals. #3027 (16 candlepower) has a new two pin, ceramic base that plugs in to make installation and removal a snap. Samples of the #3027 lamp are available in limited quantities now; production quantities will be available in the first quarter of 1975. These lamps have an iodine additive that creates a regenerative cycle that practically eliminates normal bulb blackening. They will produce approximately 95% light output at 75% of rated life.

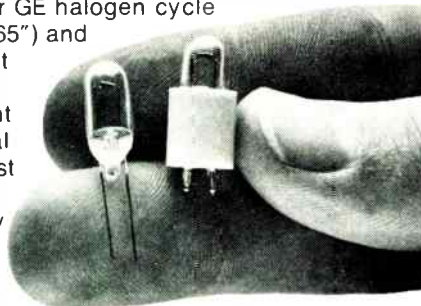

An expanded line of Wedge Base Lamps for simple, low-cost circuitry.

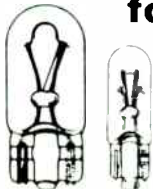

Now you can have greater design freedom than ever before with wedge base lamps. GE now offers six large lamps in its line of T-1 $\frac{3}{4}$ (.230" max.) all-glass, sub-miniature wedge base lamps. In addition to our three 14V lamps (#37, #73 and #74), we now also offer two 6.3V lamps (#84 and #86) and a 28V lamp (#85).

These lamps are ideal for applications where space is at a premium. Their wedge-based construction allows you to design for low-cost sockets and virtually ends corrosion problems because they won't freeze in the sockets. And the filament, which is always positioned in the same relation to the base, offers more uniform brightness.

Green Glow Lamp has been improved over previous lamp.



Actual Size

Now our G2B Green Glow Lamp, the only domestic green lamp on the market today, gives a more uniform, purer green light than our previous model. It's bright enough for your circuit component applications. With appropriate current limiting resistors, it can be used for 120/240 volt green indicator service. Or used together with our high-brightness C2A red/orange/yellow glow lamps to emphasize multiple functions with color.

All GE glow lamps give the benefits of small size, rugged construction and low cost — 12¢ each for the G2B, 4.4¢ each for the C2A in 100,000 quantities.

Send today for newest literature.

For the most up-to-date technical information on any or all of these lamps, write: General Electric, Miniature Lamp Products Department, #7411-M, Nela Park, Cleveland, Ohio 44112.

GENERAL  **ELECTRIC**

New products

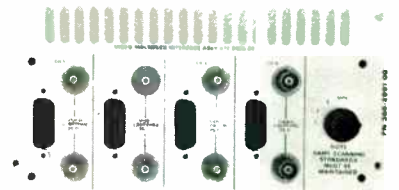

up to four standard composite signals, and from digital video signals of refreshed alphanumeric/graphic terminals. The unit allows the user to switch on any one of the four terminals for copying from a single one of them, and it also gives him the option of selecting a multiplex mode in which all four are copied in a four-channel queue. Price of the multiplexer, installed at the factory, is \$500. Price of the 4632 video hard-copy unit is \$3,395.

Tektronix, Inc., Information Display Division, P. O. Box 500, Beaverton, Ore. 97005 [365]

Speech synthesizer has unlimited vocabulary

Intended for such applications as telephone order inquiries, computer-assisted instruction, and computerized medical systems, the Votrax-VS6 produces continuous speech from Ascii commands at data rates as slow as 300 bits per second. Each Ascii command selects one of 63 available phonemes, plus one of four levels of inflection to synthesize speech with no vocabulary limit. Speech rate, volume, and pitch are adjustable through manual controls.

Vocal Interface Division, Federal Screw Works, 500 Stephenson Highway, Troy, Michigan 48084 [367]

Floppy-disk system for H-P computers

The model HPC-420-2 dual-drive floppy-disk operating system is a random-access, mass-storage, hardware/software system for use with the Hewlett-Packard 21XX series of minicomputers. The disk driver for the HPC-420-2 can operate with or

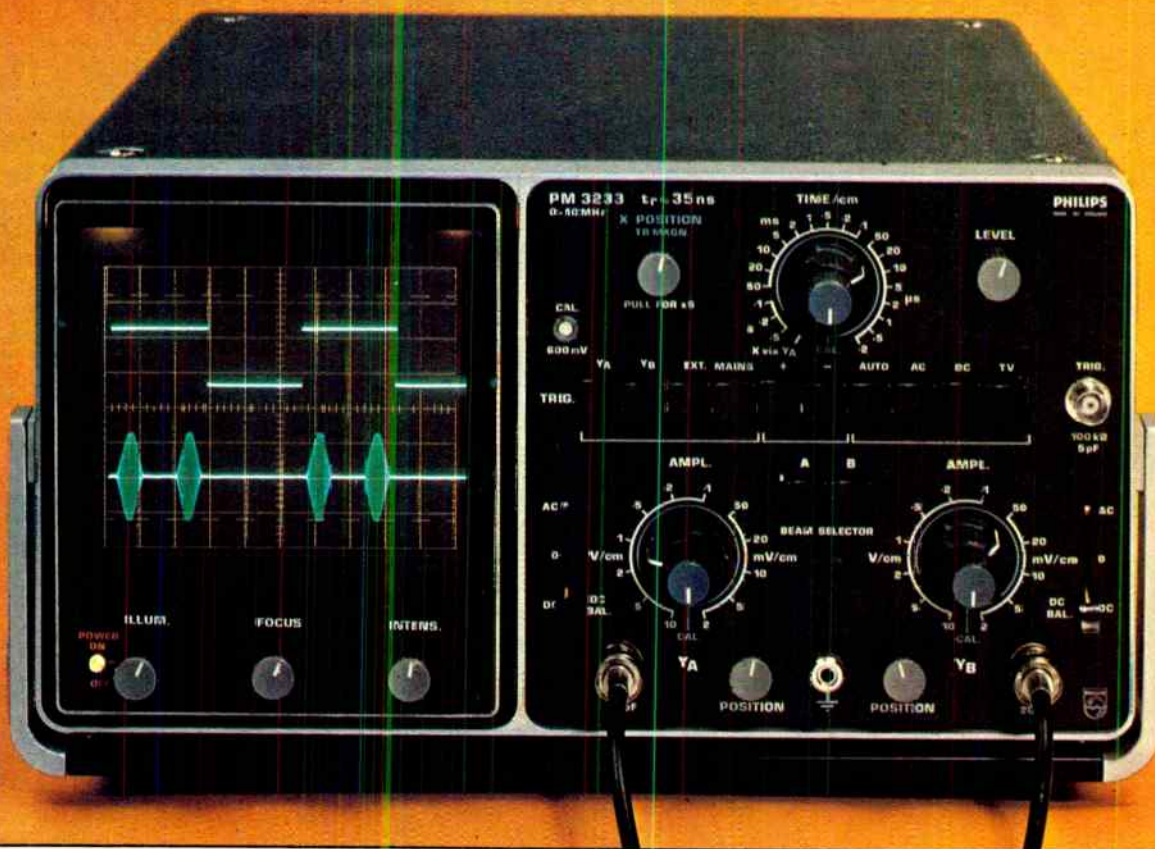

ITS A BEAUTY ALRIGHT- IN MORE WAYS THAN ONE

COMPARE THE FEATURES:

- **TRUE-DUAL BEAM DISPLAY**
Synchronous triggering eliminates phase error
No chopping or switching of waveforms
Full screen brightness on both traces
- **2mV/cm AT 10 MHZ BANDWIDTH**
Meets all basic requirements for lab, field or bench
- **FULLY AUTOMATIC TRIGGERING**
Complete mode selection including TV line/frame
- **10KV BRILLIANT DISPLAY**
Excellent visibility, even for low duty cycle pulses
- **8 x 10 cm RECTANGULAR SCREEN**
Maximum resolution from full coverage of CRT with both beams
- **COMPACT, LIGHTWEIGHT AND PORTABLE**
Only 21 lbs.; Less than 20" deep x 13" wide x 7 1/2" high
Snap on its front cover (supplied) and that's your protective carrying case !
- **FOR ADDITIONAL INFORMATION, CONTACT**
Philips Test & Measuring Instruments, Inc.
A NORTH AMERICAN PHILIPS COMPANY
400 Crossways Park Drive Woodbury, New York 11797
Telephone: (516) 921-8880 Twx: 510 221 2120
- **SPECIAL APPLICATIONS INFORMATION ' HOT LINE '**
DIAL TOLL FREE NUMBER (800) 645-3043
NEW YORK STATE, CALL COLLECT (516) 921-8880



PM3232 - complete with snap on front cover \$ 855.00
PM3233 - Priced at only \$ 895.00. Same as PM3232 with 80 nsec visible delay in both channels

PHILIPS

Circle 181 on reader service card

A year ago we introduced 7 new JCM miniature RF coaxial connectors that "do the job for a fraction of SMA prices."

Here, by popular demand, are 8 more.

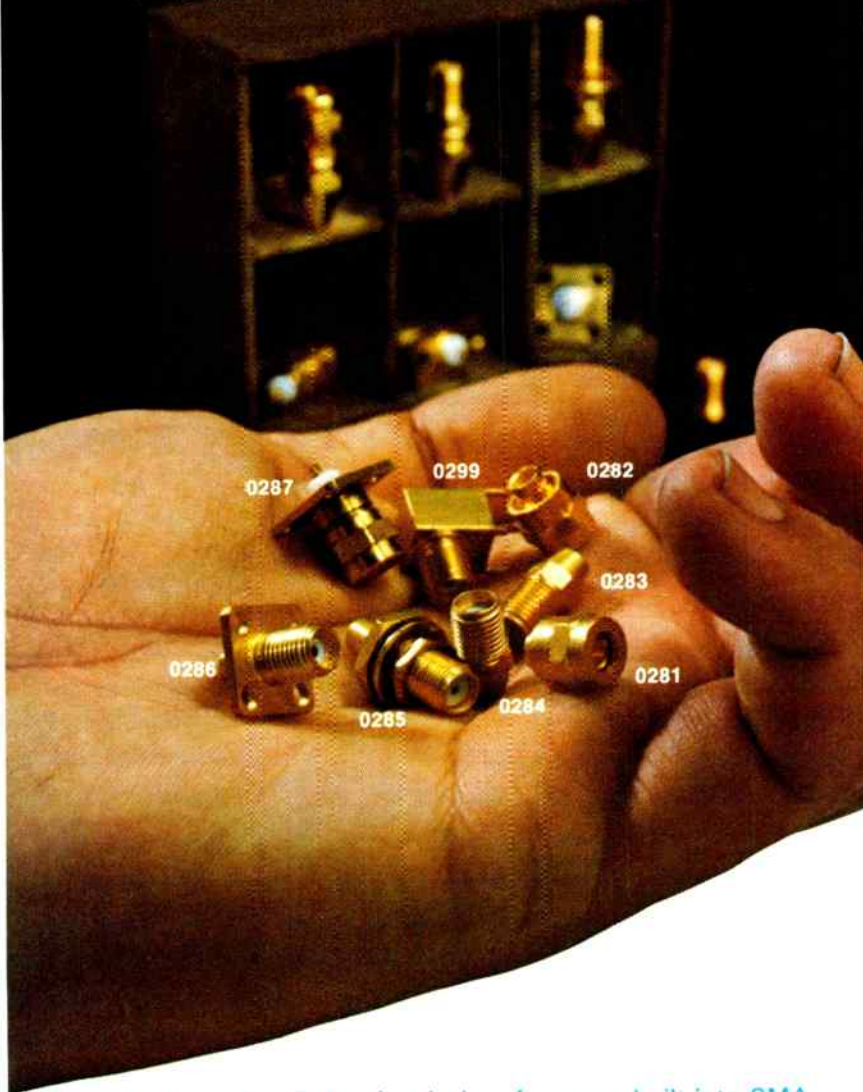

If you don't require all the electrical performance built into SMA type connectors, why pay for it? Up to 3 GHz for flexible cable assembly and even beyond 6 GHz for semi-rigid assembly, our new JCM series gives you the same electrical performance as the far more expensive SMA types. The series includes connectors for both panel and PC mounting. All are interchangeable and intermateable with the standard, expensive SMA connectors. So you can use them without making any changes . . . and without compromising required performance. There are JCM connectors to accept virtually any miniature size cable, so you don't have to stock a big variety. It's worth looking into, isn't it? All it costs is a stamp.

E. F. JOHNSON COMPANY / Waseca, Minnesota 56093

30-11

Please check for technical information or test samples of our new low-cost series 142-0200-001 JCM connectors.

- Please send technical information.
- I desire test samples. Please call me at _____

NAME _____

FIRM _____ TITLE _____

ADDRESS _____

CITY _____ STATE _____ ZIP _____



E. F. JOHNSON COMPANY

182 Circle 182 on reader service card

New products

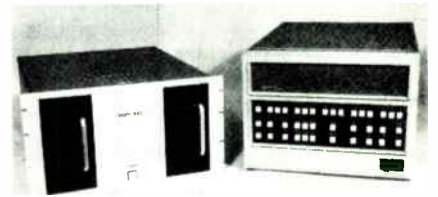

without direct-memory access, making it, according to the manufacturer, the only system which can be used with any H-P 21XX series computer. Price of the system is \$4,900; delivery is stock to 30 days. Dicom Industries, 715 North Pastoria Ave., Sunnyvale, Calif. 94086 [366]

D-a converter system routes analog data

A 32-channel digital-to-analog conversion and distribution system accepts data and address inputs from a computer, converts the data word into an analog voltage level, and routes the analog signal to one of up

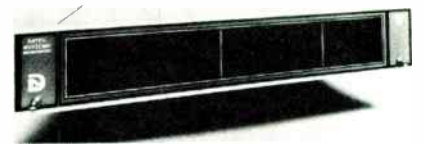

to 32 output channels specified by the address word. The system can have anywhere from one to the full 32 output channels, and can operate with 8, 10, or 12-bit input data. The output channels may be updated at a maximum rate of 500 kHz. Transfer accuracy is $\pm 0.01\%$ of full scale, $\pm \frac{1}{2}$ least significant bit. The model DDS-32 starts at \$1,360, and has a delivery time of 60 days.

Datel Systems, Inc., 1020 Turnpike St., Canton, Mass. 02021 [368]

System makes drawings, builds data base

A three-dimensional graphics system for computer-aided design, and computer-aided manufacturing applications produces engineering

Electronics/November 14, 1974

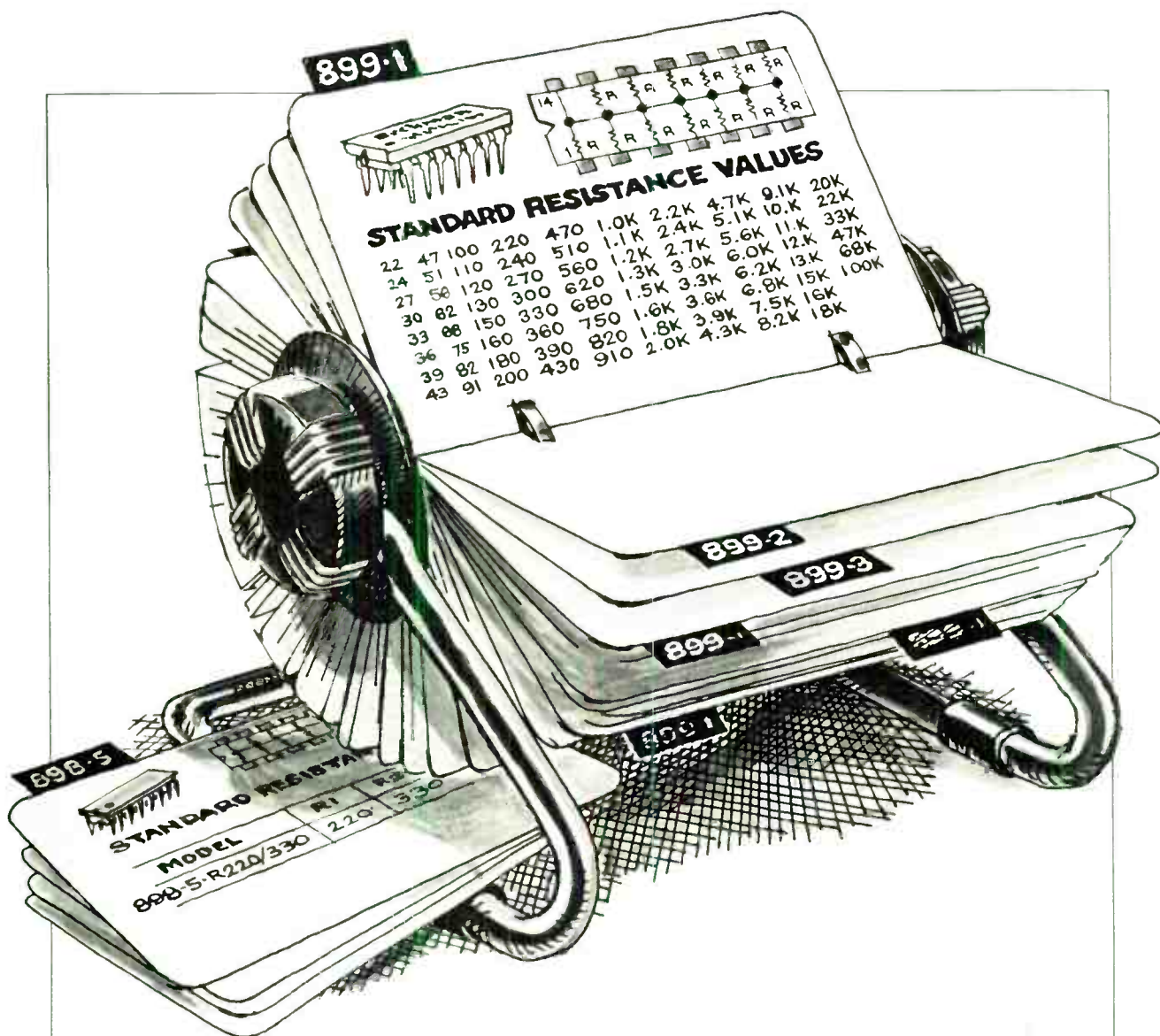

Still rolling up the score. Now, 223 standard Beckman DIPs.

We're adding more and more models to the RESNET™ DIP resistor line to make things easier for you.

Now there are 223 standard RESNET DIPs to give you wider selection, greater variety of resistance values, and less need for custom components.

Use them for applications involving pull-up/pull-down, line termination, LED current limiting, ECL termination, or interface networks. And most models are second-sourced, too.

RESNET DIPs are dimensionally uniform, ideal for automatic insertion techniques. They're also laser-tailored for precise resistance values. And every part is 100% tested.

Ours is the broadest line available and it's stocked locally by your Beckman/Heliport distributor for immediate delivery.

Prices? Truly competitive, actually giving you the quality of cermet technology at plastic prices.

Considering breadth of line, quality, availability, and good pricing, you don't have to look farther than Beckman for standard resistor networks. Or for expertly produced custom versions as well.

Check us out. For immediate literature or the phone number of your Beckman/Heliport representative, call toll-free (800) 437-4677. **Beckman®** HELIPOT DIVISION

When you
specify High-Rel Hybrids,
specify
Highbrids
from Raytheon/Quincy

Highbrids because they combine high reliability, high performance and high technology in a beam lead or chip-and-wire package.

Highbrids are the *only* hybrids we make at Raytheon/Quincy. Because we're high on the military and medical electronics markets. In fact, that's where 98% of our Highbrids are used.

All our Highbrids are custom engineered and are the most advanced design units available.

So, if you don't know all about Highbrids from Raytheon/Quincy, it's high time you do. Contact Mr. K. Singh at Raytheon Company, Industrial Components Operation, 465 Centre Street, Quincy, Mass. 02169. (617) 479-5300.

RAYTHEON

New products

drawings and design documentation, and, at the same time, builds a base of three-dimensional geometric data. The CDP3/M system hardware includes a minicomputer, a 14-million-word disk memory, and a variety of graphics terminals. Sys-

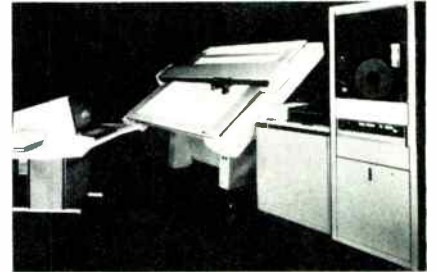

tem software allows the design engineer to make a preliminary drawing on a cathode-ray-tube display, look at the part from any angle, cross-hatch, zoom, rotate, window, insert fillets, add standard parts from a library, and define jigs and motions for numerically controlled tools. Data can also be formatted for design analysis and simulation.

The Computervision Corp., 201 Burlington Rd., Bedford, Mass. 01730 [369]

Disk drive and head unit is fast, versatile

An electronic head and drive assembly for both hard and floppy disks, patented as a magnetic actuator, is used as a driver to position read/write recording systems involving up to 256 tracks. Track-to-track step time is said to be 3.5 milliseconds. At the customer's option, the device can be supplied in configurations ranging from one-head/one-track up to a dual-pod assembly of eight heads with 64 tracks. Head resolution can be modified by the manufacturer to meet various systems requirements. The head is fitted to a bistable drive assembly that features position-verification and a head-lifter, which keeps the head off the disk when the head is in a standby mode.

Advanced Magnetic Products, Inc., 7067½ Vineland Ave., North Hollywood, Calif. 91605 [370]

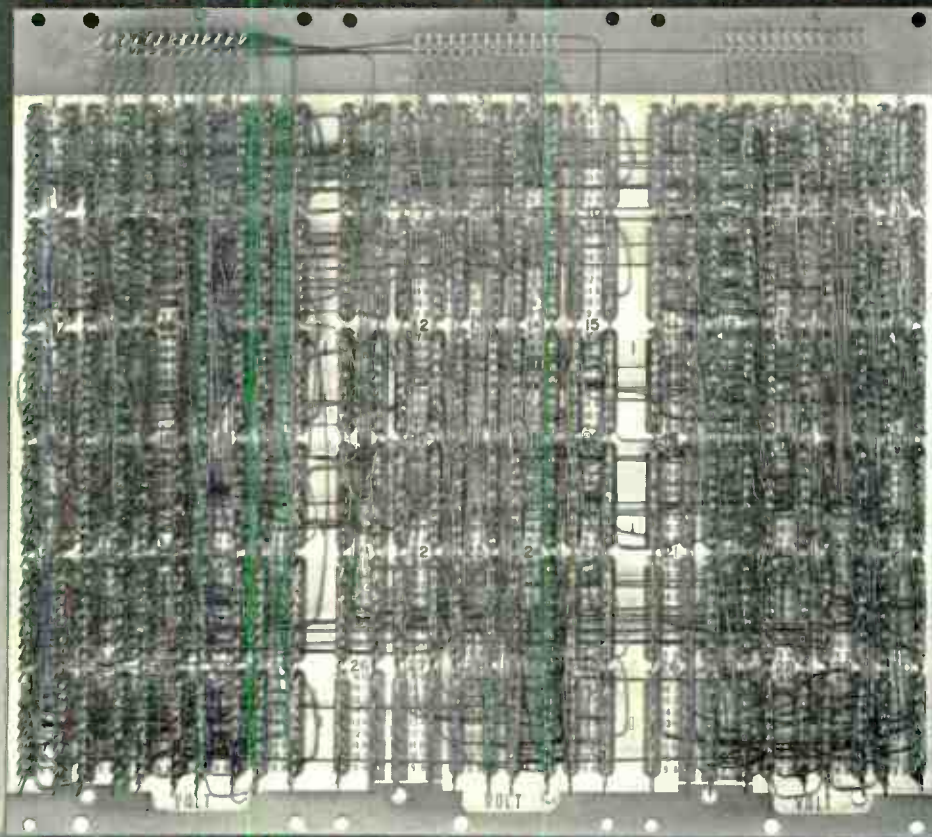

Our packaging panels are completely interchangeable. Our quality, price and delivery are the best.

Garry offers a complete line of standard, off-the-shelf packaging panels. All of which are completely interchangeable—in form, fit and function—with panels from any other manufacturer. Including the ones you're using now. But that's where the similarities end. Garry offers you faster delivery, better price and higher quality.

And if that isn't enough consider the following.

- Our pins have squareness of .025" and are the straightest in the industry.
- Our sockets offer the most reliable retention in the industry and retains even the new short I.C. leads (down to .090").
- Our gold plating on the contact is .000040" guaranteed.
- And our recently enlarged wire wrapping department features new 14FV Vertical Gardner-Denver machines.
- Engineering assistance to convert your logic diagrams to packaging hardware.

Which means you can get a better product, at a better price, in far less time from Garry than from anybody else.

All from Garry. Where our service is unique.

Garry Manufacturing Co., 1010 Jersey Avenue, P.O. Box 94, New Brunswick, NJ 08902 (201) 545-2424.

Garry

Manufacturing Co.

We won't pin a bum wrap on you.

Circle 185 on reader service card

New products

Packaging & production

PROM programmer handles 16k bits

'Universal' instrument is microprocessor-controlled, fits in attaché case

A microprocessor-controlled PROM programmer is said to be half the size and half the price of comparable models now on the market. It was developed by ProLog Corp. of Monterey, Calif., as a versatile solution to the programming needs of programmable read-only memories storing up to 16,384 bits.

Housed in an 18-by-12-by-4.5-inch attaché case and weighing only 18 pounds, the series 90 universal PROM programmer costs \$1,800. It consists of a master control unit, designated the M900, plus one of a range of personality modules that handle different types of PROM and cost an extra \$300 to \$500.

Basic to the M900 is an Intel 4004 microprocessor system, which enables the programmer to process a wide variety of PROMs and to interface with teletypewriters, paper-tape readers or punchers, minicomputers and many other kinds of equipment. Also part of the M900 are a 16-key data-entry keyboard (0-9, A-F); seven control keys (program, duplicate, list, verify, reset, correct and enter); address invert and data invert control switches; a six-digit hexadecimal display, a zero-field status light; sockets for master and copy PROMs; and a receptacle and connectors for a PM9000 personality module.

Each personality module contains the specialized interfacing, power supplies and programming instructions unique to the particular PROM or family of PROMs being programmed (pulse width, number of pulses, duty cycles and threshold level). In many cases, a single module enables the user to program several types of PROMs. Personality

modules are available for the 256-by-8-bit 1702 and 5202A and the 512-by-8-bit 5704 and 5204 MOS PROMs; the 256-by-4-bit 3601, 5603A and 82S126 fusible-link PROMs; and Intel's 512-by-8-bit 3604 fusible-link PROM.

To program a device, keyboard data is entered into a copy PROM. A hexadecimal character defines each four bits at each address location in the PROM. Both address and data are displayed for verification prior to actual programming. The unit automatically reads the PROM to verify correct programming.

To duplicate a device, data in a master PROM is automatically programmed into the copy PROM. Prior to programming, the operator can enter data corrections for up to 16 words. To verify, data in the master PROM is automatically compared to data in the copy PROM. The programmer halts on a mismatch and displays the address and data in the master PROM (in hexadecimal) and the data in the copy PROM (in binary). The operator can continue comparing beyond the mismatch. Verification of two matching PROMs takes about two seconds.

ProLog Corp., 852 Airport Rd., Monterey, Calif. 93940 [391]

Zipper tubing seals without heat or cement

A permanent zipper-tubing track closure that remains tightly closed even when twisted and flexed meets military specifications and is offered in many sizes, types and colors. Called Loc-Trac zipper tubing, the material requires no heat or cement for installation but is simply zipped tightly over the inner conductors.

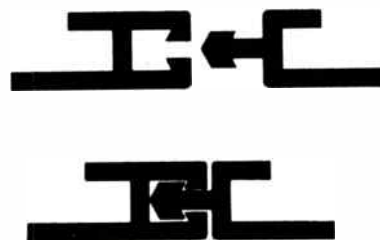

The tubing is supplied in flat, open form and can be wrapped around existing installations without re-wiring—an especially convenient feature when splices are required.

Alpha Wire Corp., 711 Lidgerwood Ave., Elizabeth, N.J. 07207 [393]

Belt-mounting kit wraps, unwraps wire

A complete wire-wrapping kit for telephone work includes a model G100 wrapping tool, a model UW-1 hand unwrapping tool, an ST-100

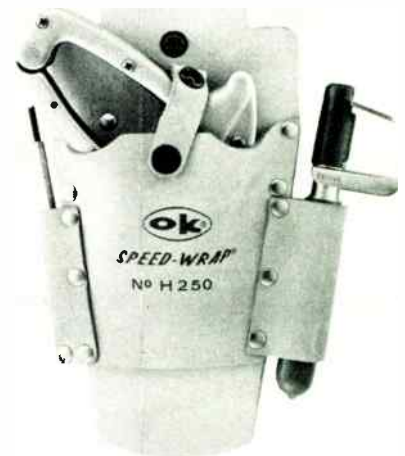

wire cutter and stripper, and bits and sleeves for 22- and 24-gauge wire. All these items are packaged in a model H250 belt-mounting leather holster. The complete kit, which is called the model T-224WWK, sells for \$79.95 and is available for immediate delivery.

O.K. Machine and Tool Corp., 3455 Conner St., Bronx, N.Y. 10475 [395]

Connector system handles 50 conductors

A termination tool and a standard-format 50-contact solderless connector are designed for telephone installations and many other rectangular-connector uses. Employing a proprietary carrier strip to gang-terminate 25 conductors at a time, the 50-contact Vitel "F" connector

Our crack team of problem solvers

has the smooth, silent answer to many of your potentiometer requirements. It's called Resolon® — Duncan's outstanding conductive plastic element that adapts to the widest variety of non-wirewound applications.

Many users find it expedient to purchase only the element and wiper instead of a complete potentiometer assembly. Result: reduced space requirements, lower costs and a reduction in driving torque — plus total product reliability. Resolon elements, featuring an operating life of over 20 million traverses, can be supplied in an almost unlimited selection of sizes and configurations including sector,

rotary and rectilinear.

When precision pots are required, non-wirewound or wirewound, check with Duncan's 'Elite Design Team' first... the industry's high performance specialists. On-time delivery and competitive prices are all part of the package. Send today for technical literature.

DUNCAN ELECTRONICS
SUBSIDIARY

SYSTRON  **ODDNER**

2865 Fairview Road • Costa Mesa, California 92626
PHONE: (714) 545-8261 □ TWX 910-595-1128



**Duncan: Your prime source for
custom designed pots.**

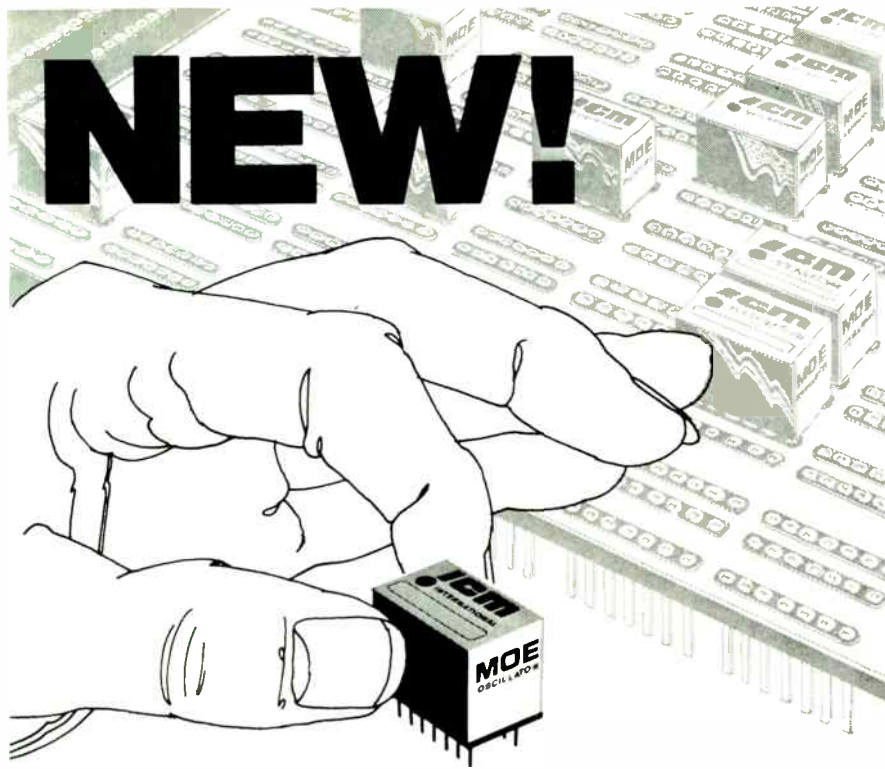

NEW!

INTERNATIONAL'S MOE Crystal Oscillator Elements provide a complete controlled signal source from 6000 KHz to 60 MHz

The MOE series is designed for direct plug-in to a standard dip socket. The miniature oscillator element is a complete source, crystal controlled, in an integrated circuit 14 pin dual-in-line package with a height of 1/2 inch. Oscillators are grouped by frequency and temperature stability thus giving the user a selection of the overall accuracy desired. Operating voltage 3 vdc to 9 vdc.



TYPE	CRYSTAL RANGE	OVERALL ACCURACY	25°C TOLERANCE	PRICE
MOE-5	6000KHz to 60MHz	+ .002% -10° to +60°C	Zero Trimmer	\$35.00
MOE-10	6000KHz to 60MHz	+ .0005% -10° to +60°C	Zero Trimmer	\$50.00

New products

can be completely terminated in less than five minutes. The carrier strip also provides individual-wire strain relief and protection for increased electrical reliability. The self-contained tool, called the Pushover, is portable and weighs less than eight pounds. Production quantities of both the Pushover tools and Vitel "F" connectors are available with an average 60-day lead time.

Viking Industries Inc., Telecom Div., 20327 Nordhoff St., Chatsworth, Calif. 91311 [394]

Electron microscope resolves 30 angstroms

A field-emission scanning electron microscope has a guaranteed resolution of 30 angstroms and uses a multiple-tip, Crewe field-emission source that is 1,000 times brighter than the conventional thermionic tungsten filament. The model HFS-25 costs less than \$100,000 and includes automatic vacuum, a drawer-

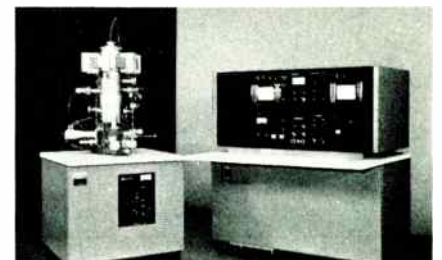

type specimen stage, and modular construction for easy addition of plug-in accessories. Twenty-six optional accessories are available, including a display unit for simultaneous dual magnification, a TV scanning device, and an energy-dispersive X-ray analyzer.

Perkin-Elmer Corp., 411 Clyde Ave., Mountain View, Calif. 94043 [396]

Lead-bending tool is fast, reliable

A fine-pitch adjusting screw is a feature of the fourth generation in a line of hand tools that bend electronic component leads fast and ac-



**It's a controller.
It's a data logger.
It's a calculator that interfaces with most of
the measurement instruments in your lab.**

Do you need an analytical instrumentation system? A data acquisition system? A system controller? You can build these—or just about any measurement system you need—by connecting the appropriate instruments to a Hewlett-Packard 9800 Series programmable calculator. Our interface cables let you connect from one to twenty-four instruments. The calculator automatically controls the operation of the instruments, stores measurement data, and rapidly reduces your data. At the same time, it can also control a full range of peripheral devices, from card and tape readers to a printer or plotter—or your own black box. And you can still use your calculator and instruments as individual tools.

The new Hewlett-Packard Interface Bus allows selected instruments to be connected to a 9820, 9821, or 9830 calculator, providing both control and

data capability, using a single I/O slot. This is true even if your lab already has one of these calculators. Other HP interface cables accommodate instruments using 8-4-2-1 BCD output, 8-bit parallel codes in any input and output formats, and bit-serial data.

You'll find that HP calculator-controlled systems substantially improve measurement speed and convenience. But even more important, they free you from repetitive measurement tasks or the need to design special controllers or data loggers. And that means more time for creative and productive work. For more information on how to interface an HP 9800 Series programmable calculator to your instrumentation, call your local HP sales office or send the coupon below.



Sales and service from 172 offices in 65 countries.
P.O. Box 301, Loveland, Colorado 80537

Tell me more about your calculators and interface systems.

Information only. Calculator demonstration

I am planning to use your calculator for: _____

Name _____

Company _____

Address _____

City _____ State _____

Zip _____ Phone _____

HP Calc. Inq. P.O. Box 301, Loveland, Colo. 80537

315F

Premier Electronic Cabinets and Cases

- ESTHETICS KEYED TO MODERN SYSTEMS
- RUGGED-FUNCTIONAL CONSTRUCTION
- ECONOMICAL PRICING
- PROMPT SERVICE & AVAILABILITY

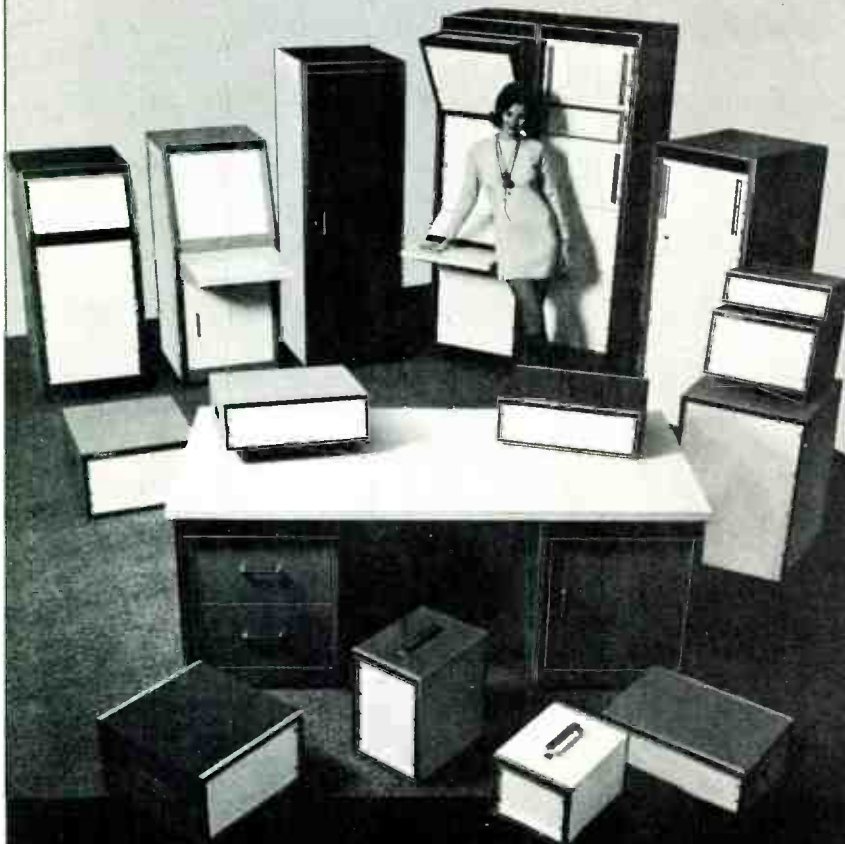

INSTRUMENT CASES—TIC SERIES

TVA Series Vertical Assembly— Construction Details (1 Frame, 2 End Panels, Rear Door)

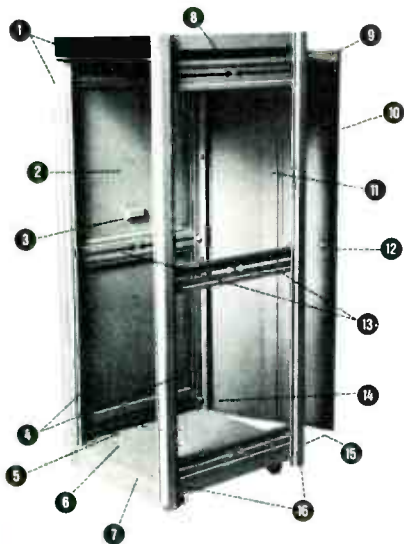

1. Trim: extruded anodized aluminum with textured vinyl inlays
2. Outside removable flush end panels (16 ga.)
3. Recessed hand grip for panel removal
4. 2 pr. panel mounting angles, fully adjustable front to rear with tapped 10-32 holes on EIA & WE Standards spacing (12 ga.)
5. 1" dia. holes for cable entry beneath base
6. Recessed caster mounting holes
7. 1 piece formed steel base provides for heavy equipment mounting area and concealed caster mounting (14 ga.)
8. 1 piece solid top for extra rigidity and squareness (14 ga.)
9. Foam gasketing (3 sides)
10. Magnetic closure gasket
11. Door stiffener channel
12. Keyed latch and brushed aluminum pull handle
13. Horizontal cross-brace and panel mounting angle supports
14. Quick release spring loaded door hinges (top and bottom)
15. 1 1/8" dia. knock-outs for rear cable entry underneath rear door
16. Formed steel uprights (14 ga.) provide 1/2" recess to panel mounting angles

All features shown are standard in the Trimline TVA Series
Welded, formed steel construction

Complete catalog and prices on request



PREMIER METAL PRODUCTS CO.
335 Manida St., Bronx, N.Y. 10474/(212) 991-6600

New products

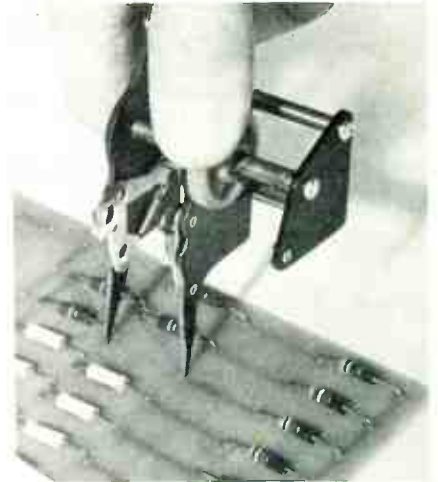

curately for insertion in printed-circuit boards. Function of the screw, which is permanently dry-lubricated for improved reliability, is smoother micrometer-type adjustment of bend spacing. Operating precision and efficiency are said to be increased. Standard features include strain relief between component and bend, replaceable plastic guides, and rigid hard anodized aluminum frame. The model N-300 costs \$32.50 and is available from stock.

Harwil Co., 903 Colorado Ave., Santa Monica, Calif. 90401 [397]

IC socket locks with quarter-turn

An IC socket that can be installed in a D-stamped hole without need for a lead-in chamfer locks in a chassis 0.020 to 0.062 inch thick after a 90° turn. Pull-out resistance is in excess

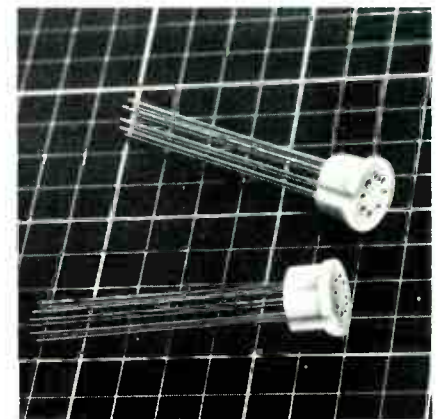

automatic transfer standards



The 1600A Auto-Balance AC/DC Transfer Standard. Precise repeatable measurements every 30 seconds. Traceable to NBS. Takes tedium and guesswork out of 100 ppm transfer measurements in Lab, QA and production.

0.25 V to 1 kV rms, dc to > 100MHz: \$4500



Ballantine Laboratories, Inc.
P.O. Box 97, Boonton, New Jersey 07005
201-335-0900, TWX: 710-987-8380

Circle 191 on reader service card

CA helps you make ends meet.

Circuit Assembly Corp. is a specialist in the field of DIP Sockets, Plugs, and Modules. We offer DIP Sockets from 8 to 42-pins (and specials, of course). We also offer an endless array of DIP Interconnect Cables and Harness Assemblies designed exactly to meet your requirements. With a reputation for quick delivery, high quality, and low prices, CA deserves to "help you make ends meet". Write for our new General Catalog No. 75-1.

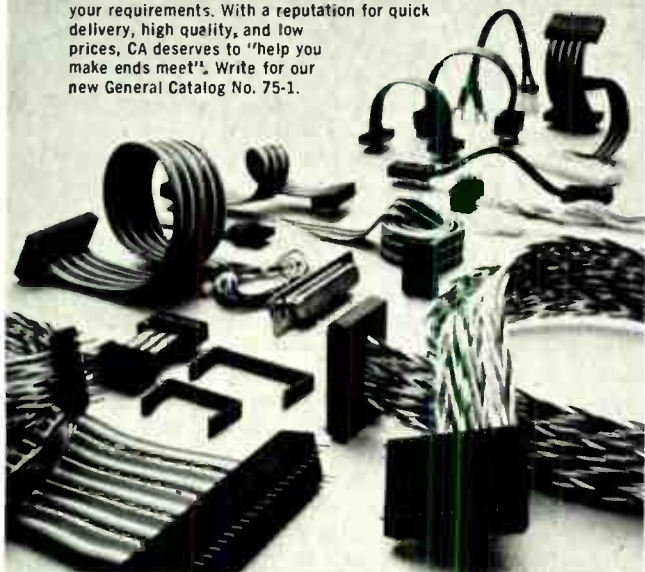

CIRCUIT ASSEMBLY CORP.

3169 Red Hill Ave., Costa Mesa, Ca. 92626, (714) 540-5490

Circle 273 on reader service card

YEW's POWERFUL FAMILY!



AC WATTS

And, that's a lot of accuracy, even with low power factors and distorted waveforms. The YEW 2885 is renown throughout the world as the AC power measuring instrument. YEW's APR-2, on the right is used as a standard by many countries in the world.



TRUE RMS V-A-W

Accuracy and versatility have generated a reputation for the YEW 2503 True RMS V-A-W instrument that's hard to beat. Distorted waveforms and low power factor hardly phase it at all.

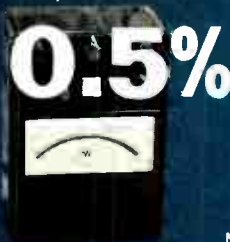

Model 2041

PORTABLE WATTMETERS

YEW has made more precision analog portables than anyone else in the world . . . and they're usable to 2 KHz and not expensive.

To find out all about YEW's extensive family of power instrumentation, just write or call. We'll be happy to prove why we're #1 in power.



YEWTEC CORPORATION

1995 Palmer Avenue
Larchmont, N.Y. 10538

© Yokogawa Electric Telephone: 914-834-3550

60 Years of Measuring and Recording Instrumentation

Circle 274 on reader service card 191

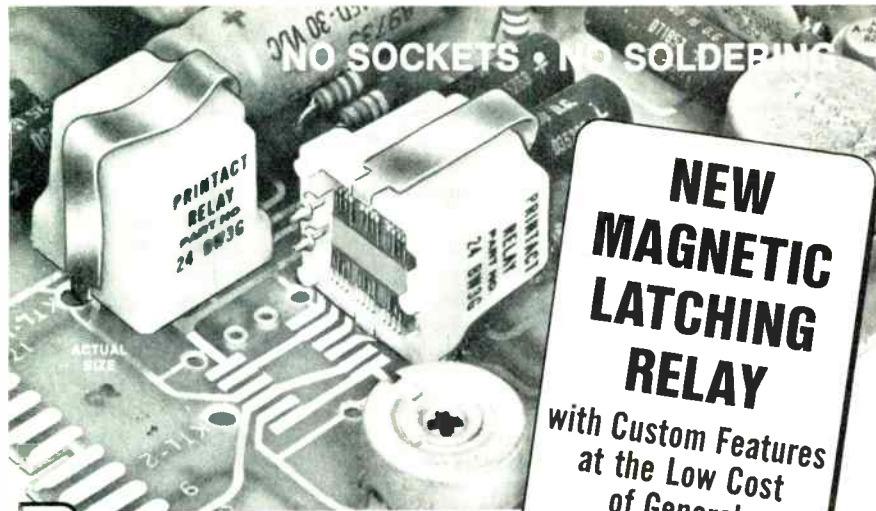

Printact®

Plugs into your PC board... mates with plated conductors

This new single coil magnetic relay has memory without power and other custom features uniquely suited for specialized applications. It costs no more than most non-latching general purpose relays. Reversal of polarity resets the armature. Double coils available.

Low contact bounce, high cross-talk isolation, low thermal EMF, and other features permit use of Printact all purpose (latching and non-latching) relays for such functions as RF, audio and thermocouple switching. Printact Relays plug into a PC board without

solder or sockets, have encapsulated coils and series break swinger contacts. A permanent magnet holds the hinged armature. Elimination of pigtails, return springs and mechanical linkage assures high reliability for millions of cycles.

Relays have 5 to 24 vdc, 500 mw coils with 2, 3 or 4 blades for up to 8 pole switching. Individual one to ten relay boards for point-to-point wiring or Bead Pin mounting, are available.

For free catalog sample, and PC design aids, call (212) EX 2-4800, or write—
Executone PRINTACT DIVISION, 29-10 Thomson Avenue, Long Island City, N.Y. 11101
 Circle 192 on reader service card

New products

of 20 pounds. Sealectro part No. 027-1707 accepts TO-5 eight-lead IC and relay units with leads on a 0.200-pitch circle. It resists shock and vibration without contact loosening because of the cold-flow properties of its Teflon insulation. The socket has gold-over-copper-plated brass leads, which are approximately 1.5 in. long. The beryllium-copper contacts have a continuous-current rating of 5.5 amperes. The Teflon insulation is available in any of the 10 standard EIA colors.

Sealectro Corp., Circuit Components Division, 225 Hoyt St., Mamaroneck, N. Y. 10543 [399]

Electrical power cord swivels through 360°

A swivel power cord, which permits a 360° cord rotation without kinking or snarling, has applications wherever power-supply cords require extreme flexibility and ease of handling. The cords, now being



produced for several personal-care-product manufacturers, can be designed to fit many different customer specifications.

Victor Electric Wire & Cable Corp., 618 Main St., West Warwick, R.I. 02893 [398]

Thinly clad boards allow increased circuit density

Micaply epoxy-glass laminates with thin copper cladding are designed for semi-additive circuitry applications and for high-line-density printed-circuit boards. The extremely thin (5-micrometer) cladding not only improves yields of high-density circuitry through the

PRECISION MADE PINS

MANUFACTURERS OF JACKS PINS AND TERMINALS.

HUNDREDS OF CONFIGURATIONS IN STOCK

SEND FOR CATALOG

CONCORD ELECTRONICS CORPORATION
 37 GREAT JONES STREET
 NEW YORK, N.Y. 10012
 (212) 777 6571 • TWX 710 581 4930

NEW! Power-On Hands-Off Signal Tracing PROTO-CLIP®

...under \$5

Now trace signals or troubleshoot fast. Inject signals or wire unused circuits into existing boards. Scope probes, test leads lock onto Dynagrip inset. Plastic construction — no springs or pivots. Thousands of operations. Narrow throat for high density pc boards.

14-pin Proto-Clip: \$4.50 each.
 16-pin Proto-Clip: \$4.75 each.

Order today from distributor or Continental Specialties Corp. Box 1942, New Haven, CT 06509 Telephone: 203/624-3103

Unique DYNAGRIP inset keeps probes from slipping

WE'LL SELL YOU A KEYBOARD SWITCH FOR 30¢

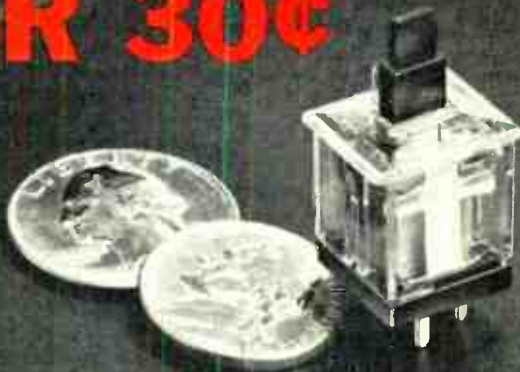

...and give you A PENNY CHANGE



How to save silver when buying gold: Spec Cherry Gold "Crosspoint" Contact keyboard switches. With a momentary Form A (SPST/NO) price tag of just 29¢ in 250,000 quantity . . . lower prices in higher quantities.

What do you get besides low price? Unique, proven Cherry Gold "Crosspoint" contact configuration that enhances reliability. Tested beyond 50,000,000 operations. (Test Report No. TK 10071 available on request.) You get Cherry's low profile Keyboard switch featuring rugged construction, 2½ ounce operating force and stable contact resistance (typically 25 milliohms over life). Made by the people who pioneered the Gold "Crosspoint" Contact in snap-action switches.

The result? Cherry keyboard switches are your ideal choice for computer terminals, electronic calculators and credit card validators.

TEST A FREE SAMPLE. Choose the 29¢ Form A switch . . . or any of Cherry's complete line of keyboard switch modules. Just TWX 910-235-1572 . . . or PHONE 312/689-7700 and ask Frank to give you facts on Keyboard Switches . . . or circle appropriate reader service number



ACTUAL SIZE

FORM A, MOMENTARY (SPST/NO)
Circle No. 251 for Free Sample

ALTERNATE ACTION (SPST)
Circle No. 252 for Free Sample

DUAL FORM A, MOMENTARY (DPST/NO)
Circle No. 253 for Free Sample

CHERRY



CHERRY ELECTRICAL PRODUCTS CORP.
3608 Sunset Avenue, Waukegan, Illinois 60085



Cherry affiliates worldwide • Hirose Cherry Precision Co., Ltd., Tokyo • G. W. Engineering Pty. Ltd., Sydney
Cherry Electrical Products (U.K.) Ltd., St. Albans, Herts • Cherry Mikroschalter GmbH, Bayreuth, Germany



DELEVAN

DEPENDABILITY

DOESN'T COST

There's a lot more than meets the eye in Delevan's lineup of miniature RF inductors and transformers. Like the unmatched dependability built into each component. Thanks to a lot of things that go on at the factory. Hard-nosed quality controls . . . complete material analysis . . . advanced in-plant environmental testing . . . automated techniques for winding, soldering and molding . . . and conscientious people who take pride in true "no-fault" production. And of course, the dependable delivery and service you always get from Delevan.

IT PAYS

Remember . . . the proven reliability of these superior made-in-U.S.A. inductive devices means greater reliability for the products and assemblies *made from them*. Sure, you can save a few pennies by using cheaper components. But this could be expensive in terms of premature failure of the finished product. When your company's reputation is on the line, you can't afford *not to use* Delevan components. Their premium performance more than justifies their use . . . because Delevan dependability pays for itself. Why not prove it to *yourself!*

Delevan
Division



AMERICAN
PRECISION
INDUSTRIES INC.

270 QUAKER RD. / EAST AURORA, N. Y. 14052
TELEPHONE 716/852-3600 TELEEX 091-289

OTHER DIVISIONS OF AMERICAN PRECISION INDUSTRIES INC.
BASCO • OUSTEX

New products

elimination of undercut problems, but it reduces the usage of processing chemicals as well. All laminates are supplied with a copper carrier over the thin copper surface, both to protect the cladding and as a drilling back-up.

The Mica Corp., 10900 Washington Blvd., Culver City, Calif. 90230 [400]

Pads convert TO-5 cans to standard DIP pattern

Funnel-shaped lead-entry ports on a series of spreader pads accept circular-patterned devices and form a standard DIP pattern at the exit. Available in eight-, 10-, and 12-lead models, the spreader pads increase heat dissipation by exposing more of the leads. In addition to being useful as integrated-circuit mounts, the pads can be employed as assembly/insertion tools, fixtures, and carriers. Outside dimensions of the pads fall within standard grid spacings, and the mounts can be banked in parallel or in tandem without sacrificing board area.

Bivar Inc., 1617 E. Edinger Ave., Santa Ana, Calif. 92705 [376]

Water demineralizer has fail-safe option

The model LD-5A automatic water demineralizer incorporates two cartridges—one for organic contaminants, the other for inorganic. It can also be configured with two inorganic cartridges for faster removal of inorganic material. The unit monitors the purity of its output by measuring its resistivity. When a preset resistivity limit, between 50,000 and 1,000,000 ohm-centimeters, is reached, an indicator lamp lights to tell the user to change the cartridge. Fail-safe operation is provided by an optional solenoid valve that shuts off the water supply when the purity falls below the selected level. Basic price is \$395.

Corning Glass Works, Scientific Glassware Dept., Corning, N. Y. 14830 [377]

If these new testers do **half** what we promise, it'd be well worth your time and effort to prove it.

These testers cost tens of thousands less than other production test systems. They fit under an airline seat, travel easily to field applications. They enable drastic reductions in set-up costs by combining normal programming with pseudo-random patterns, by being compatible with other logic testers. They dramatically increase throughput on even the most complex boards by automatic testing up to 100 times faster than other computer-controlled testers. They significantly reduce troubleshooting costs by providing many more fault-isolation techniques.

See? Half that would be extraordinary.

All that is **ordinary** — with the new MIRCO 500-Series Logic-Circuit Testers.

Join the growing list of companies who've put these testers to the test. Then bought.

**The most incredible
logic testers
ever devised?
Put your best hands
on them.**

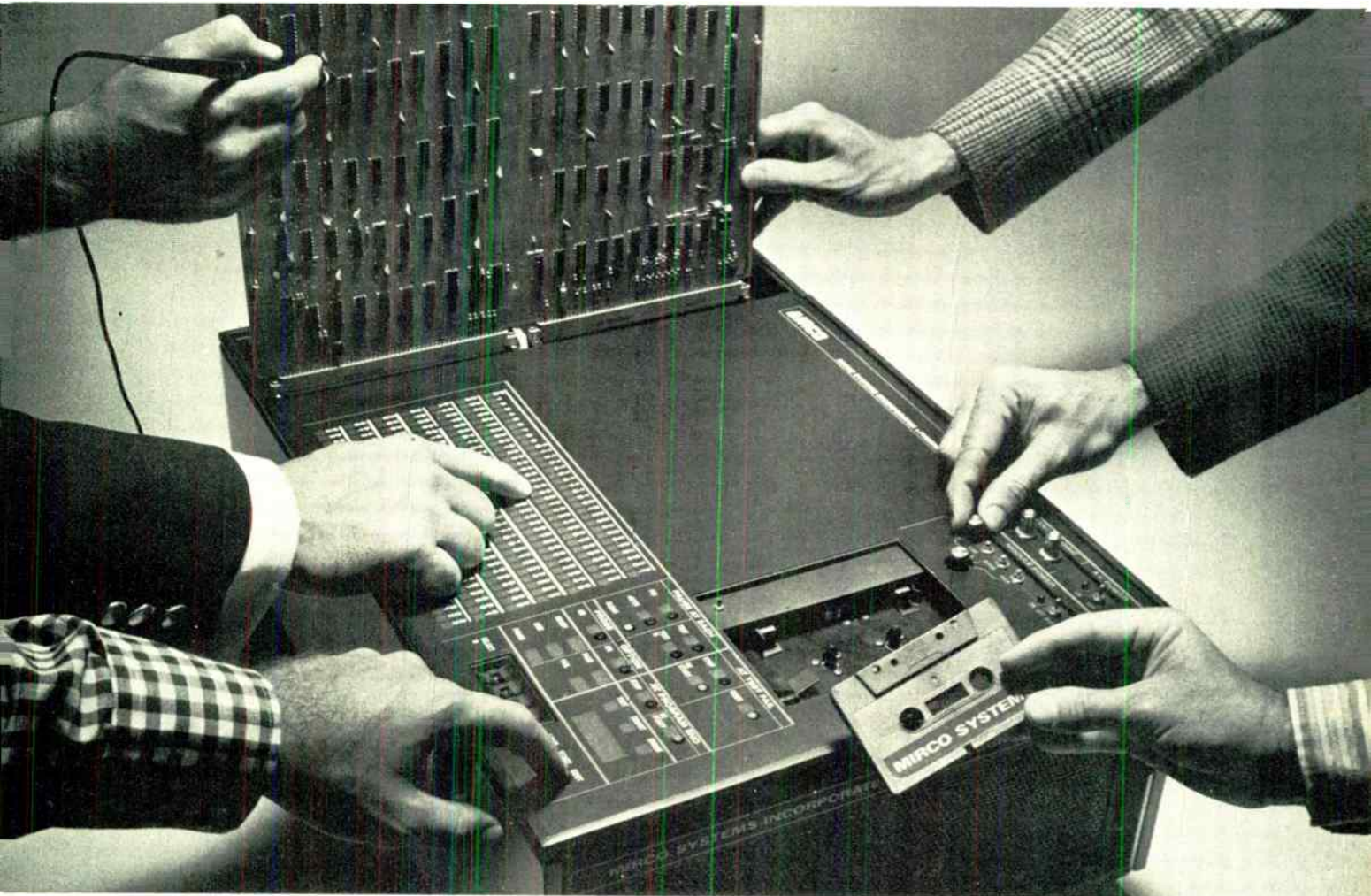

MIRCO MIRCO SYSTEMS
INCORPORATED

Circle 195 on reader service card

2106 WEST PEORIA AVENUE • PHOENIX, ARIZONA 85029 • (602) 944-4691 • TELEX 668-403

World Radio History

**All those little
wires have been
pushed around
long enough.**



Until now, all those wires have been at the mercy of packaging materials that expand when things get hot.

So we developed new Dow Corning® 480 semiconductor molding compound.

Dow Corning 480 has a low coefficient of thermal expansion.

So it virtually eliminates the hot intermittent open. And moisture penetration.

Which means that an integrated circuit stays integrated. Through all sorts of temperature and atmospheric extremes.

But that's not all that's different about 480 molding compound.

Its resistance to salt spray is excellent.

And it reduces your packaging costs because it saves time. Molding times are short—less than one minute for some components. Post curing is unnecessary.

Of course, Dow Corning 480 molding compound also has the advantages of our other silicones. Consistency. Long shelf life. Less cleaning downtime because there's no buildup. Non-flammability. And, because it doesn't irritate skin, there's no need for special handling.

Dow Corning 480 semiconductor molding compound is the kind of improved product you can expect to keep getting from Dow Corning. Our Technical Service and Development Department has more manpower and greater technical facilities than any other in the industry.

If you want to know more about 480, call us at 517 636-8000, or write Dow Corning Corporation, Dept. B-4334, Midland, Michigan 48640.

DOW CORNING



New products

Subassemblies

Converter has good linearity

12-bit a-d unit offers differential nonlinearity coefficient of $+2 \text{ ppm}/^\circ\text{C}$

Making use of thin-film nichrome resistors and precision monolithic quad switches, a 12-bit analog-to-digital converter from Hybrid Systems Corp. of Burlington, Mass., offers an exceptional maximum dif-



ferential nonlinearity temperature coefficient of $\pm 2 \text{ ppm}/^\circ\text{C}$. The model ADC-12QZ is intended to replace an a-d converter being supplied by Analog Devices of Norwood, Mass. The two devices are identical except for their differential nonlinearity temperature coefficient, which is lower for the Hybrid Systems unit.

The ADC-12QZ is a successive-approximation a-d converter that contains its own internal reference digital-to-analog converter. Because this internal d-a converter is built with a thin-film nichrome-resistor ladder network and monolithic quad switches, the linearity and stability of the a-d converter are excellent over temperature and time. Additionally, the unit's accuracy is enhanced through dynamic laser trimming (while the device's power is on) of the critical bits within the ladder network.

To make its nichrome resistors, Hybrid Systems first evaporates, un-

der high vacuum, a solid mixture of nickel and chromium, called nichrome, onto a silicon wafer measuring 2 to 3 inches in diameter. The unwanted nichrome is then etched away, leaving a geometric pattern of nichrome that gives the desired resistance. The company next evaporates aluminum onto the wafer. The aluminum is then etched away to form the desired interconnection and bonding patterns. Individual resistor networks on the wafer can occupy an area as small as 0.030 inch square.

The internal 12-bit d-a converter requires three quad switches. The least significant bit in each quad switch uses one transistor; the next-higher bit uses two transistors; the next uses four transistors; and the most significant bit uses eight transistors. Another identical transistor is used for the d-a converter's voltage-reference source. Because each of these transistors is maintained at the same current level at all times, whether the switch state is logic 1 or logic 0, the temperature tracking of the d-a converter is greatly enhanced.

Although many transistors are required, the transistors are electrically identical, so that only a single type of transistor is needed for the entire d-a converter section. Moreover, every transistor is carefully patterned in an isothermal arrangement, thereby minimizing thermal errors and eliminating hot spots and thermal gradients.

The ADC-12QZ a-d converter has a maximum error, relative to full scale, of $\pm 1/2$ least-significant bit and a maximum differential nonlinearity error of $\pm 1/2$ least significant bit. The unit's full-scale gain temperature coefficient, which is a measure of the stability of the internal d-a converter, is a maximum of $\pm 30 \text{ ppm}/^\circ\text{C}$. Maximum conversion time is 40 microseconds, and operating temperature range is 0°C to 70°C .

The converter can accommodate two input voltage ranges, $\pm 5 \text{ v}$ or $\pm 10 \text{ v}$, and several input-buffer amplifiers are available as options for the unit. Output coding can be par-

allel, serial binary, or two's complement. The device operates from a power supply of $\pm 15 \text{ v}$ and $+5 \text{ v}$.

Tentative pricing for the ADC-12QZ is \$99 each in quantities of 1 to 9. Sample quantities will be available in six to eight weeks.

Hybrid Systems Corp., 87 Second Ave., Northwest Park, Burlington, Mass. 01803 [381]

Dc power supply offers 52% efficiency

A 5-v, 25-A dc power supply with 52% efficiency at 115 v ac, full load, is designed for OEM applications. According to the company, the new unit is up to 20% more efficient than

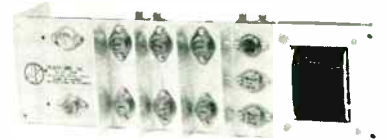

competitive models. Input is 105-125 v ac, 60 Hz. Line regulation is 0.01%, load regulation 0.02% and output ripple 1.5 mV, peak-to-peak maximum. Transient response is 30 microseconds for 50% load change. Other models at 12, 15, 24, and 28 v are available. Price is \$149.

Power-One Inc., 531 Dawson Dr., Camarillo, Calif. 93010 [383]

Power transformers built for small dc supplies

A series of plug-in printed-circuit power transformers for use in low-cost, miniaturized dc power supplies

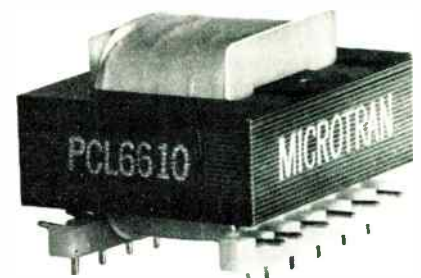

offers outputs of +5 and ± 15 volts dc for both digital and linear solid-state circuitry. Designed for 115- and 115/230-v, 50/60-Hz input, output current ratings are from 12 to 2,000 mA dc. Typical 100-piece pricing is \$4.50-\$5.50.

Microtran Co. Inc., 145 East Mineola Ave., Valley Stream, N. Y. 11582 [384]

Lightweight power dividers cover range from 1 to 18 GHz

Two-way and four-way in-phase power dividers combine transmission-line design techniques with small size and light weight to achieve good performance over wide multi-octave frequency ranges and single-octave bandwidths. Offering high isolation, low VSWR, and good amplitude and phase balance, the units are suitable for applications in high-performance mi-

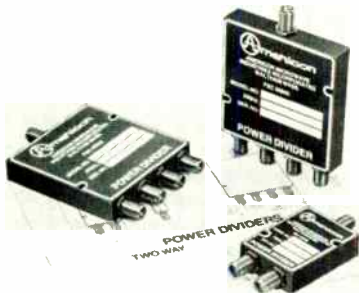

crowave systems. Frequency range is 1 to 18 GHz.

American Microwave Industries Inc., 140 4th Ave., Waltham, Mass. 02154 [385]

A-d converter provides linearity within $\pm 0.0025\%$

The model 109 "naked" analog-to-digital converter uses an improved version of the dual-slope integrating technique with automatic zero correction to provide linearity within $\pm 0.0025\%$ and low drift of better than ± 1 ppm/ $^{\circ}$ C. When combined with required counter and clock, the model 109 becomes a complete, high-performance a-d converter

There's a world of difference between Dow Corning and the other semiconductor packaging-materials suppliers.

The difference is that only Dow Corning has available worldwide a complete line of silicone molding compounds, an accomplished technical service and development team, the advantage of a completely compatible product line, and the convenience of worldwide delivery and service. If you want to give your packaging operation a competitive advantage, just call or write. One of our representatives is nearby.

J. Guillot
DOW CORNING S.A.R.L.
140, Avenue Paul Doumer
92500 Rueil Malmaison
France
Telephone: 977.00.40

M. Tedone
DOW CORNING SpA
Viale Restelli 3/7
20124 Milan, Italy
Telephone: 688.2458

ASIA

H. Takahashi
DOW CORNING ASIA LTD.
P&O Building, 9th Floor
21 Des Voeux Road, C.
Hong Kong
Telephone: 5-258035

H. Hotta
DOW CORNING ASIA LTD.
Room 803, Cathay Building
Mount Sophia
Singapore 9
Republic of Singapore
Telephone: 321213-5

AUSTRALASIA

H. Tuynman
DOW CORNING AUSTRALIA PTY LTD.
36 O'Dea Avenue
Waterloo, N.S.W. 2047
Sydney
Telephone: 699 8055

P. Winter
DOW CORNING AUSTRALIA PTY. LTD.
103 High Street
Pahran, Vic. 3181
Telephone: 51 5450

Dow Corning semiconductor molding compounds...quality and dependability worldwide.

B-11-5

NORTH & SOUTH AMERICA

Resins and Chemicals Marketing
DOW CORNING CORPORATION
Midland, Mi. 48640
Telephone: 517 636-8682

EUROPE

R. Hediger
DOW CORNING INTERNATIONAL LTD.
Chaussée de La Hulpe 177
1170 Brussels, Belgium
Telephone: 73.80.60

B. Sneddon
DOW CORNING LTD.
Reading Bridge House
Reading RG1 8PW
Berkshire, England
Telephone: Reading 57251

R. Jones
DOW CORNING GmbH
1150 Vienna
Mariahilferstrasse 180/4
Austria
Telephone: 83.85 38

S. Haberer
DOW CORNING GmbH
8000 Munchen 50
Pelkovenstrasse 152
West Germany
Telephone: 14.861

DOW CORNING

DOW CORNING



Get the Zonker-II SPDT Subminiature Toggle Switch and Save about 30%!

In these days of soaring prices, C&K offers a hi-quality SPDT subminiature toggle switch at about 30% less cost than competitive switches! Affectionately called "Zonker-11" after C&K's *Screaming Yellow Zonker*, the switch is completely machine-assembled by the time you say Zip! Zap! Zonk! And that's the reason for the low price. So, for a quality 100,000-cycle switch, specify C&K's Zonker-11. Inflation, thy days are numbered—thanks in part to C&K.

C&K Components, Inc., 103 Morse Street,
Watertown, MA 02172, Tel: (617) 926-0800
TWX: 710-327-0460

Engineering Samples on Request.



Circle 200 on reader service card

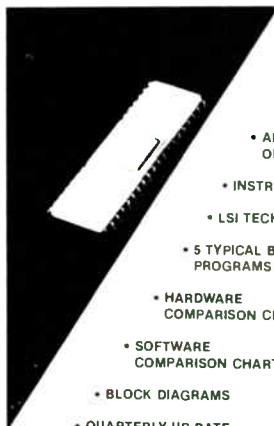

FEATURES

- SPECIFICATIONS FOR ALL CURRENT MICROPROCESSORS
- ARCHITECTURE OF CPU'S
- INSTRUCTION SETS
- LSI TECHNOLOGIES
- 5 TYPICAL BEACHMARK PROGRAMS FOR 10 CPU'S
- HARDWARE COMPARISON CHARTS
- SOFTWARE COMPARISON CHARTS
- BLOCK DIAGRAMS
- QUARTERLY UP-DATE SERVICE INCLUDED
- CONVENIENT 3-RING BINDER FORMAT

Price \$495

MICROPROCESSOR
FIELD SURVEY AND DATA BOOK

WHICH MAN IN YOUR COMPANY WILL SPECIFY THE BEST MICROPROCESSOR FOR YOUR APPLICATION? OR WHICH MICROPROCESSOR?

AH Systems provides the answers in a new service for engineers, product managers and programmers. The Data Book contains a comprehensive survey of all the current microprocessors (over 25 CPU's) and support chips.

A check or purchase order is enclosed for \$495 (additional copies are \$55 each)

Please send me more data on the survey

Please send me data on other AH Systems reports and services.

NAME _____ TITLE _____
 COMPANY _____
 ADDRESS _____
 CITY _____ STATE _____ ZIP _____



AH SYSTEMS INC. • 9710 COZYCROFT AVENUE
CHATSWORTH, CALIFORNIA 91311 • (213) 998-0223

200 Circle 105 on reader service card

New products

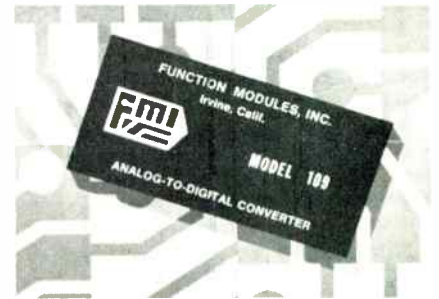

with resolutions of up to ± 16 bits binary or $\pm 5\frac{1}{2}$ digits BCD. The unit is priced at \$98 in 100-lots; other OEM discounts are available.

Function Modules Inc., 711 W. Seventeenth St., Costa Mesa, Calif. 92626 [386]

Miniature d-a converter offers 12-bit linearity

A family of precision miniature 12-bit d-a converters in 16- and 18-pin DIPs offers true 12-bit linearity and stability. Specifications include a full scale range of ± 5 -v, large-signal settling time to within 0.01% of final

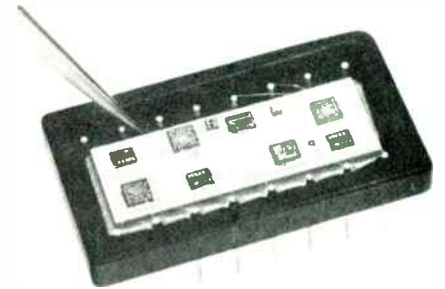

value of 15 microseconds maximum, linearity of $\frac{1}{2}$ least significant bit, and linearity temperature coefficient of 1 ppm $^{\circ}$ C, typical.

Hybrid Systems Corp., 87 Second Ave., Burlington, Mass. 01803 [387]

SCR power converters handle up to 40 A, 16 kW

The models VPDC 500 and 600 SCR power converters provide dc voltage regulation to within $\pm 0.1\%$ over 10% to 100% of the dc output range. Standard units are available for op-

Electronics/November 14, 1974

Blowbacks. Another good reason for microfilm.

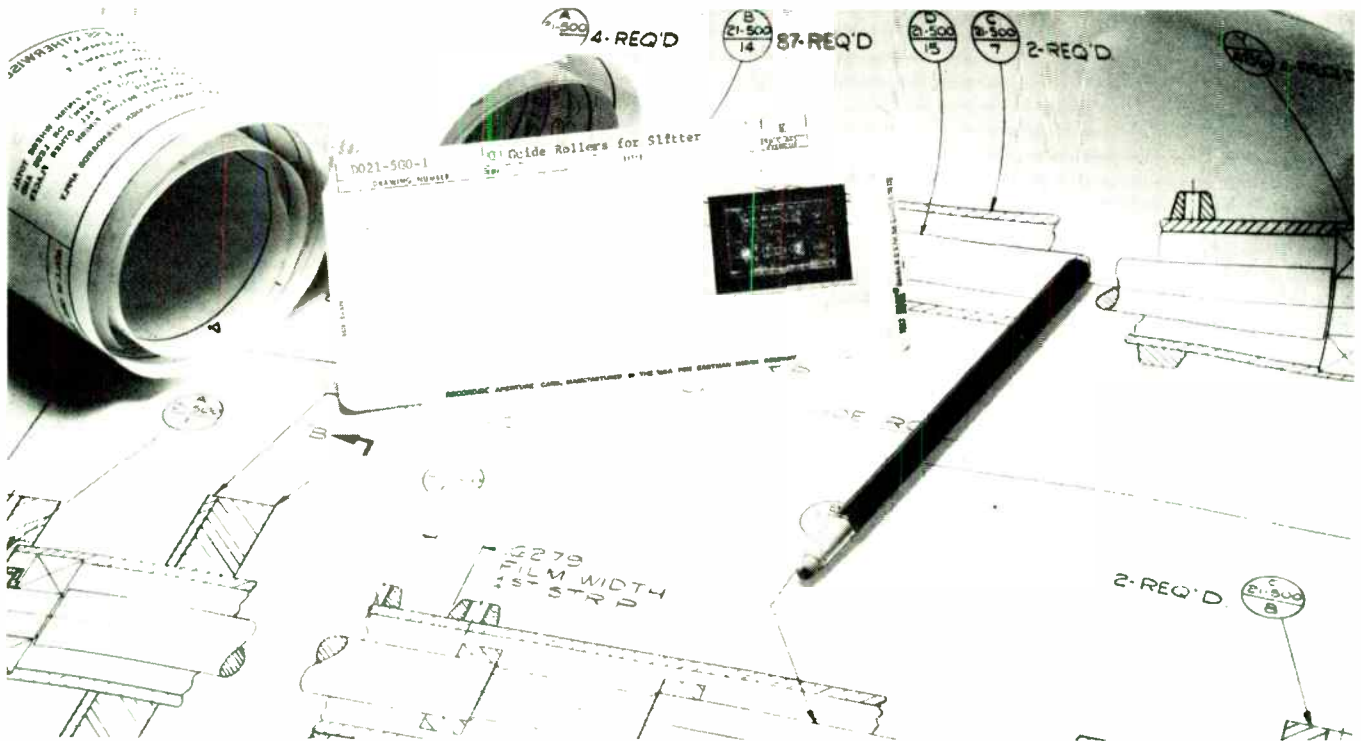

Put the flexibility of Kodak microfilm into your engineering program.

There are many advantages to microfilming your drawings. It saves space, it provides security, and it's one of the most efficient methods of filing and retrieving engineering data. And now, you can make high-quality enlargements directly from the sharp, crisp microfilm images that Kodak products have produced.

Blowing back onto Kodagraph films or papers from microfilm is a fast, easy way to make second originals. And you not only eliminate the need to use original drawings; you also save material because you can

produce the exact size reproductions you require.

You'll find that you save in other ways, too! Whether the job is revising drawings or restoring them, or even making distribution prints, blowbacks from Kodak microfilm can save you time and money.

Get the details.

Find out how Kodak microfilm and drawing reproduction products can benefit your department. Write for our booklet on Engineering Document Control or ask for a sales representative to call. Eastman Kodak Company, Business Systems Markets Division, Dept. DP801, Rochester, N.Y. 14650.

Kodak products for engineering data systems.



Gale has moved to California.

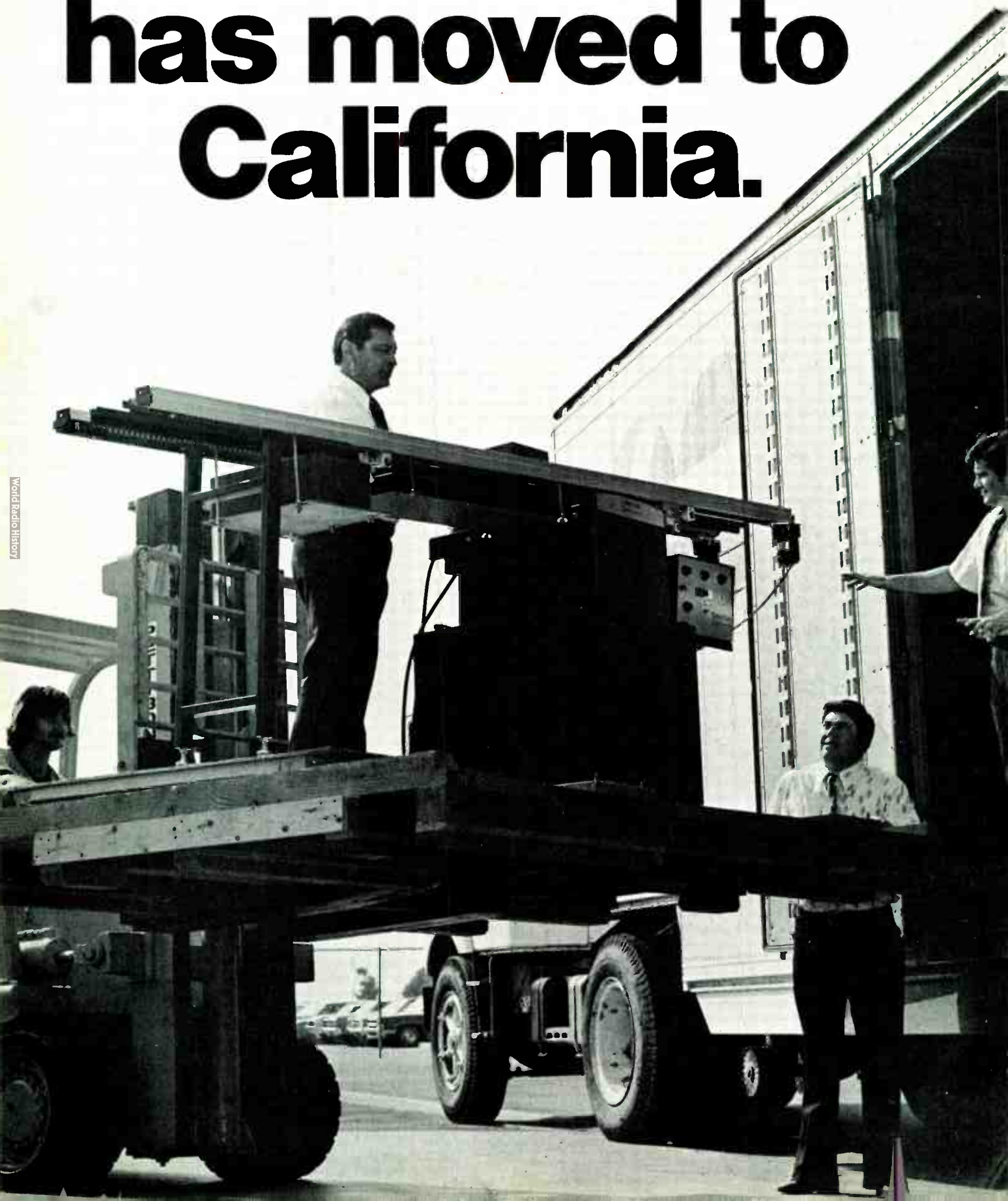

THE REASON:

Excellon Automation acquired Gale Wave Soldering Systems and will make them in Torrance.

With Gale now one of its products, Excellon Automation continues to offer the finest equipment to the p.c. board industry.

Sometimes referred to as U.S. Patent No. 3,589,590, the unique Gale oil intermix design is the heart of the Gale wave soldering system. No fussy valves, no metering, no oil waste, no splash.

There are four models in the Gale system and all may be operated *with* or *without* oil. Or oil may be intermixed in infinitely variable proportions for precise control over wettability, icicling, bridging and dross formation factors.

Intermix is controlled directly by pump speed . . . no valve to clog.

Flux Applicators

Gale foam fluxers provide optimum wetting with gentle bubbles that coat deep holes and eyelets evenly.

Improved airstone foamers operate on only 3 psi max. Extra-fine foam level control is provided by needle valve air adjustment.

Solid PVC construction is impervious to corrosive fluxes. Contamination-free.

Anti-drip brush prevents excess flux from dripping onto preheater, and is easily removed for cleaning.



Remote Control Center

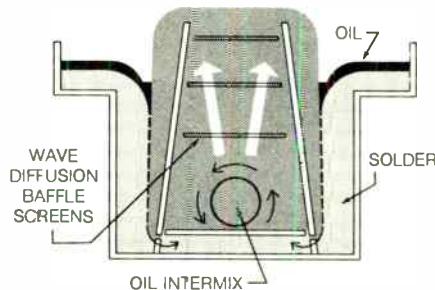

Preheaters

Gale's 30-inch long preheaters are full width of conveyor, allowing faster conveyor speeds for increased production rates. Infinitely variable heat control, adjustable height and hinged for safe and easy cleaning, even while elements are hot.

Wave Generator

Gale solder wave generators are ruggedly constructed to withstand continuously high operation temperatures. They're production workhorses. The long-life pump has a single moving part. The bearings are located above the solder bath for trouble-free operation.



Conveyors

Palletless or pallet operation . . . the Gale system is equally versatile. No tooling or special fixtures are required. Simultaneous pallet and palletless operation, with various board sizes, double row setup permits side by side



running of different size pallets. Result: Total flexibility regardless of board size and shape variation.

The Gale wave soldering system is most impressive. That's why Excellon Automation brought it into its family of quality products. It's a good move.

Gale BB-11 console model

Gale WAVE SOLDERING SYSTEMS

A Product of Excellon Automation



Excellon Automation

A Division of Excellon Industries
23915 Garnier Street
Torrance, California 90509
Phone: (213) 325-8000

Telex: 67.45.62 Cable: Excellon Torrance

Excellon Automation makes Gale Wave Soldering Systems easy for you to acquire.

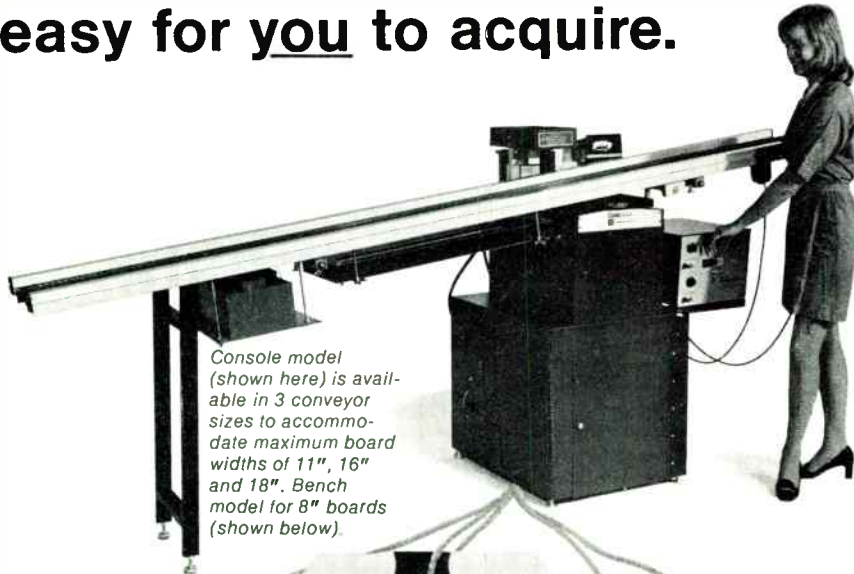

Console model (shown here) is available in 3 conveyor sizes to accommodate maximum board widths of 11", 16" and 18". Bench model for 8" boards (shown below).



The impressive, versatile Gale Wave Soldering System is another quality product from Excellon Automation. For more information call or write the nearest of our Excellon Regional Sales/Service offices:

Excellon Burlington
169 Bedford Street
Burlington, Massachusetts 01803
(617) 273-1393
Bill O'Loughlin

Excellon Kansas City
10106 Moody Park Drive
Overland Park, Kansas 66212
(913) 492-7168
Jerry Lemberger

Excellon Torrance
23915 Garner Street
Torrance, California 90505
(213) 325-8000
Herb Reed

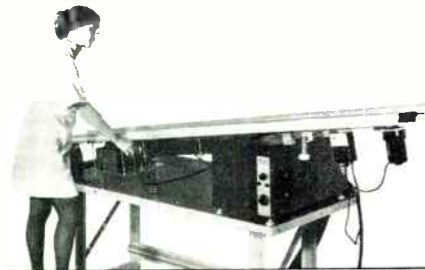

Gale WAVE SOLDERING SYSTEMS

A Product of Excellon Automation



Excellon Automation

A Division of Excellon Industries
23915 Garnier Street
Torrance, California 90509
Phone: (213) 325-8000

Telex: 67.45.62 Cable: Excellon Torrance

New products

eration from single-phase 120- to 480-volt lines. Outputs are rated at up to 40 amperes at 16 kilowatts. A second series incorporates a dc field supply and is designed for OEM applications in which dc power controllers are used as high-performance dc-motor drives.

Vectrol Inc., 1010 Westmore Ave., Rockville, Md. 20850 [388]

D-a converters feature 5- μ s output settling time

The DAC-R and DAC-TR series digital-to-analog converters feature 5-microsecond output settling time, while offering two different temperature stabilities: DAC-R models have a 30-ppm/ $^{\circ}$ C gain-temperature coefficient, while the DAC-TR series is specified at 5 ppm/ $^{\circ}$ C. Both series have a zero-drift-temperature coefficient of 10 μ V/ $^{\circ}$ C. Output voltage accuracy is externally adjustable to within .01% of full scale $\pm 1/2$ LSB; output-current capability is 0 to ± 4 mA at .02-ohm output impedance. Price is from \$69 to \$179, depending on model and number of bits.

Datel Systems Inc., 1020 Turnpike St. Canton, Mass. 02021 [389]

Active filter has a band-reject output

The model 320VT universal voltage-tuneable active filter is a two-pole device with a band-reject output in addition to its standard band-pass, low-pass and high-pass outputs. Voltage tuning is implemented with internal analog multipliers. The frequency of the filter can be set to any value from 0.1 Hz to 20 kHz, and the voltage-tuning range can be set as high as 20:1 by using external resistors and capacitors. Narrower voltage-tuning ranges may be used to improve noise and offset characteristics. Price ranges from \$210 to \$130, depending on quantity.

Frequency Devices Inc., 25 Locust St., Haverhill, Mass. 01830 [390]

HERMES LOOP ANTENNA

THREE SAMPLE SITES
ON THE NORTH AMERICAN
CONTINENT —

DIFFERENT LATITUDES
DIFFERENT CLIMATE

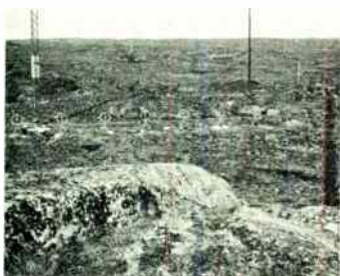

FROBISHER BAY, CANADA



MARSHFIELD, MASS.



NEAR SAN DIEGO, CALIF.

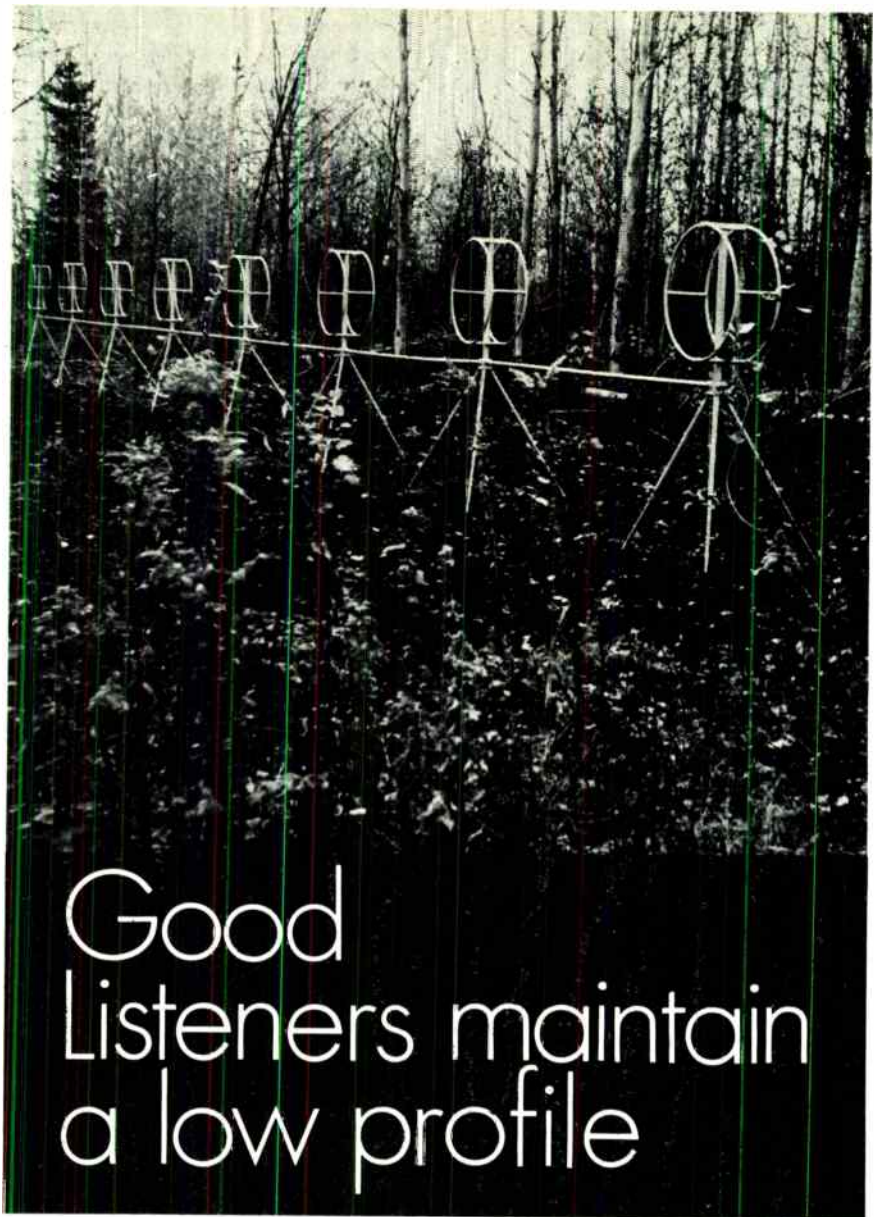

Good Listeners maintain a low profile

Even in the solitude of the forest depths, from rooftops, arctic tundra, swamps to sweltering tropics, 'neath snow, sand or ice,

the Hermes Loop antenna keeps an ear to the sky. The amazing aperiodic antenna does away with vast log periodic and rhombic arrays - those towering antenna farms.

Excellent directional characteristics in rosette configuration, the Hermes loop antenna provides an omnidirectional broadband receiving array in space merely 1/100th that of the traditional antenna farm.

More than 53 government agencies around the world have pressed the loop antenna into service.

A new, even more compact version is available. Only Hermes Electronics makes it.

**2-32MHz
BROADBAND**



ASK US Send for our Brochure

Hermes Electronics Limited
Suite 315
2020 F Street NW
Washington, DC 20006 USA
202-296 2978
TWX 710 822 1106

AVX puts class

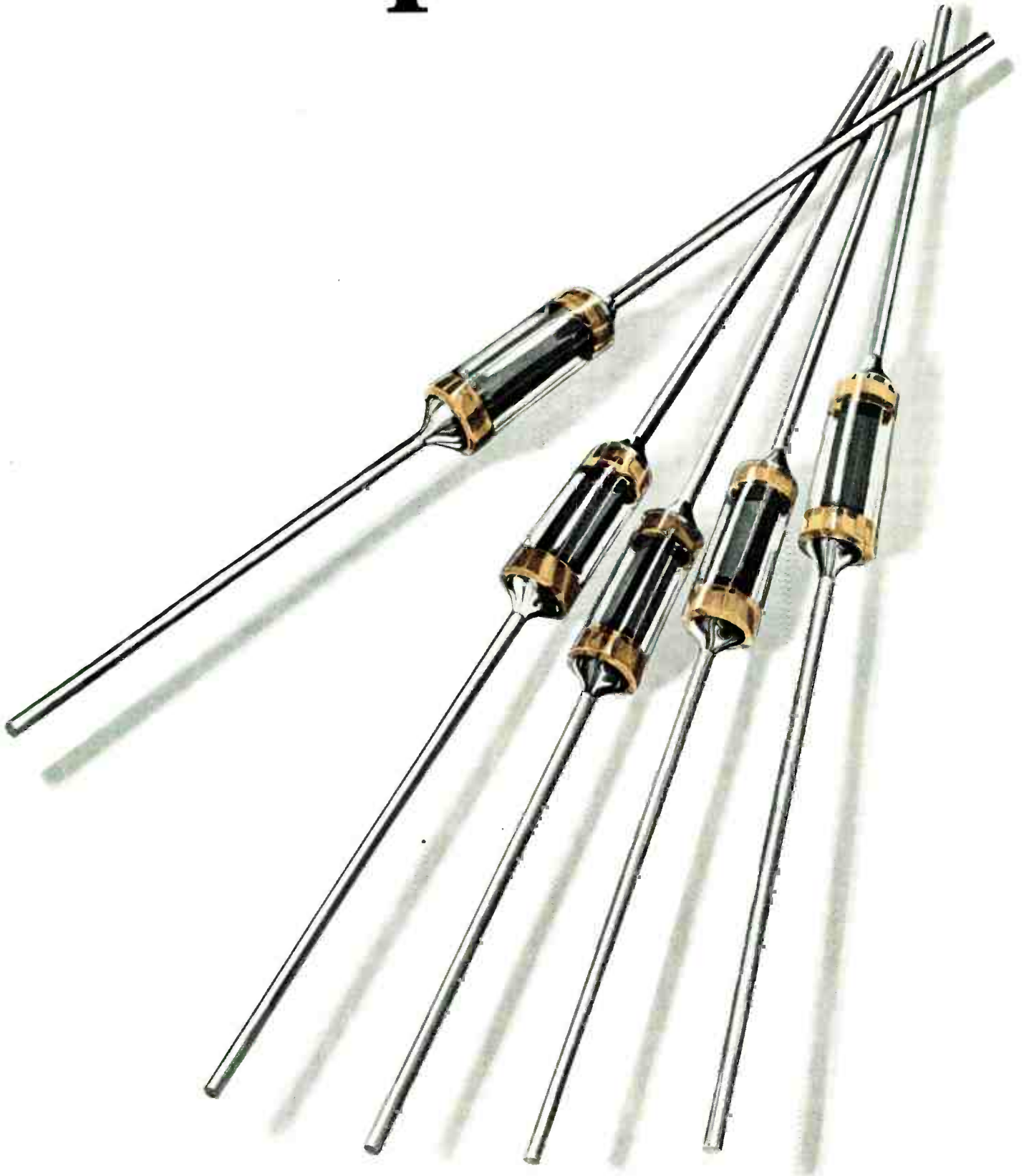

under glass.

It's GlasGuard.™ A quality AVX axial monolithic capacitor. Encapsulated in a glass package. GlasGuard lets you afford excellence. It costs less than a molded capacitor yet it provides the environmental protection required in demanding commercial applications.

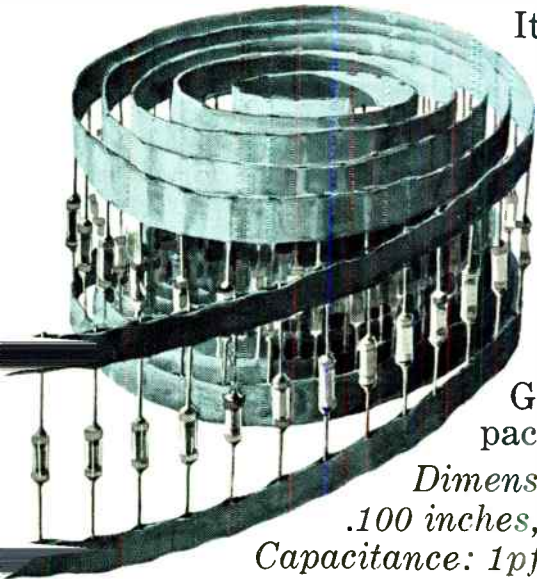

It's also a thoroughly modern component.

Axial leaded. Packaged in reels for automatic insertion allowing fast, economical, up-to-date assembly. Using the same equipment you use for your other axial parts.

Best of all, underneath it's an AVX capacitor. A precision component. Carefully manufactured and tested to provide you with greater reliability. By AVX. The industry leader in ceramic capacitors.

GlasGuards are available in three case sizes, reel packaged for automatic insertion.

Dimensions: Length .170 to .260 inches, Diameter .065 to .100 inches, Lead diameter standard size .020 inches

Capacitance: 1pf to 120,000pf, Voltage: 25, 50, 100, 200VDC

Four temperature characteristics.

AVX Ceramics, Department C-3, P.O. Box 867, Myrtle Beach, S.C. 29577

Send me detailed specifications of GlasGuard capacitors along with free sample.

Name _____

Title _____

Company _____

Address _____

Zip _____

Telephone _____

For faster delivery call AVX Ceramics directly: 803-448-3191 TWX: 810-661-2252

AVX: The Insiders

AVX Ceramics Division, P.O. Box 867, Myrtle Beach, S.C. 29577 803-448-3191 TWX 810-661-2252

AVX Distributors: Cramer Electronics Inc./Jaco Electronics Inc.
Newark Electronics/Texas Instrument Supply/Weatherford Co.

New products

Microwave

Transistor for Tacan band

Device produces 150-watt pulses; civil-aircraft market is eventual goal

Tactical air navigation/distance measuring equipment (Tacan/DME) is one of the few areas of the spectrum in which vacuum tubes are still widely used, but perhaps not for long. A new high-power microwave transistor is aimed at finally moving this market into solid state. Developed by Power Hybrids Inc., Torrance, Calif., the PH1175D transistor produces a broadband-pulse output of 150 watts over the range from 1,025 to 1,150 megahertz.

Military and commercial aircraft represent the first market for the device because here the higher initial cost is not a critical consideration. In the future, however, the big market that Power Hybrids and prospective competitors hope to crack is civil aviation, which counts for 100,000 aircraft. Today, DME is considered a luxury in civil aviation. But if costs come down through solid state design, many civil aviators would undoubtedly be interested.

Typically, the Tacan/DME band requires an output of 1,000 watts with a tolerance for aging down to 500 watts. Fred McAdara, sales manager for Power Hybrids, says a solid-state unit would not lose power with age and can meet the power specification with four of the new transistors.

"The initial cost of the solid state equipment is higher, even when taking into account the costs of the tube, power supply and cavity," McAdara says, "but transistors have much room for reduced costs whereas tubes are at the low point in costs and are starting to rise." McAdara suggests that the cost of ownership to the end user would be lower due to the higher reliability

and lower maintenance of transistor equipment.

In typical operation, at a supply voltage of 50 volts, pulse width of 10 microseconds, and duty factor of 10%, peak output is 203 watts at 1,025 MHz and 155 watts at 1,150 MHz. These figures are typical with a 35-watt peak input. A wider bandwidth is possible with lower power output.

Input impedance is typically $(5.5 + j8.0)$ ohms at 1,025 MHz, and $(6.5 + j10.0)$ ohms at 1,150 MHz. Load to be furnished at the output is $(2.5 - j3.2)$ ohms at 1,025 MHz and $(3.4 - j2.25)$ ohms at 1,150 MHz.

Housed in a hermetic ceramic-metal package with flange mount, the PH1175D is priced at \$175 in small quantities.

Power Hybrids Inc., 1742 Crenshaw Blvd., Torrance, Calif. 90501 [401]

Octave, multioctave band switches operate to 18 GHz

A series of miniature octave- and multioctave-band switches, ranging from SPST to SP4T with optional integrated drivers are for use in communications, microwave landing systems, radar, telemetry, and electronic countermeasures. A typical SPDT model operating from 2 to

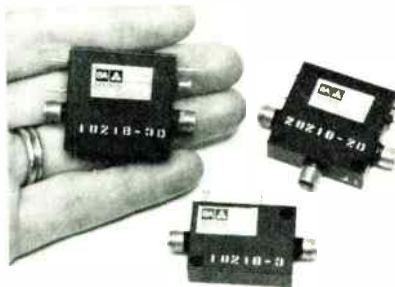

18 gigahertz yields greater than 50-dB isolation with 2.5-dB maximum loss, and it switches in less than 25 nanoseconds (50% TTL to 90% rf). Standard units handle up to 5 watts cw in a package 1.2 by 1.1 by 0.38 inch with SMA connectors. Series DS10000 and DS20000 diode switches are priced as low as \$195,

GIANT II

GENERAL INSTRUMENT ADVANCED MICROWAVE TECHNOLOGY

256x4xtwo STATIC RAMS

available from these stocking
GENERAL INSTRUMENT distributors

CALIFORNIA	
Intermark	(408) 738-1111
1020 Stewart Drive Sunnyvale, Ca. 94088	
Intermark	(714) 540-1322
2920 W. Warner Santa Ana, Ca. 92704	
Semiconductor Concepts	(213) 884-4560
21201 Osnard Street Woodland Hills, Ca. 91364	
Intermark Electronics	(714) 278-5200
7354 Convoy Street San Diego, Ca. 92111 TWX 910-335-1515	
COLORADO	
Intermark Electronics	(303) 936-8264
2600 W. Second Ave. Denver, Co. 80219	
CONNECTICUT	
Harvey Conn	(203) 853-1516
112 Main Street Norwalk, Conn. 06852	
ILLINOIS	
Semiconductor Specialists	(312) 278-1000
195 Spangler Avenue Elmhurst Industrial Park Elmhurst, Ill. 60126	
Advent Electronics Inc	(312) 298-4210
7110 N. Lyndon St. Rosemont, Ill. 60018 TWX 910-233-2477	
MARYLAND-WASHINGTON, D.C.	
Pytlonic Industries	Baltimore (301) 792-7000
8220 Wellmoor Ct. Savage, Md. 20863	
Washington (301) 953-3000	
MASSACHUSETTS	
Greene/Shaw Company	(617) 969-8900
70 Bridge Street Newton, Mass. 02158	
NEW MEXICO	
Century Electronics	(505) 292-2700
121 Elizabeth N.E. Albuquerque, N.M. 87108 TWX 910-889-0625	
NEW YORK (METROPOLITAN)	
Semiconductor Concepts	(516) 273-1234
195 Engineers Road Hauppauge, N.Y. 11787	
Pride Electronics, Inc.	(516) 293-4020
41 Sarah Drive Farmingdale, N.Y. 11735	
Zeus Components	(914) 592-4120
175 Clear Brook Rd. Elmsford, N.Y. 10523	
PENNSYLVANIA	
Hallmark Electronics	(215) 355-7300
P.O. Box 125 Trevose, Pa. 19047	
TEXAS	
Component Specialties Inc.	(713) 771-7237
7315 Ashcroft Houston, Texas 77036	
Component Specialties, Inc.	(214) 357-4576
2560 Electronic Lane Dallas, Texas 77036	
UTAH	
Intermark Electronics	(801) 359-0531
63 East Stratford Ave. Salt Lake City, Utah 84115	
WASHINGTON-OREGON	
Intermark	(206) RO 7-3160
621 S. Michigan Seattle, Wash.	
GENERAL INSTRUMENT SALES HEADQUARTERS DOMESTIC	
EASTERN AREA SALES HEADQUARTERS	
(516) 733-3107	
600 W. John St., Hicksville, N.Y. 11802	
CENTRAL AREA SALES HEADQUARTERS	
(312) 388-9200	
3101 West Pratt Blvd., Chicago, Ill. 60645	
WESTERN AREA SALES HEADQUARTERS	
(213) 781-0489	
7120 Haydenhurst Ave., Van Nuys, Calif. 91406	
INTERNATIONAL	
GENERAL INSTRUMENT CANADA LTD.	
(416) 763-4133	
81 Industry St., Toronto 337, Ontario, Canada	
GENERAL INSTRUMENT MICROELECTRONICS LTD.	
01-636-7022	
57/61 Mortimer St., London, W1N 7TD, England	
GENERAL INSTRUMENT INTERNATIONAL CORP.	
(03) 437-0281-5	
Fukide Building, 17 Fukide-cho, Minato-ku, Tokyo 105, Japan	



GIANT II™

GENERAL INSTRUMENT ADVANCED N-CHANNEL ION IMPLANT TECHNOLOGY

256x4xtwo

NOVEMBER
monday **4** 1974

**256x4
STATIC RAM**
**WITH
ADDRESS/CHIP
SELECT LATCH**
**22 PIN DIP
(#RA-3-4256B)**

*Shipping now for as low as \$6.25
For 50,000 pcs + up*

**AND MORE
GIANT II'S
COMING ...**

**NEXT.
1024 BIT S/R
DC-2MHz**

**NEXT.
16K ROM
STATIC 2K x 8**

**NEXT.
UAR/T
60 kbaud**

**NEXT.
16K ROM
STATIC 4K x 4**

**NOW
AVAILABLE**

Now there are two
GIANT II 256 x 4 static
RAMs. Both feature:

- Single +5 V supply
- TTL compatibility
- 1 μs typical Access Time/
1 μs typical Write Cycle.

And both are available
in production quantities.

For complete information
call toll-free 800-645-9247
(In New York State
call 516-733-3107) or write,
General Instrument Corporation,
Microelectronics, 600 W. John St.,
Hicksville, N.Y. 11802

JUNE
monday **17** 1974

**256x4
STATIC RAM**
**WITH
POWER DOWN**
**24 PIN DIP
(#RA-3-4256)**

*Shipping now for as low as \$6.50
For 50,000 pcs + up*

**GENERAL INSTRUMENT CORPORATION
MICROELECTRONICS**



GREAT GUNS!



WE'RE SHOOTING DOWN THE PROBLEMS

in the selection of Magnetic and Digital Pickups — often a most difficult decision.

AIRPAX is a leading manufacturer of passive and active digital pickups to provide the most effective and accurate means of converting mechanical motion into usable voltage control signals, without mechanical linkage, by accurately detecting moving ferrous discontinuities.

OUR AMMUNITION!

"MAGNETIC PICKUPS AT WORK"

... a 20 page text on theory and applications. SEND FOR IT TODAY.

AIRPAX Controls Division
P.O. Box 8488
Fort Lauderdale, Florida 33310

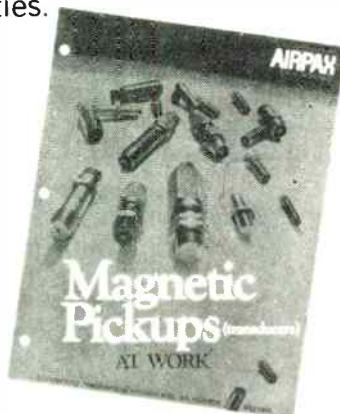

AIRPAX™

210 Circle 210 on reader service card

New products

and delivery is from stock.

Sanders Associates, Microwave Division,
Grenier Field, Manchester, N.H. [403]

Sealed couplers cover
from 500 MHz to 12.4 GHz

A family of lightweight 3-dB microwave couplers is reduced in price and weight by means of a packaging technique that completely seals the coupler structure. The quadrature (90°) couplers cover the frequency range of 500 megahertz to 12.4 gigahertz. Each of the five models covers a different octave bandwidth within this range. All models comply with the electrical, environmental, and dimensional requirements of the new military specification, MIL-C-15370/8. Price is \$60, or \$40 each in lots of 100.

Merrimac Industries Inc., 41 Fairchild Pl.,
West Caldwell, N.J. 07006 [404]

Trimmer capacitors
fine-tune rf circuits

Four series of GigaTrim trimmer capacitors include the 7260-4 series with a range of 2.5 to 5.0 pF. Also available is the 7290-4 series having an adjustment range of 7.0 to 30.0 pF and the 7270-4 and 7280-4 with intermediate ranges. GigaTrim capacitors are designed to fine-tune rf



hybrid circuits. Applications include impedance-matching in transistor amplifiers and oscillators, trimming out circuit irregularities in phased-array integrated circuits, and gap-coupling microwave circuits. Solderless construction allows them to be soldered during installation without damage. All series are available in

Electronics/November 14, 1974

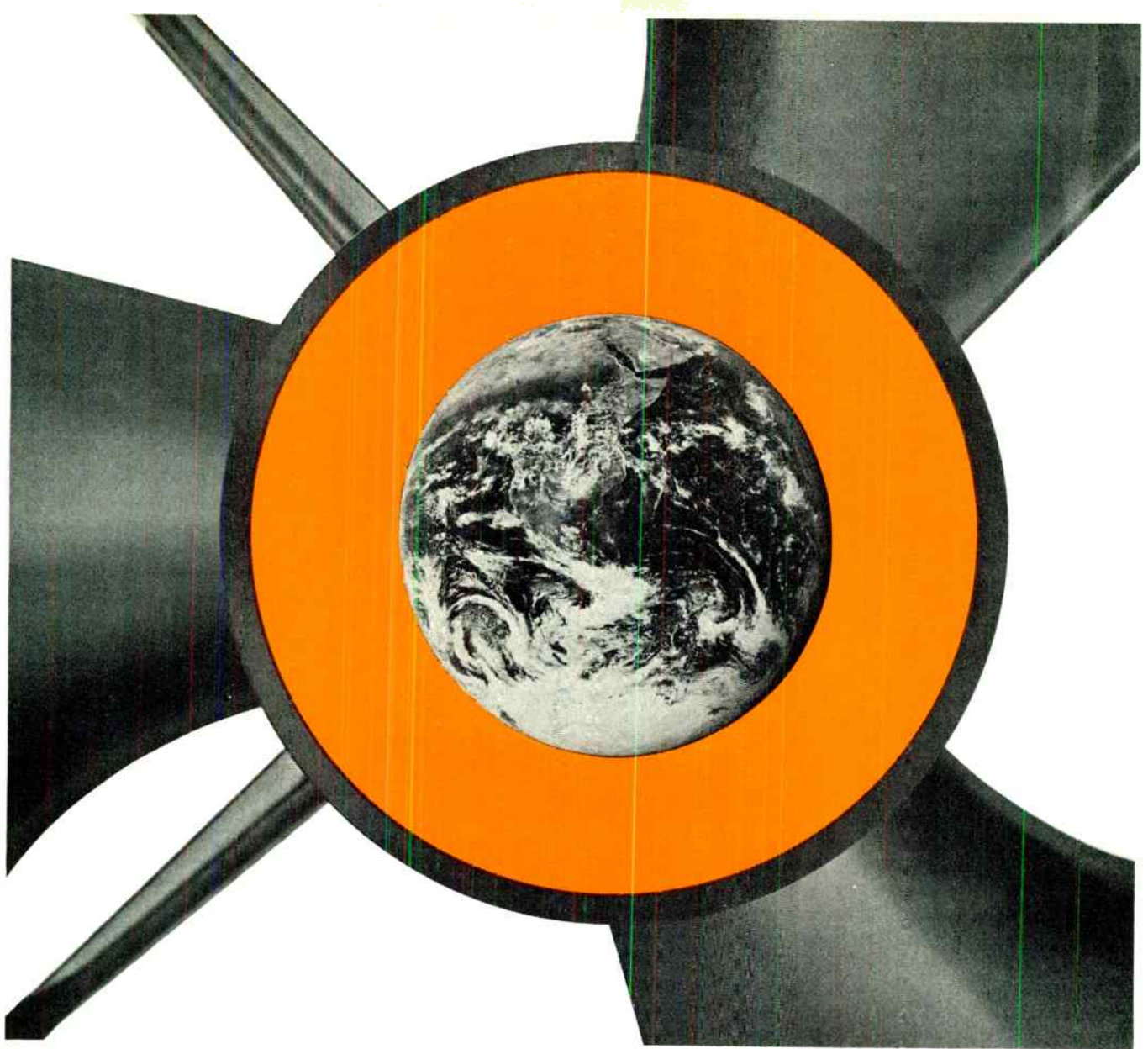

Behind every Rotron® fan and blower... Worldwide Facilities

The world is growing smaller. More and more companies are involved in international sales and international application of their products. Many in manufacturing abroad.

Rotron is such a company. If you are too, or hope to be, you'll be glad to know that Rotron is equipped to serve you throughout the world. With fan and blower manufacturing facilities not only in the U.S.A. but in The Netherlands and Japan as well. With an interna-

tional sales and distributor organization that reaches into all parts of Europe, the Middle East, the Orient, Africa, Australia, and South America.

When you deal with Rotron, you not only receive the best there is in air mover application engineering, in product quality and variety, in distributor service. You get it when and where you need it.

Why settle for less when the best costs no more?



ROTRON INC.

Woodstock, N. Y. 12498 ☐ 914 • 679-2401 ☐ TWX 510-247-9033

Pacific Div. Burbank, Cal. 91506 213-849-7871 • Rotron B.V., Breda, Netherlands, Tel: 79311, Telex: 844-54074

18514

WE'RE ADAPT -ABLE



Of course we have standard designs — hundreds of them — that can answer many of your microcircuit packaging needs. But we know there are also applications in which "ready-to-wear" packages just will not do the job in this constantly changing technology.

Whether you need a package tailored to your specifications or an industry standard, call on Isotronics .

the microcircuit
packaging specialists



Isotronics

Isotronics, Inc.
12 Coffin Ave., New Bedford, Mass. 02746
(617) 997-4575 TWX 710 344 1961
Cable — ISOTRONICS

Visit us at ISHM

New products

five mounting styles. Price is \$4.60 each in quantities of 1,000.

Johanson Manufacturing Corp., 400 Rockaway Valley Rd., Boonton, N.J. 07005 [405]

FET low-noise amplifiers operate in X band

A family of GaAs field-effect-transistor low-noise amplifiers for operation at X-band frequencies includes models designed for military satellite communications, as well as fire-control and terrain-avoidance radars. Typical specifications of the

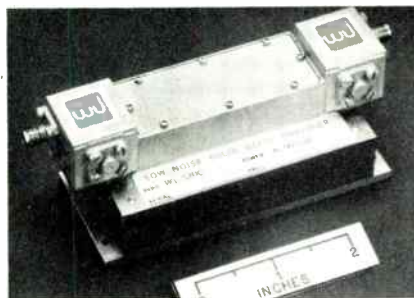

5300 series include: frequency of 7.25 or 8.4 gigahertz or 8 to 10 GHz, noise figure of 6.0 dB or 7.5 dB, small-signal gain of 30 dB or 27 dB, output power of +5 dBm or +6 dBm, and gain flatness of ± 0.5 dB or ± 1 dB.

Watkins-Johnson Co., 3333 Hillview Ave., Palo Alto, Calif. 94304 [406]

Millimeter-wave isolators handle 25 decibels or more

Two millimeter-wave isolators, each covering a full waveguide bandwidth, feature isolation of 25 dB or greater, maximum input/output VSWR of 1.5:1, and low insertion



Help college help you.

Businesses like yours gave over \$340,000,000 to higher education last year.

It was good business to do so. Half of all college graduates who seek work go into business. The more graduates there are, and the better educated they are, the more college serves the business community.

Your money was vital to colleges. It relieved financial pressures, made planning more flexible, and contributed to the kind of basic and applied research that puts new knowledge and technology at the service of industry.

So that colleges can continue to help you, give to the college of your choice now. For information on ways to do it, please write on your letterhead to Council for Financial Aid to Education, Inc., 6 East 45th Street, New York, N.Y. 10017. Ask for the free booklet, "How Corporations Can Aid Colleges and Universities."



Council for Financial Aid to Education, Inc.

Advertising contributed for the public good.



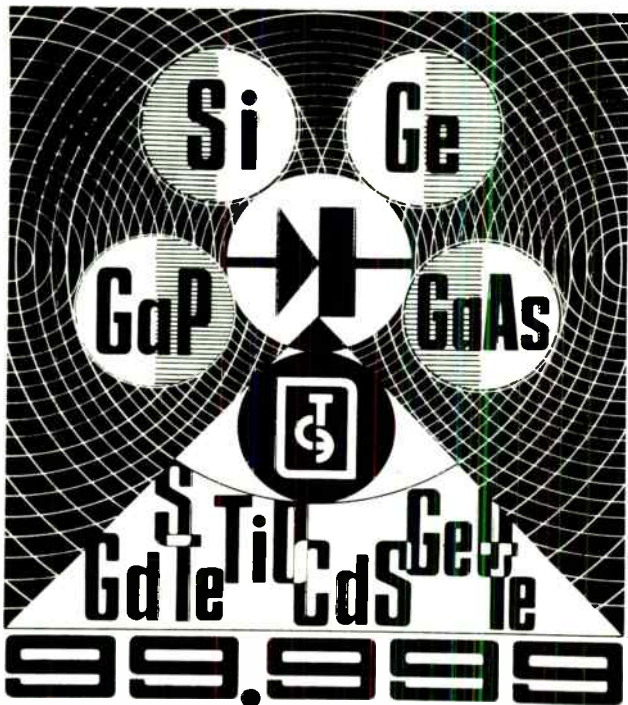

Materials for Electronics

Epitaxial structures of silicon and semiconductor structures

Germanium:

monocrystalline & polycrystalline germanium dioxide 99.99% & 99.9999% germanium monoxide

Silicon:

monocrystalline & polycrystalline

Gallium

arsenide

Indium

arsenide

Gallium

phosphide

Monocrystals of semiconductor compounds

Extra-pure materials, diffusing agents, quartz crucibles

Exporter: V/O **Techsnabexport**

Moscow G-200, USSR

Tel. 244-32-85 · Telex 7628

Circle 114 on reader service card



PICTORIALIZE THE PROBLEM

It's easy with the COMTAL 8000 Digital Image Processing Systems.

STUDIES DEMANDING HIGH RESOLUTION

Highest resolution of any system available is achieved by the 512 x 512 matrix real time display with 256 brightness levels . . . Note whisker detail on Mandrill, with full range of color intensities.

AERIAL & SATELLITE IMAGING SOURCES

Aerial mapping, earth resource studies, cartography, photogrammetry, color IR, crop and geological identification, reconnaissance applications—false color imaging—multispectral imaging.

So many industrial, scientific and medical problems lend themselves to digital image processing. COMTAL's modularized construction for easy field upgrading provides the full range of image processing, from small black and white displays to full color displays . . . over 60 different configurations. Get the full picture now.

COMTAL

IMAGE PROCESSING SYSTEMS



Call or write: COMTAL Corporation, 333 N. Santa Anita Ave., Arcadia, Calif. 91006, (213) 445-0764.

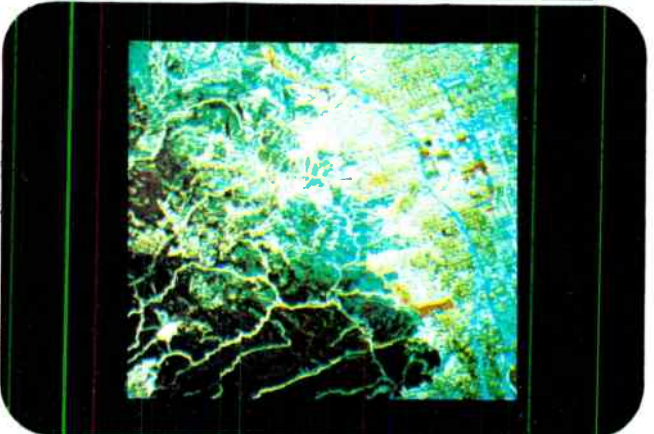

Circle 213 on reader service card 213

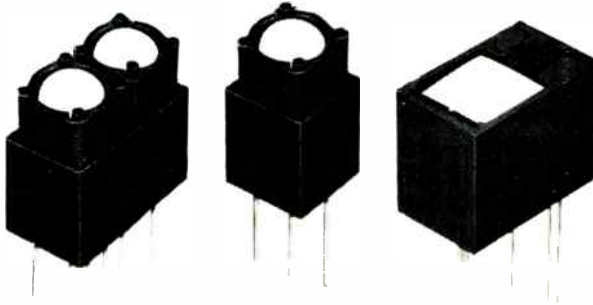

SERIES 32
0.3 inch (7.62 mm)
dual

SERIES 30
0.3 inch (7.62 mm)
single

SERIES 50
0.5 inch (12.7 mm)
single

STATUS INDICATORS

MEMORY — inherent remanent magnetism maintains the display state.

LOW POWER — one milli-watt second set/reset energy. Zero power to retain state. Drive voltages from 3-48 volts.

VISIBILITY — rotating fluorescent discs and flags provide excellent visibility over a wide range of ambient light conditions and wide viewing angles.

RELIABILITY — only one moving part rated for over 20 million operations. No lights or mechanical linkages to wear out. Virtually maintenance free.

FERRANTI-PACKARD STATUS INDICATORS

Ideal for

- Transient Recorders
- Industrial Process Displays
- Contact Status Indicators
- High Density Matrix Displays
- Portable Field Equipment.

Fluorescent discs and flags available in a range of colors.

The electromagnetic operation requires zero energy to maintain status.

Unique memory retention eliminates the need for memory circuits and reduces power supply and circuitry costs. Indicators are fully operational over a wide range of environmental conditions.

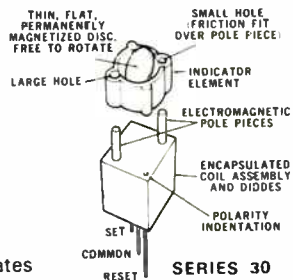

Ferranti-Packard's status indicators are light weight (Series 30, 0.17 oz (5 grams)) and are ideal for mounting on printed circuit boards and high density matrices.

For full information and specifications, contact the Display Components Department,

FERRANTI-PACKARD LIMITED

ELECTRONICS DIVISION
121 Industry Street,
Toronto, Ontario, M6M 4M3, Canada.
Telephone: (416) 762-3661.
Telex: 06-22007.

7304

New products

loss. They are designed for use with Hughes solid-state millimeter-wave sweep generators and Hughes detectors, but they may also be used with backward-wave-oscillator sweepers and klystrons to prevent instabilities caused by reflection. The isolators, of the Faraday-rotation type, consist of low-loss ferrite material and resistive elements. An external magnetic-bias field is supplied by a permanent magnet. Model 44610H, covering 33 to 50 gigahertz, is priced at \$1,175, and the model 44606H, covering 75-110 GHz, is \$1,295.

Hughes Electron Dynamics Division, 3100 West Lomita Blvd., Torrance, Calif. 90509 [408]

Voltage-tunable oscillators are rated as high as 15 W

The series 4003 high-power, low-noise, solid-state voltage-tunable microwave oscillator has low-noise varactor-tuned oscillator and a high-power amplifier/multiplier. Typical applications include transmitter drivers, wideband communications systems, doppler radar systems, and rf jammers. Each unit produces its specified power over an electronically tunable bandwidth of at least 10%. Available units produce powers as high as 15 watts in L band and 2 w in X band.

Ancom, 1000 Ames Ave., Milpitas, Calif. 95035 [407]

System measures cable losses from 2 to 18 GHz

The type 5130 swept-frequency system is for measuring standing-wave ratio and insertion loss in high-performance cable assemblies. Frequency range is from 2 to 18 gigahertz. A 7-millimeter slotted line is combined with a microwave sweeper and a matched pair of directional couplers to form a broadband measuring system. Included are the necessary detectors and interconnecting cables. Both the slotted-line measuring port and ter-



Identify and test wire and cable assemblies with dollar savings and increased productivity

If it's been some time since you investigated the high labor intensive costs of your wire harnessing and cable assembly operations — then consider the Cable-Scan System — a wire identification and test system that consistently provides man-hour savings of 30-75%.

Lower cable assembly costs are realized through increased production as well as using a more reliable and efficient method of trouble-shooting. Our Cable-Scan System can eliminate costly mistakes and the entire "rework" cycle.

Initial equipment costs are negligible — especially since the majority of our customers are able to return their original equipment investment in a matter of weeks. So how can you lose? Send for our free evaluation kit. It's your first step to realizing lower installed costs. Our kit is complete with detailed Cable-Scan instrument specifications, cost studies, case histories, customer lists and price information. We've even included an offer for a free Cable-Scan evaluation unit. Write us soon!

1. Return on Your Investment*

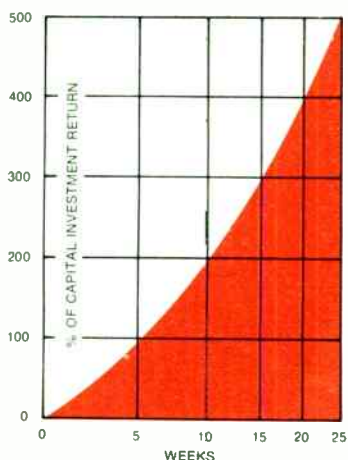

2. Dollars Saved with Cable-Scan*

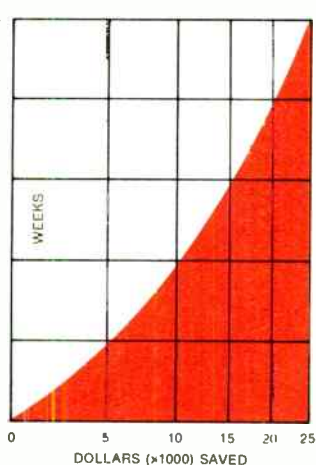

3. Cost Comparison*

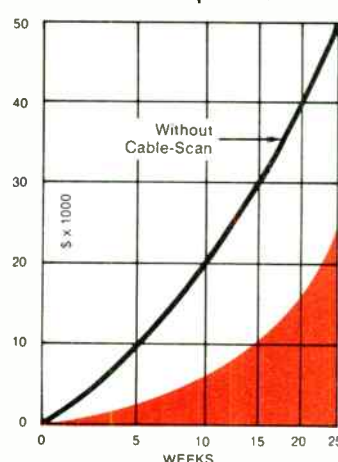

*based on actual case study

Cable-Scan Inc.

Subsidiary of Thomas & Betts Corporation

145 East Emerson Avenue • Orange, California 92665 (714) 998-1961

Circle 215 on reader service card

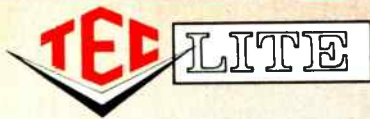

NEW!

LOW PROFILE 10-POSITION ROTARY SWITCH



ACTUAL
SIZE

**ONLY .820" HIGH
FROM THE TOP OF
ITS WATERTIGHT
SHAFT TO THE
TIPS OF ITS GOLD-
PLATED TERMINALS**

Nonshorting S-1010 Series Switch has 1/2" diameter body, positive detent, contact resistance less than 50 milliohms @ 100 uA, and long life of 50,000 cycles.

Ideal for 2-way communications, selecting speakers, or virtually any application where a compact, highly reliable, watertight switch is needed to change circuits.

Versatile device can be PCB or panel mounted. Shaft is slotted and flattened for screwdriver adjustment or knob. Contact TEC or the TEC-REP nearest you for complete details.



New products

minating-coupler port are equipped with CA-45 precision connectors.

Alford Manufacturing Co., 120 Cross St., Winchester, Mass. 01890 [409]

Stabilizer system contains two Ka-band Gunn sources

A dual coherent stabilizer system contains two Ka-band Gunn sources with required rf components and associated circuitry to provide automatic phase-locking to a multiple of

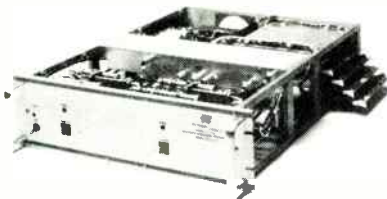

a 5-megahertz reference standard. The series of stabilizers provide discrete stabilization at frequencies from 1 to 40 gigahertz. With the automatic-lock option, these are suited for unattended or dedicated systems where maximum reliability is required.

Microwave/Systems Inc., 1 Adler Dr., East Syracuse, N.Y. 13057 [410]

Digital readouts simplify klystron tuning

A series of digital position indicators on its cavity-tuning knobs make the model VA-963A klystron easily convertible from a narrow-band device, suitable for such applications as air-traffic control radars, into a wide-band tube for frequency-agile radars. The broad- or narrow-band tuning patterns are achieved by simply setting the digital counters. The tube's basic frequency range is 1.25 to 1.35 gigahertz, and its instantaneous bandwidth, at 50 watts of drive power, is 40 megahertz. The tube can deliver peak output powers of 2 to 6.5 megawatts.

Varian, Palo Alto Microwave Tube Div., 611 Hansen Way, Palo Alto, Calif. 94303 [378]

The pollution problem.

Maybe your engineers deserve a little help.

The engineers' will be the ones to find the technical solutions to pollution problems. There's no doubt about it.

But pollution is a people problem, too. And the engineers' technological approach to pollution isn't going to solve people problems.

Maybe this booklet can help. It lists some of the things all people can do to fight pollution. And with all the people supporting your engineers we'll have a better chance of winning the fight.

For a free copy or a list of bulk rates write to Keep America Beautiful, Inc., Box 1771, Radio City Station, New York, New York 10020.

Keep America Beautiful

Advertising contributed for the public good



People start pollution. People can stop it.



Our latest addition.

The floppy disk drive. We didn't name it. Someone else did. But our new baby's the best one yet.

The CalComp 140.

What makes it better? The parents, naturally. Remember, CalComp is the leading independent producer of disk drives in the world. We made it big long before we made it small. And technology and experience are hereditary.

Our model 140 floppy disk drive holds 3.2 million bits of information. It has 6 millisecond track-to-track

access time. And a transfer rate of 250,000 bits per second.

The 140 has a self-contained air system that keeps dirt off the head and the diskette and the moving parts. And of course, our floppy disk drive is compatible with IBM's diskettes.

We can deliver our model 140 in OEM quantities. We support our customers with the CalComp worldwide service network.

If you haven't seen our newest baby yet, we'd be

proud to show it to you.

Call your local CalComp office, or contact California Computer Products, Inc., EM-11-74, 2411 West La Palma Avenue, Anaheim, California 92801. (714) 821-2011.

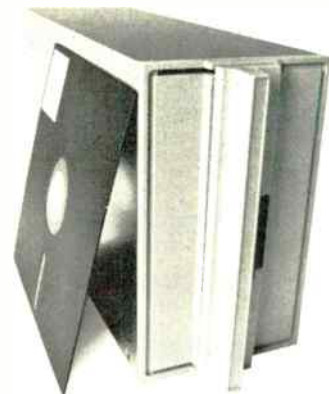

CALCOMP

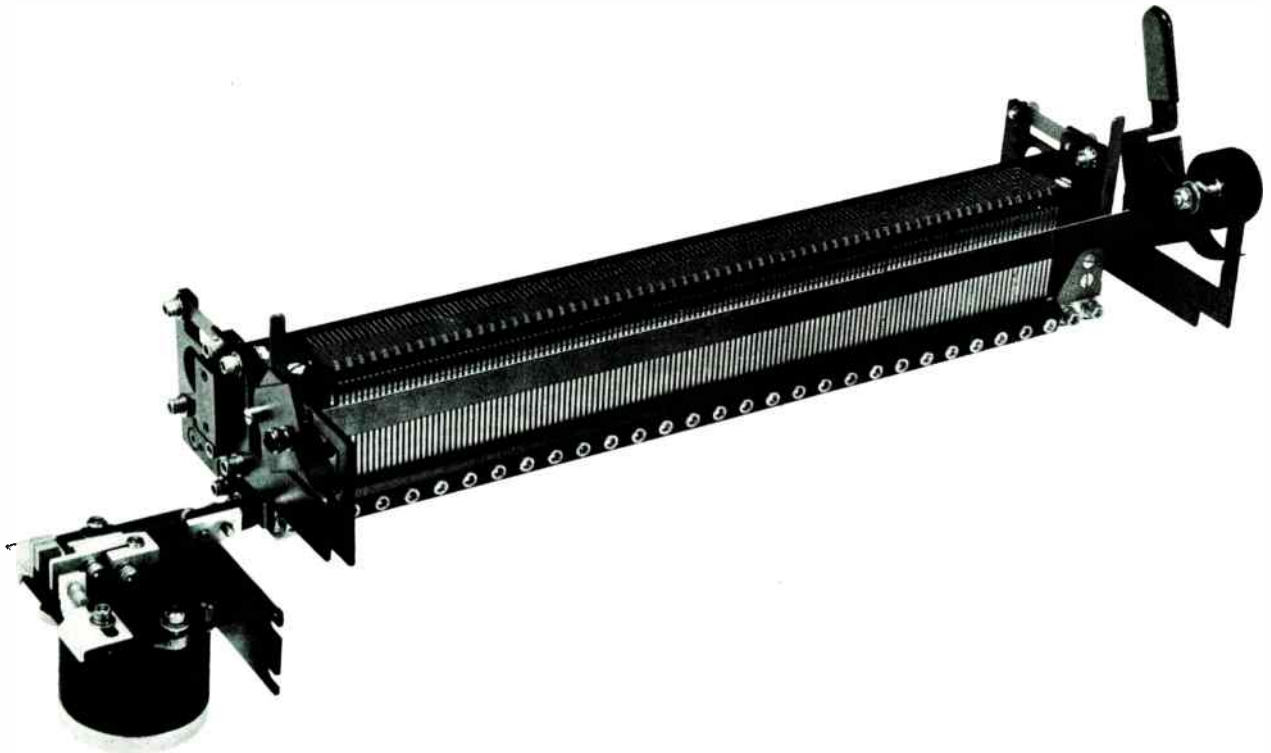

ANATOMY OF A RELIABLE LINE PRINTER

One look at the Tally print mechanism readily reveals the reason behind Tally's reliable hardware performance and consistent print quality.

The patented comb matrix printing technique minimizes moving parts. And the two elements that do move . . . don't move very far. There's a hammer for each position. The one-piece Tally print comb prints one horizontal dot row at a time. The paper advance assembly progressively steps the paper vertically one dot row to complete the matrix character.

Tally's mechanical motion boils down to light weight, low stress parts moving at low velocities over small displacements.

Not only does it eliminate wear and tear, but it delivers "locked-in" precise print registration. You get straight lines all the time. You get clean and consistent print quality all the time.

The result is a 200 lpm line printer designed for print runs measured in hours instead of minutes. With no duty cycle limitations. With no preventative maintenance except for routine cleaning. And backed by a no-nonsense warranty.

The Tally Series 2000 line printer has become the choice of major computer system manufacturers. Join Tally's list of satisfied customers who have specified the line printer for the long run. Ask for our brochure. Tally Corporation, 8301 So. 180th St., Kent, Washington 98031. Phone (206) 251-5643.

TALLY®



New products

Semiconductors

ECL transceiver is also driver

Device can receive, send simultaneously on a single bus

A new MECL 10,000 part that can at one and the same time transmit and receive signals on a single bus has been developed by Motorola's Semiconductor Products division. The device, the MC10194 dual simultaneous bus transceiver, permits full duplex operation on a high-speed line. The part operates at typical MECL 10,000 speeds—up to 80 to 100 megahertz—depending on line length, and permits faster data transfer by transmitting one message while another is being received.

The new transceivers, though designed for emitter-coupled-logic input and output, can be used with transistor-transistor-logic circuits if suitable translators (MC10124, MC10125) are added. Priced at \$1.92 in quantities of 100, the transceivers offer an additional capability as drivers that meet the interface requirements for the Atomic Energy Commission's nuclear instrument modules. This is possible because the drivers have externally adjustable current capability. In conjunction with a suitable resistor, the driver will sink the 14 to 18 milliamperes required on a 50-ohm line. Other line impedances can also be handled if another ECL receiver, such as the MC10114, is used.

Three logic levels are used on the bus. The first is 0 volt for no data being transmitted. The second, for information being transmitted by one driver, is -0.87 v, and the third, when two transmitters are sending, is -1.66 v. This allows each unit to receive data while transmitting, by subtracting its transmission from the total signal on the bus. In one mode, any driver can send to all receivers attached to a common bus. Alter-

nately, any two units can exchange data, but the other terminals will not receive valid data.

The MC10194 uses a current-source line drive and is designed to operate with a load to the collector supply (normally ground, but it can be $+5$ v for use in TTL systems). The load is usually a line termination at the end of each end of the line. Each driver (half package) can drive a load as low as 75 ohms, with the two in parallel able to drive a 37-ohm line. Higher-impedance lines can be accommodated if the proper external resistor is selected.

A typical application for the part, says William Blood, manager of memory and logic application engineering at Motorola, is between the mainframe and memory of a computer. In this application, it reduces the consequences of long transmission delays (40 nanoseconds each way on a 10-foot cable) by simultaneously transmitting and receiving. In process control applications, the feedback comes back to the controller on the same line used for commands.

Coaxial cables are normally required. Up to 50 feet or more is possible with high speeds (100 MHz), and longer lines can be used at lower frequencies.

Current drain at 5.2 v is typically 78 milliamperes with all inputs low (each section of the dual device is a dual-input gate). Switching time is typically 1.5 to 2.5 nanoseconds, and rise and fall times are 2 ns. These can be stretched to reduce crosstalk in many applications by the addition of small capacitors across the output. The devices are offered in 16-pin ceramic dual in-line packages. Plastic will be available in the future.

Motorola Semiconductor Products division, Box 20924, Phoenix, Ariz. 85036 [411]

N-channel static memories are TTL-compatible

Three n-channel static MOS random-access memories are organized as 1,024 1-bit words. Pin-compatible

HIGH PURITY ELEMENTS

We offer more than anyone else.

- Antimony
- Arsenic
- Bismuth
- Cadmium
- Copper
- Gold
- Indium
- Lead
- Selenium
- Silver
- Sulphur
- Tellurium
- Thallium
- Zinc

Asarco has the broadest selection of high purity elements in the business. All 99.999+ % pure. All ready for prompt delivery. For semiconductors, electronics, metallurgy, research, and other applications.

Our high-purity elements are also available in commercial quantities.

For more information on Asarco's array of high purity elements, write our By-Products Department at 120 Broadway, New York, N.Y. 10005.

75 Years of Progress in Metals

ASARCO⁷⁵
American Smelting and Refining Company

Visual images are fleeting—so, for the record, . . . you need pictures. No telling when or how often they can prove invaluable.

THE CHAMP

...PICTURE TAKER



Circle 220 on reader service card

That's why so many of your peers are routinely snapping pictures while looking at specimens and samples with Bausch & Lomb's Stereozoom 7 visual-photographic system. The Champ's superb optical system which gives unbeatable visuals will put the images on film right while you're looking. And they will be available as often as you want to refresh your memory, make comparisons, prove points.

There's a choice of most camera formats with the new Integrated Cameras, Series II with optional exposure meter. They're integral, but do not interfere with the optical system and interchange to fit varying needs.

Be ready. Write for our new Stereomicroscope catalog 31-15 and our free demonstration offer.

BAUSCH & LOMB 
SCIENTIFIC OPTICAL PRODUCTS DIVISION

62311 Bausch Street, Rochester, N.Y. 14602

Stereozoom, Reg. T.M.
Bausch & Lomb.

New products

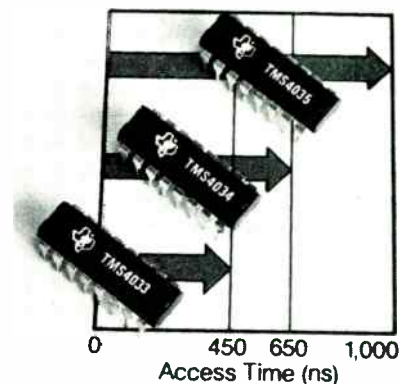

with the popular 2102-1, 2102-2, and 2102 RAMs, respectively, the TMS4033, TMS4034, and TMS4035 have respective access times of 450, 650, and 1,000 nanoseconds. Other features of the devices include full Series 74 TTL-compatibility, single 5-volt supply load, and three-state outputs for bus-driving capability. Delivery is from stock.

Texas Instruments Inc., Inquiry Answering Service, P.O. Box 5012, M/S 308, Dallas, Texas 75221 [413]

Germanium transistors handle 3-ampere peaks

A series of industrial pnp germanium power transistors have peak-current capabilities of 3 amperes and reverse voltage ratings up to 40 v. The series is available in the standard TO-8 package, and is in the 2N1183-2N1184B family. The new devices can be used in com-



Own your own holder to hold your own!

Hold your own copies of Electronics in specially designed slipcase holders. They'll keep your Electronics library neat and handy—a permanent information file, issue by issue.

Just complete the coupon and mail to Jesse Jones. He'll process your order upon receipt, postpaid.

ELECTRONICS BOXER
Jesse Jones Box Corporation
2250 E. Butler St., Philadelphia, Pa. 19137

Please send me: boxes @ \$4.25 each; 3 boxes @ \$12.00; 6 boxes @ \$22.00.
My check or money order is enclosed.

Name: _____

Address: _____

City: _____

State: _____

Zip: _____



Introducing the V-71. 32K for 8 grand.

Incredible. Getting 32K out of an off-the-shelf mini. Plus the option of a power fail/restart, teletype controller, automatic bootstrap loader for TTY's and real-time clock for only \$800 more*.

It gives us the distinction of being the cheapest computer in the world delivering 32K. And gives you the chance to get a lot more power for your money.

But the V-71 is more than just another piece of bare metal selling at a rock-bottom price (we leave that specialty to others). It—like the entire Varian V-70 family—has been elegantly designed by Varian engineers who think in terms of systems and total concepts.

With additions, the V-71 is capable of a powerful blend of hardware, systems software (the VORTEX operating system), and extensive peripherals. And Writable Control Store if that's what you need.

How much of a system you want to make out of the V-71 is up to you. The raw power is there. And Varian's open-ended architecture makes it easy to add whatever building blocks you need.

If you want more power for less money, check out the new V-71. For further information, write Varian Data Machines, 2722 Michelson Drive, Irvine, CA 92664. Or call 833-2400.

*V-71 price and options based on orders of a dozen.

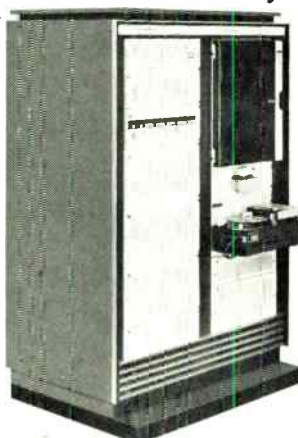

**varian
data machines**

**This Christmas give your car
a Mark Ten B Capacitive
Discharge Ignition. You and
your car will enjoy it all year.**



The Mark Ten B keeps your car in tune. That means increased mileage, less maintenance and a better running car. A well-tuned car also decreases emission contaminants. All this adds up to more driving enjoyment for you. Mark Ten B, the perfect gift—for cars—and their owners.



DELTA PRODUCTS, INC.

P.O. Box 1147, Dept. E
Grand Junction, Colo. 81501
(303) 242-9000

Here's my Christmas order. Please rush!

Please send me free literature.

Enclosed is \$ _____ Ship ppd. Ship C.O.D.

Please send: _____ Mark Ten B assembled @ \$64.95 ppd. _____ Mark Ten B Kit @ \$49.95

ppd. 12 volt negative ground only • _____ Standard Mark Ten, assembled, @ \$49.95 ppd.

_____ 6 Volt: Neg. Ground Only _____ 12 Volt: Specify _____ Pos. Ground _____ Neg.

Ground • _____ Standard Mark Ten Deltakit* @ \$34.95 ppd. (12 Volt Positive or Negative

Ground Only)

Car Year _____ Make _____

Name _____

Address _____

City/State _____

Zip _____

Circle 222 on reader service card

**Fight
Them All**

Heart Attack, Stroke
High Blood Pressure
Rheumatic Fever

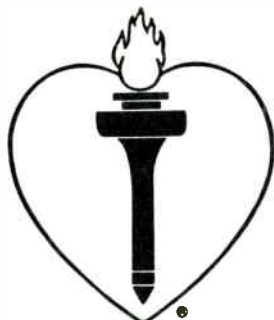

Help your Heart... Help your Heart Fund

New products

puter peripherals, communications equipment, inverters, converters, and audio amplifiers. Prices range from \$2 to \$5 according to quantities; delivery time is 2 weeks.

Germanium Power Devices Corp., P.O. Box 65, Shawsheen Village Station, Andover, Mass. 01810 [415]

Low-leakage diodes have high impedances

A line of low-capacitance, high-impedance diodes is intended for circuits requiring clipping, clamping, or over-voltage protection. The PAD (pico-ampere diode) family offers the designer impedances that are hundreds to thousands of times higher and capacitances that are two to three times lower than those of other protection devices. There are seven devices in the PAD family, with leakages ranging from 1 pA (PAD-1) to 100 pA (PAD-100). Reverse impedances range from 2×10^{13} ohms for PAD-1 to 4×10^{12} ohms for PAD-5. Capacitance in the diode family ranges from 0.8 to 2.0 pF. Typical forward voltage drop is 0.8 v. Prices, in 100-unit quantities, range from 79 cents to \$2.20 each. Delivery is from stock.

Siliconix Inc., 2201 Laurelwood Rd., Santa Clara, Calif. 95054 [414]

LEDs designed for fault indication

Several green, yellow, and red light-emitting-diode logic-state/fault indicators can be used to signal when and where a fault occurs in a complex electronic circuit. The units are also designed for use as indicator lights, panel illuminators, logic-state

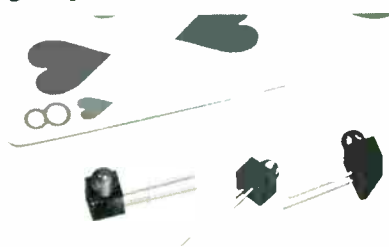

Mil spec converters and indicators: We can give you off-the-shelf delivery.

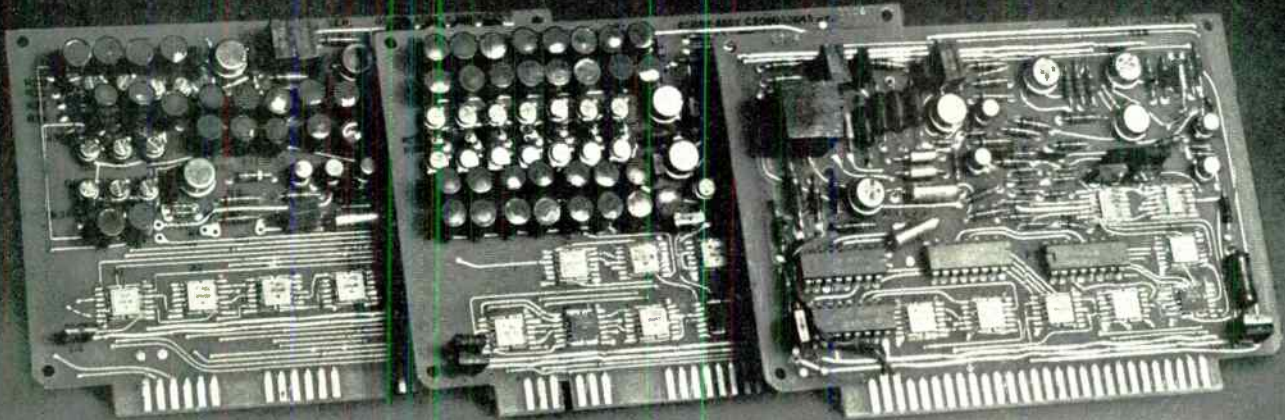

If you've got conversion problems, Kearfott production model converters and angle position indicators can help solve them. Here's how.

TRIGAC I—Single or multiplexed synchro or resolver/digital converters, accurate to 6 minutes (12 bit) 11.8 or 90 volt inputs, 60 to 400 Hz operation. Multiplex 4, 8 or multiples of 8 channels.

TRIGAC III—Synchro or resolver/digital tracking converter. 14 bit natural parallel output.

TRIGAC IV—Digital/synchro converter, 3 wire 11.8 or 90 volt output, accuracy to 4 minutes, 12 bit parallel input.

Also available:

- D.C. (sine-cosine) to synchro output. Power capability to 5VA.

- Digital resolver uses TRIGAC III circuitry. Unit equivalent to a control transformer, for digital command application.
- Synchro to D.C. converters for instrumentation applications.
- Solid state angle position indicators. TRIGAC circuitry. Available with 0-360° or ±180° outputs and LED readouts. D.C. outputs, BCD outputs also available as options with displays and special scale factors.

We can supply any of the above on cards or in mil-type corrosion-resistant enclosures. Write today for new catalog. The Singer Company, Kearfott Division, 1150 McBride Avenue, Little Falls, New Jersey 07424.

SINGER

AEROSPACE & MARINE SYSTEMS

Years ago we made a decision to let the other guys knock out all of the simple printed circuit boards they could make. We wanted the tough jobs.

Multilayer and two-sided PCs. Complex drilling, printing and plating.

And we wanted to do them better than anybody in the business. Since then, we've been doing

more of the hard work than anyone. And delivering it on time. With precision and economy.

We built a reputation on hard work. We're not about to take things easy now.

If you've got a tough job, call us at (213) 722-6810 collect. Or write Data Products Division, 6201 East Randolph Street, Los Angeles, California 90040.

We built a reputation on hard work.

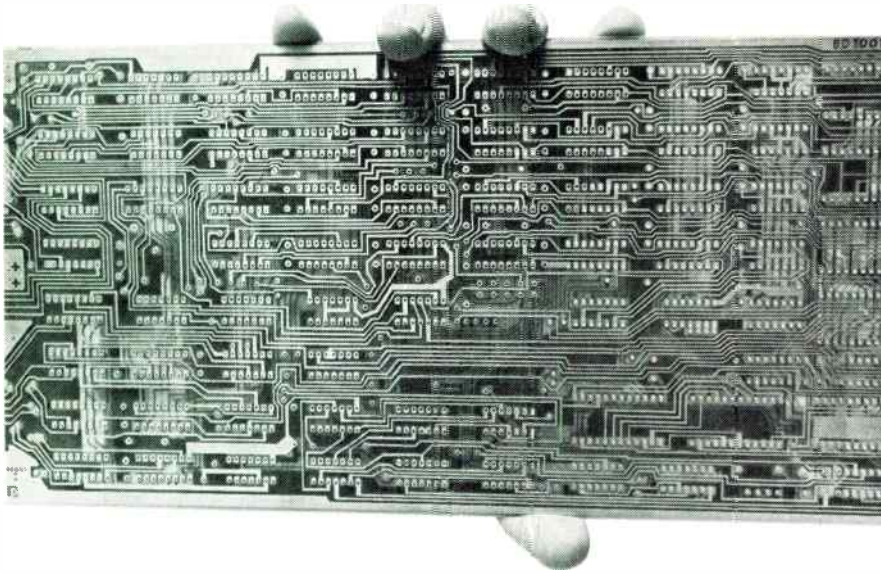

Lockheed Electronics—First In Complex PCs

15 YEARS OF LEADERSHIP IN ELECTRONICS. 1959-1974.

Circle 224 on reader service card

CUSTOM ELECTRONICS' MICA CAPACITORS: short on DELIVERY long on RELIABILITY

That describes our CMR type capacitor, ideal for "potted-in" applications where minimum size and low per-unit cost are important. All our dielectric is screened *before* production to avoid failure in the field.

Installation No.	TYPICAL UNITS:			1 to 10 Qty. Price
	Cap.	WVDC	L x W x T Max.	
CMRIA102104K	0.1 μ f	1,000	2.062" x 1.425" x 0.200"	\$8.05
CMRIA302104K	0.1 μ f	3,000	2.562" x 1.620" x 0.270"	9.25
CMRIA103103K	0.01 μ f	10,000	2.562" x 1.800" x 0.350"	8.80

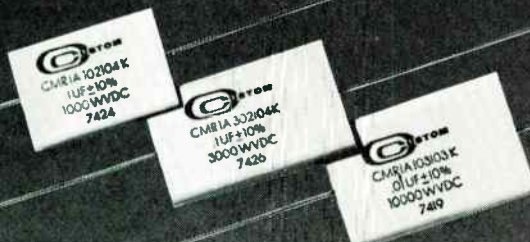

FREE: Descriptive TechniTip, Includes Mica Sample. Write:



CUSTOM ELECTRONICS, Inc.

12 Browne St., Oneonta, N.Y. 13820
PH: (607) 432-3880 TWX: 510-241-8292

New products

indicators, and binary-data displays, where they can be stacked so that multiple functions can be displayed. They are available with both axial and right-angle leads, making it possible to view the LED from any angle without having to bend or align the leads. The red devices can be purchased with or without an integral resistor. Prices in the U.S. for these units, in quantities of 1,000, are 39 cents each for red, 80 cents for green, 80 cents for yellow, and 62 cents for red with resistor. Delivery is from stock.

Dialight, 203 Harrison Place, Brooklyn, N.Y. 11237 [416]

RAMs offer 12-ns address-to-output times

Two random-access memories, designated MCM10144L/AL and MCM10147L, are available in 256-by-1 and 128-by-1 formats, respectively. Both devices have open-emitter outputs. Chip-enable inputs permit memory expansion without additional decoding. Operating over a temperature ranges of -31°C to $+85^{\circ}\text{C}$, the parts are housed in 16-pin, ceramic dual-in-line packages. Address-input access time, for the MCM10144, is a maximum of 30 nanoseconds. Address-to-output access time for the MCM10147 is a maximum of 12 ns. Maximum chip-enable to memory-output access times are 10 ns and 8 ns, respectively, for the MCM10144 and MCM10147. Prices for the memories, in hundreds, are: \$35 for the 256-bit units, and \$40 for the 128-bit RAMs.

Motorola Semiconductor Products, Inc., P.O. Box 20912, Phoenix, Ariz. 85036 [418]

Modules expand ROM simulation capabilities

Eleven bipolar memory modules have been added to the read-only-memory simulator developed by Scientific Micro Systems for debugging ROM and PROM micro-

We bridged the forward surge gap. For extra protection.

Our bridge rectifier ratings for DC output and forward surge capacities are substantially greater than those of competitive devices. Even though our physical dimensions are the same.

So, our single phase and three phase bridge rectifiers provide important added safety at normal operating levels.

You no longer have to take the chance of using a marginally rated bridge rectifier and running the chance of expensive down time and replacement costs.

Wagner single and three phase bridge rectifiers as well as center tap rectifiers come in standard size packages. Only our current ratings and forward surge ratings are higher.

B-10 Series. DC rating-30A@75°C Case. Forward Surge rating-400A@ rated load. B-10 Series replaces look-

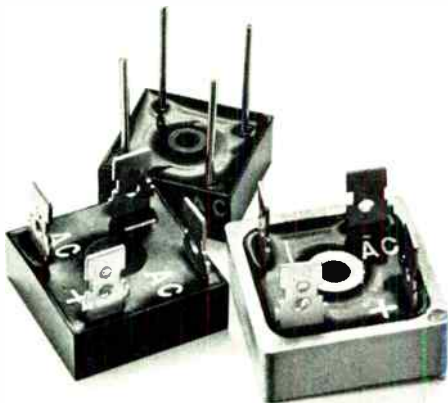
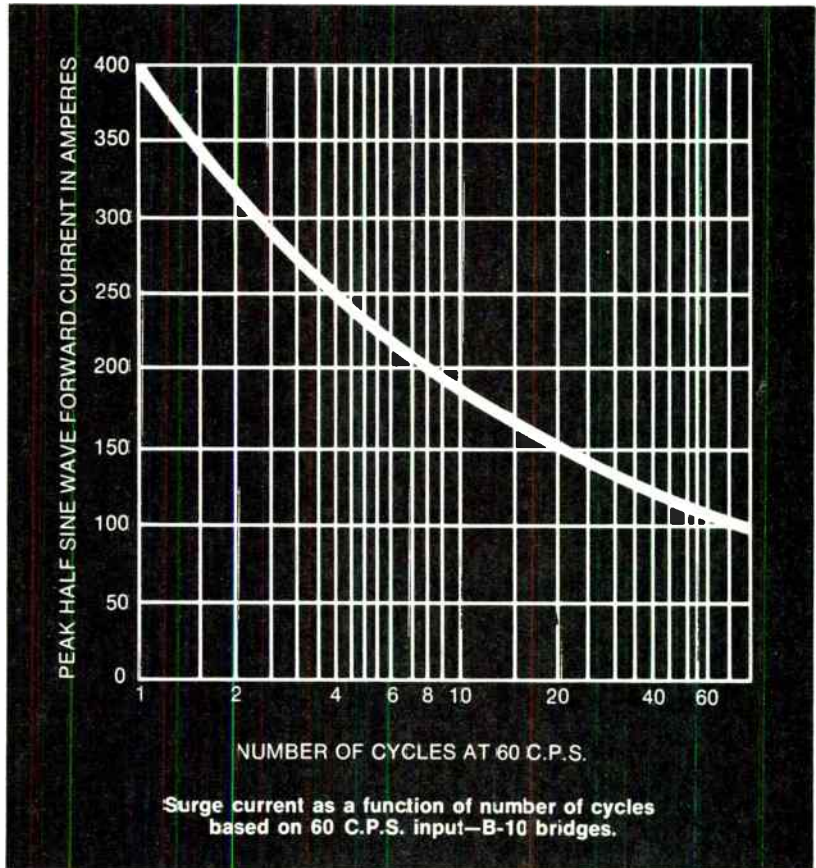

alike bridges rated up to 25A and from 50 to 1,000 PRV per leg.

B-40 Series. DC rating-15A@75°C Case. Forward surge rating-300A@ rated load.

B-50 Series. DC rating-10A@75°C Case. Forward surge rating-300A@ rated load.

For additional information on Tung-Sol® bridge rectifiers, write to: Tung-Sol Division, Wagner Electric

Corporation, 630 West Mt. Pleasant Avenue, Livingston, New Jersey 07039.

Wagner makes other quality products in volume for the electronics industry, including vacuum fluorescent readouts, power supplies and subsystems, silicon rectifiers, resistors, miniature lamps and status indicators. And Wagner offers contract manufacturing.

WAGNER®

We've got a lot more riding for you.

®Trademarks Wagner and Tung-Sol, Reg. U.S. Pat. Off. and Marcos Registradas

CHECK ALL THESE FEATURES AGAINST ANY OTHER I-C HANDLER YOU MIGHT BE CONSIDERING

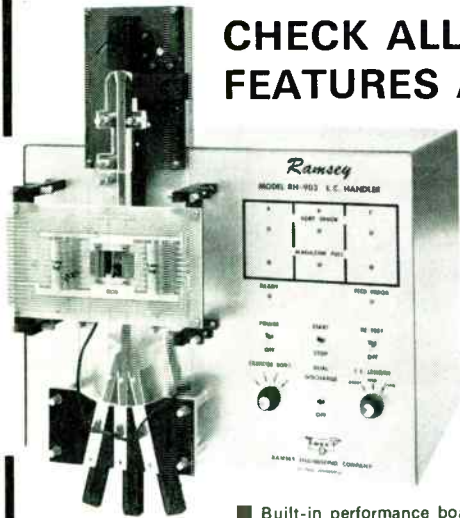

MODEL RH-903

- Three-category sort, or two-category sort with dual discharge. In dual discharge, bins which have the same sort signal automatically gate from one to the other as one becomes full.
- Built-in performance board incorporating all bypassing and decoupling networks; can be used as a mother board, with dedicated compensation modules for specific DIP types, or used for insertion of discrete components as individual test parameters are encountered.
- Precision photo detectors monitor each operation and provide continuous visual indication of handler status at all times.
- Accommodates 6 thru 18 pin packages and adjusts for a wide range of package sizes via convenient thumb screw adjustments.
- Re-test capability.
- Built-in interface board for specialized interface requirements.

For information, write or call Electromechanical Products, Ramsey Engineering Co.

RAMSEY 
ENGINEERING COMPANY
1853 W. County Road C, St. Paul, Minnesota 55113 (612) 633-5150

Circle 226 on reader service card

New products

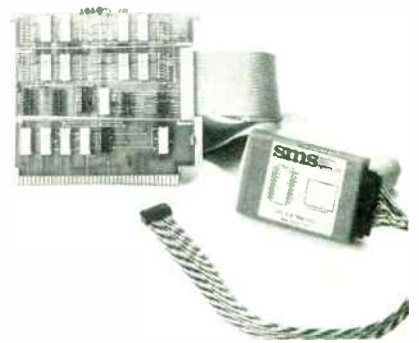

programs. These modules bring to 14 the number available to users of the simulator, called the model 1000A. The simulation options range from organizations of 256 by 4 bits to 1,024 by 4 bits and are priced from \$395 to \$795. The modules have a maximum access time of 100 ns. Microprogram-based systems are in the prototype stage.

Scientific Micro Systems, Subsidiary of Corning Glass Works, 520 Clyde Ave., Mountain View, Calif. 94043 [417]

LED indicators designed for switching, testing phones

Intended as replacements for T-2 incandescent lamps used in telephone-switching and testing equipment, two new models of slide-base light-emitting-diode indicators are offered in green and amber for color-keyed indication. Designed to retrofit existing equipment, models CM4-9131 (green) and CM4-9231 (amber) have built-in resistors to make them compatible with 48-volt telephone-panel sockets without making any changes to panel circuitry. Additional built-in diodes extend reverse-breakdown-voltage protection up to 75 v. The gallium-phosphide devices provide luminous intensity of 1.2 millicandelas at 48 v, with a half-intensity viewing angle of 70°. Package length, including lens encapsulation, is 1.96 inches, and collar-flange diameter is a standard 0.366 in. Prices range from \$2.55 each in 1,000-piece quantities to \$1.65 for 10,000 pieces. Delivery is from stock.

Chicago Miniature/Drake, 4433 N. Ravenswood Ave., Chicago, Ill. 60640 [419]

D I B*

DUAL IN-LINE BRIDGE

An integrated bridge rectifier in a miniature dual in-line package



ACTUAL SIZE PACKAGE

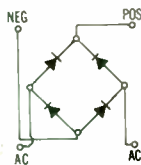

Write for free sample

- 4-pin, low-profile DIP
- Leads on standard .10" (2.54 mm) grid
- Compatible with automatic testing, handling and inserting.
- Greatly reduces labor & material costs.
- 100% surge tested at 25A.
- Meets moisture resistant requirements of MIL-STD 2021, 106C
- Two Series: 1 Amp (I_o) at 40°C; ½ Amp (I_o) at 55°C
- 25 to 1000V (V_{RRM})

* TM-Varo Semiconductor, Inc.



Design us in . . . we'll stay there **VARO SEMICONDUCTOR, INC.**

P.O. BOX 676, 1000 N. SHILOH, GARLAND, TEX. 75040 (214) 272-4551 TWX 910-860-5178

226 Circle 116 on reader service card

Electronics/November 14, 1974

Syntron Semiconductor Sales Organization

ARIZONA
Fryco, Engineering Reps.
Scottsdale
(602) 945-3281

CALIFORNIA
Carl E. Holmes Co.
Los Angeles
(213) 256-2255

COLORADO
Gossard & Associates
Denver
(303) 985-0602

FLORIDA
L. Haas Co., Inc.
North Miami Beach
(305) 949-9143
(305) 949-5157

ILLINOIS
Syntron Chicago Sales Co.
Hinsdale
(312) 325-3250

INDIANA
Seawood Sales, Inc.
Montgomery
(513) 793-6702

MARYLAND
Callas Electronics, Inc.
Baltimore
(301) 744-7711

MASSACHUSETTS
Garrett Co., Inc.
Needham
(617) 449-2640

MICHIGAN
L. H. Dickelman
Detroit
(313) 255-3300

MINNESOTA
Northport Engineering Inc.
St. Paul
(612) 698-3841

MISSOURI
Harlan J. Weisler & Associates
St. Louis
(314) 428-3934

NEW JERSEY
Syntron Newark Sales Co.
Hasbrouck Heights
(201) 288-1845

NEW YORK
J. Lazor Associates
Penfield
(716) 473-8337

NORTH CAROLINA
Jake Rudisill Associates, Inc.
Charlotte
(704) 377-6901

OHIO
Allen Nace Co., Inc.
Brecksville
(216) 526-4323

PENNSYLVANIA
W. Reeves Associates, Inc.
Media
(215) 566-6709

TEXAS
Palatine Sales, Inc.
Richardson
(214) 231-9489

WASHINGTON
Bergford & Associates
Olympia
(206) 866-2001

WISCONSIN
Syntron Semiconductor Sales Co.
Milwaukee
(414) 273-6773

Syntron Power Thyristors

Syntron Thyristors (SCRs) are diffused, three junction, semiconductor units designed for medium and high power solid state control applications.

Available in the popular standard JEDEC configurations from 25 amps rms to 850 amps rms with V_{BO} ratings to 1600 volts and transient ratings to 2000 volts, these Thyristors exhibit the same reverse voltage avalanche characteristics found in all Syntron silicon diodes.

In a single element application, they can be used for direct conversion and continuous control of AC to DC power requirements or they can be used as a DC switch to initiate current flow.

Rigid quality control and years of field testing have made Syntron Thyristors among the most reliable devices available for solid state power control.

For detailed information, contact:
FMC Corporation
Semiconductor Products
Operation
Homer City, Penna. 15748
(412) 479-8011

FMC Special Products



Circle 227 on reader service card

Q3

Quick, Quiet, Quality ...

... in the smallest thermal non-impact incremental printer available. Offering twice the speed—at half the cost—of anything else on the market, the new Q3 comes in 60- and 30-character-per-second versions, or NCR-compatible models. There's little mechanical to cause problems. Full electronic design insures maximum reliability and interface flexibility.

Check out the Q3, and see how our numbers add up to the right answer for your printer needs.



OEM Products Group
11 Ray Avenue, Burlington, Mass. 01803
617-273-1550

a
TECHVEN
corporate partner

Circle 228 on reader service card

New products/materials

Large plastic windows of acrylic or polystyrene are high in both light transmittance and mechanical strength. Applications include Schlieren systems, bubble-chamber photography, and deep-sea underwater photography. A typical acrylic window for underwater photography, 15 inches in diameter with a convex-concave 5-inch constant thickness, has a light transmittance of 86%, the company says.

Applied Products Corp., Horsham, Pa. 19044 [476]

An acrylic-polyethylene coating, which can be applied to almost any laboratory surface, goes on clear, and is dry enough to work on in 20 minutes. After a 24-hour cure, the coating will protect the surface from stains of common oil, marking pens, inks, and most chemicals. Called Nalgene protective laboratory coating, the product can be easily removed with diluted ammonia or commercial wax remover.

Nalge Co., 75 Panorama Creek Drive, Rochester, N. Y. 14602 [477]

Two porous polyimides, marketed under the Vespel trademark, are suitable for applications requiring long life and a high degree of lubricity over a wide range of temperatures. Designated SP-8 and SP-811, the polyimides are capable of being impregnated with lubricant. The SP-8 material is a homogenous polyimide, while the SP-811 contains graphite and Teflon fluorocarbon resin. Precision ball-bearing assemblies with retainers made of the new materials have operated at 48,000 rpm over the temperature range from -60 to +500°F.

Du Pont Co., Plastics Dept., Plastic Products Div., Room No. 24168, Wilmington, Del. 19898 [478]

A conductive polypropylene material—Profil J-60/30/CM—contains 30% intermediate-length glass fiber reinforcement plus an additive of electrically conductive carbon. The glass reinforcement improves physical properties above those of unreinforced polypropylene while the conductive additive gives qualities

←Circle 121 on reader service card

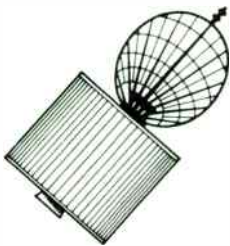

ENGINEERING MANAGERS

Advanced Development

This position will provide the successful candidate the opportunity for technical management of a department of 50 engineers and technicians, who design and develop RF and digital electronics circuits and subsystems for communication satellites. The department is designing and producing circuits and equipment which will advance the state-of-the-art in solid state transmitters, receivers, reference generators, upconverters, modulators, power amplifiers, oscillators, multipliers, and microwave integrated circuits.

Candidates with BS, MS, or PhD degrees in engineering will all be considered. A minimum of 10 years technical experience is required. Our facilities are adjacent to the Los Angeles International Airport and one mile from the Pacific Ocean, which provides superb climate and excellent recreational opportunities.

Please call collect or send your resume to: Mr. Allan St. Jacques, (213) 648-2020, Hughes Aircraft Company, P.O. Box 92919, Los Angeles, CA 90009.

U.S. citizenship required • Equal opportunity M/F employer

Microwave Solid State

This position will provide the successful candidate the opportunity for technical management of a department of 45 engineers and technicians, who design and develop microwave solid state and semiconductor devices for communication satellites. The department is designing and producing devices which will advance the state-of-the-art in parametric amplifiers, tunnel diode amplifiers, low noise transistor amplifiers, linear and class C power amplifiers, and microwave integrated circuits.

HUGHES

HUGHES AIRCRAFT COMPANY

There's no RF energy crisis with RCA power tubes.

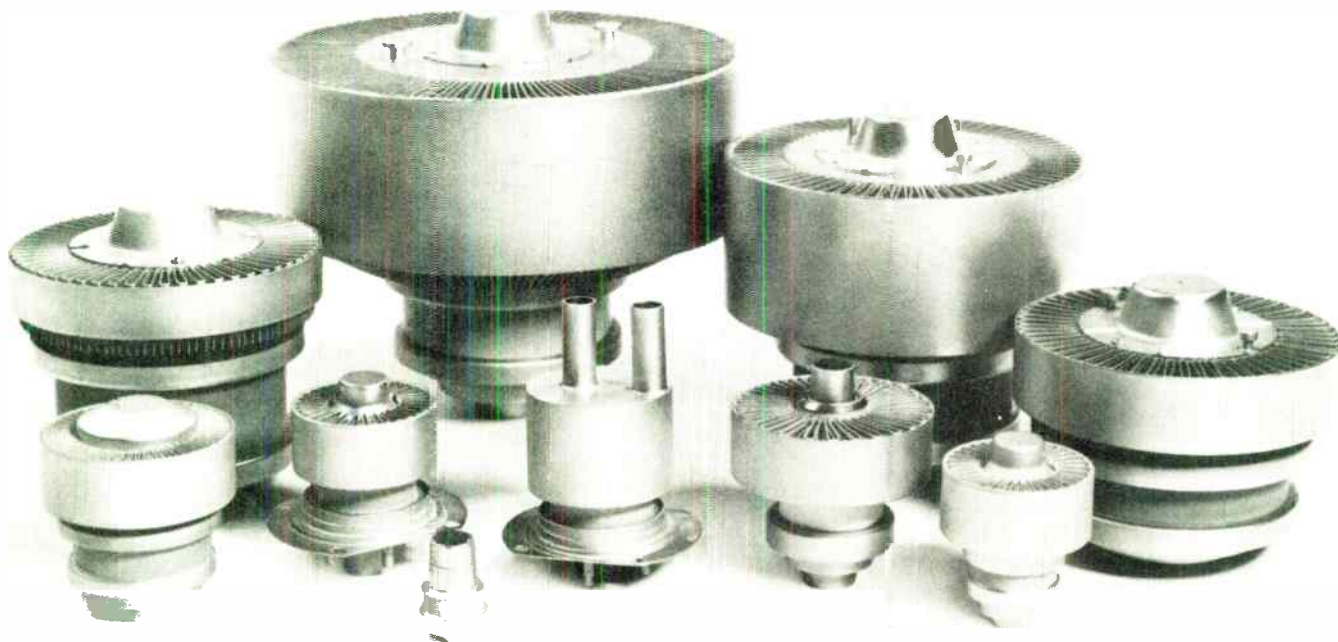

RCA's combined families of regular and large power tubes not only comprise the broadest line of such tubes in the industry, but they range in power all the way up to 250 kW . . . and in frequency to 1450 MHz.

Covering almost every major power tube application area, the RCA line also includes a comprehensive array of cavities and circuits. These cavities and circuits are specifically designed to enhance the advantages of RCA's power tubes. Together, they achieve a total power package unmatched for reliable high performance.

For more information on the entire RCA power tube line,

call your RCA Representative or RCA Industrial Tube Distributor, or fill out and return the reply coupon.

Manager, Power Devices Marketing
RCA, New Holland Avenue
Lancaster, PA 17604

Please send me the new RCA Power, Frequency and Application Chart.

Please have an RCA Representative call me. Telephone _____

Name _____

Company _____

Street _____

City/State/Zip _____

70K-14

RCA Power and
Microwave Devices

INTERNATIONAL SALES OFFICES: ARGENT. NA - Casilla de Correo 4400 Buenos Aires/BRAZIL - Caixa Postal 30433 Sao Paulo/CANADA - 21001 No. Service Rd. Ste. Anne de Bellevue 810 Quebec/ENGLAND - Sunbury-on-Thames, Middlesex/HONG KONG - P.O. Box 112/MEXICO - Apartado 17-570, Mexico 17 D.F./SWITZERLAND - 118 rue du Rhone CH1204, Geneva

Electronics/November 14, 1974

Circle 229 on reader service card 229

**SOLDERING +
DESOLDERING +
RESOLDERING =**

SOLDERABILITY
ELEMENTARY TO ELITE
WORLD'S MOST PRACTICAL SOLDER HANDLING TOOLS

meets industries demands.....

with a COMPLETELY PORTABLE SOLDERING/DESOLDERING/RESOLDERING SYSTEM

U.S. AND FOREIGN PATENTS APPLIED FOR

NEW FANOVISION

144 Page Manual

SolderABILITY TECHNIQUES

* NOTE: FANOVISION Manual will be sent FREE with purchase of \$7.95 (or more) of any EDSYN Products. Limit one FREE MANUAL to a customer.

EDSYN
15958 ARMINTA STREET
VAN NUYS, CALIFORNIA 91406
PHONE (213) 989-2324
TELEX NO. 65-1469 EDSYNEX VAN

Circle 230 on reader service card

Keys to higher production, lower cost

ECCOMOLD[®]

Transfer Molding Compounds

Epoxy Powders and Liquids for Electrical/Electronic Encapsulation

Comparative physical, and electrical properties, mold design considerations, processing techniques for both powders and liquids given in new booklet. Send for FREE copy.

EMERSON & CUMING, INC.

CANTON, MA.
GARDENA, CA.
NORTHBROOK, IL.

Sales Offices in Principal Cities

Emerson & Cuming Europe N.V., Oevel, Belgium

230 Circle 125 on reader service card

New products/materials

of static-electricity dissipation. The material is used for cooling fans in explosion-proof electric motors, battery cell connectors and other products where conductivity is essential.

Fiberfil Division, Dart Industries Inc., 1701 North Heidelberg Avenue, Evansville, Ind. 47717 [479]

A potting compound designated Aremco-Cast 554 is said to have high-temperature characteristics exceeding those of epoxy and silicone. Applications include potting of components such as transformers. The material is an organic-inorganic cross-linked polymer which, after a



low-temperature cure of 275°F, offers temperature resistance to 750°F. One-quart trial kits are priced at \$80 each and are available from stock.

Aremco Products Inc., P.O. Box 429, Ossining, N.Y. 10562 [371]

An aerosol spray aid is a cleaning, lubricating and anti-corrosion agent that reduces mechanical abrasion of all contact surfaces, thereby increasing their service life. Kontakt 61 is free of silicones and inorganic acids, and is said to be safe for use on all types of plastics, metals, and insulating materials. Low resistance is secured at contact points following a Kontakt 61 application.

Regmo Data Corp., 6992 Oxford Street, Minneapolis, Minn. 55426 [480]

Rust and corrosion protection is pro-

A low-cost scope should offer more than a low price.



The new Heath/Schlumberger dual-trace SO-4510 has DC-15 MHz bandwidth, 1 mV sensitivity, post-deflection accelerated CRT, vertical amplifier delay lines & more ... for only \$750*.

The actual value of any oscilloscope is really how much it benefits the user in price, or performance, or both. Our SO-4510 offers a low price plus DC-15 MHz bandwidth, vertical sensitivity of 1 mV/cm, time base sweep to 100 nsec/cm and complete dual-trace capability. And it also offers many features that other manufacturers don't provide at anywhere near our low price.

Like post-deflection acceleration for a brighter trace and faster writing speeds. Many input signals that wouldn't be visible on a mono-accelerated CRT are presented in a sharp, bright trace on the SO-4510. Think of your applications for an oscilloscope. Can you really do without our additional brightness?

Trigger bandwidth — is it specified? The SO-4510 will typically trigger on signals up to 45 MHz and is guaranteed to 30 MHz. And there's no stability control needed with the digitally-controlled triggering circuits. In the automatic mode, a reference baseline is generated even when the trigger signal is absent. Complete triggering controls are provided with choice of AC or DC coupling, triggering at any point on the vertical signal. An AC fast coupling mode is provided to reject low-frequency components of the trigger waveform for accurate scope triggering. Choice of automatic or normal sweep uses any one of 22 time bases from 0.2 sec/cm to 0.1 μ sec/cm.

Vertical input sensitivity of 1 millivolt — over the full bandwidth. Think of this in terms of the way you're most likely to use an oscilloscope — with a X10 probe. With the SO-4510 and a X10 probe, you can still read waveforms to 10 mV/cm, not the 50 or 100 mV/cm found on other scopes. We also offer a companion high impedance isolating probe with 10:1 attenuation for only \$23.95*.

Internal delay lines for the vertical amplifier insure start of the horizontal sweep prior to the beginning of the vertical signal. They allow display of at least 20 nanoseconds of the pre-triggered waveform, insuring that the complete waveform will be displayed. Can you really do without this pulse analysis capability?

True X-Y capability. X-Y operation uses Channel 1 for horizontal deflection and Channel 2 for vertical deflection. Phase measurements can be made using the standard vertical inputs, not the horizontal input as other scopes require.

Dependable, rugged design with easy-to-service construction. The SO-4510 was designed by service-oriented engineers who have been designing low cost scopes for a long time. The SO-4510 is remarkably easy to service. All major circuitry is located on five circuit boards for easy trouble-shooting. Push-on connectors permit fast removal of any board. Even the CRT can be removed and replaced in a matter of minutes.

Most important, the SO-4510 is designed and built by Heath — specialists in high performance, low cost instrumentation. We know how to provide good instrument value for the money, not merely another low-price instrument. And we're not just entering the low-cost instrument market, we've been here for years. The SO-4510 was designed for a maximum of performance at the lowest possible cost. And if you're interested in saving even more, our IO-4510 offers the same performance and features in an easy-to-assemble kit for only \$549.95*.



The latest Heath/Schlumberger catalog features a complete line of high performance, low cost instruments for industrial and educational applications. Our '75 Heathkit Catalog describes the world's largest selection of electronic kits — including a full line of lab and service instruments. Send for your free copies today.

Heath/Schlumberger Instruments Dept. 531-281 Benton Harbor, Michigan 49022		HEATH Schlumberger
<input type="checkbox"/> Please send the 1975 Heathkit catalog. <input type="checkbox"/> Please send the latest Heath/Schlumberger catalog.		
Name _____		
Title _____		
Company/Institution _____		
Street _____		
City _____		
State _____		Zip _____
*Mail order prices; F.O.B. factory. Prices & specifications subject to change without notice.		
		EK-435

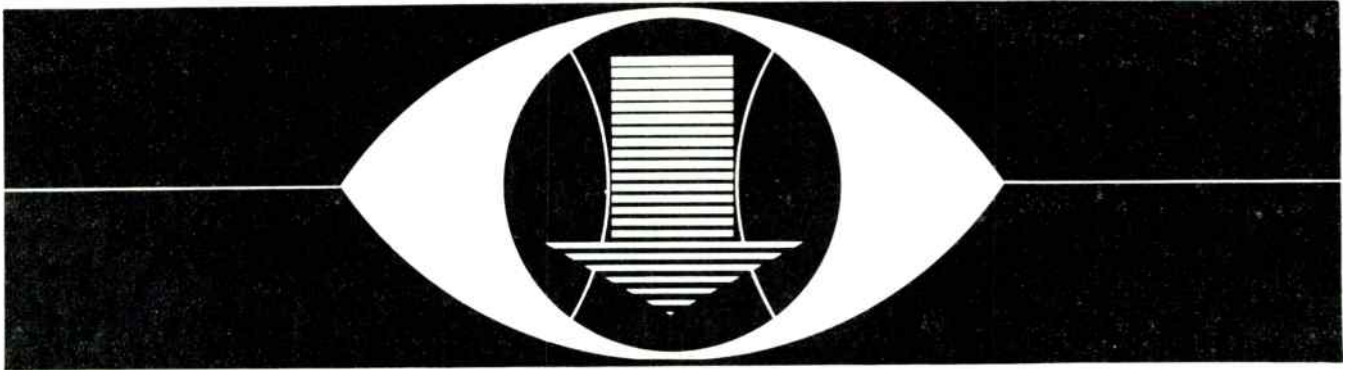

Can you find a fault with a film over a 0.000001 cm² area?

The natural answer is: NO.
The true answer is: YES,
with the

LEM-2 ellipsometric Laser microscope offering:

- Non-destructive contact-less inspection
- A wide range of thickness of dielectric films and coatings that can be measured
- Response to a variation in the film thickness less than one atomic layer
- Extra simple operation

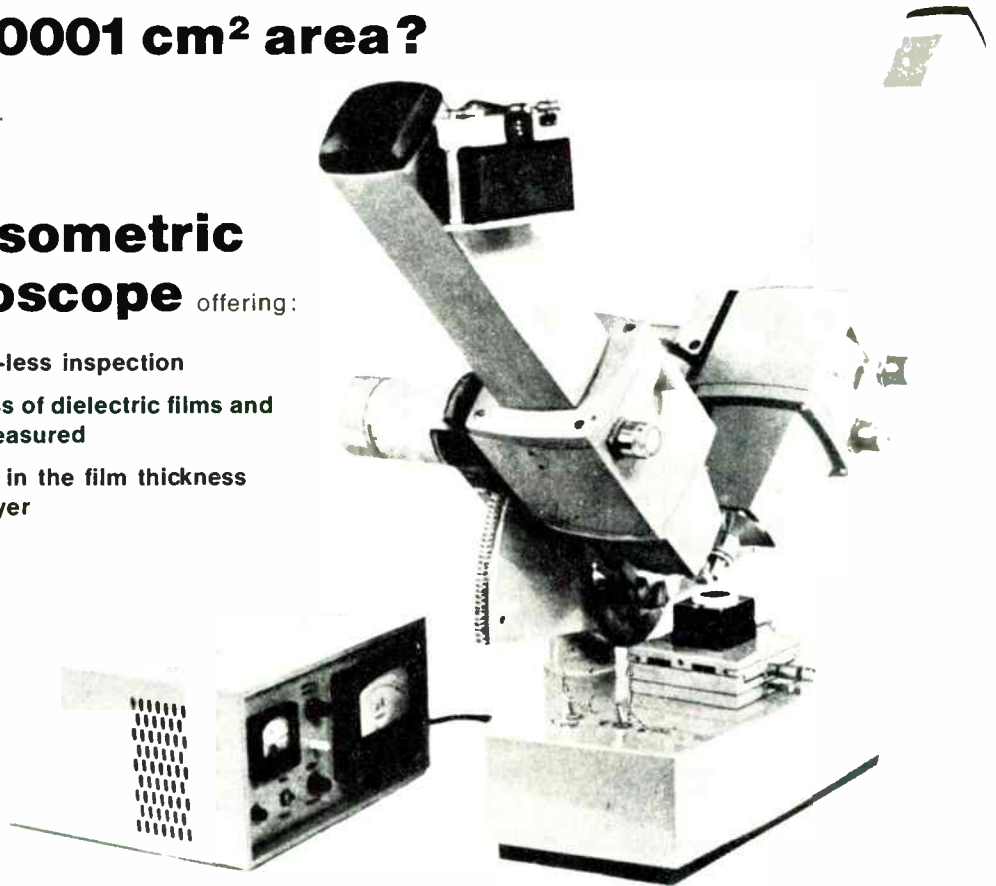

The LEM-2 is the first means to measure the thickness of dielectric films in mini-size "ports" in protective layers employed in planar techniques of production of integral circuits and individual semiconductor devices

the LEM-2 is also capable of:

- measuring the optical parameters of semiconductors & metals,
- investigating adsorption and desorption,
- detecting flaws in dielectric coatings with great sharpness.

Exporter: V/O TECHMASHEXPORT

35, Mosfilmovskaya · Moscow V-330 USSR · Telex: 7568 · Agents:

AMTORG TRADING CORPORATION 355 Lexington Avenue, New York, N.Y. 10017

50th ANNIVERSARY
of Amtorg Trading Corporation this year

TECHMASHEXPORT



1%

AMERICAN MADE

Tolerance SCHAUER 1-Watt ZENERS

Immediate Shipment Low Prices

ANY voltage from 2.0 to 16.0

Quantity	Price each
1-99	\$1.07
100-499	.97
500-999	.91
1000-4999	.86
5000 up	.82



All welded and brazed assembly

No fragile nail heads

Gold plated leads

Write for complete rating data and other tolerance prices.

Buy the kit— Save a lot



Kit contains a 51-piece assortment of SCHAUER 1% tolerance 1-watt zeners covering the voltage range of 2.7 to 16.0. Three diodes of each voltage packaged in reusable poly bags. Stored in a handy file box. Contact your distributor or order direct.

A \$54.57 value for
ONLY \$24⁵⁰

Semiconductor Division
SCHAUER
Manufacturing Corp.

4514 Alpine Ave. Cincinnati, Ohio 45242
Telephone: 513/791-3030

New literature

Micro Switch applications. The latest edition of "Uses Unlimited," the eight-page quarterly concerned with solutions to problems of sensing and control, is available from Micro Switch, a division of Honeywell, 11 W. Spring St., Freeport, Ill. 61032. Circle 421 on reader service card.

Ceramoplastics. Electrical, physical, and mechanical data on the company's line of glass-bonded mica and Supramica ceramoplastic products is available from Mycalex, 125 Clifton Blvd., Clifton, N.J. 07011 [422]

Plastic tapes. A four-page brochure lists and describes Scotch 851 Greenback, and vinyl tapes for use in solder-stripping and gold-plating of printed-circuit boards. Polyester and polyethylene tapes are also covered in the pamphlet which is available from 3M Co., Dept. IT4-29, Box 33600, St. Paul, Minn. 55133 [423]

Recording inks. A cross-referenced bulletin listing the recording inks used by 11 major recorder manufacturers has been released by TPI division, Graphic Controls Inc., 2 Springdale Rd., Cherry Hill, N.J. 08003. The bulletin also discusses the manufacturing and proper storage of inks. [424]

Microwave measurements. A combination catalog and measurement handbook, the Weinschel Engineering Instruments Catalog is available from Weinschel Engineering Co. P.O. Box 577, Gaithersburg, Md. 20760. [425]

Work stations. Deluxe-Lista Corp., 106 Lowland St., Holliston, Mass. 01746, has published a 16-page catalog of Block-Line work stations, tool bays, and storage cabinets. All data on partitions, trays, tool holders is in both English and metric (S. I.) units. [426]

Capacitor reliability. An 18-page Established Reliability Tantalum Capacitor Conversion Chart that compares MIL-C-39003D with MIL-C-

\$125

it's so easy to take . . .

You can replace your thermopile with a SBN PYROELECTRIC DETECTOR.

- BROADBAND RESPONSE—UV to microwaves
- HIGH SENSITIVITY—> to 125 V/W
- FAST RESPONSE—better than 5ns
- NO CRYOGENICS—operates from -40°C to 90°C
- RUGGED AND NONHYGROSCOPIC

This package includes a sensing element plus an integral FET and fits a standard 9 pin miniature tube socket. Available from stock for only \$125.00.

Call us at 216/248-7400 with your IR detection and measurement problems.



HARSHAW

THE HARSHAW CHEMICAL COMPANY
DIVISION OF KEWANEE OIL COMPANY

Crystal & Electronic Products Department
6801 Cochran Road • Solon, Ohio 44139
(216) 248-7400

Circle 235 on reader service card

Circle 130 on reader service card

Countdown Free!



Interstate Pulse Generators have Constant Duty Cycle

Interstate's exclusive Constant Duty Cycle mode automatically controls pulse width as a percentage of the period, so when you're varying the rep rate, the generator can't possibly skip a pulse or two and give you an invalid output.

Constant Duty Cycle is only one of many innovative Series 20 features you've never seen in a pulse generator before. Call John Norburg collect and he'll send you the new Interstate Series 20 Pulse Generator catalog—it's free, too!

Phone (714) 772-2811



Dept. 7000, Box 3117, Anaheim, California 92803
TWX U.S.A. 910-591-1197 TELEX U.S.A. 655443 & 655419.

Circle 236 on reader service card

New literature

39003C is available from Union Carbide Corp., Components department, P. O. Box 5928, Greenville, S. C. 29606. The capacitor chart compares requirements of the two specifications for testing and marking and also references part-number designations for CSR13 capacitors. [427].

Solder clads A six-page brochure describing solder-clad materials, their background and applications is available from Technical Materials Inc., 25 Holden St., Providence, R. I. 02908. The design aid includes data on thin and thick solder, and a solder-alloy guide. [428]

Temperature control A line of temperature-control equipment—including thermoelectric freezers, freezer controllers, heat controllers, voltage regulators, heating tapes and mantles, and steam generators—is described in a 12-page booklet available from the Lab-Crest Scientific division, Fischer & Porter Co., 101 Jacksonville Rd., Warminster, Pa. 18974 [429]

Abrasion resistance. An abrasion-scrape tester, designed to perform

**THE MODULAR
BREADBOARDING SYSTEM**

It's growing all the time.

Now the Adam modular breadboarding system offers even more modules to make your circuit design job faster and easier. The new resistance substitution module, connector modules, indicator module, and universal instrument modules combine with the function/pulse generator, socket, signal source, and readout modules to give you an unbeatable package.

To find out more, write for a copy of our new brochure.

E&I E&I INSTRUMENTS, INC.
61 First St., Derby, Conn. 05418
Phone (203) 735-8774

Circle 131 on reader service card



acceptance testing of the abrasion resistance (hardness and thickness) of the film coating on magnet wire is described in a technical bulletin available from Hipotronics Inc.,

Electronics/November 14, 1974

Opti-ranging... a Monsanto exclusive!

Select the Counter or Counter/Timer that provides the functions you need and get AGC and Monsanto's exclusive Opti-ranging for optimum display resolution. AGC prevents erroneous measurements at marginal input amplitudes. Opti-ranging allows the selection of resolution, prevents gate change interruption of display and retains the unit value of any one decade. In contrast to autoranging, Monsanto's unique Opti-ranging offers all the advantages of automatic and manual operation without the inherent disadvantages of both. Contact your nearest Representative or write for full specifications and prices.

Prices start at **\$595.**



SEE ELECTRONIC DESIGN'S GOLD BOOK FOR SALES OFFICES AND REPS.



8500 Series — 4 models, Universal Counter/Timers 50 MHz through 1 GHz



8700 Series — 3 models, Frequency Counters 150 MHz through 1 GHz

DigiTec

UNITED SYSTEMS CORPORATION

a subsidiary of **Monsanto**

918 Woodley Road • Dayton, Ohio 45403 • Ph: (513) 254-6251 • TWX: (810) 459-1728

"demonstration wanted" Circle 249 on reader service card

"information only" Circle 248 on reader service card

BLILEY ULTRASONIC DELAY LINES

- Application: RF systems & Digital storage
- Major Types: Analog (echo & polygonal) and Digital (low TC glass)
- Delay Time Range: 1 to 3000 μ sec
- Frequency Range: 2 to 100 MHz

Custom Design and Data Information Available On Request

Bliley if you buy quality

BLILEY ELECTRIC COMPANY

2545 West Grandview Boulevard
Erie, Pennsylvania 16512



THE SPACE SAVER

THE WORLD'S SMALLEST THUMBWHEEL SWITCH

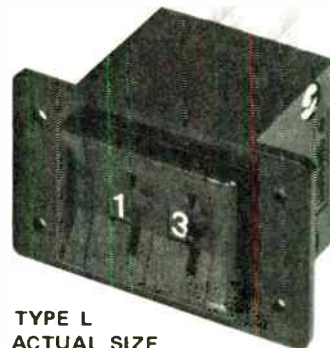

TYPE L
ACTUAL SIZE

INTERSWITCH

ONE OF THE PURDY GROUP OF COMPANIES

770 Airport Blvd • Burlingame, Ca 94010 (415)347-8217

Circle 137 on reader service card

Circle 138 on reader service card 237

from SPECTRUM.... for emi CONTROL. The 1 MF. FEED-THRU CAPACITOR.

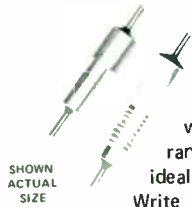

The combined technologies of SPECTRUM CONTROL, INC. and ALLEN-BRADLEY CO. have produced this exciting line of multi-layer feed-thru capacitors. Their tubular design and coaxial construction gives low inductance with capacitance values to 1 MF. The operating temperature range is -55°C to +125°C at 10 amps and 50 VDC. They are ideally suited for bypassing, filtering and coupling applications. Write today for our complete catalog.

Part No. (Threaded)	54-785-005	54-786-013	54-786-021	54-786-014
Part No. (Solder-In)	54-785-006	54-786-015	54-786-019	54-786-016
DC Working Voltage	100	50	50	50
Capacitance, MF. at 0.1 VRMS, 25°C, 1 KHz	0.05 GMV	0.3 GMV	0.5 GMV	1.0 ± 20%
Insertion Loss (db)	16	32	35	40
	50	70	70	80
Thread Size - Bolt	8-32	10-32	10-32	10-32
Mounting Hole Size (Solder-In)	.140 ± .015	.171 ± .015	.171 ± .015	.171 ± .015

Available now from these authorized distributors:

HALL-MARK ELECTRONICS	215-355-7300
METUCHEN CAPACITOR	201-442-0500
MIRCO ELECTRONICS	602-944-2281
ROSE ELECTRONICS	415-697-0224

SPECTRUM CONTROL INC.

152 EAST MAIN ST. • FAIRVIEW, PENNSYLVANIA 16415

PH. 814-474-5593

TWX 510-699-6848



Circle 238 on reader service card



The OEM Machine

The Rotaswitch 860 Series Optical Shaft Position Encoder has a low profile and a low price to make it attractive for any original equipment manufacturer's application. Only 1.5" in diameter, and 1.2" long, with a price tag of \$62.00 in quantity, the 860 Series will simplify designs, keep parts cost down, performance and reliability way up.

For premium performance the Rotaswitch 860 Series has SS ball bearings and uses a rigid, .060" slotted disc for better disc-to-mask clearance, keeping oscil-

lation to a minimum, producing a cleaner output. For reliability, the encoder's light sources are all new solid state Light Emitting Diodes that have a life expectancy measured in years.

Statistics: Uni- or Bidirectional versions; up to 1000 pulses per revolution, standard, others on special order; sine or square wave output; 5vDC @ 100 ma input power required; weighs only 3 ounces; the rest you can read in our new data sheet. Write for a copy today.



DISC Instruments, Inc., 102 E. Baker St., Costa Mesa, Calif. 92626. Phone (714) 979-5300

Disc Instruments Division
Finnigan GmbH
Dachauer Strasse 511, 8 Munchen 50, Germany
Phone: (0811) 142291 (2)

Disc Instruments Division
Finnigan Instruments Ltd.
Paradise, Hemel Hempstead Herts England
Phone: (0442) 57261

238 Circle 132 on reader service card

New literature

Brewster, N. Y. 10509. [432]

Gas chromatograph. The model 421 gas chromatograph, intended for life-science research and other demanding applications, is described in a brochure available from Packard Instrument Co., 2200 Warren-

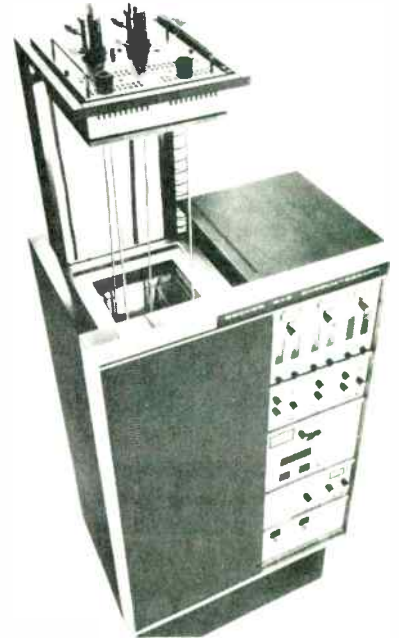

ville Rd., Downers Grove, Ill. 60515. Bulletin No. 1198 includes a description of a digital-flow-control unit and an optional special four-column, four-detector configuration. [433]

Self-latching dry reeds. The principles, operation, and applications of the company's new self-latching dry-reed switch and relay are described in a 21-page booklet available from C. P. Clare & Co., 3101 W. Pratt Ave., Chicago, Ill. 60645. The Technical Application Reference brochure discusses the electromagnetic differences between the new devices and conventional dry reeds; it contains no catalog or purchasing data. [430]

Industrial capacitors. Electrical and mechanical data on rectangular style dc Kraft dielectric capacitors is available from Cornell-Dubilier Electric Corp., 150 Avenue L, Newark, N. J. 07101. The T-N and

Electronics/November 14, 1974

If you're so rich, why aren't you smart?



So you're making a good salary. But you're not saving any of it. Instead, you want to go after the "big deal" that's going to make you a cool million. Maybe.

What happens if your big scheme goes sour? You've still got to get through the future. And, let's face it. Nobody can afford to take tomorrow for granted.

So maybe you'd better join the Payroll Savings Plan now. Just sign up at work. An amount you specify will be set aside from your paycheck and used to buy U.S. Savings Bonds.

That way, you can still afford to take a few financial risks, if that's your bag. But you'll always have a solid cash reserve to fall back on. And *that's* being smart.

Now E Bonds pay 6% interest when held to maturity of 5 years (4% the first year). Bonds are replaced if lost, stolen or destroyed. When needed, they can be cashed at your bank. Interest is not subject to state or local income taxes, and federal tax may be deferred until redemption.



Take stock in America.

Join the Payroll Savings Plan.

Ad Council A public service of this publication and The Advertising Council.

Payroll Savings. The cold, hard, calculating way to get a nice, warm feeling of security.

You can plan your future to the dime. Simply sign up for the Payroll Savings Plan. An amount you specify will be automatically set aside each payday to buy U.S. Savings Bonds.

With Bonds what you save is what you get. Plus interest. Nothing's more secure and dependable.

Ask your payroll people to get you started right away. You'll be richer later. And feel good. And warm. And secure.



Take stock in America.

Join the Payroll Savings Plan.



The U. S. Government does not pay for this advertisement. It is presented as a public service in cooperation with The Department of the Treasury and The Advertising Council.

New literature

TCO-N industrial capacitors range in value from 0.1 to 15.0 μF and have voltage ratings from 600 to 5,000 v dc. [434]

Data-acquisition components. A 20-page product brochure describes the various Deltaverta systems-building blocks available from Hybrid Systems Corp., 87 Second Ave., Burlington, Mass. 01803. Included are encoders, multiplexers, clocks, and various converters. [435]







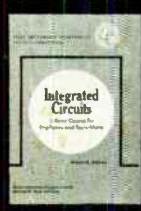

Sealed connectors. A broad line of resilient, one-piece, environmentally sealed connectors is available from Amphenol Connector Division, 2801 South 25th Ave., Broadview, Ill. 60153. Entitled "Amphenol Introduces Transcon 44," the catalog includes drawings, cross-sections, electrical characteristics, and mechanical specifications on a variety of configurations. [436]

Push-button switch. A new data sheet describes the Digitran series 12000 Minibutton push-button switches. Featuring eight- or 10-dial positions, the Minibutton is designed for military and other equipments that require tight sealing against hostile environments. The Digitran Co., 855 South Arroyo Parkway, Pasadena, Calif. [437]

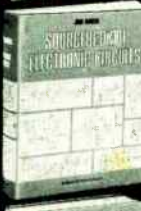
Relays. Its 1974-1975 General Relay Catalog is available from Potter & Brumfield Division of AMF Inc., Princeton, Ind. 47670. The catalog describes the company's standard line of wet- and dry-reed relays, time-delay and interval-timer relays, precision snap-action switches, and custom control assemblies. [438]

Microwave measurements. A leaflet entitled "Microwave Measurement and Shielding Effectiveness Capabilities at Emerson & Cuming Inc." describes techniques and equipment for the measurement of radar reflectivity, antenna characteristics, shielding effectiveness of materials and shielded rooms, and electromagnetic properties of materials. It is available from Emerson & Cuming Inc., Canton, Mass. 02021. [439]

Another introductory offer to new members of the ELECTRONICS AND CONTROL ENGINEERS' BOOK CLUB

	404/445 ELECTRONIC CIRCUITS MANUAL by J. Markus Pub. price, \$22.00 Club price, \$15.75		286/515 INTEGRATED CIRCUITS: A Basic Course for Engineers and Technicians by R. G. Hibberd Pub. price, \$10.25 Club price, \$8.45
	637/458 DESIGNING WITH TTL INTEGRATED CIRCUITS by Texas Instruments Inc. Pub. price, \$19.50 Club price, \$13.50		100/810 MOS/LSI DESIGN AND APPLICATION by Carr & Mize Pub. price, \$18.50 Club price, \$13.50
	404/437 SOURCEBOOK OF ELECTRONIC CIRCUITS by J. Markus Pub. price, \$21.50 Club price, \$17.50		388/458 MAGNETIC RECORDING by C. E. Lowman Pub. price, \$14.50 Club price, \$9.75
	389/756 SEMI-CONDUCTORS MEMORY DESIGN AND APPLICATION by Texas Instruments Inc. Pub. price, \$18.50 Club price, \$13.75		287/341 STANDARD HANDBOOK OF ENGINEERING CALCULATIONS by T. G. Hicks Pub. price, \$19.50 Club price, \$14.25
	491/364 THE DESIGN OF DIGITAL SYSTEMS by J. B. Peatman Pub. price, \$16.50 Club price, \$11.75		124/035 HANDBOOK OF PHYSICS, 2/e by Condon and Odishaw Pub. price, \$37.45 Club price, \$14.95

ANY ONE
of these great professional books
for only **\$1.00**
VALUES FROM \$8.45 to \$37.45

Special \$1.00 bonus book comes to you with your first club selection

	238/901 APPLICATIONS OF OPERATIONAL AMPLIFIERS by J. G. Graeme Pub. price, \$14.00 Club price, \$10.50		649/170 OPERATIONAL AMPLIFIERS by Tobey, Graeme & Huelsman Pub. price, \$15.00 Club price, \$11.50
	353/387 MINICOMPUTERS FOR ENGINEERS & SCIENTISTS by G. Korn Pub. price, \$17.75 Club price, \$10.50		209/731 STANDARD HANDBOOK FOR ELECTRICAL ENGINEERS, 10/e by Fink and Carroll Pub. price, \$34.85 Club price, \$24.95

Save time and money by joining the Electronics and Control Engineers' Book Club



HERE is a professional club designed specifically to meet your day-to-day engineering needs by providing practical books in your field on a regular basis at below publisher prices.

How the Club operates: Basic to the Club's service is its publication, the *Electronics and Control Engineers' Book Club Bulletin*, which brings you news of books in your field. Sent to members without cost, it announces and describes in detail the Club's featured book of the month as well as alternate selections which are available at special members' prices.

When you want to examine the Club's feature of the month, you do nothing. The book will be mailed to you as a regular part of your Club service. If you prefer one of the alternate selections—or if you want no book at all for that month—you notify the Club by returning the convenient card enclosed with each *Bulletin*.

As a Club member, you agree only to the purchase of four books over a two-year period. Considering the many books published annually in your field, there will surely be at least four that you would want to own anyway. By joining the Club, you save both money and the trouble of searching for the best books.

MAIL ATTACHED POSTPAID CARD (If card removed, send coupon below)

ELECTRONICS AND CONTROL ENGINEERS' BOOK CLUB
P.O. Box 582 Princeton Road, Hightstown, New Jersey 08520

Please enroll me as a member of the Electronics and Control Engineers' Book Club and send me the two books indicated below. I am to receive the higher priced of the two for just \$1, and my first selection at the special Club price. Actual postage, plus 25¢ handling charge will be added (sales tax, also, if applicable). These books are to be shipped on approval, and I may return them both without cost or further obligation. If I decide to keep the books, I agree to purchase as few as four additional books (including this first selection) during the next two years at special Club prices (guaranteed 15% discount, often more).

Write Code No. of
bonus book
here

Write Code No. of
first selection
here

Name _____

Address _____

City _____

State _____ Zip _____

E33266



Employment Opportunities

THE MARKET PLACE FOR ALL YOUR EMPLOYMENT NEEDS

CLOSING DATE INFORMATION: December 12 issue closes November 21

NEW ADS OR INQUIRIES: Send to Classified Advertising Dept., ELECTRONICS, Post Office Box 900, New York, N.Y. 10020

ECl in St. Petersburg: Where you're not just employed. You're stimulated.

Here you have the opportunity to do what you really want. To continue learning. To pursue your own special areas of interest. To use all your background and experience.

In fact, we encourage our people to be diversified. We won't hold you back.

If you're a creative electronic design or R & D engineer who really wants to produce, ECl is where you can do just that. We're involved with a wide variety of communications and electronic systems ranging from satellite terminals and missile data transmission systems to shipboard radios and thermal printers. We even help move the U.S. mail with advanced mail handling and processing systems.

What we become involved with in the future may well depend on your contribution.

This isn't only a great place to work. It's a great place to live, too. St. Petersburg and the surrounding area of Florida's West Coast offer just about everything you and your family could want in education, recreation and culture.

If ECl and St. Petersburg sound like places you'd enjoy calling home, write in confidence to William A. Peterson, Personnel Manager, Electronic Communications, Inc., Box 12248, St. Petersburg, Florida, 33733.

It could be one of the most creative moves you've ever made.



Subsidiary of NCR

SAME DAY SHIPMENT
Minis & Peripherals

PRINTERS
Some "BRAND NEW"

DATA PRODUCTS

2440— 700 LPM
2470—1250 LPM . \$9500
MOHAWK DATA SCIENCES

4320—300 LPM
4330—380LPM

CONTROL DATA CORP.

9322—200 LPM . \$2500
9352—600 LPM

ALSO
CENTRONICS, POTTER, CDC
A. B. DICK, IBM, HIS, UNIVAC
(617) 261-1100

Send for Free Report "Maintenance of Computers"
AMERICAN USED COMPUTER CORP.
P.O. Box 68, Kenmore Sta., Boston, MA 02215
member COMPUTER DEALERS ASSOCIATION

CIRCLE 951 ON READER SERVICE CARD

NEW SURPLUS—FREE CATALOG

INTEL 8008: \$69.45; 2102. 1K RAM: \$10.25
MM5203Q-1. 2048 BIT RE-PROM: \$19.50
1101A. RAM: \$2.50; MM5260. 1K RAM: \$5.00
XR2240. PROG. TIMER: \$5.95; 8038. VCO: \$5.95
AY5-1008 & 1010. TTY RX & TX: \$6.50
8288. +12: \$2.55; 2N5942. 2N6166: \$16.00

ELECTRONIC DISCOUNT SALES
138 N. 81st St., Mesa, Arizona 85207

CIRCLE 952 ON READER SERVICE CARD

RADAR SYSTEMS
TRACKING ANTENNA SYSTEMS

Nike Hercules, Nike Ajax, M-33, MPS-9, SCR-584,
TPS-1E, TPS-2B, FPS-6, FPS-14, FPS-18, FPS-75,
UPX-6, MPQ-10A, IBM 705 Computers,
HUNDREDS MORE. LARGEST INVENTORY OF RADAR
AND MICROWAVE EQUIPMENT IN THE WORLD.

RADIO RESEARCH INSTRUMENT CO.
3 QUINCY ST., NORWALK, CONN. (203) 853-2600

CIRCLE 953 ON READER SERVICE CARD

FREE CATALOG

HARD-TO-FIND PRECISION TOOLS

Lists more than 2000 items—pliers, tweezers, wire strippers, vacuum systems, relay tools, optical equipment, tool kits and cases. Also includes ten pages of useful "Tool Tips" to aid in tool selection.

JENSEN TOOLS
4117 N. 44th Street, Phoenix, Ariz. 85018

CIRCLE 954 ON READER SERVICE CARD

FREE ALARM CATALOG

Full line of professional burglar and fire alarm systems and supplies. 96 pages, 450 items. Off the shelf delivery, quantity prices.

mountain west alarm
4215 n. 16th st., phoenix, az. 85016

CIRCLE 956 ON READER SERVICE CARD

free catalog

POTTING APPLICATORS
MANUAL OR AIR OPERATED

2½cc 6cc 12cc 30cc
FOR POTTING, ENCAPSULATING ETC.

PHILIP FISHMAN CO., INC.
7 CAMERON ST. WELLESLEY, MASS. 02181

CIRCLE 957 ON READER SERVICE CARD

New books

Process Instruments and Controls Handbook, second edition, Douglas M. Considine, editor-in-chief, McGraw-Hill, 1,356 pp., \$37.50.

Analysis for Engineers, Charles W. Haines, West Publishing Co., 355 pp., \$14.95.

Theory and Application of Step Motors, Benjamin C. Kuo, West Publishing Co., 376 pp., \$25.

Introduction to Computer Simulation, A. Wayne Bennett, West Publishing Co., 455 pp., \$14.95.

Storage Batteries and Rechargeable Cell Technology, Louis F. Martin, Noyes Data Corp., 364 pp., \$36.

Circuit Theory: Foundations and Classical Contributions, M.E. Van Valkenburg, editor, Dowden, Hutchinson, and Ross Inc., 450 pp., \$24.

Handbook of Electronic Instrumentation, Testing, and Troubleshooting, Vester Robinson, Reston Publishing Co., 358 pp., \$15.95.

Essential Formulae for Electronic and Electrical Engineers, Noel M. Morris, Halsted Press, 26 pp., \$2.95 (paper).

Systems, Networks and Computation: Multivariable Methods, M. Athans, M.L. Dertouzos, R.N. Spann, and S.J. Mason, McGraw-Hill, 552 pp., \$19.50.

An Introduction to Engineering Measurements, A. Richard Graham, Prentice-Hall, 193 pp., \$11.95.

Amorphous and Liquid Semiconductors, J. Stuke and W. Brenig, editors, (Proceedings of Fifth International Conference, Sept. 3-8, 1973, at Garmisch-Partenkirchen, West Germany), Halsted Press, 1,441 pp., \$90 (two-volume set).

Handbook of Thick Film Hybrid Microelectronics, Charles A. Harper, editor-in-chief, McGraw-Hill, 672 pp., \$29.50.

High-Q Tunable Filter



The EDMAC Hi-Q Tunable Filters are general purpose active two pole filters which can be used in either a bandpass or a bandreject mode of operation.

FEATURES

- ≡ Tunable bandwidths corresponding to circuit Q's of 1000.
- ≡ Tunable frequencies from 1 Hz. to 30,000 Hz.
- ≡ Independent controls for bandwidth and center frequency.
- ≡ Simultaneous bandpass and bandreject filter functions.
- ≡ Controlled input-output phase relationship.
- ≡ Zero phase shift at center frequency.
- ≡ Selectable automatic tracking.
- ≡ Circuit overdrive indication.
- ≡ Selectable calibration mode.

WRITE FOR COMPLETE SPECIFICATIONS

EDMAC Associates Inc.

333 West Commercial Street.
East Rochester, New York 14445
(716) 385-1440

• Adret Electronique Psycho Publicite	14E	■ Continental Specialties Corp. Robert A. Paul	192	■ Grayhill, Inc. Stral Advertising Company, Inc.	168
• AEROCOM Jacster Enterprises, Inc.	32E	■ Cornell Dublier Electronics McCarthy, Scelba, DeBiasi Advertising Agency, Inc.	176-177	‡ GTI-Tensor Electronics Market Finders	21
A-H Systems, Inc. McDonald Associates	200	■ Custom Electronics, Inc. Laux Advertising, Inc.	224	Hamlin, Inc. Franklin/Mautner/Advertising	122
■ Alrpaq Electronics, Inc. Robert B. Walker & Associates, Inc.	210	■ Dale Electronics, Inc., A Sub. of the Lionel Corporation Swanson, Sinkey, Ellis, Inc. Advertising	4th Cover	■ Harshaw Chemical Co. Industry Advertising Company	235
• Allen Bradley Rodway Smith (Midlands) Limited	6E-7E	Data General Corporation Scali, McCabe, Sloves, Inc.	64-65	■ Heath/Schlumberger Scientific Instruments Advance Advertising Services	231
Allen Bradley Company Hoffman, York, Baker & Johnson, Inc.	24	Delco Electronics Division, General Motors Corp. Campbell-Ewald Company	110-111	• Heriot-Watt University	38E
American Microsystems, Inc. Wilton, Coombs & Colnett, Inc., Advertising	108-109	■ Delevan Division, American Precision Industries, Inc. Comstock Advertising, Inc.	194	Hermes Electronics, Ltd. Public & Industrial Relations Limited	205
American Smelting and Refining Company Clyne Maxon, Inc.	219	Delta Products, Inc. The William Loughran Company	222	■ Hewlett-Packard Dancer Fitzgerald Sample, Inc.	39,41
Amphenol Industrial Division, Bunker Ramo Corp. Marsteller, Inc.	22-23	■ Dialight Corporation Michel-Cather, Inc.	2nd Cover	■ Hewlett-Packard Tallant/Yates Advertising, Inc.	118-119,154
Amphenol Connectors Division, Bunker Ramo Corp. Dimensional Marketing, Inc.	124	Digital Equipment Corp. Components Group Schneider Parker, Inc.	18-19	■ Hewlett-Packard Tallant/Yates Advertising, Inc.	128-129
■ Augat Creamer, Trowbridge, Case & Basford, Inc.	171	Disc Instruments, Inc. Jansen Associates, Inc.	238	■ Hewlett-Packard Bozell & Jacobs/Pacific	2
■ AVX Ceramics TCI Advertising, Inc.	206-207	Dow Corning Corp.-Resins & Chemicals Ketchum, Macleod & Grove, Inc.	196-197,199	■ Hewlett-Packard Phillips Ramsey Advertising & Public Relations	1
Ballantine Laboratories, Inc. MLF Graphics	191	• Ducati Elettrotecnica Microfarad Studio Busoli Gastone	45	■ Honeywell Test Instrument Division Campbell-Mithun, Inc.	164-165
‡ Baron Balkeslee Kolb/Tookey & Associates, Inc.	172-173	Duncan Electronics, Inc., Sub of Systron Donner Corp. Eryart & Rose Advertising, Inc.	187	Houston Instrument Ray Cooley and Associates, Inc.	175
Bausch & Lomb, Inc. Wolff Associates, Inc.	220	‡ Eastman Kodak Co. Business Systems Markets Division J. Walter Thompson Company	201	■ Howard Industries Kolb/Tookey & Associates, Inc.	58-59
■ Beckman Instruments, Inc., Hellpot Division N.W. Ayer/Jorgense/MacDonald, Inc.	183	EDMAC Associates J.L. Newmand & Associates, Inc.	245	Hughes Aircraft Company Foote, Cone & Belding	228
■ Beckman Instruments, Inc., Information Displays Operations N.A. Winter Advertising Agency	156	Edsyn, Inc. Adsyn Agency	230	• Industrie Bitossi s.a.s. Studio Ruini	10E
Blomation Paul Pease Advertising	152	■ El Instruments, Inc. Langeler-Stevens, Inc.	236	Intel Corp. Regis McKenna, Inc.	10-11
Billiey Electric Company Barber/Drullard Division of Barlow/Johnson	237	Electromask, Inc. JMR Advertising	174	Interdata Shaw-Elliott Advertising	112
Brand-Rex Creamer, Trowbridge, Case & Basford, Inc.	74	■ Electronic Navigation Industries Hart/Conway Advertising- Public Relations	14	Interdesign, Inc. Bonfield Associates	162-163
■ Burndy Axis sprl	35E	Electronic & Control Engineers Book Club	241-243	International Crystal Mfg., Co. Robert V. Freeland & Associates	188
■ Busemann Mfg. Division of McGraw-Edison Co. Henderson Advertising Company	51	EMCON Division Illinois Tool Works, Inc. Post Keyes Gardner Inc.	60-61	International Electronic Research Corp. McCarron, Kane, Inc.	161
‡ Cable-Scan S. Michelson Advertising	215	■ Emerson & Cumling, Inc. Edwin F. Hall	230	■ Interstate Electronics Corp. Chris Art Studio, Inc.	236
California Computer Products Dailey & Associates Advertising	217	• English Electric Valve Co., Ltd. The London Advertising Partnership	8E-9E	Interswitch William J. Purdy Promotions, Inc.	237
Calma Company William Cain, Inc., Advertising	94	■ Erie Technological Products, Co., Inc. Altman Hall Associates Advertising	17	• Invest Export-Import Interwerbung	33E
■ Cambridge Thermionic Corporation Chirug and Cairns, Inc.	58-59	‡ Excellon industries	107	Ise Electronics Corp Shinwa International, Inc.	169
■ Cambridge Thermionic Corporation Chirug & Cairns, Inc.	232	■ Executone, Inc., Printact Relay Div. J.A. Richards	202-204	Isotronics Southeastern Advertising Agency, Inc.	212
• Carlo Erba MVE Pubblicita' & Marketing	40E	• Fabbrica Italiana Publicor	203	Jenoptik Jena GmbH Interwerbung	247
■ C.P. Clare International N.V. Markcom	18E-19E	Ferranti-Packard Huxley-Irwin-Price Limited	214	■ Johnson Company, E.F. Martin Williams Advertising	182
Celanese Plastics Company D'Arcy-MacManus International, Inc.	158	■ Fluke Manufacturing Co., John Bonfield Associates	3rd Cover	Keithley Instruments, Inc. Chagrin Valley Marketing Associates	250
■ Centralab Electronic Div., Globe-Union, Inc. Action Communicators	79	FMC Corporation- Semiconductor Products Operation DeSales Advertising, Inc.	227	■ Keystone Electronics Lawrence Nelson Advertising	250
Cherry Electrical Products, Corp. Kolb/Tookey and Associates, Inc.	193	• Gardner-Denver Co. Buchen Advertising, Inc.	181	Krohn-Hite Corp. Impact Advertising, Inc.	5
■ Chicago Dynamic Industries Burton Browne Advertising	250	Garry Manufacturing Barbetta Miller, Inc.	185	Litronix, Inc. Bonfield Associates	12-13
Cinch Connectors, Operation of TRW Electronic Components Stral Advertising Company, Inc.	179	General Automation Albert, Newhoff & Burr	144	Lockheed Electronics Co. McCann-Erickson, Inc.	224
Circuit Assembly AD/manager	191	■ General Electric Co., Miniature Lamp Div. Carr Liggett Advertising, Inc.	180	• LTT	34E
C & K Components Van Christo, Inc.	200	■ General Instrument Corporation, Microelectronics, Div. Norman Allen Associates, Inc.	208-209	• Marconi Instruments Ltd. Russell Powell Advertising Ltd.	5E
■ Computer Devices, Inc. Drumbeater	228	■ Gould, Inc./Instrument Systems Div. Carr Liggett Advertising, Inc.	88-89	■ Micro Switch Division of Honeywell N.W. Ayer & Son, Inc.	166
Comtal Corporation Continental Communications, Inc.	213	‡ Graphic Controls, Corp. Conklin, Labs & Bebee, Inc.	47	Mircro Systems, Inc. McAward Associates	19
■ Concord Electronics Corp. Sound Advertising	192			Monsanto Commercial Products Co., Electronic Special Products Advertising Promotion Services	48

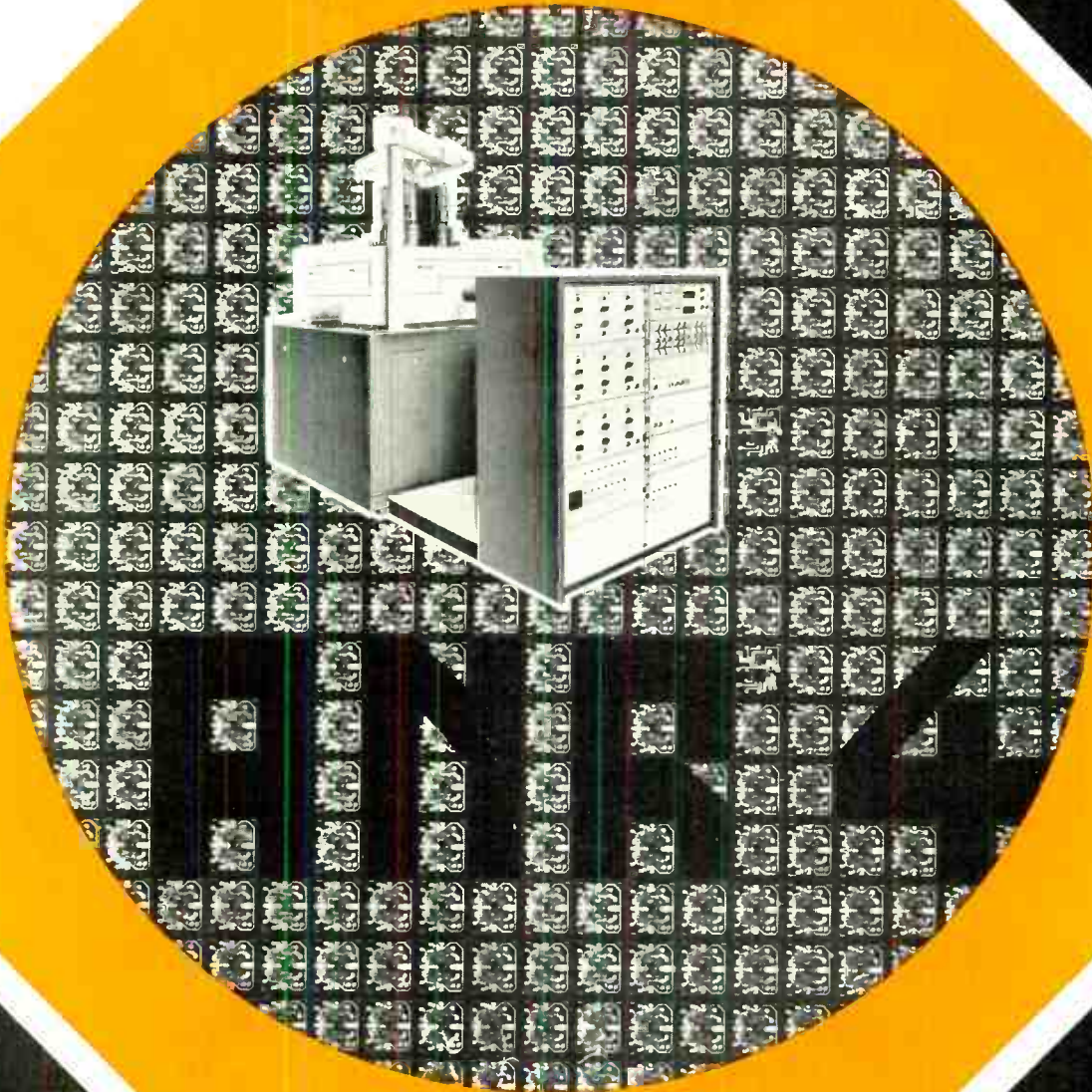

aus JENA

See us at the
electronica 74
in Munich,
Hall 20,
booth 22 204 LG!

The ANR 4 Photorepeater – an instrument offering the maximum of optical and mechanical performance

The ANR 4 is the main instrument in our

Instrument Complex “Photomask Techniques”

for the production of highly precise original photomasks for reliable circuits in microelectronics.

For the photo lithographic process we produce the following instruments:

- JUB PM 50 Mask-Alignment and Exposure Equipment
- Ascorecord 3 DPE Two-Coordinate Measuring Instrument
- MP 320 Measuring Projector
- Incident and Transmitted Light Microscopes
- Interference and Phase-Contrast Microscopes
- Stereomicroscopes

JENOPTIK JENA GmbH · DDR

DDR-69 Jena, Carl-Zeiss-Str. 1
Telefon: Jena 830
German Democratic Republic

Motorola Semiconductor Products, Inc. E.B. Lane & Associates, Inc.	77,43
National Electronics Lea Advertising	84
■ National Semiconductor Corp. Chiat/Day, Inc., Advertising	33
‡ Nicolet Instruments Corp. Hagen Advertising, Inc.	107
• Nuovo Pignone Linea Spn	172
• Oxley Developments Ltd. Peers Advertising Ltd.	40E
Panasonic Ogilvy & Mather, Inc.	83
*‡ Phillips TMI Brookies Communication Systems S.A.	82,181
Photocircuits Ries Cappiello Colwell, Inc.	150-151
■ Plezo Technology, Inc. Shattuck/Roether Advertising, Inc.	44
• Powermate Spectrum Marketing Associates	12E-13E
Premier Metal Products, Corp. Commercial Press, Inc.	190
• Procond S.p.A. Quadrangolo	117
Ramsay Engineering Co. Midland Associates, Inc.	226
■ Raytheon Company, Industrial Components Operation Provandie Eastwood & Lombardi, Inc.	184
■ Raytheon Company, Production Equipment Department Provandie Eastwood & Lombardi Inc.	6
• RCA Ltd. Marsteller, Ltd.	39E
RCA Electronic Components Al Paul Leifon Company	229
RCA-Solid State Division Marsteller, Inc.	72-73
*‡ Rental Electronics, Inc. Humphrey Browning MacDougall, Inc.	54
Reticon Corporation The House Agency	85
• Rhone Progil	13E
• Rifa MK Marknadskommunikation AB	21
• Rohde & Schwarz	1E
Rotron, Incorporated Black-Russell-Morris	211
• RT C Feldman Catleux Associates	11E
S.A.F.T. U.N.C.C.	37E
Schauer Manufacturing Corp. Nolan, Keeler & Stites	235
• Schlumberger	23E,25E,27E
Scientific Micro Systems, Inc. sub of Corning Glass Works Durel Advertising	233
Scanbe Manufacturing Corp. Wheeler & Company	80-81
• S.E. Labs (EMI) Ltd. Graphic Publicity Ltd.	92-93
• Selmar C P M Studio	47
• Seacosem Bazine Publicite	31E,52
• SGS-ATES McCann-Erickson	15E-16E
‡ SHELDahl INC. Chuck Ruhr Associates Advertising, Inc.	57
Siemens Components Division N.A. Winter Advertising Agency	37
• Silec Mexim	36E
Singer Company, Kearfott Division Gaynor & Ducas, Inc.	223
• Sivers Lab	57
‡ Sorensen Company, A Division of Raytheon Company Provandie Eastwood & Lombardi, Inc.	45
Sound Technology Frank Burkhardt Company	120
■ Spectrum Control, Inc. Egon Jackson Advertising	238

• Sprague Perez Publicite	20E-21E
Sprague Electric Company Harry P. Bridge Company	8
Syston Donner Concord Instruments Fred Schott & Associates	9
Tally Corporation Bonfield Associates	218
• TEAC Corp. Dentsu Advertising Ltd.	201
■ TEC, Inc. TEC-AD	216
■ Tektronix-IDD Young & Roehr, Inc.	126
• Teledyne Relays S. Michelson Advertising	156
Teledyne Semiconductor Regis McKenna, Inc.	7
Teletype	132-136
Teradyne, Inc. Quinn & Johnson, Inc.	66
Thomson CSF Bazaine Publicite	28
■ Tower Manufacturing Corp. Goldsmith Tregar Company	232
■ TRW/IRC Resiators Gray & Rogers, Inc.	62-63
United Systems Corp., A sub. of Monsanto Co. Advertising & Merchandising, Inc.	237
■ Unitrode Corporation Cuiver Advertising, Inc.	27
U.S. Capacitor Corp. S. Michelson Advertising	35
Varian Data Machines Durel Advertising	221
Varo Semiconductor, Inc. Warren-Guild	226
Victoreen Instrument Division Dix & Eaton, Inc.	16
V/O Technashepxport Vneshtorgreklama	234
V/O Technashepxport Vneshtorgreklama	213
■ Wagner Electric Corporation Coordinated Communications, Inc.	225
• Wandel und Goltermann Werbeagentur	203
■ Woven Prentiss Court Advertising	20
Yewtec Corporation Kenmarc Advertising, Inc.	191
• Yokogawa Electric Works, Ltd. General Advertising Agency, Inc.	183
‡ Carl Zeiss, Inc.—Micro Michel-Cather, Inc.	92-93

Classified & Employment Advertising

F.J. Eberle, Manager 212-997-2557

EQUIPMENT (Used or Surplus New) For Sale	
American Used Computer Corp.	245
Electronic Communication	245
Electronic Discount	245
Fishman, P. Co.	245
Jensen Tools and Alohs	245
Mountain West Alarm Supply Co.	245
Radio Research Instrument Co.	245

■ For more information on complete product line see advertisement in the latest Electronics Buyer's Guide
* Advertisers in Electronics International
‡ Advertisers in Electronics domestic-only edition

Advertising Sales Staff

Pierre J. Braudé New York [212] 997-3468
Director of Marketing

Atlanta, Ga. 30309: Joseph Lane
100 Colony Square, 1175 Peachtree St., N.E.
[404] 892-2868

Boston, Mass. 02116: James R. Pierce
607 Boylston St. [617] 262-1160

Chicago, Ill. 60611:
645 North Michigan Avenue
Robert W. Bartlett (312) 751-3739
Paul W. Reiss (312) 751-3738

Cleveland, Ohio 44113: William J. Boyle
[716] 586-5040

Dallas, Texas 75201: Charles G. Hubbard
2001 Bryant Tower, Suite 1070
[214] 742-1747

Denver, Colo. 80202: Harry B. Doyle, Jr.
Tower Bldg., 1700 Broadway
[303] 266-3863

Detroit, Michigan 48202: Robert W. Bartlett
1400 Fisher Bldg.
[313] 873-7410

Houston, Texas 77002: Charles G. Hubbard
Dresser Tower, 601 Jefferson St., [713] 224-8381

Los Angeles, Calif. 90010: Robert J. Rielly
Bradley K. Jones, 3200 Wilshire Blvd., South Tower
[213] 487-1160

New York, N.Y. 10020
1221 Avenue of the Americas
Warren H. Gardner [212] 997-3617
Michael J. Stoller [212] 997-3616

Philadelphia, Pa. 19102: Warren H. Gardner
Three Parkway,
[215] 997-3617

Pittsburgh, Pa. 15222: Warren H. Gardner
4 Gateway Center, [212] 997-3617

Rochester, N.Y. 14534: William J. Boyle
9 Greylock Ridge, Pittsford, N.Y.
[716] 586-5040

San Francisco, Calif. 94111: Don Farris
Robert J. Rielly, 425 Battery Street,
[415] 362-4600

Paris: Alain Offergeld
17 Rue-Georges Bizet, 75 Paris 16, France
Tel: 720-73-01

Geneva: Alain Offergeld
1 rue du Temple, Geneva, Switzerland
Tel: 32-35-63

United Kingdom & Scandinavia: Keith Mantle
Tel: 01-493-1451, 34 Dover Street, London W1

Milan: Robert Saidei
1 via Baracchini, Italy Phone 86-90-656

Brussels: Alain Offergeld
23 Chaussee de Wavre
Brussels 1040, Belgium
Tel: 13-73-95

Frankfurt/Main: Fritz Krusebecker
Liebigstrasse 27c, Germany
Phone 72 01 81

Tokyo: Tatsumi Katagiri, McGraw-Hill
Publications Overseas Corporation,
Kasumigaseki Building 2-5, 3-chome,
Kasumigaseki, Chiyoda-Ku, Tokyo, Japan
[581] 9811

Australasia: Warren E. Ball, IPO Box 5106,
Tokyo, Japan

Business Department

Stephen R. Weiss, Manager
[212] 997-2044

Thomas M. Egan,
Production Manager [212] 997-3140

Carol Gallagher
Assistant Production Manager [212] 997-2045

Dorothy Carter, Contracts and Billings
[212] 997-2908

Frances Vallone, Reader Service Manager
[212] 997-6057

Electronics Buyers' Guide

George F. Warner, Associate Publisher
[212] 997-3139

Raglna Hera, Directory Manager
[212] 997-2544

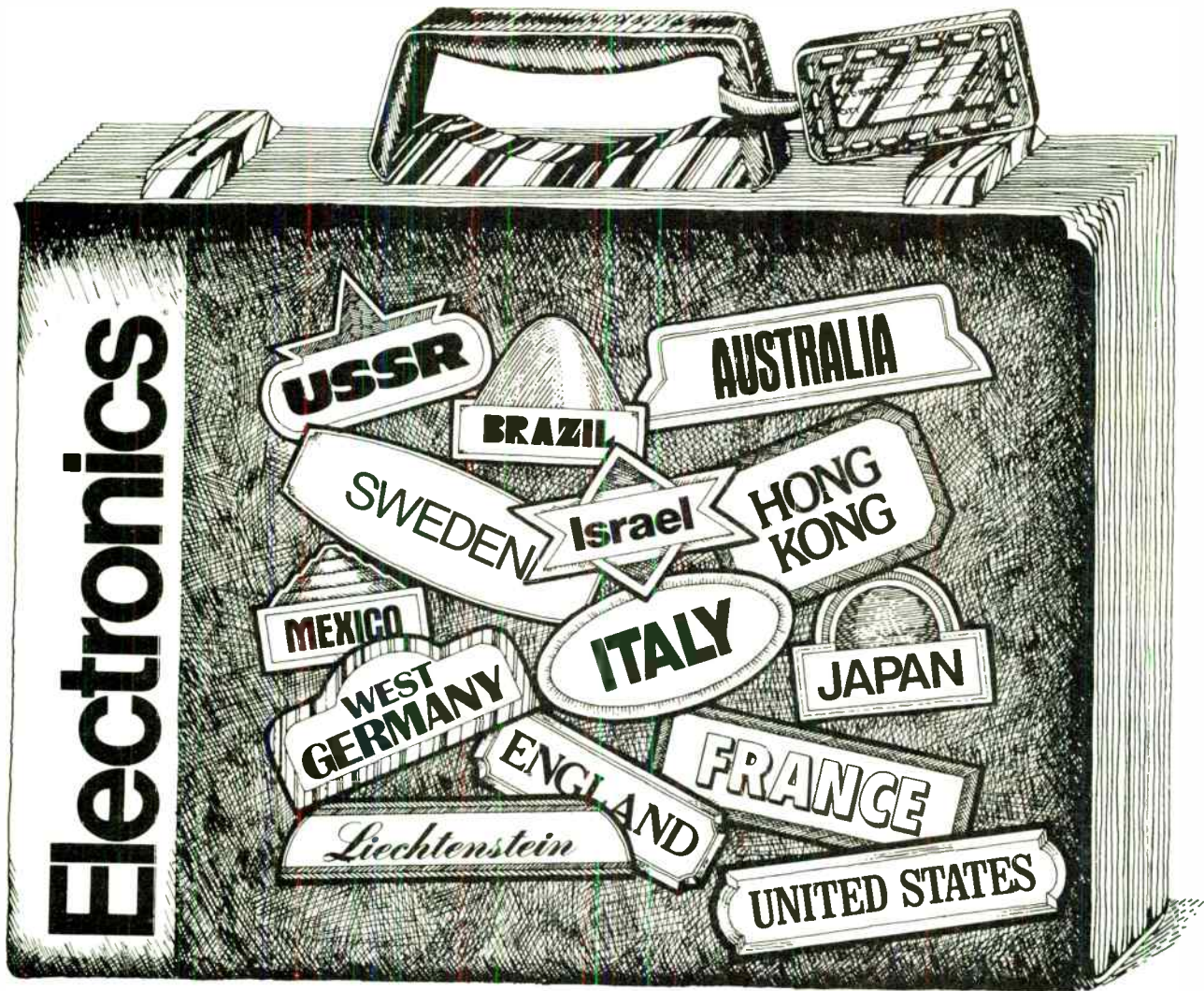

What are your colleagues doing
around the world?

Find out in **ELECTRONICS**.

Go first class. Go to **ELECTRONICS** and you'll find out first hand where the biggest growth potential is today. And where it'll be tomorrow.

ELECTRONICS knows, because its 31 editors, 11 World News Bureaus and 200 correspondents make it their business to stay on top of what's happening in the ETM—the Electronics Technology Marketplace—worldwide. Only **ELECTRONICS** offers readers annual market reports and forecasts on Japan and Europe as well as the U. S.

ELECTRONICS is *the Source*, disseminating information, and establishing and maintaining communications among people in electronics,

wherever in the world those people may be.

We sell over 86,000 subscriptions to 122 countries all over the globe. You should be getting your own copy of **ELECTRONICS** right off the press because the world of electronics—your world—is between the covers of **ELECTRONICS** magazine.

Fill out the enclosed subscription card and send it off. **ELECTRONICS** is the one magazine you can't afford to be without.

Electronics 
IS THE SOURCE.

INNOVATIVE SWITCHES by CDI



Sealed Switch Module. Completely sealed and/or RFI shielded.



Series TSM Mini Thumb-wheel switch mounts on 1/2" centers. Retrofits most miniature thumb-wheel switch panel openings.



Series SL (Pat. Pending) Linear Slide Switch. Up to 100 or more positions. Mounts EITHER left/right OR up/down. Single or multiple position selectors.

No Down-Time Rotary Switch. 5-Second wafer replacement. Mfd. under Tabet U.S. Patent 2,956,131 & others.



Miniature Add/Subtract Pushbutton units retrofit most mini-thumb-wheel switch panel openings. Pat. #3,435,167.



Series SP Rotary Switch. Economical, flexible, compact. More options on one wafer than previously available.

CDI earns its reputation every day for Consistently High Quality, Consistently Good Delivery. Request catalog.



CHICAGO DYNAMIC INDUSTRIES, INC.

PRECISION PRODUCTS DIVISION

1725 Diversey Blvd., Chicago, Illinois 60614 Phone (312) 935-4600, TELEX 25-4689

Circle 250 on reader service card

PRE-PUNCHED, PERFORATED, EXPERIMENTER or PROTOTYPE Boards.

VARIETY OF MATERIALS

GLASS EPOXY
PAPER PHENOLIC
COPPER CLAD
PAPER EPOXY

CHOICE OF THICKNESS

1/32, 3/64, 1/16, 3/32

WE CAN ALSO FABRICATE AND ASSEMBLE TO YOUR SPECIFICATION.

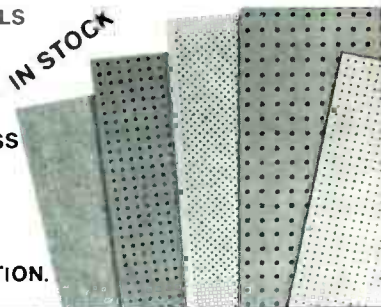

Whatever you call them... We make them!!!

SELECTION OF TERMINALS & HARDWARE

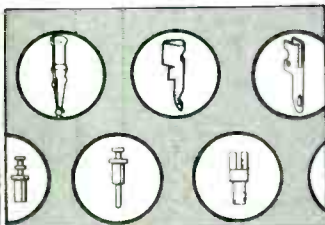

ASSORTED PATTERNS

Pattern	Centers	Hole Dia.
"A"	.265 x .265	.093
"B"	.187 x .187	.062
"E"	.250 x .250	.100
"F"	.200 x .200	.062
"G"	.100 x .200	.062
"H"	.375 x .375	.120
"P"	.100 x .100	.042

Send for new catalog.



KEYSTONE

ELECTRONICS CORPORATION

49 BLEECKER STREET • NEW YORK, N.Y. 10012 • (212) 475-4600

250 Circle 139 on reader service card

An autoranging DMM for only \$299?

Yes. And it's a KEITHLEY—no less. The new Model 168 is a full-function DMM. It measures ac/dc volts, ac/dc amps and ohms too. Autoranging, optional battery operation, two-terminal input, push-button operation and lighted function indicators are only a few of its added features. Send for full details now.

1-year accuracy guarantee, too!

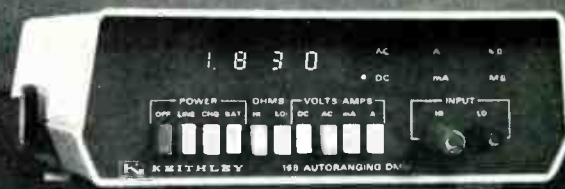

KEITHLEY

INSTRUMENTS

U.S.A. 28775 AURORA ROAD, CLEVELAND, OHIO 44139

EUROPE: 14, AVENUE VILLARDIN, 1009 PULLY, SUISSE

Circle 140 on reader service card

Electronics

52640

Please enter my subscription to **ELECTRONICS** for three years at \$24.

1. I prefer one year at \$12 Payment enclosed
 Bill my company Bill me

CHARGE MY SUBSCRIPTION TO

<input type="checkbox"/> AMERICAN EXPRESS	<input type="checkbox"/> MASTER CHARGE
<input type="checkbox"/> DINERS CLUB	<input type="checkbox"/> BANKAMERICARD
ACCT NO _____	
DATE CARD EXPIRES _____	
INTERBANK NO _____	1st No's above name on Mastercharge only

NAME _____ TITLE _____
 COMPANY _____ DIV or DEPT _____
 COMPANY ADDRESS _____
 CITY _____ STATE _____ ZIP _____
 Check here if you wish publication to be sent to home address
 STREET _____ CITY _____ STATE _____ ZIP _____

Above rates apply only to those who answer all questions listed below. All others pay higher than basic price of \$25.00 per year.

Signature _____

2. 1 PLANT 2 DEPARTMENT
- Indicate the primary product manufactured or service performed at your plant (Box 1) and in your department (Box 2). Be sure to indicate applicable letter in each of the two boxes even if they are the same letter.
- | | | |
|--|---|---|
| A Large computers | K Industrial controls, systems and equipment | U Research and development organizations which are a part of an educational institution |
| B Mini-computers | L Sub-assemblies | V Government Agency and military |
| C Computer peripheral equipment | M Passive electronic components | W Industrial companies using and/or incorporating electronic products in their mfg., research or development activities |
| D Data Processing Systems (systems integration) | N Active electronic components | X Utilities |
| E Office and business machines | O Materials and Hardware | Y Broadcasting, sound and motion pictures and recording studios |
| F Test and measuring equipment | P Aircraft Missiles space and ground support equipment | Z Commercial users of electronic equipment (railroads, pipelines, police, airlines) |
| G Communications systems and equipment | Q Oceanography and support equipment | 9 College, University |
| H Navigation and guidance or control systems | R Medical electronics | |
| I Consumer entertainment electronic equipment | S Industrial equipment containing electronic components or products | |
| J Other consumer electronic equip. (appliances, autos, hand tools) | T Independent R&D laboratory and consultant | |

3. Indicate your principal job function (place applicable number in box. If numbers 9, 10, or 11 are used, fill in name of college or university)
- General and corporate management
 - Design and development engineering
 - Engineering services (evaluation, quality control, reliability, standards, test)
 - Basic research
 - Manufacturing and production
 - Engineering support (lab assistant, technician)
 - Purchasing and procurement
 - Marketing and sales
 - Professor at _____
 - Senior student at _____
 - Graduate student at _____

Senior and graduate students are eligible for professional rate for one year subscription only.

4. Indicate your principal job responsibility (place applicable number in box)
- 1 Management 2 Engineering

5. Are you engaged in or do you supervise the design or redesign of electronic components or equipment? (check one)

YES NO

6. Estimated number of employees at this location. (check one)

1 to 49 50 to 249 250 to 999 over 1,000

FIRST CLASS
PERMIT No. 42
HIGHTSTOWN, N.J.

BUSINESS REPLY MAIL

NO POSTAGE STAMP NECESSARY IF MAILED IN U.S.

Postage will be paid by

Electronics

McGRAW-HILL, INC.
SUBSCRIPTION DEPT.
P.O. BOX 514
HIGHTSTOWN, N.J. 08520

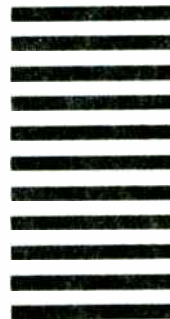

If the cards below have already been used, you may obtain the needed information by writing directly to the manufacturer, or by sending your name and address, plus the Reader Service number, to Electronics Reader Service Department, Box 2530, Clinton, Iowa 52732.

Affix
Postage here

Electronics

P.O. Box No. 2530
Clinton, Iowa 52732

Affix
Postage here

Electronics

P.O. Box No. 2530
Clinton, Iowa 52732

Electronics Reprint Service

Bulk reprints of editorial matter can be ordered from current or past issues. The minimum quantity is 500 copies. Prices quoted on request: call 609-448-1700 Ext. 5494, or write to address below.

Bringing Sight to the Blind
8 pages \$2.00
Key no. R-408

Logic's New Design Tools
16 pages \$3.00
Key R-406

U.S. Market Report
28 pages \$2.00
Key R-404

European Market Report 1974
24 pages \$2.00
Key R-402

Japan Market Report 1974
18 pages \$2.00
Key R-400

The Pervasiveness of Electronics
Complete issue 284 pages \$2.00
Key no. R-328

The Optical Spectrum
\$2.00 Key no. R-326

Semiconductor Memory Systems
16 pages \$3.00 Key no. R-324

New Electronic Displays
10 pages \$2.00 Key no. R-322

Planar Interconnection Techniques
13 pages \$3.00 Key no. R-320

Automotive Electronics
16 pages \$3.00 Key no. R-318

Hybrid Circuit Technology
16 pages \$3.00 Key no. R-316

Leadless, Pluggable IC Packages
Reduce Costs 7 pages \$2.00
Key no. R-312

Penetration Color Tubes are Enhancing Information Displays 6 pages \$2.00
Key no. R-310

Program for Transition from Non Linear to Linear Transistor Model
6 pages \$2.00 Key no. R-308

Charge Coupling Improves Its Image
8 pages \$2.00 Key no. R-306

Electromagnetic Spectrum Chart
Key no. R-213 \$2.00

Electromagnetic Spectrum Report
16 pages plus Wall Chart \$4.00
Key no. R-211

Active Filters
96 pages \$4.00 Key no. R-032

Circuit Designer's Casebook
182 pages \$5.50 Key no. R-031

To order reprints or for further information, please write to:

Electronics Reprint Department
P.O. Box 669
Hightstown, N.J. 08520

Only orders with cash, check, or money order will be accepted. No invoicing will be done.

Only Fluke digital thermometers give you error less temperature measurement

Let's face it, we're all stuck with thermocouple error, but Fluke's new digital thermometers introduce less error than any other available instruments.

Here's how we do it.

1. Digital linearization with a 64-segment ROM.
2. 0.1° resolution, 40,000 counts in one range.
3. Ultra-stable A-to-D converter with temperature coefficient less than 1 $\mu\text{V}/^\circ\text{C}$, noise less than 1/2 μV peak-to-peak.
4. Internal isothermal reference (no external ice-point reference required.)

Other features include compatibility with all common thermocouple types, light weight, rugged portability, ability to operate from either 12V dc or 115V ac standard and an optional battery pack allows complete flexibility of operation.

Here are instruments using the latest "Large-Scale-Integration" technology so you get high reliability, lowest component count, extraordinary versatility, and they are rated for a minimum 10,000 hour MTBF.

There are three instruments and a multi-point switch unit in the Fluke digital thermometer group. At \$749, the Fluke 2100A-03 reads the complete range of any one thermocouple type without range changing.

Model 2100A-06 lets you choose via pushbutton any of six thermocouple types and two voltage ranges. Price \$995.

The 2100A-10 gives the user choice of ten thermocouples of one type in a single unit for \$895.

The 2150A, 10, 20, or 30 point selector unit extends measuring capability up to 100 thermocouples when used with either the 2100A-06 or the 2100A-10. Prices from \$250.

Options are battery pack or digital output at \$150 each.

Don't be left out in the heat or cold without a Fluke digital thermometer. Ask for our free temperature wall chart with all the details.

Dial our toll free hotline, 800-426-0361, write us or circle the appropriate response number below.



Circle No. 255 for a demonstration

Circle No. 901 for literature

John Fluke Mfg. Co., Inc.
P.O. Box 7428
Seattle, Washington 98133.



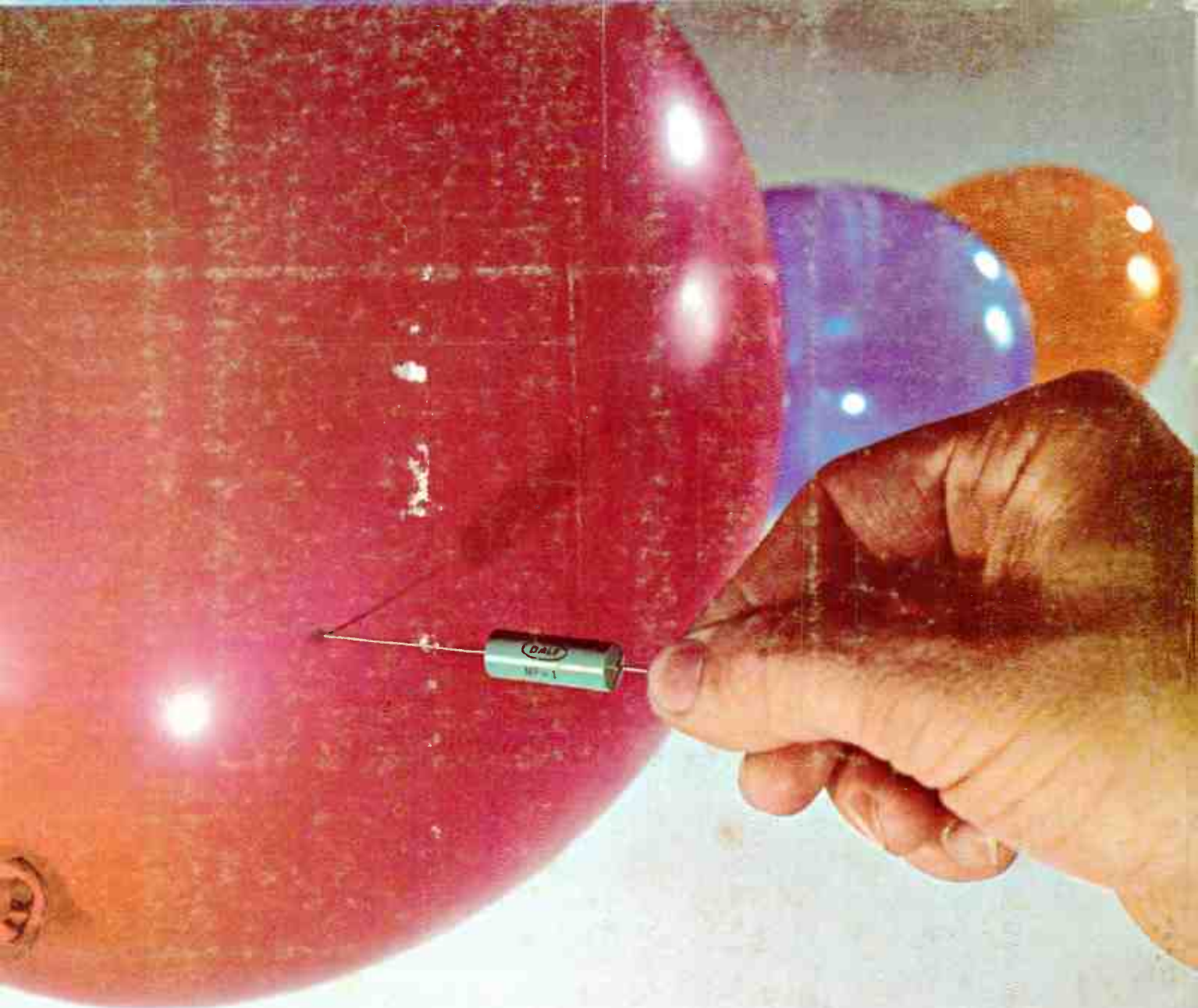

Sellers' markets don't last.

Dependable suppliers do.

Here are four positive steps Dale has taken to help end the seller's market in metal film resistors:

1. INCREASED PRODUCTION: In the past 2½ years Dale has more than tripled its metal film resistor production.

2. BROADENED CAPABILITIES: No one in the industry offers a broader spectrum of film resistors, including: ■ Standard Metal Film styles to MIL-R-10509 and MIL-R-22684 ■ E-Rel styles to MIL-R-55182 and MIL-R-39017 ■ Beyschlag Carbon Film ■ Metal Oxide and High Voltage Resistors ■ Thick Film Networks including MIL-R-83401.

3. STRONGER DISTRIBUTION: Many Dale distributors can ship metal film resistors off-the-shelf in quantity, including RN-55 and RN-60 models.

4. AND SPECIALS, TOO: In the face of record demand, we have continued to respond to customer requests for non-standard parts.

**Sellers' markets don't last.
Dependable suppliers do.**

Call Dale at 402-371-3080.



Circle 902 on reader service Card Radio History

DALE ELECTRONICS, INC.
P.O. Box 74, Norfolk, Nebraska 68701
In Canada: Dale Electronics Canada Ltd.
In Europe: Dale Electronics GMBH
8 Munchen 60, Falkweg 51, West Germany
A subsidiary of The Lionel Corporation