

Electronics®

A trainable pattern recognizer: page 86

Field effect transistors improve tuners: page 114

Weather satellite that sees at night: page 121

August 22, 1966

75 cents

A McGraw-Hill Publication

Below: A new design betters
the helix antenna, page 100

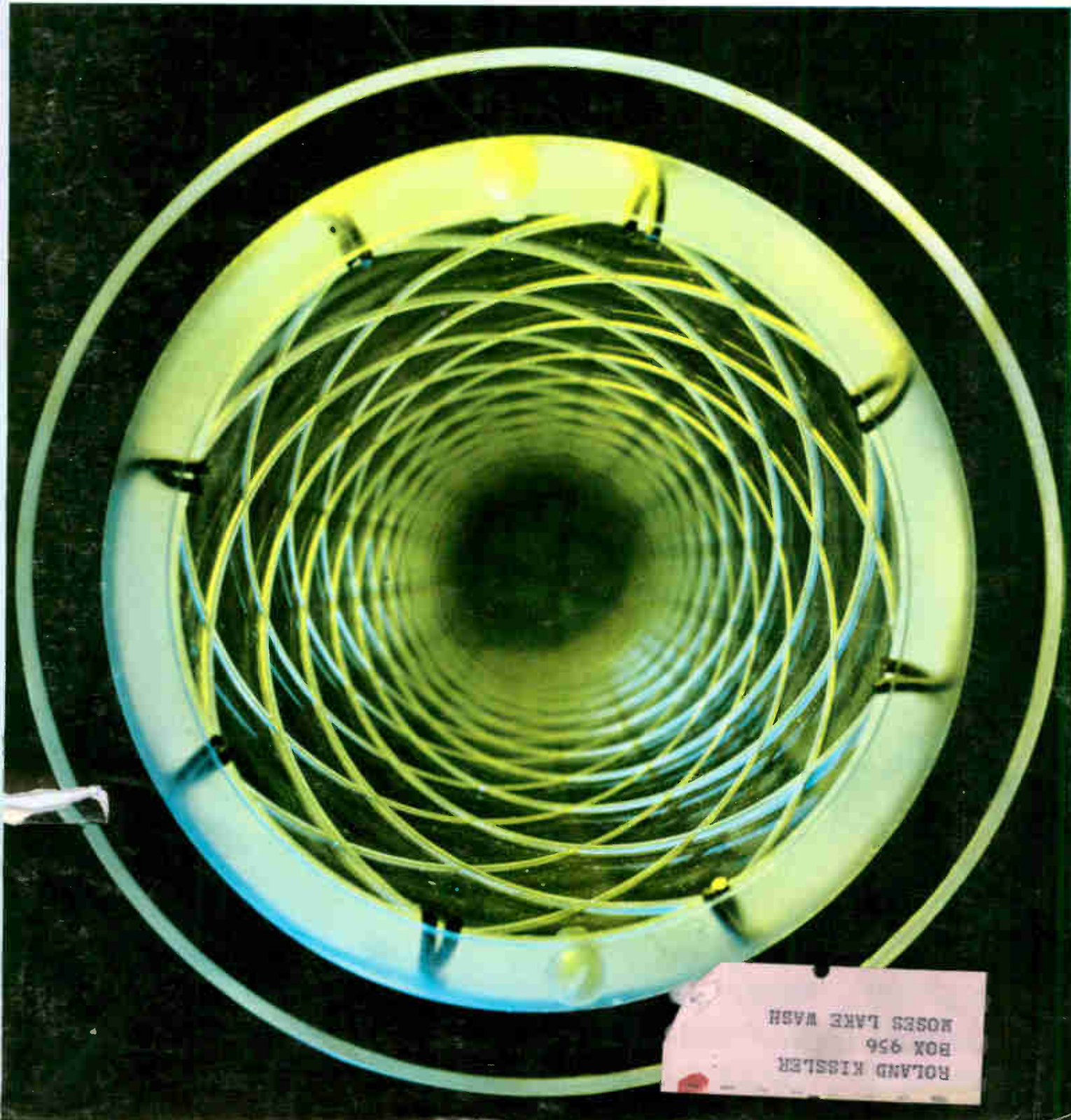

ROLAND KISSLER
BOX 956
ROSES LAKE WASH

**"SPECIAL"
CUSTOM BUILT**



POWER TRANSFORMERS & INDUCTORS

TO YOUR SPECIFICATIONS

Exceptional quality and reliability is provided in all UTC designs. Over 30 years of engineering knowledge and experience backed by complete environmental testing and life testing facilities assure the highest standard in the industry. Full analysis and evaluation of materials are conducted in UTC's Material and Chemical Laboratories. Rigid quality control measures coordinated with exhaustive statistical findings and latest production procedures results in the industry's highest degree of reliability. Range covered in Power Transformers is from milliwatts to 100 KVA. Some typical applications include: Current Limiting, Filament, Isolation, Plate, Transistor Inverter, Transistor Supply.

**MILITARY AND COMMERCIAL TYPES FOR
EVERY PHASE OF THE ELECTRONICS ART**

POWER TRANSFORMERS • AUDIO TRANSFORMERS • INDUCTORS • PULSE TRANSFORMERS • ELECTRIC WAVE FILTERS • LUMPED CONSTANT DELAY LINES • HIGH Q COILS • MAGNETIC AMPLIFIERS • SATURABLE REACTORS • REFERENCE UNITS

<p>Low capacity current limiting filament transformer. Primary 118 V. 60 cycles to 6.3 V. at 3 A., 8 A. at short circuit. 25 MMFD capacity. 30 KV hipot and 200:1 capacity divider; 5 x 3 3/4 x 4 1/2", 9 lbs.</p>	<p>MIL-T-27B ultraminiature Scott connected power transformer, 5/16" Dia. x 13/32" H., 1/10 Oz. Primary 28 V 400 — with taps @ 50% & 86.6%. Two units provide 28 V two phase from three phase source.</p>	<p>Molded Power Transformer 3 Phase. Input 200V, 380-420 cps. Electrostatic Shield, 8 output windings, 26 terminals. MIL-T-27B, Grade 2 Class S. Max. Alt. 50K Ft. Size 6 x 2 1/2 x 5", 8 lbs.</p>
<p>Commercial type molded power transformer. Primary 115/230 V., 50/420 cycles to 680 VCT-.015 A., 6.3 VCT-.12 A., 6.3 V.-.6A. Size: 2 1/2 x 3 x 2 7/8", weight: 1.6 lbs.</p>	<p>Three phase high voltage power transformer. Primary jumper hardware for easy conversion from delta to wye inputs. Made to MIL-T-27B specifications. Primary: 440 V 60 cycles delta or wye 3 phase input. Secondary: 2100 V line to line or 1215 V line to line @ 242 ma.</p>	<p>High current filament transformer. Primary 140/156 V., 47/63 cycles to 1.8 V.-1070 A. Current limiting through separate primary reactor, MIL-T-27B; 10 x 10 x 1 1/2", 150 lbs.</p>

Write for catalog of over
1,300 UTC TOP QUALITY
STOCK ITEMS
IMMEDIATELY AVAILABLE
from your local distributor.



UNITED® TRANSFORMER CO.

DIVISION OF TRW INC. • 150 VARICK STREET, NEW YORK, N. Y. 10013

Circle 900 on reader service card

New value-priced sweeper...

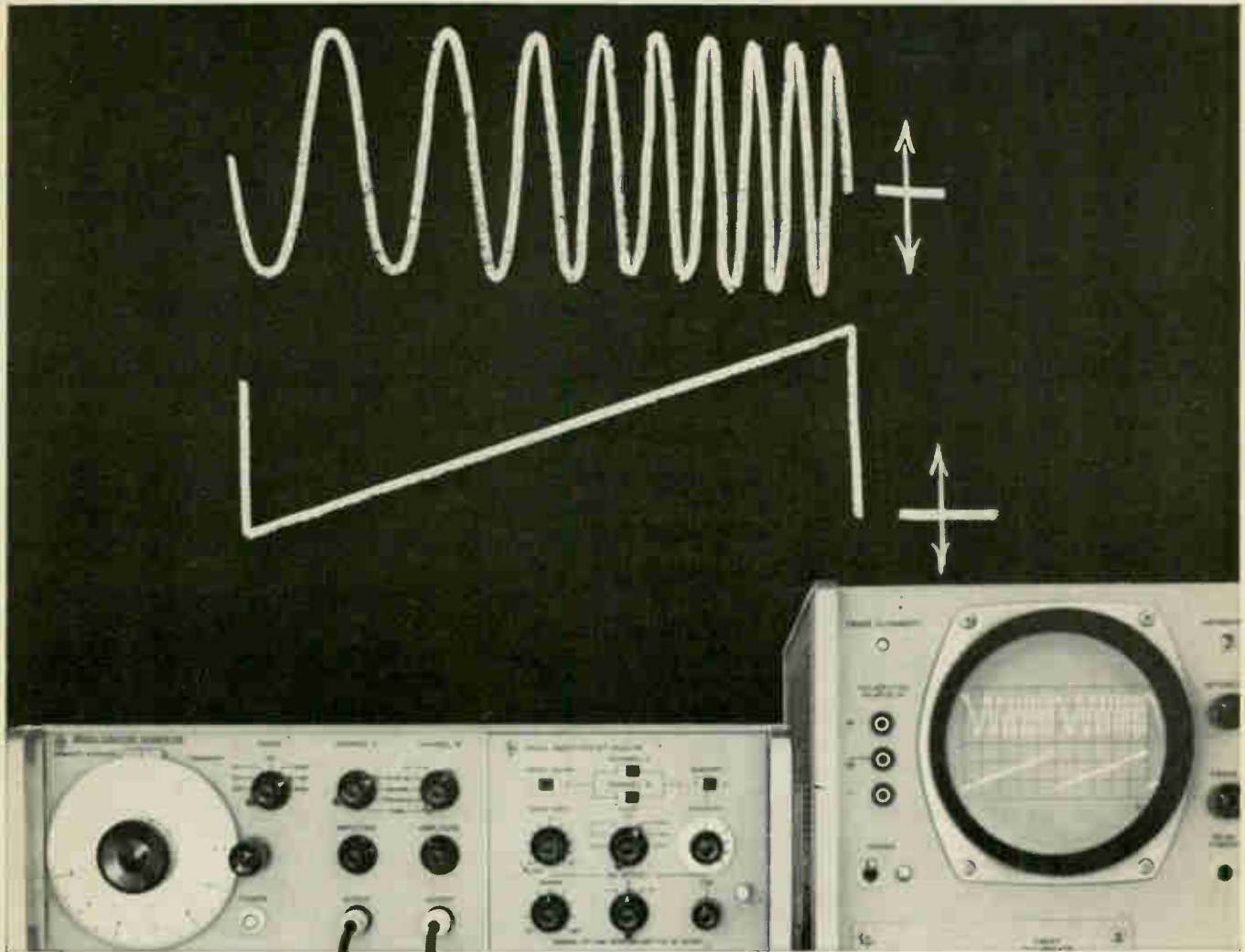

with a dc offset plug-in for your Hewlett-Packard 3300A Function Generator

Here's a low cost (\$210) plug-in, 3304A, for the Hewlett-Packard 3300A Function Generator that provides internal sweeping, up to ± 16 v of dc offset on all functions, plus sawtooth and offset square-wave outputs.

This is an instrument package you need to use on your bench . . . it provides more flexibility than words can describe. The new plug-in sweeps internally over a decade. The sweep starts at the main frame frequency setting and is controlled at the top end by the "Sweep Width" control. Any function can be offset with stability of ± 50 mv over 24 hours. The 3304A plug-in sawtooth is independent of the 3300A main frame frequency and can be used for driving external systems. The offset square wave clamps the top or bottom of the waveform either to the dc offset voltage or to ground potential.

- The plug-in provides the offset with coarse and vernier control, a 15 v sawtooth (adjustable) and the square wave over the same frequency range as the main frame. The main frame, the 3300A itself, is the first plug-in function generator to offer variable phase, phase-lock capability with accurate sine, square, triangular, output, amplitude controlled, 0.01 Hz to

100 kHz. It offers linear voltage programmability, single-cycle, multi-cycle, free-run operation, external trigger capability. It provides isolated dual output amplifiers, plus a sync pulse output for oscilloscope or recorder.

All this for just \$570, plus the cost of one of these plug-ins: 3301A Operational Plug-in, \$20; 3302A Trigger/Phase-Lock Plug-in, \$190; 3304A Sweeper/Offset Plug-in, \$210.

Ask for a demonstration. Have your Hewlett-Packard field engineer turn it on and show you what this remarkably versatile instrument can give you. Or write for a special chart showing all the outputs available from this instrument and its plug-ins: Hewlett-Packard, Palo Alto, California 94304, Tel. (415) 326-7000; Europe: 54 Route des Acacias, Geneva.

● *Data subject to change without notice. Prices f.o.b. factory.*

HEWLETT  PACKARD
An extra measure of quality

SEE NEW HP INSTRUMENTS ATTEND MEASUREMENT SEMINARS WESCON—HOLLYWOOD PARK

1369

Get a record you can *clearly* read — even at 5 KC

... from the one system
supplied complete with your
choice of amplifier

Now you can have all the Sanborn advantages of a DC—5KC optical oscillograph supplied as a *complete, integrated package ready to record* — plus clearer, higher resolution recordings made possible by improvements in optical system design and chart papers. Put one to 8 traces on the 8" ultraviolet-sensitive chart of a standard 4508B system — with p-p amplitudes up to 4" at DC—5kHz, to 8" at DC—3kHz. Or record up to 25 channels of high frequency information with a 4524B system. Save valuable time by recording all frequencies up to 5 kc with a *single set of galvanometers driven by amplifiers incorporating frequency boost and compensating circuits*, thus eliminating an "inventory" of different galvanometers and the time required to install and align a new set for each recording requirement. Make signal connections quickly and conveniently to front-panel or rear input connectors, and have complete operational control with amplifier front panel basic controls for each signal. Change system sensitivity from 2.5 mv/inch to 625 mv/inch by easily changing 8-channel amplifier modules (choice of three). Load paper in daylight . . . select any of 9 chart speeds by pushbutton or control them remotely . . . see fully developed traces a few seconds after recording . . . use system in mobile console, rack mount or portable cases.

Ask your local Sanborn Division/Hewlett-Packard sales office for technical data and expert application assistance. Offices in 47 U.S. and Canadian cities, and major areas overseas. Hewlett-Packard Company, Sanborn Division, Waltham, Massachusetts 02154.

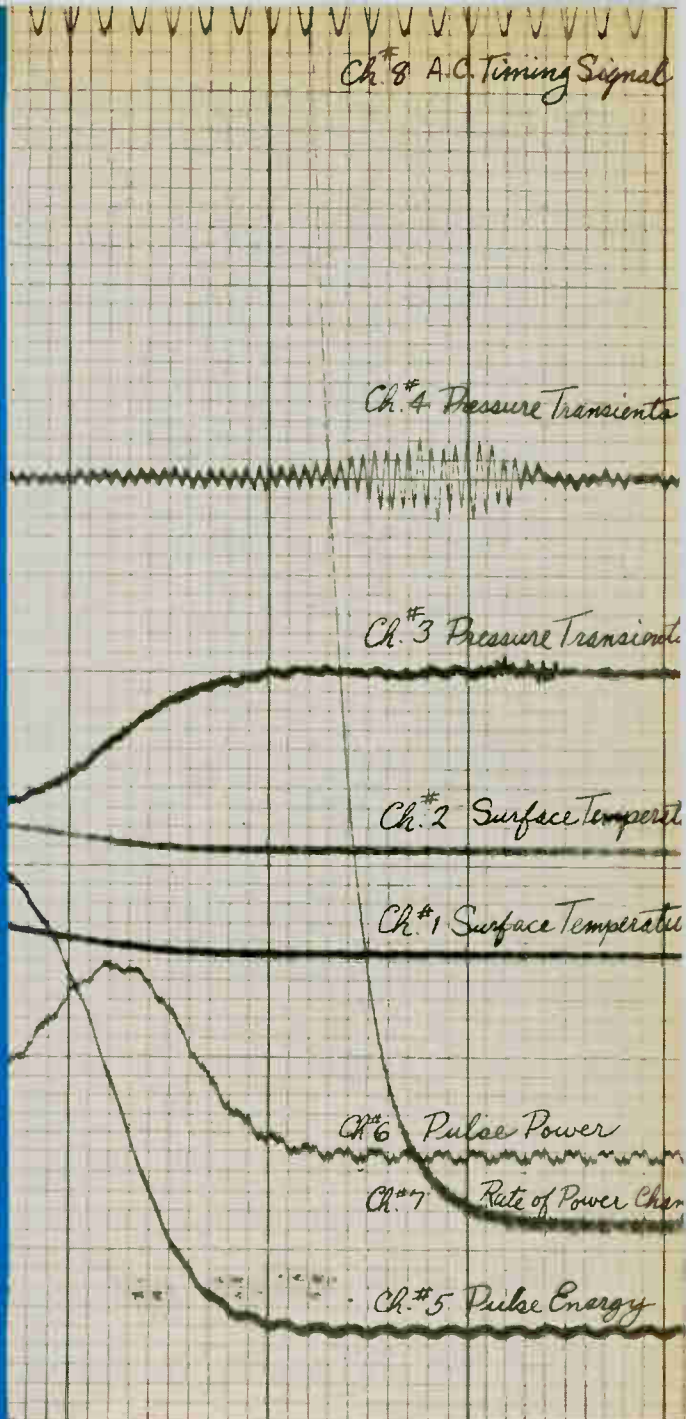
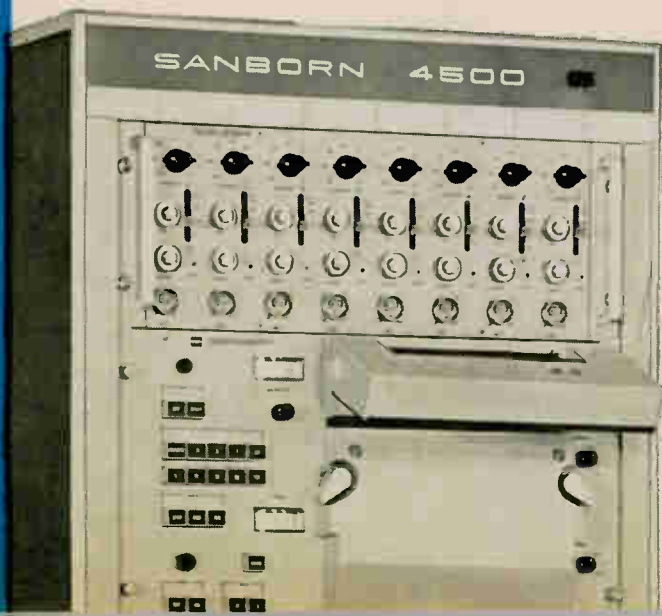

Specifications — 4500 Series Optical Oscillographs

Sensitivity	625 mv/1", 50 mv/1", or 2.5 mv/1", depending on amplifier chosen.
Frequency Response	DC to 5 KC (—3db) at 4" p-p
Common Mode Performance	Rejec. ratio at least 140 db at DC, max. c.m. voltage ± 500 v (with Medium Gain Amplifier)
Linearity	1½ % of full scale (8 inches)
Gain Stability	Better than 1%, 0° to 50°C, 103 to 127 (line) volts
Noise	0.02" p-p, max.
Chart Speeds	Nine, 0.25 to 100"/sec.
Prices	Complete 8-channel system in cabinet, with galvanometer driver amplifiers, \$7400; with medium gain amplifiers, \$8980 (F.O.B. Waltham, Mass.)

**HEWLETT
PACKARD**  **SANBORN
DIVISION**

SEE HP INSTRUMENTS AND MEASUREMENT SEMINARS
AT WESCON—HOLLYWOOD PARK™

News Features

Probing the news

- 141 What comes after Apollo?
- 145 A view from the cockpit
- 149 Behind the complaints on computer software
- 153 Open and shut case

Electronics Review

- 35 **Space electronics:**
Beyond the moon . . .
. . . and to the sun
- 36 **Patents:** The laser decision
- 37 **Advanced technology:** A better red
- 37 **Industrial electronics:**
Stalled traffic control
- 38 **Computers:** White elephant;
Integrator on a chip
- 40 **Antennas:** Widening the feedpoint
- 42 **Military electronics:** Bitter end
- 42 **Components:** Standard dose
- 44 **Communications:** Initial success

Electronics Abroad

- 209 **Japan:** Speeded by laser
- 210 **West Germany:** Repetitious
- 210 **Soviet Union:** Blocked out
- 211 **Great Britain:** Hard times
Robot tractor
- 212 **Italy:** Just checking

Departments

- 4 Readers Comment
- 8 People
- 14 Meetings
- 16 Meeting Preview
- 23 Editorial
- 25 Electronics Newsletter
- 69 Washington Newsletter
- 167 New Products
- 200 New Books
- 202 Technical Abstracts
- 204 New Literature

Technical Articles

I. Design

- Advanced technology** 86 **Training a machine to read with nonlinear threshold logic**
Typewriter-size pattern recognizer built of integrated circuits can sort alphabetic characters, classify wave forms and recognize geometric shapes
D.P. Hattaway, E.D. Hietanen and R.W. Rothfus, Bendix Corp.
- Circuit design** 94 **Designer's casebook**
 - Direct current regulator drives fluorescent lamps
 - Thermistor measures negative resistance of tunnel diode
 - Ferrite cylinder modulates microwave signals
 - Glass reed switch controls operational amplifier
 - Pulsed oscillator conserves power
 - Amplifier provides giant input resistance

II. Applications

- Communications** 100 **Helix antennas take turn for better (cover)**
A unique antenna with contrawindings connected to common feed points has large bandwidth
C.W. Gerst and R.A. Worden, Syracuse University Research Corp.
- Consumer electronics** 114 **P-i-n diode and FET's improve f-m reception**
New f-m tuner has dynamic signal range exceeding 120 decibels with minimum distortion and maximum sensitivity
Fred L. Mergner, Fisher Radio Corp.
- Space electronics** 121 **Night and day, Nimbus 2 transmits cloud pictures**
Infrared scanners have been added to automatic picture transmission system so it can report weather on the dark side of the earth
J.C. Moody and Oscar Weinstein, NASA

Electronics

Editor-in-Chief: Lewis H. Young

Senior editors

Design: Samuel Weber

Application: George Sideris

News: Kemp Anderson Jr.

Assistant to the editor: Sally Powell

Senior associate editors: John F. Mason, Don Christiansen, Robert Henkel, Joseph Mittleman

Department editors

Avionics: W.J. Evanzia

Communications: Leonard Weller

Computers: Wallace B. Riley

Design theory: Joseph Mittleman

Electronics abroad: Arthur Erikson

Electronics review: Stanley Zarowin

Industrial electronics: Alfred Rosenblatt

Instrumentation: Carl Moskowitz

Military electronics: John F. Mason

New products: William P. O'Brien

Special projects: Don Christiansen

Staff writers: Jan Rahm, A. Thomas Thorson

Regional Bureaus

Domestic

Boston: Thomas Maguire, manager; Robin Carlson

Los Angeles: William B. Wallace, manager; June Ranill

San Francisco: Walter Barney, manager; Mary Jo Jadin

Washington: Robert W. Henkel, manager; William D. Hickman, John Rhea, correspondents; Patricia C. Hoehling

Foreign

Bonn: John Gosch

Tokyo: Charles Cohen

Copy editors

James J. Moran, David Goller, William Olcott

Graphic design

Art director: Saul Sussman

Assistant art directors: Donna M. Griffiths, Ann Mella

Production editor: Arthur C. Miller

Editorial secretaries: Claire Benell, Lynn Emery, Lorraine Fabry, Kay Fontana, Lorraine Longo, Carolyn Michnowicz

McGraw-Hill News Service

Director: John Wilhelm; Atlanta: Fran Ridgway; Chicago: Reck Johnson;

Cleveland: Arthur Zimmerman; Dallas: Marvin Reid;

Detroit: N. Hunter; Houston: Ron Lovell; Los Angeles: Michael Murphy, Gerald Parkinson

San Francisco: Margaret Drosse!

Seattle: Ray Bloomberg; Washington: Arthur L. Moore, Charles Gardner,

Herbert W. Cheshire, Seth Payne, Warren Burkett, Warren Kornberg

McGraw-Hill World News Service

Bonn: John Johnsrud; London: John Shinn;

Mexico City: Bruce Cross; Milan: Ronald Taggiasco;

Moscow: Howard Rausch; Paris: Peter Kilborn;

Rio de Janeiro: Wes Perry; Tokyo: Marvin Petal

Circulation and Research Manager: Milton Drake

Reprints: Thomas M. Egan

Publisher: Gordon Jones

Electronics: August 22, 1966, Vol. 39, No. 17

Printed at 99 North Broadway, Albany, N.Y., 12207
Second class postage paid at Albany, N.Y.

Subscriptions are solicited only from those actively engaged in the field of the publication. Position and company connection must be indicated on orders. Subscription prices: United States and Possessions and Canada, \$6.00 one year, \$9.00 two years, \$12.00 three years. All other countries \$20.00 one year. Single copies, United States and Possessions and Canada 75¢. Single copies all other countries \$1.50.

Published every other Monday by McGraw-Hill Inc. 330 West 42nd Street, New York, N.Y. 10036. Founder: James H. McGraw, 1860-1948. Corporate officers: Shelton Fisher, President; John J. Cooke, Secretary; John L. McGraw, Treasurer.

Subscribers: The Publisher, upon written request to our New York office from any subscriber, agrees to refund that part of the subscription price applying to copies not yet mailed. Please send change of address notices or complaints to Fulfillment Manager; subscription orders to Circulation Sales Department, Electronics, at the address below. Change of address notices should provide old as well as new address, including postal zip code number. If possible, attach address label from recent issue. Allow one month for change to become effective.

Postmaster: Please send Form 3579 to Fulfillment Manager, Electronics, P.O. Box 430, Hightstown, New Jersey 08520

Readers Comment

Familiar techniques

To the Editor:

I have just seen the article "Integrated circuits replace the electromechanical resolver" [Jan. 10, p. 90]. I was particularly interested because I used exactly these techniques—although long before modern integrated circuits were available—in high-speed analog computations concerned with navigational problems and in particular in ground controlled interception computation, while employed by the Decca Radar Co.

In those days of vacuum tube circuitry the advantages of the method did not lie in savings of weight or power consumption but rather in its ability to provide an answer to such a trigonometric problem in a matter of a fraction of a millisecond. At the same time it allowed an electrical analog of an aircraft flight path to be constructed and displayed on a cathode-ray tube to overlay corresponding radar information.

J.S. Johnston

Technical Director
Rosemount Engineering Co.
Sussex,
England

Why the capacitor?

To the Editor:

I was intrigued by the circuit "Feedback choke reduces power supply ripple" [June 27, p. 74]. What is the purpose of the 1,000-microfarad 15-volt capacitor attached to the right hand side of the choke? I suspect the circuit would work even better without it.

J.D. Easton

Department of Physics
School of Science and Engineering
University of California
La Jolla, Calif.

■ The author replies:

The function of the filter network at the base of Q_2 is to provide a low ripple reference for the Darlington. I assume that the question concerning the purpose of the 1,000- μ f, 50-v capacitor is based upon the corresponding deterioration of response time. The regulation is stated as

Did You Know Sprague Makes 51 Types of Foil and Wet Tantalum Capacitors?

125 C FOIL-TYPE TUBULAR TANTALEX® CAPACITORS



Type 120D polarized plain-foil
Type 121D non-polarized plain-foil
Type 122D polarized etched-foil
Type 123D non-polarized etched-foil

ASK FOR BULLETIN 3602C

Circle 337 on reader service card

FOIL-TYPE RECTANGULAR TANTALEX® CAPACITORS



Type 300D polarized plain-foil
Type 301D non-polarized plain-foil
Type 302D polarized etched-foil
Type 303D non-polarized etched-foil

ASK FOR BULLETIN 3650

Circle 338 on reader service card

FOIL-TYPE TANTALUM CAPACITORS TO MIL-C-3965C

CL20, CL21 tubular 125 C polarized etched-foil
CL22, CL23 tubular 125 C non-polar etched-foil
CL24, CL25 tubular 85 C polarized etched-foil
CL26, CL27 tubular 85 C non-polar etched-foil
CL30, CL31 tubular 125 C polarized plain-foil
CL32, CL33 tubular 125 C non-polar plain-foil
CL34, CL35 tubular 85 C polarized plain-foil
CL36, CL37 tubular 85 C non-polar plain-foil
CL51 rectangular 85 C polarized plain-foil
CL52 rectangular 85 C non-polar plain-foil
CL53 rectangular 85 C polarized etched-foil
CL54 rectangular 85 C non-polar etched-foil

Circle 339 on reader service card

85 C FOIL-TYPE TUBULAR TANTALEX® CAPACITORS



Type 110D polarized plain-foil
Type 111D non-polarized plain-foil
Type 112D polarized etched-foil
Type 113D non-polarized etched-foil

ASK FOR BULLETIN 3601C

Circle 340 on reader service card

SINTERED-ANODE TUBULAR TANTALEX® CAPACITORS



Type 109D elastomer seal 85 C
Type 130D elastomer seal 125 C
Type 137D hermetic seal 125 C

ASK FOR BULLETINS 3700F, 3701B, 3703

Circle 341 on reader service card

SINTERED-ANODE CUP STYLE TANTALEX® CAPACITORS



Type 131D 85 C industrial-type
Type 132D 85 C vibration-proof
Type 133D 125 C vibration-proof

ASK FOR BULLETINS 3710B, 3711

Circle 342 on reader service card

SINTERED-ANODE CYLINDRICAL TANTALEX® CAPACITORS



Type 140D
up to 175 C operation,
3/8" diam.
Type 141D
up to 175 C operation,
1 1/8" diam.

ASK FOR BULLETIN 3800

Circle 343 on reader service card

SINTERED-ANODE RECTANGULAR TANTALEX® CAPACITORS



Type 200D negative terminal grounded
Type 202D both terminals insulated

ASK FOR BULLETIN 3705A

Circle 344 on reader service card

SINTERED-ANODE TANTALUM CAPACITORS TO MIL-C-3965C

CL14 cylindrical, 7/8" diam.
CL16 cylindrical, 7/8" diam., threaded neck
CL17 cylindrical, 1 1/8" diam.
CL18 cylindrical, 1 1/8" diam., threaded neck
CL44 cup style, uninsulated
CL45 cup style, insulated
CL55 rectangular, both terminals insulated
CL64 tubular, uninsulated
CL65 tubular, insulated

Circle 345 on reader service card

For comprehensive engineering bulletins on the capacitor types in which you are interested, write to:
Technical Literature Service
Sprague Electric Company
35 Marshall Street
North Adams, Mass. 01248

48C-418 R1

SPRAGUE[®]
THE MARK OF RELIABILITY

Sprague and "®" are registered trademarks of the Sprague Electric Co.

GENERAL RADIO at WESCON



New
1%-Bandwidth Wave Analyzer

A constant-percentage analyzer for fast measurements of complex signals from 20 Hz to 20 kHz... lets you measure components differing in level by as much as 80 dB. 100-k Ω input impedance (over 500 M Ω with accessory preamp). Eight voltage ranges from 100 μ V to 300 V, full scale (10 μ V full scale with preamp). Built-in amplitude calibrator. Can be line or battery operated. Output is available for automatic spectrum recording with the GR 1521 Graphic Level Recorder. Type 1568-A Wave Analyzer, \$1350.

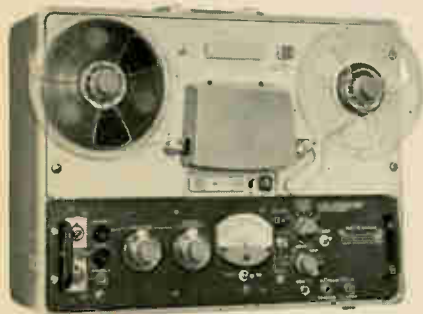

New
Data Recorder
for Acoustical Measurements

A combination sound-level meter and recorder that lets you "leave your lab at home." With it you can make calibrated recordings for analysis at leisure and for future comparisons. Two channels: one with all standard sound-level-meter circuits plus constant-current and NAB equalization; the other with constant-current equalization for narration, test signals, or binaural recordings. 10- μ V to 1-V input-level range... two tape speeds, 7 $\frac{1}{2}$ and 15 in/s. Response, flat within \pm 3 dB from 15 to 16,000 Hz (7 $\frac{1}{2}$ in/s, constant-current equalization)... excellent signal-to-noise-ratio... high input impedance... monitoring meter and overload indicator after emphasis circuits ensure recordings below tape saturation levels... Type 1525-A Data Recorder, \$1995.

Also on Display:

- A modular pulse generator that lets you produce any pulse shape you want.
- A high-performance, low-cost pulse generator.
- A pulse generator with less than 5-ns rise and fall times.
- A linear pulse amplifier with 1.2-ampere output.
- R-L-C standards, decades, and components.
- GR874 and GR900 Coaxial Connectors and Elements for use at frequencies from dc to 8.5 GHz, as well as for fast-rise-time, fast-pulse applications that require really low reflection and negligible pulse distortion.

See them all at WESCON, Booths 348-351.



New Automatic Go, No-Go Capacitor Testing

The newest addition to the GR line of automatic test equipment, the 1781-A Digital Limit Comparator, compares measurements made by the GR 1680-A Automatic Capacitance Bridge against preset limits. The Comparator can be preset to five-figure resolution for both high- and low-capacitance limits, as well as for high dissipation factor and/or conductance. Comparison is fast (2.5 ms) and entirely automatic. Readout is by Go, No-Go lights which also indicate reason for rejection. Outputs are provided to control sorting devices and to drive recorders. Companion Type 1680-A Automatic Capacitance Bridge Assembly provides automatic measurement of C from 0.01 pF to 1000 μ F in less than $\frac{1}{2}$ second.



1-pF to 1-F
Electrolytic
Capacitance
Bridge

Two-, three-, four, or five-terminal measurements... Measures D from 0 to 10... Has Orthonull[®] balancing mechanism to eliminate sliding balances on lossy capacitors... Basic accuracy, \pm 1% for C and \pm 2% for D... Complete with self-contained 120-Hz generator, detector, and 0-600 V dc polarizing supply... Measures leakage currents as small as 0.5 μ A. Type 1617-A, \$1195.



New
Precision, Low-Temperature-Coefficient,
Wire-Wound Standard Resistors

\pm 0.01% accuracy; stability, \pm 20 ppm per year... all units are heat cycled to reduce winding strains and sealed in oil-filled cases to ensure long-term stability... two terminal styles: wire leads (Type 1441) and jack-top binding posts (Type 1440)... available in 1-, 10-, and 100-ohms, 1-, 10-, and 100-kilohms, and 1-megohm. Prices range from \$18 to \$22.



10-Hz to 100-kHz
Low-Distortion
Oscillator

A sine/square-wave oscillator whose distortion is less than 0.05% for sine waves from 200 Hz to 10 kHz (open circuit, or 600- Ω load), increases to less than 0.25% at 10 Hz, and 100 kHz... Frequency characteristic is flat within \pm 2%... 5-V, open-circuit output... 60-dB step attenuator... Hum is less than 0.001% of full output (100 dB). Square-wave rise time is less than 100 ns; symmetry is better than \pm 2% over entire range... Synchronization provided for locking to external signals or for synchronizing other equipment. Type 1309-A, \$325.



A General-Purpose
100-MHz Pulse Generator for Under \$1000

Repetition rates from 1 to 100 MHz... Durations from 4 to 99 ns in 1-ns steps... Rise and fall times less than 2 ns... Period, duration, and delay jitter less than 0.1 ns... 4-volt output into 50 ohms... adjustable time delay... Synchronizes readily with external clock signals. Type 1394-A, \$995.

Also on display: the 1394-P1 Pulse Offset Control... Allows clamping of output-pulse base line to any desired level over a \pm 2-V range. Price, Type 1394-P1, \$255.



70-MHz Solid-State Synthesizer

Output adjustable up to 2 volts at accurately known, stable, sine-wave frequencies. 7-digit readout plus continuous frequency control. Frequency-coherent signals are synthesized from internal quartz-crystal oscillator. Plug-in modules give you choice of resolution: 10 Hz, 100 Hz, 1 kHz, 10 kHz, and 100 kHz, or to better than 0.1 Hz with a continuously adjustable decade. Optional continuous tuning through any decade range up to 1 MHz. Internal calibrated sweep... Programmable.

This is the fourth of a series of GR synthesizers — other models cover ranges to 100 kHz, 1 MHz, and 12 MHz. Prices range from \$3640 for a Type 1161-A3 100-Hz-per-step, 100-kHz Coherent Decade Frequency Synthesizer to \$7065 for a Type 1164-A7C 70-MHz model with 0.1-Hz resolution.

BOSTON • NEW YORK • CHICAGO • PHILADELPHIA • WASHINGTON, D.C.
SYRACUSE • DALLAS • SAN FRANCISCO • LOS ANGELES • ORLANDO
CLEVELAND • TORONTO • MONTREAL

BOURNE END, ENGLAND ZURICH, SWITZERLAND

GENERAL RADIO

WEST CONCORD, MASSACHUSETTS

Circle 6 on reader service card

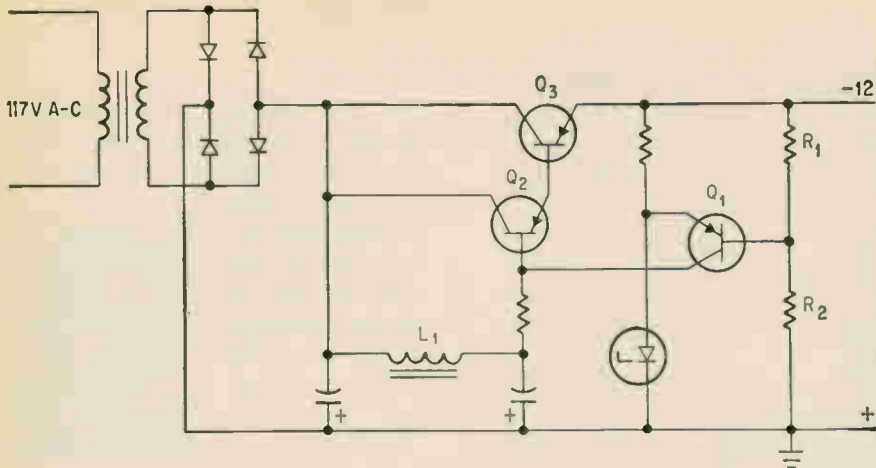

Reader Redick's improvement of author Quatse's circuit eliminates the 1,000 μf capacitor on the output.

only 1% (not uncommonly good for a regulated supply). An improvement in regulation could be gained by elimination of the capacitor, but only at the expense of increased ripple. For this circuit, 1,000 μf is about optimum. If better regulation is preferred to lower ripple, the capacitor should be entirely eliminated rather than replaced by one of lower value.

Jesse T. Quatse

Engineering Research and Development
Carnegie Institute of Technology
Pittsburgh, Pa.

Ripple filter

To the Editor:

No doubt some of your readers are wondering why there is a 1,000 microfarad capacitor on the output of Jesse T. Quatse's regulated power supply [June 27, p. 74]. This is to filter out the ripple.

To fully understand the necessity for this, three things must be realized. First, advantage is taken of the filtering capabilities of a 1,000 μf . condenser by placing it on the

base of Q_2 . This prevents any a-c feedback component from reaching the base of the pass transistor Q_3 , thereby insuring that no regulating action can take place for a-c components appearing on the output. Second, ripple transmission to the output is further enhanced by operating transistors Q_2 and Q_3 backwards. In this mode their performance is reasonably marginal and, being characterized by very low gain, practically eliminates any emitter follower action that might otherwise lower the effective output impedance of the supply. And third, there really is no feedback, particularly a-c feedback, through the feedback choke, as one might imagine.

My schematic [above] suggests a couple of modifications that eliminate the need for a 1,000 μf on the output; its only claim to novelty being, probably, the somewhat unnecessary inclusion of feedback choke L_1 .

Robert P. Redick

Leander McCormick Observatory
University of Virginia
Charlottesville, Va.

SUBSCRIPTION SERVICE

Please include an Electronics Magazine address label to insure prompt service whenever you write us about your subscription.

Mail to: Fulfillment Manager
Electronics
P.O. Box 430
Hightstown, N.J. 08520

To subscribe mail this form with your payment and check new subscription renew my present subscription

Subscription rates: In the U.S.: 1 year, \$6; two years, \$9; three years, \$12. Subscription rates for foreign countries available on request

CHANGE OF ADDRESS

ATTACH LABEL HERE

If you are moving, please let us know five weeks before changing your address. Place magazine address label here, print your new address below.

name

address

city

state

zip code

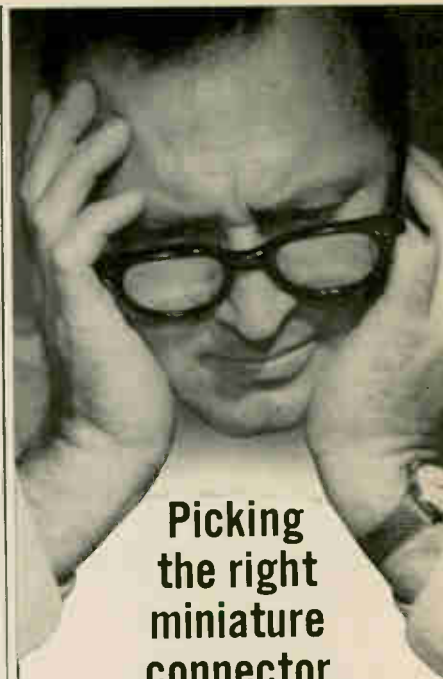

Picking the right miniature connector is a small problem

It's not hard to locate a miniature connector small enough to meet tight space specs. Lots of people make them. There is a small problem, though, in finding the quality you need at the price you'd like to pay.

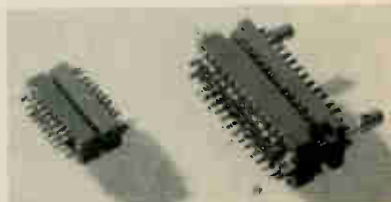

That's why business is booming at Transitron's Precision Connector Division. We design and produce miniature and subminiature connectors to exceed — not merely meet specifications. They are built to outlast the equipment you mount them on. Precision fabrication, knowledgeable design, the finest materials provide a combination that can't be surpassed by any manufacturer. Yet in quantity they cost no more than units that will barely squeeze by incoming inspection.

Send today for our new condensed catalog covering a complete line of miniature and subminiature connectors, as well as printed circuit connectors and many other types. And if you need a custom connector design, we're your source. Just give us the facts.



Precision Connector Division

Transitron

electronic corporation
Wakefield, Massachusetts

20 STANDARD MODELS...

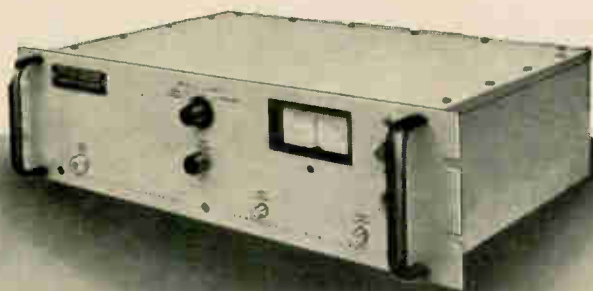

RHG MICROWAVE FM RECEIVERS

FEATURING

- Bandwidths to 60 MHz • Solid State Reliability • Coverage L, S, C, or X Band • Baseband 2 Hz to 10 MHz • Diversity Reception • RFI Tested to MIL-I-6181D

FOR APPLICATION IN

- High Resolution FM TV
- Microwave Relay Links
- FM Video Data Links

Only RHG can provide 20 off-the-shelf FM Receivers backed by an additional 33 CUSTOM DESIGNS which have been produced. The solution to your problem may be on file in our library now.

For specials, test our ONE-DAY-QUOTE Service. For standards, see complete listing in EEM Section 3400.

RHG

RHG ELECTRONICS LABORATORY, INC.

94 Milbar Blvd., Farmingdale, L.I., N.Y. 11735 • (516) 694-3100

MICROWAVE FM and AM RECEIVERS ■ MICROWAVE MIXER PREAMPS
LINEAR and LOG IF AMPLIFIERS ■ RF and OCTAVE AMPLIFIERS

People

The new director of the National Bureau of Standards' Institute for Applied Technology is a man with a mission. **John P. Eberhard, 39**, has set as his goal the kind of project planning pioneered by Defense Secretary Robert S. McNamara: he wants to see all research activity directed toward a concrete and practical objective.



Traditionally an umbrella for scientists doing a variety of basic research, the bureau was reorganized two and a half years ago into three institutes for tighter management control. Of these, Eberhard's 825-man institute is the one with the most direct contact with industry.

Evaluation. Laboratory facilities for the applied technology group should be available when the institute completes its move out of antiquated offices in Washington and into new ones in suburban Gaithersburg, Md. A division within the institute known as the technical analysis division is responsible for evaluating the relationship between benefits and costs of the research planned by the institute. It has already grown from a staff of two to 60.

The institute's Clearinghouse for Federal Scientific and Technical Information (the old Office of Technical Services) at Springfield, Va., distributes 6,000 pieces of technical literature a day to schools, industry and to other Government agencies. The Center for Computer Sciences and Technology has the job of setting standards for the Federal Government—the computer industry's biggest customer. The Government accounts for 30% of the total computer market and to handle the additional workload, Eberhard expects this staff to increase from the present 165 to 300 or 400.

Eberhard is one of the young men brought in at the time of the bureau's reorganization; at that time he was named deputy director. In his new post, he succeeds 36-

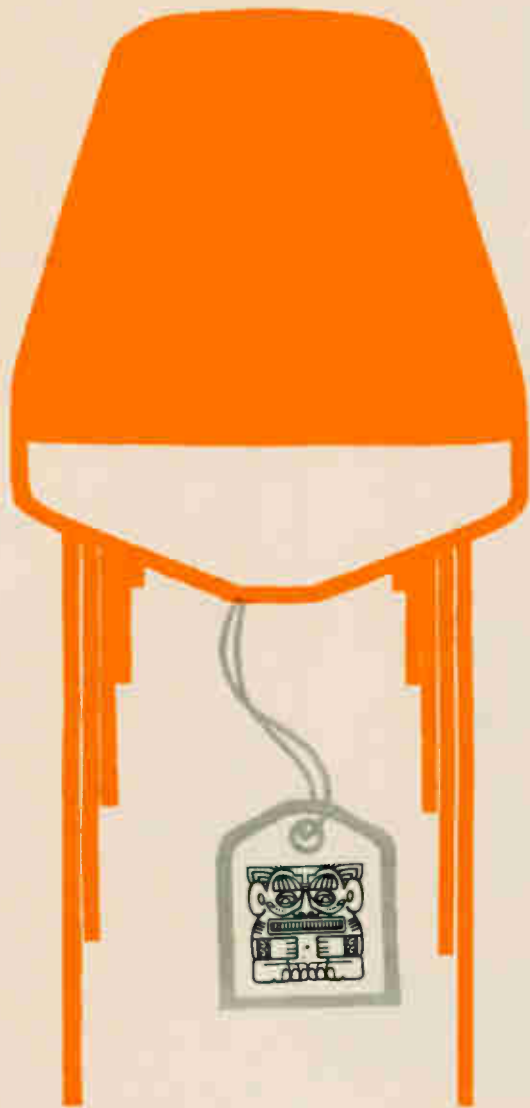

The dual inline packaging on our new E-line 930 Series DTL is almost as surprising as the price tag.

Just check over these prices:

- JK Flip Flop (100 to 999) \$2.80
- Dual 4-input Nand Gate \$1.65
- Dual 4-input Buffer \$1.95
- Dual 4-input Expander \$1.40
- Dual 4-input Line Driver \$1.95
- Triple 3-input Nand Gate \$1.65
- Quad 2-input Nand Gate \$1.65
- Hex 1-input Nand Gate \$1.65

They're the lowest on the market today, because our E-line Series DTL is packaged in our low-cost Taiwan production facility.

The other surprising feature about our dual inline packages is the specially-designed ceramic base—an excellent heat dissipator. It enables us to guarantee the same levels of fan-out and noise immunity

over 0° to 75° C that are available in hermetically-sealed packages. Special packaging features include standard 100 mil center-to-center spacing between round kovar leads, and standard 300 mil spacing between lead ranks. Our E-line packages are easy to handle, automatically insertable, and designed for stand-off. They are also immune to chemical solvents used in cleaning the p. c. board.

And one last surprise, they're available now. IMMEDIATE DELIVERY.

Call for the name of your nearest distributor. **Philco Microelectronics Division Sales Offices:** 2920 San Ysidro Way, Santa Clara, California (408-245-2966) / 999 North Sepulveda, El Segundo, California (213-772-6226) / 594 Marrett Road, Lexington, Mass. (617-862-6000) / Benson Manor, Suite 114B, Washington Lane, Jenkintown, Pa. (215-885-0430) / 314 South Missouri Ave., Suite 212, Clearwater, Florida (813-446-0124) / 815 Connecticut Avenue, N. W., Washington, D. C. (202-965-0903).

Microelectronics Division
SANTA CLARA, CALIF. • LANSDALE, PA. • SPRING CITY, PA.

PHILCO
Ford Motor Company

New from Sprague!

ISOLAYER[★] DIFFERENTIAL AMPLIFIERS WITH DIELECTRIC ISOLATION



V_{BE} voltage differential down to 3 mV
Tight beta matching · Low capacitance

Low Silballeite TO-5 Case		UD-2118	UD-2119	UD-2120	UD-2121
BV _{CEO}		50V	50V	30V	30V
h _{FE}	(<i>at</i> 10 μ A)	80	80	40	40
	(<i>at</i> 1 mA)	150	150	100	100
V _{BE1} - V _{BE2}		3mV	5mV	3mV	5mV
Δ V _{BE1} - V _{BE2}		5 μ V/°C	10 μ V/°C	5 μ V/°C	10 μ V/°C
C _{ob}		2pF	2pF	2pF	2pF

Sprague Electric also makes a broad line of standard differential amplifiers, pairs, quads, and Darlington amplifiers

*trademark For complete information, write to Technical Literature Service, Sprague Electric Co., 35 Marshall St., North Adams, Mass. 01247

SPRAGUE COMPONENTS

- | | |
|-------------------------|-------------------------------|
| TRANSISTORS | PACKAGED COMPONENT ASSEMBLIES |
| CAPACITORS | FUNCTIONAL DIGITAL CIRCUITS |
| RESISTORS | MAGNETIC COMPONENTS |
| INTEGRATED CIRCUITS | PULSE TRANSFORMERS |
| THIN-FILM MICROCIRCUITS | CERAMIC-BASE PRINTED NETWORKS |
| INTERFERENCE FILTERS | PULSE-FORMING NETWORKS |
- 455-G124R1



'Sprague' and '©' are registered trademarks of the Sprague Electric Co.

People

year-old Donald A. Schon, who moved on to the nonprofit Organization for Social and Technical Innovation in Cambridge, Mass.

Small electronics companies, formed by groups of executives who left larger companies, dot the West Coast. As

the new companies grow, their own executives see opportunity beckoning and, in turn, depart to set up new companies. An example of this kind of proliferation could be Spectra-Physics, Inc., whose five founders left Varian Associates in 1961. Spectra-Physics thrived; it now employs about 200 people and expects \$4 million in sales this fiscal year. But three of its executives, joined by three others from still two more electronics companies, have departed to set up Coherent Radiation, Inc. They will, like Spectra-Physics make lasers. Unlike Spectra-Physics, they will make carbon-dioxide lasers.



The exodus from Spectra-Physics was led by marketing manager **Eugene L. Watson**. Watson, 38, says that he and his colleagues—James L. Hobart and Wayne S. Mefferd of Spectra-Physics, Robert J. Rorden and John Cullen of Varian, and Steven M. Jarrett of TRG, Inc., had been thinking of setting up their own company for some time. It was, he says, the emergence of the CO₂ laser that determined them to go ahead.

"This laser may be the breakthrough that will make laser welding really competitive with electron beam techniques," Watson says. "It can produce the highest average power of any radiant source that can be focused on a small spot; 1,000 watts, continuous wave, has already been achieved in the laboratory. It can vaporize any known material."

The company expects to introduce its first laser, priced at "under \$10,000," in the fall.



Power tube calculator, applications data— all free from MACHLETT



Use these aids—from Machlett—to make better tube selections, determine optimum cost-performance ratios and to cut operating costs.

- Power Tube Calculator provides a simplified method of calculating operating parameters of high power tubes.
- Applications bulletins provide valuable performance and operating data on high power triodes and tetrodes, UHF planar triodes, pulse modulator tubes, variable vacuum capacitors and others.
- Cathode Press, the Machlett technical journal, covers latest developments in power tubes and new installations.

For calculator, bulletins and free subscription to Cathode Press, send reader service card. Or write:
The Machlett Laboratories, Inc.,
Springdale (Stamford), Conn. 06879



THE MACHLETT LABORATORIES, INC.

A SUBSIDIARY OF RAYTHEON COMPANY

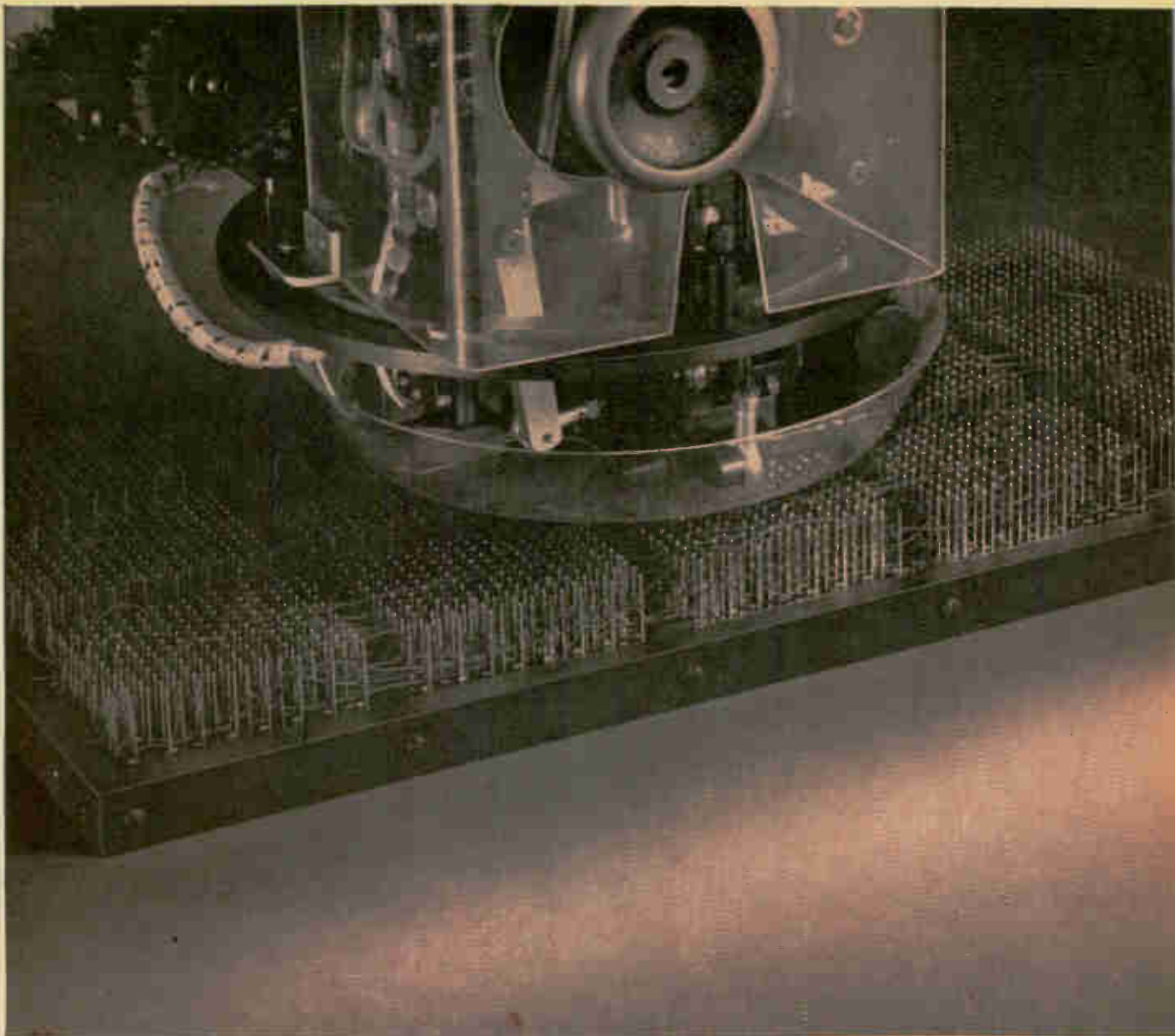

Everything you could ask for in production wiring ... **TERMI-POINT*** wiring devices

For dense point-to-point wiring applications TERMI-POINT tooling and products offer you an automatic, solderless, wrapless, weldless technique for wiring computer panels as well as industrial control and communications equipment.

This technique consists of a fine grain phosphor bronze clip which secures the wire firmly to a post, utilizing the spring "memory" of the metal clip. Wires can be bulk or pre-cut, solid or stranded—even enameled or tinsel! Best of all, the gas-tight, reliable connections may be serviced without electrically disturbing other connections on the same post using only lightweight hand tools! And the entire wire lead need not be replaced, just the clip, saving half the servicing time.

For automated production, you merely program the TERMI-POINT automatic wiring machine to suit your requirements. This remarkable machine routes wires in the pre-set programmed pattern and cuts, strips, and terminates both ends of the lead in seconds. Programs are punched on economical 8-column paper tape. In addition, several types of manual TERMI-POINT tools are available for servicing, testing or limited production. A variety of TERMI-POINT clips and post sizes are offered, including .022" x .036" posts which provide grid densities of .100". In fact, TERMI-POINT products are under development which would reduce this grid size even more.

The complete line of TERMI-POINT products includes printed circuit connectors, transition

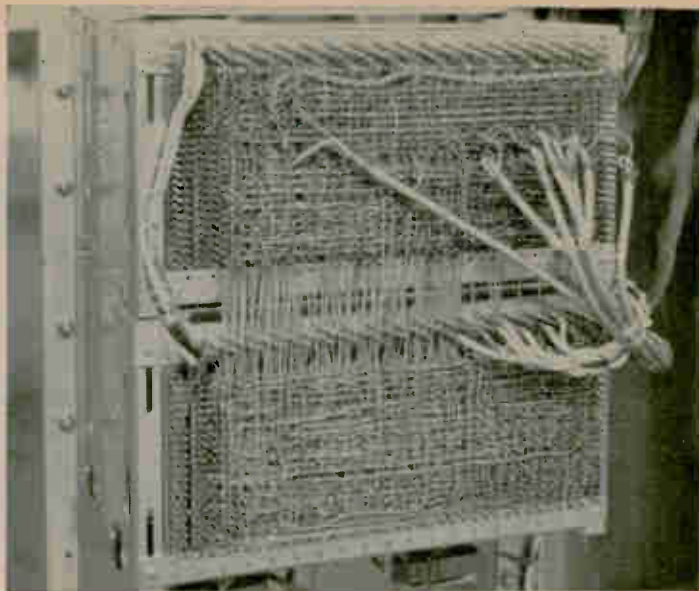

blocks, bus bars, cable connectors, junction blocks, relay blocks, and other devices. Furthermore, large-scale wiring of these products may be accomplished by mounting them on a panel and programming the TERMINAL-POINT machine for high-speed automatic wiring.

Besides the speed, density, and versatility of this wiring method, it offers an unusual degree of reliability. The reason for this is AMP's special post presents relatively large contact surfaces which are wiped clean by the wire held by the TERMINAL-POINT clip as the post is terminated. The resulting connection is highly resistant to the effects of corrosion, vibration, and temperature extremes. It is held with a high retention force which exceeds the yield strength of the wire itself, yet the post plating remains undamaged and the wire may be used again.

No other wiring method offers this combination of advantages!

With TERMINAL-POINT clips and tools, your wiring facilities will never become outdated, because unlike other automated methods, there is no

inherent limitation in density with TERMINAL-POINT wiring devices. In addition, AMP accepts total responsibility for the performance of the TERMINAL-POINT products, the technique and your completed terminations. You can save considerable time and capital investment by allowing us to wire your panels or circuit boards to your specifications.

If you plan to enlarge or improve your present wiring facilities, we suggest a comparative study of this new technique at your earliest convenience. Write or call today for a demonstration; or ask for information about the TERMINAL-POINT products which interest you most. Find out how this versatile new method can boost your future production!

*Trademark of AMP INCORPORATED

AMP
INCORPORATED
 Harrisburg, Pennsylvania

AMP's products and engineering assistance are available through subsidiary companies in: Australia • Canada • England • France • Holland • Italy • Japan • Mexico • Spain • West Germany



The shape of tomorrow, today

For more than 20 years, Ultra Carbon consistently has provided industry with advanced graphite technology. "F" purity graphite for the AEC . . . semiconductor crystal crucibles, boats, headers and fixtures made from *Ultra purity* graphite—these are typical of our past contributions to the electronic industries.

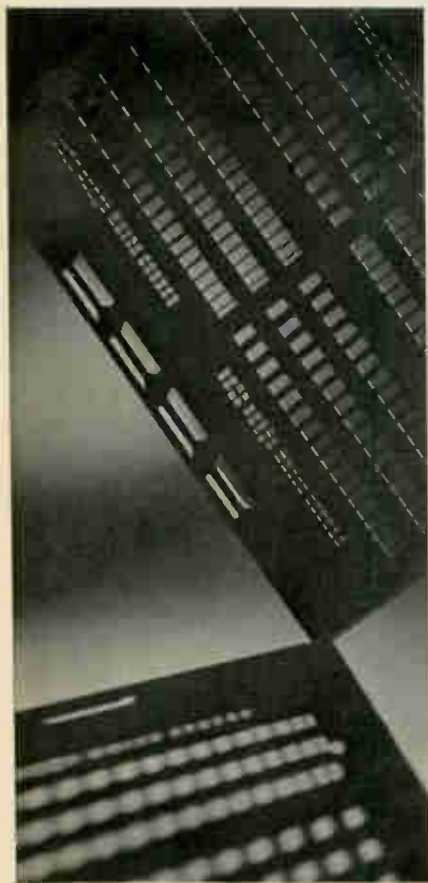

ULTRA/GRAPHITE photo masks, for processing thin film deposition circuits, are precisely machined. Write for information to Ultra Carbon Corporation, Box 747, Bay City, Mich. 48709.

Meetings

Electronics Materials Technical Conference, Metallurgical Society of the American Institute of Mining, Metallurgical and Petroleum Engineers; Sheraton Boston Hotel, Boston, Aug. 29-31.

International Conference on Instrumentation in Aerospace Simulation Facilities, Aerospace and Electronic Systems Group; Stanford University, Stanford, Calif., Aug. 29-31.

National Conference of the Association for Computing Machinery, Association for Computing Machinery; Washington Hilton Hotel, Washington, D.C., Aug. 29-31.

Ocean Electronics Symposium, IEEE; Ilikai Hotel Convention Hall, Honolulu, Hawaii, Aug. 29-31.

Technical Conference on Preparation and Properties of Electronic Materials for the Control of Radiative Processes Metallurgical Society and the Boston Section, American Institute of Mining, Metallurgical and Petroleum Engineers, Inc.; Sheraton-Boston Hotel, Boston, Mass., Aug. 29-31.

Swiss Electronics Television, Radio and Phonograph Exhibition; Exhibition Grounds of the Zuspä, Zurich, Aug. 31-Sept. 5.

General Assembly of the International Scientific Radio Union; Munich, Sept. 1-15.

National Radio and Television and International Electric Components Exhibition; Milan, Sept. 3-11.

International Conference on Semiconductor Physics; Tokyo, Sept. 5-9.

International Congress of Biophysics, International Organization for Pure and Applied Biophysics; Vienna, Austria, Sept. 5-9.

International Nuclear Industries Fair and Technical Meetings, Swiss Industries Fair; Basel, Switzerland, Sept. 8-14.

High Energy Physics Instrumentation Conference, Linear Accelerator Center of Stanford University, Stanford, Calif., Sept. 9-10.

International Conference on Microwave and Optical Generation, Institute of Electrical Engineers and the Institute of Electronic and Radio Engineers, Cambridge, England, Sept. 12-16.

Symposium on Power Semiconductor Technology, University of Missouri, Columbia, Mo., Sept. 15-16.

Joint Engineering Management Conference, American Institute of

Industrial Engineers, American Society of Mechanical Engineers, American Society of Civil Engineers, IEEE; Statler Hilton, Washington, Sept. 26-27.

Inter-society Energy Conversion Engineering Conference, American Institute of Aeronautics and Astronautics, Society of Automotive Engineers, American Institute of Chemical Engineers, IEEE, American Nuclear Society, American Society of Mechanical Engineers and the Solar Energy Society; International Hotel, Los Angeles, Sept. 26-28.

Reinforced Plastics Conference, Society of Plastics Engineers; Sheraton-Cleveland Hotel, Cleveland, Sept. 29-30.

Conference on Electrical Insulation, National Academy of Sciences, National Research Council; Pocono Manor Inn, Pocono Manor, Pa., Oct. 1-3

Aerospace and Electronic Systems Convention, IEEE; Washington, Oct. 3-5*

Industry and General Applications Group Meeting, IEEE; Conrad Hilton Hotel, Chicago, Oct. 3-6.

National Electronics Conference, IEEE, Illinois Institute of Technology, University of Illinois; McCormick Place, Chicago, Oct. 3-5.

International Exhibition on Modern Electronics, Yugoslav Committee for Electronics, Telecommunications, Automation and Nucleonics; to be held at the Ljubljana Fair, Yugoslavia, Oct. 4-9.

Allerton Conference on Circuit and System Theory, IEEE, University of Illinois; Conference Center of University of Illinois, Monticello, Ill., Oct. 5-7.

Call for papers

International Solid State Circuits Conference, sponsored by IEEE and University of Pennsylvania at the Sheraton Hotel, Philadelphia, Feb. 15-17. Oct. 17 is deadline for submitting papers to Virgil I. Johannes, Room 3E-323, Bell Telephone Laboratories, Holmdel, N. J.

Spring Joint Computer Conference, the American Federation of Information Processing Societies; Atlantic City, N. J., April 18-20. Nov. 1 is deadline for submitting papers to M.P. Chinitz, 326 Township Line Road, Norristown, Pa. 19403.

* Meeting preview on page 16

NEW MICROTRANSFORMERS AND MICRO-INDUCTORS

MIL-Spec Reliability, Laminated-Core Efficiency in a 1/4-inch Cube!

Now — microtransformers and micro-inductors created especially for tight, hi-rel military/aerospace environments. The new Bourns Models 4210 and 4220 exceed the environmental requirements of MIL-T-27B and the transformer-reliability specifications of MIL-T-39013!

In performance, too, these models hit new highs. They are the only units to give you the efficiency of laminated-core construction. At 1000 cps the insertion loss is less than 3db. In high-frequency operation, the model 4210 is dramatically superior to the smallest solid-core units available. In square-wave operation, droop is as low as 5%, overshoot as low as 10% and rise time as little as 100 nanoseconds. In every performance category, Models 4210 and 4220 give you the industry's highest ratio of performance to size.

Like Bourns potentiometers, the 4210 and 4220 are subjected to the intensive testing of the exclusive Bourns Reliability Assurance Program. The big "B" on the cover means there's a full measure of reliability in the package.

We specialize in winding custom microtransformers and micro-

inductors to meet your exact requirements, and we substantiate performance in our qualified test laboratory. Write today for complete technical data!

Standard Specifications, Model 4210 and 4220

Size: .25" x .25" x .25"
 Maximum operating temp.: +130°C
 Frequency response: -2db, 400 cps to 250 kcps (Model 4210)
 Power rating: 1 watt at 10KC (Model 4210)
 Insertion loss: 3db max. (Model 4210)
 Primary impedance range: 100Ω to 200KΩ
 Secondary impedance range: 3.2Ω to 10KΩ (Model 4210)
 Turns ratios: to 15:1 (Model 4210)
 Inductance range: .08 to 66 Hy (Model 4220)
 MIL-Specs: designed to exceed MIL-T-27B and MIL-T-39013

Units shown actual size

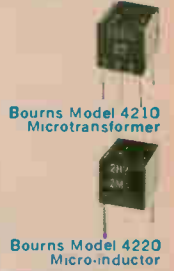

Standard Models available from stock!

Precision-assembled laminated core. Cement is applied across edges of laminations and cured while core is in assembly press.

High-temperature plastic bobbin for outstanding dimensional stability under temperature extremes.

Printed circuit pins of gold-plated nickel (MIL-STD-1276 type N), molded securely into header.

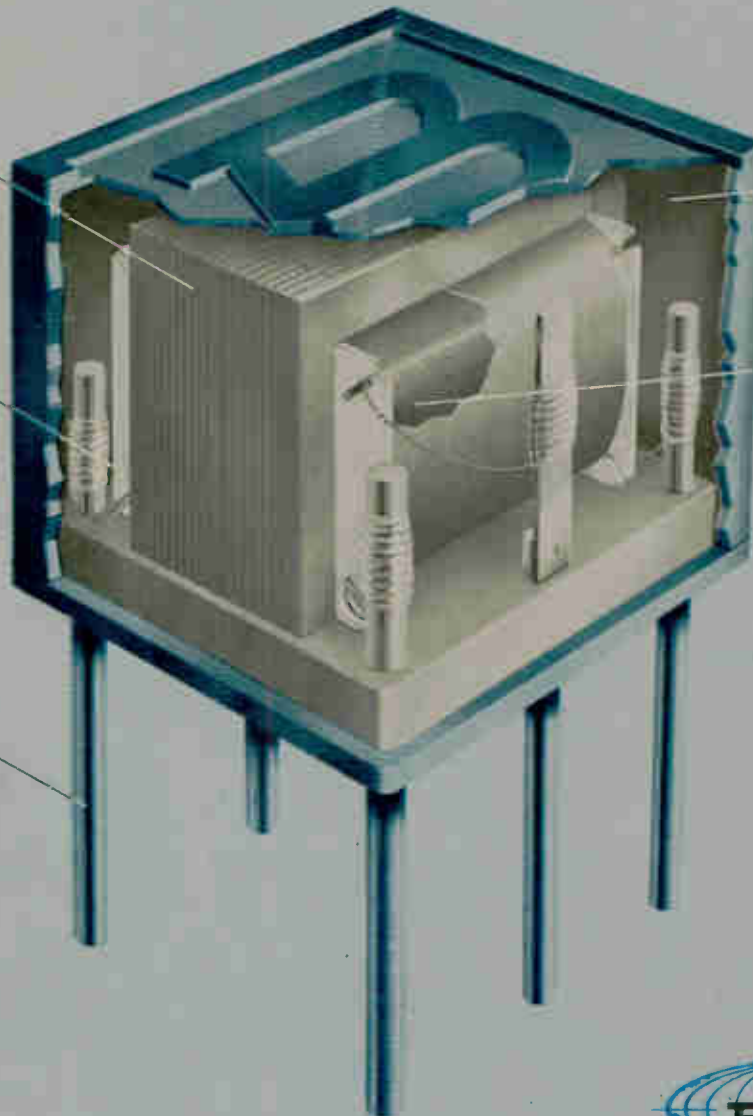

Double encapsulation. Assembly is first buffer-coated with compound which remains viscous at high temperatures and protects wires from mechanical stress during temperature change. After buffer coating is cured, cover is mounted and cavity is filled.

Superior coils—the result of 20 years of precision wire-winding experience. Coils are produced on Bourns' own winding machines.



BOURNS INC TRIMPOT DIVISION
 1200 COLUMBIA AVE RIVERSIDE CALIF
 PHONE 684 1700 TWX 714 682 9582
 CABLE BOURNSINC



...Psst, Go Cartridge!

(for tangle-free tape recording)

PUTTING THE TAPE IN A CARTRIDGE untangles more problems than you might suspect. For example, the tape recorder/reproducer doesn't need reel motors or brakes, therefore the tension arms, tape guides and springs also are gone. Eliminate half the recorder's moving parts and you have eliminated half the maintenance woes. Since there are no reels to wind or unwind, tape tension is held to several ounces instead of pounds, resulting in extended tape life (over 35,000 passes) and longer wearing magnetic heads which require less frequent cleaning.

TAKE THE D/C-1, here's a complete instrumentation, 4-channel, 1/4-inch tape recorder with FM and DIRECT electronics, that uses NAB cartridges. The cartridges can store tape loops from 12 inches to 1700 feet in length. Four speeds (1 1/2, 3 3/4, 7 1/2 and 15 ips) plus Fast Forward lets you record and reproduce short loops for analysis work, or, with full loops, continuously monitor transducers to capture random events.

PERFORMANCE with the D/C-1 is generally superior to equivalent reel-to-reel instruments. The capstan drive circuitry is servo controlled to better than 0.1%. Signal-to-noise ratio is at least 43 db for 7 1/2 ips FM operation. 2- or 4-track IRIG heads are available and various options such as End-of-Tape sensing, Erase heads, special input-output configurations or the D/C-11 Rack Mounted versions are available.

PRICED AT APPROXIMATELY \$2300 for a complete 4-channel system with record and reproduce electronics included, the D/C-1 is perfectly suited for applications where reliability, simplicity of operation, and full performance are mandatory. If your requirements are less stringent, and your bank account is bulging, buy a reel-to-reel machine. If you want the most in value, buy a DATA/CARTRIDGE recorder.

For specification and price sheets, write:

DATA/CARTRIDGE

DATA/CARTRIDGE INC.
161 Constitution Drive
Menlo Park, Calif. 94025
Phone: (415) 323-9880



Meeting preview

Military and aerospace

Engineers working in military, space and aerospace electronics will hold their first joint convention Oct. 3 to 5 in Washington. The meeting, called the Aerospace and Electronics System Convention, will replace the annual Military Electronics Convention.

The sponsors are four professional groups of the Institute of Electrical and Electronics Engineers—space electronics and telemetry, aerospace and navigation electronics, military electronics and aerospace systems.

Space power. The 90 technical papers will touch on a wide variety of subjects. In a session on spacecraft power supplies, C.M. MacKenzie of the National Aeronautics and Space Administration and R.C. Greenblatt and A.S. Cherdak, both of the Radio Corp. of America, will discuss a method of obtaining the most efficient transfer of power from solar cells to batteries.

In a paper on measuring the magnitude and direction of magnetic fields on the surfaces of spacecraft, B.W. Sherman and D.L. Waidelich of the University of Missouri will describe several experimental techniques; the most promising is the Stark effect, the splitting of spectral lines in a strong electric field. This method has detected fields smaller than 100 volts per centimeter.

Buying policy. One panel discussion will explore the Government's procurement policies and practices.

Another panel will discuss the impact of microelectronics on system design. Topics to be emphasized are the relationship of component reliability to system reliability, the advantages of redundancy and the interfaces between microcircuits and system hardware. A third panel will explore the present requirements and future needs of military command and control systems.

Another session will be devoted to the Federal Aviation Agency's research work. There will also be reports on the progress of the national airspace system and on an advanced system for radar traffic control at air terminals.

One-girl Line



When you get a Hewlett-Packard 3439A or 3440A DVM, it doesn't come off an assembly line. Each one is assembled by one person, from start to finish. That's one reason they are the most reliable DVM's you can buy. ■ When people have complete responsibility for a job, they take more pride in their work. And they make fewer mistakes. The workmanship is superior, and it has to be: Every DVM goes through a battery of tests and inspections that are guaranteed to show up any defects. ■ That testing includes an all-night cycling of every DVM and plug-in at 50°C. The next day it's checked again. If any trouble shows up, it's fixed, and the testing starts all over. ■ We take a lot of trouble with your voltmeters. That's why you have so little trouble with them. ■ By the time it leaves

our plant, we have enough faith in your 3439A, or your 3440A, that we're not afraid to back it up with a one-year guarantee. It's supported by service centers located all over the country. Nobody else backs his guarantee like that. But then nobody else makes a DVM the way we do. ■ With our kind of assembly line, we're not afraid to lay it on the line. ■ The 3439A. Solid state. 4-digit readout. Manual, automatic and remote ranging. Extra-high sensitivity. Ac/dc voltage/current resistance measurements (dc accuracy better than 0.05% of reading ± 1 digit). Price, \$950. The 3440A has BCD output. Price, \$1160. Plug-ins, \$40 to \$575.



*Data subject to change without notice.
Prices f.o.b. factory.*

HEWLETT  **PACKARD**
An extra measure of quality

Mention silicon Bendix throws book at you.

A 25-watt plastic silicon transistor for under 40¢

It's loaded with silicon power transistors. Like our new 25-watt B-5000 that sells for under 40¢ in volume. Like our nuclear radiation devices. Like our silicon mesas, best-built and lowest priced in the business. And hundreds of other Bendix units available to meet your silicon needs exactly.

Take the new sensational low-cost B-5000 with 500,000 unit hours of successful life testing behind it. 25 watts at 2.5 amps, 10 volts and 100°C. It's a real breakthrough. No power compromise on normal heat sinks. Outstanding hermeticity. And you name the mounting that suits your production methods best—several

established mounting techniques are available.

Characteristic	B-5000 ELECTRICAL SPECIFICATIONS							
	Limits			Test Conditions				
	Min.	Max.	Unit	V _{CB} V	V _{CE} V	I _C A	I _B mA	T _J °C
V _{CEO}	35	—	V	—	—	0.2	—	—
I _{CEO}	—	10	mA	—	25	—	—	—
I _{CB0}	—	1.5	mA	14	—	—	—	150
V _{BE}	—	1.2	V	—	14	0.5	—	—
h _{FE}	30	250	—	—	14	0.5	—	—
h _{FE} (s)	20	—	—	—	14	1.0	—	—
V _{CE(s)}	—	1.2	V	—	—	1.0	50	—

Or read all about our radiation-resistant 5- and 10-amp silicon transistors. With base transit times reduced to a

maximum of less than 0.5 nanoseconds at 1 amp collector current, they're great for use in advanced circuits hardened for nuclear radiation environments. Six packages to choose from, too.

RADIATION TYPES									
Max Radiation Level Exposure = 5×10^{11} NVT									
Symbol	Type	Pre Rad Limit			Post Rad Limit				
		Min	Typ	Max	Min	Typ	Max		
V _{CEO}	BR100 BR101	40 75	50 —	— —	40 75	— —	V V	I _{CEO} = 50 mA	
h _{FE}	BR100 BR101	40 30	100 —	200 150	15 7	25 10	— —	I _C = 3 A V _{CE} = 5 V	
V _{CE(s)}	BR100 BR101	— —	0.5 0.5	1.0 1.0	— —	1.5 2.0	2.0 3.0	V V	I _C = 3 A I _B = 0.3 A

Or check the chapters on our regular 3-, 5-, and 10-amp units.

Bendix Semiconductor Division
HOLMDEL, NEW JERSEY



power and the



is just the beginning.

3 AMP TYPES

VCEO=40 V to 60 V VCB0=80 V to 100 V
Pc=5 W to 7.5 W
VCE(s)=0.32 V Typ at IC=1 A, IB=100 mA
Switching Types: t on < 35 ns
t off < 75 ns at IC=1.5 A, IB=150 mA
Amplifier Types: Po>4.5 W at f=50 MHz, VCC=28 V,
Pin=0.5 W

5 AMP TYPES

VCEO=40 V to 80 V VCB0=50 V to 90 V
VCE(s)=0.4 V Typ at IC=3 A, IB=0.3 A Pc=5 W
Switching Types: t on < 40 ns
t off < 300 ns at IC=3 A, IB=0.3 A
Amplifier Types: Po>8 W at f=50 MHz, VCC=30 V,
Pin=1 W

10 AMP TYPES

VCEO=40 V to 80 V VCB0=50 V to 90 V
VCE(s)=0.7 V Typ at IC=5 A, IB=0.5 A Pc=25 W
Switching Types: t on < 40 ns
t off < 300 ns at IC=3 A, IB=0.3 A
Amplifier Types: Po>25 W at f=50 MHz, VCC=30 V,
Pin=5 W

Or review the pages on our silicon mesas. Our SOAR (Safe Operating Area) specified 2N3055 and its sister types are a natural for high power switching and amplifier applications. As well as our new B-170000 series.

2N3055

VCBO = 100 V VCEO = 60 V
IC = 15 A Ppeak = 900 W
VCE(s) = 0.4 V Typ at IC = 4 A, IB = 0.4 A
tr = 5 μs Typ
tf = 1 μs Typ at IC = 7.5 A

B-170000 SERIES

VCEO = 40 V to 100 V IC = 6 A to 15 A
IB = 3 A to 7 A Ppeak to 1200 W

AMPLIFIER TYPES

fhfe = 20 kc Typ at IC = 1 A, VCE = 10 V
VBE = 1.2 V max
hFE = 20 to 120 at IC = 500 mA, VCE = 4 V

REGULATOR TYPES

VCE(s) = 0.7 V Typ at IC = 5 A, IB = 0.5 A
hFE = 12 min at IC = 5 A, VCE = 4 V

SWITCHING TYPES

tr = 6 μs Typ
ts = 0.4 μs Typ
tf = 1 μs Typ at IC = 5 A, IB = 0.5 A

Or take the 300 different silicon power rectifiers in the rugged JEDEC DO-4 package.

TYPES MEETING MIL SPEC	AT 150°C	
	Io AMPS	PRV VOLTS
USN1N124A,26A,28A	1	200-600
USAF1N1199-1206	12	50-600
JAN1N1202,R,04,R,06,R	12	200-600
JAN1N1614,R-16,R	5	240-720
JAN1N4458,R,59,R	5	950, 1200

It's this kind of reading material that's going to make Bendix a best seller. Why don't you throw your silicon power applications at us now? Or our nearest sales office.

See us at Wescon, Booth 1651, The Sports Arena.

Baltimore (Towson), Md.—(301) 828-6877; Chicago—(312) 637-6929; Dallas—(214) 357-1972; Detroit—(313) Jordan 6-1420; Holmdel, N. J.—(201) 946-9400; Los Angeles—(213) 776-4100; Miami Springs, Fla.—(305) 887-5521; Minneapolis—(612) 926-4633; Redwood City, Calif.—James S. Heaton Co., (415) 369-4671; Seattle—Ray Johnston Co., Inc., (206) LA 4-5170; Syracuse, N. Y.—(315) 474-7531; Waltham, Mass.—(617) 899-0770; Export—(212) 973-2121, Cable: "Bendixint," 605 Third Avenue, New York; Ottawa, Ont.—Computing Devices of Canada P.O. Box 508—(613) TALbot 8-2711.

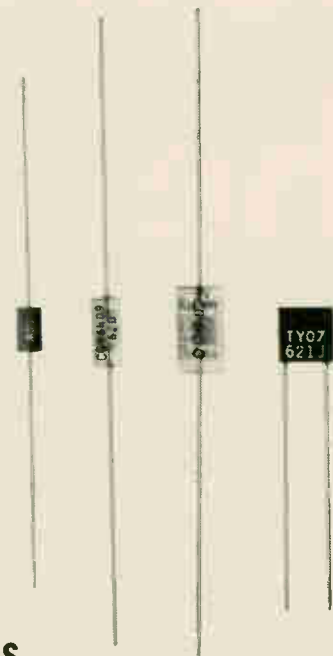

from .5 to 100,000 *pf*, nothing's as stable as glass

Boil, freeze, bury, drown or irradiate glass, and you won't measure any dielectric change.

Freeze a capacitive element inside that glass, and it's as immune as any capacitor can get to environment, temperature, time, voltage, moisture, frequency, vibration, shock.

That's why nothing comes closer to being a perfect circuit symbol than a CORNING® glass capacitor. And only Corning makes the glass capacitors to meet all these critical circuit needs:

High capacitance in small space. The CORNING® GLASS-K capacitor crams from 1,000 to 100,000 pf in a quarter-inch case size.

Dense circuitry, without doubts. The CORNING® TYO capacitor, from 1 to 2700 pf, has radial leads, precision case for snug up-right mounting.

Documented stability and reliability. Every CORNING® CYFR capacitor, from .5 to 10,000 pf, meets our punishing J-950 specification, and is backed by a heritage that includes use in Surveyor, Minuteman, Gemini, among others.

Low cost, high reliability. The CORNING® CYFM capacitor, from .5 to 10,000 pf, gives you CYFR-type environment-proof performance at substantial savings.

Why risk an entire system on capacitors that can't give you the assurance of Corning dielectric stability? Send for the new CORNING® GLASS CAPACITOR GUIDE to Corning Glass Works, 3913 Electronics Dr., Raleigh, N.C.



CORNING
E L E C T R O N I C S

IN HIGH POWER MODULES



MAKES THE DIFFERENCE!

MORE OUTPUT WATTS PER POUND PER DOLLAR... PER CUBIC INCH!

- Wide coverage of fixed output voltages from 4.5V dual to 120V single
- Kepeco patented Flux-O-Tran® provides line regulation and current limiting
- -20°C to +55°C ambient operating temperature
- Highly reliable MTBF > 140,000 hours
- Convection cooling
- Short circuit proof
- All silicon rectifiers
- Dual output and extra filtered models
- Versatile mounting (cased and uncased)
Rack adapters available to mount 1 to 5 units

Applicable Patent Nos. furnished on request

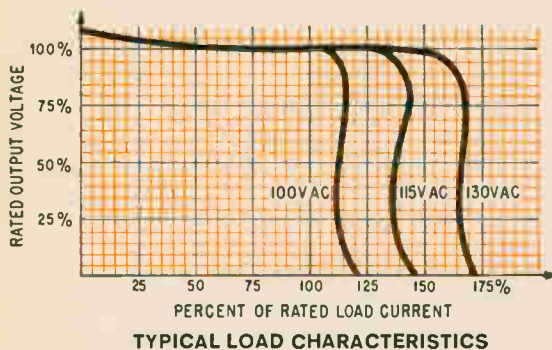

NEW 52 PAGE CATALOG
CONTAINING COMPLETE
SPECIFICATIONS AND
APPLICATIONS NOTES
IS NOW AVAILABLE

WRITE FOR YOUR
FREE COPY!

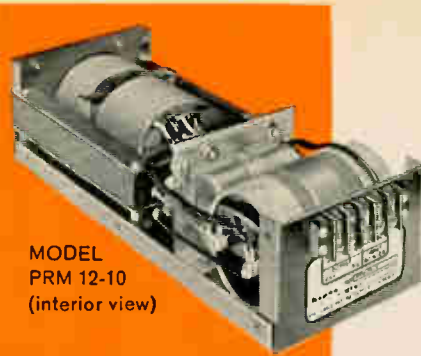

MODEL
PRM 12-10
(interior view)

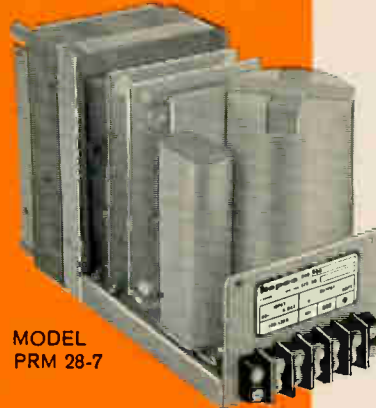

MODEL
PRM 28-7

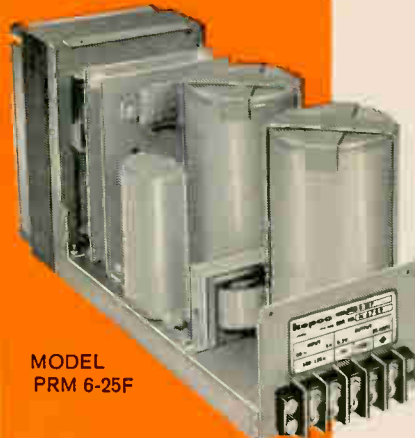

MODEL
PRM 6-25F



MODEL
PRM 2X48-3



SIZE "B" — 120 SERIES
CASED UNIT — \$99.00**
3 1/2" H x 5" W x 1 3/8" D

MODEL	DC OUTPUT	
	VOLTS	AMPS
PRM 6-15	6.3	0-15
PRM 12-10	12	0-10
PRM 18-6.7	18	0-6.7
PRM 24-5	24	0-5
PRM 28-4.3	28	0-4.3
PRM 36-3.3	36	0-3.3
PRM 48-2.5	48	0-2.5
PRM 60-2	60	0-2
PRM 120-1	120	0-1

**Available cased only

SIZE "A" — 180 SERIES
UNCASED UNIT — \$119.00*
6 3/4" H x 4 3/4" W x 10 3/8" D

PRM 6-25	6.3	0-25
PRM 12-15	12	0-15
PRM 18-10	18	0-10
PRM 24-8	24	0-8
PRM 28-7	28	0-7
PRM 36-5	36	0-5
PRM 48-4	48	0-4
PRM 60-3	60	0-3
PRM 120-1.5	120	0-1.5

EXTRA FILTERED MODELS
SIZE "C" — 180F SERIES
UNCASED UNIT — \$169.00*
6 3/4" H x 4 3/4" W x 14 3/8" D

PRM 6-25F	6.3	0-25
PRM 12-15F	12	0-15
PRM 18-10F	18	0-10
PRM 24-8F	24	0-8
PRM 28-7F	28	0-7
PRM 36-5F	36	0-5
PRM 48-4F	48	0-4
PRM 60-3F	60	0-3
PRM 120-1.5F	120	0-1.5

DUAL OUTPUT MODELS
SIZE "C" — 300 SERIES
UNCASED UNIT — \$179.00*
6 3/4" H x 4 3/4" W x 14 3/8" D

PRM 2X 4.5-20	4.5	0-20
PRM 2X 6-20	6.3	0-20
PRM 2X 12-12	12	0-12
PRM 2X 15-10	15	0-10
PRM 2X 18-8	18	0-8
PRM 2X 24-6	24	0-6
PRM 2X 28-5	28	0-5
PRM 2X 36-4	36	0-4
PRM 2X 48-3	48	0-3
PRM 2X 60-2.5	60	0-2.5

*Case optional — add \$10.00 to price

 Editorial

The high cost of insularity

Many electronics firms will remember 1966 as the year with the long, hot summer. In addition to some sizzling weather, many companies found themselves in uncommonly deep hot water because their equipment or systems did not work as well as predicted.

Third generation computers have been coming on line a lot slower and working not nearly as well as expected at many installations [p. 149]. In New York City, a plan to control traffic electronically has stalled as a result of equipment design problems [p. 37]. And in Los Angeles, a computer maker is trying to sell a large hybrid machine that the National Aeronautics and Space Administration refused to accept when development problems delayed delivery for a year [p. 38].

Trouble like this is the side of engineering most companies don't want to talk about. Yet it can produce the most valuable kind of information if somebody analyzes what went wrong and then corrects it. There's an old saw that goes: "People learn more when things go wrong than when they go right."

Government agencies are notoriously guilty of trying to cover up an engineering failure as if it were a stigma. NASA, despite its legal commitment to make technical information public, is the worst offender. It has illegally classified almost everything that has gone wrong. Curtains of secrecy shrouded projects such as the ill-fated Ranger flights of a few years ago and the S-2 second stage of Saturn 5, which blew up at the Mississippi test facility. When the Houston space facility refused to accept a \$1.4-million hybrid computer, the bureaucrats imposed a steely silence on the matter. What the politicians in such agencies cannot comprehend is that an engineering failure might have a technical cause and not be caused by agency incompetence, shaky procurement practices or just plain illegal conduct.

Troubles like those mentioned earlier can be traced in part to a common technical cause: the mushrooming complexity of systems. Discussing his company's troubles with third generation computers, an IBM executive said frankly, "We underestimated the complexity of taking this step."

In electronics these days, technology is moving so fast that the people working with it sometimes lose sight of just how fast they are advancing and what a giant step forward will mean. As the system gets more complex, a small deficiency in one part can be multiplied and transmitted throughout, wrecking the entire design concept. In the less complex arrangements of the past a similar deficiency could have been entirely ignored and forgotten.

Increasing complexity puts an added burden on the engineer. He can't concern himself solely with his circuit or his portion of the system. He has to worry not only about how his portion will perform but how it will mate with the rest of the equipment and the system.

Two new areas of concern are opening up: compatibility and reliability. Although the military has forced the industry to talk about reliability, a large portion of the effort has been devoted to measuring it after the fact, through variables such as mean-time-between failures. Not enough people recognize that reliability starts in the engineering phase with the design. Engineers need to know more about what causes failures and where they start.

Compatibility is a more frustrating problem because the failure is much harder to trace. A subsystem might work perfectly when tested alone but not work at all when put into a system. In addition, nobody is willing to take the responsibility for causing the trouble and it's easy to put the blame on somebody else or some other piece of equipment.

If cataclysmic troubles with complex systems are to be avoided, the old attitudes toward compatibility and reliability will have to be dropped. An engineer has to take responsibility not only for how his design performs but also how well it matches up. Suppliers too will have to accept additional responsibility for their products.

NOW!

Solid State Time Delay Relays for as little as

\$17⁵⁰

(P&B QUALITY, OF COURSE)

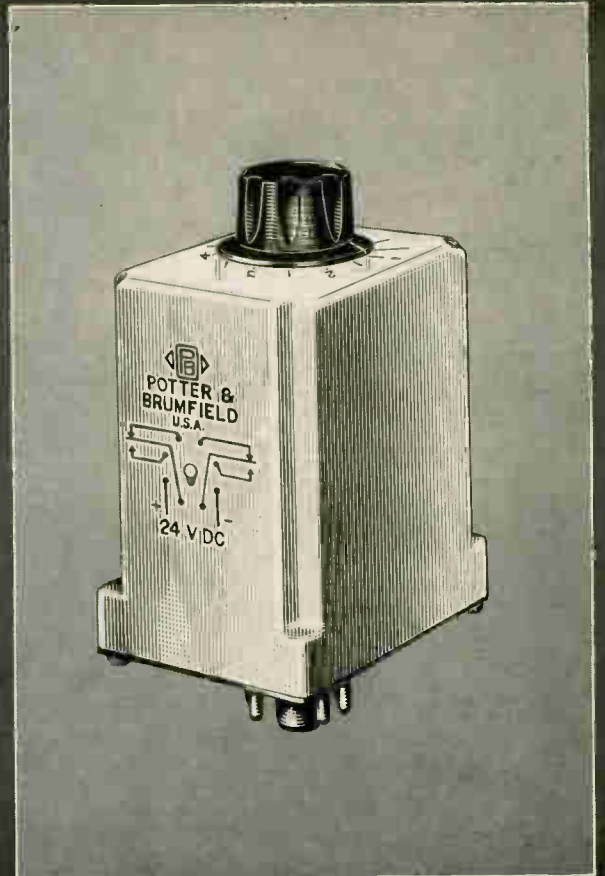

why pay for operating characteristics you don't need?

Here is a practical cost-saving answer to many timing applications which do not require the extreme precision of much more expensive relays. CH Series solid state time delay relays are quality-built to perform dependably in most industrial applications. Where more critical parameters are required, we recommend our CD Series.

SAVE UP TO 60%—You can save up to 60% of your time delay relay costs with our new CH Series. Adjustable or fixed models are available with delays on operate or release as well as “interval on”.

ACCURACY $\pm 10\%$ —Accuracy is $\pm 10\%$ over the -10° to 55°C temperature range for adjustable time delays. Fixed delays have an accuracy of $\pm 5\%$ at 25°C ambient temperature. Reset time is 100 milliseconds.

INTERNAL RELAY RATED 10 AMPERES—An internally-mounted DPDT relay is rated at 10 amperes, 115 VAC, resistive. Both AC and DC models are available and all come in a white nylon case with octal plug. CH relays for DC operation have an internal protection against damage by reversal of input polarity. Relays will not operate falsely nor be damaged by a transient input voltage having a magnitude up to twice rated input voltage and a duration of eight milliseconds.

Write for the complete catalog of P&B Time Delay Relays. You can get CH Series relays from your local electronic parts distributor.

SPECIFICATIONS CH and CD Series Comparison

	CH SERIES	CD SERIES
Dial Setting	Reference scale	Time-calibrated $\pm 5\%$ of full scale
Temperature Range	-10°C to $+55^\circ\text{C}$	-40°C to $+55^\circ\text{C}$
Accuracy Over Temperature and Voltage Range	$\pm 10\%$ of nominal	$\pm 5\%$ of nominal
Transient Protection	Twice rated input voltage for 8 milliseconds	Tested to 1000V— $\frac{1}{2}$ cycle surges (on all 115V AC models)
Inherent False Operation	Contacts may transfer momentarily if timing interval is interrupted	None
Reset Time	100 milliseconds	60 milliseconds
Repeatability	$\pm 2\%$	$\pm 1\%$
Polarity Reversal Protection (on DC)	Yes	Yes



POTTER & BRUMFIELD

Division of American Machine & Foundry Co., Princeton, Ind.
Export: AMF International, 261 Madison Ave., New York, N.Y.

Electronics Newsletter

August 22, 1966

GT&E researchers develop inorganic liquid laser

A room-temperature liquid laser, the first to use an inorganic compound, has been developed by the same laboratory that first developed an organic liquid laser. The work, performed at the General Telephone and Electronics Corp.'s Bayside, N.Y., laboratories, is significant because the lasing material (neodymium oxide dissolved in selenium oxychloride) is inexpensive and easy to make and not subject to breakdown when pumped at high power. In addition, the laser tube can be made in nearly any shape or size.

In early experiments, the GT&E scientists, Adam Heller and Alexander Lempicki, have easily achieved 1-joule pulsed operation from the laser, although they believe it can soon reach very high continuous-wave output. The researchers say that in some modes the laser's gain is so high that it is possible to produce laser action without the usual end mirrors. Output is in the invisible infrared region—1.06 microns.

The research team predicts that, because heat can be dissipated easily, the liquid laser can eventually reach higher outputs than crystalline lasers. Heller and Lempicki say they are planning to circulate the liquid in the tube during lasing action; this, they believe, will dissipate the heat built up in the system even faster, making higher outputs possible. Other liquid compounds are also being investigated.

NASA schedules Apollo guidance flight test

The first flight test of the inertial guidance system that will eventually guide American astronauts to the moon is planned for the Apollo/Uprated Saturn-1 202 mission scheduled later this month at Cape Kennedy. The system is nearly identical to the one that will be in the first manned Apollo mission. The feat may come as early as Nov. 17. The ballistic flight of 202 will take about an hour and a half as the spacecraft travels two-thirds around the globe, splashing down near Wake Island in the Pacific.

The space agency's manned flight chief, George Mueller, warned, meanwhile, that this month's 202 launch may not be the last before the design is considered ready. He also saw little chance of reaching the moon by early 1968.

First all-IC numerical control ready for market

The first numerical control for a three-axis contouring machine built exclusively with integrated circuits will be introduced in a few weeks by the Cincinnati Milling Machine Co. Within the past year other producers have developed numerical control for point-to-point machines with only some components replaced with IC's. Cincinnati Milling claims that its equipment has been tested under production conditions for more than a year without a failure.

BARTD ponders high cost of sophistication

Though preliminary specifications for the train control and communications system have already been printed and bids are to be advertised on Aug. 30, the San Francisco Bay Area Rapid Transit District (BARTD) is still tinkering with requirements. BARTD is wondering if it might not have to pay too high a price for sophistication. Preliminary specifications, for instance, call for a train to stop within ± 1 foot. But general manager B.R. Stokes and chief engineer David G. Hammond returned from a

Electronics Newsletter

world tour early this month impressed with a relatively crude method being tested by the London Transport System, which makes do with a stopping tolerance of 7½ feet. BARTD has been considering other changes also.

Foam waveguide can carry power of a billion watts

Microwaves are a common communications medium, but they also have potential for power transmission. Two Stanford University researchers, Prof. Donald A. Dunn and graduate student Walter Loewenstern Jr., displayed last week a chunk of plastic foam waveguide suitable for transmitting a billion watts of microwave power. The foam is actually only a supporting element: the r-f energy is carried on a thin copper lining.

Dunn and Loewenstern pointed out that no devices exist yet to convert large currents to microwave energy at one end of the waveguide and back again at the other. Microwave tubes can produce about a million watts in the 8-gigahertz range. "Theoretically," Dunn says, "there is nothing to prevent a large boost in the power of microwave tubes if lower frequencies are used."

Power would be transmitted in the TE₀₁ mode. To keep mode conversion losses low, the waveguide must be straight and round, with a tolerance of from 10 to 100 mils in a typical 4- to 6-foot diameter pipe. Bends would be possible if the radius of curvature were constant, and greater than a tenth of a mile.

The entire waveguide would be underground, and the foam's job would be to absorb vibrations (that would otherwise cause power losses) by converting the energy to high-loss modes.

A-c generator made of superconductors wrapped in plastic

A generator for space, nearing the prototype stage at a small company in Cambridge, Mass., underlines the progress being made toward use of superconductors for lightweight, compact electrical machinery. The a-c generator, being developed by the Dynatech Corp. with Air Force funds, is believed to be the first totally superconducting generator. Both the field coil and armature are made of niobium tin, a superconducting compound.

Since superconducting materials offer virtually zero resistance, they provide a high current-carrying capacity in a small volume.

In the Dynatech generator, a new plastic enclosure thermally and electrically isolates the armature from the iron flux path. The multiwall, vacuum-tight plastic enclosure was developed by the Hofman-Paul Cryogenic division of the Air Reduction Co. It functions like a dewar, but because it is plastic rather than metal, it permits the flux to reach the iron return path without generating eddy currents. And because the plastic is vacuum-tight, it preserves the thermal boundary between the iron return path and the armature, virtually eliminating heat transfer.

Sperry awards gyroscope contract to GM division

The Sperry Gyroscope division of the Sperry Rand Corp., one of the largest manufacturers of inertial guidance systems, has awarded a \$700,000 subcontract to General Motor Corp.'s AC Spark Plug division to build four prototype gyro systems for the Navy's Integrated Light Attack Avionics System (ILAAS). ILAAS program manager, Martin Astrow of Sperry, explained, "We looked throughout industry and felt that AC could best meet our time schedule and technical needs." Sperry will, however, build the standby gyro platforms under a \$400,000 initial contract.

Don't look at the price!



If the tag on your copy has been torn off, you'll find the price list for the basic unit plus autoranging and polarity option in the spec checklist inside. For specific questions, phone Non-Linear Systems, (714) 755-1134.

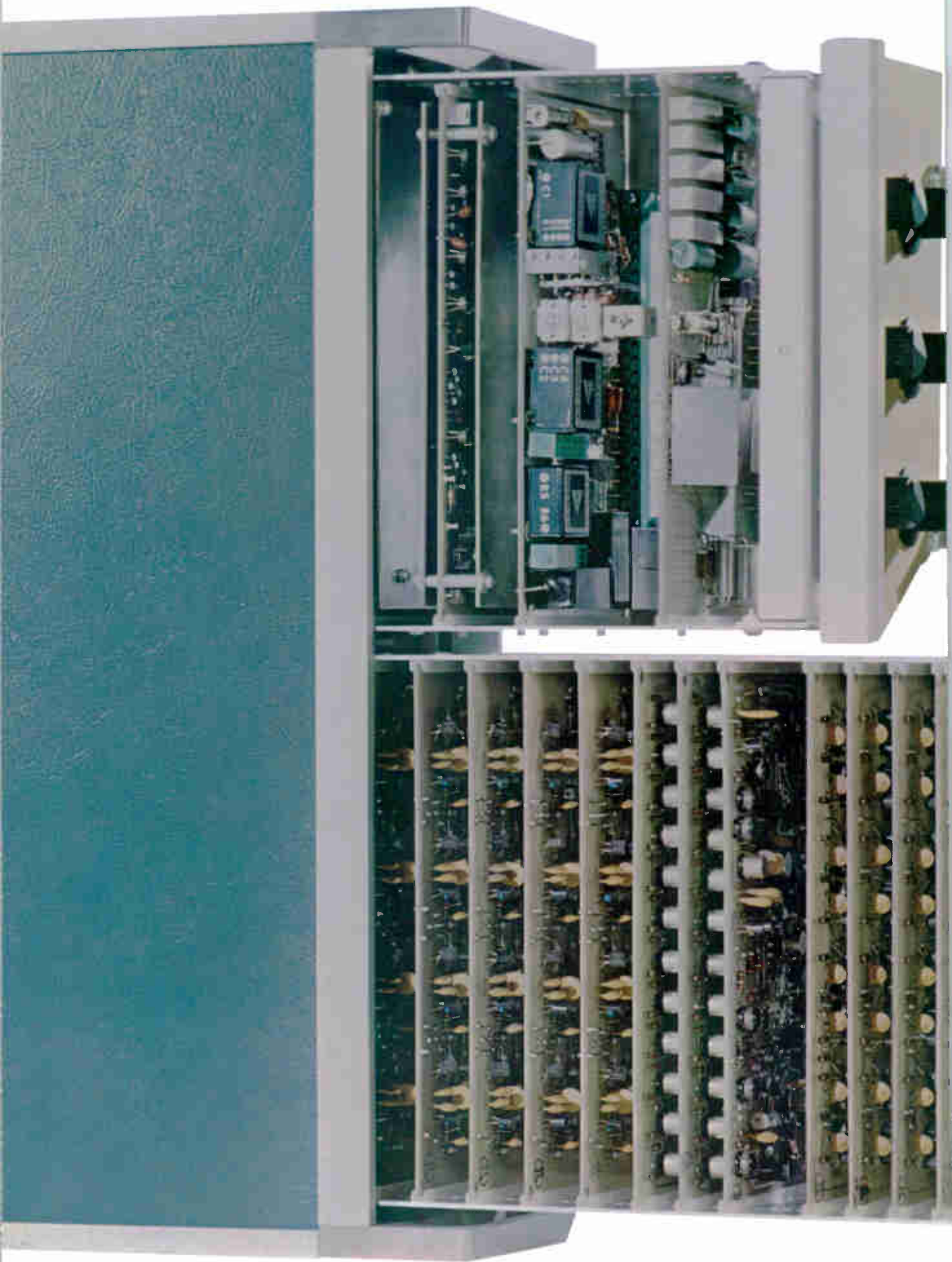



The **NLS X-1**: Latest in a history of firsts

NLS X-1 is the latest in a line of "firsts" dating back to 1952 when Andrew F. Kay designed and built the original digital voltmeter and founded Non-Linear Systems. The reputation for outstanding quality earned by these instruments is a result of specialization in digital voltmeters and associated equipment. Concentration of effort in one field has paid off with superior products for the user from the original digital voltmeter, serial number 1, to the X-1, the ultimate in precision instrumentation. A total of 58 man-years of digital voltmeter design experience went into its creation. While the NLS X-1 is the latest in a history of NLS "firsts," you can be sure it's not the last. Research goes on at Non-Linear Systems be-

cause the company is dedicated to maintaining its leadership in DVM development. You can look for the



Original DVM, serial number 1.

latest and the best at unbeatable prices from Non-Linear Systems, the company that pioneered the digital voltmeter.

Get full information on your NLS X-1

Tell us about your particular needs and let us show you how the NLS X-1 can do the job better than any other instrument in its price class. Fill out the attached card, or write directly to NLS, Dept. 800, Del Mar, Calif. 92014.



Originator of the Digital Voltmeter

non-linear systems, inc.

Del Mar, California Phone: (714) 755-1134

Design your own DVM

For years you've been using the "closest" solution to your measuring needs. Now you can get the exact instrument you require. Use any of these accessories available in the Fall, 1966 (and more later on) with the X-1:

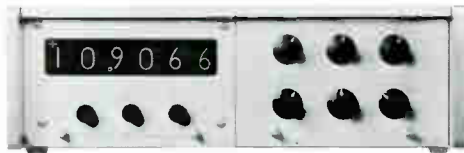

AC-DC converter:

Low cost 50 Hz to 10K Hz; High frequency 50 Hz to 100K Hz; AC reference units for AC ratio measurements.

Ohms converter:

Four range 1.19999 kilohms (including overage) to 1.19999 megohms converter; Extended range converter down to .119999 kilohms full scale and up to 11.9999 megohms full scale.

Preamp:

Low level measurements from 11.9999 millivolts full scale (including overrange) to 1199.99 millivolts full scale with automatic ranging and polarity.

Ratio:

Plug in cards for various configurations of ratio, i.e., $+/+$, $-/-$, $+/-$, and $-/+$ to give you maximum capability in this area.

Other Features

The many special features in the X-1 are based upon NLS's more than a decade of experience in DVM development and manufacturing, as well as surveys of the preferences of engineers, purchasing agents and service specialists. In the X-1 you'll find:

- ★ Zero bias control
- ★ Threshold self-triggering control
- ★ Isolated BCD contact closure output (optional)
- ★ NLS high intensity readout
- ★ Solid, compact case with handles for portable use, and optional rack-mounting hardware

More to Come



Special accessories to be added to the X-1 line will further increase the versatility of this instrument. Adding functions may merely require insertion of additional or substitute circuit boards.

Integrating Circuit Board

With a new plug-in circuit board you can make your X-1 an integrating digital voltmeter. Find out more about this from your NLS representative.

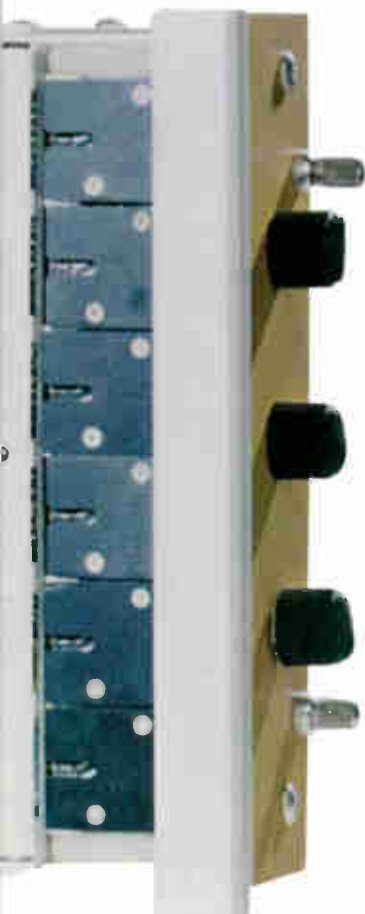

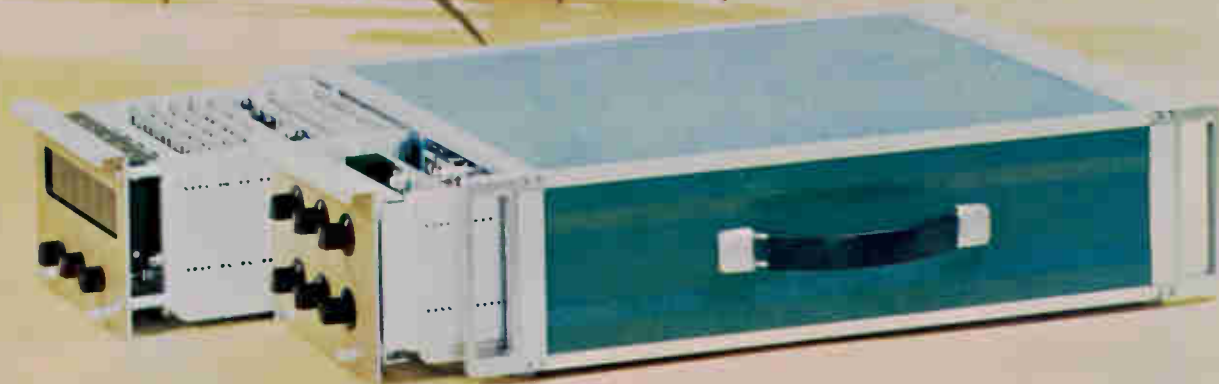
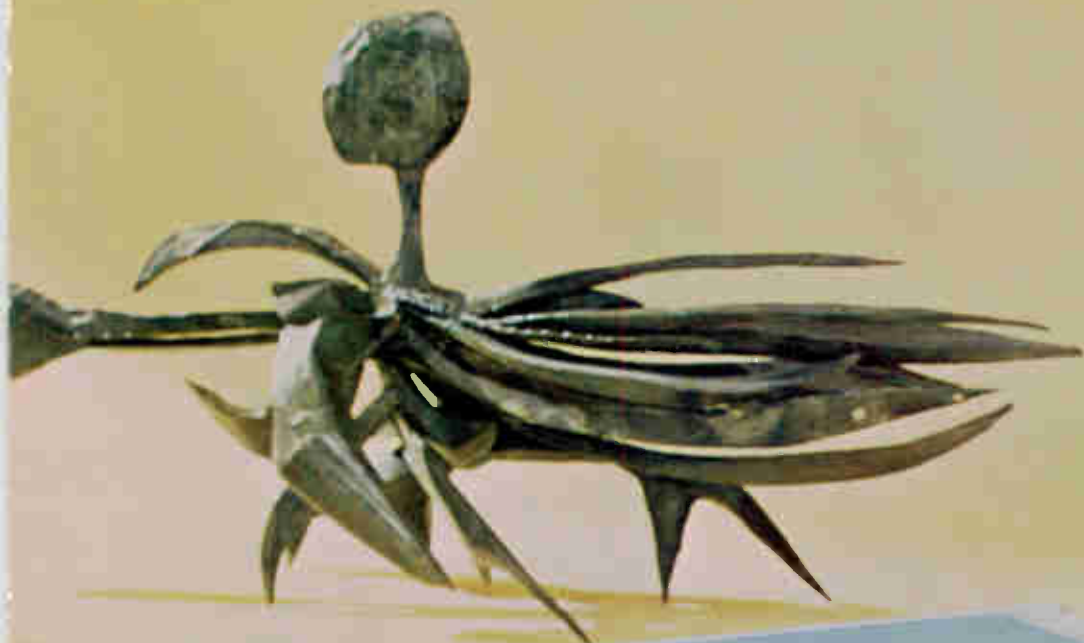

Specification Checklist

(Basic DC unit with autoranging and polarity option)

Circuitry: All solid state

A/D conversion: All-electronic successive approximation scan logic

Full scale DC ranges: ± 9.9999 , ± 99.999 , ± 999.99 with 20% overrange on the two lower ranges

Accuracy: 0.001% of full scale $\pm 0.005\%$ of reading under ASA reference conditions

Rated accuracy (six months): 0.001% of full scale $\pm 0.01\%$ of reading

Resolution: one digit

Response times: Input buffer response time – 10 ms; Digitizing time – 6 ms; Time required for transfer relays to operate – 7 ms; Time to select a fixed range remotely (operating time of range transfer relay plus operating time of range selection relay) – 10 ms; Time required for each automatic range change – 30 ms; Time required for each automatic polarity change – 30 ms

Input resistance: 10v range – 10.000 megohms; 100v and 1000v ranges – 10 megohms (input resistance is constant except when input is overloaded)

Methods of control: Range selection – automatic, manual and remote; Polarity selection – automatic and manual; Start command – internal, external and manual

Output connections: Output data – BCD contact closures for isolated output. BCD voltage levels if isolation is not required; Digital output command – contact closure for isolation. Voltage level if isolation is not required

Signal input connections: Signal inputs are on rear panel only. They consist of signal high, signal low and guard. These inputs may be floated ± 500 VDC with respect to chassis ground (earth)

Power requirements: 115 230VAC, 50-60CPS

Weight: Approximately 50 pounds

Price: Basic DC unit **\$1485**
With autoranging and polarity option **\$2450**
(f.o.b. Del Mar)

Meet all your needs with one versatile instrument

NLS X-1

FAST RESPONSE

digitizing time 6 ms

HIGH ACCURACY

5 digits with 6th digit (20%!) overranging

SOLID STATE RELIABILITY

no mechanical choppers

FUNCTIONAL EFFICIENCY

*accessory modules readily adaptable to a
wide variety of function combinations*

HIGH COMMON MODE REJECTION

120 db, unfiltered, with up to 100 ohms unbalance

“Get it right the first time”

X-1 eliminates first reading error

You can forget about the problem of “first reading error” with the fast X-1. You see the reading instantaneously and correctly the first time it appears. Digitizing time is 6 ms. With polarity change, settling time is about 20 ms. This makes the NLS X-1 the perfect instrument for systems.

Performance packaging

Take a look at packaging designed to improve performance, simplify maintenance, and extend the useful life of the instrument. Top-loading double drawers contain the Analog to Digital Converter and Input Accessory modules. The Power Supply module is easily accessible at the rear of the instrument.

Easy access to plug-in boards and use of repetitive boards and parts throughout the instrument minimizes the need for spare components and makes rarely required maintenance easy and economical.

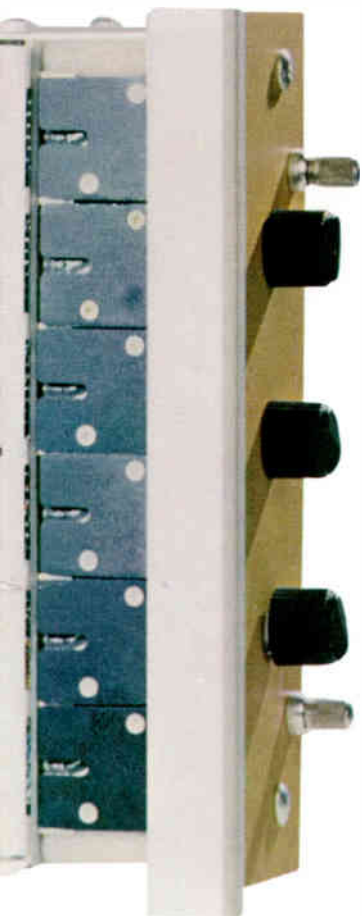

RESOLVER/SYNCHRO INSTRUMENTATION

A very short course for engineers engaged in testing and evaluation of resolvers and synchros as components or as system transducers.

Selecting a resolver/synchro test instrument for any engineering, production or system requirement is remarkably simple from North Atlantic's family of resolver and synchro instrumentation. Because this group has been developed to cover every area of need in both manual and automatic testing, obtaining the desired combination of performance and package configuration usually demands no more than 1) determining what you need and 2) asking for it.

Remote Readout of Angular Position

For remote indication of resolver or synchro transmitters in system testing, North Atlantic's Angle Position Indicators (Figure 1) provide the advantages of low cost and continuous counter or pointer readout. These high-performance instrument servos are accurate to 4 minutes of arc, with 30 arc seconds repeatability and 25°/second slew speed. Dual-mode capability, multi-speed inputs, integral retransmit components and other optional features are available to match application needs. Priced from \$895.



Figure 1. Angle Position Indicators are available in half-rack, quarter-rack and 3-inch round servo packages.

High-Accuracy Testing Of Receivers And Transmitters

Measuring receiver and transmitter performance to state-of-art accuracy is readily accomplished with North Atlantic's Resolver/Synchro Simulators and Bridges (Figure 2). Each of these dual-mode instruments tests both resolvers and synchros, and provides direct in-line readout of shaft angle, accurate to 2 arc seconds. Simulators supply switch-selected line-line voltages

from 11.8 to 115 volts from either 26 or 115 volts excitation, and so can be used to test any standard receivers. Bridges have constant null voltage gradients, making them ideally suited for rapid deviation measurements. Simulators and Bridges each occupy only 3½ inches of panel height and are available in a choice of resolutions. They are priced in the \$1500 to \$3000 range.

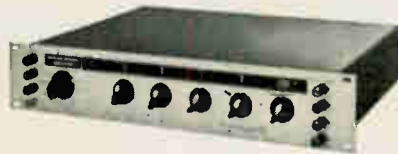

Figure 2. Resolver/Synchro Simulator provides ideal source for receiver testing.

Automatic Measurement And Conversion

Where systems require continuous or on-command conversion of resolver or synchro angles to digits, North Atlantic's Automatic Angle Position Indicators (Figure 3) handle the job without motors, gears or relays. These solid-state automatic bridges accommodate all standard line-to-line voltages and provide both Nixie display and printer output, accurate to 0.01° and with less than 1 second update time. Many variations, including 10 arc second accuracy; binary, BCD or decimal outputs; multiplexed channels and multispeed operation, are available for specific requirements. Ballpark price: \$5900.



Figure 3. Model 5450 Automatic Angle Position Indicator. It measures shaft angles, converts them to digital data.

Measuring Electrical Characteristics

Combine a Resolver/Synchro Bridge and a Simulator with a North Atlantic Ratio Box, a Phase Angle Voltmeter and a test selection panel and you have an integrated test facility for determining all electrical characteristics of resolvers and synchros in component production or Quality Control. An example is the North Atlantic Resolver/Synchro Test Console shown in Figure 4. It measures phasing, electrical zero, total and fundamental nulls, phase shift and input current, as well as angular accuracy. Standard North Atlantic instruments are used as modules, making it a simple matter to fill the exact need. The unit shown sells for about \$7500.

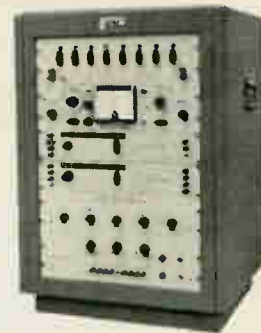

Figure 4. Model RTS-573 Test Console is a complete facility for the production line or in quality control.

If you require performance, reliability and convenience in resolver and synchro testing, we want to send you detailed technical information on these instruments (also on related instruments for computer system interface). Or, if you prefer, we will arrange a comprehensive technical seminar at your plant. Simply write to: North Atlantic Industries, Inc., 200 Terminal Drive, Plainview, N.Y. 11803 • TWX 516-433-9271 • Phone (516) 681-8600.



Now: A Fast Signal Averager

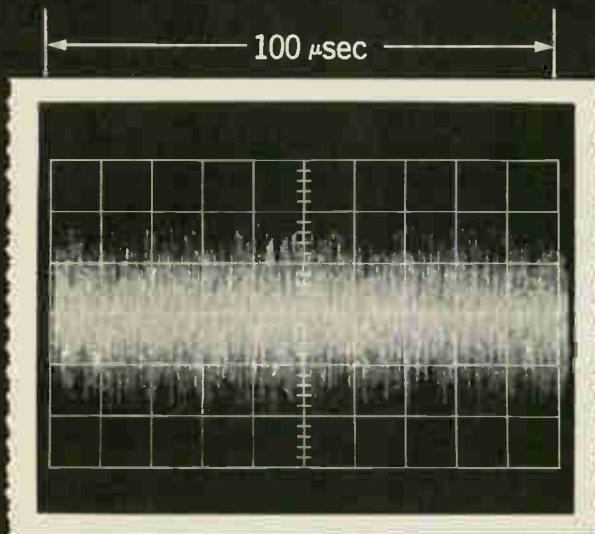

Photo #1—Input to Model TDH-9
SENSITIVITY: 5 V/cm
TIME: 10 μ sec/cm
NOISE-TO-SIGNAL RATIO: 10:1

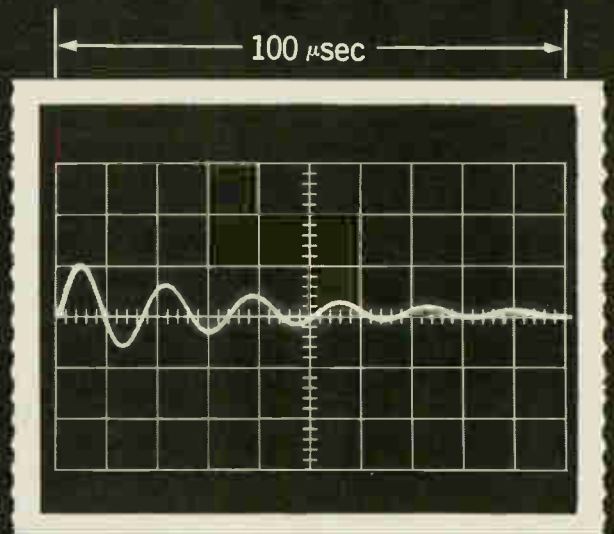

Photo #2—Output of Model TDH-9
SENSITIVITY: 5 V/cm
TIME: 10 μ sec/cm
TDH-9 VOLTAGE GAIN: 10



PAR Model TDH-9 Waveform Eductor

Photo #1 is an actual oscilloscope trace of a signal obscured by noise — a situation unfortunately prevalent in many research areas such as studies of biomedical evoked potentials, seismology, spectroscopy, fluorescent lifetime studies, and vibration analysis. Photo #2 shows the dramatic improvement in signal-to-noise ratio when the noisy signal was processed

by the PAR Model TDH-9 Waveform Eductor.

This new instrument employs a highly efficient waveform-averaging technique, and at the same time offers the fastest sweep rates obtainable in signal processing equipment of the signal-averaging type. Sweep durations as short as 100 microseconds, with dwell times per channel of 1 microsecond, are obtainable. The high resolution capability of the Model TDH-9 allows observation of waveforms or transients which have heretofore been unresolvable by averaging instruments employing a greater number of channels.

Although the Model TDH-9 Waveform Eductor sells for only \$4,200,

we invite functional comparison with the higher-priced digital averagers. We believe you will be pleasantly surprised. For more information about the PAR Model TDH-9, ask for Bulletin No. T-126.

Have a noise problem?

PAR's technical staff, unusually knowledgeable in signal processing problems and techniques as a result of its experience in the development and application of Lock-In Amplifiers, welcomes your specific inquiries. Please call or write.



Electronics Review

Volume 39
Number 17

Space electronics

Beyond the moon . . .

The five-flight, \$195-million Lunar Orbiter program may continue long after it has accomplished its primary mission—validating landing sites for the Apollo manned spacecraft. Project officials at the National Aeronautics and Space Administration and the craft's prime contractor, the Boeing Co., are studying missions for future orbiters that may send the craft as far as Venus and Mars. NASA hopes to get funds for five more Orbiter flights in its fiscal 1968 budget.

'If we had them.' As the space agency's Lunar Orbiter program manager, Capt. Lee Scherer, put it before the first spacecraft was successfully launched toward the moon on Aug. 10, "I think we could find a use for 20 of these spacecraft, if we had them." The first two Orbiters have one of the most important jobs in the space program: pinpointing an area on the moon about two miles wide and four miles long that is flat enough and sufficiently free of boulders so the Apollo astronauts can land safely.

Definite jobs for the other three Orbiters haven't been finally decided. In the event the first two Orbiters fail in their mission, the next three could act as backups. But, NASA says, if the first two are successful, new jobs will be found for the remaining three.

The Lunar Orbiters may make another contribution to the Apollo mission. The Langley Research Center, which manages the program, is working with the Manned Space Network on an idea to permit the network's stations to track future Orbiters and thus give the network practice in tracking Apollo when it orbits the moon.

After that, the opportunities for new missions are almost as limit-

less as space. One proposal, to photograph the back of the moon, would require no spacecraft modification, Scherer says. Also, he expects Orbiters to photograph areas around future Surveyors on the lunar surface. This would permit comparisons with pictures taken on the surface.

Still another plan under consideration is to investigate the area around the crater Aristarchus, where unexplained red spots were spotted first by Russian astronomers and more recently by French and American observers. The spots

Venus or Mars. This could be accomplished relatively simply, according to the company, by redesigning part of the craft and using Mariner 4 television cameras. NASA didn't buy the idea on the spot, but gave Boeing \$60,000 to continue the studies.

In the meantime, however, the schedule calls for launching Orbiters every three months. But this may not be possible because the Deep Space Network, charged with tracking and data reception, will be busy with the Surveyor and Pioneer interplanetary missions.

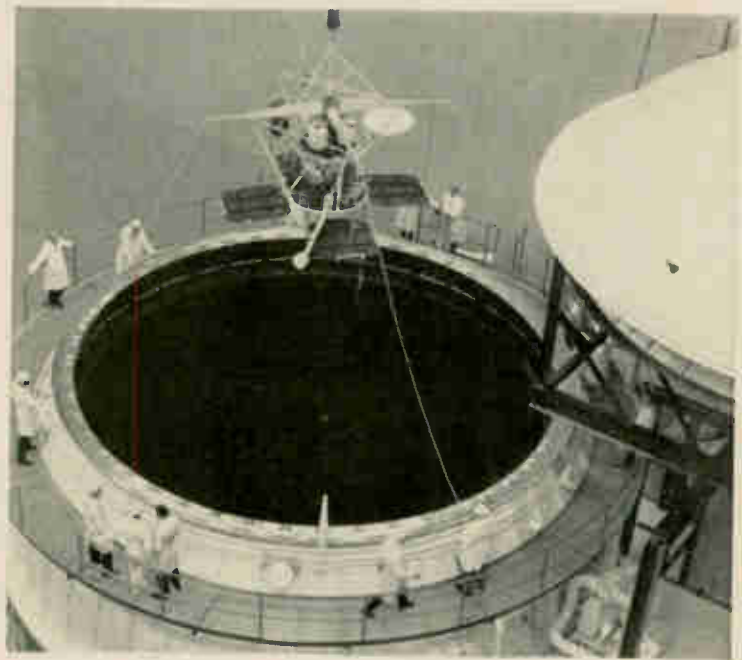

Lunar orbiter lowered into test chamber before its flight to the moon to snap photos of landing areas for Apollo.

have been the subject of scientific speculation that the moon may contain volcanoes, and some NASA planners hope that volcanic gases can be found for use in manufacturing rocket fuel on the moon.

Drop the word. Boeing would be just as happy to drop the term "lunar" from the spacecraft's name. The company recently submitted an unsolicited proposal to NASA for modifying the craft to permit it to be placed in orbit around

. . . and to the sun

Another NASA program that may be expanded beyond its current role is the Pioneer interplanetary spacecraft.

The first Pioneer in the present series is still returning scientific data eight months after its launch last Dec. 16 and two months longer than the contract demanded. A second Pioneer was to be launched on Aug. 17 to search for the tail

end of the earth's magnetosphere.

The space agency was so happy with the performance of the first satellite that it recently added another launch to the current four-flight program. NASA will decide later this year whether to add two more Pioneer flights. This may be just the beginning of what promises to be an open-ended program. Several more Pioneer missions are being studied at NASA's Ames Research Center at Moffet Field, Calif.

All paid for. One reason for the satellite's popularity is that development costs have all been paid by the \$55 million spent for the first four satellites. The space agency plans to spend only \$5 million for the fifth model, now called Pioneer-E, by building it with spare parts from the original contract.

Also, Pioneer has become NASA's workhorse for studying the interplanetary environment during the current period of increased solar activity, which builds up to a peak in 1969. This job would have been performed by the Advanced Orbiting Solar Observatory, a program wiped out earlier this year by the space agency's budget squeeze.

The first five Pioneers in the current series are designed to operate in orbits around the sun. Pioneer 6, the first in the present series, is in an orbit about 75 million miles from the sun, while Pioneer 7 was to be aimed at an orbit about 105 million miles from the sun. (Spacecraft are given letter designations before a successful launch and number designations afterwards.) NASA's earlier Pioneer series, numbers 1 through 5, back in 1958 to 1960, were not quite so successful.

Missions for the three remaining approved Pioneers haven't been decided. But NASA program manager, Andrew Edwards Jr., believes the next one will be launched in about a year and will orbit between the earth and sun. What NASA wants most of all is to have two Pioneers operating at one time to correlate data on the sun from points inside and outside the earth's orbit. This would probably

require a launch every nine months.

Biggest hurdle. The two Pioneer flights under study, now called F and G, would use a more powerful version of the Delta launch vehicle. NASA's Deputy Administrator Robert Seamans Jr. has yet to okay a detailed design study and the project still has to clear the biggest hurdle—approval in the fiscal 1968 budget. The two launches are planned for late 1969 and early 1970.

Looking further down the line, the Ames Center, along with TRW Systems Group of TRW, Inc., the satellite builder, is studying a variety of exotic Pioneer missions. They include a satellite operating within the orbits of Mercury and Venus, and probes of some 20° to 25° out of the ecliptic plane, the path in which the earth moves around the sun. Also being studied are "Biopioneers," satellites that would study biological rhythms of organisms beyond the influence of the earth's gravity. Being considered for this experiment are cockroaches, potatoes and desert pocket mice.

Patents

The laser decision

If the laser creates a billion-dollar industry, a sizable chunk of the gross will probably go to patent lawyers.

The latest spurt in laser patent activity started when the United States Court of Customs and Patent Appeals affirmed the patent awarded to Arthur L. Schawlow and Charles H. Townes for the Fabry-Perot type laser and rejected the appeal of Gordon Gould [Electronics, Nov. 29, 1965, p. 106].

The decision would seem to establish Schawlow, now head of the physics department at Stanford University, and Townes, his brother-in-law, a Massachusetts Institute of Technology professor, as co-inventors of the laser, although neither built the first operating device.

Financial rights to the Shawlow-

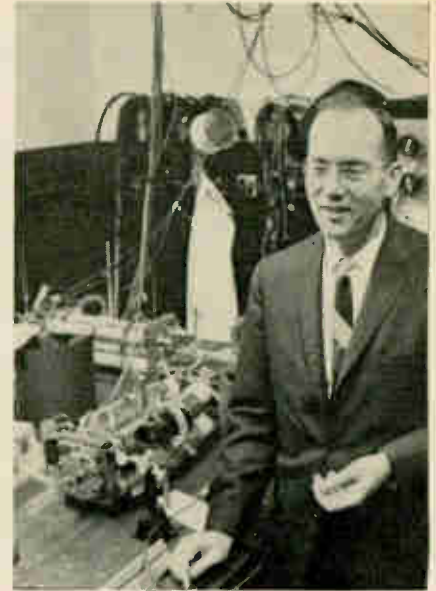

Charles H. Townes

Townes patent belong to Bell Telephone Laboratories, where Schawlow was an employee and Townes a consultant when the "optical maser" was conceived in 1958.

"I am glad the case is settled," says Gould, adding that this may speed action on a "roundup patent" he has filed. This includes claims on Brewster angle windows for lasers, the helium-neon gas system and Q-switched lasers. Bell Telephone Laboratories is opposing the first two, and the Hughes Aircraft Co.—where the first laser was built in 1960 by Theodore H. Maiman—is disputing Gould's claims on Q-switching.

An appeal? But the decision whether to continue litigation on the Schawlow-Townes patent rests with TRG, Inc., a subsidiary of the Control Data Corp., to which Gould's rights are assigned. Counsel for the company says it will be a few weeks before it decides whether to appeal to the U.S. Supreme Court. Also under consideration by the company is a request for a rehearing.

The court decision rested principally on Gould's failure to prove that he conceived the invention prior to July 30, 1958, when Schawlow and Townes filed their patent, and his failure to prove "reasonable diligence" in pursuing such an idea prior to his own filing date of April 6, 1959.

A few days after the court decision, the International Business Machines Corp. announced it was granted a patent covering semiconductor injection lasers. Four years ago this summer, research teams at IBM, the General Electric Co. and MIT's Lincoln Laboratory were racing to get coherent radiation from gallium-arsenide junctions. The contest ended in virtually a dead heat at the end of October, 1962, when all three disclosed they had succeeded. All used the injection technique, direct application of an electric current and conversion of this d-c power into coherent light at the diode junction.

The claims in the IBM patent specify injection lasers that emit light of energy less than the bandgap of the semiconductor material from which the laser is made.

Broad coverage. Patent rights in the semiconductor laser field are bound to get more complicated before long. The patent with perhaps the broadest coverage—a total of 10 claims—was awarded April 5 to GE, but it had not been publicly announced by the company.

Like IBM, GE claims that its patent is the basic injection laser patent. Asked to comment on the situation, IBM would only say that it would issue a license for any company to produce the injection laser "at a reasonable fee." Neither GE nor IBM would comment when asked whether any litigation over the patent was planned.

Lincoln Labs, one of the most

active centers in development of diode lasers, received its first patent on June 28, and it covers conception of a laser that has not yet been physically achieved: a zinc-doped germanium diode with infrared output.

The researchers at MIT make no claim to priority in achieving the first injection laser. They have publicly credited GE's Robert N. Hall and his coworkers with the initial success.

Advanced technology

A better red

A research team at the Massachusetts Institute of Technology's Lincoln Laboratory believes it is close to developing a better red solid-state laser. The group is now testing a new host material and is zeroing in on a new dopant to complement the host material. The lack of a good source of coherent red light has been delaying the development of large laser displays [Electronics, July 25, p. 143].

The new host material is yttrium vanadate. The Lincoln group, headed by Joseph R. O'Connor, has observed pulsed laser action at room temperature from crystals of YVO₄ doped with neodymium. There are hints that continuous-wave operation has also been observed, but O'Connor says only that he hopes to be able to report c-w laser action next week (Aug. 29-30) in Boston at a meeting of the Metallurgical Society of the American Institute of Metallurgical, Mining and Petroleum Engineers.

Dopant search. The output of the neodymium-doped yttrium vanadate is 1.06 microns in the near-infrared. For a visible output in the red band, the dopant under investigation is europium, the phosphor that supplies red in color television tubes. "If it goes," says O'Connor, "europium-doped yttrium vanadate may provide one of the best red c-w lasers."

O'Connor's group is also continuing studies of the spectral properties and transitions in the neodymium-doped yttrium vanadate.

Radiative lifetimes of neodymium are low, so there is hope of high pulse-repetition, says O'Connor.

Work with yttrium vanadate is also being done at the Bell Telephone Laboratories, at the General Electric Co. in Cleveland and at the Union Carbide Corp.'s Electronics division in Indianapolis.

The Lincoln Laboratory team sees YVO₄ competing successfully in many applications where YAG—yttrium aluminum garnet—is now being tried. "The fluorescent spectra are simpler," says O'Connor, "and the transitions are stronger." This means better energy-conversion; therefore, higher efficiency.

"In addition," says O'Connor, "we are hopeful that the thresholds will eventually be lower than those for "YAG."

At present, O'Connor points out, 100 to 300 watts are being obtained from YAG at a pulsed threshold of 1 to 2 joules, with 30% efficiency.

Lower threshold. In recent Lincoln Lab experiments, stimulated emission from yttrium vanadate rods was also observed at a threshold of 1 to 2 joules. The power output has not been measured, but says O'Connor, "We hope to get some accurate measurement when we have c-w action."

The single-crystal rods grown by the Linde division of Union Carbide for Lincoln Laboratory are as long as 2 inches, another advantage in using yttrium vanadate. It is a problem, says O'Connor, to get YAG crystals longer than about $1\frac{3}{16}$ inches.

Industrial electronics

Stalled traffic control

New York's computer-operated traffic-control system has hit an engineering roadblock.

The Sperry Gyroscope Co., which has a \$5.4-million contract for the city system, found that its traffic-speed radar sensors weren't working properly. Although Sperry, a division of the Sperry Rand Corp., would only say that it was having "production problems," it has been learned that the



Arthur L. Schawlow

sensors were providing speed readings with errors of as much as 30%, whereas the city's specifications called for errors no larger than 2%. Sperry began to deliver the system to the city—but without the erring sensors. Traffic Commissioner Henry A. Barnes, however, objected and ordered the company to keep the gear until all the parts met the specifications. Embarrassed, Sperry pulled the equipment back while its engineers puzzled over the sensors.

To Sperry, the contract is more than a \$5.4-million order. When the first part of the computer system is completed—and no one is willing to say when that will be in light of the sensor problem—the city will be in the market for another \$100 million of electronic gear to computerize most of its traffic lights.

Foreign aid. Apparently Barnes is more certain than Sperry that the sensor problem will be solved quickly. The traffic commissioner disclosed that the company recently mentioned the possibility of using French-made sensors to replace the troublesome gear. Barnes says he rejected the plan out of hand. The use of foreign equipment, he said, would make maintenance and parts replacement a headache.

The sensor inaccuracy, explained Barnes, is caused by spurious signals that feed from the transmitter directly into the system's two receivers. Because of this, he explains, the receivers aren't able to discriminate between the spurious signals and the authentic echoes from passing vehicles.

Computers

White elephant

Webster defines white elephant as "a property requiring much care and expense and yielding little profit." Beckman Instruments, Inc., has one that cost \$1.4 million and it is sitting in its Systems division in Richmond, Calif.

Beckman's white elephant is the

world's largest hybrid computer. The company developed it for the National Aeronautics and Space Administration and it was to have been delivered to NASA's Manned Spacecraft Center in Houston, where it would have been used as a problem-solving computer for the Apollo program, mainly in development of lunar orbit simulations.

Too late. But Beckman fell 12 months behind the delivery date because of development problems and the Apollo program progressed beyond the need for the system, says the agency. So NASA terminated the contract, giving Beckman "a financial consideration" and told the company to keep the computer. The space agency is now using existing data-processing facilities at Houston to perform the job originally planned for the Beckman system.

NASA officials say a \$1,314,000 contract was written on a fixed-price basis and, as a result, the space agency was not liable for the whole amount. They claim the loss to the Government was \$84,000 of which \$50,000 went for system development and \$34,000 for rental of interim computer equipment. Beckman had been under contract since June 25, 1964.

While Beckman seeks a buyer, the computer is being rented to companies that have special problems to solve. The rental for the complete system is \$700 an hour.

Big tasks. L.B. Horwitz, Beckman's systems division manager, commenting about the problems Beckman encountered with the huge system, said: "With a new de-

velopment you always have problems, and we didn't appreciate in the beginning just how big a task this was."

Horwitz said a group of potential customers is interested in the system, including chemical and aircraft companies which could use it for flight dynamics.

The system consists of two Beckman 2200 analog computers, a Scientific Data Systems, Inc., digital computer interface and peripheral equipment.

Money saver. The software includes the most complete hybrid library available today, according to Beckman. The concern developed a special hybrid Fortran package. The computer can handle 16 priority interrupts, an interrupt being triggered by some event that occurs during computation.

Dick Nesbit, who developed the software, explained that the system's value lies in its ability to handle large, complicated problems that a digital computer alone either could not handle or would take a long time to solve.

Integrator on a chip

The first digital integrator on a monolithic chip will be introduced later this month by the General Instrument Corp. The metal oxide semiconductor (MOS) device represents a move toward development of a computer on a chip—a goal still well beyond the current state of the art.

For \$500, buyers will get a package that includes two complete

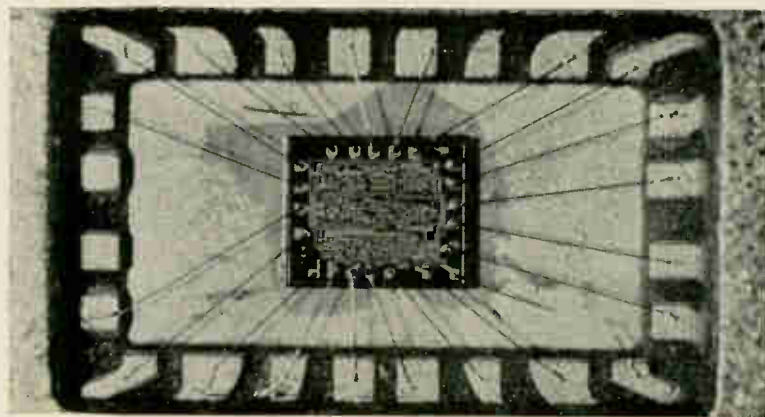

Monolithic integrator, to be introduced by General Instrument, is a step closer to the development of a computer on a single semiconductor slice.

WHO PINNED A MEDAL ON THIS TINY TRW CAPACITOR?



...nearly everybody!

For your next design where there's too little room for components and *no room for compromise*... turn to "tiny but tough" TRW Type 608 Mylar* capacitors.

Excellent electrical characteristics and exceptionally small size make the Type 608 ultra-miniature a good capacitor for exacting military and instrument applications. Add the remarkable record of space-proven reliability and TRW Type 608 becomes a great capacitor!

Look at these outstanding features!

- 50% smaller than MIL-C-27287
- 4½ lb lead pull capability

- Mylar-foil, tape-wrapped construction
- Exceeds electrical characteristics of many larger units
- MIL-C-27287 performance
- 50V and 100V, .001 to 2.0 mfd
- Temperature range -55 to +85°C; to 125°C with derating
- Tolerance to ±1% available

Contact TRW Capacitor Division, Box 1000, Ogallala, Nebraska, or phone (308) 284-3611. TWX: 910-260-0321

*DuPont's trademark for polyester film.

TRW CAPACITORS

adders on a single chip, plus two shift registers on another chip. One adder plus two shift registers make an integrator, and two or more integrators make a digital differential analyzer.

Add a chip. The dual adders are packaged in a 24-lead flatpack; the shift registers in the second chip can be extended to any desired length with additional flatpacks, depending on the application.

The 72-by-86-mil chip contains 230 MOS transistors. It's the MOS technology—which allows for extremely dense packaging—that makes the device possible. Conventional bipolar transistors occupy 20 times more space, which explains why digital differential analyzer integrated circuits haven't been practical up to now. A similar design but with bipolar transistors would have required more than 60 chips.

The digital integrator is the equivalent of an analog resolver, and is the basic unit of the oldest digital computer designs. A digital differential analyzer, made by connecting several integrators, can solve quickly any kind of problem that can be expressed as a set of differential equations. The sine and cosine of a number, for example, can be generated with two integrators, or the natural logarithm can be generated with three integrators.

A fast and accurate inertial navigation system, for instance, can be built with an array of perhaps 20 integrators—for a total cost of about \$10,000.

But such integrators have their drawbacks: they lose all control when their power supply fails even briefly. Hence, they generally are not considered for avionics or process-control systems, where power failures can be disastrous.

Built into arrays. The principal advantage of the circuit is its economical application in a special-purpose computer. Previously it would have been financially impractical to build large special-purpose computers with differential analyzers. With the chips, however, sets of analyzers could be built into arrays connected with a patchboard, the way operational amplifiers are connected to analog computers to solve complex problems.

General Instrument's Radio Receptor division is using the chip in an interferometer direction finder under a contract with the Army Signal Corps. The direction finder's computer contains 12 of the new chips, plus associated logic, and generates sines and cosines and multiplies two variables like an analog computer.

The military computer occupies less than 50 cubic inches, most of which is for code wheels for inserting constants and initial conditions. An earlier version, without the new chips, required a whole rack of electronic equipment.

Antennas

Widening the feed point

Antennas that are used for jamming radar and communication installations should be high powered to "overcome" the enemy's signal, and wideband, so that a broad range of frequencies can be selected. Conventional wideband antennas used for this military job, such as the log periodic dipoles, however, don't hold up under powers much above 3 kilowatts, primarily because the point where the antenna is fed is small.

George A. Voronoff, an antenna designer at the Dalmo Victor Co.

of Belmont, Calif., a division of Textron, Inc., has developed an unusual log periodic slot array that was designed to get around the limitations of the small feed. The Voronoff design is V-shaped, with two or more log periodic arrays cut into the metals walls that form the V. Down through center of the V is a strip of tapered dielectric. Power for the antenna is fed into the wide mouth of the V, and the result, says Voronoff, is an antenna with a bandwidth of 6 to 1, with continuous-wave power as high as 154 kilowatts. The antenna that the engineer built operates at 3.5 to 8.2 gigahertz.

Although the system has obvious applications in electronic countermeasures, it could also be used for communications.

One-sided advantage. The shape of the antenna, says the designer, makes it perfect for flush-mounting in the wing of an airplane. Another advantage, says Voronoff, is that it radiates on only one side of the slots, producing a 20° by 20° beamwidth. Conventional log periodic dipole antennas produce a beamwidth of about 75° by 75°.

The antenna's range of frequencies depends on the positioning of the slots and the taper angle of the dielectric. By using a double-ridged waveguide as a feed, the antenna is able to transmit the 154 kilowatts; but with a single-ridged waveguide, the maximum power of

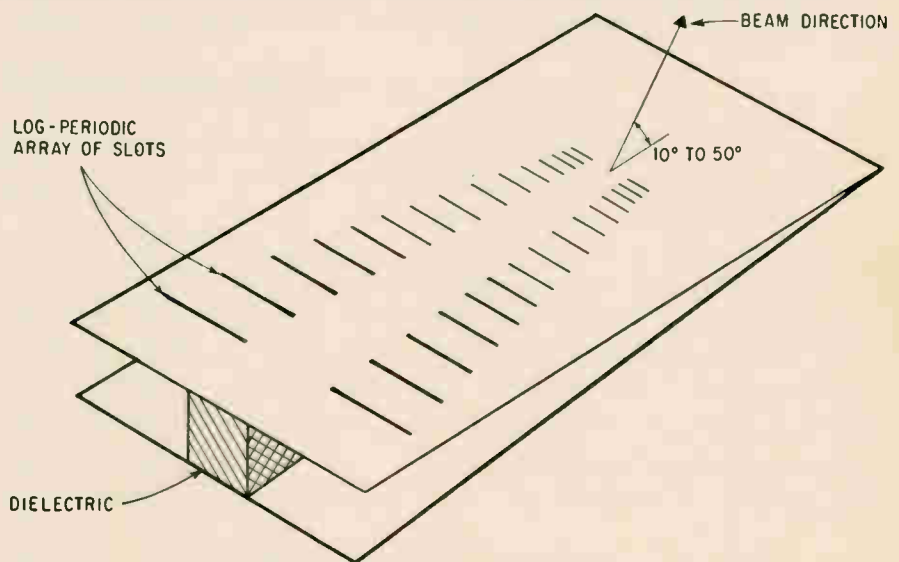

Log periodic slot antenna provides high power over a wide band of frequencies. Energy is fed into open end of V.

Tektronix Type 1S1

DC-to-1 GHz

Sampling Plug-in Unit

for your  oscilloscope
that accepts letter and
1-series plug-ins

Here's a new dc-1 GHz sampling unit with operation practically as simple as conventional plug-ins—as you can see by the front panel of the sampling plug-in. You need no pretriggers or external delay lines—the 1S1 unit has internal triggering with a built-in delay line.

Many other features add to the capabilities and operating ease of the Type 1S1, such as: A tunnel-diode trigger circuit that insures stable triggering through 1 GHz • A single control to select the sweep rate and magnify the display up to X100 when desired • Direct readout of the sweep rate even when magnified • A dc-offset control that permits observation of millivolt signals in the presence of up to ± 1 volt input levels • Less than 1 mV noise in the display, with a smoothing control for further reduction • Output signals available at the front panel for driving chart recorders—and for powering an auxiliary time domain reflectometer pulser unit.

BASIC CHARACTERISTICS

RISETIME ≤ 0.35 ns. SENSITIVITY from 2 mV/cm through 200 mV/cm, in 7 steps. DYNAMIC RANGE ± 2 V. Safe overload is ± 5 V. DC OFFSET range is greater than ± 1 V. SWEEP RATES from 100 ps/cm to 50 μ s/cm, with $\pm 3\%$ accuracy normal or magnified. SAMPLES/CM continuously variable. TRIGGERING ac-coupled, \pm internal, \pm external, and free run. DISPLAY MODES are repetitive, single display, manual scan, or external scan. VERTICAL OUTPUT is 200 mV per displayed cm through 10 k. HORIZONTAL OUTPUT is 1 V per displayed cm through 10 k.

Type 1S1 Sampling Plug-In Unit \$1100
Type 281 TDR Pulser Unit \$95

U.S. Sales Prices, f.o.b. Beaverton, Oregon

For a demonstration,
call your Tektronix field engineer.

Tektronix, Inc.

SEE THE LATEST TEKTRONIX INSTRUMENTS AT WESCON — BOOTH 428-433

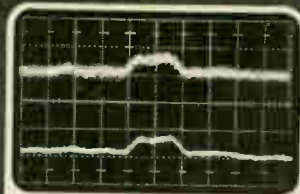
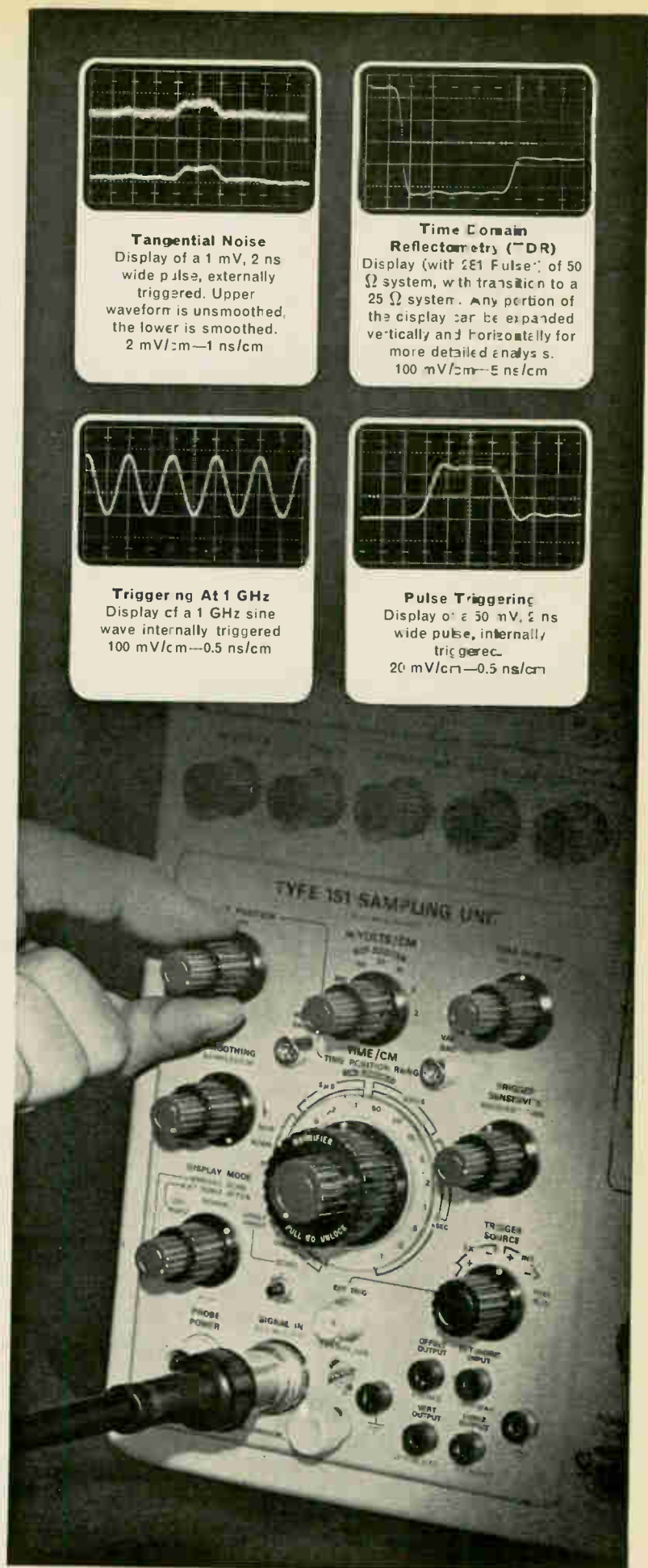

Tangential Noise
Display of a 1 mV, 2 ns wide pulse, externally triggered. Upper waveform is unsmoothed, the lower is smoothed.
2 mV/cm—1 ns/cm

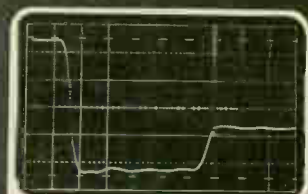

Time Domain Reflectometry (TDR)
Display (with 2E1 Pulse*) of 50 Ω system, with transition to a 25 Ω system. Any portion of the display can be expanded vertically and horizontally for more detailed analysis.
100 mV/cm—5 ns/cm

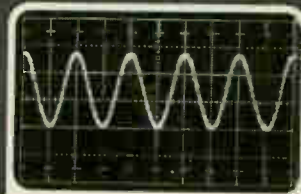

Triggering At 1 GHz
Display of a 1 GHz sine wave internally triggered
100 mV/cm—0.5 ns/cm

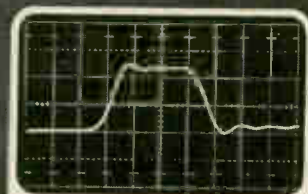

Pulse Triggering
Display of a 50 mV, 2 ns wide pulse, internally triggered.
20 mV/cm—0.5 ns/cm

the antenna is 81 kilowatts.

In one test of the Voronoff design, a slot array produced a 12 decibel gain—relatively good for a wideband antenna.

The log periodic arrangement of slots was chosen so that energy would radiate over a wide range of frequencies. However, for this to occur, energy must propagate between the metal plates in the same broad range of frequencies. This is done by choosing the dielectric taper's dimensions so that the guide propagates a wideband waveguide mode—the TE_{01} —that has no cutoff frequency. [Electronics, March 31, 1961, p. 54].

Military electronics

Bitter end

After a troubled 10-year history, the final chapter has been written on the Navy's plan for a 600-foot diameter radio telescope in Sugar Grove, W.Va.—a project that Defense Secretary Robert S. McNamara has called one of the most ill-conceived in recent military history.

In 1962, spiraling costs and unexpected difficulties halted construction of what would have been the world's largest steerable antenna, but some Navy diehards clung to the hope that the big dish would be built. Last month, after failing to obtain support from the Pentagon, they too threw in the sponge and settled for an \$11-million receiving station that will be erected on the site planned for the radio telescope.

The new station will serve as the Washington-area receiving point in the Navy's worldwide communications system as well as a link to the Defense Communication Agency's network. It will be operational in early 1969 and will replace a receiving facility in Cheltenham, Md., that the Navy says is being affected by electromagnetic interference as new houses are being built in the suburban areas. The Sugar Grove site is an ideal replacement because it is about 150

miles from Washington in an area nearly free from such interference.

Skyward costs. Although the Navy has never conceded it, the 600-foot dish was to eavesdrop on radio communications from behind the Iron Curtain with moon-reflection techniques. When construction was begun in 1957, the Navy said it would take \$60 million to do the job. In 1962, with nothing but the underground facilities completed, however, costs had soared to \$135 million, primarily due to technical difficulties. This was too much for McNamara, who told the Navy to stop construction. At the time, he estimated it would cost \$200 million to complete the ponderous paraboloid dish. Moreover, satellite state of the art had made it possible to build eavesdropping spacecraft to orbit over the Soviet Union.

However, the West Virginia Congressional delegation, as well as the Navy, continued to campaign for the completion of the radio telescope. The Congressmen pressured the Navy to build some installation at Sugar Grove that would bring people and money into the area. In 1963 the Navy said it would build a receiving station at Sugar Grove, but it marked time for three years while the admirals sought to persuade the Defense Department to finish the 600-foot antenna.

Equipment for the station, offices and other working space will be situated in the massive underground cavern originally dug for the radio telescope. Some 40,000 square feet on two levels had been constructed and the receiving station will use less than half of this space. The West Virginia Civil Defense Mobilization Agency has been invited to move in and share the underground facility.

The receiving station is now in the conceptual design stage, with Navy personnel doing the architectural and engineering work. Earlier work was done by the Federal Electric Corp., Paramus, N.J., a subsidiary of the International Telephone and Telegraph Corp. More than half of the \$11 million will be for electronic equipment. Ten antennas, including two with

circular arrays, will be constructed at the station.

The equipment. Many of the technical specifications for receivers have not yet been worked out, but Lt. Cmdr. W.R. Barret expects that about 30 of the estimated 100 units will be off-the-shelf AN/FRR-60 models. The system design will also call for AN/FGC-60 receivers.

The Navy's tentative schedule lists the electronics contract awards for early next summer. The Navy believes its investment in the station will be safe from electromagnetic "pollution" because West Virginia has protected the Sugar Grove area from the "encroachment" that hampers the Cheltenham station.

Components

Standard dose

The confusion caused by a hodge-podge of methods to test electronic components for resistance to radiation may be nearing an end. Standard procedures are expected to come from a study program originated by the Pentagon's Defense Atomic Support Agency.

The study, confined to those three components most susceptible to radiation damage—transistors, diodes and capacitors—has as its goal the development of standard test procedures. The program encompasses germanium and silicon bipolar transistors, germanium and silicon diodes and rectifiers, and all types of capacitors.

The International Business Machines Corp.'s Electronic Systems Center of its Federal Systems division, Owego, N.Y., and the Boeing Co., Seattle, are pursuing separate seven-month studies that are scheduled to wind up in less than two months. IBM's share of the contract is \$96,215; Boeing's \$63,502.

IBM and Boeing independently selected parameters to study. The proposals of both companies will be submitted to the Pentagon agency, which will combine them in a proposal that will then go out

WE CHALLENGE YOU TO TEST AND COMPARE THESE GENERAL INSTRUMENT EPOXY TRANSISTORS WITH HERMETICALLY SEALED UNITS IN YOUR OWN LABORATORY.

FREE!

We'll send you these 4 GI epoxy transistors FREE:—

Test them against these:—

2N4140 vs **2N2221**
2N4141 vs **2N2222**
2N4142 vs **2N2906**
2N4143 vs **2N2907**

**PROVE FOR YOURSELF THAT THE GI EPOXY ENCAPSULATED TRANSISTORS ARE DIRECTLY INTERCHANGEABLE*
 —ELECTRICALLY AND MECHANICALLY—WITH THE HERMETICALLY SEALED UNITS.**

PLUS (for introduction to you)
 we'll also send:

GENERAL INSTRUMENT'S
 NEW COMPLEMENTARY PAIR

2N4227
2N4228

featuring: $h_{FE} \dots 75-150 @ I_c = 150 \text{ mA}$

Fill out & mail this coupon for
 your free 6 PAK today.

GENERAL INSTRUMENT CORPORATION
 SEMICONDUCTOR PRODUCTS GROUP
 600 West John Street, Hicksville, New York

Please send me my FREE 6 PAK of epoxy transistors consisting of one sample each of the 2N4140, 2N4141, 2N4142 & 2N4143; also GI's new complementary pair, 2N4227 & 2N4228 complete with data & specifications.

Name _____

Job Title _____

Company _____

Address _____

City _____ State _____ Zip _____

*Maximum Dissipation: 300 mW

For further information on GI's broad line of epoxy transistors, contact your local GI sales representative.

GENERAL INSTRUMENT CORPORATION

600 West John Street, Hicksville, L. I., N. Y.



to industry for criticism. Later, IBM and Boeing representatives will meet with the agency to review the criticism fed back from potential users of the standard test procedures. The military will field test the revised procedures before freezing them as formal specifications.

Double damage. Device impairment from radiation is evidenced in two ways: gamma rays cause transient ionization effects and neutrons cause permanent displacement of atomic lattice structure. IBM's proposal will include procedures for tests made to simulate both types of damage for diodes and transistors. Parameters covered in the program include transistor beta, collector-emitter saturation voltage and primary photo current of pn junctions. Neutron fluences (integrated neutron flux) up to 10^{15} neutrons/square centimeter will be considered. Test standards will be proposed for doses up to 10^{11} rads/second and some procedures will be "suggested" to cover tests at 10^{12} rads/sec. Since capacitors are highly resistant to permanent damage, capacitor test standards proposed by IBM will relate only to transient damage.

Transient-effect radiation simulators covered by the IBM proposals are pulse reactors (for capacitors), low-energy flash X-rays (for transistors) and electron linear accelerators and high-energy flash X-rays (for capacitors, transistors and diodes). Simulators for permanent damage include both pulse and steady state reactors.

Communications

Initial success

A fourth Titan-3C launch has been added to the Initial Defense Communications Satellite project with signs pointing more and more toward a gradual upgrading of the research-and-development program into an operational system for long-haul military command-and-control secure communications.

One reason the Initial system

looks so attractive is because the follow-on advanced satellite system is beset by political and technical problems and is slipping continually.

Also giving the Initial system a push in this direction may be the Pentagon's tactical communications satellite for aircraft, ships and troops in the field [Electronics, Aug. 8, p. 61], which may handle some of the duties of the advanced system. The tactical communications satellite is moving toward a late 1968 flight demonstration and nearly every company in this business has design teams at work on the proposal.

Speculation. The fourth Initial system launch, which could come early next year, will carry three Philco Corp. satellites and at least three experimental communication satellites that would be ejected into orbit from a new dispenser. Philco is building a total of 22 flight models under the current contract, and reports of additional purchases are "purely speculation at this time," says Lt. Col. Nicholas S. Polio, Pentagon program element monitor.

The first launch of the Initial system on June 16 performed what some project people called a "a routine miracle" by placing the seven Philco satellites and a General Electric Co.'s gravity-gradient test satellite into a random 18,200-nautical-mile near-synchronous orbit. The second launch, following a two-week postponement, is now poised on the pad at Cape Kennedy for an Aug. 25 launch date with eight Philco satellites.

The second launch was to have included a second-generation GE gravity-gradient test satellite, which will use mercury flywheels to damp down the satellite's oscillations faster than the one now in orbit—in 5 days instead of 60 days. Pointing accuracy also will be improved from $\pm 4^{\circ}$ - 8° to $\pm 2^{\circ}$ - 2.3° degrees, GE expects.

However, because of the tight schedule the Air Force decided to postpone the second GE test until the third Initial flight. A firm schedule has not been decided for the third shot. Originally it was set for early in 1967.

Long life. There have been two

schools of thought by military project officials on the third launch: if the second flight this week is successful, resulting in 15 satellite repeaters in orbit, then the third shot should be held and used for a replenishment launch (predicted satellite lifetime was 18 months but some now predict a 3- to 5-year life). Others want to put up the third group right away even if the second launch is unsuccessful.

On the fourth launch will be a satellite to test Sylvania Electric Products, Inc.'s electronically despun antenna, a technique for focusing the antenna's entire output on the earth from a spin-stabilized satellite. Applied Physics Laboratory, in a Navy-sponsored effort, will test a gravity-gradient satellite called Dodge, which is described by a Pentagon official as a "more sophisticated experiment" than the GE test. A third test satellite will be Lincoln Laboratory's LES-5 experimental satellite, which will make direct communications tests with aircraft. Special aircraft equipment built for the test will provide some multiple-access capability at low data rates. LES-5 hardware is being built at the Radio Corp. of America and Western Microwave Laboratories Inc.

The gravity-gradient stabilization and electronically despun antennas are two of the leading competitors for future military communications satellites, and some observers are calling gravity gradient the favorite for an upgraded Initial satellite.

Swinger. However, a development earlier this month could be a fly in the gravity-gradient ointment. An Air Force project official said that a solar flare on about Aug. 6 caused a "substantial" swing in the GE gravity-gradient satellite now in orbit. He wouldn't say how much it had affected the satellite—which before the flare had damped down to about $\pm 18^{\circ}$, well ahead of the original schedule. He indicated the effect from the flare was more than anticipated.

GE, however, discounted the effect of the magnetic storm activity from the sun. GE has asked for data from the Air Force for that period, William van Patten, GE project manager, said.

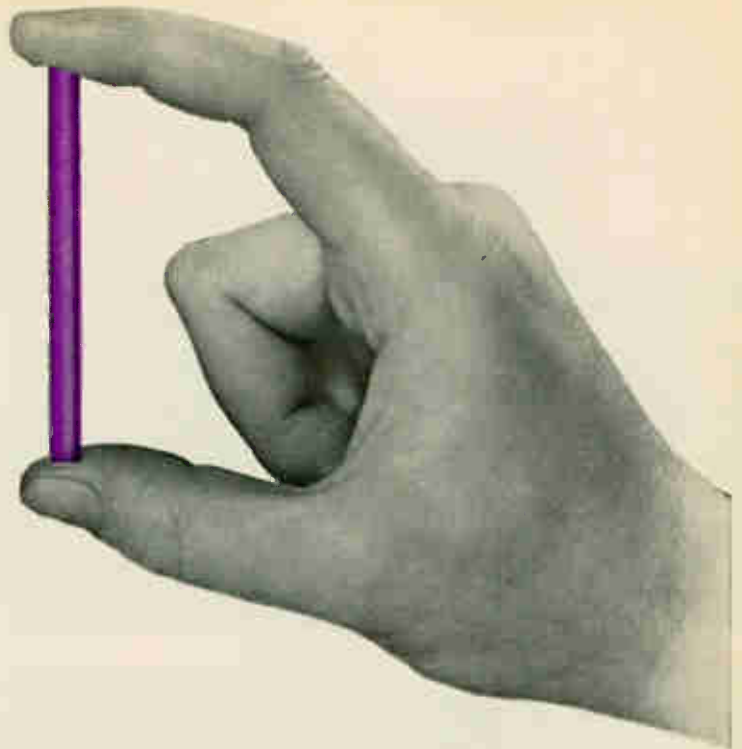

Until recently, there was only one type AOLux glass laser rod.



Today there are 10.

They're all made by American Optical and designed to suit the purpose of just about every system. They all require less input power than other solid-state materials.

We've expanded the line of general-purpose glass rods to include dopings of 2%, 3% and 6%, to give you a wider selection for high pump uniformity. This group of rods exhibits very low loss, is essentially inclusion-free, and is available with special-purpose claddings.

For you who want long fluorescent lifetime, higher efficiency for

"Q" switching and better energy storage for amplifier applications, use the AOLux long-lifetime 3%, 4% and 6% neodymium-doped rods.

Also available is a high-durability rod for extra-large laser systems, in dopings of 3% or less. Then there are AOLux neodymium YbNd double-doped rods with a 2 millisecond lifetime, still with 1.06 micron output. And AOLux ErYbNd triple-doped rods with 14 millisecond lifetime—with outputs of 1.54 microns.

Naturally, such considerations

as present cavity configuration and power supply, output wavelength, output power, pulse duration, beam spread, repetition rate, shape of spike, cooling, etc., will condition your selection.

That's where American Optical comes in. We pioneered neodymium-doped glass laser rods; we now offer 10 standard types. We're ready and willing to help you match our laser rods to your specifications. Contact American Optical Company, Space-Defense Division, 4709 Baum Blvd., Pittsburgh, Pa. 15213.



AMERICAN OPTICAL COMPANY

SPACE-DEFENSE DIVISION—SOUTHBRIDGE, MASSACHUSETTS

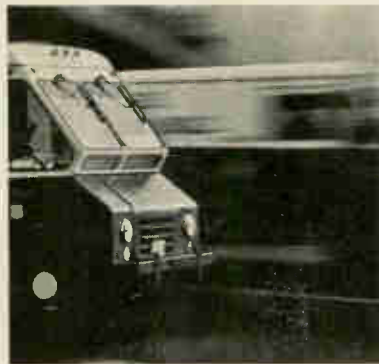
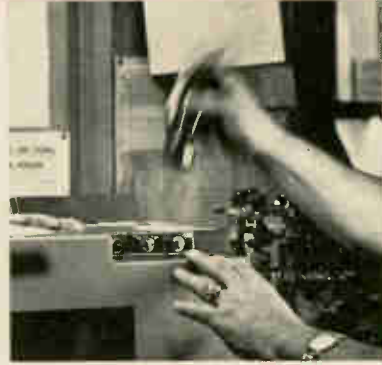



last week
we mailed a customer
one of our tape
recorders and forgot
to mark it "fragile."

we didn't have to.

It came through like a phone bill. The recorder, our MTR-3200, weighed in at 44 pounds. That's pretty compact for a unit that has to store and reproduce data in the severest of environments. And the small size is an added benefit. For another, it needs only 55 watts of 28 vdc power, and operates through 10g shock with less than 6% peak to peak flutter.

The MTR-3200 withstands accelerations up to 25g while ignoring temperatures from -40° to $+71^{\circ}$ C. Humidity up to 95% won't seep in, and it will run at altitudes up to 150,000 feet.

Convenient plug-in modules provide 14 analog or FM, or 16 digital channels. They can be used in any combination. Six tape speeds are available in standard pairs which are electrically selectable.

The MTR-3200 provides 2400 feet of laboratory performance in a "breadbox," while conforming to IRIG standards for data reduction equipment.

If we haven't mentioned all of your requirements, and they're tough ones, let us know.

Just write your specs on anything handy. Like the back of a purchase order.

Send it to Leach Corporation, Controls Division, 717 North Coney Avenue, Azusa, California.

LEACH Export: Leach International, s.a.
Or read them to us over the
phone: (213) 334-8211.

BOOTH 1515-16 WESCON

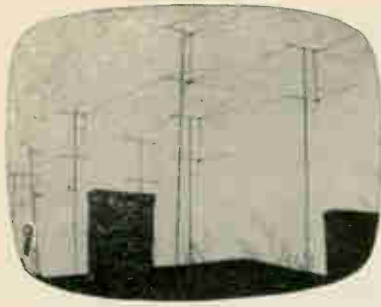

Stackpole Ceramag® ferrite components have been the accepted standard of the Television Industry for over twenty years.

In 1965, Stackpole began supplying Automatic Pincushion Correction Cores, a major advance, for color television receivers. 1964 saw the introduction of Stackpole 90° color components including Flyback, Yoke and Convergence Cores. As far back as 1954, these same components were introduced for the 70° color Deflection Systems.

The list of contributions Stackpole engineering and production know-how has made to the growth of color in television is long and varied. This same capability has been applied to the continual improvement of

black and white receiving equipment as well.

To be first with such items as Horizontal Output Transformer Cores and Automatic Pincushion Correction is not enough. Innovation must stand the test of performance. Stackpole Ceramag® components have, since 1947. Small wonder most manufacturers have come to depend so heavily on Stackpole's experience and quality. Stackpole Carbon Company, Electronic Components Division, St. Marys, Pennsylvania 15857. Phone: 814-781-8521. TWX: 510-693-4511.

Ceramag® Ferrite Components are Coloring the Entire Television Picture

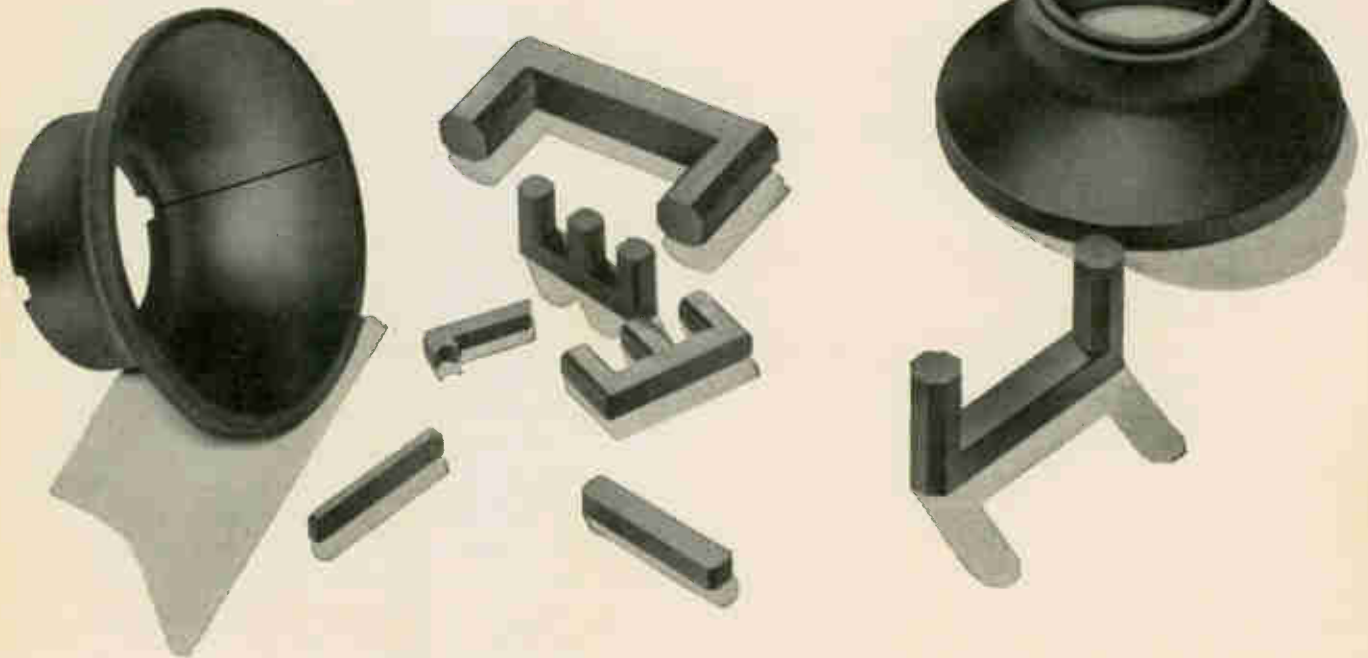

STACKPOLE

ELECTRONIC COMPONENTS DIVISION
"OUR 60th YEAR"

HEWLETT-PACKARD

*performance
and value in
electronic
counters*



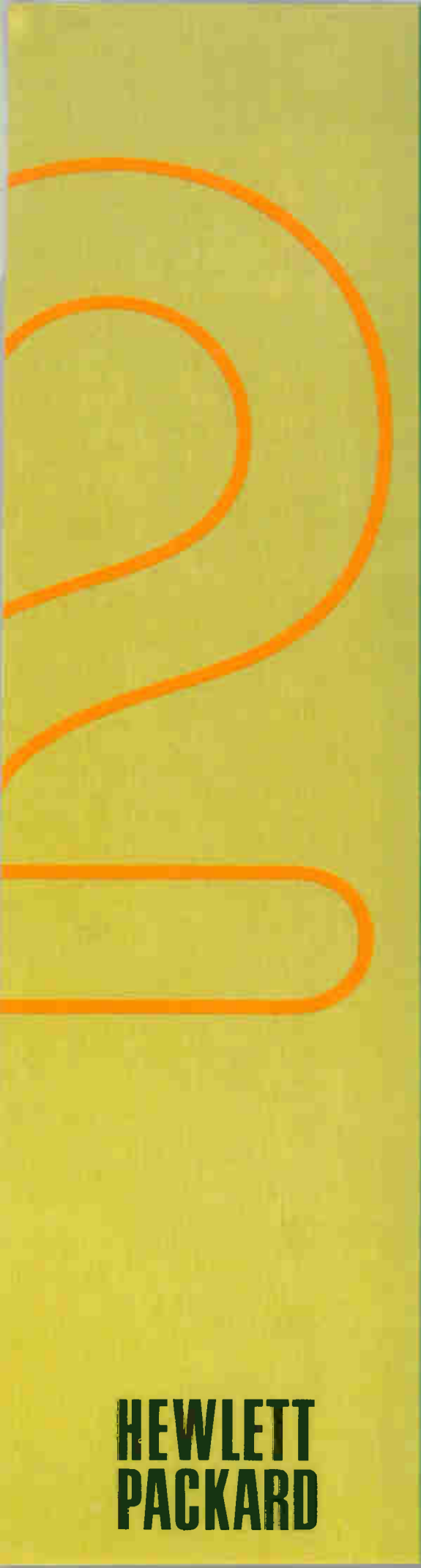

**HEWLETT
PACKARD**

From Hewlett-Packard, the world's most extensive line of electronic counters and accessory instrumentation... designed to make your measurements faster, easier, more accurate, and to make measurements that were heretofore impossible.

*Measurement code used below: F=Frequency, P=Period, MP=Multiple Period, MPA=Multiple Period Average, TI=Time Interval, R=Ratio, MR=Multiple Ratio.

50 MHz COUNTER WITH PLUG-INS TO 12.4 GHz

Model 5245L Electronic Counter measures F, P, MPA, R, MR, TI.* Frequency measurement 0 Hz to 50 MHz directly; up to 100 MHz, 500 MHz, 3000 MHz and 12.4 GHz with plug-in converters. Sensitivity, 100 mv; time base, better than $3/10^6$ /day; 8-digit in-line readout. 1 M Ω input, front panel trigger level control.

HP 5245L Counter without plug-ins, \$2950

NEW! 1 Hz resolution at X-band in 4 seconds

HP 5255A 12.4 GHz Heterodyne Converter, \$1650

HP 5251A 100 MHz Plug-in Converter, \$300

HP 5252A DC to 350 MHz Prescaler Plug-in, \$685

HP 5253B 500 MHz Plug-in Converter, \$500

HP 5254A 3000 MHz Plug-in Converter, \$825

HP 5261A Video Amplifier Plug-in, \$325

HP 5262A Time Interval Plug-in, \$300

HP 5264A Preset Unit Plug-in, \$650

HP 5265A DVM Plug-in, \$575

OTHER HIGH-FREQUENCY COUNTERS

Model 5244L 50 MHz Electronic Counter measures F, P, MPA, R, MR.* Time base $\pm 2/10^7$ /month, gate times 1 μ sec-10 sec, 7-digit in-line readout. \$2225.

Model 3734A 2.5 MHz Electronic Counter measures F, P, MPA, R, MR, TI* 2 Hz to 2.5 MHz. Time base, $\pm 2/10^6$ /week; gate times, 0.01-1 sec (to 10 sec optional); 5-digit in-line readout. \$1075.

Model 5233L 2 MHz Electronic Counter measures F, P, MPA, R, MR, TI* 0 Hz to 2 MHz. Time base, $\pm 2/10^7$ /month; gate times, 10 μ sec-10 sec; 6-digit in-line readout. \$1750.

Model 5232A 1.2 MHz Electronic Counter measures F, P, MPA, R, MR* 2 Hz to 1.2 MHz. Time base, $\pm 2/10^7$ /month; gate times, 0.01-10 sec; 6-digit columnar readout. *Model 5532A* identical but with 6-digit in-line readout. HP 5232A, \$1300; HP 5532A, \$1450.

LOW-FREQUENCY COUNTERS

Model 5211A 300 kHz Electronic Counter measures F and R* 2 Hz to 300 kHz with a 4-digit columnar readout. Uses power frequency line as time base; gate times of 0.1 and 1 second. *Model 5211B* identical except has gate times of 0.1-10 seconds. *Model H22-5211B* same as 5211B but with a 4-digit in-line readout. HP 5211A, \$600; HP 5211B, \$725; HP H22-5211B, \$825.

Model 5212A 300 kHz Electronic Counter measures F, P, MPA, R, MR* 2 Hz to 300 kHz. Time base, $\pm 2/10^6$ /week; gate times, 0.01 sec-10 sec; 5-digit columnar readout. *Model 5512A* identical but with 5-digit in-line readout. HP 5212A, \$925; HP 5512A, \$1050.

Model 5223L 300 kHz Electronic Counter measures F, P, MPA, R, MR, TI* 0 Hz to 300 kHz. Time base, $\pm 2/10^6$ /week; gate times, 10 μ sec-10 sec; 5-digit in-line readout. \$1325.

PRESET COUNTER

Measures normalized rates, ratio, normalized ratio and time for N events to occur. Direct reading in engineering units; N may be preset to any integer between 1 and 100,000; range is 2 Hz-300 kHz. HP 5214L, \$1475.

10 nsec TIME INTERVAL COUNTER

Permits measuring of time interval with resolution to 10 nsec over the full 10 nsec to 0.1 sec range. Ideal for precise digital measurement of short-time events. 7-digit columnar readout. HP 5275A, \$2500.

REVERSIBLE PLUG-IN COUNTER

Totalizes, counts sum or difference of 2 inputs, totalizes 1 signal with direction of count as a function of polarity or quadrature phase of another signal; 2 MHz counting, 1 MHz subtracting, 250 nsec reversing. HP 5280A, \$1450; HP 5285A Plug-in for described operations, \$450.

NUCLEAR SCALER-TIMER

Accepts pulses from nuclear detectors to accumulate, display and record nuclear events. Three-mode pulse height analyzer, stability is 0.01%, 6-digit in-line display. HP 5201L, \$1950. Other models down to \$950.

AUTOMATIC FREQUENCY DIVIDER

Automatic direct readout of frequency, 0.3 to 12.4 GHz, on 5245L Counter. No ambiguity offset or arithmetic processing. HP 5260A, \$3250.

DIGITAL RECORDER

Prints 5-lines/sec; 11 digits (12 available) 2 msec input data transfer time, plug-ins for BCD or 10-line codes, HP 562A, \$1080-\$2100, depending upon options.

TRANSFER OSCILLATORS

Extend frequency range of 5245L Counter (with 5252A or 5253B Plug-in) and measure CW, pulsed and FM signals to 12.4 GHz and higher. HP 540B, \$1050; HP 2590B, \$1900.

DIGITAL-ANALOG CONVERTERS

Digital-Analog Converters make possible high resolution analog records from counters, scalars, DVM's; operate directly with HP and Dymec instrumentation. HP 580, \$525.

VLF COMPARATOR

A complete system for checking counter time bases and other oscillators against U.S. Frequency Standard broadcast by station WWVB (60 kHz). HP 117A, \$1300.

hp 5233L 2 MHz Counter with Time Interval Capability

hp 5275A Time Interval Counter

hp H22-5211B Low-cost Counter

hp 5280A Reversible Counter

hp 5214L Preset Counter

hp 5245L Counter with 5255A 3-12.4 GHz Plug-in



EXCELLENCE

in electronic counters

**HEWLETT
PACKARD**

the standard of excellence

28835
2657938
3
2

in reliability

HP counters are subjected to tests that are much more stringent than normally expected for commercially priced equipment. All instruments in development undergo extensive tests such as shock, vibration, high and low temperature, humidity, electromagnetic compatibility (RFI) and line voltage and frequency. Components undergo environmental tests in the HP Components Evaluation Laboratory. Quality audits are performed regularly to ensure that original performance and quality standards are being met. Finally, each solid-state

counter gets severe temperature testing before shipment.

One result of quality assurance at Hewlett-Packard is that, in long term reliability tests, twenty Model 5245L Counters survived a total of 18,077 test hours with only two disabling failures. That's an average of one failure per 4 years at 40 hours per week! Mean-time-between-failures (MTBF) exceeded military requirements comfortably. Another result: standard hp counters have passed military environmental tests and have been assigned MIL nomenclature (data upon request).



Here's a small part of hp's extensive in-house test facility where instruments are tested under extreme shock, vibration, temperature, humidity and electromagnetic conditions.



To force any marginal components to fail before shipment, all solid-state counters are operated at +65°C for at least 16 hours in heated cabinets.



Decade counting assemblies for all solid-state counters undergo a temperature of 80°C for 2 hours to force failure of any marginal components. Despite this torture, the failure rate of decades is less than 0.5%. The assemblies are also operated for 22 hours at room temperature.



In one of numerous tests, all Model 5245L crystal oscillator assemblies are operated and observed for two weeks to determine aging rates.

Since the introduction of the first hp counter more than 15 years ago, Hewlett-Packard has been the leader in virtually all areas of frequency generation and measurement. Hewlett-Packard's proficiency in cesium beam frequency standards, quartz oscillators, frequency synthesizers, signal generators and other electronic equipment has enabled Hewlett-Packard to excel in all areas of electronic counter design.

The Frequency and Time Division of Hewlett-Packard concentrates the full efforts of hundreds of engineers, technicians and manufacturing people on frequency and time measurements and standards.

For more information on Hewlett-Packard frequency and time measuring instrumentation, call your field engineer or write, Hewlett-Packard, Palo Alto, California 94304, Tel. (415) 326-7000; Europe: 54 Route des Acacias, Geneva.

Data subject to change without notice. Prices f.o.b. Palo Alto, California; for prices in other countries, contact your hp field office.

HEWLETT  **PACKARD**
An extra measure of quality

Soliton

announces

V_{CEO} (SUS)

325 v

300 v

250 v

225 v

200 v



*in a 10 Amp. NPN Silicon
Planar Power Transistor
Plus
50 mcs 150 pfs*

Type Number	Pkg. Size	DESIGN LIMITS						PERFORMANCE SPECIFICATIONS					
		T _J	θ	P _T	BV _{CEO}	V _{CEO} (SUS)	BV _{EBO}	h _{FE}	V _{BE} (sat)	V _{CE} (sat)	I _{CBO}	f _T	
		°C	°C/W	Watts	Volts	Volts	Volts	Min. Max.	Volts	Volts	μA	mc	
		Max.	Max.	Max.	Min.	Min.	Min.	@I _C = 5A V _{CE} = 5V	@I _C = 5A I _B = 0.5A	@I _C = 5A I _B = 0.5A	V _{CB} = 100V	Min.	
MHT7201	TO-3	200	1.5	65	225	200	8	20	60	1.2	0.5	1.0	50
MHT7202	TO-3	200	1.5	65	250	225	8	20	60	1.2	0.5	1.0	50
MHT7203	TO-3	200	1.5	65	275	250	8	20	60	1.2	0.5	1.0	50
MHT7204	TO-3	200	1.5	65	325	300	8	20	60	1.2	0.5	1.0	50
MHT7205	TO-3	200	1.5	65	350	325	8	20	60	1.2	0.5	1.0	50

TRANSISTOR DIVISION

Soliton DEVICES, INC.

1177 BLUE HERON BLVD. / RIVIERA BEACH, FLORIDA / (305) 848-4311 / TWX: (510) 952-6676

Leader in Germanium and Silicon Power Transistors, Cryogenic Thermometers, High Voltage Rectifiers, Hot Carrier Diodes, Temperature Compensated Zeners, Voltage Variable Capacitors, Random/White Noise Components, Microelectronic Circuits, and High-Pac Interconnection Systems.

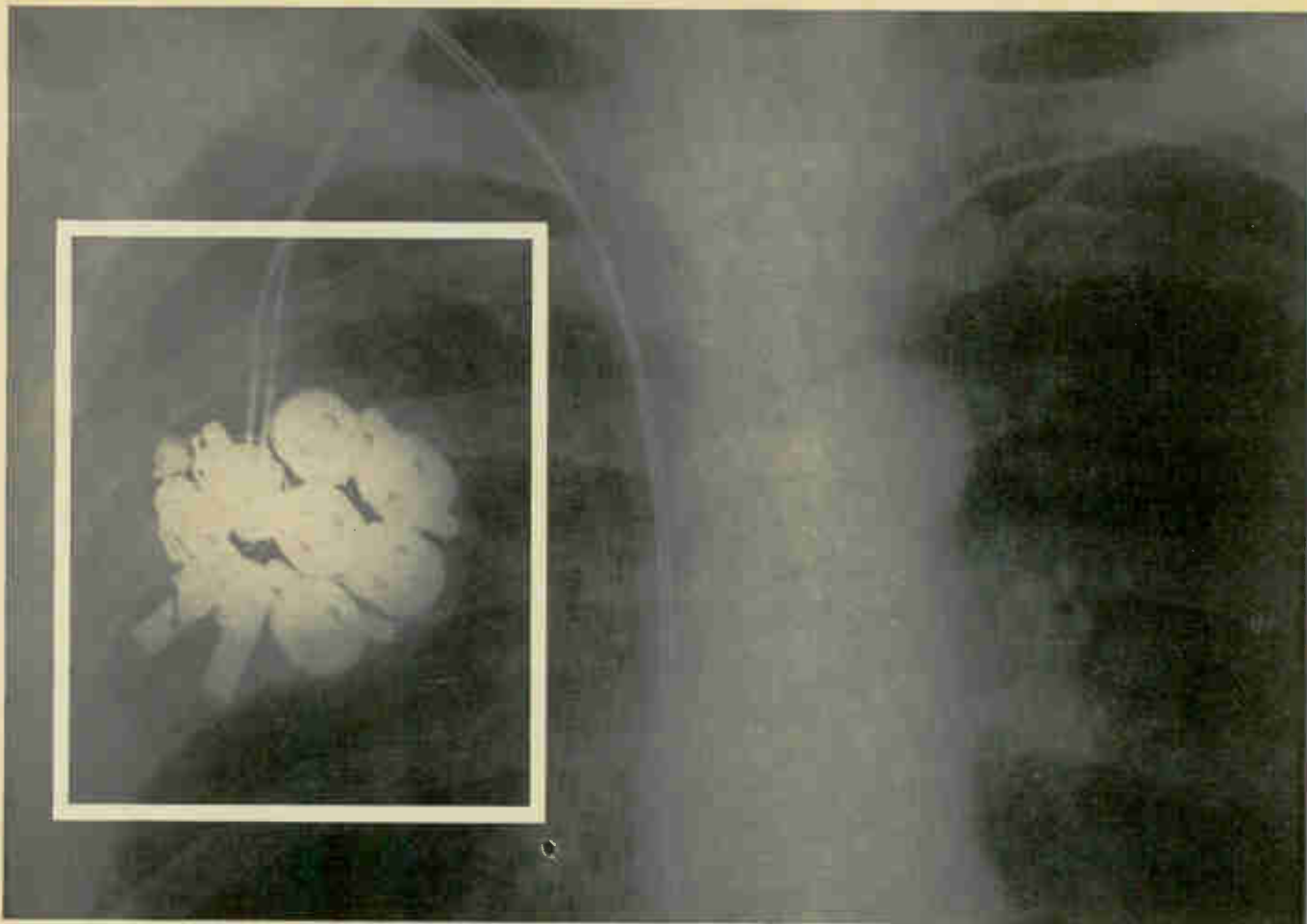

Doctors needed a battery they could trust inside you while it worked to save your life!

Mallory made it.

What can we do for you?

Medical Science needed a battery. A battery that literally could keep your heart beating. A battery to power a heart pacemaker—the electronic device that “shocks” sluggish hearts into a normal beat. A battery that would last three years or more in this surgically-implanted device even in the high temperature environment of the body. Medical researchers came to Mallory. Mallory provided the battery—the high-energy mercury battery made so reliably its manufacturing process practically insures zero defects.

BATTERY-POWERED MIRACLES

The high-energy density of the mercury battery and its extraordinary reliability have found many uses in medical electronics. Mercury batteries will be the source of power for new devices that help control your breathing, control hypertension, even stimulate bone growth. Mercury batteries can be made so small they will fit into “radio capsules” that transmit information from within the stomach. And, of course, for years Mallory mercury batteries have powered hearing aids, bringing new comfort and hope to the hard-of-hearing.

THE HIGH TEMPERATURE BATTERY

One of the special attributes of the Mallory mercury battery is its ability to withstand high temperatures. No other dry battery can approach its performance when the temperature climbs above normal—the mercury system was developed in World War II specifically for use in hot climates. Today

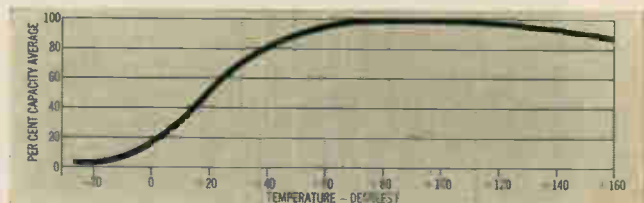

mercury batteries rated to withstand temperatures of 160°F are at work in Vietnam. Geologists use them in deep-hole experiments where the temperatures approach 200°F. And, of course, the high temperature characteristics of mercury batteries are vital to power surgically-implanted devices that must operate faithfully at 98.6°F for years!

OVER 1000 DIFFERENT TYPES

Mallory currently makes over 1000 batteries of all sizes and capacities. If we're not actually producing the battery you need, we'll be happy to work with you in designing a new one. Write the Application Engineering Department, Mallory Battery Company, a division of P. R. Mallory & Co. Inc., S. Broadway, Tarrytown, N.Y. 10591. Or call 914-591-7000. In Canada: Mallory Battery Company of Canada Limited, Sheridan Park, Ontario.

It's good business to do business with Mallory

MALLORY

50th
ANNIVERSARY

Familiar with **TEFLON**? Try this quiz.

①	TEFLON is transparent!	TRUE	FALSE
②	TEFLON can be cemented!	TRUE	FALSE
③	TEFLON can be heat sealed, thermoformed, heat bonded!	TRUE	FALSE
④	A TEFLON film is made by Du Pont!	TRUE	FALSE

All are true with **TEFLON® FEP film: a new dimension in TEFLON**

Let us tell you more.

Du Pont Company, Room 4611, Wilmington, Delaware 19898

TEFLON FEP fluorocarbon film brings the familiar properties of TEFLON *plus* a new form, versatility and ease of fabrication for applications like: conveyor belting, critical industrial packaging, gaskets, roll covers, reinforced plastics curing, closures, high temperature electrical insulation, flexible flat cable, printed circuitry.

The application I am considering is _____

To do the job, a material with the following critical properties is required:

TEFLON FEP FILM

- Mechanical high impact, abrasion, tear strength. Useful at cryogenic temperatures
 - Thermal resistance from -240 to +200°C. continuously.
 - Chemical resistance the most inert of all plastics.
 - Release, anti-stick superior
 - Electrical No tracking, non-wettable, non-flammable, low power factor and dielectric constant, dielectric strength: 4,000 vpm for 2 mil film.
 - Weatherability high transmittance of ultraviolet and all but far infrared, inert to outdoor exposure
- I am interested in these forms and processing techniques:
- Film thickness ½, 1, 2, 5, 10, 20 mil.
 - Heat bonding directly to metals.
 - Heat sealing provides a plastic weld at 300°C.
 - Cementing available with one or both surfaces treated to accept conventional adhesives, for laminating to metals, rubber, glass cloth, asbestos fabric, etc.
 - Thermoforming a true thermoplastic, thermoform at 525°F., with conventional equipment

MY REQUIREMENTS

from _____ to _____
to _____
yes _____ no _____

thickness _____
substrate _____
yes _____ no _____
substrate _____
one side _____
both sides _____
yes _____ no _____
shape _____

Please send full appropriate technical data.

Name _____ Address _____
Company _____ City _____ State _____ Zip _____
Job Responsibility _____ Business Phone _____



TEFLON® FEP fluorocarbon film

BETTER THINGS FOR BETTER LIVING... THROUGH CHEMISTRY

START PITCHING!

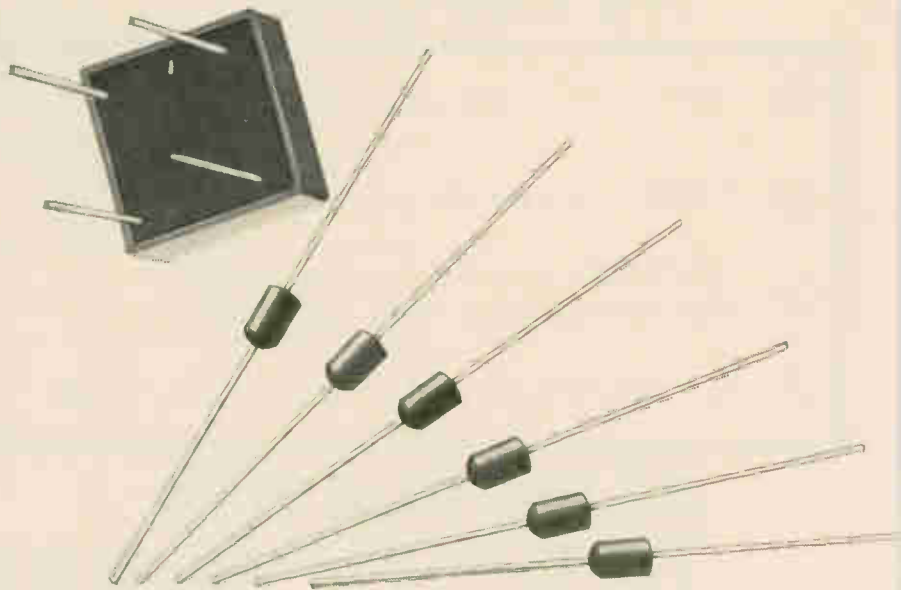

Make us show you in black and white how Slater can supply in quantity 1N3189 series diodes to MIL-S-19500/155 and high voltage rectifiers and assemblies at the lowest price per voltage and ampere rating in the industry.

Bear down! Demand to see some of Slater's 1 ampere hermetically sealed diodes up to 1000 volts with guaranteed recovery times of less than 100 nanoseconds. Too much pressure won't be necessary. We want you to sample and test these units in your high frequency applications.

Don't let up! Ask to see how we can supply combinations of specifications in our assemblies at extremely high reliability levels previously unavailable in the industry. The Slater SLA-01 to SLA-020 are 1/5 the size of comparable

units. They feature up to 20,000 volts PIV and 200 Mi average rectified current with extremely low leakage and forward voltage drop. Additional units up to 100 KV PIV are also available.

Go ahead, toss 'em in. We want your problems. Call us collect for samples of our *single junction* diffused 1 and 2 ampere silicon rectifiers with up to 2000 volts PIV. These units have a 20% safety feature on all specifications. All are controlled avalanche.

We're used to solving difficult problems when it comes to semiconductors! After all, Slater is the fastest growing semiconductor manufacturer in the industry. There must be a reason.



SLATER ELECTRIC INC.
SEMICONDUCTORS DIVISION
45 Sea Cliff Avenue • Glen Cove, N. Y.

IRG

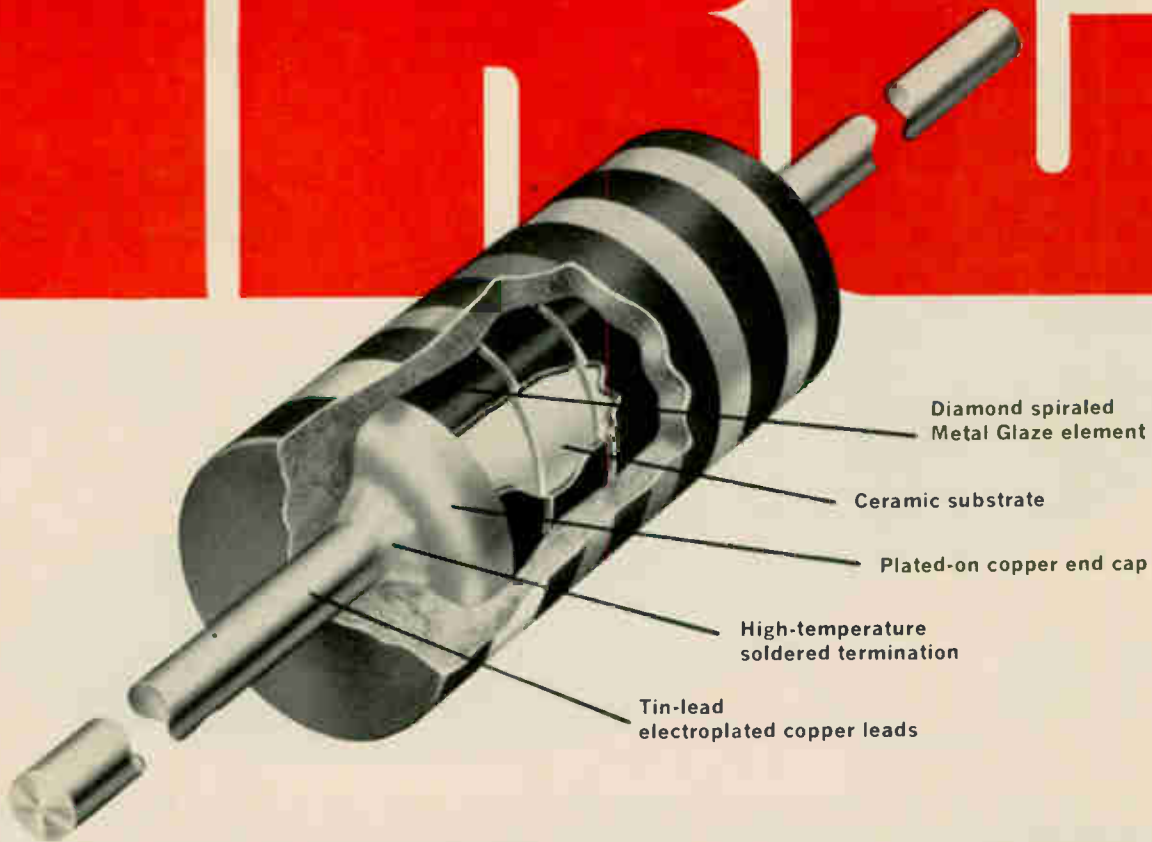

Diamond spiraled
Metal Glaze element

Ceramic substrate

Plated-on copper end cap

High-temperature
soldered termination

Tin-lead
electroplated copper leads

New low-cost Metal Glaze[®] resistors for MIL-R-22684

4 times better load-life stability

IRC's new molded Metal Glaze resistors provide stability, reliability and precision unmatched anywhere for the price.

Tested for over 15 million unit hours, they meet or exceed all MIL-R-22684 requirements. Load life stability, for instance, is four times better than MIL allowance. Typical ΔR is 0.5% after 1000 hours, full load at 70°C. Even at higher temperatures, ΔR is still typically under MIL limits.

The Metal Glaze resistance element is extremely rugged. It is 100 times thicker than conventional films and is impervious to environmental extremes. The tough, uniform molded body resists solvents and the mechanical abuse of automatic machines.

New IRC molded Metal Glaze resistors are immediately available in four forms of packaging to cut your production costs. For complete data, prices and samples, write to: IRC, Inc., 401 N. Broad St., Philadelphia, Pa. 19108.

CAPSULE SPECIFICATIONS

		
MIL-R-22684B	RL07	RL20
WATTAGE	1/4 W @ 70°C	1/2 W @ 70°C
RESISTANCE	51 Ω thru 150K Ω	10 Ω to 470K Ω
TOLERANCES	$\pm 2\%$, $\pm 5\%$	$\pm 2\%$, $\pm 5\%$
TEMPERATURE COEFFICIENT:	$\pm 200\text{ppm}/^\circ\text{C}$ max.	$\pm 200\text{ppm}/^\circ\text{C}$ max.
VOLTAGE	250V max.	350V max.
SIZE:	.250" x .090" dia.	.375" x .138" dia.
IRC TYPE:	RG07	RG20





As comfortable as an old shoe.



That's the way most engineers feel about using these 28 popular Motorola silicon annular complementary transistors in their designs.

NPN	PNP	APPLICATION
2N2218-18A 2N2219-19A 2N2221-21A 2N2222-22A	2N2904-04A 2N2905-05A 2N2906-06A 2N2907-07A	Complementary high performance STARS* for medium level switch and amplifier applications.
2N3946 2N3947	2N3250-50A 2N3251-51A	Complementary high performance BOX for low level switch and amplifier applications.
2N3252 2N3253	2N3467 2N3468	Complementary high performance SNOWFLAKES for high level switching applications.
2N2369	2N3546	Complementary high performance low level high speed switch applications.

Why ?

Because they are *versatile*. They fit anywhere — do all jobs well. If there were such a thing as a “universal” transistor, these would all be top candidates for the title.

Secondly, they're *reliable*. That's what makes it so comfortable for the designer. He knows he can depend on each and every device with patented annular structure that he uses.

He also knows he has a *dependable supply*. Motorola has been making these types by the millions for years.

And the prices? They're comfortable, too. That is the nicest part.

So, why don't you get yourself some old shoes — and *get comfortable!* Your local Motorola semiconductor distributor has them all *in stock* in up to 1000 quantities. Larger requirements can be handled by your nearest Motorola district office. For complete technical data write: Motorola Semiconductor Products Inc., Dept. TIC, Box 955, Phoenix, Arizona 85001.

*Trademark of Motorola Inc.



MOTOROLA Semiconductors

— where the priceless ingredient is care!



A switch to insulation of MYLAR[®] gave Western Electric a more reliable relay

Greater performance reliability with substantial cost savings—that's why Western Electric has switched from cellulose acetate to insulation of MYLAR* polyester film in the manufacture of relays. MYLAR gives not only superior dielectric strength for better insulation, but also greater physical strength. During assembly, it actually holds the relay terminals parallel without additional tools or supports. Over all, this has permitted Western Electric to reduce costs.

Relays are just one type of compo-

nent where MYLAR improves performance and saves money. Chances are you could take advantage of its unique balance of properties: exceptional strength in thin, weight-saving gauges . . . thermal stability from -60° up to +130 C° . . . high moisture and chemical resistance . . . long-lasting flexibility.

Why not investigate? For your free



Better Things for Better Living
... through Chemistry

only DUPONT makes



"SEE US AT WESCON, BOOTH 1533-35."

copy of the complete "Fact File" on insulation of MYLAR—mail coupon.

DUPONT REGISTERED TRADEMARK

Du Pont Company, Room 3666C
Wilmington, Delaware 19898

Please send me a copy of the
"Fact File" on insulation of MYLAR[®]

Name

Title

Company

Street

City State Zip

In Canada: Du Pont of Canada, Ltd., P.O. Box 560, Montreal

10 gram guard



Reverse-voltage defense is just one more reason for G-E tantalum foil

Forget about a surprise reverse with G-E tantalum foil capacitors. They're designed to take it. And reverse-voltage defense is just one reason for using G-E tantalum foil. Here are three others:

PROVED IN-CIRCUIT RELIABILITY: They've been proved—and improved—for over 17 years. More than 20 million have been successfully applied. G-E tantalum foil earned a 0.00023 reliability record (per 1000 hours) on Minuteman reliability tests,

based on the Minuteman acceleration factor.

NO CATASTROPHIC FAILURES: Low impedance circuits and catastrophic failures are no problem with G-E tantalum foils. They're self healing. **LONG SHELF LIFE:** We're up to the 14 year mark . . . with less than a 5% capacitance change at 25C. That's shelf life!

G-E tantalum foil capacitors are available in ratings up to 450VDC, 0.15 to 3500uf, —55 to 85 or 125C. They're

virtually risk-proof. And may cost more. But isn't a proved line your best defense?

For all the facts on G-E tantalum foil reliability, write for Reliability Report, Section 430-25, General Electric Co., Schenectady, N. Y. 12305.

ELECTRONIC COMPONENTS DIVISION

GENERAL  **ELECTRIC**

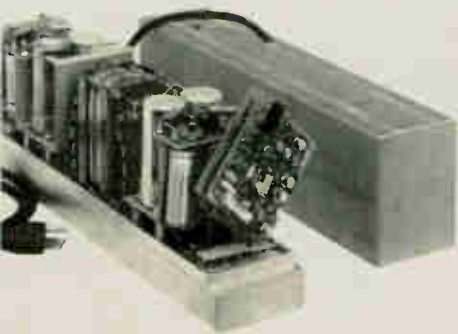

Sorensen Power Supplies for Scientific Instrumentation

Precision instrumentation requires precision power. Sorensen applies its advanced standard product technology to demanding custom designs. Here are three typical examples.

Model MQB72-1 is a silicon transistorized precision DC power supply designed for use with standard AEC nuclear instrument module bins. Voltage regulation is $\pm 0.02\%$ (line and load combined) with remote sensing • Stability, $\pm 0.1\%$ max. for 8 hours after a 30 minute warmup • Recovery time, 50μ to $\pm 0.1\%$ of the output voltage for any line change or a 10%-100% load change. Other design features include electronic overload protection for overloads above 120% of rated output current with automatic recovery. Ripple—3 millivolts (peak to peak) maximum.

Model 2400-4 high voltage DC power supply was designed to be used as part of a beam separator. Operating in pairs, these power supplies provide an electrostatic field of 800,000 volts. The application requires these units to operate for long failure-free periods without maintenance. The controller unit shown above is fully metered and offers maximum personnel and equipment protection. Output voltage is 0-400kV @ 4mA. Line regulation is $\pm .20\%$. At 1mA ripple is 0.25% peak to peak. New manufacturing techniques have been used to produce this compact design.

The XLS Series is a line of xenon lamp power supplies which utilizes NO spark gaps or relays. Sorensen's unique pulse ignition circuitry guarantees instant starting and greatly increased lamp life. These supplies deliver regulated, low-ripple power with line voltage variations of 100-130 Vac or 200-260 Vac. This precise stabilization permits use of the Xenon Arc Lamp in applications such as spectrometers, precision optical systems, spectro-phosphorimetry, spectroprojection systems, solar simulation, spectrophotography, and general photographic projection systems.

For details on any Sorensen standard/custom DC power supplies, AC line regulators, or frequency changers, contact your Sorensen representative or: Raytheon Company, Sorensen Operation, Richards Avenue, Norwalk, Connecticut 06856. Tel: 203-838-6571.



"SEE US AT WESCON BOOTHS 145 & 146 HOLLYWOOD PARK"

Circle 61 on reader service card



Model 7816
**12 CHANNEL NOISE
GENERATOR**

Simulates up to 12 voice or data channels for multiplex, troposcatter, SSB, FM multi-channel systems.

- Checks complete system line-in to line-out
- Provides 12 non-coherent independent channels 300 cps to 3400 cps

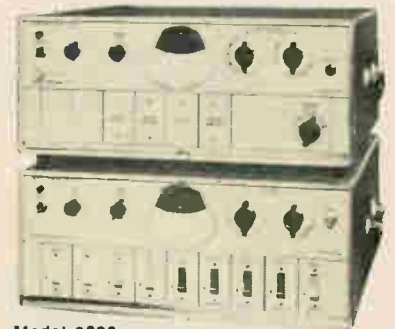

Model 2090
**2700 CHANNEL NOISE
LOADING TEST SET**

Checks Noise Power Ratio of multi-channel systems, satellite communications, cables, etc.

- Generates noise flat to 0.5db from 12 kc to 12.388mc
- Band limiting and slot filters to 2700 channels for all CCIR, CCITT and DCA recommendations and out-of-band testing.



Model 791D
FM DEVIATION METER

Covers 4 mc to 1024 mc. Xtal lock on local oscillator gives less than 20 cps FM noise.

- Deviation $\pm 5, \pm 25, \pm 75, \pm 125$ kc
- Accuracy $\pm 3\%$ fsd
- Modulating freq.: 20 cps to 35 kc

**SO MANY ORDERS
FOR THESE
MARCONI INSTRUMENTS
HAVE BEEN COMING IN
THAT WE NOW MAKE
THEM IN THE U.S.A.**

MARCONI INSTRUMENTS

Division of English Electric Corporation

111 Cedar Lane • Englewood, N. J. Telephone: 201-567-0607
SEE US AT WESCON, HOLLYWOOD PARK, BOOTH 370-1

SOMETIMES WE WONDER WHO BEN'S WORKING FOR

Ben's the head of our Technical Service Department.

And when Ben sets out to help you with a wire, cable or tubing problem, nobody but nobody rests until it's solved. It's more like a declaration of war. On the problem and on us, too, if Ben feels we're not jumping to help as quickly as he feels we should. (It's no good reminding Ben who pays his salary. We've still got the scars.)

So if you want help with an engineering or technical problem, Ben's your man.

Just as he's the man to help you select the right Alpha product for any particular application.

Or prepare detailed technical specifications on any Alpha product.

Or help out with engineering data sheets and technical monographs.

Or furnish test data.

Even though we are the industry's most complete one-stop source of wire, cable and tubing, you'll find Ben will treat you as if you're the only customer who ever bought an Alpha product.

Maybe we do sometimes wonder whose side he's on. But there's not much doubt about who benefits.

Like to know more about Alpha technical help or products? Write us. Or call your nearest Alpha distributor.





This little sample will help explain some...

New ideas for multi-layer circuitry

Formica's MLC system permits accurate registration of circuits, maximum packaging density, high-temperature stability, plus!

Many common multi-layer circuitry problems can be solved. Just ask your Formica rep to bring in his kit (with samples) detailing Formica's new MLC system. System's base laminate is FORMICA® brand copper clad laminated plastic, FR-45—documented reliability. Pre-preg has resin specifically developed for use with FR-45 . . . has inorganic additives which increase thermal conductivity of laminate; OKs use of thin

circuit lines, thin copper foil, dense packaging. And circuit pads hold tight for accurate registration . . . no slippage. Go ahead and weld or solder: bond holds. Reliable circuits . . . resin stays viscous (but not watery) to fill around all elements. Many tiny, closely-spaced holes to drill? Your Formica rep can tell you how. Also how you can use one laminate (instead of 4) for G-10, G-11, FR-4, FR-5 requirements. Write, Dept. ID-5.



Leadership through innovation • FORMICA CORPORATION • Cincinnati, Ohio 45232 subsidiary of

CYANAMID

FORMICA® is our trademark for various products, including our brand of laminated plastic.

what's the fuss here?



Ye Silicon Transistor's huge array of JAN devices

Ye Silicon Transistor Corporation has all the JAN types to quell any fuss. JAN 2N389, JAN 2N424, JAN 2N1016B (C & D, too), JAN 1047A thru JAN 1050A, JAN 2N1479 thru JAN 2N1490, and JAN 2N1724. That's real Silicon chivalry! Wrapping? TO-3, TO-5, TO-8, TO-53, TO-57, TO-61, 150W or what you behest.

Silicon Transistor Corporation makes more different silicon power transistors than any other manufacturer so why sally forth into strange territories? Just call

SILICON TRANSISTOR CORPORATION



EAST GATE BLVD., GARDEN CITY, NEW YORK 11532
516 Pioneer 2-4100, TWX 510-222-8258

ENGLAND: WARRIOR ELECTRONICS, 15-15, SEPTON ST., LONDON, W.C.2

FRANCE: DUNIP, Industrie Electronique, 125 Rue de la Paix, PARIS

WESTERN: COMMUNICATIONS SYSTEMS, 401 Park Street, Boston, MA

(TELEX) 310001, S.T.C., 10100, MARSHALL ST., NEW YORK



**HOW
MANY
VOLTS
IN A
5
NANOSECOND
PULSE
?**

ONLY RAYTHEON COMPUTER'S NEW NANOVERTER™ KNOWS FOR SURE.

Raytheon Computer's new NANOVERTER can make accurate voltage measurements on 5 nanosecond pulses. It's the only instrument around today that can.

Besides a remarkable 5-nanosecond sampling device, the NANOVERTER includes a 12-bit analog-to-digital converter. Continuous throughput is as high as 45KC with accuracy $\pm 2\%$ of full scale. Timing is easy; the entire conversion process is controlled by a single

pulse. The NANOVERTER comes in a standard 5 $\frac{1}{4}$ " x 19" rack-mountable drawer.

Benefits of the NANOVERTER are immediately evident to those concerned with high speed transients encountered in memory and integrated circuit testing, shock and vibration analysis and other high speed pulse studies. We suggest they write today

for Data File E-125. Raytheon Computer, 2700 S. Fairview Street, Santa Ana, California, 92704. Phone (714) 546-7160.

RAYTHEON

Watch the NANOVERTER run at Wescon, Booth 1238. But you'll have to be quick.

Trademark of the Raytheon Company for its data system.

Now Commercial High Speed TTL I/C'S in dual in-line packages 10 ns gates 82¢ per gate function.

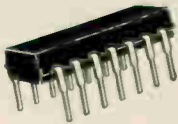

Signetics very high speed TTL integrated circuits are now available for as little as 82¢ per gate function in distributor quantity. 10 ns gate delays and 35 MHz flip-flops make SP800 series especially suitable for high speed computers and very high speed counters. Molded dual in-line packages offer lower cost, high performance and easy handling.

SP 800A (+15°C +55°C) Series available from distributor stock
ST 800A (0°C to 70°C) available on factory order only

SIGNETICS INTEGRATED CIRCUITS



A subsidiary of Corning Glass Works
811 East Arques Avenue, Sunnyvale, California
Tel.: (408) 739-7700 TWX: (910) 339-9220

		1000-2499	1 Type 100-999	Mixed 100-999	25-99	1-24
SP806A	Dual 4-Input Gate Expander	2.95	3.10	3.25	3.70	4.65
SP808A	Single 8-Input NAND Gate	2.95	3.10	3.25	3.70	4.65
SP816A	Dual 4-Input NAND Gate	2.95	3.10	3.25	3.70	4.65
SP825A	J-K Binary Element	4.55	4.80	5.05	5.75	7.20
SP826A*	Dual AC Binary Element	8.00	8.40	8.80	10.10	12.60
SP840A	Dual Exclusive-OR Gate	3.30	3.50	3.70	4.20	5.25
SP855A	Dual 4-Input Power Gate	3.30	3.50	3.70	4.20	5.25
SP870A	Triple 3-Input NAND Gate	3.30	3.50	3.70	4.20	5.25
SP880A	Quadruple 2-Input NAND Gate	3.30	3.50	3.70	4.20	5.25

*Available after July 15

SEE US AT WESCON—BOOTHS 156-158 SPORTS ARENA

Nine compatible elements

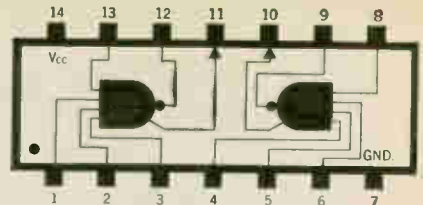

SP806A Dual 4-Input Gate Expander

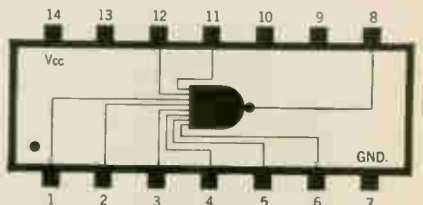

SP808A Single 8-Input NAND Gate

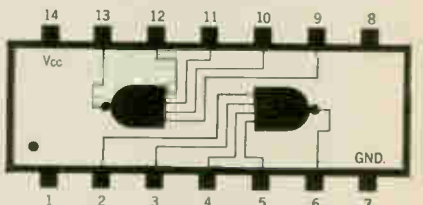

SP816A Dual 4-Input NAND Gate
SP855A Dual 4-Input Power Gate

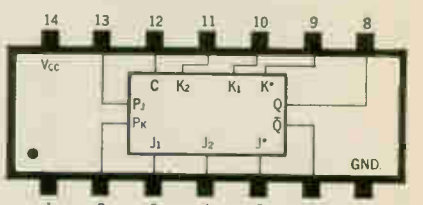

SP825A J-K Binary Element

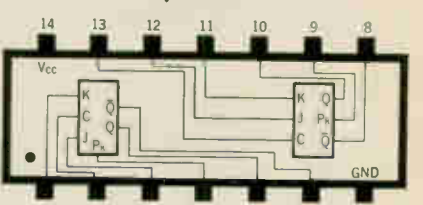

SP826A* Dual AC Binary Element

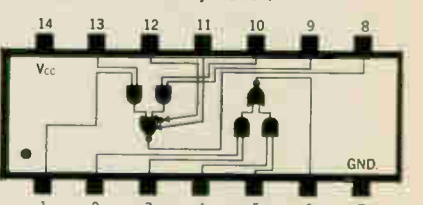

SP840A Dual Exclusive-OR Gate

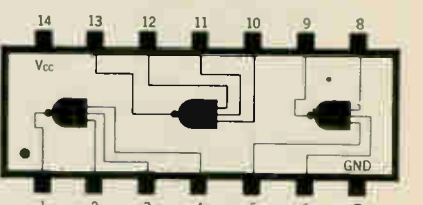

SP870A Triple 3-Input NAND Gate

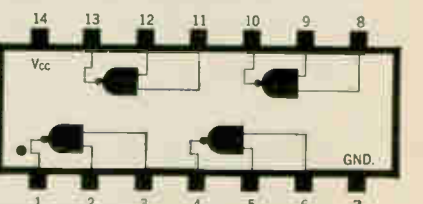

SP880A Quad 2-Input NAND Gate

MARRIAGE OF CONVENIENCE

How Sperry blends the best
of two technologies into a
superior microwave source



A V band Sperry klystron with matching solid-state power supply.

System designers who want to capitalize on the obvious advantages of solid-state without enduring the crippling power and frequency limitations are discovering a new solution: the packaged power supply/klystron oscillator combination from Sperry Electronic Tube Division.

Sperry now offers single low-voltage (28 volts) DC-to-microwave frequency sources which combine the best features of solid-state circuitry and klystron oscillators. The source consists of an all solid-state power supply, a reflex klystron, and (if required) a stalo cavity and an isolator.

For many applications, Sperry has already proved that such a combination can equal the size and weight of an all solid-state source and show considerable improvement in reliability, power handling capability, noise and other characteristics.

The Sperry designs are based on existing hardware and technologies. Tubes, power supplies and stalos already in production require only minor modifications to become usable components in packaged source combina-

Precise prediction of the interaction between microwave and solid-state elements requires in-depth understanding of both technologies. Such understanding is the principle ingredient in Sperry's "Storehouse of Knowledge." Put our understanding to work for you today.

tions. Because no development work is required, you can expect peak reliability from the first unit — the "learning curve" stage is completely eliminated.

Sperry delivers the source in a compact, integrated package . . . for a typical X band application it may be as small as 100 cubic inches and weigh as little as four pounds. While power supply maintenance should be conducted at depot level, the tube and stalo may be replaced, at any level, thanks to the fixed reflector voltage feature of Sperry reflex klystrons.

In packaging the units, Sperry pays particular attention to environmental requirements, mounting requirements and optimum RFI shielding.

If you're concerned with the performance and reliability of an all solid-state source to meet your specifications, or if you want to avoid the agony of matching a klystron to its power supply, get more information about Sperry's packaged source capability. For your free copy of a new technical paper, ask your Cain & Co. man or write Sperry, Gainesville, Fla.

SPERRY

DIVISION OF
SPERRY RAND
CORPORATION

SPERRY ELECTRONIC TUBE DIVISION, Gainesville, Fla.

National Representatives: Cain & Co., Los Angeles, 783-4700; Boston, 665-8600; Arlington Heights, 253-3578; Dallas, 369-2897; Dayton, 228-2433; Eastchester, 337-3445; Philadelphia, 828-3861; San Francisco, 948-6533; Syracuse, 463-0462; Washington, 296-8265; South Amboy, 727-1900; Huntsville, 534-7955; Dade City, 422-3460; Montreal, 844-0089.

Washington Newsletter

August 22, 1966

NASA weighs Mars mission to fill space gap . . .

The space agency is considering adding a Mars mission in 1971 to fill the present four-year gap between the Mariner and the Voyager unmanned planetary exploration programs. Under intensive study at the Ames Research Center and the Jet Propulsion Laboratory is a Mariner mission to fly past Mars and eject an instrumented probe onto the planet to measure its atmosphere. Such data would help plan future manned and unmanned Voyager landings on Mars.

Some observers consider the program an answer to criticism by Rep. Joseph Karth (D., Minn.), chairman of the House Space Science and Applications subcommittee. Karth was so unhappy with NASA's lack of an instrumented probe on the 1969 Mariner that he tried to take some money from the development of the 1967 Mariner probe of Venus and put it toward development of a 1969 Mariner instrument package. Karth and others are still worried about the wide difference in opinion on just how much atmosphere Mars has [Electronics, Aug. 8, p. 61]. Planners call a Mariner/Mars shot in 1971 a logical interim mission between a Mariner flight to Mars in 1969 and the more ambitious Voyager, due to make its first flight in 1973.

. . . and justifies Venus flyby . . .

At the same time, other Congressional criticism is keeping the space agency hopping. It currently is preparing justification for its controversial Mariner flyby of Venus in 1967. The House, in its conference report accompanying the NASA fiscal 1967 authorization, demanded a full report by Sept. 1 on NASA's plans to explore Venus.

. . . while Congress mulls probe of satellites

Dissatisfied Congressmen are looking over the space agency's shoulder in still another area—the disappointing performance of the giant observatory-class satellites. Congress is delaying a full investigation of the troublesome satellites until NASA's Observatory-Class Spacecraft Review Board has made its report.

No hearings are currently planned, but a staff study is being made for the House Science and Astronautics Committee. All NASA has been able to say about its report is that it should be finished in several weeks.

The NASA board was established right after the failure of the \$50-million Orbiting Astronomical Observatory, which was launched April 8.

In addition, the group is investigating the Orbiting Geophysical Observatory and the Nimbus weather satellite, which also have had their share of technical difficulties.

F-111 in trouble with Congress again

Congress will take a second close look at the high-priced, sometimes overweight F-111—something that may have a significant impact on the future of the Navy-Air Force aircraft. With the Pentagon now publicly admitting that costs are soaring on the program, Sen. John L. McClellan (D., Ark.) has scheduled a new series of hearings for next spring—possibly April—by his Permanent Investigations subcommittee. McClellan's panel is the same group that tore into the Defense Department in a 10-month investigation in 1963, when the F-111 was called the TFX.

Performance of the swing-winged aircraft will be the principal topic

Washington Newsletter

of conversation this time. The committee is not expected to get into whether Defense Department officials were purposely guilty of wrongdoing—something that got close scrutiny during the first investigations.

The F-111 program—which has bloomed into a development project involving four aircraft under the guiding hand of McNamara—has already cost the Government \$788 million in development with another \$100 million committed, the Pentagon acknowledges.

The cost of each aircraft is now estimated at \$8 million for the Navy version, the F-111B, and \$5 million for the Air Force model, the F-111A. The figures are nearly double the Pentagon's original estimates. The reasons given for the booming costs were unrealistic original cost estimates, technical difficulties on the Navy model and its Phoenix missile, and Government changes intended to boost the aircraft's capabilities.

Apathy may kill metric system bill

A necessary first step toward adoption of the metric system in this country may die in Congress because nobody seems to care.

A bill to authorize a study of the effects of such a switch has been passed by the Senate, but has been languishing in the House Rules Committee for more than a year. Rep. George Miller (D., Calif.), chairman of the House Science Committee and original author of the study proposal, has been promising for more than a month to press the Rules Committee to release the bill to the House floor. So far, he has failed to move, and the Rules Committee is showing no intention of acting on its own.

Patent bill faces stiff Senate fight

Long-pending legislation on Federal patent policy is being pushed toward a bitter Senate fight despite the fact that the bill is given little chance of passage. Even if the legislation—giving Federal contract administrators broad powers to assign patent rights to contractors—survives debate and a threatened filibuster in the Senate by Russell Long (D., La.), it stands little chance of success in the House.

The effect of the legislation would be to reinforce present Pentagon practices of assigning most patent rights to contractors, accelerate National Aeronautics and Space Administration tendencies to freely assign such patents and overturn restrictive patent provisions in laws governing the Atomic Energy Commission, Federal Aviation Agency and other Federal organizations.

The bill had been locked up in the Senate Judiciary Committee more than a year. The committee, unable to reach any compromise, dumped the matter in the lap of the Senate for a formal expression of Congressional sentiment. If the legislation fails to pass, patent rights will have to be debated every time an R&D bill comes before Congress.

Aeronautics satellite delayed by Comsat

The Communications Satellite Corp. will soon issue a request for proposals to study antenna design problems it is having on the planned satellite to relay very high frequency signals between aircraft and ground stations. Last week, because of antenna and other problems, Comsat told the Federal Aviation Agency that it was temporarily holding off on the experimental aeronautical services satellite planned for a 1967 launch. Comsat says it has not "formally withdrawn" its proposal to the FAA, but has told the only bidder on the program—the Hughes Aircraft Co.—that it won't accept its satellite design.

What solvent insures absolute cleaning of needle bearings?

Torrington says: **FREON** in a Baron-Blakeslee ultrasonic unit.



The Torrington Company of Torrington, Conn., must manufacture and deliver absolutely clean needle bearings. *Only* FREON solvent in a Baron-Blakeslee ultrasonic degreaser meets Torrington's rigid standards of product-cleaning. In fact, FREON's superior performance actually raised the general quality of the needle bearings.

FREON is a selective solvent—it cleans without affecting materials of construction. Its low surface tension penetrates the smallest pores and crevices. Its high density floats away all contaminants. FREON is nonflammable and relatively nontoxic. And its excellent stability permits reuse after simple distillation.

Chances are *you* can clean faster, better and more economically with FREON. For more information, write Du Pont Co., Room 4346, Wilmington, Delaware 19898. (In Europe, write Du Pont de Nemours International S.A., FREON & VALCLENE Department, 81 route de l'Aire, CH 1211 Geneva 24, Switzerland.)



Better Things for Better Living
... through Chemistry



HONEYWELL PRE-AMPLIFIERS HAVE WINNING NOISE FIGURES.

And satisfying low noise requirements is just one of the reasons they have earned an official APPROVED for sensitive receivers and spectrum analyzers. Off-shelf delivery makes them as easy to acquire as they are to work with.

SPECIFICATIONS

Tunable VHF Preamplifier/AP-501R* \$1500

Frequency Range 30-300 MHz, 2 bands
Gain 23 db nominal minimum (± 2 db)
Noise Figure..... 4.5 db maximum (less than 3.5 db below 250 MHz)

Bandwidth (3 db) Band A, 30-70 MHz, 2 MHz
Band B, 55-300 MHz, 4 MHz
at 55 MHz, 5 MHz at 300 MHz

Tunable UHF Preamplifier/AP-502R* \$1700

Frequency Range 300-1000 MHz
Gain 26 db nominal (± 3 db)
Noise Figure 4.0 db at 300 MHz; 8 db at 1000 MHz
Bandwidth 3.5 mc at 300 MHz
15 mc at 1000 MHz

For specifics write to: Honeywell, Test Instrument Division, Annapolis Operation, Box 391, Annapolis, Maryland 21404. Or telephone: 301-263-2661.

approved

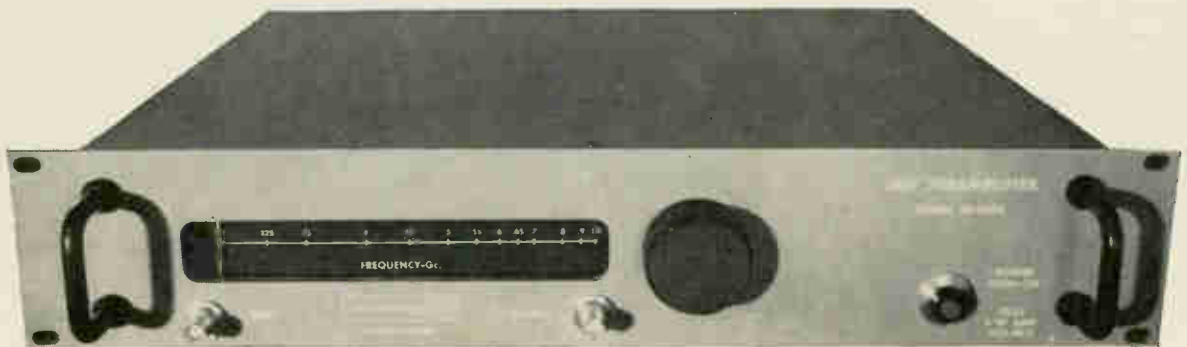

AP 502-R

*Electro International models.

DATA HANDLING SYSTEMS

Honeywell

when the
decision
calls for
precision

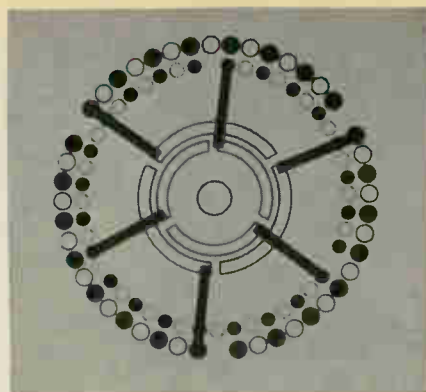

SWITCH to Hi-Q precision instrument switches!



18 Series Switch available one to eight poles per deck. Meets MIL-S-3786-B.

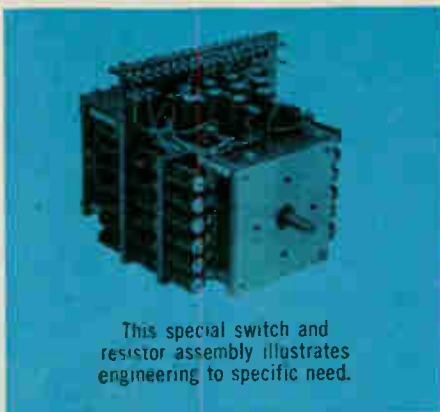

This special switch and resistor assembly illustrates engineering to specific need.



Typical type CES six deck, single pole per deck multiple position switch.



CES type switch with terminal boards. Available 1 1/4" to 8" square. Up to 144 shorting positions.



Special design incorporating resistors and rear terminals to meet customer needs.

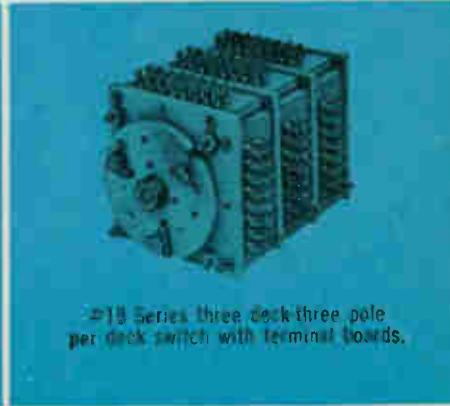

18 Series three deck three pole per deck switch with terminal boards.



Hi-Q precision instrument switches readily fulfill standard, special, and military requirements at attractive prices through the use of modular stock units from which an almost unlimited series of configurations may be assembled...and *minimum delivery time is guaranteed!*

This kind of flexibility is typical of the engineering precision found in every feature—brush blades lapped and edges stoned; insulating parts custom drilled to critical tolerances; contacts of homogenous alloys for minimum EMF, positive metal-to-metal wiping, and low electrical resistance; maximum contact wiping surface to distribute frictional wear and promulgate longer life. For installation flexibility, all units are available with either solder pot or turret type terminals.

The terminal board switch is a further indicator of the advanced engineering you may expect from Hi-Q. The use of terminal boards facilitates modular wiring harness design and reduces overall assembly costs.

Whatever your product, if design decision requires precision instrument switches, contact Hi-Q and see what they have to offer. It's quite probable that you won't find a better answer anywhere.



AEROVOX
CORPORATION
1100 CHESTNUT ST.
BURBANK, CALIF.

SEE HI-Q AT WESCON BOOTHS 1701-02

Only G-E RTV silicone adhesive/sealants are UL recognized for

insulating...



Instant see-through insulation provided by translucent RTV-108 sealant. Outstanding electrical properties. RTV also comes in colors.

sealing...



High temperature moisture sealing of heating elements. Costs less and sets up faster than epoxy. And G-E RTV stays flexible permanently.

bonding...

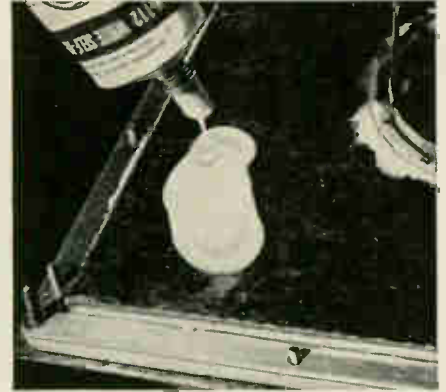

Laminated layers of mica sheeting are securely bonded with RTV sealant. Ready to use, it needs no catalyst and bonds without a primer.



Shock and vibration are cushioned by RTV's permanent resilience. Protects over wide temperature range. Won't harden, soften, crack or shrink.



Eliminate capping, taping and splicing with RTV. Easily speeds assembly line sealing. Also used to lock nuts firmly in place.

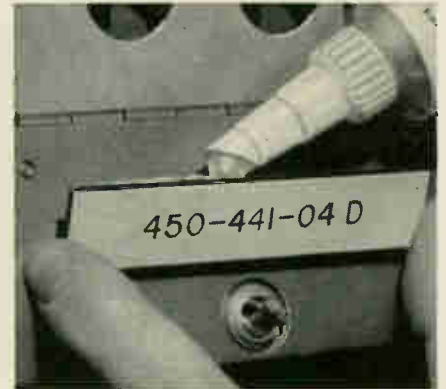

Eliminate screws and drilling by adhering identification plates with RTV. It bonds to metal, glass, wood, most plastics — almost all materials.

General Electric's RTV adhesive/sealant is a resilient electrical insulating material, weather-resistant and ready-to-use adhesive.

Recognized by Underwriters Laboratories for electrical uses, RTV sealant maintains its rubber-like properties at temperatures as low as -75°F , high temperatures up to 600°F . It stays flexible *permanently*, does not crack or shrink.

For complete information on G.E.'s family of RTV silicone adhesive/sealants write Section N8209, Silicone Products Department, General Electric Company, Waterford, New York 12188.

GENERAL  **ELECTRIC**

ULTRA-PERFORMANCE

TELONIC'S NEW MODEL 1001 SOLID-STATE SWEEP/SIGNAL GENERATOR DELIVERS UNMATCHED FLEXIBILITY AND PERFORMANCE FOR FREQUENCY AND CW TESTING FROM 100 kHz TO 20 MHz

ULTRA-WIDE SWEEP RATIO



A. Frequency response of broad-band video amplifier, 100 kHz to 20 MHz.

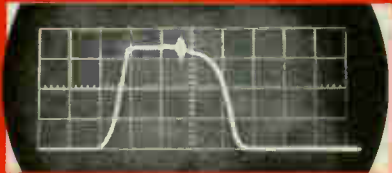

B. Crystal filter response, 1 dB bandwidth is 2.3 kHz wide at 10.7 MHz center frequency.

ULTRA-STABLE



C. Same crystal filter as in (B) above, with 100 Hz sweep width (100 Hz/Div.).

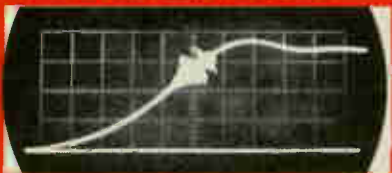

D. Five minutes later, no appreciable drift; crystal marker is 100 Hz wide.

ULTRA-NARROW MARKERS

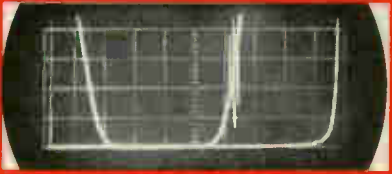

E. Location of busy marker is difficult to determine as result.

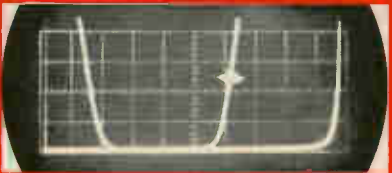

F. Filled marker permits precise frequency determination.

FEATURES

- VARIABLE SWEEP RATE FROM .01 TO 60 Hz
- MANUAL OR EXTERNAL SWEEPING FOR XY PLOT
- 1 VRMS OUTPUT WITH 30 dB ATTENUATION

The 1001 sweeps frequency in three ranges from below 200 Hz up to the full range of 20 MHz—that's a ratio of 100,000 to 1 overall—plus CW and modulated CW! This one instrument serves for narrow and broadband applications in RF, IF, and video frequencies.

New solid-state power supplies for the 1001 provide exceptional frequency stability of 100 Hz for short term operation (1 min.), and 5 kHz over long term (1 hour). Calibrating and adjusting are minimized, test results more dependable.

Harmonic (1 MHz) and variable (100 kHz-20 MHz) frequency markers may be deviated from 10 kHz to as narrow as 100 Hz for precise frequency determination. Unique time-sharing circuit allows any combination of markers to be displayed simultaneously without interference. Marker fill control provides precise readings even on steep part of skirt.

THE

1001

SWEEP/SIGNAL GENERATOR

100 kHz - 20 MHz



SPECIFICATIONS

CENTER FREQUENCY	100 kHz - 20 MHz
SWEPT RANGE	100 kHz - 20 MHz
SWEPT WIDTH	
Narrow Range	200 Hz - 200 kHz
Intermediate Range	1 kHz - 2 MHz
Wide Range	10 kHz - 20 MHz
SWEPT RATE	
Variable	0.01 - 60 Hz
Line-Lock	50/60 Hz
OUTPUT	1 VRMS into 50 ohms
STABILITY	
Short Term (1 min.)	100 Hz
Long Term (1 hour)	5 kHz
HARMONIC MARKER	1 MHz
VARIABLE MARKER, RANGE	100 kHz - 20 MHz
VARIABLE MARKER, WIDTH:	
Narrow	100 Hz
Intermediate	1 kHz
Wide	10 kHz

APPLICATION DATA FILE DESCRIBING USE OF TELONIC SWEEP GENERATORS IN RESEARCH, PRODUCTION AND Q.C. APPLICATIONS AVAILABLE ON REQUEST.

Telonic INDUSTRIES INC.
60 NORTH FIRST AVENUE
BEECH GROVE, INDIANA 46107
TEL: (317) 787-3231 TWX: 810-341-3202

Representatives in all major cities in the U.S. and foreign countries. Factory offices located at Maidenhead, England and Frankfurt, Germany

LIKE TO READ PERFORMANCE CHARTS?

Here are a couple we think you'll find interesting. They concern our 2SC685 transistor designed for use in line operated home radios and phonographs. This transistor can deliver an output of 1.0 watt with less than 10% distortion when used in class A amplifiers and is reasonably priced.

ABSOLUTE MAXIMUM RATINGS (At 25°C Ambient Temperature)

Item	Symbol	2SC685	Unit
Collector to Base Voltage	V_{CBO}	300	V
Collector to Emitter Voltage*	V_{CEX}	300	V
Emitter to Base Voltage	V_{EBO}	3	V
Collector Current	I_C	100	mA
Collector Dissipation**	P_C	4	W
Junction Temperature	T_j	150	°C
Storage Temperature	T_{stg}	-65 ~ +150	°C

* Value at $I_B = 5 \mu A$ ** Value at $T_C \leq 70^\circ C$



Same size and shape as the JEDEC TO-66.



ELECTRICAL CHARACTERISTICS (At 25°C Ambient Temperature)

Item	Symbol	Condition of Measurement	min.	typ.	max.	Unit
Collector to Emitter Breakdown Voltage	BV_{CEX}	$I_C = 1 \text{ mA}, I_B = 5 \mu A$	300	—	—	V
Emitter to Base Breakdown Voltage	BV_{EBO}	$I_E = 100 \mu A, I_C = 0$	3	—	—	V
DC Current Transfer Ratio	h_{FE}	$V_{CE} = 10 \text{ V}, I_C = 50 \text{ mA}$	30	60	150	
Gain Bandwidth Product	f_T	$V_{CE} = 50 \text{ V}, I_C = 20 \text{ mA}$	—	25	—	Mc
Base Spreading Resistance	$\tau_{bb'}$	$V_{CE} = 50 \text{ V}, I_C = 20 \text{ mA}, f = 50 \text{ Mc}$	—	20	—	Ω
Collector Output Capacitance	C_{ob}	$V_{CB} = 50 \text{ V}, I_E = 0, f = 1 \text{ Mc}$	—	5	—	pF

If you enjoyed reading the charts and found them interesting, why not inquire further to:



HITACHI SALES CORPORATION: 333, N. Michigan Avenue, Chicago 1, Ill., U.S.A. Tel: 726-4572/4 / 666, 5th Avenue, New York, N.Y. 10019, U.S.A. Tel: 581-8844 / 12715, S. Daphne Avenue, Hawthorne, Calif., U.S.A. Tel: 757-8143 HITACHI, LTD., DUESSELDORF OFFICE: 4, Duesseldorf, Graf-Adolf-Strasse 37, West Germany Tel: 10846

A BILLION STANDARD POTS AND TRIMMERS? (well, would you believe 211,209,077?)

Of course a number like two hundred million needs explaining. But if you study the Spectrol Catalog and count up such options as mountings, gangable combinations, resistance values, terminal variations, and other available features, you will find that Spectrol offers you 211,209,077 standard potentiometers and trimmers to choose from. But even as one of the industry's leading sources for "standards"

Spectrol still maintains technical leadership in the design and production of "specials." And, the Spectrol double-edged capability doesn't stop there. For no one else can offer you a broader series of miniature rotary selector switches designed for direct printed-circuit-board application, or more accurate, more readable turns-counting dials.

Still don't believe? Sorry about that. But make your own count. Write for a Spectrol Catalog... or pick one up at our Wescon Booth 1201-1202.

Spectrol Electronics Corporation
17070 East Gale Avenue
City of Industry, Calif. 91745

spectrol

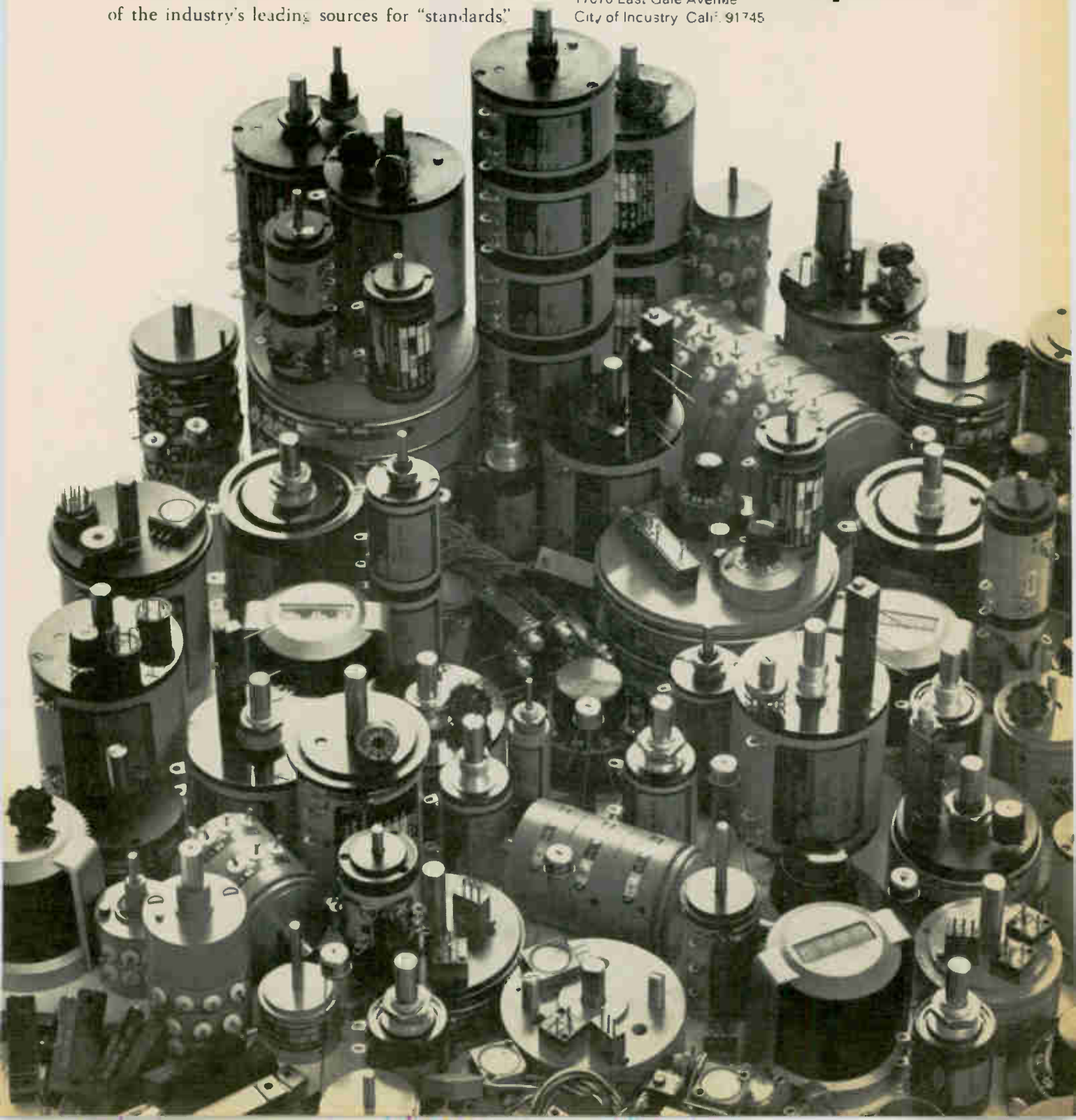



there are ordinary seals

...and then there's McCoy

The seal gets special attention at McCoy—100% inspection against temperature, altitude, vibration and shock. Only a permanent, hermetic seal can guarantee frequency stability and reliability for quality crystals. Our new *Cleanseal* process uses high pressures to flow metal enclosures together in a heatless "weld" that's more leak resistant than the metal itself. Heating distortion and



possible internal contamination by solder flux are eliminated. *Cleanseal* crystals have withstood 5000 cycles, 30 G's vibration, and 8000 G's, 0.5 millisecond pulse shock testing. Glass crystals are vacuum sealed by flame or induction heating. McCoy has the nation's most complete line of quality high and low frequency crystals. For full details, write for our new product catalog.



MCCOY ELECTRONICS COMPANY

A DIVISION OF OAK ELECTRO/NETICS CORP.
MT. HOLLY SPRINGS, PA. 17065

Lambda adds new WIDE VOLTAGE RANGE PROGRAMABLE power supplies to all-silicon LM series

Up to 60 volts.
Up to 35 amps.
7 power packages.
Prices starting
at \$69.00.

Package A 3 1/16" x 3 3/4" x 6 1/2"



MP-3 MP-5
Accessory Metered Panels: \$40.00

Model	ADJ. VOLT. RANGE VDC	I MAX. AMPS ¹				Price
		40 C	60 C	60 C	71 C	
LM 251	0-7	0.35	0.31	0.29	0.27	\$ 69
LM 201	0-7	0.85	0.75	0.70	0.55	79
LM 202	0-7	1.7	1.5	1.4	1.1	89
LM 252	0-7	2.0	1.8	1.4	1.1	99
LM 257	0.14	0.27	0.24	0.23	0.22	69
LM 203	0.14	0.45	0.40	0.38	0.28	79
LM 204	0.14	0.90	0.80	0.75	0.55	89
LM 258	0.14	1.2	1.1	1.0	0.80	99
LM 259	0.24	0.18	0.16	0.15	0.14	69
LM 260	0.24	0.35	0.30	0.25	0.20	79
LM 261	0.24	0.70	0.65	0.60	0.45	89
LM 262	0.24	0.80	0.75	0.70	0.60	99
LM 263	0.32	0.14	0.12	0.11	0.10	69
LM 205	0.32	0.25	0.23	0.20	0.15	79
LM 206	0.32	0.50	0.45	0.40	0.30	89
LM 264	0.32	0.66	0.60	0.50	0.32	99
LM 265	0.60	0.08	0.07	0.07	0.06	79
LM 207	0.60	0.13	0.12	0.11	0.08	89
LM 208	0.60	0.25	0.23	0.21	0.16	99
LM 266	0.60	0.35	0.31	0.28	0.25	109

Package E 4 1/16" x 7 1/2" x 11 1/2"

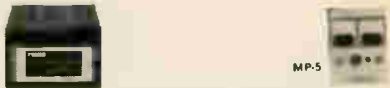

MP-5
Accessory Metered Panels: \$40.00

Model	ADJ. VOLT. RANGE VDC	I MAX. AMPS ¹				Price
		40 C	50 C	60 C	71 C	
LME-07	0-7	12.0	10.5	8.5	6.8	\$249
LME-014	0-14	7.4	6.4	5.2	4.1	249
LME-032	0-32	3.7	3.2	2.6	2.1	249
LME-060	0-60	2.1	1.7	1.4	1.1	249

Package F 3 1/2" x 19" x 16 1/2"



For metered models, add suffix (M) to model number and \$30.00 to the price below.

Model	ADJ. VOLT. RANGE VDC	I MAX. AMPS ¹				Price
		40 C	50 C	60 C	71 C	
LMF-07	0-7	25.0	21.0	17.0	14.0	\$425

Package B 3 1/16" x 4 1/16" x 6 1/2"



MP-3 MP-5
Accessory Metered Panels: \$40.00

Model	ADJ. VOLT. RANGE VDC	I MAX. AMPS ¹				Price
		40 C	50 C	60 C	71 C	
LMB-07	0-7	2.8	2.6	2.3	1.5	\$109
LMB-014	0-14	1.6	1.5	1.3	1.2	109
LMB-032	0-32	0.80	0.70	0.60	0.5	109
LMB-060	0-60	0.45	0.40	0.35	0.3	109
LM-217	8.5-14	2.1	1.9	1.7	1.3	119
LM-218	13-23	1.5	1.3	1.2	1.0	119
LM-219	22-32	1.2	1.1	1.0	0.80	119
LM-220	30-60	0.70	0.65	0.60	0.45	129

Package G 5 1/4" x 19" x 16 1/2"



For metered models, add suffix (M) to model number and \$30.00 to the price below.

Model	ADJ. VOLT. RANGE VDC	I MAX. AMPS ¹				Price
		40 C	50 C	60 C	71 C	
LMG-07	0-7	35.0	29.0	24.0	20.0	\$575

¹ Current rating is from zero to I max. Current rating applies over entire output voltage range. Current rating applies for input voltage 105-132 VAC 55-65 cps. * For operation at 45-55 cps derate current rating 10%. * For operation at 360-440 cps consult factory for ratings and specifications. * ² Prices F.O.B. Factory, Melville, N. Y. All specifications and prices subject to change without notice.

Package C 3 1/16" x 4 1/16" x 9 1/2"



MP-3 MP-5
Accessory Metered Panels: \$40.00

Model	ADJ. VOLT. RANGE VDC	I MAX. AMPS ¹				Price
		40 C	50 C	60 C	71 C	
LM-225	0-7	4.0	3.6	3.0	2.4	\$139
LMC-014	0-14	2.2	2.0	1.8	1.5	139
LMC-032	0-32	1.1	1.0	0.90	0.80	139
LMC-060	0-60	0.60	0.55	0.50	0.45	139
LM-226	8.5-14	3.3	3.0	2.5	2.0	139
LM-227	13-23	2.3	2.1	1.7	1.4	139
LM-228	22-32	2.0	1.8	1.5	1.2	139
LM-229	30-60	1.1	1.0	0.80	0.60	149

Features and Data Meet Mil. Environment Specs. RFI—MIL-I-16910: Vibration: MIL-T-4807A: Shock: MIL-E-4970A • Proc. 1 & 2: Humidity: MIL-STD-810 • Meth. 507: / Temp. Shock: MIL-E-5272C • (ASG) Proc. 1: Altitude: MIL-E-4970A • (ASG) Proc. 1: Marking: MIL-STD-130: Quality: MIL-Q-9858.

Convection cooled—no heat sinking or forced air required

Wide input voltage and frequency range—105-132 VAC, (200-250 VAC, optional at no extra charge) 45-440 cps

Regulation (line) 0.05% plus 4MV (load) 0.03% plus 3MV: Ripple and Noise—1 MV rms, 3MV p to p

Temp. Coef.—0.03%/°C

RACK ADAPTERS

LRA-3—5 1/4" height by 2 7/16" depth. Price \$35.00
LRA-4—3 1/2" height by 14" depth. (For use with chassis slides) Price \$55.00

LRA-6—5 1/4" height by 14" depth. (For use with chassis slides) Price \$60.00
LRA-5—3 1/2" height by 2 7/16" depth. Price \$35.00



Package D 4 1/16" x 7 1/2" x 9 1/2"



MP-5
Accessory Metered Panels: \$40.00

Model	ADJ. VOLT. RANGE VDC	I MAX. AMPS ¹				Price
		40 C	50 C	60 C	71 C	
LM-234	0-7	8.3	7.3	6.5	5.5	\$199
LMD-014	0-14	4.9	4.2	3.4	2.7	199
LMD-032	0-32	2.5	2.1	1.7	1.3	180
LMD-060	0-60	1.3	1.1	0.95	0.75	239
LM-235	8.5-14	7.7	6.8	6.0	4.8	199
LM-236	13-23	5.8	5.1	4.5	3.6	209
LM-237	22-32	5.0	4.4	3.9	3.1	219
LM-238	30-60	2.6	2.3	2.0	1.6	239

SEND FOR NEW CATALOG ON FIXED VOLTAGE AND WIDE RANGE MODULAR POWER SUPPLIES



LAMBDA ELECTRONICS CORP. A **Veeco** SUBSIDIARY
515 BROAD HOLLOW ROAD • MELVILLE, L. I., NEW YORK • 516 MYRTLE 4-4200

SEE US AT WESCON—BOOTHS 1634-1635

Circle 79 on reader service card

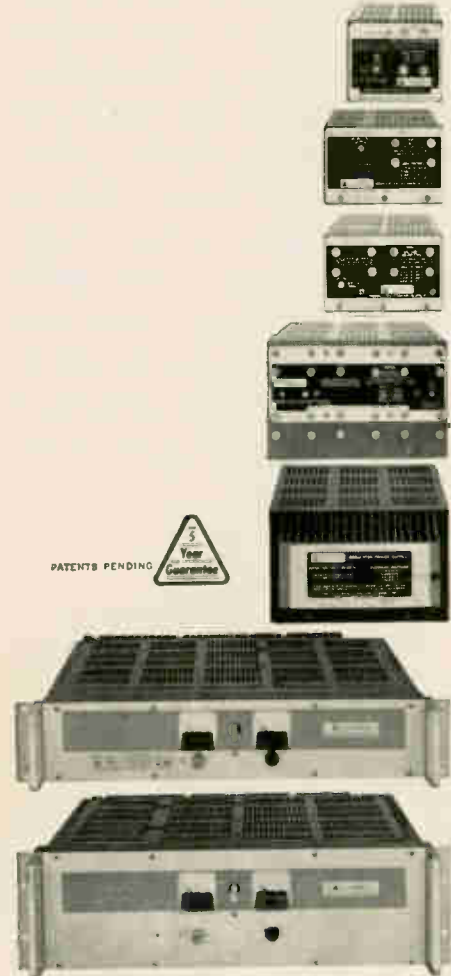

High purity of lithium niobate boules is maintained by meticulous control of temperature and withdrawal rate as well as microscopic precision in formulation.



GROWING LASER EFFICIENCY —

A tenfold increase in crystal fluorescence . . . a tunable optical source that converts a laser beam of one color to any other color in the spectrum . . . such achievements are the result of significant advances in the art of crystal chemistry. Crystals like YAG (yttrium aluminum garnet), for example, are expected to provide new host crystals for high-energy, optically-pumped ion-host lasers. Lithium niobate will provide a new and efficient means for deflection, modulation and tuning of laser outputs. Sperry's staff of crystal technologists is, in fact, actively studying no fewer than forty-six different materials and using all of the principal crystal preparation techniques: Flux growth and flame fusion as well as the Czochralski and Bridgman processes. From this research will come materials for the next generation of electronic and optical devices.

Tomorrow's answers... through Sperry Research

Variable signal delay and trillion-fold amplification characterize the performance of experimental delay lines made with YIG rods as small as one half-inch long.

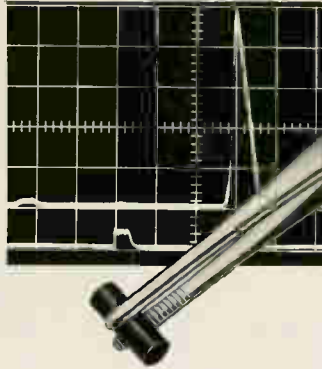

DELAYING ACTION —

A half-inch of YIG (yttrium iron garnet) and a unique parametric pumping technique have enabled Sperry physicists to demonstrate net gain amplification of delayed microwave signals at room temperature. Variable delay and signal amplification up to 20 db net gain from L to X-band are the latest results. Without getting tangled up in miles of coaxial cable, YIG delay lines hold a key to higher resolution, less costly, Doppler and pulse-compression radar and ECM systems. Other magnetic materials are also under study for microwave and computer applications.

Headed for the diffusion furnace — insulation deposited on silicon wafer base provides a better diffusion mask and greater dielectric strength than oxide growth methods.

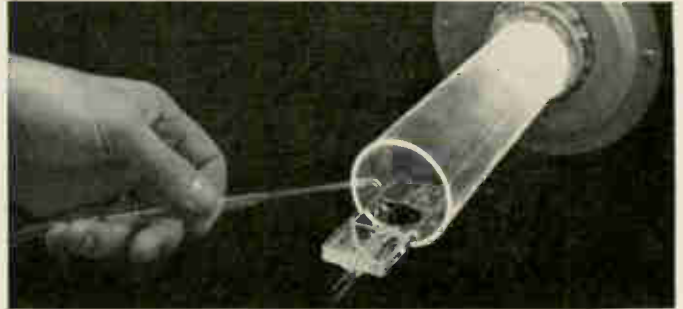

THICKSKINNED —

A new microelectronic insulating technology developed by Sperry scientists promises increased electrical stability in the newest breed of semiconductor devices and microcircuits. Reliable passivation isolates circuits from environmental deterioration without encapsulation. Insulation is deposited on the silicon base material, not grown by oxidation. Deposition is ten times faster at half the temperature required for oxide growth. Thickness can be precisely controlled in layers varying from angstroms to mils. Continuing studies are exploring possible use of this technique with other base materials, such as germanium, gallium arsenide, and indium arsenide.

DC DOES IT —

Sperry scientists tucked a tiny, silicon planar epitaxial diode into a small, tunable, resonant cavity and reverse-biased it beyond breakdown. Applied dc inputs produced microwave outputs, either pulsed or cw. This experimental transit-time oscillator has displayed high spectral purity and easy tunability in octave bandwidths over the entire microwave frequency range. As potential replacements for conventional, low power microwave sources, such devices look especially suitable for future ground, air, or space-borne radar and communication receivers, beacons, and radar altimeters. Current experiments aim at pushing the frequency capability well up into the millimeter wave region.

□ These are just a few of the many scientific achievements of Sperry Rand Research Center. Sperry can help you meet similar short- or long-term technological objectives through basic and applied research in a variety of scientific disciplines. We are currently engaged in intensive investigation and experimentation in the following areas:

SOLID STATE SCIENCES

Microelectronics
Microwave and optical signal processing
Microwave oscillators
Thin film techniques
Laser materials and techniques
Crystal chemistry
Magnetic phenomena

PLASMA PHYSICS

Microwave and optical devices
Re-entry plasmas
Energy conversion

ATMOSPHERIC PHYSICS

Environmental modeling
Active and passive radiometry
Laser atmospheric probing

SYSTEMS RESEARCH

Radar sciences
Human factors
Applied mathematics and control theory
Data processing techniques
Underwater communications and sonar

SPERRY

DIVISION OF
SPERRY RAND
CORPORATION

SPERRY RAND RESEARCH CENTER • Sudbury, Massachusetts 01776

ULTRA FAST

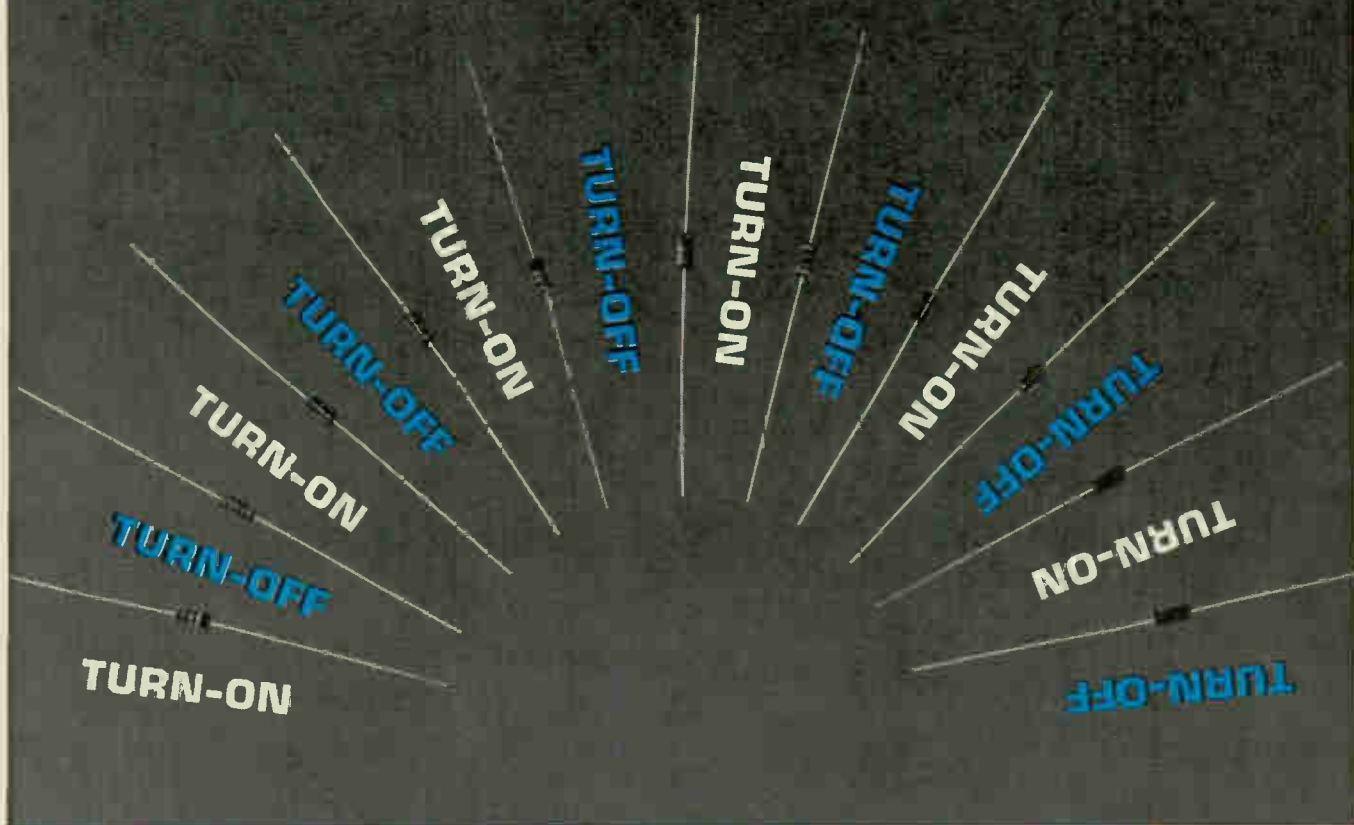

specify hot carrier diodes from hpa

For high-speed switching in ultra-fast computers, sampling circuits, test equipment or UHF and VHF mixers and detectors, you owe it to yourself to investigate low-noise, high-reliability 2300 Series Hot Carrier Diodes from hp associates. All devices in this series have minority carrier lifetimes of less than 100 picoseconds. Using the latest advances in metal-silicon technology, these devices offer increased forward current and higher breakdown voltage. Operating and storage temperature range -60°C to $+125^{\circ}\text{C}$. Power dissipation at 25°C is rated at 125 mw. Peak pulse power rating is 5 ergs. They also meet the requirements of MIL-S-19500C.

Write today for application information and complete data, including life test data, hp associates, 620 Page Mill Road, Palo Alto, California 94304, Tel. (415) 321-8510.

TYPICAL DEVICE SPECIFICATIONS

Device	Forward Current I_{F1}	Forward Current I_{F2}	Breakdown Voltage BV_R	Leakage Current I_R	Capacitance C_0	Effective Minority Carrier Lifetime ^o τ	Price 1 to 99 100 to 999
hpa 2301 Min. Max.	50 mA	1 mA	30 V	300 nA	1 pt	100 ps	\$8.50 ea. 6.35 ea.
hpa 2302 Min. Max.	35 mA	1 mA	30 V	300 nA	1 pt	100 ps	7.75 ea. 5.80 ea.
hpa 2303 Min. Max.	35 mA	1 mA	20 V	500 nA	1.2 pf	100 ps	7.15 ea. 5.35 ea.
Test Conditions	$V_F = 1\text{ V}$	$V_F = 0.4\text{ V}$	$I_R = 10\ \mu\text{A}$	$V_R = 15\text{ V}$	$V_R = 0$ $f = 1.0\text{ MHz}$		

^oThese diodes are too fast to measure in conventional circuits utilizing standard reverse recovery time measurements. Therefore, the effective minority carrier lifetime is specified as τ instead of T_{rr} . Devices are hermetically sealed in a miniature glass package 0.160" long, 0.070" in diameter, color coded.

HEWLETT
PACKARD



HP
ASSOCIATES

SEE HP INSTRUMENTS ATTEND MEASUREMENT SEMINARS WESCON HOLLYWOOD PARK

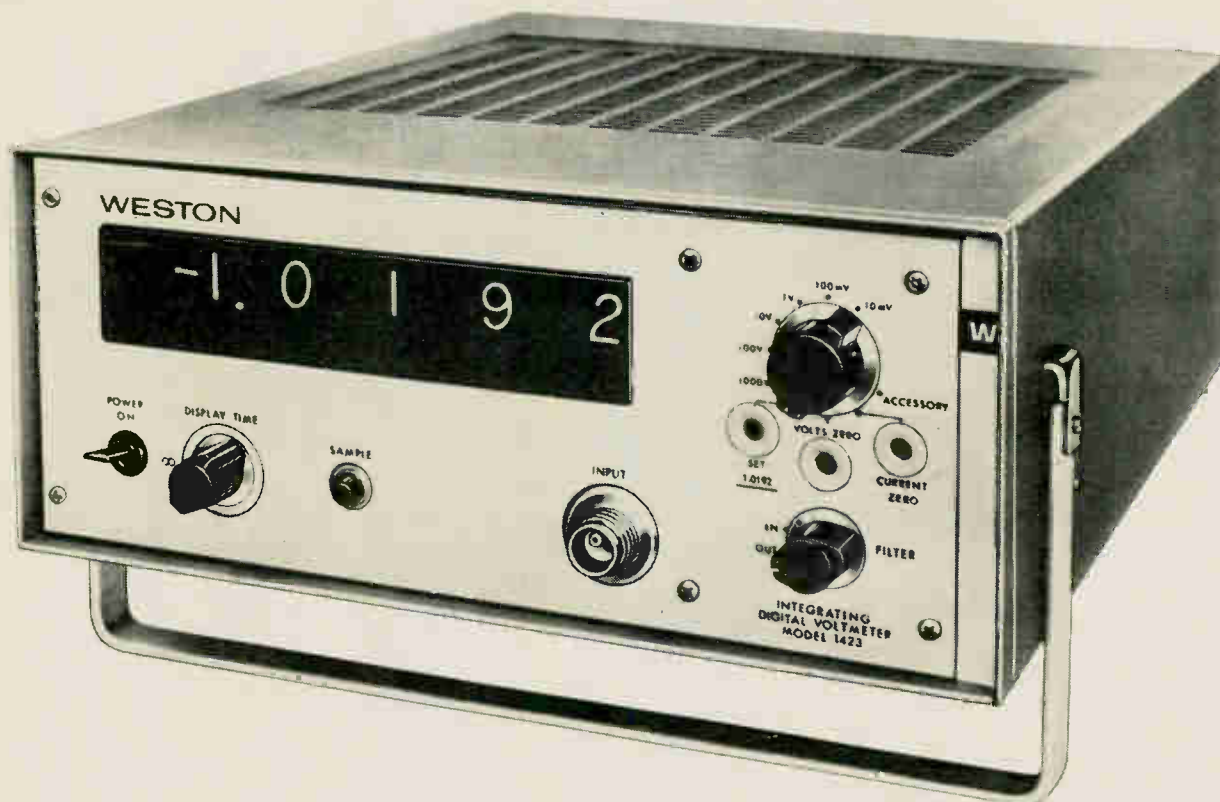

Weston Model 1423 Integrating DVM 1 μ V Sensitivity at 50 M Ω for \$1950.

FEATURES: Strain gage and thermocouple type measurements are made with meaningful accuracy due to integrating and high sensitivity features of Model 1423. High common mode rejection allows low level measurement of potentials well above ground. Loading errors are reduced by 1000 times as compared to conventional DVM's.

SPECIFICATIONS: Accuracy: 0.02% \pm 1 digit. Common Mode Rejection: 150 db DC & 130 db at 60Hz—with up to 5K unbalance between input leads, and filter in use. Series (Normal) Mode Rejection: 60 db at 60Hz with filter. Overranging: 15% with fifth digit display. Display Time Control: From 4 reading/second to 1 reading/15 seconds. Overall Dimensions: 6 $\frac{1}{2}$ " x 14 $\frac{1}{4}$ " x 16 $\frac{1}{4}$ ". Price: Bench mount, \$1950; rack mount, \$1995. Price subject to change without notice.

Input Impedance & Sensitivity

Range	Input Impedance		Sensitivity
	Minimum		
10.000 mV	50 megohms*		1 μ V
100.00 mV	500 megohms*		10 μ V
1000.0 mV	5000 megohms*		100 μ V
10.000, 100.00/1000.0 volts	10 megohms		1/10, 100 mV

*Typical values twice as large

Contact **Weston Instruments, Inc., Rotek Division, 11 Galen Street, Watertown, Mass. 02172**

WESTON[®] prime source for precision . . . since 1888

Our Microstack® will provide the memory for the Lunar Excursion Module's abort guidance system. During the round trip from the Apollo spacecraft to the moon the crew will constantly sample the Microstack memory, call up critical data, and align the LEM abort guidance system with the Apollo's primary guidance system. If required, the Microstack memory will help the Apollo's abort guidance system bring everyone back home.

Obviously, TRW was concerned with reliability when they wrote the LEM memory system specifications. Like: random vibration—Operating 20cps @ .070G²/cps to 2400cps @ .070G²/cps. Microstack's unique design met all specifications. It's a folded-array, developed by Indiana General. The "X" and "Y" axis are wired continuously, reducing failure-prone solder connections 80% and size and weight.

Indiana General leads in developing and

producing memory stacks and cores. We invented the ferrite memory core and still make and sell more of them than anyone.

If you need Mil. Spec. type memory units find out about Microstacks and our core capabilities. Write Mr. Thomas Loucas, Manager of Sales, Indiana General Corporation, Electronics Division/Memory Products, Keasbey, N.J.

INDIANA GENERAL 

**When the LEM gets ready to leave the moon
Indiana General will know the way back home.**



only from Burroughs

IMMEDIATE DELIVERY READOUT DRIVERS

and from your local Burroughs stocking dealer



Actual size all
six modules

Industry's enthusiastic acceptance of the type BIP-8211P NIXIE[®] tube readout driver and the versatility of its basic design has led to the development of other circuit variations. These compact, attractive modules not only save you design, development, testing and production costs, but also give you the best device for translating low-level BCD inputs to decimal readout. Modules currently available from stock include:

• **BIP-8211P**—accepts 8-line low-level (2V-35V separation) 8-4-2-1 BCD and drives the standard-size rectangular NIXIE tube, type 8422. • **BIP-8224P**—accepts low-level 4-line, 8-4-2-1 BCD and drives the standard-size rectangular NIXIE tube, type 8422. • **BIP-8227P**—identical to the BIP-8211P except it accepts logic-level separations as low as 0.7V (from 0°C to +85°C) making it compatible with low-level, monolithic, integrated circuits. • **BIP-8225P**—used for computer readout, it drives a NIXIE tube with an integral decimal point (type B-59956). Type BIP-8225P accepts twelve 4-bit, binary-input

combinations (numerals 0-9, decimal point and blanking) and has the capability of being electronically dimmed via a separate low-level control input. • **BIP-8222P**—drives the type B-59956 NIXIE tube with integral decimal point from low-level, 8-line, 8-4-2-1 BCD. Decimal point is independent of BCD input and can either be "on" or "off" when a numeral is "on". • **BIP-8223P**—identical to the BIP-8211P except it operates over the wide temperature range of -55°C to +85°C.

Other modules which accept other BCD codes as well as decimal inputs are also available individually or in complete Bezel Assemblies. They are completely described in a new brochure, Bulletin 1108. For further information contact your Burroughs Stocking Dealer in your area or Burroughs Corporation in Plainfield, New Jersey. Dealers names, addresses and phone numbers are listed for your convenience.

Only Burroughs manufactures NIXIE Tubes



Burroughs Corporation

ELECTRONIC COMPONENTS DIVISION

PLAINFIELD, NEW JERSEY 07061

BURROUGHS STOCKING DEALERS

CALIFORNIA

Los Angeles, 90036
Tech-Stok,
(213) 937-0780; TWX 213-937-2788.
Palo Alto, 94303
Tech-Ser, Inc.,
(415) 326-9800; TWX 415-492-9482.
San Diego, 92110
Tech-Ser, Inc.,
(714) 222-1121.

CONNECTICUT

West Hartford, 06117
Instrument Dynamics, Inc. of Connecticut,
(203) 233-5503.

INDIANA

Fort Wayne, 46802
R.O. Whitesell & Assoc., Inc.
(219) 743-4411; TWX 219-241-0894
Indianapolis, 46219
R.O. Whitesell & Assoc., Inc.
(317) 359-5374; TWX 317-635-9766.

KENTUCKY

Louisville, 40207
R. O. Whitesell & Assoc., Inc.
(502) 893-7303.

MARYLAND

Silver Spring, 20910
Technical Distributors, Inc.,
(301) 585-7512; TWX 301 439-2200

MASSACHUSETTS

Wakefield, 01880
TRICO Electronics Sales Corp.
(617) 245-5100; TWX 617-245-7479

NEW JERSEY

Plainfield, 07061
Burroughs Corp., ECD, P.O. Box 1226
(201) 757-5000; TWX 710-981-7907

NORTH CAROLINA

Winston-Salem, 27102
L.G. White & Co., Inc.
(919) 725-3612; TWX 919-725-6262.

OHIO

Cincinnati, 45231
R.O. Whitesell & Assoc., Inc.
(513) 521-2290; TWX 513-577-1750.
Cleveland, 44126
R.O. Whitesell & Assoc., Inc.
(216) 333-2585; TWX 216-333-3250.
Columbus, 43212
Electronic Marketing Corp.
(614) 299-4161; TWX 614-759-0096
Dayton, 45439
R.O. Whitesell & Assoc., Inc.
(513) 298-9546; TWX 513-944-0526.

OKLAHOMA

Midwest City, 73110
Arnold Barnes Company
(405) 737-4556.

PENNSYLVANIA

Philadelphia, 19107
Herbach & Rademan, Inc.
(215) 567-4309.

Pittsburgh, 15235
R.O. Whitesell & Assoc., Inc.,
(412) 242-0100.

TEXAS

Houston, 77027
Arnold Barnes Company
(713) 622-3620; TWX 713-571-2470.
Richardson, 75081
Richard Barnes Associates, Inc.
(214) 235-4541; TWX 214-231-1405.
San Antonio, 78216
Arnold Barnes Company
(512) 342-7311.

"See us at Wescon Booths 1258

Technical Articles

Training a machine to read with nonlinear threshold logic: page 86

Normally, machines that do pattern recognition are big, complex and expensive. By using integrated circuits and a technique called nonlinear logic in which the output is based on the weighted sum of nonlinear functions, engineers have devised a small, flexible machine. It can sort alphabetic characters, classify wave forms and recognize geometric shapes.

Helix antennas take turn for better: page 100

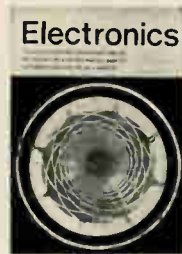

Helix antennas have been around for years, but their unspectacular performance with respect to bandwidth and gain has been a handicap. Now a new class has large bandwidth and high gain. Contrawound, the antenna has a unique property: polarization, bandwidth and gain can be controlled independently. For the cover, Vincent Pollizotto accented the contrawound design by photographing head-on through the center of the new antenna.

P-i-n diode and FET's improve f-m reception: page 114

There was a time when the makers of fine hi-fi equipment wouldn't touch solid state components because of what they did to quality. To show how far the solid state revolution has moved, a maker of good entertainment equipment has used two kinds of solid state devices to attain dynamic signal ranges exceeding 120 decibels. The new devices cut down the interference that bothers devotees of f-m stereo.

Night and day, Nimbus 2 transmits its cloud pictures: page 121

Satellites have made the job of predicting the weather easier, particularly in spotting sudden storms or hurricanes. There's been one notable weakness however; the satellites have worked only during daylight. In Nimbus 2, launched in May, an infrared system will transmit cloud pictures to earth even when the satellite is over the dark side of the globe.

**Coming
September 5**

- Using scattering parameters in design
- Sense amplifiers with integrated circuits
- A high-speed computer for navigation
- Laser hardware ready for applications

Training a machine to read with nonlinear threshold logic

Typewriter-size pattern recognizer built of integrated circuits can sort alphabetic characters, classify wave forms and recognize geometric shapes; its operation resembles the workings of the human brain

By D.P. Hattaway, E.D. Hietanen and R.W. Rothfus

Bendix Corp., Southfield, Mich.

Can a machine be trained to duplicate the ability of the human brain to recognize patterns, geometric shapes and alphabetic characters? What circuitry is needed? How large would the machine be? What about cost and efficiency? These and many more questions face engineers working with the design of pattern recognition systems vital in applications such as mail sorting, language translation, aerial photography and wave-form analysis.

Artificial logic systems on which decision making depends tend to be large and complex. Yet, most humans can master such complex things as character and speech recognition in a relatively short time—and the average brain weighs only 3 pounds and occupies a volume of 100 cubic inches.

The brain, using many fairly simple logic elements, makes its decisions because it can be trained to respond to a given set of input conditions. Because it is trainable, the brain can develop a pattern recognition system without having all the variables in a pattern defined beforehand. For example, the system can be trained to recognize the letter "a" without knowing how many other characters constitute the complete alphabet.

To recreate just this one function using discrete electromechanical elements takes thousands of components. The equipment would fill many rooms and the cost would be enormous. Yet at best, the machine could only compare unknown data against known. It could not alter its decision capability, as the brain does, when faced with a situation such as a misspelled word or a badly smeared letter. At best the machine could answer "unknown" whereas the brain would be able to change its mind or give the correct answer.

This limited type of pattern recognition has al-

ready been successfully incorporated in equipment. A mail sorter built by the Philco Corp. is in operation at a Detroit, Mich., post office. It sorts 36,000 letters an hour by zip code and costs somewhere between \$125,000 to \$150,000. Similar equipment, which reads only numbers, is made by the Burroughs Corp., National Cash Register Co. and Rabinow Electronics, Inc.

Language-translation systems have been developed by the International Business Machines Corp. at its Thomas J. Watson Center. The systems convert Russian and Chinese from a printed page of text into a printed page of English. Both the mail sorter and language translator work on the principle of page scanning. However, other techniques are being tried.

Compact and trainable

Scientists and engineers at the Research Laboratories division of the Bendix Corp. have succeeded in combining the assets of microcircuitry and a technique called nonlinear threshold logic to make possible a typewriter-size, practical pattern recognition system. The system, a demonstration model, can be trained to pick out patterns, select or reject geometric shapes and organize groups of alphabetic characters—much as the human brain does. To recognize the patterns or characters, the system need not know beforehand all the required variables.

The usefulness of nonlinear threshold logic has already been proved in the demonstration model which is not available commercially. Its principles can be extended to solve such additional problems as radar-target recognition, wave-form classification and extraction of signals from noise.

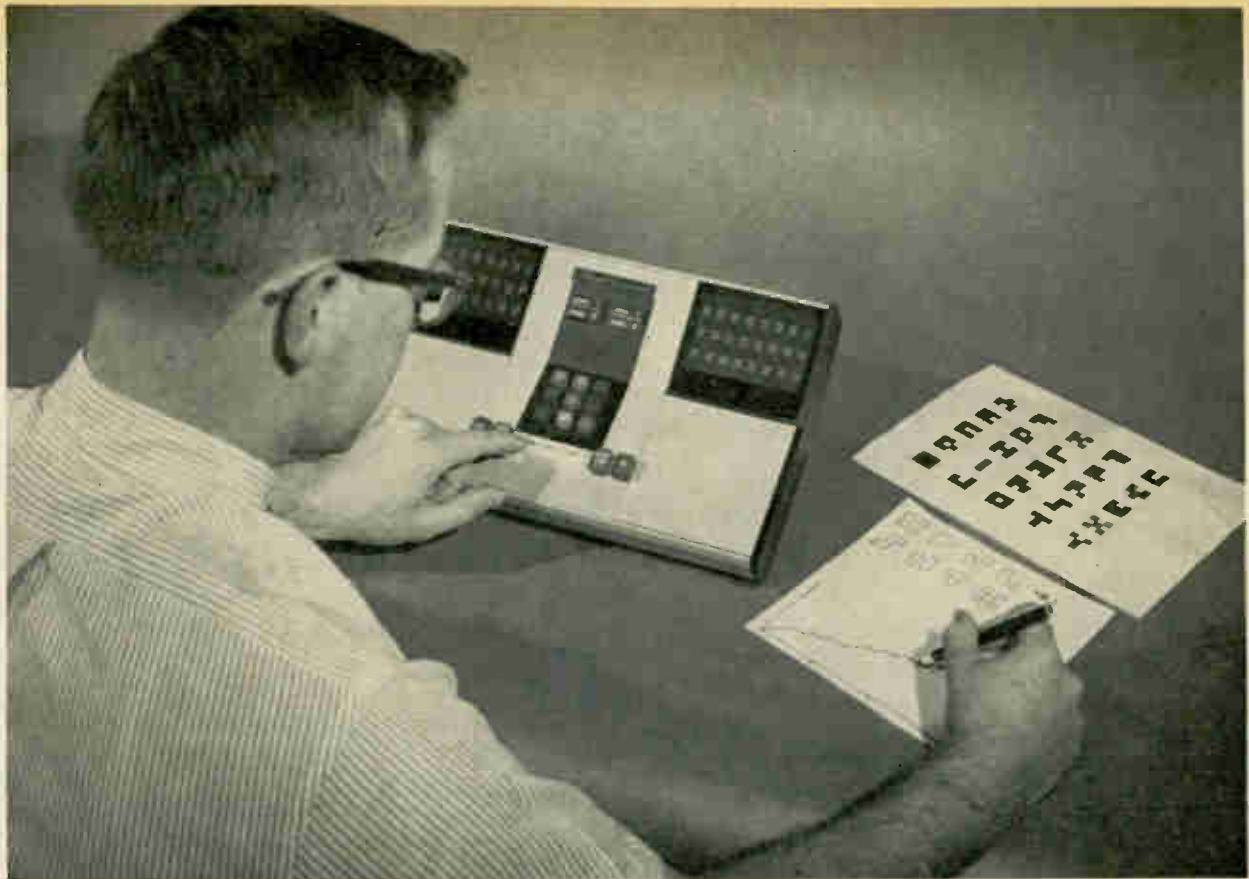

Patterns of up to 31 variables and 300 shapes can be identified by this trainable pattern recognizer. The system uses microcircuits to reduce the size of equipment and nonlinear threshold logic for decision making.

Transforming the input variables

The model uses nonlinear threshold logic to make decisions. Essentially, nonlinear threshold logic is a form of recognition logic where the output is based on a weighted sum of certain nonlinear functions of binary input variables. The model contains a linear threshold logic element preceded by a transformation matrix. The matrix transforms the input variables into a new set of variables that are properly classified by the linear threshold logic element. Inputs to a threshold logic element are weighted according to their importance in the decision-making process. The

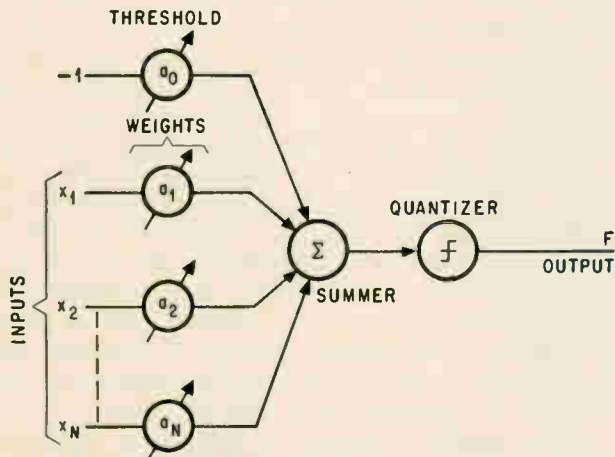

Linear threshold logic circuit inputs x_1 through x_N are binary. Acting with these inputs are weighted terms, a_0 through a_N , of either positive or negative values.

weighted sum of the inputs is compared to a predetermined threshold to give a binary decision at the element output. By making the input weights variable, the logic element is "trained" to give a desired output for a given set of input conditions.

Binary inputs, x_1, x_2, \dots, x_N , are fed into the threshold logic circuit shown at lower left and are defined by the pattern to be recognized. For convenience they are treated as $+1, -1$ instead of the usual $1, 0$. The binary inputs have algebraic weights, a_1, a_2, \dots, a_N , that can have negative or positive values. The output of the threshold logic circuit is determined by the magnitude of the sum of the weighted binary input variables. Mathematically, the output, F , is expressed:

$$\text{If: } \sum_{n=1}^N a_n x_n \geq a_0, \text{ then } F = +1; \text{ otherwise, } F = -1.$$

The term a_0 is an additional algebraic quantity called the threshold.

The function realized by the circuit can be expressed by a conventional Boolean equation or truth table. To realize a particular function, an appropriate set of weights, a_1, a_2, \dots, a_N , and threshold, a_0 , can be determined by a set of rules, or algorithms. Threshold logic can also be applied to problems where the weights are determined in an adaptive or trainable manner. Then, training algorithms are used.

Training algorithms for linear threshold logic usually takes place as follows:

- Patterns for which desired outputs are speci-

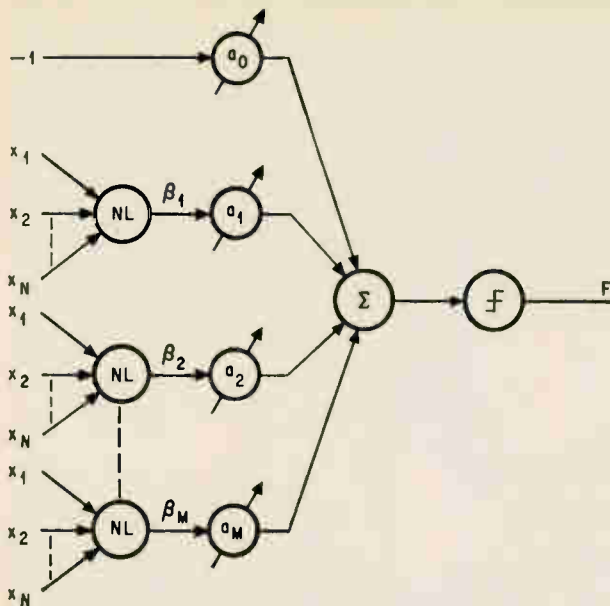

In a nonlinear threshold logic circuit elements are present that form nonlinear, binary-value functions β_1 through β_M . These functions are formed before any weighting operation takes place.

fied are applied to a circuit sequentially.

- Whenever a wrong output occurs, each weight in the circuit is adjusted by an equal amount. The adjustment is in a direction that tends to make the output correct.

It is usually necessary to make several passes through the patterns before optimum performance is achieved. With the circuit at optimum performance, or trained, the desired function may be realized without errors, or it may be partially realized with certain patterns misclassified. Once trained, the circuit is fixed, as a pattern recognizer.

Overcoming the drawbacks

Linear threshold logic, because of the mathematics defining it, limits the functions that can be handled.¹ Only a small percentage of the total possible functions can be realized for variables of five or more. To be realizable, a function must separate a group of input patterns into +1 and -1 categories by a linear equation. The function is then linearly separable.

Nonlinear threshold logic can handle a greater number of functions than can linear threshold logic. To realize nonlinearly separable functions,

x_1	x_2	x_3	β_m
-1	-1	-1	-1
-1	-1	+1	+1
-1	+1	-1	+1
-1	+1	+1	-1
+1	-1	-1	+1
+1	-1	+1	-1
+1	+1	-1	-1
+1	+1	+1	+1

Resultant β_m 's for every $x_1 \cdot x_2 \cdot x_3$ combination

a network of several threshold logic circuits or a more extended form of recognition logic is required. A more extended form of recognition logic, known as nonlinear threshold logic, has been investigated at the Bendix Research Laboratories and is incorporated in the trainable pattern recognizer.

Nonlinear threshold logic, as shown at left, differs from linear threshold logic by the presence of the encircled elements marked NL (nonlinear).

These elements form nonlinear, binary-valued functions, $\beta_1, \beta_2, \dots, \beta_M$, of the input variables prior to weighting. The form of nonlinear function used in the trainable pattern recognizer is the algebraic product in which the β_m terms are the product of selected input variables. A switching parameter, s_m^n , identifies which of the n variables is used to form the m^{th} product term, β_m . For example, if s_m^n is 1 for $n = 1, 2, 3$ then:

$$\beta_m = x_1 \cdot x_2 \cdot x_3$$

Resultant values of β_m for every possible combination of x_1, x_2, x_3 appear in the table at left. Any β_m is equal to +1 when an even number of the variables used in the algebraic product have values of -1. Conversely, β_m equals -1 when an odd number of the variables have values of -1. Training of the nonlinear threshold logic circuit adjusts both the weights (a_m terms) and the values of the switching parameters. Here a_M represents the weights that act with the corresponding β_m terms shown for the nonlinear threshold logic circuit. These are equivalent to the a_N weights originally shown for the linear threshold logic circuit. The difference between a_M and a_N is that the a_N terms directly act with the input variables and a_M terms act with the derived β_m .

Until now, the general-training algorithm for nonlinear threshold logic has only been simulated on a general-purpose digital computer. In the simulations, the initial values of each of the s_m^n terms are established either randomly or empirically. As in the linear threshold logic training algorithm, the circuit is adjusted only if a wrong output occurs. An incremental adjustment is first applied to each of the weights of the circuit in a direction which tends to make the output correct. Stored quantities—in effect weights for product terms that can be selected later—are also adjusted using the same strategy. If the weight adjustments are insufficient to change the circuit output, an s_m^n switching parameter is complemented. Thus, a new product term β_m is selected. The β_m term selected is the one that has a stored weight differing in magnitude from the weight of the present β_m by the greatest amount. The stored weight for the selected β_m term also replaces the present weight, a_m . The training process is repeated for every pattern for which a wrong output occurs, and can be repeated for several iterations.

It is usually necessary to limit each algebraic product to a prespecified set of input variables to keep the weight storage within reasonable limits. Certain s_m^n switching parameters are not allowed

to become 1 during the training. For example, if there are four variables, and, for one of the algebraic product functions, β_m , only s_m^1 and s_m^3 are allowed to become 1, the functions that are formed by β_m are $\beta_m = x_1$; $\beta_m = x_3$; $\beta_m = x_1 x_3$.

Thus, it is only necessary to determine appropriate weights for these three functions rather than for all possible functions of four variables.

In the trainable pattern recognizer, the algebraic products are not varied during training. They are specified beforehand, from empirical results.

Analog implementation

The schematic of the linear threshold logic element suggests an analog implementation is possible. An operational amplifier with several variable summing resistors on the input and connected as a level detector, as shown at top, right, could be used as a threshold logic element. The inputs are weighted by properly adjusting the variable input resistors, R_1 through R_N . Another variable input resistor, R_0 , sets the threshold level.

A major problem in the approach is finding variable elements with the appropriate characteristics. Since training signals for the logic element are in the form of electrical signals, it is desirable to have a device whose resistance (or other parameter) can be changed by means of an electrical signal.³ Such devices exist, but none has yet reached a high state of development. A servo-driven potentiometer meets the requirement, but is not feasible for a large number of logic elements because of the high cost and bulky size.

Digital implementation

The threshold logic element may also be implemented with digital techniques. The analog summing amplifier is replaced by an adder and accumulator. Various weights and the threshold value are stored in registers, each with the proper signs. Whether a given weight, a_m , is added or subtracted from the contents of the accumulator is determined by the corresponding coefficient β_m . The accumulator-sign bit indicates whether the

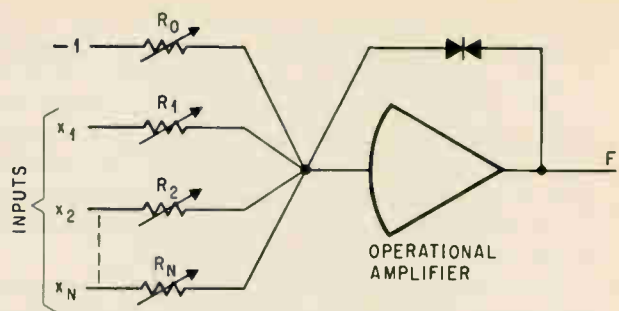

Operational amplifier coupled to variable-summing resistors make up an analog threshold logic element. Resistors act as a level detector.

sum of the weighted inputs is greater or less than the threshold value.

The digital approach was chosen for the demonstration unit for the following reasons:

- Weights are easily altered by changing the content of a register.
- Time-sharing the adder and accumulator among several threshold logic elements is possible.
- Digital circuits in microelectronic form are readily available.
- Microelectronic functional networks such as the adder, accumulator and registers can be produced in a single package.

Operating the recognizer

As shown below, the system operates in a serial mode. The basic computing cycles are start, add, reward or punish.

A pushbutton initiates the start cycle by gating on a timing generator consisting of a binary counter and decoding gates. The counter controls the subsequent cycle or cycles. Two timing generators are provided—a bit counter (12 bits) and the word counter (10 words). During the start cycle only the word counter is gated on; during the add and increment cycles both counters are on. Control of the two counters is provided by the system control logic.

During the start cycle, the set of cross-prod-

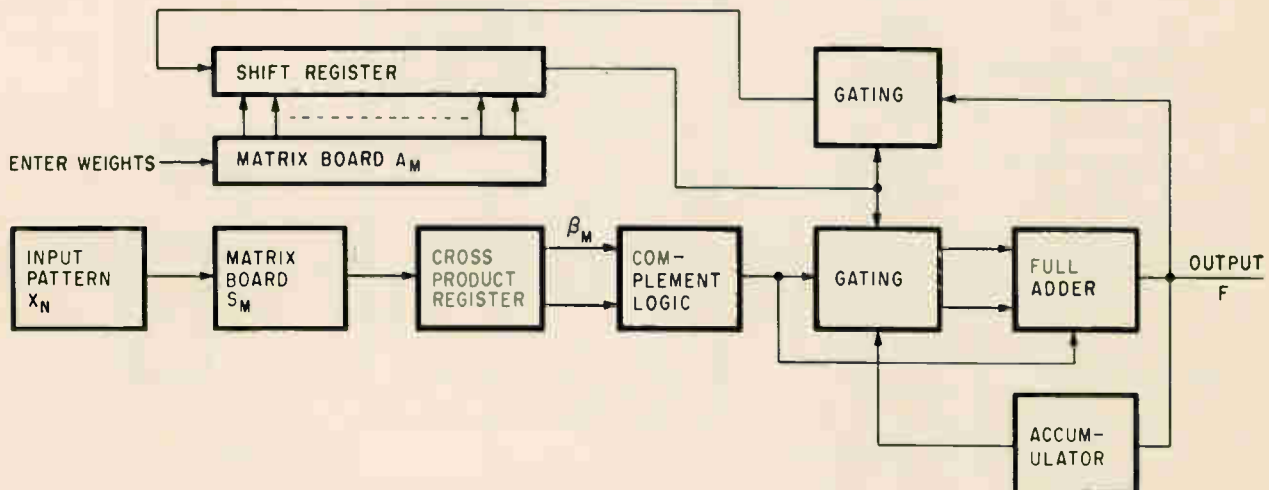

Trainable pattern recognizer operates in a serial mode. Adder, accumulator and registers are produced with IC's.

uct functions, β_m , are determined from the cross-product of the input pattern, x_N , and the s_M matrix. A cross-product term, β_m , was previously defined as the product of the inputs, x_N , for which the corresponding terms in the cross-product matrix, s_m^n , are equal to 1. The computation of each β_m term is accomplished by sequentially scanning the set of input switches, x_N , and applying this signal to the cross-product matrix, s_M .

The term s_M represents the set of s_m^n switching parameters. Nine outputs from the cross-product matrix, s_M , corresponding to the β_m terms are gated into flip-flops. Every time an input, x_n , representing a -1 is scanned and the corresponding matrix switch, s_m^n , is closed, a pulse is applied to the toggle input of each β_m flip-flop causing it to complement. Since the flip-flop is initially cleared to a reset state at the beginning of the start cycle, an even number of -1 inputs leaves the flip-flop reset and indicates a value of $+1$ for β_m . An odd number of -1 inputs to the flip-flop leaves it set to indicate $\beta_m = -1$. This operation occurs in every flip-flop of the β_m register. Thus, when all the input switches are scanned, each flip-flop contains one β_m term. These values are stored for use during the add and increment cycles.

Computing β_m

In the simplified logic circuit that illustrates the computation of the β_m terms shown below, the number of inputs, switching parameters and β_m terms have been reduced for clarity. The input pattern, x_N , is $-1, +1, +1, -1, +1$, and the three

switching parameters are

$$\begin{aligned} s_1^n &= 1, 0, 1, 0, 1 \\ s_3^n &= 0, 1, 1, 0, 1 \\ s_5^n &= 1, 1, 0, 1, 0 \end{aligned}$$

The resultant β_m terms are $\beta_1 = -1$, $\beta_3 = +1$, and $\beta_5 = +1$. Wave forms at the output of the OR gates show the sequence of pulses at the toggle input of the flip-flop. The wave forms are produced when the input switches are scanned by the timing signals T_1 to T_5 .

The start cycle terminates with an add cycle which computes the values of F . During the add cycle, the bit and word counters are used to control the movement of data in the shift register and accumulator. Data in the shift register forms the input weights (a_m terms). A predetermined set of a_m terms may be entered in parallel into the shift register by the a_m board and enter weights switch.

A full adder in conjunction with the accumulator provides a means of taking the sum of the a_m terms. The shift register stores all the positive a_m terms as straight binary numbers. Negative a_m numbers are stored in the two's-complement form of the binary number. (The two's complement of a binary number is obtained by replacing the one's with zeros and vice versa, and adding 1 to the resultant number.) Thus, both positive and negative numbers are summed by addition. As the a_m terms are moved out of the shift register, the corresponding β_m term is used to control the complement logic.

The complement logic implements the multipli-

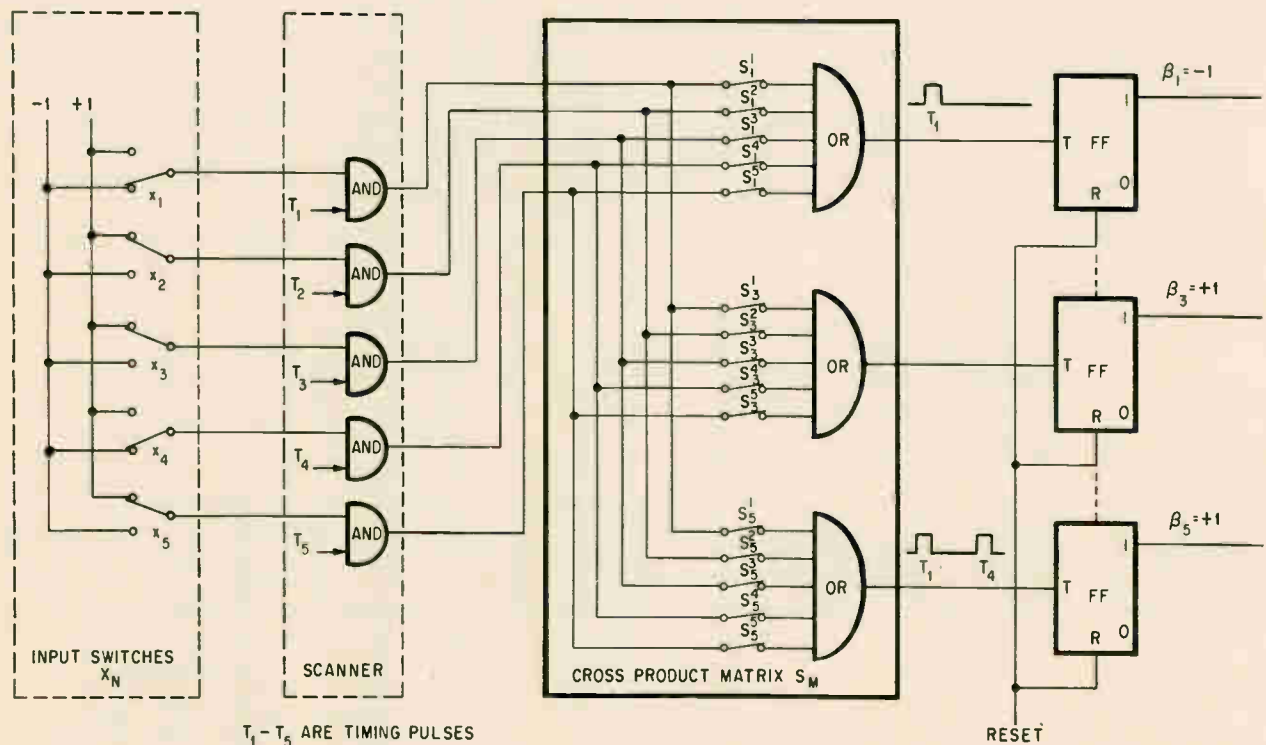

Logic circuit shows how β_m terms are computed. Input pattern consists of x_N and the three switching parameters, s_1^n , s_3^n and s_5^n . Inputs, switching parameters and β_m terms are reduced here for clarity.

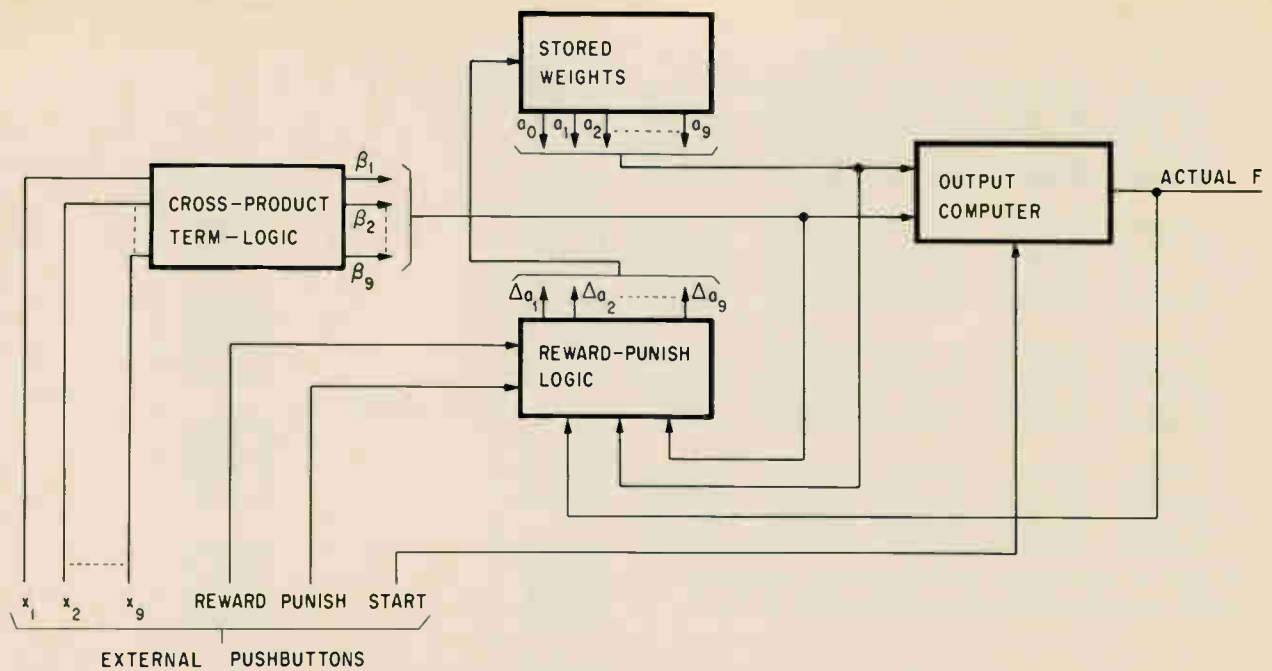

Stages of operation for trainable pattern recognizer. Input pattern enters by means of switches x_1 through x_9 . The β_m terms are produced by a plugboard matrix. Computation cycle is initiated by the start pushbutton.

cation of $a_m \beta_m$. If the β_m term is negative, the complement logic generates the two's-complement form of the corresponding a_m term. For a positive β_m term the a_m term is not complemented. At the end of the add cycle the counters are gated off and the sign bit of the accumulator is stored in a flip-flop. This flip-flop drives the actual F indicator.

Depending on the value of F , the reward or punish cycle is initiated. During either cycle the bit and word counters again control the shift register and full adder to increment each of the a_m terms. The accumulator is not used during this cycle. Each of the a_m terms is incremented up or down one count by the following relationships:

REWARD

$$\begin{aligned} \nabla a_m &= +1, & \text{if } \beta_m = F \\ \Delta a_m &= -1, & \text{if } \beta_m \neq F \end{aligned}$$

PUNISH

$$\begin{aligned} \Delta a_m &= -1, & \text{if } \beta_m = F \\ \Delta a_m &= +1, & \text{if } \beta_m \neq F. \end{aligned}$$

The incrementing is accomplished by comparing a β_m term with F and controlling the full adder to increment the corresponding a_m term.

To increment up, a 1 is applied to the full adder at the least significant bit time of the a_m term. To increment down, a number consisting of all one's is added to the a_m term. During the reward or punish cycle the output of the full adder is gated into the shift register. Therefore, at the end of the increment cycle the shift register contains new values of a_m which are increased or decreased one count from the previous values. The reward or punish cycle is completed by sequencing through the add cycle, as noted, to compute a new value of F .

The trainable pattern recognizer also can automatically select the reward or punish cycle after completion of the first add cycle. In the automatic mode a switch input is provided that enters the value of the output F corresponding to the entered input pattern. After the start cycle is completed, the actual output, F_A , is compared with the desired output, F_D . Then the reward or punish cycle is initiated depending upon whether F_A and F_D are the same or are different. Operation stops after one reward or punish cycle; however, the operator may continue training by initiating the start cycle until F_A corresponds to F_D .

Reward and punishment

As is illustrated in the block diagram of the trainable pattern recognizer, above, the system is essentially a digital implementation of a nonlinear threshold-logic element. The general operation is as follows:

- An input pattern is entered into the pattern recognizer by means of switches, x_1, x_2, \dots, x_9 arranged in a 3 by 3 matrix on the front of the recognizer's control panel.
- A plugboard matrix and associated logic produces the set of cross-product functions (β_m terms), for the given input pattern, 1.
- The start pushbutton begins the computation cycle to determine the output, $F(i)$, of the pattern recognizer. The computation is based on the existing set of stored weights (a_m terms), and the set of cross-product functions. An operator either trains the threshold-logic element by means of the reward or punish buttons or enters another pattern into the recognizer using switches x_1, x_2, \dots, x_9 .
- If the reward button is pushed, each of the

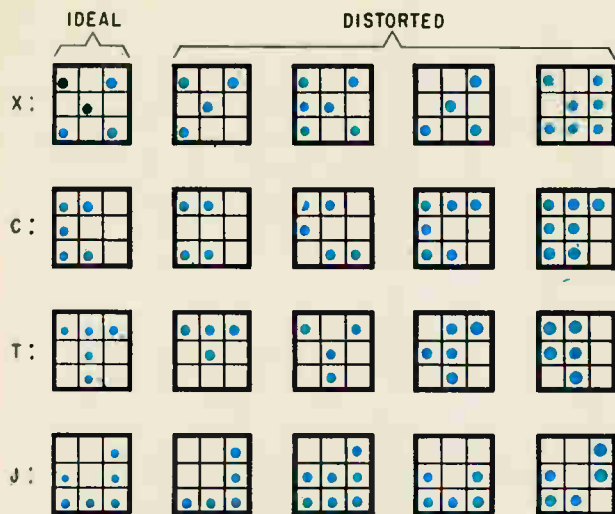

Samples of nine-variable alphabetic character patterns include ideal and distorted types of letters X, C, T and J.

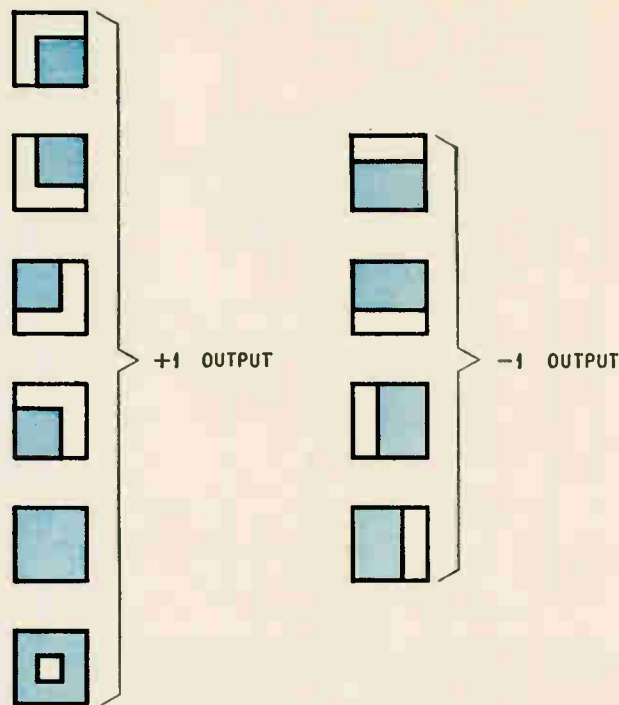
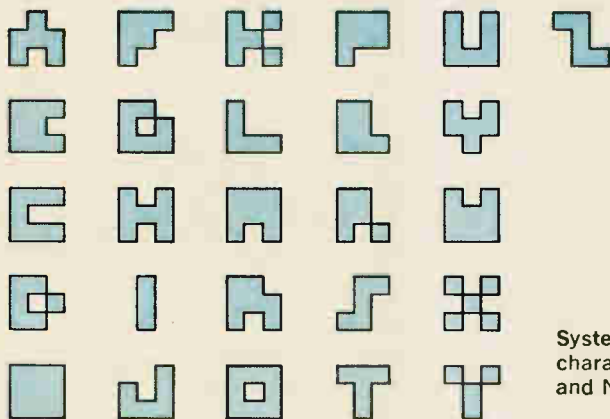

In geometric-shape recognition problem, the recognizer had to produce a +1 for squares and a -1 for rectangles. Only three iterations were required.

System solved problems based on a 3 by 3 alphabetic character representation. Groups separated from A to M and N to Z were found in eight iterations.

stored weights a_m is incremented to increase the magnitude of weighted sum, and reinforce $F(i)$.

- If the punish button is pushed, the weights are incremented to change the sign of the weighted sum thereby changing the output $F(i)$.

- If neither the reward nor punish buttons is pushed, no changes occur in the stored weights.

- The pattern recognizer is usually trained as follows:

- The pins in the cross-product matrix plugboard are set up to an optimum configuration for the problem. Computer simulations can determine this configuration, as described.

- Next, the clear logic button is pushed to set all the weights to zero.

During the first iteration through the patterns, both the reward and punish buttons are used in training the threshold logic element. That is, after entering a pattern and pushing the start button, the reward button is pushed if the actual output F equals the desired output; otherwise, the punish button is used. The reward or punish buttons are pushed only once for each pattern. During later

iterations through the patterns, only the punish button is used. The recognizer has learned the desired function when no patterns appear in a given iteration that produces an incorrect output from the pattern recognizer.

It is possible to enter a set of preselected weights into the trainable pattern recognizer by means of a plugboard matrix and enter weights pushbutton. In essence, the training is accomplished beforehand in a computer simulation of the problem.

Designed with IC's

The trainable pattern recognizer is constructed almost entirely of integrated circuits. Only the power supply, lamp drivers and clock circuit use discrete components. The logic circuits, which are Motorola series MC 350 devices, are of the non-saturating, emitter-coupled type, chosen because of the low cost and availability of flat packages rather than for their high-speed capabilities.

The clock signal for the trainable pattern recognizer runs at a relatively low rate of 250 khz. It is generated by cross coupling a pair of integrated

NOR gates with discrete component RC networks. Together they form an astable multivibrator. In addition to NOR gates, the integrated logic circuit complement includes NOR/OR gates, half-adders, flip-flops and gate expanders. About 225 flatpacs are used in the trainable pattern recognizer. Power for the logic circuits is provided by a 5.2-volt, 2-ampere supply.

Circuits are interconnected by means of double-sided printed-circuit boards approximately 3 inches by 4 inches. In most cases it was possible to mount 24 flatpacs on each card using this scheme. Multilayered printed-circuit boards permit a higher packaging density per card, but the lead time and expense of multilayered boards are considerably greater, and their use was not justified in the fabrication of the demonstration device. Connections to the p-c boards are made by means of a dual 64-pin connector that mates with printed-circuit contacts on the card. The flatpack leads are hand soldered to pads on the p-c board.

The card layouts are done on a standard format consisting of pads for three rows of eight flatpacs each. Careful attention is given to the layouts and intercard wiring because the high packaging density, attainable with integrated circuits, makes checkout, troubleshooting and wiring changes very difficult. A ground bus is also incorporated to minimize ground-noise problems.

The printed-circuit cards are packaged in two files of six cards each, mounted as closely together as the connectors allow. Openings in the cabinet beneath the card files provide air for convection cooling of the integrated circuits. No fans are required but careful attention is given to mounting major heat-producing components. These are in the lamp drivers and power supply on the chassis.

Conducting a simulation

Test results using the nonlinear threshold logic approach have been obtained from both computer simulations and the use of the trainable pattern recognizer. Computer simulations have dealt with problems of up to 31 variables and 300 patterns. The procedure for conducting a simulation is as follows:

- Patterns on punched cards are entered into the computer in any desired order.
- Masks on each cross-product, randomly chosen and limited to a certain number of variables are also entered by means of punched cards.
- During the training the computer prints out the number of patterns wrongly classified by the existing circuit configuration.
- At the end of the final iteration, the computer prints out the final number of patterns wrongly classified and the final weights and cross-product configurations. For example, one problem dealt with a total of 100 samples of the alphabetic characters X, C, T, and J. The samples included both ideal and distorted representations of the characters as indicated by the typical patterns at the top of page 92. Each cell in the matrix was assigned

to a variable, x_1, x_2, \dots, x_n . The absence of a dot in the n^{th} box was interpreted as $x_n = +1$. Presence of a dot was interpreted as $x_n = -1$.

Several of the problems to which the trainable pattern recognizer was applied used the 3 by 3 alphabetic character representations, lower figure, page 92. In eight iterations through the patterns, a solution was found for the problem of separating characters into groups of A to M and N to Z.

Problems involving a selected portion of the patterns were also demonstrated. For example, the pattern recognizer was successfully trained to produce a +1 output for one pattern out of a group of 10, and in a second case, to produce a +1 output for every other letter of a group of 10.

Variations of geometric-shape recognition problems have been demonstrated. In the problem, illustrated on page 92, it was desired to produce a +1 output for square shapes and a -1 output for rectangular shapes. Only three iterations were required to train the pattern recognizer. In another example, the device was made to differentiate between horizontal lines (a +1 output) and vertical lines (a -1 output).

References

1. R.O. Winder, "Single-Stage Threshold Logic," Proceedings of Second Annual Symposium on Switching Circuit Theory and Logical Design, AIEE Special Publication S-134, Sept, 1961.
2. W.C. Ridgeway, "An Adaptive Logic System with Generalizing Properties," Technical Report 1554-1, Stanford Electronics Laboratory, July, 1962.
3. H.S. Crafts, "Components That Learn," Electronics, March 22, 1963, p. 49.

The authors



D.P. Hattaway is a senior engineer in the control and data-handling systems department. His main experience is in development of missile guidance, analog and digital computing systems and microminature analog-to-digital converters.



E.D. Hietanen is an engineer in the control and data-handling systems department. He is working in the development of artificial-intelligence techniques and adaptive systems using statistical decision theory, pattern recognition and computer simulations of adaptive logic networks.



R.W. Rothfusz is a senior engineer in the control and data-handling systems department. He has worked primarily on analog-digital systems for instrumentation and control. Some of his recent projects include aerial photo recognition and electronic drive systems for d-c motors.

Circuit design

Designer's casebook

Direct current regulator drives fluorescent lamps

By David B. Hoisington

U.S. Naval Postgraduate School
Monterey, Calif.

Fluorescent lamps in buses, trains, boats and other vehicles are usually energized by solid state inverters operating at frequencies above 500 hertz.

However, fluorescent lamps can operate from a direct-current source. And with direct current there is no flicker, little or no acoustical noise, lamp efficiency equals the efficiency at the higher frequencies and radio-frequency interference is minimized.

D-c operation has not been widely used up to now because the required resistive ballasts are very inefficient. However, modern solid state devices permit the design of efficient constant-current sources.

The solid state circuit of a current regulator for fluorescent lamps, at the right, is designed for a yacht, but is suitable for other vehicles with a 75-volt d-c source.

Switching transistor Q_3 on and off furnishes the correct average voltage and hence the current to operate the lamp. The series inductor tends to maintain lamp current constant; the diode provides a current path when Q_3 is off.

Q_3 is controlled by the Schmitt trigger circuit consisting of Q_1 and Q_2 . When lamp current rises above a preset value, the voltage developed across the series 5.6-ohm resistor turns on Q_1 . Immediately, Q_2 stops conducting and turns off Q_3 . When the current falls, Q_3 turns on. With the circuit constants in the schematic, the lamp current varies $\pm 27\%$ from its average value at a 1-khz rate.

To start the lamp, the push button is depressed, closing the circuit through the lamp heaters. This also shunts the 5.6-ohm resistor, allowing higher currents that are needed to heat the filaments. When the switch is released, the voltage surge caused by the series inductor ignites the lamp. The shunt capacitor reduces radio-frequency interference caused by plasma oscillations in the lamp.

A range of supply voltages from 60 to 75 volts can readily be accommodated by changing the

Designer's casebook is a regular feature in Electronics. Readers are invited to submit novel circuit ideas, packaging schemes, or other unusual solutions to design problems. Descriptions should be short. We'll pay \$50 for each item published

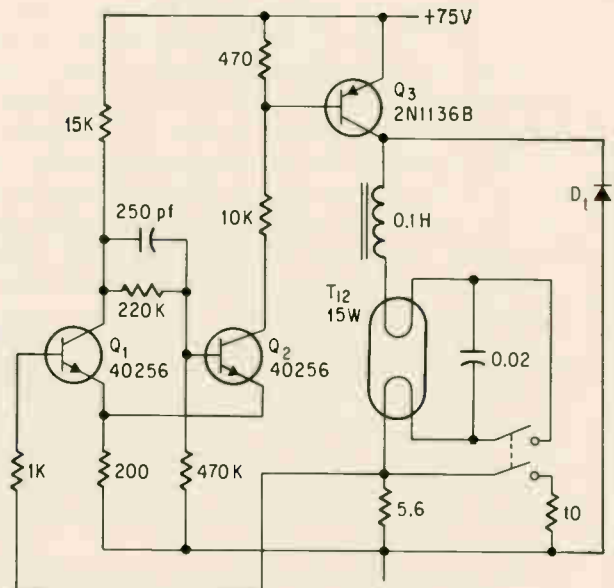

Fluorescent lamp is operated directly from d-c supply without a-c conversion. Transistors Q_1 , Q_2 and Q_3 are part of a regulated constant-current source that controls lamp current.

value of the current-sensing resistor. This is necessary because the triggering levels of the Schmitt circuit are a function of supply voltage. In case of poor source regulation, compensating circuits may be introduced.

The efficiency of this circuit is high. Total power losses in the regulating circuit, including losses in the inductor, are only 3 watts. For the same lamp with a typical 60-hz ballast, the loss is 4.5 watts.

Operation at relatively low d-c voltages is desirable because high voltage transistors are expensive. The peak emitter-to-collector voltage for Q_3 equals the supply voltage plus the forward voltage drop across the diode. This is roughly 77 volts when a 75-volt supply is used. Modification of the circuit to permit operation with a silicon controlled rectifier would make operation practical at considerably higher supply voltages.

For reliable operation over a wide temperature range and with varying voltages and variable lamp

Lamp ratings

Lamp wattage	6	8	14	15	20
Bulb size (in.)	$\frac{5}{8}$	$\frac{5}{8}$	$1\frac{1}{2}$	$1\frac{1}{2}$	$1\frac{1}{2}$
Operating voltage	48	57	41	46	59

characteristic, the d-c supply voltage should be at least 15% greater than the rated drop across the lamp. As in the table on page 94, 6-watt to 20-watt lamps are available with rated drops of 59 volts and less. A 40-watt T-12 lamp has a rated 106-volt drop.

With d-c operation the bulb temperature should be at 40°C or above, particularly if the lamp is

horizontally mounted. This is needed to prevent a mercury deficiency at the positive terminal after several hours of operation. An enclosed mounting will help maintain the required temperature. With vertical mounting, the negative terminal should be at the top, partly because most of the heat is developed at an anode end, and partly to aid the heavy mercury-atoms to return toward the anode.

Thermistor measures negative resistance of tunnel diode

By Dr. A. Ambrozy

Technical University, Budapest

The negative resistance of a tunnel diode theoretically could be measured simply and effectively by the circuit on the right. In this circuit, when the absolute value of the negative resistance of the diode equals the calibrated potentiometer resistance, there is no current flow. Thus the tunnel diode's absolute value can be read directly from the potentiometer. However, what is theoretically possible and what is practical are two different things; stray reactance associated with variable resistor R will cause the circuit to be unstable.

To eliminate the problem, a thermistor is substituted for the variable resistor as in the circuit shown below. The thermistor cancels the negative resistance of the tunnel diode and a calibrated potentiometer, whose resistance equals that of the

thermistor, will yield the absolute value of the tunnel diode's resistance at its operating point.

The tunnel diode is supported by two lamina springs and paralleled by a disk-type thermistor in series with a disk capacitor between the springs. This keeps the inductance in the loop containing R_D very small and thus its reactance very low.

The thermistor is heated by direct current provided by transistor Q_1 , with the current level adjusted with potentiometer R_6 . A 20-kilohertz, 5-volt source, divided by resistors R_3 and R_4 , provides the alternating current which modulates the tunnel diode's bias.

The operating point of the tunnel diode is set on the negative resistance slope of its voltage-current characteristic by varying R_1 . The heating current of the thermistor is adjusted at the selected

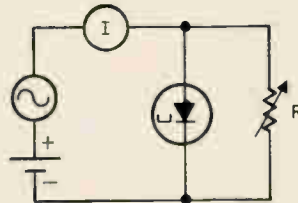

Theoretical circuit to measure a tunnel diode's negative resistance is unstable because of inherent stray reactance.

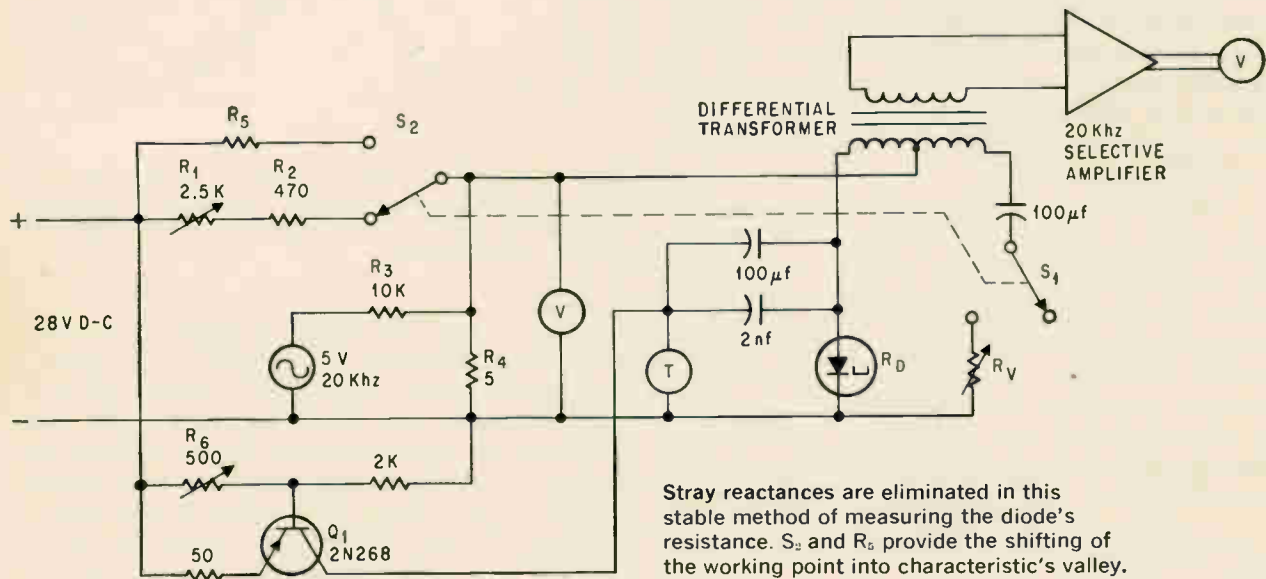

Stray reactances are eliminated in this stable method of measuring the diode's resistance. S_2 and R_6 provide the shifting of the working point into characteristic's valley.

operating point until the voltage readout of the 20-khz selective amplifier is a minimum. This occurs when the absolute value of the tunnel diode's negative resistance equals the thermistor resistance.

The value of the thermistor's resistance is determined by removing the tunnel diode from its holder or by shifting its operating point to the

valley of the characteristic curve where the tunnel diode resistance, $R_D = \infty$. After closing the switch S_1 , the differential bridge is balanced by the calibrated variable resistor R_v . Thus, the calibrated potentiometer equals the thermistor resistance which equals the negative resistance of the tunnel diode, R_{DN} ; thus $R_v = R_{th} = R_{DN}$.

Ferrite cylinder modulates microwave signals

By T. Koryu Ishii and Thomas A. Kriz*

Marquette Univ., Milwaukee, Wis.

A miniature ferrite device utilizes a novel spin alignment process in the ferrite to modulate a microwave signal. Although the maximum modulation level is only 30%, this is achieved in a simply constructed device that is physically very small.

Because low intensity, external magnetic fields are used, the modulator driver can be solid state. Tested with a simple two-wire line, the unit may be incorporated in strip line circuits and consequently has applications in microwave integrated circuits.

In the simple modulator in the diagram, a ferrite cylinder surrounds a two-wire line through which a microwave signal is transmitted. The ferrite is in a remanent state, implying that a magnetic field exists without an applied magnetizing current. In the modulating line, a current proportional to the desired modulation varies the ferrite's permeability. This amplitude modulates the microwave signal, because the ferrite behaves like an electrically controlled inductive discontinuity. In the experiment, a manganese-magnesium ferrite material was employed.

Analysis shows that modulation results from interaction of the magnetic fields of both the microwave signal and the modulating current with the ferrite's electron spins. In a remanent state, the ferrite is essentially magnetized along the closed circular path presented by the cylinder. However, within the ferrite some magnetic domains are oriented to produce components of magnetization in other directions. It is the electron spins of these domains which interact with the modulating and signal fields.

* Now with A.C. Electronics, division of General Motors Corp., Oaktree, Wis.

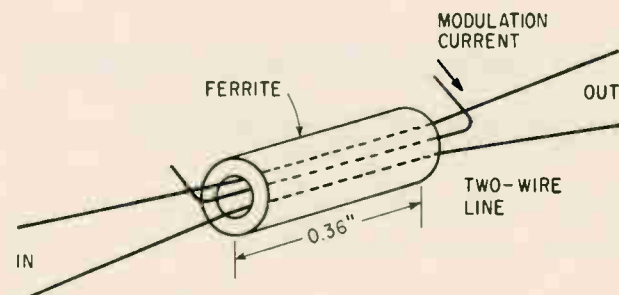

Modulator consists of a ferrite cylinder, a two-wire transmission line and a modulating current line. The outside diameter of the ferrite cylinder is 0.050 inches and the inside diameter is 0.030 inches.

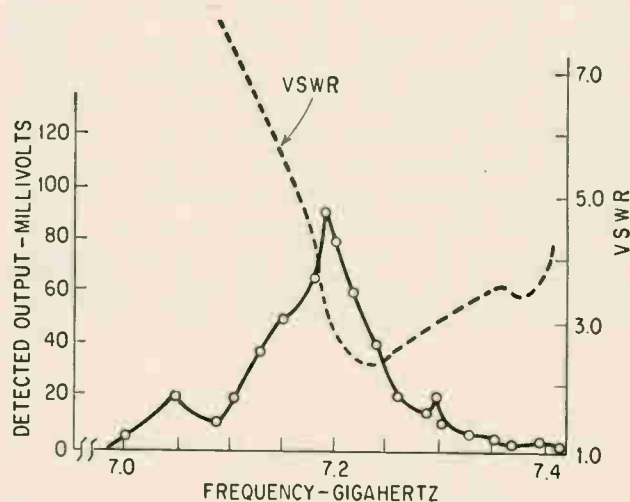

Detected output level versus frequency (solid line) was measured with modulating pulse current of 2 amperes. High voltage standing-wave ratios (broken line) partially reduces output levels.

When a microwave signal is applied it encounters a large inductive discontinuity at the ferrite. This occurs because the ferrite's relative permeability increases the line's inductance per unit length in the region near the ferrite. A small capacitive discontinuity caused by a similar abrupt change in permittivity also exists in this region. But the inductive discontinuity predominates.

Applying a modulating current changes the elec-

tron spin alignment within the domains and also the magnitude of the inductive discontinuity. The equations that describe the interaction show that the magnitude of the inductive discontinuity decreases when the modulation current, I_m , is in a direction to drive the ferrite toward saturation. As the modulation current drops, the ferrite moves away from saturation and the inductive discontinuity increases.

In one experiment the two-wire line was connected by means of wideband transformers between two sections of X-band waveguide. A microwave source fed one waveguide section and the other contained a diode detector. The source produced several milliwatts output at a reasonably constant level over a frequency range from 7.0 to 7.45 gigahertz.

A 2-amperes pulse of modulation current resulted in a detected voltage curve plotted in the graph on page 96. At each frequency the pulse duration was 10 nanoseconds. Because the transformer tapers were not smooth, a large voltage standing-wave ratio—also shown in the graph—occurred at the low end of the band. A smoother taper would have corrected this. Actually, transformers are unnecessary; one may couple the two-wire line system directly to a source and load. Radiation levels are surprisingly low because the microwave signal is propagated along the wire line as a surface wave.

The graph on the right indicates the change in detected d-c voltage as a function of d-c modulation current, I_m . The microwave frequency in

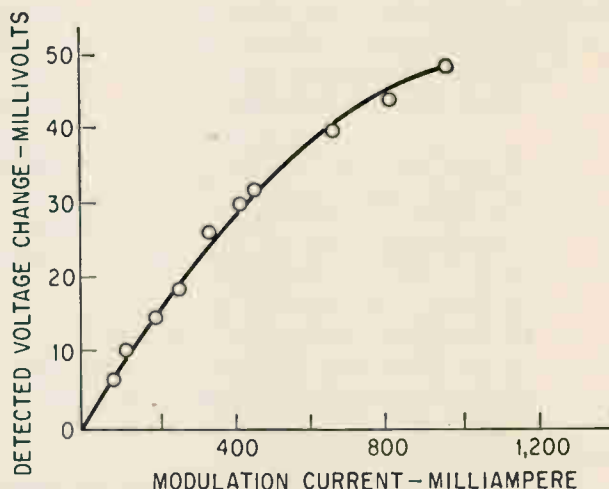

Detected voltage at constant frequency versus modulating current amplitude exhibits a nearly linear relationship.

this test was 7.19 Ghz and the quiescent reference level without modulation was 80 millivolts.

The frequency and impulse response data shows that the usable bandwidth for modulation is about 25 megahertz, the ferrite relaxation time being the major limitation.

The modulation curves demonstrate that the change in detected output is relatively linear with respect to amplitude of the modulation current. If square-law detection is presumed this means the modulation process is approximately square-law. A maximum modulation level of 30% was achieved with a modulation current of 2 amperes.

Glass reed switch controls operational amplifier

By Hays Penfield,

Harvard College Observatory, Cambridge, Mass.

High reliability, fast switching time and high leakage-resistance make the glass reed switch ideal for controlling an operational amplifier integrator.

Depending on the portion of the cycle at which switch S_1 is opened or closed, the circuit on page 98 can gate out unwanted signals or maintain the integrated output at a specified level. It can also operate as a synchronous detector. Maximum switching speed is about 300 hertz.

Switch S_2 removes the charge from feedback capacitor, C. With S_2 open, the output is the time-

integral of the difference between voltage levels applied at the inputs to the d-c amplifier. When S_1 is closed, the input signal is applied to both inputs equally and the difference signal is zero; so there is no change in integrator's output level. When S_1 is open, the input signal is applied to only the plus side of the amplifier and the output is the time-integral of the input. To hold a particular integration level, switch S_1 is closed at that level. By merely reopening S_1 , integration can continue.

Opening and closing S_1 in synchronism with an a-c input signal allows synchronous detection and integration of the signal. The amplifier will integrate only the portion of the input signal that is present while switch S_1 is open. The circuit is used for synchronous detection at the Harvard College Observatory.

An integrator, connected at the output of each of 21 filters separates the frequency spectrum of radio-telescope signals. The integrators switch in synchronism with the receiver's input switch that

connects alternately to the antenna and a comparison load. Synchronous switching speeds are about 4 to 5 hertz. Signals as low as 20 microvolts and integration times of more than 30 minutes have been used.

The integration factor is inversely proportional to the feedback capacitance, C . With S_1 open, the integration factor is $10/C$ volts per volt-second. If C is 1 microfarad, and a 100-millivolt input signal is present for 1 second, the output is 1 volt.

To zero-balance the amplifier, current is supplied to one of the inputs through a 3 megohm resistor. Adjusting the 100 kilohm potentiometer establishes the desired zero balance current. Each reed switch requires about 30 milliamperes of driving current obtained from a 2-volt source.

Almost any d-c amplifier can be used. Circuits have operated satisfactorily with the type 1507 manufactured by the Burr-Brown Research Corp. and the $\mu A709$ manufactured by Fairchild Semiconductor, a division of Fairchild Camera and Instrument Corp.

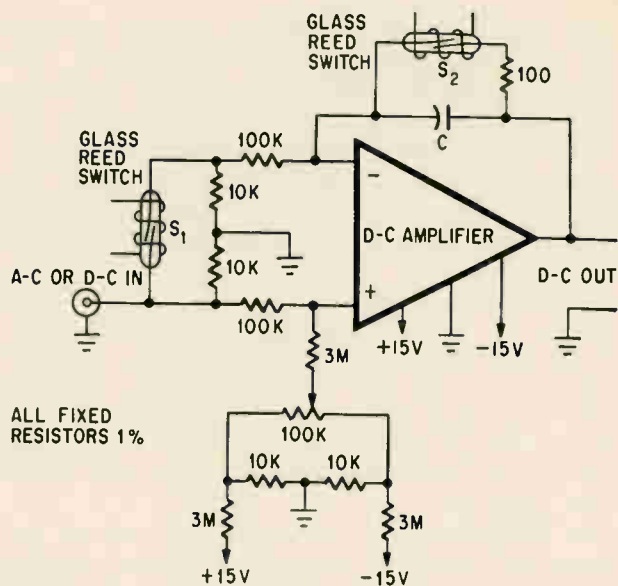

Reed switch S_1 controls integration in operational amplifier. Circuit integrates only when S_1 and S_2 are open.

Pulsed oscillator conserves power

By R.C. Lavigne and L.L. Kleinberg

Goddard Space Flight Center,
Greenbelt, Md.

The oscillator circuit shown below needs no standby power. In contrast to other oscillators that operate continuously and have their outputs gated,

this circuit is pulsed on when required. It can be used in applications such as tone generators, where the output is not needed continuously and power must be conserved.

Pulsed oscillators can also calibrate cathode-ray oscilloscopes. The gate that initiates the sweep also triggers the oscillator allowing its waveform to be displayed. If the oscillator's frequency is known, the time base can be calibrated.

The circuit, a Wien bridge oscillator, has an output-frequency range of 100 hertz to 100 kilohertz and no inductors. With no forward biasing networks, both transistors are normally off. When

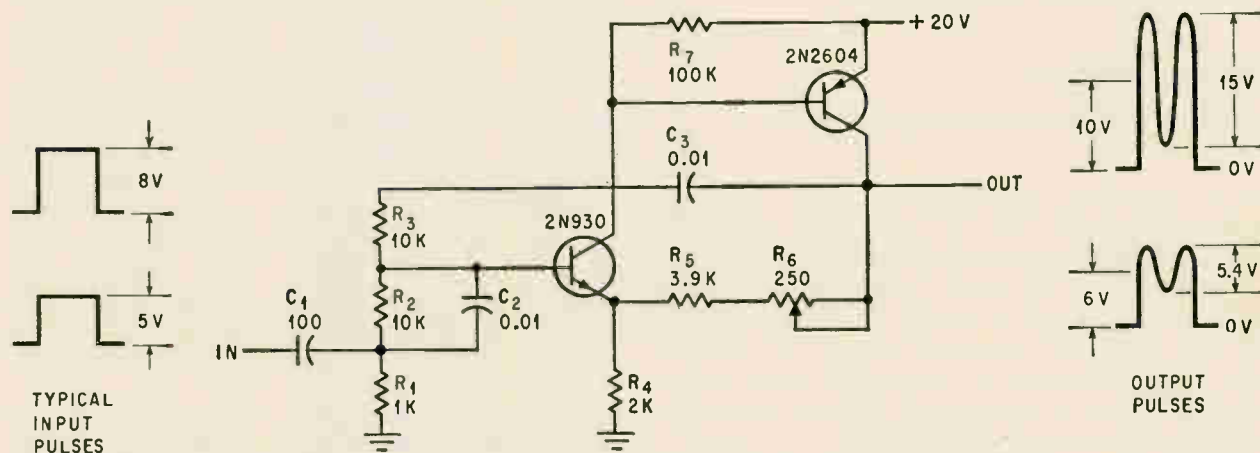

Wien bridge oscillator operates only when a gating pulse is applied to the input. Pulses at input and output indicate how amplitude of the oscillations varies with the level of the gating pulse.

a gating pulse of 5 to 10 volts is applied to the input, both transistors are turned on and oscillation occurs. If $R_2 = R_3$ and $C_2 = C_3$, the oscillating frequency is given by

$$f = \frac{1}{2\pi R_2 C_2}$$

When the gating pulse ends, both transistors turn off until the next gating pulse is applied.

The amplitude of oscillation is determined by the amplitude of the input gating pulse as shown in the diagram. If the amplitude of oscillation rises exponentially during the gating pulse, potentiometer R_4 can be adjusted to increase feedback.

Values of R_1 and C_1 are chosen so that the time constant $R_1 C_1$ is much longer than the period of the gating pulse. This prevents pulse droop which would result in a decaying amplitude of oscillation.

Amplifier provides 10^{15} -ohm input resistance

By A.D. Delagrange

U.S. Naval Ordnance Laboratory, Silver Springs, Md.

A buffer amplifier with an input impedance of 10^{15} ohms has been built with a metal oxide semiconductor field effect transistor (MOS FET). The impedance value is considered infinite for most circuits. Amplifier gain is unity to an accuracy of 0.1% for a 100-kilohm load.

Designed to drive a 100-kilohm load, the amplifier may be used directly with any system whose input-current requirement is less than 100 microamperes. For low-impedance loads the circuit at the right may be used to drive an operational amplifier in feedback configuration. A typical input and output impedance of 10^{15} ohms and 0.1 ohm respectively is possible from the over-all combination.

Input transistor Q_1 is an enhancement-mode insulated-gate field-effect MOS device with an inherent input impedance of 10^{15} ohms. It is connected as a source follower (analogous to an emitter follower for a conventional transistor). Its load is transistor Q_2 . High d-c bias without low impedance a-c signal loading is provided by transistor Q_2 .

Transistor Q_3 is an emitter follower also with a current-source load, Q_4 , for additional impedance gain. Zener diode D_3 shifts the d-c level of the output by an amount equal to the gate-source drop across the input transistor. The drain of Q_1 is connected to the emitter follower rather than to the supply voltage. Thus, the drain-source voltage is independent of the input voltage.

Since the voltage gain of the follower circuit is less than unity, a slight amount of positive feedback is added through resistor R_3 to increase the gain. Gain is adjusted by potentiometer R_2 ; potentiometer R_1 adjusts the d-c zero value. Diodes D_3 ,

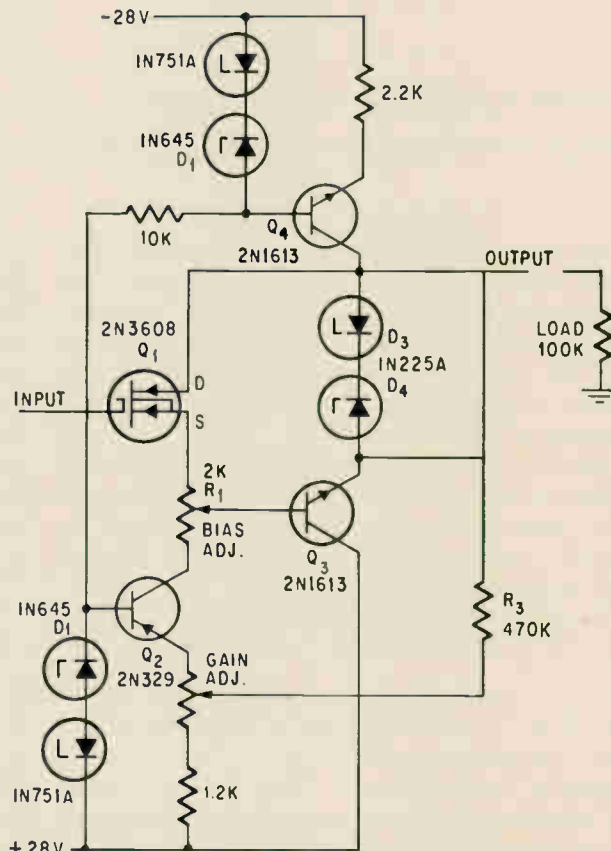

Field effect transistor Q_1 provides the circuit with 10^{15} ohms input impedance. The amplifier drives a 100-kilohm load and may be used directly with any system whose input current is less than 100 microamperes.

D_4 and D_1 are for temperature compensation. The amplifier contains several internal loops, but gain around each is considerably less than unity. There is no tendency for the transistor amplifier circuit to oscillate.

With proper adjustment, the output voltage equals the input voltage within ± 10 millivolts over the allowable range of ± 10 volts. The semiconductor device in this circuit is new and is the key element that gives the buffer amplifier its very high input impedance.

Helix antennas take turn for better

A unique antenna with contrawindings connected to common feed points has large bandwidth; it provides flexibility in choosing polarization and can operate at high gains

By Carl W. Gerst and Robert A. Worden

Syracuse University Research Corporation, Syracuse, New York

The Air Force is testing a new class of helix antennas—one that provides large bandwidth and high gain at levels up to now unobtainable together. The contrawound antenna—with multiple lines wound in different directions—boasts a unique property: its polarization, bandwidth and gain can be controlled independently.

In addition, the contrawound antenna is smaller than log-periodic antennas and previous helix models. Its polarization can be linear, right-hand or left-hand circular. It can be fabricated by printed circuit techniques. Windings wound in one direction are printed on the inside of the dielectric cylinder, while contrawindings are printed on the outside.

Contrawound helix antennas can be used for receiving or low-power transmitting. Its unique capabilities make it especially valuable in military communications, space telemetry and tracking and in some commercial applications, such as television and f-m radio broadcast receiving antennas.

The octafilar contrawound helix in the photograph on the next page operates at 300 to 3,700 megahertz. It consists of wires fitted into grooves

on a plastic cylinder. The term octafilar refers to the number of windings wound in either direction; oppositely wound helixes start at each of eight feed points. As a result, eight windings are wound in one direction on the dielectric cylinder and another eight are wound in the opposite direction. In the diagram on the next page the contrawound construction is compared with a conventional unifilar helix and a multifilar helix without contrawindings.

Ground and airborne antennas

Size and gain advantages can be visualized by comparing contrawound helix and log-periodic antennas designed for operation at 50 to 350 Mhz. Both would be about 13 feet long, but the contrawound antenna would only be about 1½ feet in diameter while the log-period antenna would be about 10 feet wide at its widest point. Both antennas would have the same gain at about 50 Mhz, but at 350 Mhz the contrawound antenna would have seven times the gain of the log-periodic antenna. The gain of the contrawound antenna increases linearly with frequency and also increases with antenna length.

Since gain implies narrower beamwidth, the antenna could also have commercial applications as television and frequency-modulated radio broadcast receiving antennas. In television, the added gain would reduce problems caused by signal reflections. The 13-foot long antenna would receive television channels 2 to 13 and f-m broadcasts.

Because the octafilar antenna in the photo extends well into S band, it could be used as a high-gain, variable polarization antenna for space telemetry and tracking. Since its phase center varies only slightly with frequency, it can also serve as a broadband feed for parabolic dish antennas.

The polarization of such antennas can be linear, right-hand and left-hand circular. Polarization can

The authors

Carl W. Gerst, a research engineer at the Syracuse University Research Corporation's special projects laboratory, developed the theory for the antenna and broadband couplers described in the article. Since his graduation from Youngstown University in 1959, he has been engaged in the development of microwave components and systems. He is presently taking doctorate courses at Syracuse University.

Robert A. Norden, also a research engineer at the special projects laboratory, has worked on a wide variety of systems including microwave ultrasonics, electronic counter-measures systems, cryogenics and wideband microwave circuits. A member of Tau Beta Pi and Eta Kappa Nu, he is completing his masters program at Syracuse University.

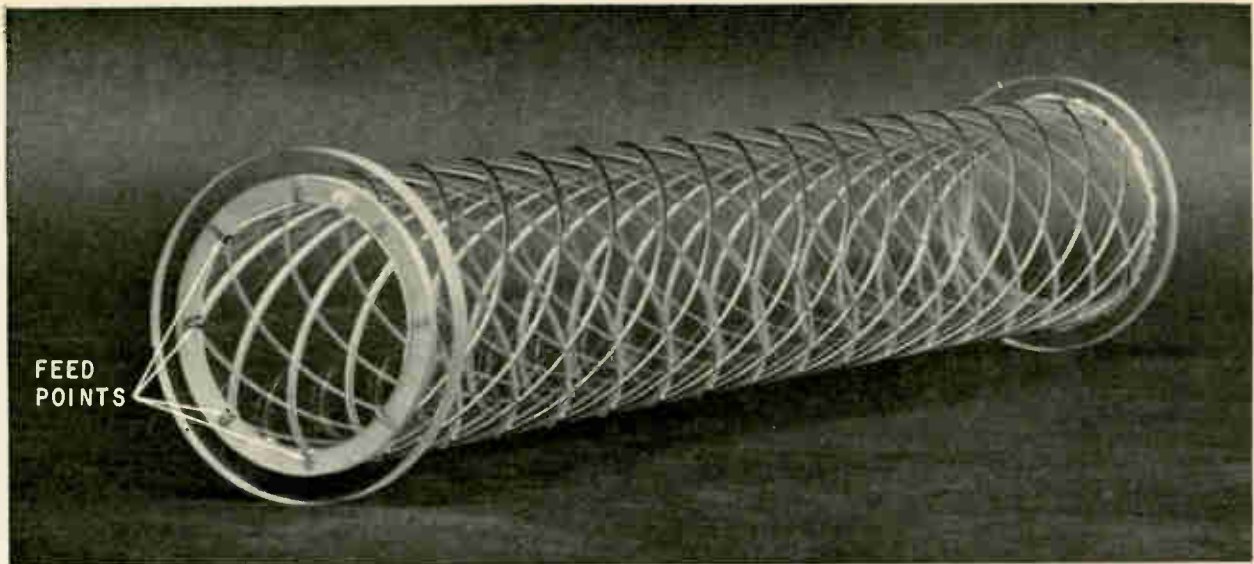

Octafilar contrawound antenna has eight feed points, each a terminal for two helices wound in opposite directions. A polystyrene tube supports windings. This experimental unit operates between 300 and 3,700 megahertz.

be changed because the contrawound design is actually two multifilar antennas, wound in opposite directions. One set of windings propagates right-hand circular polarization, and the other left-hand circular polarization. Linear polarization is a combination of these two types.

When linearly polarized, the antenna can be cut in half and mounted on a ground plane, as in the photograph on page 102. Half an antenna can be used because the antenna is physically and electrically symmetrical. The ground plane acts like a mirror, making the half antenna operate as though it were a complete antenna in free space.

The small diameter and low profile of such half antennas make them suitable for aircraft. For example, mounted along the fuselage, they would cause little aerodynamic drag. Experimental antennas have diameters as small as 0.1 wavelength—1/5 the diameter of a conventional helix antenna. Theoretically, smaller diameters are possible, but experiments indicate that 16 or more windings would be needed.

Maximum bandwidths

Although the theoretical explanation for the contrawound antenna is not fully developed, experimental versions produced the predicted bandwidth, gain and polarization capabilities.

Besides the octafilar helix, a quadrifilar contrawound antenna with four windings in each direction has also been tested. The bandwidth is 5:1—from 800 to 4,000 Mhz. Beam patterns were good and polarization could be varied at will by changing the relative phase and amplitude of the voltages connected to the helix's terminals. Each terminal feeds a winding wound in a different direction.

Theoretical and experimental studies of noncontrawound, multifilar helices (all windings in the same direction) prove that their maximum bandwidth is proportional to $N + 1$, where N is the

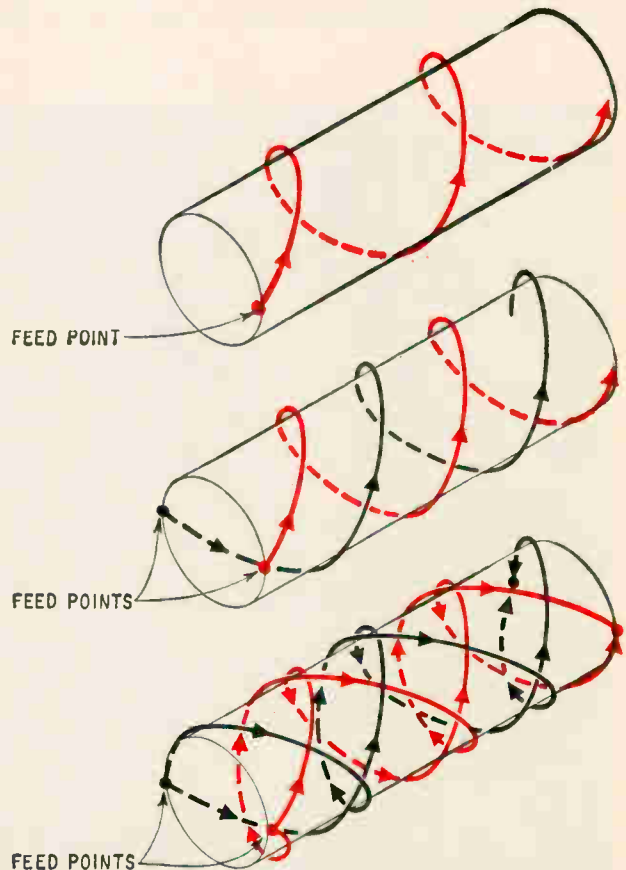

Winding geometries for helix antenna are (top to bottom) conventional unifilar helix, noncontrawound bifilar helix and a contrawound version of the bifilar design. In the bifilar noncontrawound antenna, the feed points are spaced 180° apart and both windings are wound in the same direction. Maximum theoretical bandwidth is 3 to 1. The bifilar contrawound antenna has similarly spaced feed points, but two oppositely wound helices originate at each feed point. The contrawound antenna can also provide a 3 to 1 bandwidth. In addition it has improved polarization capabilities.

number of windings in one direction. Experiments indicate this is also true for the contrawound designs. Since additional windings require more feeds, the maximum bandwidth obtainable appears to be limited only by such practical considerations as the complexity of the feed system. Wideband couplers for feeding the antenna are described on page 110.

Reason for broadband operation

The helix antenna design requires a lengthy theoretical analysis. But the reason why more windings increase bandwidth can be explained by an argument in which the helix is related to a broadband loop antenna. Contrawound antennas may be thought of as an array of broadband loops. By making a single loop broadband, the entire array can be made broadband if the loops are spaced properly. In the helix antenna, control of spacing is equivalent to adjusting the helix's pitch angle.

A loop can be broadbanded by cutting it into segments and feeding each segment with signals of proper phase, as in the diagram at the top of the next page. When signal phases are correct, the

loop radiates perpendicular to the plane of the page. Correspondingly, in the helix the direction of radiation will be along the axis of the helix.

The currents in diagonally opposite segments of the loop must flow in the same direction. The feed arrangement shown on the right side of the diagram gives the proper current flow (only one diagonal pair of segments is shown).

Each successive feed point in the loop must have a slightly different phase—the phase difference being $2\pi/N$; N in this case is the number of segments. With this feed and phase arrangement, the currents along the segments of the loop develop electromagnetic fields that reinforce one another in the direction perpendicular to the page.

However, since the phase is fixed only at feed points in the loop, there would be errors at points on each segment distant from the feed points. Also, at any arbitrary point on each segment, phase error increases as frequency increases. This is true because the electrical length of each segment increases.

Dividing the loop into more parts cuts phase variations by reducing the segment's length while in-

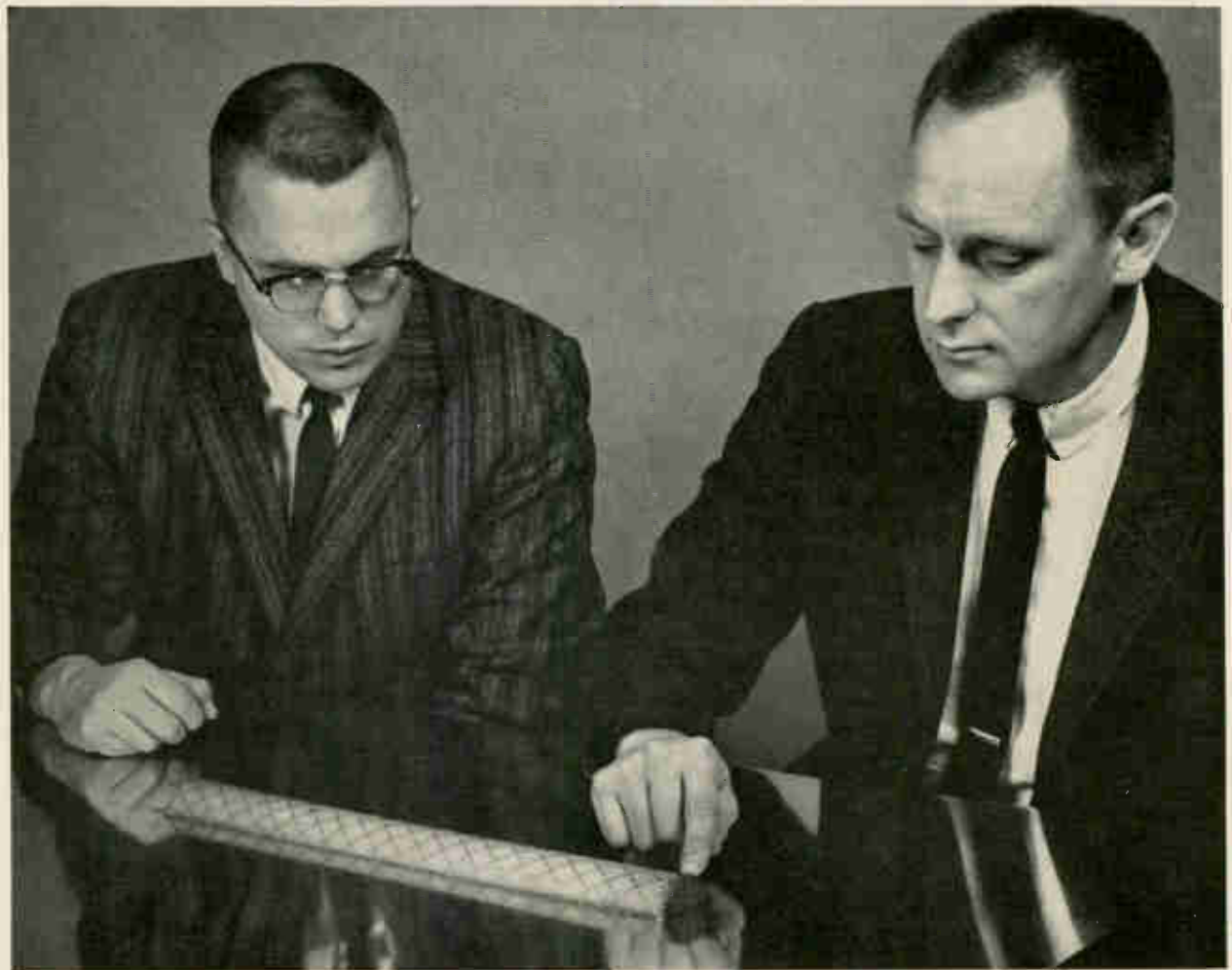

Linearly polarized contrawound helix's electrical and physical symmetry permit design of half-diameter antenna on ground plane. Carl W. Gerst, left, and Robert A. Worden look at a printed circuit octafilar version with a 9-to-1 bandwidth. Portions of eight windings are printed on each side of the dielectric cylinder.

creasing the number of fixed phase points. This insures that the fields add up over a wider range of frequencies. In other words, increasing the number of segments permits the loop to radiate over a broader band of frequencies.

More cells, more bandwidth

The sections of the helix antenna shown in the end view in the lower diagram, right, are analogous to the loops. The helix is sectioned so that a cell has only one conductor at any single value of θ , where θ is the angle measured from an arbitrary reference point on the circumference.

For a unifilar helix the cell consists of a complete turn. For a bifilar antenna, the cell consists of a half turn of each winding. In general, a helix with N windings has a cell that consists of N segments, each $1/N$ 'th of a complete turn.

The diagrams of the cells show that as the number of windings increase, the cell's length gets smaller, improving the approximation to a loop. Also, as in the loop antenna described above, the number of segments and feed points increase with the number of windings. Since the feed points in the helix are phased in the same way as in the broadband loop it can be expected that adding windings to the helix will also help overcome phase variation problems and make the helix broadband.

Although this is only a very approximate description, it does give an idea of why the multifilar helix's maximum bandwidth is proportional to $N + 1$. Experiments demonstrate that the contra-wound and noncontra-wound design exhibit the same bandwidth characteristics. Since the contra-wound design is a combination of oppositely wound multifilar antennas, it offers variable polarization capabilities.

Based on the reasoning that additional winding increases bandwidth, a quadrifilar antenna was constructed using the optimum pitch angle of 14° specified by J.D. Kraus,¹ whose extensive analysis of unifilar antennas is well known. The antenna did not show wideband characteristics, indicating clearly that the loop argument is not exact. This was expected since the argument does not consider the pitch of the windings.

Theory of helix

The theoretical analysis outlined below considers the pitch angle as well as the diameter. Although not fully developed, the analysis considerably broadens understanding of helix antennas.

The result of this analysis is design equations which relate the bandwidth characteristics to the helix's diameter, pitch angle and number of windings. Basically, the theoretical analysis shows that adding windings and feeding them with properly phased signals eliminates certain undesirable transmission modes or space harmonics that would otherwise cause attenuation. At certain frequencies, these undesirable harmonics (modes) begin to propagate along the helix's radius rather than

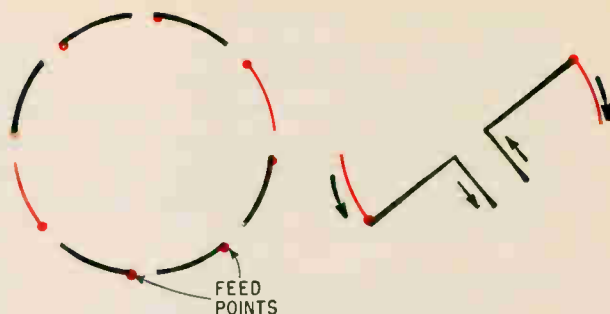

Segmented loop antenna is an approximate model of one cell in a helix antenna. The two loop segments shown in color at the left may be fed with currents in opposite directions, as at the right. This feed arrangement results in radiation perpendicular to the page when the phase difference between adjacent segments is 2π divided by the number of segments.

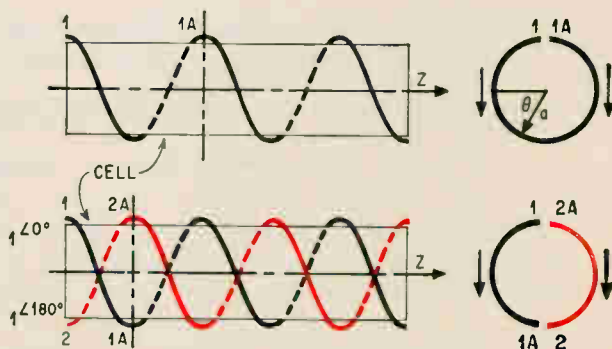

Loop analogy above is further developed in this diagram. The loops at the right represent cells of the helix antennas. The conventional unifilar helix (top) has only one loop segment per cell while the bifilar helix (bottom) has two per cell.

along its axis. Eliminating them increases bandwidth because energy propagates down the helix over a wider band of frequencies.

Periodic structure

The analysis makes use of the fact that the helix has a periodic geometry. Periodic structures have been studied extensively and have some well known general properties.² Some of these properties as related to the helix are:

- There are frequency bands in which propagation along the Z axis (the long axis of the antenna) is rapidly attenuated. These bands are called stop bands or forbidden regions; in them the helix radiates perpendicular to the helix's axis, attenuating the signal that should radiate along the Z axis. Conversely, there are passbands in which energy propagates along the Z axis with little attenuation. The passbands determine maximum antenna bandwidth.

- Electric fields may be analyzed by expressing them as a Fourier series. Each term of the series is called a space harmonic. These harmonics are a function of the frequency and of multiples of the θ and Z coordinates that describe the helix geometry. The existence of a particular space harmonic depends on frequency, helix geometry (in-

cluding number of windings, diameter and pitch angle) and the amplitude and phase of the voltages feeding the windings.

In the multifilar and multifilar-contrawound antennas, control of feed phasing and changes in antenna geometry eliminate radially propagating space harmonics, providing more passbands and greater bandwidth.

Space-harmonic phases

Associated with every space harmonic is a phase constant that determines how the phase of the harmonic varies with distance along the helix. For an antenna without losses, the phase constant for the n 'th space harmonic is given by

$$\beta_n = \beta_0 + \frac{2\pi n}{P} \quad (1)$$

where β_n = the phase constant for the n 'th harmonic
 β_0 = phase constant for the zero order harmonic

n = any positive or negative integer including zero

P = the helix's pitch distance (distance between turns)

Once the modes that can exist are known, (see p. 105) the analysis strives to find how β_n varies with frequency, because passbands exist whenever

$$k^2 < \left(\beta_0 + \frac{2\pi n}{P} \right)^2 \quad (2)$$

where k is the free-space phase constant (the phase constant for a wave traveling at the speed of light.) Equivalent expressions for k show that it is proportional to frequency:

$$k = \frac{2\pi}{\lambda} = \frac{2\pi f}{c} = \frac{\omega}{c} \quad (3)$$

where λ = the free-space wavelength

f = the frequency in hertz

ω = the radian frequency

c = velocity of light in free space

To make it easier to use, expression 2 may be written:

$$k < \pm \left(\beta_0 \pm \frac{2\pi}{P} n \right) \quad (4)$$

To obtain an expression that includes the helix's pitch angle, ψ , both sides of the above expression are multiplied by the helix's radius, a . Since the term $2\pi a/P$ is equal to the cotangent of ψ

$$ka < \pm (\beta_0 a \pm n \cot\psi) \quad (5)$$

A Brillouin diagram which plots frequency against phase makes these expressions more meaningful and shows the significance of passbands and forbidden regions. In the Brillouin diagram shown above for a unifilar helix, the vertical axis, ka , is proportional to frequency and the horizontal axis is proportional to the phase constant, β_0 . The uncolored triangles represent the passband region

specified by inequality 5. The triangle's sloping sides are determined by inequality 5 if the two terms are equated; the equation with $n = 0$ and $n = 1$ determines the first triangle as shown on the graph. The colored area surrounding the triangles is the forbidden region; it meets the axis at multiples of $\cot\psi$ as required by inequality 5. The portion of the forbidden region above $\cot\psi$ is the region in which the first Z harmonic would radiate perpendicular to the helix's axis causing attenuation along the axis. Similarly the second Z harmonic causes attenuation above $2\cot\psi$.

Multifilar windings eliminate some of the harmonics. Each successive winding on the circumference is phased so that the phase difference between windings is $2\pi N$, where N is the number of windings in one direction. To understand why this eliminates harmonics, it is necessary to examine the symmetrical properties of the helix. These symmetries require the electric fields to have the same amplitude and relative phase at periodic points in the helix.

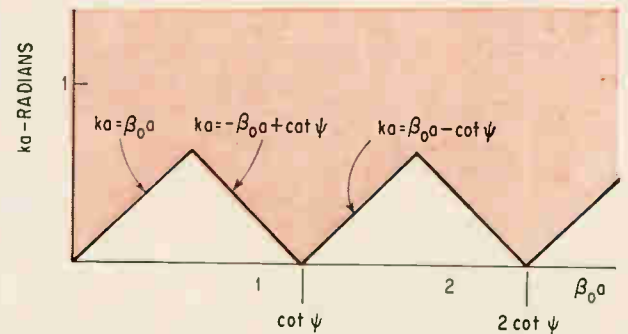

Brillouin diagram for a unifilar antenna plots ka which is proportional to frequency against $\beta_0 a$. Forbidden frequency regions are shown in color. Passbands appear as small triangles. Equations for the lines defining passband area are obtained by equating expression 5 in text. Forbidden region above $\cot\psi$ is where first Z harmonic causes axial attenuation; second Z harmonic causes attenuation in the region $2\cot\psi$.

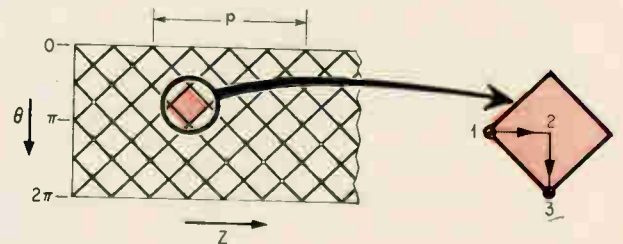

Symmetries

Type	Description
Translational	$S(Z, \theta) = S(Z + P, \theta)$
Rotational	$S(Z, \theta) = S(Z, \theta + 2\pi)$
Screw	$S(Z, \theta) = S\left(Z + \frac{P}{8}, \theta \pm \frac{2\pi}{8}\right)$

Symmetries are indicated by a drawing of a developed contrawound quadrifilar antenna—one cut along its axis and laid flat. Equations refer to the space-harmonic functions describing electric field along helix's axis. Screw symmetry means that the space-harmonic function is identical at points 1 and 3 in colored diamond.

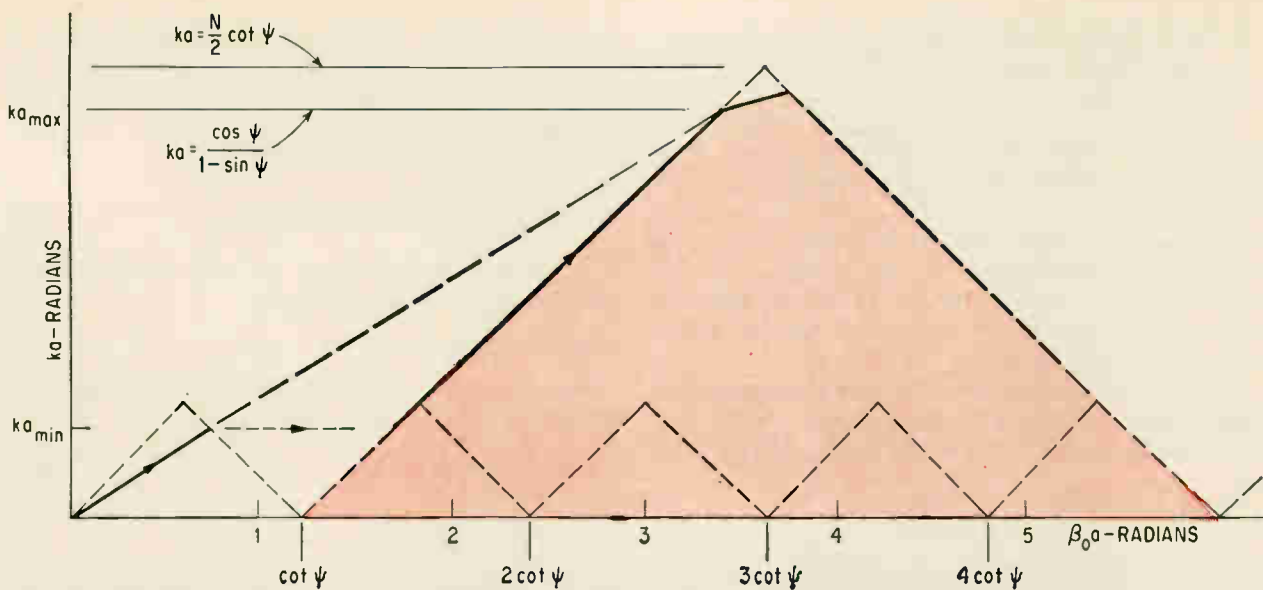

Brillouin diagram for quadrifilar helix antenna shows how the passband region (in color) grows in area when the Z harmonics 2, 3 and 4 are suppressed. Top of large triangle or intersection of dashed line with this triangle determines the highest operating frequency. For comparison, the small triangles along the bottom of the diagram represent the unifilar antenna's Brillouin diagram. Slope of solid line in first triangle is $\sin \psi$.

Symmetry of the helix

The multifilar contrawound helix has translational, rotational and screw symmetry, as shown in the lower diagram at the left. Translational symmetry means that a point moved a pitch distance, P , along the helix antenna's axis cannot be distinguished from the original point. Rotational symmetry means that a point moving around the circumference by 2π radians comes back to its starting place. Screw symmetry means that a point moving along the Z axis from points 1 to 2 and then rotating an angle from 2 to 3 returns to a similar point.

The translational symmetry allows the electric field to be represented by a Fourier series in harmonics of Z; rotational symmetry allows expansion of the fields in a Fourier series in harmonics of θ . However, the screw symmetry permits only certain Z harmonics for a given θ harmonic.

If A_{mn} is the magnitude of the electric field with an m 'th θ harmonic and an n 'th Z harmonic, then screw symmetry allows only fields where the indexes satisfy the equation:

$$m = n + b2N \quad (6)$$

where $b = 0, \pm 1, \pm 2, \pm 3, \dots$
 $N =$ number of windings

If the first θ harmonic ($m = 1$) of an N-filar contrawound helix is excited, the only other θ harmonics that can exist are harmonics with the coefficient:

$$m = 1 + bN \quad (7)$$

Thus, it is possible to control the Z harmonics by controlling the θ harmonics.

As an example of how θ harmonics are controlled, assume that each winding of a bifilar antenna (diagram on p. 101) is fed with voltages of equal

amplitude, but that the phases differ by 180° . This sets up a condition that allows only odd harmonics to exist. Only an electric field that matches the phase and amplitude of the feed at the feed points can exist in the helix. The first and all odd θ harmonics can exist because they would establish such fields. But all even θ harmonics would be suppressed because each field would be in phase at the feed points; the even harmonic fields cannot exist because the feeds and the fields have to be, in this case, 180° out of phase. Because of equation 6, all even Z harmonics are also suppressed.

When the first θ harmonic is excited on a quadrifilar contrawound helix, θ harmonics such as harmonics 1, 5, 13, and 17 can exist. Only the first θ harmonic contributes to the desired radiation along the axis. The other harmonics, which are at least 8 decibels below the amplitude of the first harmonic, radiate at other angles contributing to the sidelobes.

Among the Z harmonics suppressed are 2, 3 and 4. The effect of removing these Z harmonics in a quadrifilar antenna is most easily seen by comparing its Brillouin diagram above with that of the unifilar helix.

The dotted triangles in the diagram represent the unifilar antenna's passbands. The colored triangle represents the quadrifilar antenna's passband. Because Z harmonics 2, 3 and 4 are suppressed, the forbidden regions corresponding to these harmonics are eliminated. This makes the passband triangle four times as large. Since the height of the passband triangle is proportional to frequency, the quadrifilar antenna can operate over a much broader bandwidth than the bifilar antenna.

It is now possible to study the quadrifilar antenna's Brillouin diagram more closely to determine just what is happening as the frequency

increases from zero (that is, $k = 0$). In the process, the design equations for the multifilar helix will be developed.

Starting at zero frequency ($k = 0$) on the quadrifilar helix's Brillouin diagram, ka increases along the solid black line which has a slope of $\sin\psi$. This implies that the wave along the helix is travelling at the speed of light. In this frequency range, the energy will propagate along the Z axis, but will not radiate into space. The energy reflects from the end of the helix and travels back to the source where it is dissipated.

The antenna continues to operate along the solid black line until the forbidden region of the first Z harmonic is reached at $ka = (ka)_{\min}$ where

$$(ka)_{\min} = \frac{2\pi a}{\lambda_{\min}} = \frac{\cos\psi}{1 + \sin\psi} \quad (8)$$

As the frequency increases, ka cannot follow along the same curve since this would place it in a forbidden region. As a result ka jumps to the other side of the forbidden region—to the side of the large triangle. The normalized phase velocity V_p/c given by

$$\frac{V_p}{c} = \frac{ka}{\beta_0 a} \quad (9)$$

decreases sharply at this transition, while the normalized group velocity, given by the differential equation

$$\frac{V_g}{c} = \frac{d(ka)}{d(\beta_0 a)} \quad (10)$$

increases to a value of one. The phase velocity is less than V_g when the antenna is radiating.

As ka is further increased beyond $(ka)_{\min}$ the propagation constant follows the curve

$$ka = -\cot\psi + \beta_0 a \quad (11)$$

Now the exact condition needed for end-fire radiation is satisfied as proved by the following.

End-fire radiation

In the diagram above/below, end-fire radiation occurs when the phase length of path 2 along a turn in the helix is 2π radians longer than the phase path 1 between turns. Radiation in path 1 must

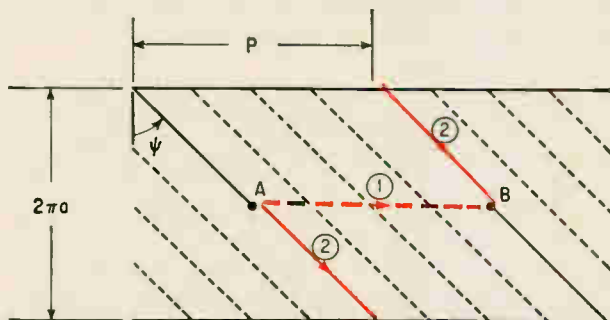

For end-fire radiation, phase length of path 1 (dashed, colored line) must be 2π radians longer than the phase length of path 2. The diagram represents a developed, quadrifilar noncontrawound antenna—one cut along its length allowing each turn to be laid flat.

travel the pitch distance, P , to go from point A to B, where $P = 2\pi a \tan\psi$. To reach point B, antenna current with a phase constant along the wire, β_w , must travel a distance $2\pi/\cos\psi$. The condition for end-fire radiation is then

$$\beta_w \frac{2\pi a}{\cos\psi} - 2\pi = k 2\pi \tan\psi \quad (12)$$

The phase constant along the axis of the helix—the Z axis—is related to β_w by

$$\beta_w = \beta_0 \sin\psi \quad (13)$$

When equations 12 and 13 are combined, the condition for end-fire radiation becomes

$$ka = -\cot\psi + \beta_0 a \quad (14)$$

Maximum frequency

As ka increases, the propagation constant continues to satisfy equation 11 until one of the following two conditions prevents propagation:

- The line representing the wave traveling at the speed of light along the conductor (black dashed line on the $ka-\beta_0 a$ graph), intersects the passband triangle at

$$ka = \frac{\cos\psi}{1 - \sin\psi} \quad (15)$$

At this point the phase velocity equals the group velocity.

- Or the top of the passband triangle is reached at a value of ka given by

$$ka = \frac{N}{2} (\cot\psi) \quad (16)$$

Beyond this point, the helix is in the forbidden region.

The maximum frequency of operation for a given pitch angle is fixed by $(ka)_{\max}$, which is the lower value of ka in equations 15 or 16. The values of ka and pitch angle over which ka satisfies the end-fire radiation condition are plotted for various values of N in the graph at the right. Because ka is equal to the helix's circumference divided by the wavelength, the vertical axis is labeled normalized circumference, C_λ . For example, the point $ka = 1$ corresponds to the frequency at which the helix's circumference is one wavelength.

The bounds of end-fire radiation for an N -filar helix are the three curves labeled

$$\begin{aligned} C_{\lambda(\max)} &= \frac{\cos\psi}{1 - \sin\psi} \\ C_{\lambda(N)} &= \frac{N}{2} \cot\psi \\ C_{\lambda(\min)} &= \frac{\cos\psi}{1 + \sin\psi} \end{aligned} \quad (17)$$

The pattern bounds for a good single-turn helix which Kraus determined experimentally are shown as a closed dashed curve. For pitch angles less than 20° , Kraus's experimental bounds agree quite well

Normalized circumference versus pitch angle

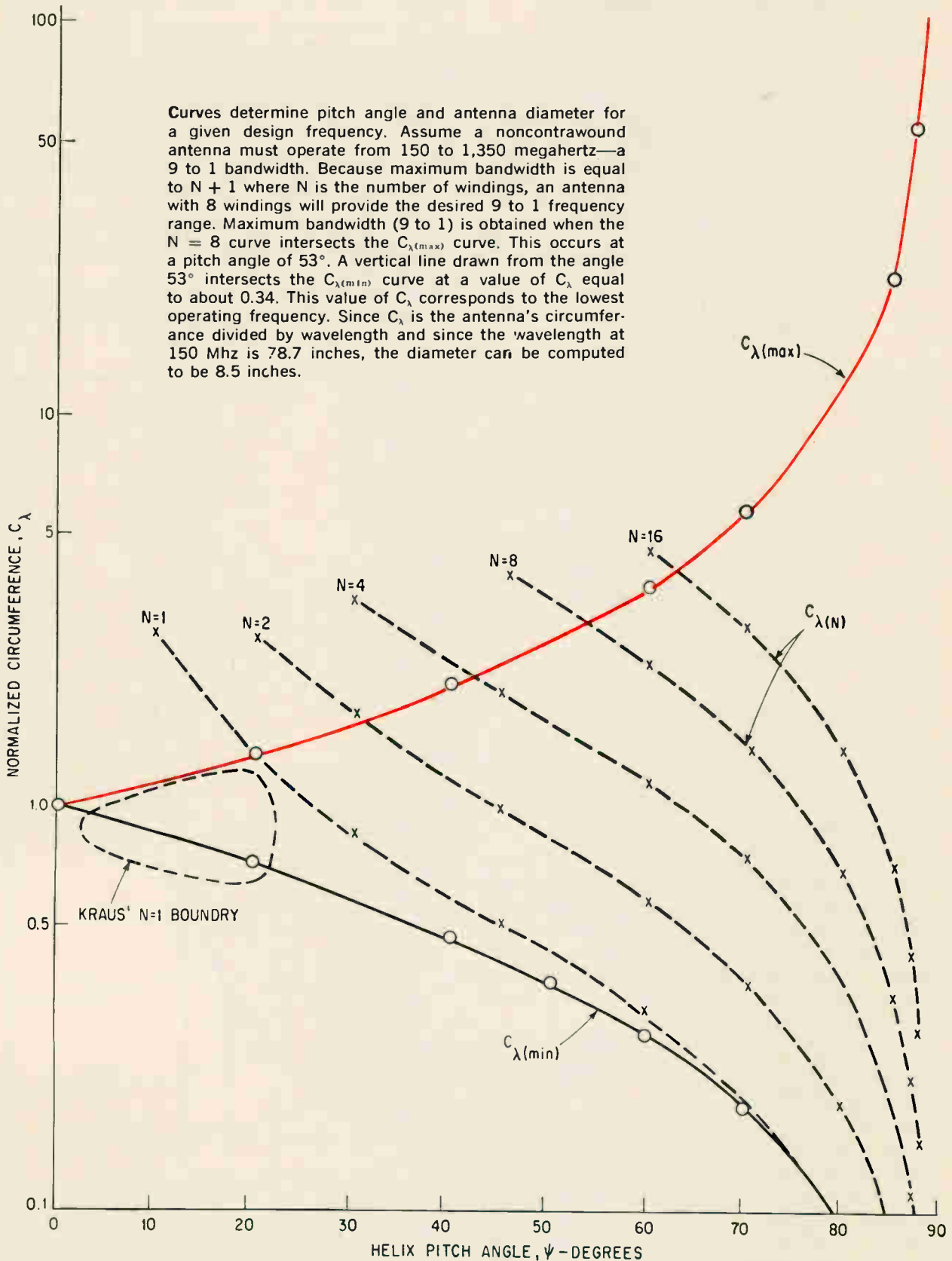

Helix antenna's circumference divided by wavelength, C_λ , is plotted against winding's pitch angle. All values of C_λ are measured in the area between the $C_{\lambda(min)}$ and $C_{\lambda(max)}$ curves. For a given pitch angle and value of N , lowest possible operating frequency is always fixed by intersection of a vertical line from the horizontal axis and the $C_{\lambda(min)}$ curve. Highest value of C_λ is determined by intersection of the same vertical line with either the $C_{\lambda(max)}$ or appropriate $C_{\lambda(N)}$ curve, whichever is reached first.

with the theoretical bounds of equation 17.

The next step in the analysis is to interpret the results in terms of bandwidth, defined as

$$BW = \frac{f_{\max}}{f_{\min}} = \frac{(ka)_{\max}}{(ka)_{\min}} \quad (18)$$

For a given pitch angle and number of windings this corresponds to the vertical distance between the $C_{\lambda(\min)}$ curve and either the $C_{\lambda(\max)}$ or $C_{\lambda(N)}$ curve—whichever is reached first. The $C_{\lambda(N)}$ curve should correspond to the number of windings in the antenna.

The exact relationship for bandwidth is that as the pitch angle, ψ , is increased from zero, the bandwidth increases according to

$$BW = \frac{1 + \sin\psi}{1 - \sin\psi} \quad (19)$$

The bandwidth increases monotonically until the pitch angle reaches ψ_{\max} given by

$$\psi_{\max} = \sin^{-1} \frac{N}{N + 2} \quad (20)$$

At this pitch angle the bandwidth is a maximum given by

$$BW_{\max} = \frac{1 + \frac{N}{N + 2}}{1 - \frac{N}{N + 2}} = N + 1 \quad (21)$$

At pitch angles above ψ_{\max} the theoretical bandwidth is

$$BW = \frac{N (\cos\psi) (\cot\psi)}{2 (1 - \sin\psi)}$$

As ψ approaches 90° , the bandwidth decreases approaching N , as shown in the graph at the right.

Designing for bandwidth

The graph at the right plots bandwidth versus pitch angle of N -filar helix antennas. As an example of how to use the graph, consider an octafilar antenna ($N = 8$) with a 40° pitch angle. The $\psi = 40^\circ$ pitch angle intersects the colored line at a bandwidth of 4. The bandwidth increases to a maximum of 9 at $\psi = 53^\circ$. At higher values of ψ , the $N = 8$ curve dips and bandwidth decreases.

As the number of windings increases, so does the pitch angle at which maximum bandwidth occurs. For example, the maximum bandwidth for a bifilar helix is $\psi = 30^\circ$; for a quadrifilar helix it is at 42° and for an octafilar helix, ψ is 53° .

With a large number of windings and high pitch angles the normalized circumferences (C_λ) can be very small at the low-frequency end of the operating band (see graph of C_λ versus ψ on p. 107). For example, a 16-filar helix with a pitch angle of 63° would operate between normalized circumference limits of 0.24 and 4.2. As a practical matter, this means that a multifilar helix antenna can be considerably smaller in diameter than a conventional helix operating with the same low-frequency limit.

Beamwidth and directivity

Beam shape of the multifilar contrawound helix can be estimated by assuming the helix is a uniformly illuminated end-fire array. The resulting radiation pattern is a $(\sin x)/x$ curve given by

$$E(\phi) = \frac{\sin [L_\lambda (1 - \sin\phi) \pi]}{L_\lambda (1 - \sin\phi) \pi} \quad (22)$$

where $L_\lambda =$ length of the array in wavelengths $\theta =$ angle measured from a line perpendicular to the Z axis.

The half-power beamwidth and directivity versus electrical length is plotted in the graph on the next page.

When N equals 4, 6 and 8 the beam width versus electrical length of the multifilar helix comes very

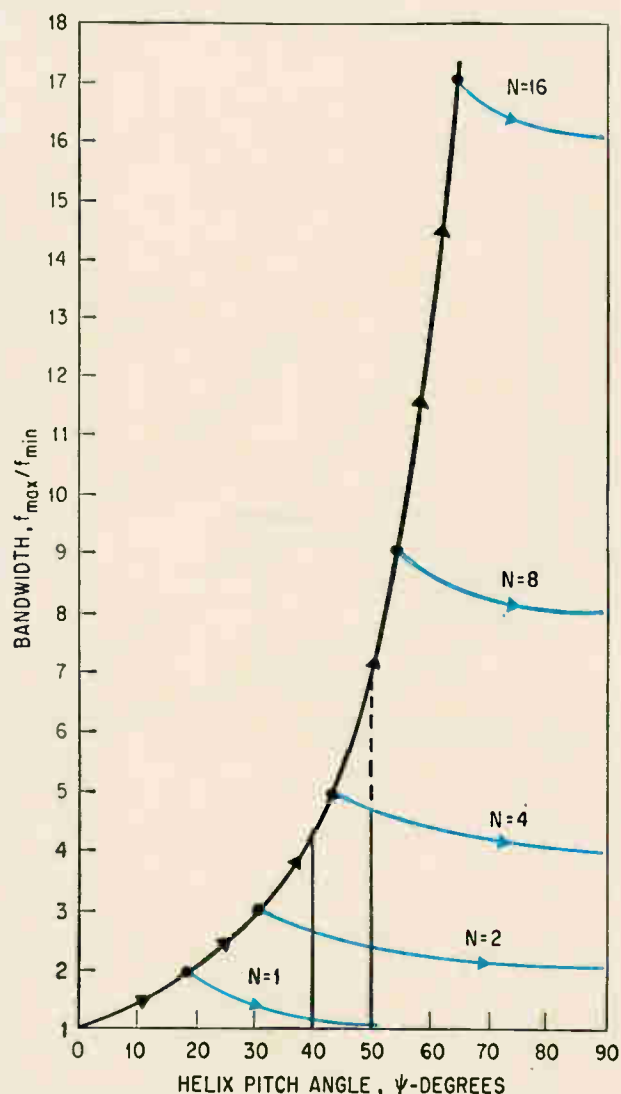

Theoretical bandwidth for a given number of windings in one direction, N , is determined by the intersection of a vertical line with the colored line corresponding to N or with the curve in black if the pitch angle is to the left of the appropriate N curve. For example, antennas with 4 and 8 windings and a pitch angle of 40° would both have a bandwidth of 4:1. At a pitch angle of 50° , the bandwidth would be 4.5:1 for a quadrifilar antenna and 7:1 for an octafilar antenna.

close to the Hansen-Woodyard³ condition for increased directivity (supergain), shown in the graph. This slight amount of supergain might be caused by an attenuated mode⁴ that is within a forbidden region but propagating along the Z axis. This is not covered in the theory, but in a real antenna an attenuated mode propagating in the Z direction does exist when ka is slightly greater than ka_{min} . The supergain condition also produces slightly higher sidelobes than an end-fire array, because the peak of the $(\sin x)/x$ pattern shifts into a so-called invisible region.

Experiments indicate there are beamwidth anomalies for $N = 1$ and $N = 2$. At $N = 1$, supergain is considerably greater than in the Hansen-Woodyard condition. Also the beamwidth is proportional to $f^{-3/2}$ rather than $f^{-1/2}$. Beam width is proportional to f^{-1} when $N = 2$. For N of 4, 6 and 8, the beamwidth varies as $f^{-1/2}$ in agreement with theory.

Polarization

Since the multifilar contrawound helix is really two cross-polarized antennas, the N feed points can be excited so as to produce any polarization. The diagram below indicates the feed requirements for linear (vertical) and right-hand circular polarization for $N = 4, 6$ and 8 . The feed requirements for the linearly polarized half-helix are also shown in this diagram.

Left-hand circular polarization requires the same phase relationship as right-hand circular, but the phase progression is in reverse order. Linear polarization is achieved by summing the amplitude and phase vectors for right- and left-hand sense polariza-

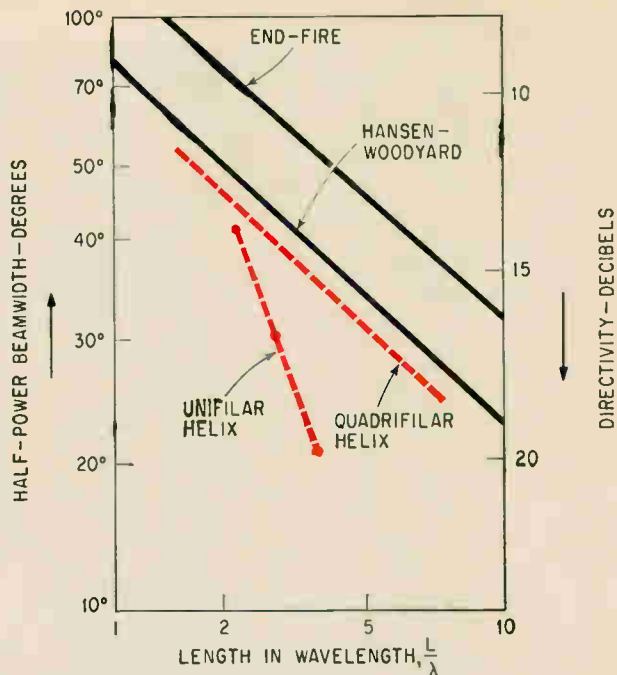

Beamwidth and directivity are plotted as a function of the antenna's normalized length. End-fire curve and Hansen-Woodyard curve are theoretical. Unifilar and quadrifilar curves (color) show experimental results.

tion. Since the antenna has odd symmetry when excited with linear polarization, a ground plane can be placed along the plane of symmetry without disturbing the fields.

For f-m radio and television applications, the feed network is as simple as those currently used with such broadband antennas as the log periodic.

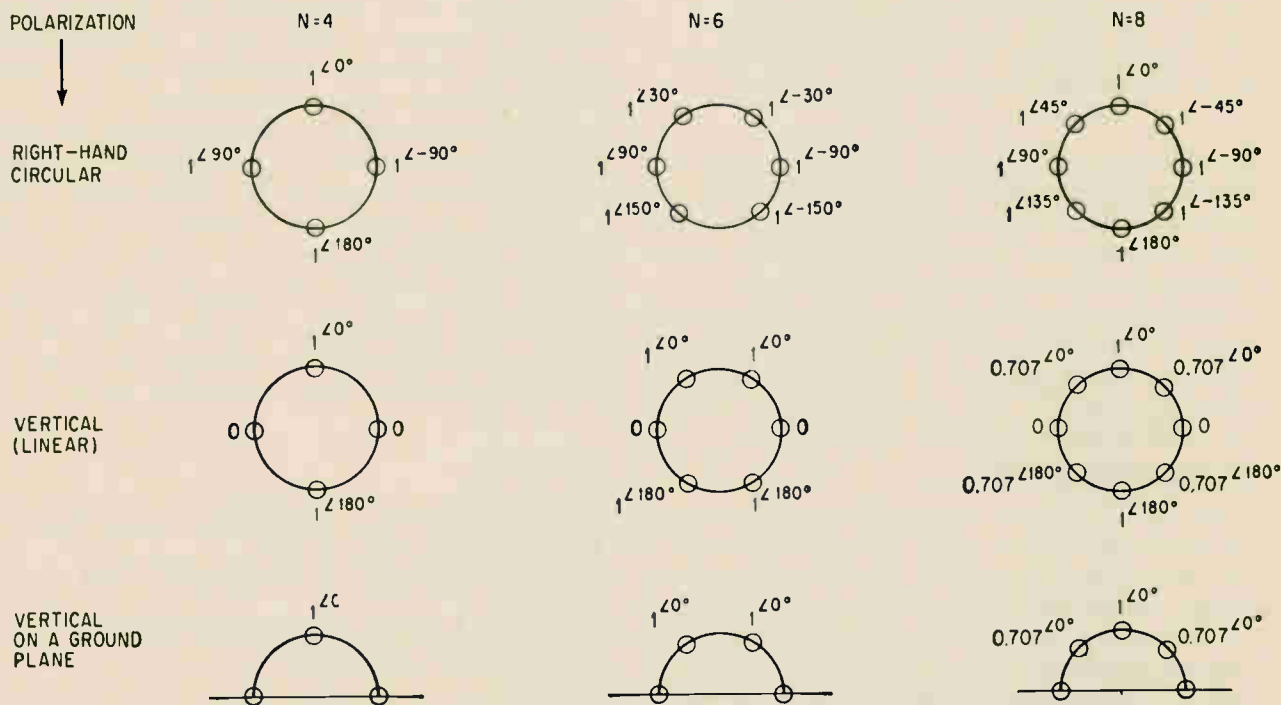

Phase and amplitude relationships required for various polarizations of quadrifilar, sexafilar, and octafilar antennas. For left-hand polarization, reverse the phase progression shown for right-hand circular polarization. For linear polarization sum the amplitude—phase vectors for right- and left-hand sense polarization.

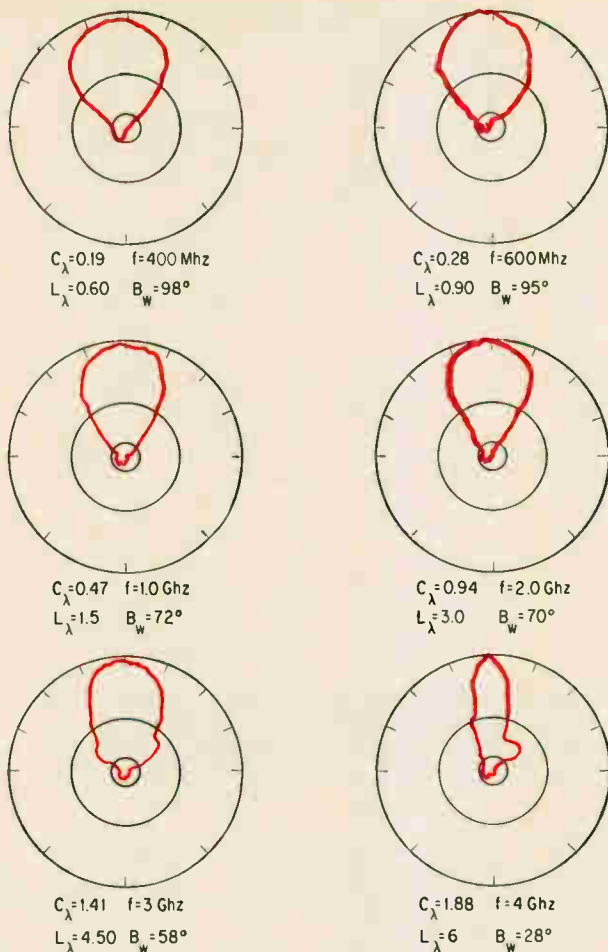

Beam patterns of a half-plane, octafilar, contrawound helix designed for operation at 400 to 3,600 megahertz. Antenna's radius is 15/16 inch and length is 18 inches. Pitch angle of each winding is 53°. At frequencies above 3,600 megahertz, sidelobe levels and back radiation increase. C_λ is normalized circumference, L_λ is normalized length, and B_w is beam width. Second circle in each diagram represents 3-dB level.

If only linear polarization is required in a quadrifilar antenna, a 300-ohm twin lead is directly connected to the horizontal feedpoints and the other two feedpoints are shorted. This yields the correct phasing for a horizontally polarized antenna.

To reduce the antenna's size, the antenna would have six windings and a 150-ohm twin lead. One lead would be connected to both 180° feed points; the other to the 0° feed points at the top. The two center feed points would be shorted.

Experimental results

Radiation patterns and input impedance measurements have been made for antennas with N ranging from 2 through 8. Six radiation patterns for an octafilar contrawound helix with pitch angle of 53° appear in the diagram shown above. The antenna is mounted on a ground plane and its polarization is linear. The radiation pattern exhibits low-level sidelobes within its 400 to 3,600 Mhz bandwidth. As the frequency exceeds 3,600 Mhz large sidelobes begin to appear.

For pitch angles above ψ_{max} where bandwidth decreases, the radiation patterns are not as good. As an example, full diameter quadrifilar helices with pitch angles of 40°, 50° and 60° were tested from 1 to 4 gigahertz. Since ψ_{max} is 42° for a quadrifilar antenna, the radiation pattern had low sidelobes and small back radiation at $\psi = 40^\circ$. The antennas with the 50° and 60° pitch angles exhibit high sidelobe levels or scalloped main beams.

Impedance measurements have been made on antennas with 2, 4, 6 and 8 windings. For each of the N input points, the input impedance to ground approaches 150 ohms. This is roughly the same input impedance that Kraus arrived at experimentally for the unifilar helix.

Much more experimental work must be done before conclusions can be drawn regarding the effects of ground plans, antenna length, and width of windings on input impedance.

Antenna feed system

The bandwidth of the couplers that link the antenna to the source voltages must equal the antenna's. Computer-designed couplers have achieved bandwidths of 8-to-1. Couplers with bandwidths of 18-to-1 are currently under study.

These broadband couplers are tandem combinations of other couplers. Coupling is varied by changing the spacing between strip-line conductors in the individual units.

Interconnecting two ports of a pair of couplers as in these broadband units, produces a combined coupler that can have a bandwidth greater than the individual units. Choosing units whose coupling curves (variation of coupling with frequency) compensate for each other's frequency response makes the response of the combination more uniform. The process is similar to producing a wideband filter circuit by combining narrowband circuits with slightly different resonant frequencies.

Parallel combinations of tandem and in-line couplers reduce line losses and permit greater spacing between coupler elements. The in-line coupler has a shorter line length and consequently less line loss, but bandwidth is limited by how small the spacing between coupling points can be made. Tandem couplers are less restricted by spacing, but the length of the transmission path can result in large line losses. Combining the two coupler types eases the spacing problem and reduces line losses.

References

1. J.D. Kraus, "Antennas" McGraw-Hill Book Co., 1950, New York.
2. Dean A. Watkins, "Topics in Electromagnetic Theory," John Wiley and Sons, Inc., New York, 1958.
3. W.W. Hansen and J.R. Woodyard, "A New Principle in Directional Antenna Design," Proceedings IRE March 1938, pp. 333-345.
4. Paul W. Klock, "A Study of Wave Propagation on Helices," Antenna Laboratory Technical Report, No. 68, University of Illinois, Urbana, Illinois, March 1963.

Acknowledgement

Antenna work is being sponsored by the Rome Air Development Center, Contract No. AF 30 (602)-3438.

Versatile DTL pulse binary counter features 12 mc clock rate, 40 ns switching time.

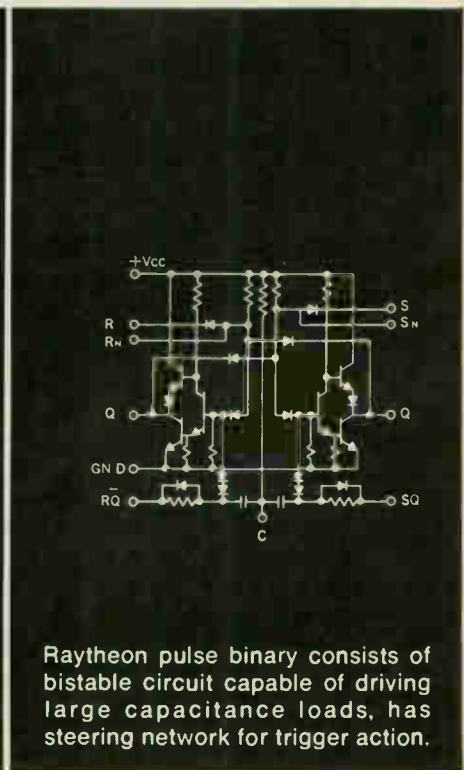
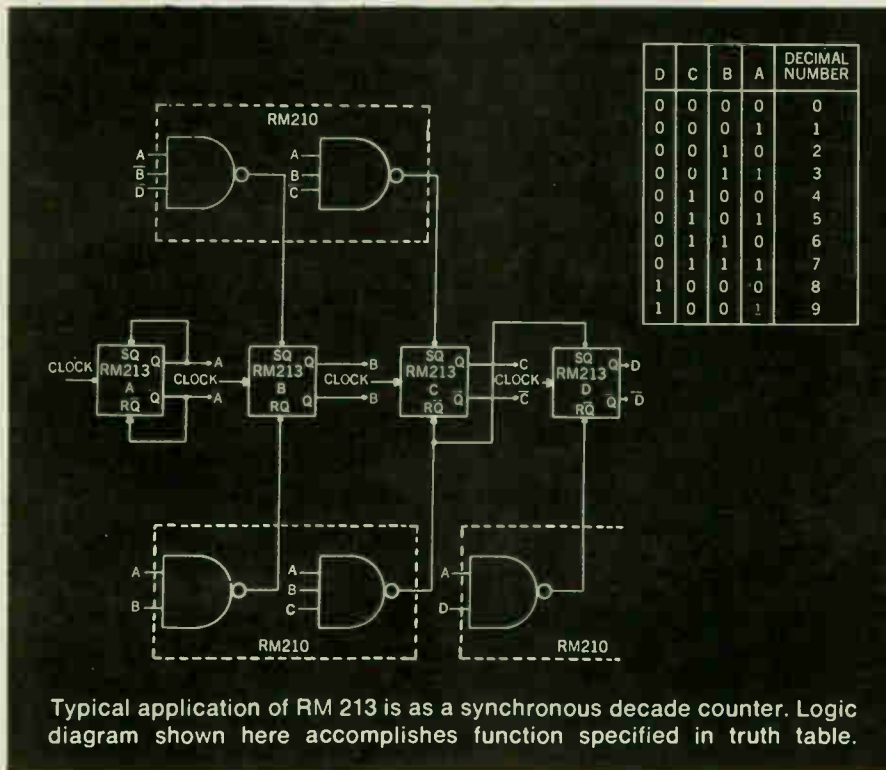

You can use this versatile and highly reliable Raytheon RM 213 DTL as a binary counter element, shift register element, clocked RS flip-flop or as a direct RS flip-flop. Besides high speed, this pulse binary counter features: fan-out of 8 over full MIL temperature

range; low power consumption; operation from a single 6-volt power supply.

Thirty-nine additional DTL circuits are available—including a broad range of NAND gates, NAND line drivers, hex gates, JK and RS flip-flops, and diode arrays.

For complete data on Raytheon's DTL integrated circuits, send reader service card. Or write: *Raytheon Company, Components Division, 141 Spring Street, Lexington, Massachusetts 02173.*





LOOK TO THE LEADER
IN INTEGRATED CIRCUITS

TEST THE BEST... WITH 50

before you buy... try TI's new

Our proposition is simply this:

We'll give you 50 molded TI integrated circuits with each order of 1000 units or more placed before November 1, 1966.

Do anything you like with these samples . . . hammer them . . . test to destruction . . . wire into your circuits . . . soak in boiling water . . . compare with any others. Prove to yourself that they're best — by test!

Money-back guarantee — If you're still not convinced that TI molded integrated circuits do your job better than any competitive types available, just return the unused circuits. We'll give you full credit for them. This offer is good for 60 days from date of any order placed before November 1, 1966.

Offer includes popular series — Devices included in this offer are the popular digital circuits from the 930-type DTL and Series 74 TTL families shown below right. Series 74 TTL is first choice of many designers for new equipment. Circuits in this line typically are 48% faster, have 25% higher fan-out and 15% better noise margin than DTL . . . at competitive prices.

Whether your system design calls for DTL or TTL circuits, you'll find a wide selection of single and multiple gates and flip-flops available. With either series, high-speed logic is now available to you at lower prices per function than ever before.

Rugged design proved by test — TI molded integrated circuits offer outstanding durability. The rugged, high-density package is molded from the same encapsulant used in millions of SILECT™ transistors and is backed by over 2,000,000 actual hours of test. Resistance to impact, heat and moisture are further borne out by testing to the following rigorous schedule without even a single failure: *Thermal Shock* — MIL Std. 750, Method 1056A; *Temperature Cycling* — MIL Std. 750, Method 1051; *Moisture Resistance* — MIL Std. 202C, Method 106B; *Hydropressure* — 3% JOY, 110 PSI for four hours.

Exclusive features save you money — You realize big reductions in total manufacturing costs with TI molded integrated circuits because they are specifically designed for use in automatic handling, assembly and test facilities. Exclusive features such as the positive index notch, pretinned leads and side-mounted lead design make it possible. Even the cartridge-type shipping container lends itself to automated production line use.

Fast delivery — Deliveries of TI molded integrated circuits are prompt . . . prototype shipments can typically be made within days. And TI's high production rates assure *continued* availability to meet your most critical production schedules.

To obtain your 50 free evaluation samples immediately, just place your order with any TI sales office or authorized TI distributor.

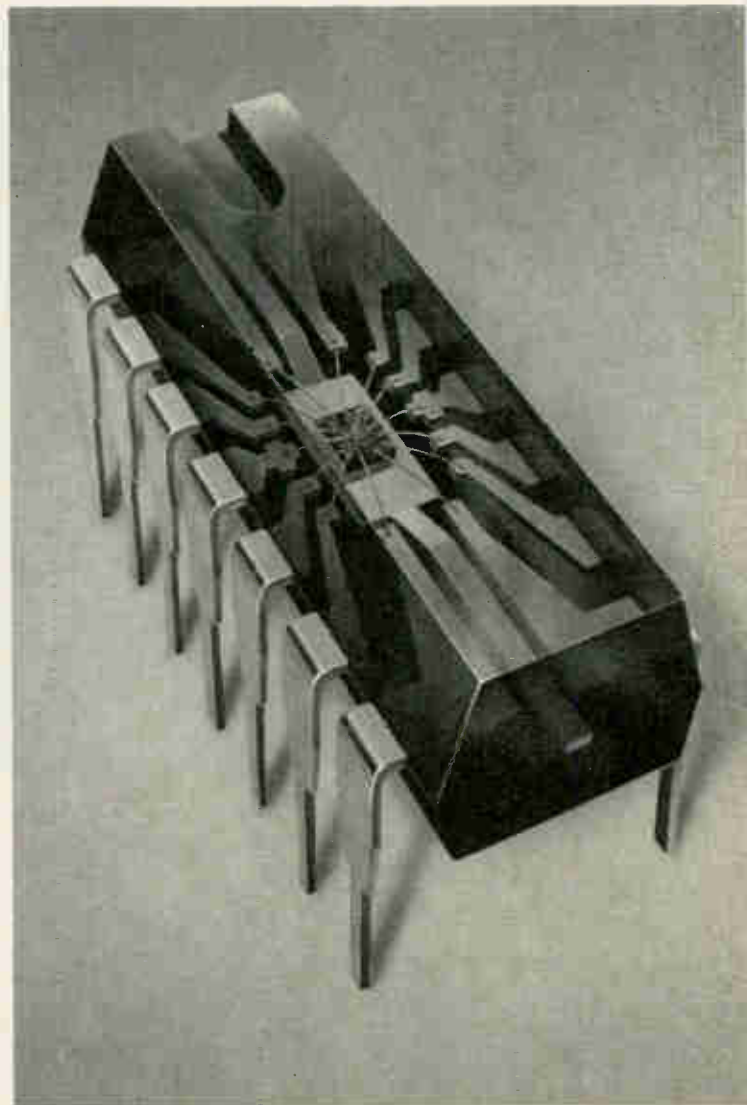

All these devices are included—

	Series 74 TTL		
	0° to 70° C Operating Temp.	SN7460N	Dual 4-input expander
SN7400N	Quad 2-input NAND Gate	SN7470N	Single-phase Flip-flop
SN7410N	Triple 3-input NAND Gate	SN7472N	Master-slave J-K Flip-flop
SN7420N	Dual 4-input NAND Gate		930 Type DTL
SN7430N	3-input NAND Gate		0° to 70° C
SN7440N	Dual 4-input NAND "power" Gate	SN15830N	Dual 4 Nand Gate
SN7450N	Expandable Dual AND-OR-INVERT Gate	SN15831N	RS/JK Flip-flop
SN7451N	Dual AND-OR-INVERT Gate	SN15832N	Dual 4 Buffer
SN7453N	Expandable 2-input 4-wide AND-OR-INVERT Gate	SN15833N	Dual 4 Expander
SN7454N	2-input 4-wide AND-OR-INVERT Gate	SN15844N	Dual 4 Power Gate
		SN15845N	RS/JK Flip-flop
		SN15846N	Quad 2 Nand Gate
		SN15850N	Pulsed AC Flip-flop
		SN15851N	One Shot
		SN15862N	Triple 2 Nand Gate

FREE SAMPLES FROM TI

molded integrated circuits

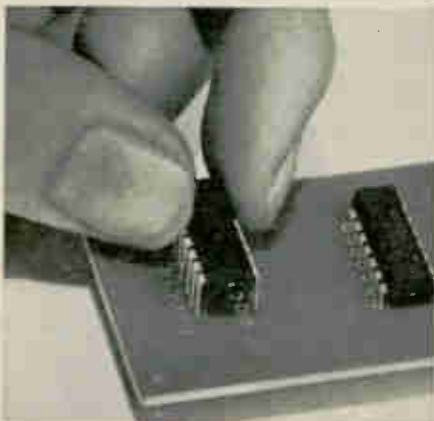
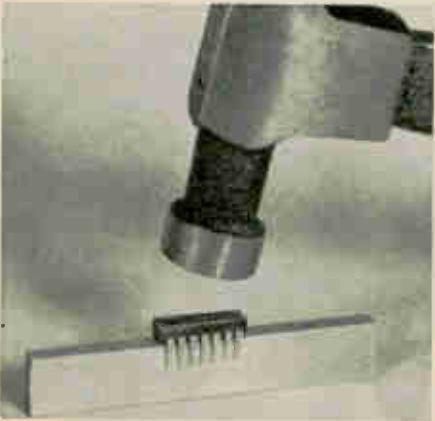
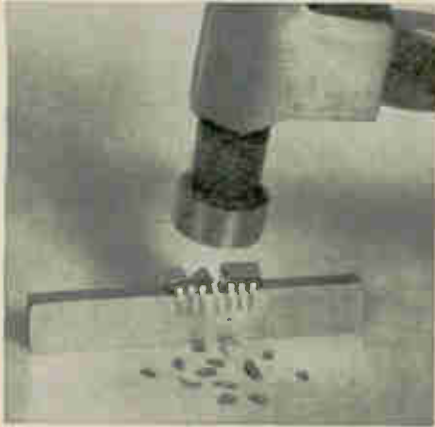

RESISTS SHOCK . . . TI molded integrated circuits resist impacts that would smash metal packages and shatter ceramic packages as shown in top photo. You benefit from fewer failures in handling accidents and greater reliability in service. The solid molded construction gives extreme resistance to acceleration, vibration and shock as proven in actual test (see opposite page).

EASY TO ASSEMBLE . . . TI molded integrated circuits are ideal for mechanized assembly, including automatic insertion and wave soldering. Faster, easier handling cuts total manufacturing costs. You realize big savings because of the in-line rigid lead pattern and convenient indexing notch. These features simplify assembly when compared with transistor-type circular lead packages.

RESISTS DAMAGE . . . You also realize savings from fewer rejects while achieving higher end-product quality because TI molded integrated circuits have outstanding durability. For instance, they'll hold up to heat that would induce failures in many competitive devices. Result: fewer assembly rejects due to high soldering temperatures.



TEXAS INSTRUMENTS

INCORPORATED

13500 N CENTRAL EXPRESSWAY
P O BOX 5012 • DALLAS 22 TEXAS

SEMICONDUCTOR PLANTS IN BEDFORD, ENGLAND • NICE, FRANCE • FREISING, GERMANY • DALLAS, TEXAS

P-i-n diode and FET's improve f-m reception

New commercial f-m tuner attains dynamic signal range exceeding 120 decibels with minimum distortion and maximum sensitivity; its secret lies in the use of new solid state components

By Fred L. Mergner

Fisher Radio Corp., Long Island City, N.Y.

Putting a p-i-n diode and field effect transistors in a frequency-modulation receiver promises to end many of the interference problems that have plagued millions of f-m enthusiasts throughout the nation. The new commercial tuner, manufactured by the Fisher Radio Corp., model TFM-1000, is a fully transistorized stereo set that permits a dynamic signal range exceeding 120 decibels, with signal-to-noise ratio and distortion well within the requirements of high-quality instruments.

Solid state circuitry permits the new set to receive without distortion signals as low as 1.5 microvolts. And, on the other end of the scale, signals as powerful as 500,000 μ V ($\frac{1}{2}$ volt) can be handled without overload and spurious response at high signal levels.

The p-i-n diode is located between the antenna and the input of the r-f amplifier. It serves as an easily controlled linear attenuator, which varies as a function of the amplitude of the input signal, and thus increases the ability of the receiver to accept a wider amplitude range of signals without distortion than previously possible.

The FET's located in the two r-f amplifier stages

of the tuner, provide a gain that is reduced linearly as the signal is being amplified; thereby further extending the dynamic range of the receiver without distortion.

To the f-m enthusiast the wide dynamic range, greater selectivity and higher signal to noise ratio means better reception and a wider choice of f-m stations for his listening pleasure. [There are about 1,180 f-m stations in the United States.]

The tuning problems

F-m reception and the problems involved in building a tuner are to a large extent determined by geography—the position of the receiver in relation to the transmitter—and factors such as the strength of the signal. F-m tuners must have more than just sensitivity. Receiving conditions, particularly in metropolitan areas, require tuners that can receive weak signals in the presence of strong interference and that can handle very strong signals without overload distortion or spurious response.

At low signal levels, two factors affect the signal-to-noise ratio of a f-m tuner: the noise figure and the amplitude-modulation rejection properties of the tuner. Both characteristics are influenced—within limits—by the design of the tuner. The overall noise figure may be kept small by a low-noise r-f amplifier,¹ proper noise match between the antenna and the r-f stage and sufficient gain in the r-f stage to overcome the noise generated by the mixer stage. A-m rejection normally is good enough in f-m receivers so that this influence can be neglected. However, other problems with f-m tuners are not so easily solved.

The author



Fred L. Mergner has been vice president in charge of engineering of the Fisher Radio Corp. since 1957. He has worked on the development of airborne communications, broadcast and high fidelity audio equipment since receiving his master's degree in Electrical Engineering in Germany in 1938.

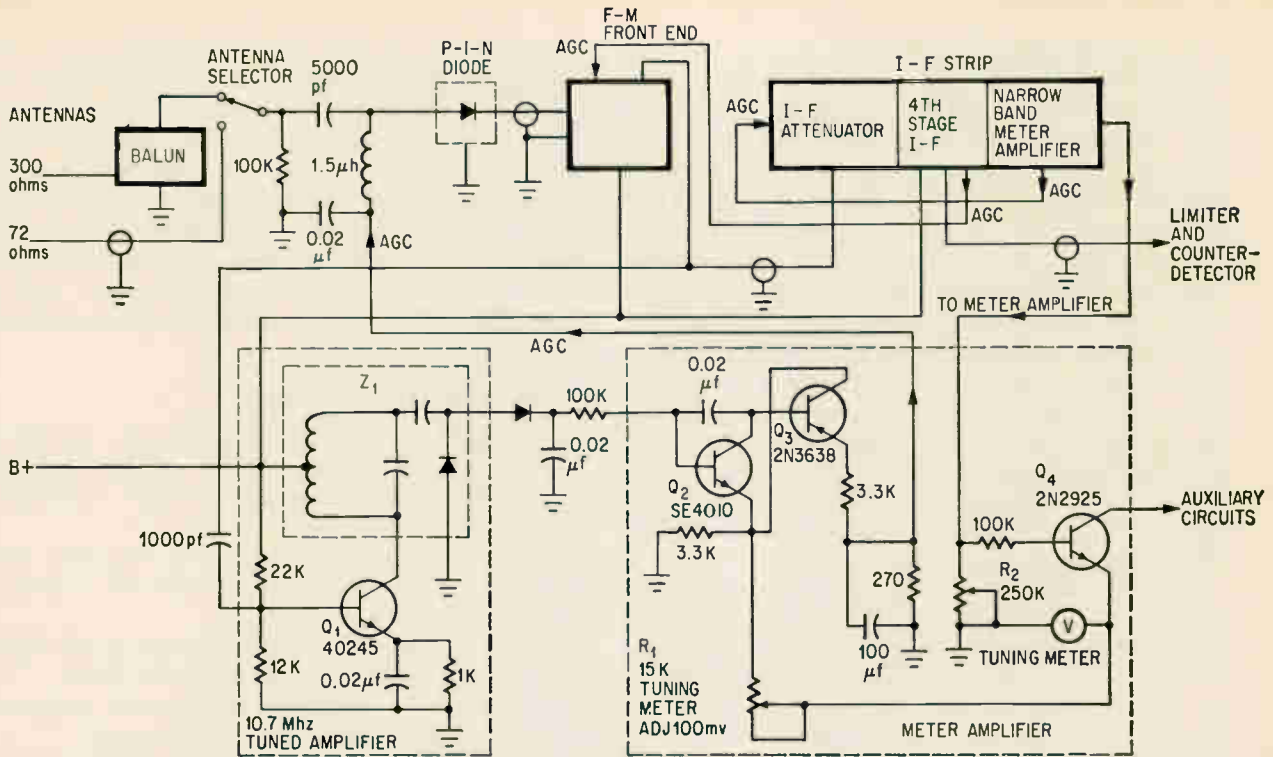

The bias and therefore the attenuating effect of the p-i-n diode, is controlled by an 10.7 Mhz i-f signal, passing through amplifier Q_1 and frequency selective filter Z_1 and is detected and then amplified by d-c amplifier, Q_2-Q_3 . The d-c voltage is fed back from the emitter of Q_3 to the input to control the p-i-n diode. Agc loops in the i-f strip and between the i-f and r-f stages produce, together with the p-i-n loop, a total agc range exceeding 120 db.

Reception of strong signals

In an f-m tuner, strong signals—either desired or interfering—can produce overload and distortion in the intermediate-frequency amplifier and both spurious responses and cross modulation distortion in the front end—the portion between the antenna and the i-f stage, including the r-f stage and mixer. Combine this with problems involved in picking up a very weak signal, particularly in areas where there are other, stronger f-m transmitters, and one may see that overload and distortion can be generated under a variety of conditions. For example:

- Suppose an f-m enthusiast lives close to the

broadcast transmitter. When the set is tuned to the station a strong single-frequency signal appears at the base of the last i-f transistor with an amplitude of several volts. The transistor is thus overdriven and the resulting change in base-emitter capacitance detunes the selective circuit to which it is connected, consequently distorting the over-all i-f response. In this case, the solution is to apply automatic gain control, (agc), to the r-f stage and to one or two i-f stages to reduce the maximum signal amplitude to acceptable levels. The mixer is normally exempted from agc to prevent the detuning of the oscillator.

- Second, in large cities with many f-m stations,

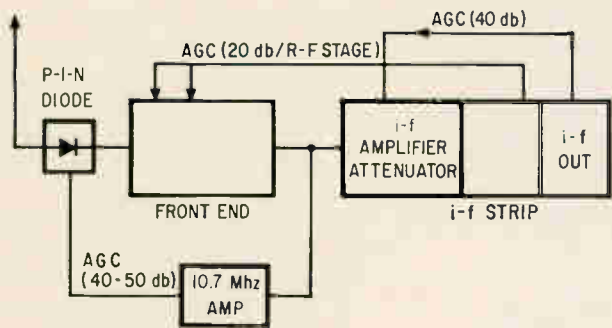

Three agc loops produce a dynamic agc range exceeding 120 db. Agc is applied across the i-f strip, to two r-f stages and to the p-i-n diode to attenuate an overloading signal, which may exceed 500,000 μ v. On the other end of the scale, signals as low as 1.5 μ v can be detected satisfactorily during conditions of minimum attenuation.

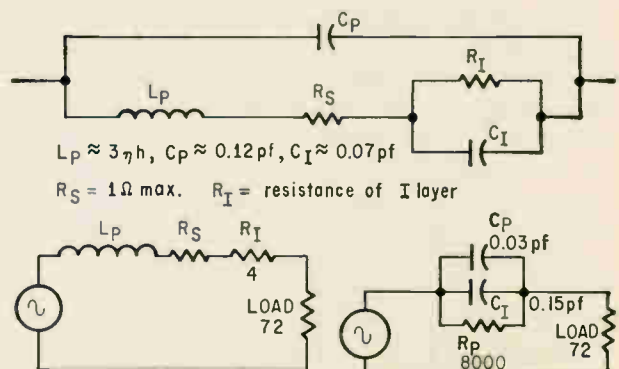

Equivalent circuit of the p-i-n diode shows the inductance, capacitance and resistance of the basic package. The equivalent circuit changes when it is used as a variable series resistor, when the condition of minimum attenuation, left, changes to maximum attenuation, right.

a number of strong signals will reach the antenna. Depending upon the selectivity of the tuner's r-f circuits, the signals will be more or less attenuated, but some may reach the mixer with amplitudes high enough to create mixing products with the desired frequency. An interfering frequency 5.35 megahertz higher than the desired one can create the 10.7 Mhz i-f in the mixer in four additional ways besides the desired one. The second harmonics of both the incoming desired antenna frequency and the local oscillator frequency when mixed with the second harmonic of the interfering frequency will each produce a 10.7 Mhz signal. In addition, the mixing of the fundamental oscillator frequency with the interfering signal and the mixing of the desired antenna signal with the interfering signal both produce a 5.35 Mhz signal which, when doubled in the mixer, equals 10.7 Mhz.

Normally, the selective circuits between the r-f stage and mixer will reject harmonics or subharmonics of the i-f generated by strong signals in the r-f stage. But the interference signal separated from the tuned frequency by 5.35 Mhz will reach the mixer if sufficient r-f selectivity isn't provided. For example, if a $10\ \mu\text{v}$ signal is amplified 20 db in the r-f stage, it reaches the mixer at $100\ \mu\text{v}$. An interference signal of 100 millivolts is also amplified 20 db, to 1 volt, but is attenuated by 60 db by the r-f selective circuits. Despite this attenuation, a residual interference level of $1,000\ \mu\text{v}$ will reach the mixer and produce spurious i-f interference. Thus, 60 db of selectivity is not enough to eliminate this type of interference.

▪ Third, suppose the f-m buff lives in a suburb of New York City, where he has available a wide selection of strong f-m signals and can receive some weaker signals from Philadelphia stations, which might be on frequencies near those of the New York stations. Normally automatic gain control and a high amount of r-f selectivity can eliminate or greatly reduce the problems created by strong interfering signals. Neither, however, is of help where a weak distant signal is being received in the presence of a strong interfering signal that is close in frequency (800 kilohertz or less). The result is cross modulation. The interfering signal amplitude-modulates the weaker signal on the slope of the r-f selectivity curve. Although the a-m components are subsequently removed by the limiter stages, the a-m signal can frequency-modulate the signal by changing the dynamic input capacity of the mixer. This, in turn, will change the frequency of the oscillator coupled to it. Loose coupling or a buffer stage can improve the situation.

▪ Finally, imagine that the f-m receiver is located an equal distance from broadcast stations that are on the same frequency and radiate approximately equal power, or that the interfering signal is originating from some form of man-made interference. Increased selectivity or agc does not help in this case. However, the capture effect, one of the major attributes of f-m, enables the tuner to suppress the weaker of the two signals. If two f-m signals

are received on the same frequency, only the stronger of the two will be found in the output. The complete suppression of the weaker carrier occurs at the receiver limiter where it is treated as noise and rejected. The minimum capture ratio of signal amplitudes for complete suppression is mainly a function of the i-f amplifier, i-f limiter and detector design. A directional antenna also helps to select the desired station by reducing the signal level of the undesired station according to its forward-backward ratio.

Cases require compromise

The four examples cited, which are typical of f-m reception situations, clearly indicate that f-m tuner design must meet difficult and sometimes contradictory requirements:

- A usable sensitivity (for a 30-db signal to noise + hum + distortion ratio) high enough to receive signals as low as 1.5 to $2\ \mu\text{v}$.
- An age range capable of maintaining the signal in any stage of the tuner at acceptable levels.
- Sufficient r-f selectivity to attenuate undesired signals to insignificant levels at the mixer.
- A low capture ratio to suppress interfering signals at the same frequency as the desired one.
- R-f and mixer stages with wide dynamic ranges.

To meet these unusual requirements, as well as the standard performance criteria for low distortion, high adjacent and alternate selectivity and good a-m and impulse noise suppression, the advanced design group at Fisher Radio Corp. turned to new solid state devices and unique circuits.

Automatic gain control

The large dynamic range of the tuner—more than 120 db—requires approximately equal amounts of agc. To maintain a high signal to noise ratio at each stage and at all signal levels, the agc action must be fairly evenly distributed over the tuner sections. This imposes the additional requirement of a delayed attenuation of the signal ahead of the tuner's front end and in its r-f section.

Automatic gain-controlled attenuation of the signal before it reaches the front end is not easy to achieve with conventional components. The device selected for this purpose must meet several stringent requirements. The range of attenuation should be at least 30 to 40 db with a minimum value of not more than 0.25 to 0.5 db because the tuner's noise factor is increased by this amount. Also, a linear characteristic over its operating range must prevent signal mixing and generation of harmonics.

The solid state p-i-n diode² designed by H.P. Associates, an affiliate of Hewlett Packard Co., meets these requirements. The device, whose basic circuit is on the bottom right of page 115, is a newly developed gain-controlled attenuator.

At frequencies above 50 Mhz the device can best be described as a variable resistor rather than as a conventional diode. It is characterized by a high dynamic resistance, greater than 10,000 ohms, which is produced by a wide, high-resistivity

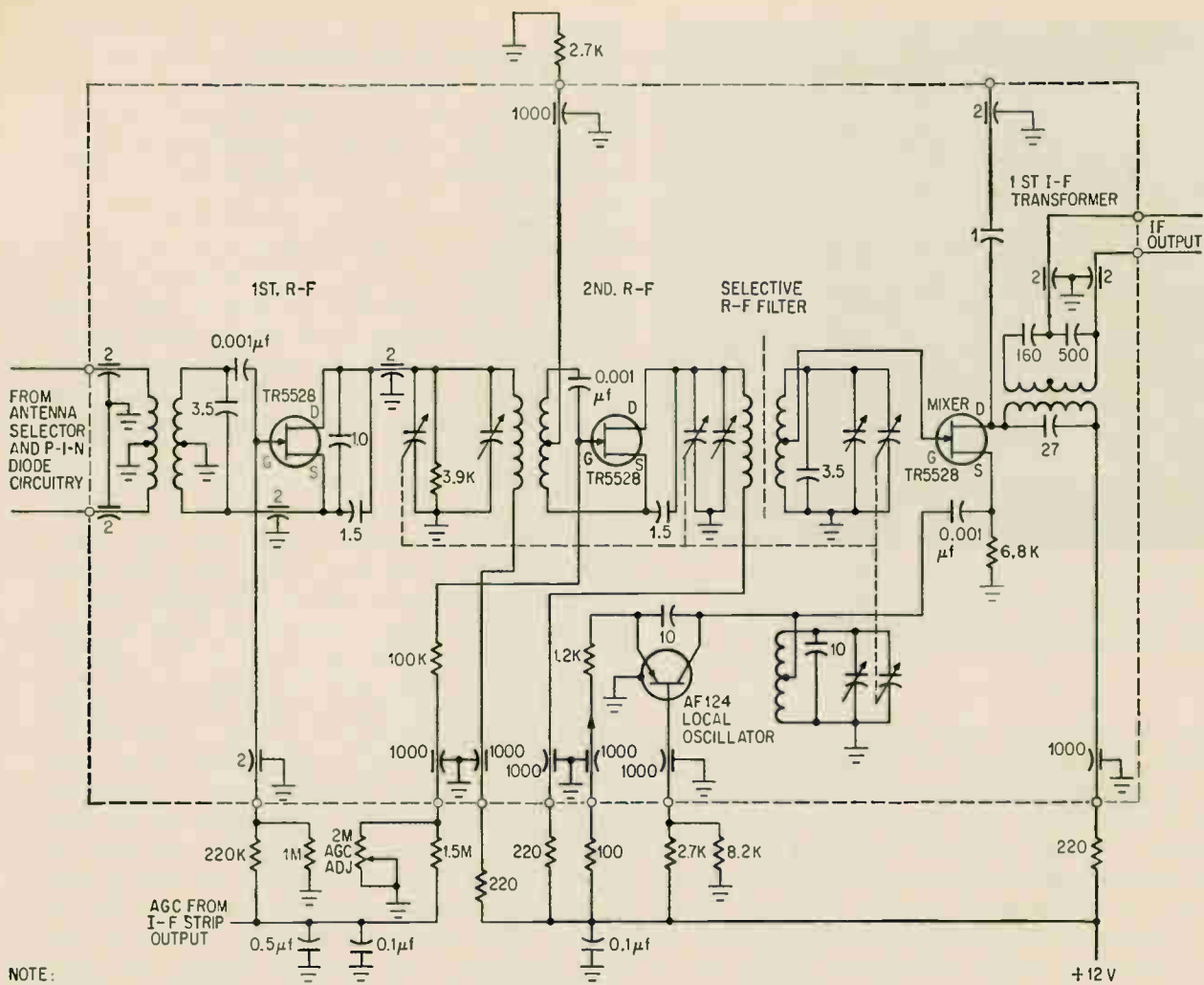

NOTE:
ALL CAPACITORS ARE pF UNLESS DESIGNATED ON DRAWING

FET's in the r-f and mixer stages and highly selective r-f circuits assure reception of a weak signal near the frequency of a strong interfering one.

layer adjacent to its junction. This resistance may be controlled by a direct agc voltage. Capacitance per unit of junction area is very low, but conductivity of the resistive layer is increased by the presence of a stored charge (conductivity modulation). At zero bias the bulk resistance of the intrinsic region is between 7,000 and 10,000 ohms.

With forward current, conductivity modulation will cause the bulk resistance, R_t to drop very rapidly as shown in empirical formula:

$$R_t = \frac{26}{I^{0.87}}$$

where I = forward bias current (ma).

These properties allow the p-i-n diode to function as a variable shunt or series resistor up to microwave frequencies. In the Fisher model TFM-1000, the diode is mounted into a shielded 72-ohm cable located between the antenna and tuner input terminals so as to exhibit a minimum of bypass capacitance across it. Low-capacitance mounting ensures a maximum spread between the low and high impedance conditions and prevents the signal from

bypassing the attenuator. As a series variable resistor, the p-i-n diode has, depending on the agc voltage (bias), a value for R_t of from 5 to 8,000 ohms. The conditions for minimum and maximum attenuation are shown in the equivalent circuits on the lower right of page 115. The resistance values for R_s and R_t shown in the figure, relative to the load of 72 ohms result in a minimum attenuation of less than 0.25 db. This is important for maintaining a low over-all noise figure.

A separate 10.7-Mhz tuned amplifier in the block diagram on the bottom left of page 115 delivers the agc voltage that, along with a d-c amplifier, controls the p-i-n diode. The tuned amplifier's action is delayed until the signal strength at the antenna terminals is approximately 1 mv. This i-f amplifier has a 3-db bandwidth of only 180 khz to prevent a strong undesired signal near the frequency of a desired weak signal from triggering the signal attenuator.

FET's extend range

To achieve an additional 40 db of agc range in the tuner's r-f section, two cascaded field effect

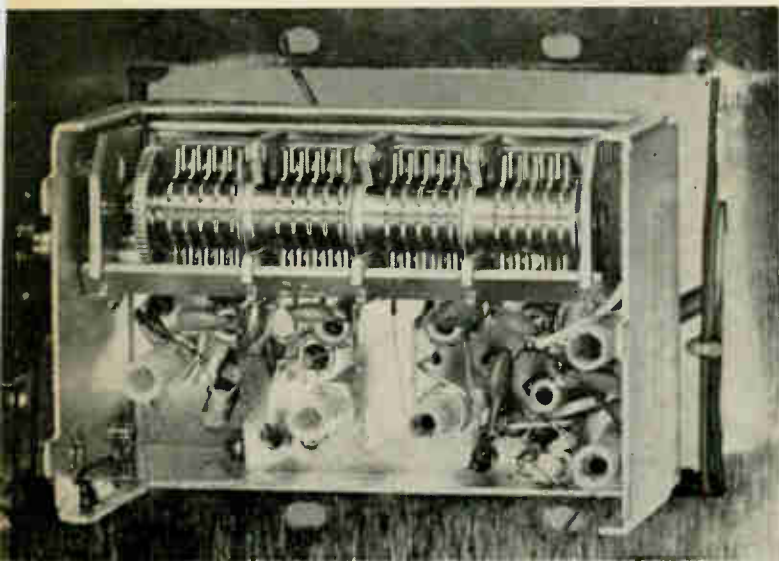

The Fisher tuner TFM-1000 features two r-f stages incorporating FET's, a four gang variable tuning capacitor and six tuned circuits. The stages reject spurious response in excess of 100 db.

transistor r-f stages were placed in the tuner.

FET's are well suited for r-f amplification and mixing because, except for the amplified fundamental frequencies, they create only second-order harmonics of the applied frequencies plus their sum and difference components—which are easily filtered out in the tuned circuits. Therefore spurious responses resulting from cross modulation of two signals are readily filtered out. As the transconductance of an FET is a linear function of its gate voltages, the drain current follows a square-law relationship to the gate voltages. This is superior to bipolar transistors and most tubes, which have high-order nonlinear transconductance. In the latter case, the mixing of two signals generates higher order harmonics which have mixing products that are difficult to filter. In addition, in FET mixers the applied signals, desired or undesired, can cover a peak to peak range up to 5 volts before clipping. The reason: the FET's pinch-off voltage (the voltage at the gate which cuts off the transistor) can be made large, allowing a wide voltage swing before clipping, that is many times the amplitude that can be handled with bipolar transistors.

Determining the agc range

To prevent overloading the limiting stages, the maximum signal level at the input of the i-f selective section is restricted by additional agc circuitry on the top of page 115. Noise considerations dictate a maximum agc range of 40 to 50 db for the additional agc amplifier between the mixer and i-f stage. In the TFM-1000 this is achieved by a wideband low-noise combination amplifier-attenuator which is inserted between the front end and the i-f amplifier.

In the combination amplifier-attenuator stage, a

separate transistor in the emitter of the amplifier controls the gain of the amplifier by acting as variable feedback resistance. The agc voltage derived from the i-f output controls the value of resistance. This offers the advantage of providing maximum current feedback at maximum signal level, preventing clipping.

The upper figure on page 115 shows the section of the Fisher TFM-1000 containing the p-i-n diode and agc amplifier circuits. P-i-n diode D_1 is connected between front end and antenna and can be switched either directly to the 72-ohm terminals or, via a balun, to the 300 ohm input. Its resistance is controlled by a d-c voltage developed across part of the emitter resistor of Q_3 which in turn is driven from a separate i-f filter, Z_1 .

Transistor Q_2 is also connected to Z_1 and operates the tuning meter via potentiometer R_1 which sets the meter deviation at high (100 mv) signal levels while R_2 , at the base of Q_4 , adjusts the meter swing at approximately 100 μ v. This double adjustment provides a large excursion at lower antenna levels without pegging the meter at high signals.

The four agc stages plus the limiter section provide the combined dynamic range of more than the 120 db required for signals as high as 500,000 μ v. This wide range eliminates any problems with strong single signals, but as indicated, cannot ensure clean reception of a weak signal near the frequency of a strong interfering one. Rejection of most spurious responses requires agc and a high amount of r-f selectivity plus the use of FET's. In the TFM-1000 there are four (instead of the more common three) tuned r-f circuits, two combined in a highly selective and high-Q bandpass filter; plus two FET r-f stages, in addition to a FET mixer and local oscillator. The arrangement of the tuner's front end circuitry can be seen in the photo above, its details are shown in the schematic diagram on page 117.

The agc voltage for the two gain-controlled FET r-f stages is derived from the fourth i-f amplifier stage, which also drives a narrow-band meter amplifier mounted on the i-f strip.

To meet the requirement for capture effect, the design of the TFM-1000 incorporates three stages of hard limiting and a counter detector. This detector, for which a patent has been applied, produces a pulse for every cycle of the incoming signal regardless of the frequency. The integrated output is linearly proportional to the frequency. The higher the frequency, the more the number of pulses and the larger the integrated signal. Both sections have a bandwidth of more than 10 Mhz to achieve an unusually low capture-ratio of 0.6 db, which permits an interfering-to-desired signal level ratio of 0.95 with full suppression of the interfering signal.

References

1. F.L. Mergner, "A Survey of Performance Requirements and Design Techniques for Highest Quality F-M Multiplex Reception," *Journal of the Audio Engineering Society*, Jan. 1965, Volume 13, No. 1.
2. The PIN Diode, Hewlett-Packard Application Note #4.



**If you are thinking of something new
and important in data-recording by photography,
you ought to have lunch in this place**

This is a dining room in the largest plant on earth devoted to photography. A majority of the Kodak men you see here are engineers whose entire professional careers are devoted to making photographic systems work supremely well.

Let us assume you are an engineer whose specialty does not happen to be photography and photographic systems, and let us assume you have a photographic problem or a photographic scheme (whichever you choose to consider it). It is quite possible that in this picture is the very guy who is best prepared in all the world to advise you to forget it and think of something else.

On the other hand, since he gets paid to make

photography successful, he has much stronger motivation to figure out with you what next step to take and what you have to decide.

But Kodak is a huge organization. How do you find him? How do you get in touch with him?

Actually there is nothing to *that* problem. We have a department whose major assignment has always been to learn enough about your case to get you together with the right party. You address that department as **Special Applications, Eastman Kodak Company, Rochester, N. Y. 14650.** Most contacts start by phone: (716)-325-2000, Ext. 5129.

Kodak

WIRE HARNESS LACING, like most manual jobs—costs money!

- Saving by using low cost lacing material seems good economy...

- ...until production lags and rejects pile up!

- For real economy you need the uniformity, the high quality of GUDEBROD LACING TAPE.

- That's why this guarantee can help you cut costs in cable harnessing!



You owe it to your zero defects program to investigate Gudebrod lacing tape. Its guaranteed quality and its constant uniformity are important to you—and to your harnessing operation. Why? Because Gudebrod smooths and speeds the hand operation of lacing and knot tying. There's no need for readjusting or retying. Rejects are minimal. The result? You save time—and that saves money and hastens delivery. Gudebrod sets its manufacturing standards high and adheres to them. When you use Gudebrod tapes you can set production goals and achieve them. This is the combination that saves you money in your harness department. Ask for the Gudebrod Product Data Book.

GUDEBROD CABLE-LACER

The first hand tool engineered for wire harnessing. Handle holds bobbins, feeds tape as needed, grips tape for knotting. Speeds, eases harnessing. Pays for itself in time saving.



Area Code 215, WA 2-1122



GUDEBROD BROS. SILK CO., INC.

FOUNDED IN 1870

Electronics Division

12 SOUTH 12TH STREET, PHILADELPHIA, PENNSYLVANIA 19107

Night and day, Nimbus 2 transmits its cloud pictures

Infrared scanners have been added to the automatic picture transmission system of the new weather satellite so it can keep the weather in view on the dark side of the earth

By John C. Moody and Oscar Weinstein

Goddard Space Flight Center, Greenbelt, Md.

Weather satellites are no longer blind at night, and are making a thing of the past the destruction and death wreaked by storms and hurricanes striking without warning.

The newest meteorological research satellite, the Nimbus 2, launched May 15, carries an infrared system that transmits cloud pictures to earth while the satellite is orbiting over the dark side of the earth. In daylight, the pictures are taken and transmitted by a vidicon system that is an improved, longer-lived version of the vidicon system carried by Nimbus 1.

Ground stations now receiving automatic picture transmission (APT) pictures from the vidicon television systems of Nimbus 2 and earlier weather satellites can be adapted to print out the infrared

scan patterns transmitted by the spacecraft. More than 160 APT stations are in use around the world, some of them homemade. A special gear box makes the slower scanning infrared compatible with the APT ground station. A new coding technique, the data code grid, tells when a picture was taken and where the satellite was at the time.

Bad weather note

Nimbus 1 and other weather satellites now in orbit have on several occasions disclosed dangerous storms brewing in remote areas and have helped meteorologists track their course.¹ Analysis of cloud pictures has also helped in the forecasting of more ordinary weather and has in other ways broadened man's knowledge of his environment.

The successful operation of both the day and night equipment on Nimbus points the way to future systems of numerous satellites that would provide around-the-clock coverage of the weather at every point on earth.

Besides the high-resolution infrared system and the vidicon automatic picture transmission system, Nimbus 2 carries two other experiments—a medium-resolution infrared system and an advanced vidicon camera system.

The first two systems are discussed because they transmit to earth at all times as the satellite orbits the earth. The infrared transmissions can be received by modified ground stations.

The outputs of both infrared systems and the advanced vidicon system are stored on the spacecraft's tape recorders. Later, the signals are transmitted through an S-band (1.23 gigahertz) data link to the Command and Data Acquisition Stations at Fairbanks, Alaska, and at Rosman, N.C.

To provide an interface between the daylight

The authors



John C. Moody has been NASA technical officer on automatic picture transmission flight equipment for two years. Before joining NASA in 1962, he worked for the Army Engineer Corps., where he developed special television systems and tubes that operate at low light levels.



Oscar Weinstein, a graduate of the Newark College of Engineering, is designing a slow-scan digital television camera system for deep-space probes. He came to NASA from the Radio Corp. of America laboratories where he helped develop the vidicon camera and automatic picture transmission systems of the early Nimbus and ESSA meteorological satellites.

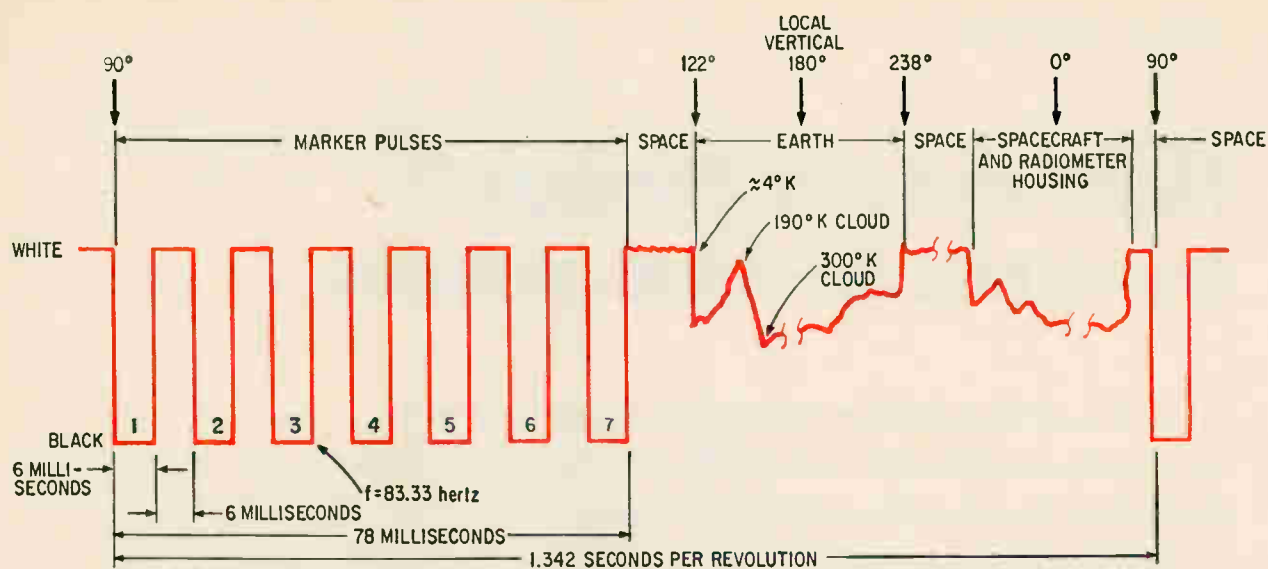

Line of infrared video signal. The earth scene represents only 33% of the total scan. As the radiometer scans a full 360°, it samples cold space (approximately 4° Kelvin) twice for a calibration reference. A portion of the radiometer's scan is blocked by the spacecraft. Marker pulses identify the beginning of each scan sequence.

vidicon signals and the infrared signals, the satellite carries a switching system known as HAX. It is operated by the National Aeronautics and Space Administration, which switches systems depending on whether the satellite is in daylight or darkness. HAX processes the infrared signals by amplitude modulating the video with a 2,400-hertz subcarrier frequency required by ground stations. In turn, the subcarrier frequency modulates the spacecraft's 136.95-Mhz transmitter frequency.

Nimbus 2 is an improvement on earlier weather satellites. Tiros 8, launched in December, 1963, has an infrared sensor for horizon scanning and experimental APT camera systems; Nimbus 1, launched in August, 1964, also carried the earlier APT systems, which consisted of slow-scan vidicon cameras that photographed the earth and clouds and transmitted a narrow bandwidth signal to earth in real time. Ground stations each day received a view of the weather within several hundred miles.

An APT system is aboard the latest Environmental Science Services Administration satellite (ESSA 2). The spacecraft is in a 750-nautical-mile circular orbit; its picture covers 1,400 miles on a side with 40% overlap along the orbital path. ESSA's transmission frequency is 137.5 Mhz. APT ground stations can be equipped to receive transmissions at both the ESSA frequency and the 136.95-Mhz Nimbus frequency. Eventually, APT-equipped weather satellites should be numerous enough to provide constant weather-picture coverage at all ground stations.

Infrared scanning

At night, the high-resolution infrared scanner depicts weather by determining the attenuation by clouds of the earth's heat energy; cold space provides a temperature reference. The system scans, line by line, through an 8.6-milliradian aperture, perpendicular to the earth. As the craft moves, one

scan line after another translates the unobstructed and the cloud-attenuated heat of the earth into a strip picture of the weather. The high-resolution infrared radiometer's scanning rate of approximately 44.71 revolutions per minute provides contiguous coverage along the orbit track.

The spacecraft's radiometer system (HRIR) contains a mirror, inclined 45° to its axis of rotation, that scans a full 360°. The optical image of a four-inch f/1 Cassegrainian telescope is mechanically chopped at the focal point to provide an a-c signal for the detector. An optical filter with a low absorption characteristic in the 3.4- to 4.2-micron wavelength region restricts the passage of light to the infrared band, which is detected by a lead-selenide infrared detector. As shown in the figure on page 127, the radiometer views cold space during each scan providing a calibration reference from the space temperature of approximately 4° Kelvin. The system has a dynamic range of 190° to 340° K.

In the line of HRIR video output shown in the drawing above, the earth scene represents only about 33% of the total scan period. A series of seven marker pulses identify the beginning of each scan line. The pulses are triggered by a magnetic pickup which tracks the scan mirror.

The lead-selenide detector is mounted on a cooling patch attached to the spacecraft and oriented to view cold space at all times. The system, entirely passive, cools the detector sufficiently for operation in the 3.4- to 4.2-micron region. The HRIR system was developed at the Fort Wayne, Ind., laboratories of the International Telephone and Telegraph Corp. under a NASA contract.

Two of a kind

Before HRIR data can be transmitted, the signal must be processed to "look like" APT video signals.² The HAX module conditions the signal by amplifying the analog output of the radiometer to

the proper peak-to-peak value (2.8 volts) and then modulating it at the 2,400-hz subcarrier frequency. The modulator output is fed to a latching OR gate relay (K_1 in the diagram on page 126), together with the APT video signal.

The HRIR provides a signal for both the APT transmission and for storage on the spacecraft's tape recorder. Medium resolution infrared radiometer (MRIR) and advanced vidicon camera system (AVCS) data are transmitted only to acquisition stations. APT ground stations are not equipped to process the information.

Improved APT camera

A new type of vidicon tube, manufactured by the General Electrodynamic Corp., is used on the improved cameras on Nimbus 2. It stores the charge image in the photoconductor rather than in a dielectric layer, as in the early vidicons. Reading the charge image directly from the photoconductor provides a higher signal level, improved resolution, increased sensitivity and better signal-to-noise ratio. Earlier dielectric vidicons had short life, because of bombardment of the dielectric layer with high-energy electrons. The storing of charge in the photoconductor overcomes the bombardment problem.

The vidicon is exposed to a scene for a few milliseconds by means of a mechanical shutter, as shown in the functional block diagram below. After exposure, the charge image on the photoconductor surface is read out at a slow rate by a beam-sampling technique. Beam sampling

raises the peak signal level and consequently the signal-to-noise ratio of the processed video signal. The beam sample rate is 4,800 hz. A synchronous detector is used to obtain baseband video. After amplification, clamping and mixing of the data code grid signals, the baseband video amplitude modulates a 2,400-hz subcarrier which is then switched into the HAX unit. The 2,400-hz subcarrier is also used as a synchronizing signal to phase lock the facsimile recorder and camera in the ground stations. This eliminates picture skew. The long-term stability of the 2,400-hz subcarrier is one part in 10^6 .

The vidicon camera is programmed to provide 3 seconds of start tone and 5 seconds of phasing signal before its 200-second picture transmission. The time interval permits automatic ground stations to turn on equipment (the receivers are usually in stand-by) and set up the gain and phasing controls for printout. The sequence is immediately repeated for every picture transmission during the orbital day. The transmissions from the ESSA satellites are interrupted for 144 seconds between sequences.

The spacecraft's cameras were photometrically calibrated by a solar simulator. Ten thousand foot-lamberts is considered the highest level of illumination the camera will encounter. The vidicon is sensitive to visible energy in the spectral region from 0.4 to 0.7 microns; however a haze filter is provided in the lens to limit the blue end of the spectrum to approximately 0.45 microns. The filter which minimizes the effects of light scattering and

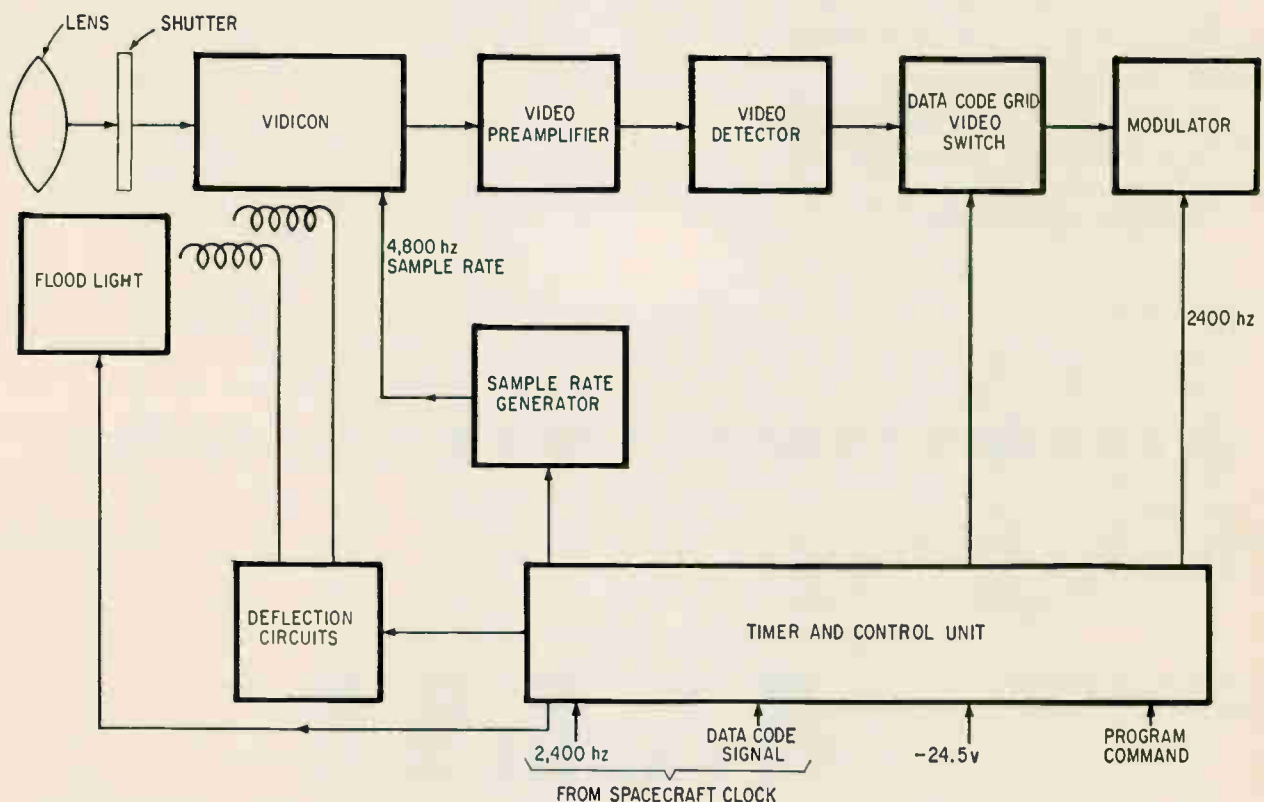

Automatic picture transmission camera system. The timer and control unit that regulate the sampling rate of the vidicon's video signal obtains its operating commands from the spacecraft's clock and ground telemetry signals.

haze in the earth's atmosphere.

The APT and HAX systems were developed by the Astro-Electronics division of the Radio Corp. of America, under a NASA contract.

Data code grid

The Nimbus 2 data code experiment provides orbital information to APT users and eliminates the need for consulting a constantly updated list of satellite positions, a publication known as an ephemeris record.³ The data code message origin-

ates at the command and data acquisition ground station and is stored on the spacecraft in the command clock. The clock, upon receiving a camera shutter signal, provides the data code message for video mixing in the camera. A series of black and white bars appears at the phasing interval of the printout, as illustrated on page 125. The data code signal provides the ground station operator with picture time, calendar day and information on the spacecraft's orbit. With it—and initial message on orbital characteristics—the

Data code information format

Word	Character block	Item	Units
1	1	Word divider	
	2-5	Reference orbit number	
	6	Hemisphere of ascending node	0= east; 7= west
	7-10	Longitude of ascending node on reference orbit	Degrees and tenths
2	1	Word divider	
	2-4	Longitude increment between successive ascending nodes	Degrees and hundredths (westward); initial 2 or 3 (20° or 30° understood)
	5-10	Ascending node time of reference orbit	Hours, minutes, seconds (universal time)*
3	1	Word divider	
	2-5	Nodal period	(1 or 2 hours, , understood) Minutes, seconds
	6	Hemisphere of perigee	0= north; 7= south
	7-10	Latitude of perigee on reference orbit	Degrees and hundredths
4	1	Word divider	
	2-7	Time of perigee on reference orbit	Hours, minutes, seconds (universal time)*
5	8-10	Motion of perigee, orbit to orbit	Thousandths of a degree of great circle arc per orbit
	1	Word divider (split)	
5	2-4	Calendar day of picture	Day 1 to day 365 (366 for leap year)
	5-10	Picture time	Hours, minutes, seconds (universal time)*

*If the code is read the day of transmission (word 5, CB 2-4), the first digit (word 2, CB 5, or word 4, CB 2) will be 0, 1, or 2; if the following day, 4 is added to first digit: 4=0; 5=1; 6=2; if second day following that of picture, 7 is added to first digit: 7=0; 8=1; 9=2.

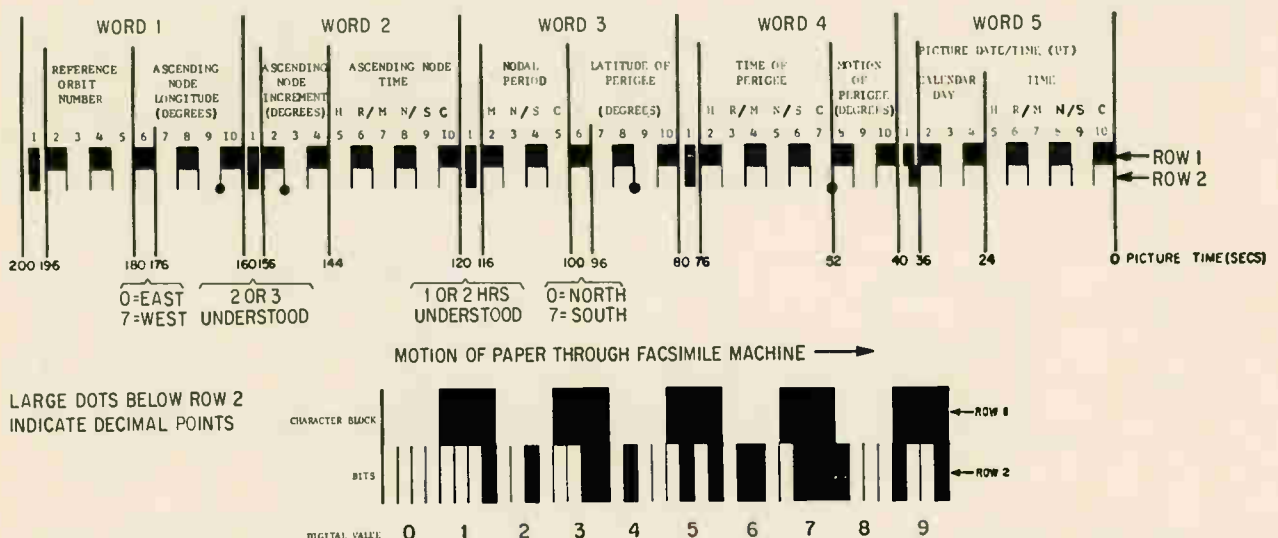

Operational data code template. The data code information is divided into five words. Row 1 is for reference; row 2 contains information on the spacecraft's orbital characteristics and the time the picture was taken.



Cloud cover photograph taken by Nimbus 2 cameras. The coded signal (bars and spaces) provides time and orbital information to ground stations. The station operator uses this data to determine the spacecraft's location.

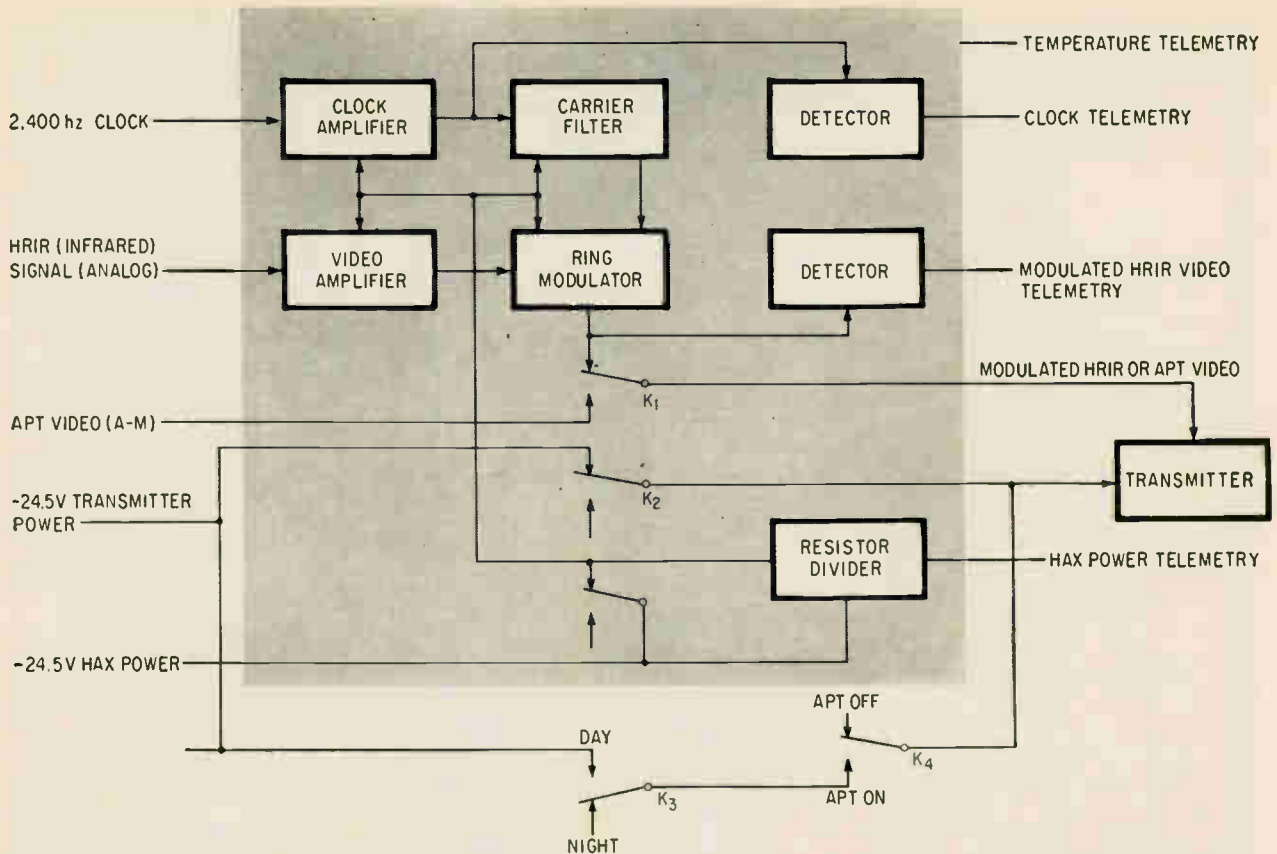

HAX interface module. On command from the ground, the HAX unit (color) selects either the infrared radiometer scanner's output or the vidicon picture for processing and transmission to ground stations.

operator can determine the craft's location and the site of the picture. To do this, he must be equipped with nomographs and geographic grids to plot the satellite's subpoint (orbit path) and to locate geographically the cloud features in the facsimile image.

The data code grid display consists of two rows, the first of which contains 50 character blocks of alternating white and black squares. Each character block represents four seconds of real-time transmission. The alternating white and black character blocks are for visual reference and identification only. The data is contained in the second row in binary code decimal notation. Four weighted bit locations are provided opposite each of the 50 character blocks. The data code template on page 124 indicates how the bits are weighted. It also shows how the data code is divided into five words, and shows the information given by each word (see the table on page 124).

Choosing the signal

Since the HAX interface is experimental, and since NASA researchers wanted flexibility in the photographic system, they decided to control the switching unit from the ground. However, the selection between HRIR and APT data could have been made automatic by sensing the transition from daylight to night with photodiode switches, or by the spacecraft's solar angle position sensor.

The HAX unit requires on and off commands from NASA. With the on command, power is applied to the HAX circuits and to the APT transmitter by means of a latching relay K_2 . At the same time, relay K_1 is energized, switching the transmitter signal input from APT video to the HRIR modulation and processing circuitry. The off command removes power from the HAX infrared-processing module and the transmitter resumes transmission of APT video.

The HAX on-command may be overridden by an APT on-command, which automatically turns off the HAX module and switches the system back to normal APT. Relays K_3 and K_4 control the APT camera and transmitter.

APT ground station equipment

The high-resolution infrared coverage was intended as a limited experiment, with only a few ground stations participating. However, a great many APT users showed interest in increasing their coverage.^{4, 5} Ground stations which use an oscilloscope or kinescope for printout may adapt easily to the infrared transmission.

An APT ground station may be assembled from the following basic components.

- Antenna—an antenna capable of receiving circularly polarized radio frequency waves is most satisfactory. Multiturn helix or crossed yagi array antennas with at least 10 decibel gain, operate well.

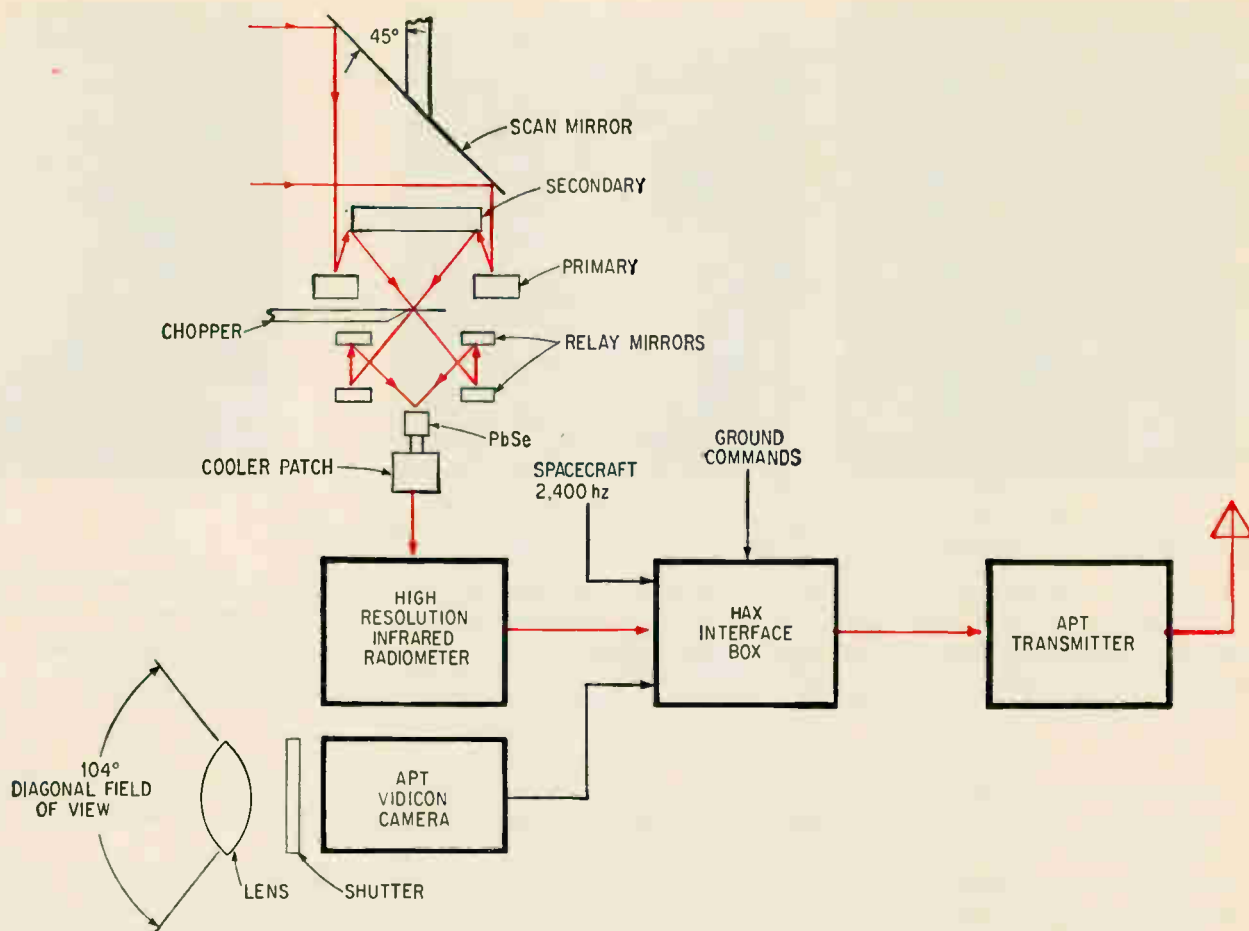

Nimbus 2 cloud pattern detection system. The infrared radiometer scans cold space, clouds and earth through a lens system and mirror inclined 45° to the spacecraft's axis of rotation. The chopper is at the focal point of the telescope and provides an a-c signal to the lead-selenide detector. The path of the infrared data is in color.

- **Preamplifier**—for best performance, the preamplifier should be located on the mast close to the receiving antenna. For amplifying devices, the preamplifier should use low-noise transistors, field effect transistors or Nuvistors (vacuum tubes). Preamplifiers having a gain of 20 db and a noise figure of 4 db are satisfactory.

- **Receiver**—any f-m receiver that can handle signals in the 136- to 138-Mhz range, with a pre-detection bandwidth of at least 30 khz, 8 db or better noise figure, and with adequate sensitivity to handle a signal level of -96 dbm or less. Amateur, military, police band and commercial mobile radio receivers may be adapted for APT ground stations.

- **Recording equipment** — commercial APT ground stations use facsimile recorders for printing the pictures, and a few are equipped for photofacsimile printout. Photofacsimile improves picture content by emphasizing certain tonal aspects.

For the best image, the recording device should be able to accommodate at least the 25-to-1 dynamic range the vidicon camera provides. The range is linearly equivalent to a printout transfer process resulting in an image with approximately 9 steps of $\sqrt{2}$ transmittance increments or a density range of 1.4 units in the image. A density unit is

Characteristics of Nimbus 2 vidicon system

Exposure duration	10.5 milliseconds
Lens aperture	f/4
Resolution response for tv lines	73% at 200 lines 55% at 400 lines 35% at 600 lines 15% at 800 lines
Signal-to-noise ratio at 10,000 foot-lamberts	39 db
Dynamic range (light level)	25:1
Scan lines per raster height	800
Line rate	4 lines/sec
Subcarrier modulating frequency	2,400 hertz

High-resolution infrared radiometer system characteristics

Sampling aperture	8.6 milliradians
Earth resolution at 600 nautical miles altitude	5.1 nautical miles
Scanning mode	line scan perpendicular to orbital track
Infrared detector	PbSe (lead selenide)
Spectral wavelength	3.4 to 4.2 microns
Usable dynamic range (temperature)	190° to 340° Kelvin

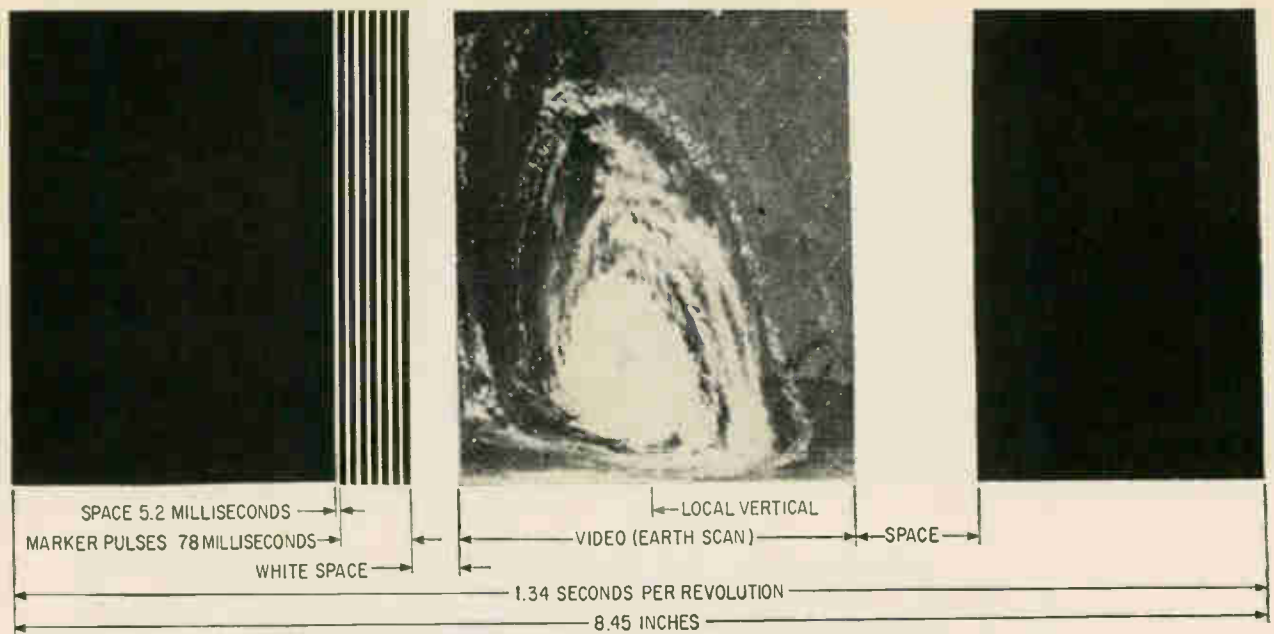

Facsimile printout. The high resolution infrared radiometer photograph looks like an APT picture produced during daylight by vidicon cameras. The scanning rate of the HRIR unit is only 44.7 revolutions per minute compared with the 240 rpm of the APT camera. A gear box at the ground stations adapts the facsimile recorder.

defined as $\log_{10} T_1/T_2$, where T_1/T_2 is the transmission ratio of the brightest highlight to lowest lowlight. Also, more satisfactory results may be obtained when controls that shape the slope characteristics (gamma correction) are used.

An article discussing approaches to a simple APT ground station is referenced.⁶ A package available from the Public Information Office at Goddard Space Flight Center describes two different approaches to a ground station.⁷ An instruction manual that explains the modification of the Fairchild and Muirhead facsimile equipment is available from the Nimbus Data Utilization Manager, Code 450, Nimbus Ground Station, Building 3, Goddard Space Flight Center.

Picking up HRIR pictures

Although the ground station's receiver picks up both infrared and APT signals, some facsimile recorder modifications are necessary before infrared pictures can be printed since their video format and line rate are different.

The spacecraft's APT system generates data at 4 lines a second with a 95% active image time. The remaining time is devoted to the data code grid information signal. The HRIR line rate, however, is 0.745 lines a second with only 33% active image time for the earth scan.

Because of the difference in the APT and HRIR scan rates on the spacecraft, the ground station's facsimile recorder must be converted. For APT pictures, the recorders operate at 240 rpm—the line rate of the spacecraft's onboard camera—and write at 100 lines per inch. The printout is approximately 8 inches square. Infrared pictures from the facsimile recorder are 3-inch wide contiguous images. The converter box has a gear ratio of 2952/550 to

make the recorder rate compatible with the HRIR scanning rate. The ratio must be tightly held to avoid picture skew.

When the Nimbus HRIR was developed, it was not intended to be used with standard APT subsystems. Consequently, it has the odd gear speed ratio. The scanning rate for the HRIR on the next Nimbus will be 48 rpm, making a gear speed ratio of 5 possible. A whole integer ratio will simplify the gearing.

Infrared pictures may also be obtained with an oscilloscope or a kinescope and a Polaroid film camera as the recording devices. The marker pulses produced by the HRIR scan (after detection) are processed in a synchronizing detector and used to trigger the horizontal sweep of the display system. The video information is then applied to the cathode of the kinescope for Z axis modulation of the scanning beam. The vertical sweep required by the kinescope may be obtained by forming a staircase function, either from the detected marker pulses or from a standard frequency tuning fork and motor-driven potentiometers.

References

1. Rudolf A. Stampfl and William G. Stroud, "Automatic Picture Transmission Tv Camera System for Meteorological Satellites," *Journal of the SMPTE*, February, 1964.
2. Rudolf A. Stampfl, "The Nimbus Satellite Communication System," A.V. Balakishman, Ed., *Space Communications*, McGraw-Hill Book Co.
3. Aracon Geophysics Division, Allied Research Associates, Inc., Concord, Mass., "The Nimbus 2 Data Code Experiment," NASA Contract NAS 5-10114, Technical Note No. 1, January, 1966.
4. John Dewitt and Charles Burch, Nimbus receiving equipment developed at WSM, Inc. for use on WSM-tv weather shows.
5. W. Anderson, "Amateur Reception of Weather Satellite Picture Transmissions," *QST Magazine*, November, 1965.
6. C.M. Hunter and E. Rich, "Birds-Eye View of the Weather," *Electronics*, July 27, 1964.
7. Instruction Manual for the Automatic Picture Transmission System (APTS) Satellite Equipment, Model F6, NASA Contract NAS 5-667 (RCA-AED), January, 1966.

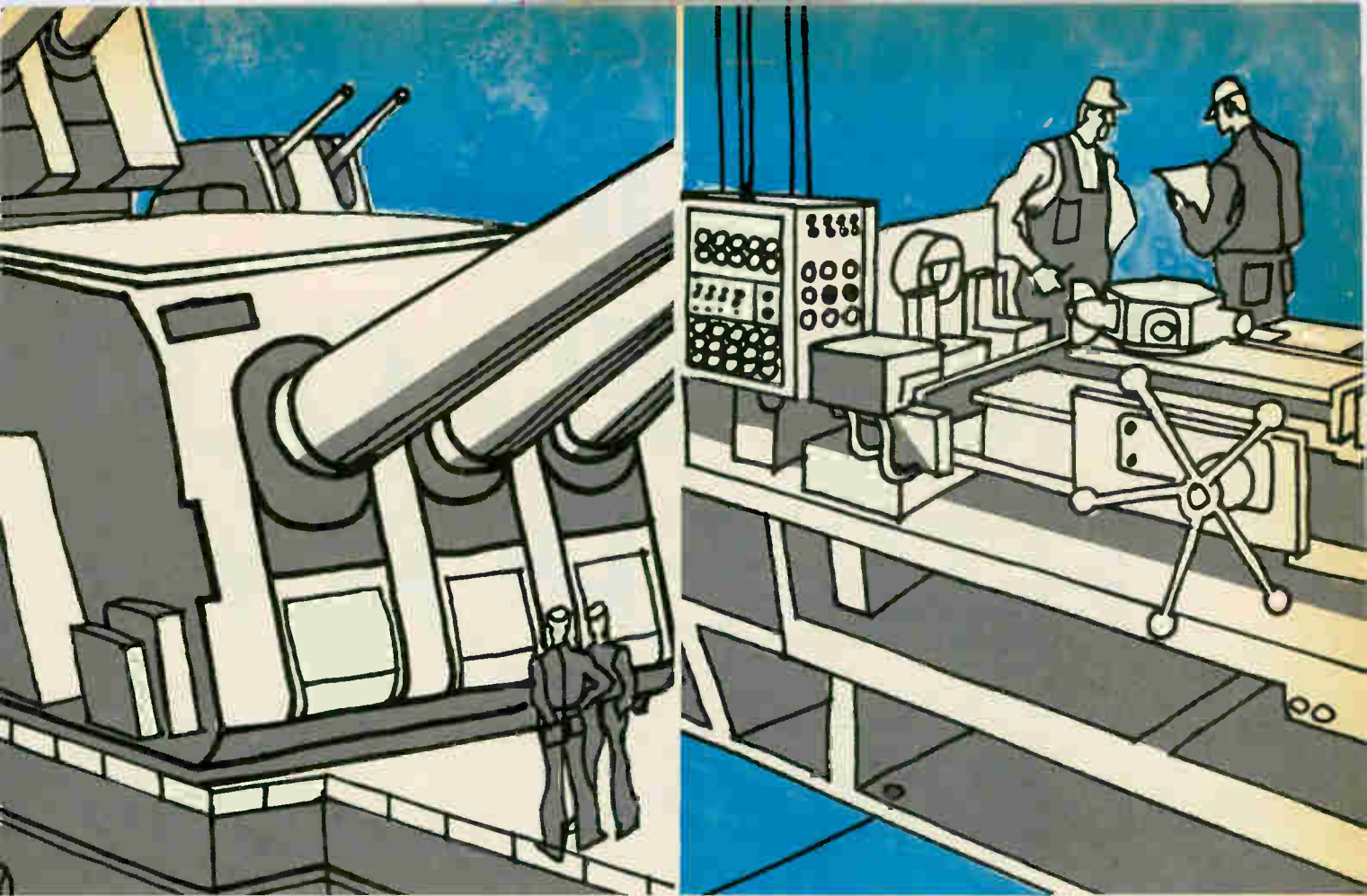

From Gun Turret to Turret Lathe... Amelco's new HNIL logic with 4 volts noise immunity helps provide accurate computer control!



SPECIFICATIONS

V _{cc}	12 volts
Logical "1"	11 volts
Logical "0"	1.2 volts
Fan Out	5
Noise Immunity	4.2 volts
Propagation Delay	60 nSec

Now you can enjoy the advantages of dependable integrated circuitry where noise and cost have been prohibitive. Amelco's new High Noise Immunity Logic is available in a full seven element family of 12 volt circuits that provide 4 volt noise immunity over a temperature range of -55°C to $+125^{\circ}\text{C}$. These same seven elements are also available in an operating temperature range of 0°C to 100°C at low, industrial prices! Use HNIL circuits in virtually any industrial or military high noise environment without fear of spurious operation.

Amelco HNIL is available in the following elements: 301 Dual 5-Input Buffer with Expanders, 311 J-K Flip-Flop, 321 Quad 2-Input Gate with Expanders, 322 Dual 5-Input Gate with Expanders, 331 Dual 5-Input Expander, 341 Dual Exclusive "OR" with Expanders, 361 Input Interface Circuit, 362 Output Interface Circuit.

AMELCO SEMICONDUCTOR

DIVISION OF TELEDYNE, INC. • 1300 TERRA BELLA AVENUE • MOUNTAIN VIEW, CALIFORNIA • Mail Address: P. O. Box 1030, Mountain View, California • Phone: (415) 968-9241 / TWX: (415) 969-9112 / Telex: 34-8416 • REGIONAL OFFICES: Southwest—Suite 213, 8621 Bellanca Ave., Los Angeles, California 90045, (213) 678-3146 • Northwest—1300 Terra Bella Ave., Mountain View, California, (415) 968-9241 East—P. O. Box 2091, Paterson, New Jersey 07509, (201) 696-4747; 60 Broad Hollow Rd., Melville L. I. New York, (516) 692-4070; P. O. Box 366, Kimberton, Pennsylvania, (215) 885-1755 • Northeast—805 High Street, Westwood, Massachusetts, (617) 326-6600 • Southeast—711 Magnolia Avenue, Orlando, Florida, (305) 423-5833 • Midwest—650 West Algonquin Road, Des Plaines, Illinois, (312) 439-3250; 3020 Woodlark Lane, St. Paul, Minnesota, (612) 646-1161. • Canada—Deskin Sales, Montreal, Quebec, (514) 384-1420.

WE JUST DROPPED OUR RTL EPOXY

PRICES.

RTL epoxy TO-5 prices now as low as 18¢ per
2-Input Gate function: 67¢ per JK Flip-Flop function.

+15°C to +55°C

DEVICE	PART NO.	PACKAGE	1-99	100-999	1,000
Buffer	U8A990028X	Epoxy TO-5	\$.80	\$.54	\$.36
Dual 2-Input Gate	U8A991428X	Epoxy TO-5	.80	.54	.36
JK Flip-Flop	U8A992328X	Epoxy TO-5	1.50	1.00	.67

FAIRCHILD
SEMICONDUCTOR

**Wouldn't it be nice if there were some way
you could get immediate delivery on
Heinemann circuit breakers?**

**We have good news for you. There are now
over 30 ways to get immediate delivery:**

AUTHORIZED HEINEMANN STOCKING DISTRIBUTORS

Alabama

Electro-Tech, Inc.
Huntsville
(205) 539-1250

Arizona

Kierulff Electronics, Inc.
Phoenix
(602) 273-7331

California

Wesco Electronics
Mountain View
(415) 968-3475

Wesco Electronics
Pasadena
(213) 795-9161

Colorado

Kierulff Electronics, Inc.
1200 Stout Street
Denver
(303) 825-7033

Florida

Parts Service Corporation
Orlando
(305) 293-5730

Georgia

Electro-Tech, Inc.
Hapeville
(404) 758-7205

Kansas

Precision Electronic Devices, Inc.
Kansas City
(913) AD 6-4343

Kentucky

E & H Electric Supply Company
Louisville
(502) 587-0991
Marine Electric Company, Inc.
Louisville
(502) 587-6511

Louisiana

Hall-Mark Electronics Corporation
New Orleans
(504) 242-7581

Maryland

D & H Distributing Co., Inc.
Baltimore
(301) 727-5100

Massachusetts

Apparatus Service Company
Allston
(617) 782-7440

Electrical Supply Corporation
Cambridge
(617) 491-3300

T. F. Cushing, Inc.
Springfield
(413) 788-7341

New Jersey

Alpha Electronic Services
Pennsauken
(609) NO 2-1310

Federated Purchaser, Inc.
Springfield
(201) DR 6-8900

New Mexico

Kierulff Electronics, Inc.
Alamogordo
(505) 437-0370

Kierulff Electronics, Inc.
Albuquerque
(505) 268-3901

New York

Federal Electronics Inc.
Vestal
(607) PI 8-8211

Schweber Electronics
Westbury, Long Island
(516) ED 4-7474

North Carolina

Electro-Tech, Inc.
Charlotte
(704) 333-0326

Ohio

The Midwest Equipment Company
Cincinnati
(513) 821-1687

Oklahoma

Hall-Mark Electronics Corporation
Tulsa
(918) TE 5-8458

Pennsylvania

West Chester Electric Supply Co.
West Chester
(215) 696-7500

Texas

Warren Electric Company
Beaumont
(713) TE 3-9405

Nelson Electric Supply Company
Dallas
(214) RI 1-6341

Hall-Mark Electronics Corporation
Garland
(214) 276-8531

Hall-Mark Electronics Corporation
Houston
(713) 781-0011

Warren Electric Company
Houston
(713) CA 5-0971

Messner Electric Supply Company
Longview
(214) PLaza 3-4484

The Perry Shankle Company
San Antonio
(512) CA 3-1801

Washington

Kierulff Electronics, Inc.
Seattle
(206) PA 5-1550

HEINEMANN ELECTRIC COMPANY  **Trenton, New Jersey 08602**

**Hoffman
micro-glass zener
regulators are the
most reliable ever made**

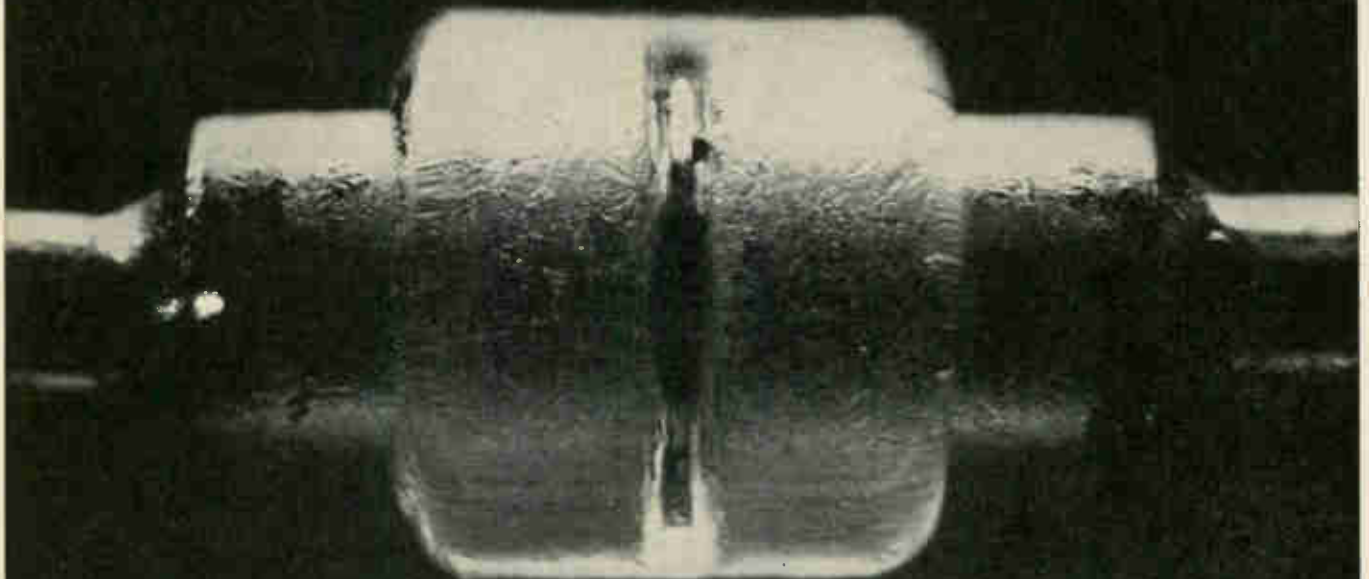

**and that's a claim you
can see through**

Unretouched photograph of unpainted Hoffman Micro-Glass Zener Regulator.

The reasons are hermetically sealed in glass. That's our exclusive way of keeping contaminants out and preventing any fusion of the metal-glass interface. The passivated silicon wafer looks like it's floating in the sleeve — the glass doesn't touch the junction anywhere.

Take a look at the slugs; you'll see they butt right up against the wafer. No intermediate contacts. And the leads are brazed not

welded or soldered to the slugs. They conduct better that way, and are about 12 times stronger than if we'd welded or soldered them.

One thing you can't see is the coefficient of expansion of the glass, slugs and wafer. They're a matched seal. That, you can test, if you must.

Thirty-seven of our 1.5 watt regulators, IN4460 through IN4496 replace 749 Jedec types. They're designed for micro-

circuitry, small space limitations and excess power requirements. Every one *guarantees* maximum limits on low level impedance, reverse leakage current and zener voltage regulation.

If you need regulator reliability, there's only one place you can get it — painted and marked to your specifications. Phone (213) 686-0123, or write: Hoffman/Semiconductor, Hoffman Electronic Park, El Monte, California 91734

Hoffman | SEMICONDUCTOR
A Division of Hoffman Electronics Corporation

How you can be one of America's foremost authorities on magnetic shielding: Read this free book.

You can be sure if it's Westinghouse

The When
Why and How
of
MAGNETIC
SHIELDING

Here's a 36-page seminar on magnetic shielding... and high-permeability Westinghouse Hipernom®



This new book on magnetic shielding is the first of its kind. It gives you the fruit of 50 years of Westinghouse leadership in magnetics research. It sums up the experience of the largest group of metallurgists specializing in magnetic alloys. It's a full seminar in when, why, and how to use magnetic shielding in low frequency applications. You get all the theory, formulae, practical tips, and technical data needed to design and evaluate shielding. One of the useful things this book documents is

Hipernom magnetic alloy. It has the highest permeability available of any magnetic alloy. Result: you can design lighter, lower-cost magnetic shielding for even your most sensitive components. This is just one sample of what you can do with this free book and Hipernom. Send for your free copy. Write: Westinghouse Metals Division, Dept. A, Box 868, Pittsburgh, Pennsylvania 15230.

J-05011

You can be sure if it's Westinghouse



Engineers:

1. If you're looking for money, our \$470,000,000 backlog of orders tells its own story.
2. If you're looking for challenge, we offer you pioneering in a brand-new ocean.
3. If you're looking for a career, we offer you stability and rapidly expanding opportunities for growth.

If you're looking for all three, we're looking for you.

We need qualified engineers for responsible jobs—challenging positions with commensurate pay—in all eight categories listed below.

Money? If you're a capable and imaginative engineer who is willing to take responsibility, we'll offer you a high starting salary plus wide-open promotional opportunities and liberal fringe benefits.

Challenge? We're in the forefront of revolutionary technological advances that are taking place in, under, and on the ocean. Nuclear submarine building. Oceanography. Engine room automation. Aircraft carrier design. You name it—we're in it. And we'll give you a chance to put your abilities to work—all your abilities.

Career? Newport News offers you permanence and a solid future. With us, you can build a lifetime career in your chosen field of engineering—and you can build it to any size. We want you to move ahead. How high you climb is entirely up to you.

If you're interested in advanced study, we are close to some outstanding institutions. Next door is Virginia Associated Research Center with one of the world's largest synchrocyclotrons, where you can study in high-energy physics. Across the harbor is Old Dominion College, offering gradu-

ate courses in such subjects as Microwave Theory, Solid State Electronics and Nuclear Engineering. Within easy driving range are Virginia Institute for Scientific Research—a world leader in solid state physics—and the University of Virginia, with its new nuclear laboratory.

Sound interesting? Then act now to get details on immediate, specific career openings in your field. Our \$470,000,000 order backlog, up \$50,000,000 in three months, makes our need for qualified engineers urgent. Write or phone John J. Gaughan, employment manager. You'll get fast action.

IMMEDIATE OPENINGS IN THESE ENGINEERING CATEGORIES

Mechanical Engineers	Naval Architects
Electrical Engineers	Nuclear Engineers
Marine Engineers	Civil Engineers
Industrial Engineers	Metallurgical Engineers

Newport News

NEWPORT NEWS SHIPBUILDING AND DRY DOCK COMPANY
Newport News, Virginia 23607 Phone: (703) 247-1211

Write or phone for illustrated, fact-packed booklet, "Blueprint of Your Future."



Chart showing the consistency of resistance change in Allen-Bradley Type HB 2-watt resistors in all resistance values from 10 ohms to 100 megohms during humidity test at 95%, 55°C for 113 hours.

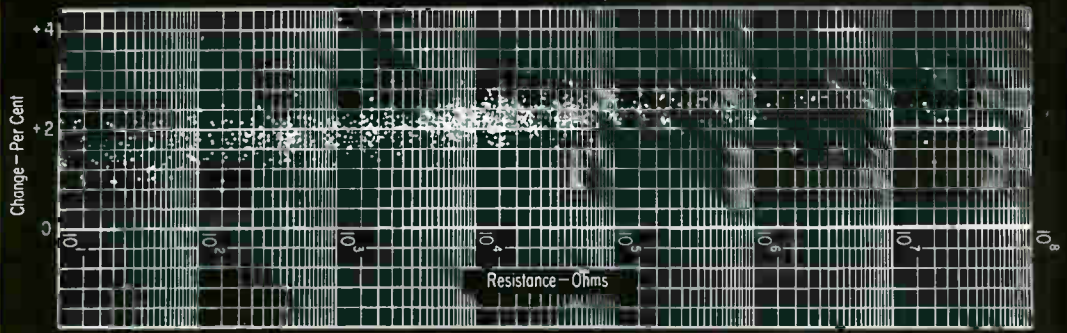

HOT MOLDED FIXED RESISTORS are available in all standard EIA and MIL-R-11 resistance values and tolerances, plus values above and below standard limits. Shown actual size.

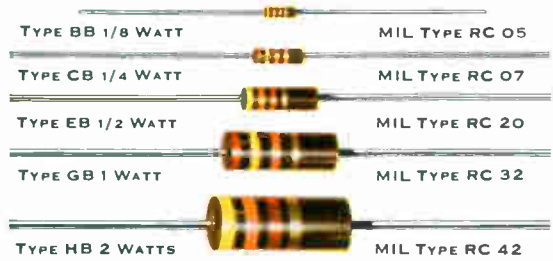

fantastically

uniform

...billion after billion!

Chart at right shows actual per cent resistance change after temperature cycling tests (5 cycles from -55°C to 85°C) on samples regularly taken from production of over 2½ billion Allen-Bradley Type EB ½ watt hot molded resistors.

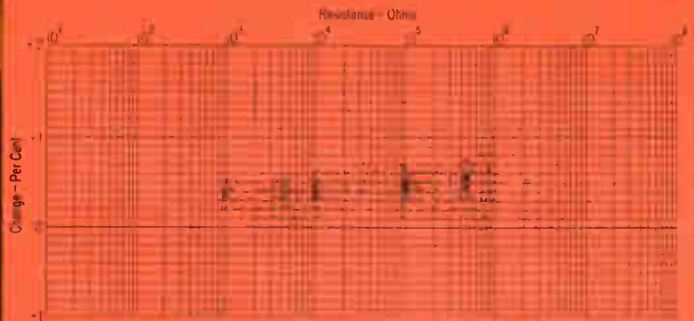

■ To maintain absolute uniformity, Allen-Bradley quality control engineers continuously take samples of resistors from production and test them. The results of these tests, as shown by the charts on this page, are truly amazing. One chart, covering the results of tests on 1248 samples representing production of more than 2½ billion resistors, shows a typical resistance change of only ½ of 1% after five cycles from -55°C to 85°C !

The other chart, plotting production sampling from more than 175 million resistors in a humidity test at 95%, 55°C for 113 hours, shows only a slight deviation in resistance—and complete freedom from any wide deviations.

So far as uniformity of electrical characteristics and physical properties are concerned, Allen-Bradley hot molded resistors have no equal. That's why they are so decidedly preferred by electronic engineers throughout the world. For complete specifications, please write for Technical Bulletin 5050: Allen-Bradley Co., 222 W. Greenfield Avenue, Milwaukee, Wisconsin 53204.

Export Office: 630 Third Ave., New York, New York, U.S.A. 10017.



ALLEN-BRADLEY
QUALITY ELECTRONIC COMPONENTS

ALLEN-BRADLEY Type J
Hot Molded Variable Resistor
rated 2.25 watts @ 70°C
shown 2 times
actual size.



**"Only Allen-Bradley Type J pots
give us the smooth control
to maintain the high calibration
accuracy of our instruments"**

Krohn-Hite Corporation

● This quickly locates the positions of the Type J potentiometers in the illustration below.

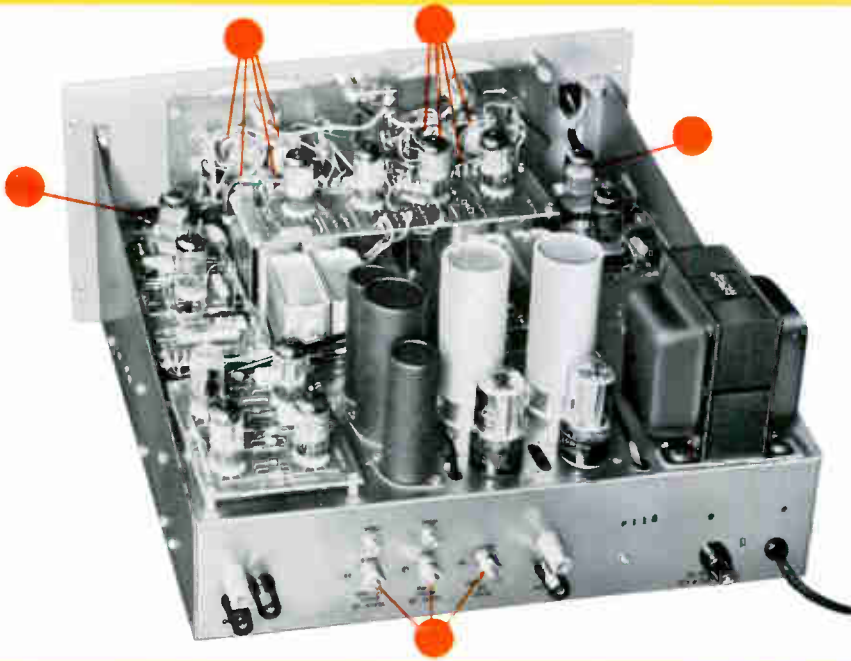

THIS KROHN-HITE VARIABLE FILTER provides low-pass, high-pass, band-pass, and band-reject operation with high and low cutoff frequencies independently adjustable from 0.02 cps to 20 kc.

IN THE MODEL 335, continuous tuning of the high and low cutoff frequencies is accomplished by simultaneously varying four potentiometers with a single knob. Only A-B Type J controls have been found to provide the smooth control and precise tracking without discontinuities to achieve the required calibration accuracy.

■ Krohn-Hite engineers have found that only Allen-Bradley Type J potentiometers provide the smooth control, low noise, long term stability, and low temperature coefficient they require for their precision instruments such as the variable electronic filter.

The Type J control has the resistor, terminals, faceplate mounting bushing, and insulating material hot molded into a solid integral unit. The solid resistance track assures smooth, quiet control that is free from the undesirable discrete steps of wire-wound units. On accelerated tests, Type J exceeds 100,000 complete operations with less than 10% resistance change.

Insure the performance of your equipment by insisting on Allen-Bradley Type J hot molded potentiometers. Besides, when you use Allen-Bradley fixed and variable hot molded composition resistors you provide your apparatus with the label of "quality." For more complete specifications, please write for Publication 6024: Allen-Bradley Co., 222 West Greenfield Ave., Milwaukee, Wis. 53204. In Canada: Allen-Bradley Canada Ltd. Export Office: 630 Third Ave., New York, N.Y., U.S.A. 10017.

ADDITIONAL ALLEN-BRADLEY HOT MOLDED VARIABLE RESISTORS

TYPE G CONTROLS are only 1/2" in diameter. Quiet, stepless operation. Rated 1/2 watt at 70°C. Values to 5 megohms. Type L are similar in construction but rated 1/2 watt at 100°C.



TYPE F CONTROLS are for mounting directly on printed wiring boards by means of their terminals. Rated 1/4 watt at 70°C. Values to 5 megohms. Type O are similar but rated 0.4 watt at 70°C.



TYPE R ADJUSTABLE FIXED RESISTORS are built to withstand environmental extremes. Only 1 1/4" in length. Have stepless adjustment. Watertight and can be encapsulated. Rated 1/4 watt at 70°C. Values to 2.5 megohms. Type N for less severe environments are rated 1/3 watt at 50°C.



ALLEN-BRADLEY
QUALITY ELECTRONIC COMPONENTS

Start designing
now with
integrated circuits
— the easiest, fastest,
most economical way



GET THESE TI DESIGNERS' KITS FROM WEATHERFORD

Here's everything you need to get a head start in modern integrated circuit design — integrated circuits in Mech-Pak carriers, breadboarding sockets, applications information, sample circuit diagrams, and complete device data — all for much less than the price of the items if purchased separately. Start now to design and breadboard both digital and linear assemblies — and demonstrate for yourself the many economies and the high performance inherent in integrated circuit systems.

SERIES 74 KIT



CONTENTS

One SN7420 Dual 4-input positive NAND gate
Two SN7450 Dual EXCLUSIVE — OR gates with expander inputs
Four SN7470 Single-phase J-K flip-flops
Four MPC-1 14-pin Mech-Pak Sockets

APPLICATIONS

- 4-bit Binary to Gray-code Converter
- 4-bit Binary Comparator
- Divide-by-5 Counter
- Binary Coded Decimal Counter

SERIES 73 KIT



CONTENTS

Three SN7331 Triple 3-input NAND/NOR gates
Two SN7302 Dual J-K flip-flops with preset
One SN7360 Quadruple 2-input NAND NOR gate
One SN7370 Dual EXCLUSIVE — OR gate
One SN7380 "one-shot monostable multivibrator"
Six MPC-1 14-pin Mech-Pak Sockets

APPLICATIONS

- Full Adder
- One shot Clock Inhibit
- Up-down Binary Counter

SERIES 72 KIT



CONTENTS

One SN723 General purpose differential amplifier
Three SN724 General purpose operational amplifiers
Two MPC-1 14-pin Mech-Pak Sockets

APPLICATIONS

- Variable gain a-c amplifier
- Stable gain circuits
- Isolation amplifiers (buffer)



R. V. WEATHERFORD CO.

DISTRIBUTORS OF ELECTRONIC COMPONENTS AND EQUIPMENT

GLENDALE 1, CALIFORNIA: 6921 San Fernando Road, VI 9-3451
ANAHEIM, CALIFORNIA: 1651 State College Blvd., KI 7-7521
PALO ALTO, CALIFORNIA: 3240 Hillview Drive, Stanford Industrial Park, DA 1-5373



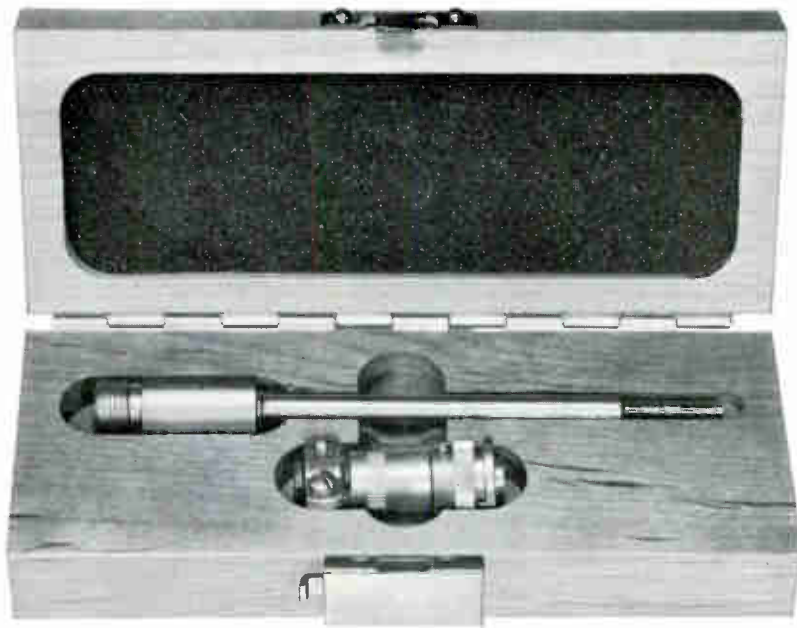

An open and shut case



CEC's new Type 4-501 Resistance Temperature Transducer is destined to be a "must" for calibration labs. And for two important reasons. (1) The 4-501 has achieved the highest state-of-the-art for accurate temperature measurement of liquids, gases and cryogenic fluids. (2) It is by far the most rugged transducer of its type ever perfected, thereby assuring *continued* accuracy and stability under all normal laboratory conditions.

As the leading manufacturer of transducers, CEC anticipates rapid industry-wide acceptance of this outstanding new addition to their line. Especially since the 4-501 has been designed to operate continuously—and does not require periodic maintenance.

A choice of models

CEC's 4-501 is available in two different versions: the 4-501-0001 for temperature measurement of liquids, gases and

for a very special transducer

cryogenic fluids; and the 4-501-0003 for temperature measurements of liquids. Both are wire-wound, four-terminal thermally strain-free transducers with fully-enclosed elements. Resistance measurements may be made with an extremely precise Mueller-type bridge.

Significant features

▣ **Accuracy:** each transducer is individually calibrated to its own matching table. (Either by CEC, or by the user from constants which CEC will supply.)

▣ **Repeatability:** resistance at ice point is repeatable and accurate to 1/1000 of an ohm.

▣ **Temperature Range:** 4-501-0001: -320°F (-195°C) to $+800^{\circ}\text{F}$ ($+427^{\circ}\text{C}$). 4-501-0003: 32°F (0°C) to $+800^{\circ}\text{F}$ ($+427^{\circ}\text{C}$).

▣ **Thermal Shock:** will withstand instant thermal shock from boiling water to LN_2 without causing a shift in the ice point calibration by more than ± 0.001 ohm.

For complete information, call or write CEC for Bulletin 4501-X4.

CEC

Data Instruments Division

CONSOLIDATED ELECTRODYNAMICS

A SUBSIDIARY OF BELL & HOWELL/PASADENA, CALIF. 91109
INTERNATIONAL SUBSIDIARIES: WOKING, SURREY, ENGLAND
AND FRIEDBERG (HESSSEN), W. GERMANY

Probing the News

Space electronics

What comes after Apollo?

Possible budget cuts are clouding the space agency's future and a lack of clearly defined goals in space is hurting the post-Apollo program

By John Rhea

Electronics Washington Bureau

Evidence is mounting that when the deadline arrives this fall for deciding on post-Apollo space missions the space agency's plans will be cut back. What major missions will come after astronauts reach the moon in the next two or three years is of prime interest to the electronics industry since it gets about half the NASA dollars.

Criticism from Congress has reached a new high, the attitude of the White House has turned cool and the National Aeronautics and Space Administration has quietly postponed major decisions on programs to follow Apollo.

Few expect any definition of goals from the White House before the end of the year—and such a decision must come from the President. The course of the war in Vietnam will play the biggest role in determining what and how big the post-Apollo program will be.

The latest Congressional criticism popped up in a recent study by the House NASA Oversight Subcommittee, which bemoaned the lack of a major space goal. The study said such a goal is necessary to rally national support. The subcommittee suggested that one possibility is a program of manned planetary flybys in the mid 1970's leading to a manned planetary landing in the early 1980's.

The report continued: "With such a rallying point, a program of unmanned and manned missions could converge, providing definition and a timetable for unmanned planetary probes to gather essential scientific data, conventional and nuclear propulsion requirement de-

velopment, life support, communications and other needs."

1. Space goals

Subcommittee chairman, Rep. Olin Teague (D.,Tex.) recommended that NASA submit by Dec. 1 a list of possible space goals so that hearings can be held before next year's budget is submitted.

The Teague subcommittee listed five factors to be considered in shaping any future goals: national security, economic advantage, scientific discovery, international and competitive position and technological progress. Based on the existing technology base, these factors would be used to develop a national program for both the near term (1967-76) and long term (1976-85).

In its talks with the subcommit-

tee, NASA outlined five possible manned space programs to follow Apollo. Each starts at a relatively low level and consequently could be added to the late stages of the current Apollo effort. Costs range from \$3 billion annually for a program emphasizing earth orbital operations to what NASA calls a prestige program where the dollar curve climbs right off the chart.

Balanced blend. The prestige program soars above a \$6-billion annual level within five years. It includes orbital stations and logistic systems, lunar stations, an orbital research complex and planetary flybys and landings. A program that concentrates only on planetary flybys and landings amounts to \$4 billion a year, and one oriented to lunar exploration

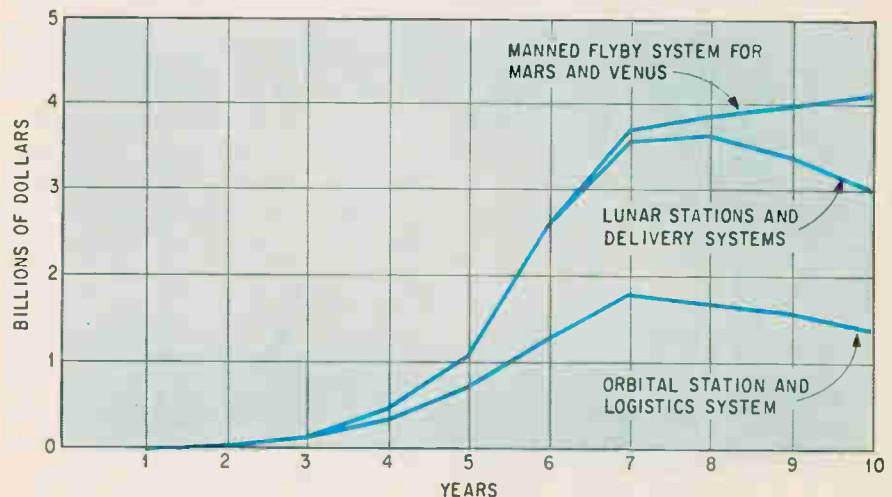

Cost of new NASA programs and starting dates. Additional cost to prepare for moon stations wouldn't begin until after the third year; for planet flybys, after the sixth year. If NASA limits itself to earth orbital missions, the cost in the tenth year will be \$1.5 billion; if it adds lunar stations, the total cost will be \$3 billion; if it goes on to planet flybys, the total bill rises to \$4.2 billion.

GLASS ENCLOSED
AMPERITE
Thermostatic
DELAY RELAYS

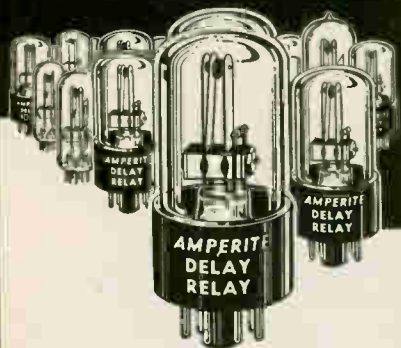

Offer true hermetic sealing
—assure maximum stability and life!

Delays: 2 to 180 seconds . . . Actuated by a heater, they operate on A.C., D.C., or Pulsating Current . . . Being hermetically sealed, they are not affected by altitude, moisture, or climate changes . . . SPST only—normally open or normally closed . . . Compensated for ambient temperature changes from -55° to $+80^{\circ}$ C . . . Heaters consume approximately 2 W. and may be operated continuously . . . The units are rugged, explosion-proof, long-lived, and—inexpensive!

TYPES: Standard Radio Octal, and 9-Pin Miniature.
List Price, \$4.00

PROBLEM? Send for Bulletin No. TR-81

AMPERITE
BALLAST
REGULATORS

Hermetically sealed, they are not affected by changes in altitude, ambient temperature (-50° to $+70^{\circ}$ C.), or humidity . . . Rugged, light, compact, most inexpensive.

List Price, \$3.00

Write for 4-page Technical
Bulletin No. AB-51

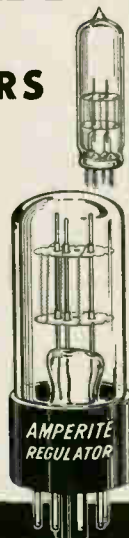
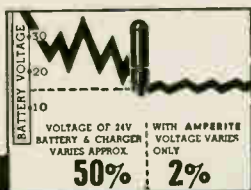

AMPERITE

600 PALISADE AVE., UNION CITY, N.J.

Telephone: 201 UNION 4-9503

In Canada: Atlas Radio Corp., Ltd.,
50 Wingold Ave., Toronto 10

... 1968 budget is NASA's last chance
to get a post-Apollo program started ...

would be slightly less expensive.

A blend of the other four comprises what NASA calls its balanced program. This would build up to an annual rate of about \$4.2 billion by first concentrating on an orbital station and logistics system, then adding lunar stations and delivery systems and finally introducing a planetary flyby system after about six years. NASA plans to get double duty from a space station by using it also as a manned interplanetary spacecraft.

II. NASA's last chance

The fiscal 1968 budget represents NASA's last chance to get a post-Apollo program under way without breaking the continuity started by President Kennedy when he announced the lunar landing goal on May 21, 1961. NASA has let it be known that it wants \$6 billion—a figure that includes a major start on the Saturn/Apollo applications program and the Voyager unmanned planetary explorational effort. However, NASA would settle for \$5.5 billion to make down payments on the two new programs. But industry representatives in Washington say the space agency will be lucky to get \$5 billion.

The war in Vietnam is not the only reason NASA's budget may have to be sliced. Rep. Joseph Karth (D., Minn.), who ranks right behind Teague on the House Space Committee, opposes a stepped-up manned planetary program because of high cost, low economic payoff and inadequate technological preparation. Yet it is exactly such a program that many inside NASA and industry want to rally the government and the public behind the space effort. They reason that putting an American on Mars by 1984 could do as much for the space program in the 1970's as Apollo did in this decade. A program such as Apollo applications lacks this glamor and is therefore difficult for the public to identify with.

Ominous note. Karth was the first to warn of a ceiling on NASA spending and others repeated the warning. At the recent Reliability and Maintainability Conference in New York, Karth said that until the

pressure of Vietnam eases, NASA's budget will be closer to \$5 billion than \$6 billion. Such a budget cut would mean putting off any firm start on lunar bases and manned planetary flight until the late 1970's.

President Johnson sounded a similar warning when he signed the NASA authorization bill. He cautioned that inflation might require reductions in government spending. Although his remarks referred to the steel price increases, he made it clear that the space program would suffer if government spending were slashed.

Countermoves. NASA has tipped its hand that it doesn't expect to get all the money it wants. The space agency had originally planned to let industrial prime contractors handle some projects. But to prevent layoffs NASA decided to do the work itself. The agency's largest installation, the 7,500-man Marshall Space Flight Center in Huntsville, Ala., recently took over the Apollo Telescope Mount and the Apollo Service Module Experiments Pallet programs—both originally destined for industry. The Mariner probe of Mars in 1969 has been assigned to the Jet Propulsion Laboratory although the original plan called for an industrial prime contractor to do the work.

Time to consider. Other programs have been kept going by the simple process of extending study contracts. In this way NASA gets more time before it makes a decision on which firms to choose. The Bendix Corp. and the Boeing Co. have had their contracts extended to December. The two companies are competing for the lunar scientific survey module vehicle that will provide mobility on the moon. At that time one will be chosen to continue development.

The Lockheed Missiles and Space Co. and the Martin Co.'s Denver division won nine-month study contracts on integration of experiments into the Apollo lunar module. Both contracts were extended to 12 months and both firms have been asked to investigate using the Apollo command module and the depleted third stages of the Saturn V launch vehicle to house

scientific experiments.

Three firms are already studying ways to use spent Saturn IVB stages for earth orbital experiments—the Douglas Aircraft Co., the McDonnell Aircraft Corp. and the Grumman Aircraft Engineering Corp. Marshall is expected to call for proposals soon to develop the Spent Stage Experiment Support Module, Douglas, builder of the stage, appears a sure winner.

III. Success schedule

Already approved NASA programs are expected to cost \$4.5 billion in fiscal 1968 no matter what the new budget amounts to. Most of this money will go to Apollo and should come close to the \$3 billion set aside for that program in the authorization for fiscal 1967. This leaves \$500 million for new programs if NASA's budget is held to \$5 billion.

Apollo applications and Voyager won't be the only programs competing for these dollars. There are the 260-inch solid rocket motor, nuclear power systems such as SNAP-8 (systems for nuclear auxiliary power), a nuclear upper stage built around the Nerva II reactor and additional purchases of approved spacecraft such as Lunar Orbiter and Pioneer. Because of this competition, one airframe marketing man speculated that "if the budget falls to the \$5-billion bottom, Voyager is in deep trouble."

The situation for all of these programs could change if Apollo exceeds its estimated rate of expenditure. NASA administrator James Webb and associate administrator George Mueller, who heads the manned flight program, say that Apollo is on what they call a success schedule. This means that the first American will step on the moon in this decade and the entire program will not exceed the \$21.7-billion estimate—if nothing goes wrong.

Regardless of what final decision emerges from this fall's sessions between NASA, the Budget Bureau and Congress, one thing is certain: some kind of direction must be given to the post-Apollo space program. NASA will then be able to tell the electronics industry whether it can count on the space program or whether it will have to turn elsewhere for business.

Versatility and simplicity in variable, regulated power supplies

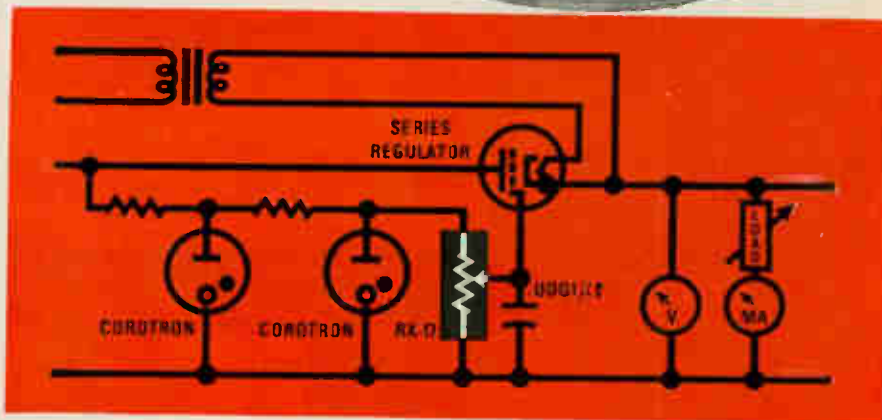
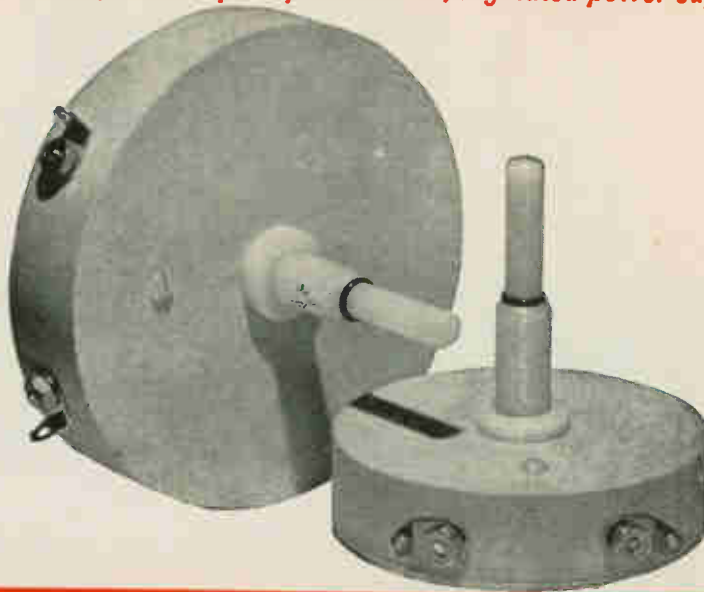

POTENTIOMETERS TO 10 KV

New Victoreen RX-17 series ceramic potentiometers, when used across a well-regulated high-voltage source, provide reference adjustment with a degree of simplicity never before available to circuit designers.

Long life, resistance stability and panel insulation capability to 20 kv make Victoreen RX-17 series potentiometers ideal for reference adjustment for variable, regulated HV supplies in CRT's, TWT's, Klystrons, GM tubes, proportional counters, etc.

Two RX-17 series are available: One for operation to 5 kv rated at 3 w, the other for 10 kv rated at 5 w. RX-17 series ceramic potentiometers are normally supplied with nominal resistance range of 1 Meg to 5000 Meg, with a linearity of $\pm 2\%$. Full technical details on request to Applications Engineering Department.

6976-A

Components Division

THE VICTOREEN INSTRUMENT COMPANY

10101 WOODLAND AVENUE • CLEVELAND, OHIO 44104

EUROPEAN SALES OFFICE: GROVE HOUSE, LONDON RD. ISLEWORTH MIDDLESEX ENGLAND



Circuit treasure

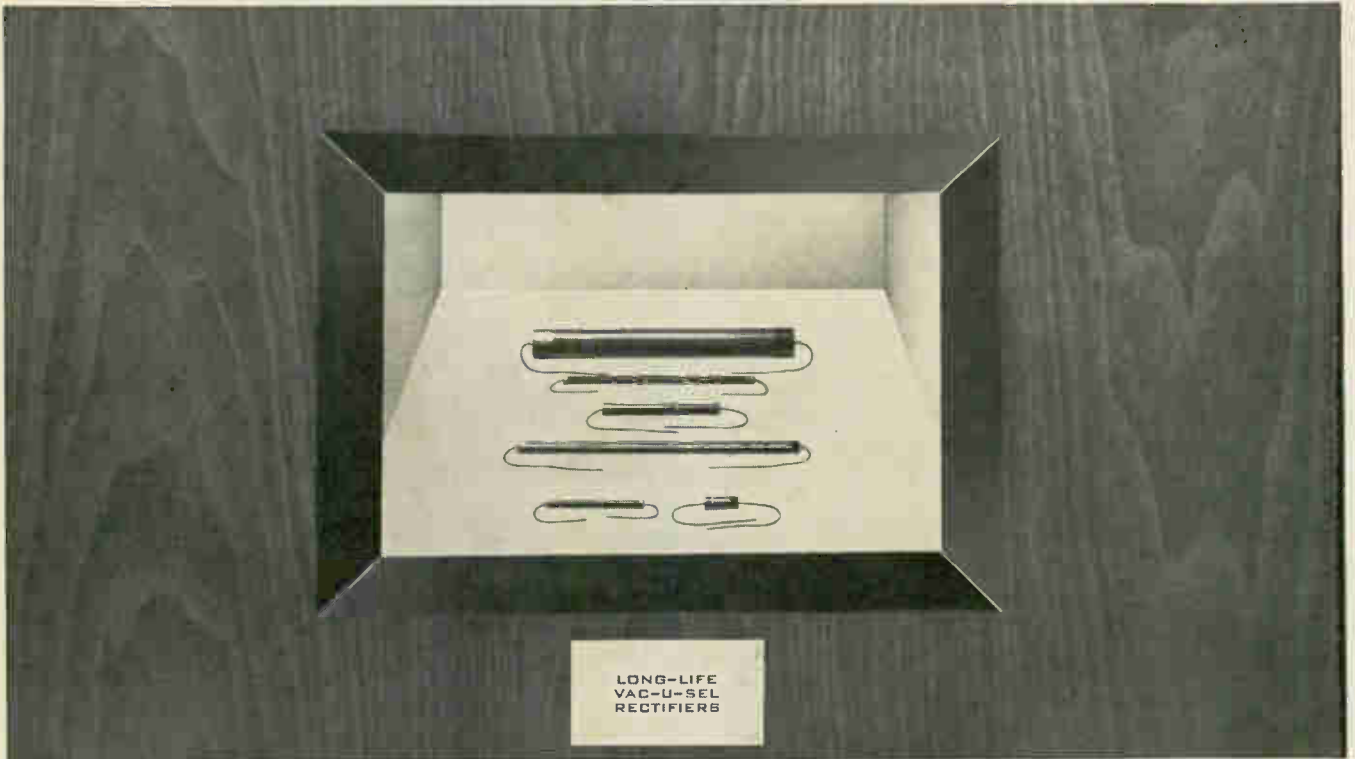

Solid-state selenium cartridge rectifiers

■ You add rare values to your oscilloscopes, radar sets, color TV, precipitators and other low-current, high voltage equipments when you specify G-E Vac-u-sel® rectifiers.

With solid-state selenium construction and no filament to burn out, these cartridges provide high circuit reliability over proved long life spans. General Electric cartridges have recorded over 100,000 hours of "on-time". That's more than 11 years of operating time.

Polycrystalline construction gives selenium rectifiers far better resistance to transient voltage than single-crystal devices. G-E Vac-u-sel rectifiers will operate in ambient tem-

peratures up to 130 C with no derating.

Thin cell space savings, high density phenolic housing, and greater product uniformity through Automatic Continuous Evaporation (ACE),

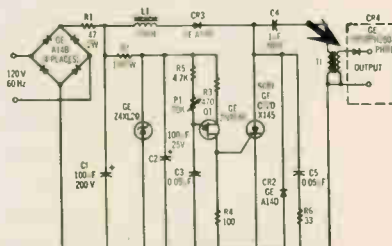

Typical circuit using G-E Vac-u-sel Selenium Cartridge Rectifiers—in this case as a compact 2 ma high-voltage power supply used for CRT's, X-ray tubes, and other d-c applications.

are three more reasons why you should consider Vac-u-sel rectifiers. G-E cartridges give you more PRV per inch than other similar rated units. If you require voltage ratings up to 31,500 PRV and current ranges from 1.5 to 25 ma, G.E. has the Vac-u-sel cartridge you need. Try them.

Call your G-E engineer/salesman or distributor for more information on Vac-u-sel cartridges or write to Section 220-37, General Electric Company, Schenectady, N. Y. In Canada: Canadian General Electric, 189 Dufferin St., Toronto, Ont. Export: Electronic Components Sales, IGE Export Division, 159 Madison Ave., New York, New York.

SEMICONDUCTOR PRODUCTS DEPARTMENT

GENERAL  **ELECTRIC**

A view from the cockpit

Army engineers are working on a contact analog display to give pilots the most flight information in the simplest possible way

By W.J. Evanzia

Avionics Editor

Every pilot who has flown by instruments knows one of his main difficulties is translating the readings of a conglomeration of dials and radar signals into a mental picture of what his aircraft is doing—as it is doing it. Faster planes and more dials are making the problem increasingly difficult, yet the advent of air mobility in ground fighting is making it imperative that pilots be able to fly ground troops and supplies at treetop level regardless of weather conditions.

Army system designers and human factor engineers believe that a contact analog display, as opposed to a conventional aircraft vertical and horizontal situation display, may be the best method of presenting the information visually. The Army is flight testing such a system at its Electronics Command's facilities at the Naval Air Station at Lakehurst, New Jersey.

Although the concept of analog displays is more than 10 years old, there is only one contact analog display in use—a simple one in the Navy's A6A attack plane.

"Too much information can be a pilot's biggest problem," says Willis (Bud) Dworzak of the Army Electronics Command's Avionics Laboratory at Fort Monmouth, N.J. "The number of instruments in the cockpit has increased to the point where interpretation, translation and integration of flight information cannot be accomplished in the split-second time required to control modern aircraft."

Dworzak, project engineer for the Advanced Aircraft Instrumentation System program (AAAIS), says the contact analog display eventually may form the basis of all cockpit displays in Army aircraft, both fixed winged and helicopters. If

the tests are successful the concept may be incorporated into the Army's Advanced Airborne Fire Support System, (AAFSS) and later in the Surveillance and Target Acquisition System, (Stass). The model being tested in a Beechcraft Twin-Bonanza J-50 consists of components already designed for other programs.

Program's evolution. The AAAIS instrumentation system evolved from the Joint Army-Navy Instru-

mentation Research program. (Janair). Janair began in the mid-1950's and was known as the Army-Navy Instrumentation Program, (ANIP).

Janair was a study program concerned with proving the feasibility of a variety of avionic concepts. It did not develop hardware or attempt to prove the practicality of its study projects. But after feasibility was proven, an individual service could continue the investigations and develop a working sys-

Contact analog display in a Twin-Bonanza J-50 after a test flight by Willis Dworzak, engineer for the Advanced Aircraft Instrumentation System program. The vertical panel and horizontal situation display at pilot's left gives him almost all the information he needs to fly the plan





Portable SOLID STATE PHASE METER

MODEL PM-720

Provides exacting accuracy with compact portability at low price. Advantages: Light weight (5 lbs.) ... $3\frac{1}{8}$ " height...Absolute panel meter accuracy of $\pm 1^\circ$ or 2%... External output relative accuracy of $\pm 0.20\%$...Equal accuracy for symmetrical waveforms of any shape...Two inputs can have amplitude differences of 1,000 to 1 without affecting phase reading... Direct phase angle readings between 0° and 360° without adjustments or phase shift insertion instruments. Price: \$950.



For complete specifications write to:
R. H. DOW, MGR., AEROMETRICS,
AEROJET-GENERAL CORPORATION,
P. O. Box 216-F5, SAN RAMON, CALIF.

AEROMETRICS



tem if it thought that a program looked promising.

I. Electronic eye

The contact analog system presents on two panel displays—one horizontal and one vertical—almost all the information a pilot needs to fly his aircraft regardless of weather conditions. The system's central computer complex also will solve navigation and fuel management problems and will ease the pilot's task of shifting from one in-flight plan to another. According to Dworzak, "AAAS has performed almost flawlessly in its early tests."

The central computer complex of the system is a modified AN/ASN-24 digital computer made by the Kearfott division of General Precision, Inc., a subsidiary of the General Precision Equipment Corp. The computer processes sensor information, stores data, commands the display of symbols on the screen of a cathode-ray tube and solves fuel management and navigational problems. An air-data computer, made by the Bendix Eclipse-Pioneer division of the Bendix Corp., reads the plane's air-speed, heading, temperature and radar altitude and converts it into a form suitable for display.

On the contact display, the earth is depicted as a grid of squares and the sky's clouds as circles. Lines along the earth parallel to the

course appear to converge at a point on the horizon. The position of the horizon depends on the attitude of the aircraft. If the craft is in a dive, the horizon will be high on the screen and it will appear tilted if the plane is making a turn.

The horizontal lines of the squares representing the earth are an equal distance apart. They move from the center of the picture to the bottom, and grow larger, giving the illusion of speed.

The display is created by a symbol generator and controlled by the central computer from stored information and data read out from sensors on the aircraft—for example, the altimeter, automatic direction finder and onboard radar.

The display patterns representing the earth show the plane's attitude, altitude and speed by changing perspective. The trapezoidal grid patterns representing the earth in level flight become squares if the aircraft dives and the size of the grid will change with altitude.

Black on white. From the ground up to 100 feet, the grid represents 15-foot squares and is presented as white lines on a black background. From 100 feet to 1,000 feet, the grid represents 150-foot squares and appears as black lines on a white background. At 1,000 to 10,000 feet, the grid represents 1,500-foot squares and the colors revert to white on black. To differ-

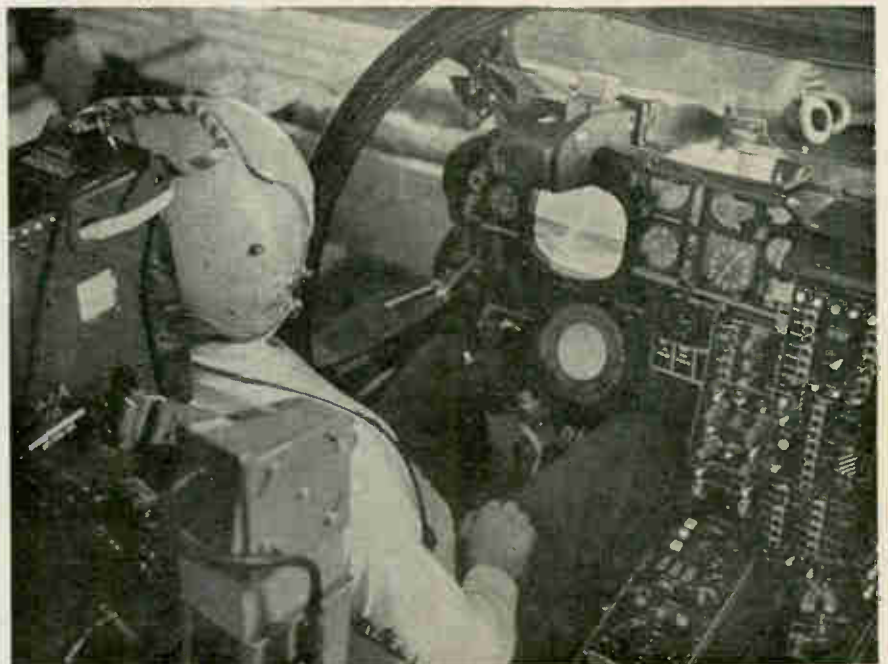

Flite-path contact analog display system in a Navy A6A attack bomber is tested by a field engineer. The system is the only cockpit display of its type operating in fighter aircraft. The Army's system will be more sophisticated.

entiate between the highest and lowest ranges, the width of every eighth line is doubled on the lowest range.

The display also includes an artificial flight path, a sort of "highway in the sky" superimposed on the picture tube. The image rises from the bottom of the screen like a triangle, giving the illusion of depth. If the pilot's heading is too far to the left the road will bend to the right. The pilot can reference the flight path symbol to the plane of the earth or to the air mass in which the aircraft is flying or to the aircraft.

Speed trap. The pilot also can select a command speed and this will be displayed as a series of dashes on the right-hand side of the flight path. Should the pilot exceed his desired speed, the marker moves out of the center of the display toward the bottom; it moves in the opposite direction if the pilot is going too slow.

Auxiliary indicators located along the sides of the vertical display include a vertical tape altimeter and airspeed indicator. These instruments present qualitative barometric altitude, terrain height and airspeed. Indicated airspeed, command speed, barometric altitude and command altitude are also presented numerically on digital readouts on each instrument. Also shown numerically are miles-to-go to target or landing area, miles of fuel, minutes-to-go and minutes-of-fuel needed to complete the flight.

II. Horizontal display

The instrument system also has a horizontal situation display—a 6-inch, 2-gun cathode-ray tube—and an input panel to manually insert data. The pilot sets fixed values, such as wind velocity and direction, fuel and magnetic variation on the input panel; these values are later used by the central computer for in-flight programing.

Inputs for the horizontal map display are generated by a vidicon scanning system developed by ACF Industries, Inc., which utilizes topographical data stored on 390 frames of 70-millimeter film. Map coordinates are programed into the computer which selects the map frame and drives the map scanner in x and y coordinates through a servosystem.

Three map scales. For the development system, the Technicolor Corp. made map reductions of an 800-nautical-mile square area of the Eastern United States in three scales. A 1:1-million scale master map, 1:250,000 scale for enroute navigation, and a 1:62,500 scale for terminal areas.

In a fixed map mode, an aircraft symbol moves over a stationary map display. In the moving map mode, the symbol is stationary and the map moves under it.

The pilot can display radar information concurrent with the map and symbol presentation. The radar data is shown on a plan position indicator scan. Texas Instruments Incorporated's AN/APN-149 terrain avoidance radar provides the video information presented by the scan.

III. Operational systems

Some visual instrumentation systems already are in operation and a number of commercial companies are developing others. Among the most prominent is a system created by the Kaiser Aerospace and Electronics Corp., a division of Kaiser Industries Corp. The Kaiser AN/AVA-1 Flite-path display is the only contact analog system that has been tested in combat. The system is mounted aboard the Navy's A6A Intruder bombers flying many of the low-level attack missions in Vietnam.

There are two versions of the Flite-path system: the sophisticated transistorized unit in the Navy's bombers and a smaller less complex unit for commercial planes and the Army's light aircraft. The smaller unit is built of discrete components and integrated circuits.

The Flite-path's contact analog picture shows synthetic cloud shapes to depict the sky and circles to represent the ground. The circles appear to move toward the front and speed up as the craft increases its speed. As the aircraft climbs, the circles get smaller and move more slowly.

An indicator similar in principal to the AAIS "highway in the sky" tells the pilot if he is on course. An output from the aircraft's inertial guidance system generates the heading signals for the displays.

Seeing in 3-D. In addition to the contact analog mode, the Flite-path

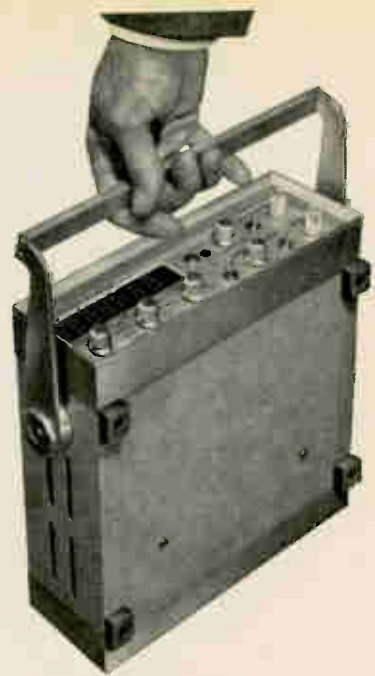

Portable ELECTRONIC COUNTER

MODEL EC-715

A compact, high speed (10 mc—7 digit), counter-timer providing frequency, period and time interval measurement capability found only in units of greater size, weight, and cost. Unique in performing as integrating digital voltmeter with optional voltage-to-frequency converter. Light weight (7 lbs.) enables ideal utilization for field service. Price: \$1450.



For complete specifications write to:
R. H. DOW, MGR., AEROMETRICS,
AEROJET-GENERAL CORPORATION,
P. O. Box 216-F5, SAN RAMON, CALIF.

AEROMETRICS



GADOLINIUM
TERBIUM
DYSPROSIUM
HOLMIUM

LANTHANUM

ERBIUM
THULIUM
LUTETIUM
CERIUM
PRASEODYMIUM
SAMARIUM
NEODYMIUM
EUROPIUM
YTTRIUM
THORIUM

**for phosphors?
catalysts?
dielectrics?
semiconductors?**

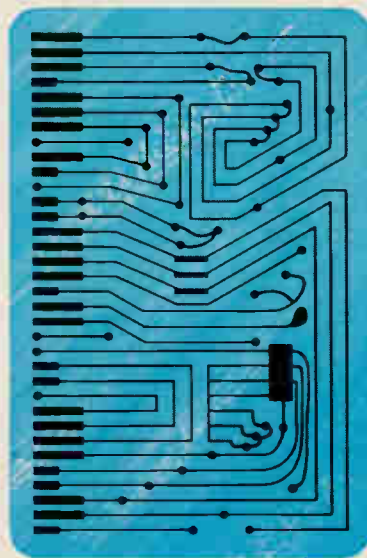

**WE MAKE LANTHANUM
MATERIALS ECONOMICALLY PRACTICAL,
WONDERFULLY USEFUL, WELL WORTH
YOUR CRITICAL APPRAISAL.**

The key to your next research project might well be lanthanum. As a catalyst, perhaps. Rare earths proved their catalytic promise with the Durabead-5 cracking catalyst. Or lanthanum for such uses as curing phenolic resins, synthesizing ammonia, decomposing nitrogen oxides. In electronics, lanthanum shows interesting semiconductor properties, and in ceramic dielectrics to control the temperature coefficient of capacitance. The special low-temperature properties of lanthanum make it useful in memory and control devices that operate at extremely low temperatures. Other lanthanum materials have been suggested for use as thermionic cathodes in applications requiring high current densities and high voltages. Still others have ferroelectric properties useful in condensers, piezoelectric elements, and electro-optical systems. Strike a responsive chord? If so, please write us. We have the materials, staff and technology that can save you headaches and money! Ask for detailed literature. RARE EARTH DIVISION, West Chicago, Illinois 60185. Phone 231-0760 (Area code 312).



American Potash & Chemical Corporation

system has a second mode in which terrain contours are displayed. Video inputs from an APQ-18 forward-looking radar are fed into a special radar data computer.

The APQ-18 radar measures both the range and altitude of terrain in a sector ahead of the plane. A computer converts this three-dimensional information (range, altitude and azimuth) into synthetic contours on the screen.

According to Kaiser engineers, tests have shown that pilots are able to follow the terrain contours of the radar display more accurately and with more confidence than visual references. The engineers say this is because radar accurately measures range while the eye can only estimate.

The terrain clearance display shows the same ground-stabilized field of view ahead of the aircraft as in the contact analog mode. The horizon is present and intervening terrain appears in perspective and is scaled so that any features that are higher than the altitude of the aircraft are shown projecting above the horizon.

Slicing the land. The terrain is sliced transversely into 10 ranges (one-quarter mile ahead, one-half mile ahead, one mile ahead, and so on). A terrain profile is generated for each range to show terrain height versus azimuth at that range, and the profiles are stacked with the nearest at the bottom of the display and the farthest at the horizon. To distinguish ranges, each profile has a different shading—light at the nearest range to dark at the horizon. Two ranges—the nearest and one other selected by the pilot—are highlighted with vertical marks.

The Norden division of United Aircraft Corp. also is working on a display system for Army and Navy helicopters equipped with the Integrated Helicopter Avionics System (IHAS). Norden also will supply the vertical situation for the display for the Integrated Light Attack Avionics System (Ilaas).

The Mark 2 avionics subsystem for the Air Force's F-111A will also include a vertical display, but its design and contractor have not been announced. The Autonetics division of North American Aviation Inc., is the prime contractor for the avionics subsystem.

Behind the complaints on computer software

Makers and users have been caught off guard by the complexity of third-generation machines; writing software is costlier than developing hardware

In Washington, a large government agency continues to operate its old computer while a new third-generation machine sits idly across the room surrounded by service engineers who are trying to make it work. A chemical company has its third-generation machine running but reports that it isn't getting anywhere near the output expected. and a Midwestern aircraft company finds its third-generation machines work well as long as operators keep the demands simple.

These examples illustrate what's been happening with third-generation computers as they go on-line. Both users and manufacturers of computers have discovered that the step from second to third generation was a bigger one than they had envisioned. At the International Business Machines Corp., whose problems have been the most severe only because it has sold so many more third-generation machines than anybody else, executives say frankly, "We underestimated what had to be done. We underestimated the complexity."

The biggest problem can be summed up in an IBM manager's comment, "Everybody's late." Mainly, the lateness has been in software, the instructions with which people communicate with the computer. Some IBM programs have fallen more than a year behind schedule. The worst snarls have happened to the operating systems and compilers. Without these programs, the computer cannot work at its planned speed or capability.

I. Bad time at IBM

Problems with the system 360 stopped IBM management cold for nearly two years. Top executives spent almost all their energy re-

solving them, one IBM man says. But he adds, "Ninety percent of the difficulties have now been solved and time will cure the rest."

Three problems. IBM has had three problems with the 360 system, any one of which might have floored a company with lesser resources. First, it couldn't develop a production process that would turn out good hybrid integrated circuits fast enough. That forced delivery schedules of the machines to slide. A massive technical effort and purchasing some services like testing and some parts like ceramic substrates from outside vendors solved that problem. Then the company discovered its model alignment was all wrong. It scrapped five models and added four new ones through a second massive engineering effort. Finally, the software turned out to be more difficult to write than anybody expected and IBM is currently making a herculean effort to resolve that.

Just how big the effort is can be seen by the number of people working on system 360 software. Over 1,000 programers and testers are writing the operating system for large models. Another 1,000 people are working on compilers and other programs that the company supplies with the computer. That compares to about 200 people who prepared all the software for IBM's 7000 series of machines, its large second-generation processors.

Writing operating systems for the third-generation computers, so that the computers could run automatically, has turned out to be far tougher than anyone expected. The new computers were designed for multiprograming—that is, solving many different problems at the same time; second-generation machines run only one program at a

time. Peripheral equipment for third-generation computers includes bulk storage devices such as magnetic tape, disks and drums; only tape is used in most second-generation installations. The new systems work so fast there is no time for manual intervention. In contrast, the second-generation operating systems often print messages telling the operator to push a certain button.

Roomful of string. To do all these jobs as fast as required calls for a gigantic program. IBM software people say the operating system for large model system 360 computers already has one and a half million instructions and its size will triple in the next two years. So many people are writing parts of the program that putting the pieces together has been a spectacular problem. Often the pieces don't fit or a change in one part offsets every other part. Said one manager, "It's like finding the loose end of a roomful of string."

The number of instructions raises another sticky problem. The operating system requires so much computer memory that a small model of the machine doesn't have enough left to do any work. Initially IBM and other makers were selling the idea of compatibility: buy a small model and move up to the bigger models in time without changing software. But the operating system will require 14,000 bytes of information in storage at any instant so that even a computer with a 32,000-byte memory has only half the memory left for application programs and data. What's really needed for such a system is a memory size of about 256,000 bytes.

The complexity increase applies to other programs too. In the city of Los Angeles case, for example



Polycarbafil housing for Dictograph speaker is injection molded by Waterbury Co., Randolph, Vt. Nylafil switch housing, push-buttons and volume control wheel are molded by Hinchman Mfg. Co., Inc., Roselle, N. J.

Polycarbafil[®] has toughness needed for new hospital speaker

Impact strength important in speaker for hospital patients

The pillow speaker for individual hospital patients made by Dictograph Products, Danbury, Conn., must be able to withstand accidental dropping on the floor. Dictograph looked for a material that would have the impact resistance and toughness for this, plus rigidity, dimensional stability and low coefficient of thermal expansion. They chose Polycarbafil, fiberglass reinforced polycarbonate. Fiberglass reinforcement increases all of these properties.

In addition, Nylafil, fiberglass reinforced nylon, was chosen for push-buttons, volume control wheel and switch housing for its strength and wear resistance.

Compare Physical Properties

Property	Unit	Unreinforced Polycarbonate	Polycarbafil G-50/20
Tensile Strength @ 73°F	PSI	8,000	18,500
Flexural Strength @ 73°F	PSI	13,500	25,000
Coef. Linear Thermal Expansion / °F.	In./In.	1.0x10 ⁻⁵	1.02x10 ⁻⁵
Heat Distortion Temp. @ 66 PSI	°F	285	308
Water Absorption 24 hrs.	%	0.15	0.11

Polycarbafil and Nylafil are only two of the full line of fiberglass reinforced thermoplastics pioneered and patented by Fiberfil. Only Fiberfil can give you complete technical data, practical experience and a full line of reinforced materials. Send for your free copy of the FRTP engineering manual. Fiberfil, Inc., Evansville, Indiana 47717.



Fiberglass Reinforced Thermoplastics[®]

... IBM's worst problems are with the software for the larger model machines ...

[Electronics, July 11, 1966, p. 129], the machine has been using a Cobol E compiler that is too slow. It should be using a Cobol F that is bigger and 10 times faster, but its delivery date slipped from June, 1966 to November, 1966 and last spring slid to December.

IBM's worst problems are with the software for the big model machines which are used primarily for scientific problem solving at sophisticated computer centers. Ironically, IBM was proudest of the large model system 360 machines when they were announced in April, 1964, because the company had been notoriously weak in that segment of the market. It is still too early to tell how much the software trouble has hurt IBM's efforts to cash in on this part of the market.

II. Other side of the coin

While manufacturers are having their own problems, the customers have introduced some unexpected ones. The user has not applied himself to the problem of operating the new system as well as he could have, some manufacturers say. The machine operator has been slow in conquering the manual tasks called for in the basic elements of the 360 operating system—and only these elements have been received.

These manual requirements are numerous and complicated. Also, the machine operator knows that when the operating system finally arrives, many of these chores will be handled automatically.

Another reason the user has not got as much out of the 360 as he might have is because he doesn't understand the software now available. For example, advanced software systems sometimes require so many control cards that the programmer has trouble deciding which to use. The programmer uses control cards, which are actually records on magnetic tapes or disks, to tell the software what language he is using, whether he wants to compile-and-run or just compile, and whatever else he expects of it.

Confused programmers have been known to specify too many control cards, producing an exception-

ally slow-running program full of error-tracing routines, most of which were meant to be used only for severe diagnostic difficulty.

III. IBM is not alone.

According to an official of a computer users' association, no computer manufacturer has put as much effort into developing software as he should have. Production techniques and quality control have not been maintained on software to the extent they have on manufacturing facilities.

Other computer manufacturers are sympathetic to IBM's problems because they are having their problems, too. Companies that have built computers compatible with the IBM 360 systems—Honeywell, Inc., for example—are facing the same problems as IBM. Usually, however, the situation is not as critical because the programs aren't as ambitious as those that IBM is attempting, and because the companies were more cautious in promising what the system would do.

One installation that has both an IBM 360 and a third-generation computer built by Control Data Corp. reports a lot of trouble with the 360 and very little with CDC's. The CDC computer compiles only Fortran and assembles programs in its own symbolic language. The IBM software is supposed to do both of these as well as accept other languages, sort data etc.

Competitors. Because their software is not as complex, IBM's competitors have not had the same horrendous problems. In addition, some competitors' third-generation machines remain compatible with their second generation rather than directly with the 360, and therefore avoid much of the software problem. An example is the Univac 1108, which is compatible with the Univac 1107. [Univac is a division of the Sperry Rand Corp.] But Univac is preparing a new 1108 operating system that may give it some of the kind of trouble that has plagued IBM.

IV. The outlook

It's clear that the problems with third-generation machines will be

solved; the only question is when. The manufacturers—notably IBM—whose software is late or deficient have massive efforts to deliver it or fix it. IBM, for example, has 16 system 360 computers of various models at its Poughkeepsie, N.Y. facility, solely checking out software.

Because of the critical needs of some users, however, IBM has overturned a long-time company precedent by releasing some software with restrictions until the final unrestricted program is ready. In June, it released a Fortran H compiler, designed for the largest models, with a long list which limited ways it can be used.

Software for IBM's smaller models of System 360, notably model 20 and 30, has been delivered and has worked well. Customers have received the rudimentary operating systems that run these small machines, the so-called basic operating system, disk operating system and tape operating system. A few users are staying away from the higher-level software systems, because the lower smaller systems work fairly well, even with their complicated manual controls.

Still others are modifying the available software themselves, rather than waiting for the manufacturer to deliver. This can be dangerous because the modified versions may not be compatible with the finalized manufacturer-supplied program.

Because of the tremendous costs of writing complex software—an IBM man estimates his company will spend 50% more on the software than it did developing hardware for system 360—manufacturers now have a greater appreciation for it. Some are even considering charging separately for it, allowing the customer to pick the best programs for his system and application.

Such a move might allow independent software companies to enjoy a more important role. Still, the ultimate design of software and hardware is based on a compromise to produce the lowest cost system. Nobody is willing to say that greater use of independent programming firms could have prevented the problems computer users ran into when they switched to third-generation machines.

MOL Resistors

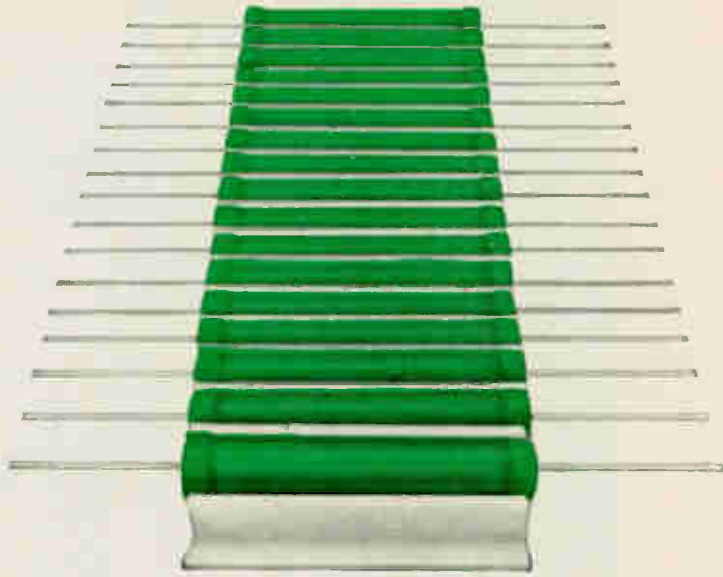

PROMPT DELIVERY

...is one reason why all major TV manufacturers use Mallory MOL film resistors.

Other reasons? Temperature coefficient only 250 PPM/°C; proved flame resistance; high stability in humidity; less than 5% resistance change after 10,000-hour load-life test. Write for data and quotation. Mallory Controls Company, a division of P. R. Mallory & Co. Inc., Frankfort, Indiana 46041.

50th
ANNIVERSARY

MALLORY

PRESS!



READ!



SPEED TESTING & INCREASE PRODUCTION OUTPUT

New hp Model 155A/1550A Push-Button, Programmable Oscilloscope

Speed production line testing of circuits and components with an easy, fast press / read on the new hp Model 155A/1550A Push-Button Programmable Oscilloscope! This 5 mv/cm, 25 MHz scope—the first designed specifically for production and automatic systems applications—increases production output by reducing test time per unit, simplifying test procedures, minimizing operator errors and fatigue, and shortening training time.

You can insert up to 18 test programs in each 1550A digital programmer, or cascade programmers for additional capability. Each test program can control any or all major scope functions—including calibrated vertical positioning, sensitivity, input coupling, sweep time, trigger source, and trigger slope. Change test programs in only a few minutes by changing diode pin settings or by interchanging programmers. Diode-controlled, digital programming makes the 155A / 1550A fully compatible with any contact-closure-to-ground programmer for high speed, automatic check-out systems.

Confidence in measurements is substantially increased because the unique DC stabilizer circuitry eliminates DC drift. The trace stays where it is positioned, regardless of

sensitivity or sweep. Calibrated vertical positioning over ± 25 cm dynamic range allows waveform to be accurately offset, magnified, and viewed in detail. Magnification with accurate offset gives big display for ease of reading and greater accuracy.

Confidence in test results is increased by push-button programming because it makes complex tests easier to make. Tests are complete—you have full confidence that you are shipping only good units and rejecting only bad units.

Find out how the new hp Model 155A/1550A Push-Button, Programmable Oscilloscope can increase your production output. Call your nearest hp sales office for a demonstration. Or, write to Hewlett-Packard, Palo Alto, California 94304, Tel. (415) 326-7000; Europe: 54 Route des Acacias, Geneva. Price: hp Model 155A Oscilloscope, \$2450.00; hp Model 1550A Programmer, \$600.00, f.o.b. factory.

HEWLETT  **PACKARD**
An extra measure of quality

Open and shut case

Camera makers turn to electronic shutters to hold their positions in highly competitive market for "point-push" models

George Eastman started it all before the turn of the century when he captured a mass market for his film-loaded Kodak camera with the slogan, "You push the button—we do the rest." Ever since, competition among camera makers has centered around making picture-taking a snap.

Electronic shutters now seem poised to snap up a substantial share of this highly competitive "point-push" camera market. Already five Japanese camera makers—including household names like Canon, Yashica and Minolta—have transistor cameras on the market. They retail for \$100 to \$125 in New York City, a price bracket for the serious, but not addicted, amateur.

Two, possibly three, more camera makers will have models with electronic shutters ready for a debut at the Photokina trade fair this October at Cologne, West Germany. As a result, shutter makers now say that models with electronic shutters will account for at least 40% of Japanese camera production by the end of the year. Right now, the figure is 20% of the 250,000 cameras turned out in the country each month.

Bandwagon. Now that the Japanese have gone to market in a big

way with electronic shutters, American and West German producers will be forced to follow suit. For the moment, the only American camera company on the market with an electronic shutter is the Polaroid Corp. Polaroid has had a two-transistor shutter for three years now but with its developed-in-the-camera film pack, Polaroid is a special case. The Eastman Kodak Co., the dominant U.S. camera maker, won't disclose its plans for electronic shutters. But it's a safe bet Kodak is keeping close watch on the competition. West German producers expect they'll be on the bandwagon within two years. Leaning on a camera display counter surrounded by a half-dozen Japanese transistor-shutter models, a camera expert at a bustling New York photo retailing shop says, "Every one will have them in the next two years."

With their share of the still-camera market on the verge of zooming, Japanese electronic shutter makers have set their sights on another mass market—home movie cameras. Electronic shutters for movie cameras, though, are trickier than still-camera shutters. For aperture control on a movie camera, a servo system is required. One Japanese

shutter maker, Copal Co., has a transistorized servosystem almost ready to go.

For the pros. Electronic shutters, too, are finding a place in the professional camera market. Two West German companies currently offer shutters for studio and press cameras. These shutters, without photocells, are at best distant cousins to the "push-point" versions. Their chief advantage is precise timing over a long life; mechanical shutter controls lose their precision as they wear.

Compur Werk GmbH, for example, has a remote-controlled shutter for studio cameras that sets aperture over a range of $f/4$ to $f/90$ and speed from $1/60$ to 32 seconds. The electronics are housed in a pocket-radio-size unit connected by cable to the camera. A two-transistor timing circuit actuates shutter magnets that open and close the blades. Diaphragm adjustment is handled by a small servomotor. Compur also produces a speed-only shutter with the electronics in the shutter mount; so does Pronto-Werk (Alfred Gauthier) GmbH.

Sturdier eye. The electronic shutters going into amateur cameras are replacing the so-called electric-eye



From New York to Tokyo, camera buyers are snapping up cameras with transistor timing circuits in the shutter.

shutters that in recent years have dominated the medium-price camera market. In the electric-eye shutter, the photocell output drives a small galvanometer inside the camera. When the shutter button is pushed, the galvanometer needle is clamped and a stepped cam rotated against it. The cam travel sets the shutter speed according to the incident light on the photocell.

This electromechanical system has a serious drawback—the delicate galvanometer. A small shock can knock the galvanometer pivots out of their bearings. Then, too, the galvanometer deteriorates with age. Most of the servicing problems for an electric-eye camera stem from the galvanometer.

Electronic shutters eliminate delicate galvanometers by means of transistor timing circuits. Basically, the photocell output charges a capacitor in a transistor switching circuit. When the capacitor charge reaches a preset value, the circuit switches to release the shutter. In the actual shutter circuits, though, refinements make operation as fool-proof as possible.

I. Half-dozen

The most sophisticated electronic shutter for amateur cameras now on the market is a six-transistor unit manufactured by Seiko-K. Hattori and Co. It turns up on cameras made by Canon Camera Co., Minolta Camera Co., Olympus Optical Co., and Ricoh Co. This shutter

varies both aperture and exposure time automatically according to the incident light. The range runs from 1/30 second at f/2 to 1/500 second at f/16.

The six transistors in the circuit (see diagram) are split up into two similar circuits, each made up of a two-transistor Schmitt trigger coupled to a single-transistor output stage. One circuit warns the photographer when there's not enough light to take a satisfactory picture. The second three-transistor circuit drives a solenoid that closes the shutter at the right instant.

Guiding light. In the warning circuit, the cadmium sulfide photocell is switched onto the trigger circuit (Q_4 and Q_5) by switch S_1 when the shutter button starts down. If there's too little light, resistance of the cell will be high and the voltage drop across it will switch the Schmitt trigger to turn on transistor Q_6 and light the warning lamp L .

If the light doesn't go on, depressing the shutter button further throws switch S_2 to the timing position. At the same time, switch S_3 closes to energize solenoid M_1 ; it opens the shutter to the smallest aperture, and also holds S_3 closed. A mechanical governor then gradually opens the camera's combination shutter-iris until solenoid M_2 snaps it closed.

Transistor Q_3 controls the shutter-closing solenoid. The second Schmitt trigger (Q_1 and Q_2) turns

on this stage. The trigger switches when the photocell current charges capacitor C . For flash shots, a variable resistor R_1 sets the aperture-speed combination to match the exposure guide number.

Protected. Diodes D_1 and D_2 route current from the photocell to the Schmitt trigger in use. Diode D_3 protects the shutter from damage should the camera user push the shutter button all the way down in darkness. The diode provides a current path that charges capacitor C to reclose the shutter immediately when there's no photocell output.

The shutter circuitry also includes a battery-check switch (S_4). It applies an input to the warning-lamp Schmitt trigger through resistor R_2 . If the battery is good, the trigger switches and the warning lamp lights.

II. Quartet

Seiko's shutter is geared for the amateur who is content to let the camera do the rest after he's pushed the shutter button. For the more sophisticated amateur who wants to select his own aperture and thus control depth of field, Copal Co. offers a four-transistor shutter that automatically matches exposures to light conditions, film speed and aperture. Yashica and Olympus both have cameras with this shutter on the market; three other companies are negotiating with Copal to buy its shutter.

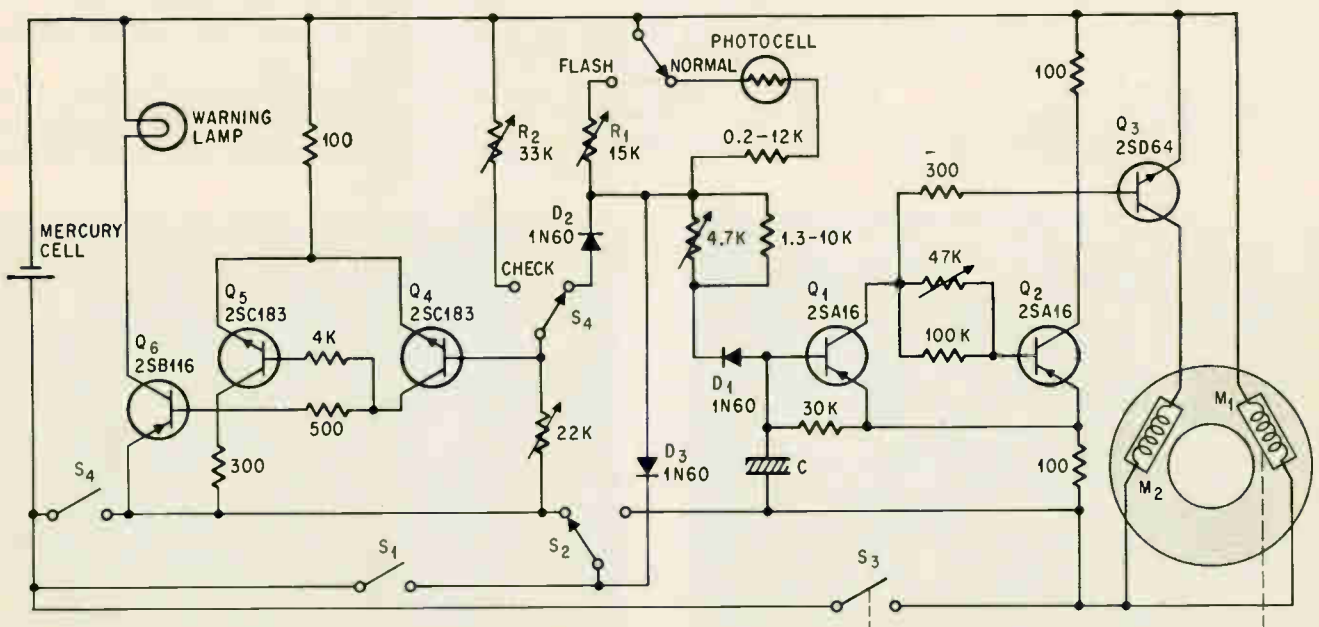

Seiko shutter circuit has six transistors. Practically all components are tucked inside shutter mount.

Copal's circuit adds up to a four-stage, direct-coupled transistor amplifier with the first three stages normally off. As soon as the shutter button is pressed, the fourth-stage turns on and powers a solenoid latch that holds the shutter open against the force of a spring.

The first stage is held off with bias across a voltage divider, which matches the shutter circuit to the aperture. A cadmium sulfide cell charges a capacitor in the first-stage input circuit; when the charge equals the hold-off voltage, the first stage conducts. It turns on stage two, which turns on stage three, which then turns off stage four to de-energize the solenoid latch.

Warning. The Copal shutter has a maximum speed of 1/500 second, meaning overexposure is possible when there's too much light and aperture. An overexposure check switch cuts out the input-circuit capacitor and cuts in a calibrated resistor in its place. If the light level is too high, the first stage turns on and the fourth stage turns off. When it does, a capacitor in the overexposure warning lamp circuit discharges to make the lamp glow.

At the slower end of the shutter-speed range, exposures run up to two minutes. To warn the user not to try to hand-hold the camera when the exposure will be longer than 1/30 second, there's also a long-exposure check circuit. Like the overexposure check, it works by switching in a calibrated resistor in place of the input-circuit capacitor.

III. On the move.

Neither of the shutters now on the market gives the user a chance to preset shutter speed for stopping fast motion. But Copal has in the works a five-transistor shutter that can handle either preset speed or preset aperture.

For preset aperture, the circuit works much the same as Copal's present shutter although there are only three stages because higher-gain transistors are used. For preset speed, the first two stages control a pair of emitter followers that drive a small servo motor.

Copal also has well along in development a simple servo system that would drive the aperture ring of a movie camera through 100 degrees of rotation to match the iris opening to the lighting.



Dr. Milton B. Dobrin, United Geophysical Corporation, Pasadena, demonstrates optical filtering technique used to enhance seismic data.

Laser helps seismic prospectors dig deeper

There's a vast fortune in oil to be found on seismic charts already recorded, from fields already explored. The trick is in enhancing the seismic data, in separating the significant information from noise, surface waves, diffractions, and other spurious events which obscure desired reflections. You can do it, if you can afford it and have the patience, with standard analog and digital processing methods. But if you want to dig deeper, processing hundreds of data channels at a time and monitoring the results at all stages, there's now another way to look at your data.

A new technique¹, called Laserscan², processes seismic data using optical filtering methods. When spatially coherent light is passed through a seismic "section" on photographic film, the seismic signals act as an optical grating to produce a diffraction pattern. By "doctoring" the diffraction pattern, then converting it back into an image of the original section, it is possible to remove unwanted frequency or directional components. Key to the success of the method is the intense, spatially coherent monochromatic light from a Spectra-Physics CW gas laser.

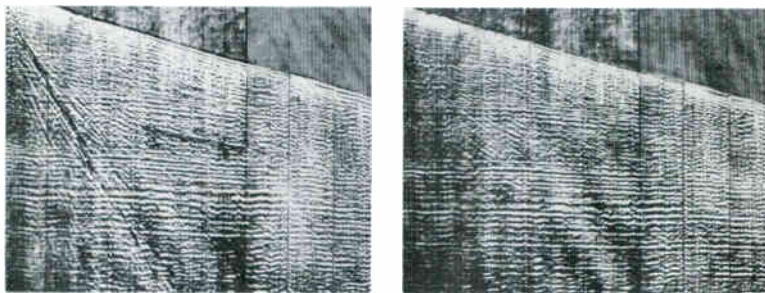

Seismic sections showing (left) reflections crossed by high-velocity and low-velocity noise, and (right) same section with high- and low-velocity events removed by optical filtering.

Similar optical data processing methods enable the removal of raster lines from televised photos, for example, or the subtraction of interference and noise to improve visual display of low-level signals. Whether you are prospecting for oil or ideas, it may pay you to investigate other ways in which the CW gas laser has found commercial application. If you'd like to be on our mailing list to receive Laser Technical Bulletins, write us at 1255 Terra Bella Avenue, Mountain View, Calif. 94040. In Europe, Spectra-Physics, S.A., Chemin de Somais 14, Pully, Switzerland.



Spectra-Physics

¹MILTON B. DOBRIN, ARTHUR L. INGALLS, AND JAMES A. LONG, 1965, VELOCITY AND FREQUENCY FILTERING OF SEISMIC DATA USING LASER LIGHT: GEOPHYSICS V, 30, PP. 1148-1178.

²TRADE MARK, CONDUCTRON CORPORATION



**The 766 HF simulates
a dual-beam scope
at a single-beam price.**

**It's a 100 MHz scope
with 100 mV/div sensitivity,
(10 mV at 90 MHz)
6 by 10 cm scan,
13 kV HV,
and algebraic add.**

**It operates in
12 different modes
on a single time base,
without changing plug-ins.**

What more can you ask for?

Our data sheet.

FAIRCHILD
INSTRUMENTATION

Do you qualify for this prize?

Our new FX-18 Core Memory isn't for everyone. It's for the systems designer who needs 200,000 to 2,000,000 bits of storage—too little for a full scale mass memory, yet too much to justify the cost of stringing a flock of small units together. If you're in this select group, your prize can be a saving of up to 30% on your memory system costs.

Storage capacity of the FX-18 is 16K words x 32 bits and it's a true 16K four area format, not a patchwork of 4K word modules. This permits significant improvements in signal-to-noise ratio over that

available with conventional single area techniques used in 4K systems. Full cycle time for the system is 8 microseconds; $\frac{1}{2}$ cycle time is 5 microseconds. Access time is less than 4 microseconds. Included as standard on the FX-18 are both the address and data registers, logic and drive power supplies, also timing and control logic. Optional features provide a wide variety of address and operating modes for optimum flexibility.

We call the FX-18 a "small" mass memory because it fills the gap between the standard 4 thousand word units and large mass memories of 5 million bits or more. But here's the clincher. It's available at mass memory prices, between 3 cents and 4 cents per bit, and you don't have to buy 5 million bits worth.

If you've been intrigued by mass memory prices, but don't need the large capacity required to get the price down, then you qualify for the FX-18. Write for Bulletin 1087.

Ferroxcube 

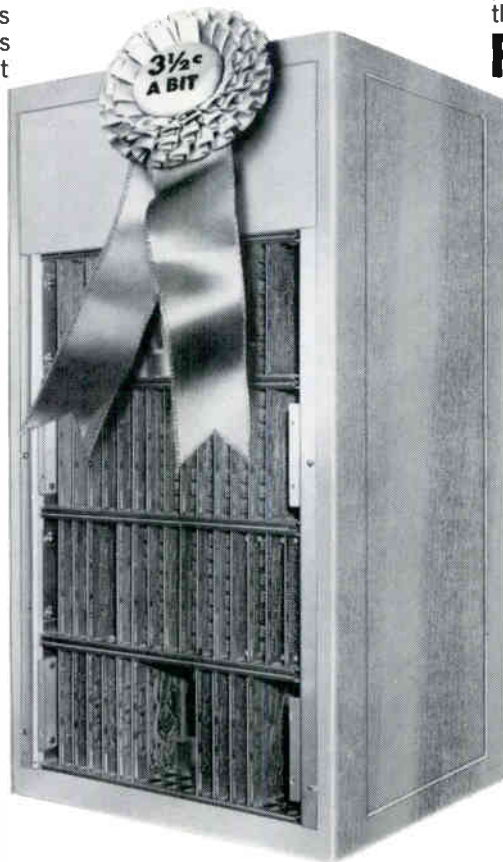

FERROXCUBE
CORPORATION
OF AMERICA
Systems Division
5455 S. Valentia Way
Englewood, Colorado
303-771-2000

Boston
617-889-3110

Chicago
312-281-7880

Dallas
214-255-0441

Los Angeles
213-837-1484

Minneapolis
612-888-4881

New York Area
201-287-5888

Phoenix
802-265-1792

Philadelphia
215-687-4885

Washington, D.C.
703-893-4900

CRT Character Generator

Many modern information handling systems include a cathode ray tube display. We have built a numeric character generator at our Application Laboratories at Fairchild, to demonstrate the economy of using integrated circuits, both linear and digital, in such an application. While the unit we built displays numbers only, the same basic principles would apply to larger character generators capable of any kind of graphic display.

DESCRIPTION: Numbers are entered through an adding machine type keyboard, encoded in 1-2-4-8 BCD, and held in a "Load" register. The keyboard is also used to address any desired memory location, and to backspace if errors are made in entering numbers. When an address is entered, it is held in an address register until the coincidence circuit finds the desired memory location, at which time the number in the Load register is placed in memory. The address register is automatically incremented by one each time a number is entered unless a backspace signal is given, or a new address is entered.

The memory holds up to 64 characters, 256 bits total. It recirculates at a rate of 4KHz, so that each character is refreshed more than 60 times a second — fast enough to eliminate any character jitter.

Numerals are derived by feeding the system clock (a free-running multivibrator at 32KHz) through a mod 8

counter, to generate 8 segments of a figure 8 pattern. The segments go through a decoder into a blanking circuit. This circuit receives a character (4 bits) from memory, and blanks appropriate segments of the figure 8 to arrive at the desired configuration for display. To control the position of the displayed character on the CRT, the output of the mod 8 counter is also directed into a mod 16 and a mod 4 counter. The output of these counters produces a 16 step X staircase, and a 4 step Y staircase. The X and Y go through a digital to analog converter, where they are mixed and used to control the deflection amplifier. (Send for circuit note RTL1 describing counter circuits.)

All circuitry, including memory, is contained on 6 printed circuit boards. Four identical boards, approximately 4.5" x 5", are used for the memory, each board containing 64 bits. The logic controlling the figure 8 pattern, the blanking, and the staircases, consists of 44 integrated circuits and takes up one of the remaining printed circuit cards. The sixth card contains the memory loading and addressing circuitry for which another 51 integrated circuits were used. In all, the unit utilizes 95 integrated circuits (exclusive of memory) compared to approximately 2000 discrete components which would be required to build a similar unit.



Logic board with counters, blanking and D-to-A conversion circuitry.

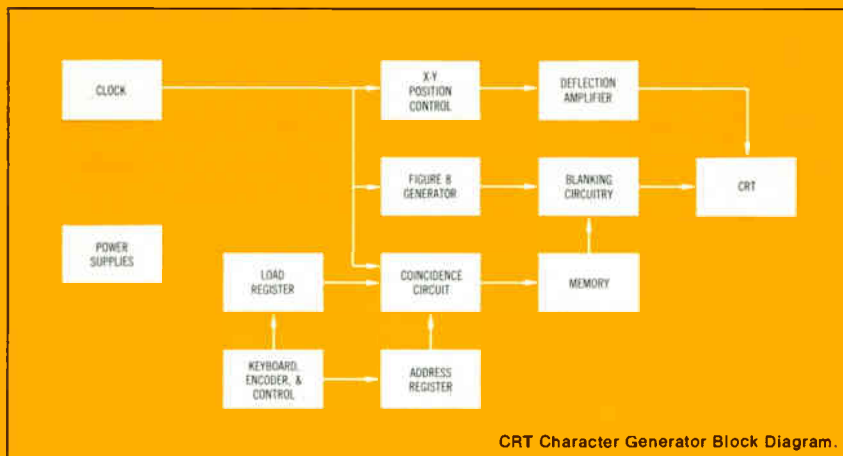

CRT Character Generator Block Diagram.



CASE HISTORY: A system using Fairchild integrated circuits for character display on a CRT is now on the market. The system is called the S-C 1100 and is manufactured by the Data Products Division of Stromberg-Carlson Corporation in San Diego. System S-C 1100 consists of interrogator stations linked through a control unit to a remote computer. Operators can address the computer's memory to retrieve data which is then displayed on the CRT. The system has full alphanumeric capabilities and is presently in use by major companies in such applications as answering customer inquiries, inventory control, purchasing, and billing procedures. Interrogating units use a standard typewriter keyboard with minor modifications, and require no special training to operate. Each unit requires 2000 Fairchild RT μ L circuits, 915 and 927, to replace more than 20,000 discrete components.

FAIRCHILD
SEMICONDUCTOR



of a series

The Switch to IC's:

Fact or Fad?

IC'S ARE HERE TO STAY: Recently a major manufacturer of consumer electronics announced the first television set using integrated circuits. The industry had not expected this development until about 1970.

This is characteristic of the speed and extent of the switch to integrated circuits in the electronics and electro-mechanical equipment industries. But the very speed of the switch has caused some design engineers to delay the usage of integrated circuits in their equipment. They are afraid of getting caught in a fad, and reason that better integrated circuits may be just around the corner. So why switch now? This line of reasoning overlooks several good bets.

GET STARTED NOW: The advantages of switching to integrated circuits are inherent in the components themselves, and are independent of the type of integrated circuit you use. Regardless of which logic family you choose, you are bound to reduce your component count by a factor of ten or more. This means fewer boards to assemble, inspect, and test. Consequently your production costs are lower. Fewer components also mean fewer interconnections and higher reliability. It is also cheaper to design with integrated circuits, because of the modular, building block nature of the components. There is little question that the use of integrated circuits results in a smaller, better product which costs less to make.

WHAT ABOUT PERFORMANCE? The only difference between one integrated circuit family and another is in performance. But if you compare the actual performance characteristics of an industrial integrated circuit family, such as Fairchild RT μ L, to the characteristics of some newly announced logic family, you will make two interesting discoveries. First, you will find that RT μ L performance is more than adequate for any industrial or commercial application. Second, you will discover that the differences in performance between the two families are so small as to render them insignificant in industrial and commercial applications. Even if we were to assume that some new logic family with better performance characteristics will be announced shortly, it would take at least two years before it is as readily available as Fairchild RT μ L, and before it compares with it in price. Finally, once you make the switch to integrated circuits, any integrated circuits, it is very easy to change to a different logic family.

HOW TO GET STARTED: On the reverse side you will find an application story and information on one type of IC usage. We will publish others in the coming months. But don't wait till we get to the one you're interested in. Let us know what you're working on. We'll respond fast with information, application notes, data sheets, and other design assistance. Just drop us a card.

(See reverse side)



Technical achievement for you... better living for you and your family

We are particularly anxious to meet you if you are a Circuit Design Engineer; Packaging and Mechanical Engineer; Electron Optics, Vacuum Technology or Materials and Process Specialist. But whatever your technical strengths, if "roll-up-the-sleeves" engineering appeals to you, we'd like to hear from you.

Here you'll find an environment that emphasizes the individual, and his personal contribution to technical development—contribution by working on projects, not writing about them. Your work will benefit advanced engineering throughout the world. You will benefit from technical association with specialists experienced in developing state-of-the-art instrumentation, components and devices.

All Tektronix R & D—financed entirely from our annual sales of over \$100 million—is directed toward *commercial* products. Our community is prosperous, balanced, with a stability of employment not typical of every industrial center. And as for the Green Land we live in—it speaks for itself.

If you're seeking technical advancement and better living for you *and* your family, why not investigate Tektronix?

Write to D. A. Thompson, Tektronix, Inc., P. O. Box 500D, Beaverton, Oregon 97005, or send in the coupon.

.....

Professional Placement Mgr., Tektronix, Inc.
P. O. Box 500D, Beaverton, Oregon 97005.

Please send me your Booklet, "Tektronix" Application Form

NAME: _____

ADDRESS: _____

CITY: _____ STATE: _____

I am interested in: _____

Tektronix, Inc.

An Equal Opportunity Employer.

.....



Three new 400-volt silicon power transistors for military duty:



HUT



TWO



THREE

They're designed for high efficiency inverters, voltage and current regulators, control and switching circuits and high-power communications where extreme reliability is required.

DTS-423M is a NPN 3.5-amp 400-volt device in a TO-3 package, offering high sustaining voltage capability.

DTS-431M is a NPN 5-amp 400-volt device in a TO-3 package, offering higher gain and lower saturation resistance.

DTS-2N2580M is a NPN 10-amp 400-volt device in a TO-36 package for extra high power applications. Specifications on all three devices are based on full

mil-type environmental tests performed in an approved military qualification test lab.

Check with our nearest sales office or Delco Radio Distributor for full details.

TYPE	V _{CEO}	V _{CB0}	V _{CEO} (sus)	I _C	I _B	hFE V _{CE} =5V @ I _C	R(sat) Max @ I _C	Power Diss Max
DTS-423M	400V	400V	325V (min)	3.5A	2.0A	10 @ 2.5A	0.8 ohm @ 1.0A	100W
DTS-431M	400V	400V	325V (min)	5.0A	2.0A	10 @ 3.5A	0.28 ohm @ 2.5A	125W
DTS-2N2580M	400V	400V	325V (min)	10.0A	2.0A	4 @ 10.0A	0.14 ohm @ 5.0A	150W

SEE YOU AT WESCON, BOOTHS 1503-4, SPORTS ARENA

**FIELD
SALES
OFFICES**

UNION, NEW JERSEY*
Box 1018 Chestnut Station
(201) 687-3770
SYRACUSE, NEW YORK
1054 James Street
(315) 472-2668

DETROIT, MICHIGAN
57 Harper Avenue
(313) 873-6560
CHICAGO, ILLINOIS*
5151 N. Harlem Avenue
(312) 775-5411

SANTA MONICA, CALIFORNIA*
726 Santa Monica Blvd.
(213) 870-8807
General Sales Office:
700 E. Firmin, Kokomo, Ind.
(317) 459-2175

*Office includes field lab and resident engineer for applications assistance.

DELCO RADIO 

Division of General Motors
Kokomo, Indiana

The future

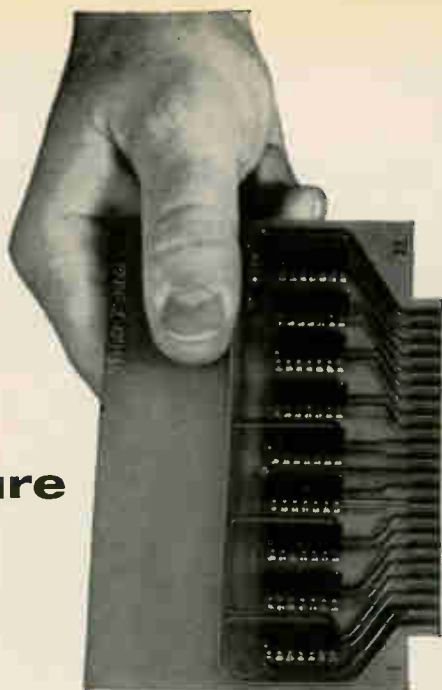

is in these cards

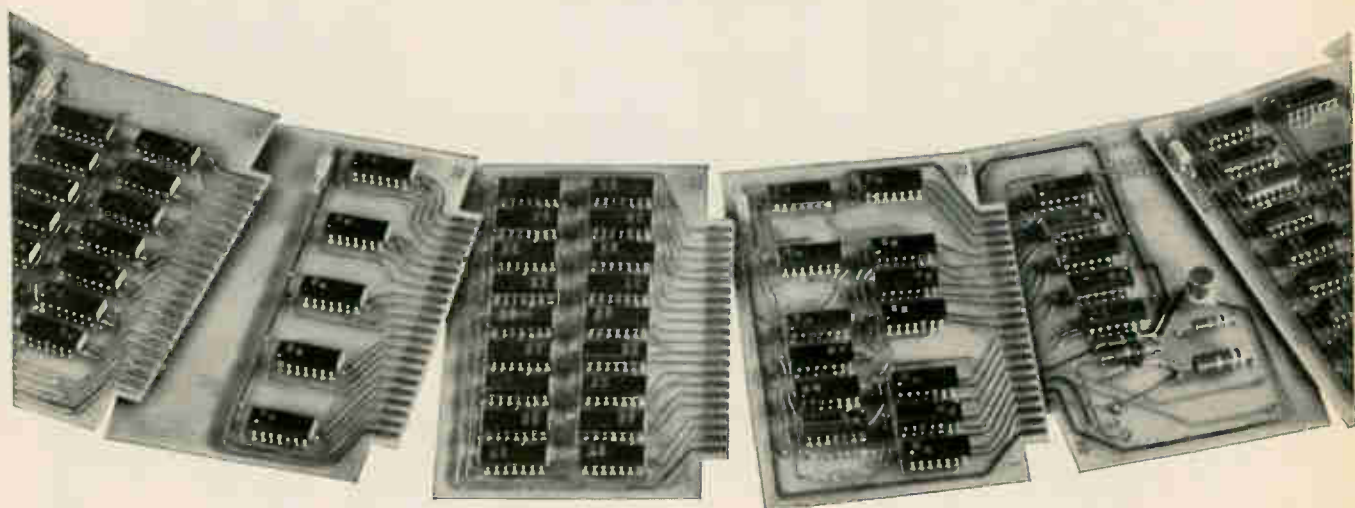

The cards of the future are Vitro Microcircuit Building Blocks. Let Vitro stack them in your favor by updating your systems utilizing the latest integrated circuit systems techniques.



The Event Control Sequencer, Model 3219, is representative of the advanced equipment designed by Vitro, West Orange, where your problems in reliable data handling, timing and control can be solved by the use of microcircuits.

For application data, write: George C. Regan, Vitro Laboratories, 200 Pleasant Valley Way, West Orange, New Jersey 07052

VITRO CORPORATION OF AMERICA
90 Park Avenue, New York, New York 10016



From CEI . . . a New Family of Pre-Tuned, Crystal-Controlled

Pulse and AM Receivers

• 4 AM AND 4 PULSE MODELS • COVER 60 MHz TO 150 MHz • COMPACT, ALL SOLID STATE



TYPE 415 AM RECEIVER

TYPE 416 PULSE RECEIVER

Introducing two new series of top-performing CEI receivers . . . the Type 415 for AM and Type 416 for Pulse reception. Both series cover the 60-150 MHz range using standard tuners.

Each receiver is a completely transistorized, fixed-tuned unit allowing the selection of any of four preset channels within its frequency range (see table at right for ranges of individual receivers). The four channels are factory-set to your requirements and may be easily and swiftly reset, when necessary, by field maintenance personnel.

The AM units are available with a choice of 50 or 100 kHz bandwidth. Compact and lightweight, all these receivers offer high sensitivity and reliability and require very little power—just 3½ watts.

Signal monitor outputs of 21.4 MHz have been provided, and a matching signal monitor (CEI Type SM-4301) may be mounted alongside one or more of the receivers to provide a visual display around the tuned frequency.

Special rack-mount equipment frames are also available, designed to accommodate two, three or four of the Type 415, 416, and/or SM-4301 units.



RACK-MOUNTS & SIGNAL MONITOR AVAILABLE—

Shown here is a Type 416 Pulse receiver and matching Type SM-4301 signal monitor in an EF-402 equipment frame. Equipment frames are available to mount two, three or four units.

Table of Standard Tuning Ranges
(other frequency combinations on request)

Receiver Type	Overall Frequency Range (MHz)	Band A Frequency Range (MHz)	Band B Frequency Range (MHz)
415-1	60-90	60-75	75-90
415-2	75-110	75-90	90-110
415-3	90-130	90-105	105-130
415-4	110-150	110-125	125-150



For complete information and specifications, please contact:
COMMUNICATION ELECTRONICS INCORPORATED

6006 Executive Blvd., Rockville, Md. 20852 · Phone: (301) 933-2800 · TWX: 710-824-9603

GROW WEST!

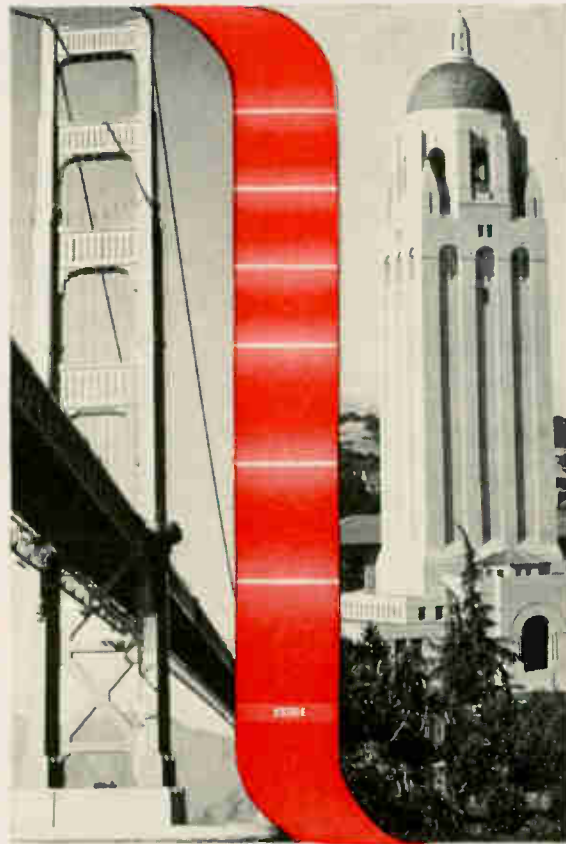

The Complete Communications Spectrum at Sylvania Electronic Systems-West



Career growth depends on opportunity, and at Sylvania Electronic Systems-West, there's the opportunity to lead — not merely match — the state of the communications art. A complete spectrum of career choice, promotion, education and personal achievement is available here:

- ■ Select your path of professional advancement, either as a senior scientist, scientist/engineer specialist, senior/development engineer, or as a technical manager. Salary levels are equivalent, and promotion from within is the rule.
- ■ Your education can continue with company support at nearby educational institutions — Stanford, University of California (Berkeley), University of Santa Clara, and San Jose State College. In addition, Sylvania has a special employment-education Honors Program with Stanford.
- ■ Live in suburban San Francisco, where climate and culture combine for the full life.

If you are seeking professional growth and personal satisfaction why not investigate the many job opportunities at Sylvania-West — working on the most advanced electronic research and development projects. We have same opportunities at our other major centers too — in suburban Boston and Buffalo. Send your resume in confidence to: Manager, Professional Staffing, Sylvania Electronic Systems, Division of Sylvania Electric Products Inc., 58 Sylvan Road, Waltham, Mass. 02154.



GT&E

GENERAL TELEPHONE & ELECTRONICS
Total Communications from a single source through

SYLVANIA ELECTRONIC SYSTEMS

RESEARCH • SYSTEMS DEVELOPMENT • PRODUCT & FIELD ENGINEERING

An equal opportunity employer

The complete spectrum of opportunity — job diversification, geographic location, professional satisfaction — is awaiting you at Sylvania Electronic Systems.

AIRPAX is in production of the **UGON** Relay at the Cambridge Division

By arrangement with Le Prototype Mécanique of L'Étang-La-Ville, France, Airpax introduced the Ugon relay in the United States in mid-1965. With immediate customer acceptance and increased demands during the year, these precision relays are now in full production at the Cambridge, Maryland plant.

UGON-3
Sensitivity, 5 mw
Volume, 2 cubic cm



UGON MICRO
Volume, 1 cubic cm



UGON-7
Insulation Resistance,
> 10⁸ megohms
Capacity, < 1 picofarad

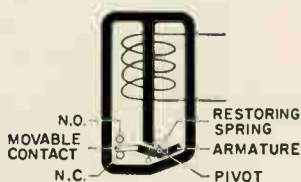

UGON
Magnetic Circuit

The UGON relay has an extremely high sensitivity due to the uniquely high efficiency of the magnetic circuit. Extreme resistance to shock and vibration is also provided by the rotating armature, which is statically balanced and magnetically balanced.

This is a uniquely different precision non-polarized relay with some remarkable qualities.

SENSITIVE

The UGON relay appears to be the smallest non-polarized sensitive — or the most sensitive small — relay in the world. The unique mechanism was invented in France and patented in the United States by Pierre Ugon. The operating power demand can be 5 milliwatts, or 200 MICROAMPS at 25 volts!

METERING

The entire UGON series of relays are precision instruments. The operate current is adjusted to a 5% tolerance, and this is maintained for the relay life, and during extremes of temperature and other environment change. In like manner, the release current is also held precisely, usually at 70% of operate. Thus, this is a measuring instrument.

MINIATURE

The UGON-3 standard has a volume of 2 cubic centimeters, and in this volume a coil resistance as high as 60,000 ohms is a practical reality. The small UGON MICRO size has a volume of about one cubic centimeter, and is arranged for printed circuit board assembly. The contacts are rated up to 700 ma and 50 V DC maximum with a 15-watt product, a practical power gain of 3000.

HIGH SPEED

The UGON relay is fast in spite of the extreme sensitivity. It can readily be driven up to an operate time of 1/2 millisecond, and is only a few milliseconds, even near the operating threshold. This presents a favorable comparison with the average sensitive relay, which is likely to require 50 to 100 milliseconds. On AC the relay doubles frequency, and will follow a driving signal to above 800 cycles.



Phone 301—228-4600

TWX 301—228-3558

CAMBRIDGE DIVISION • CAMBRIDGE, MARYLAND

Flatpacks fried in peanut oil

To solder groups of small flatpacks to printed circuit boards, a Texas firm dips entire assembly into hot oil

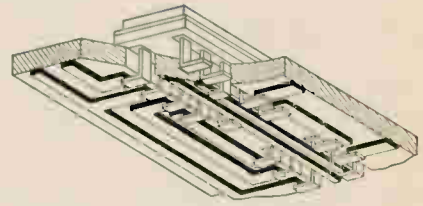
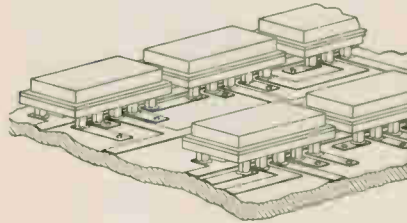
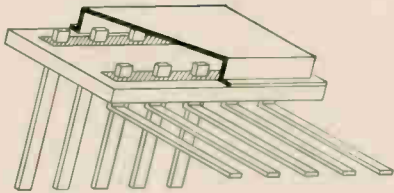

BUTT-SOLDER MOUNTING

THROUGH-BOARD MOUNTING

Axial leads of flatpacks can be bent for planar mounting (left), cut for butt soldering or plugged into circuit boards.

There's a new brand roaming the integrated circuit country west of Dallas—the Flying L Corp. of Saginaw, Texas. Its first product is an integrated circuit flatpack that may prompt systems manufacturers to trade in their soldering irons for peanut oil.

The flatpacks, as small as $\frac{1}{8}$ by $\frac{1}{4}$ inch, can be soldered en masse to printed-circuit boards by dunking an entire assembly into hot oil. Most systems manufacturers have been soldering or welding flatpack leads one at a time, or turning to large plug-in packages to avoid flatpack-assembly costs [Electronics, Nov. 1, 1965, p. 75]. "Peanut oil is the way to go," says Robert Lomerson, who founded Flying L with his brother William. He says that the Autonetics division of North American Aviation, Inc., TRW, Inc., and Ling-Temco-Vought, Inc., are among manufacturers who became interested in the design after seeing prototypes.

The Lomersons contend that their packages are more effective than the large dual in-line type for mass assembly, besides being far smaller. Because dimensional control is tight, about 1 mil (0.001 inch), automatic assembly machines can handle the new packages easily, the brothers say. Cutting or bending leads provides the standoffs needed for mass soldering and for running printed wiring under the packages. If the leads are plugged in, plated-through holes are not needed for soldering. The

leads can also be welded—that was checked out at the Hughes Aircraft Co., they add.

The flatpacks are called Axpaks because they have axial leads. But the leads can be bent into a radial configuration, as shown, so they can be used as conventional flatpacks for planar mounting. Sizes range from the $\frac{1}{8}$ -by $\frac{1}{4}$ -inch model costing 44 cents (this is expected to drop to 20 cents by late 1966) to inch square, 64-lead types that cost \$4.50 and can be used for complex circuits and monolithic arrays. Lead spacing is generally the standard 50 mils, but the Lomersons plan to produce types with 25-mil spacing.

Bending the leads doesn't stress the seals, Robert Lomerson says. The lead seals are made by fusing clear glass (7052) into slots in the package base, so the seals are encompassed by the base material. The base is generally gold-plated Kovar, but can be ceramic. Kovar is also used for the leads and the lid, which is resistance welded to

the base after an IC is mounted on the base, by the technique used to seal TO-5 cans. The seals are so strong, he says, that one prototype carried in his wallet for a year is undamaged and that packages can be heated to 500°C and plunged in cold water without breaking.

The preferred assembly configuration is butt soldering in oil or hot gas. The leads are cut short and lapped square with tooling plates. Then all the packages for a circuit-board assembly are positioned on the board with a punched-out positioning jig on top of the board and a magnetic sheet under the board. The soldering pads on the board are pretinned with solder. A hot peanut oil bath—chosen because it is harmless and easily cleaned off the assembly—reflows the solder and fuses the leads to the pads.

Trials indicate that leads spaced as closely as 25 mils can be soldered with oil without solder bridging between leads. This means that flatpacks with 14 leads can be made as small as 8-lead flatpacks.

The other assemblies illustrated are made by putting the leads into slots in the board and clinching them to the underside of the board before soldering. Pockets cut into the top of the board make positioning fixtures unnecessary; two such assemblies can be cooled by a heat-sink plate between the two boards.

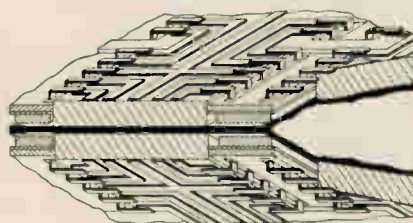

POCKET MOUNTING (DOUBLE SIDED)

Pockets cut into the circuit board eliminate the need for positioning fixtures.

Flying L Corp., 100 S. Saginaw Blvd., Saginaw, Texas 76079
Circle 350 on reader service card

Bulova can supply the crystal you need



to match your specs!

Many years of supplying crystal control units for the most advanced military and space programs enable Bulova to offer a full line encompassing virtually the entire frequency spectrum—2 kc to 125 Mc for oscillator and filter applications. We can supply every type of packaging—including koldweld and glass sealed. Our military crystals meet latest MIL-C-3098D specifications. All reasons why you should make Bulova your single source of supply.

HIGH PRECISION GLASS SEALED CRYSTALS 1 Mc to 125Mc. Available in vacuum sealed, glass enclosures of the HC-26/U and HC-27/U type.

Example: Precision SSB Crystals

Frequency: 1 Mc to 5 Mc
Holder: HC-27/U
Tolerance: $\pm .0025\%$ from -55°C to $+90^{\circ}\text{C}$, or to specification
Aging: 3×10^{-8} per week after one week stabilization at 75°C



KOLDWELD SEALED CRYSTALS—low aging, high reliability, 1 Mc to 125 Mc. Now available in TO-5, HC-6/U and HC-18/U type cans sealed by the koldweld process to eliminate effects of heat and to reduce contamination.

Example: TO-5

Frequency: 15 Mc to 125 Mc
Tolerance: $\pm .0025\%$ from -55°C to $+105^{\circ}\text{C}$, or to specification
Aging: 1×10^{-7} per week after one week stabilization at 75°C



Write or call for specifications on Bulova's complete line of crystals. Address: Dept. E-17,

BULOVA

FREQUENCY CONTROL PRODUCTS

ELECTRONICS DIVISION OF BULOVA WATCH COMPANY, INC.

61-20 WOODSIDE AVENUE WOODSIDE, N.Y. 11377, (212) DE 5-6000

New Components and Hardware

Coaxial reed relay operates fast

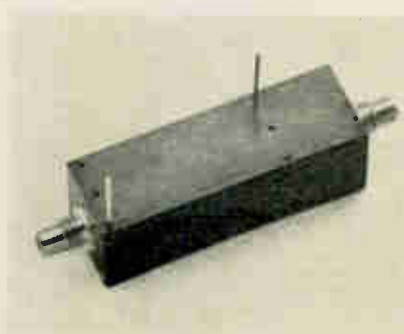

A coaxial reed relay, type 100-181, features miniaturization ($2 \times 0.5 \times 0.5$ in.), fast operate time ($600 \mu\text{sec}$) and sensitive operation (100 mw) capable of switching 10 watts of r-f power.

At 125 Mhz, isolation is 43.5 db; insertion loss, 0.16 db; vswr, 1.159:1.

The unit is epoxy encapsulated for environmental resistance. It is suited for printed-circuit mounting. Computer Components, Inc., 88-06 Van Wyck Expressway, Jamaica, N.Y., 11418. [351]

over 20×10^9 operations (with no maintenance or adjustment required); signaling capability to 120 baud at 1% maximum unbalance, 180 baud at 2% maximum unbalance; high contact efficiency (95% total dwell, compared with 90% in some polar relays).

The new relays will stand off 1500-v line surges. Switching capability is 100 v-a with no life derating (500 v max, 2 amp max). Also offered are the inherent advantages of the company's mercury-wetted contact relays, including: low and consistent contact resistance, complete freedom from contact bounce and contact force with resistance being completely independent of drive level.

The exclusive polar relay modules are compatible with modern printed-circuit system design. Standard relay packages, interchangeable with existing polar relays for wired assemblies, are also available from the manufacturer. C.P. Clare & Co., 3101 Pratt Blvd., Chicago, Ill., 60645. [352]

Push-button switches in modular design



Low-power, modular design push-button switches offer the flexibility of a modular design, p-c board mounting and prompt delivery of production quantities at a price said to compete with the most economical of other units of this type.

The design provides a self-contained, precision molded module with terminals in fixed position and internal contacts protected within the module. This permits mounting as single button units or ganging up to 19 buttons on one frame.

P-c board mounting is facilitated by the design of the fixed ter-

Polar relays provide balance stability



A line of mercury-wetted contact polar relays provide life and balance stability characteristics not available before in polar relays, according to the manufacturer.

For digital data transmission, telegraph and teleprinter service, impulse repeaters, polar signaling and polarity sensing applications, they can provide: signal fidelity of 1% maximum initial, 2% maximum

EIMAC

introduces new family of rugged triodes for industrial heating

From Eimac comes a new family of water-cooled triodes designed especially for induction and dielectric industrial heating service. The tubes feature a new cast silicon-bronze cooler design with constant cross-section spiral water channels. This design insures uniform anode cooling with minimum water flow and back pressure. For example, the 3CW20,000H3 requires only 4 GPM water flow at 3.5 psi for 20 kW plate dissipation. The new tubes feature filament connecting leads—and no sockets are required—and have grid flanges for low inductance connection to the grid. This new industrial family is rated at full power to 90 Mc, with reduced ratings to 140 Mc. All include anode tabs for ease of mounting into industrial machinery plus rugged, high-dissipation grids for industrial oscillator service. Write Power Grid Product Manager for additional technical information, or contact your nearest Eimac distributor.

CHARACTERISTICS

	Plate Dissipation (kW)	Filament Voltage (Volts)	Input Power (kW)	Useful Output (kW)
3CW5,000H3	5.0	7.5	30	15.5 to 22.5
3CW10,000H3	10.0	7.5	40	25.0 to 30.0
3CW20,000H3	20.0	6.3	60	42.0 to 45.0
3CW30,000H3	30.0	10.0	80	55.0 to 60.0
3CW40,000H3	40.0	13.0	120	75.0 to 90.0

EIMAC

Division of Varian
San Carlos, California 94070

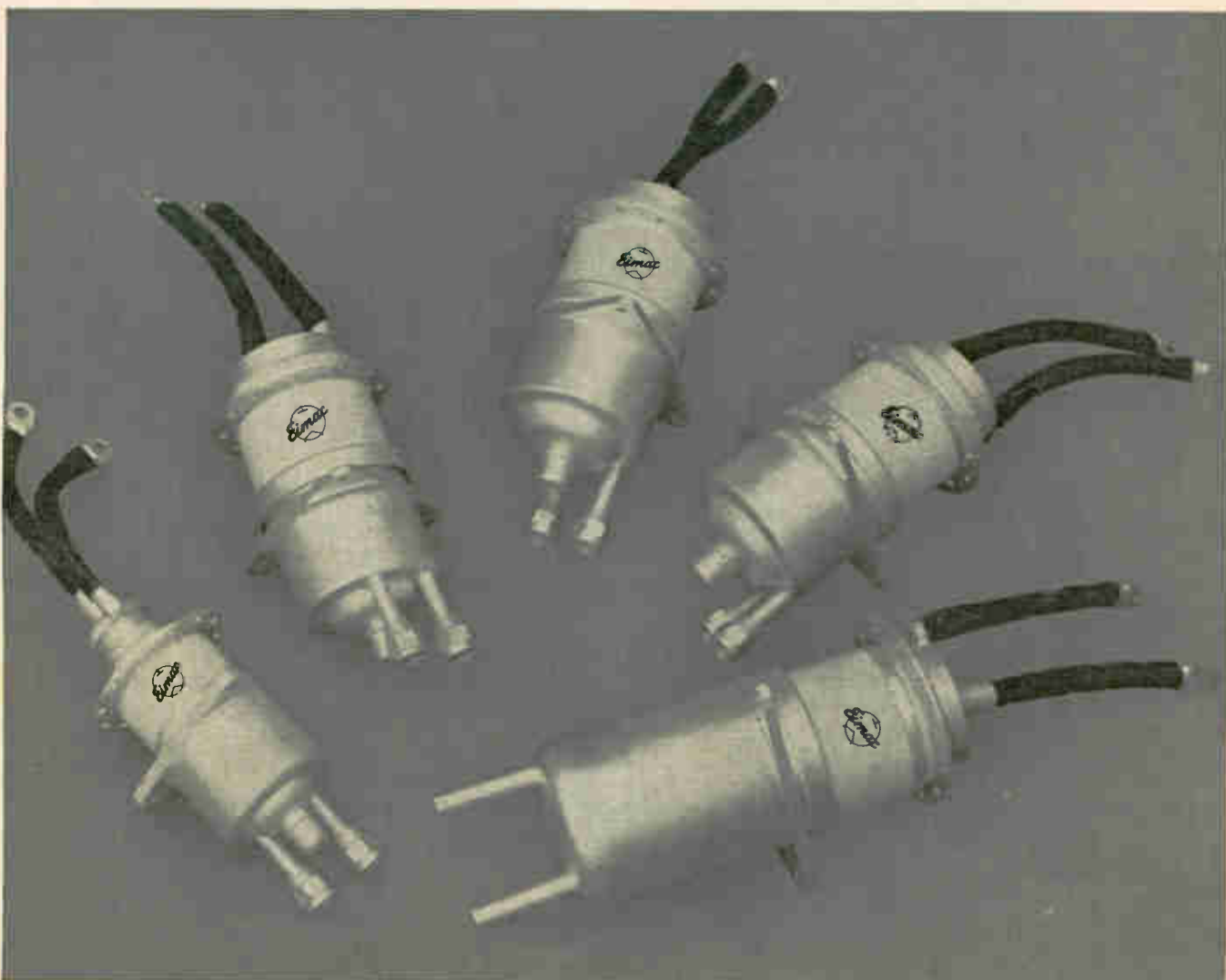

We've got our stripes!



New MIL type 1 amp silicon rectifiers

will meet MIL-S-19500/286A(EL)

Semtech Corporation can deliver, in production quantities, 1 amp silicon rectifiers to meet MIL-S-19500 286A(EL). Peak inverse voltages from 200 to 1000 volts. Featuring solid internal construction pioneered by Semtech engineers. Hermetically sealed, designed with a rugged Al_2O_3 filled glass body (.275" long by .135" dia.) and solid silver leads (.030" dia.).

Type No.	V_R	I_O (at: $T_A = +100^\circ C$)	I_O (at: $T_A = +150^\circ C$)	I_R at V_R	if (surge) * (at: 1/120-sec.)
	Vdc	Adc	mAdc	μ Adc	Adc
1N4245	200	1.0	300	1.0	10
1N4246	400	1.0	300	1.0	10
1N4247	600	1.0	300	1.0	10
1N4248	800	1.0	300	1.0	10
1N4249	1000	1.0	300	1.0	10

Operating and Storage Temperature — $65^\circ C$ to $+175^\circ C$

* $T_A = +150^\circ C$ if (surge = 10 Adc) 10 surges of 8.0 msec duration each, at intervals of 1 minute. $I_O = 300$ mAdc

All rectifiers must meet these stringent requirements:

Reverse Current Drift Test — With specified voltage (V_R) continuously applied, reverse current measured 30 seconds after thermal equilibrium has been reached at the temperature specified ($T_A = +150^\circ C \pm 3^\circ C$) shall not vary, from reverse current measured 5 ± 1 minutes after that thermal equilibrium point, by more than 2μ Adc, or 10%.

Reverse Recovery Test — T_{rr} is 5 microsec. max.

Test conditions: 0.5 amp forward current to 1.0 amp reverse current. Recovery time measured when rectifier recovers to .25 amp.

Send for Technical Bulletins.

SEMTECH CORPORATION

Western Office: 652 Mitchell Road, Newbury Park, California, (805) 498-2111
from L.A., (213) 628-5392/TWX 805-499-7137

Central Regional Office: 4957 Main St., Downers Grove, Ill. (312) 968-2322

Eastern Regional Office: 71 West 23rd St., New York, N.Y. (212) 989-7550/TWX 212-640-5060

European Sales: Bourns A G, Alpenstrasse 1, Zug, Switzerland (042) 82 72/73

New Components

minals themselves. Boards may be mounted on opposite sides of the module to create a sandwich, with the switch serving as a separating supporting member. Space may be left between modules for attaching discrete components by conventional means. The fixed terminals also lend themselves readily to automatic insertion.

Standard electrical functions are 2, 4, 6, or 8 poles, double throw per button. Combinations up to 16 poles, double throw per button, are available. A typical example of the small amount of mounting space required is that a 5-button unit requires only a 1.97-in. x 0.350-in. panel opening.

Centralab, The Electronics division of Globe-Union Inc., P.O. Box 591, Milwaukee, Wisc., 53201. [353]

High-contact density p-c board connector

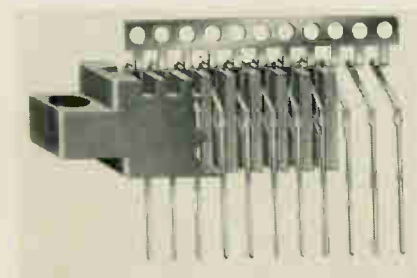

A 0.025-in. square tail contact, miniature p-c connector features cantilevered contacts for high reliability. Especially suited for automatic wire-wrapping applications, it can be used with high-density packaging techniques that are now being developed for electronic data-processing equipment.

The unit has contacts on 0.125-in. centers and can be wired at a rate up to 750 wires per hour (using a Gardner-Denver automatic wire-wrap machine). This is more than 15% faster than is possible with 0.045-in. square tail contact connectors, the company says.

The connector uses a comb contact assembly, which provides the gap uniformity of preloaded cantilevered construction and contact pressure independent of p-c board

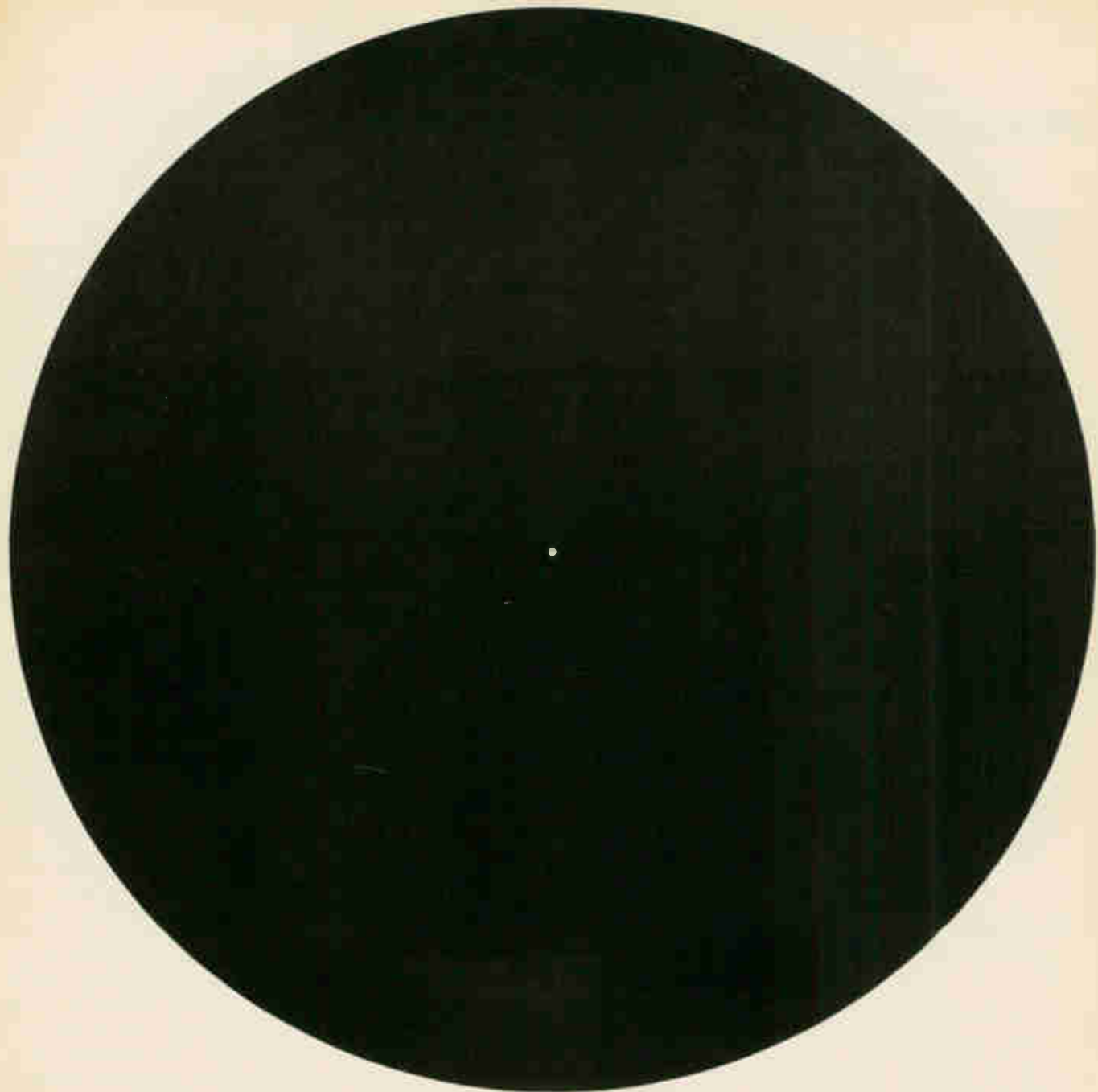

The small pin hole in the center of this circle is more than enough light for MTI Image Orthicon Television Cameras.

MTI is the world's largest manufacturer of low light level TV systems. This simply means that low light levels are our specialty. Specifically, at 1×10^{-5} foot candles of ambient light (approaching total darkness) MTI image Orthicon TV cameras will produce high resolution pictures. So the amount of light illustrated by the pin hole is more than enough.

There are hundreds of applications for MTI low light level equipment. Here are just a few: viewing nocturnal animals performing tasks, observing stars, examining small components such as transistors, diodes, capacitors and relays for minute flaws, and so on. In any application where low light levels are of prime importance, MTI can solve your problems.

Seven different line scan frequencies are available "off the shelf". Specific details available on request. If you have an application problem, call us. We can help.

mti MARYLAND TELECOMMUNICATIONS, INC.
York & Video Roads, Cockeysville, Maryland / Area code 301, 666-2727
WORLD'S LARGEST MANUFACTURER of low light level image Orthicon cameras



Reliability and Quality are a product of experience. Jennings has 24 years experience manufacturing vacuum capacitors. Time enough to design a lot of them. Here are a few:

CADB 30



Capacity (Range) 3-30 pf
Peak Test Voltage 15 KV
RF Current Rating 40 Amps RMS
Length 4.55"
Width 1.312"

USLS 465



Capacity (Range) 5-465 pf
Peak Test Voltage 5 KV
RF Current Rating 42 Amps RMS
Length 5.52"
Width 2.312"

VMMC 5000



Capacity (Range) 100-5000 pf
Peak Test Voltage 15 KV
RF Current Rating 125 Amps RMS
Length 21.31"
Width 9.25"

JSLF 5000



Capacity (Range) 5000 pf
Peak Test Voltage 5 KV
RF Current Rating 100 Amps RMS
Length 2.875"
Width 4.125"

CVJW 200 (Water-Cooled)



Capacity (Range) 25-200 pf
Peak Test Voltage 100 KV
RF Current Rating 1000 Amps RMS
Length 15.50"
Width 8.00"

CVHC 650 (Air-Cooled)



Capacity (Range) 25-650
Peak Test Voltage 45 KV
RF Current Rating 250 Amps RMS
Length 10.75"
Width 7.56"

Close to 100% of the Free World's high frequency transmitters use vacuum capacitors of Jennings design. In fact, practically every major advancement in vacuum capacitors has originated at Jennings. These include capacitor designs ranging from 100 watts to over a megawatt power ratings. Which means that in all likelihood the capacitor you need has already been designed, field tested, and proven reliable—plus possessing all the latest advances in vacuum capacitor design.

The vacuum capacitors shown here are only a few of the hundreds of standard designs available from Jennings to fit practically every RF application. If a

new design is necessary however, Jennings has an experienced applications engineering staff and Quick-Reaction Laboratory ready to solve your problem in the shortest possible time. Jennings also offers the only complete rf lab in existence for proper testing of vacuum capacitors in high power rf circuits through 100 kw that duplicate actual operating conditions.

For detailed information about Jennings vacuum capacitors request our new catalog #101. Jennings Radio Manufacturing Corporation, Subsidiary of International Telephone and Telegraph Corporation, 970 McLaughlin Avenue, San Jose, California 95108.

ITT Jennings

New Components

insertion depth. The construction combines minimum insertion force with maximum contact pressure, providing high reliability. The comb assembly technique also permits the true tip location in the required position for automatic wrapping equipment. This accurate positioning is possible because of the force fit of the contact to the insulator.

Cinch Mfg. Co., 1026 South Homan Ave., Chicago, Ill., 60624. [354]

Single-wire connector for variety of uses

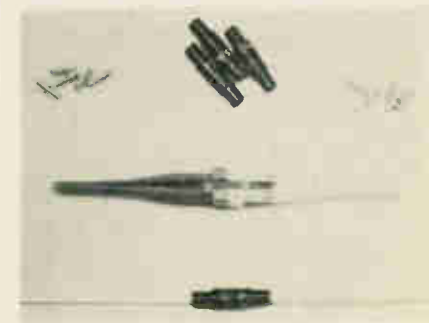

A single-wire connector, the Jiffy Junction, is a single conductor connector that may be used in a variety of applications, including as a substitute for splices. The Jiffy Junction has the same high-performance rear-release contact system as in all the manufacturer's industrial connecting devices. It uses the same hand-crimp tool, the same expendable plastic fail-safe insertion/removal tool and the same assembly procedure as is used in the company's family of rear-release electrical connectors.

The development is designed for applications where quick engagement and disengagement of single wire junctions must be reliable and at low cost. The Jiffy Junction provides a permanent mechanical connection, but can readily be disassembled should the need arise.

The Jiffy Junction offers many advantages in ground support equipment, harnessing, communications equipment, and other industrial applications. It is now available in production quantities

We expect these 150-grid relays to be copied



4-pole



2-pole

And by 1967 they'll be a standard of the industry

Right now, these General Electric 2- and 4-pole relays are years ahead of the field. Their low, low profile—just 0.32 inch high—lets you stack more circuit boards in the same space.

They're not just cut-down versions, either. These 150-grid relays can perform right up with microminiature relays four times their size.

For example, closing force is about the same to provide snap-action, positive contact mating. In addition, General Electric 150-grid relays meet or exceed environmental and mechanical specs of much larger microminiature relays.

And compared to relays of comparable size, G-E 150-

grid space relays have three times the magnetic force and over twice the contact force of their nearest competitor. What's more, they're the only relays in this size range that are all welded to eliminate flux contamination.



ACTUAL SIZE

Your G-E Electronic Components Sales Engineer can tell you more about 150-grid space relays and help with your individual applications. Contact him. Or write for bulletin GEA-8042B, Section 792-38, General Electric Co., Schenectady, N. Y. 12305.

Specialty Control Department, Waynesboro, Va.

GENERAL  ELECTRIC

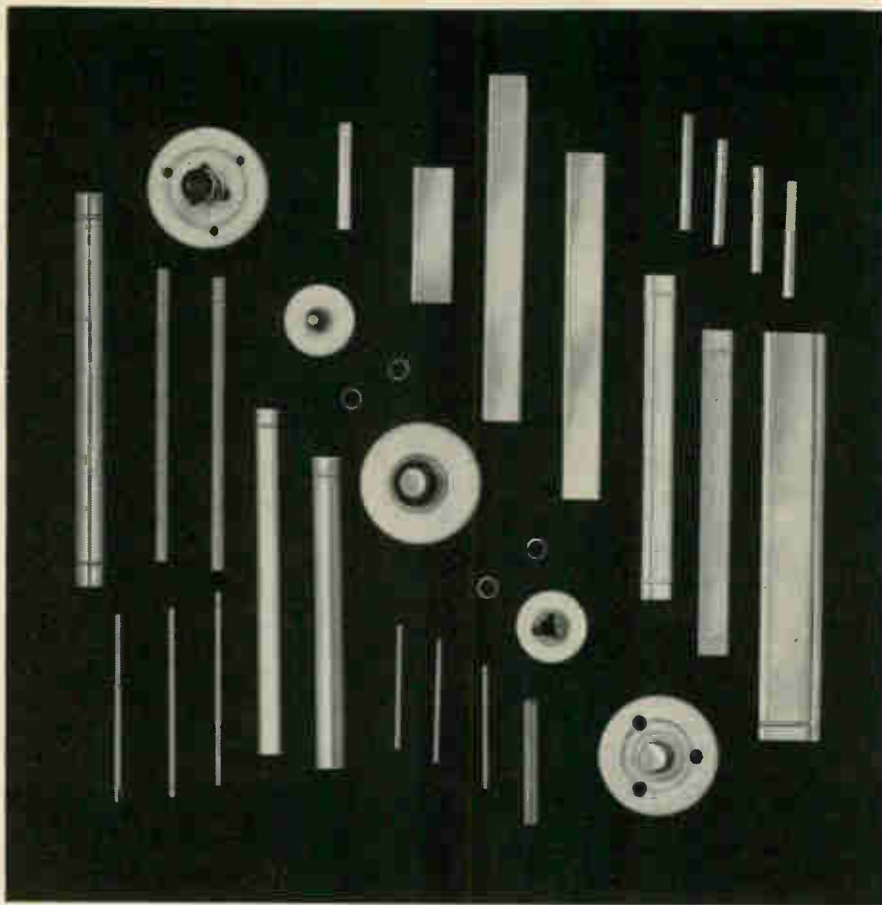

HOW RELIABLE ARE SUPERIOR TUBE'S CATHODES?

There's hardly a television set, radio, radar or any type of electronic equipment produced in the United States that doesn't use them.

Here are the reasons why Superior Cathodes are so widely used:

1. Superior is the world's leading independent cathode supplier offering the greatest variety of cathode types and materials.
2. Superior makes cathodes only for its customers . . . none for itself.
3. Superior has two large, modern plants, 500 miles apart, with identical facilities.
4. Superior delivers cathodes on time, every time.

When you specify or order cathodes consider Superior and protect yourself against delays in delivery.

Write today for your free copy of our Catalog 51. It belongs on your desk. Dept. 2500.

Superior Tube 

The big name in small tubing

NORRISTOWN, PA. 19404

West Coast: Pacific Tube Company, Los Angeles, California

Johnson & Hoffman Mfg. Corp., Carle Place, N. Y.—an affiliated company making precision metal stampings and deep-drawn parts

New Components

to terminate and join Awg-20 through 24-gage wire.

The Deutch Co., Municipal Airport, Banning, Calif. [355]

Coaxial r-f connector meets MIL-C-39012

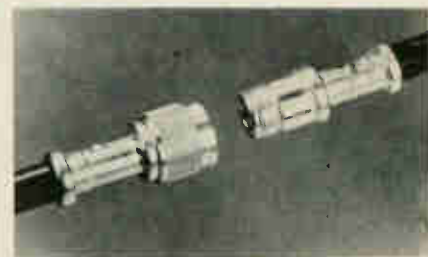

Series N Coaxicon coaxial r-f connector has been designed and tested to meet all requirements of MIL-C-39012.

Features include positive crimp of the unit's cable conductor, braided shield, and protective sleeve with a single hand tool. All crimps for a given cable size, either single or double braided, can be made with a single hand tool.

The solderless crimping technique holds noise level of the r-f connector to a minimum. Built-in retention dimples maintain proper positioning of the cable dielectric and outer pin before and after crimping.

Other features of the N series connector include: low vswr, coaxial cable undamageable by heat, high cable retention, and easy cable inspection.

The series N Coaxicon connector can be mated with compatible UG/U series connectors. AMP, Inc., Harrisburg, Pa. [356]

Epoxy transfer molded pulse transformers

Pulse transformers of the TT and MPT series, produced by the epoxy transfer molding process, meet the same dimensional parameters as units which were formerly epoxy coated.

The company claims its in-plant transfer molding techniques im-

Write

J. B. Ellis, Industrial Relations Administrator, Engineering, General Dynamics,
Fort Worth Division, Post Office Box 748-A, Fort Worth, Texas

Responsible assignments for creative, energetic engineers and scientists in F-111 and other advanced aircraft projects; missile projects; space systems and mission analysis projects; other R&D assignments.

INFORMATION TECHNOLOGY

- Mission Simulation, Display Technology

NAVIGATION, STABILITY, GUIDANCE & CONTROL

- Stability and Control, Computer Design, Servo Analysis

ELECTRONIC SYSTEMS

- ECM, Penetration Aids

ELECTRONIC AGE

- Microwave and Computer Design

ELECTRONICS LABORATORIES

- Circuit Design, Flight Test Instrumentation

ELECTRICAL INSTALLATION DESIGN

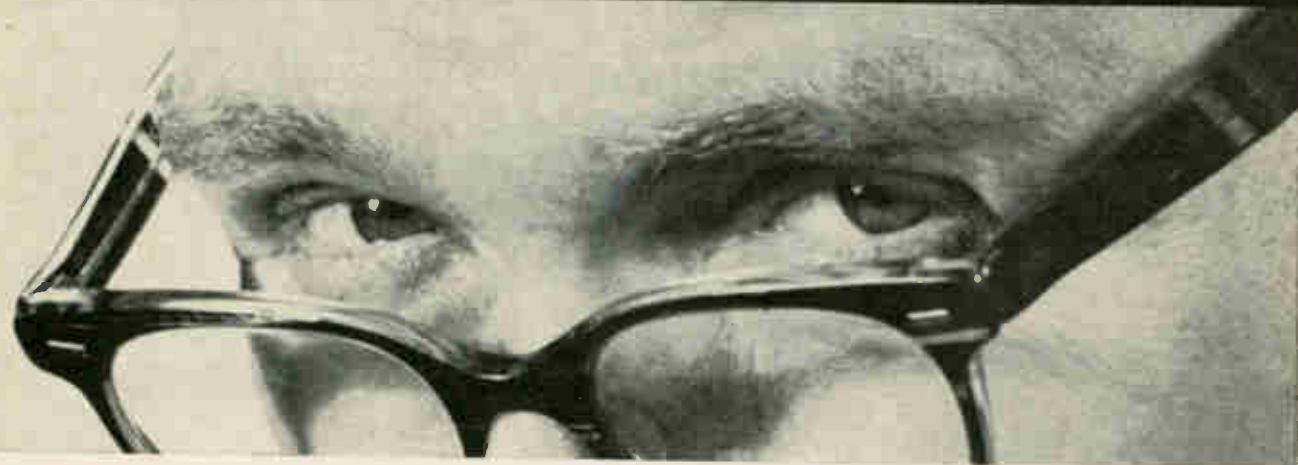

or call collect

Live in or near Fort Worth, 1965's All American City — Uncongested, easy living where your dollar buys more — Superior housing, public schools and recreation — Graduate studies at local universities and colleges — Excellent benefits including a new Savings and Investment Program. Call Collect — 817 - PE 2-4811 — Ext. 3551 — or send a complete resume of your education and experience to J. B. Ellis, Industrial Relations Administrator, Engineering, General Dynamics, Fort Worth Division, P. O. Box 748-E, Fort Worth, Texas. An equal opportunity employer.

GENERAL DYNAMICS

Fort Worth Division

CREATIVE STYLING... DISTINCTIVE QUALITY

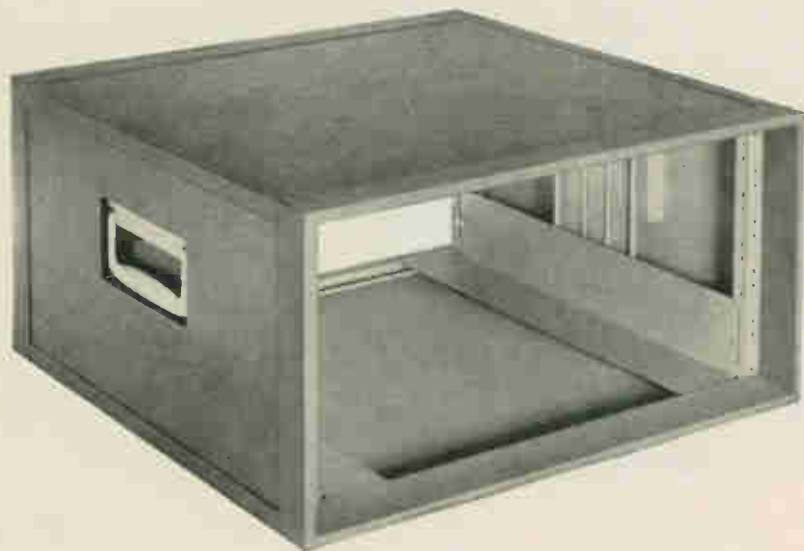

CLASSIC

CABINETS

Another outstanding series of enclosures from the skilled hands of the Bud designers. Both in appearance and construction, the CLASSIC line of cabinets presents an unusual opportunity for builders of electronic equipment and systems to house their products to the best advantage.

This new line of standard cabinets has a sturdy welded frame composed of aluminum extrusions. The panels forming the sides, top and bottom are of distinctive patterned aluminum.

CLASSIC cabinets are available in 15 sizes ranging from 3½" x 19" panel space to 28" x 19" panel space. Beautifully finished in vinyl textured charcoal gray or sand.

Write us for literature about CLASSIC cabinets or see them at your Authorized Bud Distributors showroom.



BUD RADIO, INC.
Willoughby, Ohio

New Components

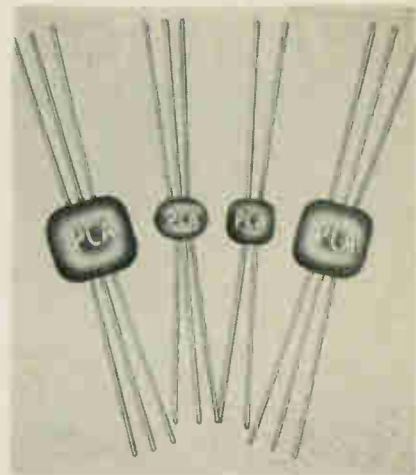

prove transformers' reliability, ruggedness, shape and appearance. Uniformity of performance also is said to be measurably improved by the process. These features make transfer molded pulse transformers suitable for application where long life and ability to withstand a wide range of environmental conditions are critical factors.

Standard leads available on this series are made of tin-coated copper. Other leads of gold-plated dumet, which are stronger and suitable for welding, may be obtained on order.

PCA Electronics, Inc., 16799 Schoenborn St., Sepulveda, Calif. [357]

Trigger transformer handles 550 volts A-C

The scr series trigger transformer is conservatively rated for operation with line voltages up to 550 v a-c. Two standard epoxy encapsulated case styles are available: a radial lead type for handwired circuits and a single-ended type for printed circuit applications.

Two and three winding unity ratio types are off the shelf. Other ratios are available on special customer order.

The manufacturer offers a designers' sample kit containing eight key values of the radial-lead type for \$45. In quantity, the units are priced at under \$2 and delivery is stock to 3 weeks.

The Gudeman Co., 340 W. Huron St., Chicago, Ill. 60610. [358]

What more can we say about relay reliability. In the strange environs of space, warranty can be a pretty empty word. We like "integrity" better...a projectable promise backed by the relay industry's most comprehensive quality assurance program.

Babcock's tenure in space began with the earliest satellites under mission-critical conditions, progressed through the life-critical missions of Mercury and Gemini, and continues now with Apollo. This is not only experience and capability...this is responsibility.

To illustrate, let's look at Apollo—from the ground up.



Transistor Can, SATURN IC stage



10 amp., Crystal Can, Latching & Non-Latching, SATURN II & IV B stages



10 amp., 4 PDT Latching & Non-Latching, APOLLO service module



1/2 Size, Latching and Non-Latching, APOLLO command module

Round Trip Ticket

Each of these units has its own pedigree, and is produced on our own "TLC" line with Tender Loving Care. Each is the result of close customer liaison and application assistance. Each is the finest, most reliable relay of its type in the world.

Get acquainted with Babcock...our service and the complete Babcock line of high reliability and general purpose relays. Write Babcock Relays, Division of Babcock Electronics Corp., 3501 Harbor Blvd., Costa Mesa, Calif.; (714) 540-1234.





For higher resolution, lower noise, better terminal linearity, smaller size, and lower price, you simply can't beat the new Fluke 24A vernier precision potentiometer!

The unique Fluke 24A takes $8\frac{1}{2}$ turns off your 10 turn precision pot and still offers better resolution than any unit of comparable size and price. Terminal linearity is excellent with no offset at either zero or 100 per cent. Noise is less than 100 ohms ENR. End resistance is less than 1 ohm. Over a wide frequency range, phase shift is zero.

It's a tough pot, too, built to meet MIL spec requirements. And cost is only \$8.50 per unit. Quantity discount applies.

For complete information, please write P. O. Box 7428, Seattle, Washington, Phone: (206) PR 6-1171.



New Semiconductors

Switching low currents with FET's

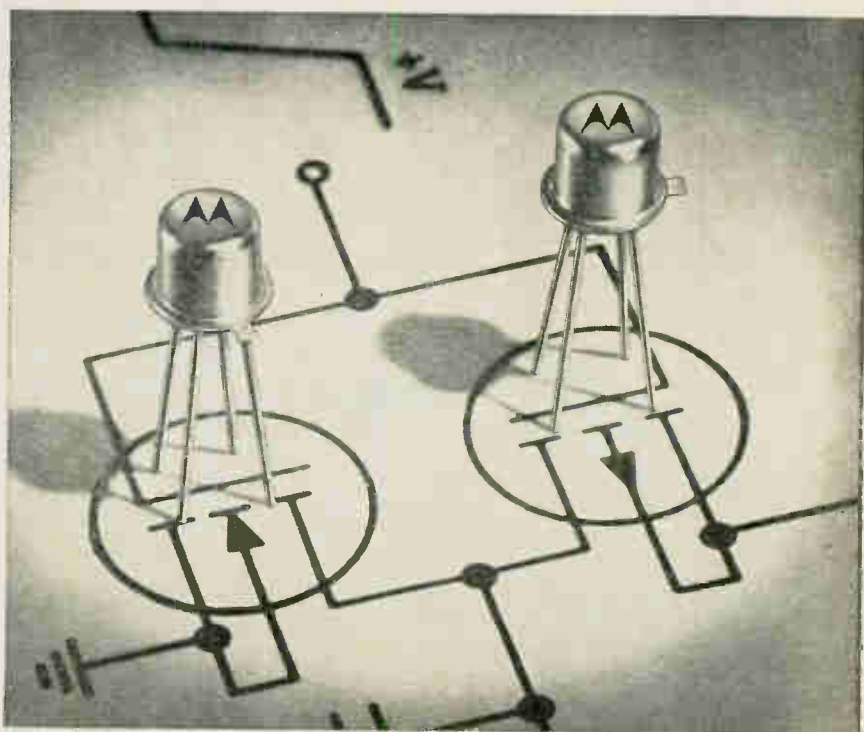

Complementary switching can now be done with metal oxide semiconductor field effect transistors. Two insulated-gate MOS FET's developed by Motorola, Inc. have leakage currents of 5 to 10 nanoamperes, making zero-current, complementary pair switching a practical reality.

The transistors, designated 2N4351 (n-channel) and 2N4352 (p-channel), are intended primarily for low-power switching applications. The FET's in the photo form a complementary switch. Driving voltage $+V$ is applied to the coupled gates; a load capacitor is connected from the coupled drains to ground. The supply is connected to the source of the p-channel FET (right) and the n-channel's source is grounded. Switching signal $+V$ simultaneously turns on the p-channel FET and turns off the n-channel, preventing a current drain from supply to ground.

Although the technique is not new, it has been difficult to achieve with low-level currents (less than 1 milliamperes). At these current levels, ordinary bipolar transistors exhibit excessive capacitance and

Specifications

Characteristics	2N4351	2N4352	
Minimum drain-source breakdown voltage	25	-25	v d-c
Maximum zero-gate-voltage drain current	10	5	nanoamps d-c
Gate-source threshold voltage	1.0 min. 5.0 max.	-1.5 min. -6.0 max.	v d-c
Maximum drain-source resistance	300	600	ohms
Price	\$4.50	\$4.50	(In quantities over 100)
Delivery	Available from stock		

switch very slowly. The MOS FET's are much faster, having switching times in the hundreds of nanoseconds. The devices' very high input impedances also provide a large fan-out capability and almost no loading of the driving source. Both units are designed for the enhancement mode, or normally off operation.

The big problem in developing a complementary pair of insulated-gate FET's has been in producing an n-channel MOS FET. Motorola claims an industry first with

ANDREW

Lower attenuation...
new HELIAX®

**1/4", 3/8", 1/2" flexible
coaxial cables for**

- Military
- Broadcast
- CATV
- Mobile Radio
- Data Processing and
Instrumentation Systems



These new air and foam cables offer lower attenuation in small physical sizes. Type FH1, 1/4" Foam HELIAX has 30% lower attenuation, 60% smaller size and 50% less weight than RG8/U. The copper inner and outer conductors assure optimum electrical performance with long life reliability. Available in long splice free lengths with or without polyethylene jacket.

For additional information on HELIAX, contact your regional Andrew sales engineer or write P.O. Box 807, Chicago, Illinois 60642.

Andrew
CORPORATION

28 YEARS OF ENGINEERING INTEGRITY

IN EUROPE: Andrew Antenna Systems, Lochgelly, Fife, Great Britain

Glass-Epoxy Copper-clad

through TAYLOR'S TOTAL RELIABILITY PLAN:

Raw materials, panels or punched blanks to your reliability requirements. You get what you order from a fully integrated source.

FAST DELIVERY from two fully equipped plants—one at Valley Forge, Pa., the other at La Verne, Calif. Or from warehouses in Chicago, Ill. and other key locations.

... FULL SIZE SHEETS, CUT-TO-SIZE PANELS or PUNCHED BLANKS to satisfy fabricating and processing requirements. Ease of fabrication is a plus value in printed circuit production.

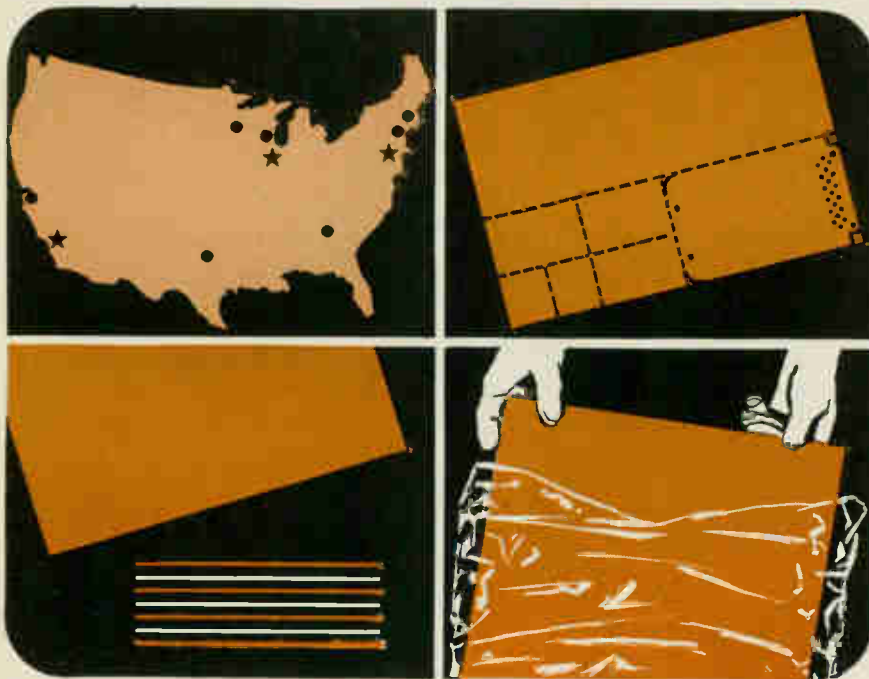

... STANDARD AND ULTRA-THIN FORMS. Standard sheets in all grades. Ultra-thin sheets and multilayer prepreps in GEC 500 (G-10) and Fireban 600 (G-10, FR-4).

... WHITE GLOVE HANDLING in atmosphere-controlled white rooms, careful processing, extremely tight quality control and special packaging assure top performance.

Taylor's copper-clad has proven total reliability demonstrated by an ever increasing number of major OEM's and commercial etchers. This acceptance substantiates our claim for unsurpassed quality, ease of fabrication and delivery to your scheduled requirements. Let us demonstrate this reliability to you. Ask for a sample (give grade designation and copper combination) and a copy of Bulletin GB-2.

New Semiconductors

the n-channel device and expects it to be applied initially in military spacecraft where power consumption in switching is significant.

Motorola Semiconductor Products Inc., Box 955, Phoenix, Arizona 85001 [361]

Silicon transistors offer high voltages

The SDT6900 family of silicon, planar npn power transistors, available in a TO-66 package, are capable of dissipating 20 watts at 100°C case temperature. They are characterized at a collector current of 1 ampere and have saturation voltages (collector to emitter) of less than 0.50 v.

There are two gain ranges in the family—20 to 60 and 40 to 120. Each gain family is available with sustaining voltages of 125 v, 150 v, 175 v, or 200 v collector to emitter.

These transistors can be used as inverters, converters, high-frequency oscillators/amplifiers and in other military, industrial and commercial applications.

Solitron Devices, Inc., 1177 Blue Heron Blvd., Riviera Beach, Fla., [362]

Germanium transistors packaged in TO-1 case

Types 2N2430 (npn) and 2N2431 (pnp) are germanium alloy transistors packaged in a TO-1 case and designed for medium power audio applications. A pair of either will deliver up to 5 watts of output power.

The devices exhibit excellent beta linearity, according to the manufacturer, and are suited for class B push-pull applications. A 2N2430 may be used with a 2N2431 for complementary symmetry requirements in transformerless circuitry.

The transistors are claimed to feature rigid processing control to insure high reliability and excellent stability. Lower cost is achieved, the company says, by advanced, higher volume production techniques.

Nucleonic Products Co., Inc., 3133 E. 12th St., Los Angeles, Calif., [363]

Tc
... your assurance
of quality

Taylor copper-clad

TAYLOR CORPORATION • Valley Forge, Pa. 19481

Phone: 215-666-0300 TWX: 215-666-0659

West Coast Plant: La Verne, Calif.

Also manufacturer of Taylor laminated plastics, Taylorite® vulcanized fibre and Tayloron® prepreps

HERE'S HOW...

THE ELECTRONIC INDUSTRY IS USING THESE TWO FAMOUS ULANO FILMS IN ULTRAMINIATURE MASK TECHNOLOGY AND COMPLEX PRINTED CIRCUITRY

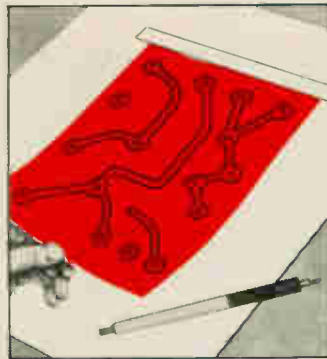

Cut a piece of the desired film large enough to cover area to be masked. Tape it down firmly at the top with dull-side up.

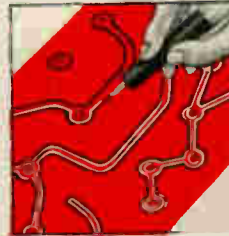

With sharp blade, outline the areas to be masked. Do not cut through the backing sheet. The Ulano Swivel Knife does the job quickly, easily.

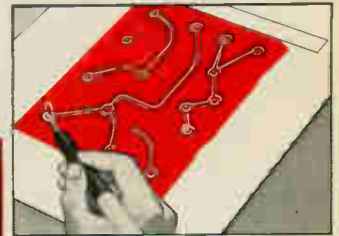

Using the tip of the blade, lift up a corner of the film thus separating it from the backing sheet.

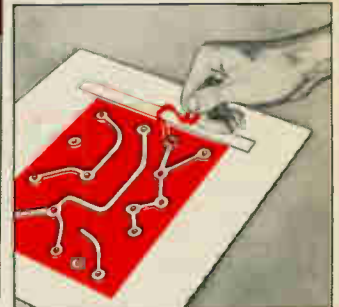

Now carefully peel off the film as outlined leaving a completed mask, positive or negative, that corresponds exactly to the desired pattern.

UlanoTM

RUBYLITHTM • AMBERLITHTM

HAND CUT MASKING FILMS FOR THE GRAPHIC ARTS

ULANO RUBYLITH... a revolutionary knife cut red film is laminated to a stable transparent plastic backing sheet. The red film is "light safe" so that when contacted to a sensitized emulsion and exposed to a suitable light source, light passes through the cut-out portions only... not through the red film. ■ The polyester backing is absolutely stable... insures perfect register. ■ Special effects such

as crayon tones, paste ups, benday sheets, and opaquing are easily combined with versatile ULANO RUBYLITH.

ULANO AMBERLITH... a companion to Rubyolith serves as a color separation medium used as the master on camera copy board to secure negatives or positives.

A wide variety of Ulano films—in rolls and sheets—is readily available

ulano

NEW YORK • CHICAGO • ZURICH

610 DEAN ST., BROOKLYN, N. Y. 11238
In Europe: ULANO A. G., Untere, Heshbachstrasse No. 22
Kusnacht, Zurich, Switzerland

"Ulano"—"Rubyolith"—"Amberlith" are registered trade marks of the Ulano Companies.



WRITE TODAY

on your letterhead for free special sample kit 1848

For solderless wrapped connections, a new automatic wire stripper

The Model 841 Solderless-Wrap Wire Stripper offers high speed preparation of 20-30 AWG solid conductor wire for insertion in a wrapping tool. It cuts wire to lengths of 1" to 50' and fully strips 1/8" to 1 9/16" from each end without nicking or scraping, whether the insulation be PVC or something as tough as Mil-Ene, Teflon or Kynar. With optional assemblies, you can also use it for shorter stripping of 10-32 AWG stranded wire. Write for information on this and other Eubanks wire strippers.



Wire is fully stripped, ready for wrapping tool.



Remaining insulation can be short as 1/2".

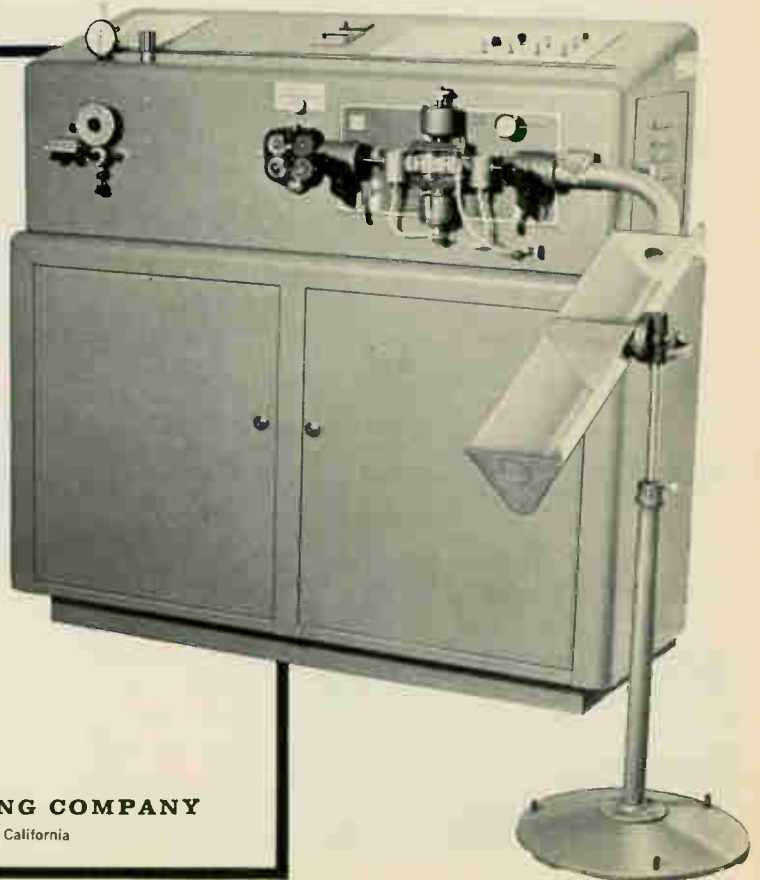

Eubanks ENGINEERING COMPANY

225 West Duarte Road • Monrovia, California

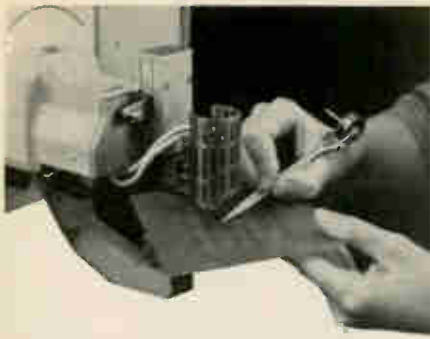

Insulated Wire Welding by Sippican

Sippican's HE (Hot Electrode) Welding System allows insulated wires to be reliably joined without prestripping the insulating material. Weld copper, nickel, high-resistance alloys, precious metals. Wire sizes from 0.002 to 0.020 inch. Applications include terminations for chokes, transformers, coils, precision resistors, computer memory devices; also interconnections for small motor assemblies and other small electric consumer products, integrated circuit packages, module assemblies and conventional component packages, miniature electromechanical assemblies.

The HE Welding System is available for either pincer or vertical motion joining operations. A precision temperature sensing, control and readout unit is included. (HE modification kits are available to present users of Sippican weld heads.)

For details and prices on complete system and accessories write or call —

The
sippican
Corporation

Industrial Products Division
Mattapoisett, Mass. 02739
Tel. (617) 758-6905



New Instruments

Spectrum analyzer goes portable

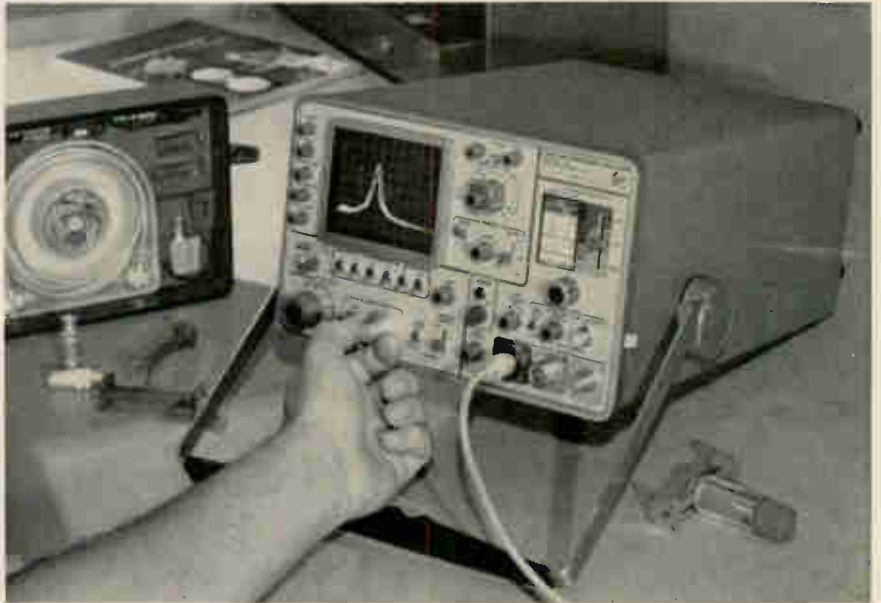

The first truly portable spectrum analyzer, according to its manufacturer, Tektronix, Inc., weighs about 40 pounds and is about the size of a suitcase. The company says the size of the type 491 analyzer does nothing to hurt its versatility. Its broad frequency range, from 10 megahertz to 40 gigahertz, and other capabilities make it suitable for most spectrum-analysis jobs.

Tektronix designers turned to solid state devices to cut the normally large and heavy instrument to 7 by 12 by 22 inches and to reduce the power requirements to 55 watts.

The entire intermediate frequency system as well as the display circuitry is solid state and the local oscillators are made with small planar diodes.

The instrument's sensitivity is from -110 to -70 decibels above 1 milliwatt, depending on frequency. The sweep range of the display can be adjusted from 10 khz to 100 Mhz with a calibrated dispersion dial. The resolution range switch, coupled to the dispersion dial automatically provides resolution—1 khz/division to 10 Mhz/division — proportional to each dispersion range. The resolution switch, however, may be uncoupled by pulling the knob out to allow any setting over a range

of 100 khz to approximately 1 Mhz when low resolution or narrow dispersion are needed independently.

The oscilloscope type of triggering and sweep circuitry makes it possible to trigger from internal, external or line sources. Sweep rates are variable from 0.5 second/division to 10 microseconds/division in a 1-2-5 sequence. An intensification circuit brightens high-speed segments of the displayed wave form.

The instrument's carrying handle adjusts to various positions to serve as a support stand. The front panel cover stores all accessories—adapters, cables, waveguide mixers and coaxial attenuators.

Specifications

Frequency range	10 Mhz to 40 Ghz
Sensitivity	-110 to -70 dbm, depending on frequency
Power requirements	90 to 136 or 180 to 272 V, 48 to 440 hz
Price	\$4,200

Tektronix Inc., P.O. Box 500, Beaverton, Ore. 97005 [371]

Transducer offers 13 pressure ranges

Model No. 109, an accurate high-pressure transducer, has pressure ranges that suit it for control, meas-



NEW FROM CRAMER...

CRAMER LIFT·LOK Stools

adjust to every worker like fine tools!

Because Cramer Lift-Lok is infinitely adjustable! Just lift the seat and stop at the most comfortable height. It takes less time than to read this sentence. Since fatigue is a critical factor in efficiency of seated workers, it makes good sense to provide tools that minimize fatigue. With Lift-Lok every worker can seek exactly his own efficient level. Available in four base types, steel, wood or plastic seats, contoured or flat, adjustable or flexible backs. To find out about the stools that qualify as production tools, write:
V.P. Sales, Cramer, 625 Adams, Kansas City, Kan. 66105.



Industrial supplier
inquiries invited.

Fine seating—safety ladders—stands and related products for office, industry and institutions.

Circle 222 on reader service card



*Quality and economy
in servo motors
and motor-tachs
depend on the
manufacturer's
experience*

...and CEDAR has it!

When it comes to sizes 8, 10 and 11 servo motors and motor-tachometers both with and without gear heads, Cedar is the leader, currently building at a higher rate than any other manufacturer in the country.

Because Cedar's volume is big and production techniques have been perfected and standardized, you are assured of the most economical price available. At the same time, the reliability testing and quality assurance programs built up on these units through years of experience guarantee you the finest quality and dependability.

When you need a servo motor or motor-tach, remember that the most advanced designs built with the most modern production techniques come from Cedar. Write or call us for complete information. You'll be glad you did.



5806 W. 36th St., Minneapolis, Minn. 55416 Phone (612) 929-1681

Circle 223 on reader service card

Designed for Advanced Data Systems...

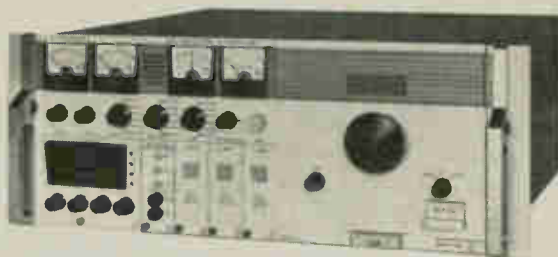

The Series 400 TELCOM Receiver

Look at these features...

- All solid state design
- Superior performance
- Completely modular, plug-in construction
- RF heads for VHF and S-Band telemetry, sweep tuned and wide band heads for surveillance applications
- Plug-in pre-detection recording converter, spectrum display, electrically switchable IF Filters

Interested? Get the detailed specifications. Write for your free copy of the DCS Series 400 TELCOM Receiver brochure.

Would you like an appointment to see a TELCOM Receiver for yourself? Just call the DCS office below nearest you...

Dept. EB-6, East Liberty Street, Danbury, Conn. 06813
Telephone: 203-743-9241 • TWX 744-1990



DATA-CONTROL SYSTEMS INC.
Instrumentation for Research

Sales Offices
Silver Spring, Md., Huntsville, Winter Park, Long Beach, Santa Clara,
Albuquerque

Copenhagen London Rome Paris Munich Amsterdam

DCS 6-66

Circle 183 on reader service card

CRAMPED QUARTERS

(Wisconsin
style)



World Famous Parker Pen Co., Janesville, Wisconsin

Wisconsin has an abundance of room in which industry can expand . . . 37 cities with populations of 5 to 10 thousand; 26 from 10 to 25 thousand; 12 from 25 to 50 thousand; and 7 with populations over 50 thousand. There are 83 cities of 5,000 population or over. And did you know that Wisconsin Power and Light Company, with an operating area of 15,000 square miles, serves more than 400 communities of all sizes. More good news, an impressive total of 292 progressive cities in Wisconsin have established controlled land for industrial parks, 73 of which are incorporated industrial site areas already developed and awaiting your inspection.

Want more facts?
Write Industrial Development, Dept. H
Wisconsin Power and Light Company,
P.O. Box 192, Madison, Wis. 53701.



Take the profitable leap to better living

WISCONSIN POWER & LIGHT

... investor owned

New Instruments



urement and computer applications. A Bourdon tube sensing element positions a differential transformer core in response to pressure variations.

The transducer has 13 pressure ranges, beginning at 0-30 to 0-60 psi and ending at 0-5,700 to 0-10,000 psi. The output signal is either a d-c voltage (1 to 5, 1 to 9, or 0 to 8 v) or current (4-20 ma). A built-in solid state amplifier and power supply can be operated directly from line power.

Accuracy is within 0.5% full scale; independent linearity, $\pm 0.1\%$ span; dead band, less than $\pm 0.01\%$ span; frequency response, down 3 db at 10 hz.

The Bourdon tube sensing element, which is temperature compensated, is isolated from the transducer case, thus rendering the device immune from pipe strain. Fine adjustments of zero, span and linearity are made electrically to provide easy calibration.

Hagan Controls Corp., P.O. Box 11606,
Pittsburgh, Pa., 15228, [372]

IC tester checks up to 20 parameters

An integrated circuit tester with internal power supplies and push-button test sequencing is announced. Model 800 tests all present IC configurations, and is designed to accommodate any foreseeable future developments, according to the manufacturer.

The tester features a 10 x 20 cross-bar matrix, which can be programmed to check up to 20 parameters. The sequencer permits rapid

What's **NEW** in laminated plastics?

Synthane FR-16!

It's a lower-cost flame-retardant, glass epoxy laminate

Designed specifically for printed circuits used in computers

Write for FR-16 Engineering Bulletin to Synthane Corporation 36 River Road, Oaks, Pa. 19456.



Laminated Plastic Sheets, Rods, Tubes and Fabricated Parts

Circle 224 on reader service card

Φ^{th} e^+ γ dose β^-
 n rads
 n/cm^2 fluence ms

Radiation Simulation Problems?

Get help with PULSE RADIATION SOURCES providing pulse widths from nanoseconds to milliseconds. Our facilities at your service include:

- TRIGA Reactors
- Accelerator Pulsed Fast Assembly
- Linear Accelerators
- Flash X-ray
- 14 Mev Neutron Generators

For information write or call now! Pulse Radiation Services, Dept. 481, General Atomic Division, General Dynamics, P. O. Box 608, San Diego, California 92112. Phone (714) 453-1000, Ext. 288.

GENERAL DYNAMICS
 General Atomic Division

Circle 225 on reader service card

New! Free!

1967

Newark

INDUSTRIAL ELECTRONICS

Catalog

- Industry's Most Complete Catalog
- Over 70,000 items
- 700 Pages
- Over \$8,000,000 Industrial Electronics Inventory including over 600 Standard Brand Lines

LISTING



2N4296 Series

Silicon Power Transistors

with 20 watts Dissipation



These new low cost devices are designed for high voltage wide band amplifiers, switches and inverters, waveform amplifiers and other military and critical industrial applications. They offer, for the first time in a silicon power transistor:

HIGH BREAKDOWN VOLTAGE ($BV_{CEO}^{(sus)}=350\text{ V}$)

HIGH GAIN BANDWIDTH ($f_T=20\text{ MHz}$)

LOW CAPACITANCE ($C_{cb}=6\text{ pF}$)

Packed in a TO-66 case these transistors are triple diffused NPN devices with exceptionally high frequency response and fast switching speed. Four types are available from stock in industrial quantities.

IMMEDIATE DELIVERY FROM STOCK • FACTORY OEM PRICES
FAST EFFICIENT SERVICE FROM 7 NEWARK WAREHOUSES

New

MAIN OFFICE AND WAREHOUSE

TO SERVE YOU BETTER

- ALL-ON-ONE FLOOR EFFICIENCY
- SPEEDY AUTOMATED ORDER HANDLING
- CONVENIENTLY LOCATED
- PLENTY OF FREE PARKING



NEWARK ELECTRONICS CORPORATION

500 North Pulaski—Chicago, Illinois 60624

AUTHORIZED RCA WAREHOUSES IN

Chicago, Illinois
 (312) 638-4411
 Cincinnati, Ohio
 (513) 421-5282
 Denver, Colorado
 (303) 757-3351

Detroit, Michigan
 (313) 548-0250
 Los Angeles Area
 (213) OR 8-0441
 New York City
 (212) 255-4600

Other Newark Warehouses in:

Grand Rapids, Michigan (616) 452-1411

Circle 185 on reader service card

What's your angle? An IMC synchro or resolver could tell you.

We could also help you resolve Indicating, Measuring and Control problems using flag and remote angle indicators, steppers, or solenoids. They are in stock at IMC Magnetics Corp., Western Division.

For Quick service contact the Applications Section at Western Division, 6058 Walker Ave., Maywood, Calif. 90270. Phone 213 583 4785 or TWX 910 321 3089.

If you need data sheets for reference or consideration for future projects, write IMC's Marketing Division at 570 Main Street, Westbury, N.Y. 11591.



Circle 236 on reader service card

**Push-pull, push-pull, push-pull, push-pull,
push-pull, push-pull, push-pull, push-pull,
push-pull, push-pull, push-pull, push-pull,
push-pull, push-pull, push-pull, push-pull,
push-pull, push-pull, push-pull, push-pull.
That's the monotony of reliability.**

Monotonous reliability characterizes IMC's solenoids, even at 4 millisecond speeds. There's a whole catalog of them in stock at IMC's Western Division, in sizes and configurations for avionics, instrumentation, computer peripherals and other systems.

If you need to push-pull, or to Indicate, Measure, and Control using steppers, synchros, resolvers, flag indicators or solenoids, contact the Applications Section at 6058 Walker Ave., Maywood, Calif., 90270. Phone (213) 583-4785 or TWX 910 321 3089.

For the catalog or data sheets contact the Marketing Div., 570 Main St., Westbury, N.Y. 11591 or circle the inquiry number.



New Instruments

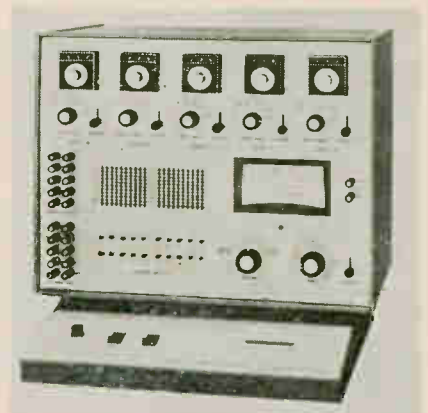

repetitive testing without reprogramming. The five built-in power supplies are available with optional digital programming. The built-in direct-reading meter for voltage and current is accurate to 1% of full scale. A connection is provided for hooking up an external digital voltmeter, and the matrix provides for up to five inputs or outputs, which can be connected to external signal sources and an oscilloscope for measurements of both digital and analog devices.

Price of the model 800 is under \$1,500; delivery, 60 days.

The Birtcher Corp., Instrument division, 1200 Monterey Pass Road, Monterey Park, Calif., 91754. [373]

Sweep generator is production oriented

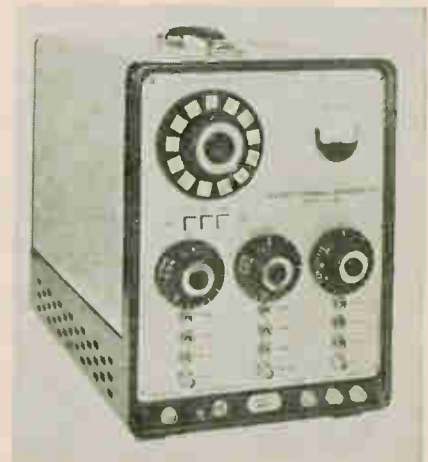

A swept frequency generator has been developed for production testing of a-m and f-m circuits. The company says that operation



ULANO EUROPEAN TECHNICAL CENTER FOR GRAPHIC ARTS

Ulano's technical center in Switzerland is headed by the very capable Mr. Henri Kunz. He is qualified by his many years of experience in the Screen Process and Graphic Arts fields. Demonstrations and technical seminars are held in many languages throughout the year. Complete laboratory facilities have been installed to provide demonstrations of the complete Ulano line. Large stocks of all famous Ulano films are available for immediate delivery to all parts of the world.

You are invited to contact Mr. Henri Kunz at ULANO A.G., Untere, Heslibachstrasse No. 22, Kusnacht 8700, Switzerland, Telephone 905959. It is our pleasure to serve you.



**DO YOU USE
SCREEN PROCESSING
IN THE PRODUCTION OF
COMPLEX
PRINTED
CIRCUITRY?**

**TWO NEW PRESENSITIZED FILMS TO
SPEED PRODUCTION — LOWER COSTS**

Ulano
I.M.



WRITE TODAY
on your letterhead
for free special
sample kit
number 5448

HI-FI RED HEAVY-DUTY INDUSTRY PROVED

Presensitized photo film used by many leading electronic firms for clean, sharp, tough, durable, almost indestructible screens of unmatched quality. Adheres tightly to wire, silk, nylon and dacron.

PREP® PRESENSITIZED FOTO FILM

.002 Polyester support guarantees good register. Does not require a dark room. Very good resolution—suitable for halftones. Excellent adhesion to silk, nylon, dacron and metal mesh. Tough, strong emulsion—good for machine printing and long runs.

J. ULANO & COMPANY, INC.

610 Dean Street, Brooklyn, N. Y. 11238, U.S.A.
Cable address: "UlanoFilm"
In Europe: ULANO A. G., Untere, Heslibachstrasse No. 22
Kusnacht, Zurich, Switzerland

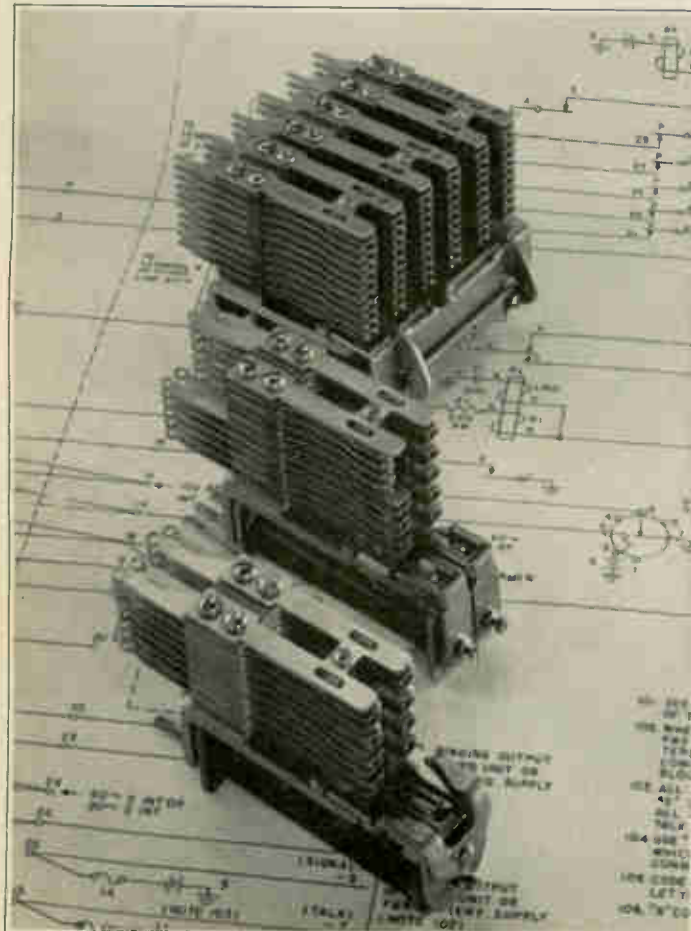

telephone quality relays

There is no higher standard for relays. Specify famous Stromberg-Carlson . . . known to telephony since 1894.

TYPE A: general-purpose relay. Up to 20 Form "A" spring combinations.

TYPE B: multi-contact relay. Up to 60 Form "A" spring combinations.

TYPE BB: multi-contact relay. Up to 100 Form "A" springs.

TYPE C: two relays on one frame; mounts in same space as one Type A.

TYPE E: general-purpose relay; universal mounting; interchangeable with relays of other manufacturers.

Write for complete technical data.

STROMBERG-CARLSON

A Subsidiary of General Dynamics

114 Carlson Road • Rochester, N. Y. 14603

ANTENNA and TOWER INSULATORS by LAPP

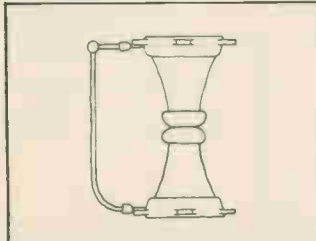
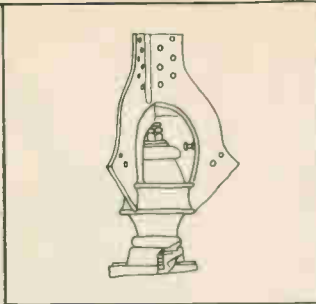
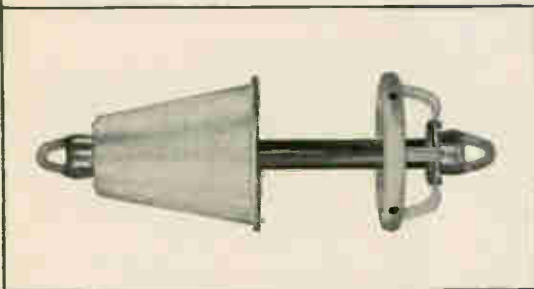

Lapp insulators support most of the world's large radio towers, both self-supporting and guyed masts. Lapp has designed and built base insulators from 80,000 lbs. to 9,000,000 lbs. ultimate strength. Lapp strain insulators have been made from 1200 lbs. to 620,000 lbs. ultimate strength. □ Lapp is also a dependable supplier of entrance, spreader and stand-off insulators for transmission lines. Other Lapp insulators and our gas filled capacitors are used in transmitters and coupling networks. □ Difficult insulating problems are welcome here at Lapp. We've been solving them for almost a half century. Write Lapp Radio Specialties Division, Lapp Insulator Co., Inc., 208 Sumner St., LeRoy, N. Y. 14482.



New Instruments

of the model SV-15 is simple, to minimize operator-instruction time and reduce human error; it is a complete test facility in itself, since it will handle virtually every frequency test necessary on an a-m/f-m circuit; and has been priced to fit production budgets.

The instrument has a rotary frequency selector that can be instantly switched to any of 13 test frequencies, which are preset by plug-in strips. Strips may be changed for new test programs. The selector capacity is five a-m frequencies, five f-m frequencies, a crystal-controlled r-f/i-f channel, a swept f-m/i-f channel and a swept a-m/i-f channel.

Push-button switches select the operating mode. The user can choose c-w, modulated c-w or swept operation. These same switches also provide the proper frequency marker for each output signal. Three connections are made available on the front panel for f-m/i-f plus a-m/i-f, a-m/r-f and f-m/r-f outputs, eliminating the need to change cables during tests. A bank of toggle switch attenuators and a rotary attenuator for each output also facilitates setting up and testing procedures.

Typical production tests made by the SV-15 include: receiver calibration, sensitivity measurement, over-all distortion measurement, alignment of bandpass circuits, signal-to-noise determination, measurement of stage gain, discriminator alignment and image rejection measurement.

The SV-15 is portable, measuring 10 in. wide x 13 in. high x 18 in. deep; it weighs 40 lbs. Telonic Industries, Inc., 60 North First Ave., Beech Grove, Ind. [374]

Thermometer offers two scale ranges

Model 390 expanded-scale thermometer measures deviation from fixed temperatures in crystal holders to a resolution of 0.01°C. It has two ranges: 0-100°C selected from an over-all span of -100°C to 500°C, and an expanded scale range of 1-0-1°C, which measures

the deviation from a particular temperature as determined from the first range.

The taut-band, suspension-type indicating meter is equipped with a 4½-in. mirror scale and red knife-edge pointer for high reading resolution. The 100°C scale has 1°C graduations and an accuracy within ±0.5°C. The 1-0-1°C scale has 0.02°C graduations and within ±0.1°C accuracy. The unit also has a 0 to approximately 43-mv recorder output.

The probe consists of a miniature platinum resistance element plus a 5-ft cable with 4 equal-length, silver-clad Pyrex glass insulated leads terminated in gold-plated contacts. It is said to provide exceptional repeatability and stability. By placing the cable in the same temperature as the sensing tip, heat loss is eliminated.

The thermometer is priced at about \$600 and is expected to be in full production in December. Radio Frequency Laboratories, Inc., Boonton, N.J. [375]

Vibration meter comes in 2 versions

A portable vibration meter, type 1-157, is suitable for both field and laboratory use. It comes in two models, one operating on a-c power, the other on d-c power; either version is available with an alternate power pack to convert the instrument or to serve as an add-on or optional feature.

Transistorized and adaptable to rack mounting or dual packaging, the 1-157 indicates peak to peak displacement and average velocity. Input signal is averaged and displayed on a meter to peak or average values based upon an equivalent sinusoidal input.

The 1-157 is useful wherever vibration is encountered—from diesel compressors, tugboat engines and gear boxes to automobile motors, gas turbines and engine test cells. Frequency range of the unit is 5 to 2,000 hz (displacement); 5 to 20,000 hz (velocity); and frequency response is ±2%.

Price of the unit is \$1,195 for a-c operation, and \$1,135 for d-c. Consolidated Electrodynamics Corp., a subsidiary of Bell & Howell, 360 Sierra Madre Villa, Pasadena, Calif. [376]

HOW

To Solve YOUR Semiconductor Encapsulation Problems

HYSOL has more answers than anyone in the business.

HYSOL's HYFLO® epoxy molding powders have solved the problems of transfer molding encapsulation of a wide range of semiconductors, from simple to the most sophisticated.

New HYSOL liquid epoxy systems, compatible with almost every type of semiconductor, open new doors for casting or potting for short or long runs and extremely delicate items.

We have devoted thousands of laboratory man hours finding answers to the kind of encapsulation problems you may be facing right now. Our laboratories are ready to tackle new problems, as technology progresses, just as we have done in the past for scores of leading electronic component manufacturers.

For application engineering help, write, wire or phone HYSOL today. For technical data on standard semiconductor encapsulation products, ask for bulletins E-258, E-259 and E-500.

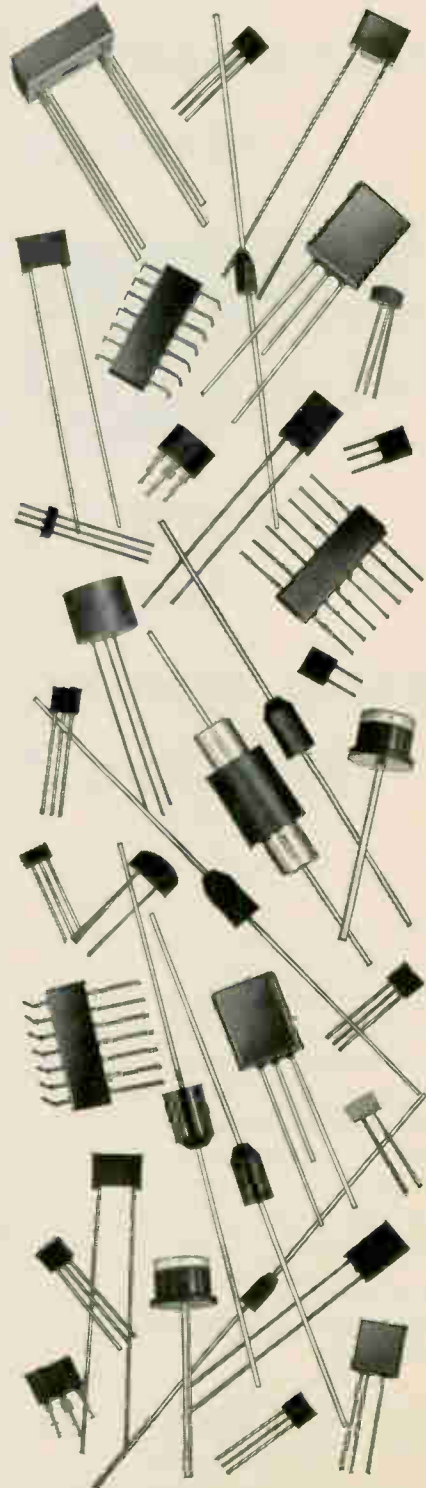

PROGRESSIVE PRODUCTS

HYSOL HYSOL CORPORATION • OLEAN, NEW YORK
THRU CHEMICAL RESEARCH Los Angeles, California/Hysol (Canada) Ltd., Ontario/London, England

**You
can display
anything
with IEE
series 10
rear-projection
readouts**



**numbers,
letters,
words, symbols,
even colors!**

IEE readouts display anything that can be put on film, even colors! Single-plane presentation makes for visual crispness; bright, bold characters (up to 1" in height) for remarkable clarity. So if readability and versatility are what you're after, look into IEE Series 10 Readouts. Five other models available with maximum character heights from $\frac{3}{8}$ " to $3\frac{3}{8}$ ".

Send today for complete information on IEE rear-projection readouts and accessories!

IEE INDUSTRIAL ELECTRONIC ENGINEERS, INC.

7720 Lemona Avenue, Van Nuys, California
Phone: (213) 787-0311 • TWX (910) 495-1707
Representatives in Principal Cities ©1955 IEE

New Subassemblies and Systems

Microcircuits cut recorder cost

By extensive use of digital and linear integrated circuits, engineers at Honeywell Inc.'s Test Instrument division designed all the data-handling and transport control circuits in the model 7600 instrumentation tape recorder with ten types of active devices. Microcircuitry produced simple, inexpensive circuits reliable enough for the production line.

By standardizing the rest of the recorder's parts and placing 90% of all parts in volume production, the company says it can assemble a general-purpose instrumentation tape recorder and sell it for 20 to 30% less than comparable machines. Honeywell claims it has established an industry first by developing a general-purpose recorder suitable for virtually all instrumentation needs, except where the recorder must be portable or airborne above 10,000 feet.

As a part of the system design, a reliability study was conducted to determine the relative importance of each component and its effect on the system's reliability. From the study engineers were able to identify the components with the highest failure rate. The components with the best combination of performance and reliability (within cost guidelines) were selected.

The study also indicated that integrated circuits would give an optimum design. Only five microcircuits, four digital and one linear, and five transistors were required to build circuits to perform nearly all of the 7600's operational functions. Nearly 90% of the sockets requiring active devices were filled with two Motorola transistors, the 2N3904 and 2N3906. The four digi-



Specifications

Weight	Approximately 650 lbs.
Supply voltage	105 to 129 v a-c (48 to 62 cps, single phase)
Didirectional tape speeds	120, 60, 30, 15, 7½, 3¾, and 1⅞ in. per sec (electrically selectable by push-button)
Maximum reel size	10½ in. or 15 in. (depending on transport selected)
Tape widths	¼ in., ½ in. or 1 in.
Tape speed accuracy	Velocity tone servo ±0.20% Phase lock servo ±0.15%
Dynamic skew	Under 1 μsec (between outside tracks on signal head stack at 120 ips)
Flutter	0.25% peak to peak (with a tape speed of 120 ips and a measuring bandwidth of 0.1 to 10,000 hz) 1% peak to peak (with a tape speed of 1⅞ ips and a measuring bandwidth of 0.1 to 312 hz)
Capstan servos available	Velocity tone or phase lock
Time displacement error	Less than ±1 μsec at 120 ips (phase-lock servo only)
Magnetic head configuration	½ in., 7-track and 1 in., 14-track (standard)
Electronics	1.6 Mhz direct: 80 khz f-m; 1,000 bits per in., digital
Optional features	Voice annotation, switch panels, patch panels, monitor meter - attenuator, panels, monitor oscilloscopes, search and control gear



tal microcircuits were Fairchild's 914 dual gate, 900 buffer, 923 j-k flip-flop and 951 one-shot multivibrator; the linear microcircuit was a Fairchild 709 amplifier. The three

other transistors were Motorola's, 2N697A and power transistors, 2N2156 and 2N1544.

A natural result of the simplified circuit design is the small size of the spare parts kit. It contains 34 components including microcircuits, transistors, diodes, trim pots, pilot lamps and fuses plus a relay, inductor and capacitor in a container the size of a small fishing tackle box. According to Honeywell engineers, these parts will handle over 90% of the failures; a user can handle 99% of all failures with the kit and a stock of resistors.

The kit will speed repair of recorders in remote locations and foreign countries. Honeywell says it plans to offer to its 7,600 customers throughout the world free replacement for any part that fails.

Honeywell, Inc., Test Instruments division, 4800 East Dry Creek Road, Denver, Colo. 80217. [381]

Ladder networks produced to order

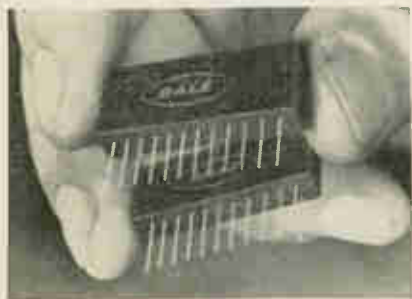

Special ladder networks designed to meet specific circuit requirements contain wirewound resistance elements. The networks can be used as voltage attenuators and digital to analog converters in computer systems and similar applications. Their modular design makes installation in a circuit more efficient than installation of individual resistors, claims the manufacturer. It also facilitates handling and storage by reducing the number of components that must be stocked and inspected.

Ladder networks are furnished with the resistors packaged in matched sets. Depending on the type of element used, they meet or exceed requirements of MIL-R-26 or MIL-R-93 in the following areas: short-time overload, mois-

MAXIMUM RELIABILITY OVER A WIDE RANGE OF AMBIENT CONDITIONS

RMC

TYPE JL DISCAPS

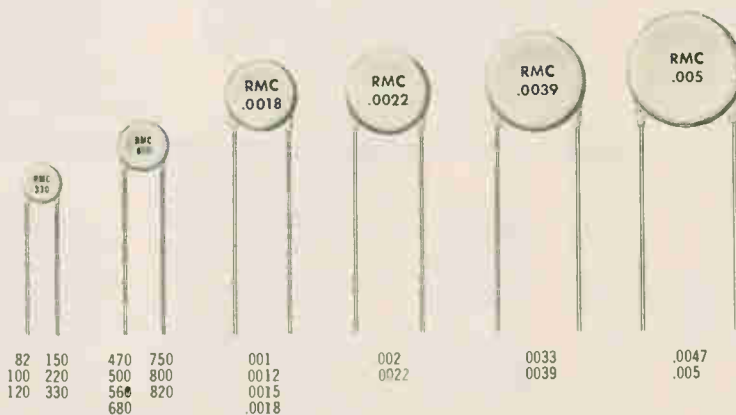

SPECIFICATIONS

CAPACITANCE: Within tolerance @ 1KC and 25°C

CAPACITANCE TOLERANCES: ±10%, 20% or +80 -20%

WORKING VOLTAGE: 1000 VDC

POWER FACTOR: 1.5% @ 1KC

INSULATION RESISTANCE: Greater than 7500 Megohms @ 500 VDC

TEMPERATURE COEFFICIENT: Z5F, Y5F, X5F

FLASH TEST: 2000 VDC for 1 second

LIFE TEST: Per EIA RS-165 Class II

POWER FACTOR AFTER HUMIDITY: 2.5% @ 1KC

INSULATION RESISTANCE AFTER HUMIDITY: Greater than 1000 Megohms @ 500 VDC

BODY INSULATION: Durez phenolic—vacuum wax impregnated

LEAD STYLES AVAILABLE— Long lead—#22 AWG tinned copper—and all types for printed wire circuits.

RMC Type JL DISCAPS exhibit less than a $\pm 7\frac{1}{2}\%$ change in capacitance over the temperature range of -55° to $+85^{\circ}\text{C}$. They are ideal units for temperature stable compensation and filter network use or other applications where stable circuit parameters are required. Rated at 1000 volts VDC, Type JL DISCAPS offer tangible cost savings over paper or general purpose mica capacitors.

Write today
on your company letterhead
for your copy
of the new RMC catalog.

DISCAP
CERAMIC
CAPACITORS



RADIO MATERIALS COMPANY

A DIVISION OF P. R. MALLORY & CO., INC.
GENERAL OFFICE: 4242 W. Bryn Mawr Ave., Chicago 46, Ill.
Two RMC Plants Devoted Exclusively to Ceramic Capacitors
FACTORIES AT CHICAGO, ILL. AND ATTICA, IND.

Electronic Relays



AEROSPACE



DRY REED

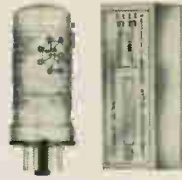

WETTED REED

Commercial Relays



COMPACT



CONTROL



POWER

Industrial Relays



PLUG-IN

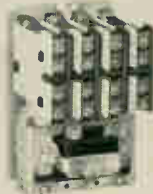

600V



MOTOR STARTERS

New Subassemblies

ture resistance, shock, dielectric strength, low-temperature storage, high-temperature exposure, low-temperature operation, temperature cycling, terminal strength, salt water, load life, vibration and temperature coefficient.

Resistors in the networks are available in a power range of from 0.1 w to 2 w each and resistance ranges of from 0.1 ohm to 500,000 ohms. The resistors can be matched to within 0.005% and have a minimum standard tolerance of 0.02%. Operating temperature range of the networks is from -65° to $+145^{\circ}$ C. Temperature coefficient match is 3 ppm/ $^{\circ}$ C from $+25^{\circ}$ to $+125^{\circ}$ C and 5 ppm/ $^{\circ}$ C from $+25^{\circ}$ to -55° C. Output accuracy is within 0.02% of input voltage.

Resistors within the networks are potted in epoxy or silicone resin and are furnished with tinned copperweld leads. Grade A nickel or gold-flashed Dumet are also available. Special requirements for tolerance, matching and other electrical parameters can also be furnished.

Dale Electronics, Inc., Columbus, Neb., 68601. [382]

Static card reader used in programing

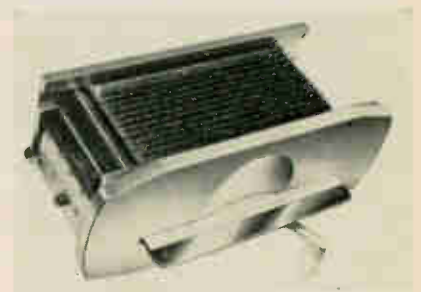

This static card reader can read 960 bits of information from a standard 12×80 IBM data-processing card. Model 1280 features remote electrical contacts actuated by mechanical sensing of a punched hole in the card. This prevents electrical failures caused by paper lint building up on contact surfaces. As a safety feature to prevent erroneous readings, each card must be properly oriented when inserted, in order for the

9 CLUES TO FINDING A RELAY... FAST!

Notice the range of the relay types above. You'll get an idea of what's available in the world's largest line of relays . . . at Struthers-Dunn. Including standards and specials. In fact, if we can't come up with the relay you're looking for, well . . . we have a feeling you'll be in for a long, hard hunt. Write for details on any type.

STRUTHERS-DUNN, Inc.

Pitman, New Jersey 08071

tel: 609-589-7500

twx: 609-589-1548



SALES ENGINEERING OFFICES IN: Albuquerque • Atlanta • Baltimore • Belmont, Calif. • Birmingham, Ala. • Boston • Buffalo • Cedar Rapids • Charlotte • Cincinnati • Clearwater, Fla. • Cleveland • Clifton • Dallas • Encino • Englewood • Glen Ellyn, Ill. • Houston • Kansas City • Las Vegas • Memphis • New York • Phoenix • Pittsburgh • Richardson, Tex. • Rome, N.Y. • St. Louis • St. Paul • Salt Lake City • Seattle • Southfield • Wichita • Wilmette. Canadian Licensee: Renfrew Electric Co., Ltd. Export Dept.: 1505 Race St., Philadelphia, Pennsylvania 19102, U.S.A.

unit to operate. When the reading has been completed, the card is automatically ejected from the reader.

The card reader is available with a choice of terminations including a push-on connector, rather than the usual solder terminations. It measures $3\frac{1}{2} \times 10\frac{1}{2} \times 6$ in., and is designed to provide maximum repetition of the process to save time in programming.

Electrical specifications of the 1280 include maximum switching voltage of 100 v resistive load, power dissipation of 50 w max total per unit, and current carrying capacity per switch of 1.5 amps static. Capacitance between any two switches is 1 pf max; across open contacts, 0.5 pf max at 1 khz.

A system of clip-on bussing terminations permits the connection of inputs of the 960 discrete switches in either vertical or horizontal directions, providing voltage coding techniques in programming. All 960 switches have individual input and output terminals.

Sealectro Corp., Mamaroneck, N.Y., 10543 [383]

D-c/d-c converter delivers high voltage



A high voltage d-c/d-c converter, series 800, has been developed for such application areas as cathode-ray tubes, photomultipliers, infrared systems and lasers.

Input is 12, 24, or 28 v d-c. Output is 5 kv to 15 kv at 1.5 w; 15 kv to 30 kv at 3 w. Ripple is less than 0.75% peak to peak. Size for the 5 to 15 kv type is $1\frac{3}{4}$ in. square by $3\frac{1}{4}$ in. high; for the 15 to 30 kv, $2\frac{1}{2}$ in. square by 4 in. high.

Prices range from \$157 to \$299; delivery, two weeks.

Universal Transistor Products, 380 Oak St., Copiague, L.I., N.Y., 11726. [384]

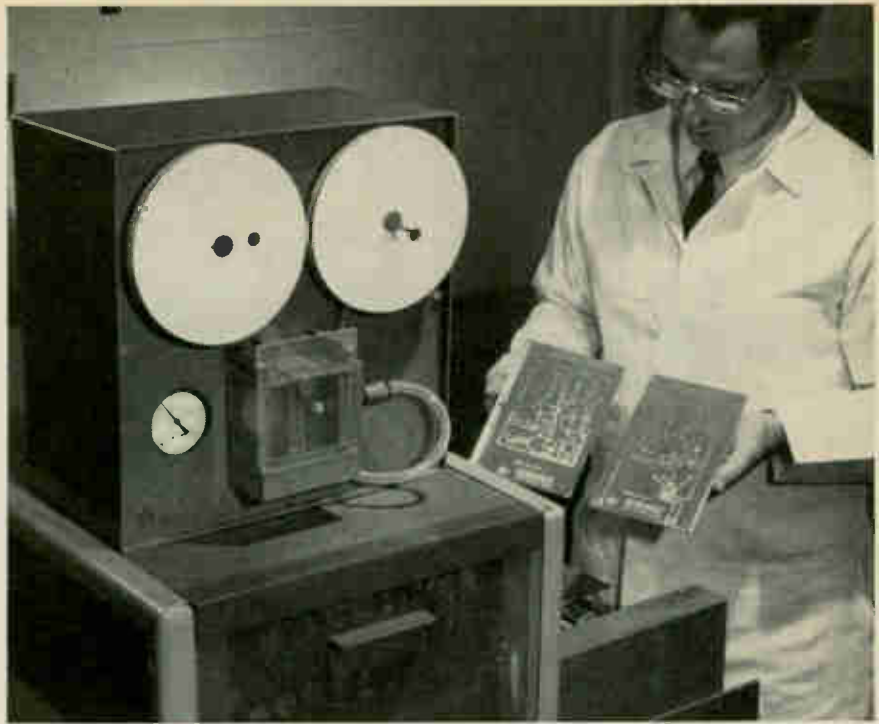

New Automatic Conveyor Control assures uniform etching of printed circuits regardless of length of production run

This new Automatic Conveyor Control monitors and adjusts etching time to make sure that the last piece to come off the etcher is exactly the same as the first. Variations in quality due to etchant depletion are eliminated, and no boards are lost due to over or under etching. You get complete use of the etchant to economical depletion. The machine operator, freed from in-process qc testing, can give full attention to overall production.

This new control system is available as optional equipment on Chemcut models 502 and 1000 horizontal conveyorized spray etchers. Since operating voltages for the system are obtained from the control panels supplied with 502 and 1000 etchers, the Automatic Conveyor Control can easily be retrofitted to etchers already in service.

CHEMCUT®

We invite your inquiry.
CHEMCUT CORPORATION
500 Science Park, State College, Pa. 16801
Circle 193 on reader service card

To order reprints: Fill in, cut out coupon below, insert in envelope and mail to: **Electronics Reprint Dept., 330 W. 42nd Street, New York, N.Y. 10036**

Reprint order form

For listing of reprints available see the Reader Service Card.

Communications Satellites Part I

Send me _____ reprints of Key no. R-89 at 50¢ each.

For reprints of previous special reports fill in below:

Send me _____ reprints of Key No.(s) @ ¢ each.

(For prices, see Reader Service Card)

Name

Number of street

City, State, Zip code

DUAL OUTPUT POWER SUPPLIES



Dual output power supplies are housed in one case 3-5/16" x 4-5/32" x 4-11/16" high. Identical or different output voltages from 1.5 to 75 are available in 1 volt increments for each of the DC outputs. The graph below furnishes maximum current corresponding to output voltage. Select the two outputs needed and telephone Acopian for all the details — plus guaranteed 3-day shipment after receipt of your order.

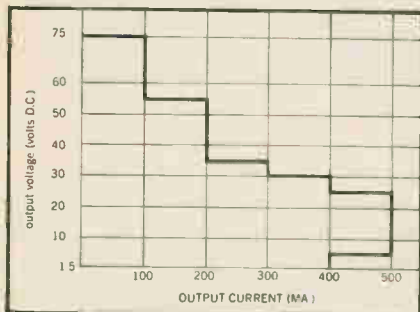

TYPICAL SPECIFICATIONS

Input Voltage: 105 to 125 VAC

Line Regulation: ± 0.5 to $\pm 0.05\%$
(depending on model)

Load Regulation: ± 1.0 to $\pm 0.05\%$
(depending on model)

Ripple: 5 to 1 mv (depending on model)

No additional external heat sinking required.

Write for Acopian's 16-page catalog and price list to: Acopian Corp., Easton, Penna., or call collect (215) 258-5441.



New Microwave

Traveling-wave tube produces 12 kw c-w



A 12-kilowatt continuous-wave traveling-wave tube (twt) was developed to satisfy military requirements for broadband, multifrequency communications systems in ground station satellite transmitters. It is expected to be of considerable interest to commercial satellite communications systems designers.

The tube is liquid cooled, and the metal-ceramic construction of the vacuum envelope provides a direct thermal path between the interaction structure and external cooling ducts, minimizing coolant requirements.

Depressed collector operation raises the twt's efficiency to 35% over a 7.7 to 8.4 Ghz frequency range and a coupled cavity interaction structure provides more than 30 db gain at saturation. As a result, the tube matches klystron efficiencies, while also providing 14 times their instantaneous bandwidth.

Microwave Electronics, 3165 Porter Drive, Palo Alto, Calif. [392]

Parametric amplifier boasts low noise



A parametric amplifier with a noise figure of 2 db is announced. Model

MT4010 is a complete, low noise r-f amplifier system featuring simple one-knob frequency tuning. It is suited for use in space communications, radar, radio astronomy and satellite or missile tracking.

The unit operates on the frequency range of 2.3 to 2.4 Ghz. Other specifications for the amplifier include an instantaneous bandwidth of 15 Mhz minimum and gain of 18 db minimum. Alpha Industries, Inc., 381 Elliot St., Newton Upper Falls, Mass. [393]

Coaxial diode limiter spans 0.1 to 8 Ghz



A coaxial diode limiter covers the frequency range from 0.1 to 8 Ghz. This passive semiconductor device provides receiver protection over a multioctave range of frequencies with insertion loss of 1.5 db maximum, flat leakage of 100 mw maximum, and extremely fast recovery time (100 nsec maximum). Peak r-f input power is 20 w and average r-f input power is 0.2 w.

The MA-8444-C4S is an extremely compact, lightweight (2 oz) receiver protector designed for applications including electronic countermeasures, broadband tracking and navigational radar, as well as ferrite duplexing networks in a variety of manpack, airborne or satellite radar, beacon or communications receivers.

Microwave Associates, Inc., Burlington, Mass. [394]

Precision coaxial standard terminations

Two new resistive terminations have been introduced for calibrating bridges, reflectometers, etc. They are the 100-ohm type 900-

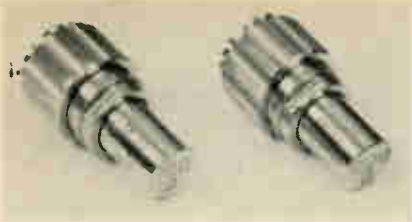

W100 and the 200-ohm type 900-W200. The 100-ohm termination holds its nominal resistance within $\pm 1.5\%$ up to 1 Ghz, within $\pm 5\%$ to 8.5 Ghz; the 200-ohm unit holds its nominal resistance within $\pm 1.5\%$ to 1 Ghz, within $\pm 10\%$ to 8.5 Ghz. Calibration charts for r-f resistance are supplied.

The position of pure resistance is nominally 4 cm from the reference plane of the GR900 connector and is further defined by a calibration chart with each unit. The manufacturer is also introducing new short-and open-circuit terminations (types 900-WN4 and 900-WO4), with the position of short or open circuits displaced 4 cm to correspond to the offset of the resistive terminations.

Each of the new terminations is priced at \$60.

The General Radio Co., West Concord, Mass., 01781. [395]

Mixer/preamplifiers weigh 2 ounces

A series of ultracompact mixer/preamplifiers is announced. Each model consists of a microwave mixer integrated with a solid state i-f preamplifier. The package is said to be one-sixth the size of previously available devices.

Available in seven models, covering contiguous frequency bands, the "dash eleven" series provides microwave conversion over a range of 0.1 to 12.0 Ghz. I-f outputs are available at 30 or 60 Mhz, in 20 Mhz bandwidth. Over-all conversion gain is 20 db. Maximum signal input for linear operation is -24 dbm. Power required is -20 v d-c at 10 ma.

Units measure 2 cu in., weigh 2 oz. Connectors are coaxial, OSM. Prices are \$695 to \$995; delivery, 5 weeks.

LEL division of Varian Associates, Akron St., Copiague, N.Y. [396]

microwave acoustic delay lines a practical reality from MEC

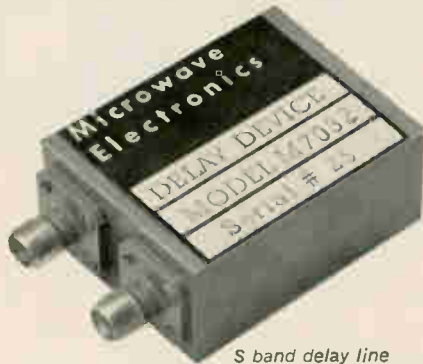

S band delay line

When it comes to specifying a state of the art device like a microwave acoustic delay line, the designer must be confident that the device is an actual piece of hardware, adaptable to the problem at hand. Laboratory curiosities won't do.

When we say that we have a product line, we mean just that. This is data that is reproducible over a wide range of environments. This is data that we guarantee on a fixed-price basis. This is the data that is the basis of our capability projections. It also represents three years of design and development experience in our laboratory and test areas.

For example: In L and S bands 1000 MHz bandwidth is "real world" at MEC.

Fixed delays between .5 and 5 μ sec. can be specified in L, S, or C band.

Insertion losses of less than 70 db are standard in C band; in other ranges the loss is correspondingly less. Across 10% of L band losses are 25 db or lower.

Applications? Some of our customers have used them in altimeters, ECM systems, radar ranging systems, and for standard two-port memory and signal delay.

Whether you want octave bandwidth in L band, or wide-band coverage at higher frequencies, call MEC. We've got the capability and experience to talk microwave acoustics, and the data to back it up.

Exceptional opportunities on our technical staff for qualified engineers and scientists. An equal opportunity employer.

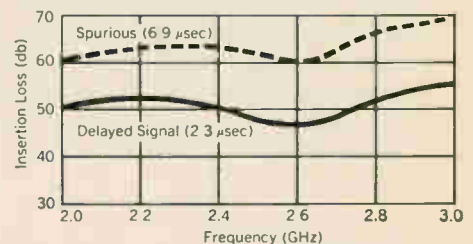

S band performance characteristics, M 7032



Microwave Electronics

3165 Porter Drive
Palo Alto, California
a division of Teledyne, Inc.

IF YOU DON'T RECOGNIZE THIS

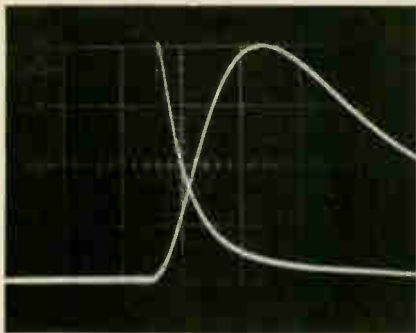

IT'S NO WONDER,

because you've probably never seen 2940 feet of coaxial cable measured this way before.

HOW COULD YOU?

We used the TRW Model 46A Trigger Delay Generator, just coming on the market. It's brand new, with some inherited virtues of its predecessor, TRW Model 2A—**nanosecond accuracy**, high power trigger to override random noise, clear digital display, selectable triggering threshold—**plus plug-in capability** so you buy exactly the triggering input you need, exactly the sensitivity and spectral range your application calls for.

ASK US FOR A TECHNICAL DATA BULLETIN AND APPLICATION NOTES

giving the characteristics of the TRW Model 46A and the plug-ins, and illustrating how you can use the TRW Trigger Delay Generator, as we did, to make direct measurement of delay lines, to generate fiducial marks, calibrate oscilloscopes, and trigger the TRW Image Converter Camera or countless other laboratory instruments.

TRWINSTRUMENTS

139 Illinois Street, El Segundo, California
AC 213, 679-9101 Extension 22884.

Developers and manufacturers of state of the art diagnostic instruments for basic and applied research.

New Production Equipment

Die bonder produces plastic transistors



In response to the growing demand for plastic-encapsulated transistors and semiconductors, the Kulicke and Soffa Manufacturing Co. is displaying equipment for their production at the Western Electronics Show and Convention.

An ultrasonic die bonder, shown above, takes six-inch long metal strips which have been either stamped or chemically etched. The loading mechanism, or magazine, consists of stacks of extruded pieces, with each piece holding one metal strip. The magazine can be modified to accommodate strips of various manufacturers and will hold enough for approximately one hour's production (about 1,000 to 1,500 units).

A rotary dice tray, which can be loaded manually or automatically, keeps the dice properly oriented for replacement on the carrier strips. A mirror-equipped viewing system permits the die bonder, designated model 630, to be operated manually, semiautomatically or automatically.

For manual operation, which might be used in a pilot line, the operator picks up each die with a vacuum unit which, on signal, transfers the die from the pickup area (a grease plate) to a pocket on one side of the rotary dice tray. A mirror then swings up to show the bonding area so that the operator can observe bonding of the die to the strip. The cycle is timed so that the operator cannot align

a second die until bonding of the first die is completed.

For faster production, the die bonder is operated semiautomatically. The mirror is locked in place for viewing the grease plate and the operator aligns one die while another is being bonded. For large-scale production, Kulicke and Soffa suggests placing a loaded dice tray into the die bonder's magazine. The machine then automatically picks up and bonds the dice. With the optical equipment trained on the bonding area, one attendant can periodically check several machines.

Loading dice directly into the die bonder is not as fast, the company says, as using its model 615 dice tray loader. The dice are placed randomly on a dish, and an operator sights and aligns each die along the cross hairs of a microscope. After x-y alignment is completed, a 180° rotation will not disturb the alignment. Cycle time is short—0.8 second—because the die-bonder's pickup mechanism is small and has to travel only a short distance.

Not being shown at Wescon, but designed to be used in tandem with the ultrasonic die bonder, is an ultrasonic wire bonder. Model 472 is a dual-tool, semiautomatic scissors bonder with a work-handling system and magazine feed identical to the die bonder. An operator is needed to align the wires to the target areas.

Two other wire bonders, using thermocompression instead of ultrasonics, will also be sold for plastic packaging. One, model 470, will be a nailhead bonder; the other, model 471, will be a scissors bonder.

All three machines will be available later this year. The die bonder and the ultrasonic wire bonder will each cost between \$8,000 and \$11,000, depending on modifications. The dice tray loader will cost about \$2,000.

Kulicke and Soffa Manufacturing Co., 135 Commerce Drive, Fort Washington Pa. 19034 [401]

Measuring machine inspects small parts



Bench model 100 Cordax digital readout measuring machine is designed for inspecting small parts, p-c boards and art, p-i-n connectors and similar components. It is equipped with a Flexowriter unit for tape-programed inspection. Measuring range is 16 x 12 x 10 in. under the Y-axis carriage. Readout is to 0.0001 in.

The machine measures the dimension of a part, hole or surface location with an optical electronic sensing stylus and indicates the measured dimension by digital display, or prints it out on tape or by typewriter.

The Flexowriter records sequence of inspection, nominal and actual dimensions. To inspect a dimension, the Cordax operator moves the gaging stylus to pick up the actual dimension and steps on the Flexowriter foot switch to record inspection sequence number as well as nominal and actual dimensions of the part at that point. Both sequence of inspection and nominal dimension are programed into the tape.

Cordax readout is positive with automatic plus or minus quadrant indication from floating zero. The machine can be used with the full range of Cordax accessories including automatic printout, microscope, optical viewing screen, pneumatic drill and the manufacturer's full line of probes.

The Sheffield Corp., a subsidiary of the Bendix Corp., 721 Springfield St., Dayton, Ohio. [402]

WIDEST RANGE OF MINIATURE (TO-18) PHOTOCELLS



Cloirex now offers the broadest selection of miniature CdS and CdSe Photoconductive Cells available anywhere. 23 types of CL 900 series offer:

- Resistance values from 2K to 1.4 megohms at 2 fc
- Voltage ratings from 100 to 250 volts
- All cells hermetically sealed in low-profile TO-18 transistor case. If you need a miniature, high-reliability photocell, send for new Photocell Design Manual.

CLAIREX

"The LIGHT Touch in Automation and Control"
1239 Broadway, New York, N.Y. 10001
212 MU 4-0940

L 109

Circle 226 on reader service card



so
precise
each
switch
component
is a
"JEWEL"!



RCL 1/2" ROTARY SWITCHES

- Up to 12 positions per deck with stops.
- As many as 6 poles per deck.
- Shorting and non-shorting poles may be grouped on one deck in any combination.

"Off-The-Shelf" Delivery - Write for complete engineering information

RCL

ELECTRONICS, INC.

General Sales Office: One Hixon Place,
Maplewood, New Jersey 07040



Books
to help you
do your job
better

1. AMPLIFIER HANDBOOK, RICHARD F. SHEA, Editor-in-Chief, NEW! This encyclopedic volume provides a tremendous fund of highly usable information on modern amplifiers, applicable at once to your daily work, or invaluable as a ready reference for special problems. Techniques and circuits are covered in thorough, specific detail; and additional design material prepares you for design of projected circuits not actually presented here.

In addition to discussions of network theory and major forms of devices—such as tubes, transistors and other semiconductors, magnetic, ceramic and ionic devices, masers and lasers—the greater part of the book explains circuits used in practically every kind of amplifier, from direct current to light, from microwatts to megawatts, embracing all the devices previously described. 1280 pp., \$37.50.

2. NOISE AND ITS EFFECT ON COMMUNICATION. By NELSON M. BLACHMAN. Clearly, concisely, this timely book unifies the useful information on random processes and their spectra, the effect of nonlinear transformation upon signal and noise, the statistical theory of detection, and information theory, much of it not found in other books. Approximately 200 problems extend the subject-matter. Complicated notation and math are avoided. 224 pp., \$13.50.

3. THE PROGRAMMER'S FORTRAN II and IV: A Complete Reference. By CHARLES P. LECHT. The only book now providing full, clear treatment of both of these computer languages—their characteristics, advantages, limitations, and use. 162 pp., \$7.95.

4. MATHEMATICS OF PHYSICS AND MODERN ENGINEERING, 2nd Edition. By I. S. SOKOLNIKOFF and R. M. REDHEFFER. Hundreds of problems add to the stimulation-value of this up-to-date, exceptionally thorough volume. 752 pp., \$14.75.

At Your Bookstore or
Direct from Publisher for

10 DAYS FREE EXAMINATION

McGraw-Hill Book Co., Dept. 23-L-882
330 West 42 Street, New York, N. Y. 10036

Send me the book(s) enclosed below for 10 days on approval. In 10 days I will remit for book(s) I keep, plus a few cents for delivery costs, and return unwanted book(s) postpaid.



1 2 3 4

Name (print) _____

Address _____

City _____ State _____ Zip Code _____

For prices and terms outside U. S. write
McGraw-Hill Int'l NYC 23-L-882

New Materials

Conductive coating for thermoplastics



A silver-filled electrically conductive coating, E-Kote No. 3042, is designed for coating vinyl and other thermoplastic insulators. Vinyl insulated wire can be shielded with this material at a much lower cost than with wire braiding, the makers say. Illustrated is vinyl wire partially coated with the E-Kote compared with conventionally braided wire. The coating is air drying and sets up by evaporation of solvent to a volume resistivity of approximately 0.001 ohm-cm. It becomes touch dry in a half hour and completely dry within 24 hours at 77°F.

A 3-oz. sample kit is available from stock for \$10.

Epoxy Products Co., division of Allied Products Corp., 166 Chapel St., New Haven, Conn., 06513. [406]

Polyolefin tubing is heat-shrinkable



A flexible, heat-shrinkable irradiated polyolefin tubing (Insultite CP-150) is available for use in almost all electrical and electronic products, according to the manu-

facturer. Specific applications recommended include wire and cable harnessing and the insulation and protection of connectors, splices, electromechanical connections and motor leads. Solid state and other electronic components can also be quickly encapsulated with Insultite CP-150.

The company says the new material will cost 50% less than polyolefins available now. It is a commercial version of the company's FP-301 Insultite, used in military and aerospace applications. It will form a quick, permanent insulating bond and will function as an insulator or as an encapsulation for components subject to shock, strain and vibration.

In addition to not splitting nor rupturing even over irregular surfaces, Insultite CP-150 has high temperature resistance (UL rated at 125°C). It will be available in sizes $\frac{3}{4}$ in. to 2 in. expanded inside diameter.

Cold impact is -30°C; heat shock, +250°C; heat aging, 25% at 150°C; dielectric strength, 100 v per mil (0.001 in.); dielectric constant, 2.7 max; dissipation factor, 0.0003; volume resistivity, 10^{14} minimum; corrosion, 1% maximum change.

Electronized Chemicals Corp., a subsidiary of High Voltage Engineering Corp., Box 57, Burlington, Mass. [407]

Encapsulation systems protect semiconductors

Compatibility with nearly all materials used in semiconductor manufacture is assured by a choice of one of two new liquid encapsulation materials, according to the manufacturer. The two chemically different systems, C58 and C59, have been developed with very similar handling properties and cured characteristics; a single system cannot be compatible with all the possible semiconductor materials.

Three potting compounds are rated to operate in the class H range. Features include high thermal conductivity, thermal stability, adhesion and toughness.

Hysol Corp., Olean, N.Y. [408]



Ask your best friend to shoot holes in your reasons for joining Martin in Florida

Once you investigate the big things happening at Martin Company in Orlando, Florida, you'll think you've got an airtight case for taking that giant step ahead in your career. But to make sure you're not swayed only by the thoughts of living in Florida, try these arguments on your best friend.

1. A challenge to work with a top-flight engineering team now designing and producing Sprint, Walleye, RADA, Shillelagh, Pershing and many other advanced systems.

2. A promise of long-term professional growth with a company that shows its faith in the future by investing over eight million dollars in new R&D facilities in the past three years.

3. An opportunity to select from a variety of more than 150 special projects aimed at long-term business development.

4. An inspiration to produce your best work by combining a rewarding career with year-round outdoor living for your family.

We believe a healthy discussion of these points will reconfirm your decision to move up with Martin. And just in case your friend likes the move up idea, have him call us collect. Phone 305/855-6100 and ask for Don Parsons, Manager, Professional Staffing.

MOVE
UP

WITH MARTIN
IN FLORIDA!

MARTIN COMPANY
ORLANDO FLORIDA

An Equal Opportunity Employer.

Radar Equipment Design Engineers

The Hughes Radar & Space Electronics Laboratories have important opportunities available for experienced Engineers.

Circuit development

Engineers are desired for assignments involving high-power transmitters for advanced design pulse/pulse doppler radars. Desirable background would include detailed familiarity with transmitter tubes, high-voltage design, solid state techniques, microminiaturization, logic/control, pulse circuits or power supply design.

Openings are available on nearly all levels—from those with a minimum of two years of applicable, professional experience through those who are interested in and qualified for senior supervisory positions.

Accredited degree and U.S. citizenship required.

For immediate consideration, please airmail your resume to:

MR. ROBERT A. MARTIN
Head of Employment
Hughes Aerospace Divisions
11940 W. Jefferson Blvd.
Culver City 18, California



An equal opportunity employer — M & F



New Books

Reliability with redundancy

Failure-Tolerant Computer Design
William H. Pierce
Academic Press Inc., 242 pp. \$8.50

The design of reliable systems using unreliable components is rapidly assuming central importance in microelectronics, and Pierce has written an excellent introduction to the problem. In expanding his doctoral dissertation on the subject into textbook form, the author has added a good deal of background information, and the results are sufficiently general to be of interest to all designers of complex systems. Workers in the field will appreciate the excellent 15-page bibliography contributed by Paul A. Jensen of the Westinghouse Electric Corp.

The conflicting requirements of the general reader and the specialist have been met by relegating the details of Pierce's own contributions to seven appendixes. From the problems after each chapter we may infer that the author has tried out the material in at least one graduate course.

There are three papers considered classics in the field of failure-tolerant network design. Pierce based his work on one of these, John von Neumann's "Probabilistic Logics and the Synthesis of Reliable Organisms from Unreliable Components," given orally in 1952 and published in 1956. Approximately two-thirds of the book is devoted to Von Neumann's approach which, in essence, consists of making three or more redundant calculations and deciding which answer is correct by a majority logic circuit or a "vote-taker."

In presenting the Von Neumann method, the author begins with the case of simple majority rule with three or more redundant elements in parallel. An obvious extension is a weighting factor when one output is known to be less reliable than the others. A further extension is an adaptive system where the weights given each output are adjusted according to performance. Thus, an output consistently opposite to that of the majority is gradually removed from the circuit. The final step is the modification of the computer elements themselves

so that they can perform the redundant logic.

The principal unsolved problem in redundant circuits is the location of the majority-logic or restoring elements. Should every single element be made redundant with majority logic? Or should three complete computers be used with a majority decision only at the output? The answer depends on the reliability of individual components, but the best solutions for particular situations are not yet known.

The chapter which discusses the two other classical papers—R.W. Hamming's "Error Detecting and Error Correcting Codes," published in 1950 and E.F. Moore and C.E. Shannon's "Reliable Circuits Using Less Reliable Relays," published in 1956—are less satisfying than the remainder of the book. For example, Moore and Shannon pointed out the distinction between relays which failed as short circuits and relays which failed as open circuits. Obviously, if relays fail only in the open position, a parallel combination of them could be made arbitrarily reliable. But then a short circuit would be a disaster. Moore and Shannon solved this problem by means of "compositions" in which each contact is replaced by a redundant network. Pierce blurs the distinction between open- and short-circuit failure and therefore loses much of the point of the Moore-Shannon approach.

Pierce's elementary introduction to Markov chains is an interesting digression from the main theme, but probably should have been relegated to an appendix. He also includes a chapter on coding theory which is short and curiously negative in tone. Pierce believes that coding redundancy is impractical because the decoders become complex, but it is still too early to write off this approach.

The mathematical level is such that the book can be read by any graduate engineer. The author has followed Von Neumann's mathematical point of view, however, and the book will be enjoyed more by those with some background in probability, statistics and in-

STUCK for MAGNETS?



CALL PERMAG

We stock all sizes, all shapes, all grades, for all uses . . . all ready for 24-HOUR DELIVERY. Including soft magnetic materials—now available for the first time in small, less-than-mill-run quantities. Also, magnets engineered and fabricated to your needs. Write for catalog and data sheets.

PERMAG PACIFIC CORP. 5441 W. 104th St.
Los Angeles, Calif. 90045 / Phones: Area Code
213 776-5656, 213 670-7060 / TWX: 213 670-0408

PERMAG CENTRAL CORP. 5301 D. Otto Ave.
Rosemont, Des Plaines, Illinois 60018 / Phone:
Area Code 312 678-1120

PERMAG CORP. 88-06 Van Wyck Expressway
Jamaica, New York 11418 / Phone: Area Code
212 Olympia 7-1818 / TWX: 212 479-3654

Circle 228 on reader service card

SPECIFY Matsunaga STAVOL



Automatic Slide Voltage Regulator

- Incorporates a servo mechanism and a motorized slide regulator.
- Assures stabilized voltage supply continuously to various electric and electronic devices by eliminating injurious over- and under-voltages.
- Compact and rugged, top performance and durability.
- Available at competitive prices.

General Specifications

Rated Input Voltage	100	200
Voltage Variation Range	80-120	160-240
Output Voltage	110	220
	adjustable within $\pm 20\%$ of rated voltage.	
Regulation Accuracy	within $\pm 1.5\%$ for line variations up to $\pm 20\%$.	
Time Constant	within one second for line variations up to 10% .	
Regulation	over 90%	

MATSUNAGA MFG. CO., LTD.



Export Division:
MATSUNAGA INTERNATIONAL, LTD.
Kyawa Bldg., 3-4, Shiba Katohira-cha,
Minato-ku, Tokyo, Japan

Circle 229 on reader service card

formation theory. In fact, the author's first effort is to derive some limit theorems similar to those of information theory. Several of these theorems involve the cost of a system. For example, if all the components are identical, the system cost for constant reliability grows faster than n , the number of units, and is proportional to $n \log n$.

The author has attempted to bring some order and logic into the new field of error-tolerant circuit design. He has encompassed, with some success, the three classical mathematical approaches to decision theory, switching theory and coding theory. He has, however, ignored several hardware-oriented approaches to reliability which also show promise. The first of these is the National Aeronautics and Space Administration's "zero-defect" program, based on the premise that so-called random failures are not really random, but have causes which can be removed if sufficient care is taken. The second is that of "functional degradation" in which failures are not catastrophic, but merely reduce the performance of the device. The third is the "self-organizing" system in which the computer organizes itself to perform a task and automatically selects operating components. There is some indication that biological computers—human brains—operate on this principle.

Ronald E. Scott

Dean of the College of
Engineering
Northeastern University
Boston, Mass.

Recently published

Electrical and Electronics Drawing, second edition, Charles J. Baer, McGraw-Hill Book Co., 402 pp., \$6.50

Packet Handbook for Engineers, Sigmund L. Smith, Strum and Smith Publishers, 40 pp., two for \$1

Optimal Control, Michael Athans and Peter L. Falb, McGraw-Hill Book Co., 879 pp., \$24.00

Transistor Circuit Analysis and Design, second edition, Franklin C. Fitchen, D. Van Nostrand Co., Inc., 412 pp., \$8.50

Semiconductor Circuits Handbook, Techpress, Inc., Vol. I, 191 pp., \$2.95; Vol. II, 127 pp., \$1.95

Fluid Amplifiers, edited by Joseph M. Kirshner, McGraw-Hill Book Co., 295 pp., \$16.50

Air Pollution Instrumentation, edited by Donald F. Adams, Instrument Society of America, Pittsburgh, 75 pp., ISA members \$4.75, nonmembers \$6.50

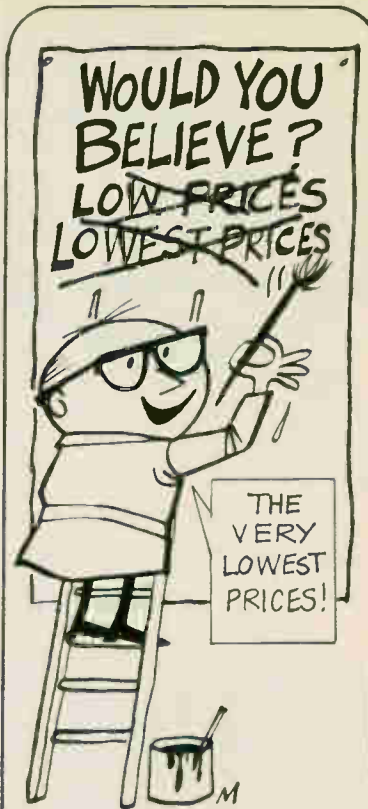

NPC 2N2430 2N2431 Germanium Transistors

High quality NPN and PNP types in TO-1 case

The Nucleonic 2N2430 (NPN) and 2N2431 (PNP) are germanium alloy transistors designed for medium power audio applications.

These reliable devices exhibit excellent beta linearity and are especially suited for Class B push-pull applications. A pair of either type will deliver up to 5 watts of output power.

A 2N2430 may be used with a 2N2431 for complementary symmetry requirements in transformerless circuitry.

Write or call NPC for specifications and our low price.



**NUCLEONIC
PRODUCTS
CO., INC.**

3133 East 12th St. Los Angeles
Calif. 90023 • Tel: (213) 268-3464
TWX: 910-321-3077

Circle 201 on reader service card

201

LIVE (REALLY LIVE) and PROFIT IN THIS ALL SEASON VACATIONLAND



*Let us show you
how to mix pleasure
with your profits!*



Millions of Americans have made SOUTH DAKOTA their ideal vacation-land . . . Now they're learning that it's also a great BUSINESS-land . . . Big, uncluttered, lots of hunting, fishing, and just plain liveability . . . Yet close to everywhere at the continent's crossroads. \$2 postage may be all that stands between you and a new future in uncrowded SOUTH DAKOTA. Let us send you our new portfolio today.

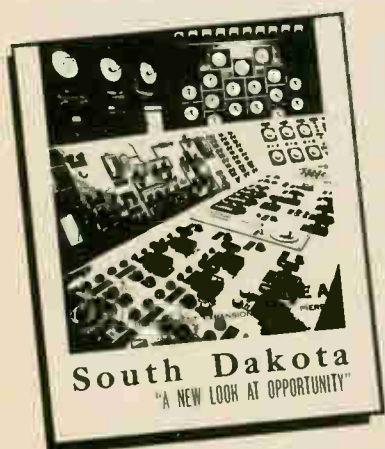

**GET THE SOUTH DAKOTA
STORY**

CONTACT

James W. Monroe, Director
Industrial Development & Expansion Agency
Room G
Pierre, South Dakota 57501
Ph. 224-5911 Area Code 605

Technical Abstracts

Microelectronic life

Current and future reliability requirements compared to present reliability levels

J.B. Brauer, Rome Air Development Center, Rome, N.Y.

Military and commercial users of microelectronic devices look forward to maintenance-free lifetime for devices, discard-at-failure maintenance for complex modules of entire equipment and logistics self-support or on-board spares. Though maintenance-free life cannot be achieved in the foreseeable future except for very simple equipment, gross simplification in maintenance and logistic procedures through modular-level repair and discard-at-failure techniques can be anticipated.

In view of present reliability techniques, can microelectronic devices be purchased that have a failure rate of 0.001% per thousand hours? The author's answer is a resounding no.

Rome Air Development Center purchased integrated circuits from one of its most dependable suppliers for use in the Mirage 1 radar plan position indicator display. Of 600 circuits delivered, 10 failed to pass incoming inspection, 10 more were damaged during installation and two more failed during 9,000 hours of equipment operation. If only the two burn-in failures are considered, the failure rate at 60% confidence is 0.14% per thousand hours. The equipment would have to operate for another 140 years without a failure in order to achieve the 0.001% per thousand hours failure rate.

In a radar intercept calculator program, Rome had the lowest percentage (0.5%) of dead-on-arrival devices. But five of these circuits had the lids on backwards, resulting in a p-i-n orientation 180° "out of phase." These devices could not have passed even the most basic d-c static test. Two more devices had defective resistors; one had a mask or photoresist defect and the other was damaged after photoresist application. Neither would pass a functional test.

In another program, Rome

bought 179 diode transistor logic gates for a reliability-techniques study. When the vendor's electrical acceptance test was repeated, the lot showed 3.9% failures. After 250 hours burn-in, another 24% was lost. A second lot delivered by the same vendor after he was informed of the difficulties showed no failures.

The author concludes that, the "time-zero quality problem" (quality at user's incoming inspection) is now an order-of-magnitude more serious than problems of continuous degradation in the field.

Presented at the Fifth Annual Microelectronics Symposium, St. Louis, Mo., July 18-20.

Failure free

Ultrahigh reliability medium power traveling-wave tubes
R.A. Brenam and N.A. Greco,
Microwave Tube division,
Hughes Aircraft Co.

The traveling-wave tube represents one of the most important microwave devices developed in the last 20 years. Operating primarily as an amplifier in the microwave region of the electromagnetic spectrum, the tube finds applications in radar, navigation and communication systems which require amplification of radio frequency signals from 1,000 to 10,000 megahertz. The power output can vary from milliwatts to megawatts and can amplify r-f signals up to one million times at octave bandwidths.

Until five years ago a traveling-wave tube was considered unreliable and its use limited to ground and airborne systems where it could be periodically replaced. To meet reliability requirements of orbital spacecraft and deep space probes, the Microwave Tube division of the Hughes Aircraft Co., developed a rugged, lightweight, medium power amplifier.

This paper discusses, in brief, the operation of a traveling-wave tube and the role played by various tube components: helix, dielectric support rods, attenuator, r-f window, metallic support rods, collector, electron gun, electron beam and magnetic field. The authors examine in detail the conditions un-

**DON'T SWITCH CHANNELS.
USE A BINARY
TWO GUN OSCILLOSCOPE**



This PROVEN INSTRUMENT Features:

- Two Separate Simultaneous Inputs
- DC to 5 MC Band Width
- 1 Millivolt/Cm Sensitivity
- Built-in Calibration
- External Horizontal and Z Modulation

Model 5Mc-2P Illustrated

Write for complete specifications.

We Are Authorized to Up Date
or Repair Your
Packard Bell
Model 5MC-2P Scope

BINARY ELECTRONICS

of California

1429 N. STATE COLLEGE BLVD.

ANAHEIM, CALIF. 92805 714-772-3070

Circle 230 on reader service card

Reprint order form

Send to: Electronics Reprint Dept.
330 West 42nd Street
New York, N. Y. 10036

For listing of reprints available see
the reader service card.

To help expedite mailing of your
reprints please send cash, check or
money order with your order.

For reprints of the latest special
report:

Communications Satellites Part I

Send me reprints of key no
R-89 at 75¢ each.

For reprints of previous special
reports fill in below:

Send me reprints of key
no.(s) at ¢ each.

For prices see the reader service
card.

Name

Number & Street

City, State

Zip code

der which the tube must operate, because "a thorough knowledge of all possible failure modes is fundamental to any reliability program." Failure-mode analysis charts provide a concise summary of typical modes and their cause and effect relationships.

The value of the charts is that all major failure modes can be easily recognized and precautions taken. It is difficult or impossible to make fundamental design changes in the late stages of a development program because of a lack of time or prohibitive costs. Using patch up methods instead of tackling the problem head on may result in mission failure or even obsolescence of the entire system.

Presented at the 5th Reliability and Maintainability Conference, New York, July 18-20.

Sound picture in 3-D

Ultrasonic holography and visual reconstruction

F.L. Thurston

Bowman Gray School of Medicine

Wake Forest College

Winston-Salem, N.C.

Ultrasonic techniques offer unique advantages for internal examinations of any opaque object: the visual probe can be performed without cutting open the object and without introducing potentially harmful energy—such as X-rays. But an analysis of the returned ultrasonic signal presents problems, because the display, usually on an oscilloscope, lacks clarity and is limited to two dimensions.

However, a way to reproduce ultrasonograms in three dimension with holograph techniques [Electronics, April 18, p. 139-143] is proposed by the author. If the ultrasonic signal were to modulate a laser beam, a hologram of an object's internal structure could be produced. Holography is an optical technique for producing the image of an object in space by photographing the object's optical interference pattern with a laser and then reilluminating the pattern. The technique could be used by doctors to prepare holograms of internal organs, which could then be studied in three dimension, or by industrial researchers to look inside a solid material.

Presented at the Symposium on Biomedical Engineering, Milwaukee, Wis., June 24-25

**6 BIT A TO D
CONVERTER
15,000,000
CONVERSIONS
PER SECOND**



**MODEL 834A ANALOG
TO DIGITAL CONVERTER**

Well-suited for telemetering or process control. Long life and high stability. All solid state, silicon semi-conductors.

SPECIFICATIONS

Method: successive comparison. Digital Output: B.C.D. 12 bit parallel. Stability: ±0.2%/6 months. Conversion time: approximately 240µs. Operating temperature: -10°C to +50°C. Width: 480 mm. Height: 199 mm. Depth: 2250m/m. AC Input: 100/110/220/240V ±10% 50 or 60 c/s.

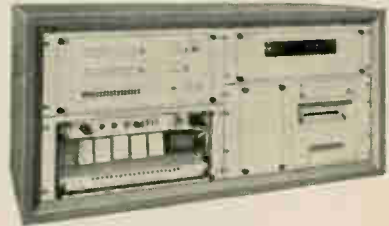

MODEL 198C OATA LOGGING SYSTEM

All solid state. Random access analog scanner. High reliability and accuracy. Operates over large temperature ranges. Low cost.

SPECIFICATIONS

Scanning capability: 16 channels. Scanning speed: up to 5 channels per second. Accuracy: 0.1%. Output: printing paper tape. Logging cycles: 10 seconds to 1 hour (specify on ordering). AC Input: 100/110/220/240V ±10% 50 or 60 cps (specify on ordering).



**MODEL 507C
DIGITAL VOLTMETER**

All solid state and high speed.

SPECIFICATIONS

Measuring range: (1) 0.001 to 1.599 volts
(2) 0.01 to 15.99 volts
(3) 0.1 to 159.9 volts
(4) 1 to 1,599 volts

Accuracy: 0.1% of full scale. A/D conversion time: 600µs. Max. repetition rate: 1kc. Reading mode auto: 100 c/s repetition rate. Digital output: 4 digit decimal 10C1, parallel code connectable to the line printer. Operating temperature: 0 to 40°C. Width: 480mm. Height: 199mm. Depth: 350mm. Weight: approx. 13 kg. AC Input: 100/110/220 240V 50 or 60 cps.

CHUO ELECTRONICS CO., LTD.

No., 21 Motohongo-machi, Hachioji-shi,
Tokyo, Japan

Arc-free, tool-less lead assemblies put an end to Hi-Voltage problems



LGH* leads and receptacles are the easiest, safest way to hook up and disconnect high voltage lines. No solder or tools are required, and because the conductive elements are recessed and fully insulated when connected, you need no arc-over space. Unlike ceramic terminals whose soldered leads break off under vibration, our unique design provides built-in strain relief. AMP's CAPITRON Division offers a complete line of color-coded leads and receptacles for CRT and HV tubes, radar components, and commercial applications.

OTHER FEATURES:

- Lightweight, space saving, safe
- -55° C to +125° C continuous operation*
- Standard rating to 50,000 VDC*
- High dielectric and mechanical strength
- Hermetically sealed for corona resistance
- Operate up to 70,000 ft. without derating
- Meet applicable mil. specs.

Special designs available on request. Other CAPITRON products include: high and low voltage power supplies, capacitors, radar pulse modulators and pulse forming networks. For full details on any of these CAPITRON products, write to:

AMP INCORPORATED

CAPITRON DIVISION
155 Park St., Elizabethtown, Pa. 17022
TWX: 717-330-4560 Phone: 717-367-1105

CAPITRON products and engineering assistance are available in Canada through Aircraft-Marine Products Ltd., Ontario, Canada

*Trademark of AMP Incorporated

New Literature

Zener and reference diodes. General Semiconductors, Inc., Tempe, Ariz. A 26-page product reference list gives electrical and mechanical specifications for over 1,200 basic Jedec zener and reference diode type numbers manufactured by the company and explains the meaning of the basic Jedec type number suffix letters.

Circle 420 on reader service card.

Volt-ohm-milliammeter. The Triplett Electrical Instrument Co., Bluffton, Ohio, 45817, offers a data sheet on the 630-APLK volt-ohm-milliammeter with overload protection and transistorized switching circuit. [421]

Desk-top computer. Wang Laboratories, Inc., 836 North St., Tewksbury, Mass., has available a brochure describing the LOCI-2, a desk-top computer. [422]

Vibration analysis systems. MB Electronics, Inc., 781 Whalley Ave., New Haven, Conn., 06508. Swept spectrum analyzer systems and their applications in vibration and acoustic analysis are detailed in bulletin 500. [423]

L-band stripline oscillator. Terra Corp., 505 Wyoming Blvd., N.E., Albuquerque, N.M., 87112. Bulletin 660701 provides specifications for a 500-watt, L-band, grid-pulsed strip transmission line oscillator designed to provide frequency stability over a wide temperature range and variations in plate voltage. [424]

Control module. Sensor Corp., 155 Bay St., Bridgeport, Conn. Technical bulletin 3001 covers the control module model 5-33201A, which is designed to work in conjunction with Sencor inductive proximity sensors. [425]

Spdt relays. Sigma Instruments Inc., 170 Pearl St., Braintree, Mass. 02185. A 12-page bulletin catalogs a wide variety of standard a-c and d-c types available in the series 5 spdt relay. [426]

Circular connectors. ITT Cannon Electric, 3208 Humboldt St., Los Angeles, Calif., 90031, has published catalog MC-2A covering the MC, KO and KM series of miniature circular connectors. [427]

Digital systems. Wang Laboratories, Inc., 836 North St., Tewksbury, Mass., offers a condensed catalog describing a line of advanced digital systems. [428]

Time code generators. Chrono-Log Corp., 2583 West Chester Pike, Broomall, Pa. Low-power, battery-operated time-code generators are discussed in a four-page, two-color bulletin. [429]

Etching-grade Kovar alloy. Westinghouse Electric Corp., Materials Manufacturing division, Blairsville, Pa., 15717. Brochure B-3401 describes etch-

ing-grade Kovar alloy for use in the chemical etching of integrated circuit lead frames. [430]

Selector switches. CTS Corp., Elkhart, Ind. Data sheet 4216 contains illustrations, dimensional drawings and technical details on four new detents and two wafer styles of the single-section and multisection line of CTS selector switches. [431]

Transistorized industrial timer. Tempo Instrument Inc., East Bethpage Road, Plainview, L.I., N.Y. A 20-page handbook covers the transistorized electronic timer, its operation, capabilities and applications. [432]

Oxide crystals. Aremco Products, Inc., P.O. Box 145, Briarcliff Manor, N.Y. 10510. Bulletin 508 describes a line of oxide crystals for magnetic, laser, and microcircuit research and production. [433]

Relay brochure. Filtors, Inc., 67 Daly Road, East Northport, N.Y., 11731, has available an illustrated booklet and short-form relay catalog. [434]

Trimmer resistors. Centralab, the Electronics division of Globe-Union Inc., P.O. Box 591, Milwaukee, Wis., 53201. Microminiature and miniature trimmer resistors are described in a 12-page catalog. [435]

Tiny chopper. Solid State Electronics Corp., 15321 Rayen St., Sepulveda, Calif., 91343, offers a single-sheet bulletin on the model 20 Microchopper. [436]

Snap-off varactors. Microwave Associates, Inc., Northwest Industrial Park, Burlington, Mass., has released bulletin 5521 describing in detail a series of nine snap-off varactors. [437]

Electron tubes. Tung-Sol Electric Inc., Newark, N.J., 07104. Manual T-23 is a handy, quick-reference guide to the company's special-purpose industrial and military tubes. [438]

Vacuum capacitors. ITT Jennings Radio Mfg. Corp., P.O. Box 1278, San Jose, Calif., 95108, announces a 44-page vacuum capacitor catalog that describes the physical and electronic characteristics of the units in detail. [439]

Varactor diodes. Bomac division, Varian Associates, Salem Road, Beverly, Mass., 01915. A four-page brochure describes the behavior of dimode varactor diodes and the properties of stored charge. [440]

Power supplies. Deltron, Inc., Wissahickon Ave., North Wales, Pa., 19454. The highly regulated, H series of variable power supplies is illustrated and described in bulletin 108A. [441]

Power connectors. Continental Connector Corp., 34-63 56th St., Woodside, N.Y., 11377, has available a 16-page catalog on series 250 miniature, rectangular rack-and-panel power connectors. [442]

Shaft-angle encoder. Dynamics Research Corp., 38 Montvale Ave., Stoneham, Mass. A six-page product bulletin provides detailed information on model 28 Optisyn shaft-angle encoder. [443]

Soft ferrite cores. The Arnold Engineering Co., Box G, Marengo, Ill., offers a two-page data sheet describing soft ferrite magnetic materials for commercial, military and industrial electronic applications. [444]

Industrial relays. Parelco, Inc., 2288 Westwood Blvd., Los Angeles, Calif., 90064, offers a product data sheet on the selection and ordering of miniature d-c operated ultrasensitive industrial relays. [445]

Differential amplifier. Neff Instrument Corp., 1088 E. Hamilton Rd., Duarte, Calif., 91010. A two-page brochure gives specifications and ordering information on the type 119 wideband differential d-c amplifier. [446]

Spectroradiometer. Beckman Instruments, Inc., 2500 Harbor Blvd., Fullerton, Calif., 92634, has released a four-page descriptive brochure on the spectroradiometer, an instrument for measuring radiance or irradiance of light sources ranging from very low intensity electroluminescent panels up to extremely high intensity solar simulators. [447]

Strip connectors. ITT Cannon Electric, a division of International Telephone and Telegraph Corp., 3208 Humboldt St., Los Angeles, Calif., 90031, has issued catalog CL-1 covering a series of microminiature strip connectors. [448]

Events counters. The A.W. Haydon Co., 232 North Elm St., Waterbury, Conn., 06720. Product information sheet 119A contains basic technical information on the series LM19501 and LM19502 microminiature events counters. [449]

Automatic counting instruments. ITT Controls and Instruments division, International Telephone and Telegraph Corp., 2000 South Wolf Road, Des Plaines, Ill., offers an eight-page catalog describing a complete line of automatic counting instruments. [456]

Vidicon camera. Ampex Corp., Mail Stop 7-14, 401 Broadway, Redwood City, Calif. Bulletin V-057 describes the CC-324 vidicon camera for closed circuit tv use in education, industry, medicine and government. [457]

Servo clamps. Theta Instrument Corp., Saddle Brook, N.J., 07662, has available an engineering bulletin on its line of standard servo clamps, that are used to hold synchros, potentiometers and encoders to mounting plates. [458]

MODULAR HEAT SINKS

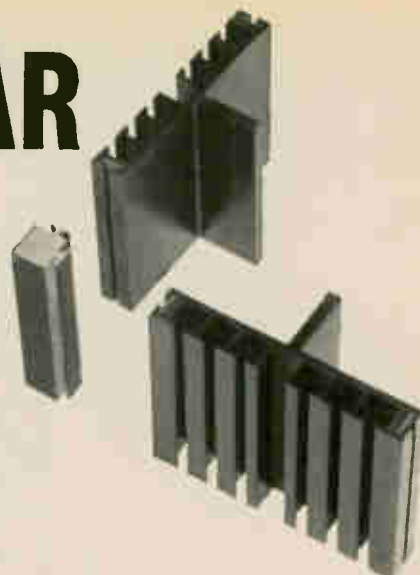

Around corners or in straight sections, these modular heat sinks are easily joined into a rigid mechanical assembly with interlocking "H" extrusion bars. Unique Astrodyne design allows custom assemblies which provide excellent heat dissipation plus packaging versatility. Assemblies may be epoxy-bonded or permanently brazed if desired. Components mount easily on the wide shelves which may be located inside or outside the assembly. Efficient T-fin heat radiators provide greater dissipation per inch of length. Corner construction permits assembly of heat sinks around a central chassis.

Standard or custom mounting hole patterns may be specified. Model 2520 units are normally supplied in 6" lengths with black anodize, but other lengths and finishes may be ordered.

Technical Bulletin on the 2520 units plus our new Short Form Catalog on NATURAL CONVECTION HEAT SINKS will be sent by return mail.



astrodyne, inc.

SUBSIDIARY OF ROANWELL CORP.
207 CAMBRIDGE ST., BURLINGTON, MASS. (617) 272-3850

Circle 227 on reader service card

New THERMOCOUPLE REFERENCE UNITS



TYPICAL 320 SERIES REFERENCE UNIT
(Shown without enclosure)

- ELIMINATES ICE BATHS
- ELIMINATES WARM-UP
- CONVERTS MILLIVOLT RECORDERS TO TEMPERATURE IN 5 MINS.
- PERMITS USE OF COPPER TRANSMISSION LINES

A new concept in thermocouple reference units. Provides easy-to-use ice-point compensation, instantly. Eliminates batteries and warm-up time forever. They install in five minutes. Available in all standard thermocouple materials. Immediate delivery from stock. Supplied ready to use, with enclosure. List Price, only \$75.00.

Request Technical Bulletin No. 32



ACROMAG
INCORPORATED

30765 Wixom Road • Wixom, Michigan 48096
Phone (313) 624-1541

CIRCUIT DESIGN ENGINEERS

TEST EQUIPMENT
DESIGN ENGINEERS

NAVIGATION & COMMUNICATIONS
SYSTEMS ENGINEERS

A.G.E. DESIGN ENGINEERS

Exercise and elbow room. You'll find both at Lear Siegler

You'd like it here. Plenty of latitude at LSI. A solid, dynamic company that likes creative thinking. Actively applying new concepts, seeking new ideas in guidance and navigation systems for sub-, super- and hyper-sonic air and spacecraft.

You can grow professionally on long-term programs for design and production of advanced flight reference and navigational systems . . . in a half-million square feet of newly-completed aerospace engineering facilities.

Send your resume in confidence or write for information to:



E. A. Mellinger
Professional Employment Manager

LEAR SIEGLER, INC.

INSTRUMENT DIVISION

1141 EASTERN AVE., S. E., GRAND RAPIDS, MICHIGAN 49508



AN EQUAL OPPORTUNITY EMPLOYER

R.U. **1** answering more than
advertisement? Then please send a
separate reply to each box number. It
will help you get an answer sooner.

EMPLOYMENT SERVICES

Your Resume—Make it sell You! Instruc-
tions, samples: \$2. Executive, Box 246EL,
Montclair, N.J. 07012.



EMPLOYMENT OPPORTUNITIES

THE MARKET-PLACE
FOR ALL EMPLOYMENT NEEDS

Send new ads or inquiries to:

ELECTRONICS

Class. Adv. Div., P.O. Box 12, N.Y. 10036



E.E.'s

For FEE PAID positions
throughout U.S.

Send Coupon Today

ATOMIC PERSONNEL, INC.
Suite L, 1518 Walnut St., Phila., Pa.
Experienced Engineers... Working
"Full Time"... For You!

Send resume today. (If none, send
coupon for confidential application.)

Name _____

Address _____

City _____

State _____

ADDRESS BOX NO. REPLIES TO: Box No.
Classified Adv. Div. of this publication.

Send to office nearest you.

NEW YORK, N. Y. 10036: P. O. Box 12

CHICAGO, Ill. 60611: 643 N. Michigan Ave.

SAN FRANCISCO, Cal. 94111: 285 California St.

POSITION VACANT

Technical Editors—The publisher of Indus-
trial Research and Oceanology magazines has
several growth positions in the writing and
editing of technical publications. Editorial
offices located in scenic Indiana dunes coun-
try along Lake Michigan. Send resume, salary
requirements, and writing samples to Indus-
trial Research Inc., Beverly Shores, Ind.

SEARCHLIGHT SECTION

- CLASSIFIED ADVERTISING
- BUSINESS OPPORTUNITIES
- USED OR SURPLUS EQUIPMENT

FOR SALE: ELECTRIC, GAS, and VACUUM FURNACES

Forming Gas Generators, Nitrogen Generators, Endo-
thermic Generators, Ammonia Dissociators, Induction
Heaters, Vacuum Metallizers, Strip Chart Recorders,
Temperature Controllers, Programmers, Mass Spec-
trometers, Spectrophotometers, Refractometers, Gas
Purifiers, Electron Tube Manufacturing, Aging, and
Testing Equipment.

INSTRUMENTS & MACHINES INC.

1200 Grove Street Irvington, N.J.
201-371-7900

CIRCLE 966 ON READER SERVICE CARD

CASH REWARD !!!

You will be rewarded with cold, hard cash by selling
us your new, used, excess or unwanted electronic
equipment. WE WANT TO BUY YOUR: AN/ARN-
21, AN/ARC-34, AN/ARC-52, -55, and ARN or ARC
equipment, ID Indicators, Military Type Test Equip-
ment, Collins and Bendix equip., Instruments and in-
strumentation. Tell us what you have—collect the
reward!

J. J. CANDEE CO. Dept. E
2525 W. Burbank Blvd., Burbank, Calif. 91505

CIRCLE 967 ON READER SERVICE CARD

RADAR AUTO-TRACK & TELEMETRY ANTENNA PEDESTALS
3 & 10 CM. SCR 584 AUTOTRACK RADARS. M-33 RADAR
TPS-1D SEARCH. APS-45 TPS-10D HT. FINDERS. WX RADARS.
FPN-32GCA. APS-10 APS-15B APS-27 (AMTI) SEARCH. ■ ■ ■
APN-102 DOPPLER. DOZENS MORE CARCINOGENS. PFM'S.
.25-5-1-2-3-6 MEGAWATT PULSE MODULATORS. CAVITIES.
PULSE TRANSFORMERS. IF STRIPS. WAVEGUIDE. BENDS
200 MC. 1 KMC. 3 KMC. 6 KMC. 9 KMC. 24 KMC. RF PKGS.

RADIO RESEARCH INSTRUMENT CO.
550 5TH AVE., NEW YORK 36, N. Y. JU 6-4691

CIRCLE 968 ON READER SERVICE CARD

SEMICONDUCTORS MAJOR BRANDS

INTEGRATED CIRCUITS • DIF. AMPS DAR-
LINGTONS • POWER DIODES & TRANSISTORS
• SPECIAL DEVICES

Write for Catalog S-1

SEMICONDUCTOR SALES OF CALIF.
1063 Perry Annex Whittier, Calif.
(213) 696-7544

CIRCLE 969 ON READER SERVICE CARD

DEQUIRE BUYERS TURN TO THE SEARCHLIGHT SECTION IN ELECTRONICS NEEDS

FOR SALE



When you have used electronics
equipment to sell, advertise
in Electronics Searchlight
Section for fastest results.

For information:
Searchlight Section
Classified Advertising Division
Post Office Box 12
New York 10036

YOU'RE HIRED

Do you need electronics engineers or technical management men? Electronics magazine is the way to recruit them. Electronics is designed specifically for the working engineer. 68,000 subscribers and an additional 133,000 pass-along readers turn to it to keep up with their industry. You can find the man that meets your qualifications with an advertisement in the Employment Opportunities Section.

For rates & information write: Electronics, a McGraw-Hill Publication. Classified Advertising Division, Post Office Box 12, New York 10036.

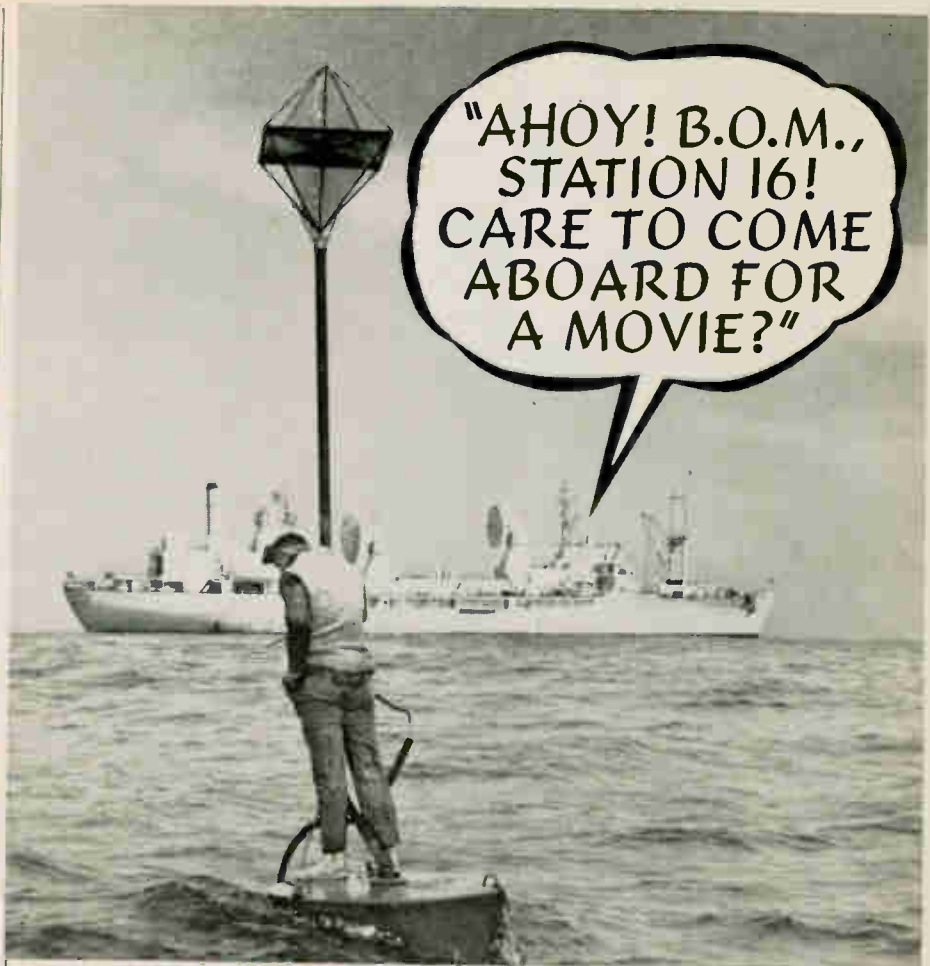

We thought you might appreciate a little inside humor. The truth of the matter is that our down range island stations for the Eastern Test Range offer a lot more solid ground to move around in than is available on the ships in the operating fleet. The situation is usually the other way around. When one of the tracking ships is in the area, the Base Operations Manager is issuing the invitations. And not always to a movie.

The point is that both jobs are vital ones in our overall responsibility during a launch. Be it missile, manned space craft, satellite or space probe, both the BOM and SOM make important split-second decisions with the chips down. A multi-million dollar mission may depend on their know-how.

They know their technology. They take full responsibility for directing the real-time monitoring of vehicle performance in flight; using pulse and CW radar, telemetry, optics, infrared, timing, command/control, data encoding and transmission equipment of the latest design. They perform in-flight trajectory measurements, utilizing digital computers and inertial navigation systems.

If you have engineering management ability, can make instant decisions, a strong technical background in any of these areas, and an EE degree, write to Manager of Professional Employment, Guided Missiles Range Division, Pan American World Airways, Inc., Dept. 28H-4, 750 S. Orlando Avenue, Cocoa Beach, Florida. An Equal Opportunity Employer.



GUIDED MISSILES RANGE DIVISION

PAN AMERICAN WORLD AIRWAYS, INC.



Some things are better flat.

Like flat cable assemblies
from ITT Cannon
(They're going places!)

Today's requirements for high-density, highly sophisticated electronic circuitry create a big, pressing need for reliability and the many other advantages of



flat cable. One case in point: missile systems, guidance computers.

Flat cable is strong. Tough. Thin. Dissipates heat quickly. Fits into corners, turns sharp angles, reaches into small, irregular or very thin spaces . . . places where wire bundles can't go.

Now, thanks to FLEX-WELD® flat cable assembly and the engineering and manufacturing capabilities of ITT Cannon:

- You can order flat cable assemblies, reliably terminated to flat, circular or D Connectors of any size or type. Terminations are welded through the insulation, without stripping, to form a bond strong as the cable material itself.
- You can order flat cable assemblies in whatever quantity, size or shape you need them. Centers to .050". Every assembly is fully tested for reliable performance.



Turn your complex interconnecting problems over to ITT Cannon's staff of flat cable specialists.

Send details of your application or write for literature. ITT Cannon Electric, 3208 Humboldt Street, Los Angeles, Calif. 90031.

A Division of
International
Telephone and
Telegraph Corp.



CANNON ITT

FLEX WELD IS A REGISTERED TRADEMARK OF DIGITAL SENSORS, INC.

Circle 208 on reader service card

Japan

Speeded by laser

Spurred by automobile makers who want to speed the progression of their models from styling studio to production line, two Japanese electronics companies have developed laser units that translate the contours of clay mockups into digital dimensional data.

Taking the measurements of the mockups with a laser is much faster than painstaking mechanical methods and points to a slash in design lead time for automobiles. The digital dimensional data from the laser, recorded on tape, can be processed by computer to generate numerical control programs for automatic milling of body-stamping dies. Like auto makers everywhere, the Japanese auto companies that backed the laser development don't broadcast their exact lead time; but it's estimated the laser technique could halve the two-year period generally considered par to get a new model into production.

The two companies that have readied laser pick-off units are Hitachi Ltd. and Mitsubishi Electric Corp. Hitachi appears to be out front at the moment. In addition to a laser pick-off, Hitachi has the computer software prepared and a numerical control milling machine that can turn out the dies. Such a system, Hitachi estimates, would cost somewhere between \$300,000 and \$500,000; the computer would be additional. Hitachi has no orders as yet and won't disclose which auto maker it worked with to develop the system.

For its part, Mitsubishi so far has developed only the laser pick-off, again at the instigation of an undisclosed auto maker. But Mitsubishi may be the first to put its laser unit to work in nonautomotive applications. The company is the leading Japanese producer of large dish antennas and the laser tech-



Hitachi laser unit translates contours into digital dimensions. Tube housing laser and detection system moves in and out to keep beam focused on surface.

nique could be used to check antenna accuracy. Mitsubishi also will have the inside track with a sister company that manufactures ships, airplanes and rockets. The laser technique, for example, could produce full-scale templates for airframe sections from half- or quarter-size models.

Two ways. Both Hitachi and Mitsubishi based their equipment on the same fundamental idea—keep a laser beam continuously focused on the target surface no matter how its contour changes. In other words, the laser head must always be kept at the same distance from the surface, moving in or out to track the contour. To achieve this, defocusing of the spot is detected in the laser head by solar cells that pick up the reflected beam. Their output is used as an error signal for a servosystem that holds the head at a fixed distance from the tracked surface. Digital dimension data then can be picked off the servodrive.

In putting the concept to work, the two firms took different tacks. The Hitachi system has a small lens to focus a neon-helium gas laser beam to a spot about 0.5 millimeter in diameter on a target

15 centimeters distant. A much larger lens—off the axis of the beam—focuses the reflected spot on an array of silicon solar cells. This arrangement, Hitachi maintains, cuts down noise since it keeps outgoing and returning laser light paths separate. The off-center lens has an added advantage: it deflects the reflected spot in one direction if the laser head is too close to the target and in the other direction if the head is too far away.

The solar-cell array that generates the error signal for the servodrive has two cells 0.5 mm square at the center; their output is fed to a differential amplifier to get a highly sensitive indication of balance. The two center cells are flanked by cells that put out "near" or "far" signals when there are large deviations from balance. With this arrangement, Hitachi gets a precision of ± 0.03 mm in the readout, which is displayed on an indicator as well as recorded on tape.

Pinhole. Like Hitachi, Mitsubishi uses a neon-helium laser with an output of a few milliwatts for the beam and it's kept focused on the target by a servosystem. Mitsubishi, though, puts both the out-

going and incoming light through a single inverted telescope with a large objective lens that focuses the beam to a very fine spot—25 to 50 microns in diameter.

A half-mirror in the optical system deflects the incoming reflected spot through a collimating lens and a pinhole onto a solar cell. A tuning fork vibrates the pinhole, moving it 0.5 mm up and down along the optical axis at a frequency of several hundred cycles per second. This vibration modulates the light hitting the solar cell, whose sine-wave output is the error signal for the servosystem. Phase comparison of the cell output signal and the tuning-fork drive frequency indicates the direction and amount the laser head should shift to focus the beam on the target. Precision with this system, Mitsubishi reports, approaches 1 or 2 microns.

West Germany

Repetitious

Although people who receive a lot of cables may not believe it, operators of intercontinental radiotelegraph systems take great pains to make sure messages get through ungarbled. Nearly all use automatic equipment to spot transmission errors and rectify them immediately by retransmitting the correct characters.

The repetition slows the outgoing flow of information so a buffer storage is needed for information fed in for transmission. The most prevalent buffer used today is a paper-tape reperforator, a slowpoke compared to the fast transmission equipment it works with. But it now seems the tape reperforator is doomed by the advent of faster, smaller, more reliable electronic buffers.

The latest to come is a magnetic-core matrix buffer developed by Siemens & Halske AG. With no moving parts, it leapfrogs the technology of two other electronic teleprinter buffers currently available, both of which store information on rotating magnetic drums.

Multichannel. Siemens' magnetic-core buffer stores up to 4,091 characters in the five-bit teleprinter code, the equivalent of about 30 feet of punched paper tape. Since this is more capacity than a single channel needs, Siemens has designed the buffer so it can be shared among four channels and thus replace a quartet of tape reperforators. Capacity then is 1,019 characters for each channel.

Characters can be read into the buffer at rates up to 400 a second for each channel and read out at the same maximum rate. This is some 10 times faster than the rate of a rotating drum buffer. Each character is read out in response to a request signal indicating that the transmitter has sent out clearly the preceding character. Information stored for a channel can be erased in 2 milliseconds.

Built-in converters that operate at telegraph speeds as fast as 2,400 bauds (320 characters per second) handle serial inputs and outputs of character code groups. Parallel output is also possible.

In addition to use as the buffer for automatic correction systems, the magnetic-core matrix equipment can be employed for data speed conversion, multiaddress transmission and for message-weighting centers that retransmit messages in order of priority rather than order of arrival.

Soviet Union

Blocked out

The drive by Soviet leaders Aleksei Kosygin and Leonid Brezhnev to give the Russian consumer a better break apparently won't lead to whopping orders for Western manufacturers of electronic plant equipment.

Earlier this year, Soviet durable-goods planners worked out deals with Fiat of Italy and Renault of France for auto plants. Many observers of the Russian scene expected a spate of factory-equipment contracts to follow, among them deals for consumer electronics plants. But hopes that a substantial new market for Western firms would open up have been dimmed by a recent Russian order for a complete tv tube factory from the United Incandescent Works of Budapest, Hungary.

Millions. The plant, which will cost about \$7.8 million at the official exchange rate, is scheduled for start-up early next year. Its yearly output will be 1.2 million tubes in three sizes—19, 21, and 23 inches. At that capacity, the factory can meet about a quarter of Soviet tube needs.

In recent years, tv set production has been between 2 million and 3 million annually. From 2.9 million



Siemens' teleprinter buffer with magnetic-core matrix replaces as many as four conventional paper-tape reperforator units.

sets in 1964, output climbed to 3.7 million last year. Judging from first-half production, the 1966 output will top 4 million sets [Electronics, Aug. 8, p. 302]. Along with the increase in receivers, a sharp rise in the number of tv broadcast stations is in sight over the next few years. Communications Minister Nikolai Psurtsev forecasts the number of stations will grow from the existing 500 to 800 by 1970.

Inside. Now that the Hungarians have landed the order for the tv tube plant, indicating the Soviets plan to keep their business inside their bloc wherever possible, France seems to be the only Western country that stands a chance of cashing in on the Soviet tv boom. Full-time color broadcasts will start in Russia within two years, using the French Secam system. This points to a deal on receiver fabrication know-how. And Soviet backing of Secam apparently hinged on a French promise of help on a Russian plant to produce the color tv tube developed by Compagnie Française de Télévision [Electronics, May 3, p. 157]. CFT, though, still has to put the tube into production itself.

Great Britain

Hard times

At one time, throngs with an itch to buy flocked to Earls Court in London for the annual Television and Radio Show, turning it into a sellers' festival. But there'll be no carnival atmosphere at the 1966 show which makes its five-day run this week. The show is restricted to people in the trade and their disposition these days tends to be dour.

For better than two years, British consumer electronics has been going downhill and the austerity measures recently put into effect by Prime Minister George Wilson's government [Electronics, Aug. 8, p. 299] can only hurt it more.

To worsen the plight of British manufacturers, foreign competitors

have their eye on the market even though it's shrinking. During the show, the International General Electric Co., the overseas arm of the General Electric Co., will unveil its plans to market receivers, record players and tape recorders under a new brand name, "Monogram". GE's announcement came just a fortnight after the Radio Corp. of America made headlines with its plan to tap the upcoming color tv market in Britain with a color tube plant.

Sinking. The sorry state of consumer electronics in Britain shows up clearly in the industry's production figures. Five years ago, radio set makers were turning out 256,000 receivers a month. By last year, output had backed off to a monthly rate of 159,000. The first two months of 1966 were even worse with a monthly average of 129,000 sets. Inroads made by foreign competitors, notably the Japanese, account in part for the decline.

Television set production shows much the same pattern. Through 1960 the industry boomed as British households acquired their first sets. Tv set makers then figured they'd have a steady replacement market. Instead, sales fluctuated as the government tightened and eased consumer credit to slow down or speed up a roller-coaster economy. From the peak of 182,000 sets per month hit in 1964, tv output slumped steadily to less than 120,000 sets monthly through the first five months of 1966.

Hoping. The only real lift in sight is the government's commitment to start color tv broadcasts next fall, using the PAL system developed in West Germany [Electronics, June 13, p. 161]. At the outset, sets will retail for something like \$750; but since rentals account for more than two-thirds of the black-and-white sets now in use, market forecasters generally see an early boom for color.

This sanguine forecast discounts the discouraging experience set makers suffered when the British Broadcasting Corp. introduced its second service in 1964. Until then, tv broadcasts were on a 405-line standard in the very high frequency band. The second service

went on the air in the ultrahigh frequency band with the 625-line standard used on the Continent. Set makers expected the new standard to buoy their sales, but the boom never materialized.

Confident that history won't repeat itself when color tv gets going, RCA has teamed up with Britain's largest tv renting company, Radio Rentals Ltd., to manufacture color tubes in northern England. The company they've formed—two-thirds owned by RCA and one-third by Radio Rentals—is called RCA Colour Tubes Ltd. Colour Tubes' plant will be producing 19-inch and 25-inch tubes by mid-1967 for British and West European markets. A good part of the output will go to Radio Rentals' set-producing facility. RCA president Robert Sarnoff predicts sales of color sets in West Europe will rise from about 300,000 in 1968 to nearly 2 million by 1972.

Looking. With foreign competition growing, British manufacturers have started to seek new markets with high-volume potential. One field is domestic appliances. Manufacturers are considering solid state speed controls, level indicators and temperature sensors for washing machines, speed controls for electric drills, even Peltier-effect devices for wine coolers. But as a spokesman for the industry points out, these ideas are for production in three years or so and will be little help in the tough period immediately ahead.

Robot tractor

Electronic robots may one day drive tractors where wise men fear to tread.

The English affiliate of the Ford Motor Co. recently demonstrated a remote-controlled tractor, largely as a promotion stunt. And although there is no program at the moment to put the robot into Ford's future, plans could well change. The demonstrations unearthed potential applications ranging from hauling logs over ice-covered rivers in Norway to handling radioactive materials from atomic power stations.

Fenlow Products Ltd. and C&L



Tractor-mounted receiver picks up binary-coded control signals.

Developments Ltd. teamed up to develop the remote-control system. It can handle up to 28 functions simultaneously—starting or stopping the tractor, shifting its gears through three forward speeds and two reverse speeds, steering it, braking it, turning its lights off and on, speeding it up, slowing it down and cutting the power takeoff in and out. The operating range extends from 10 feet to 200 yards.

Coded. At the control transmitter, pushbuttons and toggle switches establish pulse patterns for each control function. The coding is binary, with pulse durations of 250 microseconds or longer. Logic scanning circuits in the transmitting unit sequentially sample the pushbutton positions and assemble the coded signals for transmission six times per second.

Aboard the tractor, a superheterodyne receiver with a bandwidth of 5 kilohertz picks up the control pulse patterns and feeds them to a logic decoding matrix. There, individual signals are sorted out and applied to solid state holding circuits. The holding circuits drive switching transistors that operate hydraulic actuators or relays in the tractor's electrical circuits. Signal lamps on the receiver show which channels are operative.

Problems. The toughest problem in developing the remote-control system was getting around the radio interference during start-up since current surges in the tractor's

starter couldn't be suppressed. This was solved by delay circuits that transmit the start signal over a preset duration.

Fail-safe insurance also had to be built into the system. To make sure the tractor won't continue running if the transmitter goes out, there's a continuously transmitted signal that holds open a fuel supply valve spring-loaded to close when the signal stops. Also, the filter circuit that removes the 200 hertz sampling frequency for the control signals is monitored. If this sampling ripple disappears, the tractor's controls are deactivated.

Italy

Just checking

Time was when checking out a long microwave link having many repeaters meant trotting out a dozen or more separate instruments. And all too often the checks at repeater stations were based on amplitude response of the intermediate frequency, at best a rough measure of the intermodulation distortion that determines how well a repeater performs.

Now, an Italian instrument maker has put on the market a three-rack portable test set that can handle a dozen key checks on a microwave link. Although the price

tag runs from \$6,500 to \$9,000, depending on accessories, Società Generale di Telefonia ed Elettronica S.p.A. (SGTE) already has 30 orders for its microwave-link check-out equipment and expects sales will run around 200 to 250 sets a year—until a competitor comes up with something comparable. SGTE is a subsidiary of the General Telephone & Electronics Corp.

The group. SGTE stole a march on other microwave-link test equipment manufacturers by marketing a portable tester that measures group delay in video and intermediate frequency circuits, modulators and demodulators. Group delay measurements check a circuit's phase-versus-frequency linearity and give a better indication of intermodulation distortion than amplitude-versus-frequency tests.

The unit can also measure the amplitude response of microwave circuits that contain nonlinear elements such as limiters, converters and traveling wave tubes. It is important to know the response of each circuit to make sure that a variation in one does not compensate a variation in another.

Triplet. The complete set contains three basic units: a generator set, a receiver assembly and an oscilloscope rack fitted with a pair of cathode-ray tubes. Both generator and receiver can take plug-in modules to adapt the test set to the baseband frequency of the link. The switch from a broadband link to a narrow-band link, for example, is accomplished by slipping in a 27.8-kilohertz i-f module instead of a 278-khz module. In the generator, a single circuit serves either as a sweep or as an f-m modulator.

Because of the three-unit design, tests on an entire network can be centralized using a single generator set at a main station and one or more receiver sets brought in to successive repeater stations. Reference traces on the oscilloscopes make possible readout of absolute test values in 0.1-decibel steps. In addition, the scopes display, along with the test traces, calibration traces that indicate allowable variations in amplitude, differential gain, differential phase and the like.

**60% higher
surge rating**

**23% higher
current^{††}**

**1400 volts
steady state**

New 110-AMP thyristor SCR with exclusive Westinghouse CBE design widens your design options. This new Westinghouse Type 254 (JEDEC 2N4361-2N4380 series) thyristor SCR is rated at 110 amps RMS. This makes it an ideal replacement for older thyristors

such as the 2N1792 and 2N1909 series. But it can do much more. It can be run at higher case temperatures. You can use a smaller lower-cost heat sink with it. Or you can use it in higher current applications with present sink designs.

Type 254 is ideal for cycling loads. Use it for inverters, motor controls, starters, and primary controlled power systems. Its 1600-amp surge rating, combined with the industry's highest I²t rating, allows optimum fuse co-ordination. Steady state blocking voltages go through 1400 volts with a 1500 volt transient rating.

Key to these increased high temperature capabilities is Westinghouse's exclusive CBE design. (Compression-Bonded Encapsulation.) It eliminates solder joints. The result: elimination of thermal fatigue and a 30% decrease in thermal impedance. Such features also make possible the  guarantee symbol shown here. It is the symbol that says this device carries the exclusive Westinghouse Lifetime Guarantee.†

Get all the data on this higher performing thyristor now. Call your Westinghouse salesman or distributor. Ask for Technical Data 54566P3. Westinghouse Semiconductor Division, Youngwood, Pennsylvania. sc:2063

†Westinghouse warrants to the original purchaser that it will correct any defect or defects in workmanship, by repair or replacement f.o.b. factory, for any silicon power semiconductor bearing this symbol  during the life of the equipment in which it is originally installed, provided said device is used within manufacturer's published ratings and applied in accordance with good engineering practice. This warranty shall constitute a fulfillment of all Westinghouse liabilities in respect to said products. This warranty is in lieu of all other warranties expressed or implied. Westinghouse shall not be liable for any consequential damages.

††At 82°C case temperature

You can be sure if it's Westinghouse



Circle 213 on reader service card



■ Leach Corporation Jay Chiat & Associates	46, 47	■ Sorensen Operation, Raytheon Company James Advertising Inc.	61
McCoy Electronics Company, Sub. of Oak Electro/Netics Corp. Buchen Advertising Inc.	78	Spectra-Physics Hal Lawrence Advertising Incorporated	155
McGraw-Hill Book Company	198	□ Spectrol Electronics Company Jones, Maher Roberts Advertising	77, OAS 3
Machlett Laboratories Inc. Fuller & Smith & Ross Inc.	11	Sperry Electronic Tube Division Neals & Hickok Inc.	68
■ P. R. Mallory & Company Mfg. Division Aitkin-Kynett Company Inc.	151	Sperry Rand Corporation Reach McClinton & Company	80
■ P. R. Mallory & Company, Battery Div. Needham, Harper & Steers Company	54	Sprague Electric Company Harry P. Bridge Co.	5, 10
Marconi Instrument Armand Richards Advertising Agency	62	Stackpole Carbon Company, Electronic Components Meek & Thomas Inc.	48
Martin Company Shattack Roether Advertising	199	Stromberg Carlson Corporation Rumrill Hoyt Inc.	187
Maryland Telecommunications Inc. Ray E. Finn Advertising	171	Struthers-Dunn Inc. Harry P. Bridge Company	192
Matsunaga Mfg. Company, Ltd. Asia Advertising Agency Ltd.	201	Superior Tube Company Gray & Rogers Advertising	174
Microwave Electronics Corporation Bonfield Associates	195	Sylvania Electronics Systems Brian Advertising	165
Motorola Semiconductor Products Inc. Lane & Bird Advertising Inc.	58	Synthane Corporation Arndt, Preston, Chapin, Lamb & Keen Inc.	185
Newark Electronics Corporation Stral Advertising Company	185	TRW Capacitors Fuller & Smith & Ross Inc.	39
Newport News Shipbuilding & Dry Dock Cargill Wilson Acree Company	134	TRW Instruments Fuller & Smith & Ross Inc.	196
■ Non-Linear Systems Inc. Barnes/Champ Advertising	27 to 32	Taylor Corporation Gray & Rogers Inc.	180
North Atlantic Industries Inc. Murray Heyert Associates	33	■ Tektronix Incorporated Hugh Dwight Advertising Inc.	41, 161
Nucleonic Products Company Enyart & Rose Advertising Inc.	201	■ Telonic Industries Inc. Jansen Associates	75
Permag Corporation Schneider Allen Walsh Inc.	201	Texas Instrument Incorporated Semiconductor Division Dan L. Baxter Inc.	112, 113, 137
Philco/Ford Company Hoefer, Dieterich & Brown Inc.	9	Transitron Electronic Corporation, Precision Connector Div. Larcom Randall Advertising Inc.	7
■ Potter & Brumfield Div. of American Machine & Foundry Company Grant, Schwenck & Baker Inc.	24	Ulano & Company Byrde, Richard & Pound Inc.	181, 187
Princeton Applied Research Corporation Mort Barish Associates Inc.	34	Ultra Carbon Corporation Church & Guisewitz Advertising	14
RCL Electronics Inc. Morvay Advertising Agency	197	■ United Transformer Company Philip Stogel Company	2nd Cover
RHG Electronics Labs Inc. S. M. Sachs & Associates Inc.	8	Victoreen Instrument Company Palm & Peterson Inc.	143
Radio Corporation of America Al Paul Lefton & Company	4th Cover	■ Vitro Corporation of America Buchen Advertising Incorporated	163
■ Radio Materials Company Div. of P. R. Mallory Gallay Advertising Inc.	191	□ Weinschel Engineering Company George T. Petsche Advertising	OAS 1
Raytheon Company, Components Division Fuller & Smith & Ross Inc.	111	Westinghouse/Metals Division McCann/ITSM	133
Raytheon Computer Martin Wolfson Advertising	66	Westinghouse Semiconductor Division McCann/ITSM	213
S. D. Industrial Dept. Maurice Paulsen Advertising	202	Weston Instruments (Archbald Division) Arndt, Preston, Chapin, Lamb & Keen Inc.	139
Semtech Corporation Burruss Advertising	170	Weston Instruments Inc. Rotek Division Arndt, Preston, Chapin, Lamb & Keen Inc.	82
Signetics Corporation Cunningham & Walsh Inc.	67	Wisconsin Power & Light Company Ralph Timmons Inc.	184
■ Silicon Transistor Corporation A. D. Adams Advertising	65	■ For more information on complete product line see advertisement in the latest Elec- tronics Buyers' Guide	
Sippican Company Electronic Marketing Assistance	182	□ Advertisers in Overseas Advertising Section	
Slater Electric Inc. Kane Light Gladney Inc.	56		
Solitron Devices Inc. Haselmire Pearson Advertising	53		

Advertising sales staff

Frank E. LeBeau [212] 971-6464
Advertising sales manager

Atlanta, Ga. 30309: Michael H. Miller, 1375
Peachtree St., N.E.,
[404] TR 5-0523

Boston, Mass. 02116: William S. Hodgkinson
McGraw-Hill Building, Copley Square,
[617] CO 2-1160

Chicago, Ill. 60611: Robert M. Denmead,
J. Bradley MacKimm, 645 North Michigan
Avenue,
[312] MO 4-5800

Cleveland, Ohio 44113: William J. Boyle, 55
Public Square, [216] SU 1-7000

Dallas, Texas 75201: Richard P. Poole, 1800
Republic National Bank Tower,
[214] RI 7-9721

Denver, Colo. 80202: Joseph C. Page, David
M. Watson, Tower Bldg., 1700 Broadway,
[303] 255-5484

Detroit, Michigan 48226: J. Bradley
MacKimm, 856 Penobscot Building
[313] 962-1793

Houston, Texas 77002: Kenneth George,
2270 Humble Bldg.,
[713] CA 4-8381

Los Angeles, Calif. 90017: Ian C. Hill,
John G. Zisch, 1125 W. 6th St.,
[213] HU 2-5450

Minneapolis, Minn. 55402: J. Bradley
MacKimm, 1104 Northstar Center
[612] 332-7425

New York, N. Y. 10036:
Donald R. Furth [212] 971-3615
James R. Pierce [212] 971-3615
George F. Werner [212] 971-3615
500 Fifth Avenue

Philadelphia, Pa. 19103: William J. Boyle,
Warren H. Gardner, Jeffrey M. Preston,
6 Penn Center Plaza,
[215] LO 8-6161

Pittsburgh, Pa. 15222: Warren H. Gardner,
4 Gateway Center, [412] 391-1314

Portland, Ore. 97204: James T. Hauptli,
Pacific Building, Yamhill Street,
[503] CA 3-1118

St. Louis, Mo. 63105: Robert M. Denmead
The Clayton Tower, 7751 Carondelet Ave.
[314] PA 5-7285

San Francisco, Calif. 94111:
James T. Hauptli, 255 California Street,
[415] DO 2-4600

London W1: John W. Patten, Edwin S.
Murphy Jr., 34 Dover Street,
Hyde Park 1451

Milan: 1, via
Baracchini Phone: 86-90-617
86-90-656

Frankfurt/Main: Gerd Hinske, Joseph
Wuensch, 85 Westendstrasse
Phone: 77 26 65 and 77 30 59

Geneva: Michael R. Zeynel,
1, rue du Temple
Phone: 31 95 60

Paris VIII: Denis Jacob, 17 Avenue
Matignon ALMA-0452

Tokyo: Nobuyuki Sato, 1, Kotohiracho
Shiba, Minato-Ku [502] 0656

Osaka: Ryosi Kobayashi, 163, Umegee-cho,
Kilta-ku [362] 8771

Wallace C. Carmichael [212] 971-3191
Manager Electronics Buyers' Guide

David M. Tempest [212] 971-3139
Promotion manager

Milton Drake [212] 971-3485
Research and circulation manager

Wallis Clarke [212] 971-2187
Assistant to sales manager

Wallace C. Carmichael [212] 971-3191
Business manager

Stephen R. Weiss [212] 971-2044
Production manager

Thomas M. Egan [212] 971-3140
Production manager Electronics Buyers' Guide

Our DTL offers one feature we didn't license

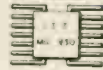

on-time delivery

ITT is licensed to build all DTL integrated circuits from the 930 series. Quantity production is a reality in ITT Semiconductors' facility in West Palm Beach, Florida.

Doubtful? Ask your ITT Semiconductor distributor, who has plenty of DTL circuits in stock. Ask your ITT Semiconductor factory salesman, who can arrange two-week ARO shipment of your quantity orders.

It's easy to recognize the DTL circuits that come from ITT in West Palm Beach. They're the ones you don't have to wait for.

ITT Semiconductors is a division of International Telephone and Telegraph Corporation, 3301 Electronics Way, West Palm Beach, Florida.

Type Number	Circuit Function
MIC930	Dual 4-input Gate with Expander
MIC932	Dual 4-input Buffer
MIC933	Dual 4-input Expander
MIC944	Dual 4-input Power Gate
MIC945	R-S or J-K Flip-Flop
MIC946	Quad 2-input Gate
MIC948	R-S or J-K Flip-Flop
MIC949	Fast Quad 2-input Gate
MIC950	Pulse-triggered Binary

ITT
SEMICONDUCTORS

FACTORIES IN WEST PALM BEACH, FLORIDA; PALO ALTO, CALIFORNIA; LAWRENCE, MASSACHUSETTS; HARLOW AND FOOTSCRAY, ENGLAND; FREIBURG AND NURENBERG, GERMANY

Electronics reader service

Use these handy post cards for more detailed information on: products advertised, new products, new literature.

Circle the number on the Reader Service post card that corresponds to the number at the bottom of the advertisement, new product item, or new literature in which you are interested.

Please print clearly. All written information must be legible to be efficiently processed.

If someone has beaten you to the post cards, you may obtain the needed information by writing directly to the manufacturer, or by sending your name and address, plus the Reader Service number, to Electronics Reader Service department.

All inquiries from outside the U.S. that cannot reach Electronics before the expiration dates noted on the Reader Service post card, must be mailed directly to the manufacturer. The manufacturer assumes all responsibilities for responding to inquiries. Electronics merely provides and clears requests for information from inquirer to manufacturer.

Correct amount of postage must be affixed for all mailings from outside the U.S.

To subscribe to or to renew Electronics

Fill in the "For Subscriptions" area on the card if you desire to subscribe to or renew your present subscription to Electronics. Send no money. Electronics will bill you at the address indicated on the Reader Service post card.

Multi-product advertisements

For information on specific items in multi-product advertisements which do not have a specific Reader Service number indicated write directly to manufacturer for information on precise product in which you are interested.

17

August 22, 1966 Card Expires October 22, 1966

14

Name _____ title _____

Company _____

Address _____

For Subscriptions
 new renewal
 3 years \$12.00
 1 year \$6.00

1	20	39	58	77	96	115	134	153	172	191	210	229	248	267	286	305	324	343	362	381	400	419	438	457	476	495	514	962
2	21	40	59	78	97	116	135	154	173	192	211	230	249	268	287	306	325	344	363	382	401	420	439	458	477	496	515	963
3	22	41	60	79	98	117	136	155	174	193	212	231	250	269	288	307	326	345	364	383	402	421	440	459	478	497	516	964
4	23	42	61	80	99	118	137	156	175	194	213	232	251	270	289	308	327	346	365	384	403	422	441	460	479	498	517	965
5	24	43	62	81	100	119	138	157	176	195	214	233	252	271	290	309	328	347	366	385	404	423	442	461	480	499	518	966
6	25	44	63	82	101	120	139	158	177	196	215	234	253	272	291	310	329	348	367	386	405	424	443	462	481	500	900	967
7	26	45	64	83	102	121	140	159	178	197	216	235	254	273	292	311	330	349	368	387	406	425	444	463	482	501	901	968
8	27	46	65	84	103	122	141	160	179	198	217	236	255	274	293	312	331	350	369	388	407	426	445	464	483	502	902	969
9	28	47	66	85	104	123	142	161	180	199	218	237	256	275	294	313	332	351	370	389	408	427	446	465	484	503	951	970
10	29	48	67	86	105	124	143	162	181	200	219	238	257	276	295	314	333	352	371	390	409	428	447	466	485	504	952	971
11	30	49	68	87	106	125	144	163	182	201	220	239	258	277	296	315	334	353	372	391	410	429	448	467	486	505	953	972
12	31	50	69	88	107	126	145	164	183	202	221	240	259	278	297	316	335	354	373	392	411	430	449	468	487	506	954	973
13	32	51	70	89	108	127	146	165	184	203	222	241	260	279	298	317	336	355	374	393	412	431	450	469	488	507	955	974
14	33	52	71	90	109	128	147	166	185	204	223	242	261	280	299	318	337	356	375	394	413	432	451	470	489	508	956	975
15	34	53	72	91	110	129	148	167	186	205	224	243	262	281	300	319	338	357	376	395	414	433	452	471	490	509	957	976
16	35	54	73	92	111	130	149	168	187	206	225	244	263	282	301	320	339	358	377	396	415	434	453	472	491	510	958	977
17	36	55	74	93	112	131	150	169	188	207	226	245	264	283	302	321	340	359	378	397	416	435	454	473	492	511	959	978
18	37	56	75	94	113	132	151	170	189	208	227	246	265	284	303	322	341	360	379	398	417	436	455	474	493	512	960	979
19	38	57	76	95	114	133	152	171	190	209	228	247	266	285	304	323	342	361	380	399	418	437	456	475	494	513	961	980

2

Business reply mail

No postage stamp necessary if mailed in the United States

Postage will be paid by

Electronics
Reader service department
Box 444
Hightstown, N.J. 08520

First class
 Permit no. 42
 Hightstown, N. J.



17

August 22, 1966 Card Expires October 22, 1966

14

Name _____ title _____

Company _____

Address _____

For Subscriptions
 new renewal
 3 years \$12.00
 1 year \$6.00

1	20	39	58	77	96	115	134	153	172	191	210	229	248	267	286	305	324	343	362	381	400	419	438	457	476	495	514	962
2	21	40	59	78	97	116	135	154	173	192	211	230	249	268	287	306	325	344	363	382	401	420	439	458	477	496	515	963
3	22	41	60	79	98	117	136	155	174	193	212	231	250	269	288	307	326	345	364	383	402	421	440	459	478	497	516	964
4	23	42	61	80	99	118	137	156	175	194	213	232	251	270	289	308	327	346	365	384	403	422	441	460	479	498	517	965
5	24	43	62	81	100	119	138	157	176	195	214	233	252	271	290	309	328	347	366	385	404	423	442	461	480	499	518	966
6	25	44	63	82	101	120	139	158	177	196	215	234	253	272	291	310	329	348	367	386	405	424	443	462	481	500	900	967
7	26	45	64	83	102	121	140	159	178	197	216	235	254	273	292	311	330	349	368	387	406	425	444	463	482	501	901	968
8	27	46	65	84	103	122	141	160	179	198	217	236	255	274	293	312	331	350	369	388	407	426	445	464	483	502	902	969
9	28	47	66	85	104	123	142	161	180	199	218	237	256	275	294	313	332	351	370	389	408	427	446	465	484	503	951	970
10	29	48	67	86	105	124	143	162	181	200	219	238	257	276	295	314	333	352	371	390	409	428	447	466	485	504	952	971
11	30	49	68	87	106	125	144	163	182	201	220	239	258	277	296	315	334	353	372	391	410	429	448	467	486	505	953	972
12	31	50	69	88	107	126	145	164	183	202	221	240	259	278	297	316	335	354	373	392	411	430	449	468	487	506	954	973
13	32	51	70	89	108	127	146	165	184	203	222	241	260	279	298	317	336	355	374	393	412	431	450	469	488	507	955	974
14	33	52	71	90	109	128	147	166	185	204	223	242	261	280	299	318	337	356	375	394	413	432	451	470	489	508	956	975
15	34	53	72	91	110	129	148	167	186	205	224	243	262	281	300	319	338	357	376	395	414	433	452	471	490	509	957	976
16	35	54	73	92	111	130	149	168	187	206	225	244	263	282	301	320	339	358	377	396	415	434	453	472	491	510	958	977
17	36	55	74	93	112	131	150	169	188	207	226	245	264	283	302	321	340	359	378	397	416	435	454	473	492	511	959	978
18	37	56	75	94	113	132	151	170	189	208	227	246	265	284	303	322	341	360	379	398	417	436	455	474	493	512	960	979
19	38	57	76	95	114	133	152	171	190	209	228	247	266	285	304	323	342	361	380	399	418	437	456	475	494	513	961	980

Reprint service

All Electronics editorial matter available in reprint form:

For reprints of special reports and feature articles see list on right side of this page. Send your order to Electronics Reprint Department at the address indicated. To expedite mailing of your order for single reprints please send cash, check or money order with your order.

Bulk reprints of editorial matter can be ordered from current or past issues. The minimum quantity is 100 copies. The higher the quantity ordered, the more economical the cost per copy. Prices quoted on request.

3

Business reply mail

No postage stamp necessary if mailed in the United States

Postage will be paid by

Electronics
Reader service department
Box 444
Hightstown, N. J. 08520

First class
 Permit no. 42
 Hightstown, N. J.

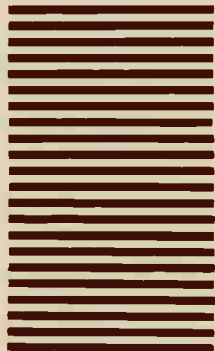

17

August 22, 1966 Card Expires October 22, 1966 14

Name _____ title _____
 Company _____
 Address _____

For Subscriptions
 new renewal
 3 years \$12.00
 1 year \$6.00

1	20	39	58	77	96	115	134	153	172	191	210	229	248	267	286	305	324	343	362	381	400	419	438	457	476	495	514	962
2	21	40	59	78	97	116	135	154	173	192	211	230	249	268	287	306	325	344	363	382	401	420	439	458	477	496	515	963
3	22	41	60	79	98	117	136	155	174	193	212	231	250	269	288	307	326	345	364	383	402	421	440	459	478	497	516	964
4	23	42	61	80	99	118	137	156	175	194	213	232	251	270	289	308	327	346	365	384	403	422	441	460	479	498	517	965
5	24	43	62	81	100	119	138	157	176	195	214	233	252	271	290	309	328	347	366	385	404	423	442	461	480	499	518	966
6	25	44	63	82	101	120	139	158	177	196	215	234	253	272	291	310	329	348	367	386	405	424	443	462	481	500	900	967
7	26	45	64	83	102	121	140	159	178	197	216	235	254	273	292	311	330	349	368	387	406	425	444	463	482	501	901	968
8	27	46	65	84	103	122	141	160	179	198	217	236	255	274	293	312	331	350	369	388	407	426	445	464	483	502	902	969
9	28	47	66	85	104	123	142	161	180	199	218	237	256	275	294	313	332	351	370	389	408	427	446	465	484	503	951	970
10	29	48	67	86	105	124	143	162	181	200	219	238	257	276	295	314	333	352	371	390	409	428	447	466	485	504	952	971
11	30	49	68	87	106	125	144	163	182	201	220	239	258	277	296	315	334	353	372	391	410	429	448	467	486	505	953	972
12	31	50	69	88	107	126	145	164	183	202	221	240	259	278	297	316	335	354	373	392	411	430	449	468	487	506	954	973
13	32	51	70	89	108	127	146	165	184	203	222	241	260	279	298	317	336	355	374	393	412	431	450	469	488	507	955	974
14	33	52	71	90	109	128	147	166	185	204	223	242	261	280	299	318	337	356	375	394	413	432	451	470	489	508	956	975
15	34	53	72	91	110	129	148	167	186	205	224	243	262	281	300	319	338	357	376	395	414	433	452	471	490	509	957	976
16	35	54	73	92	111	130	149	168	187	206	225	244	263	282	301	320	339	358	377	396	415	434	453	472	491	510	958	977
17	36	55	74	93	112	131	150	169	188	207	226	245	264	283	302	321	340	359	378	397	416	435	454	473	492	511	959	978
18	37	56	75	94	113	132	151	170	189	208	227	246	265	284	303	322	341	360	379	398	417	436	455	474	493	512	960	979
19	38	57	76	95	114	133	152	171	190	209	228	247	266	285	304	323	342	361	380	399	418	437	456	475	494	513	961	980

1

Business reply mail

No postage stamp necessary if mailed in the United States

Postage will be paid by

Electronics
Reader service department
Box 444
Hightstown, N.J. 08520

First class
 Permit no. 42
 Hightstown, N. J.



To order reprints or for further information, please write to: Electronics Reprint Department, 330 West 42nd Street, New York, N.Y. 10036. Telephone: Area code 212 971-3140.

Prices for the below listed reprints unless otherwise specified are 1-10 copies 50¢ each; 11-24 copies 35¢ each; 25-99 copies 25¢ each; price for 100 or more is 20¢ each.

You may order any of the below listed reprints by key number.

- Key no. R-90 Communications Satellites Part II. 18 pages. 75¢
- Key no. R-89 Communications Satellites Part I. 24 pages. 75¢
- Key no. R-88 Belting Out Plastic Transistors On Mechanized Assembly Lines 8 pages. 25¢
- Key no. R-87 The Packaging Revolution In Microelectronics (Parts IV, V and VI. 32 pages). \$1.00
- Key no. R-86 Computer Time Sharing Part II 12 pages.
- Key no. R-85 U.S. Electronics Markets 1966 24 page forecast report with 6 page foldout chart.
- Key no. R-84 European Electronics Markets 1966. 16 pages with 4 page foldout chart.
- Key no. R-83 A Look At Japanese Electronics Technology 36 pages.
- Key no. R-82 Computer Time Sharing Part I 20 pages
- Key no. R-80 The Packaging Revolution In Microelectronics (Parts I, II, and III. 32 pages). \$1.00
- Key no. R-79 MOS Integrated Circuits 12 pages.
- Key no. R-78 The Overlay Transistor 15 pages.
- Key no. R-77 Cold Cathode Tubes (3 part series, 28 pages).
- Key no. R-76 Automated Trains: Who's On The Right Track? 16 pages.
- Key no. R-75 Biotelemetry [2 Part series 16 pages].
- Key no. R-74 Unijunction Transistors, 24 pages.
- Key no. R-64 Field Effect Transistors (Parts I, II and III. 64 pages). \$1.00
- Key no. R-63 Silicon Power Transistors 8 pages. 25¢
- Key no. R-60 Transistor Heat Dissipators, 32 pages.
- Key no. R-31 1962 Electromagnetic Spectrum Chart, [22" x 30" foldout chart]. \$1.00



Who says 1-amp epoxy rectifiers can't stand humidity?

Write for free water-soaked samples from ITT:

Choose the PRV rating that fits your application best and write for samples. We'll ship them immersed. You'll find that ITT epoxy rectifiers exceed the humidity requirements of MIL-STD-750. While you're at it, check for cool operation, low thermal impedance and extreme stability. All are made possible by ITT's patented* "double nail-head" design. Send for your free bottle of ITT rectifiers today! *Patent No. 3081374

ITT SEMICONDUCTORS
3301 Electronics Way
West Palm Beach, Florida



Please send me a pair of water-soaked
1-amp silicon epoxy rectifiers with the
PRV rating I have indicated.

100 V 200 V 300 V 400 V
 500 V 600 V 800 V 1000 V

NAME TITLE

COMPANY

ADDRESS

CITY STATE ZIP

ITT

SEMICONDUCTORS

ITT SEMICONDUCTORS IS A DIVISION OF INTERNATIONAL TELEPHONE AND TELEGRAPH CORPORATION, 3301 ELECTRONICS WAY, WEST PALM BEACH, FLORIDA. FACTORIES IN WEST PALM BEACH, FLORIDA; PALO ALTO, CALIFORNIA; LAWRENCE, MASSACHUSETTS; HARLOW AND FOOTSCRAY, ENGLAND; FREIBURG AND NURENBERG, GERMANY.

Circle 901 on reader service card

From bright sunlight to overcast starlight

RCA thin-film semiconductive targets in Image Orthicons offer exceptionally stable performance in B/W and color TV

The RCA line of camera tubes includes three Image Orthicons—7629A, 7967, and 8092A—equipped with RCA's latest advance in TV technology, thin-film semiconductive targets. They offer the high gain and tube sensitivity that can be equivalent to photographic film with an ASA exposure index of more than 10,000,000.

RCA-7629A. Easy to set up and simple to operate, this Image Orthicon makes possible very low-light-level studio operation and remote pickup. It is excellent for industrial service, taking good black-and-white pictures with scene illumination as low as 2 to 3 lm/ft² ... equivalent to film with an ASA index of 20,000.

RCA-7967. This Image Orthicon, with a multialkali photocathode features low target-to-mesh capacitance, reduced microphonics, and S-20 spectral response. It can reproduce black-and-white scenes under extremely low-light-level conditions. Its sensitivity is equivalent to photographic film having an ASA index of ten million or more!

RCA-8092A. An Image Orthicon with field mesh, this tube makes possible full color pickup with scene illumination as low as 40 lm/ft². A quality tube noted for high resolution over a wide range of incident light levels, 8092A is available in sets of 3 with color-mated characteristics, with the designation 8092A/S.

If you are designing TV cameras, check into RCA's line of Image Orthicons. You'll find the one that's right for your special application. See your RCA Representative. For technical data, write RCA Commercial Engineering, Sect. H 19Q-4 Harrison, N. J. ALSO AVAILABLE THROUGH YOUR RCA INDUSTRIAL TUBE DISTRIBUTOR.



RCA Electronic Components and Devices



The Most Trusted Name in Electronics

Circle 902 on reader service card