

# Electronics<sup>®</sup>

The boom in the West: page 102

Generating microwaves with new diodes: page 126

Electronics in East Europe: page 157

August 8, 1966

75 cents

A McGraw-Hill Publication

Below: Making multilayer boards  
with a new technique: page 141

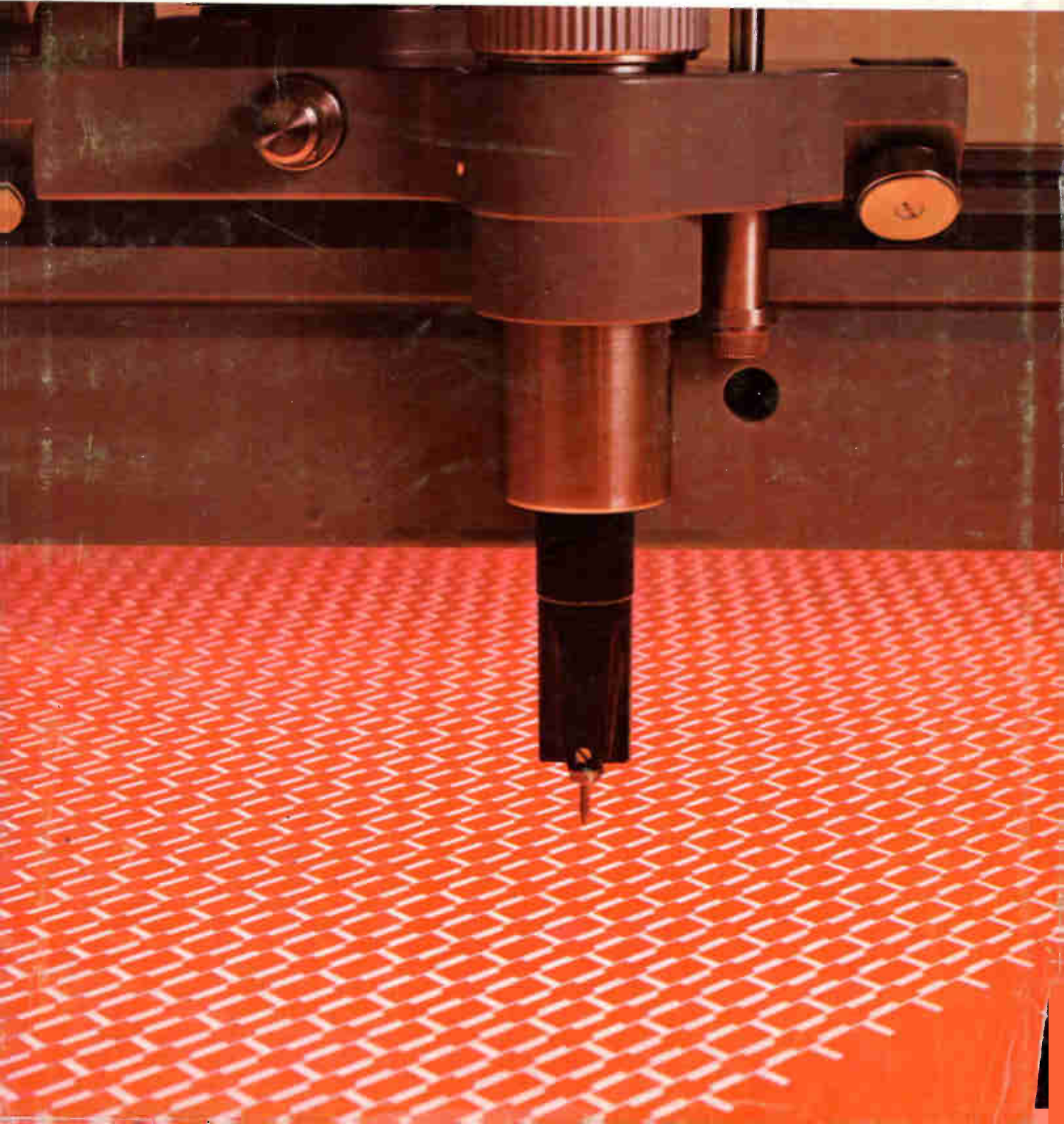



**dc to 100 kHz**

20 models available with choice of resolution from 0.0001 to 100 Hz. Shown is Type 1161-A5C with 0.01-Hz resolution, \$5070 in U.S.A.

**dc to 1 MHz**

20 models available with choice of resolution from 0.001 Hz to 1 kHz. Shown is Type 1162-AR7C with 0.001-Hz resolution and programmable/manual modules, \$6725 in U.S.A.

**30 Hz to 12 MHz**

20 models available with choice of resolution from 0.01 Hz to 10 kHz. Shown is Type 1163-A3 with 10-kHz resolution, \$3895 in U.S.A.

**10 kHz to 70 MHz**

20 models available with choice of resolution from 0.1 Hz to 100 kHz. Shown is Type 1164-A7C with 0.1-Hz resolution, \$7065 in U.S.A.

## Only GR Frequency Synthesizers have all these features . . . and low cost, too!

- Four basic models with ranges of dc to 100 kHz, dc to 1 MHz, 30 Hz to 12 MHz, and 10 kHz to 70 MHz, in digital incremental steps of 0.01 Hz, 0.1 Hz, 1 Hz, and 10 Hz, respectively.
- 80 different combinations of the basic four models . . . You can start with as few as three decades of resolution and add additional decades as your requirements expand.
- At least 2 figures of additional resolution from the calibrated continuously-adjustable-decade module.
- Electrical sweeping over bandwidth from zero to more than 1 MHz with the continuously adjustable decade.
- In addition, programmable/manual decades are available for remote programming at all steps below 1 MHz and between 1-MHz steps at higher frequencies.
- 5-MHz master crystal in each synthesizer; the instrument can be phase-locked to an external standard.
- All-solid-state.
- Small size . . . Needs only 5¼ inches of rack height.
- 2-V, rms, adjustable and metered output.
- Operates from 115/215/230 V, ac, 50-60 or 400 Hz, 55 W, or from 20-28 V, dc, 1.8 A.
- LOW COST . . . Prices start at \$3640 for a 100-kHz, 100-Hz-per-step model. Completely equipped instruments, including 7 digit-decades and a continuously adjustable decade, range from \$5960 for the 100-kHz unit to \$7065 for the 70-MHz unit. Instruments that are controllable remotely (as well as manually) are somewhat higher in price.

*See these Synthesizers at WESCON, Booths 348-351*

BOSTON • NEW YORK • CHICAGO • PHILADELPHIA • WASHINGTON, D.C.  
SYRACUSE • DALLAS • SAN FRANCISCO • LOS ANGELES • ORLANDO  
CLEVELAND • TORONTO • MONTREAL  
BOURNE END, ENGLAND      ZURICH, SWITZERLAND

# GENERAL RADIO

WEST CONCORD, MASSACHUSETTS

Circle 900 on reader service card

# More Performance Than Any Other Scope



## Large Area 8 x 10 cm CRT

- New design breakthrough offers a shorter, high-frequency CRT with picture area from 30% to 100% greater than any other high-frequency scope. Accurate measurements are easier to read and view.
- Deflection plates require only 3 v/cm drive—allows extended bandwidth capabilities.
- 12 kv accelerating potential produces bright, easy-to-see traces, even at 5 nsec/cm sweeps.
- Snap-off bezel for easy installation of new hp contrast filters or special graticules.
- Beam finder for rapid location of trace.
- Internal graticule calibrated in centimeters eliminates parallax error; flood guns allow variable background illumination for optimum contrast of graticule and trace.

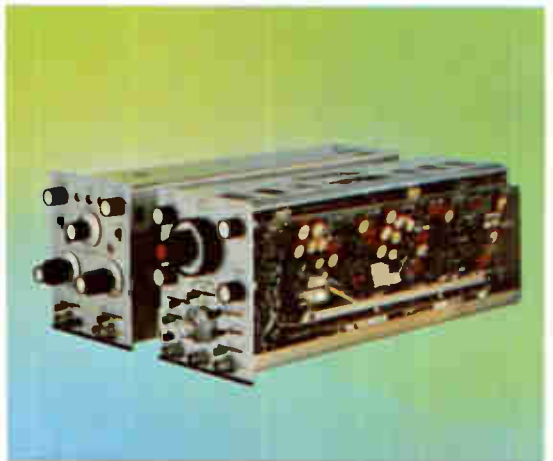

## Plug-In Versatility

- Now 1801A dual channel vertical amplifier
  - dc to 50 MHz bandwidth (all ranges). 7 nsec rise time.
  - 5 mv/cm to 20 v/cm range.
  - A + B, and A - B operation.
  - internal trigger on Channel B in ALT and CHOP modes for time correlation of traces.
- Now 1821A time base and delay generator
  - triggering to 90 MHz.
  - sweeps from 1 sec/cm to 10 nsec/cm.
  - easy-to-use delayed sweep.
  - mixed sweep for slow/fast sweep display.
  - bright line automatic triggering.
- Now 1820A time base
  - triggering to 90 MHz.
  - sweeps from 2 sec/cm to 5 nsec/cm.
  - variable holdoff locks-in complex waveforms.
  - bright line automatic triggering.
- More plug-ins to come—for extended capabilities.

## ACCESSORIES



- 1118A Testmobile, \$95.00
- 197A Camera, \$475.00
- 10176A Flexible Viewing Hood, \$7.00
- 10166A Panel Cover, \$25.00
- 10167A Carrying Cover, \$20.00
- 10004A 3½-foot 10:1 Divider Probe, \$35.00
- 10110A BNC Male to Binding Post Adapter, \$5.00
- 10360A Camera Adapter for hp 196A/B Camera, \$15.00
- 10361A Camera Adapter for Tektronix C12 Camera, \$15.00
- 10362A Camera Adapter for Tektronix C27 Camera, \$15.00



**SEE MORE!** ▶

## **NEW 180A OSCILLOSCOPE**

Get Big Picture Displays,  
Plug-In Versatility,  
100% Solid State Circuitry,  
Superior Performance,  
In a New 30-Pound Package  
For Field, Laboratory and  
Production Applications

**HEWLETT**  **PACKARD**  
*An extra measure of quality*

**DO MORE!** ▶

# scope—And in a 30-Pound Package!



## Step-Ahead Electrical Performance

- Solid triggering capability to 90 MHz, as shown above.
- New horizontal amplifier permits linear 5 nsec/cm sweep speed.
- Maximum stability with 100% solid state circuitry.
- Premium components—capacitors, potentiometers and metal film resistors.
- FET input amplifiers for exceptionally low drift, quick 15-second warm-up.
- Operates on 115 or 230 volts, 50-1000 Hz, only 95 watts—convection cooled.
- New hp CRT design permits 3 v/cm drive; therefore, vertical amplifier is smaller, lower power. Amplifier drives CRT vertical deflection plate directly. These features provide extended bandwidth capability.
- DC coupled Z axis input.
- New etched circuit delay line for clean pulse response—minimum weight and size.

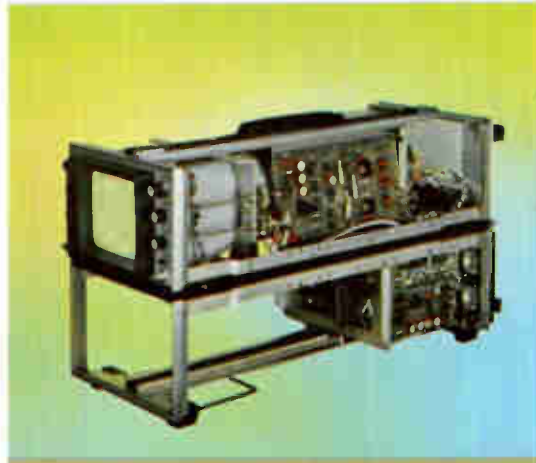

## Rugged Design for Use Anywhere

- Aircraft-type frame construction for maximum ruggedness with minimum weight.
- Easy-to-get-at circuits—covers snap off.
- Conveniently-grouped controls are easier to see, easier to operate.
- Operates with confidence at  $-28^{\circ}\text{C}$  to  $+65^{\circ}\text{C}$ , 95% relative humidity to  $40^{\circ}\text{C}$ , 15,000 feet.
- Withstands shock and vibration—built for portable use.
- Scope with plug-ins weighs only 30 pounds.
- 8" x 10" cabinet, or 5 $\frac{1}{4}$ " x 19" rack mount models.

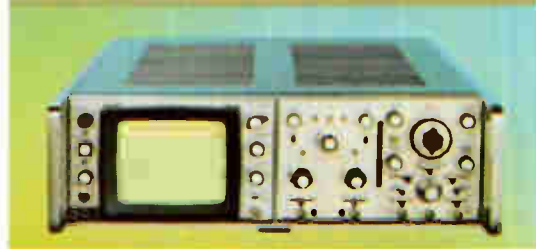

**HEWLETT** **hp** **PACKARD**  
*An extra measure of quality*

Get the BIG picture! Write or call for your demonstration, today! Hewlett-Packard, Palo Alto, California 94304, Tel. (415) 326-7000; Europe: 54 Route des Acacias, Geneva. Price: hp Model 180A Oscilloscope, \$825.00; hp Model 180AR (rack) Oscilloscope, \$900.00; hp Model 1801A Dual Channel Vertical Amplifier, \$650.00; hp Model 1820A Time Base, \$475.00; hp Model 1821A Time Base and Delay Generator, \$800.00, f.o.b. factory.

# PLUG-IN

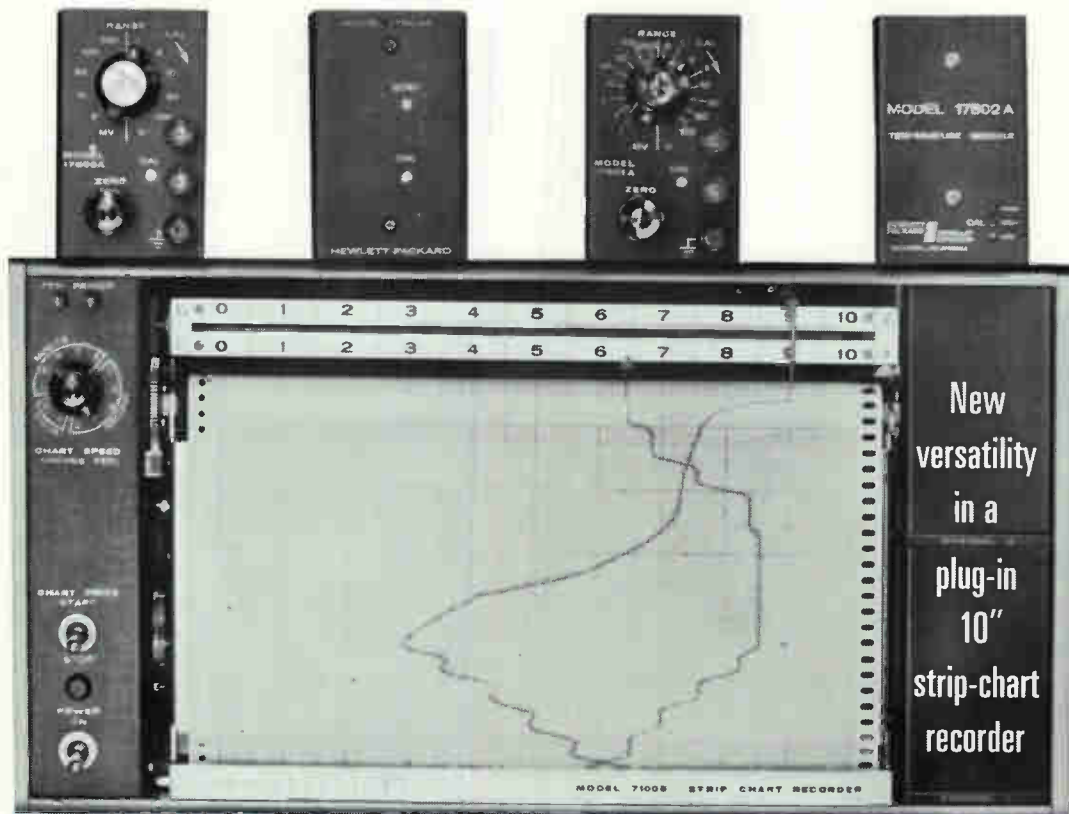

New  
versatility  
in a  
plug-in  
10"  
strip-chart  
recorder

See New hp Instruments  
Attend Measurement Seminars  
WESCON—Hollywood Park



- Input modules provide special purpose capabilities
- Mainframe available with one or two pen flexibility
- 12 instantly selected chart speeds, 1 in/hr-2 in/sec
- Half-second response time
- Chart tilts in three positions for easy viewing and notation
- Easy chart loading, tear off or storage, paper supply indicator
- All solid-state circuitry
- Rack-mount, metric models available

The basic mainframe of the 7100B (two pens) and 7101B (one pen) provides 10" strip-chart recording capabilities. Each channel accepts any of the wide variety of input modules which determine the electrical span or special-purpose recording capability.

Features offered, in addition to those above, include event markers, electric pen-lift and chart drive start-stop—all remotely controlled. Retransmitting potentiometers, adjustable high-low limit switches on both channels and remote 10-1 speed changers are also available.

Standard input modules (more to come) offer multiple span ranges, high input resistance (1 meg at null), high cmr and floating inputs to 500 v above ground. Model 17500A has 10 calibrated spans 5 mv-100 v full scale; Model 17501A has 16 calibrated spans 1 mv-100 v full

scale. Variable span and full scale zero controls are provided. Model 17502A, a temperature input module with automatically compensated reference junction, linearizes recorder presentation with standard paper. Additional low-cost single range input modules (Model 17503A, 1 mv input with filter; Model 17504A, 5 mv-100 v with plug-in range cards) are also available:

Model 7100B 2-pen Recorder, \$1300  
Model 7101B 1-pen Recorder, \$1000

Model 17500A Input Module, \$250  
Model 17501A Input Module, \$350  
Model 17502A Input Module, \$250  
Model 17503A Input Module, \$250  
Model 17504A Input Module, \$200

Ask your Hewlett-Packard field engineer for a demonstration or write for complete information to Hewlett-Packard, Palo Alto, Calif. 94304, Tel. (415) 326-7000; Europe: 54 Route des Acacias, Geneva.

*Data subject to change without notice.  
Prices f.o.b. factory.*

**HEWLETT  
PACKARD**  **MOSELEY  
DIVISION**

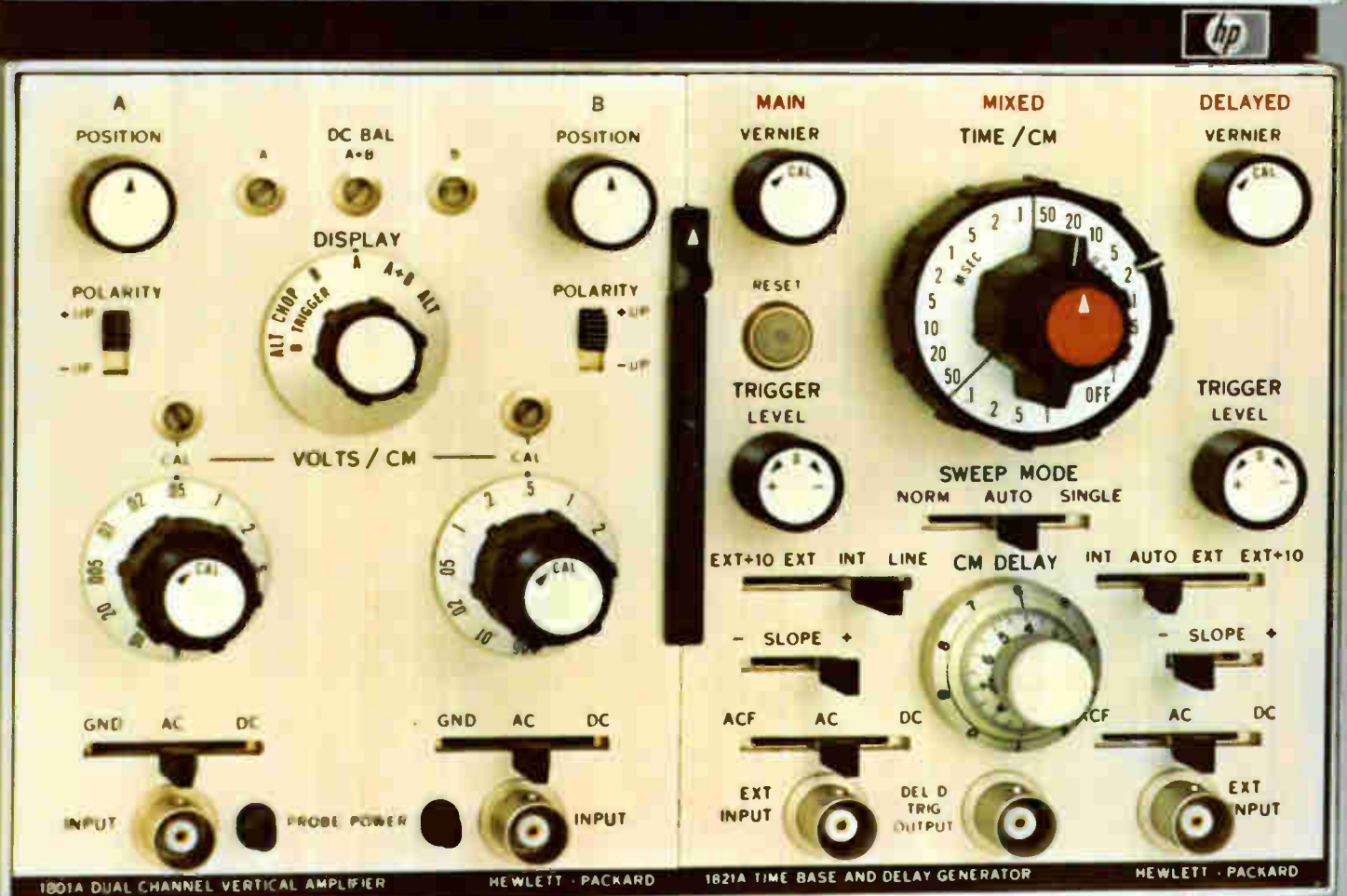
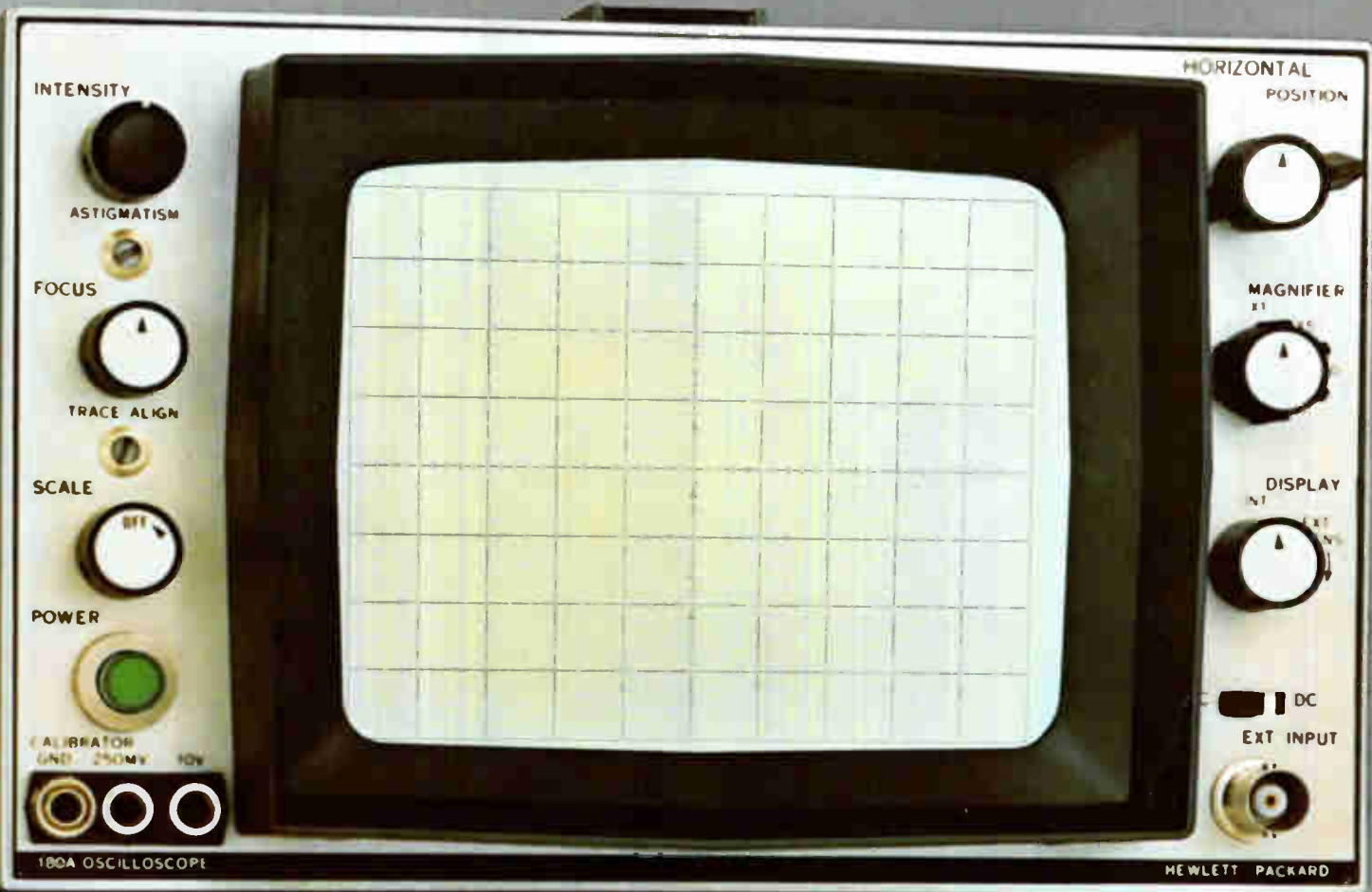

ACTUAL SIZE

# 100 $\mu$ v resolution auto polarity-display storage overrange digit



[\$595]

The new Hewlett-Packard 3430A Digital Voltmeter is a high-performance utility instrument ideal for production line work, repair or inspection stations, in the lab or for quality control. It offers the highest value available today in terms of price and performance.

- 100  $\mu$ v sensitivity for low-level measurements
- Auto polarity
- Non-blinking display, ideal for faster, easier, less vulnerable measurements
- 60% overrange with an extra digit
- Floating measurement with 10 Meg input impedance
- Fast (half second) response
- Analog dc output from amplifier, useful as a 100:1 voltage amplifier
- RATIO measurement option

Nowhere else can you get these extra "luxury" features at such a low cost. High-speed measurement, 100 mv-1000 v, accuracy 0.1% of full scale  $\pm 1$  digit, plus the 4th digit for over-ranging. Measure to  $\pm 500$  v dc with respect to ground. No worry about circuit loading with the high input impedance. High stability with the voltage accuracy guaranteed to 3 months, one-year warranty on the instrument. The only DVM of its type available with ratio measurement capability, at an accuracy of  $\pm 0.15\% \pm 1$  digit. With the ratio option 01 (\$80), you can normalize transducer dc outputs without taking time for recalculation. It offers all polarity combinations. The bonus amplifier output,  $\pm 0.1\%$  accuracy, increases testing flexibility.

Call your Hewlett-Packard field engineer for a demonstration or write for complete specifications: Hewlett-Packard, Palo Alto, California 94304, Tel. (415) 326-7000; Europe: 54 Route des Acacias, Geneva.

*Data subject to change without notice. Price f.o.b. factory.*

See New hp Instruments  
Attend Measurement Seminars  
WESCON—Hollywood Park

HEWLETT  PACKARD  
An extra measure of quality

1648



## News Features

### Probing the News

- 195 Low cost will catch train award
- 198 Wescon offers a liberal education
- 205 Congress clamps down on research
- 208 The engineer in Vietnam

### Electronics Review

- 47 **Military electronics:**  
\$1 billion insurance
- 48 **Space electronics:** Dry run
- 48 **Research:** A new contender
- 49 **Manufacturing:**  
Circuit psychology; Tailoring resistors
- 50 **Oceanology:** Shifting tide
- 52 **Antennas:** Pointing the way
- 52 **Industrial electronics:** To catch a thief
- 54 **Government:** Budgets in war
- 57 **Electronics notes**

### Electronics Abroad

- 299 **Great Britain:** Tighter Island
- 299 **West Germany:** Power packed
- 300 **Japan:** Inside job; Edge of space
- 301 **France:** Calculated independence
- 302 **International:** Double standard
- 302 **Around the World**

### Departments

- 8 Readers Comment
- 12 People
- 18 Meetings
- 20 Meeting Preview
- 29 Editorial
- 31 Electronics Newsletter
- 61 Washington Newsletter
- 221 New Products
- 284 New Books
- 286 Technical Abstracts
- 288 New Literature

## Technical Articles

- Regions** 102 **How the West was won**  
Vietnam and diversification fuel the aerospace industry  
William Wallace, Los Angeles regional editor
- 106 **Wartime is microwave time**  
With a battle impetus, the solid state revolution is accelerating  
Walter Barney, San Francisco regional editor
- 110 **Growth and diversification in instrumentation**  
Makers seek new markets under a blanket of prosperity  
Walter Barney, San Francisco regional editor
- 114 **IC's: a picture of health**  
Activity is booming with backlogs, price cuts and engineer shortages
- Circuit design** 120 **Designers casebook**
  - Hydrophone preamplifier cuts cable noise
  - Two events, in sequence, produce detector output
  - Transmission lines couple multiple-driver receivers
  - FET insures stable sawtooth wave
  - Converting audio oscillators to square-wave generators
- Solid state** 126 **Generating power at gigahertz with avalanche-transit time diodes**  
Three new devices have generated up to 350 milliwatts at 50 gigahertz  
K. D. Smith, Bell Telephone Laboratories
- Consumer** 133 **Integrated circuits make a low-cost f-m receiver**  
Tuners and i-f strips are built with off-the-shelf circuits  
Richard L. Sanquini, RCA
- Manufacturing** 141 **Making multilayer circuit boards work**  
It takes good engineering judgment and tight process control  
Robert W. Korb, TRW, Inc.
- 148 **Pattern for quick design of multilayer circuit boards (cover)**  
An x-y matrix speeds layout and makes the best use of space  
James R. Goodykoontz, TRW, Inc.
- Opinion** 157 **Electronics in East Europe**  
An evaluation of how electronics and technology are faring behind the Iron Curtain  
Lewis H. Young, editor-in-chief
- 158 **A journey to East Europe**
- 166 **Rumania's blueprint for electronics**
- 168 **Theory is fine, but application is better**
- 170 **'Come on in, the trade is fine'**  
say West European businessmen

# Electronics

Editor-in-Chief: Lewis H. Young

Senior editors

Design: Samuel Weber

Application: George Sideris

News: Kemp Anderson Jr.

Assistant to the editor: Sally Powell

Senior associate editors: John F. Mason, Don Christiansen, Robert Henkel, Joseph Mittleman

Department editors

Avionics: W.J. Evezia

Communications: Leonard Weller

Computers: Wallace B. Riley

Design theory: Joseph Mittleman

Electronics abroad: Arthur Erikson

Electronics review: Stanley Zarowin

Industrial electronics: Alfred Rosenblatt

Instrumentation: Carl Moskowitz

Military electronics: John F. Mason

New products: William P. O'Brien

Special projects: Don Christiansen

Staff writers: Jan Rahm, A. Thomas Thorson

Regional Bureaus

Domestic

Boston: Thomas Maguire, manager; Robin Carlson

Los Angeles: William B. Wallace, manager; June Ranill

San Francisco: Walter Barney, manager; Mary Jo Jadin

Washington: Robert W. Henkel, manager; William D. Hickman, John Rhea, correspondents; Patricia C. Hoehling

Foreign

European: Derek Barlow, (London)

Bonn: John Gosch

Tokyo: Charles Cohen

Copy editors

James J. Moran, David Goller, William Olcott

Graphic design

Art director: Saul Sussman

Assistant art directors: Donna M. Griffiths, Ann Mella

Production editor: Arthur C. Miller

Editorial secretaries: Claire Benell, Lynn Emery, Lorraine Fabry, Kay Fontana, Lorraine Longo, Carolyn Michnowicz

McGraw-Hill News Service

Director: John Wilhelm; Atlanta: Fran Ridgway; Chicago: Reck Johnson;

Cleveland: Arthur Zimmerman; Dallas: Marvin Reid;

Detroit: N. Hunter; Houston: Ron Lovell; Los Angeles: Michael Murphy, Gerald Parkinson

San Francisco: Margaret Drosel

Seattle: Ray Bloomberg; Washington: Arthur L. Moore, Charles Gardner,

Herbert W. Cheshire, Seth Payne, Warren Burkett, Warren Kornberg

McGraw-Hill World News Service

Bonn: John Johnsrud; London: John Shinn;

Mexico City: Bruce Cross; Milan: Ronald Taggiasco;

Moscow: Howard Rausch; Paris: Peter Kilborn;

Rio de Janeiro: Wes Perry; Tokyo: Marvin Petal

Circulation and Research Manager: Milton Drake

Reprints: Thomas M. Egan

Publisher: Gordon Jones

Electronics: August 8, 1966, Vol. 39, No. 16

Printed at 99 North Broadway, Albany, N.Y., 12207  
Second class postage paid at Albany, N.Y.

Subscriptions are solicited only from those actively engaged in the field of the publication. Position and company connection must be indicated on orders. Subscription prices: United States and Possessions and Canada, \$6.00 one year, \$9.00 two years, \$12.00 three years. All other countries \$20.00 one year. Single copies, United States and Possessions and Canada 75¢. Single copies all other countries \$1.50.

Published every other Monday by McGraw-Hill Inc. 330 West 42nd Street, New York, N.Y. 10036.  
Founder: James H. McGraw, 1860-1948. Corporate officers: Shelton Fisher, President; John J. Cooke, Secretary; John L. McGraw, Treasurer.

Subscribers: The Publisher, upon written request to our New York office from any subscriber, agrees to refund that part of the subscription price applying to copies not yet mailed. Please send change of address notices or complaints to Fulfillment Manager; subscription orders to Circulation Sales Department, Electronics, at the address below. Change of address notices should provide old as well as new address, including postal zip code number. If possible, attach address label from recent issue. Allow one month for change to become effective.

Postmaster: Please send Form 3579 to Fulfillment Manager, Electronics, P.O. Box 430, Hightstown, New Jersey 08520

## Readers Comment

### Distorted view?

To the Editor:

The complaints about electronics personnel procedures, which you printed under an "anonymous" by-line [June 27, p. 108], were poor attempts by some obviously unqualified person to rationalize his failures to find what he felt was adequate employment. Printing of such unqualified statements gives credence to these arguments; thus you present an untrue and distorted picture of the industry in general.

First, it must be remembered that this is a seller's market. Electronics firms are falling over themselves fighting for the qualified engineers. Talent has no problem in finding suitable employment. Nontalent, on the other hand, goes from one company to another, unable to impress management or personnel officials of his worth, getting more discouraged with each rejection. Possibly because he is assaying his own worth in unrealistic quantities of dollars, he remains unemployed, or holding the same position that he feels is unequal to his abilities. Eventually his complaints become wider and louder, and then, carrying a huge chip on his shoulder, he sits down at a typewriter and condemns an entire industry that he has elected to join. Possibly he should try another field.

Newly graduated engineers and experienced individuals looking for work usually have a host of companies that they can investigate. Although your author feels that the company knows more about him than he about the company, we at Fairchild Semiconductor don't find this to be true. Engineers interviewed for work in our firm have a fairly substantial knowledge of our company, its aims and goals. They wouldn't be looking for work here if they didn't.

Complaints of false advertising may be true in a small number of cases, but are unfounded in the industry in general. It costs a company thousands of dollars in time and actual expense to conduct an interview. Few companies are willing to spend sums of this size to meet a person who is not an actual

# Did you know Sprague makes...?

## UNICIRCUIT® RCTL INTEGRATED CIRCUITS

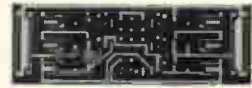

(8X actual size)

Sprague Series US-0100... a complete line of monolithic digital building blocks featuring low power consumption (2 mW typ.)

## UNICIRCUIT® mW RTL INTEGRATED CIRCUITS

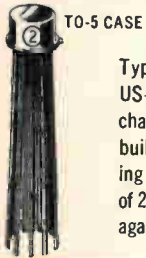

Types US-0908 through US-0921... Fully interchangeable mW digital building blocks featuring power consumption of 2 mW/node and propagation delay of 40 nsec

## DIFFERENTIAL AMPLIFIER TRANSISTOR PAIRS



NPN or PNP - Matched characteristics.  
 $h_{FE} = 10-20\%$ .  $\Delta V_{BE} = 5-20$  mV.  
 $\Delta V_{BE}/Temp = 5-20 \mu V/^{\circ}C$ .

## MULTIPLE TRANSISTORS (NPN-PNP PAIRS/QUADS)



Pairs		Quads	
2 NPN	2 PNP	4 NPN	4 PNP
1 NPN-1 PNP		2 NPN-2 PNP	

## UNICIRCUIT® CUSTOM HYBRID CIRCUITS



Combine monolithic silicon circuits with tantalum or Ni-Cr alloy resistors. Close resistance tolerances, low temperature coefficient. Resistor matching,  $\pm 1/2\%$ .

## LOW-COST HERMETICALLY- SEALED PLANAR TRANSISTORS



**TQ SERIES (PNP)**  
Low Level Amplifiers  
High Gain Switch/Amplifiers  
High Speed Switches

**TN SERIES (NPN)**  
High Voltage Switches  
Low Level Amplifiers  
High Speed Switch/Amplifiers  
Choppers  
Power Amplifiers  
Core Drivers

## SILICON ALLOY REPLACEMENT TRANSISTORS

### FULL PLANAR RELIABILITY

2N327A	2N945	2N1026
2N328A	2N946	2N1469
2N329A	2N1025	2N1917

Sprague makes 82 standard high-emitter-voltage full planar silicon alloy replacement types.

## DIGITAL-TO-ANALOG CONVERSION CIRCUITS



UT-1000—Four-bit ladder network  
UD-4001—Ladder switch for driving resistor ladder networks  
UD-4024—Buffer amplifier

## TW-3000 MICROPOWER PNP SILICON HIGH-SPEED SWITCHING TRANSISTORS



Fastest switching transistor available in the 1 to 100  $\mu A$  range  
 $C_{ib} = 0.7$  pF typ., 1.5 pF max.  
 $C_{ob} = 1.5$  pF typ., 2.5 pF max.

For complete technical data on any of these products, write to:

Technical Literature Service  
Sprague Electric Company  
35 Marshall Street  
North Adams, Mass. 01247

## SPRAGUE COMPONENTS

INTEGRATED CIRCUITS  
THIN-FILM MICROCIRCUITS  
TRANSISTORS  
CAPACITORS  
RESISTORS

PULSE TRANSFORMERS  
INTERFERENCE FILTERS  
PULSE-FORMING NETWORKS  
TOROIDAL INDUCTORS  
ELECTRIC WAVE FILTERS

CERAMIC-BASE PRINTED NETWORKS  
PACKAGED COMPONENT ASSEMBLIES  
BOBBIN and TAPE WOUND MAGNETIC CORES  
SILICON RECTIFIER GATE CONTROLS  
FUNCTIONAL DIGITAL CIRCUITS

# SPRAGUE®

THE MARK OF RELIABILITY

\*Sprague' and '®' are registered trademarks of the Sprague Electric Co.



# Hour Extender

Push a button, and you've saved the time and effort required to set up a camera and make a scope trace print. You'll save time reading waveform records, too!

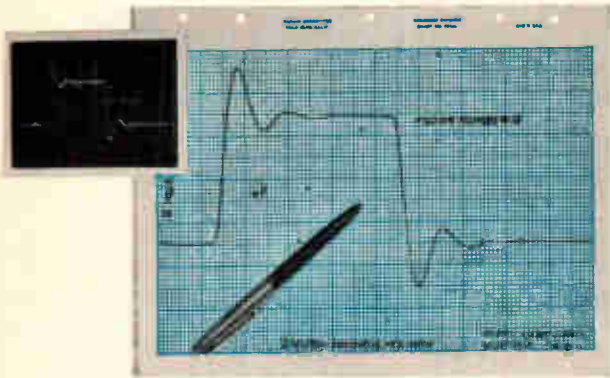

Do you ever use repetitive waveform records? Now Pacific Measurement's CRT Display Converter links your oscilloscope (up to 50 MHz) to any strip-chart or X-Y recorder. Records can be made in seconds, without affecting or obscuring the CRT trace and at 1/20th the cost of a print. The Converter output is actually as accurate as the CRT display, and will clean up signals that are too noisy to be read on the tube. The 8½x11" graph or strip-chart is much easier to read, make comparisons and reproduce than a photograph.

**DESIGN ENGINEERS** find it useful to record data, compare waveforms and accurately measure time and amplitude.

**QUALITY ASSURANCE** Departments need it to maintain permanent records of product performance that clearly indicate trends in quality.

**PRODUCTION TESTING** people find it easy to use, fast and accurate. You can reproduce and ship data with your product as proof of final test performance.

## SPECIFICATIONS

**Frequency Response:** DC to 50 MHz (to signals synchronous with oscilloscope sweep).

**Horizontal and Vertical Output Levels:** 1.0 Volt per major division of CRT graticule. (Horizontal, 0 to -10V.; Vertical, zero center + and -5 V.).

**Scan Speed:** Adjustable, 10 to 60 seconds per scan.

**Physical:** Modular style cabinet for bench or rack mounting in 5.25" panel.

**Size:** 4.97" H. x 5.25" W. x 10.5" D. **Weight:** approximately 8 pounds. **Color:** Blue-gray with contrasting light gray panel.

## ALL SOLID STATE CIRCUITRY

**Price:** \$490 with interconnecting cables, FOB Palo Alto. Phone or write today for complete specifications.

# PACIFIC MEASUREMENTS INCORPORATED

940 Industrial Avenue, Palo Alto, California (415) 328-0300



candidate for a job opening. At Fairchild Semiconductor, as is the case with other major electronics firms, newspaper and magazine advertisements represent actual job openings, and interviews are only offered to persons that may have the qualifications for the jobs.

Norman Skelton

Professional Employment  
Fairchild Semiconductor  
Mountain View, Calif.

### Recommended reading

To the Editor:

My compliments on the article, "Recruiting Merry-Go-Round," [June 27, p. 108]. It is well written, pertinent and will always be timely. In fact, I would strongly recommend repetitive publication on a quarterly basis in all of the engineering publications.

Since early in my career I have been opposed to any form of collective bargaining for or by engineers, yet some method must be devised to convince industrial concerns of the need for realistic personnel procurement policies based on facts, truth and recognition of the individual.

I have had my share of this shameful and discourteous treatment from industry. It would almost appear to be an organized industrywide policy, so few are the exceptions.

In responding to a total of 127 advertisements for engineering personnel during the fall of 1960, I received only 17 replies, as follows: four acknowledgments; seven statements that they were not hiring at this time; two referrals of my inquiry to pertinent technical departments, and four requests for completion of their application forms.

Of the latter, three firms enclosed company brochures, financial reports and program literature.

The most galling blow was the total lack of courtesy exhibited by 110 firms.

Taking the obvious as a conclusion, personnel procurement policies have not improved in the past six years. Whether this be the fault of employees in personnel departments or the impersonal attitude of industry is uncertain. Most likely it is a combination of the two.

William V. Record

Tucson, Arizona

To the Editor:

Your writer graphically describes a number of employer malpractices in hiring electronics engineers.

In civilian technical fields, other abuses of engineers are common, too: such as age restrictions in hiring, nontransferable pension plans to tie men to their jobs and assignment of "captive" engineers to non-technical work.

It is well known that U.S. leadership in a number of civilian technical fields has slipped. Thus, Japan now is ahead in ship construction and in railroad design. Italy leads in typewriters and sewing machines. Modern steel production is a German development while the Russians seem to be moving ahead in high-tension d-c power transmission.

I wonder whether the fact that enrollment in U.S. engineering colleges lags behind general university registration is related to abuse of our engineering force? And is the loss of U.S. leadership in certain civilian engineering fields related to the same cause?

[Name withheld]

Los Angeles, Calif.

## LOW MICROWAVE NOISE?



Model SE-200

### WHY NOT PROVE IT?

**SPECTRA** Microwave Noise Measuring Instruments are the only equipments yet devised that can give you the FM and AM noise content of conventional and solid state microwave sources — to accuracies as high as  $\pm 1$  DB. Proof? Maybe not, but close to it.

#### SPECTRA-EXCLUSIVES:

- RF Frequency Ranges: 1.0 Gc/s to 32 Gc/s
- Self-Calibrating for both AM & FM noise measurements
- Broad Video Frequency Coverage: 1 Kc/s to 150 Kc/s
- Residual FM Monitor: 10 cps to 1 Kc/s
- Dual Bandwidth Spectrum Analyzer: 100 cps and 1 Kc/s
- High Sensitivity: AM 135 DB below carrier level; FM .0032 cps rms deviation
- Minimum RF Input Power: 1.5 milliwatts
- Self-Contained Microwave Spectrum Analyzer
- Phase-Locked Local Oscillator

#### NEW MEASUREMENT SERVICE

A custom Noise Measurement Service is now operated by Spectra to provide accurate noise measurements of X-band sources in the frequency range from 8.5 Gc/s to 10.5 Gc/s. Readout: X-Y recordings of FM or AM noise vs. video frequency. Write today for technical data and complete details.

**SPECTRA**  **ELECTRONICS**

P.O. Box 85  
Los Altos, Calif. 94023 • (415) 948-4998

### SUBSCRIPTION SERVICE

Please include an Electronics Magazine address label to insure prompt service whenever you write us about your subscription.

Mail to: Fulfillment Manager  
Electronics  
P.O. Box 430  
Hightstown, N.J. 08520

To subscribe mail this form with your payment and check  new subscription  renew my present subscription

Subscription rates: in the U.S.: 1 year, \$6; two years, \$9; three years, \$12. Subscription rates for foreign countries available on request

### CHANGE OF ADDRESS

**ATTACH LABEL HERE** If you are moving, please let us know five weeks before changing your address. Place magazine address label here, print your new address below.

name \_\_\_\_\_  
address \_\_\_\_\_  
city \_\_\_\_\_ state \_\_\_\_\_ zip code \_\_\_\_\_

# What's the automatic way to guide search aircraft to a swift rescue?



## Granger Associates has the answer now

Finding survivors of a downed aircraft is a fast, efficient operation if the plane carries compact G/A air-sea rescue beacons. Activated immediately upon immersion in water, a G/A beacon transmits a distinct tone on a guard channel and can be heard for more than 48 hours by search aircraft up to 175 nautical miles away—even in bad weather and rough seas.

Unlike presently carried MF and HF emergency radios, a G/A beacon works automatically, needs no attention by the survivors, and is very easy for the search planes to pinpoint. It can be quickly located from the air by either VHF direction-finding techniques or a signal pick-up/signal fade search pattern.

Write for full data on G/A's rescue beacons—emergency equipment that no over-water aircraft should be without.



1601 California Ave., Palo Alto, California / Telephone: 321-4175 / TWX: 910-373-1291  
Granger Associates Ltd.  
Russell Hse., Molesey Rd., Walton-on-Thames, Surrey, England / Walton-on-Thames 29913



air-sea rescue beacon model A/R/B

CAREER OPPORTUNITIES FOR ENGINEERS IN HF/VHF COMMUNICATIONS

## People

Now that holography shows genuine promise of becoming a research tool and in the future an entertainment medium, a company has been formed to develop the basic inventions into commercial products. What these products might be is something that the company's president, **Daniel S. St. John**, declines to say. "It's still too early," he explains.



The two-month-old Holotron Corp. so far consists only of St. John and one assistant—"we're planning to hire more people"—but its parent companies are impressive: it is a joint subsidiary of E.I. du Pont de Nemours & Co. and Scientific Advances, Inc., a subsidiary of the Battelle Memorial Institute. Holotron also has an impressive asset: the exclusive rights to patent inventions from holographic research at the University of Michigan's radar and optics laboratory and at Battelle's Columbus and Pacific Northwest laboratories.

So far, the fledgling company is firmly under Du Pont's wing. St. John's office is in the Du Pont Building in downtown Wilmington, and Holotron draws on Du Pont's facilities for legal work, public relations and secretarial assistance, to say nothing of the research into holography that Du Pont is doing. St. John himself has been with Du Pont for 17 years.

**Physicist by adoption.** St. John doesn't have a background in holography: "I've worked mainly in atomic energy, with my main concern for the last 15 years reactor physics. Actually, though, I'm a physicist only by adoption; I did my doctoral work at the University of Wisconsin in physical chemistry."

From 1957 to 1964, St. John was head of the theoretical physics division at the Savannah River Laboratory at Aiken, S.C., (a nuclear facility run by Du Pont for the Atomic Energy Commission). His work with atomic energy started in World War II with the



## Two new ways to achieve higher power with Machlett planar triodes

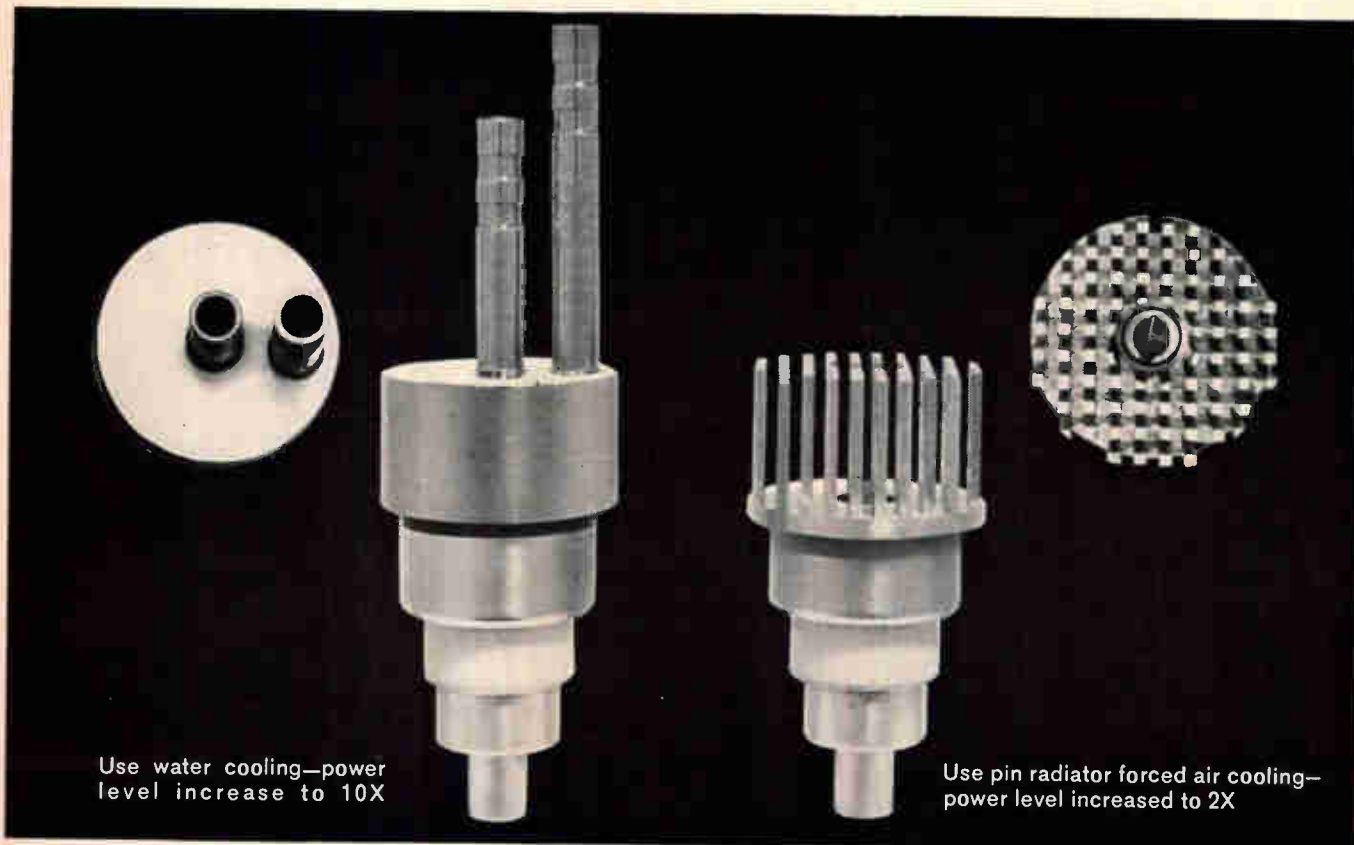

Use water cooling—power  
level increase to 10X

Use pin radiator forced air cooling—  
power level increased to 2X

Advanced cooling methods for UHF  
planar triodes now permit you to  
make full use of the high power  
range found in Machlett tubes.  
Here are two examples:



**ML-7855** with water jacket. Anode  
dissipation capability: 400 watts.  
New maximum input: 2.5kV, 300 mA.



**ML-7855** with pin radiator. Anode  
dissipation capability: 150 watts.  
An optional input: 1.75kV, 150 mA.  
For full operating details on  
Machlett tubes recommended  
for this new high-service power  
level, write to The Machlett  
Laboratories, Inc. —  
Springdale, (Stamford) Conn. 06879.

**RAYTHEON**

**THE MACHLETT LABORATORIES, INC.**

A SUBSIDIARY OF RAYTHEON COMPANY

## New from Sprague!

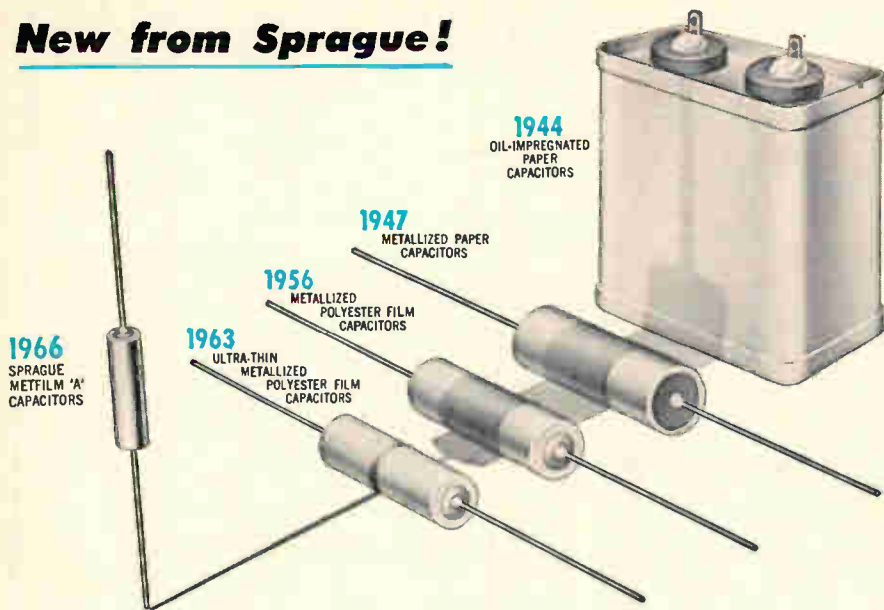

## METFILM\* 'A' CAPACITORS ... dramatically smaller in size, yet more reliable than military-grade capacitors of the past!

Just a few years ago, the only 10  $\mu$ F capacitor considered dependable enough for military applications was Type CP70 (to JAN-C-25), and was a block-busting 3 $\frac{3}{4}$ " wide x 1 $\frac{3}{4}$ " thick x 4" high. Today, you can get a military-quality 10  $\mu$ F tubular capacitor measuring only  $\frac{1}{2}$ " in diameter x 2 $\frac{1}{4}$ " long. And it's more reliable than any capacitor of the past!

Sprague Type 680P Metfilm 'A' Metallized Capacitors meet all environmental requirements of MIL-C-18312, yet they occupy only one third the volume of conventional metallized film capacitors of equivalent capacitance and voltage rating. Employing a new thin organic film dielectric system, Type 680P capacitors use a dual film totalling only 0.00008" thick, as compared to conventional polyester-film capacitors with a single film measuring 0.00015".

Another distinct advantage of the Metfilm 'A' dielectric system is minimum degradation of electrical properties during life.

Hermetically sealed in corrosion-resistant metal cases, capacitor sections are effectively of non-inductive construction, resulting in capacitors with performance characteristics superior to those of comparably-sized capacitors.

Type 680P Metfilm 'A' Capacitors are available with capacitance values to 10  $\mu$ F in both 50 and 100 volt ratings.



For complete technical data, write for Engineering Bulletin 2650 to Technical Literature Service, Sprague Electric Company, 35 Marshall Street, North Adams, Massachusetts 01247.

\*Trademark

### SPRAGUE COMPONENTS

CAPACITORS  
TRANSISTORS  
RESISTORS  
THIN-FILM MICROCIRCUITS  
INTEGRATED CIRCUITS  
INTERFERENCE FILTERS  
48C-6111

PACKAGED COMPONENT ASSEMBLIES  
FUNCTIONAL DIGITAL CIRCUITS  
MAGNETIC COMPONENTS  
PULSE TRANSFORMERS  
CERAMIC-BASE PRINTED NETWORKS  
PULSE-FORMING NETWORKS



'Sprague' and ® are registered trademarks of the Sprague Electric Co.

## People

Army Corps of Engineers at Los Alamos. He worked there after the war for the University of California. For the past two years, since leaving Savannah River, he was a staff member of Du Pont's development department.

Why was St. John picked to head Holotron? He explains, "I've done a lot of development work. My job here is to carry out commercial development in a rather highly technical field."

Marvin H. Hewitt, an expert in plasma reentry physics, has joined the technical staff at Radiation Systems, Inc., in Alexandria, Va. His job will be to apply his knowledge of plasmas to the company's main product: antennas. The main task, he explains, is to develop special antennas that can operate through the plasma sheath that envelops a spacecraft during reentry and attenuates radio signals.



Hewitt, 43, who has more than 12 years of industrial experience, has worked in other scientific fields also: applied mathematics, satellite dynamics and systems analysis. For the past three years he was a member of the technical staff of the Mitre Corp., Bedford, Mass. Earlier he was with the Raytheon Co., Lexington, Mass., and with the Martin Co. in Denver and Baltimore.

**Work on antennas.** The physicist, a consultant on the staff of George Chadwich, vice president for engineering, is devoting about a quarter of his time to plasma physics. His other efforts are directed to work in the electromagnetic theory of antennas.

Hewitt skipped undergraduate school and went directly to graduate studies at the University of Colorado. From 1948 to 1954 he lectured in physics and mathematics at a number of colleges and universities.



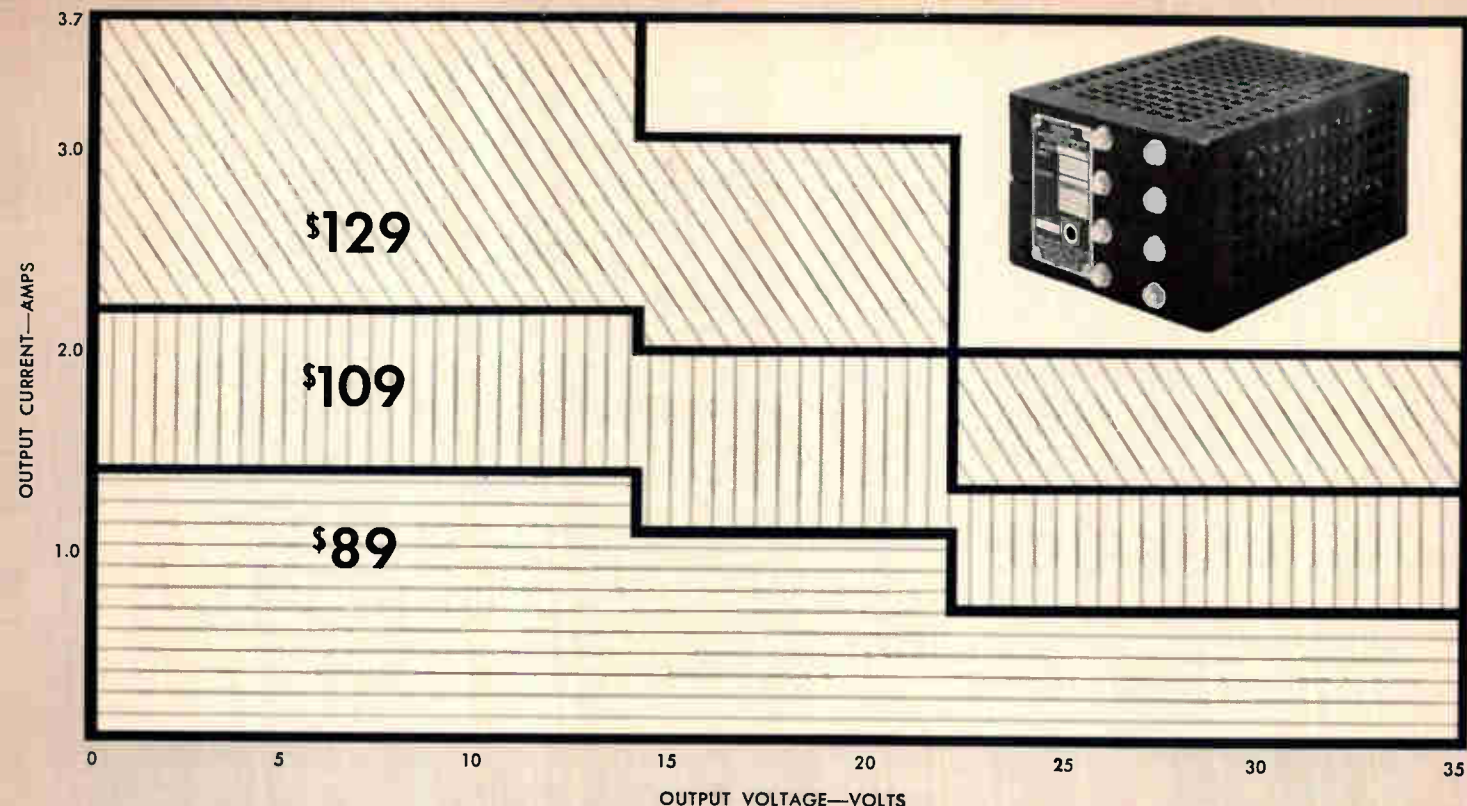

All-silicon QSA Series: 12 models; regulation  $\pm .005\%$ ; response time 20  $\mu$ s.

# New Sorensen Modular Power Supplies

The new Sorensen QSA Series offers the only modular power supply line in the 0 to 35 volt range that combines  $\pm .005\%$  regulation line and load, 20  $\mu$ s. response time, 71°C operating temperatures, 300  $\mu$ V ripple—all at prices below other lines having lesser performance specifications. Sorensen's QSA Series modules are ideal for OEM, lab or system applications. They can be used as bench models (mounted in any position) or mounted in combinations of 3 or 4 in an optional 19" (3½" high) rack adapter. Other design features include: Load current vs. temperature, 110% @ 40°C—100% @ 50°C—85% @ 60°C—66% @ 71°C • Temperature coefficient 0.01%/°C • Stability

0.025%/8 hrs. • Models QSA10-1.4, QSA10-2.2 and QSA10-3.7 permit operation of up to 20 units in series; other units permit operation of 2 units in series; All models permit operation of 4 units in parallel • No turn-on/turn-off overshoots • Remote sensing • Remote programming • Ripple voltage peak to peak 3mV. All Sorensen power sources conform to proposed NEMA standards. For additional QSA Series details or for data on other standard/custom DC power supplies, AC line regulators or frequency changers, call your local Sorensen representative, or write: Raytheon Company, Sorensen Operation, Richards Avenue, Norwalk, Conn. Tel: 203-838-6571, TWX: 710-468-2940.

#### SPECIFICATIONS

MODELS (RANGES)	QSA10-1.4 (0-10V, 1.4A) QSA12-1.4 (8-14V, 1.4A) QSA18-1.1 (14-22V, 1.1A) QSA28-.7 (22-35V, .7A)	QSA10-2.2 (0-10V, 2.2A) QSA12-2.2 (8-14V, 2.2A) QSA18-2.0 (14-22V, 2.0A) QSA28-1.3 (22-35V, 1.3A)	QSA10-3.7 (0-10V, 3.7A) QSA12-3.7 (8-14V, 3.7A) QSA18-3.0 (14-22V, 3.0A) QSA28-2.0 (22-35V, 2.0A)
SIZES (IN.)	7 x 3-5/16 x 3-7/8	7 x 3-5/16 x 5-1/8	10 x 3-5/16 x 5-1/8
PRICES (U.S. List)	\$89	\$109	\$129



See us at Wescon Booths 145 & 146, Hollywood Park

# Recap Two:

Here are seven more new product announcements you may have missed in the past month or two. (It's been a busy year.) If you would like additional information about any of these products, mark the corresponding number on the bingo card. Or call any Fairchild Distributor.

## HIGH GAIN FLAT BETA PNP AMPLIFIER

Unique features allow great applications versatility. No other family of low noise, low noise amplifiers can approach the beta ratings of our 2N4295 and 2N4295 families. To this, add our high gain of 750 at 100 A, state-of-the-art noise figure of 2 db at 1kHz, and high breakdown voltage ratings. Then consider the added versatility of availability in both metal and epoxy packages (2N4295-50). Planar II epitaxial construction, and off-the-shelf distributor delivery. No wonder this new group of amplifiers already tops like a record setter. Write for complete specifications.

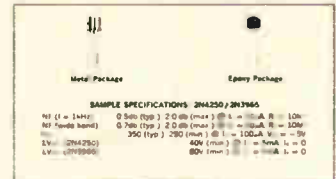

Reader Service No. 425

# PLANAR SCRs 0-400V, 0-10A, 150°C

**PNPN Planar Switching SCRs** A complete line of silicon controlled rectifiers for switching applications is now available from Fairchild. We guarantee performance to 125°C, up to 150°C in some instances. We cover the range from 0 to 400 volts, from 0 to 10 amps, in six package types (TO 3, TO 5, TO 18, TO 46, TO 59, and TO 66), for consumer, industrial, and military applications.

Whether you need a device for sensor control, for miniature motor control, for a counter or a timer, a solenoid or light dimmer, or for any of a dozen other applications, it will pay you to check with Fairchild. Our devices perform better, have lower forward and reverse leakages, and are competitively priced. And you get Planar reliability as a bonus. Sample specifications are shown below. For complete information drop us a note, or check with a Fairchild Distributor.



SAMPLE SPECIFICATIONS		OTHER FAIRCHILD SCR FAMILIES	
2N1555 96	2N2222 2B, 2N2969 42	2N4218 10	0 to 400V 0 to 10A in TO 66 packaging
$V_{RM}$	400V @ 65°C case	2N2228	0 to 400V 0 to 10A in TO 66 packaging
$I_{FM}$	100mA max @ 50 300V	2N2620	0 to 400V 0 to 10A in TO 66 packaging
$V_{RM}$	0.8V max	5E9030 33	0 to 400V 0 to 10A in TO 3 packaging
$I_{FM}$	1.0mA max		
$V_{RM}$	1.8V max @ 1.0A	2N4096 4098	0 to 200V 0 to 500mA in TO 46 packaging
$T_c$	125°C max	2N4108 4110	0 to 200V 0 to 500mA in TO 18 packaging
Package	TO 5		

FAIRCHILD SEMICONDUCTOR (A Division of Fairchild Camera and Instrument Corporation) • 211 Fairchild Drive, Mountain View, California 94035 • Tel: 916-276-6400

Reader Service No. 420

## IF YOU CAN'T AFFORD TO DESIGN WITH FAIRCHILD DT $\mu$ L, YOU CAN'T AFFORD TO DESIGN.

Industrial IC's at about \$1.00 per function. Fairchild design features. A complete line which includes both binary and gate elements, completely compatible with any other IC gates may be wired OR'ed up at the output. Expanded inputs can be used with 932, 932 and 944 elements. Low input current leakage. High noise immunity.

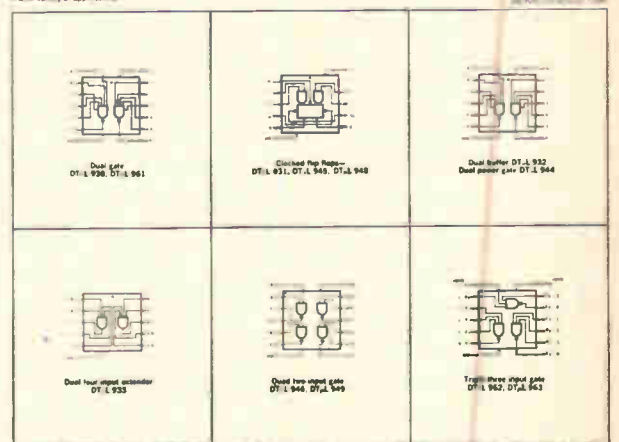

FAIRCHILD SEMICONDUCTOR (A Division of Fairchild Camera and Instrument Corporation) • 211 Fairchild Drive, Mountain View, California 94035 • Tel: 916-276-6400

Reader Service No. 421

**Here are 50 applications, in alphabetical order, for Fairchild Linear Monolithic Circuits:**

(If we left out your favorite, let us know. We'll include it next time.)

- |  |   |  |
|--|---|--|
| 1. A to D converter                                  | 18. Go/No go detector                           | 35. Scaling amplifier                        |
| 2. A.C. amplifier                                    | 19. Hysteresis comparator                       | 36. Schmitt trigger                          |
| 3. Astable (free running) multivibrator (20V output) | 20. Integrator (D.C. or A.C.)                   | 37. Sense amplifier (20 mil cores)           |
| 4. Averaging amplifier                               | 21. Isolation amplifier                         | 38. Servo amplifier                          |
| 5. Bi stable (flip flop) multivibrator (20V output)  | 22. Lag amplifier                               | 39. Summing amplifier (subtractor amplifier) |
| 6. Bridge amplifier                                  | 23. Lead amplifier                              | 40. Sweep generator (wave form amplifier)    |
| 7. Buffer amplifier                                  | 24. Level shifting amplifier (clamping circuit) | 41. Time delay amplifier                     |
| 8. Current source amplifier                          | 25. Logarithmic amplifier                       | 42. Unity gain amplifier                     |
| 9. Chopper stabilized amplifier                      | 26. Meter amplifier                             | 43. Video amplifier                          |
| 10. Clipping amplifier                               | 27. Oscillators (sine wave and square wave)     | 44. Voltage comparator                       |
| 11. D.C. amplifier                                   | 28. One shot (high speed, precision)            | 45. Voltage controlled oscillator            |
| 12. Deflection coil amplifier                        | 29. Peak detector                               | 46. Voltage detector                         |
| 13. Difference amplifier                             | 30. Phase discriminator                         | 47. Voltage follower                         |
| 14. Differential amplifier                           | 31. Preamplifier                                | 48. Voltage regulator                        |
| 15. Differentiator                                   | 32. Pulse height detector                       | 49. Wave form generator                      |
| 16. Digital clock                                    | 33. Rectifier                                   | 50. Window detector                          |
| 17. Gain control amplifier                           | 34. Sample and hold amplifier                   |  |

**Here are 4 Fairchild IC's, in numerical order, for use in the above applications:**

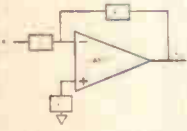

**A702C—Differential Amplifier**  
 Compensated Bandwidth: 30MHz  
 Input Offset Voltage: 2mV  
 Input Resistance: 20KΩ

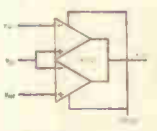

**A711C—Dual Comparator**  
 Strobe Release Time: 12nsec  
 Input Offset Voltage: 2mV  
 Input Voltage Range: 5V



**A709C—Operational Amplifier**  
 Open Loop Voltage Gain: 45,000  
 Output Voltage Swing: 14V  
 Input Resistance: 250KΩ  
 Input Offset Voltage: 2mV

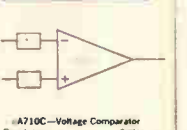

**A710C—Voltage Comparator**  
 Resolution: 2mV  
 Response Time: 40nsec  
 (5mV Overdrive)  
 Input Voltage Range: 5V



**FAIRCHILD SEMICONDUCTOR**

For complete product information and pricing, contact Fairchild Distributors or write us.

Reader Service No. 422

# MOS FET RF AMP



The Fairchild FT57 is an N channel depletion mode MOS field effect transistor. It features low noise and low cross modulation when given its superior performance characteristics in receiver RF amplifier and mixer stages. Two types are available: FT57 to meet military standards and SE5301 for industrial/commercial applications. Both are high reliability Planar II devices. Both are now in stock. Ask for complete information.

FT57 Specifications	
Low noise figure	2.7dB (typ.) 4.5dB (max.)
High power gain	20dB (typ.) 15dB (min.)
Low feedback capacitance	0.6pF (typ.) 0.8pF (max.)
All of the above specifications @ 100MHz	
High $\beta$ (T)	9,000 $\mu$ mhos (typ.)
Reverse AGC capability	6,000 $\mu$ mhos (min.)

Reader Service No. 426

## LOW NOISE, HIGH FREQUENCY TRANSISTORS

Fairchild 2N4134, 2N4135, NPN diffused silicon Planar transistors feature low noise and high gain stability over a broad range of frequencies—IF, RF, and UHF. In addition, these devices offer low reverse capacitance and a low collector to base time constant at no sacrifice in performance. For optimum use in critical amplifier design applications, these products are available under the **FACT** program. At Fairchild Distributors, or write us for complete data.



Parameter	2N4134	2N4135
RF @ 50MHz	2.5dB Max	5dB Max
NF @ 450MHz	2.5dB Max	5dB Max
Stable gain @ 50MHz	21dB Min	24dB Min
@ 450MHz	8dB Min	8dB Min
@ 800MHz	8dB Typ	0.8pF Max
Collector-emitter C <sub>ce</sub>	0.25pF Max	0.4pF Max
Collector-base C <sub>cb</sub>	0.25pF Max	0.4pF Max
f <sub>T</sub> (C <sub>ce</sub> )	500MHz Max	300MHz
L <sub>V<sub>ce</sub></sub>	30V Max	
Guaranteed forward AGC capability		

Reader Service No. 424

## RF AMPLIFIERS 2.5 dB @ 60 MHz

Fairchild low-noise NPN Planar transistors. If you design amplifier circuits in the IF, VHF or UHF bands, this new series of Fairchild transistors is what you've been waiting for. Low noise, low reverse capacitance, and high stable gain make this the best amplifier family on the market up to 800MHz. Available for military service (2N4134, 2N4135) and for industrial/commercial use (SE5050, SE5051), these transistors are stocked for immediate delivery. See our sample specifications below. Then see a Fairchild Distributor for pricing information and samples. Or write for our data sheets.



Sample Specifications — 2N4135	
NF @ 50MHz	2.5dB min
NF @ 450MHz	5.0dB min
Power gain @ 50MHz (unneutralized)	20dB min
Power gain @ 450MHz	8dB min
C <sub>ce</sub> (guaranteed C <sub>ce</sub> )	0.5pF max
L <sub>V<sub>ce</sub></sub>	30V min

Reader Service No. 423



## Jerrold's new Model 900-C is the most conceited sweep signal generator on the market!

We get a little embarrassed. The many thousands of Model 900's now in the field have built up such a tremendous reputation for dependability and service that they're beginning to act smug. They "show off" with gut features like built-in oscilloscope pre-amp, four mode operation and continuously variable sweep widths from 10 kHz to 400 MHz (center frequencies from 500 kHz to 1200 MHz) — just to name a few.

But that's not the worst of it. The New 900-C really gets overbearing when it starts performing. Say you want to observe the entire frequency range of a unit under test: . . . or examine a narrow 10 kHz beamwidth . . . or make a quantitative analysis of the response of a wide range of electronic devices such as receivers, amplifiers, filters, transformers, or transmission lines.

It does these chores so easily, so accurately, and so efficiently, we despair of ever deflating its ego.

One small revenge. Our New Model 900-C literature is very, very modest. Send for a copy.

**JERROLD** MEASUREMENT AND  
TEST INSTRUMENTATION

**JERROLD ELECTRONICS CORPORATION**  
Government and Industrial Division  
Philadelphia, Pa. 19105

## Meetings

**Guidance and Control Conference**, American Institute of Aeronautics and Astronautics; University of Washington, Seattle, Aug. 15-17.

**NATO Advanced Study Institute, NATO**; University of Keele, Staffordshire, England, Aug. 15-26.

**Joint Automatic Control Conference**, Automatic Control Group; University of Washington, Seattle, Aug. 17-19.

**Symposium on Computer and Information Science (COINS)**, Columbus Laboratories of Battelle Memorial Institute, Office of Naval Research, Ohio State University; Columbus, Ohio, Aug. 22-24.

**Technical Symposium**, Society of Photo-Optical Instrumentation Engineers; St. Louis, Mo., Aug. 22-26.

**Television and Radio Show**; Earls Court, London, Aug. 22-26.

**International Electronic Circuit Packaging Symposium**, Electrical Design News; Sports Arena, Los Angeles, Aug. 23-24.

**International Conference on Luminescence**, Research Institute for Technical Physics, Hungary Academy of Science; Budapest, Hungary, Aug. 23-26.

**Western Electronics Show and Convention**, IEEE and Western Electronic Manufacturers Association; the Sports Arena and Hollywood Park, Los Angeles, Aug. 23-26.

**International Congress of Electron Microscopy**, Institute for Chemical Research; Kyoto, Japan, Aug. 28-Sept. 4.

**Electronics Materials Technical Conference**, Metallurgical Society of the American Institute of Mining, Metallurgical and Petroleum Engineers; Sheraton Boston Hotel, Boston, Aug. 29-31.

**International Conference on Instrumentation in Aerospace Simulation Facilities**, Aerospace and Electronic Systems Group; Stanford University, Stanford, Calif., Aug. 29-31.

**National Conference of the Association for Computing Machinery**, Association for Computing Machinery; Washington Hilton Hotel, Washington, D.C., Aug. 29-31.

**Ocean Electronics Symposium, IEEE**; Ilikai Hotel Convention Hall, Honolulu, Hawaii, Aug. 29-31.

**Technical Conference on Preparation and Properties of Electronic Materials for the Control of Radiative Processes**, Metallurgical Society and the Boston

Section, American Institute of Mining, Metallurgical and Petroleum Engineers, Inc.; Sheraton-Boston Hotel, Boston, Mass., Aug. 29-31.

**Swiss Electronics Television, Radio and Phonograph Exhibition**; Exhibition Grounds of the Zuspä, Zurich, Aug. 31-Sept. 5.

**General Assembly of the International Scientific Radio Union**; Munich, Sept. 1-15.

**National Radio and Television and International Electric Components Exhibition**; Milan, Sept. 3-11.

**International Conference on Semiconductor Physics**; Tokyo, Sept. 5-9.

**International Nuclear Industries Fair**; Basel, Switzerland, Sept. 8-14.

**High Energy Physics Instrumentation Conference**, Linear Accelerator Center of Stanford University, Stanford, Calif., Sept. 9-10.

**International Conference on Microwave and Optical Generation**, Institute of Electrical Engineers and the Institute of Electronic and Radio Engineers, Cambridge, England, Sept. 12-16.

**Intersociety Energy Conversion Engineering Conference**, American Institute of Aeronautics and Astronautics, Society of Automotive Engineers, American Institute of Chemical Engineers, IEEE, American Nuclear Society, American Society of Mechanical Engineers and the Solar Energy Society; International Hotel, Los Angeles, Sept. 26-28.\*

## Call for papers

**Electronic Packaging Conference**, Science of Automotive Engineering; Roosevelt Hotel, New York, Feb. 14-16. **Aug. 26** is deadline for submission of 200- to 500-word abstracts in triplicate to A.J. Favata at SAE Headquarters, 485 Lexington Ave., New York, N.Y. 10017.

**Electrical Insulation Conference**, IEEE, National Electrical Manufacturers Association; Chicago, Oct. 15-19. **Sept. 1** is the deadline for submission of papers to M.A. Lamont, Owens-Corning Fiberglass Corp., 717 Fifth Ave. N. Y. 10022.

**IEEE, Mississippi Section**, at Heidelberg Hotel, Jackson, Miss., April 17-19. **Oct. 15** is deadline for submitting papers to J.E. May, technical program chairman, P.O. Box 811, Jackson, Miss. 39205.

\* Meeting preview on page 20

Each Fluke all-solid-state voltage calibrator gives you more for your instrumentation dollar! Things like 0.0005% line and load regulation in every model. Compact and lightweight construction for portability. Heatfree, fanfree operation for long life and best stability. High speed remote programming in two models. Calibration accuracy to 0.003%. Price range \$1,295 to \$2,490.

Model	Voltage	Current	Stability	Readout	Calibration Accuracy	Panel Height and Weight	Price
313A	0 to 50 vdc 0 to 5 vdc	0 to 2 amps	±0.002%	6 digit inline	±0.01%	5¼" -50 lbs.	\$1,295
315A*	0 to 50 vdc	0 to 1 amp	±0.005%		±0.025%	5¼" -50 lbs.	\$1,895
332A	0 to 1111 vdc	0 to 50 ma	±0.0015%	7 digit inline	±0.003%	7" -60 lbs.	\$2,490
382A	0 to 50 vdc 0 to 5 vdc	0 to 2 amps	±0.002%	6 digit inline	±0.01%	5¼" -50 lbs.	\$1,595
383B*	0 to 50 vdc	0 to 2 amps	±0.005%		±0.025%	5¼" -50 lbs.	\$1,950

\*Remotely Programmed



FLUKE • Box 7428, Seattle, Washington 98133 • Phone: (206) 776-1171 • TWX: (910) 449-2850

Model 332A  
Voltage Calibrator



Model 383B  
Remotely  
Programmed  
Voltage/Current  
Calibrator



Model 315A High-Speed  
Remotely Programmed Voltage Calibrator

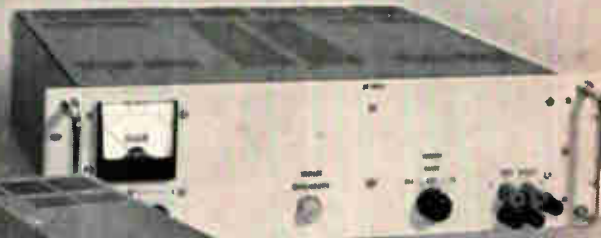

Model 382A Voltage/Current Calibrator

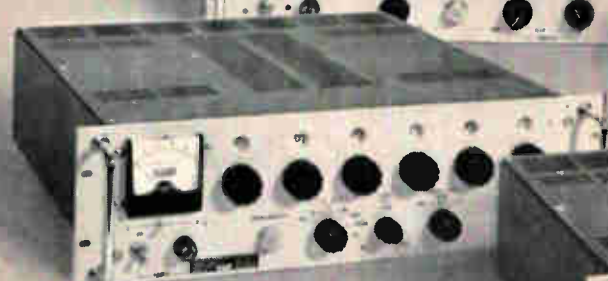

Model 313A  
Voltage Calibrator

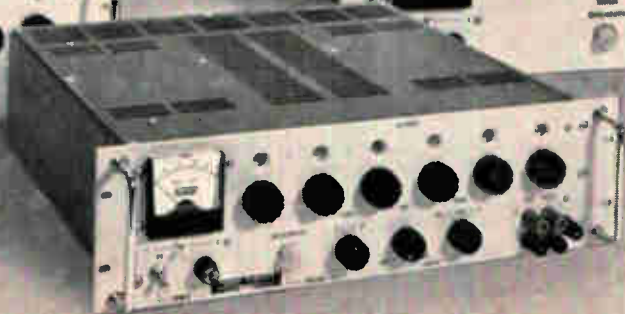

## New from Sprague!

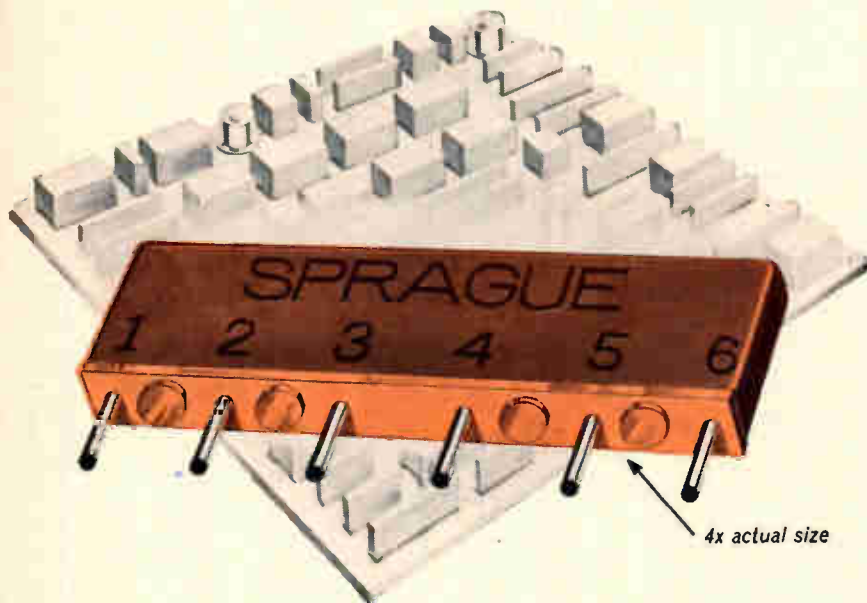

# METANET<sup>®</sup>

## TRUE METAL-FILM PRECISION RESISTOR NETWORKS

### Save Space, Time, and Money

- High packaging density—4 to 8 times that of individual components.
- Fewer components to stock, handle, inspect, install. Entire module can be hand-inserted faster than one axial-lead component.
- Permit substantial savings over equipment assembled with individual components.
- Epoxy terminal board keeps pin terminals free of resin coating, unlike conventional dipped components, and provides uniform lead spacing.
- Stand-off bosses permit effi-

cient flux removal after soldering. Also prevent dirt and moisture traps around leads.

- Extremely stable and reliable. Meet performance requirements of MIL-R-10509E. Resistance tolerances to  $\pm 1\%$ .
- Ceramic capacitors can be incorporated for further savings and size advantages over individual components.

For complete information write to Integrated Circuit Application Engineering Department, Sprague Electric Company, 35 Marshall Street, North Adams, Mass. 01248

#### SPRAGUE COMPONENTS

RESISTORS  
CAPACITORS  
TRANSISTORS  
INTEGRATED CIRCUITS  
THIN-FILM MICROCIRCUITS  
INTERFERENCE FILTERS

PACKAGED COMPONENT ASSEMBLIES  
FUNCTIONAL DIGITAL CIRCUITS  
MAGNETIC COMPONENTS  
PULSE TRANSFORMERS  
CERAMIC-BASE PRINTED NETWORKS  
PULSE-FORMING NETWORKS

48N-4145 R3



“Sprague” and “<sup>®</sup>” are registered trademarks of the Sprague Electric Co.

## Meeting preview

### Energy sources

**Unconventional power sources** for electric automobiles, space vehicles and communications equipment will be among the subjects discussed in the Intersociety Energy Conversion Engineering Conference, Sept. 26 to 28, in Los Angeles. Two sessions, one of which is secret, will deal with nuclear power for space vehicles and will include papers on thermoelectric devices and thermionic reactors.

Thomas J. Plevyak of Bell Telephone Laboratories will outline test results and the economics of operating a thermoelectric power plant for telephone microwave equipment.

**Lofty goals.** One session will deal with hydrocarbon-air fuel cells supplying 60 to 500 watts of power for sustained periods. George Ciprios of Esso Research and Engineering Co. will describe a methanol-air fuel cell capable of supplying 60 watts at a regulated 6 volts. And A.R. Poirier of the Studebaker Corp. will detail preliminary considerations in the design of a 28-volt military fuel cell. Design goals are 500 watts with propane-air cells and 200 watts with cells that use military aviation gasoline and air.

George A. Hoffman of the University of California will analyze energy requirements for electric automobiles, considering the type of power sources needed to operate a vehicle for 100 to 300 miles. C.J. Heltemes of the Atomic Energy Commission and C.A. Vansant of Operations Research, Inc., will present a status report on vehicular power sources.

**Powerful sources.** Two sessions will be devoted to a state-of-the-art review of various power sources, including photovoltaic devices, solar concentrators and batteries. Among the power sources discussed will be hydrogen-oxygen and alcohol-air fuel cells and a dry-tape battery with a rating near 200 watt hours per pound.

Among the non-nuclear sources of terrestrial power, TRW, Inc., will describe a silent, portable turboalternator that uses common hydrocarbon fuels.

# Late Show



Only our janitor sees this show. But you can see the result. It shows up in the reliability of Hewlett-Packard voltmeters like the 3439A and the 3440A. ■ Each readout board goes through a 400 kHz rate run-in, at 60°C. After 24 hours the storage and display are checked. ■ This test is only one reason these DVM's are the most reliable you can buy. Even the assembly is special. (Each instrument is assembled by one person, from start to finish. Because it's "her own" instrument, each girl takes more pride in her work. Result: better workmanship, fewer errors.) ■ After assembly, the entire instrument goes through mechanical and electronic bench check-out, then another overnight test. All night long, it's cycled on and off under extreme environmental conditions. If any

failures show up, they're fixed, and the testing starts over again. ■ We take a lot of trouble with your 3439A, or your 3440A. That's why you have so little trouble with them. ■ But suppose something does go wrong? Each one is protected by a year's warranty and backed by service centers located all over the country. ■ Thanks to the "Late Show," the quality doesn't quit early. ■ The 3439A. Solid state. 4-digit readout. Manual, automatic, and remote

ranging. Extra-high sensitivity. Ac/dc voltage/current resistance measurements (dc accuracy better than  $\pm 0.05\%$  of reading  $\pm 1$  digit). Price, \$950. The 3440A has BCD output, \$1160. Plug-ins, \$40 to \$575.

*Data subject to change without notice.  
Prices f. o. b. factory.*



**HEWLETT**  **PACKARD**  
An extra measure of quality

# This is a rather unusual frequency converter.

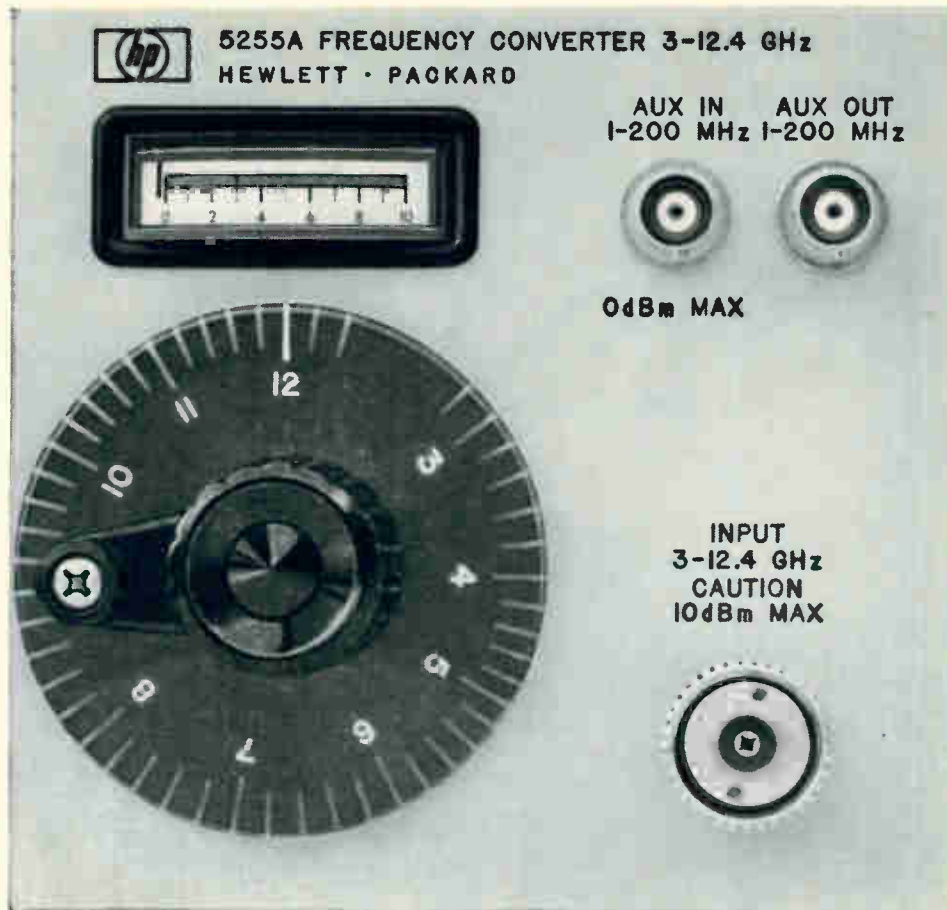

## Can you see why?



**For one thing, the frequency range is 3 to 12.4 GHz! □ For the first time you can measure through X-band with a heterodyne plug-in converter and electronic counter. □ You get up to 1 Hz resolution with unprecedented speed and simplicity. □ You retain the accuracy and every measurement capability of the 5245L Counter. □ Read about this important development in microwave measurement.**

Plug the hp 5255A into your hp 5245L Counter, and you can now measure frequencies from 3 to 12.4 GHz. The high frequency and wide range make the 5255A unique. (By comparison, no other heterodyne converter lets you measure beyond 3 GHz!) And it's so simple, even non-technical operators make fast, accurate measurements.

**Readout to 1 Hz in 4 seconds** Or 10 Hz in 0.4 seconds, etc.

**Heterodyne converter accuracy and simplicity** There are no complicated computations. Look at the front panel and you can see how easy it is to make measurements.

Start from the bottom (2.8 GHz) and tune the dial until the level indicator moves into the green. Stop and read the dial. (The marks light up to be sure you read the right one. Each one represents a 0.2 GHz increment from 3 to 12.4 on an almost linear scale.) Then, just add the counter reading to the converter dial reading, and you have your measurement.

**Measures frequency modulated signals** The 5255A will tolerate many MHz of fm and still accurately measure the average value of input frequency.

**No spurious responses** No need to waste time trying to figure out which of

several indications is true. (Another safety feature: if an input signal drop-out occurs during measurement, the converter automatically inhibits the counter from making any reading.)

**High sensitivity** 100 mv rms (-7 dbm), or better over the entire range. Low VSWR input.

**Use it as a prescaler or down-converter, too** You can use the 5255A as a prescaler to extend the direct readout range of the 5245L to 200 MHz. Inputs from 1 to 200 MHz, at the AUX IN connector, are divided by 4 and displayed directly on the 5245L Counter. No calculations needed. Sensitivity: 5 mv rms.

As a down-converter, it beats inputs from 3 to 12.4 GHz down to 200 MHz, maximum, for scope observation, etc.

Or you can use it as a receiver by adding a detector to the AUX OUT connector.

**It's the 9th plug-in** for Hewlett-Packard's 5245L Counter, making it by far the most versatile counter you can buy. For a basic investment of \$2950, you can get an easy-to-use counter for measuring frequency, period, multiple period average, ratio and multiples of ratio, and with electrical outputs for recording. Plug-ins for measurements from dc to X-band, for 1 mv sensitivity, time interval measurement, normalizing and preset counting,

and digital dc voltage measurement make it even more useful.

Call your Hewlett-Packard field engineer for complete specs or write Hewlett-Packard, Palo Alto, California 94304, Tel. (415) 326-7000; Europe: 54 Route des Acacias, Geneva.

#### SPECIFICATIONS

**Range:** As a converter for hp Model 5245L Counter, 3 to 12.4 GHz using mixing frequencies of 2.8 to 12.4 GHz in 200 MHz steps. As a prescaler, 1 MHz to 200 MHz.

**Input sensitivity:** 100 mv rms (-7 dbm) as a converter; 5 mv rms as a prescaler.

**Input impedance:** 50 ohms nominal.

**Input connector:** Precision type N (GPC-7 optional).

**Auxiliary output:** 1 MHz to 200 MHz difference signal from video amplifier.

**Price:** \$1650.

*Data subject to change without notice.  
Prices f.o.b. factory.*



HP Model 5245L Electronic Counter and the 3 to 12.4 GHz Plug-In Frequency Converter

**HEWLETT**  **PACKARD**  
An extra measure of quality

See hp Instruments Attend Measurement Seminars, Wescon—Hollywood Park

1858

# Your revised 1966 Reference Guide to CEC Analog and Digital Magnetic Tape Recorders and Accessories

This guide includes the important new  
advances achieved by the DR-3000 Recorder

**Type VR-3600** – The dean of recorders, and the ultimate choice for the most demanding pre- and post-detection and general purpose use.

☐ 400 cps to 1.5 mc direct frequency response; and dc to 500 kc FM frequency response.

☐ Bi-directional capability including reverse automatic phase equalizers – available on special order.

☐ 7- or 14-channel systems available as standard.

☐ Available in "Universal" machine configurations for compatibility with lower bandwidth CEC recorders by switch selection.

☐ Accessories include monitor meters for display of bias, input and output signals, RFI certification to MIL-1-6181D.

**Type VR-3800** – This data recorder offers the basic advantages of the VR-3600 at a modest price. Often referred to as the "work horse" of midband recorders.

☐ 300 cps to 300 kc direct frequency response; dc to 40 kc FM frequency response with high-accuracy FM system.

☐ Six speeds to 60 ips, instantly switchable.

☐ All-metal-front-surface recording heads – reduce cleaning to a minimum; reduce tape and head wear.

☐ 7- or 14-channel systems available as standard.

☐ Direct system fully amplitude- and phase-equalized.

**Type VR-2600** – Recognized as the finest, most versatile performer in its class.

☐ Available with any combination of four types of recording/reproducing electronics and configurations (direct, FM, PDM, PCM).

☐ All solid-state electronics, pushbutton controlled for operation without readjustment at six (6) tape speeds.

☐ 600 kc direct, 80 kc FM, IRIG PDM, and 1000 bit-per-inch PCM capabilities.

☐ 7- and 14-track analog systems as well as 16-track PCM systems available as standard. Accessories include edge track voice recording/reproducing, shuttle control and monitoring equipment, including both meter and oscilloscope presentation.

**Type VR-3300** – Unmatched for applications where ruggedness and mobility must be combined with outstanding performance.

☐ 100 cps to 300 kc direct frequency response; dc to 20 kc FM frequency response.

☐ Dual capstan drive system provides closed-loop speed and tension control equal to standard laboratory systems.

☐ Interchangeable record and reproduce electronics and heads with CEC's Type VR-2800 laboratory recorder/reproducer

and VL-2810 continuous loop recorder/reproducer.

☐ Six-speed record/reproduce system.

**Type VR-2800** – A highly reliable wide-band system for use in laboratory environments with direct and FM electronics.

☐ Six-speed record/reproduce operation.

☐ 100 cps to 300 kc direct system and dc to 20 kc FM system.

☐ Up to 7 or 14 channels on ½" or 1" tape respectively on 14" reels provide extended record time. 32-channel, 1" systems also available on special order.

☐ Uses all-metal-front-surface magnetic heads, as do all CEC recorders, for long life and minimum tape wear.

**Type PR-3300** – Designed for mobility at a modest cost.

☐ High-quality mobile magnetic tape recorder/reproducer for standard 100 kilocycle work.

☐ 7- or 14-channel systems on ½" and 1" tape respectively; 10½" diameter reels.

☐ Handles information via direct, FM or PDM techniques in any combination. Like the VR-3300, this unit can be operated from ac or dc power sources using its accessory precision frequency power supply.

☐ Interchangeable electronics with CEC's GR-2800 and GL-2810 magnetic tape recorder/reproducer systems.



VR-3600



VR-3800



VR-2600



VR-3300



VR-2800



PR-3300

	VR-3600	VR-3800	VR-2600	VR-3300	VR-2800	PR-3300	GR-2800	GL-2810	VL-2810	DR-3000
TAPE SPEEDS	6 speeds to 120 ips	6 speeds to 60 ips	7 speeds to 120 ips (in two ranges)	6 speeds to 60 ips	6 speeds to 60 ips	6 speeds to 60 ips	6 speeds to 60 ips	6 speeds to 60 ips	6 speeds to 60 ips	From 37½ to 112½ ips
DIRECT FREQUENCY RESPONSE	400 cps—1.5 mc	300 cps—300 kc	300 cps—600 kc	100 cps—300 kc	100 cps—300 kc	dc—100 kc	100 cps—100 kc	100 cps—100 kc	100 cps—300 kc	
FM FREQUENCY RESPONSE	dc—500 kc	dc—40 kc	dc—80 kc	dc—20 kc	dc—20 kc	dc—10 kc	dc—10 kc	dc—20 kc	dc—20 kc	
CHANNELS	up to 14	up to 14	up to 14	up to 14	up to 14	up to 14	up to 14	up to 14	up to 32	up to 9
RECORDING METHODS	Direct, FM	Direct, FM	Direct, FM, PDM, PCM	Direct, FM, PDM	Direct, FM, PDM	Direct, FM, PDM	Direct, FM, PDM	Direct, FM, PDM	Direct, FM, PDM	up to 800 bpi NRZ
ELECTRONICS	Solid-State	Solid-State	Solid-State	Solid-State	Solid-State	Solid-State	Solid-State	Solid-State	Solid-State	Solid-State

**Type GR-2800** — Commonly selected for general lab use in both industrial and military applications because of its operating economy, long life and reliability.

- ☐ General purpose laboratory recorder/reproducer system accommodating data in direct, FM or PDM recorded format in the frequency range from dc to 100 kc.
- ☐ Utilizes all solid-state electronics.
- ☐ 7- or 14-channel operation on ½" and 1" tape respectively, with reel diameters to 14".
- ☐ Closed-loop capstan drive system.
- ☐ Precision capstan drive electronics and tape speed control servo provide tape speed accuracies to within ±0.02% of recorded speed.

**Types GL-2810 & VL-2810** — Specifically designed for data reduction or data monitoring and storage where machine workload is heavy.

- ☐ Accommodate tape loop runs from 2 to 75 feet at six tape speeds from 1½ to 60 ips.
- ☐ GL-2810 handles data in the range from dc to 10 kc via FM techniques, and from 100 cps to 100 kc employing direct techniques; GL-2810 handles dc to 20 kc FM and 100 cps to 300 kc via direct.
- ☐ Utilizes ½" tape for up to 7 channels, or 1" tape for up to 14 channels, using IRIG geometry.
- ☐ Accessories include selective erase equipment providing erasure of any combination of 7 to 14 tracks, without removal of the tape loop from the machine. Bulk erase equipment also available.

**Type DR-3000** — This "universal" recorder offers unequalled versatility and performance — at the lowest cost of any comparable digital tape system. Additional recent advances have placed the DR-3000 in such a position as to virtually eliminate competition.

#### New Advantages:

- ☐ Standard choice of 3 tape speeds, 37½, 75 and 112½ ips, for complete IBM compatibility. (Previous top, 75 ips.) Other speeds to 112½ ips, on special order.
- ☐ Simplified logistics and minimum spare parts requirements through interchangeability of parts for both low, medium and high-speed systems.
- ☐ Mechanical head azimuth adjustment and individual forward and reverse static skew adjustments on read and write amplifiers reduce system static skew to less than 0.25 microseconds.

#### Original Advantages:

- 7- or 9-channel formats including 200, 556, and 800 bpi recording densities or 1600 bpi phase-encoding density on special order.
- Rigid performance specifications provide guaranteed machine-to-machine compatibility.
- Straight line tape loading requires no threading. Easiest of all to load, entire operation takes less than 10 seconds.
- Compact, rugged design with unique tape buffering provides the only high-speed system mountable in a 19" or 24" rack.
- Dual capstans with special self-adjusting actuators assure positive and gentle tape drive; eliminate tape slippage. And air bearings virtually eliminate tape friction.

## CEC's DataTape® Accessories

**The Monitor Oscilloscope** is used with tape recorder/reproducers, or any multi-channel instrumentation system to provide visual display of electrical signals ranging in frequency from dc to 3,000,000 cps. Unique features of this unit include up to 500 kc sweep rate and modular construction.

**The Type TD-2903 Automatic Tape Degausser** is designed to erase data signals from magnetic tape wound on reels up to 14" in diameter and tape widths from ½" to 2". A reel of 1"-wide instrumentation tape recorded at saturation level is erased to a nominal 90 db below normal level.

**The Dynamic Tape Tension Gage** permits accurate tension measurements directly while the recorder is in operation... helps keep your recorder in proper operating condition through routine maintenance adjustment.

For complete information on any CEC Tape Recorder/Reproducer, write or call CEC for Bulletins in Kit 9009-X4.



GR-2800



GL-2810



DR-3000

**CEC**  
Data Instruments Division

**CONSOLIDATED  
ELECTRODYNAMICS**

A SUBSIDIARY OF BELL & HOWELL/PASADENA, CALIF. 91109  
INTERNATIONAL SUBSIDIARIES: WOKING, SURREY, ENGLAND  
AND FRIEDBERG (HESSSEN), W. GERMANY



# Six more semiconductor

## 1 New microwave transistors replace TWTs, tunnel diode amplifiers and parametric amplifiers

Low-noise, high gain TIXM103-104 germanium planar transistors offer cost, size, weight, performance, and reliability advantages over other amplifiers in the 1 to 4 GHz frequency range.

The table at left, for example, compares performance of TIXM103s with top-of-the-line TWTs. Three TIXM103s in a strip-line circuit will replace a TWT. Notice that noise figure and gain compare favorably, while power consumption, size, weight, reliability and cost are far superior to TWT performance.

When compared with tunnel diode amplifiers, the TIXM103-104 offers long-term noise and gain stability. Dynamic range is typically 20 dB better, while the elimination of circulators lowers cost, reduces size and weight, and improves reliability.

A *TI-Line*<sup>TM</sup> package, designed for stripline circuitry, is used. 50 Ω input and output impedances facilitate matching. Circle 211 for data sheet.

COMPARE TIXM103 Vs TYPICAL TRAVELING WAVE TUBE AMPLIFIERS					
CHARACTERISTIC	TIXM103	1-2 GHz TWT		2-4 GHz TWT	
		LO NOISE TWT	HI GAIN TWT	LO NOISE TWT	HI GAIN TWT
1.5 GHz NF	3.8 dB	4.5 dB	20 dB	-----	-----
1.5 GHz Gain	8.5 dB	25 dB	40 dB	-----	-----
3 GHz NF	5.5 dB	-----	-----	5-6 dB	25 dB
3 GHz Gain	6.5 dB	-----	-----	25 dB	40 dB
Unsaturated Output Power	*0-6 dBm	0-6 dBm	0-6 dBm	0-6 dBm	0-6 dBm
Power Consumption	<25 mW	1-10 Watts	1-10 Watts	1-10 Watts	1-10 Watts
Size	0.25" X 0.10"	5" X 14"	5" X 14"	1½" X 12"	1½" X 12"
Weight	0.3 gram	1-10 lb.	1-10 lb.	1-5 lb.	1-5 lb.
Warm-up Time	NONE	1 hour	5 minutes	.1 hour	5 minutes
Magnetic Field	NO	YES	YES	YES	YES
Solid State Reliability	YES	NO	NO	NO	NO

\*Circuit Dependent

1 Comparison shows performance, size, weight, power consumption, and reliability advantages of TIXM103 over typical traveling wave tube amplifiers for two frequency ranges.

## 2 900 MHz $f_T$ , minus-70 dB 3rd order IM from new TI silicon transistor

The TIXS39 RF-VHF-UHF NPN epitaxial planar silicon transistor is ideal for such applications as the AMECO CATV all-band trunk line amplifier. Notice, from the curves at the left, that both gain and intermodulation is far better with TIXS39s than with the best competitive units tested.

Other suggested applications include sonobou transmitters and multicoupler amplifiers.

High  $f_T$  (900 MHz typ) and low intermodulation distortion (see curves) are combined with such other operating features as 13 dB power gain at 200 MHz, 4 dB noise figure at 200 MHz, and 5 W power dissipation at 25°C case temperature. Circle 212 for data sheet.

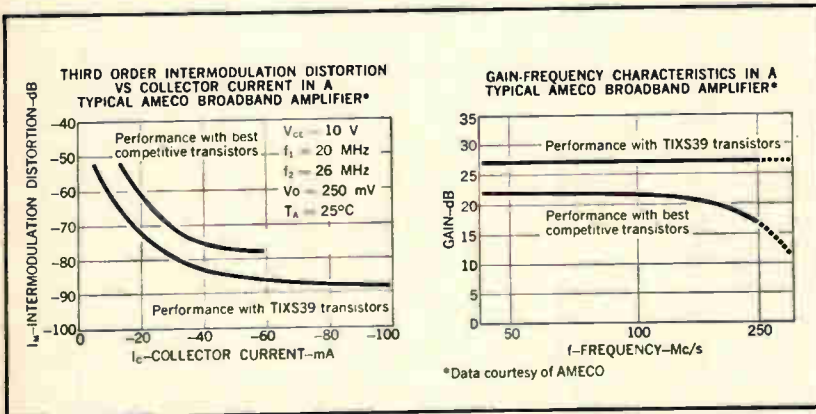

2 Data supplied by AMECO show how TIXS39 transistors reduced intermodulation and improved gain-frequency characteristics of ATM-70 CATV all-band trunkline amplifier.

## 3 New germanium FET features 12,000 to 14,000 $\mu\text{mhos}$ , 1.8 dB noise figure and useful amplification to 500 MHz

The TIXM301 is industry's first high frequency epitaxial planar P-channel germanium field-effect transistor. The inherently high mobility of germanium gives this device a higher figure-of-merit and higher transconductance than presently available FETs.

The TIXM301 is ideal for VHF amplifiers. Typically, transconductance remains above 12,000  $\mu\text{mhos}$  to beyond 300 MHz and typical noise figure is 1.8 dB at 100 MHz. Circle 213 for data sheet.

*TI cannot assume any responsibility for any circuits shown or represent that they are free from patent infringement.*

# advances from TI

## 4 17 ohms "on" resistance of new TI FET chopper permits high-accuracy analog switching

Low "on" resistance ( $17 \Omega$  typ,  $25 \Omega$  max) and low drain-gate leakage current (less than  $0.1 \text{ nA}$  typ) make the TIXS41 exceptionally well-suited for use as a series-type or shunt-type switching element. This new N-channel epitaxial-planar silicon field-effect transistor is ideal for such applications as commutators, relay-contact replacements, and high-accuracy analog-digital converters.

Two applications of the TIXS41 are shown at the right: a series connection, as in the analog gate, and a shunt connection, as in the shunt chopper. In both instances, the excellent measured performance results from low leakage and "on" resistance.

Circle 214 for data sheet.

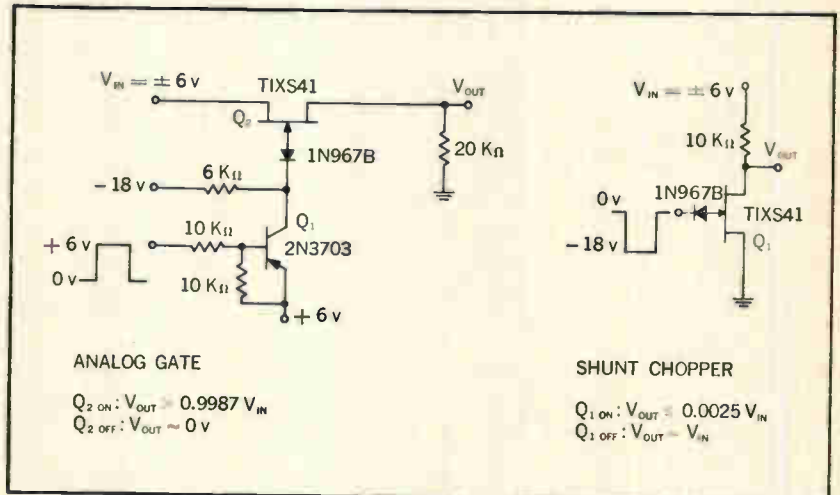

## 5 New TI Schottky-barrier UHF mixer diode features 6.5 dB typical noise figure, at 900 MHz

This planar silicon diode offers a noise figure approximately 5 dB lower than popular point-contact diodes used in UHF TV tuners, resulting in greatly improved picture fidelity. Low noise and low conversion loss permit use in fringe areas where other tuners will not work. Designated TIV305, the new device is also well-suited for use in video detectors, microwave mixers and high-speed switching applications.

Low total capacitance ( $C_T = 0.75 \text{ pF}$  typ) reduces possibility of violating FCC radiation rules.

For switching applications, the TIV305 offers a fast recovery time of 50 picoseconds typical.

Rugged Schottky-barrier construction eliminates fragile point contacts. The TIV305 withstands 20,000 G constant acceleration and 1000 G drop shock.

Circle 215 for data sheet.

4 Two circuit applications demonstrate performance advantages of TIXS41 silicon FET.

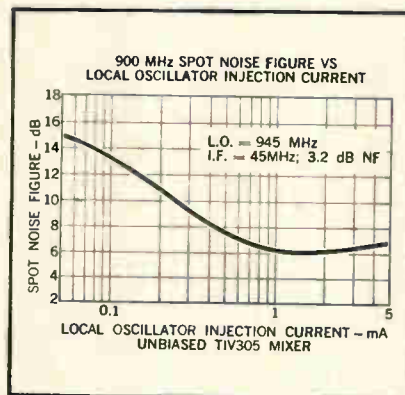

5 TIV305 diode delivers lower noise figure than conventional point contact diodes.

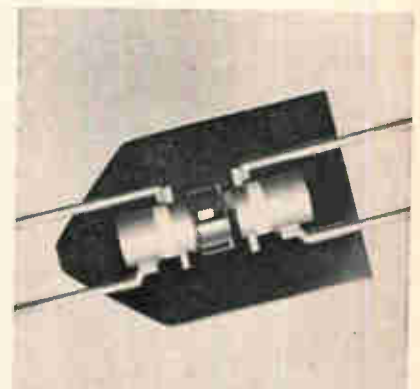

6 TIXL101 optoelectronic isolator combines two proven TI units in single package.

## 6 New optoelectronic coupling device isolates 5000 volts

The TIXL101 optoelectronic isolator combines an LS600 planar silicon light sensor and a TIXL01 gallium arsenide light source in the single opaque epoxy package shown at the right. As a replacement for electro-mechanical relays, the new device offers faster switching times (typically  $1.5 \mu\text{sec}$  reverse, and  $15 \mu\text{sec}$  forward). It also offers great mechanical ruggedness, small size and reasonable cost.

Input current rating is 50 mA, and output is  $250 \mu\text{A}$  min — sufficient to drive simple amplifier circuits.

Circle 216 for data sheet.



### TEXAS INSTRUMENTS

INCORPORATED  
13500 N. CENTRAL EXPRESSWAY  
P. O. BOX 5012 • DALLAS 22, TEXAS

SEMICONDUCTOR PLANTS IN BEDFORD, ENGLAND • NICE, FRANCE • FREISING, GERMANY • DALLAS, TEXAS

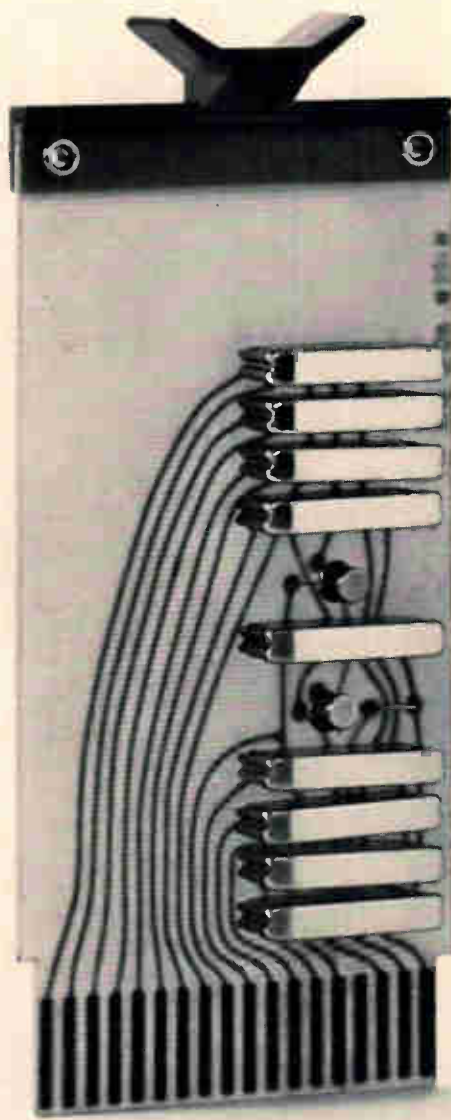

## Be Prepared

Building digital systems can be tricky business. The parameters may change. Preliminary results may call for equipment modifications. It happens all the time.

It's best to be prepared.

There are 101 different standard modules available from DIGITAL in the Flip Chip™ line. Each is electrically, physically, and logically compatible with all

the others. Result: guaranteed compatible add-ons, guaranteed available spaces. Each module is guaranteed for 10 years.

We also guarantee the counsel of an experienced DIGITAL field representative who is trustworthy, loyal, helpful, friendly . . .

Write for a free DIGITAL handbook.

*Flip Chip is a trademark of Digital Equipment Corporation*

**digital**  
MODULES · COMPUTERS

DIGITAL EQUIPMENT CORPORATION, Maynard, Massachusetts 01754. Telephone: (617) 897-8821 • Cambridge, Mass. • Washington, D. C. • Parsippany, N. J. • Rochester, N.Y. • Philadelphia • Huntsville • Orlando • Pittsburgh • Chicago • Denver • Ann Arbor • Los Angeles • Palo Alto • Seattle • Carleton Place and Toronto, Ont. • Reading, England • Paris, France • Munich and Cologne, Germany • Sydney and West Perth, Australia • Modules distributed also through Allied Radio

---

Editorial

---

## Trade with the East

### Part 3: time for reevaluation

Since the end of World War II United States trade with the countries of East Europe has been sparse. Last year, trade with Rumania—both imports and exports—amounted to only \$8 million, a minuscule amount. When the U.S. has traded in large volumes with the Eastern countries, the commodity almost always has been wheat or food. Now diplomats, politicians and industrialists are asking if this policy should not be reevaluated: if the U.S. should not step up its trade with the East.

We believe it should.

We also believe that the U.S. should sharply liberalize the restrictions that bar the trade of electronics components and equipment. But we believe the government should stop short of complete freedom, maintaining certain common sense limitations.

The time couldn't be better for a reevaluation of the U.S. position. For electronics companies, business was never better (see pages 102 to 119), so trade with the East is not a critical economic need. Rather, the question can be examined coolly, on the basis of principle, not emotion.

The main reason for liberalizing trade now is the change that is sweeping through East Europe. The cold war between the capitalistic countries of the West and the Communist countries of the East is evaporating, and is being replaced by a conflict between the haves and the have-nots. A lot of the haves are in the West while the have-nots are in the East. The have-nots want to raise their standard of living.

In Poland, deep concern is voiced about the small annual average income of the people, only \$700 per year, far under the per capita income of Western countries (in the U.S. it is nearly \$2,800). Yugoslavs, whose annual income is even lower—only \$500 per year—are even more bitter.

In our opinion the U.S. can markedly improve its foreign relations and better its image with the people of East Europe by helping them raise their standards of living—through trade not charity.

In each country, despite its own narrow partisan beliefs, the small leadership clique is being forced to face up to the low standard of living that exists. In fact, there is far more agitation to raise the level of living than to spread Communism internationally. The U.S. can cash in on the ferment by promoting trade.

Socialists have always had trouble selling the international character of their dogma to the man in the

street. Today, that difficulty is as bad or even worse than ever before. In Poland, the people consider themselves Poles, not Socialists. In Rumania, nationalism has been a battle cry. The current leaders make the point they are Rumanians first and Socialists second. The same nationalistic feeling abounds, elsewhere, too.

One feature of the Communist form of government that is easily evident is the factionalism that wracks the leadership clique. The internal stresses are more severe today than at any time in the past decade. Many a Communist with ambitions for the top job is espousing nationalism to strengthen his own candidacy and win favor with the masses.

As the countries of East Europe flex their new independence, the opportunity for trade with the West grows rapidly and the countries of West Europe and Asia are rushing to take advantage of it. By turning its back on East Europe, the U.S. accomplishes little besides losing a lot of business to its allies. The president of a U.S. company complained that his firm had lost a million dollar contract for equipment to handle materials in a steel plant to a British firm because the automatic electronic controls were on the U.S. embargo list, but not on the British one.

Losing business that way, most people agree, is foolish. As long as France, Italy, Great Britain, West Germany and Japan strongly encourage their nationals to seek electronics business in East Europe, the U.S. should too.

But there should be some restrictions. Although every country in East Europe will tell you "We want to be treated like any other country; we don't want special treatment," most of them do want special credit, special terms or special something else. Some of them even want the equipment and supplies for nothing, with a fancy name that won't make it look like charity. The U.S. should not try to finance the improvement in the standard of living in East Europe.

U.S. electronics equipment and technology should be sold to the countries of East Europe the same way an American company would sell to any international customer. Common sense, good business practices and credit restrictions are imposed, and certain models are limited. For example, U.S. semiconductor companies which license Japanese firms, do not license their latest and newest technology for integrated circuits until they've had a chance to develop and protect their markets. Sometimes the licensee is even limited to what he can do with products made under the license. Similar restraint should be shown in granting licenses to East European countries.

Still, any discussion of relations with Communist countries brings out a lot of emotion. Many people feel strongly that the U.S. should have no relations at all with these countries. But Thomas Watson Sr., the man who built IBM to a position of eminence, used to like to say, "World peace through world trade." A liberalization of trade with the Eastern bloc now could help achieve everybody's goal of peace.



cppe

# Multispeed Gimbal Pickoff Synchros

Small quantities now available in 60 days

The table below shows a small sample of the multispeed pickoff units produced by CPPC for such high reliability programs as Apollo, SIDS, Titan, Pace.

The data listed below are representative of the input/output parameters that we have supplied to meet customer requirements. The accuracies reflect the maximum errors allowed. Clifton units usually are well below these specified maximums.

The outline dimensions given in the table are applicable to rotor-stator combinations; although, as the photographs on this page show, our multispeed units are usually supplied in housings.

If you have a requirement for a high accuracy, high

reliability multispeed component, contact CPPC Sales Engineering for additional information.

Clifton Precision Products, Division of Litton Industries, Clifton Heights, Pa., Colorado Springs, Colo. 215 622-1000, TWX 215 623-6068.

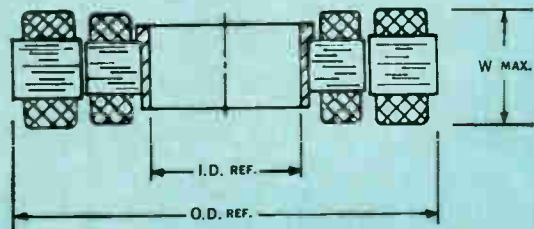

## CLIFTON Multispeed Gimbal Pickoff Synchros and Resolvers

Function	Input	Primary	Common Input Impedance	Output Imp.		TR & Phase Shift		Accuracy		Dimensions		
				1x	Prim.Shorted Nx	1x	Nx	1x	Nx	I.D.	O.D.	W.
1x, 8x Resolver	26v 800-	Rotor	85 + j190	100 + j20	20 + j15	.220 - 9°	.220 - 24°	10	1'	1.437	2.687	.500
1x, 15x Synchro	26v 400-	Rotor	105 + j165	150 + j25	160 + j130	.390 - 21°	.390 - 47°	10	20"	1.500	3.400	.600
1x, 16x Resolver	28v 800-	Rotor	175 + j600	200 Max	100 Max	1.00 - 4°	.179 - 12°	2	20"	1.687	3.687	.675
16x Resolver	28v 800-	Stator	40 + j350	--	450 + j800	--	1.00 - 6°	--	20"	1.687	3.687	.675
1x, 32x Resolver	15v 3200-	Rotor	100 + j300	100 Max	350 Max	.333 - 3°	.333 - 13°	10'	15"	2.187	3.750	.500
1x, 16x Resolver	28v 800-	Rotor	165 + j600	175 + j200	100 Max*	1.00 - 3.5°	.179 - 12°	4	20"	2.187	4.000	.610
36x Resolver	28v 800-	Stator	120 - j200	--	230 + j200	--	.300 - 28°	--	8"	1.400	3.500	.850
1x, 64x Resolver	28v 4800-	Rotor	70 + j220	70 + j45	80 + j120	.400 - 2°	.270 - 15°	30'	7"	2.250	4.000	.700
64x Resolver	28v 800-	Rotor	260 + j200	--	350 + j260	--	.179 - 55°	--	5"	2.250	4.000	.700

cppe

**CLIFTON** PRECISION PRODUCTS  
DIVISION OF LITTON INDUSTRIES





---

# Electronics Newsletter

---

August 8, 1966

## **Comsat faces fight to keep domestic satellites**

What started as a private effort by the American Broadcasting Cos. to spur the laggard Communications Satellite Corp. to launch a domestic satellite network has developed into a major battle for a lucrative market. Comsat, faced with the threat of losing the domestic business, suddenly came to life last week and proposed orbiting four satellites, one over each U.S. time zone, by 1970. Hard on Comsat's heels was the Ford Foundation, which proposed that profits from any domestic system be used to support a vast educational television system.

For the initial satellites, Comsat envisions altering the 1,200-channel satellites now being developed by TRW, Inc., for international use. By squinting the antenna beam from 20° to 6°, capacity of the craft would be boosted to about 5,000 channels each.

## **GE, Westinghouse strike looms**

Eight labor unions and two giant electrical-electronic companies are on a collision course: both sides now concede the odds favor a strike in October. In fact, so sure is one of the companies—the Westinghouse Electric Corp.—of the strike that it's urging some of its managers to take their vacations before the strike deadline.

The General Electric Co., Westinghouse and eight AFL-CIO unions are already far behind their usual bargaining timetable. Right now they are squabbling over bargaining procedures and whether the eight unions can merge their efforts instead of bargaining separately as in the past. The eight, led by the International Union of Electrical Workers, won a preliminary ruling to merge efforts, but GE is appealing. The legal maneuvering could continue for weeks, preempting the negotiation period. It's even possible the contract expiration date may be reached without the sides ever having discussed a new contract.

## **Incentive payoff rides on success of Lunar Orbiter**

The Lunar Orbiter spacecraft is poised for its maiden flight and the builder, the Boeing Co., is hoping for a big success in order to recoup some of the money it lost when the craft missed its July launch opportunity. Camera problems caused the postponement and made the company liable for a \$600,000 penalty. The launch is now set for Aug. 9.

Even though the delay was caused by the inability of the Eastman Kodak Co. to deliver the complex camera system on time, Boeing will have to pay a penalty. Boeing, however, can still earn as much as \$7 million in incentives over the five-flight program. A big chunk of this would come if the first flight goes into lunar orbit and returns medium- and high-resolution photos of nine sites on the moon.

The 850-pound spacecraft will photograph potential Apollo landing sites and the now-silent Surveyor 1. Cameras will be on for a total time of only five minutes, but it will take 17 days to telemeter the pictures back to earth. Quality will be about the same as 525-line commercial television.

## **Neuristor circuits may make flat tv**

A Tohoku University research team has built and analyzed an Esaki-diode active transmission line that works as a neuristor—the electronic equivalent to bionic transmission in nerve fibers.

Junichi Nishizawa, who heads the team, says the neuristor circuit

# Electronics Newsletter

could open the door to flat television screens made up of gallium arsenide integrated-circuit panels. The integrated circuits would combine light-emitting diodes and tunnel-diode neuristor circuits. Nishizawa maintains that his group will have prototypes of the panels in "five years at the most."

## Medical electronics controls weighed by Government

A debate is in the making over proposed Government control of electronic medical instrumentation. "I believe that protective legislation in the medical device and instrumentation field is probably necessary," Dr. James Goddard, commissioner of the Food and Drug Administration said in Boston last month. But the group he was addressing, the newly formed Association for the Advancement of Medical Instrumentation (AMI) wants self-policing within the industry.

Robert Hewitt of Instrumentation Laboratories, Watertown, Mass. says, "We're dead set against the kind of Government regulation which the pharmaceutical industry brought down upon itself."

## Litton, Martin vie to produce small missile controller

A fight for what might be \$10 million worth of business is in progress between Litton Industries, Inc.'s Data Systems division and the Martin Marietta Corp.'s Orlando division. The referee is the Army, which wants to replace with one trunk-size system the two vanloads of equipment that are required to control up to 24 batteries of Nike-Hercules and Hawk anti-aircraft missiles. Both companies have delivered prototypes of their systems to the Army. Each is designed extensively around integrated circuits. Army examiners will continue testing the units through October.

## NASA doubts own reliability methods

The space agency is taking a long, hard look at its microelectronics program and has concluded there are shortcomings: a lack of coordination in the exchange of data, repetitious vendor surveys and not enough standardization. The National Aeronautics and Space Administration has established a new microelectronics subcommittee and the group has already drafted procedures, although details of the proposals haven't been spelled out yet. However, the program might include a new data bank, perhaps coordinated by NASA and the Defense Department, with participation a contractual obligation, said C.W. Watt, component standards branch chief of NASA's Electronics Research Center.

## Addenda

A new company, Business Information Technology, Inc., of Natick, Mass., will soon introduce a tabletop data communications terminal that will have some computational capability and will be priced at about \$10,000. Word of the new data terminal comes on the heels of the introduction by the Digital Equipment Corp. of its PDP-8/S computer, the first general-purpose, core-memory computer selling for under \$10,000. PDP-8/S is priced at \$9,995—half the price of its nearest competitor, its own PDP-8. Its speed is a tenth that of the PDP-8, but it is still much faster than any similarly priced computer on the market. . . . Design studies for the Illiac 4, the University of Illinois's computer that is expected to execute over one billion instructions a second, [Electronics, April 4, p. 36] will be carried out by the Burroughs Corp., the Radio Corp. of America and the Univac division of Sperry Rand Corp.

from SYLVANIA Electronic Components Group

MICROWAVE SEMICONDUCTORS

## Ka-band product line solves wide variety of submillimeter design problems

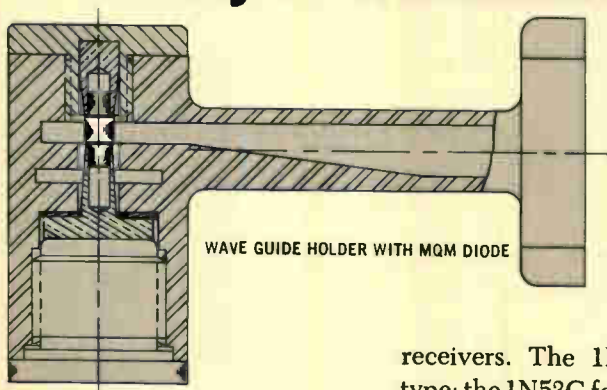

Extending the useable frequency range is seemingly a never-ending problem—to system designers and circuit designers alike. Sylvania is well known for its past and current contributions toward expanding the frequency capabilities of electronic equipment. This is due in large part to a long list of microwave semiconductor products which today includes the industry's most complete line of Ka-band devices. Sylvania didn't stop at Ka; we also have millimeter-band devices. The review here of our broad line of Ka-band componentry may assist you in solving one of today's or tomorrow's submillimeter design problems.

Sylvania's line of Ka-band semiconductor devices, the most complete line in the industry, includes mixers, video detectors, harmonic generator varactors, triplers and radiometer diodes. Thus, almost any circuit problem in the Ka-band can be handled by a product from this line.

An example of the mixers available is the 1N53 series (see table). These miniature coaxial type point-contact silicon diodes are for use as first detectors in Ka-band superheterodyne

receivers. The 1N53B is the basic type; the 1N53C features an improved noise figure while the 1N53D shows both an improved noise figure and a higher operating temperature. Reversed polarity versions of all three units are available.

From an applications viewpoint, perhaps the most exotic of these Ka units is the D4196A radiometer diode. It was used in the Mariner space program to measure radiation from Venus while the probe sped through space. This extremely narrow bandwidth device detects any radio frequency emanating from the astral body at which it is pointed.

Harmonic generator varactor types D5245C and D5245D are gallium arsenide diodes which have cutoff fre-

KA-BAND SEMICONDUCTORS

MIXERS				VIDEO DETECTORS			
	Pack- age	Noise Figure (db)	Burn- out Temp (°C)		TSS (Tangential Signal Sensitivity) (mw)	Burn- out Temp (°C)	Oper- ating Temp (°C)
1N53B	003	10	0.3	70			
1N53C	003	9	0.3	70	1N446	003	-40dbm 90 70
1N53D	003	9	0.3	150	RADIOMETER DIODES		
D4928C	071	9	0.3	150	D4196A	003	-48dbm 90 70
D51530	003	9	1.0	150	HARMONIC GENERATOR VARACTORS		
D5253B	013	10	0.3	150		Package	Frequency (GHz)
D5253C	013	9	0.5	150	D5245C	023	300
SOLID-STATE TRIPLERS							
	Min. Eff. (%)	Min. Out. (mW)	Output (GHz)				
SYG-2001	25	50	26.5-37.2		D5245D	023	350
SYG-2020	10	20	26.5-37.2				

quencies up to 300 GHz and 350 GHz respectively. A selected D5245 is used in Sylvania's own SYG-2001 and SYG-2020 wave guide triplers. Significant cost reductions result when these wave guide triplers are used to replace Ka-band klystrons. They provide designers with a simple way to convert X-band power into economical output up to 37 GHz.

Further information on each of these products is available. Just circle the appropriate number on the card on the back page. CIRCLE NUMBER 300

## This issue in capsule

**Integrated Circuits**—Designing efficiently, more economically, with plug-in packages.

**Receiving Tubes**—News of three amplifiers with 1-million-hour MTBFs.

**Diodes**—Upgrading circuit performance with MIL-tested JEDEC diodes.

**Color Television**—How true colors are "locked" into color bright 85™ tubes by Sylvania.

**Counter Tubes**—Performing counting functions the easy, economical way.

**Integrated Circuits**—Avoid design-ing compromise in your next digital system.

**CRTs**—Pack more information into less space with small-screen tubes.



SYG-2001 TRIPLER

# Upgrading circuit performance with MIL-tested JEDEC diodes

A handful of manufacturers, Sylvania included, make JEDEC and MIL versions of the 1N270 germanium diode line. In each case, the MIL version of these devices is subjected to stringent electrical testing and inspection. Normally, the JEDEC counterpart would see less severe electrical testing. But Sylvania's JEDEC versions of gold bond 1N270, -276, and -277 diodes must also pass the same electrical selection tests as MIL units. In the final analysis, this testing is also an additional assurance of the design and production capability gained by Sylvania during ten years as a major manufacturer of quality gold bond diodes.

Because Sylvania's JEDEC 1N270 miniature germanium diode line must

pass the same electrical selection tests as its military counterpart, these units may upgrade the circuit performance of your nonmilitary equipment. Using these improved gold bond diodes in computers and other commercial and industrial applications means you're buying the electrical equivalent of MIL devices without an increase in price.

Since ordinary diodes need only meet less severe JEDEC tests, the devices from Sylvania offer improved performance characteristics validated through testing. This means that all units in the 1N270 line (the 1N270, -276, -277) are subjected to the Group A electrical tests spelled out in the applicable military specification. Thus,

four additional tests not called for in JEDEC registration requirements are guaranteed on each type.

The Sylvania line includes military and improved-JEDEC versions of all three basic units in the line. The 1N270 is an 80-volt device while the 1N276 can handle 50 volts. The 1N277 is rated at a continuous reverse working voltage of 100 volts. Primary electrical characteristics of these high forward conduction diodes are shown in the table. All are mounted in the standard DO-7 package.

These gold bond units are available for off-the-shelf delivery from Sylvania distributors and warehouses in quantity.

CIRCLE NUMBER 301

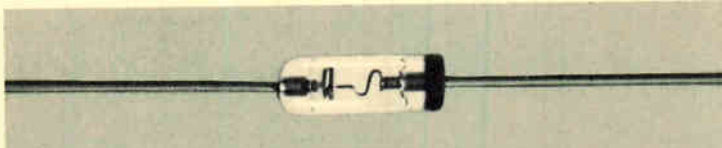

PRIMARY RATINGS AND CHARACTERISTICS 1N270 SERIES			
	1N270	1N276	1N277
Continuous Reverse Working Voltage, $V_R$	80 V	50 V	100 V
Average Forward Rectified Current, $I_O$	90 ma	40 ma	75 ma
Maximum Forward Voltage @ $I_F, V_F$	1.0 VDC @ $I_F=200$ MA	1.0 VDC @ $I_F=40$ MA	1.0 VDC @ $I_F=100$ MA
Minimum Peak Reverse Voltage, $V_R^*$	100 V	100 V	125 V
*Tested @ $I_R=1.0$ MA			

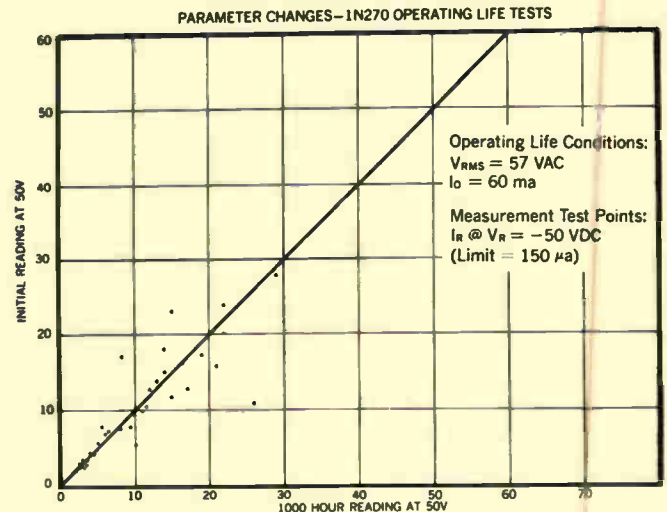

## RECEIVING TUBES

# Now three CATV amplifiers have 1,000,000-hour MTBF

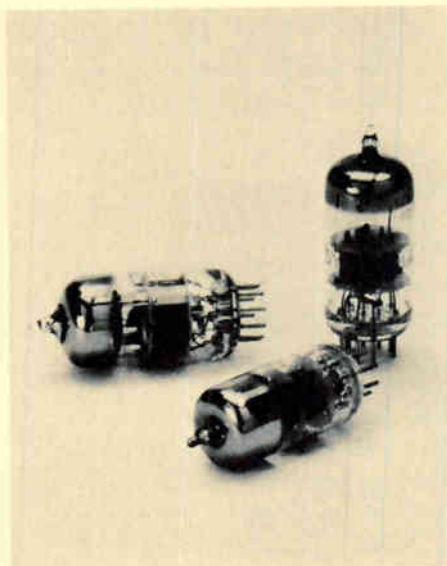

Conventional versions of amplifier tubes can't meet the severe service requirements demanded by many community antenna television systems. CATV amplifiers are remotely located, making them difficult and expensive to service. Besides, any service outage, however short, almost invariably leads to dissatisfied customers. Thus the advantage of extremely long-life tubes is evident.

Too often CATV amplifiers must be readjusted to get optimum performance when tubes are changed. Otherwise, impedance mismatch could cause ghosts. And too low a gain could result in instability and snow, while too high a gain reduces

bandwidth. Three of the most widely used amplifier tubes are the 6BQ7A, 6DJ8 and 6CY5. Now Sylvania has upgraded these tubes to Gold Brand level specifications for premium tubes, your assurance of uniform characteristics.

Sylvania's new Gold Brand tubes for CATV amplifier service have a mean-time-between-failure of 1 million hours. Thus, in equipment with 10 tubes it will be necessary to replace only one tube every 12.5 years on the average. In a system with 100 tubes, replacement is once every 1.25 years. Even in a complex system of 1000 tubes, the change is less than one tube per month. Coupling this relia-

bility with a degree of uniformity, which can eliminate readjustment problems when tubes are replaced, means that you get ideal tubes for CATV applications.

Three tubes offered by Sylvania, the GB-6BQ7A, GB-6DJ8, and GB-6CY5, are very widely used CATV types.

The GB-6BQ7A is a medium-mu twin triode found in many equipments now in the field. This tube is superseded in newer designs by the GB-6DJ8, a high gain strap frame version of the GB-6BQ7A. The sharp-cutoff tetrode GB-6CY5 and the two twin triodes are available from Sylvania distributors.

Uniformity of these tubes is assured by tight control of the spread of characteristics from rated values

on each lot and on a lot-to-lot basis. Gold Brand tubes have a narrower spread on parameter limits than found in commercial versions of these tubes. But narrowing parameter spread is only part of the job. Failure and performance degradation modes are eliminated. Tubes have been properly redesigned with tightly controlled materials and processes.

For example, Sylvania knows interface impedance is important in CATV applications. An increase in interface impedance with life can change amplifier gain. Sylvania's Gold Brand tubes use powdered metal cathodes to minimize any interface resistance layer buildup.

The powdered metal cathode is only one of the technological reasons these tubes have increased life and

better uniformity. Among the other improved materials, processes and methods are: Rhenium-Tungsten heaters, heater overcoat, duplex emissive coatings, high thermal conductivity plates, gold-plated grids, double micas, controlled atmosphere welding, gold-plated pins and controlled annealing of glass.

Do these improvements give a superior tube? The one-million-hour MTBF proves they do. And this performance is assured by the host of stringent tests and quality controls which Sylvania applies. Continuing tests include: Multiple Life Tests at high-temperature and room-temperature conditions; 500-g Shock and 10-g Vibration Tests; Thermal Shock Tests and Low Pressure Breakdown.

CIRCLE NUMBER 302

## COUNTER TUBES

# Perform your counting functions the easy and economical way

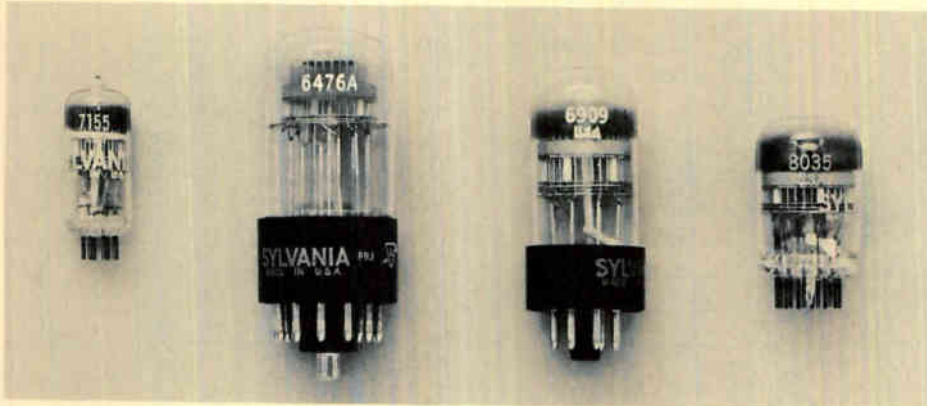

Because they combine counting, memory and readout in one glass envelope, Sylvania's line of cold cathode counter tubes offers the simplest and most inexpensive way to perform many electronic functions. Which functions? Counting, subtracting, adding, frequency dividing, keying, timing, computing, scaling, programming, modulating, matrixing, indexing, multiplexing, and reading-out.

Designers can implement just about any electronic counting or counting-related circuitry with Sylvania's cold cathode counter tubes. Couple this counting ability with the inherent memory and information display capability of these devices, and the probable result is the lowest possible price per digit of readout. And you get these benefits in the first line to contain cold cathode counters that operate as high as 100,000 pulses

per second.

Two basic counter tube designs are used to provide a line of eight different devices, all available from Sylvania distributors. Low-speed types handle 0 to 4,000 pps; high-speed units count from 0 to 100,000 pps.

Counting is performed by input pulses sequentially stepping an ion

glow around a circle of ten equally spaced cathodes. Visual readout is done by noting the position of the glow. Electrical readout in the form of a pulse is available from one or more of the ten cathodes depending on tube type. Since the counting is done by the counter tube, associated circuitry is relatively simple. Only shaping and amplifying of the input signal are required. Translation circuits normally associated with digital type readout tubes are not required in these decimal devices.

Sylvania cold cathode counter tubes are extremely reliable, offering hundreds of hours of trouble-free operation. The tubes read out in a pleasing yellow-orange, not the dark orange or red associated with older-style counter tubes. This improved readability results from new gas additives within the glass envelope. These same gas mixtures also improve tube standby life.

CIRCLE NUMBER 303

### COUNTER TUBE SPECIFICATIONS

Type	6476A	8353	6802	6879	8035	6910	6909	7155
<b>MECHANICAL DATA</b>								
Mounting Position	Any	Any	Any	Any	Any	Any	Any	Any
Zero Position (Cathode 10) Aligned with Pin No.	12 ± 10°	**	6 ± 10°	5 ± 10°	**	12 ± 10°	6 ± 10°	5 ± 10°
Bulb	T11	T9	T9	T5½	T9	T11	T9	T5½
Base	Modified Duodecal	13-Pin	Octal	7-Pin min.	13-Pin	Modified Duodecal	Octal	7-Pin min.
<b>RATINGS (Absolute Values)</b>								
Input Frequency Range	(Kpps)	0-4	0-4	0-4	0-5	0-50	0-100	0-100
Max. Total Anode Current	(mA)	0.6	0.6	0.6	0.6	0.8	0.8	0.8
Min. Total Anode Current	(mA)	0.3	0.3	0.3	0.3	0.65	0.6	0.6
Min. Anode Supply Voltage	(Vdc)	350	350	350	350	400	400	400
Min. Transfer Voltage	(Vdc)	35	35	35	35	35	35	35
<b>Max. Voltage Between Electrodes</b>								
Other than Anode	(V)	200	140	140	140	140	140	140
Max. Ambient Temperature	(°C)	60	60	60	60	60	60	60
(**Centered between Pins 12 and 13 ± 10°)								

# Prestabilizing measures lock true colors into **Color bright 85™** tubes



Time was when Sylvania's color picture tubes were some 40 percent brighter than competitive types. Rare-earth phosphors, a Sylvania-GT&E Labs development, produced most of this difference—but not all. Today, two years after they were introduced, color bright 85 picture tubes by Sylvania are still brighter—even though most other manufacturers now use rare earths. Here's why:

Two major innovations, other than Europium phosphors, that made the Sylvania tube significantly brighter and more uniform in 1964 are still

exclusive features: an exclusive "air-spun" phosphor application process, and an exclusive preshrinking process that maximizes registry by preventing screens from losing their dimensional stability. Before a screen is applied to a color bright 85 picture tube, the glass itself is actually compacted, or "preshrunk," in a Sylvania process that insures proper color registration.

The next major step before sealing the bulb together is phosphor application. Here, instead of using a wet, hard-to-control slurry, Sylvania "air-spins" color phosphors on the screen to effect the highest degree of color dot precision. This dusting technique avoids the necessity of grinding the phosphor crystals with consequent brightness loss, and also avoids the 30-degree "spokes" which are often visible in the blue field of a slurried screen and are caused by nonuniform flow of the wet slurry.

Sylvania then lacquers its dusted dots using a solvent method, a process that ideally prepares the dot for subsequent aluminizing, which produces a mirror behind the dot screen. The result is an increase in light output

as the gun's electron beam bombards the dot. Most other screens use water-base lacquer which results in a less shiny, less reflective aluminum mirror behind the dots.

Before the dot screen is applied to the tube face panel, Sylvania preshrinks the glass panels until they reach dimensional stability. In tubes made without this preliminary densification process, the phosphor screen is applied and then, when heat is added for bulb sealing, the panel shrinks and the dimensions of the dot screen change. The result is misregistration with colors tending to bleed in some areas of the picture.

Preshrinking of glass is just one significant color safeguard. Other controls include computer precision spacing between the tube's glass face panel and mask, as well as cross-hair indexing between electron beams and the phosphor dot triad. These measures obviate the adjustments that are necessary with many other tubes on the market—both before and after set installation. The full effect is unmatched color fidelity that is kept color-pure for the life of the tube.

CIRCLE NUMBER 304

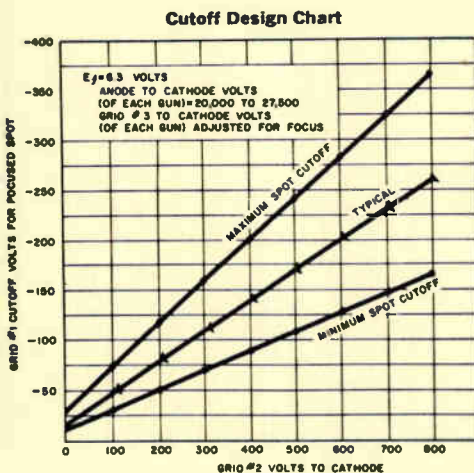

## INTEGRATED CIRCUITS

# Don't design compromise into your next digital system

Now all logic functions—NAND/NOR, AND-NOR, AND/OR—are available in one transistor-transistor-logic line.

SUHL II continues to grow, both in new circuits added to the line and in new applications with other Sylvania integrated circuit devices. Most recent additions to SUHL are the dual AND gates (SG-280 series) and expander gates (SG-290 series).

Compatibility with Sylvania's new series of Monolithic Digital Integrated Functional Arrays (fast adders, multi-bit registers, counters, and memories) insures that SUHL II units will find wider applications as designers become more familiar with the advantages of saturated logic. Advantages include propagation delay

times of 6 nanoseconds without sacrificing high noise immunity, high logic levels, low power drain, and excellent temperature stability. Also, tradeoffs in capacitance drive and in fan-out vs. fan-in are eliminated. The logic diagrams and the table of characteristics shown here provide the facts that show the inherent superiority of SUHL II integrated circuits.

How the performance of these SUHL II devices compares with other types of logic and SUHL I units is shown in this table:

LOGIC FAMILY	SPEED	NOISE MARGIN
RCTL	Low	Low
RTL	Medium	Low
DTL	Medium	Medium
TTL (SUHL I)	High	High
TTL (SUHL II)	Very High	High
CTL or ECL	Very High	Low

With advantages like these, plus competitive pricing, you don't need to design compromise into your next digital system. Sylvania hasn't made any compromise in its IC technology and you don't have to make any when you use SUHL II in your designs.

CIRCLE NUMBER 305

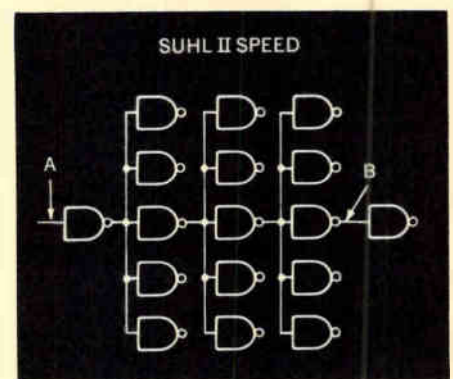

# This is SUHL II

**Expandable Dual 4-Input OR Gate**

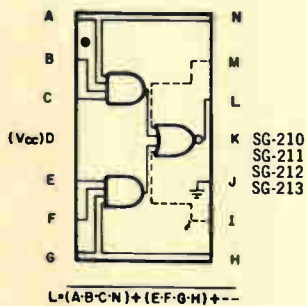

**Quad 2-Input NAND/NOR Gate**

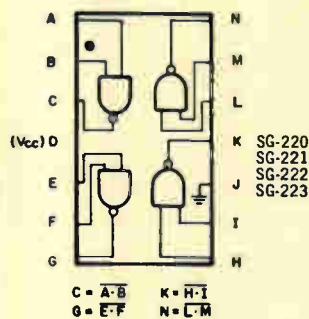

**Quad 2-Input OR Expander**

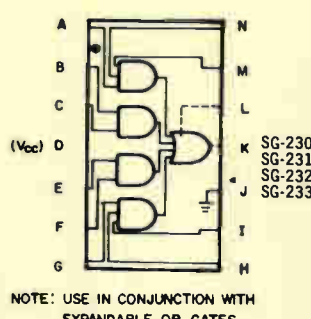

**Dual 4-Input NAND/NOR Gate**

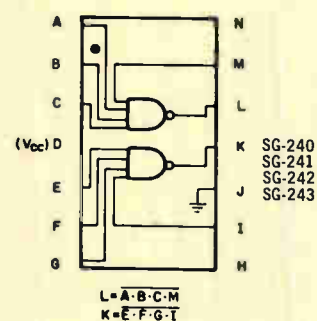

**Expandable Quad 2-Input OR Gate**

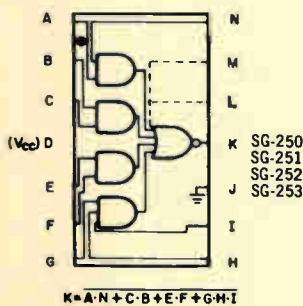

**Single 8-Input NAND/NOR Gate**

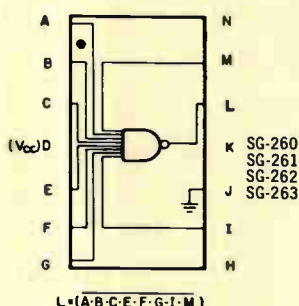

**Dual 4-Input OR Expander**

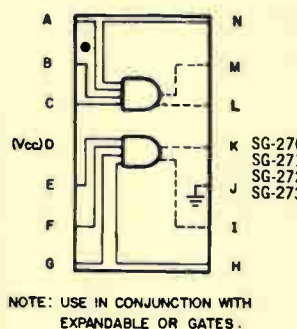

**J-K Flip-Flop (AND Inputs)**

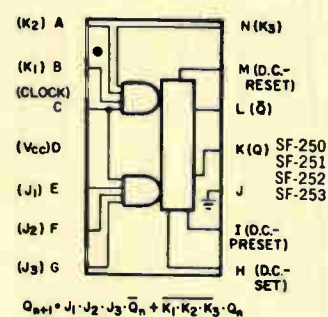

**J-K Flip-Flop (OR Inputs)**

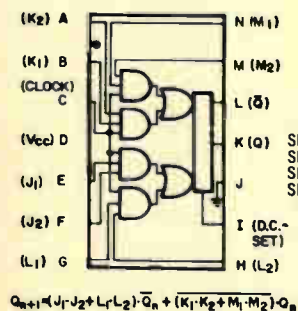

**Dual 4-Input AND/OR Gate**

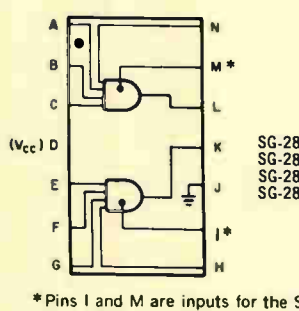

**Dual 2 + 3 Input Expander**

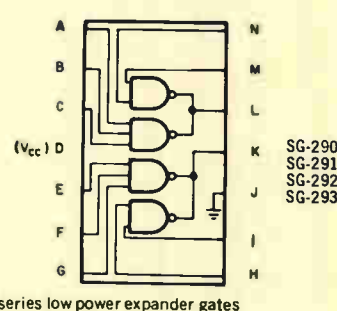

\* Pins I and M are inputs for the SG-290 series low power expander gates to perform the wired OR function.

$$L = A \cdot B \cdot C \cdot N + (\bar{M})$$

$$K = E \cdot F \cdot G \cdot H + (\bar{I})$$

## SUHL II TYPICAL CHARACTERISTICS (+25°C, +5.0 volts)

Function	Type Nos.	t <sub>pd</sub> (nsec)	Avg. Power (mw)	Noise Immunity +(volts)-	Military (-55°C to +125°C)		Industrial (0°C to +75°C)		
					Prime FO	Std. FO	Prime FO	Std. FO	
Expandable Dual 4-Input OR Gate	SG-210, SG-211, SG-212, SG-213	7	30	1.0	1.5	12	6	10	5
Quad 2-Input NAND/NOR Gate	SG-220, SG-221, SG-222, SG-223	6	22	1.0	1.5	12	6	10	5
Quad 2-Input OR Expander	SG-230, SG-231, SG-232, SG-233	2	28	1.0	1.5				
Dual 4-Input NAND/NOR Gate	SG-240, SG-241, SG-242, SG-243	6	22	1.0	1.5	12	6	10	5
Expandable Quad 2-Input OR Gate	SG-250, SG-251, SG-252, SG-253	7.5	43	1.0	1.5	12	6	10	5
Single 8-Input NAND/NOR Gate	SG-260, SG-261, SG-262, SG-263	8	22	1.0	1.5	12	6	10	5
Dual 4-Input OR Expander	SG-270, SG-271, SG-272, SG-273	2	6.7	1.0	1.5				
J-K Flip-Flop (AND Inputs)	SF-250, SF-251, SF-252, SF-253	30mc	55	1.0	1.5	12	6	10	5
J-K Flip-Flop (OR Inputs)	SF-260, SF-261, SF-262, SF-263	30mc	55	1.0	1.5	12	6	10	5
Dual 4-Input AND/OR Gate	SG-280, SG-281, SG-282, SG-283	10	38	1.0	1.5	15	7	12	6
Dual 2- & 3-Input Expander	SG-290, SG-291, SG-292, SG-293	10	38	1.0	1.5				

# You get better, more economical designs with a modern IC package

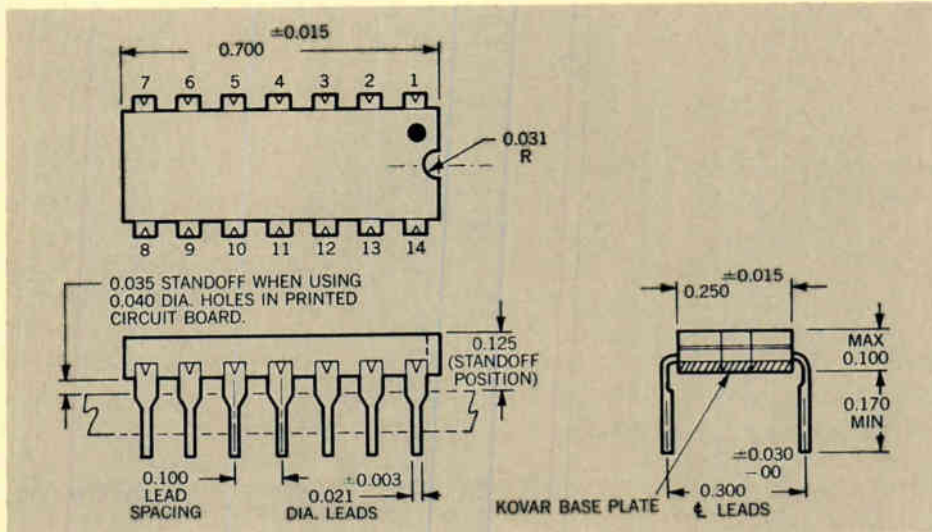

All too often, circuit designers unknowingly impose artificial and unnecessary limitations on themselves. This can be especially true in designing with integrated circuits in obsolete packages. Today, many orders for ICs still specify mounting in TO-5 cans, a package originally designed to accommodate transistors. Here the engineer self-imposes limits which prevent him from taking full advantage of all the performance capabilities of ICs. Limits which increase the total cost, size and weight of the equipment using the integrated circuits. But, with Sylvania's dual in-line plug-in flat package for ICs, there's no need to sacrifice these premiums. This package is tailored to bring out the best in the integrated circuit it protects.

Sylvania's dual in-line plug-in package for ICs offers significant advantages over the conventional TO-5 can often used to house ICs. The Sylvania plug-in flat package gives more logic capability per package, lends itself much more easily to automatic mounting onto printed circuit boards, takes up less stacking space, and has lead spacing which allows conductive pc patterns to be carried underneath without requiring the spidering of leads. These advantages are obtained without the need for changing present pc hole-drilling equipment, and at a lower total cost too.

The Sylvania plug-in package has more logic capability per package because it has a greater number of pins,

i.e., 14 vs. a maximum of 12 for the TO-5. Thus, any amount of logic which fits in the TO-5 will fit in the plug-in package with room for more. And, because of its two extra leads, the designer can now reduce the total package count necessary to implement a given system or function.

Two parallel rows of 7 pins each on the plug-in package ideally suit it for automatic insertion into pc boards. Not so with the circular lead pattern of the TO-5 can. Sure, a TO-5 having a transistor mounted in it is easy to insert. That's because the lead hole pattern in the pc board is actually a triangle. But as you add leads, the pattern becomes more and more of a circle, the holes get closer and closer together, and tolerances get tighter and tighter. The result: it's virtually impossible to automatically insert a 12-lead TO-5 can.

And if a TO-5 can is mounted on a pc board without spidering of the leads, you have additional problems. Because the leads are in such close proximity to each other, the copper lands around each printed-board hole must be closer to each other and of a smaller size. This reduces the ratio of hole size to land area, increasing the possibility of poor connections.

The small spacing between the leads of a 12-pin TO-5 adds another complication. Copper conductive patterns on the board can't be carried under the TO-5 can without spidering the leads. This is not the case with the Sylvania plug-in. Here, leads are

much farther apart (0.1") and copper patterns can be run under this package. The result is a more efficient, more easily designed board layout.

With the plug-in package, the designer also gains stacking space. The Sylvania IC package, with its preformed leads and dual in-line arrangement, stands only 0.125" off the board. A TO-5 sandwiched tight to the board (that is, without any lead spidering to overcome the disadvantages of closely spaced leads) requires 0.140" to 0.160". Thus, with the Sylvania package, more pc boards can be stacked in a given height.

Value analysis shows no premium is paid to get the advantages cited above. The IC package has the same diameter leads as the TO-5. Therefore, no new drills for present board drilling equipment are needed. Although initial cost of the TO-5 is less, analysis proves that the total overall cost is less with Sylvania's dual in-line plug-in package. This lower total cost results from reduced board layout expense, lower board assembly cost, and fewer boards because of higher density packing and more logic per package.

In addition to the advantages over the TO-5 can, the Sylvania flat package offers: leads with tapered shoulder, an extremely effective hermetic seal, and leads which can be flexed close to the body without cracking the seal.

CIRCLE NUMBER 306

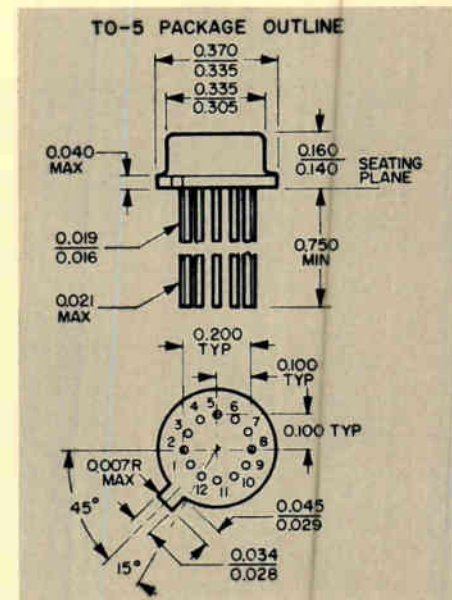



# Small-screen CRTs can pack more information into less space

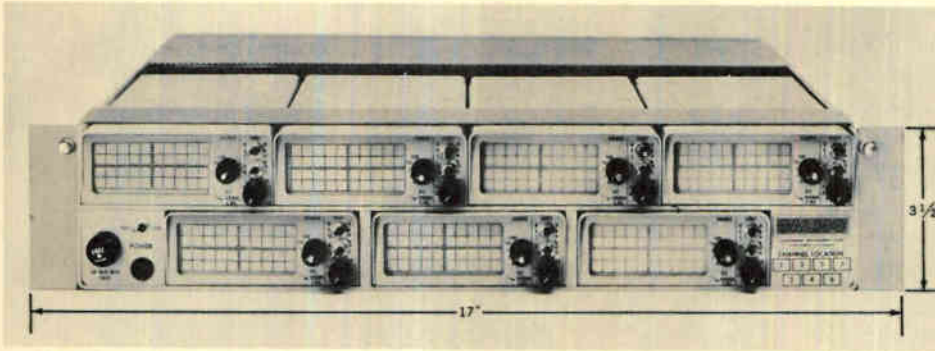

*How much space would you need on a 19-inch rack to cram in seven individual tape monitoring CRT displays, if each had a useable screen area of 2 3/4" x 1 1/8"? Not just seven CRTs stacked together, but seven display systems, each with the controls necessary to make it a complete tape monitoring system. Each with a front panel ac-dc switch to permit expanding a portion of the ac signal with dc present; each with fully automatic triggering over the entire bandwidth; and each with calibrated front panel vertical sensitivity control. Here's how one manufacturer uses Sylvania CRTs to minimize space requirements in just such an application.*

A Sylvania cathode ray tube is helping California Instruments Corporation prove that continuous visual monitoring of record-reproduce tape signals doesn't require large and bulky electronic equipment. CALICO's new series 7000 monitor oscilloscope, with seven plug-in CRT display modules installed, requires only 66.5 square inches of panel space; i.e., only 3 1/2 inches high on a 19-inch relay rack.

Key component in each plug-in module is Sylvania's SC-4348 CRT. This tube provides a useful screen area of 2 3/4" by 1 1/8" for the monitoring of magnetic tape recording signals.

The monitor into which the CRT is built is a rugged piece of equipment, tailored to the demands of ground instrumentation for the Apollo space program, that is also capable of operating in airborne environments. A typical ground application is in a wideband instrumentation analog magnetic tape recorder system installed worldwide by NASA.

One of its airborne uses is in the Apollo Range Instrumentation Aircraft (ARIA) program, a joint NASA-Air Force undertaking. Under the ARIA program, eight aircraft will be outfitted to furnish down-range airborne instrumentation for the Apollo flights. A prime function of ARIA is to receive and record information telemetered directly from the Apollo Command Module.

The monitor has a bandwidth of from dc to 5 MHz and a sweep range of 10 HZ to 1 MHz. Signals are dis-

played on the tube with sensitivities ranging from 0.1 Volt rms/inch to 10 Volts rms/inch.

The design of the high deflection sensitivity SC-4348 makes it a CRT well suited to this critical application. Key characteristics of the SC-4348 are outlined in the table. This tube can be supplied with several screen phosphors, including P1, P2 and P11.

In addition to the SC-4348, the Sylvania line of CRTs for compact equipment designs includes the round SC-3802 and the square SC-3377, SC-3511 and SC-3551. All these tubes have clear faceplates, high deflection sensitivity, low heater power requirements, and helical resistor post-deflection acceleration. CIRCLE NUMBER 307

**SC-4348 CHARACTERISTICS**

Heater Voltage .....	6.3 Volts
Heater Current .....	0.3 ±10% Amperes
Focusing Method .....	Electrostatic
Deflection Method .....	Electrostatic
Minimum Useful Screen .....	2 3/4" x 1 1/8"
Overall Length .....	9 inches
Altitude .....	35,000 feet

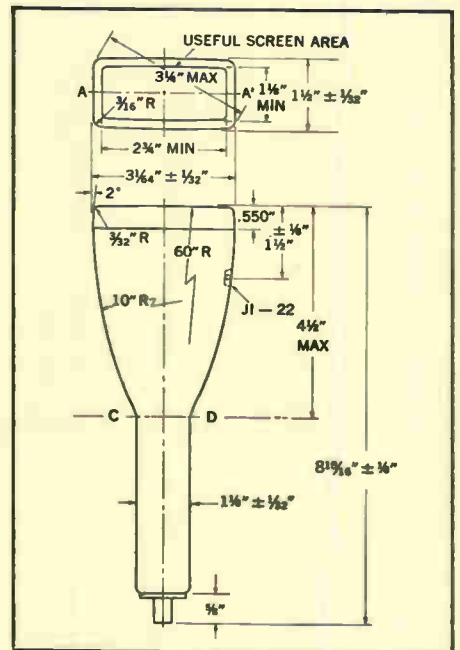

**HOT LINE INQUIRY SERVICE**

Use Sylvania's "Hot Line" inquiry service, especially if you require full particulars on any item in a hurry. It's easy and it's free. Circle the reader service number(s) you're most interested in; then fill in your name, title, company and address. We'll do the rest and see you get further information almost by return mail.

**BUSINESS REPLY MAIL**

No Postage Stamp Necessary if Mailed in the United States

POSTAGE WILL BE PAID BY

**SYLVANIA ELECTRONIC COMPONENTS GROUP**

Sylvania Electric Products Inc.  
1100 Main Street  
Buffalo, New York 14209

Dept. A7 7

FIRST CLASS  
Permit No. 2833  
Buffalo, N.Y.

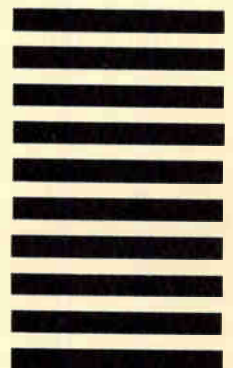

# New Products: new horizon for the Industrial Distributor

Let's debunk a popular marketing misconception.

Vendor and user alike tend to feel that the only way to handle a new electronic component is directly between the manufacturer and the potential user. Their case is this: only when the product becomes well established and is used in substantial volume can the industrial distributor enter the picture. Neither past operations nor past statistics show this theory to be justified.

The industrial distributor is a vital element in total electronic component marketing. The industrial distributor himself has brought this importance about by continually upgrading his organization's technical competence, service and management. The user has helped bring this importance about by greater dependence upon the industrial distributor for local stocks and, in the case of the smaller users, with more complete technical service. The component supplier has helped bring this importance about by recognizing and implementing the industrial distributor as a primary sales and application arm of his total marketing organization.

In today's highly competitive environment, efficiency—especially cost efficiency—is critical for survival. The component supplier who is geared to

handle high volume resembles Gulliver threading a needle when trying to handle small orders. Aside from the poor economics within the supplier's plant, service to customers invariably suffers. And it is often this "small" order that is so critical to a customer in terms of delivery.

Another factor in today's highly competitive environment is sales coverage. Potential users for most electronic components exceed 5000 accounts. Few suppliers, if any, can afford to adequately cover each and every account with their own salesmen. In fact, most suppliers adequately cover only a few hundred, and find that at least 80% of their sales dollars come from less than 20% of their active accounts.

Small wonder, then, that the industrial distributor is of such great need to both the user and the supplier, not just for well established products, but to perform a vital service in the realm of new products. By the continual upgrading of technical salesmen, the industrial distributor can competently cover all users, and service these users with the latest technology and product. By providing local stocks and an efficient service organization, the industrial distributor can provide fast, reliable delivery of small quantities—again to the benefit of the user. And

both functions are supplied within allowable economics to give the user—the customer—the greatest value.

Attesting to the industrial distributor's ability to adequately handle new semiconductor products, it is well to note that in 1965 significant dollar sales of newer products were made by manufacturers to their industrial distributors: 17% of dual transistors, 44% of field-effect transistors, 15% of silicon controlled rectifiers, and an astounding 20% of monolithic integrated circuits. In all semiconductor products, industrial distributors purchased \$105 million in 1965, up from \$80 million in 1964.

Sylvania salutes its franchised industrial distributors for the service they perform in forwarding the utilization of its new products. To the users reading these pages, your especial attention is directed to Sylvania Franchised Distributors who now carry a full line of SUHL integrated circuits (TTL) in both dual in-line plug-in package and the TO-85 flat package. These are truly new products; creating new horizons for a better world through electronic advancement.

  
F. R. FLOOD

This information in Sylvania Ideas is furnished without assuming any obligations.

## SYLVANIA

SUBSIDIARY OF  
GENERAL TELEPHONE & ELECTRONICS GTE

NEW CAPABILITIES IN: ELECTRONIC TUBES • SEMICONDUCTORS • MICROWAVE DEVICES • SPECIAL COMPONENTS • DISPLAY DEVICES

NAME \_\_\_\_\_  
TITLE \_\_\_\_\_  
COMPANY \_\_\_\_\_  
ADDRESS \_\_\_\_\_  
CITY \_\_\_\_\_ STATE \_\_\_\_\_

Circle Numbers Corresponding to Product Item

300	301	302	303	304
305	306	307		

Please have a Sales Engineer call



### HOT LINE INQUIRY SERVICE

Need information in a hurry? Clip the card and mail it. Be sure to fill in all information requested. We'll rush you full particulars on any item indicated.

You can also get information using the publication's card elsewhere in this issue. Use of the card shown here will simplify handling and save time.

# The new concept in keyboards and control panels

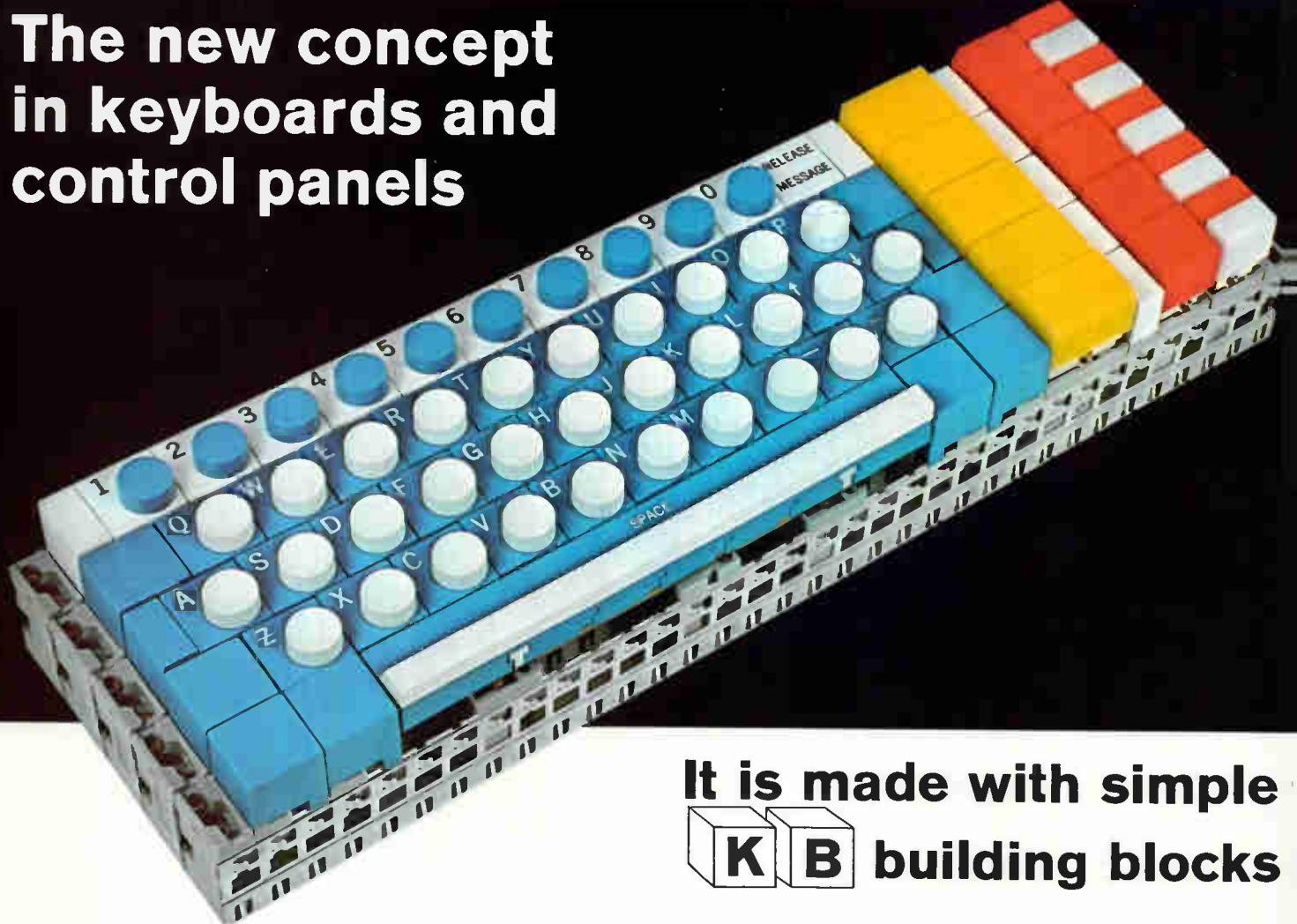

It is made with simple  
**KB** building blocks

**KB offers these exclusive advantages:**

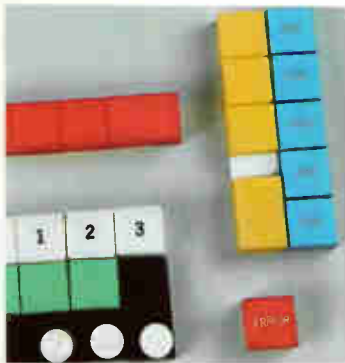

**KB allows new freedom of arrangement.** Modular construction makes it easy to customize your panels—economical, too. Switches and indicators available in a wide variety of colors, shapes, sizes. Arrange in vertical columns, horizontal rows, compact rectangles, or individually—all, in a single cutout.



**KB allows bench assembly.** Assemble a complete keyboard matrix at the bench where the job is easier, faster. Even the wiring is done before the matrix is set into the console. And only one panel cutout is required because KB forms its own self-supporting matrix—no additional support required.



**KB provides plug-in modularity.** With KB plug-in switches, simply loosen two screws, lift out the unit and plug-in a replacement—all from the front of the panel. Store a reserve unit right in the board—or "borrow" one that is not as urgently needed elsewhere on the panel. Downtime is practically eliminated.



**KB simplifies expansion.** KB modular construction makes planned or unplanned expansion easy, economical. In many cases, you simply remove spacers and plug-in additional switch or indicator modules to up-date your panel. No additional cut-outs, no wiring, no soldering, no behind-the-panel work required.

**What is KB?** The KB system provides all the components necessary for a complete, self-supporting matrix, including: Power Switches and Indicators with lighted display, Encoding Switches with up to eight output bits, Mechanical Interlock Modules for a variety of sequential functions, and a unique Modular Framework System.

Find out what KB can save you in engineering time, tooling costs, assembly costs, panel space and weight—and how KB can put more sales appeal into your panels.

For a KB demonstration, call a MICRO SWITCH Branch Office (see Yellow Pages ). Or, write for literature.

**MICRO SWITCH**  
FREEPORT, ILLINOIS 61032  
A DIVISION OF HONEYWELL

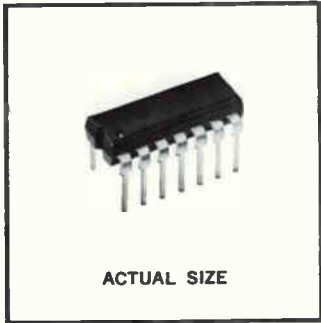

# Motorola's New MRTL Plastic Integrated Circuits Shatter IC Price Barriers

**As low as 56¢ per  
2-input gate function,  
and \$1.78 per J-K Flip-Flop  
function – (100-up)!**

These typical economies result from the multiple-circuit functions of these integrated circuits . . . For example, at a cost of \$2.25 each, the MC724P quad contains the functions of four 2-input gates, which lowers the cost to 56¢ per function. But, price is only *one* reason why you'll want to investigate this newest Motorola integrated circuit series.

The MC700P series is an expanded MRTL\* complement that offers a new level of system design flexibility with a multitude of circuit functions — including 10 entirely new multi-function devices not previously available in integrated RTL logic!

Multi-function capability in one small, low-cost package . . .

The MC700P series offers low-power milliwatt MRTL and medium-power MRTL in the 14-Pin dual in-line plastic package for such functions as:

Milliwatt MRTL	Price (100 up)
Quad 2-Input Gate (MC717P)	\$2.25
Dual 3-Input Gate (MC718P)	1.90
Dual 4-Input Gate (MC719P)	2.25
Triple 3-Input Gate (MC793P)	2.50
Dual Buffer (MC798P)	2.70
Medium-Power MRTL	
Dual 3-Input Gate (MC715P)	\$1.90
Quad 2-Input Gate (MC724P)	2.25
Dual 4-Input Gate (MC725P)	2.25
Triple 3-Input Gate (MC792P)	2.50
Hex Inverter (MC789P)	2.25
Dual Buffer (MC799P)	2.70
Dual Buffer (Non/inverting) (MC788P)	2.70
J-K Flip-Flop (MC723P)	2.70
Dual J-K Flip-Flop (MC790P)	3.55

One more point: You get the added assurance of rugged construction of the Motorola Unibloc\* package — the solid, single-piece, pressure-molded package that offers unusual physical strength for internal leads and connections, plus improved heat transfer characteristics. Write for complete data to: Motorola Semiconductor Products Inc., Dept. TIC, Box 955, Phoenix, Arizona 85001.

\*Trademark of Motorola Inc.



SEE HIGHLIGHTS OF **WESCON** AT BOOTH 1301-1304  
**MOTOROLA Semiconductors**  
*— where the priceless ingredient is care!*

# Announcing:

# The **FAST** Line\* 300 film memories...

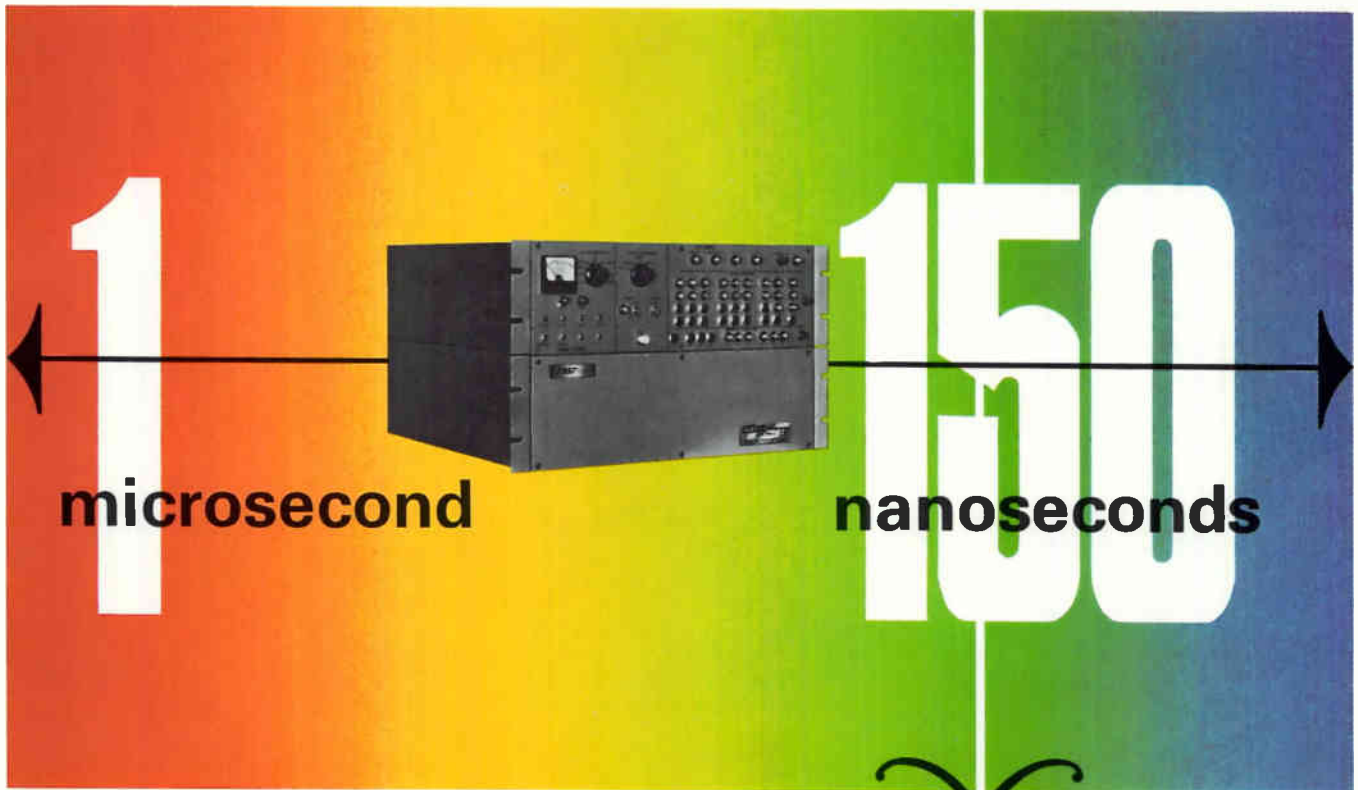

## For your **FAST** Line memory requirements in the 250-500 nsec range

At the 300-nanosecond band in the FAST Line spectrum you'll find the new FAST Line 300 magnetic film memories. Designed to the FAST Line concept, this series of film memories lets you specify the exact cycle time and capacity you need in the 250 to 500 nsec speed range. All-silicon discrete components. Integrated circuits in the logic, decoding and timing sections for optimum reliability. "Big board" packaging and standard manufacturing techniques for low per-bit price.

Remember, FAST Line means value-engineered memories with a speed-cost evaluation which always results in the lowest ultimate cost to you. Check out FAST Line before you specify a memory for your next EDP application! Call: 612-935-8811, TWX: 910-576-2913 or Write: Fabri-Tek Incorporated, 5901 South County Road 18, Minneapolis, Minnesota 55436.

### FAST Line 300 film memories: Operational Summary

- Cycle time: Choose any speed between 250 and 500 nanoseconds
- Access time: 125 to 250 nsec, depending upon cycle time chosen
- Access modes available: Random, sequential or sequential interlaced
- Capacity: To meet your requirements
- Optional operating modes: Read only, write only, read-restore, read-modify-write, parallel write
- Input/output levels: Standard +2.5 and -0.5 volts
- Control panel options: Address and data register indicators, voltage monitoring, and adjustment, self-testing controls and error checking, and data retention "Data Saver".
- Power required: 115 or 220 vac., single phase, 48-63 cps.
- Packaging: Relay-rack modules or free-standing cabinet



Available now . . .  
new FAST Line  
300 film memories  
product bulletin.  
WRITE TODAY.



**The Leader in Memory Technology**

\*T.M.

# Low fuel warning



another first for  
Ford Motor Company  
—the key is KEYSTONE



A red light glows suddenly on your Continental's instrument panel. It warns you "Low fuel," and stays bright to keep reminding. Back in the fuel tank a tiny Keystone thermistor had closed a warning circuit the moment your fuel level dropped past a predetermined limit. □ This liquid level sensor is another industry first for Ford\*. It is yet another application for quality Keystone thermistors, made for the sensitive detection and measurement of temperature variations from oven heat to the cold of outer space. Write for literature. □ KEYSTONE CARBON COMPANY, St. Marys, Pennsylvania 15857

\*OPTIONAL ON OTHER FORD-BUILT CARS

**Keystone**  
leads  
in versatile Thermistor design

# At last, a line of dual diff-amp transistors with specified differential base current drift \*

Differential base current drift is a single parameter that lumps the temperature-dependent effects of forward gain and leakage current.

Gain is dependent on temperature . . . and even with perfect  $V_{BE}$  matching between transistors...and with negligible  $I_{CBO}$ , the variation of  $h_{FE}$  with ambient temperature will limit the sensitivity and linearity of your differential amplifier design.

Simplified differential amplifier design and accurate prediction of circuit performance are the direct advantages of specifying differential base current drift in addition to the tracking parameters.

Until now it has been customary to ignore both gain and leakage-current tracking and to specify only  $V_{BE}$  matching. But now Amperex' advanced matching techniques and more sophisticated test facilities and procedures can produce, measure and guarantee the best gain/leakage tracking available today and  $V_{BE}$  matching second to none.

This close tracking of both  $V_{BE}$  and  $I_B$  is specified over a temperature range of  $-55^{\circ}\text{C}$  to  $+125^{\circ}\text{C}$ , the entire range of useful performance of the transistors and circuit components themselves.

If you specify or design differential amplifiers, the Amperex A600 Series dual diff-amp transistors in 6-lead TO-5 cases offer you the best all around performance you can get as well as the most significant, *designer-oriented* specifications available today.

TYPE NUMBER	$\frac{\Delta  I_{B1} - I_{B2} }{\Delta T}$	$\frac{\Delta  V_{BE1} - V_{BE2} }{\Delta T}$	$h_{FE}$ $I_C = 100 \mu\text{A}$	$h_{FE}$ $I_C = 10 \mu\text{A}$
A607	1.5 nA/ $^{\circ}\text{C}$	5 $\mu\text{V}/^{\circ}\text{C}$	100	50
A608	1.5 nA/ $^{\circ}\text{C}$	10 $\mu\text{V}/^{\circ}\text{C}$	100	50

  

$$* \Delta I_B \text{ (differential base current drift)} = \frac{\Delta |I_{B1} - I_{B2}|}{\Delta T_A}$$

$$\Delta V_{BE} \text{ (differential voltage drift)} = \frac{\Delta |V_{BE1} - V_{BE2}|}{\Delta T_A}$$

Detailed specifications on the transistors listed above, applications data and a special engineering report on the significance of  $I_B$  tracking are available now. Write: Amperex Electronic Corporation, Semiconductor and Receiving Tube Division, Dept. 371, Slatersville, Rhode Island 02876.

## Amperex®

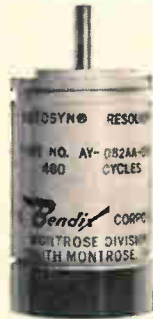

(Actual size)

# The newest, finest Bendix Autosyn Synchronos won't carry much weight.

Unless you consider the 1.3 ounces typical of the new Size 08 Autosyn® Synchronos "much". Which most engineers don't. And which, when coupled with the fact that the 16 new Size 08 Synchronos boast a maximum diameter of just 0.750 inch, is enough to influence almost every weight- and size-critical design on the drawing boards.

But subminiaturization is only one of the talents Bendix Autosyn Synchronos offer you. All sizes (08, 10, 11, 15 and 22) are available in stainless steel or aluminum housings, for instance. Some are accurate and stable at operating temperatures as high as 800° F, which makes them ideal for use in supersonic aircraft. Others are

built for increased radiation resistance. And hundreds more are specifically designed for aircraft instrument applications.

There's certain to be an Autosyn Synchrono that's right for your needs. To find out which one, call us at 717, 278-1161, in Montrose, Pennsylvania. Or write for our new 42-page catalog.

**Montrose Division**





# Electronics Review

Volume 39

Number 16

## Military electronics

### \$1-billion insurance

The Air Force is pumping hard for a new program that could mean as much as \$1 billion for the electronics industry. Late last month two companies received the go-ahead to proceed with the next study phase on the airborne warning and control system (Awacs)—a project that would extend the United States' aircraft early-warning systems beyond the East and West Coasts. The project also provides a temporary radar replacement in the event of failure of ground-based warning radar and makes feasible the deployment of a radar picket system to most anywhere in the world within hours.

The Boeing Co. and the Douglas Aircraft Co. beat out the Lockheed Aircraft Corp. for \$2.1-million contracts in the concept-formulation phase. Their selection came only days after the Pentagon's top brass gave the Air Force approval to continue the program through development of two flying prototypes.

**Good chances.** If the Pentagon decides to go into production with Awacs—and there's a good chance it will—either Boeing or Douglas will start building the prototypes in early 1968. The first flight will be in 1970. The electronics-crammed aircraft—a DC-28 or 707 type transport—will carry more electronics (40,000 pounds) than any other plane. Each aircraft will cost around \$20 million.

The early-warning aircraft would also be used for such missions as flying command posts, long-haul communication relay stations and temporary backups for Sage (semi-automatic ground environment system) and Buic (back-up interceptor control).

Between 50 and 60 of the aircraft will be built between 1970 and 1975, estimates Lt. Col. William

Y. Cole, Awacs program monitor in the Pentagon. He expects the unit price for the systems to hit \$25 million each, including about \$5 million for aircraft. Development cost will run as high as \$300 million, Cole predicts.

The Air Force now has an early-warning system on duty in Vietnam, called the airborne early warning and control system, and is being flown on EC-121 aircraft. Until recently, the older system

Two Air Force commands—the Tactical Air Command and the Air Defense Command—want Awacs. The Tactical Air Command, which has a worldwide mobility requirement, would like to equip its forces with Awacs for use as flying command posts, aerial-warning coverage, long-haul communications and to provide navigation services to smaller craft in the squadron. The defense command, which is basically in charge of protecting the



Standing guard. EC-121, with its early-warning radar, provides surveillance over Vietnam.

was used along both coasts of the U.S. as an early-warning system, but was stopped recently to save money.

**Look to sea.** The heart of the new system will be a new surveillance radar set mounted in a rotodome atop the aircraft, specifically being designed to improve the capability for detecting and tracking aircraft flying at low altitude. The radar will be designed to reject clutter and reflection as it scans an area ranging to 230 miles from the aircraft, flying at 35,000 feet.

Other equipment in the plane will include computers, a number of digital displays and several long- and short-range communication sets.

Awacs will not be effective against missiles. But the Air Force is looking to a possible threat by a country without sophisticated missile weaponry, such as Red China or Cuba, which would probably use an air-breathing delivery technique.

continental U.S., is looking at Awacs as seaward extensions of its land-based systems to increase attack warning time as well as interceptor vectoring capability.

The Air Force is laying down strong requirements for commonality in the systems to be used by the commands.

**Five on the job.** The Air Force has put five companies to work designing breadboard models of as many different approaches to the radar subsystem.

- The Hughes Aircraft Co. is working on a subsystem that features a pulsed doppler operating with a medium pulse repetition frequency radar on C band (5,000 to 6,500 megahertz). The Air Force has provided \$3.5 million in funding for this work.

- The Raytheon Co. has received the same amount to look into a low pulse repetition frequency set operating on the S band (1,500 to 5,200 Mhz.).

- The Westinghouse Electric

Corp. has entered the competition with a pulsed doppler, high pulse repetition frequency system to work on S band.

▪ The General Electric Co. is holding a joint Navy-Air Force contract to exploit a low pulse repetition frequency set operating on the P band (225 to 390 Mhz.).

▪ Finally, the Hazletine Corp. has been awarded about \$1 million to look into a low pulse repetition frequency unit to operate on the P/X band (225 to 10,900 Mhz.).

Airborne Instrument Laboratory, a subsidiary of Cuttler Hammer Corp., has been hired by the Air Force to test the competitive approaches to the radar subsystem. And IIT Research Institute will analyze the test results.

Two teams of companies are vying for the contract to design the communications, computers and data-display elements of the system. The International Business Machines Corp. is heading a team including the Radio Corp. of America. Litton Industries, Inc., is heading the second team, which includes the Bunker-Ramo Corp. and Electronic Communications, Inc.

---

### Space electronics

---

#### Dry run

High above Fort Hood, Texas, this month a dummy spacecraft will be dropped from a high-altitude airplane. Within a few moments a brightly colored steerable parachute will open and the dummy craft will slowly float to the desert below. The air drop will mark one of the first major tests of a scheme long pressed by many scientists: landing a spacecraft on dry land instead of the sea. If the series of tests is successful, the land system could be used in the Apollo mission or in succeeding manned orbital laboratory (MOL) missions.

A crucial part of the test is the operation of what amounts to a miniature mission control center. The center was developed by the Philco Corp.'s Western Develop-

ment Laboratories—the same company that designed the huge mission control console at the space agency's Houston complex. The miniature center is housed in a 40-foot-long van and provides the guidance signals that will steer the parachuting spacecraft safely to a landing on flat land.

Packed into the air-transportable van is a Scientific Data Systems, Inc.'s 920 computer, two 15-inch display consoles, a storable 60-foot antenna dish, a radar borrowed from the Atlantic Test Range and racks of electronic equipment.

**On the job.** During a real mission, the miniature control center begins its job as soon as the returning space vehicle is 600 miles away; at that range the radar starts tracking the craft and feeds elevation, azimuth, range, speed and wind-velocity information to the com-

puter. Within moments, the computer calculates the projected landing area and projects on the display consoles, out of a series of detailed maps, the one that covers the landing zone. The controllers then check the map to see if the landing terrain is safe; if not, they guide the craft to another zone that presents no danger to the astronauts.

The landing technique doesn't rely on parachutes alone. Extending downward from the underside of the spacecraft are long poles; when the tips of the poles hit the ground, they activate retrorockets that provide a last-minute thrust to brake the descending craft.

The idea of a land landing was originally planned for the Gemini series, but because of indecision among space officials the project, and funds for the project, were sidetracked into other programs. Apollo program officials still haven't come to a firm decision on whether to land on dry land or water, but those close to the project say chances are good that the dry landing plan will get the green light.

A big fan of the land landing idea is the Air Force; it reportedly wants the MOL spacecraft to have more landing flexibility than the Gemini craft, which can only land safely in the water. And it's believed that the Air Force has been pushing the space agency to speed development of the technique.



Dummy spacecraft floats to the ground supported by its steerable parachute.

---

### Research

---

#### A new contender

Legislation authorizing the National Science Foundation to extend its basic research work into the applied area stands a good chance of getting through Congress this year. This could open the door to much higher spending levels by an agency which already doles out nearly a \$500 million annually.

The House of Representatives last month approved the bill and sent it to the Senate, where it has a better than even chance of pas-

sage. The bill streamlines the operation of the foundation, strengthens the hand of the director, permits support of the social sciences, calls for the foundation to recommend projects the Government should support and orders a periodic inventory of scientific and technical personnel.

**Public interest.** The additional money the foundation may spend for applied research will not necessarily be funneled into industry pocketbooks. The new bill authorizes it to initiate and support applications research at "academic and other nonprofit institutions." Upon direction from the President, the foundation may also support scientific research, including applied research, "relevant to national problems involving the public interest"—presumably contracting directly with industry.

Under the present law, the foundation must discontinue support of a researcher when basic work on a project is completed. The scientist must halt his work and search out a mission-oriented agency—such as the Defense Department or the National Aeronautics and Space Administration—and seek new support before he can continue. The new bill, the biggest overhauling in the 16-year history of the foundation, will permit it to support a scientist even though his project has moved beyond the limits of basic research.

Supporters of the bill are taking care to assure partisans of the Pentagon and space agency that the proposed powers for the foundation will neither usurp their authority nor compete with them for research dollars. Since its establishment in 1951, the foundation's budget has grown from \$225,000 to \$480 million.

This may be only the beginning.

## Manufacturing

### Circuit psychology

Space buffs are fond of the apocryphal story about the astronaut who turned to his companion as

their spacecraft was about to lift off and said, "Just think, all the electronics aboard this ship were purchased from the lowest possible bidder." Fortunately for the astronauts, though, all the components had undergone rigorous tests before they were flown. But intensive testing isn't practical for many other applications, and increasingly around the country large users of electronic equipment are complaining that too often components they order are dead on arrival.

Last month in St. Louis, for example, an official of the Rome Air Development Center told the Microcircuits Symposium that low reliability levels has forced the Air Force facility to institute 100% testing of incoming circuits.

**Help wanted.** Many microcircuit customers believe the problem has worsened in recent months, probably because most production lines are at full capacity and skilled production workers are hard to find.

To be sure, most circuit producers are aware of the problem, and some believe they have no choice but to test all circuits before they are shipped—a costly and time-consuming procedure. But at least one company, Texas Instruments Incorporated, is experimenting with an off-beat approach based on employee relations that so far has produced some surprisingly good results—without 100% testings.

At TI, it was decided that the least controllable factor in circuit production was in manual work: the women who perform the tedious microscopic jobs on integrated circuits frequently introduce flaws. TI figured that there was some correlation between a worker's psychological state and her output. If the woman's emotional well-being could be improved, the company reasoned, her production proficiency would rise.

**Heart-to-heart.** So, explains Earl Gomersall, TI's manager of integrated circuit manufacturing, the company decided to test the theory. Last January a group of 10 newly hired girls were put through a special anxiety-reduction session that included frank employer-employee discussions. The girls were

shown company records that indicated they had good chances of advancement; they were warned about the hazing given new employees by old-timers; they were briefed about the personality of their supervisor, so they wouldn't be surprised, say, if he was an inflexible boss; and they were advised how best to communicate with their superiors.

At about the same time the company hired an equal number of girls and put them through the usual brief orientation. By the end of four weeks, the differences were apparent: the test group was already outperforming the control group. Within three months, all the girls in the test group had mastered their jobs and were producing scarcely any imperfect circuits; some reached this level within four weeks. The control group, however, required at least five months to become as skillful. In addition, the special group's output was so superior to the control group's that it no longer required 100% testing; that move alone, TI believes, went a long way to reinforce the girls' feeling of accomplishment, improving their work even more.

The result, TI concluded, reduced by one-fifth the number of integrated circuits rejected, cut training time by one-half and training costs by one-third and sliced manufacturing costs by one-fifth.

### Tailoring resistors

A new technique to produce high-accuracy cermet resistors in microcircuits is being put into production by the General Instrument Corp.

Voltage pulses of a few hundred volts amplitude and a duration of one or two seconds are applied to bring resistance values into line. Over-value resistors—20% to 40% above normal—are squeezed onto substrates and fired. Then the resistors are pulsed and resistance checked using a bridge comparator. If the resistance has not been driven down to the required value, the pulse amplitude is increased and several more pulses applied.

**A guarantee.** General Instrument

says the method is applicable to cermet resistors ranging in value from 100 ohms to 2 megohms. A few resistors up to 8 megohms have been fabricated. Tolerances are as tight as 1.25%, including effects of temperature coefficient, which run about  $\pm 300$  parts per million per degree C. General Instrument says that 2% resistors can be readily guaranteed.

One drawback is that resistors undergoing tailoring may require cooling before resistance is checked, slowing up the process.

The company says the mechanism that reduces resistance is essentially voltage aging. After firing, the cermet resistor can be pictured as a solid emulsion in which platinum compounds are distributed as pellets in varying contact with one another. It can then be hypothesized that under voltage pulsing, fusing takes place to alter resistivity.

Older methods of trimming cermet resistors include sand blasting and drilling. Sand blasting is laborious and requires mechanization for good repeatability. Furthermore, bouncing sand may rattle off unprotected portions of a circuit, causing damage that is not apparent. Carbide-tip drills, used in cutting away unwanted portions of a cermet resistor, must be kept sharp and properly aligned.

The new pulse technique permits fabrication of small lots of circuits or devices in which final characteristics of each can be "zeroed" by resistor trimming, even with the device in its final package. For example, circuit pulse width or balance of a differential amplifier could be adjusted.

**Thermal aging.** Trimming of thin-film resistors by voltage or current pulsing is not new. But its success, unlike that for the cermet process, has been attributed strictly to thermal aging. Engineers at the Radio Corp. of America's Electronic Components and Devices division, Somerville, N.J., in a paper presented last month before the Microelectronics Symposium in St. Louis, said the results of pulsing thin-film resistors can be duplicated by heat treatment.

At the Western Electronic Show and Convention later this month, engineers from the Defense Systems group of the Univac division of Sperry Rand Corp. will describe laser-induced resistivity changes in thin-film resistors. They will report that two mechanisms are at work in heat-treatment techniques—one temperature dependent and the other both time and temperature dependent. They'll recommend exploiting the first mechanism through use of pulsed laser beams.

Alternate methods for trimming thin films are electron-beam milling and laser hole burning. The former must be done in a vacuum; the latter cannot be used for fine adjustments of small-geometry resistors.

---

## Oceanology

---

### Shifting tide

Take a look at the comparatively small Federal budget for oceanology these days and then try to figure out why some electronics companies are making so much noise—and spending so much money—in their attempts to get a piece of this action.

Better yet, try to keep track of the 20-odd Government agencies that spend small sums on oceanology and areas in which they are interested.

Admittedly, the task is nearly impossible—a conclusion that President Johnson also reached back in May, 1965, when he established an oceanology panel to study the Government's efforts in this field. The decision to name a study panel came none too soon: last summer some 19 bills were introduced in Congress on oceanology and there was widespread and intense controversy over the adequacy of the national effort to explore, understand and develop the oceans.

Last month—after more than a year of study—President Johnson released the panel's 144-page report. What it contained is good news to the electronics industry.

It called for:

- A sweeping reorganization of the Federal oceanology effort, something that will probably be implemented within the next couple of years.

- A gradual increase in spending—doubling the present rate during the next five years.

The Navy was roundly criticized in the report. The panel criticized it for, among other things, the buoy development program, insufficient understanding of the basic ocean environment (which vitally affects its electronic sensors) basic research spending, lack of test facilities and the rate of progress of the "man in the sea" and deep-submergence systems projects.

**The scope.** To begin with, the 11-man panel headed by Gordon J.F. McDonald, a 37-year-old educator from the University of California, described oceanology as more than just the scientific study of the sea. Oceanology also includes activities within the ocean that have significant scientific or technological content.

The national oceanology program, which is costing the taxpayer about \$310 million in fiscal 1967, should be hiked gradually to roughly \$600 million annually by 1971, the panel says. This is not nearly as much as what is being spent for space, of course, but will be an important market for the industry since much of the money would go for electronic equipment and instrumentation. The nondefense share—now estimated at \$120 million annually by the panel—would increase to \$210 million by fiscal 1971, and basic research would rise from \$15 million to \$25 million in the next five years.

The proposed major reorganization of non-Navy Government oceanology activities would give birth to a new agency, which would be responsible for all Federal activities related to managing and developing resources of the ocean.

Setting up such a new agency undoubtedly will create many political and social problems, but the panel believes it would be worth the trouble. The National Science Foundation would continue its tra-

If your secretary knows the time of day...

# ...she can set the EECO 911 TIME CODE GENERATOR



with these  
THUMBWHEEL  
TIME SETTINGS

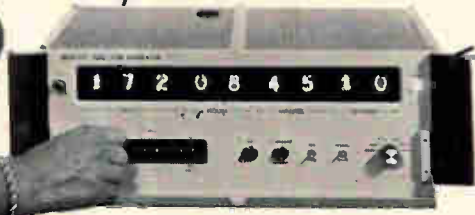

## or change codes

with these  
PLUG-IN  
CODE CARDS



## ... or move the whole thing somewhere else!

IT ONLY WEIGHS 30 POUNDS.

*Ask for EECO 911 brochure!*



### Electronic Engineering Company of California

1601 East Chestnut Ave. (Box 58) • Santa Ana, Calif. 92702 • Phone: (714) 547-5501

ditional role in support of fundamental studies and the Navy would concentrate on national security.

**Buoy view.** The present deep-ocean instrumented buoy program, which is being eagerly sought by several companies, was attacked by the panel. Too much effort has been expended on obtaining technology in a single step rather than in a broader program, the group said, and there are too many proposals for Federally sponsored experiments.

Another area of concern by the panel was the effect of the ocean environment on operation of electronic sensors by the Navy. Such sensors as active and passive sonar, magnetic anomaly detection and radar can be used effectively only if the very complex makeup of the ocean environment is known—and “that we don’t have at this point,” the panel comments.

The Navy also was attacked for its current classification policies on research and development information. The panel suggests that the Navy overhaul its policies to release unclassified R&D information as fast as possible and make classified data on sensor development more available to other Federal and industrial users.

Further, the panel recommends that the Navy should initiate studies immediately to build a test range where component systems, concepts and materials can be tested at various ocean depths. Such a range would not only serve Navy needs but should be made available to civilian users, who would pay for this service.

The panel worries that development of programs may be hamstrung by “traditional views within the Navy.” If the Navy doesn’t adequately pursue these programs, then responsibilities should be shifted to a civilian agency, it says.

---

### Antennas

---

#### Pointing the way

In at least one respect tracking antennas and violins have something

in common: no matter how fine the design and craftsmanship, they’re of little value unless finely tuned. Although a violin can be adequately tuned by ear, tracking antennas require a host of sensitive equipment to ensure the servomechanisms actually aim the antenna square on the target—and such a job usually takes months.

**Quick job.** However, the National Aeronautics and Space Administration is about to receive a portable instrument that performs the job in days. It will be used by NASA’s Goddard Space Flight Center to calibrate all the antennas in the Space Tracking and Data Network. The instrument, developed by the International Telephone and Telegraph Corp.’s Federal Laboratories-Aerospace division, is accurate to within 3.6 seconds of arc. Present equipment, using television and still cameras, although comparable in accuracy, requires time-consuming analysis before the dish’s servomechanism can be mated to the antenna.

The IIT instrument is called Pact, for portable automatic calibration tracker. It consists of a telescope, an electro-optical sensing system and an X-Y gimballed mount.

To calibrate an antenna, a plane or helicopter carries aloft a bright light target (in this case a bank of quartz-iodine lamps with an output of 4.5 kilowatts). Then, both Pact and the antenna track the moving target independently. Azimuth and elevation data from both are continuously compared, and any differences are quickly translated into the antenna’s calibration error.

**Look at Venus.** Although Pact is designed to track an artificial light, at distances up to 20 miles, the IIT developers say it could also lock onto stars. In fact, it’s already been used to track the planet Venus during daylight hours.

The fact that Pact is able to track at such distances overcomes a problem inherent in the present generation of calibration equipment, whose range is limited to about five miles. Such equipment poses a parallax problem because measurements are being made at relatively short distances; but over ranges of

20 miles or so, such problems are obviated.

Although Pact was designed specifically to meet NASA’s antenna-calibration needs, an IIT vice president, Arnold M. Levine, speculates that the instrument could be applied in several other ways. “By modifying the system with lasers and computers to determine range and other data, Pact could be used for pinpoint control of heavy airport traffic,” he notes. Furthermore, Levine, who is also general manager of the division, says it could be used to align airframe jigs, bridge structures or terrain-surveying equipment.

---

### Industrial electronics

---

#### To catch a thief

Sherlock Holmes caught criminals with little more to work with than a speck of dust or a strand of hair and a home chemistry set. Modern police officers like a bit more help than that—and they’re looking more and more hopefully to electronics for it.

At the first National Conference on Science and Criminal Justice in Washington last month, policemen and engineers exchanged ideas on just what electronics might be able to do. Thomas Redlin, Los Angeles’ deputy police chief, had a long shopping list. It covered a range of equipment that could find sizable markets in technology-conscious police organizations.

Divided into areas of surveillance command and control, evidence-gathering and training, the list called for:

- Low-cost, closed-circuit television cameras to “stake out” areas from a central control point;
- Radio jammers for preventing criminal lookouts from warning confederates by radio;
- Reliable radio homing devices to help trail vehicles;
- Radio relays to link headquarters with patrolmen who are away from their vehicles;
- Automatic vehicle-position sensors to show police commanders at

# COMPONENT COMMENTS *From Speer*

**Have you considered what MIL-R-39008 offers you in resistors?**



Let's face it, most buyers of insulated fixed carbon resistors don't need the established reliability assurance of MIL-R-39008. And don't want to pay for it. After all it's a costly business compiling "ER" data. The Life Failure Rate Level test is 10,000 hours at 50% rated wattage. Load life: 1000 hours at 100% rated wattage every six months. Quality Conformance: 2000 hours at 50% rated wattage every six months. And each lot must be tested for Load Life at 50% rated wattage for at least 250 hours. (For the "S" level, this means 35,000 units in a single style must be run for 12 months to accumulate the necessary 315 million test hours.)

So how does MIL-R-39008 benefit commercial users? Well, Speer doesn't build two products, one for MIL-R-39008 and another for general use. We build one. So when you

buy from us there's a better than 90% chance you're getting more reliability than you pay for—even though your lot isn't run through the "ER" test series.

If you're interested in more information on this subject, we're offering a technical article on "How the New 'Tri-Service' Specification MIL-R-39008 Applies to Resistors." You can get a copy by filling out the coupon.

## What price "TC"?

Are you paying for more temperature stability of resistance than you need? You certainly are when you specify using the "Temperature Coefficient (TC)" concept.

TC just isn't realistic. As you know it's based on the measurement of resistance at two specified temperature points — and is expressed graphically by a straight line through these points. The fact is, however, that when resistance is measured continuously over a temperature range (the "Deviation" concept), the picture is quite different. The rate of change isn't constant. In the case of low TC resistors, there's a reversal polarity of TC.

But even more important, TC expressions quantify only at extremes of temperature — usually broader than encountered in the resistor application. So, a resistor that might flunk a test in terms of TC may actually satisfy the "Deviation" limits needed by the circuit applications.

To build resistors that satisfy the assumed linearity of TC sends costs up. But, by telling us the maximum "Deviation" in resistance you can tolerate over a particular temperature range and/or the "Total Deviation" (including tolerance), we can give you our precision JXP resistors at about one third the cost. And with faster delivery.

To get the full facts and data on how the "Total Deviation" concept can benefit you, send for our technical article, "Specifying Resistance-Temperature Stability for Precision Resistors." Simply mail the coupon.

Get the Speer slant on MIL-R-39008 and temperature stability at the Wescon Show, August 23-26, at the Sports Arena. We'll be at Booth 1809 — see us, see our resistors.



**SPEER** Carbon Co.

### SPEER CARBON COMPANY

St. Marys, Pennsylvania

A Division of  
Air Reduction Company, Inc.

- Rush "Specifying Resistance-Temperature Stability".
- Rush "How the New 'Tri-Service' Specification MIL-R-39008 Applies to Resistors."
- Rush the name of my nearest Speer representative.

Name \_\_\_\_\_

Title \_\_\_\_\_

Company \_\_\_\_\_

Street \_\_\_\_\_

City \_\_\_\_\_ State \_\_\_\_\_ Zip \_\_\_\_\_

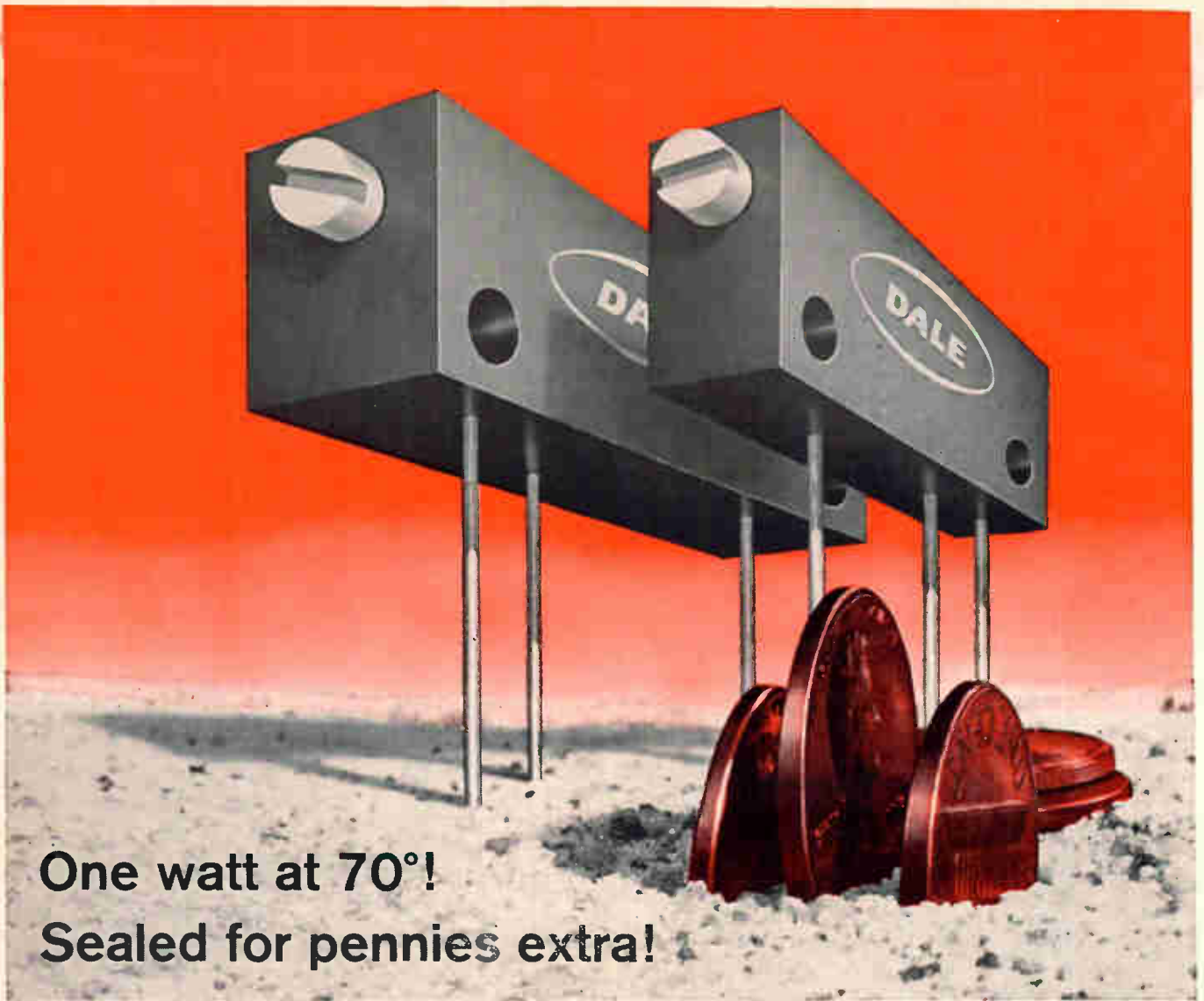

**One watt at 70°!  
Sealed for pennies extra!**

## 2 very good reasons why Dale sells so many Commercial Wirewound Trimmers

**PERFORMANCE:** Dale's 2100 and 2200 series are the commercial counterparts of RT-11 and RT-10 respectively. They can be sealed for just a few cents per unit, yielding mil-level performance in all areas except temperature.

**PRICE:** Competitive and then some! Check Dale's new lower commercial prices. They were made possible through an extensive value analysis program which actually improved overall unit quality.

**DELIVERY:** New automated production facilities plus a factory stocking program combine to put your order in your plant without delay.

*Simplify trimmer ordering — a call to Dale will do it.  
Phone 564-3131, Area Code 402*

### SPECIFICATIONS

	2100	2200
<b>CASE DIMENSIONS</b>	.28 high x .31 wide x 1.25 long	.18 wide x .32 high x 1.00 long
<b>STANDARD MODELS</b>	2187 — printed circuit pins, 21 AWG gold plated. 2188 — 28 AWG stranded vinyl leads. 2189 — solder lug, gold plated.	2280 — printed circuit pins, 22 AWG gold plated. 2292 — solid wire, 26 AWG gold plated. 2297 — 28 AWG stranded vinyl leads.
<b>POWER RATING</b>	1 watt at 70° C, derating to 0 at 125° C	
<b>OPERATING TEMPERATURE RANGE</b>	-65° C to + 125° C	
<b>ADJUSTMENT TURNS</b>	25 ± 2	15 ± 2
<b>RESISTANCE RANGE</b>	10 ohms to 100K ohms	10 ohms to 50K ohms
<b>STANDARD TOLERANCE</b>	± 10% standard (lower tolerances available)	

**Write for Catalog B**



**DALE ELECTRONICS, INC.**  
1300 28th Avenue, Columbus, Nebraska  
In Canada: Dale Electronics, Canada, Ltd.





# COMPONENT COMMENTS *From Speer*

## Have you considered what MIL-R-39008 offers you in resistors?



Let's face it, most buyers of insulated fixed carbon resistors don't need the established reliability assurance of MIL-R-39008. And don't want to pay for it. After all it's a costly business compiling "ER" data. The Life Failure Rate Level test is 10,000 hours at 50% rated wattage. Load life: 1000 hours at 100% rated wattage every six months. Quality Conformance: 2000 hours at 50% rated wattage every six months. And each lot must be tested for Load Life at 50% rated wattage for at least 250 hours. (For the "S" level, this means 35,000 units in a single style must be run for 12 months to accumulate the necessary 315 million test hours.)

So how does MIL-R-39008 benefit commercial users? Well, Speer doesn't build two products, one for MIL-R-39008 and another for general use. We build one. So when you

buy from us there's a better than 90% chance you're getting more reliability than you pay for—even though your lot isn't run through the "ER" test series.

If you're interested in more information on this subject, we're offering a technical article on "How the New 'Tri-Service' Specification MIL-R-39008 Applies to Resistors." You can get a copy by filling out the coupon.

## What price "TC"?

Are you paying for more temperature stability of resistance than you need? You certainly are when you specify using the "Temperature Coefficient (TC)" concept.

TC just isn't realistic. As you know it's based on the measurement of resistance at two specified temperature points — and is expressed graphically by a straight line through these points. The fact is, however, that when resistance is measured continuously over a temperature range (the "Deviation" concept), the picture is quite different. The rate of change isn't constant. In the case of low TC resistors, there's a reversal polarity of TC.

But even more important, TC expressions quantify only at extremes of temperature — usually broader than encountered in the resistor application. So, a resistor that might flunk a test in terms of TC may actually satisfy the "Deviation" limits needed by the circuit applications.

To build resistors that satisfy the assumed linearity of TC sends costs up. But, by telling us the maximum "Deviation" in resistance you can tolerate over a particular temperature range and/or the "Total Deviation" (including tolerance), we can give you our precision JXP resistors at about one third the cost. And with faster delivery.

To get the full facts and data on how the "Total Deviation" concept can benefit you, send for our technical article, "Specifying Resistance-Temperature Stability for Precision Resistors." Simply mail the coupon.

Get the Speer slant on MIL-R-39008 and temperature stability at the Wescon Show, August 23-26, at the Sports Arena. We'll be at Booth 1809 — see us, see our resistors.



**SPEER** Carbon Co.

### SPEER CARBON COMPANY

St. Marys, Pennsylvania  
A Division of  
Air Reduction Company, Inc.

- Rush "Specifying Resistance-Temperature Stability".
- Rush "How the New 'Tri-Service' Specification MIL-R-39008 Applies to Resistors."
- Rush the name of my nearest Speer representative.

Name \_\_\_\_\_  
Title \_\_\_\_\_  
Company \_\_\_\_\_  
Street \_\_\_\_\_  
City \_\_\_\_\_ State \_\_\_\_\_ Zip \_\_\_\_\_

# Watchdog of the Treasury

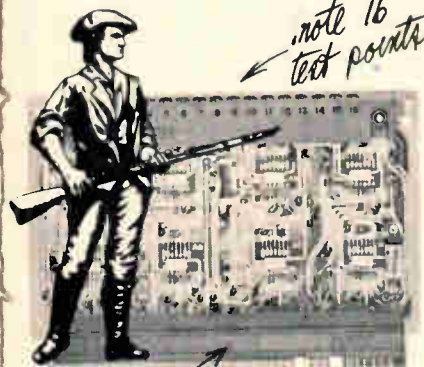

*note 40 terminal  
Elico connector*

**MONILOGIC**  
5 Megacycle  
IC Logic Cards

16 easily accessible test points  
... 40 terminal hermaphroditic connector ... 5-volt signal swings ... noise rejection exceeding 1 volt ... high fan-in and fan-out ... these are reasons enough for any performance-minded engineer to use MONILOGIC in his next data system.

But ... whether you're aware of it or not ... in MONILOGIC you're also getting a budget-cutting cost-reducer. Single MONILOGIC cards insist on doing the work of two or more cards of competing lines ... and still cost less card-for-card. Besides, with MONILOGIC a data system is quicker to design, simpler to assemble, easier to test and maintain.

So ... expect a healthy surplus in your budget when you spec MONILOGIC into your next data instrument or system.

*looks like good  
system-oriented  
card logic—read  
for literature!*

PHONE 215-646-8100  
TWX 215-646-9399

**MONITOR**  
SYSTEMS INC.

FORT WASHINGTON, PENNSYLVANIA

A SUBSIDIARY OF *Epsco*

central control boards where their men and vehicles are;

- Remote data print-out machines, preferably voice-activated;
- High-speed optical scanners tied to computer systems which can match photographs on file and identify fingerprints from only a single print at a crime scene, and compare and analyze blood types;
- Portable "bloodhounds" that can identify drug, narcotic or alcoholic influence with a minimum of body contact;
- And machines and programs to teach interrogation techniques, memory retention and human relations to policemen and to simulate a disaster or other situation that needs police action.

Redlin also asked for an automatic, remote-controlled device which could turn off engines on speeding or fleeing vehicles. It might work, for example, by sending out a high-powered radio signal to jam the vehicle's distributor system. And New York State's Intelligence and Information System said it wanted a \$500 portable tv and sound recorder to document police interrogation of suspects.

More money to develop the new devices and systems may soon be available. The new office of Law Enforcement Assistance under Attorney-General Nicholas Katzenbach may boost its budget in the next fiscal year by \$6.5 million to \$13.7 million. About half of this could go into R&D grants.

Adding encouragement is a bill before Congress by Rep. James H. Scheur (D., N.Y.), calling for a national institute on crime with a \$100-million budget. A national crime laboratory to serve all police departments is also favored by Donald F. Hornig, head of the President's Office of Science and Technology.

## Government

### Budgets in war

Congress soon will put its stamp on this year's military and space budgets, leaving the Defense De-

partment with more than it asked and the National Aeronautics and Space Administration with less than the bare-bones budget it submitted in January.

With only Senate confirmation of the appropriations bills needed, it appears that the Pentagon's budget will wind up more than \$500 million over the amount sought by the Administration. The NASA bill will probably be about \$30 million less than the amount requested.

In both, programs and figures have been juggled slightly. But the over-all dollar outlook for the electronics industry has not been drastically altered from projections made shortly after the Administration's estimates were made public. [Electronics, Feb. 7, p. 133].

Congress again prodded the Defense Department to push ahead with programs such as the Nike X. The Pentagon has so far resisted going into production of Nike X.

**More to come.** With the Defense spending bill climbing higher, even more funds will be needed in this fiscal year for Vietnam. The Johnson Administration all but formally acknowledges what has long been evident—that a supplemental appropriation bill will have to be sought for the 1967 budget, probably next January. No one knows how much will be requested, but estimates from officials range from \$5 billion to \$15 billion.

Not all of this money flows to the defense industry, of course; much of it would go for such things as personnel, operations, maintenance and construction. Perhaps half will go for procurement.

Meanwhile, the Government has announced that the Defense Department in fiscal 1966, ended June 30, spent \$54.3 billion, or \$1.4 billion more than its budget estimate of last January. Most of the increase is blamed on the war. Vietnam spending jumped from the January estimate of \$4.7 billion to \$5.3 billion, a hefty increase of 23%. While the Pentagon's book-keeping of Vietnam expenditures is admittedly arbitrary and incomplete, it does provide a clue to how rapidly the cost of the war is rising.

... and for space. The biggest

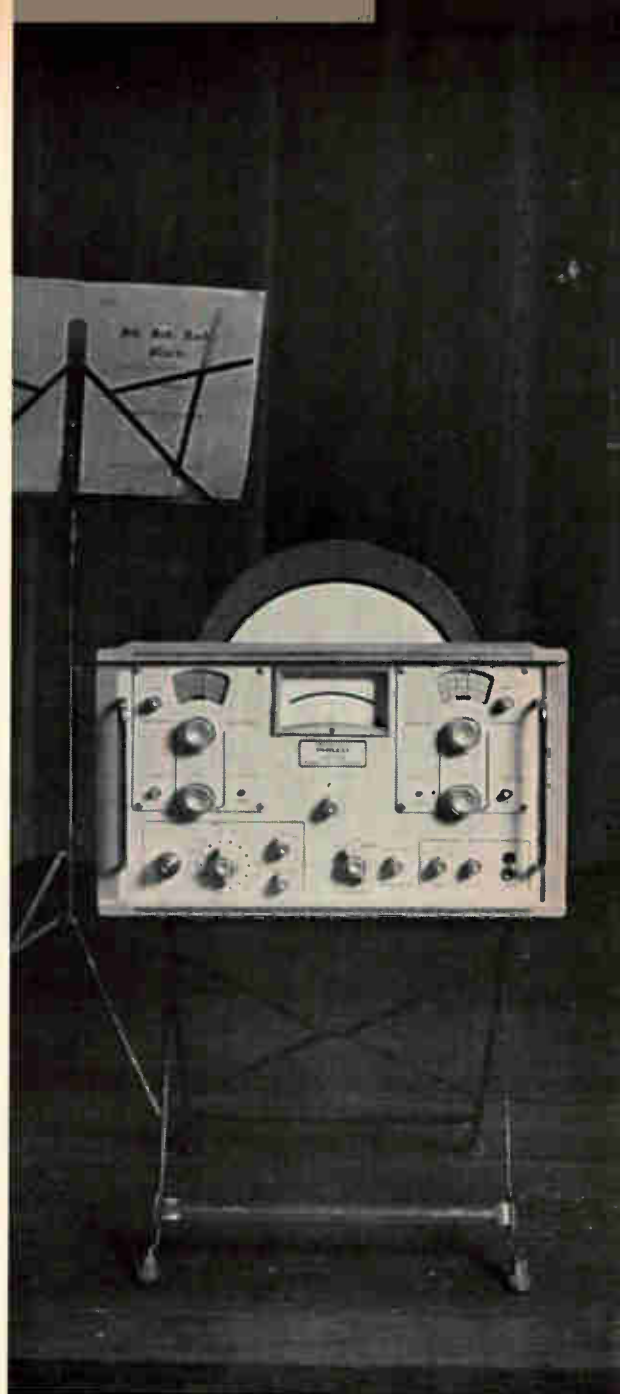

## One way to increase your frequency range

When complex waveforms begin to tax your frequency range, think twice before you switch to a two-instrument combination. Chances are you'll cover those additional octaves with a single Sierra Model 128A wide-range wave analyzer. And with far more artistic results.

The all-solid-state Model 128A takes firm control over a wide 4 kHz to 15 MHz frequency scale, with single-range continuous tuning across the entire band. Crystal references assure frequency accuracy of  $20 \text{ ppm} \pm 300 \text{ Hz}$ . Short term frequency drift is a low 5 Hz maximum over a 15-minute period. The measurement range reaches from  $3 \mu\text{V}$  to 30 V ( $-110$  to  $+32 \text{ dbm}$ ), with direct-reading dial indications in dbm and volts. An expanded scale meter, available as an accessory, lets you pinpoint readings down to 0.01 db. Model 128A offers years of trouble-free instrument service for an investment of \$3,250.

Your inquiry will produce an allegro one-bulletin response. Write to Sierra/Philco, 3885 Bohannon Drive, Menlo Park, California 94025.

## A better way from Sierra

**SIERRA ELECTRONIC DIV.**

OF  
**PHILCO**

A SUBSIDIARY OF *Ford Motor Company*

Circle 55 on reader service card

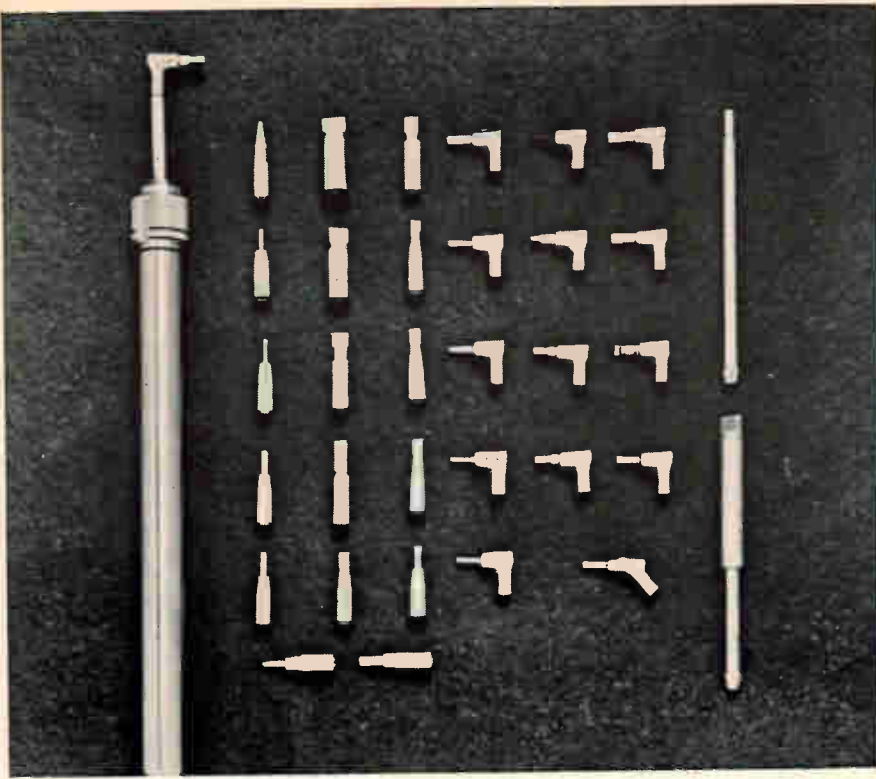

## Arsenal

These Airbrasive tips represent an arsenal of solutions to production and laboratory problems. Yours, maybe.

Would you like a really low-cost (under \$1,000) method of production-line cutting, drilling, or abrading hard, brittle, fragile materials — glass, mica (without delamination) silicon, germanium — even tungsten carbide?

Or a gentle method of deburring small, highly-finished parts of hard steel, ceramics, plastics, superior to slurries, tumbling, electropolishing? Much faster and cheaper than hand methods?

Perhaps you'd like a way of stripping a coating — potentiometer varnish, for example — without mechanically or electrically altering the substrate.

You might seek a means of cutting gems, ferrites, crystals (even single crystal elements) with great accuracy and uniformity, without heat or stress.

Airbrasive does all these and more. How much more we don't know. We're waiting for you to tell us.

Airbrasive's supersonic stream of graded abrasive particles, precisely controlled, provides cool, shockless, uniform cutting, drilling, abrading. Adapts to use with jigs, lathes, automatic machinery or may be used 'free hand' for laboratory work, repairs, etc.

How do you know if Airbrasive can solve your problem? Easy. Send it to us and we'll tell you. Or, call us collect and arrange for a free Airbrasive demonstration.

*If you already own an Airbrasive unit, one or more of our newly-designed nozzle-tips may expand its usefulness to you: write for Nozzle Tips Bulletin No. 6602.*

SEND FOR  
BULLETIN 6407A  
Complete  
Information



S. S. WHITE CO., INDUSTRIAL DIVISION  
Dept. EU, 201 East 42nd Street, N.Y., N.Y. 10017  
Telephone 212-661-3320



**S.S. WHITE COMPANY**  
Industrial Division

SEE US IN BOOTH 708—WESCON SHOW

news on the 1967 NASA budget is that Congress didn't cut it more. In the bread-and-butter section, research and development, Congress actually added \$2 million. The biggest NASA program, the Apollo man-on-moon project dashed through Congress as expected: unscratched, at nearly \$3 billion.

The Nike X antimissile system, with its enormous potential for electronics business, proved to be a real pet of Congress. Over the objection of Defense Secretary Robert S. McNamara, the lawmakers authorized an extra \$167.9 million to begin preproduction work. McNamara had sought \$447 million for aspects of the program but made it clear he had not yet decided whether to approve the building of an operational system.

Another program tacked onto the military budget was Project Jenny, an airborne propaganda broadcasting station for Vietnam. Congress voted \$12 million for an airplane to be equipped with television equipment for two channels and a-m and f-m broadcast facilities.

**Want it or not.** Something else Secretary McNamara didn't ask for but got anyway was money for a nuclear-powered frigate costing \$130.5 million and \$20 million for items with long-lead times for a second one. The ships would be equipped with the "most advanced" sonar and antisubmarine warfare systems, and two dual Tartar surface-to-air missiles systems to provide protection against aircraft and submarines.

Congress also added \$142.7 million to support research into new requirements for antisubmarine warfare, and another \$5 million for the deep-submergence systems project. It also continues to push the manned orbiting laboratory (MOL) and it added \$80 million to the Air Force request to accelerate the program. The Air Force had asked for \$150 million.

Congress also stuck to its guns in the years-old controversy over the advanced manned strategic aircraft and authorized \$11.8 million to support the contract-definition phase on the program. The Pentagon had sought only \$11 million for avionics and engine development.

## Electronics notes

▪ **Now the camera.** Marvin Camras, the researcher who developed the low-priced color video tape recorder, now is working on a companion color video camera. Camras, a scientific adviser at the ITT Research Institute, Chicago, says the camera will be designed to sell for less than \$500. Three electronics companies are negotiating for license rights to produce the recorder, which has a single, stationary recording head.

▪ **Life-size holograph.** Sometime this year Life magazine may carry as an insert a holographic plate that could reproduce a three-dimensional image with incoherent light. The magazine says several companies have expressed interest in producing the 7.2 million plates needed, but a firm proposal hasn't been received. The Conduction Corp. of Ann Arbor, Mich., is one of the companies now trying to figure out how to produce that many holograms of high quality. The Xerox Corp. has discussed with Life its thermoplastic holograms [Electronics, April 18, p. 25], but Xerox's process is still a laboratory technique and not yet ready for mass production.

▪ **Tight money.** Small-business investment company loans—a source of funds to many small, struggling electronics companies—will be harder to come by in the future. The Government's Small Business Administration, overseer of the loan program, is tightening up its rules in the face of widespread defaults that may cost the Government as much as \$18 million.

▪ **Trouble again.** The third Orbiting Geophysical Laboratory is still sending back data from its 21 experiments even though it has contracted the "family disease," a failure in the earth-oriented attitude-control system. As with the two previous OGO's, the failure forced ground controllers to shift OGO 3 to spin-stabilization. However, it completed the required 30 days in earth-oriented stabilization. A power inverter is tentatively being blamed for the difficulty.

basic measuring tools from

**HEWLETT  
PACKARD**

### hp field-proven 412A Multi-Function Meter

Basic tool for measuring 1 mv-1000 v dc, 1  $\mu$ a-1 a, 1 ohm-100 Meg  
1% accuracy, floating input, high input impedance  
No zero set

#### Use it for:

Broadband measurements  
High-gain amplification—a 60 db amplifier with rear-terminal output  
Lab or production line, where high performance and low cost are important

Ease of use and wide dynamic range are the principal benefits of using the hp 412A—only three controls, no zero set. Measurement accuracy for dc voltage is  $\pm 1\%$  of full scale; dc current is  $\pm 2\%$  of full scale; ohms accuracy is  $\pm 5\%$  of reading. Thirteen voltage and current ranges and nine resistance ranges give you maximum resolution, and an individually calibrated meter assures highest possible accuracy. hp

412A, \$400; 412AR (rack mount), \$405.

Call your Hewlett-Packard field engineer for a demonstration of the popular 412A, or write for full specifications: Hewlett-Packard, Palo Alto, Calif. 94304, Tel. (415) 326-7000; Europe: 54 Route des Acacias, Geneva.

Data subject to change without notice.  
Prices f.o.b. factory.

**HEWLETT**  **PACKARD**  
An extra measure of quality

1903



SEE HP INSTRUMENTS — ATTEND MEASUREMENT SEMINARS — WESCON — HOLLYWOOD PARK

# Transitron's

Los Angeles

# T

# PARTY

A NEW BREW  
of great products  
for the electronic designer  
on display at  
WESCON BOOTH 1741

See all these



plus a **T**-bag full of others,  
including  
a broad line of

HLTTL integrated circuits, transistors, diodes, references, zeners, regulators, rectifiers, SCR's, numerical displays, time delay relays

as well as

Wire, cable, and cord sets

by Phalo Corporation

Printed circuits and miniature connectors  
by Transitron's Precision Connector Division

Precision metal film resistors  
by Electra Manufacturing Co.

Crystals, crystal oscillators and filters  
by Midland-Wright Corporation

Wherever there's electronics . . . there's

**Transitron**  
electronic corporation  
Wakefield, Massachusetts



Now — Premium SCR's;  
Transwitches, in TO-52's  
for Low Price — Instant Delivery

**GATE TURN-OFF THYRISTORS** — Transitron's planar silicon Transwitch is now available in the hermetically-sealed TO-52 package (2N4320/4325). Result — unprecedented cost reduction . . . off-the-shelf availability . . . fast delivery on quantity orders. Ideal for use in industrial and military circuits requiring gate turn-off action. Offers anode currents to 250 ma with min. gate turn-off beta of 5.

**SILICON TRIODE THYRISTORS** — Also available from stock at new low prices, these TO-52-package units (2N4332 4337) feature low holding current; gate triggering current of less than 10 ma; extremely low leakage current.

**LIGHT-SENSITIVE SCR's** — Transitron's silicon planar photoswitch, used for light activation of switching circuits, is now available at commercial prices.



## New Transitron Diode Offers Logarithmic Response Characteristics

The Transitron SG3600 is an alloy junction diode which provides accurately predictable logarithmic response over 2 decades. The response can be stated in the form:

$$V_f = A \log_{10} I + B I + C, \text{ where}$$

$V_f$  = Forward voltage drop in mv;  $I$  = Forward current in  $\mu$ a;

A is the coefficient that determines the slope of the diode response. The coefficient has a maximum variation of  $\pm 2.5$ ;

B is the resistive coefficient determining the deviation of the slope from a straight line and has a maximum variation of  $\pm .0002$ ;

C is the offset voltage in millivolts and has a maximum variation of  $\pm 10$ .

at $-50^\circ\text{C}$	A = 48.2,	B = .0002,	C = 697
at $+25^\circ\text{C}$	A = 65.0,	B = .0005,	C = 520
at $+125^\circ\text{C}$	A = 85.7,	B = .0007,	C = 274

The SG3600 is widely used in function generators, division and root extraction, logarithmic multiplication, operational amplifier feedback circuits, etc.





## New Multiple-Emitter Transistors for UHF and High Current Switching

These two new NPN planar epitaxial transistors are designed with multiple emitters connected in parallel by aluminum metalization for excellent UHF power handling and high current switching. Both are in solid header TO-5's giving 7 watts at 25°C. case.

$BV_{CEO} - 65V$   $I_c - 1 \text{ amp}$   
 $BV_{CEO} - 40V$   $C_{ob} - 10\text{pf}$   
 $BV_{EBO} - 4.0V$   $f_t - 350 \text{ mc}$

**2N4350** — A medium-power UHF, RF amplifier offering a collector efficiency of 50% min., with output of 1.5w at 200 mc. Ideal for military and commercial HF communications, such as citizens band equipment, CATV, AM & FM transceivers. Price only \$2.50 each in 1k quantity.

**2N4349** — A 1-ampere saturated switch, ideal for driving large capacitive loads, with rise time of 35 nsec, fall time of 40 nsec. Price only \$2.50 each in 1k quantity.



## PNP Power Transistors in TO-66 Package

These double-diffused, planar PNP devices provide an excellent combination of beta linearity, 25 watt power dissipation, and 40 mc typical  $f_t$ , which makes them ideal for use in power amplifiers, relay driver or relay replacement, and complementary symmetry circuit applications. A minimum  $h_{FE}$  of 15 is provided from 1 ma to 2A, with maximum current rating of 5A, for a wide range of applications.

	$BV_{CEO}$ 50 ma	$V_{CE(sat)}$ 3A/300 ma	$h_{FE}$ 500 ma/10V	Price at 1K
2N4387	40V	3.0V	25-100	\$2.20
2N4388	60V	3.0V	25-100	\$2.95

Featuring all aluminum interconnections and ultrasonic aluminum wire bonds, coupled with the low leakages and inherent stability of the planar construction, these devices give assured quality and reliability at very modest prices.

**PNP POWER UNITS IN TO-66 PACKS** — Also available from Transiron are the following NPN devices:  
**2N3054**, with  $BV_{CEO} = 55V$  **\$1.50 at 1K**  
**2N4273**, with  $BV_{CEO} = 140V$  **\$2.10 at 1K**



## HLTTL Charge Storage J-K Flip-Flop Line Expanded

Transiron's HLTTL charge storage J-K flip-flop series now includes both 30 and 40 mc versions of the "ENABLE OR" input, "OR" input and "AND" input units, all particularly suitable for arithmetic shift register applications.

**"ENABLE OR" FLIP-FLOP** — Provides "OR" function through dual 2 input AND Gates, OR'ed on both J-K sides of flip-flop. Through internal connections, unit provides enabling of either pair of the two sets of J-K inputs. Asynchronous set, reset and preset provided for functional flexibility.

**"OR" J-K FLIP-FLOP** — Provides "OR" function of both J and K data inputs. Unit has 4 data inputs on each side, which are now internally connected, and 1 asynchronous set input.

**CHARACTERISTICS** — High fanout (up to 15), high noise immunity (1.0 volt typical), high speed (up to 40 mc), capacitance drive capability (up to 300 pF), low power, negative clock edge triggering, low loading factors, and raceless. These high speed units are designed, not selected, typically complement at 40 Megacycles with typical clock pulse width requirements of 12 nanoseconds.

**ALSO AVAILABLE:**  
**TFF3211** — 3214 "AND" input JK Standard Speed  
**TFF3241** — 3244 "AND" input JK High Speed

All units are available in 14 lead flat package or 14 lead dual in-line package.



## New HLTTL Quad 2 Input "Line" and "Lamp" Drivers

More flexibility and reduced cost in the power gate area is provided by these new additions to Transiron's versatile HLTTL series. The Quad 2 input line driver is a power gate with active darlington transistor pull-up for capacitive driving capability. The lamp driver is a power gate without active pull-up, with an output transistor which can be connected to 8 volts standard or 10 volts selected for driving lamps, relays, etc.

Both units incorporate high speed (typically 10 nanosec. driving 150 pf capacitive load), high noise immunity (>1.0 volt, typically), high fanout (line driver — 32 or 54 ma at .45V.; lamp driver — 60 ma at .5V.), plus other standard HLTTL characteristics.

With the addition of these new units, multiple buffering, clock driving, line driving and interfacing applications can be satisfied with a single package at lower cost and simplified design.

### NEW TYPE DESIGNATIONS

**TNG5511 - 5514** Quad 2 input Line Driver  
**TNG5611 - 5612** Quad 2 input Lamp Driver

Each is available in a 14-lead flat package or a 14-lead dual in-line package.





One watt at 70°!  
Sealed for pennies extra!

## 2 very good reasons why Dale sells so many Commercial Wirewound Trimmers

**PERFORMANCE:** Dale's 2100 and 2200 series are the commercial counterparts of RT-11 and RT-10 respectively. They can be sealed for just a few cents per unit, yielding mil-level performance in all areas except temperature.

**PRICE:** Competitive and then some! Check Dale's new lower commercial prices. They were made possible through an extensive value analysis program which actually improved overall unit quality.

**DELIVERY:** New automated production facilities plus a factory stocking program combine to put your order in your plant without delay.

*Simplify trimmer ordering—a call to Dale will do it.  
Phone 564-3131, Area Code 402*

### SPECIFICATIONS

	2100	2200
<b>CASE DIMENSIONS</b>	.28 high x .31 wide x 1.25 long	.18 wide x .32 high x 1.00 long
<b>STANDARD MODELS</b>	2187—printed circuit pins, 21 AWG gold plated. 2188—28 AWG stranded vinyl leads. 2189—solder lug, gold plated.	2280—printed circuit pins, 22 AWG gold plated. 2292—solid wire, 26 AWG gold plated. 2297—28 AWG stranded vinyl leads.
<b>POWER RATING</b>	1 watt at 70° C, derating to 0 at 125° C	
<b>OPERATING TEMPERATURE RANGE</b>	-65° C to + 125° C	
<b>ADJUSTMENT TURNS</b>	25 ± 2	15 ± 2
<b>RESISTANCE RANGE</b>	10 ohms to 100K ohms	10 ohms to 50K ohms
<b>STANDARD TOLERANCE</b>	± 10% standard (lower tolerances available)	

Write for Catalog B



**DALE ELECTRONICS, INC.**  
1300 28th Avenue, Columbus, Nebraska  
In Canada: Dale Electronics, Canada, Ltd.





# Washington Newsletter

August 8, 1966

## Gravity-stabilized satellite misses its launch date

The Air Force will try to shoot craps for a second time in a row Aug. 11 when it attempts to launch another set of Interim Defense Communications Satellites with a Titan 3C booster. The first shot, successful beyond anyone's expectations, put seven satellites in random 18,200-nautical-mile polar orbits.

A hitchhiker on board the June 16 shot—an experimental gravity-gradient test vehicle built by the General Electric Co.—did so well that a second-generation test satellite was being rushed to completion so that it could be orbited on the August launch [Electronics, July 11, p. 25, 46]. However, time ran out and a last-minute decision put off the improved gravity-gradient stabilization satellite until a later flight. The new three-axis satellite has a rapid-damping feature—five days to stabilize—and an improved pointing accuracy of 2° to 2.5°. The test craft now flying has only two-axis stabilization and took longer to stabilize.

## NASA unconvinced parachute can land capsule on Mars

Scientific debate has flared again on the density of the Martian atmosphere. The surface pressure is of more than academic interest since it could determine if a heavy retro-engine is needed for a soft-landing capsule and how many pounds of instruments can be landed. Two Harvard University scientists say their analysis of radar and infrared data indicates the red planet has plateaus rising as high as nine miles above the deserts and that the average surface pressure is about 12 millibars, double the measurement made in the Mariner 4 flyby last year. In fact, they believe that the desert lowlands have a pressure of 20 millibars—enough to support a parachute landing.

The National Aeronautics and Space Administration is designing a Martian soft-landing capsule for the 1973 Voyager mission and is using the 6-millibar figure, which would require the retro-engines. NASA's planetary atmosphere chief, Robert F. Fellows, concedes the possibility of a denser atmosphere, but doesn't think enough of the new data at this point to let it affect current NASA planning. He adds that the agency still doesn't know enough about the Martian atmosphere and hopes to get more data from the 1969 Mariner mission.

## Air Force to award tactical satellite contract this year

A contract to build the Tactical Communications Satellite will probably be awarded by the Air Force later this year. At least nine teams of companies are expected to respond to the July 11 request-for-proposals, which calls for technical proposals by Sept. 1 and cost proposals by Sept. 12. Skipping the competitive design phases, the Air Force Space Systems division is asking for a spacecraft feasibility demonstration within two years after the contract is let—or possibly by late 1968. If all goes well, production would follow.

The stationary satellite, spotted at an altitude of 22,300 miles, will be used as a communications relay by ships, aircraft and Army units in the field and will be high powered to link up with smaller ground stations. Effective radiated power has been tagged at 1,000 watts, or 30 decibels above one watt. The 2,000-pound craft will not push the state of the art, although the Air Force is said to be considering three-axis stabilization rather than the conventional spin stabilization.

---

# Washington Newsletter

---

## Cargo ship award due next June

The Navy will pick the prime contractor for its fast-deployment cargo ship program next June. As predicted [Electronics, July 25, p. 26], the Navy told three companies—the Lockheed Aircraft Corp., Litton Industries, Inc., and the General Dynamics Corp.—to develop proposals under three \$5.3-million awards. The proposals are due Jan. 31, 1967, but each company will get additional money (\$90,000 a month) to hold together a cadre of key personnel until the winner is chosen in June.

## Satellite may probe earth resources with infrared sensor

One of the more useful spin-offs from the nation's multibillion-dollar space program may be surveillance of the earth's natural resources by a satellite. The University of Michigan will take the first step toward such a system by looking into the possibility of developing a 20-channel infrared sensor. Most infrared sensors have from two to five channels. If the sensor can be built, the next step will be to fly a prototype unit to determine the infrared signature of various crops and mineral formations. In-house studies at the National Aeronautics and Space Administration are defining satellites for infrared surveying. NASA may test the sensors on manned Saturn/Apollo applications program flights and on small satellites tailored for the surveying job.

## Navy chief keeps F-111B afloat

The trouble-plagued F-111B is not being chucked at this point by Navy Secretary Paul H. Nitze. Calling the aircraft vital to the fleet, he declares, "We must make it work." His remarks may be directed at heading off efforts to substitute a proposed swing-wing McDonnell F-4 for the overweight Navy aircraft, which is being developed by Grumman Aircraft Engineering Corp. The admirals are calling the F-111B too heavy for carrier landings. Questioned about the weight, officials say only that it is 4,000 pounds overweight unfueled—and no one is saying how much the fuel will weigh or what good an unfueled jet fighter is.

## Pentagon boasts contract economies

The Pentagon now believes it has reached the "irreducible minimum" in cost-plus-fixed-fee contracts now that they are down to 8.9% of the total. This fiscal 1966 figure is a drop from 9.8% in fiscal 1965 and comes "despite the urgencies associated with Vietnam," the Pentagon boasts. Cost-plus-fixed-fee contracts, which accounted for 38% of the total in 1961, are said to cost 10% more than if they were let on a fixed-price basis.

## Addenda

Chances seem good that Congress will authorize the Commerce Department to study the ramifications of the United States' changing to the metric system. The Senate has already given its approval and the House Rules Committee is now pondering the bill. . . . Finding exactly where the horizon is—a problem that has plagued the National Aeronautics and Space Administration's observatory-class satellites—should get some help from the Project Scanner shot scheduled for Aug. 15. The experiment consists of a Hughes Aircraft Co. radiometer package spinning around an axis perpendicular to the earth. Two Barnes Engineering Co. infrared sensors will look down at the horizon in the 14-to-16 and 20-to-40 micron regions in an attempt to define the horizon to within 0.02°. A Honeywell, Inc., star mapper will provide absolute reference data.

# Why specify Mallory wet slug tantalum capacitors?

## Four reasons:

- most microfarad-volts per unit volume
- lowest DC leakage
- maximum freedom from catastrophic failure
- highest voltage and temperature ratings

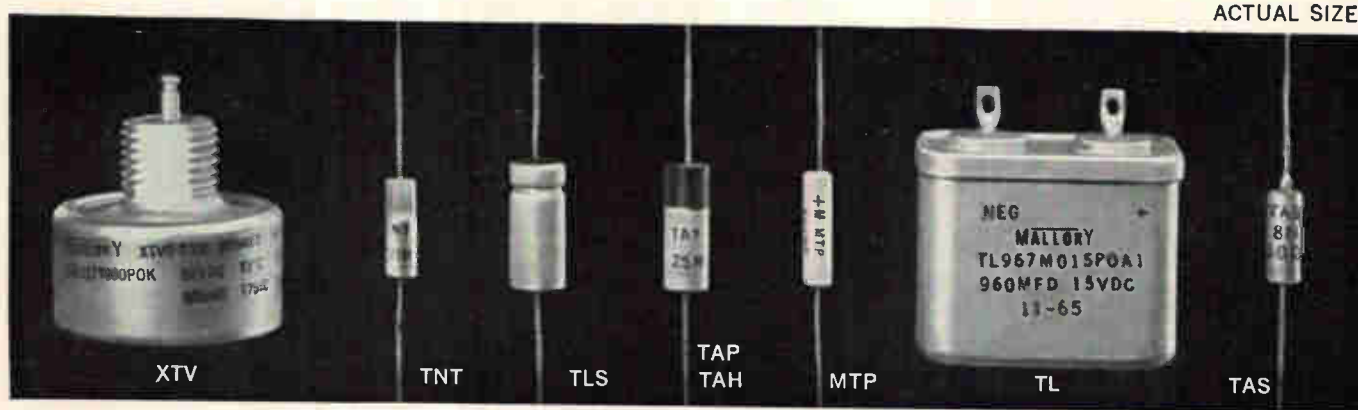

Compare these characteristics:

Mallory Wet Slug Types

Solid Electrolyte

	Mallory XTV	Mallory TNT	Mallory TLS	Mallory TAP/TAH	Mallory MTP	Mallory TL	Mallory TAS
Mfd-volts/in <sup>3</sup>	42,600	52,200	62,500	83,900	178,000	25,600	37,200
Max. DC Wkg. Voltage, 85°C	630V	50V	125V	90V	60V	150V	100V
Max. DC Leakage at highest mfd and voltage, ua/CV	.0052	.0050	.00064	.0026	.00071	.00026	.010
Failure mode	-----Degradational-----						Catastrophic
Temp. range	-55°C +200°C	-55°C +85°C	-55°C +125°C	-55°C +85°C/ +125°C	-55°C +85°C	-55°C +125°C	-55°C +125°C
Weight: grams/mfd-volt	.0018	.0021	.0015	.0012	.00067	.0024	.0024

Next time you need a capacitor for high-reliability applications, consider Mallory wet-slug tantalum capacitors. We'll recommend the best type for you: we make them all—wet

slug, solid and foil—and can recommend without bias. Write or call Mallory Capacitor Company, a division of P. R. Mallory & Co. Inc., Indianapolis, Indiana 46206.

**50<sup>th</sup>**  
ANNIVERSARY

**MALLORY**

# To put it in writing... look to the great family of *brush* recorders.

No matter what your direct writing recording requirements, look to Brush for the optimum answer. There's the famous Mark 200® series of modular systems plus a complete line of high-performance portable and general purpose recorders. All built by Brush to give you the best written records in the world.

## *brush* Recorder Mark 200® Series

### All Solid State • Series 1707 Position-Feedback Controlled

The Series 1707 line is a new generation of Brush Mark 200-Recorder System combining the advantages of all solid state electronics with modular construction and a flexibility in application never before achieved. The result is a totally new concept in instrument design which allows any system to be tailored to specific requirements by selection from a broad range of "building block" subsystems.



#### Choice of Penmotors

(Mark 200 accommodates any 4; Mark 240 accommodates any 2)



#### Choice of Input Preampifiers

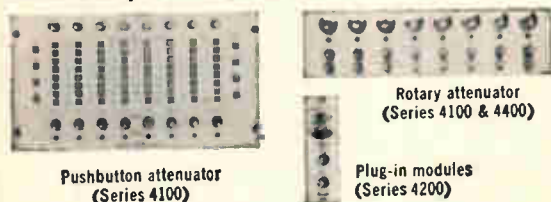

### All Solid State Recorder • Mark 240 Position-Feedback Controlled

This versatile, high accuracy direct writing recorder is a complete, self-contained system designed for a very wide range of applications where resolution and precision in measurement are required. It may be mounted vertically or horizontally in standard 19" racks to RETMA specifications, or in Brush racks, or bench-top cabinets.



	Mark 200	Mark 240
No. of Channels	Choice of 2 to 8-40 mm ch. 1 to 4-80 mm ch. 8 to 32-event ch.	Choice of 2 to 4-40 mm ch. 1 to 2-80 mm ch. 8 to 16-event ch.
(ALL ALIKE, OR IN COMBINATION)		
Penmotor type	Position feedback	Position feedback
Writing method	Pressurized ink	Pressurized ink
Trace presentation	Rectilinear	Rectilinear
Chart speeds	0.05, 0.1, 0.2, 0.5 1, 2, 5, 10, 20, 50 100, 200mm/sec.	0.05, 0.1, 0.2, 0.5, 1, 2, 5, 10, 20, 50 100, 200mm/sec.
Chart capacity	500'	275'
Frequency response	40mm penmotors 80mm penmotors	55 cps full scale; 30 cps full scale;
Linearity	1/2% full scale	1/2% full scale
Configuration	Vertical or horizontal oscillograph	Mounts in any position
Input characteristics	Depends on preamplifier used	Depends on preamplifier used
	<ul style="list-style-type: none"> <li>4- or 8-channel</li> <li>4100 SERIES (50mV, 50K)                             <ul style="list-style-type: none"> <li>• pushbutton attenuator</li> <li>• rotary attenuator</li> </ul> </li> <li>4400 SERIES (1mV, 1 meg)                             <ul style="list-style-type: none"> <li>• without calibrated zero suppression</li> <li>• with calibrated zero suppression</li> </ul> </li> <li>PLUG-IN MODULES</li> <li>4200 SERIES                             <ul style="list-style-type: none"> <li>• Coupling preamps (50mV, 50K)                                     <ul style="list-style-type: none"> <li>• without zero suppression</li> <li>• with zero suppression</li> </ul> </li> <li>• Medium gain (1mV, 1 meg)</li> <li>• High gain (100 microvolts, 1 meg)                                     <ul style="list-style-type: none"> <li>• without zero suppression</li> <li>• with zero suppression</li> </ul> </li> <li>• Very high gain 100K (1 microvolt, 1 meg)                                     <ul style="list-style-type: none"> <li>• without zero suppression</li> <li>• with zero suppression</li> </ul> </li> </ul> </li> <li>Strain-gage (carrier)</li> <li>Phase-sens. demodulator</li> <li>Hi-voltage (1000VDC off-ground)</li> <li>Frequency deviation converters                             <ul style="list-style-type: none"> <li>• 50 cps</li> <li>• 60 cps</li> <li>• 400 cps</li> </ul> </li> <li>AC watts converter</li> <li>AC volts to DC volts</li> <li>AC amps to DC volts</li> </ul>	<ul style="list-style-type: none"> <li>PLUG-IN MODULES</li> <li>4200 SERIES                             <ul style="list-style-type: none"> <li>• Coupling preamps (50mV, 50K)                                     <ul style="list-style-type: none"> <li>• without zero suppression</li> <li>• with zero suppression</li> </ul> </li> <li>• Medium gain (1mV, 1 meg)</li> <li>• High gain (100 microvolts, 1 meg)                                     <ul style="list-style-type: none"> <li>• without zero suppression</li> <li>• with zero suppression</li> </ul> </li> <li>• Very high gain 100K (1 microvolt, 1 meg)                                     <ul style="list-style-type: none"> <li>• without zero suppression</li> <li>• with zero suppression</li> </ul> </li> </ul> </li> <li>Strain-gage (carrier)</li> <li>Phase-sens. demodulator</li> <li>Hi-voltage (1000VDC off-ground)</li> <li>Frequency deviation converters                             <ul style="list-style-type: none"> <li>• 50 cps</li> <li>• 60 cps</li> <li>• 400 cps</li> </ul> </li> <li>AC watts converter</li> <li>AC volts to DC volts</li> <li>AC amps to DC volts</li> </ul>

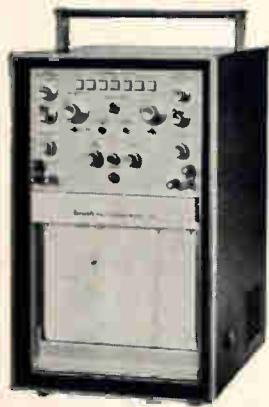

### Mark 280 Dual 80mm Position Feedback Penmotor Recorder

Portable dual channel system with rectilinear forced-fluid writing. "Double-width" 80 mm channels.



### Mark 842 Hi-torque Penmotor Recorder

Highly versatile pressure-thermal rectilinear writing system. See list of "plug-in" preamplifiers on facing page.

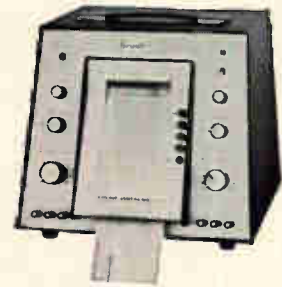

### Mark II Portable Recorder

Lightweight, highly versatile—a complete dual channel recording system. Anyone can plug it in, put it in writing anywhere!

### Mark 2300

### Lightbeam Oscillograph

Application possibilities of this versatile portable recorder are almost unlimited. Simple incandescent light-source is fail-safe.

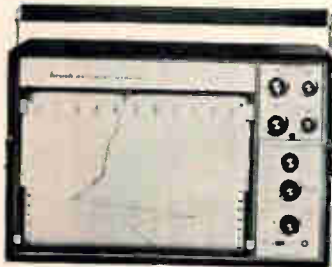

### Mark 10 Potentiometric Strip Chart Recorder

New 10" strip chart recorder. All solid state, even the ink! Lightweight, simple to use, amazingly versatile. Ten chart speeds, variable gain, broad electrical range. Ideal for lab and general purpose requirements.



### Brush Operations Monitors 30-100-150 channel models

For on-off, go/no-go or other two-state operations. Pulsed writing, with built-in electronic switching. Complete with self-contained power supply and provision for internal mounting of interchangeable decade boards for electronic input switching in a variety of input modes.

	Mark 280	Mark 842	Mark II	Mark 10	Mark 2300
No. Channels	2	2	2	1	1 to 16
Analog Event	2 standard	1 standard	2 standard	1 (accessory)	
Channel width	80mm	40mm	40mm	10"	6"
Penmotor type	Position feedback	Hi-torque d'Arsonval	d'Arsonval	Potentiometric	Lightbeam galvo
Writing method	Pressurized ink†	Pressure-thermal	Capillary ink	"Solid-state" wax-base	Tungsten lightbeam
Trace presentation	Rectilinear	Rectilinear	Curvilinear	Rectilinear	Rectilinear
Chart speeds	0.05, 0.1, 0.2, 0.5, 1, 2, 5, 10, 20, 50, 100, 200mm/sec	0.05, 0.1, 0.2, 0.5, 1, 2, 5, 10, 20, 50, 100, 200mm/sec	1, 5, 25, 125mm/sec	1, 2, 5, 10, 20 in./min. 1, 2, 5, 10, 20 in./hr.	0.2, 0.4, 1, 2, 5, 10, 25 and 50 ips, plus above speeds ÷ 100
Frequency response	35cps full scale (80mm)	75cps full scale (40mm)	35cps full scale (40mm)	1cps full scale (10 inches)	Depends on galvo selected—to 2500 cps
Linearity	½% full scale	½% full scale	2% full scale	0.2% full scale	2% full scale
Input characteristics	0.5mv/div; 1 meg constant; floating	Interchangeable preamps (see listing at left)	10mv/div; 5 meg single-ended; 10 meg balanced	50 microvolts/div; 1 meg, constant; also potentiometric	Varies with galvo selected; impedance 100K floating with Brush galvo amplifier

\*Total chart width  
†Patent pending



Write for Literature or, for Application Assistance, Contact Your Brush Factory Branch or Representative.

Brush Instruments Division, Clevite Corporation, 37th and Perkins, Cleveland, Ohio 44114. Sales, service and warehousing centers at Boston, New York, Washington, Orlando, Cleveland, Detroit, Chicago, Denver, Houston, Los Angeles, San Francisco, and Seattle; engineering representatives in all key locations.

**CLEVITE**  
*brush* INSTRUMENTS DIVISION

Would you believe 1000? This is one of a library of more than one thousand DATEX encoder code patterns. One of them is available in the right code (Binary, Gray, BCD, Monostrophic,\* etc.) the right size and the right resolution to meet your needs. These encoders interface with integrated circuit logic levels. Won't you use our library? Stop in and browse. For more information call any of the numbers listed or write.

Dallas, Texas (214) EM 3-6417 ■ Dayton, Ohio (513) 299-5565 ■ Des Plaines, Illinois (312) 827-8141 ■ Huntsville, Alabama (205) 539-9396 ■ Monrovia, California (213) 359-5381 ■ New York, New York (212) 661-4070 ■ Pasadena, California (213) 681-7152 ■ Washington, D.C. (202) 244-8700

**DATEX**

\*Monostrophic: See page 24 of DATEX

**GIANNINI CONTROLS CORPORATION**

"How to Use Shaft Encoders" textbook. 1307 S. MYRTLE AVE., MONROVIA, CALIFORNIA 91017





**New EI-85 Digital Multimeter\* in **one** encoding  
 makes  $\pm .005\%$  measurements in 10 ms !  
 and it stays there ■**

Accurate, full 5 digit measurements are now possible in 10 msec with the EI-85's successive approximation logic.

Why the "one encoding"? Because unlike other high speed instruments which are allowed to encode before their input circuitry settles to full accuracy, the EI-85 contains a sensing circuit which acknowledges settling of its high impedance input section to  $\pm .001\%$  of final value before allowing its logic circuitry to encode. All *within* 10 msec! Repeat encodings are not necessary to obtain that "last digit of accuracy" with this high speed DVM. This assures you consistent repetitive readings.

**Noise Rejection**—Not forgetting the effect of noise, the EI-85's guarded differential input and active Bessel filter provides 160 db of CMR and 60 db NMR at 60 Hz while maintaining a *constant* high input impedance of greater than 10,000 megohms to 10

volts F.S. This means, of course, no loss of accuracy due to noise or source loading during encoding!

Whether your need is for accurate high speed measurements of dynamic fast changing signals, high speed system operation (100 readings/second) or a versatile accurate multimeter for general purpose use, the EI-85 fills the bill!



\* DC, Ratio, AC, Resistance, Pre-Amplifier

**Other Features**—Complete multimeter capability utilizing plug-in card accessories • DC and Ratio comprise the basic instrument • 10  $\mu$ volts basic resolution without preamplifier (1 volt F.S.) • Differential guarded input on *all* modes of operation • Autorange and polarity in *all* modes • Storage in read-out prevents "blinking" • Storage in

electrical outputs allows time sharing operation • Isolated BCD and 10-line decimal outputs and remote control are standard • AC converter—5 digit, 10  $\mu$ volt resolution, 10 Hz to 100 KHz • Resistance converter—.01 ohms to 10 megohms • Preamplifier—for 1 microvolt resolution • Priced from \$5000.00.

**Complete EI-85 High Speed System**—EI system modules for signal conditioning, scanning, comparison, timing, automatic programming, and peripheral outputs such as computer compatible paper or magnetic tape can be easily added to your EI-85. Contact your Honeywell Sales Office or write: Honeywell, Test Instruments Division, San Diego Operation, 8611 Balboa Ave., San Diego, California 92112.



DATA HANDLING SYSTEMS

**Honeywell**

DIGITAL VOLTMETERS

HONEYWELL IS WORLDWIDE • Sales and service offices in all principal cities of the world. Manufacturing in Brazil, Canada, France, Germany, Japan, Mexico, Netherlands, United Kingdom, United States

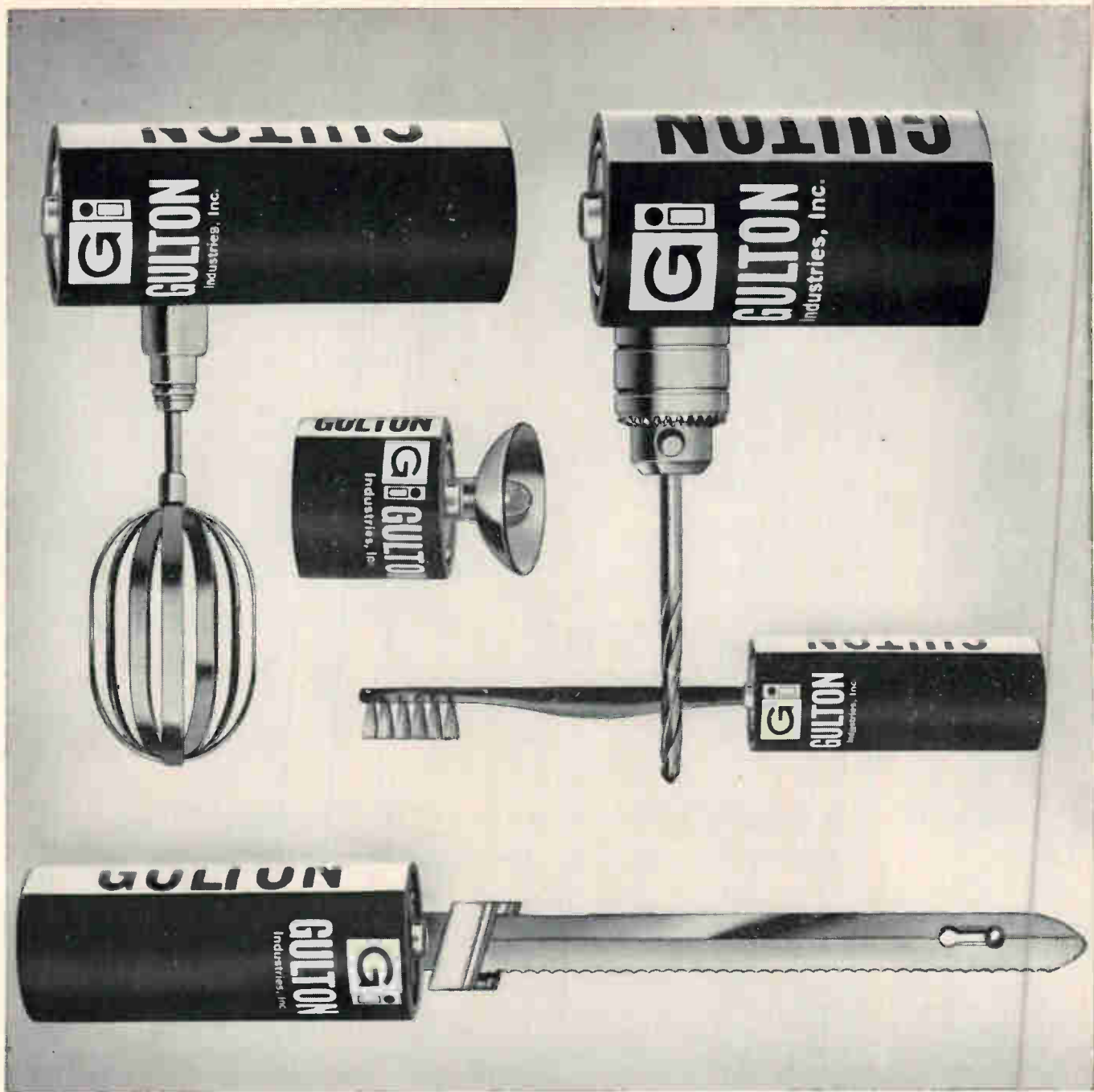

## GULTON'S In-know-vation puts cell in portability

GULTON rechargeable batteries put more than power in portability. They add dependability. And the complete line of shapes and capacities provides freedom that sales minded designs require. If stock-size GULTON batteries won't do it, use our complete custom-engineering service to develop special ones. Either way, start out by discussing your present and future portable products with a GULTON field engineer. Call or write:



**GULTON INDUSTRIES, INC.**

Battery Division, Dept. E-8, Metuchen, New Jersey 08840 (201) 548-2800

At The WESCON Show, August 22 thru 27, Visit our Booths 1436 & 1437.



Manufacturers of: Micro-Miniature Components · Ceramics · Electronic Systems · Instrumentation · Power Supplies · Industrial & Consumer Products.





## **Years from now, people can still watch Surveyor's scan of the moon's surface**

... thanks to Memorex precision magnetic tapes. When Surveyor relayed its famous closeup photographs of the moon's surface, Memorex tapes at JPL's Goldstone tracking station were busy recording these signals. All told, some 90% of the video and instrumentation tapes used in the Surveyor Program were Memorex. Now used to evaluate the mission, these tapes form a permanent record for future study.

Why was Memorex chosen? Simple. Space officials needed a tape that was rugged and reliable, and stood virtually no chance of missing any data. The logical choice was Memorex. Because of advanced design, careful manufacturing and uncompromising inspection and certification, Memorex tapes consistently outperform all others, reel after reel, year after year.

To find out what Memorex can do for you, call at one of our sales and service offices in this country and abroad, or contact us directly. We guarantee your satisfaction.

**MEMOREX**  
PRECISION MAGNETIC TAPE

Memorex Branch Offices in Boston, New York, Philadelphia, Washington, Atlanta, Orlando, Dayton, Chicago, Detroit, St. Louis, Dallas, Denver, Los Angeles, San Francisco, Honolulu. Offices and Affiliates in London, Cologne, and Paris. Distributors in Japan, Canada, India, Australia, and New Zealand.

Circle 69 on reader service card

**Why do the world's leading electronic firms come to HULL?**

**For superior systems to encapsulate electronic components,\* small or large ... that's why**

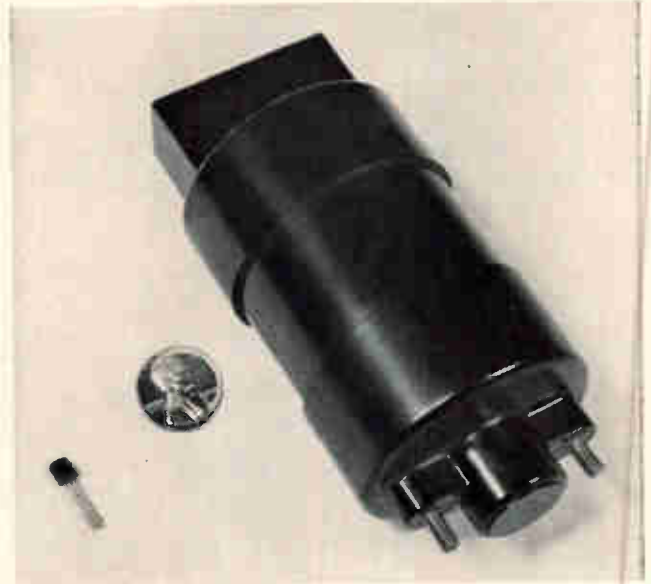

**Here's "The HULL Story" in brief:** There's more to it than simply building better machines. "The HULL Story" of superiority in encapsulation starts back in 1956. We got our feet wet helping Western Electric package their varistors in the then new "short-cure" resins. The resultant process proved ideal.

The decade that followed saw rapid developments in new electronic components and circuits. These required new methods and materials of encapsulation. More for love than money, at first, we worked in strict confidence with many electronic companies . . . helping them solve their encapsulation problems, and learning with them.

Today, several hundred installations later, we're proud to claim unques-



This 25-ton 359D packaged system includes molds, loading frames, and controls for economical, direct encapsulation by transfer molding.

tioned leadership in the field of encapsulation, offering a *complete system capability*. Our list of customers reads like a "Who's Who" in electronics: Texas Instruments, General Electric, IBM, Motorola, Philips, Fairchild Semiconductor—to name a few.

**You can easily gain the benefits of Hull's techniques**

Essentially, there are three major steps in the solution of your specific encapsulation problem:

1. We conduct a feasibility study—even while your product is still at the bread-board stage. Details of lead wires, coatings, welding, soldering, etc, are included.
2. Your component is produced in our laboratory. Molding compounds and machine requirements are determined. You get samples to test, and a full report on the development work.
3. If you're satisfied, we propose a *packaged system*—complete with machine, molds, and all accessories—to meet your production needs, present and future. This may be a smaller system (say, 12- or 25-ton size) for lower-volume production; or a larger system (50, 75, 100 and 150 tons) for high-volume production.

There's no better way to adopt this rapid, precise, economical, and modern technique for packaging your electronic component or circuit. Why not contact us today to get started? (Circle 453 on reader service card.)

\*Such as transistors, integrated circuits, capacitors, resistors, modules, transformers, and coils.

**Encapsulation by transfer molding ...**

means pushing a molten thermosetting plastic, such as an epoxy or silicone, through channels into the mold where encapsulation takes place. The process is fast ... at most a few minutes. It can match practically any production rate you want and provides a precise, dense, void-free covering over even the most delicate component.

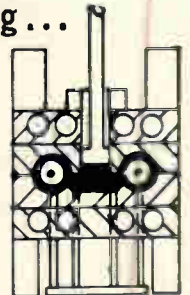

**Other Hull systems for quality electronic production**

- Precision, high-volume molding systems for thermoset plastic parts (Circle 454 on reader service card.)
- Systems utilizing vacuum technology . . . for impregnating, upgrading, drying, heat treating, potting, etc. (Circle 455 on reader service card.)
- Continuous proportioning, mixing, and dispensing ("Blendmaster") Systems. (Circle 456 on reader service card.)

Visit us at WESCON, Booth 648

See a 50-ton encapsulation system in operation; also a vacuum potter and the "Blendmaster".

**HULL CORPORATION**

6035 Davisville Rd., Hatboro, Pa. 19040  
Telephone: (215) 675-5000  
Export: 1505 Race St., Phila., Pa. 19102





# Mix these signal, power and coax leads in any combination.

Burndy Trim Trio Connectors—available in many shapes—accept three contact styles, all crimp-removable, for signal and power leads #16 thru #24, twisted pair #24 and #26, and subminiature coaxial cables.

Changing conductors is fast and simple, whether for lower voltage drop or better shielding or mechanical reasons. This makes Trim Trio Connectors ideal for breadboard and prototype work as well as

production. For large production runs you can take advantage of the economies offered by the automatic Burndy Hyfematic™ with a crimp rate of up to 3000 contacts per hour.

Get more details on how you can take advantage of the Burndy Trim Trio System—THE ACCEPTED METHOD OF INTERMIXING CONTACTS.

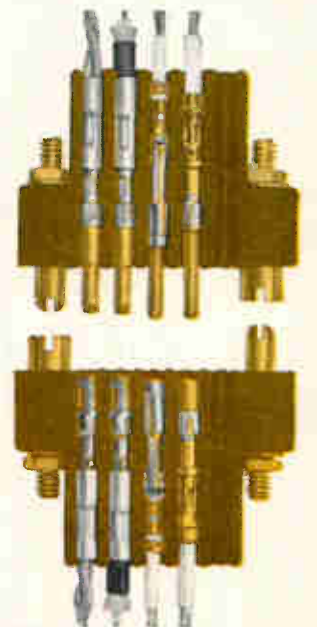

INTERNATIONAL SALES HEADQUARTERS AND MANUFACTURING FACILITIES:

CANADA: Scarborough, Ontario / ENGLAND: St. Helens, Lancs. / BELGIUM: Mechelen / MEXICO: Naucalpan de Juarez / BRAZIL: Sao Paulo / JAPAN: Tokyo / Sales Offices in Other Major Cities

See more at Wescon Booths 1749-51

# All new analog recording system

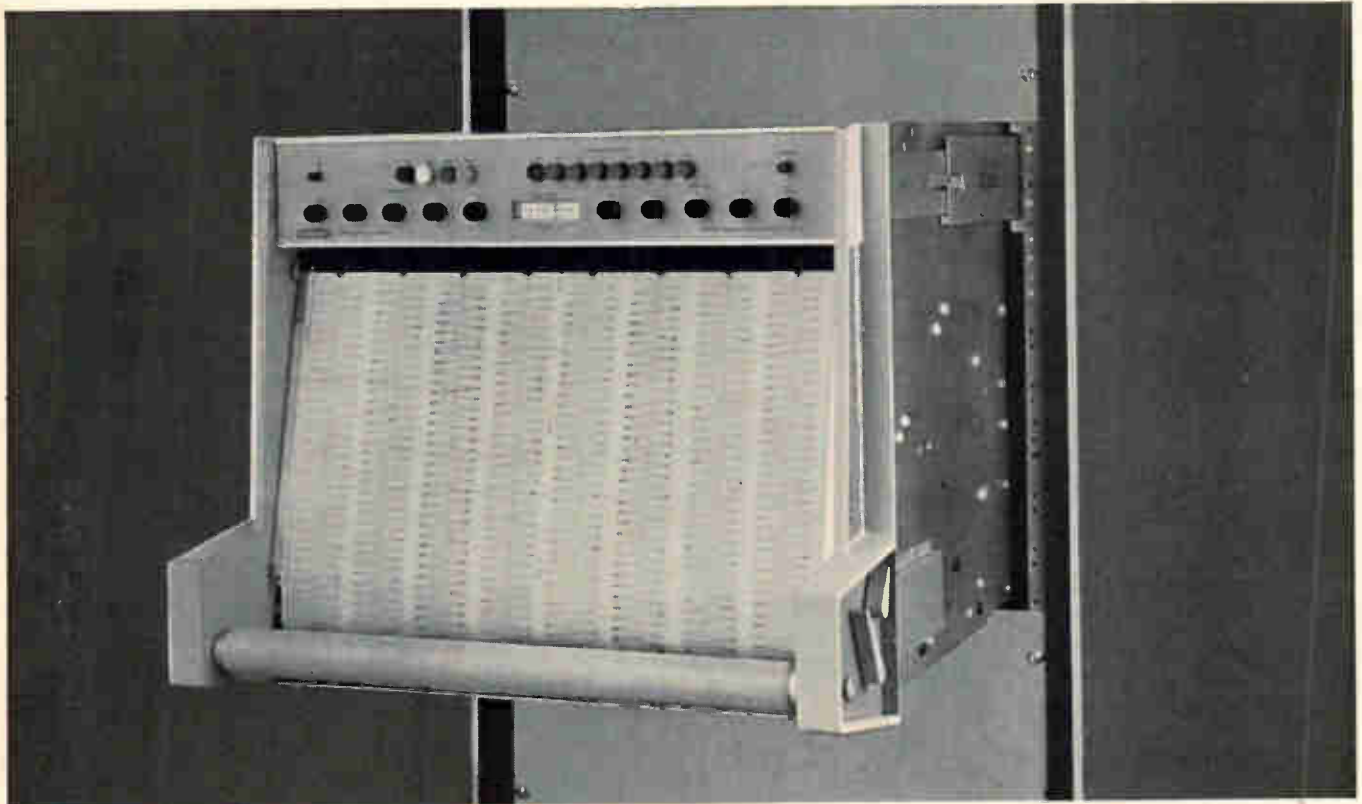

## Compare the unequalled Type R-2000 Dynograph® Recorder for:

- *Highest Frequency Response*—85 Hz full scale, 40 mm.
- *Rapid Rise Time*—Less than 3.5 ms.
- *A Complete Recording System*—Including amplifiers, power supply, writer units and paper drive.
- *A New Compact Size*—Only 15¾ inches of vertical panel space.
- *Unequalled Writing Quality*—High contrast, continuous uniform tracings.
- *All Silicon Solid-State Design*—For greater operating temperature range.

Beckman's totally new R-2000 Dynograph Recorder is a self-contained, multi-channel system delivering accurate thermal rectilinear write-out of input data. This versatile direct-writing oscillograph features new high torque writer units with a new heat stylus and positive stylus locking

cradle. Suitable, in its basic system configuration, for applications such as telemetry and analog computer read-out, the R-2000 affords even greater versatility with the addition of accessory amplifiers and input couplers to accommodate input signal conditioning for virtually all analog recording requirements. And the system will mount in any standard 19-inch rack enclosure. For complete information, contact your Beckman Dynograph recorder representative, or write direct.



INSTRUMENTS, INC.

ELECTRONIC INSTRUMENTS DIVISION  
SCHILLER PARK, ILLINOIS • 60176

INTERNATIONAL SUBSIDIARIES:  
GENEVA; MUNICH; GLENROTHES, SCOTLAND; TOKYO; PARIS; CAPE TOWN; LONDON; MEXICO CITY

# An oscilloscope picture in 10 seconds: any longer is a waste of time.

Polaroid Land films don't make you wait to see if your trace zigged when it should have zagged.

They let you know in ten seconds.

They give you an oscilloscope picture you can study, attach to a report, send as a test record with a product shipment, or file for future reference.

You have a choice of 5 films for oscilloscope recording.

The standard film has an A.S.A.

equivalent rating of 3000. It comes in both roll film [Type 47] and pack film [Type 107]. They both give you 8 pictures  $3\frac{1}{4} \times 4\frac{1}{4}$  inches. This emulsion is also available in 4 x 5 sheets [Type 57].

For extremely high-speed recording, there's Polaroid PolaScope Land film [a roll film, Type 410]. It has an A.S.A. equivalent rating of 10,000.

It can take pictures of traces too fleeting for the human eye: such as a scintillation pulse with a rise time of less than 3 nanoseconds.

One thing all these films have in common is a sharp, high-contrast image that's easy to read. Because the films are so sensitive, you can use small camera apertures and low-intensity settings.

To put these films to work on your scope, you need a camera that will take a Polaroid Land Camera Back.

Most oscilloscope camera manufacturers have one. For instance: Analab, Beattie-Coleman, BNK Associates, Fairchild, EG&G, General Atronics, Hewlett-Packard, and Tektronix.

You can get complete information by writing to Polaroid Corporation, Technical Sales Department, Cambridge, Massachusetts 02139, or by writing to one of the manufacturers mentioned above.

It will probably take a little longer than 10 seconds, but we promise the information won't be a waste of time.

"Polaroid" and "PolaScope"®

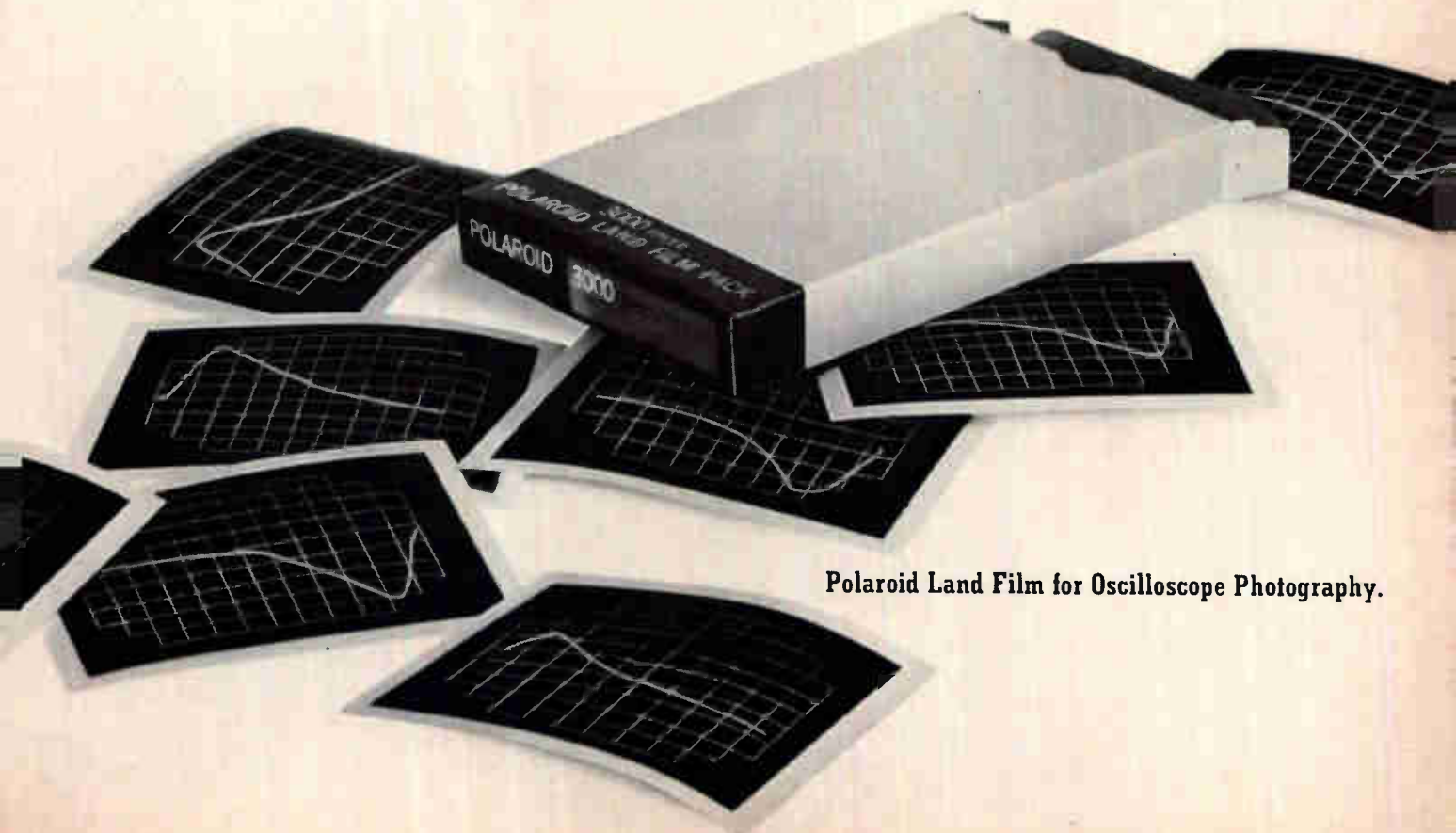

Polaroid Land Film for Oscilloscope Photography.

# Only Norden delivers monolithic integrated circuit chips with dielectric isolation of active elements on a routine production basis.

Norden's *Glastrate* isolation process shields each active element on a monolithic chip from other elements of the circuit. The *Glastrate* layer gives radiation hardening, improved performance and higher reliability by inhibiting parasitic electrical currents.

Through successive oxidation, etching, reoxidation, epitaxial growth and removal of excess silicon, Norden isolates each active area on a silicon wafer within its own *Glastrate* cocoon. Then NPN, PNP or field effect transistors are developed in the isolated regions by the usual diffusion processes.

If you need integrated circuits with improved radiation hardening, higher electrical performance and greater reliability, write Dept. E, Norden Division, United Aircraft Corp., Norwalk, Conn. 06856, or call (203) 838-4471.

*Because of its growing role in the microcircuitry field, Norden has many openings for qualified solid state engineers and technicians. Send your resume to Personnel Department, Norden, an equal opportunity employer, M&F.*

**Norden** DIVISION OF UNITED AIRCRAFT CORPORATION  
NORWALK, CONNECTICUT



See us at Booths 1130-1132, Sports Arena, WESCON  
August 23-26.

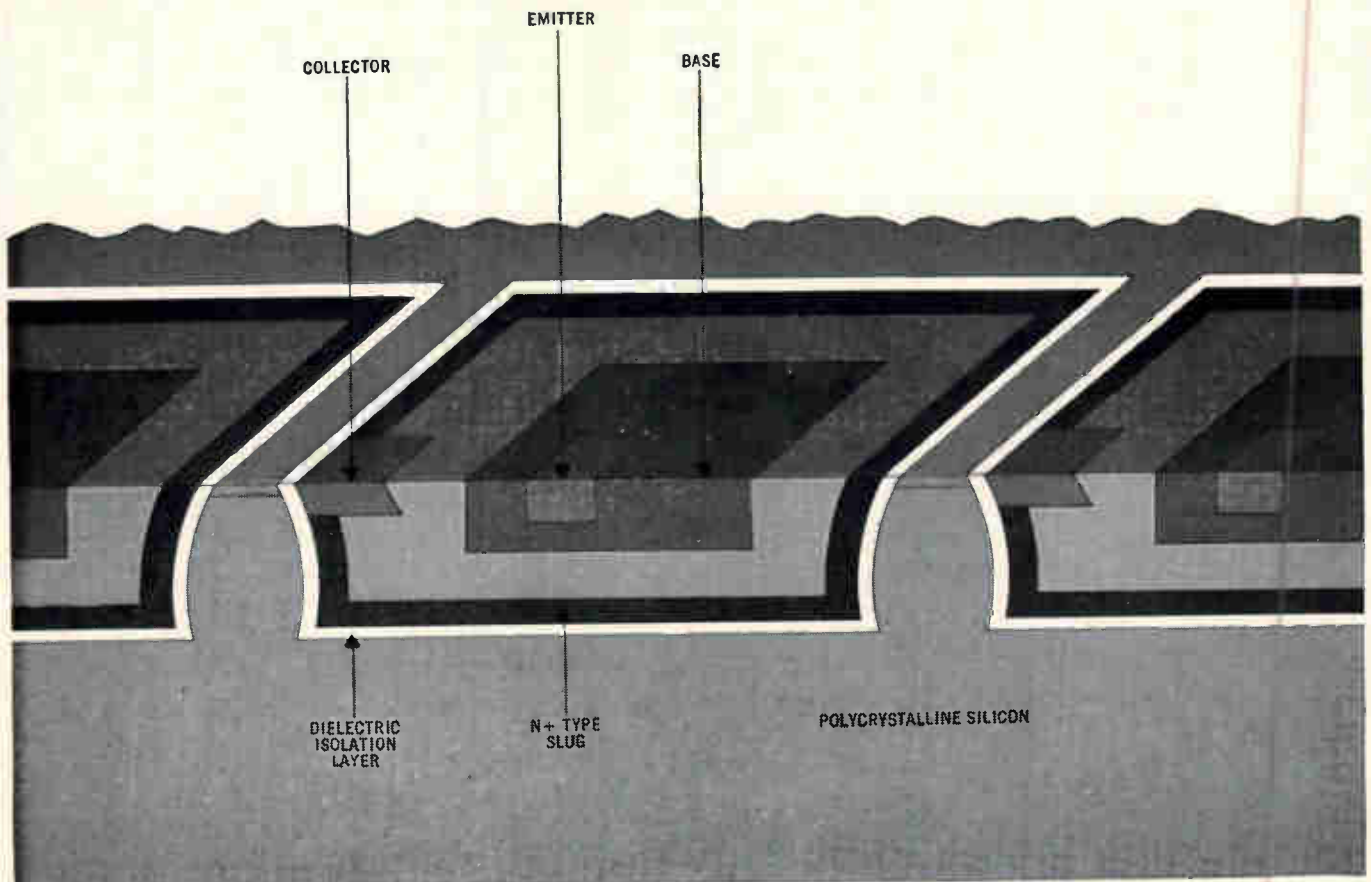

Norden — supplier to the Minuteman • Polaris • Apollo • Saturn • LEM • F-111 • C-5A • IHAS • B-58.



## And Now, the \$10,000 Computer

**PDP-8/S: A new high speed general purpose digital computer. Modular construction for repackaging. Field proven reliability. 4,096 word core memory. Microsecond speeds. Complete software including FORTRAN. Flexible input/output bus. Deliverable 90 days ARO. Teletype included.**

The single unit price for the PDP-8/S is \$10,000, and there are liberal OEM discounts for multiple units.

Designed to be used in instruments or systems, the PDP-8/S can be rack mounted or repackaged.

The new PDP-8/S is a close relation of DIGITAL's PDP-8, the most successful on-line, real time computer in the history of the scientific community. At a base price of \$18,000, more than 500 PDP-8 systems have been sold. Its success results from a design concept that makes it the most flexible, versatile, adaptable digital computer ever made.

The PDP-8/S uses the same programs, the same instructions, the same operations, and the same basic design as the parent PDP-8. It has the same size memory, is equally expandable, and indeed, uses the same line of modules and components.

But the PDP-8/S is a bit slower. It takes 32 microseconds to add. For process control and analysis, you probably won't even notice.

But you'll notice the price.

**digital**  
COMPUTERS · MODULES

# Nobody but AE makes a Class E relay with all these terminals.

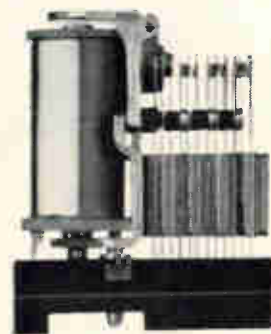

## Take your pick:

**1** *Solderless Wrap Terminals* eliminate the hazards of soldering. No splashes, heat or clippings. Faster, easier connections. And the technique is easy to learn.

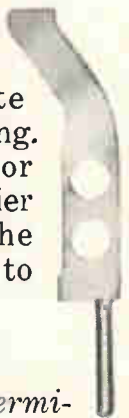

**2** *Taper Tab Terminals* accept solderless, slip-on connections which are crimped to each wire lead. Easy to connect or disconnect. Simplify circuit changes and relay substitutions.



**3** *Solder Terminals*—the conventional way. For chassis and rack mounting where quick-connect methods aren't needed.



**4** *Printed Circuit Terminals* can be inserted directly into PC cards or boards. All terminals are soldered at one time by "flowing." This process can be automated.

You can get AE Class E relay with several types of plug-in sockets, too—that further in-

crease the number of mounting options.

But don't select the Class E relay because of wiring convenience alone. This is a miniaturized version of the premium-quality Class B—with most of its best features. Perfect contact reliability exceeding 200 million operations is common. That's why, even with ordinary solder terminals, the Class E is the most popular *quality* relay of its size!

For helpful information on the full line, ask for Circular 1942. Just write the Director, Relay Control Equipment Sales, Automatic Electric Company, Northlake, Illinois 60164.

COME  
SEE US AT  
WESCON BOOTHS  
1501-1502  
SPORTS ARENA

**AUTOMATIC ELECTRIC**  
SUBSIDIARY OF  
GENERAL TELEPHONE & ELECTRONICS **GTE**



**TRW**  
*Varicap*  
**DIODES  
STRETCH  
YOUR  
TUNING  
RANGE**

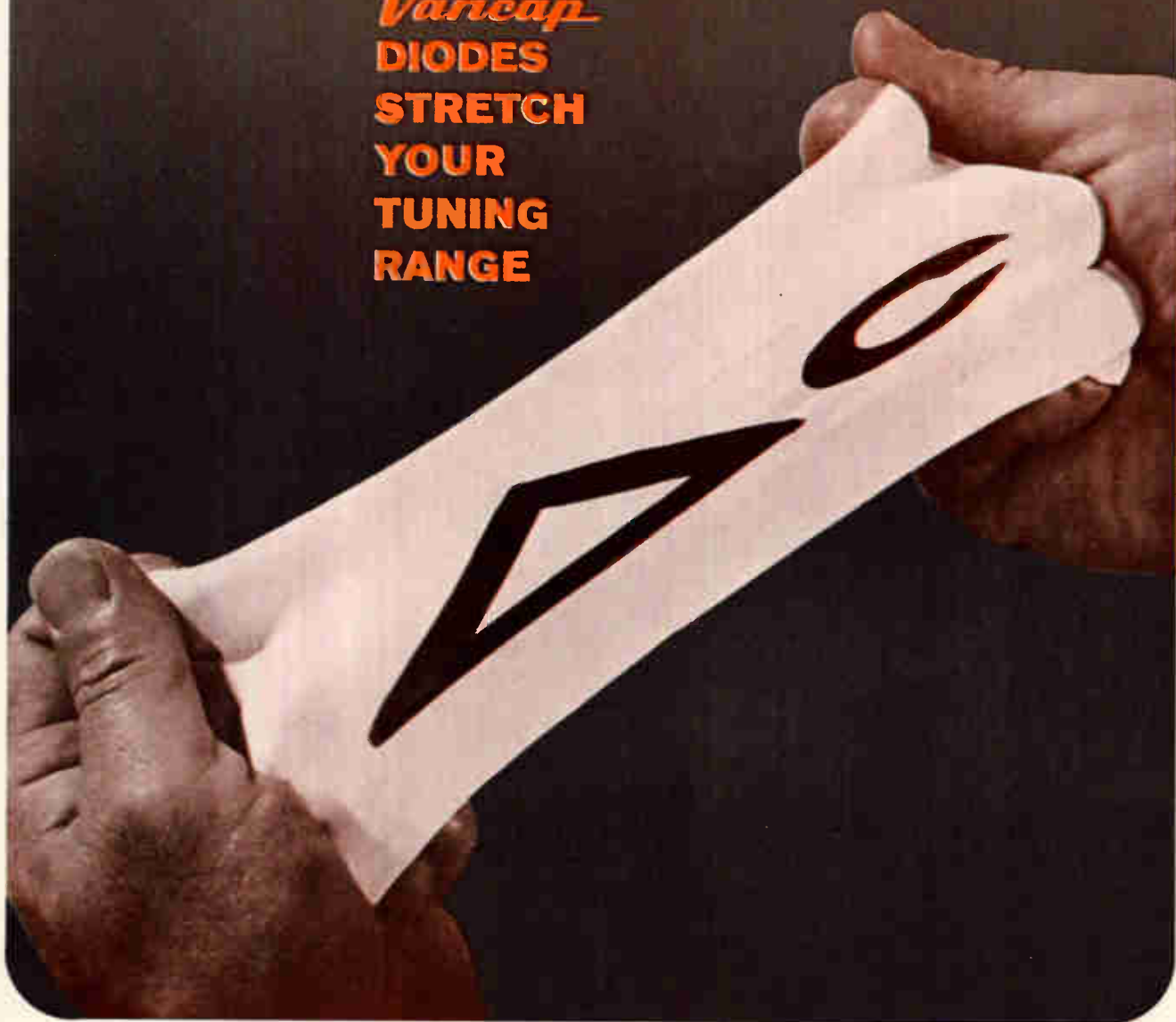

**...up to 20% greater  $\Delta c!$**

You have a lot of things working for you when you design your tuning system around TRW Varicap diodes. First of all, your circuit will provide controlled tuning range to spare—in many cases you can eliminate additional band switching.

Circuitry is simplified and fewer components are required. Varicap-controlled tuning systems assure the performance characteristics required in the most sensitive communications and monitoring networks.

TRW Varicap diodes are true abrupt junction devices, pro-

duced by proprietary processes. This construction gives the designer maximum capacitance change with voltage; optimum uniformity and tracking and superior performance under all operating conditions.

Varicap Bulletin No. 101 discusses wide-range theory in detail. Get a copy from your authorized distributor or write TRW Semiconductors Inc., 14520 Aviation Boulevard, Lawndale, California (213) 679-4561.

Varicap is the trademark of silicon voltage-variable capacitors manufactured by TRW Semiconductors Inc.

**TRW SEMICONDUCTORS**

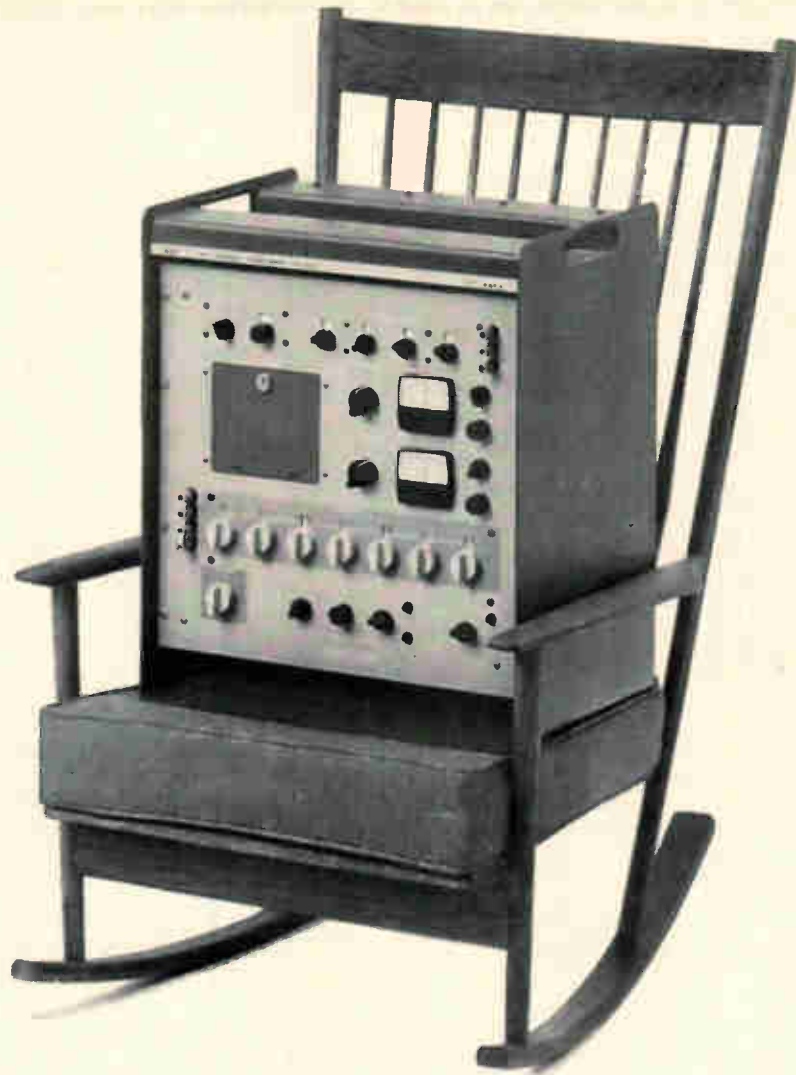

# Voltmother

**This self-calibrating system can tend your entire brood of dc voltage sources and measuring devices—with 5 ppm accuracy.**

Our new 1045A DC Voltage Measuring System is designed to serve as your final authority on voltages ranging from above 1100 volts down to less than a volt. This range used to require two or more separate instruments.

The system's accuracy—5 ppm with 7 place resolution—is the best you can get. For all this range and accuracy, you don't have to be a fuss-budget with the 1045A. Even a fledgling technician can fly with six-place accuracy.

No external calibration is required to verify the system's accuracy. It functions as a voltage comparator, comparing voltages to saturated reference standard cells. As an added safeguard, the voltage of the standard cells is continuously monitored during the measurement.

Think of the many voltage devices used in your plant or lab that you rely on for consistently accurate readings: decade power supplies, potentiometric and digital volt-

meters, X-Y Recorders, pH meters, thermocouples, electrometers, reference voltage power supplies...

If the behavior of any of these instruments is open to question, consider how they might respond to the discipline of a good Voltmother. ESI, 13900 NW Science Park Drive, Portland, Oregon (97229).

The ESI 1045A Voltage Measuring System combines a direct-reading potentiometer, direct-reading standard cell comparator, and guarded voltbox. Price: \$4,200					
	1000V	100V	10V	1V	0.1V
Limit of Error at Specified Voltages (in ppm)	11.7	4.1	3.6	4.6	21
Probable Error* (in ppm)	2.6	0.9	0.8	1.0	4.7

\*At least one-half of all measurements will be more accurate than the probable error.

Electro Scientific Industries **esi**

See ESI at WESCON—Hollywood Park Booth Numbers 401 - 402 - 403 and 404

# off-the-shelf-delivery!

## GENERAL INSTRUMENT'S

## MEM 3050 MOS MONOLITHIC

## DYNAMIC DUAL 25-BIT

## SHIFT REGISTER

featuring:

- LOW POWER DISSIPATION - TYPICALLY 10 TO 20 mW TOTAL
- OPERATING FREQUENCY - 10 kHz TO 500 kHz
- HIGH NOISE IMMUNITY - TYPICALLY 3V
- OPERATING TEMPERATURE - 55° C to -85° C
- AVAILABLE IN LOW PROFILE 10 LEAD TO-74 OR 14 LEAD FLATPAK.
- \$55.80 EACH IN QUANTITIES OF 100 UP
- NOW AVAILABLE FROM YOUR AUTHORIZED GENERAL INSTRUMENT DISTRIBUTOR



**FOREMOST**  
in SEMICONDUCTORS

Write for free Data Pak on the MEM 3050 and the complete line of GENERAL INSTRUMENT Monolithic MOS devices.

**GENERAL INSTRUMENT CORPORATION**  
600 West John Street, Hicksville, N. Y.

# Why do so many buyers come to CEC for "traceable" tape?

When the new CEC Magnetic Tape was introduced, we expected it would start a revolution. And *that* it did. For this tape, created and produced for CEC by Eastman Kodak, has eliminated virtually every tape problem in data recording.

## The key is traceability

All CEC tape is *numbered* — color-coded on the box, reel; even digitally numbered on the back of the tape itself for instant identification.

For example, on every 15 inches of tape there appears an internal Kodak reference number which immediately identifies the tape by type; and every 30 inches there is a numbered tape signature which provides an index to the coating and test records for that particular production block. So efficient is this coding method, it is possible to trace any roll of tape all the way back to the master web from which it came.

As a result, reel mixups and misplaced data have become problems of the past.

## A tape for every recorder

CEC tapes are divided into *four* specific categories. Collectively, they meet the most advanced requirements of *every* data recorder. Yet each tape records at the highest applicable resolution and sensitivity—with the greatest uniformity and lowest tape and head wear obtainable today.



# Because only CEC has it.

## Now add these other advantages:

- Only CEC tapes provide a standard nomenclature for simplified identification and ordering: S-1 standard, 100 KHz; SX-1 standard extended, 300 KHz; M-1 medium band, 600 KHz; W-1 wide band, 1.5 MHz.
- Only CEC tapes are so precisely differentiated that users are no longer subjected to the time-consuming burden of performance evaluation.
- Only CEC tapes come shielded in metal containers—packed in cardboard filing boxes covered with protective plastic sleeves.
- Only CEC tapes are protected from shipping and storage damage by means of a plastic waffle hub, thus preventing tape serration and flange deformation.

Yet, with all these exclusive benefits, CEC Instrumentation Tape costs *no more* than the conventional tape you may still be using.

Write now for your free CEC INSTRUMENTATION TAPE CHART. This special chart lists CEC tape categories, applications, and models of recorders for which each tape is recommended. Ask for CEC Chart DM-47-X1.

# CEC

Data Instruments Division

## CONSOLIDATED ELECTRODYNAMICS

A SUBSIDIARY OF BELL & HOWELL/PASADENA, CALIF. 91109  
INTERNATIONAL SUBSIDIARIES: WOKING, SURREY, ENGLAND  
AND FRIEDBERG (HESSSEN), W. GERMANY

# Amperex



## now available

*Three families of silicon planar epitaxial LID transistors  
are now available for immediate delivery in production quantities*

### **HIGH SPEED SWITCHES**

**LDS 200**

**LDS 201**

*functionally replace the following types:*

2N706	2N744	2N914
2N708	2N834	2N2368
2N743	2N835	2N2369

### **HIGH GAIN, LOW LEVEL AMPLIFIERS**

**LDA 400**

**LDA 401**

*functionally replace the following types:*

2N929	2N2483
2N930	2N2484

### **GENERAL PURPOSE AMPLIFIERS**

**LDA 402**

**LDA 403**

*functionally replace general-purpose amplifiers  
operating from 1 to 100 ma, such as:*

2N696	2N2218
2N697	2N2219
2N1613	2N3390
2N3391	



#### **NEW MICROELECTRONIC PACKAGE FOR SEMICONDUCTORS PERMITS MECHANIZED PRODUCTION OF HYBRID INTEGRATED CIRCUITS**

When Amperex LIDS were introduced at the I.E.E.E. Show, designers of hybrid film circuits were unanimous in their recognition of the LID as the ideal semiconductor package for the new technology.

The Amperex LID (leadless inverted device) is an all-ceramic package, smaller (0.075" x 0.045" x 0.032") and less costly than any existing metal package. It permits the manufacturer to reduce costs by reducing the substrate size.

Because the LID has no external leads, wire-bonding machinery and the skilled labor to operate it are no longer needed, handling is simpler and production yields of integrated circuits will be higher.

In place of delicate wire leads, LIDS have four contact legs with metallized solderable surfaces. This construction permits the LIDS to be positioned on the substrate by automatic jigs, without the need for micro-optics for orientation.

Any number of LIDS can be mounted simultaneously for true mass production. LIDS are bonded to the substrate by low-temperature soldering, which, unlike the usual high temperature techniques does not alter the transistor characteristics.

Unlike chips, LIDS can be characterized and pre-selected for critical circuits; can be color-coded and identified for easy and efficient production.

To learn more about the immediately available LIDS listed above, and other transistors and diodes coming soon in the LID

package, write: Amperex Electronic Corporation, Semiconductor and Receiving Tube Division, Dept. 371, Slatersville, R. I. 02876.

*LID (about 15 times magnification) showing  
chip placement before epoxy coating.*

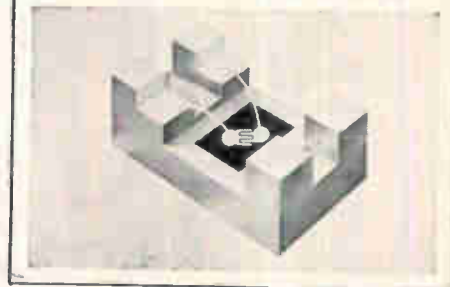

## **Amperex**<sup>®</sup>

# 3

## Tektronix Portable Oscilloscopes

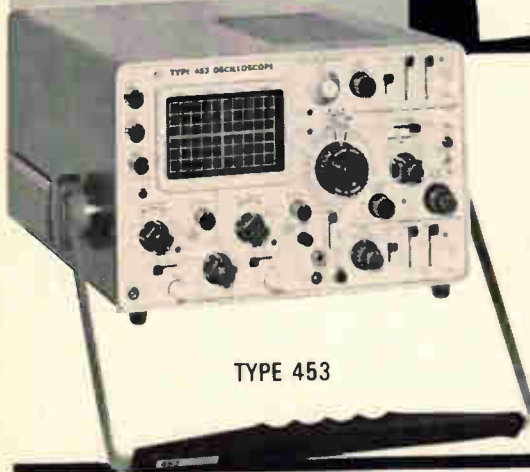

TYPE 453



TYPE 422

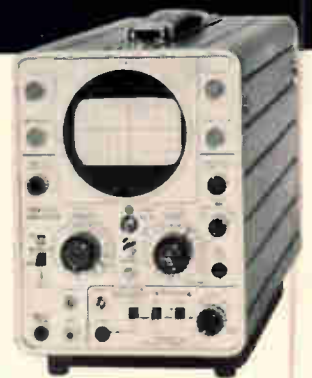

TYPE 321A

CHOOSE ONE  
FOR YOUR OWN MEASUREMENT REQUIREMENTS

	<input type="checkbox"/> TYPE 453	<input type="checkbox"/> TYPE 422	<input type="checkbox"/> TYPE 321A
Bandwidth	DC-50 MHz	DC-15 MHz	DC-6 MHz
Deflection Factor	5 mV/div to 10 V/div	10 mV/div to 20 V/div	10 mV/div to 20 V/div
Channels	Dual	Dual	Single
Delay Line	Yes	Yes	No
Sweep Delay	Yes	No	No
Size	Height	7 $\frac{1}{4}$	8 $\frac{1}{4}$
	Width	12 $\frac{1}{2}$	10
	Depth	20 $\frac{1}{2}$	14
Weight (pounds)	28 $\frac{3}{4}$	22	14
Power Requirements	AC: 96-137 V or 192-274 V; 45-440 Hz; approx 100 watts.	AC: 115 V or 230 V $\pm$ 10%; 45-440 Hz; approx. 40 watts. DC: 11.5-35 V; approx. 23 watts; accepts Tektronix 24 V battery pack.	AC: 115 V or 230 V $\pm$ 10%; 45-800 Hz; approx. 20 watts. DC: 11.5-35 V; or 10 size D batteries; approx. 700 mA
Rack Mount Available	Yes (7" Rack Height)	Yes (7" Rack Height)	No
Probes and Accessories Included	Yes	Yes	Yes
Price	\$2050	\$1400 (AC Model) *\$1750 (AC/DC Model)	*\$900

U.S. Sales Prices f.o.b.  
Beaverton, Oregon

\*without batteries

A TEKTRONIX PORTABLE will fit your specific requirements. Your Tektronix field engineer will be happy to demonstrate any of these oscilloscopes at your location. Just call him, or write Tektronix, Inc., P. O. Box 500, Beaverton, Oregon 97005.

**Tektronix, Inc.**

SEE THE LATEST TEKTRONIX INSTRUMENTS AT WESCON — BOOTH 428-433

# SCIENCE/SCOPE

Among its many other space "firsts", the Surveyor 1 spacecraft: proved out a terminal descent system very similar to that of the Apollo/LEM...recorded telemetry data on 140 channels during its descent that will now make possible more accurate earth-based simulation tests for other lunar-landing spacecraft ....sent back man's first detailed information on the surface bearing strength of another celestial body (it's sufficient to support a man)...carried out more complex commands than any other NASA lunar or planetary spacecraft.... used multiple- and variable-thrust vernier engines for automatic attitude and acceleration control....solved a major mystery about lunar radar reflectivity ....demonstrated in space, for the first time, proper radar microwave operation through the highly expanded propulsion exhausts of both the main retro and the vernier engines (a measurement impossible to run on earth and hence an unknown of great concern to the Surveyor and LEM programs).

Lowest bidder on NADGE (NATO Air Defense Ground Environment) was an international consortium headed by Hughes Aircraft Company. Members of the International Planning Group (Belgium, Luxembourg, The Netherlands, West Germany) have already purchased Hughes' systems that will link up with the \$280 million NADGE system. During recent months Hughes' tactical air weapons control systems have also been purchased by Japan and Switzerland.

A new "multiple access" communications concept was disclosed during the recent inauguration of Hughes' synchronous communications satellite research station at Caddo Gap, Ark. New concept, developed jointly by Hughes and the Nippon Electric Company of Tokyo, is called STAR (for Satellite Telecommunications with Automatic Routing). It will enable any earth station in view of a satellite to talk to any other station at random. The STAR concept will be thoroughly tested at the new Arkansas research station, which is a prototype for a simplified, low-cost ground station that can enable many nations to join a worldwide communications network.

The new SAM-D division of Hughes Aircraft Company was organized to intensify company's efforts on development of a mobile, surface-to-air missile system for the U.S. Army. Heading an industry team of Douglas and FMC, Hughes has won contracts for the feasibility-study and component-verification phases of the SAM-D program and is now competing for the contract definition phase.

The Surveyor program for JPL and NASA is an example of 553 projects at Hughes. We invite engineers and scientists who'd like to join us to write D.A. Bowdoin, Hughes Aircraft Co., Culver City, Calif. An equal opportunity employer.

THETA Communications Corporation (THETA-COM), a new jointly-owned subsidiary between the Hughes Aircraft Company and TelePrompTer Corporation, will develop and distribute electronic communications products and services. Experimental tests of a "short haul" microwave transmission technique to transport television signals in the 18,000 megacycle frequency range are now being conducted. In a separate transaction, Hughes has acquired an interest in TelePrompTer's New York City community antenna television property.

Creating a new world with electronics

**HUGHES**

HUGHES AIRCRAFT COMPANY

# Air variables from JFD solve your high Q high frequency problems

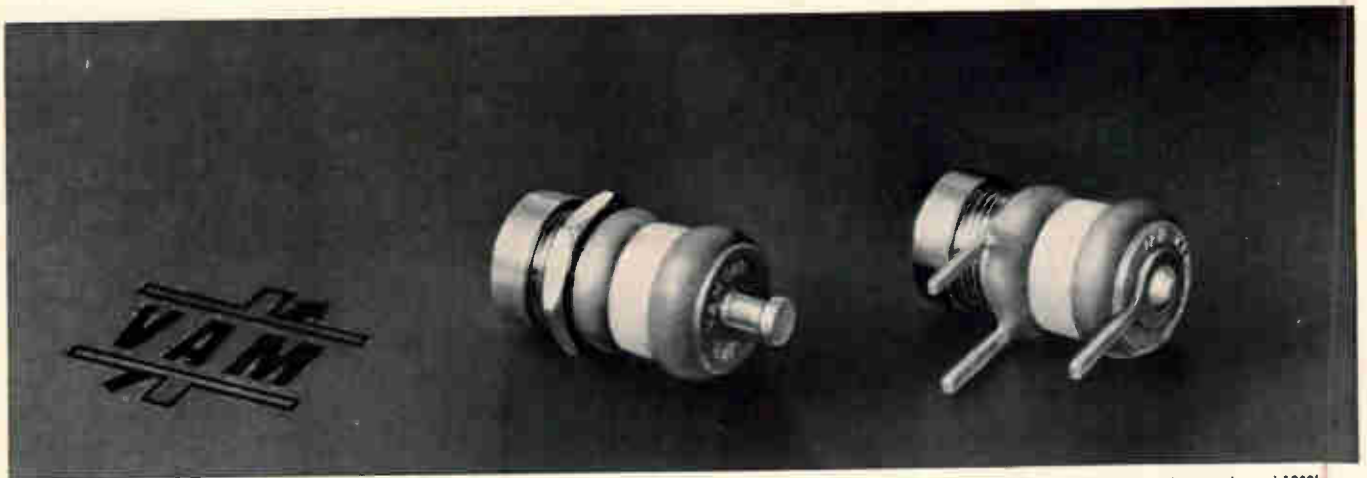

Capacitors shown enlarged 120%.

These new JFD air variable capacitors are specially designed for high frequency applications that demand ultra stability, small size and high Q—greater than 2000 measured at 10 pf and 100 MC. These rugged, miniature units are offered in both printed circuit (VAM 010W) and panel mounting (VAM 010) models

with capacitance ranges from 0.8 through 10.0 pf measured at 1 MC.

These units which measure less than 1/2" in length are completely interchangeable with competitive devices.

Internal air meshing shells are silver plated to provide good surface conductivity and to prevent corro-

sive effects. Internal contact springs assure positive electrical contact of rotor at all times. Leads on printed circuit model are tinned for ease in soldering . . . and these units are engineered to resist heat, won't come apart during soldering.

Bulletin VAM-65 gives more details. Write for your copy today.

**JFD**

"TODAY'S COMPONENTS BUILT FOR TOMORROW'S CHALLENGES"

JFD ELECTRONICS CO. / COMPONENTS DIVISION • 15th Avenue at 62nd Street • Brooklyn, New York 11219 / Phone 212-331-1000  
Sales Offices — Arcadia, California / Chicago, Illinois / Baltimore, Maryland / Saxonville, Massachusetts / Brooklyn, New York  
New Hartford, New York / Cincinnati, Ohio / Philadelphia, Pennsylvania / Pittsburgh, Pennsylvania / Paris, France / Azor, Israel

Visit us at Wescon, Booth 1418



# HERE IT IS!

The new low-priced DIGITAL VOLTMETER and RATIO METER

- **COMPACT**
- **LIGHTWEIGHT**
- **VERSATILE**
- **ACCURATE**
- **RELIABLE**



developed by COHU ELECTRONICS and designated the model 511

## CHECK THESE ABBREVIATED SPECIFICATIONS:

- 0.01% ACCURACY,  $\pm 1$  DIGIT
- 4 DIGITS RESOLUTION ON ALL RANGES
- AUTOMATIC POLARITY INDICATION
- 10 MANUAL RANGES, 1V TO 1000V, 1:1 TO 1000:1 RATIOS
- HIGH INPUT RESISTANCE
- SOLID-STATE REFERENCE AND CIRCUITRY
- BI-DIRECTIONAL, TRACKING LOGIC
- PRICE: \$995.00 F.O.B. San Diego. Additional export charge

Box 623, San Diego, California 92112 Phone 714-277-6700



for detailed specifications contact your nearest representative

See us at Wescon, Hollywood Park, Booth 111

# Semiconductor Report



NEW PRODUCTS, DESIGNS AND APPLICATIONS FROM MOTOROLA

amp, circuit protection, transistor biasing, digital analog encoding and multiple-step saw tooth and square-wave generation applications.

The MCL1300 series is available at 0.5, 1, 2, 3 and 4 mA current levels in a standard glass package.

Contact your Motorola distributor for an evaluation unit now!

## DESIGN IN HIGH-VOLTAGE DC AT LOW COST!

You get low 1.7V forward voltage drop for low power loss and improved regulation up to 1500 volts in CRT applications, X-ray, transmitting and high voltage power supply equipment, and where severe voltage overloads are encountered with the new MR990-94 HV Surmetic\* rectifier series. High temperature current handling performance—250 mA @ 95°C—and a 15-ampere surge capability offer you "above and beyond" safety factors at high voltages.



**BEAT DISCRETE WITH MIDA\*  
... NOW MORE THAN EVER!**

Prices on these tiny, 1-ampere, transfer-molded, plastic-packaged bridges, voltage doublers and center taps have just been dropped as much as 37%... giving them a bigger-than-ever edge in value over individual rectifiers! Prices now range from only 95¢ to \$2.15 (100-999) ... plus you save 75% and more in mounting time by eliminating hardware heat sinks, (if you've been using stud units) and intercomponent connections. They're only 1/7th the size of a penny, making them ideal for high density component packaging. They give you a choice of round or flat tab leads in 25 to 600 volt reverse blocking capabilities.

Factory-available, production quantities!

Use the reader service card for complete data on these diode-rectifier products or write Motorola Semiconductor Products Inc., Box 955, Phoenix, Arizona 85008.

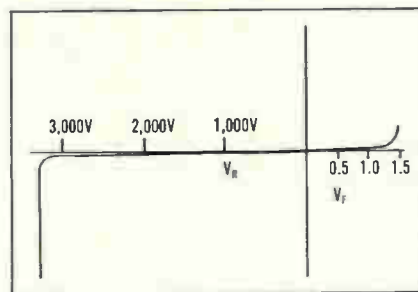

MR990-94 High Voltage Surmetic Rectifiers

You can place these subminiature (DO-7 size) devices right next to high heat-generating elements with no fear of burning, melting or deterioration with time because they're pressure-molded in high-quality, silicone polymer. They shrug off 240-hour Mil-S-750 moisture-cycling tests.

Prices start at only 95¢ (100-up, 1,000-volt). Send for a data sheet today!

## REPLACE MANY OP AMP RESISTORS WITH ONE CURRENT LIMITER...

Now you can substitute a single Motorola MCL1300 series current limiter (field effect current reference diode) for numerous op amp resistors which perform as loads for the collectors of their respective transistors. This unique device acts as a constant current source which can, in many cases, increase the open loop gain by a factor of 100. Additionally, it does not require a high supply voltage.

A typical application using the device as a pre-regulator is shown. You can also use it to stabilize operating points in A and B amplifiers where large supply voltage variations are encountered and in diff

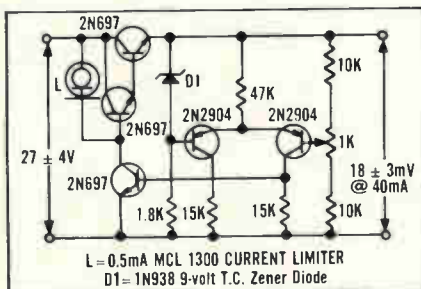

Regulated Power Supply using the current limiter as a pre-regulator

SEE HIGHLIGHTS  
OF **Wescon**  
AT BOOTH  
1301-1304



**MOTOROLA Semiconductors**  
*- where the priceless ingredient is care!*

\*Trademark Motorola Inc.

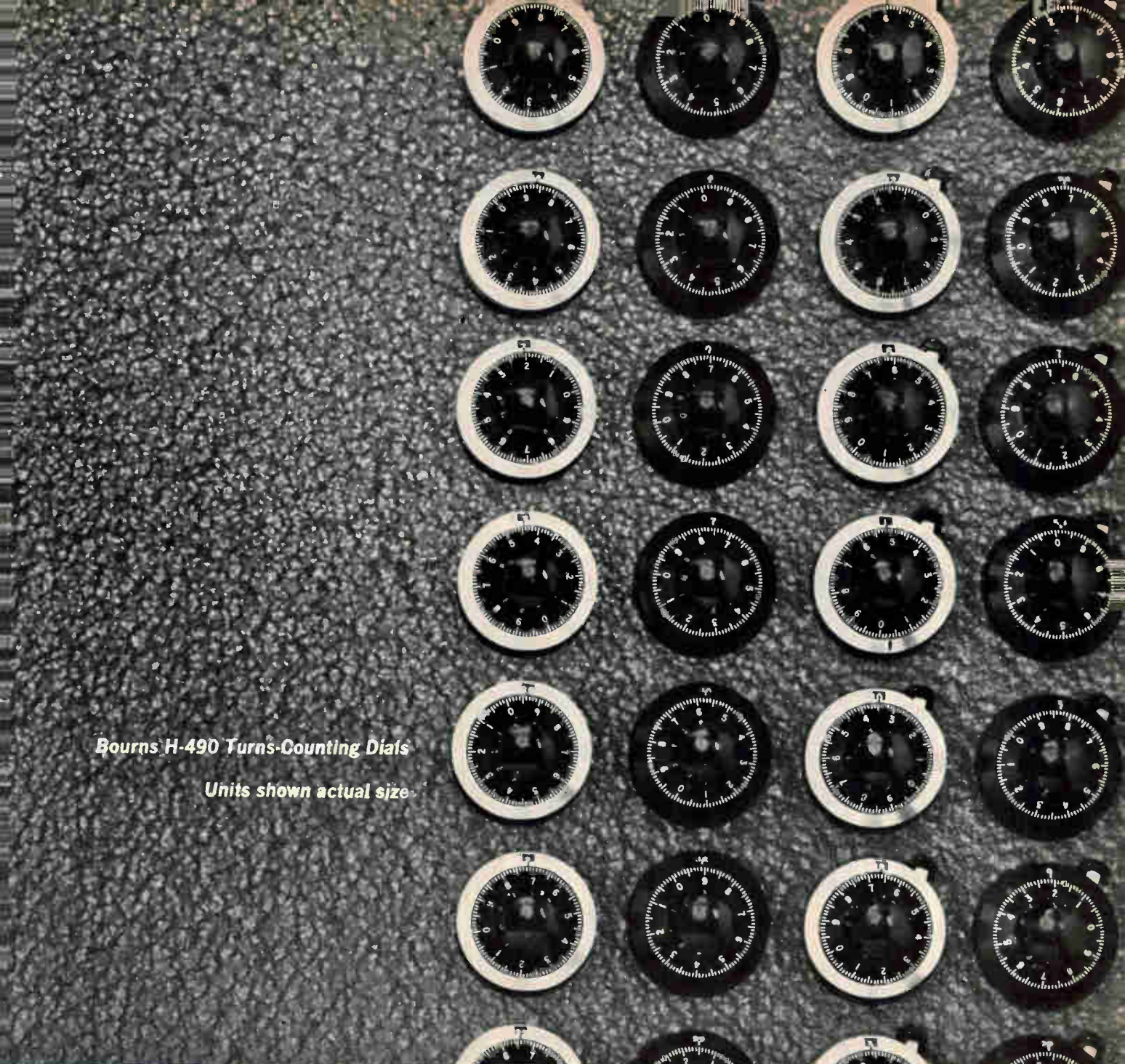

**Bourns H-490 Turns-Counting Dials**

*Units shown actual size*

# Would You Believe \$5.74<sup>\*</sup>?

Yes it is true—for just \$5.74 you can buy the most attractive turns-counting dial in existence—one that will compliment any panel! Priced below any 1" precision turns-counting dial available, the new H-490 offers excellent readability and ease of installation.

You can specify H-490 dials in either clear or black anodized body finish—with or without brake—and to fit  $\frac{3}{32}$ ",  $\frac{1}{8}$ " or  $\frac{1}{4}$ " shaft diameters. Mounting is sim-

ple too, you do not have to drill special panel holes. Delivery—from stock!

Based on price, appearance, readability and ease of installation, the new H-490 is your best buy. Write today for complete data!

*\*Unit price in quantities of 100*



BOURNS, INC., TRIMPOT DIVISION, 1200 COLUMBIA AVE., RIVERSIDE, CALIF.  
PHONE 684-1700 • TWX: 714-682 9582 • CABLE: BOURNSINC.

TRIMPOT® AND PRECISION POTENTIOMETERS — RELAYS — MICROCOMPONENTS: TRANSFORMERS, INDUCTORS, RESISTORS AND CAPACITORS



## A complete 14-bit A-to-D conversion in under 4 $\mu$ sec... that's something to write about!

We're delighted with the overwhelming number of inquiries we've received about our two new additions to the Adage VOLDICON™ line of voltage digitizers.

The high-speed, high-resolution VT13-AB and ultra high-speed VT7-AB are based on a novel design combining techniques of successive approximation and parallel threshold decoding. The VT13-AB ac-

complishes a 14-bit analog-to-digital conversion in less than 4 microseconds. The 8-bit VT7-AB performs a complete conversion in under 800 nanoseconds.

A full line of data systems components, including other A-to-D converters, D-to-A converters, multiplexers, operational amplifiers, and digital logic, is available from Adage, Inc. These components use

all-solid-state circuitry and are designed and tested to meet the most demanding requirements for accuracy and reliability.

Why not add your inquiry to the many we've already received? We would be pleased to send you a technical brochure on the VT13-AB and VT7-AB. Call or write I. R. Schwartz, Vice President 783-1100, area code 617.

*Adage, Inc. welcomes employment inquiries from professional engineers.*

**Adage**  
INC

1079 Commonwealth Avenue  Boston, Massachusetts 02215

# When you've got to put out a fire...

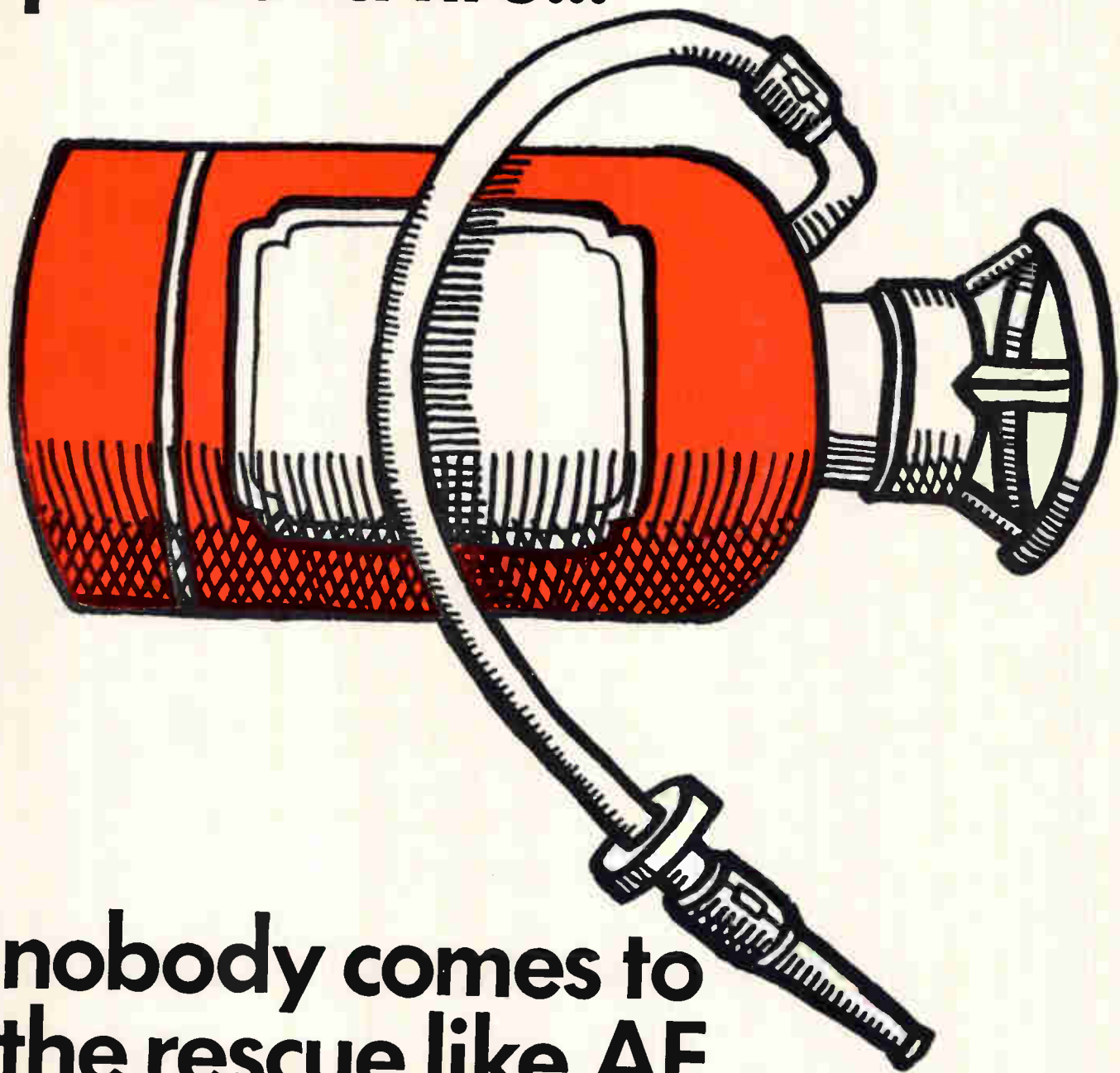

## nobody comes to the rescue like AE.

Got a burning question...like which relay is exactly right for a critical circuit?

Sound the alarm, and your AE man will speed you the answer. This is what he's trained to do. If your problem is a real four-alarmer, your AE representative can call upon a staff engineer from our district office nearest you. This relay expert has thousands of relay application experiences to help him help you.

Nobody else in the relay business can offer this kind of "firehouse" service. AE can, because we're in the

telephone business, too. We know relays and switches and how to use them.

You'll find your AE man in the Yellow Pages, under "Relays." Call him, next time the heat's on. Or drop a line to Director, Relay Control Equipment Sales, Automatic Electric, Northlake, Illinois 60164.

**AUTOMATIC ELECTRIC**  
SUBSIDIARY OF  
GENERAL TELEPHONE & ELECTRONICS **GT&E**

Got a pencil handy?

# Check these 11 provable statements about the accuracy of Sangamo's versatile family of recorders

AND BE PREPARED FOR SOME SURPRISES!

- Highest Linearity
- Lowest Drift
- Highest PCM Packing Density
- Lowest Static plus Dynamic Skew
- Highest Direct S/N
- High FM S/N
- Highest Long-term Speed Accuracy
- Highest Servo Performance
- Low Flutter
- 4000 to 1 Time-base Expansion/Contraction
- 68 db Dynamic Range

**CHECK? Now check with us on your recording needs and problems.**

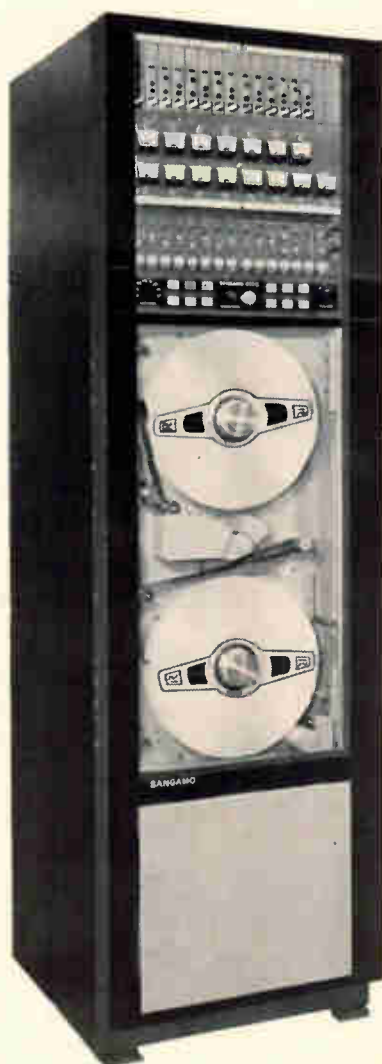

## 4700 GENERAL PURPOSE SYSTEM



### RA-5

Long term, continuous monitoring recorder and its companion reproducer

### PA-5

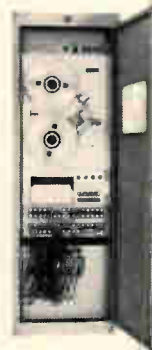

Sangamo/Geotech

### 3700

Long term, slow-speed recorder



### AR-2L

Two-level Attenuator/Restorer

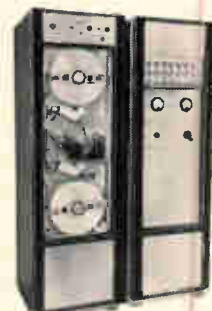

### 480

Time delay/auto cross-correlation recorder

**NEW SANGAMO PORTABLE**  
Soon to be introduced ... a new advance in the state of the art.



## SANGAMO ELECTRIC COMPANY

ELECTRONIC SYSTEMS DIVISIONS

P. O. Box 359, Springfield, Illinois 62705  
Phone: 217 544-6411 TWX: 217 546-0947

# Cinch achievements in selective plating reduce your connector costs

REDUCES GOLD  
REQUIREMENTS  
OVER 60%

This revolutionary selective plating technique can reduce gold requirements over 60%, with no adverse effects on contact reliability, durability or electrical performance. Cinch puts the gold plating only where you need it—at the area of contact. (A gold "flash" may be applied to the rest of the connector if desired.)

The new Cinch .045" square tail connector (patent pending) utilizing this selective plating, combines the contact reliability of a flexing bifurcated contact with the stability of a rigid .045" square tail. This is achieved by inserting a wire core into the tail section and forming the flexible contact material into a .045" square tail with the sharp corners so necessary for reliable wire wrap attachments.

For additional information of this connector, with selectively plated contacts, write to Cinch Manufacturing Company, 1026 S. Homan Avenue, Chicago, Illinois 60624.

CM-6509



CROSS SECTION  
OF WIRE WRAP  
TERMINATION.

Copper wire  
inner Core.

.010" phosphor  
bronze outer  
cover.

**CINCH**

DIVISION OF UNITED-CARR

**You've just  
decided to use  
a lighted  
pushbutton,**



**instead  
of a  
toggle  
switch.**



## **Are you going to have to switch SWITCH suppliers?**

Well, if you have been considering one of the 3,150 toggle switches we have at Control Switch, you can quietly stay right where you are and start considering one of our 1,800 lighted pushbutton switches.

Same salesman. Same distributor. Same supplier. Same superior engineering for applications where you can't afford to have a switch goof, even after a hundred thousand actuations.

You can stay with us just as easily, too, for leaf and lever, interlock and limit, hermetically-sealed and environment-free switches. To find out how convenient switch shopping can be, send for all the catalogs listed at the right. They'll put a mighty comprehensive switch reference file at your fingertips. Check with your nearest Control Switch distributor, too.

Here's the line-up! Check numbers on the Reader Service Card corresponding to those on the left below for any or all catalogs you want.

- 231 *Condensed Switch Catalog 100*
- 232 *Basic Snap-Action Switch Catalog 110*
- 233 *Toggle Catalog 180*
- 234 *Indicator Light Catalog 120*
- 235 *Hermetic Switch Catalog 130*
- 236 *Switchlite Catalog 220*
- 237 *Pushbutton Catalog 190*

**CONTROLS  
COMPANY**  
OF AMERICA  
CONTROL SWITCH DIVISION  
1420 Delmar Drive, Folcroft, Pennsylvania 19032





Your  
equipment is  
**OBSOLETE**

**if you can't  
measure  
nanohms**

In this day of space exploration requiring pin-point precision at distances of hundreds of thousands of miles, three basic tools . . . the wide-range Oscilloscope, the high-accuracy electronic Counter and the high-accuracy, wide-range DC Multi-Vider™ . . . are required to keep pace with the state of the art.

Rapid, high resolution readings of DC magnitudes . . . resistance, voltage, current and ratio . . . are the essential indicators of uniformity, quality, stability and reliability for almost every modern circuit and system component.

If your people can't read all these quantities quickly, with 6-place accuracy, their equipment is obsolete. They need the Julie Multi-Vider . . . the unique (patented) DC instrument that satisfies all their present-day requirements and creates new opportunities for your company in today's and tomorrow's technology.

The Julie Multi-Vider is a compact portable instrument weighing only 40 lbs. Like the modern oscilloscope it uses plug-ins to eliminate many or all specialized measuring test instruments. Its basic divider explores all DC magnitudes with 7 place sensitivity over nano\_\_\_ to giga\_\_\_ ranges. It operates easily and with the same basic accuracy and convenience as the most modern 6-place counter.

Today, the DC Multi-Vider is one of the three basic tools. You can use it anywhere . . . in the lab, on the production floor, or out in the field. It is virtually maintenance-free and calibrates itself (traceable to NBS) rapidly and completely. No specialized additional calibration equipment is required.

We have people and equipment available to put Multi-Viders to work anywhere in your plant on a free demonstration basis.

Call or Write Dept. C8

**JULIE RESEARCH LABORATORIES, INC.**

211 WEST 61ST STREET • NEW YORK, NEW YORK 10023

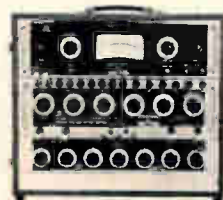

See us at WESCON  
Booth 129

# Now! Transistor chips for hybrid circuits!

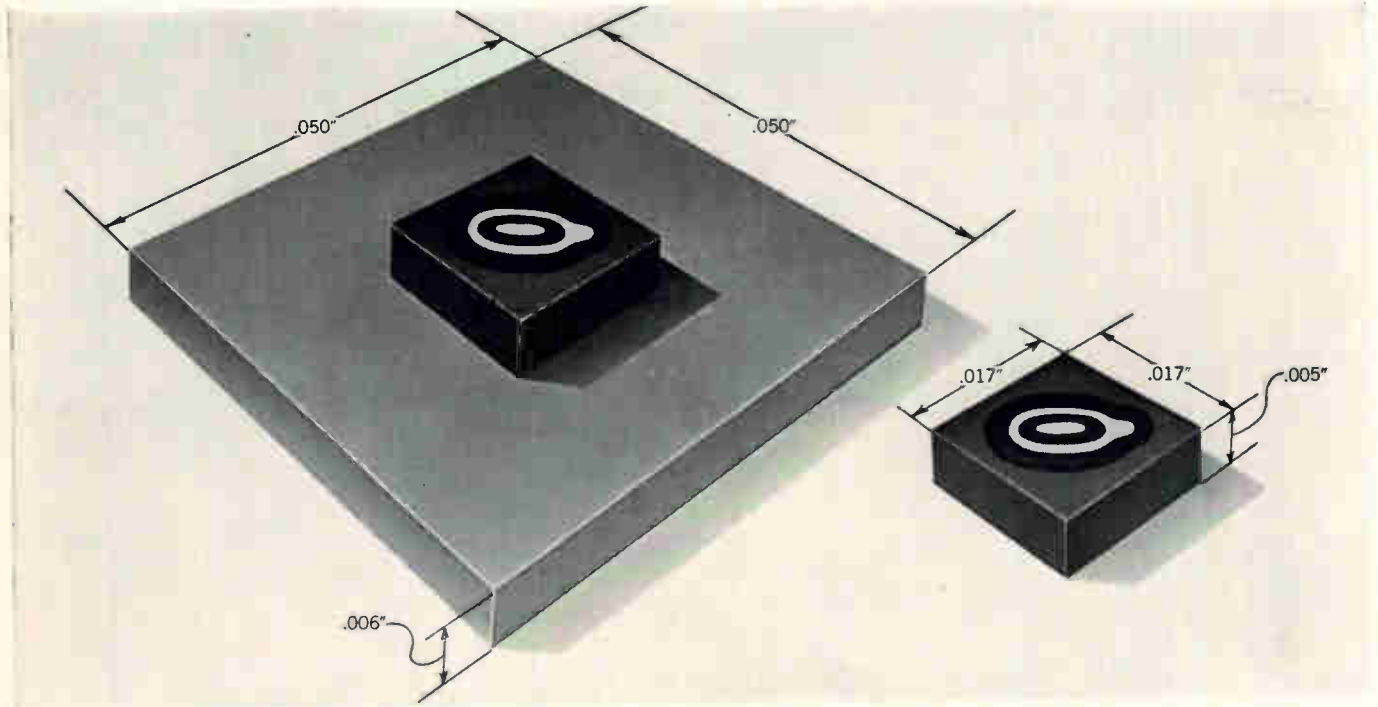

These are standard PNP and NPN silicon PLANEX\* chip transistors, supplied in gold-backed form or as chips pre-attached to gold-plated Kovar Tabs. They are available for your hybrid circuits now.

These chips are 100% tested to all low level DC parameters. Sample lots are tested for all

AC and DC data sheet parameters to assure full specification compliance.

For specifications, price and delivery information, call your nearest Raytheon regional sales office. Or write: *Raytheon Company, Components Division, 141 Spring Street, Lexington, Mass. 02173.*

TYPES	DESCRIPTION	ABSOLUTE MAXIMUM RATINGS			
		V <sub>CB0</sub>	V <sub>CEO</sub>	V <sub>EBO</sub>	I <sub>C</sub>
TA4980 (2N918)	NPN chip transistor for low-level high-frequency amplifiers. Dice size .017x.017"	30V	15V	3V	100mA
TA4981 (2N2369A)	NPN chip transistor for high-speed saturated switching. Dice size .017x.017"	40V	15V	45V	200mA
TA4982 (2N3011)	NPN chip transistor for high-speed saturated switching. Dice size .017x.017"	30V	12V	5V	200mA
TA4972 (2N2904A)	PNP chip transistors for general purpose usage. Dice size .020 x .027"	60V	60V	5V	1000mA
TA4973 (2N2905A)	PNP chip transistors for general purpose usage. Dice size .020 x .027"	75V	40V	6V	1000mA
TA4984 (2N2218A)	NPN chip transistors for general purpose usage. Dice size .020 x .027"	120V	80V	7V	1000mA
TA4985 (2N2219A)	NPN chip transistors for general purpose usage. Dice size .020 x .027"	100V	60V	7V	1000mA
TA4974 (2N1890)	NPN chip transistors for general purpose usage. Dice size .036 x .036"	50V	40V	5V	100mA
TA4975 (2N1893)	NPN chip transistors for general purpose usage. Dice size .036 x .036"	50V	40V	5V	100mA
TA4976 (2N3250)	PNP chip transistors for low-level and preamplifier usage. Dice size .017 x .017"	50V	40V	5V	100mA
TA4977 (2N3251)	PNP chip transistors for low-level and preamplifier usage. Dice size .017 x .017"	60V	60V	6V	100mA
TA4991 (2N2483)	NPN chip transistors for high-gain preamplifier usage. Dice size .019 x .019"	60V	60V	6V	100mA
TA4992 (2N2484)	NPN chip transistors for high-gain preamplifier usage. Dice size .019 x .019"	60V	60V	6V	100mA
TA4978 (2N3244)	PNP chip transistors for high current saturated switching. Dice size .036x.036"	40V	40V	5V	1000mA
TA4983 (2N3252)	NPN chip transistor for high current saturated switching. Dice size .036x.036"	60V	30V	5V	1000mA

\*PLANEX—Raytheon's designation for Planar Epitaxial



Raytheon Components Division—A single source for Transistors/Diodes/Integrated Circuits/Industrial Tubes/Control Knobs/Panel Hardware/Raysistors/Circuit Modules/Display Devices



Hewlett-Packard  
introduces a new approach  
to instrumentation  
recording...

HP 3955 Series  
MAGNETIC RECORDING  
SYSTEM—

outstanding performance  
at an economical price

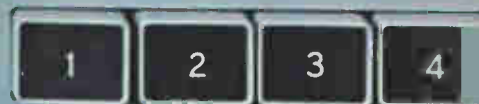
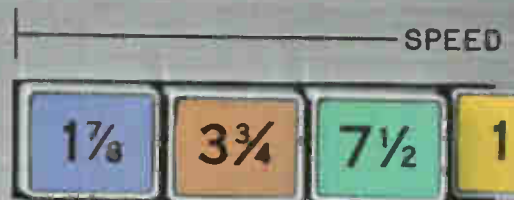

HEWLETT-PACKARD

3955 SERIES  
MAGNETIC  
RECORDING  
SYSTEM

*A new industry standard  
in performance and price*

**300 kHz Direct—20 kHz FM**

**Unprecedented ease of operation**

Any of six recording speeds are electrically controlled by means of color-coded pushbuttons. Modes of operation are also easily selected by means of pushbuttons and rear connectors are provided for remote control operation. Speed equalizers are selected by a simple push-bar and rocker system that assures immediate positive contact. It is a simple, reliable system which avoids the use of relays or diodes for switching. This system also allows any three of six equalizers to be easily inserted.



HEWLETT **hp** PACKARD

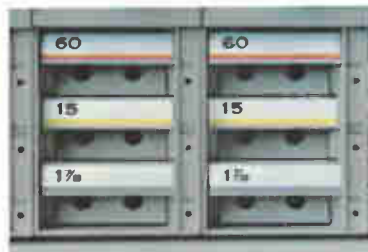
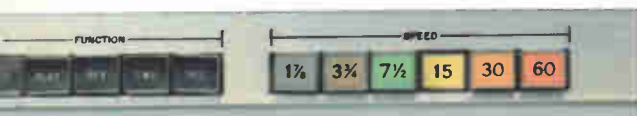

### System flexibility with high-performance transports

For long recording times (over 19 hours at  $1\frac{7}{8}$  ips) choose the larger transport that accepts reel diameters to 15". For most general-purpose applications, the smaller transport that accepts  $10\frac{1}{2}$ " diameter reels will reduce system size and cost. Rugged, cast aluminum frame is precision machined to provide permanent alignment of all tape path components. The need for field adjustments is eliminated. Both transports may be equipped to operate with  $\frac{1}{2}$ " (7-track) or 1" (14-track) tape. Each unit includes a tape footage counter with a specified accuracy of  $\pm 0.05\%$ .

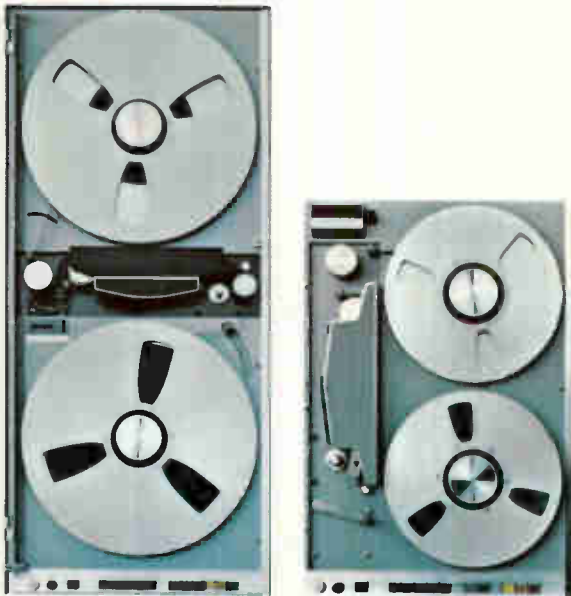

### Fast set-up and check-out

The high-performance damped open-loop system of the Series 3955 needs no adjustments and only minimum attention. Tape is threaded quickly and heads are easily accessible for cleaning. Both record and reproduce heads are permanently factory-aligned on a single rugged assembly. Record bay mainframes hold up to 7 amplifiers, each with its own monitoring meter and test points. Bias and signal levels are readily established with simple front panel adjustments. Each reproduce bay holds 7 amplifiers and a monitoring meter with pushbutton selection for each track.

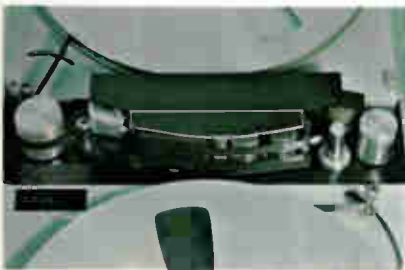

### Modular amplifiers for maximum flexibility

Record and reproduce amplifiers for the Series 3955 are solid-state, high-performance units tailored to the heads for optimum system performance. The pre-amplifiers are uniquely combined to give outstanding signal-to-noise performance. System noise is substantially below noise inherent in the tape. Both FM and Direct modules are completely interchangeable between channels, giving you great system flexibility with a minimum of effort.



# HEWLETT-PACKARD 3955 MAGNETIC RECORDING SYSTEMS

Outstanding performance and flexibility with four configurations

Model 3955A . . . . .14-tracks, up to 15" reels  
 Model 3955B . . . . .7-tracks, up to 15" reels  
 Model 3955C . . .14-tracks, up to 10<sup>1</sup>/<sub>2</sub>" reels  
 Model 3955D . . . .7-tracks, up to 10<sup>1</sup>/<sub>2</sub>" reels

Tape Speed	DIRECT		FM	
	±3 db bandwidth	S/N*	+0.5 db, -1.0 db bandwidth	S/N rms at center frequency**
60 ips	300 Hz-300 kHz	40 db	0- 20 kHz	48 db
30 ips	150 Hz-150 kHz	40 db	0- 10 kHz	48 db
15 ips	100 Hz- 75 kHz	40 db	0- 5 kHz	48 db
7 <sup>1</sup> / <sub>2</sub> ips	100 Hz- 38 kHz	40 db	0- 2.5 kHz	47 db
3 <sup>3</sup> / <sub>4</sub> ips	100 Hz- 19 kHz	40 db	0-1.25 kHz	45 db
1 <sup>7</sup> / <sub>8</sub> ips	100 Hz- 9.4 kHz	40 db	0- 625 Hz	41 db

\*with bandpass filter at output with 18 db/octave rolloff using good quality instrumentation tape. System noise is limited by the S/N of the tape.

\*\* Use of flutter compensation will further improve the S/N.

50 kHz square wave response at 60 ips.  
Horizontal scale, 2 μsec/cm.

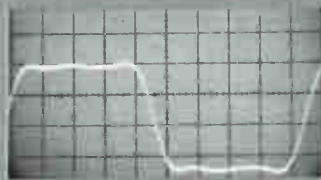

Typical Flutter. Vertical sensitivity is 0.2% p-p/cm.

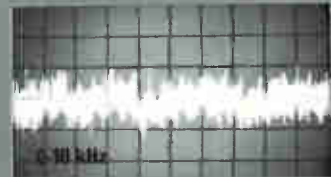
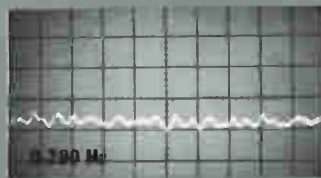

## DIRECT

**Input impedance:** 20,000 ohms, single ended  
**Input sensitivity:** 1 v rms for 1% 3rd harmonic distortion recorded on tape  
**Output impedance:** 50 ohms  
**Output level:** 1 v rms into 1 K

## FM

**Input impedance:** 20,000 ohms, single ended  
**Input sensitivity:** ±0.7 v peak for standard ±40% deviation  
**Output impedance:** 600 ohms  
**Output level:** 2.8 v p-p into 600 ohms

**FM drift:** less than ±0.4% for 10°F change; less than ±0.5% in 8 hrs. in constant ambient after warm-up

**FM linearity:** Variation less than ±1% of p-p output from a zero-based straight line

**FM total harmonic distortion:** 1.5% maximum

**Heads and recording format meet IRIG Standard 106-65; system power consumption is approximately 550 VA (14-track).**

For more information on the 3955 Series Magnetic Recording Systems and other Hewlett-Packard magnetic tape instrumentation, call your hp field engineer, or write Hewlett-Packard, Palo Alto, California 94304, Tel. (415) 326-7000; Europe: 54 Route des Acacias, Geneva.

**HEWLETT**  **PACKARD**  
An extra measure of quality

PRINTED IN U.S.A.

# OPTMANSHIP

...or  
how  
to  
rig  
an  
unbeatable  
coating  
system



We started with the fastest diffusion pump — our new 2400 liter per second VHS-6 and the highest conductance baffle/cold trap combination . . . added a precision monitor — the NRC 720 solid-state TC-Ion gauge control for direct logarithmic and linear reading of pressures to  $2 \times 10^{-9}$  torr . . . carefully assembled an electrical system, filament power supply, an easy access base plate with twelve feed-throughs, manual or automatic valving, Pyrex or s.s. work chamber, motorized hoist and functional cabinet. This gave us a basic coating system that would deliver repeatable cycles to high vacuum ( $10^{-7}$  torr range) in less than five minutes — an *optimum* accomplishment, but we didn't stop there.

We pre-wired the basic system to receive a range of accessory plug-in *option-modules* to satisfy the most varied

coating requirements. These include: a work heater power supply; a second filament power supply for simultaneous evaporation of different materials; filament and tap-changing switches for sequential evaporation; automatic liquid nitrogen level control; additional base plate feed-throughs (electrical, mechanical motion, gas and fluid); a high voltage power supply; and a bell jar tilt mechanism for fast access to the work chamber. This gave us a high performance coating system that bristled with built-in multiple capabilities — an admirable combination, but we didn't stop there either.

We have added a note of *optimism* the price. For complete specifications we would like to send you our brochure on the new . . .

## NRC 3177

 **EQUIPMENT DIVISION**  
**NATIONAL RESEARCH CORPORATION**  
A SUBSIDIARY OF NORTON COMPANY

160 Charlemont Street, Newton, Massachusetts 02161



WESCON BOOTH  
NOS. 640-641



## WOULD YOU BELIEVE **A Three-channel Portable Oscillo Graph with 100 cps frequency response?**

It's true! And only Esterline Angus offers a Three-channel Portable Oscillo Graph.

Like the Single and Two-channel units, the Three-channel Recorder's frequency response is faster than that of any other portable oscillograph . . . 100 cps  $\pm$  10% at 30 mm peak-to-peak. It's down less than 3 db at 125 cps.

All three of the Portable Oscillo Graphs have four push-button controlled chart speeds . . . 1, 5, 20 and 100 mm per second.

A balanced differential DC amplifier (with 5 millivolt per mm sensitivity) is built into the Single-channel Re-

recorder. The same amplifier in modular form is used on Two and Three-channel Recorders.

In addition, Esterline Angus Oscillo Graphs (both portable and cabinet models) employ the exclusive inkless, heatless Direct-Carbon-Transfer writing method. D-C-T chart paper costs only half as much as heat sensitive paper. You can choose either standard or reproducible (by Ozalid or Bruning processes) chart paper.

For trouble-free writing, unequalled response and economy, investigate Esterline Angus Oscillo Graph Recorders. Write for our informative Series "O" Catalog.

**ESTERLINE ANGUS INSTRUMENT COMPANY, INC.**  
**BOX 24000E • INDIANAPOLIS, INDIANA 46224**

*Excellence in  
 instrumentation for  
 over 60 years*



# ESTERLINE ANGUS



# Technical Articles

---

**The boom in the West:**  
page 102

Vietnam, diversification and a generally healthy economy have stimulated electronics companies west of the Rocky Mountains. Surveying all types of companies, Electronics' reporters found prosperous conditions in aerospace (p. 102), microwaves (p. 106), instruments (p. 110), integrated circuits (p. 114) and discrete semiconductors (p. 118).

**Generating power at gigahertz with avalanche-transit time diodes:**  
page 126

With a new family of solid state devices, the prospect of generating considerable microwave power with semiconductors comes closer. These new diodes—there are three types: pnin, p-i-n and pn—have generated up to 350 milliwatts at 50 gigahertz in the pulse mode.

**Integrated circuits make a low-cost f-m receiver:**  
page 133

Last May, RCA proved it was technically feasible to build an f-m receiver with integrated circuits. Now, the company has designed a commercial model. Not surprisingly, the new design is quite different from the feasibility study design.

**Pattern trims design time for multilayer circuit boards:**  
page 148

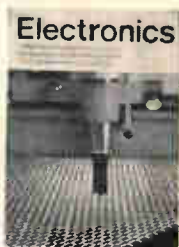

Designing multilayer boards has always been a tedious task, but integrated circuits and super dense connections have made the job even worse. From an engineering standpoint, the object is to get the design done quickly and to make the best use of space. A new master pattern accomplishes both. On the cover is the master pattern, an x-y wiring matrix developed by TRW Systems.

**Journey to East Europe:**  
page 157

Electronics' editor-in-chief spent a month in East Europe and found electronics technology and production are far below levels in the West. With his evaluation are a report on Rumania's blueprint for an electronics industry (p. 166), a look at an East German engineer (p. 168) and how West Europeans view trade with the Communist countries (p. 170).

- 
- Coming August 22**
- A trainable pattern recognizer
  - Field effect transistors in an f-m tuner
  - A new approach to helix antennas
  - A high-speed computer for navigation

# How the West was won

The Vietnam war, a rush of nonmilitary business and a generally vibrant economy have ignited the boom in the aerospace industry

By William Wallace

Los Angeles Regional Editor

**Business has been** so good in the aerospace industry that West Coast firms are running way ahead of optimistic projections made earlier this year. In January, the Western Electronics Manufacturers Association (WEMA) forecast that the western-based portion of the electronics industry would enjoy about a 10% gain in 1966—to \$4.7 billion from last year's \$4.3 billion. Now the projection has been revised upward to over \$5 billion, nearly a 20% boost. Increased activity among aerospace firms accounts for a big chunk of the gain.

Wendell B. Sell, president of Packard-Bell Electronics Corp. as well as president of WEMA, says there will be at least 20,000 new jobs in the western electronics industry this year. The Vietnam war, a rush of non-Vietnam military contracts, and a generally booming economy are the major factors. Also, West Coast companies have grabbed a healthy share of contracts in the space and communications satellite fields.

Mainly, aerospace firms supply various types of radar and communications equipment to the Vietnam inventory. Some of it comes from existing production lines as in the case of communications equipment supplied by the aerospace division of Packard-Bell; except for Vietnam the gear would have been phased out of production. Command and control systems designed in 1955 as well as spares for that and other equipment currently in the field are being supplied by the ground systems division of the Hughes Aircraft Co. Reorders for Teledyne, Inc.'s mobile radio-transmitter for jeeps, light aircraft, tanks and other vehicles have nearly tripled in the past year.

But the Vietnam conflict provides more new busi-

ness than reorders for existing equipment. The Hughes ground system division is producing a portable radio designed for use in Vietnam; the Hughes aerospace division builds infrared Falcon missiles for Vietnam.

"All our Vietnam-oriented work is on new projects," says Fred O'Green a vice president of Litton Industries, Inc., and manager of the defense and space systems group. The firm is developing advanced navigational systems for fighter aircraft of the type now in action in Vietnam and a new digital entry message device (Demed).

## Non-Vietnam military business

This year with an increased budget, military spending is expected to give western business a substantial boost over fiscal 1965, when Pentagon spending in California for hardware contracts totaled \$5.1 billion. California also racked up

\$2.0 billion in research, some 41.4% of the national total. The National Aeronautics and Space Administration added \$1.8 billion to the state's business.

California firms have been getting their share of big contracts which include heavy electronic spending. Douglas Aircraft Co. won the Manned Orbiting Laboratory (MOL) with \$200 million in spending set for fiscal 1967; the dollar value of Aerojet General Corp.'s Mark 46 torpedo has increased from \$100 million last year to \$165 million this year; Lockheed Aircraft Co. has the Poseidon submarine-launched ballistic missile contract, worth some \$900 million in total development costs. Poseidon is the second-generation Polaris.

One of the most significant avionics contracts of the year, the \$200-million Mark 2 program, was nailed down by the Autonetics division of North

## The boom in the West

On the eve of the Western Electronics Show and Conference, business was never better for that part of the electronics industry located west of the Rocky Mountains. Surveying all types of companies, Electronics' reporters found good health brimming over everywhere: in aerospace (p. 102), microwaves (p. 106), instruments (p. 110), integrated circuits (p. 114), and discrete semiconductor devices (p. 118).



"There will be at least 20,000 new jobs in the western electronics industry this year."—Wendell Sell, president of both Packard-Bell and the Western Electronics Manufacturers Association.

American Aviation Inc. The contract came at a time when division employment had tailed off from a high of 30,000 to 20,000.

Teledyne is well along in the development of another big avionics system, the Integrated Helicopter Avionics System (IHAS). They are following a modular concept which they hope will permit the system to be adapted to various aircraft. The first test of this theory will come in the use of IHAS on the Army's advanced aerial fire support system (AAFSS)—a system for which IHAS was not specifically designed. The Lockheed California Co., a division of Lockheed Aircraft Corp., holds the \$86-million AAFSS development contract.

NASA money is keeping many firms busy. TRW Systems group of TRW, Inc., has the computer contract for the lunar excursion module (LEM) and space-ground link subsystem—standard telemetry tracking command systems. This is also leading them into other applications which are classified. TRW also has the over-all responsibility for the Apollo abort guidance system—worth about \$56 million. Additionally TRW has work under way on a \$65-million contract for six satellites for the Communication Satellite Corp.

#### Some dark spots

The aerospace electronics boom on the West Coast is a reality. But like any reality, there are some dark sides to the picture.

Some projects are being stretched out. One example is the TOW missile—a heavy antitank assault weapon. Gene Blandford, marketing manager



"All our Vietnam-oriented work is on new projects."—Fred W. O'Green, a vice president of Litton Industries, Inc., and manager of defense and space systems group.

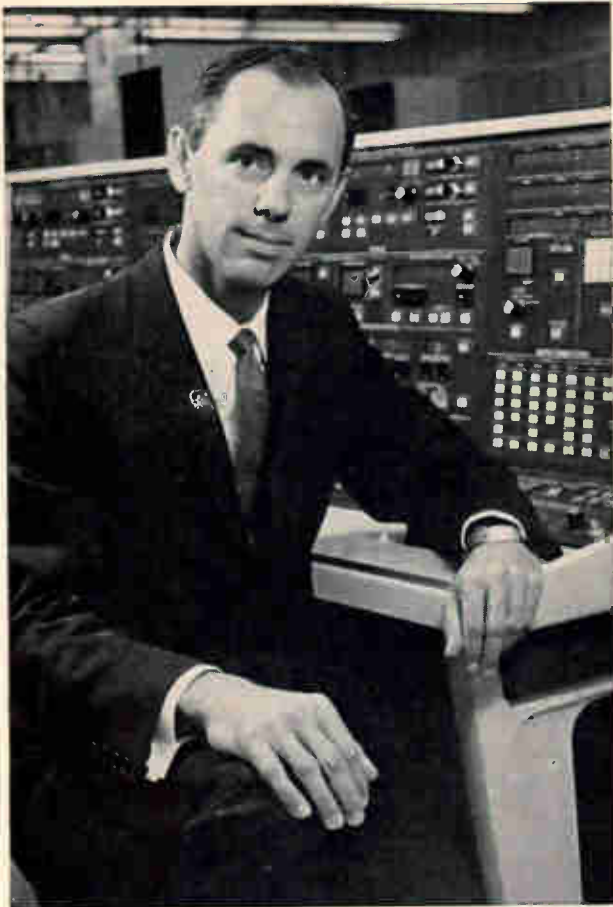

"Systems companies . . . are all feeling the pinch because of NASA's emphasis on manned-spaceflight hardware and the military concentration on tactical equipment."—L.B. Horwitz of Beckman Instruments.



"When the government wants us to perform an extra test to prove capabilities not specifically required, we have to refuse because the cost would come out of our pockets."—Hughes' Nicholas Yaru.

of the aerospace group of Hughes Aircraft, says "They're not shooting at tanks in Vietnam, so our TOW missile has no application there. There are no TOW production funds for 1967, therefore no pre-production funding for 1966."

The Vietnam war, while contributing to the boom, also exerts an adverse effect. There is little question that the National Aeronautics and Space Administration programs have been affected although the details are difficult to pin down. This is particularly true for unmanned missions. Funds are being withheld from new ground systems and existing unmanned space systems stretched out. Remaining funds are going to flight hardware for manned space programs.

"Systems companies, such as ours," says L. B. Horwitz, manager of the systems division at Beckman Instruments, Inc., "are all feeling the pinch because of NASA's emphasis on manned-space flight hardware and the military concentration on tactical equipment."

As a result, the division's sales for fiscal 1965 dropped from the preceding year. About 60% to 70% of the division's sales go to NASA.

Horwitz is more optimistic about the future. He says, NASA is going to have to buy more data systems for its Mississippi Test Facility—for which

Beckman supplied data acquisition equipment. And he adds that post-Apollo programs will be on the upswing.

A. R. Leudecke, deputy director of the Jet Propulsion Laboratory, says some JPL activities have been realigned. JPL is totally involved in NASA contracts. "We are not down in total business," he says, "in fact, we are up slightly, but not at the pace of industry in general."

Realignment is not new to JPL. When the Voyager program was shifted from 1971 to 1973, other programs kept JPL busy and a slowdown was averted. The Mariner-Venus shot—planned for 1967—and the new Mariner-Mars flyby—set for 1969—have maintained activity at a constant level. The 1967 Mariner will be the Mariner IV that backed up the 1965 Mars flyby and only modification work will be required. The 1969 Mariner will be a new craft and JPL will let out larger portions of systems and subsystems to outside contractors. However, JPL will be responsible for the mission and not turn it over to a contractor as they did with Surveyor.

#### Profit paradox

Another dark spot in the industry picture is the slowing profit rate. More money is being poured

into the aerospace industry, but the percentage returning in profit is decreasing.

"Sometimes, I think we must be crazy," says Nicholas Yaru, a Hughes vice president and manager of the radar and communications group. "We are making about 4% before taxes on our money and we could get 5% in any savings and loan account." Yaru adds: "Fixed price contracts and the stiff competition with the associative cost entailed in going after contracts is the major reason our profits are not keeping pace with upward swing of gross sales."

Several industry spokesmen claim that government purchasing agents take advantage of the fierce competition for contracts. They force many contingency costs to be trimmed from the proposal, leaving a bidder wide open for disaster if he makes a mistake.

Yaru says this method gets the most for the taxpayers' dollar, but has one serious handicap. "When a government engineer wants us to perform an extra test to prove capabilities not specifically required, we have to refuse because the total cost would have to come out of our pockets."

A manpower shortage has also struck the industry. Traffic congestion, rising taxes and housing problems in California compound the shortage.

### Shortages and delays

A shortage of materials and resultant delays further aggravate the situation. Although material shortages are not yet critical, they are beginning to pinch. Jack Sloan, assistant to the president at General Dynamics/Pomona says: "We are experiencing shortages of copper wire, semiconductors, resistors and capacitors. Lead times on all critical items have been extended and special vendors that used to give preferential treatment can no longer do this."

Delays result in more difficulties. Stretched-out delivery schedules for materials such as copper, and components including connectors and solid state devices hold up deliveries, reduce incentive payments and force less effective use of personnel. As one contract is stretched out and can no longer support a full crew, personnel have to be transferred to other work—a wasteful process in both retraining and transfer costs. In addition, it is not always possible to find a suitable job for the shifted personnel. The delays set off a chain reaction. Subcontractors can't meet delivery schedules and so they pass on the delay to the primes.

### Lesson of Vietnam

Hughes' Yaru explains: "Our Mark 1-B communication satellite ground terminal program is being slowed because some of our subcontractors can't supply their portions of the system on time. Rohr Aircraft, hit with shortages and delivery stretch-outs of their own, is unable to meet scheduled delivery of the RF room, this is the room containing the receiving electronics that is situated just behind the dish. Western Gear is having trouble

with the schedule on the drive gears."

Yaru complains about vendors who call a day or so before the scheduled delivery date with news they will be a month late. Most people blame the delays and shortages on the Vietnam war. Wendell Sell of Packard-Bell backs this up, saying that priorities on copper suggest that Vietnam is the major factor.

But the industry is taking the problems in stride. None of the major aerospace firms report any line shutdowns or massive layoffs.

### Insurance policies

Most firms are taking steps to make sure the current boom does not become a bust. Aerospace companies are still trying to diversify, and continue to increase funds being spent in research and development.

Henry A. Samulon, vice president and general manager of the electronics systems division of TRW Systems, says, "The percentage of our R&D dollar is going down but the absolute value of the R&D dollar is going up." This means they are getting more out of their R&D dollar by keeping a tighter control over it.

However companies are taking a sharper look at where their R&D efforts are going. They want to know when the payoff can be expected. The day of spending money for pure research is gone. Management demands a reasonable prospect of payoff within five or six years or they lose interest in the project.

Autonetics, with the Mark 2 program in its pocket, is a prime example that such efforts have a payoff. The division tripled its research effort—in strike avionics, astronics, and information systems—in 1964 and 1965 and doubled it again in 1966. The navigation system for the C5-A will be one of the big R&D programs at Northrop Corp. W. C. Ellet, director of market research and analysis, says, "We have a \$20-million contract for a doppler/inertial navigation system which will go on nearly 60 aircraft in the C5-A class."

The system contains four basic divisions: the inertial measurement unit; the doppler radar; the computer section, which will have two identical computers doing separate jobs with some redundancy overlap; and the display and control section. The contract also includes some ground support equipment.

Teledyne is one example of a company making a rigorous expansion effort. The company recently merged with a firm that manufactures crew boats to take workers to and from off-shore oil drilling sites. Packard-Bell merged with the Singer Co.—thus increasing sales territory as well as financial backing. North American recently formed a division to look into oceanology systems.

Lockheed Missile and Space Co. is interested in ocean systems, information systems and military nighttime fighting capabilities. They are looking forward to post-Apollo projects with particular accent on advanced land vehicle systems.

# Microwave—in tune with the times

Vietnam has increased microwave business, but the industry recalls past cutbacks and looks to commercial markets to survive any future slumps

By Walter Barney

San Francisco Regional Editor

**Wartime is microwave time.** Almost every manufacturer of microwave components and systems on the West Coast has had a chunk of the increased government spending related to the fighting in Vietnam—yet the diversification which resulted from the slump of a couple of years ago has enabled them to take the increased business as a windfall, not a way of life.

Lisle J. Smith, marketing manager for the microwave tube division of the Hughes Aircraft Co., says that his company's 1966 sales will be up 25% over 1965, which was the best year Hughes ever had. Since Hughes is heavily (95%) government-oriented, Smith's equanimity about a possible cut in spending may seem remarkable; and Smith in fact would look for a drop in business if the war ended.

"But it wouldn't be anything like the drop that occurred in the 1963-65 period," he says. Hughes makes broadband, high-power traveling wave tubes (twf) for radar, ground stations, and electronic countermeasures equipment, twf amplifier packages, and associated power supplies. Vietnam, Smith says, has revealed a need for different types of equipment, and as a consequence, twf makers are in a fairly strong position for the next three to five years.

Only the replacement tube market for systems in the field would be cut by an end to the war, Smith feels. But most manufacturers think that the Vietnam experience would ensure that the Pentagon never again let inventories drop as low as they did before the Vietnam war. J.A. McCullough, who was named a director of Varian Associates when Eitel-McCullough, Inc., became the Eimac division of Varian last January, notes that Defense Department cost-reduction programs at one time allowed the tube inventory to slip from two years to 30 to 60 days. As a result, he says, the government stopped buying and some companies quit making tubes. When Vietnam came along, the Pentagon had a very difficult time getting the replacement tubes it needed.

Tube activity at Varian is now abnormally high. McCullough says. He figures it will peak at the end of the year, but continue at a high rate during

1967, and then slack off slightly. Varian's six-month annual report, issued last April and adjusted for the Eimac merger and the acquisition of Wilkens Instrument and Research, Inc., showed sales up nearly a third and net income more than doubled.

## Protection against cutbacks

Frank J. Kelly, director of marketing at Litton Industries' electron tube division, feels that his company has insulated itself against government cutbacks. "When the Vietnam conflict ends, the defense budget will return to a \$50-billion-a-year ceiling," Kelly says. "When that happens, we know there will be some cuts made. The net result for



"Vietnam has revealed a need for different types of equipment . . . and traveling-wave-tube makers are in a fairly strong position."—Hughes' Lisle Smith.

the microwave industry will be a decline though not as bad as two years ago, because we shook out some of the marginal competitors in the last decline.

"We went through a recession that reached its lowest point two years ago, and we felt that other companies were experiencing the same thing. It was due to a decrease in inventory levels of the services under the tighter spares policy of Secretary of Defense Robert S. McNamara. It turned the constant expansion of the microwave tube market into a level and then a decline. The price competition decreased the business we had and the profitability of the business we could get.

"For us the situation has reversed itself—but not because of Vietnam. The increase is due to programs that had been in the formative state and are now productive."

### Substantial backlog

Kelly mentioned specifically some commercial applications for Litton products—primarily the cooker magnetron, a microwave heating tube which has industrial applications in chemical processing, on-line production heating and commercial and domestic ovens. Litton also supplies klystrons for the Stanford Linear Accelerator and other accelerators and is working on airborne weather radar.

The Hewlett-Packard Co. expresses equal determination not to get caught out on a limb.

"Strangely, in 1965 we foresaw all sorts of

trouble," says John Minck, marketing manager of H-P's microwave division. "Our forecast was way down—but sales were way up." As a result, the company ended the year with a substantial backlog, and now has an average delay of 10 weeks for delivery. (Priority orders, related to Vietnam, push some orders back six months, Minck says.) For H-P's \$10,000 spectrum analyzer, introduced two years ago, the delay is 22 weeks.

With the government and the big primes, such as Hughes, the Lockheed Aircraft Corp. and the Douglas Aircraft Co., Inc., buying instruments such as signal generators, wave analyzers, and noise figure meters, H-P needed to expand its productive capacity. But, in line with a corporate objective under which the company has never had a layoff in 26 years of business, expansion had to be gradual and carefully planned.

### War and peace

Last February, Minck made a two-year forecast related to the possible courses of the Vietnam war. The "upside" was for two years of continued hostilities; the "downside" was for peace in July or October of this year. Peace, Minck figured, would mean either a sudden drop in demand, or a gradual trailing off; he picked the latter possibility, on the grounds that government money would very likely be turned back to the space program or to other areas from which it had been diverted by Vietnam. The whole forecasting process was con-



"Strangely, in 1965 we foresaw all sorts of trouble. Our forecast was way down—but sales were way up."—John Minck of Hewlett-Packard's microwave division.



"When the Vietnam conflict ends the defense budget will return to a \$50-billion-a-year ceiling."—Frank J. Kelly, marketing director at Litton's electron tube division.

puterized, and so sophisticated that Minck could even punch in a 1% decline in employe incentive, and its attendant drop in productivity, when the exciting pace of peak production slackened.

"The curves worked out to a possible spread, between war production and peace production, of around 500 employes should we have peace in July," Minck said. "We figured that normal attrition, a cut in overtime, and the acceptance of a couple of million dollars of inventory would take care of the spread without a layoff."

H-P pegs each employe's productivity at about \$20,000, so its analysis of the difference between war and peace worked out to a \$10-million difference in sales. Nevertheless, confident of its figures, it began hiring in February and has added three acres of space (for all divisions, not just microwave) to its Stanford Industrial Park plant in the past year.

"In this kind of a boom," Minck says, "management gets cautious."

Early in July, H-P announced that it would acquire a 55-acre plant site in nearby Santa Clara—but its approach to actually building there exemplifies Minck's caution. Preliminary architect's plans exist for five manufacturing facilities, to employ up to 4,000 persons. The first building, H-P announced, would be a 165,000-square-foot plant that would cost \$4.5 million and employ 400.

### Need for communications

The company would not, however, say when it planned to start building. A company spokesman indicated that the date depended largely on how business developed. The first building would probably be occupied, he said, by one of the divisions now crowding facilities at the Stanford Industrial Park headquarters—the microwave division, the frequency and time division, or Dymec, which occupies separate quarters nearby.

The Lenkurt Electric Co., Inc., is a subsidiary of the General Telephone and Electronics Corp., and as such has a built-in customer for its products. However, Lenkurt does about 25% of its business with the government; it sold a microwave network for the White Sands Missile Range last fall, and in June landed a \$1.8 million contract from the Philco Corp. for microwave radio and multiplex equipment to be used in Southeast Asia. "For the past five or six years," says Lenkurt president Robert J. Gressens, "the military has been extremely aware of the essentialness of communications."

Marketing manager Herbert K. Krengel says that Vietnam has brought a bunching of orders in the past six months for microwave equipment, multiplexers, data modems, four-wire terminal sets, and single-frequency signal equipment.

### Recruiting workers

"It's anyone's guess, including our own, when the slackening will come," says Gressens. In the meantime, the company has been hiring at a rate which has brought it from 2,200 employes 18



"Solid state always seems to be farther down the pike. We are aware of it, we try to evaluate it, we will be part of it—but tubes are not dead yet."

—J.A. McCullough, director of Varian Associates.

months ago to 3,400 in June. The increase is mostly in factory labor, which is scarce on the San Francisco peninsula. To recruit workers, Lenkurt operated a free training school, with no obligation for a trainee to join the company after he completed the course.

Hiring, Krengel says, has about leveled out. But the company expects to maintain a growth in sales which has measured 50% over the past two years. He and Gressens feel that even the military quarter of the business will not be seriously affected by an end to the war.

### Shortage of engineers

That opinion is echoed by Stanley F. Kaisel, general manager of the microwave electronics division of Teledyne, Inc. This division is almost purely military, and Kaisel traces its 25% increase in sales in the past year directly to Vietnam. "I believe the high level of military electronics activity will continue for some time, regardless of Vietnam," Kaisel says, "simply because the need for it is being demonstrated—as is a great lack of capability which will be hard to ignore."

"This country is not adequately equipped in the electronic warfare area. If peace comes, one might see a continued high level of R&D, with less production effort. But the microwave shakeout has driven out a large number of engineers, and we're sitting now without enough experienced, trained manpower to satisfy the potential needs." He adds rhetorically, "Will the government recognize the need to keep the capability to respond to the next incident beyond Vietnam?" Kaisel clearly believes that it will.



Still, few companies are willing to bet on what the Penatgon will do. The trend is toward diversification, both of product lines and of markets. Four years ago, microwave tubes accounted for 73% of Varian's sales; today the figure is only 35%, with power-grid, industrial tubes, and components, which weren't even in the catalog in 1962, contributing 25%. Further, the tube sales have dropped from 90% a few years ago to 65% today.

Richard T. Orth, another Eitel-McCullough alumnus who became Varian's vice president in charge of the electron tube and device group, says that his sales were up 40% over 1965 for the six-month period ending in March. About 10% of that business was directly attributable to Vietnam—but Orth adds that the end of the war would have little or no effect on sales.

### **New markets**

First, he says, business with the military is not wholly dependent on Vietnam. Second, brush-fire wars can be expected to spring up elsewhere. And third, Varian is actively pursuing new markets. The company recently entered the light sensing and display tube field, which Orth figures at a \$50-million market today. Varian plans to organize a separate operation to make tubes that will turn light energy into an electronic signal, or a signal into light. Orth sees applications in medical instrumentation, in X-rays and image intensification.

Varian already makes some medical instrumentation, such as a linear accelerator used in cancer therapy and electron paramagnetic resonance spectrometer systems used in biomedical research. It is looking into data processing equipment.

The company's acquisitions have also served to broaden the product line. In Eimac, it picked up a negative grid tube capability which gave Varian the largest line of power transmitting tubes in the industry. Eimac itself develops new products and recently came up with the "iron cow," a chunky electrostatically focused klystron that looks like a small mine; five blunt tuners extend from the cylindrical shield. This S-band device operates at 200 watts and has no stray magnetic field.

Eimac reports considerable activity in power microwave tubes, in fact, for new radar systems and commercial uhf television. And the approach of 1970 means that the talking stage for high-power S-band telemetry transmitters is about over, and the hardware stage approaching.

### **Solid state revolution**

Hewlett-Packard has always considered itself new-product oriented, and Minck says that with transistors going to 4 gigahertz and Gunn diodes to 12 Ghz, solid state is creating a revolution in instrumentation. H-P works both sides of the street; it makes instruments with solid state components, and it produces instruments that analyze solid state components. An example of the latter was the vector voltmeter 8405A, introduced at the IEEE show last March, which analyzes the scatter-

ing parameters of transistors.

"The use of solid state brings new design opportunities," Minck says. "With klystrons, you need a transmission line, but when you're talking about an integrated circuit chip, you're back to an L-C network." However, Minck feels that microwave IC's are a long way off, and that transistors will be the next step. He sees the need for new instruments to characterize YIG (yttrium-iron garnet) filters and other functional packages.

Granger Associates is also investigating solid state. It has just completed arrangements with its Stanford Industrial Park neighbor, Melabs, to put solid state transmitters and receivers into commercial microwave communications systems. These terminals would be suited for common carrier, operational fixed, government, and broadcast bands from 5,925 Mhz to 8,400 Mhz. They would have the capacity for 600 voice channels or one color tv channel.

"Communications services are expanding worldwide at a steadily increasing rate," says company president John V.N. Granger. "We are used to a highly developed economy, and this is something we take for granted. But communications systems are desperately needed in Central Africa, Southeast Asia, and in many other parts of the world."

Says Granger's marketing director, Harrison Johnson, "Nothing we make has tubes where solid state could be used." The company makes some closed-circuit tv equipment, and has been using integrated circuits in it since last October.

Dean Watkins, president of the Watkins-Johnson Co., says that R&D, at least, in solid state has blossomed since March. "We have government support right now, and our customers are paying us for what we had to do with our own money in the past," Watkins says. The company is particularly interested in transistorized oscillators and YIG harmonic generators.

Watkins-Johnson, which operates mainly in strategic reconnaissance and surveillance systems and communications and telemetry equipment, plans to diversify. But they won't say where, except that the diversification will not be an unrelated field.

Kaisel says that "microwave electronics' solid state activity is three years old and is beginning to produce results that could lead to military products." The company is now selling sample products, such as solid state delay lines, mostly so designers can become familiar with them.

### **Diversification takes several routes**

In high-power applications, though, solid state is still a conversation piece, and diversification takes other routes. Litton has test laboratories in oceanography and data handling and expects to have hardware in a year or two. ("The hardware would be a computer memory device, and that's all I want to say about it now," says marketing director Kelly.) Litton also is working on an acoustic detection system and has two programs in microwave delay lines. "We're developing a new

tube for exposure of Kalvar film for data handling, and we have found a significant market for our ceramic capability, including ceramic vacuum chambers for linear accelerators," Kelly says.

"We are also trying to eliminate interface problems between microwave tubes and their power supplies," Kelly adds. "Some years ago we began selling packaged tubes and power supplies for lab use and equipment subject to environmental exposure; we found that most users would just as soon buy the package.

"Most recently, we entered the field of magnetron packages. We think we can solve a problem that has always plagued magnetron users: the building of magnetron modulators requires an intimate knowledge of the magnetron. So it makes sense to combine the production of both under one roof and let the designers work out the problems before the devices are manufactured."

Litton also has a research program that it claims will produce a breakthrough in the efficiency of millimeter-wave generating devices. But Kelly feels that the laser took the bloom off the millimeter wave, though the military may still be interested in millimeter waves for very high definition radar.

Lenkurt, too, has an interest in millimeter waves,

but it does not do its own research. "The spectrum is becoming so crowded, that we have to look at other systems," Gressens says.

Hughes's Smith was also uninterested in solid state. His rival for the klystron was an 8-kilowatt continuous-wave twt operating at C band, which, he felt, would have commercial applications in ground stations for communications satellites. Unlike klystrons, twt's can be used over wide bandwidths without tuning, but they have been too inefficient in the past. The new Hughes twt has an efficiency of about 30%, similar to a klystron's, compared to the normal 10% to 15%.

Hughes has also obtained 2 kw c-w power at S band with a helix twt. "We feel this is a very significant accomplishment," Smith said. "The highest power we have seen on the market is about 200 watts." The new tube, he said, would be useful in deep space communications.

"Solid state always seems to be farther down the pike," says Varian's McCullough. "We're aware of it, we try to evaluate it, we'll be a part of it—but tubes aren't dead yet."

And the microwave industry, which seems to be aware of everything, to be evaluating everything, and to be a part of everything, is very much alive.

## Instrument outlook: growth and diversification

Instrument makers—buoyed by bulging sales books—are confident they will find ever-expanding markets for their new products

By Walter Barney

San Francisco Regional Editor

The talk from instrument makers out west is growth and diversification. Where microwave companies refer to the shakeout of a couple of years ago [p. 106], and integrated circuit manufacturers hint at the shakeout to come [p. 114], the instrument world seems sure that it has an ever-expanding market for its new products.

"We seek growth rather than accept it as a reward for a job well done," says Ed Smith, marketing manager of the frequency and time division at the Hewlett-Packard Co. The Ampex Corp., in turn, figures that it's growth is due not to virtuous planning but to the development of technology. Instru-

ment makers are not only building better mouse-traps, they are—to stretch the metaphor a bit—building products that affect the whole life cycle of the mouse.

### Bulging budgets

Diversification demands research and development, and the instrument makers have solid R&D budgets. Ampex will spend more than \$16 million on R&D in fiscal 1967—10% of its record sales for fiscal 1966. In the past five years it has spent \$65 million in that area.

Friden, Inc., will set up an R&D center to work

on integrated circuits, and will boost its budgets 20% a year for the next three years.

The boom is even making electronics companies out of outsiders. Five years ago, Friden, a maker of calculators and other office equipment, had no electronic products. "We found ourselves with a line of products about to become obsolete," says executive vice president Martin H. Dubiler. The company went after an electronic capability and now expects that by next year half of its office equipment sales will be in electronics.

Hewlett-Packard spends about 6% of its \$200 million in sales on research and development. The Systron Donner Corp. spends 10% of sales on R&D.

### People analyzers

Such research results in a steady stream of new products. The scientific and process instruments division of Beckman Instruments, Inc., for instance, is working very heavily in medical instrumentation, specifically, in the area of predictive measurements [Electronics, Aug. 9, 1965, p. 64]. These are measurements which indicate a potentiality for illness in an otherwise healthy man. One Beckman researcher even believes it is possible to develop instruments to forecast "disease with a capital D"—that is, illness in general, without regard to what form it will take. Beckman's first market instrument, developed with the Humetrics division of the Thiokol Chemical Corp., is the PhonoCardioScan, a portable solid state computer designed for mass heart sound screening. The sensors are three suction-type electrocardiogram electrodes and a microphone placed on the patient's chest. Beckman is using the instrument to screen school groups in Los Angeles and Chicago.

It was the sensitivity of quartz to temperature changes, a decided disadvantage in some quartz oscillators, that provided the Dymec division of Hewlett-Packard with one of its hottest items, the quartz thermometer. Dymec put a temperature probe on one end of a flexible cable, and read off temperature changes from frequency changes in the oscillator. The thermometer is so sensitive it can be used for differential temperature analysis of an unknown chemical compound, since a different chemical structure results in a slightly different boiling point. The device can also be used for molecular weight analysis.

### Time flies

Hewlett-Packard has found that its flying clock, introduced a year ago, has filled a brand-new need. Atomic clocks provide extremely accurate time standards; the Bureau of Standards's 10-foot cesium beam tube is accurate in one part to  $10^{11}$ . But how do you tell someone in California what time it is by a clock in Washington? Propagation by radio or wire results in variations of several hundred microseconds. Hewlett-Packard came up with a small cesium beam tube with an accuracy of two parts in  $10^{11}$  that reduces the variation to



"We have broadened the product line into the video end of the business."—William E. Roberts of the Ampex Corp.

one or two microseconds. The clock can be physically transferred on an airline seat, for which it pays half fare.

Smith says that Hewlett-Packard has sold 50 of the cesium time standards for \$15,000 each. Because both the cesium tubes, which it buys from Varian Associates, and the quartz oscillators require 4 to 6 weeks aging, plus another 4 to 6 weeks aging after they are matched, delivery takes 12 weeks.

### Government markets broaden.

Government spending accounts for a large percentage of instrumentation sales, although military spending is becoming less and less significant. William E. Ayer, president of Applied Technology, Inc., estimates that 60% of the production of all San Francisco Bay Area electronics can be traced to government-end use; and James Cunningham, Systron Donner's marketing director, says that his company has felt particularly increases in grants to individuals and institutions from the National Science Foundation and the National Institute of Health.

But companies which are not basically defense-oriented are edging away from government sales. "Five years ago," says William E. Roberts, president of the Ampex Corp., "almost 50% of Ampex's sales were to the government. Today the dollar level is the same, but the percentage is down to 21%." (Ampex has gone from \$70 million in sales to \$169 million in that period, with net earnings of \$33 million, compared to \$6.5 million in earnings in its first 17 years of existence.)

### Video systems, big and small

"We have broadened the product line into the video end of the business," Roberts continues, "into

high-band color and closed circuit television. We are trying to design and develop products that can be manufactured at lower cost, to be sold for from \$1,100 to \$15,000 to schools and hospitals.

"The home video recorder hasn't even scratched the surface. In 10 years, we've gone from a \$100,000 package to a \$1,000 package. There's no reason to think that we will stop there. We have gone from almost no consumer audio to almost \$18 million in home audio sales last year. We're also making other types of raw tape—video, instrumentation, computer, and master audio recording tapes."

At the other end of the price spectrum, Ampex shipped its first videofile system to the National Aeronautics and Space Administration's Space Flight Center in Huntsville, Ala., last April. This is an analog memory file; instead of storing binary ones and zeroes, it stores pictures or documents on a reel of tape. The documents can be called up for display and a hard copy delivered; when they are of no further use, the tape can be erased just like any other recording tape.

The NASA system cost a million dollars. Ampex has also sold a videofile to the Southern Pacific Rail Road; the railroad would not let Ampex announce the price of that one, but a minimum system would cost \$250,000, and the Southern Pacific's is not minimum.

Ampex has increased its overseas sales to the point where they now represent 31% of the total. The company has plants in Great Britain, Belgium, Brazil, Hong Kong, and Japan, but estimates that more than 80% of its hardware sales are exports.

### Big jump

As far as Roberts is concerned, Ampex's expansion just won't quit. "Videotape is important to this decade as the automobile was 40 years ago, radio 30 years ago, tv 20 years ago, and xerography 10 years ago," he says. "We've come a long way since the first bulky machine was sold 10 years ago to the beginnings of home television at \$1,100. We made as many video recorders in the first six months of 1966 as we did in the entire 10 years previous." Ampex has sold a thousand of its \$3,000 video recorders and reports that its customers are continually finding new uses for them. Advertising agencies, for instance, use them to try out new commercials, athletic groups use them to show a slumping player just what he's doing wrong, and schools are beginning to buy the machines.

As a result of this activity, Ampex began its fiscal year in May with a \$52 million backlog—up 79% from the \$29 million of a year previous. Roberts says the company will increase its manufacturing capability, although because of Vietnam, the step will not be easy. Roberts says the war in Vietnam has generated a strain on an already booming economy. "It has created problems for us, rather than helped us, because of the tightening of materials, labor, and the money market," he says.

Many industry observers feel Vietnam is not a significant factor in the boom in the West. Com-

panies which have benefited from increased defense spending say that sales increases have been relatively small. They complain that defense production has diverted men and machines from what they consider more important areas. Byron Broms, marketing manager of Tektronix, Inc. says "A sudden end to the war would cause some dip in business, but we believe that the long-range effect would be good. Engineers engaged in defense projects would be freed to work on things more useful to society. Our extra productive capacity would be absorbed over a period of time into commercially oriented electronics and R&D. We've had our share of defense product orders, but it hasn't interfered with our ability to diversify. In fact, the single most important diversification move in our history—into the field of information display—was begun and has progressed during the past year."

### Solid triumph

Albert H. Rooks, vice president for marketing of the United Control Corp., near Seattle, also sees a detrimental effect from Vietnam buying. He says Vietnam diverts development funds to the buying of old hardware. United Control has experienced a 10% to 15% jump in its spare-parts business because of Vietnam—it makes transducers, recorders and avionics and temperature control systems—but apparently would just as soon forgo the increase. The company expects to increase sales from \$11 million to \$16 million this year. Its big triumph came when it snatched away from big companies like the Sperry-Rand Corp. and the Bendix Corp. a \$6.2-million contract from the Lockheed-Georgia Co. for major subsystems on the all-weather landing system for the C-141A Starlifter. United will provide an automatic throttle system, aircraft accelerometers, a test programmer and logic computer.

The Cubic Corp., of San Diego, has cut its military sales from 92% in 1962 to 69% in 1965, and is shooting this year for record sales of \$16 million. A sudden end to the war would not affect that goal greatly—but it would, a spokesman said, hurt Cubic next year. The company has developed a battlefield target location system—backpacks for 25 forward observers who spot targets and transmit information via an airplane relay link to a master control station and two base stations. A computer determines their position by trilateration. This system is now being tested by the Army at the Yuma, Ariz., proving grounds, and Cubic expects to start producing it next year.

### Voltmeter in a matchbox

Still, Cubic is increasing its nonmilitary business. It has stepped up marketing vote-counting machines. A year ago it formed a data systems division to make computer peripheral gear and data acquisition equipment. The company also makes digital voltmeters (dvm), but finds them less and less profitable. "The market is extremely competitive," says Jerry Simpson, sales manager. "People want a lot of machine at a lower price, so the mar-



"A sudden end to the war would cause some dip in business, but we believe that the long-range effect would be good."—Byron Broms of Tektronix, Inc.



"Five years ago, we found ourselves with a line of products about to become obsolete."—Martin H. Dubiler, executive vice president of Friden, Inc.

ket is going to machines under \$2,000." Profit on low-priced ones probably runs under 20%, he said, compared to 25% or 35% on more expensive instruments.

Richard Wynne, vice president for marketing of Non-Linear Systems, Inc., said that higher-priced instruments had increased from 35% to 50% of the company's sales.

Non-Linear is beginning to use integrated circuits in its digital voltmeters, and may have one such instrument on display at Wescon. The microcircuits are mostly used for ring counters; "They're a natural, because you can get a whole decade for the cost of one flip-flop," Wynne said. "We plan to use integrated circuits wherever we can because of the cost saving and the convenience of having to do less soldering." Eventually, Wynne says, they will bring about "a readout with a matchbox behind it. I think it's a couple of years off, but not much more."

The company promises what it calls a revolutionary potentiometric-integrating digital voltmeter at Wescon. This will be an advanced version of the X-1 model it introduced at the IEEE show in March; a potentiometric machine with a plug-in board for the integrating feature. The price has not yet been established, though the basic X-1 costs \$1,485.

Non-Linear has had less than spectacular success with the radically new product it introduced a

year ago, a solid state stereo receiver built in modules like aerospace electronics [Electronics, Aug. 16, 1965, p. 88]. Very few models have been sold—basically, says Wynne, because it has not had the marketing capability. Digital voltmeter salesmen are not the best qualified to sell consumer goods.

The set sells for \$695, and Wynne says that sales over the past year have been under \$100,000.

Non-Linear is not giving up, however. It has hired an experienced hi-fi marketing man in Los Angeles to arrange for retail outlets there and throughout the country.

### Counters jumping ahead

Systron Donner attributes the 30% growth at its Concord, Calif. plant, and its expected 30% growth in the next Aug. 1 to July 31 fiscal year, to a breakthrough in its own digital counters. Previously, the company's business was split 70 to 30 between the inertial division, which sold gyros, accelerometers, and flight systems for tactical missiles and space probes, such as Surveyor, and the electronic instrumentation division, which makes digital counters, analog computers, and data gathering systems. But sales of counters, says instrumentation marketing director James Cunningham, have taken off and now account for half the sales at Concord.

One factor in the jump was an automatic com-

puting transfer oscillator, which may be plugged into a counter to get an automatic readout of frequency in microseconds. At Wescon, Systron Donner will introduce a plug-in oscillator especially tailored to fit a Hewlett-Packard counter.

Hewlett-Packard itself is experimenting with integrated circuits for its digital counting instruments, and is also eyeing the nuclear instrumentation area, where the market, according to Smith of the frequency and time division, will approach \$60 million to \$90 million a year. Hewlett-Packard has built a scaler-timer to gauge the strength of a radioactive source by watching "nuclear events," such as neutron emissions, and changing them into pulses that can be counted. This is a new field for Hewlett-Packard, and since the customers are generally not familiar with other H-P instruments, there is a marketing problem.

### Electronic watchdogs

The military's strong interest in security—which is reflected in badge-happy electronics plants—has opened up a profitable market for at least two West Coast companies. Sylvania Electronic Systems' Western Operations, which designed equipment for Atlas, Titan and Minuteman missile sites, has formed a new internal organization known as Security Systems. Sylvania, a subsidiary of the

General Telephone and Electronics Corp., will build guard systems for industrial plants.

Cohu Electronics, Inc., of San Diego, is selling closed-circuit TV cameras for plant surveillance, a field to which it also moved from missile site tv, and now is considering a move into broadcast television. Cohu has built a small rugged portable camera, which measures 3 inches in diameter by about a foot long. It is now working on a solid state studio camera.

The aggressive nature of many West Coast companies may be epitomized by Friden, which has boldly announced its intention to challenge the International Business Machine Corp., the National Cash Register Co., and Pitney Bowes. Friden is working on a five-year plan under which it expects to double its sales between 1964 and 1969. It is already ahead of schedule, says vice president Dubler.

Friden has found that its move into electronics has doubled its output without an increase in plant workers. It would welcome a cut in Vietnam spending on the grounds that more engineers would be available to carry out its ambitious R&D program.

But from the plans of the other companies in the West, Friden would still have to scramble to get them.

## IC industry: picture of health

Sales are up, prices down and the industry's health shows in staggering backlogs and rapid expansion of facilities here and abroad; a shortage of engineers slows development work and new projects.

The integrated circuit industry in the West is zipping along at a fast pace with unit production more than double that of last year. Sales are up and prices have dropped. One dark spot is a manpower shortage that keeps companies from doing all the projects they want to.

Last year the IC market amounted to \$79.1 million; the industry forecast for 1966 was for a market of \$125 million. Already firms are predicting a much higher figure. One, Motorola, Inc., sees a \$140 million to \$150 million year.

---

Written by William Olcott with reporting by Walter Barney and Mary Jo Jadin in San Francisco; Marvin Reid in Dallas; Ray Bloomberg in Seattle; Gerald Parkinson and William Wallace in Los Angeles and Carol Kurtis in Brussels, Belgium.

The industry's health shows up in staggering backlogs, rapid expansion of facilities—with many firms moving abroad—and dropping prices.

But the fact that prices are dropping so fast has many firms running scared. Business has not brought great profits and many fear the industry is headed for a shakeout. Few manufacturers would contest the view of Don Valentine, marketing manager for the semiconductor division of the Fairchild Camera and Instrument Corp. He says, "Sooner or later capacity will equal demand; when that happens, the big will get bigger and the little guy will get hurt."

### Healthy industry

Actually, prices are falling so fast, many engineers are recalling the salad days of transistors a

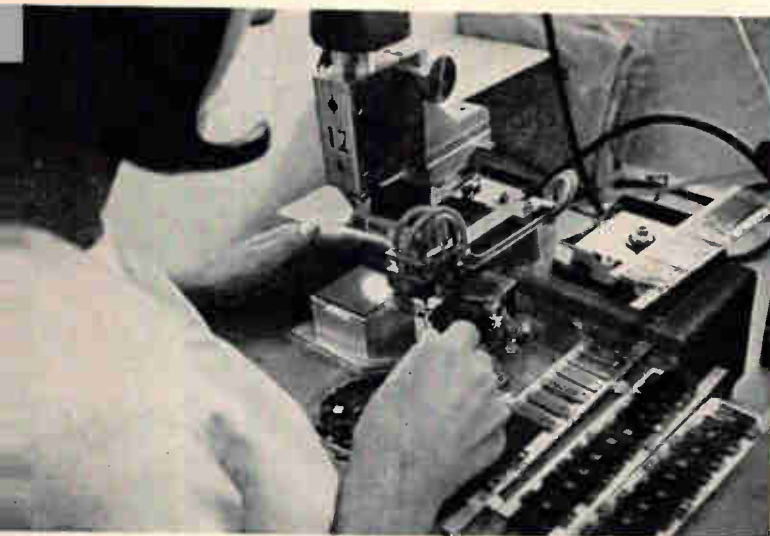

Integrated circuit makers are putting more circuits on a wafer and getting more usable circuits per wafer. A Fairchild operator attaches dice to flatpacks.

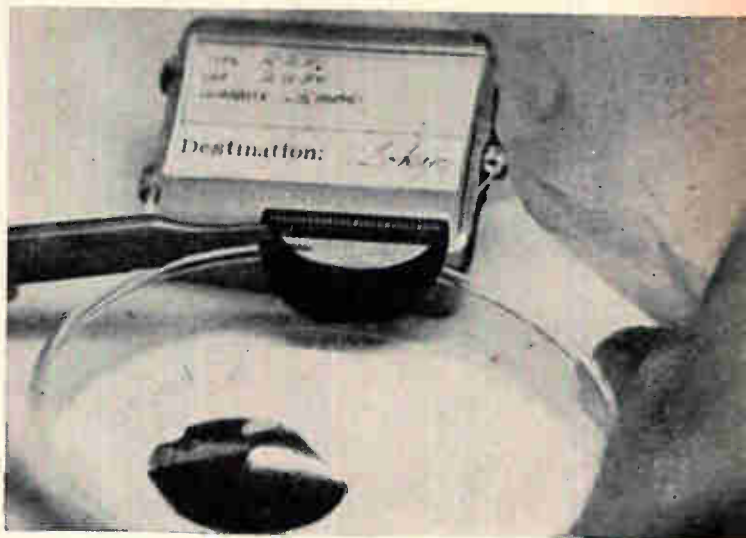

Drooping Raytheon chip, held by tweezers, is about to be put into a plastic bag for shipment to assembly plant in Tokyo. This protects the dice in shipment.

few years ago. H.F. Schunk, assistant semiconductor manager at the Raytheon Co.'s Mountain View, Calif., plant, anticipates a major price war. He says, "I think it will be a fierce one. Our prices quoted for delivery next year are already only half what they were for delivery in June. It's worse than it was with diodes and transistors.

"Any integrated circuit maker who is not planning for a serious price decline won't survive the boom. We are already tightening our belts."

On the other hand, Melvin G. Snyder, marketing manager at Stewart-Warner Microcircuits, Inc., in Sunnyvale, Calif., believes there is a limit. "The trend is still downward," he says, "but it can only go so far. Cutthroat pricing has always been a problem in the industry, but not as bad a problem as some people think, because nobody has a heavy enough inventory to support such an effort."

#### Behind the boom

The big jump in integrated circuit production is only partly a military phenomenon—although the military is still the biggest single IC customer. Large-scale industrial and commercial use is apparently nearer than anyone thought. IC marketing manager for Texas Instruments Incorporated, William L. Fowler, says that military IC's currently command only about 55% to 60% of the market, compared to 75% a year ago. He adds that industrial uses may account for more than half of next year's production, but much of the industrial market is still in the design stages.

Computers form the bulk of the nonmilitary market. And IC manufacturers are keeping up their efforts to grab a share of it. One way they are doing this is by use of complex circuits and monolithic arrays of integrated circuits (Electronics, March 21, 1966 p. 31). Complex circuits are IC's that blend several kinds of circuits, resulting in a device that can perform a complete logical func-

tion—such as a portion of a memory, a shift register, a frequency divider or a decade counter. In effect, a small subsystem is put on a single chip. One of the complex circuits now in production for computers is an 8-bit memory chip jointly developed by two West Coast firms—Scientific Data Systems, Inc. and the Signetics Corp., a division of Corning Glass Works, for an SDS computer.

Another factor contributing to the boom is the consumer market—which may be on the verge of breaking through. Fowler says that except for some 30,000 RCA television sets, the market is still mainly hearing aids, but radio is now opening up. General Electric Co., recently introduced a radio with an IC in it. At Wescon, RCA will be showing an experimental model of an f-m radio built with low-cost linear IC's (see article on page 133).

#### MOS catching up

The trend to higher circuit density suggests that more attention may be paid to MOS IC's such as the MOS shift registers being sold off-the-shelf for logic and delay-line applications. The Philco Corp. was clearly buying MOS (metal-oxide semiconductor) capability when it purchased General Microelectronics last January. GM-e's president, J. P. Ferguson says, "we believe MOS has already caught and passed the double-diffused IC in terms of cost." One transistor on the company's 100-bit shift register now costs about five cents. Says Ferguson, "we'll get it down to a tenth of a cent."

However, most of the MOS IC's are custom-made for specific systems. GM-e—now known as the Santa Clara operation of Philco's microelectronics division—put its MOS circuits into a desktop calculator in which the entire logic consists of one circuit board with 29 arrays—each having 612 transistors.

S.J. Levy, Motorola's assistant general manager for IC's, agrees that MOS will play an important

part in the IC market, but he feels that MOS and bipolar devices are complementary—an opinion he shares with Stewart-Warner's Synder. "When MOS technology is developed," says Synder, "it will have a higher yield than bipolar, but MOS can't be used in high-speed applications. I look for a marriage between the two technologies."

### Linear trails

Fairchild's Valentine says linear circuits now amount to 5% to 10% of all IC's made. Neither Valentine nor Floyd Kvamme, Fairchild's IC marketing boss, believes that linear circuits will beat out digital circuits for some time to come. A digital circuit is cheaper and easier to use because it performs an essentially repetitive function. Valentine points out that the big market for IC's is in computers, where many identical digital circuits are required.

Price is not the only holdup, even though the average price for linear circuits is \$19, against \$5 for digital IC's. Rather, says Valentine, it is the inability of engineers in small companies to become acquainted with linear circuits on a broad front that keeps sales down.

Linear circuits are expected to find use in industrial control, as well as in radio and tv sets.

### Shortage of men

Prices are not the sole problem hounding the IC industry in the West. The San Francisco Bay area—which has more IC manufacturers than any other—is also one of the nation's tightest labor markets.

Fairchild's Valentine says, "In that respect, business is too good. We're all competing for the same workers." He points out that Fairchild is already on three shifts a day and the company is contemplating busing workers from San Jose, some 15 miles from its Mountain View plant, when the summer vacation schedule makes the pinch even tighter.

Especially serious is the shortage of engineers experienced in IC design, comments Levy. The shortage forced Motorola to reluctantly shelve some development work because of the crush of current projects.

Not only the shortage of labor, but its cost and other problems have the companies looking in other areas for plant sites. Says Richard E. Lee, president and general manager of Siliconix, Inc., in Sunnyvale, Calif., "Whenever a company arrives at the state of large-scale production, California doesn't look so attractive." He blames a rising cost of living, transportation difficulties and climbing



"We anticipate another price war . . . any integrated circuit maker who is not planning for a serious price decline won't survive the boom."—Raytheon's H. Schunk.



"Our sixfold production increase this year was accomplished with no more diffusion furnaces than we had in 1965."—George H. Diding of Signetics.



tax rates for the poor production climate.

To remain competitive, IC makers have set up plants in the Far East to take advantage of cheap labor. Signetics is building an assembly plant in the Far East, Raytheon will send finished dice to be assembled in Japan and the semiconductor division of the Fairchild Camera and Instrument Corp. has had an IC plant in Hong Kong for several years.

### In search of space

Increasing sales have led to a demand for greater production facilities. As a result, companies are expanding facilities. In June, Signetics announced it will add 50,000 square feet to its main plant in Sunnyvale, thus doubling its manufacturing area and boosting employment from 800 to about 1,200. The company also announced it will lease 30,000 square feet and hire 150 employees in Provo, Utah. In addition, Signetics plans to build a complete manufacturing facility in Europe.

Other manufacturers map equally dramatic expansion. Raytheon opened a plant in Paso Robles, Calif., in April and plans to make military IC's at its Western operations headquarters in Santa Ana, Calif. The company owns a subsidiary in India and subcontracts some work in Mexico. Raytheon's

Schunk says the Mountain View plant will become, in effect, one huge furnace for silicon chips which will be assembled elsewhere.

Fairchild recently constructed a 112,000-square-foot addition to its 48,000-square-foot plant in Portland, Maine, and now produces 500,000 circuits a month there.

Motorola will open a 300,000-square-foot plant in Mesa, Ariz., and expects to double the plant's area in a few years. The company is a major supplier to European buyers and will have a facility ready for occupancy in France next year.

### Bigger and better wafers

Another factor in the IC boom is the advances made in process control and testing. IC makers are putting more circuits on a wafer, getting more usable circuits per wafer and finding faulty circuits early in the production process before they are assembled. Signetics reports that it tripled its yield between October, 1965 and March, 1966 by spending more effort on process control and making both bigger and better wafers. George H. Diding, marketing manager for Signetics, says, "Our six-fold production increase this year was accomplished with no more diffusion furnaces than we had in 1965."



"Military integrated circuits currently command only about 55% to 60% of the market, compared to 75% a year ago."—William L. Fowler of TI.



"Sooner or later capacity will equal demand; when that happens, the big will get bigger and the little guy will get hurt."—Don Valentine of Fairchild Semiconductor.

## Discrete components— not glamorous, but profitable

Although integrated circuits are earning the reputation for glamor and growth, discrete components are still the bread and butter products for most semiconductor manufacturers. And the Vietnam war has given new life to the sales of devices that many companies believed were growing obsolete.

At the semiconductor division of the Fairchild Camera and Instrument Corp., for example, statisticians report a significant increase—more than 25%—in the sale of discrete components this year. This applies to both military and civilian uses, but Fairchild calls the increase in civilian sales very significant. Transistors account for between 50% and 75% of sales and the company never expects transistor sales to drop below 33% of total semiconductor sales.

The Raytheon Co. says sales are split 70 to 30 between transistors and diodes and integrated circuits. In fiscal 1966, which ended July 31, sales of discrete components were up 35% over 1965 in dollars and 50% in units. Over-all sales were up 20% in dollars.

The TRW semiconductor division of TRW, Inc., recorded a 30% sales increase this year. "The big sellers are our RF transistors," says Robert L. Ashley, vice president in charge of marketing, "although our orders don't specifically say so, I suspect that the Vietnam war is largely responsible. These are the type of transistors used in communication equipment seeing service there."

At Hughes Aircraft Co. germanium diode production is up 40% or 50% over last year and the price of germanium devices has risen after several years of decline.



Hughes' Edson Gould

"We made germanium at a loss for many years and made it up in other areas," says Edson Gould, marketing manager of the Hughes microelectronics division. "Last year we increased our average price by about 2½ times. He adds that silicon alloy zeners, capacitors and pnp alloy transistors are also doing well, although previously they had been considered on the way out.

About 70% of Hughes' sales are to the military and the National Aeronautics and Space Administration and Gould says the jump in sales of all devices this year is about 20%.

**Familiar refrain.** Other southern California semiconductor manufacturers also report booming business. The Continental Device Corp., of Hawthorne, increased sales by 52% in the first half of its fiscal 1966, and expects to maintain the pace for the balance of the year (ending Sept. 30). The semiconductor division of the International Rectifier Corp., in El Segundo, registered the highest sales volume in its history in March. Sales were up 25% over 1965 in its fiscal year which ended June 30.

Neither company gave Vietnam much credit for the increases. Continental does about 35% of its business with the military, but has expanded heavily in the past two years into the computer field, with high-speed, high-conductance transistors and diodes. International Rectifier does only 13% of its business with the military; says marketing manager Ray Knox, "The market for silicon controlled rectifiers has been growing steadily in the past four or five years, and the consumer market is about to explode."

Knox expects big sales for solid state washers, ranges and cordless devices. "The appliance industry has historically designed things for lower cost, but it is finding that because of the better performance and reliability of solid state devices, it can command better prices," he comments.

**Big plans.** As sales records fall, semiconductor companies are not resting on their laurels: Almost all of them have extensive new product plans in the works aimed at boosting sales even further. Fairchild plans more diversification into photosensitive semiconductors, silicon controlled rectifiers and MOS FETs (metal oxide semiconductor-field effect transistors).

These areas, plus its digital integrated circuit line and power transistors, will account for the significant product volume in the next five years. The company is also building core and semiconductor memories, though production won't be significant for a couple of years.

Hughes' prime effort in the microelectronics field has been in hybrid flip-chips—glass passivated discrete or multiple semiconductor devices, planar epitaxial diffused, with "bump" leads. For about six months the company has been selling flip-chip diode arrays to computer manufacturers for use as core drivers on core memory planes. Gould says this activity now accounts for some 60% of the company's microelectronics business.

Hughes' microelectronic devices consist of a number of chips. But



IRC's Ray Knox

the company will have its first single-chip component in prototype production this fall. It will be a 14-bump dual four-input DTL NAND gate that Gould says will cost "significantly less" than comparable flatpacks at the functional level—though he would not say it would sell for less.

Hughes will introduce two new lines of signal amplifying flip-chip transistors at Wescon. One, the CAT1222, is a 35-mil square device similar to the 2N2222, with a power rating of around 200 milliwatts, minimum breakdown voltage of 35 volts and minimum gain of 100 at 150 milliamps. It is rated at 100 mw, 35 v breakdown voltage and minimum gain of 30 at 10 ma. Each will be priced at \$3 in small quantities.

At International Rectifier Knox noted a trend toward complete packages, incorporating a heat sink with a semiconductor device to ease the problems of equipment designers. He said that International Rectifier had designed some such packages and would have them on the market by the end of this year or the beginning of next.

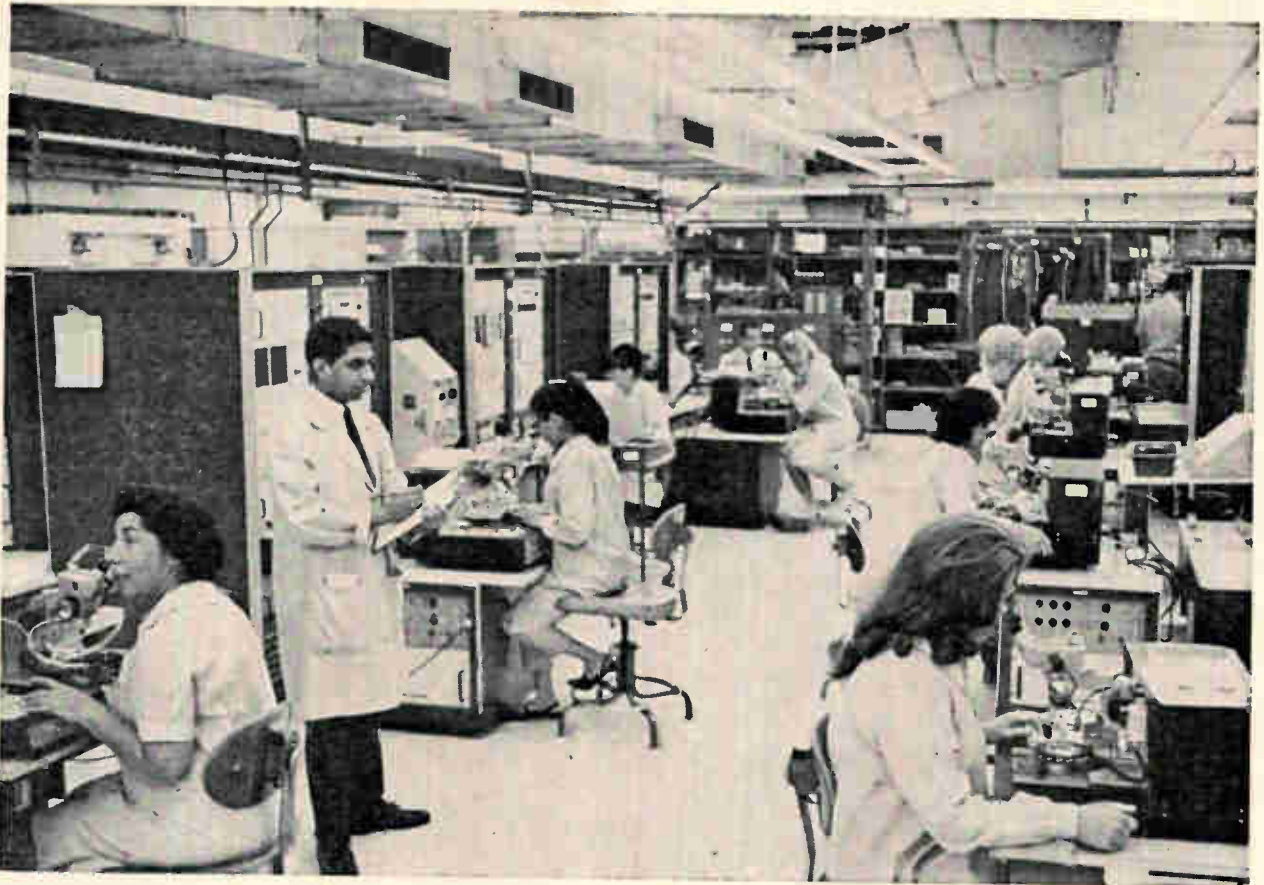

Fairchild uses automatic equipment to test each die on a wafer before the wafer is cut. In this way more of the bad circuits are discarded before assembly. This is an over-all shot of Fairchild's testing room.

Fairchild increased the size of its basic wafer from one inch to an inch and a half and decreased the size of the circuit die by 35%, thus boosting the number of dice obtained from each wafer. In addition, Fairchild uses automatic equipment to test each die on a wafer before the wafer is cut. In this way more of the bad circuits are discarded before assembly.

Other techniques have also helped in the cost race. TI's Fowler says molded plastic packaging techniques and greater complexity of circuits has reduced the cost of industrial IC's as much as 50% in the past year.

Along with the efforts in research and increased production capabilities, the search for new markets goes on. Automobile regulators, appliances and small motor controls loom as good possibilities. IC's are already being used in test and measuring equipment, digital instrumentation and in controls for some types of production machinery. But these are markets that have hardly been touched by IC's. "Wherever size, cost and power requirements are small and reliability is a big factor, integrated circuits will be used," Valentine says.

Other likely fields for IC expansion are process control, antiairborne collision devices and phased-array radar, according to James Riley, president of Signetics. He says, "This technology is so significant its impact will be felt everywhere."



"Whenever a company arrives at the state of large-scale production, California doesn't look so attractive."—Richard Lee, president of Siliconix, Inc.

# Designer's casebook

Designer's casebook is a regular feature in Electronics. Readers are invited to submit novel circuit ideas, packaging schemes, or other unusual solutions to design problems. Descriptions should be short. We'll pay \$50 for each item published.

## Hydrophone preamplifier cuts cable noise

By Frank Watlington

Geophysical Field Station,  
Columbia University, St. David's, Bermuda

A hydrophone preamplifier, built with a field effect transistor, eliminates unwanted noise and added capacitance produced by long cables. These undesirable effects occur when long cables are used with hydrophones or other piezoelectric transducers.

The FET circuit (at the right) eliminates these effects as efficiently as vacuum-tube circuits in a cathode-follower configuration and has additional advantages. The solid state circuit does not require high voltage and high filament current, as tube circuits do. A small 9-volt battery, such as the Burgess 2U6, powers the FET circuit. Continuous power can be obtained during a week-long oceanographic field trip with a portable hydrophone.

Frequency response for short lengths of cable, approximately 50 feet, is flat in the audio region down to 2 hertz. The voltage gain is approximately unity. In addition, the circuit can be used with cables up to 3,000 feet in length.

If the hydrophone lies still along the ocean floor, the 1-megohm resistor, shown dotted, is not needed. However, if the hydrophone moves in the

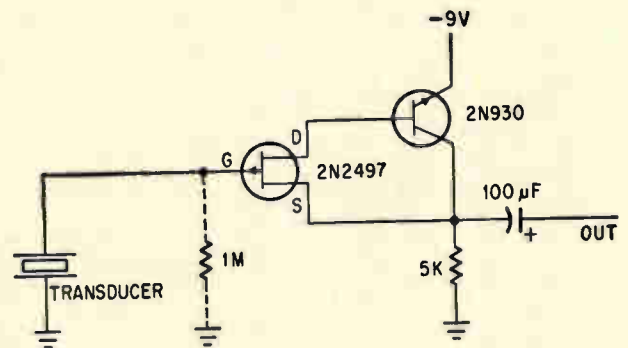

ALL RESISTORS  
METALLIZED TYPE

Effects of noise pickup and added capacitance caused by long cables are eliminated with this circuit configuration. The 1-megohm resistor, shown dotted at the input, reduces low-frequency excursions in the signal. These occur when hydrophone moves slowly in the water.

water, the motion causes tremendous low-frequency excursions in the signal. In this case the 1-megohm resistor is added. This reduces the input impedance and increases the lower frequency at the threshold point of 3 decibels. By increasing this frequency a higher cut-off point occurs and the low-frequency excursions are not transmitted.

The circuit is so small that it can be potted in epoxy, attached to the hydrophone and dropped into the water. It can be subjected to hydrostatic pressure directly if, for example, it is immersed in castor oil. The battery is not potted with the circuit and can be replaced as needed.

## Two events, in sequence, produce detector output

By Roy A. Wilson

Hycon Manufacturing Co., Monrovia, Calif.

An output pulse is provided by this amplifier only when some event, designated A, precedes another event, B. Any other sequence is ignored.

With all semiconductors in a nonconducting state, the sequence detector operates as follows:

- If signal B is applied first to the voltage divider formed by resistors  $R_1$  and  $R_2$ , a voltage of about +7 volts is placed on the base of transistor  $Q_1$ .
- Since the values of resistors  $R_3$  and  $R_4$  are equal, the potential at node M is half the voltage of the supply. Here the voltage at node M is +14 volts.
- With node M at +14 volts and the base of  $Q_1$  at +7 volts transistor  $Q_1$  will not conduct.
- When signal A is applied across the voltage divider of resistors  $R_5$  and  $R_6$ , about 9 volts appear

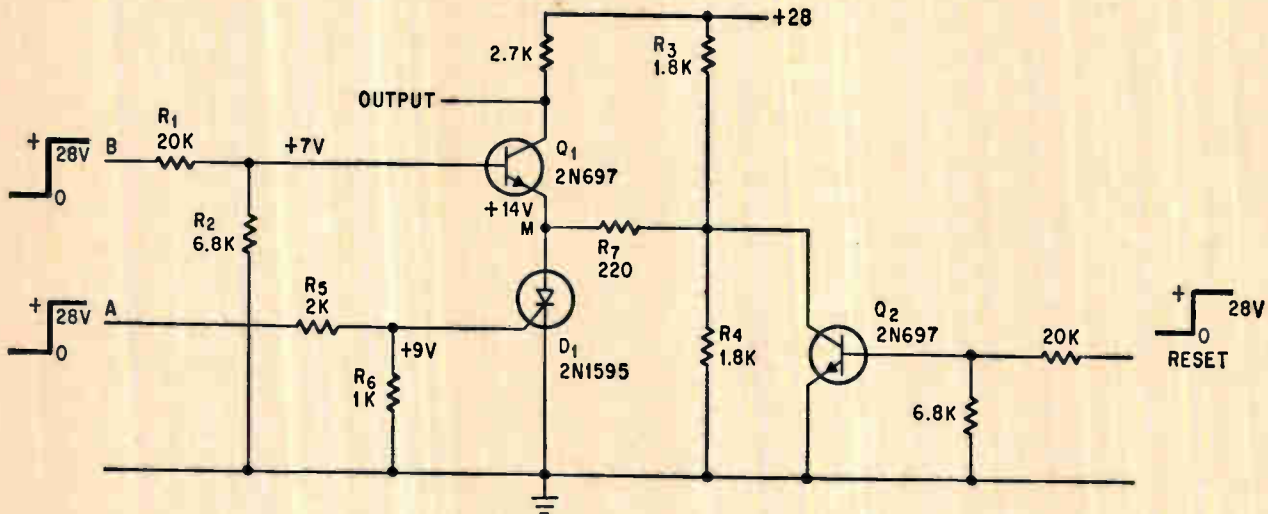

An output is provided when an event, A, precedes another event, B. Other sequences are ignored.

across the 1-kilohm resistor.

▪ Since node M is at +14 volts and the gate of the silicon controlled rectifier, D<sub>1</sub>, is at +9 volts, the scr conducts.

▪ When the scr conducts, node M drops to ground potential. Thus, when a positive signal

enters at B, transistor Q<sub>1</sub> turns on, and an output pulse is produced.

A reset pulse is generated at any time and used to short resistor R<sub>4</sub> by means of transistor Q<sub>2</sub>. Thus, the current through the scr is dropped below its holding value.

## Transmission lines couple multiple-driver receivers

By R.C. Garavalia

Automatic Electric Co., Chicago

A d-c coupled transmission line solves any ground-differential problem between driving and receiving subsystems separated by as much as 120 feet. This eliminates the costly transformer coupling usually required in such cases. The lightly twisted line—composed of 24-gage solid wire—has a characteristic impedance of approximately 100 ohms.

Using very low voltage (1.5 volts) excursions on

the line holds capacitive crosstalk between leads to a minimum. The twisted-pair distribution of signal lead and ground return minimizes inductive crosstalk. This tends to cause cancellation of the magnetic field associated with currents that flow in each.

Referencing all receivers to a single-driver ground as shown in the block diagram below makes possible the use of d-c coupling. Control of the state of these receivers is accomplished by:

- Designing receivers with a common base input;
- Connecting the base of this stage through the cable to reference ground;
- Turning the driver on and off to cause the emitter to vary above and below this ground.

By controlling receivers in this way almost three volts of ground differential can be tolerated.

This design permits coupling up to four receivers

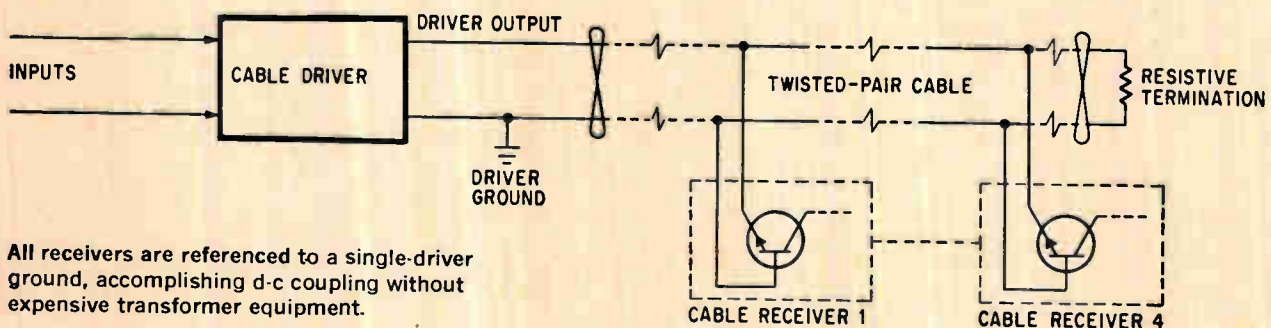

All receivers are referenced to a single-driver ground, accomplishing d-c coupling without expensive transformer equipment.

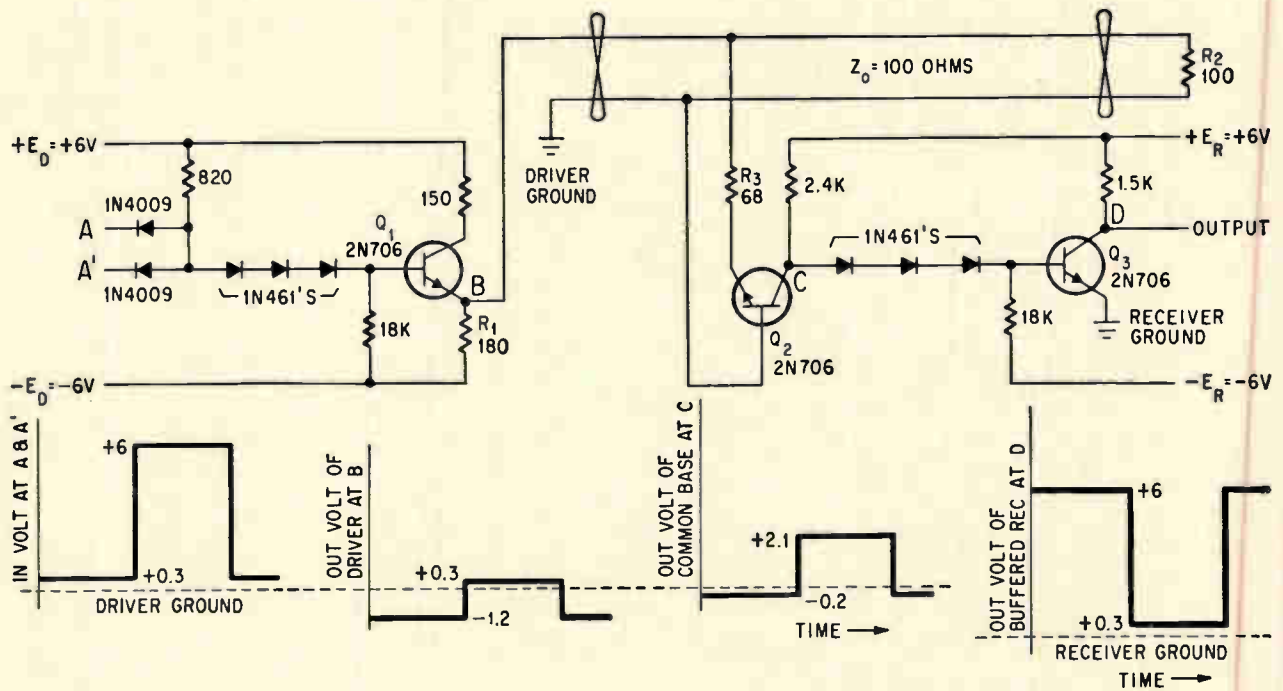

In the quiescent state, transistor Q<sub>1</sub> and Q<sub>3</sub> are biased at cut-off while Q<sub>2</sub> is held in saturation. A voltage of +6 applied to A and A' simultaneously sends Q<sub>1</sub> into conduction.

on any one line. Changing resistor values increases this maximum limitation.

A circuit schematic of the complete driver-receiver configuration appears above. Only one driver and receiver are shown on the line. The driver circuit is a low-output impedance, pulse-amplifier switch with basic topology similar to a standard DTL (diode-transistor logic) NAND/NOR gate. The receiver circuit employs the common-base amplifier and buffer circuit to increase drive capability.

In the quiescent state, transistors Q<sub>1</sub> and Q<sub>3</sub> are biased at cutoff while Q<sub>2</sub> is held in saturation. (Refer to the schematic and wave-shape diagrams.) The emitter current of Q<sub>2</sub> flows through resistors

R<sub>1</sub> and R<sub>3</sub>. Therefore, the line potential is a function of the total receivers used. Resistor R<sub>3</sub> helps isolate the individual receiver's base-to-emitter voltage variations from the line. Resistor R<sub>2</sub> terminates the line in its characteristic impedance value of 100 ohms.

This condition prevails until a positive voltage of +6 appears at A and A' simultaneously. When this occurs Q<sub>1</sub> goes into conduction. Transistor Q<sub>1</sub> saturates and supplies current to the line. This raises the potential of the line above driver ground. In turn, all receiver common-base amplifiers are reverse biased. Thus, transistor Q<sub>2</sub> cuts off while Q<sub>3</sub> goes into saturation.

## FET insures stable sawtooth wave

By Emanuel Elad

Lawrence Radiation Laboratory,  
University of California, Berkeley

The stable sawtooth wave generator on page 123 takes advantage of the extremely low drift properties of a field effect transistor to supply a constant current independent of line voltage fluctuations.

The design exploits the near-zero temperature drift of an FET at its bias point.

The generator consists of FET constant-current source, Q<sub>1</sub>, variable capacitor C<sub>1</sub> and unijunction-transistor switch, Q<sub>2</sub>. Potentiometer R<sub>2</sub> establishes Q<sub>1</sub>'s constant drain current of 0.1 milliamperes—the point that determines the zero drift bias of the FET. The negative feedback provided by the high resistance of source resistors R<sub>1</sub> and R<sub>2</sub> insures stability of the drain current, despite fluctuations of the supply voltage. The constant current delivered by the FET linearly charges variable capacitor C<sub>1</sub> to the triggering level of Q<sub>2</sub>. The charging time is a function of C<sub>1</sub>.

Varying C<sub>1</sub> adjusts the frequency of the gener-

ated wave form over the range of 500 hertz to 50 kilohertz. The storage capacitor is discharged in 1 microsecond through conducting switch  $Q_2$ . The sawtooth voltage at  $C_1$  is applied to the output terminals through emitter follower  $Q_3$ . The amplitude of the output signal is determined by potentiometer  $R_4$  in the range of zero to 8 volts. Base 2 of  $Q_2$  supplies a synchronizing output signal for oscilloscope display. The circuit can operate as a portable unit with a battery of its low current drain. The linearity of the sawtooth wave form over its dynamic range of frequencies is within 1%.

Temperature stable FET supplies a constant current to charge capacitor  $C_1$ . Varying  $C_1$  changes the sawtooth frequency.

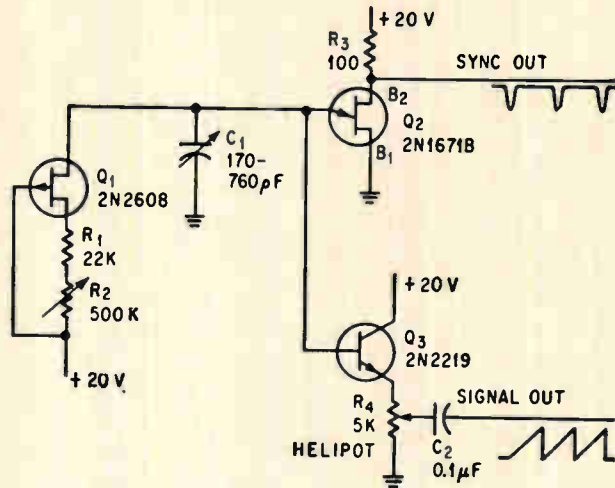

## Converting audio oscillators to square-wave generators

By R.S. Selleck

Consultant, Los Angeles

Any audio oscillator becomes a square-wave generator, at less than half the usual cost, when the conversion circuit at the right is coupled to the oscillator. The circuit will shape sine waves up to 3 megahertz before the trailing edges of the square wave begin to deteriorate.

Input signals from 0.2 volt to 10 volts in amplitude can be used to trigger the circuit. High conductance germanium transistors permit triggering at low signal levels, while silicon diodes limit the maximum input voltage to 0.7 volt. The circuit is symmetrical and either bias voltage can be easily removed when unidirectional pulses are desired. Power is provided by two 9-volt transistor batteries that can be packaged with the circuit in a single self-contained unit.

Capacitor  $C_1$  blocks any direct-current components present in the incoming signal; diode  $D_1$  cuts the positive excursion of the alternating component to 0.7 volt, and places it across the 47-kilohm resistor and the base-emitter junction of  $Q_1$ , turning  $Q_1$  on.  $Q_1$  is a germanium transistor which turns on quickly, squaring up the wave form and creating a voltage drop across its 4.7-kilohm collector resistor. This voltage turns on the wave-shaping pair,  $Q_2$  and  $D_2$ .  $Q_2$  shapes the wave to its final square-ness, while  $D_2$  clips the top of the pulse, assuring uniform height. The lower half of the circuit operates to generate negative pulses.

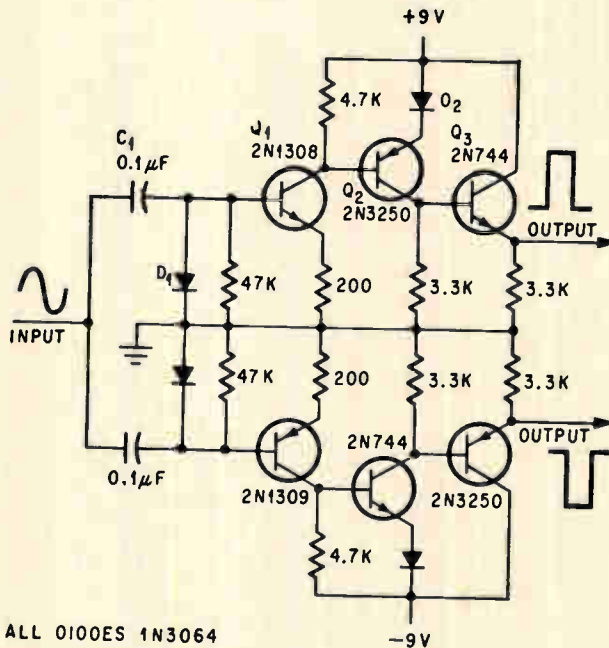

ALL 0100ES 1N3064

Positive signal turns on  $D_1$  and  $Q_1$ ; this drives the amplitude-limiting pair,  $Q_2$  and  $D_2$ , into conduction, squaring up the wave form. Similarly a negative square pulse is generated by the lower half of the circuit. Emitter followers isolate the output, preserving the integrity of the square wave.

The emitter follower formed by  $Q_3$  and the 3.3-kilohm resistor in  $Q_3$ 's emitter isolate the load from the wave-shaping circuitry; this isolation enables a pulse of 6-volt amplitude to drive a 50-ohm resistive load without wave form distortion.

Since all transistors in the circuits are biased off, a leakage current of only 20 microamperes flows when the circuit is not in operation; thus, the unit can be stored with its batteries without significant loss of battery life.

# CASE FOR THE MAN FROM E.A.G.L.E.

## STROKE... STROKE... STROKE...

What sounds like a helmsman's cry is really the objective of a leading drug manufacturer. To operate his compacting equipment for a preset number of strokes, index and reset, the man from E.A.G.L.E. suggested the beautifully simple system shown at left. START button activates a Cycl-Flex® counter which energizes an oscillating cylinder. After correct strokes, counter shuts off the cylinder and resets. HZ170 Series Cycl-Flexes are available in 40 and 80 count ranges. They have famous plug-in feature for removal and replacement in seconds. Full details are in Bulletin 725, for a copy use Reader Service Card, circle number 459.

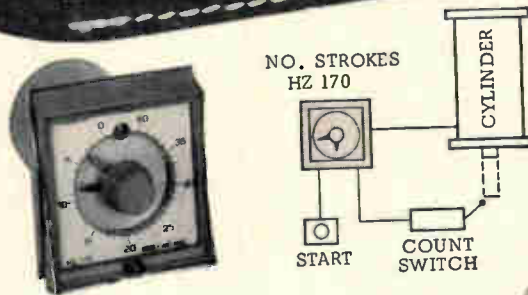

## IN WINE THERE IS TRUTH...

Although Pliny the Roman lived nearly 2,000 years ago, he must have known the vintner for whom the man from E.A.G.L.E. developed the system at the left. Nature's gently programmed portion in the work of wine making must be aided by exacting man-made blending techniques and quality procedures. To control these, Cycl-Flex HG100 timers are used as follows: the first timer fills the main vat from various pressings to create desired blend. During its adjustable "OFF" period, a second timer draws a precise sample. HG-100 series offer ranges from 60 seconds to 30 hours, features plug-in designs. Complete details are in Bulletin 321, for a copy use Reader Service Card, circle number 460.

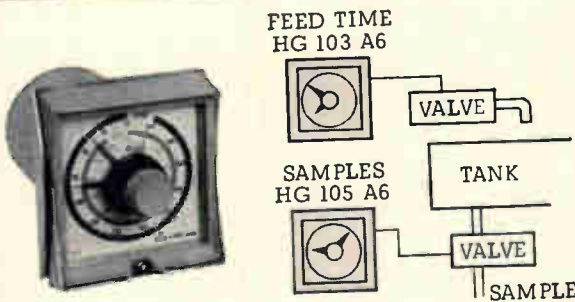

## HISS... PFFT... PFFT

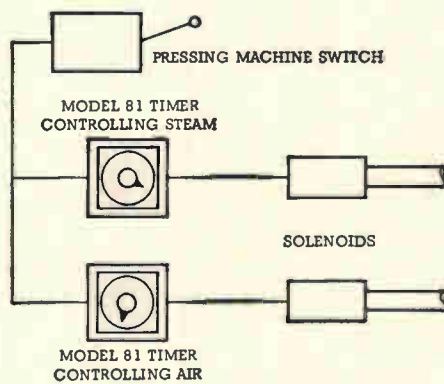

Sound like a snake breathing in short pants? Actually, it's the sound of a machine pressing long pants—men's trousers, that is. If you have a good crease in your trousers, the machine which produced it may have been controlled by the system at left, thanks to the Man from E.A.G.L.E. The operator closes the press, energizing a Model 81 Timer, which controls the steam, according to the setting. When the pants have steamed the right number of seconds, another Model 81 takes over—just long enough to have their fabric air cooled to a temperature at which it can be handled. Like everything else, pressing isn't as simple today as it used to be, for the tremendous variety of materials now in use demand exact and versatile controls for pressing operations. Model 81 supplies time ranges of .16 sec. to 5 min. Details are in Bulletin 1610. For a copy, circle Reader Service Card Number 461.



Ask the man from E.A.G.L.E. to open his "showcase" of ideas for you. Many of these ideas may help solve your process control problems. Want our Catalog Number 15? Use the handy Reader Service Card, circle number 462 or write: Eagle Signal Division, E. W. Bliss Company, Federal Street, Davenport, Iowa 52803.

**BLISS**



**EAGLE SIGNAL**

A DIVISION OF THE E. W. BLISS COMPANY

"See the Man from E.A.G.L.E. at Booth 1019 (Sports Arena) 1966 Wescon Show"



# CASE FOR THE MAN FROM E.A.G.L.E.

## UNDERCOVER OPERATOR

### 22AP Plug-in General Purpose Relay



... the epitome of relay craftsmanship and design. Versatile to the Nth degree on loads to 10 amps. Available in 8- and 11-pin styles for AC, DC and plate circuit requirements. Features include: forms to 3PDT plus specials on request; standard units have gold-plated contacts for longer shelf life; lower pull-in voltages (DC: 70% of nominal, AC: 75% of nominal); AC operating voltages 0.5 to 250, DC 0.2 to 130 in current ranges from .005 to 10 amp. Complete information is in our new relay bulletin. For your copy, use Reader Service Card, circle number 463.

### SPECIFICATIONS

- Contacts: SPDT, DPDT, 3PDT
- Contact Rating: 5 and 10 amps.
- Pull-in: 22 milliseconds average
- Drop-out Speed: 12 milliseconds average
- Size:  $1\frac{3}{8}'' \times 2\frac{1}{8}'' \times 1\frac{3}{8}''$
- Weight: 3 ounces

## POWERFUL PARTNER

### 25PS Medium Power Relay



... toss your toughest medium-power-handling assignments to this workhorse. 25PS types carry loads to 20 amps. on a fast duty cycle in a breeze. UL listed. Features include: rugged  $\frac{3}{8}''$  diameter silver cadmium oxide alloy contact; lower pull-in voltages (DC: 75% of nominal, AC: 76% of nominal); AC operating voltages 4 to 250, DC 1 to 130 in current ranges from .02 to 10 amp. For full technical information on this and other Eagle Signal general purpose and medium power relays, use the Reader Service Card, and circle number 464.

### SPECIFICATIONS

- Contacts: SPDT
- Contact Rating: 20 amps. 115/230 VAC 60 cycle resistive • 1 HP @ 115/230 VAC motor-inductive
- Pull-in: 50 milliseconds max.
- Drop-out Speed: 30 milliseconds max.
- Size:  $2\frac{1}{4}'' \times 1\frac{1}{2}'' \times 1\frac{3}{16}''$
- Weight: 3 ounces

## RELAY DESIGNERS' RELAY

### 25AA Open Frame General Purpose Relay



... and boy what a relay it is! Versatile, dependable, economical. You'll find hundreds of uses for these 5 or 10 amps., UL listed high-reliability types. Standard units have gold-plated contacts which permit longer shelf life. Other significant features include: lower pull-in voltages (DC: 70% of nominal, AC: 75% of nominal). AC operating voltages 0.5 to 250, DC 0.2 to 130 in current ranges from .005 to 10 amp. Detailed specifications on these and other Eagle Signal general purpose relays are given in a new technical bulletin. For your copy, use Reader Service Card, circle number 465.

### SPECIFICATIONS

- Contacts: SPDT, DPDT, 3PDT
- Contact Rating: 5A and 10A @ 115 VAC • 5A-1/10 HP @ 115 VAC, 1/6 HP @ 230 VAC • 10A-1/6 HP @ 115 VAC, 1/3 HP @ 230 VAC
- Pull-in: 22 milliseconds average
- Drop-out Speed: 12 milliseconds average
- Size:  $1\frac{7}{8}'' \times 1\frac{1}{32}'' \times 1\frac{1}{2}''$
- Weight: 2 ounces

Ask the man from E.A.G.L.E. to open his "showcase" of ideas for you. Many can help solve your process control problems. Want our complete catalog? Use the handy Reader Service Card, circle number 466, or write: Eagle Signal Division, E. W. Bliss Company, Federal Street, Dav-  
enport, Iowa 52803.

**BLISS**



**EAGLE SIGNAL**

A DIVISION OF THE E. W. BLISS COMPANY

"See the Man from E.A.G.L.E. at Booth 1019 (Sports Arena) 1966 Wescon Show"

# Generating power at gigahertz with avalanche-transit time diodes

Three new diodes—pnin, p-i-n and pn devices—promise to yield more power at higher frequencies than other solid state microwave amplifiers and oscillators; but designers face noise and heat problems

By K. D. Smith

Bell Telephone Laboratories, Murray Hill, N.J.

**The long-sought goal** of microwave power generation by compact, solid state devices may soon be attained with a new device, the avalanche-transit time semiconductor diode. Exploiting a combination of two mechanisms that are excited by high electric fields—avalanche generation and transit-time delay—the diode boosts outputs to power-frequency combinations never before achieved in solid state devices.<sup>1-4</sup>

Avalanche-transit time diodes have generated up to 350 milliwatts of power at 50 gigahertz in the pulse mode.<sup>5</sup> In continuous-wave (c-w) operation, one device has put out 500 milliwatts at 10 Ghz.<sup>6</sup> Such results have been obtained by exploiting the negative resistance that occurs when a pn junction is reverse-biased into avalanche breakdown while a drift-field region exists in the diode.

By comparison, tunnel diodes can produce a few milliwatts at 10 Ghz, and bulk gallium-arsenide devices, 110 milliwatts at 11 Ghz.<sup>7</sup> Transistors can conceivably provide usable power output at frequencies as high as 6 Ghz, though none commercially available are rated above 2.5 Ghz.

The avalanche-transit time devices, furthermore,

may undergo a tenfold improvement in power output within two years. Within five years, c-w power output of 1 watt at 20 Ghz may be commonplace. However, there remain significant problems, including thermal effects and noise.

## Avalanche-transit time today

As a class, avalanche-transit time diodes offer promise of reasonable power outputs (0.1 to 1 watt) at reasonable efficiencies (5% to 10%) in the range from a few gigahertz to many tens of gigahertz. Over much of this range they will be in direct competition with bulk gallium-arsenide Gunn oscillators. Thus far, the tunnel diode has been outdistanced as a power generator by both the avalanche-transit time diode and the Gunn oscillator.

The three principal avalanche-transit time structures are the Read pnin diode,<sup>1</sup> a p-i-n diode and a pn diode (see page 128 and the table on page 130).

In the experimental results for several devices in the plot on the page opposite, some values represent the very best measurement made on a single diode in the course of a development program in which several hundred diodes were tested. For the avalanche-transit time devices, which usually exhibit increasing output with higher bias current, maximum power is obtained just before the diode burns out. In many cases, this figure was plotted.

Extrapolation of recent power and efficiency improvements suggests that an order of magnitude increase in c-w output power may be achieved within the next year or two.

## How avalanche-transit time operates

For a device to function as an amplifier or oscillator, it must deliver power to its output circuit.

### The author



Kenneth D. Smith joined the technical staff of Bell Laboratories in 1930. He has developed carrier and radio-frequency field test facilities, proximity fuses, radar and broadband microwave radio. In a recent assignment, device development, he worked on voltage limiters, diodes, solar batteries and high-frequency transistors.

To do this, the device must have a negative-resistance characteristic. In the avalanche-transit time diode, the negative-resistance characteristic develops as the result of a phase delay. The twin phenomena contributing to the phase delay are avalanche generation and transit time delay.

Avalanche refers to the internal secondary emission at a pn junction reverse biased into breakdown. At high fields (of the order of several hundred kilovolts per centimeter), carriers may acquire enough energy to knock valence electrons into the conduction band, producing hole-electron pairs. These new carriers cause further generation, as is shown in the diagram below. The required critical field is reached, and the current will grow exponentially without limit, when

$$\int_0^w \alpha dx \geq 1$$

where  $\alpha$  is the ionization factor for holes and electrons (assumed equal) and  $w$  is the width of the space charge region. Under steady state conditions the maximum field across the junction will be limited to the avalanche, or critical field. But under transient conditions, if the field is moved rapidly from below critical level to above it, and then below it again, the current will still be increasing when the field has passed its maximum; in effect, a phase delay will be introduced. This current-voltage phase shift can be as great as  $90^\circ$  under small-signal conditions. Combined with transit time delay, it can be used to develop negative resistance over a range of microwave frequencies.

### Transit time delay

Charge carriers in a semiconductor drift under the influence of applied electric fields. The average velocity is, however, quite low compared with velocities of electrons in a vacuum, because of interactions with the crystal lattice. As the applied field is increased from a low value, the electron or hole velocity at first increases linearly, then less rapidly, and at a field of a few kilovolts per centimeter the velocity saturates (it becomes nearly independent of further increase in field). The curve on page 129 shows how the velocity for electrons in silicon levels off at about  $10^7$  cm/sec (or 100 kilometers/sec). Charge carriers traveling in a high-field drift region thus have an important property that enables a pulse injected at one boundary of the region to move to the opposite boundary with a time delay. But since the average carrier velocity is constant, there is little dispersion, or "smearing out" of the pulse. In other words, the integrity of the wave shape is preserved.

This constitutes the second mechanism for introducing phase delay. If total delay is between  $90^\circ$  and  $270^\circ$ , the diode will exhibit negative resistance. It can then deliver power to the circuit and has possibilities as an amplifier or oscillator.

### Ceilings on performance

Designers of avalanche-transit time devices must face limitations and tradeoffs.

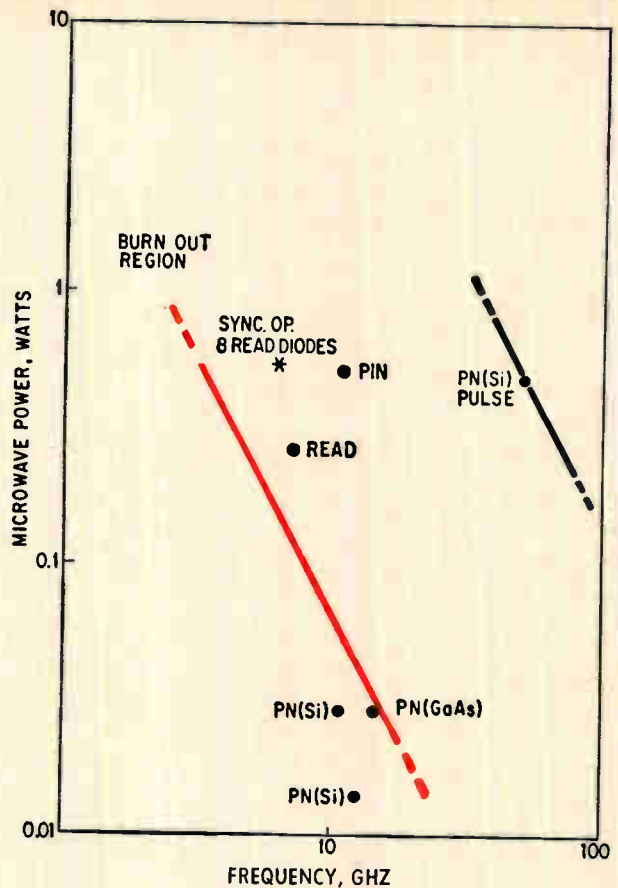

Experimental results for avalanche-transit time oscillators. For most devices, maximum power is observed just before diode burns out. Asterisk represents synchronous operation of eight Read diodes, as in circuit on page 129. Curve, left, is continuous wave; curve, right, is pulse mode.

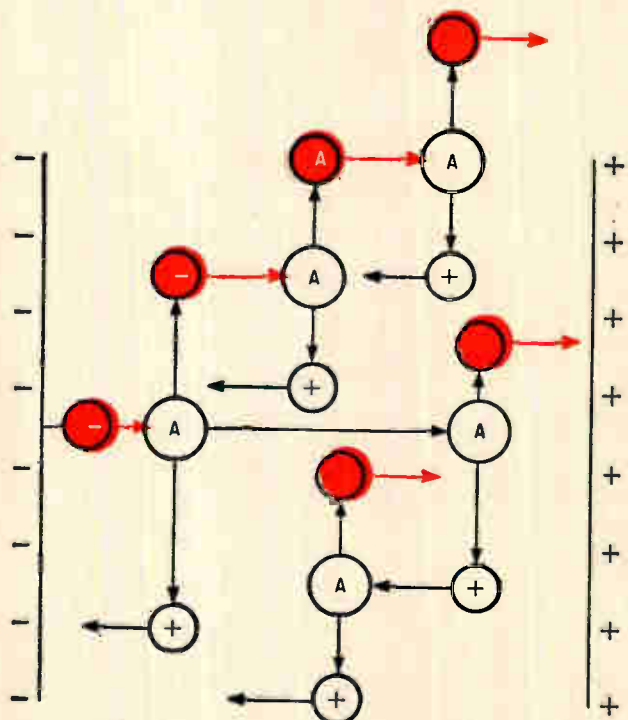

Avalanche ionization in bulk semiconductor material is one of the key mechanisms exploited in the avalanche-transit time devices. Electron (color) and hole pairs result from the jarring loose of valence electrons from atomic structure (A).

## Meet the family

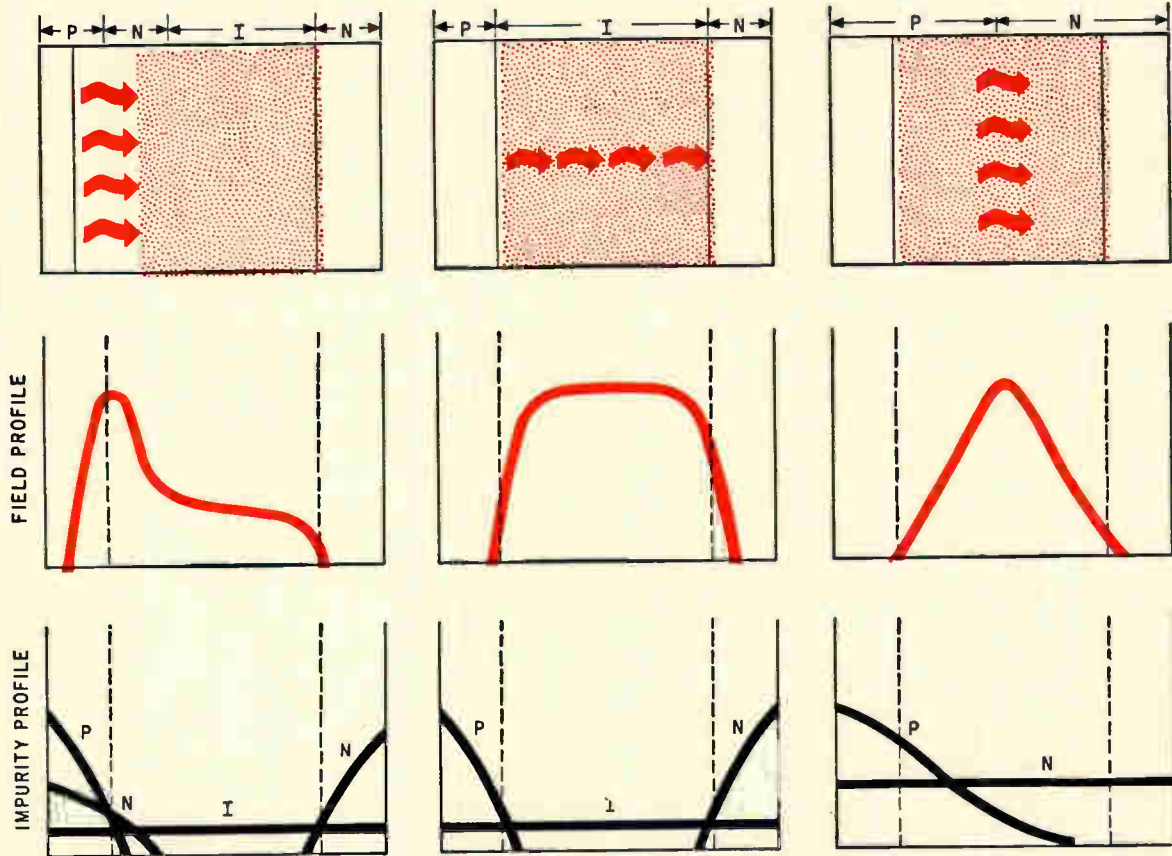

The first of the three avalanche-transit time oscillators, the Read diode, features a steeply profiled pn junction at the left end of the structure shown. It localizes the avalanche region and, incidentally, simplifies mathematical analysis of the device. Then comes a rather wide intrinsic region, and finally a heavily doped n+ region. At a reverse bias just below breakdown, the field looks like that shown. At slightly higher bias the avalanche field is reached at the pn junction, and the diode current becomes large. Holes drift into the p+ region with little delay, but electrons are delayed in transit across the drift region. An a-c voltage is superimposed on the d-c bias; this causes a negative resistance in the frequency range over which the delay in buildup of avalanche current and transit delay cause electrons to arrive out of phase with the applied voltage.

**Second member.** In the p-i-n structure the avalanche ionization is distributed through the drift-field region; also, both hole and electron drift currents are important (total delayed current comprises electrons to the right and holes to the left; in the Read struc-

ture, avalanche-produced holes are collected almost immediately). At high reverse currents, the device exhibits a negative resistance. When operated at high bias currents, experimental p-i-n diodes are competitive with Read oscillators in output power and efficiency.

P-i-n oscillators are less frequency-stable with changes in bias current than are Read diodes.<sup>14</sup> For an idealized p-i-n structure in which uniform avalanche generation takes place, it has been concluded that the resonant frequency increases approximately as the square root of the bias current.

**Number three.** The pn junction structure may be regarded as a pair of back-to-back Read diodes. That is, from the central high-field region of avalanche generation, electrons will drift to the right and holes to the left, each with a transit delay. The pn diodes are promising at high frequencies (above 20 GHz) where the drift region is very narrow. At these frequencies it is difficult to control adequately the impurity profiles of the Read and p-i-n structures.

Note: the regions within the devices are not as clearly defined as these sketches indicate. Rather, the

impurity dopants with which the bulk semiconductor material is treated result in the diffused or grown (epitaxial) junctions that correspond to the impurity profiles. In the device drawings, the heavy arrows represent avalanche; the random, scattered electrons designate the drift regions.

**... And its competitors.** Unlike avalanche-transit time diodes, the gallium-arsenide Gunn oscillator has no pn junction but generates microwaves when high electric fields result in traveling "domains" or local high-field regions where the electrons are in a lower-mobility energy state. Their behavior is similar to the avalanche diode's (generated frequency varies inversely as length of the drift region, and a high field is required), but there is no avalanche generation. Tunnel diodes derive negative resistance from quantum mechanical tunneling effects, and have no drift region to introduce delay. Thus, the negative resistance of the tunnel diode extends from lower frequencies to an upper limit that depends on the resistance-capacitance time constant of the device, and not on a transit delay.

The efficiency is lower than that attainable with a conventional low-frequency, vacuum-tube oscillator, since the permissible voltage swing is limited. On the low side, a velocity saturation field must be maintained across the drift region (several kilovolts/cm), and on the high side the field in the avalanche region cannot be raised much above the critical value.

Tradeoffs include these:

- As frequency is increased, the width of the drift region must be decreased, limiting permissible operating voltage.

- To maintain usable impedance levels (50-300 ohms), the area of the active region must be decreased at higher frequencies.

- At low frequencies (in the 1-Ghz region) the operating voltage must be raised to several hundred volts to maintain saturation fields across the wide drift region; thus susceptibility to burnout is increased—probably due to localized high current densities.

Pulse operation at low duty cycle permits much higher power operation than at c-w (by two orders of magnitude in some cases). This is because in small devices of relatively low efficiency a great quantity of heat must be removed to maintain acceptable operating temperatures.

### Avalanche noise

Unfortunately, the avalanche ionization mechanism is inherently noisy. Noise figures of 40 db have been predicted for the Read diode.<sup>8</sup> This agrees generally with observations. More efficient, higher output diodes may have less noise.

The noise problem must be recognized as a serious one; it may limit the application of avalanche-transit time devices as oscillators and low-

noise negative resistance amplifiers.

A means of operating a number of individual diodes as a synchronized or locked oscillator is demonstrated below. Individual units are connected so that the signal-frequency outputs add in phase, whereas the noise contributions do not. Compared with one device, an array of eight Read diodes provides a power gain of 8 db and noise-figure reduction of 9 db.<sup>9</sup> Extension of this method to larger arrays seems feasible.

### Too hot to handle

The traditional enemy of semiconductors is heat. And the avalanche-transit time diode's configuration doesn't diminish the heat removal problem. The thermal flux density between the active region and a heat sink can exceed twice that at the surface of the sun. As an example, a medium-frequency p-i-n diode has a 3-micron space charge width and an active region whose diameter is 100 microns. It operates c-w at 5% efficiency and 10 watts input, generating 400 megawatts/cm<sup>3</sup> in the active region. Its thermal flow into the heat sink is 120 kw/cm<sup>2</sup>.

Consequently, good heat sinks are needed. And careful design that minimizes thermal impedance at the interfaces between wafer and metal mount, and between diode package and waveguide or coaxial circuit, is a must. Sometimes, forced air cooling is required.

Problems are posed by "hot spots"—misbehavior attributed to nonuniform flow of current across the diode junctions. For simplicity of analysis uniform current flow must be assumed; however, real-life diodes do not conform to the ideal. This is made abundantly clear by the wide ranges of burnout power, frequency and efficiency of operation encountered in experimental diodes made with similar

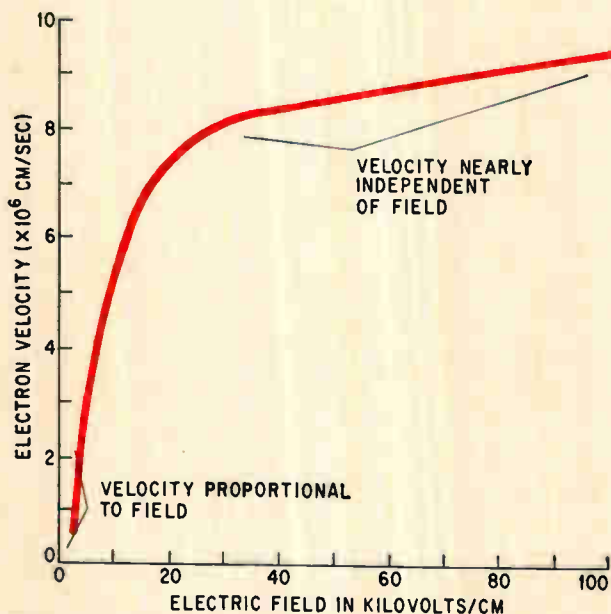

Velocity of electrons in silicon levels off at about 10<sup>7</sup> cm/sec. Carriers moving through the drift region undergo a transit time delay, the second important mechanism in avalanche-transit time devices.

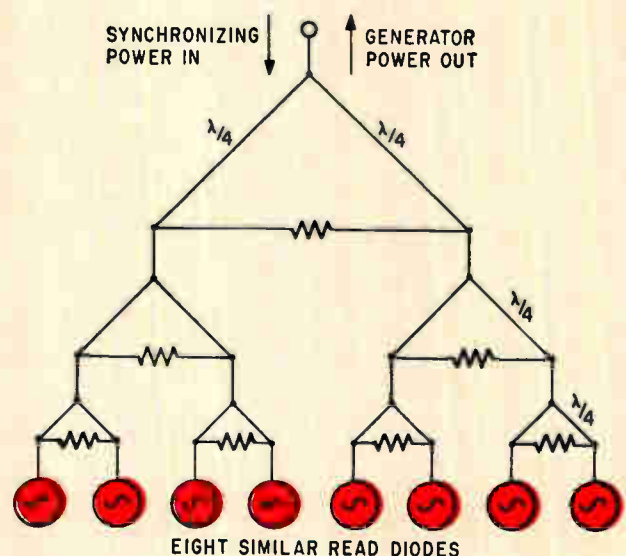

Eight Read diodes are connected for synchronized power combination. Signal-frequency outputs add in phase, noise outputs do not. The synchronizing power in is much less than the generator power out.

materials and by similar techniques.

A pair of mechanisms which may be effective in reducing the hot spot problem at higher frequencies result from the higher current densities. First, the avalanche field has a positive temperature coefficient. When there is a concentration of current in a local region, the temperature in the region will rise relative to the average temperature of the diode. As a result the local breakdown voltage in the region will increase. This tends, in part, to equalize the current distribution.

Second, it has been suggested that local regions of excess current will exhibit an effective series resistance,<sup>10</sup> which limits the local current rise; this is because of the concentration of charge in the drift region. A minor factor may be that the voltage drop in the spreading resistance of the epitaxial body will reduce the effective bias voltage at a local region of current concentration.

Imperfections causing hot spots may be grown into the material, or may result from the process sequence, or both. Improved material preparation and process technology has furthered diode performance and reproducibility, but much work remains.

#### Profile control

Developing and controlling in production the particular impurity profile desired on a specific device is more difficult than with conventional transistors. Computer synthesis of field plots and signal behavior as functions of impurity profile has been a useful study tool.<sup>11</sup>

Matching device to circuit is a problem still in the early stages of solution. Diodes having a variety of characteristics are needed for study in circuits.

In theory, avalanche-transit time devices having any area can be made. But the device designer runs head-on into the power-frequency tradeoff (power varies inversely as the square of frequency). Or he encounters nonuniform current distribution. Or he finds that large (or small) area devices cannot be operated efficiently in the available hardware.

#### Life's too short?

Little specific information is available on avalanche-transit time device reliability. Only a few low-power structures have been marketed, and reliability evaluations of these designs have not been

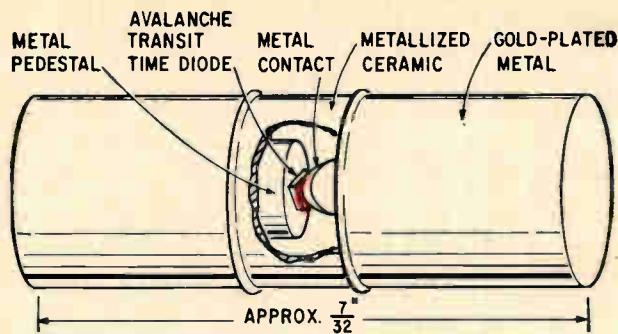

Cutaway of experimental microwave diode package used by Bell Laboratories in its studies of avalanche-transit time devices. Copper end slug is used to get low thermal resistance. Length of ceramic insulator is the same as the reduced height of the waveguide.

made generally available. The better experimental diodes are usually tested to destruction in short-time evaluation tests. Yet, this is not a reason for alarm. The avalanche-transit time diodes are operated in reverse breakdown, in the same general voltage range as the large family of voltage-regulator (zener) diodes, which have been extensively evaluated for nearly a decade. Though power avalanche-transit time diodes will operate at higher power densities and fairly high junction temperatures, suitable protection against power-supply transients and much care in the thermal design of device mountings should insure long operating life.

Since the avalanche-transit time diodes have active dimensions of only a few mils, some form of mounting or encapsulation is required. The diode package that is shown above has been used in experiments. The package capacitance is about 0.14 picofarad and the series inductance about 1.1 nanohenry. On a suitable heat sink, d-c power dissipation of 8 to 10 watts may be tolerated before burnout of diodes occurs.

#### Future

How fast and how far will avalanche-transit time oscillators be developed? It seems likely that single-package devices having c-w power output in excess of 1 watt and efficiency greater than 10% in the 10- to 20-Ghz range will be reported within a year, and that circuit operation at these levels will become commonplace within 5 years.

#### Avalanche-transit time diodes: performance now

Diode structure	Material	Frequency (Ghz)	Oscillator		Frequency (Ghz)	Amplifier	
			Power out <sup>1</sup> (mw)	Efficiency (%)		Gain (db)	Noise Figure (db approx.)
Read (pnip)	Silicon	5.3	130	4.9	5.5	20	39
	Silicon	6.0	750 <sup>2</sup>				
P-i-n	Germanium	6.0	9	0.5	7.5	20 <sup>3</sup>	45
	Silicon	12.0	250	2.8			
Pn	Silicon	10.0	500	5	11	20 <sup>4</sup>	50
	GaAs	13.6	30	6			
	Silicon	50.0	350 (pulse)	0.5			

1. Cw unless noted. 2. Eight-diode synchronized combination. 3. At 50-Mhz bandwidth. 4. At 30-Mhz bandwidth.

Progress in raising the power level at the low-frequency end of the useful range depends on developments in the fields of material and process technology which are harder to predict. The higher power theoretically available at 3 Ghz and below has not been substantiated by experimental results. It appears possible that bulk semiconductor oscillators, and, of course, transistors will retain their present lead in the 0.5- to 2-Ghz range.

Aside from low-noise applications, the field of application of avalanche-transit time diodes seems wide, indeed. Powers of several watts will be feasible by combining generators, or perhaps by using multiple diode assemblies in special low-impedance circuits. Direct frequency modulation<sup>10</sup> over moderate excursions has been demonstrated; avalanche-transit time devices can also be used as synchronized pulse amplifiers or modulated pulse generators.

Applications as carrier generators in broadband communication circuits appear probable, but the question of a-m and/or f-m noise contribution will require evaluation.

#### Winner in doubt

Prediction of the structures and materials which will dominate the avalanche-transit time devices must be quite speculative. Some rather fundamental properties of the materials, such as the velocity-field relation for holes in silicon, are still uncertain. Yet some trends appear predictable in the light of reported results and known material constants:

- For high-power c-w, silicon will be used, because of its superior thermal conductivity.

- The p-i-n structure may win out for devices offering both high power and high frequency, since it provides the highest voltage for a given space charge width.

- On the other hand, at very high frequencies, the pn device may prove best. For frequencies above 50 Ghz, the space charge region is less than one micron, and the accurate control of impurity profiles for true Read structures becomes very difficult. Gallium arsenide appears to be a promising material for very high frequencies since the carrier mobility is high, and short carrier lifetime can be tolerated.

- In low and moderate frequency applications (less than 10 Ghz) the Read diode, or possibly a Read structure having a modified profile, may come up a winner. Compared with the p-i-n diode, the Read exhibits a flatter efficiency versus power output characteristic. It seems to have a lower input power threshold of operation and good frequency versus bias power stability.

- However, the Read structure may be more costly because of the complex process control required.

#### Role of materials

Silicon holds a clear advantage in thermal conductivity; a silicon device has less than half the internal thermal drop of a gallium arsenide or

germanium device of comparable dimensions.

The highest efficiency has been reported<sup>12</sup> for gallium arsenide pn diodes—6% compared to 5% for silicon and 0.5% for germanium. Yet epitaxial gallium arsenide has exhibited more variation in quality than silicon or germanium, and its process technology is not as well defined.

Germanium p-i-n diodes have been fabricated that operate at 5 Ghz with c-w power output of 9 milliwatts and 0.5% efficiency.<sup>13</sup> Germanium is not likely to play a major role in avalanche-transit time devices though it may have an advantage in lower noise. Carrier saturation velocity in germanium occurs at lower fields than those required in silicon or gallium arsenide, but electron velocity is lower.

#### Competition for avalanche-transit time devices?

Tunnel diodes and Gunn oscillators may constitute important complements to the avalanche-transit time devices, but sometimes they'll compete.

Tunnel diodes have an established area of competence as low-noise microwave amplifiers, and may also be used as low-power microwave generators. Permissible operating voltages in the fractional volt range impose drastic restrictions on output power capability; they cannot compete with avalanche-transit time diodes or Gunn oscillators as high-power sources.

Since Gunn oscillators operate at much lower drift fields than avalanche diodes, they are at some disadvantage when operating frequencies in the tens of gigahertz are needed. The avalanche-transit time devices presently are in difficulty at the lower frequencies, say 1 Ghz, because of hot spots and related lower power burnout. All three classes of diodes, including the three avalanche-transit time types, appear to have useful fields of application. A wide variety of designs is anticipated—much as occurred for tubes and transistors. But it is still too early to say which devices will dominate specific fields of application.

#### References

1. W.T. Read Jr., "A Proposed High-Frequency, Negative-Resistance Diode," *Bell System Technical Journal*, Vol. 37, March, 1958, pp. 401-446.
2. R.L. Johnston, B.C. DeLoach Jr., and B.G. Cohen, "A Silicon Diode Microwave Oscillator," *Bell Systems Technical Journal*, Vol. 44, Feb., 1965, pp. 369-372.
3. C.A. Lee, R.L. Batdorf, W. Wiegmann and G. Kaminsky, "The Read Diode—An Avalanching, Transit Time Negative Resistance Oscillator," *Applied Physics Letters*, Vol. 6, March, 1965, pp. 89-91.
4. T. Misawa, "A Negative Resistance Due to Avalanche Multiplication in Semiconductors," *Proceedings of IEEE*, Vol. 53, Sept., 1965, p. 1,236.
5. C.A. Burrus, "Millimeter Wave Oscillations from Avalanching pn Junctions in Silicon," *Proceedings of IEEE*, Vol. 53, No. 9, Sept., 1965.
6. B.C. DeLoach Jr., *IEEE-PGMMT Conference*, May, 1966.
7. D. Brady, S. Knight, K. Lawley, M. Uenohara, to be published.
8. M.E. Hines, "Noise Theory for the Read Type Avalanche Diode," *IEEE Transactions on Electron Devices*, Vol. ED-13, Jan., 1966, pp. 158-163.
9. H. Fukui, to be published.
10. M. Gilden and M.E. Hines, "Electronic Tuning Effects in the Read Microwave Avalanche Diode," *IEEE Transactions on Electron Devices*, Vol. ED-13, Jan., 1966, pp. 169-175.
11. D.L. Scharfetter and H.K. Gummel, *Solid State Device Research Conference*, Evanston, Ill., June, 1966.
12. F.A. Brand, et al., *IEEE-PGMMT Conference*, May, 1966.
13. M.E. Lowe and R.L. Rulison, private communication.
14. T. Misawa, "Negative Resistance in pn Junctions Under Avalanche Breakdown Conditions, Part II," *IEEE Transactions on Electron Devices*, Vol. ED-13, Jan., 1966, pp. 143-151.

# Six months of evaluation testing by Burroughs engineers revealed four things about Stackpole commercial resistors.

## Quality, performance, value and service.



At their Plymouth, Michigan, Evaluation Testing Laboratory, Burroughs engineers put Stackpole resistors through the paces. What they discovered was a commercial resistor that more than matched their demanding requirements. Stackpole commercial resistors are manufactured carefully and backed by prompt delivery and service. Such attention to quality assures trouble-free machine or hand assembly and lifetime operation. These are but several reasons why Burroughs selected Stackpole commercial resistors for use on their E 2100 Direct Accounting Computer. Dependability, performance and accuracy are essential to Burroughs. Stackpole, too. For the full added-value story, write: Stackpole Carbon Company, Electronic Components Division, Kane, Pa. 16735.

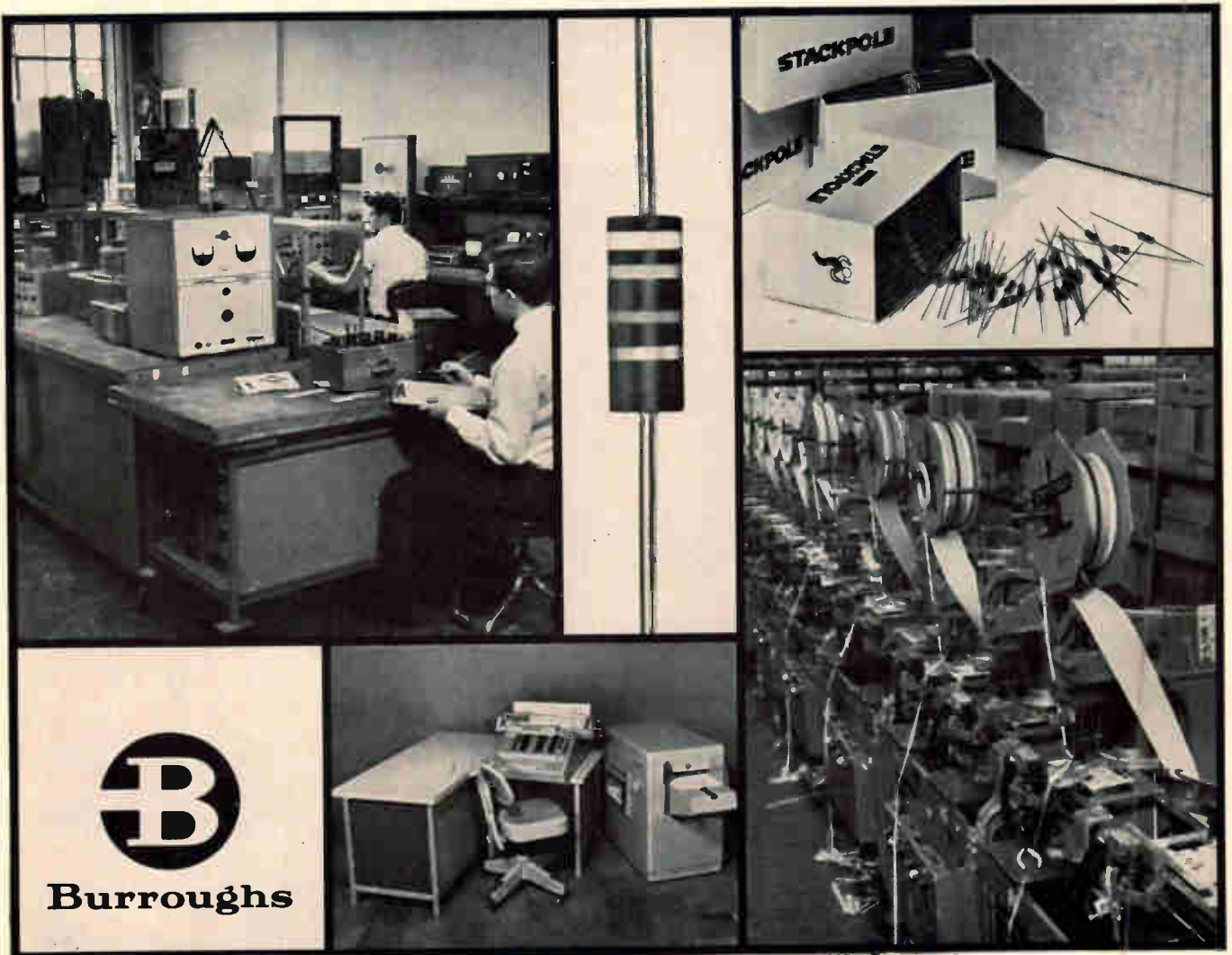



# Integrated circuits make a low-cost f-m receiver

Commercial feasibility of building f-m broadcast receivers with monolithic integrated circuits will be demonstrated at Wescon by tuners and i-f strips built with off-the-shelf microcircuits

By Richard L. Sanquini

Radio Corp. of America,  
Electronic Components and Devices, Somerville, N.J.

Last May the Radio Corp. of America demonstrated the technical feasibility of replacing the discrete transistors or tubes in commercial f-m broadcast receivers with integrated circuits. This month, at the Western Electronics Show and Convention, the company will show the commercial feasibility of the microcircuit approach by displaying the f-m receiver at the right. The unit is composed of a few low-cost, off-the-shelf chips and passive components.

The method used to build the new receiver differs substantially from the approach taken in May.<sup>1</sup> In the earlier approach, six identical microcircuits (with two transistors in cascode on each chip) were arrayed separately as mixers, oscillators and amplifiers; a seven-transistor discrete digital discriminator handled the detection and audio preamplification. The audio output levels attained with the earlier design were three times larger than those in the new receiver. Reception in the early receiver was limited to a single carrier frequency, while the new circuits tune the entire f-m band.

The new peripheral circuits are simpler than those described in May. The entire unit is built

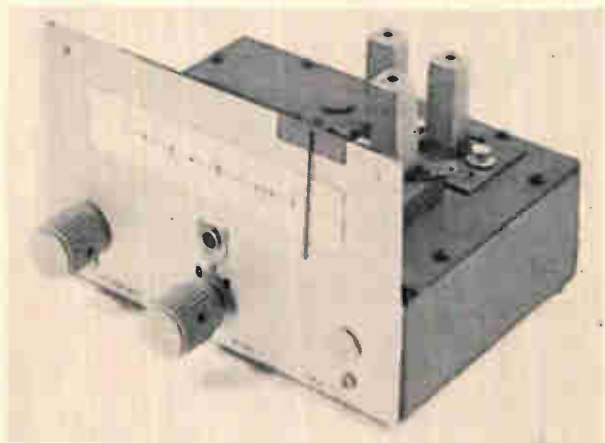

The complete f-m receiver consists of four integrated circuits—in the packages that look like transistor cans—and passive tuning components.

with four chips, and could have been built with three, with a sharp reduction in performance. One of the wafers—rather than a digital circuit—now handles discrimination. The microcircuits, however, are more complex, most of them performing a combination of functions. One silicon wafer operates as a radio-frequency amplifier, another as a mixer-oscillator and a third as a intermediate-frequency amplifier-limiter. The fourth chip is an i-f amplifier, limiter, detector and audio-frequency preamplifier.

These multifunction monolithic devices allow a choice of application circuits; for example, three different tuner designs are possible. Tuners can be built with one wafer, or with two wafers for im-

## The author



Richard L. Sanquini headed the group that designed the integrated circuits that demonstrated the technical feasibility of an micro-electronics approach to f-m receivers [Electronics, May 16, p. 80]. He also headed the group that developed the new commercial circuit design.

proved performance. In a two-chip tuner the first microcircuit is the r-f amplifier; it can be connected in either a cascode or differential mode. In addition, two different i-f strip configurations are possible, each of them requiring two microelectronic circuits.

Off-the-shelf components are employed in all designs. One of the chips for the tuner, the RCA CA3005 has been available since last November, but up to now has been used primarily in military and industrial applications. The other circuits, the CA3012 and CA3014, are similar to the circuit which RCA is using in a 12-inch black-and-white television receiver, the first such commercial application for microelectronics.<sup>2</sup>

Until recently, the relatively high cost of integrated circuits has limited their use in consumer products, but this problem has been overcome in two ways.

First, a systems approach is being followed; the microcircuits do not replace discrete components in a conventional receiver on a one-to-one basis, but do perform the required functions. This method simplifies the circuitry and cuts down on the number of components.

Second, monolithic devices suitable for consumer applications, such as the RCA circuits, are in volume production. This has reduced the unit cost to where it is now commercially feasible to build

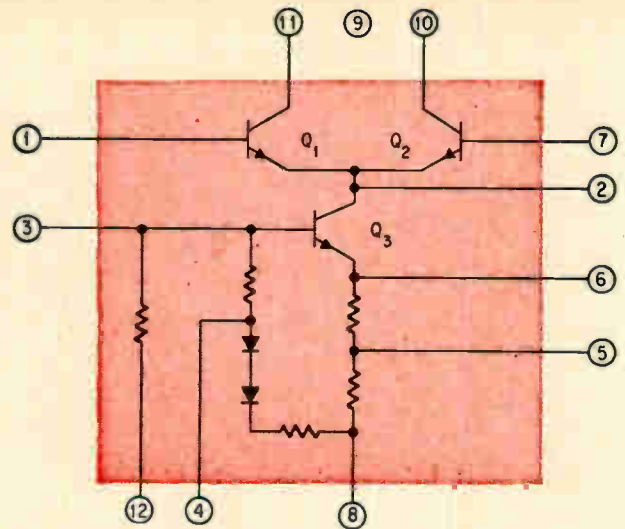

In the CA3005 circuit,  $Q_3$  supplies a constant current for the emitter-coupled pair  $Q_1$  and  $Q_2$  in the differential mode; To connect  $Q_1$  and  $Q_3$  in cascode, terminals 7 and 10 are joined.

high-performance frequency-modulation sets, comparable in quality to those built with vacuum tubes and transistors. By next year, further price reductions may give the chips a cost advantage over discrete components.

Furthermore, the small size and light weight of the microcircuits allow more flexibility in receiver design, while the reduction in the number of components improves reliability, simplifies assembly operations and reduces inventory costs. The receiver chassis in the photo on page 133 looks bare in comparison with a conventional f-m receiver chassis.

With the cost reduced to an attractive level, several manufacturers are considering using these chips and application circuits to build a-m/f-m receivers, particularly automobile radio and console sets. Microcircuits for f-m mobile communication transceivers are also under scrutiny. However, the microelectronics and application circuitry for stereo f-m (multiplex) receiving equipment have not yet been developed.

### Building blocks

Several options are available to designers of f-m receivers using the three RCA silicon wafers. The CA3005 is a versatile circuit. It may be used as a radio-frequency amplifier (in either the cascode or differential mode), a mixer-oscillator, or both, and can also give intermediate-frequency amplification. The CA3014 in the i-f section of the f-m receiver performs amplification, limiting, balanced f-m detection and audio preamplification. Its sister component, the CA3012, is simply a CA3014 chip with the detector and audio preamplifier sections left off; the CA3012 in an i-f strip with a CA3014 functions as a wideband, high-gain amplifier and limiter. The operating characteristics of the CA3005 and the CA3014 are given in the table at the left and their schematics are at the top of the page and on page 135.<sup>3</sup>

### Versatile duo

#### CA3005

##### Power gain

Cascode (100 Mhz)	20	db
Differential amplifier (100 Mhz)	16	db
Differential amplifier (10.7 Mhz)	25	db

##### Noise figure (100 Mhz)

Cascode and differential	7.8	db
--------------------------	-----	----

##### Automatic gain control range

(gain to full cutoff)	60	db
-----------------------	----	----

##### Device dissipation

	39.5	mw
--	------	----

##### Input

Offset voltage	2.6	$\mu$ v
Offset current	1.4	$\mu$ a
Bias current	19	$\mu$ a

#### CA3014 (all measurements at 10.7 Mhz)

##### Power gain

	70	db
--	----	----

##### Input limiting voltage (knee)

	500	$\mu$ v
--	-----	---------

##### Amplitude-modulation rejection

	50	db
--	----	----

##### Amplifier impedance

$R_{in}$	2.8	kilohm
----------	-----	--------

$C_{in}$	6.5	pf
----------	-----	----

$R_{out}$	41	kilohms
-----------	----	---------

$C_{out}$	3.9	pf
-----------	-----	----

##### Detector impedance

$R_{in}$	12	kilohm
----------	----	--------

$C_{in}$	7	pf
----------	---	----

##### Detector output resistance

	60	ohm
--	----	-----

##### Recovered audio-frequency voltage

	190	mv
--	-----	----

##### Device dissipation

	180	mw
--	-----	----

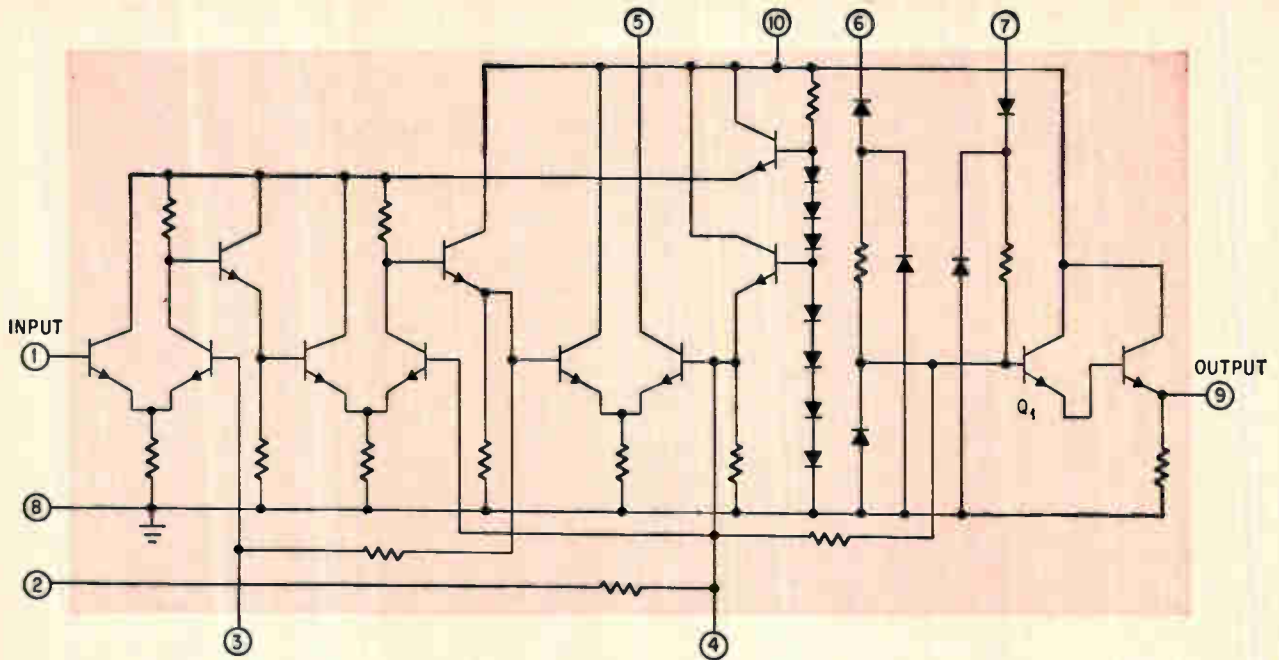

In the CA3014 circuit, the first three stages provide i-f amplification and limiting; these stages are followed by the power supply, the detector and the audio preamplifier.

### Three circuits for tuners

The CA3005 is the basic building block for three front-end approaches.

The first version of the f-m tuner consists essentially of one CA3005 and a two-gang capacitor tuning system. In this version, the CA3005 functions as an r-f amplifier, an oscillator and a mixer.

The current sink transistor,  $Q_3$ , in the schematic of the CA3005, supplies emitter currents for the differential amplifier transistors  $Q_1$  and  $Q_2$ . The conditions required for oscillation are established by the positive feedback from the collector of  $Q_2$  (terminal 10) to the base of  $Q_1$  (terminal 1) through the 5-picofarad capacitor shown in the tuner schematic. The oscillation frequency is determined by

tuned circuit  $L_1$  and  $C_1$ . The output impedance provided in the circuit at the collector of  $Q_3$  is high compared with the input impedance at the emitters of  $Q_1$  and  $Q_2$ , so  $Q_3$  is isolated from  $Q_1$  and  $Q_2$  and receives little signal from the oscillator. The r-f input is applied to the base of  $Q_3$  (terminal 3), is amplified and injected into the emitters of  $Q_1$  and  $Q_2$  to mix with the oscillator signal. The 10.7-Mhz intermediate frequency is obtained from the collector of  $Q_1$  (terminal 11).

The CA3005 draws a total current of 4.5 milliamperes from the +9-volt supply. This single-chip front end has a power gain of 15 db and a sensitivity of 10 microvolts for 30 db of quieting; it can handle a maximum input signal of 7 millivolts. This performance would be rated as adequate in a low-

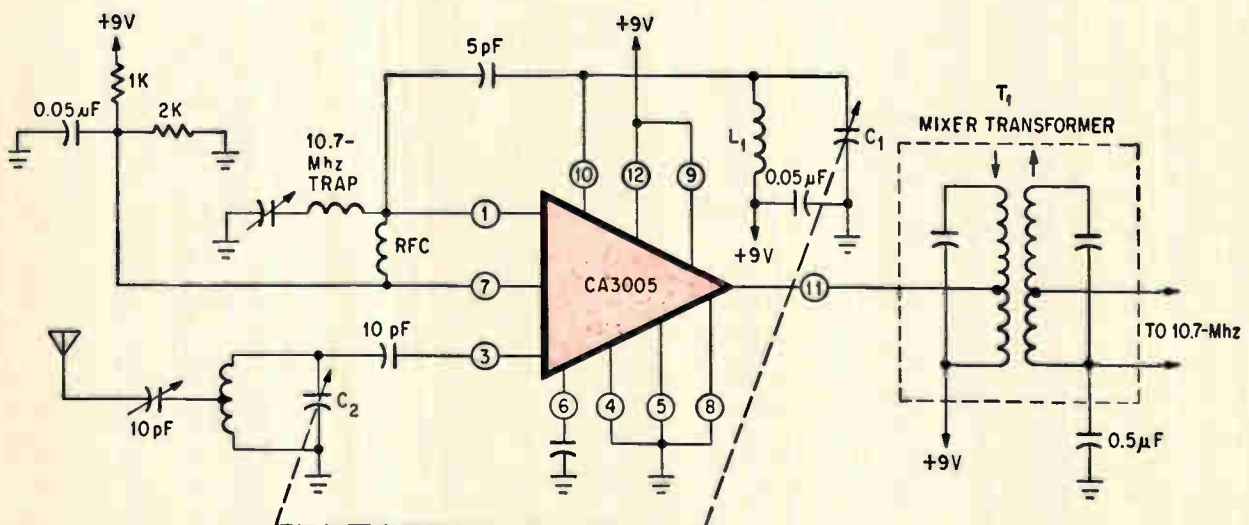

Single chip front end is tuned by ganged capacitors  $C_1$  and  $C_2$  which can be varied from 5 to 22 picofarads.

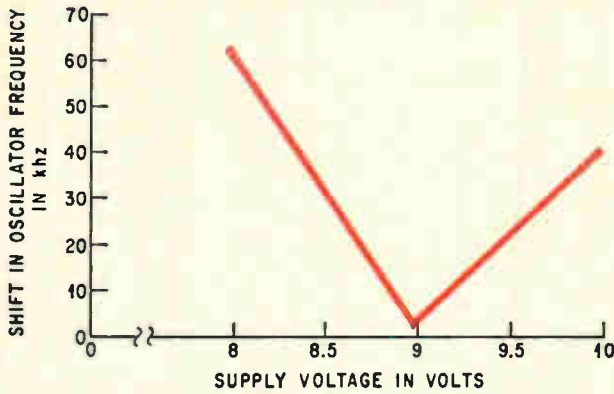

CA3005 oscillation frequency does not drift when the supply voltage is 9 volts.

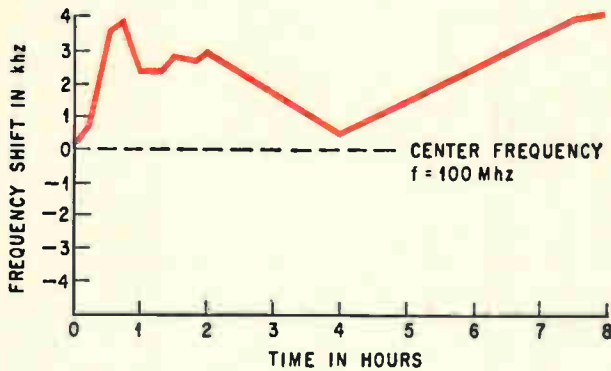

Stability of the CA3005 oscillation over a period of several hours is good; drift is never more than 4 kHz.

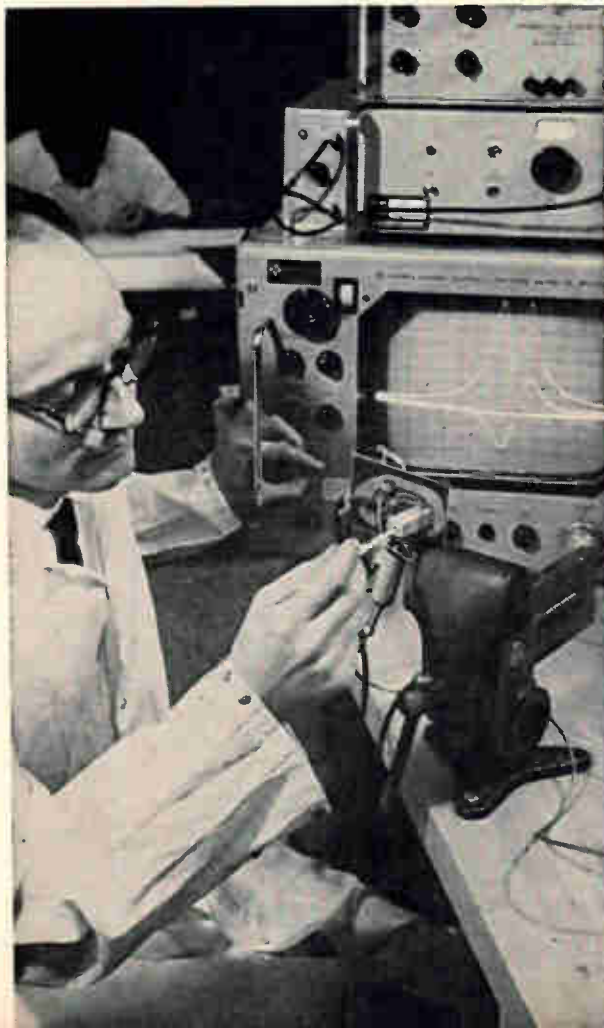

cost f-m tuner sold commercially.

Automatic frequency control can be achieved conventionally by connecting a voltage-dependent capacitor, a varactor, to the oscillator tuned circuit  $L_1$  and  $C_1$ . The graphs at the left give the oscillator's stability as a function of time and supply voltage, with no automatic frequency control. These curves indicate that, even with no automatic frequency control, the frequency drift is very small—less than 4 kHz.

### Better tuners

For better than adequate front-end performance, a second CA3005 serves as the r-f amplifier; and a three-gang capacitor tuning system is added to the basic single-chip circuit as shown in the schematic on page 137.

The additional microcircuit provides higher power gain, a lower noise figure and improved selectivity. The first chip, the r-f amplifier, can be connected as either a cascode amplifier or in the emitter-coupled differential amplifier configuration shown in the schematic.

To connect the r-f amplifier in cascode (the series-type configuration obtained by connecting the emitter of one transistor to the collector of another), several changes in interconnections are necessary on the first CA3005. The r-f input from the antenna is applied to terminal 3, terminals 1 and 10 are connected to eliminate  $Q_2$ ; terminal 1 is connected to  $V_B$ ; and terminal 6 is connected to ground through a 0.05 microfarad capacitor.

Because the input is a-c isolated from the output in both designs, no regenerative feedback can occur so the circuit requires no neutralization (the process of applying negative feedback from the collector to the base through a capacitor to cancel out the collector-to-base interelectrode feedback).

The cascode front end has a higher power gain, 28 db, compared with 24 db for the emitter-coupled configuration. The emitter-coupled front end has better cross-modulation characteristics. It can handle interfering signals up to about 15 mv with 10% cross-modulation distortion at maximum gain, while the cascode amplifier is limited to that of a single transistor.<sup>4</sup>

Automatic gain control can be applied to both configurations by removing the 9-volt d-c source from terminal 12 of the amplifier and applying the voltage from the automatic gain control source. The voltage should vary from 9 volts (maximum gain) to 4.5 volts (full cutoff) from an automatic gain control source which has the capability to deliver 0.5 milliamperes. In either the differential or cascode configuration, the amplifiers have a dynamic automatic gain control range of 60 db, from full cutoff to full gain.

I-f strip is tuned by a technician. The double-peaked curve on the oscilloscope is the input to the phase-shift discriminator. The second trace, cutting the reference line, is the S curve or audio output.

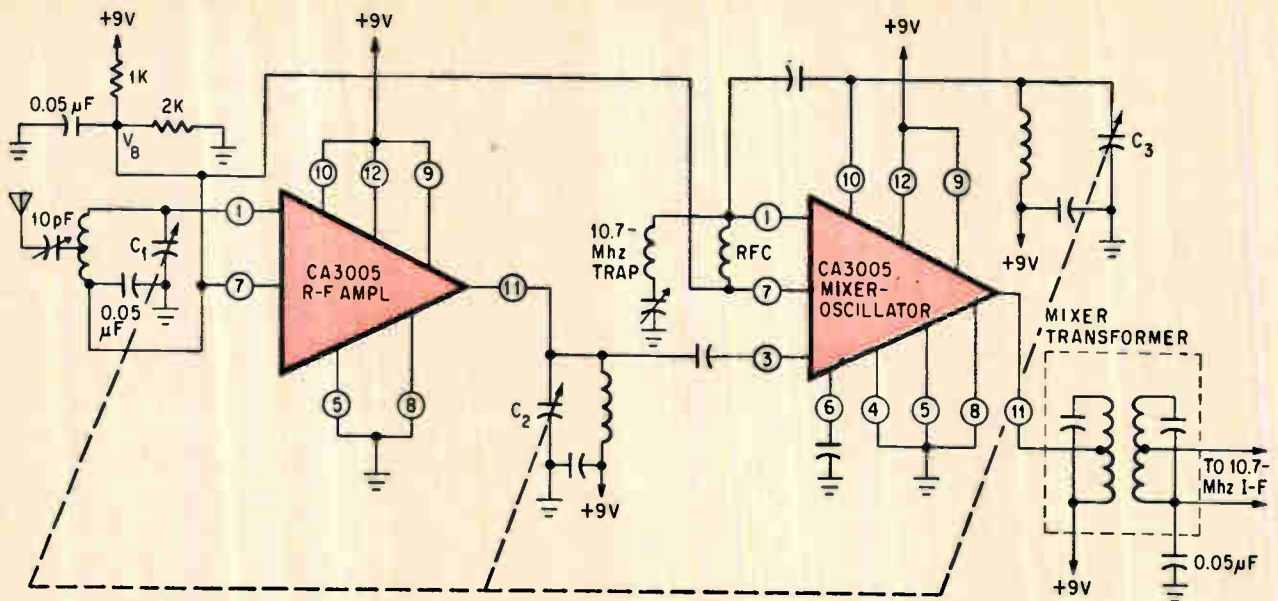

Improved gain and selectivity result when two CA3005's are connected. The first integrated circuit, in the differential mode, is an r-f amplifier yielding a receiver sensitivity of 3 microvolts.

### Intermediate-frequency strip

The i-f strip of the f-m receiver requires two integrated circuits—a CA3005 and a CA3014—and passive components, as in the schematic below. This circuit is a 10.7-MHz i-f strip and detector with a gain of 95 db. The CA3005 is an i-f amplifier-limiter; the CA3014 is a three-stage i-f amplifier-limiter, detector and audio preamplifier.

The differential amplifier, the heart of both the microcircuits, provides symmetrical limiting over a wide input voltage range. In addition, the differential amplifier is ideally suited to be made as an integrated circuit. Transistor characteristics must be matched; the  $V_{BE}$  and beta of the transistors and the resistor ratios are easier to control since the components are formed simultaneously in one chip.

The interstage transformer  $T_2$  is designed so that the impedance reflected to the output collector of the CA3005 (terminal 11) is high enough to permit reasonable gain, but low enough so that saturation does not occur. Bandpass spreading is kept to a minimum over the large input voltage swings. If saturation were allowed to occur, selectivity would be poor.

The 10.7-MHz i-f signal is applied to terminal 7 of the CA3005; this input signal may be low level since the circuit's input limiting knee is  $30 \mu\text{v}$ .

The CA3005 amplifies the input signal (25 db). If the input signal is large enough it will symmetrically limit it. The amplified signal is applied to the CA3014's input (terminal 1) via transformer  $T_2$ .

In the CA3014, the i-f signal acquires an addi-

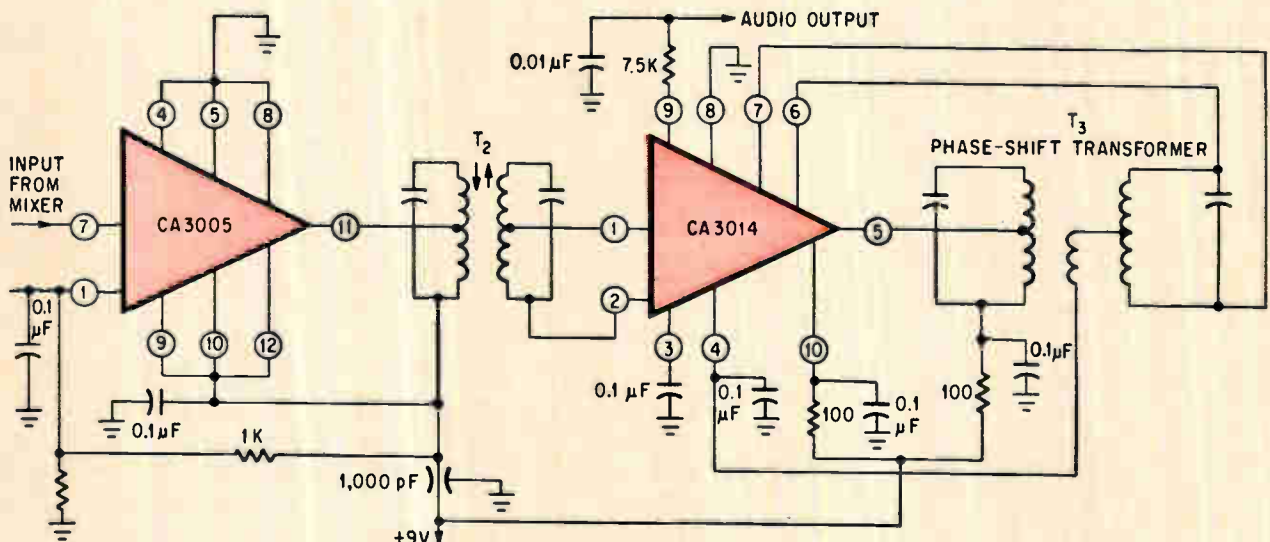

Low-cost i-f strip can be constructed with a CA3005 and a CA3014. The 30-microvolt i-f input signal gives an audio output of 220 millivolts. The audio output voltage drops less than 3 db when the input signal voltage is decreased from 0.5 volt to 30 microvolts.

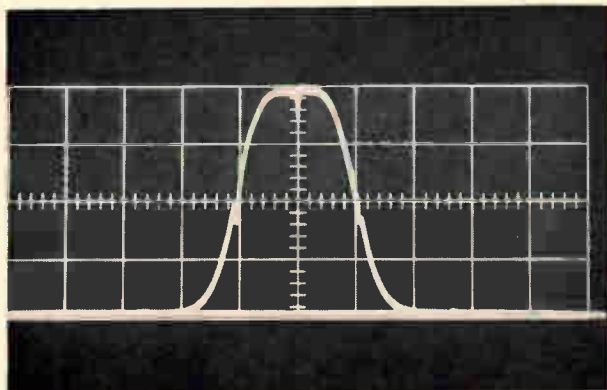

Sharp selectivity of the CA3005-CA3014 i-f strip is shown in the scope trace. The center frequency is 10.7 Mhz; markers are 100 khz apart.

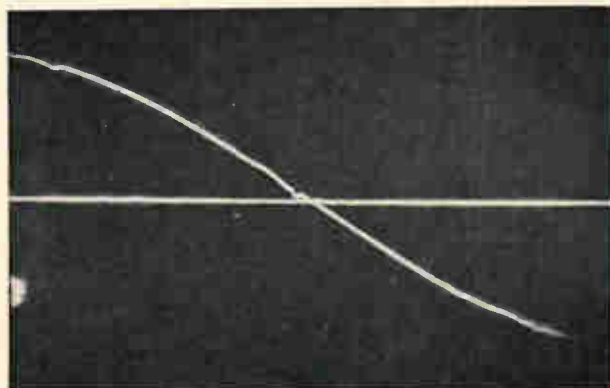

S curve of the CA3014 detector shows good linearity out to 100 khz on both sides of the 10.7-Mhz center frequency; maximum allowable is  $\pm 75$  khz.

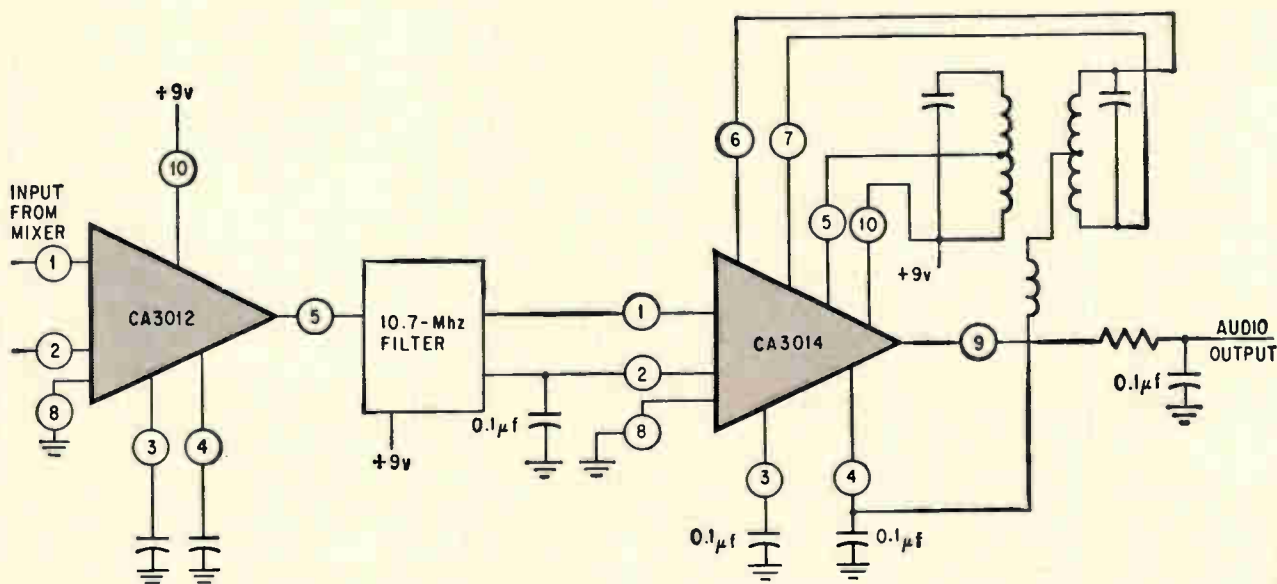

An i-f strip with improved selectivity and a theoretical gain of 140 db can be built by connecting a CA3012 to a CA3014 through a 10.7-Mhz filter of special design.

tional gain of 70 db and is further limited as it travels from terminal 1 to terminal 5.

The signal, now amplified and limited, is applied to the primary winding of phase-shift (discriminator) transformer  $T_3$ . The secondary winding of the transformer, which is fed back to the detector connected to terminals 6 and 7, is in quadrature with the primary voltage at the center frequency.

As the f-m signal varies, the phase shift of the secondary voltage follows the modulation, yielding the audio-frequency signal. The detected output at the base of  $Q_1$ , as in the schematic of CA3014 on page 135, is amplified and buffered by the circuit's output transistor. The audio signal taken from the low-impedance terminal 9 is 220 mv.

The i-f selectivity curve and the detector S curve are shown above. If more selectivity is desired in the i-f strip, an additional double-tuned transformer can be added between the CA3005 and CA3014 stages. The a-m rejection referenced to a 100% f-m signal is typically 50 db for a 30% a-m signal at a 30 mv carrier voltage level.

In the i-f strip shown above, a CA3012 wideband amplifier replaces the CA3005, and a 10.7-Mhz filter is substituted for the interstage transformer. Although a gain of 140 db is theoretically possible, the gain must be cut to avoid layout-induced oscillations. The simplest way to cut the gain is to reduce the value of the bypass capacitors connected from terminals 3 and 4 of the CA3012 which introduces negative feedback in the circuit. This technique for gain reduction along with the insertion loss of the interstage filter results in a stable, high performance i-f strip. Circuit layout and lead dress must be arranged to prevent regeneration.

#### References

1. R.L. Sanquini, "Multipurpose chips cut costs of f-m receiver," *Electronics*, May 16, 1966, p. 80.
2. J. Avins, "It's a television first . . . receivers with integrated circuits," *Electronics*, March 21, 1966, p. 137.
3. Radio Corp. of America, Technical Bulletins CA3005, CA3011-3012, CA3013-3014.
4. "Application of r-f amplifier-mixer integrated circuits CA3004, CA3005, and CA3006," RCA Application Note ICAN-5022, November, 1965.

**NEW!**

IMMEDIATE DELIVERY  
FROM STOCK  
\$5,900\*

300 Hz TO 31 MHz

ILLUMINATED  
READOUT

METERED OUTPUT

DECADE  
TUNING

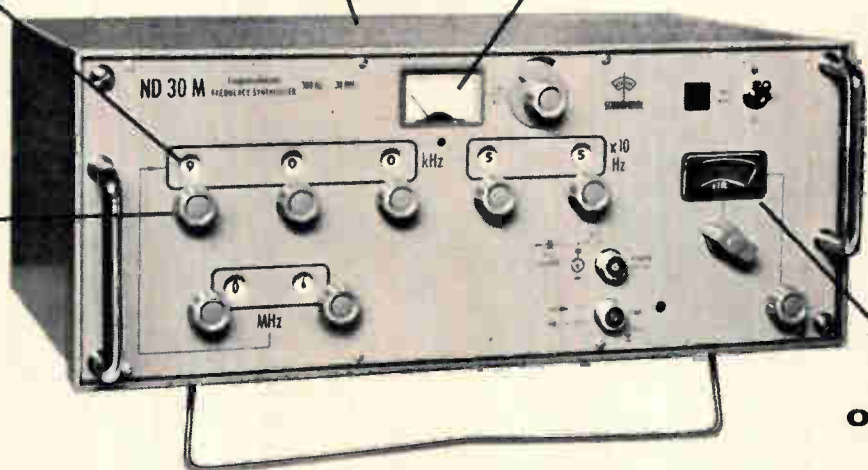

"FAD"  
INTERPOLATION  
OSCILLATOR

TYPE ND 30M

# FREQUENCY SYNTHESIZER

## FEATURES

- Built-in 1 MHz crystal has proportional oven and  $5 \times 10^{-9}/^{\circ}\text{C}$  stability
- Spurious and noise suppression better than 80 dB
- All solid state design
- Modular construction
- High resolution search oscillator . . . 130 divisions
- AC or battery operated

FNA-SPEKTROGRAMM

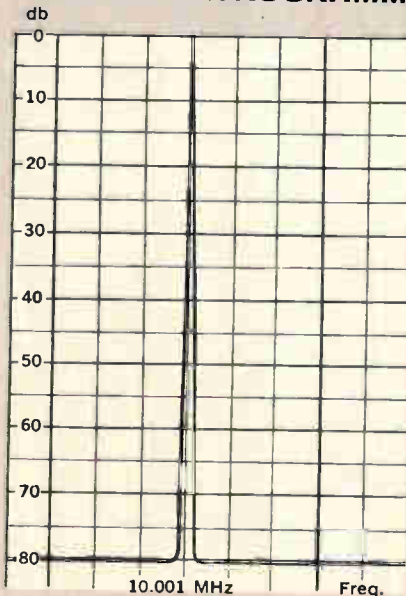

SPECTRAL PURITY OF ND 30M  
FREQUENCY SYNTHESIZER  
200 Hz per division Measured at BW of 10 Hz

Type ND 30M is the latest in a line of Frequency Synthesizers providing unusually high accuracy and ease of operation. Continuously variable over its range, each model provides a direct digital readout, with no tuning required. Perfect for bridge measurement, work with filters, networks, nuclear magnetic resonance, and as a source of reference frequencies for standards labs. These units can also be supplied in 19" rack mountings.

\*Type ND 30M  
without crystal \$5,290

Other ranges start at \$3,180  
Type ND 1M (300Hz to 1.1MHz)  
Type ND99K (0 to 110kHz)

Get The Extra Capability,  
Greater Reliability, and  
Longer Useful Life Of . . .



**ROHDE & SCHWARZ**

111 LEXINGTON AVENUE, PASSAIC, N. J. 07055 • (201) 773-8010

Inquiries outside the U.S.A. should be directed to: Rohde & Schwarz, Muehlhofstrasse 15. Munchen 8. West Germany.

SEE US AT WESCON—BOOTH # 301-302, HOLLYWOOD PARK.

# New Philbrick Battery - Powered Instrument - Grade Operational Amplifiers

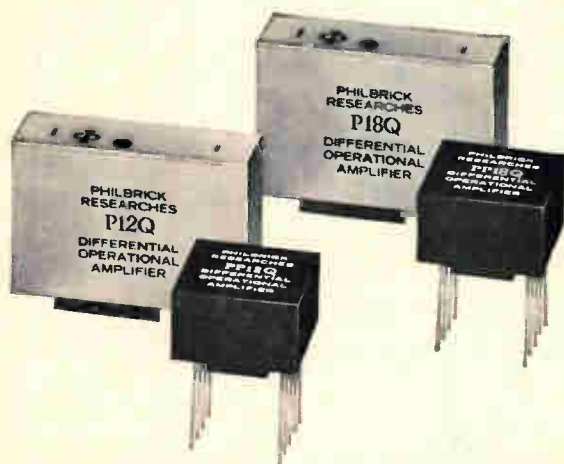

## ... 2000-5000 hours on two 1.35 V mercury cells

Here are two high-performance amplifier families specifically designed for battery-powered, portable (or non-portable) instrumentation. They operate from a pair of cells: mercury (1.35 V); carbon-zinc penlight (1.5 V); or silver zinc rechargeable (1.5 V). Despite their low voltage and current requirements (2-5 mw quiescent), both designs are rated at a maximum output voltage of  $\pm 1.0$  V with a 500 $\Omega$  load ( $\pm 2$  mA). Operating life on a pair of standard #502 mercury cells is 2,000-5,000 hours depending on the application. Both amplifiers are available in either a 2 $\frac{1}{4}$ " x 1 $\frac{1}{2}$ " x  $\frac{3}{4}$ " plug-in "P" case or epoxy-molded "PP" modules, 1 $\frac{1}{8}$ " x 1 $\frac{1}{8}$ " x  $\frac{5}{8}$ ". The P12Q and PP12Q units, which have FET's in the input circuit, are ideal for high impedance applications requiring very low current offset ( $I_o$  about 100 pA), and the P18Q and PP18Q for applications in which common-mode error is significant, and voltage offset must be minimized. For more information, call your nearest Philbrick engineering representative or Philbrick Researches, Inc., 22-G Allied Drive, Route 128, Dedham, Massachusetts 02026.

**ENGINEERING REPRESENTATIVES** — Ala.: Huntsville (205) 536-8393, Mobile (205) 954-9298; Ariz.: Phoenix (602) 265-3629; Cal.: Mountain View (415) 969-9770, Van Nuys (213) 782-1532; Colo.: Denver (303) 733-3701; Conn.: West Hartford (203) 233-5503, Greenwich (203) 661-5140; Fla.: Ft. Lauderdale (305) 564-8000, Orlando (305) 425-5505; Ill.: Chicago (312) 676-1100, (312) 676-1101; Ind.: Indianapolis (317) 356-4249; La.: New Orleans (504) 242-5575; Md.: Baltimore (301) 727-1999; Mass.: Wakefield (617) 245-5100; Mich.: Detroit (313) 838-7324; Minn.: Minneapolis (612) 545-4481; Mo.: St. Louis (314) 741-3779; N.M.: Albuquerque (505) 268-3941; N.Y.: Buffalo (716) 835-6186, DeWitt (315) 446-0220, Valley Stream (516) 561-7791; N.C.: Winston-Salem (919) 725-5384, (919) 725-5385; Ohio: Dayton (513) 298-9964, Westlake (216) 871-8000; Okla.: Tulsa (918) 627-6199; Pa.: Philadelphia (215) 277-0559, Pittsburgh (412) 371-1231; Tex.: Dallas (214) 526-8316, Houston (713) 781-1441; Utah: Salt Lake City (801) 466-4924; Va.: Alexandria (703) 836-1800; Wash.: Seattle (206) 723-3320.

**EXPORT:** N. Y.: New York (212) 246-2133.

**CANADA:** Quebec: Montreal (514) 482-9750, Ontario: Toronto (416) 789-4325.

**ELECTRONIC ANALOG COMPUTING EQUIPMENT for MODELLING, MEASURING, MANIPULATING and MUCH ELSE**



**PHILBRICK**

Visit us at Wescon Booths 130-131



# Multilayer circuit boards: sharpening an imperfect art

Multilayer printed circuits are likely to have some flaws, but the boards can be used confidently in high-reliability applications if design and processing controls prevent or catch mistakes

By Robert W. Korb

TRW Systems Group, TRW, Inc., Redondo Beach, Calif.

**Multilayer boards** have proven how well they can interconnect microelectronic components, but too little is known about what causes the occasional failure of a board. It's still early to expect statistical certainty in board reliability or to draft firm standards and specifications for their design and processing.

Nevertheless, multilayer boards can be made reliable enough for even space systems by exercising good engineering judgment in their design and tight control in their processing. The more complex the board design, the tighter the controls must be. A board's electrical integrity must be established before expensive integrated circuits and other parts are mounted to it, because if a flaw is found after assembly the IC's are usually discarded along with the board.

However, flaws in a multilayer board can be prevented—or detected by testing—before it is too late. The numerous pitfalls in design and processing must be recognized, too, and side-stepped. If a board should fail in its primary function, providing electrical continuity between designated points in the wiring matrix, it is gen-

erally because one of the many steps in the processing was done incorrectly.

## Size down, delicacy up

None of the basic process steps stands out as the most troublesome and the process itself is not inherently unreliable. The processes were established years ago for production of single and double-sided printed circuits; multilayer boards are laminated assemblies of several such circuits.

However, laminating and interconnecting the layers and the delicacy of the conductors in multilayer boards complicates the processes. As a rule, the individual layers are etched from epoxy-glass boards that are only 4 mils (0.004 inch) to 12 mils thick, compared with a minimum of 31 mils for regular boards. Multilayer conductor lines are usually 1.4 mils thick and 10 mils wide, but line width and spacing may go as small as 5 mils.

The layer-to-layer interconnection most used is the plated-through hole, the upper structure in the diagram on page 143. It has several variations.<sup>1</sup> Ordinarily, the individual layers are etched so that conductor lines terminate in round pads of copper. Holes are drilled through these pads after the layers are stacked and laminated by the application of heat and pressure. Then, the interior of the hole is plated with copper by electroless (chemical) and electroplating steps.

Through-hole boards have been extensively evaluated by TRW Systems Group of TRW, Inc. and used by TRW Systems in several spacecraft. The weakest link in such boards—overcome by process modifications—is that the hole plating has only 1.4 mils of pad thickness to connect to. The other two interconnection techniques in the

## The author



Robert W. Korb, a member of the technical staff at TRW Systems, is responsible for the development of printed circuits and microminiature interconnections. He holds two patents.



Perfect appearance (of the multilayer board, of course) is what an inspector looks for in X-ray film.

diagram at the right provide copper-to-copper contacts that are more solid, but there are only a few suppliers of those kinds of boards and processing is more difficult.

### Shorts and cuts

While many things can go wrong in multilayer-board processing, the most serious failure modes are electrical shorts and discontinuities. When these occur, the assembly will not operate.

Discontinuities appear when the laminate's copper cladding is deeply scratched before processing, when over-etched conductors burn out during test-

ing or use, or when laminating stresses break a conductor. Narrow lines that are nicked or scratched are likely to break during lamination. So are lines that move during lamination, a condition caused by inadequate hot-peel strength (a measure of how well the copper adheres to the epoxy glass when heated).

Another form of discontinuity is a missed through-hole connection, which happens when layers are misregistered (as in the X-ray photograph on p. 146) or when the through-hole processing is faulty.

Short circuits are caused by five conditions: badly misregistered internal layers; misalignment of the hole-drilling pattern with internal pads; a design that does not provide sufficient space between plated-through holes and conductors; leaking of electroless plating solution into voids between closely spaced holes or conductors; or entry of foreign materials into the board during processing (see the table below for major failure modes).

The defects listed in the military specification for conventional printed wiring boards (MIL-P-55110A) apply, with modifications, to multilayer boards.

### Accuracy starts in design

No amount of craftsmanship and process control can compensate for mistakes made by circuitry designers and draftsmen in conductor and pad layout and spacing [see the article on p. 148].

If a mistake gets into the manufacturing master artwork, it may not be caught for 16 weeks—about 8 weeks in design and another 8 in production. Designers must specify realistic tolerances to maintain reasonable production costs and yields. Occasionally, designers call for tolerances that are too tight

Multilayer failure modes and probable causes

Failure Modes	Design			Stock	Manufacture						Use	
	Geometry	Artwork	Electrical and thermal		Camera and photoresist	Plating	Drilling	Etching	Laminating	Testing and inspection	Attachment and handling	Protection and support
Line discontinuity		-		+	-			+	-	-		
Line resistance	+	+	+	+		-		+		-		
Hole plating open						+	+				-	-
Conductors oversize	+	+			-	-		+		-		
Conductors undersize	+	+			-	-		+		-		
Short, lines and pads	-	-			-	-		-	+	-		
Short, hole to lines	-	-			-		+		+	-		
Pad breakout	+	-			-		+	-	+	-		
Pad loss, external				+					-		+	
Line loss, external				+					-		+	
Delamination			-	+				+			-	-
Finish failure				-		+				-		
Improper impedance	+	-	+	-		-			-			
Low resistance				+				+	-			-

+ Probable Cause; - Contributing Factor

or spacings that are too small.

For example, the design may call for a hole diameter of 23 mils after plating. But the minimum pad diameter cannot be based on this; it must be based on the worst-case combination of tolerances for the positions of the holes and pads. Taking into account the tolerances listed below, which are realistic, internal pads should be at least 41 mils in diameter. A 41-mil pad allows an annular ring of copper less than 5 mils wide around the hole; the ring should be made wider if more space is available for pads. The ring prevents escape of electroless plating solution from the hole and consequent depositing of copper between conductors on a layer. This bridging, a cause of short circuits, could still occur if drilling fractured the ring.

The tolerances that may add up to cause a worst-case condition are:

- Undercutting allowance: 2 mils should be added to the pad diameter for each ounce of copper cladding (one-ounce copper cladding is 1.4 mils thick) to compensate for undercutting of the copper during etching.

- Layer-to-layer registration: 5 to 10 mils from true position, depending on board size and tooling quality. The larger the board, the larger the tolerance should be.

- Hole-location: its location in relation to the center of a pad can vary by 3 to 5 mils.

- Through-hole plating thickness: 1 to 1.5 mils is usually required as the total copper thickness. The trend is to use 1-mil plating, for smaller holes and thinner plating on external layers.

- Hole diameter: 3 mils, if the copper is to be plated with gold; 5 mils, if the plating is to be tin-lead solder.

Artwork should be at least four or five times larger than the actual board and allow for the line-narrowing during contact printing of artwork, printing and development of the photoresist and undercutting during etching. Reductions become significant when line width is less than 20 mils. If the artwork is prepared with tape, it is difficult to compensate for line narrowing by making lines oversized because tape widths are ordinarily standard. Also, taped line widths vary—the tape is stretched and compressed during layout and light may leak under the tape during contact printing.

Line widths are more accurate when a coordinategraph and the cut-and-strip technique are used. Machine cutting is restricted to straight lines, but allows adjustment of line width. Extra spacing between lines on the artwork should be allowed if possible, since it gives the board manufacturer the opportunity to "balloon" the lines during processing.

Pad areas should be increased by providing fillets of copper at the junction of pads and lines. Fillets on external layers prevent pad lifting during etching and soldering and improve the formation of solder joints. Fillets on internal layers add to the tolerances for eccentrically drilled holes. Artwork forms usually have pads at all standard hole posi-

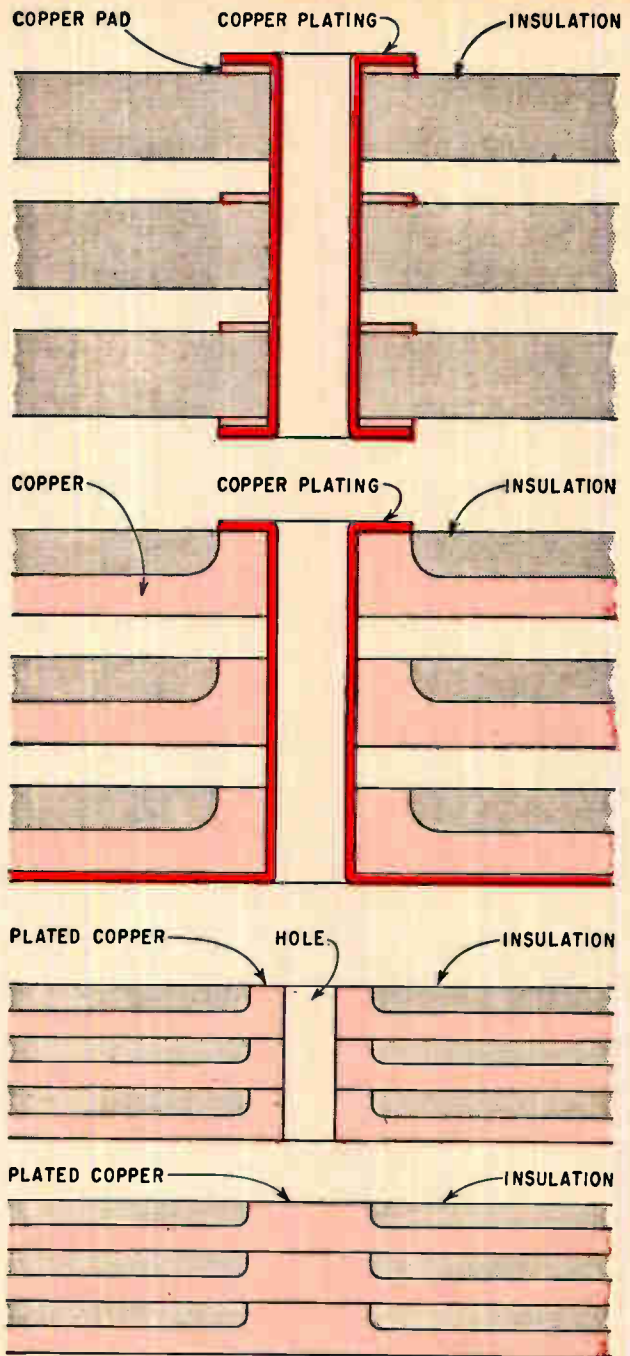

Three forms of layer-to-layer interconnection for multi-layer boards are (top to bottom) plated-through holes, plated-through mesas and plated monolithic boards. Monolithic boards use a hole or solid copper.

tions. The unused pads should not be removed until all the circuitry has been laid out, to prevent the routing of conductors too close to plated-through holes. The pads should be removed from the contact prints, since the excess copper impedes the even distribution of insulation during lamination.

#### Through-hole dimensions

Regardless of the number of process controls and inspections, some plated-through holes of poor quality occur at random. But two fairly frequent flaws, incomplete plating in the hole or a void in

## Perfect and not-so-perfect plated-through holes.

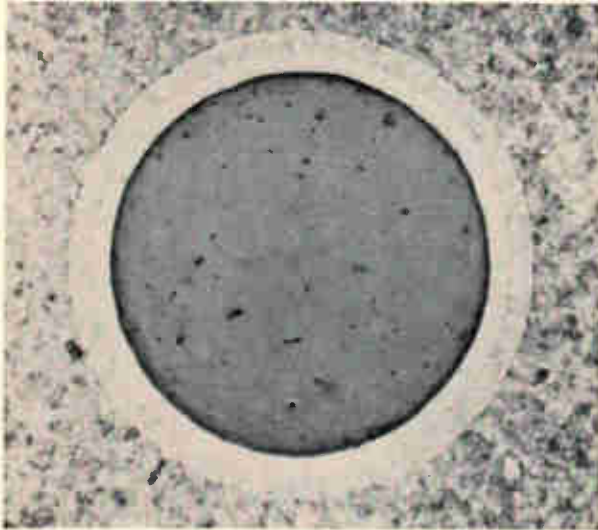

Cross-section through the barrel of a perfect plated-through hole. The circumference is completely connected to the surrounding pad.



Laminating stresses caused a marginal connection (A) and an open connection (B). However, the flaws do not extend completely around the hole; the comparable connections at the left side of the hole are good.



Vertical section through one side of a hole exhibits a discontinuity caused by improper cleaning; a blob of epoxy isolates the hole plating from the pad.

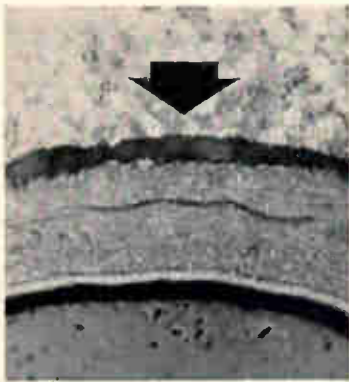

Discontinuities seen along the hole plating are caused by entrapped air, due to improper cleaning.



It doesn't take much epoxy to ruin a connection. This discontinuity was caused by smearing of the epoxy during drilling and inadequate cleaning afterward.

Forcing the drill into the hole too fast or rotating the drill too slowly will bevel the edges of a hole or cause the conductors to become distorted or torn.

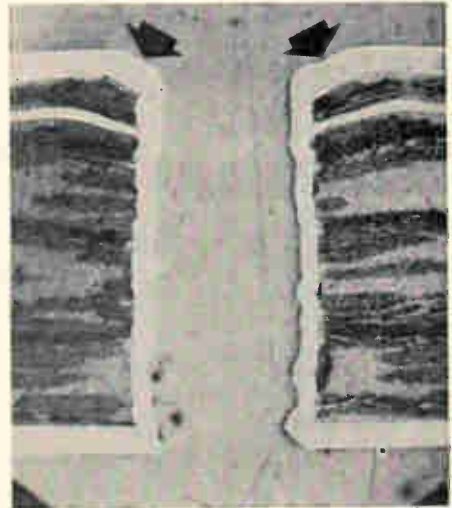

the plated connection between the hole and the pad, will not necessarily cause the board to fail (see photo at top right, above). A margin for small gaps and voids exists if the joint-circumference area is much larger than the conductor-line width. A small gap in the plating will not make it less conductive than the line.

Conductance depends upon cross-sectional area, given in the graph at the right. For example, a line 10 mils wide and 1.4 mils thick has a cross-sectional area of  $1.4 \times 10^{-5}$  inch and a resistance of 0.05 ohm per linear inch. The smallest hole in a multilayer board is generally 20 mils in diameter; its cross-sectional area is  $8.8 \times 10^{-5}$  square inch, so its resistance is about one-sixth that of the 10-mil line. The line width would have to increase to 45 mils to make the areas equal, which isn't likely since wider lines generally mean larger holes.

The ratio of hole to conductor area is  $\pi D/W$ , where  $D$  is the hole diameter and  $W$  the line width. As long as the ratio is 1.5 or better, small gaps in the plating can be tolerated.

The designer must also watch the ratio between board thickness and hole size. Even though ratios as high as 10:1 have been reported, in practical production ratio is limited to about 3:1—a maximum board thickness of 60 mils when hole diameters are 20 mils. A board 60 mils thick can have 12 circuit layers on two-sided boards, including 6 mils of epoxy adhesive between boards. The adhesive should be at least twice as thick as the copper; that is, 2.8 mils of adhesive for 1-ounce copper.

### Hole drilling and cleaning

The results of improper board drilling and cleaning are shown in the photographs above.

The conductors bend and tear when the drill rotates too slowly or is forced into the hole too fast. Sharp carbide drills, revolving at high speeds, prevent pinching or beveling of the pads and fracturing of the laminate. Fracturing causes voids and irregularities in the plating.

If epoxy smears are not cleaned, the pad will be electrically isolated from the hole plating.

The best all-around cleaning is by chemical etch-back. Besides removing epoxy smears, it raises the pad edges in relief above the insulation. There is a greater contact surface for the hole plating and the plating mechanically interlocks with the board, as in the photographs at the right.

The etchant is a mixture of sulfuric acid to dissolve the epoxy and hydrofluoric acid to dissolve the glass exposed as the epoxy dissolves. A proportion of about four parts sulfuric to one part hydrofluoric must be maintained; too much hydrofluoric acid will interfere with the sulfuric acid. An excess of hydrofluoric acid is generally signified by the appearance of a white powder.

### Plating processes

The critical step in through-hole plating is the initial, electroless deposit of copper. Some engineers refuse to specify multilayer boards because of doubts about the integrity of the interfaces between the electroless plating and the other materials. Yet properly made connections do withstand the stresses of military-specification environmental and soldering tests.

Electroless deposition is a sequence of chemical reactions. The reactions will not be completed if the plating solutions do not perfectly wet the interior of the hole. Air entrapped along the edges of improperly drilled and cleaned holes will cause discontinuities resembling those shown at the left. Discontinuities up to 75% of the pad circumference have been observed.

A number of hole-plating processes have been developed.<sup>2</sup> TRW Systems prefers a three-step process in which palladium sensitizes the surface for copper plating.

Stannous ( $\text{Sn}^{+2}$ ) ions from a solution of stannous chloride are absorbed on the surface of the epoxy-glass insulation and the copper pads. Other sensitizers, such as titanium and silicon tetra-

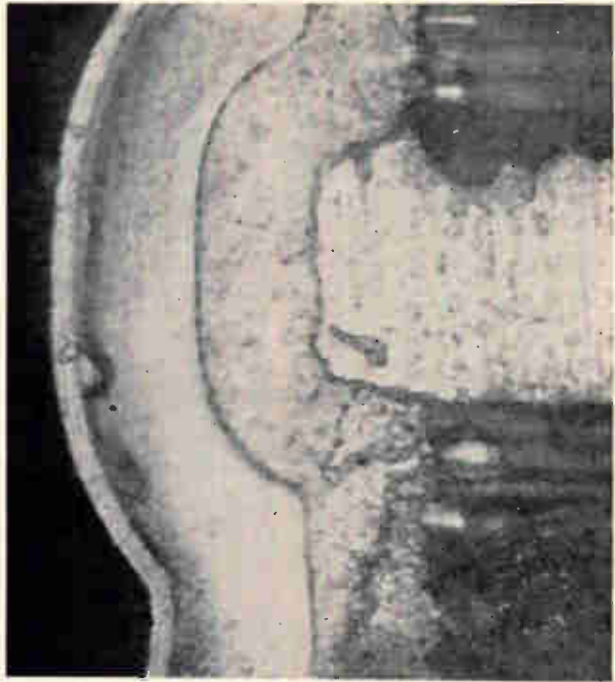

Chemical etch-back cleaning method puts the pads in relief against the epoxy wall of the hole. This provides a greater contact area for the plating and mechanical locking of the hole plating to the board.

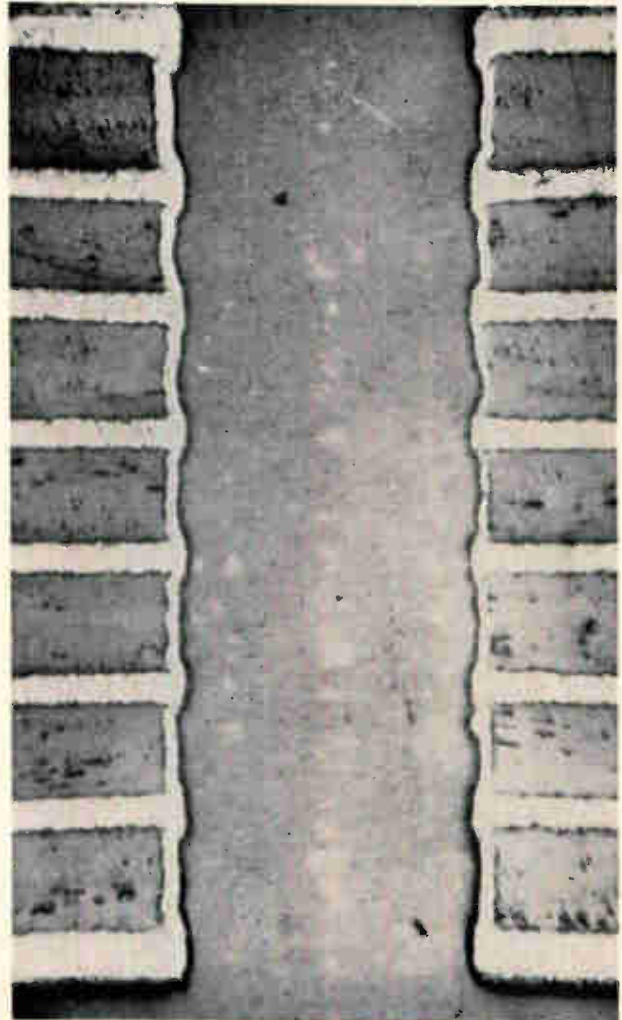

Hole after etch-back cleaning and plating.

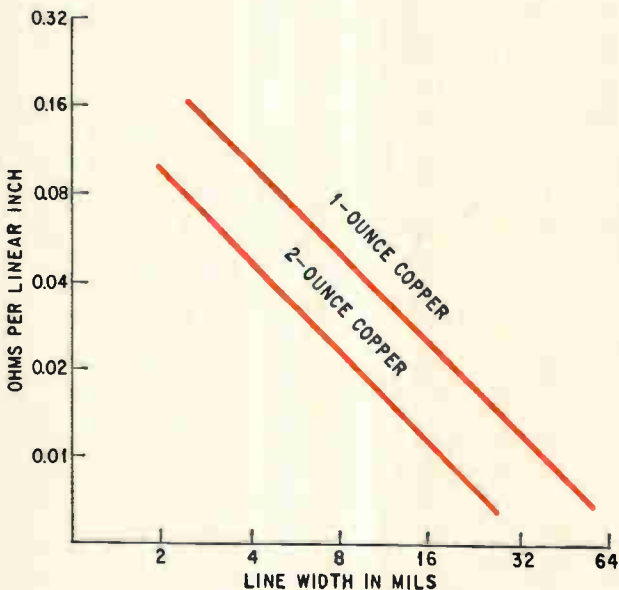

Resistance of conductor lines are estimated with graph.

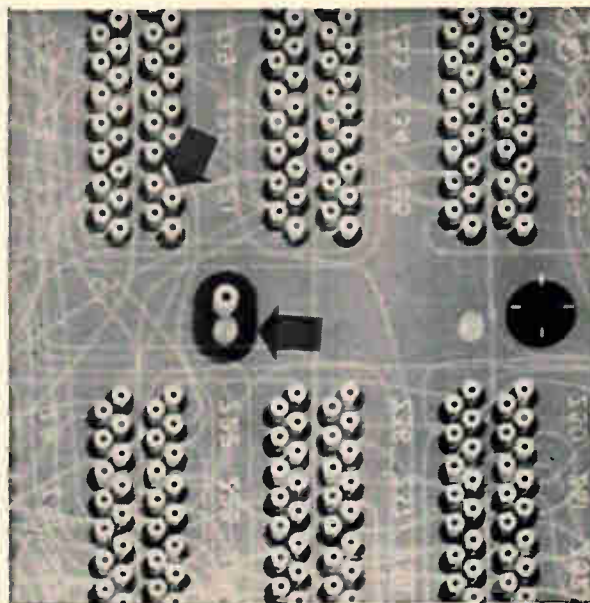
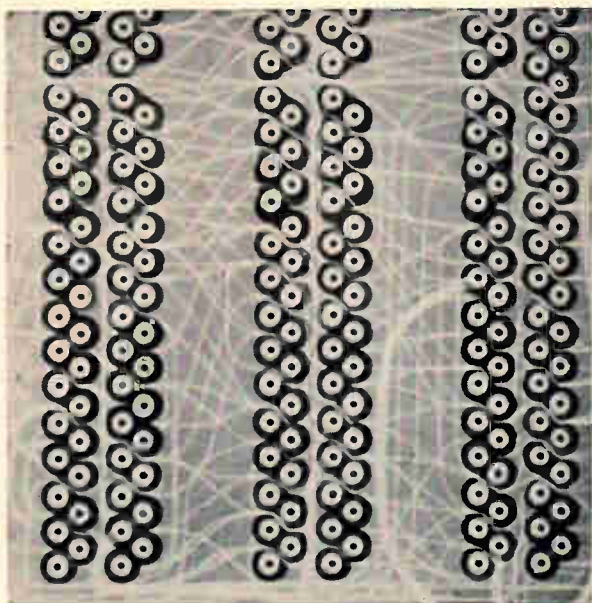

X-ray films disclose shorts and other internal flaws that cannot be seen and may not be detected by electrical tests. The board at the left is acceptable. Excessive misalignment of the layers of the board at the right caused shorts between lines and pads (top arrow) and mismatching of sections of through holes (lower arrow).

chloride, can also be used.

The second step is to dip the boards in a solution of palladium chloride. A thin layer of palladium is deposited by an oxidation-reduction reaction in which palladium ions from the chloride solution are reduced to metallic palladium by the stannous ions. The stannous ions are reduced to the stannic state:

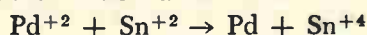

The complete reaction is:

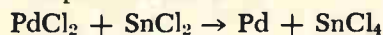

Finally, the palladium catalyzes the reduction of copper from an alkaline-formaldehyde solution of copper salt:

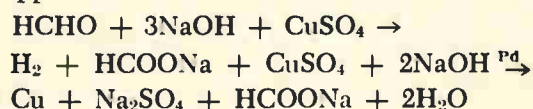

The activity of each solution must be kept nearly constant through periodic analysis and replenishment of the plating baths.

The last step liberates small bubbles of hydrogen gas that can become entrapped by glass fibers that project into the hole or by other irregularities. Gentle agitation of the solution helps prevent entrapment. Bubbles interfere with copper deposition and blister the electroplated copper.

The electroless copper is overlaid by the standard pyrophosphate electroplating method. As a rule, the total thickness of copper is 1½ mils, approximately the thickness of one-ounce cladding. Some applications, requiring small pads and low current levels, require 1-mil plating. The external layers are plated along with the holes, and it is difficult to etch very small pads if the external cladding is heavily plated because the thicker the copper, the more the undercutting.

### The outer layers

The metal on the external layers should be restricted to through-hole pads and soldering or welding pads. Conductor lines should be avoided, particularly if the lines are narrow and closely spaced. Conductor lines are delicate, and etching the outer layers is almost a final step in board manufacture; a rejection of the entire board because of a flaw in the outer layers is expensive in time and effort lost. Generally, the external pads are made larger than the internal pads.

If outer circuitry is essential, the two preferred methods of making it are by pattern plating or controlled metal removal. Both compensate for the problems posed by the plating buildup: the plating thickness over the board area is not uniform, which complicates the etching problems. It takes longer to etch, so the etching resist is more likely to break down, and the undercutting of copper is more severe.

In pattern plating, plating resist is applied in a reverse image—a pattern that exposes only the pad and conductor pattern to the plating solutions. The plating enlarges the conductor lines a little, but the copper cladding between the lines remains thin and is easier to etch.

The other method is to remove the plating from the cladding before etching, for example, by grinding the plating down with a precision belt sander. The grinding must be controlled to avoid separation of the through-hole plating and the circuitry. Even if separation doesn't cause failure, it makes it difficult to clean out the connections before the copper is plated with gold or solder. If the gold or solder is flawed, there will be problems with resistive joints, corrosion and soldering.

The final plating of gold, tin-lead solder, or sometimes tin and tin-nickel, protects the copper from

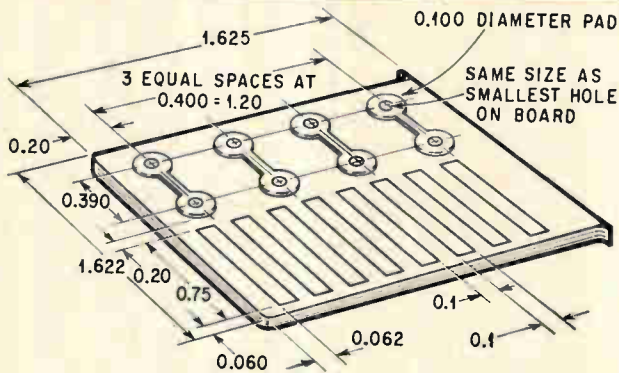
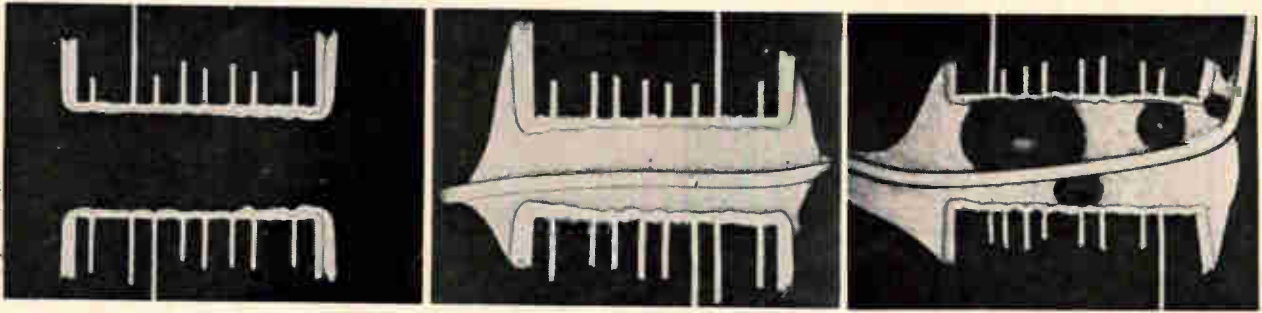

Pattern for a test tab. When a tab is processed as a part of a board, it can be sectioned and destructively tested to determine hole quality, layer-to-layer registration, how well the conductors accept solder and other quality factors. The cross sections in the photographs, taken from test tabs, show plating and soldering quality (left and center). The last sample shows poor solder wetting and capillary action.

corrosion and damage and aids in soldering.

A gold plating about 0.07 mil thick alloys with solder when components are assembled to the board and makes the solder joints as strong as if the solder were fused to clean copper.

There is no military specification for tin-lead plating, so a company specification must be set. Solder plating is usually 0.5 to 1.5 mils thick. A reduction of up to 3 mils in hole diameter cannot be tolerated if very narrow lines and compact hole patterns are needed. However, a small inside diameter is allowable if component leads are not soldered into the hole—if, for example, the leads are soldered to large surface pads. The tin-lead proportion of eutectic solder, 63% tin and 37% lead, cannot be held constant during plating. However, an alloy containing 57% to 76% tin is acceptable.

### Test tabs for process control

Quality control and inspection at each stage of board manufacture are vital. Required are visual and X-ray inspections, electrical testing of the board, and destructive testing of test tabs that are made as a part of each board.

Each layer can be inspected before lamination by comparing the etched wiring with a transparent master pattern and by looking for nicks, scratches or other defects. After lamination and plating, only exposed surfaces can be seen, which is no guarantee that the through-hole plating is connected to the internal conductors or that the layers and drilled holes are properly aligned.

Point-to-point continuity testing detects discontinuities and high-resistance interconnections. However, test currents are generally low, since the boards operate at low levels in most applications, making it difficult to detect marginal conditions. All boards should be tested 100% for continuity,

but there is no good electrical test for leakage (shorts). Leakage testing takes too long and requires too much engineering effort for 100% inspection, except when a long production run warrants computer-programmed tests. A board having 1,000 connection points could require some 500,000 checks.

Experience has shown that partial continuity testing, plus visual and metallurgical examination, results in very few defective assemblies.

Inspection of board X-rays is one of the few nondestructive tests that disclose internal spacing and registration. During fabrication, X-ray films allow a check of drilling accuracy before through-hole plating and the etching of outer layers. After fabrication, X-rays disclose misregistration, reversed internal layers, discontinuities and possible short circuits, as in the photos at the left. X-rays made before hand can save many hours of continuity testing of boards that are clearly bad.

Test tabs, shown above, should be processed as an integral part of every board, whether the user makes or buys the board. When the boards are bought, the tabs provide some assurance that process conditions were controlled by the supplier. Metallographic inspection of the tabs provides a check on registration, plated-through hole quality, plating thickness and solderability. The inspection will disclose whether random conditions or poor processing cause marginal operation and it will provide insight into possible failure modes. If there are only a few random flaws, they can be repaired by selective drilling and jumper wiring.

### References

1. Stephen A. Hays, "The packaging revolution, part IV: bigger better multilayer boards," *Electronics*, Nov. 29, 1965, p. 90.
2. T.D. Schlabach and D.K. Rider, "Printed and Integrated Circuitry," McGraw-Hill Book Co., New York, 1963.

# Pattern trims design time for multilayer circuit boards

New version of the old x-y wiring matrix saves space by putting plated-through holes into windows formed by conductor and feedthrough patterns, simplifying interconnection design and making boards more compact

By James R. Goodykoontz

TRW Systems, TRW, Inc., Redondo Beach, Calif.

**At best**, designing the wiring of a multilayer circuit board is a laborious chore. At worst, more wiring must be crammed into less space for higher-density assemblies of integrated circuits. The master-artwork pattern at the right and on the cover will ease both problems. It will get the job done quickly and it doesn't waste space in the board.

An x-y wiring matrix is created when elements of the pattern are coupled by a few simple layout techniques. Since wiring paths are regular, not random, they can be laid out in almost any sequence without becoming bogged down in roundabout routes to avoid intersecting. This advantage, shared with earlier x-y arrangements, will allow computers to design the layouts automatically.

The distinctive advantage of the new pattern is that it achieves design orderliness without the price usually paid for a standardized design—wasted space. Normally, a specific wiring layout cannot use all the positions allotted in a standardized pattern to conductor lines, feedthroughs, plated-through holes and clearance areas.

At first glance, this would appear to be true of

the new pattern, since it, too, is a regular array of conductor, feedthrough and hole positions. But feasibility studies show that the improved pattern will allow the external layers of a multilayer board to carry a maximum number of IC flatpacks, for high assembly density, while reducing the number of internal layers compared with random wiring, for higher interconnection density. The pattern is still experimental.

## Holes in windows

The space that appears to be wasted on the master pattern is put to use when the pattern is converted to a specific wiring layout, as indicated in the diagrams at the right.

One master pattern is overlaid on another, at a 90° angle, to form the basic x-y pattern of the internal layers. Conductors run horizontally on one side of two-sided board stock and vertically on the other, with feedthroughs at the intersections. The interstices of this grid are "windows" for the through-holes and their large pads. Both the x-y pattern and the hole-pad pattern follow the 50-mil spacing of flatpack leads, but are offset by 25 mils; in effect, they are superimposed.

To provide the windows, the conductors are spaced more widely than is usual in high-density boards. However, since most or all of the through-holes will be used for mounting IC's, the window space is well used. Because the pads are coupled to the adjoining conductors and to the small feedthrough pads during layout, the pad area is enlarged. This sharing and enlarging, which aids in overcoming the manufacturing-tolerance problems noted in the article on page 141, represent a re-

## The author



James R. Goodykoontz, a staff engineer, coordinates microelectronics research and development programs and participates in advanced planning of microelectronic product design. He received his electrical engineering degree at the United States Naval Academy.



capturing of space on the internal layers. This advantage does not exist when hole-pad sizes, positions and clearances are fixed. Hole pads usually require a disproportionate share of the space on internal layers.

In sum, the orderliness of the x-y pattern makes the layouts efficient and easy to create, allows a maximum number of wiring paths to be placed on the internal layers and provides a maximum number of usable flatpack-lead positions on the external layers.

### Pairs of patterns

The master artwork was developed to speed the design of multilayer boards for high-speed digital systems. It does not require a change in the basic processing steps described in the previous article, but it does help avoid some of the design errors mentioned there.

The x and y patterns are used in pairs, since both sides of an internal board have to be designed simultaneously for efficient layout. A typical cross-section of a multilayer board after lamination and through-hole fabrication is at the right, below. The feedthroughs—plated-through holes 10 mils in diameter—are drilled, plated and inspected at the time the two-sided stock is etched. The feedthroughs can be made small because the board stock is only about 5 mils thick. They have to be small to prevent them from encroaching on the positions for other feedthroughs and plated-through holes.

The plated-through holes must be as large as possible, because of the plating and tolerance problems discussed in the other article. So, during layout, the through-hole pad area is enlarged. It has to be coupled to a connecting conductor, which adds 20 mils width to one side. It can also be coupled to other conductors when the layout permits. The resulting pad area of 40 mils square, or larger, is normally ample, but if there is a slight breakout of the hole from the pad, as in the sketch shown below, the hole plating will still be a reliable connection.

The feedthrough and hole pads are octagonally shaped because this shape provides more pad area than a circle does, the 45-degree cuts at the corners

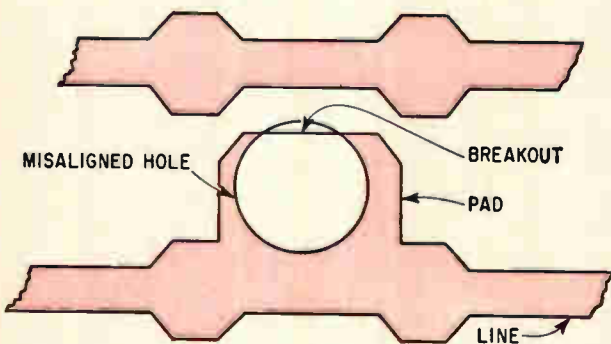

Slight breakout of hole from pad will not significantly affect through-hole reliability. The length of the pad-to-hole connection will still be ample.



Master pattern is cut from artwork film by drafting machine. The pattern, being inspected by a technician, is paired with a similar pattern and modified to create wiring layouts for multilayer circuit boards.

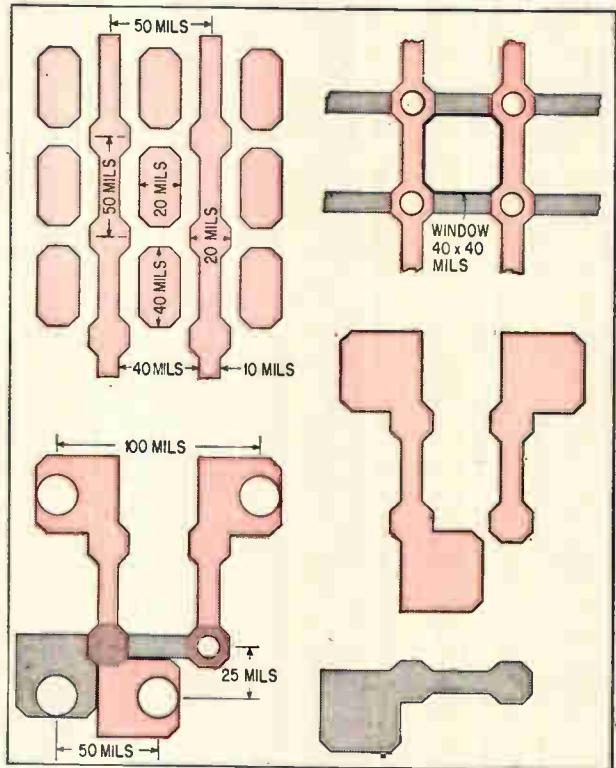

Basic pattern is shown above, left, aligned in the y direction. An x-y pair of patterns form windows for through-hole pads. Typical vertical layout and horizontal layout, shown at lower right, are superimposed to form the conductor, feedthrough and hole combinations of crossover connection, left.

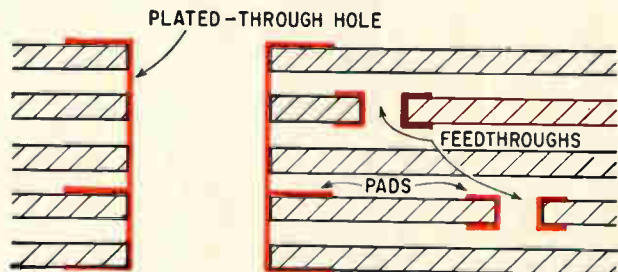

Plated-through holes connect internal layers to the external layers; feedthroughs connect opposing sides of internal boards.

## Regular patterns overcome routing problems

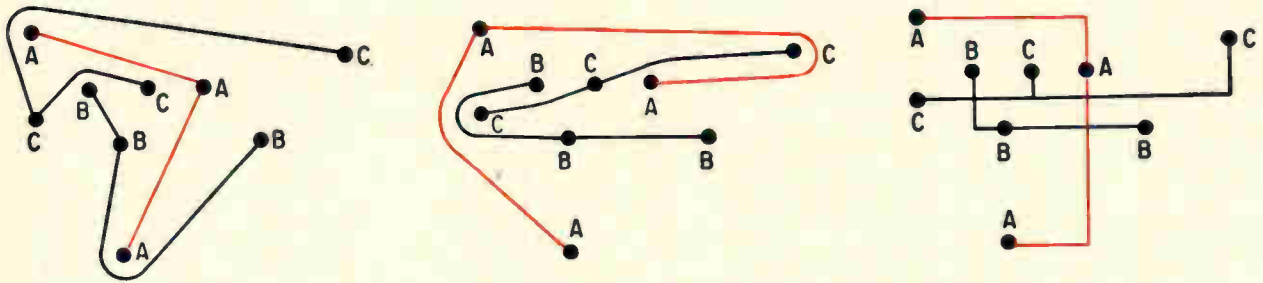

Random routing, left, causes path detours to avoid path intersections. Path length depends on routing order (note the increase, in first two sketches above, in length of path A when it is drawn last instead of first). In x-y routing, path length does not depend on plotting order.

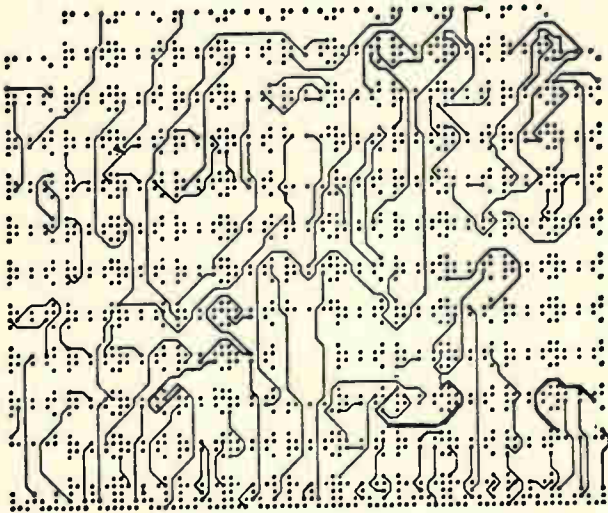

Layout is more efficient and orderly when lines run alongside offset through-hole positions, top, rather than through or around hole positions, bottom.

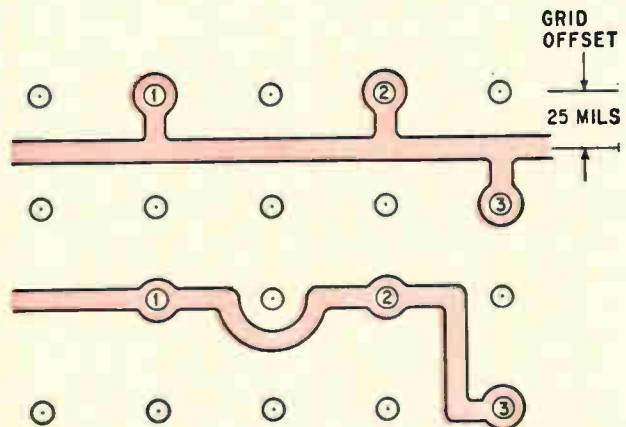

give better clearance than a square, and straight lines are easier to form with a drafting machine than are curves.

### Reasons for the design

Three design considerations led to development of the pattern:

- A 50-mil grid corresponds to the lead arrangement of flatpacks when they are placed as closely together as possible in a symmetrical arrangement.

- The x-y pattern was chosen rather than random routing, because random routing forces the designer to choose between long, crooked wiring paths and a large number of layers. Also, the order in which random paths are routed affects the routing, as in the sketches shown above. The x-y pattern eliminates intersection problems as long as the designer has an ample choice of feed-throughs. Line length is rarely minimum since diagonals are not used, but length does not depend on routing order. Alternate paths of equal length are available between any two points.

- It is generally more efficient to pass conductors alongside pad positions than to route them through or around the pads, as illustrated above, right.

### Reworking the patterns

The designer cannot depart from the rules for using the master artwork without degrading layout efficiency. The maximum use of board space leaves little allowance for variation, beyond the design options inherent in the x-y and pad arrangement.

Master patterns are cut from standard artwork film with a drafting machine equipped with a blade. Negative copies, four times the actual board size, made on stable plastic film 7 mils thick, are used for layout.

Several layout procedures can be used. The simplest seems to be to place the negative over a wiring sketch prepared by hand or by a computer. Unwanted pads and lines are deleted and pads squared off by inking over the clear areas on the negative or by applying black tape. Then, white tape is applied to couple the desired pads to the lines. The layout is then checked, placed on a white background and photographed to produce the etching and tool films. Only circuit routing needs to be checked; dimensional verification—in the past a tedious, expensive procedure—is not needed since the required precision is built into the master artwork.

# Any material that can help Western Electric cut down its phone bill must be something.

## Something called Plaskon Epoxy.

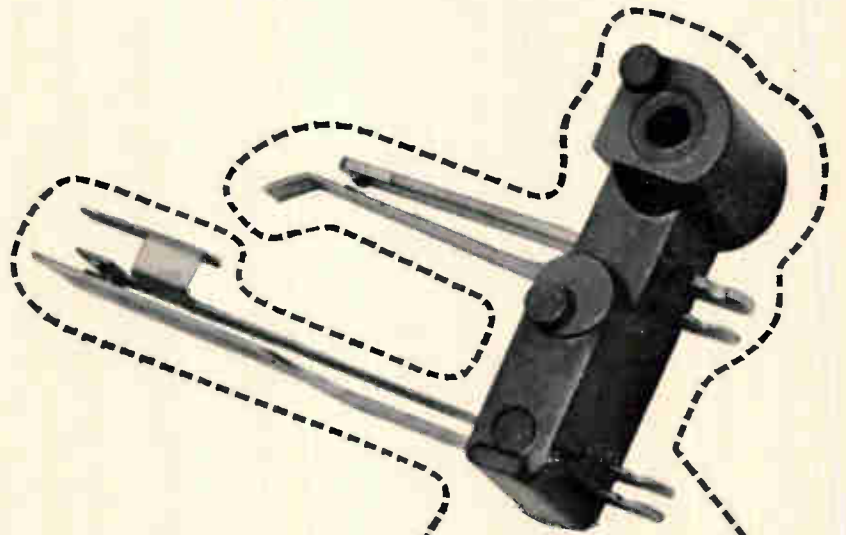

This phone dial relay switch used to be molded of soft-flow phenolic. Now it's made of a stronger, more versatile Plaskon® epoxy molding compound. Because of that, Western Electric was able to eliminate an expensive metal flange with no loss of strength. And at a substantial saving, considering the millions of parts that were made.

They were also able to use the existing molding equipment for the job.



Plaskon epoxies have excellent dimensional stability. They cure fast and shrinkage is often less than one percent. And because of great electrical insulation value, applications are numerous.

Allied Chemical has an extensive line of epoxy molding compounds, including DAP, phenolics and alkyds. Whatever your application requires, one of them should work best — and most economically. Call your Plastics Division representative for more information. Or, mail the coupon, and start saving right away.

Gentlemen:

I'd like to know more about the complete line of Plaskon epoxy molding compounds. Please send me your technical brochure.

E-8

Name \_\_\_\_\_

Company \_\_\_\_\_

Address \_\_\_\_\_

City \_\_\_\_\_ State \_\_\_\_\_

**PLASTICS  
DIVISION**  
POST OFFICE BOX 365  
MORRISTOWN, N. J.

**Allied  
Chemical**



# WESCON

## Oscillators -2000 Generator



Telonic's SM-2000 Sweep Generator, standard of the industry for the past 4 years, has now become even more versatile with the addition of two new plug-in oscillators, the models 3001 and 3005 respectively, will sweep frequency ranges of 50 to 230 MHz and 460 to 960 MHz.

A series of unique, extremely small, lightweight bandpass filters are being shown at Wescon by Telonic Engineering Co. Designated the Telonic Series TSA, they are helical resonant 0.05 db Chebyshev design cavities that provide state-of-the-art performance over a frequency range from 200 MHz to 10 sections, the TSA utilizes its volume far more efficiently than any other standard design approaches of comparable size. Typical dimensions for a 4-section, 250 MHz filter are  $\frac{1}{4} \times 9.16 \times 2$  inches, weight only 14 $\frac{1}{2}$  grams.

## New Miniature Bandpass Filters For High Frequency, Power Applications

Two new series of miniature microwave bandpass filters are being introduced by Telonic Engineering Co. Both are only a little more than 2 inches long, and are capable of handling 100 watts. The devices are constructed of precision bored aluminum blocks, with rigidly controlled finishing for minimum insertion loss.

The 3001 Oscillator is capable of sweeping its range or a section as small as 25% of center frequency, making it well suited for test-broadband devices such as VHF TV circuits, FM equipment, navigational gear, filters and attenuators.

Also capable of sweeping its entire range, the 3005 Oscillator has a dual sweep-to-retrace ratio for oscilloscope or XY recorder presentation. Its range and versatility suit it well to applications in UHF circuitry.

Both oscillators produce fundamental outputs, for maximum purity and flatness.



The TSA filters are available with 3 db bandwidths from 2% to 20%. Connectors may be of standard coaxial type, cables, or pin and tab combinations for attachment to printed circuit boards; the connectors can be supplied on any set of faces on the filter.

Circle 452 on Reader Service Card

## Readout Rate At Frequency

ATELINE WESCON '66 - Telonic Engineering Co.'s TSM-1 Rho-Meter VSWR Meter permits 2.0% accurate VSWR readings at any signal frequency. The device is designed to operate with Telonic's TRB Rho-Tectors and similar VSWR detection devices to form a VSWR measurement system ideally suited to laboratory, production and field testing of coaxial devices. VSWR range is 1.02:1 to 4.0:1, with minimum sensitivity approximately 50 microvolts dc, and



Series TCH filters are very narrow band devices, with 3 db bandwidths from 0.1% to 1.0%, operating at center frequencies from 6 to 12 GHz. Power capability is limited primarily by the connectors used. They are TM010-mode cavities of 0.05 db Chebyshev design, available with from 2 to 4 sections, and provide low insertion loss, high Q and low VSWR and ripple in the passband.

The Series TCC filters operate at center frequencies from 2 to 6 GHz, with 3 db bandwidths from 0.3% to 3.0%. They are available with from 2 to 15:1 VSWR up to 4 GHz, 2.0:1 VSWR from 4 to 6 GHz. They use quarter wavelength resonators for minimum Q and low insertion loss.

Data sheets with complete specifications are available from Telonic Engineering Co.

Circle 451 on Reader Service Card

## New Kits Measure 13 Standard Values Of VSWR, Provide Bandwidths Up To 5000 To 1

A new series of Telonic VSWR Measurement Kits, containing a TRB Rho-Tector VSWR detector, 2 standard matched terminations and 2 or 6 mismatches as specified by the customer, will be on display at WESCON '66 at the Telonic Engineering Co. display, Booths 451-452.

The kits contain any one of 5 standard TRB detectors, operating at frequencies from 5 MHz to 4 GHz, and offering either 30 or 50 db minimum imbalance. Maximum input power is 0.5 or 1 watt, depending on the model TRB specified.

Telonic Microwave Terminations, Series TRM-1, -2 and -3 are also provided in the kits. These are designed to meet the requirements for broadband, calibrated VSWR standards and are available in thirteen standard VSWR values ranging from 1.00:1 to 2.00:1. All items in the Telonic TRK kits are packaged in fitted wooden instrument cases. Special units, available on special order, are optimized for specific frequency ranges and have higher return losses. Further information is available from Telonic Engineering Co., or from the Telonic display at WESCON '66.



Circle 452 on Reader Service Card

over a new test initiated. The tor has capacity frequencies, 5 FM es, a crystal-con M/IF channel, and a AM/IF channel.



100 microvolts p-p ac. The unit is portable, with a rechargeable battery which provides about 16 hours continuous operation.

The TSM-1 provides a convenient operating mode which permits accurate calibration of swept VSWR oscilloscope displays. It contains a built-in preamplifier for use with oscilloscopes and similar readout devices.

Circle 452 on Reader Service Card

## Company Problem

## New Products

## Wescon Display For

## "State-Of- The-Art" Performance

## RF, Microwave Engineers Endorse Instru

# SEQUENTIAL SWITCHING— Compact, Efficient, Low Cost with **CLARE STEPPING SWITCHES**

Counting • Totalizing • Sequence Control • Monitoring

■ Where circuit requirements call for selecting, interrupting, or changing connections in response to momentary impulses of current, CLARE's full line of rotary stepping switches provides exactly the device you need.

Compact and ruggedly built, CLARE Stepping Switches have many new, improved features which contribute to longer service life, greater capacity and unusual freedom from maintenance. Contacts are bifurcated for maximum operating reliability. They may be gold plated for low-level switching, with consistently low contact resistance. Your choice of terminals: taper tabs, solder, or plug-in. Special units available to meet airborne shock and vibration requirements.

## ONLY CLARE GIVES YOU ALL THIS:

### 1 Special Purpose Shorting Switches...for Test and Encoding Circuits



#### "All but one"

Ideal for the classic "multi-conductor cable" test for leaks, shorts, continuity, etc. Shorts all circuits except one together, making possible sequential testing of each circuit individually.

#### "Progressive"

Useful for location of trouble sources in test circuits. Provides incremental increases and decreases in power as required by some control systems.

#### "Alternate"

An excellent device for process control functions, generating a wide variety of coded control outputs. Useful in transmitting special coding in sequential repetition. Readily adaptable to binary coded decimal encoding.

### 2 High Voltage Sequential Control Capacity

CLARE will provide special stepping switches to stand off voltages up to 2500 volts. Number of switch levels available depends upon voltage.

### 3 Special Enclosures for Adverse Environments

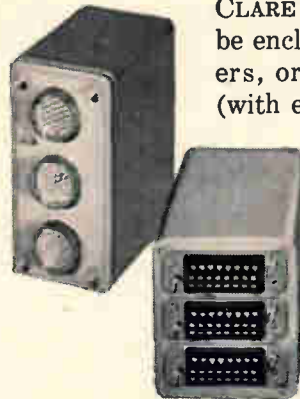

CLARE Stepping Switches may be enclosed in removable covers, or hermetically-sealed (with either nitrogen or fluid)

to minimize undesirable effects of tampering, shock, or vibration, as well as salt air, humidity, fungus, corrosive atmosphere, sand and dust.

Type 26: Up to 624 contact points

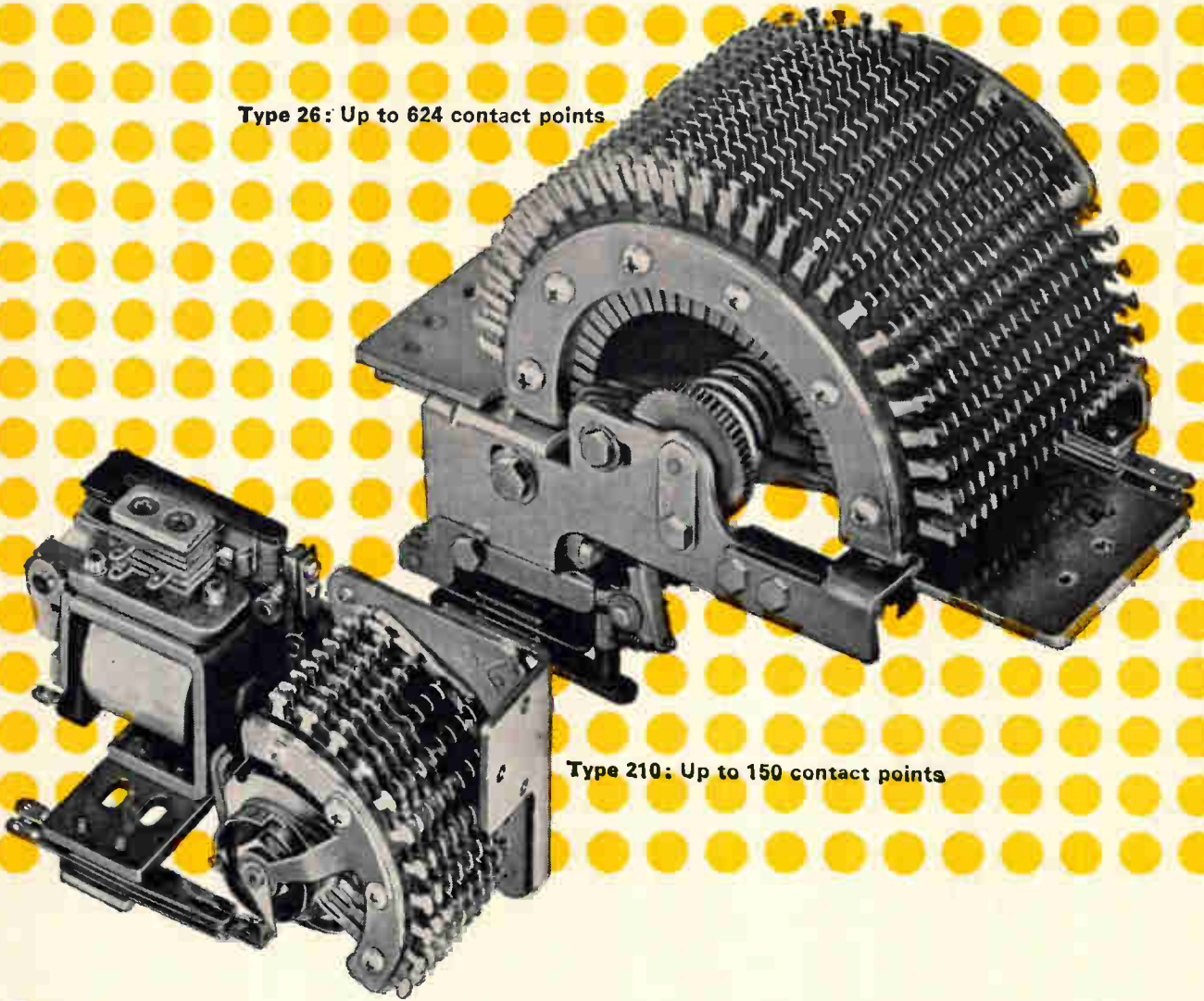

Type 210: Up to 150 contact points

#### 4 Custom-Designed Functional Sequence Control Units...

CLARE engineering can provide functional assemblies incorporating such features as variable time delay pulse generators. Combining stepping switches with solid state (for time delay and pulse generation) and relays (for switch-over between stepper levels), these assemblies expand the capabilities of Clare Stepping Switches.

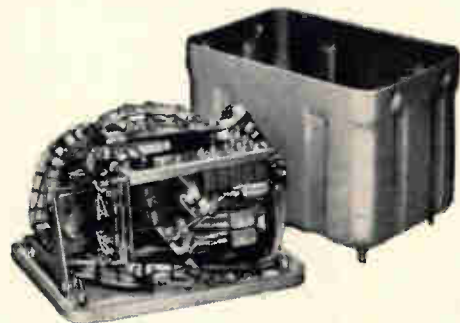

Typical Clare-designed sequential switching unit: 104 point sequence scanner. Solid State pulse generator, driving 10-level, 52-point stepping switch, provides predetermined time interval of 160 ms to 10 seconds at each position.

#### 5 Easy Installation with New Plug-in Connector for Type 211 Stepping Switches

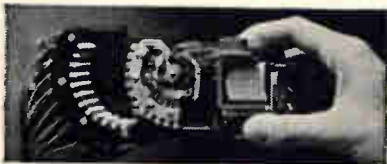

Faster, easier assembly and replacement. Connector contacts, crimped to lead wires, snap into connector frame. Plated contact areas (tin or gold over nickel) for contact reliability.

For information write:  
**C. P. CLARE & CO.**  
Group 08N6,  
3101 Pratt Boulevard,  
Chicago, Illinois  
60646



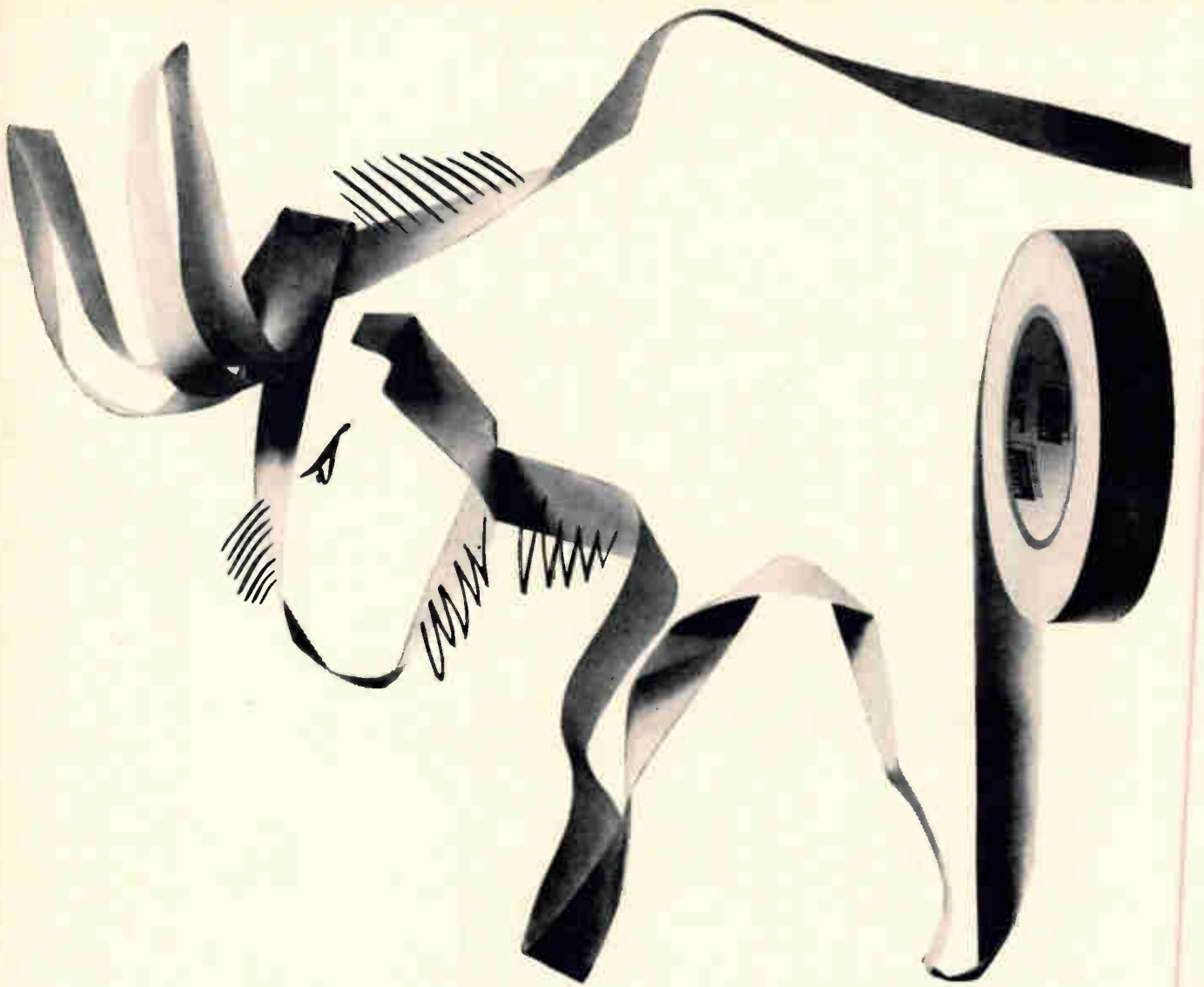

## What's gnu? Mystik NOMEX<sup>®</sup>, KAPTON<sup>®</sup> and TEDLAR<sup>®</sup>, that's what!

*For more news...  
see us at the  
1966 WESCON  
Booth #604-605  
Hollywood Park*

Mystik scores again by being the first to utilize three new materials ... Nomex, Kapton and Tedlar ... and add them to their already extensive line of pressure-sensitive tapes.

**NOMEX** — a highly conformable tape that offers excellent holding power and dielectric strength characteristics.

**KAPTON** — the featherweight of wire insulations ... excellent high temperature applications which require low weight structures.

**TEDLAR** — ideal for electrical applications because of high dielectric strength combined with excellent weather and hydrolytic resistance.

If you would like more information on these or any other Mystik special-purpose tapes, contact your local Mystik distributor. He is listed in the yellow pages under "Tapes—Adhesive". Or, write Mystik Tape Division, The Borden Chemical Company, 1700 Winnetka Avenue, Northfield, Illinois 60093.



**BORDEN  
CHEMICAL**





# Electronics in East Europe

- p. 158 A journey to East Europe
- 166 Rumania's blueprint for electronics
- 168 Theory is fine, but application is better
- 170 'Come on in, the trade is fine'  
say West European businessmen

By Lewis H. Young  
Editor-in-Chief

# A Journey to East Europe

Although the Communists have belatedly discovered electronics and are force-feeding the infant industry, the lag in technology and bureaucracy are hindering its development

Lewis H. Young

Editor-in-Chief

## **Somewhere, somehow, the grand plan had gone wrong.**

Following the economic teachings of Marx, for 20 years the countries of East Europe have dutifully poured their investment money and energy into heavy industry—steel, chemicals, mining and machine-building—ignoring light industries and services. Still, the result is not an advanced economy. Rather, today, each of these nations has an economy more in tune with the Leninist years of the 20's than the sophisticated technology-oriented times of the 60's. When rigid control by central planners straight-jacketed the men who ran the factories and technical institutes, they shelved their initiative and imagination; docilely, they rationalized the shortcomings, omissions and mistakes of the central plan.

Now all that is scheduled to change. Flexibility has become a popular word; initiative is another; and the Communists realize that they urgently need light industry and services. In every country, the planners have discovered electronics and what lack of an electronics industry has cost industry. Suddenly this infant industry is being force-fed. By 1970, if the goals of the current five-year plans just started this year are achieved, Poland, Rumania, Czechoslovakia, Hungary, Yugoslavia, Bulgaria and the German Democratic Republic (GDR) will have well-developed electronics industries.

Summing up East Europe's electronics production, a French businessman offered the opinion: "It's the way West Europe was 15 years ago." Though East Germany, Poland, Czechoslovakia and Hungary have many plants, a part of whose task is building electronic products, the total output is neither

great nor impressive.

Probably the standout performer is the German Democratic Republic (East Germany) which produces good test instrumentation [Electronics, April 4, p. 161], better-than-average short-wave radio, particularly for marine applications, and workhorse teletypewriter equipment. Polish broadcasting and telecasting equipment is also considered well designed. Some Czechoslovakian instruments are admired in the West, though an Englishman who sells them in the United Kingdom described them as "... well engineered though the styling's a bit stodgy."

In any country—and all the countries of East Europe are alike in their shortcomings—the number of important electronics production facilities is not impressive. Generally, there are several plants producing components, one semiconductor plant producing obsolete germanium devices, mostly

low power and low frequency; a television receiver plant turning out a few tubed models; a radio plant; factories to produce simple test equipment; and maybe a facility to produce devices for industrial automation. Even as a group, East Europe's electronics assets are not imposing: there is a small, poorly run computer plant in Wroclaw, Poland, trying to supply the entire Eastern bloc with digital machines; a barn-like factory in East Berlin to build transmitters for ships; and in Baneasa, Rumania, a new semiconductor plant whose most impressive feature is a spectacular flower garden which forms a central mall in front of its three manufacturing sheds.

Governments of the Communist countries have taken the first step; they have earmarked large sums of money to expand existing electronics plants or build new ones. Rumania, for example, expects to triple its production by 1970; and Poland wants to increase the output of digital computers fivefold.

Even as the construction plans are approved and the first shovels of dirt are turned over, a handful of scholars are asking themselves whether plants are enough. Their answer is "no." In Poland, economist Bohdan Glinski at the Institute of Planning, sees the need for more than factories. "When a country has no industry," he explains, "it is very easy to arrange

rapid economic growth by building a few factories. But once the factories are built, it is not so easy to keep up the rate of growth." According to Glinski, what's now missing is technology.

### The weaknesses

He says bluntly, "The technical growth of capitalist countries is faster than that of Socialist ones. Technology advances faster. The problem of technological progress is the most important one we have to solve."

Although a technological lag is difficult to evaluate in specific numbers, a lot of people have tried to estimate how far East Europe trails the West. The consensus is 3 to 12 years, depending on the technical area. In semiconductor technology, the lag is 5 to 7 years; in the development of large-scale computers and peripheral equipment, nearly a full 12 years; in the design of transistorized consumer products, 4 to 6 years; in the development of very high frequency instruments and equipment, over 5 years.

According to Glinski, who has been studying the structure of the Polish economy, his country's research and development expenditures are far below those of Western nations: an estimated \$3 per capita per year compared with about \$75 per capita in the United States and \$15 per capita in Great Britain, France and West Germany.

Czechoslovakia too has finally recognized the need for some kind of stimulus to speed up progress in technology. It was an industrialized country before the Communists took over 20 years ago but despite the industrial bent of the Czechs, Communist planners concentrated on heavy industry while the traditionally strong glass, china, jewelry and auto industries stagnated. As a result, electronics developments are only slightly ahead of where they were 20 years ago, when the Dutch firm Philips Gloeilampenfabriek N.V. operated there with several plants.

To change that, in January, the Czechs established a special National Commission of Technology, formed of bright young engineers. The commission's objective, pure and simple, is to raise the level of technology. Still so new it has not yet been able to formalize a pro-

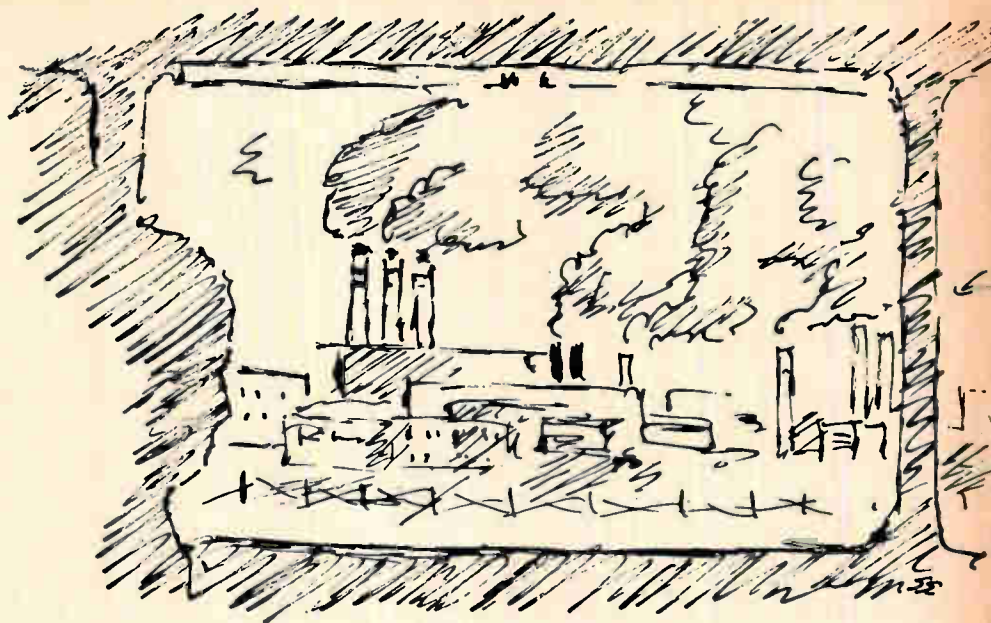

Traveling across East Europe, the visitor sees a countryside dotted with big smoky plants of heavy industry. In the Silesia section of Poland, Poles boast that the air, sullied by burning soft coal, is the dirtiest in the world—as if it were concrete evidence of a modern industrial economy.

gram, the commission has started to expose Czech engineers to what's going on technically elsewhere by sponsoring international technical meetings in Prague. Experts on Czechoslovakia are now saying that the main purpose of the International Computer Fair held in Prague in May may have been to show Czech engineers what electronic computers could do and how they operate—rather than as a mart at which the Czech government would buy millions of dollars worth of Western computers as Western companies first believed.

Although recognition of a technological lag is almost universal, not everybody is as willing to face the hard facts as Glinski or the Czechs. One of East Europe's most difficult problems, according to some observers, is the refusal of its leaders to recognize that the lag in technology is worsening.

Some technical men refuse to accept any talk of retrogression now that the new five-year plans have started. At the Elwro factory in Wroclaw, Poland, East Europe's sole producer of digital computers, director Stefan Rylski pooh-poohed the use of integrated circuits (the Eastern bloc doesn't have them) in computers before a group of visiting journalists in June. He told them, "In a reasonable range of machines, our technology is satis-

factory. There is no need for integrated circuits except in machines for space and military applications." He asserted that the Odra 1013, Elwro's small data processor, and its only computer product now, . . . "is as good as any computer anywhere in the world."

Computer men who have studied the 1013 believe Rylski has overstated his case. The machine is slow because of its germanium transistors and logic design, has limited peripheral equipment available and has access to a software library that contains only about 100 programs and subroutines. A British computer specialist offered the opinion that the Poles would have had trouble selling the 1013 in the West in 1960, let alone in 1966.

Rylski's confidence stems from . . . "sixteen years experience in computers at (Polish) scientific institutions and technical institutes . . ." though Elwro's practical experience in designing and building computers goes back only to 1962. This year, the plant will produce about 50 of the small machines.

This almost naive belief that theoretical work is sufficient to solve all problems is characteristic of technical men who work behind the Iron Curtain. It stems from the basic agricultural tradition of these countries. Industrial operations are new, so many people have not

## ... engineering staffs at most East European plants are minuscule in size ...

learned the importance of engineering development and practical experience.

In Bucharest, for example, planners have decided that Rumania too must have its own computer industry to build medium-size central processors while buying peripheral equipment from foreign suppliers. Even though there are fewer than 30 computers in the entire country now, there is little doubt among Rumanian technical men that a computer plant will prosper—because several technical institutes have studied computers.

Although an American economist in Bucharest says, "The Rumanians are two generations behind in the application of computers," Professor A. Sobaru, a director of the State Planning Committee, notes that a course in the application of computers is being taught at the Institute for Economic Sciences and at the Academy of Statistics and implies that therefore Rumania is abreast of computer applications.

Professor Mihai Draganescu, who headed the electronics department at the Bucharest Polytechnic Institute before he was named to head a scientific commission with the awkward name of the National Council for Scientific Research Commission on Metallurgy, Machine Building, Electronics and Electrical Engineering, says, "We have a lot of experience building computers. Many technical and research institutes have designed and built their own." Draganescu's commission, along with a similar commission on Mathematics and Physics, is currently writing Rumania's plans for a home-based computer industry and their report is due in the early autumn.

One reason why the countries of East Europe continue to slide further behind the West is the shortage of engineers for design and development at production plants. Most engineering graduates of the polytechnical institutes, springing up over East Europe prefer the more cloistered atmosphere of research institutes, Acad-

emy of Science offices and ministry headquarters.

In some countries there just aren't enough electronics engineers to go around, particularly in the face of the planned growth. Rumania, for example, graduates only 300 electronics engineers a year. Proposed expansion of one plant—Electronica, which manufactures radio and television components and sets in Bucharest—will take one-third of this year's graduates.

By U.S. standards, the engineering staffs at most East European plants are minuscule. Poland's Glinski says, "At many of our big plants, departments that work on new products have only 10 or 20 people in them. Such a small group can't design a product as good as one developed by a United States company nor keep pace with U.S. companies."

Take the Elwro plant which builds computers as well as tv subassemblies (tuners and channel selectors) and control panels for chemical and food processing plants. Of its 3,500 employees, 300 are college graduates, 230 of whom have technical degrees. These engineers, mathematicians and physicists make up most of the plant's management. But they must also do these jobs: design new products for all three divisions in the plant (computers, tv subassemblies and automation), engineer automatic control systems, write computer software, perform systems analysis for data processing applications and study new ways to use computers.

Other Polish plants are only a little better off. Of 2,000 workers at the Ostrow Zaklady Automatyki Przemyslowej plant, which builds automatic control systems for electric generating plants and steel mills, about 200 are in the engineering department. At the Krakowska Fabryka Aparatow Pomiarowych plant, only 63 of its 950 employees are graduate engineers (seven are women) to design the 210 types of process measuring instruments built there.

So far the Poles have given en-

gineers little incentive to work in industry. At the KFAP plant, for example, the average engineer earns 2,800 zlotys a month, while the average worker on the production line earns almost as much, 2,300 zlotys (about \$35 or \$40) a month, with no technical education or background. That situation should change soon. Endowed with new powers under a new liberalized economic plan, plant managers will be able to pay salaries that are needed to interest talented people instead of being limited to scales fixed by the state central planning commission.

Not as much technical help has come from the Soviet Union as many people expected. Asked about Soviet technical aid, a Polish official thought for a minute before he answered sarcastically, "Often Soviet technology is connected with industries we don't develop, like space technology, rockets and atom bombs. There is no sense for Poland to develop such technologies."

In addition, until recently, the USSR has considered the countries of East Europe as colonies to whom it could sell those products it wanted to sell, at prices it arbitrarily established. Passing along technology would set up competition, which the USSR did not want, and would destroy these markets. Finally, the Soviet economy has had its own troubles. The sixth five-year plan (1956-1960) was folded in 1957 because it proved to be unrealistic; its seven-year successor just completed (1959-1965) fell embarrassingly short of its stated goals.

Earlier this year, when the countries of East Europe passed regulations to liberalize their economies—following the suggestion of the Russian economist, E. Lieberman, to decentralize planning and responsibility, to allow smaller units some say in investments, and to make plants perform on a profitable basis—they also sowed the seeds for a concentration of technical effort. According to the new plan, plants and enterprises that belong to the same branch of industry are joined into associations.

In East Germany, for example, three associations produce almost all the electronic equipment. With



In the library of the Economics Club in Warsaw, economist Bohdan Glinski describes how the lag in technology is the severest problem Poland has to solve. "Technology moves faster in capitalist countries," he complains.

the identical name of R F T, one produces communications and measuring equipment; a second, radio and tv equipment; and the third, components. In addition, the German Democratic Republic has one association to produce data processing and business machines, another to make automatic control equipment and the Carl Zeiss Association to develop lasers and magnetic tape as an adjunct to its main optical business.

Officials of the GDR will use the new organization plan not only to concentrate research and development efforts but also as a means to close the gap between theory and practice. One of the enterprises in the association that makes communications and measuring instruments is the Institut für Nachrichtentechnik (Institute for Telecommunications). Dr. Peter Fey, its director, claims the institute was established five years ago solely to fill a need for product development . . . "to apply the theory of discovery to industrial applications." Under the new organization scheme, the institute does much of the product development for the manufacturing plants in the association; the factories take the finished designs and put them into production. Thus, in 1967, Funkwerk Kopeniek, an East Berlin factory will start producing these new products developed at Fey's institute: a transistorized demodulator for single-sideband equipment, a transistorized all-

wave transmitter, 14 kilohertz to 30 megahertz; and a transistorized device to switch among several antennas searching for the strongest input for a professional receiver.

#### The wide gap

The visitor to East Europe discovers that the technology lag exists in every area.

In East Berlin, for example, at the important Institute for Telecommunications, engineers have to solve system problems on an archaic computer that the Institute's director, Dr. Fey, describes as "more a stove than a computer" because it dissipates 20 kilowatts of power. Built by the Carl Zeiss plant at Jena and designated the ZRA-1, the machine is no longer in production—for obvious reasons. Its magnetic core logic, driven by 800 vacuum tubes, proved to be a wrong approach. Since the ferrites switch slowly, compared with transistors, addition times are painfully slow, 18 to 20 milliseconds—a thousand times slower than today's so-called third generation computers like the International Business Machines Corp.'s system 360 or RCA's Spectra 70.

This clumsy computer has been at the Institute for three years and there are about 40 others in East Germany. Fey took it gladly even though he knew it was obsolete rather than wait for some unknown amount of time for a better and faster machine. Even now, no one knows when—or if—the computer

will be replaced by a better one.

The production of semiconductor devices is another area of technology where the lag shows up clearly and hurts. Although almost every country of East Europe has its own semiconductor plant, none is producing silicon planar devices in large quantities.

The Polish TEWA plant in Warsaw supplies three kinds of silicon mesa transistors, but no planar ones. At the semiconductor plant in Baneasa, Rumania, built under license to the French Compagnie Générale de Télégraphie sans Fil (CSF), chief engineer Michael Neagu says the plant has just started to produce silicon diodes but will not produce silicon transistors until next year. In East Germany, a new semiconductor plant at Frankfurt-on-Oder is making silicon devices in a pilot plant; mass production is months away and the plant is having start-up problems that have prevented it from achieving its scheduled output. The Tesla plant of Czechoslovakia also produces only germanium devices.

The lack of silicon technology slows the design of other products too. Dr. Fey says frankly, "There is a component gap in the German Democratic Republic." And he could have added . . . in other countries of East Europe, too. Because they have only germanium devices, engineers at the Institute for Telecommunications have designed solid state microwave links only up to 2 gigahertz; above that frequency they have to use tubes. Varactor diodes are still experimental in the GDR, so there are no large quantities in production.

In Poland, a tv engineer estimates it will be five years before transistorized black-and-white television will be in production because of a lack of suitable transistors. Almost half the transistors going into the Polish Elvro 1013 computer are imported from Britain.

Because semiconductors are so crucial to developing an electronics industry, some of the hardest development is being done in that field. In the GDR, for example, some tube manufacturing plants are being converted to make semiconductor devices to speed the transition. A new plant is being out-

fitted in Hermsdorf to produce hybrid integrated circuits by thin film techniques developed at the Von Ardenne Research Institute in Dresden [Electronics, March 7, p. 110]; the semiconductor plant at Frankfurt will supply the active elements. Monolithic integrated circuits are still in the development stage so quantities are limited to one or two units handmade at a research institute.

Despite the great effort, development has not been as fast as expected and there have been some disappointments. Though the Research Institute for Semiconductors in Potsdam, near Berlin, has produced prototypes of gallium arsenide crystals and devices, no work is being done on Gunn-effect devices because pure gallium arsenide is not available.

And while two kinds of lasers have been built at the Carl Zeiss works, a pulsed ruby device and a gas (helium-xenon) type, the first semiconductor laser is still being developed at Potsdam and has not yet worked.

### Overreaching

Such gaps underline another problem that plagues East European planners as they rush to develop electronics industries: in which areas should they concentrate? Traditionally, Communist countries have tried to build everything, even though economists warned that such broad efforts were wasteful and uneconomical. Czechoslovakia, a country of only

14 million people, produces nearly 70% of all the varieties of machine tools built in the world. "Far too broad an assortment for such a little country," a Czech official now complains.

In Poland too, economists worry about trying to do too much. Glin-ski says, "Our range of production is too wide. We need more experience in specialization." Because all the Socialist countries based their economies on similar theoretical grounds, starting with heavy industry and machine building, they are producing the same products and trying to sell them to each other. Despite entreaties to the contrary, the countries of East Europe are heading down the same road with electronics; they are determined to be almost completely self-sufficient.

In the German Democratic Republic, whose electronics industry is probably the most extensive in East Europe, the three associations that design, build and service electronic equipment already employ nearly 90,000 people. The communication and measuring instrument association has 29 enterprises: 22 factories, each specializing in one type of product such as switching devices, measuring devices or short-wave transmitters; four organizations that service the products built by the factories; an export sales organization to sell the products outside the GDR; and Dr. Fey's research institute to develop new products for the plants.

Although it has only 500 em-

ployees, the research institute tackles a broad variety of development work. Currently the major activity is in microwave links and laser communications, ultra short-wave for mobile communications, radar, short-wave communications and systems analysis. In addition, the institute also develops new manufacturing and fabrication processes, is currently working on wire wrapping, surface finishes, encapsulating, climatic testing and component standardization.

In Poland, the country with the second largest electronics industry, Unitra is the association that produces almost 80% of the country's electronics products. Its 46 factories turn out everything from television receivers and broadcasting-studio equipment to communications gear and components. Another association, MERA, (Association of Polish Automation and Measuring Apparatus) produces most of the rest in its 16 plants, which turn out such products as computers and electronic controls. A third association, BUTI (Bureau of Nuclear Equipment), produces the country's electronic nuclear instrumentation.

Czechoslovakia builds many of these same products. Tesla is the name of the main electronics association and its plants produce semiconductors, tv sets, measuring instruments like transistor testers, electron microscopes, radios and components. The Czechs, with their historic strength in consumer products, have also pushed the

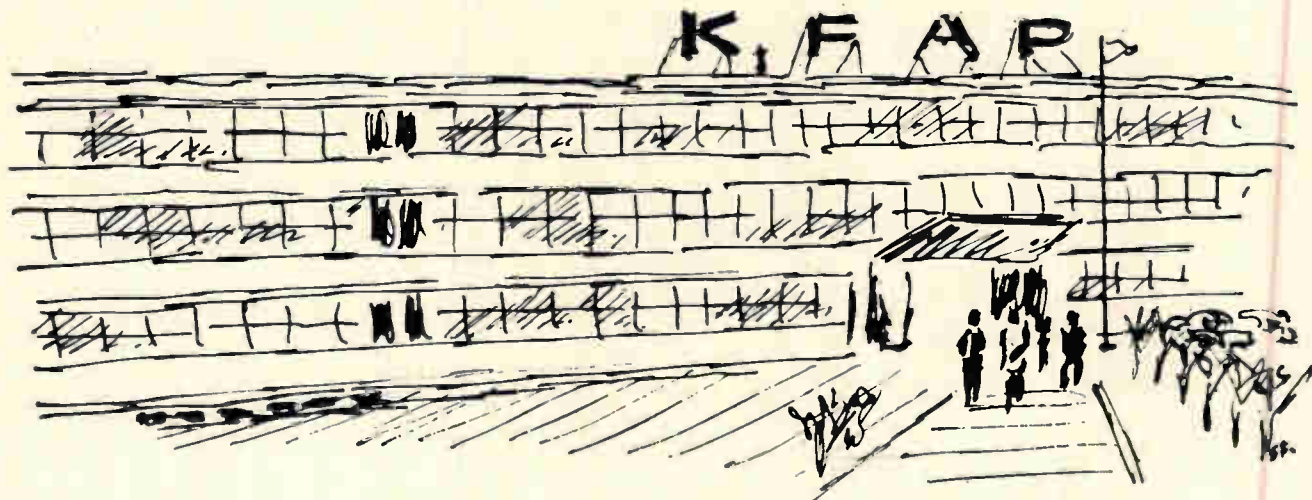

Engineers shy away from working in plants even when they are newly built like this automation device plant in Krakow, Poland. In East Europe, status and prestige stay with the engineers who have the title of professor at universities, research institutes or offices of the Academy of Science.

## ... some talk is heard of technical cooperation in electronics ... but it's mostly talk ...

design of such home-oriented devices as tape recorders and have broadened their tv-receiver line to include an 11-inch portable.

Some talk is heard of technical cooperation in electronics among the Socialist countries, mainly through the medium of the Council for Mutual Economic Assistance (Comecon) based in Moscow. In East Berlin, the Germans urge an all-Socialist project to develop an electronic switching system for telephones. In Warsaw, the Poles want cooperation in data processing, with each of the Socialist countries producing a different piece of peripheral equipment for the Polish computer.

But mostly it's talk. Cooperation through Comecon has been almost nonexistent since the organization was set up in the early 50's. One reason is that the Soviet Union originally planned to assign each country a specialty and thus maintain political control of all the satellites. Poland and Rumania balked and Rumania is balking still.

Even inside a Socialist country cooperation does not come easily. In the GDR, for example, the research institutes are supposed to concentrate on product development and leave the theoretical studies and basic research to universities and the Academy of Science. In theory it works. The Institute for Telecommunications has awarded several contracts to such "think tanks." For example, one went to the Academy of Science's Heinrich Hertz Technical Institute, whose specialty is radio astronomy, to develop new microwave generating devices. The work has slipped far behind schedule, prompting an engineer to comment, "If we want quick results, we have to do the work ourselves."

### Turning to the West

Still, catching up in electronics is too much for any country alone or for the Eastern block, so the Communist countries are turning to the West for help. Every one of the satellite countries is anxious

to buy the latest electronic equipment or to license the latest technology.

Every member of the bloc has already been doing business with the West. Rumania's television and semiconductor plants were built under license to a French company. Rumania has also bought Italian microwave systems and British components. Czechoslovakia has purchased English Electric Co. computers to run a steel mill and its national railway has just installed an English Electric Leo 360 machine for data processing. Poland's chief automation plant OZAP (Ostrow Zaklady Automatyki Przemyslowej) does its system analysis on a Solartron analog computer purchased from the British company four years ago. Since production of plant television picture tubes is far below the bloc's demand, almost all of the countries have turned to the West for cathode-ray tubes, buying mainly from French, West German and Italian companies.

A few countries are even talking about joint ventures with Western-owned companies. Within the past 12 months, Poland announced two joint ventures with West German firms, one with Krupp and the other with Grundig to build equipment in Poland and sell it elsewhere in the world. After the first well-trumpeted announcement, however, both Polish deals fell through: the Krupp venture collapsed on political grounds because Krupp is synonymous with the Nazi war machine, hatred of which the Polish government is trying to perpetuate; and the Grundig project on financing.

Rumania says it too wants joint ventures, but the Rumanians have been unable to find any company willing to agree to their terms, which include accepting payment in the goods manufactured by the venture. What Rumania wants to do, for example, is to license silicon planar technology or form a joint venture to make silicon planar devices, and then to pay its share in silicon devices made by the part-

nership. Joint ventures have been proposed by Yugoslavia but none have developed because of the problem of defining and sharing profits.

Even though the Communist countries now say their new economic plans require that plants operate on a profit basis, the Socialist definition of profit is quite different from the Western definition. For one thing, prices of goods are still set arbitrarily by East European government agencies and sometimes have little relation to costs—if the costs are known.

Cost accounting is brutally crude in most Socialist countries and is ignored completely in many plants. Several do not know what it costs to produce their goods. In Czechoslovakia, economists tell this joke about pricing: "When Communism conquers the world, we will have to keep one capitalist country to set prices." There is a hard ring of truth underneath the humor. Most Communist countries set their export prices on the basis of what Western countries charge for similar goods.

On paper, the joint-venture idea sounds good because the cost of labor appears to be very cheap in most East European countries. The average worker at Poland's Krakowska Fabryka Aparatow Pomiarowych, which produces 210 different types of instruments for process control, earns about \$35 to \$40 a month. When bonuses and fringe benefits like low-cost housing, medical care, education, baby sitters and retirement are added, the average wage comes to nearly \$154 a month, only slightly lower than the \$168 a month most people estimate as the average wage in Japan. But productivity of the average Socialist worker is much less than that of the Japanese. In fact, a visitor to Communist plants is startled by the leisurely pace in most of them and by the awkward industrial engineering that often relies on manpower rather than machines, jigs and fixtures.

### 'People are cheap'

Although the industrialists of Europe talk a lot about automation, they put very little of it to work. One reason is that most of the

## ... Communists demand the newest and latest, but they have to buy where they have money ...

countries are more concerned with keeping large numbers of people working than in improving efficiency. Poland has an excess of workers at present and worries about unemployment. Rumania will need 400,000 jobs over the next five years for workers moved from farms by mechanization.

Only in the German Democratic Republic is there a severe shortage of labor of all kinds. In fact, it was this shortage, made worse by constant emigration to the West, that prompted the Communists to build the infamous wall in Berlin to shut off the route of escape. Although nearly 20% of those who left East Germany have returned, emigration is still such a serious problem that the East Germans are building walls on other borders with the West.

At one station in the Polish Elwro plant two girls, instead of the one you might expect, wire the main frame of the central processor. One reads the wiring instructions to the second who does the actual work. At another point, assembled circuit boards are tested manually by a technician who has to look up the parameters for each different board before it is tested, make the electrical connections, then read a scope to determine if the board meets specifications. Asked about these operations, a computer engineer shrugged off the implied criticism. "We have a lot of people who need work," he explained, "and automation costs too much money. The people are cheap."

Western companies may also have trouble getting used to some Socialist customs such as the workers' council in each plant. This council has to approve the operating budget of its factory and even has to okay the technical plans.

At the KFAP instrument plant in Krakow, Poland, chief design engineer Baranowski explained that the workers council takes as long as 10 hours to hear and approve his technical plans—new designs for instruments, redesign of existing products, new processes, plans for outside research and

money to be spent for all of these. Because the councils often object to big expenditures—they can cut into workers' bonuses—Baranowski always prepares a conservative plan for the year, a compromise between what's really needed and what he believes the council will approve.

As they expand their dealings with the West, the countries of East Europe are demanding the newest and the latest in technology. In fact, the demand for new technology is approaching a mania. Executives of the state trading agencies, which have a monopoly on buying for the Eastern bloc countries, feel cheated if they do not get the latest equipment even when there is a question whether it can be handled.

The technical director of an English instrument company says his firm turned down a Communist request for a direct digital control system for a chemical plant. Explained the Englishman, "That's the last place we'd want to put something that new. The newest gear is the equipment that has the trouble. We want such installations close by, where we can get to them fast when things go wrong."

In Rumania, American visitors are chastized because IBM cannot sell its system 360 computers behind the Iron Curtain. Although IBM has been pushing its 1400 series, the Rumanians have been reluctant to deal because they believe these machines are outdated.

### Lowering the trade barriers

Sometimes in their search for the newest equipment the Communists seem to regress and buy a lot of not-so-new technology. For example, the director of Kovo, the Czechoslovakian trading agency that imports electronic equipment, states loudly and determinedly that his country must have the newest and latest electronics. Yet he has bought six Polish 1013 computers and is shopping for more.

The reasons are simple: the Western embargo on technology, most strictly enforced by the

United States at present, and the shortage of foreign exchange that plagues every country of East Europe.

The embargo clearly has hurt Eastern progress and it is the cause of irritation to many Eastern engineers. In their zeal for trade, however, some Western countries are fudging the embargo rules. Thus, in the German Democratic Republic, for example, a microwave engineer says he gets Western high-frequency instruments even though they are on the embargo list. "A Japanese company will leave one part of the instrument off, a part that we can easily replace, so that it meets the embargo rules. When we receive the instrument, we add on the part and so we have instruments that can measure to 2 gigahertz, even though anything above 300 megahertz is embargoed."

Fey, at the Institute for Telecommunications, claims he has studied every type of integrated circuit built in the U.S. "We get them around the corner, not straight," he explains with a sly smile.

Currently, the trend in the West is to loosen the embargo rules to encourage more trade. Even the United States has joined in, though the U.S. list of forbidden goods is far longer than any other country's; the British are said to have the shortest one. U.S. policy has changed so that if an Eastern country can obtain a product on the U.S. embargo list from another Western country, the Department of Commerce will issue an export license to allow its sale. The only exceptions are when the U.S. product is markedly superior to anything being offered by other Western countries or if the item is considered likely to be used for military purposes.

The latter restriction has started many debates because some people think anything electronic can be used militarily. They say, "The computer in the shoe factory can be paying soldiers next year." But businessmen who have traveled extensively in the Eastern bloc say that kind of thing won't happen. "The shoe factory would fight so hard for its computer nobody would take it away."



Only someone who has visited East Europe can understand this psychology. The bureaucracy in each of these countries appalls Westerners. The paperwork and procedures to do even the simplest things—like changing money, setting up appointments, making airplane reservations or hailing a taxi—can become complex and time-consuming. In Poland, young people call this massive, unwieldy structure *Parkinsoniada* after the English satirist, J. Northcote Parkinson.

Complained one young Polish engineer, "We are a mysterious country. It is impossible to change anything. We see stupid things but we can't change them. You can't even get a drink of cold water in a restaurant because it has never been done before. You have to get a law or rule passed." He added, "The system is set up so that risk is forbidden. As long as something is covered by a rule, nobody has the responsibility for doing it. People in our country won't take responsibility."

### One million eggs

Because the Socialist countries started their growth by trading with each other and the Soviet Union—they still do 65% to 75% of their trade with other Communist countries—all of them are short of Western currencies with which to buy Western electronics equipment and technology. Many times, after a long involved technical discussion that has lasted months, the buying decision is made solely on the basis of what kind of money the buyer has.

Because of the shortage of exchange, Communist countries try to barter goods, with a shocking impact on Westerners unused to such deals. When the English subsidiary of the Foxboro Corp. was making its first sale of process control instruments to Poland a few years ago, its negotiating team was stunned by the Poles opening price offer: one million eggs. Not too long ago, a French electronics company politely refused a Bulgarian offer of snails and roses for microwave equipment and cathode-ray tubes.

As trade with the East expands,

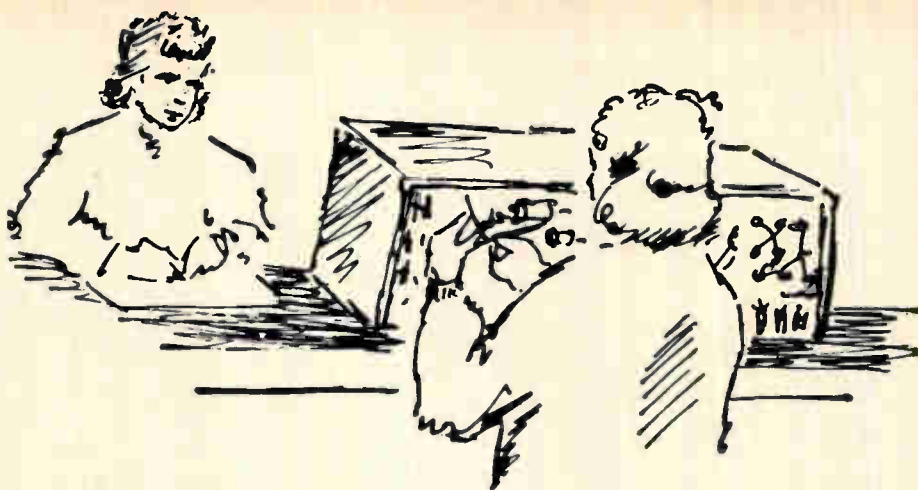

Although East Europeans talk about automation, they rarely apply it because most of the countries are more interested in keeping people working than efficiency. At Poland's computer plant, for example, two girls wire main frames, one reading instructions to the other.

Western companies are becoming more amenable to barter deals. In Austria, West Germany, Lebanon and Hong Kong, middlemen who will sell off the goods received in such trades for the seller have sprung up. Still barter deals are limited in size.

Most Westerners feel that Rumania, Poland and Czechoslovakia are the ripest markets because they all have means of earning Western exchange. Rumania has oil; Poland, ham and coal; Czechoslovakia, the best beer brewed in Europe, fine china, glass and jewelry.

Though the wind of economic change is blowing through East Europe, there is no sign that any of the countries are interested in a change of government or a return to capitalism. State ownership of industry is well entrenched. One American who has worked for a long time in Eastern Europe pointed out that the people of these countries never got very much from capitalism before the Communists took over 20 years ago. "As bad as things look to Westerners, they are usually far better for most people than they were before World War II," he adds.

Another businessman pointed out, "The average man working on the production line doesn't care who owns the plant—an individual, stockholders or the state—as long as he is taken care of."

In some of the Communist countries, plants cater to this feeling by offering extensive recreational facilities and fringe benefits.

One in East Berlin, for example, even has separate dining halls for smokers and nonsmokers.

Still a few cracks are visible. Almost 85% of the farms are privately owned in Poland because farmers put on state-owned farms and collectives did not work very hard and productivity slumped.

State-ownership of the soda-water pushcarts, a long-time tradition in Poland, didn't work either, because the vendors quit work after their eight-hour day, leaving the populace with none of its much-wanted soft drinks after 4:00 p.m. Now an entrepreneur can rent a soda cart from a municipality for a fixed fee, and work as long as he wants, keeping the proceeds.

In Budapest, guides on sightseeing tours tell tourists that the best shops on Vaci Street, the main shopping avenue, are the small privately-owned ones.

Though most westerners who have tramped over the eastern bloc in search of business believe there is great potential behind the iron curtain [p. 170], many have no illusions that it could be transitory business. Said an executive at an Italian computer company, "Eastern countries need 12,000 to 14,000 computers now. They will buy machines from western countries for the next three or four years. Then they will build their own and kick us out."

Unhappily, trade and technology in East Europe are still shaped and directed more by politics than any other factor.

# Rumania's blueprint to build an electronics industry

Mihai Draganescu, an electronics engineer, has the job of putting theory to practice so Rumania can triple production

**On the first day** of 1966, the Rumanian Government established a National Council for Scientific Research, an important step in the implementation of its new five-year plan.

One of the first appointments to that council was Mihai Draganescu as president of the Commission on Metallurgy, Machine Building, Electronics and Electrical Engineering. Draganescu was tapped for this post because he is a young, energetic specialist in electronics; before his appointment he had been dean of the electronics department at Bucharest's influential Polytechnic Institute. His appointment signifies Rumania's determination to build a nearly self-sufficient electronics industry quickly, after previous planners had neglected electronics in favor of heavy industry.

By the end of the summer, Rumania's Ministry for Machine Building will have organized an Institute for Electronics, Draganescu's first recommendation, to coordinate the country's electronics research and development efforts. Next year, a newly built factory will start producing industrial electronic devices—under Japanese license—and another new plant will make electronic measuring instruments. By 1970, Rumania's biggest electronics plant, Electronica, in Bucharest, will be split into two plants and will have doubled its production.

Sometime in the autumn, Draganescu and a commission on mathematics and physics will complete the blueprint for Rumania's soon-to-be computer manufacturing industry. The decision has already been made that Rumania must produce its own medium-sized proc-

essors. Peripheral equipment and large machines will probably be bought from foreign concerns, most likely Western ones.

This turnabout stems partially from the change in leadership which took place in Rumania last year. After long-time Communist leader Gheorge Ghu died, Nicolae Ceausescu took his place as General Secretary of the Communist Party and top man in the government. To solidify his position, Ceausescu has followed a strongly nationalistic route: Rumania first, Communism second. One manifestation of this nationalism has been his determination to build a self-sufficient electronics industry. The Soviet Union, through the Council of Mutual Economic Assistance (Comecon), has urged Rumania to concentrate on agriculture and oil production. Ceausescu is ignoring the Soviet suggestion.

With a population of 19 million, of whom 12 million still live in rural areas, Rumania has only limited resources on which to build an electronics industry. The electronics department at the Polytechnic Institute turns out almost all of the country's electronics engineers—about 300 a year. The strength of the Institute has always been in theory; most of the practical electronics experience in Rumania has been imported.

Electronica and the semiconductor plant at Baneasa were built and started under license to the French Compagnie Générale de Télégraphie San Fils (CSF). Though Electronica now processes from raw materials to finished television sets and designs its own radios and tv receivers, many of the components are still imported. Currently,

the plant is building its own variable capacitors but it is negotiating to buy a foreign design from a British, West German or Japanese firm. Its phonographs, for combination sets, are imported from the German Democratic Republic.

In addition, Rumania now builds telecommunications equipment and industrial automation devices at separate plants. One of them produces the Rumanian-designed electronics systems for process control: Unidyne for quick response, Uni-log for slower response and CR-160 for very slow response.

At the end of World War II, Rumania was an unlikely place for an electronics industry. It had only one plant owned by Philips Gloeilampenfabrieken N.V. assembling about 10,000 radios a year from kits shipped from Holland. Mainly, the country was agricultural, producing wheat, maize (a variety of corn), and fruit. Petroleum, its second largest industry, had been badly damaged by Allied bombers.

After 1948, when all industry was nationalized, the main economic objective in Rumania was to develop heavy industry. The results can be seen in industrial facilities that dot the country producing chemicals, trucks, buses, agricultural machinery, tractors and machine tools. The current pride of Rumania is the new steel mill at Galati (pronounced Gal-lots) which will produce four million metric tons of steel when it is completed in a few years.

Rumania wants to develop an electronics industry primarily to automate its plants and improve their productivity. Although the economy has grown at a whopping 14.5% a year over the past five

years, and is slated to grow 10.5% a year during the new five-year plan, the country is at the point where new plants are not enough to maintain the high rate of growth. "The necessity to develop an electronics industry is felt throughout our economy," says Alexander Sobaru, a director of the State Planning Committee.

Though the planners talk most of the new factories, the real driving power of a new electronics industry will have to come from technology. That's why Draganescu's commission is so important. In his plush, red-carpeted office in an old palace, once the home of Rumanian princes, he makes no bones about the importance of his training in electronics—it's why the Rumanian government wants him.

Draganescu has a painfully thin technical base on which to build. Most of the work has been theoretical and a lot of it was done at the Bucharest Polytechnic Institute. It includes:

- Cartianu's work on frequency modulation. He built experimental f-m receivers and transmitters, culminating years of experiment in a book which has been translated into Russian, Hungarian and French.

- Draganescu's work in semiconductor theory. Before he took his new position, he studied the behavior of transistors at high levels of injection, the inductive behavior of transistors, and switching circuits for electronic telephone exchanges.

- Studies in the theory of circuits including the design of class C amplifiers, the theory of oscillators, stability problems and, most recently, circuit synthesis.

- The Institute's color television transmitter. The Polytechnic has studied the three most common systems; only color bars have been transmitted—no pictures—even on an experimental basis.

At the Institute for Atomic Physics, according to Draganescu, several groups have built electronics equipment primarily for experimental work. There is a laboratory for nuclear electronics; another group designs electronic equipment that uses radioisotopes; and a computation group has built its own

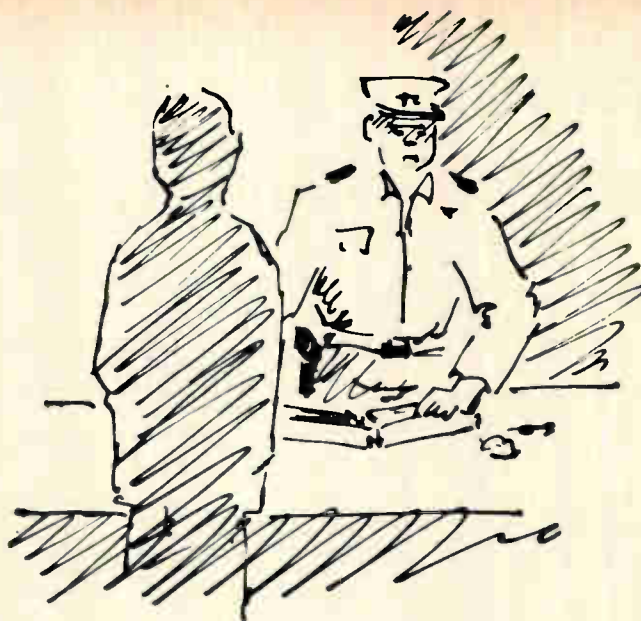

Westerners who travel in East Europe get used to having their luggage checked carefully as they enter and leave a Communist country to prevent their bringing in or removing any of the nation's currency.

digital computers—the first one was a tubed model and a later one has been transistorized.

Another research center, the Institute for Telecommunications, has done more practical work. Although the great bulk of its effort has been on the mechanical and electromechanical parts of the telephone, engineers at the Institute have designed a transistorized multiplexer to switch telephone circuits and are studying radio systems and radio relays. Up to now, Rumania has purchased most of its radio and microwave systems from Western countries.

Draganescu wants to speed the startup of the Institute for Electronics by taking groups already working in electronics at factories and in the electrical engineering institute of the Ministry of Machine Building. Even so, it will be three years before the new institute is fully equipped and staffed. He believes it will need an additional 175 engineers by 1970 when it reaches its full strength of 750 people.

Under Draganescu's plan, the institute will concentrate on industrial electronics, particularly automation. Members of Rumania's National Academy of Sciences have done some strong theoretical work: C. Penescu has written several papers on adaptive control;

M. Popov is considered an expert on nonlinear systems; and Gregory Moasil is a specialist in Boolean algebra. The Institute will try to convert this theoretical work to practice.

Two other research centers will be attached to the new Institute for Electronics even though they are physically located near the factories that will manufacture the products that come out of the Institute's work. One center will concentrate on semiconductor research and the other on radio and tv.

As Rumania embarks on an expansion of its electronic activities, planners have earmarked special attention to the development of components, a particularly embarrassing weakness now. As a starter, Rumania will pour men and money into a study of the physics of semiconductors to develop new devices and new manufacturing processes; the design of elements for automation and remote control, such as power amplifiers and servos; and the design of solid state circuitry.

With this new emphasis on application, Draganescu predicts that Rumania will soon be able to build its own picture tubes for television; it will be producing transistorized tv within two years; and in five years, it will be able to produce television with all components designed and built locally.

# Theory is fine, but application is better

The director of the Institute for Telecommunications in East Berlin is typical of the new wave of East European electronics engineers who are shifting the emphasis from theory to practical application

**Dr. Peter Fey**, director of the Institut für Nachrichtentechnik der VVB Nachrichten und Messtechnik (Institute for Telecommunications) in East Berlin is typical of the new breed of electronics engineer emerging in East Europe. He is a theoretician who has left the theory to concentrate on application.

Medium height, plump and enthusiastic, at 38, he heads an institute that employs 500 people, of whom 20 have doctorates in engineering and 112 are what the Germans call Diploma engineers, a degree somewhere between the United States' bachelor's and master's degrees. In his words, "The

institute was set up to apply the theory of discovery to industrial applications."

Fey started his career as a technician, switched to theory at the Technical University of Dresden, and now is back at practical engineering. He became interested in radio when as a boy he built a tiny set. During World War II, he was a very young fire control man on an anti-aircraft radar set. After the war, he went into radio repair work then moved to a tube factory as a technician. In 1951 he enrolled at the Technical University at Dresden, receiving his Diploma degree in 1955. He stayed on at the Uni-

versity studying for a doctor's degree and specializing in information theory, which is still his hobby. His dissertation led to a book on information theory.

But today Fey says about information theory, "It's only a theory. It's in the same class as the laws of thermodynamics. There is no possibility of ignoring them but they are no guide for building systems." His prime interest now is developing information theory into applications, and he is revising the second edition of his book to reflect this shift in emphasis.

After receiving his doctorate in 1961 he went into industry at a

In an industrial section of East Berlin the Institute for Telecommunications occupies an old factory building, sandwiched in among other factories. Its most redeeming scenic feature is its location on the banks of the river Spree, a canal-like stream that connects East and West Berlin.

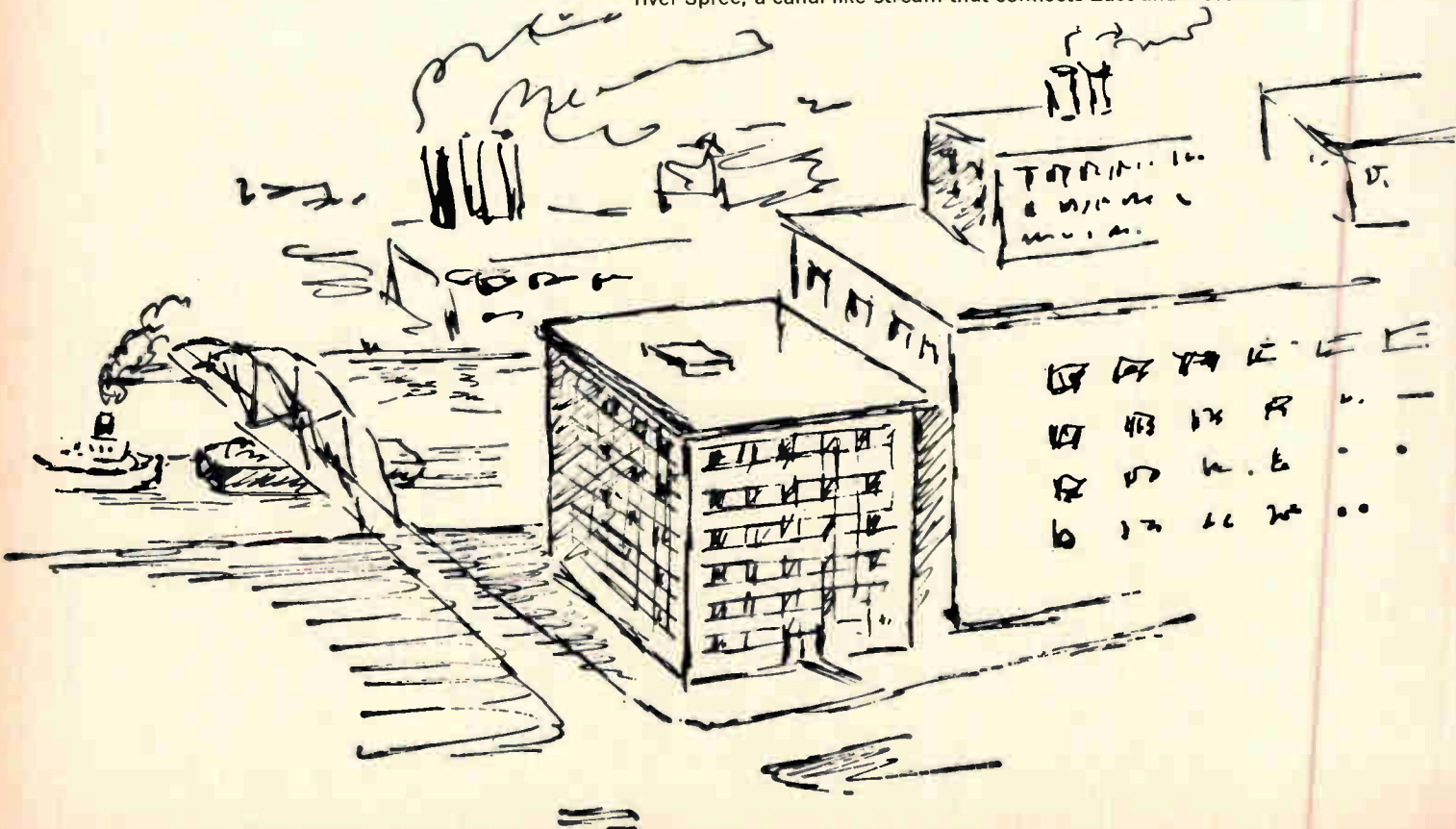

plant that produced wireless communications equipment, and he became technical director of the plant a year later. In 1963, he was appointed director of the Institute for Telecommunications to replace the retiring founder, Freitag, under whom he studied at Dresden.

Fey's most difficult problem as director will sound familiar to many of his counterparts in the West: finding enough good engineers. The Institute has grown from 50 people to 500 in just five years. Fey's search is complicated by a severe shortage of engineers, partially caused by a broad emigration to West Germany and partially because every other electronics facility in the German Democratic Republic (GDR) also is looking for engineers. He seeks the right combination of youth and experience, but often has to settle for engineers right out of school and the young ones have to be able to produce as soon as they start working.

The shortage has been so severe that the GDR allows non-Communist party members to attend technical universities. Quips Fey, "We need technical people more than party members."

With its scarcity of technical manpower and the increasing complexity of technology, the GDR finds itself on a treacherous treadmill. It has to put engineers to work as soon as they graduate; still they need postgraduate training to keep pace with the advancing technology. At the institute, many engineers have to work during the day and go to school at night; Fey himself teaches institute engineers after the day's work is over.

Running the institute is made more difficult by some of its obsolete equipment. It has a clumsy, slow computer, a Carl Zeiss ZRA-1, whose 18-millisecond addition time and 5-millisecond access time were obsolete years ago. Even worse is the need to develop so much equipment and components locally because the equipment is on Western embargo lists. For example, Fey's people have had to develop their own microwave tubes as German interest in microwave has grown. It used to be that only television broadcasts were carried by microwave; all telephone messages were

## Improving the quality

A year ago, the East Germans watched the flow of locally produced electronics with mixed emotions. It was satisfying to see the stream of radios, transmitters, ship navigation systems, television sets, and communication gear broadening, but a lot of what came off the lines did not work. Quality was such a serious problem that the Institute for Telecommunications had to set up a department of reliability to help factories in its association improve quality. Today, engineers like Peter Fey believe the problem is well on the way to being solved.

Almost invariably, the level of quality that has to be matched is that of similar equipment made in the West. One reason is the tacit admission that western technology is leading; another is the desire of the East German government to boost its exports of electronic equipment with gear that can compete.

To enforce better quality, the German Democratic Republic formed a special agency, Deutsches Amt für Messwesen und Warenprüfung, which guarantees quality. It operates by hitting the manufacturing plant where it hurts the most, in the pocketbook. The agency grades the output of a plant and labels it, first class or second class or third class—according to quality—then sets the price based on the label.

As a final persuader, a customer has the right to complain to the agency about the quality of a product he has bought. If the complaint is upheld, the manufacturing plant has to give the buyer a refund.

carried by cable. But as telephone traffic rises, the GDR is going to microwave systems to add channels.

Because most Western countries do not recognize the existence of the German Democratic Republic—to them it is the Eastern Sector or the Soviet Zone of Germany—Fey and his people have difficulty attending Western technical meetings. He accuses the Allied Travel Office in West Berlin of deliberately discriminating against electronics people. He claims, "If a hosiery specialist, a candy specialist and an electronics expert apply for a travel passport, the first two will get them but the electronics specialist will be turned down."\*

Like many young technical executives in East Europe today, Fey is not bashful about criticizing the way things are done. His pet peeve is the bureaucracy and paperwork that slows development work. "To get a resistor in my institute, an engineer has to fill out a requisition, have it signed by his superior, send it to the bookkeeping department for costing, have the costing requisition signed again, then pick

it up. He complains, "The paperwork costs far more than the resistor."

Fey chafes under the load of support people he has to carry in his institute, nearly half of his employees. He figures it costs too much—nearly 25,000 East Deutschmarks a year (roughly \$6,200)—to support each engineer. An average engineer earns about 900 East D-marks a month. The plants, in his opinion, also have too many office workers and not enough production workers.

What makes this situation so critical is that every facility has a manpower ceiling imposed on it because of the shortage of technical people. Only the total number of people are restricted, not the kinds. So if the institute, for example, has to have so many bookkeepers, it must have that number fewer engineers.

Still, Communism has been good to Peter Fey. It educated him and it supplies him now with a chauffeur-driven car—an old, grey, six-passenger Russian Volga. He, his wife, and two children live comfortably in a new apartment on Karl Marx Allee, the broad boulevard that sweeps through East Berlin, in four rooms, kitchen and bathroom. The rent is only 140 East D-Marks a month (roughly \$35), which amounts to less than 10% of his monthly salary.

\* Dr. Fey got a little retribution in June, when the government of the German Democratic Republic refused Electronics' Editor-in-Chief Lewis H. Young a visa to visit electronics facilities in Dresden.

# 'Come on in, the trade is fine' say West European businessmen

Selling to East European countries takes patience and perseverance but it's lucrative business once you understand how to go about it

"It's darn interesting business," says Jack Arnold, vice president of Societa Generale di Telefonia ed Electronica SPA, the General Telephone and Electronics Italian subsidiary which has negotiated three large contracts worth nearly \$4 million for microwave systems with East European countries. "Having established ourselves there, we expect steady growth," he adds.

That is the consensus of opinion of West Europeans who have sold electronic equipment to the countries of East Europe, even though in dollars electronics trade has been very small—the French industry group Federation Nationale des Industries Electroniques (F.N.I.E.) doesn't even keep statistics on it. It is a potentially lush market, but fraught with difficulties and frus-

trations. "You have to go into East Europe with a different frame of mind," a French engineer warned. "Selling equipment takes a long time. It is a slow hard process."

The first warning from everybody who has successfully sold in East Europe concerns the power of the government trading agencies which have monopolies on importing. They buy everything. The end

## The embargo on technology

After World War II, when the cold war froze relations between the political East and West (politically, Japan is considered a Western country), 15 countries of the West agreed to restrict the export of many materials, products and processes because they could be helpful in building up the war-making potential of the East. Meeting in Paris regularly ever since, in a group called the Coordinating Committee (or Cocom), the member countries review requests to remove an item from the list on the grounds that it is no longer new, or it is being manufactured in the East, or it can be used only for civilian purposes. Thus the embargo list is a changing document.

Despite a few efforts to fudge on the rules and some smuggling, the embargo on technology to East Europe has been amazingly effective, particularly in electronics. To some Western countries, however, the very existence of the embargo has been a source of embarrassment. In fact, for a long time, some members tried to keep the existence of Cocom secret. Its deliberations are still secret, as much to hide the fact that discussions are taking place as the content.

In Paris, commercial agents make a cloak-and-dagger game of trying to find out what products are up for removal from the embargo list.

The commodity control list, as the embargo is called in the United States, is contained in a book which is four inches thick. But it is not a cut and

dried listing. Some items are embargoed to all East bloc countries; Poland and Rumania receive preferential treatment on others; and still other items can be sold to any country except Communist China, Cuba and Albania which are in still another very restricted category.

In general, the embargo applies to any electronics technology that is very new or that can be used for military purposes. But companies are continually surprised to see items that are on the list or are not.

For example, Western countries can sell airborne navigation and communications equipment and electronics for airport traffic control and communications. They can sell instrument landing systems (ils) and Voice or Ranging (vor) equipment which is standard commercial gear. The reason: the West endorses a worldwide effort to standardize equipment in aircraft and at airports.

**Tricky question.** In communications equipment, the rules get tricky. Western companies may—and do—sell broadcast and television equipment, though the frequency and power might be scrutinized. If the U.S. Office of Export Control believed a powerful transmitter was being ordered to jam U.S. broadcasts or to bombard a Western country with propaganda, it might embargo the sale for foreign policy reasons or public relations.

Communications equipment with large channel capacity is embargoed. Transmitters operating in the frequency 108 megahertz to 156 megahertz and

user may get into discussions eventually, but it is the trading agencies—like Kovo in Czechoslovakia, Masinimport in Rumania, and Electric and Metronex in Poland—that have the final say.

In buying complex communications, which are an exception, the end user may initiate the negotiations and bring in the trading agency after the kind of equipment required has been determined. That's because sometimes the country doesn't know what it wants and lets potential suppliers educate its people and set the specifications. Such help, incidentally, is no guarantee of any business.

Unless a western company has the confidence of the trading agency it will be shut out of any orders. In fact, it won't even know what business is up for grabs because it won't be invited to discuss the requirements, the way companies usually learn about oppor-

tunities in the East. A French executive cautioned, "You don't go snooping through East Europe looking for business unless you want to end up in jail."

"Once they trust you, they are all right," says an English engineer. "They fear you are selling them junk. They remember when they were let down and by whom."

At the trading agencies, executives tell you that price, quality and the availability of foreign exchange are the criteria by which they buy. Sometimes delivery is added. They seek the newest equipment and the latest technology. But there are some other factors equally important, even if the trading agencies are loath to mention them.

One is politics. If a company is not politically acceptable, it won't get any business. Currently, Italian firms are in favor because the Communist bloc wants to cultivate Italy as a buffer against the West. Since

General DeGaulle's amiable visit to Moscow, representatives of French firms have been getting firmer handshakes and warmer welcomes. In Rumania, a government executive of the Chamber of Commerce confides, "We want to trade more with the United States but Vietnam keeps getting in the way."

The countries of East Europe make no bones about their displeasure over U. S. tariff treatment. Only Poland receives "most favored nation treatment" (its goods are admitted at the same tariffs applied to the merchandise of the country which receives the most favorable treatment under the terms of the Smoot-Hawley Act).

Westerners have their most difficult moments when they encounter eastern bureaucracy and shortages. In Bucharest and East Berlin, for example, they walk to appointments unless they can hire a car because taxis are scarce and almost

above 235 megahertz are embargoed. The ban on the very high frequency band is based on the belief it lends itself better to secret communications than the ultrahigh frequency bands.

**Guessing game.** In semiconductor technology, integrated circuits and silicon transistors are embargoed. Silicon controlled rectifiers with high speed switching times are embargoed, too. Some germanium transistors are not forbidden, but it is a delicate situation. One expert in the Office of Export Control of the Department of Commerce says, "The best I can do is guess and say, 'I think these are okay,' but it's only a guess."

Part of the problem that plagues Cocom is defining generic equipment so special cases can be embargoed or exported depending on their applications. For example, all ultraviolet equipment is embargoed because of its application in military reconnaissance and guidance equipment. When a manufacturer tried to export ultraviolet controls for home oil burners, he found his product came under the ultraviolet embargo. Similarly, ultrasonic devices have been embargoed to keep sonar equipment from being traded. As a result the sale of ultrasonic dishwashers is banned.

### Easing the bonds

Clearly, the current trend at Cocom is to loosen the ties that impede trade with the East. And the U.S. finally is following along. At the Office of Export Control, an official admits that "We are more restrictive. A Western country could stay within

the letter of Cocom and ship goods which a U.S. company could not." But the policy is changing. He adds, "Now if the effect of turning down an export license would be to transfer the sale to another Western country, the license would probably be approved."

Already U.S.-made consumer electronics can be shipped to East Europe without a license—but no company has been able to sell them. Occasionally, somebody from a foreign embassy will ship one home or an American will send one to a friend in a foreign country. Medical electronic equipment can move freely, too.

**Holding firm.** The ban on many electronic instruments still holds, however. For years, Eastern countries have wanted U.S. electronics instruments—so badly in several cases they have even broken into warehouses located in border countries like Austria and West Germany and stolen them—but the tight controls are staying on them.

One practice that bothers electronics companies in the West is the occasional embargo on the application of instruments rather than on the devices themselves. For example, electronic instruments for process control are not embargoed if they are used in, say, a paper and pulp plant. But if the very same instruments were to be used on an atomic reactor they would be embargoed. So far, U.S. officials have turned deaf ears to the pleas of marketing men, who say, "They can take these instruments off the pulp machines and put them on the reactor, and buy new ones for the paper mill."

## CURRENCY EXCHANGE



A common sight at the airport of every capital of East Europe is the long line at the money exchange windows and western businessmen trying to recash vouchers for money left behind on their last trip. Because of the strict currency controls, changing money under any circumstances is a long, time-consuming and sometimes painful operation.

impossible to hail on the streets.

In all the countries businessmen wait 15 to 45 minutes to change money because of the strict currency controls. Every country prohibits the import or export of its currency. If a businessman still has local currency when he is ready to leave, he has to turn it in for a voucher on the national bank, supposedly good for the money when he returns to the country. But a common scene at the airports in the capitols of East Europe, is the western businessman trying to convert such vouchers into money. Most of the countries are reluctant to honor the vouchers. In Prague, a Swiss businessman waved a tattered voucher that was five years old. He tries to cash it every time he visits Prague, two or three times a year, but so far he's had no luck. In Posnan, a Finnish businessman showed a Rumanian voucher that he had just failed to collect; it had been only three months between trips.

Aside from these minor frustrations, westerners get annoyed by the trading agencies' practice of making appointments and not keeping them. "Come back tomorrow at 11:00 a.m., they tell you when you show up," an Englishman said.

"And you may come back every day at 11:00 for a week before you see your man."

Once a businessman gets inside, the negotiations can drag on for years. "They love to talk and they want to talk to the people on top," a Frenchman explained. "In fact, sometimes, they talk so long, the product under discussion becomes obsolete and the technology changes."

Some of the talk is extremely meaningful, although it has to be viewed with a different set of ethics than most Westerners are used to. "The men in the trading agencies are good businessmen who operate with sharp pencils," a Frenchman said. "They play one company against another," he added. "It's not unusual to have them say, after months of discussion, 'Siemens has offered to sell us this for so many dollars, what's your price?' And then two days later, they have the man from Siemens in with our price." One Italian company was even asked by a Yugoslavian agency for an engineer to accompany the agency representative on a visit to a French company. The purpose: to tell the French company that its equipment was not as good as the Italian's.

Many companies report the experience of negotiating for as long as two years, of giving up hope of ever selling anything, and of suddenly receiving a telegram with the order. And they also report the reverse—cases when they were sure of an order, and they never heard a word again.

In general, western Europeans find the eastern countries are in the market for equipment they cannot build themselves, gear that has slid way behind schedule in the economic plan, equipment that was not included in the original plan, or equipment needs that resulted from changes in the plan. Most sales are for industrial equipment. Few companies have had much success selling consumer goods because the Eastern countries prefer to supply such items themselves.

Most western companies worry about eastern countries copying their designs. Some companies will sell only equipment whose design is so old that copying will be no loss. Others feel it will be years before the East European countries will be capable of supplying the components to copy a complex microwave system design, for example. And still others say their products can't be copied. Said one businessman who believes the threat of copying is overrated, "You can't peel a semiconductor and see how to make it."

From the liberalization which is sweeping East Europe, businessmen in the West expect big changes. When an English company entertained a group of Czechs at a luncheon in London just a few weeks ago, one of the visitors confided, "There isn't a single party member here. Six months ago, not one of us would have gotten out of the country."

But the greatest change may come from diminution of the power of the trading agencies. Starting next year, end users in Poland and Czechoslovakia will be able to contact prospective sellers directly, maintaining the trading agency as a form of consultant. Most westerners agree that this move will sharply curtail the influence of the agency monopolies and will make it easier to sell electronics equipment to eastern countries.



# Ruby, sapphire, YAG— you know our single crystals.

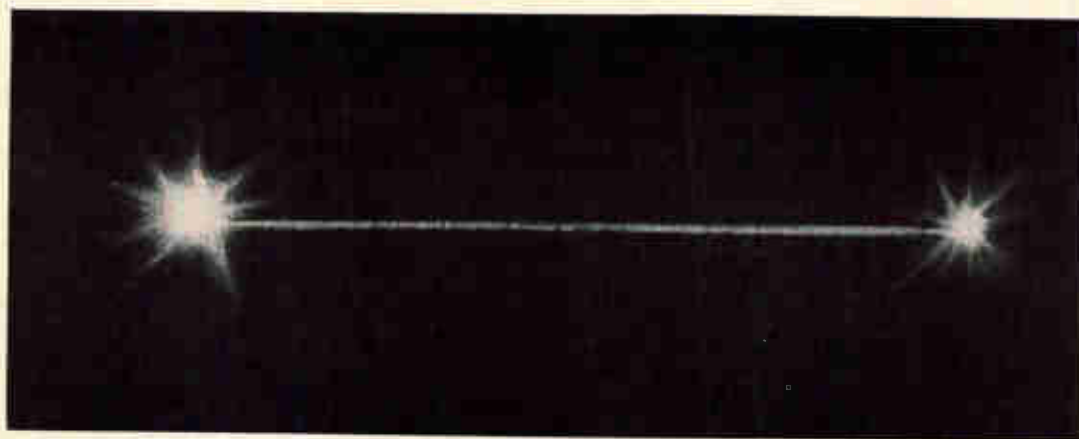

## Now see what you think of our bright new laser.

It's the brightest laser in the world —  $25 \times 10^{10}$  times brighter than the sun...nearly triple the brightness of any previous commercial laser. It's the new K-1500 laser, now available from KORAD Corporation, a subsidiary of Union Carbide.

We are committed to leadership not only in crystals and laser products...but also in such fields as special transistors, integrated and modular circuitry, and solid tantalum

and foil-film capacitors. What sort of company innovates such important new products and backs them with multi-disciplined technology? Union Carbide — dedicated to growth through research.

For specific data on single crystals or laser systems — or if you'd like more information on our electronics activities — write Union Carbide Corporation, Dept. E-82, Electronics Division, 270 Park Ave., N. Y. 10017.



KORAD is a registered trade mark of Union Carbide Corporation.

# NEW FROM DURANT AT WESCON/66

new count/control components for total design versatility in printed and electrical readout systems. See these and the complete Durant product line at Booth 2112-2113.



## UNIPRINT MODULE and UNIPRINT PLATEN

Designed to be companion components for use in your count-printout systems. Nearly two years of controlled life tests back-up these new Durant components. Count speed is 50 counts per second. Minimum count life, 100 million counts. Print life, 10 million. Operated from 12 or 24V DC pulses. Mount on 1/4" centers with mounting accessories available from Durant.

Also new, Unicount, visual readout module. For design-in decade build-up where printed or electrical readout is not required. The Unicount is equipped to provide an electrical transfer signal. Specifications and dimensions are identical to Uniprint.



## PLASTIC FRAME ELECTRIC COUNTER

The new Durant 6-Y-40803-PE counter is a non-resettable, totally cheat-proof unit specially developed for OEM instrumentation. It has been proven in totalizing service applications in liquid metering and as billing counters on leased equipment. All design features found in Durant's finest electric counters have been packaged in a smaller, high impact plastic frame designed for top mounting. 3/16" figures provide maximum readability. Standard voltages are 115V AC and 90V DC. UL approved. Six-figure model available from stock, specials are available for volume applications.



## DIGITAL CALENDAR/CLOCK

Designed for use in reduction systems wherever data or material handling with a time base is required. A choice of models provides visual or electrical readout in hours, minutes and fractions of minutes or in hours and fractions of hours. Utilizing the Durant Unipulser, remote time readout can be available to computers, printers and controls.

Cabinet, panel or relay rack mounting models available with or without wiring. 115V or 230V AC, 50 or 60 cycle.



## NEW UNIPULSER MODELS

3 1/2 years of field service in thousands of applications are your assurance of proven accuracy and dependable performance. Durant Unipulsers are now available in 14 basic models. Each provides speeds up to 40 cps, plug-in wiring for simple installation. Life expectancy has been proven in tests exceeding 100 million counts.

Durant Unipulsers offer widest voltage range available — 10-150V for electrical readout, switching or transfer switching. For complete specifications and application data, write for Catalog 90, Durant Manufacturing Company, 612 North Cass Street, Milwaukee, Wisconsin 53201.

**DURANT**  
MANUFACTURING COMPANY

MILWAUKEE, WISCONSIN

In Europe: Durant (Europa) N.V. Barneveld, Netherlands

# Ruby, sapphire, YAG— you know our single crystals.

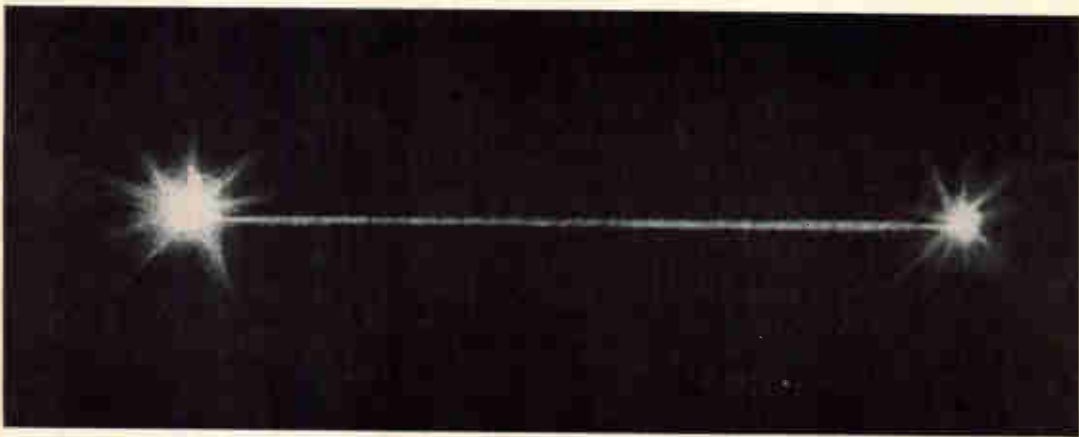

## Now see what you think of our bright new laser.

It's the brightest laser in the world —  $25 \times 10^{10}$  times brighter than the sun...nearly triple the brightness of any previous commercial laser. It's the new K-1500 laser, now available from KORAD Corporation, a subsidiary of Union Carbide.

We are committed to leadership not only in crystals and laser products...but also in such fields as special transistors, integrated and modular circuitry, and solid tantalum

and foil-film capacitors. What sort of company innovates such important new products and backs them with multi-disciplined technology? Union Carbide — dedicated to growth through research.

For specific data on single crystals or laser systems — or if you'd like more information on our electronics activities — write Union Carbide Corporation, Dept. E-82, Electronics Division, 270 Park Ave., N. Y. 10017.



KORAD is a registered trade mark of Union Carbide Corporation.

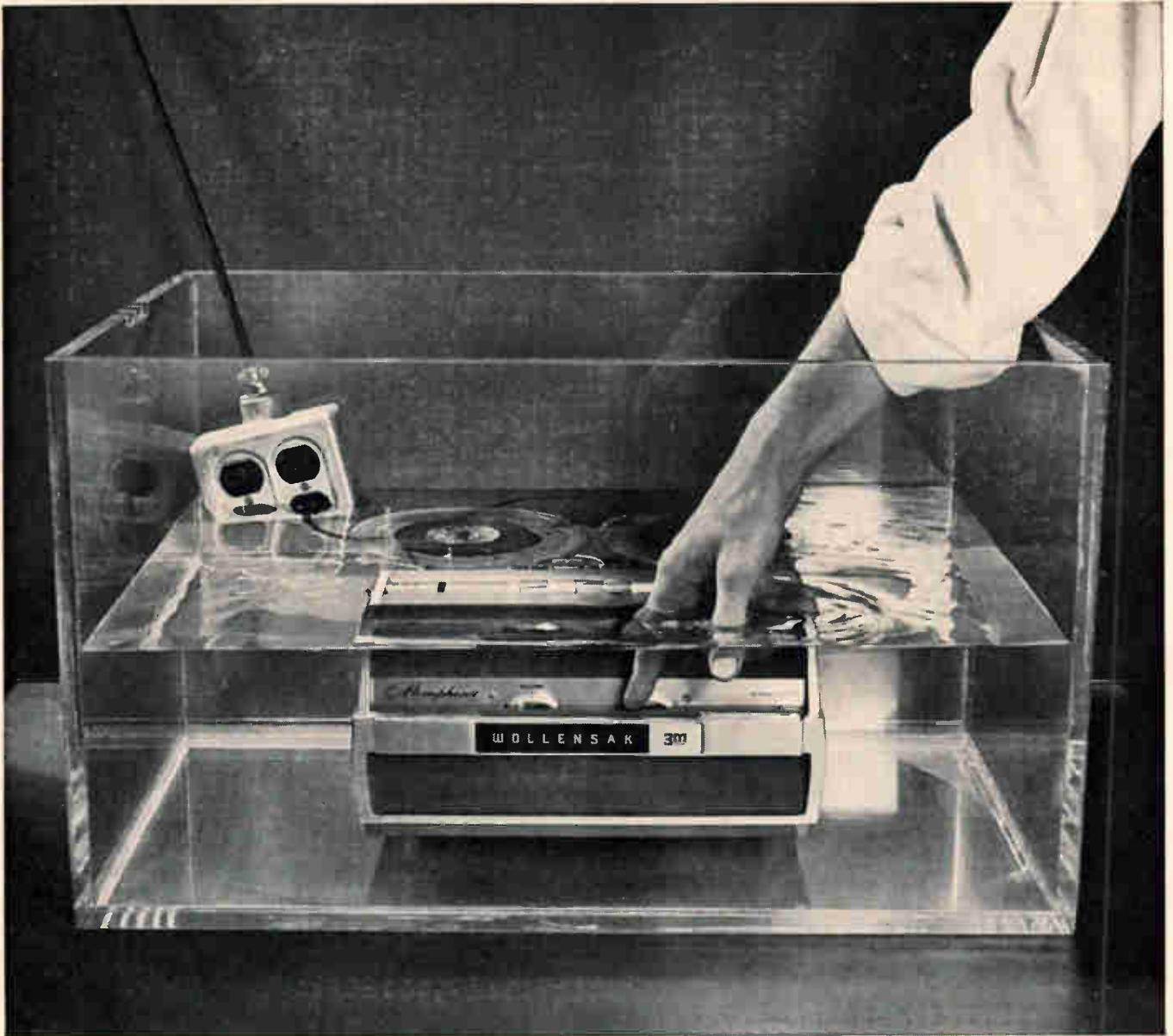

## WHAT IS A TAPE RECORDER DOING IN FC-77 COOLANT?

### Playing!

This traffic-stopping demonstration of the completely inert dependability of FC-77 coolant has been featured at several national electronic trade shows. An ordinary "right-out-of-stock" tape recorder is lowered into a tankful of FC-77, plugged into an electrical outlet and a hand reaches in and pushes the button to start a practically continuous concert that plays during the show.

All this time, recorder parts of steel, copper, chrome, plastic, rubber, elastomers, glass, nylon, adhesives, as well as recording tapes are directly immersed in FC-77 coolant. Nevertheless the recorder plays on. When at the end of a show, the player is removed from the tank none

of its components are affected. How's that for "inertness"!

All members of 3M's fluorochemical coolant family have this exceptional compatibility with most materials (even at temperatures above the maximum permissible with other dielectric coolants). This "easy-to-get-along-with" coolant, incorporated into your system can bring about better reliability. *Want more?* These coolants have wide liquid ranges, excellent electrical properties, thermal and chemical stability, are non-flammable, non-corrosive, non-toxic. Write and ask about them, particularly our new, economical FC-77. 3M Company, Chemical Division, Dept. KAX-86, St. Paul, Minn. 55119.

Chemical Division **3M**  
COMPANY

# ELECTRON BEAM/VACUUM DEPOSITION AT EVERY PRODUCTION LEVEL



Model 1865, 18" bell jar vacuum evaporator

Model 36-B10 vacuum evaporator with three continuously fed electron beam sources.

CV-10-330 10KW constant voltage electron beam power supply.

The increasing use of thin-film products requires a new look at their production techniques. In many instances, requirements have increased to the point where bell jar, low volume per unit systems are no longer adequate. Automated, continuously operating equipment, that yields consistent quality at low unit cost, is needed to satisfy the new demands economically.

To service this expanding market, Temescal has delivered over 5,000 kilowatts of electron beam and sputtering power supplies for thin-film applications. We have delivered many completely integrated vacuum deposition systems... systems that operate in a continuous, semi-continuous or batch type basis with guaranteed capacity.

If you would like more information on our capabilities, please contact us or one of our regional offices; we'll be pleased to discuss your application.

Temescal is the world's largest producer of electron beam equipment and systems.

**TEMESCAL**  
metallurgical corp

2850 SEVENTH STREET, BERKELEY, CALIFORNIA 94710 • PHONE: (415) 841-5720 • FAX: FGC  
Regional Offices □ 10515 South Western Ave., Chicago, Illinois 60643 • Phone: (312) 233-0232 □ Merwin Bldg., Wilton, Connecticut 06897 • Phone: (203) 762-8361

# NEW FROM DURANT AT WESCON/66

new count/control components for total design versatility in printed and electrical readout systems. See these and the complete Durant product line at Booth 2112-2113.



## UNIPRINT MODULE and UNIPRINT PLATEN

Designed to be companion components for use in your count-printout systems. Nearly two years of controlled life tests back-up these new Durant components. Count speed is 50 counts per second. Minimum count life, 100 million counts. Print life, 10 million. Operated from 12 or 24V DC pulses. Mount on 1/4" centers with mounting accessories available from Durant.

Also new, Unicount, visual readout module. For design-in decade build-up where printed or electrical readout is not required. The Unicount is equipped to provide an electrical transfer signal. Specifications and dimensions are identical to Uniprint.



## PLASTIC FRAME ELECTRIC COUNTER

The new Durant 6-Y-40803-PE counter is a non-resettable, totally cheat-proof unit specially developed for OEM instrumentation. It has been proven in totalizing service applications in liquid metering and as billing counters on leased equipment. All design features found in Durant's finest electric counters have been packaged in a smaller, high impact plastic frame designed for top mounting. 3/16" figures provide maximum readability. Standard voltages are 115V AC and 90V DC. UL approved. Six-figure model available from stock, specials are available for volume applications.



## DIGITAL CALENDAR/CLOCK

Designed for use in reduction systems wherever data or material handling with a time base is required. A choice of models provides visual or electrical readout in hours, minutes and fractions of minutes or in hours and fractions of hours. Utilizing the Durant Unipulser, remote time readout can be available to computers, printers and controls.

Cabinet, panel or relay rack mounting models available with or without wiring. 115V or 230V AC, 50 or 60 cycle.



## NEW UNIPULSER MODELS

3 1/2 years of field service in thousands of applications are your assurance of proven accuracy and dependable performance. Durant Unipulsers are now available in 14 basic models. Each provides speeds up to 40 cps, plug-in wiring for simple installation. Life expectancy has been proven in tests exceeding 100 million counts.

Durant Unipulsers offer widest voltage range available — 10-150V for electrical readout, switching or transfer switching. For complete specifications and application data, write for Catalog 90, Durant Manufacturing Company, 612 North Cass Street, Milwaukee, Wisconsin 53201.

**DURANT**  
MANUFACTURING COMPANY  
MILWAUKEE, WISCONSIN  
In Europe: Durant (Europa) N.V. Barneveld, Netherlands

What's different about OFHC® brand copper?

# Its uniform high conductivity

The conductivity of current-carrying products can't be any more uniform than the material they're made from. And, in the case of copper, conductivity can't be any more uniform than its purity. It is certain impurities in solution, such as iron and phosphorus, that depress conductivity. Thus, a copper offering uniform high conductivity must be uniformly pure. OFHC brand copper is just such a copper... oxygen-free, 99.99+% copper. □ This unvarying purity is the essential factor that sets OFHC apart from conventional coppers. It results in unique combinations of high conductivity (averaging 101.6% IACS) with properties such as ductility, impact strength, and

immunity to hydrogen embrittlement. □ OFHC has improved the performance of many products while at the same time lowering their manufacturing costs through good workability and high yield. Perhaps it can do the same for yours. To find out how, request your copy of *OFHC® Brand Copper at Work* ...today!

## AMAX

AMERICAN METAL CLIMAX, INC.

Oxygen-Free Copper Products Group  
1270 Avenue of the Americas, New York, N. Y. 10020

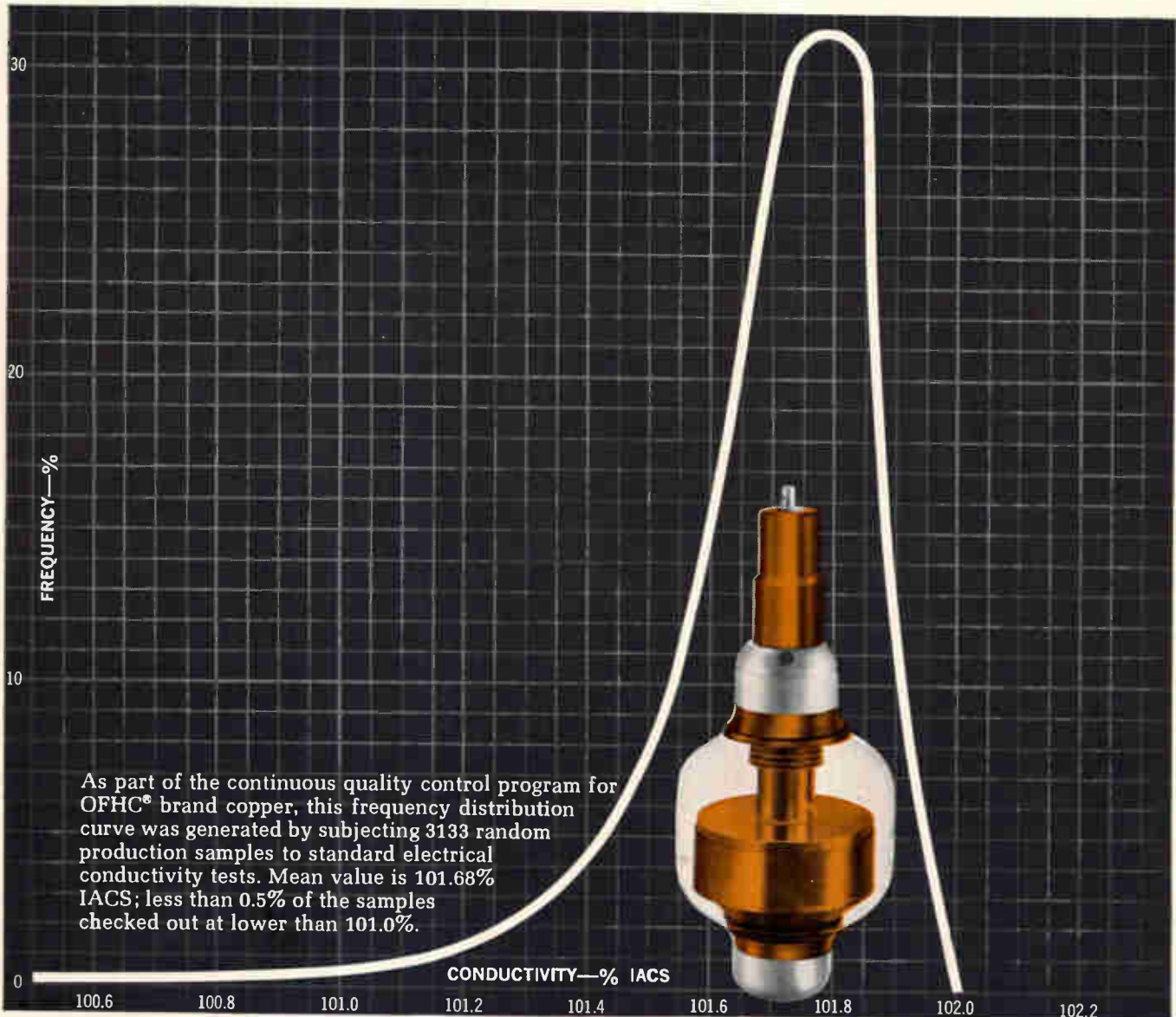

**OFHC® brand copper...**  
**the different copper**

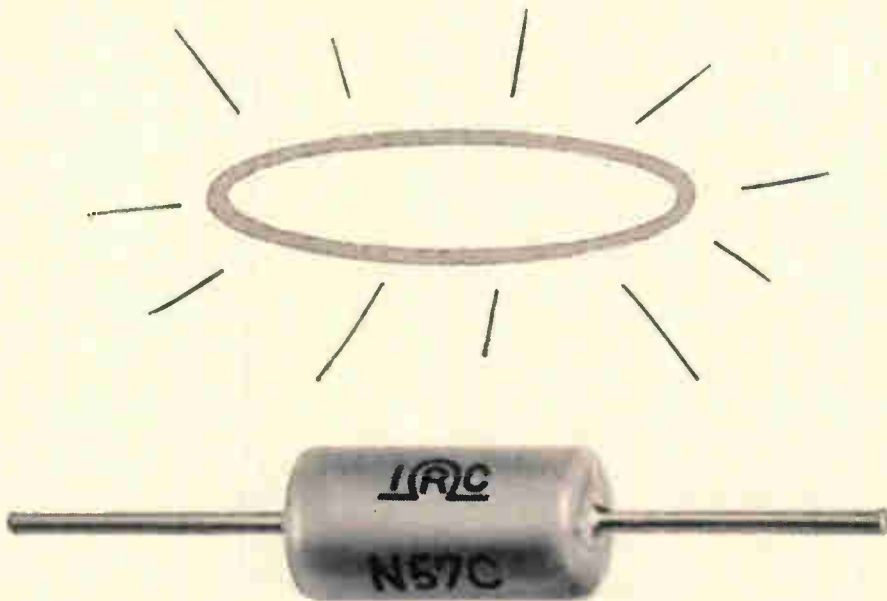

## Reliability is a halo some companies wear better than others

IRC type XLT resistors have undergone over a ½-billion unit hours of testing to various stress levels without a single failure. Documented failure rate is less than 0.0003%/1000 hours, full load at 125°C. This far exceeds the toughest MIL-R-55182 requirements.

Since 1959, IRC has supplied over 2 million XLT resistors for critical circuit use in Minuteman, Saturn, Surveyor, Agena, Apollo, LEM, Mariner and many others. Not a single failure.

IRC also offers other optimum economical levels of reliability in resistors, potentiometers and semiconductors to match your cost and performance needs.

We have earned our halo. For no one can match IRC's record of reliability—or its experience in achieving it. Address your questions on reliability to our Director of Reliability. They will get the attention of top management.

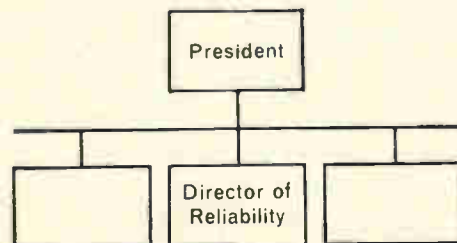

IRC, Inc., Philadelphia, Pa. 19108





# VOLTAGE-TO-FREQUENCY

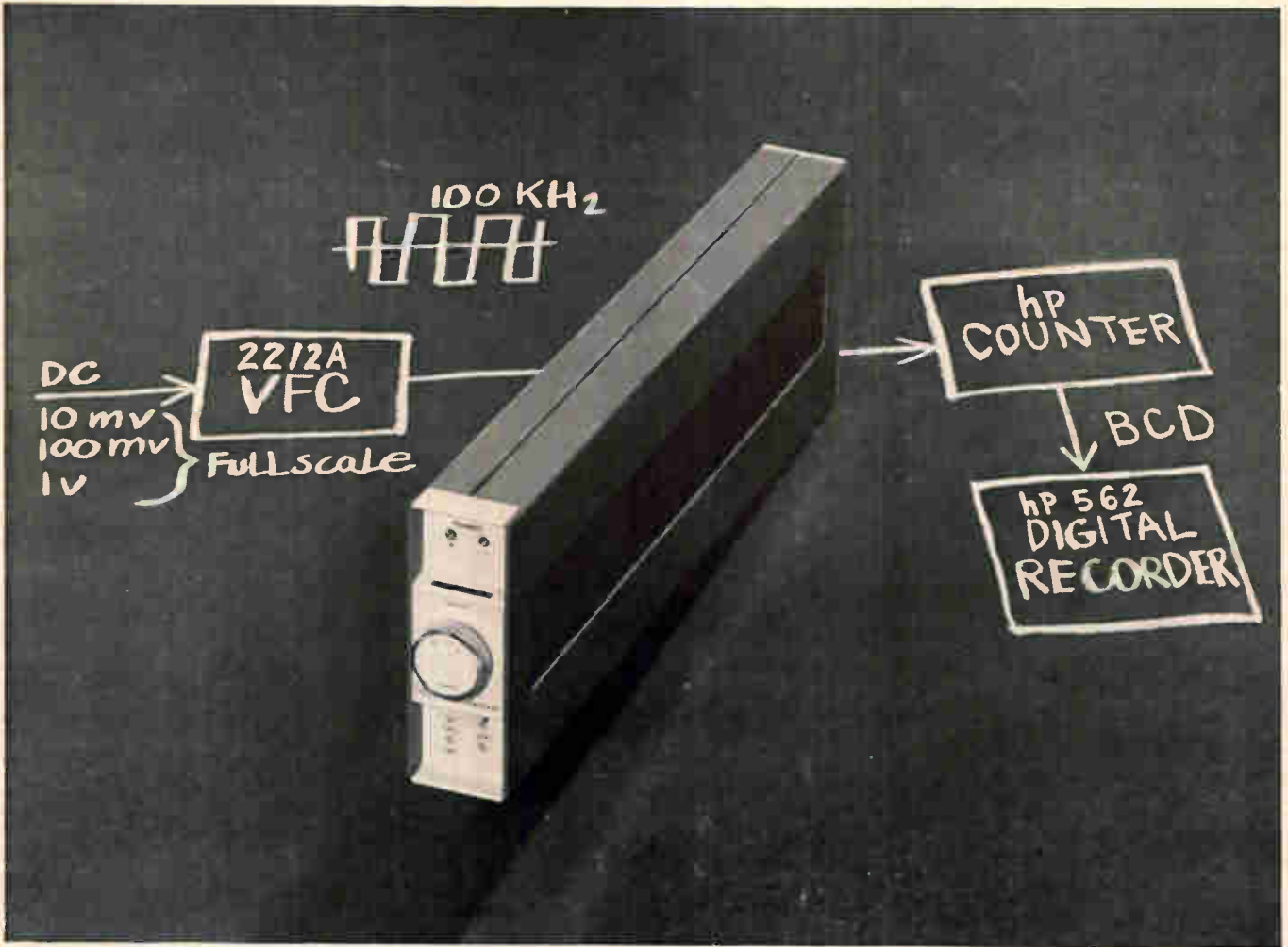

## CONVERTER

### High-performance low-level analog-to-digital conversion

The Hewlett-Packard 2212A Voltage-to-Frequency Converter delivers an output pulse train with rate directly proportional to the magnitude of a dc input signal. Full-scale inputs of 10 mv, 100 mv and 1 v produce an output frequency of 100 kHz; 150% overranging on all ranges. Other ranges, precision vernier control and internal calibration source are optional.

Here's a converter ideal for all types of low-level analog-to-digital conversion applications. Used with an electronic counter it tracks an input voltage by repetitive sampling to form a noise rejecting integrating digital voltmeter. The VFC responds to both positive and negative input voltages; used with a reversing counter it tracks around zero with no crossover error. Provides polarity indication and output signal.

Differential input for low drift, high cmr (120 db all ranges); true integration averages out noise superimposed on signal. Input impedance is 1000 megohms all ranges for minimum circuit loading; input and output circuits are isolated by internally driven guard shields. Fast 100  $\mu$ sec settling, 100  $\mu$ sec overload recovery gives maximum usefulness in multi-channel system applications.

The 2212A MTBF is predicted in excess of 10,000 hours. Hermetically-sealed silicon transistors are used throughout, and passive and active components are selected for reliability, as well as performance. VFC speci-

fications are guaranteed at 95% relative humidity at 40°C. A factory 100-hour "run-in" test at elevated temperature assures reliable operation.

A rugged, unique molded dielectric case encloses VFC circuitry and built-in power supply...all in a package less than 5¼" high. A combining case is available to hold 10 instruments side-by-side in a rack-width module. The 2212A VFC costs \$900.

Call your Hewlett-Packard field engineer for complete information or write the Dymec Division of Hewlett-Packard, 395 Page Mill Road, Palo Alto, Calif. 94306, Tel. (415) 326-1755; Europe: 54 Route des Acacias, Geneva.

*Data subject to change without notice. Price f.o.b. factory.*

See NEW HP INSTRUMENTS  
Attend Measurement Seminars  
Wescon—Hollywood Park

HEWLETT  
PACKARD  DYMEC  
DIVISION

1317

# VAST:

## Space and Dollar Saver for Naval Avionics

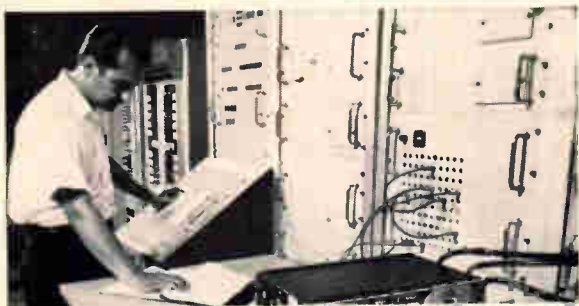
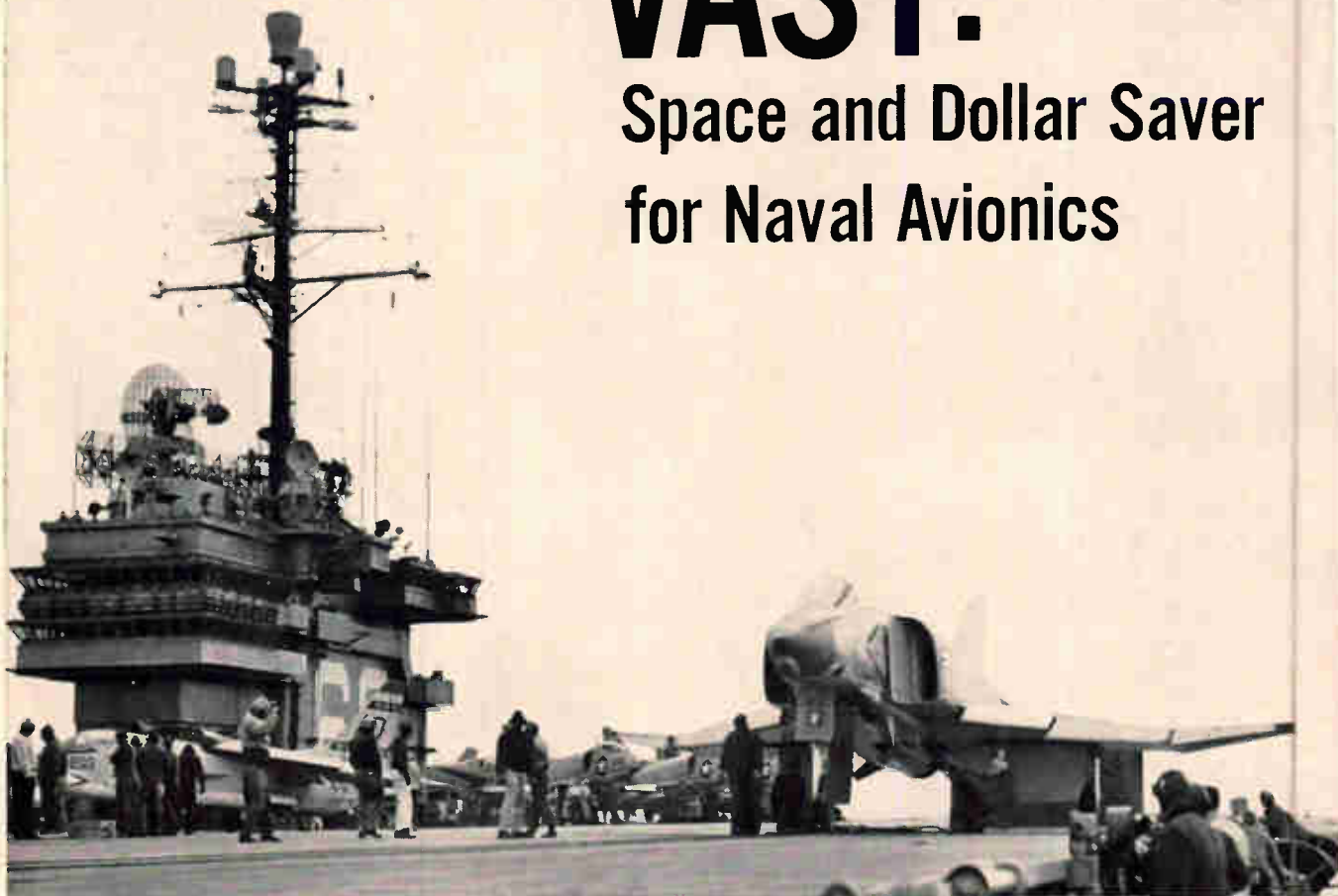

Compact computer-controlled VAST will replace out-moded test methods and equipments with pre-engineered test sequences conducted at very high speeds for extremely rapid checkout of equipments.

The increasing number and complexity of functions being performed electronically in naval aircraft has generated a need for an automatic test system capable of handling maintenance requirements on aircraft carriers. The *Versatile Avionic Shop Test System* (VAST), developed for the Navy by PRD Electronics, will quickly isolate faults in at least 85% of the carrier-based avionic black boxes in present and projected Navy inventory.

**VAST: A SINGLE LIFE-OF-CARRIER INSTALLATION WILL ALSO . . .**

- Save 30 to 50% of avionic shop space.
- Reduce number of technicians by 25% and lower required training and skill levels.
- Reduce turn-around time of defective black boxes to ready-for-issue status by a factor of 2 to 5.
- Eliminate non-recurring or R & D costs and the recurring hardware cost of approximately 85% of the special support equipment being procured today.

**ENGINEERS:** VAST new horizons beckon at PRD today. Investigate the many challenging opportunities to work on such stimulating projects as VAST . . . LEM . . . Mobile Calibration Laboratories, microwave instrumentation, and measurements systems. PRD is dealing in *futures* . . . futures such as yours. Send your resume in confidence and salary desired to our Personnel Dept. — E1.



## PRD ELECTRONICS, INC.

A Subsidiary of HARRIS-INTERTYPE Corporation  
1200 PROSPECT AVENUE, WESTBURY, L. I., NEW YORK 11590

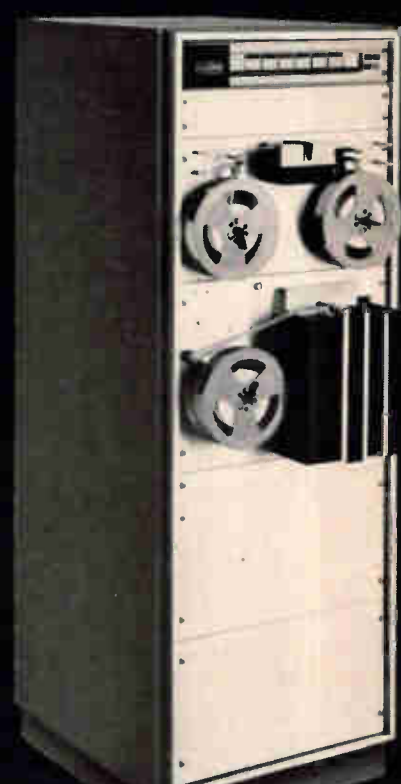
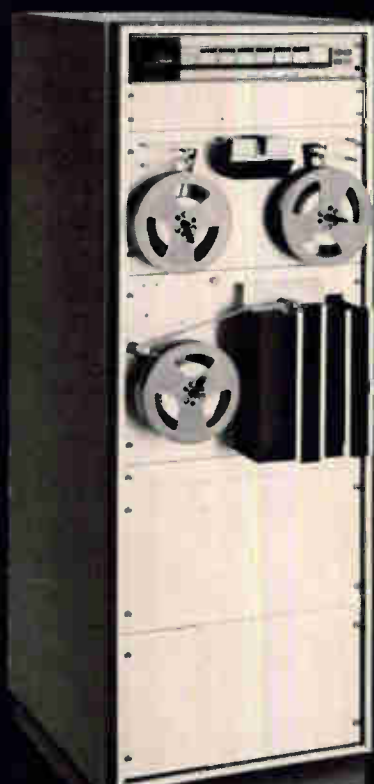
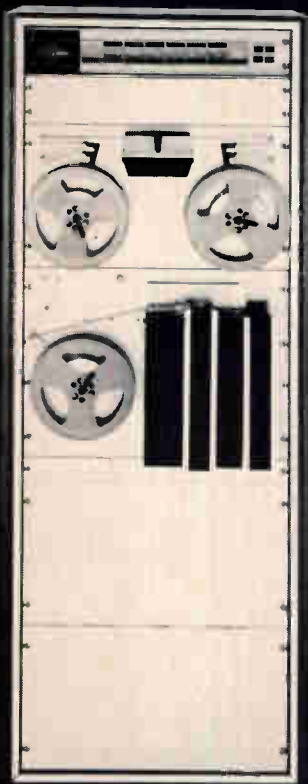

# Moving data fast is half the battle. The other half is moving it without mistakes.

The new Tally Business Communications System 311 Send/Receive Terminal is the most versatile perforated tape station ever offered and the only one which detects and deletes errors. Use the System 311 for transmitting and receiving data over ordinary dial up telephone lines at 120 characters per second and for off-line tape duplication and editing in its spare time.

The compact System 311 can be operated unattended. Thus, a central data processing center can automatically handle data messages during off-peak/evening hours and still have data processed and retransmitted by the next morning. Easy loading is a key feature. In 30 seconds or less, you can load a new roll of tape.

Now, for the first time, you don't pay extra for error-free data. So if you have data communications problems, we think it will be well worth your while to take a look at the Tally 311—the machine that transmits clean, error-free perforated tape. For full details, please address Robert Olson, Tally Corporation, 1310 Mercer Street, Seattle, Washington 98109. Phone: (206) MA 4-0760. TWX: (910) 444-2039. In the U.K. and Europe, address H. Ulijohn, Tally Europe Ltd., Radnor House, 1272 London Road, London, S.W. 16, England. Phone: POLIards 9199.

**Now you can get  
error free data  
from here to there  
(or there to here)  
at 1200 words  
per minute.**

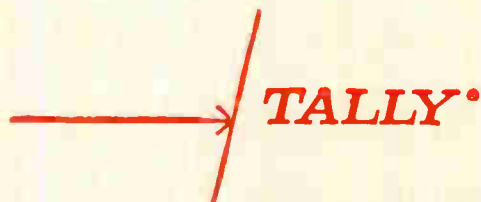



John Muschinske has an M.S.E.E. and a job at Fairchild R&D. He works long hours, but when he creates something, he gets to follow it out the door. He helps cost it, change it, and sometimes, sell it. For the last year, he's been working on power device development. Right now, he's following his latest device through Volume Manufacturing — and he's late for dinner.

We need three more like him. All three of you, contact Jack Sheets at Fairchild Semiconductor, 313 Fairchild Drive, Mountain View, California.

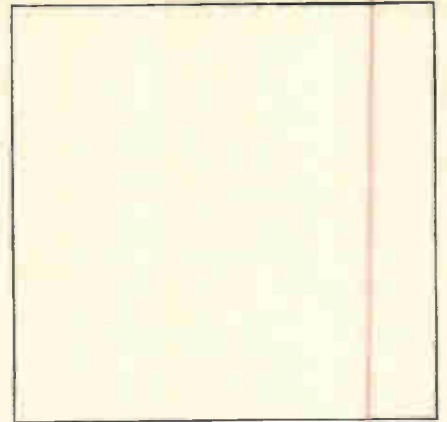

We need an M.S. in Physics or E.E., with experience in semiconductor design, to fill the chair next to Bob in Device Development. He'll design and develop advanced SCR's and related devices.

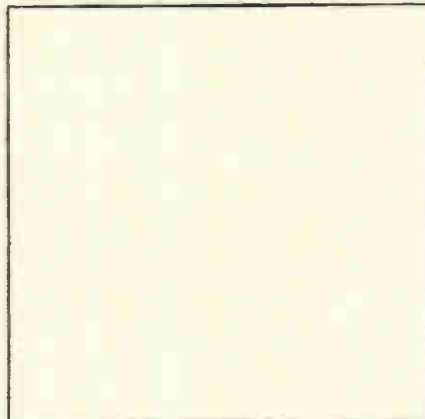

We're also looking for an M.S. in Chemistry, with two years experience in metallurgy or ceramic technology. He'll direct research in materials and develop new concepts in sealing and encapsulation of advanced integrated circuits.

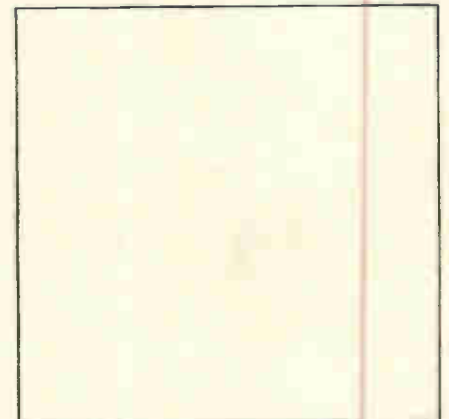

And we need a B.S. or M.S. in Chemistry with applicable experience, to develop and direct wafer fabrication processes in the development of high performance linear integrated circuits.

**FAIRCHILD**  
SEMICONDUCTOR



## Something new in an ion-pumped system

### ...Sputtering!



Here's the only system specially designed to deposit thin films by sputtering in an ion-pumped chamber. The new CVI-18 combines with CVC's PlasmaVac<sup>®</sup> sputtering unit to give you the first and finest ion-pumped sputtering system capable of electronic and optical thin-film deposition.

With the CVI-18 you get faster, more efficient coating cycles for pilot plant or production line operation:

An automatic pre-bake saves up to two hours every working day. The high efficiency Quick-Start ion pump and gettering system give you faster pumpdown, high throughput that allows starting in the 50 micron range, and ultimates to the  $10^{-10}$  range.

You get more consistent performance, too—with a new titanium sublimation unit. System pressure may be automatically held below a

preset process pressure over a wide range of gas loads.

Typical CVI-18 applications include electronic, optical, and opto-electronic coating as well as environmental studies. The CVI-18 is something new, something better in an ion-pumped coater. Just write for full details. Consolidated Vacuum Corporation, Rochester, N.Y. 14603.

See us at WESCON, Booths 1510-11-12



*Consolidated Vacuum Corporation*

ROCHESTER, N. Y. 14603 • A SUBSIDIARY OF BELL & HOWELL  
International Subsidiaries: Woking, Surrey, England  
& Friedberg, West Germany

## MORE AIRCRAFT UP TIME—LESS DOWN TIME

### With NEW Automatic Wiring Analyzer

Keeping today's complex aircraft ready for action is a major challenge. Dalmo Victor is helping meet the challenge with the AN/USM-185\*, a mobile, versatile wiring analyzer that checks electrical integrity of oft-neglected aircraft wiring by automatically making error-free resistance, leakage and continuity tests. Though developed specifically for the F-105 and F4C, this analyzer can be used for depot or field maintenance to check out all present and future aircraft in all commands...all services.

Results of Air Force Project CAST and earlier related studies plus current operational command field tests that compare automatic and manual methods of checking aircraft wiring integrity indicate the true significance of automatic wiring analyzers. For example, automatic equipment revealed marginal and faulty wiring normally not detected by manual means...test accuracy was significantly increased...and reduction in test times consistently averaged minutes (vs. hours).

These studies also indicated that wiring age equals marginal wiring. Translated into more dramatic—but valid—terms, automatic wiring analyzers can contribute heavily to more aircraft up time, improved mission success and saved aircraft.

The USM-185 will make maximum contributions in these areas. With the simplest tape programming yet devised, the USM-185 is designed to automatically make go/no-go tests on a 5,000 point harness in only 36 minutes. Maximum test capacity is 40,000 points. Operational versatility is provided with automatic, semi-automatic, "manual" and self-programming operating modes. The central data processor is expandable for functional versatility. Self-test features ensure dependability and maintainability. When required, the USM-185 is readily adapted to card programming.

For more information, contact Dalmo Victor's Automatic Test Equipment Product Manager today.

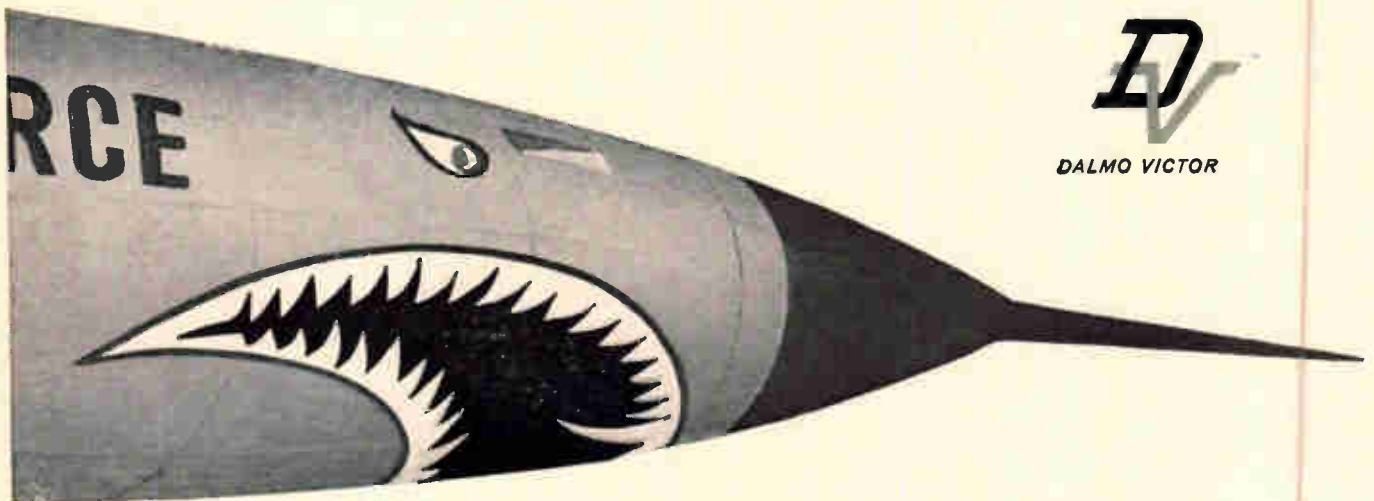

DALMO VICTOR



\*AN/USM-185, completely militarized automatic wiring analyzer being developed by Dalmo Victor under contract to the Aeronautical Systems Division, Air Force Systems Command, USAF, Wright-Patterson AFB, Ohio. This analyzer meets or exceeds requirements of MIL-T-38218A, MIL-T-21200 and MIL-R-26667. Contract terms call for delivery of the first unit early this summer.

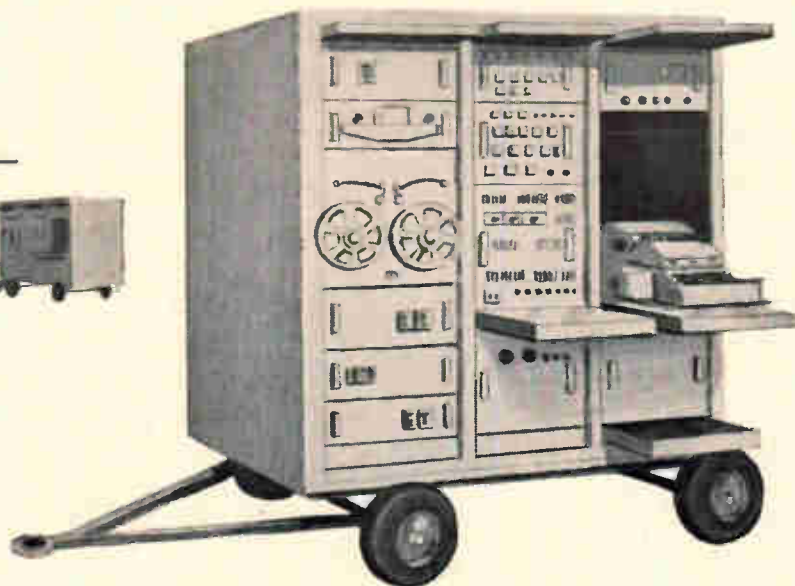

**DALMO VICTOR**

1515 INDUSTRIAL WAY • BELMONT, CALIFORNIA 94002  
TELEPHONE: 415/591-1414 TWX: 910/376-4400

A **textron** DIVISION

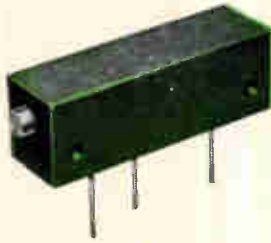

## what's in it for you?

Just this... 15 times the winding length and 10 times the resolution in the Clarostat Series 76JA Trimming Potentiometer... and it looks and mounts like any ordinary trimmer pot. That's the kind of superb engineering you've come to expect from Clarostat. Naturally, it's designed for your needs; production time is reduced by eliminating critical mechanical settings, and you enjoy more mechanical freedom than with bulky multi-turn pots. Completely interchangeable with other trimmers. But most important... resolution is ten times better than you can get from ordinary trimming potentiometers.

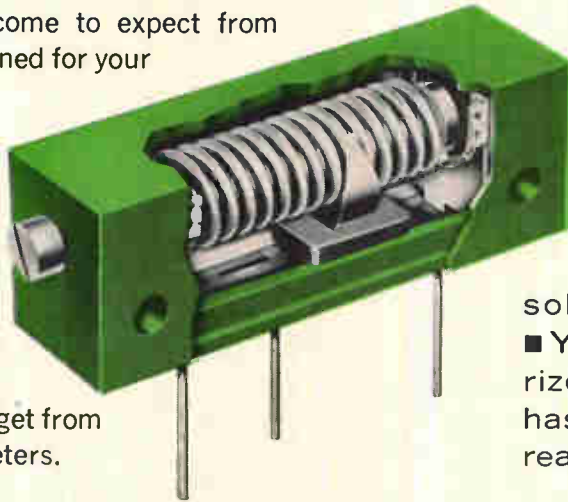

**SPECIFICATIONS:** Mechanical Travel: 12 turns approximate; ■ Effective travel: 11 turns ( $\pm 1/4$ ); ■ Resistance Range: 100 ohms to 20,000 ohms; ■ Resistance Tolerance:  $\pm 5\%$ ; ■ Power Rating: .75 watts @ 85°C. derated linearly to zero power @ 150°C. ■ Available with printed circuit or solder lug terminations. ■ Your local Clarostat Authorized Industrial Distributor has the Series 76 in stock ready for immediate delivery.

# CLAROSTAT

CLAROSTAT MFG. CO., INC. DOVER, NEW HAMPSHIRE

Visit CLAROSTAT at WESCON Booth 1106

# What do you want from a new operational amplifier?

More gain?



Say 1,000,000 (120 db)?

Lower long-term drift?



Like less than 100  $\mu$ V/60 days?

Predictable performance at extreme temperatures?



How about specs that apply from  $-55^{\circ}\text{C}$  to  $+125^{\circ}\text{C}$ ?

Tight little package?



Would you believe 3.5 grams in 2cc?

Reliability?



Like you can get from solid state silicon design in an all-welded MicroCircuit Pack™?

Added dividends?



For example,  $\pm 10$  volts output at 5mA; short circuit protection?

If that's what you want, you need Hamilton Standard's A-505 operational amplifier. It meets all these expectations and more. We'll send you a data sheet free. And a sample unit for \$95.

For technical data, price and delivery, write to Marketing Manager, Electronics Department, Hamilton Standard, Broad Brook, Connecticut 06016; or call direct: (203) 623-1621, Ext. 6106. TWX: 203-623-0879.

**Hamilton Standard**  
BROAD BROOK, CONNECTICUT

DIVISION OF UNITED AIRCRAFT CORPORATION  
**U**  
**A**

Examine the A-505 on display at WESCON, Los Angeles Sports Arena, August 23-26.





CONTROL DATA

CORPORATION

TRG/A Subsidiary of Control Data Corporation

TRG, Inc., pioneer in the development of millimeter microwave components and systems, has a full line of catalog components plus the engineering experience to assist you in the development of a system to meet your particular need . . . or the necessary professional staff and facilities to undertake a complete research and development program.

For more complete information, send for TRG's short form catalog which contains the most complete listing of millimeter components available anywhere. TRG, Inc., 400 Border Street, East Boston, Massachusetts 02128.

MILLIMETER MICROWAVE COMPONENTS



## for the most complete line of Millimeter Microwave Components - 12.4 to 220Gc



**DETECTOR MOUNTS:** In-guide construction eliminates noisy finger contacts. Dielectric windows protect the delicate bolometer element from air currents and dust. Most sensitive detecting elements known in the millimeter region.



**FERRITE DEVICES:** • Complete ferrite duplexers • Four port circulators • Three port reciprocal switches • Variable attenuators • Modulators • On-off switches • Isolators • Y Circulators • Variable phase shifters.



**DIRECT READING FREQUENCY METERS:** Compact, with integral stand and adjustable legs. Cavity tuning is accomplished by a precision drive screw and non-contacting short circuit. Small hole in waveguide couples energy to the cavity and results in a resonance dip in transmitted power of 0.5 to 1.0 db over the waveguide band.



**ANTENNAS:** • Horn-fed parabolooids 3" to 48" • Waveguide slot arrays • Conical scan antennas • Monopulse antennas • Circular polarized feeds • Linear-circular polarized feeds • Solid dielectric lenses • Electroformed gain standards.



**UNIVERSAL KLYSTRON POWER SUPPLY — MODEL 940:** Provides continuously variable voltages for operating klystron oscillators over a wide range with a large variety of tubes. Total weight is only 49 lbs.



**MILLIMETER SYSTEMS:** TRG's experienced engineers are available to design complete systems for your particular requirements. Their background of working in the millimeter region will prove invaluable, and they have at their disposal all of the necessary facilities, as well as the most complete stock of components, to fulfill your needs.



**LOW LOSS CIRCULAR WAVEGUIDE COMPONENTS:** • Mode filters • Corrugated bends • Rectangular to TE<sub>01</sub> circular mode transitions • Rotary joints • Slotted lines • Variable attenuators.



**HARMONIC MIXERS AND GENERATORS:** Available for second to eighth harmonic mixing. Useful for stabilizing millimeter sources, with lower frequency standards, calibrating millimeter frequency meters with lower frequency standards and serving as the front ends of millimeter receivers in the 12.4 to 220Gc region.

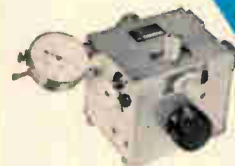

**TEST BENCH COMPONENTS:** • Slotted lines • Directional couplers • Wavemeters • Variable attenuators • Precision attenuators • Phase shifters • Detector mounts • E/H tuners • Slide screw tuners • Sliding short circuits • Transitions • Tees • Twists • Bends • Terminations • Drill jigs.



**SCALAR FEEDS:** Low-noise, high aperture efficiency, equal E and H plane beamwidths, and broad bandwidth. Available from 400Mc to 300Gc.

TRG Inc., ANTENNA & MICROWAVE DEPARTMENT 400 Border Street • East Boston, Massachusetts 02128 • Tel. (617) 569-2110

See us at WESCON — Booths 178-181

# Did you wipe the smile off Lou Bessant's face?

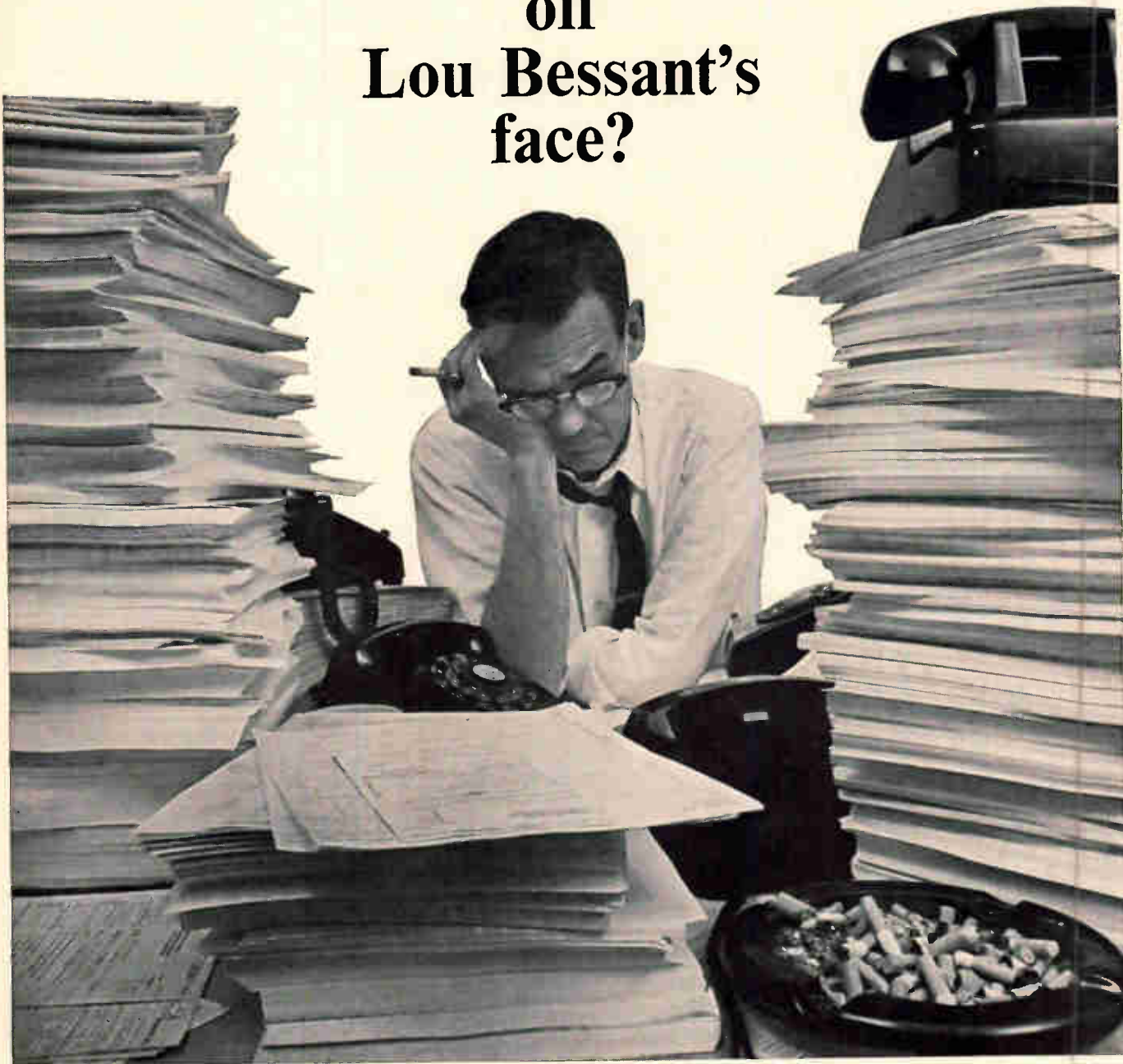

■ A few weeks ago Lou Bessant was a smiling recruiter. Then hundreds of electronics engineers accepted Lou's challenge to find his address. Now look at the poor man. Unshaven . . . bug-eyed . . . surrounded by stacks of resumes. Is your resume on Lou's desk? If not, call him collect. He only has time now to answer the phone. Are you clever enough to find his number? He still has lots of jobs available.

177-88

*P.S. You can't expect Lou to stay all heart after this horrendous experience. That's why he left just two small clues to help you find him. Do you see them in the picture? Refer to Lou's other clues in the June 13 and July 11 issues of this magazine if you need more help.*

# No other RF transistor can offer this performance



ACTUAL SIZE

- ✓ 5 dB max. NF at 450 MHz
- ✓ 11.5 dB min. gain at 450 MHz
- ✓ Hermetically sealed metal case for high temperature capability
- ✓ low-leakage silicon construction

at this price... \$1.60 2N4259 in quantities of 1,000 and up

RCA's new 2N4259 low-noise, low-capacitance RF transistor simplifies the design of UHF/VHF receiver circuits... offering more gain... less noise... at frequencies up to 500 MHz!

APPLICATIONS INCLUDE: Commercial, industrial and military communications equipment such as: mobile and aircraft radio, expendable military equipment, telemetry equipment, amateur equipment, wide-band amplifiers in industrial, military and nuclear applications.

The RCA 2N4259 silicon RF transistor is hermetically sealed in a 4-lead metal case for added high temperature capability. Shielding, achieved by grounding the case with the fourth lead, provides these extra advantages:

- reduced spurious signal pickup and device radiation
- reduced feedback capacitance
- higher usable gain

RCA skill and experience in silicon technology and mass production economy techniques make the 2N4259 RF transistor a unique combination of top performance and top value. For complete information, pricing and delivery, call your RCA Field Representative. For technical data, write RCA Electronic Components and Devices, Commercial Engineering, Section EN 8-2, Harrison, N. J.

SEE YOUR RCA DISTRIBUTOR FOR HIS PRICE AND DELIVERY

## ELECTRICAL SPECIFICATIONS

### High Breakdown Voltage

$$BV_{CEO} = 30V \text{ min.}$$

### High Beta

$$h_{FE} = 60 \text{ min.}$$

### High Gain Bandwidth Product

$$f_t = 750 \text{ MHz min.}$$

### Low Feedback Capacitance

$$C_{cb} = 0.55 \text{ pF max.}$$

### Low Collector-To-Base Time Constant

$$r_b'C_c = 8 \text{ ps max.}$$

### High Dissipation

$$P_T = 175 \text{ mw max. at } 25^\circ\text{C Ambient}$$

### High Temperature Capability

$$T_J \text{ (Junction Temp.)} = 175^\circ\text{C max.}$$



The Most Trusted Name in Electronics

SEE US AT WESCON BOOTHS 1240-1244; 1317-1321

Circle 189 on reader service card

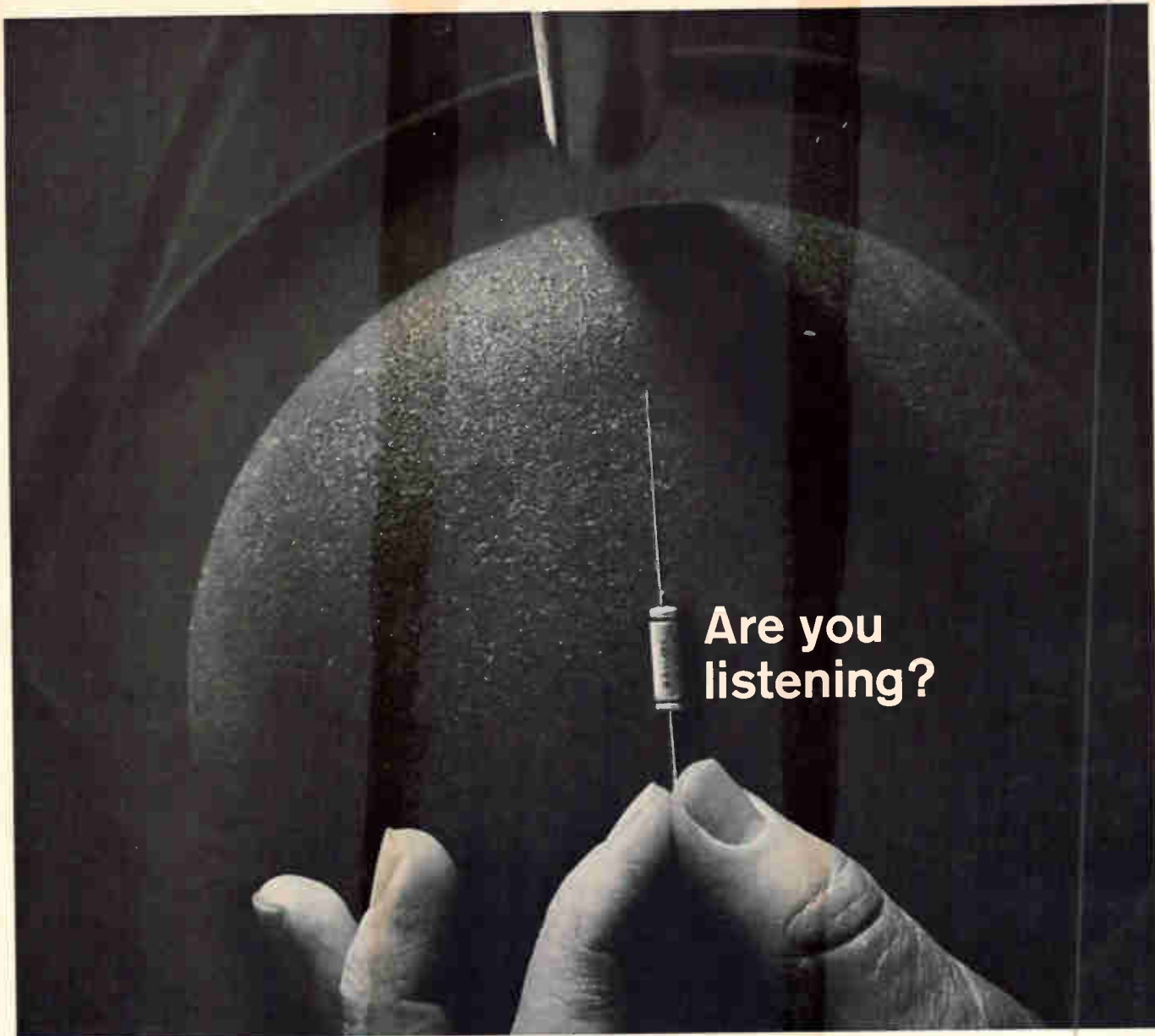

Are you  
listening?

## Mallory Capacitor Company chooses GAF x-ray film to make sure everyone gets the word

Computers, telemetry, AC/DC converters, navigational gear, radar and other sensitive electronic components used in our space and missile programs rely on tantalum capacitors for long life and dependable communications.

Mallory Capacitor Company, manufacturer of these tantalum capacitors, relies on GAF Industrial 'H-D' x-ray film to detect inclusions, excess bonding material, and check casing element clearances on all electrical connections.

To quote Mr. John E. Beckley, Quality Control Supervisor, "Only Industrial 'H-D' is used to radiograph our capacitors. It's the one x-ray film

producing the definition, sensitivity and contrast that reveals minute detail within tiny components."

Ultra-fine grain and very high contrast characteristics make Industrial 'H-D' film the ultimate for pinpoint radiographic examination. Your distributor of GAF x-ray products can supply you with information on our complete line of films and chemistry.

GAF maintains a nationwide staff of full-time Industrial X-ray Specialists—trained to render expert radiographic counsel, assistance and service. We have one in your area. Don't hesitate to call on him.

E88

**gaf**

GENERAL ANILINE & FILM CORPORATION

140 WEST 51 STREET, NEW YORK, NEW YORK 10020

# Fast, convenient direct reading measurements of impedance and phase angle 500 kHz to 108 MHz...



See New HP Instruments and  
Measurement Seminars at  
WESCON—Hollywood Park

## THE 4815A RF VECTOR IMPEDANCE METER

This new Vector Impedance Meter is a versatile instrument that provides fast, direct reading measurements of impedance and phase angle over the frequency range from 500 kHz to 108 MHz. It is continuous tuning over this frequency range, and does not require balancing or data interpretation. Thus, it is an extremely useful tool for the evaluation of the complex impedance of both active circuits and components. The convenience of probe measurement, ease of operation, and direct reading features make the instrument equally useful for laboratory, receiving inspection or production line measurements.

The 4815A is a convenient and powerful measuring tool for any application involving measurements over a band of frequencies or in-circuit measurements. It may be used to determine the self-resonance point of capacitors, the series and parallel resonance points of crystals, or the characteristics of high frequency transformers and transducers. Price: \$2650 f.o.b. factory. For complete specifications, contact your local Hewlett-Packard field engineer or write Hewlett-Packard, Rockaway Division, Green Pond Road, Rockaway, N. J. 07866; Europe: 54 Route des Acacias, Geneva.

### Advantages:

- Fast, continuous tuning from  
500 kHz to 108 MHz
- Provides data directly in impedance  
and phase angle, 1 ohm to 100K ohms  
0 to 360°
- Convenient probe for in-circuit measurements
- Analog outputs permit permanent  
data recording
- Self calibration check provides  
measurement confidence
- Low-level test signal minimizes  
circuit disturbance

HEWLETT  PACKARD  
An extra measure of quality

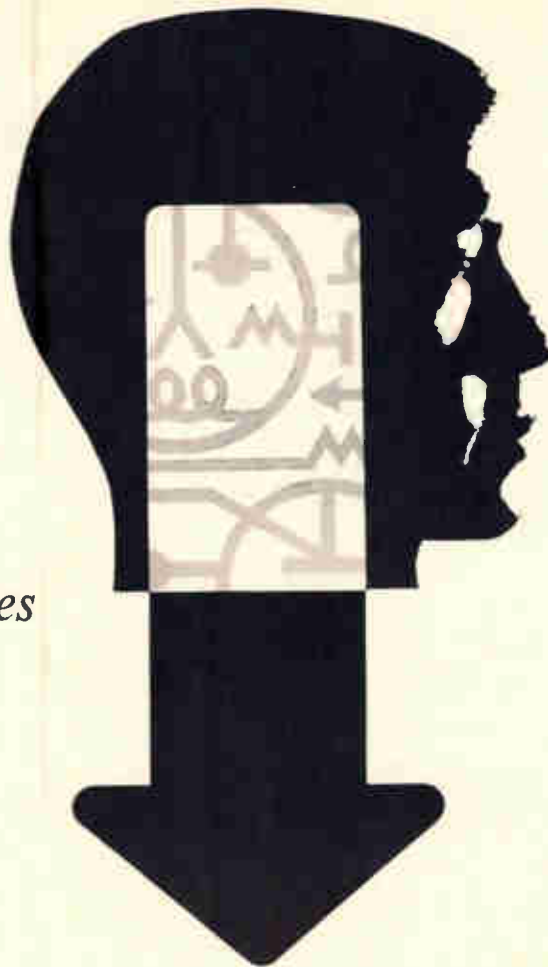

*Look into the vehicles  
of opportunity  
at Lockheed...*  
FOR CIRCUIT  
DESIGNERS.

Opportunity broad enough to interest every circuit designer, that's the sweep of electronics assignments at Lockheed. Big, wide-ranging programs that extend from deep sea to deep space. And with ever-growing commitments comes an increasing need for new concepts and major technical advances in flight controls, communications, antennas and state-of-the-art electronics check-out equipment in both spacecraft and fleet ballistic missiles. In addition to its major vehicle programs... Agena, Poseidon, and Polaris, Lockheed is involved in deep submersibles; unique advanced land vehicles; information systems for states and hospitals; and many other technically alluring programs. For complete information, write Mr. K. R. Kiddoo, Professional Employment Manager, P. O. Box 504, Sunnyvale, California. Lockheed is an equal opportunity employer. *Engineers and scientists attending Wescon are invited to visit Lockheed's booths 2102A and 2103A.*

**LOCKHEED**  
MISSILES & SPACE COMPANY  
A GROUP DIVISION OF LOCKHEED AIRCRAFT CORPORATION

# “We demand minimum size plus maximum reliability. That’s why we use capacitors of Mylar®”

says Worthington C. Lent, Vice President,  
Telephone Development & Operations,  
Lear Siegler, Inc.

Central telephone office equipment must be designed as compactly as possible. At the same time, this equipment must be reliable for a service life of many years. So Lear Siegler uses capacitors of MYLAR\*. And nothing but capacitors of MYLAR in the R-635 Voice-Frequency Repeater. The extremely high dielectric strength of MYLAR means smaller capacitors. The extremely high stability of MYLAR means long-term reliability.

Other dielectric materials could have been used but anything else that would meet specifications would cost much more than capacitors of MYLAR, according to Lear-Siegler, Inc.

If size, reliability and price are important to you, check the ways capacitors of MYLAR could help you improve your designs. For some interesting technical data, write Du Pont Co., Room 3241-A, Wilmington, Delaware 19898. (In Canada, write Du Pont of Canada Ltd., P. O. Box 660, Montreal, Quebec.)

only DU PONT makes

**MYLAR®**  
POLYESTER FILM

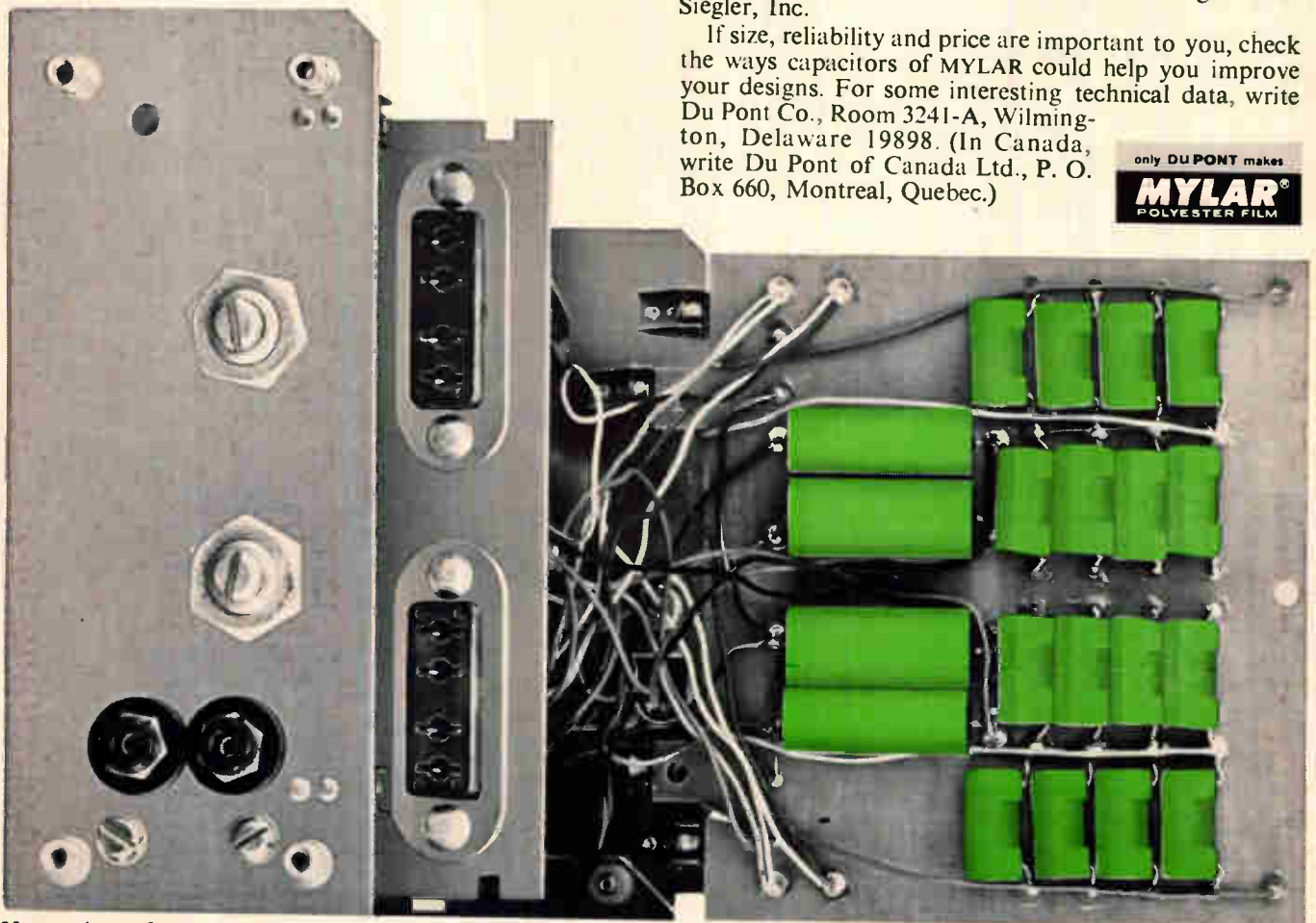

20 capacitors of MYLAR\* polyester film are used in the R-635 Voice-Frequency Repeater manufactured by the Electronic Instrumentation Division of Lear Siegler, Anaheim, California.

\*Du Pont's registered trademark for its polyester film.

See us at WESCON, Booth 1533-35



BETTER THINGS FOR BETTER LIVING... THROUGH CHEMISTRY

# MOS FET RF AMP



The Fairchild FT57 is an N-channel depletion mode MOS field-effect transistor. It features low noise and low cross-modulation which give it superior performance characteristics in receiver RF amplifier and mixer stages. Two types are available: FT57 to meet military standards, and SE5301 for industrial and consumer applications. Both are high-reliability, Planar II devices. Both are now in stock. Ask for complete information.

**FAIRCHILD**  
SEMICONDUCTOR

#### FT57 Specifications:

Low noise figure . . . . .	2.7dB (typ.), 4.5dB (max.)
High power gain . . . . .	20dB (typ.), 15dB (min.)
Low feedback capacitance . . . . .	0.6pF (typ.), 0.8pF (max.)
All of the above specifications @ 100MHz	
High $g_m(Y_{fs})$ . . . . .	9,000 $\mu$ mhos (typ.) 6,000 $\mu$ mhos (min.)

Reverse AGC capability

Planar is a patented Fairchild process.

FAIRCHILD SEMICONDUCOR/A Division of Fairchild Camera and Instrument Corporation ■ 313 Fairchild Drive, Mountain View, California (415) 962-5011 ■ TWX: 910-379-6435



# Probing the News

Industrial electronics

## Low cost may catch train award

Philco joins four other major contenders for contract to build control system for San Francisco's automatic train

By Walter Barney

San Francisco Regional Editor

**The contest** for the automatic train control contract for the San Francisco Bay Area Rapid Transit District (Bartd) will be decided by costs—not, as originally said, by which of four competing methods works best. All worked well during nine months of tryouts at the transit district's Diablo test track. Further, a fifth entry, the Western Development Laboratory division of the Philco Corp., has tested a partial system which differs radically from the other four [Electronics, June 27, 1966, p. 26].

Philco definitely plans to bid against the other four: the General Electric Co., the General Railway Signal Co., the Westinghouse Electric Corp., and the Westinghouse Air Brake Co. Bids will be advertised at the end of this month. The complete specifications, which have been distributed in preliminary form, are drawn in terms of performance levels, which may be met any way a contractor wishes.

"It all boils down to a matter of cost," says John R. Asmus, chief electrical engineer for Parsons Brinckerhoff-Tudor-Bechtel, the engineering consortium which is general consultant to the transit district. "It's a close horse race and I'd hate to try to predict who'll win."

At stake is a train control and communications contract expected to run as high as \$30 million, with train control alone accounting for just under \$20 million. The successful bidder will have to supply a system to keep trains running automatically over a 75-mile route, at speeds up to 80 miles per hour,

and with an average speed, including station stops, of 50 mph. So tight is the competition that General Electric is having second thoughts about its elaborate radar system to maintain train separation. The system works fine, but may cost too much.

More than 30 companies requested copies of the preliminary specifications, but many are interested only in subcontracts. Some, such as the International Business Machines Corp. and the Control Data Corp., are computer makers; others, like the Lenkurt Electric Co., a subsidiary of the General Telephone and Electronics Corp., are communications specialists.

At least two, however, are large systems companies: TRW Systems group of TRW, Inc., and the Hughes Aircraft Co. Both are tight-lipped about the transit contract.

Philco and any other newcomers will be on an equal footing with the original four companies. Some Bartd officials and consulting engineers seem a little nervous about buying an untested system; but track tests are not a requirement for successful bidding, and the Philco team says that the specifications are "very fair."

### I. Space-age control

Philco, a Ford Motor Co. subsidiary, feels that its experience



Philco's automatic control system determines the train's location by recognizing combinations of tall and short pickets it passes.

in space systems gives it a good chance. "Line supervision is our business," says R.W. Porter, manager of ground instrumentation subsystems at Philco. "That mission control center at Houston is one huge line-supervision system."

Philco uses wayside controllers and a velocity position programmer on the train to regulate speed. A microwave transmitter interrogates each 1,000-foot block of track serially, by block address, with a 24-bit data word that is pulse-code modulated on a 960-megahertz carrier. In effect, the controller asks: "Is there a train in block 10? If so, you should be traveling at such-and-such a speed." The velocity position programmer acknowledges the speed command and retransmits the data word back to the controller for error checking.

Each controller governs 15 blocks, interrogating the entire sequence twice a second. Responses, coded differently for each block, tell how many unoccupied blocks there are between trains.

The two microwave transmitting and receiving horns tell the on-board logic where the train is. They are cross-polarized to avoid crosstalk, and they are continuously transmitting and receiving—except when interrupted by the aluminum pickets shown on page 195. A short picket interrupts only one path, creating a clock pulse interpreted as a binary one. A tall picket blocks both paths and is interpreted as a binary zero. Different arrangements of ones and zeroes indicate sections of track.

For vernier control at station stops, the system counts a row of zeroes. In four tests of braking from 55 mph, the system stopped the test car within one inch of the same point, Philco says.

Philco appears a tough opponent in the cost battle. Each of the original four companies that demonstrated control systems received a grant of more than \$500,000 from Bartd and claims to have matched the sum. Philco, with an admittedly marginal system, which in some respects does not yet meet specifications, spent only \$50,000 for its prototype. Some of the equipment is much simpler than the others. The onboard gear, for instance, weighs only 150 pounds, against several hundred pounds for the

competition.

Both the velocity position programmer and the wayside controller use Philco's digital logic building blocks, a family of integrated circuits. The train logic has 180 blocks, mainly NOR and NAND gates and flip-flops, with some operational amplifiers and oscillators. The wayside controller has 80 to 100 blocks.

## II. A switch in time?

Bids on the control system are due Dec. 6, which means that GE will have to decide soon whether it will stick with its radar train-separation system. During the Diablo tests, GE used trackside waveguide to transmit a radar signal from a following train to a leading train. The company expected to get accuracy of  $\pm 50$  feet; but even the 150 feet it achieved was good enough, since the specifications require trains to be separated by 1,000 feet.

Still, other methods of train separation worked well too, and do not require expensive waveguide and radar equipment. GE's accountants and engineers are doing some soul-searching. And according to Robert W. Volpe, manager of product planning, the cost factor is number one on the list of considerations.

GE reportedly may substitute a very low frequency track circuit, at frequencies from the top of the audio range to 440 khz, for its main separation method. It would keep the radar system only for vernier control at station stops. That would toss away the flexibility that GE claimed for its moving-block radar system; but Asmus says that "you couldn't prove on the test track that trains could actually run any closer with moving blocks."

## III. From test to specs

The thick book of specifications labeled "preliminary—for review only" that is currently the bible of so many engineering offices is a direct outgrowth of the Diablo tests [Electronics, July 26, 1965, p. 71]. "The choice of specific methods and equipment that are required shall be at the contractor's option, unless otherwise specified," the manual states. The exceptions deal mainly with general design characteristics and the requirement for

the use of solid state components wherever possible. Philco's is the only system to use integrated circuits.

There are three subsystems in the train control system:

- Train protection, to maintain safe operation and ensure that trains operate at prescribed distances apart. Functions are train detection and separation, route interlocking, speed limiting and speed determination, train-movement command transmission and detection and right-of-way hazard detection.

- Automatic train operation, to make scheduled starts and stops, regulate speeds, and open and close doors.

- Line supervision, to monitor and control train operation and adjust schedules to provide the best possible service. The functions are train identification and dispatching, route assignment and control, train-performance monitoring and control, alarming and recording and station platform sign control.

**Train protection.** The specifications demand continuous detection of trains, with a fail-safe provision so that if a train is "lost" because of signal failure, the zone covered by detection equipment must appear to be occupied; separation limits are defined as "greater than the maximum stopping distance of the following train." The basic unit is 1,000 feet; it is modified for up-grades and downgrades.

Logic circuits are necessary to govern route interlocking, where trains may diverge or cross. The system must perform 10 functions, from receiving a route request to unlocking switches when the train clears the interlocking zone, in a particular order. If a train is approaching a locked "gate" to a zone, it must be given a stop command, and must halt, 50 feet from the gate; and the gate can be unlocked only when all other gates are locked and a proper routing sequence has been initiated.

The measurement of actual speed must be within  $\pm 0.5\%$ , regardless of train wheel wear. Any error in the determined speed which tends to cause a speed indication lower than actual speed must initiate open-loop braking.

Signal transmission which governs train movement must be con-

tinuous, with any interruption lasting longer than 1.0 second triggering open-loop braking.

**Train operation.** If the train protection system is not issuing special commands to avoid danger, or the line supervision system is not imposing a hold on the train because of scheduling conflicts, the automatic train operation system can function. Its job is to provide a swift, smooth ride. The automatic operation keeps the train running at the maximum allowed speed for each block, and regulates the dwell time at stations. Trains must achieve maximum acceleration or deceleration within 3.0 seconds of receiving a command; but to keep the ride smooth, the "jerk rate," or rate of change of acceleration (equivalent to the second derivative of velocity) must be between 1.0 and 1.5 mph per second per second. Station stops must be made with an accuracy of plus or minus a foot.

**Line supervision.** It is the automatic operation and protection systems that have brought Bartd most of its public notice, but Asmus believes that the over-all line supervisory system, which keeps the trains on schedule, is the really revolutionary aspect of the project.

The line supervision monitors, and to some extent controls, the other two subsystems. The central computer will store information on train schedules, car and control pad availability, crew availability, passenger flow, arrival and dispatch times, train identification numbers, normal headways, critical check-point times and critical train convergence times. From this information it must choose strategies to maintain the best possible service under normal and abnormal conditions.

In case of a major delay, the computer will automatically revise the schedule of one, several or all trains, and distribute the operating gaps ahead of and behind a delayed train among its leaders and followers. It will also recommend to the operations supervisor a number of other strategies, on the basis of passenger delays, additional passenger transfers caused by skipping stations, the time to return to the normal operating schedule and the availability of additional equipment and men.

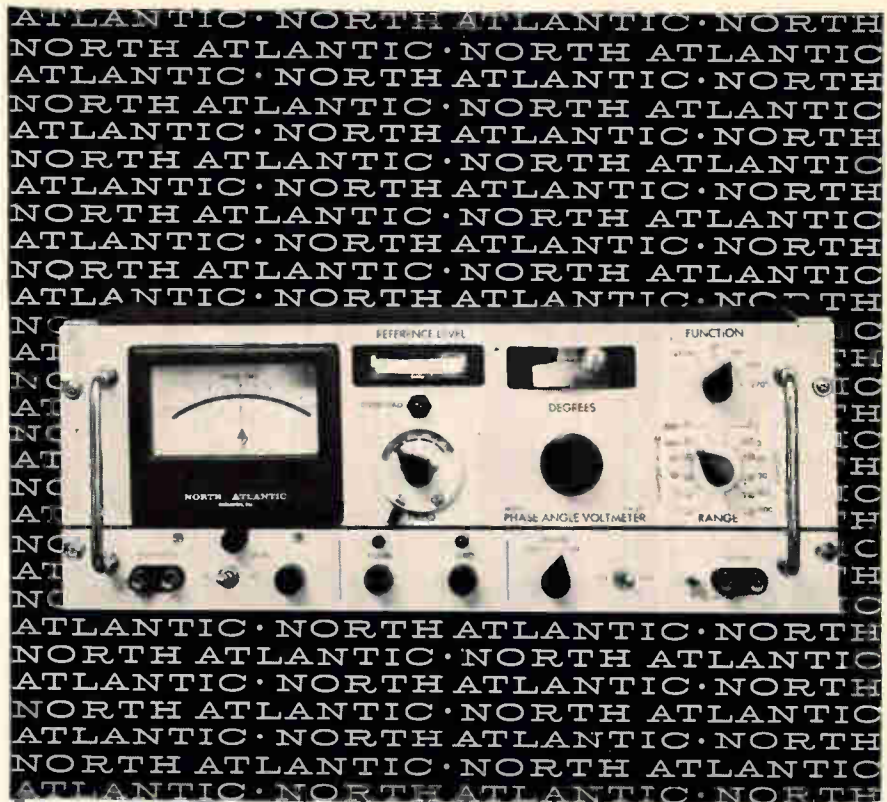

## how to measure in-phase, quadrature and angle while sweeping frequency to 100 kc

North Atlantic's latest addition to the PAV line of Phase Angle Voltmeters\* enables you to make measurements while frequency is varying over half-decades without recalibration. The VM-301 Broadband Phase Angle Voltmeter\* provides complete coverage from 10 cps to 100 kc, and incorporates plug-in filters to reduce the effects of harmonics in the range of 50 cps to 10 kc with only 16 sets of filters. Vibration analysis and servo analysis are only two of the many applications for this unit. Abridged specifications are listed below:

Voltage Range.....	1 mv to 300 volts full scale
Voltage Accuracy.....	2% full scale
Phase Dial Range.....	0° to 90° with 0.1° resolution (plus 4 quadrants)
Phase Accuracy.....	0.25°
Input Impedance.....	10 megohms, 30μf for all ranges (signal and reference inputs)
Reference Level Range.....	0.15 to 130 volts
Harmonic Rejection.....	50 db
Nulling Sensitivity.....	less than 2 microvolts
Size.....	19" x 7" x 10" deep
Price.....	\$2290.00 plus \$160.00 per set of filters

North Atlantic's sales representative in your area can tell you all about this unit as well as other Phase Angle Voltmeters\* for both production test and ground support applications. Send for our data sheet today.

\*Trademark



**NORTH ATLANTIC** industries, inc.  
TERMINAL DRIVE, PLAINVIEW, L. I., NEW YORK • OVerbrook 1-8600

# Wescon to offer liberal education

While few breakthroughs are expected, the program will offer a comprehensive look at the latest advances in the field

Engineers who want to bring themselves up to date in any of the latest technological developments can keep busy at Wescon's technical sessions. The program, which repeats the format that was successfully introduced last year—sessions organized along specific rather than general subject lines—is a thoughtful compilation of

discussions of the latest and most significant topics in electronics.

Last year, the new format was responsible for a 20% increase in technical session attendance, according to Don Larson, Wescon's general manager. But the critics who complained last year that single companies dominated too many sessions will probably be

heard from again. This year's program shows that one-organization sessions will be presented by the International Business Machines Corp., Sandia Corp.'s Laboratory, the Radio Corp. of America, the Watkins-Johnson Co. and the Hewlett-Packard Co. The Massachusetts Institute of Technology will offer four out of five papers in the

## Wescon technical sessions at a glance . . .

The 27 sessions of the Wescon technical program are grouped below in 16 subject categories. The listing does not include the special symposia running concurrently during Wescon week, nor does it bear a direct relationship to the titles of the sessions in the convention program. The material has been selected and grouped to help you plan your time at Wescon.

**Circuits**—recent advances in solid state mobile communications systems, microwave transistors, varactors and multipliers, **session 8**, papers 1 through 5; solid state, high-frequency linear amplifier theory and design, **session 17**, papers 1 through 4; designing five

kinds of h-f amplifiers, those with small signals, large signals, low noise, those using MOS-FET's (metal oxide semiconductor-field effect transistors), and junction-FET's; one paper deals with design tradeoffs, **session 22**, papers 1 through 6; applying integrated circuits in control systems, **session 20**, papers 1 through 6.

**Communications**—military and commercial applications of communication satellites, **session 4**, papers 1 through 5; theoretical considerations in applying state-variable techniques, **session 7**, papers 1 through 5; array antennas for interplanetary communications systems, **session 24**, papers 1

through 5.

**Computer-aided design**—all four papers in **session 1** delve into the mysteries of this relatively new field; for more on the subject, there is the third paper in **session 5** and the second in **session 10**.

**Computers**—advanced spaceborne computer concepts, with NASA's Electronics Research Center contributing two papers on spaceborne multiprocessing and voice insertion of data, **session 9**, papers 1 and 4; associative memories and logic design techniques for error control are discussed in the second and third papers in **session 9**; designing high-availability computer systems and assessing their

Subject	Session	When	Where*	Subject	Session	When	Where*
Circuits	8	Tues., 2:00-4:30 p.m.	Renaissance Room	Instrumentation	23	Fri., 9:30-noon	Renaissance Room
	17	Thurs., 9:30-noon	Music Room	Integrated circuits and solid state devices	2	Tues., 9:30-noon	Ballroom
	22	Fri., 9:30-noon	Music Room		5	Tues., 9:30-noon	Galeria Room
Communications	4	Tues., 9:30-noon	Renaissance Room	8	Tues., 2:00-4:30 p.m.	Renaissance Room	
	7	Tues., 2:00-4:30 p.m.	Music Room	10	Wed., 9:00-11:30 a.m.	Biltmore Bowl	
	24	Fri., 9:30-noon	Galeria Room	11	Wed., 9:30-noon	Ballroom	
Computer-aided design	1	Tues., 9:00-11:30 a.m.	Biltmore Bowl	12	Wed., 9:30-noon	Music Room	
Computers	9	Tues., 2:00-4:30 p.m.	Galeria Room	18	Thurs., 9:30-noon	Renaissance Room	
	21	Fri., 9:30-noon	Ballroom	20	Fri., 9:30-noon	Biltmore Bowl	
Electric power systems	C	Fri., 2:00-4:30 p.m.	Ballroom	Manufacturing	14	Wed., 9:30-noon	Galeria Room
Electron tubes	6	Tues., 2:00-4:30 p.m.	Ballroom	Microwaves	12	Wed., 9:30-noon	Music Room
Engineering education	15	Thurs., 10:00 a.m.-12:20 p.m.	Biltmore Bowl	19	Thurs., 9:30-noon	Galeria Room	
				24	Fri., 9:30-noon	Galeria Room	
Error-correcting codes	13	Wed., 9:30-noon	Renaissance Room	Rapid transit systems	16	Thurs., 9:30-noon	Ballroom
Information management	A	Wed., 2:00-4:30 p.m.	Ballroom	On-line computing	B	Thurs., 2:00-4:30 p.m.	Ballroom
				Piezoelectric devices	3	Tues., 9:30-noon	Music Room

\*All sessions take place in the Biltmore Hotel in Los Angeles, Aug. 23 through Aug. 26.

session on the application of state-variable techniques in communication and radar. Univac, a division of Sperry Rand Corp., will give four out of five papers in the session on nondigital applications and interconnection aspects of integrated electronics.

### I. Microelectronics

As might be expected, solid state devices and integrated circuits will dominate the show. The speakers will discuss microelectronics from a number of angles—complex arrays, maintainability, systems considerations, interconnections and packaging case histories.

M.G. Smith of IBM will discuss the advantages and disadvantages of large-scale integration, the technology used to build large-scale arrays. Advantages include lower hardware costs, fewer parts and

small capital investment. Among the disadvantages are yield sensitivity, longer turn-around time, less opportunities for high parts usage, complexity of mask making and testing and higher power density. Smith believes that early use of large-scale integration will be restricted in those areas characterized by stringent performance requirements and few part numbers. In high performance systems, he believes, first arrays will be limited to storage applications and low-speed interface functions. The unavoidable need to make changes, Smith predicts, will be one factor discouraging widespread use of large-scale integration. In many cases, he says, a mixture of large-scale integration and small-scale integration will be a good solution. The engineer wondering whether large-scale integration is appro-

priate for his application should not miss this paper.

**Systems approach.** The growing requirement for the systems designer to take part in device design will be discussed in a paper entitled, "A new dimension in micro-electronic systems," by A.C. Lowell, T. Mitsutomi and S.A. White of the Autonetics division of North American Aviation, Inc.

The paper will discuss devices and how they are fabricated. The systems designer must have this knowledge since it affects the functions he can perform, the interconnections he must deal with and the manufacturing yield he will obtain. The authors base their discussion on experience with silicon-on-sapphire (SOS) technology with which they have fabricated large-scale integrated circuit arrays.

New forms of system organiza-

performance, **session 21**, papers 1 through 6 (organized by the IEEE Computer System Committee); on-line computing, present and future applications, **special session B**, papers 1 through 4.

**Electric power systems**—the effects voltage and frequency fluctuations can have on information-processing systems, **special session C**.

**Electron tubes** — high-power linear tubes, beam-plasma amplifiers, cathode ray tube displays, **session 6**, papers 1 through 4 (a tutorial session organized by the IEEE group on electron devices); traveling wave tubes and backward wave oscillators, **session 19**, papers 1 and 2.

**Engineering education**—a panel of educators and industry executives discuss education for students and professionals, **session 15**.

**Error-correcting codes**—theory, design and testing of error-correcting devices, **session 13**, papers 1 through 4.

**Information management**—present and future requirements of the information retrieval field, including discussion of hardware; **special session A**, papers 1 through 5.

**Instrumentation** — ultrahigh-speed sampling techniques and their application (organized by the Hewlett-Packard Co.), **session 23**, papers 1 through 4.

**Integrated circuits and solid state devices**—the subject category with the greatest number of papers. Sessions include the second of two tutorial sessions organized by the IEEE Group on Electron Devices, dealing with metal-semiconductor Schottky barriers and devices, micropower linear circuits and large-scale integration, **session 2**, papers 1 through 4; recent advances in interconnection techniques and linear integrated circuitry, **session 5**, papers 1 through 5. Other sessions deal with transistors in mobile communications systems, microwave varactors and multipliers, **session 8**, papers 1 through 5; large-scale arrays of silicon integrated circuits, **session 10**, papers 1 through 5 and **session 2**, paper 3; a tutorial session on field effect transistors offered by engineers from five manufacturers, **session 11**, papers 1 through 5 and **session 17**, paper 3, **session 22**, paper 3, **session 22**, paper 4; millimeter-wave generation and reception, **session 12**, papers 1 and 5; linear high-frequency amplifiers using tunnel diodes, field effect transistors, transistors, **session 17**, papers 1 through 4; plastic-encapsulated silicon transistors and their impact on industry, **session 18**, papers 1 through 4; integrated circuits in control-type functions which are neither strictly digital nor linear, **session**

**20**, papers 1 through 6.

**Manufacturing**—how grid-based interconnection systems can be used effectively, **session 14**, papers 1 through 4.

**Microwaves** — applying millimeter waves to atmospheric research, astronomy and spectroscopy, **session 12**, papers 2 and 3 and 4 and solid state millimeter-wave components and systems, **session 12**, papers 1 and 5; solid state high-frequency amplifiers, **session 17**, papers 1 through 4; selecting microwave components such as traveling wave tubes, backward wave oscillators, yttrium iron garnets, ferrites for advanced receiver systems, **session 19**, papers 1 through 4; array antennas for interplanetary communications systems, **session 24**, papers 1 through 5.

**On-line computing**—current command and control and educational, engineering applications followed by a panel discussion on the challenges of further work, **special session B**, papers 1 through 4.

**Piezoelectric devices**—recent advances in ceramic materials and device technology, ferroelectric logic and memories, **session 3**, papers 1 through 5.

**Rapid transit systems**—electronics needed in urban transportation of the future, **session 16**, papers 1 through 4.

# 160 PAGE POWER SUPPLY HANDBOOK

The Kepco Power Supply Handbook, written by Paul Birman, Kepco's Application Engineer, covers the subject of regulated DC Power Supplies in detail. Particular emphasis is placed on the programming concept and its myriad applications to complex systems control problems.



The Handbook starts with a basic treatment of the AC-DC rectification process and quickly works up to regulating circuits both open and closed loop. The concept of the bridge regulator is treated in considerable detail and is approached from several directions, including an unusual operational analysis. Such treatment of basic power supply regulators in general terms permits ready extension to more complex external loop control systems with ready understanding. A comprehensive chapter on Power Supply testing will be of value to the test engineer.

Profusely illustrated with innumerable circuit diagrams, block diagrams and photographs, the Kepco Power Supply Handbook is a valuable addition to any engineering library.



52 PAGE CATALOG CONTAINING COMPLETE SPECIFICATIONS AND APPLICATIONS NOTES ON MORE THAN 325 STANDARD MODELS IS ALSO AVAILABLE

FOR A COMPLIMENTARY COPY OF THE KEPCO HANDBOOK AND CATALOG WRITE ON COMPANY LETTERHEAD TO:

**HANDBOOK, Dept. O**  
**G.P.O. BOX 67 • FLUSHING, N.Y. 11352**

tion and combinations of electronics elements will be needed with the large arrays, the authors say. The systems designer must become familiar with devices so he can partition or modularize his system for the minimum number of interconnections.

**Tailored wiring.** Texas Instruments Incorporated's J.W. Lathrop will describe a "Discretionary wiring approach to large scale integration." Lathrop will consider the role of both catastrophic failures and out-of-spec parameters. Interestingly enough, as the number of circuits or cells in an array increases, the array will tolerate cells that are farther away from center specifications.

A pair of procedures by which large-scale integration can be applied automatically will be described by IBM's H. Freitag in "Design automation for large scale integration." The two techniques are a programed interconnect process and automatic mask generation.

R.L. Ward and T.O. Holtey of Honeywell Inc., EDP division, describe how a powerful diagnostic capability built into a computer can fulfill the promise of high maintainability and up-time. In "The maintainability factor in the design of digital systems using microelectronics," the authors analyze a pair of techniques.

One is the implementation of the system's control section with read-only memory replacing complex highly sequential logic circuitry with a regular, reliable, easily checked device. The other is building the rest of the data manipulation logic using relatively large, functionally partitioned, repetitive modules.

**Laminate chassis.** Traditional circuit interconnection techniques will not be adequate for future large-scale, integrated-circuit machines. This is the contention of Univac's J.A. Kimlinger in his paper, "Laminate printed circuit interconnection of integrated circuits." Kimlinger uses the example of a test laminate chassis that contains 293 fourteen-lead integrated circuits in a 5½ by 7 by 1/8 in. space. The author will discuss how automated design can simulate the logic operation for debugging prior to fabrication, how wire routing can be generated and how artwork can be plotted.

J.W. Stanbus, of Univac, will show how a Fortran program can relieve many arduous design tasks in "Thin-film memory sense amplifier using linear integrated circuits." Essentially, the computer assists in analysis and selection of a reliable optimum design by running through many possible combinations of the sense-amplifier component variables.

A good example of advanced manufacturing techniques will be given in "Packaging monolithic integrated circuits in the Univac 1824 Aerospace Computer Central Processor," by R.A. Beck and E.I. Moore, also of Univac. The 1824 computer makes wide use of integrated circuits in its sophisticated logic-arithmetic sections to provide high density but low power.

Early pressures to encourage widespread use of integrated circuits involved squeezing more and more elements into a single monolithic substrate, notes V. Usunoglu, ARINC Research Corp., in his paper, "Some future aspects of microelectronics." Usunoglu says the time has come for a new tack—exploiting the functional properties of semiconductor devices.

## II. Low-cost semiconductors

An excellent overview of the plastic-encapsulated semiconductor field, including some predictions about future market growth will be presented by James Bockhaus of the General Electric Co.

Speaking of the broad line of available plastic semiconductors, he separates the market into six categories; signal transistors, integrated circuits, power transistors, silicon controlled rectifiers, diodes and specialty devices. He gives a good general description of typical plastic devices available in each category including their prices.

Bockhaus predicts a bright future for low cost semiconductors and says there is a potential demand for 600 million units. In addition, the low prices may stimulate design of entirely new products such as home computers.

A good outline of the development of plastic-encapsulated transistors for the consumer market will be given by John S. MacDougall, manager of consumer application for the Semiconductor division of Fairchild Camera and In-



JEDEC TO-3 Outline

# 400 Volt NPN Silicon Power Transistor

**400 VOLT VCER**

**325 VOLT VCEO(SUS)**

**HFE > 30 min. @ IC = 1A, VCE = 5V**

**HFE > 10 min. @ IC = 2.5A, VCE = 5V**

For complete specifications  
contact any Industro  
distributor or  
sales office



**TRANSISTOR  
CORPORATION**

35-10 36th Ave., Long Island City, N. Y. 11106 • Phone (212) 392-8000

**REPRESENTATIVES:** Argus Associates, Inc., P. O. Box 68, Warminster, Penna., 215-675-4131 • Domac, Inc., 1950 Bank St., Ottawa, Ontario, Canada, 613-733-3390 • Dorado Elec. Rep., 13615 Victory Blvd., Van Nuys, Calif., 213-873-4124 • Lectropon Ltd., Kinbex House, Wellington St., Slough, Buckinghamshire, England, Slough 27629 • Machine & Products (European Export), 52 Wall St., New York, N. Y., WH 4-4370 • Melvin Sales, 113 Camino Real, Millbrae, California, 414-697-6922 • Memac Sales Co., Inc., 4740 N. Austin Ave., Chicago, Ill., 312-545-1033 • SL Ass., P. O. Box 15096, Denver, Colo., 303-238-1807 • W. J. Stulgis Co., Inc., 698 W. Crockett St., Seattle, Washington, ATwater 2-7870 • Western Elect. Components, 4301 Birch St., Newport Beach, Calif., 714-540-1322 • White Sales Co., P. O. Box 8432, Minneapolis, Minnesota, 929-5710 • Callas Electronics, 6409 Frederick Ave., Balt., Md., 301-744-7711 • Frank E. Kahsar Sales, 5229-A Glenway Ave., Cincinnati, O.,

## "BLUE CHIP" TRANSFORMERS NOW AVAILABLE IN CASE SIZE #7

**IN STOCK**—is the latest addition to the versatile family of Blue Chip transformers for printed circuit applications. This still smaller size; (Height .340 inch maximum, volume .060 cubic inches), transformer offers design engineers more flexibility for electrical and mechanical transistor circuit applications. The size #7 Blue Chip transformers provide a response of  $\pm 2$  db from 300 to 100,000 Hz in a number of impedance ranges and are designed to meet Mil-T-27B, Grade 5, Class S. Write for your copy of complete electrical and mechanical specifications.

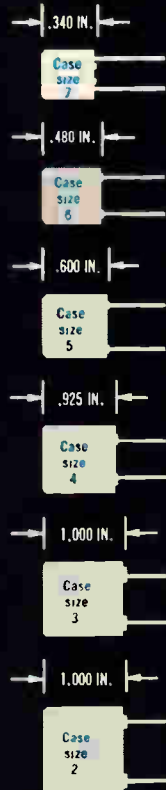
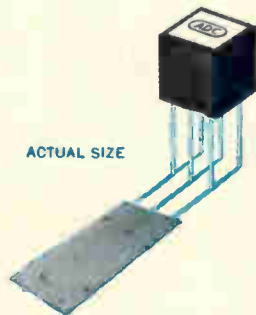

# ADC

## ADC PRODUCTS

6405 Cambridge Street • Minneapolis, Minnesota 55426

strument Corp. His paper is entitled, "Plastic semiconductors and their impact on the consumer industry."

MacDougall recounts the developments that enabled manufacturers to lower the price of quality transistors from \$15 to 30 cents.

**Ferroelectric materials.** Five scientists from Sandia Corp. will report on theoretical work and applications of ferroelectric materials. These materials may eventually be used for small computer memories or as filters for hybrid integrated circuits. Previously the inductances required in filters always took too much space to be used in integrated circuits.

D.G. Schueler will describe a seven-bit, disk-shaped memory made of a ferroelectric ceramic material. The memory, although slow, is small, consumes little power, and is impervious to nuclear and electromagnetic radiation.

Sandia's Cecil E. Land will describe the design of filter networks made from ferroelectric materials. A wafer with two or three electrodes on it, somewhat similar to Schueler's memory disk but with fewer connections, has an equivalent T or pi network and can be designed to pass or suppress any desired frequency band.

Sandia is a subsidiary of Western Electric Co., which is a subsidiary of American Telephone and Telegraph Co.

### III. High-frequency amplifiers

Those who design amplifiers in the 0.5 to 1.0 gigahertz range will find "Semiconductor high frequency amplifier design" by R.Q. Lane of Fairchild Semiconductor valuable. Lane discusses the design and performance of bipolar, junction field effect and metal oxide silicon transistor amplifiers.

Roy C. Hejhall of Motorola, Inc. will concentrate on a new technique for designing large signal, high-frequency semiconductor amplifiers. The developments discussed will interest engineers working in this field, and the summary of state-of-the-art changes will prove valuable to engineers in related fields. Among the highlights of the roundup is a discussion of the performance capabilities of silicon bipolar transistors and varactor diodes.





Performance is going up... »

# Nexus prices are still coming down



**Here's a good example:** The SQ-10a\* solid-state, general-purpose operational amplifier started at \$24 ..... 6 months ago dropped to \$19 ..... **NOW ONLY \$17!**

Now the versatile Nexus SQ-10a costs you less than ever before . . . in spite of the fact that it is *better* than ever before. Its new unit price — \$17 — is the lowest in the industry for a quality, encapsulated operational amplifier.

This should interest many . . . but surprise no one.

Ever since we developed the first encapsulated operational amplifier, Nexus has been improving product quality and reducing prices.

Actually, one is a direct result of the other. When the product is better, you buy more. When the volume goes up, costs come down, and everybody wins. That has been the unvarying trend at Nexus since we first opened our doors.

The SQ-10a is a widely-used moderate-performance, general-purpose amplifier. As its performance has improved, its price has dropped, as indicated by the comparative characteristics.

If you would like to know more about the remarkable, low-cost SQ-10a, or its performance counterpart the low profile (.375" high) SF-10 at only \$22.00, write for complete data today.

\*An improved version of the SQ-10

WESCON BOOTH #1805-1806 — ISA BOOTH #1440

COMPARATIVE PERFORMANCE — TYPICAL CHARACTERISTICS	SQ-10	SQ-10a
Supply Voltage	±15 volts	±15 volts
Open-Loop Gain @ D. C.	20 K	100 K
$\Delta I_{os}/\Delta T$	3 na/°C	1.5 na/°C
$\Delta E_{os}/\Delta T$	20 $\mu$ v/°C	5 $\mu$ v/°C
ft	1.5 mc	2 mc
Output Current Range	±2 ma	±5 ma
$I_{os}$	±100	±30
$f_p$	15 KC	25 KC
Operating Temperature Range	-5° to +70°C	-25°C to +85°C

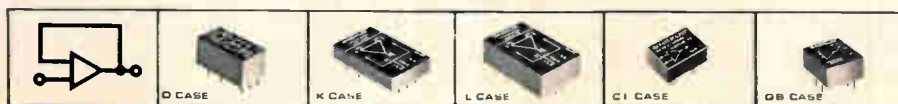

Prices F.O.B. Canton, Massachusetts — Prices apply to North America only.

**NEXUS**  
RESEARCH LABORATORY, INC.  
480 NEPONSET STREET, CANTON, MASS. 02021  
TEL: (617) 828-9000 TWX (617) 828-1022

Circle 203 on reader service card

# MICRO-MINIATURE CONNECTORS WITH CRIMP REMOVABLE CONTACTS AND CENTER SCREWLOCK

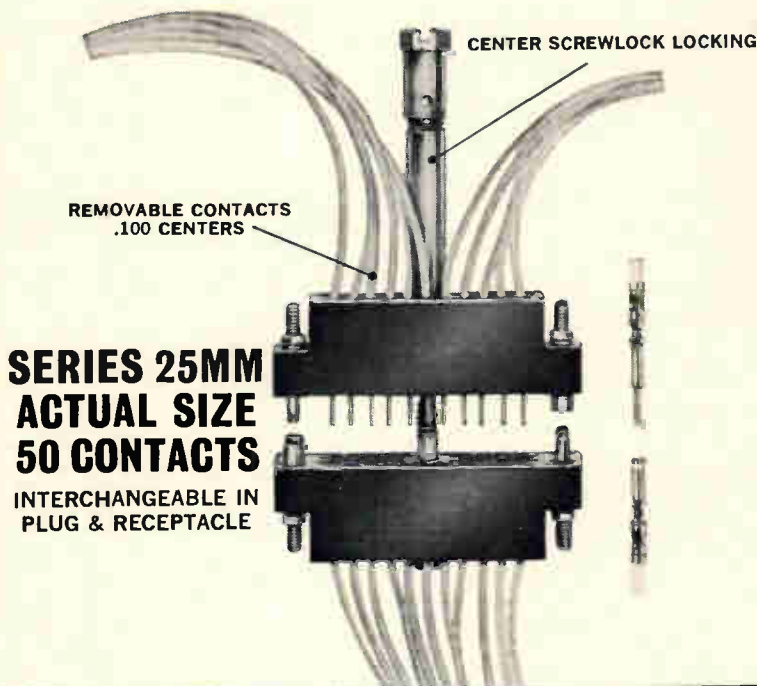

**SERIES 25MM  
ACTUAL SIZE  
50 CONTACTS**  
INTERCHANGEABLE IN  
PLUG & RECEPTACLE

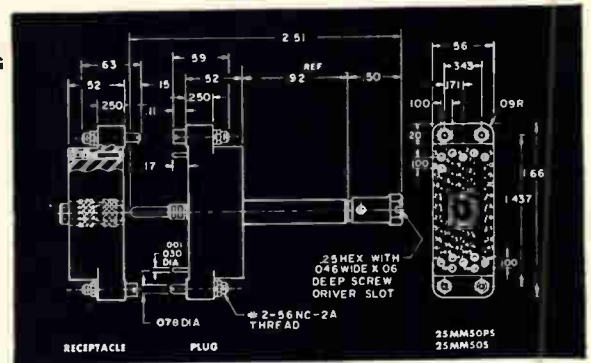

STANDARD TYPE TOOLS  
FOR REMOVABLE CONTACTS

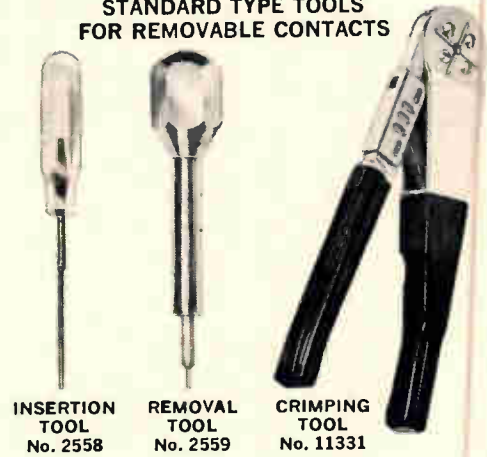

INSERTION TOOL No. 2558  
REMOVAL TOOL No. 2559  
CRIMPING TOOL No. 11331



ENLARGED VIEW OF CONTACT TO SHOW DETAIL

Now, crimp termination, removable contact connectors are available in microminiature size with the added feature of a center screwlock locking device for plug and socket. Rectangular configuration supplied with 50, 100 or 200 contact sizes. Three-tine tension spring clutch on pin and socket contacts provides maximum holding area between contact and molded block. All sharp-edged "molded-in" metal inserts have been eliminated with this clutch-type construction. Contacts are supplied separately and wired independently of the connector body. This permits mounting of the plug and

socket units at any convenient time without waiting for completion of the wiring operation.

Write or phone for complete technical information on Series 25MM and Series 25 Removable Contact Connectors. Free 16-page catalog includes outline drawings, specifications and ordering information. Phone (212) TW 9-4422 or write Continental Connector Corporation, 34-63 56th Street, Woodside, N.Y. 11377.



MICRO-MINIATURE • MINIATURE • PRINTED CIRCUIT • RIGHT ANGLE PIN & SOCKET • CENTER SCREWLOCK • SPECIAL DESIGNS

# CONTINENTAL CONNECTORS

CONTINENTAL CONNECTOR CORPORATION • WOODSIDE, NEW YORK 11377 • TELEPHONE: (212) 899-4422  
SEE US AT WESCON BOOTHS 1248-1249

# Congress clamps down on research

Industry will have little voice in reshaping Pentagon policy on independent research and development due to pressure for quick action

By Warren Burkett

Washington News Bureau

**Congress is forcing** the Pentagon to take a harder line on the way it pays industry millions of dollars a year for independent research and development. The result may be a complete shake-up in the program without industry's getting a chance to thoroughly examine the program.

Representative George Mahon, (D., Tex.), powerful chairman of the House Appropriations Committee and its Defense Subcommittee, has applied the pressure. His committee report released last month says, "Before the committee reviews the research, development, test and evaluation (RDT&E) budget for fiscal year 1968, steps should be taken to integrate the independent research and development effort into the total research and development program of the Defense Department, even though the funds are appropriated in accounts other than RDT&E."

Until recently, industry believed that a proposal the Pentagon has been studying for some time, called Cite, for contractors independent technical effort, would eventually be adopted in one form or another. But industry didn't think this would take place for a year or so, and then only after it had had a chance to study the proposal and make recommendations. Now, all this may not happen. Because of Mahon, strong reports concerning independent research and development (IR&D) may well be formulated and frozen into the next defense budget.

Since basic budget decisions are made in the Summer, before details are worked out for congressional presentations in January, changes to meet Mahon's objections are being made now. Representatives of the Electronics Industry Association, the Aerospace

Industries Association, and the National Security Industrial Association have been working closely with Defense Department representatives on several proposals. But industry fears that congressional pressure may force the Pentagon to change procurement regulations without giving all contractors a chance to view and comment on the proposed changes.

## I. What is IR&D?

Strictly speaking, independent research and development is not a program of the Department of Defense. Yet IR&D finances the lion's share of research departments at an estimated 150 to 200 defense contractors. It is an overhead or cost-of-doing-business item which contractors can charge off proportionately on every government contract along with depreciation, maintenance and executive salaries. Thus, IR&D costs do not necessarily apply directly to any specific government contract—which is one objection government officials have to the arrangement—but is spread across all of them. And a certain amount of the cost must be absorbed by civilian or commercial business done by the company.

**How much?** There is wide disagreement regarding the amount of IR&D the government supports each year. The Government Accounting Office says it comes to \$900 million. Mahon says it's about \$500 million. John Foster, Director of Defense Research and Engineering, told Congress he thinks the figure will be closer to \$350 million for fiscal year 1967. Foster says that sustaining the contractors' private research programs cost about \$343 million in fiscal 1966 and \$330 million in 1965. Also, one Pentagon research official notes, "All these

figures are extrapolations from about 40 or 50 contracts. We don't know that they represent a real financial picture because they were drawn from the biggest companies that were the easiest to audit."

For companies whose only customer is the Defense Department, overhead allowances for IR&D cover, by some Pentagon estimates, as much as 80% to 90% of all costs associated with company research and development programs. Some defense suppliers of consumer or commodity type goods have very little research effort, of course.

**Looking ahead.** To control these costs and to hold down the violent swings in company research budgets, 95 electronics and aerospace companies hold annual, negotiated contracts with the Pentagon for IR&D expenses. These advance agreements usually set a fixed upper limit on the amount of company research costs that can be charged off as military business.

The agreements protect a company against losing a large share of research funds if it loses a single contract. The research department budget can be spread across other defense contracts without being renegotiated.

## II. Let's get specific

Congress and the military cite two objections in this practice. First, the basic research work only generally, not specifically, applies to areas of technology and engineering in which the Defense Department may be interested—undersea technology or communications, for example.

This sustains industry's capability in defense-related work, but when research promises a specific Defense Department application, it shows up as a company's unsoli-

## Who needs this surprising new quarter-rack power supply?

You might—if you're looking for precision regulation with the versatility needed in today's labs. Consider the advantages.

The new Series HH Silicon Quarter-Racks give you the ranges you need, without derating—even at +60° C! Three precisely regulated supplies—0-7V at 4 amps (HH7-4), 0-14V at 3 amps (HH14-3) and 0-32V at 1.5 amps (HH32-1.5). And you can put any four of them in a 5¼" rack, series or parallel them—or combine them with Trygon's renowned half-racks for added flexibility.

Small? Sure. But they're big in performance! Regulation: .01% load and line. Ripple: .5mv rms. Stability: .05% (.01% optional). There's more.

Constant voltage and constant current operation. Automatic adjustable current limiting. Front panel overload indicator. Remote voltage programming. Remote sensing. Vernier voltage adjustment controls. Optional automatic tracking over-voltage protection.

Who needs it? If you want a versatile, compact precision lab or system supply for as little as \$189... plus Trygon reliability,

**you do!**



For all the exciting features, write

**TRYGON**  
POWER SUPPLIES  
Roosevelt, New York  
TEL (516) 378 2800 · TWX (516) 868 7508

cited proposal. The Defense Department is in fact financing research and development for which it gets no patent rights. Another objection is that these IR&D payments lack elements of competition and cost comparisons. And the advance agreements and their dollar amounts are classified secret by the Defense Department for competitive, not security, reasons; contractors feel this protects them from competitors who would like to know what they spend on research or allocate to "hot research areas of Pentagon interest."

**Late protection.** When a project nears fruition, the company usually gets a specific research and development contract from the Defense Department with the usual product and patent protection.

But direct support of company research is no solution, according to Foster. "This would place all independent research and development under sole-source negotiation," Foster told the Mahon committee. "It would eliminate the advantage the Government now receives from the sharing of fixed-price, competitive and commercial work."

### III. Two birds—one fund

Foster's advisors have not announced specific changes to meet Mahon's requirements. However, current discussions in the Pentagon revolve around Cite. One of Cite's appeals lies in combining two troublesome research and development activities into one funding which, it is hoped, can be subjected to cost-effectiveness controls. As proposed, Cite combines IR&D expenses with those of the technical research and development required by companies seeking specific defense contracts.

Almost every contractor now finds it necessary to conduct some research and development work to substantiate the feasibility of bids and proposals submitted for new electronics and weapon systems. These costs can be recovered directly from the contracts awarded. Such bids and proposal costs, however, are usually beyond the competitive guidelines favored by the Defense Department and cannot be questioned so long as the company documents the expenditure. Items can be allowed or disallowed on the

basis of "reasonable cost," but this involves a great subjectivity in judgment by contract examiners.

Defense officials say that there is such a fine line between the two expenditures—independent research and technical costs related to bids and proposals—that they cannot be separated. Industry spokesmen disagree, saying the companies can separate expenses for basic engineering and technical research from those expended directly preparing a specific proposal, either solicited by the Defense Department or unsolicited. This is an ordinary, daily bookkeeping decision, industry maintains.

**Agree to differ.** Both industry and Government agree the combined costs—research and bids—run well over a billion dollars a year. Both agree that the point where a basic research and development effort becomes applicable to a specific defense project is uncertain.

Government research administrators maintain, however, that companies sometimes recover their research and development money from the government as bid and proposal expenses with this bookkeeping device.

**Will it work?** Industry negotiators are willing to accept Cite's lumping principles, but they have many reservations about the proposals for "tests for reasonableness." They want these spelled out in detail for study and comment.

Another of Cite's suggestions to induce competition includes the controversial "cost-weighting average-share" concept. This includes not only a consideration of each company's military-civilian mixture of business but also a sliding scale of research costs which can be recovered in the defense contracts. If a company's contracts are mainly fixed price, perhaps 80% of research costs would be paid in overhead charges without question.

This assumes that a company aiming at fixed-price business will not—and cannot—support an overfed research and development operation which is not directly contributing to the company's business. Companies doing most of their Defense Department work on cost-plus-fixed-fee contracts would recover less of their research and development overhead.

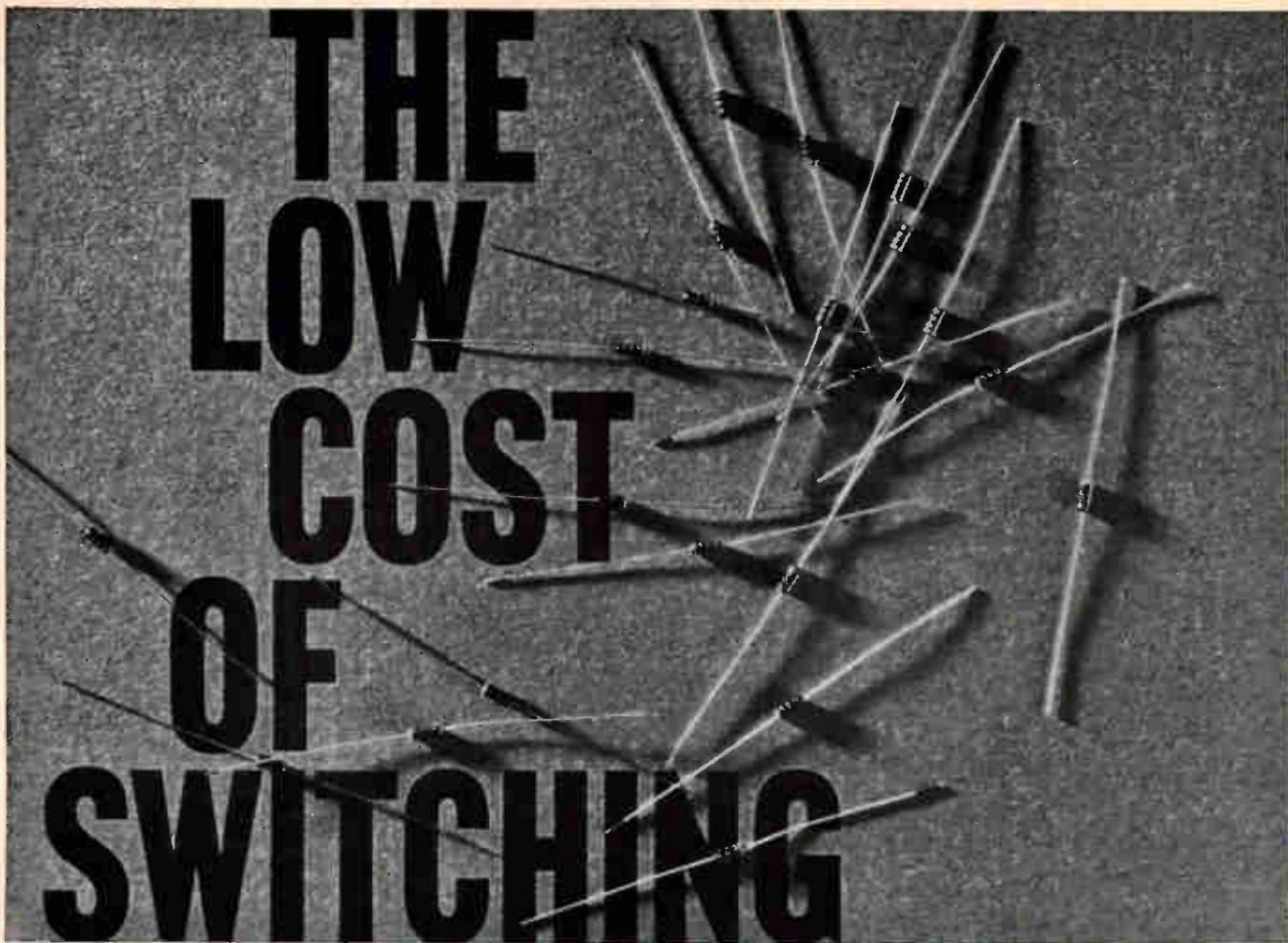

**... new value  
from new pricing  
on hot carrier diodes  
from HPA**

Ultra-fast switching with HP Associates 2900 Hot Carrier Diode is now more economical than ever. New production techniques and experience have reduced the cost of these popular devices, and the savings is passed on to you.

The performance characteristics and pricing listed in the chart make the HPA 2900 ideally suited for use in TV tuners, commercial communications limiters, detectors and mixers, and multiplexing in signal processing.

Contact your Hewlett-Packard field engineer for complete data or write HP Associates, 620 Page Mill Rd., Palo Alto, California 94304, Tel. (415) 321-8510.

TYPICAL SPECIFICATIONS, HPA 2900		
<b>Forward Current</b> $I_{F1}$	<b>Breakdown Voltage</b> $BV_R$	
20 ma min. @ $V_F = 1.0$ v 1.0 ma min. @ $V_F = 0.4$ v	10 v @ $I_R = 10$ $\mu$ a	
<b>Leakage Current</b> $I_R$	<b>Lifetime</b> $\tau$	<b>Price</b>
100 na @ $V_R = -5.0$ v	120 ps	1 to 99, \$3.00 100 to 999, \$2.25

*Data subject to change without notice. Prices f.o.b. factory.*





Engineers, like this one from Federal Electric Corp., a subsidiary of International Telephone and Telegraph Corp., have done a great deal of work on Saigon's communications system and in teaching the Vietnamese how to operate it.

## Employment

# The engineer in Vietnam

Military forces rely on company engineers and technicians to install, maintain and operate complicated electronic equipment

**In Southeast Asia**, a small army of civilian engineers and technicians is building, maintaining and operating one of the most complex communications and radar networks ever installed in a battle area.

At dusty airfields and on aircraft carriers they are maintaining complicated surveillance and navigation systems in planes. And in laboratories air conditioned to withstand the intense heat of Saigon and Bangkok, they are studying ways to fight an elusive enemy in a jungle. More than 1,000 of these men in Thailand and South Vietnam are United States citizens.

Under the guidance of the Defense Communications Agency, the Philco Corp., a subsidiary of Ford Motor Co., and Page Communications Engineers, Inc., a subsidiary of Northrop Corp., install, operate

and maintain the backbone communications network. It consists of troposcatter, microwave and high-frequency terminals [Electronics, May 16, p. 95]. Philco has over 400 United States citizens—mainly in Thailand—and Page has 266—mostly in South Vietnam.

The Army Electronics Command at Fort Monmouth, N.J., has contracts with 21 companies employing 110 U.S. citizens.

On every aircraft carrier the Navy keeps a contingent of civilian engineers to service aircraft navigation gear and to take care of the big shipboard radars.

The State Department's Agency for International Development has contracts with nine U.S. electronics companies: Motorola, Inc. is installing radios, Gates Radio Co., a subsidiary of Harris-Intertype Corp.,

is setting up transmitters, Hammarlund Manufacturing Co. has distributed 20,000 radios, the Hallcrafters Co. is providing radios to native villages and General Telephone and Electronics Corp. has completed one contract for engineering and design work for military communications and is scheduled to receive another.

About 50 Collins Radio Co. men in South Vietnam install and maintain point-to-point and airborne communications.

Approximately 15 General Electric Co. employees in South Vietnam work at Air Force bases. The Radio Corp. of America has a few people in Vietnam—one RCA man is touring the area now to see what the company can develop that will be useful.

Litton Industries, Inc., keeps 25

to 30 technical representatives in Southeast Asia and the Pacific. Ten are in South Vietnam; others are in Okinawa, the Philippines, Formosa and on aircraft carriers.

In addition to its 266 U.S. citizens, Page employs 8 Canadians, 2 Britishers, an Australian, 151 Filipinos, 36 South Koreans and 151 Vietnamese.

Philco also hires men of many nationalities. Under an agreement with Philco, the government of South Korea screens workers to go to South Vietnam. Philco pays for their transportation and the men join the labor forces Philco provides under contract with the U.S. military. One group of 600—many of them electronics technicians—works for the U.S. Navy near Da Nang.

For these civilians, the complications of an engineering job are real and deadly. They never know when a sniper may be taking aim. Even in urban areas, if they travel to work by car through busy streets, they keep the windows rolled up—despite the 100° heat—to protect against a small boy on a bicycle who might ease a hand grenade into the back seat as he smiles and pedals past. In return for the risks, a Vietnam-based engineer earns higher pay, and holds a job that is exciting and often rewarding.

The civilians are an essential technical extension of the military in South Vietnam and Thailand. They handle electronic equipment that is too complicated for the military to attempt to train its personnel to set up and maintain. Less complicated equipment is sent to Vietnam and Thailand along with



Overseas work is a way of life for engineer Gerald Wightman, responsible for Sperry Gyroscope Co.'s giant AN/TPS-34 at Marine base of Chu Lai.

an expert who gives instructions in its operation and upkeep.

A sizeable number of engineers are in Saigon and Bangkok as members of research and development teams, studying new ways to use electronics in jungle warfare.

For many working engineers, there is an additional job to perform for the company back home: they must keep an eye out for new business and learn what the military is looking for and how their company can meet the needs.

The number of engineers or companies in Southeast Asia is apparently not known by any one agency in Washington or in Southeast Asia. Each agency sending people to the Far East has its own needs, awards its own contracts and does not worry about what others are doing.

## I. Recruitment

Companies with large contingents of men in Southeast Asia report less difficulty with recruiting than they had expected.

Loren Bailey, Page's project manager in Saigon, said in the company's small office across from the French hospital on Rue Gia Long, "We thought we would have trouble recruiting many high caliber technicians. But we didn't."

The personnel manager for another company said, "With hundreds of U.S.-trained Filipino technicians willing to go to Vietnam, we are beginning to be more choosy. If an American does not perform better than a Filipino or a Japanese, I fire the American immediately. Today, the worst part of the emergency is over. There was a time when we would hire almost anyone. Now we want qualified technicians who stay out of trouble. It costs the same amount to transport and feed a first rate man as it does a troublemaker."

Another company says, "We can spot the misfit pretty easily now, and know how to steer clear of him. We don't want people who are running away from an emotional problem. They don't usually find the solution in Vietnam. We want men who are a little on the adventurous side and who plan to enjoy their tour."

## II. Who volunteers

Who signs up to go to South Vietnam and Thailand, and why? Money is a big reason; there's additional pay for expenses and hazardous conditions. Adventure plays a big role; personnel men say it's a bigger factor than most engineers themselves realize, or at any rate, admit. And there is patriotism as well or the opportunity for challenging work.

"It's a good opportunity to save money and to study," says Lew Wood, one of the 13 Page employees who operate and maintain the big troposcatter communications station at Pleiku.

"I'm a technician now, but when my contract expires in 1967, I'll go back to school and get an engineering degree."

For Ben Clark, 31 years old, of Paducah, Ky., Vietnam is also a way to save money. Clark wants to



Ben Clark bought a motor scooter to go to and from work at Decca Navigator System, Inc. When he saves enough money he plans to go back to his hometown of Paducah, Ky., and open an electronics repair shop.

# Andersen the source for SERIAL MEMORIES

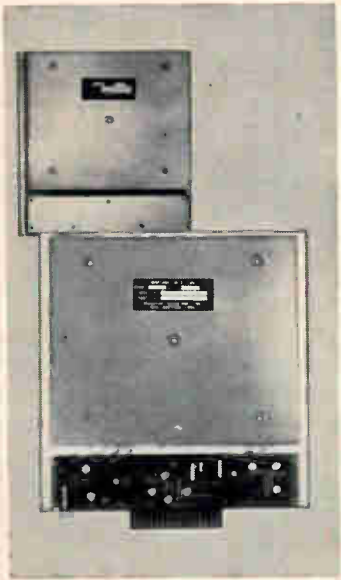

Model 3000 Low Frequency  
Serial Memory

Storage capacity up to 20,000 bits  
Data rate up to 2 Mc  
Logic levels from 3 to 12 V ( $\pm$  3V to  $\pm$  12V)  
Availability of micro logic and transistorized circuitry

Andersen is the recognized leader in Serial Memories, supplying by far the greatest number of units for computer buffers, data telephone and video display applications. Here is a wide range of proven design concepts from which to choose to meet your specific requirements.

Ask Andersen about Low Frequency Serial Memories, High Frequency Serial Memories and other advanced signal and data processing systems for radar, sonar, communication, telemetry, simulation, navigation and analysis.

ANDERSEN LABORATORIES, INC.  
501 NEW PARK AVENUE,  
WEST HARTFORD, CONN. 06110



Ben Clark cooks some of his own meals in the \$150-a-month apartment he rents between Saigon and Ton Son Nhut airport where he works.

save enough to go home and start an electronics repair shop. While in Vietnam working for the Decca Navigator System, Inc., he is taking a correspondence course in radio engineering. Clark completed one 12-month tour in South Vietnam in 1963, then returned in December, 1965 for a second tour. He plans to spend 18 months in Vietnam, which will enable him to get a refund on the income tax he paid while away.

Clark's living expenses are fairly high. Although the company provides quarters for \$5 a day in a large house near Ton Son Nhut, the airfield outside of Saigon where he works, Clark prefers a place of his own. He rented a 3-room apartment for \$150 in a middle-class neighborhood halfway between Saigon and Ton Son Nhut and hired a housekeeper who cleans the apartment, shops and does the cooking. Food costs him \$75 a month.

Charles Harrow, 25, who works with Clark, is also in Vietnam to save money. He wants to open an avionics repair shop back home. "To save the \$10,000 I'll need," Harrow says, "would take me 10 years back in the States. Here in Vietnam, I hope to do it in 18 months."

Harrow has asked to be assigned to a remote outpost where there won't be much to buy and where he can concentrate on his correspondence course in electronics. "I will send my wife \$300 a month for herself and the two children and try to save half of my per diem."

**Career traveler.** Gerald E. Wightman, a field technician for Sperry Gyroscope Co., a division of the Sperry Rand Corp., is in Vietnam because supervising the operation and maintenance of sophisticated equipment in remote places is his career. An honor graduate in electrical engineering, Wightman for the past 15 years has nursed millions of dollars of delicate, new Sperry equipment into operation all over the world and trained personnel in its operation and upkeep.

He went to England with a Strategic Air Command squadron of B-47's to take care of its airborne radar; he has worked at a number of Air Force bases in the United States; he has gone on sea trials with the Navy's cruiser USS Galveston to see that the AN/SPQ-49, a high-powered, C-band radar tracker worked all right; he was site director at Kwajalein Island for Sperry's target discrimination radar—part of the Nike Zeus system—for almost two years; he recently accompanied the Marines to Okinawa and then to Japan with the TPS-34 radar, before it and he went to Chu Lai in South Vietnam, a Marine base down the coast from Da Nang. There he has the sea on one side and brush and Viet Cong on the other three.

Wightman, who is 42 and single, adapts so well to military conditions that the commanding officer of the Marines in Okinawa gave him a letter of commendation in which he was "adopted as a Marine."

Chu Lai, which gets mortar fire



# FOR CIRCUIT ENGINEERS USING RESISTOR NETWORKS

## NEW TEST DATA OPENS MORE DESIGN PATHS FOR CTS INDESTRUCTIBLE CERMET SEMI-PRECISION RESISTORS

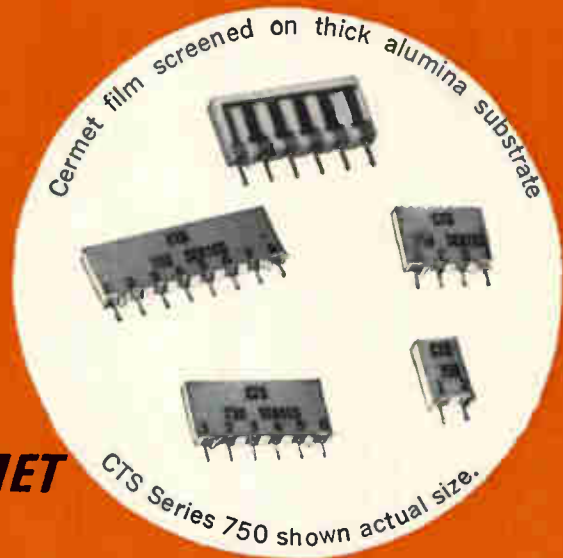

The data speaks for itself. Examine and judge its value for your application:

Extreme Stability and Reliability

High Power Capability: (Up to 1 watt per resistor)

Note Low Price: (See Table)

- Space saving—a single module replaces up to 7 discrete resistors.
- Available in an infinite number of circuit combinations.
- Custom-built to your exact requirement.
- Ideally suited for cost-saving automatic handling.
- Cover coating unaffected by solvents.

### Extra cost options

Resistance Range	10 to 49 $\Omega$ , 101K to 1 meg. $\Omega$
Resistive Tolerance	$\pm 0.5\%$ , 1%, 2.5%
TC	$\pm 150$ ppm/ $^{\circ}\text{C}$

Request Cermet Catalog.

### STANDARD MODULE SPECIFICATIONS FOR ALL SIZES

Resistance Range	50 $\Omega$ to 100K $\Omega$
Resistive Tolerance	$\pm 5.0\%$
TC	$\pm 300$ ppm/ $^{\circ}\text{C}$
Load Life: 0.1 W per resistor at 70 $^{\circ}\text{C}$ , 1000 hrs. (Over 4,000,000 resistor hours)	$\pm 0.40\%$ $\Delta$ R max. $\pm 0.20\%$ $\Delta$ R av.
Moisture Resistance: .1 rated wattage at 70 $^{\circ}\text{C}$ , 90-98% humidity, 1000 hrs.	$\pm 0.50\%$ $\Delta$ R max. $\pm 0.20\%$ $\Delta$ R av.
Insulation Resistance: measured wet after moisture resistance test, 200 VDC	500 meg. $\Omega$
Thermal Shock: 5 cycles, -63 $^{\circ}\text{C}$ to +125 $^{\circ}\text{C}$ , no load	$\pm 0.10\%$ $\Delta$ R max. $\pm 0.03\%$ $\Delta$ R av.
Short Time Overload: 2.5 times rated voltage, 5 sec.	$\pm 0.25\%$ $\Delta$ R max. $\pm 0.05\%$ $\Delta$ R av.
Low Temperature Exposure: -63 $^{\circ}\text{C}$ , 4 hrs.	$\pm 0.10\%$ $\Delta$ R max. $\pm 0.04\%$ $\Delta$ R av.
Terminal Strength: 5 lb. tensile & compression, 30 sec.	$\pm 0.10\%$ $\Delta$ R max. $\pm 0.03\%$ $\Delta$ R av.
Effect of Soldering: 63/37 solder, 246 $^{\circ}\text{C}$ , 2 sec.	$\pm 0.10\%$ $\Delta$ R max. $\pm 0.05\%$ $\Delta$ R av.



founded 1896

**CTS**  
**OF BERNE, INC.**  
**BERNE, INDIANA**

SUBSIDIARY OF  
CTS CORPORATION • ELKHART, INDIANA

Series 750	2-Pin (1 Resistor)	4-Pin (3 Resistors)	6-Pin (5 Resistors)	8-Pin (7 Resistors)
Total Module Load	0.5 Watts	1.0 Watts	1.5 Watts	2.0 Watts
Approx. 10,000 cost	\$0.22 ea.	\$0.24 ea.	\$0.26 ea.	\$0.31 ea.
Approx. 100,000 cost	\$0.20 ea.	\$0.22 ea.	\$0.24 ea.	\$0.28 ea.

## Control Products at WESCON/66

**Rotary Switches** Broad new line of manual rotary switches, from 1" to 2 $\frac{3}{16}$ " diameter; 12, 18, 20 & 24 positions. Ceramic, epoxy glass, kel-F, mycalex and phenolic insulation.



WILMINGTON CONTROLS DIV., LEDEX INC.  
360 South Nelson Road, Wilmington, Ohio 45177  
Phone 513/382-3767



**New Contactless Reed for Audio Tone Control Systems** New Bramco resonant reed works as audio tone filter with sharp selectivity or as frequency source for stable audio tone generator. It has four terminals with isolated input and output. Frequency range is 80 to 3000 cps, accuracy  $\pm .15\%$ . A major state-of-the-art advance, the device has no mechanical contacts. Its life and reliability approach that of solid state circuitry. Sugar cubed size, plug-in package shown measures  $1\frac{3}{32}$  x  $\frac{9}{16}$ .



BRAMCO CONTROLS DIV., LEDEX INC.  
College and South Streets, Piqua, Ohio  
Phone 513/773-8271

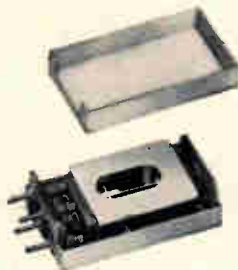

RF20 Resonant Reed

**Push/Pull Solenoids** Precision built for rapid response, high force. Flat-face plunger for strokes to .030, conical for strokes from .030 to .250. Force beyond output beyond 350 pounds. Now 10 basic models to choose from.

LEDEX  
FLAT-FACE PLUNGER  
(Short Stroke)



LEDEX  
CONICAL PLUNGER  
(Medium Stroke)



**Rotary Solenoids** Our latest solution for space squeezed actuating application problems, this disc-shaped rotary solenoid has a  $1\frac{5}{16}$ " diameter and is only  $\frac{7}{16}$ " thick. Torque is 20 ounce-inches at intermittent duty. Other rotary solenoids with torque to 98 pound-inches, strokes from 20 to 95 degrees. Ledex endurance engineered solenoids have life of 100,000,000 actuations and are now available from the shelf.



**Packaged Control Solutions** Here we put our disc-shaped solenoid to work as a driver for a miniaturized (4.5" x 1.3" x .550) 12-position stepping switch. Model shown is an armament control (intervalometer). It is used in pairs to fire 19 rockets sequentially, at 10 ms intervals. We can tailor one like it for your stepping or sequentially timed switch application.



LEDEX INC., 123 WEBSTER STREET, DAYTON, OHIO 45402  
Designers & Manufacturers Electronic & Electro-Mechanical Components  
& Remote Control Switching Systems Phone 513/224-9891

See these control products plus others at WESCON booths 1006-8.

at night and sniper sharpshooting during the day, is considered a combat area—and Wightman gets extra pay. When his six months are up—this month—he'll have the opportunity to go elsewhere. He gets three weeks' vacation a year, as do Sperry's 15-year employees in the States.

Page employees sign for a minimum tour of one year. The standard work week is 48 hours, although often, especially in installation work, hours depend on circumstances. If equipment breaks down, an engineer might work 24 hours straight. When the monsoon begins, he might have nothing to do for two weeks.

Page employees have two weeks' vacation; many spend their holidays in Hong Kong or Bangkok and then return to South Vietnam for another tour.

Besides a base salary, most companies grant a living allowance that varies according to location, and on completion of a 12-month contract, a bonus. The most sought after places in South Vietnam, besides Saigon, are the coastal cities of Vung Tau and Nha Trang and the cool mountain resort of Dalat.

**A hardy group.** Americans have a reputation for being adaptable. Electronics engineers follow the pattern. The small team working with the U.S. Signal Corps at Phu Bai near the hostile city of Hue don't complain, even though they're restricted to the base much of the time.

Apart from the diarrhea that initiates most new arrivals to the tropics, there's little sickness and very few cases of serious disease. Dengue fever, which keeps a man out of work three to seven days occurs from time to time, but so far, no U.S. civilian has come down with malaria.

One reason for good health may be the Americans' lack of interest in exotic food. Says one lean, rugged Texan in Saigon, "We stick pretty much to American food whenever we can. We have access to open messes and clubs operated by the military and we eat there when we can.

"Once in a while we may go to a French restaurant downtown. But as food goes, we like it American style. Our only weakness is for the local beer."

ONLY 3C OFFERS

**30 DAY DELIVERY**

ON THE HOTTEST COMPUTER  
IN THE \$28,500 PRICE RANGE

DDP-116 computers are now operational in over 50 installations including communications, data acquisition, hybrid and other real-time control applications. Specifications include: 16-bit word, 1.7 $\mu$ sec cycle, expandable 4096-word memory and keyboard with paper tape I/O unit.

Software is a proven factor! The compact DDP-116 offers as many as 134 subroutines in its ASA FORTRAN IV library. Also, it is compatible with the DAP assembler and desectorizing loader. A/D and D/A subsystems, a full peripheral line and special purpose systems capability are available to extend the flexibility of the basic DDP-116.

Write for full details, or telephone today to test operate the DDP-116 at a selected 3C regional office nearest you.

**DDP-116**

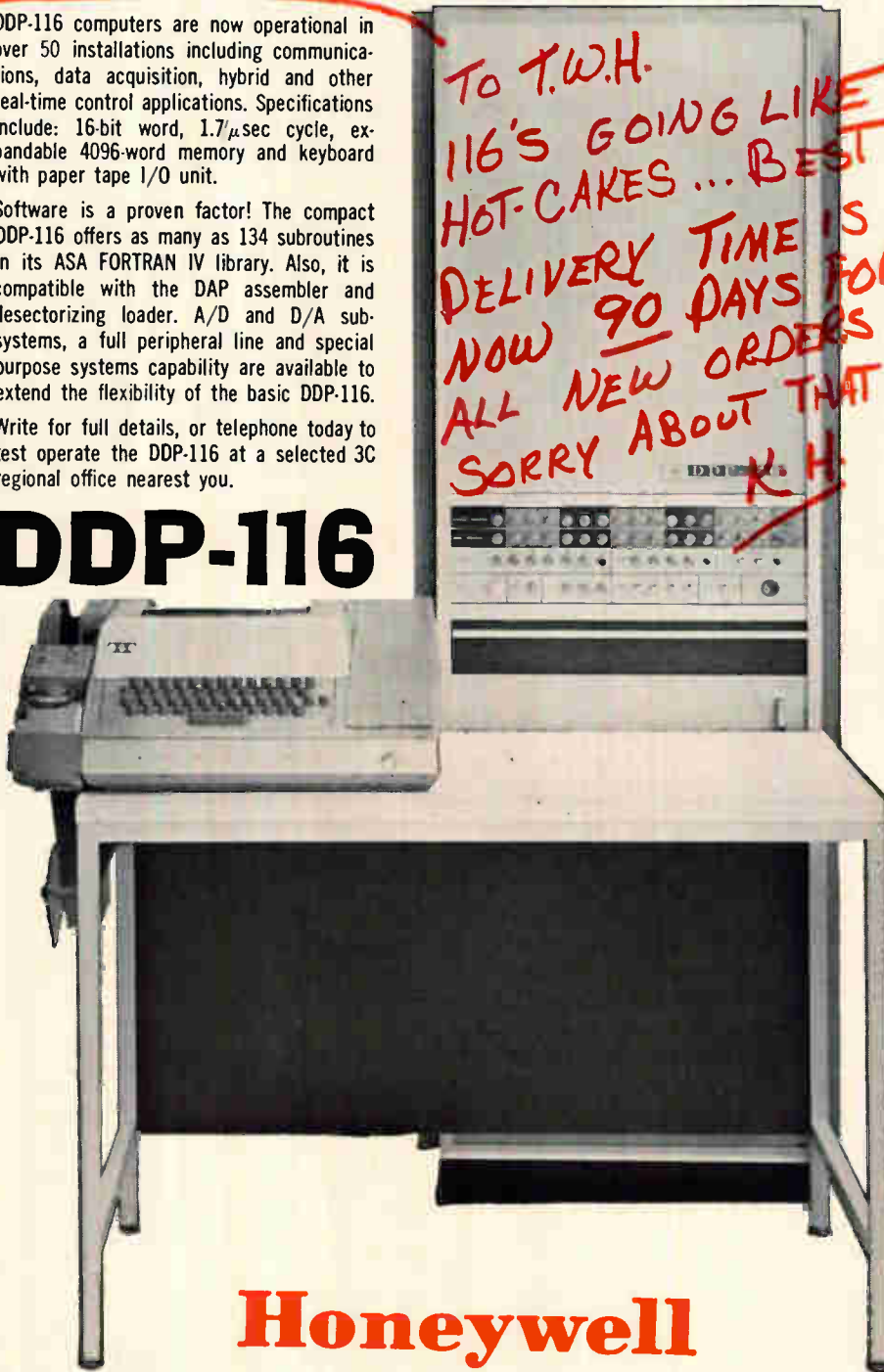

**Honeywell**



COMPUTER CONTROL DIVISION

OLD CONNECTICUT PATH, FRAMINGHAM, MASSACHUSETTS

# Two new high power silicon transistors: 200V & 300V, 3.5A, low cost



These new Delco NPN transistors are designed to do a better job in your medium-high voltage inverters, converters, regulators and switching circuits.

Low saturation resistance (typically 0.3 ohm) and built-in protection against high-voltage transients make these two new devices ideal for rugged switching applications.

High punch-through voltage, high frequency response, and low saturation resistance are provided by the silicon element itself, which is fabricated by our unique triple sequential diffusion process. Exceptional resistance to thermal and mechanical shock are a result of ultrasonic bonding of aluminum to aluminum

base and emitter contacts.

Both devices are packaged in solid copper Delco TO-3 packages which give them ruggedness and low thermal resistance (typically 0.75° c/w).

Contact your nearest Delco sales office or distributor for complete data, the low prices and off-the-shelf delivery.

TYPE	V <sub>CEO</sub>	V <sub>CBO</sub>	V <sub>CEO</sub> (sus)	I <sub>C</sub>	I <sub>B</sub>	h <sub>FE</sub> V <sub>CE</sub> = 5V@I <sub>C</sub>	R(sat) typ @ I <sub>C</sub>
DTS 410	200V	200V	200V min	3.5A	2.0A	10 @ 2.5A	0.3 ohm @ 1.0A
DTS 411	300V	300V	300V min	3.5A	2.0A	10 @ 2.5A	0.3 ohm @ 1.0A

**SEE YOU AT WESCON, BOOTHS 1503-4, SPORTS ARENA**

<b>FIELD SALES OFFICES</b>	<b>UNION, NEW JERSEY*</b> Box 1018 Chestnut Station (201) 687-3770	<b>DETROIT, MICHIGAN</b> 57 Harper Avenue (313) 873-6560	<b>SANTA MONICA, CALIFORNIA*</b> 726 Santa Monica Blvd. (213) 870-8807
	<b>SYRACUSE, NEW YORK</b> 1054 James Street (315) 472-2668	<b>CHICAGO, ILLINOIS*</b> 5151 N. Harlem Avenue (312) 775-5411	<b>General Sales Office:</b> 700 E. Firmin, Kokomo, Ind. (317) 459-2175

\*Office includes field lab and resident engineer for applications assistance.

**DELCO RADIO**   
Division of General Motors  
Kokomo, Indiana



# PPO<sup>®</sup>

POLYPHENYLENE OXIDE



## is self extinguishing

(UL GROUP I)

Even in a section just 30 mils thick, PPO<sup>®</sup> polyphenylene oxide is self extinguishing and nondripping. That's one-half the thickness of the minimum of 62 mils demanded by UL for our Group I rating (the toughest there is). Furthermore, PPO can be dip soldered, copper clad, staked and easily cleaned with Freon TF.

These are key features of PPO, the new wide temperature range engineering thermoplastic from General Electric.

PPO also has superior electrical properties. Dissipation factor and dielectric constant are very low...and very constant...over a wide tempera-

ture and frequency range. Dielectric strength is high.

As an engineering material, PPO offers: 1) a heat deflection point of 375°F @ 264 psi. 2) a tensile modulus of 310,000 psi at 300°F. 3) only 1% creep after 10,000 hours at 73°F and *under 2% at 200°F*. 4) excellent dimensional stability, with a maximum water absorption of 0.12 percent. 5) moldability to close tolerances.

What design of yours would go better in PPO? For a starter, look at the pictures. You'll see a tv tuner strip... connector... tv deflection yoke... thin-walled electrical shell... and molded printed circuit board. Each of

them end up better and less expensive in PPO. The same characteristics make PPO a candidate for double insulated housings.

Our technical people know of many more areas where you can benefit with PPO. They'll be glad to help solve your problem. Call your local Chemical Materials Sales Representative, or write Section 6H2, Polymer Products Operation, General Electric Company, One Plastics Ave., Pittsfield, Mass.

*(By the way, PPO is also the greatest hot water resistant engineering thermoplastic yet developed.)*

**GENERAL  ELECTRIC**

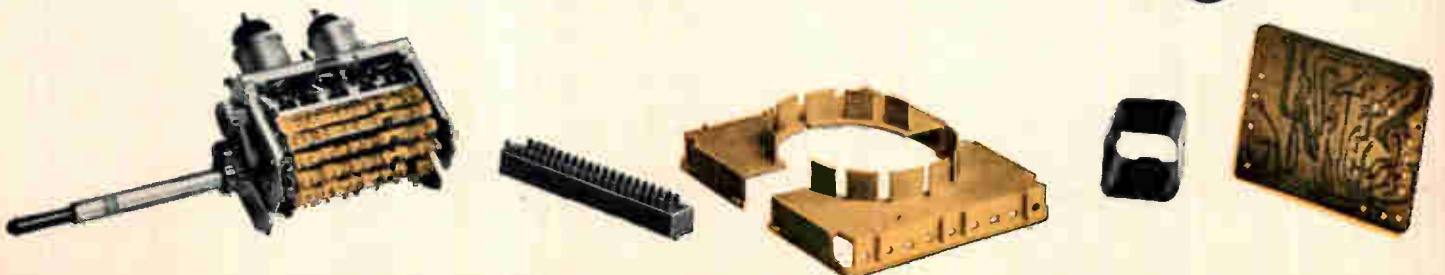

# Why Lockheed is for Engineers who work with speed.



**Subsonic.**

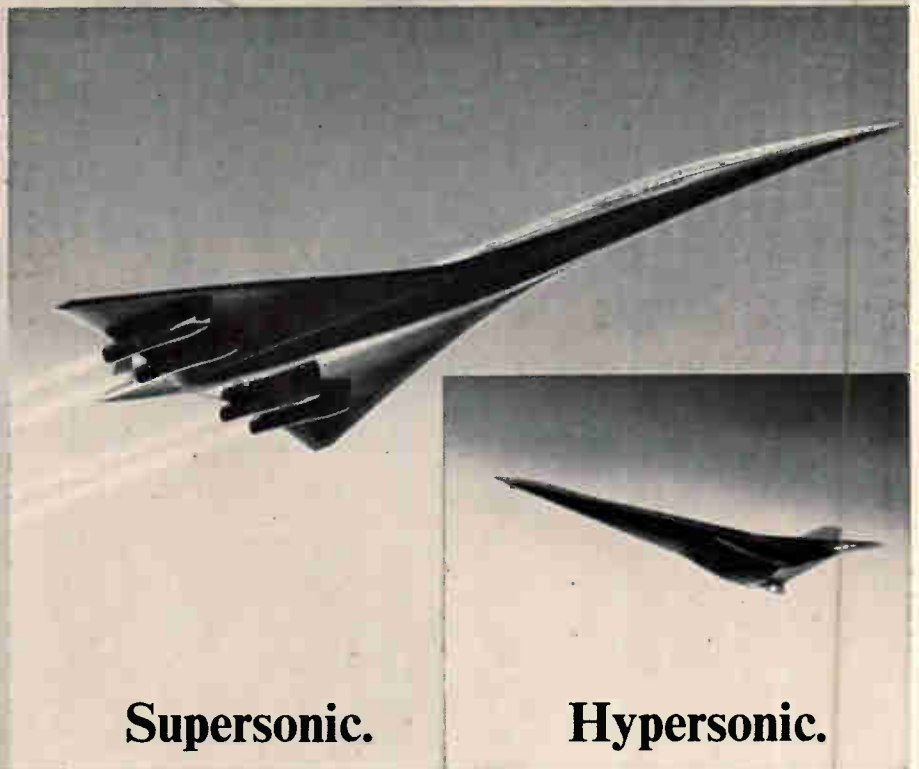

**Supersonic.**



**Hypersonic.**

There are no speed limits on progress in developmental aviation at Lockheed. An unusually diverse range of advanced programs is offered in three speed regimes—hypersonic, supersonic, subsonic. A diversity that is unmatched elsewhere in the aerospace industry today.

Working towards the day when high priority passengers and cargo will travel at speeds many times faster than sound, Lockheed is using the SCRAMJET approach in manned hypersonic test and cruise vehicles.

In the supersonic speed regime, Lockheed is designing an exceptionally advanced airplane with capabili-

ties far superior to any craft in the skies today. At the same time, other remarkable aircraft, for Mach 3 flight, are in development. In commercial aviation, Lockheed is working on America's SST Program, a major and growing endeavor. Other supersonic programs include extremely advanced versions of Lockheed's famed F-104 Starfighter.

A revolutionary composite rotary-wing craft, able to stop, fold, or start blades in forward flight, is one of Lockheed's most promising subsonic endeavors. Also, work on the Army's Advanced Aerial Fire Support System—AAFSS—goes rapidly ahead.

In addition, mass short-haul travel between major cities is another focal point of Lockheed's expanding subsonic STOL and V/STOL research and development programs.

A large number of significant positions are open for engineers and scientists on these and other sub, super, and hypersonic programs. For information, write: Mr. E. W. Des Lauriers, Professional Placement Manager, Dept. 1508, 2404 North Hollywood Way, Burbank, California. Lockheed is an equal opportunity employer.

**LOCKHEED-CALIFORNIA COMPANY**  
A DIVISION OF LOCKHEED AIRCRAFT CORPORATION

# What cable jacket material has the toughness Grumman wants



for its  
A6A Intruder?

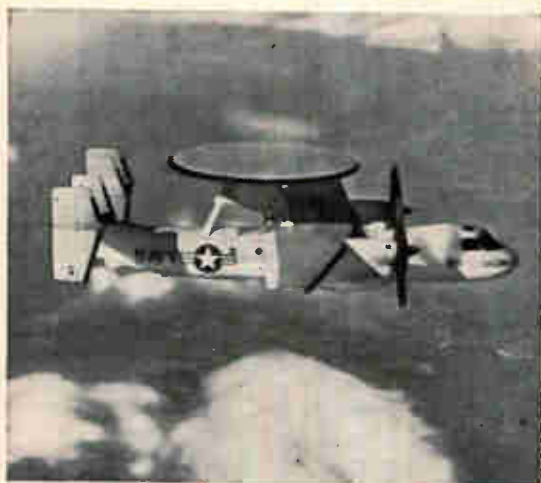

for its  
E2A Hawkeye?

## Answer: Kynar\*...the fluoroplastic that's tough!

Grumman Aircraft's own tests showed Kynar to be an ideally tough jacket material for single, double and triple conductor cabling. It has twice the cut-through resistance of any other fluoroplastic insulation. It resists a wide variety of solvents and corrosive fluids. And, it won't degrade with age or severe

environmental conditions.

When your design calls for cable jacket, wire insulation or heat-shrinkable tubing that's tough . . . really tough . . . specify Kynar. Write for a list of suppliers. Plastics Department, Pennsalt Chemicals Corporation, 3 Penn Center, Philadelphia, Pa. 19102.

***Kynar...the fluoroplastic that's tough!***

\*Kynar is a registered trademark of Pennsalt Chemicals Corporation for its vinylidene fluoride resin.



CHEMICALS EQUIPMENT

## MENT

ith strong  
terest in  
physical  
asis is on  
of solids  
sical, elec-  
and elec-  
e similar  
ellent re-  
available.  
esign and  
histicated  
is the pro-  
results as  
asic, solid-  
tives. Ad-  
ed. Recent  
onsidered.

## ATORY

to take  
te labora-  
a service  
id applied  
Requires  
and close,  
th princi-  
dern labo-  
ves vacuum  
ies, diffu-  
ful growing  
quipment.  
rge from  
and x-ray  
electro-  
rt instru-  
beck, and  
icant must  
ar with a  
the avail-  
anced de-  
experience

electrical  
nents and  
ledge of  
onversion,  
magnetic  
Must have  
orque mot-  
otentiom-

AL  
stable plat-  
will require  
ge of dy-  
alysis. The  
clude con-  
rk at the  
erience in  
of instru-  
c motors,  
ros is de-

alysis, and  
frequency  
or missile  
e work in-  
art tech-  
d circuits  
ier design.  
of carrier  
gn is de-

gn to im-  
sfer func-  
ploy inte-  
associated  
nponents.  
del of de-  
parametric

## DESIGN

### MECHANICAL

Perform mechanical design to include airframe, mechanisms, lightweight structures design and preliminary stress, dynamic and thermo analyses. Perform design and development of electro-mechanical or hydraulics or pneumatic actuators and seeker platforms. To include the design of actuators, the analytical synthesis, test evaluation, driving circuits, and the design release.

Provide engineering support to the production factory in regard to design investigation, layout, dimensional analysis and changes to mechanical structures, airframe and aerodynamics services in order to meet specifications, facilitate production, increase reliability or reduce cost.

### ELECTRICAL

Design and develop electrical power system components and sub-systems. Knowledge of electrical energy conversion, transistor circuit and magnetic devices is required. Must have basic knowledge of torque motors, drive motors, potentiometers and batteries.

### ELECTRO-MECHANICAL

Design and develop stable platforms. Design tasks will require a thorough knowledge of dynamics and vector analysis. The design tasks also include considerable design work at the drafting board. Experience in the design and use of instruments, small electric motors, ball bearings and gyros is desired.

### ELECTRONICS

Perform design, analysis, and evaluation of low frequency electronic circuits for missile guidance systems. The work involves state of the art techniques in integrated circuits and low noise amplifier design. A general knowledge of carrier servomechanism design is desired.

Perform circuit design to implement existing transfer functions. Design to employ integrated circuits and associated microminiature components. Derive analytical model of design and perform parametric analysis using a digital computer program. Plan the testing necessary to assure design adequacy.

Design of electrical circuits employing transistors, integrated circuits, and logic networks. Requires ability to analyze circuits and to be familiar with hardware. Will work with low frequency and DC in RED-EYE launcher electronics area.

Design of precision instruments involving bearings, gears, electro-mechanical sensors, magnetic transducers, and rotating gyroscopic elements. Will require analytical as well as detailed parts design experience.

## COMPUTER DESIGN

Provide technical leadership for computer development projects aimed at upgrading the hybrid and analog simulation and computing capability at GD/P. Requires experience in digital circuit and systems design, computer programming, and analog hardware development.

## PROGRAMMING

Computer programmer to work on missile simulation, war games and real time control problems.

## DYNAMICS

Conduct analytical and computer studies leading to the design of control surface servos, tracking antenna systems and guided missile autopilots. Linear control system techniques as well as modern control theory technology will be utilized along with both analog and digital simulations. The programs involved include advanced anti-ICBM studies and air-to-ground missile systems.

## FLIGHT ANALYSIS

Provide technical plans for missile flight tests. Consult as engineering member of missile firing team, submit detailed analysis of flight results. Analysis tools used include: analog and digital computers, telemetry data processing facilities and film viewing equipment. This offers travel to various test sites inside and outside the U.S.

## FLIGHT TEST

Direct flight test planning, operations, and reporting for a total missile project. Perform liaison with Project Office, design groups, test base, and other agencies in accomplishment of the test program.

Experience in planning and directing preparation and flight test of an assigned missile. Should be familiar with telemetry systems, test range instrumentation, radar and fire control systems. Should have good electronic background. Experience with homing systems desirable but not mandatory.

## RELIABILITY/ MAINTAINABILITY ENGINEER

Develop reliability predictions and goals, perform failure analysis, assessment and reliability studies. Monitor reliability program activities.

## MICROWAVE COMPONENTS

Perform microwave design. System and component design experience in the solid-state areas such as mixers, modulators, oscillators, multipliers, switchers and small r.f. pre-amplifiers is mandatory. Strip line experience is desired.

## ANTENNA AND RADOMES

Design and development of microwave antennas and radomes. Must have good practical R & D background and capability to do theoretical analysis and synthesis of the devices.

## INSTRUMENTATION

### R.F. CIRCUIT DESIGN

Analyze design and evaluate R.F. circuits employing solid-state components. Circuits will include VHF discriminators, oscillators, mixers, power amplifiers and frequency multipliers. Design experience on related circuitry is desirable.

### INSTRUMENTATION

Perform systems design and evaluation of FM/FM telemetry and related instrumentation. Must be familiar with transmitter and sub-carrier oscillator characteristics

### CIRCUIT DESIGN

Analyze, design and evaluate circuits employing solid-state components. Circuits will include voltage regulators, ultra-stable multi-vibrators, logic circuits, pulse and video amplifiers.

## SYSTEMS ENGINEERING

Conduct studies to determine requirements of missile systems and sub-systems. Analyze performance and optimize parameter distribution. Conduct studies to insure optimal mechanical and electrical interfaces.

## PUBLICATIONS ENGINEERING

Excellent openings in our technical publications department for young electrical engineers interested in system analysis and who are capable of converting engineering data to information which can be assimilated by military users. Publications engineering is involved in all major programs of the division and affords an excellent opportunity for personal growth and development. Publications assignments now available include semiactive and IR missiles, complex weapon systems, and digital test equipment.

## PHYSICS PHYSICAL

Require p  
backgroun  
modern n  
measurem  
the basic  
including e  
tro-optical  
tron spin  
characteri-  
search fac  
Position c  
performan  
experimen  
fessional e  
an integra  
state rese  
vanced deg  
graduates

## SOLID-STATE

Require  
charge of  
tory which  
function t  
research  
technical  
scientific  
pal investi-  
ratory inc  
and sputte  
sion furna  
and zone  
Analysis  
electronmi  
equipmen  
physical r  
ments as  
NMR facil  
be intima  
substantia  
able equip  
gree or e  
required.

## ELECTRIC

Design an  
power sys  
sub-syste  
electrical  
transistor  
devices is  
basic know  
tors, drive  
eters and

## ELECTRO-

Design and  
forms. De-  
a thoroug  
namics an-  
design tas  
siderable  
drafting t  
the design  
ments, sn  
ball beari  
sired.

## ELECTRON

Perform c  
evaluation  
electronic  
guidance  
solves sta  
niques in  
and low n  
A general  
servomech  
sired.  
Perform c  
plement e-  
tions. Des  
grated cir  
micromin  
analysis

# WE'RE SURROUNDED



# BY OPPORTUNITIES

For interview - Please call collect  
(714) NA. 9-5153

—Interviews—  
Daily 8 to 4:30  
OR

Send resume to

**Lou Cecchi**

Engineering Personnel Manager

Dept. EW

P.O. Box 2507

Pomona, Calif. 91766

An Equal Opportunity Employer

**GENERAL DYNAMICS**

*Pomona Division*



We'd manufacture the best connectors in the business. Only Deutsch got there first.

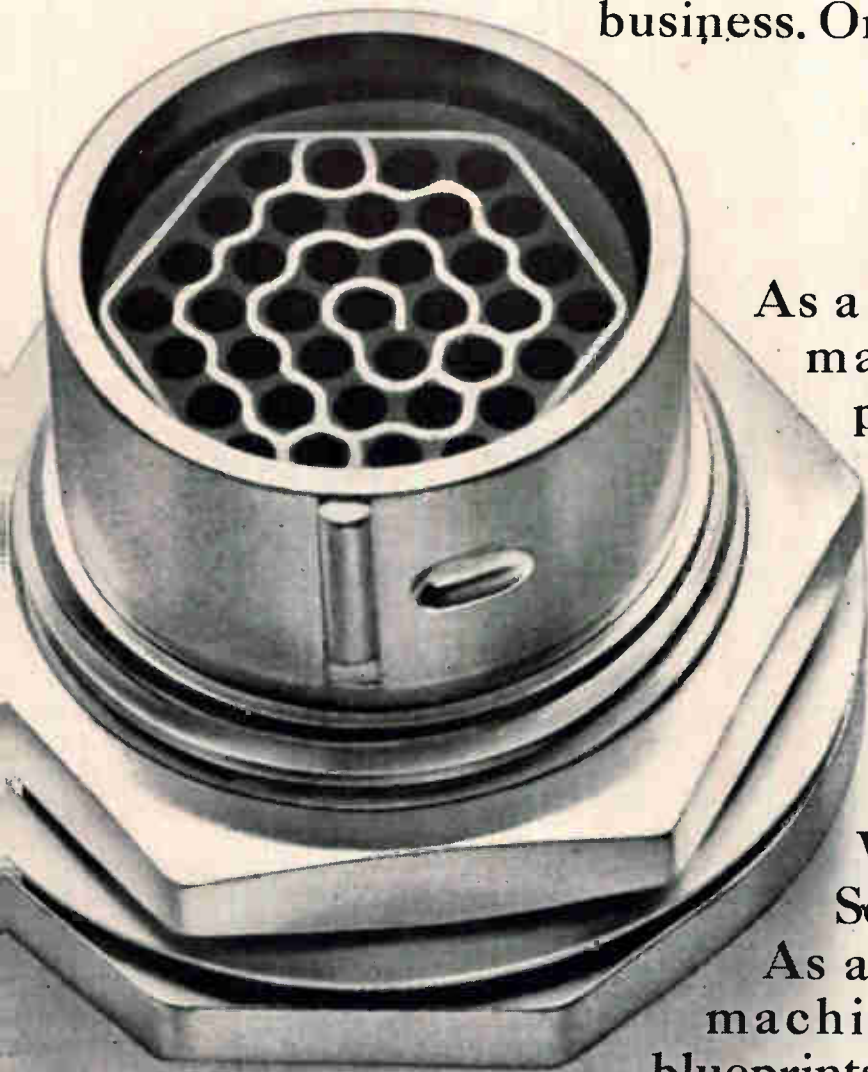

As a manufacturer, we'd like to make the top line in every product category we enter.

Yet there are some lines so good we just couldn't better them.

It's lucky that we're also a distributor.

Take connectors.

Deutsch makes the best.

We couldn't make better.

So we sell Deutsch.

As a manufacturer, we have the machines, tools, components, blueprints and factory-trained people to assemble and test Deutsch connectors with the same care and precision Deutsch uses.

And as a distributor, we're ready to ship them to you as fast as you need them. Three pieces or three hundred.

You benefit because Arco is a distributor.

And you benefit because Arco is a manufacturer.

DIVIDED WE STAND.

**Arco Electronics**  
A Division of Loral Corporation  
Community Drive, Great Neck, N. Y.  
Dallas, Texas, Pasadena, California,  
Menlo Park, California.



# CTC

CONTROLLED TEMPERATURE CHARACTERISTIC

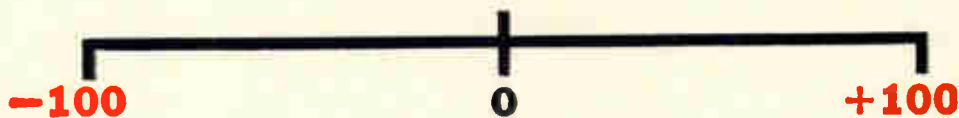

## IRC metal film resistors with any specified TC between -100 and +100ppm

Now, IRC announces Controlled Temperature Characteristic—a new line of precision metal film resistors available with any specified TC between -100 and +100ppm,  $\pm 5$ ppm.





New CTC resistors offer fast rise times, negligible inductance and capacitance, and superior reliability . . . especially at higher resistance values. They replace wirewound resistors with significant space and cost savings.

Previously available only as a costly "lab" item or "special," IRC offers delivery at a price that makes them practical for temperature compensating in analog computers and delicate sensing instruments. Write for data and prices. IRC, Inc., 401 N. Broad St., Philadelphia, Pa. 19108.

### CAPSULE SPECIFICATIONS

	
SIZE	RN65
TC	Any TC between -100 and +100ppm, $\pm 5$ ppm
TEMP. SPAN	Any 50°C increment between -55°C and 165°C
POWER	$\frac{1}{4}$ -W@125°C, $\frac{1}{2}$ -W@70°C
RESISTANCE	50 $\Omega$ to 1 meg $\Omega$
STD. TOLERANCES	0.1, 0.05, 0.025%

### INDUSTRY'S LARGEST SELECTION OF METAL FILM RESISTORS

 <p><b>ASSURED RELIABILITY METAL FILM</b></p> <p>An industry first. 0.1, 0.01 or 0.001% levels. 1/20 to 2 watts. 20 ohms to 1 meg. <math>\pm 25</math>, 50 and 100ppm. 0.25, 0.5 and 1% tolerances.</p>	 <p><b>HIGH STABILITY METAL FILM</b></p> <p>Molded and coated types, including microminiature, 1/10 to 2 watts. 30 ohms to 10 meg. 8 TC's from <math>\pm 25</math>ppm. Tolerances from 0.05%.</p>	 <p><b>ECONOMICAL METAL FILM</b></p> <p>Molded and coated types for MIL-R-10509. TC guaranteed to within 100ppm. 1/10 to 2 watts, 10 ohms to 10 meg. 0.5 and 1% tolerances.</p>	 <p><b>DEPOSITED CARBON FILM</b></p> <p>Molded types from <math>\frac{1}{8}</math> to 2 watts, coated types from <math>\frac{1}{2}</math> to 2 watts. 10 ohms to 1 meg. 0.5, 1 and 2% tolerances. MIL-R-10509.</p>
---	--	--	---



# Gunn-effect oscillator makes its debut

Gallium-arsenide Gunn-effect oscillator generates tens of milliwatts of c-w power and pulses up to 100 watts at microwave frequencies

A much heralded and debated semiconductor oscillator is on the market—three years after the first device was built by J. D. Gunn. International Semiconductor Inc., of Newburyport, Mass., claims to be the first to offer the oscillator commercially, beating out larger companies that have invested heavily in Gunn-effect research [Electronics, Feb. 21, 1966, p. 146].

"The device is still in the pilot-line stage", says Daniel Shea, vice president for engineering. "We were making gallium-arsenide devices and the Gunn-effect oscillator looked like a good product. It did not require much of a change in the techniques that we were using."

The company's Gunn-effect oscillator generates a maximum of 50 to 70 milliwatts of continuous wave power at frequencies around 2 to 3 gigahertz when operated at room temperature. When operated at low duty cycles of about 2%, the unit generates pulses with a peak power of 100 watts.

Although tests haven't been completed, the company expects the oscillator to deliver 20 to 30 mw at 10 Ghz. At 2 to 3 Ghz, input voltages for pulse or c-w operation range from 15 to 30 volts; the efficiency in converting d-c power to d-c radio frequency power is 5%.

Shea believes the Gunn-effect oscillator can substitute for reflex klystrons as local oscillators in both S-band and X-band radars. By building Gunn-effect oscillators for these frequencies, Shea says, "We feel we were shooting for the bulk of the market."

He explains that power outputs are suitable for this application and the d-c power supplies can be smaller.

Another advantage over the reflex klystron, he says, is that Gunn-effect oscillators generate frequencies relatively free of random

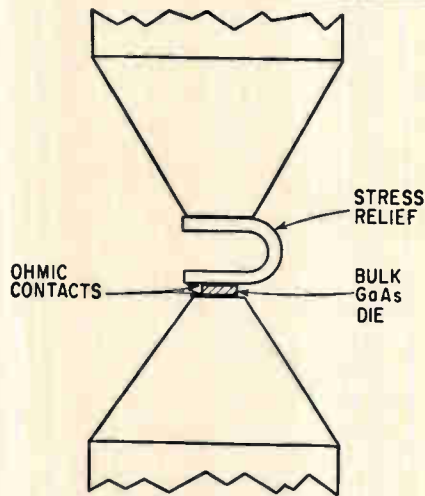
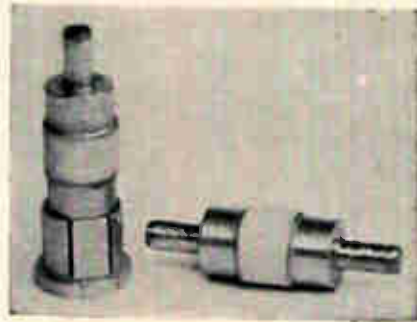

Gunn oscillator package size is that of an 1N23 diode. Internal view of package shows GaAs die connected between two ohmic contacts.

modulation and consequently have better spectral purity. This can be an advantage in doppler radars. In the 2- to 3-Ghz region, the Gunn-effect oscillator's line width is about 1 kilohertz.

In contrast to transistors, varactors and tunnel diodes, a Gunn-effect device uses a thin wafer of uniform material with no junctions. International Semiconductor uses a thin die of gallium arsenide (GaAs) about 2-mils (0.002 inch) thick and 6-mils square. A terminal is attached to either side of the thin section as illustrated. The packaged device is about 3/4 inch long and 1/4 inch in diameter.

To use the device, the microwave cartridge containing the

GaAs die is placed in a resonant cavity and tuned to the desired operating frequency. A standard microwave detector mount that can accept a 1N23 diode connects it across the waveguide. A tunable section in the waveguide matches the device to the load.

Oscillations occur when the applied voltage raises the d-c electric field beyond 3,000 volts per centimeter. However, the input voltage required to establish the field depends on the thickness of the GaAs. Shea says that chemical etching techniques permit thickness to be held with 1.8 to 2.2 mils, accounting for the range of input voltages the company specifies. The 6-mil dimensions are carefully controlled to maintain a small area and therefore control series resistance. The GaAs is lightly doped so that series resistance ranges from 20 to 50 ohms. This facilitates matching to waveguide and reduces d-c current requirements.

Compared with transistors or tunnel diodes, Gunn-effect devices have higher power outputs at higher frequencies. In the 2- to 3-Ghz region the power is about 5 to 10 times above a tunnel diode's.

The thinner the gallium arsenide the higher the operating frequencies. To get a thin layer of material for operation above 10 Ghz, Shea says it is necessary to use epitaxial layers of GaAs rather than the conventional bulk material. International Semiconductor plans to produce such units.

## Specifications

Type	ISX-3400 Gunn-effect oscillator
Frequency for peak power	2-3 Ghz
D-c voltage input	14-30v
Operating temperature	25°C
Delivery	2 to 5 weeks
Price	\$175

International Semiconductor, Inc., 1 Charles St., Post Office Box 569, Newburyport, Mass.

Circle 350 on reader service card

Honeywell's new gold-tab plating tank uses Engelhard E-70 Bright Gold Process.

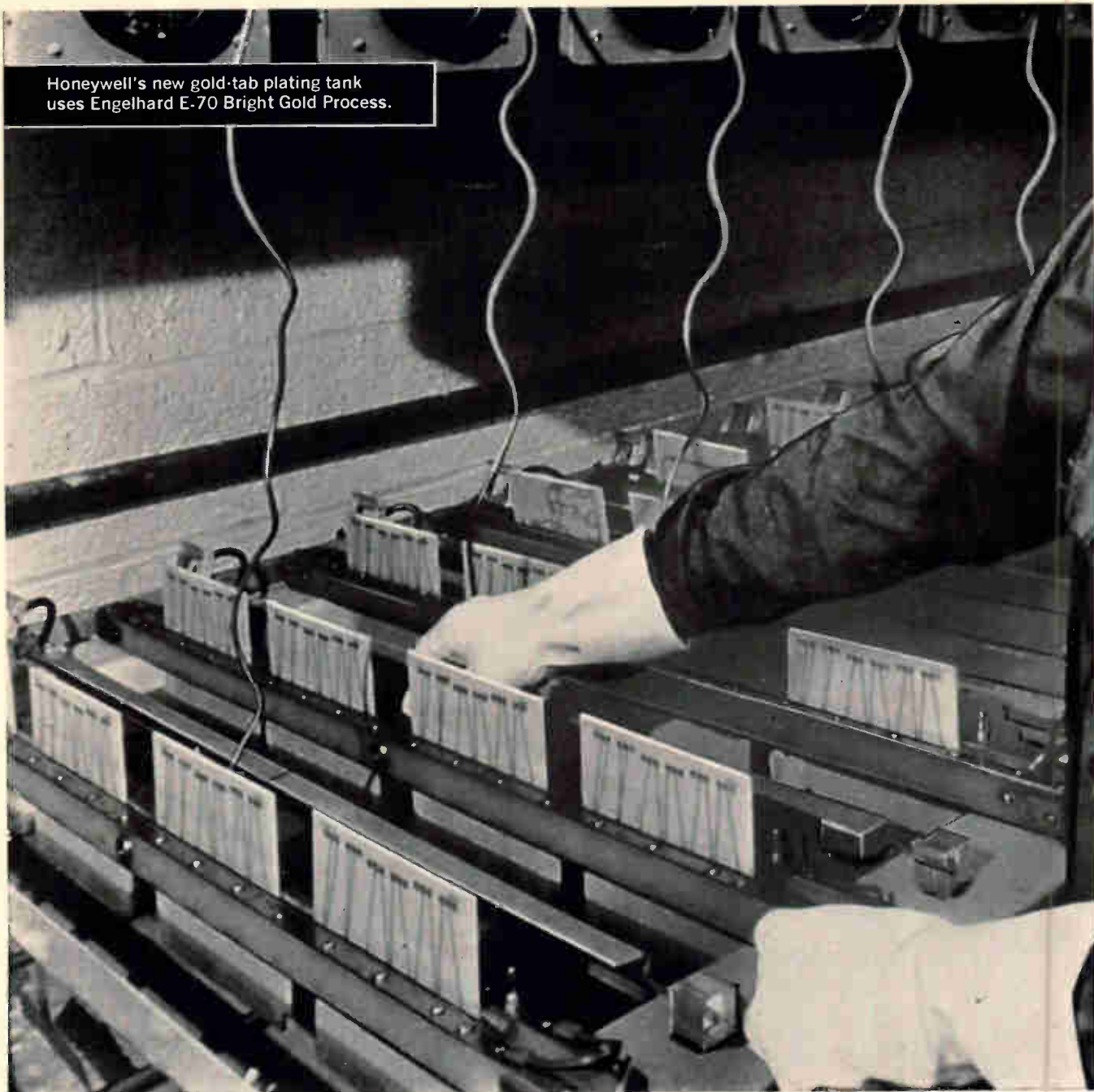

## **ENGELHARD** E-70 Bright Gold Process helps Honeywell meet high demand for computer equipment...

Engelhard's E-70 Bright Gold Process helped Honeywell solve a problem: How to produce more printed circuit boards for fast-selling Honeywell Series 200 computer equipment, without sacrificing rigid specifications. The solution is a new large scale, in-plant, gold-tab plating operation. A specially designed thickness-control system and Engelhard's E-70 both play vital roles.

This new operation utilizes speed and consistency of deposit to keep plating costs low. Individual current-time monitors, at each station, automatically open circuits, when the precise gold plating thickness has been obtained. The 23+ K surface has relatively low stress

... incredibly fine grain structure ... hardness of 100+ Knoop.

E-70 is valuable in many other commercial, industrial or military applications. It adapts easily for processing connectors, contacts, diodes, switches, relays, glass and ceramics. It meets Military Specification MIL-45204 for abrasion and wear resistance... does not adversely affect copper laminates or photo resists... has unlimited decorative applications.

For complete information on E-70 Bright Gold Process, write on your company letterhead, without obligation, to our Technical Service Department.

Some other

## ENGELHARD

products

**NEW PLATINIZED TITANIUM ANODES** make excellent primary anodes for both gold and rhodium plating, or auxiliary anodes for base metal plating.

**SILVER ANODES** are extruded and scientifically-shaped to retain 80% of original active surface area after 85% by weight has been plated off! Costs are cut by longer life, minimized polarization and reduction of silver scrap. Grain size is controlled within definite, ideal limits to provide smooth, uniform corrosion. Shedding is virtually eliminated. Rejects are a comparative rarity.

**WIRE AND TUBING** of noble metals and alloys are produced to exacting design requirements. Critical tolerances are maintained on wire from .004" diameter. Tube sizes range from .01" dia. with .004" wall to 1½" dia. with .042" wall. Standard items are stocked for prompt shipment.

**LIQUID GOLD** produces an excellent heat barrier when applied to metals and other surfaces. Solutions are easy to use. Resulting metallic films are highly efficient reflectors of infra-red, often permit important weight reduction of substrate materials.

**CLAD PRECIOUS METAL WIRE** is an excellent conductor of electricity that is highly corrosion resistant. Additionally, it may be easily soldered. This wire may be furnished annealed or tempered, in a wide variety of shapes.

**LAMINATED CONTACT MATERIALS** are produced in virtually any combination of precious metals and alloys with base metals and alloys. Types include edge, strip, inlay, spot, single or double-face laminations. Supplied in flat lengths, in strip, coil or fabricated forms.

**PRECIOUS METAL RECOVERY** yields high returns from spent metal catalysts and industrial residues. Engelhard assures highest purchase prices or will return recovered metals if you wish. Our modern and complete facilities are backed by an experienced technical service group.



## New Components and Hardware

### Graduated scales ease squeeze



**Compact expanded scales**, printed on tapes, help to solve the panel space squeeze and improve scale accuracy and readability. The graduated scale modules measure only 7/8 x 1½ x 1¾ in. but can provide from one to four scales each having over 20 in. of useful readout length. The module's transparent face plate is designed for edge lighting. In comparison, a graduated circular disk would have to be over 6 in. in diameter to provide a scale length and accuracy equivalent to one of the four tapes in a modular unit.

For example, two prestressed printed tapes provide radio-frequency information for tuning. One tape indicates megahertz and the other is a vernier adjustment readout. Similar modules can be designed and made to specific requirements. Four tapes could be accommodated in the same package by using concentric shafts. The printed tapes are lightly prestressed Neg'ator springs which are self-adjusting and require no external anti-backlash or tensioning mechanism.

▪ To be introduced at Wescon. Hunter Spring division of Ametek, Inc., Hatfield, Pa. [351]

### Small filters build bigger ones

Three-pole, active, elliptic low-pass filters in the LN300 series meet the general specifications of MIL-F-18327-B. The stable, low-noise units are expected to find wide use as filter building blocks.

The filters may be used singly,

in cascade or in parallel. Optimum results occur when an emitter follower drives them. Modular in construction, they require only approximately 1 cu in., and will accommodate a wide range of terminating impedances.

The relatively small noise these units introduce suits them for low-frequency applications such as sonar, oceanography, seismology, speech-spectrum analysis and other l-f usage where data analysis, pulse shaping, noise reduction and similar functions are performed. This is especially true where a wide, dynamic signal range (in excess of 90 db) is of value.

Output noise (input shorted) is 10 μv rms typical (actual noise depends on frequency and type of filter and will not exceed 50 μv rms in any type); insertion loss, 2 db ±0.5 db. Power supply is ±12 v d-c ±5% regulation at ±15 ma maximum; maximum output signal linear range, ±0.5 v peak, 10,000 ohms load. Operating temperature is 0°C to 70°C; storage temperature, -30°C to +95°C.

▪ To be introduced at Wescon. Guillemin Networks, Inc., 170 Brookline Ave., Boston, Mass., 02215. [352]

### Slide switches come in 8 basic series

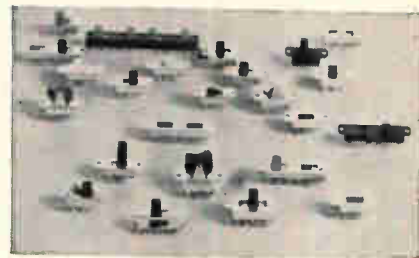

A line of double-wipe slide switches breaks down into eight basic series, including general purpose, tandem, rocker and miniature. Contact and switching parts of all series in the line contain bifurcated type sliders of silver-plated brass that provide continuous wiping action on mating silver-plated brass contacts.

Contact ratings are 0.5 amp, 125 v a-c/v d-c; 3 amps a-c only. A wide variety of switches with single and multiple poles and throws are

# 21

**MATTER-OF-FACT**

**REASONS  
WHY...**

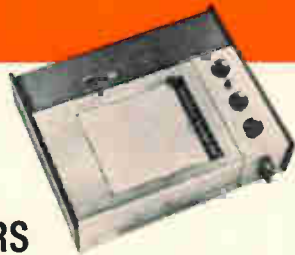

## BAUSCH & LOMB V.O.M. RECORDERS ASSURE YOU OUTSTANDING PERFORMANCE

1. Directly measure and record d-c voltage, current and resistance
2. Five built-in variable chart speeds
3. Built-in event marker
4. 17 different input ranges
5. Zener diode reference supply
6. High off-balance input impedance
7. Can be used in three positions—flat on bench, at a 30° tilt or wall mounted
8. Photoelectric modulator
9. Full scale zero set—anywhere on chart span
10. Floating input with separate chassis ground
11. Built-in 100' take-up reel
12. Modular assembly and plug-in connections for rapid access service and maintenance
13. Serve as accurate vacuum tube voltmeters in measure position
14. Lightweight and portable
15. All calibration adjustments made without disassembling units
16. Zener diode d-c supply for ohms scale
17. Adjustable damping
18. Efficient pen design
19. Low cost, high quality chart paper
20. Backed by years of experience in engineering sophisticated electronic circuitry
21. An entire division is devoted exclusively to the development and production of electronic products

Bausch & Lomb V.O.M. Recorders are available in a variety of models with different full scale sensitivity. We have a wide range of accessories that make our recorders equal to just about any task required. For your special needs, we have the capability of designing customized recorders . . . modified to handle whatever applications you have in mind. Let us hear about your recorder requirements. Write for Catalog 37-2068. Better yet, ask for a personal demonstration. Bausch & Lomb, 62332 Bausch Street, Rochester, New York 14602.

**BAUSCH & LOMB**

ELECTRONICS DIVISION

VISIT OUR BOOTH #112 AT THE WESCON SHOW, LOS ANGELES, AUG. 23-26

## New Components

available from stock.

Switch housings are rugged, one-piece, cadmium-plated cold-rolled steel. Additional finishes can be obtained where quantities warrant special handling. Standard mountings have 0.140-in. holes on switch housings. Extruded and tapped mounting holes in a variety of sizes are also available.

Standard terminals are silver-plated brass. Gold-flashed terminals can be gotten on special order. Standard  $\frac{5}{16}$ -in. terminal blades have  $\frac{5}{64}$ -in. hole and side notches for through-the-terminal or wrap-around wiring connections. Many switches in the line can be purchased with terminals for mounting on printed circuit boards.

Prices on double-wipe slide switches range from 5 cents and up, depending upon quantity and design specifications. Standard models are in stock.

▪ To be introduced at Wescon. Switchcraft, Inc., 5555 North Elston Ave., Chicago, Ill., 60630. [353]

## Tiny relay operates at high speed



A mercury-wetted contact relay for p-c board applications occupies only 0.332 cu in. of space. Type HGSR high-speed relay provides two sensitivity ratings—40 mw single-side stable and 20 mw bi-stable.

Either Form D (bridging) or Form C (non bridging) contacts are available. The contacts can handle power switching requirements from extremely low level to 100 v-a, a-c or d-c, in billions of operations. The HGSR has a contact circuit resistance of 20 milliohms maximum, and a nominal operate time of 1.0 msec at maximum coil power.

The relay is suitable for both

**KLYSTRONS**

Reflex  
CW Amplifiers  
Pulse Amplifiers

**MAGNETRONS**

Conventional  
CEM/ICEM  
Voltage Tunable

**CROSSED FIELD AMPLIFIERS**

**POWER GRID TUBES**

Rectifiers  
Triodes  
Tetrodes  
Pentodes

**TRAVELING WAVE TUBES**

Low-noise  
CW  
Multi-Megawatt

**BACKWARD WAVE OSCILLATORS**

**NOISE SOURCES**

**CERAMIC SEALS**

**GAS SWITCHING TUBES**

TR's, ATR's, and pre-TR's  
Thyratrons  
Ignitrons

**CAVITIES**

Stabilizing  
Oscillator  
Amplifier

**MIXERS AND MODULATORS**

**MIXER-PREAMPLIFIERS**

**THERMAL AND VACUUM SWITCHES**

**I-F CIRCUITS AND COMPONENTS**

**STRIP TRANSMISSION LINE  
COMPONENTS**

**SOLID STATE PRODUCTS**

Varactor Diodes  
Power Sources  
Frequency Multipliers  
Silicon Controlled Rectifiers

**INDUSTRIAL PROCESSING  
EQUIPMENT**

**AEROSPACE COMPONENTS**

**HYBRID AMPLIFIERS**

Twystrons®

**CUSTOM ELECTRONIC PACKAGES**

**POWER SUPPLIES**

**FILTERS AND WATER LOADS**

**MICROWAVE PLUMBING**

**READOUT TUBES**



Again...  
years-ahead  
developments  
from

**varian**  
electron tube  
and device group

Booths  
1349-50-51-52-53  
54-55-56-57-58

**WESCON/66**

Sports Arena

# hipololo \*

## New Components

commercial and military electronic systems. For example, the complete freedom from contact bounce, isolation between coil and contacts and high speed make it an excellent input buffer to solid state circuitry. Or, for use as an output buffer, low power logic circuitry can drive it with an input to output power gain of up to 5,000.

As scanner contacts in checkout systems, this relay can stand off a hi-pot voltage of 1,000 v a-c and, at the same time, offer a contact resistance consistent to within  $\pm 2$  milliohms of initial value over life for critical resistance measuring circuits. High speed and no bounce, combined with low contact noise generation, recommend it for tape transport read-write head switching.

▪ To be introduced at Wescon. C.P. Clare & Co., 3101 Pratt Blvd., Chicago, Ill., 60645 [354]

## Small capacitors fit circuit needs

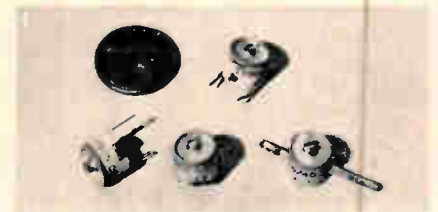

The Stangard DV01 series disk ceramic trimmer capacitors are very small units possessing the physical and electrical characteristics needed for integrated and hybrid circuits. The manufacturer reports that the volumetric efficiency is high and stability excellent.

The capacitors are intended for commercial and industrial applications such as in broadcast and tv receivers, test equipment and communications equipment. However, the capacitors meet or exceed requirements of MIL-C-81A.

Eight Delta C ranges are available: 2 to 8, 2.5 to 11, 3 to 10, 3 to 15, 5.5 to 18, 7 to 25, 8 to 25, and 9 to 35 pf. This capacitance range covers 180°. Provisions exist for screw-driver adjustment from either side of the capacitors.

Q factor is a minimum of 500 at

\*Our way of getting across the remarkable **high power, low loss** characteristics of Phelps Dodge Electronics Helical Membrane cable.

Semiflexible and aluminum sheathed, Helical Membrane is constructed with a copper inner conductor; solid in smaller diameters, a tube in larger diameters; supported in an aluminum jacket by a thin polyethylene helix. Here's a cable that offers not only simple construction, but no radiation, uniform electrical properties and operational capability within wide temperature and frequency variations and practically unlimited operating life.

If you're in the market for a high power, low loss coaxial cable, specially developed for low attenuation, high velocity of propagation, real power handling capability and excellent uniformity, specify Helical Membrane. Available, from stock, in 1/2", 7/8", 1 1/8" diameters, 50 ohm impedance in 1000' reels, custom cut lengths, or specially fabricated assemblies.

Want to know more? Write for Bulletin HM, Issue 1.

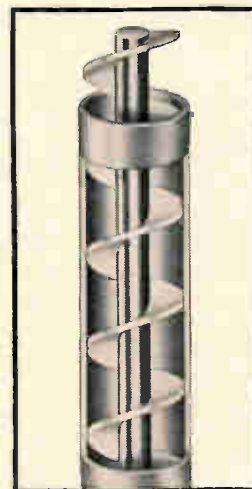

**PHELPS DODGE** ELECTRONIC PRODUCTS  
NORTH HAVEN, CONNECTICUT







The World's Most Complete Line of...

# PRECISION TRIMMER CAPACITORS

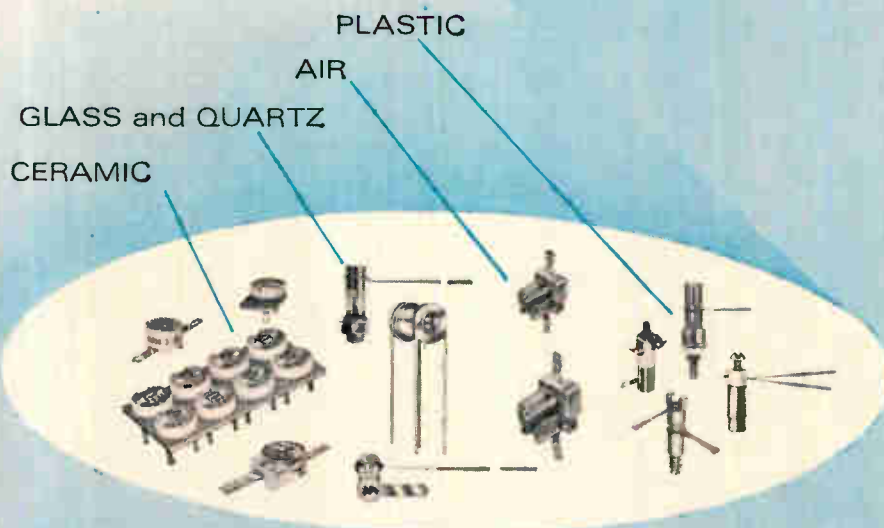

## MINIATURIZED ERIE TRIMMER CAPACITORS FOR PRINTED CIRCUIT BOARD... OR PANEL MOUNT APPLICATIONS—MILITARY OR COMMERCIAL TYPES

When knowledgeable engineers discuss quality Precision Trimmer Capacitors... ERIE is the name most often mentioned as the best single-source in the industry.

Today, miniaturized ERIE Trimmer Capacitors are available in a wide selection of dielectrics for virtually any circuit application... Ceramic, Glass, Quartz, Air and Plastic.

For more than 20 years ERIE has earned an enviable reputation for quality components. Quality, however, is a by-product of experience and advanced engineering capability. At ERIE, Precision Trimmer Capacitors are smaller than ever with better than ever quality.

If you have a specific Trimmer Capacitor problem... we suggest ERIE as your one-stop source. One of our standard units will probably fulfill your requirements. If not, our Trimmer Engineering Department will welcome the opportunity to discuss your circuit needs.

Write TODAY for new Precision Trimmer Capacitor catalog.

Another Series of Components in Erie's Project "ACTIVE"  
Advanced Components Through Increased Volumetric Efficiency

ERIE

TECHNOLOGICAL

PRODUCTS, INC.



Formerly  
Erie Resistor  
Corporation

Erie, Pennsylvania

# Get immediate delivery on Vector 2N3866 and 2N4012 RF power transistors

Vector's 2N3866 NPN silicon power transistor is available now in production quantities. This unit can also be ordered in a TO-18 alumina channel or stripline package.

Also, Vector's new 2N4012 transistor is in stock for immediate delivery in quantities up to 1,000 units. The 2N4012 features a JEDEC TO-60 package with isolated electrodes, and stud mounting for maximum thermal capability.

Vector offers a wide range of RF power transistors with guaranteed performances as shown in this chart.

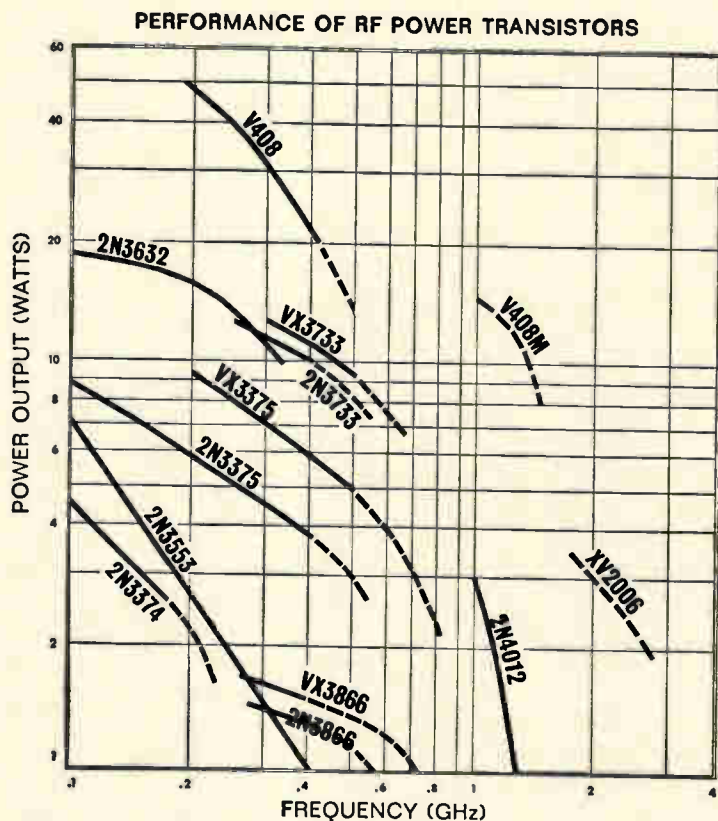

For additional information, price quotations, or immediate delivery, call Vector Solid State Laboratories (215) 355-2700. TWX 510-667-1717.

**Vector** DIVISION OF UNITED AIRCRAFT CORPORATION  
SOUTHAMPTON, PENNSYLVANIA 18966

**U  
A**

See us at Booths 1130-1132, Sports Arena, WESCON August 23-26.

## New Components

isolation of individual sections.

In the LCP-10, 11 or 12 types, two or more runs of aluminum or copper tubing are bonded with Delta Bond 152 in the channels with legs rolled over the tubing. The series LCP-20 offers two flat sides to which modules may be affixed; the four runs of tubing are imbedded between two  $\frac{3}{8}$ -in.-thick aluminum plates tied together with interlocking tongue-and-grooves. Compression, flair, brazed or sweat fittings can be installed. Availability of the LCP's is immediate in lengths up to 6 ft.

▪ To be introduced at Wescon. Wakefield Engineering, Inc., Wakefield, Mass., 01880. [356]

## Coaxial connectors offered in two versions

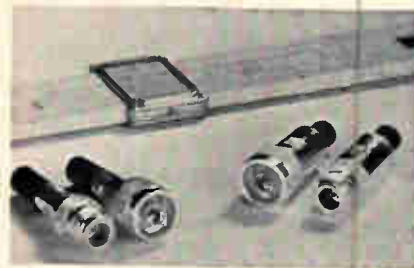

Type N coaxial connectors, electrically identical in both field-serviceable and crimp versions, enable design engineers to use the field-serviceable type for prototype equipment and for field replacement and the crimp unit for production. The connectors are said to be the first to meet MIL-C-39012 specifications.

The "N" units offer not only time and cost savings of crimp assembly (30 seconds versus 5 minutes or longer for a solder-type "N") but they also eliminate electronic problems involved in using a standard field-serviceable connector for breadboarding and then switching over to a crimp unit for production.

Impedance of the connectors is 50 ohms; voltage rating is 1,000 v rms; and specified frequency range extends up to 10 Ghz. Maximum vswr is 1.12:1. Cable retention exceeds the MIL-C-39012 specification requirement of 75 lbs. Reten-



The World's Most Complete Line of...

# PRECISION TRIMMER CAPACITORS

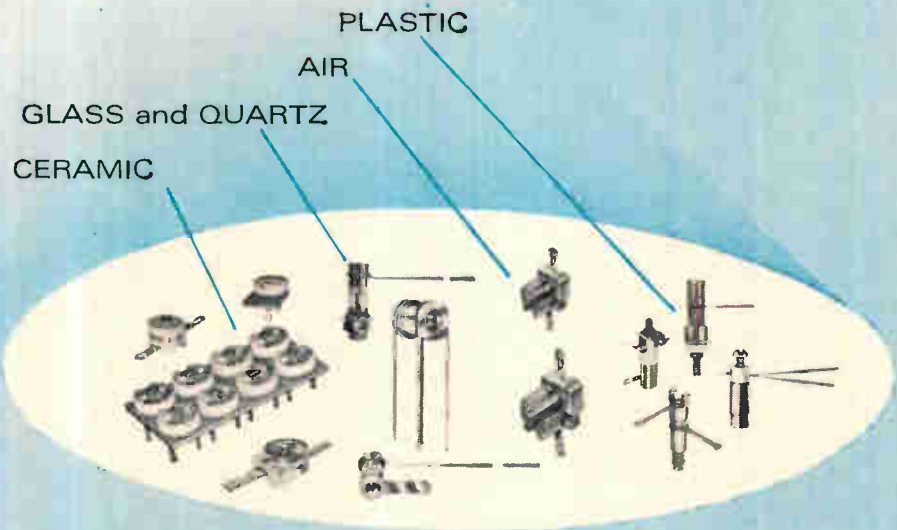

## MINIATURIZED ERIE TRIMMER CAPACITORS FOR PRINTED CIRCUIT BOARD... OR PANEL MOUNT APPLICATIONS—MILITARY OR COMMERCIAL TYPES

When knowledgeable engineers discuss quality Precision Trimmer Capacitors... ERIE is the name most often mentioned as the best single-source in the industry.

Today, miniaturized ERIE Trimmer Capacitors are available in a wide selection of dielectrics for virtually any circuit application... Ceramic, Glass, Quartz, Air and Plastic.

For more than 20 years ERIE has earned an enviable reputation for quality components. Quality, however, is a by-product of experience and advanced engineering capability. At ERIE, Precision Trimmer Capacitors are smaller than ever with better than ever quality.

If you have a specific Trimmer Capacitor problem... we suggest ERIE as your one-stop source. One of our standard units will probably fulfill your requirements. If not, our Trimmer Engineering Department will welcome the opportunity to discuss your circuit needs.

Write TODAY for new Precision Trimmer Capacitor catalog.

Another Series of Components in Erie's Project "ACTIVE"  
Advanced Components Through Increased Volumetric Efficiency

**ERIE**

**TECHNOLOGICAL**

**PRODUCTS, INC.**



Formerly  
Erie Resistor  
Corporation

Erie, Pennsylvania

# NEW TORQUE MOTOR DRIVER

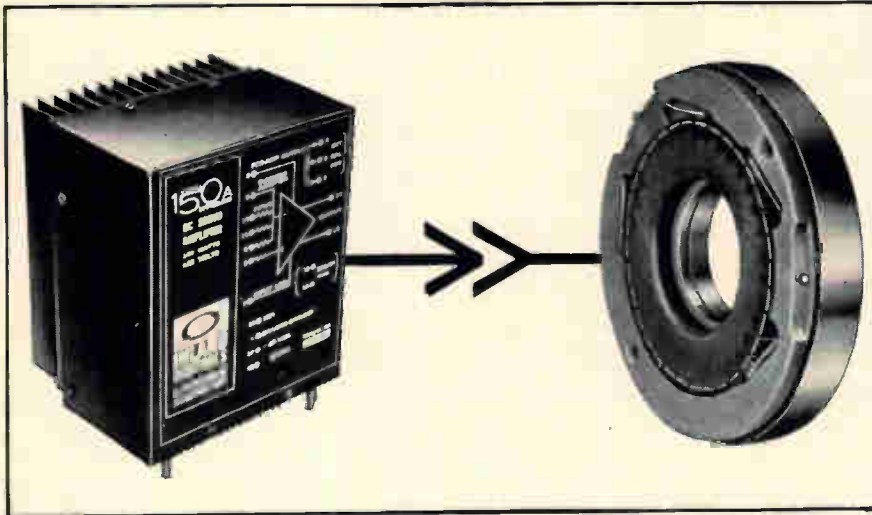

## Cut costs and time with off-the-shelf HYBAND DC Servo Power Amplifiers by INLAND

Inland Controls specializes in the design and manufacture of reversible polarity, wide bandwidth DC servo power amplifiers that help you:

- ELIMINATE design and development costs
- ACCELERATE delivery *schedules*
- AVOID motor/amplifier interface *problems*

Ranging from 50 watts to 3000 watts, these amplifiers, designed specifically for driving Inland Motor\* DC torque motors, are available in either compact modular design or standard rack-mounted design. Current-limiting, short-circuit protection, multiple summing inputs, high gain preamplifier, and provisions for servo compensation networks are built-in standard features of the HYBAND amplifiers.

To avoid your interface problem entirely, why not let Inland Controls supply guaranteed matching amplifiers, or complete amplifier and torque motor blocks? We can do this

and satisfy your most demanding needs. Don't let interface and transfer function problems get you down . . . call on the INLAND team and relax . . . our amplifiers offer proven and outstanding compatibility, reliability, and availability.

A Condensed Selection guide offering detailed information on the HYBAND amplifiers is available immediately and we will be happy to send you a copy.



*This Demonstrator Kit, designed to illustrate exactly how these amplifiers operate in a closed-loop servo, can be shown in your plant at your convenience. All it takes is a call or letter from you.*

*\*Inland Motor Corporation  
is also a subsidiary of Kollmorgen*



**INLAND  
CONTROLS**

A SUBSIDIARY OF  
**KOLLMORGEN**

342 WESTERN AVENUE • BOSTON, MASSACHUSETTS 02135  
Telephone: 617 254-0442 TWX: 710 330-0143

## New Components

1 Mhz, which makes the capacitors suitable in h-f applications where losses must be extremely low. Working voltage is 350 v d-c from  $-55^{\circ}$  to  $+85^{\circ}\text{C}$ , derated to 200 v d-c at  $+125^{\circ}\text{C}$ , for most of the DVO1 series; and 200 v d-c up to  $+85^{\circ}\text{C}$ , derated to 100 v d-c at  $+125^{\circ}\text{C}$ , for the balance of the series.

Typical physical dimensions, exclusive of leads, are 0.375 in. in diameter with a thickness of 0.330 in. Four styles of leads are offered: short, crimped p-c board leads; flat axial leads with wire holes; flat p-c board leads with wire holes; and crimped leads for right-angle mounting on p-c boards.

▪ To be introduced at Wescon. The JFD Electronics Co., 15th Ave. at 62nd St., Brooklyn, N.Y., 11219. [355]

## Plates cool high-power devices

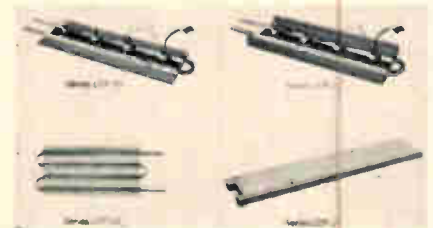

Series 10 and series 20 liquid-cooled plates can be used to mount most types of power transistors, rectifiers and controlled rectifiers using custom mounting holes.

Power dissipation in very high current rectification and regulation systems often reaches levels which make the LCP series units more desirable than the more conventional forced air systems, according to the manufacturer. Typical examples of such requirements are plating rectifiers, particle-accelerator magnet regulators and high-density computer packages.

The liquid-cooled plates may be considered an integral portion of the high current bus work and may be run at higher current densities than open uncooled busing. Using plastic or rubber hose for connection between the units and the coolant supply achieves electrical

when there are footsteps  
on the moon...

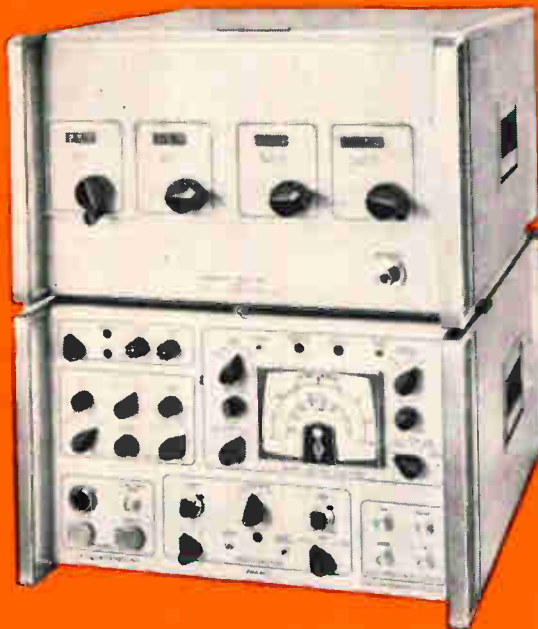

the

**NEW**

EMA-910 analyzer will still be

**THE STANDARD**

in 1 to 22 GHz EMI measurements

Model EMA-910 is the ultra-sensitive, automatic Noise and Field Intensity Analyzer designed with the features and performance characteristics to fulfill your present and future EMI measurement needs:

- Solid State reliability
- Sensitivity guaranteed to  $-100$  dbm
- Remote programming
- Sector sweep over any range with completely automatic band switching
- Four accurate bandwidths
- Internal impulse calibration
- 120 db case shielding
- 1 to 10 GHz and 1 to 22 GHz versions
- Compact
- Lightweight
- IMMEDIATE DELIVERY.

For detailed information, contact your local SINGER Instrumentation representative, or write to The Singer Company, Metrics Division, 915 Pembroke St., Bridgeport, Conn. Phone (203) 366-3201.

WESCON booths 414-416/439-441



EMPIRE • GERTSCH • PANORAMIC • SENSITIVE RESEARCH

**SINGER**  
INSTRUMENTATION

EMC Instrumentation Inc., A Subsidiary of THE SINGER COMPANY • Bridgeport, Connecticut • Los Angeles, California



**350 cfm performance  
from this new compact (7" SQUARE)**

# TARZAN FAN™



WITH NEW, PATENTED  
**aerodynamic design**

- Centrifugal blower performance in a compact axial flow fan
- Long maintenance-free life
- Designed to meet UL specifications (when thermally-protected)
- Five bladed air foil design propeller of polycarbonate-aluminum spider
- Fire retardant construction throughout
- Weighs only 5 pounds
- 60 cps performance on 50 cps (Model TN2)
- Ball bearings—lubricated for life

Here's another big design breakthrough from Rotron. Performance you'd only expect from a centrifugal blower but all the compactness and installation flexibility (reverse air flow just by turning fan around) you can only get from a fan. And naturally every ounce of the design and construction quality you expect from Rotron. If you need high volume cooling in tightly packed cabinets, card racks and the like, the TARZAN Fan may be the only sensible answer. Price is right, too. As low as \$23.50 in quantity. Write us for full details on performance and unique features of the TARZAN.

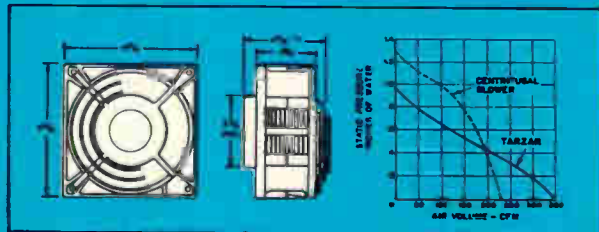
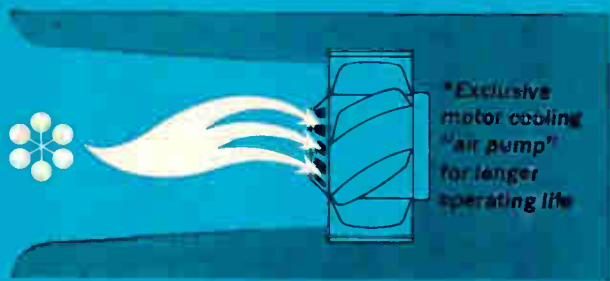

**ROTRON** mfg. co., inc.

WOODSTOCK, NEW YORK • ORiole 9-2401

West Coast: Rotron/Pacific, Glendale, Calif.  
Canada: Aerovox Canada Ltd., Hamilton, Ont.  
Rotron Europa (N.V.) Breda, The Netherlands

# HOW TO MAKE ENDS MEET

6.2834" is circumference of this  
2" dia. metal cylinder.



Blanks for your cylinders can be cut to a tolerance in thousandths on a Di-Acro shear. Close enough to make ends meet perfectly. To form your cylinders, the Di-Acro roller forms any diameter circle without flat spots — or straight sections at any point of the bend.

Want perfect holes punched in your cylinders, too? The Di-Acro Horn Punch does the job. Get full information from your distributor or write us for new catalog.



## DI-ACRO

A Division of Houdaille Industries, Inc.  
438 8th Ave., Lake City, Minn. 55041

## New Components

tion rating is equal to the strength of the cable braid, since the connector can only be pulled off by breaking the braid. Operating temperature is 200°C maximum.

Price in 100 quantity is 70 cents to \$2 per pair in crimp version. Field-serviceable units cost 10 to 20% higher.

Amphenol RF division of Amphenol Corp., 33 E. Franklin St., Danbury, Conn. [357]

## Transformer suits printed circuits

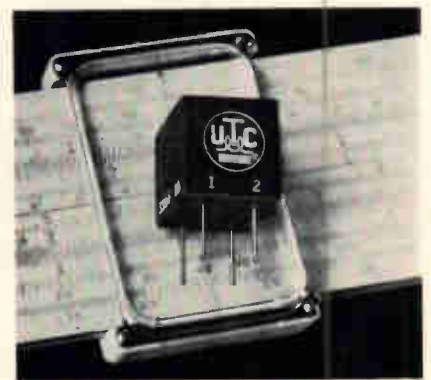

An input transformer has been designed, manufactured, and tested to MIL-T-27B specifications. It is a molded Grade 5 unit, MIL type TF5RX16ZZ.

Straight pin gold-plated terminals make it well suited for printed-circuit application. The unit measures  $\frac{1}{2} \times \frac{1}{2} \times \frac{1}{2}$  in. and weighs only  $\frac{1}{4}$  oz.

Primary impedance is 75 ohms; secondary impedance, 135 ohms; frequency range, 50 khz to 125 khz  $\pm \frac{1}{4}$  db; maximum level, 0 dbm.

▪ To be introduced at Wescon. United Transformer Corp., 150 Varick St., New York, N.Y., 10013. [358]

## Low-pass filters feature small size

A line of electromagnetic-interference / radio-frequency-interference low-pass filters is said to be the smallest ever offered to the industry. Type 1-VB-50 measures 0.16 in. in diameter by 0.34 in. long.

These filters have extremely high and smooth attenuation char-



# ONE MILLION OHMS PER VOLT



## V-O-M

### Model 630-M VOLT-OHM-MICROAMMETER

# \$200.00

Suggested U.S.A. user net

Triplet Model 630-M features the input impedance of a VTVM with the convenience of a V-O-M. The 630-M's sensitivity is derived from the singular achievement of its basic 0-1 D.C. microampere movement. The 630-M incorporates no amplifiers, no warm-up, and no power requirements. Model 630-M is a true V-O-M whose engineering excellence is based on 60 years of instrument manufacturing, and contains the top quality associated only with Triplet.



- 1** 1,000,000 ohms per volt D.C. for greater accuracy on high resistance circuits. 20,000 ohms per volt A.C.
- 2** 1 ua Suspension Meter Movement. No pivots, bearings, or rolling friction. Extremely rugged. Greater sensitivity and repeatability.
- 3** 61 ranges, usable with frequencies through 100KC. Temperature compensated. 1½% D.C. accuracy, 3% A.C. in horizontal position.

**TRIPLET ELECTRICAL INSTRUMENT COMPANY, BLUFFTON, OHIO**



MANUFACTURERS OF PANEL AND PORTABLE INSTRUMENTS; ELECTRICAL AND ELECTRONIC TEST EQUIPMENT

Zenith demands

*thin*

"SCOTCHPAR" IS A REG. TM. OF 3M CO.

Zenith power transformer for color TV.

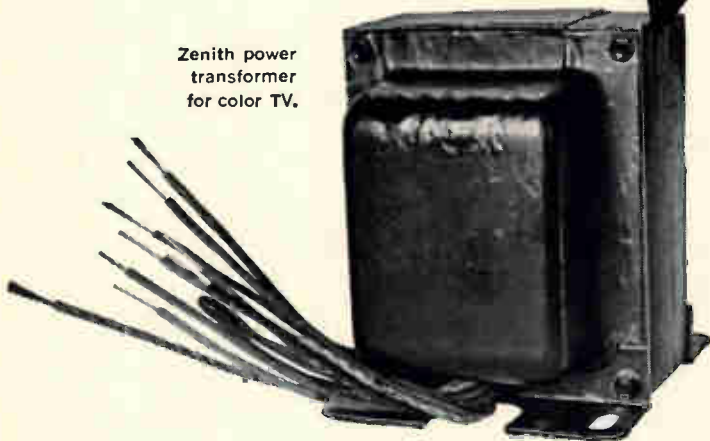

## If Scotchpar<sup>®</sup> polyester film is thin enough for transformers . . . how about your needs?

Zenith Radio Corporation demanded a thin .001" insulation for transformer coils that had outstanding dielectric properties...plus physical strength...plus resistance to moisture and solvents. "Scotchpar" polyester film answered all their requirements. Now think how well this thin, tough, dielectric film can give you more volts per mil per insulation dollar. Besides its strength and thinness, it offers stability over a wide range of temperatures. It's nonhygroscopic. It won't get brittle with age. Resistant to oils, impregnants, varnish, refrigerants. It's inert to fungus and won't corrode copper. There is a thickness and type of "Scotchpar" polyester film to match your exact needs. Call or write: Film & Allied Products Div., 3M Co., 2501 Hudson Rd., St. Paul, Minn. 55119. Dept. ICL-86.



### New Components



acteristics. One type has a guaranteed minimum attenuation of 100 db from 1,000 to 10,000 Mhz, 90 db from 200 to 1,000 Mhz, 80 db from 100 to 200 Mhz and 70 db from 50 to 100 Mhz.

They will also pass large d-c or low frequency currents without affecting attenuation. The ceramic and magnetic materials used provide high insulation resistance over the entire temperature range of  $-55^{\circ}$  to  $+125^{\circ}$ C.

The present line of six types is available from immediate to 30-day delivery.

▪ To be introduced at Wescon. Denesco, Inc., 2408 San Mateo Place, N.E., Albuquerque, N.M., 87110. [359]

### Variable resistor for circuit designers



The Varizistor, a new variable resistor, combines the function of a precision resistor with the adjustability of a trimmer potentiometer. It can be mounted on breadboards, allowing the fabrication and adjustment of such circuits as bridges, multivibrators, amplifiers and voltage regulators.

The new component consists of a deposited metal, thin-film resistance element, bonded to a ceramic substrate, inserted into a rectangular-shaped housing. A multi-contact wiper is attached to the lead and insulated on one side. The lead runs through the body, allowing the clip to make contact

These two electrometers may look alike, perform almost alike. Both measure virtually every dc parameter. But, one is battery-powered, operates 1500 volts off-ground... the other makes more measurements over broader ranges than any other dc instrument.

**WHICH  
ELECTROMETER  
MEETS YOUR  
DC  
MEASUREMENT  
NEED?**



The off-ground capability and 1000-hour battery life of the portable 601 and the extraordinary measuring performance of the line-operated 610B are Keithley features untouched by other electrometers. These instruments precisely measure voltage from extremely high impedance sources, current signals in the picoampere region and ultra-high levels of resistance. They even quantify coulomb charge.

Both the 601 and 610B have only 200 microvolts per hour zero drift. That's 10 times better than other tube-type electrometers. Big, easily read mirror-backed meters feature 1% accuracy. A 0.005% unity-gain output provides impedance matching. And for driving recorders, there's a 1 ma variable-gain output.

For more details or an in-plant demonstration, there's your man from Keithley. Give him a call — or contact us direct.

MODEL 601	MODEL 610B
1 mv f.s. to 10v ( $10^{14}$ ohms input resistance)	1 mv f.s. to 100v ( $10^{14}$ ohms input resistance)
$10^{-14}$ amp. f.s. to 0.3 amp.	$10^{-14}$ amp. f.s. to 0.3 amp.
100 ohms f.s. to $10^{13}$ ohms	100 ohms f.s. to $10^{14}$ ohms
$10^{-12}$ coul. f.s. to $10^{-6}$ coul.	$10^{-12}$ coul. f.s. to $10^{-5}$ coul.
only \$595	only \$565



Write for technical literature on these and other products

**KEITHLEY INSTRUMENTS**

12415 Euclid Ave. • Cleveland, Ohio 44106 / EUROPE: 14 Ave. Villardin, 1009 Pully, Suisse

*Organized for your purpose  
and satisfaction!*

## NEW SUBMINIATURE SWITCH SERIES

Provision for Illumination  
with Replaceable Lamp



Unlimited Code  
Capability

1-2-2-4  
(COM) DECIMAL BCD  
DIODE ETC.

Designed to Meet or Exceed  
Requirements of MIL-S-22710

6000  
Family  
--Sealed--

5000  
Family  
--Unsealed--

Cable Termination



6100 SERIES

P. C. Board Termination



5300 SERIES

Wire Loop Termination



6200 SERIES

**ECCoSWITCH<sup>®</sup>**  
ROTARY THUMBWHEEL SWITCHES

*A leader  
at any level!*

## New Components

with the resistance element, to provide circuit continuity. The entire body slides, within fixed limits, moving the wiper across the resistance element.

A 20% variation above or below the nominal value is available in units from 0.5 ohm to 1 megohm in 1/4, 1/2 and 1 watt ratings.

▪ To be introduced at Wescon. Radio Products International, 1501 So. Hill St., Los Angeles, Calif., 90015. [360]

Transistors control  
time-delay relays

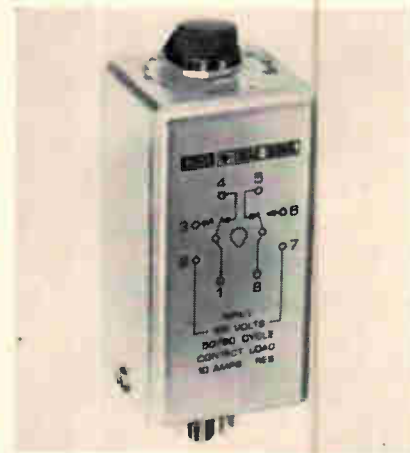

A transistor circuit unaffected by +10, -15% voltage fluctuations provides reliable timing in a CG series of octal-base, time-delay relays. The versatile devices are interchangeable with popular octal-base conventional relays. The relays are particularly suitable for process, machine tool, elevator, X-ray, reproduction equipment, packaging and molding-machine control.

Time settings are adjustable on standard dial ranges of 2, 10, 30 and 60 seconds. Other ranges can be custom produced. A direct-reading dial and linear calibration facilitates making settings.

Various CG configurations available are: 1. with integral time-interval varying potentiometer; 2. with remote mounted potentiometer for location on control panels and at push-button stations, or a fixed resistor can be employed where a fixed timing unit is re-

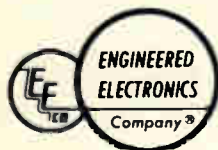

Digital Circuit Modules ■ Custom Welded and Packaged Circuits ■ Systems  
Area Phone Numbers: Boston (617) 275-0540 ■ New York City (201) 444-3220  
Washington, O.C. (301) 779-3636 ■ San Francisco (408) 253-5951

**ENGINEERED ELECTRONICS Company**

1441 EAST CHESTNUT AVENUE, SANTA ANA, CALIFORNIA 92702  
PHONE: (714) 547-5651 TWX: 714-531-5522 CABLE: ENGELEX  
"SEE ECCO AT WESCON, BOOTHS 2016-2019"

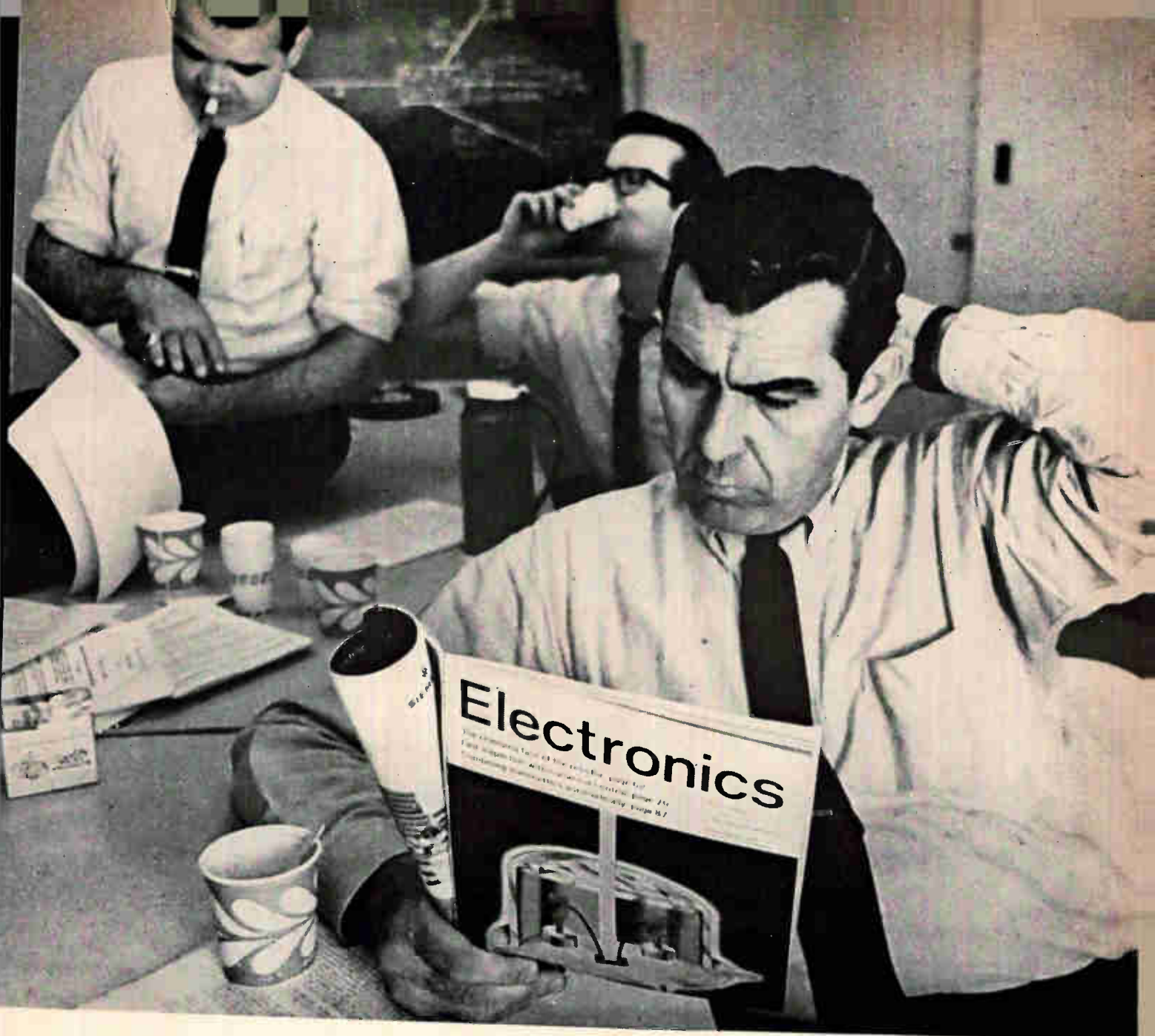

**Great editorial is something he takes to a meeting**

(What a climate for selling!)

## **Electronics**

**A McGraw-Hill Market-Directed Publication**  
330 West 42nd Street, New York, N. Y. 10036

MEMBER: AUDIT BUREAU OF CIRCULATIONS, AMERICAN BUSINESS PRESS



## SAGE Resistors Travel 22,300 Miles to Start a New Job

The "job" of course, was to work in unison with thousands of other components which make up the Early Bird Satellite. Perched high in a hovering orbit over the Atlantic since April 6, 1965, this marvel of the electronic age provides a direct link for both visual and audio communication between Europe and North America.

Sage was selected to produce the special high reliability resistors used in this complex assembly which was built by the Hughes Aircraft Company for the Communications Satellite Corporation (COMSAT).

Needless to say, we are proud of our significant contribution to the success of this undertaking which has opened a new and exciting chapter in world-wide communications.

*Your resistor requirements may not be as "far out" as this particular application. However, it could be to your advantage to consult us—whatever they may be. You'll find us most cooperative.*



Catalog R-66 gives detailed information about the complete Sage Resistor line. A request on your company letterhead will bring you a copy.

SEE OUR SPECIFICATIONS IN  
**VSMF**  
THE MICROFILM CATALOG FILE

# SAGE

**SAGE ELECTRONICS CORP.**  
BOX 3926 • ROCHESTER, N. Y. 14610

## New Components

quired; and 3. as a preset nonadjustable style.

In each CG unit there is a 10-amp dpdt relay actuated at the end of the desired delay period. Removing the line voltage releases the relay. Less than 50 msec are required to fully reset units.

Also available is a socket with screw terminals requiring a panel of only 2 x 2½ in. making this a replacement unit for other time-delay relays or timers.

Eagle Signal division, E.W. Bliss Co., 736 Federal St., Davenport, Iowa. [361]

## Tiny transformer ready for space use

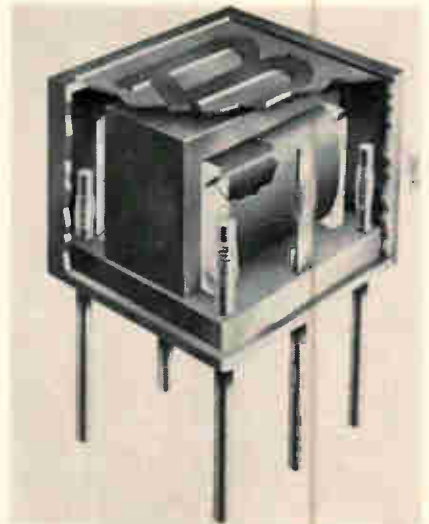

A ¼-in. cube transformer for high-reliability military and aerospace environments is model 4210 Micro-transformer which exceeds environmental requirements of MIL-T-27B. It has a precision laminated core, and according to the company, this ultrathin lamination process produces higher efficiencies than competitive solid-core designs.

At 1,000 hz the insertion loss is less than 3 db. Frequency range is 400 hz to 250 khz with no specification degradation. In square-wave operation, the droop is as low as 5%, the overshoot is as low as 10%, and the rise time is as little as 100 nsec.

Maximum operating temperature is +130°C; power rating, 1 w maximum; primary impedance range, 100 ohms to 200,000 ohms; sec-

ondary impedance range, 1 ohm to 10,000 ohms; turns ratios, to 100:1.

Price is approximately \$10 in 100-piece quantities.

The Trimpot division of Bourns, Inc., 1200 Columbia Ave., Riverside, Calif. [362]

## Tiny relay offers high reliability



A 4-pdt relay is available in a 1/6 crystal-can-size package. Type JR relay occupies only a 0.04 cu in. volume, yet provides a contact rating of 0.05 amp 28 v d-c resistive load. Its light weight and high reliability suit the JR to applications in oceanographic research, aerospace and ground support equipment.

The relay is virtually unaffected by vibration and g levels many times those required by military specifications. Other features include: contact arrangement, 4 Form C contacts; operating life, 100,000 operations minimum; dielectric strength at sea level, 500 v rms, 350 v rms across open contacts; dielectric strength at 70,000 ft, 300 v rms all points; insulation resistance, 1,000 megohms. Four case styles are offered.

▪ To be introduced at Wescon. Branson Corp., Vanderhoof Ave., Den- ville, N.J. 07834. [363]

## Vaneaxial fans in two models

Two sturdy vaneaxial fans (9.3 in. and 7.5 in.)—designed for cooling high-power transmitters and similar applications—offer high pressure-to-volume ratio and ease of ducting. Air flow can be reversed by physically turning the unit around and utilizing the flanges at either end of the fan.

Both models are provided with



## New TI cooling effect detector revolutionizes overheat protection of forced-air-cooled equipment!

KLIXON® 2ST Cooling Effect Detectors combine unprecedented sensitivity, reliability, simplicity and economy to prevent harmful overheating in computers, radar and microwave systems, copying machines, film projectors and other fan-cooled equipment. They completely eliminate the need for vane switches and thermostats.

Reliable solid-state sensing makes the difference! The sensor is a self-heated NTC (negative temperature coefficient) resistor. Mounted in the air stream and connected in series with a special rating of the KLIXON 4MC magnetic circuit breaker, it monitors the cooling capacity of the air stream. Loss of cooling effect as a result of clogged inlets, fan failure, air conditioner loss, or any combination of these causes a sharp drop in sensor resistance. The resultant increased current will trip the circuit breaker.

Unlike conventional thermistors, KLIXON 2ST Detectors sense over their entire surface, instead of only one point. This simplifies installation and mounting. Moreover, they can handle directly a current large enough to actuate a circuit breaker without intermediate amplification. They can be designed to operate at any voltage between 3 and 24 v-dc/60 cycle ac.

Bulletin PRET-16 gives you all the facts you need to evaluate these exclusive TI developments. Write for your copy today.



METALS & CONTROLS INC.  
5008 FOREST ST. ATTLEBORO MASS.  
A CORPORATE DIVISION OF  
**TEXAS INSTRUMENTS**  
INCORPORATED

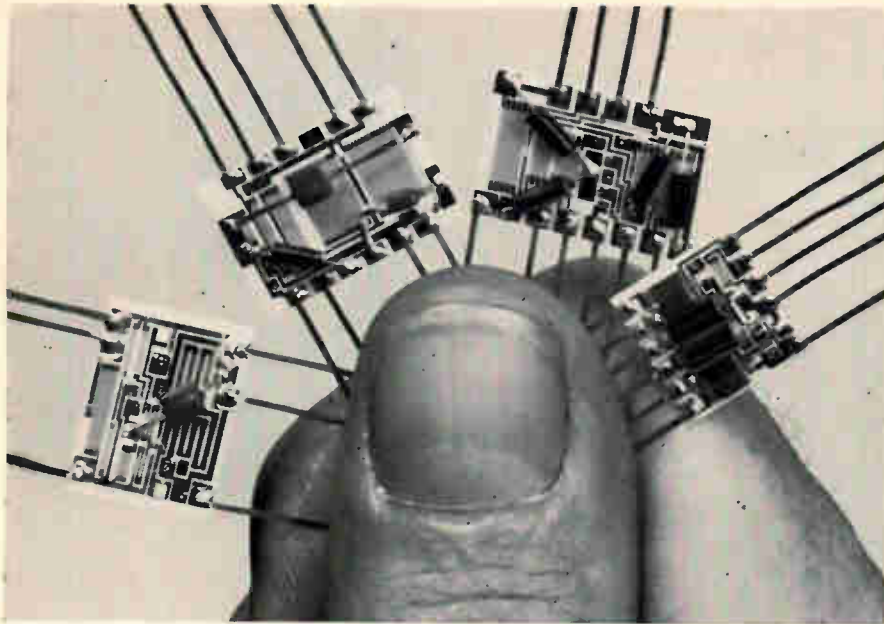

High reliability circuits produced for the Lunar Excursion Module

# BUNKER-RAMO CUSTOM HYBRID MICROCIRCUITS

## DESIGN AND PACKAGING FREEDOM

Mix integrated circuits, precision resistors, tunnel diodes—whatever you need to get the function you want in the package you want.

## SPEED

Digital logic circuits to 250 megacycles; other circuits to microwave frequencies.

## POWER

Up to 40 watts per square inch of resistor area without heat sink.

## LOW COST, QUICK DELIVERY

Simplified processes mean lower tooling and start-up costs even for short runs or prototypes; faster delivery, too.

## PRECISION RESISTORS

Production-run thin-film resistor tolerances to  $\pm 0.01\%$  initial adjustment, with  $\pm 0.05\%$  tracking accuracy at full load for 10,000 hours;  $\pm 5\text{ppm}/^\circ\text{C}$  temperature coefficient control.

## APPLICATION ENGINEERING

To explore solutions to your circuit problems, call or write our application engineers.

See us at WESCON—Booth 2140



**THE BUNKER-RAMO CORPORATION**  
DEFENSE SYSTEMS DIVISION

8433 FALLBROOK AVENUE · CANOGA PARK, CALIFORNIA 91304 · (213) 346-6000, EXT. 546

## New Components

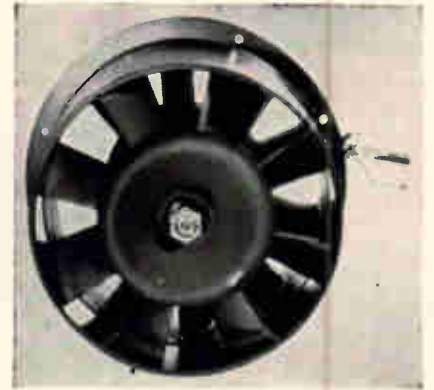

internal thermal protection and heat-treated, cast aluminum impellers and housings.

Available in single- or 3-phase, 60-hz or 400-hz versions, each unit can be supplied to meet applicable military or commercial specifications. Design options include mountings, electrical connections, terminal boards, voltages, temperature and speed ranges.

▪ To be introduced at Wescon. IMC Magnetics Corp., 570 Main St., Westbury, N.Y., 11591. [364]

## Terminals permit tighter packaging

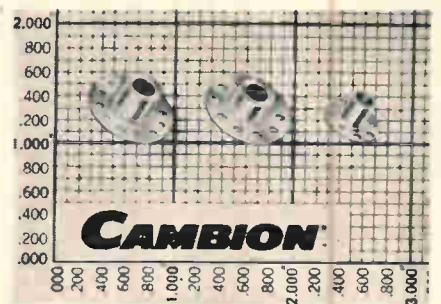

Three new circular, stud-type ground terminals meet the requirements of MIL-T-55155/26. Designated part numbers 1037, 1038, 1039, the terminals provide 8, 10 and 12 tie points, respectively. All three terminals measure less than  $\frac{3}{8}$  in. above board.

The terminals are readily mounted by drilling a panel hole, aligning stud portion over hole and securing terminal to panel with machine screws. Counter-bore construction at the tie-point flange end of the terminals permits stacking of two or more terminals,



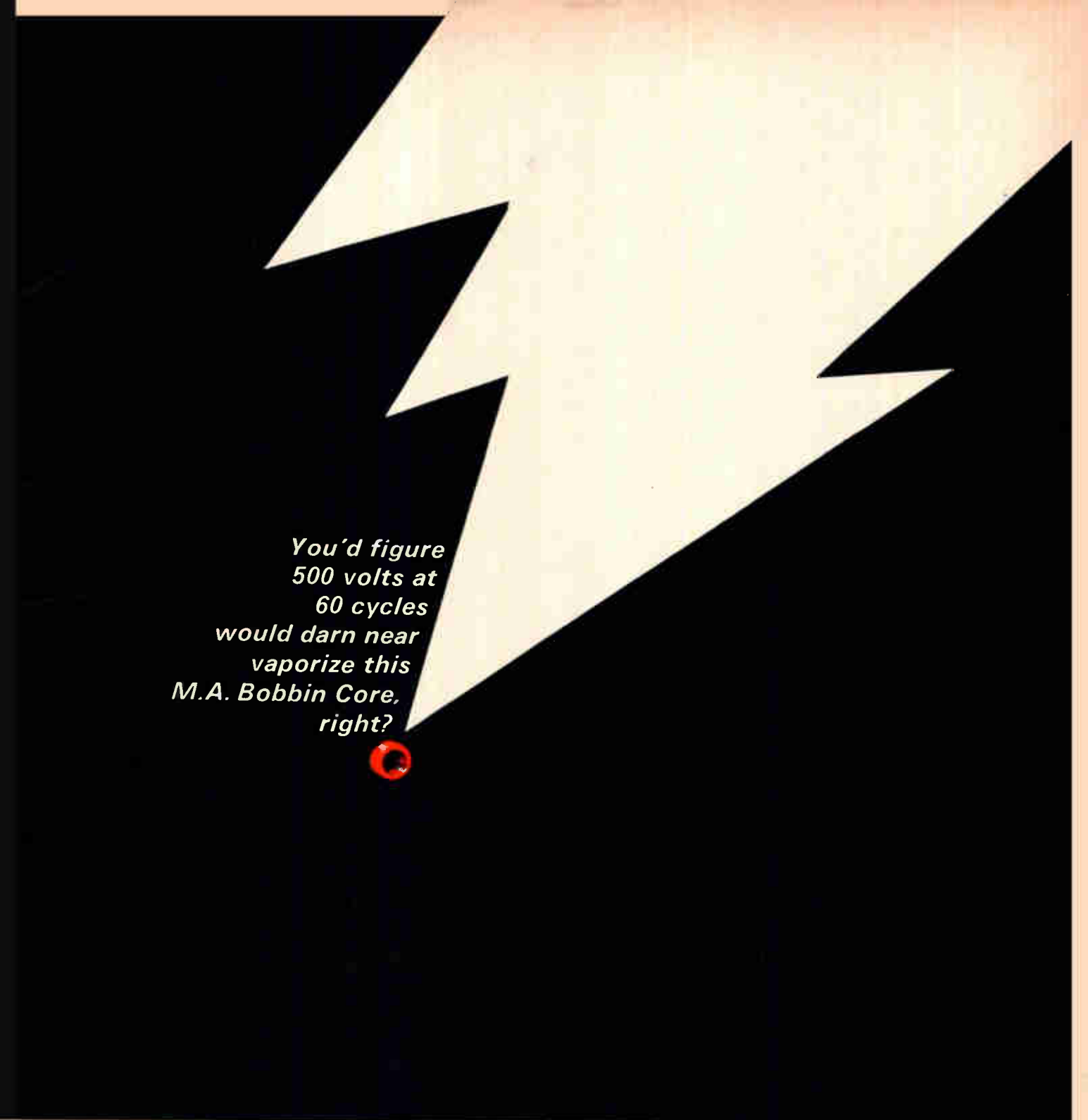

*You'd figure  
500 volts at  
60 cycles  
would darn near  
vaporize this  
M.A. Bobbin Core,  
right?*



**Wrong! Its got GVB\***. Even at more than 1500 volts, tests show no breakdown on M.A. bobbin cores with GVB. In addition to guaranteeing the core's ability to withstand at least 500 volts between bare winding and bobbin, GVB finish also seals the bobbin to withstand a ten-inch mercury vacuum.

It seals against potting material, provides a resilient, non-slip base for winding, and its epoxy skin protects the core against wire cuts. Abraded wire problems are eliminated and no prior taping is required.

GVB has proven itself on thousands of cores . . . and now Magnetics has applied it to the bobbin core, the

miniature workhorse of computers, high frequency counters, timers, oscillators, inverters and magnetic amplifiers.

Made from ultra-thin permalloy 80 and Orthanol® (0.001" to 0.000125"), Magnetics' bobbin cores are available in tape widths from 0.023" to 0.250" or wider on request. Core diameters range down to less than 0.100" with flux capacities down to several maxwells.

For more information on GVB Bobbin Cores, write Magnetics Inc., Dept. EL-42, Butler, Pa. 16001.



\*Guaranteed voltage breakdown

if you want...

# PRECISE POSITIONING



- RAPID ACCELERATION
  - IMMEDIATE RESPONSE
- IN YOUR TAPE TRANSPORT  
CAPSTAN DRIVE

## INLAND MOTOR has the answer in its DC DIRECT DRIVE TORQUE MOTORS

**Precise Positioning**... No gears — No backlash. The direct-drive torque motor shaft IS THE capstan itself... ensures high coupling "stiffness." It gives high mechanical resonant frequency offering design capabilities of an extremely wide servo bandwidth.

**Rapid Acceleration and Deceleration**... Produces more torque, size for size, than any other electro-mechanical device. As a capstan drive it has the highest, practical torque-to-inertia ratio.

**Immediate Response**... Since its torque is a direct function of applied current, independent of speed, response is positive and instantaneous at all operating speeds — limited only by the characteristics of the tape.

Direct Coupling = Precise Positioning

High Torque - Low Inertia = Rapid Acceleration

DC Control = Immediate Response



### TORQY SAYS:

If you would like full information on Inland's Torque Motors used as a capstan drive in a tape transport application or engineering assistance on a particular servo design problem, let us know... we'll be glad to help.



## INLAND MOTOR

CORPORATION  
RADFORD, VIRGINIA  
703-639-3973

SUBSIDIARY OF **KOLLMORGEN**

Booth #2149 Wescon Show

## New Components

providing numerous applications for dense packaging conditions. Stacked terminals are also mounted by use of appropriately sized machine screws.

The terminals are priced at 19 cents each in quantities of 500 to 999 pieces.

▪ To be introduced at Wescon. Cambridge Thermionic Corp., 445 Concord Ave., Cambridge, Mass., 02138. [365]

## H-v vacuum relay can switch to 50 kv



A high-voltage vacuum relay is capable of switching up to 50 kv a-c at 60 hz in air and can carry up to 15 amps. Applications include polarity reversing in h-v power supplies, switching between test circuits and dummy loads, controlling anode voltages on microwave tubes (magnetrons, klystrons, etc.), X-ray applications, lasers, and other applications that require switching high-power loads.

The spdt model H-25 has a maximum operating time of 20 msec, standard coil resistance of 120 ohms, and a coil voltage of 26.5 v d-c. It can also be supplied with 115 v d-c coil. The H-25 will withstand vibration to 5 g from 55 to 500 hz and shock to 15 g for 11 msec. Delivery is 20 to 30 days; prices on request.

High Vacuum Electronics, Inc., 538 Mission St., South Pasadena, Calif. [366]



## Precise people make precision products

The red carpet is symbolic of our regard for those who make Tempress the sort of organization it is today . . . technically sound, service oriented, and one hundred percent dedicated to the development and production of high precision products. It requires very special people to deliver, day in and day out, in quantities sufficient to satisfy the burgeoning semiconductor industry, using materials such as tungsten carbide, diamonds, and sapphires at ten thousandths tolerances: capillary tubes, probe contact needles, flame-off torches, diamond scribes, diamond lapping points, and the new automatic scribing machine. They receive the red carpet

treatment, because we realize that the Tempress product can be had from only the finest people, working under ideal conditions . . . and they, in turn, reserve a large portion of that carpet for our customers, whose requirements and whose loyalty are the ultimate reasons for the Company's existence. We have already put in our order for a larger carpet, as this one was outgrown while the picture was being taken.



# TEMPRESS

Tempress Research Co., 566 San Xavier Ave., Sunnyvale, Calif.

*Opportunities for*

## **Design & Development Engineers in Electronic Signal Processing and Display Systems**

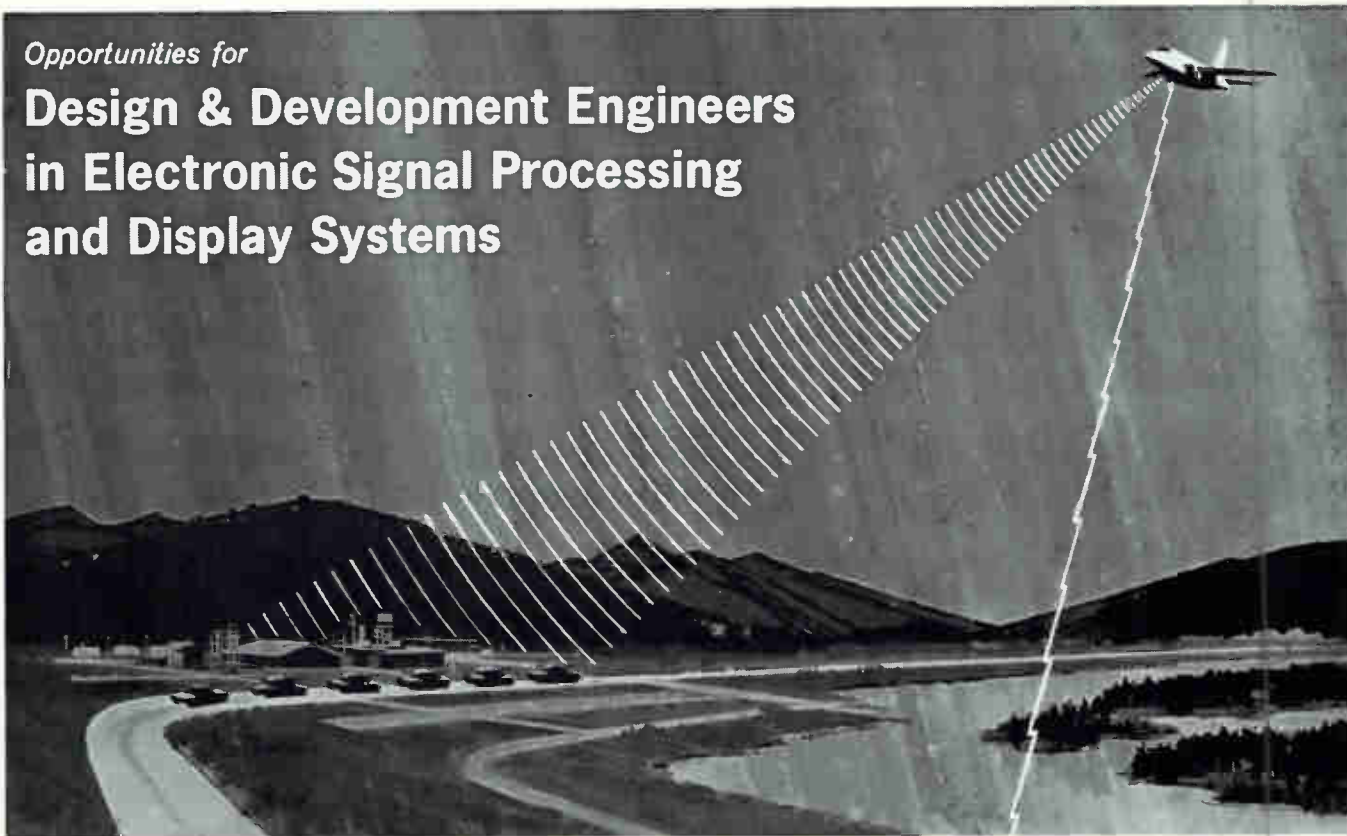

Design and Development activities in the field of Electronic Signal Processing and Display are rapidly expanding today at HUGHES Aerospace Divisions.

Advanced development is being accelerated on **high resolution pulse doppler radars** and other sensors utilizing matched filter, synthetic array, pattern recognition and other exotic correlation techniques.

Specialists will be interested in the many challenging and rewarding assignments now available in Project Engineering, Radar System Design, Performance Analysis, Signal Processing with emphasis on synthetic array, Information Display, System Simulation and Human Factors; in Circuit, Mechanical and Packaging Design.

Stimulating assignments are immediately available for graduate Engineers with accredited degrees and several years of applicable, professional experience in one or more of the following areas:

1. Highspeed Timing & Sampling Circuits
2. Optical & Electronic Moving Maps
3. Ultrahigh Speed Film Development
4. Wideband Video & IF Amplifiers
5. Mixers & Balanced Modulators
6. High Precision CRT Circuitry
7. Scan Converters Storage Tubes
8. Aerospace System Simulation
9. Multisensor Data Display
10. Precision Film Transport

All interested persons are invited to submit resumes in confidence.

For immediate consideration please write:

**Mr. Robert A. Martin**  
Head of Employment  
**HUGHES Aerospace Divisions**  
11940 W. Jefferson Blvd.  
Culver City 12, Calif.

*Creating a new world with electronics*

# **HUGHES**

HUGHES AIRCRAFT COMPANY  
AEROSPACE DIVISIONS

An equal opportunity employer

U. S. CITIZENSHIP REQUIRED



## It took a while, Mr. Faraday, but Sangamo did it.

It is said even Michael Faraday doubted if a farad could ever be realized. Certainly he couldn't have imagined one stuffed into a container this size. But here it is . . . the product of Sangamo ingenuity. Giant thunderbolts in small packages, anyone? Take a few seconds and dial 803-878-6311.

**SANGAMO ELECTRIC COMPANY • Pickens, South Carolina**

EC66-4



## CONTROL KNOBS FROM RAYTHEON

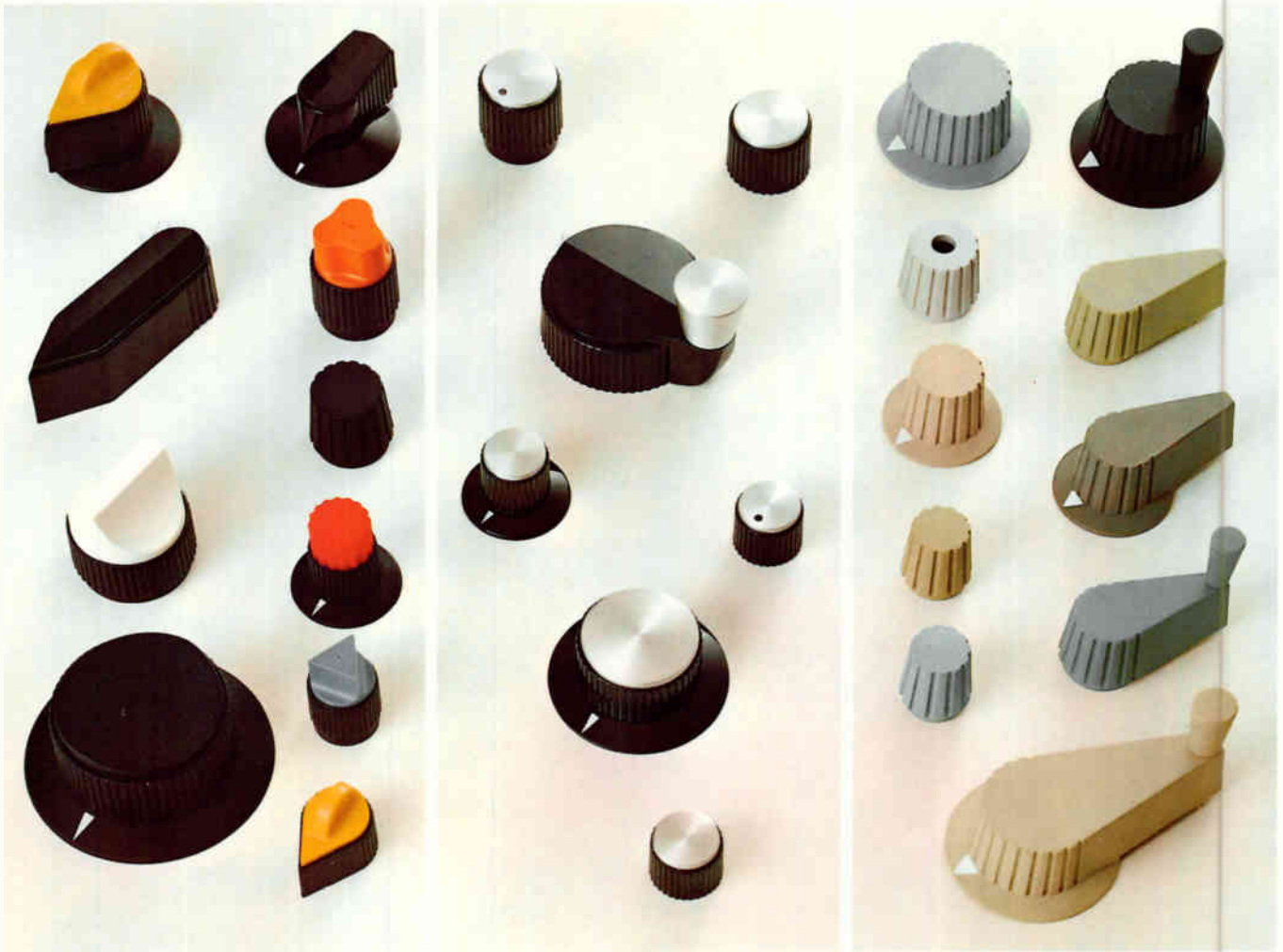

## Military knobs, aluminum cap knobs, color knobs for every panel requirement

You can meet military specs, select styles and colors that harmonize or contrast with any panel design and decor — when you specify Raytheon control knobs.

Because, Raytheon offers the largest selection of military and commercial knobs. And *makes them promptly available to you through distributors from coast to coast.*

**Meet MS91528C Military Specifications** from more than 300 standard types. Raytheon has custom designed over 2,000 "specials."

Every knob in the Standard Series is functionally designed. All styles have an integrated design to give uniformity to your panel. And each knob meets MS91528C for resistance to flame, torque, temperature and humidity extremes, salt spray and

ultraviolet radiation. Colors include black, red, gray or to your special order.

**Or, specify aluminum-cap knobs.** These handsome knobs are made of strong plastic with satin finish aluminum caps. Raytheon aluminum caps are treated with an epoxy coating for corrosion resistance. Colors: black, gray, or to your order.

**Color knobs highlight panels.** Choose from eight colors plus black — in ten styles — to harmonize or contrast with commercial equipment design. Raytheon makes these 400 Series Knobs of durable high-impact ABS.

**Call your distributor** or nearest Raytheon regional sales office for catalogs and data sheets. Or, circle the reader service card. *Raytheon Company, Components Division, Lexington, Mass. 02173.*

Raytheon Components Division — A single source for Transistors/Diodes/Integrated Circuits/Industrial Tubes/Control Knobs/Panel Hardware/Circuit Modules/Display Devices



## RAYTHEON MECHANICAL COMPONENTS

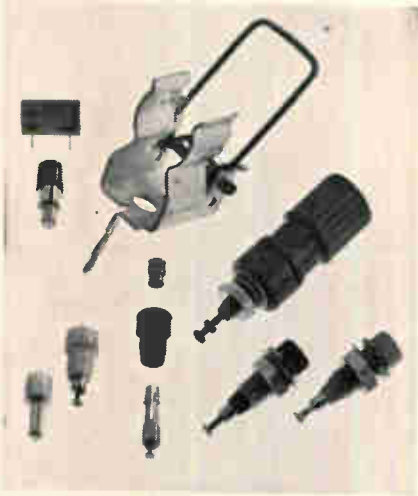

Select from Raytheon's broad line of panel components. Binding posts and all standard and subminiature test jacks and printed circuits meet military specifications. Fuse and resistor clips meet BuShips Spec 16E4 and MIL-E-16400.



Raytheon knob and shaft locks provide smooth locking action with simple adjustment—prevent slip in control settings or adjustments—meet military specs.

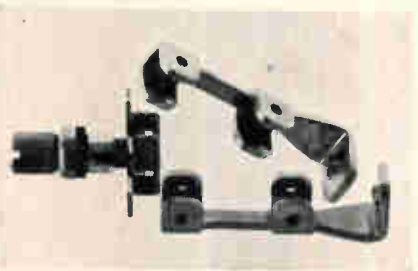

Select Raytheon panel hardware for reliability, economy. Terminal board brackets meet MIL-E-16400A, MIL-E-5400, MIL-P-11268. Unique captive hardware assembly meets MIL-E-16400.

For more information, call your distributor or Raytheon regional sales office. Or write: Raytheon Company, Components Division, 141 Spring Street, Lexington, Mass. 02173.



## New Semiconductors

### Rectifier assemblies mean less weight

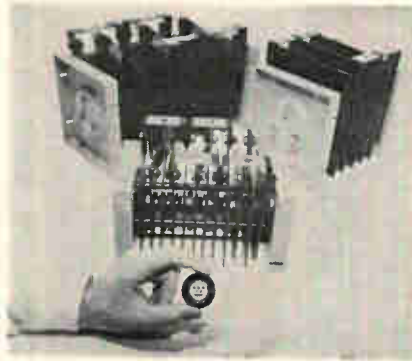

High power silicon rectifier assemblies now available offer a 50% reduction in size and weight, as well as a 30% savings in cost compared with conventional units, the company claims.

Available in single-phase ratings to 550 amps and in 3-phase ratings to 820 amps, the rectifiers should be useful in welding, charging bat-

teries, plating, and other applications requiring high-current d-c power supplies.

Construction featuring a  $\frac{3}{8}$ -in.-thick by 1½-in.-diameter, disk-type, compression-bonded rectifier and aluminum cooling fins makes possible the significant reduction in size and weight. The aluminum fins are coated to insure satisfactory performance in difficult environments. As an added convenience in installation and maintenance, all connections to the rectifier are accessible from the top of the assembly.

Dimensions for the single-phase assemblies, depending on the plate size chosen, range from 7½ x 6½ x 7¼ in. to 11 x 8½ x 9 in. Weights range from 8½ to 17 lbs. Similar dimensions for the 3-phase assemblies range from 10 x 6½ x 7¼ in. to 15½ x 8½ x 9¼ in. Weights range from 10 to 20 lbs.

Westinghouse Semiconductor division, Westinghouse Electric Corp., Youngwood, Pa. [367]

### Radiation resistant power transistors

Twelve radiation resistant, silicon power npn transistors are designated the BR-100 and BR-101 series. These 5- and 10-ampere transistors are available in six different package configurations.

With base transit times reduced to a maximum of 0.5 nsec at 1-amp collector current, the transistors are for use in circuits hardened for application in nuclear radiation environments. They are specifically designed for radiation environ-

ments having exposure levels as great as  $5 \times 10^{14}$  NVT (total integrated neutron flux with energy levels greater than 10,000 electron volts).

Some of the featured electrical characteristics are: power dissipation to 35 watts; collector current to 10 amperes; operating and storage temperature,  $-65^\circ$  to  $+200^\circ\text{C}$ ; typical gain bandwidth product, 500 Mhz at 28 v and 0.5 amp; collector to base voltage, 40 v to 75 v.

Prices are \$40 to \$200 quantities of 1 to 99.

■ To be introduced at Wescon. Bendix Semiconductor division, The Bendix Corp., Holmdel, N.J., 07733. [368]

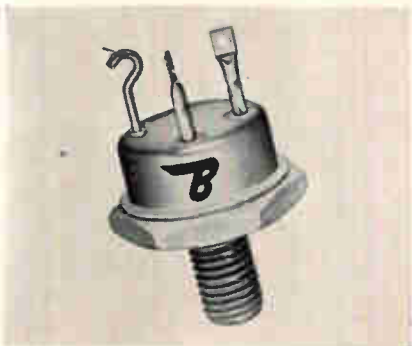

### Silicon rectifiers feature fast recovery

Four new silicon rectifiers have been added to the company's line. The units, Catalogs No. SLA-02-HF (2,000 v piv) through SLA-05-HF (5,000 v piv), feature recovery times of less than 300 nsec, with

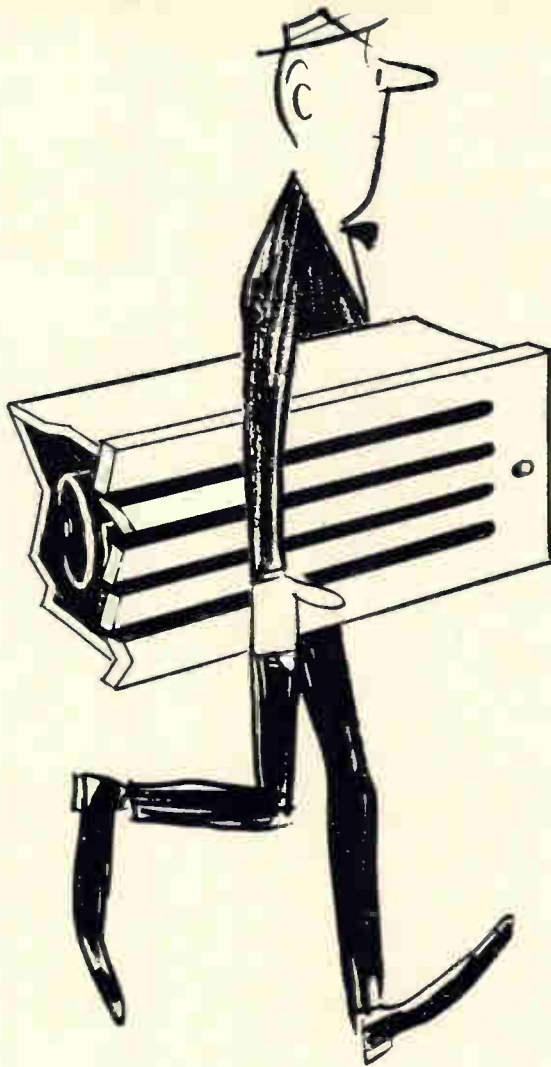

## Are you settling for half of your cooling needs?

Half a loaf is not better than none, when it comes to the reliability of your electronic systems.

And when it comes to cooling those systems, make sure the blowers you install are as good as your systems . . . not half as good.

At McLean full value means all these things; (1) engineering assistance so that the blower you select will be practical, economical, and do an adequate cooling job; (2) guarantee of motor and blower life under your operating conditions; (3) experience on the firing line in cooling the most complex systems; and (4) complete manufacturing facilities for all parts of our blowers including the motors.

McLean's engineering judgment is based on that which is best for you . . . and not what is available!

SEND FOR  
NEW 1966  
44-PAGE  
CATALOG



**McLEAN** ENGINEERING  
LABORATORIES

P.O. Box 228, Princeton, N. J. 08540  
Phone 609-799-0100 • TWX 609-799-0245  
TELEX 083-4345



See us at the Wescon Show, Booth 445 in Hollywood Park

## New Semiconductors

high voltage and current, permitting operation in high frequency applications such as inverters, ultrasonic generators and power supplies.

This series of units features the lowest cost per kv and current rating available in the industry for fast switching h-v rectifiers, according to the manufacturer. They have been designed to meet all applicable requirements of MIL-S-19500, and are of avalanche construction, so no matching is required.

Slater Electric Inc., Semiconductor division, 45 Sea Cliff Ave., Glen Cove, N.Y. [369]

## Silicon diode for voltage reference



A silicon voltage-reference diode costing only 40 cents in large quantities is being offered in a plastic encapsulated package with TO-98 dimensions.

The D16H1 is a two-diode, common-anode device designed for general-purpose voltage-reference and voltage-regulator applications at currents up to 15 ma.

The availability of a third lead, located at the common point between the diodes opens the possibility of many new applications for the voltage reference diode. Since the device is symmetrical, it could be specified with both polarities with high yield. Other potential uses include dual diodes with common anode, stabistor diode and dual zener diode.

Excellent forward characteris-





## Technical achievement for you... better living for you and your family

We are particularly anxious to meet you if you are a Circuit Design Engineer; Packaging and Mechanical Engineer; Electron Optics, Vacuum Technology or Materials and Process Specialist. But whatever your technical strengths, if "roll-up-the-sleeves" engineering appeals to you, we'd like to hear from you.

Here you'll find an environment that emphasizes the individual, and his personal contribution to technical development—contribution by working on projects, not writing about them. Your work will benefit advanced engineering throughout the world. You will benefit from technical association with specialists experienced in developing state-of-the-art instrumentation, components and devices.

All Tektronix R & D—financed entirely from our annual sales of over \$100 million—is directed toward *commercial* products. Our community is prosperous, balanced, with a stability of employment not typical of every industrial center. And as for the Green Land we live in—it speaks for itself.

If you're seeking technical advancement and better living for you *and* your family, why not investigate Tektronix?

Write to D. A. Thompson, Tektronix, Inc., P. O. Box 500A, Beaverton, Oregon 97005, or send in the coupon.

Professional Placement Mgr., Tektronix, Inc.

P. O. Box 500A, Beaverton, Oregon 97005.

Please send me your  Booklet, "Tektronix"  Application Form

NAME: \_\_\_\_\_

ADDRESS: \_\_\_\_\_

CITY: \_\_\_\_\_

STATE: \_\_\_\_\_

I am interested in: \_\_\_\_\_

**Tektronix, Inc.**

An Equal Opportunity Employer.



# you can have glass-to-metal seals

**bulged  
flared  
flanged  
crimped**

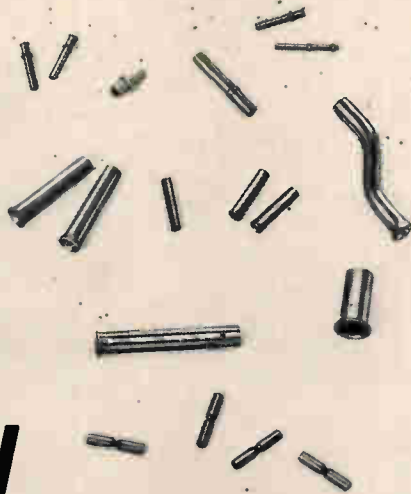

**quickly to close tolerances**

ACTUAL SIZE

Tubular parts of glass-to-metal sealing alloys for electronic components can be fabricated in any shape to your exact dimensions with surfaces absolutely free of scratches and imperfections. This high quality in glass-to-metal seals from Uniform Tubes carries additional bonuses—fast delivery and low cost. If you do not need a special shape, you can get the same high quality and even faster delivery on straight lengths for we stock many glass-to-metal sealing alloys in the most popular tubing sizes.

In O.D.'s from 0.187" down to 0.040" and wall thicknesses from 0.025" to as thin as 0.003", the tubing is cut to exact lengths to fit your requirements. Then bulges, flares or flanges are formed to specification. As illustrated, two bulges can be formed if required. For easy assembly and mating with companion parts, ends can be ID-radiused at very slight additional cost.

To prove our point, send us your drawing and specifications for a tubular part in a glass-to-metal sealing alloy and let us submit a quotation along with samples of similar parts we have made for other customers. You'll like both the price and the quality of the workmanship. After all, *Quality in Quantity* is our working philosophy.

EGS

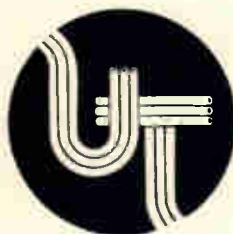

## UNIFORM TUBES, INC.

Collegeville, Pa. 19426 • (215) 489-7293 • TWX: 510-660-6107

Visit Booth No. 664 at WESCON, Hollywood Park

## New Semiconductors

tics, high conductance and close thermal coupling of the two series-connected diodes in a single pellet structure contribute to minimum temperature differentials and good transient response. It exhibits a reference-voltage temperature coefficient of less than 0.025% and a reference voltage of between 5.6 v and 6.8 v at a bias current of 5 ma. The device features a low capacitance, typically 19 pf at zero volts bias and a frequency of 1 Mhz.

▪ To be introduced at Wescon.  
General Electric Co., Syracuse, N.Y.  
[370]

## DTL semiconductor IC's in 14-lead flatpack

The 200-series DTL semiconductor integrated circuits are immediately available. Series 14200, a new IC family, includes 15 equivalents of competitive types. The company's circuits are electrically and mechanically interchangeable with the competitive DTL circuits in such general-purpose digital applications as computers, instrumentation and control systems.

Propagation delay for series 14200 gates is typically 25 nsec. Power dissipation is 7.5 mw per gate. Fan-out is 11, and d-c noise margin is typically 1 volt. The line is characterized for operation at 6-v collector supply voltage.

Two temperature ranges are available for the DTL family. Series 14200, with an operation temperature range of  $-55^{\circ}$  to  $+125^{\circ}\text{C}$ , is designed for aerospace use. Its sister line for industrial and commercial environments, series 14300, features an operating temperature range of  $0^{\circ}$  to  $75^{\circ}\text{C}$ .

Included in the line are a number of NAND/NOR gates and inverters—singles, duals, triplets, quads and hexes. The gates and inverters are available with or without collector resistors, giving the system designer an option to trade power consumption for capacitive drive capability.

Also available are two a-c coupled bistable circuits, a pulse binary counter and a J-K flip-flop. The line is rounded out with a 10-

# HERE'S HOW...

THE ELECTRONIC INDUSTRY IS USING THESE TWO FAMOUS ULANO FILMS IN ULTRAMINIATURE MASK TECHNOLOGY AND COMPLEX PRINTED CIRCUITRY

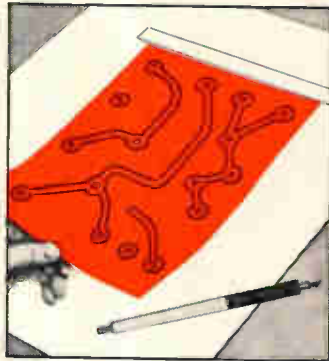

Cut a piece of the desired film large enough to cover area to be masked. Tape it down firmly at the top with dull-side up.

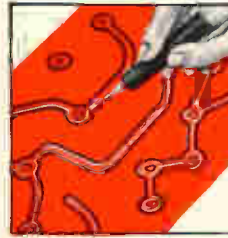

With sharp blade, outline the areas to be masked. *Do not cut through the backing sheet.* The Ulano Swivel Knife does the job quickly, easily.

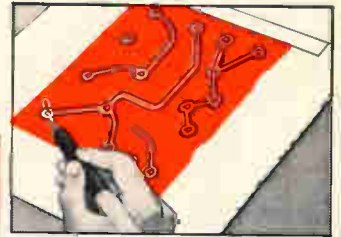

Using the tip of the blade, lift up a corner of the film thus separating it from the backing sheet.

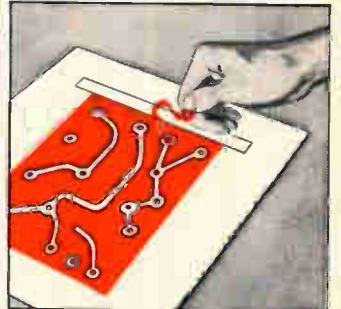

Now carefully peel off the film as outlined leaving a completed mask, positive or negative, that corresponds exactly to the desired pattern.

# Ulano

T.M.

## RUBYLITH™ • AMBERLITH™

HAND CUT MASKING FILMS FOR THE GRAPHIC ARTS

**ULANO RUBYLITH**... a revolutionary knife cut film is laminated to a stable transparent plastic backing sheet. The red film is "light safe" so that when contacted to a sensitized emulsion and exposed to a suitable light source, light passes through the cut-out portions only... not through the red film. ■ The polyester backing is absolutely stable... insures perfect register. ■ Special effects such

as crayon tones, paste ups, benday sheets, and opaquiing are easily combined with versatile ULANO RUBYLITH.

**ULANO AMBERLITH**... a companion to Rubyolith serves as a color separation medium used as the master on camera copy board to secure negatives or positives.

A wide variety of Ulano films—in rolls and sheets—is readily available

**ulano**

NEW YORK • CHICAGO • ZURICH

610 DEAN ST., BROOKLYN, N. Y. 11238

In Europe: ULANO A. G., Untere, Haslibachstrasse No. 22  
Kusnacht, Zurich, Switzerland

"Ulano" "Rubyolith" "Amberlith" are registered trade marks of the Ulano Companies.



**WRITE TODAY**

on your letterhead for free special sample kit 1848

# DIGITAL INSTRUMENTATION



Model 201



Model 500



Model 610-620

## WESCON/66

See us at Booth  
206-207 at the track

### DIGITAL DC VOLTMETERS

- 9 Models offering F.S. ranges of 10 MV to 1000 V • Certified accuracy to .1% F.S. • Floating or grounded input • Reliable silicon transistor circuitry • Individually calibrated and certified • Available options include BCD output, retransmitting pot., auto-polarity, minimum or maximum retention.

From \$315.00

### DIGITAL PRINTERS

- BCD 1-2-4-8 low level parallel input • Prints 8 columns in 2 banks of 4 • 45 line/minute print rate • Uses standard 2 1/4" paper tape • Remotely programmable • Designed for use on all "DigiTec" instruments with BCD coded output and other instruments with compatible coding.

• Time, Identification and Scanning Accessories available.

From \$750.00

### DIGITAL THERMOMETERS

Precision digital measurement of temperature reading directly in degrees C or F.

#### THERMISTOR BASED (Series 500)

- Ranges covering -50 to +100° C.
- Accuracy to 0.15° ± 18 interchangeable probes.

#### PLATINUM BULB (Series 530)

- Ranges covering -390° to +1000° F. • Accuracy to 0.70° F.
- Interchangeable probes.

#### THERMOCOUPLE (Series 560)

- Ranges covering -300° to +2000° F. • Accuracy to 1.5° F.
- Reading resolution to 0.05°.
- For use with ISA Type "J," "K," and "T" thermocouples.

From \$345.00

DIGITEC

**UNITED SYSTEMS CORPORATION**

918 Woodley Road Dayton, Ohio 45403

Stocking representatives throughout the world

# SEARCHING FOR LOW-COST, MILITARY QUALITY, $\frac{1}{2}$ INCH, 10-TURN POTS?



COMPARE THESE SPECS AGAINST COMPETITIVE EQUIVALENTS (IF YOU CAN FIND ANY!)

Resistance Range: 100 ohms to 100K ohms  
Resolution: 0.101 to 0.015% • Linearity: 0.30%  
Power Rating: 2 watts @ 40°C.  
Operating Temperature: -55°C. to +125°C.

## spectrol

Prices start at less than \$9.00 in 100 quantities, and yet these quality pots meet or exceed many military environmental specifications. For full information, send for a data sheet.

Spectrol Electronics Corporation, 17070 E. Gale Ave., City of Industry, Calif. 91745

# ...YOU'VE JUST FOUND THEM!

A standard  $\frac{1}{2}$ -inch shaft  $\frac{1}{4}$ -32 thread bushing mount,  
a popular  $\frac{1}{4}$ -inch shaft  $\frac{3}{4}$ -32 thread bushing mount,  
and a unique low-cost servo mount—all with  
rear terminals!



## New Semiconductors

diode expander (4-3-3 array), and a dual driver with totem-pole output.

Standard package for series 14200 and 14300 is a 14-lead welded and hermetically sealed TO-84 flatpack. In addition, the 14300 industrial family is available in the 14-pin molded plug-in package.

Texas Instruments Incorporated,  
13500 North Central Expressway,  
Dallas, Tex. [371]

## Variable capacitance microminiature diodes



Variable capacitance diodes are now available in an egg-shaped plastic package 0.090 in. long with a maximum diameter of 0.075 in. and 0.020-in. diameter solid-silver leads. These tiny units are useful in microcircuit and high-frequency applications.

Their abrupt junction, silicon epitaxial structure makes it possible to offer high capacitance ratios with maximum working voltage to 100 v and 4-v, 50-Mhz quality factor to 450. Capacitance values at 4 v range from 6.8 to 56 pf with  $\pm 10\%$  tolerance.

Availability is stock to two weeks.

Somerset Electronics Corp., P.O. Box 115, Manville, N.J., 08835. [372]

## Silicon rectifiers rated 6 to 12 amps

A series of 6- to 12-ampere silicon rectifiers combine recovery capabilities of 100 to 200 nsec, reverse ratings of up to 1,000 volts and high rectification efficiencies at frequencies up to 300 khz. Packaged

# MATHEMATICAL MAGIC

faster—quieter—more efficient

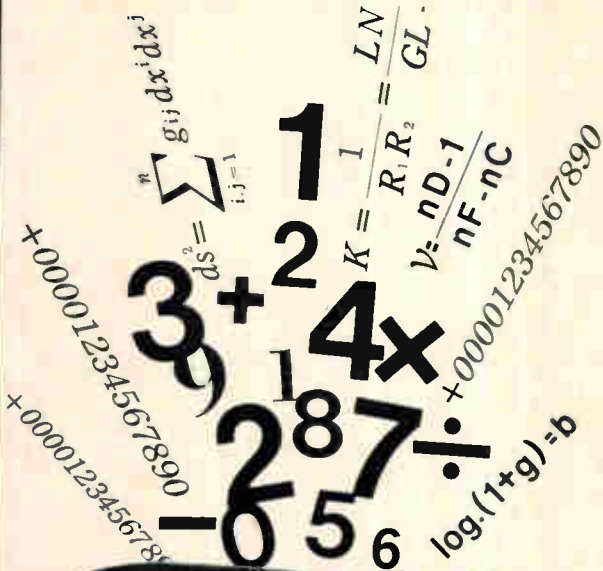

THE ELECTRONIC DESK CALCULATOR MODEL CS-20A weaves a magic spell over your calculating problems. Calculates 14 digits instantaneously • adds or subtracts in 6/1000th of a sec. • multiplies or divides in 1/10th sec. Convenient 10-key operation includes a three-zero key **000** to dispose of three zeros at a touch • no two keys can be pressed at the same time • displays +, - and decimal signs automatically • and the COMPET CS-20A will not break down under misuse. Ideal wherever rapid, accurate calculations are required.

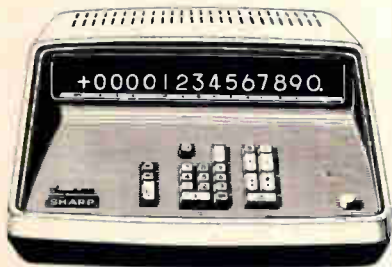

COMPET Model CS-20A

**SHARP**

... to the point of perfection

**HAYAKAWA ELECTRIC CO., LTD.**

OSAKA, JAPAN

U.S. Subsidiary: Sharp Electronic Corp.

178 Commerce Rd., Carlstadt, New Jersey, U.S.A.

Circle 319 on reader service card

THE



# MULTI-TRACK MIND...

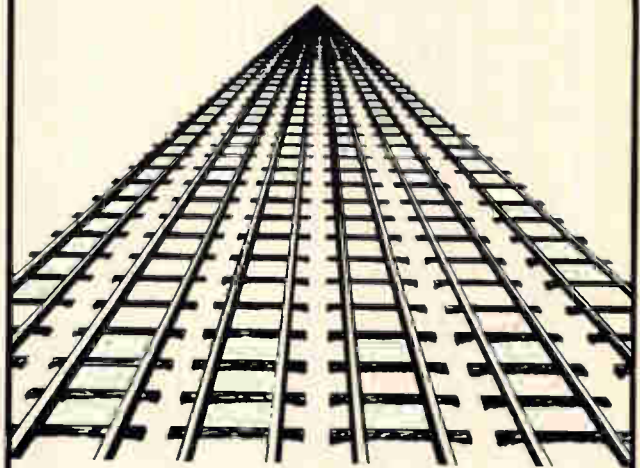

Want to handle several PCM links simultaneously?  
Need to rapidly switch from format to format?

DCS has the efficient answer —

## Series 1100 PCM SYSTEMS



Look at these features:

- Multilink simultaneous processing, 2 to 16 links
- IBM compatible tapes
- Multilink time correlation
- Immediate format switching
- Pre-switching synchronization and data validity checking
- Memory not used for format synchronization

INTERESTED?

Write for your **free** copy of the new **DCS Series 1100 PCM PROCESSING SYSTEMS** brochure . . . or call the DCS office nearest you.

Dept. E8-6, East Liberty Street, Danbury, Conn. 06813

Telephone: 203-743-9241 • TWX 744-1990



**DATA-CONTROL SYSTEMS INC.**

*Instrumentation for Research*

Sales Offices

Silver Spring, Md., Huntsville, Winter Park, Long Beach, Santa Clara, Albuquerque

Copenhagen London Rome Paris Munich Amsterdam

Circle 253 on reader service card

basic measuring tools from

**HEWLETT  
PACKARD**

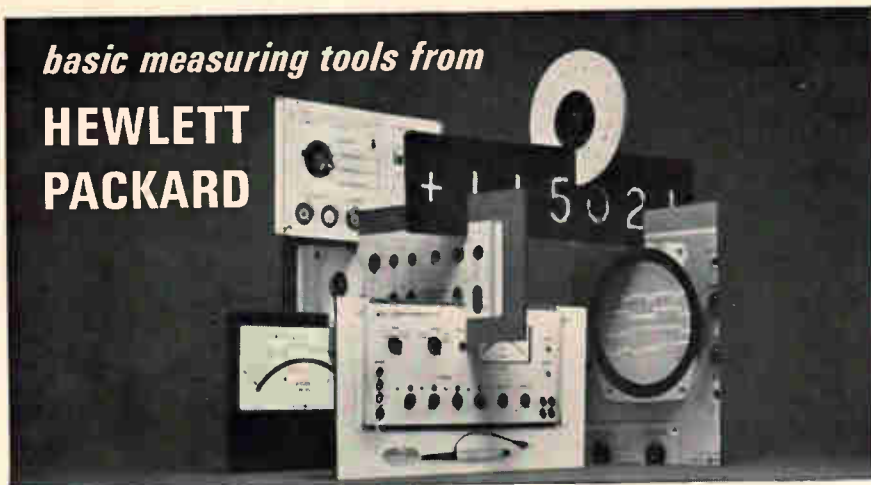

## hp 741A AC-DC Differential Voltmeter/DC Standard

Multi-purpose calibration tool—5 functions for only \$1475  
Special probe for ac differential VM measurements with <math>< 5\text{ pf}</math> capacity at point of measurement  
Input impedance  $> 10^7$  on all ranges  
Five-digit resolution, all modes of measurement

### Use it as:

- A dc standard,  $\pm 0.02\%$  of setting  $\pm 10\ \mu\text{v}$ , 0-1000 v-20 ma, floating output, 0.005%/month stability
- An ac differential voltmeter, 50 mv-1000 v,  $\pm 0.05\%$  of reading  $\pm 0.01\%$  end scale
- A dc differential voltmeter, 0-1000 v,  $\pm 0.02\%$   $\pm 10\ \mu\text{v}$ ,  $> 10^7$  ohms input impedance (independent of null), 0.005%/month stability
- A  $\pm 2\%$  floating high-impedance voltmeter
- A voltage amplifier with 60 db gain, a  $\pm 0.02\%$  unity-gain power amplifier

Use in conjunction with new 463A Voltage/Power Amplifier to make measurements at: 100 mv at 0.07%, to 10 kHz; 10 mv at 0.16%, to 10 kHz; 1 mv at 0.36%, to 10 kHz. (Reduced specs to 100 kHz.)

Features include overload indicator, output sensing, low-capacity ac probe. For a

demonstration, call your Hewlett-Packard field engineer or write Hewlett-Packard, Palo Alto, California 94304, Tel. (415) 326-7000; Europe: Route des Acacias, Geneva.

Data subject to change without notice. Prices f.o.b. factory.

**HEWLETT**  **PACKARD**  
An extra measure of quality

1672



## New Semiconductors



in DO-4 stud containers, they serve to reduce the size of transformers, chokes and other power supply components by permitting higher frequency inputs. Applications include high-frequency power supplies, ultrasonic generators and d-c to d-c inverters and converters.

The new series has 16 rectifiers, including 6-amp JEDEC types IN3879 to IN3883 and 12-amp JEDEC types IN3889 to IN3893 with peak reverse ratings ranging from 50 to 400 v. The 6-amp series ED8307 to ED8309 and 12-amp ED8310 through ED8312 offer reverse voltages from 400 v to 1 kv.

Peak one-cycle surge at  $100^\circ\text{C}$  for 6-amp types is 75 amps and for 12-amp types, 150 amps. D-c reverse current at piv and  $25^\circ\text{C}$  is  $15\ \mu\text{a}$  and  $25\ \mu\text{a}$  respectively. Static forward voltage at  $25^\circ\text{C}$  for both 6- and 12-amp rectifiers is 1.4 v at rated current.

Prices are \$3 to \$30 depending on piv rating and quantity ordered. Delivery is from stock to four weeks.

Electronic Devices, Inc., 21 Gray Oaks Ave., Yonkers, N.Y., 10710. [373]

## High-gain, low-noise silicon transistor

An npn silicon transistor of planar epitaxial construction has been developed for use in small-signal r-f amplifiers, telemetry, test equipment and any equipment requiring high gain and low noise.

The A485 transistor, packaged in a TO-72 case, has a gain bandwidth of 1,500 Mhz and beta of 100 at both 2 and 20 ma. Specified values of noise figure are 3.5 db at 200 Mhz and 4.5 db at 450 Mhz. Typical intermodulation distortion rating is  $-53$  db.

Amperex Electronic Corp., Slatersville, R.I., 02876. [374]

what if we told you  
your graphic recorder  
is now obsolete?

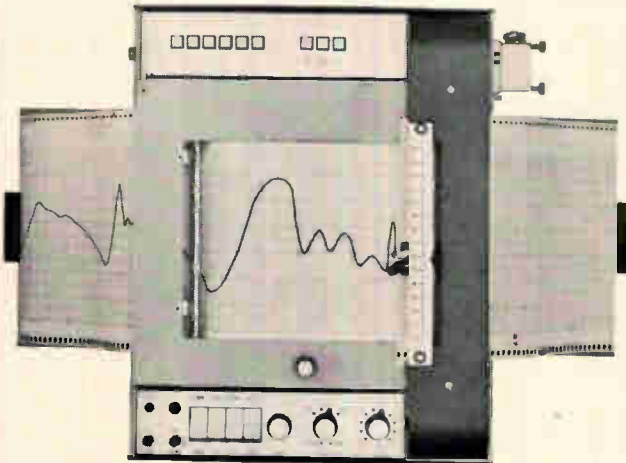

## the OMNIGRAPHIC RECORDER<sup>TM</sup> can prove it!

Your strip chart recorder... your X-Y recorder... your T-Y recorder is totally obsolete today because the new OMNIGRAPHIC<sup>TM</sup> RECORDER combines all their functions into one! In fact, it:

**performs all these functions**

- STRIP CHART
- X-Y
- T-Y (Sequencing Chart)
- PROGRAMMING CHART
- PROGRAMMABLE CHART
- PULSE CHART DRIVE

**with these features**

- Z-fold paper
- 144,000:1 range
- 1/3 sec. f.s. pen response
- 20 voltage ranges
- .15% accuracy
- potentiometric input

Dollar for dollar, this new OMNIGRAPHIC<sup>TM</sup> RECORDER will deliver more functions, more features and more conveniences than any other recorder... or any other **two** recorders on the market today. It is a genuine new concept in graphic recording. The cost is far less than you may imagine.



Push button selection

Z-fold paper

Tears to std. chart size

**houston OMNIGRAPHIC corporation**

a subsidiary of houston instrument corporation  
4950 Terminal Ave. / Bellaire, Texas 77401  
(713) 667 7403 / cable HOINCO / TWX (713) 571 2063

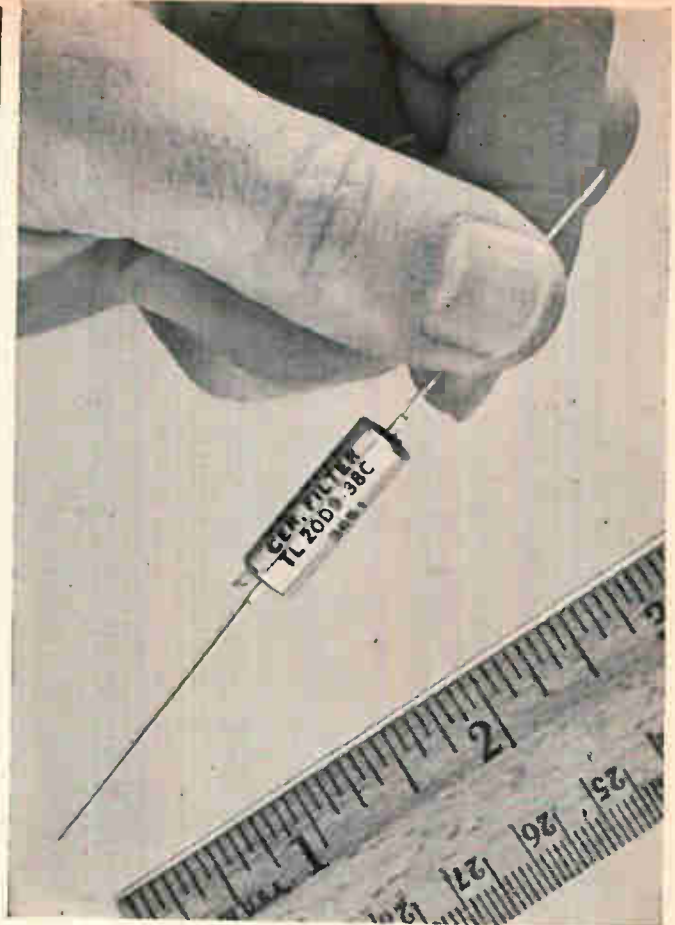

## Just Out! Compact Ladder Filter from Clevite

### Good Selectivity at a Practical Price

Take a close look at the newest member of Clevite's family of i-f filters. This 9-disc ceramic miniature is a rugged, light-weight device (MIL 202B) that offers excellent selectivity and stability in less than .07 cu. in. It's perfect for transistorized i-f amplifier circuitry plus many other applications requiring a fixed-tuned filter element. Stop band rejection is 50 db, center frequency tolerance is  $\pm 3$  kc. Stability: within  $\pm 0.2\%$  for 5 years; within 0.2% from  $-40^{\circ}\text{C}$  to  $+85^{\circ}\text{C}$ . Impedance (in and out) @  $27^{\circ}\text{C}$ : 10 kc B/W 2000 ohms, 16 kc B/W and above 1000 ohms.

Following models standard (custom models on special order):

Model Number	B/W @ $27^{\circ}\text{C}$	
	min. @ 6db	max. @ 60db
TL10D9-20A	10 kc	20 kc
TL16D9-32A	16 kc	32 kc
TL20D9-38A	20 kc	38 kc
TL30D9-57A	30 kc	57 kc
TL40D9-72A	40 kc	72 kc

\*PRICES: 1 to 24—\$25 ea; 25 to 99—\$20 ea; 100 to 499—\$17.50 ea; 500 to 1999—\$15 ea; 2000 to 4999—\$12.50 ea.

Send order or request for Bulletin 94021 to: Clevite Corporation, Piezoelectric Div., 232 Forbes Rd., Bedford, Ohio 44014.

\*Prices subject to change without notice.

# CLEVITE

See it at WESCON Booth 420

**You  
can display  
anything  
with IEE  
series 10  
rear-projection  
readouts**



**numbers,  
letters,  
words, symbols,  
even colors!**

IEE readouts display anything that can be put on film, even colors! Single-plane presentation makes for visual crispness; bright, bold characters (up to 1" in height) for remarkable clarity. So if readability and versatility are what you're after, look into IEE Series 10 Readouts. Five other models available with maximum character heights from 3/8" to 3 3/8".

Send today for complete information on IEE rear-projection readouts and accessories!

**IEE INDUSTRIAL ELECTRONIC  
ENGINEERS, INC.**

7720 Lemona Avenue, Van Nuys, California  
Phone: (213) 787-0311 • TWX (910) 495-1707  
Representatives in Principal Cities © 1966 IEE

## New Instruments

### Digital voltmeter aimed at assembly line



A digital voltmeter that costs about the same as an analog voltmeter is a good candidate for the assembly line and field use. To make its latest digital voltmeter more attractive for production use, the Hewlett-Packard Co. has built in a storage feature that keeps the display from blinking or changing after a measurement until a new measurement is made. However, the display will flash when there is an overload, lessening the chance of operator misuse.

The model 3430A can measure d-c voltages from  $\pm 100$  millivolts full scale to  $\pm 1,000$  volts with an accuracy to within 0.1% of the reading  $\pm 1$  digit. It can maintain this accuracy for three months.

The instrument makes two readings a second and displays them on a three-digit, in-line Nixie-tube display. A fourth digit, for ranging, gives a 60% overranging capability on all measurements except those in the 1,000-volt range.

The range is selected with the front panel switch. The signal to be measured is attenuated, then filtered and applied to an input amplifier. Matched, dual field-effect transistors form the amplifier's input circuit and make possible a 100-microvolt sensitivity and a high input impedance.

The amplifier's output is accurate to within 0.1% when fed into a 10-kilohm load, so the output can go to an outside instrument such as an x-y recorder. The amplifier's output goes to a polarity amplifier that automatically sets the polarity flip-flop for the correct polarity indication. It also goes to a ramp comparator. Since the comparator's input must be negative, the amplifier's output is directly connected for a negative input signal. For a positive signal, a relay, controlled by the polarity flip-flop, switches a  $-1$  amplifier between the comparator and the amplifier.

The second input signal to the comparator comes from a ramp

#### Specifications

Ranges	$\pm 100$ mv, 1,000 mv, 10.00 v, 100.0 v, and 1,000 v.
Accuracy	Within $\pm 0.1\%$ of reading, $\pm 1$ digit from 15°C to 35°C on all ranges
Input impedance	10 megohms
Superimposed noise rejection	40 db at 60 hz, increasing at 12 db per octave at higher frequencies
Ratio option display	input volts ref. volts
Ratio accuracy	Within $\pm 0.15\%$ from 15°C to 35°C
Reference input range	1 + 0.8 to 1.2
resistance	20 kilohms $\pm 2\%$
Price	\$650



**KOKUSAI CAN SUPPLY  
ANY  
MECHANICAL FILTER  
YOU NEED.**

**50 c/s ..... 500,000 c/s  
EXTREME STABILITY  
SMALL SIZE  
INEXPENSIVE**



**VX12 CHANNEL FILTER**  
Carrier Telephone Terminal Equipment Application

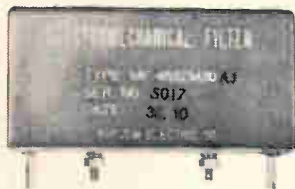

**SSB USE  
AM • FM USE  
TRANSCEIVER USE**



**LOW FREQUENCY ML TYPE**  
50c/s.....50,000 c/s



**LOW FREQUENCY FK TYPE**  
300 c/s....  
6,000 c/s

*Write today for complete information and a better solution to all your filter problems.*

Patented in France, Federal Republic of Germany,  
Great Britain, U.S.A. and Japan



**KOKUSAI ELECTRIC CO., LTD.**

9, Nishikubo-Sakuragawa-cho, Minato-ku, Tokyo, Japan  
Cable Address: SINESHIBA TOKYO

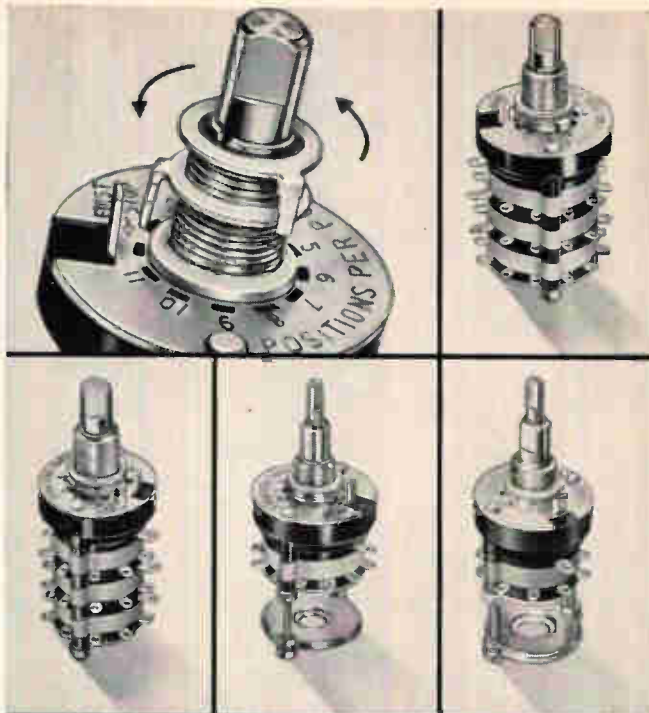

Miniature  
Adjustable Stop  
Rotary Switches...

... the Difference Between  
Excellent and Adequate ...

Select your own circuitry.  
Ideal for prototype and  
small production runs.

**Select Materials:**

- Contacts: Silver Alloy
- Terminals: Brass, Lead-Tin Plated and Fused
- Common Plate: Brass, Silver Plated

**Typical Specifications:**

- Explosion Proof
- Stop strength: 12 Pound-Inches Minimum
- 1 to 12 Decks
- 1 to 4 Poles per Deck
- 2 to 12 Positions per Pole
- Life Expectancy; 100,000 Operations

... in  
Design  
Materials  
Construction



Send for  
Engineering  
Data  
Book



523 Hillgrove Avenue  
LaGrange, Illinois 60526  
Area Code 312, Phone 354-1040

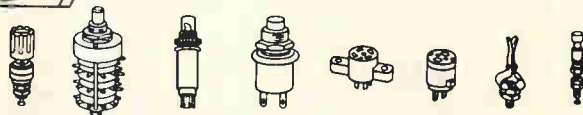

'PIONEERS IN MINIATURIZATION'



**CASES  
CASES  
CASES...**

**over 30 standard sizes**

**from stock for immediate delivery**

Skydyne maintains a complete stock of over 30 standard fiberglass equipment transportation cases for off-the-shelf delivery with an honest to goodness price list. Custom vibration and shock absorbing interiors and modifications to meet MIL-21200 or MIL-945 take a couple of weeks longer and may cost a bit more.

We can also make fast, fast deliveries on sandwich panel cases, for every MIL spec in hundreds of sizes and shapes

through our complete inventory of case components.

Write for our comprehensive design manuals or, better yet, pick up the telephone and let us know your requirement.



See SKYDYNE at WESCON BOOTHS 668-669

Circle 329 on reader service card

## JOHANSON VARIABLE AIR CAPACITORS ARE DESIGNED TO EXCEED MIL-C-92/MIL-C-14409

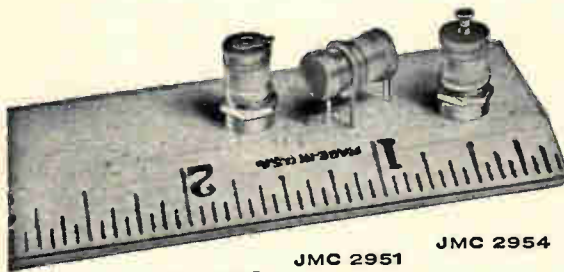

### JMC 2950 "Miniature" Series

- Low Temp Coef & Capacity Drift
- Exceeds MIL Vibration & Shock requirements
- Fungus, Salt Spray, & Humidity protection

CAPACITANCE RANGE: 1.0-10.0  $\mu$ f

OPERATING TEMP RANGE:  $-55^{\circ}$  C to  $+125^{\circ}$  C

DIELECTRIC BREAKDOWN:  $> 500$  VDC (sea level to 150,000 ft)

INSULATION RESISTANCE:  $> 1,000,000$  megohms @ 50% RH

Q:  $> 2000$  @ 100 MC

*Write for complete information*

**Johanson**

**MANUFACTURING CORP**

Rockaway Valley Road • Boonton, New Jersey

See the Johanson line at Booths 1449 and 1450, Wescon, Los Angeles

## New Instruments

generator. Pulses from a 5-kilo-hertz multivibrator are counted by the instrument's decade counters until the two signals agree. Then, the comparator generates an output signal which changes the state of the comparator flip-flop and closes the count gate so that no more pulses can be entered into the counters.

At the end of the sample period, which is controlled by a 2-hz multivibrator, a reset pulse changes the comparator flip-flop back to its original state, opening the gate for the next measurement. Simultaneously, the reading stored in the counters is transferred to the display.

▪ To be introduced at Wescon.  
Hewlett-Packard Co., P.O. Box 301,  
Loveland, Colo. 80537 [375]

## Wave analyzer works on battery or line



A portable, audio-frequency wave analyzer, type 1568-A, can be operated either by line or battery. It has a 1% bandwidth, with an attenuation of at least 75 db at twice and at one-half center frequency. Sensitivity is from 100  $\mu$ v to 300 v full scale.

Because of its very narrow bandwidth and ability to separate closely spaced components, the analyzer is especially useful in electrical wave analysis as well as in sound and vibration measurements. At very low frequencies, the type 1568-A bandwidth is said to be considerably narrower than that of analyzers with fixed-frequency



## ULANO EUROPEAN TECHNICAL CENTER FOR GRAPHIC ARTS

Ulano's technical center in Switzerland is headed by the very capable Mr. Henri Kunz. He is qualified by his many years of experience in the Screen Process and Graphic Arts fields. Demonstrations and technical seminars are held in many languages throughout the year. Complete laboratory facilities have been installed to provide demonstrations of the complete Ulano line. Large stocks of all famous Ulano films are available for immediate delivery to all parts of the world.

You are invited to contact Mr. Henri Kunz at ULANO A.G., Untere, Heslibachstrasse No. 22, Kusnacht 8700, Switzerland, Telephone 905959. It is our pleasure to serve you.



**DO YOU USE  
SCREEN PROCESSING  
IN THE PRODUCTION OF  
COMPLEX  
PRINTED  
CIRCUITRY?**

**TWO NEW PRESENSITIZED FILMS TO  
SPEED PRODUCTION — LOWER COSTS**

**Ulano**  
T.M.



### HI-FI RED

#### HEAVY-DUTY INDUSTRY PROVED

Presensitized photo film used by many leading electronic firms for clean, sharp, tough, durable, almost indestructible screens of unmatched quality. Adheres tightly to wire, silk, nylon and dacron.

### PREP®

#### PRESENSITIZED FOTO FILM

.002 Polyester support guarantees good register. Does not require a dark room. Very good resolution—suitable for halftones. Excellent adhesion to silk, nylon, dacron and metal mesh. Tough, strong emulsion—good for machine printing and long runs.

**WRITE TODAY**  
on your letterhead  
for free special  
sample kit  
number 5448

### J. ULANO & COMPANY, INC.

610 Dean Street, Brooklyn, N. Y. 11238, U.S.A.  
Cable address: "UlanoFilm"  
In Europe: ULANO A. G., Untere, Heslibachstrasse No. 22  
Kusnacht, Zurich, Switzerland

## Miniaturization by Mitsubishi!

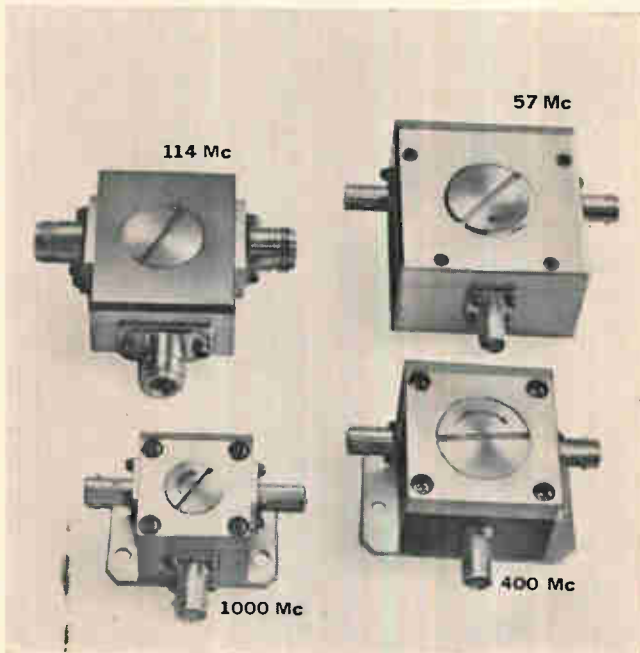

## VHF—UHF circulators (isolators) small enough to fit in the palm of your hand!

These new Mitsubishi circulators stabilize amplifiers, oscillators, and multipliers in solid states circuits and reduce transmitter intermodulation. The special inner fabrication devised by Mitsubishi engineers reduces size and weight, yet permits these circulators to be used in extremes of high and low temperature. They are protected against magnetic interference and constructed to withstand severe vibration. For complete information on the frequency ranges listed (or, for that matter, any other frequency) write to Mitsubishi's head office in Tokyo or cable directly to MELCO TOKYO.

#### Performances (example)

Frequency (Mc)	57	114	170	413	680	1000
Power (W)	50	40	30	30	15	10
Forward Loss (dB)	1 (0.8)	0.7 (0.5)	0.7 (0.5)	0.6 (0.4)	0.6 (0.4)	0.5 (0.35)
Backward Loss (dB)	15 (20)	15 (20)	15 (20)	20 (20)	20 (20)	20 (20)
Input VSWR	1.4 (1.3)	1.4 (1.3)	1.4 (1.3)	1.3 (1.3)	1.3 (1.3)	1.3 (1.3)
Band Width*(Mc)	1	2	3	15	20	40
Temperature Range (°C)	-10 ~ +40 (usable up to +60)					
Dimensions (cm)	(ca 5 x 7 x 3.3)					

( ) typical value; \* 25°C



**MITSUBISHI ELECTRIC CORPORATION**

Head Office: Mitsubishi Denki Bldg., Marunouchi, Tokyo. Cable Address: MELCO TOKYO

## NEW - FROM BENRUS



### ULTRA COMPACT, LOW COST X-Y INDICATORS designed for panel mounting

Identical characteristics for horizontal and vertical amplifiers. Input provided for DC coupled blanking from external signal. Solid state circuitry assures optimum reliability and environmental performance. In general, the use of ruggedized components provides conformance to military requirements. Fully self-contained, requiring no additional plug-ins or power other than AC line.

The Benrus Type RA840C X-Y Indicator mounts on a standard 3 1/2" rack panel; up to six can be mounted on a standard 7" x 19" panel. Behind-panel depth is less than 10 1/2"; weight approx. 8 pounds.

Your request for information will also bring you a copy of the latest catalog, giving complete data and prices for the comprehensive Benrus line of modular system instrumentation.

AT WESCON — BOOTHS 116-118



# BENRUS

TECHNICAL PRODUCTS DIVISION

30 CHERRY AVENUE • WATERBURY, CONNECTICUT 06720

Circle 260 on reader service card

To order reprints: Fill in, cut out coupon below, insert in envelope and mail to: Electronics Reprint Dept.,  
330 W. 42nd Street, New York, N.Y. 10036

#### Reprint order form

For listing of reprints available see the Reader Service Card.

Communications Satellites Part I

Send me ..... reprints of Key no. R-89 at 50¢ each.

For reprints of previous special reports fill in below:

Send me ..... reprints of Key No.(s) ..... @ .....¢ each.

(For prices, see Reader Service Card)

Name .....

Number of street .....

City, State, Zip code .....

## New Instruments

bandwidths. At 20 hz, for instance, the 156S-A has a bandwidth of only 0.2 hz between 3 db points.

The wave analyzer is housed in either a portable, flip-tilt case or a relay-rack cabinet. Both are priced at \$1,350.

▪ To be introduced at Wescon. General Radio Co., West Concord, Mass., 07181. [376]

### Modulation meter covers 4 Mhz to 1 Ghz



A transistorized f-m/a-m modulation meter, model 2300, covers a frequency range from 4 Mhz to 1 Ghz. It measures deviation in five ranges:  $\pm 5$ ,  $\pm 15$ ,  $\pm 50$ ,  $\pm 150$  and  $\pm 500$  khz at modulating frequencies up to 150 khz and is relatively unaffected by the presence of spurious a-m up to 80%.

The local oscillator may be locked to harmonics of internal crystals anywhere in the range from 20 Mhz to 1 Ghz and provision is made for driving with an external local oscillator, for example, a programed synthesizer.

De-emphasis circuits are provided and a 15-khz low-pass filter may be switched in to limit the demodulated signal bandwidth. Deviation due to f-m noise is less than 15 hz using 15-khz bandwidth and a crystal-controlled local oscillator. A-m measurement is provided in two ranges of 30% and 95%; peaks and troughs, selected by a switch.

Applications include broadcast signal measurement, tv sound, f-m stereo and narrow band and wide-band modulation systems used in communications and telemetry. Price is \$1,735; delivery, November, 1966.

▪ To be introduced at Wescon. Marconi Instruments, Englewood, N.J. [377]

Immediate openings for circuit design and sales engineers.



## another ZELTEX FIRST...

### Model 145 Operational Amplifier with 0.5 $\mu\text{V}/^\circ\text{C}$ and 1 $\text{pa}/^\circ\text{C}$ drift!

More amplifier news from Zeltex... announcing a miniature chopper stabilized amplifier in a rugged die cast aluminum case with exceptional drift and speed.

Use the new Model 145 for D/A conversion, precise integration, low level amplification—you name it! Write for full technical data today.

#### KEY SPECIFICATIONS

Voltage drift ..... 0.5  $\mu\text{V}/^\circ\text{C}$   
Current drift ..... 1.0  $\text{pa}/^\circ\text{C}$   
Gain B.W. .... 100 MHz  
Slew rate ..... 100  $\text{V}/\mu\text{sec}$   
DC gain .....  $10^8$   
Output .....  $\pm 10\text{V}$  @ 20 ma

SPECIALISTS IN AMPLIFIERS AND COMPUTER ELEMENTS



**ZELTEX, INC.**  
1000 Chalamar Road  
Concord, California 94520  
Phone (415) 686-6660

Circle 330 on reader service card

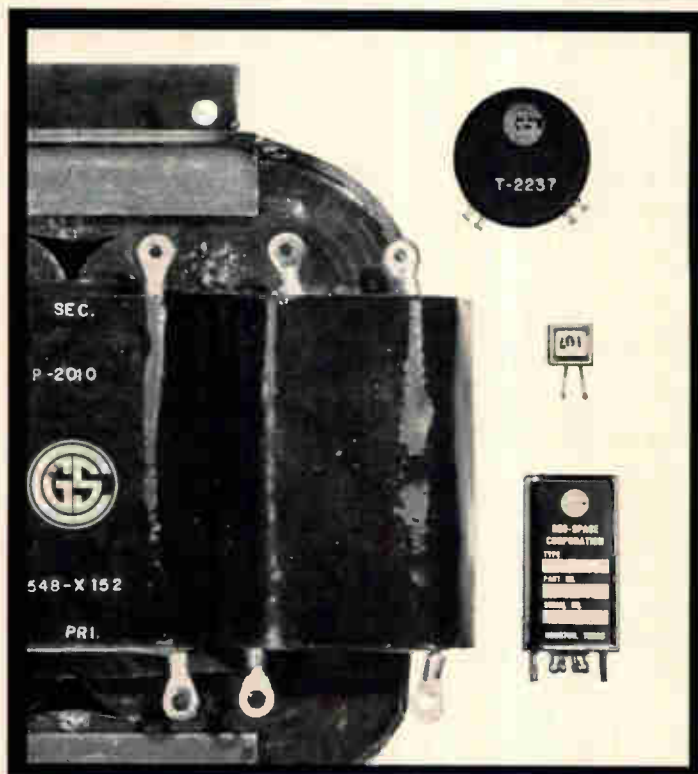

## CUSTOM TRANSFORMERS

### NORMAL DELIVERY BEGINNING 8 WEEKS A.R.O.

Custom design and manufacture of signal and power transformers and inductors with quality assurance built-in.

For fast response submit specifications and drawings to:

**GEO SPACE CORPORATION**  
A Subsidiary of Westec Corporation  
5803 Glenmont Drive • Houston, Texas 77036  
Telephone: 713/666-1611    Telex: 077-374

VISIT US AT  
WESCON BOOTH 2162

**GEO SPACE**  
INDUSTRIAL  **PRODUCTS**

# NEW... FREE...



## VITREOSIL® PURE FUSED QUARTZ CATALOG

From Thermal American Fused Quartz Company . . . A comprehensive 48 page catalog describing the latest in VITREOSIL pure fused quartz laboratory ware, industrial ware, tubing, fabrication and special quartz products.

Also included are informative sections giving technical and application data.

Price information is included with each catalog — see separate price list.

Ask for your copy today. 46



## New Subassemblies and Systems

### Converting digits to angles

Solid state switching of precision a-c inductive dividers bridges the electrical incompatibility between a digital computer's output and the analog input required by such computer-controlled devices as machine tools, fuel controls, shaft positions, antennas and other actuators.

A number of techniques exist for translating digital information into mechanical action, but almost all have some disadvantage. North Atlantic Industries, Inc., has developed a technique which it claims avoids these disadvantages. It was first applied in a computer-controlled simulator for the Gemini space program.

Transistors, instead of electro-mechanical relays, switch a-c inductive dividers. This allows a precision inductive divider's output voltage to be selected accurately in response to computer commands. Some digital-to-analog conversion systems, resistance divider networks or d-c servo systems generate analog signals from digital inputs. In the inductive divider method, however, the accuracy depends upon the turns ratio and not on the stability of the resistors or d-c power supplies. As a result, the a-c divider has better long-term accuracy than a resistive divider, the company points out. In addition, the divider has a low output impedance and can supply ½ ampere to a 10-ohm load. Loading is a serious problem with resistive dividers. Also, North Atlantic's method does not require the digital-to-multiphase a-c converter needed for resolver-synchro converting systems.

In a typical conversion, an electromechanical resolver is linked to a computer's digital commands through two electronically switched inductive dividers. The two dividers are excited from the same a-c source. They are wound so that the output taps of one divider provide a sinusoidally increasing voltage amplitude, while the other divider develops cosine voltage variations. The computer-controlled tap switching, therefore, translates a

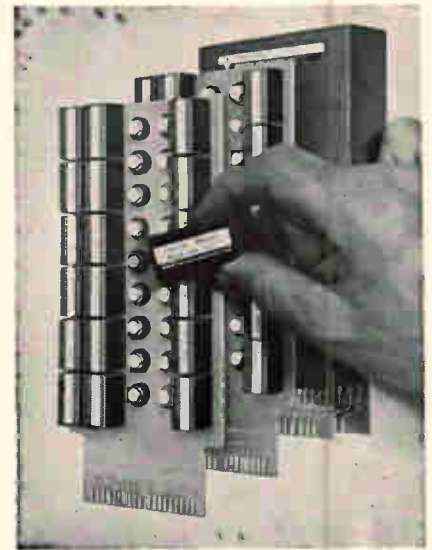

digital command into an equivalent sine/cosine value.

The inductive divider's sine and cosine outputs are fed directly to the stator coils of a precision resolver; its rotor moves to the angular position defined by the ratio of the two input voltages.

Over-all accuracy (no load) is within 0.1° for the 11-bit version. The actual configuration is custom designed to meet the needs of customers. The 11-bit version, model 537, is packaged on three 7½- by 4½-inch computer cards. This unit's output will power a pair of size 11 torque receivers (resolver positioners). The modular construction allows more equipment to be added after installation.

▪ To be introduced at Wescon.

#### Specifications (model 537)

<b>Digital Input</b>	
Data	11-bit binary angle
Logic	One: +2.5 v d-c to 6.3 v d-c at milliamperes Zero: 0 v to 1 v d-c at 5 ma
<b>Resolver/synchro</b>	
output	
Voltage	11.8 v, line to line
Frequency	400 hz
Accuracy	Within 0.1°, no load
Conversion time	Less than 1 millisecond
<b>Power</b>	
Reference	26 v, 400 hz
D-c	±4.5 v and -55 v
Price	Approximately \$1,500, depending upon options

North Atlantic Industries, Inc., Terminal Drive, Plainview, N.Y. [378]

## Pressure transducer can take a beating

Model VT-12 pressure transducer is suited to airborne, ground-support equipment and commercial applications. The unit weighs only 7 oz, yet it will withstand shock and vibration up to 50 g and temperature variations from  $-100^{\circ}\text{F}$  to  $+300^{\circ}\text{F}$ , without adversely affecting its operational efficiency. Zero shift is less than 0.1% with no change in accuracy.

The heart of the VT-12 is the patented Vaccobeam design that consists of four temperature-compensated, bonded strain gages which are isolated from contact with the fluid or gas being measured. The pressure diaphragm is made of high tensile strength stainless steel,



which allows linear movement throughout the rated pressure range. A positive, mechanical stop limits the movement of the diaphragm at the upper end of the pressure range to prevent damage from sudden surges or overloads.

Pressure transducers are available in a wide variety of pressure ranges and are capable of handling all gases and liquids compatible with stainless steel.

■ To be introduced at Wescon.

Vacco Electronics division of Vacco Industries, 10350 Vacco St., South El Monte, Calif. [379]

## Solid state, variable repeat cycle timer

An all solid state intervalometer permits pulse signals to vary in selected increments of 10 msec to any rate from 30 msec to 9.9 sec. It can be used as a pulse source or can be coupled to a solid state or electro-mechanical switching device to

a handful is all  
it takes...  
for many tests



## Simpson MICRO-TESTERS...18 Types...Get Several

If you run tests on communication systems, motors, wiring, appliances, tubes, components, batteries, or coolers, these nifty little testers are just what you're looking for. Micro-Testers measure only  $3'' \times 5\frac{7}{8}'' \times 2\frac{1}{2}''$ . They give you Simpson quality in a tester that is compact in both size and price. All 18 are in stock for immediate delivery. Call your Electronics Distributor or the factory for Bulletin 2072.

AC/DC VOLT-OHM-MILLIAMMETER: 12 ranges.....	Model 230	\$34.00
AC/DC VOLT-OHM-MILLIAMMETER: 14 ranges.....	Model 240	35.00
OHMMETER: 6 ranges, 0 ohms to 50 meg.....	Model 372	33.00
LOW-OHMMETER: 0-5, 0-25 ohms.....	Model 362	28.00
AC AMMETER: 0-1, 2.5, 5, 10, 25 amp. $\pm 5\%$ FS.....	Model 370	26.00
DC AMMETER: 0-1, 2.5, 5, 10, 25 amp. $\pm 3\%$ FS.....	Model 375	25.00
AC MILLIAMMETER: 0-5, 25, 100, 250, 1000 ma, $\pm 5\%$ FS.....	Model 378	30.00
DC MILLIAMMETER: 0-1, 5, 10, 25, 50, 100, 250, 1000 ma, $\pm 3\%$ FS.....	Model 373	25.00
DC MICROAMMETER: 0-50, 100, 250, 500, 1000, ua $\pm 3\%$ FS.....	Model 374	30.00
AC VOLTMETER: 0-5, 10, 25, 50, 100, 250, 500, 1000 v, $\pm 5\%$ FS.....	Model 376	28.00
AC VOLTMETER: 0-150, 300, 600 v, $\pm 3\%$ FS.....	Model 371	26.00
DC VOLTMETER: 10 ranges, 0 to 1000 v, $\pm 3\%$ FS.....	Model 377	30.00
DC MILLIVOLTMETER: 0-10, 30, 100, 300, 1000 mv, $\pm 3\%$ FS.....	Model 387	30.00
AC VOLT-AMP-WATTMETER: 8 ranges (300 v, 15 a, 3000 w. max) $\pm 5\%$ FS.....	Model 390	55.00
AC/DC VOLT-WATTMETER: 4 ranges (260 v, 3000 w. max) $\pm 5\%$ FS.....	Model 391	50.00
AC/DC VOLT-WATTMETER: 4 ranges (260 v, 5000 w. max) $\pm 5\%$ FS.....	Model 392	55.00
BATTERY TESTER: for radios, flashlights, hearing aids.....	Model 379	30.00
TEMPERATURE METER: $-50^{\circ}$ to $+70^{\circ}\text{F}$ (up to 3 temp. one time).....	Model 385-3L	36.00

  
INSTRUMENTS THAT STAY ACCURATE

**SIMPSON ELECTRIC COMPANY**  
5203 W. Kinzie Street, Chicago, Ill. 60644  
Phone: (312) ESTEbrook 9-1121  
In Canada:  
Bach-Simpson Ltd., London, Ontario

**TRYLON CONICAL MONOPOLE ANTENNA**  
Vertically-polarized, omnidirectional, for any  
4:1 range from 2 to 30 mc. 4 db/iso gain.  
50-ohm input. Power to 50 kw PEP

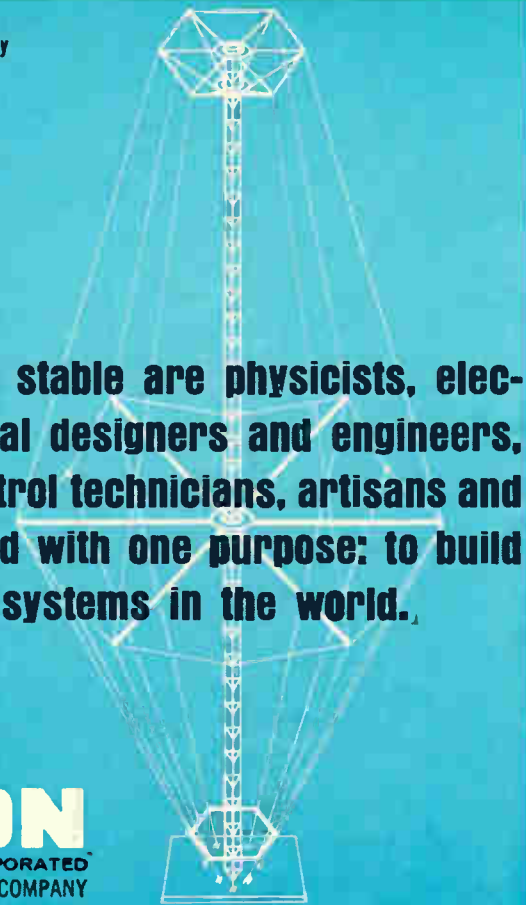

**Here in one stable are physicists, electrical and structural designers and engineers, production and control technicians, artisans and expeditors—all fired with one purpose: to build the finest antenna systems in the world.**



ELVERSON, PA. 19520

(215) 942-2981

Circle 331 on reader service card

## Low speed 30 inch per second

### AKAI VIDEO TAPE RECORDER MODEL VX-1100

- \* With Cross Field Bias Head Longitudinal Recording System
- \* Using 1/4 inch audio magnetic tape
- \* Dual tracks
- \* Easy to Operate
- \* Solid State Circuitry throughout



#### SPECIFICATIONS:

Recording Method: Longitudinal Special Modulation System using Cross Field Bias Head  
Tape Speed: 30 inch per second  
Tape Width: 1/4 inch audio magnetic tape  
Reel Size: 10 1/2 or 7 inch  
Recording Time: 10 1/2" 7200ft 100 minutes (50 a pass)  
Number of Tracks: Dual; Audio, Video totally four tracks  
Video Band Width: 60 Hz to 1 MHz  $\pm 6$ db  
Signal Noise Ratio: more than 34 db  
TV Signal: Input & Output 1.4 Vpp Sync-Negative 75 ohm

Audio Signal Recording Method: Direct Recording system Band Width: 50 Hz to 10 KHz  
S/N Ratio: more than 40 db  
Power Consumption: 100 VA  
Dimension: 17-3/8 (W) x 16 3/8 (H) x 10-3/8 (D) Inch  
Weight: net 45 pounds

see us at WESCON booth 2164

**AKAI ELECTRIC CO., LTD.**  
HIGASHIKOJIYACHO OHTA-KU TOKYO JAPAN

## New Subassemblies



provide timed distribution of sequential programs.

Although it is adaptable to laboratory, production and other timing applications, the model was specifically designed as a flexible, universal timing solution for armament controls—where airborne rocket firing, chaff dispensing, or bomb-release requirements call for precise and variable interval control.

Timing tolerance is  $\pm 5\%$  over a voltage range of 18 to 32 v and temperature range of  $-55^\circ$  to  $+85^\circ\text{C}$ . The package includes built-in suppression to protect solid state circuitry when switching inductive loads.

Prices range from \$355 for quantities to 1 to 4 to \$128 each in lots of 100 to 249. Delivery for prototypes is 10 weeks; production, 14 weeks.

■ To be introduced at Wescon. Ledex Inc., 123 Webster St., Dayton, Ohio, 45402. [380]

## Event counter and slave plug-in

The DP-140 event counter and slave plug-in extends the application of the company's DMS-3200 digital measuring system to provide inexpensive, all-electronic counting and display of totalized count of events in both industrial and laboratory applications.

A single plug-in/main frame combination provides a three-digit





Visit our Booth 1014 WESCON SHOW

GLOBE

## 5/8" DIA. ULTRA MINIATURE MOTOR



VT motor

VT gearmotor

Globe's Type VT permanent magnet d.c. motor is the smallest standardized power motor we know about. Fourteen standard armature windings are available for 3 to 50 v.d.c., with no-load speeds from 5,000 to 22,000 rpm. You can apply this miniaturized unit for continuous duty ratings up to 1-1/2 watts, and for starting torques up to 1.0 oz. in. Unit is 5/8" in diameter by 1-5/8" long; weight is 1.5 ounces.

Type VT precision planetary gearmotors are available with 19 gear ratios from 14.58:1 to 36,873:1. Request Bulletin VT. Globe Industries, Inc., 2275 Stanley Avenue, Dayton, Ohio 45404, Tel: 513 222-3741.

Circle 332 on reader service card

## Who Said Precision Scopes Have To Be Expensive?

Compare the new **HEATHKIT® DC-8 MHz triggered-sweep scope kit**  
**10-14 \$299.00**  
 wired  
**10W-14 \$399.00**

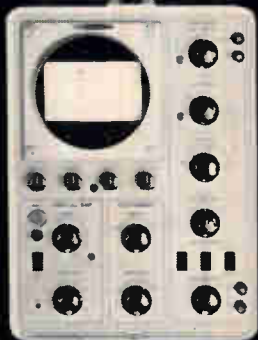

• DC to 8 mc bandwidth — 0.04 usec rise time • Triggered sweep — 18 calibrated rates • Delay-line vertical amplifiers for fast-rise signal analysis • 3% calibrated vertical attenuator — 0.05 v/cm to 120 v/cm, 600 v. (max.) input • Electronically regulated power supplies • Forced air ventilation • Built for continuous-duty industrial & lab use

HEATHKIT

### FREE CATALOG

Describes this and over 250 other Heathkits. Save up to 50%. Use this coupon for your free copy.

Heath Company, Dept. 67-8  
 Benton Harbor, Michigan 49022

Please send FREE Heathkit Catalog & Information describing the New Heathkit 10-14 Oscilloscope

Enclosed is \$\_\_\_\_\_ plus shipping. Please send model\_\_\_\_\_.

Name \_\_\_\_\_

Address \_\_\_\_\_

City \_\_\_\_\_ State \_\_\_\_\_ Zip \_\_\_\_\_

Prices & specifications subject to change without notice. TE-146



**Haven't you enough to worry about... without this?**

Insulation tubing shouldn't be a design engineer's worry anyhow. But it's vital to your product's performance... so you worry! Why not unload this worry on us? Just give us the facts about your insulation need and we'll come up with the right tubing to do the job. This way, you'll have one less worry! You can take our word for it... because we've been insulation specialists for 44 years.

THERE'S **FLEXITE®** TUBING TO MEET YOUR SPECIFICATIONS

Markel FLEXITE extruded tubings are manufactured of Teflon, silicone rubber, vinyls, polyethylene, Nylon and other plastics. Special formulations provide properties to meet the widest range of applications and operating conditions... at continuous temperatures as low as -70°C and as high as 250°C. Every type and grade meets the highest standards of dielectric and mechanical reliability. Included in the FLEXITE line are Shrinkdown Heat Shrinkable Tubings and TGL Triangular Guide Line Wrapping Tape. We'll gladly send you specifications and Sample File on the full FLEXITE line... just write.

**L. FRANK MARKEL & SONS**

SINCE 1922

Norristown, Pa.

215-272-8960

INSULATING TUBINGS & SLEEVINGS • HIGH TEMPERATURE WIRE & CABLE

Circle 333 on reader service card

Circle 265 on reader service card

265

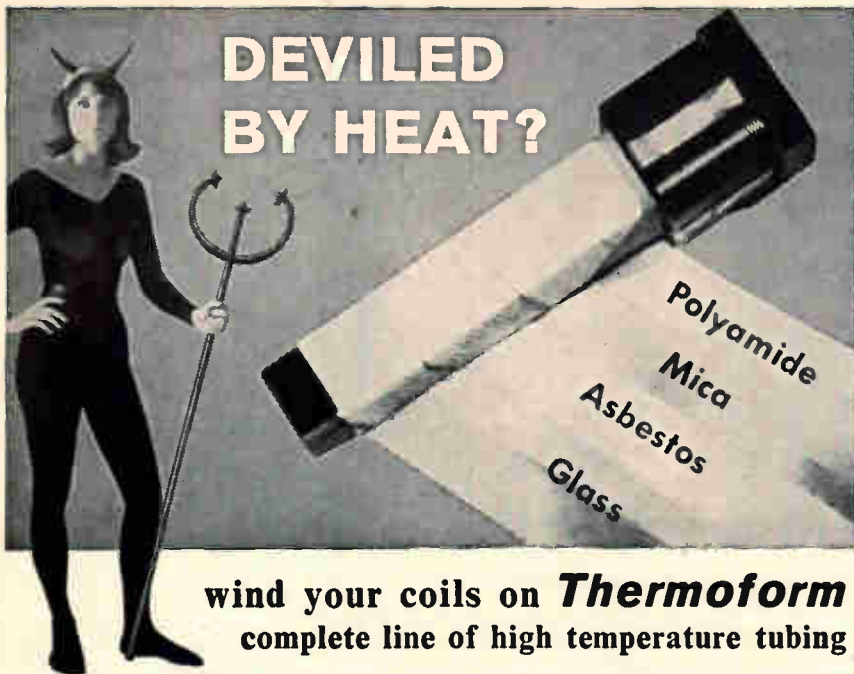

DEVEILED  
BY HEAT?

wind your coils on **Thermoform**  
complete line of high temperature tubing

Thermoform tubing is a scorching solution to high temperature coil problems—up past 180°C.—self generated or environmental heat. Diabolically made from a variety of materials; asbestos, glass, mica, polyamide. Wickedly wound to meet your specifications. Tempted to investigate? Write for technical data.



**PRECISION PAPER TUBE COMPANY**  
1033 South Noel Avenue, Wheeling, Ill. 60090  
Phone: 631-1445 (Chicago) or 312-537-4250 (Long Distance)

Circle 335 on reader service card

**New Subassemblies**

display; additional combinations may be added in cascade to provide 6-, 9-, or 12-digit display. The combination also may be used to extend the readout of the manufacturer's DP-150 1-Mhz frequency counter to a simultaneous 6-digit display of frequency or period.

Up to 1 million pulses per second can be counted by the DP-140, and it can be remotely controlled to start count, stop count, resume count or reset. Sensitivity is 100 mv.

The unit is fully transistorized and silicon transistors and diodes are used throughout. It weighs only 2¾ lbs. Price is \$75.

▪ To be introduced at Wescon.  
The Hickok Electrical Instrument Co.,  
Cleveland, Ohio. [381]

**Operational amplifier**  
for high-speed use

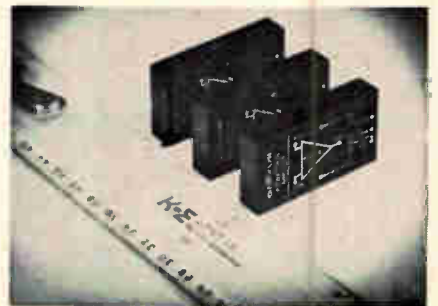

A high-speed, inverting amplifier, the FSK-8, is designed for service where a fast slewing rate, microsecond settling time, high d-c gain and low offsets are required. The amplifier is damped by the equivalent of a single resistor-capacitor network so that a -20 db/decade amplitude response and a phase shift of -90° is controlled to beyond 10 Mhz. This damping method guarantees unconditional stability and reduces the settling-time errors associated with step inputs. It has the added feature of being long-term, short-circuit proof against faults to ground.

Some typical applications for the FSK-8 are high-speed comparator, summing amplifier for digital-to-analog converters, summing amplifier for sample and hold systems, video recordings and rectifiers.

Typical electrical characteristics

**MINIATURE CLIP  
and LEADS**

Make "Impossible"  
Connections



Make test connections never before possible with world's smallest connector . . . actually reach 1¾" through ⅛" hole . . . reach ¼" through .080 slot. Insures positive hook-up . . . won't jump off. Fully insulated to prevent shorting out. Ideal for printed circuits, transistor sets, CB transceivers, computer units, and for temporary muscle and nerve connections in (Heart) surgery.

No. X100 E-Z-Mini-HOOK "Q" Ball Clip only, 49¢  
No. AX-1 Test Lead (.080 tip), 89¢ ea. No. BX-1 Lead (banana tip) 94¢ ea.

**Unique Design  
HARNESS  
BOARD CLIP**

Saves on board construction. Saves on cable assembly . . . increases production, improves quality.

Write for reprint telling how a firm estimates savings at \$20,000 annually with this clip. Only 14¢ each in 250 quantity.

Both items cataloged in EEM, Radio Master, VSMF. Satisfaction guaranteed. Order from distributor or direct.  
No. 81-1 E-Z-HOOK "Nail" Clip (Use T-20 Tool) 24¢ ea. — 10 for 1.98  
No. K8150T-1 "Nail" Clip Kit (50 Clips, Tool & Instr.) Wt. 2 oz. — ea 8.95  
No. T-20 E-Z-HOOK "Nail" Clip Driving Tool Wt. ½ oz. — ea. 35

**E-Z-HOOK®**  
BOX 105, COVINGTON, KY. 41012

**Metronix**

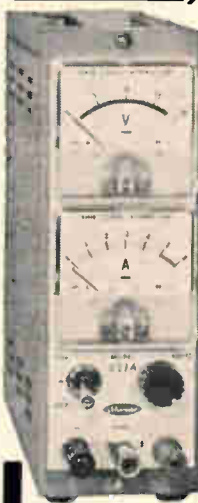

**REGULATED  
DC  
POWER  
SUPPLIES**

MODEL  
**521A**

RIPPLE: 3mVp-p

MODEL	VOLTS	AMPS	REGULATION (line or load)
521A	1-18V	0.5A	± 20mV
541A	1-35V	0.25A	± 20mV
543	1-35V	0.5A	± 20mV
531B	0-35V	1A	± 10mV
535C	0-35V	5A	± 3mV

**Metronix Corp.**  
76, CHOFU-CHIDORI-CHO, OTA-KU, TOKYO, JAPAN

# Helipot® Industrial Servo System

## \$169.95

... all you need is a cord

With standard Helipot servo components, you can build a complete, reliable servo system that will satisfy most industrial control applications. Components include: 1) *motor-pots*, compact models which combine a precision potentiometer with a small d-c gearhead motor; 2) *power supply*, which operates from 115v, 60 Hz input and provides d-c output for amplifier; 3) *amplifier*, solid-state d-c unit with gain of 300 volts per volt; 4) *command pot*, any standard Helipot precision pot (there are hundreds) to supply system input; and 5) *turns-counting dial* from Helipot's wide selection. Typical price for the whole works: just \$169.95. Contact your Helipot sales rep for information.

**Beckman®** INSTRUMENTS, INC.  
HELIPOT DIVISION  
FULLERTON, CALIFORNIA • 92634

INTERNATIONAL SUBSIDIARIES: GENEVA; MUNICH; GLENROTHES, SCOTLAND; TOKYO; PARIS; CAPE TOWN; LONDON, MEXICO CITY



Circle 337 on reader service card

*Speed-up*  
Wire  
Marking  
with a  
**KINGSLEY**  
Wire & Tube  
Marking Machine  
*right in your plant!*



Write  
for  
Details

Now you can *permanently* mark wire or tubing directly on the insulation... quickly... economically... right in your own plant!

Cut costs and speed production with the same machine that has consistently proven so successful in the aircraft/missile field.



**KINGSLEY**  
MACHINES

850 CAHUENGA • (213) 469-7243  
HOLLYWOOD, CAL. 90038

A-207

Circle 338 on reader service card

# The Finest Precision Coaxial Connectors



GRFF produces TNC, TM (Miniature), GM (Microminiature), and Series 2900 (which mate with OSM, BRM and others) connectors in a wide range of standard and crimp configurations; also TPS connectors; and specialized microwave components to individual customer requirements. Complete descriptive literature is immediately available.

**General RF Fittings, Inc.**

702 BEACON ST. / BOSTON, MASS. 02215  
Telephone: 617 267-5120

Visit GRFF at Wescon Booth #1409

Circle 267 on reader service card 267

# SWITCH TO G-E SILICONE RUBBER INSULATION ELIMINATES COSTLY BAKE CYCLE

Many relay and contactor operating coils for locomotive and rapid transit car control systems are varnish impregnated, then baked to cure the varnish. Some of these coils have lead wires connected internally and extending through the coil surface insulation.

A typical production cycle includes two varnish dips and two bake cycles at 150°C for 12 to 14 hours — tough treatment for any insulation.

One coil manufacturer had these problems when using lead wire with conventional insulation:

1. Lead wire insulation hardened during bake cycle.
2. Lead wire insulation cracked at extension point.
3. Considerable difficulty in cleaning varnish off lead wires after impregnation.

In 1960, this manufacturer switched to G-E silicone rubber insulation. And in the six years since, the problems have not recurred.

## Lower costs, fewer rejects

The switch to silicone was primarily made to improve product quality for customers. But because the baked varnish did not adhere tightly to the silicone rubber leads, it was easily removed. So the manufacturer also got two cost-saving bonuses: fewer rejects and lowered labor costs.

## FREE NEW DATA BOOK

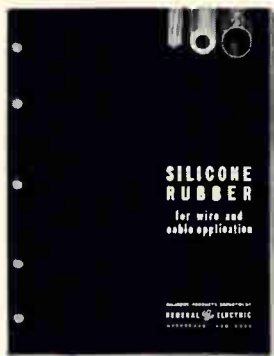

For more ways on how G-E silicone rubber insulation can save money, get Technical Data Book CDS-592, a comprehensive 36-page guide to high performance wire and cable.

Write to Section N8207, Silicone Products Dept., General Electric Co., Waterford, New York 12188.

**GENERAL ELECTRIC**

## New Subassemblies

for the FSK-8 include a maximum frequency for full output of 1 Mhz; unity gain frequency, 30 Mhz; d-c gain, 10<sup>3</sup>; output voltage and current  $\pm 10$  v at 20 ma; offset current,  $\pm 10$  na; change in offset current/change in temperature, 1 na/°C; change in offset voltage/change in temperature,  $\pm 10$   $\mu$ v/°C.

Operating temperature range is -25°C to + 85°C; storage temperature range, -55°C to + 100°C. Size is 2.02 x 1.14 x 0.40 in. Price for 1 to 9 is \$90.

▪ To be introduced at Wescon.

Nexus Research Laboratory, Inc., 480 Neponset St., Canton, Mass., 02021. [382]

## Digital supplies are all solid state

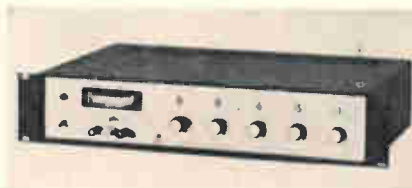

A complete line of digital power supplies is available. Units are all silicon solid state supplies featuring five-digit setting, dial readout accuracy of 0.01% and monthly stability of 0.01%.

Model 3512B is a zero to 100 v, 100 ma supply, while model 3514 is a 10 v, 100 ma version. A higher current model, the 3522, provides 500 ma over the 100-v range. All three models are priced at \$995.

For systems applications, two models are designed to be remotely programmed with BCD logic. One application of these supplies is as signal-conditioning voltage calibrators in data acquisition systems. Since the supplies are completely isolated they are suited for driving bridge-type transducers such as strain gages, load cells and pressure transducers.

The 3512B and its companions can be used in the field without any additional equipment since the output voltage can be set to 0.01%.

▪ To be introduced at Wescon.

Systems Research Corp., 2309 Pontius Ave., Los Angeles, Calif., 90064 [383]

## See For Yourself By Testing Sankyo's Family of Time Switches, Timing Motors and Elec- tro-Mechanical Parts!



TS60-S



DFC

**TS60-S**.....Spring wound time switch, 60 minutes, 100 to 240 VAC, 50 or 60 cps, 5 amp. Other models for 5, 15 and 45 minute timers are also available.

**DFC**.....Automatic defrost timer for refrigerators. Defrost time 30 minutes for every 12 hours. Other specifications are available. 100 to 240 VAC, 50 or 60 cps, 1 to 5 amp.



GMD



ATM

**GMD**.....Synchronous type timing motor, 100 to 240 VAC, 50 or 60 cps, 2 to 3W, 3 550 to 3.6 rpm, 0.2 to 3 kg-cm torque. Other model GMC, GME (Synchronous types) and GMA (Inductor type) are available.

**ATM**.....DC motor driven automatic tuning mechanism for radios. Rated voltage is 6 VDC. Used for AM & FM radios of portable, home and car radios.

**TS-2H**.....AC motor driven time switch, 2 hours, 100 to 240 VAC, 50 or 60 cps, 5 amp. Other models are available upto 24 hours interval.

**DFS**.....Automatic defrost timer with thermostat for refrigerators. Defrost at fixed time and terminate at fixed temperature. 100 to 240 VAC, 50 or 60 cps, 5 amp.

**ATA**.....Spring wound automatic tuning mechanism for radios.

**ITH**.....Tape counter for tape-recorders.

# Sankyo

AMERICAN SANKYO CORP.: Rm. 808-10, 95 Madison Ave., N.Y.C., N.Y., U.S.A. Tel. LE-2-8020  
SANKYO (EUROPE) EXPORT-IMPORT G.M.B.H.: 4 Düsseldorf, Bahnstraße 45-47, W. Germany Tel. 25652-3  
SANKYO SEIKI MFG. CO., LTD.: Shimbashi, Tokyo, Japan Tel: 991-8371



Send for **FREE**  
engineering data  
on Vacuum Pumps

## Precision High Vacuum Pumps are job-rated

From this newest, most complete line of internal vane mechanical vacuum pumps you can select a model with guaranteed performance matched to your requirements. For lab use, for roughing or backing a system, or for integral use in your product—take your choice of both single and two stage models in capacities from 25 to 1500 liters/minute (free air) at prices from \$100 to \$1500. Guaranteed ultimate vacuum runs to 0.1 micron of mercury. And these pumps are quieter, smaller and more efficient than any on the market today. Consult your Precision Scientific distributor, or send for 24-page Bulletin 650.



3737 W. Cortland St., Chicago, Ill. 60647  
Local Offices: New York • Chicago • Los Angeles

Circle 340 on reader service card

## Weld, Solder and Bond with this Versatile Machine!

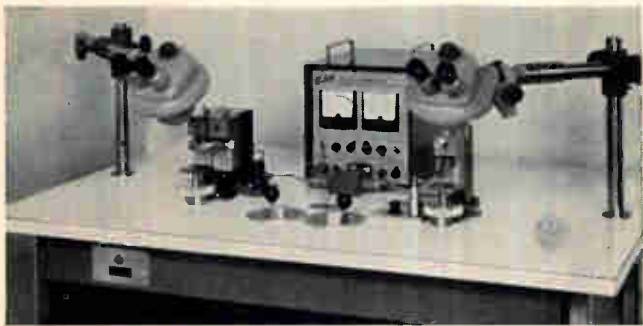

Weltek's new Model 750 can be set up in minutes to do micro-miniature welding, controlled soldering or "nail head" bonding. With this one piece of equipment you can solder or weld flat packs to p.c. boards, do module welding, point-to-point microsoldering or bond a wire to a transistor chip! The possibilities are unlimited. The 750 can do *all* of your miniature joining work . . . in the lab or in production. And it is reasonably priced.

### FREE SAMPLING SERVICE!

Send us your miniature joining problems  
...we sample quickly. No obligation.

**Weltek**

**Precision Bonders**

by **WELLS ELECTRONICS, INC.**

1701 S. Main Street, South Bend, Indiana, U.S.A.

Circle 341 on reader service card

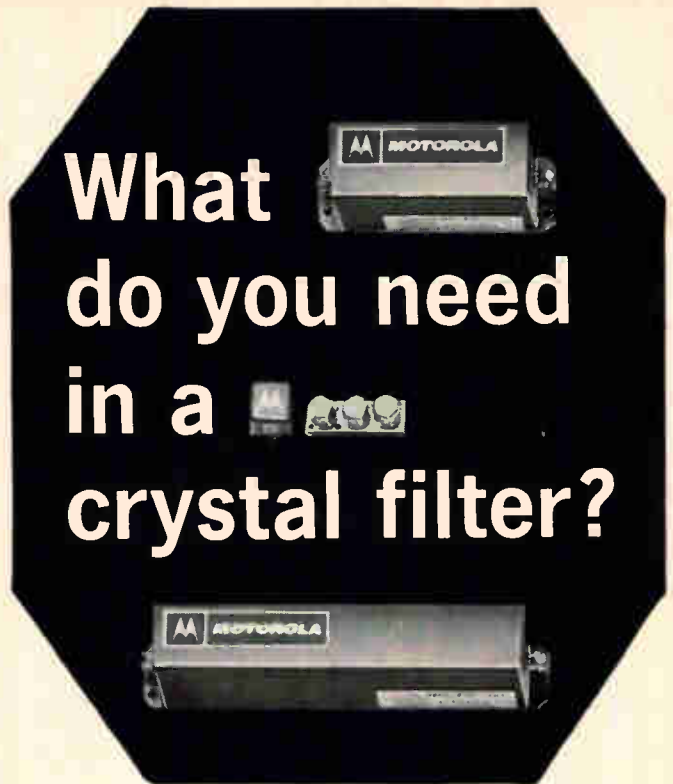

What  
do you need  
in a  
crystal filter?

### HIGHEST POSSIBLE FREQUENCY?

Motorola has supplied precision filters with center frequencies over 200 MC.

### SMALL SIZE?

Motorola sub-miniature sizes are as small as 0.125 cubic inches for reduced equipment volumes.

### HIGH SELECTIVITY?

Motorola gives better than 1.15 to 1.

### WIDE BANDWIDTH?

How about as wide as 2.5% of C.F.?

### ATTENUATION?

Up to 100 db.

### ASSURANCE OF PERFORMANCE?

Motorola crystal filters result from more than 20 years experience of meeting the most exacting specifications for fine quality crystals. All specifications are guaranteed.

*And only Motorola provides all the critical performance characteristics you need in a single package. Write for details: Motorola Communications & Electronics, Inc., 4900 West Flournoy, Chicago, Illinois 60644. A Subsidiary of Motorola Inc.*



**MOTOROLA**

PRECISION INSTRUMENT PRODUCTS

Circle 269 on reader service card

269

# TRON SUB-MINIATURE PIGTAIL FUSES

BODY SIZE ONLY  
.145 x .300 INCHES

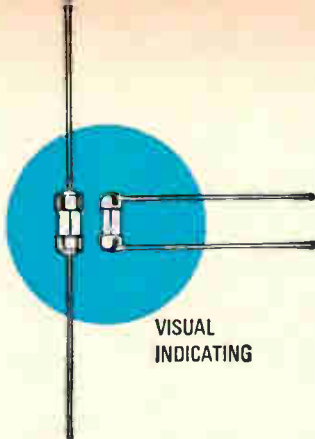

For use on miniaturized devices, or on gigantic space tight multi-circuit electronic devices.

Glass tube construction permits visual inspection of element.

Smallest fuses available with wide ampere range. Twenty-three ampere sizes from 1/100 thru 15 amps.

Hermetically sealed for potting without danger of sealing material affecting operation. Extremely high resistance to shock or vibration. Operate without exterior venting.

Tell us what you need or . . .

Write for Buss Bulletin SFB

INSIST ON **BUSS**  
**QUALITY**

BUSSMANN MFG. DIVISION McGraw-Edison Co., St. Louis, Mo. 63107  
Circle 271 on reader service Card

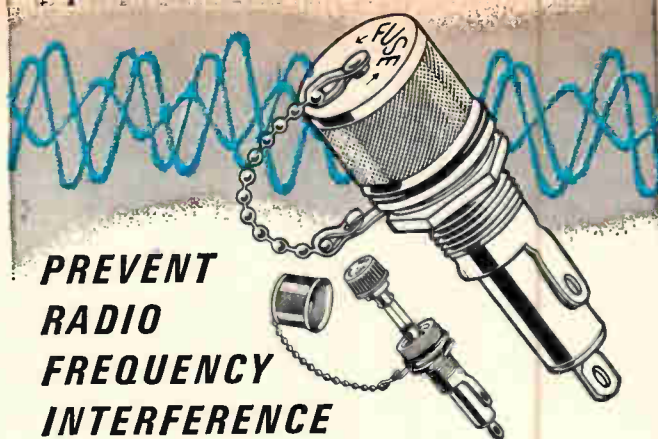

**PREVENT  
RADIO  
FREQUENCY  
INTERFERENCE**

For use where fuse and fuseholder could pick up radio frequency radiation which interferes with circuit containing fuseholder—or other nearby circuits.

Fuseholder accomplishes both shielding and grounding.

Available to take two sizes of fuses— $\frac{1}{4} \times \frac{1}{4}$ " and  $\frac{1}{4} \times 1$ " fuses.

Meet all requirements of both MIL-I-6181D and MIL-F-19207A.

Write for BUSS Bulletin SFH-12

INSIST ON **BUSS**  
**QUALITY**

BUSSMANN MFG. DIVISION, McGraw-Edison Co., ST. LOUIS, MO. 63107  
Circle 271 on reader service Card

## BUSS: The Complete Line of Fuses and . . .



miniaturization!



That's a pretty big word in the electronic and aerospace industries. VIP maintains "peak-load" support to these industries through its service center. Multiple units of VIP's MARK-42 Vertical Layout Plotters are used by our capable engineers to scribe intricate patterns for printed and multilayer circuits thin film devices, etc. on our special emulsion coated glass. Under white-room conditions tolerances of  $\pm .0001$  are maintained. Final images are inspected at 100x to 200x magnification on our panelescent tables, such tables are part of the VIP product line, designed specifically for this application. For more information about VIP's engineering facilities, or our complete line of products, write or call:

**VISUAL INSPECTION PRODUCTS / vip**

112 CENTRAL AVENUE LYNN, MASSACHUSETTS  
PHONE 617-595-2366 TWX 617-599-1847



### A New Waterproof Series



**MINIATURE  
TOGGLE SWITCHES  
with the most  
wanted features**



New case design with double high voltage barriers, and extremely low-loss, high impact, high temperature materials.

Wide silver contacts bonded on silver-plated copper turret terminals. Neoprene "O" rings and sealed terminals provide a waterproof advantage. Conservatively rated 6 amps @ 125 VAC. Available in One, Two, Three and Four Pole configurations all in compact unitized bodies.

SPECIFY THE NEW "E" SERIES BY

FREE  
PRODUCT  
PLANNING  
CATALOG

**ALCOSWITCH**

DIV. OF ALCO ELECTRONIC PRODUCTS INC., LAWRENCE, MASS.

## New Microwave

### Magnetically shielded b-w oscillators

The VA-184M magnetically shielded backward-wave oscillator delivers at least 50 mw over a 2- to 4-Ghz band. It is suitable for such applications as local oscillators in spectrum analyzers, swept-frequency signal generators, wide-band radar receivers, panoramic receivers and special test sets.

Adjusting the helix voltage tunes the oscillator. The resulting voltage-versus-frequency curve follows an exponential function and lacks any discontinuities. A nonintercepting negative control grid permits amplitude modulation of the output without drawing current in the modulating circuit.

Shielding reduces magnetic field leakage to less than 10 gauss  $\frac{1}{2}$



inch from the tube surface, allowing the oscillator to be operated in contact with ferrous materials or in stray magnetic fields typically found in microwave equipment. This feature simplifies equipment design and layout and eliminates special handling and storage precautions.

Other features of the VA-184M include rugged metal-ceramic construction, a smooth output characteristic, rapid sweep rate capabilities, and excellent a-m, f-m, and spurious noise performance. The r-f is brought out through a type N

female connector, but a flexible coaxial lead terminated in a type N connector is available on special order. Cooling is by conduction. Varian Associates, 611 Hansen Way, Palo Alto, Calif., 94303. [384]

### Limiter-attenuator recovers in 200 nsec

The MA-8452-X15 limiter-attenuator is a receiver protector designed for applications including tracking, target detection and navigational radar. It functions equally effectively as an electronically controlled variable attenuator designed to increase the dynamic range of the over-all radar system.

The unit provides receiver protection over the 8.5 to 9.6 Ghz frequency range with a maximum insertion loss of 1.0 db, flat leakage of 100 mw and recovery time of 200

## Fuseholders of Unquestioned High Quality

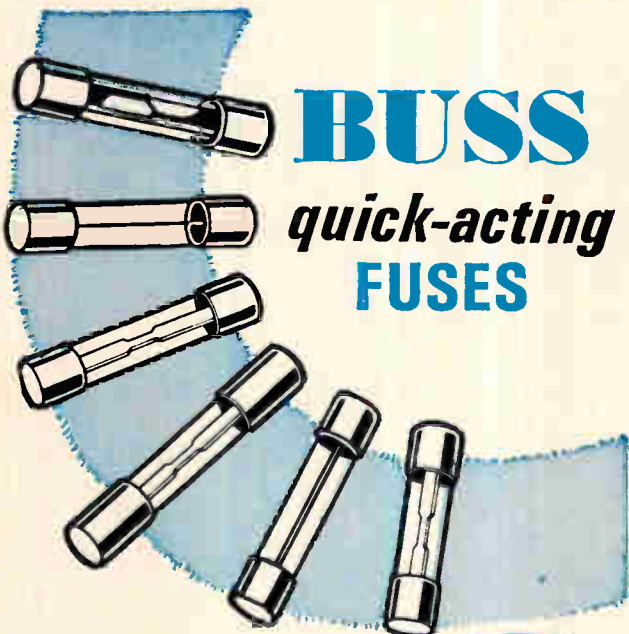

### BUSS quick-acting FUSES

"Quick-Acting" fuses for protection of sensitive instruments or delicate apparatus;—or normal acting fuses for protection where circuit is not subject to current transients or surges.

Write for  
BUSS  
Bulletin SFB

INSIST ON **BUSS**  
QUALITY

BUSSMANN MFG. DIVISION, McGraw-Edison Co., ST. LOUIS, MO. 63107

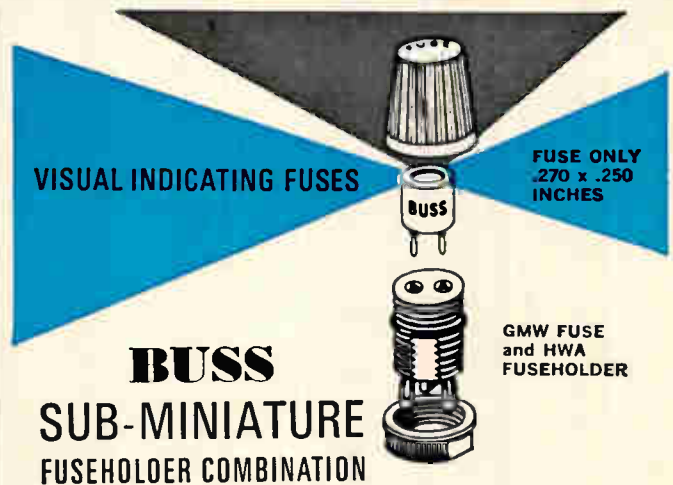

### BUSS SUB-MINIATURE FUSEHOLDER COMBINATION

For space-tight applications. Fuse has window for inspection of element. Fuse may be used with or without holder.

Fuse held tight in holder by beryllium copper contacts assuring low resistance.

Holder can be used with or without knob. Knob makes holder water-proof from front of panel.

Military type fuse FM01 meets all requirements of MIL-F-23419. Military type holder FHN42W meets all military requirements of MIL-F-19207A.

Write for BUSS Bulletin SFB

INSIST ON **BUSS**  
QUALITY

BUSSMANN MFG. DIVISION, McGraw-Edison Co., ST. LOUIS, MO. 63107

FOR  
DRILLING  
AND ROUTING  
CIRCUIT BOARDS  
AND  
REINFORCED  
RESINS

**SOLID  
CARBIDE**

◀ DRILLS

◀ FLUTED  
ROUTERS

◀ FIBERGLASS  
ROUTERS

UNEQUALLED METAL REMOVAL  
COMPANY SERVICE, QUALITY  
AND SELECTION INCLUDING:

1. World's largest inventory of centerless ground drill blanks and finished tools ready-for-shipment.
2. Fifteen centerless grinders in production of drills and rotary carbide tools.
3. Every size carbide drill, ground from the solid . . . the smallest — .008" diameter to the largest — 1.500" diameter.
4. Precision ground to 5 micro-inch finish or better.
5. Delivery from stock, through our distributors, of any standard solid carbide tool in 48 hours.

Your assurance of product quality, lowest cost and dependable service is the fact that the nation's leading carbide tool users are placing their tool contracts with The Metal Removal Company.

**THE METAL REMOVAL COMPANY**  
1859 W. Columbia Avenue  
Chicago, Illinois 60626  
Plants Located in CHICAGO • LOS ANGELES • SAN JUAN



MASTER TOOL AND WHEEL  
MAKERS FOR THE WORLD

## New Microwave

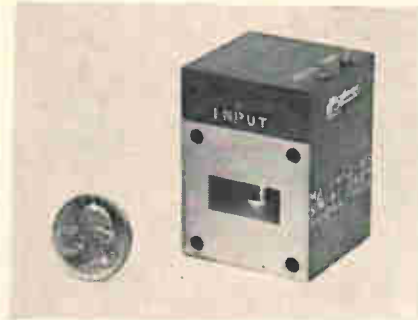

nsec. Peak power is 50 watts and average power is 2 watts. Over-all dimensions of the unit are 1½ x 1½ x 2¾ in. Weight is 6 oz.

▪ To be introduced at Wescon.

Microwave Associates, Inc., Burlington, Mass. [385]

## Plug-in isolators cover wide temperature range

Miniature X-band plug-in isolators offer 35-db minimum isolation and 0.5-db maximum insertion loss over a wide temperature range.

Typical of the isolators is model J-7881, for use from 9.1 to 9.5 Ghz in temperature environments from -55° to +80°C. Maximum voltage standing-wave ratio is 1.15. Tests on the J-7881 across the temperature range provided measured isolation of 40 to 50 db, insertion loss of 0.3 to 0.4 db, and vswr typically less than 1.10.

The component, a four-port device with two internal terminations, is of plug-in design for compatibility with strip-line assemblies. It is 1 in. long (plus overlaps), 0.75 in. wide, and 0.625 in. thick, including terminations. Weight is 1 oz. Availability is 45 to 60 days.

Melabs, 3300 Hillview Ave., Stanford Industrial Park, Palo Alto, Calif. [386]

## Transistor amplifier has low noise

A microwave transistor amplifier that has a 4.0-db maximum noise figure at 1.3 Ghz, the TA1300-15 can be packaged with a small mixer preamplifier for a complete miniature low-noise receiver.

Center frequency is 1.3 Ghz;

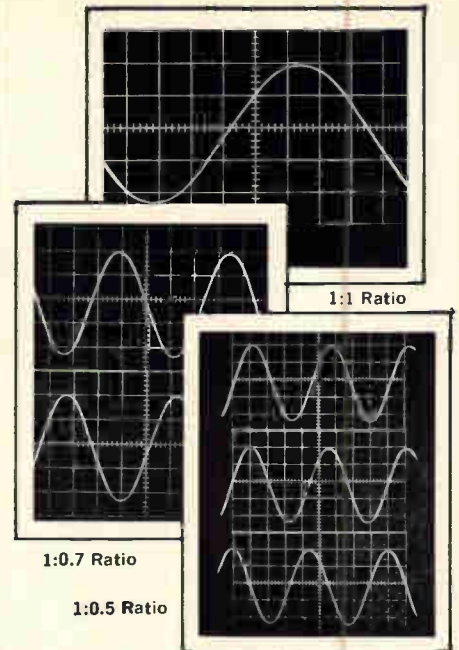

## CHANGE YOUR RECORDING RATIO QUICKLY / EASILY

Record at any object-to-image ratio from 1:1 to 1:0.5 without extra lenses with the Beattie-Coleman MIIA Oscillotron. This highly versatile camera also offers these plus features:

- Rugged construction for field test instrumentation.
- Fully enclosed electric shutter actuator and lens.
- Records ultra-high speed traces.
- Synchronous electric shutter.
- Polaroid and 4 x 5 backs.
- Hinged at CRT to swing away for unobstructed viewing when not recording.
- Data recording optional.
- Shutter-open indicator light.

43 different models. Send for catalog, Coleman Engineering Co. Inc. Box 1974, Santa Ana, Calif. 92702

**BEATTIE-COLEMAN  
OSCILLOTRON®**  
OSCILLOSCOPE CAMERAS





# "RELAIS"

In my Father's high school Physics textbook this device was described as a "Relais." It could lift a lot of weight—even you and me together—reliably.

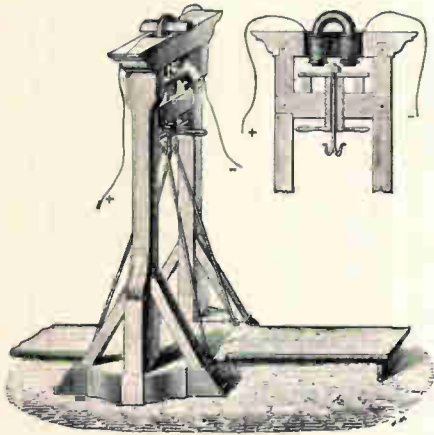

The relays we make today can energize this contraption and fit in the palm of your hand. Here are some examples:

#### RELAY-CONTACTOR G11 Series

25 Amperes, single or three phase loads, either 3PST normally open or 2PST, double make, double break, .45 lbs., 1.490" x 1.490" x 1.812".

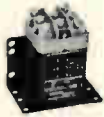

#### MINIATURE POWER RELAY G12 Series

10 Amperes 2PDT, .07 lbs., .525" x .935" x 1.025".



#### MINIATURE POWER RELAY G14 Series

6PDT double make, double break, 10 Amperes and 3PDT 20 Amperes, double make, double break, both .03 lbs. 1.070" x 1.250" x 1.800".



Write us about your problems (I mean relay problems); you will not be disappointed.

*Gabriel M. Giannini*

**GIANNINI** | **VOLTEX**

12140 E. RIVERA RD., WHITTIER, CALIF. 90606  
PHONE: 213-723-3371, TELETYPE: 213-685-6261

An Independent Company/An Equal Opportunity Employer

Circle 322 on reader service card

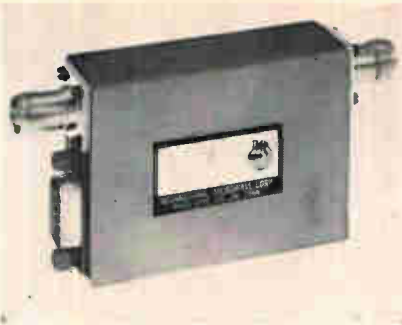

bandwidth is 300 Mhz. Input signal at the 1-db compression level equals -25 dbm; gain is 15 db; input-output impedance (nominal), 50 ohms; d-c power, ±12 v; current, 20 ma. Size is 7/8 x 2 x 3 in. Connectors are standard coaxial.

▪ To be introduced at Wescon.  
International Microwave Corp., River Road, Cos Cob, Conn., 06807. [387]

## R-f coaxial connector useful to 18 Ghz

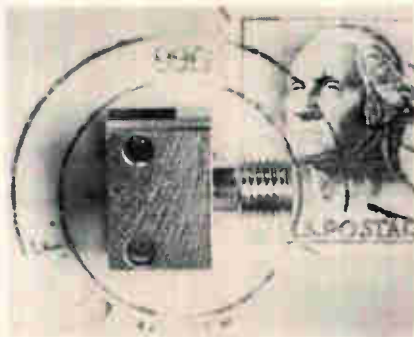

This r-f coaxial connector is intended for edge feed from microwave strip circuitry. It is useful from d-c to a frequency of 18 Ghz. In 50-ohm circuits, it exhibits a typical vswr of 1.25:1. The connector, model MOE-1, mates with male OSM type connectors. It mounts to the end of solid-dielectric, metal-backed laminate of 1/4-in. thickness and is particularly useful with lines of 1/8-in. dielectric with 1/16-in. metal backing top and bottom.

The center (female) pin of the connector may be soldered to a 0.005-in. center copper conductor of a strip circuit prior to assembly, after which the outer shell (recessed to fit the 1/4-in.-thick completed circuit) is pushed on. Two 2-56 screws are required.

The MOE-1 connector, now in stock, is priced at \$5 each in sam-



... 35 YEARS LEADERSHIP  
IN ROTARY SWITCHES

now  
the  
perfect  
index—  
**UNIDEX**



UNIDEX™ is the universal index for Oak rotary switches. Its revolutionary new method of operation provides a consistent "velvet-feel" torque for the life of the switch, a longer index life—by many thousands of operations, a lubrication reservoir and a sturdy one-piece housing that guarantees electrical continuity.

Only Oak® offers you Unidex . . . and at no extra cost. For more information write for Bulletin SP 178.

**OAK MANUFACTURING CO.**

A DIVISION OF OAK ELECTRO/NETICS CORP.  
CRYSTAL LAKE, ILLINOIS 60014 • Telephone: 815-459-5000  
TWX: 815-459-5628 • Cable Address OAKMANCO

Circle 273 on reader service card 273



Please send me the latest Acopian catalog that lists

**62,000  
DIFFERENT  
POWER  
SUPPLIES**

available  
for shipment  
in 3 days.

Name \_\_\_\_\_

Title \_\_\_\_\_

Company \_\_\_\_\_

Address \_\_\_\_\_

City \_\_\_\_\_

State \_\_\_\_\_

ZIP \_\_\_\_\_

ACOPIAN CORP.  
EASTON, PENNSYLVANIA  
TEL: (215) 258-5441



## New Microwave

ple (1 to 4) quantities. Minimum order billing is \$10. LEL division, Varian Associates, Akron St., Copiague, L.I., N.Y. [388]

## Coaxial circulators are light and tiny



A series of subminiature coaxial circulators is claimed to be as much as 50% smaller in size and weight over the best previous units. Custom selected frequencies are provided at standard prices with an 8% bandwidth offered from 1.6 to 1.9 Ghz and 10% bandwidths from 1.9 to 12.0 Ghz.

All units have 20-db isolation and 1.25 vswr with 0.4-db insertion loss in the low frequency units and 0.3 db above 1.9 Ghz. An example of the size and weight offered are the units from 5.4 to 12.0 Ghz which measure 1/2 in. on each side and weigh 20 grams. The reduced volume and weight are advantageous in missile, satellite and telemetry applications.

E&M Laboratories, 7419 Greenbush Ave., North Hollywood, Calif. [389]

## Coaxial couplers have high directivity

A series of highly directive coaxial couplers is designed to sell at 30% below the industry's average price. The couplers are completely potted, for ruggedness, yet, the manufacturer claims, they are smaller than most units available today.

Designated model CB, the 3- and

**“9 years ago we had a great idea that put us in the high-rel relay business.”**



**It's still a great idea, and now we've put it in a one-inch package!”**

Wedge-action\* was the great idea. By combining long precious-metal contact wipe with high contact force, it gives Electro-Tec relays the highest dry-circuit confidence level ever reached. (90%, based on a failure rate of only .001% in 10,000 operations.)



Packing wedge-action into a one-inch envelope wasn't easy. But it was worth it. It gives you maximum reliability in minimum space. And it's available for both 6PDT and 4PDT operations, in relays that exceed all requirements of MIL-R-5757/1 and /7.

The one-inch relay is just one of our family of wedge-action relays, which cover almost every dry-circuit to 2 amp application. When you need a high-rel relay that really works, remember our great idea, and put it to work for you.

\* U.S. Patent No. 2,866,046 and others pending.



**Electro-Tec Corp.**

SLIP RINGS • RELAYS • SWITCHES • OPTICS

P.O. Box 667 • Ormond Beach, Florida

(904) 677-1771 • TWX 810-857-0305

Manufacturing Facilities:

Ormond Beach, Fla. • Blacksburg, Va.

## MITSUMI COMPONENTS

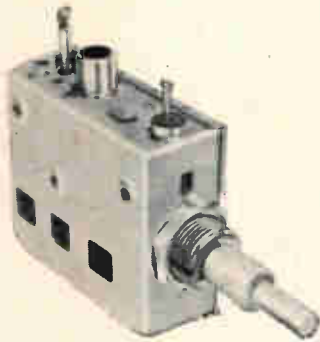

**UHF U-AS11**

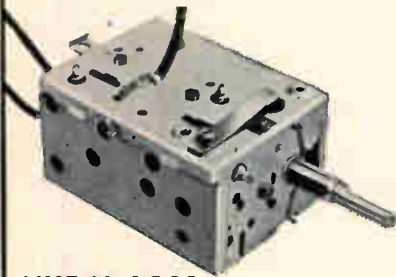

**VHF V-AS11**

### NEW TRANSISTOR TV TUNER

The characteristics of Mitsumi transistor TV tuner are high sensitivity, small spurious radiation and high durability.

The tuner is available for both VHF and UHF. It has a unique fine adjustment mechanism and is superior in humidity characteristics and temperature characteristics.

#### Main Products

Polyvaricon • IFT • Oscillator coil • Antenna coil • Composite coil • Special coil • Micro motor • Synchronous motor • Variable resistor • Trimming potentiometer • FM tuner TV tuner • Various sockets • CdS photoconductive cell.



### MITSUMI ELECTRIC CO., LTD.

New York office: 11 Broadway, New York, N.Y. 10004, U.S.A. Phone: HA-5 3085, 3086.

Main office: 1056, Koadachi, Komae-machi, Kitatama-gun, Tokyo, Japan. Phone: Tokyo 415 6211/23



4-port couplers offer 25-db directivity over a full octave frequency range. Models offering 10, 20 and 30 db are available, with a vswr of 1.15, type N and TNC connectors. Prices start at \$90 and the units are available from stock.

▪ To be introduced at Wescon. Microlab/FXR, 10 Microlab Road, Livingston, N.J. [390]

### Fixed-frequency reflex klystrons



Millimeter reflex klystrons are available at any specific frequency from 50 to 101 Ghz. The fixed-frequency tubes, which are trimmable by  $\pm 1$  Ghz, are less expensive than standard klystrons with 10-Ghz ranges.

Average power outputs range from 50 to 300 mw, depending upon frequency. Higher power levels can be supplied on special order.

The high-reliability, single-mode klystrons feature excellent frequency stability and are warranted for one year or 500 hours.

Raytheon Co., Microwave and Power Tube division, Willow St., Waltham, Mass., 02154. [391]



...35 YEARS LEADERSHIP  
IN ROTARY SWITCHES

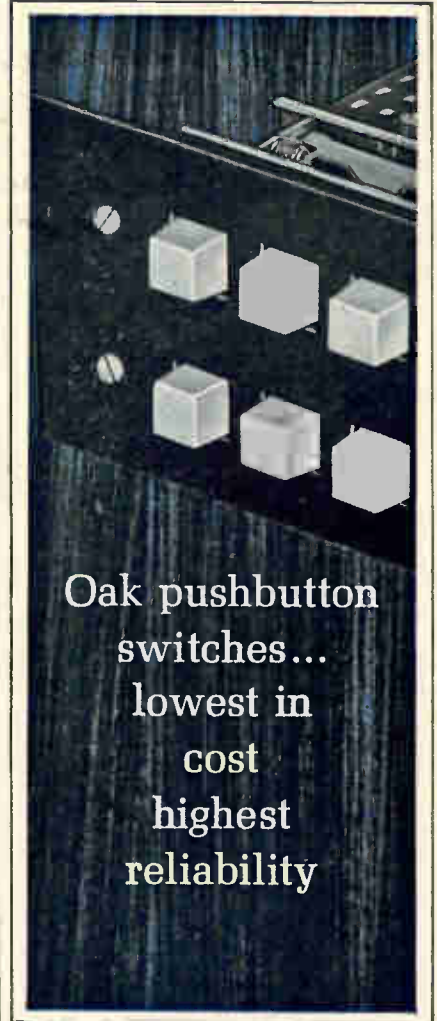

Oak pushbutton  
switches...  
lowest in  
cost  
highest  
reliability

Built-in economies reduce costs and maintenance. Modern Oak® styling gives smart appearance for simplified or complicated arrangements. More flexible circuit design than provided by many rotary switches because of the large number of blade shapes combined with plunger actions. Oak-pioneered double-wiping action contacts are used in push-button switches. Special frames for lamps prevent vibration and shock, give long lamp life. Lighted push-buttons use one lamp to illuminate 1, 2 or 4 buttons. Unlighted pushbutton switches also.

For full details, write for Bulletin SP-165.

## OAK MANUFACTURING CO.

A DIVISION OF OAK ELECTRO/NETICS CORP  
CRYSTAL LAKE, ILLINOIS 60014 • Telephone: 815-459-5000  
TWX: 815-459-5628 • Cable Address OAKMANCO



# Qualified Electronics Technicians

(Where do you find them?)

Many Companies will tell you the best source is their present staff of technical personnel. These men have the necessary aptitude and ambition ... can be readily up-graded through a planned electronics training program.

Since 1934 Cleveland Institute has developed such programs for hundreds of leading companies ... has provided thousands of men with practical, useable knowledge of electronics theory and fundamentals. These men understand the "why" of electronics ... can install, maintain, troubleshoot, and repair the sophisticated equipment you're using today, and will be using in the years ahead. Learn how CIE can "tailor" an Electronics Training Program to your specific needs. Its effectiveness and economy will amaze you. Send coupon today for FREE brochure. Cleveland Institute of Electronics, Dept. E-23, 1776 E. 17th St., Cleveland, Ohio 44114.

**SEND COUPON TODAY**

**Cleveland Institute of Electronics**

Dept. E-23, 1776 E. 17th St., Cleveland, Ohio

Gentlemen: I am interested in learning more about your Electronics Home Study Programs. Please send complete information.

Name \_\_\_\_\_  
 Title \_\_\_\_\_  
 Company \_\_\_\_\_  
 Address \_\_\_\_\_  
 City \_\_\_\_\_ State \_\_\_\_\_ Zip \_\_\_\_\_

Accredited Member, National Home Study Council.

## New Production Equipment

### Ultrasonic bonder is portable

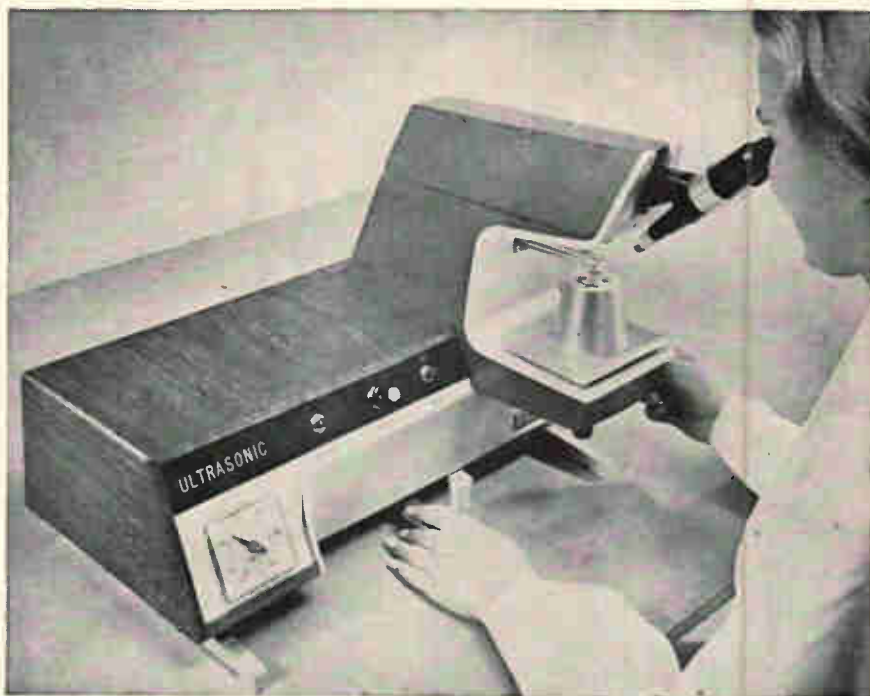

An ultrasonic bonder that can go anywhere and attach lead wires to a variety of semiconductor devices owes its portability to a suspended micromanipulator and its versatility to a mating of manual and automatic controls. The bonder is small enough to be carried from one workbench or desk to another. It can be used as soon as it is plugged in because the manipulation system is suspended without reference to the bench top.

Bonding and wire-cutting operations are not programmed, but are controlled manually. This saves time when different devices are being bonded one after another, because the operator can make corrections and changes in the bonding cycle without stopping for a new setup. It also reduces rejects, the company claims, since a cycle need not be completed before a correction can be made. If different work fixtures are required in the machine, only two screws have to be removed to change them. A spring holds the work in place.

Gold or aluminum wire is handled automatically. A push-button control takes wire from a spool above the work station and an air

jet feeds the wire through the capillary. The wire loop is formed automatically between bonds to the semiconductor die and a header post. The looping operation was made automatic, the company says, because of problems experienced during manual looping with tweezers. Besides taking more time, it frequently resulted in work damage, wire breakage or a too taut wire that could rip the bond.

Bonding force is developed by an air cylinder and is adjustable. After being bonded the wire is cut by a guillotine.

The operator moves the micromanipulator with a handle that moves in a 4.5-inch square. The motion is reduced 15:1 or 10:1 at the work piece. With coarse positioning, the range is extended to 0.65 inch. The work piece can be rotated with another handle.

▪ To be introduced at Wescon.

#### Specifications

Bonding force	10 to 300 grams
Optics	stereo, 15X magnification
Power	200 w; 115v, 50-60 hz
Air supply	30 to 300 psig

Lindberg Hevi-duty, division of Sola Basic Industries, 304 Hart St., Watertown, Wis. [392]

## NEW BLILEY COMPONENT OVENS

WITH PROPORTIONAL  
TEMPERATURE CONTROL



New type BPCO ovens maintain cavity temperature within  $\pm 0.1^\circ\text{C}$  with solid state noise-free circuitry. Ovens mount flat on PC board and provide eight wire lead connections for components.

### STANDARD MODELS

Model	Heater	Cavity Size
BPCO 30-1	27VDC	1.25 cubic inches
BPCO 31-1	12VDC	1.25 cubic inches
BPCO 40-1	27VDC	2.25 cubic inches
BPCO 41-1	12VDC	2.25 cubic inches

Request Bulletin 544 for complete information

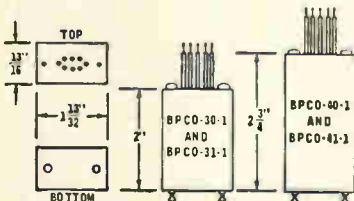

**Bliley** If you buy quality

**BLILEY ELECTRIC COMPANY**  
Union Station Bldg., Erie, Pennsylvania

## Coil winder offers absolute accuracy

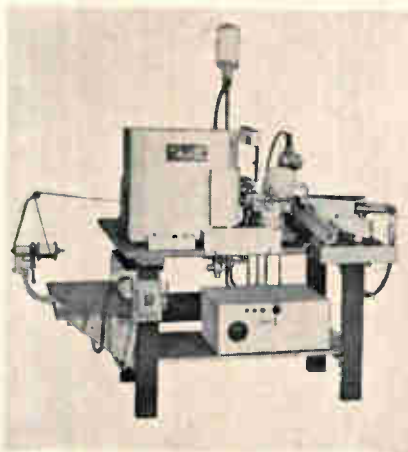

Model 67-AM continuously winds all types of tv tuner and other single-layer solenoid coils to  $0^\circ$  accuracy. Up to 900 nontap coils and up to 700 tap coils can be produced hourly. The accuracy of lead placement and turns count is absolute, the company reports. For example, a toolplate provides start, tap and finish leads to any required position without error. Coils are front loaded on the machine to increase speed.

Adjacent turns are fused by an acetone applicator with gravity feed and adjustable flow-control. A cementing and color-coding applicator applies a stripe of colored rubber-based cement to secure the windings to the coil form.

The cement is dried and cured by a forced hot air applicator before automatic lead severing. Finished coils are ejected automatically. A resettable batch counter gives the total of completed coils wound. Turns are counted by an automatically resetting mechanical-gear counter.

For operator safety, all winding and finishing operations take place behind shielding. Maintenance and downtime over long production runs are eliminated by a ball bearing supported level wind mechanism, according to the manufacturer. Even normal maintenance is virtually eliminated by automatic air operated indexing—complete with all necessary filters, lubricators and regulators.

The machine is furnished completely tooled, cammed and geared for one winding specification. De-



...35 YEARS LEADERSHIP  
IN ROTARY SWITCHES

Miniaturize  
...use new Oak  
184 Lever Switch  
with  
Molded Stator



This new switch gives versatility in a small area. Available with one or several sections, optional spring return. Lever switch design and construction provide for long life. Also offers advantages of molded "A" stator... more clips per stator, recessed clips provide secure mounting and minimize electrical leakage, Diallyl Phthalate Stator provides improved or equal dielectric characteristics at no extra cost. Made with Oak-pioneered double-wiping action contacts.

Only Oak<sup>®</sup> offers you this compact lever switch with molded "A" stator. Breaks 1.0 amp @ 28 vdc, 0.5 amp @ 110 vac. Carries 5 amps. For full details, write for Bulletin SP-199.

**OAK MANUFACTURING CO.**

A DIVISION OF OAK ELECTRO/NETICS CORP  
CRYSTAL LAKE, ILLINOIS 60014 • Telephone: 815-459-5000  
TWX: 815-459-5628 • Cable Address OAKMANCO

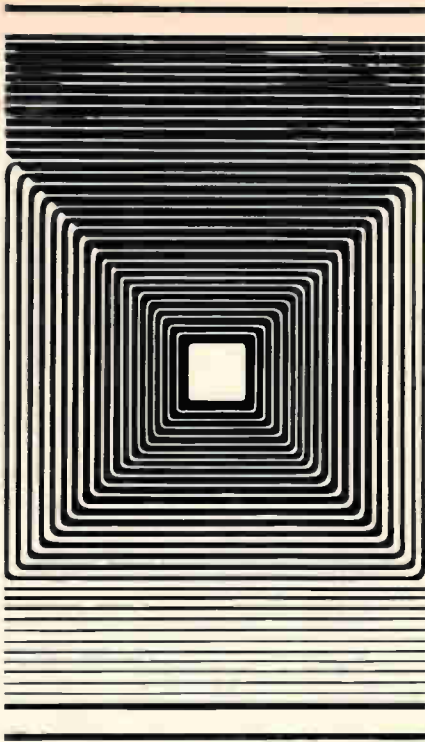

## PRECISION

is progressive. Yesterday's standards are no longer adequate. In nonferrous tubing, today's standards of precision are set by Precision . . . in dimensional accuracy, heat treatment, finish and fabrication. This precision in tubing may improve your product's performance or reduce production costs . . . or both.

This new symbol of Precision identifies the world's most dependable source for nonferrous metal tubing, Bourdon tubing, pointer tubing, custom-fabricated tubular parts, 'Coaxitube' semirigid coaxial cable. May we send you information?

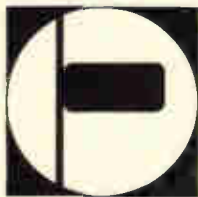

**PRECISION TUBE COMPANY, INC.**  
 Tube Mill Division • Special Products Division  
 North Wales, Pennsylvania 19454

## Production Equipment

livery is 4 to 6 months. Price is \$12,000 to \$14,000 depending on coil specifications.  
 Geo. Stevens Mfg. Co., Inc., 6001 No. Keystone Ave., Chicago, Ill., 60646. [393]

## Electric glue gun suited for many uses



Hot-melt, quick dry adhesion is provided by a polyethylene-based glue used in a new eight-ounce Thermogrip electric glue gun. The glue can be used as a replacement for tape in insulating and waterproofing splices and exposed parts in chassis wiring.

The glue also can replace rubber grommets where wires run through holes in a metal chassis; a tapered coating of Thermogrip glue on a wire will prevent damage to the wire caused by excessive flexing. After broken wires in a connector plug are repaired, a bit of glue will immobilize the wires in their plugs. The glue is moderately flexible.

The black plastic, pistol-shaped tool heats to 400° in three minutes in a thermostatically controlled aluminum melting chamber. A-c or d-c outlets operate the glue gun, using 70 watts power at 120 volts. When cartridges of the glue are forced through the chamber with slight thumb pressure, the glue is reduced to liquid and emitted from the 1/8-inch diameter nozzle.

Approximately 90% of the ulti-

# HIGH STABILITY CRYSTAL OSCILLATORS



Compact modules contain glass-sealed crystal units, transistorized circuitry, and proportional control ovens for freedom from RFI. For precision frequency or time base reference in counters, signal generators, and master oscillator systems. Industry's smallest package sizes, lowest power requirements, and fastest warm-up time. Custom-designed units such as multiple-frequency oscillators also available.

### SPECIFICATIONS

**Frequency Range**  
10 kc to 100 mc

**Short Term Stability**  
up to 1 part in 10<sup>9</sup>

**Long Term Stability**  
up to 1 part in 10<sup>8</sup>

**Ambient Temperature Range**  
-55°C to 95°C

**Oscillator Supply**  
±6 V, ±12 V, +24 V, +28 V, etc.

**Oven Supply**  
+28 vdc or 115 vac

**Standard Oven Sizes (inches)**  
2 x 2 x 4; 1.5 x 1.5 x 3.25

**Output Power**  
up to 500 mw

**Output Waveform**  
Sine, square, or special

Write for Bulletin 6350



**MICROSONICS, INC.**

a subsidiary of the  
SANGAMO ELECTRIC COMPANY

60 Winter Street  
 Weymouth, Massachusetts 02188  
 Area Code 617 337-4200

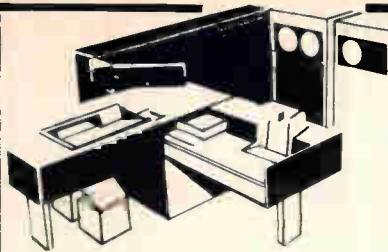

## DESIGN and DEVELOP

### POWER SUPPLIES

At the Research and Engineering Division of Honeywell EDP we have developed many new techniques in computer design and capabilities. An integral function of these advances are the design and development of power supplies utilizing passive regulating, switching type regulating or C.V.T. techniques. Another activity would be the design of electronic power control, sensing and interlocking circuits for computer systems.

If you are currently a power supply designer familiar with magnetic circuit as well as electronic circuit design OR if you have three to four years' electronic circuit design and a hankering to design power circuits,

call or write Mr. Edwin Barr, Employment Supervisor, Dept. E 8, 200 Smith Street, Waltham, Massachusetts (617) 891-8400

# Honeywell

ELECTRONIC DATA PROCESSING

An Equal Opportunity Employer

## NCC to be Sure

### POLYESTER FILM CAPACITORS

#### Type MXT



In Plastic Tube.  
Capacitance  
Range : .001 MFD to .22 MFD.  
Voltages : 100v, 200v, 400v, 600v DC.

#### Type MFL

Dipped Flat Shape.  
Capacitance  
Range : .001 MFD to .47 MFD.  
Voltages : 35v, 50v, 100v, 200v DC.

#### Type MFK

Dipped Flat Shape.  
Non-Inductive Construction.  
Capacitance  
Range : .01 MFD to .22 MFD.  
Voltages : 100v, 200v, 400v, 600v DC.

### METALLIZED POLYESTER FILM CAPACITORS

#### Type FNX-H

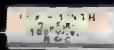

Mylar Wrapped Serrival  
With Epoxy End Seal.  
Capacitance  
Range : 1 MFD to 10 MFD.  
Voltages : 50v DC.

### SOLID TANTALUM CAPACITORS

Type TSL.  
Sealed with Epoxy Resin.



Capacitance  
Range : 1 MFD to 220 MFD.  
Voltages : 3v, 6v, 10v, 15v, 20v, 25v, 35v DC.

Type TAX.  
MIL-C-26655A Hermetically Sealed.

## MATSUO ELECTRIC CO., LTD.

HEAD OFFICE: 3-chome, Sennari-cho, Toyonaka-shi, Osaka, Japan.  
Cable Address "NCC MATSUO" OSAKA

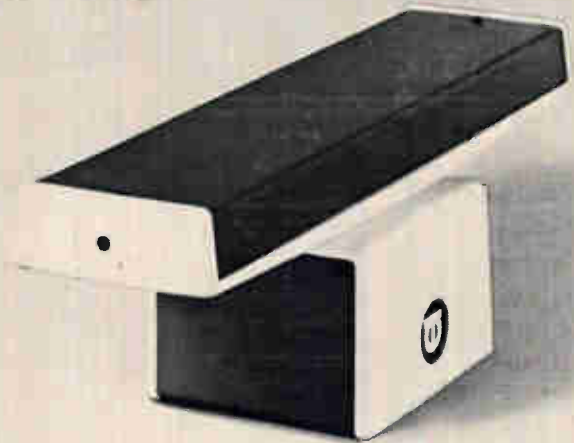

# \$295 GAS LASER

(\$295?)

Right. Here's the world's only under-\$300 gas laser. Another important first for Optics Technology. We've been able to design a precision laser which we can produce for only \$295. It's our Model 170 Continuous Gas Laser.

Rounding out our complete line of quality lasers and laser products, the Model 170 offers:

- Adjustment-free, reliable operation
- A plasma tube with built-in reflectors
- No Brewster windows, or optics, to collect dust or get damaged
- Built-in power supply provides the plasma tube with low-ripple dc
- Power over .3 milliwatts in TEM<sub>00</sub> mode, guaranteed
- Internal collimating optics; beam divergence less than .4 milliradians

The Model 170 is being widely accepted in education, in optical and mechanical alignment, and as a basic laboratory tool. We'll be glad to send complete data. Just write \$295 Laser on a postcard (with your name and address) and mail it to:

## OPTICS TECHNOLOGY INC



901 California Avenue, Palo Alto, Calif.  
327-6600 (Area Code 415)

In Europe, contact  
Optics Technology Instruments,  
Ghent, Belgium

## MINIATURE REGULATED POWER SUPPLIES

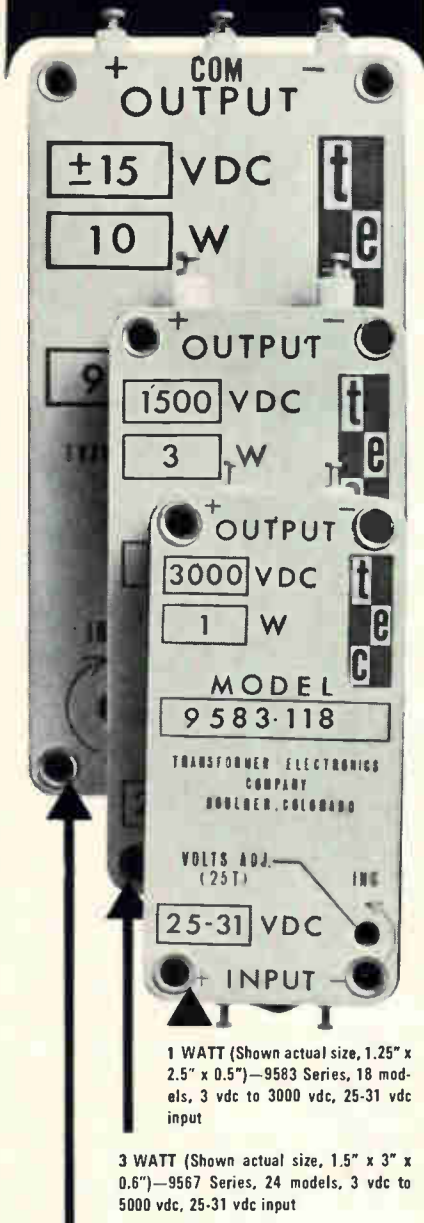

1 WATT (Shown actual size, 1.25" x 2.5" x 0.5")—9583 Series, 18 models, 3 vdc to 3000 vdc, 25-31 vdc input

3 WATT (Shown actual size, 1.5" x 3" x 0.6")—9567 Series, 24 models, 3 vdc to 5000 vdc, 25-31 vdc input

10 WATT (Shown actual size, 2" x 4" x 0.8")—9584 Series, 23 models, 5 vdc to 5000 vdc, 25-31 vdc input

*Cost-Performance Optimized • Reduces System Design Effort • Meets Extreme Environments*



**TRANSFORMER  
ELECTRONICS  
COMPANY**

BOULDER INDUSTRIAL PARK  
BOULDER, COLORADO  
TWX 303 443-2561 PHONE (303) 442-3837

POWER SUPPLIES • INVERTERS  
CONVERTERS • TRANSFORMERS

PLAN TO VISIT US  
AT BOOTH 1807 AT WESCON

## Production Equipment

mate bond strength is achieved within 60 seconds as the glue cools, and the final 10% within 24 hours. There is nothing to dry or evaporate.

A sealer or caulking cartridge is also available to fit the tool. Both glue and sealer materials have a temperature limitation of approximately 130° to 150°F depending on stresses involved. The adhesive as well as the sealer is nontoxic, nonirritant and nonflammable. Both the glue and the sealer have indefinite shelf life.

Price of the gun is \$7.95. Refills are packaged seven for 49 cents and 60 for \$2.49.

United Shoe Machinery Corp., 784 Memorial Drive, Cambridge, Mass. [394]

## Fully automatic thin-film evaporator

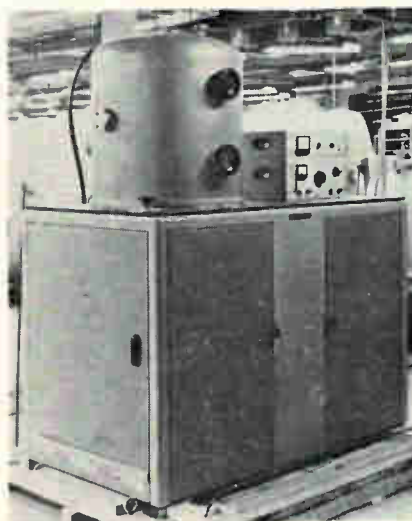

A fully automatic high-vacuum evaporator is available for the mass production of thin films. Model BA-710V-A evaporator is a complete packaged system with controls for both the high-vacuum pumping system and the evaporation process.

The manufacturer states that it meets requirements for optics and microelectronics production. It has a 28-inch-diameter bell jar that provides more work space than the standard 18- or 20-in. bell jar systems, without sacrificing pump-down performance or the flexibility of standard accessories. It pumps

## TAIYOHM FIXED COMPOSITION RESISTOR

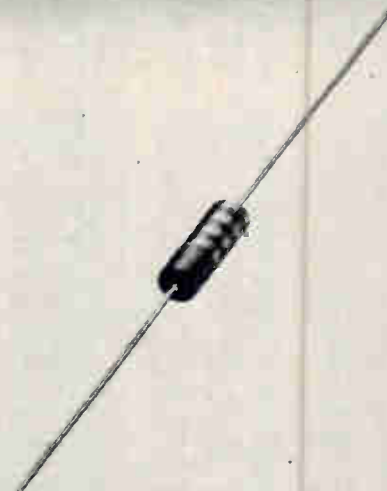

## TAIYO DENKI CO., LTD.

1-12, 3-chome, Sunamichi,  
Sakai C., Japan.  
Phone: Sakai-3-6841

Circle 342 on reader service card

## PRECISION SERVO REPEATERS

847A (160 cps)  
770A (400 cps)

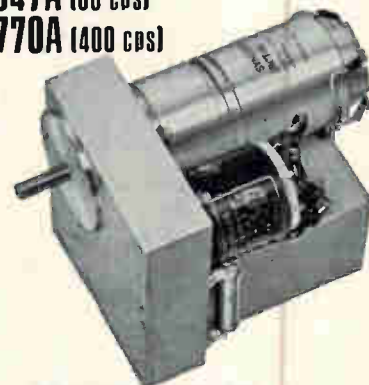

- Follow 3 wire synchro data
- Require only 117v power
- Modular construction
- Built-in, solid state amplifier

A versatile line of precision synchro followers for universal industrial and military applications.

WRITE FOR OUR GENERAL CATALOG describing our complete line of Servo Systems, Servo Amplifiers and Servo Testers

**INDUSTRIAL CONTROL COMPANY**  
CENTRAL AVENUE  
AT PINELAWN FARMINGDALE, L. I., N. Y.  
516-694-3000

Circle 343 on reader service card



# For fast delivery of Specialty Motors

the new **Diehl** call  $\wedge$

We don't know what *your* recollection of Diehl's delivery is. But with small motors in short supply we think you'll want to hear about delivery from the *new* Diehl. We are now supplying motors much faster than the industry average. Some of our current accounts tell us we move *three to four times faster* than other well known motor suppliers. Diehl has been building motors since 1888. But now we're building them faster! Try us again, East Coast or West, at the numbers below. THE SINGER COMPANY, Diehl Division, East: FINDERNE Plant, Somerville, N. J. 08876 (201) 725-2200; West: LA Plant, 2221 Barry Ave., Los Angeles, Cal. 90064 (213) 478-0896. Also, representatives in all major cities.

Circle 344 on reader service card

## Leadership is no accident!

in sports or in industry

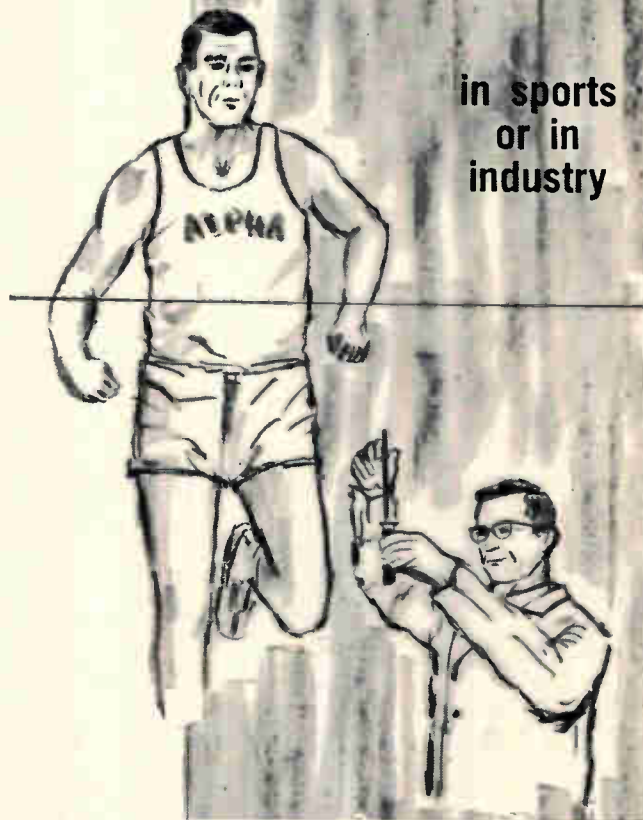

## RESEARCH is one of the reasons for ALPHA'S LEADERSHIP

Research is the cornerstone of Alpha's success. Heavy emphasis on R & D is responsible for the continual stream of product innovations that keep Alpha Metals out in front. Some of the Alpha Firsts include: Cen-Tri-Core® Void-Free Solder, Vaculoy® Oxide-Free Bar Solder, Continuous Conductive Coated Metals, Special Multi-layer Materials, Intricate Close Tolerance Stampings and Alpha Solder Cream.

Additional reasons for Alpha's leadership include authoritative Soldering Technology Seminars; prompt, reliable service; unequalled know-how and experience in the development and production of solders, soldering chemicals, preforms and ultra-high purity metal fabrications for the semi-conductor industry; and the most complete quality product line available anywhere.

BULLETIN A104 TELLS THE ALPHA STORY.  
WRITE FOR YOUR FREE COPY TODAY.

**alpha** alpha metals, inc.

56 WATER STREET, JERSEY CITY, N. J. 07304 201-434-6778

Los Angeles, Calif. • Alpha Alloy Corp. (Div.), Chicago, Ill.  
Alpha Metals, Inc. (U.K.) Ltd., Hounslow, Middlesex, Eng.

J-6828

SEE US AT WESCON—BOOTH 644

## ULTIMATE IN PERFORMANCE

TOHOKU METAL'S



NEFERRITE POT CORES

NEFERRITE—developed by Nippon Electric Co., Ltd., and exclusively produced and sold by Tohoku Metal—a new type magnetic ferrite material which offers higher magnetic permeability and a low core loss coefficient even at high frequency. Highly

suitable for tele-communications and electronic equipment. NEFERRITE CORE—utilized for coils and transformers over a wide frequency range, tremendously improves functional characteristics and helps reduce their size and weight.

### SPECIFICATIONS:

Item	Grade 1	Grade 2	Item	Grade 1	Grade 2
$\mu$	2000	2000	$\mu$ , cm A	10 kc 15	15
B <sub>100</sub> Gauss	4200	4200	100 kc	20	20
Br Gauss	1000	1000	T, F	0-40°C	$\times 0.5 \times 10^{-4}$ $0.8 \pm 0.5 \times 10^{-4}$
Hc Oersted	0.3	0.3	T, c (°C)	180	180
$\tan \delta$	10 kc $0.7 \times 10^{-4}$	$0.7 \times 10^{-4}$	D.F.	$3 \times 10^{-4}$	$3 \times 10^{-4}$
$\mu$	100 kc $2 \times 10^{-4}$	$2 \times 10^{-4}$	$\mu$ , U cm	700	700
$\mu$	500 kc $15 \times 10^{-4}$	$15 \times 10^{-4}$			

U S PAT. No. 3106534

Further information, please write to:

**Tohoku Metal Industries, Ltd.**

7-4, GINZA-HIGASHI, CHUO-KU, TOKYO, JAPAN  
Tel. Tokyo (542) 6171 Cable Address: "TOHOKUMATAL TOKYO"

Circle 345 on reader service card

Circle 281 on reader service card

281

# ELGENCO Noise Generators



Model 610A

## SOLID STATE NOISE GENERATORS

Model 602A 5 cps to 5 mc, 3 Ranges \$ 290  
 Model 603A 5cps to 5 mc, 3 Ranges \$ 495  
 Model 610A 5 cps to 5 mc, 8 Ranges \$1,175  
 Series 624 (Fixed frequency) 5 cps to 500 kc  
 \$245 to \$490. Write for details on frequency  
 ranges and spectral flatness.



Model 312A

## VACUUM TUBE NOISE GENERATORS

Model 301A DC to 40 cps . . . . . \$1,995  
 Model 311A Two outputs DC to  
 40 cps and 10 cps to 20 kc . . . . \$2,395  
 Model 312A Two outputs DC to  
 120 cps and 10 cps to 20 kc . . . \$2,495  
 Model 321A DC to 120 cps . . . . . \$2,095  
 Model 331A 10 cps to 20 kc . . . . \$1,275



Model 3602A

## NOISE GENERATOR CARDS

Series 3602, 3603, and 3606 \$144 to \$389  
 Various frequency ranges and output flat-  
 ness available. Size: 4½" x 6½" x 1". Write  
 for details.

## ENCAPSULATED NOISE SOURCE MODULES

Series 1602, 1603, and 1606 . . \$95 to \$340  
 Various frequency ranges and output flat-  
 ness available. Size: 1¾" x 1½" x ¾". Write  
 for details.

## ELGENCO INCORPORATED



1550 Euclid Street  
 Santa Monica, California  
 Phone: (213) 451-1635  
 TWX: (213) 879-0091

DEMONSTRATOR MODELS AVAILABLE  
 See EEM or Write for Name of Nearest Rep.

## Production Equipment

down to less than  $5 \times 10^{-8}$  torr  
 with liquid nitrogen. The BA-  
 710V-A evaporator utilizes a new  
 BBV3500 liters/second oil diffusion  
 pumping system; made fail safe  
 with an interlocked automatic se-  
 quenced valve control.

Standard optional accessories in-  
 clude single or multiple electron  
 beam sources, 8-position mask-sub-  
 strate changer, optical and con-  
 ductance thin-film monitors, glow  
 discharge, rotary cage, planetary  
 drive and many others.

Bendix-Balzars Vacuum, Inc., 1645 St.  
 Paul St., Rochester, N.Y. [395]

## Inserting drive screws automatically in p-c's



An automatic contact inserting ma-  
 chine has been designed for pro-  
 duction of printed circuits. Drive  
 screws used in completing the ter-  
 minal contact are automatically in-  
 serted in a pattern established by  
 a work jig.

As a fixture is manipulated in  
 this pattern, the drive screws are  
 pressed into the circuit face in the  
 proper holes, one at a time, as fast  
 as the operator positions the index-  
 ing point of control. The indexing  
 is arranged so that the press does  
 not actuate unless the fixture is in  
 the proper pattern position.

The fixture can be changed to ac-  
 sume the new pattern and the ma-  
 chine is ready for a new job.  
 Burklyn Co., 3429 Glendale Blvd., Los  
 Angeles, Calif., 90039. [396]

## High selectivity and stability

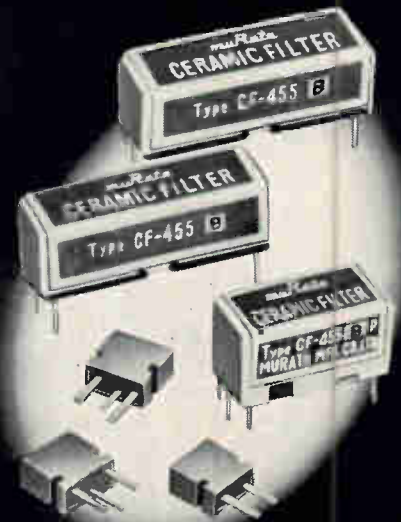

*Murata*

## CERAMIC FILTER

Murata ceramic filters  
 include the series type, the  
 by-pass type and ladder type.

These filters are compact,  
 require no alignment or tun-  
 ing, remain perfectly flat  
 regardless of temperature  
 changes and stay in A-1 oper-  
 ating condition for years. And  
 they're designed to provide  
 effective operation beyond  
 the scope and capacity of  
 IFT.

Write today for detailed  
 information to:

## MURATA MFG. CO., LTD.

Nagaoka, Kyoto, Japan  
 Cable Address: MURATA KYOTO

MURATA CORP. OF AMERICA  
 440 Park Avenue South, New York  
 N.Y. 10016

## New Materials

### Glass-paper laminate bonded with epoxy

Grade RF-16 laminate has a reinforcement of nonoriented glass fibers, produced on a modified papermaking machine and bonded with a flame-retardant epoxy resin.

Specific gravity of the material is low because of high resin content, making it attractive for airborne electrical insulation applications. The insulation resistance of FR-16 approaches that of grades G-10 and G-11 (glass fabric-epoxy grades).

In addition to lower initial cost, the material is said to offer economies in fabrication, mechanical strength and machineability and the electrical advantages of woven-glass laminates.

The manufacturer is producing FR-16 in sheets from  $\frac{1}{8}$  in. to 1 in. thick, with copper cladding on one or both sides.

■ To be introduced at Wescon. Synthane Corp., Oaks, Pa. [397]

### Resistor pastes for hybrid circuitry

Resistor paste formulations for silk screening onto hybrid or thick-film microelectronic circuitry contain no silver or palladium, so they are not adversely affected by hydrogen liberated during encapsulation. There is no significant resistance change because of dip soldering or moisture.

Resistors made from these pastes have guaranteed temperature coefficients less than  $\pm 150$  ppm/ $^{\circ}$ C when measured from  $-55^{\circ}$  to  $+175^{\circ}$ C. After 1,000 hours at  $150^{\circ}$ C, the change in resistance is less than 0.4%, and consequently no post-firing aging treatment is necessary or recommended.

Six Firon resistor pastes are presently available with sheet resistances of approximately 300, 1,000, 3,000, 10,000, 30,000 and 100,000 ohms/sq./mil. These materials can often be blended to give intermediate values. The manufacturer will also formulate pastes with special

sheet resistances and/or special temperature coefficients on request. Electro Materials Corp. of America, 605 Center Ave., Mamaroneck, N.Y., 10543. [398]

### Thermocouple wire gives longer life

Thermoplatinum FG is a new thermocouple grade platinum that is not subject to the usual grain growth at high operating temperatures. It is used with conventional platinum-rhodium wires to form types R&S thermocouples conforming to NBS electromotive force values.

Because of its fine grain structure, Thermoplatinum FG retains high ductility and tensile strength after long exposures to temperatures well above  $1200^{\circ}$ C. This means a greatly increased life for the thermocouples using it in place of normal high-purity platinum.

Electric Thermometers, Inc., 615 Schuyler Ave., Kearny, N.J., 07032. [399]

### Fiber optic magnifier eliminates distortion

A fiber optic magnifier transfers and magnifies or minifies information with no distortion. The cone-shaped bundle of fused fiber magnifies information at its large end or minifies information at the attenuated end.

Typical parameters are: numerical aperture, 0.1 to 1.0; fiber diameters, 5 microns to 10 mils; magnification, up to 10X; output size, up to 3 in.; shape of field—round, rectangular or square; transmission, water white or selectively absorbing.

Prices of the fiber optic magnifiers are competitive with lens optic systems of comparable performance. Advantages of the fiber optic magnifiers include one-piece construction and small size. They meet military standards 446 and 202.

■ To be introduced at Wescon. Corning Glass Works, Corning, N.Y. [400]

## COMMUNICATIONS ENGINEERS

### SYSTEMS INTEGRATION

If you're the kind of engineer who enjoys the challenge of complex system interface situations, ECI has the opportunity you are seeking.

At ECI, system integration touches many phases of communication: radio systems in all frequency ranges, multiplexing, telemetry, switching systems, etc. Programs involve satellite communication systems, airborne command posts on two continents and over the Pacific, communications for the Marine Tactical Data System and other air-ship-ground combinations of command and control systems.

Opportunities are immediate and attractive for professionals who are highly knowledgeable in aircraft, ground terminal and shipboard electronic communication systems and who



Communications Central for MTDS. System Integration by ECI.

are familiar with complex communication equipment installation and field test programs.

You will work for an aggressive, professionally oriented company and live in the pleasant atmosphere of Florida's Gulf Coast. Positions are available in St. Petersburg, Florida, with or without occasional field assignments.

For details send your resume, in confidence, to Budd Cobb, ECI, Box 12248E, St. Petersburg, Florida, or call him collect at (813) 347-1121. (An equal opportunity employer.)



ELECTRONIC COMMUNICATIONS, INC.  
St. Petersburg, Florida

## Compact electronics package?

# COOL IT...

...with a small size, long life, high output AiResearch fan.

Garrett-AiResearch special purpose fans are individually designed and custom built to deliver more flow and greater pressure rise with a minimum envelope size.

Take a typical AiResearch small size fan: computer-optimized for required performance under all operating environments; our own motor, engineered and manufactured for a perfect match to its fan; and up to 40 percent more airflow than any other ventilating fan of similar input, size, and weight.

Next time you need a ventilating fan for a very special airborne or ground electronics enclosure specify AiResearch. Available for high temperature and cryogenic applications, with flow rates and power requirements as specified. AiResearch Manufacturing Division, Torrance Facility, 2525 190th Street, Torrance, California 90509.

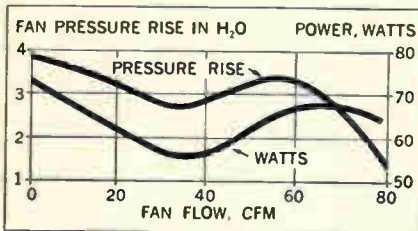

## AIRESEARCH SPECIAL PURPOSE FANS



## New Books

### Materials science

Electromagnetic and Quantum Properties of Materials  
Allen Nussbaum  
Prentice-Hall, Inc., 424 pp., \$15

Materials such as ferrites, ferro-electrics, semiconductors and insulators are the basic constituents of a variety of electronic devices. It is not surprising, therefore, that materials science is becoming an accepted part of the electrical engineering curriculum. Nussbaum's book, in recognition of this trend, is intended as a text for the third or fourth year of undergraduate study.

The discussion of electromagnetic properties starts with a review of elementary field theory and vector calculus. It includes a section on the macroscopic properties of dielectric and magnetic materials that touches upon their fields, forces and boundary-value problems. The portion of the book on quantum properties is addressed to students with little or no background in modern physics. The author presents, briefly but thoroughly, selected topics from atomic theory, thermodynamics, quantum mechanics, solid state physics and statistical mechanics to explain the quantum properties of materials.

Quantum theory provides the groundwork for chapters on semiconductors and quantum electronics. The chapter on semiconductor principles and devices—the only chapter with calculations on practical electronic devices—centers around energy-band theory, Fermi levels, pn junctions, contacts, transistor theory and transport phenomena. The chapter on quantum electronics is devoted primarily to a qualitative description of masers and lasers.

Quantum-mechanical concepts are also applied to dielectric and magnetic materials, with examination of the atomic nature of ferroelectric, paramagnetic, ferrimagnetic and ferromagnetic materials.

Those not familiar with atomic theory or quantum mechanics will find this book an excellent introduction to materials science. The presentation is clear and concise, and the author achieves a good

balance between physical insight and mathematical detail.

The book, however, is not a good guide to related literature since there are few references and no bibliography. Practical data, such as the numerical values of material parameters, is scarce. The author's intention was to explain the fundamental concepts of materials science to provide his readers with a broad basic knowledge. In this he has succeeded.

R.A. Soref

Sperry Rand Research Center  
Sudbury, Mass.

### Ladder networks

Synthesis of filters  
Jose L. Herrero and Gideon Willoner  
Prentice-Hall, Inc., 192 pp., \$10.50

Filter-design specialists should find of interest the new mathematical technique for analyzing ladder networks explored in this book. The technique, called a "network cumulant," was developed by the authors, and this is the most comprehensive treatment of the material available.

However, for the engineer who only occasionally designs a filter with modest requirements, the book is probably too detailed for quick reference. It also lacks the tabulated designs one expects in handbooks. Besides, the design of filters is, in general, best left to specialists when such things as minimum complexity, cost and size are the considerations of critical importance.

After rules of manipulation are covered, the authors apply their cumulant to the problems of driving-point and transfer-function synthesis. Descriptions of the standard attenuation filters, such as Butterworth, Chebyshev, Cauer, etc., are also given in terms of the cumulant. In each case the discussion includes the important situation where the filter is terminated and driven by a source with a finite output impedance.

The authors claim that formulation of a problem in terms of the cumulant will give more accurate results than other techniques because the rounding-off errors of

## FREE FOLDER

ECCOSHIELD®

R F SHIELDING MATERIALS



Brand new six page folder in color describes a complete line of Eccoshield products to combat RFI.

This valuable Folder is yours.  
Write or use Reader Service Card.

**EMERSON & CUMING, INC.**



- Canton, Massachusetts
- 604 W. 182 St., Gardena, Calif.
- 3450 Commercial Ave., Northbrook, Ill.

Circle 346 on reader service card

# Primo

Super High Sensitivity

**SOUND LEVEL  
METER MICROPHONE  
(DYNAMIC TYPE)**



#### Specifications

- Frequency Response: 20-16,000%  $\pm 1.5$ dB
- Impedance: 50  $\Omega$   $\pm 10\%$
- Sensitivity: -84dB  $\pm 2$ dB
- Dimensions: 35 $\times$  220mm
- Weight: 7.30 gm.

**DM-1332**

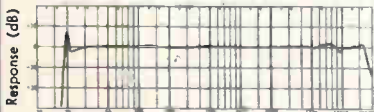

For catalog write to

**PRIMO COMPANY LTD.**

2043 MURE, MITAKASHI, TOKYO, JAPAN  
TEL. 0422-43-3121 (Calling from Tokyo)

Circle 285 on reader service card

standard pole-removal or cascade techniques are avoided.

The cumulant is used to generate a set of algebraic equations for the values of the components from the prescribed transfer function. However, once the algebraic equations have been determined, the problem is far from solved since the equations are usually non-linear. The authors' iteration procedure for solving the equations is a standard one, but it does not converge uniformly with respect to all the component values. There is merit in the technique, however, since computational errors could be avoided with successive iteration on a digital computer.

The book deals primarily with lossless components, with a chapter on the practical problem of using finite Q components in terms of the cumulant. In practice, the success or failure of a specific design depends upon whether proper provision is made for noninfinite Q, and the authors' treatment of this topic is a bit generalized and skimpy. However, references are made to the pertinent literature.

M.R. Wohlers

Grumman Aircraft Engineering Corp.  
Bethpage, N.Y.

### Recently published

Einführung in die Mikroelektronik (Introduction to Microelectronics), Andreas Lewicki, R. Oldenbourg Verlag, Munich, 588 pp., \$25

Digital Computer Theory, Louis Nashelsky, John Wiley & Sons, 321 pp., \$3.95

Junction Transistors, John J. Sparkes, Pergamon Press, 249 pp., \$3.95

Vibrations: Theoretical Methods, Yu Chen, Addison-Wesley Publishing Co., 285 pp., \$9.75

Physics of the Solar Corona, Second Edition, I.S. Shklovskii, Addison-Wesley Publishing Co., 475 pp., \$16.75

Advanced Electric Circuits, A.M.P. Brookes, Pergamon Press, 186 pp., \$2.95

Electronic Designer's Handbook, T.K. Hemingway, Mercury House, London, 296 pp., \$8.82

Instrument and Chemical Analysis Aspects of Electron Microanalysis and Macroanalysis, Herbert A. Elion, Pergamon Press, 256 pp., \$14

Methods in Computational Physics, Vol. 5, Nuclear Practice Kinematics, edited by B. Alder, S. Fernbach and Manuel Rotenberg, Academic Press, 264 pp., \$11.50

Principles of Aerial Design, H. Page, D. Van Nostrand Co., 172 pp., \$8.75

Communication Switching Systems, Murry Rubin and C.E. Haller, Reinhold Publishing Corp., 394 pp., \$16.50

## COMMUNICATIONS ENGINEERS

### MICROELECTRONICS

Unusual ground-floor opportunities in microcircuit design are available at ECI for engineers who have exceptional competence in this technology. An extensive capability in microelectronics has been built and continues to develop at ECI.

A UHF digital frequency synthesizer employing integrated circuits, one of the first in the industry, is an example of technical achievements recently attained at ECI. Continuing programs deal with application of microelectronic technology to multiplex, data link, and telemetry systems and with its greater exploitation in radio communications.

Immediate professional openings involve theory and application of thermodynamics, mechanics of materials and electronic component design in the development and application of microelectronic circuitry. If you have experience and career interest in these fields, plus a BS or MS in EE or physics, you can capitalize on ECI opportunities today.



1-inch microcircuit developed at ECI for UHF digital synthesizer.

For challenging assignments in microcircuit applications programs, for opportunity in an unusual professional atmosphere, and for pleasant living on Florida's "Sun Coast," investigate ECI now.

Send your resume, in confidence, to Budd Cobb, ECI, Box 12248E, St. Petersburg, Florida, or call him collect at (813) 347-1121. (An equal opportunity employer.)



**ELECTRONIC COMMUNICATIONS, INC.**  
St. Petersburg, Florida

## NOW! top and side adjust 1/4" trimmers

Enjoy the design freedom and versatility in 1/4" multitrans (25:1), wire-wound precision trimmers available only from TECHNO. You get the size you want in the style you want without sacrificing performance.

Resistance range: 100 ohms to 25K ohms. Temperature coefficient: of 20 PPM/°C. Operating temperature: -65° to 175°C. Power rating: 0.5 watt at 50°C. Call or write for complete technical data:

TECHNO-COMPONENTS CORP.  
7803 Lemona Avenue  
Van Nuys, California 91405  
(213) 781-1642

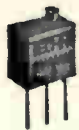

MODEL 12  
TOP ADJUST  
(ACTUAL SIZE)

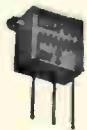

MODEL 14  
SIDE ADJUST  
(ACTUAL SIZE)

## Technical Abstracts

### Semiconductors and sputtering

Preparation and properties of reactively sputtered silicon nitride  
Alan R. Janus and George A. Shirn,  
Sprague Electric Co.,  
North Adams, Mass.

Sputtering of beam-lead interconnections and contacts  
Ernest M. Symes, General Electric Co.,  
Syracuse, N.Y.

Some applications of triode sputtering to integrated circuits  
John H. Hall, Union Carbide Corp.,  
Mountain View, Calif.

Low energy sputtering of resistive films  
Edward M. Michalak, Allen-Bradley Co.,  
Milwaukee, Wis.

Whenever semiconductor processors run into a difficult materials-deposition problem these days, they seem to try sputtering. The technique allows the deposition of many materials that are difficult or impractical to deposit by conventional vacuum evaporation—such as complex dielectrics and some noble metals. Sputtering dislodges these materials from one surface, by ion bombardment, so the material will deposit on another surface.

The papers listed discuss recent applications for sputtering. They were presented, with several other reports, at the first symposium ever devoted exclusively to the subject of thin-film sputtering, a conference sponsored by the University of Rochester, and the Consolidated Vacuum Corp.

Silicon nitride promises to perform several functions very well in semiconductor devices. It may allow the etching of thinner, more precise diffusion masks. It may also provide high-temperature capacitors in integrated circuits. As the dielectric in insulated-gate field-effect transistors, it appears to improve the transistors' performance and stability. The authors report on a reactive sputtering technique that permits silicon nitride to be deposited on silicon at relatively low temperatures.

Beam-lead semiconductor devices and circuits have extra-large leads. It is essential that the lead-device interface be physically strong as well as a good electrical contact. Ohmic contacts are formed by reacting a thin deposit of platinum with the silicon. Then, titanium is deposited atop the silicide

and also over the silicon-oxide passivation coating, then more platinum is deposited. Finally, the leads are built up with electroformed gold. Platinum is difficult to deposit by evaporation, Symes points out, but is easily and economically sputtered. The titanium is also sputtered, to keep the deposition processes compatible. The sputtering process cleans the substrate and improves the adhesion of titanium. Both glow-discharge sputtering and hot-cathode sputtering can be used.

Triode sputtering, says Hall, is a good way to form precision thin-film resistors on integrated circuits. One of its chief advantages is that the composition of resistive alloys is not significantly changed by the sputtering process. However, there is a danger that oxidizable films may react with the silicon dioxide on the IC surface, resulting in crystalites that are unstable at high temperature. High-purity silicon will probably avoid this problem; thin films of sputtered silicon will form extremely stable resistors, provided suitable processing precautions and improvements are carried out.

Low-energy sputtering, with a magnetic field to confine the plasma, was evaluated by Michalak as an alternative to vacuum deposition of thin-film alloy resistors. Sputtering still has some drawbacks, notably a tendency of the alloys to become contaminated by gases in the sputtering chamber. But sputtered films have consistent composition, they adhere better to the substrate than evaporated films and temperature coefficients can be controlled.

Presented at the Symposium on the Deposition of Thin Films by Sputtering, Rochester, N.Y., June 9.

### Thin-film chemistry

Chemical deposition of dielectrics for thin film circuits and components  
T.L. Chu, Westinghouse Research Laboratories, Pittsburgh

Chemical deposition is a versatile technique for preparing dielectric films used in thin-film circuits and it will undoubtedly play a prom-

# Telrex

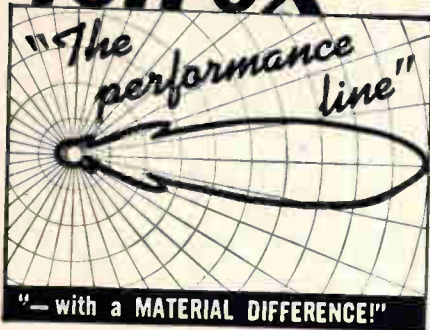

The Choice of the Discriminating Communication Engineer... the Man who Never Settles for Anything Less than THE-VERY-BEST!

## telrex "BEAMED-POWER" ANTENNAS and ANTENNA SYSTEMS

Provide optimum performance and reliability per element, per dollar. Antennas from 500 Kc to 1500 Mc. Free PL88 condensed data and pricing catalog, describes military and commercial antennas, systems, accessories, Towers, Masts, Rotators, "Baluns" and transmission line data.



Asbury Park 41, New Jersey, U.S.A.  
Circle 347 on reader service card

# Kyocera



New Ceramic Products from:

- Alumina Forsterite Zircon
- Berylia Steatite Multiform Glass

for Better Performance

For further information, please contact

### Marubeni-Iida (America) Inc.

Los Angeles Branch 530 West Sixth Street  
Los Angeles 14, Calif.  
MADison 8-6271

Chicago Branch 1181 Merchandise Mart  
Chicago 54, Ill.  
Tel. 467-6993

Head Office 42nd Floor, Pan American  
Bldg. 200 Park Ave  
New York, N. Y. Tel. 973-6500

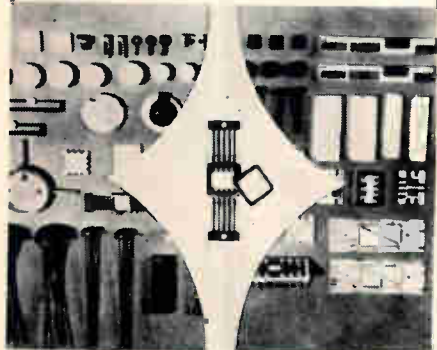
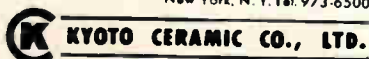

inent role in the further exploration of new electronic materials. The technique allows the preparation, at relatively low temperatures, of materials of controlled compositions. It also yields a greater variety of materials than other deposition techniques.

In one chemical reaction all materials except the one deposited are volatile at the processing temperature. The process is usually carried out in a flow system by passing reactants over heated substrate surfaces where the chemical reaction takes place. If the right reaction is chosen, there will be no solid products in the gas phase. Solids, deposited on the substrate, would interfere with the adherence of the film material desired. In some cases, the application of the reacting material at partial pressure will avoid that problem.

Many substances can also be deposited by other chemical reactions that are suitable for substances that will react reversibly with a gaseous transport agent to form volatile products.

Chemical deposition of silica is attractive since silica films can be deposited on surfaces of many materials at room temperature. The commonly used reactions for this deposition are the hydrolysis of silicon halides and the pyrolysis of compounds containing silicon-oxygen bonds. These reactions have been known for many years, but techniques for their application were not fully developed until recently when the significance of silica films in semiconductor technology was recognized. Summaries of important findings are listed in tabular form.

Despite its wide application in thin-film circuits and semiconductor devices, silica has several drawbacks. Silicon nitride is under consideration as a replacement for silica. Amorphous silicon nitride films have been deposited on silicon substrates by the reaction of silane and ammonia at high temperatures.

Chemical deposition has also been used for the preparation of dielectric films of aluminum oxide, titanium dioxide and silicon carbide. The techniques are similar to those for preparing silica films.

Presented at the National Electronic Packaging and Production Conference, New York, June 21-23

## ELECTRONICS ENGINEERS

### SPACE ELECTRONICS

Exciting things are happening in space electronics at ECI. Present programs include flight control computers for Saturn IB and Saturn V; digital switch selectors; solid-state telemetry transmitters from VHF to X band; solid-state receivers and transmitters for ICBM launch sites, and an advanced microminiaturization program for the flight control computer.

ECI has immediate professional openings for development, senior and staff engineers on these and other space instrumentation programs. To qualify, you'll need experience in digital systems design, analog instrumentation or RF circuit design. And you'll need the kind of in-depth technical understanding that lets an engineer make genuine contributions to state-of-the-art programs.

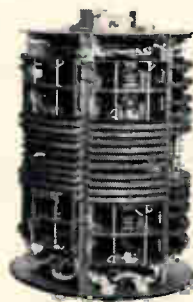

ECI's flight control computer for Saturn IB.

You'll work in a unique, highly stimulating professional environment. And while you work at one of America's most respected and most stable communications companies, you and your family will enjoy living in St. Petersburg, Florida — one of America's truly desirable residential locations.

Get the details today. Send your resume, in confidence, to Budd Cobb, ECI, Box 12248E, St. Petersburg, Florida, or call him at (813) 347-1121. (An equal opportunity employer.)



ELECTRONIC COMMUNICATIONS, INC.  
St. Petersburg, Florida

# BURR-BROWN operational amplifiers

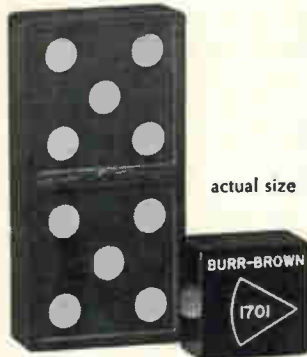

less than  
2/10 cubic inch  
in size

This new family of Burr-Brown general purpose operational amplifiers is just the ticket for thousands of applications where space is at a premium. Each one is a complete solid-state amplifier, requiring only external power to operate. Features include: built-in frequency compensation, input-output protection and output booster stage for  $\pm 10$  V at 10 mA.

**Model 1701** — Integrated Circuit Operational Amplifier, state-of-the-art performance

**Model 1706** — Discrete Component Operational Amplifier, low current offset and drift

**Model 1572** — FET Input Operational Amplifier, high input impedance

**Model 1719** — 50 mA Power Booster for use with above models



These amplifiers may be used in any of the typical circuits shown in Burr-Brown's Handbook on Operational Amplifier Applications and the Handbook of Active RC Networks.

For complete information visit  
Wescon Booth #1102-3 or write for  
special Wescon new product packet

## BURR-BROWN

RESEARCH CORPORATION

INTERNATIONAL AIRPORT INDUSTRIAL PARK  
BOX 11400, TUCSON, ARIZONA 85706  
PHONE 602-294-1431 • TWX 910-952-1111

## New Literature

**Three-axis numerical control.** Westinghouse Electric Corp., Box 868, Pittsburgh, Pa., 15230. Model 30, said to be the only three-axis numerical machine tool control that has integrated circuits, is the subject of brochure B-9231.

Circle 401 on reader service card.

**Tape recorder deck.** Ampex Corp., Mail Stop 7-14, 401 Broadway, Redwood City, Calif. Brochure A-066 covers the series LD-700 tape-recorder deck for use in teaching laboratories for language and other subjects. [402]

**Twist-prong electrolytics.** Cornell-Dubilier Electronics, 50 Paris St., Newark, N.J., 07101, has published a new 112-page reference catalog on twist-prong electrolytic capacitors. [403]

**Control modules.** New Product Engineering, Inc., a subsidiary of Wabash Magnetics, Inc., 812 Manchester Ave., Wabash, Ind., 46992, offers a four-page folder on control module boards for digital control systems. [404]

**Constant-current power supplies.** Spartron Southwest, Inc., P.O. Box 1784, Albuquerque, N.M. Product data sheet 6 gives specifications and operating performance of a new series of stable, miniaturized, programable, constant-current power supplies. [405]

**Solid-state control system.** Norbatrol Electronics Corp., 356 Collins Ave., Pittsburgh, Pa., 15206, has announced technical bulletin 59-500 describing SenSwitch, a solid state control system for a variety of industrial systems. [406]

**Ferrite switch.** Microwave Associates, Inc., Burlington, Mass., has released bulletin 1054, describing the MA-138E high-average-power ferrite switch. [407]

**Solid state choppers.** Solid State Electronics Corp., 15321 Rayen St., Sepulveda, Calif., 91343, offers a bulletin on models 50P, 60P and 70P miniature, plug-in solid state choppers. [408]

**Integrated circuits.** Westinghouse Molecular Electronics division, Westinghouse Electric Corp., Box 7377, Elkridge, Md., 21227. An eight-page quick-reference guide presents schematic diagrams, design features, and complete model designations of more than 60 digital and linear integrated circuits. [409]

**Data amplifier selector.** Dana Laboratories Inc., Irvine, Calif., 92664. A condensed catalog of data amplifiers compares characteristics of 34 differential and single-ended models. [410]

**Decimal-to-visual translator.** Shelly Associates, 111 Eucalyptus Drive, El Segundo, Calif. Bulletin 66-040 describes

the TR-100 decimal-to-visual translator, a high reliability module for translating decimal code into seven-bar display segments. [411]

**Low thermal switch.** Norfax Corp., 1152 Morena Blvd., San Diego, Calif., 92110, has published a specification sheet on the model LTS-2 low thermal switch which has closed contact thermal voltages with 10 v across the coil of 5  $\mu$ v (nominal), 10  $\mu$ v (maximum). [412]

**Electronic gaging systems.** Radio Corp. of America, 41225 Plymouth Road, Plymouth, Mich., 48170. A 28-page brochure shows RCA's high-speed automatic gaging systems, which include parts feeding and orienting, inspection, classifying and match-fit assembly devices. [413]

**Shielded Chamber.** Magnetic Shield division Perfection Mica Co., 1322 No. Elston Ave., Chicago, Ill., 60622. Data sheet 184 covers a portable Netic Conetic shielded chamber to test magnetically sensitive components or small systems. [414]

**A-c voltage stabilizers.** General Electric Co., Schenectady, N.Y., 12305. Bulletin GEA-7376A is a 12-page publication describing a-c line stabilizers for electronic and electrical equipment. [415]

**R-f interconnection equipment.** Trompeter Electronics, Inc., 8936 Comanche Ave., Chatsworth, Calif., 91311. Catalog T-6 illustrates a complete line of coaxial, twinaxial and triaxial connectors, cable assemblies and patching system used in video, radio, telemetry and data handling systems. [416]

**Monolithic linear circuits.** Fairchild Semiconductor, a division of Fairchild Camera and Instrument Corp., 313 Fairchild Drive, Mountain View, Calif., 94041. An eight-page brochure illustrates and describes linear monolithic integrated circuits. [417]

**Airport ground control system.** Eagle Signal division, E.W. Bliss Co., 736 Federal St., Davenport, Iowa. An eight-page, four-color booklet details how the Arrow system facilitates the movement of airplanes into and out of terminals and helps eliminate the problem of overloaded radio frequencies. [418]

**Preamplifiers.** Avantek, Inc., 3001 Copper Road, Santa Clara, Calif., 98051. A four-page short form catalog now available covers a complete line of standard, solid state, low-noise preamplifiers. [419]

**Diode curve tracer.** Hughes Instruments, Hughes Aircraft Co., 2020 Oceanside Blvd., Oceanside, Calif., 92054, has issued a two-color flyer on its low-cost model CT-501, which dy-



# MICO

## NEW MODEL 885 SEVEN RATIO WIDE-RANGE ENGRAVER

NO. 885

FOR LONG AND  
MULTI-LINE WORK

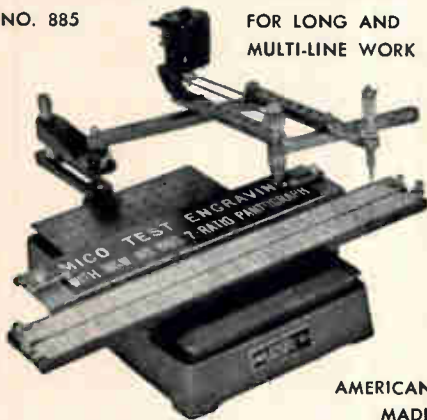

AMERICAN  
MADE

- A time-saver for large plate work.
- Engraves 3" x 19" area in one set-up.
- Seven pantograph ratios—from 1.5:1 to 6:1.
- Choice of 3-ball-bearing spindle assemblies for 1/8", 3/16" or taper-shank cutters.
- HSS, COBALT and Solid Carbide Cutters.
- Single and multi-line copy carriers for holding blanks 3/4" to 3 1/2" high.
- Accommodates Mico standard accessories.

Send for bulletins and prices

### MICO INSTRUMENT CO.

77 Trowbridge St. Cambridge, Mass. 02138

Circle 289 on reader service card

#### Reprint order form

Send to: Electronics Reprint Dept.  
330 West 42nd Street  
New York, N. Y. 10036

For listing of reprints available see  
the reader service card.

To help expedite mailing of your  
reprints please send cash, check or  
money order with your order.

For reprints of the latest special  
report:

#### Communications Satellites Part I

Send me . . . . . reprints of key no  
R-89 at 75¢ each.

For reprints of previous special  
reports fill in below:

Send me . . . . . reprints of key  
no.(s) . . . . . at . . . . . ¢ each.

For prices see the reader service  
card.

Name . . . . .

Number & Street . . . . .

City, State . . . . .

Zip code . . . . .

namically presents the characteristics  
of all types of diodes for rapid graphic  
analysis. [427]

Finger contact strips. Instrument Spe-  
cialties Co., 244 Bergen Blvd., Little  
Fall, N.J. The electric performance of  
standard finger contact strips of beryl-  
limum copper for electronic shielding is  
the subject of bulletin D-65. [428]

Rfi filters. RF Interonics, Inc., 15 Neil  
Court, Oceanside, N.Y., 11572, has  
available bulletin 2610A describing its  
standard line of cylindrical radio-fre-  
quency interference filters. [429]

Miniature coaxial cables. Raychem  
Corp., Oaksid at Northside, Redwood  
City, Calif. A six-page brochure, bul-  
letin No. 7, compares sizes and weights  
of miniature coaxial cables. [430]

Miniature digital dial. Theta Instrument  
Corp., Saddle Brook, N.J., 07663. A  
two-page engineering bulletin de-  
scribes the Midgi-Dial, which is used  
for the angular positioning of synchros  
and pots. [431]

Time delay relays. The A.W. Haydon  
Co., 232 North Elm St., Waterbury,  
Conn., 06720. Product information  
sheet No. 126 contains essential appli-  
cation data for the K41300 series of  
precision delay relays for industrial  
and commercial applications. [432]

Heat sinks. Astrodyne, Inc., 207 Cam-  
bridge St., Burlington, Mass., 01803. A  
series of miniature, gear type, natural  
convection heat sinks is described in a  
technical data bulletin. [433]

Transducers. Associated Engineering  
Ltd., Cawston, Rugby, Warwickshire,  
England, has published a four-page  
leaflet on its current range of subminia-  
ture inductive displacement and vibra-  
tion transducers and their associated  
electronics. [434]

Current drivers. Computer Test Corp.,  
12 Fellowship Road, Cherry Hill, N.J.,  
has published a technical bulletin de-  
scribing a complete family of 20 new  
current drivers with highly linear rise  
and fall times. [435]

Operational amplifiers. Analog Devices,  
Inc., 221 Fifth St., Cambridge, Mass.,  
02142. A one-page application note  
shows how to get both fast response  
and high impedance with operational  
amplifiers. [436]

Connectors and cables. Amphenol  
Corp., 2875 S. 25th Ave., Broadview, Ill.  
A 26-page catalog, designated RF-2,  
simplifies the selection and specifica-  
tion of radio-frequency connectors and  
coaxial cable [437]

Infrared devices. AEL/Davers Corp.,  
P.O. Box 552, Lansdale, Pa., has an-  
nounced a 10-page technical brochure  
on its solid state infrared detectors and  
radiation sources. [438]

## COMMUNICATIONS ENGINEERS

### RF ENGINEERING

ECl, a recognized leader in high  
performance RF communications  
equipment, has immediate and chal-  
lenging opportunities for outstand-  
ing RF engineers.

The AN/ART-47 and AN/ARR-71,  
an airborne transmitter/receiver  
combination, typify the challenges  
being met at ECl. This equipment  
has 1 kW transmitter output, and  
it covers 3500 UHF channels with  
AM or FM duplex capability. Yet  
the transmitter/receiver combina-  
tion occupies only 2.65 cubic feet.

Many other equally ambitious  
programs are in progress. They in-  
clude communication equipment for  
satellite, airborne, shipboard and



AN/ART-47 and AN/ARR-71  
transmitter/receiver combination.

ground transportable applications  
in voice or data link systems.

You can work on these exciting  
programs — and live in one of  
America's most desirable locations  
— if you are an unusually compe-  
tent RF engineer. You'll need at  
least a BS degree, three years of  
appropriate experience and sound  
knowledge of solid-state design  
theory.

Find out about ECl opportunities  
in RF equipment design. Send your  
resume, in confidence, to Budd  
Cobb, ECl, Box 12248E, St. Peters-  
burg, Florida, or call him collect at  
(813) 347-1121. (An equal oppor-  
tunity employer.)



ELECTRONIC COMMUNICATIONS, INC.  
St. Petersburg, Florida

# Today, Americans hold over \$49 Billion in U. S. Savings Bonds . . .

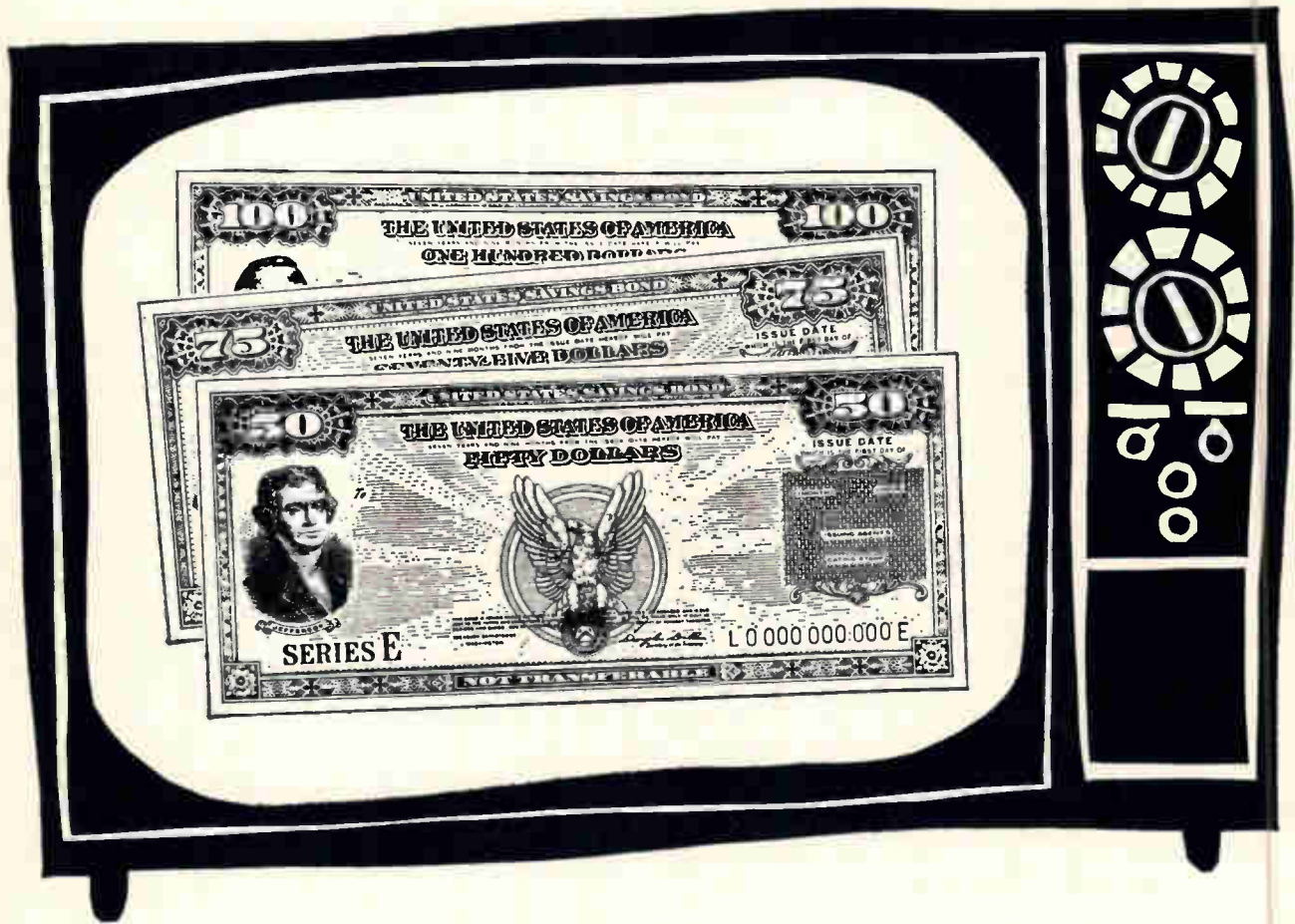

## enough to buy 140 million color TV sets

Get the picture? Two color TV's for every household—and then some. That's reserve buying power. For consumer purchases, for new homes and equipment, this buying power translates ambitions into dollars-and-cents realities and provides a continuous stimulus to the American economy.

Every week, millions of workers put aside a small amount from each paycheck through the Payroll Savings Plan for U. S. Savings Bonds. Painlessly, systematically, these savings add up.

When you bring the Payroll Savings Plan into your plant—when you encourage your employees to enroll—

you're taking part in a mighty sound investment. An investment that has been paying dividends to employers and employees alike—and to a stronger and safer America—for the past twenty-five years.

Contact your State Savings Bonds Director. He can give you complete information on installing and promoting the Payroll Savings Plan in your plant. Or write today to the Treasury Department, United States Savings Bonds Division, Washington, D.C. 20226.



**U.S. SAVINGS BONDS NOW PAY 4.15% WHEN HELD TO MATURITY**

**In your plant...promote the PAYROLL SAVINGS PLAN for U.S. SAVINGS BONDS**



• The U.S. Government does not pay for this advertisement. It is presented as a public service in cooperation with the Treasury Department and The Advertising Council. •

## QUALIFICATION FORM FOR POSITIONS AVAILABLE

### ATTENTION: ENGINEERS, SCIENTISTS, PHYSICISTS

This Qualification Form is designed to help you advance in the electronics industry. It is unique and compact. Designed with the assistance of professional personnel management, it isolates specific experience in electronics and deals only in essential background information.

The advertisers listed here are seeking professional experience. Fill in the Qualification Form below.

### STRICTLY CONFIDENTIAL

Your Qualification form will be handled as "Strictly Confidential" by Electronics. Our processing system is such that your form will be forwarded within 24 hours to the proper executives in the companies you select. You will be contacted at your home by the interested companies.

### WHAT TO DO

1. Review the positions in the advertisements.
2. Select those for which you qualify.
3. Notice the key numbers.
4. Circle the corresponding key number below the Qualification Form.
5. Fill out the form completely. Please print clearly.
6. Mail to: Classified Advertising Div., Electronics, Box 12, New York, N. Y. 10036.

COMPANY	PAGE#	Key#
ATOMIC PERSONNEL INC. Philadelphia, Pa.	223*	1
CORCORAN PERSONNEL CONSULTANTS, J.P. Lafayette Hill, Pa.	296	2
ELECTRONIC COMMUNICATIONS INC. St. Petersburg, Fla.	283, 285, 287, 289	3
FAIRCHILD SEMICONDUCTOR Div. of Fairchild Camera & Instr. Corp. Mountain View, Calif.	218	4
GENERAL DYNAMICS Pomona Div. Pomona, Calif.	218	5
GENERAL DYNAMICS Fort Worth Div. Fort Worth, Texas	166*	6
GENERAL ELECTRIC CO. Light Military Electronics Dept. Utica, N.Y.	295	7
GRUMMAN AIRCRAFT ENGINEERING CORP. Bethpage, Long Island, N.Y.	292	8
HEWLETT PACKARD Palo Alto, Calif.	266*	9
IBM CORP. Federal Systems Div. Gaithersburg, Maryland	293	10

Continued on page 296

(cut here)

## Electronics QUALIFICATION FORM FOR POSITIONS AVAILABLE

(cut here)

(Please type or print clearly. Necessary for reproduction.)

### Personal Background

NAME .....

HOME ADDRESS .....

CITY ..... ZONE ..... STATE .....

HOME TELEPHONE .....

### Education

PROFESSIONAL DEGREE(S) .....

MAJOR(S) .....

UNIVERSITY .....

DATE(S) .....

### FIELDS OF EXPERIENCE (Please Check)

8/8/66

- |  |  |                                       |
|--|--|---------------------------------------|
| <input type="checkbox"/> Aerospace           | <input type="checkbox"/> Fire Control        | <input type="checkbox"/> Radar        |
| <input type="checkbox"/> Antennas            | <input type="checkbox"/> Human Factors       | <input type="checkbox"/> Radio-TV     |
| <input type="checkbox"/> ASW                 | <input type="checkbox"/> Infrared            | <input type="checkbox"/> Simulators   |
| <input type="checkbox"/> Circuits            | <input type="checkbox"/> Instrumentation     | <input type="checkbox"/> Solid State  |
| <input type="checkbox"/> Communications      | <input type="checkbox"/> Medicine            | <input type="checkbox"/> Telemetry    |
| <input type="checkbox"/> Components          | <input type="checkbox"/> Microwave           | <input type="checkbox"/> Transformers |
| <input type="checkbox"/> Computers           | <input type="checkbox"/> Navigation          | <input type="checkbox"/> Other .....  |
| <input type="checkbox"/> ECM                 | <input type="checkbox"/> Operations Research | <input type="checkbox"/> .....        |
| <input type="checkbox"/> Electron Tubes      | <input type="checkbox"/> Optics              | <input type="checkbox"/> .....        |
| <input type="checkbox"/> Engineering Writing | <input type="checkbox"/> Packaging           | <input type="checkbox"/> .....        |

### CATEGORY OF SPECIALIZATION

Please indicate number of months experience on proper lines.

	Technical Experience (Months)	Supervisory Experience (Months)
RESEARCH (pure, fundamental, basic)	.....	.....
RESEARCH (Applied)	.....	.....
SYSTEMS (New Concepts)	.....	.....
DEVELOPMENT (Model)	.....	.....
DESIGN (Product)	.....	.....
MANUFACTURING (Product)	.....	.....
FIELD (Service)	.....	.....
SALES (Proposals & Products)	.....	.....

CIRCLE KEY NUMBERS OF ABOVE COMPANIES' POSITIONS THAT INTEREST YOU

1 2 3 4 5 6 7 8 9 10 11 12 13 14 15 16 17 18 19 20



# EMPLOYMENT OPPORTUNITIES

SEND NEW ADS TO:  
Electronics, P.O. Box 12, N.Y. N.Y. 10036  
September 5th closes August 15th

## FIELD ENGINEERS FOR EXTREMELY COMPLEX ELECTRONIC EQUIPMENTS



The A-6A Intruder now being produced by Grumman for the U. S. Navy is a unique system of airborne electronics, radar, computers, cockpit displays and inertial navigational systems. A low-level, terrain-following aircraft, it can, with a wide variety of means, detect and destroy targets completely obscured by weather or darkness.



The E-2A Hawkeye designed by Grumman for the U. S. Navy is an early warning and control aircraft. Housing radar, IFF detection, tracking, height finding, radio relay, automatic surveillance and data link equipment, the E-2A can fly higher and for longer duration than any other carrier-based early warning aircraft in existence.

The two aircraft described above contain some of the most advanced electronic equipment yet devised. Comprehensive training at Grumman and subsequent field experience with the equipment will prove a "badge" of extremely high technical proficiency to the talented Electronic Field Engineers we are seeking. Possessing the mental outlook found in leaders everywhere, successful candidates will require all-around drive and a desire to understand and master "systems." He may be ready to team captain now or develop this capacity as his comprehension of the equipment is achieved.

These are challenging career positions for qualified Weapons or ECM Systems Engineers experienced in search and track radars, computers, inertial guidance systems who are familiar with digital techniques and transistor circuits. BS degree in Electronics or Physics (or equivalent), with a minimum of 6 years' experience desirable. In-plant training will be given to the applicants chosen.

To arrange an immediate interview,  
SEND COMPREHENSIVE RESUME to Mr. Peter E. Van Putter  
Director of Employment, Dept. GR-76.



**GRUMMAN**  
AIRCRAFT ENGINEERING CORPORATION  
Bethpage • Long Island • New York  
An equal opportunity employer, (M/F)

## ENGINEERS

Located on the beautiful San Francisco Peninsula, Memorex Corporation is the growth-minded leader in the sale and manufacture of precision magnetic tape for use in computer, instrumentation and video recording systems.

### Magnetic Recording Engineers

These challenging positions will offer Engineers or Physicists with magnetic recording systems design background opportunities for individual contribution and recognition as:

Digital Recording Engineer  
Instrumentation Recording Engineer  
Video Recording Engineer

The successful applicants must have a minimum of a BSEE or Physics Degree, 2-5 years' experience designing and operating magnetic tape systems, be capable of assisting in the developing of new tape products, and be ready to accept full responsibility for the design of magnetic tape test systems, tape evaluation programs and the creation and maintenance of test specifications for both advanced tape development and quality control programs.

### Recording Research Engineer

Job Scope—Perform engineering analysis in the field of applied research. Work includes experimental apparatus design and development, investigation of magnetic recording phenomena in analog, digital and video recorders.

Education—BSEE or Physics Degree required. Experience—2-10 years' engineering experience in the recorder industry desired. Some background in magnetic recording is essential.

### Mechanical Engineers

Requires BSME with 4 years minimum electro-mechanical machine design. Positions involve developmental work in design and construction of mechanical and electro-mechanical manufacturing process machinery and production test equipment.

### Research Physicist

Position requires Degree in Physics, Engineering Physics, Electrical or Chemical Engineering. Emphasis will be placed on applicant's background in vacuum technology, preferably with some experience in deposition and testing of magnetic materials. Responsibilities include experimental and analytical projects related to vacuum deposition and development of new products. Outstanding new growth position.

For additional information, in complete confidence, please send your resume to: Mr. E. Jack Shannahan:

**MEMOREX**  
PRECISION MAGNETIC TAPE

1180 Shulman Avenue  
Santa Clara, California

An Equal Opportunity Employer

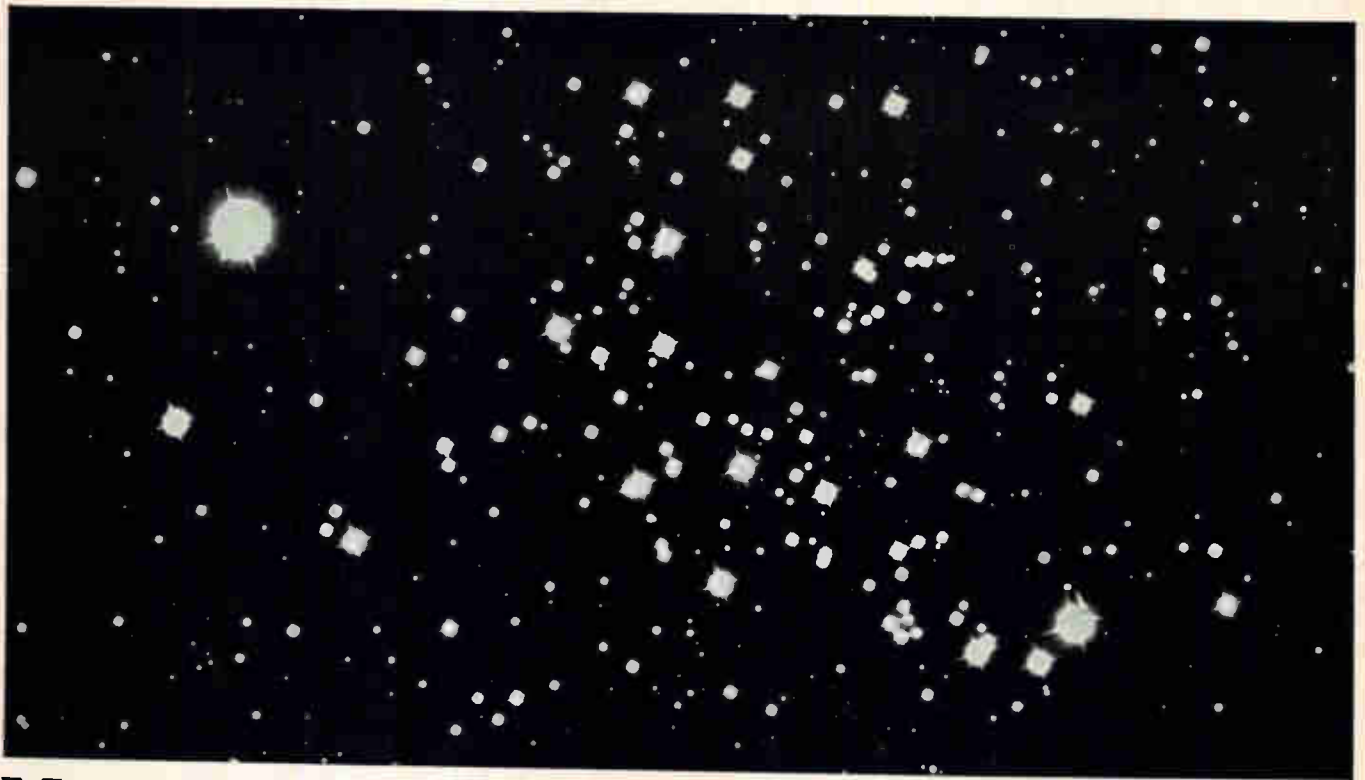

# You are standing on the threshold of the future.

## Take that giant step.

Step into a world of challenge and excitement. A world of intellectual stimulation. A world of real and meaningful personal rewards.

How? By joining IBM's Space Systems Center in Bethesda, Maryland.

Here you will have the opportunity to develop and integrate complete space systems—from outer space to inner space. As a member of this elite idea team, it will be your responsibility to answer our clients' immediate

challenges, and define what's going to be happening in inner and outer space in ten to twenty years. There are immediate openings for:

Atmospheric Scientists •  
Communications Engineers • Data  
Processing Engineers • Display  
Engineers • Electrical Engineers •  
Engineering Scientists • Geologists/  
Hydrologists • Meteorologists •  
Oceanographers/Marine  
Geophysicists • Physicists • Reliability  
Engineers • Spacecraft Engineers •

Space Simulation Engineers • Systems  
Analysts • PERT Systems Analysts •  
Systems Engineers • Cost Analysts

Please write in complete confidence  
to Mr. J. Martone, Dept 554U5  
IBM Federal Systems Division,  
18100 Fredrick Pike,  
Gaithersburg, Maryland

**IBM**®

IBM is an Equal Opportunity Employer  
(M/F).

# DISCOVER THE WIDENING WORLD OF WESTON



**WE HELP FORD  
BUILD BETTER  
CARS**



**WE HELP BOEING  
CREATE SAFER  
JETS**



**WE HELP NASA  
EXPLORE  
SPACE**



**WE HELP YOU  
TAKE BETTER  
PICTURES**

From 1888 (when we developed the first practical yardstick for measuring electrical current) to the present, Weston has been the nation's prime source for precision.

Our six integrated divisions are currently keeping pace with the needs of industry and government through thousands of different products, programs and projects.

We developed the Xact-Ray gauge to help Ford get uniform fender thickness, and indicators for Boeing to create safer jets. We designed and developed 27 indicator displays for

NASA's Apollo spacecraft. We are also nationally known for the famous Master V and Ranger 9 exposure meters, first choice of amateur and professional shutterbugs.

These examples are just a minute part of the Weston spectrum. We provide precision measuring devices for use under every conceivable condition.

If you're an engineer, looking for new challenges, we invite you to discover the widening world of Weston. *And widen your personal world, too!*

Write in confidence to Corporate Personnel Manager

## WESTON

INSTRUMENTS, INC.

614 Frelingheusen Avenue, Department E.-1, Newark, New Jersey

### PLANTS AND DIVISIONS

Weston-Newark  
Newark, N.J.

Weston-Archbald  
Archbald, Penna.

Weston-Poughkeepsie  
Poughkeepsie, N.Y.

Weston-Transicoll  
Worcester, Penna.

Weston-Rotek  
Watertown, Mass.

Weston-Boonshaft & Fuchs  
Hatboro, Penna.

**Weston • Prime Source for Precision . . . Since 1888**

An Equal Opportunity Employer

# If you think combinations and permutations can do great things for a company,

**you should see what they can do for a career.**

At Light Military we're proving that crossing two or more technical specialties is a most prolific way to come up with new ideas, new products and new directions.

This diversification of ours already covers a lot of ground (to say nothing of space).

Right now we're putting the advanced technologies we're developing to work in next generation programs that range from Early Warning radar to attack radar to low light-level sensing systems and that include television, and infra-red sensors, digital data processing, and weapons and flight control systems.

Nothing but diversification this broad could do so much for so many so well. For example, because of it the Department has a basis for growth that would be hard to top. And because of it our engi-

neers are constantly presented with multi-avenue and multi-specialty opportunities for professional growth.

It might well be that crossing your experience and capabilities with ours could lead to some pretty rewarding results all around. The first step couldn't be easier. Just put an "X" next to the technical skills itemized below that are in line with your interests and experience. Then fill out the coupon. We'll get back to you promptly with information on current openings. If you have a resume handy, send it along.



LIGHT MILITARY ELECTRONICS DEPARTMENT



An Equal Opportunity Employer

**ANALOG CIRCUITRY**

**1 LOW LEVEL LINEAR AMPLIFIERS**

- Direct Current
- Low Frequency
- High Frequency
- Operational
- Buffer
- Low Noise
- Other

**2 NONLINEAR SINUSOIDAL CIRCUITS**

- Frequency Multipliers
- Frequency Dividers
- Mixers and Converters
- Modulators
- Demodulators
- Other

**3 AMPLITUDE OPERATORS**

- Amplitude Selection
- Amplitude Discrimination
- Amplitude Comparison
- Level Setting
- Other

**4 GENERATORS**

- Fixed Frequency Sinusoidal
- Variable Frequency Sinusoidal
- Precise Frequency Sinusoidal
- Pulse
- Square Wave
- Time Base
- Other

**5 POWER SUPPLY CIRCUITS**

- Unregulated Power Supplies AC to DC
- Power Converters, DC to DC
- Power Converters, DC to AC
- Voltage Multipliers
- Other

**6 FREQUENCY OPERATORS**

- Frequency Selection
- Frequency Discrimination
- Other

**7 TIME OR PHASE OPERATORS**

- Time Selection
- Time Discrimination
- Time Comparison
- Time Delay
- Phase Shifting
- Other

**DIGITAL CIRCUITRY**

**8 LOGIC CIRCUITS**

- Logical Gates
- Counters and Digital Frequency Dividers
- Registers and Memory Circuits
- Digital Arithmetical Circuits
- Other

**9 GENERATORS**

- Pulse
- Square Wave
- Time Base
- Other

**10 AMPLITUDE OPERATORS**

- Amplitude Comparison
- Level Setting

**CONTROL AND SERVO CIRCUITRY**

**11 CONTROL AND SERVO MECHANISM CIRCUITS**

- Automatic Gain Control
- Automatic Frequency Control
- Servomechanism, Position
- Other

**12 POWER SUPPLY CIRCUITS**

- Regulators, AC and DC
- Regulated Power Supplies, AC to DC

**ANTENNA AND MICROWAVE CIRCUITS AND RF POWER**

**13 POWER AMPLIFIERS**

- Direct Current
- Low Frequency
- High Frequency
- Low Distortion
- Other

**MECHANICAL DESIGN**

**14 PACKAGING DESIGN**

- Space
- Missile
- Aircraft
- Ground

**15 ENVIRONMENTAL ANALYSIS AND TEST**

- Thermal
- Dynamics
- RFI/EMI

**16 FIELD SERVICE**

**SYSTEMS ANALYSIS**

- 17 RADAR
  - AEW Radar
  - Multi-Mode Radar
- 18 PHOTICS
- 19 GUIDANCE
- 20 ECM
- 21 LOGIC

**RELIABILITY**

- 22 RELIABILITY DESIGN (CIRCUITS)
- 23 COMPONENTS
- 24 STATISTICS
- 25 RELIABILITY PROGRAMS

**TEST EQUIPMENT DESIGN**

- 26 MANUAL
- 27 SEMI-AUTOMATIC
- 28 FULLY-AUTOMATIC
- (these test positions for all categories listed above)
- 29 SYSTEMS TEST POSITIONS

**TECHNICAL WRITING**

- 30 TECHNICAL MANUALS
- 31 TECHNICAL REPORTS

**MANUFACTURING ENGINEERING**

- 32 PROCESS DEVELOPMENT ENGINEERING
- 33 PRODUCIBILITY ENGINEERING
- 34 FACILITIES ENGINEERING

Name: \_\_\_\_\_

Home Address: \_\_\_\_\_

Home Telephone: \_\_\_\_\_

Job Title: \_\_\_\_\_

Years Experience: \_\_\_\_\_

Degree: \_\_\_\_\_ Year Received: \_\_\_\_\_

**CIRCLE AREAS OF INTEREST:**

1	2	3	4	5	6	7	8	9	10	11	12
13	14	15	16	17	18	19	20	21	22	23	24
25	26	27	28	29	30	31	32	33	34		

**OTHERS (Fill in your specialty if you don't see it here.)**

Mail coupon to William H. Gilmore, Light Military Electronics Department, General Electric Company, Sect. 61R, French Road, Utica, N.Y. All replies will be held in strict confidence.

**The Scientists and Engineers served by Corcoran in the last year have found the difference between "a job" and "the job."**

● Whether your search for a new working environment is based on a desire for larger responsibility, wider scope of action, broader technical interests, or for financial gain, the individual attention offered by Corcoran assures a greater chance of success.

● Nationwide, we serve large and small clients on a fee paid basis. Please airmail background to:

**JOSEPH P. CORCORAN**  
*Personnel Consultants*  
 505 B Germantown Pike  
 Lafayette Hill, Pa. 19444

# Electronics

## QUALIFICATION FORM FOR POSITIONS AVAILABLE

(Continued from page 291)

	Page#	Key#
LOCKHEED CALIFORNIA CO. Burbank, California	216	11
LOCKHEED MISSILES & SPACE CO. Sunnyvale, Calif.	192	12
MEMOREX CORP. Santa Clara, Calif.	292	13
MOBIL CORP. Dallas, Texas	223*	14
NEW YORK STATE DEPARTMENT OF CIVIL SERVICE Albany, N.Y.	223*	15
PAN AMERICAN WORLD AIRWAYS INC. Guided Missiles Range Div. Cocoa Beach, Fla.	227*	16
PRATT & WHITNEY AIRCRAFT United Aircraft Corp. E. Hartford, Conn.	211*	17
TEXTRONIX INC. Beaverton, Oregon 97005	249	18
UNITED AIRCRAFT CORP. Norden Div. Norwalk, Conn.	225*	19
WESTON INSTRUMENTS INC. Newark, New Jersey	294	20

\*These advertisements appeared in the July 25th issue.

# SEARCHLIGHT EQUIPMENT LOCATING SERVICE

**No cost or obligation**

This service is designed to help you, the reader of Searchlight Section, to locate used or rebuilt equipment not currently advertised.

**How to use:** Check the ads in this Searchlight Section to see if what you want is advertised. If not, print clearly the specifications of the equipment and/or components wanted on the coupon below, or on your own letterhead.

**This is a service to our readers. This publication does not buy, sell or stock equipment or materials of any type.** Your requirements will be brought promptly to the attention of the used equipment dealers advertising in this section. You will receive replies directly from them.

Obviously, the list of such advertisers is limited by comparison with the over 68,000 subscribers to Electronics, all directly engaged in the electronics industry. A small 'Equipment Wanted' advertisement in the Searchlight Section will bring your needs to the attention of ALL who read Electronics. The cost is low . . . just \$27.25 per advertising inch — 7/8" x 2 3/8".

Electronics  
 Searchlight Equipment Locating Service  
 P.O. Box 12, New York 10036

Please help us to locate the following used equipment:

---

---

---

---

---

---

---

---

NAME

TITLE

COMPANY

STREET

CITY

STATE

ZIP CODE

## PROFESSIONAL SERVICES

**GIBBS & HILL, Inc.**  
*Consulting Engineers*

Systems Engineering  
 Operations Research • Development  
 Field Studies • Design • Procurement  
 Power • Transportation • Communications  
 Water Supply • Waste Treatment

393 Seventh Avenue New York 1, N. Y.

### *The Consulting Engineer*

*By reason of special training, wide experience and tested ability, coupled with professional integrity, brings to his client detached engineering and economic advice that rises above local limitations and encompasses the availability of all modern developments in the fields where he practices as an expert.*

# YOU'RE HIRED

Do you need electronics engineers or technical management men? Electronics magazine is the way to recruit them. Electronics is designed specifically for the working engineer. 68,000 subscribers and an additional 133,000 pass-along readers turn to it to keep up with their industry. You can find the man that meets your qualifications with an advertisement in the Employment Opportunities Section.

For rates & information write: Electronics, a McGraw-Hill Publication. Classified Advertising Division, Post Office Box 12, New York 10036.



# In electronics it's Electronics magazine to sell used equipment!

Your advertisement will produce Results in Electronics. Engineers turn to Electronics magazine for the latest technical developments — and for the latest buying information. You can reach them inexpensively in Electronics Searchlight Section.

For information:  
Searchlight Section  
Classified Advertising Division  
Post Office Box 12  
New York 10036



## AUTOTRACK ANTENNA MOUNT



360 degree azimuth, 210 degree elevation sweep with better than 1 mil. accuracy. Missile velocity acceleration and slewing rates. Amplidyne and servo control. Will handle up to 20 ft. dish. Supplied complete with control chassis. In stock—immediate delivery. Used world over by NASA. USAF. MP-61-B. Type SCR-584. Nike Ajax mounts also in stock.

## PULSE MODULATORS

**MIT MODEL 9 PULSER 1 MW—HARD TUBE**  
Output 25kv 40 amp. Duty cycle .002. pulse lengths .25 to 2 microsec. Also .5 to 5 microsec. and .1 to .5 microsec. Uses 6C21. Input 115v 60 cycle AC. Mfg. GE. Complete with driver and high voltage power supply. Ref: MIT Rad. Lab. Series, Vol. 5, p. 152.

**2 MEGAWATT PULSER**  
Output 30 kv at 70 amp. Duty cycle .001. Rep rates. 1 microsec 600 pps. 1 or 2 msec 300 pps. Uses 5948 hydrogen thyratron. Input 120/208 VAC 60 cycle. Mfr. GE. Complete with high voltage power supply.

**15 KW PULSER—DRIVER**  
Biased multivibrator type pulse generator using 3E29 Output 3kv at 5 amp. Pulse lgths .5 to 5 microsec. easily adj. to .1 to .5 msec. Input 115v 60 cy AC. #575. Ref. MIT Rad. Lab. Series, Vol. 5, pps. 157-160.

**MIT MODEL 3 PULSER**  
Output: 144 kw (12 kv at 12 amp.) Duty ratio: .001 max. Pulse duration: 5, 1 and 2 microsec. Input: 115 v 400 to 2000 cps and 24 vdc. \$325 ea. Full desc. Vol. 5, MIT Rad. Lab. series, pg. 140.

**250 KW HARD TUBE PULSER**  
Output 16 kv 16 amp. Duty cycle .002. Pulses can be coded. Uses 5D21, 713C or 4P100A. Input 115 v 60 cy. AC \$1200 ea.

**PLAN POSITION INDICATOR CONSOLE**  
Complete PPI console operating from 115 volt 60 cycle AC. 10" CRT range 1 to 250 miles. Digital height readout. Complete AN UPA-25. Price \$1200.

**SCR 584 AUTOTRACK RADARS**  
Our 584s in like new condition, ready to go, and in stock for immediate delivery. Ideal for telemetry research and development, missile tracking, satellite tracking. Fully Desc. MIT Rad. Lab. Series, Vol. 1, pps. 207-210, 228, 284-286. Comp. Inst. Bk available \$25.00 each.

## MICROWAVE SYSTEMS

### L BAND RF PKG.

20 KW peak 990 to 1040 MC. Pulse width .7 to 1.2 micro sec. Rep. rate 180 to 420 pps. Input 115 vac. Incl. Receiver \$1200.

### 200-225 mc RADAR SYSTEM

1 Megawatt output, 200 nautical mile range for long range detection of medium and high altitude jet aircraft as well as general search. Complete system in stock. Input 120/208 V, 60 cy. Type TPS-28. Mfg. Hazeltine.

### C-BAND RADAR

250 KV output. C-band. PPI indicator. 5C22 thyratron modulator. Antenna hi gain parabolic section. Input 115 volts 60 cycle AC. complete \$2750.00.

### 200 TO 2400 MC RF PKG.

200 to 2400 MC CW. Tuneable. Transmitter 10 to 30 Watts. Output. As new \$175.

### 500 KW L BAND RADAR

500 kw 1220-1359 msc. 160 nautical mile search range P.P.I. and A scopes. MITI. thyratron mod 5J26 magnetron. Complete system.

### 100 KW X BAND RADAR

Complete 100 kw output airborne system with AMTI. 5C22 thyr. mod. 4J52 magnetron. PPI. 360 deg az sweep. 60 deg. elev. sweep, gyro stabilizer, hi-gain revr. Complete with all plurs and cables.

### AN/GP-1 SKY-SWEEP TRACKER

3 cm. automatic tracking radar system. Complete package with indicator system. Full target acquisition and automatic tracking. Input 115 volts 60 cycle. New. In stock for immediate delivery. Entire System 6' long, 3' wide, 10' high. Ideal for Infrared Tracker, Drone Tracker, Missile Tracker, R. & D.

### 500 KW S-BAND RADAR

250 miles search 115V 60 cy AC. Mfg. G.E.



**RADAR AUTO-TRACK & TELEMETRY ANTENNA PEDESTALS**  
3 & 10 CM. SCR 584 AUTOTRACK RADARS. M-33 RADAR TPS-10 SEARCH. APS-45 TPS-100 HT. FINOERS. WX RADARS. FPN-32GA. APS-10 APS-15B APS-27 (AMTI) SEARCH. ■ ■ ■ APN-102 DOPPLER. DOZENS MORE. CARCINOTRONS. PFM'S. 25-5-12-3-6 MEGAWATT PULSE MODULATORS. CAVITIES. PULSE TRANSFORMERS. IF STRIPS. WAVEGUIDE. BENDS 200 MC. 1 KMC. 3 KMC. 6 KMC. 24 KMC. RF PKGS.

## RADIO RESEARCH INSTRUMENT CO.

550 5TH AVE., NEW YORK 36, N.Y. JU 4-6991

CIRCLE 966 ON READER SERVICE CARD

## TEST EQUIPMENT

For over 20 years specializing in top brands only. Write for our latest listing. We buy complete inventories.



## ELECTRONIC SALES

1413 Howard Street, Chicago, Illinois 60626  
Telephone ROgers Park 4-0600

CIRCLE 968 ON READER SERVICE CARD

## ELECTRON TUBES

KLYSTRONS • ATR & TR • MAGNETRONS  
SUBMINIATURES • C.R.T. T.W.T. • 5000-6000 SERIES  
• SEND FOR NEW CATALOG A2 •  
A & A ELECTRONICS CORP.  
1063 PERRY ANNEX  
WHITTIER, CALIF.  
696-7544

CIRCLE 969 ON READER SERVICE CARD



When you have used electronics equipment to sell, advertise in Electronics Searchlight Section for fastest results.

For information:  
Searchlight Section  
Classified Advertising Division  
Post Office Box 12  
New York 10036

## SYNCHROS • GENERATORS INVERTORS • SERVOS

- 23TR6 Torque Receiver \$32.50
- 23TX6 Torque Transmitter 32.50
- 23CX6 Control Transmitter 32.50
- 1 F Motor 115/90 V. 60 Cy 24.95
- 1 G Generator 115 V. 60 Cy 24.95
- 1 HG Generator 115 V. 60 Cy 39.95
- 1 HDG Differential Generator 39.95
- 5 G Navy Ord. Size 115 V. 60 Cy 24.95
- 5 HG Navy Ord. Size 115 V. 60 Cy 39.95
- 5 F Navy Ord. Size 115 V. 60 Cy 24.95
- Bendix Type M Size 5 115 V. 60 Cy 24.95
- Bendix Type A Size 5 115 V. 60 Cy 24.95
- 23RS6 Resolver Size 23 60 Cy 49.95
- Globe PM Motors 35 VDC 10 RPM 9.95
- Globe PM Motor 24 VDC 278 RPM 12.50
- Globe PM Motor 24 VDC 28 RPM 12.50
- Ampex, Ashland 105/125 V. 58/62 Cy. Hyst. syn. 1800 RPM Tape Recorder Motor 24.95
- Ampex, G.E. 115 V. 60 Cy. Rewind Motor dual shaft 14.95
- Ampex, Dale 117 V. 60 Cy. Hyst. Syn, 1800 RPM, Recorder motor 24.95
- Ampex, Redmond 115 V. 60 Cy. 1800 RPM rev. Tape Recorder Motor 12.50
- Ampex, IMC 115 V. 60 Cy. 1800 RPM Tape recorder torque motor 19.95
- Ampex, Bodine 117 V. 60 Cy. Hyst. Syn. 1800 RPM Tape Recorder Motor 24.95
- Ampex, Ashland 117 V. 50/60 Cy Hyst. Syn. 1800-3600 RPM Tape Recorder Motor 24.95
- Bendix, Inverter E-1617-1, 24 V. Input, 115 V. 400 Cy. 3 Ph. V.A. output 25.00
- Jack-Heintz Inverter, 24 V. Input Output 115/230 V. 1/3 Ph. 400 Cy. 2250 V.A. 75.00
- General Electric E-1823 120/208 V. 400 Cy. Generator 60 KVA 250.00
- Westinghouse, Generator 120/208 V. 3 Ph. 400 Cy. 75.00

### LARGE STOCK OF ROTATING DEVICES

All Items F.O.B. Oakland  
Send for Free Catalog  
(On Company Letterhead, Please)

### ELECTRO GADGET SUPPLY

DOOLITTLE & LANGLEY STREETS  
Oakland Airport Oakland, Calif.  
Phone 562-6641

CIRCLE 967 ON READER SERVICE CARD

# If our old line was so good, how come we're handing you a new one?

Good question.



We're handing you a line.

Good old line.

It isn't easy to make a good thing even better. But we found we could add greater performance and versatility to our line without increasing prices.

All of the new instruments have the same basic specifications and features. For example, dynamic frequency ranges from 0.0015 Hz to 1 MHz. Waveforms include sine, square, triangle, ramp and sync pulse.

All models have at least 6 simultaneous outputs while some have as many as 9. And except for our lowest-priced instrument, all models can be

voltage controlled (which means you can program or modulate any frequency by an external voltage).

But besides such basic features, each instrument offers something different. Right now the Wavetek line consists of 10 models, including the Series 150 Programmable Function Generators. Actually, we have closer to 20 models when you figure that each portable instrument is available in a rechargeable battery version.

Prices for portable models range from \$445 to \$845.\* If you want more detailed

specs and prices, that's what the bingo card is for.

Better yet, we'll hand you our new line in person at Wescon. Booth 142.

- |   |
|---|
| Model 110: Function Generator                 |
| Model 111: Voltage Controlled Generator (VCG) |
| Model 112: Triggered VCG                      |
| Model 114: Sweep/Trigger VCG                  |
| Model 115: Trigger/Phase Lock VCG             |
| Model 116: Trigger/Tone Burst/Phase Lock VCG  |
| Model 120: VCG on a single 5x7 circuit card   |

**WAVETEK**  
8159 Engineer Rd., San Diego, Calif., Tel. 279-2200  
European Sales: 3000 Bern 9, Seidenweg 17, Switzerland

Great new line.



\* U. S. prices.

## Great Britain

### Tighter island

Prime Minister Harold Wilson's harsh austerity program has made Britain's electronics industry queasy. Consumer electronics manufacturers figure they'll be hit hard by the package of anti-inflation measures. Industrial electronics firms still aren't sure how much of a buffeting they'll be in for but they hope any downturn in business will be slight.

Forced to strengthen the pound sterling, Wilson late last month prescribed the most bitter economic medicine Britain has had to swallow in a decade. The measures included a rise in the bank rate, a six months' freeze on wages and prices, tougher instalment-plan terms, higher postal and telephone rates and cutbacks of \$450 million in public investments. All in all, the measures will shrink the economy some \$1.5 billion over the next year, bringing a mild recession to Britain.

For capital goods manufacturers, the recession won't have serious impact. Some companies, in fact, feel that the restrictions on instalment buying will make the banks more inclined to finance plant investments. Computer makers, for example, expect at worst a slight falloff in business. Most have order backlogs that will carry them through 12 months of austerity.

**Sales tonic?** Some automation equipment manufacturers actually see the austerity package as a tonic for sales. Their reasoning: pressure to automate plants and thereby boost productivity will increase over the coming months.

Controls makers also have going for them a strong export position. Even as Wilson announced the measures, British automation equipment makers had their wares on display at a Moscow show in a bid to win Russian business.

But for consumer electronics, a setback seems inevitable. Well before the austerity package was announced, radio and tv production was in a decline. For the first five months of the year, the downturn in deliveries to wholesalers was 12%. A spokesman for the British Radio Equipment Manufacturers Association says the new measures will cut deliveries even more. He also forecasts layoffs of unskilled assembly line workers—mostly women. The set makers' plight is heightened by the fact that their tv market is mostly in replacements rather than first sets. With austerity, says the association spokesman, "People will hang on to their sets just that bit longer."

Wilson's anti-inflation moves so



Austerity-minded Harold Wilson.

far have not changed plans to start color tv broadcasts in the fall of 1967, the sales tonic set makers are waiting for. Although the post office, which will foot the bill for the transmitters, is slated for a \$39-million slash in funds, color tv is viewed as a long-range program and thus outside the scope of the 12-month austerity program. The slash will, though, bring a slow-down in spending for telephone exchange and trunk-line equipment.

## West Germany

### Power packed

A 250-watt thermionic element for a 10-kilowatt nuclear power source for spacecraft now is getting a 1,000-hour trial in a reactor at the West German Karlsruhe nuclear research laboratory.

The test covers only the emitter half of the thermionic diode developed by Brown-Boveri & Cie. AG, the West German subsidiary of the Swiss company with the same name. But next month, a test run will start on a complete element in a reactor at Euratom's Ispra Research Center near Milan, Italy.

Brown-Boveri has set 1967 as the target date to ready a 500-watt, two-diode package. By 1971—maybe even sooner—the company expects to build a six- or seven-diode reactor fuel rod with 1.5-kw output. Seven of the rods will make up a 10-kw reactor power package. Ultimately, a 100-kw unit is envisioned.

**Out front.** With its 250-watt element, Brown-Boveri apparently has hit a power level no one else has attained with a thermionic device. The National Aeronautics and Space Administration, however, has classified projects in progress and a target of "hundreds of kilowatts" by the 1970's. The Atomic Energy Commission completed last December design and component development for SNAP-23, a thermionic device with 200-watt output, but the AEC hasn't set a date to built this SNAP package. SNAP is the acronym for Systems for Nuclear Auxiliary Power.

To be sure, NASA in the spring of 1965 sent aloft SNAP-10A, with 500-watt output from a thermoelectric converter. But thermoelectric converters can't match thermionic converters in weight to power ratio, the kingpin characteristic for space applications. SNAP-10A's

ratio (kilograms/kilowatts) was well over 500:1. Brown-Boveri's 10-kw thermionic power supply will have a ratio of just 15:1 and a lifetime of more than one year.

Such a supply system would open the door to a family of satellites that, unlike Early Bird and its ilk, could transmit television broadcasts directly to home receivers. With 8-kw of power for each tv channel, experts say, a stationary active satellite could cover an area almost half the size of the United States.

**Torrid.** Like all thermionic elements, Brown-Boveri's functions as a diode. Its two electrodes are separated by a gap of about 0.1 millimeter. Nuclear reactor heat applied to one electrode causes it to emit electrons. They are collected on the second electrode, which is some 1,000°C cooler. Only metals like tungsten, rhenium, molybdenum, tantalum or niobium can be used for the electrodes and their container since temperatures run as high as 1,700°C.

One way of stepping up the efficiency of the thermionic element is to fill the electrode container with cesium vapor. Properly done, this lowers the work function of the emitter from 4 electron-volts to 3 electron-volts and gives an output per square centimeter of emitter surface between 8 and 10 watts.

**Additive.** By adding cesium fluoride to the cesium vapor, Brown-Boveri dramatically stepped up output per square centimeter to between 20 and 25 watts. Researchers at AEC's Los Alamos facility first hit on the idea of the fluoride additive, but Brown-Boveri maintains no one before has successfully put the idea to work.

The higher power density is possible because cesium fluoride molecules disintegrate on the hot emitter surface and the resulting negative fluorines on the surface increase the bonding energy of the positive cesium ions. It is these ions that lower the emitter work function to increase efficiency.

At the same time, the additive makes it possible to get an adequate power output with emitter-collector spacings of 0.1 to 0.2 mm. In a pure cesium-vapor diode, out-

put drops off sharply as the gap widens from 0.05 to 0.1 mm. Spacings as close as these can't be held over long periods at high temperatures.

The Brown-Boveri element that will go into a reactor for tests next month has a cylindrical emitter about 2 inches long made of molybdenum. Its outside diameter is 16 mm and it fits inside a niobium collector tube. Sixteen bore holes, filled with a total of 6 grams of uranium dioxide, are spaced evenly around the wall of the emitter. In the reactor test, the uranium fuel will generate about 2,000 watts of thermal energy and somewhere between 10% and 15% of it will be converted into electricity by the diode.

---

## Japan

---

### Inside job

Although the laser is still a device in search of applications to match its promise, many companies around the world have developed laser range finders, an obvious and relatively simple use of coherent light beams.

So far, laser range finders generally have had rotating prisms to build up giant pulses for ranging. The prisms, or Q switches, inhibit resonance in the laser until it has stored enough energy for a worthwhile burst.

Now a Japanese company, Mitsubishi Electric Corp., is marketing a laser using a passive Q switch; one that does away with the external drive and high-speed switching and synchronizing circuits needed for prisms. Passive Q switches were first developed in the United States [Electronics, Oct. 18, p. 91], but Mitsubishi apparently is the first company to place one in a commercial product.

**Bleached.** Mitsubishi's passive Q switch consists of vanadyl phthalocyanine, a bleachable dye, dispersed in a disc of acrylate resin. Operation is quite simple. The disc, in front of the mirror in the laser cavity, absorbs photons from the laser until virtually all the bleachable-dye ions are excited. This boosts the pump-energy threshold for lasing.

At saturation, the disc becomes transparent and the pent-up laser energy is released as a giant pulse. The dye ions return from their metastable excited condition to normal energy levels after a fixed lifetime and the Q-switching action repeats. Repetition frequency in the Mitsubishi range finder is six to ten times a minute, with pulses of 15 to 20 nanoseconds duration and energy of 0.03 to 0.05 joules.

**Countdown.** Except for the passive Q switch, the Mitsubishi range finder works much the same as those with ruby rods switched by rotating prisms. Counting circuits store the output from a 30-megahertz oscillator from the time the giant pulse is transmitted until the

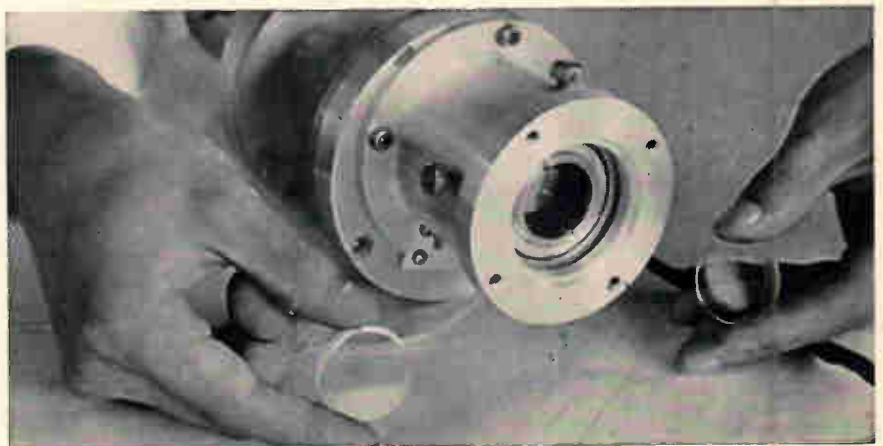

Bleachable dye dispersed in plastic disc replaces the usual whirling prism and complicated synchronizing circuits for Q-switching in lasers.

light reflected by the target returns. A portion of the laser output picked up by a photodiode starts the count; the stop pulse comes from a photomultiplier tube. The count then is fed to a readout.

One full cycle of the 30-Mhz clock represents 10 meters of back-and-forth travel of the laser beam, or 5 meters distance between range finder and target. But because there is an uncertainty of one cycle in the count, accuracy is within 10 meters regardless of the range, which can reach a maximum of 9,995 meters.

Integrated circuits make up most of the electronics of the unit, which Mitsubishi now sells for about \$8,000. Mitsubishi plans to cut the price of the range finder as the costs of the chips go down.



Engineering model has been completed for Tokyo University's experimental satellite that will be launched during the first half of 1968.

## Edge of space

Next month, a small rocket carrying a 44-pound satellite will lift off from the space complex on Kyushu, the southernmost major Japanese island. The satellite won't go into orbit, but the flight will put Japan just one launch away from becoming the fourth nation to get into space, following the Soviet Union, the U.S. and France.

The launch that will qualify Japan for full membership in the space club now is slated for next December or March, 1967. Then, space researchers from Tokyo University expect to achieve a near-earth orbit with their 44-pound satellite. For domestic political reasons, the flight will be billed as an "accident": Tokyo University went ahead with its space plans before it had an okay from government officials to attempt an orbital launch. Still another "accidental" orbiting is on tap for late 1967.

**Official entry.** During the first half of 1968 Japan will go into space "officially" with an experimental satellite weighing somewhere between 155 and 175 pounds put into an almost circular orbit 300 to 500 miles high. Actually, the four-stage rocket being developed for the flight will have a payload capability of 330 pounds; but the Tokyo University space

team doesn't want to take any chances that the wrong sort of accident might happen in its first official satellite launching.

The University has completed the engineering model of the spin-stabilized satellite which will carry geiger counters, scintillation counters, probes to measure electron temperature and a pair of probes to check solar noise at frequencies of 5 megahertz and 7 megahertz. To get data back to earth, there's a telemetry transmitter with power output of about 20 milliwatts at 136 Mhz; up frequency for the receiver is 148 Mhz.

Silicon solar cells with total output of 25 watts power the satellite's electronics. But since the satellite will be in the dark half of the time, average output into the nickel-cadmium batteries will be 12 watts. The Nippon Electric Co. has the prime contract to build the satellite.

---

## France

---

### Calculated independence

Two years ago, the French government failed in a desperate attempt to keep the General Electric Co. from swallowing up the only im-

portant French manufacturer of computers, the Compagnie des Machines-Bull. Ever since, President Charles de Gaulle has hankered to restore a measure of independence to his country's computer industry.

Late last month, the De Gaulle government hatched a long-incubated plan to build a strong national computer industry. Under the so-called "Plan-Calcul," the government will set up a small agency to aid, abet and supervise French producers of computers and automation equipment. The still-unnamed computer czar who will head the agency will report directly to the prime minister.

In setting up the new agency, De Gaulle aims to free France of technical dependence on the United States for process control computers and automation equipment. In his view an independent, industrialized country has to maintain its own competence in computers. With the same realism that has marked many of his diplomatic moves, De Gaulle has shied away from the big-computer field, dominated in France and in Western Europe by giant American companies and particularly by the International Business Machines Corp.

**Concentration.** Under the computer czar, France will concentrate on the development of three or four small- and medium-size computers. The first machines will be based largely on licensed technology, but by the early 1970's all-French machines should be ready for the market. The plan calls for production of these computers and their peripheral equipment by one or two strong companies formed out of French firms that otherwise almost certainly would have been snuffed out by competition from the Yankee giants.

Even before the new plan was adopted, the restructuring of the French computer industry—through government pressure—had started. Two computer makers, Compagnie Européenne d'Automatisme Electronique (CAE) and Société d'Electronique et d'Automatisme (SEA), joined forces in June to develop a line of medium-

size computers [Electronics, June 27, p. 198]. For peripheral equipment, two other companies have negotiations under way for a tie-up. They are Société Européenne pour le Traitement de l'Information, a subsidiary of the Compagnie des Compteurs, and Société Nouvelle d'Electronique et de la Radio-Industrie, which belongs to Compagnie Française Thomson-Houston.

Along with pressure, the new computer czar will have potent persuasion at his disposal to speed the restructuring of the industry. Although the De Gaulle government hasn't announced yet how much it will spend on the plan, industry sources figure about \$20 million yearly will be earmarked to finance computer development. What's more, the new computer agency will coordinate all government computer purchases and undoubtedly "buy French" whenever possible.

**Problem.** Plan-Calcul leaves unresolved an irksome computer problem for De Gaulle—getting giant computers for the French atomic energy agency which needs them for long-range development of nuclear warheads. So far, the United States has refused to grant export licenses for the giant computers France wants and no change in U.S. policy seems likely. The French government has asked the CAE-SEA combine to study a large scientific computer but has yet to fund the project.

---

### International

---

#### Double standards

For the kingpin item on the agenda—color tv standards—telecommunications officials from some 80 countries merely went through the motions at the recent month-long plenary session of the International Radio Consultative Committee (CCIR) at Oslo. In their last chance to agree on a single color tv system for Europe, the delegates wound up the session the same way they started it—hopelessly deadlocked over the West German PAL and the French Secam systems.

That means Europe is doomed to a double standard for color, much to the disappointment of most set makers. France and the Soviet-bloc countries will go with Secam. The rest of Europe will be colored PAL.

The United States was only indirectly involved in the wrangle over a color tv system for Europe, but U.S. delegates had plenty to keep them occupied. The U.S. managed to get just about what it hoped for at Oslo on standards for stereophonic broadcasts, maritime mobile transmissions and satellite communications. And the U.S. delegation lined up enough backers to get Jack W. Herbstreit elected director of CCIR after three ballots. Herbstreit, 48 years old, currently is deputy director of the Department of Commerce's Institute for Telecommunications Sciences and Aeronomy. He will take over as top administrative officer of CCIR for a six-year term starting September 1.

**Piloted.** For frequency-modulated stereo broadcasts, CCIR recommended adoption of both the pilot-tone system used in the United States and the Russian system, with quadrature modulation on a 31.5-kilohertz subcarrier [Electronics, June 13, p. 256]. This double standard won't bring division to Western Europe; countries broadcasting stereo there use the pilot-tone system.

**At sea.** In maritime mobile standards, the U.S. delegation managed to win backing for a recommendation that sets a 16-decibel suppression for the carrier as one standard for single-sideband transmission in ship-to-shore telephone services. At this level, receivers can lock onto the carrier for both automatic frequency and automatic gain control. Most of the European countries, Britain excepted, most likely will use the other half of the double standard—full suppression of 40 db or more for the carrier. Although frequency tolerance for both standards is 100 cycles, U.S. ship-to-shore service operators maintain automatic frequency control is a must for high-quality voice transmission.

The U.S. delegation also was successful in its holding action on

a standard for selective calling of ships at sea. The decision won't be taken until the fall of 1967. A system developed by Siemens & Halske AG had nearly unanimous support at an interim CCIR meeting last year. But before the plenary session, AMP Inc. readied a system that U.S. officials feel is substantially more versatile than Siemens'. The U.S. delegates persuaded the other maritime-country delegations to defer the decision until everyone had a chance to look over the AMP system.

**Space.** There was also satisfaction for the American delegation in a recommendation that restrictions on total power flux for f-m transmission from satellites be lifted. The limit, set by treaty, currently is  $-130$  decibel-watts per square meter. The limit for power in a 4-kilohertz band would be retained, but lifted from the current  $-149$  dbw/m<sup>2</sup> to  $-152$  dbw/m<sup>2</sup> with up to 6 dbw/m<sup>2</sup> additional for satellites 15° or more above the horizon.

---

### Around the world

---

**Soviet Union.** Electronics was one of the fastest growing sectors of the Soviet economy during the first half of this year. Output of automation and control equipment was up 15% over 1965. Production of tv sets climbed to 2.1 million, a gain of 28%. The only electronics sector that lagged the over-all rise of 8% in industrial output was radios and phonographs, up 4% to 2.6 million sets.

**International.** Eurocontrol, the seven-nation agency set up to control traffic in the upper air lanes from 20,000 to 40,000 feet, has let its first equipment contracts. One, for some \$1.8 million, went to a consortium headed by The Marconi Co. of Great Britain and Compagnie Française Thomson-Houston. The consortium will supply "Secar" secondary radar sets [Electronics, May 3, 1965, p. 155] for area control centers in Brussels, Shannon and Birkenfeld, West Germany.

# FM SUBCARRIER DISCRIMINATOR

...with TAPE SPEED COMPENSATION

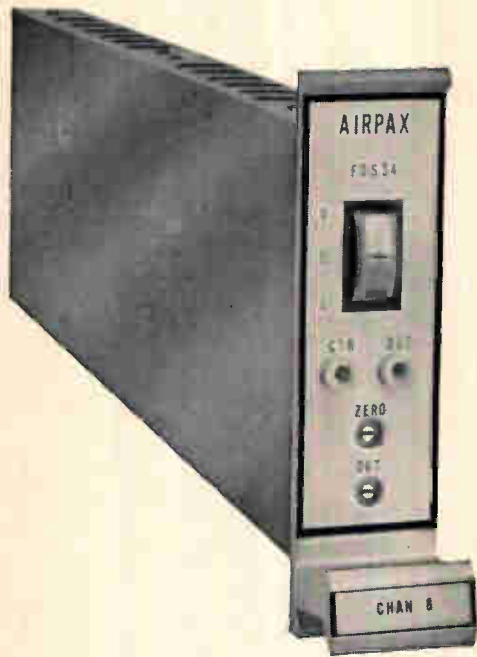

**Model FDS34**  
**\$395!**

Low cost, high performance and compact size are combined in the Airpax FDS34 Subcarrier Discriminator. Advanced circuit design employed for tape speed error compensation yields concurrent superior dynamic response and low harmonic distortion. All conventional channels are accommodated. Low-pass filter characteristics can be easily changed via a plug-in module.

## CHARACTERISTICS

- ★ SOLID STATE PULSE AVERAGING DESIGN AT LOW COST!
- ★ A MINIMUM IMPROVEMENT OF 20DB FOR WOW AND FLUTTER TAPE SPEED VARIATIONS AS GREAT AS  $\pm 3\%$ !
- ★ MODULAR PACKAGING—14 DISCRIMINATORS AND POWER SUPPLY FIT IN  $3\frac{1}{2}$ "x19" WIDE RACK ADAPTER!
- ★ EACH FDS34 DISCRIMINATOR CONTAINS INTEGRAL BANDPASS FILTER DELAY COMPENSATING NETWORK!
- ★ PLUG-IN CONSTANT AMPLITUDE OR LINEAR PHASE LOWPASS FILTER!
- ★ ALL IRIG & CONSTANT BANDWIDTH CHANNELS! ★ OPERATION FROM 120VRMS  $\pm 10\%$ , 47-440 CPS!
- ★ 0.1% LINEARITY! ★ OUTPUT  $\pm 1$  TO  $\pm 10$  VOLTS, ZERO TO  $\pm 10$  MA!



**AIRPAX ELECTRONICS** |

SEMINOLE DIVISION, FT. LAUDERDALE, FLA. 33310  
TELEPHONE 305 587-1100 • TWX 305 587-1000





# Electronics advertisers

August 29, 1966

Honeywell Test Instruments Campbell Mithun Inc.	67	■ Mitsubishi Electric Corporation Hakuhodo Inc.	259	Sperry Electronic Tube Company Neals Hickok Inc.	3rd Cover
■ Houston Omnigraphic Corporation Ray Cooley & Associates	255	■ Mitsumi Electric Company Ltd. Dentsu Advertising Ltd.	275	Sprague Electronic Company, The Harry P. Bridge Company, The	9, 14, 20
■ Hughes Aircraft Company Foote Cone & Belding Inc.	83, 244	Monitor Systems Incorporated Serendipity Associates	54	Stackpole Carbon Company Meek & Thomas Inc.	132
■ Hull Corporation Michener Company Advertising	70	Motorola Communications & Electronics Inc. K & A Incorporated	269	Sylvania Electric Products Inc. Tatham-Laird & Kudner Inc.	33 to 40
IRC Incorporated Gray & Rogers Inc.	178, 220	Motorola Semiconductor Products Inc. Lane & Bird Advertising Inc.	42, 86	TRG Incorporated Culver Advertising Inc.	187
■ Industrial Control Company Beecher Associates Inc.	280	■ Murata Mfg. Co. Ltd. Dentsu Advertising Inc.	282	TRW Semiconductor Division Fuller & Smith & Foss Inc.	77
Industrial Electronic Engineers Inc. Gumpertz Bentley & Dolan Inc.	256	National Research Corporation S. Gunnar Myrbeck & Company	99	■ Taiyo Denki Company Ltd. Sanko Sha Advertising Company	280
Industro Transistor Corporation Leo Hecke Inc. Advertising	201	■ Nexus Research Laboratories Larcom Randall Advertising Inc.	203	Tally Corporation Bonfield Associates Inc.	181
Inland Controls Sub. of Kollmorgen Corporation S. Gunnar Myrbeck & Company	228	North Atlantic Industries Inc. Murray Heyert Associates	197	Techno-Components Corporation J. R. Bloome Company	286
Inland Motors Sub. of Kollmorgen Corporation S. Gunnar Myrbeck & Company	242	■ OAK Manufacturing Company Buchen Advertising Inc.	273, 275, 277	■ Tektronix Incorporated Hugh Dwight Advertising Inc.	82, 249
■ J F D Electronics Corporation Michel-Cather Incorporated	84	Optics Technology Inc. Hoefer, Dieterich & Brown Inc.	279	■ Telonic Engineering Company Jansen Associates Inc.	153
Jerrold Corporation Irving Gould Advertising Inc.	18	PRD Electronics Inc. Caroe Marketing Inc.	180	■ Telonic Industries Inc. Jansen Associates	152
Johanson Mfg. Company Josephson Cuffari & Company	258	Pacific Measurements of Palo Alto Stadler/Cowman Advertising	10	Telrex Laboratories George Homer Martin Associates	287
Julie Research Laboratories Inc. The Stanley Schwartz Company	93	■ Pennsalt Chemicals Corporation Aitkin Kynett Company Inc.	217	Temescal Incorporated Bonfield Associates Inc.	175
Keithley Instruments Inc. Bayliss Kerr Company	235	Perfection Mica Company, Magnetic Shield Division Burton Browne Advertising	306	Tempress Research Company Inc. Hal Lawrence Inc.	243
■ Kepco Incorporated Weiss Advertising	200	Phelps Dodge Electronic Products Corporation Smith, Dorian & Burman Inc.	226	Texas Instruments Incorporated Semiconductor Division Don L. Baxter Incorporated	26, 27
Keystone Carbon Company Downing Industrial Advertising Inc.	44	■ Philbrick Researches Inc. Culver Advertising Inc.	140	Thermal American Fused Quartz Inc. Knip Associates	262
Kingsley Machine Company Nides Cini Advertising Inc.	267	Philco/Sierra Company Hal Lawrence Inc.	55	Tohoku Metal Industries Ltd. Kokusai Tshuin Sha KK	281
Kokusai Electric Co. Ltd. Asia Advertising Agency, Inc.	257	Polaroid Corporation Doyle Dane Bernbach Inc.	73	Transformer Electronics Company Dacey, Wolff & Associates	280
■ Kyoto Ceramic Company Ltd. Daiko Ltd.	287	Precision Paper Tube Company T. W. Blakeslee Advertising	266	Transitron Electronic Corporation Larcom Randall Advertising Inc.	58, 59
Ledex Incorporated Yeck & Yeck Incorporated	212	Precision Scientific Company Tri State Advertising Company	269	Triplet Electrical Instrument Company Burton Browne Advertising	233
Lockheed Missiles & Space Company McCann Erickson Company	192	■ Precision Tube Company George Moll Advertising Inc.	278	Trygon Electronics Solow/Weston Company Inc.	206
Lockheed California Company McCann Erickson Company	216	■ Primo Company Ltd. General Advertising Agency	285	■ Tylon Incorporated George Moll Advertising Inc.	264
McLean Engineering Laboratories Healy Advertising Inc.	248	Radio Corporation of America Al Paul Lefton Company	189, 4th Cover	Ulano & Company, John Byrde, Richard & Pound Inc.	251, 259
Machlett Laboratories Inc. Div. of Raytheon Corporation Fuller & Smith & Ross Inc.	13	Raytheon Company Components Division Fuller & Smith & Ross Inc.	94, 246, 247	■ Uniform Tubes Incorporated Michener Company	250
■ Magnetics Inc. Lando Advertising Agency Inc.	241	Rhode & Schwarz Inc. Armand Richards Advertising Agency	139	Union Carbide Corporation Linde Division J. M. Mathes Inc.	173
■ Mallory & Company, Mfg. Division Aitkin Kynett Company Inc.	63	■ Rotron Mfg. Company Inc. Lescarboura Advertising Inc.	231	United Aircraft Norden Division Cunningham & Walsh Inc.	74
■ Markel & Sons, L. Frank George Moll Advertising Inc.	265	■ Sage Electronics Corporation Mathison Advertising Inc.	238	United Aircraft Vector Division Cunningham & Walsh Inc.	230
■ Matsuo Electric Company Ltd. Fuji Agency	279	Sangamo Electric Company Winius Brandon Company	90, 245	United Aircraft Hamilton Standard Division Cunningham & Walsh Inc.	186
Memorex Corporation Hal Lawrence Inc.	69	Sankyo Seiki Company Ltd. Shinwa Advertising Company Ltd.	268	United Systems Corporation Advertising & Merchandising Inc.	251
Metals & Controls Div. of Texas Instruments Incorporated Horton Church & Goff Inc.	239	Simpson Electric Company The Fensholt Advertising Agency	263	Varian Associates Tube Division Hoefer, Dieterich & Brown Inc.	225
■ Metal Removal Company Advertising Producers Associates	272	Singer Company Diehl Division Michel Cather Inc.	281	Visual Inspection Products Inc. Robert F. James Advertising	270
Metronix Corporation Standard Advertising Inc.	266	■ Singer Company Metrics Division Hepler & Gibney Inc.	229	Wavetek Inc. Chapman, McQuiston, Susuki & Wright Advertising	298
Mico Instrument Company	289	Skydyne Inc. Lescarboura Advertising Inc.	258	Wells Electronics Incorporated Weco Advertising	269
■ Microsonics Incorporated S. Gunnar Myrbeck & Company	278	■ Sorensen Operation, Raytheon Company James Advertising Inc.	15	White & Company S. S. W. L. Towne Company Inc.	56
■ Micro Switch Division of Honeywell Company Batten, Barton, Durstine & Osborn Inc.	41	■ Spectra Electronics Corporation Stadler/Cowman Advertising Inc.	11	■ Zeltex Inc. Sturges & Associates	261
Minnesota Mining & Mfg. Co. Chemical Division MacManus, John & Adams Inc.	174	Spectrol Electronics Company Jones, Maher Roberts Advertising	252		
Minnesota Mining & Mfg. Co. Scotchpar Division Klau-Van Pietersom-Dunlap Inc.	234	Speer Carbon Company Inc. Hazard Advertising Company Inc.	53		

■ For more information on complete product line see advertisement in the latest Electronics Buyers' Guide

# MAKE YOUR OWN MAGNETIC SHIELDS

To Your Specs

*Cut Quickly—  
Wrap Easily*

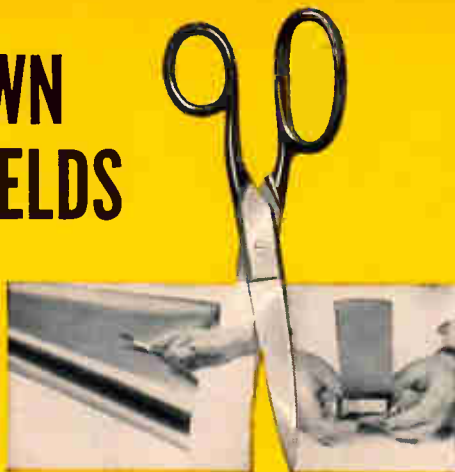

With ordinary scissors, cut flexible Co-Netic and Netic foil to any size or outline. Your component is quickly wrapped and protected—within seconds. Component performance is dramatically enhanced. Co-Netic and Netic foils stop degradation from unpredictable magnetic fields. When grounded, they also shield electrostatically. Foils are not significantly affected by dropping, vibration or shock, and do not require periodic annealing. Available in thicknesses from .002" in rolls 4", 15", and 19-3/8" wide. High attenuation to weight ratio possibilities. Widely used in experimental evaluation and production line operations for military, commercial and industrial applications.

## MAGNETIC SHIELD DIVISION

Perfection Mica Company

1322 N. ELSTON AVENUE, CHICAGO 22, ILLINOIS

ORIGINATORS OF PERMANENTLY EFFECTIVE NETIC CO-NETIC MAGNETIC SHIELDING

Circle 469 on reader service card



### Advertising sales staff

Frank E. LeBeau [212] 971-6464

Advertising sales manager

Atlanta, Ga. 30309: Michael H. Miller, 1375 Peachtree St., N.E., [404] TR 5-0523

Boston, Mass. 02116: William S. Hodgkinson McGraw-Hill Building, Copley Square, [617] CO 2-1160

Chicago, Ill. 60611: Robert M. Denmead, J. Bradley MacKimm, 645 North Michigan Avenue, [312] MO 4-58

Cleveland, Ohio 44113: William J. Boyle, 55 Public Square, [216] SU 1-7000

Dallas, Texas 75201: Richard P. Poole, 1800 Republic National Bank Tower, [214] RI 7-9721

Denver, Colo. 80202: Joseph C. Page, David M. Watson, Tower Bldg., 1700 Broadway, [303] 255-5484

Detroit, Michigan 48226: J. Bradley MacKimm, 856 Penobscot Building [313] 962-1793

Houston, Texas 77002: Kenneth George, 2270 Humble Bldg., [713] CA 4-8381

Los Angeles, Calif. 90017: Ian C. Hill, John G. Zisch, 1125 W. 6th St., [213] HU 2-5450

Minneapolis, Minn. 55402: J. Bradley MacKimm, 1104 Northstar Center [612] 332-7425

New York, N. Y. 10036: Donald R. Furth [212] 971-3615 James R. Pierce [212] 971-3615 George F. Werner [212] 971-3615 500 Fifth Avenue

Philadelphia, Pa. 19103: William J. Boyle, Warren H. Gardner, Jeffrey M. Preston, 6 Penn Center Plaza, [215] LO 8-6161

Pittsburgh, Pa. 15222: Warren H. Gardner, 4 Gateway Center, [412] 391-1314

Portland, Ore. 97204: James T. Hauptli, Pacific Building, Yamhill Street, [503] CA 3-5118

St. Louis, Mo. 63105: Robert M. Denmead The Clayton Tower, 7751 Carondelet Ave. [314] PA 5-7285

San Francisco, Calif. 94111: James T. Hauptli, 255 California Street, [415] DO 2-4600

London W1: John W. Patten, Edwin S. Murphy Jr., 34 Dover Street, Hyde Park 1451

Milan: 1, via Baracchini Phone: 86-90-617 86-90-656

Frankfurt/Main: Gerd Hinske, Joseph Wuensch, 85 Westendstrasse Phone: 77 26 65 and 77 30 59

Geneva: Michael R. Zeynel, 1, rue du Temple Phone: 31 95 60

Paris VIII: Denis Jacob, 17 Avenue Matignon ALMA-0452

Tokyo: Nobuyuki Sato, 1, Kotohiracho Shiba, Minato-Ku [502] 0656

Osaka: Ryosi Kobayashi, 163, Umegee-cho, Kita-ku [362] 8771

Wallace C. Carmichael [212] 971-3191 Manager Electronics Buyers' Guide

David M. Tempest [212] 971-3139 Promotion manager

Milton Drake [212] 971-3485 Research and circulation manager

Wallis Clarke [212] 971-2187 Assistant to sales manager

Wallace C. Carmichael [212] 971-3191 Business manager

Stephen R. Weiss [212] 971-2044 Production manager

Thomas M. Egan [212] 971-3140 Production manager Electronics Buyers' Guide

Subminiature

## ILLUMINATED PUSH BUTTON SWITCHES and matching Indicator Lights

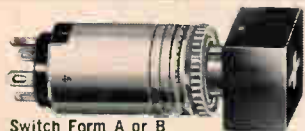

Switch Form A or B with 3/4" sq. cap



Switch Form C with 1/2" rnd. cap



Matching Indicator with 3/4" rnd. cap



Matching Indicator with 1/2" sq. cap

DIALCO Switches and Indicator Lights provide almost limitless applications—are flexible in arrangement—economical in price—and feature high reliability.

Switches are the silent, momentary type—requiring 24 oz. (approx.) operating force. Contact arrangements are: S.P.S.T., normally open or normally closed; S.P.D.T. two circuit (one normally open, one normally closed). Ratings: 3 amps, 125V A.C.; 3 amps, 30V D.C. (non-inductive). The switch is completely enclosed and independent of the lamp circuit. The light source is the T-1 1/4 incandescent lamp, available in voltages from 1.35 to 28V. Units are made for single hole (keyed) mounting in panels up to 3/16" thick and mount from back of panel in 1/2" clearance hole. Switch forms for dry circuits are also available.

Other features include: 1/2" or 3/4" interchangeable caps, round or square, rotatable or non-rotatable, in a choice of 7 color combinations.

For complete data, request current Catalog.

Illust. approx. 75% actual size

FOREMOST MANUFACTURER OF PILOT LIGHTS

# DIALIGHT CORPORATION

60 STEWART AVENUE, BROOKLYN, N.Y. 11237 212 HYACINTH 7-7600

# DIALCO

# MARRIAGE OF CONVENIENCE

How Sperry blends the best  
of two technologies into a  
superior microwave source



A V band Sperry klystron with matching solid-state power supply.

System designers who want to capitalize on the obvious advantages of solid-state without enduring the crippling power and frequency limitations are discovering a new solution: the packaged power supply/klystron oscillator combination from Sperry Electronic Tube Division.

Sperry now offers single low-voltage (28 volts) DC-to-microwave frequency sources which combine the best features of solid-state circuitry and klystron oscillators. The source consists of an all solid-state power supply, a reflex klystron, and (if required) a stalo cavity and an isolator.

For many applications, Sperry has already proved that such a combination can equal the size and weight of an all solid-state source and show considerable improvement in reliability, power handling capability, noise and other characteristics.

The Sperry designs are based on existing hardware and technologies. Tubes, power supplies and stalos already in production require only minor modifications to become usable components in packaged source combina-

Precise prediction of the interaction between microwave and solid-state elements requires in-depth understanding of both technologies. Such understanding is the principle ingredient in Sperry's "Storehouse of Knowledge." Put our understanding to work for you today.

## SPERRY

DIVISION OF  
SPERRY RAND  
CORPORATION

tions. Because no development work is required, you can expect peak reliability from the first unit—the "learning curve" stage is completely eliminated.

Sperry delivers the source in a compact, integrated package . . . for a typical X band application it may be as small as 100 cubic inches and weigh as little as four pounds. While power supply maintenance should be conducted at depot level, the tube and stalo may be replaced, at any level, thanks to the fixed reflector voltage feature of Sperry reflex klystrons.

In packaging the units, Sperry pays particular attention to environmental requirements, mounting requirements and optimum RFI shielding.

If you're concerned with the performance and reliability of an all solid-state source to meet your specifications, or if you want to avoid the agony of matching a klystron to its power supply, get more information about Sperry's packaged source capability. For your free copy of a new technical paper, ask your Cain & Co. man or write Sperry, Gainesville, Fla.

## SPERRY ELECTRONIC TUBE DIVISION, Gainesville, Fla.

National Representatives: Cain & Co., Los Angeles, 783-4700; Boston, 665-8600; Arlington Heights, 253-3578; Dallas, 369-2897; Dayton, 228-2433; Eastchester, 337-3445; Philadelphia, 828-3861; San Francisco, 948-6533; Syracuse, 463-0462; Washington, 296-8265; South Amboy, 727-1900; Huntsville, 534-7955; Dade City, 422-3460; Montreal, 844-0089.

Circle 901 on reader service card

Experiments with vacuum date back 300 years. Today, Von Guericke would be amazed at RCA's "airtight" capabilities for probing ultra-high vacuum. These include simple connectors, instrumentation feed-thrus, sapphire windows, sputter ion pumps, and complete systems simulating outer space to  $10^{-13}$  torr.

□ Total vacuum capability at RCA, however, embraces more than hardware. It also includes sophisticated applications engineering to meet any challenge—any need.

□ RCA's UHV capability, acquired through more than 30 years experience with vacuum tubes, has developed research, testing, and production resources unmatched for reliability in experimental physics, space simulation, thin-film technology and materials research. For information on how RCA's experience in vacuum technology can be applied to your work, see your

RCA Representative. For your copy of the latest RCA catalog on Vacuum Components — VAC-100A, write: RCA Commercial Engineering, Section H-19DE-2, Harrison, N. J.

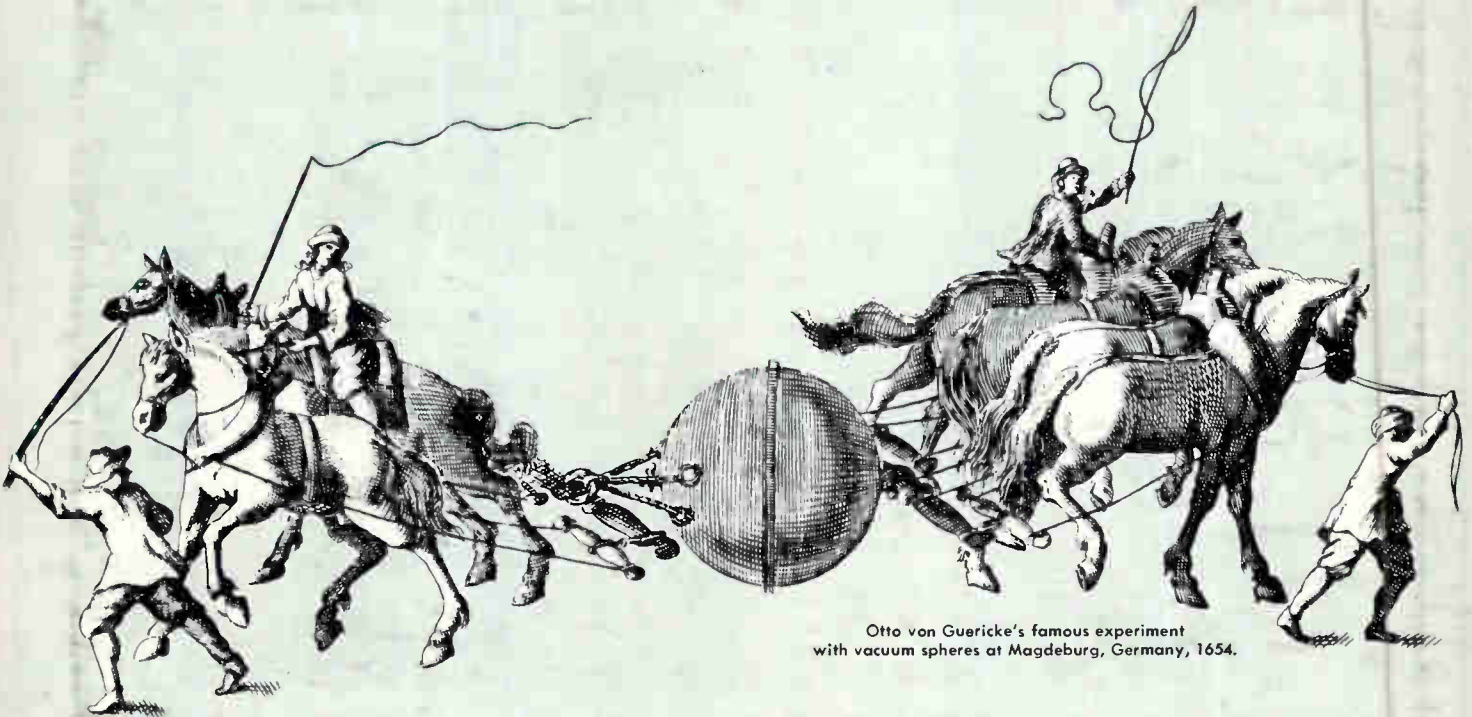

Otto von Guericke's famous experiment with vacuum spheres at Magdeburg, Germany, 1654.

***Never underestimate the capability of a vacuum***

RCA ELECTRONIC COMPONENTS AND DEVICES



**The Most Trusted Name in Electronics**