

electronics®

FREQUENCY-SHIFT KEYING

How to get rid of transients, p 58

CERAMIC FILTERS

Design and application, p 54

GLASS DIGITAL DELAY LINES

New computer components, p 60

Golf ball and stained-glass window—or outside and inside the giant Project Haystack radome. See p 49

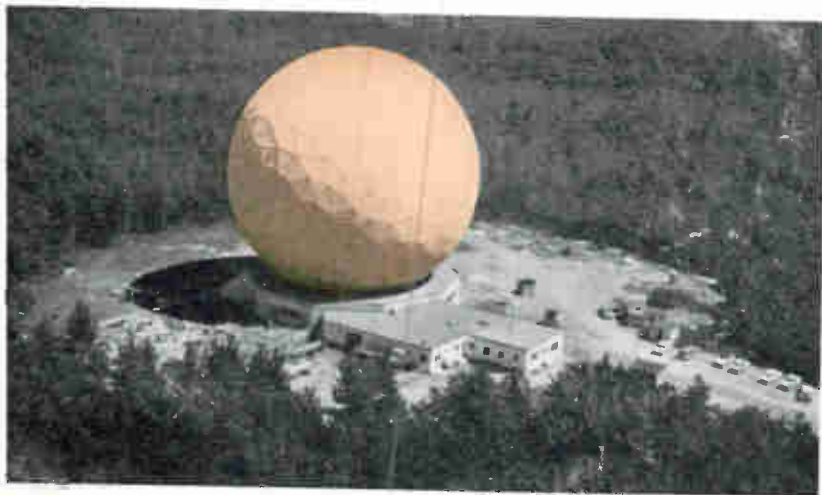

010 2

MOSES LAKE WASH

BOX 956

L 11-6

ROLAND KISSLER



SPECIAL FILTERS

TO YOUR REQUIREMENTS

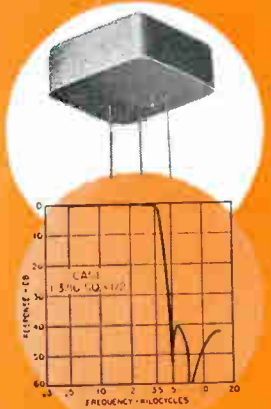

Miniaturized 3.5 KC low pass filter. 10K ohms to 10K ohms. Within 1 db up to 3500 cycles. Greater than 40 db beyond 4800 cycles.

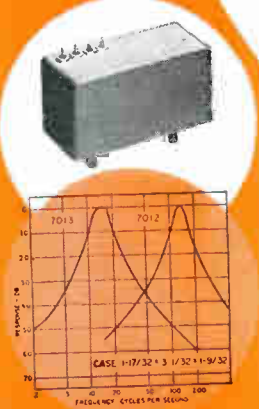

Fifteen cycle and 135 cycle filters for Tacan. 600 ohms to high impedance. Extreme stability —55°C. to +100°C.

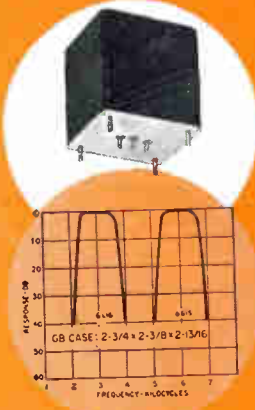

Three KC and 6 KC flat top band pass filters. 400 ohms to 20K ohms. MIL-T-27A; each filter 1.7 lbs.

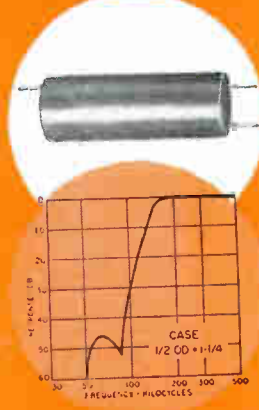

High frequency Mini-filters, .33 oz. MIL-T-27A Grade 5. 150 KC High Pass 3 db to 150 KC, down 45 db below 85 KC. 7500 ohms.

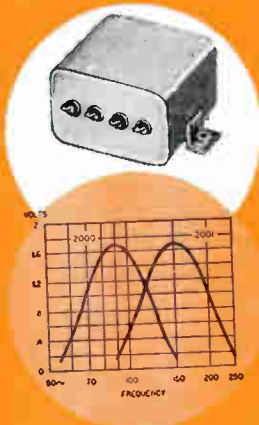

Curves of our miniaturized 90 and 150 cycle filters for glide path systems. 1 1/4" x 1 3/4" x 1 5/8".

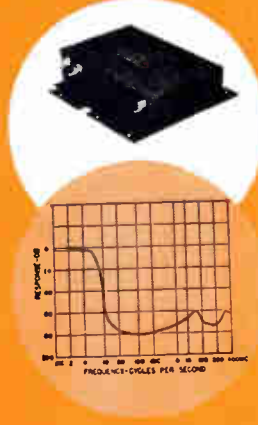

Power line filter from sources of 50 to 400 cycles . . . attenuation from 14 KC to 400 MC . . . 29 cubic inches.

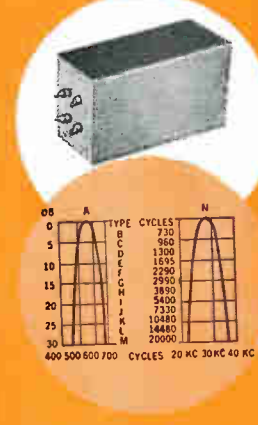

Multi-channel teletype band pass filters for 400 cycle to 40 KC. Miniaturized units for many applications.

Plus over 1,000 STOCK ITEMS with UTC High Reliability from your local distributor



→ write for catalog

UNITED TRANSFORMER CORP.

150 VARICK STREET, NEW YORK 13, N. Y.

PACIFIC MFG. DIVISION: 3630 EASTHAM DRIVE, CULVER CITY, CALIF.
EXPORT DIVISION: 13 EAST 40th STREET, NEW YORK 16, N. Y. CABLES: "ARLAB"

CIRCLE 900 READERS SERVICE CARD

electronics

A McGraw-Hill Publication 75 Cents



W. W. MacDONALD, Editor

J. M. CARROLL, Managing Editor
 SENIOR EDITORS: Samuel Weber,
 George W. Sideris. SENIOR ASSO-
 CIATE EDITORS: Michael F. Wolff,
 John F. Moson. ASSOCIATE EDITORS:
 Michael F. Tomoino, Sylvester P.
 Carter, William P. O'Brien, Sy Vogel,
 Leslie Solomon, George J. Flynn, Lou-
 rence D. Shergolis. ASSISTANT EDI-
 TORS: Nilo Lindgren, Stonley Froud,
 Stephen B. Gray, Roy J. Bruun, George
 V. Novotny, Leon H. Dulberger. RE-
 GIONAL EDITORS: Harold C. Hood
 (Pacific Coast, Los Angeles), Thomas
 Maguire (New England, Boston), Cletus
 M. Wiley (Midwest, Chicago). ART DI-
 RECTOR: Howard R. Berry. AS-
 SISTANT ART DIRECTOR: John C.
 Wright, Jr. EDITORIAL ASSISTANTS:
 Glaria J. Meurer, Lorraine Rossi,
 Virginia T. Bastian, Lynn Emery,
 Rosemary Abbruzzese, Ann Mella,
 Lorraine Werner. FOREIGN NEWS
 BUREAU: Director, John Wilhelm,
 Alyne Elias. LONDON—John Shinn,
 Derek Barlow, Nicholas Landon.
 BONN—Peter Forbath, Silke McQueen.
 PARIS—Robert Farrell, Arthur Erikson.
 MILAN—Marc A. Messina. MEXICO
 CITY—Bruce Bendow. RIO DE JAN-
 EIRO—Leslie Warren. MOSCOW—
 Stewart Ramsey. TOKYO—Richard
 Hallaran, Charles Cohen, John Yama-
 auchi.

W. W. CAREY, Publisher

GOLF-BALL is a 0.03-in. thick plastic radome sheltering a 120-ft dish antenna atop Haystack Hill near Tyngsboro, Mass. The facility belongs to MIT's Lincoln Lab. *The triangular pattern, reminiscent of a stained-glass window, permits use of a rigid metal framework without excessive signal degradation.* See p 49

COVER

CUBA CRISIS. Electronics Industry Is Ready for Emergency. Manufacturers say they can quickly step up production by using excess capacity and putting on second shifts. *There are few shortages*

20

SERGEANT MISSILE Has Big Future. Mobile field-artillery weapon for Army passes tactical test firing. *European forces will be getting the missile next year*

20

ELECTROSTATIC FOCUSING Gives Klystrons Greater Efficiency. By avoiding the use of magnets, one tube developer got a 5-pound, 15-Kw, S-band tube with efficiency of 25 percent. *Speakers at Electron Devices meeting also report new progress in semiconductor techniques*

26

OPTICAL COMPUTER Systems Can Raise Data-Processing Speed. Researchers hope for operating speeds in the megacycle and gigacycle range. *Recent developments in fiber optics and lasers have broken the trail*

30

TELSTAR TRANSMITS COMPUTER DATA. Eleven manufacturers participate in communications tests. *Results indicate that intercontinental satellite links will work fine*

30

VOSTOK SPACESHIPS Did Not Try Rendezvous. According to Russians, target distance was 5 Km. *A report in Pravda summarized equipment used and flight results. The Russians say they can make space flights of several hundred hours*

32

GIANT HAYSTACK RADAR FACILITY: First System Details. This precision tracking facility provides for simultaneous operation of two-way communications, beacon-tracking and skin-tracking radar in one package. *Four phase-locked klystrons generate 100 Kw at X band.*

By T. Maguire 49

CERAMIC RESONATOR FILTERS: Easy Way to Design Them. Insertion-loss design technique specifies a desired insertion loss as a function of frequency. *It enables filter designers to get precise pass-band and time-delay characteristics.*

By J. D. Schoeffler, Case Institute of Technology
and D. R. Curran, Clevite 54

Published weekly, with Electronics Buyers' Guide and Reference Issue as part of the subscription, by McGraw-Hill Publishing Company, Inc. Founder: James H. McGraw (1860-1948).

Title ® registered U.S. Patent Office; © copyright 1962 by McGraw-Hill Publishing Co., Inc. All rights reserved, including the right to reproduce the contents of this publication, in whole or in part.

Executive, editorial, circulation and advertising offices McGraw-Hill Building, 330 West 42nd Street, New York 36, N. Y. Telephone Longacre 4-3000. Teletype TWX N.Y. 212-640-4646. Cable McGrawhill, N. Y. PRINTED IN ALBANY, N. Y.; second class postage paid at Albany, N. Y.

OFFICERS OF THE PUBLICATION DIVISION: Nelson L. Bond, President; Shelton Fisher, Wallace F. Traendly, Senior Vice Presidents; John R. Callahan, Vice President and Editorial Director; Joseph H. Allen, Vice President and Director of Advertising Sales; A. R. Venezian, Vice President and Circulation Coordinator; Daniel F. Crowley, Vice President and Controller.

OFFICERS OF THE CORPORATION: Donald C. McGraw, President; Hugh J. Kelly, Harry L. Waddell, Executive Vice Presidents; L. Keith Goodrich, Executive Vice President and Treasurer; John J. Cooke, Vice President and Secretary.

Subscriptions are solicited only from those actively engaged in the field of the publication. Position and company connection must be indicated on orders. Subscription rates: United States and Possessions, \$6.00 one year, \$9.00 two years, \$12.00 three years. Canada: \$10.00 one year. All other countries \$20.00 one year. Single Copies, United States and Possessions and Canada 75¢. Single copies all other countries \$1.50.

THE PUBLISHER, UPON WRITTEN REQUEST FROM ANY SUBSCRIBER TO OUR NEW YORK OFFICE, AGREES TO REFUND THAT PART OF THE SUBSCRIPTION PRICE APPLYING TO COPIES NOT YET MAILED.

Subscribers: Please address change of address notices, subscription orders or complaints to Fulfillment Manager, Electronics, at above address. Change of address notices should provide old as well as new address, including postal zone number if any. If possible, attach address label from recent issue. Allow one month for change to become effective.

Postmaster: Please send Form 3579 to Fulfillment Manager, Electronics, 330 West 42nd Street, New York 36, New York.



Audited Paid Circulation

CONTENTS continued

GETTING RID OF TRANSIENTS In Frequency-Shift Keying. Most generators require clipping and filtering circuits after the oscillator to remove undesirable transients. This generator prevents transients from developing. *It does this by keeping the frequency-shifting reactance and oscillator tank at the same potential.* By N. C. Hekimian, Page Communications Engineers 58

GLASS DIGITAL DELAY LINES: New Computer Components. Delay lines using time-invariant glass as delay medium combine high-frequency response of mercury delay line with time stability of wire lines. *The glass lines can be operated from 2.5 to 30 Mc or higher.* By Delay Line Engineering Group, Corning Glass 60

REFERENCE SHEET: Microphone Calculations for the Space Age. The missile and space industry uses microphones as pressure gages as well as speech transducers. *This chart helps the engineer convert between two reference levels in common use.* By D. Abrams, Gulten Industries 66

DEPARTMENTS

Crosstalk. <i>After Cuba, Space?</i>	3
Comment. <i>More on Avalanche Breakdown</i>	4
Electronics Newsletter. <i>Laser Development Takes Significant New Turn</i>	7
Washington Outlook. <i>NASA Revising Patent Regulations</i>	12
Meetings Ahead. <i>Symposium on Thin Films for Electronic Applications</i>	34
Research and Development. <i>New Tube Shifts Phase Linearly with Current</i>	70
Components and Materials. <i>Increasing Corona Thresholds in Dielectric Films</i>	80
Production Techniques. <i>Wiring Patterns Bonded to Pellet Modules</i>	90
New Products Design and Application. <i>Multiplexer uses Capacitive Charge Transfer</i>	102
Literature of the Week	118
People and Plants. <i>Machlett Announces Two Promotions</i>	120
Index to Advertisers	130

After Cuba, Space?

IF THERE IS ONE LESSON to be learned from the Cuban incident it is that the precarious balance of power between East and West can be upset almost overnight by some unexpected development.

What if the next crisis comes in space?

Suppose, for example, the Russians put up several satellites ostensibly to serve as communications relays. Suppose they put up more and more to replace those in which power supplies had "failed." Suppose the orbits of these satellites could be readily altered to place them within striking distance of any spot on earth. And suppose some or all of them contained nuclear warheads.

How would we know, and what would we do about it?

All of this is speculative, but it is a possibility that cannot be overlooked. What are we doing to police space? Not enough. And we are not doing enough because we are not devoting enough of our space effort to strictly military needs.

We have been plowing three to four times as much money and effort into peaceful space programs as into military programs. It is explained that what NASA finds out is immediately made available to the military, and this is quite true. But it is not necessarily true that the answers our space agency is looking for are precisely those most needed by the military. For example, detection and interception are not the primary peaceful goals, but they could be vital to military needs in space.

The United States has a great deal of scientific and technical competence in space. Its space defense equipment and facilities in being do not match this competence. Let's see that they do.

We hope the crisis now apparently passing causes the Administration to revise upward its ideas about the urgency of purely military space programs. We hope it realizes that the peril in space could quickly become as real and as great as the peril in Cuba.

LOOKING FOR NEEDLES. Between the era of the SCR-584 radar of World War II and the advent of BMEWS and Millstone Hill radars, radar system

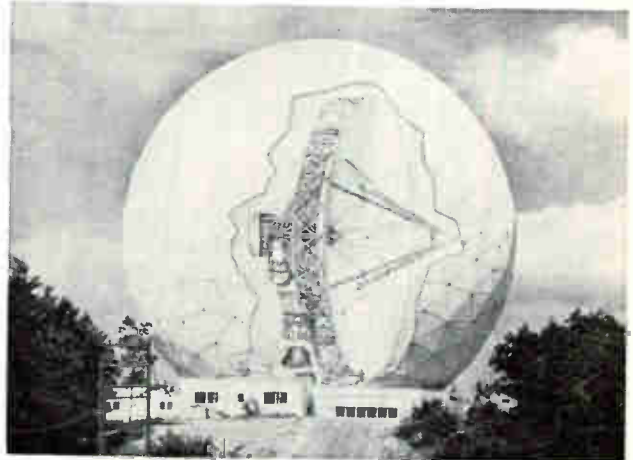

sensitivity has improved by about 80 db. We are now witnessing a further gain increase of about 35 db, as exemplified by the experimental Haystack system designed by MIT Lincoln Lab for the USAF. "And the radar people haven't run out of gas yet," says Herbert G. Weiss, Lincoln Lab Project manager for Haystack, commenting on further tricks held up his and his radar colleagues' sleeves.

It wasn't so long ago, 1946, that radar came dramatically to attention of astronomers, when the Army Signal Corps used war-developed equipment to bounce signals off the moon (*ELECTRONICS*, p 92, April, 1946.) Now, 16 years later, successive advances in system sensitivity hold out the possibility of bringing all the planets of our solar system into radar view. Straightforward improvements along the lines of Haystack system techniques could achieve this.

Gains in system sensitivity have been made by using larger-apertured antennas, higher frequencies, better receivers, higher power, and more sophisticated data processing methods. When arrays finally come into their own, they will probably take over the job of further extending—to what limits of sensitivity we don't know—the reach of radar.

The Haystack system is a milestone in communications and radar techniques, and was realized by combining the latest hardware with the designer's skill in pushing contemporary knowledge into future usage.

Haystack Hill in Tyngsboro, Mass., is connected by road to Millstone Hill, less than a mile away in Westford, Mass., site of the five-year-old tracking station which made the first radar contact with Venus in 1958. Haystack and the newly modified L-Band Millstone Hill system will be working together on space physics problems.

A description of the system, by New England Editor Maguire, begins on page 49. The illustration shows the installation with a sketch of the antenna.

NEW! FACILOGIC BY H-K FOR DIGITAL SYSTEMS BREADBOARDING

FaciLog modules provide a new simplified system for breadboarding, building specialized test equipment and training personnel...easily, sensibly and economically. FaciLog offers: BUILT-IN INDICATOR LIGHTS show "logical state of circuit" ■ FRONT AND BACK PLUG CONNECTIONS Use front for breadboard and checkout...rear for semi-permanent wiring ■ "NO-MAZE" WIRING with modular construction ■ MIL SPEC SYMBOLS and simplified loading rules on front of each module. And 14 more exclusive features. Breadboard and checkout with FACILOG. Specify your system with H-K Encapsulated Logic Modules on FLEXI-CARD Assemblies.

Data Systems Division

harman kardon

Incorporated ■ Plainview, Long Island

Write for FREE guide to Boolean Algebra and complete FACILOGIC and exclusive "Lease-Loan" information. Dept. E-119

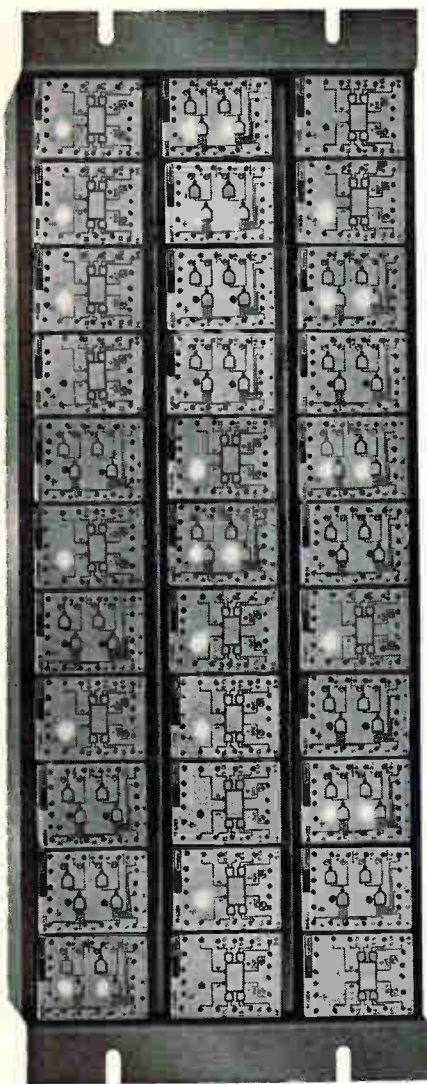

COMMENT

More on Avalanche Breakdown

In rereading the September 28th issue just to make sure that I didn't miss anything, I found something that I had missed the first time around. The *Comment* column (p 4) carried several letters by Frommer and Fairchild, discussing a point to which neither really had the answer [—placing voltage divider resistors in parallel if diodes are used in series]. I have had to solve this problem in the past for a case where the resistors simply could not be used because of space limitations. I asked the same questions that reader Frommer did, but came up with the following answers:

1. One of the most important factors in any discussion of transient diode failure is the capacitance to ground from the junction points between diodes. Thus, with two diodes in series, the midpoint may not assume a potential based on current flow through the diodes alone, since a displacement current also flows through the diode that is not grounded at either end, which will not flow through the other diode. This displacement current will cause a larger voltage drop across one diode, *even though the diodes themselves are exactly equal in all respects*. This analysis can be extended for more than two diodes where the capacitances from each of the junctions to ground do not have identical values.

2. Although author Fairchild quotes a classic equation that describes the avalanche current in a diode, it just isn't so in very many diodes that come in our receiving door. The best way in the world to select diodes for series-string operation is to sweep the reverse-voltage curve from 0 volts up to about 2,000 volts (with suitable current-limiting resistors, of course). Higher voltages could be used in some cases; this value was arrived at for 600-volt diodes. A test like this will show up diodes that will pass every constant-current voltage-limited test in the world, and yet fail soon after placed in series-string operation. The reason: many diodes possess a perfectly adequate

reverse-voltage capability until they once experience avalanche. Then for some reason, their reverse curve drops sharply and their reverse rating may assume a new low value—sometimes even zero. This does not mean that the diode shorts, merely that it has a reverse curve that leaves the zero-current axis at a large slope for any reverse voltage. Other strange behavior, together with this effect, caused us to reject nearly 60 percent of all diodes tested. Our acceptance criteria was simple: every diode must be taken out to its avalanche point three times, and left there for three seconds each time, during which time its reverse characteristic must exhibit a sharp knee at higher than 600 volts and remain perfectly stable. The improvement in diode reliability following this procedure was startling.

I hope that these comments don't come along too late to be of value. I'll read the next issue of *ELECTRONICS* more closely the first time through.

THOMAS P. PROUTY
MHD Research, Inc.
Newport Beach, California

Canadian Kudos

My congratulations to you on *Electronics* in Canada in the Sept. 28 issue of *ELECTRONICS* (p 37). We feel that it did quite a complete survey of this complicated field.

F. W. PRICE
Northern Electric Company Ltd.
Ottawa, Ontario
Canada

Feet, Not Inches

In the small item at the bottom of p 26 of the October 12 issue, about the Commonwealth Scientific and Industrial Research Organization radio telescope at Sydney, Australia, I'm afraid 210 *inches* doesn't get one very far in radio astronomy these days!

CHET YOUNG
Walter V. Sterling, Inc.
Claremont, California

On page 50 of this issue, the table of characteristics of six high-gain steerable antennas includes the 210-foot Australian radio telescope.



10,000 hours without parametric drift...

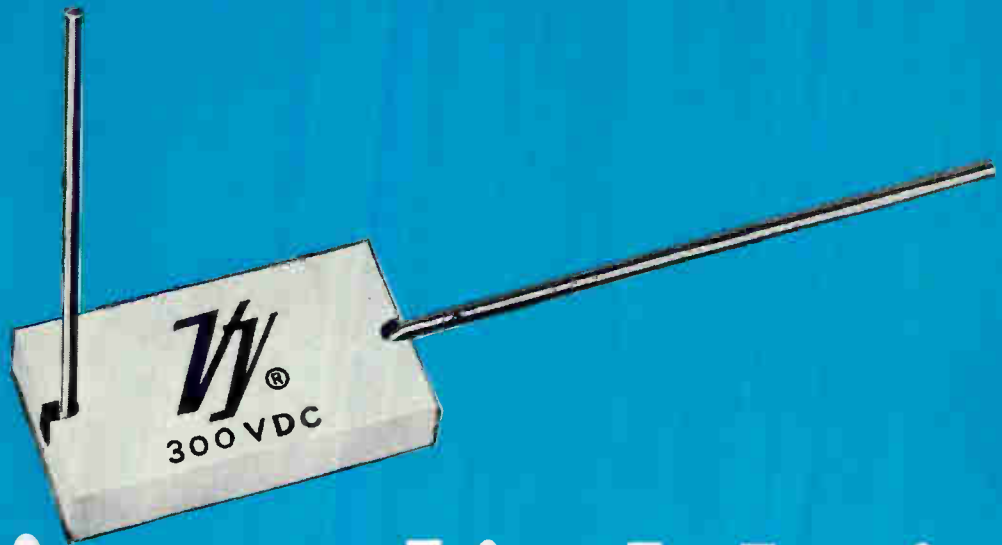

it's reliable!



solid state
PORCELAIN CAPACITORS

- * low loss
 - * low noise
 - * greater stability
- * wide temperature range
 - * impervious to humidity

-55°C to +125°C operation
0.5 mmf to 6800 mmf
50 to 500 vdc
Conforms to MIL-C-11272B

© Vitramon, Inc. 1962

Punishing life tests under both accelerated and long term conditions have verified the reliability of "VY" Capacitors for use over extended periods of time. After an accelerated test of 10,000 hours at 125°C with 150% of rated voltage applied (equivalent to a 5-year test at maximum rated conditions) Dissipation Factor was .00203, Insulation Resistance 10^{10} , and capacitance drift was typically .1 mmf. After a long term test of 30,000 hours at 25°C and rated voltage, Dissipation Factor was .00072 and Insulation Resistance 100 ohm farads. In actual application, "VY" Capacitors designed into VANGUARD II are still performing after more than two years in orbit.

Write for complete catalog and TR 321

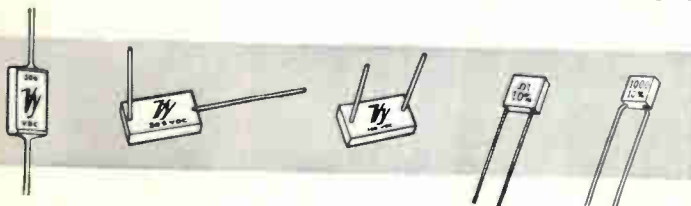

Vitramon®
INCORPORATED

Box 544 • Bridgeport 1, Connecticut

1963 SAAB . . . built so well that it has a 24,000-mile/24-month written warranty*

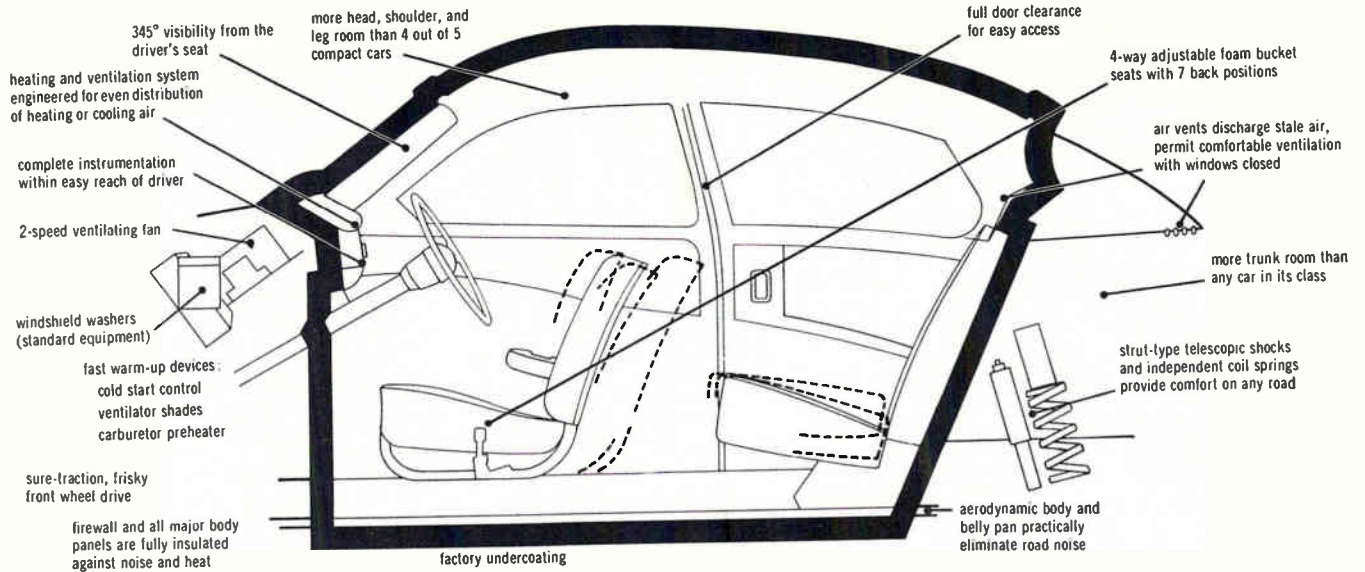

Take a critical look at SAAB comfort and convenience

Aircraft reliability and performance standards are blended with an entirely new approach to over-all automotive design in the Swedish SAAB 96. This car was built to be better and more comfortable, not different . . . built by one of Europe's leading aircraft man-

ufacturers . . . built for those who enjoy mechanical excellence, technical uniqueness, and extraordinary craftsmanship.

A critical look at *all* the facts and specifications will prove that SAAB is unquestionably one of the world's best engineered cars.

* Engine, transmission (3- or 4-speed gear box available), and differential have a written warranty for 2 years or 24,000 miles.



SAAB STANDARD EXTRAS place complete comfort and convenience within easy reach of its driver. At no extra cost, SAAB provides: electric clock, temperature and fuel gauges, ammeter, on easy-to-read instrument panel; heater and defroster to warm or cool car interior as required and keep all windows fog-free; dual padded sun visors; cold start control, ventilator shades, and carburetor preheater for instant starts in any weather; windshield washers, lockable glove compartment; safety belt fittings; factory undercoating—all *standard* equipment!

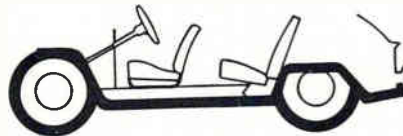

SAAB RIDING COMFORT is based on front wheel drive, which eliminates driveshaft, makes all floor space flat and usable, permits quick conversion of SAAB interior to a bedroom big enough for two. Front wheel drive, combined with carefully calculated understeering, low center of gravity, and advanced suspension design, provides swayless directional stability for relaxed driving. The sure-footed traction of front wheel drive pulls the rest of the car firmly and easily around sharp curves and corners, through mud, ice, and snow.

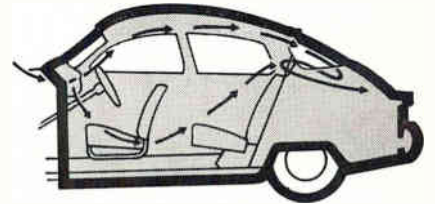

SAAB HEATING AND VENTILATION provides draft-free, year-round comfort. Fresh air is circulated and discharged through ducts below the rear window and vents behind the side windows. Removable ventilation lids help keep engine compartment and car interior cool in summer, warm in winter. New ultra-efficient hot water heating system eliminates hot spots and danger of exhaust fumes . . . provides even heat to front and back seats. Strategically-positioned air jet holes keep front and side windows clear and defrosted for fog-free vision.



Arrange a test drive at your nearest SAAB dealer. Or write for more information—and the SAAB North American Road Atlas, a 64-page comprehensive travel guide valued at \$1.00, but yours for only 25¢ to cover postage and handling. SAAB Motors, Inc., Dept 311, 405 Park Avenue, New York, New York.



\$1895 P.O.E. (little enough for one of the world's best engineered cars)

SAAB MOTORS, INC. — NEW YORK • NEW HAVEN • JACKSONVILLE • ST. LOUIS

FOR INFORMATION OTHER THAN ROAD ATLAS CIRCLE 299 ON READER SERVICE CARD

ELECTRONICS NEWSLETTER

Diode Injection Laser Off and Running

LASER DEVELOPMENT took a new turn last week with announcements by IBM (p 7, Nov. 2) and GE that coherent infrared emission has been obtained from gallium-arsenide diodes. One effect may be diverting a large part of industry's R&D effort from ruby and gas lasers to the new injection types.

The injection laser is simpler than previous types. It is pumped electrically by d-c pulses rather than by light or r-f energy; this may make it easier to modulate.

Both IBM and GE formed their diodes from junctions of *p* and *n* GaAs doped with zinc and tellurium, respectively. Both were operated at a temperature of 77 K. IBM says its diode also lased at room temperature. Emission is at a wavelength of 8,400 angstroms when the device is forward-biased by 5 to 20 μ sec pulses with current densities of 8,000 to 20,000 amp/cm². Both firms anticipate c-w operation soon.

Several organizations have been working in this area, as evidenced by recent reports of noncoherent infrared emission from gallium-arsenide diodes (p 27, Feb. 9; p 7, Aug. 3; p 44, Oct. 5 and p 28, this issue).

MIT Lincoln Laboratory says it has achieved "very satisfactory" laser action, but won't elaborate. RCA, GT&E Labs, Texas Instruments and Bell Labs are also working on gallium-arsenide lasers; none has reported coherent emission. A GT&E spokesman said that scientists there had succeeded in making gallium-arsenide-like radiation with other materials. This new radiation is visible and may be made highly efficient and coherent, he said.

Lasing at Ultraviolet Wavelength Reported

STIMULATED EMISSION of ultraviolet radiation at a wavelength of 3,125 angstroms has been achieved by the U. S. Naval Research Laboratory. The device employs a gadolinium-activated silicate glass pumped by xenon flash tubes.

The work was performed by

H. W. Gandy and R. J. Ginther, who observed a 55-angstrom wide luminescence emission at the operating wavelength, at room temperature. Most of the pumping is concentrated in the range of 2,700 to 2,800 angstroms.

The scientists believe that the device may prove to be a laser where non-axial modes dominate. A spatial analysis of the far field pattern has not been attempted yet. Optical inhomogeneities in the laser material presently being used may preclude achievement of a pencil type of far-field pattern.

Is Mariner in Trouble? Solar Power Drops

LOS ANGELES—Sudden sharp drop last week in voltage supplied by Mariner II solar panels indicates the Venus mission may be in jeopardy. Mariner was 11.7 million miles from earth and in its 65th day

of travel when the voltage drop occurred.

To conserve power for operation of the microwave and infrared radiometer experiments during Venus fly-by on December 14, the four interplanetary experiments (p 26, Oct 26) have been shut down by signal from the Goldstone DSIF transmitter. These are solar plasma, cosmic dust, magnetometer, and radiation detector experiments.

Unofficial speculation points to two possible causes of the voltage drop—collision by a solar panel with a fair-sized meteorite, and failure of a spaceborne voltage regulator. Jet Propulsion Laboratory reports it hopes that the rechargeable battery aboard the vehicle may provide sufficient power for successful operation of the two planetary experiments.

Submillimeter Detector Goes Into Production

LONDON—Mullard is going into production of a submillimeter photodetector with a response time less than 1 μ sec. The physics department of the Royal Radar Establishment, Malvern, made the initial design of the detector (p 44, Feb. 16).

Wavelength range of the first detectors will be 0.1 mm to 8 mm, but later developments are expected to extend the range down to 0.01 mm or lower by using a variety of doped

Mother Nature Is a Teacher, Not a Model

BOSTON—Air Force Major Jack E. Steel, who coined "bionics" (p 38, Feb. 9), said this about bionics at NEREM this week:

As the art of copying or borrowing principles and techniques from living systems to design synthetic ones, bionics "is at best a technique for solving design problems, at worst an excuse for building cute models." Copyable virtues of living systems are usually more subtle than microminiaturization ("generally more of a handicap to observation than an inspiration to design") and sensitivity ("more apparent than real").

Over-identification is a common problem. There has been little profit in considering a relay as a neuron, the eye as a camera and the retina as a phototransducer. It's better to treat the retina as a data-processing net. Nor have servo engineers used the complex or dual feedback of living motor control systems to provide complete information when properties of both controlled and controlling systems are subject to variation

germanium crystals interchangeable with the indium-antimonide crystal.

The detector element is a slice of indium antimonide, $5 \times 5 \times 2$ mm, placed in the field of a superconducting magnet made of niobium wire. The whole assembly is immersed in liquid helium. Radiation is fed to the detector by a light pipe.

Weather Program Would Give Thin Films a Lift

YORKTOWN, N.Y.—Putting thin-film circuits on the surface of large meteorological balloons—instead of hanging gear from the balloons—to reduce hazards to aircraft was proposed last week at a geophysics conference at the IBM research center here. If a plane accidentally struck the balloon, the balloon would fly apart.

The plan, put forward by V. E. Lally, of the National Center for Atmospheric Research, has been under consideration for some time. Negotiations with other countries on the use of the balloons is underway and a small transmitter for a balloon application has been made.

Lally said global coverage for research on large-scale atmospheric processes could be provided by 4,000 such balloons, constrained to fly at a constant-density atmosphere and coupled with a satellite locating system.

Guidance Computer Fits Into 34-Pound Package

GENERAL MOTORS' AC Spark Plug division reports development of a 34-pound, airborne digital computer. The weight includes a random-access core memory with a capacity of 4,096 24-bit words. It uses some 2,100 Fairchild Semiconductor micrologic elements. Memory, memory circuits and logic elements are all assembled on seven magnesium plates, bolted together, that also serve as heat sinks.

The memory stores the program, constants and variables. Serial in organization, it handles the 24-bit words 2 bits at a time in 12 successive read-write cycles, each lasting $4 \mu\text{sec}$. This allows for double

instead of triple coincidence for operation, substantially reduces the circuits required and provides wider operating margins, AC says.

The company plans to integrate the computer with the inertial measurement unit of its inertial guidance system for further lab evaluation. It should also be useful in aircraft navigation systems, it was reported.

Sonic Phase Shift to Show Altitude of Boat

AUTOPILOTS on hydrofoil landing vehicles being developed by Lycoming for the Marine Corps will include sonic height measuring units. The autopilot will control the height of the craft above water so all the driver has to do is steer it, at speeds to 35 knots. The sonic units, to be built by Arma division of American Bosch Arma, will measure height by detecting the phase shift in a sonic signal reflected from the water.

Eight-Dish Antenna Tracks Mars Probe

MOSCOW—The Russians are reportedly using a huge radiotelescope of unusual design to maintain contact with the Mars probe launched last week. Transmitters in the space probe operate at frequencies of 922.76 and 183.6 Mc. The probe is expected to reach Mars in June.

Konsomolskaya Pravda said the "distant space radio communication center" was equipped with an antenna that resembles "a family of large radiotelescopes placed close to one another and revolving on the same axle." It consists of eight concave, Duralumin mirrors, each some 16 meters in diameter, placed in two rows of four each.

The upper part of the antenna was said to be about 12 stories high. Weight, without land foundation, was put at more than 1,000 metric tons. A "huge" foundation maintains antenna dimensions within 1 mm, the newspaper said. The antenna can move in both horizontal and vertical planes, it was reported.

In Brief . . .

NASA IS EXPECTED to launch the RCA Relay communications satellite (p 46, Oct. 5) around mid-December. Relay and Telstar II launches had been postponed so their launch vehicles could be used for Explorer 15, now probing the artificial radiation belt.

BELL TELEPHONE is extending its Data-Phone service for facsimile transmission, eliminating need for private-line transmission. It was also announced by Digitronics Corp. that its Dial-o-verter system, working with regular Data-Phone will be used by the *New York Times* to transmit news copy to Los Angeles for its western edition.

HALLICRAFTERS CO. has bought Radio Industries, Inc., of Kansas City. Power Designs, Inc., is negotiating to buy Carad Corp., of Palo Alto. Epoxy Products has entered into 10-year manufacturing, marketing and technical agreement with Ciba Ltd., of Switzerland.

UNIVAC is going into the OEM market, starting with computer subsystems. Company anticipates OEM market for peripheral computer equipment will double in two years to \$150 million a year and reach \$350 million by 1970.

PHILCO has a \$3.6-million contract to develop a data-processing system using a Philco 2000 computer. System will be used by North American Air Defense Command to test real time information systems.

LEACH CORP. has a \$1-million contract from Lockheed to develop radiation-resistant satellite tape recorders. They are to have life spans five times previously supplied recorders.

NAVY AWARDED \$7.5 million more to Sperry Gyroscope for missile submarine navigation subsystems. Collins Radio will provide two air - transportable communications systems to Air Force for \$3.8 million. Air Force also ordered \$1 million worth of airborne early warning radars from Hazeltine.

New from Sprague!

PACER® FILMITE® 'E' CAPACITORS

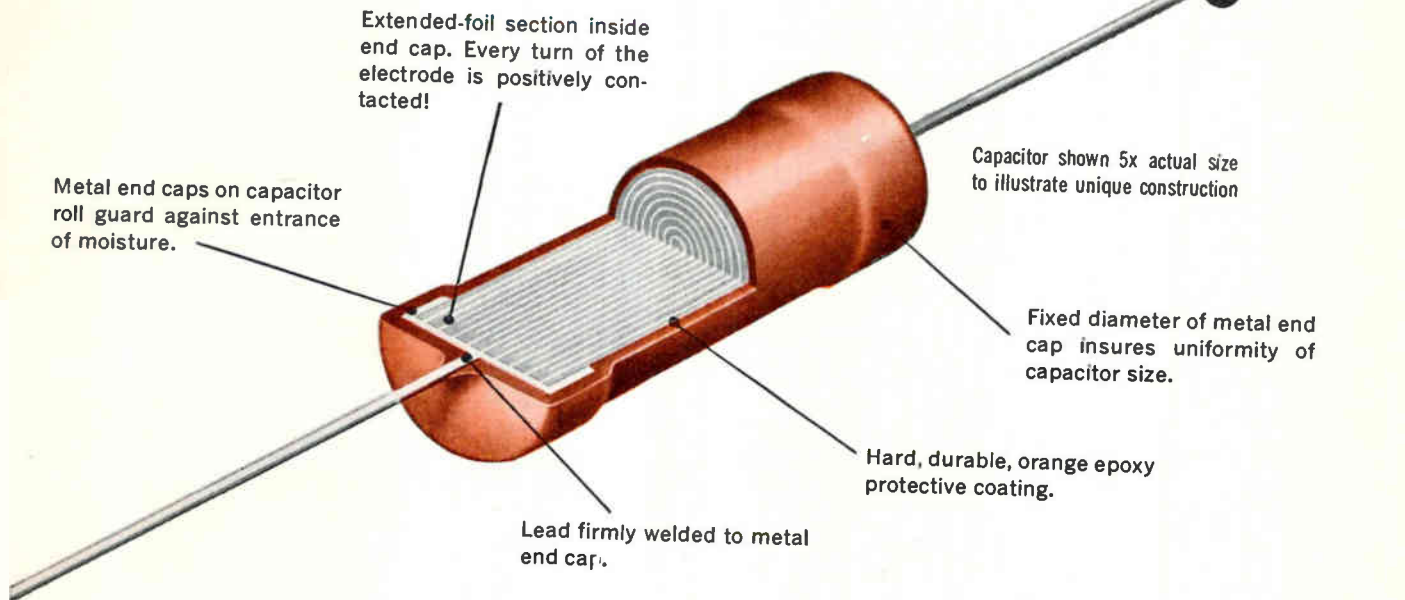

Multi-advantage Construction in a Low-cost Film Capacitor!

MINIFIED SIZE—

Rating for rating, Pacer Capacitors are almost one-third the size of conventional paper or paper-film tubulars, making them ideally suited for transistorized circuitry and other space-saving applications where small size with dependability is an important consideration.

BEST POSSIBLE NON-INDUCTIVE SECTION—

Metal end caps over extended foil sections assure non-inductive capacitors, since all turns of the electrode are contacted beyond question.

IMPROVED HUMIDITY RESISTANCE—

End caps act as effective moisture barriers. Capacitor sections are further protected by hard, durable, orange epoxy coating.

UNIFORMITY OF SIZE—

Unlike other epoxy-coated units, the end caps on Pacer Capacitors assure the rigid fixed diameters needed for use with automatic insertion equipment. The two smallest sizes are identical with resistor and diode sizes, making them especially suitable for 'cordwood' packaging.

For complete technical data on Pacer Capacitors, write for Engineering Bulletins 2066 and 2067 to Technical Literature Service, Sprague Electric Co., 35 Marshall Street, North Adams, Massachusetts.

SPRAGUE COMPONENTS

CAPACITORS
TRANSISTORS
MAGNETIC COMPONENTS
RESISTORS
MICRO-CIRCUITS

INTERFERENCE FILTERS
PULSE TRANSFORMERS
PIEZOELECTRIC CERAMICS
PULSE-FORMING NETWORKS
TOROIDAL INDUCTORS

HIGH TEMPERATURE MAGNET WIRE
CERAMIC-BASE PRINTED NETWORKS
PACKAGED COMPONENT ASSEMBLIES
FUNCTIONAL DIGITAL CIRCUITS
ELECTRIC WAVE FILTERS



'Sprague' and '®' are registered trademarks of the Sprague Electric Co.



NEW PRODUCTS FOR SOLVING YOUR DESIGN PROBLEMS

Texas Instruments Announces New Field-Effect Transistor Line

Operation From -196°C to $+200^{\circ}\text{C}$ Now Possible With New Silicon Field-Effect Transistors
Four new P-channel Planar diffused silicon field-effect transistors have been announced by Texas Instruments.

Outstanding parameters include high input impedance greater than five megohms at 1 kc, and noise figures as low as 1 db at 1 kc. These devices operate at temperatures ranging from -196°C to $+200^{\circ}\text{C}$, and are resistant to radiation intensities as high as 10^{15} neutrons ($E > 100$ kev)/ cm^2 . Circuit design problems are

minimized because input impedance and bias requirements are similar to vacuum tubes. Many circuits originally developed for vacuum tubes may be modified to use field-effect transistors.

These units are especially well adapted for use in satellites and space vehicles. Their high tolerance to temperature extremes and radiation simplifies application and increases reliability.

In addition to the usual transistor advantages of small size, light weight and ruggedness, silicon field-effect transistors generate less noise at low fre-

quencies than vacuum tubes. Since they have no filaments, they can be used in infrared applications where heater filaments would cause interference.

Suggested applications include: high-input-impedance, low-noise amplifiers; active low-frequency filters; timing circuits, and differential amplifiers. They can be used with either positive or negative power supplies, and are compatible with either NPN or PNP transistor circuitry.

For more information, write for Bulletin 485-1.

New TI Unijunction Transistors Offer Greater Circuit Economy And Reliability

A full line of 22 grown silicon unijunction transistors has been announced by Texas Instruments. These three-terminal devices exhibit a stable negative incremental resistance region under certain conditions. This negative resistance makes possible the design of unique switching circuits comprising fewer components than conventional transistor circuits. Input impedance in the OFF state is high — about five megohms. This feature makes the unijunction suitable for high-input-impedance, voltage-sensing circuits.

Circuit simplicity is a major advantage. In many applications, the number of circuit components can be reduced by as much

as half those required with conventional transistors, giving you lower cost, greater reliability

and ease of design.

For more information, write for Bulletin 485-3.

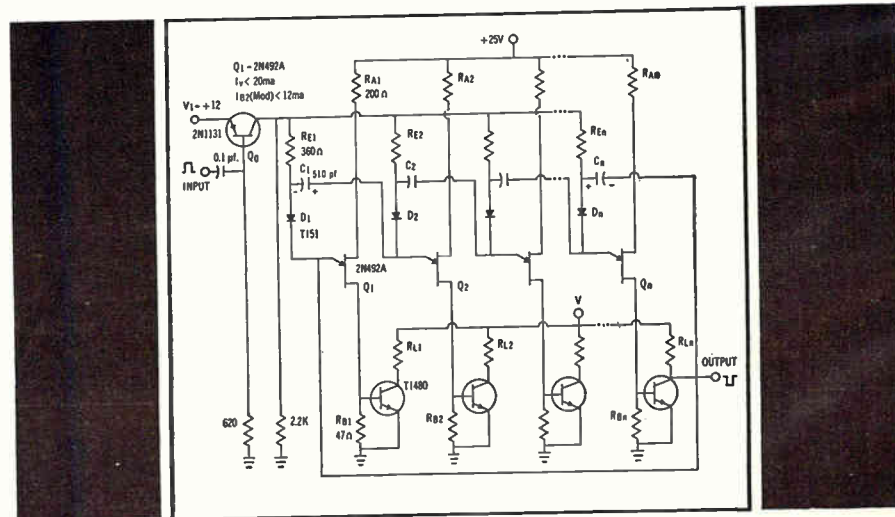

The ring-counter circuit shown here illustrates how TI's unijunction transistors can enhance the over-all economy and reliability of your equipment.

High-speed Magnetic Memories Introduced by Texas Instruments

Magnetic-film memories capable of exceptionally high speeds are now available from Texas Instruments.

These new high-speed, word-organized memory systems use continuous sheets of thin magnetic film deposited on aluminum substrates as the storage medium. Low noise level, low drive power and excellent mechanical rigidity result from the use of aluminum substrates.

A system typical of those now being designed has a memory of 8000 words, 50 bits per word, with a cycle time of 1.0 microsecond. Such systems are expected to be especially attractive for a number of military and commercial applications because of their inherent high speed coupled with potential low cost. To simplify engineering evaluation of the memory systems by computer manufacturers, Texas Instruments offers a pair of magnetic-film memory planes arranged in a word-organized

array comprising 64 words of 18 bits each. This array, designated the MS-1 memory stack, was designed for use in experimental applications. The MS-1 memory stack, together with conven-

tional electronics components, yields a small memory system capable of 0.2 microsecond cycle time.

For more information, write for Bulletin 485-4.

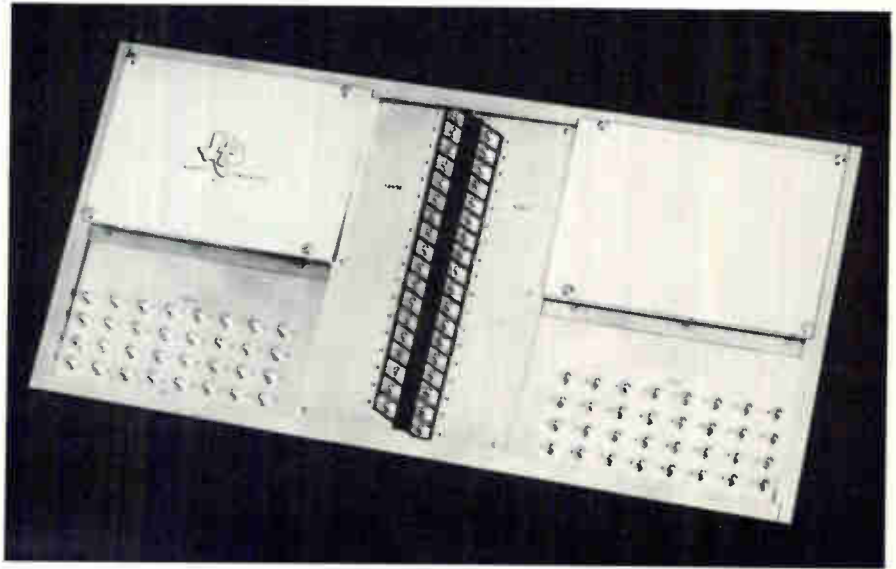

MS-1 magnetic memory stack now available from Texas Instruments for engineering evaluation of new high-speed magnetic memory systems. The MS-1 is a pair of memory planes arranged in a word-organized array comprising 64 words of 18 bits each.

First High-Current Solid State DC Switches in Electronics Industry Announced By TI

A new line of silicon gate-controlled switches (SGCS) — the first high-current, solid-state d-c switches in the industry — has been announced by Texas Instruments. These units have gate turn-off capacities for load currents 100 times greater than any previously available on-off devices.

Designated TIX120A0, A1 and A2, these switches are available in ratings from 50 through 200 volts. Other characteristics include a minimum turn-off beta of

10 at 5 amps, a maximum turn-on current of 50 ma at 25°C, and a maximum turn-off current of 360 ma. A single gate element performs both turn-on and turn-off functions.

Specific applications are expected to include power regulation, pulse-forming, pulse-width modulation, relay placement, and many other d-c power-control requirements.

For more information, write for Bulletin 485-5.

WANT MORE DETAILS ON THESE NEW PRODUCTS?

If you would like to have more detailed specifications and application information on the products featured in this advertisement, simply call your local TI sales engineer or write to Texas Instruments Incorporated, P. O. Box 5012, Dallas 22, Texas.

For more information on:

Silicon field-effect transistors — write for Bulletin 485-1

Unijunction transistors — write for Bulletin 485-3

Magnetic memories — write for Bulletin 485-4

Solid state DC switches — write for Bulletin 485-5

SEMICONDUCTOR COMPONENTS
DIVISION



TEXAS INSTRUMENTS

INCORPORATED
13500 N. CENTRAL EXPRESSWAY
P. O. BOX 5012 • DALLAS 22, TEXAS

19547

WASHINGTON OUTLOOK

NASA EASES UP ON ITS PATENT REGULATIONS

NEW PATENT AND LICENSING REGULATIONS issued by NASA will make it easier for contractors to get exclusive patent rights on inventions rising out of government contracts. However, the new rules extend NASA control over such rights to more categories.

The licensing changes are now in effect. They permit granting to all applicants non-exclusive, royalty-free licenses. If after two years there is still no commercial development, non-exclusive licenses can be revoked and an exclusive license granted to a single developer.

Changes in patent waiver regulations are held up pending a hearing December 10. Contractor would get exclusive patent rights if an invention is in his established commercial area, if development cost is so high that exclusivity is necessary, or if patent applications were filed before a NASA contract was signed. NASA listed a number of exceptions to the waiver rule.

RUSH IS ON FOR UHF-TV LICENSES

DEVELOPMENTS IN UHF TV have resulted in something akin to a rush by tv broadcasters to get in on the ground floor. FCC officials are beginning to worry if there will be enough channels in key markets. Behind the new interest are all-channel set legislation, \$32 million in federal aid for educational stations, and advance reports that an FCC test of uhf reception in the New York area was successful. The test report purportedly will show that uhf reception in skyscraper cities is as good as vhf if outside aerials are used.

FCC is getting a swell of applications for commercial stations and, for the first time, has channel contests on its hands—in New York and Paterson, N.J. Educators feel they may need as many as 1,000 uhf stations. Kaiser industries has applied for five uhf stations. Sylvester (Pat) Weaver, former president of NBC, is talking with key broadcasters about the possibility of a uhf network.

LUNAR ROCKET IN PRODUCTION

LARGER EXPENDITURES FOR ELECTRONICS are coming as large boosters for manned lunar landings reach the production stage.

NASA has made a \$319.9-million award to North American Aviation for nine flight rockets plus test units for the million-pound-thrust S-11, second stage of the big advanced Saturn C-5. Boeing is expected to get an even larger contract by the end of the year, for the 7.5-million-pound-thrust first stage booster. Contracts call for first flights in 1965.

AEROSPACE WORKERS NIX UNION SHOPS

AUTO WORKERS AND MACHINISTS UNIONS failed to get the necessary two-thirds majority to win union shops contracts at the West Coast plants of North American Aviation and General Dynamics. The "for" votes barely reached 54 percent among IAM members at GD, just under 60 percent among Auto Workers at NAA.

The defeat came in an area of a growing labor force—the space technician and white collar worker. This manpower group has one of the largest growth potentials in industry. The outcome means the missile unions will be fighting an uphill battle to organize industrial technicians and skilled workers.

RELIABLE products from RAYTHEON

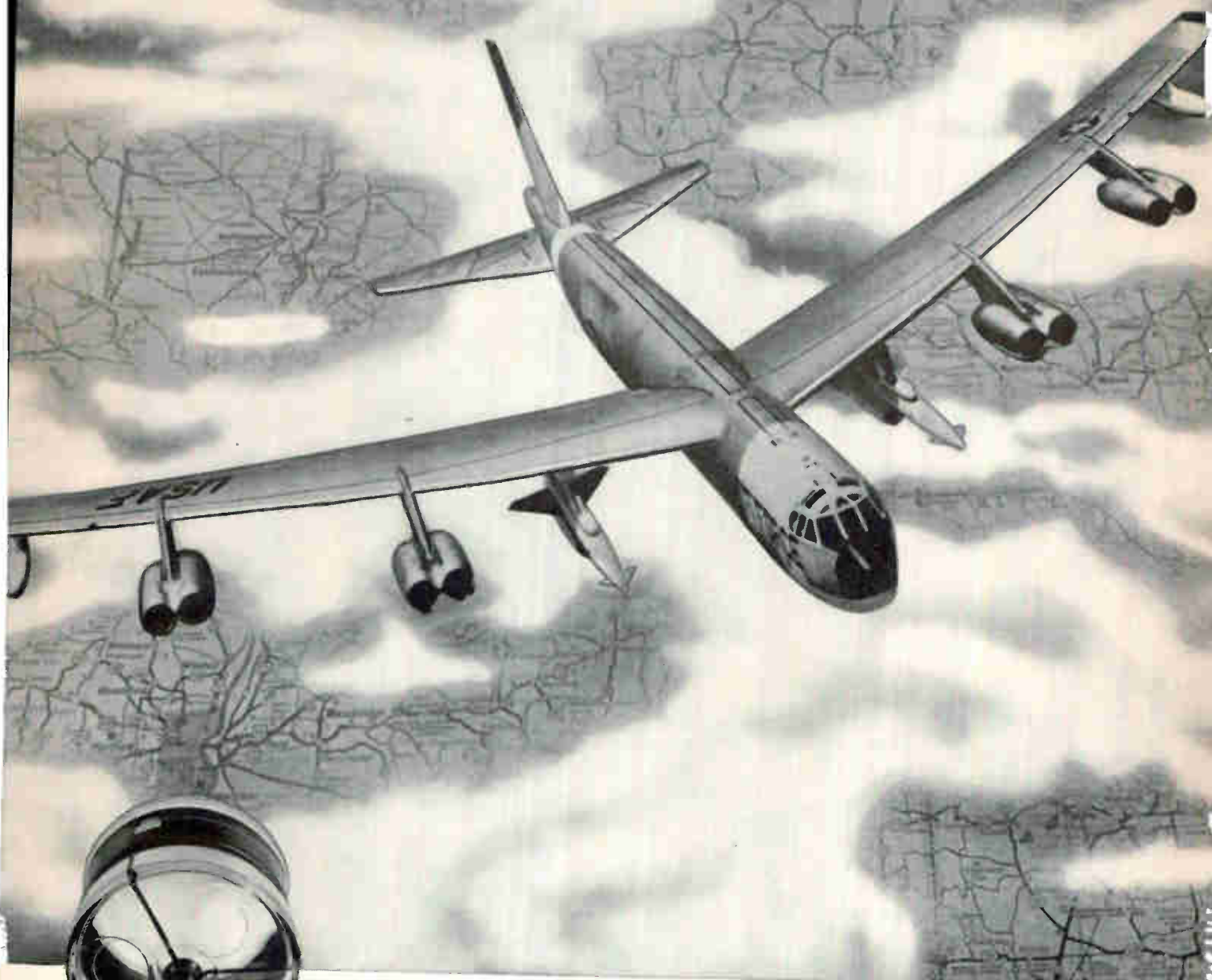

"Three-eye" CRT maps and films targets

Raytheon's unusual "3-eye" radar display tube has two optical windows in its sides which permit:

- A moving map of the target area to be projected onto the screen in conjunction with radar target sightings.
- A permanent photographic record of the composite picture for later analysis by air intelligence.

These 10-inch "3-eye" tubes, now in use by the Air Force, are an example of Raytheon's capabilities for producing cathode ray tubes for specialized equipment.

We also make a very reliable line of display devices, such as the metal-envelope 16ADP, in both radar and infrared-stimulable phosphor types. For complete details, please contact: Raytheon, Industrial Components Division, 55 Chapel Street, Newton 58, Massachusetts.

Send for the Electron Tube Data File.



CIRCLE 13 ON READER SERVICE CARD

Yes, we have some smaller



7/16" d.c. spur gearmotor

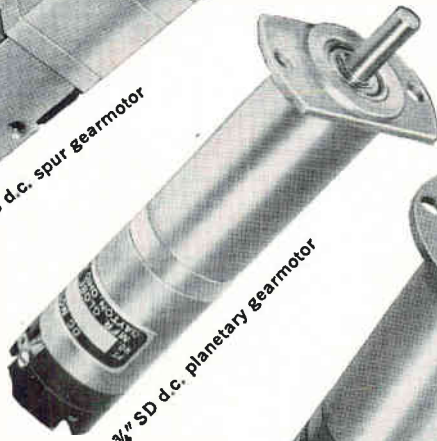

3/8" d.c. planetary gearmotor



1/2" d.c. planetary gearmotor



1 1/8" s.c. planetary gearmotor



1 1/2" s.c. spur gearmotor



Globe small precision gearmotors offer every

Tell us the kind of power you have (d.c. or a.c., 60, 400 cycle, variable or special frequency, or square wave). Tell us the speed you want. Or tell us the torque you want. If it can be met in a motor of 1/10 hp or less, Globe will deliver the gearmotor you need in 30 days or less. **Many combinations are available for 24-hour delivery from stock.** We can send your prototype quickly because we already have a head start!

Globe is the largest manufacturer of precision miniature a.c. and d.c. motors. This lets us recommend a motor no larger than you really need — advantages: size and weight. Second, every Globe motor can be fitted with a precision gearhead—of spur or planetary design using

case hardened gears. Note that Type MM and MC motors offer a choice of 101 standard planetary ratios, plus 28 standard spur ratios. In-between speed-torque combinations are provided by changes in the armature winding. Globe gear reducers are up to 90% efficient per stage; special gearing is always welcome. The reason Globe precision gearmotors are economical is that we meet custom requirements from standardized components. And we have the capability to modify, design, test, and manufacture new types quickly.

Request Bulletin GPG from Globe Industries, Inc., 1784 Stanley Avenue, Dayton 4, Ohio. Tel. 222-3741.
GLOBE INDUSTRIES, INC.

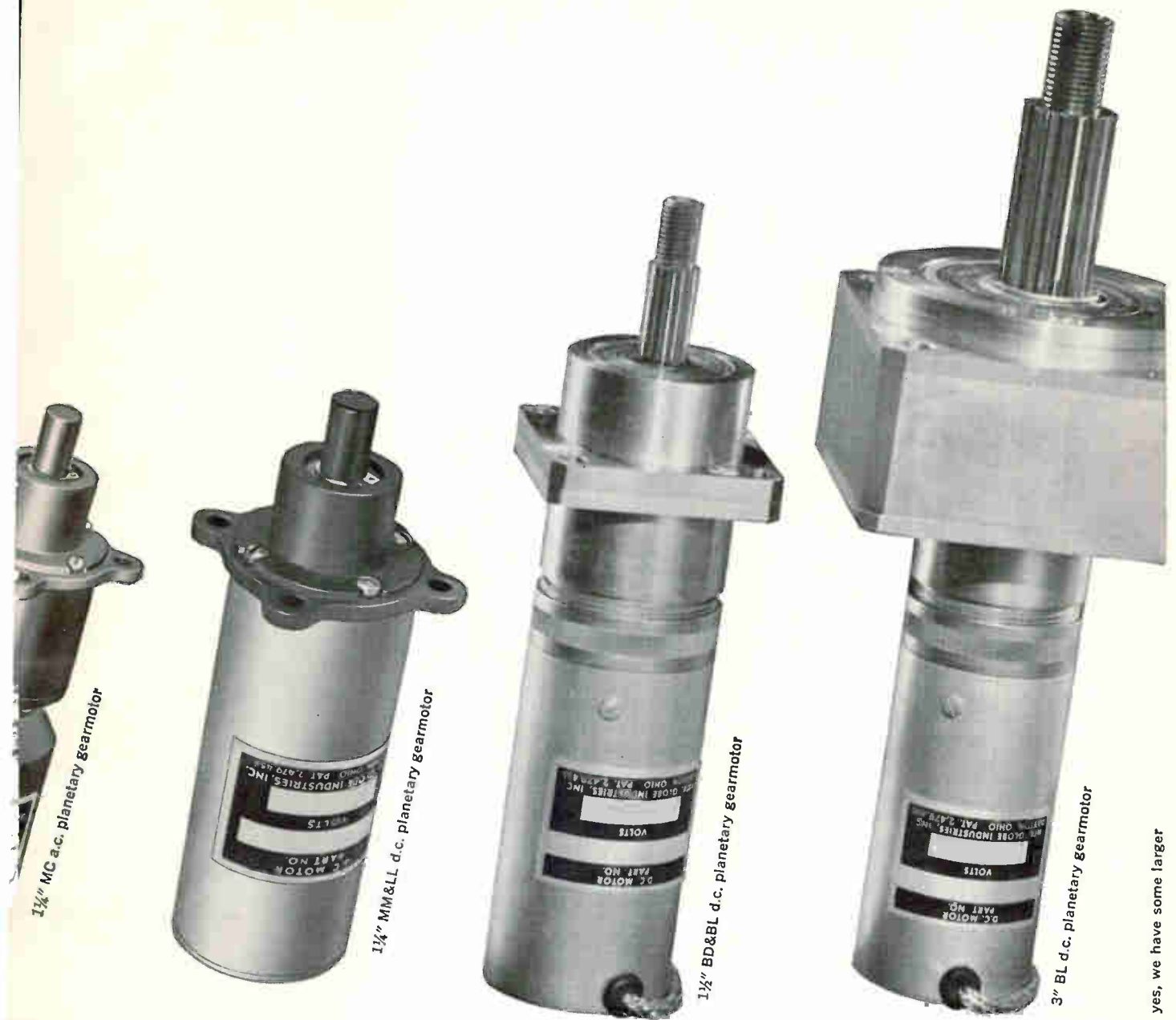

1 1/4" MC a.c. planetary gearmotor

1 1/4" MM&LL d.c. planetary gearmotor

1 1/2" BD&BL d.c. planetary gearmotor

3" BL d.c. planetary gearmotor

yes, we have some larger

speed-torque combination through 1/10 hp.

basic gearing size	gearing type	std. motor types	no. of ratios	max. intermittent duty torque
7/16"	spur	VS	62	50 oz. in.
3/4"	planetary	SD	21	300 oz. in.
7/8"	planetary	SS, SC	21	300 oz. in.
1 1/16"	spur	SC, (SS, MM, LL, MC)*	28	50 oz. in.
1 1/4"	planetary	MM, LL, MC, (FC, GJ)*	101	1000 oz. in.
1 1/2"	planetary	BD, BL, (GN)*	18	3200 oz. in.
3"	planetary	BL, (BD, GR, LC)*	10	16000 oz. in.

* not illustrated

PRECISION MINIATURE A.C. & D.C. MOTORS, ACTUATORS, TIMERS, CLUTCHES, BLOWERS & FANS, MOTORIZED DEVICES

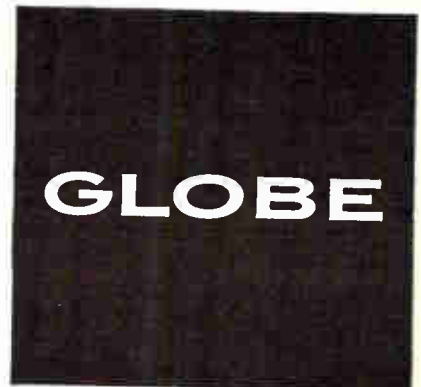

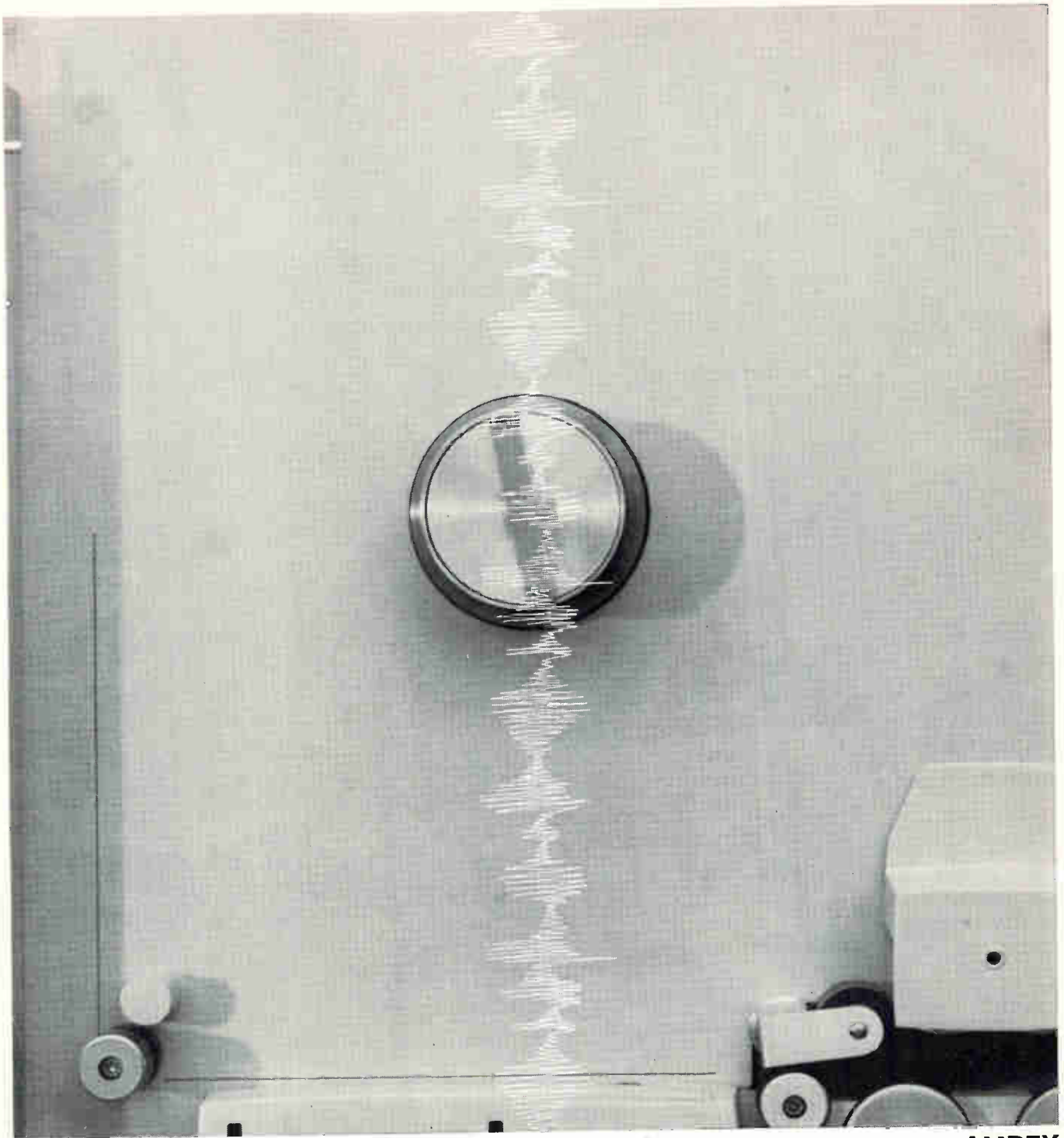

Who has both: 1.5 Mc recorder and 1.5 Mc tape?

AMPEX

We just don't like to leave things undone. Recently, our engineers developed the first 1.5 Mc per track, multi-track recorder—the FR-1400. Like every Ampex recorder, it gives you outstanding performance. We felt we had to develop a tape that equalled the FR-1400 in quality of performance. Hence: Ampex 9101—a 1.5 Mc tape. This new tape is a high resolution, heavy duty type with excellent wear characteristics. It offers high reli-

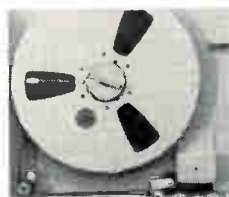

ability and superior performance. And can record 1.5 Mc of data at a speed of 120 ips. Ampex 9101 tape rounds out a recording system that gives you the highest frequency in longitudinal recording today. For more information write the only company providing recorders, tapes and memory devices for every application: Ampex Corp., 934 Charter St., Redwood City, Calif. Worldwide sales and service.

AMPEX

SANGAMO

RESIN-DIPPED SILVERED-MICA

CAPACITORS

Incorporating Nearly Forty Years Experience in the Design & Manufacture of Mica Capacitors

New Sangamo Type D dipped-mica capacitors are designed for applications requiring high stability, high reliability and low-loss characteristics.

Multiple coatings of the thermosetting resins provide excellent environmental protection and thermal shock characteristics. The case resists the high temperatures of soldering without damage.

Standard Type D dipped-mica capacitors are available in 4 case sizes corresponding to sizes CM05, CM06, CM07 and CM08 of Mil-C-5B and in voltage ratings of 300 and 500 wvdc. Units can be supplied with C, D, E or F characteristics for operation over a temperature range of -55°C to $+125^{\circ}\text{C}$. Special units are available with voltage ratings up to 3000 wvdc and a temperature range to $+150^{\circ}\text{C}$.

STANDARD RATING		
STYLE	VOLTAGE	CAPACITANCE RANGE PF
D-15	500	1- 400
	300	1- 820
D-19	500	5- 5,100
	300	5- 6,200
D-30	500	470-22,000
	300	470-30,000
D-42	500	3,300-51,000
	300	3,300-68,000

Write for complete information.



SANGAMO ELECTRIC COMPANY
SPRINGFIELD, ILLINOIS



SANGAMO
SANGAMO
SANGAMO
SANGAMO
SANGAMO
SANGAMO
SANGAMO
SANGAMO

Special Pliers for the Highly Specialized Electronics Field

When the early transmission lines were strung in this country a century ago, it was Klein Pliers in the hands of linemen that helped do the job.

Klein has kept pace with the development of the electrical field, meeting each new challenge with tools specially designed to do the wiring job better . . . more economically.

Shown here are a few of the many highly specialized Klein Pliers carried in stock to meet the needs of electrical and electronics manufacturers.

You will find your assemblies go together more smoothly and wiring is done more rapidly when the right Klein Plier is used.

SEE YOUR DISTRIBUTOR

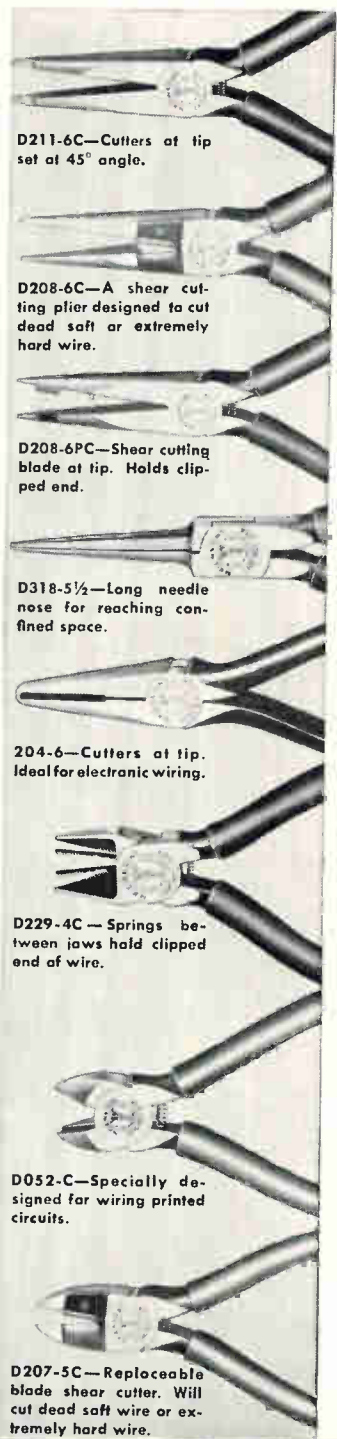

D211-6C—Cutters at tip set at 45° angle.

D208-6C—A shear cutting plier designed to cut dead soft or extremely hard wire.

D208-6PC—Shear cutting blade at tip. Holds clipped end.

D318-5½—Long needle nose for reaching confined space.

D204-6—Cutters at tip. Ideal for electronic wiring.

D229-4C—Springs between jaws hold clipped end of wire.

D052-C—Specially designed for wiring printed circuits.

D207-5C—Replaceable blade shear cutter. Will cut dead soft wire or extremely hard wire.



Mathias KLEIN & Sons
Established 1857 **Chicago, Ill., U.S.A.**

INCORPORATED
7200 McCORMICK ROAD, CHICAGO 45, ILL.



Mathias Klein & Sons, Inc. 7200 McCormick Road, Chicago 45, Ill.
Please send me the Klein Plier Catalog and information.

Name _____

Title _____

Company _____

Address _____

City _____ State _____

Electronics Industry Is

There is plenty of capacity to meet any military stepup

By **LEON H. DULBERGER**
Assistant Editor

SOLDIER WORKS on trailer for Hawk surface-to-air guided missile. Missiles like this are now deployed in Florida for defense against low-flying planes and missiles. Electronics content is about 65 percent

INDUSTRY LEADERS say the electronics industry can readily cope with any government demands arising from the Cuban crisis.

Military electronic manufacturers assert they can put on extra work shifts, use inactive production space and facilities, and realign engineering efforts to meet emergency demands.

Several electronics firms reveal they have already been queried by the Department of Defense, or alerted to standby for requests. Even companies not queried said they have studied their own capabilities, and know they are ready

Sergeant Missile Ready to Replace Army's

Overseas U. S. troops and Germans will get missile by early 1963

By **JOHN F. MASON**
Senior Associate Editor

WHITE SANDS, N. M.—Success of the first firing by a tactical unit of the second-generation, field artillery, ballistic missile, Sergeant, late last month means the Army will go ahead with plans for the missile system.

- Sergeant, representing a \$½-billion investment—although not all of this money has been spent—will go into full-scale production.

- More contracts will be awarded, and subsystems may be bid on competitively in the future when

such a change “does not jeopardize the system.”

- More battalions will be activated—three are already equipped with the weapon and are in training at Ft. Sill, Okla.

- The missile will be deployed overseas early next year by U.S. troops.

- The Federal Republic of Germany has bought the Sergeant system, and will deploy it in Germany early next year for the defense of NATO. The German missiles will be bought from the U.S. government and produced in this country.

- Other NATO countries, although not named, “have shown interest.” Indication of which countries these might be is revealed in a Sergeant missile brochure printed in English, German, French and Italian, distributed by Sergeant's prime contractor, Sperry Utah Co., a division of Sperry Rand Corp.

- In the meantime, test firings will continue through 1964. Before June, three Sergeants will be fired from the Pacific Missile Range and three at White Sands.

REPLACES CORPORAL—Advantages of the Sergeant over the

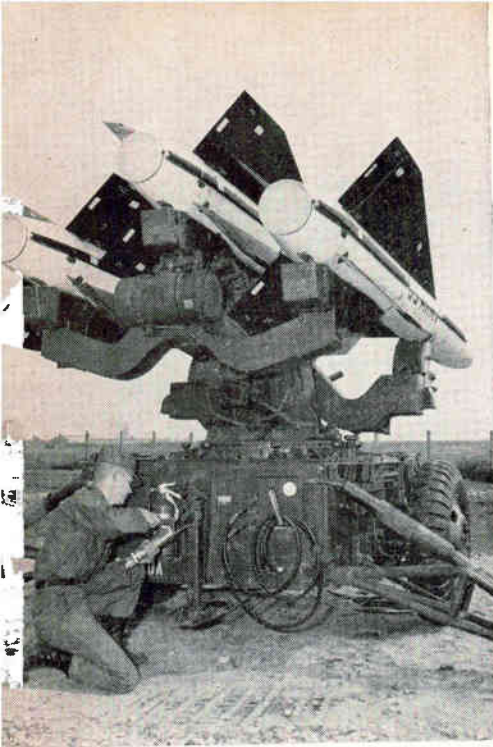

WARHEAD SECTION being removed from container and mated to rest of Sergeant missile on mobile erector-launcher

FIRST FIRING by a tactical unit hits a target 75 miles up the White Sand range. The missile burned 30 seconds, reached a speed of 2,000 mph and an altitude of 45 miles

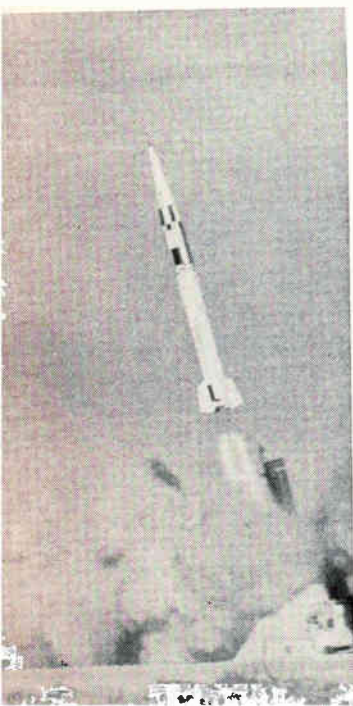

Ready for Emergency

to react on short notice to military needs.

NO SHORTAGES—Industry leaders add that large stockpiles of raw materials and partly finished goods are available. Few shortages should be experienced.

Leon Alpert, president of Loral Electronics Corp., declared his firm always has a plan ready to meet such emergencies. The company has already responded to a government request to evaluate its two-shift production capability, and find out how long it would take to put it into effect.

Loral feels it can meet any new requirements effectively. It keeps a list of subcontractors that it would call upon for certain jobs during stepped up production. Alpert said this list is constantly being screened and updated by visits to vendors to find out what they can do in an emergency. He thinks his firm and the entire electronics industry are prepared to meet any possible emergency.

Many electronic companies wouldn't talk about their proposed role in a growing emergency, but all said they would do their best to satisfy government needs if called upon.

General Electric Co. says the electronics industry is in a much better position today than it was in the 1950 Korean emergency. Planners declare that industry production can be more than doubled by going to a second shift. They say that the defense business has excessive capacity today.

The electronics industry can build up to limited-war capacity in six months if off-the-shelf equipment rather than newly developed items can be used. The industry has sufficient engineering personnel, manufacturing space and production capacity.

CONSUMER PRODUCTS — GE adds that there will be no supply problem in consumer, industrial and utility electronic goods unless a large-scale emergency erupts. This again is because of excess production capacity.

NASA officials said that in a large emergency NASA would be particularly able to serve the country in aeronautics, missile technology and space operations. NASA already has the management staff, scientific ability and a total capability that could be pressed into effective service as a unit.

Some NASA personnel might don uniforms; the operation would be similar to that of the National Advisory Committee for Aeronautics during World War II. NASA could quickly apply many of its space techniques in a military manner.

Corporal

Corporal, which it will replace, are mobility, reliability and reaction time.

The entire system is packed in six pieces, and is air transportable and mobile: launcher, field maintenance test station, organizational maintenance test station, two transport trailers, and a communications vehicle. It can be quickly emplaced and fired by a six-man crew.

The Sergeant missile is 34.5 feet long, 31 inches in diameter, and weighs 10,000 lb. The warhead—nuclear, chemical or biological—weighs 1,600 lb. Guidance is inertial and propulsion is solid propellant. Range is 25 to 75 nautical miles.

Inertial guidance system consists of an inertial platform, computer and control assembly. The computer was built by Sperry-Utah and the four guidance-fin servos by Lear Siegler, Inc. The servos, which actuate both the aerodynamic and rocket blast guidance vanes of the missile, are the first electromechanical servos to be selected for a current-production guided missile, according to the producer.

Three GG-49 gyros (MIG) built by Minneapolis-Honeywell are used in the system.

"Few things are impossible to diligence and skill."

These are the trademarks of some of our customers—each an important contributor to a dramatically growing industry. We at Potter pledge our diligence and skills to this growth through a constantly expanding program of research and development.

the POTTERTM



MT-120
eliminates
program
restrictions

The new Potter MT-120 Magnetic Tape Transport features high performance in a COMPLETELY STANDARD, LOW COST PACKAGE. An evolutionary development of the reliable M906II tape deck, the MT-120 incorporates a patented tape handling system* that eliminates program restrictions. This unique engineering achievement permits Start/Stop, Reverse/Stop or Forward/Reverse operation at up to 200 commands per second and at tape speeds to 120 ips without external program delays.

The MT-120 delivers extremely high data transfer rates. Using the Potter Contiguous Double Transition** High Density recording technique, rates of 1.6×10^6 information bits per second are obtained. And with standard 7-channel format, 556 bits per inch are provided at speeds of 120 ips.

To learn more about the MT-120 and its unprecedented 1-year warranty of reliability, write to our Director of Marketing today...



*Potter Patent No. 3,016,207
**Potter Patent No. 2,853,357
and other patents pending

POTTER INSTRUMENT CO., INC.
151 Sunnyside Boulevard • Plainview, New York

"Computing" data logger simplifies complex test problem

By WILLIAM KIEVIT • District Manager
Nutley, N.J. Office • Non-Linear Systems, Inc.

MILTON BAXTER • Group Leader
Product Development Laboratory
Cities Service Research and Development Co.
Cranbury, N.J.

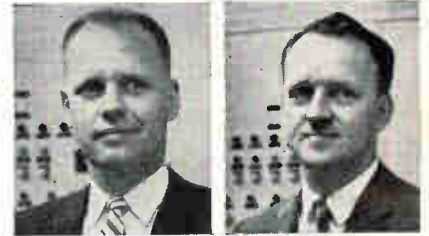

THE PROBLEM: Making valid performance comparisons of fuels and lubricants posed a problem for Cities Service Research and Development Company that has a familiar ring. Many scientific, industrial, and military establishments encounter a similar set of requirements:

- To collect, measure, record large amounts of data with speed, accuracy and reliability in addition to performing rudimentary computation. In this case, Cities Service required a system that would monitor operation of many internal combustion engines running simultaneously to ensure that performance with fuels and lubricants would be compared under identical operating conditions.
- To automatically evaluate each measurement as it is made and, when desired, record only data deviating from specified operating conditions. Both features would eliminate the need for reviewing substantial quantities of insignificant data.
- To present measurements in the most meaningful terms for each situation. For Cities Service, this meant displaying any measurement in terms of (1) voltage, (2) percentage (with 100% as "normal"), (3) per cent of deviation from "normal," or (4) engineering units such as pressure, temperature, flow rate, etc.

- To provide uninterrupted testing in the absence of technical personnel.
- To sound an alarm for abnormal conditions.
- To make the resulting instrumentation easy to understand and easy to program.

THE SOLUTION: The requirements were met by a versatile data logger formed of an NLS V24 Digital Voltmeter-Ratiometer, DVM accessories, and other standard instruments together with simple programming. The V24, with a speed of three measurements per second, was selected primarily because its reliability had been demonstrated for four years in such applications as measuring and transmitting data from unattended power stations, nuclear facilities, missile checkout operations. Much of the interconnecting circuitry was designed on-the-spot by engineers of Cities Service and Non-Linear Systems, Inc.

In 15 seconds, the system can make and record (complete with time of measurement and channel identification) 20 measurements of temperature, fuel flow, engine speed, engine torque and pressure. In 3¾ minutes, all such pertinent data can be collected from as many as 15 different makes of engines running simultaneously. The system also sounds an alarm whenever any measurement varies from its pre-set range of limits. Or it can be easily programmed to record *only* abnormal values, eliminating tedious data sorting.

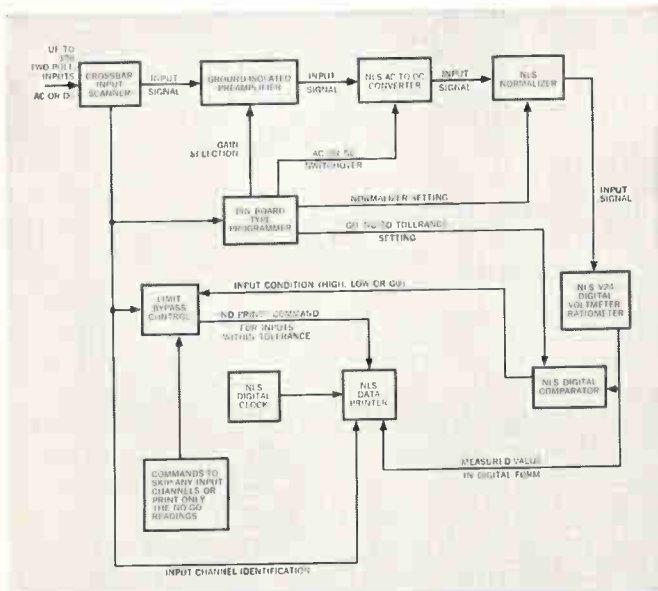

Simplified functional chart illustrating the versatility of the system.

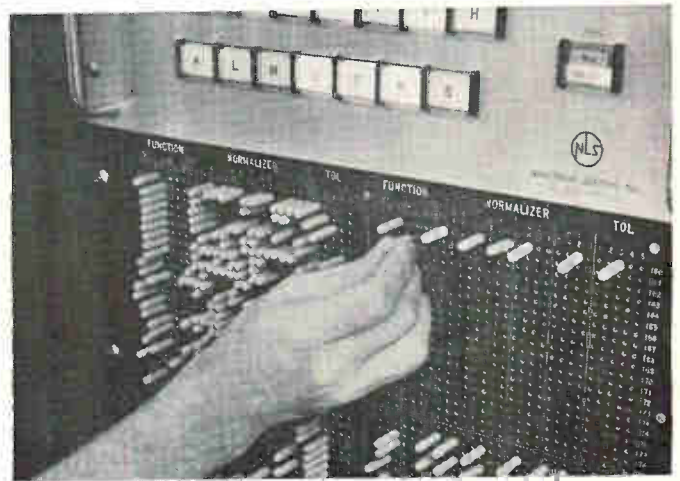

Changing pin locations permits Cities Service to program the system for any desired set of test conditions.

The key to obtaining immediately interpretable data lies in the system's automatically programmed variable gain preamplifier and normalizer which act as computing elements. They perform the input signal multiplication and division operations which furnish data in terms of engineering units such as pressure, temperature, etc., or in terms of percentage, with 100% representing "normal" pressure, "normal" temperature, etc. Preamplifier gains of 1, 10, or 100 and normalizer settings of $\times 0.0001$ to $\times 0.9999$ (in steps of 0.0001) can be programmed for any input channel. Thereby, a digital voltmeter display of 100.0 can be achieved for any input signal from 0.001 v. to 9.999 v. DC, or 0.007 v. to 6.999 v. AC, or for a DC voltage ratio up to .9999.

Elimination of insignificant data results from use of an automatically programmed digital comparator which permits the system to be programmed to record only those measurements which deviate too far from their normal (100%) value. Coincident with such recording (which includes the measurement, input channel number and time of occurrence), visual and audible warnings can be activated to notify the operator of abnormal conditions. One advantage of expressing the data in terms of percentage shows up in the digital comparison system; i.e., the programmer and interconnecting wiring can be simplified since only one digit (10 numerals) of tolerance data need be handled for tolerances from $\pm 1\%$ to $\pm 9\%$. For example, if percentage expression were not used, a 4-digit tolerance number would be required; e.g., the tolerance number .2628 would be required to represent 5% of the measurement 5.250.

Programming through use of the programmer, which resembles a king-sized cribbage board (left section of the system), is fast and simple. Rearranging position of the small pins programs amplifier gain, selection of AC or DC measurement, normalizer setting and go/no-go limits for each input channel



A "start-up" system, composed of an NLS V60 Digital Millivoltmeter and selector switch with built-in normalizers, is used to adjust each engine's operating conditions to standard values prior to connecting that engine into the automatic system. Above, a pressure of 34.89 psi is being displayed.

— over 3 billion individual settings in all. Pre-drilled plastic overlays can allow the operator to quickly program the system for any pre-established test situations simply by placing the appropriate overlay on the programmer board and filling the overlay's guide holes with pins. Up to 300 input channels can be sequentially scanned by the Cunningham Crossbar Scanner. Each time the scanner selects a new input channel for measurement, it issues channel identification data which tells the programmer which set of gains, normalizer settings, go/no-go tolerances, etc., to apply to the system for the channel being measured. Channel identification is also utilized by the limit bypass control to inhibit data recording for channels that are within tolerance.

If desired, some measurements can be displayed in engineering units and others in percentage. Or an engine can be checked twice, once in engineering units and once in terms of percentage. In addition to indicating and recording time with each measurement, the system's digital clock can repetitively initiate new test runs at time intervals from less than 1 minute up to 2 hours, as selected on the clock panel. This timed cycling makes it possible for Cities Service to operate the system overnight and throughout weekends in the absence of technical personnel.

OTHER USES: The system has proved to be a practical, relatively low-cost approach to this over-all problem of data acquisition, computation and logging which lies in the "no-man's-land" of testing—between the simple, standard data logger and the expensive, complex computer. Built-in versatility of the system makes it particularly attractive for a wide range of applications in electronic systems checkout, research and development involving hundreds or thousands of data points, and industrial processing supervision. Where required, similar systems with greater versatility are quite feasible; measuring range can be extended to 1,000 volts and can include resistances from 0.01 ohms to 10 megohms, voltage digitizing speed can be increased to 67 microseconds, and scanning capacity can be increased to over 1,000 channels and to 4 or 6 poles per channel.

FOR ADDITIONAL INFORMATION ON DIGITAL MEASUREMENTS: Circle the reader's service number or contact one of the 19 NLS factory offices located throughout the U.S.A., or write Non-Linear Systems, Inc., Del Mar, California.

NLS non-linear systems, inc.
originator of the digital voltmeter

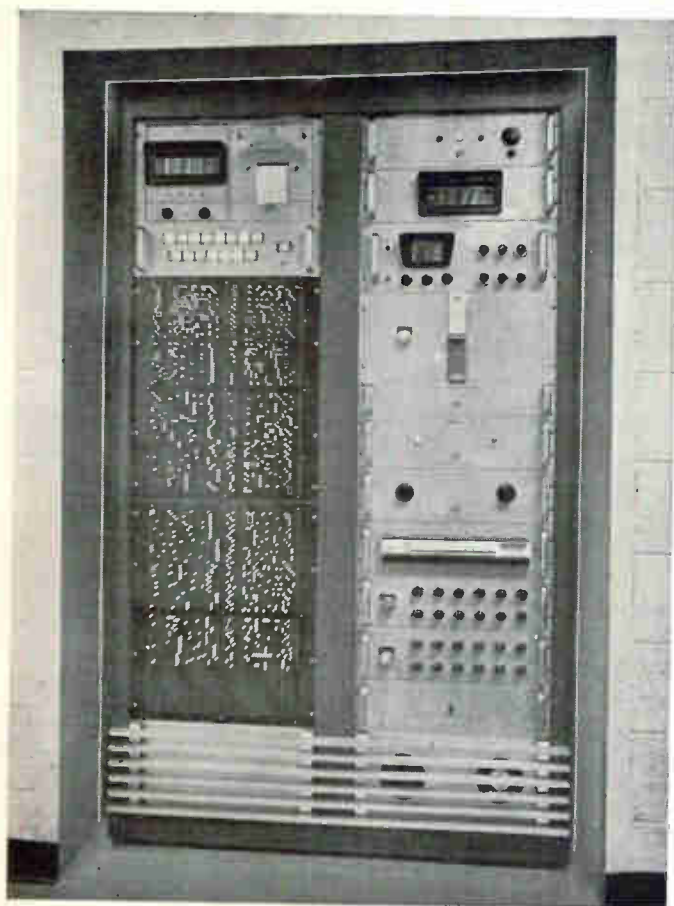

This universal data logger features simplicity in programming, as illustrated by the pin-type Sealectro programmer board (center and bottom left portion of system).



Why you couldn't buy a Fansteel controlled rectifier until now



You may be one of the frustrated silicon controlled rectifier purchasers who approached us several months ago . . . prior to our entry into the SCR field. We were asked to design and produce a unit that would:

1. Resist severe thermal fatigue.
2. Be of uniform structural quality and characteristics.

We have good news for you.

Fansteel development engineers have overcome problem No. 1 with a special hard-solder construction that can take repeated thermal shocks.

Problem No. 2 was met and solved by adoption of all-diffused construction. Fansteel engineers found this method vastly su-

perior to the conventional combination of alloying and diffusion.

Thus, Fansteel can now announce the availability of a silicon controlled rectifier line that can handle power, switch it fast, and not come apart in the process.

These compact Fansteel SCRs presently range in blocking voltages from 50 to 500 PRV, with RMS output currents at 4.7, 10, 16, and 25 amps. Maximum operating temperatures: -65°C to $+150^{\circ}\text{C}$ (4.7 amps), -40°C to $+100^{\circ}\text{C}$ (10 amps), -65°C to $+125^{\circ}\text{C}$ (16 and 25 amps).

Be our guest and test one of these new Fansteel SCRs. Just write to Glen Iaggi, Rectifier-Capacitor Division, Fansteel Metallurgical Corporation, North Chicago, Illinois.

FANSTEEL **RC**
METALLURGICAL CORPORATION
RECTIFIER-CAPACITOR DIVISION

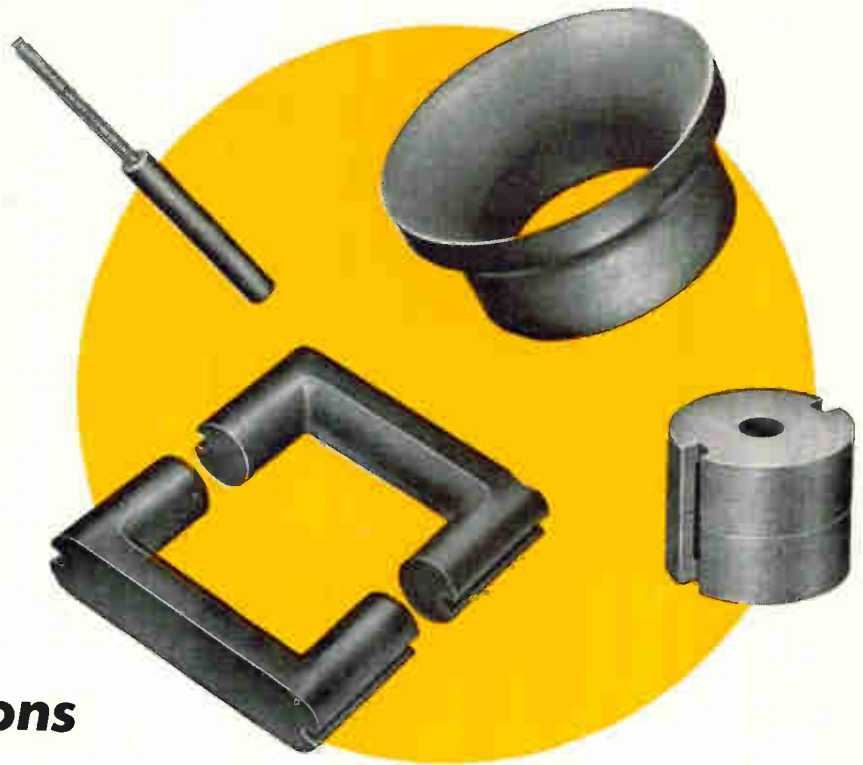

**Ferrite core
applications**

KNOWN or UNKNOWN *are handled best by STACKPOLE*

Stackpole CERAMAG® ferrite cores have been the standard of the industry since their introduction in 1946. Flyback transformers, deflection yokes, R-F and I-F transformers, magnetic amplifiers, filters of all types . . . these are some of the known areas where CERAMAG cores have licked design and production problems.

Right now, Stackpole research is adding to one of the industry's most impressive variety of ferrite grades . . . perfecting new types and uses for CERAMAG ferrite cores . . . looking for those areas where they can help you make your product better or easier to produce.

Maybe you have pending applications where CERAMAG ferrite cores can offer distinct advantages over other materials or methods . . . or maybe you are searching for fast, on-time deliveries of ferrite cores for present applications with each core as accurate physically and electrically as the lab sample.

In either case, you should see Stackpole.

STACKPOLE

CARBON COMPANY, *Electronic Components Division*
St. Marys, Pennsylvania

Electrostatic Focusing Gives Klystrons Greater Efficiency

By SAMUEL WEBER, Senior Editor

MICHAEL F. WOLFF, Senior Associate Editor

Device designers also report new progress in semiconductor techniques

WASHINGTON—Use of electrostatic techniques in a wide variety of devices showed up as a trend at the 1962 Electron Devices Meeting sponsored by the IRE-PGED late last month.

Electrostatic focusing reduces weight and sometimes power requirements as compared with magnetic systems, but devices using electrostatic focusing have been limited in power output and versatility.

NEW KLYSTRONS—An electrostatically focused klystron amplifier was described by J. R. Hechtel, of Litton Electron Tube Corp.

The new tube avoids using focusing magnets with their weight and power penalties and resultant reduced efficiency. According to Hechtel, the 5-pound tube gives a big watts/lb increase over present klystrons. It uses an electrostatic Einzel lens system, that allows the lens electrode to be connected internally to the cathode, thus providing single-voltage operation.

The tube operates at S-band and produces a peak power of 15 Kw at an efficiency of around 25 percent. Hechtel told *ELECTRONICS* that these figures may be revised upward by new designs. With scaling for higher voltages, the tube may achieve 1 Mw peak at S-band, and several megawatts at L-band, at an efficiency of 35 percent. Cooling may extend these limits further.

Another departure in focusing methods was announced by John

Romaine and Henry Striegl, of Sperry. They have developed 24 Mw five-cavity klystrons using permanent magnet focusing, for Stanford's two-mile linear accelerator.

Electrostatics also provided new advances in display tubes.

A zoom lens for an experimental image-converter tube has been developed at Mullard Research Labs by P. Schagen. Conventional zoom lenses mechanically vary the lens' focal length. Several years ago, electromagnetic focusing was employed successfully, but was limited to a magnification of only two. The new lens system using electrostatic techniques achieves continuously variable magnification over a range of at least a factor of six.

DIELECTRIC CAMERA—W. G. Reininger said Westinghouse's Applied Research Department has been developing for the Air Force's Aerial Reconnaissance Lab an electro-optical tape-storage camera tube with storage capacity of 10^{11} bits.

Information is electrostatically written and stored on storage tape reeled on spools inside the vacuum. It comprises a nickel or copper base that is an electroformed replica of a diffraction grating. Over the broad slope of the grooves in the grating is deposited a dielectric such as magnesium fluoride, cadmium fluoride or silicon oxide, while the narrow and almost vertical surface of the grooves is left exposed.

The tape moves first beneath an erasing and priming device that showers electrons on the tape, bringing the surface potential to equilibrium with respect to the spaced barrier grid on the tape. Information can be written by scan-

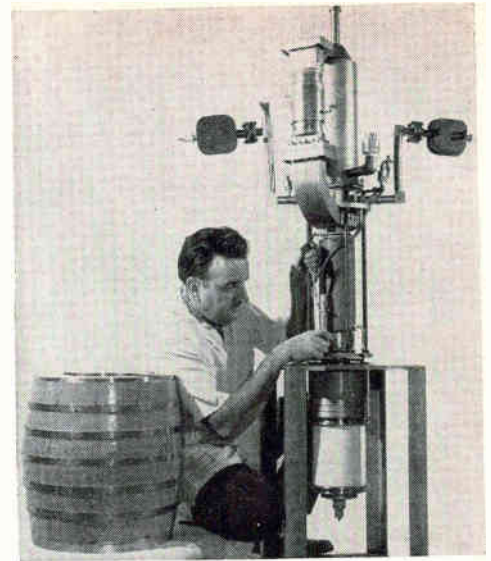

BARREL-SHAPED 550-lb permanent magnet focuses Sperry's new high-power klystron

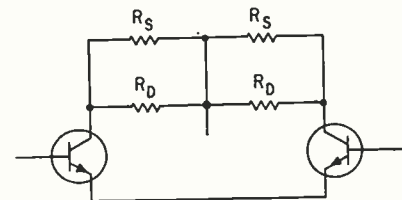
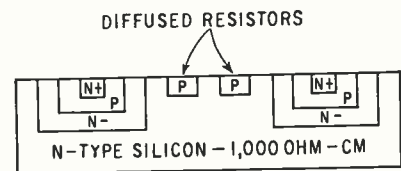

LINEAR AMPLIFIER by Motorola and its equipment circuit

ning the tape with an electron gun, or with photoelectrons from the image section of the tube. Nondestructive reading is done by an image-orthicon scanned reading beam of small diameter. Reininger reported storage times of more than eight hours with negligible signal loss. Image signals with resolution greater than 2,000 lines an inch were stored and read, and more than 20,000 halftone copies were read out from a single frame.

SEMICONDUCTORS — Advances in semiconductor technology and microelectronic techniques were also reported at the meeting. Feasibility of constructing integrated circuits by alternately applying epitaxial growth and selective diffusion was demonstrated in work reported from two companies.

Papers by L. O. Hill and F. E. Boerger, of Westinghouse, described how this technique gave

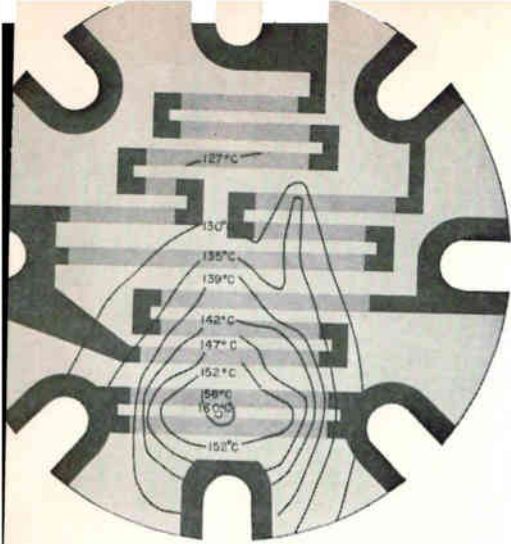

THERMAL PROFILE of micro-circuit under load at ambient temperature of 100 C, obtained by Philco with infrared scanning

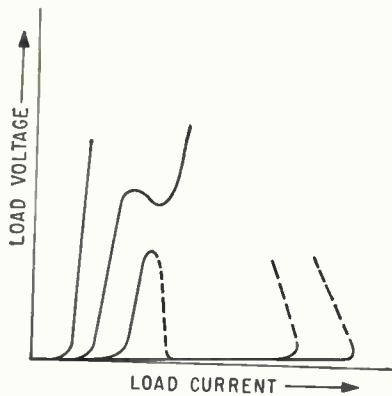

CHARACTERISTIC of emitter-controlled npn switch

more design freedom to silicon planar integrated circuits than completing all epitaxial growths prior to diffusion. The new technique permits modifying the electrical properties of internal regions and electrically isolating multiple epitaxial layers. Hill said it was successfully used to construct adjacent bipolar and unipolar field-effect transistors with well-matched characteristics.

Variations of this process have also been used at Motorola. D. S. King described the fabrication of a silicon integrated flip-flop having a 2-Mc clock rate and 50-mw power dissipation, a NAND circuit with an average propagation delay of 80 nanoseconds, and a two-stage linear amplifier whose cascaded gain (with a hybrid capacitor of 10,000 pf) was 30 db at 12 Mc.

The linear amplifier was constructed by first forming transistors in opposite ends of a high-

UHF

Phormat Cathode

The Phormat Planar Triodes



High Voltage Stability



ML-7211

Osc., amplif. osc. to 2.5 Gc. High cathode current to 190 Ma. Extended anode insulator and Phormat cathode assure high voltage, high altitude stability.



ML-7698

Pulse Service: G- or P-pulsed to 3.0 Gc Max. DC Plate volts 2000 v dc. Peak Plate current 5.0 amps. Extended anode insulator and phormat cathode assure high voltage, high altitude stability.

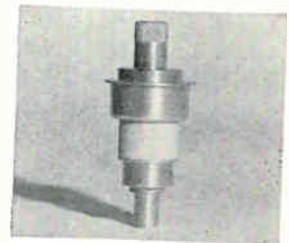

ML-7815

Pulse Service: G- or P-pulsed to 3.0 Gc Max. DC Plate volts 2000 v dc. Peak Plate current 3.0 amps. Extended anode insulator and phormat cathode assure high voltage stability.

Phormat Cathode provides the high voltage stability needed to withstand very high d-c plate voltages (typically used in grid-pulsed circuitry).

Phormat Cathodes tested to 7000 volts dc and more have shown only a few arc marks. Conventional cathodes were destroyed under these conditions. The Phormat Cathode—a nickel matrix cathode—uses a porous layer to:

- improve electrical conductivity between base metal and coating
- improve electrical and thermal conductivity of coating itself
- inhibit arc development, reduce detrimental effects of arcing and thus improve high voltage stability.

Send for Machlett UHF Planar Tube Brochure



CYLINDRICAL INTERFERENCE FILTERS

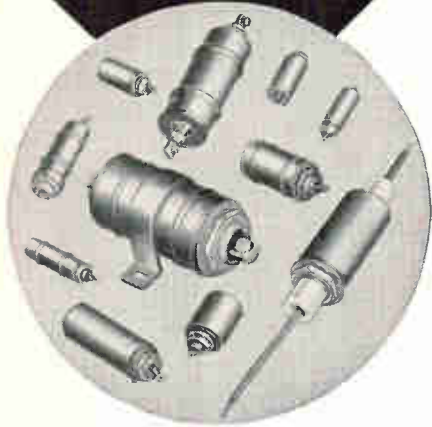

the Smallest, Lightest, Most Efficient Designs Available!

- Basic cylindrical design follows natural shape of rolled capacitor sections and toroidal inductors.
- Threaded-neck bulkhead mountings assure proper isolation between input and output terminals as well as firm peripheral mounting with minimum impedance to ground.
- Popular low pass design, intended for use as 3-terminal networks connected in series with circuits to be filtered.
- Excellent interference attenuation characteristics reflect the use of Thrupass® capacitor sections.
- Designs to meet the requirements of Military Specifications MIL-I-6181, MIL-I-26600, MIL-I-16910, and MIL-I-11748.

For additional information, write for Engineering Bulletin 8100A to Technical Literature Service, Sprague Electric Company, 35 Marshall St., North Adams, Massachusetts.

SPRAGUE
THE MARK OF RELIABILITY

45-468

NEW CIRCUIT GEOMETRY NEEDED?

ONE TREND in microelectronics is to develop devices capable of operating at very low supply power levels. Microwatt levels have been reached and researchers are now pushing toward nanowatt levels.

Describing the problems of building nanowatt devices, W. W. Gaertner, of CBS Laboratories, said that to achieve significant speeds it will be necessary to reduce size an order of magnitude beyond that of the smallest present devices. He says the present planar surface passivated transistor may have to be abandoned for a filamentary construction that would avoid junction capacitance problems. Such a structure would be supported by or embedded in an insulator of high resistivity and low dielectric constant. Electron beam technology will be valuable in achieving this, he said

resistivity silicon bar, as shown. Temperature coefficient of resistance was then reduced from 12,000 ppm/deg C to approximately 3,000 by paralleling the bar resistance (R_b) with the sheet resistance of two diffused resistors (R_n).

M. Walker of Philco described a thermal mapping method for thin films. He reported being able to generate isothermal patterns (see illustration) in tantalum microcircuits at temperatures from 50 C to above 250 C with an infrared scanning system using a photosensitive indium antimonide cell. Hot spots 1.3 mils in diameter were detected.

NEW DEVICES—An emitter controlled *pnpn* switch was reported by E. A. Karcher, of Army Signal R&D Lab. He said the characteristic shown occurs because the electron current gain of the *nnp* section varies with load current even though the current across the electron injecting junction is constant. Ability to control oscillation with the emitter current makes the device suitable for a controlled oscillator, he said. No data on temperature dependence of the characteristics were available, as yet.

F. P. Heiman of RCA Labs reported new data on the insulated-gate, field-effect transistor. In this thin-film transistor the control mechanism can be either depletion of the conducting channel charge, enhancement of the charge, or a combination of both. Units fabricated to date have these typical characteristics: 2.8×10^{-9} ohms transconductance, $-8v$ cutoff bias (depletion mode units), 10 nanosecond rise time, and input impedance of 7 pf, 10^{16} ohms. Goal is

integrated logic circuits; 16-NOR-gate blocks have been fabricated.

INFRARED DIODES—Conferees showed high interest in three papers on gallium arsenide infrared diodes. The papers dealt with their mechanism of operation (see also ELECTRONICS, p 44, Oct. 5).

J. R. Biard, of Texas Instruments, Inc., said the infrared that is generated by the diodes is an area effect, and that terminal quantum efficiencies of 1 to 2 percent and internal efficiencies of 44 percent had been observed. Claiming that the four-terminal device application seems a fruitful area of research, he said power gain has been exhibited in such a device, constructed by optically coupling a diode and a silicon phototransistor in a loop with a 500-cps feedback network. Modulation was observed at 900 Mc.

Flight Plotter



NAVIGATION display by ACF Electronics division receives bearing and distance inputs from Vortac ground stations and shows plane's position as luminescent dot (at pencil tip). Pilot inserts navigation chart under cursor disk

NATIONAL SEMICONDUCTOR

APPLIES

THE VERSATILE INCH* AS A PULSE AMPLITUDE DISCRIMINATOR

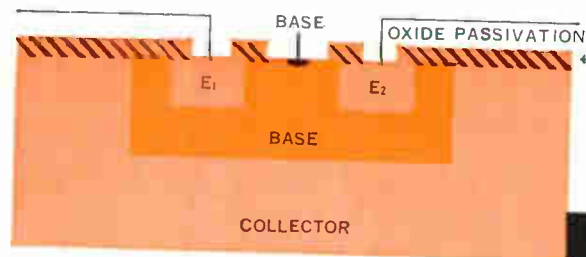

2nd

in design series

3N69/NS3050 PARAMETERS

PULSE AMPLITUDE DISCRIMINATOR

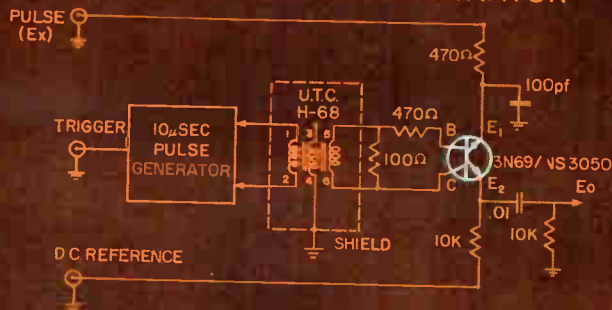

$E_{V_{1/2}}$	10 V min
V_o	$\pm 100 \mu V$ max
$I_{E1,2}$	5 nA max
R_e	50 Ω max
$R_o = \frac{\Delta V_o}{\Delta I_b}$	25m Ω

EXCLUSIVE FEATURES:

- 10 μ sec. sample time
- Fast controlled recovery time
- Standard components
- Bi-directional output

FOR COMPLETE TECHNICAL DESCRIPTION OF CIRCUIT SHOWN WRITE FOR "PRECISION PULSE AMPLITUDE DISCRIMINATOR CIRCUIT" GEM #9 AND DATA SHEETS TO PRODUCT MARKETING DEPT., NATIONAL SEMICONDUCTOR CORP., BOX 443, DANBURY, CONN.

*TRADEMARK



NATIONAL SEMICONDUCTOR

CORPORATION

DANBURY, CONN. • TEL. Pioneer 3-7624 • TWX DANB 452-U

November 9, 1962

CIRCLE 29 ON READER SERVICE CARD

29

Optical Techniques Can Raise Computer

Developments in fiber optics and lasers have broken the trail

WASHINGTON — General-purpose optical digital computers may be nearer than you think. More research is needed but progress

stood out prominently at the Symposium on Optical Processing of Information here last week.

W. F. Kasonocky, of RCA Labs, declared that an all-optical computer using laser devices as the active components could be built if right materials were available. Such a computer might operate at gigacycle rates. The computer

would use laser action in optic fibers. These fibers would be active transmission lines working either as neuristor lines or other types of digital lines.

REQUIREMENTS — Kasonocky said a study for the Air Force showed that the main requirements for a digital computer could be met,

Hitching Computer Data to Telstar

Eleven manufacturers participate in communications tests

OCTOBER was a busy month for the data channels of AT&T's Telstar, with 11 business machine manufacturers transmitting and receiving information on the last three Thursdays and Fridays of that month, in tests to show that the experimental satellite communication system can work with data-processing equipment.

Bell Laboratories made several preliminary tests earlier in the month, transmitting at 875,000 bits per second from Andover to Andover, between Great Britain and

Andover, and then from France to Andover. During the 18.5-minute test of data transmission from France, there was only one bit error in almost a billion bits. The transmission rate was equivalent to 1,460,000 English words a minute.

COMPUTER TESTS—IBM and Tally Register transmitted data across the Atlantic.

In a 17-minute test, IBM sent computer data from a 1401 in Endicott, New York, to a 1401 at La Gaude, near Nice, France, by the stations in Andover and in Pleumeur-Bodou, France. The trans-Atlantic experiment was performed both from computer memory to memory and from computer to mag-

netic tape, and was conducted in cooperation with the French postal, telephone and telegraph service.

Tally Register transmitted perforated-tape information between their Seattle office, by the Andover station, to their London subsidiary, by the Goonhilly station. Messages included machine-tool programming instructions, medical data, book-keeping data and computer input information.

The other manufacturers sent and received data using only the Andover station. These were Burroughs, Control Data, General Electric, Honeywell, National Cash Register, Smith-Corona Marchant, Stewart-Warner, Univac, and Victor Adding Machine.

Burroughs used their new D285 data processing system to send computer messages between Detroit and Paoli, Pennsylvania.

General Electric transmitted computer messages between GE-225 computers at Phoenix and Schenectady, using GE's Datanet-15 data-communications system, at 70 characters per second.

National Cash Register transmitted 10 different types of simulated savings-account transactions, in a test of their on-line banking computer system.

Univac transmitted over 16 million bits from its 490 computer, and received them back with only 4 bit errors, which were attributed to an open electrical connector. Some photographer kicked it apart accidentally.



COMPUTER ENGINEERS send messages from an IBM 1401 in Endicott, N.Y., to a 1401 in France by Telstar. Other channels were used for voice communications

Speed

namely: establishing a threshold for signal amplification, achieving pulse inhibition or control, and standardizing the pulse amplitude.

He said that optical directional coupling is possible when two optic fibers are in close proximity. And this means laser logic circuits can be built.

Here are the major problems: obtaining a suitable combination of emissive and absorptive resonant ions in the fiber line and achieving sufficiently high pumping rates for gigacycle repetition rates to keep the lines short enough.

For 1-Gc repetition rates, a 1-micron-diameter line might handle an average power of approximately 10 milliwatts if the lifetime of fluorescence is 0.4 millisecond and pulse duration is 10^{-10} second.

LOGIC—Elias Snitzer and D. J. Koester, of American Optical Co., discussed the possibility of optical computer logic. They said studies of dielectric waveguide modes in glass fibers showed there were differences in phase velocity for various modes, as well as crosstalk between closely spaced fibers.

Also, when radiation from one neodymium glass laser is sent into another, the radiation from the first reduces the degree of population inversion in the second laser, thus causing oscillation to cease. This implies the possibility of NOR logic.

They also said the fiber laser has potential as an amplifier.

BEAM DEFLECTION — Techniques for rapidly deflecting light beams were discussed by U. J. Schmidt, of Thompson Ramo Wooldrige. Deflection at a rate of around 1 Mc would allow for addressing memory cells, multichannel switching, and display devices. One approach changes the refractive index of the active laser material during optical pumping. He predicted that new laser materials would permit deflection through large angles with high resolution.

Another technique is to pass a plane polarized laser beam through a Kerr cell and a birefringent uni-



SAVE MONEY WITH AUTOMATIC TESTING*



Model LA 303

***More than one test per second with unskilled labor saves over 50% of cost!**

Lavoie's Robotester provides rapid and reliable automatic checkout of components, assemblies and systems. Fully programmable by punched tape, the Robotester eliminates human error and releases highly specialized technicians for other critical tasks.

Unsurpassed versatility through pre-programmed tape insures adaptability throughout the production line.

Tests:

Resistances
Insulation resistances
AC and DC volts
Capacitive and
inductive reactance
Complex impedance

Features:

Low cost
Small physical size
Better service and reliability
Easy to program
Go-No-Go testing
Permanent printed test record
Self-checking and fail safe

Let us show you how Robotester can serve you.

Lavoie Laboratories, Inc.

MORGANVILLE, NEW JERSEY • (201) LOWell 6-2600 • TWX (201) 566-0837

Since 1939, one of America's leading manufacturers and designers of: Oscilloscopes, Spectrum Analyzers, Frequency Standards, Frequency Comparators, Pulse Generators, Digital Counters, Automatic Test Equipment.

"Diamond H" Series W
Gives You

More Relay
... 25 amps!



More Circuits!

TYPE	DIAGRAM	CODE
SPDT/Z		Z
DPDT/Z		2Z
SPDT/C		C
DPDT/C		2C
SPST/NO		X
DPST/NO		2X.
SPST/NC		Y
DPST/NC		2Y

a-c or d-c units available

More Plug-In Relays
... in less space!



For more complete information on Series W general-purpose Relays, write for Bulletin WU-09 which gives complete data, specifications, applications and illustrations.

The **HART**

Manufacturing Company

202 Bartholomew Avenue
Hartford 2, Connecticut
Phone: JACKSON 5-3491



axial crystal prism. Sending a beam through n such combinations allows deflecting the beam in 2^n directions, he said. Switching time could 'be in the 10-nanosecond range.

STORAGE—Design study of a large-capacity, fixed store or memory for a high-speed digital computer was described by G. R. Hoffman, of Manchester University. Information in the store would be recorded on a photographic matrix at half a million bits per square inch. For interrogation light pulses would be transmitted along optic fibers. Access time is 20 nanosec-

onds, repetition rate is 100 nanoseconds. A practical store could hold 7.5×10^6 bits in 300 square inches and a total volume of 6 cubic feet.

Experimental opto - electronic functional block was described by E. E. Loebner, of Hewlett Packard Associates. The device is a chopper assembly. It consists of two silicon phototransistors and two electroluminescent gallium arsenide diodes mounted on a 7-pin TO5 transistor header.

The symposium was co-sponsored by ONR's Information Systems Branch and American Optical Co. Registration exceeded 600.

Vostoks Did Not Rendezvous

Pravda quotes
earlier statements
by Vostok pilots

MOSCOW—*Pravda* has published a lengthy report on the group space flight last August. It quoted the statements by the pilots that no attempt was made to rendezvous Vostoks 3 and 4.

The target distance, the report indicated, was 5 kilometers and the ships actually came within 6.5 kilometers of each other. The report claimed that both Vostoks took off from the same launching pad, one slightly less than 24 hours after the other.

The pilots could have selected the landing locations, it added, but elected to parachute. The unmanned ships landed safely, it was reported.

Cabins were shielded and neither the pilots nor biological objects experienced harmful radiation doses. Flights lasting several hundred hours were considered feasible.

COMMUNICATIONS—Only a general description of electronic equipment was given.

Communications equipment was based on that used in previous flights. Pilots had their choice of three radiotelephones and could also communicate to ground by telegraph code through the telemetry

transmitter. Both transmitters and receivers were made with semiconductor devices. Transmitter sensitivity was listed as within 1 microvolt.

Frequencies were specified as "shortwave" and "ultra shortwave." Receivers could be tuned to the 25, 31 and 49-meter bands and also between 190 and 580 meters (h-f and m-f). The pilots used recorders which played back at an accelerated rate on ground command.

Pilots were viewed with two low-power vidicon tv cameras. These operated at 10 frames a second, 400 lines, with progressive scanning. *Pravda* said this permitted the standard signal of 6 to 6.5 Mc bandwidth to be reduced to 800 Kc. The signal was converted on the ground for tv broadcasting.

DATA PROCESSING—Communications lines linked telemetry and communications stations, at unspecified locations in USSR territory, to digital computing stations. Data was converted to code before ground transmission and was placed on punched cards for computer input.

Several computers worked the same problems simultaneously to avoid possible errors. Incoming data was keyed to astronomical time. Flight parameters were computed several orbits in advance with the aid of radar fed to computer stations, *Pravda* said.

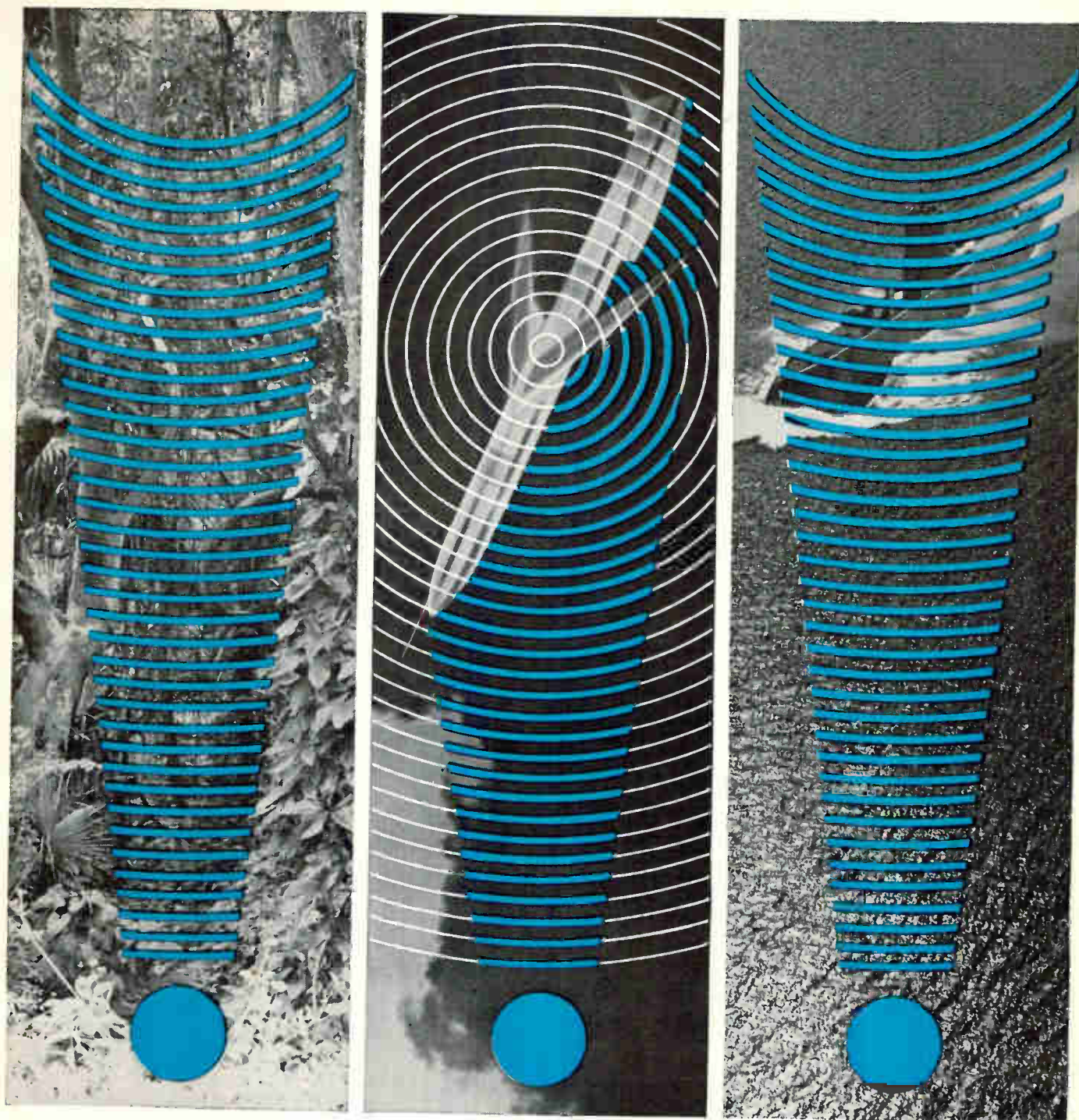

UNDETECTABLE DETECTION

Advances in microwave radiometry, through 15 years of Sperry research and testing, are astounding! Completely passive, thermal sensing devices—light in weight and low in power consumption—are now possible for detection on land and sea, in the air or aerospace environments under all weather conditions.

Undetectable detection equipment for surveillance and reconnaissance in limited warfare, strip-mapping, guidance and target location, space navigation, ice-berg and forest fire detection, and submarine

wake detection are but a few of the unlimited applications now feasible. Sperry has pioneered in the field of radiometry, developing and testing specific devices for various defense groups.

Long concentration on passive radiometric systems has advanced capabilities of Sperry Microwave from a promise to the positive. Its complete staff of experienced and highly qualified physicists and engineers, many recognized experts in their specialized fields, are equipped to further explore the unlimited potentials of radiometry.

SPERRY

DIVISION OF SPERRY RAND CORPORATION **SPERRY MICROWAVE ELECTRONICS COMPANY** CLEARWATER, FLORIDA
 Solid State Devices and Materials • Microline Instruments • **Systems Instrumentation** • Radar Test Sets • Microwave Components and Antennas

November 9, 1962

CIRCLE 33 ON READER SERVICE CARD 33

HOW TO LACE FOR



Why Gudebrod's Common Sense Approach to Lacing Problems Pays Dividends for Customers!

Recently a customer involved in the missile program came to us with a problem. He wanted a lacing tape that would be easy to use but must withstand extremely high temperatures . . . well above 1000°F!

We had to admit that we had no such tape. Our high temperature tapes such as GUDE-GLASS® have a maximum temperature range of 800°F. To solve this customer's problem, we developed GUDE-Q®, a revolutionary new lacing tape *that is essentially stable to temperatures in excess of 1500°F.*

GUDE-Q is a flat braid made from continuous length silica fibers that have been especially impregnated with a silicon finish to produce excellent handling and tying qualities. GUDE-Q lacing tape allows harnesses to be easily tied . . . knots don't slip, yet it withstands temperatures in excess of 1500°F.

Creating a new tape to meet high temperature requirements is but one of many ways in which we serve customers' needs. Whatever your lacing tape needs—civilian, military, fungus proofing, high temperature, color coding—Gudebrod's common sense approach to the problem will pay dividends for you because:

1. *Gudebrod lacing tape increases production!*
2. *Gudebrod lacing tape reduces labor costs!*
3. *Gudebrod lacing tape means minimal maintenance after installation!*
4. *Gudebrod is quality—our standards for lacing tape are more exacting than those required for compliance with MIL-T!*

Write today for our Technical Products Data Book which explains in detail the many advantages of Gudebrod lacing tape for both civilian and military use.

Address your inquiry and your lacing tape problems to:



GUDEBROD BROS. SILK CO., INC.

FOUNDED IN 1870

Electronics Division

225 WEST 34th STREET, NEW YORK 1, NEW YORK

MEETINGS AHEAD

- RADIO FALL MEETING, IRE-PGBTR, PGRQC, PGED, EIA; King Edward Hotel, Toronto, Canada, Nov. 12-14.
- MAGNETISM & MAGNETIC MATERIALS CONFERENCE & EXHIBITION, IRE-PGMITT, AIEE and Amer. Instit. of Physics; Penn Sheraton Hotel, Pittsburgh, Pa., Nov. 12-15.
- ASTRONAUTICAL EXPOSITION, American Rocket Society; Pan Pacific Aud., Los Angeles, Calif., Nov. 12-18.
- LOUDSPEAKER INDUSTRY MEETING; EIA; Pick-Congress Hotel, Chicago, Ill., Nov. 14.
- CANADIAN IRE COMMUNICATIONS SYMPOSIUM, IRE Montreal Section; Queen Elizabeth Hotel, Montreal, Nov. 16-17.
- MID-AMERICAN ELECTRONICS CONFERENCE, IRE; Continental Hotel, Kansas City, Mo., Nov. 19-20.
- VEHICLE SYSTEMS OPTIMIZATION SYMPOSIUM, IAS; Garden City Hotel, Garden City, N. Y., Nov. 28-29.
- ULTRASONIC SYMPOSIUM, IRE-PGUE; Columbia University, New York City, Nov. 28-30.
- FALL JOINT COMPUTER CONFERENCE, IRE-PGEC, AIEE, ACM; Sheraton Hotel, Phila., Pa., Dec. 4-6.
- VEHICULAR COMMUNICATIONS CONFERENCE, IRE-PGVC; Disneyland Motel, Anaheim, Calif., Dec. 6-7.
- SPACE PHYSICS CONFERENCE, American Rocket Society; Philadelphia, Pa., Dec. 26-31.
- MILLIMETER & SUBMILLIMETER CONFERENCE, IRE Orlando Section; Cherry Plaza Hotel, Orlando, Florida, Jan. 8-10.
- RELIABILITY & QUALITY CONTROL SYMPOSIUM, IRE-PGRQC, AIEE, ASQC, EIA; Sheraton Palace Hotel, San Francisco, Calif., Jan. 21-24.
- MILITARY ELECTRONICS WINTER CONVENTION, IRE-PGMIL; Ambassador Hotel, Los Angeles, Calif., Jan. 30-Feb. 1.
- IEEE INTERNATIONAL CONVENTION, Institute of Electrical and Electronic Engineers; Coliseum and Waldorf-Astoria Hotel, New York, N. Y., March 25-28.

ADVANCE REPORT

THIN FILMS FOR ELECTRONIC APPLICATIONS SYMPOSIUM, ELECTROCHEMICAL SOCIETY (*Electronics, Electric Insulation, Electrothermics and Metallurgy Divisions*); Penn Sheraton Hotel, Pittsburgh, Pa., April 15-18. Dec. 14 is the deadline for submitting three copies each of a 75-word abstract and a 500-1000 word extended abstract to: Electrochemical Society Headquarters, 30 East 42nd St., New York 17, N. Y. All aspects of thin film technology having electronic application are of interest including: materials (metals, insulators, semiconductors) and combinations thereof (i.e., cermets); monitoring and testing techniques for thin film deposition; materials for specific application (magnetic, dielectric, superconducting, tunneling); properties of thin films (experimental and theoretical); ageing effects in thin films; compatibility of thin films.

Moving air is easy . . . controlling it takes an expert



A mixture of nitrogen, oxygen, argon, carbon dioxide, helium, krypton, neon and xenon can be controlled in a musical instrument to bring enjoyment to millions. These same gases, commonly known as air, can also be piped through a high frequency whistle to summon an errant dog. In either case the air must be controlled to be effective. In our capacity as air moving specialists we have brought many complex problems to heel and won the applause of our customers. Write for Brochure 102 to the Torrington Manufacturing Company, Torrington, Conn.



TORRINGTON

It's more than likely you'll find the magnetic performance you need when you order motor or transformer core laminations from our stock of standard shapes. Though they're available right off the shelf, they're designed within exceptionally narrow limits to meet *specific* performance designations. Standard shapes can be supplied in most grades and gages of silicon, soft magnetic iron or nickel alloy material. Special shapes

can be made to your specifications on short notice. You can be sure of highest quality in Magnetic Metals laminations—quality achieved through custom-selection of material, rigidly controlled methods of manufacture, ultra-precise tooling and stamping, special skills in annealing. Write or call today for a discussion of your lamination requirements. MAGNETIC METALS COMPANY, Hayes Avenue at 21st Street, Camden 1, N.J.

OFF-THE-SHELF LAMINATIONS

...with specific performance designations



MAGNETIC METALS

transformer laminations • motor laminations • tape-wound cores • powdered molybdenum permalloy cores • electromagnetic shields

MAGNETIC
METALS

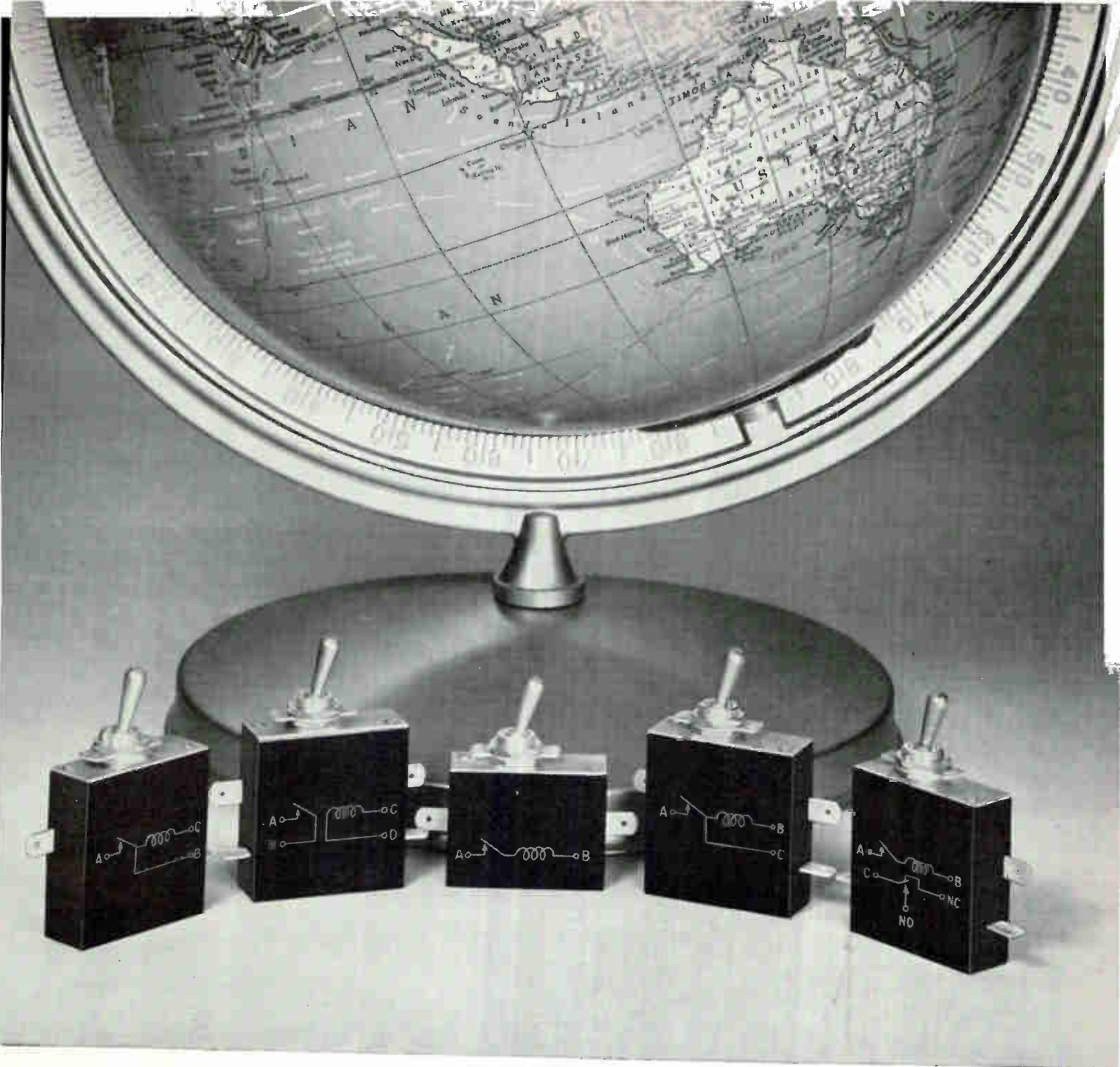

What in the world will you think of next?

We are continually amazed by the ingenious things equipment designers do with Heinemann special-function circuit breakers.

You, yourself, might be less impressed. You could probably think up dozens of possible uses just by looking at the schematics of the breakers' internal circuits.

Our picture shows five of our most commonly used circuit arrangements. Four are special-function designs. (The one in the middle is our conventional series-trip model, used for run-of-the-mill protection jobs.)

The two breakers on the left are applicationally similar, but function-

ally different. The first, a shunt-trip model, is designed for remote tripping through some other device. The one next to it, a relay-trip breaker, will do the same thing, but at a voltage or current different from the line supply.

On the other side of the series-trip breaker is a calibrating-tap breaker. It permits you to control two circuits, with tripping in response to main-circuit overloads only. The last in line is a breaker with auxiliary contacts. You can use the breaker-coupled auxiliary contacts (SPDT) to switch just about anything you like.

All of these special-function circuits can be supplied in most any

Heinemann breaker type. Shown here is the Series VP, which is a subminiature model, exceptionally light in weight and extremely compact. Like our other breakers, it is magnetically actuated and so does not require derating for high-ambient operation. It can be had in fractional as well as integral current ratings, to your precise specification, and is available with a choice of time delays or instantaneous response. Our Bulletin VP will tell you more about it.



**HEINEMANN
ELECTRIC COMPANY**

2600 BRUNSWICK PIKE
TRENTON 2, NEW JERSEY

CIRCLE 37 ON READER SERVICE CARD

Here are Type 581/585 Oscilloscope Capabilities

- **PASSBAND** typically dc-to-85 Mc (3-db down) at 100 mv/cm (12-db down at 160 Mc), and typically dc-to-80 Mc (3-db down) at 10 mv/cm
- **CALIBRATED STEP ATTENUATION** variable between steps
- **SWEEP RANGE** from 10 nsec/cm to 2 sec/cm
- **INTERNAL AND EXTERNAL TRIGGERING** to beyond 100 Mc
- **DUAL-TRACE OPERATION** with 4 operating modes and independent controls for each channel — to allow individual attenuation, positioning, inversion, and ac or dc coupling as desired.

TYPICAL APPLICATIONS

PHASE COMPARISON

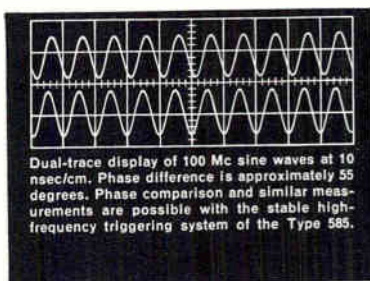

TIME COINCIDENCE

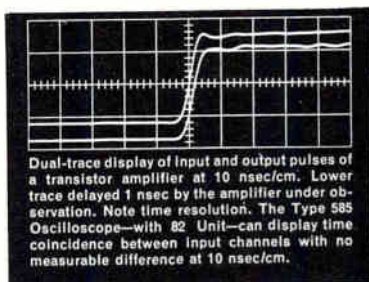

- Type 82 Dual-Trace Unit \$ 650
(includes 2 low capacitance passive probes)
- Type 581 Oscilloscope \$1425
(without plug-in)
- Type 585 Oscilloscope \$1725
(without plug-in)
- Type 585 Oscilloscope has 2 modes of calibrated sweep delay—either triggered or conventional—ranging from 1 μ sec to 10 seconds. U. S. Sales Prices f.o.b. Beaverton, Oregon



Note: Some early Type 581/585 Oscilloscopes must be modified to provide optimum transient response with the Type 82 Dual-Trace Unit. If in doubt about instrument modification, please consult your Tektronix Field Engineer.

For a demonstration of the new Type 82 Plug-In Unit in a Type 581/585 Oscilloscope, please call your Tektronix Field Engineer.

Tektronix, Inc. P. O. BOX 500 • BEAVERTON, OREGON / Mitchell 4-0161 • TWX-503-291-6805 • Cable: TEKTRONIX

TEKTRONIX FIELD OFFICES: Albuquerque, N. Mex. • Atlanta, Ga. • Baltimore (Towson) Md. • Boston (Lexington) Mass. • Buffalo, N.Y. • Chicago (Park Ridge) Ill. • Cleveland, Ohio • Dallas, Texas • Dayton, Ohio • Denver, Colo. • Detroit (Lathrup Village) Mich. • Endicott (Endwell) N.Y. • Greensboro, N.C. • Houston, Texas • Indianapolis, Ind. • Kansas City (Mission) Kan. • Los Angeles, Calif. Area (Encino • Orange • Pasadena • West Los Angeles) • Minneapolis, Minn. • New York City Area (Albertson, L.I., N.Y. • Stamford, Conn. • Union, N.J.) • Orlando, Fla. • Philadelphia (Bala-Cynwyd) Pa. • Phoenix (Scottsdale) Ariz. • Pittsburgh (Monroeville) Pa. • Portland, Ore. • Poughkeepsie, N.Y. • San Diego, Calif. • San Francisco, Calif. Area (Lafayette • Palo Alto) • Seattle, Wash. • Syracuse, N.Y. • Washington, D.C. (Annandale, Va.).

TEKTRONIX CANADA LTD: Montreal, Quebec • Toronto (Willowdale) Ontario.

TEKTRONIX OVERSEAS DISTRIBUTORS: Kentron Hawaii Ltd., Honolulu, Hawaii, Tektronix is represented in twenty-seven overseas countries by qualified engineering organizations. European countries and the countries of Lebanon, Syria, and Algeria, please contact TEKTRONIX INTERNATIONAL A.G., Torrassenweg 1A, Zug, Switzerland, for the name of your local overseas distributor. Other Overseas areas, please write or cable directly to Tektronix, Inc., International Marketing Department, P. O. Box 500, Beaverton, Oregon, U.S.A. Cable: TEKTRONIX.

with New Tektronix Type 82 Dual-Trace Unit

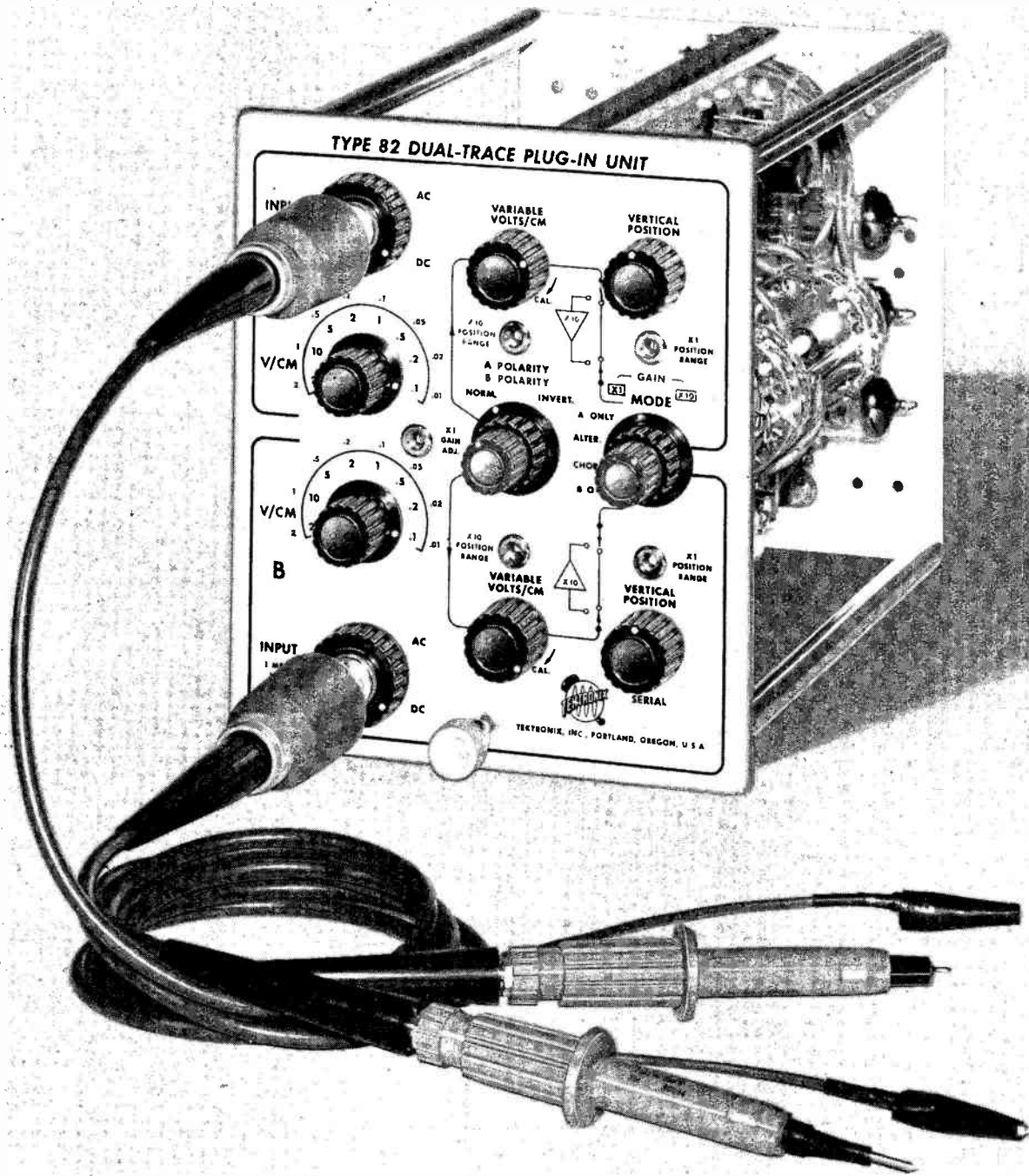

Supplied small size passive probes provide high input impedance characteristics. Probes increase input R to 10 megohms and decrease input C to approximately 7 pf.

Risetime (of supplied probe, plug-in unit, oscilloscope) at overall sensitivity of 1 v/cm is approximately 5 nsec.

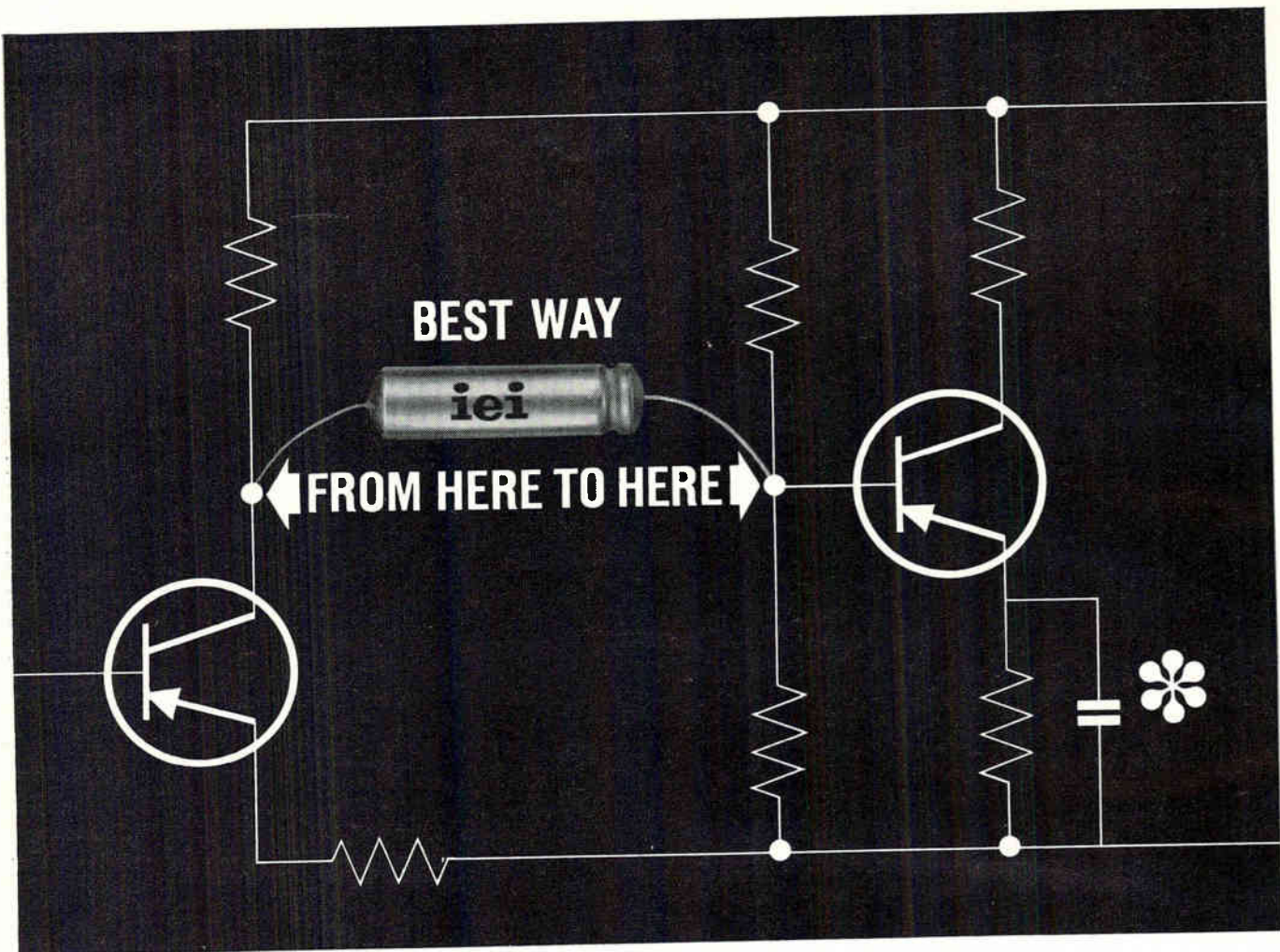

iei SUPER SERIES miniature electrolytic capacitors

Twice as much capacitance per case size. In many circuits, a smaller unit can couple stages. Or, one SUPER SERIES electrolytic can take the place of a pair of standard units.

Half the impedance. Reduce circuit size without loss of performance. Or increase transfer and response functions without size penalty.

Lower d-c leakage. Less waste of power, minimum loss of signal.

SUPER SERIES miniature electrolytics achieve their exclusive electrochemical breakthrough without sacrificing reliability, as shown by 2,000-hour life tests in the approved **iei** laboratories. SUPER SERIES units include all the other features you have come to expect in **iei** capacitors . . . exceptional stability, long shelf and operating life, reliability over a full temperature range. Complete data in new Bulletin 2850, free on request. International Electronic Industries Division, Standard Pressed Steel Co.

85° Tantalum Foil Electrolytic Capacitors		
Case Size	MIL-C-3965/2 MFD @ 15 WVDC	SUPER SERIES MFD @ 15 WVDC
C5	580	1160
C4	400	800
C3	200	400
C2	60	120
C1	15	30

SUPER SERIES units have twice as much capacitance in every voltage rating; 15 to 150 WVDC.

***iei** SUPER SERIES are ideal for filter and bypass applications, too.

International Electronic Industries Div.

SPS

BOX 9036 - 94, NASHVILLE, TENNESSEE

FOUR NEW WAYS TO HOUSE MICROFUSES

(SUB-MINIATURE)

282001



Front panel mount Microfuse holder (with the hexagon nut rear of panel). Rugged aluminum body and knurled cap; both can be anodized in color. Fungus and shock resistant. Sealing "O" rings in cap and on body. "Eye" type terminals specially designed for easy soldering.

282002



Rear panel mount Microfuse holder (with the round nut mounted from front of panel). Rugged aluminum body and knurled cap; both can be anodized in color. Fungus and shock resistant. Sealing "O" rings in cap and on body. "Eye" type terminals specially designed for easy soldering.

281002



Front panel mount Microfuse holder (with the hexagon nut rear of panel). Molded from high strength, high dielectric material. Knurled cap for easy grip, with skirt for positive "O" ring seal. Rugged "Eye" type plated brass terminals separated by molded barrier to provide complete insulation.

284000 Series



Indicating Microfuse holder — when the fuse blows indicating bulb glows. Knob molded from transparent material with serrations for easy gripping. Skirt of knob for positive "O" ring seal. Body from high strength, high dielectric material. Indicating holders available in wide voltage ranges from 2½ to 125 volts.

PRODUCTS
SHOWN
ACTUAL
SIZE

Microfuses achieve low fuse resistance values with high reliability in ultra-fast blowing characteristics. Microfuses can be hermetically sealed, suitable for potting applications. Glass enclosed visible filament. Microfuses available in 1/500 through 5 amps at 125 V. Short circuit interrupting capacity 125 V—10,000 amps DC.

LITTELFUSE

Des Plaines, Illinois

CIRCLE 41 ON READER SERVICE CARD



**NEW WAY
TO MEET
A FRIEND
IN SPACE**

DECOR... Digital Electronic Continuous Ranging... a new *digital* technique providing constant range measurement between spacecraft, from thousands of miles to rendezvous. Accuracy—*inches!* Developed by Fairchild Stratos-ESD, DECOR uses a continuous signal. It makes simple "go, no-go" determinations regarding phase-shift during propagation time. Phase-shift is directly relatable to distance. Because of this

digital approach, equipment is compact, reliable and easily mated with other spacecraft subsystems. Included in the many ranging requirements suited to DECOR solution is the altimeter function for soft lunar and planetary landings. A working briefcase unit showing DECOR* capability is available for demonstration by FS-ESD engineers. Interested? Contact our Director of Customer Relations.

*A TRADEMARK OF FAIRCHILD STRATOS PATENTS APPLIED FOR

When there's a need to know: Fairchild Stratos-Electronic Systems Division capabilities are best reflected in an integrated approach to data requirements. Extensive experience in acquisition, processing, transmission and display has given FS-ESD engineers a particularly sensitive awareness of both final information needs and the many subsystems required to answer them. • For knowledgeable engineers interested in career opportunities in advanced data techniques, may we

suggest a note to our Director of Industrial Relations for the brochure "Grow Your Own Future". FS-ESD, an equal opportunity employer.

 **FAIRCHILD STRATOS**
ELECTRONIC SYSTEMS DIVISION
WYANDANCH, LONG ISLAND, NEW YORK



Ceramic-to-Metal Seals • Vacuum-tight seals for continuous operation at 500°C are available with Centralab's ceramic-to-metal seals. Whether metalizing for the attachment of hardware or in preparation for hermetic sealing, Centralab's techniques will satisfy the most critical requirements.



Complete Mechanical Assemblies • Mechanical applications for Centralab ceramics are virtually unlimited. Complete ceramic assemblies including attached metal parts, ready for installation in your equipment are produced in their entirety in Centralab's modern facilities. Tolerances to .00025" can readily be achieved.



Mass Production Parts • Centralab has unsurpassed facilities for the production of ceramics in quantity. Specialized automatic forming, pelleting, and extrusion equipment, continuous kilns, and highly skilled engineering and production staffs assure you that your requirements will be ably met.

THE ELECTRONICS DIVISION OF GLOBE-UNION INC.
914L E. KEEFE AVE. • MILWAUKEE 1, WISCONSIN
In Canada: Centralab Canada Ltd., P. O. Box 400, Ajax, Ontario

ELECTRONIC SWITCHES • POTENTIOMETERS • CERAMIC CAPACITORS • PACKAGED ELECTRONIC CIRCUITS • TECHNICAL CERAMICS

November 9, 1962

1.
2.

**3 BROAD
TYPES
of
TECHNICAL
CERAMICS**

all from one expert source . . . Centralab

Over a million ceramic pieces are produced in an average day at Centralab . . . a record no other manufacturer can match. Some require extremely exacting tolerances; others demand vacuum-tight seals; on others, fast delivery and favorable prices are the major criteria. Centralab's staff and facilities are equipped to assure your satisfaction in every aspect of technical ceramic production.

If you work with ceramics, you'll find Centralab's brochure on ceramic design considerations an invaluable reference. Write for your free copy of Bulletin 42-874.

X6243

Centralab[®]

CIRCLE 43 ON READER SERVICE CARD 43

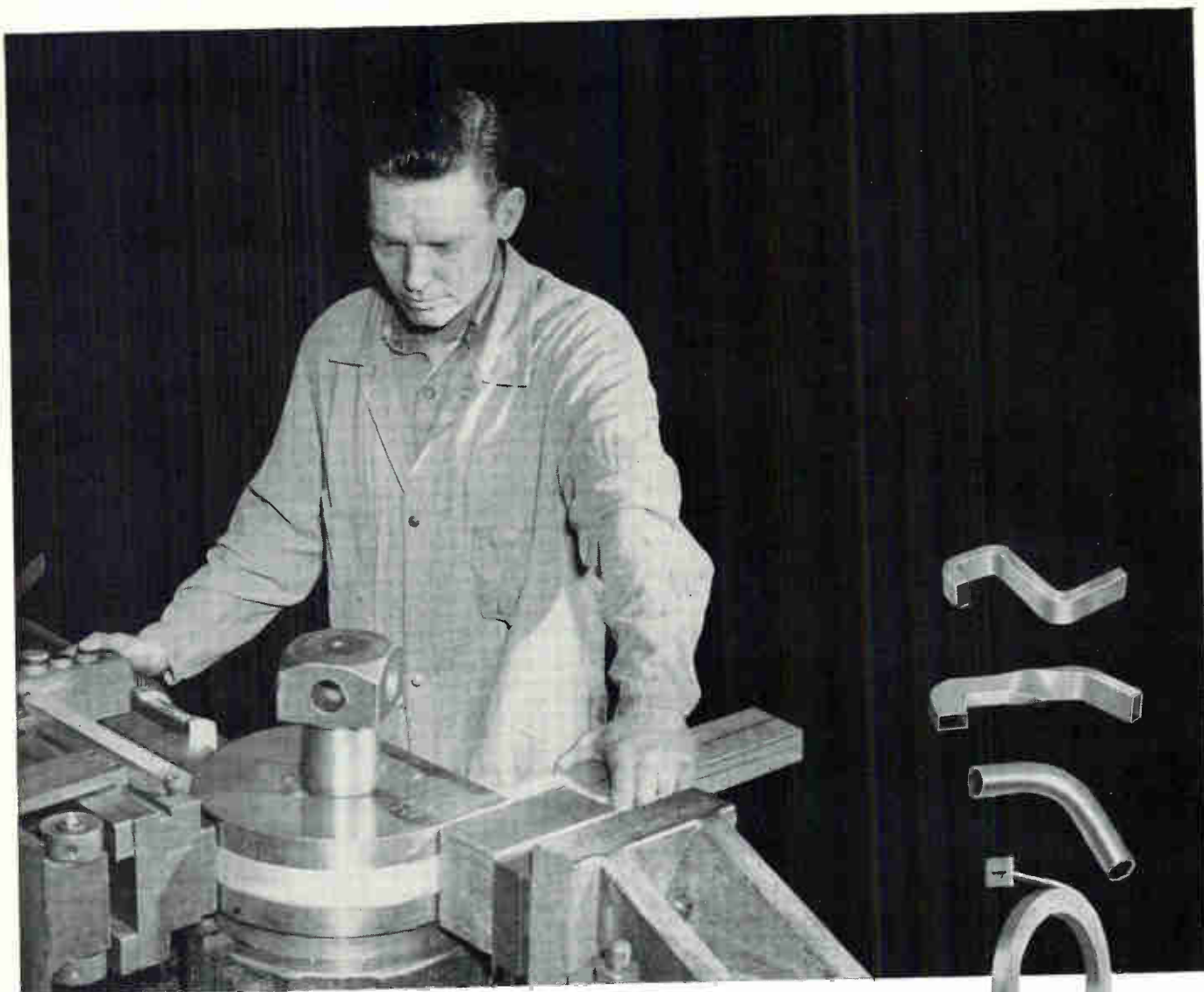

PRECISION WAVEGUIDE BENDING TO YOUR SPECIFICATIONS

Whatever your needs — bends, twists, offsets, coils, transitions, fabrications, complete assemblies — Specialty Automatic is ready to precision manufacture to your prints.

In 1947 Specialty Automatic was first called upon to help solve intricate and complex waveguide bending problems. Since then it has rapidly become one of America's leading suppliers of waveguide bends. With its advanced techniques and rigid quality control, Specialty Automatic will continue to assure satisfaction in your every waveguide bending requirement.

Send for brochure — "the technique of precision waveguide bending".



Specialty **AUTOMATIC
WAVEGUIDE
CORPORATION**

12 Wilmington Road, Burlington, Massachusetts • BRowning 2-0800

NEWS FROM
BELL TELEPHONE LABORATORIES

New high-purity alloys make better electron tubes

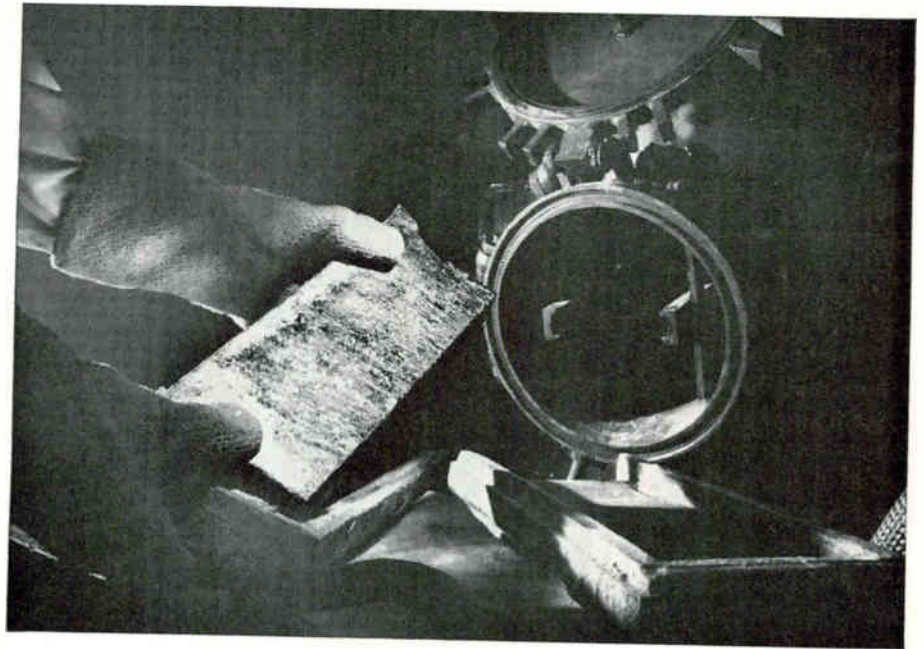

Ingot of high-purity nickel alloy is removed from controlled atmosphere melting furnace. Alloy is virtually free of impurities which inhibit electron emission. The new alloying technique and the methods for making cathodes and evaluating their electron-emitting properties were developed by K. M. Olsen and H. E. Kern.

Scientists at Bell Telephone Laboratories have developed new high-purity nickel alloys which are proving highly effective in lengthening the life of advanced-design electron tubes used in the Bell System. This development meets the demand of new electronic technology for long life and high reliability in electron tubes.

One of the new alloys is now providing the outstanding performance required in the electron-emitting cathode of the traveling wave tube in the Telstar satellite.

The first step was to devise new means for the fabrication of ultra-pure nickel to eliminate those impurities harmful to cathode performance. It was then possible to add to the ultra-pure nickel the alloy constituents and activating agents desired for optimum cathode performance, and at the same time to hold the undesirable impurities at levels below 50 parts per million. These techniques involved purifying the nickel raw materials and melting, alloying and casting in controlled atmospheres of hydrogen and helium.

This development is an example of how metallurgical scientists work to improve communications. The new nickel alloys are now being produced by the Western Electric Company, manufacturing unit of the Bell System.



Bell Telephone Laboratories

World center of communications research and development

THE MARTIN COMPANY HAD A PROBLEM

How to condition and calibrate 100 variable missile signals simultaneously, select any circuit from 1 to 100, and monitor the calibration voltage on the transducer output voltage during test.

ANSWER ■ THE AIRTRONICS AUTOMATIC CALIBRATION CONSOLE

REDUCES TEST & CALIBRATION TIME BY 75%

The Airtronics Calibration console provides an accurate and efficient means to condition and calibrate up to 100 AC and DC transducer signal channels. The input and output signals are conditioned to the voltage level and impedances required by the recording equipment and transducers. An accurate .1% step calibration is provided to each recording channel. The following operational efficiencies are attained in a test program:

1. A sound electrical and orderly termination point for signal input and recorder cables.
2. Signal output sensitivities may be adjusted for each channel.
3. Conditioning networks may be selected for each channel.
4. Calibration signals may be selected manually or automatically for one or all channels.
5. Individual channel input signals may be switch-selected for evaluation on the oscilloscope or for measurement on an auxiliary voltmeter.
6. Excitation voltage is available for each transducer as required.

Thus the time required to set up and perform a test program is materially less than that required for the breadboard and patch panel type of test preparation.

The Martin Company has used the Airtronics Calibration Console in Pershing missile test operations for NASA since 1961. The performance time of these test programs has been reduced as much as 75%!

■ **AIRTRONICS** ...is proud to have designed, engineered, and built an automatic calibration console which has met the rigid requirements specified by the Martin Company.

DETAILED SPECIFICATIONS GLADLY FURNISHED ON REQUEST

another product first by

AIRTRONICS INTERNATIONAL CORPORATION

P. O. BOX 8429
FORT LAUDERDALE, FLORIDA

TRIPLETT

EXTRA QUALITY IS HIDDEN*

MODEL 630 V-O-M PRICE † \$49.50

Standard Of The Industry

USES UNLIMITED:

- Field Engineers
- Application Engineers
- Electrical, Radio, TV, and Appliance Servicemen
- Electrical Contractors
- Factory Maintenance Men
- Industrial Electronic Maintenance Technicians
- Home Owners, Hobbyists

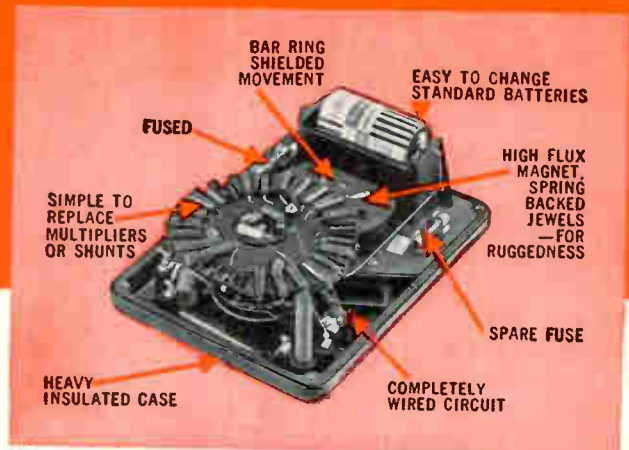

FACTS MAKE FEATURES:

- 1** Popular streamlined tester with long meter scales arranged for easy reading. Fuse protected.
- 2** Single control knob selects any of 32 ranges—less chance of incorrect settings and burnouts.
- 3** Four resistance ranges—from .1 ohm reads direct; 4½ ohm center scale; high 100 megohms.

Attention to detail makes the Triplet Model 630 V-O-M a lifetime investment. It has an outstanding ohm scale; four ranges—low readings .1 ohm, high 100 megs. Fuse affords extra protection to the resistors in the ohmmeter circuit, especially the XI setting, should too high a voltage be applied. Accuracy 3% DC to 1200V. Heavy molded case for high impact, fully insulated.

†630A same as 630 plus 1½% accuracy and mirror scale only \$59.50

TRIPLETT ELECTRICAL INSTRUMENT COMPANY, BLUFFTON, OHIO

RANGES

DC VOLTS	0-3-12-60-300-1,200-6,000 at 20,000 ohms per volt.
AC VOLTS	0-3-12-60-300-1,200-6000 at 5,000 ohms per volt.
OHMS	0-1,000-10,000.
MEG OHMS	0-1-100.
DC MICRO-AMPERES	0-60 at 250 millivolts.
DC MILLI-AMPERES	0-1-2-12-120 at 250 millivolts.
DC AMPERES	0-12.

DB: -20 to +77 (600 ohm line at 1 MW).

OUTPUT VOLTS: 0-3-12-60-300-1,200; jack with condenser in series with AC ranges.

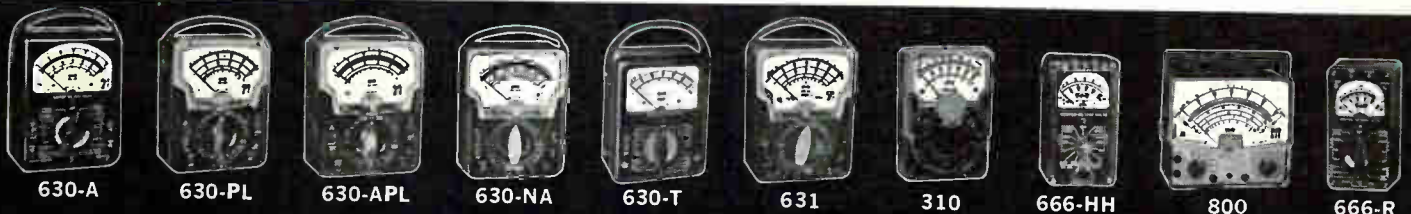

THE WORLD'S MOST COMPLETE LINE OF V-O-M'S. AVAILABLE FROM YOUR TRIPLETT DISTRIBUTOR'S STOCK.

NOW

ULTRA

DRY

AIR OR GASES

at less than 25% of former costs with the

GILBARCO HEATLESS DRYER

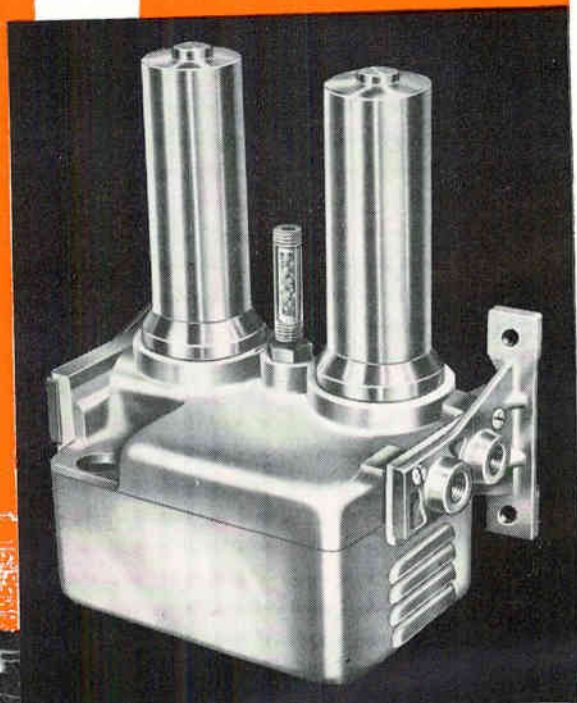

A NEW LOW-COST DRYER WHICH OPERATES CONTINUOUSLY WITHOUT MAINTENANCE OR SERVICE

Dewpoint? As low as -100°F . Capacity? 1 to $7\frac{1}{2}$ SCFM. Pressures? Up to 125 PSIG. Cost? About one-quarter of what you'd expect to pay. That's the new Gilbarco Heatless Dryer, a small compact, lightweight dryer employing a principle of operation developed and patented by one of the world's great research laboratories, Esso Research and Engineering Company. If you have need of ultra-dry air, there is no more economical or efficient way to obtain it than with this new Gilbarco unit. Write for catalog and complete information.

Gilbarco

APPLIED PNEUMATICS DIVISION
GILBERT & BARKER MFG. CO.
WEST SPRINGFIELD, MASS.

SPECIFICATIONS

Model No.	HF-200-4	HF-200-6	HF-200-9	HF-200-12
Flow Operating at 100psig	1 SCFM	2½ SCFM	5 SCFM	7½ SCFM
Model No.	HF-201-4	HF-201-6	HF-201-9	HF-201-12
Flow Operating at 125psig	1 SCFM	2½ SCFM	5 SCFM	7½ SCFM
Weight (approx.)	4 lb.	5 lb.	6 lb.	7 lb.
Height (approx.)	9"	11"	14"	17"
Width (approx.)	8"	8"	8"	8"
Depth (approx.)	5"	5"	5"	5"
Power Requirements	110 volts or 220 volts, 50 cycles or 60 cycles, single phase 15 watts. Other voltages and frequencies available.			

Models are available in accordance with MIL-E-16400 and qualified under the requirements of MIL-T-17113 and MIL-STD-167.

November 9, 1962

FIRST SYSTEM
DETAILS ON

Giant Haystack Radar Facility

Haystack—first U. S. system for simultaneous operation of two-way communications, beacon-tracking radar, and skin-tracking radar in a unified package—will be a high-precision facility that will find wide usage

By THOMAS MAGUIRE, New England Editor

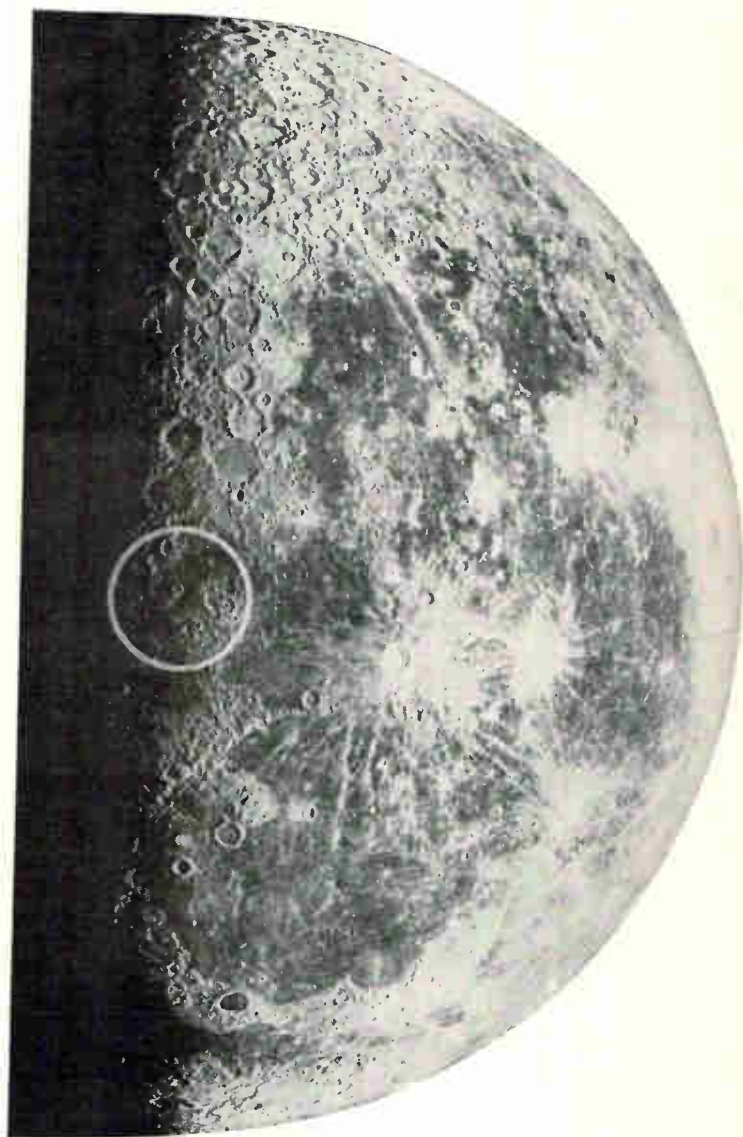

RESOLUTION of Haystack radar at 8 Gc is 250-mile-diameter circle at moon's surface, shown for comparison on this Mt. Wilson Observatory photo—Fig. 1

A NEWS STORY GROWS UP

At NEREM in Boston this week, Project Haystack is being discussed. Our New England Editor, Tom Maguire, started out to get a news story, talked to Herbert Weiss who supervises Lincoln Lab's role in Haystack, and ended up with technical story on details that are being revealed at NEREM for the first time. For those who can't be in Boston this week, here it is...

HAYSTACK, a powerful and sensitive experimental radio and radar facility using the most precise large movable antenna ever built will go into operation next summer in Tyngsboro, Massachusetts. The 120-foot Cassegrainian reflector will be sheltered by a rigid metal-space-frame radome 150 feet in diameter.

Project Haystack (ELECTRONICS, p 51, Nov. 25, 1960), costing the Air Force an estimated \$10 million, is bringing a new generation of capability in space communications and high-power radar trackers.

Initially it will be used to explore the potential of orbital scatter communications.

Haystack will be America's first system designed for simultaneous operation of two-way communications, beacon-tracking radar and skin-tracking radar in a unified instrumentation system. The facility takes on added significance in view of two recent DOD decisions: abandonment of the Navy's 600-foot Sugar Grove antenna project; and discontinuance of the Army's Advent program and assignment of

PLUG-IN equipment room under construction for West Ford communications experiments. Incorporated into the antenna structure, this room will hold two tons of electronics, including feed-horn assembly, transmitter components and low-noise receiving equipment—Fig. 2

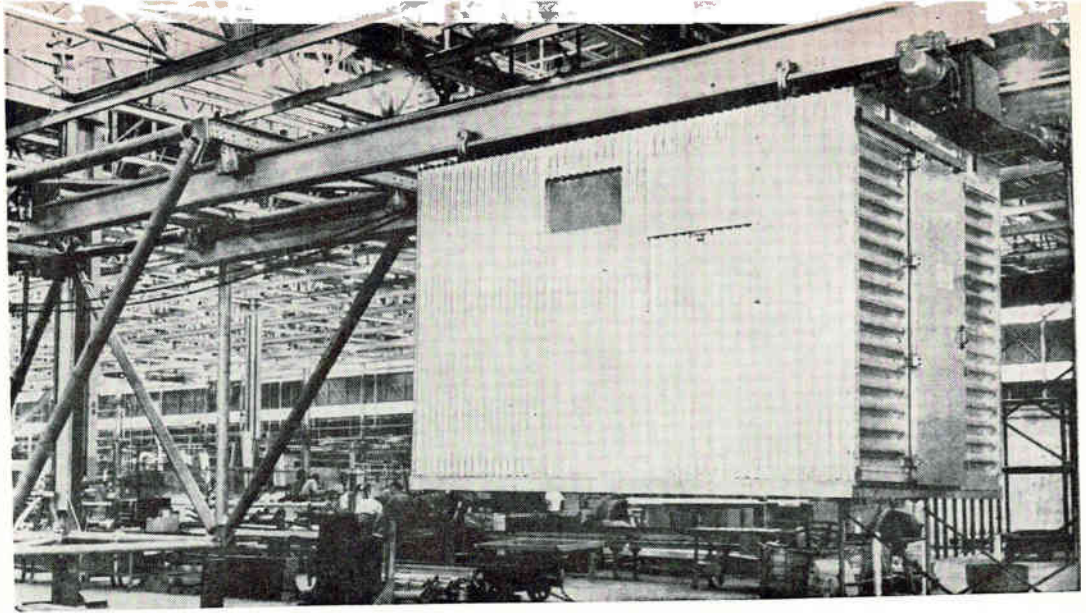

CHARACTERISTICS OF HIGH-GAIN STEERABLE ANTENNAS*—

TABLE I

	Diameter (D)	Estimated** RMS Surface Tolerance (t)	Shortest Operating Wavelength (λ_{min}) [where $t = \lambda/16$]	D/λ_{min}	Calculated Beamwidth (degrees)
Jodrell Bank Manchester, England	250 ft (76 m)	± 3 cm	48 cm (625 Mc)	160	0.4
National Radio Astronomy Obs. Greenbank, W. Va.	300 ft (91 m)	± 1.3 cm	20 cm (1.5 Gc)	450	0.15
C. S. I. R. O Parkes, Australia	210 ft (63 m)	± 0.7 cm	10 cm (3 Gc)	630	0.1
Lincoln Laboratory Lexington, Mass.	28 ft (8.6 m)	± 0.05 cm	0.8 cm (35 Gc)	1,070	0.06
P. N. Lebedev Institute Serpukhov, USSR	72 ft (22 m)	± 0.05 cm	0.8 cm (35 Gc)	2,750	0.025
Haystack (Lincoln Lab.) Tyngsboro, Mass.	120 ft (37 m)	± 0.07 cm	1.1 cm (27.5 Gc)	3,300	0.02

* Compiled by H. G. Weiss, MIT Lincoln Laboratory

** Exact surface tolerance data not available

military communications satellite development to the Air Force.

Conceived and designed by MIT Lincoln Laboratory in Lexington, Mass., Haystack will be used initially as an X-band system. The precision being built into the antenna, however, assures operation at 20 Gc, and indicates the possibility of reaching 35 Gc, with perhaps 80 percent of the reflector surface employable at this 8-mm wavelength. Its nominal operating frequencies will be 7,750 Mc and 8,350 Mc in the communications mode, and 7,750 Mc and 8,050 Mc in the radar mode.

OBJECTIVES—The system is being built under the sponsorship of the Directorate of Communications Programs at AF Electronic Systems Division, Bedford, Mass., as part of the SPACECOM program, to provide communications for support of

ANTENNA CHARACTERISTICS—TABLE II

Type	Paraboloidal reflector—Cassegrain optics
Size	Primary reflector: 120 ft dia. Secondary reflector: 9 ft 4 in. dia.
Useful Frequency Range	1 Gc through 10 Gc (to 35 Gc with reduced efficiency)
Gain at 10 Gc (theoretical)	69 db, half power BW = 0.05 deg
Dynamic Pointing Accuracy	± 0.005 deg
Max Rotation Rate	3.5 deg/sec in az and el
Feed Horn	Monopulse, dual polarization
Plug-in Room Behind Reflector	Size: 8 ft \times 8 ft \times 12 ft; 4,000 lb capacity

RADOME CHARACTERISTICS—TABLE III

Electrical	
Transmission Loss at 8 Gc	0.7 \pm 0.1 db (measured)
Temperature Contribution at 8 Gc	20 deg \pm 5 deg K (measured)
Boresight Shift	< 0.1 milliradian
Mechanical	
Diameter	150 feet
Height	131 feet
Cross Section of Frame Members	3 inches \times 5 inches
Length of Frame Members	9 feet to 15 feet
Thickness of Glass-Fiber Panels	0.032 inch

R-F BOX NO. 1—TABLE IV

(1) Main Transmitter	
Function	Communications and radar (long pulse)
Frequency	7,750 Mc
Power Output	100 Kw (c-w)
System Bandwidth	30 Mc
(2) Receivers	
2 Masers	7,750 Mc and 8,350 Mc (temp = 20 deg K)
6 Parametric Amplifiers (cooled)	7,750 Mc and 8,350 Mc (temp = 90 deg K)
Overall System Temp	< 75 deg K maser; < 150 deg K paramp
(3) Tracking Radar	
Frequency	8,050 Mc
Power Output	50 Kw peak
Pulse Length and PRF	Variable

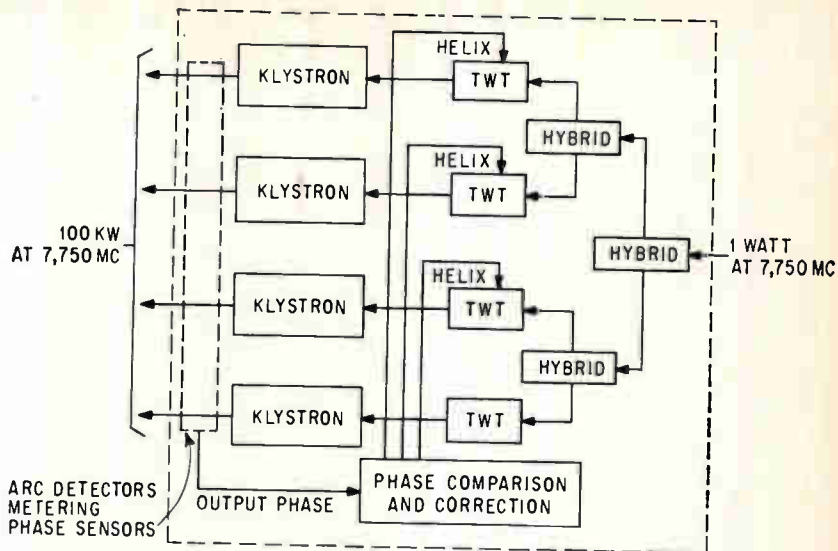

HIGH-POWER, X-band transmitter uses 4 phase-locked klystron amplifiers to generate 100 Kw of output power at 7,750 Mc—Fig. 3

global Air Force operations. Herbert G. Weiss is supervising Lincoln Laboratory's part in this program, and Lt. John H. Shock is the AF project manager.

Haystack will test out new communications concepts, first of which is Project West Ford, orbital scatter communications by tuned dipole belts.

Other possible communications applications involve moon-bounce experiments and work with Echo, Syncom and future satellites. It will develop techniques applicable for communications with Gemini, Apollo and other space vehicles; and may be used in developing long-haul, low-capacity emergency military communications with forces around the world.

In the radar mode, Haystack's high resolution capabilities could be employed for detection and tracking of satellites and space vehicles, to provide more accurate orbit information. It could be used also for testing navigation aids for space vehicles, and for observing missile fringes from Cape Canaveral and Wallops Island. No system now in operation could radar skin-track Advent-type high-altitude satellites if the beacon went dead. Haystack will have that capability.

With a half-power beamwidth of 0.06 degree at X-band, Haystack will illuminate an area only 250 miles wide on the moon (Fig. 1). Its high system sensitivity will be capable of tracking a 0.22 caliber shell at 1,000 miles.

In radio physics, Haystack should permit the first radar echoes from Mars, Mercury and Jupiter; it will receive emissions from planetary atmospheres and from the solar corona. It will be used for interplanetary distance measurements and will probe the atmosphere and rotation rate of Venus.

Because of system sensitivity, it will be able to see Venus at all times of the year, not just during the planet's closest approach to earth.

"Unless there are unforeseen anomalies in space transmission," Lincoln Laboratory Associate Director William H. Radford said at NEREM this week, "the Haystack system will be able to receive 10-cps bandwidth signals from a deep-space probe at ranges approaching 10^8 nautical miles."

ELECTRONICS—Interchangeable antenna-mounted r-f packages will contain the Haystack transceiver equipment. The first package is shown in Fig. 2. Measuring 8 ft. \times 8 ft. \times 12 ft., it can be lifted by crane to be plugged into the system behind the reflector, where it will be part of the moving system. Thus, different modes of operation can be undertaken within a few hours time. First working-package will be the West Ford transmitter and receiver. Next will come "the best pulsed radar that can be dreamed up within the present state-of-the-art."

For the West Ford experiments, two tons of electronics will be

plugged into the dish: a high-power transmitter, low-noise receiver system and low-power tracking radar. Frequency separation techniques will allow simultaneous operation of the three modes.

The transmitter, under construction by Radiation-at-Stanford, will put out 100 Kw of c-w power in the band from 7,125 to 8,500 Mc. Two transmitters are being built for the Air Force at a total cost of \$1.7 million. The second is for Rome Air Development Center and will be used at the Floyd Communications Terminal Site, Griffiss AFB. Final amplifier will consist of four Varian klystrons each capable of putting out 25 Kw of average power and all four phase-locked as one source, as illustrated in Fig. 3. The power supply, located on the ground, will be capable of producing 1 Mw on continuous d-c over a wide voltage range.

The receiver front end will consist of several masers and up to nine liquid-helium-cooled parametric amplifiers recently developed at Lincoln Laboratory, where the masers are also being built.

A closed-cycle helium system, A. D. Little's cryodyne, will provide refrigeration for the masers and paramps. The refrigerator will be in the r-f box, and the compressor mounted on the antenna yoke.

The West Ford r-f package will also include a radar, which will have high performance because of the 69 db of antenna gain at X-band. Its 1-Kw power will provide about

the same capability as the Millstone Hill radar of Lincoln Laboratory. The two tons of electronics in the r-f package will enable researchers to transmit and receive communica-

tions and to radar-track simultaneously. They will have the option of using one or more paramps or a combination of paramps and masers. Paramps will be used most of

the time, but masers will be available "when we're really fighting for db's."

The r-f configurations for the three modes of system operation are outlined in Fig. 4.

In this first r-f working-package, designers are shooting for an overall system noise temperature of less than 60 deg K—equivalent to a noise figure of about 1.1 db. In the radiometer package, which will be used for calibration and pattern measurements, a system temperature of about 35 deg K is expected.

About 450 gallons of water per minute will be pumped up, into, and out of the r-f box for heat dissipation. In addition to automatic arc detection and monitoring, the high power level of the transmitter necessitates water-cooled waveguide in the 12 feet of plumbing from the r-f box to the focus of the reflector system. From this point, feed horns will be beamed at a secondary reflector, which will in turn illuminate the main dish.

DATA HANDLING—A new computer under construction at Lincoln Laboratory will be the interface between Haystack's wide-band communications channel and conventional high-speed signal-processing equipment.

Eventually, the facility will be operating a 30-Mc bandwidth, and this will require a real-time, high-speed buffer and data sorter. The interface computer will be a second-generation FX-1, with logic circuits capable of 100-megapulse operation. The FX-1, with 50-megapulse transistor logic, has been operating at Lincoln Laboratory for almost two years. It was designed as a test vehicle for high-speed logic circuits, new packaging techniques and magnetic-film memories.

In the Haystack application, the FX-2 will probably use cores for bulk storage, and thin films for internal memory. Operation at 100 Mc will require 5-Gc transistors, and Lincoln Laboratory has in-house and contractor programs for development of these components on a reproducible basis. Circuit designers are meanwhile taking a second look at tunnel-diode logic and at hybrid circuits.

For real-time detection and processing of narrow-band radar re-

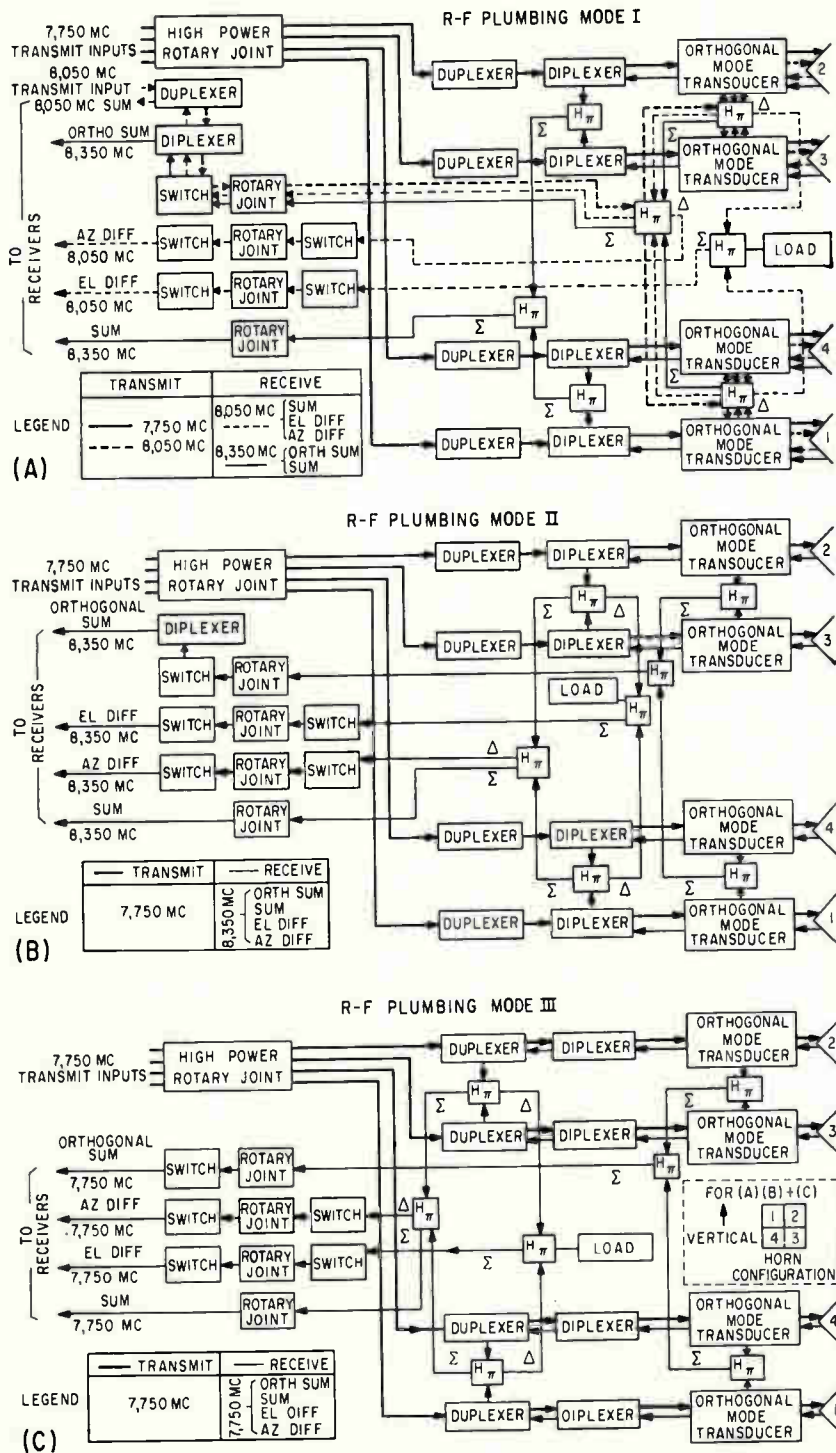

HAYSTACK SYSTEM MODES. Modes I (A) and II (B) are for satellite communications particularly, Mode I being appropriate for passive satellite communications. Target will be tracked and antenna steered by low-power 8,050 Mc radar integrated with simultaneous high-power communications. In Mode II, small radar is turned off, system is transmitting at 7,750 and receiving at 8,350 Mc. Antenna is controlled, target tracked by the received signal. Mode III (C) is the long-pulse-radar mode for interplanetary probes—Fig. 4

turns falling in a wideband noisy spectrum, Lincoln Laboratory has developed a new two-step system: the first step giving a coarse, high-false-alarm indication of range and doppler, and the second providing high-quality detection and parameter estimation. This sequential detection and processing method will replace the filter-bank system previously used at Lincoln Laboratory's Millstone Hill facility.

CONSTRUCTION — Nearly two years of engineering work went into design analysis and materials pre-testing before any part of the Haystack antenna was fabricated.

Designers pioneered in the technique of using digital computer analysis to determine the behavior of large, redundant mechanical structures, a technique that may have wide applications in large civil engineering projects involving complex structures, such as bridge-building.

Design and construction of the antenna is being carried out by North American Aviation, Inc. in Columbus, Ohio; a concurrent supporting program at Lincoln Laboratory critically monitors the design as it is developed and provides an independent analysis of the behavior of the antenna structure. The Haystack antenna design was computer-evaluated and optimized at least 40 times before construction was begun, says Herbert G. Weiss of Lincoln Laboratory.

Besides extensive computer optimization, the project included the development of a 1/15 scale model, built and intensively tested by North American at Columbus, where in-plant final assembly of the full-scale Haystack antenna has been going on since May. Vibration and static loading tests are now underway. The antenna will then be disassembled and shipped to Tyngsboro, where it will be erected under the huge radome.

TOLERANCES—To achieve high-frequency operation and required system gain at microwave frequencies, extremely fine mechanical tolerances are required of the antenna. The reflector surface must remain within 0.075 in. of an ideal parabolic contour under all environmental conditions and for all angular velocities and accelerations.

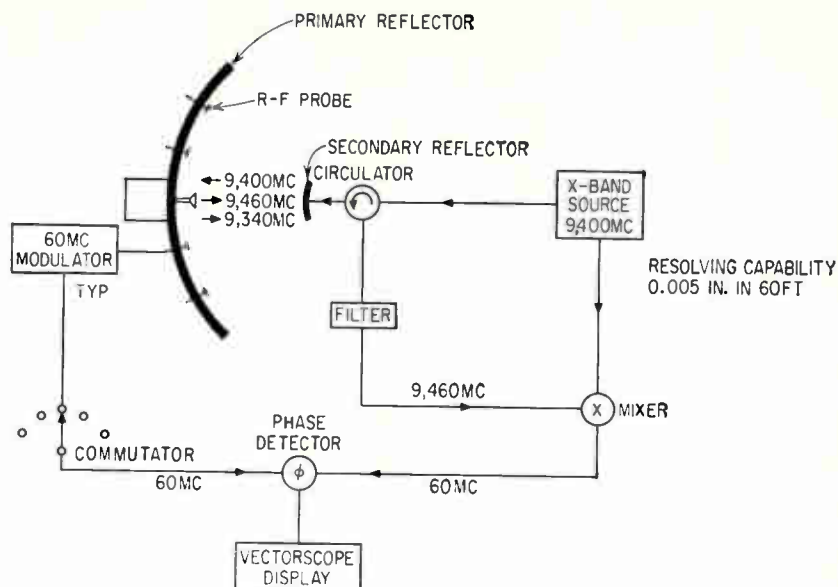

MICROWAVE INTERFEROMETER measurement system designed at Lincoln Laboratory will continuously monitor actual displacement of selected points on the reflector surface. Antenna test range measurements indicate interferometer is capable of determining displacement with an uncertainty of only 0.005 in.—Fig. 5

Design analysis, therefore, dictated a high stiffness-to-weight ratio and a simple deflection compensation system as well as a protective radome.

Both optical and electrical surveying techniques will minutely check the reflector surface. Over \$120,000 of the special optical tooling has been built by Keuffel & Esser Co. for initial setup and for once-a-year calibration. This optical probe which can be plugged in behind the antenna focus like an r-f package, will look at 384 optical targets around the surface of the dish. The surface can then be aligned by adjustable struts and locked to keep it within the required tolerance.

The electrical survey technique is shown in Fig. 5. Designed at Lincoln Laboratory, it will operate like a microwave interferometer or an r-f bridge-balancing system and will permit continuous, real-time surveying and calibration. Dipoles embedded in the surface of the reflector will operate as fixed-array antennas. Phase differences in the signals from these antennas will be displayed on a scope to fix their positions within 0.005 inch.

The 180 tons of movable structure must be pointed with a precision of better than ± 0.005 degree, requiring special bearings, shaft-

angle-encoding and control equipment. For operation at mm-wave frequencies, the half-power beamwidth will be so small—about 0.02 degree—that it will be necessary to steer the giant dish with an even greater accuracy. Steering instructions will be generated by a Univac 490, which will also have additional capacity to assist in data processing.

Incorporation of a general-purpose digital computer in the antenna control system will provide flexibility for the antenna search and track functions. The computer will accept pointing information from remote sensors, by standard teleprinter circuits, and will accomplish real-time parallax and time coordinate corrections.

The antenna yoke will rest on a 14-ft.-diameter hydrostatic bearing, believed to be the world's most precise, and the whole antenna will be floating on a film of oil 0.003 inch thick. At a rotation rate of 3.5 deg./sec. in each axis, Haystack will be able to track even low-altitude satellites.

Telecomputing Corp. will supply a precision shaft-angle-encoding system for Haystack. Pulse-timing and frequency translation equipment will be furnished by Hughes. The rigid radome was built by H. I. Thompson Fiber Glass Co.

PIEZOELECTRIC PARTS

Piezoelectric ceramics are versatile and have excited the imagination of filter designers for many years. Some recently developed devices include simple resonators, multielectrode resonators, cascaded combinations of resonators, mechanically coupled pairs and lattice filters. Commercial versions of these units in the 455-Kc range are in use in both military and commercial equipment

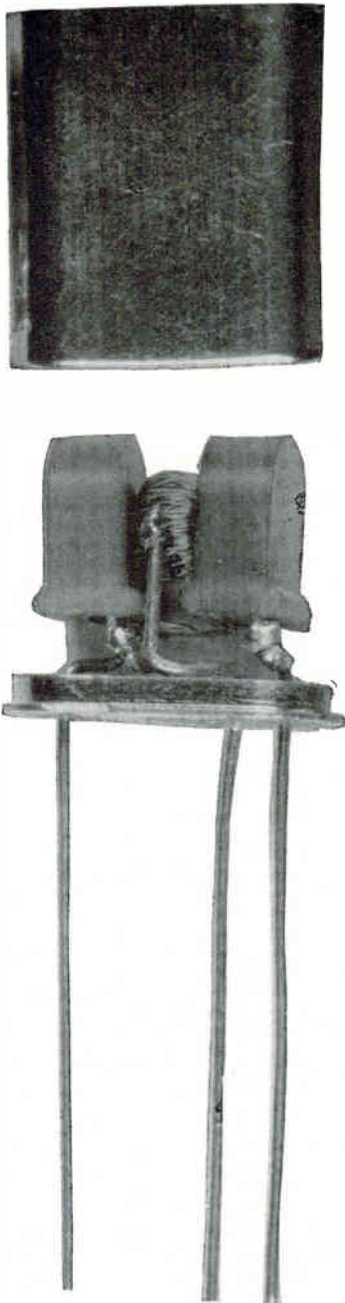

PIEZOELECTRIC ceramic resonators packaged in a commercial can. Toroid autotransformer is mounted between the ceramic elements

Easy Way to Design

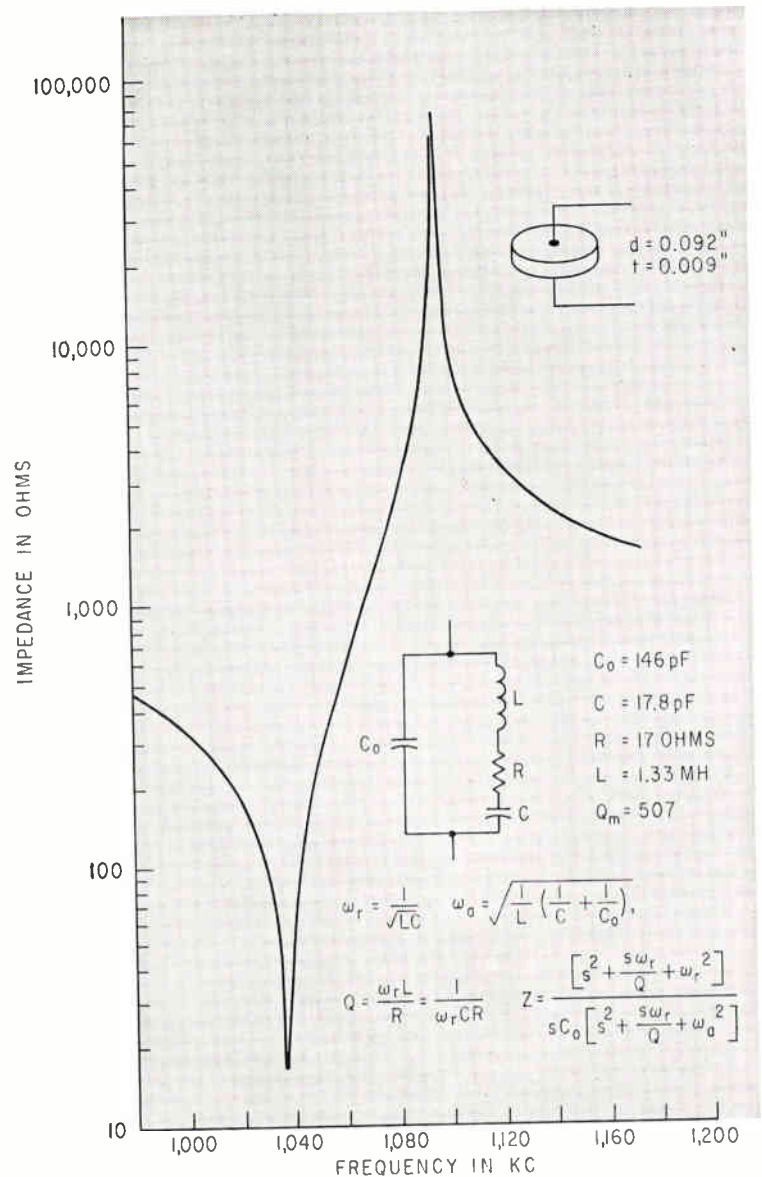

CERAMIC RESONATOR CHARACTERISTICS and their equivalent circuit—Fig. 1

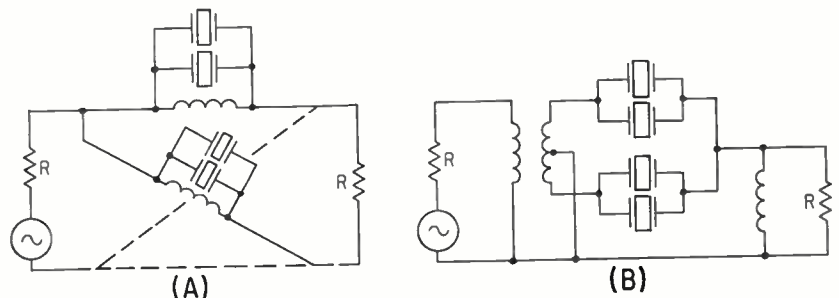

BALANCED LATTICE FILTER (A) and an equivalent unbalanced version (B) using a transformer—Fig. 2

Ceramic Resonator Filters *Use of insertion loss*

technique enables filter designers to get precise passband and delay characteristics

By J. D. SCHOEFFLER

Case Institute of Technology, Cleveland, Ohio

D. R. CURRAN

Clevite Corp., Cleveland, Ohio

CERAMIC FILTERS have been designed and fabricated, using resonators operating in the flexural, radial extensional and thickness modes of vibration, to cover a frequency range of 5 to 12,000 Kc. Although ceramic filters can be designed using image parameter methods developed for crystal filters, insertion-loss design, which realizes a prescribed insertion loss as a function of frequency, is attractive when the filter response must be carefully controlled. For example, the behavior of the filter near the edges of the passband or the time delay of the filter as a function of frequency can be controlled this way. Insertion-loss design proceeds from a mathematical specification of insertion loss versus frequency to a specification of the values of the individual circuit elements, in this case, the characteristics of the individual ceramic resonators. Thus resonators are required that have a wide range of characteristics.

CERAMIC RESONATOR—Selection of a type or shape of resonator depends on the mode of vibration to be used and on the frequency range. Over a frequency range of 150 to 6,000 Kc, radial extensional modes of disks are applicable.

A thin ceramic disk with fully electroded faces and polarized normal to these faces has its lowest excitable resonance in the fundamental extensional radial mode. This is a strong mode, inherently free from spurious responses and has its first overtone at about 2.5 times fundamental frequency. The zero and pole of impedances of the disk occur at the resonant and antiresonant frequency respectively. Response of a typical ceramic disk with its equivalent circuit is shown in Fig. 1. Z is the resonator impedance at a complex frequency s . Available ceramic resonators have Q 's from 400 to 1,400 and dielectric constants from 600 to 1,100. Resonant and antiresonant frequencies are stable within ± 0.1 percent from -40 to 85 C, and increase slowly and logarithmically with time by less than 0.1 percent per decade.

The ceramic resonator can be characterized either in its equivalent circuit elements using relationships in Fig. 1, or by its resonant frequency, shunt capacitance, Q , and $\Delta f/f$ ratio defined by

$$\frac{\Delta f}{f} = \frac{f_a - f_r}{f_r} \quad (1)$$

where f_r and f_a are the resonant and antiresonant frequencies and the $\Delta f/f$ ratio gives the percentage

of the separation between these two frequencies.

Ceramic resonators are versatile because each of these parameters can, to first order, be controlled independently. For the radial mode, f_r is inversely proportional to diameter, and C_0 directly to diameter squared over thickness. The $\Delta f/f$ ratio is determined by the electromechanical coupling coefficient, a physical property of the material that can be controlled over a wide range in processing. Q is principally a function of composition and is normally made as high as possible consistent with other properties. Ranges of characteristics for radial mode ceramic resonators are shown in Table I with typical values for a resonator operating in the radial mode at 455 Kc.

INSERTION LOSS DESIGN—The physical form of the filters is the symmetrical lattice with each arm broadbanded by a single inductor, Fig. 2A. While this network needs a transformer for grounding, it does allow realization of a wide range of insertion-loss characteristics. The presence of the inductor is convenient, because the unbalanced version of the lattice has transformers to absorb the shunt inductor, and thereby reduce the problem of transformer design (Fig. 2B).

For convenience, the band-pass filter is designed by first designing a low-pass filter, which need not be realizable, then transforming to a band-pass filter realizable with ceramic resonators. For convenience the low-pass prototype is chosen to have its cutoff frequency at 1 radian per second and to be terminated in 1-ohm resistors. The various forms of insertion loss such as the Butterworth, Chebychev and Darlington elliptical forms are directly applicable. Most of the design is independent of the center frequency and bandwidth.

The transmission function of a network is the ratio of load power to maximum power available or $|\tau(\omega)|^2$ where ω is the angular frequency in rad/sec. Insertion loss in db is then defined as $-10 \log_{10}$ of the transmission function. The design starts from a specification of the transmission function

$$|\tau(\omega)|^2 = \frac{1}{1 + (P/Q)^2} \quad (2)$$

the reciprocal of 1 plus the square of a rational function of frequency. If $P(\omega)$ and $Q(\omega)$ are even or odd functions of frequency, the insertion loss is symmetrical about center frequency. But for odd func-

tions of frequency, the passband is nonsymmetrical about center frequency, thereby allowing the design of single sideband filters and other unsymmetrical filter forms. Typical insertion loss specifications might include the Butterworth functions

$$|\tau(\omega)|^2 = \frac{1}{1 + \omega^{2n}} \quad (3)$$

Other examples are Chebychev and Darlington or elliptic functions. A Darlington elliptic filter is designed as this example, but the design technique is valid for any insertion-loss function that can be written in the form of Eq. 2.

First the insertion loss of the lattice network is written in terms of admittances of arms y_a and y_b .

$$|\tau(\omega)|^2 = \left| \frac{y_b - y_a}{1 + y_a + y_b + y_a y_b} \right|^2 \quad (4)$$

This is equated to a mathematical expression for insertion loss (Eq. 3 for example) and the resulting equation solved for y_a and y_b . These admittances are then transformed by the low-pass to band-pass transformation to yield admittances of the desired band-pass filter. An additional transformation is applied to these admittances to make them realizable by ceramic resonators. Actual circuit elements are obtained from these admittances.

DESIGN PROCEDURE—Design an unbalanced two resonator filter terminated in 1,000 ohms at each end to have a maximum of 0.5 db attenuation in the passband, a minimum of 20-db attenuation in the stop band and a 20 percent bandwidth centered at 455 Kc.

Step 1. Choose an analytic expression for the transmission function of the equivalent low-pass filter.

The two-resonator filter is the unbalanced equivalent of a one-resonator-per-arm lattice, Fig. 3. The Darlington elliptic form for the equivalent low-pass filter is selected to achieve

$$|\tau|^2 = \frac{1}{1 + \epsilon^2 F^2} \quad (5)$$

$$F = \frac{\omega^2 \omega_1^2 - 1}{\omega^2 - \omega_1^2}$$

Insertion loss is $-10 \log |\tau|^2$. Maximum loss in the passband occurs at $\omega = 0$ and the minimum loss in the stop band at $\omega = \infty$. Thus

$$\text{Insertion loss at } \omega = 0 \text{ is } +10 \log \left[1 + \frac{\epsilon^2}{\omega_1^4} \right] = 0.5 \text{ db, and}$$

$$\text{Insertion loss at } \omega = \infty \text{ is } 10 \log [1 + \epsilon^2 \omega_1^4] = 20 \text{ db.}$$

From these two relations, $\epsilon = 1.87$ and $\omega_1 = 2.31$ rad per sec.

Step 2. Identify the polynomials P and Q by comparing this transmission function with Eq. 2, and determine the polynomial $A + jC$ containing the upper half ω -plane, usual left half s -plane, roots of $P^2 + Q^2 = 0$.

From Eq. 5 and 2 $P = 10\omega^2 - 1.87$ and $Q = \omega^2 - 5.35$. Then $P^2 + Q^2 = 10\omega^4 - 48.1\omega^2 + 32.1$.

The polynomial containing the upper half ω -plane roots of this polynomial is $A + jC$ and is given by $A + jC = -10\omega^2 + 5.66 + j8.08\omega$, from which $A = -10\omega^2 + 5.66$ and $C = 8.08\omega$.

Step 3. Form the admittances of the arms of the lattice.

Use any of the expressions

$$y_a = \frac{j(C + Q)}{A \pm P} \text{ and } y_b = \frac{j(C - Q)}{A \pm P}, \text{ or}$$

$$y_a = \frac{A + Q}{j(C \pm P)} \text{ and } y_b = \frac{A - Q}{j(C \pm P)}.$$

Each of these sets of admittances satisfies Eq. 2.

It is important that the admittances have a pole at infinity so that capacitances result that can be incorporated into the ceramic resonators. This dictates the choice of the four possible arm admittances. Equation 4 is unchanged if y_a and y_b are replaced by their reciprocals. Hence if a choice for arm admittances yields zeros at infinity rather than poles, the expressions can be replaced by their reciprocals without affecting the insertion loss. If no pole at infinity can be obtained, the admittance will be a constant at infinite frequency and this can be realized with a real capacitance or inductance using Baum's approximation. In this example, no choice yields a pole at infinity, so the admittances are selected so that y_a and y_b are nonzero at infinity. Choose

$$y_a = \frac{A + Q}{j(C + P)} = \frac{j(9\omega + 1.70)}{10\omega + 9.95}$$

$$y_b = \frac{A - Q}{j(C + P)} = j \frac{11(\omega - 1)}{10(\omega - 0.19)}$$

Step 4. Form the partial fraction expansions of the arm admittances

$$y_a = j0.9 - j \frac{0.7255}{\omega + 0.995}$$

$$y_b = j1.1 - j \frac{0.90}{\omega - 0.19}$$

Step 5. Transform the low-pass equivalent to the desired band-pass form by the low-pass to band-pass transformation, and scale the impedance level from one ohm to the desired level by dividing each arm admittance by R , the desired terminal resistance.

In Step 4, replace ω by $\frac{\omega^2 - \omega_0^2}{B}$ where ω_0 is the

center of the pass band ($2\pi \times 455 \times 10^3 = 2.86 \times 10^6$) and B is the ratio of the desired bandwidth to the low-pass bandwidth. Plotting of Eq. 5 shows that cutoff (0.5 db) occurs at 0.61 rad per sec. Hence

$$B = \frac{0.2(2.86 \times 10^6)}{0.61} = 0.938 \times 10^6$$

Transforming the arm admittances with impedance level raised to 1,000 ohms yields

$$y_a = j0.9 \times 10^{-3} - j \frac{684\omega}{\omega^2 + 0.935 \times 10^6 \omega - 8.19 \times 10^{12}}$$

$$y_b = j1.1 \times 10^{-3} - j \frac{850\omega}{\omega^2 - 0.178 \times 10^6 \omega - 8.19 \times 10^{12}}$$

Step 6. Transform the arm admittances to a form realizable by ceramic resonators.

Each term of the arm admittance is generally of the form

$$\frac{-jk\omega}{\omega^2 + a\omega - \omega_0^2} = \frac{-jk\omega}{(\omega - \omega_0)(\omega + \omega_0)}$$

or its reciprocal and this form is not realizable by resonators because ω_a and ω_b are different. Terms of this form can be replaced by

$$\frac{-jk \left(\frac{\omega_a}{\omega_0} \right) \omega}{\omega^2 - \omega_a^2}$$

with small error near the passband, because the term $(\omega + \omega_a)$ does not vary significantly in the vicinity of the passband, and the changed residue corrects the value at the center of the band. In this example, the leading term of the arm admittances is a constant not yet realizable since no constant reactance element is available. Baum's approximation yields a realizable term

$$jk = \frac{jk\omega_0}{\omega_0} \approx j \left(\frac{k}{\omega_0} \right) \omega$$

Thus there finally results for the transformed arm admittances

$$y_a = 314 \times 10^{-12} j\omega + \frac{580j\omega}{-\omega^2 + (2.43 \times 10^6)^2}$$

$$y_b = 384 \times 10^{-12} j\omega + \frac{875j\omega}{-\omega^2 + (2.95 \times 10^6)^2}$$

Each of these admittances is of the form

$$y = j\omega C_0 - \frac{j\omega/C}{\omega^2 - 1/LC}$$

and is realizable with passive components.

Step 7. Break up the shunt capacitance.

Associate part of it, C_i , with each tuned circuit. The resonant frequency of the i th resonator is $(f_r)_i = \omega_a/2\pi$. The antiresonant frequency, at which C_i and its resonant circuit have zero impedance, is

$$(f_a)_i = \frac{1}{2\pi} \left[\omega_a + \frac{k}{2C_i \omega_a} \right]$$

Then

$$\left(\frac{\Delta f}{f_r} \right)_i = \frac{k}{2C_i \omega_a \omega_a}$$

The only restriction on breaking up the shunt capacitance is that the sum of the individual resonator capacitances must add up to the calculated C_0 , ($\sum C_i = C_0$). The breakup is arbitrary but should be done so that realizable $\Delta f/f_r$ ratios result.

Only one resonator appears in each arm and all of the capacitance is associated with that resonator. The specifications for the resonators in the two arms then become:

Arm	Capacitance	$\Delta f/f$ Ratio
a	314 pf	6.15 percent
b	384 pf	4.98 percent

These are well within the limits of available ceramic resonator parameter values.

Step 8. Convert the lattice into a more convenient form.

Equivalences, Fig. 3A and 3B, are used to derive the more convenient form, Fig. 3C. The form of the filter realizing the specifications of the example is shown in Fig. 4. Although the resonators are not very lossy, a critical design could take this loss into account by the usual predistortion schemes.

CERAMIC RESONATOR PARAMETERS

Parameter	Range	Typical Values for 455 Kc Resonator
Shunt Capacitance	8:1	75 pf \rightarrow 600 pf
Q	3.5:1	100 \rightarrow 1,400
$\Delta f/f_r$	24:1	0.3 \rightarrow 8 percent
f_r	150-6,000 Kc	—

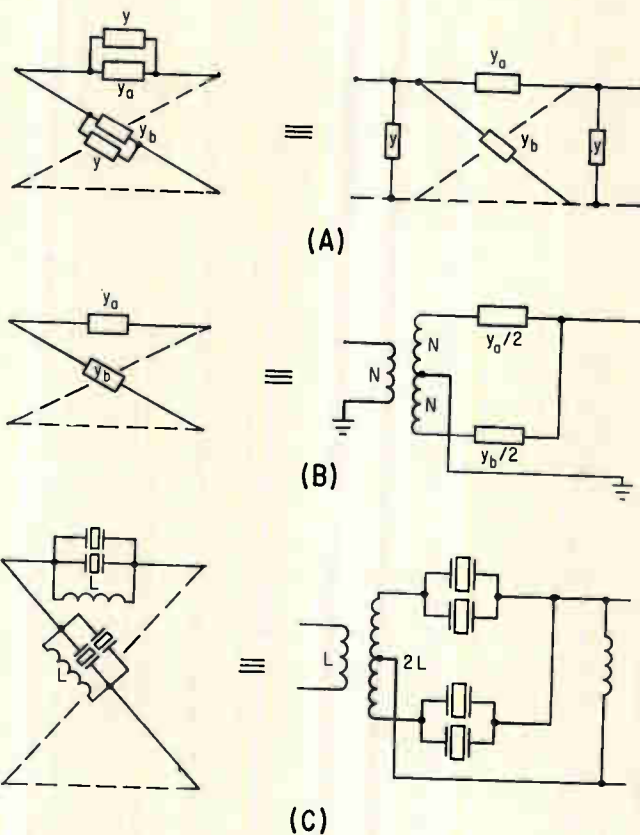

EQUIVALENTS of various lattice circuits. Forms (A) and (B) can be used to derive a more convenient form (C)—Fig. 3

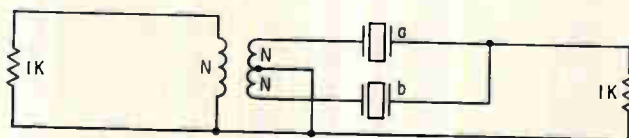

FINAL FORM of the design example realized from the specifications—Fig. 4

Getting Rid of Transients In

Major problem eliminated in frequency-shift-keyed oscillator circuit by keeping frequency-shifting reactance and oscillator tank at the same potential

By N. C. HEKIMIAN, Page Communications Engineers, Inc., Washington, D.C.

WHEN AN OSCILLATOR is shifted in frequency by inserting a series impedance or shunt admittance, a severe transient is created. This is due to instantaneous voltages and currents within the oscillator that differ from those during steady-state operation with the new component. A capacitor keyed across an L-C oscillator tank usually has no initial charge. There is then an abrupt redistribution of charge between the new capacitor and the tank capacitor that causes large transients to develop. These transients must be removed by signal processing with filters and clippers. By eliminating transients, shaping, filtering and clipping circuits can be simplified, resulting in greater reliability and economy. Also, the necessity of taking corrective steps is eliminated by preventing transients from occurring at all.

Here is a way to eliminate transients by causing the voltage across a frequency-shifting reactance to be essentially the same as the tank voltage at all times; even when that

RELIABILITY AND ECONOMY

Here is a circuit that offers a high degree of reliability and simplifies design of frequency-shift keying generators by eliminating the need for clipping and filtering circuits following the oscillator.

This approach shows how to remove transients in an oscillator rather than suggesting preventive measures to be added after transients have been generated

reactance is not used to cause a frequency shift.

CIRCUIT OPERATION—A typical circuit in which the frequency-shifting reactance is a capacitor is shown in Fig. 1. Inductor L and capacitor C_1 resonate at the higher of two operating frequencies. Capacitor C_2 is in parallel with C_1 , through the action of switch S_1 , causing a shift to the lower operating frequency. Amplifier A has a gain near unity, high input impedance and low output impedance.

It provides ample current gain but unity voltage gain. With current gain β , the effective capacitance of the combination of amplifier A and capacitor C_2 is C_2/β , which is much smaller than the capacitance of C_2 itself. When switch S_1 is closed, the amplifier is disabled and the capacitance across the tank is C_2 itself; thus, the capacitance across the tank is greatly increased. There is no significant switching transient since capacitor C_2 has the same voltage as the tank at all times.

In a transistor circuit, a push-pull complementary emitter-follower can be used as amplifier A as shown in Fig. 2. The current gain is designated either β_2 or β_3 , depending on which of the transistors is conducting. When the tank swings negative, Q_2 conducts and when it is positive Q_3 takes over. In either case, the peak current is about ± 1 ma. No d-c return is ever required for a push-pull emitter-follower output; hence, there is little degradation of the Q of the tank.

Only one switch pole is needed, since shorting the emitter to the base of either transistor completely disables it. Keying can also be accomplished electronically by gating the collector supplies of the transistors. This can easily be done due to the low peak collector currents of ± 1 ma.

It is possible to introduce variations of the circuit that will improve its operation even more. Transistors Q_2 and Q_3 can be replaced by Darlington compounded emitter-followers to attain gains closer to unity. There are several other types of amplifiers and oscillator variations that are possible.

However, if the amplifier output

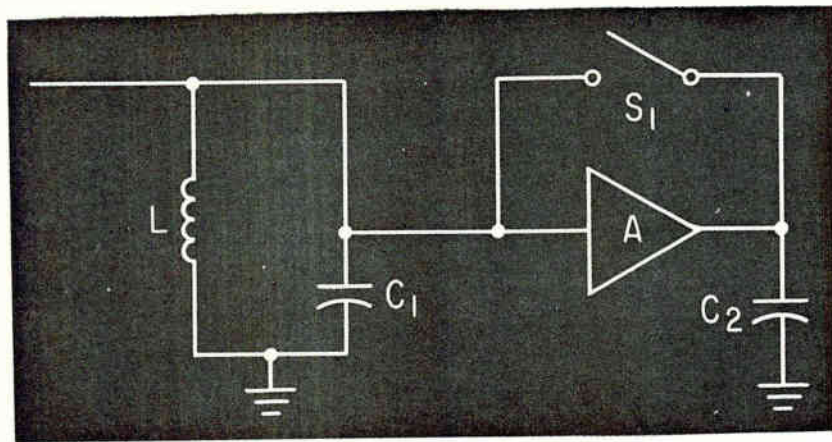

CAPACITOR is frequency-shift reactance in typical circuit—Fig. 1

Frequency-Shift Keying

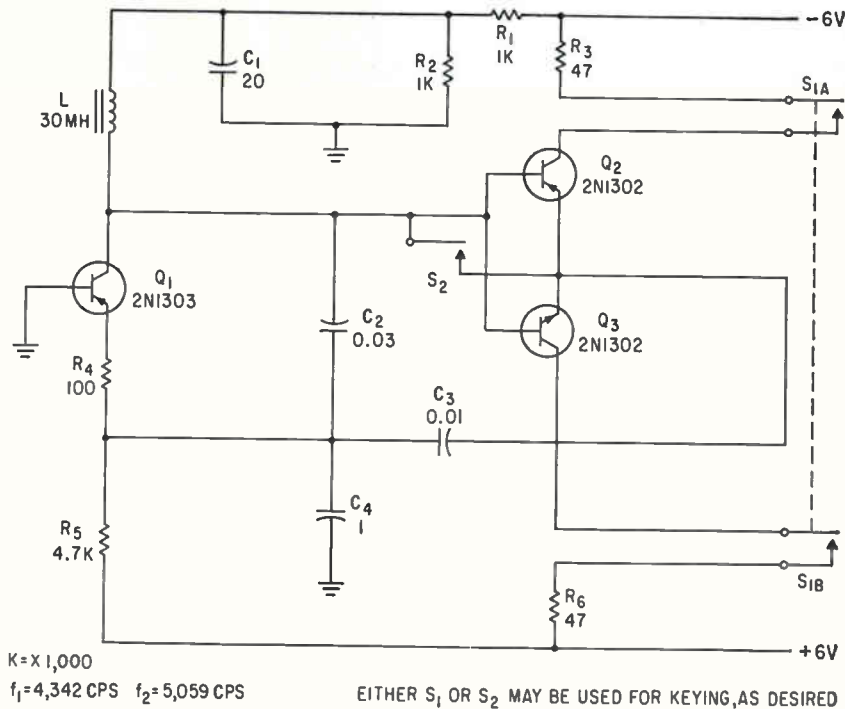

PUSH-PULL emitter-follower used as amplifier—Fig. 2

impedance is not greatly increased by switching capacitor C_s directly across the tank, heavy damping and reduced oscillator feedback will occur. As a result, the oscillations can stop. If the effective series resistance of the amplifier is too high, the series combination of this resistance and capacitor C_s will lower the effective Q of the tank.

Figures 3A and 3B show the absence of transients during keying. The slight steps in amplitude are desirable to identify the keying apparatus. If otherwise objectionable, these can be eliminated by balancing the impedances of the tank at the two resonant frequencies. Figure 3A shows the waveforms of voltages in the circuit of Fig. 2. The voltage waveforms of a circuit that operates at a considerably higher frequency are shown in Fig. 3B. The advantages of the technique are even more evident for the higher frequency circuit.

TYPICAL DESIGN PROCEDURE
 —With a Q of 10 and a resonant impedance of 10,000 ohms at about

5 Kc, $X_L = 10,000/Q = 1,000$ ohms; $L \cong 24$ mh. For resonance $C \cong 0.027 \mu f = C_s$. Since the shift has been chosen as 1 Kc, the shifting capacitance is $\Delta C/C = 2\Delta f/f = 2(1/3) \therefore \Delta C \cong 0.01 \mu f = C_s$. For a feedback ratio of 5:1 use $C_4 = 1.0$. The collector supply for the Colpitts oscillator transistor Q_1 is set to half or less of the supply for the pair Q_2, Q_3 . This is done to limit the input swing to emitter-followers Q_2 and Q_3 . Emitter resistor R_4 is added to the oscillator to improve the waveform.

Switching can be accomplished as shown or by gating the collector supplies of transistors Q_2 and Q_3 . Since the peak collector currents are simply the peak currents through C_s , these currents are given by $i_{peak} = 3V/XC_s = 2\pi fC \times 3 = 2\pi \times 6 \times 10^3 \times 0.01 \times 10^{-6} \times 3$. The keying can be accomplished electronically if desired.

This work was begun while the author was employed by the Department of Defense and the initial development was sponsored by that agency.

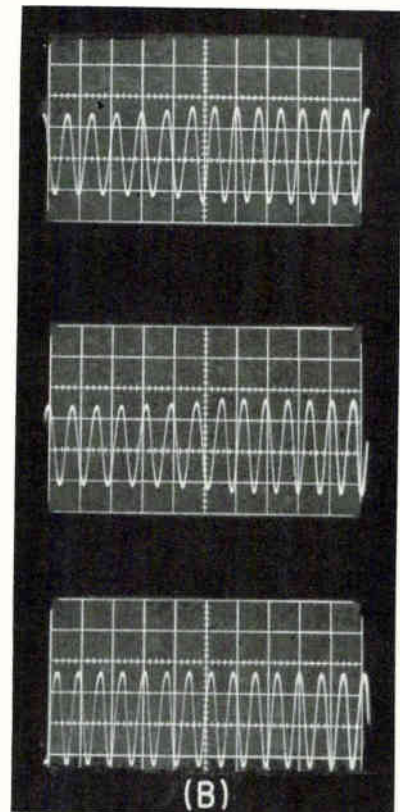
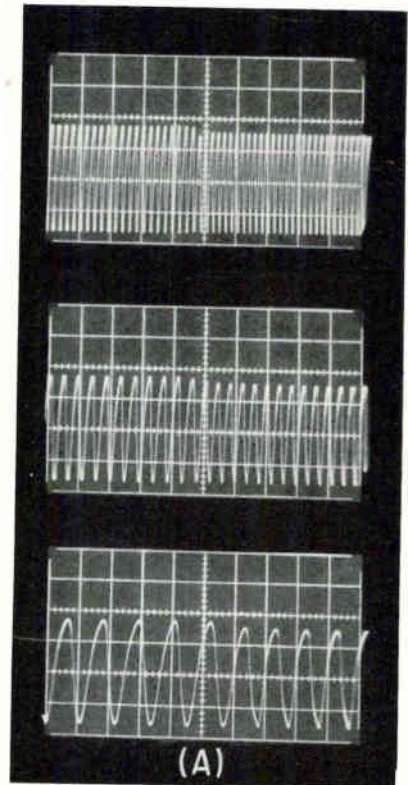

OSCILLOSCOPE PRESENTATIONS of voltage waveforms for circuit in Fig. 2 (A) and waveforms for a higher frequency circuit (B)—Fig. 3

GLASS DIGITAL Delay Lines: New

Delay lines using time-invariant glass as the delay medium combine the high-frequency

ULTRASONIC lines, the delay medium used in early computers, were generally mercury lines and the information bits consisted of r-f bursts between 10 to 30 Mc. Transducers were usually quartz crystals. These lines had a time-delay variation with temperature and needed complicated driving and detection circuits.

The use of mercury lines was abandoned after the development of the core memory. Recently, work in delay-line memories has concentrated on magnetostrictive lines. These devices operate with short video pulses, eliminating the need for a carrier. The delay medium is a metal wire that can be made almost time invariant with temperature. But the upper frequency of operation is generally limited to about 2 Mc in the nrz (non-return to zero) mode and the lines are sensitive to vibration and moisture.

A new generation of delay lines has been developed combining the high-frequency action of the mercury line with the video response and time stability of the wire lines. These devices use time-invariant glass as a delay medium

WHAT IS A DIGITAL DELAY LINE?

Digital delay lines operate on d-c pulses, while delay lines designed for r-f applications are excited with either r-f pulses or c-w signals. Because of the much greater percentage bandwidth required to transmit d-c pulses faithfully, phase and amplitude distortion of digital delay lines are held to a minimum. Digital delay lines are used as storage devices in memories and buffers by feeding back the electrical signal from the output of the delay line to its input. Any pulse or train of pulses can be recirculated until the data is required elsewhere in the computer system.

and either quartz or ceramic transducers.

DIGITAL ULTRASONIC LINES—Glass digital delay lines can be operated at frequencies from 2.5 to 30 Mc or higher. Due to this high-frequency operation, access time of an ultrasonic line is up to 15 times

smaller than a high-speed magnetostrictive line of comparable storage. Maximum bit storage in the rz (return to zero) mode is presently 4,000 bits for lines using zero-temperature-coefficient glass. Larger bit capacities are possible on lines using fused silica as the delay medium. The acoustic attenuation coefficient of fused silica is 1/20 to 1/40 that of zero-temperature-coefficient glass, allowing faster data rates and longer time delays. Delay lines storing as high as 20,000 bits have been made in the laboratory.

Digital delay lines usually take one of two forms, a flat plate of glass packaged in a metallic or epoxy case, or a rod of glass with mounting brackets and coated for physical protection.

Rod lines are limited in time delay because the velocity of sound in zero-temperature-coefficient glass is approximately 0.1 inch per 1 μ sec. Any line above 100 μ sec is inconveniently long. Temperature-invariant lines of the plate type with delays up to 200 μ sec are generally packaged in cases approximately 4 inches square or smaller

TYPICAL delay line is fused silica or glass with zero nominal temperature coefficient of time delay. Waveforms show storage capacity of 250 bits at 2.5 Mc

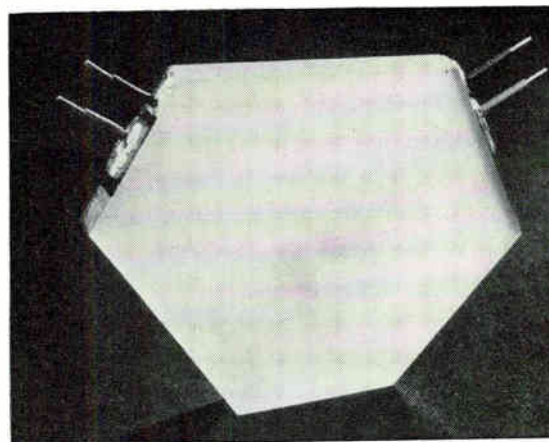

Computer Component

By DELAY LINE ENGINEERING GROUP
Corning Glass Works, Bradford Pa.

action of a mercury line with the video response and time stability of wire lines

and 0.5-inch thick. Fused silica lines are usually much larger because of the greater bit storage and the possible requirement for temperature control.

In general, solid ultrasonic delay lines have an extremely simple construction and can be produced very economically.

APPLICATIONS—Digital delay lines can be used either for main memories or as buffers. Their resistance to vibration makes them ideal for military applications, especially as memories in guidance computers. Other applications include deltic data processors and one-word memories. Glass digital delay lines have been used successfully as replacements for cores, drums and magnetostrictive lines.

DEFINITIONS—

Delay time: Delay time of a digital delay line is equal to the total path or length of the beam divided by the velocity of sound in the delay line blank. Figure 1 shows the configuration of a typical delay line while Table I gives velocities for three glass delay media.

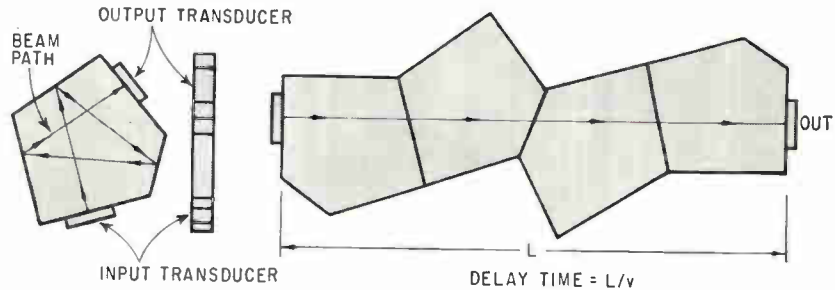

DELAY TIME is equal to total path or length of beam divided by the velocity of sound in the media—Fig. 1

Delay time tolerance: Table II illustrates the grinding tolerance required to achieve a given delay-time tolerance on fused silica and zero t-c (temperature-coefficient) blanks of various reflection schemes. In addition to grinding tolerances, time delay tolerance is affected by velocity variation in the zero t-c glasses. Velocity variation in fused silica is also present but to a lesser degree.

Time delay stability: Plots of the variation of t-c and time delay for 100- μ sec lines made from code 8875 and code 8877 glasses are given in Fig. 2A. A plot of a line made from code 7940 fused silica is

shown for comparison. The equations for the calculation of delay-time change with temperature are Code 8875—delay variation (μ sec) $= (3 \times 10^{-5}) (\text{delay time}) (T - 25C)^2$. Code 8877—delay variation (μ sec) $= (5.5 \times 10^{-3}) (\text{delay time}) (T - 25C)^2$.

The coefficients important to delay-time stability of digital delay lines are listed in Table III.

Figure 2B shows the temperature control required to hold a fused silica line to within ± 1 bit at various delay times and frequencies.

BIT FREQUENCY—The bit capacity of a digital delay line is the

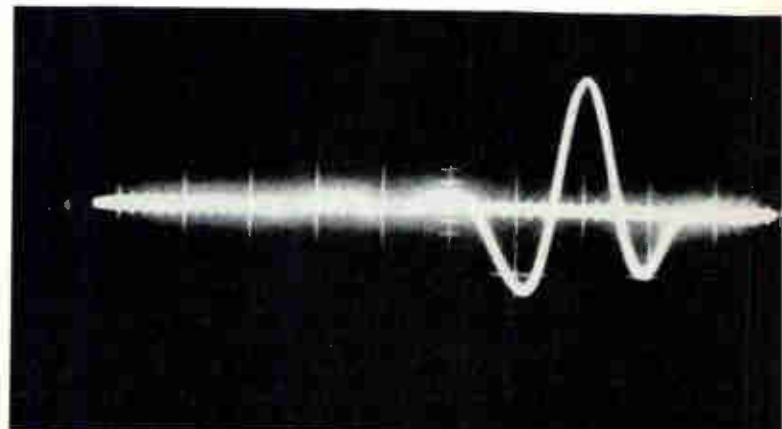
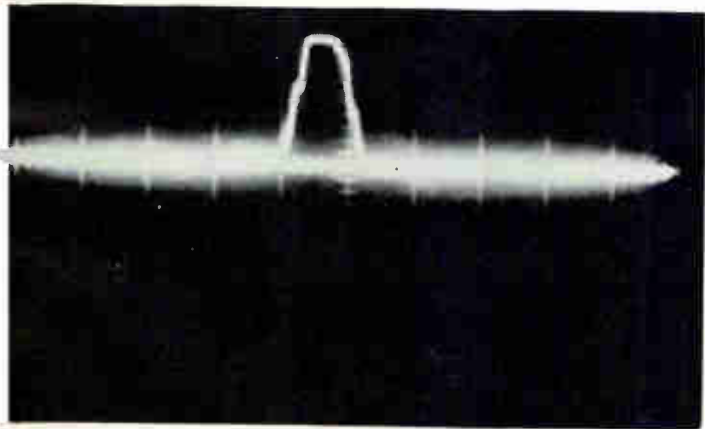

product of the delay time and the data rate. Generally, the maximum data rate is considered to be equal to the peak frequency of the line when the line is operated in the rz

mode. The peak frequency of the line is the frequency at which the attenuation in the line is minimum. This peak is determined by the frequency response of the transducer

pair and the medium loss variation with frequency. Since the medium loss increases with frequency, peak frequency of a delay line is below the resonant frequency of the transducer pair. The lines can be used in nrz systems if conversion circuits at the output are employed. This effect doubles the bit capacity of the delay line.

Most of the signal loss in the medium is due to absorption of the signal by the glass. A smaller amount of the loss is due to spreading of the acoustic beam. The loss constants for absorption in the glass are given in Table IV. The loss constant for fused silica is so low that it rarely is the limiting factor in the maximum capacity of a digital line. The maximum frequency as a function of delay time for the two zero t-c glasses is given in Fig. 2C.

ATTENUATION — Figure 3A shows the digital attenuation of a quartz crystal transducer pair as a function of end cell capacitance, transducer frequency and crystal cut. A fourth variable, terminal resistance, is not included.

The attenuation of a digital delay line cannot be determined directly from this graph because it does not take into consideration losses due to signal absorption in the glass, beam spread and operation off crystal resonant frequency.

Losses due to absorption by the delay medium can be calculated from the loss constants given in Table IV. This loss varies with temperature as listed in Table V. The loss due to the spreading of the

DESIGN EXAMPLE—Given the value of the time delay, a graph such as Fig. 2A shows whether the change in time delay over the operating temperature range is within some acceptable amount. Often a change is permissible up to $\frac{1}{4}$ pulse width or $\frac{1}{4}$ bit. For example, a 200 μ sec line made of code 8875 glass experiences a nominal change in delay of four nanoseconds (4×10^{-9} seconds) over commercial temperature ambients of 0 to 50C. Therefore, if a $\frac{1}{4}$ bit change can be permitted, pulse widths of 16 μ sec can be handled. This is comparable to a square-wave frequency of 30 Mc.

However, Fig. 2C shows that the maximum possible operating frequency for a 200 μ sec line is only about 15 Mc. A practical maximum is 10 Mc when the effect of transducer capacitance and terminal impedance is taken into account. This means that the duration of the input pulse should be approximately 50 μ sec to obtain the performance indicated in Fig. 5. A 4- μ sec change with temperature is then considerably less than $\frac{1}{4}$ bit.

Figure 2C is based on 60-Mc transducer, and if the line must run at 5 Mc (100- μ sec pulse width) then lower frequency transducers would have to be used to reduce the peak frequency of the delay line if time delay is to be the same. The crystal frequency is chosen

primarily from experience, but it is possible to repeat Fig. 2C for lower-frequency transducers and refer to each graph for combinations of pulse width and time delay.

Minimum size of transducer is usually determined by beam spreading. Experiments indicate the size, but rules of thumb are helpful such as $L^2 = [(TD) V_s^2] / [10^{12} f]$ where L is the width of the transducer, f is the operating frequency in Mc, TD is the time delay in μ sec, and V_s is the velocity of sound in the glass.

Choosing the minimum size transducer reduces the overall size of the delay line and reduces the transducer capacitance that loads the driver and post-amplifier. For a particular size, the capacitance can be computed and the attenuation of the transducer pair can be obtained from Fig. 3A. A 200 μ sec line operating at 10 Mc uses 60 Mc transducers approximately 0.23-inch square in area. For AC-cut transducers, the attenuation is approximately 57 db as determined by the intersection of the horizontal line marked 100 pF with the vertical line marked 10 Mc.

Accounting for glass loss—using the constants in Table IV—the attenuation is $57 + 6 \times 10^{-3} \times 200 \times 10 = 69$ db.

If any single characteristic is objectionable, changes can be made in the transducer area and frequency.

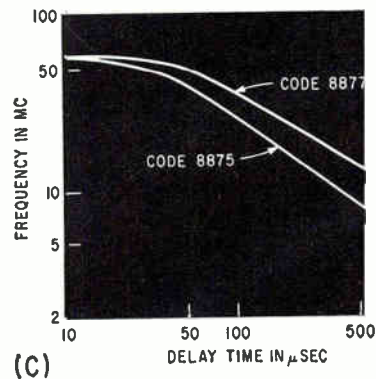
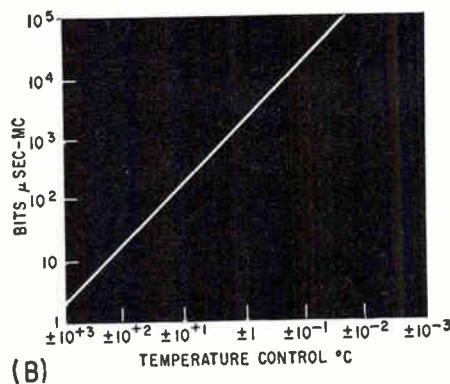
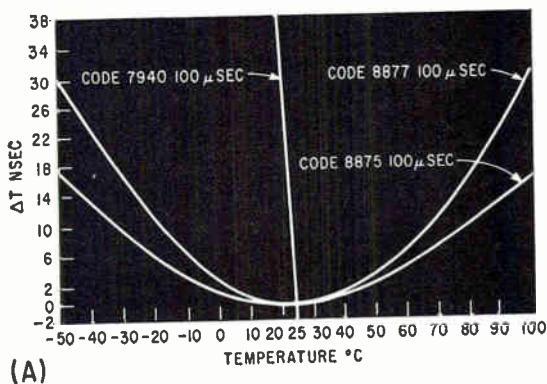

DELAY time change with temperature (A), temperature control against bit capacity for fused silica to keep time delay variation at $\frac{1}{4}$ bit (B) and maximum frequency against delay time and glass type (C)—Fig. 2

acoustic beam is difficult to calculate since it is a complex function of the length of the line, the length of the transducer and the frequency. However, this loss will be less than 6 db. For lines operated above 10 Mc the loss amounts to only one or two db.

The shape of the frequency response of a transducer pair is drawn in Fig. 3B. The increasing loss with frequency due to signal loss in the glass will bring the peak response of the line below the resonant frequency of the transducer pair. The loss due to operation off the resonant point of the transducer pair can be found directly from the graph if the ratio of the peak frequency to the transducer resonant frequency is known. A line will peak at the frequency at which the glass-loss slope is equal and opposite to the transducer response slope as illustrated in Fig. 3C.

The main signal attenuation of a digital delay line into a resistive load of 50 ohms can be calculated from the graphs and formulas. This is based on a known equivalent circuit for quartz transducer. The equivalent circuit of a delay line with matched input and output transducer is shown in Fig. 4.

Typical values might be $C = 65 \pm 5$ pf, $R_s = 10,000$ ohms, $R_L = 50$ ohms and frequency = 20 Mc.

At the output, this delay line looks like a constant-current generator, so increasing R increases the voltage output of the line until $X_c \ll R_L$. The attenuation of a digital line with a quartz trans-

TABLE I—VELOCITIES OF DELAY LINE GLASSES

$v = 0.0985$ in./ μ sec for code 8875 zero t-c glass
 $v = 0.1080$ in./ μ sec for code 8877 zero t-c glass
 $v = 0.1182$ in./ μ sec for code 7910 fused silica

TABLE II—GRINDING TOLERANCE VS DELAY TIME TOLERANCE
 Grinding Tolerance Each Facet in Mils, Disregarding Tolerance on Transducer Facets

Time Delay Tolerance in nsec	Fused Silica No. of Reflections				Zero T-C Glass (8875) No. of Reflections			
	1	5	10	20	1	5	10	20
± 1	± 0.075	± 0.014	± 0.0075	± 0.0037	± 0.05	± 0.01	± 0.005	± 0.0025
± 5	± 0.37	± 0.075	± 0.037	± 0.0185	± 0.25	± 0.05	± 0.025	± 0.0125
± 10	± 0.75	± 0.14	± 0.075	± 0.037	± 0.5	± 0.1	± 0.05	± 0.025
± 20	± 1.5	± 0.295	± 0.15	± 0.075	± 1.0	± 0.2	± 0.10	± 0.05
± 30	± 2.2	± 0.445	± 0.22	± 0.11	± 1.5	± 0.3	± 0.15	± 0.075
± 50	± 3.7	± 0.75	± 0.37	± 0.185	± 2.5	± 0.5	± 0.25	± 0.125
± 100	± 7.5	± 1.4	± 0.75	± 0.37	± 5.0	± 1.0	± 0.5	± 0.25

TABLE III—DELAY TIME STABILITY COEFFICIENTS

	Code 8875	Code 8877	Code 7910
Temp Coeff of Time Delay	0 ± 1.0 ppm/ $^{\circ}$ C at 25 $^{\circ}$ C	0 ± 1.0 ppm/ $^{\circ}$ C at 25 $^{\circ}$ C	-81.5 ± 1.5 ppm/ $^{\circ}$ C
Temp Coeff Variation of Time Delay with Temp	$+0.06$ ppm/ $^{\circ}$ C ²	$+0.11$ ppm/ $^{\circ}$ C ²	$+0.07$ ppm/ $^{\circ}$ C ² approximately
Delay Time Aging	-1 part in 30,000 for life, 15 day half life, -1 part in 120,000 from time of grinding	-1 part in 15,000 for life, 15 day half life, -1 part in 60,000 from time of grinding	None ever measured

TABLE IV—ACOUSTIC LOSS CONSTANTS FOR DELAY LINE GLASSES

Code 8875	6.0×10^{-3} db/ μ sec-Mc
Code 8877	4.0×10^{-3} db/ μ sec-Mc
Code 7910	0.15×10^{-3} db/ μ sec-Mc

TABLE V—VARIATION OF GLASS LOSS WITH CHANGE IN TEMPERATURE

Code 8875	-0.3% / $^{\circ}$ C approx.
Code 8877	-0.3% / $^{\circ}$ C approx.
Code 7910	-5 to -10% / $^{\circ}$ C

TABLE VI DELAY LINE TRANSDUCER MATERIAL CHARACTERISTICS

Material	Coupling Coefficient	Dielectric Constant
Ceramic	0.66	870
Quartz, Y cut	0.142	4.58

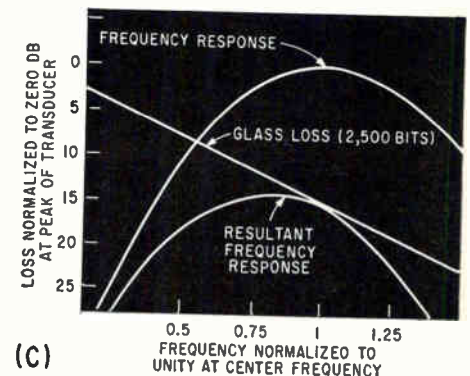
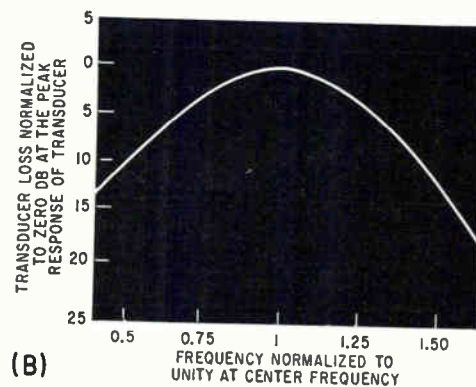
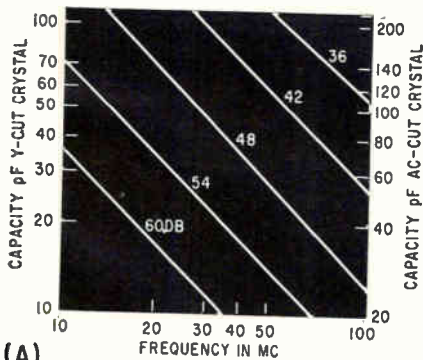

MAIN signal attenuation into 50 ohms of a transducer pair as a function of capacitance and frequency (A), transducer pair frequency response shape (B) and typical delay line frequency response (C)—Fig. 3

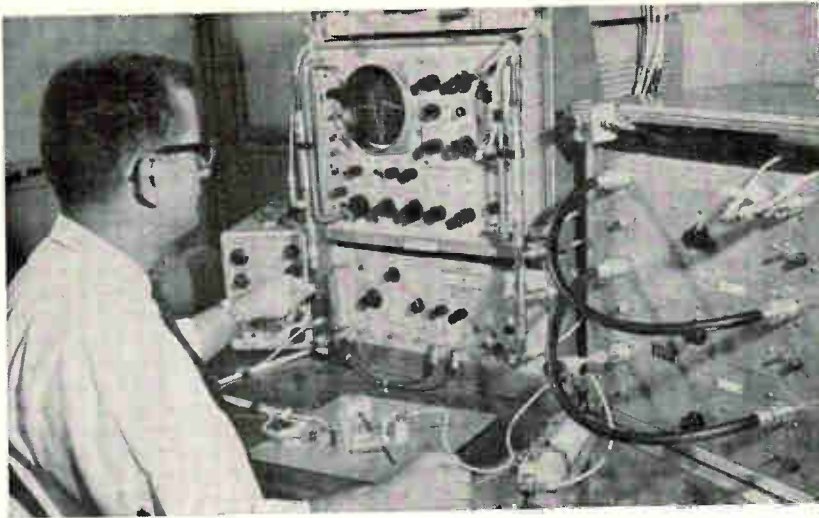

LABORATORY equipment checks output pulse response of a glass digital delay line. Tripolar waveform on cro is typical of good delay line response

ducer at the output can be reduced by operating it into a higher resistance than the conventional 50 ohms. However, this gain is offset by a loss of electrical bandwidth and an increase in the R-C time constant. An optimum R_L exists for each delay line and pulse requirement.

Attenuation in lines using ceramic transducers is much less than those using quartz transducers. The ceramic transducer differs from the quartz transducer in coupling coefficient and dielectric constant. A comparison is shown in Table VI for transducers operating in the thickness shear mode.

Since the efficiency of a transducer varies as the square of the coupling coefficient and directly as the dielectric constant, the ceramic transducer is more efficient than the quartz transducer. However, the large dielectric constant of the ceramic yields a transducer with an extremely high capacitance. In addition, the terminal resistance R_a , a measure of the energy put into the delay medium and backing material, will be several orders of magnitude lower than that of comparable quartz transducers. Typical values for a 20 Mc transducer are $C = 4,000$ pf and $R_a = 1.5$ ohms.

If the size of the transducer required is known, $C = 2,000 (Af)$ pf and $R_a = 60$ to $150/Af^2$ ohms where A is the area in square inches and f is the transducer resonant frequency in megacycles.

An average transducer might be 0.1 in². Lines with high frequency ceramic transducers will have intolerable

transducer capacitances. Proper engineering design can produce more desirable values of C and R .

Attenuation produced by a ceramic transducer delay line results from a combination of the

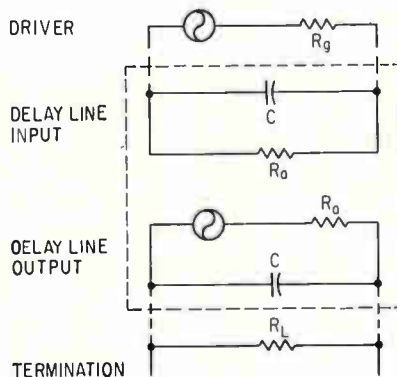

DELAY LINE equivalent circuit at transducer resonant frequency—Fig. 4

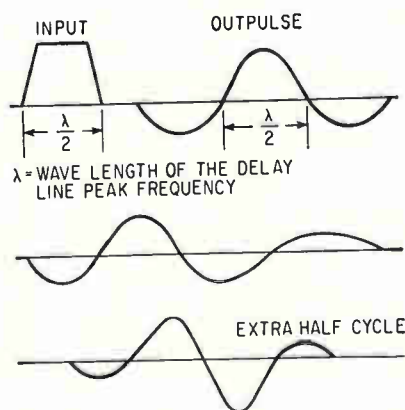

TRIPOLAR response has negative area approximately equal to positive area—Fig. 5

same factors as that of the quartz line — transducer, glass, beam spread and off-transducer resonance operation. If a transducer pair is properly terminated, its contribution to the loss of the line will be 15 to 25 db for practical lines regardless of the size or frequency of the transducer. For calculation of the loss due to operation off crystal resonance, the curve for the quartz transducer can be used to a good approximation. Actually the bandwidth runs between 50 and 65 percent of the center frequency and the curve is flatter in the center than for quartz.

RESPONSE—Response of a delay line to a unipolar pulse is a function of how well the acoustic impedances of the transducer materials and delay medium match and how well the electrical impedances of the input and output transducers match the driving and detection circuits. In general, a good digital line will have a tripolar response with the negative area of the pulse approximately equal to the positive area of the pulse as shown in Fig. 5. Pulse distortion can be experienced if the transducer materials are improperly chosen. If phase dispersion occurs in the line, pulse distortion takes the form of the middle wave. In most digital delay lines, pulse distortion takes the form of an extra half cycle on the end or beginning of the pulse or both, as shown in the bottom wave. This extra half cycle is generally the most serious spurious signal in the line and the ratio of its amplitude to the desired pulse normally defines the signal to noise ratio of the delay line.

Several glass digital ultrasonic delay lines are available each with various ranges of delay time. They use a zero t-c glass or fused silica as delay media and are equipped with ceramic or quartz transducers. One of these devices is a low-capacitance 2.5 Mc line, which is used primarily for serial arithmetics in military applications such as missile and satellite guidance systems. Another line operates at 20 Mc with a delay time as high as 167 μ sec. It is the memory in real-time controls that feature high speed logic.

Characteristics of other lines will be published.



**so smooth
so positive**
you can almost feel it...

*another common-sense reason for
choosing a 260[®] VOM*

Simpson

SIMPSON ELECTRIC COMPANY 5203 West Kinzie Street, Chicago 44, Ill.
Phone: (312) ESTebrook 9-1121

In Canada: **Bach-Simpson Ltd.**, London, Ontario
Representatives in Principal Cities... See Telephone Yellow Pages

Reading after reading, the pointer sweeps directly to its destination. No hesitation. No faltering. No indecision. No need to tap the window just to make sure. The 260 lets you concentrate on the test... not on the "tools."

Some people say this is due to the fine Simpson meter. Others say this is due to the component choice. Still others to circuit design. Actually it's all of these factors blended together by Simpson specialists in the design and manufacture of volt-ohm-milliammeters—expert engineers and production technicians whose judgment is backed by experience with over a million 260's.

So whenever you need a VOM, the logical choice is a Simpson 260. Call your Electronic Distributor. He stocks them in quantity. **\$4895**

complete

NEW USES FOR MICROPHONES

Traditionally, microphones have been used to pick up speech or music. The missile industry, however, uses them as pressure gages as well. Here a problem has appeared: what is the reference level for gain calculations? Everyone uses decibels, but there are at least two reference levels in common use. This chart helps the engineer carry out calculations at different levels easily and rapidly

Microphone

Calculations for the Space Age

By D. ABRAMS, Chief Engineer, Instrumentation Division, Gulton Industries, Inc., Metuchen, New Jersey

MICROPHONE sensitivities are usually specified in db below 1 v/ μ bar, while sound pressures levels (spl) are specified in db above 0.0002 dyne/cm². The equations relating sound level, sensitivity, and output voltage are simple; the calculations, however, are time consuming.

This nomograph helps to determine quickly the output voltage from sensitivity and spl. Also included is a chart of sound pressure in db reference (ref) 0.0002 dyne/cm² and pressure in dynes/cm² and psi.

Example 1. Microphone sensitivity, -95 db (ref: 1 v/ μ bar). Determine output voltage at spl of 130 db (ref: 0.0002 dyne/cm²).

Solution: draw a line between -95 in column A

and 130 in column C and read microphone output voltage in column B or 12 mv.

Example 2. Microphone output 2.5 mv at spl of 120 db (ref: 0.0002 dyne/cm²). Determine microphone sensitivity (ref: 1 v/ μ bar).

Solution: draw a line between 0.0025 in column B and 120 in column C and extend the line to column A; read the microphone sensitivity in column A or -99 db (ref: 1 v/ μ bar).

Example 3. A minimum signal of 0.01 volt is required from a microphone at 140 db spl (ref: 0.0002 dyne/cm²). Determine the minimum sensitivity in db (ref: 1 v/ μ bar) that can be used.

Solution: (1) draw a line between 0.01 in column B and 140 in column C and extend the line to column A; (2) read the minimum microphone sensitivity in column A or -106 db (ref: 1 v/ μ bar).

The actual spl in psi or dynes/cm² is determined by reading the psi value, in column D, or the dynes/cm², in column E, directly opposite the db value in column C.

USEFUL HINTS—For microphone sensitivities given in db below 1 v/ μ bar the output voltage will be x -db below 1 volt when the microphone is subjected to a 1- μ bar spl. Since 1 μ bar is equal to 1 dyne/cm² (74 db above 0.0002 dyne/cm²) the output voltage will be x -db below 1 volt when the microphone is subjected to spl of 74 db (ref: 0.0002 dyne/cm²).

The spl at which the output of any microphone is 1 volt can then be readily determined by arithmetically adding 74 to its sensitivity in db (ref: 1 v/ μ bar). For example, a microphone having a sensitivity of -60 db will produce a 1-volt output at a sound level of 60 + 74 = 134 db (ref: 0.0002 dyne/cm²). This can be checked by drawing a line between -60 in column A and 1 in column B and extending it to column C. The value read in column C is 134.

The units for voltages and sound levels must be of the same order—that is, rms, peak or peak-to-peak.

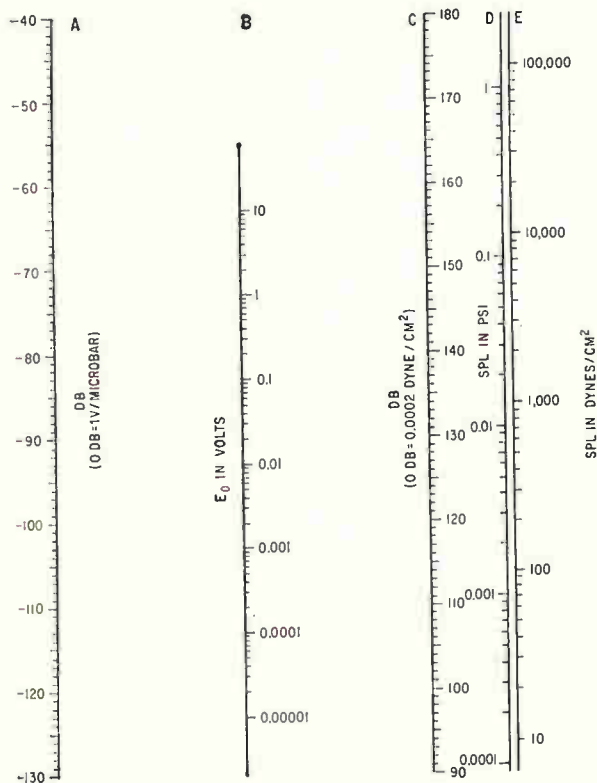

AMP set the GOLD standard!

In this AMPin-cert* Blade Connector, gold over nickel plating is standard, never an option . . . never an extra. Gold over nickel plating coupled with engineered contact pressures assure longer life, maximum performance and reliability, setting the highest standard in crimp, snap-in type printed circuit connectors. AMP research and testing have proved conclusively that gold over nickel plating is superior in every way. Crimp, snap-in type contacts are plated with .000030" gold (min.) over .000030" nickel (min.). Uniformity in plating thickness is controlled by X-ray measurement. There is no metal "creep" and no debili-

tating oxide insulation buildup. Three areas of contact are pressure engineered to avoid excessive or quick plating wear.

Another bonus feature is that AMPin-cert Printed Circuit Connectors are not pre-loaded. They can be loaded to accommodate only those circuits actually required. You buy and use only the receptacle contacts you need.

ADDITIONAL FEATURES:

- Encapsulated male tabs prevent misalignment of contacts
- Staked down male tab housing eliminates board warpage
- Guide pins assure positive mating of connector halves
- Raised barrier section and large contact cavities avoid moisture entrapment
- Built-in egg crate construction, and crimp snap-in receptacle contacts eliminate sleeving and soldering.

Why not insure your own standard of quality and reliability by using AMPin-cert Printed Circuit Connectors. You'll find they exceed the most stringent applicable requirements both military and commercial.

Send for more information and a free copy of "A Compilation of Papers published on AMP Research Activities in the Field of Plating."

*Trademark of AMP Incorporated



The image shows a close-up of an AMP Blade Connector and its corresponding Receptacle. The connector is a grey plastic housing with a series of gold-plated contacts protruding from one side. The receptacle is a larger, rectangular metal component with a grid of contact points. The background is dark, highlighting the components.

AMP
INCORPORATED
Harrisburg, Pennsylvania

AMP products and engineering assistance are available through subsidiary companies in: Australia • Canada • England • France • Holland • Italy • Japan • Mexico • West Germany

November 9, 1962

CIRCLE 67 ON READER SERVICE CARD

67

Sigma Series 32 and 33 polarized relays are performing dependably in tens of thousands of circuits, where minimum power drain and maximum environmental stability are mandatory / No other crystal can relays available today duplicate their performance.

In over three years of volume production, Series 32 and 33 relays have been repeatedly and successfully applied in a variety of major space vehicle and control system applications ■ The Series 32 is a polarized single- or dual-coil magnetic latcher with standard sensitivity of 50 mw, conservatively rated vibration immunity of 30 g to 5000 cycles, shock and constant acceleration of 100 g, the ability to operate positively on slowly changing signals or momentary pulses, and the "fail-safe" and "no stand-by power" benefits of permanent magnetic latching ■ The Series 33 is a polarized magnetically-biased relay with the same vibration immunity, designed for energization on 100 mw signals. Both relays have hermetically sealed, 0.80" x 0.40" x 0.90" cases, two-tenths grid-spaced connections, and a choice of 12 combinations of mounting and terminal styles. Complete specifications and application engineering from Sigma Division, Sigma Instruments, Inc., Dept. 62, Braintree 84, Mass.

SIGMA
Division of Sigma Instruments, Inc.

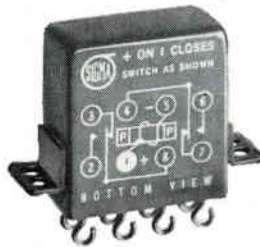

sensitive . . . stable . . . successful



How to stop voltage transients and diode failures

Any circuit that is switched can generate high voltage spikes of harmful amplitude to semiconductor devices. Sarkes Tarzian voltage transient suppressors (Klipvolts) offer an economical, efficient solution.

One recurrent problem that suppressors solve is encountered when switching is at the primary of a transformer. Magnetizing currents are interrupted, causing a voltage spike many times the steady state value of secondary voltage. The result is failure of voltage sensitive devices in the circuit.

Transient voltage spikes of very short time duration often

escape detection by instruments of normal sensitivity. Spikes occurring in control circuits where oscillation or "ringing" can occur are also hard to find. These transients can often be the reason for circuit problems that seem to have no obvious cause.

Standard Tarzian suppressors can handle discharge currents as high as 430 amperes (43,000 ampere load current in a three-phase circuit). Special types can be custom-designed for any practical rating. The diagrams shown here represent actual applications in which Klipvolt suppressors have been used. Your circuit is probably well within their wide range of application.

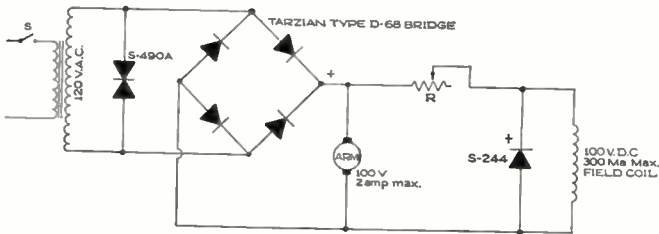

Transient Voltages in Motor Speed Control Rectifier (Fig. 1)

Problem: D-68 bridge rectifier assembly with 400V diodes is used to supply DC to controlled speed DC motor. Switching is accomplished at primary of an isolation transformer. Random switching causes intermittent rectifier failures. Tests show transients to 600V without suppression.

Solution: Use S-490A non-polarized Klipvolt across transformer secondary. Use S-244 Klipvolt across the motor field coil to limit transient spikes to less than 150V.

Result: Rectifier failure eliminated.

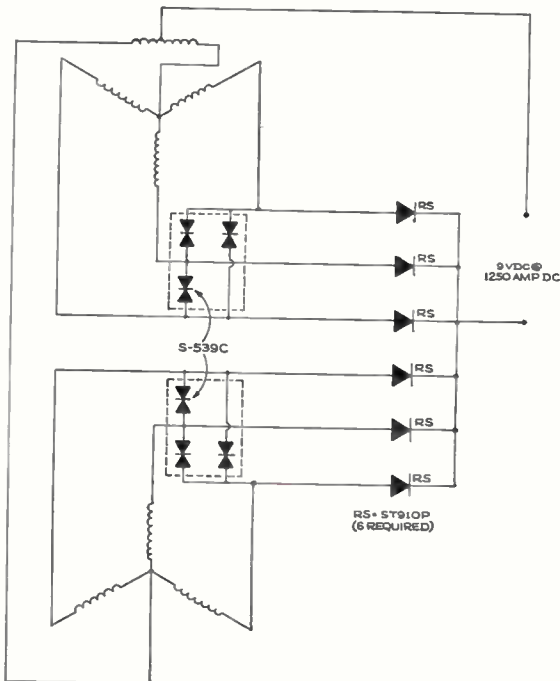

Voltage Transients in Electroplater (Fig. 2)

Problem: Three-phase center tap and six-phase star connections causing transient voltages several times the steady state peak value at the secondary...in excess of 200V.

Solution: Connect an S-539C suppressor across the secondary to reduce transients to below 100V. Use 100 PIV rated diodes instead of 300 PIV ratings.

Result: Substantial cost saving on heavy current diodes.

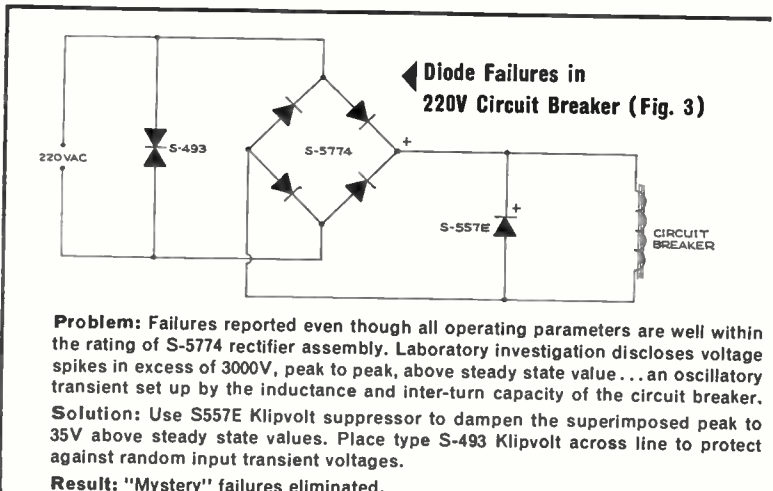

Diode Failures in 220V Circuit Breaker (Fig. 3)

Problem: Failures reported even though all operating parameters are well within the rating of S-5774 rectifier assembly. Laboratory investigation discloses voltage spikes in excess of 3000V, peak to peak, above steady state value...an oscillatory transient set up by the inductance and inter-turn capacity of the circuit breaker.

Solution: Use S557E Klipvolt suppressor to dampen the superimposed peak to 35V above steady state values. Place type S-493 Klipvolt across line to protect against random input transient voltages.

Result: "Mystery" failures eliminated.

TYPICAL TARZIAN KLIPVOLT SUPPRESSORS

POLARIZED				NON-POLARIZED			
Type	Max DC Volts	Max PIV	Peak Dischg. Amperes	Type	Max RMS Volts	Max PIV	Peak Dischg. Amperes
S-550	27	45	5.5	Single Phase	S-487	35	50
S-550L	27	45	430		S-490A	140	200
S-554	135	225	5.5		S-492L	210	300
S-554L	135	225	430		S-493	400	280
S-556	189	315	5.5		Three Phase	S-539C	50
S-556L	189	315	430	S-544L		210	300
S-557E	216	360	65				



SARKES TARZIAN, Inc.

World's Leading Manufacturers of TV and FM Tuners • Closed Circuit TV Systems • Broadcast Equipment • Air Trimmers • FM Radios • Magnetic Recording Tape • Semiconductor Devices

SEMICONDUCTOR DIVISION • BLOOMINGTON, INDIANA

Canadian Licensee: Marstrand Engineering Limited • 350 Weber Street North, Waterloo, Ontario

New Tube Shifts Phase Linearly With Current

Insertion losses in tube are low and are constant with phase shift

PHASE can be shifted linearly in either direction with an applied current in an experimental phase-shifting tube. The device, which has constant insertion loss for phase changes of more than 360 degrees, is expected to be useful in phased-array radar systems. The cyclotron-wave phase shifter was described at the National Electronics Conference in a paper by George Ryan and William Sackinger of Zenith Radio Corp.

THEORY—Structure and operating principle are similar to a low-noise, electron-beam parametric amplifier. However, the quadrupole gain section between the input and output is replaced by a phase-shifting section. The electron beam from the gun in the phase shifter in Fig. 1 passes successively through an input coupler, the phase-shifting section and an output coupling region. The parallel-

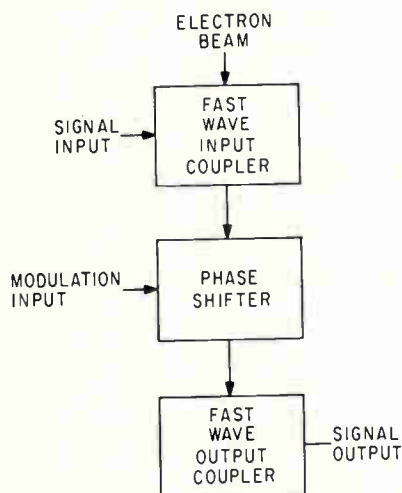

PHASE-SHIFTING region replaces quadrupole gain section of electron-beam parametric amplifier—Fig. 1

plate Cuccia-type input and output couplers produce a transverse field at signal frequency.

Applying an r-f signal at cyclotron frequency to the input coupler causes the electrons in the beam to rotate at cyclotron frequency, as shown in Fig. 2A. Because of the transverse velocities of the orbiting electrons, in the output coupler they induce currents in the load and give up their rotational energy. In this case, the electrons in the input and output couplers are in phase.

If input and cyclotron rotation frequencies are not exactly equal, electrons entering the input coupler may start synchronously with the r-f field but then rotate at cyclotron frequency. Because each electron is slightly displaced in phase from those immediately in front of or behind it, the beam pattern becomes slightly twisted as in Fig. 2B. The beam remains twisted after leaving the coupler because there are not r-f fields in the drift space. Thus phase of input and output signals are different when signal frequency differs from cyclotron frequency.

To change relative phase between the input and output signals, pitch of the spiraling beam must be changed. This pitch is linearly dependent on the difference between signal and cyclotron frequencies, and cyclotron frequency is proportional to magnetic field.

Although changing cyclotron frequency produces a phase shift, it also changes impedance of the input and output couplers. However, if a drift space is provided between the couplers, the magnetic field can be modulated only in the drift space with the couplers left in a constant field.

CONTROL COIL—In practice, a single-layer solenoid between the input and output couplers changes cyclotron frequency. The solenoid

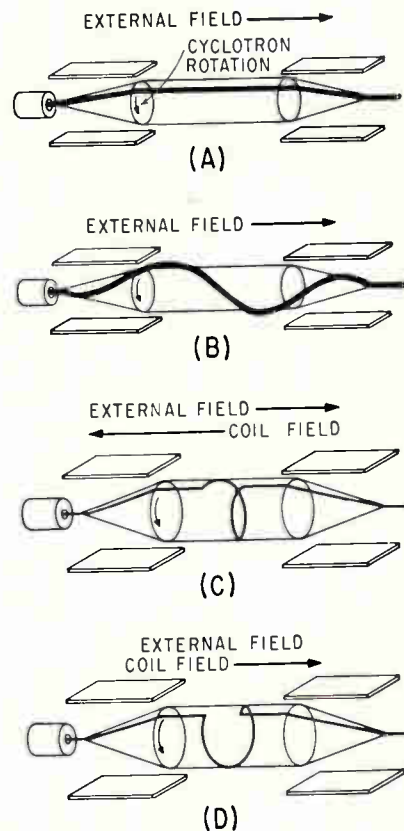

INPUT and output signals are in phase (A) when signal and cyclotron frequencies are equal, but beam is twisted (B) when they are not equal. Coil current that produces field opposite to external field (C) delays phase while current in opposite direction (D) advances phase—Fig. 2

field adds to or subtracts from the uniform externally imposed magnetic field. The change in magnetic field is directly proportional to solenoid current.

Current in the solenoid twists the center section of the beam, as in Fig. 2C and D. Polarity of the current determines whether the solenoid field is in the opposite direction from the externally applied field producing a phase delay or in the same direction producing a phase advance.

An experimental tube was made to operate at 1,300 Mc and provide

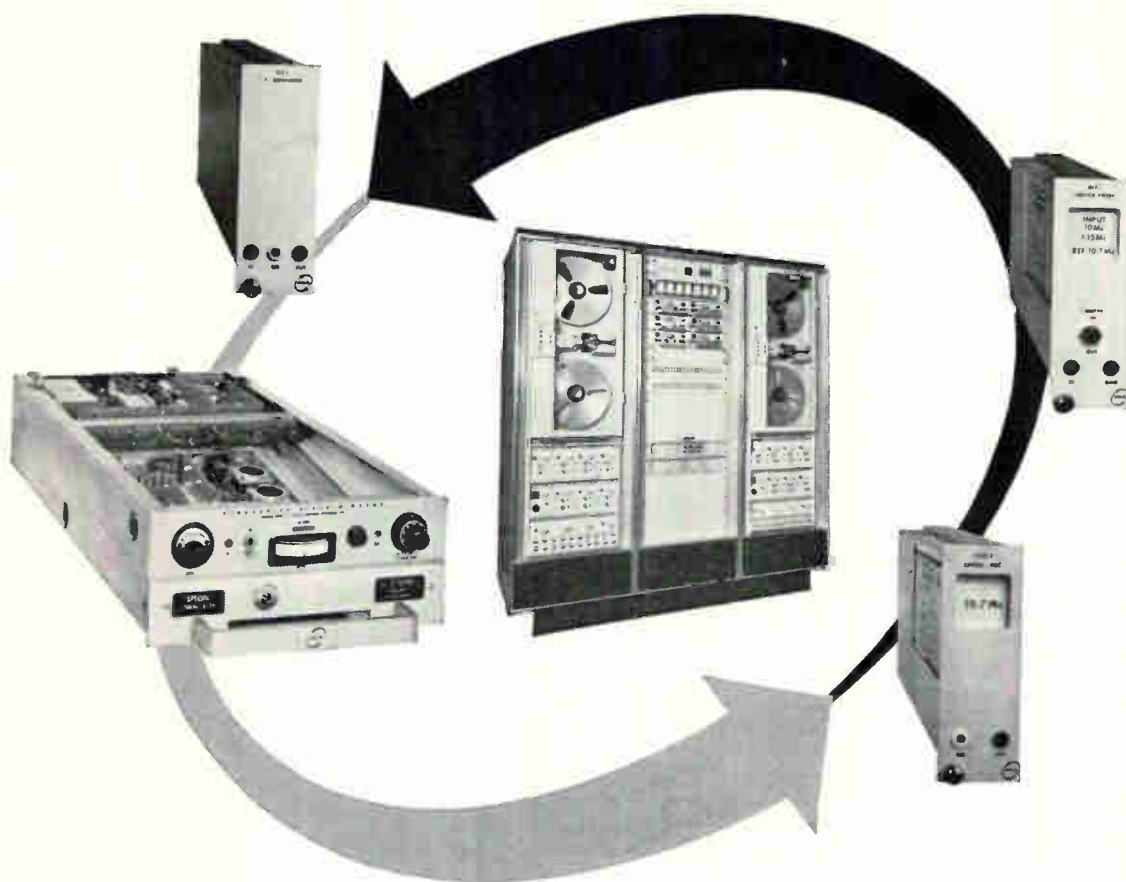

Predetection Recording by DCS gives you these 7 features:

- Best s/n performance • Best transient characteristics
- Up to 800,000 bit/second response • Tape speed compensation
- Off-the-shelf modular flexibility • 100% solid state • Usable with most receivers and recorders

Considering predetection recording? Only DCS can give you *all* these advantages:

First, the phase lock loop design of the GFD-4 Discriminator permits playback at the recorded frequency without incurring the noise and transient degradation typical of up-conversion systems. And in addition, response from DC to beyond that required for 800 Kilo-bit NRZ PCM is provided, for full IRIG requirements.

What's more, DCS has the only system providing tape speed compensation of reproduced data. Components are all solid state . . . modular (just plug 'em in!) . . . and available off the shelf.

Whether you need a complete predetection recording system, or want to build one using your present receiver and recorder (DCS components are compatible with most), DCS can help you.

Write us for complete information. Address: Dept. E-2-7.

DATA-CONTROL SYSTEMS, INC.
Instrumentation for Research

Los Angeles • Santa Clara • Wash., D. C. • Cape Canaveral

Home Office: E. Liberty St., Danbury, Conn. • Pioneer 3-9241



4 1/2 MILLION



TO WORLD MARKETS

Last year Foster Electric Co., Ltd. produced nearly 5½ million speakers in a dozen sizes—from the 1½" (4 cm.) 4B2 to the 12" (30 cm.) PW-120. Of these, fully 4½ million were exported both as components and in electrical products to the world's foremost electronics manufacturers.

A major reason for this demand is unmatched quality at popular prices. A perfect example is the 2" 5A61. This fast-selling 100 ohm speaker is ideal for use in compact portable radios and sound equipment. Its high impedance makes output transformers unnecessary, and therefore reduces space requirements, production costs, and distortion. It has a frequency range of 450 to 4,500 c/s and weighs only 1.55 ounces. Like all Foster speakers its cone is made of select kapok fiber by a patented method that assures exceptional tone quality, low resonance, and great resistance to cone break-up. 5A61 also uses Foster's own special high precision magnetic circuit.

Foster speakers are now available in production quantities for immediate delivery anywhere in the world. For details about quality Foster speakers write directly to the address below.



FOSTER ELECTRIC CO., LTD.

384 Shimo-Renjaku, Mitaka, Tokyo, Japan •
CABLE: FOSTERELECTRIC MUSASHINOMITAKA

±180 degrees phase shift. The phase-shift coil between the two couplers is made of thin copper wire wound into a 20-turn helix with an inside diameter of 0.05 inch and about 8 inch long.

In measuring phase shift using the setup in Fig. 3, the 1,300-Mc signal from the generator was split to provide one channel to the phase-shift tube and the other to a coaxial slotted line. Output of the phase-shift tube was connected to the opposite end of the slotted line. A well-defined null was found in the standing wave on the slotted line, and its position was found from the electrical length of the two signal channels. A phase change was clearly indicated by a change in the null position on the slotted line.

PERFORMANCE—Using a regulated current supply, phase shift through the tube was determined at different levels of solenoid current. In this experiment, phase shifts of ±180 degrees were obtained with coil currents of ±1.5 amperes, and the predicted linear relationship between current and phase shift was demonstrated. Greater phase shifts were also possible with a practical limit of 4 amperes coil current because magnetic field in the drift space was too low to keep the beam focused. Phase shift at 4 amperes was 470 degrees.

The measurement method used was sufficiently accurate to demonstrate the linearity of phase shift with control current from zero through more than 360 degrees.

Attenuation of signals passed through the tube was only about 1.8 db. Apparently, there is no attenuation of the signal when it has been impressed on the beam, and insertion loss results from resistance in the input and output couplers. Insertion loss in parametric amplifiers using the same type couplers is about 1 db, which can also be expected in phase shift tubes constructed in the future.

Phase shift is independent of insertion loss, and no changes in amplitude were observed even at phase shifts of 360 degrees.

Current in the small phase-shift coil can be changed quickly, and some measurements were made using a 600-Kc modulating signal

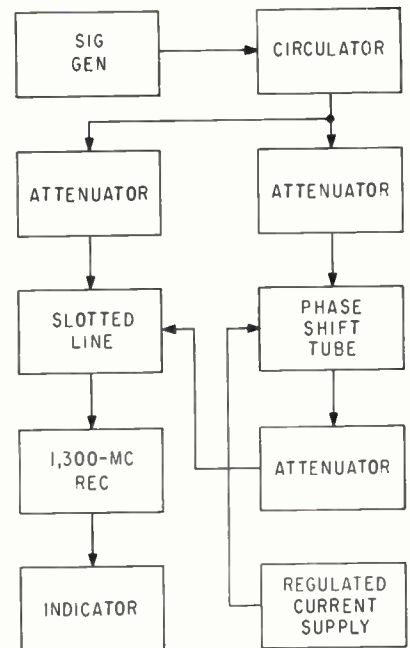

TEST setup verified that phase shift and control coil current are linearly related—Fig. 3

applied to the coil. The 1,300-Mc signal frequency was phase modulated ±1.5 Mc. Higher modulating frequencies are now being used in additional experiments to determine optimum design of future phase-shift tubes.

Providing Thermocouple Compensation at Low Cost

By PAUL J. BOUDREAUX
Physics Dept., Loyola Univ.
New Orleans, Louisiana

THERMOCOUPLE compensating circuit using a thermistor features simplicity and low cost. Mean percentage error throughout its operating range is less than 0.1 percent.

The thermocouple-compensation circuit was required for a crystal furnace being used in an undergraduate research participation program being conducted under a National Science Foundation grant. Since the furnace is operated over extended periods, use of an ice-bath to maintain a cold-junction reference temperature was inconvenient.

Basic requirements for the compensating circuit were reasonable precision and low cost. The most common of the various circuits proposed for thermocouple compensa-

tion is the Wheatstone-bridge type. However, this circuit requires materials that are relatively difficult to procure, such as pure annealed nickel wire and precision components.

The principle used in the newly designed circuit is the same as that used in compensating circuits now being produced by Consolidated Ohmic Devices, Inc. The circuit, which is shown in Fig. 1, provides compensation by adding a potential in series with thermocouple output that is a function of ambient temperature.

The values of all components except thermistor R_t do not vary appreciably with changes in ambient temperature T_0 . Thus, when the circuit operates into a potentiometer, current i is directly proportional to T_0 . For accurate compensation, the circuit must satisfy two conditions. Potential drop E_r across resistor R must equal potential E_t of a thermocouple at all temperatures from 0 to T_0 degrees C. Also, the rate of change of these two voltages must always be equal.

Under these conditions and with no current flowing in the compensating circuit except i ,

$$E_t = E_r = VR (R_t + R_c + R)^{-1} \quad (1)$$

$$\frac{dE_r}{dT} = \frac{dE_t}{dT} = \frac{-VR}{(R_t + R_c + R)^2} \frac{dR_t}{dT} \quad (2)$$

where V is battery voltage.

Within a specified temperature range, a thermocouple can be chosen having a linear output within the range. For example, Chromel-Alumel has a potential of 0.04 millivolt per degree C between 15 and 30 degrees C. Within this range, therefore, dE_t/dT is constant, and dR_t/dT is also constant for common thermistors.

The values of R and R_c are found

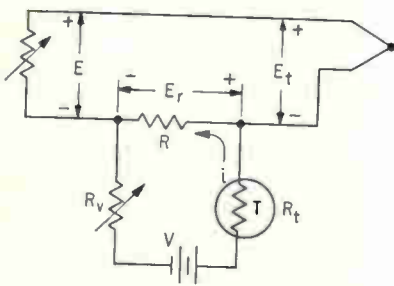

THERMISTOR varies current through resistor in series with thermocouple output to compensate ambient temperature variations—Fig. 1

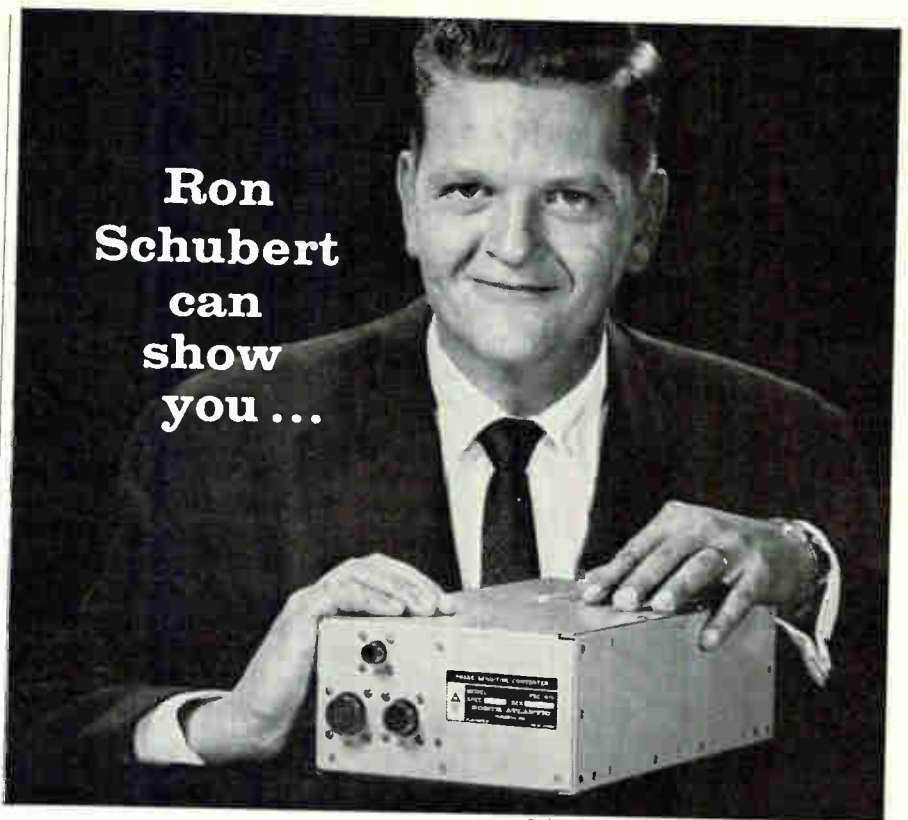

Sales Engineer, Carlson Electronic Sales

how to measure in-phase and quadrature with 0.1% accuracy—in milliseconds

Previously unobtainable accuracy and millisecond response are only two of the reasons why NAI's Phase Sensitive AC-to-DC Converters meet the most critical requirements in computer, recording, automatic test and digital display systems.

Unlike conventional converters, these all solid state modules measure not only total signal—but quadrature, in-phase and fundamental components as well. DC output is proportional to selected input component, yet unaffected by harmonics. A wide range of manual and relay-actuated models permits selection and programming of function, range and frequency to suit test or system requirements.

Specifications of relay-programmed models are given in the table. Data on manually switched models PSC-415 and -416 upon request.

	PSC-410/411	PSC-420/421
Voltage Range	(410 & 420)	1 v f.s. to 300 v f.s., 4 ranges
	(411 & 421)	10 mv f.s. to 300 v f.s., 6 ranges
Frequency Range	(phase sens.)	1 frequency*
	(total volts)	3 frequencies*
Linearity	60 cps — 20 kc	60 cps — 20 kc
Functions	0.1% f.s.	0.1% f.s.
Output Voltage	E + , E f , Ein and E q	
Input Impedance	0-10 v dc, into 10 k load, for all functions	
Response Time	1 megohm	1 megohm
	0.1 sec	





*any frequency between 60cps and 10kc.

The North Atlantic man in your area can quickly show you how the PSC-410 and -420 simplify AC measurement jobs from GSE to production test of transducers, networks and amplifiers. Call today for his name, or request Bulletin PSC-1.

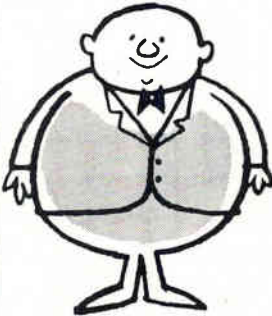
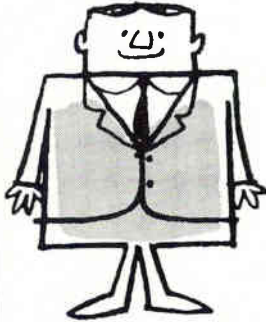

NORTH ATLANTIC industries, inc.
TERMINAL DRIVE, PLAINVIEW, L. I., NEW YORK • Overbrook 1-8600

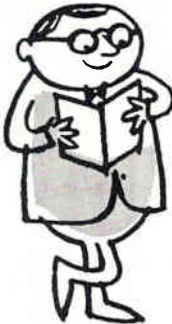
SUPERIOR SUPPLIES CATHODES FOR EVERY ENGINEER'S REQUIREMENTS

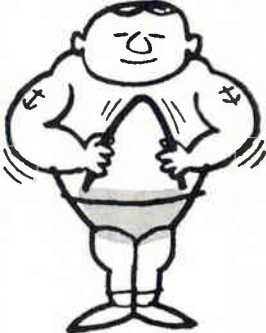
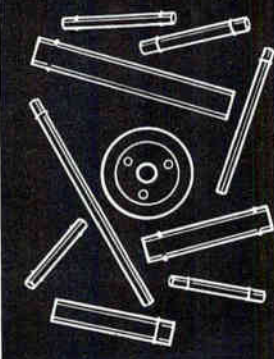
		
I want high-purity nickel	I want round shape	I want square shape
		
I want king size	I want active	I want passive
		
I want all-purpose	I want high strength	Which kind do you want?

Whatever kind of cathodes you need, Superior can supply them. For all sizes of receiving tubes, transmitting tubes, special purpose tubes. Seamless, WELDRAWN,[®] Lockseam,^{*} lalseam. Choice of over 25 different alloys. Shaped, beaded or tabbed. Disc cathodes in standard, miniature and subminiature sizes. Quality is unmatched. Fast delivery. Write for selector guide. Superior Tube Co., 2500 Germantown Avenue, Norristown, Pa. ^{*}Manufactured under U.S. patents

Superior Tube

The big name in small tubing
NORRISTOWN, PA.

Johnson & Hoffman Mfg. Corp., Mineola, N.Y.

—an affiliated company making precision metal stampings and deep-drawn parts

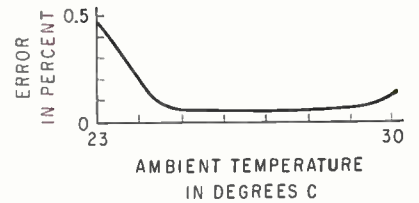

MEAN percentage error over operating range is less than 0.1 percent
—Fig. 2

by solving Eq. 1 and 2, since E_r , E_i , V , R , dE_r/dT and dR_i/dT can be found for any particular value of T_0 .

In the present operating model, a thermistor is used having 5,000 ohms resistance at 25 degrees C and a dissipation constant of 0.7 milliwatt per degree C. The value of R , must fulfill the requirements of Eq. 1 and 2. Current i must not have an appreciable affect of temperature of the thermistor, and the thermistor time constant should be as small as possible.

The value of R , was calculated to be 546 ohms, so a 1,000-ohm carbon potentiometer was used. The value of R was found to be 4.14 ohms and a resistor was wound to this value using Chromel wire. A mercury cell was selected as the power source because of its long life and constant output.

Mean percentage error achieved using the parameters indicated was less than 0.1 percent over the operating range, as shown in Fig. 2.

REFERENCE

(1) J. Bruce Brownwood, Thermocouple Compensating Circuit Design, *ELECTRONICS*, p 98, January 5.

Fiber Optics Provides High-Speed X-Ray Photos

FIBER OPTICS image-dissection camera can take a sequence of 75 x-ray pictures at 40,000 frames per second. Good resolution was claimed for the pictures, which were made in recent experiments at Bell Telephone Laboratories.

The camera was described at the 6th International Conference on High-Speed Photography at The Hague by J. S. Courtney-Pratt. The glass fibers, phosphor-coated at one end to convert x-rays to visible light, are embedded in a matrix to

ESTERLINE ANGUS

D. C. Milliamperes

0 .2 .4 .6 .8 1.0

NEW

Case design by Raymond Loewy

rec'ti·lin'e·ar refined

New! An infinitely better rectilinear writing movement, the latest achievement of Esterline Angus *master craftsmen*, is now available in a line of graphic instruments proven in over a half-century of dependable, trouble-free performance.

Simply designed, compactly sized, ruggedly constructed—it's the kind of precision rectilinear movement you'd expect from the manufacturers of instruments with the highest reliability rating in the industry. Called *RECTIGraph*, the movement is a close-coupled, translating mechanism with "V" jeweled pivots. It provides continuous, skip-free records with (you'll appreciate this!) a

minimum of maintenance. Calibration is locked-in. It operates dependably under adverse conditions and will not fail at crucial times.

Our complete line of rectilinear recorders is most reasonably priced, and greater and greater discounts apply as the quantity of recorders you purchase increases.



For detailed information and specifications, send today for free copy of "Rectilinear Recorders." Address: ESTERLINE ANGUS INSTRUMENT COMPANY, INC., Box 596E, Indianapolis 6, Indiana.



AMOS JACKSON,
veteran E A toolmaker

Excellence in graphic recording for over 50 years—ESTERLINE ANGUS

CIRCLE 75 ON READER SERVICE CARD

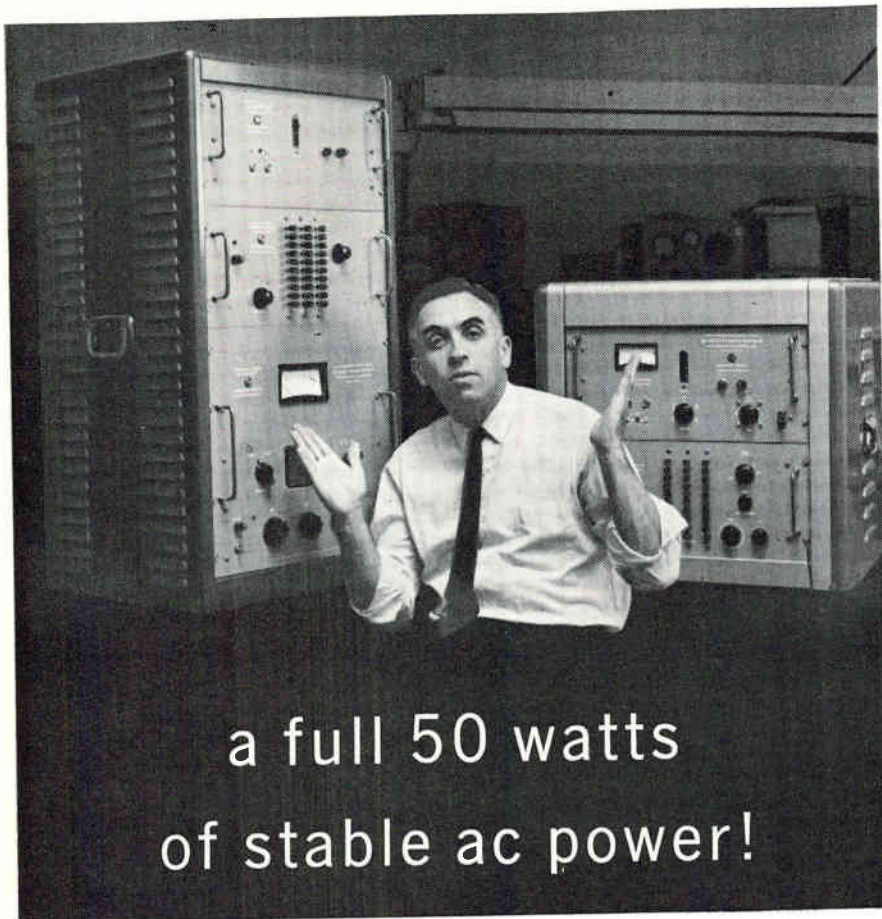

a full 50 watts
of stable ac power!

from these variable-frequency
power sources

Now — here's 50 watts of stable power from Krohn-Hite's new variable-frequency, low-distortion power sources! The perfect power sources for ac meter calibration, for precise comparisons and measurements, for digital voltmeter testing. An invaluable instrument for standards and quality control laboratories.

Krohn-Hite's power sources offer a continuously adjustable frequency range from 20 cps to 20 kc, with 50 watts output over the entire range. Short-term amplitude stability is 0.01%, and amplitude modulation is 0.1%. Hum and noise: less than 0.02% of the output voltage. Line voltage variations have virtually no effect on the output voltage — less than 0.01% for a 10% change.

The Model LDS-1500 Power Source offers voltages to 1500 volts, current to 15 amperes. Harmonic distortion is 0.1% over most of the frequency range.

The Model LDS-115 Power Source, with outputs of 115 volts and 7 amperes, features ultra-low distortion of 0.02%. The source will supply 25 watts of power to matched loads at frequencies as low as 10 cps and as high as 50 kc.

These distortion-free, ultra-stable power sources are ideal for high power level testing of precision resolvers, inductors, gyro motors and other electro-magnetic components. They can also be supplied as polyphase sources for calibration of wattmeters, varmeters and gyro testing. Write for full specifications on these new Stable Power Sources!

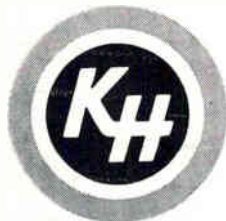

KROHN-HITE CORPORATION
580 Massachusetts Avenue • Cambridge 39, Mass.
Pioneering in Quality Electronic Instruments

conduct light to a photographic plate. The matrix and the rapidly moving plate beneath it act as a high-speed recorder.

High-speed cinematography is an important tool for research into many physical phenomena. X-ray pictures are particularly useful for studying actions like that of a melting fuse or of an electrical contact inside a sealed relay system. In rocket propulsion, such x-ray pictures can be useful in determining mass and velocity distribution of particles in the combustion process.

In the camera, the fiber-filled matrix is about 3 inches square and 1 inch thick. Each 1-inch long fiber is a rod of flintglass 0.001 inch in diameter. The rod is surrounded by a thin sheath of crown glass having a lower index of refraction that provides total internal reflection. The crown glass sheath is coated with a second sheath of opaque glass. The closely packed matrix of 32,000 fibers is held together by an opaque epoxy resin.

OPERATION—Light from the image is transmitted efficiently by the fiber assembly to the photographic emulsion, which is positioned close to the opposite side of the matrix. With the image continuously illuminated, each fiber produces a line varying in intensity with the light reflected by the image. Subsequent exposure of an entirely new pattern of light and dark areas requires that the film be displaced only the width of one fiber. This displacement of only about 1 mil combined with the rapid movement (36 feet per second maximum) of the film plate results in the extremely high speed capability of the arrangement.

The film plate is mounted in a trolley that moves in a track by compressed air. Despite acceleration and deceleration exceeding 100 g's, the plates do not break.

The pictures from the composite plate must be decoded to get recognizable pictures. This reconstruction is accomplished by aligning the plate in accordance with a recognizable pattern originally exposed on the plate. The plate is slowly pulled through the same physical sequence resulting in a slow-motion reproduction that can be directly observed or copied using conventional photographic techniques.

SOLID STATE

IN

Electronics

Men of vision thrive here. And it takes men of vision to cope with today's electronics and space problems. Space in more ways than just up. Space problems of a different nature plague the manufacturer who must expand, but hasn't the land to expand on.

Here in Florida we have the space, the climate, the work force. Florida has more to offer electronics firms than any other area on earth. Men think better where life is pleasant, where off hours can be devoted to just plain *living*—and to just plain *thinking*.

Yes, Florida is a Solid State in Electronics. Already the sun, Mother of Life, shines on over sixty thriving electronics firms in our busy state.

Cape Canaveral is here, too, with its massive, awesome missiles blasting off to make space history. Electronics makes possible every thrust into the universe. Every hope of getting to the moon depends upon electronics—and the first American to the moon will definitely soar to history from Florida.

Engineers and their families dream of living here in Florida. Give them this dream by moving your plant here. Nurture the brains that will give your business a greater and greater stature in this, the Electronics Age.

For complete details of the many advantages Florida offers the Electronics Industry, write us. Let us tell you why some of the greatest names in electronics have impressive plants here in Florida.

MEET US AT THE SHOW!

Our Industrial Representatives will be at the FLORIDA DEVELOPMENT COMMISSION BOOTH at the AMERICAN ROCKET SOCIETY SHOW to answer your questions about FLORIDA.

FLORIDA'S ASSURANCE POLICY

"You have my personal assurance of a sunny business climate here in Florida. You have positive assurance of every aid and assistance possible from our Florida Development Commission and from the overwhelming majority of our businessmen, industrialists, and financiers. We have everything to make your large or small enterprise healthy and successful. Write, wire, or phone us TODAY. The only thing better than a FLORIDA vacation is having your plant here."



FARRIS BRYANT
Governor

Investigate

Florida

...A 10 BILLION DOLLAR MARKET

Ask about free film "Profile of Progress"
FLORIDA FOR CONVENTIONS—
Write for free information on Florida's wonderful facilities for your group meeting.



Mr. Wendell Jarrard, Chairman
FLORIDA DEVELOPMENT COMMISSION
Box 4247-C • Tallahassee, Florida

Please send me brochure, "Why Your New Plant Should Be Located In Florida," containing the facts about FLORIDA's opportunities for New Industry, the 10 BILLION DOLLAR CONSUMER MARKET, Labor, Climate, Schools, Natural Resources, Favorable Tax Structure.

Name.....

Firm Name.....

Address.....

City..... Zone..... State.....

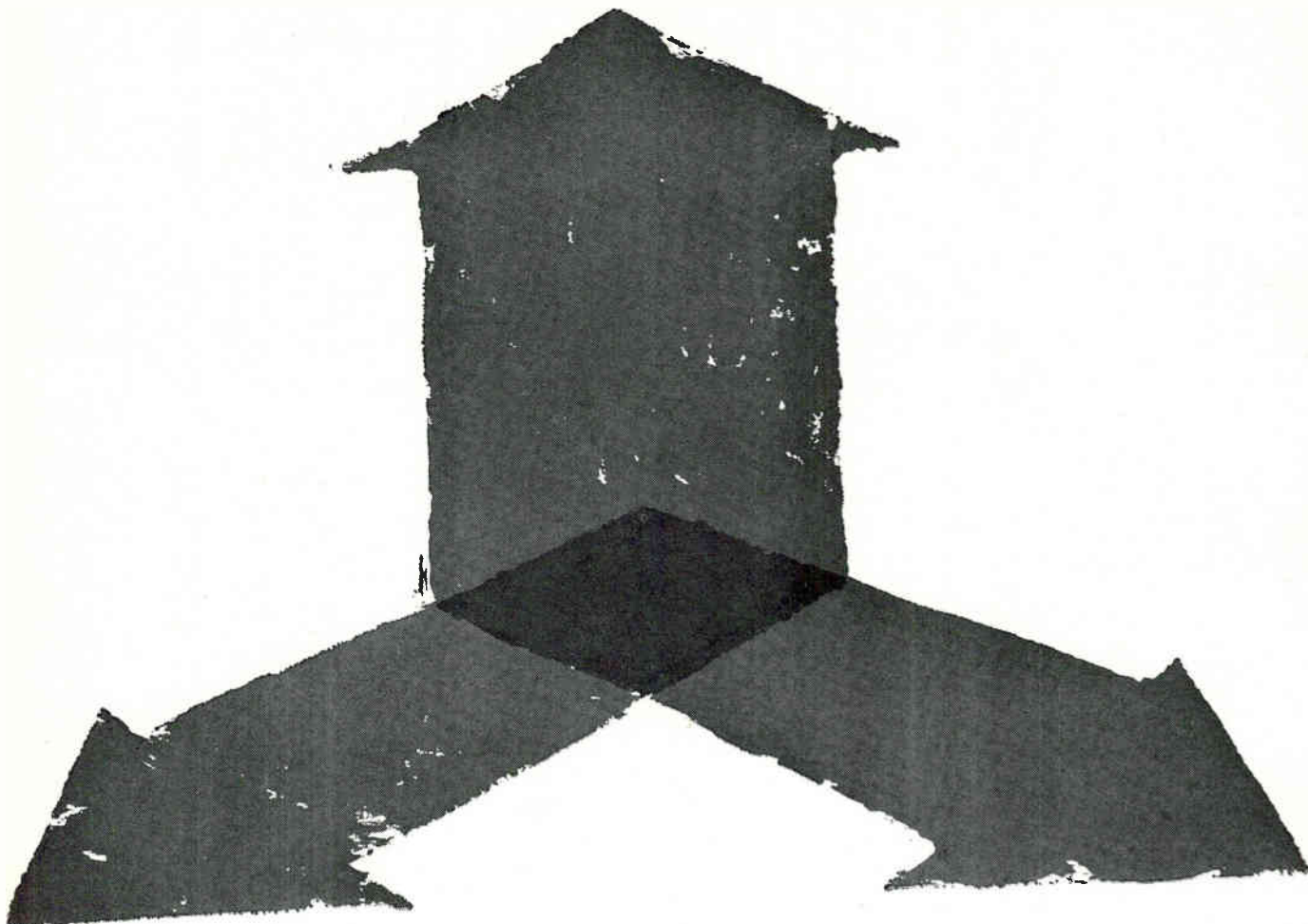

Said Hans Oersted: *"When a conductor carries current through a magnetic field at right angles to it, the resultant reaction thrusts the conductor in a direction perpendicular to both the current and the magnetic field."*

A light-weight, low fuel-consuming propulsion system is a primary requirement for interplanetary space vehicle travel. One such system now being carefully studied utilizes plasma propulsion.

This concept employs an electrical field to produce a plasma and to energize it. A magnetic field then ejects the plasma, thereby providing a reactive thrust to the vehicle.

Plasma propulsion is but one of many subjects under investigation at Lockheed Missiles & Space Company. Outstanding facilities, equipment and scientific personnel mark the organization as eminently capable of exploring many unusual aspects of space travel. This, coupled with Lockheed's favorable locations in Sunnyvale and Palo Alto on the beautiful San Francisco Peninsula, consistently attracts scientists and engineers interested in pursuing work in their special fields.

Why not investigate future possibilities at Lockheed? Write Research and Development Staff, Dept. M-26B, 599 Mathilda Avenue, Sunnyvale, California. An Equal Opportunity Employer.

LOCKHEED MISSILES & SPACE COMPANY

A GROUP DIVISION OF LOCKHEED AIRCRAFT CORPORATION

Systems Manager for the Navy POLARIS FBM and the Air Force AGENA Satellite in the DISCOVERER and MIDAS programs. Other current programs include SAINT, ADVENT and such NASA projects as OGO, OAO, ECHO, and NIMBUS. SUNNYVALE, PALO ALTO, VAN NUYS, SANTA CRUZ, SANTA MARIA, CALIFORNIA • CAPE CANAVERAL, FLORIDA • HAWAII

SPACE AGE FUSES by BUSS

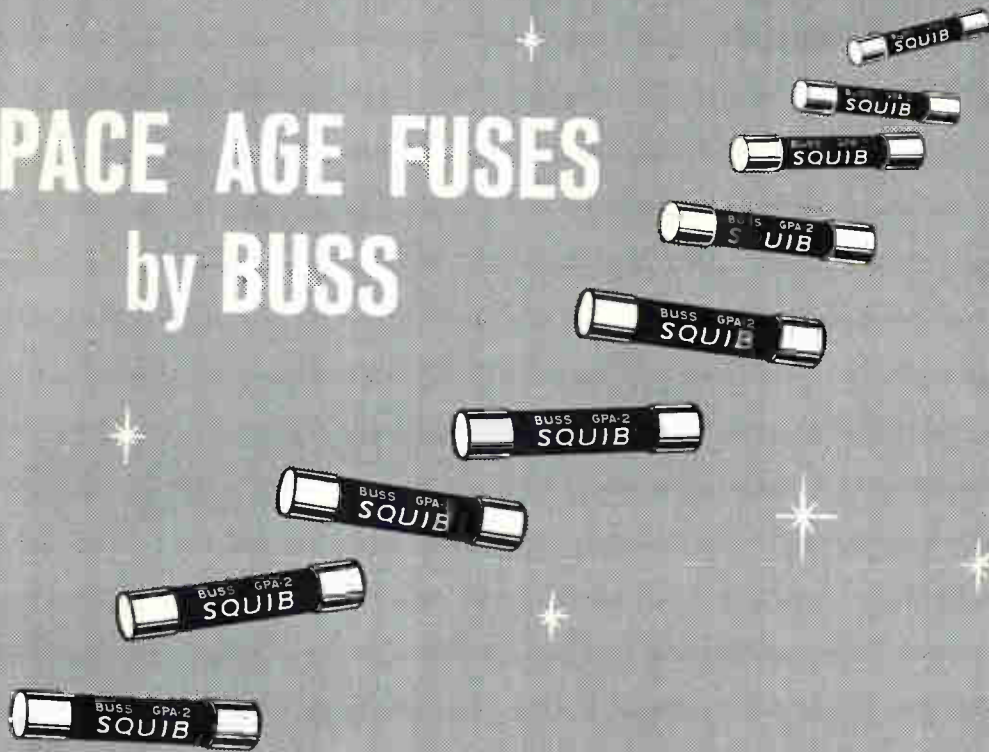

Especially designed for
Squib Circuitry

*Another outstanding
development by the
makers of BUSS fuses.*

 The space-age speeded the need for Squib circuitry—and to meet the need for protection and control of such circuits, BUSS engineers worked closely with the engineers who design and produce Squib circuits.

The result is a line of BUSS Squib fuses that have the needed electrical characteristics and are almost unbelievably accurate and dependable.

If you, too, should have a special problem in electrical protection . . . you can save engineering hours by turning to BUSS where the facilities of the world's largest fuse research laboratory and its staff of engineers are always at your service.

And don't overlook the complete line of BUSS fuses for your day in and day out protection needs . . . whatever your electrical protection needs—turn first to BUSS—it pays.

BUSS

BUSSMANN MFG. DIVISION

**MAKERS OF THE COMPLETE LINE OF
FUSES OF UNQUESTIONED HIGH QUALITY**

McGraw-Edison Co. • St. Louis 7, Mo.

Increasing Corona Thresholds in Dielectrics

Metallized coating of dielectric films raises a-c corona levels

By R. A. SAMODEN

Film Department,
E. I. du Pont de Nemours and Co.,
Wilmington, Delaware

UNTIL recently, the high dielectric strengths of polymeric films could not be utilized fully in many a-c power applications because of low corona levels of these films. Studies towards improving corona levels have been conducted with capacitors made from Mylar polyester film. Same techniques are applicable for other electrical apparatus where corona can occur.

Initial effort to improve corona

levels of conventional film foil capacitors was by liquid impregnation. Units were subjected to a vacuum and heat treating cycle for eight to twenty hours, the end point being determined by the corona level of the unit.

Corona was observed with a narrow band detector, Addison Model AC2.

No difference was observed in corona starting levels when metallized film was used in place of ordinary film of comparable gauge.

Corona threshold level of a capacitor made from three-mil Mylar is 3,600 volts. However, subjecting such film-foil capacitors to voltages ranging from 2,400 to 3,000 volts resulted in early failures. Inspections invariably indicated failure at the foil edges with

pits in the film, erosion of the foil edges and x-waxing.

Transients incurred during switching, one to two times the rms voltages, were sufficient to ignite corona and cause dielectric breakdown.

Stress distribution across the capacitor imposed a stress on the liquid which exceeded breakdown strength. This stress possibly caused local heating followed by bubble formation and corona which ultimately broke down the dielectric film. Castor oil, polybutenes, askarels, and fluorinated liquids would not withstand stress levels incurred during these switching transients.

REDUCING STRESS — Two-side metallized film was tried in conjunction with foil to conduct the current. This construction reduced the stress on the oil between the two electrodes. Also, the effect of the switching transients may be minimized by the increased impedance of the extended metallized electrode. Using a metallized film-foil construction, two-mil capacitors have operated at 2,000 volts as long as 18 months while subjecting the units to on-off switching transients three times per day.

Dielectric gases at pressures of 50 to 100 psi have been used to suppress corona in plastic films. Nominal pressures of 5 to 10 psi increased significantly the corona threshold level of light gauge film. Use of a gas resulted in a lighter unit with much less process time. Corona threshold level and extinction level are almost the same. Although transient overvoltages produce corona for a fraction of a second, corona disappears on return to operating voltage.

Corona threshold levels of 0.75-mil film capacitors in Freon C-318, Freon F-115, and nitrogen show that increases with Freon are significant and sufficient to utilize high inherent dielectric strength

Vacuum in a Vacuum Simulates Deep Space

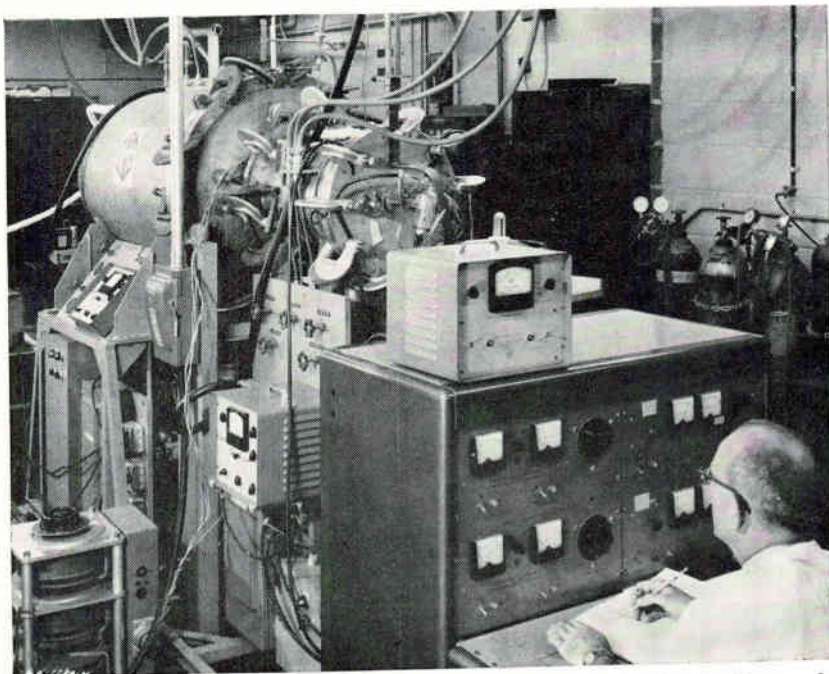

DOUBLE-WALLED vacuum chamber developed by National Research Corp. has reached pressures as low as 10^{-15} torr—equivalent to interplanetary space, NRC says. The test chamber is surrounded by a second high-vacuum chamber, to minimize leaks, and is made of polished stainless steel to limit gas absorption. NRC will use the chamber in tests of space components and materials and other high-vacuum work. Vacuums are checked with Redhead cold-cathode gage and mass spectrometer

NEW G-E CERAMIC TUBES REDUCE MICROWAVE COMPONENT SIZE* UP TO 40 TIMES

Detailed value-analysis chart shows how size, cost and performance advantages can be yours. Clip coupon, or circle reader service number, for free copy.

In many UHF applications, up to 10 Gc (KMC), microminiature G-E ceramic tubes can replace TWT's, magnetrons, klystrons, and parametric amplifiers with no sacrifice in performance. G-E ceramic tubes are up to 40 times smaller and 20 times lighter than most UHF devices. Often, ceramic tubes can effect component cost reductions as high as \$1,400.

To determine the specific reductions G-E ceramic tubes can make in your equipment, check these 6 size- and weight-saving features:

1. Microminiature size and weight range:
Length: 0.315" to 2.75"
Diameter: 0.325" to 1.25"
Weight: 0.972 gram to 66.6 grams
2. High-gain, low-noise ceramic tubes eliminate components, require less complex circuitry. Useful to "C" and "X" band frequencies.
3. Ceramic tubes withstand strong spurious signals and switching transients; minimum protective circuits required.
4. Lower power requirements mean smaller, less elaborate power supplies.
5. High-temperature tolerance (400°C., max.) can eliminate cooling equipment.
6. Ceramic tubes are highly resistant to nuclear radiation; heavy shielding is eliminated. Ceramic planar structures tolerate high shock and vibration.

Most G-E ceramic tubes are on approved MIL-spec lists and are available "off-the-shelf" from your local General Electric Receiving Tube Sales Representative. Send today for your free value-analysis chart which lists all the size, cost and performance advantages that can be yours with G-E ceramic tubes.

Progress Is Our Most Important Product

GENERAL  ELECTRIC

G-E TIPS (Technical Information and
Product Service)
General Electric Receiving Tube Dept.
Room 1730
Owensboro, Kentucky

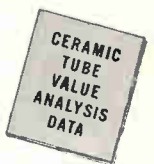

Name _____ Title _____
Company _____
Address _____
City _____ Zone _____ State _____

CIRCLE 81 ON READER SERVICE CARD

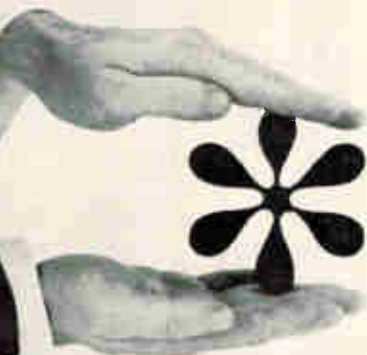
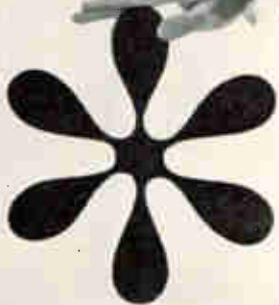

*APPROXIMATE SIZE RANGE
OF COMPETITIVE DEVICES

ACTUAL SIZE



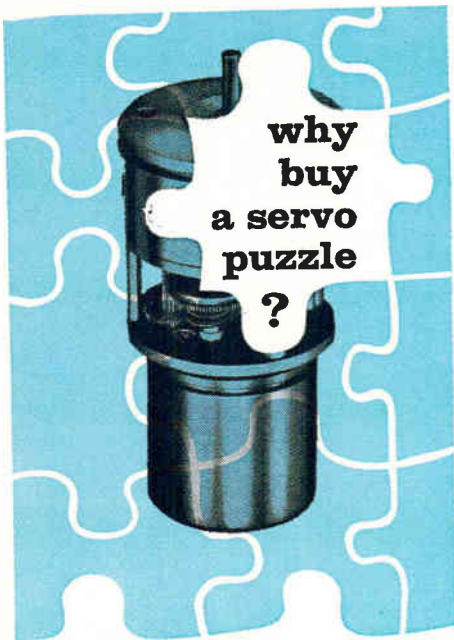

when you want a
SERVO SYSTEM



Single Responsibility:

ENGINEERING, COMPONENTS, PRODUCTION

KOLLSMAN ENGINEERING SPECIALIZATION

The Kollsman engineer is a specialist in servo design. To help your system take maximum advantage of the newest servo possibilities, the Kollsman engineer (where requested) will come to your plant to help develop specification and design approach. And, the same engineer will follow your servo system right through production making sure no compromises or delays occur.

KOLLSMAN ADVANCED COMPONENTS

Kollsman components going into your assembly include all recent advances. For example, the patented adjustable backlash gear train, high gain amplifier, and miniaturization techniques provide the optimum in performance in the smallest package.

KOLLSMAN FULL PRODUCTION

Kollsman produces 85% of all materials used by Kollsman products in the Dublin, Pennsylvania plant. The result is design and packaging flexibility that cannot be matched. Quality is consistent; delivery dependable.

WRITE or call for assistance with your servo problems.

kollsman motor corporation
DUBLIN, PENNSYLVANIA (215)249-3561
A subsidiary of Kollsman Instrument Corp.

of the films to advantage, with no need of pressure vessels. No differences in corona threshold levels were noted between metalized and plain films.

Subjecting a metalized film capacitor to corona discharge in the presence of a fluorinated gas resulted in an increase in its corona threshold. Amount of increase de-

pends upon time of exposure, applied voltage, gas pressure, type of gas, resistivity of metalized coating and alignment of metalized coatings.

Samples tested for various gases showed Freon F-115 to exhibit greatest increase in corona threshold, with Freon C-318 and SF₆ following.

Switching High Microwave Power

Active ceramic material in low-loss switch is not susceptible to burnout

By A. L. STANFORD, Jr.
R. T. ARNOLD

Sperry Microwave Electronics Co.,
Clearwater, Florida

FAST ferroelectric microwave switch has been developed recently to operate at L-band frequencies. Device is a transmission-reflection type used in conjunction with a circulator to perform as a spdt switch. Constructed in a strip transmission line, unit exhibits low insertion loss and high isolation.

Low-loss characteristics of the switch are attribute to a new microwave encapsulation of ferro-magnetic material into a cartridge which has been termed a FEVAC (ferroelectric variable capacitor).

Capacitance is varied rapidly by application of voltage across its terminals. It has been incorporated into a device shown schematically in Fig. 1.

Tuning capacitor transforms sufficient inductance to the position of the variable capacitor to resonate it when no bias voltage is applied to the ferroelectric, resulting in a high impedance point which is further transformed to appear as a low impedance across the main line.

Under these conditions, microwave energy incident to the device

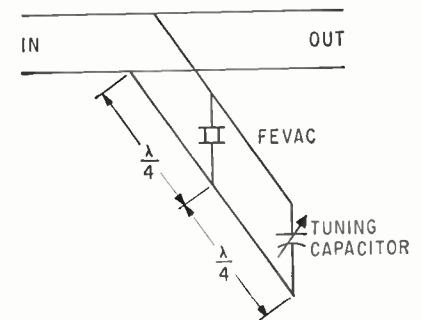

CAPACITANCE is varied rapidly by applying voltage across terminals—Fig. 1

is reflected. When voltage is applied to the variable capacitor, the resonance is destroyed and a high impedance is effected at the main line, so that incident microwave energy is transmitted through the device.

Isolation in the *off* condition was measured to be greater than 20 db, while insertion loss in the *on* condition was less than 0.5 db. Switch is capable of operation in less than 0.1 μsec, though the limit of switching speed has not been determined.

Subsequent improvements in the switch have been made by incorporating a second ferroelectric variable capacitor on an identical stub a quarter wavelength down the main line. This has resulted in a single device with isolation in excess of 40 db and insertion loss of 0.8 db.

Since the material is ceramic, it is not susceptible to burnout, and it is expected that this type device will be able to accomplish fast

**THIS IS
THE LOOK
OF THE
NEW POLARIS**

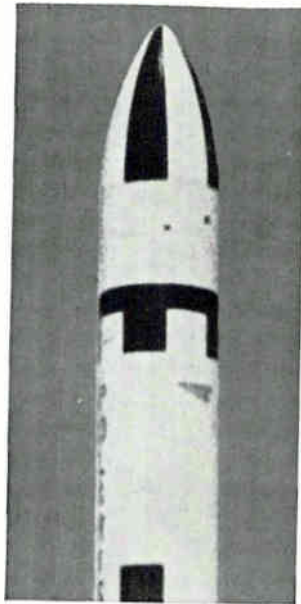

Polaris has a new nose-cone configuration and a new extended capability. And extended capability is also the phrase for Daystrom Transicoil, supplier of servo components for both generations of Polaris. Our extended capability stems from newly increased plant area (now 65,000 square feet) backed by strengthened facilities for engineering and production. Result: still greater prowess for design and delivery.

**THIS IS THE NEW LOOK
OF DAYSTROM TRANSICOIL...**

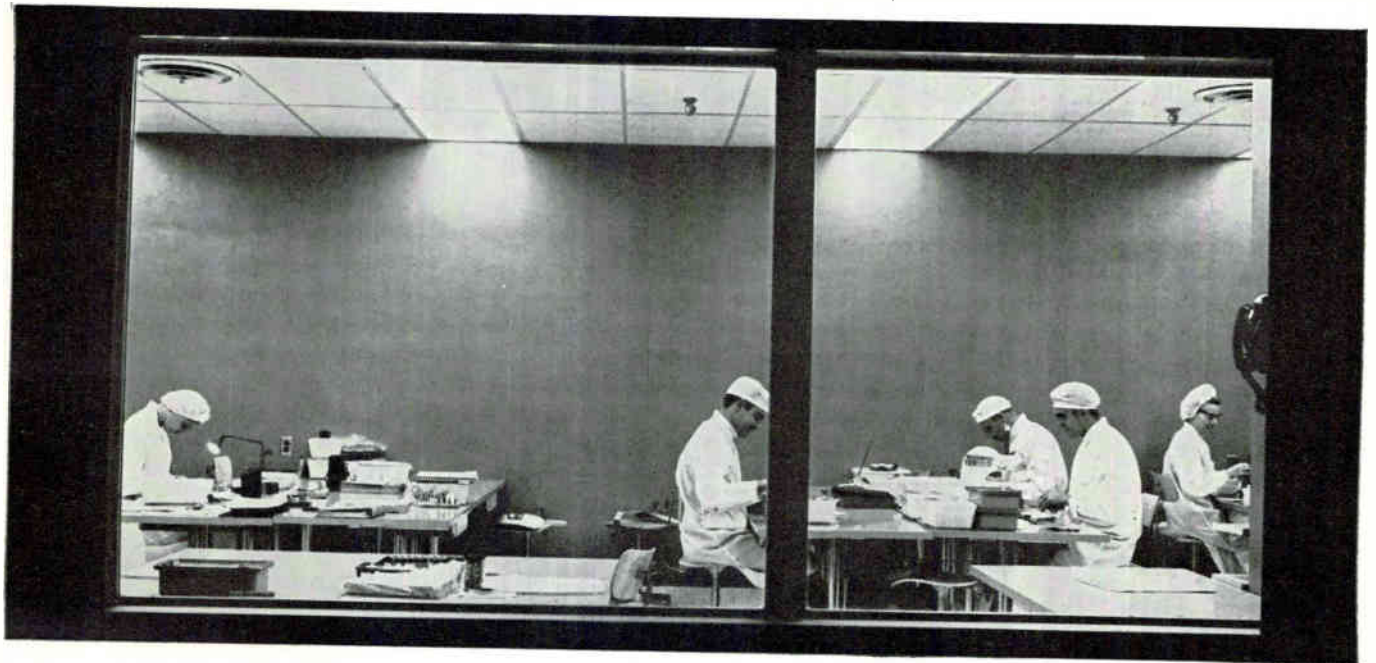

**AND THIS IS A LOOK
AT THE COMPONENTS
THAT UNITE THEM**



Daystrom Transicoil components aboard Polaris include: Size 11 motor generators, Size 15 motor generators, and solid-state servo amplifiers. All are manufactured "from beginning to end" in our Worcester, Pa., plant. We start with the raw materials—wire, bar stock, and other basics—and finish with precision components ready for the most rigorous aerospace applications. If you have such an application, contact Daystrom Transicoil and find how the new look pays off in all ways for you.

DAYSTROM TRANSICOIL
A DIVISION OF DAYSTROM, INCORPORATED
WORCESTER, PA. • PHONE: 215-584-2421

ask
MARKEM
to show you
how to
identify
your products
completely
— at
least
cost

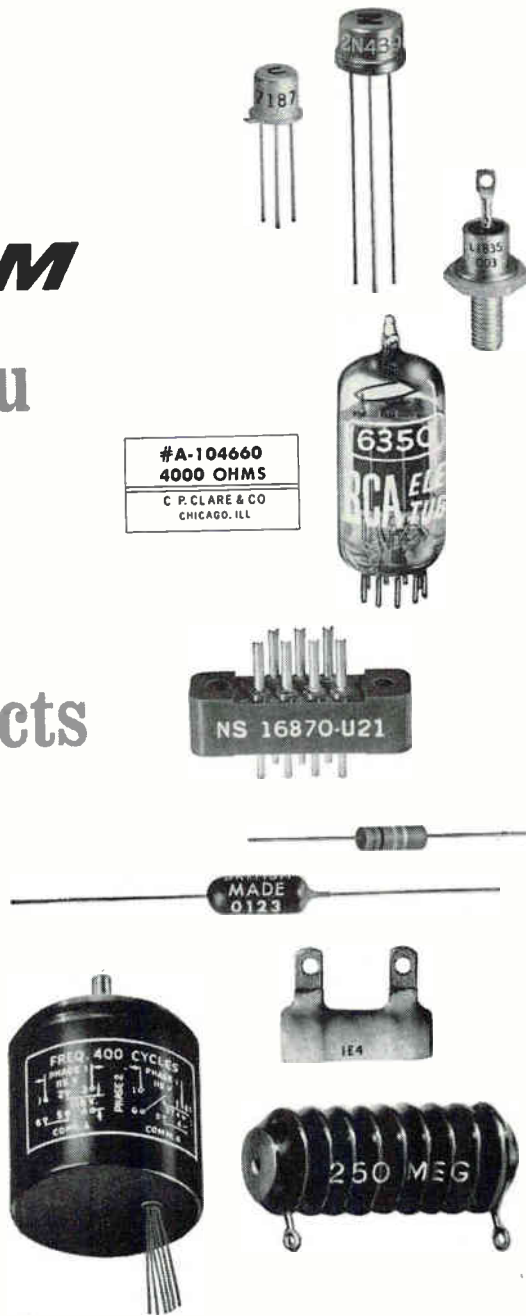

#A-104660
4000 OHMS
C. P. CLARE & CO
CHICAGO, ILL.

Whether your electrical and electronic products range from subminiature and microminiature components to large panels and "packages", you can identify them *all* completely and clearly, at production speeds, with economical Markem methods engineered to your particular requirements. For example: methods to mark odd shapes, sizes and surfaces with your complete, detailed legend, using quick-change type flexibility and ink to meet military specifications and withstand unusual environmental conditions—and above all, with savings in time and money—are offered by Markem, one responsible source for the entire process.

For a complete in-plant analysis of all your product identification processes—or a practical answer to a specific problem—call in your local Markem Technical Representative. Markem Machine Co., Electronics Division, Keene 5, N. H.

12-page catalog on request. Please use inquiry card.



MARKEM

HELPS YOUR PRODUCT SPEAK FOR ITSELF

switching of high microwave power with low insertion loss.

New Alloy Solves Brazeing Problems

FURNACE BRAZING of electronic components that require extremely low dew point atmospheres presents many metallurgical and furnace control problems. Such problems have been eliminated by an unusual approach. Instead of experiments in controlling furnace atmosphere to enhance the brazability of an existing alloy, a special alloy has been developed that can be brazed in higher dew point atmospheres.

According to Huntington Alloys' J. L. Shaw and C. L. Ramsey, difficulty in making successive brazes of certain nickel-copper and copper-nickel alloys during the manufacture of large power tubes of the klystron and magnetron types led to the development of the alloy, tailored specifically for the electronics industry.

Alloy is particularly suitable for electronic parts since its low magnetic permeability is not significantly affected by processing and fabrication. Thermal expansion characteristics of the material (Monel alloy 401) developed enable the firing of the composite metal tubes with negligible distortion.

The material can be brazed in wet hydrogen. Furnace leakage and inability to maintain a good purge become less significant, and maintenance is reduced, they said.

Other prime requirements considered in the development of the alloy were nonmagnetic properties, strength and low content of volatile elements. The 55 percent nickel, 45 percent copper alloy has a strength at least comparable to an alloy of slightly higher nickel (57.5 percent) and lower copper (40 percent).

MAGNETIC PERMEABILITY—Because manganese is not desirable in vacuum tubes, this element was omitted from its composition. To compensate for the effect of manganese on magnetic permeability, copper content of the alloy ensures a low magnetic permeability.

Magnetic transformation of fer-

Progress Report on **ALSiMAG** Ceramics TO CLOSE TOLERANCES WITHOUT GRINDING



O.D. $.350 \pm .003$



Thickness $.040 \pm .001$



O.D. $.133 \pm .0005$

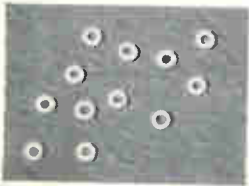

Hole $.042 \pm .001$

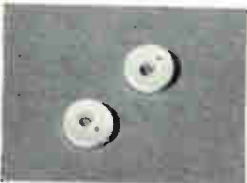

Holes $\pm .002$
Thickness $.062 \pm .002$



O.D. $.6345 \pm .0025$
Holes $.041 \pm .0005$

Precision technical ceramics are usually produced by grinding to final dimension. This is not always satisfactory or practical. Surface characteristics of ground ceramics may be unsuited for substrates. There is also a greatly increased demand for large quantities of miniature ceramics, thin, flat ceramics and ceramics with complicated contours — all to close tolerances.

Users of technical ceramics will be interested in American Lava progress in close tolerance production in four areas:

1. AISiBase process produces a wide range of thinner and flatter ceramics.
2. Injection molding of AISiMag ceramics permits complex contours.
3. Isostatic pressing gives precise control over certain critical internal dimensions and shapes.
4. New dry pressing techniques and equipment permit new tolerances in certain AISiMag ceramics.

Unless otherwise specified, the AISiMag parts shown here are from present volume production by the new pressing techniques. Significant dimensions and tolerances are indicated.

Outline your requirements and let our engineers make suggestions. Though your tolerance requirements may be met, please bear in mind that the largest tolerances permit the lowest costs.

Parts illustrated approximately actual size. A wide range of parts too small to illustrate is regularly processed with tolerances on the order of those shown here.

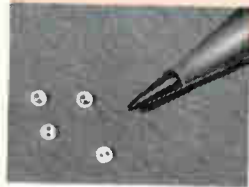

O.D. $.0815 \pm .0015$
Holes $.017 \pm .001$
Thickness $.016 \pm .001$



O.D. $.590 \pm .003$
O.D. $.182 \pm .002$
Thickness $.125 \pm .002$



Holes $.064 \begin{matrix} + .002 \\ - .000 \end{matrix}$



Length $.850 \pm .005$



Hole $.050 \pm .002$



O.D. $.588 \pm .0025$



Length $.906 \pm .005$



Hole Centers $1.000 \pm .005$



Holes $.0185 \pm .002$
Height $.235 \pm .002$



Hole $.010 \pm .001$

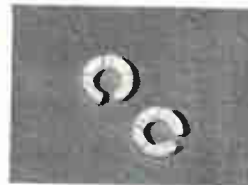

O.D. $.251 \pm .003$
Wall Thickness $.053 \pm .002$

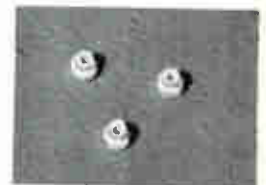

O.D. $.140 \pm .002$
Hole $.048 \begin{matrix} + .002 \\ - .000 \end{matrix}$



O.D. $.2695 \pm .000$
Thickness $\pm .0015$



54 Holes, Each Held to $\pm .002$
Spacings to $\pm .002$
Thickness to $\pm .0005$
Tape, Ground After Firing

A subsidiary of
Minnesota Mining and
Manufacturing Company



AMERICAN LAVA CORPORATION

CHATTANOOGA 5, TENN.
60TH YEAR OF CERAMIC LEADERSHIP

For service, contact American Lava representatives in Offices of Minnesota Mining and Manufacturing Co. in these cities (see your local telephone directory): Boston: Needham Heights, Mass. • Chicago: Bedford Park, Ill. • Cleveland, Ohio. • Farmington, Mich. • Laurens, S. C. • Los Angeles, Cal. • Milwaukee, Wis. • Metropolitan New York: Ridgefield, N. J. • Up-State New York: Newark, N. Y. • Philadelphia, Pennsylvania • Richardson, Texas • St. Paul, Minnesota • South San Francisco, California • Seattle, Washington

All export except Canada: Minnesota Mining and Manufacturing Co., International Division, 99 Park Ave., New York, N. Y.

CIRCLE 85 ON READER SERVICE CARD

JENNINGS VACUUM CAPACITORS

OVER 300 TYPES

TO MEET HIGH VOLTAGE CIRCUIT DESIGN PROBLEMS

Of course this unusually large selection didn't just happen overnight. It represents the accumulation of twenty years experience in the manufacture of vacuum capacitors. During this time Jennings has developed exclusive vacuum processing techniques. Examine the representative types shown below, all of them proven successful in thousands of applications.

HIGH VOLTAGE

Type VMMHHC
 Capacitance Range 25 to 200 mmfd
 Peak Voltage 120 kv
 RF Current 125 amps RMS
 Length 20 1/4 inches



HIGH CURRENT

Type VMMHCW
 Capacitance Range 50 to 400 mmfd
 Peak Voltage 55 kv
 RF Current 500 amps RMS
 Length 17 inches



HIGH RATIO OF CAPACITANCE CHANGE

Type UCSSL
 Capacitance Range 7 to 1000 mmfd
 Peak Voltage 5 kv
 RF Current 42 amps RMS
 Length 7-9/16 inches



SMALL SIZE

Type ECS
 Capacitance Range 3 to 30 mmfd
 Peak Voltage 15 kv
 RF Current 20 amps RMS
 Length 4 1/4 inches



Our radio frequency laboratory with 12 functioning transmitters ranging from 17 KC to 600 MC and up to 100 KW CW power is at your service to test our products under your particular circuit conditions.

Write for our special brochure describing our complete line of vacuum capacitors.

RELIABILITY MEANS VACUUM / VACUUM MEANS *Jennings*®

JENNINGS RADIO MFG. CORP., 970 McLAUGHLIN AVE., SAN JOSE 8, CALIF., PHONE Cypress 2-4025

romagnetic nickel takes place with no alteration of crystal structure. On heating above the magnetic transformation temperature (Curie point), the alloy (low temperature magnetic phase) loses its magnetism. Magnetic characteristic is regained on cooling below this point. The Curie point is lowered or raised by alloying elements that form solid solutions, to an extent which varies greatly with the different elements. Curie point decreases with increasing percentages of copper. For example, Curie point decreases from 360 deg C at zero percent copper to -90 deg C with 45 percent copper.

Once the basic nickel-copper ratio was set, elements were selected for deoxidizing and desulfurizing the melt. Elements selected establish optimum composition for the brazing applications, and two types of braze tests were conducted to make a comparison of 21 different laboratory melt compositions.

Tables have been worked out for brazing results at various dew points; room temperature mechanical properties; and short time, high temperature, tensile properties.

Diode Makes Accurate Cryogenic Thermometer

LINEAR variations of the voltage-temperature characteristics in a gallium arsenide *pn* diode makes generally useful device for low-temperature measuring. Voltage varies nearly linearly with temperatures over the entire range from room temperature down to 1.4 deg K. Temperature is read as voltage taken from a potentiometer connected across diode.

Zinc-diffused gallium arsenide diodes have a sensitivity of 3.5 millivolts per deg K at room temperature, and 1.5 millivolts per deg K at around 1.4 deg K. In this area, a resolution of ± 0.01 deg K is possible when current is held steady to ± 0.02 percent.

Diode is tiny, uses only 10 microwatts, and has little effect on temperature of area it measures. Bell Laboratories reports use as a temperature monitor in masers and parametric amplifiers.

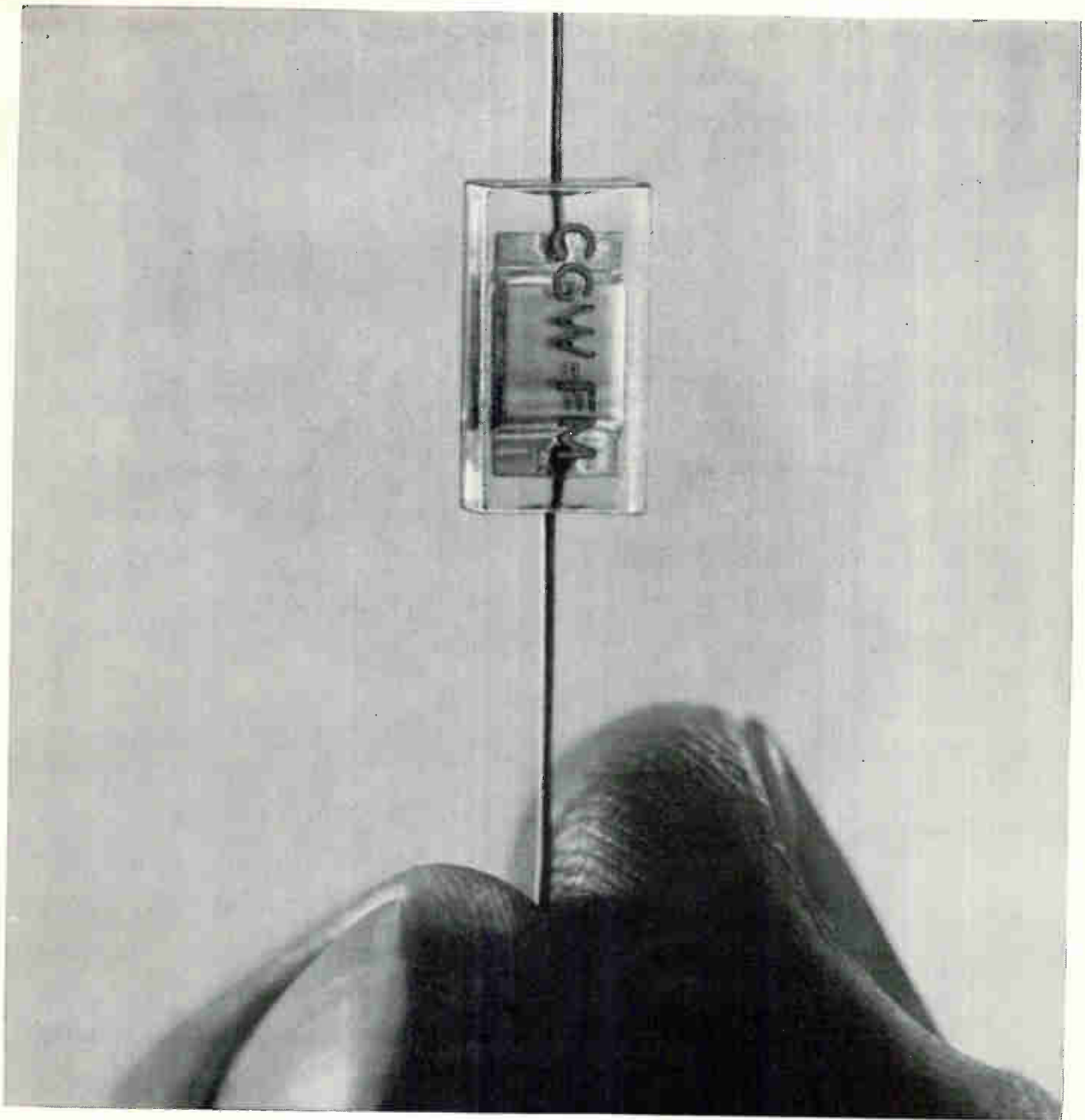

SECOND BEST?

That's the Corning CYFM capacitor. It's topped only by the Corning CYFR—the first one that completed the Autonetics/Minuteman hi rel program.

We learned how to make the CYFM while working to improve reliability. It's electrically and environmentally interchangeable with the CYFR. The major difference is price, and that's because we use refined processes on the CYFR for applications requiring guaranteed failure rates and reliability.

All in all, the CYFM is a positively sealed capacitor for complete environment-proof performance (it goes far beyond MIL-C-11272B), and it sells for less.

Developmental testing of the CYFM went 6,000,000 test hours, and included load life, boiling salt, salt spray, fluxes, and solvents.

You can get its reliable capacitive element of foil and ribbon glass, frozen inside glass with hermetic seals at the

leads, in four types. The CYFM-10 gives *pf* values from 0.5 to 300; CYFM-15, 220 to 1200; CYFM-20, 560 to 5100; CYFM-30, 3600 to 10,000. Your Corning distributor can give you fast delivery at factory prices.

But, when you must have the ultimate in *guaranteed* reliability to your specifications, specify the CYFR. It's available in the same sizes and capacitance range. The CYFR is second to none.

For complete information, write for data sheets to Corning Glass Works, 3901 Electronics Drive, Raleigh, N. C.

CORNING

Electronic Components



MORE TIMING PROBLEMS

more effectively solved...

...because HANSEN
takes more time
to be sure!



HANSEN SYNCHRON® Timing Motors and Movements are results of thorough and continuous research and development. None is released until it has been solidly tested and proved for its applications. Each is a product of more than 50 years of specializing in this one area.

This adds up to an unequalled backlog of engineering experience that you command at Hansen. Whatever your timing problem, you can count on Hansen engineers to come up with the most effective solution — with the timing motor or movement that has been *pre-proved right* for the job.

Distance no obstacle to 
Hansen service

Hansen service knows no limits — as present customers know from profitable experience. A company airplane stands ready to fly Hansen engineers to study “on-the-job” difficulties — and to determine the surest solution to every timing problem.

SEND TODAY for complete data on all Hansen SYNCHRON Motors and Clock Movements.



HANSEN REPRESENTATIVES:
ELECTRIC MOTOR ENGINEERING, INC.
Los Angeles, Calif., Oakland, Calif.
THE FROMM COMPANY
Chicago, Illinois
H. C. JOHNSON AGENCIES, INC.
Binghamton, N.Y.
Fayetteville, N.Y.
Rochester, N.Y.
Schenectady, N.Y.
Williamsville, N.Y.
WINSLOW ELECTRIC COMPANY
Essex, Connecticut
New York, N.Y.
Philadelphia, Pa.
EXPORT DEPARTMENT
15 Moore Street, New York, N.Y.



Around the world it's **KEW**



MODEL F-98



MODEL EW-16



MODEL P-22



MODEL VR-2P



MODEL VO-38



MODEL TK-20A



MODEL FL-202



MODEL PV-200



MODEL TR-A



SWR & RF WATTMETER

KYORITSU ELECTRICAL INST. WORKS, LTD.
No. 120, Nakane-cho, Meguro-ku, Tokyo, Japan
Cable Address: "KYORITSUKEIKI TOKYO"
Tel: (717) 0131 ~ 5 • 0151 ~ 3

CIRCLE 201 ON READER SERVICE CARD

Planning to change your address?

Use the form below to indicate a change of address. Because our issues are addressed in advance, please try to allow at least 5 weeks for change of address to become effective. Attach the address label from your most recent issue in the space provided below.

(Please print the following information for proper service)

Name

Title or position.....

Chief Job Responsibility.....

Distributor
Manufacturer

Company and Div.....

Product or Service Approx. No. of Employees

Address

City State or Prov.

Mail to home address below:

Address

City State or Prov.

Mail to: Fulfillment Manager, electronics
330 West 42nd Street, New York City 36, N. Y.

*Paste present mailing label or address
from wrapper or envelope here.



where do you
fit in the
space picture?

Today, the design and development of space systems, vehicles and weapon systems is achieving an even greater degree of importance than before. Expenditures are increasing. The pace is being stepped up.

Hughes Aerospace Divisions are expanding with each of these progressions. Important projects such as SURVEYOR, SYNCOM, advanced POLARIS guidance and Anti-ballistic Missile Defense (boost-intercept, mid-course, terminal) are now underway. Others will begin soon. This expansion is producing new, challenging assignments which never existed before. You can now be a part of, and benefit from, Hughes further expansion into the space age.

If you hold a degree from an accredited university in Mechanical Engineering, Electronic Engineering or Physics, are a U. S. citizen and have experience or interests related to Aerospace Vehicles or Weapon Systems, you can qualify. A few of the openings include:

controls engineers

Concerns airborne computers and other controls related areas for: missiles and space vehicles, satellites, radar tracking, control circuitry, controls systems, control techniques, transistorized equalization networks and control servomechanisms.

circuit designers

Involves analysis and synthesis of systems for: telemetering and command circuits for space vehicles, high efficiency power supplies for airborne and space electronic systems, space command, space television, guidance and control systems, and many others.

systems analysts

To consider such basic problems as the requirements of manned space flight; automatic target recognition requirements for unmanned satellites or high speed strike reconnaissance systems; IR systems requirements for ballistic missile defense.

infrared specialists

To perform systems analysis and preliminary design in infrared activities involving satellite detection and identification, air-to-air missiles, AICBM, infrared range measurement, air-to-air detection search sets, optical systems, detection cryogenics and others.

Inquire today. Fit yourself into the space picture at Hughes.
Please airmail your resume to:

Mr. Robert A. Martin
Head of Employment
Hughes Aerospace Divisions
11940 W. Jefferson Blvd.
Culver City 2, California.

We promise you a reply within one week.



Creating a new world with electronics

HUGHES

HUGHES AIRCRAFT COMPANY
AEROSPACE DIVISIONS
An equal opportunity employer.

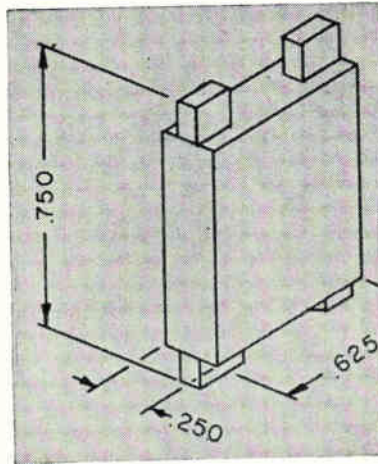
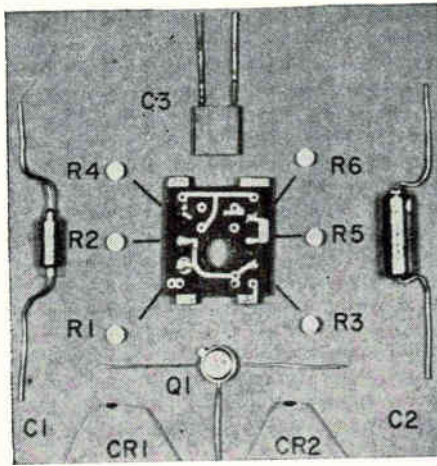

COMPONENTS of amplifier stage are pellet and axial lead type. Pellet type transistors and capacitors can be used as soon as they become available in a sufficient range of ratings. Volume of this module after encapsulation is 0.117 cubic inch. Schematic is at right

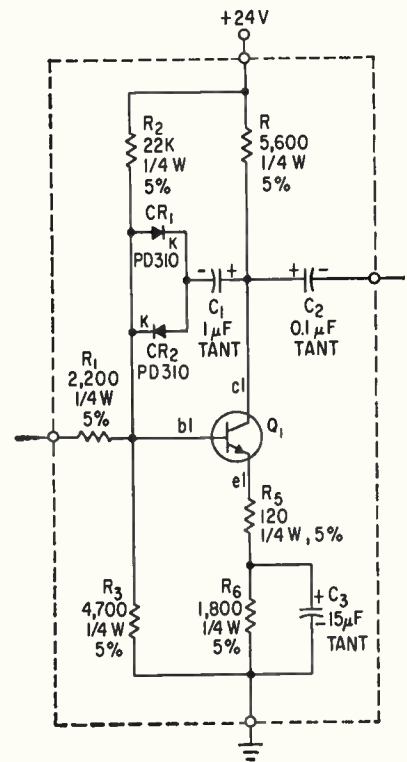

Wiring Patterns Bonded to Pellet Modules

Soldering occurs simultaneously with circuit transfer

By FRANKLIN T. JARVIS

Raytheon Co., Missile and Space Div.,
Bedford Mass.

COPPER CIRCUITS are being transferred from thin Teflon film to substrates in a circuit packaging technique developed by this division.

The major objective of the packaging method was to apply miniaturization techniques to analog type circuits, and to use readily available components of known reliability.

Other aspects of the technique are listed in the table; the ultimate in miniaturization was not an objective.

In the first stage of the process, copper is bonded with a special resin to 0.01 inch thick film. Wiring patterns are then etched in the copper using conventional techniques, and the copper wiring re-

maining on the film is then plated. Meanwhile, the substrate is prepared, first by coating it with

another resin. Holes are punched in the coated substrate such that registration is obtained between the etched wiring pattern on the film and the required circuit components. Pellet components with pre-tinned conducting end caps are then inserted in the substrate.

The film with etched wiring pattern is then placed on the component-loaded substrate and heat and pressure are applied. The two resins—the one holding the copper to the film and the one on the substrate—have been carefully selected; the resin holding the copper to the film releases, and the resin on the substrate kicks over and bonds the wiring pattern to the substrate. At the same time, soldering occurs simultaneously between pellet components and copper wiring takes place.

Critical temperature for the three stage process is approximately 400 F, since solders of the type used fuse in this range and since higher temperature can cause excessive resistance changes in the pellet resistors used. (Other techniques of applying the bonding epoxy between

OBJECTIVES OF TRANSFER CIRCUIT PROCESS

- (1) Use smallest size components presently available and of known reliability
- (2) A composite design concept using various conventional techniques to best advantage
- (3) Modularize to a cost, complexity, and minimum interconnection level consistent with economic throwaway. So far as possible, modules should coincide with natural circuit boundaries
- (4) Where possible, each module is to be a functional entity, capable of separate testing
- (5) Design concept should permit incorporation of evolutionary circuit changes without requiring radical changes, or extreme expense resulting from scrapped tooling.
- (6) The construction techniques to be capable of being automated
- (7) Applicability to a variety of end usages (submarine, surface, airborne, space, etc.)
- (8) Technique to be practical, reliable and capable of future improvement.



Cubic Digital Ohmmeter System saves time, cuts costs, insures thermistor quality for G.E.

In the Specialty Resistor business of the General Electric Company at Edmore, Michigan, 100% inspection of close-tolerance thermistors is carried out on a high-speed Cubic Digital Ohmmeter System. This accurate test enables G.E. to assure its customers that every close-tolerance thermistor will meet the rigid standards set for it. The Cubic system checks as many as 20 units in 70 seconds — cutting production time and keeping testing costs down. A permanent record is printed on paper tape for every lot shipped. In this installation, the Cubic Digital Ohmmeter System remains at a fixed position. Multiple cables are wired to the temperature-controlled oil baths where the thermistors are tested. The Cubic 4-wire ohmmeter system, along with careful wiring by G.E., eliminates the resistance of the leads and the contact resistance of the loading racks. The Cubic line of quality digital instruments is designed for easy integration into flexible, multi-purpose systems. Write, telling your system requirements, to Department A-180.



INDUSTRIAL DIVISION
SAN DIEGO 23, CALIFORNIA • ROME ITALY

OTHER OFFICES: LOS ANGELES, CALIFORNIA — ROME (CUBIC EUROPA S. p. A.) REPRESENTATIVES IN PRINCIPAL U.S. AND CANADIAN CITIES

November 9, 1962

CIRCLE 91 ON READER SERVICE CARD 91

ACCURATE PULL TESTER

for

■ leads	■ connectors
■ terminals	■ joints and bonds
■ welds	■ solderless wraps



■ Portable... Air-Operated... Laboratory Accurate... Available in Ranges up to 500 Lbs. ■ Write for Bulletin 750p.



HUNTER SPRING
A DIVISION OF AMETEK, INC.

31 SPRING AVENUE • LANSDALE, PENNSYLVANIA
ULysses 5-6815 TWX: 215-858-0984

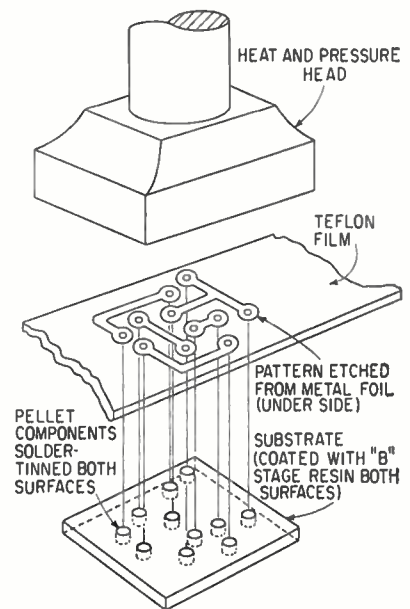

CIRCUIT is transferred from film to substrate when heat and pressure are applied; soldering occurs at the same time

substrate and copper wiring are feasible.)

APPLICATIONS—One of the photographs shows how the packaging method was used for an amplifier stage. Pellet components were used for resistors but not for capacitors because of non-availability of pellet type units of the desired value and rating. After wiring and pellet components are connected, capacitors are wired in. After all circuit connections are complete, the module is

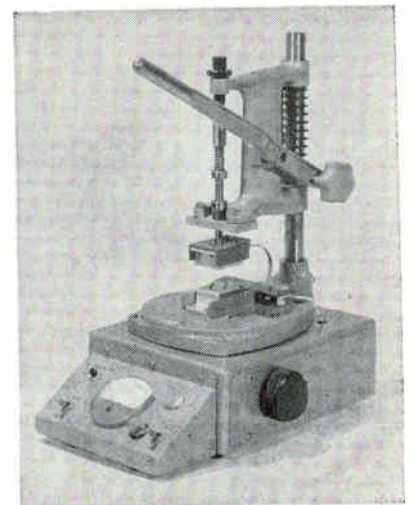

EXPERIMENTAL, hand operated, two-surface transfer machine is being used with prototype work with the modules

encapsulated, using material selected either for minimum weight or for high thermal conductivity. Shielding is easily applied by overplating. Modules are keyed by tab locations or by thickness—which is the only dimension that varies—so that interconnection errors are minimized when the modules are installed in their parent interconnecting boards.

The film on which the copper is bonded and the circuit etched can be processed in long strips, with the same width as 35 mm photographic film and with sprocket holes. Sprocket drive is suitable for automating the process.

A plated copper platten is used to effect the transfer operation. It

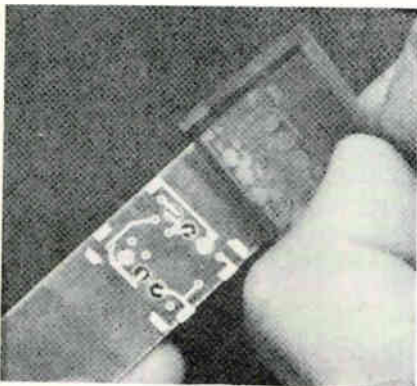

AFTER CIRCUIT has been transferred to substrate, film is peeled off

is square and flat and has a thermocouple, which is inserted near its face through a drilled hole. In an automated production set up, an extra heating pulse would be used to prevent a rapid temperature drop when the platten contacts the substrate. The platten applies force and heat to the Teflon film and substrate for about 15 seconds, then the heat input is terminated but pressure is maintained until the temperature drops below the solidification point of the solder. The heater platten is then withdrawn.

Initially, circuits will be applied to one side of a substrate at a time, but the technique can easily be modified to apply circuits to both sides of a substrate simultaneously.

The first assemblies made with the process have used both pellet and axial lead type components, chiefly because an adequate range

**FEW make MORE
precision resistors
than  ... (now, there's a
little-known fact!)**

**FEW make MORE
PRECISE resistors
than  ... (that will surely
evoke an argument!)**

**FEW can match the
 QUANTITY of
types (more than 450
available!)**

**NOBODY can offer
prompter DELIVERY
in any quantity-at lower
prices -or higher quality
than  !!**

Write for free catalog.

WIRE WOUND Precision	METAL FILM Precision	CARBON FILM High Voltage High Frequency High Megohm	RESISTANCE NETWORKS Precision units— canned or encapsulated
--------------------------------	--------------------------------	---	--

*Conformance to MIL-R-93: MIL-R-9444: MIL-R-14293A:
MIL-R-10683A: MIL-R-10509C



Resistance Products Co.

914 S. 13th Street, Harrisburg, Pa.

Canadian Representative: Janak R. Aurora, Canadian Curtiss-Wright, Ltd., 518 Evans Ave.,
Toronto 14, Ont. Phone: CL. 52391

BALLANTINE Wide-Band VTVM

Measures 300 μ V to 300 V at frequencies 10 cps to 11 Mc

Logarithmic scales with high precision and constant accuracy at any point

Usable as 100 μ V null detector, or as wide-band amplifier to 20 Mc

Binding post, or coaxial input to reduce ground current error

Cathode follower probe has high input impedance of 10 M Ω —7 pF



model 317
Price: \$495. with probe

A stable, multi-loop feedback amplifier with as much as 50 db feedback, and 10,000 hour frame grid instrument tubes operated conservatively, aid in keeping the Model 317 within the specified accuracy limits over a long life. Its uses extend from simple audio frequency measurements to accurate RF measurements made directly in the circuit using the low-loading cathode-follower probe. Individually calibrated logarithmic scales provide uniformly high accuracy over their entire length. Accuracy is 2%, 20 cps to 2 Mc; 4%, 2 Mc to 4 Mc; 6%, 4 Mc to 11 Mc.

Write for brochure giving many more details,



B BALLANTINE LABORATORIES INC.
Boonton, New Jersey

CHECK WITH BALLANTINE FIRST FOR LABORATORY AC VACUUM TUBE VOLTMETERS, REGARDLESS OF YOUR REQUIREMENTS FOR AMPLITUDE, FREQUENCY, OR WAVEFORM. WE HAVE A LARGE LINE, WITH ADDITIONS EACH YEAR. ALSO AC/DC AND DC/AC INVERTERS, CALIBRATORS, CALIBRATED WIDE BAND AF AMPLIFIER, DIRECT-READING CAPACITANCE METER, OTHER ACCESSORIES.

of proven pellet type components are not available. As more types of pellet components become available, the amount of automation possible increases. Certain types of components used in analog circuits are too bulky for pellet type construction, especially at low frequencies; these include some transformers, large value capacitors, etc. It is not intended to make these items integral parts of the modules.

Massive Shake Table Tests Radar Sets

ONE OF THE largest vibration testing machines in the world has been installed in the environmental

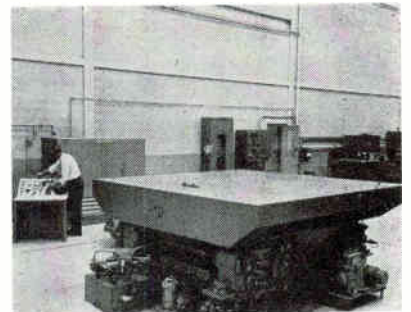

TABLE can vibrate a 10,000 lb. fixture at 3 g's from 1 to 35 cps

test facilities of General Electric Company's Heavy Military Electronics Department at Syracuse, N.Y.

The table, built to specifications by the L. A. B. Corp. of Skaneateles, N.Y., will be used to test large radar antennas and electronic system components. It has a 10,000 lb. dead-weight load capacity and a 10-foot square top. Vibration can be produced either vertically or horizontally at a maximum force of 3 g's, from 1 to 35 cps.

Tests of large and partially flexible structures on reaction type vibration machines have been difficult to control. This is due to an unfavorable mass ratio between the test load with its high center of gravity and the compact, freely suspended reaction table. Frequently, this type of load condition causes a shift in table amplitude or a rocketing motion.

The new machine operates on brute force and is rigidly attached to a 500,000 lb concrete block in the floor. It can resist massive force couples produced by vibrating



WORLD'S FIRST TRULY PORTABLE, SELF-POWERED DATA RECORDER—FROM LOCKHEED

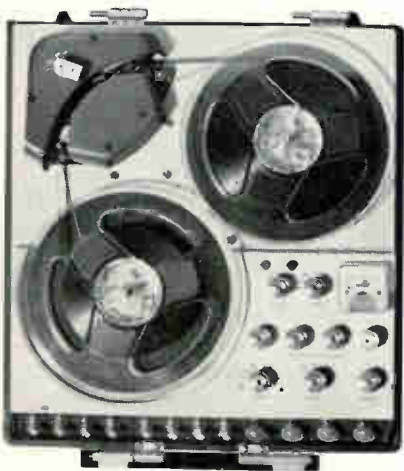

WEIGHS ONLY 25 POUNDS!

Now you can carry a portable precision recorder and record data in remote or difficult locations without the need for external power. The new Lockheed 411 Instrumentation Tape Recorder/Reproducer weighs only 25 pounds, is completely battery-powered yet has precision features and performance characteristics of console instruments.

It can record 4 tracks, FM or direct, at 3 switchable speeds on standard 7-inch reels. Ideal for recording all kinds of precision data: shock, vibration, temperature, pressure, voltage, torque, acceleration, flow, acoustics and shaft rotation, etc.

MAIL COUPON TODAY for full information. Lockheed Electronics Company, Industrial Technology Group, Metuchen, N. J., a Division of Lockheed Aircraft Corporation.

Lockheed Electronics Company
Instrumentation Sales, Dept. E-11,
Metuchen, N. J.

Mr. Bernard Mayer: Send me free product specification folders on the Lockheed 411 Instrumentation Recorder/Reproducer.

NAME _____
TITLE _____
COMPANY _____
ADDRESS _____
CITY _____ STATE _____

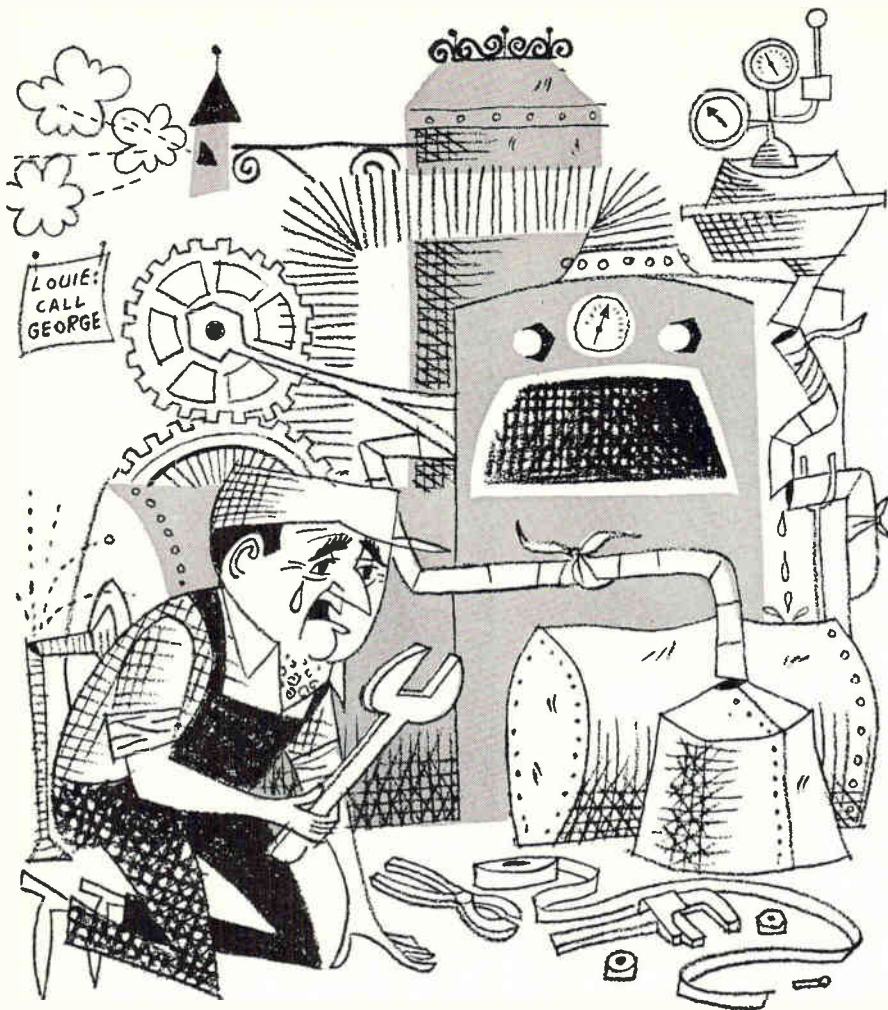

BETTER GET OUR BETTER GETTER

Another short essay clearly indicating the innate superiority of VacIon® pumps

Remember our friend, George, whose vacuum pump went pffft when the power failed? This is George's friend, Louie.

Louie has troubles, too. They center around a bargain-price ion-getter pump he bought. Pump worked at its rated speed... for a while. Louie didn't notice the speed was falling off until the pump pooped out in the middle of the boss' pet project.

Better Louie should get a VacIon pump. They're better getters. They will pump at exact rated speeds. Never less. (Besides, our engineer-salesmen are 1×10^{-10} mm Hg types.) Ion-getter pumps? Heard a colleague's small son committing the principle to memory: "Gettering is when gas molecules are ionized by collusion with elections and are attracted to and deposited on a a geranium anode."

Close, but not quite accurate, Son.

(Although it's possible that poor Louie's pump was designed around just such a principle.)

Back to VacIon pumps. We know exactly what they can do. Not only did we invent VacIon diode-type pumps; we also test them. Constantly. They're fail-safe. No compromised vacuums if pump power fails. They produce vacuums in the 10^{-10} mm Hg region, which is very good indeed. They're all-electronic. No moving parts. They're available in a wide range of sizes and pumping speeds, from 0.15 to 10,000 litres/second. They provide the cleanest vacuums in the business. Never can a stray organic molecule taint your vacuum. Here's what we'll do. If your VacIon pump fails or otherwise doesn't come up (or down) to snuff, we'll replace it or refund your money. We ask only that you heed the considered recommendations of our vacuum experts when you set up your system.

VACUUM
PRODUCTS
DIVISION

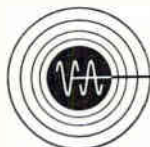

VARIAN associates

PALO ALTO 1, CALIFORNIA

test specimens that have a center of gravity as high as 10 feet above the table. Selected input amplitudes at the table are maintained even under conditions of severe load resonance.

The table can produce peak-to-peak displacements to 1 inch at low frequencies. It can also produce linear, and circular and elliptical motions, and tipping, to simulate of ship and other transportation motions.

Solder Ingots Hold Component Leads

HOLDING device for lead wires during assembly of thermistors and resistors is lead ingots in a production method used by Carborun-



LEAD INGOTS are used to hold components during manufacture

dum Company, Niagara Falls, New York. First the lead wires are placed on end in small troughs containing molten lead. The lead is allowed to harden and forms an ingot, with the wires held firmly in place.

Thermistor disks and resistor blanks are attached to wires in a conventional production operation and are then spray-coated or encapsulated as the process requires. When this part of the operation is complete, the wires of all units held by the ingot are sheared off simultaneously.

The ingots are melted down for reuse. Besides providing firm support for the components during manufacture, the technique clears up small wire ends from the working area and is compatible with any scrap recovery program.

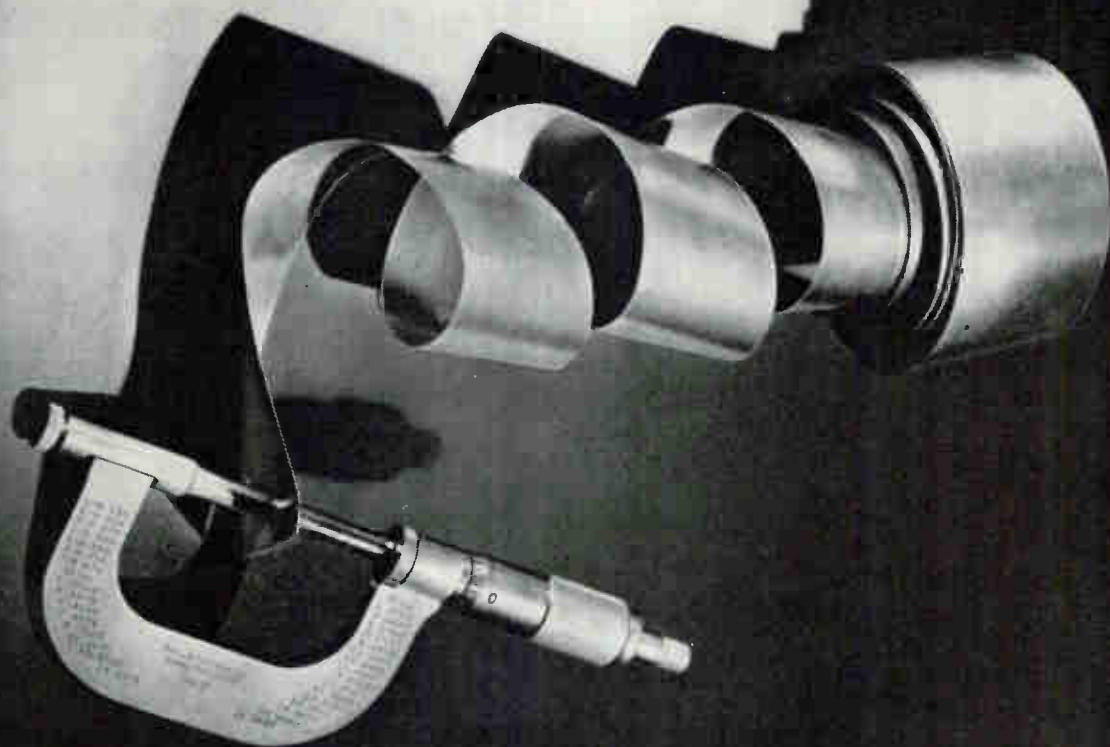

This Nickel foil strip is 1/3 as thick as this page!

0.00075-inch thick to be exact. So thin that every step in its production is a critical test of the metal worker's skill.

Even the air must be kept clean. One speck of dust or particle of grit allowed to enter the rolling operation could perforate the foil. It's *that* delicate.

This nickel foil is just one example of how you can get Huntington Alloys in any form or size you may want, right down to the fine sizes produced by specialists in strip, wire and tubing. These alloys offer exceptional combinations of high mechanical properties, corrosion resistance, magnetic or non-magnetic properties, good magnetostrictive properties, excellent high temperature performance and oxidation resistance, plus a wide variety of unusual electronic characteristics.

Who needs remarkably thin nickel foil...or heavy plates... or an exceptional combination of physical properties?

Perhaps you do. Or will some day. That's why we've prepared a booklet, "Huntington Alloys for Electronic Uses." It's packed with helpful information on composition, general characteristics, available forms, and specifications. A copy is yours for the asking.

HUNTINGTON ALLOY PRODUCTS DIVISION
The International Nickel Company, Inc.
Huntington 17 West Virginia



HUNTINGTON ALLOYS

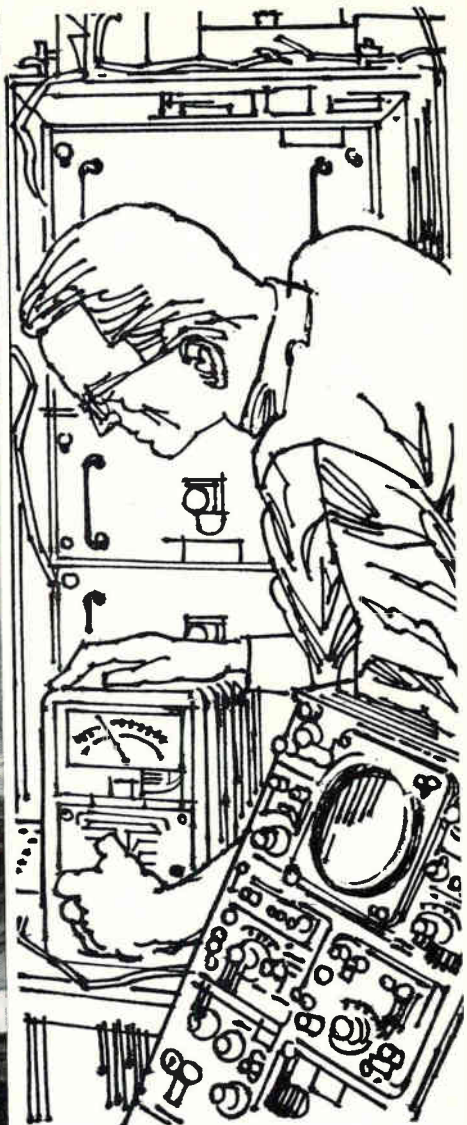
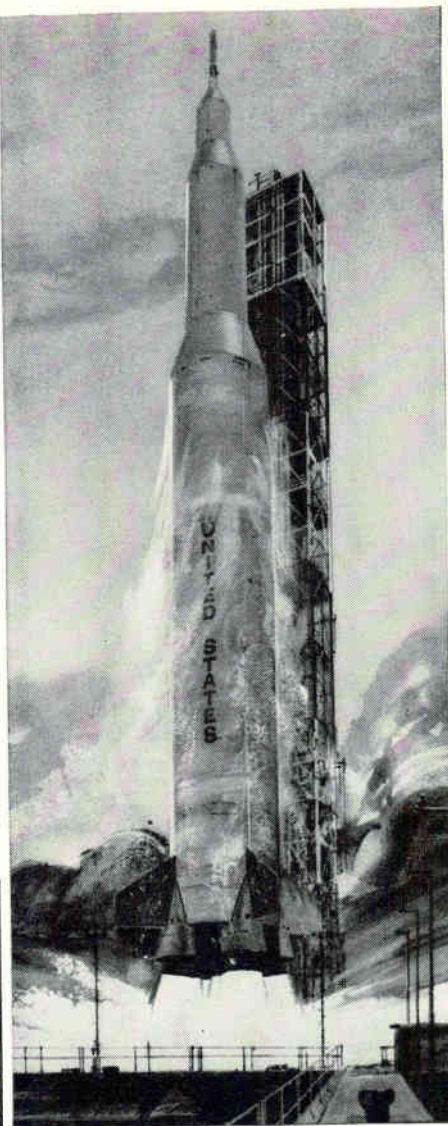
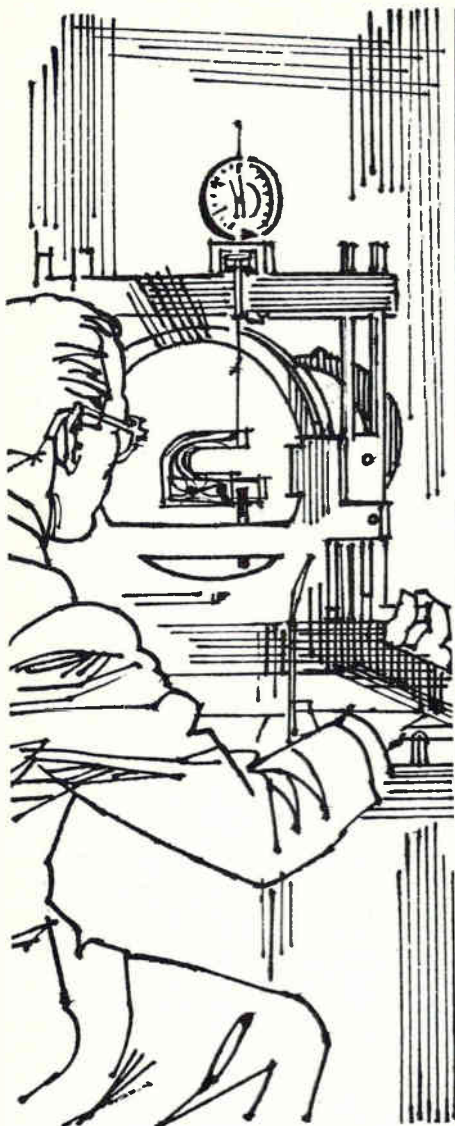

Saturn openings at Boeing for Engineers and Scientists

Boeing has been awarded primary developmental, building and test responsibility for the Saturn S-IC advanced first stage booster. The Aero-Space Division's newly-formed Saturn Booster Branch has a number of immediate, long-range openings offering professional challenge, rapid advancement and ground-floor opportunities to graduate engineers and scientists.

This new Saturn program is expanding rapidly, providing unique advancement advantages to properly qualified Structural Design, Electronics/Electrical, Propulsion, Aeronautical, Cryogenics, Systems Test, Thermodynamics, Mechanical Design, Industrial and Manufacturing Engineers, as well as to Physicists and Mathematicians. Assignments are immediately available in many areas of activity,

including Research and Development, Design, Manufacturing and Test. Salaries are commensurate with all levels of education and experience. Minimum requirements are a B.S. degree in any applicable scientific discipline. Boeing pays travel and moving allowances to newly-hired engineers.

Assignments are in New Orleans as well as in Huntsville, Alabama. Positions with Saturn and with other expanding missile and space programs at Boeing — including the solid-fuel Minuteman ICBM and Dyna-Soar boost-glide vehicle — are also available at Seattle, Cape Canaveral and Vandenberg AFB, California.

Send your resume, today, to Mr. Wendell L. Hays, The Boeing Company, P. O. Box 26088 - ECP, New Orleans, Louisiana. Boeing is an equal opportunity employer.

BOEING

Divisions: Military Aircraft Systems • Transport • Vertol • AERO-SPACE • Industrial Products — Boeing Scientific Research Laboratories

VHF RECEIVERS UHF

Communication  Electronics, Inc.
4900 HAMPDEN LANE BETHESDA, MARYLAND



Type 901 RECEIVER
 Frequency range30-300mc
 IF Bandwidth20kc-300kc
 Noise figure4db(30-60mc)
 6.5db(60-300 mc)
 Power consumption40w
 Weight18 lbs

Low Noise AM, FM, CW
 Small Size Light Weight



Type 702 RECEIVER
 Frequency range235-1000 mc
 IF bandwidths50 kc-300 kc, 2 mc
 Noise figure10 db 235-500 mc
 12 db 490-1000 mc
 Power consumption60 w
 Weight21 lbs

Low Power Consumption
 Frequency Coverage 30-1000mc



Type 501 RECEIVER
 Frequency range54-260 mc
 IF bandwidth,300kc (AM-FM, CW)
 10kc (AM-CW)
 Noise figure6db
 Power consumption35w
 Weight18 lbs



**Type SM-9310A
 SIGNAL MONITOR**
 This unit is used to provide a visual display of signal in a band around the received signal. Sweep width is continuously adjustable 0 to 3 mc.



**Type FE-25-1
 FREQUENCY EXTENDER**
 When used with any receiver tuning to 60mc, this unit gives additional frequency coverage from 235 to 1000 mc.

CIRCLE 202 ON READER SERVICE CARD



TKK INDUSTRIAL MOTORS

Lowest Drain, Minimum Noise,
 Longest Life — at Low Cost



RM-170 T

FM-250 R

FM-250 N

APPLICATIONS

- * Tape-recorders
- * Record-players
- * Clocks
- * Shavers
- * Music Boxes
- * Cinecameras
- * Turntables
- * Automations
- * Other Appliances

type	voltage (D.C.)
RM-170 T models	1.5 ~ 3.0 V
RM-170 S models	1.5 ~ 6.0 V
RM-170 SC models	3.0 ~ 12 V
FM-250 N models	1.5 ~ 4.5 V
FM-250 R models	1.5 ~ 6.0 V

Large orders executed reliably and on schedule by the world's largest factory specializing in D.C. magnetic low current motors (Output: up to 2½ million units per month!) Your detailed inquiry is invited — your satisfaction guaranteed.

MABUCHI SHOJI K.K.

37, Kabuto-cho 2-chome, Nihonbashi, Chuo-ku, Tokyo, Japan
 C.P.O. Box 1084, Tokyo Cables: "NIHONKAKOCO TOKYO"

CIRCLE 203 ON READER SERVICE CARD

Now, KWIK-TRIM

THE POTENTIOMETER WITH THE
VISUAL INDICATOR

IMPROVED RESOLUTION APPROX. 10% TO 25% OVER MANY COMPARABLE TYPES.

Designed for the ultimate in reliability and performance and to meet applicable military specifications for shock, temperature cycling, vibration, altitude, fungus, humidity, immersion, salt spray, sand and dust.



MULTIPLE ADJUSTMENT

A KWIK-TRIM one to one nominal adjustment . . . A vernier 45:1 ratio for precise setting . . . Shaft is journaled at each end with precision bearing fit . . . These precision features are your assurance for ease of setability and the stability of setting.



Please Write for
 ELECTRICAL,
 MECHANICAL AND
 ENVIRONMENTAL
 SPECIFICATION
 CATALOG.



General Scientific

CORP.
 A SUBSIDIARY OF SAN FERNANDO ELECTRIC MFG. CO.
 1535 FIRST ST. SAN FERNANDO, CALIF.
 EM 1-1193 . . . TWX S.F. CAL 9900

NEW

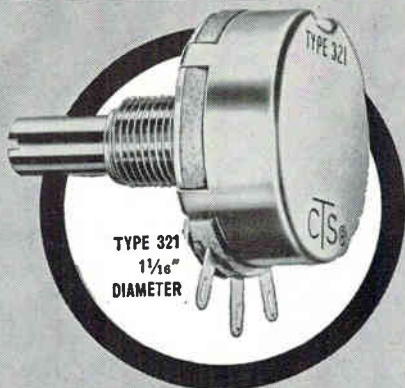

3-WATT
Military Grade
VARIABLE RESISTOR
AT 2-WATT
INDUSTRIAL PRICE

The excellent heat sink of unique carbon-ceramic element offers stability under high wattage and temperatures—plus the performance and reliability of a military grade variable resistor at a commercial price.

CTS Type 321 has the stability of MIL-R-94B. Write for Catalog 5675.

FOUNDED 1896
CTS OF BERNE, INC.
BERNE, INDIANA
SUBSIDIARY OF
CTS CORPORATION • ELKHART, INDIANA



Are you a
COMPLETELY INFORMED
electronics engineer?

Today you may be working in microwaves. But on what project will you be working tomorrow? You *could* have read **electronics** this past year and kept abreast of, say, microwave technology. *There were 96 individual microwave articles between July, 1961 and June, 1962!*

But suppose tomorrow you work in some area of standard electronic components, in semiconductors, in systems? Would you be up-to-date in these technologies? Did you read the more than 3,000 editorial pages that **electronics'** 28-man editorial staff prepared last year?

electronics is edited to keep you current *wherever* you work in the industry, *whatever* your job function(s). If you do not have your own copy of **electronics**, subscribe today via the Reader Service Card in this issue. Only 7½ cents a copy at the 3 year rate.

electronics

SCIENTISTS AND ENGINEERS: Today, Motorola digital systems and equipment are providing fresh and forceful solutions to problems of communications, command and control for... the Air Force data acquisition and relaying system at the Edwards AFB high speed flight corridor... the NASA/JPL Mariner and NASA/McDonnell Gemini space digital command systems... and the Navy/Gyrodyne DASH drone helicopter control system. Current studies also encompass random access digital communications, digital-to-voice translation, and ACCESS, a combined digital/voice approach to air-ground-air communication.

If you are interested in shaping the future on these or other challenging programs, write today describing in detail your experience in the following areas:

Mindpower and Manpower...

shaping the future in **DIGITAL COMMUNICATIONS SYSTEMS**

Systems Design • statistical communication techniques, coding theory and logic organization concepts

Equipment Design • receivers and transmitters for satellite air-ground-air and undersea applications, signal conditioners for telemetry systems.

Research • advanced display techniques, oceanographic instrumentation, underwater sound engineering

Familiarity with State-of-the-Art • coding and decoding methods, modulation techniques, sensors, transmitters, receivers and displays, integrated circuit applications and ultra-reliability techniques

We are particularly interested in programs on which this experience was obtained, and the extent of your technical responsibility. Address information to our Manager of Engineering at the location of your choice.

MOTOROLA  **Military Electronics Division** *An equal opportunity employer*

CHICAGO 51, Illinois, 1450 N. Cicero Ave. / SCOTTSDALE, Arizona, 8201 E. McDowell Road / RIVERSIDE, California, 8330 Indiana Ave.



DESIGN AND APPLICATION

Multiplexer Uses Capacitive Charge Transfer

Sampling aperture is 0.25 μ sec, rate is 200 Kc and error less than 0.5 mv

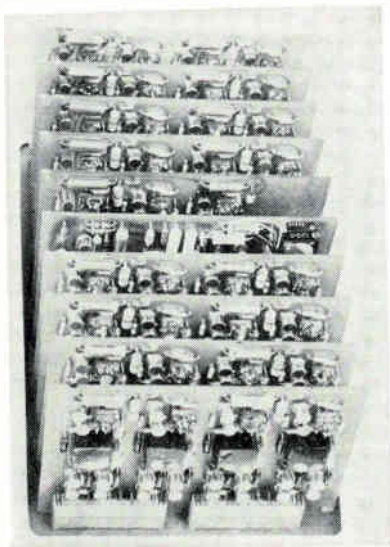
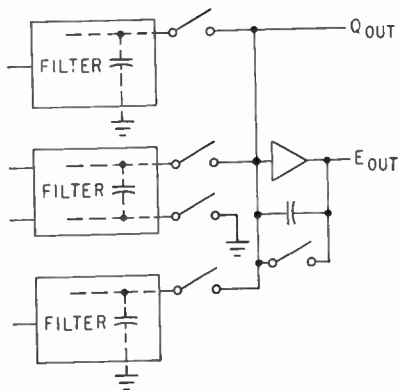

ANNOUNCED by Towson Labs., Inc., 200 E. Joppa Rd., Baltimore 4, Md., the Caplexer device handles analog inputs in the range from 0 to ± 10 v with effective sampling aperture of 0.25 μ sec or less at rates as high as 200 Kc. Sampling errors of less than 0.5 mv are available. Single ended or balanced inputs are provided. Each plug-in board accommodates 4 channels of analog information. A 32 channel unit at maximum sampling consumes less than 1 watt. The unit uses low-pass sampling filters ranging from simple RC types to elaborate RLC combinations. One is an active low-pass filter using little power and complete freedom from d-c amplifier drift. Each channel uses a sampling capacitor that charges proportional to analog input signal (see sketch). The charges are sequentially transferred into an a/d converter. Both grounded and floating inputs can be used. Sampling switch closes for 1 μ s or less so operating duty cycle is low. Series input impedance is high to prevent appreciable charge flow from the analog source thus negligible transient is reflected to sampled source. Voltage gain is obtainable by making sampling capacitance larger than capacitor across charge transfer amplifier. Device is useful in PCM telemetry, data logging and communications systems.

CIRCLE 301, READER SERVICE CARD

noise and thermal noise is approximately several μ v. Response is almost instantaneous and time lag of

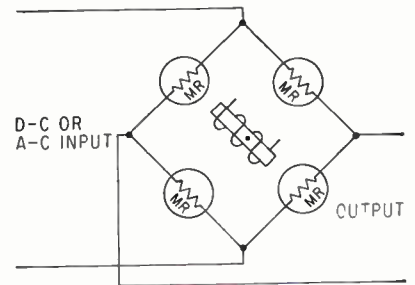

magnetic circuit is usually maximum frequency limitation. The unit is purely resistive (non-inductive) and can be used in either a-c or d-c circuits, without phase shifts, harmonics, quadrature or other influences. The sketch shows application as waveform generator or servo positioner. When the magnet is rotated so that its field acts on alternate legs of the 4-arm bridge, output is a-c whose frequency varies as a function of magnet speed of rotation. The output waveshape depends on the physical relationship between the magnetoresistive element arrangement and the magnet arrangement. (302)

Magnetoresistive Element Has Many Functions

RECENTLY announced by American Aerospace Controls, Inc., 123 Milbar Blvd., Farmingdale, N. Y., the Mistor device is a high-impedance, thin-film, solid-state magnetoresistive element whose electrical resistance changes directly as a function of applied magnetic flux

density. Resistance change as a function of magnetic field is linear from 1,000 to over 30,000 Gauss. Nominal resistance values extend to 10,000 ohms. Sensitivity increases as temperature decreases so device may find use in cryogenic areas. The device has no junction

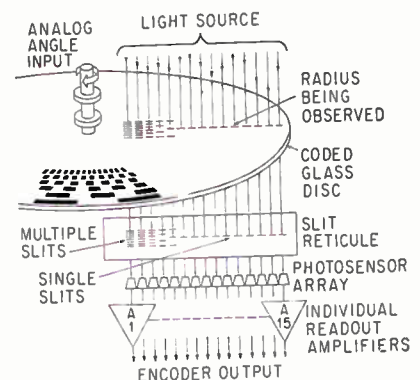

Optical Encoder Uses Multiple Slit Technique

DEVELOPED by Computer Control Co., Old Connecticut Path, Framingham, Massachusetts, the model

5010
 HIGH VOLTAGE DC REGULATED
 POWER SUPPLY
 1-10KV 0-8MA

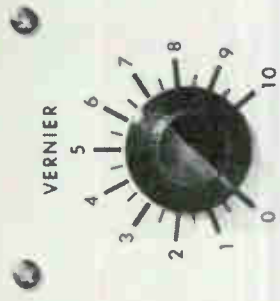
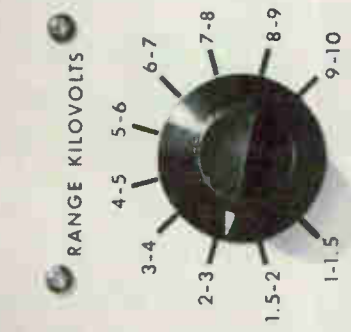

TODAY'S BIGGEST VALUE IN REGULATED HIGH VOLTAGE DC POWER

In many applications your high-voltage power supply dollar will go twice as far with a Sorensen 5010-8. This high-performance DC supply (1,000 to 10,000 V DC; 8 MA continuous current) offers:

1. Precise output voltage regulation ($\pm 0.05\%$ for line voltage changes of $\pm 10\%$, and $\pm 0.05\%$ for load changes from no load to full load.
2. Low ripple . . . less than 300 millivolts RMS.
3. Easily reversible polarity.
4. Variable output (coarse and fine controls).
5. Ease of operation (all controls on front panel).
6. Maximum protection for personnel and equipment.
7. Panel height $8\frac{3}{4}$ inches.
8. Removable end bells (optional) for quick conversion from cabinet to rack mount.

Price ? \$750.

Interested in biggest value in high-performance, high-voltage DC supplies? Get more information on Sorensen's 5000 series. Contact factory or use reader service card number **256.**



A UNIT OF
RAYTHEON COMPANY
 RICHARDS AVE., SO. NORWALK, CONN.

No. 4 OF A SERIES . . .

The Difference Between Digital Voltmeters:

Franklin Electronics Makes Every Kind of Digital Voltmeter

HERE IS THE



Model 1500 . . . ± 0.0001 to 1000.0 V DC

MODEL 1500

CIRCUIT: Transistorized.

METHOD: Voltage-to-time conversion, electronic ramp.

This type of digital voltmeter is preferred where (1) readings need not be more than five per second; (2) the measured voltage is subject to instability or noise; (3) printer operation is desired; (4) transistorized operation offers advantages.

In addition to having all the above features, the Model 1500 is unique in a very special way. It is also a digital ratiometer. In this use, an external reference is applied so that the voltmeter reads the ratio between the external reference and any measured voltage.

Standard features of the Franklin Model 1500 include automatic range and polarity switching, printer output drive, effectively infinite input resistance, external trigger provisions and many other features . . . all fully described in DATA SHEET 2029.



FRANKLIN
electronics, inc.
BRIDGEPORT • PENNSYLVANIA

DIGITAL VOLTMETERS OF EVERY KIND

3C Dicotron encoder package is a series of optical shaft angle encoders using multiple slit techniques. Models come with parallel cyclic binary (Gray) code and binary coded decimal. The device involves an increase in the number of slits in the stationary reticule that admits light to the encoders photosensors. Conventional optical encoders now use one reticule slit for each track on the code disc. This new device uses a number of slits for each of the finer, more densely packed (least significant bit) tracks. As more light reaches the photosensors, the increased intensity permits several additional code tracks to be built in yielding a 2X increase in resolution and accuracy. Also, additional light can increase reliability as output is higher and signal-to-noise ratio is improved. Multiple slits also average out small imperfections (foreign matter) on the disk. By using an inside-out code disk (least significant bit code track is on the inner track), the device produces uniform transition slopes and uniform signal levels.

CIRCLE 303, READER SERVICE CARD

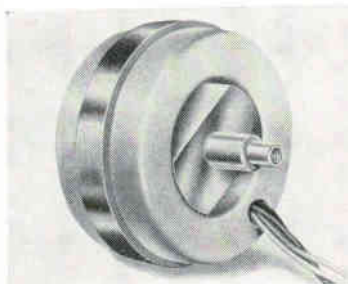

New Shape in High Sensitivity Transducer

MANUFACTURED by Pickering and Co., Inc., Sunnyside Blvd., Plainview, L. I., New York, the model 7056 linear variable differential transformer has its armature and stator constructed using stacked laminations. Coils are epoxy encapsulated and covered with a protective cap. High sensitivity of 2 w at 4,800 cps is not obtained at the expense of input power. Low source impedance of 200 ohms at 4,800 cps does not impose a loading problem. Output is 12 v at 0.040-inch displacement from the null position. Range is 0.040-in axially from null, output is 0.3 v per 0.001-in displacement, linearity is ± 0.5 percent,

phase shift is +5 degrees, null output is 60 mv, voltage input is 26 v at 4,800 cps and source impedance is 200 ohms. (304)

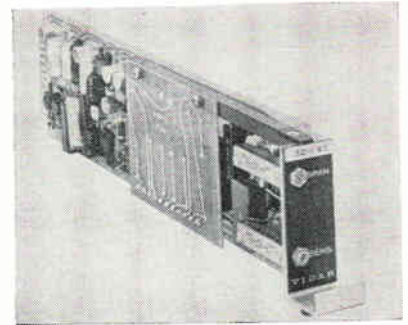

Converters Feature High Output Level

VIDAR CORP., 2296 Mora Drive, Mountain View, Calif. An all solid state frequency-to-voltage converter designed for high accuracy multi-channel data acquisition features 0.1 percent stability and linearity. Ten standard full scale frequencies are available, ranging from 500 cps to 100 Kc. High output level (10 v) allows direct use with magnetic recorders, digitizers, computers, oscilloscope monitors and other data processing equipment. (305)

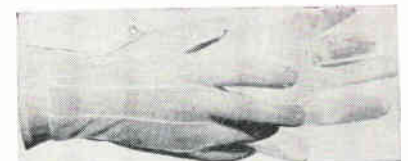

Clean-Room Gloves Are Lint-Free

CLEAN ROOM SPECIALTIES, 511 Victor St., Saddle Brook, N.J. Clean room gloves are manufactured by a special process where the edges are neatly trimmed and sealed to prevent fraying. This permits the hand to be removed from the glove without carrying lint into the area from within the glove. The gloves, lint free inside and outside, are made of a vinyl laminated Nylon cloth palm with a clear monofilament Nylon-back that permits the hand to breathe. They are skin fit, static free and washable. (306)

Antenna Multiplexers

ALLEN-BRADLEY CO., 102-N West Greenfield Ave., Milwaukee 4, Wisc.,



An idea grows from one mind to another.

It may begin with nothing important. Just a word. Or a notion. But as each succeeding mind brings a fresh viewpoint, the idea begins to grow and mature.

If you like working in an atmosphere that breeds ideas, you'll like working at Northrop. Stimulating minds and stimulating projects are all a part of the climate here. We have more than 70 active projects in work, and we're constantly evaluating new lines of inquiry. Projects range from space guidance and navigation to automatic checkout equipment, from computer design and world-wide communications to laminar flow control.

On the following pages you'll find some specific positions available now at Northrop Space Laboratories and Northrop Norair. Look them over. One may be just the spot for you.

But even if you don't find your specialty listed — don't go away. We simply don't have room to mention all the opportunities to be found throughout Northrop's several divisions. For more specific information, write to Dr. Alexander Weir at Northrop Corp., Box 1525, Beverly Hills, Calif. You'll receive a prompt reply.

NORTHROP
AN EQUAL OPPORTUNITY EMPLOYER

When You Need
ELECTRIC WAVE FILTERS

Depend on Sprague for

✓ SERVICE

✓ DELIVERY

✓ RELIABILITY



Sprague Electric Wave Filters for use in telemetry, telephony, and various types of communications systems and laboratory equipment which require selection and/or rejection of specific frequencies are now being designed by *Modern Network Synthesis*, which assures exact matching of wave filter characteristics to application requirements for Low Pass, High Pass, Band Pass, and Band Rejection filters.



Drawing on Sprague's long experience in component manufacture, wave filter engineers are able to employ capacitor, inductor and resistor production facilities for particular sizes, shapes, and materials best suited for specific filter applications. Unlike most filter manufacturers, Sprague is not dependent upon other component suppliers, therefore faster deliveries can be provided.



To further Sprague capabilities, wave filter design and field engineering offices as well as pilot production facilities are maintained in North Adams, Mass.; Vandalia, Ohio; and Los Angeles, Calif. Specialized mass production facilities are located at Visalia, Calif. and North Adams.

For additional information on Sprague Electric Wave Filters, write for Engineering Bulletin 46000 to Technical Literature Section, Sprague Electric Company, 35 Marshall Street, North Adams, Massachusetts.



SPRAGUE

THE MARK OF RELIABILITY

45-444

Cylindrical Interference Filters—the Smallest, Lightest, Most Efficient Design Available

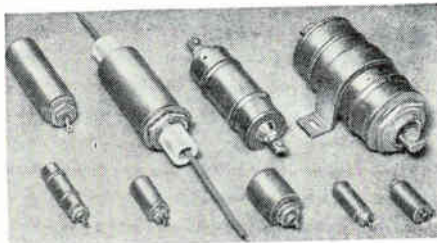

Pioneered by the Sprague Electric Company in order to achieve the maximum reduction in physical volume and weight requirements, cylindrical-style radio interference filters follow the natural shape of rolled capacitor sections and toroidal inductors.

Threaded-neck mountings, for use on panel, bulkhead, or firewall, assure isolation between input and output terminals, as well as a firm peripheral mounting with minimum impedance to ground.

Sprague Cylindrical Interference Filters are of the popular low pass design, intended for use as three-terminal networks connected in series with the circuits to be filtered. The excellent interference attenuation characteristics reflect the use of Thrupass® capacitor sections.

Since maximum effectiveness of filtering involves elimination of mutual coupling between input or noise source and output terminals, these filters should be mounted where the leads being filtered pass through a shielded chassis or bulkhead. The threaded-neck mounting gives a firm metallic contact with the mounting surface over a closed path encircling the filtered line and eliminates unwanted contact resistance.

Because military applications have figured prominently in the development of these filters, Sprague has many designs which meet the requirements of Specifications MIL-I-6181, MIL-I-26600, MIL-I-16910, and MIL-I-11748.

With an extensive "library" of proven cylindrical filter designs available as standard catalog items, one of these can probably solve your next interference problem. Or, if special circumstances dictate special designs to meet unusual interference, rating, or space problems, the Sprague Interference Control Field Service Department is always at your service.

For additional information, write for Engineering Bulletin 8100A to Technical Literature Service, Sprague Electric Company, 35 Marshall Street, North Adams, Massachusetts.

45-467

offers antenna multiplexers, designed to permit two or more simultaneous telemetry signals to be transmitted or received from one antenna without mutual interference, and intended for use in extreme conditions encountered in second generation missiles.

CIRCLE 307, READER SERVICE CARD

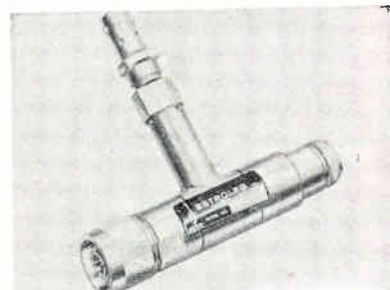

Signal Sampler Uses Ferromagnetic Material

ASTROLAB INC., 120 Morris Ave., Springfield, N. J. Signal sampler, using ferromagnetic material to give broader bandwidth and lower vswr, is an adjustable 50 ohm line coupled with coil type loop to monitor the level of magnetic r-f energy on the main transmission line. (A safety device is incorporated to prevent damage to loop). This adjustable line can be positive locked in any position. Electrical characteristics optimized to your specific frequency band. (308)

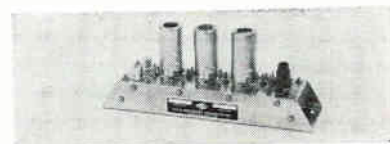

Wideband Preamplifier Has 40 Db Gain

RHG ELECTRONICS LABORATORY, INC., 94 Milbar Blvd., Farmingdale, N. Y. Preamplifier series are centered at 30 and 60 Mc with noise figures of 2.0 and 3.5 db respectively. Bandwidth is 10 Mc at 1 db down. Gain is 40 db minimum with 50 db typical. Balanced and unbalanced inputs are available for any type of crystal mixer. Units are priced at \$140. (309)

Delay Line

ESC ELECTRONICS, Palisades Park, N.J. A 20 μ sec, 500 ohm delay line with 200 equally spaced taps located

CIRCLE 211 ON READER SERVICE CARD

electronics

to a tolerance of ± 30 nsec. the model 53-13 has a pulse rise time of $0.2 \mu\text{sec}$ maximum and a pulse attenuation of 3 db max. (310)



H-V Power Supply Offers High Stability

WALDEN ELECTRONICS CORP., 85 Mystic St., Arlington, Mass. Model 538 series of power supplies is designed for high resolution crt's (accelerating voltage). Specifications include all-semiconductor circuitry, output voltage from 15 Kv to 27 Kv. Output current 0 to 0.5 ma. Regulation 0.1 percent line and load combined. Ripple is 0.1 percent. (311)



Pulse Generators Require No Oven

SOLID STATE ELECTRONICS CO., 15321 Rayen St., Sepulveda, Calif., announces models PG111 and PG112 silicon transistorized crystal controlled pulse generators for 2 Kc to 20 Mc. The encapsulated units were designed to provide a precision pulse or square wave output having high reliability over temperatures from -55 C to $+85 \text{ C}$. Temperature stability is achieved without the use of an oven. (312)

Epoxy Molding Powder Has Room Stability

EPOXY PRODUCTS DIVISION, Waldman, 133 Coit St., Irvington, N. J., has developed a line of epoxy molding and encapsulating powders which

We need men with contagious ideas.

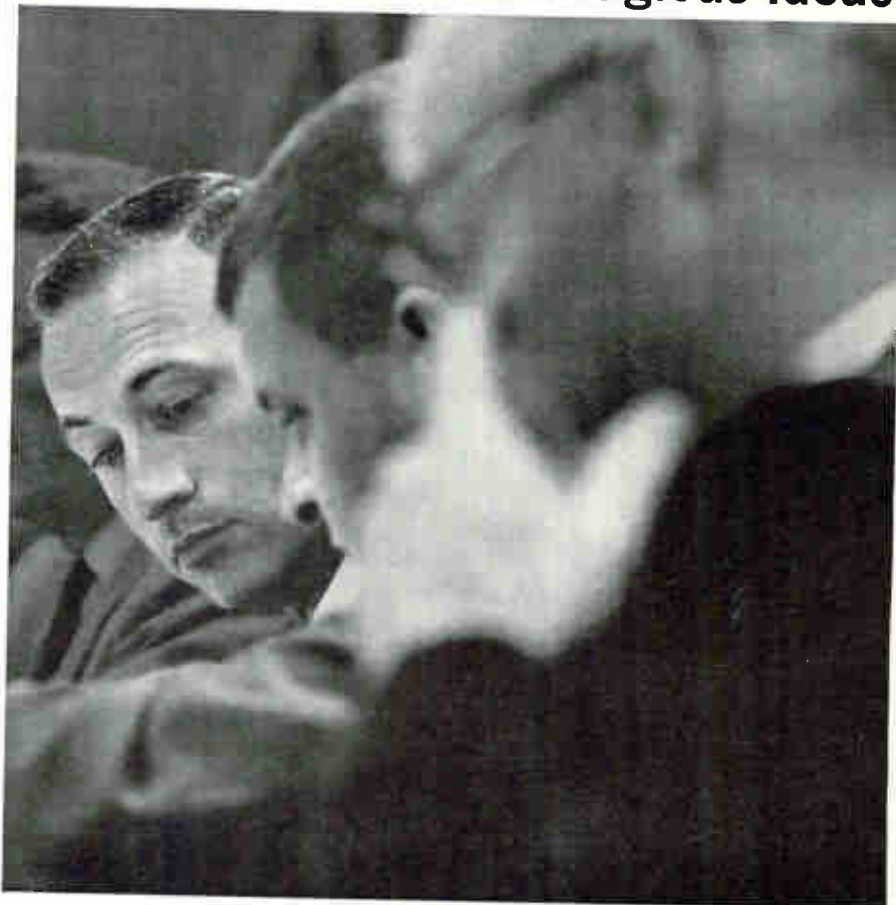

Northrop Space Laboratories is looking for men whose ideas set off a chain reaction. Men with insights that open new doors of thinking to those around them.

Northrop Space Laboratories is a new part of Northrop, a group exploring many advanced areas of space technology. We're growing rapidly. And we need men with stimulating minds to grow with us, to help point the directions for the years ahead. The following key openings are immediately available:

Research scientists, to conduct independent research on properties of surfaces with particular emphasis on stability in a simulated space environment. Also to conduct research on sealants and self-sealing and penetration resistant composite structures for the control of meteoroid damage to space vehicles.

A radiation effects physicist, to do research with emphasis on solid state devices.

A flight test engineer, who can conceive programs, estimate manpower requirements and costs.

A reliability engineer, to perform reliability analyses of space systems and subsystems in proposal and development phases.

Stress analysts, to develop fresh analytical techniques and apply them to new space structural concepts; to do stress analysis and design optimization studies on advanced space vehicle structures.

A plasma physicist, to join our growing program in the measurement of plasma properties, spectroscopy, diagnostics, accelerators, and power conversion devices.

A mathematician-physicist, to concentrate on systems analysis and operations research applied to military and non-military space systems.

Physicists experienced in electro-optical imaging devices and laser theory; engineering mathematicians interested in detection theory, reconnaissance and tracking; electronic engineers who know their way around statistical communications theory and noise phenomena; for new and original work in satellite detection systems.

For more information about these and other opportunities, write to W. E. Propst, Space Personnel Office, 1111 E. Broadway, Hawthorne, Calif. You will receive a prompt reply.

NORTHROP SPACE LABORATORIES

AN EQUAL OPPORTUNITY EMPLOYER

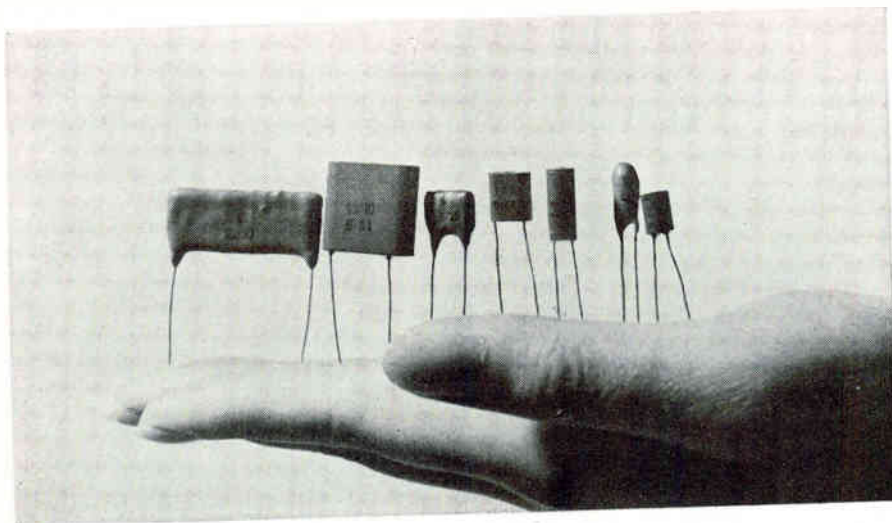

The F/T 'Aloxcon', A New Electrolytic Capacitor: The high quality of tantalum at the low cost of aluminum

Designed for use in printed and transistorized circuits, F/T's newly developed aluminum-oxide electrolytic capacitor 'Aloxcon' functions effectively at temperatures ranging from -60°C to $+80^{\circ}\text{C}$ and frequencies up to 100 kc or more. A semiconductor layer replaces the usual type of electrolytic and so the capacitance of an 'Aloxcon' is less affected by temperature and frequency than other types. 'Aloxcon' capacitors are highly resistant to moisture, and have low leakage current and extremely high life expectancy. They are ideal for transistor circuits requiring low impedance and miniaturization. Detailed specifications and application data available from our representatives.

	Working Voltage (V)	Surge Voltage (V)	Capacitance (mf)					
			1	2	5	10	20	
AR & GR Type (Standard Style)	6	8						
	10	12	0.5 1 2 5 10					
	25	30	0.1 0.2 0.5 1 2					
AZ & GZ Type (Compact, moisture resistant style)	6	8	0.1 0.2 0.5					
	10	12	0.05 0.1 0.2					
	25	30	0.01 0.02 0.05 0.1					

"Where the Future
is Today"



FUJI TSUSHINKI SEIZO K.K.
Fuji Communication Apparatus Mfg. Co., Ltd.
Tokyo, Japan.

Represented by: The Nissho American Corporation: New York 5, 80 Pine St., WH 3-7840, Chicago 3, 140 S. Dearborn St., CE 6-1950
 The Nissho Pacific Corporation: San Francisco 4, 120 Montgomery St., YU 2-7901, Los Angeles 14, 649 S. Olive St., MA 7-7691

CIRCLE 108 ON READER SERVICE CARD



Did you swipe this magazine?

Only 7½ cents a week is the easy way! (\$6 one year, \$9 for two years, \$12 three years.) Just fill in the handy "For subscriptions" section of the Reader Service Card in this issue . . . and you'll get instant subscription.

electronics: 330 West 42nd St., N. Y. 36.

are stable at room temperatures. The formulations can be stored for one year or longer at 75 F and are usable after storage for three months at 95 F. Curing time has been greatly reduced and molded parts are hard on ejection from the mold. For some grades curing time is as fast as 15 sec.

CIRCLE 313, READER SERVICE CARD

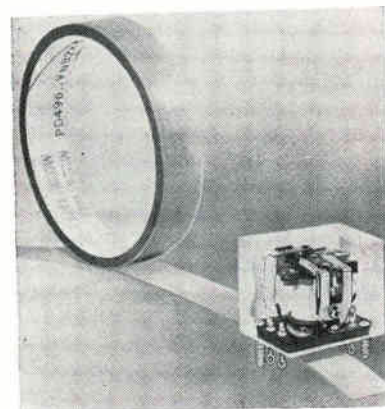

Pressure-Sensitive Tape Prevents Corrosion

MYSTIC ADHESIVE PRODUCTS, INC., 2635 N. Kildare Ave., Chicago 39, Ill., has announced a non-gassing pressure-sensitive tape that prevents corrosion and pitting in electronic components. Known as PD-496, it has a three-mil Teflon backing and a thermostetting rubber-based adhesive. It is especially designed for insulating the coil windings of Class F hermetically-sealed components. The tape is available from stock in 36-yard rolls and in a broad range of width. (314)

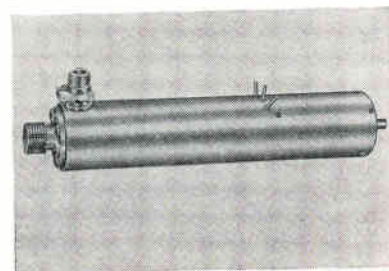

C-W Oscillator Tunes From 2.0 to 4.1 Gc

TRAK MICROWAVE CORP., Tampa, Fla., has developed a c-w oscillator with a continuous manual tuning range from 2.0 to 4.1 Gc. Type 2982 has a power output of 1 w, with a frequency stability of 25 ppm/deg. C. Power input requirements are 325 v d-c at 60 ma; 6.0 v at 0.9 amp.

The oscillator is 2 in. in diameter and 11 in. long including projections. The tuning mechanism is of the non-contacting type, resulting in a tuning resolution of better than 40 Kc, with the discontinuities or reversals. (315)

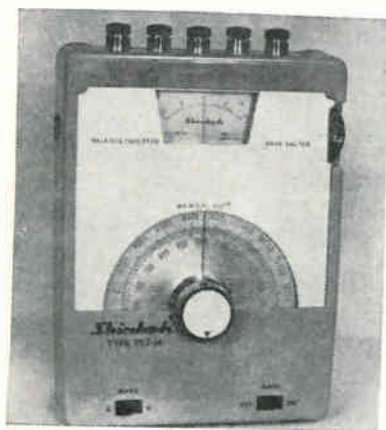

Strain Indicator Used in Lab and Field

METRIX, INC., P.O. Box 683, Walnut Creek, Calif. Model PS7-H miniature portable strain indicator features transistor circuit design. Single dial control permits strain measurement over a wide range. Other controls are for gage factor setting, 2 or 4 gage selector and on-off. Unit is powered by self contained flashlight cells which provide approximately 60 hr of operating life. (316)

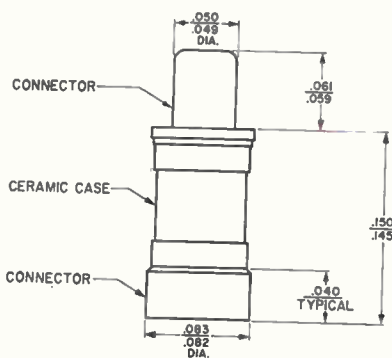

Varactor Diodes Are Ruggedized Units

AIRTRON, a division of Litton Industries, 200 E. Hanover Ave., Morris Plains, N. J., has available point-contact gallium arsenide varactor diodes with nominal cutoff frequencies of 150 Gc at zero bias, and guaranteed minimum of 100 Gc. Other nominal specifications include: non-linearity, 0.4-0.55 from

Wanted: Men who are looking for trouble.



Northrop Norair needs men who question. And question. And question. The kind of men who take nothing for granted. Who search out every flaw, every imperfection. Are you a perfectionist? If so, then the place for you is Norair. The following aerospace positions are available now:

Propulsion. Men with knowledge of the fundamental technologies to do research and development on solid, liquid, hybrid, and air-breathing systems.

Vehicle dynamics and control. For research and development in aerodynamics and flight controls as applied to VTOL vehicles, space trainer aircraft, and six-degree-of-freedom near-earth trajectory problems.

Electromagnetics. For studies in energy propagation and field theory pertinent to such areas as communications antennas, radar cross-sections, and plasma sheaths.

Fluid mechanics. For analyses of subsonic, supersonic and hypersonic flows.

Communications. To conduct analysis and integration of new concepts in telemetry command, detection, and tracking systems.

Experimental aerodynamics. To work with a group that will support theoretical aerodynamic research with experimental approaches and will initiate experimental research to fill voids in the theoretical techniques.

Operations research. To visualize complete weapons systems, and apply basic knowledge to new and diversified problems.

Guidance and controls. To conduct study and analysis of sensors and computers.

Systems research. To work on systems performance optimization.

Numerical analysis. To develop large-scale numerical procedures for aerodynamic design and flow field analysis.

Avionics. To work on the design, development, and analysis of avionics systems for airborne applications.

Reliability. To assess the reliability and optimize the configuration and mission profiles of space systems.

Chemical research. To work on the development and applications of structural adhesives for aerospace vehicles.

Metallurgical research. For research and development on materials and joining.

If you'd like more information about these opportunities and others that may be available, write to Roy L. Pool, Engineering Center Personnel Office, 1001 East Broadway, Hawthorne, California.

NORTHROP NORAIR
AN EQUAL OPPORTUNITY EMPLOYER

0 to -5 v; junction capacitance at zero bias, 0.1-0.4 pf \pm 0.02 pf; case capacitance, 0.06 pf; reverse breakdown voltage, 6 v min (2 μ a reverse current).

CIRCLE 317, READER SERVICE CARD



Germanium Transistors For High Power Uses

TUNG-SOL ELECTRIC INC., One Summer Ave., Newark 4, N. J., has added five new transistor types to its high power germanium devices. They have a collector current rating of 5 amp and were designed with low leakage current and high voltage protection which suits them for use in applications such as high power amplifiers, motor controls, d-c to d-c converters, relay drivers and high power switches. Max collector dissipation is 106 w. Derat-

ing factor is 0.8 C/w and max junction temperature 100 C. (318)

Trimmer Capacitors

JFD ELECTRONICS CORP., 6101 Sixteenth Ave., Brooklyn 4, N.Y. Four new Hi-Life precision trimmer capacitor series exceed MIL-C-14409A adjustment life requirements by more than 600 percent. (319)



Null Detector Has Extended Range

WEINSCHEL ENGINEERING, 10503 Metropolitan Ave., Kensington, Md. With the model ND-2, a 1000 cps differential null detector, the dynamic range of the Weinschel dual channel insertion loss test set is ex-

tended to 35 db as compared to the 20 db formerly obtainable. The improvement results from the synchronous detector and associated meter which have been introduced to permit finer resolution of the null. An external control is provided to permit selecting the sensitivity over a wide range. For measurements up to 20 db, a typical half-scale sensitivity of the meter is 0.01 db. (320)



D-C Amplifier Provides Gain of 250

SONEX, INC., 20 E. Herman St., Philadelphia 44, Pa. The TEX-3804

CURTISS-WRIGHT ELECTRONICS...

adding a new dimension to the capability of man

DEMON is the second generation of Curtiss-Wright's programmed comparator automatic checkout equipment. It consists of 4 major sections: Command generator, stimuli generators, system exerciser, and output translator. The equipment combines increased test capacity with simplified NOR logic circuitry. The display unit can be automatic typewriter, punched paper tape, alphanumeric printer or visual indicator.

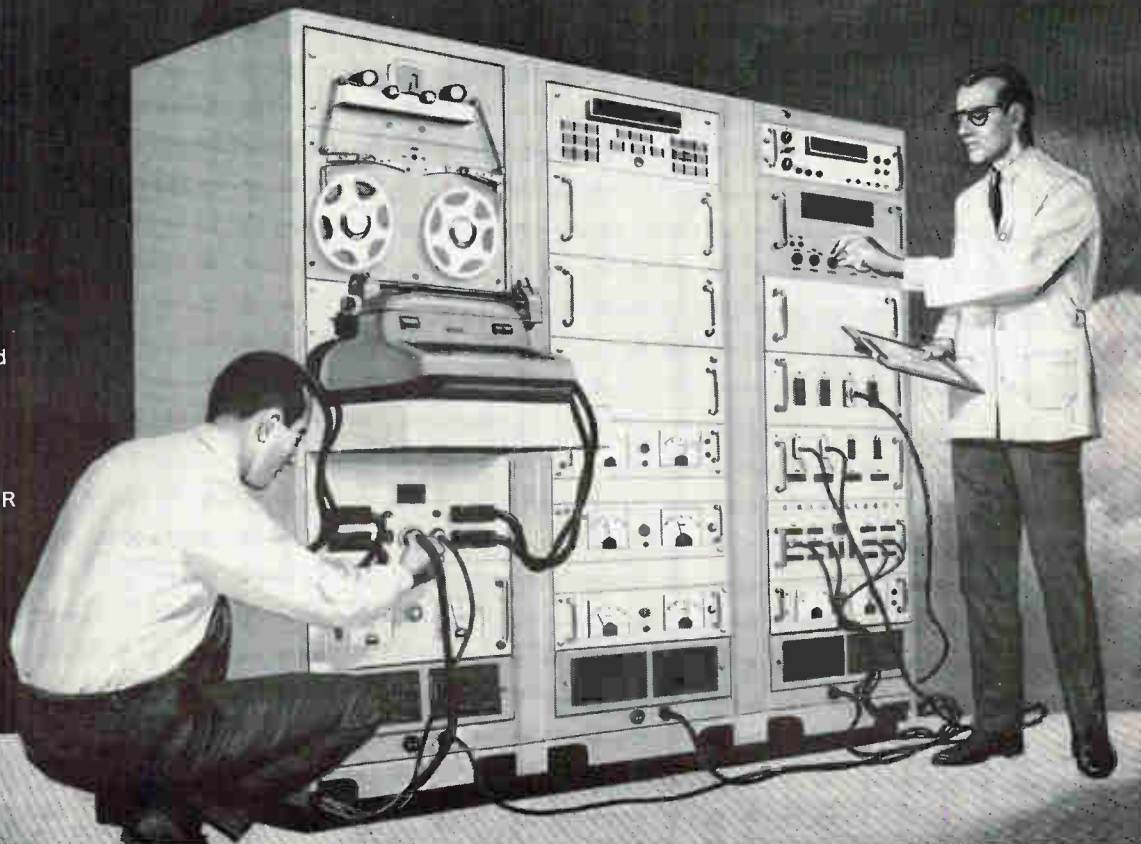

Is an all solid-state high environmental d-c amplifier, designed for aircraft and missile use where minimal size is vital. Characteristics include airborne ruggedness, differential input, gain 250, 5 v p-p output, and an output impedance of 3000 ohms max. It features adaptability to combination form. Piggybacked with the TEX-3007 high-level voltage controlled oscillator, the d-c amplifier achieves low cost flexibility as a new low-level voltage controlled oscillator. (321)



Porcelain Capacitors Handle up to 14 Amp

VITRAMON, INC., P.O. Box 544, Bridgeport 1, Conn. Miniature solid state porcelain capacitors will handle up to 14 amp of current and

range from 1 to 2,000 pf. They permit drastic reduction in the size of equipment, such as transmitters and other applications requiring high current operation. Operating range is from -55 through 125 C and from 2-30 Mc the units will operate at 1,500 v a-c rms. (322)

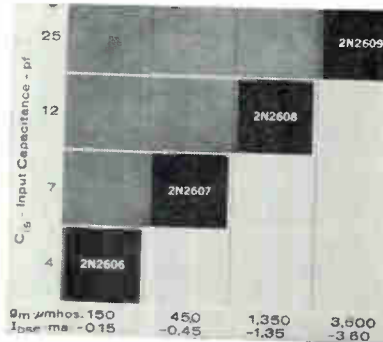

Field-Effect Transistors Have Low Pinch-Off

SILICONIX INC., 1140 W. Evelyn Ave., Sunnyvale, Calif., announces four new P-channel planar silicon unipolar field-effect transistors in the TO-18 package. They offer in-

dividual geometries and corresponding tightly controlled ranges of g_m , I_{DSS} , and C_{ig} . All have typical pinch-off of 2 v at $I_{DS} = -1 \mu a$. Minimum gate-drain breakage voltage of 30 v is guaranteed at $I_G = 1 \mu a$. Typical small signal input resistance exceeds 100 megohms suiting them for high input impedance amplifiers, analog multipliers and analog function generators. (323)



Tachometer Generator Needs No Maintenance

VIBRAC CORP., 281 Billerica Road, Chelmsford, Mass. Unit consists of a precision wound stator and p-m rotor. Since it uses no bearings or brushes, it requires no maintenance and less than 2 cu in. of space. An encapsulation process and a molded epoxy case make it essentially im-

PRODUCT IN POINT:

DEMON AUTOMATIC CHECKOUT EQUIPMENT ... sets new standards for testing!

At Curtiss-Wright, new applications of science and technology develop products which become integral parts of military and industrial programs.

Product in Point: Demon—a new approach to testing and checkout for today's weapons systems. Demon is a highly reliable modular Go/No-Go automatic checkout system which can be custom configured. It is adaptable to projects ranging from readiness determination of satellite launch vehicles, missiles or aircraft to the high speed production line testing of subsystems and components.

There is an intensive program for the development of Demon and related projects (digital computer controlled systems, automatic waveform analyzers, peak reading voltmeters) being carried forward at Curtiss-Wright Electronics Division. These and other advanced activities have created immediate opportunities for systems engineers and circuit designers with specific experience on automatic checkout equipment.

For complete information, please write Mr. Gene R. Kelly, Manager of Professional Placement, Electronics Division. An equal opportunity employer.



ELECTRONICS DIVISION
CURTISS-WRIGHT CORPORATION

35 MARKET STREET, EAST PATERSON, N. J.



Preferred
for
Quality
and
Economy

ELECTROPLATED WIRES

For many years we have specialized in the continuous electroplating of wires... Gold, Silver, Nickel, Rhodium, Indium, Tin and many other metals, or combinations, can be plated onto wires of Tungsten, Molybdenum, Nickel, Bronze, Copper, Silver, etc.... Purity of the metals and quantity deposited are precisely controlled. Send us your specific requirements.

SIGMUND COHN Mfg. Co., Inc., 121 So Columbus Ave.
Mount Vernon, N.Y.

Since 1901 

SIGMUND COHN CORP. OF CALIFORNIA • 151C NORTH MAPLE STREET, BURBANK, CALIFORNIA
CIRCLE 204 ON READER SERVICE CARD



QUALITY to the Nth Degree

Fine Wire engineered to your requirements. Ultra-pure metals . . . Precise, homogeneous alloys . . . Optimum physical and electrical characteristics . . . combine to give you the utmost in quality. Write for data.

Let us quote on our requirements.

CONSOLIDATED REACTIVE METALS, inc.
115 Hoyt Avenue — Mamaroneck, N. Y. — OWens 8-2300



pervious to oil, grease, moisture and corrosive solvents. The Vibratac is easily installed on any rotating device. Its output voltage at a given rpm is proportional to its speed and is readily measured by an inexpensive voltmeter. It can be supplied with a voltage output from 1 to 6 v/1,000 rpm.

CIRCLE 324, READER SERVICE CARD



Choppers Feature Low Noise Level

CAMBRIDGE SCIENTIFIC INDUSTRIES, INC., 18 Poplar St., Cambridge, Md. Series of 60 cycle choppers are available in both make before break, and break before make contact action. They feature a noise level of less than 0.5 μv into a 1,000 ohm load, and less than 5 μv into a 1 megohm load. Standard plug-in models are conservatively priced at \$36.90 each in sample quantities. Flange and strap mounted units are priced slightly higher. (325)

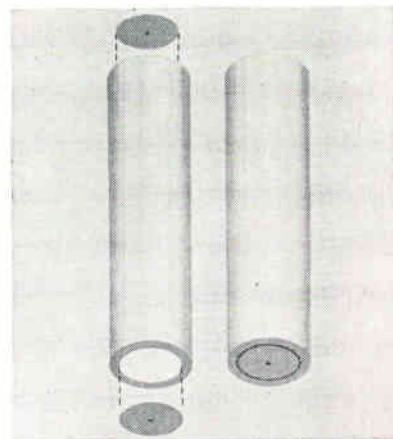

Hermetic Seal Made of Ceramic

ADERHOLD ELECTRONICS & CERAMIC SPECIALTIES, INC., Saxonburg, Pa. The Aderseal is made from an epoxy-impregnated ceramic tube with matching caps that has a coefficient of expansion halfway between the ceramic and the epoxy.

When the element to be sealed is encased in the tube, the ends are closed with the caps and coated with additional Aderseal material. A simple curing procedure completes the seal and makes it hermetic, as determined by a helium leak detector mass spectrometer apparatus. (326)



Phase Meter Provides High Resolution

INDUSTRIAL TEST EQUIPMENT CO., 55 E. 11th St., New York 3, N.Y., announces the model 210AB direct reading Phazor phase meter. A projection read-out device is utilized to display the quadrant of the phase angle. The number of degrees within that quadrant is read directly on the meter. This arrangement coupled with utilization of the full meter scale length to read an angle of 45 deg provides a high degree of phase resolution. (327)



Temperature Console Has Three Chambers

CINCINNATI SUB ZERO PRODUCTS, 3932 Reading Road, Cincinnati 29, O. Three individually controlled chambers provide comparative temperature testing facilities, or instrument calibrating media, over a temperature range from -65 to +300 F. Immersion heaters equalize the temperature during the refrigeration cycle resulting in

TI has what you need in pulse programming!

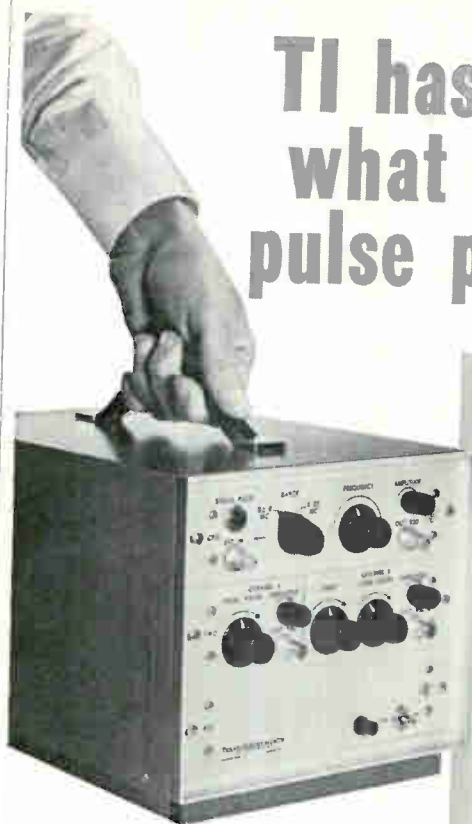

VERSATILITY

Custom combination of modules for any desired performance characteristics.

HIGH REP RATE

Repetition rates of 100 cycles to 100 megacycles.

PORTABILITY

Compact, lightweight, easy to carry.

Texas Instruments Series 6000 Pulse Generators are the smallest instruments available with the advantages of modular construction plus a wide range of operating features which include:

- Variable Width and Delay
- Variable Rise and Fall Times
- Plus and Minus Outputs
- Pulse Mixing
- Programmed and Random Word Generation

TI Pulse Generators combine dependable performance with a high degree of versatility and convenience. Circuitry is all solid state with compact controls. Modular construction provides extreme flexibility in combining features to suit specific applications. Write for complete information.



TEXAS INSTRUMENTS
INCORPORATED
3609 BUFFALO SPEEDWAY
P. O. BOX 66027 HOUSTON 6, TEXAS

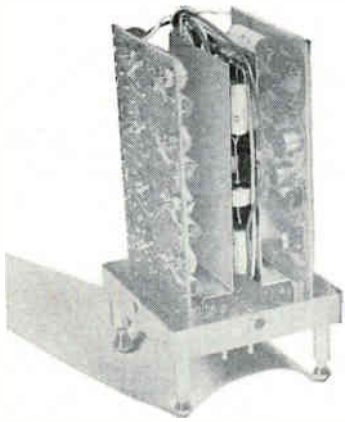

leave
well enough
alone?

no!

Rixon's SCR-601 semiconductor relay is an excellent device. It works quietly and efficiently, even at high data rates like 2400 bits per second (more than 4000 words per minute.) So why tamper with it? Well, mainly because we got curious about RFI problems. The result—shown above with its case removed—is the SCR-601-RFI relay.

We added filters to each input/output connection except the ground lead, and, just to be safe, we enclosed them in a brass sheath. The whole filter assembly fits between the two printed circuit cards. Result? Now we have an *ultra quiet* signaling relay for applications where security is standard operating procedure.

For more information about this relay, with or without RFI suppression, contact the Marketing Department at . . .

RIXON ELECTRONICS, INC.

2121 INDUSTRIAL PARKWAY—MONTGOMERY INDUSTRIAL PARK—SILVER SPRING, MARYLAND
TELEPHONE: 622-2121

TWX: S SPG 213

CIRCLE 205 ON READER SERVICE CARD

How To Get Things Done Better And Faster

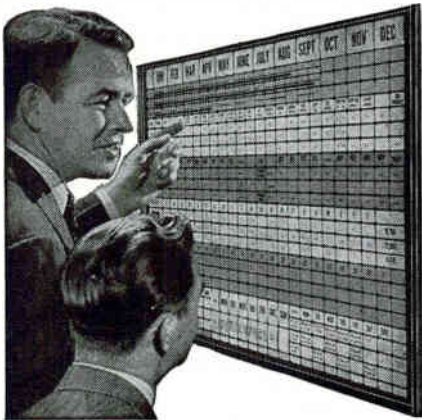

BOARDMASTER VISUAL CONTROL

- ☆ Gives Graphic Picture—Saves Time, Saves Money, Prevents Errors
- ☆ Simple to operate—Type or Write on Cards, Snap in Grooves
- ☆ Ideal for Production, Traffic, Inventory Scheduling, Sales, Etc.
- ☆ Made of Metal. Compact and Attractive. Over 750,000 in Use

Full price \$4950 with cards

FREE

24-PAGE BOOKLET NO. C-10
Without Obligation

Write for Your Copy Today

GRAPHIC SYSTEMS
YANCEYVILLE, NORTH CAROLINA

Are you selling the whole buying team

Tough competition *demands* that the electronics man be reached and *sold* wherever you find him: *Research, Design, Production, and Management*. Only advertising in **electronics** reaches all four... the same men your salesmen call on. Put your advertising where it works *hardest*....

in **electronics**

accuracy of ± 1 F. Temperature stratification is minimized through the use of agitated convection fluid in the liquid tight chambers. Console type cabinet is 44 in. long, 31 in. wide and 50 in. high.

CIRCLE 328, READER SERVICE CARD

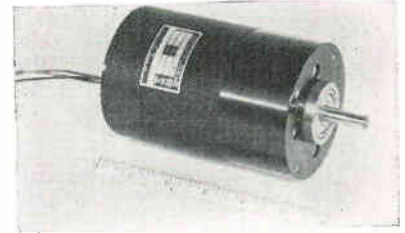

A-C Gear Motor Weighs About 5 Lb

GLOBE INDUSTRIES, INC., 1784 Stanley Ave., Dayton 4, O. Gearmotor combines the type LC motor with the 1½ in. planetary gear box to produce 75 in. lb of torque from a low speed a-c motor. The drive motor is a 2 pole, 115 v, 60 cycle, single phase LC type which will draw 2 amp and 120 w of power when running at full load. Qualified to MIL-E-5272B, life of gearmotor is in excess of 1,000 hr when run at intermittent duty. (329)

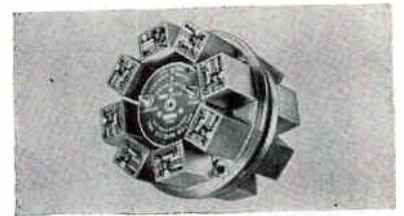

Telemetry System Fits in Small Space

VECTOR MFG. CO., INC., Southampton, Pa. This specially packaged system is designed for the nose of a small missile and consists of seven TS-54 oscillators and a TA-58 mixer amplifier on one side of a 5-in. plate; on the other side are TV-56 and TV-53 voltage regulators, six TLA-55 low level amplifiers, and a TRPT-2V transmitter. (330)

Millivoltmeter

DAWE INSTRUMENTS, LTD., Western Ave., Acton, London W. 3, England. Type 616A transistor millivoltmeter is a portable battery operated in-

strument which measures alternating voltages from less than 1 mv to 300 v over a frequency range of 2 cps to 100 Kc. (331)



Vacuum Phototube Measures Laser Pulses

CETRON ELECTRONIC CORP., 715 Hamilton St., Geneva, Ill. The XR-798 phototube, because of its close spaced anode-cathode configuration, has found application in measurement of high intensity, short duration light flashes. Minimum sensitivity is 25 μ a per lumen; max sensitivity, 70 μ a per lumen. Max recommended anode voltage, d-c or peak a-c. is 250; max dark current at 200 v d-c, 25 C is 0.1 μ a. (332)

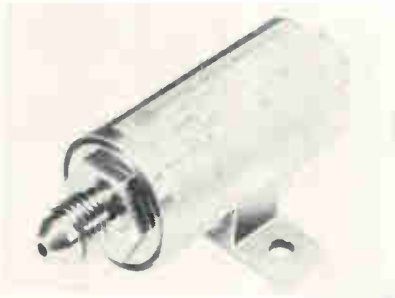

Pot Type Transducer Weighs 4 Ounces

SERVONIC INSTRUMENTS, INC., 1644 Whittier Ave., Costa Mesa, Calif. Model 3021 miniature low pressure transducer withstands 35 g vibration with less than 1.0 percent error. Featuring a new pressure-sensing concept, the unit has two separate sets of aneroid capsules attached to opposite ends of a driving frame. One set is connected to a pressure fitting and the other is evacuated for an absolute pressure reference. The second can be vented to the atmosphere for gage pressure measurement. (333)

HONEY OF A



New Improved

HYGRADE

POLYTUBE

FLEXIBLE FIBERGLASS SLEEVING

Hygrade Polytube, "Queen of the B's" among Class B sleeveings, is now even better. Its braided fiberglass base is coated with newly-formulated resins which impart the flexibility and dielectric dependability usually found only in vinyl coated sleeving, together with improved thermal stability, oil and chemical resistance, and compatibility with other insulations. It is non-thermoplastic, exhibiting good cut-through resistance, and excellent abrasion resistance (tested to MIL-T-5438). Polytube performs to NEMA VS-1 and MIL-I-3190B, and is rated for continuous use from -45°C (brittle point) to 130°C . It is made in all standard colors, in Grades A, B, C-1, C-2, and C-3.

WITH THE
flexibility
OF VINYL AND THE
compatibility
OF ACRYLICS



For test samples, data and prices,

make a Bee-Line to
L. Frank Markel & Sons
Norristown, Pennsylvania



SOURCE for EXCELLENCE in
Insulating Tubings and Sleeveings
High Temperature Wire and Cable

HOUSINGS UNLIMITED

WITH SLIMLINE IMLOK

Slim, trim and terrific for "do-it-yourselfers", prototype builders and even for production quantities. The size and shape of housings which may be built with Slimline Imlok is limited only by your requirements. Only simple hand tools are required.

While similar in principal to the standard Imlok system, Bud Slimline is of smaller, lighter weight aluminum. When fully completed, enclosures present a sleek, streamlined appearance since the exposed surface of the extrusion is narrower and of lighter gauge. The corner connectors are never exposed.

Ask your distributor to point out the advantages of Bud Slimline Imlok or write for Bulletin BIM-61.

BUD RADIO, INC.

CLEVELAND 3, OHIO



CIRCLE 206 ON READER SERVICE CARD

PRODUCT BRIEFS

SUBMINIATURE R-F CHOKES are magnetically shielded. Inductance range is from 0.1 μ h to 180 mh. Vanguard Electronics Co., 3384 Motor Ave., Los Angeles 34, Calif.
CIRCLE 334, READER SERVICE CARD

RACK AND PANEL CONNECTORS designed for use with MIL-C-26636 type contacts. They are available in six insert arrangements and three shell sizes. The Deutsch Co., Municipal Airport, Banning, Calif. (335)

BREADBOARDING MODULES designed for building semiconductor circuits. Each of the 35 solderless connectors accepts up to four leads. Vari-L Co., Inc., 207 Greenwich Ave., Stamford, Conn. (336)

DUAL TWO-INPUT GATE MODULES permit cost and space savings. They have standard seven-pin miniature base configurations. Cambridge Thermionic Corp., 445 Concord Ave., Cambridge 38, Mass. (337)

FIXED NEON INDICATOR LIGHTS are all plastic, subminiature. Lenses are available in colors of red, white, amber, or clear. The Solan Co., Box 367, Sun Valley, Calif. (338)

COAXIAL R-F CONNECTORS accept micro-miniature RG cables from 50 to 95 ohms. They feature crimp type, captive contact. Tamar Electronics Division, 2045 West Rosecrans Ave., Gardena, Calif. (339)

SELENIUM RECTIFIERS packaged in Mylar film. They are available in ratings of 2-30 Kv prv at 5 ma average d-c. Bradley Semiconductor Corp., 275 Welton St., New Haven 11, Conn. (340)

TEFLON FLAT CABLE has construction that permits almost unlimited design possibilities. It is available in temperature requirements up to 200 C. Hitemp Wires Co., 1200 Shames Drive, Westbury, N.Y. (341)

PHOTOELECTRIC TAPE READER has varied applications. It is bidirectional, with a 28-v d-c control signal to reverse tape motion. Seattle Development Laboratory, Honeywell Ordnance Division, 5303 Shilsole Ave. N.W., Seattle 7, Wash. (342)

MINIATURE MULTI-GANG POT has linearity better than ± 0.3 percent. Standard resistances are 10 to 20,000 ohms. The Gamewell Co., Newton Upper Falls, Mass. (343)

VARIABLE POWER DIVIDER has a frequency range of 400 to 6,000 Mc, with tuning range of 15 percent. Max vswr is 1.5. Microlab, Livingston, N.J. (344)

ELECTRICAL CONNECTORS offer quick connect and disconnect. They are designed with field indexable keying for application in control, power, and communication circuits. The

PROFESSIONAL

TEST and LAB INSTRUMENTS

AT 1/2 THE COST!

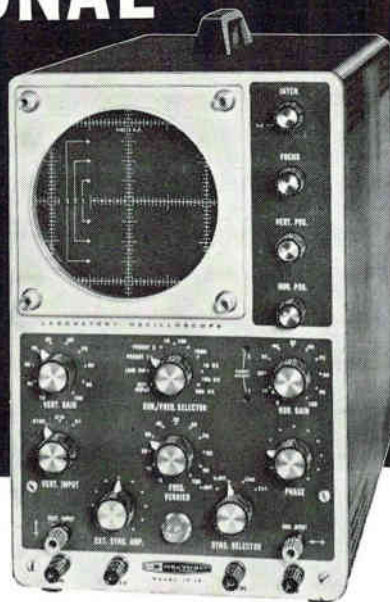

HEATHKIT

'63 CATALOG

100 pages with over 250 kits you can assemble and save 50% or more! New advanced engineering... new professional styling... with guaranteed specifications! Send for your free catalog today!



HEATH COMPANY Benton Harbor 67, Michigan
PLEASE SEND FREE 1963 HEATHKIT CATALOG

NAME _____

ADDRESS _____

CITY _____

ZONE _____ STATE _____

Pyle-National Co., 1334 N. Kostner, Chicago 51, Ill. (345)

SILICONE DIELECTRIC COMPOUND designed for use as a general purpose protective coating. It features ease of application. General Electric Co., Waterford, N.Y. (346)

ELECTRONIC PEGBOARD KITS aid in circuit design and instruction. Pegs may serve both as solder points and as temporary circuit junctions. Laguna Labs, 2419 S. Coast Blvd., Laguna Beach, Calif. (347)

DIVIDING HEAD for both automatic and semiautomatic operation. Accuracy is 10 sec-of-arc. Gertsch Products, Inc., 3211 S. LaCienega Blvd., Los Angeles 16, Calif. (348)

SOLID STATE CONTACTORS with extremely low noise. They are designed for use in computer power circuit switching where transients developed would be troublesome in the computer. LJ Products, 7450 Girard Ave., LaJolla, Calif. (349)

SOLID-STATE INVERTER is a low-cost unit. It offers reliability, frequency stability and small size. Humphrey, Inc., 2116 E. Central Ave., Wichita, Kansas. (350)

SPECTRUM RESOLVER/INTEGRATOR requires no tape, either perforated or magnetic, to resolve information. It operates with the 400 series pulse height analyzers. Technical Measurement Corp., 441 Washington Ave., North Haven, Conn. (351)

TRANSISTOR PROTECTOR safeguards circuitry against overload and over-voltage. It is a three terminal device suitable for mounting in p-c boards or used with standard wire connections. Littelfuse, Inc., Des Plaines, Ill. (352)

COAXIAL DIRECTIONAL COUPLERS provide octave coverage, 2.0-8.0 Gc, at coupling values of 10, 20 or 30 db. They weigh only 2 ounces. Omni Spectra, Inc., 8844 Puritan Ave., Detroit 38, Mich. (353)

AUTOMATIC MACHINE welds headed leads to transistor bases. It produces from 4,000 to 6,000 welds per hour. Mann-Made Enterprises, Addison, Ill. (354)

SNAP-ACTION ACCELERATION SWITCH operates between 2.5 g and 50 g. Unit measures 2 by 2 $\frac{1}{2}$ by $\frac{1}{8}$ in. and weighs 4 oz. Maxson Electronics Corp., 475 Tenth Ave., New York 18, N.Y. (355)

PRESSURE TRANSDUCER is small and hermetically sealed. Pressure ranges are 0-10 to 0-100 psia. Servonic Instruments, Inc., 1644 Whittier Ave., Costa Mesa, Calif. (356)

MOTOR GENERATOR is temperature and frequency compensated. Model CR4 0860 014 is designed for high response systems. Kearfott Division, General Precision, Inc., Little Falls, N.J. (357)



specialized alloys for glass hermetic seals

RODAR[®] NIRON[®] 52 NIROMET[®] 46

Specified Industry-wide for

PERMANENTLY-BONDED VACUUM-TIGHT SEALS!

Thermal Expansion

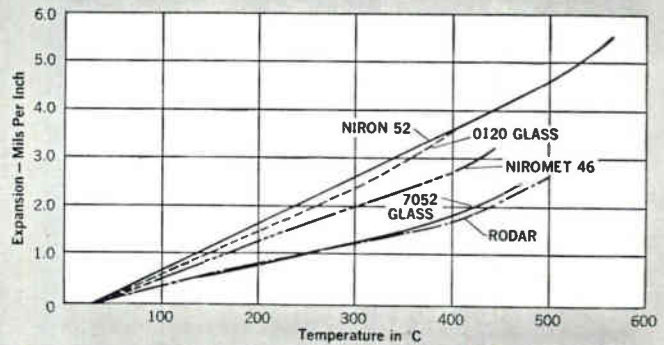

RODAR[®]

NOMINAL ANALYSIS: 29% Nickel, 17% Cobalt, 0.3% Manganese, Balance—Iron

Rodar matches the expansivity of thermal shock resistant glasses, such as Corning 7052 and 7040. Rodar produces a permanent vacuum-tight seal with simple oxidation procedure, and resists attack by mercury. Available in bar, rod, wire, and strip to customers' specifications.

Temperature Range	Average Thermal Expansion *cm/cm/°Cx10-7
30° To 200°C.	43.3 To 53.0
30 300	44.1 51.7
30 400	45.4 50.8
30 450	50.3 53.7
30 500	57.1 62.1

COEFFICIENT OF LINEAR EXPANSION
*As determined from cooling curves, after annealing in hydrogen for one hour at 900° C. and for 15 minutes at 1100° C.

NIRON[®] 52

NOMINAL ANALYSIS: 51% Nickel, Balance—Iron

This Wilbur B. Driver nickel iron alloy contains 51% nickel. Niron 52 sealing alloy is exceptionally well adapted, and widely employed, for making seals with 0120 glass.

NIROMET[®] 46

NOMINAL ANALYSIS: 46% Nickel, Balance—Iron

A 46% nickel-balance iron alloy with expansion properties between Niron 52 and Rodar. It is used extensively as terminal bands for vitreous enameled resistors.

WILBUR B. DRIVER CO.

NEWARK 4, NEW JERSEY, U.S.A.

IN CANADA: Canadian Wilbur B. Driver Company, Ltd.
50 Ronson Drive, Rexdale (Toronto)

Call or
write for
Sealing
Alloy
Bulletin

Precision Electrical, Electronic, Mechanical and Chemical Alloys for All Requirements

Literature of the Week

SILICON CONTROLLED RECTIFIERS Silicon, Inc., 200 Sweetwater Ave., Bedford, Mass., has available a silicon controlled rectifier interchangeability guide.
CIRCLE 358, READER SERVICE CARD

GLIDE SLOPE ANTENNA Sparton Electronics, division of Sparton Corp., Jackson, Mich. Product data sheet No. 6 covers the AT-983/ARN glide slope receiving antenna. (359)

EXPANDED CURRENT METER Paulte Mfg. Co., P. O. Box 85, Merrick, L. I., N. Y., has published a technical bulletin on the model 101 expanded current meter. (360)

COMPUTER INDICATOR POWER SUPPLY Power Devices, Inc., 8710 Darby Ave., Northridge, Calif., offers a technical data sheet on the PS50/1-15 computer indicator power supply. (361)

INTEGRATED CIRCUITS Signetics Integrated Circuits, 680 W. Maude Ave., Sunnyvale, Calif., has published two brochures detailing characteristics and specifications of integrated circuits and the step-by-step manufacturing process. (362)

RECORDING OSCILLOGRAPH Consolidated Electro Dynamics Corp., 360 Sierra Madre Villa, Pasadena, Calif. Capabilities and specifications of the type 5-123 recording oscillograph are given in a bulletin. (363)

LASER SYSTEMS Trion Instruments, Inc., 2320 Washtenaw Ave., Ann Arbor, Mich., has available a bulletin describing the research, development and production of laser systems. (364)

TRACKING AND RANGE DATA EQUIPMENT Resdel Engineering Corp., 990 South Fair Oaks Ave., Pasadena, Calif., offers a brochure on equipment used in acquisition and reduction of track and range data. (365)

METALLIZED PAPER CAPACITORS Aerovox Corp., New Bedford, Mass. A revised bulletin gives complete technical data on microminiature Aero-lite molded metallized paper capacitors. (366)

MAGNETIC TAPE DATA RECORDERS Precision Instrument Co., 1011 Commercial St., San Carlos, Calif. A series of compact data recorders are described in an illustrated 12-page technical brochure. (367)

SOLDERING TIPS Hexacon Electric Co., 130 W. Clay Ave., Roselle Park, N. J. Catalog 651 shows the Durotherm line of non-freezing soldering tips. (368)

SYNCHROS John Oster Mfg. Co., Racine, Wis. A 16-page catalog describes electrical parameters and mechanical characteristics of more

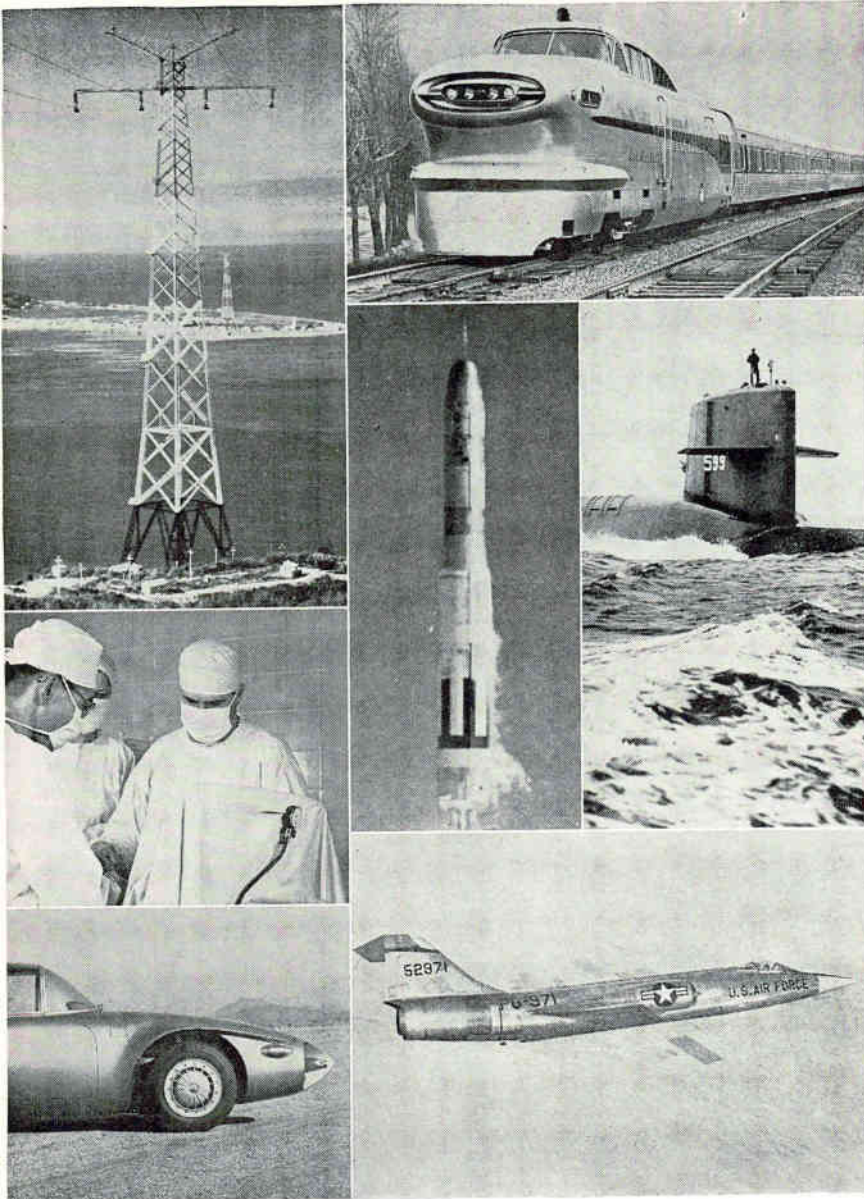

WHEN OSCILLOGRAPHY COUNTS

In almost every imaginable area of science and industry, you'll find that CEC multi-channel recording oscillographs measure up as the very finest measuring and recording instruments available. Their versatility, dependability and accuracy have made them the recognized standard of excellence for literally thousands of dynamic testing programs currently being carried out in all parts of the world. And, in addition to the broad variety of recording oscillographs, CEC also produces signal conditioning equipment and power supplies that represent the ultimate in reliability.

CEC

Data Recorders Division

CONSOLIDATED ELECTRODYNAMICS
PASADENA, CALIFORNIA • A SUBSIDIARY OF BELL & HOWELL

than 175 basic synchros and variations. (369)

SENSITIVE RELAYS Babcock Electronics Corp., 3501 Harbor Blvd., Costa Mesa, Calif. Bulletin describes the BR-13 all-welded sensitive relay series. (370)

PROGRAMMER Trio Laboratories, Inc., Dupont St., Plainview, L. I., N. Y. Technical bulletin describes a self-powered relay-type programmer compatible with 4-bit binary-coded digital equipment. (371)

POWER TRANSISTOR Tung-Sol Electric Inc., One Summer Ave., Newark 4, N. J. Product bulletin describes a power transistor with a 15 amp collector current. (372)

SILICONE DIELECTRIC COMPOUND Dow Corning Corp., Midland, Mich. Technical data sheet describes a grease-like, non-melting silicone dielectric material. (373)

AIRBORNE PRESSURE TRANSDUCER Taber Instrument Corp., 107 Goundry St., North Tonawanda, N. Y. Bulletin gives specifications and prices on a lightweight pressure sensing unit for space vehicle and rocket applications. (374)

HEAT DISSIPATION Astro Dynamics, Inc., Second Ave., Northwest Industrial Park, Burlington, Mass., offers an 18-page application manual for heat sinks. (375)

METALLIZED MYLAR CAPACITORS San Fernando Electric Mfg. Co., 1509 First St., San Francisco, Calif. Bulletin 71662 contains complete information on West-Cap Midget metallized Mylar capacitors. (376)

MEASUREMENT INSTRUMENTS Power Instruments, Inc., 7352 North Lawndale Ave., Skokie, Ill., has published a condensed catalog illustrating and describing its line of instruments. (377)

MAGNETORESISTIVE ELEMENTS American Aerospace Controls, Inc., 123 Milbar Blvd., Farmingdale, N.Y. Product data bulletin describes Mistor thin-film, solid-state magnetoresistive elements. (378)

ENCODER PACKAGE Computer Control Co., Inc., Old Connecticut Path, Framingham, Mass., offers a portfolio of Dicotron optical shaft angle encoders incorporating Multiple Slit Technique. (379)

MINIATURE PREAMPLIFIER Ad-Yu Electronics Lab., Inc., 249 Terhune Ave., Passaic, N.J. Data sheet contains description and specifications for type A102 miniature nonmicrophonic preamplifier. (380)

CROSSBAR SCANNER James Cunningham, Son & Co., Inc., 10 Carriage St., Honeoye Falls, N.Y., offers a bulletin on a transistor driven crossbar scanner with remote decimal readout. (381)

HIGH-Q FIXED INDUCTOR Nytronics, Inc., 550 Springfield Ave., Berkeley Heights, N.J. Therm-L inductor for temperature applications is covered in a data sheet. (382)

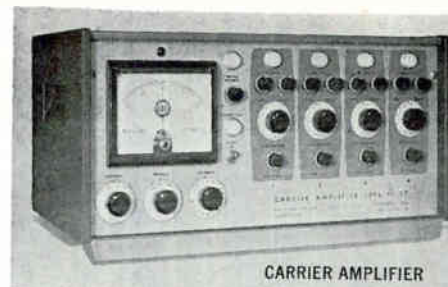

CARRIER AMPLIFIER

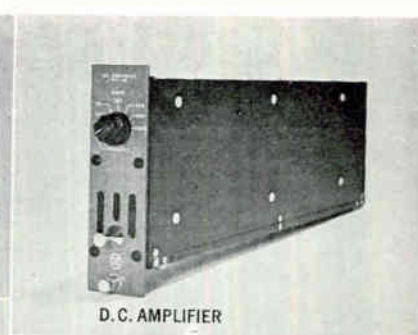

D.C. AMPLIFIER

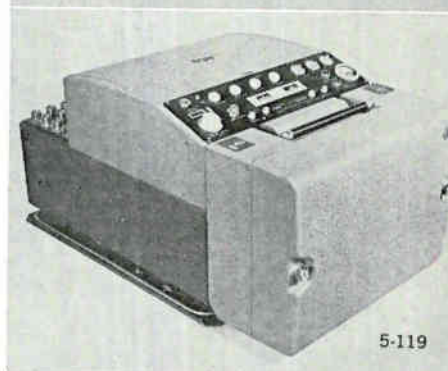

5-119



5-118



POWER SUPPLY

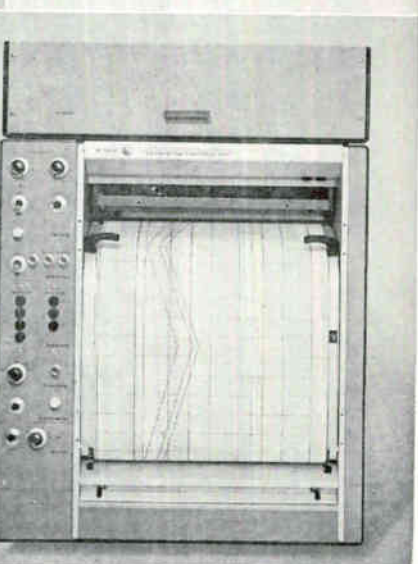

5-123



5-124

... COUNT ON CEC

Just name your specific requirements—there's a CEC multi-channel oscillograph to serve you. Examples: Type 5-118 for minimum size and space, ruggedness and use in high environment; Type 5-119 for flexibility and use in medium-high environment; Type 5-123 for direct readout with 36-52 channels in laboratory environment; and Type 5-124 for portability and 18 channel capacity in laboratory environment. CEC's oscillographs are the very definition of excellence and product line completeness. Full facts? Call your CEC office or write for Bulletin CEC 1310-X5.

CEC

Data Recorders Division

CONSOLIDATED ELECTRODYNAMICS
PASADENA, CALIFORNIA • A SUBSIDIARY OF BELL & HOWELL



Thomas H. Rogers



Howard D. Doolittle

Announce Two Promotions at Machlett

THOMAS H. ROGERS director of engineering for The Machlett Laboratories, Inc., Springdale, Conn., has been elected vice president and x-ray product line manager of the Raytheon subsidiary. At the same time it was announced that Howard D. Doolittle, associate director of engineering, has been named to the new post of technical director for the firm.

Machlett president Joseph W. Skehan said that Rogers, who joined the company 28 years ago, will be responsible for the design and manufacture of x-ray products.

His experience in the x-ray tube field includes many important contributions to the development of Dynamax rotating anode tubes.

Doolittle, in his new position, will be responsible for overseeing the technological advancement of the company across its whole area of interests including x-ray tubes, large power tubes, high power radar tubes, small power tubes, tv camera tubes, x-ray image intensifiers, and solid state rectifiers. He joined the firm in 1945 and was named associate director of engineering 10 years later.



Leesona Moos Labs Advances Mezzina

ALESSIO MEZZINA has moved up to director of physical and electronic

research for Leesona Moos Laboratories, Jamaica, N.Y., a division of the Leesona Corp.

Founded in 1948, and formerly known as Patterson Moos Research, the Laboratories are engaged in basic and applied research.

Engelmann Sets Up New Company

HERBERT F. ENGLEMANN has formed a new company, Engelmann Microwave, Mountain Lakes, N.J., for the design, development and manufac-

ture of coaxial components and subassemblies. The company will specialize in the development of highly reliable microwave hardware for space communications and military defense systems.

Engelmann was formerly vice president and technical director of Microlab, Livingston, N.J.

Hewlett-Packard Forms Two New Divisions

HEWLETT-PACKARD CO., Palo Alto, Calif., has converted two of its wholly-owned subsidiaries, Boonton Radio Corp. and Palo Alto Engineering Co., into divisions of the company. Both new divisions produce instrumentation equipment complementary to the H-P product line.

The establishment of Boonton Radio and PAECO as divisions is part of the parent company's program of gradually divisionalizing its corporate structure, according to president David Packard.

Packard pointed out that the new divisions will retain present policies and product lines. He announced that John C. Beckett, now president and general manager of PAECO, will continue as general manager of that division.

He also said that William D. Myers has been named general manager of the Boonton Radio division. He succeeds George A. Downsborough who recently resigned the presidency of Boonton Radio. Myers was formerly manufacturing manager of H-P's Microwave division in Palo Alto.

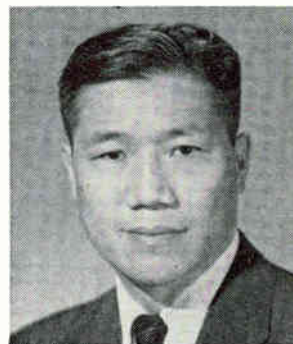

Singer Metrics Names Wu to Direct R&D

WILLIAM I. L. WU, formerly chief engineer of Panoramic Electronics,



"Bounce-Free" for pulse and digital systems that operate in less than a microsecond. *Data Sheet 177.*



"DC Pulse Circuit" produces square wave millisecond pulse for high speed devices. *Data Sheet 194.*



"One-Shot" produces one square wave of 0.1 to 10.0 microseconds regardless of actuation speed. *Data Sheet 150.*



Synchronized "One-Shot" generates single square wave output pulse in synchronism with external clock pulse. *Data Sheet 172.*

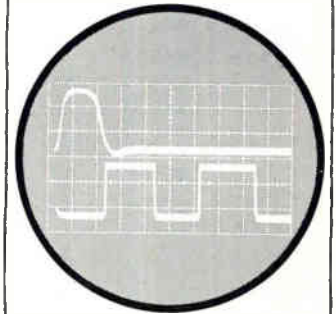
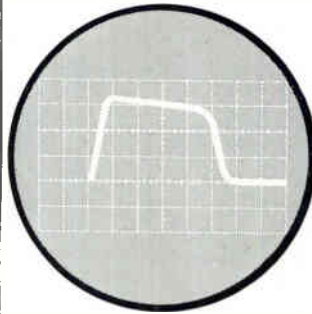
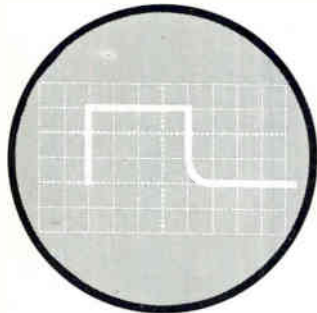
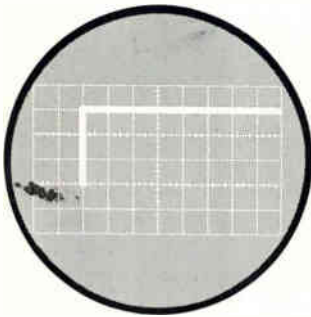

PACKAGED PULSE CIRCUITS

save circuit development time

MICRO SWITCH pre-engineered electronic circuit "packages" help speed equipment design by eliminating the need for custom circuit development. These compact packages save space in equipment racks and control consoles. Four Data Sheets on MICRO

SWITCH circuit packages are available. Write for them . . . or contact our nearest Branch Office (See Yellow Pages) for expert engineering assistance.



MICRO SWITCH

FREEPORT, ILLINOIS

A DIVISION OF HONEYWELL

IN CANADA: HONEYWELL CONTROLS LIMITED, TORONTO 17, ONTARIO

THINNER THAN EVER!



is the thermo module newly developed by Sanyo Electric Co. The technique evolved by Sanyo eliminates high cost and brittle nature of the bismuth telluride alloys used in production of thermoelements. Our exhaustive study reveals possibilities of still reducing its thinness, resulting in wider and more

economical applications to scientific and electronic equipment.

SPECIFICATIONS

Type	Thermo couple	Optimum Current (amp.)	Optimum Voltage (Volt)	(1) ΔT (°C)	Insulation Voltage(2) (Volt)	Dimensions mm (inch)
STM-1028	10	28	0.9	55	50	57×43×10.5 (2.24×1.69×0.413)
STM-1021	10	21	0.9	55	50	57×43×10.5 (2.24×1.69×0.413)
STM-1016	10	16	0.9	55	50	57×43×10.0 (2.24×1.69×0.393)
STM-1012	10	12	0.9	55	50	41×32.5×9.5 (1.62×1.28×0.374)
STM-1006	10	6	0.9	55	50	41×29×9.5 (1.62×1.28×0.374)

Subject to change without notice.
Note: (1) No heat load; T_c is 27°C.
(2) Voltage applied between circuit and hot or cold plate.

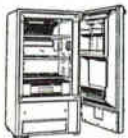

Thermo-electric Refrigerator



Thermo Electric Jar



Power Unit



Power Units



Thermo Pac



Thermo Processing Tray

Apply for further details to:

SANYO

SANYO ELECTRIC INC., ELLENVILLE, N.Y.
SUBSIDIARY OF SANYO ELECTRIC CO., LTD. OSAKA, JAPAN
MAKERS OF RADIO, TV, STEREOGRAPH, ROOM AIR CONDITIONER,
REFRIGERATOR, WASHING MACHINE, SEMICONDUCTOR, THERMOELEMENT.

CIRCLE 122 ON READER SERVICE CARD

**HELP YOUR POST OFFICE
TO SERVE YOU BETTER
BY
MAILING EARLY IN THE DAY
NATIONWIDE IMPROVED MAIL SERVICE
PROGRAM**

has been appointed director of R&D at Singer Metrics division of The Singer Mfg. Co., Bridgeport, Conn.

Singer Metrics is engaged in research and production of electronic laboratory instruments for precise measurement, calibration and spectrum analysis—subsonic through microwave; and precision electro-mechanical systems and components.



**PRD Electronics
Appoints Prager**

PRD ELECTRONICS, INC., Brooklyn, N. Y., manufacturer of microwave and electronic test equipment, has announced the appointment of Jerome Prager as applications engineer.

Prior to joining PRD, Prager was with the communications and electronics department of ITT's Federal Electric Corp. as a systems and installation engineer.



**Anderson Accepts
USI Position**

APPOINTMENT of David Anderson, Col. USAF Ret., as director of engineering for the United States Instrument Corp. has been announced by William A. Rockwood, president.

USI produces telecommunications systems and equipment for private commercial and military use, as well as for the independent telephone in-

dustry. In his new post, Anderson will play a primary role in the company's current product diversification and expansion program, Rockwood said.

Anderson's last military assignment was with the electronic systems division of the USAF Systems Command at Hanscom Field, Bedford, Mass.



Martin Company Appoints Bender

WELCOME W. BENDER, director of Martin Company's Research Institute for Advanced Study, Baltimore, Md., has been appointed director of research for the company.

Bender will have overall responsibility for the programming, integration and quality of Martin's research effort in the company's six operating divisions located in Maryland, Florida and Colorado.

He will also continue as director of the Research Institute for Advanced Study.

Trask to Direct BMEWS Office

AIR FORCE Col. John A. Trask has been named director of BMEWS System Program Office at Electronic Systems Division, Bedford, Mass.

SPO is managing construction of the third BMEWS site at Flyingsdale Moor, Yorkshire, England.

Barnes Engineering Expands in Florida

BARNES ENGINEERING CO., Stamford, Conn., a firm engaged in infrared and electrooptical instrumentation, has acquired the assets of the Versatronics Corp., Fort Walton

Pushbutton Welding INCREASES MODULE PRODUCTION BY 30%

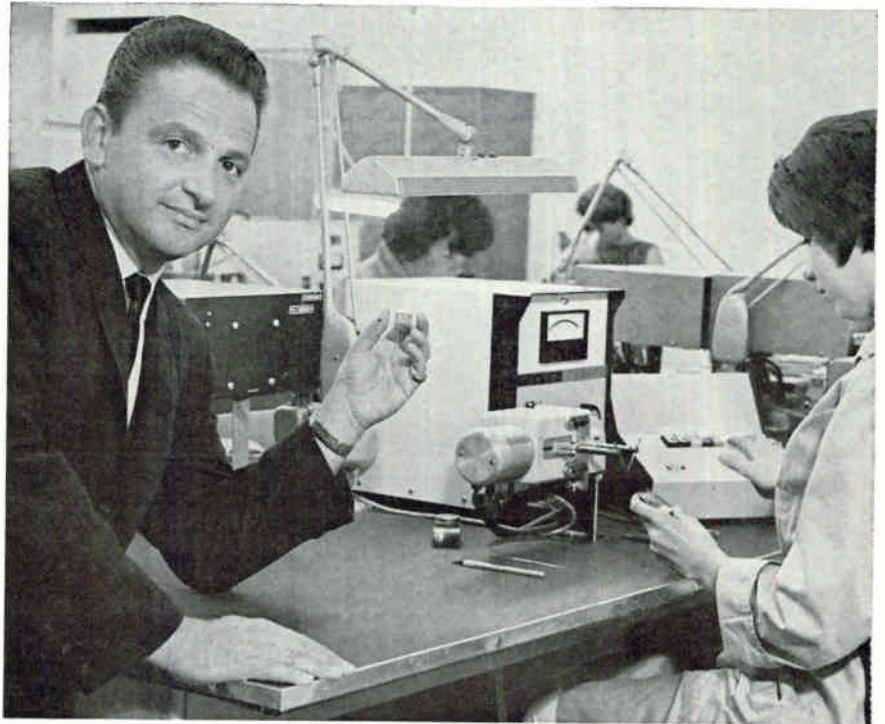

says EUGENE GOULD, president, Allen-Jones Electronics Corporation, Gardena, California



For clear, uncluttered work surface the Model 1072 Production Power Supply mounts under the workbench. Is used in combination with Remote Condition Selector Model 1073.

"Pushbutton welding removes two time-consuming variables in production welding. We get higher reliability and fewer rejects. Operators learn faster... and find it easier to concentrate on making good welds."

It will pay you to look into Pushbutton Welding. Pushbutton selection heat and force, or heat alone, make the operator's job simpler; increases product reliability by providing exactly repeatable welds, throughout the entire weld schedule. Send for more information on MAWS, Modular Automatic Welding System, now. Write Weldmatic Division/Unitek, 950 Royal Oaks Drive, Monrovia, Calif.

WELDMATIC DIVISION / UNITEK

NOW

NEW AM SIGNAL GENERATOR

Model 801D/1 \$1290

WIDER FREQUENCY RANGE
10 mc to 470 mc

HIGHER ACCURACY
± 0.2% with crystal calibrator

70 INCH SCALE LENGTH
A. L. C.

for bandwidth measurement

HIGH OUTPUT
0.5 volt into 50Ω



MARCONI INSTRUMENTS

DIVISION OF ENGLISH ELECTRIC CORPORATION
111 CEDAR LANE, ENGLEWOOD, NEW JERSEY
MAIN PLANT: ST. ALBANS, ENGLAND

Beach, Fla. All Versatronics personnel have been retained.

According to Eric M. Wormser, vice president in charge of Barnes' defense and space activities, the purchase extends the company's capability to provide complete systems for missile range applications.



Sonex Appoints Porst To Vice Presidency

LEE PORST, western regional manager of Sonex, Inc., Philadelphia, Pa., has been promoted to vice president of the firm.

Sonex produces a diversified line of airborne telemetry components, power supplies, printed circuit boards and component assemblies.

Porst, with Sonex for the past 1½ years, had previously been associated with Tele-Dynamics, Inc., and with North American Aviation's engineering department.



REL Names Burrows Senior Scientist

CHARLES R. BURROWS has been appointed to the post of senior scientist of Radio Engineering Laboratories, Inc., Long Island City, N. Y. He will be based at the Bethesda, Maryland, division. REL, the communications subsidiary of Dynatronics Corp. of America, manufactures tropospheric scatter radio commu-

nications equipment.

Burrows joined REL in the spring of this year. His industrial experience includes a vice presidency of Ford Instrument Co., where he was responsible for the long range planning of R&D projects. He has also been associated with Radiation, Inc., and Page Communications, Inc.

PEOPLE IN BRIEF

Dutch Grimm, formerly with Transformer Engineers, joins Monitor Products Co., Inc., as electronic assembly mgr. David Kramer, previously with Minneapolis-Honeywell Regulator Co., now an applied scientist at MB Electronics. D. T. Latimer, Jr., leaves Hoffman Electronics Corp. to join ITT Federal Laboratories as director of the Airways Aids lab. Evan Ragland of Motorola's Chicago Military Center advances to mgr. of its Teledata Laboratory. Joseph B. Merrill moves up to v-p, production, at High Vacuum Equipment Corp. Daniel G. Dow promoted to mgr. of tube research for Varian Associates' Tube div. Milton J. McNeal, ex-Stewart Engineering Co., appointed director of mfg. at Warnecke Electron Tubes, Inc. Paul S. Collins from Hughes Aircraft Co. to The Electrada Corp. as v-p, corporate planning and product development. Computer Control Co., Inc., elevates Franklin R. Dean to v-p for operations. Sidney A. Greenberg, formerly with the Portland Cement Association, named staff scientist at Ampex Corp.'s magnetic tape lab. Henry K. Kindig promoted to general mfg. mgr., black and white tv picture tubes, for Sylvania's Electronic Tube div. Bourns, Inc., ups M. E. Harrison to director of engineering of the Trimpot div. Richard M. Bloch named asst. v-p of Honeywell Electronics Data Processing. He is succeeded as director of product planning by J. Chuan Chu, previously associate director. Beckman Instruments, Inc., advances James L. Donahoe to quality control mgr. for its Offner div.

electronics

WEEKLY QUALIFICATION FORM FOR POSITIONS AVAILABLE

ATTENTION: ENGINEERS, SCIENTISTS, PHYSICISTS

This Qualification Form is designed to help you advance in the electronics industry. It is unique and compact. Designed with the assistance of professional personnel management, it isolates specific experience in electronics and deals only in essential background information.

The advertisers listed here are seeking professional experience. Fill in the Qualification Form below.

STRICTLY CONFIDENTIAL

Your Qualification form will be handled as "Strictly Confidential" by ELECTRONICS. Our processing system is such that your form will be forwarded within 24 hours to the proper executives in the companies you select. You will be contacted at your home by the interested companies.

WHAT TO DO

1. Review the positions in the advertisements.
2. Select those for which you qualify.
3. Notice the key numbers.
4. Circle the corresponding key number below the Qualification Form.
5. Fill out the form completely. Please print clearly.
6. Mail to: D. Hawksby, Classified Advertising Div., ELECTRONICS, Box 12, New York 36, N. Y. (No charge, of course).

COMPANY	SEE PAGE	KEY #
ATOMIC PERSONNEL INC. Philadelphia, Penna.	126	1
BELL AEROSYSTEMS COMPANY Div. of Bell Aerospace Corp., A Textron Company Buffalo, New York	84*	2
BRISTOL COMPANY Waterbury, Conn.	84*	3
CURTISS WRIGHT CORPORATION Electronics Div. E. Paterson, N. J.	110, 111	4
DOUGLAS AIRCRAFT CO. Missile and Space Systems Division Santa Monica, Calif.	53*	5
GENERAL DYNAMICS/ASTRONAUTICS San Diego, California	126	6
HIGH VOLTAGE ENGINEERING CORPORATION Burlington, Massachusetts	79*	7
INTERNATIONAL BUSINESS MACHINES New York, N. Y.	127	8
LOCKHEED MISSILES AND SPACE COMPANY Sunnyvale, California	78	9
NATIONAL CASH REGISTER CO. Dayton, Ohio	85*	10
NORTHROP CORPORATION Norair Div. Hawthorne, California	105, 109	11
NORTHROP CORPORATION Space Laboratories Hawthorne, California	105, 107	12
PHILCO WESTERN DEVELOPMENT Sub. of Ford Motor Co., Palo Alto, California	83*	13
REPUBLIC AVIATION CORPORATION Farmingdale, L. I., New York	84*	14
REPUBLIC AVIATION CORPORATION Mineola, L.I., New York	128	15

* These advertisements appeared in the Nov. 2nd issue.

(cut here)

electronics WEEKLY QUALIFICATION FORM FOR POSITIONS AVAILABLE

(cut here)

(Please type or print clearly. Necessary for reproduction.)

Personal Background

NAME

HOME ADDRESS

CITY ZONE STATE

HOME TELEPHONE

Education

PROFESSIONAL DEGREE(S)

MAJOR(S)

UNIVERSITY

DATE(S)

FIELDS OF EXPERIENCE (Please Check)

11962

- | | | |
|--|--|---------------------------------------|
| <input type="checkbox"/> Aerospace | <input type="checkbox"/> Fire Control | <input type="checkbox"/> Radar |
| <input type="checkbox"/> Antennas | <input type="checkbox"/> Human Factors | <input type="checkbox"/> Radio-TV |
| <input type="checkbox"/> ASW | <input type="checkbox"/> Infrared | <input type="checkbox"/> Simulators |
| <input type="checkbox"/> Circuits | <input type="checkbox"/> Instrumentation | <input type="checkbox"/> Solid State |
| <input type="checkbox"/> Communications | <input type="checkbox"/> Medicine | <input type="checkbox"/> Telemetry |
| <input type="checkbox"/> Components | <input type="checkbox"/> Microwave | <input type="checkbox"/> Transformers |
| <input type="checkbox"/> Computers | <input type="checkbox"/> Navigation | <input type="checkbox"/> Other |
| <input type="checkbox"/> ECM | <input type="checkbox"/> Operations Research | <input type="checkbox"/> |
| <input type="checkbox"/> Electron Tubes | <input type="checkbox"/> Optics | <input type="checkbox"/> |
| <input type="checkbox"/> Engineering Writing | <input type="checkbox"/> Packaging | <input type="checkbox"/> |

CATEGORY OF SPECIALIZATION

Please indicate number of months experience on proper lines.

	Technical Experience (Months)	Supervisory Experience (Months)
RESEARCH (pure, fundamental, basic)
RESEARCH (Applied)
SYSTEMS (New Concepts)
DEVELOPMENT (Model)
DESIGN (Product)
MANUFACTURING (Product)
FIELD (Service)
SALES (Proposals & Products)

CIRCLE KEY NUMBERS OF ABOVE COMPANIES' POSITIONS THAT INTEREST YOU

1 2 3 4 5 6 7 8 9 10 11 12 13 14 15 16 17 18 19 20 21 22 23 24 25

LET'S TALK About the New Field of AEROSPACE GROUND ELECTRONICS!

The rapidity with which we are reaching further and further into outer space . . . the many new and as yet completely unexplored related technologies . . . are giving birth to a vital new field—Aerospace Ground Electronics.

To be sure, ground support equipment, test equipment design and the like are involved. But the enormity of the tasks which lie ahead require different approaches than before and can only be described in new terms, and by the creation of a new master-field.

General Dynamics/Electronics is very active in Aerospace Ground Electronics and expects to become even more heavily involved. Our preliminary ideas in the field evolve from the disciplines listed below. If you have the required background, we would like to explore the possibilities of AGE with you.

SYSTEMS ENGINEERING

Broad knowledge of Aerospace Ground Electronics design. Will analyze aerospace electronic sub-systems for test requirements and determine test equipment needs. Experience in Air Force Shop or Naval Carrier Installations desirable, with emphasis on equipment layout, intercabling, work flow analysis, operational and calibration procedures.

PROJECT ENGINEERING

Project Engineers to supervise design and integration of test equipments and test stations. Should be familiar with all types of testing equipment and techniques in one or more of the following areas.

- Flight Control Systems
- Radar
- HF-UHF Navigation & Communication Equipment
- Microwave Equipment
- Antenna Systems
- Electronic Countermeasures

DESIGN ENGINEERING

MICROWAVE—Engineers experienced in the design of signal generators and receivers in the following frequency bands: L, S, C, T, Ku, Ka. Should also know techniques for remote control of frequency and signal amplitude.

LOW FREQUENCY—Experience in the design of audio and sweep signal generators and servo systems test equipment. Knowledge of remote control of audio generator frequency and output using digital techniques is desirable, or in cathode ray tube sweep circuits.

HF-UHF—Engineers with experience in the design of HF and UHF signal generators, using both transistorized and vacuum tube circuitry. Knowledge of techniques for digital selection of frequency, such as frequency synthesis, and remote control of signal amplitude required.

CIRCUIT DESIGN

Digital and Pulse engineers with experience in the design of transistorized logic circuits, pulse generators and other digitally controlled circuits such as numerical indicators.

Assignments Immediately Available in:

RELIABILITY SPACE NAVIGATION
ADVANCED DEVELOPMENT & ENGINEERING DESIGN
OF DATA & RADIO COMMUNICATIONS

Send us your qualifications now. A discussion can be arranged.
Address Mr. M. J. Downey, Dept. 22.

GENERAL DYNAMICS | ELECTRONICS
AN EQUAL OPPORTUNITY EMPLOYER
ROCHESTER

1400 N. Goodman St., Rochester 1, New York



E. E.'s
for FEE-PAID Positions
WRITE US FIRST!
Use our confidential application for professional, individualized service . . . a complete national technical employment agency.
ATOMIC PERSONNEL, INC.
Suite 1207L, 1518 Walnut St., Phila. 2, Pa.

EMPLOYMENT OPPORTUNITIES



The advertisements in this section include all employment opportunities—executive, management, technical, selling, office, skilled, manual, etc.

Look in the forward section of the magazine for additional Employment Opportunities advertising.

— RATES —

DISPLAYED: The advertising rate is \$40.17 per inch for all advertising appearing on other than a contract basis. Contract rates quoted on request.

An advertising inch is measured 3/4" vertically on a column—3 columns—30 inches to a page.

Subject to Agency Commission.

UNDISPLAYED: \$2.70 per line, minimum 3 lines. To figure advance payment count 5 average words as a line.

Box numbers—count as 1 line.

Discount of 10% if full payment is made in advance for 4 consecutive insertions.

Not subject to Agency Commission.

FOR INFORMATION About Classified Advertising

Contact The McGraw-Hill
Office Nearest You

ATLANTA, 9 1375 Peachtree St. N. E. D. HICKS	TRinity 5-0523
BOSTON, 16 Copley Square O. DAVIS	COngress 2-1160
CHICAGO, 11 645 No. Michigan Ave. W. J. HIGGINS—D. BERAN	MOhawk 4-5800
CLEVELAND, 13 1164 Illuminating Bldg. I. C. HILL	SUperior 1-7000
DALLAS, 2 1712 Commerce St., Vaughn Bldg. F. LE BEAU	RIverside 7-9721
DENVER, 2 1700 Broadway, Tower Bldg. J. PATTEN	ALpine 5-2981
DETROIT, 26 856 Penobscot Bldg.	WOodward 2-1793
HOUSTON, 25 Prudential Bldg., Room W-724 Holcombe Blvd. J. PAGE	JAckson 6-1281
LOS ANGELES, 17 1125 W. 6th St. B. McGINNIS	HUntley 2-5450
NEW YORK, 36 500 Fifth Ave. H. T. BUCHANAN	LOngacre 4-3000
PHILADELPHIA, 3 Six Penn Center Plaza W. B. SULLIVAN—R. LEWIS	LOcust 8-4330
PITTSBURGH, 22 4 Gateway Center J. WILLIAMS	EXpress 1-1314
ST. LOUIS, 3 7751 Carondelet Ave.	PArkview 5-7285
SAN FRANCISCO, 11 255 California St. J. A. HARTLEY	DOuglas 2-4600

at **IBM**[®]

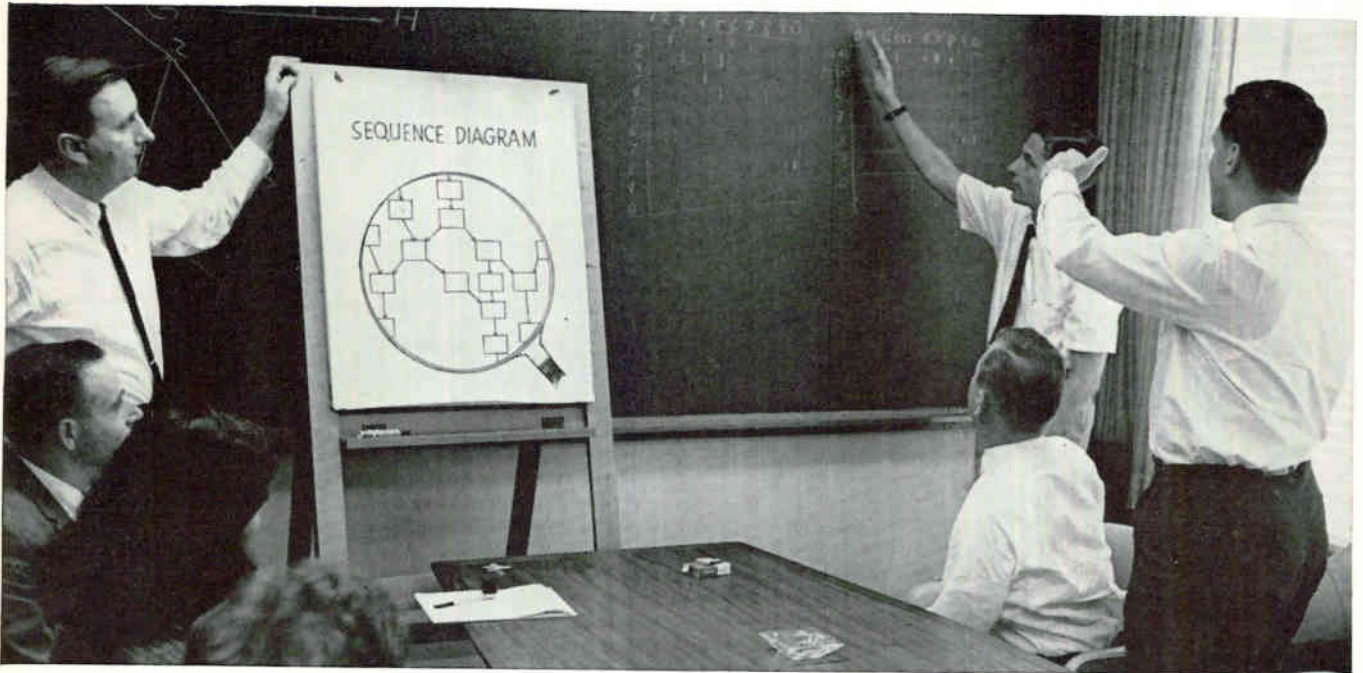

PROGRAMMERS shape the future of a new technology

IBM programmers, working with professional associates in research, development and manufacturing, are contributing expert knowledge and ideas in the creation of future computing systems.

This teamwork represents a striking advance in the role of the programmer and dramatizes the important part being played by this young but rapidly growing profession. At IBM, programmers are creating new concepts in software, and contributing to the design of new systems for virtually every phase of business, science and industry.

In response to the vastly increasing versatility of computers and their widespread applications, IBM programmers at all levels of endeavor are establishing new standards of achievement. They are designing programs that will simulate business and industrial operations. They are developing systems for government projects in space, defense and communications, where their data processing skills will help produce significant advances in tomorrow's computer technology. They are also studying the complex programs for . . . information-handling systems . . . scheduling methodology . . . information-retrieval studies.

IBM programmers also face challenging tasks in developing new programming systems. For example, they are devising programs that in turn use machine capability

for formulating new programs. They are creating programs that enable computers to diagnose their own faults through self-checking. And they are helping to design the systems that will let scientists and engineers "talk" to machines in the everyday language of science and engineering.

Programmers at IBM take pride in their professional status and enjoy the unusual opportunities offered by a leader of the computer industry. In an atmosphere so receptive to new ideas, their concepts flourish. They find that their keen interest in exploring the capabilities of electronic computing is supported by IBM's full resources. This combination results in significant accomplishments recognized throughout the field.

Openings for programmers exist in all IBM facilities, including: San Jose, California; the Washington, D. C., area; Lexington, Kentucky; Rochester, Minnesota; Omaha, Nebraska; and New York City, Endicott, Kingston, Owego, Poughkeepsie and Yorktown Heights, New York. In addition to its extensive benefits programs, the IBM Educational Program is one of the most extensive in the country today. IBM is an Equal Opportunity Employer.

If you have experience in computer programming and would like to have more information about careers with IBM, we'd like to hear from you. Please write to:

Manager of Professional Employment
IBM, Dept. 554Y2
590 Madison Avenue
New York 22, New York

**ELECTRONICS SCIENTISTS
& ENGINEERS**

**concentrated
research
in space
communications**

Republic's Missile Systems Division is focusing its creative forces on breakthrough concepts in space communications. Particular emphasis is being given vehicle-to-vehicle and vehicle-to-ground contacts, broadbanding techniques, transmission through ionized environments, communication over cosmic distances and the all-encompassing requisite of random noise reduction.

For those who can turn these demanding assignments into personal achievement, there are select openings in the following areas:

- MICROWAVE THEORY
- RADAR DEVELOPMENT
- COMMUNICATIONS RESEARCH
- IR & OPTICS DESIGN
- ANTENNA MINIATURIZATION
- MIXER, MODULATOR AND FILTER DEVELOPMENT
- MICROCIRCUITRY
- DIGITAL & ANALOG DESIGN
- HF PULSE CIRCUITRY
- MULTIPLEXER DESIGN
- SECURE COMMUNICATIONS SYSTEMS
- SYSTEMS ANALYSIS
- TRANSMITTER, RECEIVER DEVELOPMENT

Write Mr. Paul Hartman,
Technical Employment Supervisor

**MISSILE
SYSTEMS
DIVISION**

**REPUBLIC
AVIATION CORPORATION**

223 Jericho Turnpike
Mineola, Long Island, New York

An Equal Opportunity Employer

SEARCHLIGHT SECTION

(Classified Advertising)

BUSINESS OPPORTUNITIES

EQUIPMENT - USED or RESALE

**ANTENNA PEDESTAL
SCR 584-MP 61B**

Full azimuth and elevation sweeps 360 degrees in azimuth, 210 degrees in elevation. Accurate to 1 mil. or better over system. Complete for full tracking response. Angle acceleration rate: AZ, 9 degrees per second squared EL, 4 degrees per second squared. Angle slewing rate: AZ 20 degrees per sec. EL, 10 degrees per sec. Can mount up to a 20 ft. dish. Angle tracking rate: 10 degrees per sec. Includes pedestal drives, selsyns, potentiometers, drive motors, control amplifiers. Excellent condition. Quantity in stock for immediate shipment. Ideal for missile & satellite tracking, antenna pattern ranges, radar system, radio astronomy, any project requiring accurate response in elevation and azimuth. Complete description in McGraw-Hill Radiation Laboratory Series, Volume 1, page 284 and page 209, and Volume 26, page 233.

2 MEGAWATT PULSERS

(A) 31 KV at 60 amps .002 Duty Cycle Ideal for 5J26 at 500 KW \$950.
(B) 30 KV at 70 amps .001 Duty Cycle. \$1250 w/pulse output trans.

MIT MODEL 9 PULSER

1 MEGAWATT-HARD TUBE

Output pulse power 25KV at 40 amp. Max. duty ratio: .002. Uses 6C21 pulse tube. Pulse duration 25 to 2 microsec. Input 115 volts 60 cycles AC. Includes power supply in separate cabinet and driver. Fully guaranteed as new condition. Full Desc. MIT. Rad. Lab. Series "Pulse Generators."

500 KW PULSER

5C22 Hyd. Thyr. Modulator. 22KV at 28 Amps. W/HV & Fil Supplies. 3 pulse length rep rates: 2.25 usec 300 pps. 1.75 usec 550 pps. .4 usec 2500 pps. 115V 60 cy. XVII deliver nominal 225 KW X Band using 4J50 magnetron.

L BAND RF PKG.

20KW peak 900 to 104MC. Pulse width .7 to 1.2 micro sec. Rep rate 180 to 420 pps. Input 115 vac. Incl. Receiver \$1200.

SCR 584 RADAR AUTO-TRACK

3 CM & 10 CM. Our 584s in like new condition, ready to go, and in stock for immediate delivery. Used on Atlantic Missile Range, Pacific Missile Range, N.A.S. Wallops Island, A.B.M.A. Write us. Fully Desc. MIT Rad. Lab. Series. Vol 1, pgs. 207-210, 228, 284-286.

300 TO 2400MC RF PKG.

300 to 2400MC CW. Tuneable. Transmitter 10 to 30 Watts. Output. As new \$375.

AN/TPS-1D RADAR

500 kw. 1220-1359 mcs. 160 nautical mile search range P.P.I. and A. Scopes. MTI, thyatron mod. 5J26 magnetron. Complete system.

AN/TPS-10D HEIGHT FINDER

250 KW X-Band. 60 & 120 mile ranges to 60,000 feet. Complete.

AN/APS-15B 3 CM RADAR

Airborne radar. 40kw output using 725A magnetron. Model 3 pulser. 20 in. parabola stabilized antenna. PPI scope. Complete system. \$1200 each. New.

100 KW 3 CM. X BAND RADAR

Complete AN/APS-23 radar system using 4J52 magnetron. PPI antenna 360 degree rotation azimuth 60 degree elevation APX. Complete installation including gyro stabilizer \$2800.

M33 TRACKING SYSTEM

Complete two van complex 3 CM automatic tracking system and search system (10 CM) like new.

CARCINOTRON

Type CM 706A Freq. 3000 to 4000 mcs. CW. Output 200 Watts minimum. New. with full guarantee.

VA-800 KLYSTRON

1.7 to 2.4 KMC. (continuously tunable). 10 KW. CW. 50 db Gain output UG-435 A/U Flange \$975 each.

**RADIO RESEARCH
INSTRUMENT CO.**
550 FIFTH AVE., NEW YORK
JUDSON 6-4691

CIRCLE 950 ON READER SERVICE CARD

**LIFSCHULTZ
FAST FREIGHT**



**PIGGYBACK
TO BOTH COASTS**
**TRUCKLOAD RATES
TO BOTH COASTS**
•We welcome your inquiry.

PROMPT
DAILY
PICKUP
and
DELIVERY

**FASTEST
TO BOTH COASTS!**

CIRCLE 951 ON READER SERVICE CARD

**HUGE SAVINGS ON TUBES
SPECIAL**

3CX100A5 (2C8913) tested & fully guar. \$9.95 ea.
Brand new tubes in original cartons
6072 (reliable 12AY7) 1.10 ea.
6005/6AQ5W .85 ea.
X26B Varian Relux Klystron 45.00 ea.
(7125-7425 MC)
ELECTRO SALES CO.
1608 Milwaukee Ave., Chicago 47, Ill. BR 8-8080

CIRCLE 953 ON READER SERVICE CARD

Wilgreen

can deliver **Amphenol**
Bendix
Cannon
CONNECTORS
FITTINGS & CLAMPS

We stock more than 5,000,000 MS/AN CONNECTORS . . . of 50,000 variations! In PRODUCTION QUANTITIES . . . we sell BELOW "O.E.M." PRICE . . . and offer IMMEDIATE "OFF-THE-SHELF" DELIVERY!

FREE . . . Send for latest brochure "LIST-PRICE SHEET"

WILGREEN INDUSTRIES, Inc.
102 Warren Street, New York 7, N. Y.
WOrth 4-2490-1-2 Wire: FXX

CIRCLE 952 ON READER SERVICE CARD

**FOR RESEARCH — DEVELOPMENT
& EXPERIMENTAL WORK**

Over 10,000 different electronic parts: waveguide, radar components and parts, test sets, pulsers, antennas, pulse xmfrs, magnetrons. IF and pulse amplifiers, dynamotors, 400 cycle xmfrs, 584 ant. pedestals, etc.
PRICES AT A FRACTION OF ORIGINAL COST!
COMMUNICATIONS EQUIP. CO.
343 CANAL ST., N. Y. 13, WQ 6-4045
CHAS. ROSEN (Formerly at 131 Liberty St.)

CIRCLE 954 ON READER SERVICE CARD

It's UNIVERSAL . . .

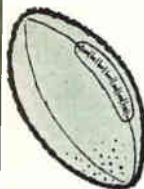

This is our idea of a little fun and at the same time . . . let you test your knowledge of the most spectacular achievements of man and nature.

Do you know . . .

the name of the player who made the longest scoring forward pass?

John Woerner tossed a 67 yard pass to Maynard Schultz (Oregon State) in 1935 to establish a gridiron record.

Universal has established records too . . . for quality and economy . . . and you can count on Universal integrity.

**WE STOCK
2,000,000 RELAYS**

SEND FOR
NEW
CATALOG EE



Universal RELAY CORP.

42A White St., N. Y. 13, N. Y. Walker 5-6900
MIDWEST OFFICE: Industrial Rd., Crystal Lake, Ill.
Phone 459-2313 (Code 815)

CIRCLE 955 ON READER SERVICE CARD

CAPACITORS

MFD	VOLTS	PRICE	MFD	VOLTS	PRICE
*.025	50KV	29.50	† 2	6000V	24.50
†.2	50KV	64.50	† 2	10KV	69.95
†.25	15KV	15.95	† 2	20KV	125.00
†.25	20KV	22.50	† 4	10KV	67.50
†.25	32.5KV	44.50	† 5	10KV	70.50
†.5	25KV	29.50	† 10	10KV	115.00
† 1	7500V	8.00	† 15	5000V	48.00
† 1	25KV	59.50	† 75	6000V	69.50

PLUS

Oil bathtub, channel & tubular types. Also mica receiving and transmitting capacitors.
* Case Common
† Large qua. available

Write for complete listing

MONMOUTH RADIO LABS.
BOX 247—OAKHURST, N. J.

CAPITOL 2-0121 ART HANKINS, Prop.

CIRCLE 956 ON READER SERVICE CARD

SMALL AD but BIG STOCK

of choice test equipment
and surplus electronics

Higher Quality—Lower Costs
Get our advice on your problem

ENGINEERING ASSOCIATES

434 Patterson Road — Dayton 19, Ohio

CIRCLE 957 ON READER SERVICE CARD

OSCILLOSCOPES

And other types of Test Equip.
Gov't. Surplus

Send for Free Catalog to

SELETRONICS

Dept. E, 1206 Napa St. Philadelphia, Pa.
Tel: HD 8-4645 HO 8-7891

CIRCLE 958 ON READER SERVICE CARD

FREE...CATALOG
BARRY ELECTRONICS

512 BROADWAY WALKER 5-7000
NEW YORK 12, N.Y. TWX: NY 1-3731

CIRCLE 959 ON READER SERVICE CARD

SPECIAL PURPOSE TUBES

OA280	4-65A12.00	25Z6WGT1.50	725A10.00	5751WA2.00
OA2WA1.50	4-125A20.00	26Z5W1.50	726A5.00	57631.75
OA385	4-250A35.00	FG-27A20.00	726B5.00	5777150.00
OB260	4-400A30.00	28D7W3.50	726C7.50	5783150.00
OB2WA1.50	4-1000A80.00	FG-3210.00	750TL112.50	57882.25
OB375	4AP1010.00	35T7.50	NL-76020.00	578A2.50
OC350	4B3115.00	35TG2.50	8027.50	57872.50
OD350	4C3515.00	FP-54100.00	8033.50	579610.00
CIA7.50	4CX250B30.00	FG-5710.00	80415.00	5800/VX-417.50
1AD41.75	4CX1000A125.00	RK-60/16411.50	8057.50	5803/VX-555.00
1B247.50	4D3215.00	HY-693.00	8071.50	5814A1.35
1B24A12.50	4J32100.00	BL-753.00	807W2.25	58291.00
1B35A3.00	4J34100.00	75TL17.50	8082.50	583650.00
1B63A10.00	4J50100.00	HF-1008.85	8095.00	583750.00
1C/3B225.00	4J5235.00	100TH12.00	81017.50	58402.50
1D21/SN45.00	4J62150.00	100TL12.00	8112.50	58456.00
CIK7.50	4J63150.00	FG-10525.00	811A4.00	58525.00
1P2132.50	4J64150.00	F-123A5.00	812A4.75	58767.50
1P228.00	4PR60A50.00	FG-17225.00	81312.50	58791.15
1P2510.00	4X150A13.50	HF-20015.00	8143.50	5881/6L6WGB2.00
1P2815.00	4X150D15.00	212E50.00	8155.00	58863.50
1Z22.50	4X150F20.00	FG-23550.00	8162.25	589310.00
2-01C12.50	4X150G25.00	242C10.00	8263.50	589419.85
2AP1A8.50	4X250B20.00	244A3.50	82812.50	59151.00
2B2320.00	4X250F30.00	245A3.50	829B10.00	5933/807W3.00
2BP110.00	5BP1A9.50	249B8.50	832A7.50	5948/1754100.00
2C3622.50	5C2217.50	249C6.50	833A37.50	5949/190775.00
2C395.00	5CP1A9.50	250R10.00	8362.50	59631.00
2C39A9.75	5CP7A9.50	250TH25.00	8371.00	596485
2C39B15.00	5J2650.00	251A50.00	8427.50	596585
2C407.50	5J317.50	254A3.50	8457.50	597650.00
2C424.00	5LP17.50	FG-258A100.00	84975.00	59935.00
2C437.50	5R4GY1.25	259A5.00	85150.00	6005/6AQ5W1.50
2C465.00	5R4WGA4.00	262B4.00	866A2.00	60124.00
2C504.00	5R4WGB6.00	267B5.00	869B75.00	6021A2.00
2C511.50	5R4WGY2.00	271A10.00	872A5.00	603210.00
2C522.50	5RP1A9.50	274A3.50	8841.25	60451.15
2C537.50	5Y3WGT1.25	283A3.50	88585	60721.50
2D2165	5Y3WGTB2.50	287A3.50	889RA150.00	60731.50
2D21W1.25	6AC7W75	QK-288200.00	891R200.00	60741.75
2E223.00	6AC7WA2.00	HF-30035.00	9139.50	60803.35
2E243.50	6AG5WA1.50	300B5.00	9202.50	6080WA5.00
2E262.50	6AG7Y1.00	304TH35.00	9271.50	6080WB10.00
2J4275.00	6AK5W1.25	304TL35.00	931A5.00	608125.00
2J5150.00	6AL5W60	307A50	1000T80.00	60823.35
2J5575.00	6AN51.75	310A3.50	R1130B10.00	6087/5Y3WGTB2.50
2K2225.00	6AN5WA3.50	311A3.50	1500T150.00	6101/6J6WA1.50
2K258.50	6AQ5W1.00	313C1.50	16142.75	61061.50
2K2635.00	6AS6W1.00	323A6.00	16204.00	6115/QK35150.00
2K2825.00	6AS7G2.50	328A4.50	16241.00	6130/3C456.50
2K2925.00	6AU6WA1.25	329A4.50	162550	6136/6AU6WA1.25
2K3050.00	6B4G3.35	336A2.50	162950	61463.00
2K33A175.00	6B6W75	337A3.50	184650.00	61593.50
2K3475.00	6B6W1.50	347A1.00	1855250.00	616135.00
2K35200.00	6B7F2.00	348A4.50	20501.25	6186/6AG5WA1.50
2K39150.00	6B86W2.75	349A3.50	ZB-3200100.00	6189/12AU7WA1.50
2K4150.00	6B8620.00	350A3.50	5528/C6L3.50	61971.75
2K42150.00	6B8620.00	350B2.50	554520.00	619935.00
2K43200.00	6B86A30.00	352A8.50	555030.00	6201/12AT7WA1.85
2K44125.00	6C4W2.50	354A12.50	5551/FG27150.00	6202/6X4WA1.50
2K4520.00	6C4WA1.00	355A12.50	5552/FG23560.00	621175
2K47150.00	6C2125.00	371B2.50	5553/FG258100.00	62132.50
2K4860.00	6D41.50	QK-38180.00	5557/FG175.00	62163.00
2K50125.00	6F45.00	388A5.00	5558/FG3210.00	6236125.00
2K5410.00	6GJ10.00	393A5.00	5559/FG5710.00	62639.00
2K5515.00	6J41.75	394A3.00	5560/FG9520.00	6265/6B86W2.50
2K5650.00	6J4WA2.50	395A2.25	5561/FG10440.00	629135.00
2P2140.00	6J6W60	396A/2C511.50	5586125.00	62934.50
2X2A1.25	6J6WA1.00	398A/56033.00	5608A5.00	629937.50
3A575	6K42.00	401A/55901.00	56362.25	6316/BL800A100.00
3AP1A12.50	6L43.00	403B/55913.00	56422.25	6322/BL2512.50
3B42.50	6L6GAY1.25	404A/58477.50	56433.00	63368.75
3B24W3.00	6L6WGA1.50	407A3.75	56473.50	6336A12.75
3B24WA5.00	6L6WGB2.00	408A/60282.75	56511.00	63501.25
3B252.50	6Q5G2.50	409A/6A561.00	5654/6AK5W1.50	63527.50
3B263.50	6S17WGT1.25	410R75.00	56565.00	638510.00
3B283.00	6SK7W75	GL-41480.00	56631.00	6390125.00
3B295.00	6SK7WA2.00	416B/628020.00	5665/C16J35.00	639412.75
3BP1A7.50	6S17WGT1.25	417A/58428.50	5667125.00	64385.00
3C2220.00	6SN7W75	418A9.50	56701.00	644225.00
3C234.00	6SN7WGT1.00	420A/57555.00	56721.35	64631.00
3C24/24G7.50	6SN7WGT2.50	421A/59987.50	567510.00	64851.50
3C453.50	6V6GT1.00	429A6.50	56761.25	65336.50
3CX100A512.50	6X4W75	GL-434A10.00	56781.25	65425.75
3D21A5.00	6X4WA1.50	450TH50.00	56862.25	65503.50
3D228.00	6X5WGT1.00	450TL40.00	56871.50	680720.00
3DP1A5.00	6Y17G125.00	QK-54950.00	56915.00	681640.00
3E297.50	7AK72.50	5785.00	56923.50	68833.50
3GP12.50	7AP722.50	KU-6107.50	56933.50	70441.50
C3J7.50	10KP715.00	GL-62310.00	56961.00	739147.50
3J2135.00	12AT7WA1.25	631-P15.00	57181.50	7521100.00
3J31100.00	12AU7WA1.50	67315.00	5720/FG3317.50	7580 . .

- Sigma Instruments, Inc. 68
- Simpson Electric Company..... 65
- Sorensen 103
- Specialty Automatic Waveguide Corp. 44
- Sperry Microwave Electronics Co.,
Div. of Sperry Rand Corp..... 33
- Sprague Electric Co.....9, 28, 106
- Stackpole Carbon Co..... 25
- Superior Tube Co..... 74

- Tektronix, Inc.38, 39
- Texas Instruments Incorporated..... 113
- Texas Instruments Incorporated
Semiconductor-Components Division.10, 11
- Torrington Mfg. Co..... 35
- Triplett Electrical Instrument Co..... 47

- United Transformer Corp.....2nd Cover
- Unitek/Weldmatic Division 123

- Varian Associates 96
- Vitramon, Inc. 5

CLASSIFIED ADVERTISERS
F. J. Eberle, Business Mgr.

EMPLOYMENT OPPORTUNITIES 126, 127, 128

SPECIAL SERVICES 128

EQUIPMENT
(Used or Surplus New)
For Sale128, 129

INDEX TO CLASSIFIED ADVERTISERS

- Atomic Personnel Inc. 126
- Barry Electronics Corp..... 129
- Communications Equipment Co..... 128
- Electro Sales Co..... 128
- Engineering Associates 129
- General Dynamics/Electronics 126
- International Business Machines..... 127
- Lifschultz Fast Freight..... 128
- Monmouth Radio Labs..... 129
- Radio Research Instrument Co..... 128
- Republic Aviation Corp..... 128
- Selectronics 129
- Universal Relay Corp..... 129
- Western Engineers 129
- Wilgreen Industries Inc..... 128

• See advertisement in the July 25, 1962 issue of Electronics Buyers' Guide for complete line of products or services.

This Index and our Reader Service Numbers are published as a service. Every precaution is taken to make them accurate, but electronics assumes no responsibilities for errors or omissions.

DYNAMICS

INSTRUMENTATION AMPLIFIERS

—designed for
system flexibility
and highest quality
operation—where the
ultimate in perform-
ance is essential

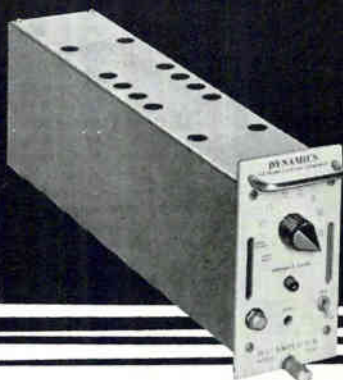

Model 6050—differential dc amplifier. Designed specifically to meet the system engineer's requirements, unit incorporates the following features:

- Wide bandwidth: DC to 10 kc.
- Dual outputs (simultaneous): $\pm 10v$ at 100 ma and $\pm 10v$ at 10 ma.
- High common-mode rejection with 1000-ohm input line unbalance: Withstands 117 VAC common mode voltage between input and output ground.
- Isolation: Input and output are completely isolated from each other—from rack cabinet, and power line.
- Small size: 2 $\frac{7}{8}$ " W x 5 $\frac{1}{4}$ " H x 16 $\frac{1}{2}$ " D.

Dynamics manufactures many types of instrumentation amplifiers—guarded, insulated, and isolated. Write for literature on the Model 6050, or the entire line.

DYNAMICS

INSTRUMENTATION COMPANY

583 Monterey Pass Road, Monterey Park, Calif.
Phone: CUMberland 3-7773

CIRCLE 207 ON READER SERVICE CARD

For Production

Line Testing...



EICO SCOPES

give you:

- professional performance
- reliability
- ruggedness
- versatility

... at moderate cost

EICO's high quality standards and low initial cost add up to true economy: EICO units outperform scopes selling for two or three times EICO's prices. With kits, the initial cost is even lower. And the experience each operator gains in building his own, increases his efficiency, and enables him to keep his scope in better condition, with less "down" time.

	prices		freq. resp.(sinusoidal)		sensitivity (rms)	
	kit	wired	vert.	horiz.	vert.	horiz.
5" Push-Pull Scope #427	\$69.95	\$109.95	DC-500 KC/FLAT	2 CPS TO 450 KC/FLAT	10mv P-P/cm	0.5V P-P/cm
5" DC-4.5 MC Scope #460	79.95	129.95	DC-4.5 mc/flat	1 cps to 400 kc flat	25 mv/in	0.6 V/in



See the 41 additional EICO test instruments helpful for your lab and production work. Write for free Catalog & name of neighborhood Distributor.
3300 NORTHERN BOULEVARD, Dept. E-11A, L. I. C., 1, N. Y.

add 5% in the West

EXPANDING?



Why put YOUR money?
in brick and mortar?

NEW MEXICO

offers tax-exempt financing for land, buildings, tooling exclusively for companies with profitable production and an interest in growing in the space center of the Southwest.



Write today
for Full Details

INDUSTRIAL DIVISION
NEW MEXICO

Department of Development
Box 1300 State Capitol,
Santa Fe, New Mexico

CIRCLE 208 ON READER SERVICE CARD

FASTENERS FROM

GRC

DIE CAST
ZINC ALLOY



Wing Nuts



Cap Nuts



Thumb Nuts



Thumb &
Wing Screws

MOLDED
NYLON &
DELRI



Screws



Hex Nuts



Washers



Screw
Insulators



MOLDED NYLON SCREW INSULATORS and WASHERS

Insulators completely insulate metal screws from mounting . . . used as light load bearings and bushings. Washers used in a wide variety of insulating applications. Both are stocked in sizes to fit #4 to 1/4" screws.

Elastic and resilient, they conform to irregular surfaces, seal, dampen vibration . . . are economical.

GRC's special automatic molding techniques assure high quality at lowest possible cost—let you make the most of nylon's high strength-to-weight ratio, electrical insulating and other qualities.

Write, wire, phone TODAY for samples, prices, literature on GRC's unique molding techniques.

GRIES

GRIES REPRODUCER CORP.

World's Foremost Producer of Small Die Castings
151 Beechwood Ave. • New Rochelle, N.Y.
Phone: (914). NEw Rochelle 3-8600

electronics



Audit Bureau
of Circulations



Associated Business
Publications

Audited Paid Circulation

JAMES T. HAUPTLI

Advertising Sales Manager

R. S. QUINT:
Assistant Publisher Buyers'
Guide and Business Manager
FRED STEWART:
Promotion Manager
B. ANELLO:
Market Services Manager

RICHARD J. TOMLINSON:
Production Manager
GEORGE E. POMEROY:
Classified Manager
HUGH J. QUINN:
Circulation Manager

ADVERTISING REPRESENTATIVES

ATLANTA (9):
Michael H. Miller, Robert C. Johnson
1375 Peachtree St. N.E., Trinity 5-0523
(area code 404)

BOSTON (16):
William S. Hodgkinson, Donald R. Furth
McGraw-Hill Building, Copley Square,
Congress 2-1160 (area code 617)

CHICAGO (11):
Harvey W. Wernecke, Robert M. Denmead
645 North Michigan Avenue, Mohawk 4-5800
(area code 312)

CLEVELAND (13):
Paul T. Fegley
55 Public Square, Superior 1-7000
(area code 216)

DALLAS (1):
Frank Le Beau
The Vaughn Bldg., 1712 Commerce St.
Riverside 7-9721 (area code 214)

DENVER (2):
J. W. Patten
Tower Bldg., 1700 Broadway,
Alpine 5-2981 (area code 303)

HOUSTON (25):
Joseph C. Page, Jr.
Prudential Bldg., Halcombe Blvd.,
Riverside 8-1280 (area code 713)

LOS ANGELES (17):
Peter S. Carberry, Ashley P. Hartman,
W. C. Gries
1125 W. 6th St., Huntley 2-5450
(area code 213)

NEW YORK (36):
Donald H. Miller, Henry M. Shaw,
George F. Werner
500 Fifth Avenue, LO-4-3000
(area code 212)

PHILADELPHIA (3):
Warren H. Gardner, William J. Boyle
6 Penn Center Plaza, LOcust 8-4330
(area code 215)

SAN FRANCISCO (11):
R. C. Alcorn
255 California Street, Douglas 2-4600
(area code 415)

LONDON W1:
Edwin S. Murphy Jr.
34 Dover St.

FRANKFURT/Main:
Matthae Herfurth
85 Westendstrasse

GENEVA:
Michael R. Zeynel
2 Place du Port

"Headquarters for Business Information"

McGraw-Hill Technical and Business Publications

American Machinist/Metal-
working Manufacturing
Aviation Week and Space
Technology
Business Week
Chemical Engineering
Chemical Week
Coal Age
Construction Methods and
Equipment
Construction Daily
Control Engineering
Electrical Construction
and Maintenance
Electrical Merchandising Week
Electrical Newsletter
Electrical West

Electrical Wholesaling
Electrical World
Electronics
Engineering Digest
Engineering and Mining Journal
E & MJ Metal and Mineral
Markets
Engineering News-Record
Factory
Fleet Owner
Industrial Distribution
National Petroleum News
Nucleonics
Nucleonics Week
Platt's Dilgram News
Platt's Dilgram Price Service
Power

Product Engineering
Purchasing Week
Science Week
Textile World

Overseas only:
Automobile International
(English, Spanish)
Ingenieria Internacional
Construccion (Spanish)
International Management
(English, Spanish
Portuguese editions)
Metalworking Production
(Great Britain)

Available by subscription only — to qualified persons actively engaged in the field of the publication. For subscription rates and information describing the editorial coverage of any of the above publications, write to: Subscription Manager, Circulation Department, McGraw-Hill Publishing Company, 330 West 42nd Street, New York 36, N. Y.

Another Fairchild first:

SINGLE CHIP REFERENCE DIODES

with microwatt power dissipation

- * 665 Microwatts dissipation
- * .0005%/°C at 100μA
- * 6.65 Volts ±5% [Tighter tolerances available]
- * Planar* stability and reliability
- * Available in sub-miniature glass package

100μA TEMPERATURE COMPENSATED REFERENCE DIODES

ELECTRICAL CHARACTERISTICS AT 25°C				
Type Number	@100μA 25°C (V)	Voltage Temp Coeff @100μA (%/°C)	Temp Range (°C)	Max Dyn Imp (OHMS)†
FC136 FC105	6.65	.005	-55 to 100 25 to 100	750
FC137 FC106	6.65	.002	-55 to 100 25 to 100	750
FC138 FC107	6.65	.001	-55 to 100 25 to 100	750
FC122 FC108	6.65	.0005	0 to 100 25 to 100	750
FC191 FC192 FC193	13.30 19.95 26.60	.005	25 to 100	1500 2000 2500

Fairchild Semiconductor reference diodes are diffused Planar[®] temperature compensated silicon devices intended for applications which require a high degree of voltage stability with life, and low power dissipation (less than 700 microwatts).

The unique single chip construction puts both Planar junctions in one piece of silicon, and eliminates the main cause of drift in reference diodes: the soldering of two chips together. Mechanical ruggedness plus Planar junctions provide zener voltage stability for life. This stability is unobtainable with other types of reference diodes.

FAIRCHILD
SEMICONDUCTOR
545 WHISMAN RD., MOUNTAIN VIEW, CALIF. • YORKSHIRE 8-8161 • TWX: 415-969-9165
A DIVISION OF FAIRCHILD CORP. AND INSTRUMENT CORPORATION

*Planar: A patented Fairchild process †I equals 10μA rms superimposed on 100μA dc., 25°C

CIRCLE 901 READERS SERVICE CARD



ACTUAL SIZE

SS111 Tunnel-Diode Oscillator



SS504 Down Converter

At the RCA Electron Tube Division

Packaged Tunnel-Diode devices...now in pilot production

AGAIN—RCA DEMONSTRATES SOLID-STATE CAPABILITY!

Now... in pilot production at RCA: SS111 L-Band Tunnel-Diode Oscillator and SS504 L-Band Down Converter—establishing at the RCA Electron Tube Division a capability that marks another milestone in solid-state achievement.

SS111 is designed to serve as a reliable local oscillator in most applications demanding moderate rf power output. SS504 is a tunnel-diode device well-suited for radar and telemetry applications—or wherever low-noise (5.5 db max.), low-power converters are required.

Opening up new areas of design and application, the SS111 and SS504 incorporate the latest advances in solid-state technology. Both of these compact, efficient, low-cost units are now ready for sampling.

Announcements of other new solid-state products will be made soon. For specifications of SS111 and SS504, see accompanying chart. For additional technical information, consult your RCA Industrial Tube Representative or write: Section K-19-Q-2 Commercial Engineering, RCA Electron Tube Division, Harrison, N.J.

Typical Operating Conditions

SS504 ELECTRICAL		NOTE 1 This is a double sideband noise figure based on employing a 30-Mc, 300-ohm input impedance intermediate-frequency amplifier with a noise figure of 1.7 db, and a bandwidth of 3 Mc.
Input Frequency (4)	1250 Mc	
Output Frequency	30 Mc	
Input Impedance	50 ohms	
Noise Figure (1)	5.5 db max.	
Bandwidth	3 Mc	
Tuning Range (2)	± 20 Mc	
Isolator	None required	
R.F. Input Power		
Dynamic Range (3)	Up to 0.1 mw 1.0 watt max.	
Maximum Input Pulse Energy	80 ergs	NOTE 2 By varying the frequency of the local oscillator
Local Oscillator Power	5.0 mw	
MECHANICAL		NOTE 3 Minimum power input at which the gain is reduced by 3.0 db from its small-signal value
Weight	7 oz.	
Size	2" diam. x 1 1/2"	NOTE 4 Units having similar performance can be supplied in the frequency range of 800 to 1500 Mc.
SS111 ELECTRICAL		
Ebb	0.4 to 0.6 volt	
Ibb	0.5 to 0.8 amp	
Frequency	1600 Mc	
Power Output	6.0 mw min.	NOTE 5 Units can be supplied with type N, BNC, or TNC connectors
MECHANICAL		
Size (5) (excluding connectors)	2 1/2" diam. x 3/4"	
Weight	5 oz.	



The Most Trusted Name in Electronics

INDUSTRIAL TUBE PRODUCTS FIELD OFFICES: OEM Sales: Newark 2, N. J., 744 Broad St., 48 5-3900 • Chicago 54, Ill., Suite 1154, Merchandise Mart Plaza, WH 4-2900 • Los Angeles 22, Calif., 6801 E. Washington Blvd., RA 3-8361 • Burlingame, Calif., 1838 El Camino Real, OX 7-1620 • **Government Liaison:** Harrison, N. J., 415 South Fifth St., 48 5-3900 • Dayton 2, Ohio, 224 N. Wilkinson St., BA 6-2366 • Washington 7, D. C., 1725 "K" St., N.W., FE 7-8500 • **International Sales:** RCA International Division, Clark, N. J., FU 1-1000.