

ELECTRONICS WORLD

MAC II

**RADIO
& TV NEWS**

NOVEMBER, 1959
50 CENTS

**SPECIAL / GREAT CIRCLE MAP
CHART / FOR RADIO AMATEURS**
COOKING & PRESERVING FOODS WITH ELECTRONICS
HOW TO TEST YOUR SPEAKERS
BEAM ANTENNA FOR CITIZENS BAND

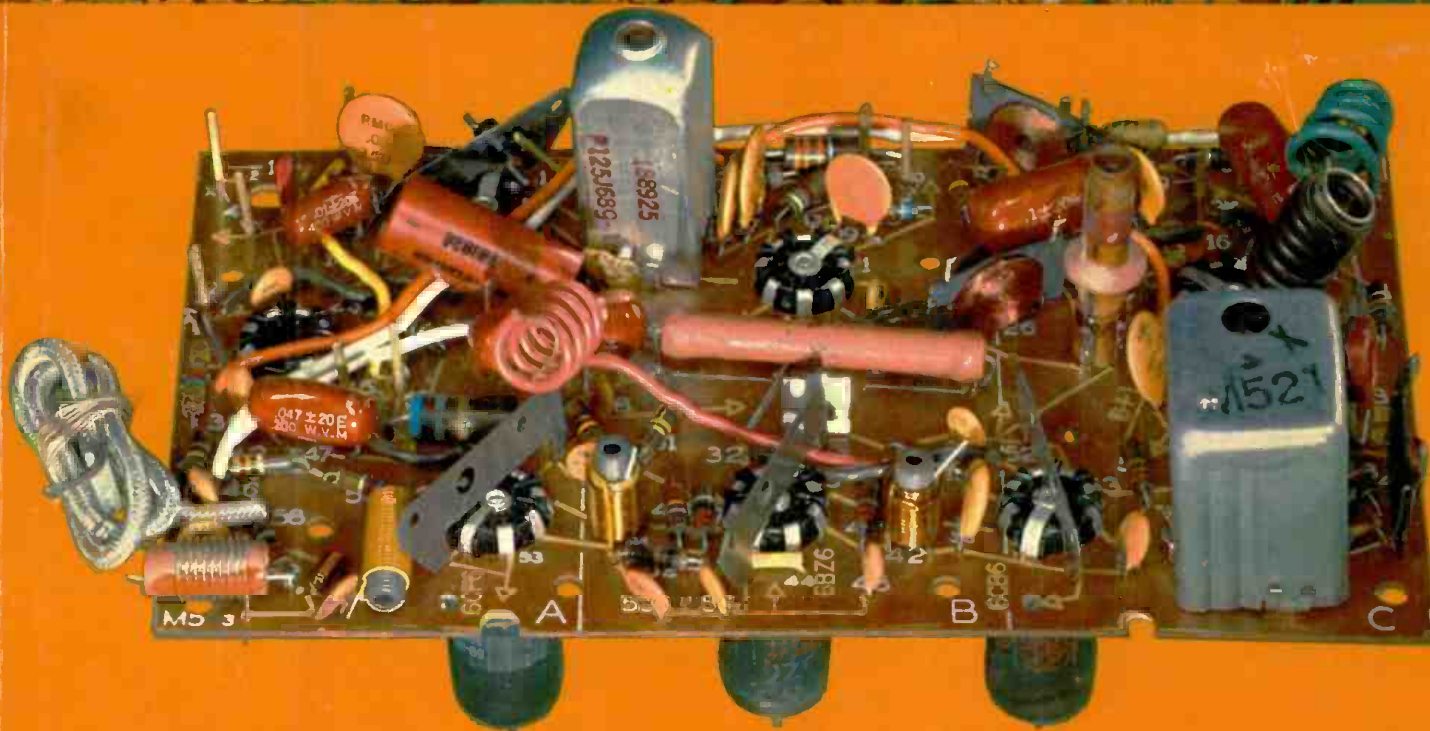

**NEW PRINTED BOARDS
USE ROAD-MAP TECHNIQUE
(SEE PAGES 50 & 51)**

YOU CAN HAVE YOUR CAKE AND EAT IT TOO!

WITH THE 3 NEW **Amperex** HIGH-GAIN VHF TRANSISTORS:

Unrivalled for—RELIABILITY,
OPERATING STABILITY
and UNIFORMITY

*And yet they cost no more, in many cases,
than equivalent vacuum tubes and are
available now in production quantities.*

At last, you can realistically employ high frequency transistors for RF and IF amplifiers in production FM receivers; as mixers, oscillators and RF and IF amplifiers in mobile radio equipment, car radios and short wave receivers; and as broadband amplifiers in instrumentation and industrial applications.

Implemented and fully proven by Amperex, a unique manufacturing technique originating with Philips of the Netherlands now enables Amperex to provide you with production VHF transistors of unparalleled laboratory quality at truly reasonable prices.

The new Amperex "alloy-diffusion" P-N-P transistors combine the best qualities of both the alloy and the diffusion approaches to transistor construction. As a result of the special "self-jigging" techniques, a maximum degree of uniformity is achieved. Thus the necessity for "selection" is completely eliminated.

The Type OC170 is designed for use as a mixer oscillator in short wave receivers, as an IF amplifier in FM receivers, and as a broadband linear amplifier for instrumentation and industrial applications. The OC170 features a high cut-off frequency of 70 Mc and a low collector-to-base capacitance of 1.8 μf .

The Type OC169 is designed for lower frequencies and gain.

The Type OC171 is designed for use as a local oscillator and preamplifier in FM receivers and has a cut-off frequency of 100 Mc.

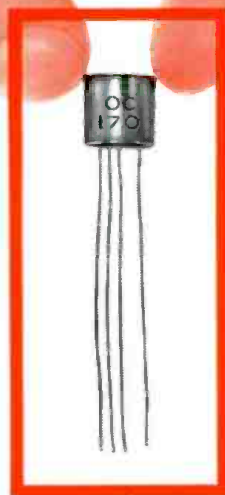

The Breakthrough...

How It Was Accomplished!

This VHF transistor breakthrough was made possible by a new alloy-diffusion process, a manufacturing method that combines the best features of the currently used alloy and diffusion processes, without their drawbacks.

The limitation of the alloy process is encountered when attempting to manufacture transistors with an average cut-off above 20 Mc. In this process the collector and emitter elements are fused (or alloyed) to the base. For this to be successfully accomplished the base must be relatively thick and the thickness very accurately controlled in order that during the fusion process the collector and emitter elements do not flow through the base and short the transistor. This relatively thick base increases the transit time, precluding any usable response above 20 Mc.

In the diffusion process the base is formed on the collector by gaseous diffusion in a high temperature oven. Very thin bases can be manufactured by this method with low transit time and very high cut-off frequencies. In this process the problem lies in attaching the emitter junction and base lead.

In the AMPEREX "alloy-diffusion" process, alloying and diffusion take place simultaneously. The transistor is built up on a piece of P-type germanium. Two small pellets are placed on the germanium. Pellet B, the base pellet, contains only an N-type impurity. Pellet E, the emitter pellet, contains a P-type and an N-type impurity.

When this assembly is heated at a certain temperature, the germanium dissolves into the metal pellets until saturation is reached, and the pellet impurities diffuse into the solid germanium.

However, the P-type impurity in pellet E has such a low diffusion constant, that for practical purposes it does not penetrate into the germanium. The N-type impurity in pellets E and B has a much greater diffusion constant and readily penetrates into the solid germanium to form a diffused N-type layer underneath the pellets.

When the assembly is cooled down, a layer of germanium recrystallizes from the pellets as in the normal alloy technique. The recrystallized layer of pellet E contains many atoms of the P-type impurity and is, therefore, a P-type germanium layer. The germanium layer recrystallized from pellet B is, of course, the N-type because there are no other impurities in the pellet.

Connections are made to the germanium and the metal pellets and a P-N-P transistor is obtained. The original P-type germanium is the collector, pellet B the base, and pellet E the emitter.

This process makes it possible to mass produce transistors with a base layer of a few microns for very short transit time and high cut-off frequencies. The yield is also very high which enables AMPEREX to supply these transistors at low prices.

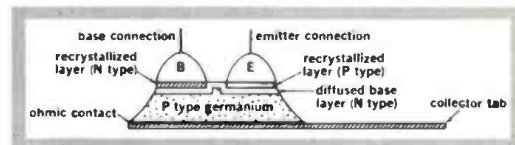

MAXIMUM RATINGS	OC169	OC170	OC171
V _{CE}	20 V	20 V	20 V
I _C	10 mA	10 mA	5 mA
P _C at T _{amb.} = 45°C.....	50 mW	60 mW	60 mW
TYPICAL CHARACTERISTICS			
Cut-off frequency f _{oc b}	70 Mc	70 Mc	100 Mc
Power gain P _g at 0.45 Mc	35 db	57 db	—
P _g at 10.7 Mc	20 db	31 db	—
P _g at 100 Mc	—	—	23 db
Noise figure NF at 0.45 Mc	4 db	4 db	—
NF at 10.7 Mc	5 db	5 db	—
NF at 100 Mc	—	—	11 db



ask Amperex

**the industry's reliable source of quality
transistors and diodes for industrial and
entertainment applications.**

Amperex Electronic Corp., 230 Duffy Avenue, Hicksville, Long Island, New York
In Canada: Rogers Electronic Tubes & Components, 116 Vanderhoof Avenue, Toronto 17, Ontario

CBS FIRSTS IN TUBES

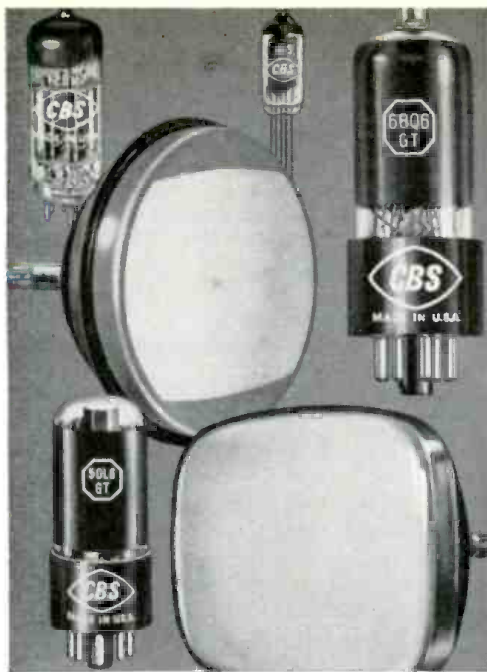

FIRST Bantam GT receiving tubes

FIRST Bantam Jr. subminiature tubes

FIRST rectangular picture tubes

FIRST receiving tubes designed especially for TV

FIRST receiving tubes rated for Continuous Television Service

FIRST practical color picture tube, CBS-Colortron

CBS FIRSTS IN COLUMBIA RECORDS



FIRST double-faced phonograph disc

FIRST (LP) long-playing record

FIRST complete symphony recording in U. S. A.

FIRST "360" hi-fi phonograph

FIRST major recording company with a record club

FIRST Stereo Seven — new seven-inch 33 $\frac{1}{3}$ rpm record

Leonard Bernstein, outstanding musical personality, is a Columbia Records star.



Receiving, industrial and picture tubes • transistors and diodes • audio components • and phonographs

WHAT THESE FIRSTS MEAN TO YOU

In records or tubes, the CBS family habit of being first helps guarantee you the quality of performance that only leadership can deliver. This leadership is your further assurance that:

- CBS tube quality cuts call-backs to the bone.
- CBS tube quality insures your customers of dependable performance.
- CBS tube quality offers built-in profits for you.

Ask for the leader with the top-rated name your customers know and trust. Ask first for CBS.

CBS ELECTRONICS

Danvers, Massachusetts

Electronic manufacturing division of Columbia Broadcasting System, Inc.

ELECTRONICS WORLD is published monthly by Ziff-Davis Publishing Company, William B. Ziff, Chairman of the Board (1946-1953), at 434 S. Wabash Ave., Chicago 5, Ill. Second class postage at Chicago, Illinois. Authorized by Post Office Department, Ottawa, Canada, as second-class matter. SUBSCRIPTION RATES: one Year U. S. and possessions, and Canada \$4.00; Pan American Union Countries \$4.50; all other foreign countries \$5.00.

ELECTRONICS WORLD

NOVEMBER, 1959

VOL. 62 ■ NO. 5

Publisher

OLIVER READ, D. Sc., WIETI

Editor

WM. A. STOCKLIN, B. S.

Technical Editor

MILTON S. SNITZER, W2QYI

Service Editor

SIDNEY C. SILVER

Associate Editor

P. B. HOEFER

Assistant Editor

J. JUSTER

Industrial Consultant

WALTER H. BUCHSBAUM

Art Editor

MILTON BERWIN

Art and Drafting Dept.

**J. A. GOLANEK
A. J. LICHOTA, JR.
K. W. PAUL, JR.**

Advertising Director

JOHN A. RONAN, JR.

Advertising Manager

GEORGE E. MORRISSEY

Midwest Adv. Manager

W. ROBERT WOLFE

Western Adv. Manager

DON CENA



ZIFF-DAVIS PUBLISHING COMPANY
William Ziff, President; W. Bradford
Briggs, Executive Vice-President;
Michael Michaelson, Vice-President and
Circulation Director; Hershel B. Sorbin,
Vice-President; J. L. O'Donnell,
Treasurer.

Editorial and Executive Offices
One Park Avenue
New York 16, N. Y. OR. 9-7200



Member
Audit Bureau of
Circulations

MEMBER
INSTITUTE OF



BRANCH OFFICES: **Midwestern Office,**
434 S. Wabash Ave., Chicago 5, Ill.;
Western Office, 215 W. 7th St., Los
Angeles 14, Calif.; **James R. Pierce,**
manager.

FOREIGN ADVERTISING REPRESENTA-
TIVES: **D. A. Goodall Ltd.,** London;
Albert Milhodo & Co., Antwerp and
Dusseldorf.

First in radio-television-audio-electronics

CONTENTS

ELECTRONICS—GENERAL

Spot News.....	Washington Correspondent	28
Preserving & Cooking Food With Electronics.....	Walter H. Buchsbaum	37
Recent Developments in Electronics.....		48
Numbers Systems and Codes.....	Ed Bukstein	69
Largest Induction Heating Project.....		102
Space Platforms for the Future.....		140
Calendar of Events.....		145

HIGH FIDELITY AND AUDIO

Simplified Speaker Testing.....	R. D. Herlocker	41
Subdivided Hi-Fi Speaker Enclosure.....	D. F. Rehberger	57
Harmonic Distortion—What It Is and How It's Measured.....	Milton S. Snitzer	72
Hi-Fi—Audio Product Review.....		86
Measuring Your Audio Power Output.....	Harold Reed	92
Certified Record Revue.....	Bert Whyte	120
Sound on Tape.....	Bert Whyte	124

TELEVISION-RADIO

Are You "Alignment Happy"?.....	Ken Bramham	47
Printed Boards: Roadblocks or Road Maps?.....		50
Cover Story.....		51
Is Your Business Geared for Change?.....	William Leonard	52
Transistor and Diode Substitutions.....	E. G. Louis	65
Mac's Service Shop.....	John T. Frye	74
Service Notes.....		96
Mobile Receivers: Alignment & Service.....	Jack Darr	116
Service Industry News.....		132
Transistor Radio Circuits (Part 1).....		144

TEST EQUIPMENT

New Tube Tester Data.....		94
---------------------------	--	----

AMATEUR AND COMMUNICATIONS

Citizens Band Operation (Editorial).....	W. A. Stocklin	8
A Compact Beam for the Citizens Band.....	Hartland B. Smith	44
Radio Amateur Prefixes.....		53
Radio Amateur Great Circle Chart.....		54-55
Alphabetical Listing of Countries with Prefixes.....		56
Citizens Band Transceiver Kit (ELECTRONICS WORLD Lab Tested).....		60
Restoration of Old-Time Wireless Gear.....	Howard S. Pyle	62
Violations of Citizens Radio Regulations.....		106

DEPARTMENTS

Letters from Our Readers.....	12	Technical Books.....	138
Within the Industry.....	30	Manufacturers' Literature.....	146
What's New in Radio.....	150		

Net Paid Circulation 242,396

Radio & TV News • Radio News • Television News Trademarks Reg. U. S. Pat. Off.

Copyright © 1959 by Ziff-Davis Publishing Company. All rights reserved.

SUBSCRIPTION SERVICE: Forms 3579 and all subscription correspondence should be addressed to Circulation Department, 434 South Wabash Avenue, Chicago 5, Illinois. Please allow at least four weeks for change of address. Include your old address as well as new—enclosing if possible an address label from a recent issue.

CONTRIBUTIONS: Contributors are advised to retain a copy of their manuscripts and illustrations. Contributions should be mailed to the New York Editorial Office and must be accompanied by return postage. Contributions will be handled with reasonable care, but this magazine assumes no responsibility for their safety. Any copy accepted is subject to whatever adaptations and revisions are necessary to meet the requirements of this publication. Payment covers all author's, contributors', and constant's rights, title, and interest in and to the material accepted and will be made at our current rates upon acceptance. All photos and drawings will be considered as part of the material purchased.

ELECTRONICS WORLD



Now! Work Over
300 PRACTICAL
PROJECTS with these
PARTS AT HOME!



to help You learn

ELECTRONICS

RADIO - TELEVISION - RADAR

NOW . . . at home in your spare time you can get the very kind of training and subsequent Employment Service you need to get started toward real earnings in one of today's brightest opportunity fields—TELEVISION-RADIO-ELECTRONICS. Now that Electronics is entering so many new fields, here is a chance of a lifetime to prepare to cash in on its remarkable growth.

DeVry Tech's amazingly practical home method enables you to set up your own HOME LABORATORY. You spend minimum time to get maximum knowledge from over 302 practical projects, using the same type of basic equipment used in our modern Chicago and Toronto Training Centers!

DeVry Tech Provides EVERYTHING YOU NEED . . .

—to help you master TV-ELECTRONICS. In addition to the home laboratory and easy-to-read lessons, you even use HOME MOVIES—an exclusive DeVry Tech advantage. You watch hidden actions . . . see electrons on the march. Movies help you to learn faster . . . easier . . . better.

LABORATORY TRAINING

Full time day and evening training programs in our modern Chicago and Toronto Laboratories are also available. MAIL COUPON TODAY for facts.



BUILD and KEEP Valuable TEST EQUIPMENT

As part of your training, you build and keep a fine Jewel-Bearing Vacuum Tube VOLTMETER and a 5-inch COLOR OSCILLOSCOPE—both high quality, needed test instruments.

EFFECTIVE EMPLOYMENT SERVICE

Get the same Employment Service that has helped so many DeVry Tech graduates get started in this fast-growing field.



"One of North America's Foremost Electronics Training Centers"

Accredited Member
of National Home
Study Council



DeVRY TECH INSTITUTE
Formerly DeForest's Training, Inc.
CHICAGO 41, ILLINOIS

EARN WHILE YOU LEARN

DeVry Tech's practical training helps you toward spare time income servicing Radio and Television sets.

✕ CHECK
*These Exciting
Job
Opportunities:*



VACUUM
TUBE
VOLTMETER



5-INCH
COLOR
OSCILLOSCOPE



21 INCH

Build and keep this BIG DeVry Engineered TV set—easily converted to U.H.F. (DeVry offers another home training, but without the TV set.)

- TV-Radio Broadcast Technician
- Color Television Specialist
- Radar Operator
- Laboratory Technician
- Airline Radio Man
- Computer Specialist
- Quality Control Manager
- Your Own Sales & Service Shop
- . . . PLUS MANY OTHERS

MAIL COUPON TODAY!

DeVRY TECHNICAL INSTITUTE
4141 Belmont Ave., Chicago 41, Ill., Dept. EW-11-P

Please give me your FREE booklet, "Electronics and YOU," and tell me how I may prepare to enter one or more branches of Electronics.

Name _____ Age _____

PLEASE PRINT

Street _____ Apt. _____

City _____ Zone _____ State _____

2045 Canadian residents address DeVry Tech of Canada, Ltd.
626 Roselawn Ave., Toronto 12, Ontario



General Electric's all-new VR-22 Stereo Cartridge

try it in your own home

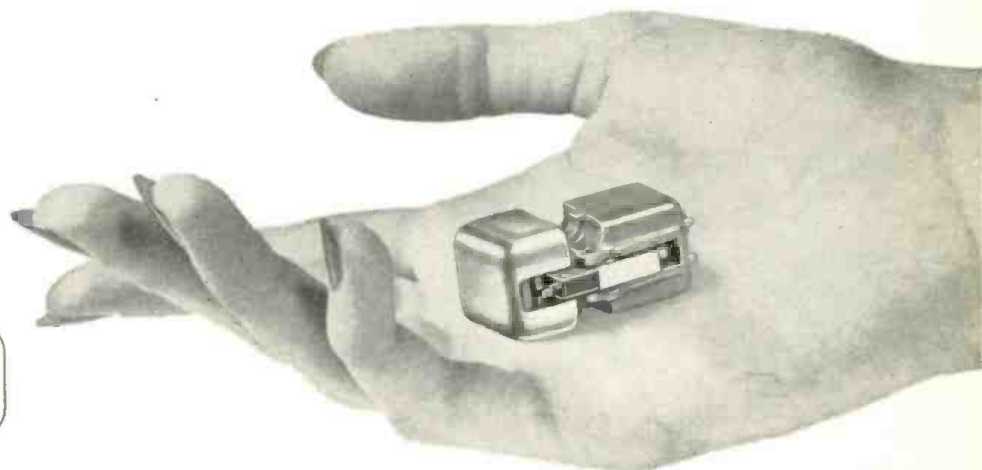

money-back guarantee!

We believe that once you hear General Electric's all-new VR-22 in the privacy of your own home, on your own equipment, you'll want to have this superb stereo cartridge for your very own.

We're so sure of it, in fact, that we are making you an offer virtually without precedent in the Hi-Fi field: Try the VR-22 at home for 10 days. If you don't agree that this is *the* stereo cartridge for you, bring it back and the full purchase price will be cheerfully refunded. You have nothing to lose and a whole new world of enjoyment to gain! See your participating General Electric Hi-Fi dealer.

The VR-22 is outstanding in all four critical areas of stereo cartridge performance: *Channel separation—Response—Freedom from hum—Compliance.*

VR-22-5 with .5 mil diamond stylus for professional quality tone arms, \$27.95*. VR-22-7 with .7 mil diamond stylus for professional arms and record changers, \$24.95*. TM-2G Tone Arm—designed for use with General Electric stereo cartridges as an integrated pickup system, \$29.95*. General Electric Co., Audio Components Products Section, Auburn, N. Y.

*Manufacturer's suggested resale prices.

Acclaimed
by the
experts!



Oliver P. Ferrell
Editor
Hi-Fi Review
as quoted
in issue
of Aug. 1959

"... the VR-227 is a top performer. The frequency response is as flat as any cartridge tested to date. Channel-to-channel separation in the vital area between 700 cycles and 8000 cycles was equal to the very best stereo cartridges now offered the public."



Wm. A. Stocklin
Editor
Electronics World
as quoted
in issue
of Sept. 1959

"... listening tests did not show up any flaws. Frequency response from 30 to 15,000 cps (limits of our test) was within 2.25 db of flat. Provides about the best channel separation available of any checked with the exception of [cartridge selling for \$65.00] in the frequency range from about 5000 to 9000 cps."



C. G. McProud
Editor
Audio
as quoted
in issue
of Sept. 1959

"... is even better than its predecessor with respect to output, channel separation and extended frequency response and the two channels balance within ± 2 db to 15,000 cycles. The shielding has been improved and the grounding of the shield and the method of shorting the two 'ground' terminals are well thought out."

GENERAL  ELECTRIC

ELECTRONICS WORLD

Opportunities in Electronics

Do you know how you can convert your present electronics knowledge into a profitable and interesting career in any of the fields listed here?

Thousands of interesting well paid jobs in electronics must be filled. To fill such jobs, you need sound technical training. An FCC license is convincing proof of technical skill. Send for the three Cleveland Institute booklets offered here. They explain how you can prepare for an interesting and profitable career in electronics. Mail the coupon today—no obligation.

Find out how modern technical training and a Government License (FCC) can lead to profitable employment in any branch of electronics.

good training doesn't cost—it pays!

- **Radar**
- **Guided Missiles**
- **Broadcasting**
- **Aeronautical Electronics**
- **Computers**
- **Automation**
- **Industrial Electronics**
- **Home Electronics**



**Send for these
3 FREE Booklets**

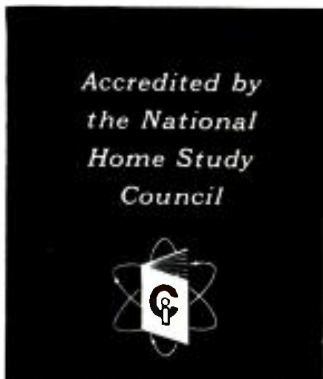

Cleveland Institute of Electronics

Desk RN-35

4900 Euclid Ave.

Cleveland 3, Ohio

Please send FREE Booklets prepared to help me get ahead in Electronics. I have had training or experience in Electronics as indicated below:

- | | |
|---|--|
| <input type="checkbox"/> Military | <input type="checkbox"/> Home |
| <input type="checkbox"/> Radio-TV Servicing | <input type="checkbox"/> Experimenting |
| <input type="checkbox"/> Manufacturing | <input type="checkbox"/> Telephone |
| <input type="checkbox"/> Amateur Radio | <input type="checkbox"/> Company |
| <input type="checkbox"/> Broadcasting | <input type="checkbox"/> Other _____ |

In what kind of work are you now engaged?

In what branch of Electronics are you interested?

Name _____ Age _____

Address _____

City _____ Zone _____ State _____

RN-35

HOW TO MAKE MONEY

Selling Commercial Sound

Here today and here tomorrow — Commercial Sound is a steady-profit 12-months-a-year business of sales, installation and servicing with lots of customers right in your own neighborhood. Take advantage of the Atlas complete line of speakers — manufactured, advertised and supplied directly by Atlas. Speakers for every application, a mike support for every purpose — plus a wide variety of accessories so necessary for a complete professional installation.

Good markets in stadia, racetracks, athletic fields, etc.

Profitable markets in swimming pools, amusement parks, clubs, schools, etc.

Excellent markets in industry, factories, warehouses, etc.

Write for latest catalog and selling aids to help you get profitable commercial sound business.

ATLAS SOUND CORP.
RN-11
1445 - 39th St.
Brooklyn 18, N. Y.

In Canada: Atlas Radio Corp.,
Toronto, Canada

...for the Record

By **W. A. STOCKLIN**
Editor



CITIZENS BAND OPERATION

WELL, the FCC is beginning to bear down heavily on many 27-mc. Class D Citizens Band licensees. Those in the industry never doubted that the time would come when the FCC would have to take action, but we are all somewhat surprised that it is coming so soon. Possibly we should not have been if we consider the number of applications that are being filed daily. The FCC has issued approximately 58,000 Citizens Band licenses. Of this number, there are probably some 30,000 that are Class D. Remember that this is only from the first of this year and the pace has stepped up rapidly to a point where some 5000 new Class D applications are being filed each month. After all the years of amateur radio, there are only about 180,000 to 200,000 licensed operators in this country. Of this number, perhaps only about 100,000 are active. If the pace continues in Class D authorizations, these may very well surpass the number of amateur radio licenses. Again, let's consider that the allowed radio spectrum for Class D operation is only a small fraction of that allowed to the radio amateurs. It should be obvious that overcrowding of the band is practically a certainty.

To cope with this problem, the FCC is contemplating some rule changes which may limit transmission times and operating frequencies for the Class D operator. But no one should sit back and criticize the Commission for these moves. Opening up the Class D Citizens Band has been of tremendous help to the electronic industry and to the great numbers of individuals who now have their licenses. But, violation notices will be in vogue and operation will be stopped if the operators today do not abide by the rules and regulations set up by the FCC for this type of operation. (Refer to article "Violations of the Citizens Radio Service Rules," which appears on page 106 of this issue. This band is *not* to be used for DX purposes or for general chit-chat as is allowed on the ham bands. The Class D band was set aside strictly for point-to-point operation for personal or business use and for those citizens who have real need for direct communication. It is *not* to be used to discuss Aunt Martha's

upcoming party—as one would use the telephone. There is no time limit on transmissions now and the FCC probably would not consider any changes in this rule if present operators would use this service wisely.

There are movements afoot for groups to unite in protest to the FCC concerning the present methods of operation that are permitted. No one would consider this unethical providing the complaints are justified and not simply selfish. Every holder of a Class D license today would probably like to have the FCC cut off future applicants. This certainly would be one answer but it is a selfish solution and certainly unrealistic.

Time limits on contacts will probably be set up and the FCC no doubt will follow up with many other limitations through necessity.

There are quite a large number of companies now manufacturing Citizens Band equipment. They are, in many respects, divided into two groups: those who produce the more costly equipment for the commercial users of this band and, on the other hand, those companies who produce the lower-priced equipment looking toward the non-commercial or personal users. These two groups have been plaguing the FCC for rule changes directed solely to their own fields of interest. This is an unfortunate situation and it is our hope, since there is no unified voice for the operators, that the FCC does not permit itself to be swayed toward any single interest but will consider the interests of everyone.

Everyone should bear one thought in mind. The limitations set forth by the FCC when the Class D Citizens Band first opened were not too restrictive and, obviously, severe restrictions were not necessary. There were so few licensees at the beginning that one could take certain operating liberties without the danger of interference. But as more and more operators go on the air, it will become necessary for all to live strictly by the rules and, further, to conform to any rules that may be promulgated in the future for the benefit of all. Only in this way will the band be utilized fully and to its best advantage by all concerned.

FREE

ALLIED'S 1960

ELECTRONIC SUPPLY CATALOG

*it's value-packed...
send for it!*

*your complete money-saving
guide to everything in electronics*

WORLD'S LARGEST STOCKS

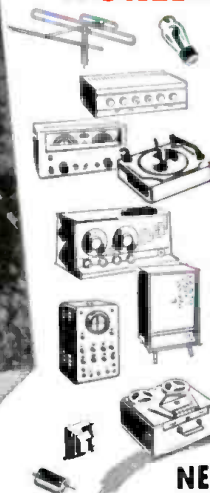

- Latest Stereo Hi-Fi Systems— Everything in Hi-Fi Components
- Money-Saving, Build-Your-Own KNIGHT-KITS for Every Need
- Values in Recorders and Supplies
- Latest Public Address Systems, Paging and Intercom Equipment
- Amateur Receivers, Transmitters and Station Gear
- Test and Laboratory Instruments
- TV Tubes, Antennas, Accessories
- Huge Listings of Parts, Tubes, Transistors, Tools, Books

NEW LOW EASY PAY TERMS

Only \$5 down (or less) on orders up to \$200. Up to 24 months to pay. Fast handling—no red tape.

Get every buying advantage at ALLIED: lowest money-saving prices, fastest shipment, expert personal help, guaranteed satisfaction...

*send for the leading
electronic supply guide*

FREE

ALLIED RADIO CORP., Dept. 1-19
100 N. Western Ave., Chicago 80, Ill.

Send FREE 1960 ALLIED Catalog.

Name _____

Address _____

City _____ Zone _____ State _____

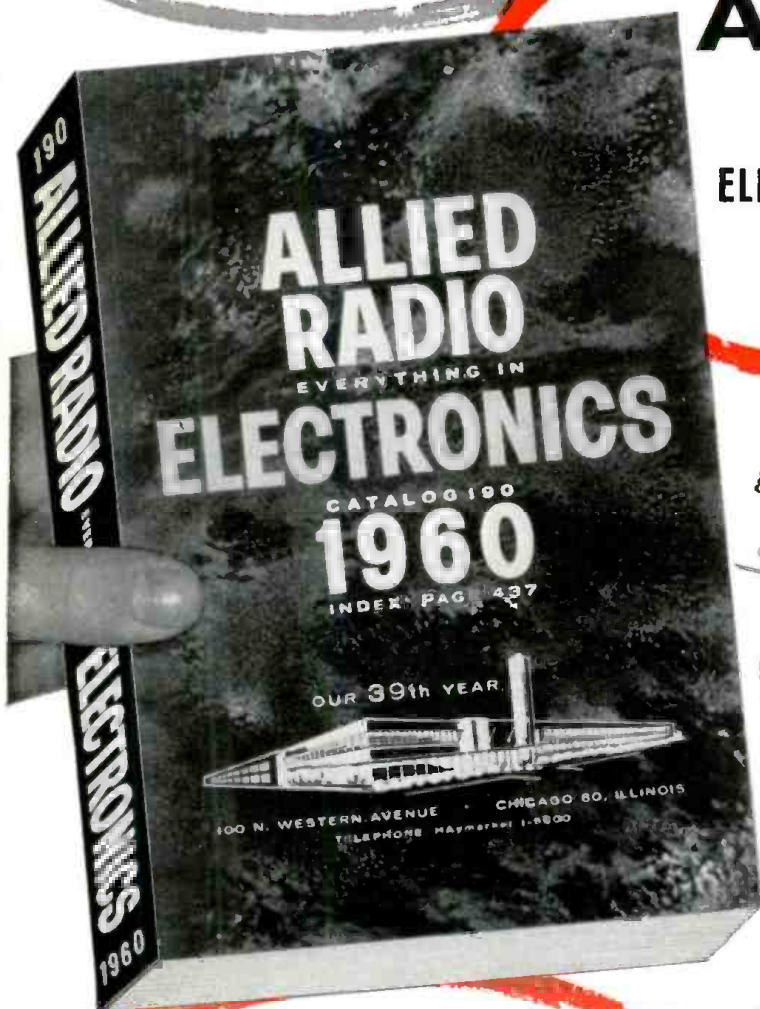

*featuring
these ALLIED exclusives:*

MONEY-SAVING KNIGHT-KITS®—the very best in build-your-own electronic equipment—designed to save you up to 50%. "Convenience Engineered" for easiest assembly; the only kits covered by Money-Back Guarantee. Complete selection of Stereo hi-fi kits, Hobbyist kits, Test Instrument and Amateur kits. KNIGHT-KITS are an exclusive ALLIED product.

KNIGHT® STEREO HI-FI—truly "honored for value"—the best you can buy, yet far lower in cost. Select super-value KNIGHT components or complete systems and save most. Also see the world's largest selection of famous name hi-fi components and money-saving ALLIED-recommended complete systems.

ALLIED RADIO



*our 39th year
World's Largest Electronic Supply House*

GET BEHIND THE

SYLVANIA

\$2.00 Combination

America's biggest magazines deliver this business-building offer to over 100 million readers!

On June 20th Sylvania launched the dramatic combination coupon offer appearing in America's biggest weekly magazine, TV Guide, and America's biggest monthly magazine, Reader's Digest—plus Sunday and Parade newspaper supplement magazines.

Your Service shares the spotlight with top-quality Sylvania picture tubes and receiving tubes in a three-point program to make your customer's old TV set better than when it was new.

Month after month, more set owners will be saving the \$2.00 coupon. Many will attach it to the back of their TV set so it's there for you to see.

You can identify yourself with this program by featuring Silver Screen 85 and Sylvania receiving tubes. Get behind the biggest, most practical, business-building offer ever made to the Service industry.



Look for this ad in these leading national magazines.

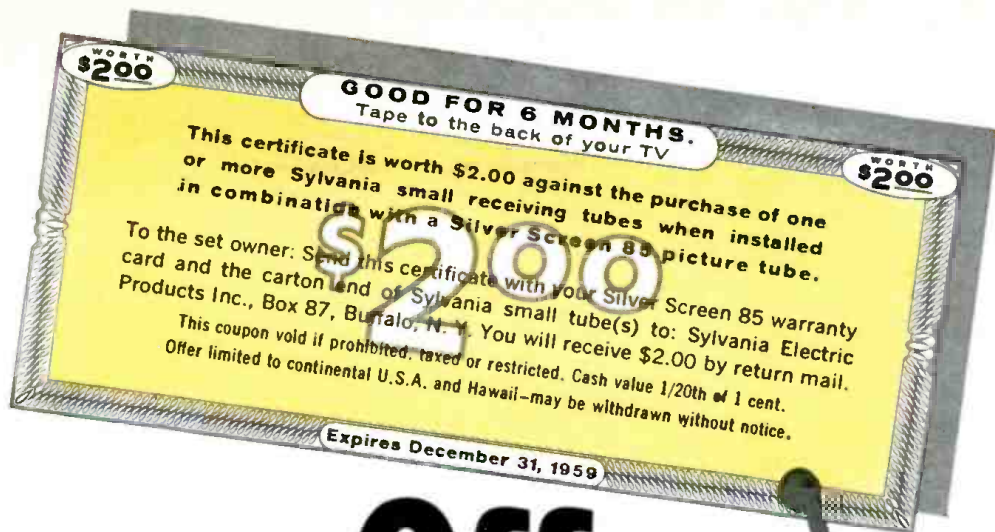

Coupon Offer

Sells your service and Sylvania receiving tubes in combination with every Silver Screen 85 you install

Here's an action-packed offer that can add an average of \$3.00 to \$6.00 in receiving tube business every time you install a Silver Screen 85 picture tube.

Sylvania urges your customers to have their receiving tubes checked to make sure they get full performance from their new Silver Screen 85. And, to emphasize the importance of replacing weak tubes, Sylvania offers to pay \$2.00 toward the cost of Sylvania receiving tubes installed in combination with a Silver Screen 85.

Your customers mail the \$2.00 certificate directly to Sylvania with the picture-tube warranty card and receiving-tube carton end. Nothing for you to sign or send.

Stock up on Sylvania. Be prepared for greater-than-ever consumer demand for America's Number One picture tube and receiving tubes.



SYLVANIA
 Subsidiary of
 GENERAL TELEPHONE & ELECTRONICS





maybe you've seen
such quality before but
never at these low prices:
SONIC
STEREO COMPONENTS

Engineered by one of the nation's foremost independent phonograph manufacturers. These new high fidelity stereo components represent this firm's vast engineering and experience.



SONIC CUSTOM-CRAFT S-200 12 watt stereo, master control center and dual amplifiers. 6 watts per channel develops 24 watts of peak power. Frequency response, ± 1.5 db from 50 to 15,000 cps. Total harmonic distortion, less than 2% at full rated output. Stereo or monophonic inputs. Internal audible stereo test signal for channel and speaker balance adjustment. 9 separate front-panel controls. 4, 8 and 16 ohm outputs for single, double, or triple channel operation.

audiophile net with enclosure \$49.95



SONIC CUSTOM-CRAFT S-100 low-priced hi-fi 10 watt stereo, master control center, and dual amplifiers. 5 watts per channel develops 20 watts of peak power. 50 to 15,000 cps response with less than 5% of total harmonic distortion at full rated power. Hum and noise, 45 db below maximum rated power. 4 stereo or monophonic inputs. 8 ohm outputs for single or double operation.

audiophile net with enclosure \$34.95



SONIC CUSTOM-CRAFT MODEL 19 FM-AM TUNER Super-sensitive tuner features drift-free automatic frequency control performance and 3-gang tuning capacitor for optimum selectivity. Sensitivity-FM 5 μ v for 30 db quieting. Total harmonic distortion at rated output, less than 1.5%. Selectivity bandwidth at 6 db point: FM 200 kc, AM 9 kc. Frequency response, FM ± 2 db of standard de-emphasis curve, AM 20 to 9,000 cps. Function switch AM, FM or FM-AFC.

audiophile net less cabinet \$79.95

MODEL 19C with handsome mahogany cabinet. audiophile net \$99.95

SONIC CUSTOM-CRAFT S-400 (pictured above) Quality combination 40 watt stereo amplifier, master control center, and transistorized preamplifier. 20 watts per channel delivers 80 watts of peak power. Frequency response, flat from 20 to 20,000 cps ± 0.5 db. Less than 1% total harmonic distortion at full rated output. Built-in stereo test signal to adjust channel and speaker balance as well as speaker phasing. Sonic Stereo Monitor, a precision meter shows when both channels are properly balanced. 8 inputs and 9 front panel controls handle any program source. 4, 8 and 16 ohm outputs for single, double or triple channel operation. audiophile net with enclosure \$99.95

at your local hi-fi dealer, or write EW-11

SONIC INDUSTRIES, INC.

19 Wilbur Street, Lynbrook, N. Y.



OUR STEREO TEST RECORD

To the Editors:

May we thank you for sending us one of your stereo test records because that phasing check is worth twice the price and is most satisfactory. We cannot imagine a better solution to this perplexing difficulty than the one you have come up with. It seems infallible and certainly belongs with every stereo system.

I. C. WHITTEMORE, JR., Manager
Sirocco Enterprises
Milford, Connecticut

We are still receiving many nice comments from users of our stereo-monophonic test record. The phasing test is quite simple to use and really works.—Editors.

* * *

TRANSISTOR STEREO TAPE SYSTEM

To the Editors:

Hobbyists who contemplate the building of the equipment described in my article "All-Transistor Stereo Tape System" (July, 1959 issue of ELECTRONICS WORLD) will be interested to know that a saving of about \$13.00 can be realized by substituting the following semiconductors.

Use a 2N525 in place of a 2N43 for V_2 and V_3 of Fig. 6.

Use 1N1692's in place of 1N1115's for the bridge of Fig. 15 (no heat sink required).

Hobbyists may also be interested in knowing that a similar system with seven- to eight-watts per channel appears in the new fourth edition of the *General Electric Transistor Manual* that is now available. This system uses less expensive transistors since it operates from a lower voltage supply.

D. V. JONES
General Electric Co.
Syracuse, New York

We know our readers will be very interested in the above suggestions from Author Jones with respect to his tape system.—Editors.

* * *

TRANSISTOR PHONO PREAMP

To the Editors:

A question has come up on the derivation of the input impedance (18,000 ohms) indicated in my article "Transistorized Phono Preamp for Stereo" (August, 1959 issue). It was said that this impedance is the result of the parallel combination of R_1 (240,000 ohms) and R_2 (24,000 ohms). Of course, the actual parallel resistance is 21,800 ohms. However, as far as impedance multiplication is concerned, only resistor R_2 is multiplied since only it is connected between base and emitter. Therefore, in order to com-

pute the effective input impedance of the preamp, it is necessary to multiply the value of R_2 at each frequency and then parallel this multiplied value with the fixed R_1 . Obviously, this method is cumbersome and would be difficult to describe effectively.

In order to avoid this, the 18,000-ohm figure mentioned actually represents an *effective* parallel resistance that can be multiplied by the input impedance multiplication factor and yields proper results for reasonably small values of multiplication (below about 100). Therefore, 18,000 ohms was listed in order to avoid complexity in the discussion. Since this use of 18,000 ohms is not overly confusing and simplifies the understanding of the basic processes—it was used.

FRANCES A. GICCA
Sr. Engineer
Raytheon Co.
Bedford, Massachusetts

We appreciate having Author Gicca clear up this point for our readers.—Editors.

* * *

A "TOUGH DOG" TAMED

To the Editors:

I was working on a *Westinghouse* chassis V-2317 that was so full of ambition it insisted on showing three complete, steady pictures. I was just about ready to start substituting components from the tuner to the picture tube when the postman delivered the July issue of ELECTRONICS WORLD.

I happened to see the article "Tame TV 'Dogs' with Technique" by Warren J. Smith on page 58. It was a case of perfect timing. I followed the advice given, and in two minutes, the set was working properly.

WILLIAM NEILSON
San Jose, California

That's what you call split-second timing.—Editors.

* * *

SHOCK HAZARDS

To the Editors:

I appreciated Mr. Greenfield's article "Eliminating Shock Hazards" in the August, 1959 issue of ELECTRONICS WORLD. I feel that he should have included a fourth step in his conversion procedure, to wit: Check the outlet to which the equipment is to be connected to be sure that the wider slot is indeed the ground side of the line. Perhaps this will occur to most everyone really interested in carrying out your safety procedures, but I feel it is worth mentioning because I have tried using a similar technique and discovered that many electricians realize that all power equipment that is not of the three-



Today's FP is available in the improved "red top" design with new positive leakproof seal that ends the possibility of leakage. A new patented spring clip mounting gives improved resistance to shock and vibration plus improved heat dissipation.



Prevent "Middle Age" Hum with Mallory FP's—the Capacitor with ETCHED CATHODE

Why risk annoying filter hum? Always use Mallory FP capacitors . . . and be sure of life-long hum-free performance. The etched cathode FP offers increased cathode surface that prevents loss of capacitance. What's more, you can use the FP with assurance in today's tightest, hottest chassis. The FP is

the original 85°C capacitor . . . gives you premium service without premium price.

Try the new FP capacitor for yourself. See how it stops expensive, time-consuming call-backs. Your Mallory distributor has them . . . see him today.



TC Tubular Electrolytics—now in handy new twin pack with the same high quality and performance characteristics.



RMC Discaps®—Long the original equipment standard, now available for replacement in the handy "file card" five pack.



Mallory GEMS—five tubular capacitors in easy-to-use dispenser: best bet for outstanding service in buffer, by-pass or coupling applications.

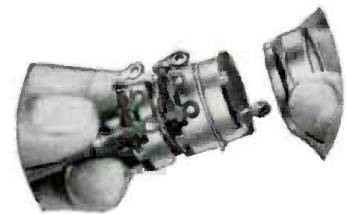

Sta-Loc®—New design enables your distributor to custom-build the exact replacement you need in just 30 seconds, eliminates waiting for out-of-stock controls.
*Trade Mark

®Registered trade mark of Radio Materials Company, a division of P. R. Mallory & Co. Inc.

P. R. MALLORY & CO. Inc.
MALLORY

P. R. MALLORY & CO. Inc., INDIANAPOLIS 6, INDIANA

RESIDENT SCHOOL COURSES

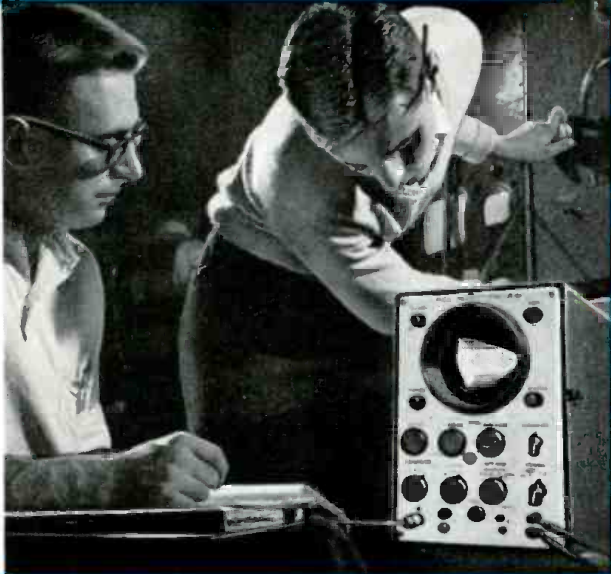

Industry needs Electronic Technicians!

Let RCA train you in Advanced Electronics

This is the college-level training you need to work with professional engineers on research, development or production projects in such fields as: automation, guided missiles, radar, television, computers and other advanced electronic applications.

RCA Institutes Resident School in New York City offers this comprehensive course that prepares you for any field of electronics you may choose. Other courses in TV & General Electronics, Radio & TV Servicing, and Radio Telegraph Operating.

Classes start four times each year. Applications now being accepted. Approved for Veterans.



RCA INSTITUTES, INC.
SCHOOLS OF TELEVISION
AND ELECTRONIC TECHNOLOGY
A Service of Radio Corporation of America
ANOTHER WAY RCA SERVES EDUCATION THROUGH ELECTRONICS



RCA INSTITUTES, DEPT. EWR-119
350 W. Fourth St., N.Y. 14, N.Y.

Please send me your FREE catalog of
Resident School courses in New York.

NAME.....
please print

ADDRESS.....

CITY..... ZONE..... STATE.....

For Resident School Courses see ad on opposite page.

prong variety is not polarized, and they don't really take the time to insure the proper wiring of receptacles (regardless of the National Electrical Code and most local codes). This opinion has been borne out in talking to a number of electricians.

I have no doubt that Mr. Greenfield's method of enlarging the ground prong on equipment is the best way, but a simple and effective method can be accomplished by placing the cutting end of a pair of "dikes" at the hole near the end of the prong and splitting the end thereof, while concomitantly enlarging the width of the prong. This has worked well for me on a number of occasions.

Let's have more "fold-outs." I've used every one you have had to good advantage.

DON A. POTTS
Electronic Service
Kansas City, Kansas

Perhaps the precautionary check mentioned above should not have been taken for granted in the article. Also, local practice may vary. Our experience indicates that, around New York at least, the recommended wiring will be found in all but very old installations.—Editors.

* * *
ONE-TUBE FM FRONT END

To the Editors:

I read with some concern your article in the August issue of *ELECTRONICS WORLD* titled "Don't Dodge the One-Tube FM Front End" (page 52).

It is certainly true that tuners of this type are in wide use today. However, my concern is with the reference to the *General Instrument* tuner and the *Telefunken* tuner and (the lack of reference) to the *Gorler* tuner.

Paragraph three of the article appears to infer that *Admiral*, *Motorola*, and *RCA-Victor* are using one of the aforementioned tuners. These manufacturers plus others are using the tuners manufactured by the *Julius Karl Gorler Co.* of Mannheim, Germany, sold nationally through this sales office.

R. J. SHERWOOD, President
Sherwood Sales Inc.
Chicago, Ill.

The article mentioned a few but not all manufacturers to highlight widespread use of the "general type of one-tube wonder." Paragraph three states: "relatives of it are being used in the FM lines of such manufacturers as Admiral, Motorola, and RCA-Victor." To J. K. Gorler and others not mentioned we say, "Welcome, relatives!"—Editors.

NOTES ON TWO-WAY RADIO SERVICE

FOR THIS clarification of certain points discussed in Jack Darr's "Hints on Two-Way Radio Service" (April, 1959) and additional information, we are indebted to the Federal Communications Commission in Washington, D. C.; William E. Clyne, Marine Supervisor in the FCC office at San Pedro, Calif.; and Author Jack Darr himself, in response to the comments of the first two.

The form number given for renewal of operator's license (212W) is incorrect. Actually FCC Form 756 (with 756B) is used. With respect to station-license renewal, the applicant should not wait until the last month before expiration of the old one to file for renewal. The Washington source states that renewal applications should be submitted "not less than 30 days nor more than 60 days prior to the expiration date." The California source, quoting another portion of the regulations, says, "An application for renewal of license shall be filed at least 90 days prior to expiration, with certain exceptions."

Concerning the licensing of personnel who will use and operate equipment, it is not necessary for the truck drivers, policemen, and others who operate the *mobile* units to obtain such licenses. This requirement is mandatory only for personnel at the base station. In fact, the FCC would prefer to avoid the issuing of unnecessary licenses, as this creates a burden.

Other points were raised, but most seem to indicate that, despite adherence to the general regulations laid down by the FCC, there is considerable variation in local practice. The best thing to do, when in doubt or when seeking information, is to get in touch with the nearest FCC field office. If it is distant, ask the inspecting engineer of the office to drop by on one of his field trips.



LET RCA TRAIN YOU IN ELECTRONICS

RCA Institutes celebrates Fifty Years of Electronic Training by introducing its newest Home Study Course . . .
ELECTRONICS FOR AUTOMATION

. . . Now you have *four* comprehensive courses for your electronic training . . . from basic electronic theory to the more advanced principles of color TV and Automation.

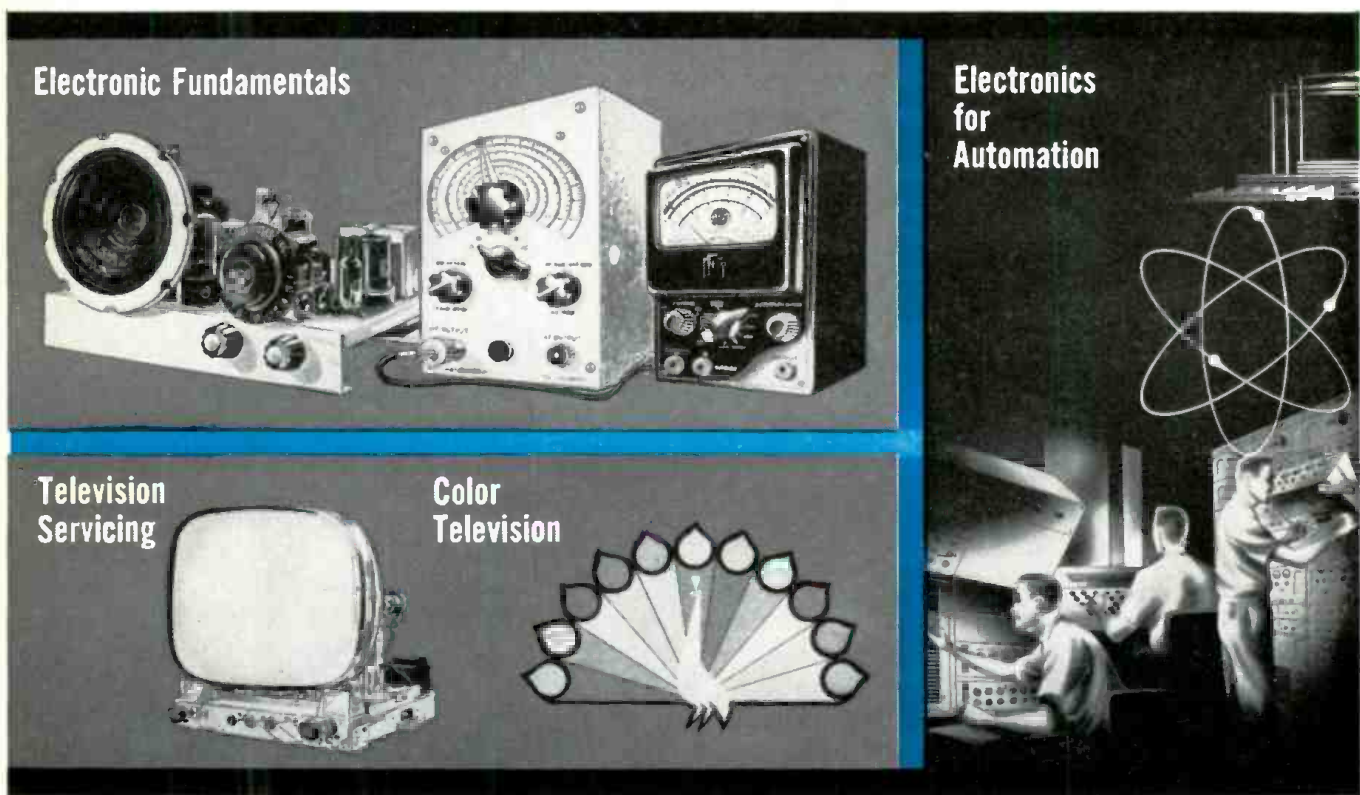

Send for our
64 page Home
Study Catalog

FREE!

**FOR RESIDENT SCHOOL
COURSES SEE AD ON
OPPOSITE PAGE.**

ANOTHER WAY RCA SERVES EDUCATION THROUGH ELECTRONICS

November, 1959

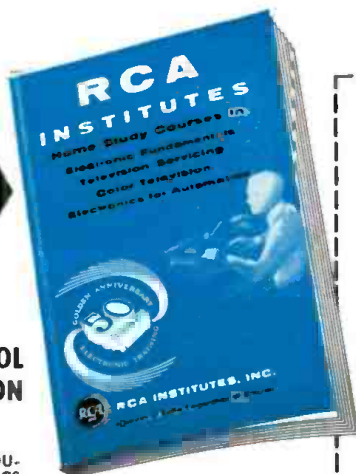

Practical work with the very first lesson. Pay-as-you-learn. You need pay for only one study group at a time.

RCA INSTITUTES, Inc. Home Study School, Dept. EW-119

A Service of Radio Corporation of America
350 West Fourth Street, New York 14, N. Y.

Without obligation, send me the FREE catalog of Home Study Courses. No salesman will call.

Name Please print

Address

City Zone State

Korean Vets! Enter Discharge Date

CANADIANS — Take advantage of these same RCA courses at no additional cost. No postage, no customs, no delay. Send coupon to:
RCA Victor Company, Ltd., 5001 Cote de Liesse Rd., Montreal 9, Quebec

To save time, paste coupon on postcard.

Get this stereo tape bonus...



when you buy a **BELL** stereo tape transport

Four new 4-track,
7½ ips Bel Canto Stereo
Tapes **free**—to start your
library with a 4-track
Bell Tape Transport



Stereo Tape Bonus applies to
Models T-223, T-228, T-238.

With scores of brand new 4-track stereo tapes already available, now's the time to buy the tape transport you've wanted for your stereo system. Make sure it's a Bell . . . because only Bell gives you a STEREO BONUS of four new 4-track stereo tapes to help you start your tape library with a Bell Tape Transport.

These stereo bonus tapes have been carefully selected from the complete Bel Canto library. Wonderful music. More than 2 hours of enjoyable listening. Worth nearly \$32.00 to you!

But it's all yours, absolutely free, from your Bell dealer when you buy a Bell 4-track Stereo Tape Transport. Rated best for stereo recording, Bell gives you the best in performance and features

. . . three motors for positive tape control . . . automatic stop mechanism . . . add-on pre-amps for stereo recording . . . many more.

If you already own a Bell Tape Transport, ask your Bell dealer about easy-to-install 4-track-head conversion kits for as little as \$25.00.

See and hear the Bell Stereo Tape Transport—and get the bonus tapes shown on this page when you buy. Do it today at your Bell dealer's.

Bell dealers offer this stereo record bonus, too!

*Four Mercury LP Stereo Records, worth nearly \$24.00, as a bonus when you buy a model 3030 Bell Stereo Amplifier—now priced at only \$149.95**

**slightly higher west of the Rockies*

 **BELL Sound Division** · Thompson Ramo Wooldridge Inc. · Columbus 7, Ohio
In Canada: THOMPSON PRODUCTS, Ltd., Toronto

NOW!
at a price
you can afford!

MAKE MORE MONEY in TELEVISION RADIO-ELECTRONICS

**BETTER...MORE COMPLETE...LOWER COST...
WITH NATIONAL SCHOOLS SHOP-METHOD
HOME TRAINING!**

BETTER... Training that is proved and tested in Resident School shops and laboratories, by a School that is the **OLDEST** and **LARGEST** of its kind in the world.

MORE COMPLETE... You learn **ALL PHASES** of *Television-Radio-Electronics*.

LOWER COST... Other schools make several courses out of the material in our **ONE MASTER COURSE**... and you pay more for less training than you get in our course at **ONE LOW TUITION!**

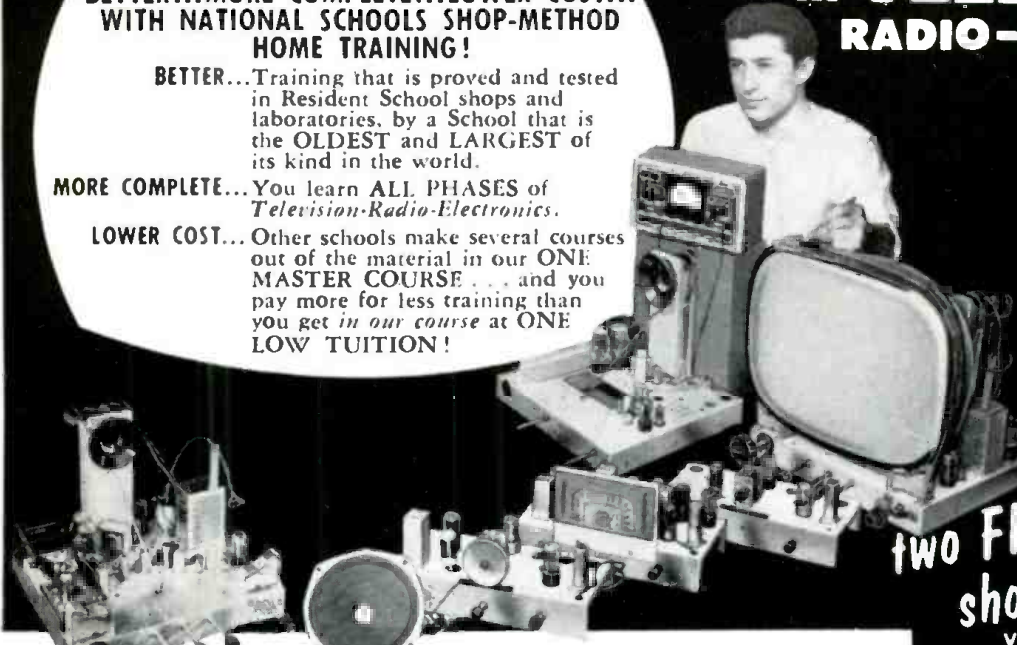

These two **FREE** books will show you how!

You get all information by mail... You make your own decision... at home! **NO SALESMAN WILL CALL**

TOP PAY... UNLIMITED OPPORTUNITIES LIFETIME SECURITY CAN BE YOURS!

You are needed in the Television, Radio, and Electronics industry! Trained technicians are in growing demand at excellent pay—in **ALL PHASES**, including Servicing, Manufacturing, Broadcasting and Communications, Automation, Radar, Government Missile Projects.

NATIONAL SCHOOLS SHOP-METHOD HOME TRAINING, with newly added lessons and equipment, trains you in your spare time at home, for these unlimited opportunities, including many technical jobs leading to supervisory positions.

YOU LEARN BY BUILDING EQUIPMENT WITH KITS AND PARTS WE SEND YOU. Your National Schools course includes thorough *Practical training—YOU LEARN BY DOING!* We send you complete standard equipment of professional quality for building various experimental and test units. You advance step by step, perform more than 100 experiments, and you build a complete TV set from the ground up, that is yours to keep! A big, new TV picture tube is included at no extra charge.

EARN AS YOU LEARN. We'll show you how to earn extra money right from the start. Many of our students pay for their course—and more—while studying. So can you!

LESSONS AND INSTRUCTION MATERIAL ARE UP-TO-DATE, PRACTICAL, INTERESTING. Every National Schools Shop-Method lesson is made easy to understand by numerous illustrations and diagrams. All instruction material has been developed and tested in our own Resident School Shops, Laboratories and Studios.

SEND FOR INFORMATION TODAY... it can mean the difference between **SUCCESS** and failure for you! Send for your **FREE BOOK** "Your Future in Television-Radio-Electronics" and **FREE Sample Lesson.** Do it **TODAY**, while you are thinking about your future. It doesn't cost you anything to investigate!

GET THE BENEFITS OF OUR OVER 50 YEARS EXPERIENCE

Approved for
GI Training



NATIONAL SCHOOLS
Los Angeles 37, Calif.

YOU GET...

- 19 Big Kits—**YOURS TO KEEP!**
- Friendly, Instruction and Guidance
- Job Placement Service
- Unlimited Consultation
- Diploma—Recognized by Industry
- **EVERYTHING YOU NEED FOR SUCCESS!**

SHOP-METHOD HOME TRAINING COVERS ALL PHASES OF INDUSTRY

1. Television, including Color TV
2. Radio AM & FM
3. Electronics for Guided Missiles
4. Sound Recording and Hi-Fidelity
5. FCC License
6. Automation and Computers
7. Radar & Micro-Waves
8. Broadcasting and Communications

RESIDENT TRAINING AT LOS ANGELES

If you wish to take your training in our Resident School at Los Angeles, the world's TV capital, start **NOW** in our big, modern Shops, Labs and Radio-TV Studios. Here you work with latest Electronic equipment... professionally installed... finest, most complete facilities offered by any school. Expert, friendly instructors. Personal attention. Graduate Employment Service. Help in finding home near school... and part time job while you learn. Check box in coupon for full information.

NATIONAL TECHNICAL SCHOOLS

WORLD-WIDE TRAINING SINCE 1905

MAIL NOW TO
NATIONAL SCHOOLS, Dept RH-119
4000 S. FIGUEROA ST. LOS ANGELES 37, CALIF.

Rush free TV-Radio "Opportunity" Book and sample lesson. No salesman will call.

NAME _____ AGE _____
ADDRESS _____
CITY _____ ZONE _____ STATE _____

Check if interested **ONLY** in Resident School training at Los Angeles
 VETERANS: Give date of Discharge _____

**For top customer value...
top dealer profits...
promote RCA Silverama Picture Tubes!**

Of the 3 largest-selling brands of replacement TV picture tubes...

**Only RCA
Guarantees you
an All-New Tube**



Let's face it—when you have to replace your TV picture tube, it means a sizeable investment. Doesn't it make sense, then, to be sure that the tube you get is all-new? That's why you should bear this in mind: Of the 3 largest-selling brands of replacement TV picture tubes, only 1...RCA...offers you a line of completely all-new tubes...RCA Silverama!

With RCA Silverama, you know what you're getting!
RCA guarantees that each and every Silverama picture tube is all-new, totally new...new glass, new phosphor, new gun, new everything...and gives you the added assurance of a full-year warranty.

If your TV picture tube needs replacing, guarantee yourself the clearest, sharpest picture possible—insist on an RCA Silverama. There's one to fit virtually every make and model TV set. Ask your TV technician for complete information and prices.

RCA RADIO CORPORATION OF AMERICA - Foreign Tube Division, Harrison, N. J.

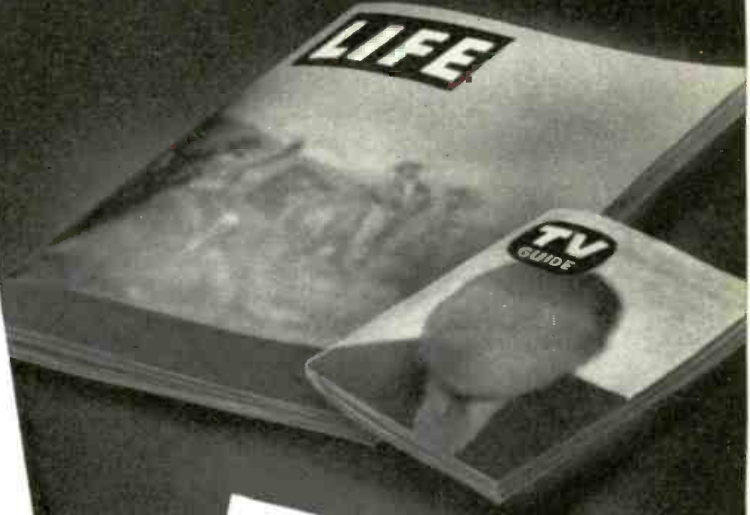

Of the 3 largest-selling brands of replacement TV picture tubes...

**Only RCA
Guarantees you
an All-New Tube**

Let's face it—when you have to replace your TV picture tube, it means a sizeable investment. Doesn't it make sense, then, to be sure that the tube you get is all-new? That's why you should bear this in mind: Of the 3 largest-selling brands of replacement TV picture tubes, only 1...RCA...offers you a line of completely all-new tubes...RCA Silverama!

With RCA, you know what you're getting!
RCA guarantees that each and every Silverama picture tube is all-new, totally new...new glass, new phosphor, new gun, new everything...and gives you the added assurance of a full-year warranty.

If your TV picture tube needs replacing, guarantee yourself the clearest, sharpest picture possible—insist on an RCA Silverama. There's one to fit virtually every make and model TV set. Ask your TV technician for complete information and prices.

RCA RADIO CORPORATION OF AMERICA - Foreign Tube Division, Harrison, N. J.

Ads like these in Life and TV Guide are pre-selling millions of TV-set owners on RCA Silverama Picture Tubes. Cash in!



RADIO CORPORATION OF AMERICA
Electron Tube Division
Harrison, N. J.

Silverama®

Learn Radio-TV Electronics

*by Practicing
at Home in
Spare Time*

**Without Extra
Charge You Get**

special NRI kits developed to give actual experience with Radio-TV equipment. You build, test, experiment with receiver or broadcasting circuits. All equipment yours to keep.

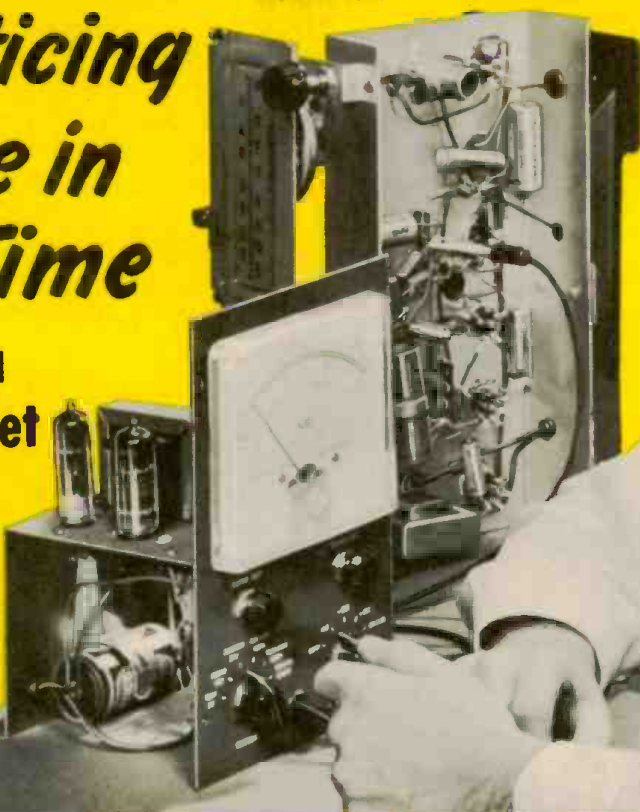

Have High Pay, Prestige, Good Future as a Skilled Radio-TV Electronic Technician

People look up to and depend on the Technician, more than ever before. Offices, plants, homes everywhere are obliged to buy his knowledge and services. His opportunities are great and are increasing. Become a Radio-TV Electronic Technician. At home, and in your spare time, you can learn to do this interesting, satisfying work—qualify for important pay. To ambitious men everywhere here in the fast growing Radio-TV Electronic field is rich promise of fascinating jobs, satisfaction and prestige as well as increasing personal prosperity.

Increasing Opportunities in Growing Field

A steady stream of new Electronic products is increasing the job and promotion opportunities for Radio-Television Electronic Technicians. Right now, a solid, proven field of opportunity for good pay is servicing the tens of millions of Television and Radio sets now in use. Color TV, Hi-Fi is growing. The hundreds of Radio and TV Stations on the air offer interesting jobs for Operators and Technicians.

More Money Soon—Make \$10 to \$15 a Week Extra Fixing Sets in Spare Time

NRI students find it easy and profitable to start fixing sets for friends and neighbors a few months after enrolling.

Picking up \$10, \$15 and more a week gives substantial extra spending money. Many who start in spare time soon build full time Radio-Television sales and service businesses—enjoy security.

Act Now—See What NRI Can Do for You

NRI has devoted over 40 years to developing simplified practical training methods. You train at home in spare time. Get practical experience, learn-by-doing.

NATIONAL RADIO INSTITUTE
Washington 16, D.C.



NRI Has Trained Thousands for Successful Careers in Radio-TV



Studio Engr., Station KATV
"I am now Studio Engineer at Television Station KATV. Before enrolling, I was held back by limitation of a sixth grade education." **BILLY SANCHEZ**, Pine Bluff, Ark.



Has All the Work He Can Do
"I have repaired more than 2,000 TV and Radio sets a year. NRI training certainly proved to be a good foundation." **H. R. GORDON**, Milledgeville, Georgia.



Has Good Part Time Business
"Early in my training I started servicing sets. Now have completely equipped shop. NRI is the backbone of my progress." **E. A. BREDÁ**, Tacoma, Washington.

◆ ◆ ◆ ◆ **SEE OTHER SIDE** ◆ ◆ ◆ ◆

Cut Out and Mail This Card—No Stamp Needed

Sample Lesson and Catalog Both Sent FREE

National Radio Institute
OLDEST & LARGEST HOME STUDY RADIO-TV SCHOOL
Dept. F, Washington 16, D.C.

Please send me sample lesson of your Radio-Television Training and Catalog FREE. (No salesman will call.)

Name.....Age.....

Address.....

City.....Zone.....State.....

ACCREDITED MEMBER NATIONAL HOME STUDY COUNCIL

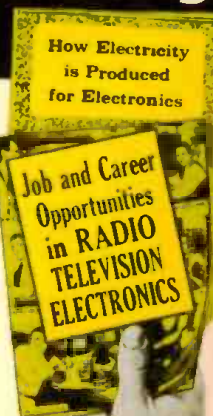

How Electricity
is Produced
for Electronics

Job and Career
Opportunities
in RADIO
TELEVISION
ELECTRONICS

NRI SUPPLIES LEARN-BY-DOING KITS WITHOUT EXTRA CHARGE
Technical Know-How Pays Off in Interesting, Important Work



YOU BUILD AC-DC Superhet Receiver

NRI Servicing Course includes all needed parts. By introducing defects you get actual servicing experience practicing with this modern receiver. Learn-by-doing.



YOU BUILD This 17 Inch Television Receiver

As part of your NRI course you can get all components, tubes, including 17" picture tube, to build this latest style Television receiver; get actual practice on TV circuits.

YOU BUILD Broadcasting Transmitter

As part of NRI Communications Course you build this low power Transmitter, learn commercial broadcasting operators' methods, procedures. Train for your FCC Commercial Operator's License.



YOU BUILD Vacuum Tube Voltmeter

Use it to earn extra cash fixing neighbors' sets; bring to life theory you learn from NRI's easy-to-understand texts.



For Higher Pay, Better Jobs Be a Radio-TV Electronic Technician



Servicing Needs More Trained Men

Portable TV, Hi-Fi, Transistor Radios, Color TV are making new demands for trained Technicians. Good opportunities for spare time earnings or a business of your own.

Broadcasting Offers Satisfying Careers

4000 TV and Radio stations offer interesting positions. Govt. Radio, Aviation, Police, Two-Way Communications are growing fields. Trained Radio-TV Operators have a bright future.



J. E. Smith, Founder

Train at Home the NRI Way Famous for Over 40 Years

NRI is America's oldest and largest home study Radio-Television school. The more than 40 years' experience training men for success, the outstanding record and reputation of this school—benefits you in many ways. NRI methods are tested, proven. Successful graduates are everywhere, from coast to coast, in small towns and big cities. You train in your own home, keep your present job while learning. Many successful NRI men did not finish high school. Let us send you an actual lesson, judge for yourself how easy it is to learn.

No Experience Necessary—NRI Sends Many Kits for Practical Experience

You don't have to know anything about electricity or Radio to understand and succeed with NRI Course. Clearly written, well-illustrated NRI lessons teach Radio-TV Electronic principles. You get NRI kits for actual experience. All equipment is yours to keep. You learn-by-doing. Mailing the postage-free card may be one of the most important acts of your life. Do it now. Reasonable tuition. Low monthly payments available. Address: NATIONAL RADIO INSTITUTE, Washington 16, D. C.

NRI Graduates Do Important Work



Now Quality Control Chief
 "Had no other training in Radio before enrolling, obtained job working on TV amplifiers before finishing course. Now Quality Control Chief." T. R. FAYALORO, Norwich, N. Y.

NRI Course Easy to Understand
 "I opened my own shop before receiving my diploma. I have had to hire extra help. I am independent in my own business." D. P. CRESSEY, Stockton, Cal.

Works on Color-TV
 "NRI changed my whole life. If I had not taken the course, probably would still be a fireman, struggling along. Now Control Supervisor at WRCA-TV." J. F. MELINE, New York, N. Y.

FIRST CLASS
 Permit No. 20-R
 (Sec. 34.9, P. L. & R.)
 Washington, D.C.

BUSINESS REPLY CARD

No Postage Stamp Necessary if Mailed in the United States

POSTAGE WILL BE PAID BY

NATIONAL RADIO INSTITUTE
 3939 Wisconsin Avenue
 Washington 16, D.C.

SAMPLE LESSON
64-page CATALOG
both FREE

SEE OTHER SIDE

Service Technicians! YOU EARN MORE... YOU RATE with the public when you own the **PHOTOFACT**® service data library!

"Time saved is the main reason we feel a real need for the PHOTOFACT Library. We could repair a set by trial and error but PHOTOFACT lays all the facts before us and reduces bench time to a minimum".

—William C. Dixey
Riverside, N.J.

"PHOTOFACT gives us the best and latest information on part numbers, etc., as well as excellent schematics. Couldn't do without them".

—Johnny Wheeler
Mobile, Ala.

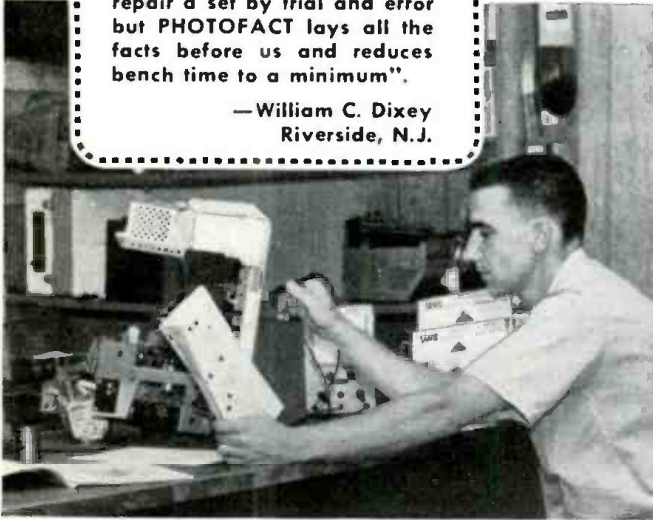

Yes, if you are one of the thousands of owners of a complete PHOTOFACT Service Data Library, you are enjoying maximum earnings. It's inevitable, because no matter how expert you are, you can always *save more time on any job, get more jobs done daily—EARN MORE, DAY IN AND DAY OUT...*

Moreover—as the owner of a complete PHOTOFACT Library, you know your customers' sets *best*. You can actually show each customer you have the PHOTOFACT Folder covering his very own set. Result: You command public respect and acceptance which paves the way to expanded business for you...

HERE'S HOW TO STAY AHEAD...

Today, the truly successful Service Technicians are those who own the complete PHOTOFACT Library, who can meet and solve any repair problem—faster and more profitably. And these men *keep ahead* because they're on a Standing Order Subscription with their Distributors to receive all new PHOTOFACTS as they are released monthly.

For PHOTOFACT Library Easy-Buy Plan details and Standing Order Subscription, see your Sams Distributor today, or write to Howard W. Sams...



BIG NEW PLUS "PEET" PROGRAM

If you now own a PHOTOFACT Library, you can apply at once for qualification in the powerful new "PEET" program. Designed to help you gain deserved recognition as a reputable businessman; develop and command public respect; justify better earnings warranted by your business investment and skill; pave the way to expanded business and increased profits for you. Ask your Sams Distributor about "PEET" or write to Howard W. Sams.

HOWARD W. SAMS & CO., INC. 2203 E. 46th St., Indianapolis 6, Ind.

Send me full details on the new "PEET" Program, designed to build prestige and business for the Service Technician who qualifies. Include full information on the Easy-Buy Plan and Free File Cabinet deal.

I'm a Service Technician: full-time: part-time

My Distributor is: _____

Shop Name: _____

Attn: _____

Address: _____

City _____ Zone _____ State _____

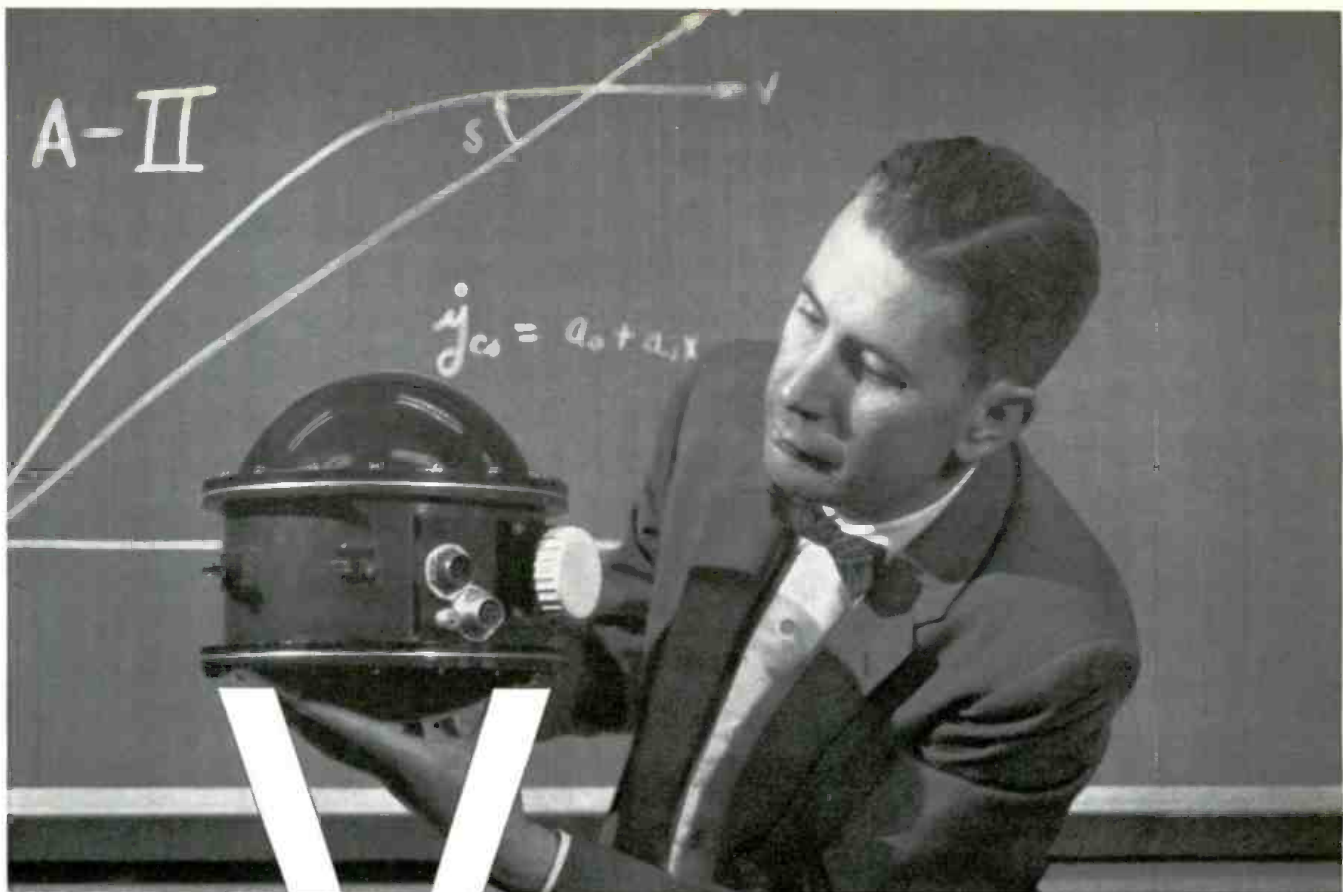

Edwin Felch, project director in charge of developing the Titan guidance system, holds the "voice" of the ICBM.

Voice OF A GUIDED MISSILE

This is a missile-borne transmitter. It is the "voice" of a missile in flight . . . part of a new radio-inertial guidance system developed by Bell Telephone Laboratories for the Ballistic Missile Division of the Air Force.

This versatile system helped deliver the nose cone of a Thor-Able test missile precisely to its South Atlantic target area—5000 miles from Cape Canaveral, Florida. So accurately was the nose cone placed that a waiting group of ships and planes retrieved it in a matter of hours. It was the first nose cone ever to be recovered after so long a flight.

The command guidance system which made such accuracy possible combines precision tracking radar with a special Remington Rand Univac computer. Fed a steady stream of signals from the missile-borne transmitter, the ground-based equipment compares the missile's flight path with the preselected path. Corrective steering orders are computed and transmitted automatically to the missile. The ground

station monitors the progress of the flight continuously and obtains immediate evaluation of mission success. And since the principal control equipment is kept on the ground, expendable hardware in the missile itself is minimized.

This radio-inertial guidance system is a product of the Bell Laboratories-Western Electric development-production team. It is in production at Western Electric for the first operational squadrons of the Titan intercontinental ballistic missile.

Bell Labs scientists and engineers developed the world's most versatile telephone network and much of our nation's radar. They have constantly pioneered in missile systems. From their storehouse of knowledge and experience comes this new achievement in missile guidance.

BELL TELEPHONE LABORATORIES

*World center of communications research
and development*



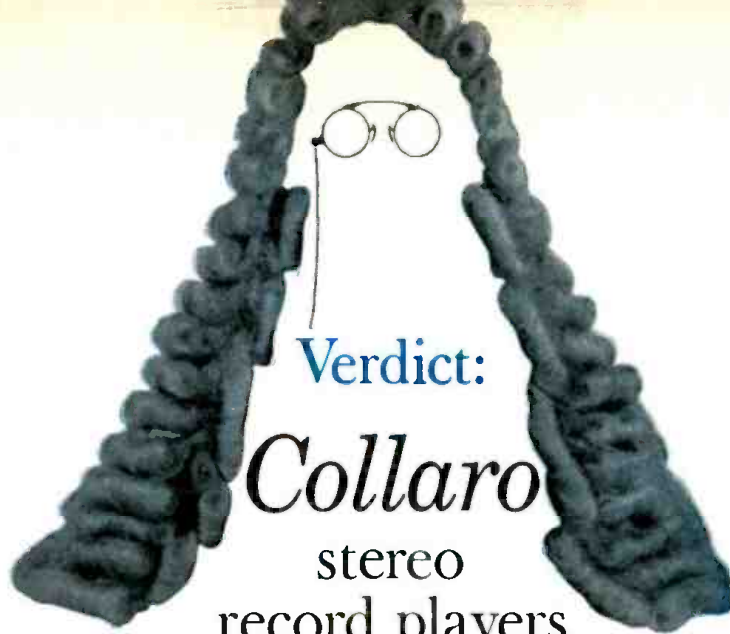

Verdict:

Collaro

stereo
record players
are **innocent**
of rumble,
wow, flutter

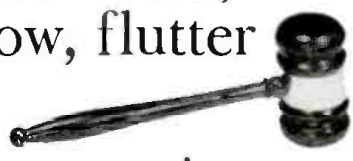

or any noises
that
interfere
with enjoyment
of music



The Constellation, Model TC-99—\$59.50



The Continental II, Model TSC-840—\$49.50



The Coronation II, Model TSC-740—\$42.50
*The Conquest II, Model TSC-640—\$38.50



Transcription Turntable, Model 4TR-200—\$49.50

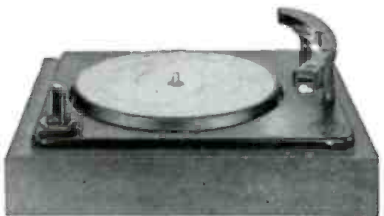

Manual Player, Model TP-59—\$29.95



Every Collaro stereo record player is built with typical British attention to every detail. They are precision engineered and rigidly tested to give truly professional performance and the ultimate in operating convenience. Here are some of the more important features that make Collaro the logical choice for stereo or monophonic records. • Performance specifications exceed NARTB standards for wow, flutter and rumble — with actual performance test reports accompanying each model TC-99. • Extra-heavy, die-cast, non-magnetic turntables (weighing up to 8½ lbs.). Extra-heavy weight is carefully distributed for flywheel effect and smooth, constant rotation. • Shielded four-pole motors are precision balanced, screened with triple interleaved shields to provide extra 25 db reduction in magnetic hum pick-up. • Detachable five-terminal plug-in head shells (on TC-99, TSC-840, TSC-740, TP-59) provide two completely independent circuits, guaranteeing ultimate in noise reduction circuitry. • Transcription-type stereo tonearms are spring-damped and dynamically counterbalanced to permit the last record on a stack to be played with virtually the same low stylus pressure as the first. • All units are handsomely styled, available with optional walnut, blond and mahogany finished bases or unfinished utility base. There's a 4-speed Collaro stereo record player for every need and budget! Prices slightly higher in the West. For free catalog on the Collaro line, write to: Rockbar Corporation, Dept. EW-11 Mamaroneck, N. Y. (*Not shown. Similar in appearance to The Coronation.)



STARRING
DAVE GARROWAY
in NBC-TV's
"Today" Show

CHANNEL MASTER[®]

Channel Master is telling the T-W story to almost every family in the United States with the MOST SPECTACULAR ANTENNA PROMOTION OF ALL TIME!



STARRING
JOHN PAINE
in ABC-TV's
"The Restless Gun"



STARRING
GALE STORM
in ABC-TV's
"The Gale Storm Show"



STARRING
BOB CUMMINGS
in ABC-TV's
"Love That Bob"



the STARS ★ are out FOR THE



THE BEST OF ANTENNAS DELIVERS
THIS BEST OF PROMOTIONS!

To help you sell more antenna replacements, Channel Master commercials will be broadcast from coast to coast by 4 of America's most popular TV shows over the entire NBC and ABC networks—210 TV stations.

In addition to this full network coverage, 2 powerful national magazine campaigns will put the T-W story into 17 million homes... many of them right in your community.

These ads are aimed at telling consumers that their antenna installations are becoming old, worn out, obsolete, and that for the best possible TV reception they should replace their antennas with the T-W. This campaign has been designed to create new business for you by making the TV family T-W conscious.

ONLY CHANNEL MASTER GIVES THE DEALER
THIS KIND OF SUPPORT!

2 NATIONAL
TELEVISION
NETWORKS!



4 TOP-RATED
TV SHOWS!



8 WEEKS OF
STAR-STUDED
PROMOTION!

PLUS

2 HARD-HITTING
NATIONAL
MAGAZINE
CAMPAIGNS!



FARM MAGAZINES

To reach the rural market
... where the big fringe in-
stallations are sold!

FARM JOURNAL
SUCCESSFUL FARMING
PROGRESSIVE FARMER



GENERAL MAGAZINES

To reach the vast reader-
ship of these widely-read
publications... in every city
and hamlet in the country!

SATURDAY EVENING POST • CORONET

Now meet the real star of the show...

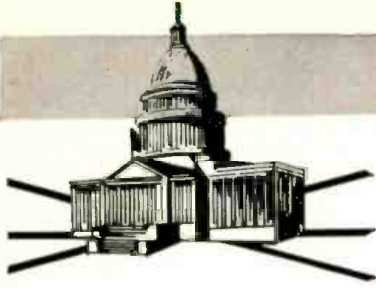

Latest Information
on the Electronic Industry

Spot News

By **ELECTRONICS WORLD'S**
WASHINGTON EDITOR

IN-FLIGHT TV CAMERA SETUP DEVELOPED TO DETECT ENGINE ICING—A closed-circuit television system is now being used by the Wright Air Research and Development Command (Dayton, Ohio) to detect and study the crippling effects of icing conditions within 6000 horsepower engines of a four-engine turboprop C-133 cargo aircraft. TV scanning, via a camera mounted on the outside of the nacelle of the No. 3 engine, faced downward into the engine, covers a section of the inlet guide vanes and various moving parts of the engine. Inside the plane, a project engineer views a screen intently as ice forms, builds up, and breaks off, carefully noting the effects produced by falling pieces of ice tumbling into the engine and cutting off or limiting critical air flow. A KB-29 tanker plane is being used to set the stage for icing conditions by spraying water into the cold air high in the sky. Trailing behind the tanker, the cargo plane flies into the spray. The introduction of closed-circuit TV now permits observations which would previously have been impossible because of adverse location and environment.

SCORES OF CLASS D CITIZENS RADIO RULE VIOLATIONS REPORTED BY FCC—A wide misunderstanding of the purpose of Class D Citizens Radio Service—evidenced by approximately 100 violation notices issued—has become a disturbing factor, the FCC reported recently. Of the rule violations cited, 44 were for misuse of the short-distance provision; another ruling, involving conversation limitations, which notes that communications should be carried out in minimum practicable time, was reported to have been violated 61 times. Off-frequency operation was responsible for 57 citations, while overmodulation accounted for 3 instances. The Commission is so concerned over this situation that it is carrying out an intensive educational campaign to make it clear that Citizens Radio has no relation to Amateur Radio Service and that it may not be used to conduct ham communications, such as calling "CQ" (except in an emergency) and trying to contact distant stations. (See "For the Record", page 8 and "Violations of Citizens Radio Regulations", page 106.)

MISSILE TEST SLED TRACK WIRED FOR SOUND TO FRIGHTEN BIRDS—The famed 35,000-foot missile track at Holloman Air Research and Development Command AFB, New Mexico, has been wired for sound to frighten off the many birds perched on the glistening rails and the cause of unbelievable damage to sleds traveling at hypersonic speeds of more than 3000 miles per hour. Since the birds cannot hear the approaching sleds racing at faster-than-sound speeds, it was decided to scare them by jarring the air with recordings of machine-gun blasts, hawk cries, and thunder—all pumped into rows of speakers mounted up and down the track. Commenting on the incidents which prompted this installation, test supervisor R. C. Rethmel said that recently the impact of a bird on a 212-pound monorail sled caused a jagged 10-inch hole through a quarter-inch steel nose cone. Additional accidents of this kind included a 4-inch rupture in the wedge-like steel prow of a sled speeding at 2850 mph.

SOUTHERN MISSILE SCHOOL SEES WEAPON-REPORT PICTURE OVER CCTV FROM WASHINGTON—A 45-minute film on weapons was transmitted recently from Washington via a closed-circuit TV network to the Army Ordnance Guided Missile School at Redstone Arsenal, Alabama, 730 miles from the nation's capital. The pictorial report, introduced by Major General J. H. Hinrichs, the Army's Chief of Ordnance, was also seen on a 20 by 15 foot screen in the ballroom of the Sheraton-Park Hotel during the closing session of the annual meeting of the Association of the U. S. Army.

HIGH-FIDELITY TAPE RECORDINGS are now being used in a new training device to help sonar operators distinguish the characteristic "bark" of a school of frolicking porpoises from the tell-tale blip of an enemy submarine. This new Sonar Operators' Target Classification Trainer System is being supplied by ITT and consists of a device in which the magnetic tape runs at a speed of 60 ips with 14 separate recording tracks of information being "played" simultaneously. In addition to identification of the target, its bearing can also be simulated by the system. The sonar trainer incorporates all types of sonar-received sounds, enabling seamen to distinguish actual or real targets from false ones.

ASTATIC 77

DYNAMIC CARDIOID MICROPHONE

with the industry's most positive anti-feedback characteristics



Something to Sing about

LIST PRICES

Model 77 (Illustrated)
Chrome Finish, \$82.50;
Gold Finish, \$92.50.
Model 77L (Head only),
Chrome Finish, \$72.50;
Gold Finish, \$82.50.
Model G-77 (Complete with G-Stand),
Chrome Finish, \$97.45.

When you're looking for the ultimate in cardioid microphones, consider these advanced features of Astatic's Model 77 and see if you don't agree that no other manufacturer has SO MUCH TO SING ABOUT—the most positive anti-feedback characteristics ever achieved, -18 db; exclusive Mylar diaphragm that is pop-proof and blast-proof, retains like-new flex properties for more years; an exclusive sintered bronze method of acoustic phase shifting that creates the industry's top directional characteristics; -52 db output and exceptionally flat response through 30 to 15,000 cps.

Do one thing for your own satisfaction. On your next installation, make a direct comparison of the Astatic 77 with any other cardioid. We'll guarantee —when anyone mentions the word "cardioid" again, you'll sing the praises of this incomparable Astatic instrument.

THE **Astatic** CORPORATION, CONNEAUT, OHIO

IN CANADA: CANADIAN ASTATIC LIMITED, TORONTO, ONTARIO
EXPORT SALES: ROBURN AGENCIES INC. 431 GREENWICH ST., N. Y. 13, N. Y., U. S. A.

**GO BY BRAND
—GO BUY ASTATIC**

FROM What
You HEAR

SINGING SOUNDS BETTER WHEN THERE'S AN ASTATIC MICROPHONE ABOUT

DYNACO

STEREODYNE II PHONO PICKUP



New, hum free push pull magnetic stereo pickup of superb characteristics. True stereo reproduction because of wide channel separation. Smooth response and light tracking combine to give clean natural sound from both stereo and monophonic recordings. Mounts in all standard arms. With replaceable diamond stylus—\$29.95* net.

TONE ARM

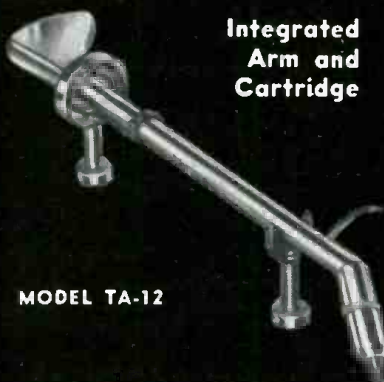

Integrated
Arm and
Cartridge

MODEL TA-12

Combined arm and Stereodyne II Cartridge for optimum results. Dynamically balanced, gimbal-pivoted arm permits 2 gram tracking. Simple to mount, handsome appearance, and outstanding in performance. Only \$49.95* net.

*Slightly higher in the West

Available from leading high fidelity dealers everywhere

DYNACO, INC.

3916 Powelton Ave., Phila. 4, Pa.
Cable address: Dynaco, Phila., Pa., U.S.A.

Within the Industry

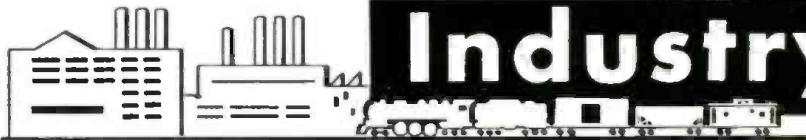

WALTER A. CLEMENTS has been appointed to the position of vice-president in charge of distributor sales and advertising for *Littelfuse, Inc.*, Des Plaines, Illinois.

The company, manufacturers of fuses for the electronic, electrical, and automotive markets, also announced the appointment of **Herbert A. Cornelius** to vice-president in charge of sales to industrial manufacturers.

These appointments are said to be part of the firm's long-range expansion program.



ELECTRONIC INDUSTRIES ASSOCIATION has announced the following chairmen for the fiscal year 1950-60. They are:

John B. Swan, Jr., *Philco Corp.*, re-named chairman of the traffic committee.

Michael F. McCormack, *Sylvania Electric Products Inc.*, re-appointed chairman of the tax committee.

Ben Edelman, *Western Electric Co.*, re-named chairman of the educational coordinating committee.

EDWARD C. HUGHES, JR. has been appointed to the position of manager, commercial engineering, *RCA* electron tube division. He succeeds **Robert S. Burnap** who recently retired.

In his new post **Mr. Hughes** will be responsible for the technical publications of the electron tube division.

He joined the company in 1930 as a technical writer and three years later was promoted to manager, amateur radio tube and apparatus sales section. Subsequent promotions led to his appointment in September, 1958 as administrator, commercial engineering programs of the electron tube department.



ROBERT F. CHAMBERS, of *Hycon Manufacturing Co.*, has been appointed chairman of the executive committee of the western branch, military relations department, *Electronic Industries Association*.

Also announced were the following appointments of committee chairmen for this department: **George Hogg, Jr.**, *Westinghouse Electric Corp.*, accounting and cost principles; **A. David Russell**, *Sylvania Electric Products Inc.*,

facilities and government property; **Frank E. Greene**, *RCA*, general contract provisions; **Elmer J. Gorn**, *Raytheon Co.*, patents and copyrights; **C. L. Covington**, *Texas Instruments Inc.*, renegotiation; and **Edwin P. James**, *Collins Radio Co.*, termination.

JENSEN MANUFACTURING COMPANY, division of the *Muter Company*, has broken ground for a new engineering building adjoining its Laramie Avenue plant in Chicago.

CLEVITE ELECTRONIC COMPONENTS is now located at 3405 Perkins Avenue, Cleveland 14, Ohio.

Construction has begun on **RAYTHEON COMPANY'S** sixth building to be located along Route 128, Boston's "Electronics Highway."

NEWARK ELECTRIC COMPANY has recently purchased additional land for its West Coast branch at 4747 W. Century Blvd., Inglewood, Calif.

HERB HOROWITZ has been appointed director of *Audio Empire*, the high-fidelity product arm of *Dyna-Empire, Inc.*, Garden City, New York.

Prior to joining this firm, **Mr. Horowitz** spent many years as chief engineer of *Electro-Sonic Laboratories, Inc.* and chief of audio products for *CBS Columbia* during which time he was responsible for a number of high-fidelity component designs.

In his new position, **Mr. Horowitz** will be responsible for marketing and promotion, as well as supervision of the engineering, of the company's product line.



ROBERT W. CARR has been named manager of the microphone development department of *Shure Brothers, Inc.* *General Electric Co.* has announced the following appointments: **DALE L. BUNDAY**, national product planning manager for two-way radio equipment; **JOHN R. CRITTENDEN**, "severe environment specialist"; and **JAMES E. PITMAN**, manager of product planning for point-to-point communication equipment.

RICHARD M. ROSS has been named to the newly created post of manager of marketing services for the semiconductor division of *Sylvania Electric Products Inc.* *CBS Electronics* has appointed **WARREN E. DALBKE** district manager, equipment sales. *Amperex Electronic Corp.* has appointed **JOHN MESSERSCHMITT** to the position of manager, power tubes and renewal sales and **IRWIN RUDICH** to the post of manager, special purpose tubes

ELECTRONICS WORLD

WE'RE MAKING IT EASIER THAN EVER TO BECOME A WELL PAID RADIO-TELEVISION SERVICE TECHNICIAN

NOW - Just \$6 Starts You Training in
RADIO-TELEVISION

the SPRAYBERRY "Learn-by-Doing" Way . . .

25 BIG, COMPLETE KITS of PARTS & EQUIPMENT

To help you learn *fast* the practical side of Radio-Television, we send you expertly engineered training kits to test and assemble for interesting, valuable shop-bench practice!

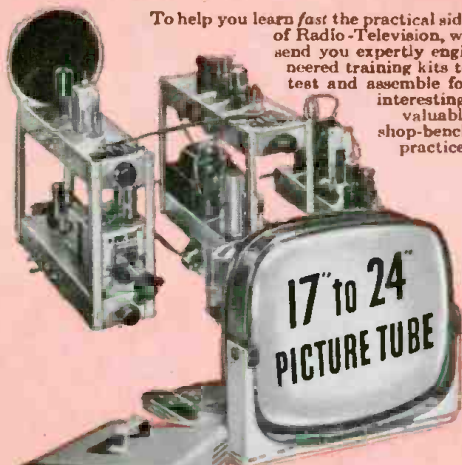

• The new Sprayberry Training Television Receiver, built and tested in 5 sections.

• Now offered . . . this fine modern oscilloscope.

• You build this powerful two-band superheterodyne radio receiver.

Big New CATALOG AND Sample Lesson FREE!



You build the new Sprayberry tester—a complete 18-range Volt-Ohm-Milliammeter test meter.

★ ★ ★ This great industry is begging for trained men . . . to step into good paying jobs or a profitable business of their own! Our new plan opens the doors of Radio-Television wide to every ambitious man who is ready to act at once!

Men by the thousands . . . trained Radio-Television Service Technicians . . . are needed at once! Perhaps you've thought about entering this interesting, top paying field, but lack of ready money held you back. Now—just \$6 enrolls you for America's finest, most up to date home study training in Radio-Television! Unbelievable? No, the explanation is simple! We believe Radio-Television *must* have the additional men it needs as quickly as possible. We are willing to do our part by making Sprayberry Training available for less money down and on easier terms than ever before. This is your big opportunity to get the training you need . . . to step into a fine job or your own Radio-Television Service Business.

Complete Facts: Free—Act Now; Offer Limited

Only a limited number of students may be accepted on this liberal and unusual basis. We urge you to act at once . . . mail the coupon below and get complete details plus our big new catalog and an actual sample lesson—all free. No obligation . . . no salesman will bother you.

HOME STUDY TRAINING IN SPARE TIME

Under world-famous 27-year old Sprayberry Plan, you learn entirely at home in spare time. You keep on with your present job and income. You train as fast or as slowly as you wish. You get valuable kits of parts and equipment for priceless shop-bench practice. And everything you receive, lessons and equipment alike, is all yours to keep.

LET US PROVE HOW EASILY YOU CAN LEARN!

Radio-Television needs YOU! And Sprayberry is ready to train you on better, easier terms, that any ambitious man can afford. Just \$6 starts you! Mail coupon today . . . let the facts speak for themselves. You have everything to gain. Let us prove the kind of opportunity that's in store for you!

SPRAYBERRY Academy of Radio-Television
 1512 Jarvis Avenue, Dept. 25-D, Chicago 26, Illinois

Mail This Coupon Now—No Salesman Will Call

Sprayberry Academy of Radio-Television
 Dept. 25-D, 1512 W. Jarvis Ave., Chicago 26, Ill.
 Please rush all information on your ALL-NEW Radio-Television Training Plan. I understand this does not obligate me and that no salesman will call upon me. Include New Catalog and Sample Lesson FREE.

NAME _____ Age _____
 ADDRESS _____
 CITY _____ ZONE _____ STATE _____



Now...from Sonotone—

4 Big Improvements

in the quality stereo cartridge

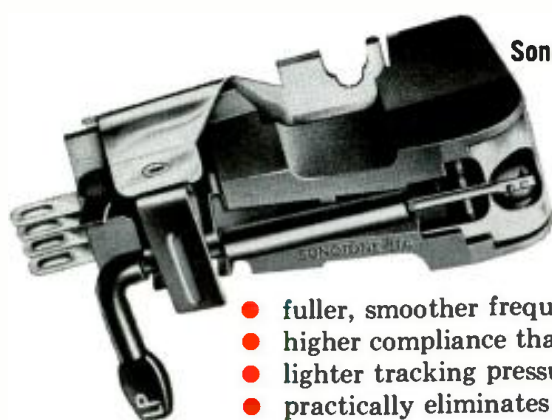

Sonotone 8TA cartridge replaces 8T as industry standard

The new Sonotone 8TA cartridge gives greater than ever stereo performance... has 4 big extras:

- fuller, smoother frequency response
- higher compliance than ever before
- lighter tracking pressure
- practically eliminates dust pile-up

ONLY
\$1450*

Sonotone 10T unitized stereo at lowest price ever

New 10T cartridge sells at record low price of \$6.45.* And it covers the complete high fidelity range. 10T's unitized construction makes it easiest to install, easiest to replace. Low price means more sales—more profits.



SPECIFICATIONS

	8TA	10T
Frequency Response	Smooth 20 to 20,000 cycles. Flat to 15,000 with gradual rolloff beyond.	Flat from 20 to 15,000 cycles ± 2.5 db.
Channel Isolation	25 decibels	18 decibels
Compliance	3.0×10^{-6} cm/dyne	1.5×10^{-6} cm/dyne
Tracking Pressure	3-5 grams in professional arms 4-6 grams in changers	5-7 grams
Output Voltage	0.3 volt	0.5 volt
Cartridge Weight	7.5 grams	2.8 grams
Recommended Load	1-5 megohms	1-5 megohms
Stylus	Dual jewel tips, sapphire or diamond.	Dual jewel tips, sapphire or diamond.

*including mounting brackets

Sonotone makes only 6 basic ceramic cartridge models... yet has sold over 9 million units... used in over 662 different phonograph models. For finest performance, replace worn needles with genuine Sonotone needles.

Sonotone

CORP.

Electronic Applications Division, Dept. CN.119
ELMSFORD, NEW YORK



Leading makers of fine ceramic cartridges, speakers, tape heads, microphones, electronic tubes.
In Canada, contact Atlas Radio Corp., Ltd., Toronto

and semiconductors . . . **CARL SCHLADEN** has been named manager, manufacturing division of *Orr Industries Inc.* . . . **KENNETH R. JACKSON** has been appointed to the position of technical assistant to the director of *Packard Bell Computer Corp.* . . . **S. EDWIN PILLER** has been appointed group supervisor of the SSB section of the *Eldico Electronics Division of Radio Engineering Labs.* . . . *Cornell-Dubilier Electric Corp.* has made known the following elections to its board: **THOMAS M. COLE**, **FRANK H. ROBY**, **EDWARD BIERMA**, and **LOUIS W. COLE** . . . *Erie Resistor Corp.* has appointed **WILLIAM G. TUSCANY** as senior sales representative of the electronics division . . . **JACOB B. TAYLOR** has been elected executive vice-president, finance and **LEON C. GUEST, JR.** has been elected vice-president and controller of *General Telephone & Electronics Corp.* . . . **WILLIAM M. WEBSTER** has been appointed director, electronic research laboratory, *RCA Laboratories* . . . **ZAMBRY P. GIDDENS** has been named to the newly created post of executive vice-president of *Dynamics Corporation of America* . . . **FREDERICK R. LACK** has been elected a director of the *Sprague Electric Company*.

HAROLD A. WHEELER has been elected a vice-president and director of *Hazeltine Corporation*. He is president of *Wheeler Laboratories, Inc.*, a recently acquired, wholly owned subsidiary of *Hazeltine*.



Mr. Wheeler has been a consultant to the research and development board of the Department of Defense and is currently a consultant to the scientific advisory board of the National Security Agency.

An early pioneer in the electronics industry, Mr. Wheeler founded the *Laboratories* in 1947. The firm has played important roles in designing microwave circuits and antennas for the Nike family of missiles and the Terrier-Tartar, as well as similar special electronics equipment for the Titan and Thor-Able missiles.

WILLIAM H. THOMAS, president of *James B. Lansing Sound, Inc.*, has been elected president of the Electronic Industry Show Corporation, heading operations for the 1960 Electronic Parts Distributors Show. He succeeds William S. Parsons, president of *Centra-lab*.

George E. Wedemeyer, president of *Wedemeyer Electronic Supply Company* has been elected vice-president; Mrs. Helen S. Quam, vice-president, treasurer, and distributor sales manager of *Quam-Nichols Company* is now secretary; and Edward Rothenstein, general manager of *Arco Electronics, Inc.*, is the newly elected treasurer.

Eight new directors have taken office for two-year terms. They are:
(Continued on page 98)

It's Newly Revised And Brought Up-To-Date!

Send for this **FREE** 54-Page Book today!

- See what can be yours in the rapidly expanding field of . . .

ELECTRONICS

- including: GUIDED MISSILES • RADAR
- INSTRUMENTATION • COMPUTERS
 - AUTOMATION • ASTRONAUTICS
 - SERVOMECHANISMS
 - AERONAUTICAL ELECTRONICS
 - TELEMETERING • COMMUNICATIONS
 - MANUFACTURING

Electronics offers you a

- ◆ BETTER POSITION
- ◆ BETTER PAY
- ◆ PROMOTION
- ◆ GREATER SECURITY
- ◆ GREATER CONFIDENCE
- ◆ BETTER LIVING FOR YOU AND YOUR FAMILY

All these benefits can be yours if you act now! Take that first step this minute—No obligation whatsoever! Write

**CAPITOL
RADIO
ENGINEERING
INSTITUTE**

Dept. 1111-F, 3224-16th St., N. W.
Washington 10, D. C.

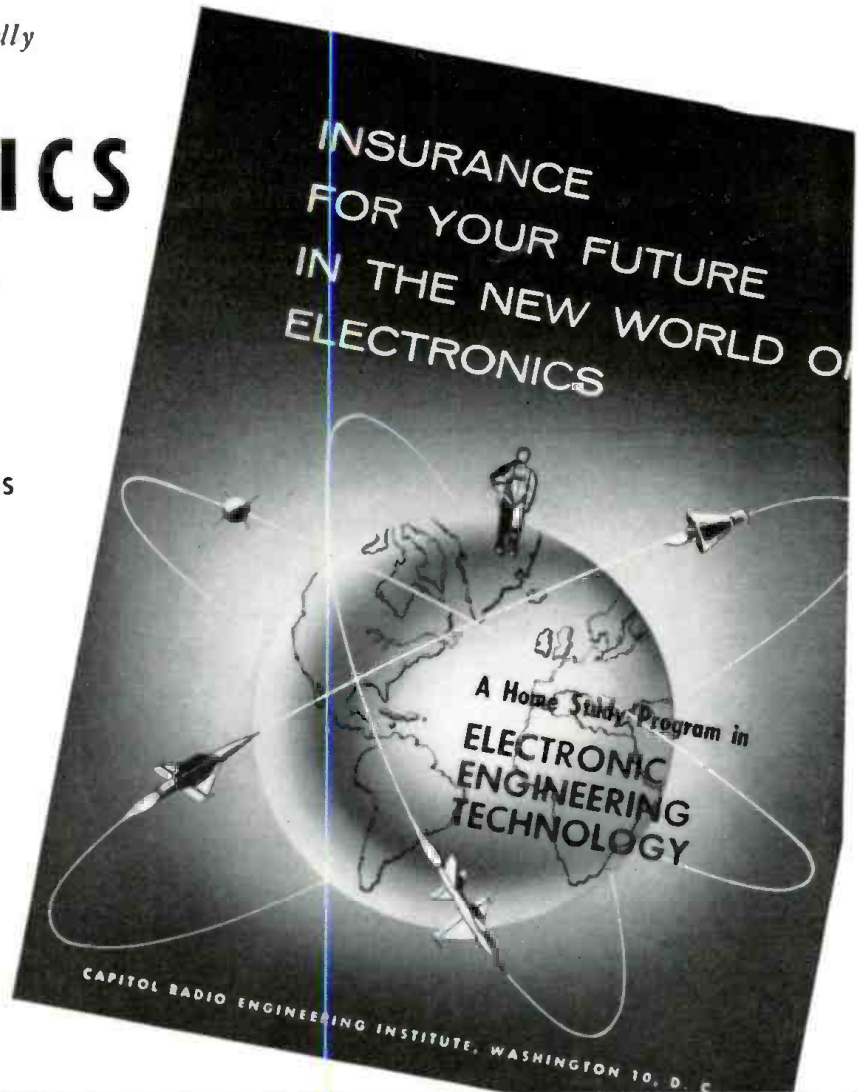

TAKE A MINUTE TO MAIL THIS COUPON FOR FREE 54-PAGE BOOK!

CAPITOL RADIO ENGINEERING INSTITUTE

ECPD Accredited Technical Institute Curricula—Founded 1927

Dept. 1111-F, 3224 Sixteenth St., N.W., Washington 10, D. C.

Please send me your course outline and FREE 54-page Book, "Insurance For Your Future in the New World of Electronics" . . . describing opportunities and CREI Home Study courses in Practical Electronic Engineering Technology.

- CHECK FIELD OF GREATEST INTEREST
- Radar, Servo and Computer Engineering Technology
 - Electronic Engineering Technology
 - Communications Engineering Technology
 - Television Engineering Technology
 - Aeronautical Electronic Engineering Technology
 - Automation and Industrial Electronics Engineering Technology

Name..... Age.....

Street

City Zone..... State.....

Check: Home Study Residence School Korean Veteran

To obtain fast, immediate service, and to avoid delay, it is necessary that the following information be filled in:

Employed By.....

Type of Present Work.....

Education:
Yrs. High School.....

Other.....

Electronics Experience.....

IS ONE OF THESE TYPICAL BLONDER-TONGUE AMPLIFIED INSTALLATIONS THE ANSWER TO BETTER TV RECEPTION IN YOUR AREA?

Blonder-Tongue reception improving TV products

NEW BLONDER-TONGUE B-24 POW-R BOOSTER



Powerful booster or amplified coupler provides sharp, clear pictures on 1, 2 or more TV sets with only one antenna. 10 db gain as 1-set booster, 5 db gain per set as amplified 2-set coupler. No-loss 4-set distribution system with B-T A-104 4-set coupler. New 6DJ8 frame-grid tube for highest signal gain. 24.95 list

NEW VHF ANTENNA BOOSTER, MODEL AB-2



Brilliant, clear reception in fringe and weak signal areas — more than 10 db gain on all VHF channels. Utilizes advanced RF amplifier circuit with frame-grid tube for maximum signal-to-noise ratio. Can be mounted up to 500 feet from remote control unit. 53.95 list

Model AB-FM for superior FM reception. 53.95 list

'NO-STRIP' 2-SET COUPLER, MODEL A-102



300 ohm coupler provides low-loss, matched installation for superior two-set performance. Delivers more signal to each TV or FM set, with greater inter-set isolation than other couplers. No ghosts, no smears. Ideal for outside or indoor mounting, color TV, FM. 3.50 list

Model A-104 — 4 set coupler, list 4.50; Model A-105 high-low antenna list 3.50; A-107 UHF-VHF Mixer, list 3.50; A-100 Outdoor Mounting Kit, list 90¢

DISTRIBUTION AMPLIFIER, MODEL DA8-B



Powerful all-channel amplifier ideal for small TV systems (garden apartments, motels, TV showrooms), provides 8 isolated TV outlets from 75 or 300 ohm input and delivers more than 10 db gain on all VHF channels. Requires no tuning or other special accessories. 94.50 list

for every reception area — primary or fringe. for every type of installation — one set to 100

WEAK SIGNAL AREAS



INTERMEDIATE SIGNAL AREA

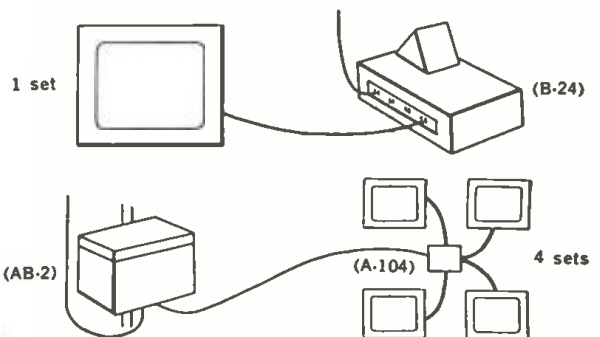

PRIME SIGNAL AREA

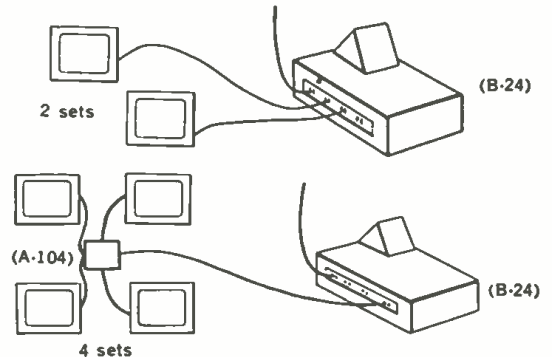

WEAK, INTERMEDIATE, PRIME SIGNAL AREAS Small TV System — 8 sets

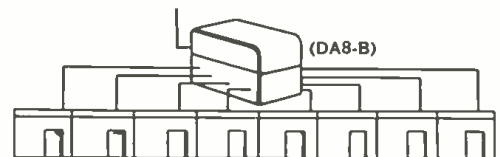

'NO-STRIP'— these Blonder-Tongue TV products feature exclusive B-T No-Strip terminals for speedy, secure positive installation.

More than 2,000,000 installations provide superior TV reception with B-T products.

Available at parts distributors. For further information write Dept. EW-11

BLONDER-TONGUE LABORATORIES, INC.

9 Alling St., Newark 2, N. J.

In Canada: Teleequipment Mfg. Co., Ltd., London, Ont. Export: Morhan Export Corp., N. Y. 13, N. Y.

hi-fi components • UHF converters • master TV systems • industrial TV cameras • FM-AM radios



In **STEREO**
STEREO

and Mono Hi-Fi... the experts say
your best buy is **EICO**

"The overall design of the HF-81 is conservative, honest and functional. It is a good value considered purely on its own merits, and a better one when its price is considered as well."

— Hirsch-Houck Labs (HIGH FIDELITY Magazine)

- Advanced engineering • Finest quality components
- "Beginner-Tested," easy step-by-step instructions
- LIFETIME service & calibration guarantee at nominal cost
- IN STOCK — compare, then take home any EICO equipment — right "off the shelf" — from 1500 neighborhood EICO dealers.



Stereo Amplifier-Preamplifier HF81

HF81 Stereo Amplifier-Preamplifier selects, amplifies, controls any stereo source & feeds it thru self-contained dual 14W amplifiers to a pair of speakers. Provides 28W monophonically. Ganged level controls, separate balance control, independent bass & treble controls for each channel. Identical Williamson-type, push-pull EL84 power amplifiers. "Excellent" — SATURDAY REVIEW; HI-FI MUSIC AT HOME. "Outstanding quality... extremely versatile." — ELECTRONICS WORLD LAB-TESTED. Kit \$69.95. Wired \$109.95. Includes cover.

HF85 Stereo Preamplifier is a complete, master stereo preamplifier-control unit, self-powered for flexibility & to avoid power-supply problems. Distortion borders on unmeasurable even at high output levels. Level, bass, & treble controls independent for each channel or ganged for both channels. Inputs for phono, tape head, mike, AM, FM, & FM-multiplex. One each auxiliary A & B input in each channel. Switched-in loudness compensator. "Extreme flexibility... a bargain." — HI-FI REVIEW. Kit \$39.95. Wired \$64.95. Includes cover.

New HF87 70-Watt Stereo Power Amplifier: Dual 35W power amplifiers of the highest quality. Uses top-quality output transformers for undistorted response across the entire audio range at full power to provide utmost clarity on full orchestra & organ. IM distortion 1% at 70W, harmonic distortion less than 1% from 20 to 20,000 cps within 1 db of 70W. Ultra-linear connected EL34 output stages & surge-protected silicon diode rectifier power supply. Selector switch chooses mono or stereo service; 4, 8, 16, and 32 ohm speaker taps, input level controls: basic sensitivity 0.38 volts. Without exaggeration, one of the very finest stereo amplifiers available regardless of price. Use with self-powered stereo preamplifier-control unit (HF85 recommended). Kit \$74.95. Wired \$114.95.

HF86 28W Stereo Power Amplifier Kit \$43.95. Wired \$74.95.

FM Tuner HFT90: Prewired, prealigned, temperature-compensated "front end" is drift-free. Prewired exclusive precision eye-tronic® traveling tuning indicator. Sensitivity: 1.5 uv for 20 db quieting; 2.5 uv for 30 db quieting, full limiting

from 25 uv. IF bandwidth 260 kc at 6 db points. Both cathode follower & FM-multiplex stereo outputs, prevent obsolescence. Very low distortion. "One of the best buys in high fidelity kits." — AUDIOCRAFT. Kit \$39.95*. Wired \$65.95*. Cover \$3.95. *Less cover, F.E.T. Incl.

New AM Tuner HFT94. Matches HFT90. Selects "hi-fi" wide (20c — 9kc @ —3 db) or weak-station narrow (20c — 5kc @ —3 db) bandpass. Tuned RF stage for high selectivity & sensitivity; precision eye-tronic® tuning. Built-in ferrite loop, prealigned RF & IF coils. Sensitivity 3 uv @ 30% mod. for 1.0 V out, 20 db S/N. Very low noise & distortion. High-Q 10 kc whistle filter. Kit \$39.95. Wired \$65.95 Incl. Cover & F.E.T.

New AF-4 Stereo Amplifier provides clean 4W per channel or 8W total output. Inputs for ceramic/crystal stereo pick-ups, AM-FM stereo, FM-multi stereo, 6-position stereo/mono selector. Clutch-concentric level & tone controls. Use with a pair of HFS-5 Speaker Systems of good quality, low-cost stereo. Kit \$38.95. Wired \$64.95.

HF12 Mono Integrated Amplifier provides complete "front-end" facilities and true high fidelity performance. Inputs for phono, tape head, TV, tuner and crystal/ceramic cartridge. Preferred variable crossover, feedback type tone control circuit. Highly stable Williamson-type power amplifier circuit. Power output: 12W continuous, 25W peak. Kit \$34.95. Wired \$57.95. Includes cover.

New HFS3 3-Way Speaker System Semi-Kit complete with factory-built ¾" veneered plywood (4 sides) cabinet. Bellows-suspension, full-inch excursion 12" woofer (22 cps res.), 8" mid-range speaker with high internal damping cone for smooth response, 3½" cone tweeter, 2¼ cu. ft. ducted-port enclosure. System Q of ½ for smoothest frequency & best transient response. 32-14,000 cps clean, useful response. 16 ohms impedance. HWD: 26½", 13¾", 14¾". Unfinished birch \$72.50. Walnut, mahogany or teak \$87.50.

New HFS5 2-Way Speaker System Semi-Kit complete with factory-built ¾" veneered plywood (4 sides) cabinet. Bellows-suspension, ¾" excursion,



Stereo Preamplifier HF85



**70W Stereo Power Amplifier HF87
28W Stereo Power Amplifier HF86**



**FM Tuner HFT90
AM Tuner HFT94**



Stereo Integrated Amplifier AF4



**12W Mono Integrated Amplifier HF12
Other Mono Integrated Amplifiers:
50, 30, & 20W (use 2 for stereo)**



**2-Way Bookshelf
Speaker System HFS1
3-Way Speaker System HFS3
2-Way Speaker System HFS5**

tion, 8" woofer (45 cps res.), & 3½" cone tweeter, 1¼ cu. ft. ducted-port enclosure. System Q of ½ for smoothest frequency & best transient response. 45-14,000 cps clean, useful response. HWD: 24", 12½", 10½". Unfinished birch \$47.50. Walnut, mahogany or teak \$59.50. **HFS1 Bookshelf Speaker System** complete with factory-built cabinet. Jensen 8" woofer, matching Jensen compression-driver exponential horn tweeter. Smooth clean bass; crisp extended highs. 70-12,000 cps range. 8 ohms. HWD: 23" x 11" x 9". Price \$39.95.

LGS-1 Brass Tip Matching 14" Legs — \$3.95. **HFS2 Omni-Directional Speaker System** (not illus.) HWD: 36", 15¼", 11½". "Eminently musical" — HIGH FIDELITY. "Fine for stereo" — MODERN HI-FI. Completely factory-built. Mahogany or walnut \$139.95. Blond \$144.95.

IMPORTANT NOTE: All EICO kits built according to our instructions, and all EICO factory-assembled equipment, conform to the high standards and specifications as published in EICO literature and advertisements. All EICO factory-assembled equipment is completely and meticulously hand-wired throughout — no printed circuitry; each factory-assembled unit is 100% final-tested throughout for each feature and function — no "spot" or "partial" checking. In EICO's final-test techniques, nothing is left to chance.



Over 1 MILLION EICO Instruments in use throughout the world.

Add 5% in the West.

Copyright 1959 by Electronic Instr. Co., Inc. 33-00 N. Blvd., L. I. C. N. Y.

The specs prove it...your best buy is



B
TV-FM SWEEP GENERATOR
AND MARKER #368
KIT \$69.95 WIRED \$119.95

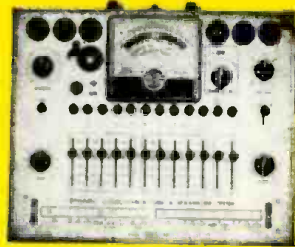

A
DYNAMIC CONDUCTANCE
TUBE & TRANSISTOR
TESTER #666
KIT \$69.95 WIRED \$109.95
Complete with steel cover & handle

C
RF SIGNAL GENERATOR #324
KIT \$26.95 WIRED \$39.95



D
PEAK-TO-PEAK
VTVM #232 &
UNIPROBE (pat. pend)
KIT \$29.95
WIRED \$49.95



E
COLOR & MONOCHROME
DC TO 5 MC LAB & TV
5" OSCILLOSCOPE #460
KIT \$79.95 WIRED \$129.50
5" PUSH-PULL
Oscilloscope #425:
Kit \$44.95 Wired \$79.95

A Tests all receiving tubes (picture tubes with adapter), n-p-n and p-n-p transistors. Composite indication of Gm, Gp & peak emission. Simultaneous selection of any one of 4 combinations of 3 plate voltages, 3 screen voltages, 3 ranges of continuously variable grid voltage (with 5% accurate pot.). Sensitive 200 ua meter. 10 six-position lever switches: freepoint connection of each tube pin. 10 pushbuttons: rapid insert of any tube element in leakage test circuit. Direct reading of inter-element leakage in ohms. New gear-driven rollchart. CRA Adapter \$4.50.

B Entirely electronic sweep circuit with accurately-biased inductor for excellent linearity. Extremely flat RF output. Exceptional tuning accuracy. Hum and leakage eliminated. 5 fund. sweep ranges: 3-216 mc. Variable marker range: 2-75 mc

In 3 fund. bands, 60-225 mc on harmonic band. 4.5 xtal marker osc., xtal supplied. Ext. marker provision. Attenuators: Marker Size, RF Fine, RF Coarse (4-step decade). Narrow range phasing control for accurate alignment.

C 150 kc to 435 mc with ONE generator in 6 fund. bands and 1 harmonic band! $\pm 1.5\%$ freq. accuracy. Colpitts RF osc. directly plate-modulated by K-follower for improved mod. Variable depth of int. mod. 0-50% by 400 cps Colpitts osc. Variable gain ext. mod. amplifier: only 3.0 v needed for 30% mod. Turret-mounted, slug-tuned coils for max. accuracy. Fine and Coarse (3-step) RF attenuators. RF output 100,000 uv, AF output to 10 v.

D Uni-Probe — exclusive with EICO — only 1 probe performs all functions: half-turn of probe tip selects DC or AC-Ohms. Calibration without re-

moving from cabinet. Measure directly p-p voltage of complex & sine waves: 0-4, 14, 42, 140, 420, 1400, 4200. DC/RMS sine volts: 0-1.5, 5, 15, 50, 150, 500, 1500 (up to 30,000 v. with HVP probe, & 250 mc with PRF probe). Ohms: 0.2 ohms to 1000 megs. $4\frac{1}{2}$ " meter, can't-burn-out circuit. 7 non-skip ranges on every function. Zero center.

E Features DC amplifiers! Flat from DC to 4.5 mc, usable to 10 mc. Vert. Sens.: 25 mv/in.; Input Z 3 megs; direct-coupled & push-pull throughout. 4-step freq.-compensated attenuator up to 1000:1. Sweep: perfectly linear 10 cps — 100 kc (ext. cap. for range to 1 cps). Pre-set TV V & H positions. Auto sync. lim. & ampl. Direct or cap. coupling; bal. or unbal. inputs; edge-lit engraved lucite screen with dimmer control; plus many more outstanding features.

FREE CATALOG shows you HOW TO SAVE 50% on 65 models of top quality professional test equipment. MAIL COUPON NOW!



New Transistor
Portable Radio RA-6
Kit \$29.95
Wired \$49.95
Incl. F.E.T.; less 9V batt.
Preamplified RF, IF
xfmrs; push-pull
audio; 6" spkr.



NEW Power & Bias
Supply for
Transistorized
Eqpt. #1020
Kit \$19.95
Wired \$27.95



NEW Tube &
CRT Fil.
Tester #612
Kit \$3.95
Wired \$5.95
Fast-checks
radio/TV tubes,
pilot lamps, etc.



Series/Parallel
R-C Combination
Box #1140
Kit \$13.95
Wired \$19.95



Tube Tester #625
Kit \$34.95
Wired \$49.95
• tests 600 mil
series string type
tubes
• illuminated
chart
Pix Tube Test
Adapter.....\$4.50



6V & 12V Battery
Eliminator
and Charger #1050
Kit \$29.95
Wired \$38.95
Extra-filtered for
transistor equipmt.
#1060 Kit \$38.95
Wired \$47.95



20,000 Ohms/Volt
V-O-M #565
Kit \$24.95
Wired \$29.95
1000 Ohms/Volt
V-O-M #536
Kit \$12.90
Wired \$14.90



33-00 Northern Blvd. L.I.C. 1, N.Y.

Add 5% in the West. © 1959

TURN PAGE FOR MORE EICO VALUES



R-C Bridge & R-C-L
Comparator #950B
Kit \$19.95
Wired \$29.95
Reads 0.5 ohms-
500 megs,
10 mmfd-5000 mfd,
power factor



VTVM Probes

	Kit	Wired
Peak-to-Peak	\$4.95	\$6.95
RF	\$3.75	\$4.95
High Voltage Probe-1		\$6.95
High Voltage Probe-2		\$4.95
Scope Probes		
Demodulator	\$3.75	\$5.75
Direct	\$2.75	\$3.95
Low Capacity	\$3.75	\$5.75

EICO
33-00 Northern Blvd.
L.I.C. 1, N.Y.

R-11

Show me HOW TO SAVE 50% on Test Instruments
 Hi-Fi Ham Gear. Send free Stereo Hi-Fi
Guide. Send me FREE Catalog, name of neighborhood
dealer.

Name.....
Address.....
City..... Zone..... State.....



Preserving & Cooking Food With Electronics

By **WALTER H. BUCHSBAUM**, Industrial Consultant

Fresh bread baked six months ago—fresh milk a year old—sirloin steak cooked in seconds—these and other food miracles are possible today, thanks to electronics.

FOOD is one of man's basic needs and when electronics invades the food industry, miracles are naturally expected. We count on these miracles because we have seen them happen in other areas where electronics has created completely new industries, as was the case with radio and TV, or in the many military applications where entirely new concepts of warfare are possible because of electronics.

The parade of electronic miracles continues. Like most "miracles" in our industry, the impact of electronics on the field of food storage and cooking will not come suddenly but rather through gradual evolution. Only when we look back to today from a vantage point ten years in the future will we realize the great extent to which electronics has contributed to our comfort, well-being, and enjoyment.

Frozen foods are a casually accepted part of our daily diet and, although only 15 years ago they were rare, we

have become quite used to them. In a similar way canned foods were once a rarity and then, between the two World Wars, became commonplace. Now both canned and frozen foods appear to be headed for some stiff competition. An entirely new process, using neither heat nor cold, promises to preserve our food from the day of harvest until we need it—fresh and unspoiled.

Bread baked six months ago? Strawberries in November? Fresh milk a year old? All these are quite possible and some of them are already available on a laboratory basis. The trick that makes these "miracles" possible is the amazing power of the electron and its cousin, the *gamma* particle.

Cooking by microwaves is another application of electronics to the food industry but this technique is not quite as novel since it has been used in restaurants and institutions for several years. The new aspect of microwave cooking is its introduction into the

home at prices comparable to the more conventional stove and the reliable, simple circuitry used in such units.

How Foods Are Preserved

Before going into the matter of food preservation we must first know what makes various foods spoil. We know that heat tends to hasten the decay of most foods but, unless frozen at very low temperatures, many fresh foods rot or deteriorate even when refrigerated. Food chemists have learned that there are two major factors which contribute to spoilage. One is the growth of micro-organisms, bacteria, of various microbes which multiply and cause decay. The second factor is largely chemical and is due to enzymes which cause changes in the chemical structure of organic matter. Both these attackers must be forestalled in order to preserve any food, but because bacterial changes occur much faster, the exclusion of bacteria alone will

help extend the food's storage life.

Every housewife knows that either heat or cold help to preserve food, although the length of time this preservation lasts varies widely. In the home, the heating or freezing processes cannot reach the temperature extremes possible in the commercial food processing plant, but the method is basically the same. Canned food is generally heated to kill all micro-organisms and then sealed under vacuum to prevent outside contamination. In deep freezing, storage temperature must be kept low because both micro-organisms and enzyme action are slowed at very low temperatures.

Both heating and freezing alter the color, taste, and texture of some foods. Potatoes, for example, cannot be frozen raw and bread that has been overheated just isn't bread. A little thought will quickly show the limitations of both these conventional preservation methods. The new irradiation scheme uses neither heat nor cold but attacks micro-organisms and enzymes by "atomic shotgun" bombardment. It

and neither heat nor cold is required to sterilize or store the sealed food container.

A typical example is the two slices of bread shown in Fig. 2. Both are two months old, but while the untreated bread is practically decomposed, the slice irradiated by a 1 mev (million electron volt) electron beam is still fresh and edible.

On hearing of this nuclear miracle, it is natural to wonder about the danger of radiation contamination. This danger might exist if the neutrons used could induce radioactivity into the food or the container. *Gamma* radiation (which accompanies some nuclear changes and is similar to x-rays but of shorter wavelength) does not produce atomic changes in the food atoms and leaves no radioactive material in the tissues. The same applies to electrons. We know that just because x-rays have passed through one's hand this does not make the hand radioactive or give it the power to emit radiation after the x-ray machine is turned off. In a similar manner, food remains edible and

non-radioactive after an exposure to *gamma* particles, electrons, or x-rays. The electron beams used for food preservation are similar to the beam which "paints" the picture on the face of the cathode-ray tube, but here a vacuum is not required, nor is a special cathode structure needed. Electrons in the air are accelerated until their speed reaches the equivalent of several million electron volts. This speed is achieved either by high-voltage machines such as the Van de Graff generator or by high-frequency units such as the linear accelerator.

Electron-beam treatment has certain advantages over *gamma* radiation in that relatively few technicians are required in the process and there is little danger to personnel of overexposure to harmful radiation. The exact dosages are easily controlled and monitored, but the penetrating power of the electron beam is relatively low. Fig. 1 shows cranberries in plastic bags passing under the swept electron beam of an early experimental high-voltage generator. With a 10-million-volt gen-



▲ Fig. 1. Cranberries are passed under swept beam of a super voltage electron beam generator by conveyor belt and subjected to electron bombardment and sterilization.

has been found that when most foods are bombarded with high-speed electrons or with *gamma* particles, the micro-organisms are destroyed. The exact theoretical explanation for this process is still under study, but the principle seems to be that the molecular structure of most foods is loose enough to pass these high-speed particles while the microscopic animal life of the bacteria is smashed by them. Whatever the mechanism of the process, the practical facts are that it is possible to pass food in sealed plastic bags under an electron beam or source of *gamma* radiation and, after only seconds of exposure, the food remains edible for long periods of time. The heat rise in the food is insignificant

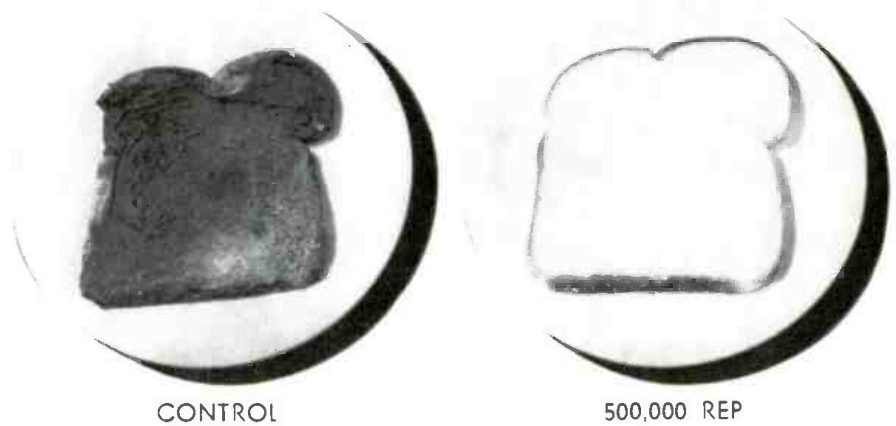
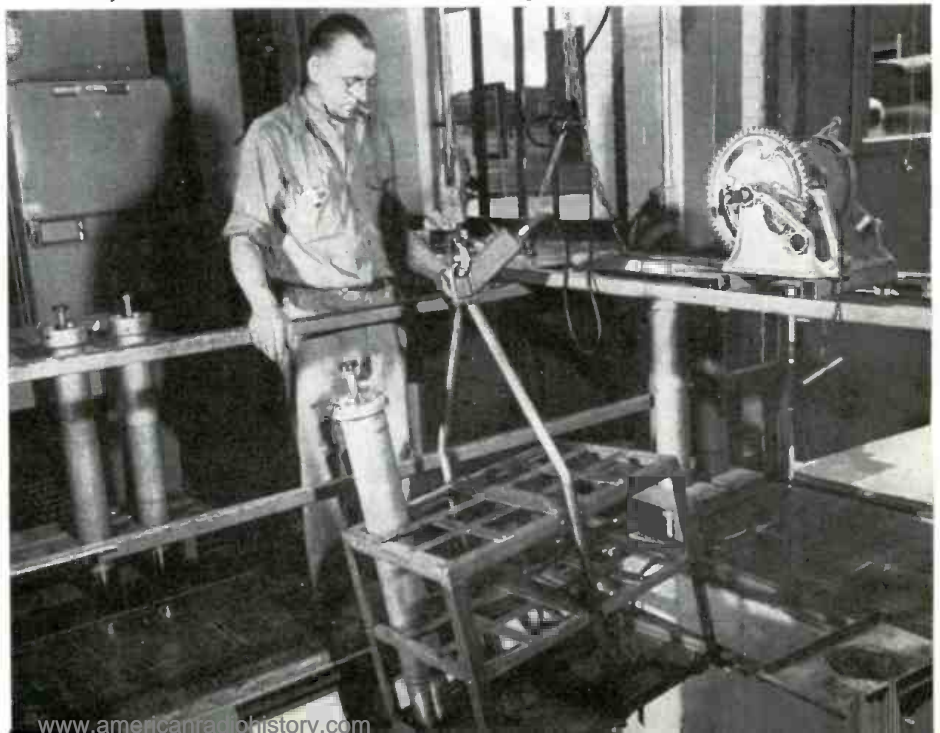

Fig. 2. Both pieces of bread were stored at room temperature for two months. The untreated control slice is moldy and not edible while the irradiated slice (right) is fresh. REP (Roentgen Equivalent Physical) indicates amount of radiation used.

Fig. 3. A research worker is lowering a sealed, thin-wall aluminum urn containing samples of material to be irradiated into tank by means of overhead electric hoist. ▼





CONTROL



10,000 REP

Fig. 4. Irradiation inhibits sprouting of potatoes, as shown in this photo taken six months after harvest. The potatoes at right were irradiated two months after harvest.

erator, the penetration is less than 2½ inches, which would hardly be suitable for a side of beef, for example.

At the Army Ionizing Radiation Center in Lathrop, California, a new linear accelerator will be available which will generate up to 24-million electron volts and have a penetrating power of 6 inches. It will be able to handle 3000 pounds of food per hour at a high level of radiation and will approximate at least pilot plant operation of a future commercial enterprise.

Sources of *gamma* radiation have much greater penetrating power but the handling of radio-isotopes, in general, still requires extreme care and specially trained personnel must be employed. The biggest problem in this area is to use *gamma* sources which do not also emit other radiation and which can be controlled. Various atomic waste products have been used experimentally, but since they are usually part of a nuclear reactor installation, the precautions involved in handling such materials have thus far presented a serious drawback to their efficient use for food preservation. Fig. 3 shows how food samples are irradiated at Argonne National Labs. Special containers, monitoring meters, and hoists are required because of the dangers of radioactivity. After extensive study, it was decided to provide the Army Ionizing Radiation Center with radioactive cobalt 60 as a source of *gamma* radiation. The energy level of this source will be approximately two million Curies which will probably make it the largest single source of *gamma* radiation in the country. With a really effective means of irradiating food by either method, it will be possible to resolve some of the remaining problems and, in a short time, radiation preservation can be extended to many more foods.

Present Limitations

Certain subtle chemical changes, caused by either type of radiation, result in flavor or odor variations in some foods which limit the usefulness of this preservation method in the case of

such foods. These changes are very slight, but to the person accustomed to certain flavors or odors, the particular food "just doesn't taste right." Strawberries, butter, milk, and cheese, for example, can be sterilized for long storage life, but the changes in their taste or odor are sufficient to make them unacceptable at the present time. Carrots, pork, ham, spinach, peas, and



Fig. 5. Raytheon's Mark III Radarange oven.

mackerel, on the other hand, develop no noticeable change after irradiation and taste just like the familiar fresh food. Several means have been found to reduce the undesirable changes in taste and odor. Irradiation in the absence of oxygen, in a frozen state, or with the addition of ascorbic acid solves this problem in many foods.

Future Uses

In addition to long-term storage, irradiation can also be used in smaller dosages to inhibit sprouting in potatoes, as shown in the photo of Fig. 4, eliminate insect infestation of grain, and kill trichina parasites in pork and ham. When grain is irradiated, all insects, larvae, and eggs are destroyed, permitting almost indefinite storage in

sealed bags. These effects, in themselves, are of great importance in the food industry since spoilage due to these and similar causes result in millions of dollars loss annually.

Food preserved by radiation need not be refrigerated, but it must be sealed off from any attack by bacteria, insects, or parasites after sterilization. Plastic containers, bags, or cans which can be hermetically sealed are used to store irradiated food.

For the past four years, the U. S. Army has been conducting a series of experimental feedings of irradiated food with human volunteers and with many generations of rats. No bad effects have been reported, either to the human subjects or to any of the generations of laboratory animals.

These studies are far from complete and before irradiated foods appear in neighborhood markets several years are bound to elapse. There is no doubt, however, that at least for many types of food, irradiation will be the standard means of preserving it. Just as the advent of frozen foods brought new delicacies to the average dinner table and changed our buying, storing, and preparation habits, so will food irradiation make itself felt. New, lighter, and more efficient packaging means will be used, shipping and storing will be cheaper and simpler, and, especially in areas where refrigeration is not generally available, food spoilage will be greatly reduced. For the average American the biggest improvement in his daily diet will be the availability of fresh fruits and vegetables at all seasons, without the changes necessitated by freezing or canning.

Electrons for Cooking

Most of our readers have heard about cooking with microwave energy, but both the principles and the actual circuitry are not widely understood. Unlike the irradiation method of preserving food, microwave cooking is already being employed in restaurants throughout the country and now effi-

Fig. 6. Tappan electronic oven for home.



PRESERVING & COOKING FOOD WITH ELECTRONICS

cient home-type microwave stoves are being advertised at less than a thousand dollars. Fig. 5 shows the "Mark III Radarange"—a restaurant-type model—while Fig. 6 is the latest *Tappan* electronic range, listed at \$895.00. We will discuss briefly the principles of microwave cooking and then describe the actual equipment from the point of view of the technician who might have to service this latest "electronic servant."

Electronic cooking differs from industrial dielectric heating only in that the frequencies used are much higher and in its application to foods rather than plastics. All foods contain water to some degree and are therefore quite "lossy" when it comes to microwaves. Those familiar with testing radar

in the same dish in which it is served.

Microwave Oven Circuit

Fig. 9 is a partial schematic of the *Raytheon* "Mark III Radarange," which is typical of heavy-duty restaurant installations. We have omitted the various safety interlocks, timers, relays, and motors which make up the actual electrical system. Also omitted are two pumps which circulate the cooling liquid which serves as heat exchanger for cooling the two Type QK-707 magnetrons.

The "Mark III Radarange" delivers 1600 watts of microwave energy at 2450 mc. and, as can be seen from the diagram, is modulated by the 60-cps line voltage. With the plate grounded, the filament and cathode are at nega-

tive 6.3 kilovolts r.m.s. Oscillation is produced by separate electromagnets surrounding the magnetrons and the d.c. power for these coils is obtained through full-wave selenium rectifiers. Microwave energy is generated into the cavity of the magnetron tube and is conducted by means of a waveguide into the cooking cavity—the oven. Two identical magnetrons are used with separate power sources for filament, plate, and magnet coil, but in Fig. 9 the circuit of only one is shown. Use of two magnetrons permits applying only half the cooking power, 800 watts, for smaller loads.

One of the important features of most ovens is the "stirrer"—a fan-like device which rotates in the cavity during the cooking cycle. In an ordinary microwave cavity there are spots where the r.f. energy level reaches zero. Unless the food load is distributed correctly, it could happen that some parts would receive less cooking energy than the rest. Housewives cannot be expected to consider correct electronic loading of a cavity and for this reason, the stirrer is introduced. It detunes the resonant cavity slightly and, by rotating, deflects some energy in a semi-random fashion. This dispersion assures an even energy distribution, irrespective of the size or placement of the food in the oven.

We mentioned that microwave cooking results in uniform heating of the foods and this means that there would be no brown crusts on meats, pies, etc. The formation of such a crust is actually incidental to the cooking process and, in most microwave ovens, this feature is added by means of regular, resistance-type heating elements. In the photograph of Fig. 7 the browning elements can be seen at the top of the oven cavity. Foods are usually cooked first and then browned to just the right coloring. The total oven time, even with the browning, is still only a fraction of that normally required with conventional stoves.

(Continued on page 141)



Fig. 7. Westinghouse electronic range and surface cooking unit do all of the work.

equipment will recall the use of water loads to test out high-energy radar transmitters. In effect, the food represents the load of the microwave transmitter which is the heart of the microwave oven. The simplified diagram of Fig. 8 shows the basic circuit of an electronic cooking device. The resonant circuit in microwave work is usually a cavity and, when this has "lossy" material in it, it is just as if a resistor were connected across the tank circuit. The energy in the cavity is dissipated in the food, heating it up. The r.f. energy penetrates the food completely and this creates a uniform heating effect. Microwave ovens make it possible to bake bread without crust, roast meats without splattering or burning the outside fat, and perform many other similar tricks.

It will be apparent that metal dishes in such an oven would not merely "load" the cavity but detune or even "short" it electrically. For that reason all microwave cooking is done in glass, porcelain, or ceramic dishes. These materials have very small losses at microwave frequencies and therefore remain relatively cool. This means that there will be no burned-on foods—making them easier to clean and handle. In most cases, food is cooked

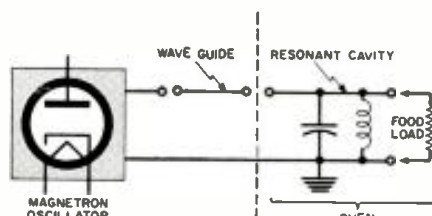

Fig. 8. Basic circuit for microwave oven.

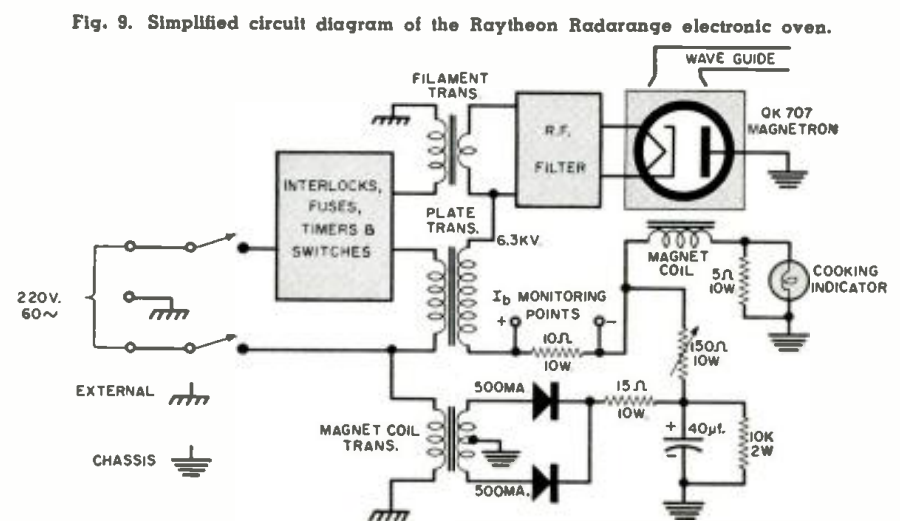

Fig. 9. Simplified circuit diagram of the Raytheon Radarange electronic oven.

Simplified Speaker Testing

By R. D. HERLOCKER

Use an oscilloscope and audio oscillator to measure loudspeaker impedance, phase angle, and distortion.

MANY audiophiles test their own amplifiers either as a matter of routine maintenance to keep their equipment in top-notch working order or to modify them for improved operation. On the other hand, it seems that relatively few make any attempt to check the performance of their speaker systems. This is in spite of the well-known fact that the average amplifier of today is freer from distortion and has a more uniform frequency response than even the better speakers now in use.

What accounts for this difference in attitude? Is it because so many of the factors controlling response and distortion are "built-in" to the speaker and thus are presumably not subject to improvement? Or is it because so many persons seem to have the idea that in order to determine any significant characteristics of a speaker system, test equipment is needed which is beyond the reach of all but well (and expensively) equipped laboratories?

It is quite true that many items which affect response and fidelity are inherent in any speaker and are fixed at the time of manufacture. However,

other factors, which are also quite important in determining the over-all response of the system, are very much under the control of the user. These controllable factors are primarily those which are concerned with mounting or enclosing the speaker and locating it within the room, and their importance should not be underestimated. For example, a speaker with a free-air resonance near 30 cycles, or even lower, and a smooth response above that point, may sound best in an infinite-baffle type of enclosure, while another speaker with a sharp resonance falling within the normal bass range (50 to 70 cycles, for instance) may need a bass-reflex type enclosure to tame the resonance and generally smooth out the lower end of its range. The type, amount, and location of sound absorbing material within the enclosure will also affect the response, but usually in a higher range, since the lack of such material may permit other resonances due to reflections within the enclosure. Then, too, if tests can be made in the room in which the speaker is to be used, it will probably be found that the location of the speaker in the room has

a considerable effect on its performance. This is particularly true in the case of stereo reproduction.

It seems to be commonly felt that any measurements of loudspeaker performance must necessarily be made with a lot of complicated and expensive equipment, which typically include a microphone which has been calibrated over the frequency range to be tested, an expensive audio oscillator, a couple of amplifiers, distortion and output meters, and other associated pieces of equipment, and preferably including either an anechoic chamber or "wide open spaces" for free-field testing. Rigorous testing under these conditions will undoubtedly give results which are as nearly definitive as can be had and which will correlate well with the sounds as actually heard. Of course, we all recognize that these sounds constitute the ultimate test of any audio system, although in many cases where the sound is considerably less than perfect, tests, even on the small scale which can be made at home, will help to pinpoint the cause or causes of faulty response, and may suggest measures to improve the

Fig. 1. Equipment setup for speaker tests.

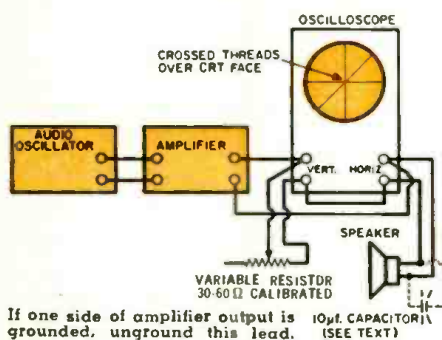
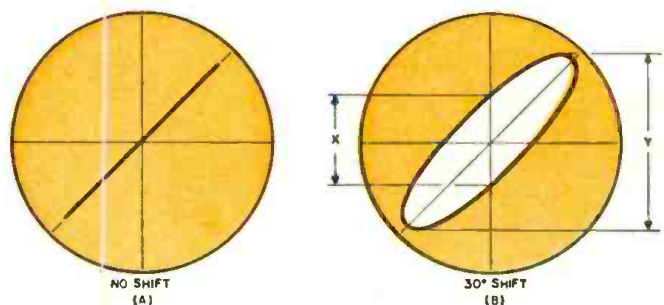

Fig. 2. Shown here are a pair of distortion-free oscilloscope traces with and without some phase shift.



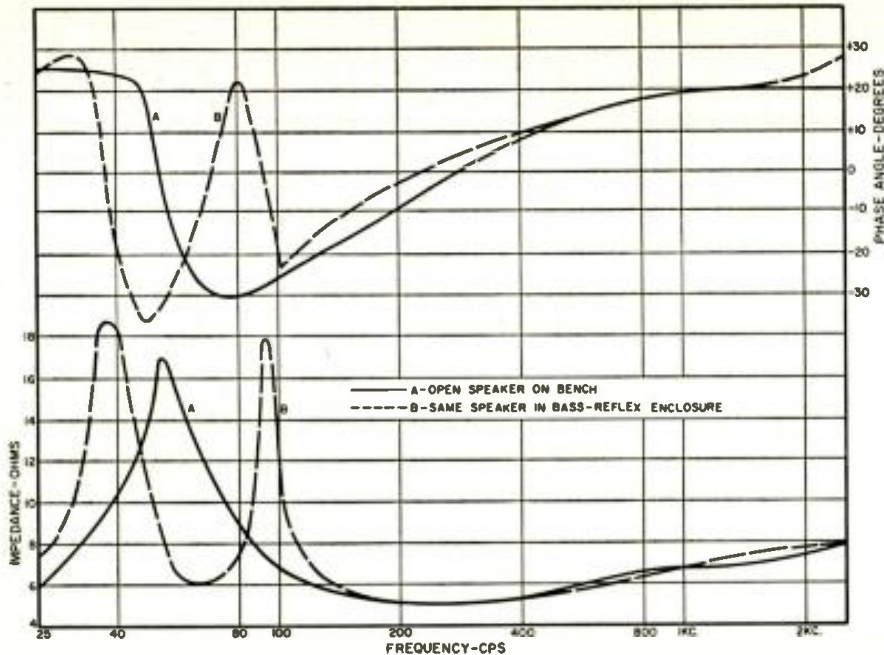

Fig. 3. Typical phase-angle and impedance curves for mounted and unmounted speaker.

over-all performance of the system.

Equipment

Much valuable information about your speaker and its performance can be obtained with simple equipment, such as is available to many experimentally inclined audio fans. The characteristics which can be measured with this simple setup are those which involve the electrical system of the speaker, either directly or because of energy reflected back into it from the mechanical or acoustical systems. They include impedance and phase shift and qualitative indications of harmonic distortion and useful power handling capacity. The equipment needed includes an audio oscillator capable of producing good sine waves over the desired frequency range: 20 to 20,000 cycles should be more than adequate; a power amplifier: ten watts is big enough for most purposes, but it must be free

X/Y = sin ϕ	ϕ	X/Y = sin ϕ	ϕ
0.00	0°	0.50	30°
0.05	3	0.55	33½
0.10	6	0.60	37
0.15	9	0.65	40½
0.20	12	0.70	44½
0.25	15	0.75	48½
0.30	18	0.80	53
0.35	21	0.85	58
0.40	24	0.90	64
0.45	27	0.95	71
		1.00	90

Table 1. Abridged sine-function table.

from distortion over the frequency range to be measured; an oscilloscope: practically any one will do; and a calibrated wire-wound variable resistor. Thirty ohms maximum resistance is about right for working with 8-ohm speakers and 50 to 60 ohms for 16-ohm speakers. The resistor calibration can be made with a low-range ohmmeter,

ments to be discussed here, the oscilloscope must be adjusted so that the vertical and horizontal gains are equal and the no-signal point is at the intersection of the three threads.

Impedance

Impedance is the simplest characteristic of a speaker to measure. Using the hook-up of Fig. 1, feed a single-frequency signal into the oscilloscope network, adjusting the amplifier output so that the trace nearly fills the face of the cathode-ray tube. Adjust the variable resistor to give a trace that falls on the 45° thread, as in Fig. 2A, if the trace is a single line. If the trace is an ellipse instead of a line, as is more apt to be the case, the proper resistor setting will put the trace with the long axis of the ellipse on the 45° thread, as in Fig. 2B. The impedance of the speaker at the frequency being tested is now the same as the resistance of the variable resistor. Measurements should be repeated at intervals over the desired frequency range and a curve drawn connecting the meas-

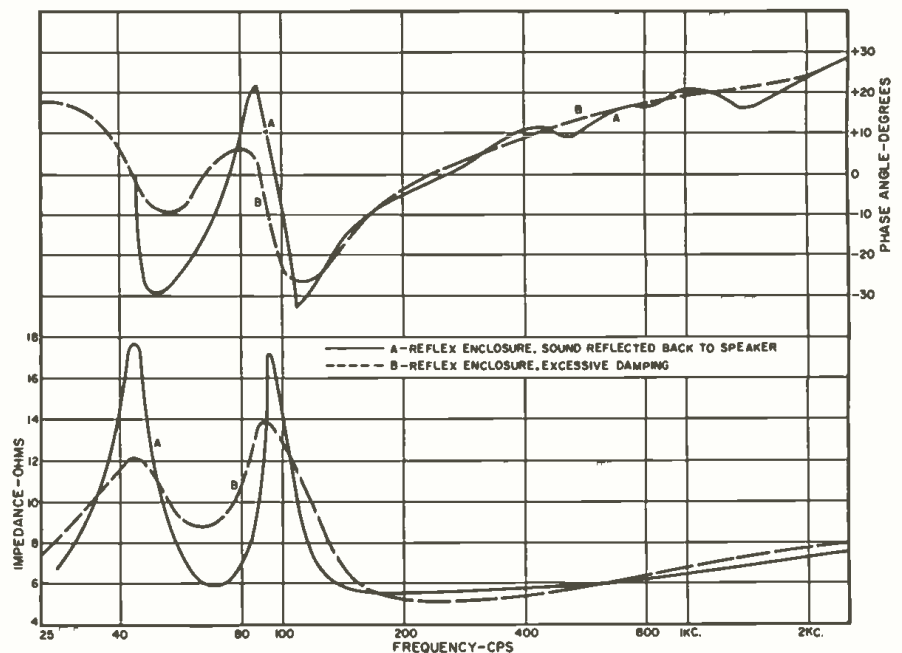

Fig. 4. Phase and impedance curves in reflex cabinet under two different conditions.

such as is incorporated in any vacuum-tube voltmeter. This gives sufficient accuracy for present needs, since relative values are more important than absolute values in this application.

The equipment is connected as indicated in Fig. 1. If the oscilloscope does not have a measuring grid over the face of the cathode-ray tube for determining the size of the trace, a satisfactory substitute may be made by simply fastening three threads over the face of the tube with Scotch tape. One of these should go vertically across the center of the face and the second horizontally, as determined by the vertical and horizontal traces of the oscilloscope. The third thread is to go across the intersection of the first two, at a 45° angle, from lower left to upper right. For all measure-

ured points, as in Fig. 3, for easier visualization of the results. Impedance should be plotted against the logarithm of frequency. Usually a change of 20% to 25% in frequency between adjacent points is permissible, although intermediate points will be needed at frequencies where a small change in frequency produces a disproportionately large change in impedance, as is the case in the vicinity of resonant frequencies.

Phase Shift

The elliptical trace which will be found throughout a large part of the frequency range of any speaker is a direct reflection of phase shift in the speaker. Phase shift can be caused by reactive components in the electrical, mechanical, or acoustic networks of

the speaker and is inherent in these networks. While it can be modified by changes in any of these networks, the acoustic network is the only one which can be readily changed by the home experimenter, since this is the one which is controlled by speaker mounting and by enclosure dimensions and design. Phase shift, in itself, is neither good nor bad in its effect on the sound put out by the speaker system. What is bad is the presence of abrupt changes in phase shift, especially at frequencies differing widely from the bass resonant frequency or frequencies of the system.

The phase shift of a speaker system can be readily determined at the same time the impedance is being measured. Measurements of two dimensions of the oscilloscope trace are needed at each frequency. These are the overall height of the trace and its height through the center (Y and X , respectively, in Fig. 2B). Now $X/Y = \sin \phi$ so the value of the phase angle, ϕ , can be found in any trigonometry table from the ratio between these two heights, or it may be estimated from the abridged sine table given in Table 1.

Whether the reactance causing the phase shift is inductive (positive shift) or capacitive (negative shift) can easily be checked by momentarily placing a capacitor across the speaker terminals, as shown by the dotted lines in Fig. 1. The value of the capacitor is not important, as long as it is large enough to change the shape of the ellipse noticeably when contact is made. A 10 μ f. filter capacitor has served quite satisfactorily in the author's tests. If the ellipse is fatter with the capacitor in the circuit, the shift is negative and the reactance of the speaker is capacitive. If the ellipse becomes thinner when the capacitor is placed in the circuit, the shift is positive and the speaker reactance is inductive.

At high frequencies there is normally a positive shift of 20° to 45° , since the inductive reactance of the voice coil is sufficient to have a noticeable effect in this range. At some intermediate frequency, the phase angle will pass through zero and then become negative as the frequency is lowered. Near the resonant frequencies of the speaker and enclosure, the phase angle is apt to undergo quite rapid changes, as shown in Fig. 3. These rapid changes may indicate unevenness of response, particularly if the amplifier with which the speaker is to be used is not highly damped. At frequencies above about 200 cycles, an uneven phase curve is related to the response. For example, the rather erratic phase curve A in Fig. 4 was found to be due to reflections from an enclosure wall, back to the speaker cone. The disturbance was not large enough to show up on the impedance curve. A small change in the enclosure, to eliminate the reflections, smoothed out the curve, as in B of Fig. 3, and at the same time removed a distinct coloration which earlier had been noticed in

the sound from this particular speaker-enclosure combination.

The internal damping of a bass-reflex enclosure has quite an effect on the impedance and phase curves obtainable, as well as on the sound emanating from it. This point is illustrated by a comparison of curves B of Figs. 3 and 4, which were taken with the same speaker-enclosure combination. The only difference between the two sets of conditions was that, for curves B of Fig. 4, additional damping material was used, including cotton sheeting across the port to provide extra acoustical resistance at that spot. Curves B of Fig. 4 can be seen to be much smoother, without the sharp impedance peaks or sudden phase changes at resonant frequencies noted in curves B of Fig. 3. However, a price must be paid for all this, which is not apparent from examination of the curves. The low end was quite smooth sounding, but very noticeably weakened by the additional damping. The moral is that test results such as these should always be interpreted in conjunction with actual listening.

Distortion

Harmonic distortion developed in the speaker is made apparent in this test procedure by deviations of the oscilloscope trace from the straight line or elliptical shapes previously discussed. It is in this connection that a

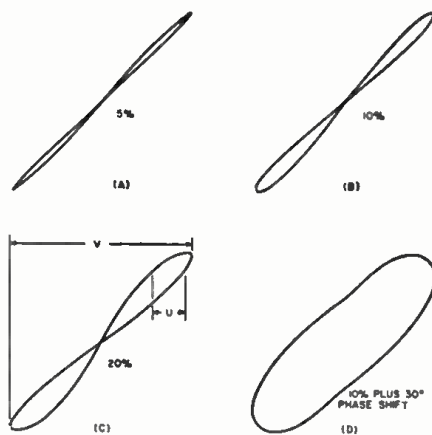
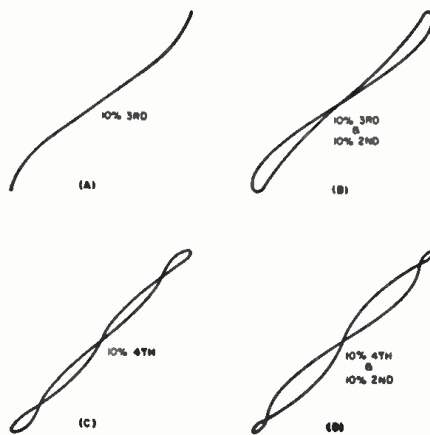

Fig. 5. Traces of 2nd harmonic distortion.

Fig. 6. Oscilloscope traces that contain both 3rd and 4th harmonic distortion.



distortion-free amplifier between the audio oscillator and the speaker is especially important, since a distorted signal being fed to the speaker will complicate the trace on the oscilloscope and may easily make it seem that the speaker is distorting the signal when, in reality, the amplifier or even the generator, may be responsible for the distortion.

Accurate measurements of harmonic distortion are not feasible by this method although, with care, a fairly good estimate may be had. In the useful audio-frequency range, by far the commonest harmonic distortion met with is second harmonic, otherwise known as doubling, in the lower frequency range. Figs. 5A, B, and C show the traces obtained with 5%, 10%, and 20% second harmonic added to the fundamental frequency without any phase shift in the speaker. Fig. 5D shows a trace containing 10% second harmonic, but with a 30° phase shift of the fundamental. It is obviously almost impossible to get any valid estimate of harmonic distortion from a trace of this type, so to be able to estimate the distortion, the phase shift must be compensated for. This can be done, at least approximately, by shunting either the variable resistor or the speaker with a suitable capacitor, until the phase shift is eliminated on the oscilloscope trace. The value of the capacitor will have to be found by trial, since it is dependent on frequency, the impedance being shunted, and the phase shift to be compensated. The capacitor should be placed across the speaker, as in Fig. 1, to compensate for a positive (inductive) phase shift or across the resistor to compensate for a negative (capacitive) shift. When second harmonic distortion alone is present, it may be estimated as follows:

$$\% \text{ Second Harmonic} \approx 100 (U/V)$$

where U is the width of the widest part of the curve and V is the overall width of the trace (see Fig. 5C).

Third and higher harmonics will be found much less often. Their estimation does not seem to be practical with this simplified testing setup. Examples of curves containing third and fourth harmonics, alone and in combination with second harmonics, are given in Fig. 6, so that they can be identified, even though they cannot be measured. Third harmonic distortion (no phase shift) gives a curved line, while the fourth harmonic alone gives a triple crossing loop. It can be seen from examination of Figs. 5 and 6 that analysis of the traces to give distortion values is feasible only in the simplest cases.

Some indication of the power handling capacity of a speaker can be had by repeating the tests, particularly in the low-frequency range (say below 200 cycles) at successively higher powers, cutting back the oscilloscope gain as power is increased to keep the trace on the face of the tube. At any given frequency the voltage across the speaker and its impedance can be

(Continued on page 126)

A Compact Beam for the Citizens Band

By HARTLAND B. SMITH / An easy-to-build 2-element beam antenna that just about triples the effective power of your Citizens Band rig.

THE "ground plane" is undoubtedly the most popular type of Citizens Band antenna. It is an excellent choice when you want omni-directional coverage for dispatching nearby mobile units. However, it is not adapted for long-haul contacts between fixed stations. This is because the ground plane radiates a signal to all points of the compass. In view of the 5-watt limit imposed on Class D stations, the loss of power which results from such a scattering of energy cannot be tolerated if you wish to maintain solid copy communication over distances of 20 miles or so.

A beam antenna, designed to concentrate your signal in one direction, must be employed for long distance point-to-point work. Actually, a beam is desirable for all contacts between fixed stations, even over relatively short distances, because it can radiate such a strong signal toward the desired station. At the same time, its directive pattern will reduce or prevent co-channel interference to stations located either to its side or rear.

The compact beam shown in Fig. 1 consists of two elements—a radiator and a director. The radiator receives power from the transmitter by means of a 75-ohm coaxial cable. The director, about 4% shorter than the radiator and spaced .1 wavelength from it, is parasitically excited, that is, no electrical connection exists between the director and the radiator. Since its elements are only a little longer than those of a channel 2 television yagi, the beam should arouse a minimum of comment from the neighbors when it is installed in a residential area. It is so light that even a thin TV antenna

mast may be used as a support and a low-cost TV rotator will easily turn it in any desired direction. The inexpensive materials required in its construction can be readily purchased either locally or by mail.

Horizontal polarization, as used in this antenna, tends to discriminate against automobile ignition noise, a form of interference which seems to be at its worst in the vicinity of 27 mc. Anything you can do to reduce the effect of ignition noise will help to extend the distance over which weak signals can be heard and worked. Another factor which favors the horizontal beam for Citizens Band use is the 20-foot height restriction imposed on antennas by the FCC. It is the center- or high-current portion of a half-wave antenna that does most of the radiating. The higher you can put the center of the antenna, the greater your transmission range will be. If a vertically polarized 27 mc. beam is constructed, its high-current portion will be 8½ feet below that of a horizontal beam, providing both are installed so that no part of either one is more than 20 feet above the supporting structure.

A difference in antenna height of only 8½ feet can have a distinct effect on the performance of your station. For example, during preliminary tests of the beam under discussion, it was operated at a point 29 feet above ground. Later, when it was finally mounted permanently at 37 feet (17 feet above the house roof) results were greatly improved. The signal from the transmitter jumped 7 db on the meter of a communications receiver situated at ¼ mile and 10 db on a set located 2 miles away. Further-

more, a station in an unfavorable location, at a distance of 7 miles, which was previously unreadable started to come in loud and clear. The extra 8 feet of antenna height was easily equal to a 500% increase in transmitter power, possibly a 1000% increase if you have implicit faith in receiver "S" meters.

There are two popular ways to restrict antenna size. You can either use short elements which are resonated with loading coils or you can use bent full-length elements. The author prefers the latter approach, because loading coils reduce antenna efficiency and are often affected adversely by wet weather. Loading coils also tend to complicate and weaken the structure of a beam.

Construction

The elements of the antenna shown in Fig. 1 are standard 12-foot lengths of ½" aluminum tubing to which are added aluminum wire droopers. When purchasing the tubing, make certain that it is hard, not soft aluminum. Specify either 61ST6 or 6061T6. If you can't procure such tubing locally, it may be obtained by mail from *World Radio Laboratories*, Council Bluffs, Iowa or *Dick's*, Cherry Avenue, Rt. 1, Tiffin, Ohio. The tubing must be ½" in diameter. Any other size will invalidate the dimensions of Fig. 2.

The boom which supports the radiator and director is a 48" length of 1" x 2" clear pine. Two pieces of 1" x 2" each 4" long are used for element clamps. A 3" piece of 1" x 2" acts as a clamp for the coaxial cable. Place one of the 4" blocks at the end of the 48" piece and drill three holes for No. 6

Fig. 1. The author's beam uses an antenna rotator on a short mast.

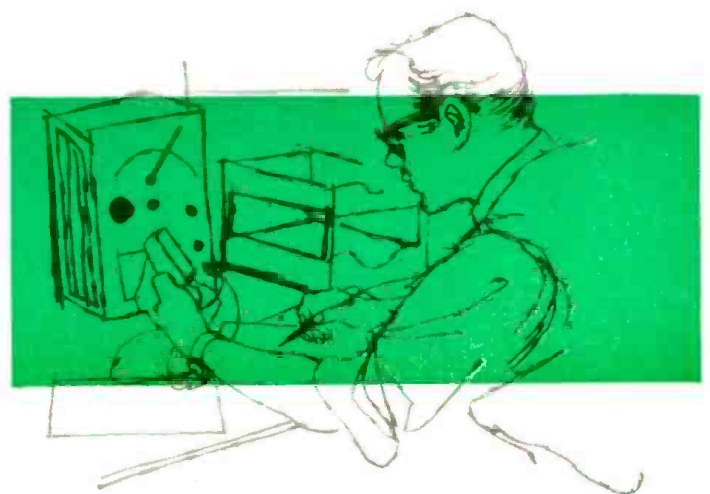
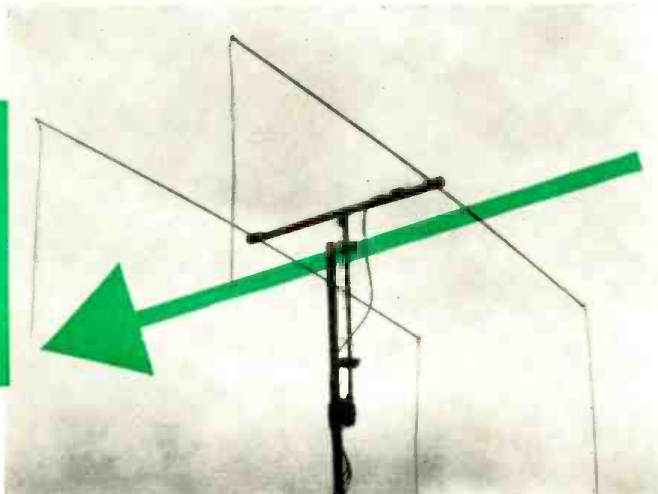

wood screws through the block and partially through the boom as shown in Fig. 4A. Now place the other 4" block of wood at the opposite end of the boom and drill it in the same manner. Fasten the two blocks tightly to the boom.

A Telco 8800-U antenna mount is used to hold the boom to the mast or rotator. It should be attached at the center of the boom with a couple of $\frac{3}{16}$ " bolts that are $1\frac{1}{4}$ " long. Drill the holes for these bolts now, but don't fasten the 8800-U to the boom yet because it will be in the way of some of the work which follows.

Drill a $\frac{1}{2}$ " hole $17\frac{3}{4}$ " from one end of the boom. This hole is for the coaxial cable which will later be pulled up through it. The 3" block of wood used for a cable clamp must be hollowed out lengthwise on its underside, with a file or saw, to provide room for the cable which will pass beneath it. The groove should be just a little bit smaller than the cable. Then, when the block is securely fastened to the boom by two $1\frac{1}{2}$ " No. 6 wood screws, there

that the elements may be pushed through the holes drilled for them. Carefully center the elements so that their weight is equally distributed on each side of the boom. Tighten the clamping blocks. Drill a small hole at the center of each block. These holes should extend only far enough to penetrate the tops of the elements. No. 8 sheet metal screws, 1" long, go through these holes and are drawn up tightly. See Fig. 4A.

A standard Bakelite two-terminal tie-point is fastened to the side of the boom. Make certain that its nearest terminal is exactly 5" from the radiator. The antenna mount may now be bolted to the underside of the boom. Use both lockwashers and flat washers under the heads of the bolts and lockwashers under the nuts. Just before tightening the nuts securely, give the bolts, nuts, and washers a heavy coating of exterior house paint. The paint, along with the lockwashers, will help to keep the bolts from loosening under the strain set up by wind and vibration.

One end of the coaxial cable should

be cut and stripped. Solder about a 12" length of No. 20 plastic covered hookup wire to the exposed shield braid. A 5" piece of hookup wire should be soldered to the cable's center conductor. Carefully tape the end of the coax to prevent the entry of moisture. Feed the cable through the half-inch hole in the boom. Put the 3" grooved piece of 1" x 2" over it and tighten the two screws so that the cable is clamped firmly in place. The end of the cable should be flush with the edge of the 3" block which is nearest the radiator.

The droopers are cut from No. 8 aluminum TV ground wire and are soldered to the ends of the elements. Soldering to aluminum can be a rather tricky process. However, if you take your time and use the proper tools, you will be able to produce joints between the droopers and elements which are both mechanically and electrically sound. Use a gun or iron rated at least 200 watts. A torch is not recommended because it will heat the aluminum so fast that it will oxidize before the solder can get a chance to take hold. Use wire-type solder that contains no flux. Rosin-filled radio solder and acid-core solder are unsuitable. "Sal-Met" flux, which is listed in most radio catalogues, works well on aluminum and should be used for this particular operation.

At the ends of the elements, for a distance of about $1\frac{1}{2}$ ", scrape the metal with a knife or clean it with sandpaper until it is bright and shiny all the way around. Absolutely no dark oxidized spots should be allowed to remain. Apply a thin coating of flux over the entire cleaned area. Heat the iron until you are sure that it has reached its normal operating temperature. Put a small amount of solder on the tip of the iron and then touch the tip to the flux-covered area. More solder should now be applied to the element, right next to the point where the iron is touching it. As soon as the solder begins to melt, slowly rub the tip of the iron back and forth across the metal. If the aluminum has been properly cleaned and coated with flux and has been heated sufficiently by the iron, the

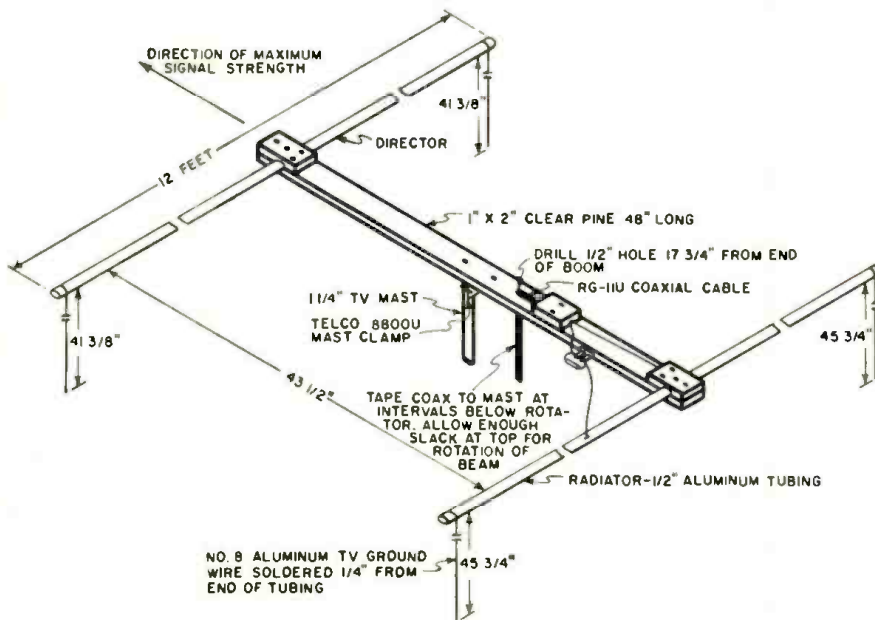

Fig. 2. Both elements in the beam are 12-foot lengths of half-inch aluminum tubing.

will be just enough pinching action to hold the cable in place. The correct location for the cable clamp is shown in Fig. 3.

Exactly 2" from each end of the boom, along the cracks between the boom and the 4" blocks, drill $\frac{1}{2}$ " holes for the aluminum elements. This operation must be performed with great care. Unless the two holes are exactly at right angles to the long dimension of the boom, the elements will not be parallel in the finished antenna. As a result both the appearance and performance of the beam may suffer. You can do this rather precise job best with a drill press. However, if you're careful, even a hand brace will provide acceptable results.

Loosen the screws which hold the tubing clamp blocks just enough so

Fig. 3. The coax line used with the beam is connected to the radiator in this manner.

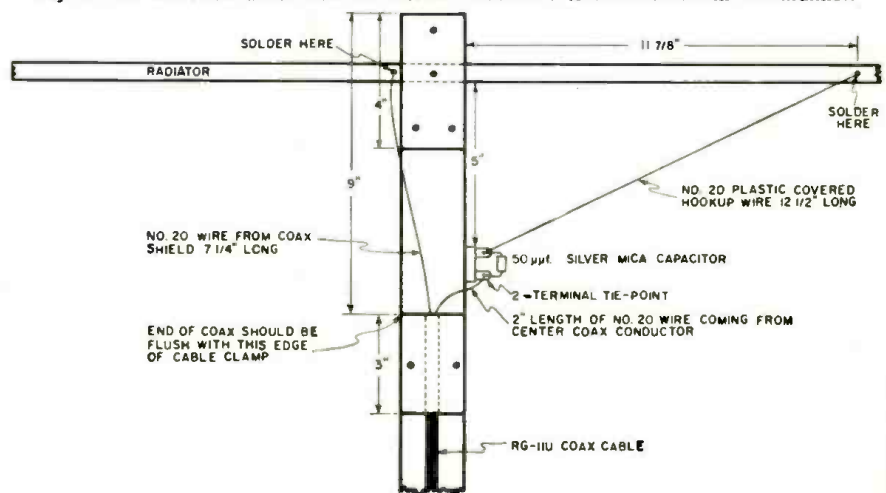

solder will flow over it like water. Keep working the iron back and forth, adding a little solder until the end of the element has been completely covered. Tin both ends of each element in this manner.

Cut a piece of the aluminum ground wire to a length of about 55". Tin one end of the wire with solder for a distance of 4", just as you did with the elements. After the wire has cooled, carefully wrap one turn of it around an element, 1/4" from the end. Dab a little flux on the area and now apply a generous amount of solder to the wire and element. Use enough heat to insure that the newly added solder fuses with that which was previously applied during the tinning process. Attach the other three droopers in the same way. After they are all in place, trim them to the exact lengths shown in Fig. 2.

The longer of the two pieces of No. 20 wire, the one attached to the shield of the coax, is now soldered to the radiator as close as possible to the element clamp. This lead must be kept short. Cut off any excess beyond that required to reach the radiator. The shorter piece of No. 20 wire is trimmed so that it barely reaches the nearest terminal of the tie-point. Another piece of No. 20 wire, approximately 12 1/2" long runs from the tie-point terminal nearest the radiator to a spot on the radiator which is exactly 11 1/2" from the edge of the boom. See Fig. 3.

In case you lack the necessary tools and supplies required for effective soldering, the droopers may be bolted to the boom and the No. 20 wires from the coax can be attached to solder lugs which are fastened to the radiator by means of No. 6 sheet metal screws. These alternatives, however, are inferior ones which should be accepted only as a last resort. Whether you use solder, or bolts, seal all connections to the elements with Scotch electrical tape.

The leads of a *Cornell-Dubilier* 22R-5Q5 50 μ f. 5% tolerance silver mica capacitor should be trimmed until they are just long enough to reach between the two terminals of the tie-point. Wrap the capacitor with electrical tape to protect it from the ravages of rain and snow. Solder it to the two tie-point terminals. Don't attempt to use a substitute for the specified capacitor. Any deviation in the value of this

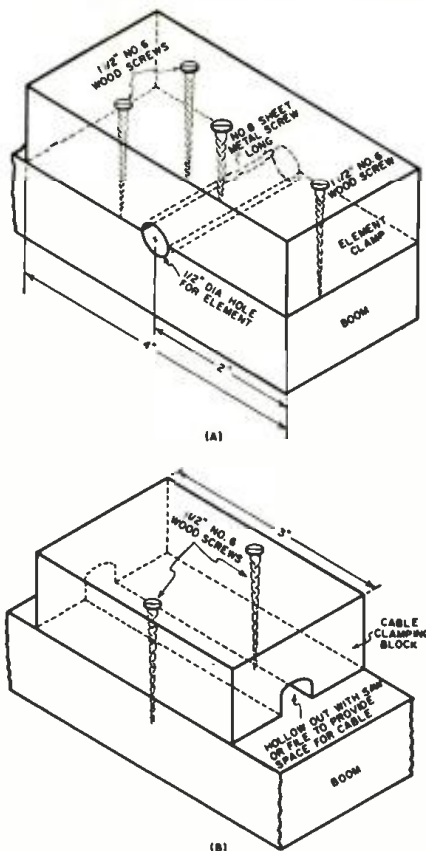

Fig. 4. Details of the element clamps (A) and clamp for the coaxial cable used (B).

part will adversely affect the match between the feeder and the radiator. Standing waves will then appear on the coax and the over-all efficiency of the antenna system will suffer. *Never* connect a high-powered transmitter to the beam! Although the capacitor will easily take all the output a 5-watt Citizens Band rig can deliver, it will go up in smoke if it is subjected to any great amount of radio-frequency energy.

Erecting the Beam

After giving the boom a couple of coats of paint, you can clamp the beam either to a standard 1 1/4" TV mast or to a TV rotator. Due to the antenna's small size and light weight, you should have little trouble mounting it at the legal limit of 20 feet above the roof of your home or office. A neat installation will result if the coaxial cable is tightly

taped to the mast at 2-foot intervals. Near the rotator, however, you must allow sufficient slack in the cable so that the antenna is free to make at least one revolution without putting excessive strain on the coax. Keep the 75-ohm feeder as short as possible. Every extra foot of line will cause additional signal loss. RG-11U cable probably offers the best compromise between efficiency and cost.

Provisions for adequate lightning protection should never be overlooked when installing an outside antenna. Be sure to effectively ground the mast and install a lightning arrester on the coax at the point where it enters the building. A suitable arrester is the *Cush-Craft* "Blitz Bug," a unit which has been designed especially for coax. It is available from many suppliers who cater to the amateur radio trade.

Results Obtained

Results obtained with the beam, when used in conjunction with the "Versatile Citizens Band Transmitter" (*ELECTRONICS WORLD*, August 1959 issue) have been very good even though the author lives in a valley and is surrounded by trees, houses, and power lines. Over a two-mile path, with beams at both ends of the circuit, signals are S9 plus 40 db. A station 12 1/2 miles away, which is equipped with a dipole and the transceiver described in the March, 1959 issue of this magazine, comes in at S9 plus 10 db. Another station 21 miles away has a beam and is received well above the noise level. Signals are 100% readable in both directions.

Although horizontal and vertical antennas usually aren't very compatible, a mobile unit equipped with an *Elmac* CD-5 "Citi-fone" transceiver and a base-loaded 42" whip has been heard on the beam with good strength at a distance of 11 miles. Another mobile, 8 miles away in the downtown section of a large city, pushed the meter on the NC-300 receiver clear up to 30 db over S9. Undoubtedly he was in a very favorable spot at the time. Nevertheless, this kind of performance shows that the beam is capable of doing a good job on mobile contacts besides functioning well in point-to-point work.

The standing-wave-ratio which appears on the feedline at midband is less than 1.1 to 1. This rises to not more than 1.3 to 1 at the band edges. The front-to-back ratio is better than 16 db, while the front-to-side ratio is in the neighborhood of 45 db. Since the antenna is such an excellent performer, there seems little reason to doubt that its gain closely approaches 5.5 db (a 3.5 times power increase), the theoretical maximum for a two-element beam. Consequently, if you construct a similar antenna it should make your little 5-watt Citizens Band rig sound like a 15 watter, at the very least. To achieve significantly better results you'd need a full sized three-element beam, one with a 14-foot boom and 17-foot elements.

MATERIALS LIST FOR BEAM ANTENNA

- 1 6-foot length of 1" x 2" clear pine
- 8 No. 6 woodscrews, 1 1/2" long
- 2 No. 8 sheet metal screws, 1" long
- 2 3/16" bolts, 1 1/4" long with 2 nuts, 2 flat washers, and 4 lock washers
- 1 Telco 8800U antenna mount
- 1 two-terminal tie-point with small woodscrew for mounting it
- 1 25-foot length No. 8 aluminum TV ground wire
- 2 12-foot lengths of 1/2" 61ST6 or 6061T6 aluminum tubing
- 1 Cornell-Dubilier 22R5Q5 50 μ f., 5% silver mica capacitor
- 1 3-foot length No. 20 plastic-covered hookup wire
- 1 piece RG-11U coax cable (long enough to reach from beam to transmitter)
- 1 roll wire-type solder without flux
- 1 "Sal-Met" flux
- 1 roll Scotch electrical tape
- 1 small can outside house paint

EDITOR'S NOTE: In "The Outside Call: What to Take Along" by Murray Barlowe, which we ran last July, the author said, "we are convinced that most r.f. and i.f. adjustments are sufficiently stable so that they should not require re-adjustment for the life of the receiver! . . . the bulk of our alignment work is the direct result of activity on the part of screwdriver-happy customers and technicians!" Also writer Jack Darr, discussing the service of two-way communications equipment in one of his articles, says, "Actually the receiver section . . . should almost never need alignment. However, there is an unfortunate habit prevalent among many technicians to 'play' with i.f. adjustments with very little provocation."

The emphasis necessarily given to tricky alignment procedures in technician training programs has left many with the attitude that alignment should be the first rather than the last resort. This attitude gives particular relevance to Ken Bramham's sensible appraisal of the problem.

CORRECT ALIGNMENT of a TV receiver is necessary for full picture detail, but how many re-alignment jobs are really necessary? Let us assume that a TV receiver is correctly aligned at the factory (they usually are), that it gives a satisfactory picture in the dealer's showroom, and that it continues to do so in the customer's home until such time as a breakdown occurs. Then, during the repair process, the technician decides it is necessary to re-align the i.f. circuits. For what reason?

A typical i.f. stage consists of a tube, two transformer windings, two or three resistors, and a couple of bypass capacitors. The tuned circuits, which were correctly adjusted at the factory, are each made up of one transformer winding and the capacitance introduced by the windings plus the inter-electrode capacitance of the tube. If re-alignment is needed, one of these quantities of inductance or capacitance in one of the i.f. stages must have changed.

A change in the inductance of the coil would affect the tuning, but what could change the inductance to so great an extent? The number of turns or the coil diameter would hardly be changed or, if it has, it is time to change the transformer before attempting to re-align the circuit. The slug position, which would not change of its own volition, would have to be changed by someone at the time of the breakdown. That is not very probable.

How about a change in circuit capacitance? This is far more likely: the tube could suddenly have changed its electrode positions, shorted, or become gassy and completely changed its inter-electrode capacitance values. There is a slight chance that an alignment job may restore the set to operating conditions—a very slight chance. A much better method is to install a new tube.

Large changes in resistance values are needed to change the i.f. tuning. This can only be corrected by replacement of the resistor involved. A shorted cathode bias resistor, for example, will permit changes in signal strength to vary the alignment curve.

Obviously, retuning at one particular level of signal strength and a.g.c. action is not going to remedy this condition.

Do the foregoing points mean that the service shop can throw out its complement of alignment equipment or, if it has not yet acquired the instruments adequate for alignment work, that this acquisition may no longer be considered necessary? Not at all. The importance of such equipment cannot be overstated. It is only the use to which it is put that is open to question.

The first and most important application of the sweep generator and scope is to *observe* the alignment curve—without attempting any adjustments whatever. With this approach, curve observation can often provide a more rapid method of localizing a specific circuit defect than other techniques, particularly where the fault is obscure. Finally, in those relatively rare cases where re-alignment is indeed called for, its necessity can be demonstrated with the minimum amount of guesswork by eliminating other possibilities.

Starting with the tubes, components may be substituted one at a time until an appreciable change in the response curve is noted. This immediately indicates a significant difference in value between the old component and the one with which it is replaced. A change in curve shape will invariably be accompanied by a change in over-all amplitude—and the latter may be either an increase or decrease depending on the type of failure involved. For example, a gassy tube or a shorted cathode resistor could increase circuit gain at the expense of proper curve shaping. Replacement with a new, good tube or resistor would therefore decrease gain while restoring the curve shape.

Re-alignment for increased bandwidth (and consequently for reduced gain) may compensate for a circuit fault *without correcting that fault*. The result usually is a callback when signal conditions change or when the fault becomes worse. This applies to any component failure that produces overloading on strong signals: the failure may be in the a.g.c., video-output, or sync circuits. A similar condition which may be located during an alignment check is failure of the video-detector diode.

Perhaps the worst instances of un-

(Continued on page 134)

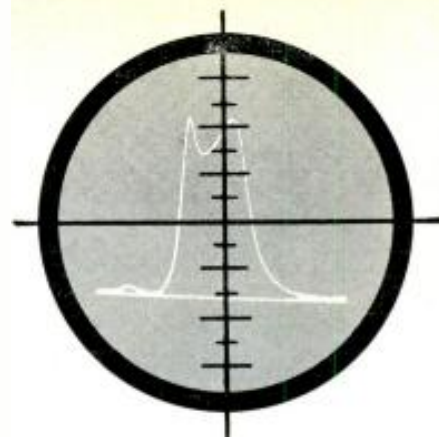

Are You "Alignment Happy"?

By KEN BRAMHAM

Instead of "re-aligning out" circuit defects, use your scope and sweep equipment to pinpoint such faults.



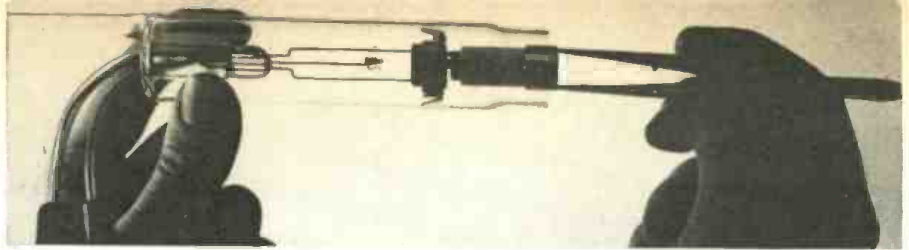

▲ "Transistorized" Electron Tube

Experimental electron tube, being developed by *Westinghouse*, gets its supply of electrons from tiny crystals of silicon carbide. The crystal replaces the hot, power-consuming cathode. The tube depends on a new form of electron emission discovered in the semiconductor silicon carbide. Successful application of the discovery would result in a "solid state" electron tube that would combine many of the advantages of semiconductors and vacuum tubes. The crystal is inside the cartridge being inserted in the tube.

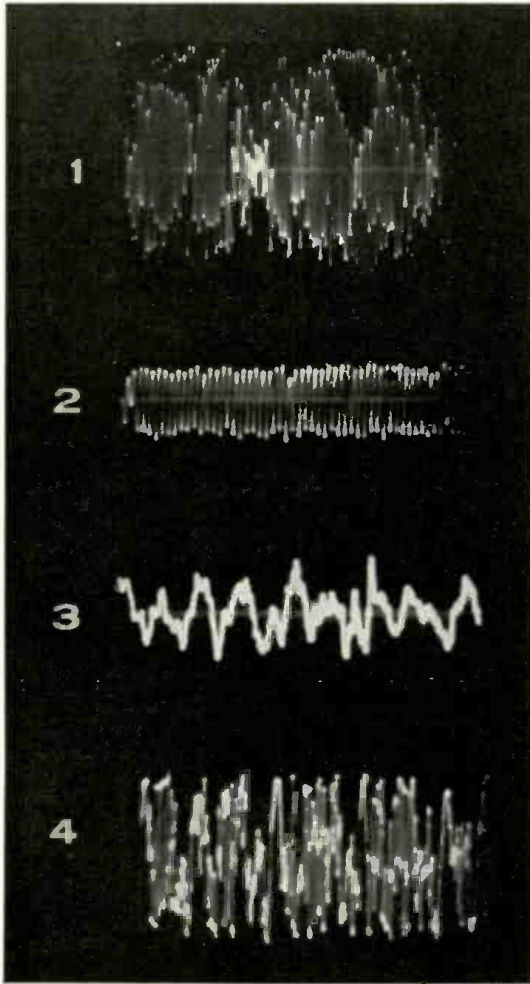

▲ Ultra-Sensitive Combat Radar

Demonstrating an almost human ability to tell differences in targets, a new Army surveillance radar, designed and developed by *Hazeltine Corp.*, can distinguish between moving trains and vehicles, at ranges up to 20,000 yards, and personnel at ranges up to 10,000 yards. The radar, the AN/TPS-25, uses pulse doppler techniques and presents its information aurally to the operator. An experienced operator can even tell the difference between a man and a woman target because differing walking methods produce audible differences in the received signals. Waveforms above are scope traces of the sounds heard with the following targets in range: (1) moving train, (2) moving automobile, (3) walking man, and (4) walking woman.

Recent Developments in Electronics

▼ Crystals from Rust

"Flameless fusion," a method of transforming a few cents worth of rust-like substance into a nearly perfect crystal worth hundreds of dollars to the electronics industry, has been disclosed by *ITT*. The method produces a monocrystalline ferrite. Scientists hope it will be a new electronic workhorse like some semiconductors. To produce it, r.f. in the metal loop (center) heats a powdered mixture of ferric oxide, a form of common rust, and other oxides.

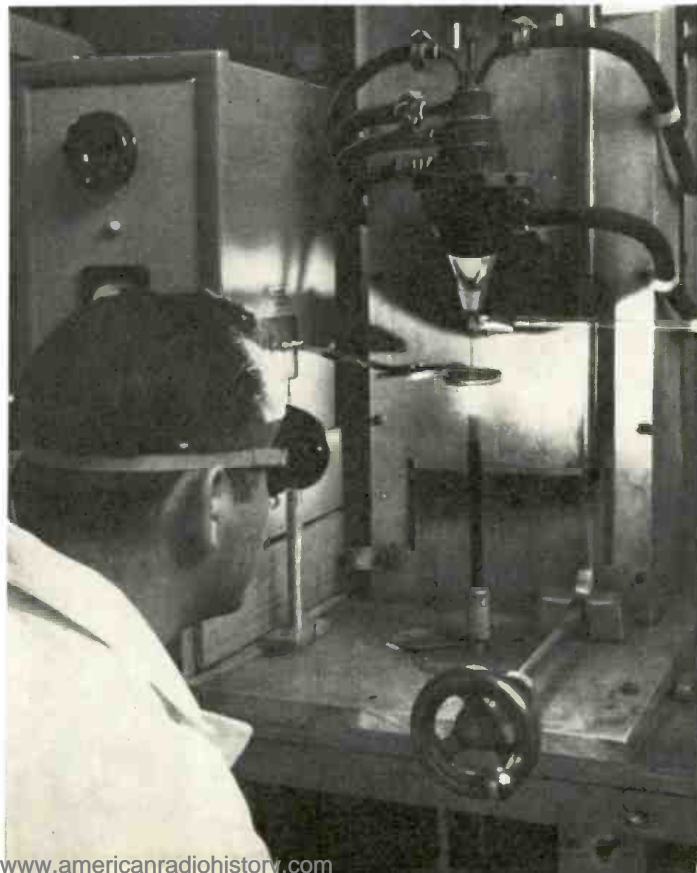



P.A. Feedback Stopped by Modulator

As he switches on frequency-shift modulator, *Bell Telephone Laboratories'* Manfred R. Schroeder observes reverberations of the voice of girl at microphone in background. By shifting frequencies of room reverberations slightly as they feed back into microphone, instability of public-address systems is minimized and a two-fold increase in gain is permitted.

Electronic Air-Defense System

Use of the U. S. Army's new technical air-defense system (AN/MSQ-18) is shown in this panoramic view of a battalion-level combat area. Cut-away shows radar operator at operations central monitoring hostile aircraft picked up by radar at left. Commander with him makes target assignments to missile batteries. Inset shows one of these distant batteries, with its local radar, power supply equipment, and truck which houses coder-decoder unit that is part of anti-aircraft system. The new system was announced by U. S. Army Signal Corps and *Hughes Aircraft Co.*



"World Communications" Sculpture

Internationally known sculptor-in-metal Harry Bertoa is shown with his abstract sculptural grouping at *Zenith Radio Corp.'s* display salon in Chicago. First of his work to be used in consumer products showcase, the glittering brass units symbolize world communications in the atomic age. Smaller units at right represent sight, sound, and electronic control and respond to transmissions of light from 8-foot main unit.

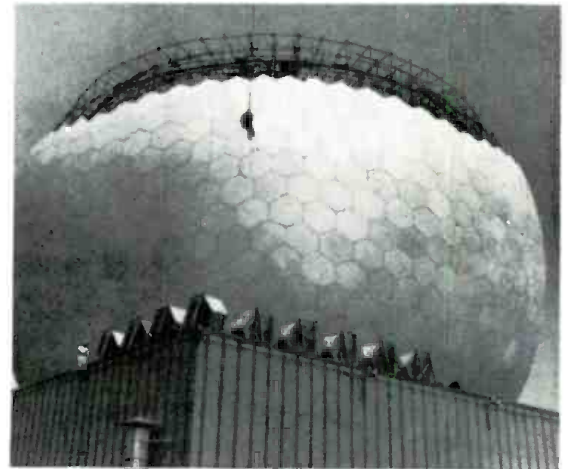

Giant Radar Test Dome

Giant 140-foot diameter dome, made by *Goodyear Aircraft Corp.* from pressed paper faced with plastic-impregnated fiberglass, is being erected east of Camden, N. J. It will be used by *RCA* as a radome to protect huge radar antennas of the type to be constructed in the Far North for the Air Force's Ballistic Missile Early Warning System.

Printed Boards:

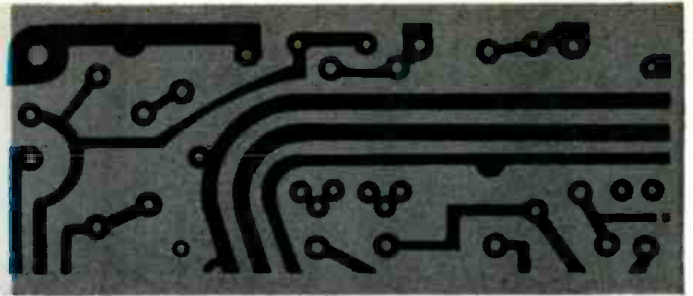

Roadblocks or Road Maps?

Significant changes in these panels may overcome objections by service technicians and set owners.

WHEN THE early outcry against the use of printed boards in TV sets began to gather momentum, proponents of these panels had a conventional answer ready. Any innovation meets resistance at first, and printed wiring was no exception. Increasing familiarity with the board would produce acceptance and the furor would die down. But the furor lasted.

That there were causes for the opposition aside from sheer novelty soon became clear. Witness the stand of a few leading manufacturers who flatly committed themselves to the continued use of hand wiring, at least until the newer technique could be brought to a more satisfactory stage of development.

In favor of printed wiring from the outset has been the accuracy it makes possible in the mass duplication of desired circuits. Out-and-out errors in hand wiring, as well as less obvious but often significant variations introduced by the human factor, could be wiped out. Reduced fabrication costs would be reflected in lower consumer prices—a commendable achievement if quality were not simultaneously impaired. As to arguments against the panels, these were numerous but more difficult to analyze.

Typical of the confusion surrounding the matter is the use of the term "printed circuits" to describe the boards. Strictly speaking, the technique of printing or depositing actual circuit components is not the issue. One form of printed-circuit technique has been in use for some time—even in hand-wired sets—without causing prolonged debate. Single-package networks of components, like vertical-integrating of audio-coupling assemblies, fall into this class. Actually the controversy centers about the replacement of conventional connecting wires by conductive strips that have been plated or otherwise "printed" on non-conductive chassis boards, and also about the secondary changes that this practice has brought in its wake.

However, the error in terminology marks only the beginning of the confusion. There was much doubt as to why

printed wiring was being resisted. Were the drawbacks so inherent in the basic technique that printed wiring should be abandoned, or could they be resolved? To find the answers, the two industry groups most directly concerned with the problem got together. The Institute of Printed Circuits, a non-profit manufacturers' group, joined hands with the National Alliance of Television & Electronic Service Associations in conducting an extensive survey (see "Service Industry News," June, page 129, and July, page 136). The results were fruitful. Although some conclusions had already been reached and some changes were already under way, the survey confirmed or refuted some of the guesses, brought additional facts to light, and accelerated the trend to a new look.

Objections to the boards were based on problems of long-term reliability in use as well as service difficulties. In fact, these two considerations often run together. Most complaints involved the following factors: 1. Board breakage, 2. Lifting of conductors, 3. Mounting of controls, tube sockets, and other components, 4. Component placement on both sides of a board, 5. Accessibility, 6. Circuit tracing, and 7. Component identification. The order of presentation is

Fig. 1. Part of the component side of a G-E printed panel.

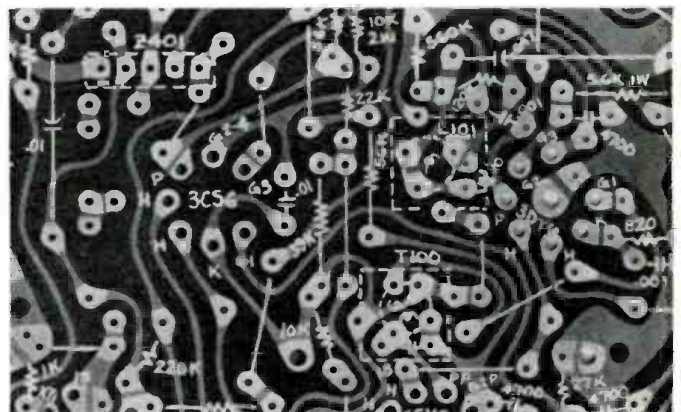
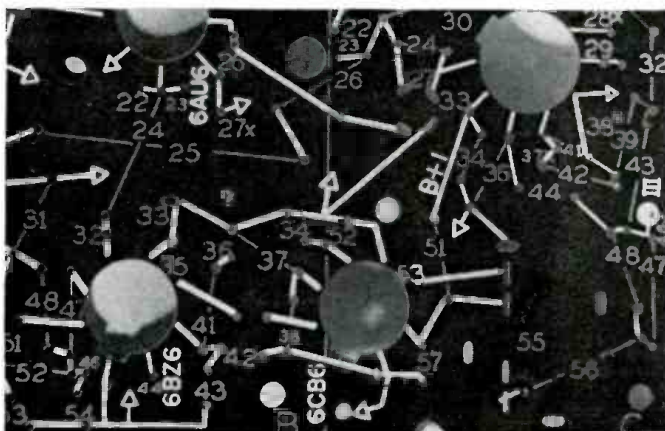

Fig. 2. Westinghouse uses schematic notations for clarity.

the one most convenient for discussion, without regard to relative importance.

Since some of these points may be further subdivided and others overlap each other, we would appear to be left, still, with confusion. However, balancing this out, we find that resolving one of several related problems often automatically takes care of the others. Let's take an example. A tendency to board breakage may be eliminated by strengthening the board itself or by mounting it more securely in the receiver. Whichever approach is used, a complaint that may have been registered under either of two different headings is answered.

Several approaches have been applied to increase board strength. Using improved, stronger base materials, increasing board thickness, re-inforcing the basic compound with

such materials as fiberglass—all have proved to be useful.

Lifting of the conductive strips has been cut back by new plating techniques that provide a better bond to the panel, and also by improved materials for coating the conductive strips that aid in adhesion. Mounting problems involving controls, tube sockets, and the like have been handled by redesigning these items somewhat so that they are lighter and more adaptable to use in printed-wiring techniques. Take the case of the i.f. can in the lower right-hand corner of the G-E board depicted on the cover. It is *plugged* into the panel rather than being soldered. Snap it off and you find that the transformer-detector assembly inside is itself a separate, miniature board that plugs into contacts on the main board. It may be removed for service or replacement without a soldering iron.

As to the mounting of components on both sides of the board, most manufacturers no longer do this. However, as the G-E board just mentioned proves, it is possible to continue the practice, to some extent, while eliminating the problem. All components except tubes are on one side. This makes tube sockets available on the component side for convenience in measuring—but how does one get at the tubes for removal? (We now find ourselves led into the related problem of accessibility.) The answer lies in the way chassis boards are mounted in the receiver. They are placed vertically rather than horizontally. More important, these panels are viewed on edge from the back of the set. Thus either side is equally available.

Another treatment of the accessibility problem is used by *Motorola*. Their first TV set to mark the swing away

from complete hand wiring (see "Innovation in Plated Circuitry," October, page 100) incorporates a main chassis board that sits horizontally at the bottom of the cabinet, much in the manner of a conventional metal chassis. However, since all components are mounted on the top side, accessibility is good without board removal. When removal does become necessary, this is easier to accomplish than with conventional chassis. Securing screws are removed and the board, which is plugged into a series of contacts along its forward edge, is simply slid back. If continuity is desired while the board is out of the cabinet, the long strip of contacts may also be unscrewed and removed with the board. Leads from this contact strip to the rest of the set have been deliberately made long enough to permit this.

The most dramatic changes in new printed-wire panels involve the related factors of component identification and
(Continued on page 142)

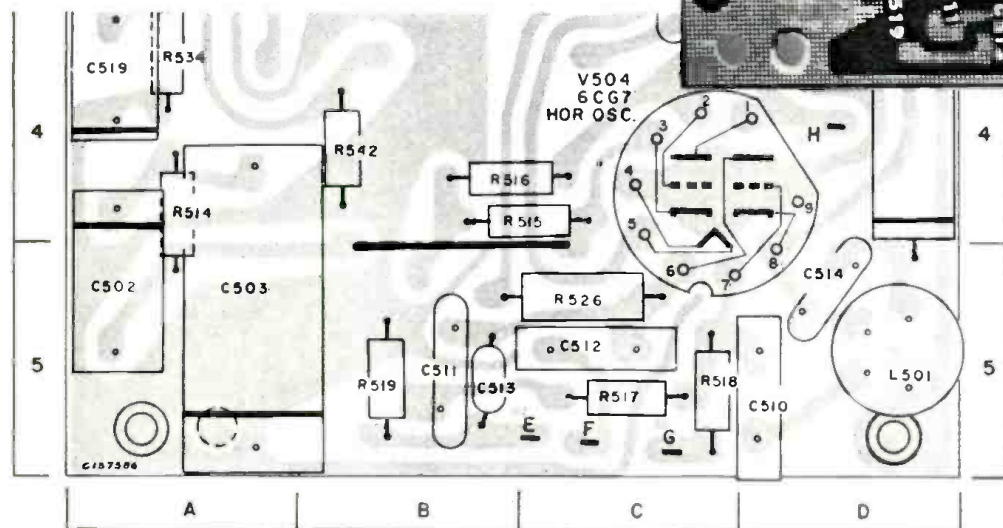

Fig. 3. (Left) Part of a printed-board diagram from the manufacturer's service data, to assist in component location.

Fig. 4. (Above) Part of the component side of an actual RCA board that corresponds to the portion in the diagram of Fig. 3.

IF THE ADAGE, "There are many ways to skin a cat," needs new support, the variety highlighted by the printed-wiring boards on this month's cover could do the job. When the use of these panels in TV receivers began several years ago, it brought with it many service problems. Not the least of these was the difficulty in circuit tracing, which is essential to troubleshooting. Now aware of this obstacle, set makers are moving in the direction of easier component and circuit identification. Although the broad goal is the same, the techniques for achieving it are quite varied.

The Westinghouse board shown at the top of the cover and projecting into the bottom center appears with the wiring (bottom) side up. The green insulating coating highlights all connections made by board wiring. Nonconductive yellow ink is used to identify all tubes, components (including values), and connections found on the reverse (top) of the board. The result is a "built-in" schematic.

On the G-E board, shown running horizontally through the center of the cover, components are also mounted on the top

side of the board except for tubes. However, tube-socket contacts are available at the top for testing. Key points, tube types, and connections are also marked on this side, with plating on the tube side.

The new Motorola board, a portion of which appears at the lower right, has wiring plated on both sides. However, all components are mounted on the top only, and a complete picture of circuit connections is printed on both sides. Here identification and tracing are predicated on a color code based on the EIA code, with combinations of four basic colors used.

Part of the bottom of an RCA board, in the lower left-hand corner, shows what the unadorned wiring looks like after it has been plated on. On the other side of this unit, the wiring pattern has been duplicated faithfully in ink. Also in ink are the identifying numbers of all components, printed next to the top-mounted components themselves. For easy correlation with the service data covering the TV sets, code numbers used on the boards are the same as those on the schematics.

(Cover photo by Bob Loeb)

COVER STORY

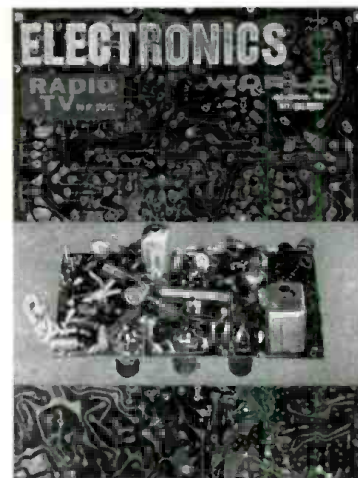

BACK IN THE DAYS just prior to World War I, when women's skirts started to creep above the shoe tops, the owner of a business dealing in dry goods and ready-to-wear dresses vowed he would never handle dresses or patterns that would expose women's ankles to the lecherous gaze of the pool-hall and street-corner habitués. A few years later, still adamant in his opinion that the revealing styles of women's dresses were immoral, he was unable to salvage anything from his bankrupt business.

This merchant, who was successful as long as consumer wants and preferences pleased him, was the prototype of thousands of small retailers and dealers who, since then, have failed because they refused to bow to the dictates of change and to adjust their businesses to conform to its requirements. Just a cursory examination will reveal that the rapid acceptance by the public of innovations in food, drug, and wearing-apparel retailing swept thousands of die-hard dealers out of business. These were the men who refused to join in the march of progress

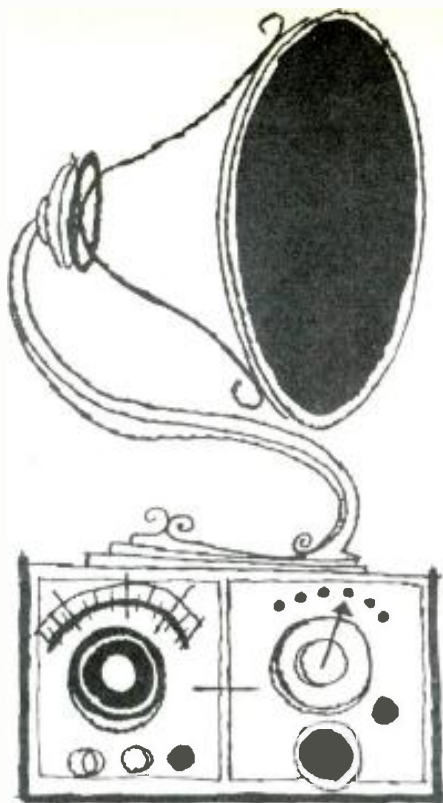

tributed substantially to the breakdown of vertical retailing. The main product consideration now in either type of store is not its type, but whether the product will sell in sufficient volume to warrant the capital investment and the space required to handle it.

Now take a brief look at the changes that have taken place in the business of servicing TV sets. Large service contractors handled the bulk of the business during the early boom days of the industry. These businesses folded up rapidly when contract service was abandoned and set owners were left to their own devices to get the service they required. This shifted the business into the hands of thousands of small dealers and paved the way for hundreds of TV technicians to establish their own businesses.

Records indicate that, for a period of several years, eighty per-cent of the TV service calls could be completed in the home by replacing burned out or ineffective tubes. Dealers enjoyed profit on the tubes they sold plus the charge for the service call. But set

Is Your Business Geared for Change?

By **WILLIAM LEONARD**

Your ability to stay alive depends on continuous adaptation to factors you do not yourself control.

or, at any rate, the march of change.

The fast-moving pace of modern business will not tolerate laggards. To stay in the race, owners of small businesses must be alert opportunists, ready to take advantage of every new product or service that will add volume and profit to their businesses.

The trend of modern business concerned with the general public is a steady shift away from product specialization. The rapid public acceptance of the "service club" idea is a straw in the wind. Across-the-board service on any product used in the home has a strong consumer appeal because it meets a definite need.

Consider the drug business. There was a time when the filling of prescriptions was the most important factor in drug-store operation. Today, in modern drug stores, the prescription department is usually located in an obscure corner. The do-it-yourself tube tester is probably situated where a customer can spot it quickly when he comes in the front door. Service dealers may not approve of its presence there but, to the drug-store owner, it is just one of the thousands of items that help provide the income to keep his store in operation.

Is it unethical or "immoral" for a drug store to sell electronic tubes? A druggist feels no moral responsibility if some customer takes a lethal overdose of aspirin tablets purchased at his store. Neither is he inclined to throw out his cigarette counter because some authorities claim heavy

smoking is a contributing factor in the increase of lung cancer. So why should he be concerned when Joe Public, electing to fix his own TV set, messes it up with tubes purchased at his store?

In view of the fact that the majority of TV service shops leaned heavily on the income from their tube sales to take care of their operating expenses, it is understandable that they would be deeply concerned over the loss of this business to non-electronic retail establishments. Under the most favorable circumstances, it is very difficult to sell time and labor at a profit. The average charge for a home service call is barely enough to pay for the time involved and the transportation, without contributing anything toward the shop overhead and operating expenses. Because of that, a substantial part of the service dealer's income must come from the sale of components, tubes, or other products. Since it is apparent that the trend toward self-servicing of TV sets will continue, and set owners will buy tubes wherever it is most convenient at the time they want them, dealers must re-orient their methods of operation and handle products that will provide income to compensate for the loss of tube sales.

In the early days of the revolution in retailing, druggists were up in arms when grocery stores started handling packaged drugs, hair tonics, and other items that had been considered essentially drug-store products. Since then the transition in the philosophy of drug-store merchandising has con-

owners took a dim view of a situation where they had to pay from eight to fifteen dollars for service that required only a few minutes to perform and needed only the replacement of a tube or two. This is what paved the way for the do-it-yourself tube testers.

Now the service industry is faced with a tightening market and a trend toward lower income per service call. What can the average dealer do under these conditions to maintain his establishment as a business that will continue to provide worthwhile income?

A number of opportunities are open to him. The one which is best for a particular business can be determined only on the basis of the local conditions and circumstances peculiar to the individual shop and its owner. The most important factors are the shop location, available display and selling area, the basic motivation of the dealer, and the capital available for change and possible expansion.

The simplest and easiest move for a TV service dealer to make is to shift part of the business emphasis into some other type of electronic products. For instance, the sale of high-fidelity components, stereo units, and stereo conversions are naturals for any electronic service shop. However, in order to take full advantage of the growing opportunities in the audio field, the dealer must do a top-flight promotion job to identify his business with these products.

Marching along hand-in-hand with
(Continued on page 136)

RADIO AMATEUR PREFIXES

CALL	LOCATION
AC3	Sikkim
AC4	Tibet
AC5	Bhutan
AP2	Pakistan
BV (C3)	Formosa
C (unofficial)	China
C9	Manchuria
CE	Chile
CE	Juan Fernandez
CE0	Easter Island
CM, CO	Cuba
CN2	Tangier
CN8	Morocco
CP	Bolivia
CR4	Cape Verde Islands
CR5	Portuguese Guinea
CR5	Principe, Sao Thome
CR6	Angola
CR7	Mozambique
CR8	Goa
CR9	Macao
CR10	Portuguese Timor
CT1	Portugal
CT2	Azores
CT3	Madeira Islands
CX	Uruguay
DJ, DL, DM	Germany
DU	Philippines
EA	Spain
EA6	Balearic Islands
EA8	Canary Islands
EA9	Ibni
EA9	Rio de Oro
EA9	Spanish Morocco
EA0	Spanish Guinea
EI	Republic of Ireland
EL	Liberia
EQ	Iran
ET2	Eritrea
ET3	Ethiopia
F	France
FA	Algeria
FB8	Amsterdam & St. Paul Islands
FB8	Comoro Islands
FB8	Kerguelen Islands
FB8	Madagascar
FB8	Tromelin Island
FC (unofficial)	Corsica
FD	Togo
FE8	French Camerouns
FF8	French West Africa
FG7	Guadeloupe
FI8	French Indo-China
FK8	New Caledonia
FL8	French Somaliland
FM7	Martinique
FN2	French India
FO8	Clipperton Island
FO8	French Oceania
FP8	St. Pierre & Miquelon Islands
FQ8	French Equatorial Africa
FR7	Reunion Island
FS7	Saint Martin
FU8, YJ1	New Hebrides
FW8	Wallis & Futuna Islands
G	England
GC	Channel Islands
GD	Isle of Man
G1	Northern Ireland
GM	Scotland
GW	Wales
HA	Hungary
HB	Switzerland
HC	Ecuador
HC8	Galapagos Islands
HE	Liechtenstein
HH	Haiti
HI	Dominican Republic
HK	Columbia
HK0	Archipelago of San Andres & Providencia
HL	Korea
HP	Panama
HR	Honduras
HS	Thailand
HV	Vatican
HZ	Saudi Arabia
II, IT1, IP1	Italy
II	Trieste
I5	Italian Somaliland
IS1	Sardinia
JA, KA	Japan
JT1	Mongolia
JY	Jordan
JZ0	Netherlands New Guinea
K, W	United States of America
KA0, KG6I	Bonin & Volcano Islands
KB6	Baker, Howland & American Phoenix Islands
KC4	Navassa Island
KC6	Eastern Caroline Islands

CALL	LOCATION
KC6	Western Caroline Islands
KG4	Guantanamo Bay
KG6	Mariana Islands
KH6	Hawaiian Islands
KJ6	Johnston Island
KL7	Alaska
KM6	Midway Islands
KP4	Puerto Rico
KP6	Palmyra Group, Jarvis Island
KR6	Ryuku Islands
KS4	Swan Islands
KS4	Rancador Cay & Serrana Bank
KS6	American Samoa
KV4	Virgin Islands
KW6	Wake Island
KX6	Marshall Islands
KZ5	Canal Zone
LA	Jan Mayen
LA	Norway
LA	Svalbard
LU	Argentina
LX	Luxembourg
LZ	Bulgaria
M1	San Marino
MP4	Bahrein
MP4	Qatar
MP4	Trucial Oman
OA	Peru
OD5	Lebanon
OE	Austria
OH	Finland
OH0	Aland Islands
OK	Czechoslovakia
ON4	Belgium
OQ5, OQ0	Belgian Congo
OX, KG1	Greenland
OY	Faeroes
OZ	Denmark
PA0, P11	Netherlands
PJ	Netherlands West Indies
PJ2M	Sint Maarten
PK1, PK2, PK3	Java
PK4	Sumatra
PK5	Netherlands Borneo
PK6	Celebes & Molucca Islands
PX	Andorra
PY	Brazil
PY0	Fernando de Noronha
PY0	Trindade & Vaz Island
PZ1	Netherlands Guiana
SL, SM	Sweden
SP	Poland
ST2	Sudan
SU	Egypt
SV	Crete
SV	Dodecanese
SV	Greece
TA	Turkey
TF	Iceland
TG	Guatemala
TI	Costa Rica
TI9	Cocos Island
UA1, 2, 3, 4, 6,	European Russian Socialist Federated Soviet Republic
UA1	Franz Josef Land
UA9, UA0	Asiatic Russian S.F.S.R.
UA0	Wrangel Island
UB5	White Russian S.S.R.
UD6	Azerbaijan
UF6	Georgia
UG6	Armenia
UH8	Turkoman
UI8	Uzbek
UJ8	Tadzhik
UL7	Kazakh
UM8	Kirghiz
UN1	Karelo-Finnish Republic
UO5	Moldavia
UP2	Lithuania
UQ2	Latvia
UR2	Estonia
VE, VO	Canada
VK	Australia
VK	Tasmania
VK	Lord Howe Island
VK9	Cocos Island
VK9	Nauru Island
VK9	Norfolk Island
VK9	Papua Territory
VK9	Territory of New Guinea
VK0	Heard Island
VK0	Macquarie Island
VP1	British Honduras
VP2	Anguilla
VP2	Antigua, Barbuda
VP2	British Virgin Islands
VP2	Dominica
VP2	Grenada & Dependencies
VP2	Montserrat
VP2	St. Kitts, Nevis
VP2	St. Lucia

CALL	LOCATION
VP2	St. Vincent & Dependencies
VP3	British Guiana
VP4	Trinidad & Tobago
VP5	Cayman Islands
VP5	Jamaica
VP5	Turks & Caicos Islands
VP6	Barbados
VP7	Bahama Islands
VP8	Falkland Islands
VP8, LU-Z	South Georgia
VP8, LU-Z	South Orkney Islands
VP8, LU-Z	South Sandwich Islands
VP8, LU-Z	South Shetland Islands
VP9	Bermuda Islands
VQ1	Zanzibar
VQ2	Northern Rhodesia
VQ3	Tanganyika Territory
VQ4	Kenya
VQ5	Uganda
VQ6	British Somaliland
VQ8	Chagos Islands
VQ8	Maritius
VQ8	Rodriguez Island
VQ9	Seychelles
VR1	British Phoenix Islands
VR1	Gilbert, Ellice Islands & Ocean Island
VR2	Fiji Islands
VR3	Fanning & Christmas Islands
VR4	Solomon Islands
VR5	Tonga Islands
VR6	Pitcairn Island
VS1	Singapore
VS2	See 9M2
VS4	Sarawak
VS5	Brunei
VS6	Hong Kong
VS9	Aden & Socotra
VS9	Maldiva Islands
VS9	Sultanate of Oman
VU2	India
VU4	Laccadive Islands
VU5	Andaman & Nicobar Islands
XE, XF	Mexico
XE4	Revilla Gigedo
XV5	Cambodia
XW8	Laos
XZ2	Burma
YA	Afghanistan
YI	Iraq
YK	Syria
YN, YN0	Nicaragua
YO	Roumania
YS	Salvador
YU	Yugoslavia
YV	Venezuela
YV0	Aves Island
ZA	Albania
ZB1	Malta
ZB2	Gibraltar
ZC3	Christmas Island
ZC4	Cyprus
ZC5	British North Borneo
ZC6	Palestine
ZD1	Sierra Leone
ZD2	Nigeria
ZD3	Gambia
ZD4	Gold Coast, Togoland
ZD6	Nyasaland
ZD7	St. Helena
ZD8	Ascension Island
ZD9	Tristan da Cunha & Gough Island
ZE	Southern Rhodesia
ZK1	Cook & Manihiki Islands
ZK2	Niue
ZL	Chatham Islands
ZL	New Zealand
ZL1	Kermadec Islands
ZM6	British Samoa
ZM7	Tokelau
ZP	Paraguay
ZS1, 2, 4, 5, 6	Union of South Africa
ZS2	Prince Edward & Marion Island
ZS3	Southwest Africa
ZS7	Swaziland
ZS8	Basutoland
ZS9	Bechuanaland
3A	Monaco
3V8	Tunisia
3W8	Vietnam
4S7	Ceylon
4W1	Yemen
4X4	Israel
5A	Libya
9G1, ZD4	Ghana
9K2	Kuwait
9M2	Malaya
9N	Nepal
9S4	Saar

OFFICIAL A.R.R.L. COUNTRIES LIST
Courtesy of American Radio Relay League

Great circle chart

ELECTRONICS 
WORLD

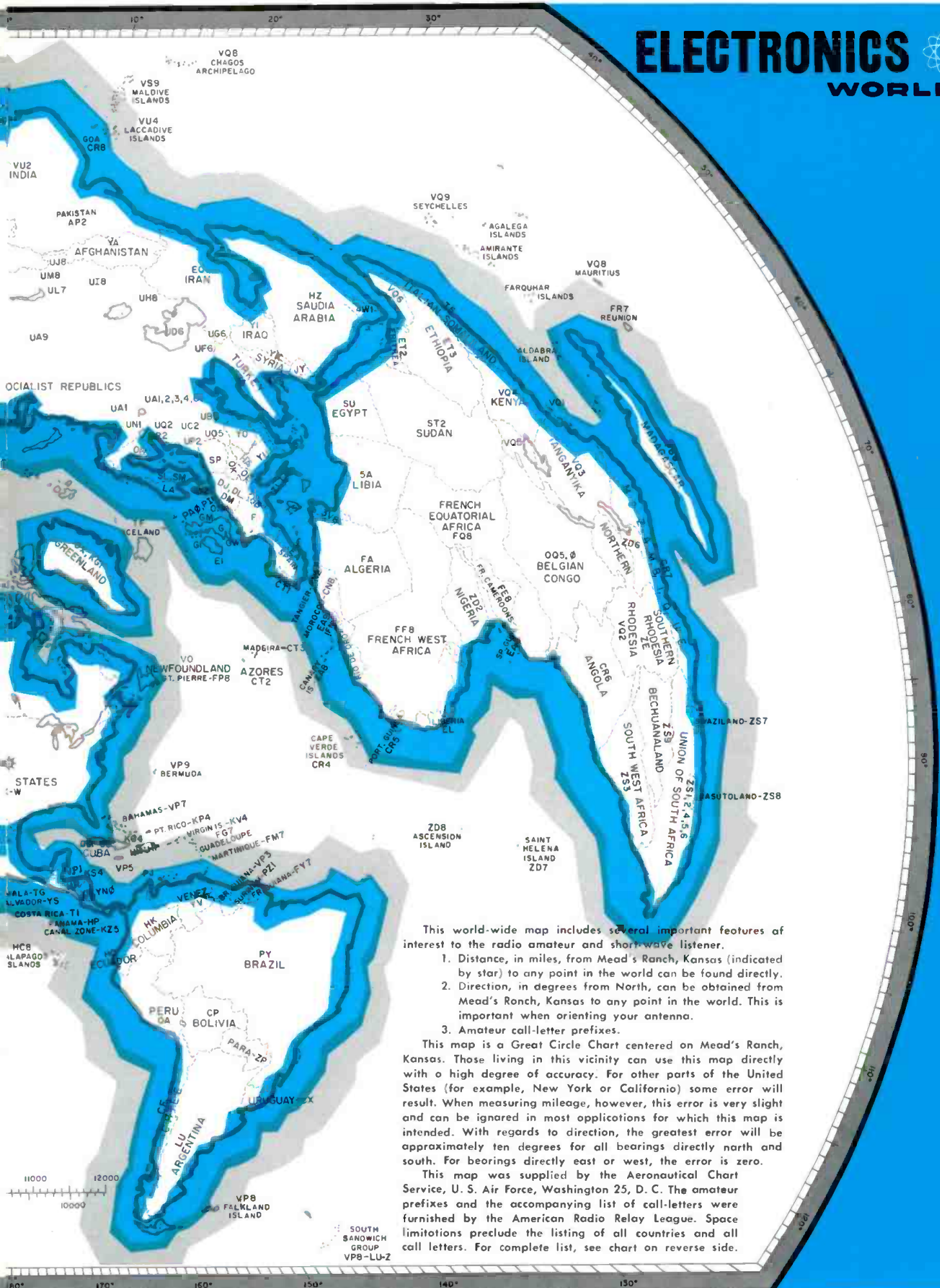

This world-wide map includes several important features of interest to the radio amateur and short-wave listener.

1. Distance, in miles, from Mead's Ranch, Kansas (indicated by star) to any point in the world can be found directly.
2. Direction, in degrees from North, can be obtained from Mead's Ranch, Kansas to any point in the world. This is important when orienting your antenna.
3. Amateur call-letter prefixes.

This map is a Great Circle Chart centered on Mead's Ranch, Kansas. Those living in this vicinity can use this map directly with a high degree of accuracy. For other parts of the United States (for example, New York or California) some error will result. When measuring mileage, however, this error is very slight and can be ignored in most applications for which this map is intended. With regards to direction, the greatest error will be approximately ten degrees for all bearings directly north and south. For bearings directly east or west, the error is zero.

This map was supplied by the Aeronautical Chart Service, U. S. Air Force, Washington 25, D. C. The amateur prefixes and the accompanying list of call-letters were furnished by the American Radio Relay League. Space limitations preclude the listing of all countries and all call letters. For complete list, see chart on reverse side.

Alphabetical Listing of Countries with Prefixes

CALL	LOCATION	CALL	LOCATION	CALL	LOCATION
VS9	Aden & Socotra	VP2	Grenada & Dependencies	VR6	Pitcairn Island
YA	Afghanistan	FG7	Guadeloupe	SP	Poland
OH0	Aland Islands	KG4	Guantanamo Bay	CT1	Portugal
KL7	Alaska	TG	Guatemala	ZS2	Prince Edward & Marion Island
ZA	Albania	VP3	Guiana, British	CR5	Principe, Sao Thome
FA	Algeria	PZ1	Guiana, Netherlands	KP4	Puerto Rico
FB8	Amsterdam & St. Paul Islands	CR5	Guinea, Portuguese		
VU5	Andaman & Nicobar Islands	EA0	Guinea, Spanish	MP4	Qatar
PX	Andorra			K54	Rancador Cay & Serrana Bank
CR6	Angola	HH	Haiti	FR7	Reunion Island
VP2	Anguilla	KH6	Hawaiian Islands	XE4	Revilla Gigeo
VP2	Antigua, Barbuda	VK0	Heard Islands	VQ2	Rhodesia, Northern
LU	Argentina	HR	Honduras	ZE	Rhodesia, Southern
UG6	Armenia	VP1	Honduras, British	EA9	Rio de Oro
ZD8	Ascension Island	VS6	Hong Kong	VQ8	Rodriguez Island
VK	Australia	HA	Hungary	YO	Roumania
OE	Austria			UA9, UA0	Russian S.F.S.R., Asiatic
YV0	Aves Island	TF	Iceland	UA1, 2, 3, 4, 6	Russian S.F.S.R., European
UD6	Azerbaijan	EA9	Iran	UB5	Russian S.S.R., White
CT2	Azores	VU2	India	KR6	Ryukyu Islands
		FN2	India, French		
VP7	Bahama Islands	FI8	Indo-China, French	9S4	Saar
MP4	Bahrein	EQ	Iran	FS7	Saint Martin
KB6	Baker, Howland & American Phoenix Islands	GI	Ireland, Northern	YS	Salvador
		EI	Ireland, Republic of	K56	Samoa, American
EA6	Balearic Islands	YI	Iraq	ZM6	Samoa, British
VP6	Barbados	GD	Isle of Man	HK0	San Andres, Archipelago of & Providencia
ZS8	Basutoland	4X4	Israel	VP8, LU-Z	Sandwich Islands, South
ZS9	Bechuanaland	11, IT1, IP1	Italy	M1	San Marino
ON4	Belgium			VS4	Sarawak
VP9	Bermuda Islands	VP5	Jamaica	IS1	Sardinia
AC5	Bhutan	LA	Jan Mayen	HZ	Saudi Arabia
CP	Bolivia	JA, KA	Japan	GM	Scotland
KAO, KG61	Bonin & Volcano Islands	PK1, PK2, PK3	Java	VQ9	Seychelles
ZC5	Borneo, British North	KJ6	Johnston Island	VP8, LU-Z	Shetland islands, South
PK5	Borneo, Netherlands	JY	Jordan	ZD1	Sierra Leone
PY	Brazil	CE	Juan Fernandez	AC3	Sikkim
VS5	Brunei	UN1	Karelo-Finnish Republic	VS1	Singapore
LZ	Bulgaria	UL7	Kazakh	PJ2M	Sint Maarten
XZ2	Burma	VQ4	Kenya	VR4	Solomon Islands
		FB8	Kerguelen Islands	VQ6	Somaland, British
FE8	Cameroons, French	ZL1	Kermadec Islands	FL8	Somaland, French
XV5	Cambodia	UM8	Kirghiz	I5	Somaland, Italian
VE, VO	Canada	HL	Korea	ZS3	Southwest Africa
KZ5	Canal Zone	9K2	Kuwait	EA	Spain
EA8	Canary Islands			ZD7	St. Helena
CR4	Cape Verde Islands	VU4	Laccadive Islands	VP2	St. Kitts, Nevis
KC6	Caroline Islands, Eastern	XW8	Laos	FP8	St. Pierre & Miquelon Islands
KC6	Caroline Islands, Western	UQ2	Latvia	VP2	St. Vincent & Dependencies
VP5	Cayman Islands	OD5	Lebanon	ST2	Sudan
PK6	Celebes & Molucca Islands	EL	Liberia	PK4	Sumatra
4S7	Ceylon	5A	Libya	LA	Svalbard
VQ8	Chagos Islands	HE	Liechtenstein	KS4	Swan Islands
GC	Channel Islands	UP2	Lithuania	ZS7	Swaziland
ZL	Chatham Islands	VK	Lord Howe Island	SL, SM	Sweden
CE	Chile	LX	Luxembourg	HB	Switzerland
C (unofficial)	China			YK	Syria
ZC3	Christmas Island	CR9	Macao		
FO8	Clipperton Island	VK0	Macquarie Island	UJ8	Tadzhik
T19, VK9	Cocos Islands	FB8	Madagascar	VQ3	Tanganyika Territory
HK	Colombia	CT3	Madeira Islands	CN2	Tangier
FB8	Comoro Islands	VS2, 9M2	Malaya	VK	Tasmania
OQ5, OQ0	Conqo, Belgian	V59	Maldives Islands	HS	Thailand
ZK1	Cook & Manihiki Islands	ZB1	Malta	AC4	Tibet
FC (unofficial)	Corsica	C9	Manchuria	CR10	Timor, Portuguese
TI	Costa Rica	KG6	Mariana Islands	FD	Togo
SV	Crete	KX6	Marshall Islands	ZM7	Tokelaus
CM, CO	Cuba	FM7	Martinique	CR5	Tonga Islands
ZC4	Cyprus	VQ8	Mauritius	11	Trieste
OK	Czechoslovakia	XE, XF	Mexico	PY0	Trinidad & Vaz Island
		KM6	Midway Islands	VP4	Trinidad & Tobago
OZ	Denmark	UO5	Moldavia	ZD9	Tristan de Cunha & Gough Island
SV	Dodecanese	JT1	Mongolia	FB8	Tromelin Island
VP2	Dominica	3A	Monaco	MP4	Trucial Oman
HI	Dominican Republic	VP2	Montserrat	3V8	Tunisia
		CN8	Morocco	TA	Turkey
CE0	Easter Island	EA9	Morocco, Spanish	UH8	Turkoman
HC	Ecuador	CR7	Mozambique	VP5	Turks & Caicos Islands
SU	Egypt				
G	England	VK9	Nauru Island	VQ5	Uganda
FQ8	Equatorial Africa, French	KC4	Navassa Island	ZS1, 2, 4, 5, 6	Union of South Africa
ET2	Eritrea	9N	Nepal	K, W	United States of America
UR2	Estonia	PA0, PI1	Netherlands	CX	Uruguay
ET3	Ethiopia	FK8	New Caledonia	UI8	Uzbek
		VK9	New Guinea, Territory of		
OY	Faeroes	IJ0	New Guinea, Netherlands	HV	Vatican
VP8	Falkland Islands	FU8, YJ1	New Hebrides	YV	Venezuela
VR3	Fanning & Christmas Islands	ZL	New Zealand	3W8	Vietnam
PY0	Fernando de Noronha	YN, YN0	Nicaragua	KV4	Virgin Islands
VR2	Fiji Islands	ZD2	Nigeria	VP2	Virgin Islands, British
OH	Finland	ZK2	Niue		
BV (C3)	Formosa	VK9	Norfolk Island	KW6	Wake Island
F	France	LA	Norway	GW	Wales
UA1	Franz Josef Land	ZD6	Nyasaland	FW8	Wallis & Futuna Islands
				FF8	West Africa, French
HC8	Galapagos Islands	FO8	Oceania, French	PJ	West Indies, Netherlands
ZD3	Gambia	VS9	Oman, Sultanate of	UA0	Wrangal Island
UF6	Georgia	VP8, LU-Z	Orkney Islands, South		
VP8, LU-Z	Georgia, South	AP2	Pakistan	4W1	Yemen
DJ, DL, DM	Germany	ZC6	Palestine	YU	Yugoslavia
9G1, ZD4	Ghana	KP6	Palmyra Group, Jarvis Island		
ZB2	Gibraltar	HP	Panama	VQ1	Zanzibar
VR1	Gilbert, Ellice Islands & Ocean Island	VK9	Papua Territory		
		ZP	Paraguay		
CR8	Goa	OA	Peru		
ZD4	Gold Coast, Togoland	DU	Philippines		
SV	Greece	VR1	Phoenix Islands, British		
OX, KG1	Greenland				

OFFICIAL A.R.R.L. COUNTRIES LIST
Courtesy of American Radio Relay League



Subdivided Hi-Fi Speaker Enclosure

By **D. F. REHBERGER**

Physics Dept., Univ. of Penna.

Complete construction details on unusual "infinite baffle" employing inexpensive speakers, based on a British design.

A GREAT deal of design and experimental manpower has been, and is being, expended in the improvement of low-frequency response in a given area—particularly with regards to cost. Considering size and price, most speaker-baffle combinations result in a compromise, with the low-frequency response below 500 cycles suffering. The major cause of poor low-frequency response, and one often overlooked in enclosure designs, is failure to remove low-frequency standing-wave effects from within the cabinet. Size and cost are limiting factors in conventional designs, as they usually go hand-in-hand so that the resulting system is either large or expensive, or both, without possessing the desired performance characteristics. Realistic reproduction is, of course, the prime concern but this can only be obtained after the basic problems of standing-wave effects and panel resonances are solved.

The purpose of the design to be discussed is to solve the major problems of enclosing a speaker in a baffle so that it produces good results, without the need for gimmicks or novelties. The design, basically a completely closed box or so-called infinite baffle, utilizes subdivisions as an acoustic filter, resulting in extremely good performance at a cost far less than the price normally paid for an enclosure to be used in the usual high-fidelity system. The size, too, has been reduced, being only 10-inches deep by 24-inches high.

The cabinet encloses a volume of air

that is compressed and rarefied with the cone movement. This causes the bass-resonant frequency of the speaker to rise, due to the interaction of the speaker's resonant frequency with the resonant frequency of the air column. Besides the "air-column resonance," the reflective properties of the inside walls create standing waves at all but the high frequencies. Standing-wave effects with loudspeakers would be analogous to the standing-wave principle with transmission lines. Where there is no reflection from the load, in this case the interior of the cabinet, the sound waves would decrease exponentially toward the load. However, when the load reflects back part of the incident energy, it combines with the direct energy and varies, as to amplitude, periodically along the distance. This results in nodes (nulls) and antinodes (peaks). At a certain frequency and distance, with the rear of the cone located near an antinode, the output would be reduced by a large amount. The action of nodes and antinodes results in uneven response from the front of the cone and is attributed to standing-wave effects.

The reflecting sound waves (standing-wave effects) within the enclosure can be eliminated at all frequencies above about 500 cps by use of sound absorbing material within the cabinet. Below this frequency the standing waves cannot be eliminated successfully without some type of acoustic filter.

Panel resonances tend to color the program and produce nodding if not constructed with extremely rigid panels. Good speaker enclosures of conventional design must be heavy and properly reinforced, with some being sand-filled or built with brick or reinforced concrete. Such a rigid cabinet would improve the transient response of the system, thereby resulting in a much cleaner output sound.

One of the early designs incorporating effective damping of standing waves was presented by D.E.L. Shorter of the *BBC* and consisted of subdividing partitions inside the cabinet (British Patent No. 696,671).¹ He states that the principle of subdivision may be achieved in various ways and the enclosure would have to be divided into many small sections, each of which would be unable to support standing waves at the low-frequency end. To prevent any reflecting-wave effects at higher frequencies, he suggests the use of sound absorbing material placed over two or more compartments around the back of the speaker. This prevents the cabinet from receiving any sound at high frequencies and eliminates the need for further acoustic treatment.

Of the many possibilities, the method used to subdivide the cabinet involved mounting radial partitions around the rear of the speaker. This not only accomplishes the necessary subdivision of the cabinet but also provides extremely rigid construction, re-

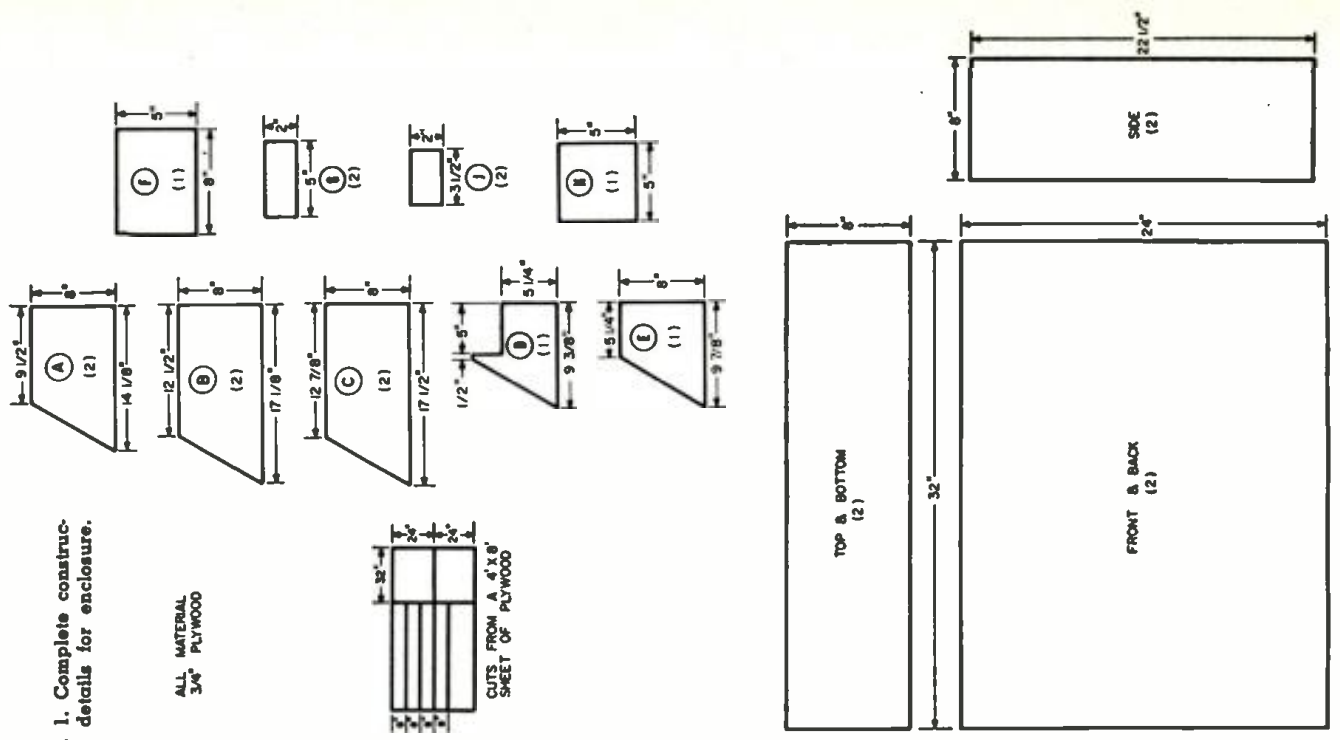
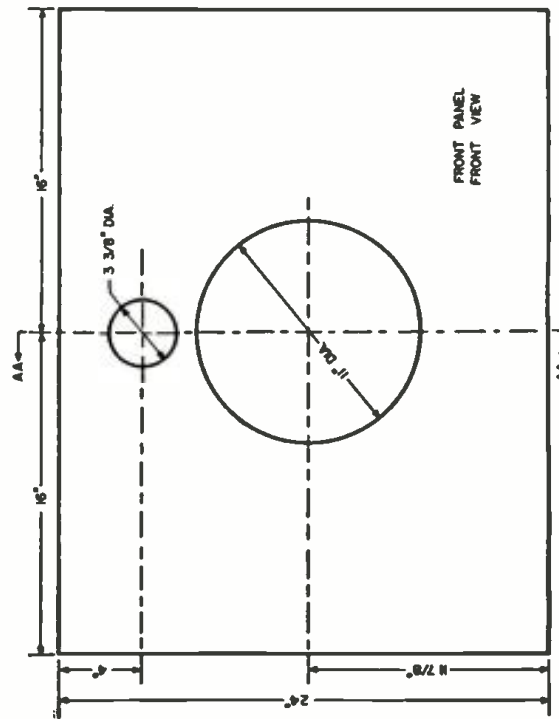
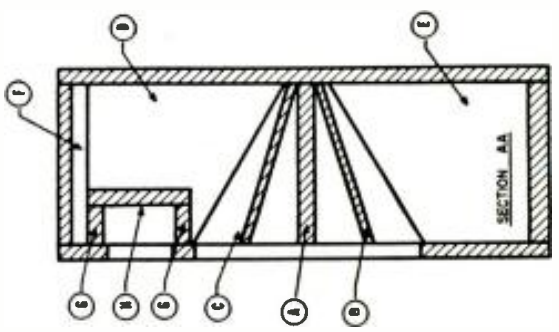
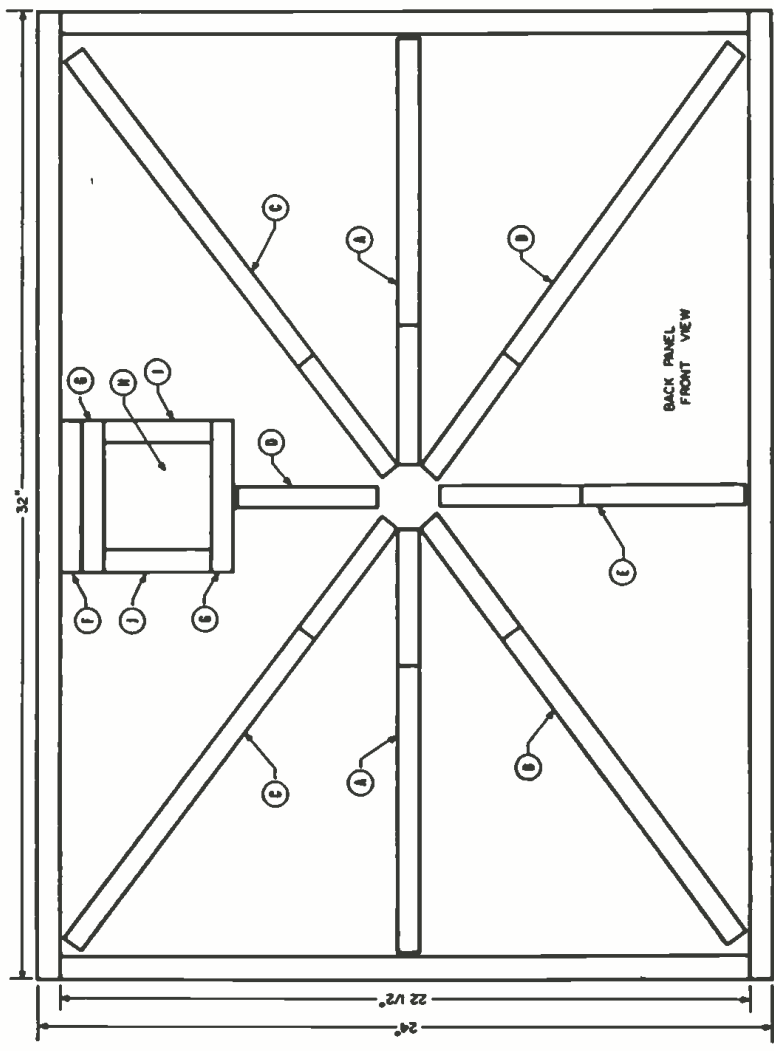

Fig. 1. Complete construction details for enclosure.

ALL MATERIAL
3/4" PLYWOOD





Front-panel view with speakers mounted, prior to being covered.

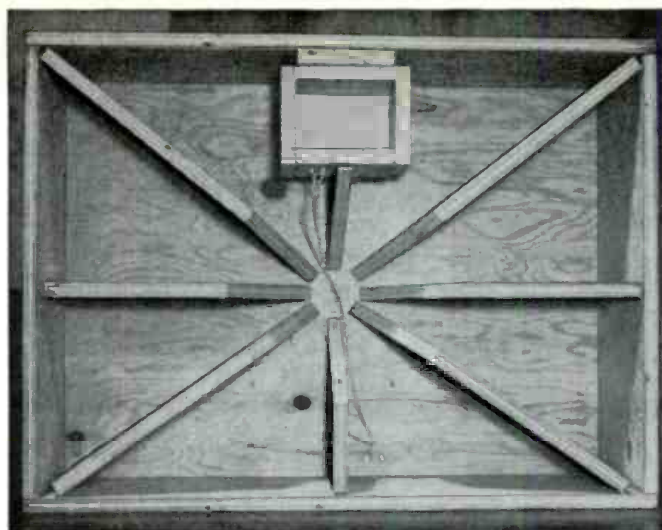

Front view of the back panel with the dividing partitions shown.

ducing the resonances of the panels.

The cone of the speaker used was treated, as suggested by Mr. Shorter, to obtain a reduction in the speaker's bass-resonant frequency by providing a freer suspension. The first model tested with the recommended speaker did not show any peaks below 1000 cps and it was felt that resonances were eliminated to a point where no further experimentation was necessary.

To obtain good, smooth response throughout the required range, without audible peaks or dips, the choice of speakers becomes fairly critical. Of the many 12-inch speakers tried, the *Jensen P-12-P*, which nets for about \$17.00, was found to be most satisfactory with this enclosure. The tweeter is not as critical as the low-frequency unit but must have a smooth output without cone break-up and a level that matches the *P-12-P*. The *Jensen P-35-VH*, which costs about \$4.00, matches the *P-12-P* and helps to provide the results obtained in the response curve of Fig. 2A. A simple high-pass filter is used, consisting of a 1- μ f. capacitor in

series with the tweeter, which makes up the "crossover network."

Treating the Woofer

A method of lowering the bass-resonant frequency can be applied to any large cone speaker that is not already treated (viscous edge damping) and

provides a marked improvement. The cone edge, and only the edge, is impregnated with a hygroscopic material which will retain moisture in the cone edge and keep it more compliant. This results in a freer suspension and a lower bass-resonant frequency.

The cone edge is first treated with a wetting agent which provides a rapid path for the penetration of the hygroscopic material. The most convenient wetting agent is *Kodak "Photo-Flo,"* available in four-ounce bottles at photographic supply houses. For use, dilute a bottle-cap-full of "Photo-Flo" in eight ounces of water (or 1-100 solution).

While the cone edge is still wet apply the hygroscopic solution. This is a saturated solution of calcium chloride (silica gel). The solution is made by dissolving as much calcium chloride as possible in about four ounces of water at room temperature. Allow the mixture to set a day and if none of the crystals has settled out of solution, dissolve more calcium chloride. A one-

(Continued on page 112)



The method of making the seal required for the woofer is illustrated above.

The placement of the sound-absorption material may be seen through woofer hole.

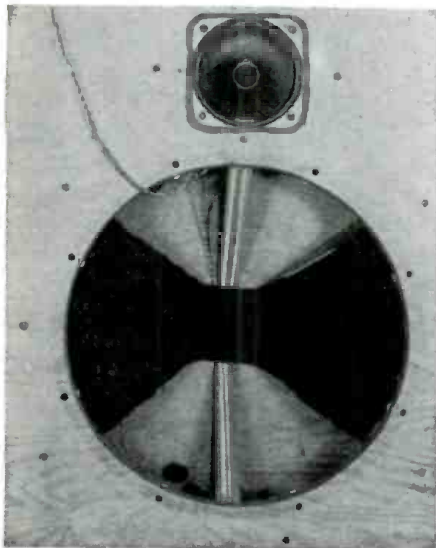
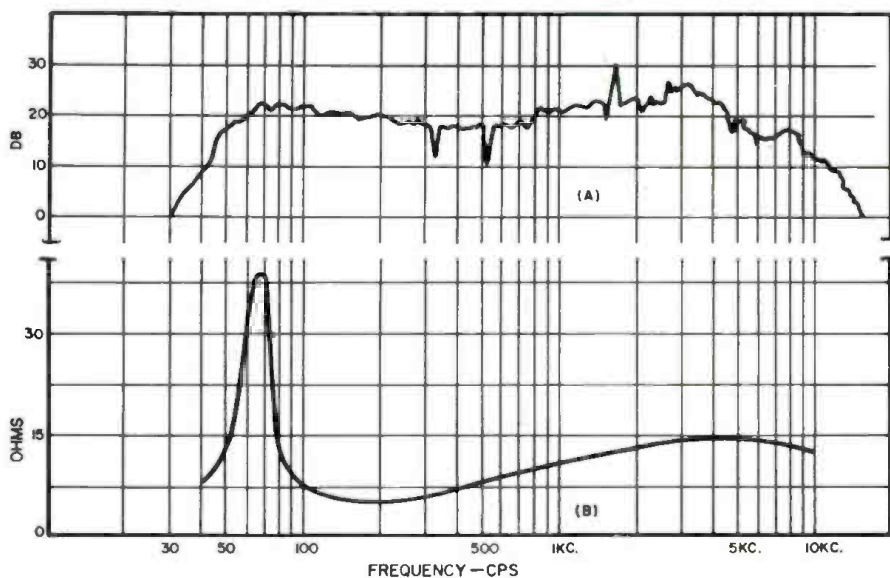

Fig. 2. (A) Acoustic output and (B) impedance curve of the speaker system described.



Citizens Band Transceiver Kit



Tunable superregen receiver combined with single-channel 5-w. transmitter.

The Heath CB-1 is available either in kit form at \$42.95 or wired at \$60.95.

It was not too long ago that your editor received his Class D Citizens Band station license and we are now operating with the call 1W1542 out of Connecticut. Our plans involve using this equipment for personal applications, but, at the same time, we will take the opportunity of checking out various pieces of Citizens Band equipment. It took the FCC sixty-five days to process our application, which is not too bad considering the large number of Citizens Band and other service applications received.

There are quite a few companies planning to market equipment designed for Class D operation and all of them are working under crash programs to complete their designs. By the time this issue is published anyone interested in this type of operation should have a wide selection of equipment from which to choose.

One of the earliest designs to hit the market is the *Heath Company's* Model CB-1. This is the first unit we have been able to check and it gave us an opportunity to put our newly acquired license to use.

The circuit of the *Heath* unit is almost identical to the one published in our March, 1959 issue ("Build This Citizens Band Transceiver" by Don Stoner). This one created quite a stir, not only among our own readers but also in the entire industry. The *Heath* unit employs a different power supply and some other minor circuit changes. The CB-1 is a transceiver, combining both the transmitter and the receiver in a single package and using some of the same circuits for both transmitting and receiving. It is self-powered for 117-volt operation but an external adapter can be obtained from *Heath* to convert the unit to 6- or 12-volt battery operation. (See circuit on facing page.)

The transmitter section, which is crystal-controlled in accordance with FCC requirements, is designed around

EDITOR'S NOTE: *Almost too late—but just hours before we go to press—we found time to make further tests. We mounted one of Heath's units in our boat and with the standard mobile-type, quarter-wave whip antenna, we extended our range of coverage from Stamford, Conn. to the shores of Long Island, giving us a total distance of ten miles. Seven miles of this was across water and actual reception improved as we crossed Long Island Sound. Even at the ten-mile limit, the performance was exceptionally good, indicating that even greater distances can be covered with this equipment.*

a single tube, a 6AU8. The receiver is of the superregenerative type which does have some limitations when compared to a superheterodyne but it has the one great advantage of providing high sensitivity by means of a very simple circuit. Basically *Heath's* design is about as simple as can be had. All the frills, such as squelch circuits and push-to-talk microphone operation, have been omitted in order to keep the cost as low as possible.

The actual construction of the kits turned out to be extremely simple. One of the units was built by a 15-year-old boy who completed the construction in about twelve hours, including the entire tuning procedure, using a dummy load.

One problem that did come up, which we believe is inherent in most Citizens Band units available today, is that even if perfect adjustment is achieved when using a dummy load (either pilot lamp or resistive type), the adjustments may be thrown off when an antenna is connected. Obviously the dummy load is not an exact equivalent circuit. We have talked to several manufacturers regarding this problem and there seems to be no simple solution. Some manufacturers are advising their customers to perform transmitter adjustment procedures while on the air. This, of course, is against FCC regulations at the present time if such adjustments cause "improper operation." We have

heard, though, that the FCC is considering permitting on-the-air adjustments on commercially built or kit built units that meet certain oscillator design requirements. Each manufacturer, of course, should be in a position to advise regarding this particular point. In our case a neighbor, who holds a second class commercial operator's license, was more than pleased to make the proper on-the-air adjustments for us.

One of our greatest pleasures was in field testing the units. We had heard many comments to the effect that Citizens Band units should provide reliable coverage anywhere from one mile to the ridiculously high figure of 3000 miles. Our particular area of operation is far from ideal. We certainly can never cover any great distances in that we are in an extremely wooded location and somewhat in a valley since a high ridge encloses us on one side. Our first attempt was made using low-priced utility antennas (45½-inch base-loaded whip) at both stations, with one of the stations located inside the house and the other in a car as a mobile unit. Our distance of operation was just short of one mile. We then installed a quarter-wave ground-plane antenna, *Heath's* Model CBS-1, on top of the house about twelve feet below the maximum permitted height. The utility antenna was still being used on our mobile unit. We were then able to extend our coverage to approximately two miles.

Our next attempt was made with a standard quarter-wave 27-mc. whip on the mobile unit. Our coverage was again extended, this time to just over three miles. We were backed up against the Long Island Sound at this

(Continued on page 111)

Complete schematic diagram of *Heath's* CB-1 Citizens Band transceiver for Class D use.

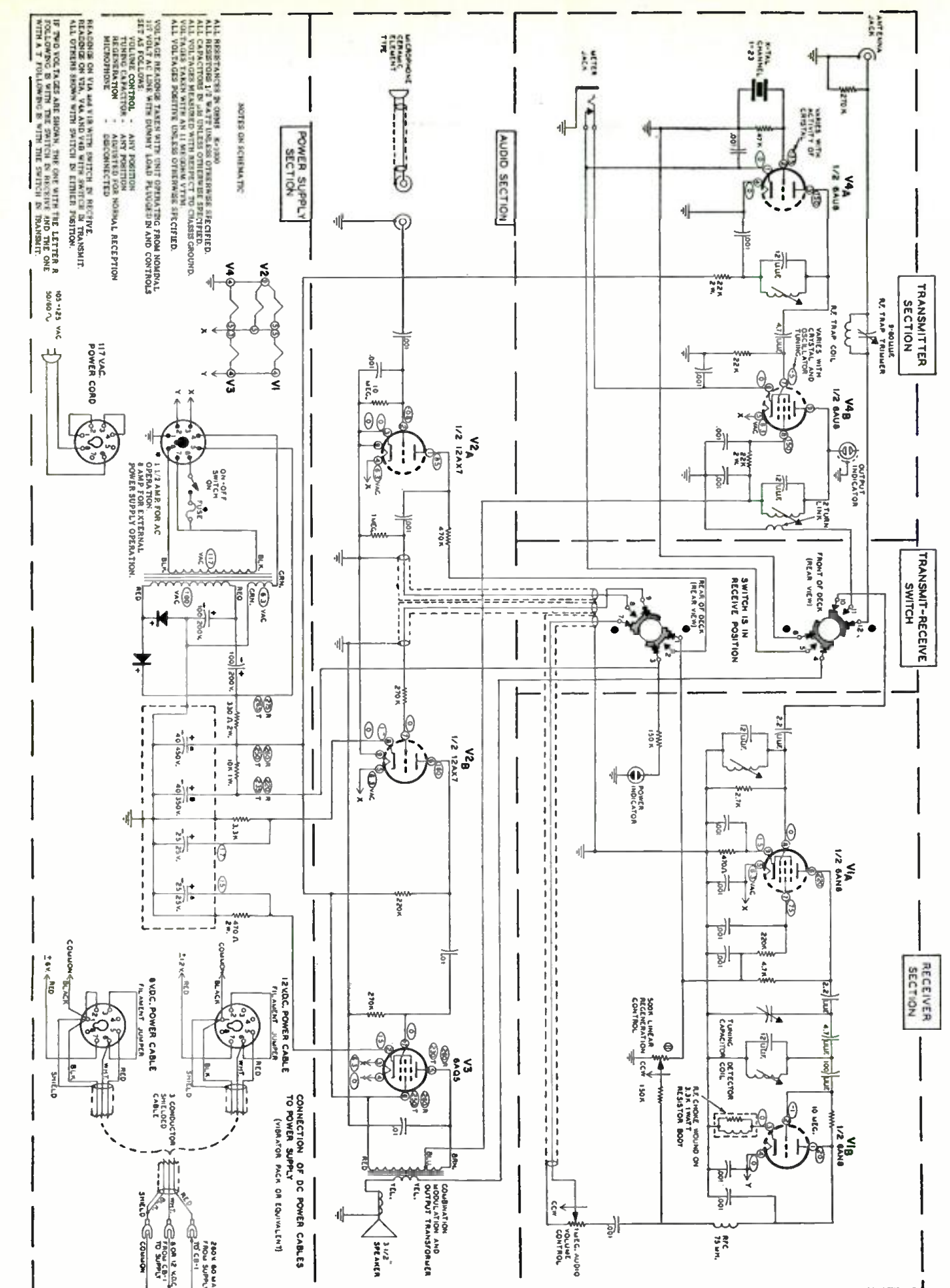

NOTES ON SCHEMATIC:

- ALL RESISTANCES IN OHMS, K=1000
- ALL CAPACITANCES IN MICROFARADS UNLESS OTHERWISE SPECIFIED.
- ALL VOLTAGES MEASURED WITH RESPECT TO CHASSIS GROUND.
- VOLTAGE TAKEN WITH AN 11 MEGOHM VTVM.
- ALL VOLTAGES POSITIVE UNLESS OTHERWISE SPECIFIED.
- VOLTAGE MEASURED TAKEN WITH UNIT OPERATING FROM NORMAL SET AS FOLLOWS:
- VOLUME CONTROL - ANY POSITION
- REGENERATION - DISCONNECTED
- REGENERATION - ADJUSTED FOR NORMAL RECEPTION MICROPHONE

IF TWO VOLTAGES ARE SHOWN THE ONE WITH THE LETTER R FOLLOWING IS WITH THE SWITCH IN RECEIVE AND THE ONE WITH A FOLLOWING IS WITH THE SWITCH IN TRANSMIT.

POWER SUPPLY SECTION

AUDIO SECTION

TRANSMITTER SECTION

TRANSMIT-RECEIVE SWITCH

RECEIVER SECTION

CONNECTION OF DC POWER CABLES TO POWER SUPPLY (VIBRATOR PACK OR EQUIVALENT)

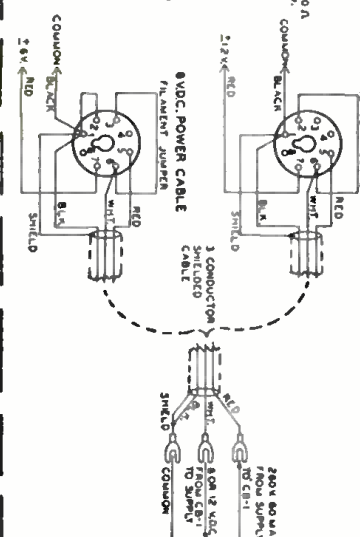

Restoration of Old-Time Wireless Gear

By HOWARD S. PYLE

Over 160 pieces of gear have been restored in last 2 years and display set up in cooperation with local parts dealers.

THERE is perhaps no more nostalgic group of "Old Timers" in the world than the early day amateur and professional "wireless" operators. Fond memories of the flashing, crackling sparks, the smell of ozone, the breathless searching for a more sensitive spot on a tiny mineral crystal, brings a lump to the throat of the real "wireless" pioneer. "Wireless" was romance; patient hand-filing of nickel and silver to blend within a glass tube and form a "coherer" detector; laborious winding of hundreds of turns of wire on a cardboard tube to form a "tuner"; melting paraffin on the kitchen range to pour in half a cigar box stacked with alternate sheets of tinfoil and paper to create a "condenser"! And the thrill . . . the ecstasy of holding one's breath to catch every faint dot from a powerful station some fifteen miles distant with this crude, inefficient but serviceable, home-made apparatus from days gone by!

Those days, alas, are forever past. "Radio" has replaced "wireless" . . . inert, unimaginative metal-encased vacuum tubes have taken the place of the brightly glowing incandescence of the early deForest "audion" bulbs

which, in their turn, pushed the crystal detector in the background. Relatively small glass-enclosed electron tubes and even the tiny transistor are receiving excellent signals around the world from transmitters occupying no more space than a conventional shoe box or, at most, an orange crate!

Just as amateur radio today is a far cry from amateur "wireless" of the past, commercial applications of communication without wires has also undergone a complete transformation. No longer is a shipboard operator faced with the necessity for "tearing the works" from a huge, coffin-like open core transformer to find and repair the flash-over in the 20,000-volt secondary; no more does he patiently file the points of a rotary spark gap nor does he have to clean the surfaces of the quenched type.

Such thoughts as these constantly flick through the minds of the real "Old Timers." I am no more immune than other pioneer "wireless" operators. Could we possibly bring back a semblance of the "good old days"? This started a train of thought. I well knew that a goodly number of old-time amateur and professional operators

had been collecting what they could in the way of early day "wireless" equipment and had set up their own private "museums" where they could drool by the hour and occasionally proudly display their pioneer collections to sympathetic visitors. Ed Raser, W2ZI in Trenton, N. J. and Vance Phillips, W6GH of Santa Barbara, Calif., are outstanding examples of collectors of old "wireless" gear and both have impressive displays. Why could not I also begin to gather what I could from whatever sources available?

The "kick-off" came when a local radio club presented me, as the then Chairman of the Pacific Northwest Chapter of the Veteran Wireless Operator's Association, with a Navy type SE-1420 receiver of World War I vintage. A marvelous receiver for the times, it represented the foremost scientific advances and out-performed any previous receivers developed by any nation. Its immediate predecessor, the SE-143, was every bit as good but did not incorporate an "audion" detector. The Navy Department, although having had a number of experimental installations of deForest's little "hair pin in a pickle bottle" for several years, was still somewhat skeptical of the superiority of the audion over more conventional methods of detection. Early day "audions" were gassy and erratic, required critical adjustment of both plate and filament voltages, and were frequently burned out by careless operation. Operators were unfamiliar with the new device and many had only mediocre success. Rather than bother with the relatively intricate adjustment procedures, many took the "easy" way and reverted to the mineral crystal detector.

With continued improvement in the "audion" bulbs themselves by a number of prominent licensees under deForest's patents, many of the drawbacks were eliminated. Better exhaustion of the envelope, stabilization of the elements, and elimination of necessity for critical voltage adjustments, went a long way to popularize deForest's "Aladdin's Lamp." With the development by the Bell Telephone Laboratories and Western Electric of the oxide-coated filament and the consequent introduction of the "VT-1" and "VT-2" types of tubes, "audion" detection became even simpler from an operating standpoint than the time-tried crystal method and was manifold more efficient. The SE-

Some pioneer commercial wireless receivers restored to original appearance and operating condition by author. (Top) Canadian Marconi Co. marine receiver with carborundum crystal detector, widely used in Canadian vessels around 1910. (Left) A popular receiver of the Marconi Wireless Telegraph Co. of America. Equipped with a "Cerussite" crystal detector, this type 106-D receiver was standard equipment on many vessels of the American merchant marine from about 1914 to 1917. (Right) The famous Navy type SE-1420, the first U. S. Naval receiver to be produced with an integral audion or vacuum tube. This was produced during World War I and found wide usage in the Naval service and on commercial vessels during and after the war.

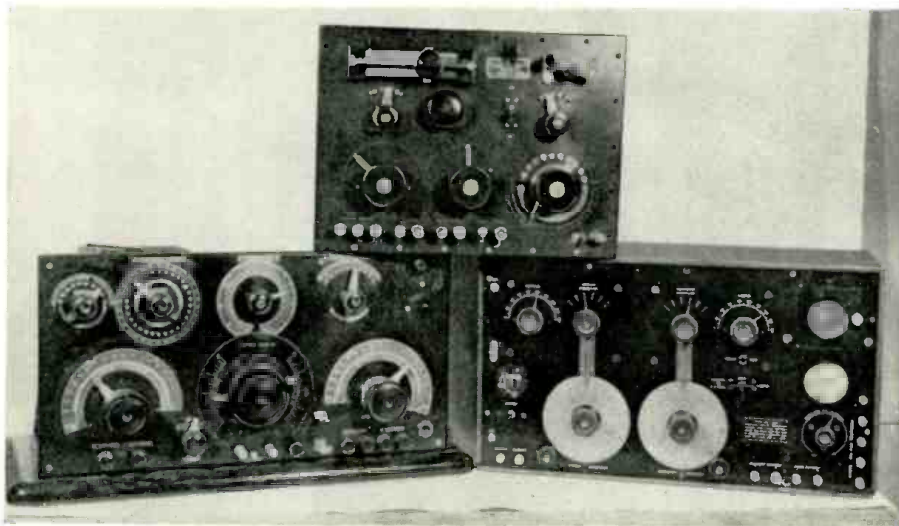

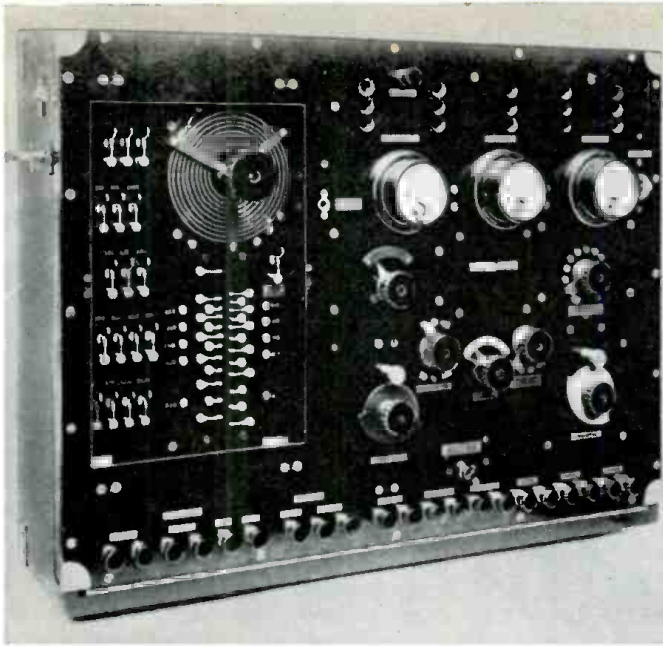

The first commercially produced radiotelephone and telegraph transmitter and receiver unit made on a production basis was the Western Electric CW-936. The unit was installed on sub-chasers of the Navy in World War I and its use was rapidly extended to other Navy ships. Oxide-filament VT-2 vacuum tubes were employed for the transmitter and the smaller VT-1's for the receiver.

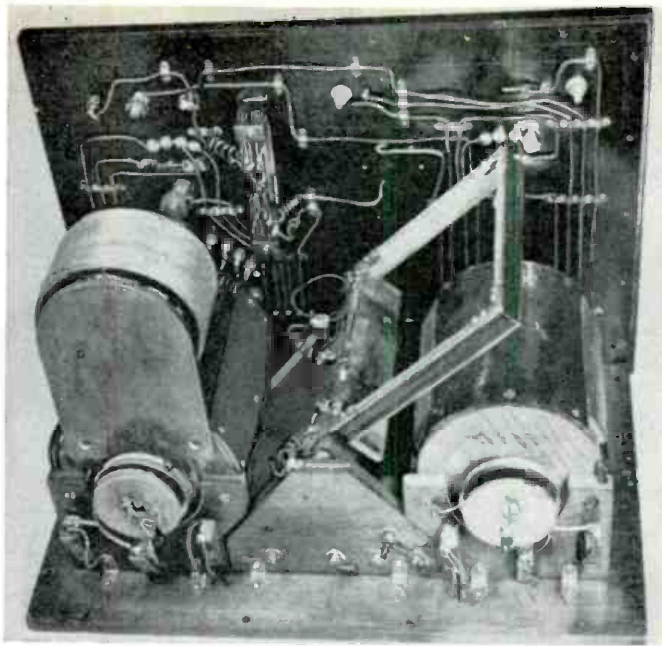

Internal view of the early Canadian shipboard receiver. Hardwood was used for coil forms, brackets, and supports. Hard rubber was used for the panel and for curved protector over right-hand coil. Since variable tuning capacitors had not as yet come into very wide usage at that time, tapped variometers, loading coils, and coupling coils were used to vary the tuning.

143 receiver, while not "audion" equipped integrally, did make provision for both an external "audion box" and an external crystal detector. A "tickler coil" was also incorporated in the design so that full advantage could be taken of the regenerative and oscillating properties of the audion. The combination of the SE-143 receiver and its associated type SE-1071 "Audion Control Box" proved so successful that the SE-143 receiver was re-designed to incorporate the "audion" integrally and, with a few additional refinements, became the SE-1420.

The SE-1420 receiver presented to me was in horrible shape electrically, mechanically, and in general over-all appearance. The whole thing had possibilities but I could foresee the many hours it would take to restore it. Was it worth it? I decided that it was.

The internal assembly appeared to present less of a problem than the cabinet and front panel. As a "feeler" I started there. Every soldered joint was unsoldered, surplus solder removed with a discarded toothbrush, and the joints re-soldered with resin-core solder. Broken connections were repaired and a few frayed wires replaced. The connecting links and other mechanical contrivances were removed and put on a buffing wheel, using medium-grade jeweler's rouge as a polishing medium. Coils and similar parts were carefully cleaned with a stiff bristle brush and re-lacquered. The inner surface of the panel was cleaned with an automotive lacquer cleaner and wiped with a lightly oiled cloth. The result was a feast for the eye! Internally, I had the good old SE-1420 looking as good or better than when it left the factory!

Next, the front surface of the panel.

Alcohol, lacquer thinner, white gasoline, and several cleaning fluids made discouragingly little impression on the panel scum. As a last resort, painter's thinner (plain old turpentine) proved the answer. The scum came loose like frosting on a cake! Not bad. Next, a good grade of automotive chrome cleaner, using the reliable old standby, the discarded toothbrush, for an applicator, worked wonders on the switch points, binding posts, dials, and other metal parts. Once more the panel was washed with turpentine which removed the residue from the chrome cleaner. All front panel bright work was then given a high gloss polish using the medium jeweler's rouge and a lamb's wool buffing wheel chucked in a quarter-inch electric drill. The final touch was a thin coat of liquid furniture polish on the Bakelite panel itself, well burnished with the lamb's wool wheel.

And now, the cabinet. Paint removers of various kinds were common in the local hardware store. A little discussion with an intelligent clerk and I came home with a "can of magic." I mean that; all I did was brush it on generously, let it set for an hour or so and wipe off the residue with a damp cloth! Presto! I saw mahogany! Spotty of course, with some varnish clinging here and there, but a fine grade of sandpaper on a disc fitted in the electric drill chuck and I was down to bare wood with a beautiful grain. No filler was required as the original stain and varnish had filled the pores. Two coats of water white clear lacquer and I had "a thing of beauty."

The final step was an actual receiving test. The crystal detector was connected to the marked posts as well as a

a pair of headphones, an antenna, and ground. Mechanical moving parts, such as internal coupling links, switch levers, etc., all worked smoothly (I had previously given them a treatment of "clock oil" with a small artists' brush). Setting the dials and switches to the approximate frequency of a local broadcast station, I connected a dry cell to the test buzzer battery terminals, pushed the "test" button which actuated the buzzer, and went back many years to the thrill of hunting for a sensitive spot on the crystal. And . . . I found one! Manipulating the dials slightly, I heard faint music; a bit more twiddling and I was listening to voice and music of superb quality . . . not loud, but very plainly audible. The crystal detector and tuning component portions worked. All that remained was the "audion." The original "VT-1" vacuum tube was still in the socket; whether good or bad was anyone's guess. Hooking a few old dry cells to the filament terminals, I turned up the rheostat. No soap; the tube remained cold and dark.

My collection of old tubes contained a couple of VT-1's and a VT-2; what shape they were in I had no idea but digging them out of their nest I found one of the VT-1's with a continuous filament and it glowed (dully, as they did with their oxide-coated filaments). Now for a plate battery. I was stumped there until it occurred to me to take 45 volts from the power plug on my little amateur transmitter. Connecting this, I donned the headphones, turned up the filament rheostat, and wiggled the "tickler" knob. Nothing; absolutely nothing! Fiddle as I did, brought no change. I ran a continuity check through the binding posts from

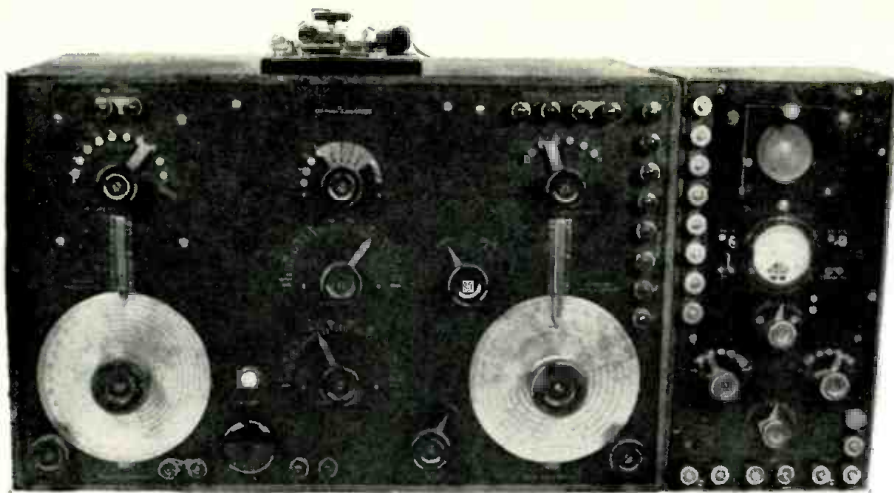

U. S. Navy type SE-143 receiver introduced early in World War I. The audion or vacuum-tube detector was contained with its controls in the separate cabinet at the right. A silicon-antimony crystal detector (on top of main cabinet) was provided in case the audion proved unreliable. Although the audion was incorporated as an integral part of the later type SE-1420 receiver, provision for crystal detection appeared in the SE-1420 as well since there were many who were skeptical of the tube.

the front panel . . . whoops, an open somewhere in the plate circuit. Nothing for it but to remove the umty-teen screws from the panel and pull it out of the cabinet. A point-to-point check revealed an error. In re-soldering the internal connections I had inadvertently reversed the positive and negative plate leads. Correcting this, I tried again; still nothing.

It occurred to me that mere reversal of terminal connections would most certainly not indicate an "open" on the ohmmeter; must be an actual open circuit somewhere. There was; right at the plate terminal of the tube socket; I had apparently overlooked that in re-soldering. Easily fixed and back under the headphones. Oh, brother! The soft, gentle "hiss" as I turned the regeneration control up into the oscillating range. The local broadcast station (I had not changed the tuning settings since changing from crystal to audion) was many times louder, accompanied by the whistle of his carrier while my tube was oscillating. Backing down on the regeneration control brought him in full and clear without a trace of the carrier.

I tuned around . . . all through the broad range of the receiver (250 to 8000 meters) . . . "frequency" then was an awesome word used only by scientists! I heard many signals both modulated and pure c.w.; several broadcast stations, ships at sea, tone modulated telegraph stations, marine and airway beacons. I had it made! A dignified, professional receiver operating most excellently and presenting an appearance equal to its debut from the production line!

It was fascinating work; slow, tiresome, and hard, but the great sense of satisfaction which comes from accomplishment, far overrode the effort expended. I was enthusiastic for "more." Where to acquire other "antiques" like this? Inquiry among local hams brought many pieces of early amateur equipment, both receiving and trans-

mitting. I went to work on these with equally satisfying results. An amateur friend on a trip to Canada ran across a 1910 *Canadian Marconi Company* ship-board receiver in a farmer's barn! A couple of "fins" changed hands and a few days later he delivered it to me . . . a real prize!

A "strike" equal to that in the Yukon in '98, to my notion, turned up when the owner of the *Washington Radio & Television School* in Seattle gave me the key to his basement storeroom and invited me to ". . . get a shovel and clean it out!" What a find! The present school is one which had its inception in 1914 when the *Marconi Wireless Telegraph Company of America* established training schools strategically located throughout the country to relieve the shortage of trained wireless operators. Practically all of the original *Marconi* equipment plus some later, but now obsolete, apparatus had been gathering dust for lo, these many moons in a dark storeroom in the basement of the Seattle YMCA where the training school has always been located!

Two Navy SE-143 receivers, a *Marconi* Type 106-D receiver, *Federal Telegraph Company* "tone changer," World War I Navy frequency meter, a *Kolster* "Decremeter," and myriads of more minor "rarities" over which I simply gloated! I took them all! My basement shop and my outdoor shack were literally bulging with these "wireless ghosts of the past," and more kept coming in from various sources! I had to establish a routine. As I acquired equipment, I stored it in the outdoor shack, bringing it to the basement shop a piece at a time to work on. Fine, but the problem went further; after completion, what?

Space was not a particular problem but why should I keep these mementos of bygone days for my own pleasure and entertainment and that of the relatively few Old Timers who were my particular cronies? Why not place

them where *all* of the hams and professional operators in my local area could also enjoy them?

In discussing this with other enthusiastic "wireless" pioneers, the suggestion was made that perhaps one of the local electronic supply stores would be sufficiently interested to donate display space. Following this thought, I approached the proprietor of one of the leading establishments of this type in Seattle. He was enthusiastic and offered to supply not only the space but a large, double showcase, fitted with locked doors in which to set up such a display. The next thought was to "divorce" such an exhibit from personalities; make it a group-sponsored display, rather than that of a private individual. The Northwest Chapter of the Quarter Century Wireless Association was contacted; they enthusiastically agreed to officially sponsor the amateur equipment portion of such an exhibit. Local members of the Veteran Wireless Operator's Association were most agreeable to acting as sponsors for the commercial equipment so displayed. I agreed to act as "curator" for both organizations and to take care of the few minor details involved. We were off!

It has been just about 2 years since the spark was struck. The Seattle display remained in place for an entire year and was viewed by many hundreds of amateur and professional operators not only with local addresses but the register shows visitors from nearly every state in the Union and a number of foreign countries! Not only operators but many laymen . . . "the man on the street," visited and enjoyed the display. The equipment carried sufficient explanatory information on neatly typed cards so that an appreciation of what "wireless" was, was conveyed to the non-technical visitor as well as to members of the commercial operating profession and the radio amateur fraternity. The Seattle store reluctantly gave up the display because they needed the space and the exhibit was then moved to a similar store in Spokane, Wash., for an indefinite "run."

Equipment continued to be loaned or donated; every bit of it was restored and put in working condition. The Spokane exhibit, although but a few months old at this writing, already occupies two whole show cases and the overflow apparatus was sufficient to permit the establishment of similar "museums" in Tacoma, Wash., and Portland, Ore. where the electronic distributors have also enthusiastically cooperated.

It is *fun!* For you Old Timers with nostalgia for the "good old days" you'll get an immense amount of satisfaction and pleasure from establishing such a program. At the same time you are giving the current generation of hams as well as professional operators a chance to gain a much more intelligent idea of the birth, development, and growth of their hobby and/or profession.

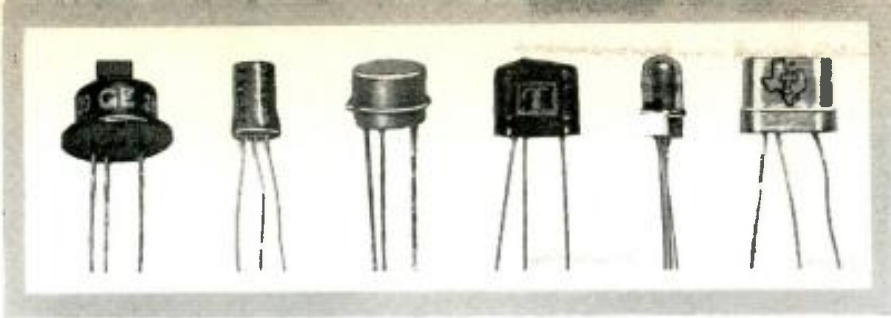

Some low-power (left) and multi-watt (below) transistors, shown about full size.

Transistor and Diode Substitutions

By E. G. LOUIS / What to look out for when you want to substitute one transistor for another in some construction project.

THE average hobbyist or technician should have little or no difficulty modifying typical construction projects to use substitute transistor and diode types if he has a fair understanding of circuit operation and either owns or can borrow such basic test gear as a multimeter, signal generator, transistor tester, etc.

Transistors

If only *general* characteristics are considered, all currently available transistors can be grouped into a few general classes: low-power audio types, high-power audio units, low-power r.f. types, and special-purpose units. The latter group includes not only special transistors such as tetrodes and surface-barrier units but related semiconductor devices with transistor-like characteristics, such as the Unijunction transistor, the Thyristor, and the controlled rectifier. Popular "experimenter's transistor" types included in the first three categories are listed in Table 1.

Within any of these basic classes, individual transistors may have either *n-p-n* or *p-n-p* characteristics and may be manufactured by any of a variety of methods. Detailed electrical specifications and maximum ratings may vary considerably from one unit to another, depending on type number and intended application.

Thus, in the low-power audio group we may find high- and low-gain units, low-noise transistors, high-voltage types, units made with either germanium or silicon, grown or alloy junction types, etc. In Table 1, the *p-n-p* and *n-p-n* types are listed separately but, in practice, all low-power audio units may be considered as a single class.

In general, any transistor within a general class may be substituted for any other transistor type within that class providing: (a) maximum ratings are not exceeded, (b) circuit parameters, bias, and load values, are adjusted for optimum performance, and (c) the circuit can tolerate minor variations in the characteristics required.

Let's consider a few specific examples.

If you have a circuit calling for, say, a CK722, a type 2N107 or 2N34 will probably work in the same circuit if

bias values are re-adjusted. Or if the diagram calls for a 2N307, you should be able to use a 2N554 in the same circuit.

As far as circuit operation is concerned, re-adjusting bias and load values for optimum performance generally will be enough to insure acceptable operation. There are, however, exceptions to this rule. For example, if the diagram calls for a high-gain audio transistor and a low-gain unit is substituted, the circuit may still work but may not have enough "hop." Similarly, if a preamp or hearing-aid diagram calls for a low-noise transistor, a general-purpose unit may "work" satisfactorily, but the background noise level may be unacceptable.

At this point, we can state another general rule: transistors in different general classes are *not interchangeable*. Thus, a multi-watt power transistor, such as the 2N255, *cannot* be used as a substitute for, say, a 2N229.

Neither of these two general rules applies to the "special-purpose" class and, as might be expected, there are a few exceptions. For example, an r.f. transistor, such as the CK768, often can be used in an audio circuit. Similarly, due to their broad tolerances, it is quite common to find that an *individual* "audio" transistor will work in r.f. applications.

This leads to the statement of another "general rule": transistors with "superior" characteristics or higher maximum ratings may be substituted for other types—other specifications being the same. For example, in a given r.f. amplifier circuit, a transistor with a 5 mc. cut-off should work just as well (perhaps better) as a type having a 3 mc. cut-off, other specifications remaining the same. Similarly, a power transistor with a maximum rating of, say, 50 volts (collector-to-emitter) will serve as a satisfactory substitute for a unit with a maximum rating of, say, 24 volts—but not *vice versa*.

Specifications

As far as selecting a substitute unit for use in a construction project is concerned, a transistor's most important electrical specifications are: (a) kind, *i.e.*, triode, tetrode, etc.; (b) basic type, that is, *n-p-n* or *p-n-p*; (c) saturation

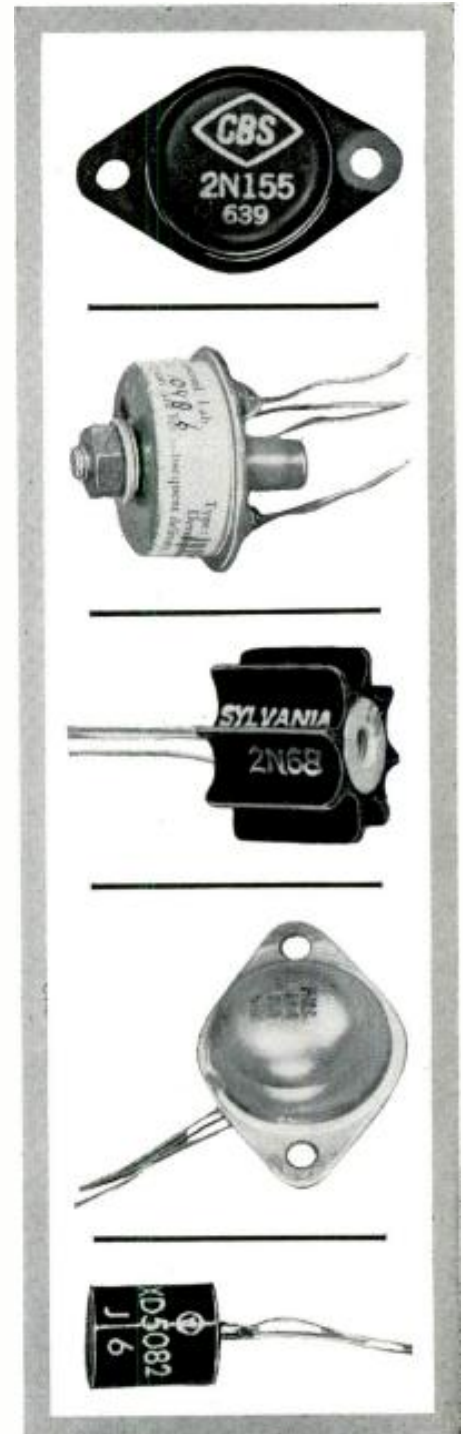

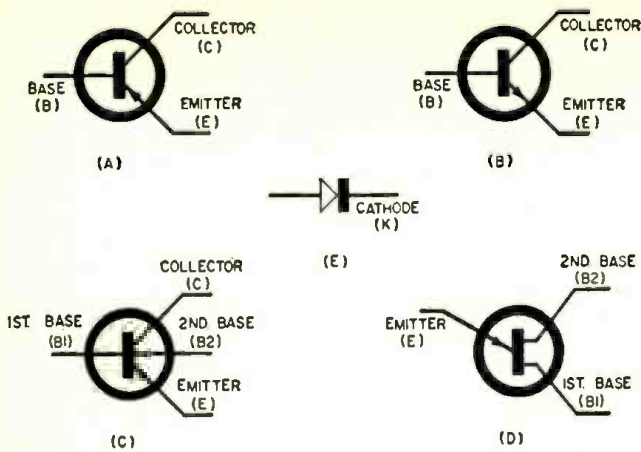

Fig. 1. Symbols for semiconductor devices. (A) "p-n-p" triode transistor. (B) "n-p-n" triode. (C) "p-n-p" tetraode—"n-p-n" is similar, with reversed arrow. (D) Unijunction transistor. (E) diode.

(or leakage) current; (d) maximum ratings; (e) gain (*beta*); and, in the case of r.f. or high-speed switching applications, (f) its cut-off frequency. If these basic specifications can be matched between two units (of different type number), there is a good chance that the units are directly interchangeable (except for lead connections) in most experimental circuits.

In a few instances, other specifications may become important. In a high-gain audio circuit, for example, low-noise units may be mandatory. In critical r.f. circuits, interelectrode capacities may have to be matched for optimum performance.

Often, transistors with different type numbers will be almost identical ex-

perimenters to select a suitable replacement.

Now, suppose you are planning to build a broadcast-band superhet receiver. You can identify all transistors except the one used as an i.f. amplifier. How do you pick a suitable type?

If the symbol shown in Fig. 1B is used, you know that an *n-p-n* unit is needed. Further, since the transistor used is an i.f. amplifier, you know that its cut-off frequency must be well above the receiver's i.f. (455 kc., for example). Chances are a unit with a 3 to 5 mc. cut-off would be used. If the receiver has two i.f. stages, a moderate-gain transistor may be used in each stage; if a single i.f. stage is employed, probably a high-gain type would be used. Finally, take a look at the receiver's power supply. If a 6-volt battery is called for, the transistor should have a maximum (emitter-collector) voltage rating of at least 12 volts.

Occasionally, a schematic diagram will specify a type number that is not readily available and for which electrical specifications are as hard to determine as the transistor itself is to locate. Here, the schematic symbol representing the transistor, the circuit arrangement, and other component values (such as transformer impedances and bias resistor values) will provide a good clue to the "unknown" transistor's specifications and allow the

experimenter to select a suitable replacement.

The basic schematic symbols used to represent transistors and related semiconductor devices are given in Fig. 1. The *p-n-p* and *n-p-n* triode symbols are shown in Figs. 1A and 1B respectively, a *p-n-p* junction tetraode symbol in Fig. 1C and the Unijunction transistor symbol in Fig. 1D. A common diode symbol (Fig. 1E) is included for comparison.

By referring to the condensed specification charts supplied by semiconductor manufacturers (or found in the catalogues issued by the larger mail-order parts distributors), you should have no difficulty selecting a transistor which will meet these basic requirements.

A similar technique can be employed in selecting transistors used in other stages of a receiver, amplifier, preamp, hearing aid, or test instrument.

Lead Connections

Unfortunately, semiconductor manufacturers have not as yet adopted an industry-wide standard covering the physical shape and basing arrangement to be used in making transistors. Two basic "standards" are in use—one proposed by JETEC and the other suggested by EIA. However, not all manufacturers adhere to either of these "standards." Most have at least one "standard" of their own, although they may produce several type numbers matching either JETEC or EIA standards.

The experimenter wishing to use a

EXACT OUTLINES VARY WITH TYPE

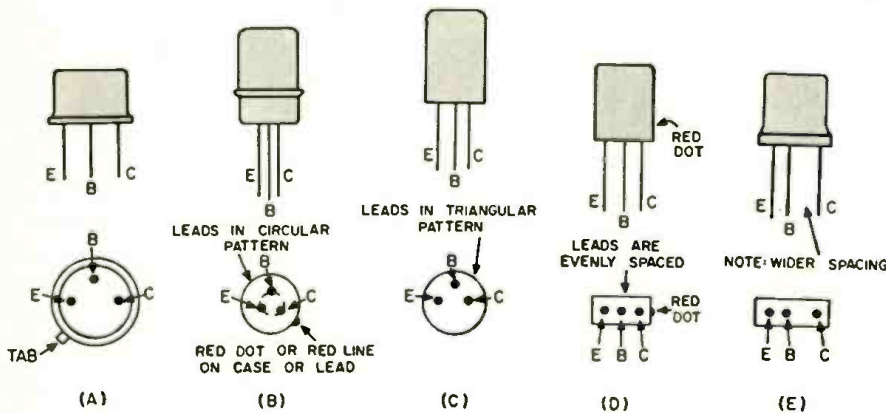

NOTE: NOT TO SCALE

Fig. 2. Electrode lead connections for common low-power and r.f. triode transistors.

cept for one specification. Where this is the case, the "better" transistor is generally a satisfactory replacement for the other. For example, the CK721 is basically a high-gain version of the CK722. The 2N256 is identical to the 2N255 except for maximum voltage rating.

A certain amount of leeway must be allowed in making a choice on specifications alone. Remember that transistors are manufactured to rather broad tolerances. A manufacturer's specification may indicate only a mean or average value. Thus, in checking through a random assortment of, say,

Fig. 3. Not all four-lead transistors are tetrodes. A triode drift r.f. transistor, such as the 2N247, uses the arrangement at (A). Typical tetraode lead connections are shown at (B) and (C).

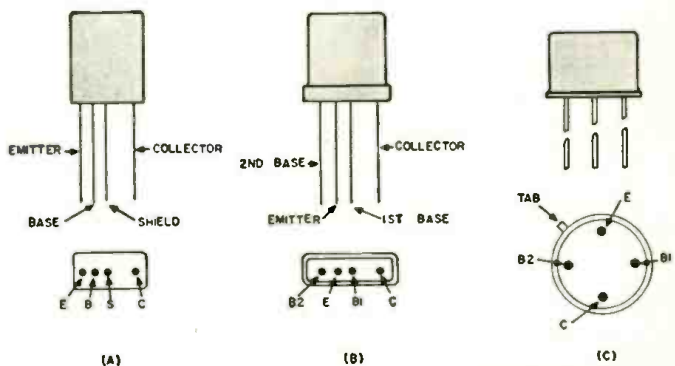

replacement (substitute) transistor type is often faced with a real problem involving the mechanical installation of different unit, especially if the equipment is wired to use a transistor socket or if he is unable to obtain basing information for his substitute unit.

If a transistor socket is used, it may be possible to reposition the transistor's leads to fit into the proper socket holes, using a pair of "jeweler's" long-nose pliers. Care must be exercised not to short the leads nor to bend the leads too close to the transistor body since they may break off.

Where repositioning of leads is impossible, the transistor may be permanently soldered into the circuit. Use as long leads as practical and complete the soldering operation quickly. Use a clean, hot, well-tinned iron. Hold the lead being soldered with a pair of long-nose pliers since this serves as a heat sink to conduct heat away from the transistor itself.

spacing between leads may be used.

Four-terminal transistors may be encountered from time to time. While many of these are tetrodes (see Fig. 1C), some may be triodes with an internal shield. The basing arrangements used for both triode and tetrode 4-terminal transistors are shown in Fig. 3. Note that the lead arrangement for a 4-terminal triode, Fig. 3A, and for a tetrode, Fig. 3B, may be identical. To identify the type of transistor used, refer to the schematic diagram or to the unit's type number. A "2" prefix is used to identify triodes, for example, 2N107, 2N247, etc. A "3" prefix identifies tetrodes, for example, 3N24, 3N30, etc.

Multi-watt power transistors, like low-power units, may be made in any of a variety of physical shapes and sizes and with various lead arrangements. These units may be identified by: (a) their larger physical size; (b) their mechanical design, usually such

that they can be mounted directly to a metal plate or chassis; and (c) their electrical construction—in most cases the unit's collector is connected *directly* to its outer metal case.

The most common power-transistor basing arrangements are shown in Fig. 4. In the case of units employing the designs of Figs. 4B and 4C, an electrical connection to the collector is obtained by attaching a lead to the transistor's case.

Special Techniques

In the case of vacuum tubes, it is not uncommon to find two or more types that are fully interchangeable, that is, the alternate types can be plugged into the same socket and, in most cases, circuit performance remains unchanged without any need for modification of component values, voltages, or re-adjustment of trimmers or similar components.

Where transistors are concerned, however, this seldom happens. While any of a large number of transistors may "work" in a given circuit, there is generally some small change in performance and, often, a re-adjustment of bias voltages or circuit component values may be necessary to obtain optimum performance.

If low-cost transistors are used—units which are manufactured to rather broad tolerances—it may be found that even transistors of the *same type number* are not fully interchangeable. In some cases, circuit values must be tailored for best performance with the individual transistor used.

When choosing a substitute transistor, then, first try to pick a unit of the same general class (low-power audio, for example) with the same electrical characteristics (*p-n-p* or *n-p-n*) and with specifications as close as possible to those of the unit you wish to replace. Pay particular attention to leakage current, gain, cut-off frequency, and maximum ratings.

If you are unable to find a substitute meeting these requirements, pick a unit

BASIC TYPE	TYPE NUMBER	MANUFACTURER	REMARKS
Low-Power Audio (p-n-p)	CK722	Raytheon	
	CK721	Raytheon	Higher gain unit
	GT222	General Transistor	
	2N222	General Transistor	
	2N107	General Electric	
	2N34	Sylvania	
	R-65	Texas Instruments	
Low-Power Audio (n-p-n)	R-66	Texas Instruments	
	R-72	Texas Instruments	
	2N35	Sylvania	
	2N229	Sylvania	
R.F.-I.F. Units	GT229	General Transistor	
	R-67	Texas Instruments	
	R-68	Texas Instruments	Higher gain unit
	CK768	Raytheon	p-n-p
High-Power Units (all p-n-p) Multi-watt audio	2N170	General Electric	n-p-n
	2N233	Sylvania	n-p-n
	AO-1	Philco	30 mc. Surface Barrier
	2N255	CBS Electronics	
2N256	CBS Electronics	12-volt version	
2N307	Sylvania		
2N554	Motorola		

Table 1. A listing of some of the popular transistors used by experimenters.

Although the physical shape and size of transistors will vary considerably from one manufacturer to another, most adhere to several common basing arrangements. As far as low-power audio and r.f. transistors are concerned, nearly every unit will use one of the five basing arrangements shown in Fig. 2. With this diagram as a guide, you should have no difficulty identifying the emitter, collector, and base connections of the transistors you use. The JETEC "standard" basing arrangement is shown in Fig. 2A while the EIA basing is shown in Fig. 2E.

When using this basing guide, remember that the physical arrangement of the leads is important, not their actual spacing. For example, the arrangements shown in B, C, and D may be used for both "normal" sized transistors, where lead spacing may be moderate, and for subminiature "hearing-aid" types, where extremely close

Fig. 4. Electrode lead connections for popular multi-watt transistors. In all of these, the collector is internally connected to the unit's metal case.

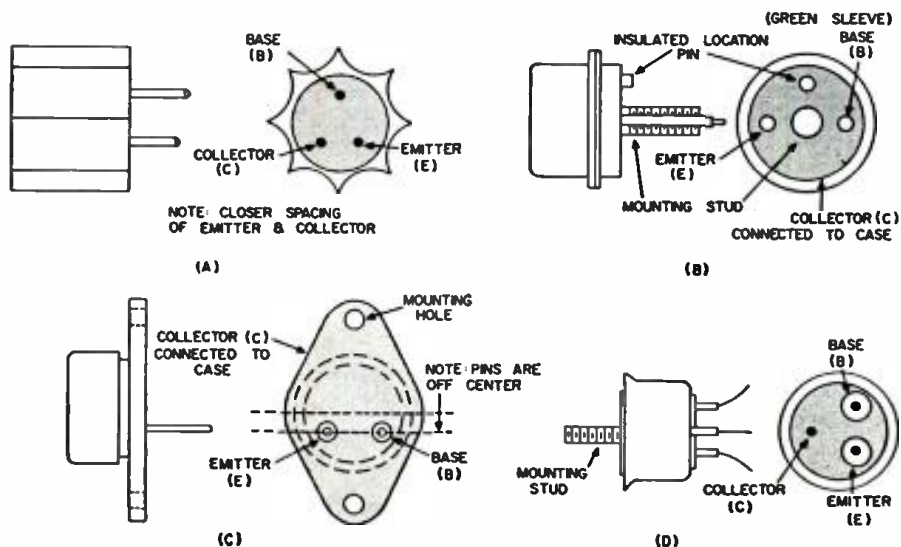

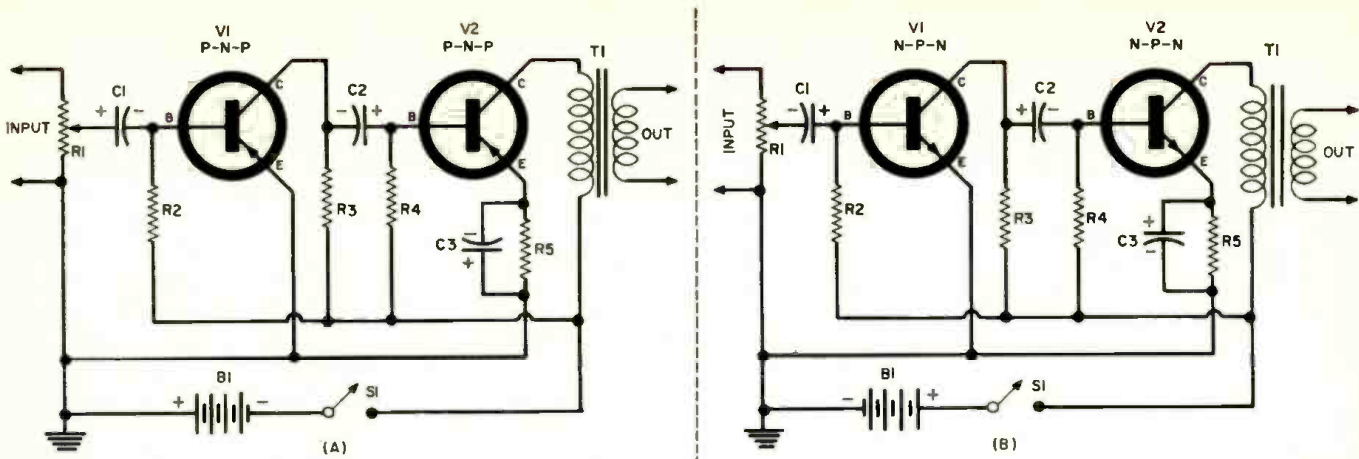

Fig. 5. Typical two-stage amplifiers with "p-n-p" and "n-p-n" transistors. Note changes in d.c. polarities and polarized components.

which differs from the original in some minor specification—a 2N256 as a substitute for a 2N255, for example.

Sometimes you may have a choice of a number of different transistors. Where this is the case, you can often pick "duplicate" units by using an inexpensive transistor tester to select two or more units having identical leakage and gain characteristics. Such a technique is valuable, too, for selecting matched pairs of transistors for use in class B push-pull amplifier circuits.

Where circumstances preclude your choosing a substitute transistor of the same electrical type (*p-n-p* or *n-p-n*), you can often substitute units of the *opposite* type, provided other specifications (gain, leakage, etc.) are similar. The proper technique is illustrated in Fig. 5.

A two-stage resistance-coupled amplifier using cascaded *p-n-p* transistors in the common-emitter configuration is shown in Fig. 5A. Appropriate *n-p-n* transistors with similar electrical specifications may be used in this circuit if (a) the power-supply polarity is reversed, B_1 ; (b) the polarity of electrolytic capacitors is reversed, C_1 , C_2 , and C_3 . The same circuit modified for *n-p-n* units, is shown in Fig. 5B. Note that the connections to battery B_1 and to capacitors C_1 , C_2 , and C_3 have been reversed. In practice, any polarized component (such as diodes or polarized relays) would have to have its connections reversed when changing from one transistor type to another.

Once a substitute transistor has been installed, circuit performance and general operation should be checked. In some cases, any change in performance will be so small as to hardly justify modification of component values or bias voltages. In most cases, however, some modification of the circuit itself may be required to restore optimum circuit performance.

Where r.f. circuits are involved, for example, complete re-alignment may be indicated. Neutralization adjustments, if provided, should be checked. Generally, a re-adjustment of base bias voltages will be needed. Refer to Fig. 6.

If the biasing arrangement shown in Fig. 6A is employed, base bias current

may be re-adjusted by changing the value of R_1 . If the biasing arrangement shown in Fig. 6B is used, base bias may be changed by varying the ratio of voltage divider R_1 - R_2 . In either case, a resistance substitution box is handy for determining final component values.

Irrespective of the method used, final bias resistance values should be determined experimentally for optimum circuit performance rather than by attempting to meet arbitrary bias current or voltage figures. In this way you can compensate, to a large extent, for both gain and leakage differences between the substitute transistor and the original unit.

If the substitute transistor has much higher gain than the original unit, the

circuit may become unstable and may develop a tendency to oscillate. Often, any tendency towards instability will be corrected when you adjust bias currents. However, in stubborn cases, an unbypassed emitter resistor may be added to the circuit. This will introduce degenerative feedback, reducing stage gain and improving over-all stability.

Referring to Fig. 6C, unbypassed emitter resistor R_2 has been added to a common-emitter single-ended amplifier. In circuits using low-power transistors, R_2 may have a value between 100 and 2000 ohms. Where power transistors are used, R_2 may have a value between .5 and 10 ohms.

Diodes

In most experimental construction projects, diode characteristics are not too critical hence semiconductor diode substitutions are relatively easy to make.

Where a diode is used as a power rectifier, simply choose a replacement with peak voltage and current ratings at least equal to those of the original unit. Higher ratings may be used; for example, a 75 ma. selenium rectifier may be used as a replacement for a 60 ma. unit of the same voltage rating.

If a small diode is used as a detector or limiter, any diode with similar characteristics will generally work as well without any circuit modification. For most applications in receivers and instruments, general-purpose types, such as the 1N34A or CK705, may be used almost universally.

Occasionally, a diode may be used as a mixer or modulator in u.h.f. circuits. Here, any similar type designed for this general application will serve as well. The 1N82 is a popular u.h.f. mixer, for example. In some instances, a slight re-adjustment of r.f. circuit trimmers may be needed when a substitute diode is installed.

Finally, if a diode is used in a critical special-purpose application, as a zener diode or in test instrument circuits, for example, it is best to stick to exact replacements. If a substitute is mandatory, pick a unit with identical electrical characteristics.

Fig. 6. Transistor biasing arrangements are shown at (A) and (B). The unbypassed resistor in emitter circuit (C) reduces gain.

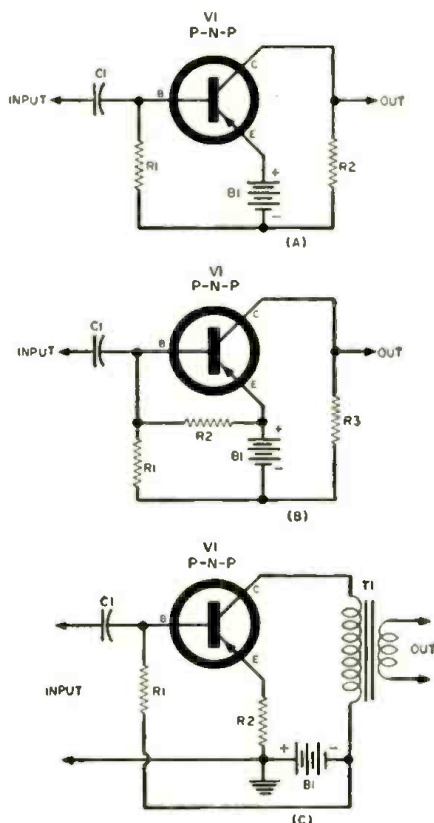

NUMBERS SYSTEMS and CODES

By ED BUKSTEIN

Northwestern TV and Electronics Institute

Various counting and letter-coding methods that are convenient with electronic computing equipment.

ANYONE who attempts to read a cornerstone date expressed in Roman numerals is immediately impressed by the clumsiness of this form of notation. The confusion becomes even greater when one accustomed to our decimal system considers that, although V represents 5 and II represents 2, VII does not represent 52. Try a simple calculation, like multiplying XXV times IV (without converting to familiar decimal digits), and the shortcomings of the Roman system will be even more obvious. It is apparent then that the ease with which a given calculation can be performed is determined, to a large extent, by the number system used.

The choice of number system is particularly important in the electronic computer because it determines the degree of complexity of the circuits required to store the numbers and to perform the calculations. It is for this reason that the binary number system and its modifications are used extensively in computer practice.

Since the decimal system, based on tens, hundreds, thousands, and so on, is the one by which we count, we tend to take it for granted that it is the only possible "natural" system. As a matter of fact, it is purely arbitrary, and other systems have actually been used in various parts of the world at certain points in history. We have already become familiar with the binary system, because it is a convenient one to use in connection with prevalent electronic counting circuits. However, other systems for counting are also used, and familiarity with them there-

fore is well worth a little study.

One of the characteristic features of a number system is its *radix*, or "fundamental" quantity, which may be defined as the number of permissible symbols used in the system. The familiar ten-symbol or *decimal* number system has a radix of ten, because quantities are specified by combinations of ten permissible symbols: 0, 1, 2, 3, 4, 5, 6, 7, 8, and 9. A number system based on the 26 letters of the alphabet (*aaa, aab, aac, aad*, etc.) would be a system of radix 26.

An automobile mileage indicator illustrates an important characteristic of orderly number systems. Each numbered wheel in the mileage indicator advances through all permissible symbols up to 9 and then returns to 0. At this time, the numbered wheel in the next position to the left advances to its next permissible symbol. In a number system based on the letters of the alphabet, *aaz* would therefore be followed by *aba*, and *bzz* would be followed by *caa*, which would be followed by *cab*.

As shown in Fig. 1A, the positional values of the decimal number system are ones, tens, hundreds, thousands, and so on. To specify a given quantity, the proper symbols must therefore be written down in the proper order. The number 3749, for example, differs from the number 3479 because the symbols are written in a different order. This idea of positional values, although it now seems obvious and elementary, represents one of the giant steps in the development of mathematics. The number 3749 is actually an abbrevia-

tion meaning 3 thousands, 7 hundreds, 4 tens, and 9 ones. This also may be expressed in powers of ten (since ten is the radix of our system), as follows: $3 \times 10^3 + 7 \times 10^2 + 4 \times 10^1 + 9 \times 10^0$.

The Octal System

As the name implies, the octal number system has a radix of eight because it has only eight permissible symbols: 0, 1, 2, 3, 4, 5, 6, and 7. The symbols 8 and 9 are not used in this system, as shown by the following examples of octal numbers: 1347, 256, 714423, and 20435. As in other orderly number systems, counting progresses according to the following rule: *When all of the permissible symbols have appeared in one position, the first permissible symbol again appears in this position, and the next position (to the left) advances to its next permissible symbol.*

This can be visualized by imagining a mileage indicator in which each of the numbered wheels carries the symbols 0, 1, 2, 3, 4, 5, 6, and 7. When a given wheel has advanced through all of the permissible symbols up to 7, it returns to 0 and the wheel to its left advances. Such an indicator would show mileage expressed as an octal number.

Since, as indicated in Fig. 1B, the positions of an octal number represent ones, eights, sixty-fours, etc., octal number 125 actually means 1 sixty-four, 2 eights, and 5 ones. This may be expressed in powers of eight (since eight is the radix) as: $1 \times 8^2 + 2 \times 8^1 + 5 \times 8^0$. The decimal system equivalent of octal number 125 can be determined by evaluating the above expression:

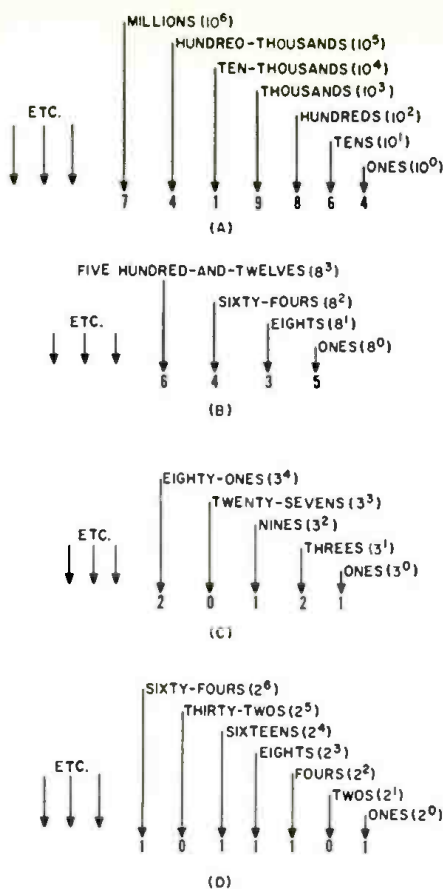

Fig. 1. Positional values of decimal, octal, trinary, and binary number systems. Values are successive powers of the radix of each system. See text for details.

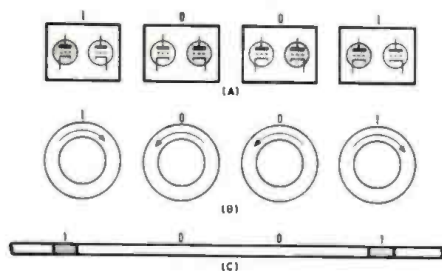

Fig. 2. Binary numbers can be stored in (A) flip-flop stages in which either the left-hand or right-hand tube is conductive; (B) magnetic cores which can be magnetized either clockwise or counterclockwise and (C) magnetic tape magnetized in one direction to represent binary 1 and the opposite direction to represent binary 0. See text.

$$1(64) + 2(8) + 5(1) = 64 + 16 + 5 = 85.$$

The Trinary System

The trinary number system has a radix of three since the only permissible symbols are 0, 1, and 2. Symbols such as 3, 4, 5, and higher are not used in specifying trinary numbers as indicated by the following examples: 122-102, 2001, and 1112.

Fig. 1C shows the positional values of the trinary system: ones, threes, nines, twenty-sevens, and up. Trinary number 212 therefore actually means 2 nines, 1 three, and 2 ones. This may be expressed as: $2 \times 3^2 + 1 \times 3^1 + 2 \times 3^0$. Trinary number 212 can therefore be converted to its decimal system equivalent

as follows: $2(9) + 1(3) + 2(1) = 18 + 3 + 2 = 23$.

The Binary System

The binary number system has only two permissible symbols, 0 and 1, and is therefore a system of radix two. As in other orderly number systems, each position advances to the next symbol after all permissible symbols have appeared in the preceding position to the right. Binary counting can be visualized by imagining a mileage indicator in which each of the number wheels carries only two symbols: 0 and 1. When one of the wheels advances from 1 to 0, the wheel to its left advances to the next permissible symbol. Such an indicator would show mileage expressed as a binary number.

As shown in Fig. 1D, the positional values of the binary number system are ones, twos, fours, eights, sixteens, and up. Binary number 10110 therefore means 1 sixteen, 0 eights, 1 four, 1 two and 0 ones. This may be expressed as: $1 \times 2^4 + 0 \times 2^3 + 1 \times 2^2 + 1 \times 2^1 + 0 \times 2^0$. Binary 10110 can therefore be converted to its decimal system equivalent as follows: $1(16) + 0(8) + 1(4) + 1(2) + 0(1) = 16 + 4 + 2 = 22$.

The octal, trinary, and binary equivalents of the familiar decimal numbers from 0 to 20 are listed in Table 1. As shown, octal number 10, which should be read as "octal one-oh" and not as ten, is equivalent to decimal number 8: $1 \times 8^1 + 0 \times 8^0 = 1(8) + 0(1) = 8$.

In the trinary column of Table 1, 10 follows 2 since all of the permissible symbols have been used in the right-hand position. Trinary number 10 (trinary one-oh) is equivalent to decimal number 3.

In the binary column of Table 1, 10 follows 1 because all of the permissible symbols have appeared in the right-hand position. Binary 10 (not to be

read as ten) is equivalent to decimal number 2.

The binary number system is used extensively in electronic computers, as noted, because it results in a simplification of the circuits and components required to store and manipulate the data. A binary (flip-flop) stage, for example, can be used as a storage device because it can exist in either of two stable states: left-hand tube at cut-off and right-hand tube conducting or left-hand tube conducting and right-hand tube at cut-off. One of these states can represent 0 and the other 1. Fig. 2A illustrates the use of four flip-flop stages to store binary number 1001. Binary numbers can also be stored in ring-shaped magnetic cores. Such cores can be magnetized in either of two directions (clockwise or counterclockwise) and can therefore be used to store so-called binary "bits." Four cores storing binary number 1001 are shown in Fig. 2B, with arrows indicating direction of magnetization. Magnetic tapes and drums are also frequently used as storage devices for binary numbers. The binary bit 1 may be represented by magnetization in one direction and the bit 0 by magnetization in the opposite direction. Or else, as with tape (Fig. 2C), an area magnetized in one direction represents binary bit 1 while an area magnetized in the other direction represents 0.

Storage of numbers expressed in the decimal system would require the use of circuits having ten stable states or of magnetic devices having ten possible directions of magnetization. It is obvious that such circuits and components would be considerably more complex than those used for storing binary numbers.

The two permissible symbols of the binary system are known as bits. Binary numbers 101011, 1101, and 10110 are therefore 6-bit, 4-bit, and 5-bit numbers respectively. Some computers are designed to handle binary numbers 30 to 40 bits in length.

Binary Codes

Since the quantities involved in a calculation are initially expressed in decimal notation, and since computers are usually designed to operate on binary numbers, the decimal numbers must be converted to binary quantities before the computer can use them. This process of conversion is tedious and time-consuming. It is possible, of course, to design into the computer the circuits necessary to perform this conversion. This expedient, however, increases the complexity and size of the equipment. For this reason, a combination binary-decimal system is frequently used.

In one such system, known as *binary-coded decimal*, the decimal number is converted to binary on a digit-by-digit basis. Table 2 shows the 4-bit binary equivalents of the decimal digits. Decimal number 149 would therefore be expressed, in binary-coded decimal, as 0001 0100 1001. Note that this digit-

Fig. 3. Section of magnetic tape coded according to Table 5. Small rectangles represent magnetized areas corresponding to binary 1. For discussion refer to text.

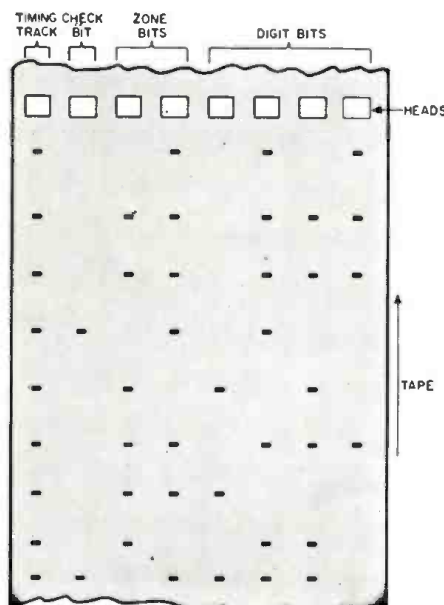

DECIMAL	OCTAL	TRINARY	BINARY
0	0	0	0
1	1	1	1
2	2	2	10
3	3	10	11
4	4	11	100
5	5	12	101
6	6	20	110
7	7	21	111
8	10	22	1000
9	11	100	1001
10	12	101	1010
11	13	102	1011
12	14	110	1100
13	15	111	1101
14	16	112	1110
15	17	120	1111
16	20	121	10000
17	21	122	10001
18	22	200	10010
19	23	201	10011
20	24	202	10100

Table 1. Octal, trinary, and binary equivalents of decimal numbers. Each system, as discussed by author, uses a limited number of different symbols according to its radix.

by-digit conversion differs from pure binary, in which decimal 149 would be expressed as 10010101.

Circuit design can sometimes be simplified by the use of 4-bit combinations other than those listed in Table 2. The frequently used *excess-3* code, which has certain advantages that will be noted shortly, is shown in Table 3. Here, the 4-bit combination used to represent decimal 2 is the same as that used to represent decimal 5 in the system shown in Table 2. Likewise, the excess-3 representation for decimal 4 (Table 3) is the same as the representation for 7 in the other code (Table 2). It is this feature which accounts for the name *excess-3* code. Conversion of a decimal number to excess-3 code also is made on a digit-by-digit basis. Decimal number 12470 would therefore be represented as 0100 0101 0111 1010 0011.

One of the advantages of the excess-3 code is that it avoids use of the 4-bit combination 0000. This permits the computer to distinguish between the quantity zero (0011) and the combination 0000, which may be produced as a result of circuit failure. This aids in the detection of malfunctioning equipment. Another advantage of the excess-3 code is that a decimal digit expressed in this code can be subtracted from 9 simply by changing the ones to zeros and the zeros to ones. To subtract 3 from 9, for example, the 4-bit combination representing 3 (0110) is changed to 1001, which is the representation for 6. This convenient characteristic of the code simplifies the design of some of the arithmetic circuits of the computer.

Some applications require the use of a code in which the 4-bit representations of any two consecutive integers differ in only one bit. A code of this type, known either as a *cyclic* code, *reflected-binary* code or *Gray* code, is shown in Table 4. Note that the representations for 5 and 6 differ in only one bit, the representations for 6 and 7 differ in only one bit, and so on. By

contrast, the excess-3 code may involve several bit changes, as in going from 0111 (4) to 1000 (5).

Alphabetic Codes

Computers are frequently required to handle alphabetic as well as numerical data. This is particularly true in data-processing computers designed for business applications. The sample code in Table 5 shows a comprehensive code using bit combinations to represent numerals, alphabetic characters, punctuation marks, and math symbols. The decimal digits from 0 through 9

DECIMAL	BINARY-CODED DECIMAL
0	0000
1	0001
2	0010
3	0011
4	0100
5	0101
6	0110
7	0111
8	1000
9	1001

Table 2. Conversion of decimal numbers to pure binary is tedious and time-consuming. Binary-coded decimal permits digit-by-digit conversion. Decimal 963, for example, converts to the binary 1001 0110 0011.

DECIMAL	EXCESS-3 CODE
0	0011
1	0100
2	0101
3	0110
4	0111
5	1000
6	1001
7	1010
8	1011
9	1100

Table 3. Excess-3 code uses 4-bit combinations to represent decimal digits. Decimal number 429 converts to 0111 0101 1100.

DECIMAL	REFLECTED BINARY
0	0000
1	0001
2	0011
3	0010
4	0110
5	0111
6	0101
7	0100
8	1100
9	1101

Table 4. In the reflected-binary code, the 4-bit combinations representing successive decimal integers differ in only one bit.

Table 5. Code shown uses 6-bit combinations to represent numerals, alphabetic characters, punctuation, math symbols, etc. The letter R, for example, is represented by 111000.

	ZONE BITS			
	00	01	10	11
0000				
0001			=	#
0010			+	+
0011	0	A	B	C
0100	1	D	E	F
0101	2	G	H	I
0110	3	J	K	L
0111	4	M	N	O
1000	5	P	Q	R
1001	6	S	T	U
1010	7	V	W	X
1011	8	Y	Z	.
1100	9	.	?	:
1101		#	%	-
1110		!	*	
1111				

are represented by 4-bit combinations according to the excess-3 code in this case (although other codes may be used).

Each 4-bit combination is used to represent not only a numeral but also as many as three other characters. The combination 1011, for example, is used to represent the numeral 8, the letter Y, and the letter Z, and the comma. To differentiate among these four possible meanings, the 4-bit combination 1011 is preceded by two other bits known as *zone bits*. The 6-bit combination 001011 therefore represents the numeral 8, and 011011, 101011, and 111011 represent Y, Z, and comma respectively.

Such 6-bit combinations, when used to represent numerals and other characters, are often preceded by a seventh bit known as a *check* or *parity* bit. The check bit is used for error-detecting purposes, and may be either 0 or 1, whichever satisfies the following requirement: the 7-bit combination should contain an *odd* number of "ones." The 7-bit representations for 8, Y, Z, and comma would therefore be 0001011, 1011011, 1101011, and 0111011 respectively. Each of these combinations has, as required, an odd number of ones.

This feature is useful in detecting such errors as may occur in the computer as a result of dust or surface defects on a magnetic tape. For example, a defect might result in the production of a noise pulse that could be mistaken for a pulse representing binary 1. When such an error occurs, one of the bits in the 7-bit representation changes, and the total number of ones becomes even instead of odd. This condition can be recognized by appropriate error-detecting circuitry in the computer. The latter can then be made to sound an alarm.

Fig. 3 illustrates a section of magnetic tape employing 7-bit coding. The small rectangles represent areas of magnetization corresponding to binary bit 1. An additional track, to the left, having a binary 1 recorded in each position is known as a *timing track*. The so-called *sprocket bits* recorded in this track, which serve to identify the locations of the 7-bit combinations, are used to activate the circuits required later to read the information from the tape.

HARMONIC

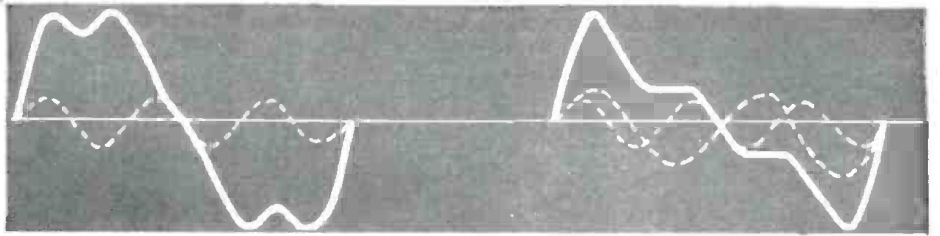

By **MILTON S. SNITZER**
Technical Editor, **ELECTRONICS WORLD**

DISTORTION

What It Is and How It's Measured

The meaning and significance of one of the most important specifications of high-fidelity gear.

THE rich harmonics of music and the characteristic tonal quality of musical instruments are largely the result of the presence of harmonics. For example, if low C is struck on a concert grand piano, high amplitude harmonics, up to almost the fiftieth of the 32.7-cps fundamental tone, are present. As a matter of fact, the sound-board of the instrument is not large enough to radiate frequencies much below 50 or 60 cps, so that the fundamental is missing entirely. Further, the tonal quality, or *timbre*, of musical instruments depends on harmonic structure.

High-fidelity amplifiers, however, are not musical instruments and they must not insert their own tone color into the sound being handled. The job of this

equipment is to reproduce, as exactly as possible, the original quality of the sound. This task is far from simple since only absolutely perfect equipment is entirely free from all types of distortion which alter the nature of the sound signal.

The hi-fi enthusiast must therefore tolerate some distortion, or some change in the sound signal, although with good equipment the extent of such distortion may be below the level where it can be perceived.

Of the several types of distortion to which equipment is subject, one of the most important is *harmonic distortion*. This occurs when the unit being used alters the shape of the sound signal the same way that it would be altered if harmonic frequencies were added to it.

For example, assume that a pure 1000-cps sine wave were applied to a perfect amplifier. Its output would be exactly the same as its input (Fig. 1A), except for an increase in amplitude, and we would have no distortion. On the other hand, if the output were as shown by the solid-line waveforms of Figs. 1B or 1C, then harmonic distortion is present. The circuit acts as though it were generating additional frequencies, which when added to the original pure sine wave, produce the waveforms shown. The distorted wave of Fig. 1B is the result of adding a second harmonic to the fundamental sine wave; the distorted wave of Fig. 1C is the result of adding a third harmonic. When the circuit alters the waveform so that it looks like Fig. 1D, then, in effect, both second and third harmonics have been added. Other distorted waveforms shown in Fig. 1 are the result of adding a larger number of harmonics.

Though almost no music is purely sinusoidal, or lacking in harmonics, we do not want our equipment to generate the harmonics. This is the job of the original sound source whose output must not be modified in any way by the reproducing device. The perfect amplifier then, one whose output varies directly and exactly in accordance with the input, will produce an output waveform that is a replica of the input. It will not modify the waveform and appear to add harmonics to distort the original signal in any way.

Total Harmonic Distortion

The distortion factor of a signal waveform is the ratio between the

Fig. 1. Some examples of severe harmonic distortion discussed in the text.

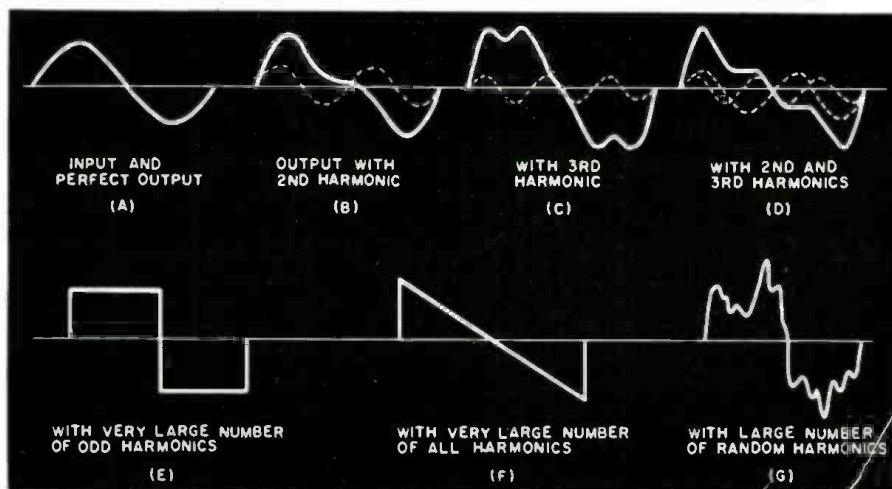

total r.m.s. values of all the harmonics to the total r.m.s. value (the fundamental plus all the harmonics). When this factor is expressed as a percentage, we have a measure of the percentage of total harmonic distortion (THD). To be more specific, the percentage of THD is equivalent to the square root of the sum of the squares of all the harmonics divided by the square root of the sum of the squares of the fundamental and the harmonics, all multiplied by 100. If we have a distorted waveform with an r.m.s. value of 100 volts and we find that we have, in addition to the fundamental signal, a second harmonic of 4 volts and a third harmonic of 3 volts, our percentage of THD is 5% ($[\sqrt{4^2 + 3^2} / 100] \times 100$).

Distortion Limits

But just how little distortion should we have in our hi-fi system? In general, we can tolerate less distortion with music than with speech. Also, as we increase the range of frequencies that our system covers, we can tolerate less distortion. This is part of the price we must pay for being able to reproduce the full musical range. What is more, for frequencies above about 400 cps, we can tolerate far less distortion than at the lower frequencies.

It is not easy to set down definite limits we should seek for total harmonic distortion. The reason for this is that the figure given actually lumps together all the harmonics without specifying what types of harmonics are involved. For example, consider a waveform with a THD of 5%. Now nothing is said as to whether this percentage represents mainly even harmonic, odd harmonic, or a combination of all harmonics. What is more, if there are several harmonics, nothing is indicated in the percentage figure as to the relative amplitudes of the various harmonics making up the total. Any of the conditions just mentioned would produce a different waveform and a different effect on the listener. In general, listeners will tolerate a much larger amount of even harmonic distortion than odd harmonic. Then again, some circuits and even some tubes are more prone to emphasize certain harmonics than others. The harmonic distortion in most push-pull stages, for example, is largely odd-harmonic distortion, the even harmonics being cancelled out.

Because of these variables, and others, the harmonic distortion percentage certainly does not tell the whole story. It does, however, provide a convenient, easily duplicated test that permits one unit to be compared with another. Olson¹ has conducted distortion tests with a limited number of critical observers using single-ended, 3-watt triode and pentode amplifiers. Following are the approximate percentages of total harmonic distortion with wide-range reproduction for three subjective conditions:

DISTORTION	%THD
Perceptible	0.7 (music) 0.9 (speech)



Fig. 2. The basic setup that is employed in measuring total harmonic distortion.

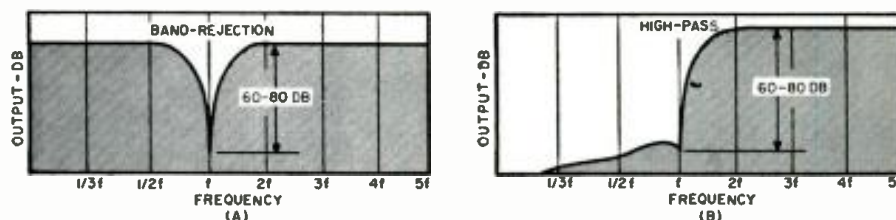

Fig. 3. The two types of response curves used in harmonic distortion analyzers.

DISTORTION	%THD
Tolerable	1.3-1.8 (music) 1.9-2.8 (speech)
Objectionable	2.0-2.5 (music) 3.0-4.2 (speech)

Other tests, made with telephone line equipment by the British Post Office in conjunction with the BBC, disclosed the following results for just detectable second and third harmonic distortion:

For 2nd harmonic—up to 25% below 100 cps; up to 3% below 200 cps; up to 1% below 400 cps; below 1% above 400 cps.

For 3rd harmonic—up to 5% below 100 cps; up to 2% below 200 cps; up to 1% above 400 cps.

More experimental work is certainly required along these lines, but it is safe to say that THD figures below 1 per-cent are very good, while figures below 0.5 per-cent are exceptional.

Harmonic Distortion Measurement

The measurement of total harmonic distortion percentage can be done with the setup shown in Fig. 2. A low-distortion audio generator, set to the frequency at which THD is to be measured, is connected to the equipment under test. This equipment, perhaps a preamp or power amplifier, is properly loaded and adjusted to produce a level of output at which it is desired to make the measurement. A harmonic distortion meter, which can read %THD directly, is then connected across the load.

The harmonic distortion meter consists of a selective audio voltage amplifier, with adjustable attenuation, whose output is connected internally to a vacuum-tube voltmeter circuit. The selective amplifier is needed so that the fundamental frequency may be suppressed in order to take a measurement of the remaining harmonics. The most common way to obtain this selectivity is with a tunable Wien bridge or bridged-T network that puts a sharp notch in the instrument's response (Fig. 3A). With the notch set to the frequency of the audio generator, the fundamental is removed. The meter now has applied to it all the other components in the waveform—mainly harmonics, but also hum and noise.

In using the instrument, the selective amplifier is first bypassed entirely and a meter reading is taken of the amplifier's output. This reading is that of the fundamental frequency plus the distorting harmonics. The meter is adjusted for full-scale (100%) reading. Now the selective amplifier is switched in and carefully balanced to suppress the fundamental. The residual meter indication now reads directly in percentage of total harmonic distortion.

Some harmonic distortion meters use sharp cut-off high-pass filters to eliminate the fundamental (along with hum and noise below the fundamental frequency) and pass all the harmonics (Fig. 3B). Since such filters are not usually adjustable, these instruments may use a half dozen or so filters with different cut-off frequencies to permit measurements to be made at various fundamental frequencies. With such meters only the harmonics and high-frequency noise are measured since the low frequencies are not passed. The measurements taken with the two types of instruments yield somewhat different figures. What is more, the consumer usually does not know which type has been used to make the measurement. In most cases, however, the bridge-type unit, which is far more common, will be the instrument used.

In the early days of hi-fi, it was common to take harmonic distortion measurements at only one or two frequencies around the middle of the audio band, commonly 400 or 1000 cps. With improvements in the quality of equipment, however, many manufacturers are anxious to show just how good their units are. Hence, now it is common to make THD measurements throughout the entire range from 30 to 15,000 cps or even from 20 to 20,000 cps. Such measurements impose a severe test on an amplifier or preamplifier because it is far more difficult to handle the very low and very high frequencies with a minimum of distortion than it is to handle the mid-frequencies.

It is also common to make amplifier THD measurements over a wide range of output powers, up to the full rated
(Continued on page 84)

By JOHN T. FRYE

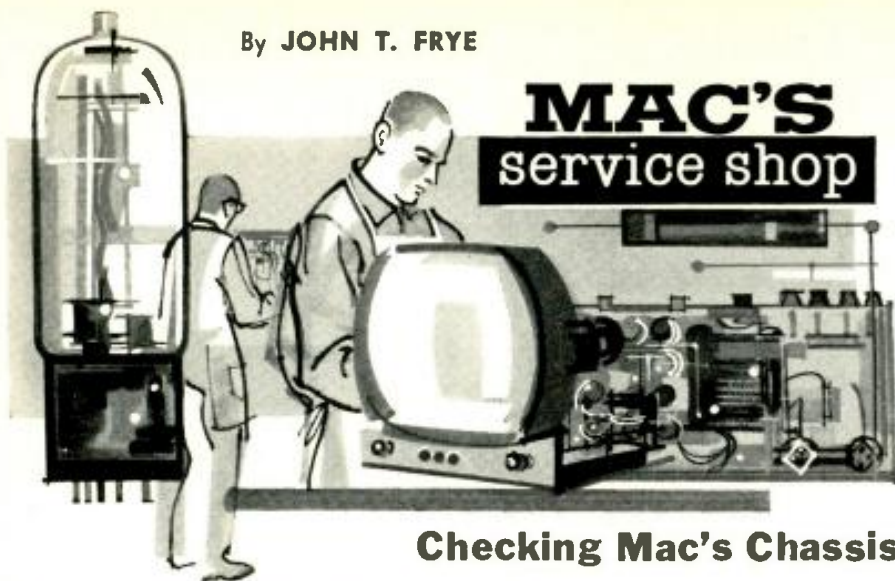

Checking Mac's Chassis

BARNEY was working alone at the service bench. Mac, his employer, had gone to the local clinic early in the morning for his annual physical checkup. About an hour before closing time, though, the door opened and Mac strode in, looking rather strange and out of place in the shop in "civvies."

"Hi," Barney greeted him; "you gonna live?"

"Hate to disappoint you, but it looks like it," Mac answered with a grin.

"What kind of a going over do they give you?" Barney asked curiously. "I never had a checkup."

"Well, let's see now," Mac drawled as he perched himself on a high stool and clasped his long arms around his knees. "I'll have to try and give it to you in language you can understand. The first thing they did was shuck my chassis out of the cabinet so they could work on it. Before going any farther they wanted to be sure, just as we would, that nothing was overheating; so they checked my operating temperature with a thermometer.

"Then the Doc got out a sort of signal tracer with a pair of fancy chrome-plated earphones and checked my local oscillator. It was ticking away right on frequency; but this guy was a good technician and wanted to see the waveform, just as we like to look at the waveform of the bias oscillator of a tape recorder. He used an electrocardiograph to do this. Personally I thought the trace showed a good bit of odd-harmonic distortion, but the Doc said it was OK, and I didn't argue. I remembered how we hate having a customer tell us how to do our job. Incidentally, while Doc was using the signal tracer he did a good bit of checking around in what I would call my converter and i.f. section to see if he could hear any unusual noise.

"Apparently he couldn't, for he put away the signal tracer and got out his meter. This seemed to be a sort of cross between a clamp-on type and a slide-back v.t.v.m., for he wrapped the test lead around my arm and then pumped up pressure with a little squeeze-bulb. Anyway he got a pretty

good potential reading on the meter, and then he tried a little 'circuit disturbance' testing by having me hop up and down a few times to see if this made the meter reading change much. The reading must have been close enough to the proper potential expected, for he put that thing away, too.

"Next on the agenda was some 'signal injection' testing. He had me cross my knees and then rapped me just below the kneecap with a little rubber hammer that I'd like to have for rapping tubes. Every time he injected a pulse signal into the nervous system in this fashion my foot would kick, and that seemed to make him happy.

"From there I went to what I figure must have been a 'front-end-or-tuner-specialist.' He took a real lively interest in my ears, eyes, nose, and throat. When he got to the eyes he found my stereo balance wasn't quite what it should be; so he wrote a prescription for a new pair of lens to take care of that. He also ran a frequency response check on my ears and found the response was drooping a few db on the high-frequency end, but I guess that goes along with getting old and wise—especially old.

"Oh yes, I almost forgot, they ran a sort of efficiency check on me, too. They called it basal metabolism, but actually all they did was check my idling current, you might call it. An interesting thing was that they did this by the same roundabout method we use when we measure the voltage drop across a resistor to get at the current through it. The energy required to maintain the basic body functions is indicated by the amount of heat thrown off by the body at rest in a twenty-four hour period. Since it would be extremely difficult to measure this directly, they simply measured the amount of oxygen I consumed in a given period of time. They know that every liter of oxygen consumed by a normal person under controlled conditions gives off 4.825 calories of heat; so figuring out my basal metabolism rate was as easy as using Ohm's Law."

"I can see you felt right at home,"

Barney said enviously. "While you were goofing off with pretty nurses fluttering all around, I was wrestling with the worst bunch of stupid, crabbed, demanding, insulting, ornery customers I've seen in many a day."

A smile creased Mac's face, and finally he broke into a reminiscent chuckle. "That brings up one more thing I learned today," he said, "something I'm sure I'll remember for a long, long time. I told the doctor I had been feeling a little pooped lately but that I couldn't tell if I were run down or just lazy. That led to talk about how a person could tell when he really needed a vacation, and Doc came up with this story about how a doctor friend of his decided the matter:

"When this doctor would begin to wonder about himself, he would park his car behind his office and let himself quietly in through a back door. Then he would tiptoe forward through his suite of rooms until he came to a spot where a camouflaged peephole permitted him to look into his waiting room without being seen. He would take a long and careful look through that peephole, and when he saw the waiting room was filled with nothing but slobbs, he knew it was time to take a vacation!"

Barney laughed in spite of himself. "That makes a lot of sense," he agreed. "Customers aren't really all angels one day and all fiends the next; but the way we feel can make them so. The next time I run into a string of goat-getters, I'll remember the doctor and his waiting room."

"Well," Mac said as he walked over to the bench, "what did you do today to help me pay the whopping bill I have in my pocket? You've been turning out sets like hot-cakes, I hope, I hope!"

"Not exactly," Barney said hesitantly.

"What do you mean: 'Not exactly'?" Mac demanded.

"Well, I've been working on that little transistor set on the bench ever since lunch."

"What's the matter with it?"

"Take a listen," Barney said as he slowly tuned the receiver across the broadcast band. At the high end of the band reception was fair, but as the dial was turned to the lower frequencies, the background noise rose higher and higher until it almost swamped stations normally heard with good noise quieting.

"How's the alignment?"

"Right on the button; I checked it twice."

"Did you try signal injection and signal tracing to try and find out which circuits were not acting normally?"

"When I run an i.f. signal into the input of the converter-oscillator transistor, it goes right on through; and the sensitivity seems good; but when I try to pull in a station, especially one below 1000 kc., the signal-to-noise ratio is stinko."

"Hm-m-m-m, did the customer give you any clue?"

(Continued on page 110)

SAVE 1/2 THE TIME

Make Twice The Profit!

in TV
Trouble-Shooting

THIS EASY
SIGNAL INJECTION
POINT-TO-POINT
DIRECT VIEWING
WAY

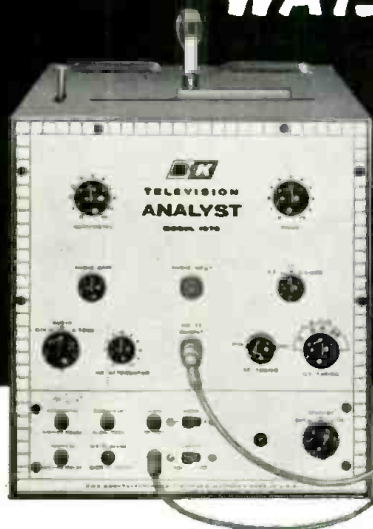

MODEL 1075 TELEVISION ANALYST

Solve Rough Sweep Output Problems



NEW Model A107 DYNA-SWEEP CIRCUIT ANALYZER

Saves many hours of service work. Provides vertical and horizontal sync and driving pulses that enable you more easily and quickly to check out every stage in the sync and sweep sections of a television receiver.

Tracks down troubles in the horizontal and vertical output circuit including defective output transformer and yoke; checks for shorted turns, leakage, opens, short circuits, and continuity. Includes unique high-voltage indication. Eliminates trial and error replacements.

Model A107 Dyna-Sweep. Companion unit for use only with B&K Model 1075 Television Analyst for driving source.
Net, \$49.95

Model 1070 Dyna-Sweep. Same as Model A107 but has its own horizontal and vertical driving pulse, and is used independently of the Model 1075.
Net, \$69.95

New Technique Makes TV Servicing Easier, Faster, More Profitable

Thousands of service technicians already save thousands of hours every day with the amazing B&K TELEVISION ANALYST. Enables you to inject your own TV signal at any point and watch the resulting test pattern on the picture tube itself. Makes it quick and easy to isolate, pin-point, and correct TV trouble in any stage throughout the video, audio, r.f., i.f., sync, and sweep sections of black & white and color television sets—including *intermittents*. Makes external scope or wave-form interpretation unnecessary. Enables any serviceman to cut servicing time in half, service more TV sets in less time, really satisfy more customers, and make more money. Color generator provides both rainbow pattern and color bars.

MODEL 1075 TELEVISION ANALYST. Complete with standard test pattern, white dot, white line, and color-bar slide transparencies, and one clear acetate. Net, \$259.95

See your B&K Distributor or Write for Bulletin ST24-N



B & K MANUFACTURING CO.

1801 W. BELLE PLAINE AVE • CHICAGO 13, ILL.

Canada: Atlas Radio Corp., 50 Wingold, Toronto 10, Ont.
Export: Empire Exporters, 277 Broadway, New York 7, U.S.A.

New Transistor Clock Radio Kit



EVERYTHING A CLOCK-RADIO CAN OFFER ... AND PORTABLE TOO!

- Completely portable, all-transistor circuit
- Runs up to 500 hours on standard batteries
- Deluxe features at half the cost
- Easy to assemble

HEATHKIT TCR-1
\$45⁹⁵

"YOUR CUE" TRANSISTOR CLOCK RADIO KIT (TCR-1)

Take all the deluxe features found in the most expensive clock-radios, add the convenience of complete portability, plus a modern 6-transistor battery operated circuit . . . then slash the price at least in half, and you have the new Heathkit "Your Cue" Transistor Portable Clock Radio.

Packing every modern clock-radio feature into a compact, beautifully styled turquoise and ivory plastic cabinet, "Your Cue" lulls you to sleep, wakes you up, gives you the correct time and provides top quality radio entertainment in and out-of-doors. It can also be used with the Heathkit Transistor Intercom system, opposite page, to provide music or a "selective alarm" system for one or more rooms covered by the intercom system.

An "Alarm-set" hand, hour hand, minute hand and sweep second hand grace the easy-to-read clock dial. All controls are conveniently located and simple to operate. The "lull-to-sleep" control sets the radio for up to an hour's playing time, automatically shutting off the receiver when you are deep in slumber. Other controls set "Your Cue" to wake you to soft music, or conventional "buzzer" alarm. A special earphone jack is provided for private listening or connection to your intercom or music system. At all times crystal-clear portable radio entertainment is yours at the flick of a switch.

The modern 6-transistor circuit features prealigned IF's for ease of assembly. A tuned RF stage and double tuned input to the IF stage assure top performance. The built-in rod-type antenna pulls in far-off stations with outstanding clarity while a large 4" x 6" speaker provides tonal reproduction of unusual quality.

Six easily obtainable penlight-size mercury batteries power the radio receiver up to 500 hours, while the clock operates up to 5 months from a single battery of the same type. Ordinary penlight cells may also be used with reduced battery life.

The handsome two-tone cabinet, measuring only 3½" H. x 8" W. x 7½" D. fits neatly into the optional carrying case for beach use, boating, sporting events, hunting, hiking, or camping.

Wherever you are, you'll find "Your Cue" your constant companion. Shpg. Wt. 5 lbs.

LEATHER CARRYING CASE
HEATHKIT
NO. 93-3
\$4⁹⁵
Shpg. Wt. 2 lbs.

HEATH COMPANY / Benton Harbor, Mich.

a subsidiary of Daystrom, Inc.

New Transistor Intercom Kit

TALK WITH ANY OR ALL FIVE STATIONS WITH YOUR OWN INTERCOM SYSTEM

- Battery Power Permits Placement Anywhere
- Versatile Unit has Many Important Uses
- Complete Privacy of Conversations Assured

TRANSISTOR INTERCOM KIT (XI-1 and XIR-1)

A flexible, versatile transistor intercom, has been developed by Heath engineers to enable you to set up your own communications system at an unbelievably low price.

Consisting of a master unit (XI-1) and up to five remote stations (XIR-1), the system is designed for any remote unit to call the master, for any remote station to call any other remote station, or for the master unit to call any single remote unit or any combination of remote units. Complete privacy is assured, since a call to a remote station cannot be interrupted or listened to while the remote unit is in operation unless switched in by the master unit. Used with clock-radio, opposite page, it can serve as a music or "selective alarm" system.

Transistor circuitry means long life, instant operation and minimum battery drain. Eight ordinary, inexpensive "C" flashlight batteries will run a unit for up to 300 hours of normal "on" time. Circuitry is especially designed for crisp, clear intelligible communication and the instant operation feature allows tuning of the units off between calls, extending battery life. Use of battery power does away with power cords, allowing each unit to be placed where most convenient. Only two wires are required between the master unit and each remote station. Beautifully styled, the Heathkit Intercom presents a new approach in design. Both master and remote stations have two-piece cases in ivory and turquoise for a rich, quality appearance. Batteries not included. Shpg. Wt. 6 lbs.

AC POWER SUPPLY (XP-1)

A permanent power supply for 24-hour operation of the XI-1 Intercom on household current. Converts 110 V. AC to well filtered 12-volt DC output, eliminating the need for batteries. Power supply is small, compact and fits in space normally occupied by batteries.

HEATHKIT XP-1 \$9.95



HEATHKIT XI-1 (Master)

\$27⁹⁵

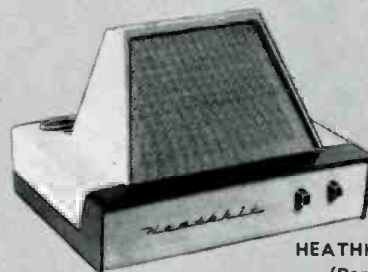

HEATHKIT XIR-1 (Remote)

\$6⁹⁵

Shpg. Wt. 4 lbs.

NEW IMPROVED DESIGN

STEREO-MONO PREAMP KIT (SP-2A, SP-1A)

Get the SP-2A Stereo Preamp kit now, or the SP-1A monophonic version which you can easily convert to stereo whenever you choose by assembling the second channel (C-SP-1A) and plugging it into your SP-1A.

The SP-2A permits stereo, two channel mixing, or either channel monophonic use, and includes a remote balance control.

Six inputs (12 in the stereo version) accommodate tape, magnetic phono and microphone, plus three separate high level inputs. Level controls provided on "mag. phono" and high level inputs. Switch selects NARTB equalization for tape head input, and RIAA, LP or 78 RPM compensation for mag. phono input

HEATHKIT SP-1A (monophonic) Shpg. Wt. 13 lbs. \$37.95

HEATHKIT C-SP-1A (not shown) (converts SP-1A to SP-2A) Shpg. Wt. 4 lbs. \$21.95

New

HEATHKIT SP-2A (stereo)
Shpg. Wt. 15 lbs.

\$56⁹⁵

\$5.70 down. \$6.00 mo.



THE WORLD'S BIGGEST BARGAIN IN A HI-FI AMPLIFIER

55 WATT HI-FI AMPLIFIER KIT (W-7A)

Utilizing advanced design in components and tubes to achieve unprecedented performance with fewer parts, Heathkit has produced the world's first and only "dollar-a-watt" genuine high fidelity amplifier. Meeting full 55-watt hi-fi rating and 50-watt professional standards, the new improved W-7A provides a comfortable margin of distortion-free power for any high fidelity application.

The sleek, modern styling of this unit allows unobtrusive installation anywhere in the home. The clean, open layout of chassis and precut, cabled wiring harness makes the W-7A extremely easy to assemble. Shpg. Wt. 28 lbs.

New



HEATHKIT W-7A

\$54⁹⁵

SPECIFICATIONS—Power output: Hi-Fi rating, 55 watts; Professional rating, 50 watts. Power response: ±1 db from 20 cps to 20 kc at 55 watts output. Total harmonic distortion: Less than 2% from 30 cps to 15 kc at 55 watts output. Intermodulation distortion: Less than 1% at 62 watts output using 60 cps and 6 kc signal mixed 4:1. Hum and noise: 80 db below 55 watts, unweighted. Damping factor: Switch on front panel for selecting either maximum (20:1) or unity (1:1). Output impedances: 4, 8 and 16 ohms and 70-volt line. Power requirements: 117 volts, 50/60 cycles, 90-160 watts. Dimensions: 8 1/2" D. x 6 3/4" H. x 15" W.

New



HEATHKIT SA-1

\$79⁹⁵

Stereo Amplifiers

FOR THE FINEST IN STEREO...

"DELUXE" 20-WATT STEREO AMPLIFIER KIT (SA-1)

Offering every deluxe feature imaginable in a stereo amplifier, the SA-1 also provides 20 watts per stereo channel and 40 watts total monophonic power. Separate bass and treble tone controls for each stereo channel permit you to adjust sound reproduction to suit your taste. A 4-position function switch (stereo, stereo reverse, channel A, channel B) makes it possible for any monophonic source to be fed into either channel individually or to both channels simultaneously. By adjusting the individual channels, you can even impart a pseudo-stereo effect to monophonic program material. A special "dimension" control eliminates the "hole-in-the-middle" effect sometimes produced through varying stereo recording practices. The SA-1 features five switch-selected inputs for each channel; magnetic phono, tape head, and three auxiliary inputs for high level sources. A special sixth position on the selector switch permits use of a monophonic magnetic phono cartridge, through either or both channels. Magnetic phono inputs are RIAA equalized; tape head input is NARTB equalized. All inputs, except that for the "tape head" feature individual level controls. Ganged volume controls permit adjusting the gain of both channels simultaneously, and a separate balance control allows precise channel balancing. Internal amplifier controls for each channel are also provided. Beautifully styled with vinyl-clad steel cover in leather-like texture of black and inlaid gold design. Shpg. Wt. 30 lbs. Available Soon.

New



HEATHKIT SA-2

\$52⁹⁵

YOUR BEST DOLLAR VALUE IN STEREO...

14-WATT STEREO AMPLIFIER KIT (SA-2)

Complete control of your entire stereo system is at your fingertips with this versatile Stereo Amplifier-Preamplifier combination. Providing 14 watts per stereo channel, or 28 watts total monophonic, the SA-2 offers every modern feature required in a master stereo control center, and at a price to please the budget minded. Shpg. Wt. 23 lbs.

SPECIFICATIONS—Power output: 14 watts per channel, "hi-fi"; 12 watts per channel, "professional"; 16 watts per channel, "utility". Power response: ± 1 db from 20 cps to 20 kc at 14 watts output. Total harmonic distortion: less than 2%; 30 cps to 15 kc at 14 watts output. Intermodulation distortion: less than 1% at 16 watts output using 60 cps and 6 kc signal mixed 4:1. Hum and noise: mag. phono input, 47 db below 14 watts; tuner and crystal phono, 63 db below 14 watts. Controls: dual clutched volume; ganged bass, ganged treble; 4-position selector; speaker phasing switch. AC receptacle: 1 switched, 1 normal. Inputs: 4 stereo or 8 monophonic. Outputs: 4, 8 and 16 ohms. Dimensions: 4 $\frac{1}{2}$ " H. x 15" W. x 8" D. Power requirements: 117 volts, 50/60 cycle, AC, 150 watts (fused).

New



HEATHKIT SA-3

\$29⁹⁵

GO STEREO FOR \$29.95

ECONOMY STEREO AMPLIFIER KIT (SA-3)

This amazing performer delivers more than enough power for pure, undistorted room-filling stereophonic sound at the lowest possible cost. Featuring 3 watts per stereo channel and 6 watts as a monophonic amplifier, the SA-3 has been proven by exhaustive tests to be more than adequate in volume for every listening taste.

You will find its ease of assembly another plus feature. Heathkit construction manuals, world famous for their clarity and thoroughness, lead you a simple step at a time to successful completion of the kit. Larger than life-size diagrams show you exactly what each part looks like, where it goes, and how it is installed.

The amplifier is tastefully styled in black with gold trimmed control knobs and gold screened front and rear panel. A tremendous buy at this low Heathkit price! Shpg. Wt. 13 lbs.

SPECIFICATIONS—Power output: 3 watts per channel. Power response: ± 1 db from 50 cps, 20 kc at 3 watts out. Total harmonic distortion: less than 3%; 60 cps, 20 kc. Intermodulation distortion: less than 2% @ 3 watts output using 60 cycle & 6 kc signal mixed 4:1. Hum and noise: 65 db below full output. Controls: dual clutched volume; ganged bass; 7-Position selector; speaker phasing switch; on-off switch. Inputs (each channel): tuner, crystal or ceramic phono. Outputs (each channel): 4, 8, 16 ohms. Finish: black with gold trim. Dimensions: 12 $\frac{1}{2}$ " W. x 6 $\frac{1}{2}$ " D. x 3 $\frac{1}{4}$ " H.

ELECTRONICS WORLD

New



Amplifiers & Tuners

A NEW AMPLIFIER AND PREAMP UNIT PRICED WELL WITHIN ANY BUDGET

14-WATT HI-FI AMPLIFIER KIT (EA-3)

This thrilling successor to the famous Heathkit EA-2 is one of the finest investments anyone can make in top quality high fidelity equipment. It delivers a full 14 watts of hi-fi rated power and easily meets professional standards as a 12-watt amplifier.

Rich, full range sound reproduction and low noise and distortion are achieved through careful design using the latest developments in the audio science. Miniature tubes are used throughout, including EL-84 output tubes in a push-pull output circuit with a special-design output transformer. The built-in preamplifier has three separate switch-selected inputs for magnetic phono, crystal phono or tape, and AM-FM tuner. RIAA equalization is featured on the magnetic phono input. Shpg. Wt. 15 lbs.

NOTE THESE OUTSTANDING SPECIFICATIONS—Power output: 14 watts, Hi-Fi; 12 watts, Professional; 16 watts, Utility. Power response: ± 1 db from 20 cps to 20 kc at 14 watts output. Total harmonic distortion: less than 2%, 30 cps to 15 kc at 14 watts output. Intermodulation distortion: less than 1% at 16 watts output using 60 cps and 6 kc signal mixed 4:1. Hum and noise: mag. phono input, 47 db below 14 watts; tuner and crystal phono, 63 db below 14 watts. Output impedances: 4, 8 and 16 ohms.



HEATHKIT EA-3

\$29⁹⁵

NEVER BEFORE HAS ANY HI-FI AMPLIFIER OFFERED SO MUCH AT SO LOW A PRICE

"UNIVERSAL" 14-WATT HI-FI AMPLIFIER KIT (UA-2)

Meeting 14-watt "hi-fi" and 12-watt "professional" standards, the UA-2 lives up to its title "universal" performing with equal brilliance in the most demanding monophonic or stereophonic high fidelity systems. Its high quality, remarkable economy and ease of assembly make it one of the finest values in high fidelity equipment. Buy two for stereo. Shpg. Wt. 13 lbs.

SPECIFICATIONS—Power output: Hi-Fi rating, 14 watts; Professional rating, 12 watts. Power response: ± 1 db from 20 cps to 20 kc at 17 watts output. Total harmonic distortion: Less than 2% from 20 cps to 20 kc at 14 watts output. Intermodulation distortion: Less than 1% at 14 watts output using 60 cps and 6 kc signal mixed 4:1. Hum and noise: 73 db below 14 watts. Output impedances: 4, 8 and 16 ohms. Damping factor: Switched for unity or maximum; maximum damping factor 15:1. Input voltage for 14 watt output: .7 volts. Power requirements: 117 volts 50/60 cycles, 55 watts. Dimensions: 10" W. x 6 1/2" D. x 4 3/4" H.



HEATHKIT UA-2

\$22⁹⁵

New

MORE STATIONS AND TRUE FM QUALITY ARE YOURS WITH THIS FINE TUNER KIT

HIGH FIDELITY FM TUNER KIT (FM-4)

This handsomely styled FM tuner features better than 2.5 microvolt sensitivity, automatic frequency control (AFC) with on-off switch, flywheel tuning and prewired, prealigned and pretested tuning unit. Clean chassis layout, prealigned intermediate stage transformers and assembled tuning unit makes construction simple—guarantees top performance. Flywheel tuning and new soft, evenly-lighted dial scale provide smooth, effortless operation. Vinyl-covered case has black, simulated-leather texture with gold design and trim. Multiplex adapter output also provided. Shpg. Wt. 8 lbs.

SPECIFICATIONS—Tuning range: 88 to 108 mc. Quieting sensitivity: 2.5 uv for 20 db of quieting. IF frequency: 10.7 mc. Image ratio: 45 db. AFC correction factor: 75 kc per volt. AM suppression: 25 db. Frequency response: ± 2 db 20 to 20,000 cps. Harmonic distortion: Less than 1.5%, 1100 uv, 400 cycles 100% modulation. Intermodulation distortion: Less than 1%, 60 cycles and 6 kc mixed 4:1 1100 uv, 30% modulation. Antenna: 300 ohms unbalanced. Output impedance: 600 ohms (cathode follower). Output voltage: nominal .5 volt (with 30% modulation, 20 uv signal). Power requirements: 105-125 volts 50/60 cycle AC at 25 watts. Overall dimensions: 4 1/2" H. x 13 1/2" W. x 5 1/2" D.



HEATHKIT FM-4

\$34⁹⁵

New

HEATH COMPANY / Benton Harbor, Mich.

 a subsidiary of Davstrom, Inc.

November, 1959

79

New



Tape Recorders

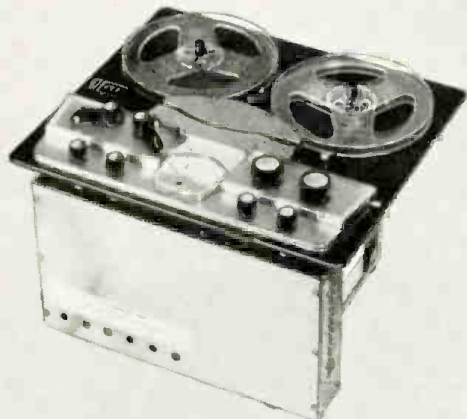

- Choice of 3 Outstanding Models
- Compare With \$350-\$400 Machines
- Preassembled Tape Mechanism

- Choice of Monophonic or Stereo models
- Complete versatility
- Easy to assemble, easy to use

PROFESSIONAL QUALITY TAPE RECORDER KITS (TR-1 Series)

Enjoy the incomparable performance of these professional quality tape recorders at less than half the usual cost. These outstanding kits offer a combination of features found only in much higher priced professional equipment, generally selling for \$350 to \$400. Not the least of these special features is the handsome styling which characterizes the kits... a semi-gloss black panel is set off by a plastic escutcheon in soft gold, which is matched by black control knobs with gold inserts. The mechanical assembly, with fast forward and rewind functions, comes to you completely assembled and adjusted; you build only the tape amplifier. And, you'll find this very easy to accomplish, since the two circuit boards eliminate much of the wiring. Separate record and playback heads and amplifiers allow monitoring from tape while recording and a "pause" control permits instant starting and stopping of tape for accurate cueing and tape editing. A digit counter is provided for convenient selection of any particular recording. Push-pull knob provides instant selection of 3/4 or 7/2 IPS tape speed. Safety interlock on record switch reduces possibility of accidental erasure of recorded tapes. Shpg. Wt. 30 lbs.

SPECIFICATIONS—Tape speed: 7.5" and 3.75" per second. Maximum reel size: 7". Frequency response (record-playback): ± 2.5 db, 30 to 12,000 cps at 7.5 IPS; ± 2.5 db, 30 to 6,500 cps at 3.75 IPS. Harmonic distortion: 1% or less at normal recording level; 3% or less at peak recording level. Signal-to-noise ratio: 50 db or better, referred to normal recording level. Flutter and wow: 0.3% RMS at 7.5 IPS; 0.35% RMS at 3.75 IPS. Heads (3): erase, record, and in-line stereo playback (TR-1C, monophonic playback). Playback equalization: NARTB curve, within ± 2 db. Inputs (2): microphone and line. Input impedance: 1 megohm. Model TR-1D & TR-1E outputs (2): A and B stereo channels. Model TR-1C output (1): monophonic. Output levels: approximately 2 volts maximum. Output impedance: approximately 600 ohm (cathode followers). Recording level indicator: professional type db meter. Bias erase frequency: 60 kc. Timing accuracy: $\pm 2\%$. Power requirements: 105-125 volts AC, 60 cycles, 35 watts. Dimensions: 15 1/2" W. x 13 1/2" D. Total height 10 1/2". Mounting: requires minimum of 8 1/2" below and 1 1/2" above mounting surface. May be operated in either horizontal or vertical position.

MODEL TR-1C Monophonic Tape Deck: \$159.95 \$16.00 DWN. Monophonic Record and Playback. \$14.00 MO.

MODEL TR-1D Two Track Stereo Tape Deck: Monophonic Record and Playback, plus Playback of 2-track Pre-recorded Stereo Tapes (stacked). \$169.95 \$17.00 DWN. \$15.00 MO.

MODEL TR-1E Four Track Stereo Tape Deck: Monophonic Record and Playback, plus Playback of 4-track Pre-recorded Stereo Tapes (stacked). \$169.95 \$17.00 DWN. \$15.00 MO.

MODEL C-TR-1C Conversion Kit: Converts TR-1C to TR-1D (see TR-1D description above). Shpg. Wt. 2 lbs. \$19.95

MODEL C-TR-1D Conversion Kit: Converts TR-1D to TR-1E (see TR-1E description above). Shpg. Wt. 2 lbs. \$14.95

MODEL C-TR-1CQ Conversion Kit: Converts TR-1C to TR-1E (see TR-1E description above). Shpg. Wt. 2 lbs. \$19.95

STEREO-MONO TAPE RECORDER KITS (TR-1A Series)

Here are the tape recorders the avid hi-fi fan will find most appealing! Their complete flexibility in installation and many functions make them our most versatile tape recorder kits. This outstanding tape recorder now can be purchased in any one of three versions. You can buy the new two-track (TR-1AH) or four-track (TR-1AQ) versions which record and play back both stereo and monophonic programming, or the two-track monophonic record-playback version (TR-1A) and later convert to either two-track or four-track stereo record-playback models by purchasing the MK-4 or MK-5 conversion kits. The tape deck mechanism is extremely simple to assemble. Long, faithful service is assured by precision bearings and close machining tolerances that hold flutter and wow to less than 0.35%. Power is provided by a four-pole, fan-cooled induction motor. One lever controls all tape handling functions of forward, fast-forward or rewind modes of operation. The deck handles up to 7" tape reels at 7.5 or 3.75 IPS as determined by belt position. The TR-1A series decks may be mounted in either a vertical or horizontal position (mounting brackets included). The TE-1 Tape Electronics kits supplied feature NARTB equalization, separate record and playback gain controls and a safety interlock. Provision is made for mike or line inputs and recording level is indicated on a 6E5 "magic eye" tube. Two circuit boards simplify assembly.

MODEL TR-1A: Monophonic two-track record/playback with fast forward and rewind functions. Includes one TE-4 Tape Electronics kit. Shpg. Wt. 24 lbs. \$99.95 \$10.00 DWN. \$9.00 MO.

TR-1A SPECIFICATIONS—Frequency response: 7.5 IPS ± 3 db 50 to 12,000 cps; 3.75 IPS ± 3 db 50 to 7,000 cps. Signal-to-noise ratio: better than 45 db below full output of 1.25 volts/channel. Harmonic distortion: less than 2% at full output. Bias erase frequency: 60 kc (push-pull oscillator).

MODEL TR-1AH: Two-track monophonic and stereo record/playback with fast forward and rewind functions. Two TE-4 Tape Electronics kits. Shpg. Wt. 36 lbs. \$149.95 \$15.00 DWN. \$13.00 MO.

TR-1AH SPECIFICATIONS—Frequency response: 7.5 IPS ± 3 db 40 to 15,000 cps; 3.75 IPS ± 3 db 40 to 10,000 cps. Signal-to-noise ratio: 45 db below full output of 1 volt/channel. Harmonic distortion: less than 2% at full output. Bias erase frequency: 60 kc (push-pull oscillator).

MODEL TR-1AQ: Four-track monophonic and stereo record/playback with fast forward and rewind functions. Two TE-4 Tape Electronics kits. Shpg. Wt. 36 lbs. \$149.95 \$15.00 DWN. \$13.00 MO.

TR-1AQ SPECIFICATIONS—Frequency response: 7.5 IPS ± 3 db 40 to 15,000 cps; 3.75 IPS ± 3 db 40 to 10,000 cps. Signal-to-noise ratio: 40 db below full output of .75 volts/channel. Harmonic distortion: less than 2% at full output. Bias erase: 60 kc (push-pull oscillator).

HEATH COMPANY/Benton Harbor, Mich.

a subsidiary of Daystrom, Inc.

ELECTRONICS WORLD

New "Acoustic Suspension" Hi-Fi Speaker System Kit

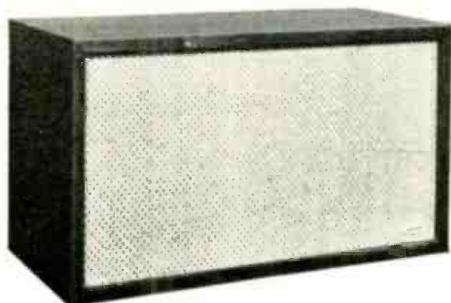

HEATHKIT AS-2U (unfinished)

\$69⁹⁵

HEATHKIT AS-2M (mahogany) **\$79.95**
HEATHKIT AS-2B (birch) **EACH**

**NOW—FOR THE FIRST TIME
—EXCLUSIVELY FROM HEATH**

ACOUSTIC SUSPENSION HI-FI SPEAKER SYSTEM KIT (AS-2)

A revolutionary principle in speaker design, the Acoustic Research speaker has been universally accepted as one of the most praiseworthy speaker systems in the world of high fidelity sound reproduction. Heathkit is proud to be the sole kit licensee of this Acoustic Suspension principle from AR, Inc., and now offers for the first time this remarkable speaker system in money-saving, easy-to-build kit form.

The 10" Acoustic Suspension woofer delivers clean, clear extended-range bass response and outstanding high frequency distribution is provided by the specially designed "cross-fired" two-speaker tweeter assembly.

Another first in the Heathkit line is the availability of preassembled and prefinished cabinets. Cabinets are available in prefinished birch (blond) or mahogany, or in unfinished birch suitable for the finish of your choice. Kit assembly consists merely of mounting the speakers, wiring the simple cross-over network and filling the cabinet with the fiberglass included. Shpg. Wt. 32 lbs.

SPECIFICATIONS—Frequency response (at 10 watts input): ± 5 db, 42 to 14,000 cps; 10 db down at 30 and 16,000 cps. Harmonic distortion: below 2% down to 50 cps, below 3% down to 40 cps at 10 watts input in corner room location. Impedance: 8 ohms. Suggested amplifier power: 20 watts minimum. Suggested damping factor: high (5:1 or greater). Efficiency: about 2%. Distribution angle: 90° in horizontal plane. Dimensions: 24" W. x 13½" H. x 11¼" D.

New Test Equipment



HEATHKIT FMO-1 Price to be announced

**AN INSTRUMENT LONG-AWAITED
BY SERVICE TECHNICIANS
EVERYWHERE!**

HEATHKIT FM TEST OSCILLATOR KIT (FMO-1)

Here in one compact, easy-to-use instrument are provided all the test signals and sweep frequencies required for fast, easy alignment and troubleshooting of RF, IF and detector sections of FM tuners and receivers. An instrument unique in the test equipment field . . . being the only one of its type designed especially for FM service work.

SPECIFICATIONS—Output frequencies: for RF alignment, 90 mc (FM band low end), 100 mc (FM band middle range), 107 mc (FM band high end). Modulation: 400-cycle incidental FM. IF and detector alignment: 10.7 mc sweep. Sweep width markers: 100 kc to over 1 mc, variable, 10.7 mc (crystal), 100 kc sub-markers. Modulation: 400-cycle AM. For other applications: 10.0 mc (crystal) and harmonics, 100 kc, 400-cycle audio. Controls: main frequency selector, modulation switch/concentric level control, marker oscillator switch/concentric level control, sweep width—power switch, output control, AF-RF (source impedance) switch. Power supply: transformer, selenium rectifier. Power requirements: 105-125 V, 50/60 cycles, 12 watts. Cabinet size: 7½" H. x 4½" W. x 4¾" D.



HEATHKIT RF-1

\$27⁹⁵

**PREASSEMBLED AND ALIGNED
BANDSWITCH/COIL ASSEMBLY**

RF SIGNAL GENERATOR KIT (RF-1)

Moderately priced, and capable of precision performance the RF-1 provides highly accurate and stable RF signals for trouble-shooting and aligning RF and IF circuits of all kinds. Modulated or unmodulated RF output of at least 100,000 microvolts is available, controlled by both fixed-step and continuously variable controls. A built-in 400 cycle audio generator with 10-volt output provides internal modulation of RF signal and is available separately for audio tests. A preassembled bandswitch and coil assembly, aligned to factory precision standards, eliminates the need for special alignment equipment. Shpg. Wt. 7 lbs.

SPECIFICATIONS—Frequency range: Band A, 100 kc to 320 kc; Band B, 310 kc to 1.1 mc; Band C, 1 mc to 3.2 mc; Band D, 3.1 mc to 11 mc; Band E, 10 mc to 32 mc; Band F, 32 mc to 110 mc. Calibrated harmonics: 110 mc to 220 mc. Accuracy: 2%. Output: impedance, 50 ohms; voltage, in excess of 100,000 uv on all bands. Modulation: internal, 400 cycles approx. 30% depth; external, approx. 3 V across 50 k ohm for 30%. 400 cycles audio output: approx. 10 V open circuit. Tube complement: V1 12AT7 RF oscillator, V2 6AN8 modulator and output. Power requirements: 105-125 V 50/60 cycles AC, 15 watts. Aluminum cabinet dimensions: 6½" W. x 9½" H. x 5" D.

New

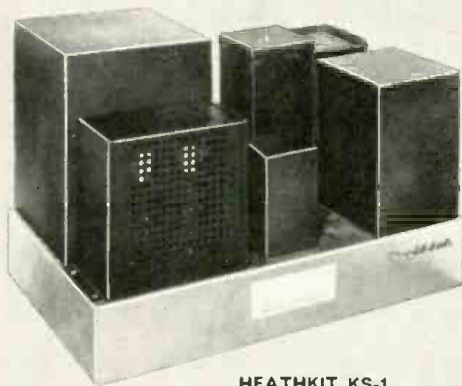

HEATHKIT KS-1

\$169⁹⁵



HEATHKIT KL-1

\$415⁰⁰



HEATHKIT XC-2

\$36⁹⁵



HEATHKIT UT-1

\$28⁹⁵

Ham Radio Gear

TOP POWER WITH ECONOMY AND SAFETY

KILOWATT POWER SUPPLY KIT (KS-1)

The KS-1 is designed as a companion to the "Chippewa" Linear Amplifier and is also suitable for supplying plate power to most other RF amplifiers in the medium to high power class. The KS-1 features an oil-filled, hermetically sealed plate transformer to minimize corona, a swinging choke in the filter circuit for good regulation, and a 60-second time delay relay to permit adequate heating of the mercury vapor rectifiers before application of plate voltage. All components are conservatively rated and well insulated for long life and dependable service. Shpg. Wt. 105 lbs.

SPECIFICATIONS—Maximum DC power output: 1500 watts. Nominal DC voltage output: 3000 or 1500 volts. Maximum DC current output: Average 500 ma. peak 1000 ma. Regulation: 180 to 600 ma (typical linear amplifier), 8%; 0 to 300 ma (typical class C amplifier), 10%; 0 to 500 ma, 15%. Ripple: Less than 1%. Tube complement: (2) 866A mercury vapor rectifiers. Recommended ambient temperature: 50 to 100 degrees F. Circuit: Two half-wave mercury vapor rectifiers in a full wave, single-phase configuration with swinging choke input filtering. Line power requirements: 115 V, 50/60 cycles, 20 amperes; 230 V, 50/60 cycles, 10 amperes. Chassis size: 17 1/2" W. x 12" H. x 13" D.

MOVE TO THE TOP IN TRANSMITTING POWER

"CHIPPEWA" KILOWATT LINEAR AMPLIFIER KIT (KL-1)

The KL-1 operates at maximum legal amateur power inputs in SSB, CW or AM service using any of the popular CW, SSB and AM exciters as a driver. Premium tubes (4—400's) push the "Chippewa" to top performance levels while a centrifugal blower provides more than adequate cooling. Shpg. Wt. 70 lbs.

SPECIFICATIONS—RF section: Driving power required (10 meters): Class AB1 (tuned grid) 10 watts peak; Class C (tuned grid) 40 watts; Class AB1 (swamped grid) 60 watts peak. Power input: Class AB1 (SSB-voice modulation) 2000 watts PEP; Class AB1 (SSB-two tone test) 1300 watts; Class AB1 (AM linear) 1000 watts; Class C (CW) 1000 watts. Power output (20 meters): Class AB1 (SSB-voice modulation) 900 watts PEP; Class AB1 (SSB-two tone test) 550 watts; Class AB1 (AM linear) 300 watts; Class C (CW) 750 watts. Output impedance: 50 to 72 ohms (unbalanced). Input impedance: 50 to 72 ohms (unbalanced). Band coverage: 80, 40, 20, 15 and 10 meters. Panel metering: 0 to 50 ma. grid current; 0 to 100 ma screen current; 0 to 5000 volt plate voltage; 0 to 1000 ma plate current. Tube complement: Final tubes, (2) 4-400A; clamp tube, (1) 6DQ6; voltage regulators, (4) OD3, (2) OC3. Power requirements: AC (power supply primary circuit), 250 watts, 115 volt, 50/60 cycles; DC, 3000 to 4000 volts, 450 ma. Cabinet size: 19 1/2" W. x 11 1/2" H. x 16" D.

2-METER CONVERTER KIT (XC-2)

Extends coverage of the Heathkit "Mohawk" Receiver to the 2-meter band. May also be used with receivers tuning a 4 mc segment between the frequencies of 22 and 35 mc when appropriate crystal is used. Shpg. Wt. 7 lbs.

SPECIFICATIONS—Noise figure: 4.5 db; 1 uv signal provides 20 db thermal noise quieting. Sensitivity: approx. .1 uv input will provide a signal better than 6 db over noise level. Gain: approx. 40 db. Pass band: essentially flat 144 to 148 mc; approx. 35 db down at 143 and 149 mc. Image rejection: better than 100 db (tunable). Output impedance: 50 to 75 ohms. Input impedance: 50 to 75 ohms; 300 ohms with balun. Frequency: input, 144 to 148 mc; output, 22 to 26 mc with crystal supplied. Tubes: 6AM4, 6BS8, 6EA8, 12AT7. Crystal: .005% 3rd overtone. Power requirements: 150 volts DC at 50 ma (dropping resistor supplied for 210 VDC RX-1 operation) 6.3 volts AC/DC at 1.375 amps. Size: 9" W. x 5 1/2" H. x 4 3/4" D.

"BEST BUY" UTILITY POWER SUPPLY KIT (UT-1)

This power supply is ideal for converting the Heathkit "Cheyenne" and "Comanche" mobile transmitter and receiver to fixed station operation; or may be used to provide necessary filament and plate voltage for a wide variety of amateur equipment. Features silicon diode rectifiers, high capacity filters for superior dynamic regulation, and line filtering to minimize TVI and reduce receiver line noise. On ICAS basis, provides 150 watts DC plus filament power for 6.3 volt or 12.6 volt filament applications (6.3 VAC., 8 amps. or 12.6 VAC., 4 amps.; 600 VDC., 250 ma or 600 VDC., 200 ma and 300 VDC., 100 ma). Less than 1% ripple; excellent regulation. Housed in attractive green and gray-green cabinet measuring 9" long, 4 3/4" wide, 6" high. Shpg. Wt. 15 lbs.

New Citizen's Band Transceiver

WIRED OR KIT FORM

HEATHKIT CB-1
\$42⁹⁵
 (kit model)

HEATHKIT W-CB-1
\$60⁹⁵
 (wired model)
 \$6.10 down., \$6.00 mo.

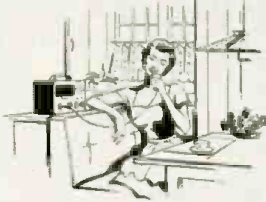

Both models include transceiver, crystal, microphone and two special power cords.

- No Tests to Take—No Operator's License Required
- Any Citizen 18 or Older Can Have Own Station
- Hundreds of Business and Personal Uses

CITIZEN'S BAND TRANSCEIVER KIT (CB-1)

The Heathkit CB-1 Citizen's Band Transceiver is a compact radio transmitter and receiver combination designed to operate on the new 11-meter "Citizen's Band". No tests to take, no special knowledge or operator's license required . . . you need only fill out forms we supply, and mail them to FCC to apply for station license. Operates just like any short wave radio used by police and other communication services. Front panel switch selects both "transmit" and "receive". Two or more Heathkit Transceivers provide you with your own 2-way radiotelephone system for making necessary business and personal contacts with family, friends or associates. A Heathkit accessory power supply makes the CB-1 completely portable for use in cars, trucks, boats, etc., using 6 or 12 volt batteries. With appropriate accessory antenna, the CB-1 can be used for communicating between truck and office, home and automobile, boat and shore, farm-house and field . . . literally hundreds of useful applications. Comes complete with microphone, 2 power cords for mobile or fixed operation, station ID card, call letters, and crystal for one channel and FCC application form. Order power supply and antenna separately. Attractively styled in two-tone "mocha" and "beige". Shpg. Wt. 10 lbs.

SPECIFICATIONS—Receiver type: Superregenerative detector w/rf stage. **Power input:** 5 watts maximum to plate of final RF amplifier (FCC requirement). **Transmitter frequency control:** Third overtone type quartz crystal operating within 0.005% of marked channel frequency between -20° and +130° F. **Modulation:** AM plate and screen modulation automatically limited to less than 100% (FCC requirements). **Power supply:** Internal 117 V, 50/60 cycles, AC (35 watts). For 6 V battery power, use Model VP-1-6 Vibrator Power Supply (6.5 amps); for 12 V battery power, use VP-1-12 (4 amps). **Total B+ requirements:** 260 volts at 60 ma; total heater requirements, 6.3 volts at 1.8 amps, or 12.6 volts at 0.9 amps. **Power rectifier:** 2 silicon diodes in full wave voltage doubler circuit. **Microphone:** Combination hand-held and desk type, ceramic element, plastic case, with cord and connector. **RF output impedance:** 50 ohms. **Speaker size:** 3 1/2" (round). **Undistorted audio power output:** Approximately 1 watt. **Line cords:** Two supplied, one for AC operation, one for battery operation. Power circuits automatically switched when appropriate line cord is plugged in. **Cabinet dimensions:** 8" H. x 6" D. x 9 1/2" W.

SPECIFY FREQUENCY CHOICE (1st and 2nd choice)

CLASS D CITIZEN'S BAND

FREQUENCIES

26.965 mc	27.035 mc	27.115 mc	27.185 mc
26.975 mc	27.055 mc	27.125 mc	27.205 mc
26.985 mc	27.065 mc	27.135 mc	27.215 mc
27.005 mc	27.075 mc	27.155 mc	27.225 mc
27.015 mc	27.085 mc	27.165 mc	*27.255 mc
27.025 mc	27.105 mc	27.175 mc	

*This channel shared with Class C Radio Control.

ANTENNAS

CBU-1 "UTILITY" ANTENNA \$9.95
 Good coverage, portable antenna for temporary mobile or fixed installations. 45 1/2" base-loaded antenna, 12' connecting cable, mounting bracket and clip. 3 lbs.

CBM-1 "MOBILE" ANTENNA \$19.95
 Best coverage mobile installation. Easy to install spring base, 1/4 wave, 9' whip; 15' connecting cable and necessary hardware. 7 lbs.

CBF-1 "FIXED LOCATION" ANTENNA . . . \$19.95
 Excellent coverage, 1/4 wave "ground plane", 9' elements; 50' connecting cable and mounting bracket. 7 lbs.

WIRED AND KIT FORM

POWER SUPPLIES FOR MOBILE USE

6 volt Vibrator Power Supply for use with 6 volt batteries.
KIT—Model VP-1-6. Shpg. Wt. 4 lbs. \$7.95
WIRED—Model WVP-1-6. Shpg. Wt. 4 lbs. \$11.95

12 volt Vibrator Power Supply for use with 12 volt batteries.
KIT—Model VP-1-12. Shpg. Wt. 4 lbs. \$7.95
WIRED—Model WVP-1-12. Shpg. Wt. 4 lbs. \$11.95



ORDER BLANK

NOTE: all prices and specifications subject to change without notice.

Enclosed find () check () money order. Please ship C.O.D. ()

On Express orders do not include transportation charges—they will be collected by the express agency at time of delivery.

On Parcel Post Orders include postage for weight shown. All prices are NET F.O.B. Benton Harbor, Michigan, and apply to Continental U.S. and Possessions only. 20% Deposit required on all C.O.D. orders.

HEATH COMPANY BENTON HARBOR 15, MICH.

a subsidiary of Daystrom, Inc.

Name _____
 Address _____
 City & Zone _____ State _____
 (PLEASE PRINT)

SHIP VIA

- Parcel Post
- Express
- Freight
- Best Way

QUANTITY	ITEM	MODEL NO.	PRICE
<input type="checkbox"/> SEND FREE HEATHKIT CATALOG			POSTAGE
			TOTAL

HEATHKITS are also available at your Dealer

see listing on next page

Here's where to buy your HEATHKIT locally . . .

Harmonic Distortion
(Continued from page 73)

CALIFORNIA

BERKELEY
zackIT Corporation

CHICO
Dunlap Radio & TV

EL CAJON
Telrad Electronics

FRESNO
Dunlap Radio & TV

LOS ANGELES
Kierulff Sound Corporation
(2 Locations)

MARYSVILLE
Dunlap Radio & TV

MERCED
Dunlap Radio & TV

MODESTO
Dunlap Radio & TV

PALO ALTO
Zack Electronics

RIVERSIDE
Kierulff Sound Corporation

SACRAMENTO
Dunlap Radio & TV

SAN DIEGO
Telrad Electronics

SAN FRANCISCO
Zack Electronics

SANTA BARBARA
zackIT Corporation

STOCKTON
Dunlap Radio & TV

TARZANA
Kierulff Sound Corporation

VISALIA
Dunlap Radio & TV

DELAWARE

WILMINGTON
Radio Electric Service Co.

FLORIDA

COCOA
Thurow Distributors, Inc.

DAYTONA BEACH
Thurow Distributors, Inc.

JACKSONVILLE
Thurow Distributors, Inc.

MIAMI
Thurow Distributors, Inc.

ORLANDO
Thurow Distributors, Inc.

PENSACOLA
Thurow Distributors, Inc.

ST. PETERSBURG
Thurow Distributors, Inc.

TALLAHASSEE
Thurow Distributors, Inc.

TAMPA
Thurow Distributors, Inc.

ILLINOIS

ALTON
Radonics—Alton, Inc.

INDIANA

FORT WAYNE
Ft. Wayne Electronics Supply, Inc.

INDIANAPOLIS
Graham Electronics Supply, Inc.

LAFAYETTE
Lafayette Radio Supply Co., Inc.

MUNCIE
Muncie Electronics Supply, Inc.

IOWA

DES MOINES
Radio Trade Supply Co.

FORT DOUGE
Radio Trade Supply Co.

MARSHALLTOWN
Radio Trade Supply Co.

WATERLOO
Radio Trade Supply Co.

LOUISIANA

LAFAYETTE
Sterling Electronics, Inc.

MARYLAND

BALTIMORE
American Distributing Co.
(2 Locations)
The Hi-Fi Shop

SALISBURY
Radio Electric Service Co.

MASSACHUSETTS

BOSTON
Audionics, Incorporated

MICHIGAN

ALLEN PARK
Volta Electronics

DETROIT
High Fidelity Workshop

PONTIAC
High Fidelity Workshop

MINNESOTA

DULUTH
Lew Bonn Company

LA CROSSE
Lew Bonn Company

MINNEAPOLIS
Hi-Fi Sound
Lew Bonn Company

ST. PAUL
Hi-Fi Sound
Lew Bonn Company

MISSOURI

ST. LOUIS
Radonics
(2 Locations)
Radonics-West, Inc.
Radonics-Graois, Inc.

NEW JERSEY

ATLANTIC CITY
Radio Electric Service Co.

CAMDEN
Radio Electric Service Co.

MOUNTAINVIEW
Federated Purchaser, Inc.

NEWARK
Federated Purchaser, Inc.

NEW YORK

ALBANY
Fort Orange Radio Dist. Co., Inc.

BATH
Rochester Radio Supply Co., Inc.

BELLEROSE
Cross Island Electronics, Inc.

BINGHAMTON
Stack Electronics, Inc.

BROOKLYN
Acme Electronics, Incorporated

ELMIRA
Stack Electronics, Inc.

FARMINGDALE
Gem Elec. Distributors, Inc.

FOREST HILLS
Beam Electronics, Incorporated

GENEVA
Rochester Radio Supply Co., Inc.

HERKIMER
Herkimer Electronics Co., Inc.

HICKSVILLE
Gem Elec. Distributors, Inc.

MINEOLA
Arrow Electronics, Incorporated

MT. VERNON
Davis Radio Distributing Co., Inc.

NEW YORK
Arrow Electronics, Incorporated
Harvey Radio Company

ROCHESTER
Rochester Radio Supply Co., Inc.

SYRACUSE
Syracuse Radio Supply Co., Inc.

UTICA
Genesee Electronics Company

VALLEY STREAM
Elm Electronics, Inc.

WATERTOWN
Watertown Electronics Company

ND. CAROLINA

CHARLOTTE
Southeastern Radio Supply Co.

FAYETTEVILLE
Southeastern Radio Supply Co.

GREENSBORO
Southeastern Radio Supply Co.

KINSTON
Southeastern Radio Supply Co.

RALEIGH
Southeastern Radio Supply Co.

OHIO

AKRON
Sun Radio Company

CHILLICOTHE
Buckeye Electronics Dist., Inc.

CLEVELAND
Pioneer Electronic Supply Co.
(2 Locations)

COLUMBUS
Buckeye Electronics Dist., Inc.

DAYTON
Ham 'n' Hi-Fi, Inc.

LORAIN
Pioneer Electronic Supply Co.

MAPLE HEIGHTS
Pioneer Electronic Supply Co.

NEWARK
Buckeye Electronics Dist., Inc.

SANDUSKY
Pioneer Electronic Supply Co.

SPRINGFIELD
Standard Radio-Springfield, Inc.

TOLEDO
Lifetime Electronics

ZANESVILLE
Buckeye Electronics Dist., Inc.

OREGON

PORTLAND
Eccles Electric Company

SALEM
Cecil Farnes Company

PENNSYLVANIA

ALLENTOWN
Federated Purchaser, Inc.

EASTON
Federated Purchaser, Inc.

ERIE
J. V. Duncombe Co.
(2 Locations)

PHILADELPHIA
Austin Electronics, Inc.
Radio Electric Service Co.
(3 Locations)

PITTSBURGH
House of Audio

WILLOW GROVE
Radio Electric Service Co.

YORK
Radio Electric Service Co.

RHODE ISLAND

PROVIDENCE
Audionics, Incorporated

TEXAS

BEAUMONT
Sterling Radio Products, Inc.

BRYAN
Sterling Radio Products, Inc.

DALLAS
Hilicrest Records & Hi-Fi

HOUSTON
Sound Equipment, Incorporated
Sterling Radio Products, Inc.

LUFKIN
Sterling Radio Products, Inc.

VIRGINIA

ARLINGTON
Key Electronics, Inc.

NEWPORT NEWS
Cain Electronics Company, Inc.

NORFOLK
Cain Electronics Company, Inc.
(2 Locations)

PORTSMOUTH
Cain Electronics Company, Inc.

RICHMOND
Meridian Electronics, Inc.

WASHINGTON

SEATTLE
Seattle Radio Supply, Inc.

WISCONSIN

MAOISON
Hi-Fi Corner
Satterfield Electronics, Inc.

MILWAUKEE
Hi-Fi Center
Netzow's

power output. In general, as the output power is increased, so is amount of distortion. Usually, the increase is smooth and gradual up to the overload point, where there is a sudden jump in distortion. Amplifiers should be rated at a power just below this overload point, while the THD is still only a small value. In the case of preamps, measurements are frequently made with certain input and output voltages. For example, we might measure distortion at 1-volt input and 1-volt output or else at .5-volt input and 2-volts output.

A high-quality 50-watt hi-fi amplifier might have the following THD specification: "Total harmonic distortion below 1% from 20 to 20,000 cps within 1 db of 50 watts." Such an amplifier would probably have no trouble at all in producing up to a full 50 watts of output at less than 1% THD over most of the audio range. At the very extremes of the range, however, it would still be generating less than 1% distortion at powers up to 40 watts (which is 1 db below 50 watts).

Another unit might be rated as follows: "Total harmonic distortion below 2% from 30 to 15,000 cps." This amplifier might very well have a THD of a fraction of 1% at 1000 cps, but distortion would not exceed the 2% figure at full-rated power output over the frequency range specified.

A measurement of total harmonic distortion, then, although it does not tell the whole story, is one of the most useful performance specifications that can be measured.

REFERENCE

1. Olson, Harry F.: "Acoustical Engineering" D. Van Nostrand Co., New York. —30—

QUICK SOLDERING

By WILLARD WEISS

A WELLER or similar type soldering gun can be used to heat joints by the resistance method. By cutting off the end of the regular copper heating element and applying the two ends to the joint to be soldered and closing the trigger switch, heat is developed directly in the joint itself.

This method will develop a rapid and localized high temperature and, in crowded chassis, will help prevent damage to adjacent components.

The author has found this technique to be useful when soldering components such as precision resistors, diodes, and transistors to turret lugs on terminal boards. It is important not to overheat these types of components.

If a "Variac" is available, it may be used to control the heating rate and temperature by plugging the soldering gun into the "Variac" and reducing the line voltage.

After using this technique for some time, the author hasn't observed any damage to the soldering gun. In actual fact, the gun runs cooler than normal since it heats the point more rapidly than usual. —30—

Careful selection of reliable qualified dealers is a slow process . . . so please bear with us if your area has not been covered. Thank you.

New York Service Representative
Empire State Electronic Serv., Inc.
180-14 Union Turnpike
Flushing 66, Long Island, New York



HEATH COMPANY/Benton Harbor, Mich.

Ⓛ a subsidiary of Daystrom, Inc.

page ads in the nation's top magazines tell the story!

The New JERROLD TV-FM RECEPTOR* Ends Rabbit Ears!



the first
really small
really powerful
TV-FM antenna

the new antenna that
hides while it works!

Model TVR **\$5.95** List

- No gadget or unproven gimmick . . . it's guaranteed by Jerrold Electronics Corporation.
- No more rabbit ears cluttering up the top of the TV set!
- Even eliminates outside antennas in many areas!
- Easy to install, slides over line cord of TV or FM set!
- Push button tuning for best reception . . . set it and forget it!
- Absolutely safe . . . uses no electricity!
- Designed for VHF, UHF, Color and FM!
- Handsomely packaged in a self display unit. Priced to sell fast!

JERROLD

Contact your Jerrold Distributor or Write:

*Trade Mark

Patent Pending

ELECTRONICS CORPORATION *Distributor Sales Division*
Dept. PD180 The Jerrold Building • Philadelphia 32, Pa.
Jerrold Electronics (Canada) Limited

Export Representative: CBS International, New York 22, N. Y.

PICK THE BEST FOR YOUR STEREO PICKUP SYSTEM by WEATHERS

These are the same components which play an important role in producing Weathers TrioPhonic Stereo—the sound that outmodes conventional stereo.

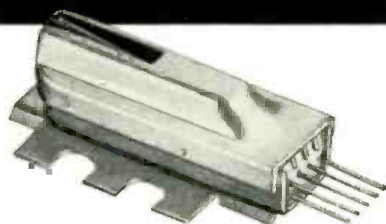

StereoRamic Cartridge C-501

The first ceramic cartridge to outperform the finest magnetic pickups.

SPECIFICATIONS

Frequency Response.....15-30,000 cps
Compliance..... 6×10^{-6} cm/dyne
Dynamic Moving Mass.....1.0 milligrams
Recommended Tracking Force
Professional Arms.....1-2 grams
Changers and other type arms.....2-6 grams
Stylus.....0.7 mil diamond or sapphire
Separation.....25 db
Signal-to-noise Ratio.....-60 db
Output per channel.....0.25 Volts 7 cm/sec
Audiophile Net

C-501-D—Diamond....\$17.50
C-501-S—Sapphire....\$9.75



StereoRamic Pickup System

MC-1. Features the StereoRamic cartridge and the Micro-Touch Tonearm. Leads plug directly into the phono magnetic input of all preamplifiers.

SPECIFICATIONS

Arm Bearing System.....Viscous Damping
Tracking Force.....Easily adjusted 1 to 8 grams
Finish.....Ebony with gold trim
Overall Length.....13 inches
Pivot to Stylus Tip Length.....9 3/4 inches
Recommended Overhang.....1/2 inch
Audiophile Net

MC-1-D—(Diamond)....\$55.95
MC-1-S—(Sapphire)....\$48.25

For more information about Weathers components, write for "The Audiophile's Album"

WEATHERS INDUSTRIES

Division of Advance Industries, Inc.

66 E. Gloucester Pike, Barrington, N.J.
Export: Jos. Plasencia, Inc., 401 Broadway, N. Y.



PORTABLE MEGAPHONE

Audio Equipment Company, Inc. of Port Washington, L.I., New York has recently released a transistor-powered portable megaphone which is being marketed as the "Audio Hailer" Model S-168.

The circuit includes a three-stage push-pull amplifier using three power transistors and one voltage amplifier



transistor. Acoustic output is 115 db at 5 feet, power is 7 watts. The entire circuit is powered by twelve flashlight cells whose battery life approximates shelf life.

The megaphone has a two-tone green, weatherproof baked-enamel housing with a die-cast aluminum pistol grip handle. The unit measures 12 3/4" over-all and weighs 5 3/4 pounds. A colorful data sheet giving complete specifications on this new unit is available from the manufacturer on request.

MATCHED MIKES FOR STEREO

Shure Brothers, Inc., 222 Hartrey Ave., Evanston, Ill., has introduced high-fidelity matched microphones



which permit tape recording fans to obtain professional quality stereo tapes.

The Model 55S "Unidynes" are precision made and guaranteed to be matched within 2 db across their entire frequency range of from 50 to 15,000 cps. "Unidynes" are unidirectional

dynamic microphones with multi-impedance switches to permit matching low (35-50 ohms), medium (150-250 ohms), or high (100,000 ohms and up) impedance inputs. Their super-cardioid pickup patterns make them effective at a 75 per-cent greater distance than standard microphones, according to the company.

The manufacturer will supply full details and price information on these new matched microphones upon request.

BOOKSHELF SPEAKER

ALCOR, Inc. of Ithaca, New York is currently in production on a new bookshelf speaker system which is especially adapted to stereo applications.

The "Polaris" incorporates a radical tweeter design which uses acoustic reflection to provide smooth, wide dispersion even at the highest audible frequencies. This wide dispersion makes it unnecessary to sit exactly midway between the speakers to hear balanced

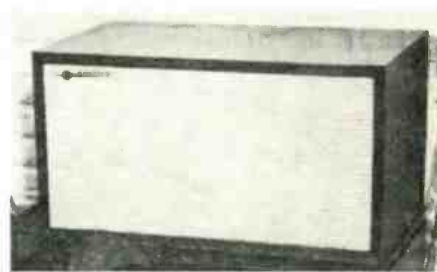

stereo and allows several listeners in various parts of the room to enjoy excellent reproduction.

The woofer is a soft-suspension, cast-frame, low-frequency driver and is used with a true LC crossover. Amplifier distortion is reduced since the system presents a nearly constant impedance to the amplifier at all frequencies. The system may be used with any amplifier rated at 10 watts or better. Frequency response is 35 to 17,500 cps.

The enclosure measures 11 3/4" x 11 3/4" x 24 3/4" and will fit any 12" bookshelf. It is available in unfinished birch, genuine blonde or dark mahogany, and genuine walnut or cherry finishes.

Write the manufacturer direct for complete details and prices.

FISHER TUBE LINE

Fisher Radio Corporation, 21-21 44th Drive, Long Island City 1, N. Y. is now marketing a new line of laboratory tested and matched-paired vacuum tubes for audio, radio, and television applications.

According to the company, the laboratory matching of tubes in pairs makes it possible to balance sensitive

"The new Citation Kits represent for me the successful culmination of years of research and experimentation to achieve the ultimate in high fidelity design."

Stewart Hegeman, Director of Engineering, Citation Kit Division, Harman-Kardon, Inc.



THese are strong words from a conservative audio engineer. But the proof is overwhelming. All that's necessary is a look at the technical specifications of the new Citation I Stereophonic Preamplifier Control Center and Citation II 120 Watt Stereophonic Power Amplifier. (We'll gladly send them to you.

Hegeman is recognized as one of the world's great audio engineers. His original designs for the famous Brociner amplifier and preamplifier, and the Hegeman-Lowther speakers, are still regarded as classics by audio engineers and audiophiles. In his capacity as head of the kit engineering group at Harman-Kardon, he has again created new classics.

Easily Assembled— Professional Performance

There are many exciting new concepts built into the Citation Kits. The engineering is so wonderfully precise that the instrument constructed by the kit builder will duplicate the precision of the finest factory-assembled products. Here are some of the remarkable new assembly features that distinguish the Citation Kits:

Military Type Construction: For ease of assembly and durability, rigid phenolic boards are used. **Special Cable Harness:** Unique harness template enables builder to make a professional cable harness to facilitate wiring and insure accuracy. **Special Aids:** Resistors and condensers are filed individually on special component cards so that they can be quickly identified. Wire strippers are supplied free with each kit to produce clean wire junctions.

The Citation I Stereophonic Preamplifier Control Center

Here is the first brilliant expression of the advanced design concepts which

sparked the new Citation Kit Line: the incomparable Citation I, Stereophonic Preamplifier Control Center.

The Citation I consists essentially of a group of circuit blocks termed active and passive networks. Active networks incorporate the vacuum tubes and furnish amplification; passive networks consist of resistors and condensers and provide precise equalization. The active networks are treated as one- or two-stage amplification units, flat over an extremely wide frequency range, and each one of these networks is surrounded by a feedback loop. This results in levels of distortion so low as to prove unmeasurable. The passive networks are constructed of precision components and are designed for minimum phase shift.

PROFESSIONAL STEP-TYPE tone controls are used on the new Citation I. They overcome the limitations of continuously variable potentiometers; each position on a step control can be engineered to perform a specific function which is absolutely repeatable when necessary. The flat position of the controls by-passes all tone control circuitry, thereby eliminating transient distortion and phase shift.

Other features include: The new Citation Blend Control which introduces a continuously variable amount of cross-feed between the two channels to eliminate the "hole-in-the-middle" effect of many stereo records; DC heated preamplifier filaments; six silicon diode rectifiers to provide unexcelled B+ and filament regulation; separate turnover and rolloff controls to provide precise equalization.

The Citation I is available with an optional walnut hardwood enclosure which sets off its magnificent sculptured satin-gold escutcheon. The Citation I... \$139.95; Factory Wired... \$239.95; Walnut Enclosure, WW-1... \$29.95.

The Citation II 120 Watt Stereophonic Power Amplifier

HERE IS ALL the power required from a stereophonic amplifier. Two 60 Watt Channels—with a combined peak power output of 260 Watts!

The Citation II reflects a dramatic new approach to amplifier design. Audio engineers have discovered that the characteristics of an amplifier in the non-audible range strongly influence sound quality in the audible range. This can be determined in critical listening tests where the pro-

gram material for each amplifier is laboratory controlled.

Because of this vital consideration the Citation II is engineered to produce frequencies as low as 5 cycles virtually without phase shift. At the high end—the amplifier has a frequency response beyond 100,000 cycles without any evidence of ringing or instability.

AUDIO ENGINEERS have also found that the higher the degree of feedback—and the consequent lower distortion—the more apparent the improvement in sound quality and the greater the reduction in listener fatigue. In order to increase the degree of feedback in the Citation II, a "multiple loop" technique is used in contrast to conventional "single loop" techniques. This results in a 20/1 to 30/1 reduction in distortion compared with the 10/1 to 20/1 reduction in conventional amplifiers.

Other important Citation II features include: video output pentodes in all low level stages for exceptional wide frequency response and low distortion; power supply consisting of four silicon diode rectifiers, choke and heavy duty electrolytics with potted power transformer for superb regulation and long life; bias meter to adjust individually the plate current of each KT88 for balance and lowest distortion.

The Citation II is a handsomely styled brown and gold instrument with an optional Charcoal Brown protective cover. The Citation II... \$159.95; Factory Wired... \$219.95; Charcoal Brown Enclosure, AC-2... \$7.95.

All prices slightly higher in the West.

For a complete report on the new kits write to Harman-Kardon, Inc., Citation Kit Division, Dept EW-11, Westbury, N. Y.



Citation I



Citation II

Build the Very Best

CITATION KITS

by

harman kardon



Fairchild is progress



... the progress which started when Fairchild turned out its first piece of professional recording equipment. Never a company to be satisfied with the status quo, Fairchild's engineering staff developed one major improvement after another, keeping giant-steps ahead of the industry. The transition and expansion to professional-quality equipment for the serious home music enthusiast was a logical one. Today, with an established record of achievement, Fairchild presents its *pièce de résistance* in stereophonic transducers...

The SM-1 Rotating Magnet Compatible Stereo/Monophonic Cartridge. Its high output (16.2 mv at 7 cm/sec) permits quiet operation of the most economical of kit amplifiers, while the wide response (better than ± 2 db from 20-15000 cycles) will test the finest stereo amplifier-preamplifier units on the market. These features coupled with high vertical and lateral compliance make the SM-1 a stand-out choice for your music system. And Fairchild's rugged design will stand the abuse of any record changer. Yet it will enhance the performance of the finest professional arms and turntables.

See and hear the Fairchild SM-1 at your sound dealer now. Price, including installation hardware, gram gauge and screwdriver... \$34.95.



FAIRCHILD RECORDING EQUIPMENT CORP.
10-40 45th Ave., Long Island City 1, N. Y.

circuits and maintain this balance with perfect stability. While the new tube line was introduced primarily for use in the company's own audio components, the tubes are completely interchangeable with all standard brands and may be used in any equipment.

The new matched tubes are currently available at audio salons and service shops.

INTEGRATED STEREO AMP

Lafayette Radio Corp., 165-08 Liberty Ave., Jamaica 33, N. Y. has announced the availability of a new stereo preamp-amplifier which is being offered in both kit and wired versions.

The KT-250 has been designed to handle all stereo or mono sources. Each channel will provide 25 watts of power (50 watts if used in the mono mode) with terminations for 4-, 8-, or 16-ohm speakers.

The full range of controls includes a unique "blend" control which provides continuously variable channel separation from full monophonic to full stereo. This control may be used to reduce the exaggerated channel separation



found in some stereo source material or to eliminate vertical rumble when playing a monophonic record with a stereo cartridge. Individual or simultaneous level control of both channels is made possible by the use of a clutch-type volume control and each channel has its own bass and treble controls.

Frequency response at normal listening level is 17 to 21,000 cps ± 1 db. Hum and noise is 74 db below rated output at full volume for high-level inputs and -54 db for low-level inputs. Harmonic distortion is less than 0.25% and IM distortion is less than 1%. Channel separation, with separation control in full stereo position, is greater than 50 db.

The unit measures 14 $\frac{1}{2}$ " x 12 $\frac{3}{4}$ " x 4 $\frac{1}{2}$ " including the legs and knobs. Write the company direct for full details on both the wired and kit models.

TURNTABLE SPEED INDICATOR

Sela Electronics Company, 545 West End Ave., Chicago 24, Ill. is currently marketing a turntable speed indicator, the Model T-7.

This new strobe flasher incorporates an advanced-design gas discharge bulb in conjunction with a germanium diode rectifying circuit and operates from 117-volt, 60-cycle power sources.

Flash duration on each cycle is as short as 100 microseconds, imparting sharp bar images to the rotating stroboscopic markers. The strobe card is marked in concentric bands for different phonograph speeds. Clockwise

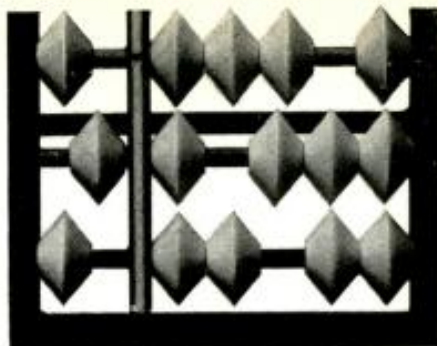

IT ALL ADDS UP
WITH
SPEAKERS BY

wigo
PRONOUNCE IT WEEGO

Engineering integrity placed ahead of mere appearance, plus...

Prices related to actual costs, and not to "what the traffic will bear", plus...

Reliance on your ability to judge real quality and value. For literature, write...

united  Audio

PRODUCTS OF DISTINCTION
202-4 East 19th St., N. Y. 3, N. Y.



DYNACO
Super
Fidelity

**OUTPUT
TRANSFORMERS**

Advanced pulse techniques and Dynaco's patented para-coupled windings and massive grain-oriented cores insure superior square wave performance and near-perfect transients. All transformers handle full rated power from 20 cps to 20 KC, and are conservatively rated and guaranteed to handle double nominal power from 30 cps to 15 KC.

SPECIFICATIONS

Response: Plus or minus 1 db 6 cps to 60 KC.
Power Curve: Within 1 db 20 cps to 20 KC.
Square Wave Response: No ringing or distortion from 20 cps. to 20 KC.
Permissible Feedback: 30 db.

MODELS

A-410	15 watts	EL-84, 6V6, 6AQ5	14.95
A-420	30 watts	5881, EL-34, KT-66	19.95
A-430	60 watts	KT-88, EL-34	29.95
A-440	120 watts	KT-88, 6550	39.95
A-450	120 watts	pp por KT-88, EL-34	39.95

(all with tapped primaries except A-440 which has tertiary for screen or cathode feedback)

Write for complete data on Dynaco transformers including suggested circuits and modernization of Williamson-type amplifiers to 50 watts output.

DYNACO INC.

3916 Powelton Ave., Philadelphia 4, Pa.

movement means that the turntable is too fast while the counterclockwise rotation indicates too slow operation. There are four concentric marker circles on the strobe card for 16 $\frac{1}{2}$, 33 $\frac{1}{2}$, 45, and 78 rpm.

For a data sheet on this new device, write the company direct.

CARTRIDGE INSTALLATION KIT

Fairchild Recording Equipment Corp., 10-40 45th Ave., Long Island City 1, N. Y. is now supplying a free

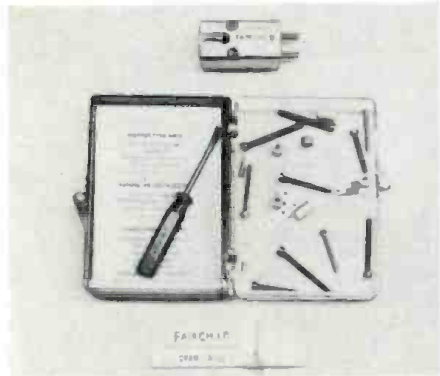

cartridge installation kit, complete with necessary tools, with its new stereo and monophonic cartridge, Model SM-1.

The kit includes, in addition to the usual hardware, a gram gauge, small screwdriver, and instructions printed in three languages. The gram gauge, for measuring stylus pressure on recordings, can be retained for continuing verification of pressure to preserve both records and stylus.

HARTLEY "DUO" SPEAKER

Hartley Products Company, 521 E. 162nd St., New York 51, N. Y. is now offering a deluxe model of its "Duo Stereo" speaker system in a single cabinet.

The cabinet is crafted in natural woods, with the angled speaker mount-



ing boards hidden by a grille which encloses the corners—giving a more conservative appearance. The enclosure houses two full-range speakers which deliver both stereo channels evenly throughout the room by direct radiation and reflection from the walls.

The enclosure is available with or without companion speakers. Write the manufacturer for prices and finishes.

"DYNAKIT" 40-W. AMPLIFIER

Dynaco Inc., 617 North 41 St., Philadelphia 4, Pa. is now offering a new 40-watt amplifier in both wired and semi-assembled kit form.

November, 1959

The Very Best Now Costs You Less



KNIGHT® STEREO HI-FI

A PRODUCT OF ALLIED RADIO

... challenges comparison with the costliest components ...

prove it for yourself on our 15-day free home trial... doubly guaranteed: specifications meet or exceed published figures or we refund your money... unconditionally guaranteed for one full year...



deluxe 60-watt complete stereo amplifier

Fifteen stereophonic and monophonic controls • 60 watts rated stereo output... 76 watts usable... 152 watts peak-to-peak • ± 0.5 db, 25-20,000 cps • Third channel speaker output with new additive full-range circuit • 5 pairs of stereo inputs... including auxiliary for new cartridge tape playback • Long-life silicon diode heat-free power supply with oversize transformer • Humless DC on all preamp tubes • Vinyl-clad metal case included in price • Anodized front panel in brushed gold and charcoal brown • Shpg. wt., 35 lbs....only \$149.95. \$5.00 down.



deluxe stereo FM-AM tuner

Separate FM and AM sections for stereo reception • Adjustable DSR corrective feedback for lowest distortion of FM • Front panel audio and a.c. switching for multiplex • Dual limiters on FM • Tuned RF stage on both FM and AM • 2.5 microvolt sensitivity on FM • ± 0.5 db, 20-20,000 cps • Cathode follower multiplex and tape output jacks • Dual "Microbeam" tuning indicators • Illuminated 9 $\frac{1}{2}$ " tuning scale • Low-noise 50-ohm extra antenna terminals • Solid aluminum front panel, gold anodized, with vinyl-clad case. Shpg. wt., 21 lbs....only \$139.95. \$5.00 down.

order from

ALLIED RADIO

New Easy Terms:
Only \$5 down (or less)
on orders up to \$200.
Up to 24 months to pay.

FREE 1960 ALLIED CATALOG

Send for your complete, money-saving guide to the world's largest selection of hi-fi components and systems. See everything in stereo; all the new KNIGHT components; all leading make lines. For everything in hi-fi, for everything in Electronics, get the 1960 ALLIED Catalog. FREE—write for it today.



ALLIED RADIO, Dept 54-L9
100 N. Western Ave., Chicago 80, Ill.

Ship the following Knight components:

KN-760. \$_____ enclosed (I understand your 15-day trial and money-back guarantee applies to this purchase.)
 KN-125. \$_____ enclosed

Send FREE 1960 ALLIED Catalog

Name _____

Address _____

City _____ Zone _____ State _____

"IT TAKES TWO TO STEREO" *



... the perfect team for stereo!
 For matchless reproduction of stereo recordings
 — the Model 196 UNIPOISE Arm
 with integrated Stanton Stereo FLUXVALVE pickup
 and the GYROPOISE 800 airborne Stereotable.
 Only the Stanton Stereo FLUXVALVE
 has the exclusive "T-GUARD" stylus assembly
 with the parallel reproducing element so important for stereo...
 only the GYROPOISE Stereotable revolves on a bearing-of-air
 — in magnetic suspension
 only the Stereo FLUXVALVE is warranted for a lifetime.
 In plain truth, here is more to enjoy —
 from both stereophonic and monophonic records.
 Fine quality high fidelity products
 by PICKERING & Co., Inc., Plainview, N. Y.



FOR THOSE WHO CAN HEAR THE DIFFERENCE

Pickering

FLUXVALVE, GYROPOISE, STEREO TABLE, "T-GUARD" UNIPOISE
 * NEWLY REVISED — IT TAKES TWO TO STEREO — ADDRESS DEPT. F119 FOR YOUR FREE COPY

PURCHASING A HI-FI SYSTEM?

Send Us Your List Of Components For A Package Quotation

WE WON'T BE UNDERSOLD!

All merchandise is brand new, factory fresh & guaranteed.

AIREX RADIO

CORPORATION
 64-R Cortlandt St., N. Y. 7, CO 7-2137

PARTIAL LIST OF BRANDS IN STOCK

Altec Lansing
 Electrovoice
 Jensen
 Hartley
 University
 Acoustic Research
 Janszen
 Wharfedale
 Karlsen
 Viking
 Concertone
 Bell • G.E.
 Weathers
 Harman-Kardon
 Eico • Pilot
 Sherwood
 Acrosound
 Fisher
 Bogen • Leak
 Dynakit
 H. H. Scott
 Ferragraph
 Tanberg
 Penton
 Ampex • DeWald
 Revere
 Challenger
 Wollensak
 Garrard
 Miracord
 Glaser-Steers
 Rek-O-Kut
 Components
 Norelco
 Fairchild
 Pickering • Gray
 Audio Tape
 Conrac TV
 Full Line of
 Wellcor Cabinets

DYNACO B&O

Wide-Band Ribbon Microphones

- SMOOTHEST RESPONSE
- PRECISE FIGURE 8 PATTERN
- FOR PROFESSIONAL AND HOME USE



FOR STEREO AND MONO

STEREO SPACER

for consistently superior stereo recordings

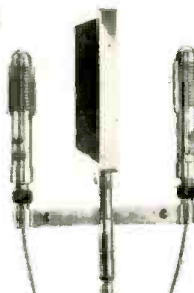

Complete Data Available on Request

DYNACO, INCORPORATED

3916 Powelton Ave., Philadelphia 4, Pa.

Tradenamed the "Dynakit Mark IV," the circuit features the firm's A-470 output transformer and is suitable for either stereo or monophonic applications. The amplifier delivers its rated 40 watts of power at less than 1% distortion within the 20 to 20,000 cps range. Frequency response is ± 1 db from 10 to 40,000 cps. Noise is better than 90 db below rated output. Transient response, as evaluated by pulse tests and square waves, is said to be excellent.

The circuit uses matched EL-34 tubes driven by the new 7199 pentode-triode tube. The use of prewired printed circuitry, detailed step-by-step instructions, and pictorial diagrams enables even novice kit builders to construct this amplifier quickly and easily. Average construction time is said to be about 3 hours.

The Mark IV measures 5"x14"x6½" and weighs 23 pounds. It is finished in bright nickel with charcoal brown vinyl coated cover.

MULTIPLEX ADAPTER

Sherwood Electronic Laboratories, Inc., 4300 N. California Ave., Chicago 18, Ill. has developed a multiplex adapter which enables reception of any of the various stereo multiplex programs now being transmitted experimentally over FM stations throughout the country.

Matrix circuitry, switching, and balance adjustments are included in the SMX adapter for both the Crosby sum/

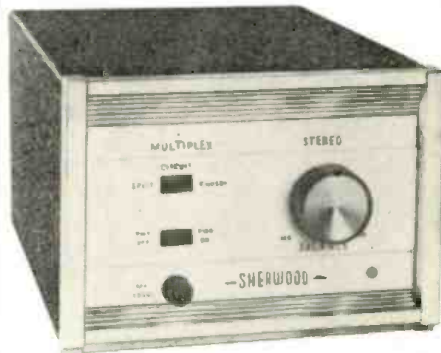

difference system and split-channel systems. The subchannel bandpass extends from 22,500 to 120,000 cps and is adequate to receive transmissions at 26, 41, 50, or 67 kc. with up to 60 kc. bandwidth.

Normal monophonic FM tuner reception is possible with the Model SMX power switch off without upsetting either the adapter controls or interconnecting cables. The unit is self-powered and can be operated with any FM tuner.

The adapter can be housed in an accessory case which is available in brown or black Flexstone. The unit measures 5¾"x10½"x4" and weighs 8 pounds packed for shipping.

BLANK TAPE CARTRIDGES

The Electron Tube Division of Radio Corporation of America, Harrison, N. J. has announced the availability of magnetic tape cartridges containing blank

ELECTRONICS WORLD

tape and suitable for all home recording applications.

The new pre-threaded and self-contained units can provide up to two full hours of monophonic play or one full hour of stereo play on one cartridge.



Made of rugged plastic, the small compact units may be easily stored. The cartridge also has an automatic safeguard which prevents accidental erasure. Windows on both sides of the cartridge show the amount of unrecorded tape remaining.

These blank cartridges are currently available at authorized RCA dealers as Type 264C1.

ALTEC "DUPLEX" SPEAKER

Altec Lansing Corporation of Anaheim, Calif. is now in production on a new "Duplex" speaker with controlled linear excursion.

The Model 605A is the successor to the company's 604D and features improvements in both the bass and treble sections. In the bass section the 605A has high-compliance suspension components for controlled linear excursion, stress-free assembly for ultimate linearity of the suspension system, a voice coil confined to a uniform magnetic field, magnetic field high flux density for optimum damping, and a low cone resonance of only 25 cps for reproduction of the lowest bass notes.

The treble section improvements include a lighter voice coil, a higher acoustic transformation, and smoother high-end response. Power rating is 35 watts with frequency response from 20 to 22,000 cps. Resonant frequency is 25 cps and impedance 16 ohms. Vertical distribution is 40 degrees while horizontal distribution is 90 degrees. Crossover frequency is 1600 cps.

The speaker measures 15 3/4" in diameter and is 10" deep. Shipping weight is 36 pounds.

AUDIO CATALOGUES

RECOTON CATALOGUE

Recoton Corp., 52-35 Barnett Ave., Long Island City 4, N. Y. has announced publication of its 8th annual catalogue and simplified replacement needle reference guide.

Well illustrated, this 12-page publication includes the firm's complete line of phono needles, cartridges, accessories, and sales promotion material. It serves as a handy reference manual for dealers. Copies are obtainable without charge direct from the manufacturer.

-30-

A QUARTER-CENTURY OF **PRECISION** KNOW-HOW IS YOURS IN

P A C O

QUALITY ELECTRONIC EQUIPMENT IN KIT FORM

FOR:
electronic hobbyists
and amateur radio

hi-fi custom building
and service

science education and
technical schools

industrial testing and
quality control

PACO is the only line of test instrument kits engineered and produced under the auspices of a leading test equipment and meter manufacturer.

and, you pay nothing extra for the convenience of buying PACO kits directly from your own local parts distributor.

COMPARE PACO against any other kits for performance, appearance, ruggedness, ease of operation and simplicity of assembly and wiring.

COMPARE PACO's superbly detailed, step-by-step instruction manuals and giant size wiring diagrams, against any you have ever seen.

SEE HOW PACO sets an entirely new standard in electronic instrument kit design and kit assembly instruction.

■ Available and on display at leading electronic parts distributors.

■ Write for latest, complete catalog.

P A C O

Electronics Co., Inc.,

70-31 84th St., Glendale 27, L. I., N. Y.

Export: 458 B'way, N. Y. 13, U.S.A.,

Canada: Atlas Radio Corp., Toronto 19.

A DIVISION OF

PRECISION APPARATUS CO., INC.

 <p>MODEL B-10 Battery Eliminator Kit • less than 0.3% ripple output • no external filters required Kit Net Price:\$41.95 Factory Wired:\$49.50</p>	 <p>MODEL S-55 Wideband 5" Oscilloscope • response DC to 5 Mc • push-pull V and H amplifiers Kit Net Price:\$87.50 Factory Wired:\$139.50</p>
 <p>MODEL C-20 Res-Cap-Ratio Bridge Kit • 10 mmdf to 2000 mfd • 1/2 ohm to 200 megs Kit Net Price:\$20.95 Factory Wired:\$31.50</p>	 <p>MODEL T-60 Tube Checker Kit • full free-point lever selector system • built-in roll chart Kit Net Price:\$38.75 Factory Wired:\$54.50</p>
 <p>MODEL G-30 RF Signal Generator Kit • 160 Kc to 240 Mc in 8 bands • 120 Mc fundamental output Kit Net Price:\$28.50 Factory Wired:\$39.95</p>	 <p>MODEL T-65 Transistor and Crystal Diode Tester Kit • tests I_{co}, gain, leakage, etc. • tests both p-n-p and n-p-n types Kit Net Price:\$39.95 Factory Wired:\$59.50</p>
 <p>MODEL M-40 High Sensitivity V-O-M Kit • 20,000 ohms/volt DC • 10,000 ohms/volt AC Kit Net Price:\$31.50 Factory Wired:\$37.50</p>	 <p>MODEL V-70 Vacuum Tube Voltmeter Kit • wide-range • peak-to-peak Kit Net Price:\$31.50 Factory Wired:\$47.50</p>
 <p>MODEL S-50 5" Cathode Ray Oscilloscope Kit • push-pull vertical and horizontal amplifiers Kit Net Price:\$49.50 Factory Wired:\$84.50</p>	 <p>MODEL Z-80 RF-AF Signal Tracer Kit • high gain RF and AF amplifier • visual and audible indicator Kit Net Price:\$29.50 Factory Wired:\$42.50</p>
 <p>MODEL SA-40 40-Watt Stereo Preamp-Amplifier • silicon diode • low impedance power supply • 14 controls for optimum flexibility Kit Net Price:\$ 79.95 Factory Wired:\$129.95</p>	<p>COMING SOON!</p> <p>MODEL ST-45 AM/FM Stereo Tuner Kit Matching companion for the SA-40</p>

P A C O

IN HOLLYWOOD, CALIF.
SEATTLE, WASH.
KANSAS CITY, MO.
WASHINGTON, D.C.

In all of these cities, Grantham School of Electronics offers regular resident classes and home study training in *communications electronics* — training which prepares you to pass the Federal Communications Commission examinations for a *first class* commercial F.C.C. operator license.

YOU CAN PREPARE FOR YOUR
FIRST CLASS COMMERCIAL

F.C.C. LICENSE

by training in a Grantham School resident class for 12 weeks. Or, if you are unable to leave your work to attend school, Grantham can train you by correspondence. Both resident classes and correspondence instruction are offered at all Divisions of the School — Hollywood, Seattle, Kansas City, and Washington.

In resident classes or by home study, Grantham training is the easy way to learn more quickly — to prepare more thoroughly — for F.C.C. examinations. And your first class F.C.C. license is the quick, easy way to prove to your employer that you are worth more money.

Be good to yourself. Prepare for the better things that a higher salary can make possible — and for greater future security in the radio-TV-electronics industry.

Grantham training — In Hollywood, Seattle, Kansas City, Washington, or in your own home — can do the job. Get complete details free. Mail the coupon below to the Grantham School nearest you. Here are the different addresses. Send coupon to any one of these:

•
GRANTHAM SCHOOL OF ELECTRONICS
1505 N. WESTERN AVE.
HOLLYWOOD 27, CALIFORNIA

•
GRANTHAM SCHOOL OF ELECTRONICS
408 MARION STREET
SEATTLE 4, WASHINGTON

•
GRANTHAM SCHOOL OF ELECTRONICS
3123 GILLHAM ROAD
KANSAS CITY 9, MISSOURI

•
GRANTHAM SCHOOL OF ELECTRONICS
821 — 19TH STREET, N.W.
WASHINGTON 6, D. C.

To: **GRANTHAM SCHOOL OF ELECTRONICS**
(Select address from those listed above)

Please send me your FREE booklet explaining how Grantham can prepare me for my F.C.C. license. I understand there is no obligation and no salesman will call.

NAME _____

ADDRESS _____

CITY _____ STATE _____

96-S

Measuring Your Audio Power Output

By HAROLD REED

Comparative tests with load resistor and voltmeter and voltmeter-ammeter method show surprising results.

WHEN checking the power output of an audio amplifier, it is customary to use a substitute load resistor of ohmic value equivalent to the amplifier output impedance. The temperature of the load resistor, unless of considerably higher power rating than the power output of the amplifier under test, will rise rapidly and its rated resistance value may change enough to result in erroneous measurements. This deviation can be serious when making critical distortion tests.

Suppose, as an example, an amplifier rated at 20 watts output is being checked with a 4-ohm resistor load. The amplifier output would be adjusted to obtain 8.95 volts across this load. Thus, it would be said that $W = E^2/R$, or $8.95^2/4 = 20$ watts. Also, suppose the load value rises due to heating by just 0.7 of an ohm. The author has seen this occur when using a good sized resistor for the load. Then, with this same output voltage, the power would be $8.95^2/4.7$, or only 17 watts. A distortion measurement made under these conditions may look very good and it would be assumed that it was taken at the 20-watt level. This same amplifier may severely distort the signal waveform as the maximum power output is approached.

Therefore, to check a 20-watt amplifier at rated output, make certain it is delivering 20 watts to the load. Sometimes, the last few watts can change the scope waveform pattern from a Jekyll to a Hyde. Heating of the load resistor must be avoided. Its power rating should, preferably, be at least 5 times the power output of the amplifier.

Amplifier power output measurements have been made by the voltmeter-ammeter method. The voltmeter is connected across the load resistor as before and the ammeter is inserted in series with this load. Then, it would be assumed that $W = EI$. This can prove to be even more erroneous.

Ordinary a.c. ammeters are designed for low-frequency applications and although their accuracy may be given as 2% of full scale, the deviation from this tolerance value is considerable with increasing signal frequency.

An example of this discrepancy is shown in Table 1. The data given in this table was obtained from measurements made with a representative low-frequency a.c. meter, 0-2 amperes. A load resistor of known ohmic value and

high power rating, to avoid heating, was used in these measurements. It is readily seen that $W = EI$ does not equal E^2/R except in one case. This equality is observed only at a frequency of 30 cycles.

Using a low frequency as described, both methods may be employed to provide a double check on the power output figure. When the amplifier is first turned on, note the E^2/R and $E \times I$ values which should result in about the same power output figure. After running the amplifier for about 15 minutes re-adjust the output voltage, if necessary, to the level first noted. Again note the product of $E \times I$ and, if it is not equal to E^2/R , then the load resistor has changed value due to heating.

As mentioned previously, most a.c. meters have a full-scale accuracy within 2%. In the previous example given for a 20-watt amplifier, if the meter should be off by the full 2% either on the high side or low side, the indicated power output would be 20.4 watts or 19.6 watts, respectively, a negligible deviation from true power output. It is advisable to work in the upper half of the meter scale to minimize error.

Some manufacturers offer, for an additional charge, a.c. meters designed for operation at higher frequencies. *Weston*, for example, will supply meters designed for operation up to 2500 cycles.

When using ordinary type a.c. meters for audio power measurements, stick to frequencies under 100 cycles or apply a suitable correction factor which can be derived by obtaining test data on the particular meter as shown in Table 1.

Table 1. These are the results of the a.c. ammeter test performed by the author. A 4-ohm load resistor was employed and the output voltage of the amplifier was held at a constant 4-volt output. The power being delivered in this case was 4 watts.

FREQ. (cps)	OUTPUT CURRENT (I)	OUTPUT POWER (W)
30	1.0 amp.	4.0
50	.99	3.96
100	.98	3.92
500	.96	3.84
1000	.95	3.80
10,000	.80	3.20
20,000	.65	2.60



**Dependability
is a
built-in
feature
of
all
Delco
Radio
Service
Parts!**

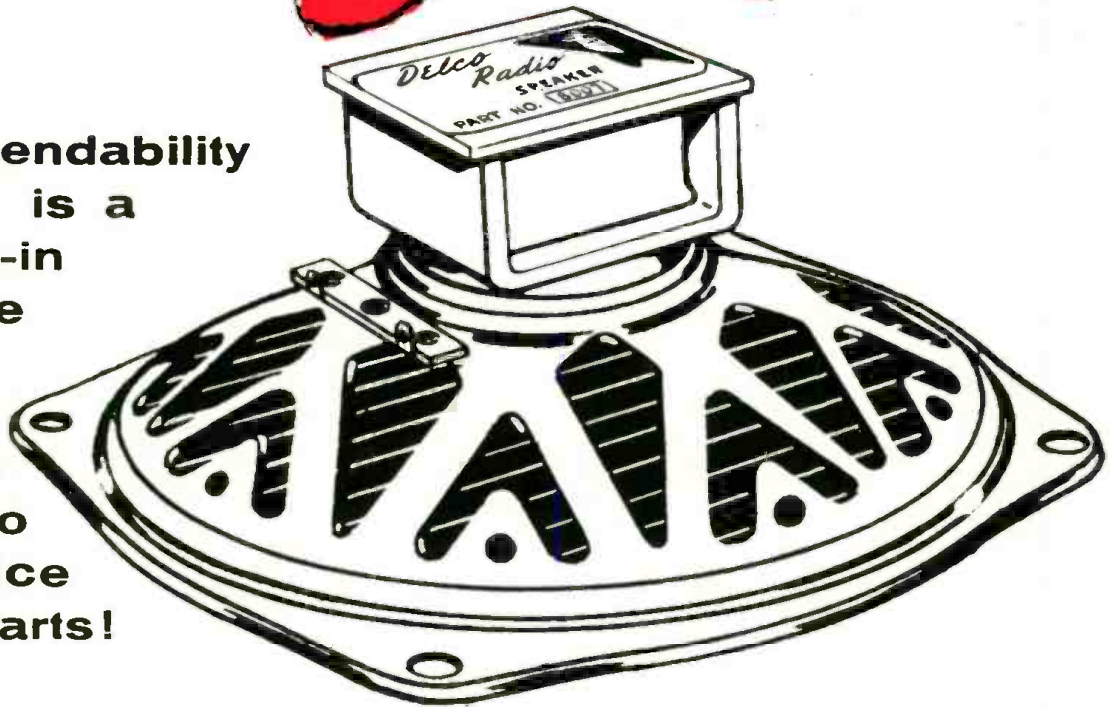

Take speakers, for instance. Delco electronic speakers are built rugged for long life and resistance to extreme weather conditions. You can rely on them for exceptional power handling and rich distortion-free tone.

Delco's popular 8-inch "Hi-Fi" speaker, No. 8007, provides the most power and tonal range for the money. Designed for replacement use and high fidelity audio systems, it's a good, fast seller with price and quality appeal.

For speakers, transistors, transformers and other fine parts for Delco and other radios, see your Delco Electronic Parts Distributor. He carries the complete line. Other extras you get with Delco are • Wide selection of special application parts • Complete technical training program • Effective warranties • Dealer identification signs.

Stock with Delco Electronic Parts—more dependability and reliability for your customers, more profit for you.

DELCO
DEPENDABILITY
RADIO
RELIABILITY

Division of General Motors • Kokomo, Indiana

Available everywhere through
Electronic Distributors
associated with

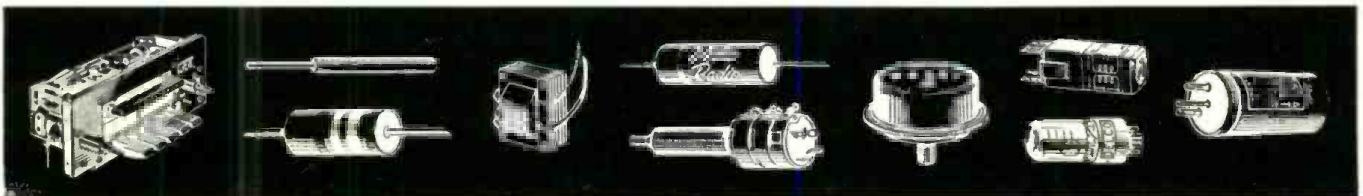

CITIZEN BAND



CLASS "D" CRYSTALS

All 22 Frequencies in Stock

3rd overtone. .005% tolerance—to meet all FCC requirements. Hermetically sealed HC6/U holders. 1/2" pin spacing—.050 pins. (.093 pins available, add 15c per crystal.) Add 5c per crystal for postage and handling. **\$2.95 EA.**

The following frequencies in stock (frequencies listed in megacycles): 26.965, 26.975, 26.985, 27.005, 27.015, 27.025, 27.035, 27.055, 27.065, 27.075, 27.085, 27.105, 27.115, 27.125, 27.135, 27.155, 27.165, 27.175, 27.185, 27.205, 27.215, 27.225.

RADIO CONTROL CRYSTALS in HC6/U holders in stock for immediate delivery (frequencies listed in megacycles) sealed crystals 26.995, 27.045, 27.095, 27.145, 27.195, 27.255, tolerance .005% 1/2" pin spacing . . . pin diameter .050. **\$2.95** ea. .093 pin spacing, add 15c.

SEALED OVERTONE CRYSTALS Supplied in metal HC6/U holders. Pin spacing .486, diameter .050
15 to 30 MC .005 tolerance **\$3.85** ea.
30 to 45 MC .005 tolerance **\$4.10** ea.
45 to 60 MC .005 tolerance **\$4.50** ea.



QUARTZ CRYSTALS for every service

All crystals made from Grade "A" imported quartz—ground and etched to exact frequencies. Unconditionally guaranteed! Supplied in:

FT-243 holders MC-7 holders
pin spacing 1/2" pin spacing 3/4"
pin diameter .093 pin diameter .125
DC-34 holders FT-171 holders
pin spacing 3/4" pin spacing 3/4"
pin diameter .156 banana pins

MADE TO ORDER CRYSTALS

1001 KC to 2600 KC:
.01% tolerance **\$2.00** ea. .005% tolerance **\$2.75** ea.
2601 KC to 9000 KC: .005% tolerance **\$2.50** ea.
9001 KC to 11,000 KC: .005% tol. **\$3.00** ea.
Specify holder wanted

ANY AMATEUR, NOVICE, TECHNICIAN BAND CRYSTALS

80 meters 3701-3749 KC .01% tolerance
40 meters 7152-7198 KC
15 meters 7034-7082 KC
6 meters 8335-8650 KC (within 1 KC) **1.50 ea.**

MARINE FREQUENCY CRYSTALS—All marine frequencies from 2000-3200 KC .005 tolerance **\$2.50** ea. (supplied in either FT-243, MC-7 or FT-171 holders)

STOCK CRYSTALS in FT-243 holders from 5675 KC to 8650 KC in 25 KC steps **75c** each or **3 for \$2.00**
FT-241 Lattice Crystals in all frequencies from 370 KC to 540 KC (all except 455 KC and 500 KC) **50c** ea.
Pin spacing 1/2" Pin diameter .093
Matched pairs — 15 cycles **\$2.50** per pair
200 KC Crystals **\$2.00** ea.
455 KC Crystals **\$1.50** ea.
500 KC Crystals **\$1.50** ea.
100 KC Frequency Standard Crystals in HC6/U holders **\$4.50** ea.

Socket for FT-243 crystal **15c** ea.
Dual socket for FT-243 crystals **15c** ea.
Sockets for MC-7 and FT-171 crystals **25c** ea.
Ceramic socket for HC6/U crystals **20c** ea.
(Add 5c per crystal for postage and handling)
Write for FREE Catalog Complete with Oscillator Circuits.

ASK YOUR PARTS DEALER FOR TEXAS CRYSTALS
See big red display . . . if he doesn't stock them, send us his name and order direct from nearest factory.

OUR FLORIDA PLANT NOW IN OPERATION ORDER FROM NEAREST PLANT TEXAS CRYSTALS

Texas Crystals, Dept R-119 8538 West Grand Ave. River Grove, Ill. Phone GL 3-3555
OR Texas Crystals, Dept R-119 1000 Crystal Drive Ft. Meyers, Florida Phone WS 6-2100

ALL ORDERS SHIPPED FIRST CLASS MAIL

FILL OUT AND ATTACH THIS COUPON TO YOUR ORDER FOR SHIPMENT VIA 1ST CLASS MAIL AT NO EXTRA COST!

NAME

ADDRESS

CITY.....ZONE.....STATE.....

TERMS: All items subject to prior sale and change of price without notice. All crystal orders must be accompanied by check, cash or M. O. with PAYMENT IN FULL. NO COD'S. Add 5c per crystal for postage and handling charge. Dept. R-119

New Tube Tester Data

Owners of RCA hole-card automatic testers: here are hole locations to be punched for new tubes.

RCA AUTOMATIC TESTER, WT-110A

TUBE TYPE	HOLE LOCATIONS TO BE PUNCHED	NOTES
4BA6	A3, B4, C7, C2, D1, E6, G5, I6, I10, J2, K6, L1, L6, L7, M4, M6, N1, N6	
4DE6	A3, B4, C7, C2, D1, E6, G5, I6, I7, J1, K5, L7, L8, L1, M6, M1, N6, N5	
5BZ7	A4, B5, B9, C8, D7, F1, G6, I7, I8, J1, K4, L1, L6, L7, M4, M10, N1, N9	Test P1 and P2
5EA8 Pentode	A1, B5, C7, D2, E3, G6, I6, I10, J2, K3, L1, L6, L7, M5, M10, N1, N9	
5EA8 Triode	A4, B5, C8, D9, G1, I6, I9, J1, K1, L1, L6, L7, M5, M10, N1, N9	
5EH8 Pentode	A4, B5, C6, C1, D7, E8, G9, I10, I6, J2, K4, L1, L7, L6, M5, M10, N1, N9	
5EH8 Triode	A4, B5, C6, C1, D2, G3, I6, I10, J2, K8, L8, L6, L1, M5, M10, N1, N9	
6BX7GT	A7, B8, C6, C3, D4, D1, F2, G5, J7, K5, L6, L7, L1, M10, M4, N9, N2	Test P1 and P2
6DE7 Triode 1	A4, B5, C8, D7, G6, I10, I6, I7, K10, L7, L6, L1, M10, M4, N9, N2	
6DE7 Triode 2	A4, B5, C9, D2, G1, I6, I10, J10, K9, L8, L6, L1, M10, M4, N9, N2	
6DK6	A2, B4, C7, C2, D1, E6, G5, I10, I7, J1, K7, L8, L6, L1, M10, M4, N9, N2	
6DN7 Triode 1	A8, B7, C6, D4, G5, I6, I10, J6, K5, L1, M3, M10, N9, N1	
6DN7 Triode 2	A8, B7, C3, D1, G2, I10, I6, J8, K7, L7, L6, L1, M5, M10, N9, N1	
6DT5	A4, B5, C7, D2, C1, G9, I10, I6, J9, K6, L7, L6, L1, M10, M4, N9, N2	
6DT8	A4, B5, C3, C8, D2, D7, F1, G6, J1, K6, L1, L6, L7, M10, M3, N1, N9	Test P1 and P2
6DW5	A4, B5, C7, D3, D6, E1, G9, I6, I10, J8, K1, L1, L6, L7, M4, M10, N2, N9	
6EA8 Pentode	A4, B5, C7, D2, E3, G6, I6, I10, J2, K3, L1, L6, L7, M4, M10, N2, N9	
6EA8 Triode	A4, B5, C8, D9, G1, I6, I9, J1, K1, L1, L6, L7, M4, M10, N2, N9	
6EB8 Triode	A4, B5, C1, D2, G7, I6, I10, J2, K6, L1, M10, M3, N9, N1	
6EB8 Pentode	A1, B5, C6, D7, E8, G9, I10, I7, J1, K7, L8, L6, L1, M10, M4, N9, N2	
6E1H8 Pentode	A4, B5, C6, C1, D7, E8, G9, I10, I6, J2, K4, L1, L7, L6, M10, M4, N9, N2	
6E1H8 Triode	A4, B5, C6, C1, D2, G3, I6, I10, J2, K8, L8, L6, L1, M10, M4, N9, N2	
6SV7 Pentode	A7, B8, C3, D2, E4, G6, I10, I6, J2, K3, L4, M10, M5, N9, N2	
6SV7 Diode	A7, B8, C3, G5, I6, I10, K7, L7, L6, L3, M10, N9, M4, N2	Reject if below 4
6U7G	A7, B2, C5, C8, D10, E4, G3, I6, I10, J6, K10, L6, L7, L1, M3, M10, N1, N9	
8BQ5	A4, B5, C3, D2, E9, G7, I6, I10, J5, K7, L1, L6, L8, M5, M10, N3, N9	
8CN7 Triode	A4, A5, B9, C6, D7, G8, I6, I10, J2, K7, L1, M4, M6, N1, N6	For gas test, see instructions
8CN7 Diode	A4, A5, B9, C3, F2, G1, K7, L3, L6, L8, M4, M6, N1, N6	Test P1 and P2 Reject below 3
8EB8 Triode	A4, B5, C1, D2, G3, I6, I10, J2, K6, L1, M3, M10, N2, N9	
8EB8 Pentode	A4, B5, C6, D7, E8, G9, I10, I7, J1, K7, L8, L6, L1, M10, M3, N2, N9	
8SN7GTB	A7, B8, C6, D1, D4, F2, G5, I6, I10, J1, K1, L1, I9, M2, M10, N1, N9	Test P1 and P2
12A4	A4, B5, C1, D7, G9, I6, I10, J4, K6, L1, L6, L8, M2, M10, N4, N9	
12AH7GT	A7, B8, C2, C4, D1, D5, F6, G3, I6, I10, J6, K6, L1, M2, M10, N4, N9	Test P1 and P2
12BW4 Diode	A4, B5, C9, F1, G7, I6, I10, K5, L5, L6, L10, M2, M10, N3, N9	Test P1 and P2
12DT5	A4, B5, C7, D3, E1, G9, I6, J9, K6, L6, L7, L1, M10, M2, N4, N9	
12DT8	A4, B5, C3, C8, D2, D7, F1, G6, J1, K6, L1, L6, L7, M2, M10, N4, N9	Test P1 and P2
12EK6	A3, B4, C7, C2, D1, E6, G5, I10, I6, J1, K6, L6, L7, L2, M10, M2, N9, N4	
12EN6	A2, B7, C8, D5, E4, G3, I10, I6, J9, K10, L9, L6, L1, M10, M2, N9, N4	
12J7GT	A2, B1, B7, C5, C8, D10, E4, G3, I6, I10, J6, K8, L1, M2, M10, N4, N9	
12SR7 Triode	A7, B1, B8, C3, D2, G6, I6, I10, J7, K8, L1, M2, M10, N3, N9	
12SR7 Diode	A7, B1, B8, C3, F4, G5, K8, L4, L6, L7, M2, M10, N3, N9	Test P1 and P2 Reject below 3
13DE7 Triode 1	A4, B5, C8, D7, G6, I10, I6, J7, K10, L7, L6, L1, M10, N9, M1, N3	
13DE7 Triode 2	A4, B5, C9, D2, G1, I6, I10, J10, K9, L8, L6, L1, M10, M1, N9, N3	
17BQ6GTB	A2, B7, C8, D5, E4, G10, I8, I10, J10, K5, L1, L6, L7, M3, M9, N2, N8	
17D4	A7, B8, C3, G5, I6, I10, K5, L4, L6, L10, M4, M9, N2, N8	

ACCOLADES AGAIN!

Again, without peer!... still the best super high frequency tweeter at any price... tested and top-rated again in September by laboratory reports!

REALISTIC ELECTROSTAT-3 \$27⁵⁰

\$2 Down

Tweeters come and tweeters go—but one, and only one, is here to stay! "Best value at any price", again say the laboratory testers! (And "best tweeter I've ever heard", say literally thousands of Electrostat-3 owners!). When used with any of the better high compliance speakers—or any speaker, for that matter—Realistic's Electrostat-3 delivers a uniquely smooth response to 25,000 cps and beyond. It adds a musical transparency you've rarely, if ever, heard before! Exclusive Realistic design has 3 electrostatic elements for 120° sound dispersion, built-in double-fused AC supply for true electrostatic operation, and every unit is automatically tested for frequency response on a Bruel and Kjaer. The most vainly imitated tweeter in audio history! Complete, in handsome furniture-finish cabinet measuring 11 1/2" x 5 3/4" x 4 1/4" deep. Ship. wt. 7 lbs.

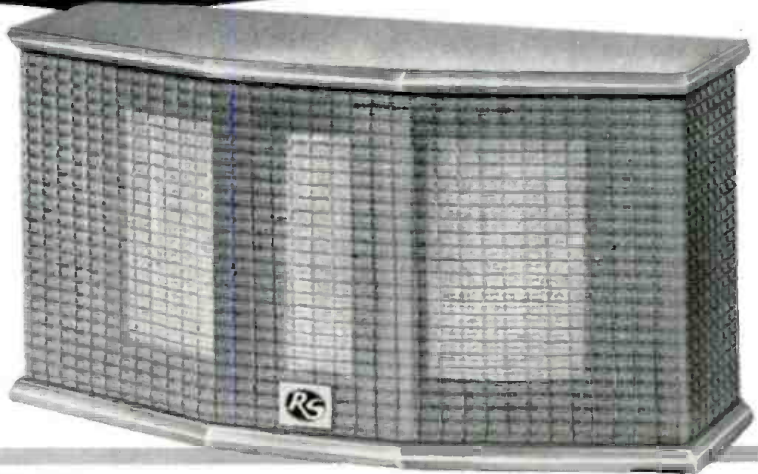

REALISTIC FULL-RANGE ELECTROSTAT-4

NEW!

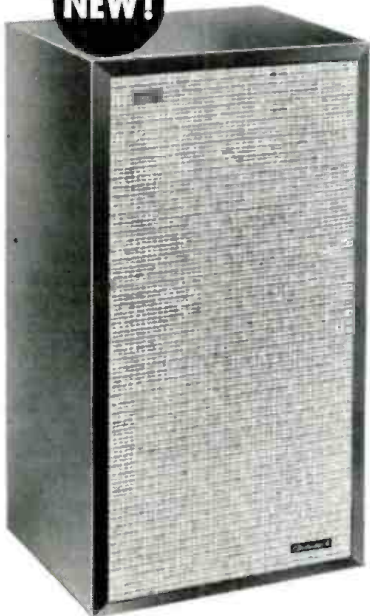

\$119⁵⁰

\$5 Down

NOW... world's first and only complete-range (30-25,000 cps) speaker system incorporating — and especially designed for — a built-in Electrostat-3! "Magnificence goes full-range" in a complete 3-way "pneumatic compression" speaker system built with, around and for the sensational Electrostat-3 tweeter! (With "lows" and "middles" that match the quality of those "highs"!). New Electrostat-4 features built-in Electrostat-3, new-design mid-range cone speaker, amazingly rugged high compliance woofer, self-enclosed built-in 3-way Crossover with polarizing supply and a complete set of rear panel balance controls. Completely sealed and enclosed in fine furniture-finish cabinet 24 1/2" x 13 1/2" x 11" deep. Ship. wt. 41 lbs.



FREE Bargain Bulletins 1960 Electronic Guide

Crossover Network for Electrostat-3

\$6⁹⁵



Designed for the Electrostat-3—may be used with any 8 or 16 ohm tweeter-woofer combination. 5000 cps crossover, plus built-in low frequency attenuator control for perfect tweeter-woofer balance. Screw terminals, no soldering. Ship. wt. 2 lbs.

RADIO SHACK CORPORATION, Dept. 11-F
730 Commonwealth Ave., Boston 17, Mass.

- Send... FREE Bargain Bulletins 12-months subscription FREE. Famous Radio Shack Bargain Bulletins give you first crack at hi-fi, "ham", optical, record VALUES!
- Send... 1960 Electronic Guide Over 40,000 items, plus articles, illustrations, etc. 312 book-size 8 1/2 x 11 pages. Biggest, most valuable handbook ever! Only 35c.
- Send Electrostat-3 tweeter, No. 36CX017Y (mahogany) @ \$27.50
- 8-ohm Crossover network, No. 91L534 @ \$6.95
- 16-ohm Crossover network, No. 91L531 @ \$6.95
- Electrostat-4 speaker system, No. 90LX243 (mahogany) @ \$119.50
- Complete stereo system, No. 92LX195 @ \$96.50

Name _____

Address _____

City _____ Zone _____ State _____

Check Money Order C.O.D.

STEREO SURPRISE!

A component hi-fi stereo system at a price actually less than a mediocre phonograph! Famous imported British Monarch 4-speed intermix changer, stereo crystal cartridge with diamond stylus, new Realistic Stereo-7 amplifier, 2 Realistic Solo-1 speaker systems (cabinets included!). Nothing else to buy in the system the experts now call the "stereo buy of the year"! Ship. wt. 47 lbs.

Radio Shack's Complete Stereo System... the sound that fooled the experts in a recent hi-fi magazine article!

\$5 DOWN \$96⁵⁰



RADIO SHACK CORPORATION

167 WASHINGTON STREET, BOSTON 8, MASS.
730 COMMONWEALTH AVENUE, BOSTON 17, MASS.
230-234 CROWN STREET, NEW HAVEN 10, CONN.

...Build the Best

Portable... **TEICO**



6-TRANSISTOR RADIO RA-6

Kit \$29.95 Wired \$49.95

INCLUDES F.E.T., LESS 9V BATTERY

Easy creative fun to build... a lifetime of big-set entertainment wherever you go... designed so that even the novice can build it & obtain a handsome professional assembly & outstanding performance. American-made modern super-heterodyne all-transistor circuitry, plus finest quality parts throughout, assure you of highest durability & stability. • high sensitivity & selectivity • big-set volume & tone quality with 4" x 6" PM speaker & 250 mw push-pull audio output stage • built-in Ferrite rod antenna for good reception in any location • pre-aligned RF & IF transformers • planetary vernier tuning (7:1 reduction) for easy station selection & tuning • high-impedance earphone jack for private listening; eliminates drain of output stage when using earphone • attractive tan leatherette case, retractable handle • compact: 8½" w, 4½" h, 2½" d. Only 3 lbs.

Build the BEST BUYS in

"HAM" gear... **TEICO**



90-WATT CW TRANSMITTER #720

Kit \$79.95 Wired \$119.95

"Ideal for veteran or novice" — ELECTRONIC KITS GUIDE. "Top quality" — POPULAR ELECTRONICS. "Well designed" — ELECTRONICS WORLD. 80 thru 10 meters with one-knob band-switching. Full "clean" 90W input, 65W external plate mod. Matches loads 50 to 1000 ohms. May be used as basic exciter unit. TVI shielded. Tubes: 6146, 6CL6, 2-6AQ5, GZ34. Attractive "living room" low-silhouette design. 15" w, 5" h, 9" d.

UNIVERSAL MODULATOR-DRIVER #730

Kit \$49.95

Wired \$79.95

Cover E-5 \$4.50

Delivers 50W undistorted audio. Modulates transmitters having r.f. inputs up to 100W. Unique over-modulation indicator. Output transformer matches 500-10,000 ohms. Low-level speech clipping & filtering. Inputs for xtal or dynamic mikes, phone patch, etc. 7 tubes. 6" h, 14" w, 8" d.

GRID DIP METER

Kit \$29.95

Wired \$49.95 #710

Includes complete set of coils for full band coverage. 400 kc-230 mc in 8 overlapping ranges. 500 ua meter. Plug-in coils are pre-wound, pre-calibrated to 0.5% accuracy. Transformer-operated power supply. 2¼" h, 2¾" w, 6¾" l.

Compare—judge for yourself—at your neighborhood EICO distributor. For free catalog on 65 models of EICO test instruments, hi-fi & "ham" gear, fill out coupon on Page 36

TEICO ELECTRONIC INSTRUMENT CO., Inc.
33 00 N. Blvd., L. I. C. I. N. Y.

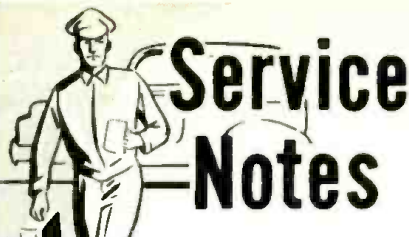

Service Notes

OLYMPIC V-O TRANSFORMERS

TV chassis HA, HB, HD, HE, HF, HJ, and HH use part TR-2579 as the original vertical-output transformer. If this unit should become defective, the available, suitable replacements are transformers TR-25791-1, and -25791-2. Although these are satisfactory, differences in color coding of the leads may produce confusion unless care is taken. If the new unit is TR-25791 or -25791-1, connect the red lead to pin 1 of the vertical-output tube (6CM7); the blue lead to the filtered, boosted "B+" tie point on the terminal strip; the yellow lead to chassis ground; and the green lead to pin 7 of the yoke socket. If the replacement unit is TR-25791-2, connect the blue lead to pin 1 of the vertical-output tube (6CM7); the red lead to the filtered, boosted "B+" tie point on the terminal strip; the green lead to ground; and the yellow lead to pin 7 of the yoke socket.

MOTOROLA: INTERMITTENT PIX

If TV receivers using the TS-542 chassis exhibit an intermittent loss of video information, two specific possibilities are worth checking out before investing the time that will be required by conventional localization techniques. First try moving the channel selector knob. If this movement tends to induce the symptom, C_{22} , a .001- μ f. feed-through capacitor in the tuner circuit, will probably be in need of replacement. Mechanical stress on this component produced by manipulation of the selector may cause intermittent shorting, disabling the mixer.

If the symptom does not appear to originate at the point just noted, check the ground connection on the chassis plug in which the wires from the front-panel controls are terminated. A poor ground connection here, which can be corrected by simple re-soldering, may also cause the symptom of intermittent video.

SYLVANIA: HEATER CHECKING

Although the S-110 TV chassis, widely employed throughout the *Sylvania* line, uses series-string wiring for the tube heaters, the usual problem of locating a single, burned-out heater when the entire string is extinguished has been simplified. A rapid narrowing-down of suspects can be performed before any tubes need be checked individually and without removing the chassis from the cabinet, reducing possibilities to four tubes or fewer.

First an ohmmeter is used to check the CRT heater (pins 3 and 4) directly at the CRT base. Continuity of heaters

A... Always
B... Buy
C... Columbia

TECHNICIANS! GENERALS! NOVICES!

5 CR-5 Table Top Receiver-Transmitter-Receiver \$12.50
 12 VDC or 24 VDC or 115 V 60 cye. AC. (See below.)
 Covers 100-156 Mc.—naturally! Crystal controlled, transmitter has 2-832 tubes, etc. Complete in case, with ALL TUBES. Easily converted to 6 meters. Excellent condition. **\$12.50**

DOPE FOR CONVERSION TO 6 METERS \$1.00
 REGULATED AC POWER SUPPLY for above. 29.95
 12 VDC DYNAMOTOR POWER SUPPLY for above. 8.95
 24 VDC DYNAMOTOR POWER SUPPLY for above. Good condition. 3.95
 6C-1303 LOCAL ADAPTOR CONTROL BOX for above. Like new. 4.95
 PLUGS, ANTENNAS, OTHER ACCESSORIES FIT ABOVE. WRITE IN FULL DATA.

DM-35 DYNAMOTOR
 12 V. input. 623 V. @ 223 ma. output. Like new, gov't reconditioned, in orig. box! **\$8.95**

RDZ UHF COMMUNICATION RECEIVER
 220-400 Mc. Table top model; with built-in 110 V. 60 cps. power supply. Includes dB meter, noise meter, RF gain, audio gain, etc. Complete with all tubes! Excellent condition. Orig. cost over 2,000.00 **\$39.95**
 Ship. Wt. approx. 100 lbs.

WANTED! R-540 ARN-14C Receiver and ANY GIC or PIC Equip. Top \$\$\$ paid!

BC-620 RECEIVER-TRANSMITTER
 Same as above BC-650 except frequency is 20-28 Mc. BRAND NEW, with power supply. A Columbia leader. **\$19.50**
 TELEPHONE HANDSET, New. **\$3.95**
 TELESCOPING ANTENNA—New, Only **\$2.95**

TUBES! TOPS IN TUBE BARGAINS! BRAND NEW!
 832 TRANSMITTING TUBES, New, Boxed, Ea. **\$3.95**
 6X150A \$ 7.95 4-65A \$ 9.95
 4-125A 17.95 4-400A 29.95
 3047L 25.00 4-250A 24.50

APR-1 TUNING UNITS, EXCEL. COND.!
 Can be used in conversion with any 30 Mc. Receiver. TR-2: 40-100 Mc. ONLY **\$14.95**
 TN-3: 300-1,000 Mc. **\$4.95**

T-14/TRC TRANSMITTER
JUST REDUCED! For action this month!
 70-100 Mc. 30 W. input power on phone. Single channel. Built-in 110 V. 60 cps. power supply. Table top size. Easily converted to 6 meters. Complete. Fair condition, excellent **\$24.95**

CITIZENS' BAND, ETC.
BC-603 RECEIVER
 Covers 20-28 Mc. FM. Terrific for citizens' band. 10 push-button. Built-in speaker and squelch control. May be operated mobile on 12 V. dynamotor (see prices below) or 110 VAC w a power pack. Converts in 1 minute to **\$9.95**
 AM Int. omitted. New condition. **\$ 3.95**
 12 V. DYNAMOTOR, for above **\$ 7.95**
 115 VAC PACK **11.95**
 2-1 V. DYNAMOTOR **2.95**
 1-15 V. KIT **7.95**
CRYSTAL SET FOR ABOVE—Box of 80 New
Only \$4.95
WATCHING TRANSMITTER FOR ABOVE—BC-604:
 30 W. 10-channel, push-button FM crystal controlled 20-27 Mc. New condition. **\$5.95**
 complete with tubes, glass device, compact COMBO DEAL! Above BC-603 & IC-603, excellent. BUILT for **\$13.00**

BC-659 TRANSMITTER-RECEIVER
 6 or 12 V. 27-30 MC. Easily converted to citizens' band. (See CQ, Magazine for conversion.) Used, excellent, WITH POWER SUPPLY, Only **\$14.95**

WRITE FOR FREE BARGAIN BULLETIN!
 All orders FOB Los Angeles. 15% deposit required. All items subject to prior sale. Note: MINIMUM ORDER \$3.00. WRITE TO DEPT. R

ELECTRONICS
Columbia 2251 W. WASHINGTON BLVD.
 LOS ANGELES 18, CALIF.

The Battery That's Used in Guided Missiles Now Released as Government Surplus

For Photography, Aircraft, Models, Searchlights, Radios, etc. **\$1.95 ea.** Postpaid

Sintered-plate Nickel-Cadmium alkaline storage batteries designed for "NIKE" missile and now surplus due to design change. A lifetime battery with no known limit of service (over 5000 recharges on test without loss of capacity). Other features: Virtually indestructible, compact & lightweight, withstands heavy shock and vibration. Flat voltage curve during discharge retains charge year or more, high discharge rate up to 50 amps. for this cell, no corrosive fumes to harm clothing or equipment. Spill-proof construction, discharge in any position, indefinite storage without deterioration, operates in temperatures -60° F to 200° F. Each cell is approx. 6 amperes hour capacity. Nominal voltage per cell is 1.2 volt. 6 V. battery requires 3 cells. Cell size 6" H. x 2" W. x 1½" T. Wt. 6 oz. ea. Uses Potassium-Hydroxide (30% electrolyte). Negligible loss during lifetime service. Add only distilled water once a year. A fraction of Government cost.

Used Test Cells **\$1.95 ea.** Postpaid
 Brand New Cells **2.95 ea.** Postpaid
 24 V. Battery (20 cells) in metal case used \$40.00 New \$60.00

All cells guaranteed to your satisfaction or money refunded (less postpaid). Plastic battery cases may have slight cracks—repaired easily with household cement or you may add 25c to price of each to insure uncracked cases.

ESSE RADIO COMPANY Dept. N5
 42 W. South Street Indianapolis 25, Indiana

in the tuner section may be checked next by placing the ohmmeter leads across the two filament lugs mounted on top of the tuner subchassis. To check out heaters of the 5T8, 5BR8, 5AQ5, and 12BY7, the socket on the base of the CRT is removed (Fig. 1A) and one ohmmeter lead is inserted in the hole for pin 4. The other lead is connected to circuit ground. If no discontinuity has been observed to this point, one ohmmeter lead is now moved to the tuner filament connecting pin nearest to the shaft (Fig. 1B) and the other lead is moved to the contact of the a.c. interlock shown in the illus-

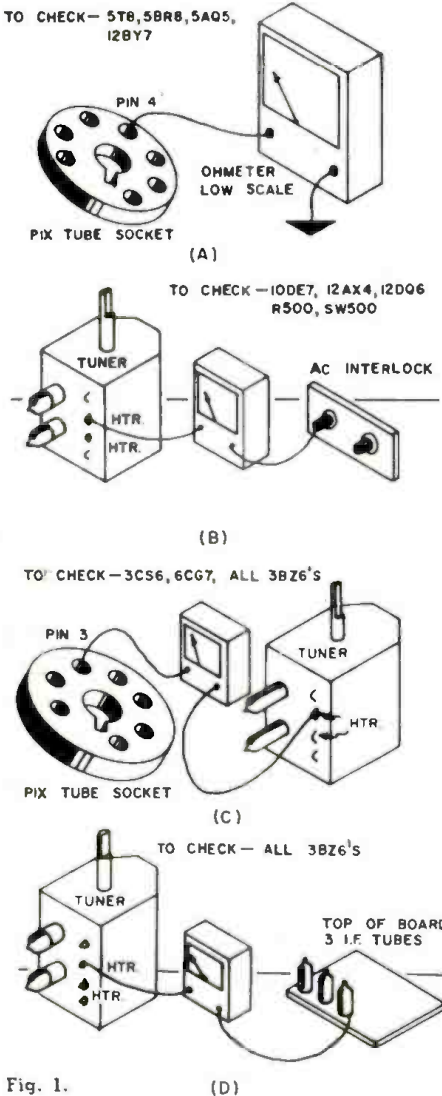

Fig. 1.

tration: included in this part of the string are the 10DE7, 12AX4, 12DQ6, filament-dropping resistor R_{500} and "on-off" switch SW_{500} . The connection shown in Fig. 1C, from the hole on the CRT socket for pin 3 to one of the tuner filament connections, will include the 3CS6, 6CG7, and all 3BZ6 i.f. tubes. If an open reading is obtained in this string of five, another step is possible. A check between one tuner filament pin (Fig. 1D) and pin 3 of the 1st video i.f., which is accessible from the top of the chassis board, will check continuity of the three 3BZ6 tubes separately.

Outperforms Costliest Speaker Systems

ENJOY THE BEST AT GREATEST SAVINGS

EXCLUSIVE

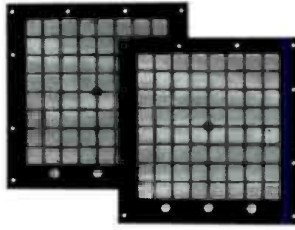

ARTHUR JANSZEN DESIGN patented dual electrostatic radiators... rated the best again and again. Built-in power supply; velvet-smooth response to beyond 25,000 cps.

EXCLUSIVE



HIGH-COMPLIANCE 12" woofer featuring weighted cone in solid cast-aluminum alloy frame... with heavy-duty sintered ceramic magnet for extremely dense flux.

EXCLUSIVE: Acoustically correct enclosure of choice hardwoods, finished on 4 sides...



High-Compliance Electrostatic Speaker System

ONLY **\$129⁵⁰** Comparable to speaker systems selling at 50% more! Here's an Allied exclusive—**\$5 Down** the hi-fi speaker sensation of the year—combining patented Arthur Janszen design dual electrostatic tweeters with a new and revolutionary high-compliance woofer. The results are amazing: Distortion is held to a mere 0.5% at full 50 watts input. Response is clean and level, 30-25,000 cps. You have to hear it to believe it—transparent high frequencies to beyond audible limits—smooth, honest bass. The KN-3000 enclosure, of 3/4" wood throughout, is finished on 4 sides; 14 x 26 1/2 x 13"; available in mahogany, limed oak or walnut. Impedance, 8 ohms. U. L. Approved. Shpg. wt., 50 lbs.

KN-3000. Only \$5.00 Down. NET \$129.50



15-Day Trial & Moneyback Guarantee. Try the KN-3000 Speaker System in your home for 15 days; if you are not completely satisfied, your purchase price will be refunded by Allied upon return of the equipment.



SEE YOUR ALLIED 1960 CATALOG for a detailed description of the remarkable new KN-600 HC high-compliance 2-way speaker, with the sensational 4.6 lb. ceramic magnet and 1/2" thick polystyrene cone. See hundreds of other top buys on everything in Hi-Fi in the 1960 Allied Catalog. Write for your FREE copy today.

New Easy Terms: Only \$5 down (or less) on orders up to \$200. Up to 24 months to pay.



order from

ALLIED RADIO

ALLIED RADIO, Dept. 181-L9
100 N. Western Ave., Chicago 80, Ill.

Ship me _____ KN-3000 Speaker System(s). Mahog. Oak. Wal.
\$ _____ encl. (Shipped F.O.B. Chicago)

I am interested in saving money on everything in Hi-Fi. Send me your FREE 1960 Catalog.

Name _____

Address _____

City _____ Zone _____ State _____

Within the Industry
(Continued from page 32)

RADIO
TELEPHONE
LICENSE
MANUAL

PREPARE FOR ALL
USA Commercial Radio-
Telephone Operator's License
EXAMS!

RADIOTELEPHONE LICENSE MANUAL

\$5.00
HARDBOUND
NEW EDITION

QUESTIONS ON BASIC LAW
BASIC OPERATING PRACTICE
BASIC RADIOTELEPHONE
ADVANCE RADIOTELEPHONE

In one convenient volume, complete study-guide questions with clear, concise answers for preparation for all U.S.A. commercial radiotelephone operator's license examinations.

BUY FROM YOUR FAVORITE DISTRIBUTOR

at above price or add 10% on direct mail orders to:
EDITORS and ENGINEERS, Ltd.
Summerland California

BOOKSTORES: ORDER FROM BAKER & TAYLOR CO., HILLSIDE, N. J.

INSIST ON
PROVED BRAND
NAMES
insist on the
GENUINE
"NO NOISE"
big **3**
Beware
Of
Cheap Substitutes!

**NO-NOISE
VOLUME CONTROL
and
CONTACT RESTORER**
• Cleans • Protects
• Lubricates
NOT A CARBON TET SOLUTION
2 Oz. Bottle 6 Oz. Spray Can
\$1.00 **\$2.25**
NET to Servicemen



**NO-NOISE
TUNER-TONIC**
With PERMA-FILM
• Economical—a little
does a lot.
• Cleans, lubricates,
restores all tuners,
including water
type.
• Non-toxic, non-in-
flammable
• Use for TV, radio
and FM
\$3.25
NET to Servicemen



NOW AVAILABLE
FREE
AT YOUR JOBBERS
**5" PLASTIC
EXTENDER**

With Push Button Assembly... For
PIN-POINT APPLICATIONS!
Does Not Cause Shorts!

**NO-NOISE
RUBBER
COAT SPRAY**
• Insulates
• Waterproofs
• Protects
\$3.25
NET to Servicemen



Hugh Moore, *Lerco Electronics, Inc.*, representing WEMA; Robert E. Svoboda, *Amphenol-Borg Electronics Corp.*, representing EP & EM; Robert Ferree, *International Resistance Co.*, representing PACE; Norman A. Triplett, *The Triplett Electrical Instrument Co.*, representing EIA; and Sam Poncher, *Newark Electric Co.*, William Green, *Electronics Center, Inc.*, Joseph S. Forti, *Electronic Wholesalers, Inc.*, and C. T. Kierulff, *Kierulff Electronics, Inc.*, all of whom will be representing NEDA.

HEWLETT-PACKARD COMPANY has acquired all outstanding stock of **BOONTON RADIO CORP.** The firm will become a wholly owned subsidiary of the parent organization . . . Stockholders of *Howard W. Sams & Co., Inc.*, *The Waldemar Press, Inc.*, and *The Howard Company* have approved a merger of the three firms under the corporate name of **HOWARD W. SAMS & CO., INC.**

MOTOROLA INC. has acquired **THE DAHLBERG COMPANY.** The acquisition also includes the wholly owned sales subsidiary, *Dahlberg, Inc.* . . . **GONSET DIVISION.** *Young Spring & Wire Corp.* has announced the sale of inventory, design, and manufacturing rights of its former *Link Mobile Radio Division* to the **PLATT SALES CORPORATION** . . . **ARNOUX CORPORATION** has announced the acquisition of the common stock and personnel of **INSTROL INC.** . . . **CORNELL-DUBILIER ELECTRIC CORP.** has completed negotiations with the **TOSHIBA COMPANY** of Japan to form a new international manufacturing-distribution association to market the Far Eastern firm's transistors in the U.S.

ELECTRONIC INDUSTRIES ASSOCIATION has re-appointed J. A. Milling, president of *Howard W. Sams & Co., Inc.*, chairman of the Association's distributor relations committee.

In addition, the following were named by the EIA president, David R. Hull, as members of the committee for the fiscal year 1959-60: N. A. Triplett, co-chairman, *Triplett Electrical Instrument Co.*; E. P. Atcherley, *Sylvania Electric Products Inc.*; H. F. Bersche, *RCA*; F. J. Chamberlain, *Clarostat Manufacturing Co.*; E. Clover, *Triad Transformer Corp.*; R. D. Ferree, *International Resistance Co.*; C. Golenpaul, *Aerovox Corp.*; J. H. Hauser, *CBS Electronics*; A. N. Haas, *Bud Radio, Inc.*; E. T. Herbig, Jr., *E. F. Johnson Co.*; J. D. Hughes, *Littelfuse, Inc.*; R. S. Laird, *Ohmite Manufacturing Co.*; W. L. Larson, *Switchcraft, Inc.*; H. S. Quam, *Quam-Nichols Co.*; W. Stuart, *Belden Mfg. Co.*; R. E. Svoboda, *Amphenol-Borg Electronics Corp.*; E. Templeton, *P. R. Mallory & Co., Inc.*; J. T. Thompson, *Raytheon Co.*; and B. E. Vinkemulder, *Centralab, Div. Globe Union, Inc.*

—50—

WALTER ASHE
has
hallicrafters NOW!

AMATEURS—WHY WAIT for “PROMISED” DELIVERY on your new Single-Sideband Equipment?

Guaranteed same day shipment of any SSB equipment on this page!

Why wait for promised delivery on equipment that may take months to hit the market . . . when Walter Ashe can make actual delivery on all Hallicrafters Single Sideband equipment. We can make shipment the same day your order reaches us!

TIME PAYMENT TERMS AVAILABLE ON ALL EQUIPMENT!

**YOUR PRESENT
XMITTER
OR RECEIVER
IS WORTH
BIG MONEY**

Get Our “Surprise” Allowance

Tell us what you have to trade . . . any name brand equipment made since 1946 . . . and we'll rush our biggest-ever “Surprise” allowance that is sure to make you wonder how Walter Ashe can do it. Incidentally, all used equipment we sell is checked thoroughly and guaranteed to work the same as new. Whether you're trading up to new or purchasing used equipment . . . you're always money and satisfaction ahead at Walter Ashe!

Why Wait? Get on SSB With This Powerhouse Combination . . . NOW!



HALLICRAFTERS
HT 32 A
CW-AM-SSB
Transmitter
Amateur Net

\$695

Shipping Weight 85 Lbs.



HALLICRAFTERS
HT 33 A
LINEAR KW
Amateur Net

\$795

Shipping Weight 130 Lbs.



HALLICRAFTERS S-107
All Band RECEIVER
Amateur Net

\$89⁹⁵

Shipping Weight 19 Lbs.

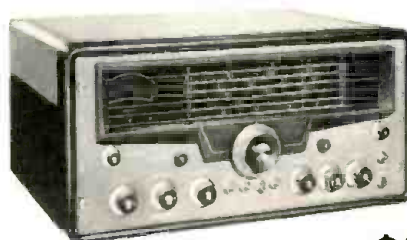

HALLICRAFTERS
famous
SX 101A
AMATEUR BAND
RECEIVER

Amateur Net

\$395⁵⁰

Shipping Weight 80 Lbs.

HALLICRAFTERS
precision-built
SX-110 RECEIVER
Amateur Net

\$159⁹⁵



Shipping Weight 36 Lbs.

NEW 1960 CATALOG READY!

Here's the “ham's own” catalog . . . compiled and designed entirely with the amateur in mind. Exclusively new mobile and fixed station equipment . . . parts and supplies . . . of interest to the amateur. Rush coupon for your copy.



Walter Ashe RADIO CO.
Dept. R-11-59, 1125 PINE STREET
ST. LOUIS 1, MISSOURI

“SURPRISE TRADE-IN” COUPON

WALTER ASHE RADIO CO.
YOUR ONE-STOP SUPERMARKET

Dept. R-11-59 • St. Louis 1, Mo.

In Our 38th Year

- Rush New Catalog
- Send latest lists of guaranteed Used Equipment
- Rush “Surprise Trade-in” offer on my _____

For _____
(Show make and model of equipment desired)

Name _____

Address _____

City _____ Zone _____ State _____



TWO-WAY RADIO
communications equipment

VHF-FM FOR: MOBILE, AIRCRAFT, MARINE, MOTORCYCLE, PORTABLE, BASE

VHF-AM FOR: AIRPORT VEHICLES, GROUND STATIONS, POINT-TO-POINT

VHF: ANTENNAS, REMOTE CONTROLS, ACCESSORIES



COMCO'S ALL NEW "580" FLEETCOM VHF-EM MOBILE RADIO

The new "580" is compact, light weight, has high performance, and features an original concept in Mobile equipment packaging by combining the control head, speaker, and transistorized power supply in one small easily mounted case assembly.

FEATURES

- ★ **HIGH PERFORMANCE**... meets "split channel" technical requirements, all FCC and FCDA requirements.
- ★ **FULL POWER OUTPUT**... 35 Watts in 25-50 Mcs. 25 Watts in 144-174 Mcs.
- ★ **BUILT-IN RELIABILITY**... Preproduction Models field tested in 5 states and 3 foreign countries before starting production.
- ★ **SMALL AND LIGHT WEIGHT**... Chassis in case 13"x9 1/2"x5 1/2". Control-power Supply-Speaker case 5"x5"x3 1/2". Complete Mobile installations 24 lbs.
- ★ **EASY TO INSTALL**... "Two-unit" package so small most installations are under dash.
- ★ **LOW COST**... Complete mobile package

★ **EFFICIENT**... Transistor power supply gives high efficiency. Total standby drain 5.25 amp.

★ **INTERCHANGEABLE CHASSIS**... Mobile transmitter-receiver chassis instantly interchangeable with base stations in simplex systems.

\$398 f.o.b. factory

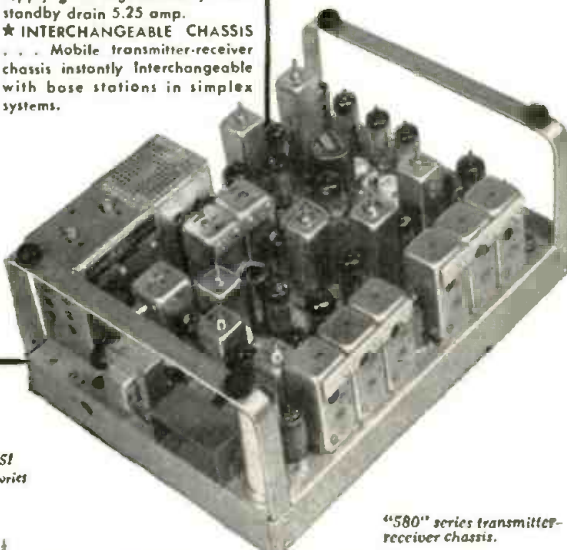

ATTENTION DEALERS!
Write for available territories



DESIGNERS AND MANUFACTURERS OF **COMMUNICATIONS COMPANY, Inc.** RADIO COMMUNICATIONS EQUIPMENT

FOUNDED 1938 CORAL GABLES, MIAMI 33, FLORIDA

Largest Induction Heating Project

Simulates high temperatures found in high-speed flight.

THE age of manned space vehicles may be brought closer to reality by a new radio-energized heat testing device designed by General Electric's Communication Products Dept. to simulate high temperatures encountered in high-speed flight. Described as the first undertaking of its scope in the world, the new electronic equipment uses r.f. induction heating principles. The equipment required is being built by G-E for the Air Force.

The contract involves several million dollars and provides for initial installation at the Aircraft Structures High-Temperature Laboratory maintained by the Air Force at Wright Patterson Air Force Base near Dayton, Ohio.

Designated as "Project Heat," the system will concentrate a total of 10 million watts of r.f. energy in a relatively small area of approximately 100 square feet. It is the largest induction heating project that has ever been undertaken and is the result of a decade of research in the field.

Up to now, space vehicle experiments of the Air Force have been conducted using infrared lamps, plasma jets, shock tubes, and similar equipment. The major advantage of induction heating is that it can be readily controlled and yet it can create temperature changes at an extremely high rate. The purpose of "Project Heat" is to provide valuable test data to engineers designing aircraft, missiles, and space vehicles. Similar techniques will eventually be used for a wide variety of applications by other government agencies and aircraft manufacturers.

The r.f. induction equipment for this project will be especially designed to operate compatibly with the Air Force's existing radiant heat system at Wright Field. The over-all system will consist of forty power loops with associated load-matching networks. Each is capable of inducing 250,000 watts of r.f. power into the test specimen at frequencies within the range of 200 kc. to 2 mc. The equipment has provision for future extension to 5 mc.

The over-all contract, awarded to Helldoerfer-Castellini, prime contractor, of Dayton, Ohio, calls for a complete system installation including 60-cycle back-up power equipment to be supplied by G-E's Apparatus Sales Division. Original feasibility studies were carried out by scientists at the University of Florida. The Vitro Corporation in New York is the architectural engineer for the facility.

GET INTO ELECTRONICS

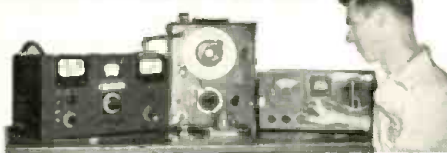

V.T.I. training leads to success as technicians, field engineers, specialists in communications, guided missiles, computers, radar and automation. Basic and advanced courses in theory and laboratory. Associate degree in electronics in 29 months. B.S. in electronic engineering obtainable. ECTPD accredited. G.I. approved. Graduates in all branches of electronics with major companies. Start February, September, Dorms, campus. High school graduate or equivalent. Catalog.

VALPARAISO TECHNICAL INSTITUTE
Dept. RD Valparaiso, Indiana

BARGAIN HUNTING? TV SERVICEMEN!

Write for SENSATIONAL CATALOG

HENSHAW RADIO SUPPLY
3619 TROOST KANSAS CITY, MO.

TAPE RECORDERS

HI-FI COMPONENTS SLEEP LEARN KITS

MERITAPE Low cost, high quality recording tape, in boxes of cans.

UNUSUAL VALUES FREE 1960 Catalog

DRESSNER, 69-02 RA, 174 St., Flushing 65, N.Y.

How to keep your profits from going to the "dogs"!



AVOID CALLBACKS DUE TO PREMATURE TUBE FAILURE...

...when you replace a defective horizontal output tube check operating cathode current.

Premature horizontal output tube ("H.O.T.") failure can be caused by excessive cathode current—higher than recommended by the manufacturer—due to misadjustment or defective components in the horizontal output stage. Whenever you replace the "H.O.T.", protect your profits with these precautions: (1) measure "H.O.T." cathode current; (2) if excessive, find the trouble and fix it; and (3) adjust Horizontal Drive, Width, and Linearity.

Keep your hard-earned profits to yourself. Take time to check "H.O.T." cathode current. And, do as most successful service technicians do: always replace defective horizontal output tubes with *power-to-spare* RCA tubes. They pay off in fewer callbacks, finer reputation, and bigger profits.



RCA-6DQ6-A—typical of RCA's excellent tube quality. Mount structure is designed to give maximum heat dissipation, prevent "hot spots" on the plate, allow cooler operation of the grids—help cut callbacks! Available at your RCA Tube Distributor.



RADIO CORPORATION OF AMERICA

Electron Tube Division

Harrison, N. J.

4 SIMPLE WAYS TO MEASURE "H.O.T." CURRENT

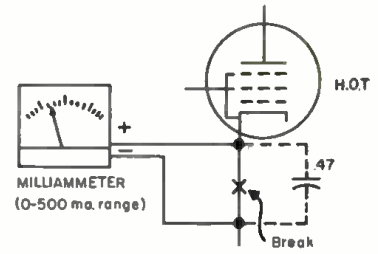

Disconnect cathode circuit of the "H.O.T." socket. Connect 0.47 μ f capacitor and dc milliammeter as shown.

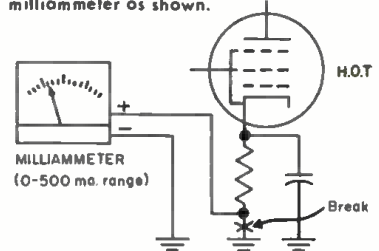

If "H.O.T." circuit has bypassed cathode-bias resistor, connect milliammeter as shown.

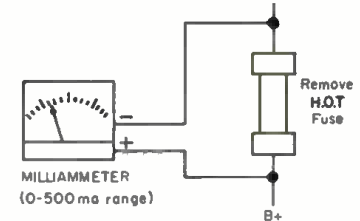

Remove "H.O.T." circuit fuse. Connect meter across fuse holder as shown. Indicated current will be slightly higher than actual cathode current because it includes boosted "B" current to vertical oscillator and/or other circuits.

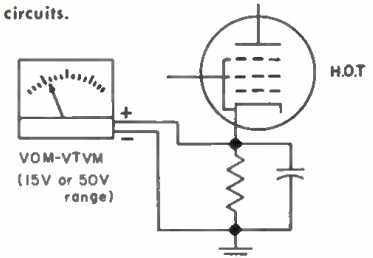

Measure dc-voltage across "H.O.T." cathode-bias resistor. Voltage should not exceed value shown in service data for the set. Compute cathode current by dividing the voltage by the resistance.

TYPICAL RCA "H.O.T." TYPES AND MAX. A DC CATHODE CURRENT (MILLIAMPERES)

6AU5-GT	110
6AV5-GA	110
*6AV5-GT	110
*6BG6-G	110
6BG6-GA	110
*6BQ6-GT	110
6BQ6-GTB/6CU6	112.5
*6CB5	200
6CB5-A	220
*6CD6-G	200
6CD6-GA	200
6DQ5	285
6DQ6-A	140
12AV5-GA	110
12BQ6-GTB/12CU6	112.5
12DQ6-A	140
17BQ6-GTB	112.5
17DQ6-A	140
*19BQ6-G	110
19BQ6-GA	110
*25BQ6-GT	110
25BQ6-GTB/25CU6	112.5
25CD6-GA	200
25CD6-GB	200
25DN6	200

*Discontinued RCA Type—Replaced by RCA "A" or double-branded version.

ΔValues shown are measured with the receiver operating at a line voltage of 117 volts, 60 cycles.



Superior's New
Model 82A

Multi-Socket Type TUBE TESTER

TEST ANY TUBE IN 10 SECONDS FLAT!

- ① Turn the filament selector switch to position specified.
- ② Insert tube into a numbered socket as designated on our chart (over 600 types included).
- ③ Press down the quality button —

Model 82A — TUBE TESTER . . . Total Price \$36.50 — Terms: \$6.50 after 10 day trial, then \$6.00 monthly for 5 months if satisfactory. Otherwise return, no explanation necessary.

To test any tube, you simply insert it into a numbered socket as designated, turn the filament switch and press down the quality switch—THAT'S ALL! Read quality on meter. Inter-element leakage if any indicates automatically.

THAT'S ALL! Read emission quality direct on bad-good meter scale.

SPECIFICATIONS

- Tests over 600 tube types • Tests OZ4 and other gas-filled tubes
- Employs new 4" meter with sealed air-damping chamber resulting in accurate vibrationless readings • Use of 22 sockets permits testing all popular tube types and prevents possible obsolescence • Dual scale meter permits testing of low current tubes • 7 and 9 pin straighteners mounted on panel • All sections of multi-element tubes tested simultaneously • Ultra-sensitive leakage test circuit will indicate leakage up to 5 megohms

Model 82A comes housed in handsome, portable Saddle-Stitched Texon case. Only

\$36⁵⁰



SUPERIOR'S NEW MODEL 83

C.R.T. TESTER

TESTS and REJUVENATES ALL PICTURE TUBES

ALL BLACK AND WHITE TUBES

From 50 degree to 110 degree types—from 8" to 30" types.

- Model 83 is not simply a rehashed black and white C.R.T. Tester with a color adapter added. Model 83 employs a new improved circuit designed specifically to test the older type black and white tubes, the newer type black and white tubes and all color picture tubes.
- Model 83 provides separate filament operating voltages for the older 6.3 types and the newer 8.4 types.
- Model 83 employs a 4" air-damped meter with quality and calibrated scales.
- Model 83 properly tests the red, green and blue sections of color tubes individually—for each section of a color tube contains its own filament, plate, grid and cathode.

ALL COLOR TUBES

Test ALL picture tubes—in the carton—out of the carton—in the set!

- Model 83 will detect tubes which are apparently good but require rejuvenation. Such tubes will provide a picture seemingly good but lacking in proper definition, contrast and focus. To test for such malfunction, you simply press the rej. switch of Model 83. If the tube is weakening, the meter reading will indicate the condition.
- Rejuvenation of picture tubes is not simply a matter of applying a high voltage to the filament. Such voltages improperly applied can strip the cathode of the oxide coating essential for proper emission. The Model 83 applies a selective low voltage uniformly to assure increased life with no danger of cathode damage.

Model 83 comes housed in handsome portable Saddle Stitced Texon case—complete with sockets for all black and white tubes and all color tubes. Only

\$38⁵⁰ NET

Model 83—C.R.T. Tube Tester
Total Price \$38.50
Terms: \$8.50 after 10 day trial, then \$6.00 monthly for 5 months if satisfactory. Otherwise return, no explanation necessary.



GENOMETER

7 Signal Generators in One!

- ✓ R.F. Signal Generator for A.M.
- ✓ R.F. Signal Generator for F.M.
- ✓ Audio Frequency Generator
- ✓ Bar Generator
- ✓ Marker Generator
- ✓ Cross Hatch Generator
- ✓ Color Dot Pattern Generator

A versatile all-inclusive GENERATOR which provides ALL the outputs for servicing:

A.M. Radio • F.M. Radio • Amplifiers • Black and White TV • Color TV

R. F. SIGNAL GENERATOR: The Model TV-50A Genometer provides complete coverage for A.M. and F.M. alignment. Generates Radio Frequencies from 100 Kilocycles to 60 Megacycles on fundamentals and from 60 Megacycles to 180 Megacycles on powerful harmonics.

VARIABLE AUDIO FREQUENCY GENERATOR: In addition to a fixed 400 cycle sine-wave audio, the Model TV-50A Genometer provides a variable 300 cycle to 20,000 cycle peaked wave audio signal.

BAR GENERATOR: The Model TV-50A projects an actual Bar Pattern on any TV Receiver Screen. Pattern will consist of 4 to 16 horizontal bars or 7 to 20 vertical bars.

THE MODEL TV-50A comes absolutely complete with shielded leads and operating instructions.

Model TV-50A—Genometer
Total Price \$47.50
Terms: \$11.50 after 10 day trial, then \$6.00 monthly for 6 months if satisfactory. Otherwise return, no explanation necessary.

CROSS HATCH GENERATOR: The Model TV-50A Genometer will project a cross-hatch pattern on any TV picture tube. The pattern will consist of non-shifting, horizontal and vertical lines interlaced to provide a stable cross-hatch effect.

DOT PATTERN GENERATOR (FOR COLOR TV): Although you will be able to use most of your regular standard equipment for servicing Color TV, the one addition which is a "must" is a Dot Pattern Generator. The Dot Pattern projected on any color TV Receiver tube by the Model TV-50A will enable you to adjust for proper color convergence.

MARKER GENERATOR: The Model TV-50A includes all the most frequently needed marker points. The following markers are provided: 189 Kc., 262.5 Kc., 456 Kc., 600 Kc., 1000 Kc., 1400 Kc., 1600 Kc., 2000 Kc., 2500 Kc., 3579 Kc., 4.5 Mc., 5 Mc., 10.7 Mc., (3579 Kc. is the color burst frequency)

\$47⁵⁰ NET

EXAMINE BEFORE YOU BUY!
USE APPROVAL FORM ON NEXT PAGE

SUPERIOR'S NEW MODEL 77

VACUUM TUBE VOLTMETER

WITH NEW 6" FULL-VIEW METER

Compare it to any peak-to-peak V. T. V. M. made by any other manufacturer at any price

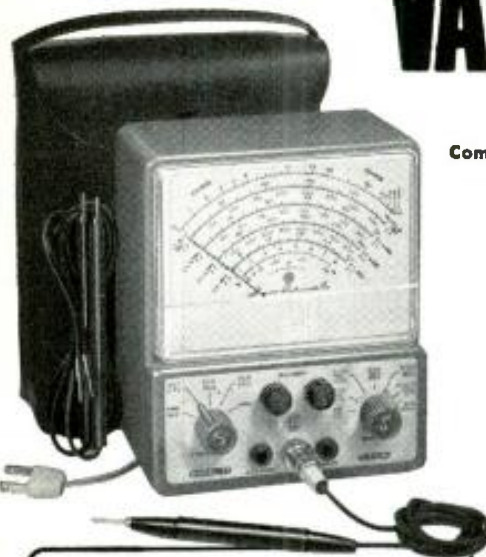

Model 77 — VACUUM TUBE VOLTMETER
 ... Total Price \$42.50—Terms: \$12.50 after 10 day trial, then \$6.00 monthly for 5 months if satisfactory. Otherwise return, no explanation necessary!

- ✓ Model 77 completely wired and calibrated with accessories (including probe, test leads and portable carrying case) sells for only \$42.50.
- ✓ Model 77 employs a sensitive six inch meter. Extra large meter scale enables us to print all calibrations in large easy-to-read type.
- ✓ Model 77 uses new improved SICO printed circuitry.
- ✓ Model 77 employs a 12AU7 as D.C. amplifier and two 9006's as peak-to-peak voltage rectifiers to assure maximum stability.

- ✓ Model 77 uses a selenium-rectified power supply resulting in less heat and thus reducing possibility of damage or value changes of delicate components.
- ✓ Model 77 meter is virtually burn-out proof. The sensitive 400 microampere meter is isolated from the measuring circuit by a balanced push-pull amplifier.
- ✓ Model 77 uses selected 1% zero temperature coefficient resistors as multipliers. This assures unchanging accurate readings on all ranges.

AS A DC VOLTMETER: The Model 77 is indispensable in Hi-Fi Amplifier servicing and a must for Black and White and color TV Receiver servicing where circuit loading cannot be tolerated.

AS AN AC VOLTMETER: Measures RMS values if sine wave, and peak-to-peak value if complex wave. Pedestal voltages that determine the "black" level in TV receivers are easily read.

AS AN ELECTRONIC OHMMETER: Because of its wide range of measurement leaky capacitors show up glaringly. Because of its sensitivity and low loading, intermittents are easily found, isolated and repaired.

SPECIFICATIONS

• DC VOLTS — 0 to 3/15/75/150/300/750/1,500 volts at 11 megohms input resistance. • AC VOLTS (RMS) — 0 to 3/15/75/150/300/750/1,500 volts. • AC VOLTS (Peak to Peak) — 0 to 8/40/200/400/800/2,000 volts. • ELECTRONIC OHMMETER — 0 to 1,000 ohms/10,000 ohms/100,000 ohms/1 megohm/10 megohms/100 megohms/1,000 megohms • DECIBELS —10 db to +18 db, +10 db to +38 db +30 db to +58 db. All based on 0 db = .006 watts (6 mw) into a 500 ohm line (1.73v). • ZERO CENTER METER—For discriminator alignment with full scale range of 0 to 1.5/7.5/37.5/75/150/375/750 volts at 11 megohms input resistance.

Model 77 comes complete with operating instructions, probe and test leads. Use it on the bench—use it on calls. A streamlined carrying case, included at no extra charge, accommodates the tester, instruction book, probe and leads. Operates on 110-120 volt 60 cycle. Only

\$42⁵⁰ NET

SUPERIOR'S NEW MODEL 80

20,000 OHMS PER VOLT ALLMETER

THE ONLY 20,000 OHMS PER VOLT V.O.M. SELLING FOR LESS THAN \$50 WHICH PROVIDES ALL THE FOLLOWING FEATURES:



Model 80 — ALLMETER ... Total Price \$42.50—Terms: \$12.50 after 10 day trial, then \$6.00 monthly for 5 months if satisfactory. Otherwise return, no explanation necessary!

- ✓ 6 INCH FULL-VIEW METER provides large easy-to-read calibrations. No squinting or guessing when you use Model 80.
- ✓ MIRRORED SCALE permits fine accurate measurements where fractional readings are important.
- ✓ CAPACITY RANGES permit you to accurately measure all condensers from .00025 MFD to 30 MFD in addition to the standard volt, current, resistance and decibel ranges.

- ✓ HANDSOME SADDLE-STITCHED CARRYING CASE included with Model 80 Allmeter at no extra charge enables you to use this fine instrument on outside calls as well as on the bench in your shop.

NOTE: The line cord is used only for capacity measurements. Resistance ranges operate on self-contained batteries.

SPECIFICATIONS:

- 7 D.C. VOLTAGE RANGES (At a sensitivity of 20,000 Ohms per Volt) 0 to 15/75/150/300/750/1500/7500 Volts.
- 6 A.C. VOLTAGE RANGES: (At a sensitivity of 5,000 Ohms per Volt) 0 to 15/75/150/300/750/1500 Volts.
- 3 RESISTANCE RANGES: 0 to 2,000/200,000 Ohms. 0-20 Megohms.
- 2 CAPACITY RANGES: .00025 Mfd. to .3 Mfd., .05 Mfd. to 30 Mfd.
- 5 DC. CURRENT RANGES: 0-75 Microamperes, 0 to 7.5/75/750 Milliamperes, 0 to 15 Amperes.
- 3 DECIBEL RANGES: -6 db to +18 db, +14 db to +38 db +34 db to +58 db

FEATURES:

- A built-in Isolation Transformer automatically isolates the Model 80 from the power line when capacity service is in use.
- Selected, 1% zero temperature coefficient metalized resistors are used as multipliers to assure unchanging accurate readings on all ranges.

Model 80 Allmeter comes complete with operating instructions, test leads and portable carrying case. Only

\$42⁵⁰ NET

SHIPPED ON APPROVAL NO MONEY WITH ORDER — NO C. O. D.

Try any of the instruments on this or the facing page for 10 days before you buy. If completely satisfied then send down payment and pay balance as indicated on coupon. No Interest or Finance Charges Added! If not completely satisfied return unit to us, no explanation necessary.

MOSS ELECTRONIC, INC.

Dept. D-683, 3849 Tenth Ave., New York 34, N. Y.

Please send me the units checked on approval. If completely satisfied I will pay on the terms specified with no interest or finance charges added. Otherwise, I will return after a 10 day trial positively cancelling all further obligations.

- Model 82A..... Total Price \$36.50 \$6.50 within 10 days. Balance \$6.00 monthly for 5 months.
- Model 77..... Total Price \$42.50 \$12.50 within 10 days. Balance \$6.00 monthly for 5 months
- Model 83..... Total Price \$38.50 \$8.50 within 10 days. Balance \$6.00 monthly for 5 months.
- Model 80..... Total Price \$42.50 \$12.50 within 10 days. Balance \$6.00 monthly for 5 months.
- Model TV-50A..... Total Price \$47.50 \$11.50 within 10 days. Balance \$6.00 monthly for 6 months

Name

Address

City Zone..... State.....

All prices net, F.O.B., N.Y.C.

Operate your...

- tape recorder
- P. A. system
- portable TV set
- hand tools

FROM YOUR CAR, Boat or Plane!

with



INVERTERS



for changing your storage battery current to A.C. HOUSEHOLD ELECTRICITY Anywhere... in your own car!

OPERATES
PORTABLE TV SET
directly from your car!

OPERATES

- RADIOS
 - RECORD PLAYERS
 - MIXMASTERS, ETC.
- directly from your car!

MAKE YOUR CAR, BOAT OR PLANE
"A ROLLING OFFICE!"



OPERATES

- TAPE RECORDERS
 - DICTATING MACHINES
 - PUBLIC ADDRESS SYSTEMS
 - ELECTRIC SHAVERS
- directly from your car!



mounted out of sight under dash or in trunk compartment

ATR UNIVERSAL INVERTERS

Especially designed to change 6 or 12 volt D.C. to 110 volt A.C. 60 cycles. for...

- EXECUTIVES
- SALESMEN
- OUTDOOR MEN
- POLICEMEN
- REPORTERS
- FIREMEN
- PUBLIC OFFICIALS

MODELS 6U-RHG (6 volts) 125 to 150 watts. Shipping weight 27 lbs. List price...\$99.50

DEALER NET PRICE...\$66.34

12U-RHG (12 volts) 150 to 175 watts. Shipping weight 27 lbs. List price...\$99.50

DEALER NET PRICE...\$66.34

Write for literature on other Sizes and Models of ATR INVERTERS, priced as low as \$9.95 list.

SEE YOUR JOBBER OR WRITE FACTORY

- ✓ NEW MODELS
- ✓ NEW DESIGNS
- ✓ NEW LITERATURE
- "A" Battery Eliminators
- DC-AC Inverters
- Auto Radio Vibrators



AMERICAN TELEVISION & RADIO CO.
Quality Products Since 1931
SAINT PAUL 1, MINNESOTA, U. S. A.

Violations of Citizens Radio Regulations

Off-frequency operation and improper use of the service are responsible for the FCC issuing large numbers of citations to licensees for violations.

EDITOR'S NOTE: The following material is reprinted from a recent Federal Communications Commission release. This information should be read by all who are interested in using the new Class D Citizens Radio Service.

THE Commission's monitoring stations are continuing to detect violations of the Citizens Radio Service Rules and are issuing large numbers of citations to licensees.

The violations cited fall mainly into two large groups—off-frequency operation and the use of Citizens Radio Service stations for communications which are not permissible.

It is the licensee's responsibility to see that his equipment is at all times operating in accordance with the Citizens Radio Service Rules. Off-frequency operation can be guarded against by having measurements made by a service engineer or other person who has the proper frequency-measuring equipment and the skill required to use it. The answer to the question of how often depends upon the equipment used. Some equipment may require daily checks whereas more stable equipment may not require frequency checks for six months.

Most citations for improper use result from the mistaken belief that the Citizens Radio Service (particularly the Class D Service) is similar to the Amateur Radio Service with respect to permissible communications and that amateur-type communications (such as calling "CQ," working distant stations for the fun of talking to someone that far away, and so on) are permitted. Nothing is farther from the truth.

The Citizens Radio Service was set up by the Commission on a regular basis in 1947. At that time, frequencies were made available only in the 460-470 mc. band. Later, one other frequency, 27.255 mc. was made available for control (not communications) purposes only. In September, 1958, two new groups of frequencies (one group for control purposes and the other for voice communications) were made available. However, control stations are licensed as "Class C" and voice stations as "Class D." No changes were

made in the scope of permissible communications.

The new frequencies were set up in a band formerly assigned to the Amateur Radio Service in the 27-mc. region. For this reason, it seems likely that the former association of these frequencies with the Amateur Radio Service is partly responsible for the misunderstanding regarding the use of Class D stations. Some licensed amateurs have obtained Citizens Radio licenses and are continuing to operate on Class D frequencies much as they did when the frequencies were available to holders of amateur licenses. It is also apparent that many who could not or would not obtain amateur licenses have seized upon the Class D Service to carry out activities which are permissible only in the Amateur Radio Service. It seems to be these two groups who are receiving most of the violation notices being issued by the Commission's monitoring stations.

Licensees should remember that:

The Citizens Radio Service was set up to provide for the radio communications needs of the citizens of the United States on much the same basis as a party-line telephone, and Citizens Radio stations must be used with the same consideration of other users.

The Amateur Radio Service is available to all citizens of the United States who are interested enough to qualify themselves—and the knowledge and code skills required to obtain a Novice Class ham license are easily acquired.

Citizens Radio, properly used, is a valuable communications tool for the professional man (such as the doctor and engineer), the small businessman, and the plain citizen. Improperly used, it can be made worthless to everyone because of excessive interference.

Continued violations of the rules will result in license revocation and loss of all operating privileges.

Any Citizens Radio station may communicate with any other Citizens Radio station (except Class C) for the purpose of exchanging necessary and useful communications.

Don't put your Citizens Radio transmitter on the air unless you have a message which you need to send. —30—

FREE

LAFAYETTE'S 1960 CATALOG 308 GIANT SIZED PAGES Our 39th Year

The Complete Catalog Featuring "The Best Buys In The Business"

FOR THE NEWEST AND FINEST IN
STEREOPHONIC HI-FI EQUIPMENT AND SYSTEMS

- TAPE RECORDERS ● PUBLIC ADDRESS SYSTEMS
- AMATEUR EQUIPMENT ● INDUSTRIAL SUPPLIES
- MINIATURE COMPONENTS ● RADIO & TV TUBES AND PARTS
- EXCLUSIVE LAFAYETTE TRANSISTOR & HI-FI KITS

Send for Lafayette's FREE Catalog—the most complete, up-to-the-minute electronic supply catalog crammed full of everything in electronics at our customary down-to-earth money-saving prices.

CONTAINS HUNDREDS OF EXCLUSIVE LAFAYETTE ITEMS NOT AVAILABLE IN ANY OTHER CATALOG OR FROM ANY OTHER SOURCE — SEND FOR YOUR COPY NOW!

A "must" for the economy-minded hi-fi enthusiast, experimenter, hobbyist, engineer, technician, student, serviceman and dealer.

Leaders in Hi-Fi

The most complete selection and largest stocks of hi-fi components and systems—available for immediate delivery at the lowest possible prices. Save even more on Lafayette endorsed "best-buy" complete systems.

EASY PAY TERMS Available on orders over \$20
Only 10% down—Up to 18 months to pay

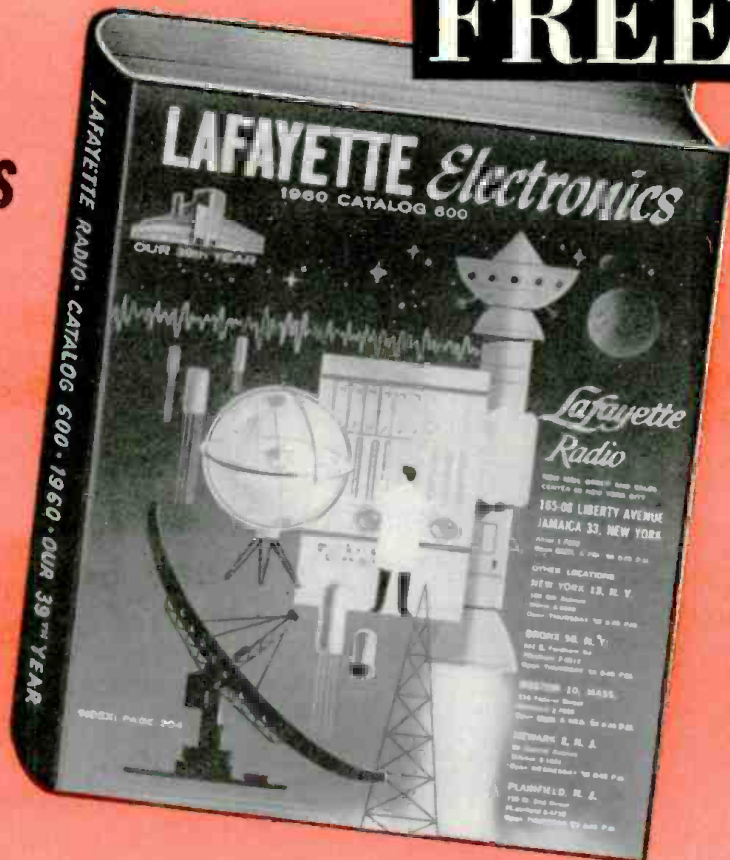

TM-66 STEREO
AUDIO ANALYST
11.95



KT-135
4-BAND
RECEIVER
KIT
(Less Cabinet)
18.50



PK-330
4 SPEED CHANGER
WITH BRAND NEW
GE VR-22 (.7 MIL) DIAMOND
STEREO CARTRIDGE
39.95



PA-56 TRANSISTORIZED
POWER MEGAPHONE
29.50



PK-331 33 1/3 RPM
HYSTERESIS TURNTABLE
47.50



PROFESSIONAL
COMMUNICATIONS
RECEIVER
KT-200 KIT 64.50
HE-10 WIRED 79.95



RW-60
20,000
OHM
PER VOLT
MULTITESTER
13.50



SK-128 ULTRA-LINEAR
8" DUALAXIAL SPEAKER
19.50

Lafayette Radio

"Everything in Electronics"

FREE

308 GIANT
SIZED PAGES



CUT
OUT
AND
PASTE
ON
POST
CARD

LAFAYETTE RADIO, Dept. RK-9
P.O. Box 222, Jamaica 31, N. Y.
SEND FOR THE WORLD'S LEADING ELECTRONICS,
RADIO, T.V., INDUSTRIAL, AND HI-FI GUIDE

Send FREE LAFAYETTE Catalog 600

Name

Address

City..... Zone.... State.....

Lafayette Superior Quality Hi-Fi Kits

50 WATT INTEGRATED STEREO AMPLIFIER



KT-250
IN KIT FORM
64.50

LA-250
COMPLETELY WIRED
89.50

- 50 WATTS MONAURALLY—25 WATTS EACH STEREO CHANNEL
- RESPONSE 17-21,000 CPS \pm 1 DB (at normal listening level)
- UNIQUE "BLEND" CONTROL
- PREMIUM EL86 OUTPUT TUBES
- SEPARATE BASS AND TREBLE CONTROLS
- CLUTCH-OPERATED VOLUME CONTROL
- 3RD CHANNEL OUTPUT

A completely new stereo high fidelity amplifier with a high quality of reproduction, versatility of operation, and distinctive styling. A full range of controls enable you to enjoy the utmost in listening pleasure in any situation. Deluxe features include: unique "Blend" control for continuously variable channel separation—from full monaural to full stereo, 4-position Selector, Mode, Loudness and Phase switches. Also provided are outputs for 4, 8 and 16 ohm speakers. Hum-free operation is insured by the use of DC on all pre-amp and tone control tubes. Harmonic distortion, less than 0.25%, IM distortion, less than 1%. Hum and noise, 74 db below full output. Designed with the kit builder in mind, assembly is simple—no special skills or tools required. Complete with deluxe cabinet and legs, all parts, tubes and detailed instruction manual. Shpg. wt., 26 lbs.

KT-250 Stereo Amplifier Kit.....6.45 Down.....Net 64.50
LA-250 Stereo Amplifier, wired.....8.95 Down.....Net 89.50

LAFAYETTE PROFESSIONAL STEREO MASTER AUDIO CONTROL CENTER

Solves Every Stereo/Monaural Control Problem!



KT-600
IN KIT FORM
79.50

LA-600
COMPLETELY WIRED
134.50

- UNIQUE STEREO & MONAURAL CONTROL FEATURES
- AMAZING NEW BRIDGE CIRCUITRY FOR VARIABLE 3d CHANNEL OUTPUT & CROSS-CHANNEL FEED
- PRECISE "NULL" BALANCING SYSTEM
- RESPONSE 5-40,000 CPS \pm 1 DB
- 6 CONCENTRIC FRONT PANEL CONTROLS

A REVOLUTIONARY DEVELOPMENT IN STEREO HIGH FIDELITY.

Provides such unusual features as a Bridge Control, for variable cross-channel signal feed for elimination of "ping-pong" (exaggerated separation) effects. Also has full input mixing of monaural program sources, special "null" stereo balancing and calibrating system. 24 equalization positions, all-concentric controls, rumble and scratch filters, loudness switch. Clutch type volume controls for balancing or as 1 Master Volume Control. Has channel reverse, electronic phasing, input level controls. Sensitivity 2.2 millivolts for 1 volt out. Dual low-impedance outputs (plate followers), 1500 ohms. Response 5-40,000 cps \pm 1 db. Less than .03% IM distortion. Uses 7 new 7025 low-noise dual triodes. Size 14" x 4 1/2" x 10 1/2". Shpg. wt., 16 lbs. Complete with printed circuit board, case, profusely illustrated instructions, all necessary parts.

LAFAYETTE KT-600—Stereo Preampifier kit7.95 Down.....Net 79.50
LAFAYETTE LA-600—Stereo Preampifier, Wired.....13.45 Down.....Net 134.50

Outstanding Design—Incomparable Performance

LAFAYETTE STEREO/MONAURAL BASIC POWER AMPLIFIER KIT



KT-310
IN KIT FORM
47.50

LA-310
COMPLETELY WIRED
72.50

- 36-WATT STEREO AMPLIFIER—18-WATTS EACH CHANNEL
- 2 PRINTED CIRCUIT BOARDS FOR NEAT, SIMPLIFIED WIRING
- EMPLOYS 4 NEW PREMIUM-TYPE 7189 OUTPUT TUBES
- RESPONSE BETTER THAN 35-30,000 CPS \pm 1/2 DB AT 18 WATTS
- LESS THAN 1% HARMONIC OR INTERMODULATION DISTORTION

A superbly-performing basic stereo amplifier, in easy-to-build kit form. Dual inputs are provided, each with individual volume control, and the unit may be used with a stereo preamplifier, for 2-18 watt stereo channels, or, at the flick of a switch, as a fine 36-watt monaural amplifier—or, if desired, it may be used as 2 separate monaural 18-watt amplifiers! CONTROLS include 2 input volume controls, channel Reverse switch (AB-BA), Monaural-Stereo switch, DUAL OUTPUT IMPEDANCES are: 4, 8, 16 and 32 ohms permitting parallel (monaural) operation of 2 speaker systems of up to 16 ohms. INPUT SENSITIVITY is 0.45 volts per channel for full output. TUBES are 2-6AN8, 4-7189; GZ-34 rectifier. SIZE 9-3/16" d (10-9/16" with controls) x 5 1/4" h x 13 1/4" w. Supplied complete with perforated metal cage, all necessary parts and detailed instructions. Shpg. wt., 22 lbs.

KT-310 Stereo Power Amplifier Kit.....4.75 Down.....Net 47.50
LA-310 Stereo Power Amplifier, Wired.....6.95 Down.....Net 72.50

LAFAYETTE STEREO TUNER KIT The Most Flexible Tuner Ever Designed

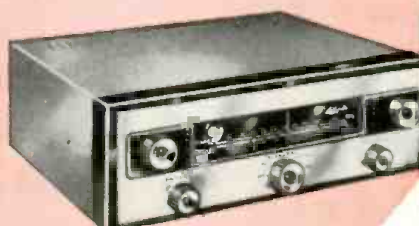

KT-500
IN KIT FORM
74.50

LT-50
COMPLETELY WIRED
124.50

- 11 Tubes (including 4 dual-purpose) + Tuning Eye + Selenium rectifier Provide 17 Tube Performance
- Pre-aligned IF's
- Tuned Cascode FM
- Dual Cathode Follower Output

More than a year of research, planning and engineering went into the making of the Lafayette Stereo Tuner. FM specifications include grounded-grid triode low noise front end with triode mixer, double-tuned dual limiters with Foster-Seeley discriminator, less than 1% harmonic distortion, frequency response 20-20,000 cps \pm 1/2 db, full 200 kc bandwidth and sensitivity of 2 microvolts for 30 db quieting with full limiting at one microvolt.

The AM and FM sections are separately tuned, each with a separate 3-gang tuning condenser, separate flywheel tuning and separate volume control for proper balancing when used for stereo programs. Simplified tuning is provided by magic eye. Automatic frequency control "locks in" FM signal permanently. Two separate printed circuit boards make construction and wiring simple, even for such a complex unit. Complete kit includes all parts and metal cover, a step-by-step instruction manual, schematic and pictorial diagrams. Size is 13 1/4" W x 10 1/4" D x 4 1/2" H. Shpg. wt., 22 lbs.

KT-500.....7.45 Down.....Net 74.50
LT-50 Same as above, completely factory wired and tested.....12.45 Down.....Net 124.50

LAFAYETTE RADIO

165-08 LIBERTY AVE., JAMAICA 33, N. Y.
AXtell 7-7000

NEW YORK, N. Y.
100 6th Ave.
Worth 6-5300

BOSTON, MASS.
110 Federal St.
HUBbard 2-7850

BRONX, N. Y.
542 E. Fordham Rd.
FORDham 7-8813

NEWARK, N. J.
24 Central Ave.
MARKet 2-1661

PLAINFIELD, N. J.
139 W. 2nd St.
PLAINfield 6-4718

NEW! *Lafayette* 50 Watt Complete Stereo Phono System



LA-250



SK-58

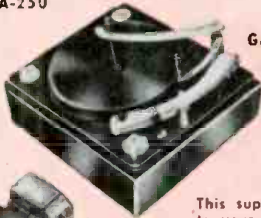

GARRARD
RC121/11

WOOD
BASE



NEW
GE VR-22



(OPTIONAL)
LAFAYETTE
ELIOFLEX
SERIES

COMPLETE
STEREO SYSTEM
174⁵⁰

COMPONENTS

LAFAYETTE LA-250 50-WATT STEREO AMPLIFIER	89.50
GARRARD RC121/11 STEREO CHANGER	41.65
NEW GE VR-22 (.7 MIL) DIAMOND STEREO CARTRIDGE	24.45
LAFAYETTE PK-111 WOOD CHANGER BASE	3.95
2-LAFAYETTE SK-58 FAMOUS FREE EDGE 12" COAXIAL SPEAKERS at 29.50	59.00

Regular Catalog Price ~~218.55~~

YOUR GUARANTEED BEST STEREO SYSTEM BUY!

YOU SAVE 44.05

This superb system will add a new dimension in living to your home with all the excitement and realism of a live concert. The new Lafayette LA-250 50-watt stereo amplifier (25 watts each channel) forms the heart of this outstanding stereo hi-fi phonograph music system—the features, versatility and advanced circuitry of this unit are second to none—all the necessary inputs and outputs are provided if you wish to add stereo tape and stereo FM/AM later. A unique blend control allows continuously variable channel separation—from full manual to full stereo. Also included is the famous Garrard RC121/11 intermix 4-speed automatic record changer with full manual or automatic operation supplied with your choice of stereo cartridges—the new GE VR-22 (.7 mil) diamond stereo cartridge, Pickering 3717D (.7 mil) diamond stereo cartridge, Shure M7D (.7 mil) diamond stereo cartridge or the new Electro-Voice 31MD7 (.7 mil) diamond stereo cartridge. Supplied with the Lafayette PK-111 wood base cut for the RC121 in your choice of finishes. These outstanding components are coupled with the 2-

famous free-edge Lafayette SK-58 12" Coaxial speakers with built-in crossover network and brilliance level control. System supplied with plugs, cables and simple instructions. Shpg. Wt., 67 lbs.

HI-FI STEREO PHONO SYSTEM with choice of cartridge and mahogany, walnut or blond changer base (please specify).

HF-681. 17.45 Down Net 174.50

Same as HF-681, but with 2-Lafayette ElioFlex Series Bookshelf Enclosures (please specify finish.) Shpg. Wt., 143 lbs.

HF-683. 22.99 Down Ne: 229.95

STEREO AM-FM-PHONO SYSTEM: Same as HF-681 but including the new Lafayette LT-50 stereo tuner. Shpg. Wt., 85 lbs.

HF-682. 28.75 Down Net 287.50

Unquestionable Economy—Elegant Styling

LAFAYETTE 36-WATT INTEGRATED STEREO AMPLIFIER KIT

NEW!
KT-236
IN KIT FORM
52.50

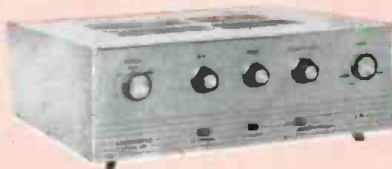

- 36 - WATTS MONAURALLY - 18 - WATTS PER CHANNEL
- FREQUENCY RESPONSE 15-30,000 CPS ± 1 DB
- UNIQUE "BLEND" CONTROL
- CONCENTRIC CLUTCH - OPERATED VOLUME CONTROL
- DUAL CONCENTRIC BASS AND TREBLE CONTROLS.
- 4 - EL84 TUBES IN PUSH PULL.

An outstanding achievement in kit engineering . . . This exciting new amplifier kit combines dual preamplifiers and dual 18 watt power amplifiers on one compact chassis. It's complete versatility allows connecting both stereo and monophonic sources permanently, with instant selection provided by the turn of a switch. Controls include an amazing new "Blend" control which provides continuously variable channel separation from full monophonic to full stereo, thus insuring the correct degree of stereo separation for individual listening tastes and room acoustics. Additional features are: Concentric clutch-operated volume control for independent or simultaneous level adjustments of both channels; Dual concentric bass and treble controls (furnish 4 independent tonal adjustments); Selector Switch provides for Aux, Tuner and Phono. Dual output impedances are: 8 and 16 ohms. Harmonic distortion is less than 0.15% at normal listening level. IM distortion is less than .3%. Hum and noise 70 db below rated output. Complete with cage, legs and detailed instructions. Shpg. wt., 24 lbs.

KT-236 Stereo Amplifier Kit 5.25 Down Net 52.50

DELUXE 70 WATT BASIC AMPLIFIER

KT-400
IN KIT FORM
69.50

LA-70
COMPLETELY WIRED
94.50

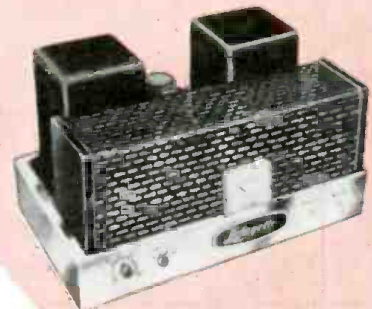

- CONSERVATIVELY RATED AT 70 WATTS
- INVERSE FEEDBACK
- VARIABLE DAMPING
- METERED BALANCE AND BIAS ADJUST CONTROLS
- AVAILABLE IN KIT AND WIRED FORM

Here's ultra-stability in a 70 watt basic power amplifier employing highest quality components conservatively rated to insure performance and long life. Features matched pair KT 88's and wire range linear Chicago output transformer, variable damping control, meter for bias and balance and gold finish chassis. Frequency response 10-100,000 cps ± 1 db. Hum and noise 90 db below full output. IM distortion less than 1 1/2% at 70 watts, less than 0.3% below 30 watts. Harmonic distortion less than 2% at 70 watts from 20 to 20,000 cps ± 1 db. Output impedance 4, 8 and 16 ohms. Handsome decorative cage perforated for proper ventilation. Size 14 1/2 x 10 x 7 1/4" including cage and knobs. Shpg wt., 40 lbs.

KT-400—In Kit Form 6.95 Down Net 69.50

LA-70—Completely Wired 9.45 Down Net 94.50

MONEY-BACK GUARANTEE

Lafayette Kits are exclusive products of Lafayette Electronics. Each Lafayette Kit must meet or exceed its published specifications, or your money is refunded in full.

FREE!
1960
CATALOG

CUT OUT
AND PASTE
ON POST
CARD

LAFAYETTE RADIO

P.O. BOX 222
JAMAICA 31, N. Y.
DEPT. RK-9

Name
Address
City Zone State

"GOODHEART'S GOODIES"

RECEIVER/RF PRESELECTION/RF AMPLIFIER

TUNES 550-32,000 KC
 CME-50083 RF Preselector. New clean, in factory pack with tech. manual. TRF tuner/amplifier to improve any receiver. Add xtl diode in series with headset across output and it is a complete receiver for BC, SW, Citizens. With 25 mmf instead of headset, it is a Hi-Fi tuner. As a preselector, it is a powerful signal booster, adds 20-25 db sensitivity, improves selectivity and signal/noise ratio, and cuts image to 1/50,000. Complete and self-contained. 9 1/4" h, 10 1/2" w, 13" d OA. Net 19 lbs. Input 120 v, 60 cy. Includes rect., 2 6K7, 3 sets of 6 RF xtms (ant., 2 RF), 6-sect. tuning gang, band sw., gain control, and In-Out sw. 40:1 ratio vernier tuning. Large illuminated dial accurately calibrated in 6 overlapping bands, plus a 6 1/4" long, 180-division logging scale. Input for double or lead/ground. Input 100-300 ohms. Shpg wt 35 lbs fob **\$29.95**
 Stockton or Seattle. ONLY 12 mos at \$2.52/mo. if combined with other purchases. See footnote at bottom of column.



ARB RECEIVER
 CRV-46151, RCA AM superhet. Voice, cw, mcw, 19.5-90 kc. 4 bands in 4 bands. 6 tubes include RF & 2 IF. On a.c., needs ext. power supply & control modification described in instruction sheet you get. Ad-18, with added ctrl box, a great favorite for Marine. Sharp & Less 29.4 dynamtr. Easy to convert to 2 v. Sheet tells how. Clean used. With all schematics & instructions. Shpg wt 30 lbs fob Los Angeles. **\$17.95**
 A rare buy at. 12 mos at \$1.26 mo.
 Time Pay Plan: \$4.65 cash and 12 mos at \$1.26 mo.



\$850 TEST OSCILLOSCOPE FOR ONLY \$69.50
 T5-34/AP. The Armed Forces' accepted standard to see a pulse as it really is. Video response 11 cy to 3 1/2 mc. Use for color TV. Ready to use on 105/125 v, 50/1200 cy. Has all standard facilities, with sweep 10 cy to 50 kc. PLUS automatic triggered sweep to show random or recurrent pulses one per sweep. Compact, but the lens gives 5" picture equivalence. Exc. used, checked out OK, in its carrying suitcase, with reprint of the most important 16 pages of the tech manual. **\$69.50**
 Shpg wt 40 lbs fob Los Angeles. ONLY 12 mos at \$4.83 mo.
 Time Pay Plan: \$17.75 cash and 12 mos at \$4.83 mo.

VHF-UHF MICROVOLTER SIGNAL GENERATOR



LAF-2. 90-600 MC accurate to 1%; less than .1% drift. Bolometer-Bridge-measured CALIBRATED 50-ohm output CW or mod. 1 uv to .1 v. leaks less than 1 uv. Ext. pulse or sine mod., or int. rect-wave mod. 0-100%, 2-30 u-sec wd, 60-2500 pps. May also use ext. sync. with adj. delay 3-300 u-sec before sync fires int. wave. May also be used as sync. ext. equipment. Works on 105/125 volts, 50/60 cy. Exc. used, checked out, w/calibration charts and reprint of the needed parts of the manual. FOB Los Angeles. Gross 100 lbs. **\$89.50**
 Only 12 mos at \$6.23 mo.
 Time Pay Plan: \$22.75 cash and 12 mos at \$6.23 mo.

MEASUREMENTS CORP. MODEL 84 SIG. GEN.

300-1000 mc. accurate to 1/2% and mod. by internal sine or pulse. MICROVOLTER CALIBRATED output .1 uv to .1 v. Exc. condition, checked PERFECT by Standards Lab. 160 lbs gross fob **\$179.50**
 Los Angeles. ONLY 12 mos at \$12.53 mo.
 Time Pay Plan: \$45.25 cash and 12 mos at \$12.53 mo.

OYNAM. MUTUAL-CONDUCTANCE TUBE TESTER

L-177-B: Recognizing that a tube tester is only as good as the data and sockets available, we went to great expense to reproduce the latest data book (March 1957) and to print diagram of simple socket adapter kit, plus the most important parts of the tech manual. With the adapter, you will test 9-pin 5887, 12AX7, etc., plus smtg tubes such as 632Z, 829B, etc. Every shipment will include the literature, 25 lbs fob Los Angeles. **\$29.50**
 Good used condition
 Time Pay Plan: \$7.75 cash and 12 Payments of \$2.03 per month.



Minimum time payments are \$5.88/mo. for 12 mos.. so order enough more to get it up to that or more.

SCHEMATICS CONVERSIONS FOR SURPLUS GEAR

Send stamped addressed envelope for NEW List E; Includes many Tech Manuals. Add 25¢ for chart explaining AN Nomenclature. **DO IT TODAY!**
 Calif. buyers please add 4% when remitting.

R. E. GOODHEART CO.
 P. O. Box 1220-A Beverly Hills, Calif.

Mac's Service Shop
 (Continued from page 74)

"None that helps. He said the radio went dead when he was on vacation over East a month ago, and he took it to a shop and had it repaired. The technician told him that he had replaced the converter transistor. The set seemed to work fairly well when he was listening to strong local stations, but when he got where he knew what constituted normal reception for the little receiver, he was quickly aware that it was not working right. Of course I checked the new transistor in the transistor tester, and it checks quite good. All the voltages seem normal, and everything is quiet when I listen to the unmodulated i.f. signal from the generator feeding through from the input of the converter."

Mac studied the compact chassis of the little set for a few minutes, and then he held the point of the solder gun close to the oscillator coil until a wax seal fastening one of the two windings to the cardboard core was softened. Working very gently, he slid this winding toward the other, stopping every now and then to listen to the receiver that was tuned to a station on the low end of the band. As the coil was moved, the signal-to-noise ratio improved spectacularly. By trial and error Mac determined the best position for the coil winding, and the wax was permitted to set again.

"I got mad at those customers this afternoon because I was really mad at myself for not being able to find what was wrong with that set," Barney confessed. "Now I'm madder than ever. All the symptoms I reeled off to you so glibly pointed to low injection voltage from the local oscillator, but that possibility never crossed my mind."

"Don't be too hard on yourself," Mac consoled. "That doesn't occur very often in tube sets—or at least it doesn't occur in such a severe form as we had in this receiver; but it does happen fairly often in transistor sets when the oscillator transistor is changed. The reason is simply that transistors are not yet as uniform as tubes. So-o-o-o, when a converter-oscillator transistor is changed, it quite often is necessary to vary the coupling between the windings of the oscillator coil so as to reset the injection voltage to the optimum value."

"What gets me," Barney muttered, "is how you know these things. How many times have you run across this condition before?"

"This is the first time," Mac confessed blandly.

"Then how—?" Barney began.

"I read about it in an article on transistor receivers and tucked it away in a corner of my mind," Mac explained. "When you started talking about the converter being changed and demonstrating the symptoms, little wheels started to turn and came up

WHO NEEDS MILES OF WIRE?

GET HOME ELECTRICITY ANYWHERE WITH A terado CONVERTER



Change 6 or 12 volt D.C. to 100 watt, 60 cycle A.C.

No Installation—Just plug into cigarette lighter of car, truck, or boat, and it's ready to go!

Operate lights, electric shavers, dictation machines, record players, small electric tools, portable TV, and testing equipment.



Models from 15 to 200 watts, with prices as low as \$12.95.

"Chief": 75-125 watts, for 6 or 12 volt batteries . . . **\$64.95 LIST**

See Your Electronic Parts Dealer or Jobber
terado COMPANY
 DESIGNERS & MFRS. OF ELECTRONIC EQUIPMENT SINCE 1927
 1056 RAYMOND AVE., ST. PAUL 14, MINNESOTA
 IN CANADA: ATLAS RADIO CORPORATION LTD.-ONTARIO

Olson

*** FREE ***

Fill in coupon for a FREE One Year Subscription to OLSON RADIO'S Fantastic Bargain Packed Catalog—Unheard of LOW, WHOLESALE PRICES on Brand Name Speakers, Changers, Tubes, Tools, Hi-Fi's, Stereo Amps, Tuners and thousands of other Electronic Bargains.

NAME _____
 ADDRESS _____
 CITY _____ ZONE _____ STATE _____

If you have a friend interested in electronics send his name and address for a FREE subscription also.

OLSON RADIO CORPORATION
 601 S. Forge St. Akron 8, Ohio

with the answer. Learning by experience is fine, and I'm all for it; but there's only one thing wrong with experience: it gives the examination first and the lesson afterward. Study and reading is after all simply a method of benefiting by someone else's experience, and that's why I like to see you with your nose in a book or magazine pretty often. Well, cut off the bench and the lights and let's close up shop. We've both had a hard day."

"I'm with you," Barney said with a tired sigh. "I'm going home and curl up with a good book!" -30-

Heath CB Transceiver
(Continued from page 60)

point but transmission was extremely good and we believe that if we had been able to extend our tests we could have increased the range considerably. Remember that our tests were made under fairly extreme conditions. If one were to operate this type of equipment in the Midwestern plains areas, for example, or between two high hills or mountains, we believe that reliable coverage up to about ten miles could be obtained. Any further extensions of reliable transmissions beyond this are most unlikely unless unusual atmospheric or sky-wave conditions prevail.

Another important point to consider is that reception drops rapidly in metropolitan areas. Large buildings and an accompanying increase in electrical interference will, of course, limit the transmission range considerably. -30-

MARS SCHEDULES FOR NOVEMBER

THE First Army MARS SSB Technical Net, which operates on 4030 kc. upper sideband, Wednesdays at 9 p.m. (EST), has announced the following speakers for November.

Nov. 4—"SSB Exciter Circuits for a New Beam Deflection Tube" by Harold Vance, K2FF, manager sales engineering, distributor products, RCA Electron Tube Division.

Nov. 11—"Modern Communications Receiver Circuitry" by Byron Goodman, WIDX, asst. technical editor, ARRL.

Nov. 18—"Tubes vs Transistors in R.F. Circuits" by Kenneth Redmond, applications engineer, Amperex Electronics Corp.

Nov. 25—"Transistorized Gadgets and Gimmicks" by Robert Gunderson, W2JIO, editor, Braille Technical Press.

THE Long Island Section of the IRE is conducting an experiment in cooperation with local high schools making available to them the experience of members of local industry. The MARS Eastern Technical Net, in conjunction with this program, is presenting a series of eight radio talks on successive Sunday afternoons which can be heard from 2 to 4 p.m. (EST) on 7540 kc. and 13,715 kc.

This series began in October and the November schedule will include such topics as elements of radar, guided missiles and propulsion systems, elementary particles, applications of the atom, and semiconductors. -30-

The Top Technical Reference To High Fidelity Is Yours For Only \$1.00!

1960 HI-FI ANNUAL & AUDIO HANDBOOK

Now on sale at newsstands and electronic parts stores or order by coupon today!

If you're a man with a background in electronics theory and you know your way around hi-fi—here's the perfect workshop companion! It's the all new 1960 Edition of the HI-FI ANNUAL & AUDIO HANDBOOK that will provide you

with the latest available technical information. And its cost—just \$1.00. You'll find over 30 big, definitive articles—prepared under the supervision of the Editors of ELECTRONICS WORLD. Five big sections covering:



STEREO — Authoritative articles on low cost systems...adding a third channel...phantom channels.

AMPLIFIERS AND PREAMPLIFIERS — Features on the push-pull single stage for both stereo channels...single stereo amplifiers.

LOUDSPEAKERS AND ENCLOSURES—All that's new on loudspeakers for stereo...reflex enclosures and how they work...testing electrostatic loudspeakers...simplex for low-level crossover...hi-fi crossover networks.

FM, TAPE RECORDERS AND RECORD CHANGERS — How to improve your FM tuner...tips on FM alignment...drift and A.F.C. in FM...FM Multiplex...20 CPS tape recorder switch...measuring flutter...slow speed tape recording...reducing recorder noise and hum...electronic level indicators.

PLUS — GIANT COLOR FOLD-OUT SECTION on "Sound": authoritative charts on audio frequency ranges...sound levels...equal loudness curves.

Ziff-Davis Publishing Company, Department EW 119
434 S. Wabash Avenue
Chicago 5, Illinois

Please send me a copy of the 1960 HI-FI ANNUAL & AUDIO HANDBOOK. I enclose \$1.00. (Canada and Foreign \$1.25.)

NAME _____

ADDRESS _____

CITY _____ ZONE _____ STATE _____

All the skill and know-how of the nation's top hi-fi authorities are yours for only \$1.00 in the 1960 HI-FI ANNUAL & AUDIO HANDBOOK. Use handy coupon to order by mail today!

XCELITE PLIERS

have a . . .

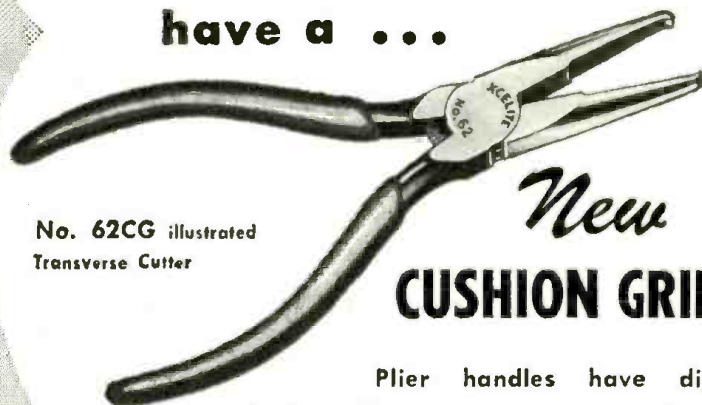

No. 62CG illustrated
Transverse Cutter

New
CUSHION GRIP!

Plier handles have dipped plastic coating . . . permanent, comfortable. Heads polished and buffed to a "mirror finish". All pliers available . . . See Your Distributor!

Gives pliers a "Feel" that inspires Craftsmanship!

XCELITE, INCORPORATED
ORCHARD PARK, NEW YORK
Canada: Charles W. Pointon, Ltd., Toronto

XCELITE
Quality Hand Tools
PREFERRED BY THE EXPERTS

Subdivided Speaker Enclosure

(Continued from page 59)

pound bottle of $\text{CaCl}_2 \cdot 6\text{H}_2\text{O}$ should be enough, as only about half would be required. Kodak "Print Flattening Solution," used straight, would be an ideal substitute for the calcium chloride solution.

No matter which solution you pick, apply it with an acid brush or a paint brush. In the case of the calcium chloride solution, re-apply after about ten hours.

Because of the unique internal construction of the enclosure there is a need for a new method of speaker mounting and the final finishing of the complete enclosure. This can be accomplished by having the grille cloth removable instead of the back panel. All units built to date have been made of $\frac{3}{4}$ -inch plywood, as this adds to the weight and rigidity. The enclosure can be made from a single 4 x 8 foot sheet and most lumber yards will make the cuts if the buyer doesn't have the equipment. The four pieces, 8 x 56 inches, must be within $\frac{1}{16}$ -inch on the 8" cuts, as these make up the top, bottom, sides, and partitions.

The entire enclosure is assembled using No. 5 flat-head woodscrews, 1 $\frac{1}{2}$ -inches long. White glue is used throughout to provide a good air-tight seal. The top, sides, and bottom are first assembled, followed by the back, partitions, and tweeter box. Wiring is completed next and then the front is secured in place.

The acoustic material is ordinary rug padding and is placed across two chambers on each side of the speaker as shown in the photograph. The 12-inch speaker is mounted in place with 10-24 "Tee-Nuts" (available at hardware stores) and round-head machine screws, one-inch long. If woodscrews are used they should be $\frac{3}{4}$ -inch, No. 8 round-head. The tweeter is mounted with No. 6 round-head woodscrews, $\frac{3}{8}$ -inch long. Both speakers are sealed with "Mortite," available at local hardware stores in four-ounce packages as shown in one of the photographs. Be careful, when tightening the screws, not to damage the cone or warp the chassis.

The most practical method of finishing the enclosure is to use grille cloth to cover both sides as well as the front. This reduces the total surface of finished wood to a minimum. The cloth is stretched around the cabinet and secured in place with wood strips and wire nails.

Testing the Enclosure

It is quite obvious that the final test of a speaker system is by objective listening and this is something that cannot be put into words, due to the many variables. This leads to a need for visual information, hence, the frequency response and impedance curves shown in Fig. 2.

ELECTRONICS WORLD

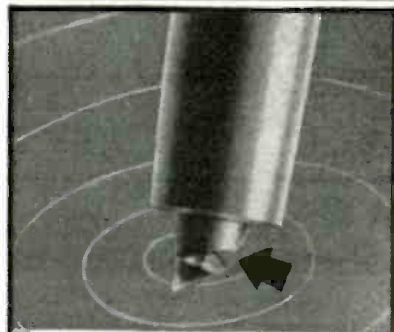

FROM ONE WHO LEARNED

This enlargement shows a diamond-chip needle sent us by a disappointed user, who learned all diamond needles are not O.K. Shows what happens if a heat bubble forms when a chip is welded on. Can't happen with a Duotone Needle that uses only the *whole* diamond set deep in the metal shank.

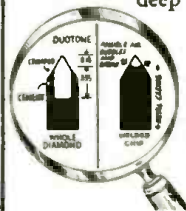

Insist on Duotone. Be sure. Duotone's whole diamond can't break off.

DUOTONE DIAMOND NEEDLE

"that remembers"
Keyport, N. J.

In Canada: Chas. W. Pointon, Ltd., Toronto

for your workbench . . .

NEW!
THE ALPHA WIRE
dispens A rack
T.M.

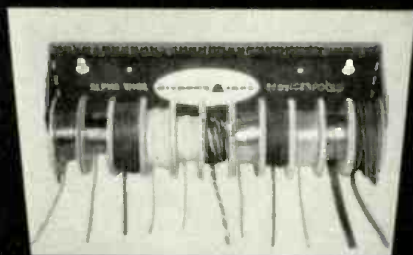

THE ALL-PURPOSE
SELF-STACKING
WIRE DISPENSER

49c

at your radio-electronics parts distributor

- fits anywhere, any space
- unlimited combinations
- handy ruler
- no snarling—ends wire loss
- designed for all Alpha Service Spools

STACK 'EM . . . build them up, back to back, side by side

MOUNT 'EM . . . on a bench, on a wall, on a peg board, under a bench

ALPHA WIRE CORPORATION
200 Varick Street, New York 14, N. Y.

The frequency response curves were taken in an average living room, using the procedure described by G. A. Briggs² and devised by Shorter.¹ The microphone was placed on the axis of the 12-inch unit at a distance of one foot and the system then covered with sound absorbing material to reduce room effects. Heavy wool blankets were used as the damping material and room effects were reduced sufficiently to provide a good compromise between an anechoic chamber and a live listening room. Response curves taken by Shorter in the arrangement described² were within 2 db below 1000 cps and within 1 db above 1000 cps of curves taken outside in free-field conditions. For response curves above 1000 cps, the microphone was moved back to three feet so as to include the output of both speakers.

The curves were plotted just as they appeared in the form of voltage changes converted to decibels, and peaks and dips were not altered in any way. This gives a representation of the acoustic output from 40 to 15,000 cps. Since the ear cannot detect narrow peaks or dips these can be ignored for all practical purposes, giving a much smoother over-all curve.

The two speakers are of different impedance, the woofer being 8 ohms and the tweeter 16 ohms. This difference helps give a smoother impedance curve (Fig. 2B), resulting in a better frequency response curve.

The transient response is very good,

due to the absence of panel resonance and the use of an amplifier with a high damping factor. In order to realize the maximum performance of the system, it should be used with an amplifier having a damping factor of 5 or more. Most amplifiers using triodes or beam power tubes with feedback would be acceptable.

Since the methods of determining the efficiency of a speaker system are somewhat ambiguous, little will be mentioned here. This system is more efficient than most infinite baffle and reflex systems. It is safe to say that a 10-watt amplifier would be adequate for home use as only 50 to 80 milliwatts are required to provide a level of about 80 db (0 db = .002 dyne/cm²).

The results obtained certainly qualify this speaker system as a "high-fidelity" unit. Considering the initial cost, it is an excellent basic unit and two of them will make a fine stereo speaker setup.

In keeping with the wishes of the *British Broadcasting Corporation*, which has given the author permission to make use of its patent specifications, we wish to state that they are in no way connected with this specific design.

REFERENCES

1. Shorter, D. E. L.: "Sidelights on Loud-speaker Cabinet Design," *Wireless World*, November 1950.
2. Briggs, G. A.: "All About Audio and Hi-Fi—Testing Loudspeakers" (Part 4), *RADIO & TV NEWS*, August 1957.

New! Here's the First and Only
Trouble-Shooting Guide for All
Transistor Circuits

**Pin Point
TRANSISTOR
TROUBLES
IN 12 MINUTES**

**SIMPLE CHECK-CHART
SYSTEM SPEEDS UP SERVICING!**

At last! A practical reference handbook that shows you how to find the trouble in ANY transistorized circuit. FAST! The latest book in Coyne's famous "Pin Point Series." Everything you need to know to take on those profitable transistor repair jobs... portable radios and TV sets, amplifiers, hearing aids, phonographs, car radios, other special equipment! Famous Check-Chart system actually pin-points the trouble for you in minutes! No complicated theory or math. Down-to-earth, practical circuit descriptions, service methods and trouble-shooting techniques. 525 pages; hundreds of illustrations, photos, diagrams; 120 Check-Charts; special reference and specification sections. This amazing new trouble-shooting book will quickly pay for itself in profitable new business added and valuable time saved!

USE IT FOR 7 DAYS FREE

Send no money, just the coupon. We'll rush your copy on FREE TRIAL. After 7 days, send only \$5.95 plus postage... or return the book and pay nothing! Fill out the coupon and mail today!

MAIL COUPON NOW!

Educational Book Publishing Div.
COYNE ELECTRICAL SCHOOL, Dept. B9-RT
1501 W. Congress Pkwy., Chicago 7, Ill.
Rush TRANSISTOR handbook for 7-day FREE TRIAL per offer.

Name Age

Address

City Zone State

Check here if you enclose \$5.95. We pay postage. 7-day money-back guarantee.

PERFECT GIFT FOR ANYONE . . . INTERNATIONAL'S KB-1 CITIZEN BANDER KIT!



FOR BUSINESS

Ideal for office inter-com and service trucks.



FOR THE FARM

Solution to fast communication from the farm home to the field.



FOR THE HOME

Saves steps from kitchen to den or workshop . . . from living room to sick room.



FOR SPORTS

Ship to share, base camp to scene of the hunt, adds enjoyment to sports!

ORDER BY MAIL! Terms F. O. B. Oklahoma City, or C. O. D. with 1/3 down payment.

International
CRYSTAL MFG. CO., INC.

18 N. LEE • OKLAHOMA CITY, OKLA.

complete kit
for 115 V A.C.

\$90⁰⁰
only



FREE! Gift wrapping on all orders received by Dec. 15.

SHIPPED ON APPROVAL

CRT TESTER-REACTIVATOR Model CRT-2

NOW . . . a TESTER-REACTIVATOR really designed to test, repair and reactivate EVERY PICTURE TUBE MADE — whether black and white or color . . . with exclusive features never before found in picture tube testers.

NEW



Housed in hand-rubbed oak carrying case — completed with MULTI-HEAD*



Model CRT-2
\$57.50 Net
TERMS: \$13.50 within 10 days. Balance \$11 monthly for 4 months.

The CRT-2 steps in and solves the limitations and shortcomings of present day CRT Testers. Unlike ordinary CRT testers that keep entering the field with a limited range of operation, the CRT-2 employs a new brilliantly engineered circuit designed to test, repair and reactivate every black and white or color picture tube made. The CRT-2 eliminates the guesswork and risk that until now, has always been present when a picture tube is reactivated. It accomplishes this by providing perfect control of either the 'Boost' or 'Shot' method of reactivation.

THE CRT-2 DOES ALL THIS RIGHT IN THE CARTON, OUT OF THE CARTON OR IN THE SET

- TEST**
- ✓ for quality of every black and white and color picture tube for all inter-element shorts and leakage up to one megohm for life expectancy
- REPAIR**
- ✓ Will clear inter-element shorts and leakage
 - ✓ Will weld opens between any two elements in the tube gun
- REACTIVATE**
- ✓ The unique controlled 'SHOT' (high voltage pulse) method of reactivation provided by the CRT-2 will restore picture tubes to new life in instances where it was not possible before. Furthermore the high voltage is applied without danger of stripping the cathode as you always have perfect control of the high voltage pulse.
 - ✓ The 'BOOST' method of reactivation also provided by the CRT-2 is used effectively on tubes with a superficially good picture but with poor emission and short life expectancy. It will improve definition, contrast and focus greatly and add longer life to the picture tube.

- 1. THE MULTI-HEAD (patent pending) . . . A SINGLE PLUG IN CABLE AND UNIQUE TEST HEAD** — A tremendous advance over the maize of cable and adapters generally found with other testers. Enables you to test, repair and reactivate every type of picture tube with greater convenience than ever before . . . 50 degree to 110 degree types from 8" to 30", whether 12 pin base, 8 pin base, 14 pin base . . . even the very latest 7 pin base. A special color switch on the MULTI-HEAD enables you to test, repair and reactivate each of the red, green and blue color guns separately.
- 2. WATCH IT REACTIVATE THE PICTURE TUBE** — You actually see and control the reactivation directly on the meter as it takes place, allowing you for the first time to properly control the reactivation voltage. This eliminates the danger of stripping the cathode of the oxide coating. It enables you to see the speed of reactivation and whether the build-up is lasting. You will see if the cathode contamination is too great and if the picture tube is too far gone to be reactivated.
- 3. CONTROLLED "SHOT" WITH HIGHER VOLTAGE FOR BETTER REACTIVATION** — Stronger than any found in other testers . . . high enough to really do the job — yet controlled to avoid damage to the picture tube.
- 4. UNIQUE HIGH VOLTAGE PULSE CIRCUIT** — Will burn out inter-element shorts and weld open circuits with complete safety to the picture tube.
- 5. VISUAL LIFE TEST** — Enables both you and your customer to see the life-expectancy of any picture tube right on the meter. The fact that your customer can see the results of your tests as you make them virtually eliminates resistance to picture tube replacement when necessary.
- 6. TESTS, REPAIRS AND REACTIVATES SPECIAL LOW SCREEN VOLTAGE TUBES** — Many new type picture tubes use special low voltage of approximately 50 volts. The CRT-2 will test, repair and reactivate these types with the same thoroughness as the regular types with complete safety.
- 7. SEPARATE FILAMENT VOLTAGES** — Including the very latest 2.35 volt and 8.4 volt types as well as the older 6.3 volt types.
- 8. TESTS, REPAIRS AND REACTIVATES 'SF' PICTURE TUBES** — found in the newest Sylvania and Philco TV sets. These picture tubes have different base pin connections than standard picture tubes and there is always an element of risk that the tube may be burned out when tested with ordinary picture tube testers. The CRT-2 is designed to accommodate this new base pin arrangement and will test the tube with no danger of damage.

ADDITIONAL FEATURES

- Employs the time proven dynamic cathode emission test principle
 - Large 4 1/2" meter with heavily damped movement for smooth action, accuracy and long life
 - Provides separate shorts test for each element in the picture tube
 - Filament continuity is shown on a separate glow indicator
 - An easy to read instruction manual contains all the latest testing information on old and new type picture tubes
 - Housed in handsome hand-rubbed oak carrying case with special compartment for MULTI-HEAD and line cord.
- * patent pending

IN-CIRCUIT CONDENSER TESTER Model CT-1

Here is an IN-CIRCUIT CONDENSER that DOES THE WHOLE JOB! The CT-1 actually steps in and takes over where all other in-circuit condenser fail. The ingenious application of a dual bridge principle gives the CT-1 a tremendous range of operation . . . and makes it an absolute 'must' for every serviceman.

in-circuit checks:

- ✓ Quality of condensers even with circuit shunt resistance . . . (This includes leakage, shorts, opens, intermittents)
- ✓ Value of all condensers from 200 mmfd. to .5 mfd.
- ✓ Quality of all electrolytic condensers (the ability to hold a charge)
- ✓ Transformer, socket and wiring leakage capacity

out-of-circuit checks:

- ✓ Quality of condensers . . . (This includes leakage, shorts, opens and intermittents)
- ✓ Value of all condensers from 50 mmfd. to .5 mfd.
- ✓ Quality of all electrolytic condensers (the ability to hold a charge)
- ✓ High resistance leakage up to 300 megohms
- ✓ New or unknown condensers . . . transformer, socket, component and wiring leakage capacity

OUTSTANDING FEATURES

- Ultra-sensitive 2 tube drift-free circuitry
- Multi-color direct scale readings for both quality and value . . . in-circuit or out-of-circuit
- Simultaneous readings of circuit capacity and circuit resistance
- Built-in hi-leakage indicator sensitive to over 300 megohms
- Cannot damage circuit components
- Electronic eye balance indicator for every greater accuracy
- Isolated power line
- Housed in sturdy hammertone finish steel case . . . comes complete with test leads

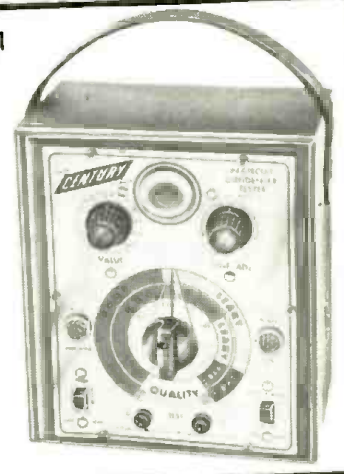

Model CT-1
\$34.50 Net
TERMS: \$9.50 within 10 days. Balance \$5 monthly for 5 months.

EASY TO BUY IF SATISFIED — see order form on facing page

FOR 10 DAY FREE TRIAL in your every day work. Send for instruments of your choice without obligation... try them for 10 days before your buy... only then, when satisfied, pay in easy-to-buy monthly installments — without any financing or carrying charges added.

NOW a Battery Operated **VACUUM TUBE VOLT METER** Model VT-1
Peak-to-Peak WITH LARGE EASY-TO-READ 6" METER —

featuring the sensational new **MULTI-PROBE** Patent Pending

No extra probes to buy! The versatile MULTI-PROBE does the work of 4 probes

- ① DC Probe ② AC-Ohms Probe ③ Lo-Cap Probe ④ RF Probe

The VT-1 is a tremendous achievement in test equipment. With its unique MULTI-PROBE it will do all the jobs a V.T.V.M. should do without the expense of buying additional probes. No longer do you have to cart around a maize of entangled cables, lose time alternating cables or hunting for a misplaced probe. With just a twist of the MULTI-PROBE lip you can set it to do any one of many time-saving jobs. A special holder on side of case keeps MULTI-PROBE firmly in place ready for use.

FUNCTIONS

DC VOLTMETER... Will measure D.C. down to 1.5 volts full scale with minimum circuit loading, and give accurate readings of scale divisions as low as .025 volts... Will measure low AGC and oscillator bias voltages from .1 volts or less up to 1500 volts with consistent laboratory accuracy on all ranges... Zero center provided for all balancing measurements such as discriminator, ratio detector alignment and hi-fi amplifier balancing.

AC VOLTMETER... True Peak-to-Peak measurements as low as 3 volts of any wave form including TV sync, deflection voltages, video pulses, distortion in hi-fi amplifiers, AGC and color TV gating pulses... Scale divisions are easily read down to .1 volts... Measures RMS at 1/20th the circuit loading of a V.O.M... Unlike most other V.T.V.M.'s there is no loss in accuracy on the lowest AC range.

ELECTRONIC OHMMETER... Measures from 0 to 1000 megohms... Scale divisions are easily read down to .2 ohms... Will measure resistance values from .2 ohms to one billion ohms... Will detect high resistance leakage in electrolytic and by-pass condensers.

RF and LO-CAP MEASUREMENTS... With these extra VT-1 functions you can measure voltages in extremely high-impedance circuits such as sync and AGC pulses, driving saw tooth voltages, color TV gating pulses, mixer output levels, I.F. stage-by-stage gain and detector inputs.

OUTSTANDING FEATURES

- Completely portable — self powered with long life batteries — permits use everywhere
- New advanced pentode amplifier circuit assures amazingly low battery drain
- Large 6" 100-microampere meter, many times more sensitive than meters used in most V.T.V.M.'s
- Laboratory accuracy performance — 2% of full scale on DC, 5% of full scale on AC
- Simplified multi-color easy-to-read 4-scale meter
- No heat operation assures rigid stability and accuracy
- Immune to power line fluctuations
- Amplifier rectifier circuit with frequency compensated attenuator — a feature found only in costly laboratory instruments
- Meter completely isolated — practically burn-out proof
- Hand-crafted circuitry eliminates the service headaches of printed circuitry
- 1% resistors used for permanent accuracy
- Separate RF ground return for low-loss RF measurement
- Micro-phon type co-axial connector
- Matching cover protects instrument face — snaps on and off instantly.



Housed in hammertone steel-case — complete with MULTI-PROBE

SPECIFICATIONS

- DC Volts — 0 to 1.5/6/30/150/300/600/1500 volts
- AC Volts (RMS and Peak-to-Peak) — 0 to 3/12/60/300/1200 volts
- Ohms — 0 to a billion ohms, 10 ohms center scale — Rx1/10/100/1K/10K/100K/1M
- RF — Peak reading demodulator supplied for use on all DC ranges
- Zero Center — available on all DC volt ranges with zero at mid-scale
- Decibels — from -10 Db to +10, 22, 36/50, 62 based on the Dbm unit: 0db-1MW in 600 ohms
- Impedance — 11 megohms DC, 1 megohm AC, 10 megohms Lo-Cap
- Input Capacity — 130 mmfd. RMS, 250 mmfd. Peak-to-Peak, 25 mmfd. Lo-Cap

Model VT-1
\$58.50 Net
 TERMS: \$14.50 within 10 days. Balance \$11 monthly for 4 months.

FAST-CHECK TUBE TESTER Model FC-2

Simply set two controls... insert tube... and press quality button to test any of over 700 tube types completely, accurately... IN JUST SECONDS!

Over 20,000 servicemen are now using the FAST-CHECK in their every day work and are cutting servicing time way down, eliminating unprofitable call-backs and increasing their dollar earnings by selling more tubes with very little effort. See for yourself at no risk why so many servicemen chose the FAST-CHECK above all other tube testers.

PICTURE TUBE TEST ADAPTER INCLUDED WITH FAST-CHECK

Enables you to check all picture tubes (including the new short-neck 110 degree type) for cathode emission, shorts and life expectancy... also to rejuvenate weak picture tubes.

RANGE OF OPERATION

- ✓ Checks quality of over 700 tubes types, employing the time proven dynamic cathode emission test. This covers more than 99% of all tubes in use today, including the newest series-string TV tubes, auto 12 plate-volt tubes, O24s, magic eye tubes, gas regulators, special purpose hi-fi tubes and even foreign tubes.
- ✓ Checks for inter-element shorts and leakage.
- ✓ Checks for gas content.
- ✓ Checks for life-expectancy.

SPECIFICATIONS

- No time consuming multiple switching... only two settings are required instead of banks of switches on conventional testers
 - No annoying roll chart checking... tube chart listing over 700 tube types is located inside cover. New listings are added without costly roll chart replacement
 - Checks each section of multi-section tubes and if only one section is defective the tube will read "Bad" on the meter scale
 - 41 phosphor bronze beryllium tube sockets never need replacement
 - 7-pin and 9-pin straighteners mounted on panel
 - Large 4 1/2" D'Arsonval type meter is the most sensitive available, yet rugged — fully protected against accidental burn-out
 - Special scale on meter for low current tubes
 - Compensation for line voltage variation
 - 12 filament positions
 - Separate gas and short jewel indicators
 - Line isolated — no shock hazards
 - Long lasting etched aluminum panel.
- NOTE:** The Fast-Check positively cannot become obsolete... circuitry is engineered to accommodate all future tube types as they come out. New tube listings are furnished periodically at no cost.



Housed in hand-rubbed oak carrying case complete with CRT adapter

Model FC-2
\$69.50 Net
 TERMS: \$14.50 within 10 days. Balance \$11 monthly for 5 months.

CONVENIENT TIME PAYMENT PLAN — NO FINANCING CHARGES

ALL CENTURY INSTRUMENTS ARE GUARANTEED FOR ONE FULL YEAR

The extremely low prices are made possible because you are buying direct from the manufacturer.

CENTURY ELECTRONICS CO., INC.

CHECK INSTRUMENTS DESIRED

- Model CRT-2 CRT TESTER REACTIVATOR \$57.50 \$13.50 within 10 days. Balance \$11 monthly for 4 months.
- Model CT-1 In-Circuit Condenser Tester \$34.50 \$9.50 within 10 days. Balance \$5 monthly for 5 months.
- Model VT-1 Battery Vacuum Tube Volt Meter \$58.50 \$14.50 within 10 days. Balance \$11 monthly for 4 months.
- Model FC-2 Fast-Check Tube Tester \$69.50 \$14.50 within 10 days. Balance \$11 monthly for 5 months.

Prices Net F.O.B. Mineola, N. Y.

111 Roosevelt Avenue, Dept. 211, Mineola, New York

Please rush the instruments checked for a 10 day free trial. If satisfied I agree to pay the down payment within 10 days and the monthly installments as shown. If not completely satisfied I will return the instruments within 10 days and there is no further obligation. It is understood there will be NO INTEREST or FINANCING charges added.

Name
 Address
 City State

Please print clearly

Mobile Receivers: Alignment & Service

By JACK DARR

Practical procedures and specific tips to help the technician with unfamiliar components and steps.

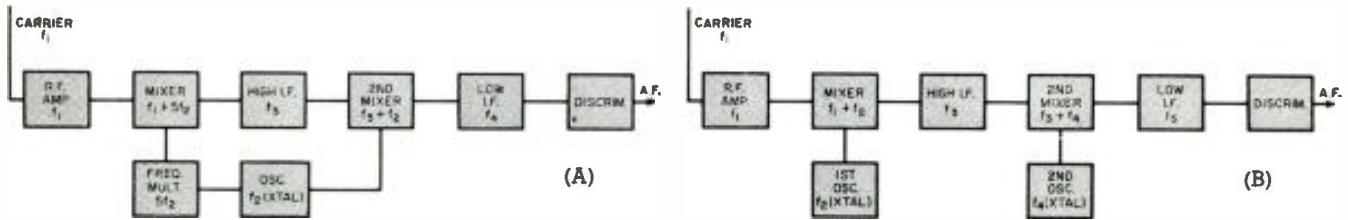

Fig. 1. Double superhet communications sets use either a frequency multiplier (A) or two separate oscillators (B).

NINETY-NINE per-cent of the mobile radio-communications equipment in use today employs frequency modulation. Greater relative freedom from noise and simplification of transmitter design are just two of the reasons for this preference. The receiver, a vital link in the system, must be kept at peak condition at all times. This becomes even more necessary with the new split-channel systems, where misalignment may seriously affect operation.

For the most part, earlier receivers and systems used a maximum allowable bandwidth of 40 kc., referred to as "40F3 emission." New standards that began in February, 1959 and will be in use on all bands by February, 1963 allow only ± 5 -kc. deviation (20F3 emission) to increase utilization of limited spectrum space. This sharpens the need for exact alignment procedures and precise equipment. A relatively slight degree of misalignment in a wide-band set of the past, which would be scarcely noticeable, may render a split-channel set virtually useless.

Receiver Circuits

Practically all commercial receivers use the same circuitry despite inevitable variations among manufacturers. This is a dual-conversion superheterodyne: the transmitted r.f. signal is picked up, beat against a local oscillator, and the resultant i.f. (known as the high i.f.) is amplified and beat against a second oscillator, resulting in the production of the low i.f. The latter is converted to audio by a discriminator circuit and amplified. Both oscillators will be crystal-controlled for stability. Frequency tolerance of split-channel sets is much smaller: in the 25-50 mc. band, instead of the old .01% tolerance, we have only .002%. Above this, in the 150-174 mc. and 450-570 mc. bands, instead of .005%, we have only .0005%!

Fig. 1 shows the two ways in which double-heterodyning is achieved: older production sets often used a single crystal oscillator for both stages, employing the oscillator fundamental to produce the low i.f. and a harmonic to produce the high i.f. as in Fig. 1A.

Modern sets tend to use two separate crystal oscillators (Fig. 1B). The trend is toward the use of a standard frequency for the second oscillator that will be the same in all sets. *Motorola*,

for example, uses a 455-kc. second i.f. and the second oscillator crystal is always 5955 kc. The first oscillator crystal is the only variable in the system, and is chosen so as to be always 5.5 mc. above the carrier frequency. This allows the use of a fixed high i.f. strip at 5.5 mc. In some of the older models, the high i.f. stages vary. Transformers were made in three "sets"; the same basic coils were used with different resonating capacitors.

The low i.f. crystals work on their fundamentals. Most of the higher-frequency oscillators work on a harmonic of the crystal employed to allow the use of thicker crystals for greater stability. First crystals are mounted in heated holders, as shown in Fig. 2, with built-in thermostats, to insure constant temperature. This also insures stability. While some of the older sets used heated crystal holders, even these must be changed to better ones meeting the new standards.

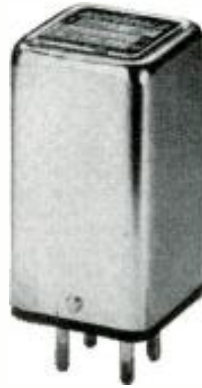

Fig. 2. Crystal in a temperature-controlled holder prevents frequency drift.

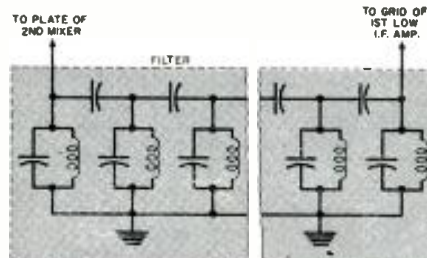

Fig. 3. Potted bandpass filter consists of a series of fixed-tuned i.f. tanks.

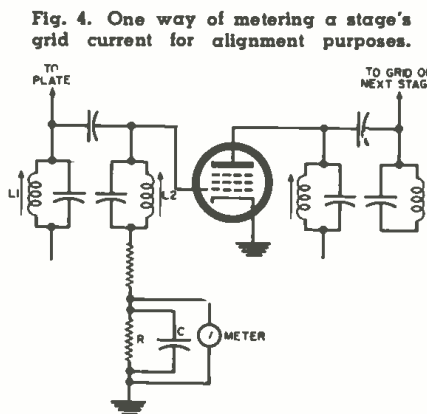

Fig. 4. One way of metering a stage's grid current for alignment purposes.

Selectivity

A radio-frequency stage working in the v.h.f. bands, from 25 to 50 mc., has inherently rather broad tuning when compared to the desired bandwidth limits. Even the use of resonant cavities found in some high-band (150-170 mc.) sets leaves the r.f. amplifier with much to be desired. Most of the actual selectivity is accomplished in the design of the low i.f. stages, where special, fixed-tuned, bandpass filters (Fig. 3) follow the second mixer.

Functionally, these filters do a job similar to that of the crystal filters found in some communications receivers used by hams and short-wave listeners. The bandpass filters consist of a large number of resonant circuits, in series, permanently tuned to the low i.f., and permanently potted. They are designed with varying characteristics: older sets use filters with a ± 15 -kc. bandpass while split-channel models have only a ± 5 -kc. bandpass, but the curve has steep sides in either case to eliminate undesired signals and noise.

Alignment adjustments on most sets are inductive, using coils with adjustable slugs. In the past, some set makers sealed the tuning adjustments, but

most of the newer models leave them unsealed.

All of the commercial receivers seen by the writer so far, following the low i.f., use the Foster-Seeley discriminator circuit for audio detection. Most use dual, cascaded limiter stages preceding the discriminator.

Output Indicators

In any alignment procedure, some method of indicating when maximum output is reached is needed. In these FM receivers, the old, faithful "output meter across the speaker" is not recommended because of the presence of the limiters. Some other method must be used. Most receiver manufacturers have thoughtfully provided a built-in alignment indication system, although minor variations are found among different makes.

In FM receivers, the i.f. amplifier stages are operated very near to class C: each tube is driven into grid-current conduction, especially on large signals. The amplitude of each stage's grid current is directly proportional to the applied signal voltage, with the exception of the limiters, of course, which will saturate at certain levels.

stage can be checked by means of a selector switch on the tester. Other measurements (not shown in Fig. 5) are provided on the tester, such as relay voltage and "B+."

There are three connections for the actual "peaking" of the i.f. stages: the low i.f. grid and the first and second limiters. The high i.f. may be aligned by metering the low i.f. grid current, while the low i.f. section is aligned by measuring the grid current of the first limiter. Two additional points are provided, as seen in Fig. 5, for properly aligning the discriminator: connected to pins 6 and 7 of the test socket, they are used for aligning the primary and secondary of the discriminator.

Other manufacturers use the same setup, with variations. Some use individual test-pin jacks on the chassis, and the meter is plugged into each in turn. Some of the older receivers included the test selector switch in the receiver itself, with only a single pair of jacks for the meter.

Bench Setup

Vehicular 2-way sets are remotely controlled with the exception of the smaller units, which are mounted un-

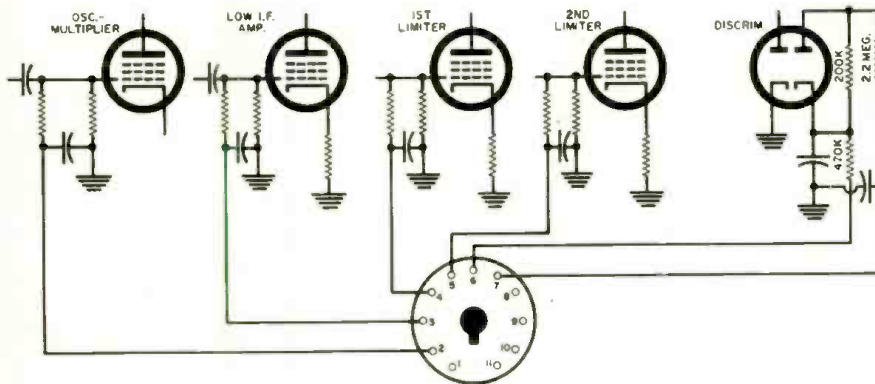

Fig. 6. Motorola test set plugs into this maker's receivers for quick checks.

Fig. 5. Typical metering network for mobile receiver. Manufacturers may bring out test points to single multiple socket or separate pin jacks.

Thus, by setting up "metering points" in the grid return circuit of a stage, the amount of current can be read on a sensitive meter, as shown in Fig. 4. A "metering resistor" (R) is inserted in the grid circuit, bypassed for r.f. (by C), and the indicating meter connected across the resistor.

A v.t.v.m. on a low scale may be used, or a 0-50 microammeter, which then functions as a millivoltmeter, reading the voltage drop across resistor R . Thus, this connection may be used as an indication of the state of alignment of coils L_1 and L_2 . Note the interstage coupling capacitors shown: these are quite common, especially in the high i.f. stages. The coils are often mounted in separate cans with no inductive coupling between primary and secondary.

Fig. 5 shows one typical metering circuit for a complete receiver (used by Motorola). All metering points are brought to a special metering socket on the chassis. In this case, a special test instrument made by the set maker (Fig. 6) should be used. The 11-prong plug is inserted in the metering socket of the receiver. Then each

der the vehicle's dash with the controls on the front panel of the cabinet. The majority, however, are "trunk-mount" types, which use remote-control heads on the dash. Therefore, for bench testing, a substitute control head must be provided.

This is not too difficult: all that is needed is one of the special plugs used for interconnection on the particular set, and substitutes for the regular controls: volume and squelch. These, together with a switch, speaker, and the cabling, make up a control head (Fig. 7) that will operate the set on the bench. Such a unit might even be built into the bench panel. Volume-control circuits are nearly standardized, most being grid-circuit controls, with a few sets using low-value pads across the speaker itself, which the pot shown in Fig. 7 was intended to replace. Squelch controls will run from 15,000 to 25,000 ohms: as most of the sets work "in the center" of this range, a single 25,000-ohm wirewound control might be used for all or most of them. The details of the dummy control head for any shop will depend on the receivers most often encountered.

Fig. 7. One type of dummy control head to operate receiver on the bench.

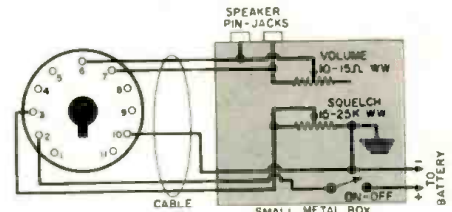

water! However, the benefits offered by this power-supply arrangement are well worth the chore.

Alignment Equipment

Actually the receiver sections of these communications sets should almost never need alignment. However, there is an unfortunate habit prevalent among many technicians to "play" with i.f. adjustments with very little provocation. As a result, the need for a complete bench re-alignment comes up every now and then. This requires a stable signal generator covering the range from 455 kc. up to at least 30 mc. For receiver alignment (as distinguished from transmitter alignment) there are many good, standard generators that will serve. As we shall see, accuracy of dial calibration is not as important as stability. Also, the generator does not have to provide the carrier frequency: work with the latter

(Continued on page 128)

why your next speaker system should be

THE NEW AUDAX PARAFLEX

• Only Audax incorporates the Patented Paraflex Foam Suspension to give longer travel to the cone, resulting in honest bass without boom or hangover. You get bass with real bottom!

• New Styrofoam Radial Strut-Bracing reinforces cone, assures rigid piston action, preventing cone break-up. Eliminates distortion, provides clean reproduction up to the full-rated power output. Needs as little as 10 watts output. You get greater amplifier economy in stereo installations.

• New Oriented Grain-Processed Magnet gives 20% more efficiency than standard Alnico V.

• New Ducted-Slot Enclosure specifically designed to enhance the depth and striking realism of the Paraflex high-compliance speaker units. Speakers are located symmetrically on each side of the ducted slot, resulting in clean bass without trace of boom or unnatural heaviness.

• New, dramatic enclosure styling by George Nelson—featuring... new, three-dimensional Dynel "Acoustiscreen" grille, removable for cleaning!

• Audax Paraflex Speakers are lab-tested and a performance seal on each unit indicates its resonant frequency ± 1 cycle.

Model CA-80 12" x 12" x 24" with two full range speakers—\$99.95

Model CA-100 15" x 12" x 25" with two 10" full range speakers and 2 matching cone tweeters—\$139.95

Also full line of component speakers

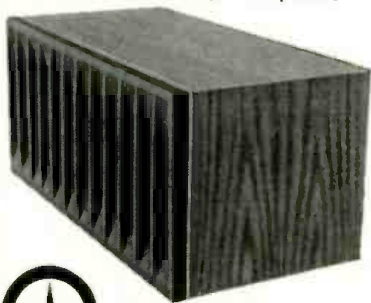

Write for free catalog and specifications, to:
AUDAX Division of the Rek-O-Kut Co., Inc.
Dept. EW-11, 38-19 108th St., Corona 68, N. Y.

Name _____

Address _____

City _____ State _____

Export: Morhan Exporting Corp., 458 Broadway, New York 13
Canada: Atlas Radio Corp., 50 Wingold Ave., Toronto 19, Ont.



CERTIFIED RECORD REVUE

By
BERT WHYTE

BY the time you read this, the New York High Fidelity Show will be over and the new audio season officially launched. As in former years, I will try to bring you up to date on the newest developments, but publishing being what it is, my report will have to wait until next issue.

One thing I hope to find at the Show are some innovations in turntable design. It is pretty well known that the advent of the stereo disc created some formidable problems of turntable rumble. There is a vertical component of rumble that was present in some turntables of the pre-stereo era, and even though the 45-45 stereo disc system was designed to eliminate some of the problems inherent in a strictly vertical/lateral stereo groove, there is also a small vertical sensitive component in the 45-45 system. Now with many of the present-day smaller speaker systems which lack really low bass response, this rumble is no problem. But if one is using a pair of king-sized speakers that have very extended low-frequency response, this newly compounded rumble is causing a lot of grief.

There have been some design changes in turntables which were initiated to overcome the vertical rumble and some of them were very clever and fairly effective. But, if you are like me, that is, an absolute crank about any spurious noise such as hum and rumble, you would feel that there is still some residual rumble which is at a sufficient level to be obtrusive and annoying.

How much farther in practical terms... as regards cost, etc... the manufacturers can go in reducing rumble in their turntables, is hard to say. Of course there is always the possibility of some laboratory genius coming up with a cheap and clever answer to the whole problem—which is what makes an audio show such a fascinating place—where hope is always burning in the *aficionado's* breast.

But, barring this, there are several things one can do to get rid of that nasty rumble. I've mentioned these ideas before, but it has been many years and long before the stereo disc. I freely confess these may not be the most elegant solutions to the problem... but they do *work*. The principal idea of rumble reduction here is to use a turntable mounting board of great mass and, preferably, high density. The resonant frequency of such a mounting is so low that even the finest cartridges with the very lowest frequency response will not reproduce this frequency.

There is a lot of work and a fair amount of money involved in this, but here goes... Among the best materials to use are steel plate, such as boiler plate, in thicknesses ranging from one-half to one inch; granite of good density from 3/4- to 1 1/2-inch thick;

marble from 1- to 2-inches thick; and, as a last and least satisfactory resort, plywood, cemented by casein or other suitable strong adhesive from 1 1/2- to 2-inches thick.

All of these mounting plates must be cut for the particular turntable and arm to be used. I need not tell you that this is no simple deal with steel, granite, etc. Generally, the work will be beyond the facilities and skills available at home and had best be left in the hands of experts. Once cut, the plates must be contained in a heavy frame or shell, usually constructed of at least 3/4-inch ply. One other thing is advisable, and that is to have a square cut out of the plate at approximately the pivot point of most generally used arms. The cut square is then replaced by heavy plywood which can be bolted rigidly to the plate. The reason for this is that turntables don't change too much over a fairly long period of time and one of the top-quality units should provide good service for years. On the other hand, arm and pickup design change fairly frequently and if you have a hankering to try out the newest designs as they come along, then with the removable pivot block you can always replace the old arm and put in the new without the necessity for drilling all sorts of holes.

As a matter of fact, this is something I would like to see on commercial mounting boards and, if memory serves me, I think the *Thorens* people have some sort of similar scheme and at one time I believe *H. H. Scott* instruments had this facility.

Well, there you have it... it is a lot of trouble all right, but if you want noiseless backgrounds for your music, this is the only alternative I know of at the present time. As I said... maybe some genius at the Show will have it all worked out for us... we'll see.

WAGNER

DAS RHEINGOLD (Complete Opera)
Kirsten Flagstad, George London, Jean Madeira, Set Svanholm, and other soloists with Vienna Philharmonic Orchestra conducted by Georg Solti. London Stereo OSA1309. Three discs. Price \$17.85.

The only word for this recording is the much over-worked "monumental." It is simply staggering in its impact! This is a new point of departure in opera recording and will, in the future, be regarded as an important milestone in the art of stereo.

Take an absolutely superb cast, such as the seemingly ageless Flagstad as Fricka, George London as Wotan, Jean Madeira as Erda, Set Svanholm as Loge, and Gustav Neidlinger as the evil Alberich, add the tremendously vital and penetrating performance of Georg Solti, and the Wagnerian virtuosity of the Philharmonic, and then enrobe all in a stereo record-

IF YOU PRIZE IT...KRYLON-IZE IT!
Seal electronic parts completely
...instantly...the "push button" way



KRYLON
CRYSTAL-CLEAR
ACRYLIC SPRAY

A "must" in every repairman's kit!

Radio, TV and hi-fi equipment need Krylon Crystal-Clear, the protective coating with high dielectric strength and weatherproof qualities that seal the surface indefinitely.

- Prevents corona in high voltage section
- Keeps lead-in connections tight
- Prevents rusting and pitting of antenna
- Goes on in seconds—**DRIES IN MINUTES**

Use Krylon Spray Paints (22 colors) for quick, easy, professional touch-up jobs

IF YOU PRIZE IT...KRYLON-IZE IT!

TARZIAN Offers 48-Hour,
Direct Factory Service
on Tuner Repairs

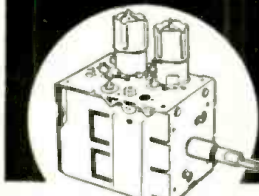

only
\$7.50

That's right. Net, \$7.50 per unit and \$15 for UV combinations, including ALL replacement parts. 90-day warranty against defective workmanship and parts failure. Tuners repaired on approved, open accounts. Replacements offered at these prices* on tuners not repairable:

- VHF 12 position tuner . . \$22.00
- VHF 13 or 16 position tuner 23.00
- VHF/UHF combination 25.00
- UHF only 15.50

*Subject to change



Tarzian-made tuners are easily identified by this stamping on the unit. When inquiring about replacements for other than Tarzian-made tuners, always give tube complement . . . shaft length . . . filament voltage . . . series or shunt heater . . . IF frequency and chassis identification. Use this address for fast, 48-hour service:

SARKES TARZIAN, Inc.

Att.: Service Mgr., Tuner Division
 East Hillside Drive
 Bloomington, Indiana

November, 1959

ing of such scope and depth as to be almost frightening in its realism—and you have a brief idea of what is in store for the listener!

One could rave on about every aspect of this recording. As in most of its other opera recordings, *London* has not chosen to keep the stage action static . . . here, as never before, is the feeling of participating in an actual performance as the characters are so artfully deployed. Not only is this in terms of lateral positioning but in the superb realization of depth. The balance between voices and orchestra is such that nothing is lost nor inarticulate.

The over-all sound quality and the "special effects" beggar description. Frequency and dynamic range are tremendously wide. There is no discernible transient distortion and if you take pride in your system for its transient response, wait until you turn loose the sound of 18 tuned anvils, thunder sheets, and bass drum and tympani blasts galore. Near the end of the opera when Donner unleashes his thunderbolt, your hair will stand on end! This is the tremendous sound of a mighty blow by a heavy sledge on a big anvil accompanied by thunderous drum rolls! Lovers of brass can revel in the hugely sonorous Wagner tubas and bass trombones.

One could go on and on about the fabulous characterizations of the cast, but by now I think you get the idea. An overwhelming and thrilling experience, you must hear it to believe it!

BRAHMS

SYMPHONY #2

Minneapolis Symphony Orchestra conducted by Antal Dorati. Mercury Stereo SR90171. Price \$5.95.

Dorati faces formidable competition from such Brahms specialists as Walter and Klemperer in this work. He comes off fairly well, as he conducts the work with a properly light hand and is a welcome relief from some of the funereal expositions I have heard. In the sound department Dorati has little competition as this is superbly registered stereo with everything in the right place and a notable smoothness and spacious acoustic perspective.

SCHUMANN

SYMPHONY #3 ("RHENISH")

Detroit Symphony Orchestra conducted by Paul Paray. Mercury Stereo SR90133. Price \$5.95.

Paray's vigorous, spirited reading of this work was highly praised in the monaural version released some time ago. Here with the blandishments of stereo the appreciation of his artistry is heightened. Most impressive is his intelligent and expressive phrasing and his dynamic shadings. This is lovely stereo, not obtrusively directional, but with all the virtues we have come to expect, such as a fine sense of depth and the realistic acoustic perspective which is productive of this depth. All is very clean and smooth with good separation and no perceptible level or dynamic changes from the mono recording.

VAUGHN WILLIAMS

SYMPHONY #8 IN D MINOR

BUTTERWORTH
A SHROPSHIRE LAD
BAX

THE GARDEN OF FAND

Halle Orchestra conducted by Sir John Barbirolli. Mercury Stereo SR90115. Price \$5.95.

The prize here is, of course, the Vaughn Williams symphony, the Bax and Butterworth pieces being nice atmospheric little works, pleasant to listen to but not of the stature of the symphony. This 8th symphony of Vaughn Williams has much in it that reminds one of his preceding work, the "Sinfonia Antarctica." It is not written in the usual symphonic form

Model S-5000, 20+20W Stereo Dual Amplifier—\$189.50



Model S-3000 II, FM Tuner—\$105.50



Model S-400, Stereo Preamp. +36W Amp.—\$159.50



Model S-2000 II, FM-AM Tuner—\$145.50



Model S-1000 II, 36W Monaural Amplifier—\$109.50



The "complete matching home music center"
 —monophonic or stereophonic.

Again another year—recommended by one of the most respected and authoritative Research Testing Organizations as embodying more numerous, more advanced engineering "firsts"—more inherent quality for trouble-free operation—more real value for every dollar than many competitive products selling for more. PLUS: Features that in their unsurpassed engineering win the most discriminating audio-hobbyist; but also features that in their simplicity and ease of operation appeal to everyone—housewife, novice, or just plain music lover. Cabinetry of quiet elegance that blends with any decor. And Sherwood, unmatched at any price, is Fair Trade priced for your assurance that once you have bought Sherwood, you didn't miss a better "deal" someplace else. Sherwood is only for those who want the ultimate. For further details write: Sherwood Electronic Laboratories, Inc., 4300 N. California Avenue, Chicago 18, Ill.

most honored of them all

SHERWOOD

Burton Browne Advertising

FOR COMPLETE SPECIFICATIONS WRITE DEPT. EW-11

The Spotlight of Leadership is on...

arkay

Kits and Wired

HI-FI STEREO

TODAY'S BEST QUALITY BUY

Acclaimed the finest by technicians and hi-fi enthusiasts who pass the word along "You get so much more with Arkay!" advanced engineering • exclusive new features • award-winning styling • matchless performance • at amazing low cost. Prove it to yourself. Ask your dealer for a demonstration.

NEW! ARKAY FM-7 FM TUNER



Brilliantly designed with outstanding features in styling, circuitry and ease of assembly. The pre-wired and pre-aligned front end plus pre-adjusted coils and IF Transformers eliminate need for alignment equipment. New "Liteline" traveling tuning indicator provides precision on-station tuning. Drift-free AFC; 3 double-tuned IF stages; band width 26C kc at -6 dB. Sensitivity 1.9 uV for 20 dB quieting. Image rejection 40 dB. Frequency response 20 to 20,000 cps $\pm 1/2$ dB. Distortion less than 1%. Hum level -70 dB. Multiplex and cathode follower outputs. 7 tubes plus selenium rectifier. Wired and tested \$54.95. Easy-to-build Kit **\$39.95**

NEW! MUSIC MASTERPIECE



ARKAY CS-28 STEREO AMP/PRE-AMP COMPLETE CONTROL CENTER

Full 28 watts stereo or monaural, 60 watts peak • 14 watts each channel • reverse stereo • balance control • two-channel gain control • full range bass and treble controls • IM distortion, 4 to 1 • harmonic distortion, 1% 30-20,000 cps • dual pre-amp 2V output jacks • speaker outputs, 4-, 8, 16, 32 ohms • response, 20-20,000 cps • push-pull EL84 Williamson circuit • beauty of design that won Fashion Foundation's coveted Gold Medal! Many other incomparable features. Wired and tested \$99.95 Easy-to-build Kit **\$64.95**



ARKAY CS-12 STEREO AMP/PRE-AMP

12 watts of clean power with dual inputs and outputs for excellent stereo reproduction • operates from ceramic or crystal cartridge, tape, tuners, auxiliary equipment • push-pull outputs for each channel. Easy-to-build Kit **\$36.95**



ARKAY ST-11 AM-FM STEREO TUNER

Here, for the first time, is an AM-FM STEREO Tuner within the reach of every audiophile. Unmatched by units costing twice the price, the ST-11 is two distinct receivers in one featuring 4 uV for 20 db quieting. Variable AFC. Single front panel switch controls AM, FM or STEREO selection. Wired and tested \$74.50 Easy-to-build Kit **\$49.95**

SPA-55 STEREO AMP 55 watts stereo/monaural, 27 1/2 watts each channel. Wired \$79.95 Kit **\$64.95**

See and hear ARKAY Kits at your dealer. FREE! Stereo booklet and catalog. Write Dept. EW



but contains such oddities as a second movement for winds alone, the third movement for strings alone, and then with typical Vaughn Williams tongue-in-cheek it ends with a Toccata in which a great variety of percussive elements are used—such as glockenspiel, xylophone, vibraphone, tubular bells, and tuned gongs.

The performance is eloquent and definitive and it is obvious Sir John appreciates Vaughn Williams for dedicating the score to him. Not as accessible as some of Vaughn Williams other symphonies, nor hinting of the granitic sonorities that were to come in his 9th and last symphony, this still has much to recommend it. Soundwise the score receives the benefit of Mercury's stereo know-how and all rests very easy on the ear.

BRAHMS

SYMPHONY #1 IN C MINOR
Amsterdam Concertgebouw Orchestra conducted by Eduard Van Beinum. Epic Mono LC3603. Price **\$3.98.**

A thoroughgoing and learned performance of this Brahms symphony is another legacy left to us by the late Van Beinum. This is not as incandescent as Toscanini's reading nor on the scale of Walter's, but then there is more Brahms in his reading and less of Van Beinum.

His musical language here is straightforward and is superbly translated by his "splendiferous" orchestra. The sound is gratifyingly clean, with especially fine strings and rich brass. For most tastes I think the pickup is just a bit spacious, which softens detail slightly. All is beautifully balanced however and, on the whole, very listenable.

MOZART

THE MAGIC FLUTE (Highlights)
Vienna Philharmonic Orchestra and Vienna State Opera Chorus and soloists, conducted by Karl Bohm. London Stereo OS25046. Price **\$5.95.**

For those who like opera but who are loathe to wade through the complete recording (or who feel they cannot afford the entire set) this should be very welcome. The excerpts are wisely chosen and, of course, there is still the superb cast which includes Hilde Gueden, Wilma Lipp, Walter Berry, etc. Nor has there been any degrading of the wonderful stereo sound which, in London opera recordings, is a very special sound indeed. There are other highlights from London operas, all equally good buys.

SCHUMANN

CONCERTO IN A FOR PIANO AND ORCHESTRA

WEBER

KONZERTSTUCK IN F MINOR FOR PIANO AND ORCHESTRA

Friedrich Gulda, pianist with Vienna Philharmonic Orchestra conducted by Volkmar Andreae. London Stereo CS6082. Price **\$5.95.**

Appearing previously in mono format, the over-all sound and general impression are favorably enhanced by the excellent stereo sound. Gulda, exposed to the merciless light of stereo, seems less facile and assured, but still turns in a reading better than most. He will run into severe competition from some of the keyboard giants, but with the high quality of the stereo may find favor with many. Lovely piano sound is aided by expert acoustic balance.

DVORAK

SYMPHONY #5

Cleveland Symphony Orchestra conducted by George Szell. Epic Mono LC3575. Price **\$3.98.**

This old warhorse takes on new life and luster under the urgings of George Szell, who has an obvious affinity for this work. There

CAMERA FANS:

KNOW BEFORE

YOU BUY!



You'll find the most complete catalogue of photographic equipment ever published in the brand new 1960 PHOTOGRAPHY DIRECTORY AND BUYING GUIDE!

Now on sale at your newsstand—
or order today using handy coupon below!
Only **\$1.00**

Here's a rundown of over 5,000 of the latest photo products—complete with data, prices, comparisons, illustrations! Get all the facts on everything from cameras to lenses to films and filters... from black and white or color to movie or still photography. Make intelligent comparisons before you shop—and save time, money and effort.

You'll also enjoy these other extra features:

- **CAMERA COMPARISON CHARTS**
Compare prices, shutter ranges, lens speeds, special features on over 300 cameras of all types.
- **PORTRAIT LIGHTING SETUPS**
How to light a model, complete with diagrams.
- **MODEL RELEASE FORMS**
May save you from costly legal tangles.
- **ROUNDUP OF LATEST PHOTO BOOKS**
Your guide to the latest in good photo reading.

PLUS—NEW SPECIAL FEATURE:

FOTO FACTS FILE CARDS—Handy data section bound right into the 1960 PHOTOGRAPHY DIRECTORY—figures on films, lenses, filters, exposure and conversion scales right at your finger tips. Will be supplemented every year—so start your file now!

Compiled by the Editors of POPULAR PHOTOGRAPHY—World's largest selling photographic magazine—the 1960 PHOTOGRAPHY DIRECTORY AND BUYING GUIDE will save you far more than the dollar it costs.

Buy your copy today at your favorite newsstand—or better still, send for a copy by using the handy coupon below!

Ziff-Davis Publishing Company
Department EW 119
434 South Wabash Avenue
Chicago 5, Illinois

Please send me a copy of the 1960 PHOTOGRAPHY DIRECTORY AND BUYING GUIDE. I enclose \$1.00, the cost of the DIRECTORY, plus 10¢ to cover mailing and handling charges. (Canada and Foreign \$1.25 plus 10¢ postage.)

(name) _____

(address) _____

(city) _____

(zone) _____

(state) _____

is a firmness and vitality to his reading, along with the most lovely lyrical exposition of the Largo heard in a long time. Fine sound too, with the *Epic* engineers taking advantage of the acoustic transformation recently given Severence Hall.

All is quite clean, with good balance among the various choirs of the orchestra. Good dynamic and frequency range aided by just enough reverb for smoothness and spaciousness without blurring inner detail.

RESPIGHI

ANCIENT DANCES AND AIRS FOR LUTE

(Suites 1, 2, and 3)

Philharmonia Hungarica conducted by Antal Dorati. Mercury Stereo SR90199. Price \$5.95.

These lovely and delicate suites have been recorded before, but neither with the authoritative reading imparted by Dorati, nor the virtuosity of the orchestra, nor with the benefits of smooth stereo sound. The orchestra, composed of Hungarian refugees who fled during the 1956 uprising, has, in a relatively short time, established itself as a first-rank group.

Dorati, of course, enjoys wonderful rapport with his countrymen and this teamwork is evident in their performance. The works, originally for lute, have been transcribed for orchestra and the result is charming, lyrical pieces of wonderful transparency. The stereo sound is marvelously effective in showing these textures.

FRANCK

SYMPHONIC VARIATIONS

D'INDY

SYMPHONY ON A FRENCH MOUNTAIN AIR

Robert Casadesus, pianist, with Philadelphia Orchestra conducted by Eugene Ormandy. Columbia Mono ML5388. Price \$3.98.

This is a recording which has been avidly awaited by Casadesus fans for a long time. They had enjoyed his matchless way with this score on the old recording made about 6 years ago, and now they can look forward to a modern recording, considerably upgraded in quality and of course with the further blandishments of stereo (which version I unhappily do not have).

Even in mono, however, the improvement is impressive. The piano was recorded moderately close-up and is in good balance with the orchestra. The tone is nothing short of opulent, a tribute to engineer and artist alike and, as abetted by the glorious Philadelphia sound, makes for a happy listening experience.

RAVEL

BOLERO ALBORADA DEL GRACIOSO

FALLA

THREE CORNERED HAT SUITE

WEBER-BERLIOZ

INVITATION TO THE WALTZ

Paris Conservatoire Orchestra conducted by Albert Wolff. London Stereo GS6077. Price \$5.95.

Potboilers all . . . yes, but they take on a new dimension in stereo and do not suffer unduly under the baton of Wolff. He is normally a bit more lighthanded than he is here, and I can only conclude that the intoxications of the stereo playback may have tempted him to "lay it on a bit." Some may like this gruffer quality in these lightweight works.

What makes this disc is the stereo sound. It is extremely finely wrought and very wide in frequency response, and I can warn you that if your pickup is the slightest bit "peaky," or your stylus is not tracking properly, the strings will sound brittle and edgy. Played under optimum conditions, the sound is quite exciting and very clean.

To
Make
Your
Components
Sound
NEW
Again!

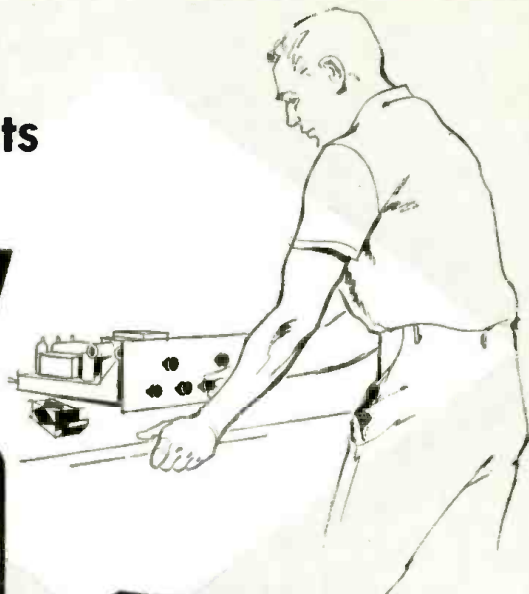

Available
Singly and in
Matched Pairs

**THE FISHER
Laboratory Matched Tubes**

Every new FISHER product has attained leadership for one essential reason: it filled a need which, until its introduction, no other comparable product could fully satisfy. FISHER Laboratory Matched TUBES have the same objective. If your high fidelity components sound "wrong" because of tube difficulties, FISHER TUBES can restore them to top performance again.

FISHER TUBES are individually selected to fulfill the maximum requirements of your components, exactly as specified by the manufacturer (no "variables," nothing less than the best in every box.)

FISHER TUBES are chosen for stability, maximum gain, low noise, exact tolerances, long life and for absolutely identical performance characteristics, as revealed by rigid comparison tests!

The next time you need any tubes, insist on FISHER.

Audio-Fans, Servicemen, Dealers—

WRITE TODAY FOR COMPLETE INFORMATION



FISHER RADIO CORPORATION, 21-38 44th Drive, L. I. C. 1, N. Y.

I want to know more about FISHER Laboratory Matched TUBES!

NAME _____

STORE NAME _____
(If a serviceman or dealer)

ADDRESS _____ CITY _____ STATE _____

Special Offer 25¢

Hear these
authentic recordings
of dramatic events
from



"The Amazing World of Short Wave Listening"

narrated by Alex Dreier, Radio-TV "Man on the Go"

- President's voice from outer space!
- Actual capture of a desperate criminal!
- Radio amateur at Little America!
- Ships at sea . . . aircraft in action!



SX-110
receiver
\$159.95

Standard broadcast plus short wave coverage from 1550 kc. to 34 mc. Cal. electrical bandspread.

MAIL
COUPON
TODAY!



hallicrafters

DEPT. 20, CHICAGO 11, ILL.

Gentlemen: Please rush by return mail my recording. "The Amazing World of Short Wave Listening." I enclose 25¢.

NAME _____

ADDRESS _____

CITY _____

STATE _____

SOUND ON TAPE

By BERT WHYTE

THERE is plenty of evidence at hand to show that tape is making a solid comeback. The furor over the merits of open reel *versus* cartridge is still going on . . . but shall we say the battle lines are now more firmly drawn . . . and don't be too surprised if a sudden truce is called in which the open-reel people also embrace the cartridge, and the cartridge people also decide to go along with the open reel. I really feel that co-existence will soon be the byword and I think that both factions are beginning to realize that any prolonged battle will scuttle the new upsurge of tape.

Naturally tape will be in full swing at the New York Hi-Fi Show, but I don't expect that we shall see any really revolutionary new equipment. Of course there will be more machines fitted with 4-channel heads and there will be a number of new cartridge machines. There will probably be more evidence of stereo recording facilities, in anticipation of regular stereo multiplex broadcasts. Also expect to see an expanded push to sell higher quality microphones with relatively low-priced tape machines. It is true that the Achilles heel of most home-recording machines is the poor mike that is usually furnished. You would be surprised just how much fine recording quality can be had from these units, when used with mikes in the \$25 and up class. Needless to say, all this activity will furnish the tape manufacturers with a new market and already many companies which had stopped making stereo tapes are now back in business. Many of the companies have signed with *Ampeax' United Tape Distributors* which will greatly facilitate getting tapes into the hi-fi dealers' shops. Well, whatever goes at the Show, I'll be reporting to you next month.

I'm happy to report that I have received the first batch of regular production 4-channel tapes and they are far, far better than the first samples I had. While the problem of cross-channel modulation still exists when played on my big system, it is now greatly reduced and, depending on the type of music on the tape is so low in some cases as to be unobtrusive. Played on the smaller system, there was no discernible crosstalk.

In addition to these nice developments, the tapes had a definitely brighter transient response and frequency range and dynamics were much improved. Tape hiss varied from brand to brand but, on the whole, was no more offensive than that heard on two-

PRE-PUBLICATION SPECIAL OFFER!

YOU MAY HAVE EITHER OR BOTH OF THESE BIG, HARD-COVER ELECTRONICS GUIDEBOOKS ON A

7-DAY FREE EXAMINATION



COMPUTERS AND HOW THEY WORK
\$4.95

Here is a fact-filled, exciting guidebook to the wonder-world of electronic computers, with more than 120 illustrations and easy-to-follow tables in 10 big chapters. Step by step, you'll see and understand the workings of every type of computer ever used. This important new book illustrates the basic principles of computers with crystal-clear clarity. It's must reading for career-minded students and for electronics professionals who want a more complete knowledge of computers.

THE ELECTRONIC EXPERIMENTER'S MANUAL
\$4.95



THE ELECTRONIC EXPERIMENTER'S MANUAL is a big, informative volume, containing hundreds of specially prepared diagrams and construction drawings. There are 10 individual sections, each covering a specific phase of electronic construction. One giant chapter shows projects, test equipment and special tools you can build, plus plans for a complete workshop! With just a few dollars worth of tools, and this book to guide you, you'll have the know-how you need to get started, or advance, in electronic experimentation.

GET ONE OR BOTH FOR 7-DAY FREE EXAMINATION! MAIL THIS COUPON TODAY

ELECTRONICS BOOK SERVICE
A Division of the Ziff-Davis Publ. Co.
One Park Avenue • New York 16, N. Y.

Gentlemen: Send me a copy of:

- COMPUTERS AND HOW THEY WORK
 THE ELECTRONIC EXPERIMENTER'S MANUAL and bill me at only \$4.95 a copy plus postage. I understand that I may return the book(s) within 7 days and owe nothing.

\$_____ enclosed. (SAVE MONEY! Enclose payment now and we'll pay the postage.)

Name _____

Address _____

City _____ Zone _____ State _____

(N.Y.C. orders add 3% sales tax.)

High Fidelity 3 SPEAKER SYSTEMS

Here is a perfectly matched team with 3-way cross-over network. Kit includes 12" woofer; 8" midrange; 3 1/2" tweeter; hardware and network. Model 3W20 . . . audiophile net \$39.00.

Beautiful cabinets available in variety of modern finishes and designs . . . write for FREE literature.

OXFORD

Export: Raburn Agencies, New York • In Canada: Atlas Radio, Toronto
OXFORD BRANDS: Supreme Transformers, Hudson Lamps, Tempo Hi-Fi, Oxford Speakers & Rear Deck Kits.

Leading distributors carry OXFORD COMPONENTS, INC.

556 West Monroe Street
Chicago 6, Illinois



channel tapes . . . on this question of hiss, it's like anything else . . . some people are more sensitive to it than others and of course it also depends on what level you are playing back the tape . . . the louder the playback . . . the louder the hiss. Also room acoustics contribute their bit . . . if the room is very hard you hear more hiss than with a well-damped room.

Anyway, on the whole, it's a good step forward—this latest batch—and I can tell you that several of the residual problems are being strongly attacked and should soon yield, in which case 4-channel tape should be off and running with real professional form!

SONGS OF THE FABULOUS THIRTIES

David Rose and his Orchestra. Kapp 4-channel stereo KT45004. Price \$7.95.

Here is a really good tape. David Rose is, of course, an old favorite and he has an especially smooth way with a tune. On this tape he gives us a king-sized sampling of hits that were popular in the Thirties.

Among notable numbers are such items as "Stardust," "Deep Purple," "Begin the Beguine," and many others. This is big sound, with close-up recording leavened by spacious acoustics. Stereo directivity was good and not overdone, center fill was well handled. Over-all sound was clean and bright, strings especially smooth.

There was the least crosstalk on this tape of any I've heard so far, being, for the most part, absent. Frequency and dynamics seemed to be on a par with similar types of two-channel tapes and, in terms of hiss, played at good room filling level, it was present but not over-obtrusive.

SWINGING HIGH WITH ELLINGTON AND BASIE

The Big Bay Band conducted by Francis Bay. Omegatape 4-channel stereo ST4007. Price \$9.95.

Alas, this is not really the Duke and the Count with their great bands, but is by way of a "salute" by the Big Bay Band, an Omega recording outfit. Nonetheless, the essential styles and all the great Basie and Ellington numbers are here and played fairly well considering the band is not Basie or Ellington.

The sound is the most attractive part, being very big and bright, recorded close-up, and with only moderately spacious acoustics to soften the contours and smooth out the rough spots.

The frequency range here came as close to anything of similar nature I have heard on two-track. Transient response was very good with percussives coming through cleanly. Cross-channel talk was a little more noticeable here, mainly because of the razzle dazzle type of music but here, again, it was below that experienced with the first tapes.

All-in-all, the tape quality has been encouraging and I hope to bring you some symphonic material next month.

-30-

November, 1959

THORENS TD-124 lets you concentrate on music... not on mechanics



Finest Swiss-precision craftsmanship, famous for generations, is embodied in the Thorens TD-124. It's the *one* turntable that lets you forget technical problems—rumble, wow, flutter, incorrect speed and consequent "off-pitch" reproduction . . . all the rest of them, as if they never existed. Relax. Concentrate solely on music as it was *meant* to be heard. See, hear this world-renowned transcription turntable at your Thorens franchised dealer's today. 9-17



\$99.75 net.

Thorens TD-124. Finer craftsmanship, more features, than any other turntable anywhere. Acclaimed by critics throughout the world.

AND THESE OUTSTANDING VALUES COMPLETE THE "TD" FAMILY OF FINE TURNTABLES:

Thorens TD-184, \$75.00 net. A "TD" transcription table with integral arm, "Dial-o-matic" operation. Arm wired for standard stereo pickup.	Thorens TD-134, \$60.00 net. A manually-operated transcription table with stereo-wired arm for any superlative quality with minimum expense.	Thorens TDK-101, \$47.50 net. "TD" precision in kit form. Simple to assemble with no special tools for superlative record reproduction.
--	--	---

Sold only through carefully selected franchised dealers



THORENS

SWISS MADE PRODUCTS
HI-FI COMPONENTS • LIGHTERS
SPRING-POWERED SHAVERS
MUSIC BOXES
NEW HYDE PARK, NEW YORK

125

CLIMB THE PROFIT TOWER

in
2-WAY MOBILE-RADIO MAINTENANCE

Mobile radio communications are booming! All around... you can see the vertical radiators going up... each one is a definite lead to more and higher profits for qualified service men.

To learn more about contract fees... labor rates... and upping YOUR profits... mail the coupon below for your free copy of: "HOW TO MAKE MONEY IN MOBILE-RADIO MAINTENANCE."

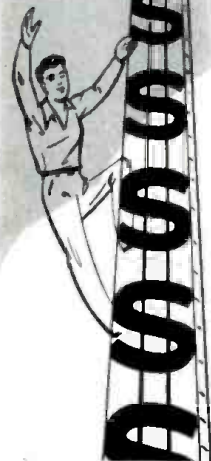

LAMPKIN 105-B FREQUENCY METER. RANGE 0.1 TO 175 MC AND UP. PRICE \$220.00 NET.

LAMPKIN INSTRUMENTS ARE THE MOST POPULAR MOBILE-MAINTENANCE METERS.



LAMPKIN 205-A FM MODULATION METER. RANGE 25 TO 500 MC. PRICE \$240.00.

MAIL
COUPON TODAY

LAMPKIN LABORATORIES, INC.
MFM Division BRADENTON, FLORIDA

LAMPKIN LABORATORIES, INC.
MFM Division, Bradenton, Florida
At no obligation to me, please send
 Free booklet Data on Lampkin meters
Name _____
Address _____
City _____ State _____

ENGINEERING HOME STUDY COURSES

Courses written by world authorities in all branches of engineering and science and proved successful by thousands of our graduates. One hour each day in your spare time will start you off to higher pay, security and prestige. Personalized instruction methods ensure rapid progress. Fill in the coupon and indicate the course of interest. We will send you a complete outline of the course and a booklet describing the Institute and our advanced teaching methods.

RADIO
ELECTRONICS
TELEVISION
CIRCUIT
MATHEMATICS
ELECTRICAL ENG.
TELEPHONY
CIVIL ENG.
SURVEYING
ARCHITECTURE
FORESTRY
MINING
STRUCTURAL
MECHANICAL ENG.
INDUSTRIAL ENG.
& MANAGEMENT
REFRIGERATION
DRAFTING
PLASTICS
AERONAUTICAL
ENG.
HIGH SCHOOL
CHEMICAL
MATHEMATICS
JOURNALISM
ACCOUNTING

MAIL THIS COUPON TODAY

CANADIAN INSTITUTE OF SCIENCE & TECHNOLOGY LIMITED
731 Century Bldg., 412, 5th St. N.W., Wash., D.C.

NAME _____

ADDRESS _____

CITY _____ STATE _____

COURSE OF INTEREST _____

Canadians: Send to C.I.S.T., 731 Garden Bldg.,
263 Adelaide St. West, Toronto, Ontario.



C. I. S. T.

ONE CENT SALE

BUY ONE AT OUR REGULAR LOW
PRICE AND GET THE SECOND
FOR ONLY 1c MORE

CITIZENS BAND TRANSMITTER (27 MC) chassis complete with crystal. \$9.99 ea. two for \$10.00.

TRANSMITTER similar to above but with 5 watt RF stage instead of 1 watt. \$14.99 ea. two for \$15.00.

CITIZENS BAND RECEIVER chassis tunable through all 22 channels. Complete with audio amplifier. \$9.99 ea. two for \$10.00.

AMATEUR BAND TRANSCEIVER (144-148 MC) chassis with dual VHF triodes for walkie-talkie radiophone. \$9.99 ea. two for \$10.00.

MICROPHONE High output 200 ohm carbon with terminal lugs. \$1.49 ea. two for \$1.50.

COILED CORD 4 conductor 11" telephone cord. Extends to over 4 ft. .99 ea. two for \$1.00.

KIT OF PARTS for AM-FM VHF radio receiver. Tunable from 80-200 mc. which includes U. S. satellite frequencies. \$6.99 ea. two for \$7.00.

TRANSISTOR AUDIO AMPLIFIER gives 50X voltage gain on low level signals. Operates on 1½ volts. \$3.99 each. 2 for \$4.00.

SUPER SPECIAL: 25 watt, 30 to 40 mc. crystal controlled FM radiophone mobile transmitter with 8 tubes and dynamo power supply. Orig. cost over \$300.00. Can be converted to Citizens Band. Used good condition \$24.99 ea. two for \$25.00 F.O.B. Hollis, N. Y.

LIMITED QUANTITY—
NO LITERATURE OR CATALOG

Remit in full. Include sufficient postage.
No C.O.D.'s.

VANGUARD ELECTRONIC LABS

BOX 12-EW11 HOLLIS 23, N. Y.

Simplified Speaker Testing (Continued from page 43)

measured at the power level at which the shape of the trace becomes markedly distorted. Volts squared divided by impedance equals watts (power), which in this case is the useful power capacity of the speaker. Two notes of warning on this kind of testing should be sounded: First, stay within the manufacturer's power ratings on both the speaker and the variable resistor to avoid physical damage to them. Second, a continuous tone, such as is produced in these tests, can seem intolerably loud even at a power input of only one to two watts. This last statement applies with double force to uninterested wives.

It might be of interest to point out that all of the impedance and phase shift curves shown in Figs. 3 and 4 were made using the same speaker, a twelve-inch, wide-range unit of standard make and all were made with the speaker in the same location in the room. In this manner, variables not directly concerned with the enclosure were eliminated. The primary purpose was to help in a study of the design of bass-reflex enclosures.

Interpretation of the test results has not been discussed in any detail, because that has been better covered in other recently published material both from the theoretical and design view points^{1, 5, 6, 7, 8, 9} and from the more subjective viewpoint of the would-be listener^{2, 3, 4}.

To sum up, this simplified loud-speaker testing technique can be used to measure speaker impedance and phase shift and to give a qualitative indication of distortion generated in the speaker or its enclosure and the useful power-handling capacity of the speaker. It must also be understood that there are several things this technique will not do. One is to measure the frequency response or range of a loudspeaker (for this, one needs the more sophisticated test methods referred to at the beginning of this article). Another, and probably most important of all, it will not replace a good pair of educated ears in making the final determination as to whether the sound produced is "right."

REFERENCES

1. Augspurger, G. L.: "Loudspeaker Damping and Tonal Response," RADIO & TV NEWS, March 1957.
2. Briggs, G. A.: "All About Audio and Hi-Fi" RADIO & TV NEWS, June, July, August, September 1957, February, March 1958.
3. Crochurst, N. H.: "Why Do Loudspeakers Sound Different?" RADIO & TV NEWS, October 1956.
4. Hartley, H. A.: "Realistic High Fidelity," RADIO & TV NEWS, May, June, July, October 1956.
5. Jordan, Edward E.: "Baffles Unbaffled," Audio, August, September 1956.
6. Moir, James: "Ported Speaker Cabinets," Audio, October 1956.
7. Sanford, Robert C.: "Bass Reflex, Design or Accident," RADIO & TV NEWS, July 1956.
8. Vilchur, Edgar: "Speaker Enclosures," Audio, June, August 1956.
9. Vilchur, Edgar: "Speaker Damping," Audio, October 1957.

your best buy . . .

TRU-VAC®

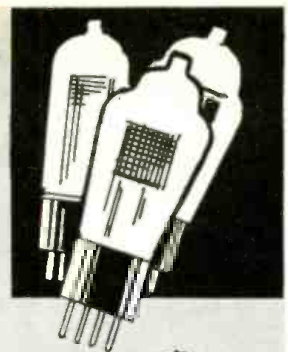

REMARKABLE TUBE VALUES AT 1950 PRICES

ALL TUBES INDIVIDUALLY BOXED, CODE DATED AND BRANDED "TRU-VAC®"

Typical TRU-VAC® Bargains!

THIS IS A PARTIAL LIST
Thousands More Always In Stock

6SN7GT	-----	ALWAYS	30c						
6W4GT	-----	ALWAYS	30c						
OY4	3AU6	6A6	6B8	6C8	657	784	12AT6	12SA7	36
OZ4	3BC5	6AB4	6BA6	6CL6	658GT	785	12A17	12S17	38
1A7GT	3BN6	6AC7	6BC5	6CM6	65A7	786	12AU6	12SK7	39/44
1B3GT	3B26	6AF4	6BC8	6CM7	65D7GT	787	12AU7	12SN7GT	41
1C6	3C86	6AG5	6BD6	6CN7	65F5	788	12AV6	12SQ7	42
1C7	3Q4	6AM4GT	6BE6	6CQ8	65F7	7C4	12AV7	12V6GT	43
1F4	354	6AM6	6BF5	6CR6	65G7	7C5	12AX4GT	12W6GT	45
1F5	3V4	6AK5	6BG6G	6CS6	65H7	7C6	12AX7	12X4	50A5
1G4	4BQ7A	6AL5	6BM6	6CU5	65J7	7C7	12A27	14A7/12B7	50B5
1H5GT	4B58	6AM8	6BJ6	6CU6	65K7	7E5	12B4	14B6	50C5
1L4	4BZ7	6AN8	6BK5	6D6	65L7	7E6	12BA6	14O7	50L6
1L6	4C86	6AQ5	6BK7	6DE6	65O7	7E7	12BA7	14P7	56
1N5GT	5AM8	6AQ6	6BL7GT	6DG6GT	65R7	7F7	12BD6	19AU4GT	57
1R5	5AN8	6A07	6BN6	6DO6	614	7F8	12BE6	19BG6G	58
1S5	5AT8	6AR5	6BO6GT	6F5	618	7G7	12BF6	19J6	71A
1T4	5AV8	6AS5	6B07	6F6	6V6GT	7H7	12BM7	19T8	75
1U4	5AZ4	6AT6	6BR8	6M6	6W6GT	7N7	12B06	24A	76
1U5	5BR8	6AU4GT	6B58	6J4	6X4	7O7	12BR7	2526GT	77
1V2	5J6	6AUSGT	6BY5G	6J5	6X5GT	757	12BY7	26	78
1X2	5R4	6AU6	6BZ6	6J6	6X8	7X6	12CA5	27	80
2AF4	5U4	6AU8	6BZ7	6J7	6Y6G	7X7	12CN5	35	84/6Z4
2BN4	5U8	6AV5GT	6C4	6K6GT	7A4/XXL	7Y4	12D4	35A5	117Z3
2CY5	5V4G	6AV6	6CB6	6K7	7A5	7Z4	12F5	35B5	
3A4	5V6GT	6AW8	6CD6G	6N7	7A6	12A8	12K7	35C5	
3A5	5X8	6AX4GT	6CF6	6O7	7A7	12AB5	12L6	35W4	
3AL5	5Y3	6AX5GT	6CG7	654	7A8	12AQ5	12O7	35Z5	

35¢

1 YEAR GUARANTEED PICTURE TUBES

Brand New* Allied A-1 Tubes Brand New
Below Listed prices do not include dud. Add Additional \$5.00 Deposit on tube sizes to 20"; on 21" and 24" tubes - \$7.50. Deposit refunded immediately when dud is returned prepaid. Aluminized tubes - \$4.00 extra.

Picture tubes shipped only to continental USA and Canada — All tubes F.O.B. Harrison, N. J.

108P4	7.99	16MP4	12.19	17CP4	16.99	19AP4	18.39	21CTP4	18.79	21FP4	18.39	21YP4	18.39
121P4	10.49	16KP4	11.99	17GP4	17.89	20CP4	15.89	21AMP4	17.99	21KP4	18.39	21ZP4	17.49
14B/CP4	11.99	16LP4	12.19	17HP4	16.99	20DP4	15.89	21AU4	18.79	21MP4	22.39	24AP4	39.49
16AD4	16.09	16RP4	11.99	17IP4	16.99	20NP4	17.89	21AVP4	18.79	21YP4	18.39	24CP4	27.79
16PD4	12.19	17AVP4	15.49	17QP4	13.89	21AP4	21.49	21AWP4	17.49	21WP4	17.49	24DP4	29.79
16GP4	16.09	17BP4	12.49	17IP4	16.99	21ALP4	18.79	21EP4	17.29	21XP4	17.49		

\$33
PER HUNDRED

For any used or factory second tube!

SENSATIONAL \$100,000 GIVE-AWAY
We want 100,000 new customers by Dec. 1st. For every new order of \$25 or more received by that date, we will send you a crisp, new dollar bill.

FREE FUSE CLIP!
Sent With Any Order Of \$5 Or More

GUARANTEE
Only TRU-VAC guarantees to replace free any tube which becomes defective in use within one year of date of purchase.

USED TV CONSOLES GUARANTEED To Work When You Receive Them

10" & 12"	\$29
14" & 12"	\$37
17" & 16"	\$45
19"	\$59
20" & 21"	\$70

All sets shipped in two cartons to avoid breakage. Sets shipped express to continental U.S.A. and Canada only. F.O.B. Harrison, New Jersey.

FREE BONUS—RABBIT EARS
\$7.95 Value
FREE with each set purchased

ATTENTION QUANTITY USERS!

Big Discounts Are Yours . . . Call or Write For Our 1000 Tube "Private Label" Special! Attention Branding Dept. MGR.

MONEY CHEERFULLY REFUNDED WITHIN FIVE (5) DAYS, IF NOT COMPLETELY SATISFIED!

TRU-VAC® PAYS YOUR POSTAGE

On orders of \$5 or more in U.S.A. and Territories. Send approximate postage on Canadian and foreign orders. Any order less than \$5 requires 25c handling charge. Send 25% on C.O.D.'s. All orders subject to prior sale.

Complying with Federal regulations, the following statement appears in all Tru-Vac advertising: Tubes appearing in this ad may be FACTORY SECONDS or USED tubes and are clearly marked.

TRU-VAC®

Harrison Avenue Box 107 Harrison, New Jersey
HUMboldt 4-9770

Electric Company

Write Dept. L For FREE LIST Of Other Tube Types and Products Sold By TRU-VAC®

Visit Our Huge Testing Dept. In The Heart Of Harrison, N. J.'s Electronics Industry

MADE FOR EACH OTHER

by Madison Fielding

Here are two magnificent stereophonic components that are positively made for each other. Each epitomizes audio engineering and design.

Series 360, 40-watt Stereophonic Preamp-Amplifier — Exclusive Aural Zero Null (AZN) circuit permits precise channel balancing by tuning for silence. Other outstanding features include: 10 jewelled indicator lights to instantly show source of signal and mode of operation; separate bass, treble, and level controls; plus normal-reverse, phasing and noise-rumble filter switches.

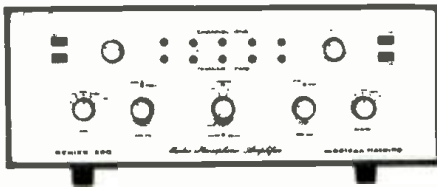

Model 360, \$180; Matching cabinet, \$20

Series 380, AM/FM Stereophonic Tuner Permits use of AM and FM sections individually for monophonic broadcasts or simultaneously for AM/FM stereo programming. Jewel lights indicate mode of operation. This highly competent "front end" unit provides high sensitivity and selectivity, extra outputs for multiplex and AM/FM stereo, and "Dual Stereoscopic" tuning indicator.



Model 380, \$160; Matching cabinet, \$20

Both units mount 3/32" solid brushed brass panels, deep etched for long life. Handsome hand-rubbed cabinets available in a number of choice finishes.

madison fielding
stereo

by Crosby Electronics, Inc.

For complete information, write:

Brand Products Inc.

Department EW119
39 West 56th Street
New York 19, N. Y.



Marketing organization for Madison Fielding

Mobile Receiver Alignment

(Continued from page 117)

can be done using the base station's transmitter as a signal source.

I.F. Alignment

The alignment procedure should begin with the discriminator with the generator set to the low i.f. Assuming the usual 455-kc. i.f., a crystal at this frequency can be used with the generator. If no crystal is on hand, tune an AM broadcast receiver to a station that is the closest to 910 kc. of those that can be received. Zero-beat the second harmonic of the generator (set at half the station frequency) against this station. If you know the station's exact frequency, you have a very accurate standard. Note the amount of error in dial calibration and use this as a guide for correctly setting the generator to 455 kc. If a station at exactly 910 kc. is not available, it may be best to use the two nearest transmissions, one on either side of that frequency. To avoid possible drift, the signal generator should be allowed to warm up for at least fifteen minutes before beginning alignment work.

Feed the 455-kc. signal into the first limiter grid, connect the meter to the discriminator secondary metering point, and adjust the secondary winding for a zero reading. If you have the right point, the voltage will go positive on one side and negative on the other, as the secondary alignment adjustment is turned. (A good, rough check of discriminator symmetry is possible here, by noting the amplitude of maximum meter deflection on either side of the zero-voltage point. The peaks should be equal.)

With the secondary aligned to zero, move the meter to the discriminator primary's alignment point, as shown in Fig. 5, and tune the primary slug for maximum. Next, move the meter to the grid of the second limiter and connect the signal generator to the output of the second mixer. The low i.f. transformers may now be aligned for maximum reading. If the reading shows a tendency to saturation (reaching a certain level and refusing to go higher), reduce the input signal level from the generator, or move the meter to the first limiter grid.

Sets Using Filters

If the receiver uses a fixed-tuned filter, this reliable network may be used to set the signal generator on the right frequency instead of the zero-beating process. Connect the generator to the second mixer grid, and the meter to either the low i.f. grid or first limiter grid. Now, tune the generator slowly through the low i.f., until a peak reading is found. This will be exactly on the peak frequency of the filter. If a distinct "flat top" is noted instead of a sharp peak because of the bandwidth characteristic of the filter, note the outer limits of the bandpass

KEEP CANDEE HANDEE!

- BC-603 FM RECEIVER
This Special Re-run is Popular Demand!
20-27.6 MC. 10 push-buttons for channel selection. Continuous tuning. Squelch circuit. Complete with tubes, speaker (less dynamotor.) THIS IS BRAND NEW! AND ONLY \$9.95
Two for \$18.95.
DM-34 12 v. DYNAMOTOR for above... \$3.95
- BC-611 HANDIE-TALKIE CHASSIS
Crystal controlled. 3-6 Mc. Brand new. Boxed. WITH antenna, less tubes, crystals. \$6.95
ccts. Only
- APN-1 FM TRANSCEIVER
420-460 Mc. Complete with tubes. Excel. \$6.95
- TBY POWER SUPPLY
With tech book. BRAND NEW. Only... \$7.95
- 2 SPECIALS FOR MARINERS
R/25 ARC-5 MARINE RECEIVER—1.5-3 Mc. Excellent condition. With tubes... \$14.95
T-18 ARC-5 MARINE TRANSMITTER—2.1-3 Mc. Excellent condition. With tubes... \$9.95
- FAMOUS Q 5'ER RECEIVER
190-550 kc. Excellent. With tubes... \$12.95
- MD-7 PLATE MODULATOR—Comp. with tubes. Excel. \$6.95
- DM-35 DYNAMOTOR
Input 12.5 VDC, output 625 VDC; input 18.7 A, output 225 MA. Depot repack. \$9.95
Like new
- T85/APT-5 TRANSMITTER
Has lightweight tube 3C22 oscillator in tunable cavity modulated by two type 829B tubes powered by 631 noise generated Photocell. Output approx. 30 W. CW @ 115 V, 400 cycles. \$49.95
Excellent condition
- AN/APA 38 PANADAPTOR
115 VAC. Single phase. 300-2700 cycles. 30 Mc. adaptor. Approx. 10 Mc. band width. For conversion dope, see July/59 C.Q. Mag. \$14.95
azine. Excellent cond.
- MODEL 84 MEASUREMENTS CORP. SIGNAL GENERATOR
Frequency 300-1000 MC in one band. Individually calibrated direct reading dial. Frequency Accuracy $\pm 0.5\%$. Output voltage continuously variable from 0.1-100,000 microvolts. Output impedance 50 ohms. Modulation 0-100%. Choice of 400, 1000, 250 cycles. Pulse frequency 60-100 kc. in three ranges: 60-1,000, 800-10,000; and 6,000-100,000 pulses per second. Power supply 117 V., 50/60 cycles. Dims.: 13 x 26 x 12 1/2". Approx. ship. wt. 160 lbs. \$149.95
Excellent. Checked out. \$100.00
AS IS. Not checked out.
- LP-5 SIGNAL GENERATOR
Freq. 0.5-30,000 Kc. $\pm 1\%$ in 7 bands. 30-50 Mc. $\pm 3\%$ (extended range) Output imp. 10 ohms. Amplitude modulated. With power supply. Excel. Checked out. \$195.00
- NEW TS-13 HANDSET Ea. \$3.95; Two for \$6.95
- YOU GOT IT! WE WANT IT! LET'S DEAL!
We're paying top \$\$\$ for GIC-9; PRG-6, -8, -9, -10; GN-58A; All elect. test equip.
- APR-1 RECEIVER
Just removed from airport so you know it's good! Has self-contained 110 V. 60 cycles power supply. Input 110 V. 60 cyc. Excel. \$22.50
- PLUG-IN TUNING UNITS FOR ABOVE:
TN-1, 38-90 Mc. 15.00
TN-2, 80-300 Mc. 15.00
TN-3, 300-1000 Mc. 19.95
- SCR-522 TRANSCEIVER
4-channel. Crystal controlled. 100-156 Mc. Ideal for 2 meters. Complete with tubes. Excel. \$14.95
- All items FOB Burbank, Calif., subject to prior sale. In Calif. add 4%. Min. order \$3.95.

CRYSTAL CONTROLLED CONVERTERS

POLICE • FIRE • COMMERCIAL



For use with
12 V. Transistor type
car radios—
26-50 MC.

\$24.50

Can be self installed in seconds. Other models for 152-162 MC available. Also complete line of conventional powered converters, tuners and receivers.

A practical converter for emergency use with powered home or auto sets. Tuneable over 12 MC. 26-50 MC or \$13.95
108-174 MC. . . .

Also available crystal controlled up to 54 MC. \$18.95



ORDER TODAY OR WRITE FOR LITERATURE

KUHN ELECTRONICS
20 GLENWOOD CINCINNATI 17, OHIO

ELECTRONICS WORLD

(i.e., the points where the reading begins to fall off) and set the generator halfway between them.

The High I.F. Stages

The high i.f. stages will usually be found somewhere in the range between 5 and 6 mc. Once again, extreme accuracy of the generator is not as important as stability: we can check the former. With the low i.f. section and discriminator properly aligned, move the meter back to the secondary of the discriminator. Connect the generator to the input of the first mixer. Now, move the generator dial back and forth in the vicinity of the high i.f. (Assume that this is near 5.5 mc.)

As you tune through the correct frequency, the meter will deflect either positive or negative, return to zero, then deflect in the other direction. Set the generator exactly at the point where the zero reading is obtained on the meter. Whatever its exact dial reading, the generator is now set up to produce the correct high i.f. The accurate, crystal-controlled first oscillator has helped establish this frequency! Now align all stages for maximum reading. The meter may be connected to the low i.f. grid or first limiter.

R.F. Alignment

If the signal generator will go up to the carrier frequency, it may be calibrated against the transmitter, again using the discriminator to locate the correct zero point. The r.f. stages are then aligned. Harmonics of the signal generator can also be used. For instance, in the 150-mc. band, a setting at 50 mc. will usually produce a third harmonic of usable amplitude. However, for best results, "rough in" the alignment adjustments on the r.f. stages with the signal generator, then connect an antenna to the receiver and finish the alignment using the base station's transmissions.

If the base station is very powerful, or very close, watch out for saturation of the limiters when these metering points are used. The low i.f. metering point may be a better choice. If the signal is still too high, take the antenna off or reduce the coupling.

Final Touch-up

For best results, make a final receiver check *after* re-installation in the vehicle, as follows: connect the meter to the low i.f. metering point, call the base station for a test transmission, and adjust the antenna transformer for maximum reading. Next, connect the meter to the discriminator secondary, get another test transmission, and set the secondary to exact zero reading.

If the base station's transmissions are too powerful for accurate adjustment of the antenna transformer, get in touch with another vehicle, far enough away to give a weaker signal, or wait until one of these vehicles calls the base station. In most radio systems, you won't have long to wait, as they stay pretty busy!

YOU PAY A LITTLE MORE FOR VOCALINE CITIZENS BAND RADIO BUT *you get a lot more performance!*

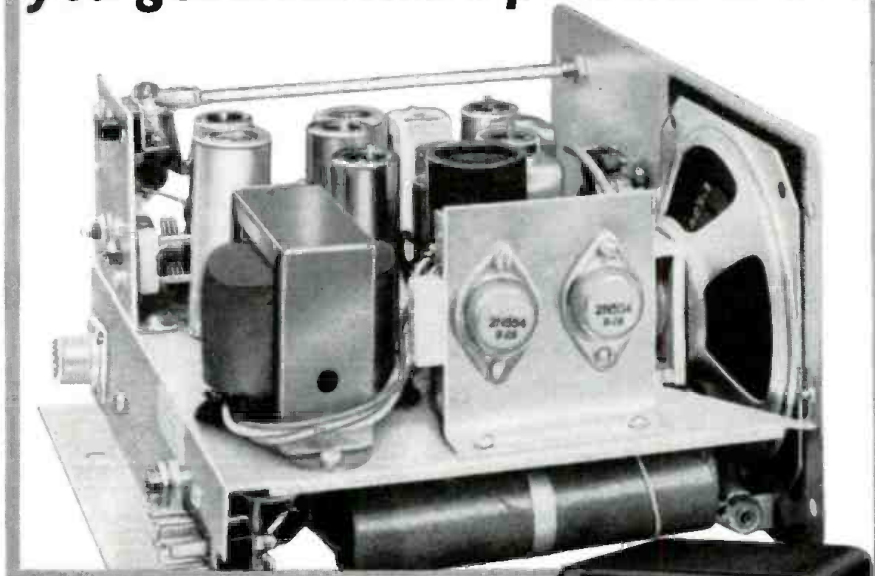

The real worth of equipment is measured by its performance—and that's where Vocaline's ED-27 Commaire outdistances them all. If you're serious about Class D Citizens Band communications, then be equally serious about your choice of equipment. Compare Commaire's superlative (and, in most cases) exclusive features with competitive equipment. It makes sense to spend a little more to get so much more!

Model
ED-27
\$179.50 each

THE MOST SELECTIVE & SENSITIVE RECEIVER

Crystal-controlled—double conversion superhetrodyne. Selectivity: ± 5 kc at points 6 db down. Sensitivity: 0.1 mv. PLUS twice the audio output of any other class D receiver—4.5 watts!

SILENT-AIRE SQUELCH U.S. PAT. 2,632,812

At last a squelch that really works! ... Combines with exclusive noise suppression to assure complete silence in stand-by.

1/2 MORE OUTPUT

5 watts input, 3 watts output—for greater range!

TRANSISTORIZED POWER SUPPLY

Assures service-free, reliable operation.

UNMATCHED AUDIO CIRCUITRY

Combined with the above features—results in the best-performing class D radio on the market... unequalled for range, signal-to-noise ratio, audio fidelity and dependability.

Supplied with push-to-talk microphone with coiled cord, hanger, universal mount, antenna loading light. 2 models—115 VAC and 12 VDC; 115 VAC and 6 VDC. Ask for Vocaline Antennas and Accessories.

WRITE FOR COMPLETE DATA
Commaire Dept. A

VOCALINE
COMPANY OF AMERICA, INC.
OLD SAYBROOK, CONN.

V3

129

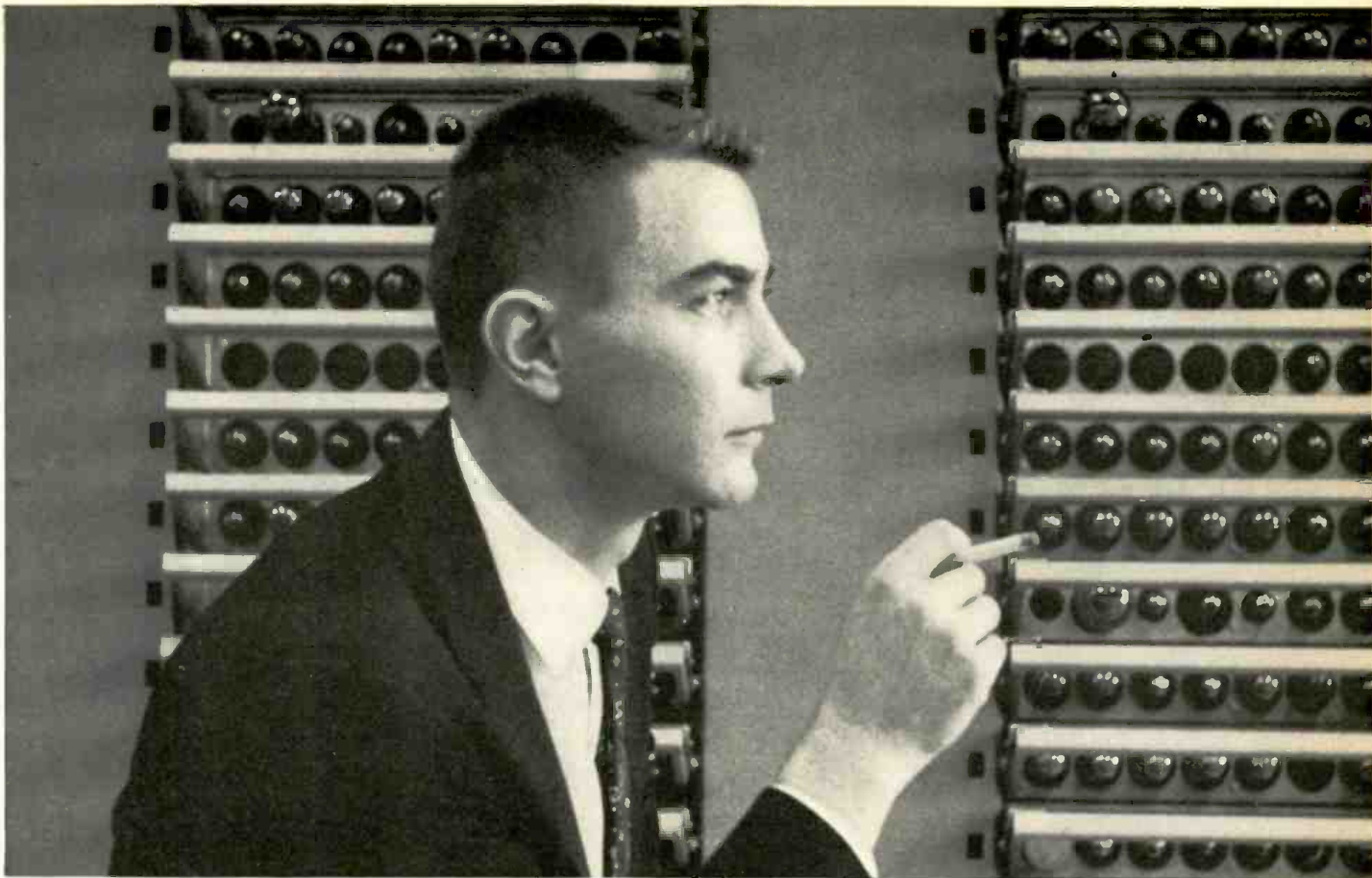

How far can you go in electronics .

"Just being called a Field Engineer—an impressive title for a man without a degree—that really gives me a lift."

This is James A. Pieratt talking. With a high school education and Navy Technical training behind him, he holds a key job in one of America's most important electronic projects. He's an IBM Computer Units Field Engineer on the SAGE program.

Jim Pieratt is 25, lean, crew-cut and soft-spoken. He smiles modestly when you ask him about his accomplishments. We were curious to know whether he had been technically inclined when he was a youngster.

"The truth is that I didn't become interested in electronics until I joined the Navy," he says. "Before that, the only technical thing I might have done was to take a couple of alarm clocks apart. I chose electronics in the Navy because I thought there was a future in it."

Change of attitude

"A lot of fellows may think, as I did, that a computer is too complicated for anybody but an Einstein to understand. It's not so. I didn't know this when I went for my employment interview—and I wondered if the algebra and trig I'd taken at Kalamazoo Central High would qualify me. Then my interviewer told me a little about computers . . . how they work and what my job would be after I finished IBM school. I made up my mind right then; I wanted this job."

Training school

Soon, Jim Pieratt and 21 other fellows with more or less similar backgrounds started training in Kingston, New York, getting on really intimate terms with IBM's electronic giant. Marvel of complexity though it is, when it sits on the floor and you study it part by part, the computer loses its mystery. Little by little, you begin to understand the whole from the sum of the components.

"The 20 weeks I spent in training were very happy," he says. "It's interesting all the way. They encourage you to think for yourself and your efforts are recognized. During the training period, I received a living allowance in addition to my salary."

Strategic job on the SAGE project

Jim Pieratt is stationed in North Dakota, near Grand Forks. His duties include installing, checking and testing out computer units. The giant electronic computers are the very heart and mind of SAGE (Semi-Automatic Ground Environment). To the input section of the computer comes data from radar sites, ships, reconnaissance planes and ground observer posts throughout the country. The display consoles give a visual representation of the complete air defense situation. His prime responsibility is to keep the display consoles running.

8 pleasant hours a day

"I'm essentially my own boss and I'm encouraged to

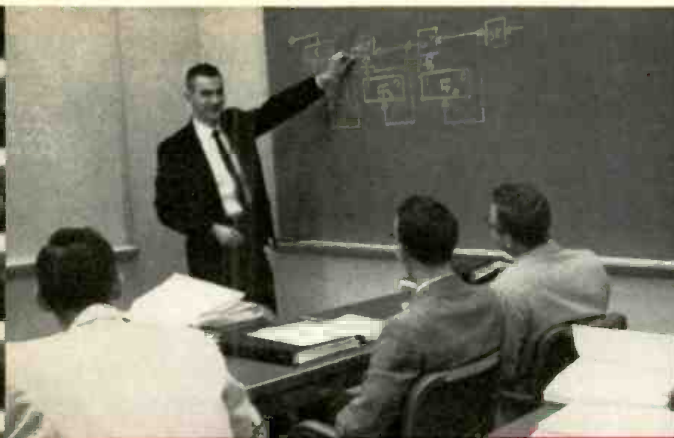

Discussing block diagram in class



Testing a pluggable unit



Programming a control board



Adjusting console photo cell

• without a degree?

think for myself. For me, this is an ideal environment. What do I like best about my job? Trouble-shooting, I think. I enjoy being able to repair anything that isn't working properly. As a Field Engineer, I have opportunities to assume other engineering functions. For instance, while I have nothing to do with design engineering, I do suggest changes for review by the design engineers. I also rewrite engineering procedures."

Jim Pieratt's future

"There's plenty of room for me to grow at IBM. My next step up should be to Systems Engineer. This calls for more headwork. After that, if I display enough initiative, I may become a Group Supervisor."

Family, friends, recreation

Jim Pieratt, his wife and three-year-old daughter live in a pleasant ranch home, just a few miles from the site. Social life? "We've made quite a few friends here," he says. "Mostly among the IBM fellows and their wives. We play golf together."

Where do you go from here?

Can you look ahead, as Jim Pieratt does, and see yourself as a man on the way up? Maybe you should give some thought to IBM Federal Systems and the SAGE project program. Opportunities are greater than ever as the long-range program continues to grow in importance.

If you have a minimum of 3 years' technical schooling—or equivalent experience—you may be eligible for advanced training for 20 weeks as a Computer Units Field Engineer. While training, you receive full salary plus overtime pay and living allowance before assignment to a permanent location.

From then on, you can go as far as your abilities and ambition will take you. And, as you may already know, at IBM you receive company-paid benefits that set standards for industry today.

Mr. N. H. Heyer
Dept. No. 650-K
Federal Systems Division
IBM Corp., Kingston, N. Y.

WRITE TODAY TO:

You'll get a prompt reply. Personal interviews arranged in all areas of the United States.

IBM®

INTERNATIONAL BUSINESS MACHINES CORPORATION

NEW IMPORTANT SAMS BOOKS



"Printed Circuit Diagnosis Made Easy"



Helps you become an expert in servicing printed circuit boards. Practical, simplified approach saves time troubleshooting all types of printed circuits. Explains correct way to interpret and use various styles of data shown in service literature. Describes best procedures to follow when only a schematic diagram is available.

Sample problems illustrate each phase of printed circuit troubleshooting. A "must" book for your service library. Illustrated; 96 pages; 5 1/2 x 8 1/2". Only **\$125**

"Radio Receiver Servicing"

ALL-NEW EDITION



Latest enlarged edition of John T. Frye's famous best-seller. Includes new chapter on how to service transistor radios and printed circuits. The most understandable and valuable guide to radio servicing; based on the author's 25 years of practical experience. Includes a separate chapter on each type

of trouble, such as the dead set; tubes light but no sound; noisy sets; weak sets; sets unable to separate stations, etc. 208 pages; 5 1/2 x 8 1/2". Only **\$295**

"Howard W. Sams Handbook of Electronic Tables and Formulas"



FOR ELECTRONIC TECHNICIANS

Specially prepared for electronic technicians, junior engineers and students. A valuable compilation of tables, charts, formulas and laws useful to all who work in electronics. Five comprehensive sections include: Formulas and Laws of Electronics; Constants, Standards, Symbols, Codes; Service and Installation Data; Mathematical Tables and Formulas; Miscellaneous.

Features full-color frequency spectrum chart based on latest 1959 FCC allocations. 134 pages; 5 1/2 x 8 1/2"; hard-cover. Only **\$295**

"Television Tube Location Guide" Vol. 9

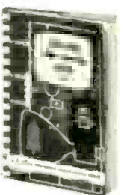

Latest volume in this invaluable series. Gives tube location data for TV sets produced in 1958-1959. Shows position and function of tubes in over 250 receiver models—just find the trouble and replace defective tubes without removing chassis! Shows major component placement; signal path; pin orientation on socket;

series string filaments; fuse location. Includes tube failure check charts. 96 pages; 5 1/2 x 8 1/2"; comb binding. Only **\$125**

HOWARD W. SAMS & CO., INC.

Order from your Sams Distributor today, or mail to Howard W. Sams & Co., Inc., Dept. L-19 2201 E. 46th St., Indianapolis 6, Ind.

Send me the following books:

- "Printed Circuit Diagnosis Made Easy" (PC-1)
 "Radio Receiver Servicing" (RS-2)
 "Handbook of Electronic Tables" (MTF-1)
 "Television Tube Location Guide" Vol. 9 (TGL-9)

\$..... enclosed. Send Free Book List

Name _____

Address _____

City _____

Zone _____

State _____

(outside U.S.A. priced slightly higher)

Service Industry



IN A SPIRITED contest for votes, "Mac" Metoyer of Kansas City, Missouri, was elected president of the National Alliance of Television and Electronic Service Associations (NATESA), at the recent annual convention. He succeeded Vincent J. Lutz of St. Louis, Mo. With a background of ten years of active participation in national, state, and local association work, including two years as NATESA's secretary general, Metoyer is noted for his energy in working toward objectives that he feels are in the best interests of the service industry.

Benny Benoit, dynamic association leader from New Orleans, La., was elected to the post of secretary general and Nelson Burns of Memphis, Tenn., was re-elected treasurer of the national service organization.

Members of the executive council elected to serve for the coming year include Irving Toner of Buffalo, N. Y., eastern vice-president; George Carlson of Jamestown, N. Y., eastern secretary; Cordell Britt of Nashville, Tenn., east central vice-president; Gerald Hall of Milwaukee, Wis., east central secretary; W. E. Johnson of Beaumont, Texas, west central vice-president; Leroy Ragsdale of Fort Smith, Ark., west central secretary; Winston Haines of Burlingame, Cal., western vice-president; and O. W. Andrews of Denver, Colo., western secretary.

The resolutions adopted by the delegates to the convention included the following:

The association urged "all service people to exercise selective buying and channel their buying power to those companies that are non-competitive."

"NATESA recognizes only the Electronic Industries Association standard warranty plan; namely, 90 days on all parts and tubes and one year on picture tubes. No labor warranty by factories is recognized."

The association urged all TV receiver manufacturers to "permanently and indelibly imprint serial and chassis numbers on all chassis and to issue a certificate of title for each set which is to accompany the set in all transactions."

One purpose of this resolution was to help put a stop to the growing number of set thefts.

Tulsa, Oklahoma, was selected as the site for the Association's annual Spring convention in 1960.

Unity: NATESA's Story

Rejection of the application by TSA of Detroit, Michigan for membership

in NATESA was followed by a wave of commentary critical of NATESA for turning down the former group. (See "Service Industry News," September 1959, pp. 136 and 137.) In rebuttal NATESA has set forth its position via a release entitled "What Is Unity?" which has been circulated to local associations throughout the country. It is issued over the signature of executive director Frank Moch, against whom many charges have been leveled personally, growing out of the TSA rejection.

"The word unity is being bandied about more than ever (begins the statement), despite the fact that NATESA today has well over 100 affiliates and the fact that it has grown every single month since its birth... the only possible reason for this growth can be the fact that NATESA philosophies parallel those of honest, ethical service people across the nation."

Moch then charges that those outside NATESA who have spoken loudest about unity are the ones who have done the most, unsuccessfully, to destroy the unity represented by that national group. He further states that those within NATESA who have taken up the same cry are the ones who have been least successful in bringing new groups into NATESA to achieve unity.

On the background of the TSA attempt to gain membership, the release says, "Those of you who were at the Nashville meeting will recall the 'dramatic' announcement of TSA-Michigan's intention of affiliating... It was hoped that spontaneous and unthinking acceptance would be voted. You may or may not have heard of the maneuvering to give a special 'deal' to TSA-Michigan (Detroit). You did see the report that the TSA application was rejected."

The statement also points to the legal problems involved, raising the question as to whether the national office could have stepped in to maneuver the acceptance of TSA without violating constitutional limitations.

"Here is how this (the TSA application) was handled, and I can assure you that it follows specifically the constitutional provisions and that it follows exactly the same procedure followed for acceptance of your group as an affiliate. When the application was finally received, in view of the fact that we had the Michigan state affiliate who already had a Detroit affiliate, the application was submitted to TESA-Michigan. They turned down the application completely in accord with

their rights as a state affiliate. For this I have been maligned and libeled."

As to the reasons for the unfavorable decision on the application, the NATESA statement is accompanied by a copy of a letter to Frank Moch from John H. Stefanski, president of TESA-Michigan ("Service Industry News," October 1959, page 144). In the letter, Stefanski presents his version of association activities in Detroit and Michigan from 1954 on, questioning the actions and motives of TSA. Copies of this correspondence are available from NATESA's national office on request.

Moch also refers to two stories that have appeared in print in recent months: the rumor that TEA (Texas) was considering affiliation with NATESA and the story that ITTA (Indianapolis) had not received approval of its application for membership. He charges that these stories, both untrue, were put in circulation to create confusion. In view of the legal limitations placed on his role in handling the TSA application, Moch concludes, "I doubt if sincere officers and directors feel that the abuse heaped upon the executive director is fair and a part of the job."

TV Service Charges

Many dealers, in trying to adjust their service charges to a level that is compatible to the present costs of operating, look around for some standard of comparison based upon known costs of doing business. Some of the widest and most exhaustive surveys to determine the actual costs of performing home and shop service on TV sets have been conducted by dealers in the Detroit, Mich. area. Using the information from these surveys as the basis, Harold Chase of Detroit, Mich. recently compiled a new chart of "Average Labor Charges for Television Service and Repairs." The charges are based on a time rate of \$6.00 per hour. Readers who would like to check their own charges against those listed in this chart may obtain a copy of it by sending ten cents to Hal Chase, *Chase TV Service*, 16311 Grand River, Detroit 27, Mich.

ETG of Boston Elects

Lawrence J. McEvoy was elected president of the Electronic Technicians Guild of Boston at their recent annual election. Officers named to serve with him include George Catavolo, vice-president; James Kelley, re-elected secretary; and Donald Cicolini, treasurer. The address of the association is: James H. Kelley, secretary, ETG of Boston, 236 Main Street, Woburn, Mass.

President McEvoy named the following members to serve as delegates to the Massachusetts state association: Warren Gagosian of Medford, state director; Hy Leve of Brighton and Ted deBruyn of Woburn, state delegates.

The members of the association report that one of the best affairs ever sponsored by ETG was that held in

a vitally important message for every service technician

HOWARD W. SAMS
INDIANAPOLIS 6, INDIANA

Dear Friend:

Your Electronic Parts Distributor will soon present to you a remarkable new program designed to help you:

1. Gain deserved recognition as a reputable businessman in your community
2. Develop and command public respect and acceptance through favorable national and local publicity
3. Justify better earnings warranted by your business investment and skill
4. Pave the way to expanded business and increased profits for you

This program, known as "PEET", is made possible by a unique industry-wide relationship in which the Sams Company occupies a key position. Your Distributor will invite you to qualify for the program which has been planned solely in your behalf.

Please give your Distributor's representative the few minutes required for his presentation of "PEET." It may prove to be the most profitable time of your business career.

Some of you may already have been presented the "PEET" Program and you may be well on the way to qualify. I want to make certain *every* Service Technician is offered the opportunity—so—if you don't hear from your Distributor in the next few weeks, write to me personally. I will see to it you get the full details immediately.

Cordially,



ASK YOUR ELECTRONIC
PARTS DISTRIBUTOR



QUALIFY FOR
"PEET"

**A Wire-Stripping Notch
That REALLY WORKS!**



#728
LONG-REACH
DIAGONAL CUTTER

(Patent Pending)

Specially Designed

CHAN NEL LOCK

ELECTRONICS PLIERS

You'll do hundreds of electronics jobs easier, faster with these specially designed pliers by Channellock. You'll like the l-o-n-g reach . . . the precision-matched jaws . . . the hand-honed, specially hardened cutting edges . . . the easy-to-handle "feel" of the blue plastic grips. And you'll appreciate the quality of Channellock pliers . . . they're forged from high grade steel, properly heat treated. Ask your Electronics Equipment Supplier for Channellock Electronics Pliers . . . or write us direct for further information.



#718 LONG-REACH FLAT-NOSE PLIER



#738 LONG-REACH ROUND-NOSE PLIER



#748 LONG-REACH END CUTTER

Channellock Pliers are made only by

CHAMPION DeARMENT TOOL COMPANY
Meadville, Pennsylvania

June when more than 425 members and guests registered. It was cited as an impressive show of strength in favor of the ETG License Bill. Also during the same month, the association cooperated in a radio program designed to bring the proposed ETG license measure to the attention of the general public. President Larry McEvoy, George Catavolo, and Pat La Fauci served as members of a panel to answer questions telephoned in about the licensing plan, ETG, and the independent electronic service industry.

Mid-State ESDA Rating Plan

Wayne Prather, president of the Electronic Service Dealers Association of Mid-State Pennsylvania, announced that the Keystone-State organization will establish a customer rating plan as its fall project.

The program, intended to protect the members of the association, revolves around the compilation of a list of customers who are poor payers, so-called "dead-beats," and those who are generally antagonistic or abusive to service people. Pointing out that the information will be strictly for the 28 members of Mid-State ESDA, Mr. Prather emphasized that the program is not to be construed as a credit-information plan.

The mailing address of Mid-State ESDA is % Wayne Prather, president, 17th and Herr Streets, Harrisburg, Pa.

FRTSAP Developments

The Federation of Radio & Television Service Associations of Pennsylvania was recently informed by the state's sales tax department that sales taxes are applicable to in-warranty work performed by service firms on behalf of dealers, distributors, and manufacturers.

Until the present, most service firms were not charging taxes on work performed under in-warranty arrangements, assuming that the tax should be paid by the manufacturer, distributor, or dealer on both labor and parts.

Other developments in the Pennsylvania association include a demand to the *National Broadcasting Company* for equal time to answer the "charges" and "insults" said to have been made against the service industry by Alexander King on a recent Jack Paar Show.

The association delegates authorized officers to send a letter to the Pennsylvania Governor urging him to sign the "Wholesale Bill" which had been passed by both houses of the State Legislature. The "Wholesale Bill" is said to define operations of wholesale distributors in that the distributors must sell only to "people in the trade." The delegates also heard first reports on the review of a proposed state-wide service licensing measure now under consideration by member local associations. The bill, setting up the provisions for licensing radio, electronic, and television technicians, is being readied for presentation at the next session of the legislature.

Are You "Alignment Happy"?

(Continued from page 47)

justified alignment are brought on by defective alignment equipment or lack of experience by the technician using that equipment. Here again, alignment checks *without adjustments* will help. In the case of defective equipment, curve checking of a number of sets, preferably including new sets known to give satisfactory pictures, will eventually prove even to the most trusting technician that something is adrift with his set-up or equipment. Surely every set cannot have the same defect. As for the technician seeking more experience in the use of alignment equipment: he will gain that know-how soon enough if allowed to check but *not adjust* the alignment curve of every set going through the shop.

Even if a curve check indicates a genuine need for alignment, it should not necessarily be done if any decrease in gain would be involved. Remember, the customer is not watching an oscilloscope trace. He is watching a picture, often quite happily through a dirty glass with full, excessive contrast and near-full brightness. Scanning lines may be paired and blobs of snow bigger than the detail represented by a whole megacycle of bandwidth may flit unnoticed across the screen. To such a viewer, a nicely balanced curve may have meaning only with reference to the female form. Why spoil his fun by improving his picture at the expense of gain? With less gain he might not even have a picture unless you are able to improve the signal strength available at the antenna terminals. This is not to say that alignment should never be undertaken. However, the decision should not be made lightly.

Some knowledge of the service history and the general appearance of the chassis will often help in deciding whether or not to re-align. If it is apparent that the tuning slugs in the i.f. circuits have been adjusted previously, if components in the i.f. circuits obviously have been changed, and if the present signals are of sufficient strength to warrant it, alignment should be considered. There is also the matter of the customer's willingness to pay for an alignment job.

In any event, before proceeding with the alignment, a curve check should be made and tubes and other suspect components checked by substitution. Voltage readings should be taken and any defects in other parts of the set corrected. Tube shields and other metal screening should be installed as the designer intended them to be. Then, if you are sure of yourself and your equipment, the set may be re-aligned, according to the manufacturer's service information, to provide the best possible picture and sound along with satisfactory gain. Only in this way will both the technician and the customer be satisfied that the work was really necessary.

NOT USED, NOT PULLED OUT OF OLD SETS

Brand New TUBES

BETTER
THAN
70%
OFF!

BETTER
THAN
70%
OFF!

and RAD-TEL'S FIRST QUALITY!
**REMEMBER . . . ALL RAD-TEL TUBES
GUARANTEED ONE FULL YEAR**

SEND FOR NEW FREE BROCHURE OF TUBES & PARTS

NATIONALLY ADVERTISED BRANDS!

50% and More Off Regular Net Prices

	Reg. Net	Rad-Tel Price
SUPERIOR 5 Way Binding Post: highest quality.	\$.40	\$.20
HAMMARLUND Silicone Treated Steatite Base: 3/4 x 3/4" Straight line cap.		
MAC 10—8.7 to 1.7 MMF	1.17	.58
MAC 15—14.2 to 2.2	1.23	.61
MAC 20—19.6 to 2.7	1.32	.66
	MFD	VV
CORNELL DUBILIER 40.40.40	350.300.50	1.00
CORNELL DUBILIER 8	1000	2.95
CORNELL DUBILIER 60.40	500.500	.65
CORNELL DUBILIER 20	450	.15
SPRAGUE 10.10.10	450.450.450	.25
PHILCO 80.200.400	350.300.50	.45
PHILCO 10.100.10.100	475.300.300.25	.55
INDUSTRIAL 500	5 Non Polarized	.75
INDUSTRIAL 8.8.8	5	.10
CORNELL DUBILIER J	1600	.25
CORNELL DUBILIER .04	1600	.15
BILLEY CRYSTAL 4500 KC. Type VN4		2.25
BILLEY CRYSTAL 1500 KC. Type VN4		2.00
STANCOR COUPLING TRANS. Ratio 1:3. Type A53		.50
WESTON Tube Checker TRA S. 117V with all taps.	9.00	3.00
MEISSNER 456KC OCS. Coil shielded. List \$1.35		.25
MEISSNER 16MH RF Choke 19-5590. List \$1.33		.20
ACME Step Down Trans. Input 200 240; Output 115. Complete—just plug in. Type No. T-10264. 125V/A		2.10
BELDEN TEST PROB CABLE. Type 8899. No. 18. Cotton wrap rubber over-all.		ft. 2c
RAYTHEON Constant Volt TRANS. 95/130V; output 6V. 25 Watt		5.95
SOLA Constant Volt Trans. 105/125V; output 7V; 20VA	16.00	6.95
JONES Barrier Type Terminal Strips. 10 terminal size.	.56	.25
ERY BINDING POSTS. Twins. Same Type as Type 21R; One Marked — and Other	.55	.20
WESTON Scope Transformer. Used in Weston model 983. Hi-Volt., Lo-Volt., 5 Filament Windings.		5.85 ea.
BI PASS COND. KIT. 100 assorted. 200 to 1000V		3.50

Type	Price	Type	Price	Type	Price	Type	Price
1AX2	.62	6AC7M	.96	6CG8	.77	12AV6	.41
1B3GT	.79	6AF4	.97	6CM7	.66	12AV7	.75
155	.51	6AG5	.65	6CN7	.65	12AX7	.63
1U4	.57	6AH6	.99	6CS6	.57	12A27	.86
1U5	.50	6AK5	.95	6CU6	1.08	12B4	.63
1X2B	.82	6AL5	.47	6CY7	.71	12BD6	.50
2AF4	.96	6AM8	.78	6DE6	.58	12BE6	.53
28N4	.60	6AN8	.85	6DG6GT	.59	12BH7	.73
3AL5	.42	6AQ5	.50	6DQ6	1.10	12BQ6GT	1.06
3AV6	.51	6AT6	.43	6DT6	.53	12BY7	.74
3AV6	.41	6AT8	.79	6J5GT	.51	12C5	.56
3BZ6	.55	6AU4GT	.82	6J6	.67	12CU5	.58
3BY6	.55	6AU6	.50	6K6GT	.58	12CU6	1.06
3CB6	.54	6AU8	.87	6L6	.84	12DQ6	1.04
3CF6	.60	6AV6	.40	654	.48	12F8	.66
3DT6	.50	6BA6	.49	6SK7GT	.74	12K5	.65
3V4	.58	6BC5	.54	65N7GT	.65	12L6	.58
48N6	.75	6BD6	.51	6T4	.99	12S7M	.86
48Q7	.96	6BE6	.55	6T8	.80	12SK7GT	.74
4DT6	.55	6BF6	.44	6UB	.78	12SN7GT	.64
4BZ7	.96	6BG6G	1.66	6V6GT	.54	12V6GT	.53
4CB6	.59	6BH8	.87	6W4GT	.57	12W6	.69
5AM8	.79	6BK7	.85	6W6GT	.69	17AX4	.67
5AN8	.86	6BN4	.57	6X4	.39	17BQ6	1.09
5AQ5	.52	6BN6	.74	6X8	.77	19AU4	.83
5AT8	.80	6BQ/CU6	1.25	6Y6G	.65	19BQ6	1.39
5BK7A	.82	6BQ5	.65	8AU8	.83	19T8	.80
5BQ7	.97	6BQ6GT	1.05	8AW8	.93	25BQ6GT	1.11
5CG8	.76	6BQ7	.95	11CY7	.75	25C5	.53
5CL8	.76	6BR8	.78	12A4	.60	25CD6	1.44
5J6	.68	6BY6	.54	12AD6	.57	25CU6	1.11
5T8	.81	6BZ6	.54	12AF6	.49	25L6	.57
5U4GB	.60	6BZ7	.97	12AQ5	.52	35C5	.51
5UB	.81	6C4	.43	12AT6	.43	35Z5GT	.60
5V6	.56	6CB6	.54	12AT7	.76	50B5	.60
5X8	.78	6CD6	1.42	12AU6	.50	50C5	.53
5Y3GT	.46	6CF6	.64	12AU7	.60	50L6GT	.61
6AB4	.46	6CG7	.60				

All Tube Prices Subject To Change Without Notice! Ask for Types Not Listed! Use This Ad As Your Order Blank.

RAD-TEL TUBE CO.

Est. 1945

55 Chambers Street
Newark 5, N. J.
Mitchell 2-3147

NOT AFFILIATED WITH ANY OTHER MAIL ORDER TUBE CO.

TERMS: A 25% deposit must accompany all orders—balance C.O.D. Please send approximate postage. All shipments F.O.B. Newark warehouse. Orders under \$5—50c Handling Charge. Subject to prior sale. No C.O.D.'s outside continental U.S.A.

Are You Geared for Change?

(Continued from page 52)

hi-fi and stereo in many areas, FM offers countless opportunities for dealers who will seek the business aggressively. In many locations, the full benefits from FM broadcasts can be realized only through the use of an outdoor antenna. Any dealer who will develop a consistent promotion program on this type of equipment and do a conscientious job of satisfying his customers will add a substantial amount of pleasantly earned income to his business.

Service dealers located in good business areas with reasonable pedestrian traffic should study the possibility of retailing other types of merchandise, especially if they can allot adequate display area for it. Such items that relate to electronics are good, but anything at all is fair game for supplementary income, especially if it fills a demand not already being met by someone else in the vicinity. As an extreme case, greeting-card centers set up in spare corners of service shops have proved profitable, also improving the service business itself by creating more store traffic! In at least one such example of "diversification," the dealer's wife handles the greeting-card end of the business, leaving him free to conduct his service operation without distraction.

Hobby centers inside the shop, involving such items as model planes, boats, and trains, are magnets that draw local boys and men, particularly if a reasonable amount of window space is devoted to interesting displays. The tie-up with the hobbyist concerned with radio-controlled models or with electronics in general is something of a "natural." Many dealers who have been able to devote floor space and capital to such experiments have found that these added "departments" carry overhead for the entire shop once they are publicized and established.

In virtually every trading area, there are products or groups of products not carried by other businesses in the area for which a demand can be found. Discovering what they are and arranging for the space they must occupy are challenges to one's capabilities in business management. Remember this: it is easier and safer to add a side-line venture than to start an entirely new business.

The important point to keep in mind is that changes taking place in the handling of consumer electronic service are not simply affecting income of independent shops for the brief present: these changes are likely to have even greater impact as time goes on. To remain in business, the dealer must be constantly on the alert for activities which will re-inforce possible losses of income and help insure his ability to meet overhead and operating costs.

ELECTRONICS WORLD



Photo courtesy National Co., Inc.

IF THIS MAN IS ON YOUR CHRISTMAS LIST —

A subscription to **ELECTRONICS WORLD** will make a perfect gift for him, and every other man with a stake in electronics.

If he makes his living in electronics or is an advanced hobbyist who loves Hi-Fi, Radio, TV, Audio, R/C, ham radio and communications, he'll be delighted to get **ELECTRONICS WORLD** as a gift. For **ELECTRONICS WORLD** offers the best

technical coverage in the field. It provides men in electronics with tips and techniques on repairing, installing and maintaining radio and TV sets and circuits, latest Hi-Fi developments, newest ham techniques, fresh audio ideas, test equipment, and current industry news. There is no more thoughtful Christmas gift, or flatterer one, than a subscription to **ELECTRONICS WORLD**, the first and most authoritative magazine in the field. Each of your gift subscriptions will be announced by an attractive card, inscribed with your name. What's more, you can enter or extend your own subscription to **ELECTRONICS WORLD** at the special Christmas gift subscription rates, too!

Check the special Christmas gift order form, bound in this issue, for low gift rates. Then fill in the names and addresses of your friends, and mail it today!

WRAP UP YOUR CHRISTMAS GIVING NOW! DO IT EASILY, AND APPROPRIATELY, WITH **ELECTRONICS WORLD**



ELECTRONICS WORLD • 434 S. WABASH AVE. • CHICAGO 5, ILL.

FM TRANSMITTER-RECEIVER



APN-1. 420 to 460 Mc Aircraft Radio altimeter equipment. Tubes: 4—955, 3—12SJ7, 4—12SH7, 2—12H6, 1—VR150. Complete with all tubes and mount. For 27 V DC. **\$8.95**
BRAND NEW
 Original operating manual for above. **\$1.00**

TS-100AP OSCILLOSCOPE **\$3333**
 (worth \$750) **OUR LOW PRICE**

Can be used with linear sweep or general purpose test scope. Cables included. Also used with circular sweep as precision range calibrator. Self-contained in metal case 8" x 12 1/2" x 16" deep. For 110 V 50 to 1200 cycles AC. Excellent used, like new, with all tubes including crystals and C. R. Tube.

BC-929 3-INCH SCOPE



Low cost station monitor and/or bench scope. Has Horiz., focus, sweep, intensity controls. Tubes: 2—6SN7, 2—6BX6, 1—6X5, 1—6G6, 1—2X2, 3BP1 CR Tube. Voltage req. 115V 400 cy. and 24VDC. Complete with tubes. exc. **\$9.95**
 used **\$12.95**
BRAND NEW **\$12.95**
 Conversion instructions for 110V 60 cyc AC **65c**

BC-733 VHF 10-TUBE AIRCRAFT RECEIVER.
 6-channel xtal control. Freq. 108.3 to 110.3 Mc. Dual filter range. Easily converted for tracking Sputnik! **\$7.95**
 Exc. used. Complete with tubes.
 Brand New complete with tubes. **\$8.95**
 Dynamotor for above 12 or 24 V.—New **\$5.95**

AN/ARR-5A AIRCRAFT RECEIVER. 11 tube superhet, 3-crystal control UHF for static-free reception. **\$9.95**
 Exc. used with tubes.

ASB-5 SCOPE INDICATOR
BRAND NEW, including all tubes, together with 5BP1 Scope Tube. Originally used in Navy Aircraft RADAR equipment. Easily converted for AC operation. **VALUE \$250.00!**
DUR LOW PRICE \$15.95



SCR-522 2-METER RIG!

Terrific buy! VHF Transmitter-receiver, 100-156 Mc. 4 channels. Xtal-controlled. Amplitude modulated voice. They're going fast! Excellent condition.

SCR-522 Transmitter-Receiver, complete with all 18 tubes, top rack and metal case. **\$32.32**
COMBINATION Special

Receiver only, with all tubes. **\$19.50**
 Transmitter Only, with all tubes. **\$22.25**
 Accessories for above available.

LORAN APN-4
FINE QUALITY NAVIGATIONAL EQUIPMENT



Determine exact geographic position of your boat or plane. Indicator and receiver complete with all tubes and crystal.

INDICATOR ID-6B/APN-4, and RECEIVER R-9B/APN-4, complete with tubes. Exc. used **\$49.50**
 Receiver-Indicator as above. **BRAND NEW** **\$69.50**
 Inverter for above unit available from stock.

LORAN APN/4 OSCILLOSCOPE



Easily converted for use on radio-TV service bench.

Completely Assembled

LIKE NEW! Supplied with 5" Scope, type SCPI only **\$14.95**
 Brand New **\$19.50**

BC1206-C BEACON RECEIVER

195 to 420 Kc. made by Satchel-Carlson. Works on 24-28 volts DC. 135 Kc. IF. Complete with 8 tubes. Size 4" x 4" x 6". Wt. 4 lbs. **\$8.88**
BRAND NEW
 USED, less tubes. **\$2.95**

LORAN R-65/APN-9 RECEIVER & INDICATOR



Used in ships and aircraft. Determines position by radio signals from known transmitters. Accurate to within 1% of distance. Complete with tubes and crystal. Exc. used. Value \$1200.00. **\$79.50**
 Our Price.

REMOTE CONTROL RM-52

Direct remote control for radio equipment. Uses 4 flashlight batts. Provides bias for Microphone and sidetone to headset. Hi or Lo Imp., Mike and Phone Jacks. Makes good phone patch unit. **BRAND NEW** **\$2.49**

SCHEMATIC DIAGRAMS For any equipment on this page, each. **65c**

SEND FOR FREE CATALOG, many more Wonderful Surplus Buys!

ARC-5/R28 RECEIVER

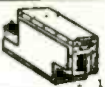

2-meter Superhet. 100 to 156 Mc in 4 crystal channels. Complete with 10 Tubes. **BRAND NEW \$24.45**
 110V AC Power Sup. Kit for above **\$9.75**

ARC-5/T-23 TRANSMITTER
 100-150 Mc Includes 2—832A, 2—1625 Tubes. **BRAND NEW \$21.50**
SPECIAL Limited quantity ARC-5/T23 xmtr. OFFER! Excellent Used, less tubes. **\$5.95**
MO-7 MODULATOR for T-23, complete with 4 tubes. **LIKE NEW \$9.95**

ARC-5 MARINE RECEIVER-TRANSMITTER

Navy Type Comm. Receiver 1.5 to 3 Mc **BRAND NEW** with 6 tubes. **\$16.95**

Navy Type Comm. Transmitter 2.1-3 Mc **BRAND NEW** with 4 tubes and Xtal **\$12.45**
MODULATOR for above, new with tubes. **\$5.95**

BC-906 FREQ. METER—SPECIAL
 Cavity type, 145 to 235 Mc. **BRAND NEW**, complete with antenna. Manual included. **OUR LOW PRICE \$9.88**



STANDARD TUBES

REMOVED FROM BRAND NEW EQUIPMENT	RECEIVING	6J4	6X5	6AC7	6J6	6BA6	6AS6	SPECIAL PURP.	3E29	4Z5	4X-150	6X4	6X5	6A5
155	35	59	813	6.95										
304	35	59	814	2.25										
6AG5	35	59	815	2.15										
12AT7	45	68A6	35	1625	29									
12X4	35	6AS6	35	1629	29									
6AK5	35	SPECIAL PURP.	2014	39										
6CA	25	3E29	4.25	4X-150	5.95									
6X4	32	6D7	.98	78P1	1.49									

BC-659 TRANSMITTER & RECEIVER
 27 to 38.9 Mc F.M. Two preselected channels crystal controlled. 5 to 10 watts. Complete with 11 tubes, speaker, tubes. Exc. Used. **\$11.95**

POWER SUPPLY for BC-620, 659, available for 6.12 or 24 Volts DC. Specify. **\$8.95**

SCR-625 MINE DETECTOR
 Complete portable outfit in original packing, with all accessories. Brand New. **\$22.50**

TG-34A CODE KEYER



Self-contained automatic unit, reproduces code practice signals recorded on paper tape. By use of built-in speaker, provides code-practice signals to one or more persons at speeds from 5 to 25 WPM. **\$16.88**

DYNAMIC ROOM MIKE M-33/AIC. Low impedance. With mounting bracket for attachment to headsets. A REAL VALUE at **\$9.95**

DYNAMIC HANDMIKE. with "Press-to-talk" switch on handle, cord and plug—**BRAND NEW**. Only **\$2.95**

DYNAMIC HANDMIKE. aircraft, made by Telephonics Corp. Press-to-talk switch on mike. **BRAND NEW** **\$4.95**

HI-FI DYNAMIC HEADSET with Cushions
 Freq. Range: 40-14000 CPS. No Distortion. **BRAND NEW \$7.85**

MICROPHONES Excellent BRAND

Model	Description	Used	NEW
T-17	Carbon Hand Mike	\$ 34	74
T-30	Carbon Throat Mike	1.25	5.95
T-45	Army and Navy Lip Mike	5.95	3.88
T-24	Carbon Mike	2.69	4.75
TS-9	Handset		
RS-38	Navy Type		

HEADPHONES Excellent BRAND

Model	Description	Used	NEW
HS-23	High Impedance	\$2.19	\$4.65
HS-33	Low Impedance	2.69	4.65
HS-30	Low Imp. (featherwt.)	1.15	1.89
H-16/U	High Imp. (2 units)	3.75	7.95

TELEPHONICS—600 ohm Low Impedance HEADSETS. BRAND NEW, PER PAIR **\$3.25**
CD-307A Cords, with PL65 plug and JK26 Jack **.99**
 Earphone Cushions for above—pair. **.50**

MOBILE-MARINE DYNAMOTOR



Input 12V DC. Output: 625 V DC @ 225 Ma. for pre- to talk intermittent operation. Shpg. wt. 14 lbs. **\$6.45**
DUR LOW PRICE

OTHER DYNAMOTOR VALUES: Excellent BRAND

Type	Input	Output	Used	NEW
DA-19-A	28V 11A	400V .400A	54.95	
DM-28	28V	224V .07A	2.75	4.75
DM-32A	28V 1.1A	250V .05A	2.45	4.45
DM-33A	28V 5A	575V .16A	1.95	3.75
	28V 7A	540V .25A	4.15	5.75
DM-34D	12V 2A	220V .080A	3.75	5.45
DM-53A	28V 1.4A	220V .080A	3.75	5.45
DM-64A	12V 5.1A	275V .150A	7.95	10.50
PE-73C	28V 20A	1000V .350A	7.95	10.50
PE-86	28V 1.25A	250V .050A	2.75	4.95

Please include 25¢ Deposit with order—Balance C.O.D., or Remittance in Full. 50¢ Handling Charges on all orders under \$5.00. All shipments F.O.B. Our Warehouse, N.Y.C. All Merchandise subject to Prior Sale and Price Change.

G & G Radio Supply Co.
 Telephone: CO 7-4605
 51 Vesey St., New York 7, N. Y.

AN/ART-13 100-WATT XMTR



11 CHANNELS
200-1500 Kc
2 to 18.1 Mc **\$4850** Complete with Tubes

Famous Collins Autotune Aircraft Transmitter. AM, CW, MCW. Quick change to any of ten pre-set channels or manual tuning. Speech amplifier/clipper uses carbon or magnetic mike. Highly stable, highly accurate VFO. Built in Xtal controlled calibrator. PP811s modulate 813 in final up to 90%, class "B." A Real "HOT" Ham buy at our low price! Orig. cost \$1800. **\$48.50**
 Exc. Used
O-16 Low Freq. Osc. Coll for ART-13 **7.95**
24V Dynamotor for ART-13 **11.95**

NAVY AIRCRAFT RADIO RECEIVER
CRV-46151(ARB). Communications receiver made by RCA. Complete coverage 195 to 9050 Kc in 4 bands continuous tuning. Complete with tubes and dynamotor, used. **\$17.95**
 Like New **\$26.50**

POWER SUPPLY for above, 110V AC, complete ready to plug in, wired. **\$9.75**

234-258 MC RECEIVER
AN/ARR-2



BRAND NEW 11-tube UHF Tunable Receiver with schematic. Only a few at this low price! Complete with tubes. **\$8.88**

SCR-274 COMMAND EQUIPMENT
ALL COMPLETE WITH TUBES

Type	Description	Used	NEW	Like
BC-453	Receiver 190-550 KC.	\$14.50	\$16.50	
BC-454	Receiver 3-6 Mc.	9.45	12.45	
BC-458	Receiver 6-9 Mc.	10.45	12.45	
BC-450	3-Receiver Control Box	1.25	1.75	

110 Volt AC Power Supply Kit, for all 274-N and ARC-5 Receivers. Complete with metal case, instructions. **\$7.95**
 Factory wired, tested, ready to operate. **\$11.50**

SPRINED TUNING KNOB for 274-N and ARC-5 RECEIVERS. Fits BC-453, BC-454 and others. Only **49c**

BC-457 TRANSMITTER—4-5.3 Mc. complete with all tubes and crystal. **BRAND NEW \$7.85**
BC-458 TRANSMITTER—5.3 to 7 Mc. Complete with all tubes and crystal. **BRAND NEW \$9.75**
BC-459 TRANSMITTER—7-9.1 Mc. complete with all tubes and crystal. **BRAND NEW \$12.75**
ARC-5 T-19 TRANSMITTER—3 to 4 Mc. BRAND NEW complete with all tubes & crystal. **\$8.85**
BC-456 Modulator USED 3.45 NEW 5.95
BC-451 Transmitter Control Box 1.25 NEW 5.95
ALL ACCESSORIES EQUIPMENT.

BC-603 FM RECEIVER
20 TO 27.9 MC. **\$1495**
 Like New



10-Channel, pushbutton tuning or continuous tuning. Complete with speaker, tubes, squelch.

12 or 24V Dynamotor for Above
 Exc. Used \$4.25 **Brand New \$8.50**

BC-683 same as above except 27 to 38.9 Mc. **LIKE NEW \$23.50**

AC POWER SUPPLY for BC603, 683 Interchangeable, replaces dynamotor. Has On-Off Switch. NO REWIND, CHANGE NEEDED. Provides 220 VDC @ 80 Ma. 24VAC @ 2 Amps. Complete with 220 VAC with exc. instructions. **\$10.49**
 Wired
 Complete 240-page Technical Manual for BC-603, 604 **\$2.95**

MIDGET FAN MOTOR



1 1/2" square x 2" long. 1/8" shaft extends 1/8". 10,000 RPM. 24V DC. **\$2.19**
 Input. Complete with fan.

FL-5 FILTER **\$1.19**

WILLARD 6-VOLT MIDGET STORAGE BATTERY



3 Amp. Hour. **BRAND NEW** 3 3/4" x 1-13/16" x 2 3/8". Uses Standard Electrolyte. **Only \$2.88**

2 VOLT BATTERY "PACKAGE"



1-2V, 20 Amp. Hr. Willard Storage Battery Synchronous **\$2.79**
 1-2V, 7 prong Synchronous Plug-in Vibrator Electrolyte for 2 1.49
 1-Quart Bottle Electrolyte (for 2 cells) **1.45**
ALL BRAND NEW! **\$5.45**
 Combination Price

COYNE offers
LOW COST
TELEVISION
Training in
Spare Time **AT HOME**

The future is **YOURS** in
TELEVISION—RADIO
COLOR TV!

A fabulous field—good pay—fascinating work—a prosperous future! Good jobs, or independence in your own business!



Coyne brings you **MODERN—QUALITY** Television Home Training; training designed to meet Coyne standards. Includes **RADIO, UHF and COLOR TV**. No previous experience needed. Practical Job Guides to show you how to do actual servicing jobs—make money early in course. You pay only for your training, no costly "put together kits."

Send coupon or write to address below for **FREE Book**

and full details including easy Payment Plan. No obligation, no salesman will call.



B. W. Cooke, Jr., President

Coyne — the Institution behind this training... the largest, oldest, best equipped residential school of its kind now in its new home pictured here... Founded 1899.

COYNE
ELECTRICAL SCHOOL

1501 W. Congress Pkwy., Chicago, Dept. 89-H6
Chartered as an Educational Institution
Not For Profit

COYNE Television, Home Training Division
Dept. 89-H6—New Coyne Building
1501 W. Congress Pkwy., Chicago 7, Ill.
Send Free Book and details on how I can get Coyne Quality Television Home Training at low cost and easy terms.

Name _____

Address _____

City _____ State _____

(It is understood no salesman will call)



"TRANSISTORS IN RADIO, TELEVISION AND ELECTRONICS" by Milton S. Kiver. Published by McGraw-Hill Book Company, Inc., New York. 419 pages. Price \$7.95. Second Edition.

The three years that have elapsed since the first edition of this book made its appearance have witnessed amazing progress both in the improvement of transistors themselves and in their application to a wider variety of circuits. Because of these many important changes, this volume represents a complete revision of the earlier text.

Written primarily for the service technician in radio and television, the text covers point-contact and junction transistors, transistor characteristics, amplifiers, oscillators, radio receivers, transistors in TV receivers and in electronic circuits, additional transistor developments, servicing transistor circuits, experiments with transistors, and transistor amplifier design.

A bibliography, test questions, and transistor data tables complete the text, making it a self-contained volume for the student and technician. Most readers of this magazine are familiar with Mr. Kiver's lucid style and will find in this volume the same clear-cut, thoroughly intelligible exposition which characterizes his other textbooks for practicing technicians. Extensive use of line drawings, graphs, cut-away diagrams, and photographs has eliminated the need for elaborate mathematical exposition.

"FUNDAMENTALS OF NUCLEAR ENERGY AND POWER REACTORS" by Henry Jacobowitz. Published by John F. Rider Publisher, Inc., New York. 114 pages. Price \$2.95. Soft cover.

Since the day is rapidly approaching when the electrical power in our homes will be generated by nuclear reactors (several pilot plant operations are already under construction by the utilities), the subject matter of this book is not as remote from our daily lives as might be expected.

This is an up-to-the-minute, not-too-technical discussion of the part the "peaceful atom" can play in our future. The author discusses the construction, principles of operation, cost, and power output of specific plants and covers experimental reactors which will serve as prototypes for commercial units of the future.

The text is lavishly illustrated with photographs, line drawings, cut-away views, and pictorial diagrams. Since

the treatment is largely non-mathematical, the intelligent layman should derive as much benefit from this book as utility company personnel.

"CLASS 'D' CITIZEN RADIO 1959 CALL BOOK" compiled and published by International Crystal Mfg. Co., Inc., Oklahoma City, Okla. 101 pages. Price \$1.00. Soft cover.

This is Vol. 1, No. 1 of what the company expects to be a series of "call books" for the "Class D" service in the Citizens Band. The material is presented in familiar "call book" format by zones and, in addition, information on Citizens Band channels, radio districts, hanging coax antennas, message codes, radio codes, and pertinent FCC regulations has been included.

Calls are listed in numerical order with the license holder's name, street address, city, and state following. Those now licensed in the "Class D" Citizens Radio Service will undoubtedly find this material extremely helpful in view of their assumed inexperience with radio procedures.

"BASIC ELECTRONIC TEST PROCEDURES" by Rufus P. Turner. Published by Rinehart & Co., Inc., New York. 316 pages. Price \$6.50.

The sub-title of this volume aptly describes its content—"a practical handbook for electronic technicians." The novice technician, who already knows the basics about test instruments, possibly from this author's companion volume "Basic Electronic Test Instruments," will find in the present text step-by-step instructions on the use of meters, scopes, bridges, distortion checkers, and many other instruments. A large number of typical test setups are illustrated and described, ranging all the way from how to measure line voltage with a meter to industrial measurements.

Readers of this magazine are familiar with the author's clear, direct presentation. As a further aid to students each chapter is followed by a complete summary and a large number of review questions and exercises. The text should be of great value to all who use basic electronic test instruments professionally, as a hobby, or those who want to learn to use these instruments properly and profitably.

"SCIENCE STUDY SERIES" published by Doubleday & Company, Inc., Garden City, N. Y. Five volumes. 95 cents each. Paper bound.

This new and basic series of "handbooks" represents a unique and dra-

matic approach to the teaching and study of physics. Born as the result of a conference of scientists and educators meeting at MIT, this series is under the aegis of the Physical Science Study Committee of Educational Services, Inc. and published by *Doubleday Anchor Books* and Wesleyan University working cooperatively.

Each volume is written by an authority in the field who is also endowed with that rare gift of enthusiasm for his subject plus an ability to transmit both his knowledge and his enthusiasm.

There are currently five volumes in the series—"The Neutron Story" by Donald J. Hughes, a senior physicist at the Brookhaven National Laboratory; "Magnets" by Francis Bitter, professor of physics and associate dean of the School of Science at MIT; "Soap Bubbles" by C. V. Boys, (Sir Charles—1855-1944); "Echoes of Bats and Men" by Donald R. Griffin, professor of zoology at Harvard University; and "How Old Is the Earth?" by Patrick M. Hurley, specialist in the history of the earth at MIT. The volumes are numbered 1 through 5 in the order listed.

It would be difficult to find a more worthwhile venture in the paperback publishing field than this series of books—the information is authoritative, vital, and interestingly presented. Illustrative material has been used unstintingly and math sparingly—making these volumes basic enough for the beginner but authoritative enough for the

serious student of the subject. All concerned with this project are to be congratulated on their foresight and public-spirited interest in the dissemination of scientific knowledge.

"RADIOTELEPHONE LICENSE MANUAL" by Woodrow Smith. Published by *Editors and Engineers, Ltd.*, Summerland, Calif. Price \$5.00. Second Edition.

This manual is designed as an aid to those preparing for FCC license examinations covering basic radiotelephone and advanced radiotelephone tickets. It doesn't supplant standard texts on theory but does indicate the scope of the examinations and the areas on which the prospective licensee should concentrate his study efforts.

The text is divided into four chapters and an appendix. The chapters coincide with the "Elements" in the FCC exam and cover basic law, basic operating practice, basic radiotelephone, and advanced radiotelephone. The appendix includes useful formulas, radio mathematics and calculations, plus logarithm and decibel tables.

The material is presented in question and answer form for succinctness and to give the student a "feel" for the actual examination. The answers are brief and explanatory material is accurate but concise. For further exposition on any particular point, the student should consult standard engineering texts. Diagrams of circuits called for have been included.

MOBILE RADIO EQUIPMENT

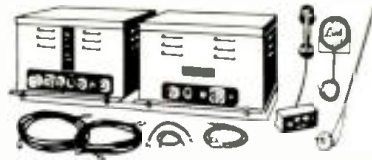

2 PIECE MODEL FMTR 30-50 MC ED. 1 FM MOBILE TRANS. & REC.—6 VOLTS
Unit complete with Peak Modulation control head, mike, antenna, cables & crystals ground to your specific frequency. Modified for 20F3 emission.
Emission MODEL FMTR-12V. operation.....\$109.95

MODEL 2210 152-162 MC FM MOBILE TRANSMITTER & RECEIVER—6 VOLTS
Trans. constructed in accordance with latest FCC Reg. for 20F3 emission. Complete with antenna cables, control head, mike & crystals ground to your specific frequency. Ready for immediate installation. Specially priced.
MODEL 2210—12V. operation.....\$139.50
MODEL 2210—12V. operation.....\$162.50

MODEL 2365 FM MOBILE TRANS. & REC.
As above covering 25-40 or 30-50 MC.
6 V. Modified for 20F3 emission..... \$119.50
MODEL 2365—12V. operation.....\$149.50

MOTOROLA TRANSCEIVER Model FMTRU 80D (A) DSP13
Strip construction, 30 W. Power output, Permabay filter, narrow-band, 6 V. Dynamotor power supply. Freq. 152-174 Mc. Complete with Cables, Controls, checked-out, excellent condition.
For 12 V. operation.....\$199.50
For 12 V. operation.....\$239.50

SPECIAL!
UNIVERSAL 6/12 VOLT VIBRATOR POWER SUPPLY WIRED, Mfg. by DUMONT.
Rating 300 V. @ 100 mill. Ideal for all types of mobile applications. Chassis measures 5 1/4" x 5 1/4" x 8"
Brand New.....\$11.95

Include 25% deposit with order—balance C.O.D. 50¢ handling charge on all orders under \$5.00. All shipments FOB our warehouse, NYC.

PLATT ELECTRONICS CORP.

20 MURRAY ST., NEW YORK 7, N. Y.
Telephone: COrmandt 7-2575



ARR-2 UHF RECEIVER

R-4/ARR-2 Receiver is tunable over the frequency range of 234-258 mc. Uses 11 miniature tubes. In excellent condition complete with TUNING MOTOR and ALL TUBES.
ONLY.....\$2.95

RM-52 REMOTE CONTROL FOR PHONE PATCHES

Also can be used with RM-53 as separate phone system direct control for radio equipment. Provides bias for misc. & sidetone headset. High or low impedance. THIS IS BRAND NEW!
ONLY.....\$1.95

EE-8 FIELD PHONES

The standard signal corp. field telephone requires 2 flashlight cells for operation over many miles. Good checked out condition.
ONLY \$7.95 Each \$15.00 Per Pair

FM TRANSMITTER-RECEIVER

AFN-1 Transceiver ideal for conversion to citizens band. Has a frequency range of 420-430 mc. Complete with 14 tubes in excellent condition. ONLY.....\$3.95



TG-10 CODE PRACTICE SET

Learn to copy code, or improve your speed with this unit. For individuals and especially fine for schools or groups. Complete automatic unit operating from 110 volt 60 cycle using inked paper tapes to reproduce via an audible means the Morse code. The keyer may be set from 5 words per minute to 25 words per minute. Use of a key instead of tapes for classroom work especially good due to 10 watt amplifier allowing many sets of earphones to be connected. These are NEW IN ORIGINAL BOXES for only.....\$19.95
TG-10 in used excellent condition only.....\$14.95
COMPLETE SET OF 15 Code Tapes in Carrying Case.....\$18.95

BC-728 MARINE RECEIVER

2.6 Mc. AM. Self-contained 12 V. or portable power supply AMB speaker! May be pre-tuned to any four frequencies thru simple adjustment of 4 push-button assembly. In good, used condition.
Top bargain at.....\$7.95

FILTER CHOKE

9 henries @ 500 MA DC. 47 ohms DC resistance. 12,500 RMS Volt Test. Size: 9 1/4" high x 1 1/4" long x 1 1/2" wide. MFR. for Collins Radio by Chicago Transformer! Brand new & Individually Boxed! Original \$59.30. Our special to you Kw boys.
ONLY.....\$9.95

RGS-U COAX CABLE: NEW! 50 ft. length. Connectors @ each end. Limited quant.....\$2.95
PL-59 CO-AX CONNECTORS—Shining new. Ea. 29¢ 4 for \$1.00

WILLARD WET CELL BATTERY

This is the standard Willard 25-2 dry charged. Made to fit many portables using rechargeable wet batteries. 2 Volt 25 Amp. ONLY \$2.95

THE STEAL OF A LIFETIME

BC-442-A or RE-2/ARC-5 Antenna switching units. Contain double pole double throw Antenna change over relay, thermocouple, RF amp and 5000 volt vacuum capacitor. Complete unit.....\$1.50
excellent condition..... ONLY

T-17 CARBON MICROPHONES.....USED EXC. \$3.95
BRAND NEW, BOXED.....\$5.50

POWER SUPPLY SPECIALS BOTH MOBILE AND FIXED

DM-35-D Mitey Mite dynamotor. 12VDC input will give you 625 VDC @ 225 ma. in an extremely small package. Will fit the glove compartment of almost any auto. BRAND NEW..... ONLY \$7.95



PE-100

Originally built for 19" panel mounting. Unit has panel and 6 volt dynamotor on chassis. Dynamotor outputs are 225 VDC @ 60 ma. Continuous or better Intermittent. Complete filtered and fused with pilot light indicator on panel.
BRAND NEW..... ONLY \$2.95



CIA-20330

This is the steal of the century. This power supply is voltage regulated, completely enclosed with its own crackle finish cover, and fused. Input voltage is 115 volts 60 cycle. The Three outputs deliver 105 VDC, 165 VDC, and 0.3 VAC for filament. Only a few at this remarkable \$4.95 price..... ONLY \$4.95

CODE PRACTICE SET TG-5

Ideal for Novice training. This unit comes complete with carrying case and earphone with built in standard telegraph key. Two or more units may be used together for CW training or for communications purposes over several miles.
Brand New. Ea. ONLY \$4.95
Set of 2.....\$9.50

COILED MIKE OR TELEPHONE CORD

Off-line special! Has seven color coded conductors built-in speaker, 10 pre-selected push-button channels at each end with made lug on each. Extends over 5 ft.—yet is no larger in diam. than standard telephone cord. Neoprene covered. New. Boxed. Recent manufacture (1956). Each.....95¢
Save by buying three for one!.....\$2.50

BC-603 RECEIVER

20-27.9 Mc. FM. Operates from 12 V. dynamotor. New or Signal Corps overhauled. In orig. Signal Corps cartons. ONLY.....\$9.50

95¢ BARGAINS BOX!

Control Boxes as follows: all 95¢ each.
C-35/ARR-2 C-118/ARR-2
C-26/ARC-5 for single receiver.
C-125/ARC-5 Later model than C-26.
MT-65/ARC-5 Fibre Receiver Racks.
BRAND NEW.....95¢ each
MT-71/ARC-5 Dual Transmitter Racks.
BRAND NEW.....95¢ each

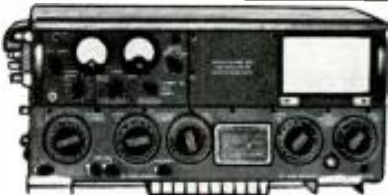

100 W. COLLINS AUTOTUNE TRANSMITTER
Famous ART-13 AM. CW, MCW, 11 channel Transmitter tunes the band from 2-18.1 mc. Quick automatic tuning to any of 11 preset frequencies or manually tuned. Has extremely accurate VFO. Self contained modulator uses 1F 811 to modulate B13 final up to 40% class "B." Will give top performance with either carbon or magnetic mike. COMPLETE WITH ALL TUBES.
Excellent condition..... ONLY \$34.95

SEND FOR NEW FREE BARGAIN-LOADED INTRODUCTORY FLYER!
TERMS: all orders F.O.B. our warehouse Los Angeles. 25% deposit required on all C.O.D. orders. All items subject to prior sale. Minimum order \$3.00. Orders over 20 lbs. shipped via motor truck or rail express whichever may be cheaper.

5645 WEST ADAMS BLVD.
LOS ANGELES 16, CALIF.
PHONE WEbster 3-7538

AERONETICS INTERNATIONAL

NOW!

**Step ahead faster
as an
INDUSTRIAL
ELECTRONICS
TECHNICIAN**



Turn your experience into a big, new better-paying career! Day by day industrial plants are adding more electronic devices—for sorting, counting, checking almost any control job you can name. Cash in on industry's great need for men who can keep these devices in top working order. Make more money, feel more secure, doing work that is second nature to you. With what you already know about electronics you have a long head start in a field just beginning to boom. GET INTO IT RIGHT NOW with the help of

**PRACTICAL INDUSTRIAL
ELECTRONICS LIBRARY**

No long sessions on math or theory! These 4 practical volumes show you how to keep the plant's electronic equipment working . . . how to locate and correct tube and circuit troubles . . . how to install, service, and maintain even brand new equipment without being stumped by new circuits. **FREE TRIAL—EASY TERMS**

4 volumes (1369 pp., 1102 illus.)
Chute's Electronics in Industry
Miller's Maintenance Manual of Electronic Control
Markus & Zeluff's Handbook of Industrial Electronics Circuits
Henney & Fahnestock's Electron Tubes in Industry

McGraw-Hill Book Co., Dept. ELW-11,
327 W. 41 St., N. Y. C. 36

Send me the Practical Industrial Electronics Library for 10 days' examination on approval. In 10 days I will send \$3.50, then \$3.00 a month until \$23.50 is paid. (A saving of \$5.00 under the regular price of \$28.50.) Otherwise I will return books postpaid. (Print)

Name

Address

City Zone State

Company

Position ELW-11

For price and terms outside U. S. write
McGraw-Hill Int'l., N. Y. C.

EXPECTING A CHECK?
You'll get it quicker if you give your postal delivery zone number with your address.

**TV PICTURE TUBES
At Lowest Prices**

10BP4 \$ 7.95	17BP4 \$ 9.95	21AMP4 \$15.75
12LP4 8.50	17CP4 17.00	21ATP4 15.75
14B/CP4 9.95	17GP4 17.60	21AUP4 15.75
16DP4 12.00	17HP4 12.50	21EP4 13.50
16EP4 12.75	17LP4 11.50	21FP4 14.50
16GP4 14.50	17QP4 9.95	21WP4 14.00
16KP4 9.95	17TP4 17.00	21YP4 14.50
16LP4 10.95	19AP4 16.00	21ZP4 13.50
16RP4 9.95	20CP4 13.50	24CP4 23.50
16WP4 12.00	20HP4 14.50	24DP4 24.50
16PT4 9.95	21AP4 22.10	27P4 39.95
17AVP4 12.50	21ALP4 15.75	27RP4 39.95

1 Year Warranty
Aluminized Tubes \$5.00 more than above prices. Prices include the return of an acceptable similar tube under vacuum. These tubes are manufactured from reprocessed used glass bulbs. All parts and materials including the electron gun are brand new.

ALL PRICES FOR CHICAGO, ILLINOIS. Deposit required, when old tube is not returned, refundable at time of return. 25% deposit required on COD shipments. Old tubes must be returned prepaid. Tubes shipped Rail Express.

WRITE FOR COMPLETE LIST.

PICTURE TUBE OUTLET

3032 MILWAUKEE AVE.
CHICAGO 18, ILLINOIS
Dickens 2-2048

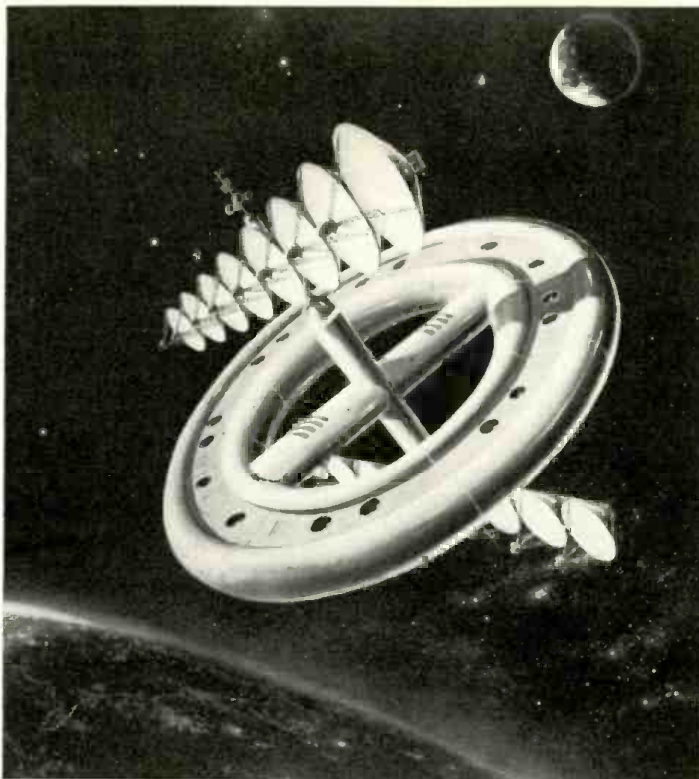

RCA's version of manned satellite that would hover far above the earth.

Space Platforms for the Future

Both manned and unmanned communications sky stations are now on government and on company drawing boards.

COMMUNICATIONS space stations of the type shown above—based on actual plans developed by engineers of RCA's Astro-Electronic Products Div.—may become future "orbital post offices," relaying messages around the world by microwave radio. The satellite would remain in fixed orbit at 22,000 miles altitude, with antennas beamed at receiving and transmitting stations on earth. A network of three or four such stations may ultimately link all of the world's major cities with live television and microwave radio communications.

Shown below is a sky station proposed by Raytheon Company's Government Equipment Div. that would be powered by microwave energy beamed from the ground and then converted into heat energy in the satellite itself. The company has been awarded an Air Force study contract to spur the development of efficient forms of power conversion techniques. In addition to the radar antenna, the artist's conception also shows a number of relay antenna dishes that would be employed for long-range microwave communications.

Raytheon's sky station would be unmanned and powered by microwave energy from earth.

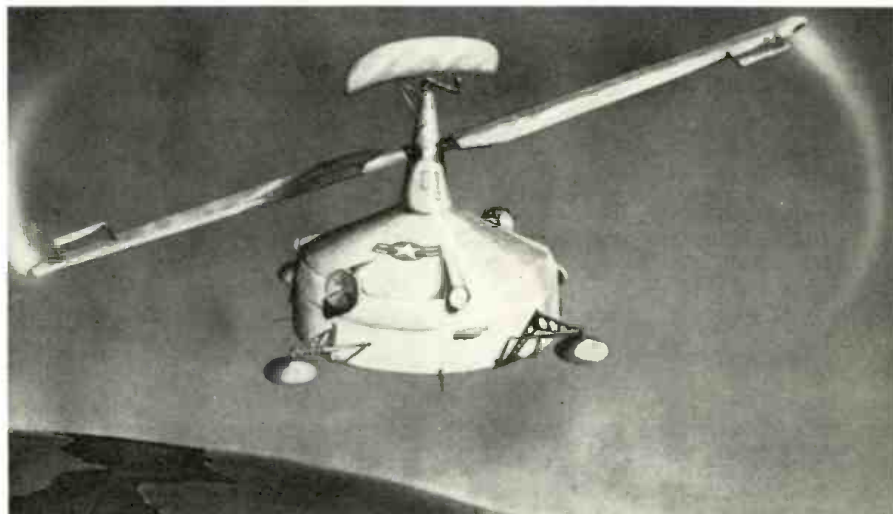

Preserving & Cooking Food

(Continued from page 40)

Surprisingly enough, the technician called to service a microwave oven will not be confronted by an immensely complex device. The only essential test equipment is a volt ohmmeter such as any radio and TV technician already owns. The service manual of the *Raytheon* "Mark III" unit shows a series of troubleshooting steps which will appear really easy to anyone accustomed to following TV service procedures. Most troubles are either magnetron failures, which can be determined by d.c. current or 60-cps voltage measurements, as indicated by the monitoring points in Fig. 9, or else poor contacts, broken leads, etc., which ohmmeter tests will show up quickly. Probably the most time-consuming part of servicing would be the disassembly of the power transformers and electromagnets because they contain a liquid cooling jacket. Fortunately, these parts are rarely the cause of trouble.

Routine servicing includes replacement of the air filters, defective or jammed interlock repair, adjustment or replacement of timers and burned out indicator lights, and fuses.

Conclusion

As mentioned at the beginning of this article, the "miracles" produced by the impact of electronics on the

food industry will not be sudden but we can look forward to steady progress. Irradiation of food will soon move out of the laboratory and will probably first be used to meet the needs of our Armed Forces. Like many other uses of electronics which were pioneered by the Services, irradiation of foods will eventually be accepted by industry and, while the progress will be slow, the day will come when irradiated bread and many other items make their appearance in our daily diet. At first there will be competition among frozen, canned, and irradiated foods, but eventually the most economical method for each particular food will win out. While fresh irradiated fruits may be better than frozen or canned ones, beer should still be served cold, beans canned, and ice cream . . . irradiated?

The effect of microwave cooking is much easier to foretell. Since our ladies will enjoy even greater freedom from the "hot stove," they will be able to relax more and therefore continue on their merry road to "full emancipation." There is a bright side, too. It will take no longer to prepare a nice roast than it takes to cook frankfurters—so we can anticipate an occasional improvement in our diets. Our technically minded readers may face a new hazard though. They may have to fix, not only all the other household appliances, but "put a new tube in the oven" from time to time.

—30—

CUT HOLES IN 1-1/2 MINUTES

(OR LESS)

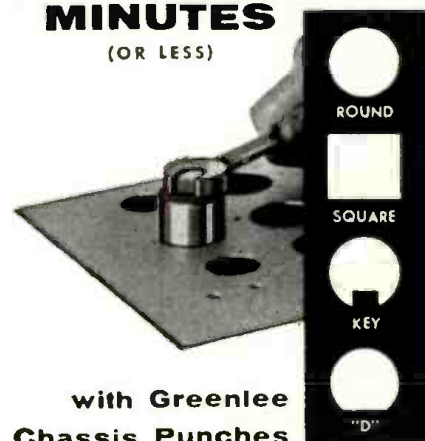

with Greenlee
Chassis Punches

Many sizes . . . quickly make smooth, accurate holes in metal, hard rubber, or plastics . . . for sockets, plugs, controls, meters, panel lights, etc. Easy to use, simply turn with wrench. Write for literature.



GREENLEE TOOL CO.
1782 Columbia Avenue
Rockford, Illinois



New
4th edition
now available!

The book that keeps growing in usefulness and popularity

It's here! The brand-new 4th Edition of General Electric's famous Transistor Manual . . . 227 pages jam-packed with vital information you need to keep abreast of this fast-moving and fabulous field.

You'll find 74% more information . . . new material on small and large signal characteristics, transistor radio servicing techniques and basic computer circuits . . . all the latest G-E transistor specs and a complete, up-to-date list of registered JEDEC types.

This is the one book in the transistor field you can't afford to do without! Get your copy from your General Electric Tube Distributor, or by mailing the coupon at right.



Partial List of Contents:

- Basic Semiconductor Theory
- Transistor Construction Techniques
- Small Signal Characteristics
- Large Signal Characteristics
- Biasing
- Audio Amplifiers
- "Hi-Fi" Circuits
- Radio Receiver Circuits
- Transistor Radio Servicing Techniques
- Switching Characteristics
- Basic Computer Circuits
- Logic
- Unijunction Transistor Circuits
- Silicon Controlled Rectifier
- Tetrode Transistors
- Power Supplies
- Transistor Specifications
- Rectifier Specifications

GENERAL  **ELECTRIC**

General Electric Company
Semiconductor Products Dept., Section 558119,
Electronics Park, Syracuse, N. Y.

Rush me the new enlarged 4th Edition of the General Electric Transistor Manual. I enclose \$1.00. (No stamps, please.)

Name _____

Address _____

City _____ Zone _____ State _____

NEW VACUUM CAPACITORS

EIMAC VC 12 MMF-32KV	ea. \$6.95
EIMAC VC 25 MMF-32KV	ea. 7.95
EIMAC VC 50 MMF-32KV	ea. 8.95
JENNINGS JHC-150 MMF-50KV	ea. 39.95

FREQUENCY METER

Vibrating REED type. Range 57 to 63 cycles. 6 reeds, 110 V. Bakelite case. ea. **\$10.95**

BRAND NEW MOBILE DYNAMOTORS

MADE BY EICOR—SMALL SIZE
Input 12 Volts. Output 400V. 180Ma. Cont. Duty. 250 Mil. Int. Duty. ea. **\$4.95**
Input 12V. Output 440V. 200Ma. Cont. Duty. 300 Mil. Int. Duty. ea. **\$6.95**

POWER TRANSFORMER

Pr. 110V. 60 Cy. Sec. 300-0-300 V. 125 Ma. 12 Volt CT @ 3 Amps; 12 Volts @ 3 Amps; 2 Amps/Replacement Transf. for 5V @ 2 Amps/Replacement Transf. for BC 342 Rec. (also for 24V. Use) ea. **\$2.50**
Pr. 115V. Secs. 320-0-320V. @ 150 Ma. 5V. @ 2 Amps 6.3V. @ 3 Amps. Write for quantity prices **\$2.95**

FILAMENT TRANSFORMERS

Prim. 115V. 60 cy. Sec. 6.3V. @ 20 Amps. H-41/2" x W-4" x D-31/4" ea. **\$3.50**
Primary 110V. 60 cy. Sec. 5V. @ 40 Amps. Int. 10,000 V. Small size. 2 for 57.50. Each **\$3.95**
Primary 110 volts 60 cycle. Secondary 2 1/2 V. 30 Amps. 10,000 V. Insulation. Suitable for pair of 856 tubes. ea. **\$3.95**

WESTON 506 SQ. VU METER

Calibrated Minus 20 to plus 3 and 0-100 VU. Square case. ea. **\$6.95**

CHOKE—FULLY CASED

5 HENRY @ 200 Ma	1.95
5 HENRY @ 250 Ma	2.95
4 HENRY 400 Mil	3.95
12 HENRY 500 Mil	8.95
4 HENRY 500 Mil	12.95
6 HENRY 600 Mil	19.95

BRAND NEW OIL CONDENSERS

2 MFD 600 VDC .50	1 MFD 2000 VDC .85
3 MFD 600 VDC .60	2 MFD 2000 VDC 1.50
4 MFD 600 VDC .75	3 MFD 2000 VDC 2.75
5 MFD 600 VDC .80	6 MFD 2000 VDC 4.95
6 MFD 600 VDC .85	8 MFD 2000 VDC 5.95
8 MFD 600 VDC .95	2 MFD 2500 VDC 2.50
10 MFD 600 VDC 1.19	1 MFD 3000 VDC 1.85
12 MFD 600 VDC 1.50	2 MFD 3000 VDC 3.50
3X8 (24 MFD) 600 VDC 2.50	4 MFD 3000 VDC 6.95
1 MFD 1000 VDC .60	1 MFD 4000 VDC 3.25
2 MFD 1000 VDC .85	2 MFD 4000 VDC 6.25
3 MFD 1000 VDC 1.35	3 MFD 4000 VDC 8.95
4 MFD 1000 VDC 1.35	1 MFD 5000 VDC 6.95
5 MFD 1000 VDC 1.35	3 MFD 7500 VDC 2.95
10 MFD 1000 VDC 2.50	1 MFD 12,500 " 19.95
12 MFD 1000 VDC 2.95	1 MFD 15,000 " 3.50
15 MFD 1000 VDC 3.50	1 MFD 15,000 " 3.50
1 MFD 1200 VDC .45	5 MFD 125 AC 2.50
1 MFD 1000 VDC .75	4 MFD 330 AC .85
2 MFD 1500 VDC 1.10	10 MFD 330 AC 1.95
4 MFD 1500 VDC 1.95	50 MFD 330 AC 2.50
8 MFD 1500 VDC 2.95	15 MFD 440 AC 2.50

REDMOND BLOWER

110V. 60 cyc. .3 Amp. 1800 Rpm. 3 3/4" Blower wheel—Outlet 2" Diameter. ea. **\$7.95**
2 for **\$15.00**

SIGMA 5F RELAY

16,000 ohm in dual 8,000 ohm coils. SPDT adjustable silver contacts and armature tension. Operates on 500 Microamperes or less. ea. **\$3.95**
Write for quantity prices

RELAYS

Allied Relay 110 V. AC. DPST	ea. \$1.35
Hermetically Sealed Relay Coil 110V AC 60 cy SPDT Contacts 5 Amps	ea. \$1.50
6 Volt DC DPDT H.S.	ea. 99c
12 Volt DPST DC Relay	ea. \$1.10
12 Volt DPDT DC Relay	ea. \$1.35
SIGMA type 22RJC 8,000 ohms. SPDT, small sealed relay	ea. \$2.49
Sealed Relay. SPDT. 6,000 ohm coil	ea. \$1.95
G.E. Relay control, contains 8000 ohm relay, sensitivity 2 mils 10 for 59.25. ea. LEACH ANT. RELAY 110V. AC DPDT Ceramic Int.	ea. \$3.45

DUAL GANGED SUPERIOR POWERSTAT
Brand New—0-110 V. AC 60 Cy. Each unit 18 Amps (36 Amps total) ea. **\$59.50**

PANEL METERS

G.E. WESTINGHOUSE	W.E. SIMPSON, etc.
1 1/2" METERS	3" METERS
0-1 Mill DC	100-0-100 Micro Amps DC
0-100 Micro	0-10 Mill DC
	0-50 Mill DC
2" METERS	0-100 Mill DC
0-50 Micro (0-5 scale)	0-12 Volts AC
0-300 Mill DC	0-15 Volts AC
0-10 Amps DC	0-800 Volts DC
0-20 Volts DC	0-2.5 KV DC
18-36 Volts DC	0-4 KV DC
0-150 V. AC	"S" Meter Calib. to 50db
0-3 Amps RF	Running Time Meter, 0-999.9 hrs. 110V. 60 cy. ea. 9.50

MISCELLANEOUS SPECIALS

36 OHM 50 Watt Globar Non-Ind. Res.	ea. 60c
3-12 MMF Erlo Ceramic Trimmers.	2 for 9.00
Murdoch Headphones—BRAND NEW 10,000 ohm Imped. with std. phone plug.	ea. \$2.95
Replacement 6" phone cord for Standard Headsets	ea. 35c
UTC DUNGER TRANS. Pr. 100 ohm. Sec. 125,000 ohm. Ideal for mike or phone patch.	2 for \$1.00
CUTLER-HAMMER TOGGLE SWITCH	ea. 29c
SPDT (752) 4 for \$1.00.	ea. 29c
WILLARD STORAGE CELL—2V. 28 Amp Clear plastic case.	ea. 2.50

Shipped dry. Write for quantity prices on all special items

All merchandise sold on a 10 day money back guarantee basis

Min. Order \$3.00—25% with Order—F.O.B. New York

PEAK

ELECTRONICS COMPANY
66 W. Broadway, New York 7, N. Y., WO-2-5439

Printed Boards

(Continued from page 51)

circuit tracing. From the beginning, set manufacturers had some awareness that a service technician would need some sort of aid to guide him through the impossible labyrinth deposited on the board. Earliest attempts involved pictorial aids included with the service data, like the one shown in Fig. 3, which the technician was required to correlate with the "blind" board. While this approach had its shortcomings, the use of numbered and lettered coordinates running along the top, bottom, and sides of the pictorials is noteworthy. This is the same technique used for pinpointing exact locations on conventional road maps—and the comparison is prophetic.

The pictorial aid is valid and still used, but it now plays second fiddle to identification directly on the boards themselves. In Fig. 4 we see a portion of the top or component side of the RCA board that corresponds to the pictorial aid in Fig. 3. For clarity, Fig. 4 is shown with no components mounted. All actual wiring occurs on the underside of the panel, but the conductive paths have been faithfully transferred to the top in ink to facilitate tracing. In addition, the same numbers that identify components, tubes, and key circuit points on the schematic (such as C_{502} , R_{510} , E_1 , G_2 , L_{501}) are clearly printed beside the actual parts.

G-E does things a little differently. Fig. 1 is the lower right-hand portion of the board shown at the center of the cover, with no components mounted. Identification in bright yellow indicates tube types (6CB6, 6BZ6). Point-to-point circuit connections, instead of following the twisting paths below the board, are shown as direct, straight lines. Ground points are indicated by triangular symbols. Other important connections ("B+1") and key test points (Roman numerals, such as "III") are marked to correspond with the service data. The fainter indications in Fig. 1 are in-plant production markings in white, to be ignored by the technician.

The Westinghouse answer to the problem of "reading" the board (Fig. 2) is based on another distinctive approach. All components are mounted on one side of the board. Everything else—this includes actual wiring as well as all identification—is on the other side. The protective, insulating overcoating on the conductive paths is in bright green for easy tracing. All other connections, components, and key points are shown *schematically* in yellow, nonconductive ink. Conventional symbols for resistors, capacitors, and coils are used, and actual values are printed beside them. Actual tube type numbers and functional pin connections are marked, instead of arbitrary code numbers. In other words,



KNOW-HOW!

That's the real difference between the average home-movie fan and the professional out in Hollywood!

Know-how doesn't come easy. But if you're sincerely interested in better movies you can start yourself along the road with the all-new HOME MOVIE MAKING ANNUAL.

Prepared by the Editors of POPULAR PHOTOGRAPHY, the 1960 HOME MOVIE MAKING ANNUAL goes on sale at your newsstand November 5th and costs only \$1.00.

You'll get facts, tips and pointers from the experts on every phase of home-movie making. You'll enjoy the big special book bonus—THE AMATEUR CAMERAMAN'S HANDBOOK—bound right into the magazine. And you won't want to miss features like:

- The Language of Color
- Special Effects for the Amateur
- How to Dramatize the Stories Around Us
- How to Make an Abstract Film
- Complete Guide to Camera Movement
- Acting for Amateurs
- Movie Music
- Directory of Equipment
- Complete Guide to Movie Exposure

PLUS . . . articles covering Sound . . . Accessories . . . Scripting . . . Tinting . . . Film Processing . . . Editing . . . Lighting . . . Zoom Lenses . . . Composition . . . Electric Eyes . . . and much, much more!

Start getting the know-how that will make you a topflight movie-maker! Reserve the HOME MOVIE MAKING ANNUAL at your newsstand—or send for it today with the coupon below! Only \$1.00.

Ziff-Davis Publishing Company
Department EW119,
434 S. Wabash Avenue
Chicago 5, Illinois

Please send me a copy of the 1960 HOME MOVIE MAKING ANNUAL. I enclose \$1.00, plus 10¢ to cover mailing and handling charges. (Canada and foreign, \$1.25 plus 10¢ postage).

NAME _____
ADDRESS _____
CITY _____ ZONE _____ STATE _____

you will not find such markings as V, or "pin 2." Instead you see "3CS6" or K (cathode) or G₁.

On the *Motorola* board, partially shown in the lower right-hand corner of the cover, little reliance is placed on readable symbols. Although conductive paths are on both sides of the board, the complete labyrinth of connections is duplicated in brightly colored ink on each side. Combinations of four colors are used in a code based on the EIA color coding system. With filament, plate, ground, and other types of connections dramatized in this way, we have still another way of getting across an idea of what is going on in a circuit, simply by glancing at the board that carries that circuit.

Most of the basic methods used for making the printed panels directly convey information have been covered with the four examples chosen. Samples from other manufacturers show variations of the techniques described. For example, the component-and-information side of a *Philco* board uses a system similar to that of *RCA*. However, in addition to component numbers, many key points are designated with such legends as "tuner," "vertical sync," or "2nd detector."

The effect of the new look, whatever its specific nature, is hard to overestimate. The final decision must be left to time, but those who make the most optimistic predictions might turn out to be right. Instead of being almost impossible to service, the coded panels—or the "road-map" boards, as many manufacturers are calling them—may indeed turn out to be easier to work with than conventional hand-wired chassis.

Because component and board mounting have been worked out anew with the problem of accessibility in mind, some claim it is now possible to reach, check, and replace all or most components without removing chassis from their cabinets. The "good, old" sets were never like this.

Because so much information that, in the past, could only be found in separate service data is now right on the panels, it should be possible to do far more work than was once feasible without so much as referring to a schematic. Some manufacturers give actual percentage figures on how much can be done, either in the cabinet or without auxiliary data, on their designs. Such figures as "80%" or "90%" may raise the eyebrows of the conservative-minded, but they appear frequently. In any case, the general methods have been laid down for convenience and speed in servicing that were unheard of a few years ago, and the "new look" is only beginning.

At this point, the technician may begin to feel a little grateful that no one has succeeded—yet—in getting all of the necessary data inside the set to the extent that supplementary information can be eliminated altogether. After all, some remaining challenge to individual ingenuity is still appreciated.

VIDEO ELECTRIC COMPANY says: DOWN WITH RISING COSTS OF ELECTRON TUBES OVER ONE MILLION USED TUBES TO SELECT FROM

Each and every tube is tested by our supplier under actual operating conditions in Radio, FM, Hi-Fi, Industrial Equipment and Television Chassis or Intricate Testing Equipment for Mutual Conductance and Life Test.

Below is a Partial List of Over Three Hundred Popular Types!
Write for Free Complete List and Order Blank!

0A2	5A4AGT	6BC5	6L7	7J7	19
0B2	5A4A	6BC7	6N7	7M7	19AUGCT
1A5CT	5BK7	6BD6	6Q7	7Q7	19BGC
1A7CT	5BP8	6BE6	6S4	7X7/KFM	1916
1B3GT	5CQ6	6BF8	6SR5	7Y4	1918
1C3CT	5E8	6BG6G	6S7	7Z4	2A5
1A4CT	5E8	6BH6	6SB7	12A8	2A5A
1M5CT	5UAC	6B16	6SF5	12AB5	25A4
1J6	5UAGB	6BR5	6SG7	12A05	25A44
1L6	5U8	6BR7	6SH7	12A16	25B06
1L6	5U8	6BL7CT	6S17	12A17	25L6CT
1N5CT	5V8	6BN6	6S8	12A17	25Z3
1Q5CT	5X8	6B06CT	6SL7GT	12A17	25Z6
1R5	5Y8	6B07	6SH7GT	12A17	26
1S5	5V8CT	6B58	6S17	12A17	35A5
1T4	5V8G	6B75	6S27	12A17	35B5
1T5CT	6A7	6B75CT	6S7	12A17	35C5
1U4	6A8	6B76	6S7	12A17	35L6GT
1U5	6A8A	6B76	6S7	12A17	35W4
1V2	6A87	6B77	6S7	12A17	35W4A
1X2	6A7	6C4	6S7	12A17	35Z4CT
2A3	6A7A	6C5	6S7	12A17	35Z6CT
2A7	6A7A	6C6	6S7	12A17	36
2A7A	6A7A	6C6	6S7	12A17	37
3A1S	6A8AGT	6C85	6S7	12A17	39/44
3A16	6A8A	6C85	6S7	12A17	42
3A16	6A8A	6C85	6S7	12A17	43
3A16	6A8A	6C85	6S7	12A17	44
3A16	6A8A	6C85	6S7	12A17	45
3A16	6A8A	6C85	6S7	12A17	46
3A16	6A8A	6C85	6S7	12A17	47
3A16	6A8A	6C85	6S7	12A17	48
3A16	6A8A	6C85	6S7	12A17	49
3A16	6A8A	6C85	6S7	12A17	50
3A16	6A8A	6C85	6S7	12A17	51
3A16	6A8A	6C85	6S7	12A17	52
3A16	6A8A	6C85	6S7	12A17	53
3A16	6A8A	6C85	6S7	12A17	54
3A16	6A8A	6C85	6S7	12A17	55
3A16	6A8A	6C85	6S7	12A17	56
3A16	6A8A	6C85	6S7	12A17	57
3A16	6A8A	6C85	6S7	12A17	58
3A16	6A8A	6C85	6S7	12A17	59
3A16	6A8A	6C85	6S7	12A17	60
3A16	6A8A	6C85	6S7	12A17	61
3A16	6A8A	6C85	6S7	12A17	62
3A16	6A8A	6C85	6S7	12A17	63
3A16	6A8A	6C85	6S7	12A17	64
3A16	6A8A	6C85	6S7	12A17	65
3A16	6A8A	6C85	6S7	12A17	66
3A16	6A8A	6C85	6S7	12A17	67
3A16	6A8A	6C85	6S7	12A17	68
3A16	6A8A	6C85	6S7	12A17	69
3A16	6A8A	6C85	6S7	12A17	70
3A16	6A8A	6C85	6S7	12A17	71
3A16	6A8A	6C85	6S7	12A17	72
3A16	6A8A	6C85	6S7	12A17	73
3A16	6A8A	6C85	6S7	12A17	74
3A16	6A8A	6C85	6S7	12A17	75
3A16	6A8A	6C85	6S7	12A17	76
3A16	6A8A	6C85	6S7	12A17	77
3A16	6A8A	6C85	6S7	12A17	78
3A16	6A8A	6C85	6S7	12A17	79
3A16	6A8A	6C85	6S7	12A17	80
3A16	6A8A	6C85	6S7	12A17	81
3A16	6A8A	6C85	6S7	12A17	82
3A16	6A8A	6C85	6S7	12A17	83
3A16	6A8A	6C85	6S7	12A17	84/624
3A16	6A8A	6C85	6S7	12A17	117L7GT
3A16	6A8A	6C85	6S7	12A17	117N7GT
3A16	6A8A	6C85	6S7	12A17	117P7GT
3A16	6A8A	6C85	6S7	12A17	117Z
3A16	6A8A	6C85	6S7	12A17	117ZC
3A16	6A8A	6C85	6S7	12A17	117ZG

GUARANTEE: We guarantee to replace FREE for one (1) year any tube purchased from us which fails to function efficiently under actual operating conditions. Refunds will be made promptly for any defective merchandise.

WE HAVE OVER 1000 USED TV SETS
At All Times In Our Huge Warehouse
Buy one or more of these WORKING TVs to sell or use as your own second set! All sets in GOOD WORKING condition!
Your Choice—Console or Table Model
10" ... \$23.00 17" ... \$46.00
12" ... \$28.00 19" ... \$58.00
14" ... \$33.00 20" ... \$64.00
16" ... \$40.00 21" ... \$72.00
17" ... \$49.00
When ordering TV's, state whether table model or console is desired. Also preference on make of set. All TV's sent railway express F.O.B. Newark. On any quantity, WIRE or CALL today!

Phone Humboldt 4-9848

SEND for our FREE complete TUBE & PARTS LIST and order blank.

FREE Bonus Antenna Given with Any TV Set Order!!

FREE RCA "Cheater" Cord Given with Any Tube Order of \$7.00 or More!!

FREE POSTAGE in U.S.A. and Territories on orders over \$5.00. 25¢ handling charge on orders under \$5.00. 25% deposit required on C.O.D.'s. Please send approximate postage or freight on Canadian and foreign orders. Subject to prior sale.

ELECTRIC COMPANY
9-15 Sixth St., Harrison, N. J.

ENGINEERING 

B.S. DEGREE IN 27 MONTHS

Prepare for unlimited opportunities of the Electronic Age!

Students study engineering under accelerated program leading to B.S. degree in 27 months or standard 4-yr. program leading to B.E. degree in 36 mo. B.S. degree (36 mo.) in Math., Chem., Physics. Year-round classes. Comprehensive training in electronics, television, advanced radio theory and design, math., nuclear physics and elec. engineering. Also prep courses. Low rate. Earn board. G.I. approved. Enter Dec., March, June, Sept. Catalog.

INDIANA TECHNICAL COLLEGE
9119 E. Washington Blvd., Fort Wayne 2, Indiana

Please send me free information on B.S. ENGINEERING DEGREE IN 27 MONTHS as checked.

Electronics Chemical Aeronautical
 Civil Mechanical Electrical

B. E. DEGREE IN 36 MO. IN:
 Aeronautical Mechanical Electrical (Power or Electronics)
 Civil Metallurgical

B. S. DEGREE IN 36 MO. IN Math. Chem. Physics

Name

Address

SENDING RECEPTION SPEED



Be a "key" man. Learn how to send and receive messages in International Morse code. Communicate with operators around the globe. Learn at home quickly through famous Candler System. Used by best operators. Qualify for Amateur or Commercial License. Write for FREE BOOK.

CANDLER SYSTEM CO. Dept. 2-M.
Box 9226, Denver 20, Colo., U.S.A.

BEST IN HI-FI VALUES!

NO DELAY SERVICE All orders rushed to you in factory-sealed cartons.
Write for free catalog.

 **audion**

25-W Oxford Road
Massapequa, New York

FREE CAREER BOOKLET

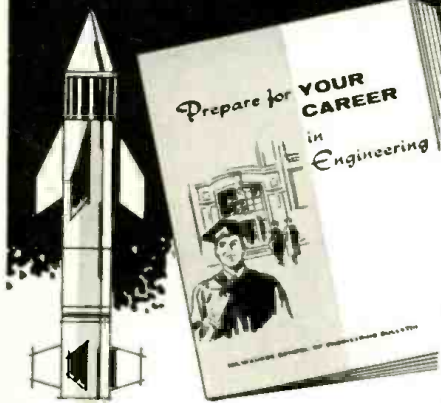

to guide you to a successful future in **ELECTRONICS RADIO-TV COMPUTERS ELECTRICAL ENGINEERING**

This interesting pictorial booklet tells you how you can prepare for a dynamic career as an Electrical Engineer or Engineering Technician in many exciting, growing fields:

MISSILES • RADAR • RESEARCH ELECTRICAL POWER • ROCKETRY AUTOMATION • AVIONICS SALES • DEVELOPMENT

Get all the facts about job opportunities, length of study, courses offered, degrees you can earn, scholarships, part-time work — as well as pictures of the Milwaukee School of Engineering's educational and recreational facilities. No obligation — it's yours free.

MILWAUKEE SCHOOL OF ENGINEERING

MAIL COUPON TODAY!

MILWAUKEE SCHOOL OF ENGINEERING
Dept. EW-1159, 1025 N. Milwaukee St.
Milwaukee, Wisconsin MS-113

Please send FREE "Your Career" booklet
I'm interested in Electronics Radio-TV
 Computers Electrical Engineering
 Mechanical Engineering
(PLEASE PRINT)

Name _____ Age _____

Address _____

City _____ Zone _____ State _____

I'm eligible for veterans education benefits.
Discharge date _____

Transistor Radio Circuits

Part 1. Initial installment of a series that will analyze circuits widely used in automobile and portable receivers covers the r.f. amplifier.

EDITOR'S NOTE: This material on transistor circuits, appearing here and in subsequent issues, is being reproduced with the kind permission of the Delco Radio Division of General Motors Corporation. Although originally prepared and distributed to those servicing Delco auto radio receivers, much of the information is also applicable to other types of transistorized radios and we believe it worthwhile to present this material to our readers.

TRANSISTORS employed in automobile radio receivers are generally divided into two major groups—low-power junction transistors and high-power junction types. Low-power transistors of the *n-p-n* and *p-n-p* variety are useful in the following applications: r.f. and i.f. amplifiers, oscillators, mixers, detectors, audio preamps, a.g.c. amplifiers, and trigger stages. High-power transistors, referred to as "power transistors," are usually of the *p-n-p* type and are to be found in such circuits as: single-ended class A audio output stages, push-pull class AB audio output stages, and square-wave oscillator circuits utilizing transistors in place of the vibrator.

R. F. Stage

Fig. 1 shows a typical transistorized r.f. stage. The purpose of this stage is to amplify the small signal voltages received at the antenna and to discriminate between wanted signals and unwanted ones (images). The amount of selectivity obtained depends primarily upon the "Q" of the tuned circuits used and the signal amplification is primarily dependent upon the transistor and how it is operated.

The transistor is a 2N150 low-power unit of the *n-p-n* variety, connected in a common-emitter configuration. This means that the emitter element is common to both the input and output circuits. In the input circuit the untuned tickler winding, L_2 , inductively couples the signal from the parallel-tuned an-

tenna circuit. L_1-C_1 , to the transistor base. A step-down ratio between L_1 and L_2 is used to match the high impedance of the antenna circuit to the low impedance of the transistor input.

"Forward bias" voltage is obtained for the transistor by a voltage divider network in the base circuit, consisting of a 3900-ohm and a 5600-ohm resistor connected in series across a 6.5-volt line. The voltage at the base connection between these two resistors is approximately 2.5 volts, derived from simple bleeder current through the resistors and a small amount of base current which flows.

A positive voltage on the base of an *n-p-n* transistor attracts electrons from the emitter and causes collector current to flow. Since both the collector current and a small base current must return through the emitter circuit, a voltage drop is produced across the 2700-ohm emitter resistor. In vacuum-tube circuits, a similar resistor in the cathode circuit is commonly known as a "self-biasing resistor." Here, the voltage drop across the resistor reduces the forward bias between base and emitter. In transistor circuits, the emitter resistor is more commonly referred to as a "stabilizing resistor" since it tends to control collector current due to its influence on emitter voltage. Although the emitter is positive with respect to ground, it is negative with respect to the base and a .4-volt forward bias exists on the input diode. However, this bias is further reduced on strong stations by the a.g.c. voltage which is coupled to the emitter. As the a.g.c. line swings positive, the emitter voltage increases and reduces the gain of the stage—sometimes to the point of completely cutting off collector current and allowing the signal to pass through only by inter-electrode capacitance within the transistor. This is true on very strong signals at which time it is desirable to keep the sensitivity of the receiver at a low level.

The collector is biased in the "reverse direction" by a positive 5 volts and collector current variations are introduced through the r.f. coil L_3 and the collector resistors. Powdered iron cores tune L_3 and L_1 through the same frequency range by their physical connection to a common core bar. The tuned parallel-resonant collector tank circuit allows the 2N150 to "see" a high output impedance and the RC signal-coupling network R_1 and C_1 lets the input of the following stage see the proper low impedance.

(To be continued)

Fig. 1. This "n-p-n" r.f. amplifier uses a common-emitter configuration.

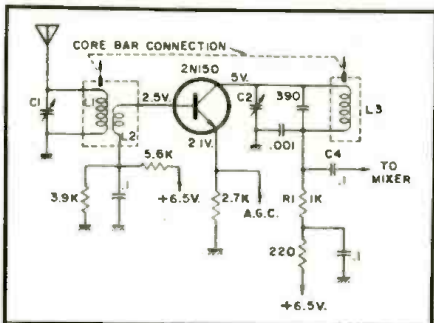



CALENDAR of EVENTS

OCTOBER 29-30
Fifth Annual Electron Devices Meeting.
 Sponsored by Professional Group on Electron Devices, IRE. Shoreham Hotel, Washington, D. C. Dr. John A. Hornbeck, Bell Labs, Murray Hill, N. J., technical program chairman.

NOVEMBER 3-5
Mid-America Electronics Conference.
 Sponsored by Kansas City Section of IRE. Municipal Auditorium, Kansas City. Program details available from MAECON, 5109 Cherry St., Kansas City 10, Mo.

NOVEMBER 4-6
National Automatic Control Conference.
 Sponsored by PGAC, PGIE, Dallas Section ISA, and AIEE. Sheraton-Dallas Hotel, Dallas, Tex. Program information available from George Axelby, Westinghouse, Box 746, Friendship Airport Station, Baltimore, Md.

NOVEMBER 5-6
Eighth Annual Instrumentation Conference.
 Sponsored by School of Engineering, Louisiana Polytechnic Institute, Ruston, La. Papers and exhibits. Contact Institute for program.

NOVEMBER 9-11
Radio Fall Meeting. Sponsored by IRE

and EIA. Syracuse Hotel, Syracuse, N. Y. Virgil M. Graham, % EIA, 11 W. 42nd St., N. Y. C., program chairman.

Fourth Instrumentation Conference. Sponsored by PGI of IRE. Atlanta, Georgia. Details from W. B. Jones, Jr., Georgia Tech, Atlanta 13, Ga.

NOVEMBER 10-12
Twelfth Annual Conference on Electrical Techniques in Medicine and Biology.
 Sponsored by AIEE, ISA, and PGME of IRE. Sheraton Hotel, Philadelphia, Pa. Dr. L. E. Flory, RCA Labs, Princeton, N. J., for program details.

NOVEMBER 11-13
Sixteenth National Meeting. Sponsored by Operations Research Society of America. Huntington-Sheraton Hotel, Pasadena, Calif. Technical sessions and panel meetings. Contact Sidney I. Firstman, % The Rand Corporation, 1700 Main St., Santa Monica, Calif., for program information.

NOVEMBER 16-19
Conference on Magnetism and Magnetic Materials. Sponsored by IRE, AIEE, APS, AIM, and ONR. Sheraton-Cadillac Hotel, Detroit, Mich. Program information from J. E. Goldman, Scientific Lab., Ford Motor Co., Box 2053, Dearborn, Mich.

NOVEMBER 17-19
1959 NEREM Meeting. Sponsored by Region I of IRE. Boston Commonwealth Armory, Boston, Mass. Program information from Dr. Gardner A. Norton, % Avco, Lawrence, Mass.

FOR 11 METER OPERATION THE gain CITIZEN BAND ANTENNAS

the Citizens Mobile

Model CM

\$11.95



Chrome plated and stainless steel telescoping whip extends to 73" and down to only 23" for easy carrying. Weatherproof, polyethylene enclosed, high efficiency base loading coil includes exclusive Hy-Gain "L" matching network for perfect 50 ohm match. Complete with universal swivel body mount, only one hole to drill for easy mounting.

Model CC-12 Coaxial Kit for mobile\$2.95

Other Hy-Gain Citizen Band Antennas

- Citizens Whip, Model CW\$ 6.95
- Citizens Dipole, Model CD 12.95
- Citizens Ground Plane, Model CGP 16.95
- Heavy Duty Ground Plane, Model GP-1..... 29.95
- Citizens Beam, Model 113-G 29.95

SEE YOUR NEAREST DISTRIBUTOR OR WRITE FOR FREE BROCHURE



1135 NO. 22ND • LINCOLN NEBRASKA

Just Out

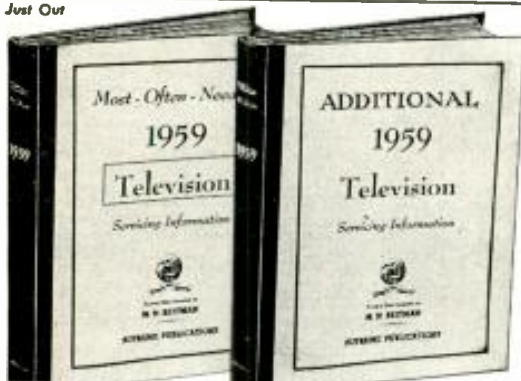

These two 1959 TV volumes cover practically all sets of all makes. The new **ADDITIONAL 1959 TV** manual includes material almost to the minute. Each giant manual has 192 pages of service data and repair hints, factory changes, double-size circuits. Special price, each only...

\$3

New ADDITIONAL 1959 TV Volume

LARGE MANUAL COVERS NEWEST 1959 TV SETS EARLIER TV VOLUMES STILL SOLD AT ONLY \$3

AMAZING BARGAINS

Supreme twin 1959 TV manuals are the scoop of the year. Cover all sets of all important makes. New **ADDITIONAL 1959 TV** volume gives you the very latest material. Your price for this mammoth manual is only \$3. Supreme super values defy competition. Most prior-year manuals (at only \$3) have a whole year of service material. Each volume covers different material, from 1948 to very latest sets. Include circuits, wave-forms, alignment, voltage charts, service hints, changes, and double-page diagrams. Practically tell you how to make every repair. More pages, more diagrams, more service data per dollar of cost. To get the best for less, get Supreme manuals.

Supreme TV manuals supply all needed service material on every TV set of every important manufacturer. Here is helpful, practical, factory-prepared data. It will really make TV servicing and adjustment easy for you. Join 167,000 servicemen who use, benefit, and save with SUPREME service manuals. In these volumes you get correct factory-checked circuits, alignment procedure, printed boards views, service hints, recommended changes, wave-forms, voltages, easy-to-use giant-size diagrams.

BEST AT LOWEST COST

Here is your TV service material to help you do expert work double-quick; and priced at only \$3 per annual volume. Be ready to repair any model by carrying in your car all 14 TV volumes listed in coupon below. Or try one of the new 1959 TV manuals to see what an amazing bargain you get for only \$3. Send no-risk coupon.



TELEVISION SERVICING COURSE

Let this new course help you in TV servicing. Amazing bargain, complete, only \$3, full price for all lessons. Giant in size, mammoth in scope, topics just like a \$200.00 correspondence course. Lessons on picture faults, circuits, adjustments, short-cuts, UHF, alignment facts, hints, antenna problems, trouble-shooting, test equipment, picture analysis. Special, only

\$3

Radio Volumes



RADIO DIAGRAMS

Supreme is your best source for all needed RADIO diagrams and service data. Covers everything from the most recent 1959 radios to pre-war old-timers; home radios, auto sets, combinations, changers, stereo, FM, and portables. Sensational values. Only \$2 for many volumes. Every manual has extra large schematics, all needed alignment facts, printed boards, voltage values, trimmers, dial stringing, and helpful hints. Volumes are large in size, 8 1/2 x 11 inches, about 190 pages. See coupon at right for a complete list of these radio manuals. →

NO-RISK TRIAL ORDER COUPON

SUPREME PUBLICATIONS, 1760 Balsam Rd., Highland Park, ILL.

- 1959 } Popular RADIO
- 1958 } Diagram Manuals
- 1957 } at only \$2.50
- 1956 } each

- 1955 Radio Manual, only \$2
- 1954
- 1953
- 1952
- 1951
- 1950
- 1949

- 1948
- 1947
- 1946
- 1942
- 1941
- 1940
- 1926-1938 Manual, \$2.50
- Radio and TV Master Index, 25¢

Rush today TV manuals checked below and Radio manuals at left. Satisfaction guaranteed.

- New Additional 1959 Television Manual, only \$3.
- Early 1959 Television Manual, \$3. 1958 TV, \$3.
- Additional 1957 TV, \$3. Early 1957 TV, \$3.
- 1956 TV Manual, \$3. Additional 1955 TV, \$3.
- Early 1955, \$3. 1954 TV, \$3. 1953 TV, \$3.
- 1952 TV, \$3. 1951 TV, \$3. 1949 TV, \$3.
- 1948 TV, \$3. 1957-58 RCA TV Manual, \$1.50
- New Television Servicing Course, complete... \$3.

- I am enclosing \$..... Send postpaid.
- Send C.O.D. I am enclosing \$..... deposit.

Name:
 Address:

Supreme Publications
 Sold by All Leading Parts Jobbers

November, 1959

	BC-659 \$16.95 RE-NEW	PE-120 \$7.95 RE-NEW
---	---	--

BC-659 FM RECEIVER-TRANSMITTER—27 to 39.1 MC FM.; 5 Watt.; Crystal Control on Two Pre-Set Channels; with Tubes and Speaker—Re-New \$16.95
PE-120 POWER SUPPLY for BC-659 or BC-620; with Vibrator for 12 Volt operation—Re-New \$7.95
BA-41 BIAS BATTERY F/BC-659-620. New \$4.95
AN-29 Telescoping ANTENNA F/BC-659. New \$2.95
FT-250 SHOCK MOUNTING F/BC-659-PE-120—U. 4.95
SCHEMATICS F/BC-659-PE-120 w/voltage & Resistance: 2.00

BC-603 \$14.95 RE-NEW	BC-683 \$24.95 RE-NEW	
---	---	---

BC-603 FM RECEIVER—20 to 27.9 MC. Re-New: \$14.95
BC-683 FM RECEIVER—27 to 39.1 MC. U. \$19.95—Re-N: \$24.95
BC-604 FM TRANSMITTER—20 to 27.9 MC. U. \$4.95—Re-N: \$7.95
BC-684 FM TRANSMITTER—27-39.1 MC. Re-New: \$7.95
FT-237 MOUNTING for Rec.-Trans. Re-New: \$7.95
FT-346 MOUNTING for Receiver only. Re-New: \$4.95
DM-34 DYN. 12V. 1/BC-603-683—U. \$2.95—R-N: \$4.95
DM-35 DYN. 12V. 1/BC-604-684—U. \$6.95—R-N: \$9.95

AC POWER SUPPLY
F/BC-603-683—Output: 220 VDC 80MA & 24VAC 2Amps.
 Tube Rectification; mounts on rear Plug of BC-603-683. Can be adapted to other Receivers.
KIT: \$16.00—WIRED: \$14.95

RECEIVERS:
BC-733 Localizer Rec.—108.3 to 110.3 MC. Used: \$4.95
R-23/BC-453 Rec.—190 to 550 KC. Used: 14.95
R-4/ARR-2 Rec.—540-830 KC. 230-258 MC.R-N: 8.95
BC-1206 Beacon Receiver—200 to 400 KC. Re-N: 9.95
BC-652 Receiver—2 to 6 MC—Less Dyn. Used: 19.95
BC-342 Receiver—1.5 to 18 MC For AC on. Used: 69.50
BC-312 Receiver—1.5 to 18 MC Less Dyn. Used: 39.50
BC-344 Rec.—150 to 1500 KC—For AC on. Used: 49.50

PULSE ANALYZER AND OSCILLOSCOPE
IP-148/APA-11A RADAR PULSE ANALYZER with repetition Freq. of 200 to 6000 CPS with either a negative or positive pulsed signal. Has calibrated dials for pulse width & rate. Used with APR-1, APR-4, and other receivers. Also can be used as an oscilloscope. Complete with 1/3JP2 Cathode Ray Tube, 6/12AT7, 2/6AG7, 2/6AG5, 2/2X2, & 1/5R4 Tubes. Voltage required: 115 V 400 cycle & 24 Volts. USED: \$19.95

COLLINS ART-13 TRANS. — \$49.50
2 to 18.1 MC—100 WATT—PHONE, CW, MCW
 The most desired Set on the surplus market—Easily converted to 10 Meters (See Surplus Conversion Manual No. 2—\$2.50). Automatic Tuning for selection of 11 Channels in the Freq. Range. Tube Line-Up: 1/18Z7, 1/813, 2/16Z5, 1/12S17, 2/6V6, 2/811, 2/12SL7, 1/12SA7. AC Power Supply requirements: 28 VDC/10 A, 400 VDC/225 MA & 1250 VDC/250 MA. Size: 23 1/2 x 16 x 11 1/2. Wt.: 70 lbs. Price, USED: \$49.50
 Price—Same as above—except. Less Tubes: 30.00
DY-12/ART-13 24 V. Dyn. w/Filter & Relays—U: 12.95

ALL BAND RECEIVER
NAVY ARB/CRV 46151—190 to 9050 KC—Four Band, 6 Tube Superhet—Local & remote tuning and band change; illuminated dial, sharp & broad tuning; AVC, CW, provisions for operation of DU-1 Loop. Complete with Tubes: 1/12SA7, 1/12A6, 4/12SF7, & 24 Volt Dynamotor. Size: USED: \$18.95
8 x 7 x 16" Used: \$18.95
ABOVE—Converted to 12 Volt. with Dynamotor (No electric band change) \$24.95
Conversion for 115 V 60 cycle with Spin Dial, Phone Jack, CW. \$24.95
Volume Control, On & Off Switch (All on front panel) —KIT of Parts with Instructions. \$10.00
Conversion—as Above—for 12 Volt DC—KIT of Parts, with Dynamotor 10.00
Remote Control Box: \$2.00—Remote Control Shaft: 1.50
Remote Control Head 2.00
Tuning Knob for large spined shaft 1.00
T-Shift Adapter for remote and local tuning 1.50
PLUGS only—for Receiver or Control Box. Each: 1.00

KEYERS, TELEPHONES, HEADSETS, MICS.
TS-9 Handset. Used: \$2.95—New: \$3.95
TS-13 Handset. w/PL-55 & PL-68. U: \$2.95—N: 3.95
T-17 Microphone. Used: \$3.95—New: 6.95
CM-1-SC Hand Carbon Mic.—Mobile type. New: 6.95
EE-8 Field Telephones. Used: \$12.95—Recond: 16.95
BD-71 Switchboard—6 Line. U: \$14.95—New: 24.95
BD-72 Switchboard—12 Line. U: \$24.95—New: 34.95
RM-29 Control Unit. New: \$6.95—W/Handset 8.95
RM-52 Control Unit (Patch Found.) U: \$1.95—N: 2.95
H-16/U Headset—8000 ohm. U: \$1.95—New: 2.95
HS-33 Headset—300 ohm. U: \$4.95—New: 7.95
J-45 Tel. Key—with cord and plug. New: 1.50

SEND FOR FREE CATALOG!
 Address Dept. RN • All Prices F.O.B. Lima, Ohio. Minimum Order \$5.00. & 25% Deposit on all C.O.D.'s

FAIR RADIO SALES
 132 SOUTH MAIN ST. • LIMA, OHIO

Manufacturers' Literature

"THYRATRONS ARE DIFFERENT"
CBS Electronics, Parker Street, Newburyport, Mass., has a new technical bulletin entitled, "Thyratrons Are Different," written by Bud Tomer. Known as PA-223, the bulletin is available from the company's advertising service at the above address.

Author Tomer explains the mechanism of ionization, describes the "critical characteristic" curve, and discusses the effects of temperature on ionization time and tube life. Installation precautions are also given.

PARTS SELECTOR CATALOGUE
Ram Electronics Sales Company, 600 Industrial Avenue, Paramus, N. J., has issued a new 36-page catalogue of electronic component service replacements and technical information for the electronic technician. This brochure is available without charge by writing direct to the company.

The new two-color, illustrated parts selector guide features the latest in up-to-date listings of the firm's components. It includes details on i.f. coils, power and audio transformers, filter chokes, as well as a great deal of technical information and "service hints" that are extremely useful to the electronics technician.

AUTOMATION AGE "SPOOF"
Audio Devices, Inc., 444 Madison Avenue, New York 22, N. Y., has acknowledged the age of automation with a collection of cartoons illustrating the effect of electronics on life today.

Particularly appropriate for those involved in the computer and telemetry fields, the booklet may be obtained at no charge by writing to the firm.

Reprinted from leading periodicals, the booklet is tersely entitled, "A Study of the Unique Influence of Space-Automation Technology on the Present-Day Environment with Special Attention to its Implications for the Behavioral Sciences."

AUTO RADIO COIL GUIDE
J. W. Miller Co., 5917 South Main Street, Los Angeles 3, California, is offering a complete 20-page auto radio coil guide which lists every auto radio coil in use and quickly identifies each item for replacement.

Available through the firm's distributors or by writing to the company, this catalogue (No. 260) provides the technician with a cross-reference of 1000 part numbers from 45 manufacturers to the company's equivalents.

RADIO ELECTRONIC SURPLUS

SILICON RECTIFIERS

1N1454	25 amp. 100 volts	\$3.00
1N1455	25 amp. 200 volts	\$3.50
1N1456	25 amp. 300 volts	\$4.00
1N1457	25 amp. 400 volts	\$4.50
1N1451	5 amp. 200 volts	\$1.25
1N1452	5 amp. 300 volts	\$1.50
1N1447	.750 amp. 200 volts	.75
1N1448	.750 amp. 300 volts	.85

BC603 FM RECEIVER
 20-27.9 mc. Equipped with 10 push buttons for selecting channels. Cont. variable tuning over the entire range. Unit complete with tubes, built-in loud speaker, squelch circuit, head phone jacks, schematic diagram on bottom of case. Approx. weight 34 lbs.
Used Good: \$9.95
Like New: \$12.95
DM-34 Dynamotor 12 or 24-volt D.C. each \$3.95
BC-604 Transmitter, 20-27.9 mc. NEW: \$4.95
 Crystals (set of 80) for BC604 transmitter, 20 to 27.9 mc Price: \$5.00 per set
 Manual with schematic for BC603/BC604. Price: \$1.00 each

DM35 DYNAMOTOR, 12 Volt input, output 625V, 225A Used with BC-604. \$9.95
12V Eicor Dynamotor, Output 440V, 200A. NEW \$7.95

PE120 POWER SUPPLY
 6, 12 or 24-volt (specify voltage).
 Used with BC659 and 620. \$6.95 each

TEST SCOPE—SYNCHROSCOPE—PULSE ANALYZER
ID-59/APA-11. Late production. Modular subassembly construction. Video amplifier is flat to 4 mc. 38P1 presentation. Test-scope sawtooth 25-20,000 cy. Has all normal test-scope controls. As synchroscope and pulse analyzer, accepts positive or negative pulses. Video delay circuit permits leading edge of pulse to be seen. Calibrated-dial horizontal shift measures pulse durations from 0.5 to 100 microseconds. Sine-wave-oscillator calibrator measures recurrence rates from 200 to 6000 pps accurate within 0.4%. Built-in power supply requires 115v, 400 cy, 196 watts. External 60 cy power supply may be made to furnish plus 350 and -1300 vdc and 6.3 vac. In excellent condition, with all 19 tubes, schematic with parts values, parts-location pictures, operating instructions, theory explanation, and maintenance charts. Shipping weight 60 lbs. Used, good. Price each \$19.50

NO C.O.D.'s. REMIT FULL AMOUNT WITH ORDER. ALL PRICES F.O.B. PASADENA.

C & H SALES CO.
 2176 E. Colorado St. • Pasadena 8, Calif.

GLOBE ELECTRONICS
A World of Values!

HICKOK MICRO-VOLT SIGNAL GENERATOR
 Power supply 115 V. 60 cycles AC. Crystal controlled output. 10-1600 kc. 1.6-144 MC. Used. Good cond. \$39.95

LAE-1 UHF MICROVOLTER SIGNAL GEN.
 520-1300 Mc. Calibrated. With chart. \$79.50
 Like new. 110 VAC. 50.60 cye. \$49.50
 Used. Less chart. Only \$49.50

AN/APX-2 TRANSMITTER-RECEIVER
 Complete with 44 tubes, motors, all controls, relays, ANS. PART OF OTHER PARTS. \$14.95

MULTI-CHANNEL OSCILLOGRAPH
 Mfd. by Brush Instruments. Model No. HL-206. 6-Channel. Excl. cond. (checked out). 110 VAC. 50/60 cye. Equivalent \$995.00
 to Model 101-2861 00

HICKOK 3" OSCILLOSCOPE
 Type OS-88/U. 3-30 KC. 105-125 VAC. 50-1000 Cycles. 1 Phase. In Portable Carrying Case. \$99.50
 Good Condition. Excellent Buy!

DAVEN POWER OUTPUT METER
 Model No. OP-182. Good Condition. \$95.00
 Only

STABILIZATION DATA GENERATOR
 Model TS-1018/AVQ. Manufactured by O & H Dept. U.S.N. Ideal Tester for Servo-Mechanism Systems. 115 Vac. 400 Cycles. Single Phase. 90 VDC. Like New. A Globe Electronics Special \$69.50

GLOBE ELECTRONICS
 3103 PICO BLVD. SANTA MONICA, CALIF.
 Phone: EXbrook 3-7206

The text includes specifications and prices on intermediate frequency transformers, r.f. coils, chokes, and other related items.

SEMICONDUCTOR DEVICES

Transitron Electronic Corporation, 168-182 Albion Street, Wakefield, Mass., has a new condensed catalogue of semiconductor devices—TE-1340A.

The brochure provides a rapid reference source and features a listing of all basic silicon and germanium products in the company's line. Package photos of the various components accompany accurate data charts which supply information regarding the actual range of performance of each device.

A description of the component type underlines the significant features as they relate to various aspects of individual application.

1960 ALLIED CATALOGUE

Allied Radio Corp., 100 N. Western Ave., Chicago 80, Ill., has announced the release of its 1960 general catalogue of electronic parts and equipment. It is available free upon request direct to the company.

The 444-page catalogue, which includes 232 pages in rotogravure and 4-color covers, lists over 40,000 items. The company's line of "Knight-Kits" is illustrated and described in a 64-page, 2-color rotogravure section.

A full presentation of the latest stereophonic high-fidelity equipment in all leading makes is shown, including such items as amplifiers, tuners, speakers, enclosures, cartridges, record changers, recording and playback decks, and add-on components for conversion of conventional systems to stereophonic sound. Stereo records, tapes, and tape recorders for professional and home use are also covered.

The catalogue also offers a television and amateur radio section, and listings on transistors, tubes, television antennas, Citizens Radio transceivers, intercom units, electronic counters, rectifiers, transformers, accessories, and technical books.

OTS TRANSISTOR CATALOGUE

Office of Technical Services, U. S. Department of Commerce, Washington 25, D. C., has published a revised edition of its catalogue of technical reports on transistors (CTR-310 Transistors). Copies may be ordered from the Department at a cost of 10¢ each.

The catalogue lists 146 technical reports on transistors available to industry through the facilities of OTS, in some cases in printed form and in others in photocopy or microfilm.

The reports are the result of research by the Army, Navy, and Air Force between 1949 and June, 1959.

RCA SEMICONDUCTORS

RCA, semiconductor and materials division, Somerville, N. J., has released its revised and expanded edition of the booklet entitled, "RCA Semiconductor Products." It is available at a cost of 30¢ through the firm's semiconductor

November, 1959

It's what you know about USING INSTRUMENTS

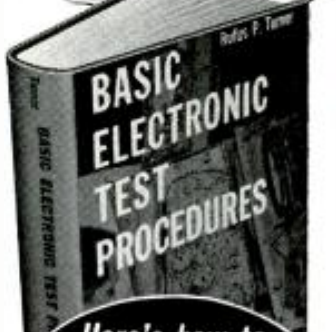

Here's how to
**TROUBLESHOOT IN
HALF THE USUAL TIME**
...with a bare minimum
of instruments!

CONSIDER OSCILLOSCOPES for instance!

Simplified explanations of modern oscilloscope techniques show how to use your 'scope as a volt-meter, current meter, variable frequency oscillator, etc., or for making RF, phase or AM measurements; for distortion and deflection checking; square wave testing; visual AM and FM alignment, and for many other jobs. Every detail is explained—from making connections, to adjusting controls and analyzing patterns.

Consider INDUSTRIAL ELECTRONICS too!

Still another big feature is the book's usefulness in acquainting you with industrial electronic test techniques—including testing non-electronic phenomena such as strain, pressure, etc.



LOOK
NO FURTHER . . . IF YOU'RE
UNHAPPY WITH "HI" HI-FI
PRICES. WRITE FOR OUR
UNUSUAL AUDIO CATALOG.
KEY ELECTRONICS CO.
120-C Liberty St., N.Y. 6,
Phone EV 4-6071

CODE FOR PRACTICE OR COMMUNICATION



U.S. Signal Corps surplus telegraph set—clear 1,000 cycle tone—use for code practice or communication up to 25 miles—uses regular batteries—wt. 10 lbs.—brand new only \$9.95 complete with case and earphones.
DEROSIER and PUGH ELECTRONICS
DADE CITY FLORIDA

...that really counts!

Almost anyone can repair TV's, radios and other electronic equipment AFTER THE TROUBLE HAS BEEN LOCATED. The real trick is in spotting the trouble—and that means knowing how to use instruments fast, accurately, and intelligently. Actually, it's amazing what you can do with only a few instruments—providing you know how to use different kinds for the same job; how to select the right ones; where to use them; how to connect them into circuits; how to set the controls; how to read them; and how to follow professional test procedures every step of the way. And that's exactly what this new 316-page book with its more than 190 how-to-do-it pictures, operational procedure sketches and pattern designs teaches you!

A new, down-to-earth guide to BASIC ELECTRONIC TEST PROCEDURES

Alternate test methods—cautions—correct instrument usage—connections—readings—test techniques—time saving tricks . . . and all the rest

BASIC ELECTRONIC TEST PROCEDURES by Rufus Turner explains every detail of the work in a way you can hardly fail to understand. Covers the different methods for doing specific jobs. For instance, you learn to check distortion by either the 'scope, rejection filter, harmonic-distortion meter, wave analyzer or audio oscillator methods. You learn to make resistance measurements with a current-meter, a volt-ammeter, a volt-meter, an ohmmeter, or via the bridge method . . . and so on through all basic test procedures.

Subjects include current checks; power, capacitance, inductance, resistance, AF, RF, phase, distortion, and modulation measurements; tube and semi-conductor testing; audio amplifier tests; sensitivity, RF gain, fidelity, AVC voltage, operating voltage checks, etc.; visual alignment techniques—even transmitter as well as industrial electronic test and measurement procedures. Price \$6.50.

PRACTICE 10 DAYS . . . FREE!

Dept. RN-119, RINEHART & CO., INC.
232 Madison Ave., New York 16, N. Y.

Send BASIC ELECTRONIC TEST PROCEDURES for 10-day FREE EXAMINATION. If I decide to keep book, I will then send you \$6.50 plus a few cents postage in full payment. If not, I will return book postpaid and owe you nothing. (SAVE! Send \$6.50 with your order and Rinehart pays the postage. Same 10-day guarantee with money promptly refunded if you're not more than satisfied with book.)

NAME

ADDRESS

CITY, ZONE, STATE

OUTSIDE U.S.A.—Cash with order only. Price \$7.00. Money back if book is returned in 10 days.

REALIZE YOUR DREAM

Become a graduate Electronics Engineer. Share rewards awaiting college men . . . higher income, rapid advancement. Important firms interview seniors here regularly.

Electrical Engineer in 27 months

B.S. degree in Electrical (Electronics or Power major), Mechanical, Civil, Chemical, Aeronautical Engineering. In 36 Months a B.S. in Business Administration (General Business, Accounting, Motor Transport Management majors). For earnest, capable students. Small classes. More professional class hours. Mature students. Well-equipped labs. Modest costs. Veteran approved. Year-round operation. Enter, January, Mar., June, Sept. Write J. H. McCarthy, Director Admissions, for Catalog and "Your Career in Engineering and Commerce" Book.



TRI-STATE COLLEGE
16119 College Ave., Angola, Indiana

These men are getting practical training in...

ELECTRICITY ELECTRONICS

ON REAL
Motors • Generators
Switchboards • Controls
Modern Appliances
Automatic Electronic
Control Units

TELEVISION RADIO ELECTRONICS

ON REAL
TV Receivers
Black & White and Color
AM-FM and Auto Radios
Transistors • Printed
Circuits • Test Equipment

Train in NEW Shop-Labs of COYNE

In Chicago—Electrical and Electronic Center of the World. Prepare for a better job and a successful future in a TOP OPPORTUNITY FIELD. Train on real full size equipment at COYNE where thousands of successful men have trained for 60 years—largest, oldest, best equipped school of its kind. Professional and experienced instructors show you how, then do practical jobs yourself on more than a quarter of a million dollars worth of equipment. No previous experience or advanced education needed. Employment Service to Graduates.

Start Now—Pay Later—Liberal Finance and Payment Plans. Pay most of tuition after graduation. Part-time employment help for students. Choose from nine yearly Starting Dates.

Mail Coupon or Write to Address Below for Free Book—"Guide to Careers." Whether you prefer ELECTRICITY, TELEVISION-RADIO or COMBINED ELECTRONICS, which includes both fields, this book describes all training offered.

Information comes by mail. No obligation and NO SALESMAN WILL CALL.

B. W. Cooke, Jr., Pres. Founded 1899
COYNE ELECTRICAL SCHOOL
Chartered as an Educational Institution Not For Profit
1501 W. Congress Pkwy., Chicago 7, Ill., Dept. 89-6C

MAIL COUPON OR WRITE TO ADDRESS BELOW

COYNE ELECTRICAL SCHOOL
New Coyne Building Dept. 89-6C
1501 W. Congress Pkwy., Chicago 7, Ill.

Send BIG FREE book and details of all the training you offer. I am especially interested in,

Electricity Television Both Fields

Name _____
Address _____
City _____ State _____

(I understand no Salesman will call)

products distributors or by sending payment direct to the company at the Somerville address.

The new 40-page edition contains technical data on the company's germanium and silicon transistors and silicon rectifiers. Maximum ratings, typical operating characteristics, and dimensional outline are given for each type.

Also included in this booklet are a section on transistor theory, an interchangeability directory which lists over 1100 type designations of 29 different manufacturers, and a section on circuits containing 37 schematic diagrams illustrating some of the more important applications of transistors and silicon rectifiers.

RAYTHEON BROCHURE

Raytheon Company, industrial tube division, 55 Chapel Street, Newton 58, Mass., has released a new brochure which describes the firm's welded assembly technique for high density packaging of electronic components. Free copies are available from the company. Contact Mr. Wesley J. Davis, Dept. 2528, at the above address.

The six-page booklet describes the new technique, which was developed by the company's industrial tube division working with Massachusetts Institute of Technology's instrumentation laboratory. It details the savings in space, weight, and power consumption made possible with welded assemblies and shows how their reliability and mechanical ruggedness make them particularly adaptable to installations in data processing equipment, computers, and airborne electronic systems.

G-E TUBE HANDBOOK

General Electric Company's electronic components division, Owensboro, Kentucky, is offering a new edition of its receiving tube and television picture tube handbook, "Essential Characteristics," at a price of \$1.00.

This 260-page book contains a total of 1392 receiving and special-purpose tube types and 399 television picture tube types. A new section lists the domestic near-equivalents of 95 foreign tubes for ready reference by service technicians.

The handbook also includes classification charts for quick and convenient reference to tube families that are available for specific classes of service. Outline drawings and configurations are keyed to each type, giving designers essential dimensions. Characteristic curves are given for 13 basic families of receiving tubes.

Still featured is the popular comb binding which permits keeping the book flat on desk or workbench and the inclusion of pertinent basing diagrams on each page.

BATTERY CHARGERS

Terado Company, 1068 Raymond Avenue, St. Paul 8, Minn., is offering a catalogue sheet which illustrates and describes the firm's new battery chargers.

HOT SURPLUS FOR A COLD WINTER

DYNAMOTORS

DM-35 12 Volt Input 18 Amps. Output 625 V. 225 MA. **\$8.95**

35X-27 Volt Input 1.75A. Output 285 **\$2.50**

CAY 21772 12 Volt Input 3 Amp Output 235 Volt @ 75 MA **\$2.95**

COAX CABLE

RG-11 U-9 Foot Lengths with Standard PL-259 Connector on each end. **75c ea.**

DIAL TELEPHONES

French type phone made by Conn. Tel. & Tel. Can be used for standard extension phone. Used. With Dial. **\$4.95**

R-65/APN-9 LORAN

Loran Receiver and Indicator used by Planes and Boats for determining position by Radio Signals. Complete with Tubes and Crystal. **\$49.95**

MID RANGE DRIVER

Hacon Revux-B similar to PM 615 Operating Watts 30; Peak Watts 60; Frequency Response 90-7000 cycles, 15 ohm VC Imp., 1/7/16 mounting bushing. **\$7.50**

PRECISION RESISTORS

Need some 1% Resistors? We have 41 Resistors mounted on a board removed from new equipment. 12 Ea. -10,000 Ohm; 3 Ea. -10,700 Ohm; 5 Ea. -25,000 Ohm; 5 Ea. -33,300 Ohm; 2 Ea. -50,000 Ohm; 2 Ea. -80,000 Ohm; 1 Ea. -100,000 Ohm; 3 Ea. -60,700 Ohm; 1 Ea. -6,670 Ohm. WGT. Approx. 2 Lbs. Ea. An Exc. Buy @ **\$1.50 Ea.** 4 Boards **\$5.00**

CODE PRACTICE OSCILLATOR

Type TG-5 Code Oscillator provides 1000 Cycle tone for practice. Use two units for transmission over wire between 2 points. Uses 1-22 1/2 Volt Battery and 2 Flashlight Batteries. Tone Oscillator is relay actuated and will follow a bug. All New Complete with single Earphone, less batteries. **\$7.50**

Set of batteries for above. **\$2.00**

RECORDING WIRE

Magnetic Recording Wire on 3 3/4" Diam Alum Spool, 1 Hour Recording Time. Will fit most wire recorders or wire can be respoled on your own spools. All new. **\$1.50 per Roll. Four Rolls \$5.00**

See our previous ad for Special Surplus Items. All prices F.O.B. S. F., Calif. Calif. orders add 3% Sales Tax. 30% Dep. on all C.O.D.'s. Purchases under \$3.00 send full amount. Items subject to prior sale.

STANDARD SURPLUS

1230 Market St., San Francisco 3, Calif.
Telephone MEmlck 1-3106

WANTED!

Equipment, Components or Parts!

If you have something to sell, let ELECTRONICS WORLD readers know about it in our classified section. It costs very little: just 50¢ a word including name and address. Minimum message: 10 words. For further information, write:

Martin Lincoln
ELECTRONICS WORLD
One Park Ave.
New York 16, N. Y.

ELECTRONICS

PREPARE FOR A GOOD JOB!
BROADCAST ENGINEER
RADIO SERVICING AUTOMATION

TELEVISION SERVICING
BLACK & WHITE—COLOR

APPROVED FOR VETERANS AND SURVIVORS OF VETERANS
BUILDING AIR CONDITIONED
SEND FOR FREE LITERATURE

BALTIMORE TECHNICAL INSTITUTE
1425 EUTAW PLACE, BALTIMORE 17, MD.

The four-color sheet covers details on the company's Model 50180 high power charger and the Model 50181 super charger for cars, boats, and tractors.

Write direct to the manufacturer for further details.

"SILCAD" BATTERIES

Yardney Electric Corp., 40-50 Leonard St., New York, N. Y., has issued a technical brochure on "Silcad" batteries entitled, "The Battery For You . . . Wherever Long Life, Maximum Power and Minimum Space and Weight Are Required."

The six-page booklet supplies extensive data on physical and electrical characteristics of the cells, as well as numerous graphs comparing performance of this system with that of other types of batteries.

For additional information, contact the company at the above-mentioned address.

TRANSISTOR HANDBOOK

Allied Radio Corp., 100 N. Western Ave., Chicago 80, Ill., has published a new 64-page handbook entitled, "Understanding Transistors" by Milton S. Kiver. Priced at 50¢, the handbook is available direct from the company.

Beginning with a discussion of the properties of germanium, the opening sections of the book clarify important basic theory and provide a solid foundation for the succeeding chapters. Some subjects covered include atoms and molecules, electrons and holes, current flow, junction transistors, drift and tetraode transistors, surface barrier transistors, basic transistor amplifier circuits, power amplifiers, r.f. and i.f. amplifiers, transistor oscillators, silicon transistors, etc.

Many additional transistorized circuits, with a detailed explanation of each, are also included. There are over fifty diagrams and illustrations. —50—

AUDIO-VISUAL AIDS TO SCIENCE EDUCATION

SIX new audio-visual aids to science education have just been produced by Bell Telephone Laboratories, and they are being made available without charge to educational institutions and professional groups through local Bell Telephone Co. offices.

The aids include 16-mm. sound films on "Crystals—an Introduction," "Brattain on Semiconductor Physics," and "Submarine Cable System Development." Also available are filmstrips with record narration on "Zone Melting" and "The Formation of Ferromagnetic Domains." Finally, a record album consisting of two 33 $\frac{1}{3}$ rpm discs on "The Science of Sound" is available.

The training aids, which have been double-checked for technical accuracy and proper educational values, have been produced to complement regular lectures in science and engineering. If the record album is an example of the quality and excellence of the other aids, then we would not hesitate to recommend them as valuable adjuncts to training courses dealing with the subjects covered. —50—

November, 1959

Mr. Service Dealer...

in CR Tubes Philco offers you

Double Protection

with Bond and Warranty

- ALL NEW... Electron Gun
- ALL NEW... Exclusive Phosphor Coating
- ALL NEW... Long Life Filaments
- ALL NEW... Super Efficient Cathode
- ALL NEW... Focusing Anodes
- ALL NEW... Aquadag Shell Coating

Quality Tested—
Life Tested

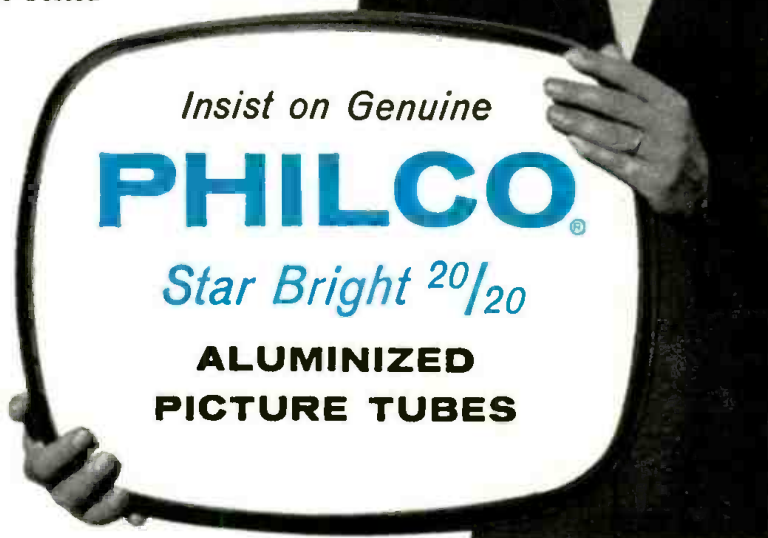

SENSATIONAL FREE OFFERS! PHILCO PROTECT WHEEL PROGRAM

Get All of the Details From Your
Local Philco Distributor

PHILCO ACCESSORY DIVISION
WORLD-WIDE DISTRIBUTION

SUPER POWERED SINGLE CHANNEL AMPLIFIER

Minimum 20V—5 Watts on All Channels

This all new super powered unit has the highest output of any TV channel amplifier with sufficient power to cover large communities with ample signal voltage and deliver a strong signal thru many miles of cable. The unit was designed specifically for community television and is the only unit of its kind that does not produce power in fractions of a watt. For full rated output a high-powered commercial transmitting tube is used.

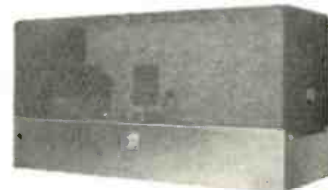

- C. C. S. Service
- 26 db min. gain
- 6-8 mcs. band width
- Channels 2-13 as specified
- Requires only 1 V input
- Co-axial input and output connectors for 75 OHM Line
- Linear class A operation
- Low Power Drain 11 Amp.

MODEL SPA

\$350

Write for details today

SEG Electronics • 1778 Flatbush Ave., Brooklyn 10, New York

for FUN, BUSINESS, SPORTS, INDUSTRY, BOATING, AUTOMOBILE the **NEW Citizens Broadcaster**

**COMPLETE 11 METER
TRANSCIVER**

**NO EXAMINATION
REQUIRED!**

**May Be Used
by Anyone!**

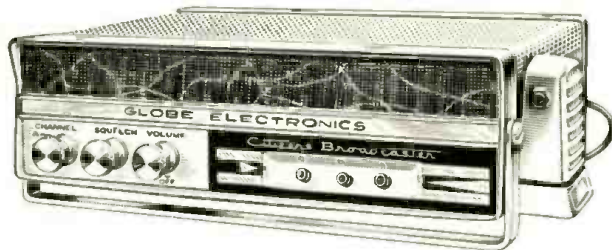

- ★ Universal operation. One unit works on 115V AC or 12V mobile. Operates in Home, Office, Car or Field. No tests or examinations required. Any citizen over 18 years of age may use any of the FCC assigned 22 channels in the 27mc range (11 meters) for transmitting and receiving.
- ★ EXCLUSIVE! Channel switch allows choice of three channels for operation. Receiver and broadcaster units are tuned to same channel simultaneously.
- ★ Operation extremely easy; only three controls: Channel, Squelch and On/Off/Volume. Squelch control subdues background noise for muted standby operation. Offers push-to-talk operation for instantaneous transmission or reception.
- ★ 10 Tube Receiver/Transmitter in crystal controlled for stable operation. With proper crystals, all channels are covered. Tested pairs available for any channel.
- ★ Power Input: — 3 watts. AM modulated. Compact: — only 3 1/2 x 13 x 10 1/2". Light weight, 9 lbs. Meets all FCC requirements.
- ★ Modern "living room" design. Carrying handle also acts as tilt stand for fixed operation or mounting bracket for permanent installation, making the Broadcaster extremely versatile.

**COMPLETE WITH CRYSTALS
FOR CHANNEL 11 AND
PUSH-TO-TALK MICROPHONE**

Only \$129.95

\$13.00 DOWN \$7.48 per mo.



MULTI-PURPOSE TESTER

Sencore of Addison, Illinois has announced the release of its new SS105 "Sweep Circuit Troubleshooter"—an



instrument specifically designed to pinpoint sweep troubles in both horizontal and vertical circuits.

The new unit, according to the company, is actually a "6-in-1" instrument, serving as a universal horizontal oscillator, horizontal output cathode-current checker, universal deflection yoke, dynamic flyback transformer checker, voltmeter, and universal vertical oscillator. Checking cathode current in the horizontal output stages is greatly simplified by an easily replaceable roll chart which gives all necessary pin, current, and voltage data. An adapter socket eliminates the need for breaking connections.

The instrument weighs only four pounds and measures 7" x 6" x 3 1/2". It is currently available at electronic parts distributors.

"POLY-COMM" CLASS D SET

Polytronics Laboratories Inc., 253 Crooks Ave., Clifton, N. J. is now offering a 4-channel Class D Citizens Band transceiver in a choice of two dual-voltage models.

The circuit features a super-sensitive, dual-conversion 10-tube superhet receiver which incorporates fast-acting



adjustable tube squelch circuit, delayed a.g.c., floating series-gate-type noise limiter, and full 2 watts of audio.

A unique electronic changeover circuit switches from transmit to receive without use of relays by actuation of

ELECTRONICS WORLD

PLEASE RUSH NEW BROCHURE ON THE GLOBE CITIZENS BROADCASTER TO

World Radio LABORATORIES
PH 2 0277
1415 W. BROADWAY COUNCIL BLUFFS IOWA

NAME: _____
ADDRESS: _____
CITY & STATE: _____

SEND FREE CATALOG, TOO

EW-11

NEVER FAIL— ZONE YOUR MAIL

The Post Office has divided 106 cities into postal delivery zones to speed mail delivery. Be sure to include zone number when writing to these cities; be sure to include your zone number in your return address—after the city, before the state.

CLOSE-OUT! Government Surplus

\$100 Worth of Brand New Amphenol and Monowatt PLUGS and CONNECTORS! FOR ONLY **\$5.** post paid

Ideal for laboratories, Hobbyists, repair shops, etc.

Packed in original government cartons. Postage paid anywhere in U.S.A.

DIAMOND ELECTRIC COMPANY
1230 LYELL AVE. ROCHESTER, N. Y.

'HI-FI' YOUR SPEAKER SOUND with FLEXICONE



**SPEAKER
RESONANCE IMPROVEMENT KIT**

PRICE **\$3.00**

Here's what John Dodgson, Editor of National Radio Institute News of Washington, D. C. says about FLEXICONE: "After a Flexicone treatment, a 12" speaker, which had been resonating at 90 cps, dropped to 41 cps. Listening tests clearly show the improvement . . . medium and high frequencies are cleaner and less harsh."

- Softens outer edge of speaker cone
- Improves frequency response and speaker tone
- Easy 1-2-3 application
- Reduces speaker cone resonance 10 to 40 cps.
- One treatment lasts a speaker life-time.
- Greatly increases bass range
- Each kit treats one 15", two 12", four 8" or six 6" speakers

PORTER & DIETSCH
2459 University Avenue St. Paul 14, Minn.

SPECIAL INTRODUCTORY OFFER

To acquaint you with FLEXICONE, Porter and Dietsch will give you FREE OF COST, one \$3.25 5" x 7" Tiny Tom high impact styrene Speaker Housing with each Flexicone Kit at \$3.00 during the next 45 days. Available in 6 colors: Brown, Grey, Pink, Green, Blue or Yellow. Install anywhere or use on test bench.

\$6.25 VALUE FOR ONLY \$3.00, post-paid

RUSH ORDER COUPON

PORTER & DIETSCH, Dept. J
2459 University Avenue St. Paul 14, Minn.

Gentlemen: Enclosed is my check for \$3.00. Please send me postpaid the \$6.25 value, one \$3.00 FLEXICONE KIT plus one \$3.25 Tiny Tom Speaker Housing. (All for \$3.00) State choice of "Tiny Tom" color _____

Name _____
Address _____
City _____
State _____

All Porter and Dietsch products are protected by Lloyds of London

New Pressing!



Special to
our readers
for only...

The demand for this new, trouble-shooting test record has been, and still is, stupendous! So great, our original pressing quickly sold out! However, we've just received a new supply—and are prepared to fill your order by return mail. If you already have this wonderful disc, get several more as Christmas gifts for hi-fi-minded friends. If you haven't already ordered one, we urge you to join the tens of thousands whom it has helped achieve top hi-fi reproduction. By all means, fill in and return the coupon below, right now!

Here are some of the questions this record will answer for you!

- ✓ How good is my stylus? Is it worn?
- ✓ Will it damage my records?
- What about my stereo cartridge?
- ✓ Does it have enough vertical compliance so that it won't ruin my expensive stereo records?
- ✓ Is my turntable running at the right speed? Is it free of rumble, wow, and flutter?
- ✓ What sort of standing waves do I get in my listening room?
- ✓ Are my speakers hooked up correctly? Are they phased properly, and is the correct speaker connected to the right stereo channel?
- ✓ How perfectly is my system equalized?
- ✓ What about separation? Is it adequate?

You'll get on-the-spot-answers to these and many other questions when you use this Stereo-Monophonic Test Record. It's the most complete test record of its kind—contains the widest range of essential check-points ever incorporated into one test disc! And, best of all, you need no expensive test equipment when you use this record! Just listen and get the thorough results you want—all checks can be made by ear!

As a man who is seriously interested in hi-fi, you can immediately see the ex-

traordinary 2-way value you get from this special test record. First, it guides you in evaluating the quality of reproduction your equipment now produces. Second, it specifies the adjustments necessary to get the best recorded sound you have ever heard! Add up the advantages! Check the special low price! This is easily the best value of the year for everyone who owns a hi-fi system—either monophonic or stereo!

Don't miss out—Order your Test Record for just \$1 now!

This Stereo-Monophonic Test Record has been produced as a service for readers of *Electronics World*. You can be sure that it comes as close to perfection as is humanly possible, because the editors have poured their accumulated know-how into this project for a period of many, many months. You

may obtain a copy at the special reader-price of just \$1. If you wish to order several test records for gifts, check the appropriate box in the coupon below for immediate shipment. Fill in and mail the coupon, together with your check (\$1 per record) today!

Special Features of ELECTRONICS WORLD 7" Stereo-Monophonic Test Record

- Four bands for stereo checks only — plus three bands for checking stereo or monophonic equipment!
- Made of top-quality virgin vinyl for long wear!
- Specially-reinforced center resists wear!
- Delivered in special polyethylene envelope—dust and dirt are sealed out!
- Fully guaranteed!

ELECTRONICS WORLD • P.O. Box 523, New York 8, N. Y.

Please send me _____ tests records at \$1 each. My money order or check for \$_____ is enclosed. I understand that you will pay the postage and that each record is fully guaranteed.

PLEASE RUSH! To be used as gifts.

**FILL IN
AND
MAIL
TODAY!**

Name _____ Please Print

Address _____

City _____ Zone _____ State _____

SORRY—no charges or C.O.D. orders!

NOV.

Advance POWER SUPPLY KIT BARGAIN!

Primary 115V, 60 Cy. Sec., 400-0-400 V. @ 200 Ma., 6.3 VCT @ 4 Amp., 5 VCT @ 2 Amp. std. mounting plus 8 Hy 200 Ma chokes and two 8 Mfd. 600 V oil condensers. Kit **\$7.50**

RELAYS!	RELAYS!	RELAYS!
110 V AC DPDT \$2.95	24 V AC SPDT	Sigma 41-F 1.35
110 V AC DPDT	Ceramic-Leach 3.45	110 V AC SPDT 1.65
12 V DC DPDT 1.35	6 V DC SPDT 1.35	16,000 Ohm Plate, Sigma 5F SPDT - adj. Will operate on 500 Ma. \$3.95
Sigma 5,000 ohm SPDT 2.25	LARGE STOCK AC, DC RELAYS	

*****Solenoids*****
 115V 60 Cyc cont. duty, 18 Lb. pull... each \$5.50
 8 lb. pull each 2.75 (2 for \$5) (2 for \$10.00)
 24V & 230V SOLENOID IN STOCK!

POWER TRANSFORMER
 117V Pri., 0-0-220 V.C.T., 275 Ma. 6.3 V., 9 Amps; 5 V., 6 Amps. Flat mounting. SPECIAL 5.95
 350 Mills. SPECIAL 7.95

McELROY TAPE PULLER
 115V AC-DC... **\$8.95**

CHOKES FULLY CASED	Signal Corps Earphones
6 Hy, 100 Ma. \$1.09	Hi-Impedance Dual Headset, complete w/ Headband & Cord, Used - terrific Value \$1.79
8 Hy, 100 Ma. 1.49	Per Set 2 for \$3.25
8 Hy, 200 Ma. 1.89	
10 Hy, 150 Ma. 1.99	
20 Hy, 300 Ma. 8.95	
22 Hy, 100 Ma. 2.59	

*** Transformers ***
 ALL WITH 110 VOLT PRIMARY

6.3 V 1 Amp \$1.25	3 Amp \$1.85
4 Amp 2.45	15 Amp C.T. 3.95
12 V SEC. 2 Amp \$1.19	
24 V SEC. 1 Amp 1.25	

Step up down Transformer
 110 V-220 V 12 Amp \$9.95
 110 V-220 V: 110 V-440 V at 5 Amps \$5.95
 Primary 115, sec. 44.95 V - 8 V. 75 Va. \$18.95
 Plate 3100 V CT 300 MA
 Sola constant voltage, 95-125 V in 6.3 @ 10 Amps out. \$9.50

CO-AX RELAYS!!
 12 or 24 V DC (please specify). NEW \$10.75 ea.

RG CO-AX CABLE!

8/U, 52-ohm Impd., 100 ft. length \$7.75
58/U (72-ohm) w/ male and female connectors, 50 ft. coils and female 2.45 ea.
58/U, 100 ft. length 4.75 ea.

OIL CONDENSER BARGAINS

SPECIAL!! 3x8 mfd 500 VDC	\$2.95
2 Mfd 600 VDC .45	12 Mfd 1000 VDC 2.75
4 Mfd 600 VDC .75	4 Mfd 1500 VDC 1.75
8 Mfd 600 VDC .90	16 Mfd 1500 VDC 2.95
10 Mfd 600 VDC 1.10	2 Mfd 2000 VDC 1.50
12 Mfd 600 VDC 1.35	3 Mfd 2000 VDC 1.75
15 Mfd 600 VDC 1.90	1 Mfd 3000 VDC 1.85
50 Mfd 600 VDC 4.25	2 Mfd 4000 VDC 5.75
20 Mfd 650 VDC 2.75	2 Mfd 5000 VDC 8.75
1 Mfd 1000 VDC .60	2 Mfd 10000 VDC 19.50
2 Mfd 1000 VDC .75	1 Mfd 12500 VDC 19.50
8 Mfd 1000 VDC 1.60	2 Mfd 12500 VDC 27.50

L-O-O-K! PANEL METERS

1" METERS	0.150 V AC	4.45
0-1 Ma. \$3.50	0-1 Mill. 4.45	
0-200 Micro-amps 3.50	0-5 Milli 3.45	
0-500 Micro-amps 3.50	0-100 Mills 3.45	
2" METERS	0-5 Amp AC (scale marked 0-150) 2.95	
0-1 Ma. 3.25	0-200 Mills 3.45	
0-3 amps. RF 3.25	200-0-200 V DC 3.45	
0-200 Micro-amps 2.95	0-300 Amps DC. w/ shunt 5.45	
0-30 Milli-amps. 2.95	-10.0 to +60DR. 5.45	
0-250 Milli-amps. 2.95	RUNNING TIME METERS	
0-300 V AC 3.25	0-9999 GE 110V 7.45	
-10.0 to +6 DB. 3.95	0-9999 JBT 230V 9.50	
75 Micro-amps null indicator. 5.75	Comb w/ freq. meter, JBT. 110 V AC 17.95	
0-7.5 V DC 2.95	Cramer freq. meter 110-130 V 58-62 cyc 9.95	
0-150 V DC 2.95		
0-200 VDC 2.95		
3" METERS		
0-200 Micro-amps 4.95		
0-8 V AC 3.45		

SELENIUM RECTIFIERS **
 -FULL WAVE BRIDGE-

130 110 VAC input 12 amps 19.75	
150 mills \$1.25	30 24 VAC input 1.15
200 mills 1.75	1/2 amp 2.15
300 mills 2.50	2 amp 6.25
500 mills 3.50	7 amp 12.95
1 1/2 amps 5.25	20 amp 12.95

SPERTI-VACUUM SWITCH! ... 2.95
 same as used in ART-13 TELEPHONE STUFF!

4 WIRE TELEPHONE COILED CORDS 89c ea.
 6 for \$5.00

TELEPHONE DIAL Automatic Elec. 3.19
 TELEPHONE HAND SET W.E. TYPE G1 6.39
 STEPPING RELAYS 2 deck, 44 pos. 6.95
 16 deck, 22 pos. 22.50

POWER SUPPLY Special!!
 BC-1086 ALL WIRED-READY TO USE
 PRI-115V AC, SEC. 300V @ 200 Ma.
 105V SEC. Reg. supply 20 Ma.
 1 Meter 0-15 Ma; 3 Tubes (6SK7, 6V105, 6H6, 5U4, 6SN7) ONLY. **\$19.75**

PYROMETER POTENTIOMETER
 Single scale, electrically compensated, made by Lewis Eng. in mahog. box. \$36.50

POWERSTAT
 0-135 V AC dual-36 Amp. \$64.95

M A R POWER SUPPLY
 115 V. 60 Cyc. Input 12-14 VDC, 2 Amp output filtered and fully housed. **\$8.95**

Min. Order \$3.00-25% with order F.O.B. New York 10 DAY GUAR. PRICE OF MDSE. ONLY

Advance Electronics
 6 West Broadway • New York 7, N. Y. • REctor 2-0270

the press-to-talk button on the carbon mike. The microphone has a hang-up clip on the front for mobile applications. A separate microphone preamp virtually eliminates all background or wind noise. Separate oscillator and a straight-through plate-modulated final yields a minimum of 2.5 watts output to any 52- or 72-ohm resistive antenna load. There is a built-in carrier and modulation indicator.

Available for 6-v.d.c./117-v.a.c. or 12-v.d.c./117-v.a.c. operation, the transmitter comes equipped with a crystal for one channel while other channels may be activated by plugging in additional crystals. Customers should specify channel and desired power supplies when ordering.

A specification sheet on the "PolyComm" will be supplied by the manufacturer on request.

RCA SCOPE KIT
 The Electron Tube Division of Radio Corporation of America, Harrison, N. J. is now offering a new portable oscilloscope in both kit and factory-wired form.

The WO-33A is designed for lab technicians, hobbyists, hams, and experimenters. The kit contains simple step-by-step instructions, laminated circuit board construction, and oversize drawings. Components, keyed to their proper location, are mounted on one side of the circuit board and solder connections are made on the other side.

On narrow-band position for the vertical amplifier, sensitivity is 3 mv. per inch and bandwidth within -3 db from 20 to 150,000 cps. On wide-band position sensitivity is 100 mv. per inch and bandwidth within -3 db from 5.5 cps to 5.5 mc.

The 3-inch scope is small, lightweight, compact, and truly portable. It weighs 14 pounds and measures 6 1/2" wide, 8 3/4" high, and 10 1/4" deep.

COMPACT MV./AMMETER
 Weston Instruments Division of Daystrom, Incorporated, 614 Frelinghuysen Ave., Newark 12, N. J. has announced the availability of a single, compact electronic millivolt/ammeter which boasts zero-drift comparable to that of PM moving-coil instruments.

The Model 1477 is designed for the measurement and amplification of a wide range of d.c. currents and voltages from 10 to 1000 microamperes and 1 to 1000 millivolts. The instrument is a true d.c. meter with essentially zero-power drain from the source being measured combined with power-gain sufficient to supply 1 ma. output to drive its own indicating meter and external load of 5000 ohms or less. Since zero-drift is dependent only on a position of the galvanometer coil, long-time drift can be maintained to less



BC 603—20 to 27 MC FM RECEIVER
 See Sept. and Oct. 1958 issues of "CQ" for conversion to 20-50 MC and AM. **\$12.95**
 UNUSED. ea.

BC 604—TRANSMITTER—20-27 MC FM. UNUSED \$7.95
 Set of 80 crystals for the above.
 New... per set of 80 \$5.95
 Hand Set for above. New \$4.95
 Excellent \$3.95

AN/ART-13 100 WATT TRANSMITTER
 (Removed from Aircraft)
 Designed to provide radio communication by voice, (MCW) or CW telegraphy. Class "B" audio modulator system capable of modulating the carrier at least 90% on voice or MCW. Incorporates automatic tuning mechanism which may be used to select any one of 11 frequencies, range 2000 KC to 18,100 KC. Frequencies 200 KC to 1500 KC range is provided by addition of oscillator 0-16/ART-13A. Condition good. Shipping Wt. 90 lbs. (Government original cost \$1,000.00.) **\$39.50**

With tubes and meters. \$24.50
 Less meters but with tubes. \$12.95
 0-16 Low frequency oscillator. \$ 5.95

SO239 Coax. Chassis Connectors... ea. \$ 29
 10 for \$ 2.00
 PL-259A Connectors—New... ea. \$ 39
 10 for \$ 3.00

ARR-2 RECEIVER. 234 MC to 258 MC. Easily converted to 220 MC. See August '59 issue "CQ" for conversion instructions. Complete with tubes. **\$3.95**

IE19-5 PIECE TEST SET consisting of Signal Generator 100-156 MC, Field Strength Meter, 0-1 MA -DC Meter, Battery Box and Chest. Shipping Wt. 100 lbs. **\$19.95**

T-17 CARBON HAND MIKE—200 ohm. Press-to-Talk Switch. BRAND NEW **\$5.95**

ID 169/APN-12. SCOPE INDICATOR. Complete with tubes and conversion instructions for 110 V. 60 cyc AC. BRAND NEW **\$9.95**

HEAD SETS—HS 30—Low Imp... ea. \$1.09
 RS 38 CARBON MIKE... \$3.49

BC 659 TRANSCIEVER 27-39 MC
 Brand New \$19.95
 Hand Set for above. New \$4.95
 Excellent \$3.95

METER—0-20 Micro-Amps. New \$4.95
 METER—0-200 Milliamps. New \$2.19

CRYSTALS—100 Assorted FT 241's. per 100 \$4.95

BC-458 TRANSMITTER—5.3-7 MC **\$4.95**
 Used
BC-459 TRANSMITTER—7 to 9 MC **\$9.95**
 Excellent

DU MONT OSCILLOSCOPE Model 256. Govt. Acq. Cost \$1700.00. **\$99.50**
 Excellent

WRITE FOR BARGAIN FLYER
R W ELECTRONICS
 2430 S. Michigan Ave., Dept. N
 Phone: CALumet 5-1281 Chicago 16, Ill.

Say you saw it in
ELECTRONICS WORLD

2 WAY PORTABLE RADIO SET
 Sends—Receives up to 10 miles as shown
 or hundreds of miles with outside antenna! 80 and 40 meter amateur radio bands (novice) also Aircraft and overseas broadcasts (3 to 8 mc) POWERED WITH SELF-CONTAINED PORTABLE RADIO BATTERIES. NO AC PLUG-INS NEEDED! Take it with you everywhere you go—Keep in contact with home, friends, and 5 watt crystal controlled transmitter—Sensitive Regenerative Receiver. Send receive switch. Wt. only 3 lbs. Size, only 4" x 4" x 4" TESTED—PROVED—81MPLIFIED—PRACTICAL. Full information given on quick easy to get license.

SEND ONLY \$3.00 (bill. ex. mo) and pay postman \$16.95 COD postage on arrival or send \$19.95 for postpaid delivery. Complete kit includes all parts, tube, coils, steel cabinet, easy instructions. (Set of batteries—\$3.99; crystal \$1.99). COMPLETELY WIRED AND TESTED POSTPAID \$24.95. A regular \$59.95 value—Order now before price goes up. **GUARANTEED AVAILABLE ONLY FROM:**

WESTERN RADIO Dept. BNT-11 KEARNEY, NEBR.

than 2 μ v. after a few minutes' warm-up time.

This new instrument uses no mechanical switches or choppers and is designed with a special electronic servo-

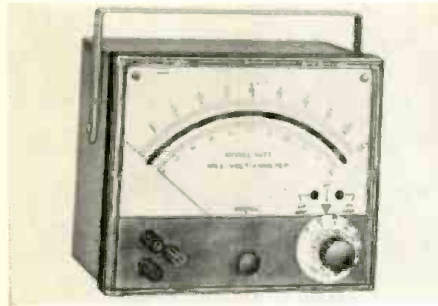

amplifier whose high gain, coupled with full feedback, provides accuracy and stability without the adverse effects resulting from variations in line voltage or frequency, condition of amplifier tubes, and other such variables.

Full details on the Model 1477 electronic millivolt/ammeter will be supplied by the manufacturer on request.

"COMPLEMENTARY" TRANSISTORS

The first in a series of complementary *n-p-n-p-n-p* power transistor lines has been announced by CBS Electronics' Semiconductor Operations.

These complementary pairs of transistors permit new circuit design economies. They eliminate input and output transformers in push-pull circuits to save money and space while providing improved frequency response, according to the company.

This planned line of "pairs" is the result of consumer demand. The *n-p-n* transistors have electrical characteristics identical to those of their *p-n-p* counterparts. The pairs feature high

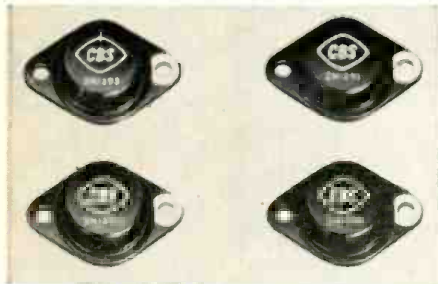

voltages—up to 100 volts—for audio, control, voltage-regulation, servo, and computer applications.

All types in the line have a maximum collector current of 3 amps, a minimum large-signal current gain of 30, and a maximum thermal resistance of 3 degrees C per watt.

Complete technical data on this new series is available from the Information Services of the company at 100 Endicott St., Danvers, Mass. Ask for Bulletin E-355.

SIGNAL TRACER—GENERATOR

Electronic Measurements Corporation, 625 Broadway, New York 12, N. Y. is now marketing a combination signal tracer and generator as its Model 802.

In the absence of a signal, the unit

FABULOUS Pre-Christmas SALE

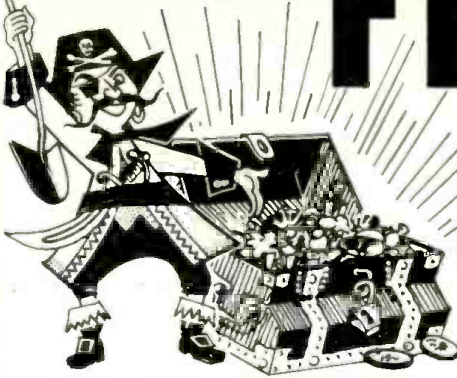

worth \$15

with every
FREE 12-PAK
order
TREASURE CHEST
of
Electronics

2nd free CHRISTMAS GIFT! PICK ANY PAK BELOW FREE WITH EVERY 12-PAK ORDER!

- \$2.50 SUN BATTERY: similar to famed B2M: .88c
- 10 VOLUME CONTROLS: some w/switches: .88c
- 15 ROTARY SWITCHES: asstd. knobs. Reg. \$12 .88c
- 35 TWO WATTERS: carbons: incl. 1%. Reg. \$15 .88c
- 4 OSCILLATOR COILS: mini: 650-1600 kes. .88c
- \$2 16-END WRENCH SET: 15/64 to 7/16". .88c
- 15 RED MOLDED TIP JACKS: for testers: .88c
- 50 PLUGS/RECEPT'L'S: audio, pwr., bat'y. .88c
- 20-PC. DRILL SET: 1/16 thru 1/4" x 64ths: .88c
- 2 VARI-LOOPSTICKS: 540-1500 kes. .88c
- \$25 SURPRISE PAK: large, asst. radio-TV parts: .88c
- 60 TERMINAL STRIPS: solder-lug, binding: .88c
- 40 HI-Q COND'S'R'S: porcelain, NPOs too: .88c
- 20 ARTISTS BRUSHES: 100% bristle. Reg. \$2.50 .88c
- 12-HR. CLOCK: penlite cell powered: .88c
- 6 SILICON DIODES: Sylvania, 1N22, 1N23. Reg. \$36 .88c
- \$7 POSTAGE STAMP MIKE: XTAL. 100-7000 cps .88c
- 70 ONE WATTERS: asst. value carbons, 5% too .88c
- 2 TRANSISTOR IFS: 1/2" sq. 456 kes. .88c
- \$5 HEARING AID PHONE: xtal w/cord set. .88c
- 30 ASST. MOLDED CONDENSERS: finest: .88c
- 10 ELECTROLYTICS: 10-500mf-450VDC. \$12-val .88c
- 8 SUB-MINI SOCIETS: for transistors. Mica-til .88c
- 10 POLY BOXES: plastic, snap locks, hinged: .88c
- 8 GERMANIUM DIODES: glass-sealed, leads: .88c
- 35 DISC CONDENSERS: to 3000 VDC. \$5-reg. .88c
- 5 JEWELERS SCREWDRIVERS: submini work .88c
- 5 ROLLS MICRO-WIRE: #24 thru #32; for transistor, sub-mini circuits .88c
- 40 "SILVER" MICAS: finest made: 1 to 5". asst. values, Reg. \$25, some reg. \$3 ea. .88c
- 20 HI-Q MOLDED OILS: condensers used in finest commercial-gov't eqpt.: 1 mf to 1 mf to 600V. Reg. \$40 .88c
- MINI GEIGER COUNTER TUBE: dozens of radiation detection uses. 2" long, 1/2" dia. .88c
- 30 POWER RESISTORS: WW 5 to 50W to 10K. Vitreous too. Reg. \$15 .88c
- 75 RESISTOR SPECIAL: WW, precision, carbon, variable, miniature types. Worth \$15 .88c

LEKTRON'S FREE Treasure Chest includes: transistor, diode, resistors, condensers, controls worth \$15.00 — all pre-packed in a handy "useful chest" to save you money!

- 20 PILOT LIGHTS: mini, bat'y, screw: 2V to 6V .88c
- 35 TUBE SOCKETS: 4-9 pin; shield-based too .88c
- WIRE STRIPPER: cuts #18 thru #22 hookup .88c
- 2 NPN TRANSISTORS: used in popular radios .88c
- 1500 pcs HARDWARE: nuts, screws, etc. .88c
- 2 SELENIUM RECTIFIERS: AC-DC, 650 mA .88c
- 3 TRANSISTRON SEMI-CONDUCTORS .88c
- 6 AC-DC LINE CORDS .88c
- 60 TUBULARS: paper, molded. 0.00025 to 0.3 mf to 1000V. Reg. \$14 .88c
- 5-IN-1 DRILL BIT: reams, saws, codes, shapes, drills, use with hand or power drills .88c
- 2 TRANSISTOR VARIABLES: 1/2" sq., 2" shaft. Dual, 805 mmf. Reg. \$3 .88c
- 40 SUBMINI CONDENSERS: for transistor. Printed circuit work. Reg. \$7 .88c
- 40 PRECISION RESISTORS: asst. carbon. W.W., 1% .1, 1.2W. Reg. \$10 .88c
- 60 RADIO-TV KNOBS: asstd. colors. Inau. lation. Reg. \$17, some reg. \$1 ea. .88c
- 300-FT. HOOKUP WIRE: tinned, asstd. sizes, colors. Reg. \$5 .88c
- 8 RCA PLUG-N-JACK: sets matched. For amps, tuners, phones .88c
- 60 MICA CONDENSERS: to .01 to 1200V. Silver too. Reg. \$28 .88c
- 40 SUBMINI RESISTORS: 1/4" long. Asstd. values 1/5W to 10 megs. Reg. \$6 .88c
- 3 TRANSISTOR XFMR'S: and couplers. Sub-mini size. 100's of uses, audio, etc. Reg. \$10 .88c
- 100 HALF-WATTERS: asstd. value carbon resistors incl. 5%. Reg. \$12 .88c
- 60 CONDENSER SPECIAL: molded, paper, ceramic, oil, mica, discs, variables .88c
- 70 HI-Q RESISTORS: insulated, carbon: 1% too, 1/2 & 1W, 10 ohms to 10 megs. Reg. \$12 .88c
- 2 "FLEA" POWER MOTORS: 1 1/2 to 6 VDC: penlite cell powered, Perm. main. Size: 1 1/4" sq., 1" shaft .88c
- 15 "SEALED" CIRCUITS: built-in resistor-condenser coupling circuits for sub-mini work. Reg. \$9 .88c

Free Surprise Gift with Every Order!

FREE! WRITE FOR GIANT BARGAIN CATALOG—Year's Subscription!

MINIMUM ORDER
2 Poly Paks per order

ORDER BY BLACK-TYPE HEADLINES, i.e., 10 VOLUME CONTROLS, 88c. State price with each item. Send check or m.o., including sufficient postage; excess returned. C.O.D. orders, 25% down; rated, net 30 days. **INCLUDE POSTAL ZONE** in address. (Canada postage, 48¢ 1st lb.; 28¢ ea. add'l lb.)

VOM OWNERS
Get FREE COPY of unusual reference bulletin packed with valuable data:
"ALL ABOUT VOM's"
Rapid answers to all VOM problems. No strings attached, but quantity is limited. **SEND TODAY** a post card; paste this ad. or write. **GIVE MAKE & MODEL OF YOUR VOM.**
NEW WORLD LABORATORIES P.O. BOX 127-W11 Astoria, L.I. 2, N.Y.

MAIL ORDER HI-FI
You can now purchase all your Hi-Fi from one reliable source and be assured of perfect delivery. Carston makes delivery from NY stock on most Hi-Fi, Recorders and Tape within 24 hours. **SEND US A LIST OF YOUR HI-FI REQUIREMENTS FOR OUR WHOLESALE QUOTATION and our FREE wholesale catalogue.**
CARSTON STUDIOS
125-TD East 88 St. New York 28, N.Y.

LEKTRON 133 Everett Ave. Chelsea 50, Mass.

THE ULTIMATE IN CITIZENS RADIO EQUIPMENT
A new & different C-B Transmitter-Receiver. The very maximum in performance from presently known methods. A single unit housing a separate 5 watt (4 watt output) transmitter and a 14 tube ultra sensitive selective receiver (not a transceiver), only the power supply is common to both units.
XMT-R consists of 3 stage RF circuitry using xmitting type tubes, 8 channel crystal selector, relay switching, dual conversion stabilized 23 channel tuneable receiver, WWV marker at 27mc for exactness in tuning, BFO & "S" meter, in short the Esco ULTIMATE has everything you could ask for to obtain maximum performance. Worth double **169.95**
Our low price of **169.95** owners, you asked for this. **ATTENTION HEATH** C-B-1 owners, you asked for this. A unique attachment that converts the present super regen. receiver to a selective super-het. Factory completed unit ready for easy installation in C-B-1 case. Requires small amt. rewiring in original detector stage. Present tuning control used for **SELECTIVE 26.95** reception of all C-B channels. Standard model. Special model with 5 point, XMT-R crystal set. **29.95**
CAN'T GET YOUR PRESENT C-B unit to put out? Order an Esco **TINIMITTER**. Complete wired & tested RF unit of maximum eff. Ready to install **19.95** with your present power supply & modulator.
The **ESCO DUAL GP** antenna, sturdy tempered steel elements. 3db power gain will double your **27.95** present range.
"THE C-B NEWS" A monthly info packed bulletin. Will help you obtain the mostest from C-B operation. Send self addressed #10 envelope for free copy.
ESCO C-B HQTS 58 WALKER ST. NYC 13, N. Y.

the most important Hi-Fi dollar
you'll spend
this year
will be
for the
new



HI-FI DIRECTORY

& BUYERS' GUIDE

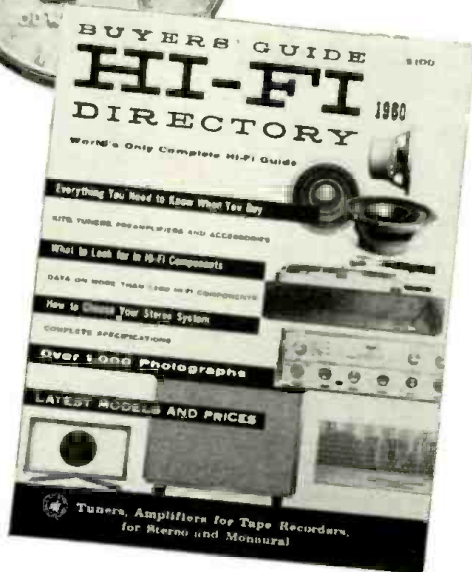

Now on sale or order by coupon today. Only \$1

The hi-fi enthusiast who makes the smartest investment knows long beforehand exactly what equipment, prices, and specifications await him. You too can get the complete story—before you ever actually step into a store by buying the big 1960 edition of the Hi-Fi DIRECTORY & BUYERS' GUIDE. It's jammed from cover to cover with listings covering virtually every piece of hi-fi equipment manufactured.

Complete with all prices and specifications, it includes illustrations of hundreds of products. The world's most comprehensive hi-fi reference gives you entire sections on:

- TUNERS • RECORD PLAYERS • TAPE RECORDERS
- CARTRIDGES • TONE ARMS • TURNTABLES
- AMPLIFIERS • PREAMPS • LOUDSPEAKER SYSTEMS
- RECORD CHANGERS • ENCLOSURES AND CABINETS

PLUS: Helpful articles and features on what to look for, how to buy, advantages and disadvantages of different models, how to judge quality and recognize a bargain.

BUY YOUR COPY OF THE 1960 HI-FI DIRECTORY & BUYERS' GUIDE AT YOUR NEWSSTAND OR RADIO PARTS STORE, OR ORDER BY MAIL TODAY USING THE HANDY COUPON BELOW. ONLY \$1

Ziff-Davis Publishing Company
Department EW 119
434 S. Wabash Avenue
Chicago 5, Illinois

Please send me a copy of the 1960 HI-FI DIRECTORY & BUYERS' GUIDE. I enclose \$1.00, the cost of the DIRECTORY, plus 10¢ to cover mailing and handling charges. (Canada and Foreign, \$1.25 plus 10¢ postage.)

NAME _____

ADDRESS _____

CITY _____

ZONE _____

STATE _____

generates its own signal for audio, i.f., or r.f. testing. The Model 802 also incorporates a noise locator circuit for checking noisy components and uses a magic-eye tube for visual detection and a speaker for aural detection of the



signal. In addition, provisions are made for using the instrument as a substitute speaker or amplifier. It can be used for checking and comparing magnetic, ceramic, and crystal cartridges.

The instrument is transformer-operated for safety and high efficiency. It uses separate high-gain r.f. and low-gain audio input channels and generates an audio signal of approximately 400 cps for testing audio systems. It also generates a modulated signal of 455 kc. for testing i.f.'s in radios using this i.f. frequency.

The Model 802 comes complete with a shielded crystal demodulator probe and two shielded audio probes. It is available in either wired or kit form. It measures 10" x 7" x 5" and weighs 7½ pounds.

PLASTIC "EXTENDER" FREE

Electro Chemical Corporation of Jersey City, N. J., is offering users of its "No-Noise Volume Control" and "No-



Noise Tuner-Tonic" a free bonus in the form of a 5-inch plastic extender for use with these aerosol packaged products.

The extender, which fastens to the top of the spray can, has a push-button assembly. It is ideal for pin-point applications of the liquids and does not cause shorts. This free premium is available through jobbers.

SHARP CUT-OFF TETRODE

Westinghouse Electric Corporation has recently introduced a new high-frequency, sharp cut-off tetrode for use as the r.f. amplifier in v.h.f. television tuners.

Designated as the Type 6EV5, its high transconductance and high input impedance at 200 mc. makes it suitable for use in i.f. amplifiers and other

v.h.f. applications. The new tube is very similar in construction to the 6CY5 but has higher available gain and lowered noise figure as the result of its high input impedance, high transconductance, and low value of screen current. Under typical operating conditions—plate voltage of 250 volts d.c. and screen voltage of 80 volts d.c.—the new tube has a transconductance of 8800 μ mhos for a plate current of 11.5 ma. and a screen current of 0.9 ma.

For full information on this new tetrode, write the company at P.O. Box 2099, Pittsburgh 30, Pa.

SMALL ULTRASONIC CLEANER

The NARDA Ultrasonics Corporation, 625 Main Street, Westbury, L.I., New York has recently introduced a

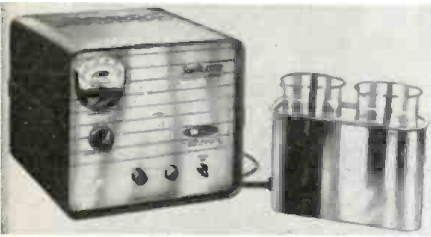

new, low-cost multi-purpose "SonBlaster" ultrasonic cleaning unit which can handle two different jobs at the same time.

The Series 400 ultrasonically agitates the contents of two 400 ml. Pyrex glass beakers. This permits the washing and rinsing of parts simultaneous-

ly, using two different solutions at the same time.

The new "SonBlaster" consists of an ultrasonic generator, Model G-401; a transducerized ultrasonic tank, Model NT-401; and two 400 ml. Pyrex glass beakers. Items to be cleaned or processed may be placed in separate beakers or directly in the tank itself. The device operates from a standard 117 volt, 50-60 cps line and draws no more current than an electric light bulb.

The company suggests its use in cleaning delicate products and parts including dentures, dental instruments, contact lenses, gears, relays, potentiometers, miniaturized components, radioactive lab apparatus, semiconductors, timing mechanisms, etc.

Write the manufacturer direct for additional details and price.

NEW TUBE FOR SSB

The Electron Tube Division of Radio Corporation of America, Harrison, N. J. is now offering the first beam-deflection tube specifically designed for balanced-modulator, balanced-mixer, and product-detector service in single-sideband communications equipment.

The RCA-7360 will make possible simplified, low-cost circuitry with improved performance for single-sideband and double-sideband, suppressed-carrier communications equipment, according to the company.

The unique deflection systems of the tube makes it suitable for use in low-distortion audio-fader circuits, remote

HANDLE THE TOUGH SERVICE JOBS



as slick as you do the easy ones!

This giant, 822-page guide brings you the kind of PROFESSIONAL Service training that helps you handle the toughest radio-television-electronic jobs as slick and as accurately as you now do the easy ones.

For beginners, Radio & TV Receiver TROUBLESHOOTING AND REPAIR is a complete, easily understood training course. For experienced servicemen, it is an ideal way to "brush up" on specific jobs; to develop better troubleshooting methods and shortcuts; and to find quick answers to puzzling problems.

COMPLETE TRAINING in modern Professional methods

Invaluable step-by-step guides help you troubleshoot in less time—and with a minimum of testing. Each service procedure, from locating troubles to fixing them fast and accurately, is covered in text and by more than 417 how-to-do-it illustrations. Price only \$6.75.

PRACTICE 10 DAYS . . . FREE!

Dept. RN-119, RINEHART & CO., Inc.
232 Madison Ave., New York 16, N. Y.

Send TROUBLESHOOTING & REPAIR manual for 10-day examination. If I like book, I will then send you \$6.75 (plus postage) in full payment. Otherwise, I will return book and owe nothing. (Save! Send \$6.75 with order and Rinehart pays postage. 10-day money-back guarantee.)

Name _____
Address _____
City, Zone, State _____

MICRO ELECTRON TUBE

INTRODUCES FOR THE FIRST TIME ANYWHERE A SELECT STOCK OF USED TUBES AT A FABULOUS LOW PRICE

37¢ ea.

FOR any TUBE LISTED

Jan Surplus Tubes!

\$35 PER HUNDRED ASSTD.

ALL TUBES SENT POSTAGE PAID

Please send 25c handling for orders under \$5. Send 25% deposit on C.O.D. orders. Send approximate postage on Canadian and foreign orders.

MICRO ELECTRON TUBE CO.

P.O. BOX 55 Park Station, Paterson 3, N. J.

- Each and every tube is tested in our own laboratory for mutual conductance and life test.
- We guarantee FREE replacement for one year of any tube purchased from us which fails to function efficiently under any or all operating conditions. Prompt refunds are made on any defective merchandise.
- The advertised tubes are not necessarily new, but may be electrically perfect factory seconds or used tubes—each is clearly so marked.

0A2	5X8	6BM6	6SF5	7Z4	198G6G
024	5Y3GT	6BJ6	6SF7	12A8	19J6
1A7GT	5Y4G	6BK5	6S17	12A05	19T8
1B3GT	6A7	6BK7	6SK7	12AT6	24A
1H4G	6A8	6HL7GT	6SL7GT	12AT7	25A5V
1M5GT	6AB4	6BN6	6SN7GT	12AU6	25B06
1L4	6AC7	6BQ6GT	6SQ7	12AU7	25D06
1L6	6AF4	6BQ7	6SS7	12AV6	25DNE
1M5GT	6AG5	6BY5G	6T4	12AV7	25L6GT
1Q5GT	6AC7	6BZ6	6T8	12AX4GT	25W4GT
1R5	6A4GT	6BZ7	6U8	12AX7	25Z5
1S5	6AH6	6C4	6V6	12AZ7	25Z6
1T4	6AK5	6C5	6W4GT	12B4	26
1U4	6AL5	6C6	6W6GT	12BA6	35A5
1U5	6AL7	6C8	6X4	12BA7	35B5
1V2	6AM8	6CB6	6X5	12BE6	35C5
1X2	6AN8	6CD6G	6X8	12BF6	35L6GT
2A3	6AQ5	6CF6	6Y6G	12BM7	35W4
2AF4	6AQ6	6CG7	7A4/XXL	12BQ6	35Y4
3BC5	6A07GT	6CM6	7A5	12BR7	35Z5GT
3BN6	6AR5	6CM7	7A6	12B7	37
3BZ6	6AS5	6CN7	7A7	12CA5	39/44
3CB6	6AT6	6CS6	7A8	12J5	42
3CF6	6AT8	6CS6	7B5	12K7	43
3CS6	6AT8	6CU6	7B6	12L6	48
3LF4	6AU4GT	6DE6	7B7	12Q7	50A5
3Q4	6AU6GT	6DQ6	7B8	12S7	50B5
3S4	6AUSGT	6E6	7C4	12S17	50C5
3V4	6AUSGT	6E6	7C5	12SK7	50L6GT
4BQ7A	6AV5GT	6G6	7C6	12SN7GT	50X6
4BZ7	6AV6	6H6	7C7	12SQ7	56
5AS8	6AW8	6J4	7E6	12V6GT	57
5AS8	6AX4GT	6J5	7E7	12W6GT	58
5AT8	6AX5GT	6J7	7F7	12X4	71A
5AV8	6AX5GT	6K6GT	7F8	12Z3	75
5AW4	6BB	6K7	7H7	12Z3	76
5BK7	6BA6	6K8	7N7	14A7/12B7	77
5I8	6BC5	6L7	7Q7	14B6	78
5T8	6BC8	6M7	7X7/XXFM	14Q7	80
5U4G	6BD6	6N7	7Y4	19A4GT	84/624
5U8	6BE6	6Q7			117Z3
5V4G	6BF5	6S4			117Z6
5V6GT	6BF6	6S8GT			
	6BG6G	6SA7			
		6SC7			

WRITE DEPT. EW-11 FOR OUR FREE COMPLETE LIST OF TUBES & SPECIAL PURPOSE TUBES

Coming in December *Electronics World*:

JAMMING

Secret Warfare in Electronics!

Jamming could save your life! The old art of deceiving an enemy's radio or radar system looms as one of the most important defensive weapons in our arsenal.

In next month's exciting *ELECTRONICS WORLD* article "Electronic Countermeasures"—you'll get authoritative, important answers to such problems as false range information... decoy missiles... misleading radar echoes... plus a complete historical survey that will show you how electronic countermeasures saved thousands of lives and helped bring us victory in World War II.

You'll also enjoy such important December *ELECTRONICS WORLD* articles as:



- **LET'S LEGALIZE AMATEUR PHONE PATCHES**—A prominent telephone company official tells you how the now illegal phone patch could be legalized—to the benefit of all concerned.
- **DIELECTRIC HEATING**—Find out how this important process is now being used to package goods, prepare plywood, bake foundry cores, mold boats, make plastic bags, produce many other varied products for home and industry.
- **BUILD YOUR OWN STROBE ANALYZER**—Complete construction details on an unusual and versatile strobe unit that can be used to "freeze motion". It's helpful in looking for causes of vibration in equipment, checking turntable motors, and performing many other important jobs.
- **BALANCING YOUR STEREO SYSTEM**—Here are complete instructions that make a handy guide for matching the acoustic output of your stereo channels.

All of these features are coming your way in December *ELECTRONICS WORLD*—typical of the coverage you'll enjoy month after month in the world's most authoritative technical electronics magazine. Subscription rates will go up January 1st, so take advantage of the present low rates to bring *ELECTRONICS WORLD* to your door every month. Subscribe today!

SUBSCRIPTION RATES

one year \$4 • two years \$7 • three years \$10

ELECTRONICS WORLD • 434 South Wabash Avenue, Chicago, Illinois

switching of studio and high-fidelity equipment, and other applications in which isolation of control voltage and signal voltage is required. The tube is capable of operation up to at least 100 mc.

This nine-pin miniature features balanced push-pull output with single-ended input; high gain and large output-signal voltages; self-excited operation; stable balance with life over a wide range of temperatures; high input impedance, 60 db carrier suppression in balanced-modulator service, and 40 db oscillator-signal suppression in balanced-mixer service.

Full specifications on this tube are available from the company's tube distributors.

CRT REJUVENATOR-TESTER

B&K Manufacturing Co., 3726 N. Southport Ave., Chicago 13, Ill. is now offering a new, completely self-contained CRT cathode rejuvenator and tester as its Model 440.



This new model is completely integrated. It tests and rejuvenates all black-and-white and color picture tubes at the correct filament voltage from 1 to 12 volts, including 110-degree tubes with 2.34, 2.68, 6.3, and 8.4 volt filaments. The unit tests and rejuvenates each gun of color picture tubes the same as black-and-white.

Testing and rejuvenating can be performed with the picture tube in the set. The Model 440 checks leakage, restores emission and brightness, repairs inter-element shorts and open circuits, life-test checks gas content, and indicates picture quality by means of grid cut-off readings.

The unit is housed in a leatherette-covered carrying case. A data sheet on this new service equipment will be supplied by the manufacturer on request.

PACKAGED CIRCUITS FOR TV

Centralab, Division of Globe-Union, Inc., Milwaukee, Wis. has announced

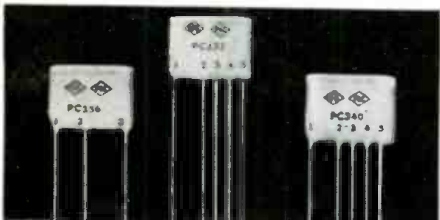

the addition of three new packaged electronic circuits for replacement applications in television receivers.

Designed primarily for RCA and Philco sets, the new units are the No. PC-336 retrace suppression circuit, the No. PC-337 phase comparator circuit, and the No. PC-340 a.g.c. voltage divider.

There are an estimated 500,000 tele-

YOU NEED THIS...

FREE GIANT ALL NEW 1960 BA CATALOG

A Complete Buying Guide for Everything in

RADIO 1960 TV ELECTRONICS

ANNUAL CATALOG 601

BA

SINCE 1927

204 KING-SIZED PAGES

EVERYTHING IN RADIO TV AND ELECTRONICS

100'S OF NEW ITEMS LISTED HERE FOR 1st TIME

21 PAGES OF BARGAINS NOT IN ANY OTHER CATALOG

Guarantee

We guarantee every item in our catalog to be carefully described and illustrated... to be the best... represented... to order in the amount described, and to give the quality guaranteed by the maker... (This offer may be cancelled at any time.)

RUSH COUPON TODAY!

BURSTEIN-APPLEBEE CO. Dept. M,
1012-14 McGee St., Kansas City 6, Mo.

Send Free 1960 B-A Catalog No. 601.

NAME _____

ADDRESS _____

CITY _____ STATE _____

RADIO PARTS STORES & HI-FI SALONS!

Hundreds of dealers across the nation profit by selling ELECTRONICS WORLD each month to their customers. Are you one of them? ELECTRONICS WORLD helps build store traffic... keeps customers coming back month after month for the merchandise you sell—and, best of all, you earn a neat profit on each copy sold—NO RISK INVOLVED.

So get details on selling ELECTRONICS WORLD, the world's largest selling technical electronics magazine. Or, order your copies now. Just use the handy coupon below.

Direct Sales Department
Electronics World
One Park Avenue
New York 16, New York

Att: Jerry Schnelder

Send me copies of ELECTRONICS WORLD for resale in my store each month. No risk involved on my part.

Send me details on selling ELECTRONICS WORLD in my store.

STORE NAME _____

ADDRESS _____

CITY _____ ZONE _____ STATE _____

SIGNATURE _____

EW 119

BARRY ELECTRONICS CORP.

TUBE HQS.

HAM-TV INDUSTRIAL

WRITE FOR FREE TUBE PRICE LIST

- 7.5 KVA Isolation Transformer Pri: 115/ or 230/1/60 CPS with 10% taps. Sec: 115/1/60 CPS @ 7.5 KVA. 500 lbs. Value \$600.00. Unused @ \$150.00
- Auto-Transformer Pri: 115/1/60 CPS—30 Amps. Sec: 115 thru 135 Volts in two Volt steps @ 24 Amps. (3.37 KVA). Unused, orig. pack. Only \$16.00
- Scintillation Counter Brand new. Orig. cartons. Ready to operate with fresh set batteries. Reg. \$245.00. Special price \$49.95. 10 times more sensitive than usual Geiger Counter. \$5.00
- Evans Gasolina or Kerosene Heaters Orig. pack. Special \$6.00
- Dual Emergency Lamp. Use as portable lamp or attach to 110 VAC or DC line. When power fails, lamp lights. 7 1/2" dia. 7 1/2" high. \$3.95 (less battery)
- Telephone Wire. 3,000 Ft. Reel @ \$12.00. (two reels \$22.50)
- Electro-Voice Xtal Mike. Model 915. Brand new/ orig. mfrs cartons. \$4.95
- Acorn Socket @ 15c each.
- Five-Way Binding Posts 22¢ each (red or black—specify).
- Special! W2EL SSB Transformers. New. 95¢ (3 for \$2.50, 10 for \$7.50)
- T-17 Mika. Brand new. Sealed package Only \$4.95
- Glas-Line @ \$2.89 per hundred feet.
- Gelezo Tape Recorder \$179.95. Brochure available.
- CLOSED-CIRCUIT TV CAMERA. NEW. Brochure available.
- Freed Power Transformer Pri. 117 V. @ 60 CPS Sec. (1) 900 V.C.T. @ 60 Ma. DC; (2) 5 V. @ 2 amps.; (3) 6.3 V. @ 10 amps.; (4) 6.3 V. @ 1.5 amps. Freed-19952. Packed two to orig. box. Net weight each xfmr: 12 lbs. Price \$2.50 each 75c
- Electrolytic Capacitor Special 4 times 20 Mfd @ 450 VDC \$5.00 each (10 for \$4.00 each)
- Binary Scaler G.E. Model 4SN181. For industrial counting, interval timing, repeat cycling, nuclear applications, etc. Complete with 5963 Tube. Scaler fits regular octal sockets. \$5.00 each (10 for \$4.00 each)
- FTR Miniature Choke. Brand new. Hermetically sealed. 2 Hys. at 130 Ma. 2 3/4" H x 1 1/2" W. x 1" D. Price 40¢ each (ten for \$3.00, one hundred for \$20.00)
- 175 KC IF Transformer @ 50¢ each.
- 866A Metal Plate Cap. Fits other similar tubes. Special 10¢
- Special G.E. Auto Lamps 6.3 Volts. Orig. packing. Box of ten 50¢ per box.
- G.E. Single Pole Six Position Heavy-Duty Ceramic Switch W/ Knob @ \$1.50.
- Precision ES-500A Wide Range 5" Scope @ \$125.00
- 10 KV Heavy-Duty Test Leads. ICA-4317 @ \$1.25
- VTYM Signal Tracer Probe. ICA-4310 @ \$1.75
- .002 Mfd Mica Capacitor @ 12,500 Volts. New @ 6.95
- Automatic Electric DeLuxe Desk Phone. Complete with Ringer (no dial). Has necessary connecting cable. It has complete hand set. Ideal for private phone intercom, extensions, etc. Good, used condition. Special Price \$5.95 each.
- Hammarlund Giant Split Stator. Dual 150 Mmf. Capacitor. .375" spacing with built-in right-angle precision worm-gear drive in center of unit, allowing capacitor to be installed parallel to panel. Brand new, boxed. \$19.50.
- G.E. Power Supply. Input: 115 VAC @ 60 CPS. Output: 6,000 Volts for CR tube, etc. Heavy-duty relay rack panel. Brand new. Original crate. \$24.95 with tubes.
- Heavy-Duty SPDT Knife Switch. \$1.00.
- Collins Transformer. 115 VAC @ 50/60 CPS. Sec: 500 VCT @ 130 Ma. \$2.00
- Tone Generator. Provides 4 fixed tone frequencies, having high freq. stability and sq. wave form. Output: 1 KC, 1.5 KC, 8 KC, 12 KC—all square waves. Like new, with schematic, less tubes. \$22.50
- G.E. Pyranol .2 Mfd @ 10 KV Capacitor. \$4.95
- Triplett 0 to 300 VAC Voltmeter. (Round) Excellent for checking industrial 220 VAC lines, etc. Large 4" Dia. Complete w/hardware. Brand new in original Triplett carton. \$4.95
- 0 to 15 RF Ammeter. 3 1/2" Rd. Brand New. Orig. Boxed. Simpson. W/hardware. \$3.95
- Heinemann Circuit Breaker. 230/115 AC Volts. Trips @ 10/20 Amps respectively. New. Boxed. \$2.75
- Strobe Light Unit. Useful for Airports/Photographers. Visible 3 miles in bright daylight. Super buy at only \$29.00, with instruction book. (Write for details or order direct.)
- Jennings Model "U" Variable Vacuum Capacitor—50 to 250 MMFD, @ 15 KV. New \$69.00
- Medium Diheptal C.R. Socket—2 1/4" diam. \$1.00

All prices F.O.B. N.Y.C. Specify method of shipment. All merchandise insured and guaranteed for cost of mds. only. Receiving tubes guaranteed 90 days—Special purpose & Xmtg tubes guaranteed 30 days. Phone WA1ker 5-7000.

BARRY ELECTRONICS CORP.

512 Broadway, Dept. EW-11, New York 12, N.Y.

vision sets now in the field incorporating PEC circuits as original equipment.

TUBE FOR HYBRID RADIOS

The Electron Tube Division of RCA, Harrison, N. J. has just introduced a new twin-diode—power tetrode which has been especially designed for hybrid auto radio receivers operating directly from 6-cell storage battery systems.

The 12DS7-A is a multi-unit of the 9-pin miniature type containing two diodes and a high-perveance power tetrode of the space-charge-grid type in one envelope. Used in hybrid receivers operating from 12-volt batteries, the diode units are used for AM signal detection and automatic volume control while the tetrode unit serves as the driver for the transistorized power-output stage.

The 12DS7-A is unilaterally interchangeable with the 12DS7.

OLDEST ASTATIC MIKE

ASTATIC CORP., Conneaut, Ohio is staging a world-wide contest to unearth the oldest Model D-104 microphone owned by an amateur operator. The contest is open to licensed hams only.

First prize is a working model D-104 cast in sterling silver, mounted for use or display as a trophy. In addition, the winner will receive his choice of either a standard model D-104 or a model 10-D or 10-C, all equipped with stand.

The D-104 has been made for 25 years. Contestants should send the serial number of their D-104, name, call letters, and address to "Astatic D-104 World-wide Contest," The Astatic Corp., Conneaut, Ohio. The deadline is midnight December 1st. Winners will be announced in April.

W. E. HOLDS "OPEN HOUSE"

WESTERN ELECTRIC, the manufacturing "arm" of the Bell System, recently held a week-long "Open House" at its Allentown Works to permit the press to inspect its 783,900 square feet of manufacturing facilities.

This modern manufacturing center makes tubes, switches, control units, transistors as well as serving as a research center for improving products used by the Bell System.

The plant has been in operation at Allentown since 1946 and now employs 3400 with 200 additional Bell Labs' resident personnel. The installation includes a manufacturing building, office quarters, and power and gas houses, and a service building.

PHOTO CREDITS

Page	Credit
38, 39 (Fig. 4)	U.S. Army Photo
39 (Fig. 5), 140 (bottom)	Raytheon Co.
39 (Fig. 6)	Tappan Co.
40, 48 (top)	Westinghouse
48 (center)	Hazeltine Corp.
48 (bottom)	ITT
49 (top)	Bell Telephone Labs
49 (center)	Hughes Aircraft
49 (bottom left)	Zenith Radio Corp.
49 (bottom right)	Goodyear Aircraft Corp.
60, 61	The Heath Company
116 (Fig. 2), 117 (Fig. 6)	Motorola Inc.
140 (top)	Radio Corporation of America

SURPLUS BUYS

- NEW—OIL CONDENSERS—NEW**
- | | | | |
|-------------|-------------|-------------|--------------|
| 600VDC | 1,000VDC | 2,000VDC | 4,000VDC |
| 1Mfd \$.40 | 1Mfd \$.60 | 1Mfd \$.85 | 1Mfd \$ 1.30 |
| 2 " .50 | 2 " 1.35 | 2 " 1.50 | 2 " 2.25 |
| 4 " .75 | 4 " 2.50 | 4 " 3.50 | 4 " 5.00 |
| 10 " 1.15 | 10 " 3.50 | 10 " 5.00 | 10 " 7.50 |
- BC733 AIRCRAFT RECEIVER—10 Tubes, w/Dyna., 20 lbs., 115/110 Mc. Constant for this unit appeared in CQ Magazine Surplus, Col. Oct. '59 for 2 or 6 meters. Price on this unit sure to go up. With all tubes like new cond. While they last! \$9.95
- DC POWER SUPPLY—US Navy—EP 231/U. Input 115 VAC 60 Cy. Output 28V. 9A Fansteel Rect. Filtered. Housed in Gray Cabinet 7X7X7 Pilot lite, 3 matching connectors. Under Rated—12 lbs. Brand New \$9.95
- DC POWER SUPPLY—Input: 115V-60CY. Output: 14VDC, 3 amperes Filtered. Relay Control, in Metal Chest. This is a useful item for dynamotors, relays, battery chargers, model RR, etc. 8" x 12" x 8"—35 lbs. Brand New \$8.95
- WILLARD PLASTIC WET CELL—2V—28 Amp Hrs. Ind. Carton. Brand New \$2.79 ea.—12 for \$30.00
- PANEL TYPE FREQUENCY METER—Recd type. 115V AC. 0-100 cycle. Brand New \$10.95
- POW. FILA. XFORMER—Pri—115V-60 Cy. Sec. 300-0-300V—100 Ma; 12-6 VCT-3A; 12-6V-3A; 5.0V-3A. Open Frame—Compact—Useful as 12 or 24 Volt Transf. for Surplus Gear (U/W RA-20 P.S.). Brand New \$2.49
- 4 1/2" Sq. METER—Mirror Scale, 1% accur. Basic 0-1 Mil movement. Scale 0-2.5KV with original multiplier. Sig. Corp. Brand New \$7.95
- PANEL METERS**
- Min. Meters—1 1/2" Sq.—DeJur 0-100 u/a. \$3.95
 - Min. Meters—1 1/2" Sq.—DeJur 0-100 u/a. 2.95
 - 2" Rd.—Weston—New—0-3A RF. 2.95
 - 2" Rd.—Tripp—500 Mill. 3.49
 - 2" Rd.—Bert—1000 over 5000 New. 3.49
 - 2" Square—Tripp—50 Amp AC. 2.49
 - 2" Square—Simpson—50 Micro Amp. Boxed. 4.95
- ARC-S Recvr.—3-6 Mc BC 454. Brand New \$11.95
- 1625 RCA, W.E., GE—DeJur 0-100 u/a. Box. \$2.50
- MO-7 PLATE MODULATOR for ARC/5 Used. OK \$5.95
- BC-45E SCREEN MOD. for ARC/5. Used. OK \$5.95
- 3" SCOPE UNIT HOUSING 3FP7. These are the units used as modulation monitors, and TV set testers. Sorry, no instructions now. Used. OK \$1.95
- WESTON VU METER—2 1/2" Sq. 500 Boxed. (J.R.) Brand New \$6.95
- POWERSTAT—Superior 0-130VAC—50/60 Cps—2W 18 Amp windings in tandem (can be separated). Cap. No. 1000. Brand New \$89.95
- SELENIUM RECTIFIER—FWB—0-30VAC. Input—20 Amps—with matching Xformer 115V—60 Cy—30VAC—12 Amps. Deliver 24VDC—12 Amps—Perfect for Art. \$24.95
- WE IN IMPEDANCE BRIDGE—Inductance range + 500 to - 500 Millihenry. Effective resistance range 0-11.10 ohms. Accuracy 2-2 Millihenry. Consists of 3 components. 1—2A inductance (Fixed) 100 Millihenry. 2—Inductometer (Brooks Type) scale calibrated in Millihenry 50-480. 3—14B Rheostat. Photo arms and 4 resistance decades—Complete in crates. NEW \$110

REX RADIO SUPPLY CO.
84 Cortlandt St.
New York 7, N. Y.
In the Heart of New York's Radio Row

SCHEMATIC BOOK
Over 25 Schematics, popular surplus gear—24 pages, large 11 x 7 foldovers, printed one side, fiber cover, less than 15¢ ea. Includes: See ELECTRONICS WORLD, August, September
postpaid COMPLETE BOOK \$3

- BC-603 AC-SUPPLY AC Power Supply for BC-603 Receiver and BC-683 no modification needed. BUE directly into Jones. \$9.95
- T-47/ART-13 TRANSMITTERS 100 Watt 2-18 MC Autotune, excellent cond., with tubes. \$39.00
- TS-328/U FREQUENCY METER 400 cycle, vibrating reed type, bakelite case with test leads, excellent condition, checked \$22.50

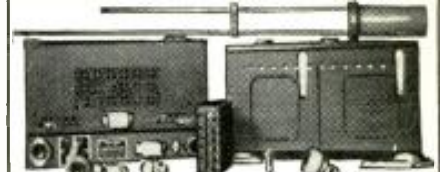

- MOBILE & FIXED VHF SETS Complete 140-v operation including SCR-522 Transceiver, RA-62 Rectifier, J-type ground antenna, control box, mounts, connectors, tubes (less crystals). Excellent condition CA \$124.00
- Same as above for 12 or 24-v operation including PE-98 (12-v) or PE-98 (24-v) dynamotor instead of rectifier. Excellent condition CA \$89.00
- Both Mobile and Fixed Sets purchased together, limited time only \$194.00
- RA-62-C POWER SUPPLY A-C for SCR-522 VHF 110/60 cye. Like new LTD QTY. \$59.50
- KITS only for above. Contains special xformer, rectifier, regulator and connectors w/schematic. SPECIAL ONLY \$17.00
- REC. MICROWAVE R-111/APR-5 Frequency range 1000-8200 mc, fully metered power 110V/60/1 ph. self contained, one unit \$49.00

- GROUND-PLANE VHF ANTENNAS \$4.95 GOOD FOR CETERANS BAND FROM 30-300 MC NEW
- SPIRT VACUUM SWITCH SP21 or CY824163 or G.E. GL-34, new, factory boxed. Cost—\$9.50 Special \$1.25 each \$12.00 dozen—\$85.00 hundred

SEND FOR NEWEST FREE CATALOG
\$5.00 Min. - 25% Dep. C.O.D.'S - F.O.B. Conn.
HI-MU ELECTRONICS
133 HAMILTON ST., NEW HAVEN, CONN.

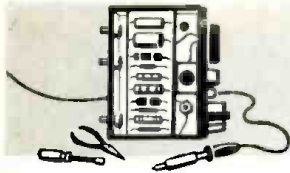

ELECTRONICS MARKET PLACE

RATE: 50¢ per word. Minimum 10 words. December 1959 Issue closes October 12th. Send order and remittance to ELECTRONICS WORLD, One Park Ave., N. Y. C. 16, N. Y.

RADIO ENGINEERING

ELECTRONICS! Associate degree—29 months. Technicians, field engineers, specialists in communications, missiles, computers, radar, automation. Start February, September. Valparaiso Technical Institute. Dept. N. Valparaiso, Indiana.

BACHELOR of Science in Electronics Engineering. Degree in 4 years of Home Study. No resident attendance necessary. Pacific International College of Arts and Sciences. Primarily a correspondence school. Resident classes also available if desired. 5719-U Santa Monica Boulevard, Los Angeles 38, California.

FOR SALE

DIAGRAMS for repairing radios \$1.00. Television \$2.00. Give make, model. Diagram Service. Box 672-RN. Hartford 1, Conn.

RADIO & TV Tubes at manufacturers prices. Guaranteed—Send for free price list. Edison Electronic Tube Co., Menlo Park, N. J.

PROFESSIONAL Electronic Projects—Organs, Timers, Counters, Intercoms, etc.—\$1. each. List Free. Parks, Box 1665, Lake City, Seattle 55, Wash.

STOP TV commercials, complete plans for remote control \$1.00. Kittymack, Box 34EW, Monclova, Ohio.

FREE Fluorescent Bargain Catalog—Fixture kits, Fixtures, Circlines, Parts. Shoplite, 650N Franklin, Nutley 10, New Jersey.

FM TUNERS, 88-108 megacycles, 4 tubes complete, \$14.95. Grutmans, 1 E. 167 St., N.Y.C. 52, N. Y.

GOVERNMENT Surplus Snooperscopes, parabolic reflectors, Receivers, Transmitters. Picture list 10¢. Meshna, 580 N. Lynn, Malden 48, Mass.

TELEVISION Sets \$9.95, plus shipping. Jones TV, Sanatoga, Pa.

TELEVISION & Radio Tubes, Parts and Supplies Guaranteed. Hi-Quality Tube Co., Inc., 284 Lafayette St., Rahway, New Jersey.

GIZMOS & Such of Still River, Mass., offer a limited number of BC779 Hammerlund super pros guaranteed to please at \$74.50 each.

TUBES—TV, Radio, Transmitting And Industrial Types At Sensibly Low Prices. New, Guaranteed, 1st Quality, Top Name Brands Only. Write for Free Catalog or Call WALKER 5-7000, Barry Electronics Corp., 512 Broadway, New York 12N, N. Y.

FOREIGN Auto Radio Distributor, FM-AM and AM, trade discount. Square Electronics, 150-60 Northern Blvd., Flushing, N. Y.

ELECTRONICS Surplus—Wholesale and retail monthly. 12 issues, \$1. Box 784, Washington 4, D. C.

ATTENTION citizen band operators and hams. Get maximum output from any transmitter with this new RF meter. Measures any Rf output. \$9.95. Fort Worth Electronics, 5907 East Lancaster, Fort Worth, Texas.

KITS wired and tested. Naczas Kit Service, 273 Belmont Street, Manchester, N. H.

BUILD a Battery Charger or Power Supply. New surplus Westinghouse 5 amp Mercury rectifiers. \$3.95. Two for \$6.95. Electronic Specialties, Box 509, Charleston, S. C.

RADIO & TV Tubes at Manufacturers Prices! 100% Guaranteed! Brand New! No re-brands or pulls! United Radio, Box 1000, Newark, N. J.

PHONOGRAPH Records cheap, postpaid. Catalogue. Paramount, Box 2026-N, Pine Castle, Fla.

SHORTWAVE attachment receives international broadcasts through superheterodyne radios. Complete, \$2.50 postpaid. John Dittrich, 247-44 76th Avenue, Bellerose 26, New York.

LIKE New Hickok alignment units 690, 691, 695 half price. Robert Ireland, Pleasant Valley, N. Y.

GOVERNMENT SELLS: Surplus Electronics; Test Equipment; Oscilloscopes; Transceivers; Jeeps; Boats; Air-crafts; Misc.—Send for U. S. Depot Directory & Procedure \$1.00—"Government Surplus Sales," Box 425—RT, Nanuet, N. Y.

WANTED

WANTED: Tubes—special purpose and receiving. Top prices for Klystrons, Power Tubes, Thyratrons, T.V. and Receiving Tubes. Tubes must be unused. Also laboratory grade test equipment such as manufactured by HP and GR and AN UPM prefix. V. & H. Radio & Electronics, 2053 Venice Blvd., Los Angeles 6, California.

CASH For Used Short-Wave Ham Receivers, Transmitters & Accessories. Treger W9IVJ, 2023 N. Harlem Ave., Chicago 35. Tuxedo 9-6429.

CYLINDER and old disc phonographs. Edison, Conqueror, Idelia, and Oratorio models. Berliner Gramophones and Zono-o-phones. Columbia cylinder Graphophones, and coin-operated cylinder phonos. Want old catalogues and literature on early phonos prior to 1919. Will pay cash or trade late hi-fi components. Classified Box 50 % Electronics World, 1 Park Ave., N. Y. C. 16, N. Y.

CASH Paid! Sell your surplus electronic tubes. Want unused, clean transmitting, special purpose, receiving. TV types, magnetrons, klystrons, broadcast, etc. Also want military & commercial lab test and communications gear. We swap too, for tubes or choice equipment. Send specific details in first letter. For a fair deal write, wire or telephone. Barry, 512 Broadway, New York 12, N. Y. WALKER 5-7000.

WANTED!

Equipment, Components or Parts!

If you have something to sell, let **ELECTRONICS WORLD** readers know about it in our classified section. It costs very little: just 50¢ a word including name and address. Minimum message: 10 words. For further information write:

Martin Lincoln
ELECTRONICS WORLD
One Park Ave.
New York 16, N. Y.

TAPE & RECORDERS

TAPE Recorders, Recording tape, Bell tape decks, hi-fi equipment, Norelco speakers. We Will Not Be Undersold! Send for our discount catalog and see why! Commissioned Electronics, 1776 Columbia Road, Washington, D. C.

SCOTCH recording tape at 'Profit Sharing' prices—send for catalog—you'll be glad you did!—Tapeco, Dept. L, P.O. Box 4353, Inglewood 3, California.

RENT Stereo Tapes—over 800 different—all major labels—free catalog. Stereo-Parti, 1608-L, Centinela Ave., Inglewood 3, California.

TAPE Recorders, Hi-Fi Components. Sleep Learning Kits, Tapes. Unusual Values. Free Catalog. Dressner, 69-02R 174 St., Flushing 65, N. Y.

AMPEX, Concertone, Crown, Ferrograph, Presto, Tandberg, Pentron, Bell, Sherwood, Rek-O-Kut, Dynakit, Others. Trades. Boynton Studio, 10RT Pennsylvania, Yonkers, N. Y.

RECORDERS, Tapes, HiFi Components, Four Track Stereo Replacement Heads. Catalogue, Efesco, 270-E Concord, West Hempstead, N. Y.

HIGH-FIDELITY

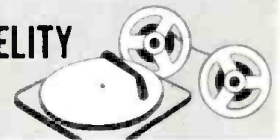

INDUCTORS for Crossover Networks. 118 types in stock. Send for brochure. C & M Coils, 3016 Holmes Avenue N.W., Huntsville, Ala.

RECORDERS, Hi-Fi. Free Wholesale Catalogue. Carston 125-R East 88, NYC 28.

DISGUSTED with "Hi" Hi-Fi Prices? Unusual Discounts On Your High Fidelity Requirements. Write. Key Electronics, 120 Liberty St., New York 6, N. Y. Evergreen 4-6071.

REPAIRS and SERVICING

SPEAKERS repaired fast, any type, write for price list. JaMac, 8845 N.E. Sandy Blvd., Portland, Oregon.

METERS and test equipment repaired. Meter sales. Free list. Bigelow Electronics, P.O. Box 1, Bluffton.

ALL Makes High Fidelity Speakers Repaired. Amprite, 70 Vesey St., N.Y. 7, N.Y. BA 7-2580.

INSTRUCTION

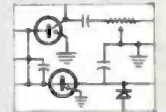

LEARN transistor and Electron tube fundamentals from latest Army Manuals. Over 450 pages, \$2.50. James Mullin, 25-34 88 St., Jackson Hghts., 69, N. Y.

SPECIAL offer, complete correspondence course in Electronics, Television and Radio only \$400.00. 43 texts, over 2000 pages. Limited number available. Write dept. EW Electronics Training, P.O. Box 764, Pittsburgh 30, Pa.

ELECTRONIC And Aeronautical Engineering Technology. Two Year Courses. Bachelor of Science Degree in three years. Northrop Institute in Southern California prepares you for highly paid positions in Aviation and Electronics industries. Employment assistance during school and after graduation. Approved for Veterans. Write for free catalog. Northrop Institute of Technology, 1183 Arbor Vitae, Inglewood 1, California.

CALCULUS. Powerful Modern Mathematics, Easy Practical Lessons, First Four \$1, Mathco, 4256-3 Mlmmor, Cincinnati 17, Ohio.

ENGINEERING and Art Degrees earned through home study. Electronics, Electrical, Mechanical, Civil, Physics, Business Administration, Liberal Arts. When writing, specify course desired. Pacific International College of Arts & Sciences, primarily a correspondence school. Resident classes also carried. 5719-C Santa Monica Boulevard, Hollywood 38, California.

USED Correspondence Courses and Books sold and rented. Money back guarantee. Catalog Free. (Courses Bought). Lee Mountain, Pisgah, Alabama.

If you have a background in Electronics, but are having trouble passing FCC phone exams, my 13 years experience as chief instructor of electronics school can help you over the hump. Not a course. Write me personally for free literature. Wallace Cook, P. O. Box 10634, Jackson 9, Miss.

BUSINESS OPPORTUNITIES

TV Picture tube rebuilding plant and training program still available for many territories. Investment \$8,000-\$11,000. Annual volume \$25,000 to \$100,000. Windsor Co., 999 N. Main St., Glen Ellyn, Ill.

RADIO parts stores and Hi-Fi salons! Someone "borrowing" your personal copy of Electronics World each month? You ought to be taking advantage of Electronics World convenient re-sale plan. Sell copies in your store . . . perform a good service for your customers . . . with no risk involved. For details, write: Direct Sales Department, Electronics World, One Park Avenue, New York 16, New York.

SHOPPING GUIDE

Classified

A HANDY GUIDE TO PRODUCTS, NOT NECESSARILY ELECTRONIC, BUT OF WIDE GENERAL INTEREST.

PHOTOGRAPHY—FILM, EQUIPMENT, SERVICES

ALASKA—Hawaii—Yosemite—or Yellowstone. Eight Colorslides \$1.00. Eddings, Roberts Avenue, Corning, N. Y.

OPTICAL Bargains—Request Free Giant Catalog "CJ." 120 pages—Astronomical Telescopes, Microscopes, Lenses, Binoculars, Kits, Parts. Amazing war surplus bargains. Edmund Scientific Co., Barrington, New Jersey.

BUSINESS OPPORTUNITIES

JOBS Overseas! Write Janecek Development Co., 109 Hub Station, New York 55, N. Y.

EARN Extra money selling advertising book matches. Free Samples furnished. Matchcorp, Dept. MD-119, Chicago 32, Ill.

OVERSEAS Employment. American Firms and United States Government. Comprehensive Job Information \$2.00. Foreign Opportunities, Box 172, Columbus 16, Ohio.

MAKE \$25-\$50 Week, clipping newspaper items for publishers. Some clippings worth \$5.00 each. Particulars free. National, 81-DG, Knickerbocker Station, New York.

FOREIGN Employment Information—\$1. Parks, Box 1665A, Lake City, Seattle 55, Wash.

MISCELLANEOUS

"WINEMAKING; Beer, Ale Brewing." Illustrated. \$2.00. Eaton Books, Box 1242-TC, Santa Rosa, California.

coming soon...

The Big, Exciting **RIGO**
HIGH FIDELITY MUSIC SHOWS
 featuring hundreds of exhibits
 and displays of the very latest
 in hi-fi and stereo-equipment!

All shows open to the
 public Fri., Sat., Sun., 1 to 10 P.M.
 Admission 75c, children free.

- **BUFFALO**—Oct. 30, 31, Nov. 1. Statler Hotel
- **SEATTLE**—Nov. 6, 7, 8. New Washington Hotel
- **PORTLAND, ORE.**—Nov. 13, 14, 15
New Heathman Hotel
- **PHILADELPHIA**—Nov. 20, 21, 22
Benjamin Franklin Hotel

RIGO Enterprises, Inc.
 500 N. Dearborn St. • Chicago 10, Ill.

RADIO PARTS STORES & HI-FI SALONS!

Hundreds of dealers across the nation profit by selling **ELECTRONICS WORLD** each month to their customers. Are you one of them? **ELECTRONICS WORLD** helps build store traffic . . . keeps customers coming back month after month for the merchandise you sell—and, best of all, you earn a neat profit on each copy sold—**NO RISK INVOLVED.**

So get details on selling **ELECTRONICS WORLD**, the world's largest selling technical electronics magazine. Or, order your copies now. Just use the handy coupon below.

Direct Sales Department
Electronics World Att: Jerry Schneider
 One Park Avenue
 New York 16, New York

- Send me copies of **ELECTRONICS WORLD** for resale in my store each month. No risk involved on my part.
- Send me details on selling **ELECTRONICS WORLD** in my store.

STORE NAME _____
 ADDRESS _____
 CITY _____ ZONE _____ STATE _____
 SIGNATURE _____

EW 119

INDEX OF Advertisers

NOVEMBER
 1959

ADVERTISER	PAGE NO.	ADVERTISER	PAGE NO.
Advance Electronics	152	Home Movie Making Annual	142
Aeronetics International	139	Hy-gain Antenna Products	145
Airex Radio Corporation	90	Indiana Technical College	143
Allied Radio Corp.	9, 89, 97, 100, 101	International Business Machines Corporation	130, 131
Alpha Wire Corporation	112	International Crystal Mfg. Co., Inc.	113
American Television & Radio Co.	106	Jerrold Electronics Corporation	85
Amperex Electronic Corp.	SECOND COVER	Key Electronics Co.	147
Arka	122	Krylon	121
Ashe Radio Co. Walter	99	Kuhn Electronics	128
Astatic Corporation, The	29	Lafayette Radio	107, 108, 109
Atlas Sound Corp.	8	Lampkin Laboratories, Inc.	126
Audax Division of the Rek-O-Kut Co., Inc.	120	Lektron	153
Audion	143	McGraw-Hill Book Co.	140
B & K Manufacturing Co.	75	Mallory & Co., Inc., P. R.	13
Baltimore Technical Institute	148	Micro Electron Tube Co.	155
Barry Electronics Corp.	158	Milwaukee School of Engineering	144
Bell Sound Division	16	Moss Electronic, Inc.	104, 105
Bell Telephone Laboratories	22	National Radio Institute	19, 20
Blonder-Tongue Laboratories, Inc.	34	National Schools	17
Burstein-Applebee Co.	157	New World Laboratories	153
CBS Electronics	3	Olson Radio Corporation	110
C & H Sales Co.	146	Oxford Components, Inc.	124
Canadian Institute of Science & Technology Limited	126	Paco Electronics Co., Inc.	91
Candee Co., J. J.	128	Peak Electronics Company	142
Candler System Co.	143	Philco Accessory Division	149
Capitol Radio Engineering Institute	33	Photography Directory	122
Carston Studios	153	Pickering & Co., Inc.	90
Century Electronics Co., Inc.	114, 115	Picture Tube Outlet	140
Champion DeArment Tool Company	134	Platt Electronics Corp.	139
Channel Master Corp.	24, 25, 26, 27	Porter & Dietsch	150
Cleveland Institute of Electronics	7	RCA Institutes, Inc.	14, 15
Columbia Electronics	96	R W Electronics	152
Communications Company, Inc.	102	Rad-Tel Tube Co.	135
Coyne Electrical School	113, 138, 148	Radio Corporation of America	18, 103, 118, 119
Crosby Electronics, Inc.	128	Radio Shack Corporation	95
Delco Radio	93	Rex Radio Supply Co.	158
DeRosier and Pugh Electronics	147	Rigo Enterprises, Inc.	160
DeVry Technical Institute	5	Rinehart & Co. Inc.	147, 155
Diamond Electric Company	150	Rockbar Corporation	23
Dressner	102	Sams & Co., Inc., Howard W.	21, 132, 133
Duotone	112	Sarkes Tarzian, Inc.	121
Dynaco, Incorporated	30, 88, 90	Seg Electronics	149
EICO	35, 36, 96	Sherwood Electronic Laboratories, Inc.	121
Editors and Engineers, Limited	98	Sonic Industries, Inc.	12
Electro-Voice, Inc.	FOURTH COVER	Sonotone Corp.	32
Electronic Chemical Corp.	98	Sprayberry Academy of Radio-Television	31
Electronics Division Book Service	124	Standard Surplus	148
Electronics World	156	Supreme Publications	145
Electronics World Classified Information	148	Sylvania	10, 11
Electronics World Direct Sales Dept.	160	Terado Company	110
Electronics World Stereo Discs	151	Texas Crystals	94
Electronics World Subscriptions	136	Thorens	125
Esco C-B Hqts.	153	Tri-State College	147
Esse Radio Company	96	Triplett Electrical Instrument Company	THIRD COVER
Fair Radio Sales	146	Tru-Vac Electric Company	127
Fairchild Recording Equipment Corp.	88	United Audio	88
Fisher Radio Corporation	123	Valparaiso Technical Institute	102
G & G Radio Supply Co.	137	Vanguard Electronic Labs	126
General Electric Company	6, 141	Video Electric Company	143
Globe Electronics	146	Vocaline Company of America, Inc.	129
Goodheart Co., R. E.	110	Weathers Industries	86
Grantham School of Electronics	92	Western Radio	152
Greenlee Tool Co.	141	Wigo	88
Hallicrafters	124	World Radio Laboratories	150
Harman-Kardon, Inc.	87	Xcelite, Incorporated	112
Heath Company	76, 77, 78, 79, 80, 81, 82, 83, 84		
Henshaw Radio Supply	102		
Hi-Fi Annual & Audio Handbook	111		
Hi-Fi Directory & Buyers' Guide	154		
Hi-Mu Electronics	158		

... the smartest move you can make

is to **TRIPLETT VOMs**

... the world's most complete line of VOMs for every purpose!



Model 639-N Case \$9.50. Handsome, black cowhide leather. Center-cover flaps snap back for full view of scales and complete access to instrument without removal from case.

Model Pt. T-225-A-33 Tester Stand \$0.50. Metal, holds tester in approximately 45° angle; facilitates easy reading.

Probe for High Voltage Testing \$14.50. For models 630, 630-A, 630-PL, 630-APL, and 631. Completely insulated polystyrene; guard-type handle, 11¼" long; 48" hi-voltage wire lead with banana plug at tester end. Available in 0-12,000 AC or DC volts, and 0-30,000 AC or DC volts.

Model 630-T \$54.50. Specially designed for telephone maintenance. 2% accuracy on DC. Fused protected circuit protects resistors and meter in ohms ranges. Special neck strap holds instrument, freeing both hands. Banana jack connectors eliminate all shock hazard. Completely insulated case protects from ground.

Model 666-R Pocket VOM \$29.50. Hand size, ideal for electrical maintenance. With recessed range knob it fits easily into case. AC rectifier pre-calibrated unit for easy replacement. Banana jacks at panel top prevent leads falling over meter dial. Single king-size selector switch minimizes incorrect settings, burnouts, 20 ranges. Molded case streamlined, fully insulated.

Model 666-MH Pocket VOM \$27.50. Compact, hand-size; 3" meter integral with panel, adjusted to 400 microamperes at 250 millivolts. Only 3 jacks necessary for all ranges. 19 ranges.

Model 625-NA \$54.50. Dual sensitivity for extra ranges; large mirror scale for super readability, 3-color meter scale 5" long, 6" instrument. 0-50 microamp. AC volts at 10,000 D/V for checking many audio and high Imped-

ance AC circuits usually requiring VTVM. 38 ranges. Molded insulated case.

Interior View showing advanced engineering features of all Triplett VOMs. Molded mounting for resistors and shunts allows direct connections without cabling. Eliminates shorts. Longer life.

Model 630 \$44.50. Popular, streamlined; long meter scales for easy reading. Outstanding linear ohm scale; low reading .1 ohm, high 100 megs. Single king-size selector-switch minimizes incorrect settings, burnouts. High sensitivity; 20,000 ohms per volt DC; 5,000 AC. Molded, fully insulated case.

Model 630-A \$54.50. Laboratory type; ½% resistors for greater accuracy. Long mirrored scale eliminates parallax. Banana jacks, low resistance connections; high flux magnet increases ruggedness. Single king-size selector switch minimizes incorrect settings, burnouts. Molded fully insulated case.

Model 630-PL \$44.50. Instant-peek, wider spread scales; streamlined case; handsome modern design. Unbreakable window. Outstanding linear ohm scale, low reading .1 ohm; high to 100 megs. Single king-size selector switch minimizes incorrect settings, burnouts. 5 to 500,000 cps frequency response in AC measurements. DC Polarity Reversing switch. High sensitivity; 5,000 ohms per volt AC; 20,000 ohms per volt DC.

Model 10 Clamp-On Adapter \$14.50. Checks line loads with model 310 (can also be used with 6 other models). Instant, accurate, safe. No circuit breaking or work interruption. Easy range switching. Available in 6 AC Ammeter ranges: 0-6-12-30-60-120-300. Clips around single wire to read AC. Amperes direct. Use with adapter 101 to instantly divide 2-conductor cords. Molded case fully insulated, black plastic with engraved white markings.

Model 630-APL \$54.50. Laboratory type with ½% resistors, more accurate movement. Long mirrored scales eliminate parallax. Unbreakable window. Single king-size switch minimizes incorrect settings, burnouts. 5 to 500,000 cps frequency response in AC measurements. DC Polarity Reversing switch. High sensitivity; 5000 ohms per volt AC; 20,000 ohms per volt DC. Molded case fully insulated.

Model 630-NA \$74.50. Super DeLux with 70 ranges—nearly double conventional types. Frequency compensated from 35 cps to 20 kc. Temperature compensated. Accurate within 1½% full scale reading on DC. Large open front meter easy to read. Unbreakable window. Mirrored scale. Meter protection against overloads. Molded fully insulated case.

Model 631 Combination VOM and VTVM \$64.50. Two fundamental units at the price of a single tester. The No. 1 instrument for all electronic men. Battery operation assures VTVM stability and long life. Sensitivity PLUS. 1.2 volt (VTVM) range is equal to more than nine million ohms per volt. Large easy to read meter with unbreakable face. Single king-size selector switch minimizes incorrect settings, burnouts. Molded case fully insulated.

Model 310 \$34.50. The only complete miniature VOM with 20,000 ohms per volt and selector range switch. Self-shielded against strong magnetic field. Rugged, high torque, barring instrument. Unbreakable plastic meter window. Converts to common probe—frees one hand—by fitting interchangeable test prod into top. Standard sensitivity 20,000 ohms per volt DC, and 5,000 ohms per volt AC. Accuracy 3% DC. Molded fully insulated case.



**TRIPLETT ELECTRICAL INSTRUMENT COMPANY
BLUFFTON, OHIO**

FIRST CARDIOID AT SUCH LOW COST!

CUTS BACKGROUND NOISE

Accepts Only the Sound You Want

IDEAL FOR STEREO RECORDING OR PUBLIC ADDRESS

Unidirectional pick-up and tailored response of the *new E-V 729 Cardioid* make it economically ideal for many applications in public address, paging, dictating, home recording, amateur communications, and other sound use. The 729 Cardioid *rejects unwanted rear-background noise and room reverberation*. Permits working from nearly twice the distance of conventional microphones. *Reproduces only the sound you want*, more faithfully and distinctly. Instantly slips in or out of desk-base supplied with microphone. Feels good in the hand.

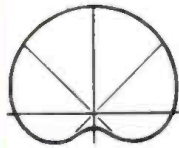

Typical Cardioid Polar Pattern



Model 729

Model 729 Cardioid Ceramic. Complete with desk-base and floor stand adapter. Ceramic generating element withstands extremes of temperature and humidity. Response 60-8000 cps. Output -55 db. High impedance. Two-tone gray.

List Price, \$24.50

Model 729S. With switch. List, \$26.50

Where economy is a factor, you still have every advantage in selecting *Electro-Voice*. You get the benefit of the same high quality engineering and manufacturing that have made E-V the choice of television networks. You choose from the *most complete line, the most accepted microphone line, in the world*. You are certain of finest value and *guaranteed satisfaction or your money back*.



924

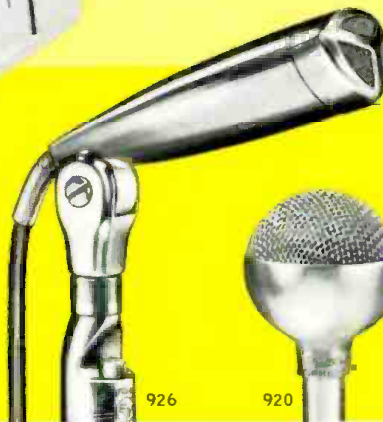

926



920



712

727



715



615

718

Model 715 "Century" Ceramic. Non-directional. For table, stand or hand. Ceramic element. Response 60-7000 cps. Output -55 db. High impedance. Satin chrome. List, \$13.00

Model 715S. With switch. List, \$15.00

Model 615 "Century" Dynamic. Has exclusive indestructible Acoustalloy diaphragm. Response 80-8000 cps. Output -55 db. Choice of 50 ohms or high impedance. List, \$25.50

Model 718 Ceramic. Non-directional. For hand or table use. Ceramic generating element. Response 60-6000 cps. Output level -55 db. High impedance. List, \$12.00

CHOOSE FROM THESE AND OTHER E-V LOW COST MICROPHONES

Model 926 Slim Crystal. For hand or stand use. Non-directional. Moisture sealed crystal. Response 60-8000 cps. Output -60 db. High impedance. Tilttable head. Satin chrome. List, \$29.50

Model 920 "Spherex" Crystal. All-direction pick-up. Moisture sealed crystal. Response 60-7000 cps. Output level -50 db. High impedance. Satin chrome finish. List, \$27.50

Model 712 Compact Ceramic. Fits comfortably in the hand. Non-directional. Response 70-7000 cps. Output -55 db. High impedance. Gray Styron case. List, \$7.50

Model 924 Lavalier Crystal. For chest or hand use. Non-directional. Moisture sealed crystal. Response 60-8000 cps. Output -60 db. High impedance. With neck cord, support clips, and cable. Satin chrome finish. List, \$20.00

Model 727 Slim Ceramic. Instantly lifts out of base for hand use. Non-directional. Ceramic generating element. Response 60-8000 cps. Output -55 db. High impedance. Two-tone gray. With desk-base and floor stand coupler. List, \$18.00

Model 727S. With switch. List, \$20.00

Wide choice of Dynamic models, also available.

See Your E-V Distributor, or Write for Catalog No. 136 to Dept. 119-N

No Finer Choice than **Electro-Voice**[®]

ELECTRO-VOICE, INC., BUCHANAN, MICHIGAN, U.S.A.