

# Electronic Design. 6

VOL. 26 NO.

FOR ENGINEERS AND ENGINEERING MANAGERS — WORLDWIDE

MARCH 15, 1978

**Minicomputer architecture** — it's changing, but slowly. The latest diagnostic routines help increase mini reliability, while LSI chips and  $\mu$ Ps improve performance

by easing the CPU's burden. Further progress in architecture hinges on availability and cost of standardized components. To see what's building, go to p. 26.

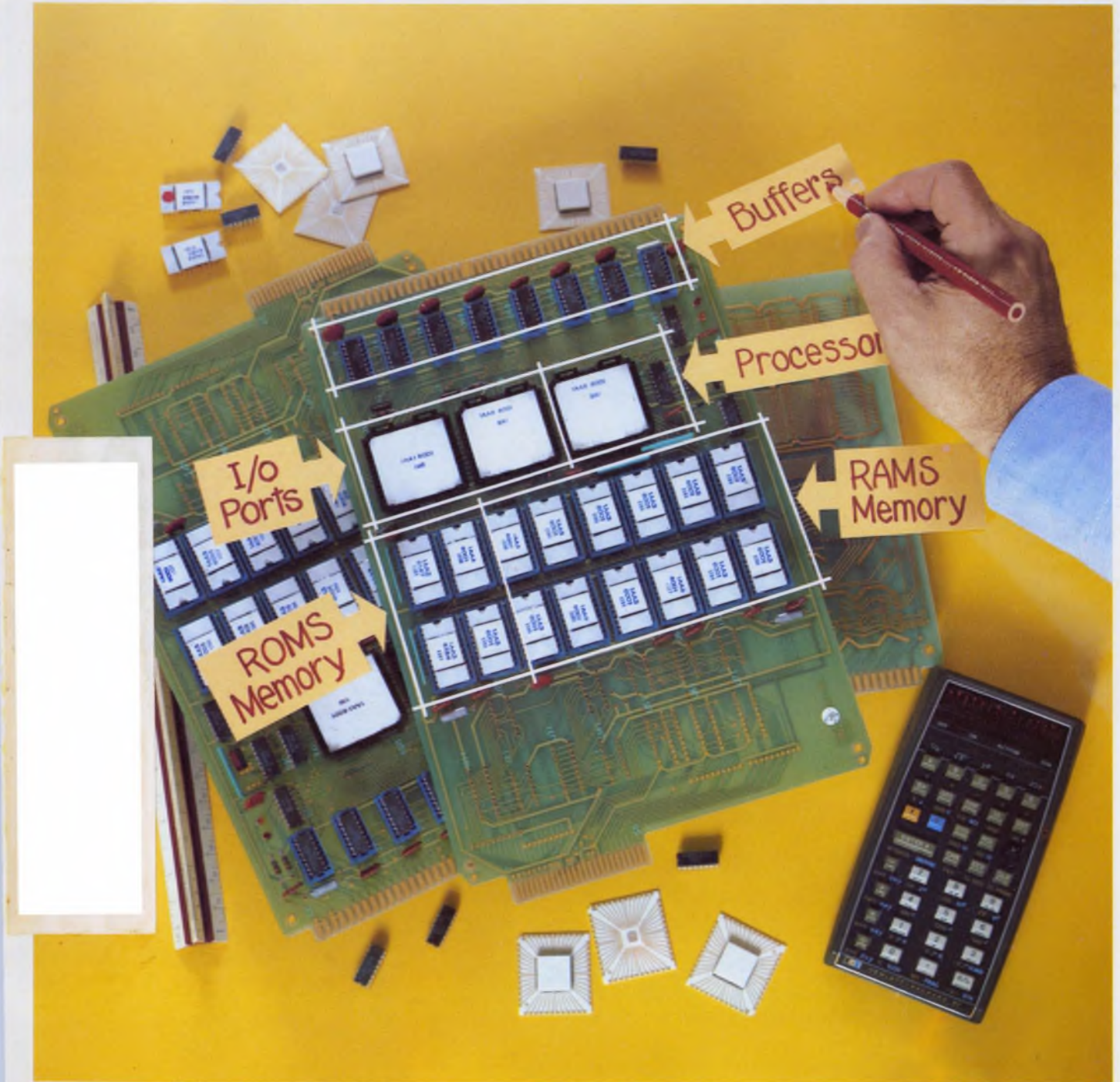

# The World's First SIP Trimmer...

## A new space saver from Bourns.

Now there's a new dimension in space savings... the Model 20 Trimpot® SIP Cermet Trimmer... a standard SIP, designed to meet your high density PC board needs.

With no sacrifice in performance, the Model 20 trimmer occupies only 25% of the precious board space used by comparable DIP configurations and only 50% of that used by conventional 3/4" rectangular trimmers. Featuring .100-inch spacing and a lower board profile... only .185-inches off the board... it's priced at a modest 75¢\* in 1,000 to 4,999 quantities. And, it's available in 18 standard resistance values ranging from 10 ohms to 5 megohms.

Conquer your space problems. Send today for complete details on the Model 20 SIP trimmer... the latest of many space saving "firsts" from Bourns.

TRIMPOT PRODUCTS DIVISION, BOURNS, INC., 1200 Columbia Avenue, Riverside, CA 92507. Phone: 714 781-5050 — TWX: 910 332-1252.

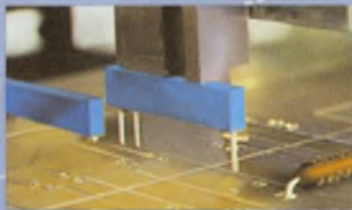

The Model 20 SIP trimmer... machine insertable and compatible with automatic test equipment for significant cost savings.

\*Domestic U.S.A. price only.



# BOURNS®

International Marketing Affiliates: European Headquarters — Switzerland 042/23 22 42 • Belgium 02/218 2005 • France 01/2039633 • Germany 0711/24 29 36 • Italy 02/32 56 88 • Netherlands 70/87 44 00 • United Kingdom 01/572 6531 • Norway 2/71 18 72 • Sweden 764/20 110 • Japan 075/921 9111 • Australia 02/55-0411 03/95-9566 • Israel 77 71 15/6/7

For Immediate Application — Circle 130  
For Future Application — Circle 230

Our Model 3001 starts at \$2,980. For that you get a signal generator that's already frequency programmable with 0.001% accuracy over the 1 to 520 MHz frequency range. If you also want to program your output power, we have a programmable attenuator option available for \$500.

If you'd like to spend a little more, add our external frequency standard option for \$150. That makes the accuracy the same as your standard. Or spend another \$500 for an internal reference frequency standard with  $5 \times 10^{-9}$  day stability. But if you want to spend much more than that, you're going to have to buy some-

body else's signal generator. Count on at least \$10,000. Frankly, we think your money would be better spent buying another Wavetek Model 3001.

Here's another advantage. If you need to get on the bus (now or later), our new Model 3910 Converter makes you GPIB compatible. But before you spend anything on any signal generator, get a demonstration of our Model 3001. That won't cost you a cent.

#### SPECIFICATIONS

Frequency Range: 1-520 MHz  
Accuracy:  $\pm 0.001\%$   
Resolution: 1 kHz

Stability: 0.2 ppm per hour  
Output Range: +13 dBm to  
-137 dBm

Flatness:  $\pm 0.75$  dB  
AM Modulation: 0-90%  
FM Deviation: 0-10 kHz and  
0-100 kHz

Internal Modulation Rates:  
400 Hz and 1 kHz

WAVETEK Indiana Incorporated,  
P.O. Box 190, 66 North First Avenue,  
Beech Grove, Indiana 46107,  
Phone (317) 783-3221,  
TWX 810-341-3226.

CIRCLE NUMBER 2

# WAVETEK®

# You can pay a lot more for a programmable signal generator. But why?



# The most significant price breakthrough in DOUBLE-BALANCED MIXERS!

...from Mini-Circuits of course!

# \$2.95

500 pieces

\$3.95 (10-49)



Model SBL-1

Model SBL-1, metal case, non hermetic seal

Frequency Range, MHz

LO 1-500 RF 1-500 IF DC 500

Conversion Loss, dB	Typ	Max
One Octave from Band Edge	5.5	7.5
Total Range	6.5	8.5
Isolation, dB	Typ	Min
Lower Band Edge to One Decade Higher	50	35
Mid Range	45	30
Upper Band Edge to One Octave Lower	40	25
Lower Band Edge to One Decade Higher	45	30
Mid Range	40	25
Upper Band Edge to One Octave Lower	35	25
Upper Band Edge to One Octave Lower	30	20

Signal, 1dB Compression Level -1dBm

Impedance, All Ports 50 ohms

Electronic Attenuation Min (20mA) 3dB

For demanding industrial and commercial applications, where low-cost and high-performance are critical, model SBL-1 will fill your need.

Don't let the low price mislead you. As the world's number one manufacturer of double-balanced mixers, Mini-Circuits' has accumulated extensive experience in high-volume production and testing, a key factor in achieving a successful low cost/high performance line of products.

The tough SBL-1 covers the broad frequency range of 1-500 MHz with 6 dB conversion loss and isolation greater than 40 dB. Only well-matched, hot-carrier diodes and ruggedly constructed transmission-line transformers are used. Internally, every component is bonded to the header for excellent protection against shock, vibration and acceleration.

Here are some of the steps taken to ensure quality: Every SBL-1 is RF tested two times, every solder connection is 100 per cent inspected under a high power microscope, all transformer leads are double-wrapped, and all components are rated for more than +85 °C operation. Of course, our one-year guarantee applies to these units.

World's largest manufacturer of Double-Balanced Mixers

## Mini-Circuits

MINI-CIRCUITS LABORATORY

A Division of Scientific Components Corp.

OUR NEW ADDRESS AND PHONE NO IS

2625 East 14th Street Brooklyn, New York 11235 (212) 769-0200  
Domestic and International Telex 125460 International Telex 620156

## WE'VE GROWN

Customer acceptance of our products has been so overwhelming, we've been forced to move to larger facilities — THANKS

**International Representatives:** □ **AFRICA:** Alitra (PTY) Ltd, P.O. Box 9813, Johannesburg 2000, S. Africa □ **AUSTRALIA:** General Electronic Services, 99 Alexander Street, New South Wales, Australia 2065 □ **ENGLAND:** Dale Electronics, Dale House, Wharf Road, Frimley Green, Camberley Surrey □ **EASTERN CANADA:** B.D. Hummel, 2224 Maynard Avenue, Ulica NY 13502 (315) 736-7821 □ **FRANCE:** SCIE, D.I.M.E.S. 31 Rue George, Sand 91120 Palaiseau, France □ **GERMANY, AUSTRIA, SWITZERLAND, DENMARK:** Industrial Electronics GMBH 6000 Frankfurt/Main Klüberstrasse 14 West Germany □ **INDIA:** Gaekwar Enterprise, Kama Mahal, M.L. Dananukar Marg, Bombay 400 026 India □ **ISRAEL:** Vectors Ltd, 69 Gordon Street, Tel Aviv, Israel □ **NETHERLANDS, BELGIUM, LUXEMBOURG:** Coimex, Veldweg 11, Hattem, Holland

□ **NORWAY:** Datamatik AS, Ostensjøveien 62, Oslo 6, Norway □ **SINGAPORE & MALAYSIA:** Electronics Trading Co. (PTE) Ltd, 87 Bukit Timah Road, Singapore 9, Malay Peninsula □ **SWEDEN:** Intergrad Elektronik AB, Box 43, S-18251, Djursholm, Sweden

**U.S. Distributors:** □ **NORTHERN CALIFORNIA:** PENN-STOCK Co., Foothill Office Center, 105 Fremont Avenue, Los Altos, CA 94022 (415) 948-6533 □ **SOUTHERN CALIFORNIA, ARIZONA:** Crown Electronics, 11440 Collins Street, No. Hollywood, CA 91601 (213) 877-3550  
**NEW YORK, NEW YORK MICROWAVE DISTRIBUTORS COMPANY:** 61 Mail Drive, Commack, NY 11725 (516) 543-4771

---

## NEWS

- 21 **News Scope**
- 26 **Minicomputer architecture**—Advancing, but with caution. An Electronic Design special report.
- 32 **Airborne TV systems are jammable** but MPs may be part of a solution.
- 38 **How fast are you driving?** That sign on the overpass knows.
- 47 **Washington Report**

---

## TECHNOLOGY

- 56 **Diagnose computer ills** with an analog monitor. It's inexpensive, very easy to build, and does not interfere with computer operation.
- 62 **Microprocessor Basics: Part 22.** Take advantage of powerful instructions in the PIC-1650 microcomputer chip. Its 12-bit instruction size and the register-file architecture make a potent pair.
- 72 **Multiprocessing boosts microcomputer** power dramatically. You can build systems from 8080s and a few other chips. And such systems are expandable.
- 78 **Choosing a scope to measure time?** Look at some relative pulse-width and delay measurements. Wider bandwidth doesn't necessarily mean better results.
- 84 **The bandwidth of phase-lock loops** for synchronous data transmission should first be wide, then narrow. Solve the dilemma with a modified loop.
- 90 **Modulo-N counter speed** is limited by the counter module's propagation delays. But asymmetrical clock inputs can raise the speed substantially.
- 94 **Collect data via pulse-code modulation** in your next data-acquisition system. PCM handles bandwidths of 5 kHz and has a high s/n ratio.
- 102 **Multilayer coil design** is made easy with a programmable calculator. AWG numbers are provided, and wire material and tempco can be changed.
- 110 **Quantize the feedback** in a/d converters. With microprocessor control, you trade inexpensive program-storage space for crucial speed and accuracy.
- 120 **Make your time generator versatile.** You won't have to redesign hardware to change system timing if you start out with a 'universal' timing generator.
- 128 **Lee Wilson of Corning** speaks on centralizing engineering.
- 136 **Ideas for Design:**  
Constant-current feedback loop improves photodetector performance in optical sensors...Field-programmable logic array decodes keyboard without a debounce circuit...Improve double-balanced mixer with an active circuit.
- 147 **International Technology**

---

## PRODUCTS

- 151 **ICs & Semiconductors:** True 12-bit CMOS multiplying DAC is low priced.
- 163 **Instrumentation:** Video monitor takes the lead in resolution and distortion.
- |     |                      |     |                         |
|-----|----------------------|-----|-------------------------|
| 174 | Micro/Mini Computing | 206 | Power Sources           |
| 184 | Components           | 208 | Modules & Subassemblies |
| 200 | Data Processing      | 210 | Packaging & Materials   |

---

## DEPARTMENTS

- |     |                                   |     |                            |
|-----|-----------------------------------|-----|----------------------------|
| 51  | <b>Editorial:</b> The frozen mind |     |                            |
| 7   | Across the Desk                   | 221 | Employment Opportunities   |
| 212 | New Literature                    | 228 | Advertisers' Index         |
| 214 | Design Aids                       | 228 | Information Retrieval Card |
| 214 | Vendors Report                    |     |                            |

**Cover:** Photo by George Young, courtesy of Hewlett-Packard.

---

ELECTRONIC DESIGN is published biweekly except 3 issues in July by Hayden Publishing Company, Inc., 50 Essex St., Rochelle Park, NJ 07662. James S. Mulholland Jr., President. Printed at Brown Printing Co., Waseca, MN. Controlled circulation postage paid at Waseca, MN and New York, NY, postage pending Rochelle Park, NJ. Copyright© 1978. Hayden Publishing Company, Inc. All rights reserved. POSTMASTER: Please send form 3579 to ELECTRONIC DESIGN, P.O. Box 13803, Philadelphia, PA 19101.

# Mostek's 64K ROM sets new standards for speed and power.

Pin compatibility, from 8K to 64K,  
means easy system upgrade in density  
and performance.

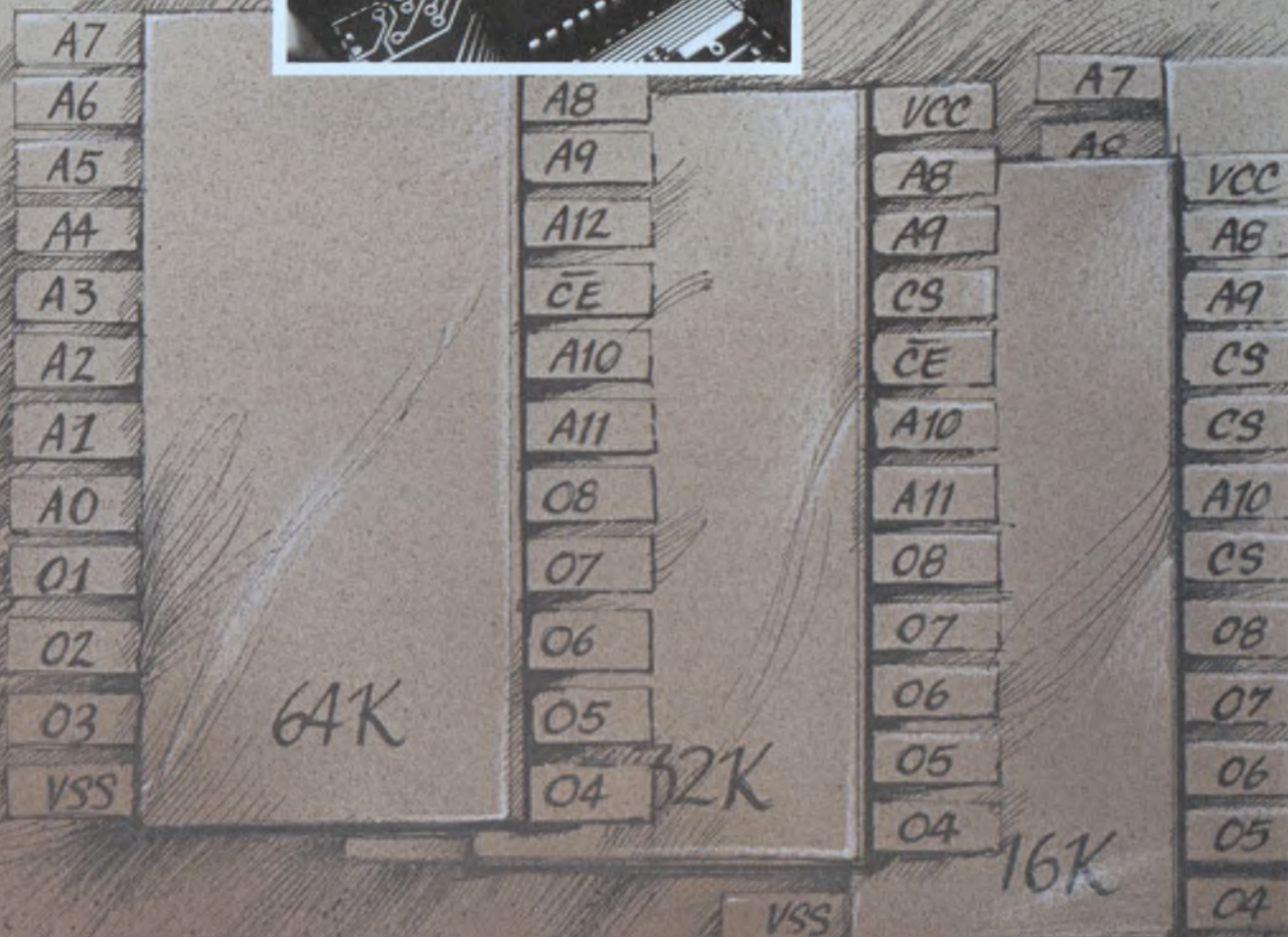
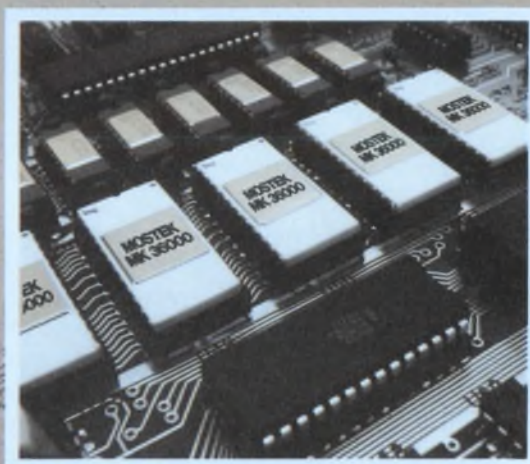

*MK 36000 is compatible with industry standard pinouts.*

Mostek's newest ROM was developed by a design and process team with years of experience in dynamic RAMs. Their goal was to produce the industry's highest density ROM with all the features you expect in Mostek RAMs.

They met that goal with the MK36000 65,536-bit Read-Only Memory. It sets new standards with the industry's highest density, fastest access, and lowest power.

**Speed and power.** Mostek's MK 36000-4 offers 250 ns access time max! It's ideal for fast microprocessor applications like Mostek's 4MHz Z80, as well as

storage for higher level languages. With speeds like this you might expect a sacrifice in power. Not from Mostek. The MK 36000-4

requires only 200 mW active power max. Automatic standby power is just 25 mW typical.

**Greater system performance and efficiency.** Mostek's ROM family now includes 8K, 16K, and 64K organizations. All are pin-for-pin compatible so you can easily upgrade your existing de-

signs in both density and performance. (With each increase in bit density a chip select input is replaced by the necessary address pin.) The 36000 is pin-compatible with existing EPROMs also allowing upgrades to higher density at much lower costs.

Mostek's Edge-Activated design concept provides many other features including +5V only power with  $\pm 10\%$  tolerance,

on-chip address latches, totally static operation and direct TTL compatibility with common I/O.

In applications with Mostek's Z80 microcomputer and Mostek 4K static RAMs you can activate the entire system with one common timing signal achieving a 75% reduction in device operating power for an automatic standby power mode.

**Proven technology for lower cost, greater reliability.** The proven technology for high performance and volume production is N-Channel, Silicon Gate MOS. Mostek's years of experience with Poly I<sup>TM</sup> process allow confident planning of next-generation products like the 36000. Now, Mostek process engineers can quickly move these designs from R&D to full production with proven reliability in millions of circuits.

There's more information on Mostek ROMs. Contact your nearest field sales representative or Mostek Corporation, 1215 W. Crosby Road; Carrollton, Texas 75006, (214) 242-0444. In Europe contact Mostek GmbH, West Germany; Telephone, (0711) 701096

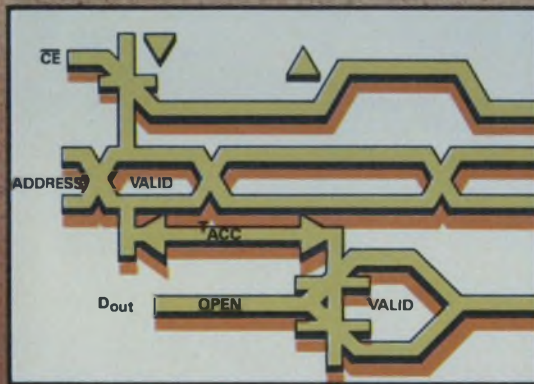
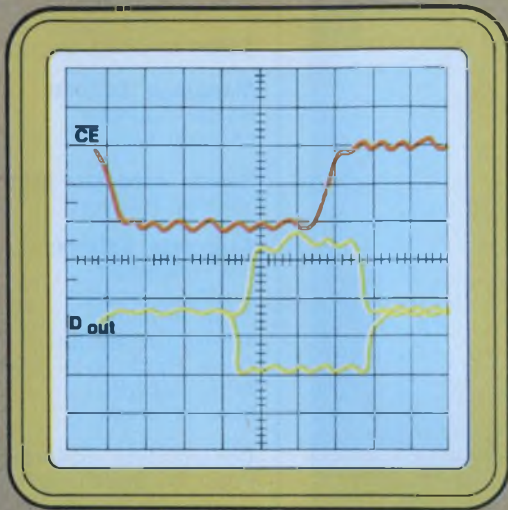

# MOSTEK

- VCC
- A8
- A9
- NC
- CS
- NC
- CS
- O8
- O7
- O6
- O5
- O4

3K

# economy

We became the world's largest manufacturer of SCR power supplies by offering higher quality at lower prices.

In a word: economy. In another word: value.



One- and three-phase rack-mounted power supplies from 500 to 10,000 watts. Call TOLL FREE 800-631-4298 for complete information and prices, or write for our catalog.



## ELECTRONIC MEASUREMENTS INC.

405 Essex Road, Neptune, N.J. 07753  
Phone: (New Jersey) 201-922-9300. TOLL FREE 800-631-4298  
Specialists in Power Conversion Equipment

CIRCLE NUMBER 5

## Publisher

William Maass

## Editors

Editorial Offices  
50 Essex St.  
Rochelle Park, NJ 07662  
(201) 843-0550  
TWX: 710-990-5071  
(HAYDENPUB ROPK)  
Cable: Haydenpubs Rochellepark

**Editor-in-Chief** George Rostky

## Managing Editors:

Ralph Dobriner  
Michael Elphick

## Senior Associate Editor

Stanley Runyon

## Associate Editors:

Sid Adlerstein  
Nicholas Bodley  
Dave Bursky  
Morris Grossman  
Gene Heftman  
Andy Santoni  
Max Schindler

## Contributing Editors:

Peter N. Budzilovich, Jules H. Gilder,  
Sidney Moskowitz, Nathan Sussman

## Editorial Field Offices

### East

Jim McDermott, Eastern Editor  
P.O. Box 272  
Easthampton, MA 01027  
(413) 527-3632

### West

Dick Hackmeister, Western Editor  
8939 S. Sepulveda Blvd., Suite 414  
Los Angeles, CA 90045  
(213) 641-6544  
TWX-1-910-328-7240  
Dave Barnes, Western Editor  
465 S. Mathilda, Suite 302  
Sunnyvale, CA 94086  
(408) 736-6667

## Editorial Production

Marjorie A. Duffy, Production Editor  
James Keane, Copy Editor

## Art

**Art Director**, William Kelly  
Richard Luce, Anthony J. Fischetto

## Business Manager

Thomas E. Vachon

## Production

**Manager**, Dollie S. Viebig  
Nancy Hurey

## Circulation

**Director**, Barbara Freundlich  
**Senior Assistant**, Gail Stone

## Information Retrieval

Paula Greenleaf

## Advertising Promotion

Judith Nappo

## Reprints

Maxine Sassano



# Across the desk

## Engineering decisions from nonengineers

Basically, I agree with Mr. Morroni's comments (see "Sons of Laetrile," ED No. 23, Nov. 8, 1977, p. 14). But I do believe that several aspects of the problem should be restated. For example, what can the individual do when companies refuse to let engineering decisions be made on a sound engineering basis? Too often nonengineering managers box us in by making these decisions, and too often price is *not* a controlling factor.

I will note just a few examples:

1. The use of "n" to designate the following kinds of devices:

- npn silicon transistors
- npn germanium transistor
- Enhancement FETs, p type
- MOSFETs, both types
- Depletion FETs, p type
- pnp silicon transistors
- pnp germanium transistor
- SCRs
- Enhancement FETs, n type
- Dual diodes
- Darlington pairs, all types
- Unijunctions
- Depletion FETs, n type

The "n" could easily be replaced by a two or three-letter code that would identify *all* of these by type.

2. The use of beta as a prime characterizing parameter for bipolar transistor devices, it being a *small difference* of large numbers.

3. Failure to recognize the importance of transconductance-per-unit-current efficiency as it relates to small-signal and power-circuit design.

4. Inept characterization of all solid-state devices I know of. This has been true since electron tubes first came on the market. Tube transconductance as a function of plate current is an important parameter with these devices (and the corresponding relation for both bipolar and field-effect transistors), whereas transconductance as a function of control-grid bias is indefensible.

Yet *no* tube manufacturer credits this parameter with its true importance, and one of the major manufacturers still presents such data as he gives as a function of grid bias, a singularly unreliable relation.

5. Integrated-circuit manufacturers' turning out special-code ICs by the millions, using "MOSFET" technology. These get out onto the market by the millions, too, and you can't even find out the pinout or supply-voltage requirements. Manufacturing says, "Get the dope from our customer," but doesn't even take the trouble to tell you who the customer is. The result? You don't even dare try to test the stuff, it is so delicate and sensitive!

All we need to do is to get some checks and balances that will assure that the views of a spectrum of engineer and technician users are fairly considered in the decision-making process, instead of having governance controlled completely by the manufacturers themselves. Otherwise, we will continue to require that Naderites, Common Causers and others of their ilk scream for more government regulations. And since we apparently *won't* police our own operations adequately, we really can't argue much about their views, even though they really aren't sound.

Keats A. Pullen, Jr. E.D.

Box 381  
Jerusalem Rd.  
Kingsville, MD 21087

## Rise time probed

The assumed input-circuit topology of "Let Your Scope Measure Its Own Rise time—Almost," by Raymond Pizzi (ED No. 24, Nov. 22, 1977, p. 130) is not valid for most oscilloscopes. But the mathematical derivations are interesting.

At the risk of divulging a scope-  
*(continued on page 10)*

Electronic Design welcomes the opinions of its readers on the issues raised in the magazine's editorial columns. Address letters to Managing Editor, Electronic Design, 50 Essex St., Rochelle Park, NJ 07662. Try to keep letters under 200 words. Letters must be signed. Names will be withheld upon request.

## Need a custom Power Supply fast?



### Hop on the Design-As-You-Order express!

With our miniaturized building-block approach, a custom power supply from someone else is a standard from Arnold Magnetics. You design from over 1200 mix and match configurations, and your power supply is potted and burn-in tested before delivery. Let us fill your special needs fast, and save you engineering charges too.

#### Look under our hood.

**INPUTS** — Single or dual —

- AC: 50 to 500 Hz
- DC: 12, 28, 48 or 115 VDC

**MULTIPLE OUTPUTS** — Up to 10

- 3 to 400 watts
- Up to 3.9 watts per cubic inch
- Efficiencies to 80%

**REGULATION** — Line and load to 0.1%

#### There's more.

**HIGH VOLTAGE SUPPLIES** — Outputs to 5000 VDC

**SPECIAL NEEDS?** We have the design and manufacturing capability to handle them and save time and resources.

Don't miss the Design-As-You-Order express... call or write for more information today!



**Arnold Magnetics Corporation**

11520 W. Jefferson Blvd.  
Culver City, Ca. 90230 • (213) 870-7014

# Intel delivers six single that provide economy

Intel leads the way with both the lowest cost and the highest performance single-chip microcomputers available. We now deliver the industry's broadest and most complete selection of compatible economy microcomputers. So there's no need to compromise your standards when your application requires low cost intelligence.

That's good news if you're designing for home appliances, automobiles, communications equipment, vending machines or any price-sensitive product. Now you can take advantage of microcomputer power

to replace hardwired logic and electromechanical devices, and achieve unmatched design flexibility, improved reliability and reduced product cost.

At \$3 in OEM quantities, our new 8021 is quite simply the world's lowest priced 8-bit microcomputer. It's a cost reduced version of our 8048, the

microcomputer which won industry acceptance for the single-chip system concept. Then there's our new top-of-the-line 8049, the microcomputer that sets a new standard for single-chip system performance.

The entire line of MCS<sup>®</sup>-48 microcomputers is priced right and designed to lower your total system cost. For example, they all operate from a single 5V power source, and the 8021 has the broadest operating range in the industry (4.5V to 6.5V).

The 8021 also has an internal clock generator that lets you control system

timing with a single 2 $\Omega$  resistor. Built-in zero cross detection enables the 8021 to accurately control system



# chip microcomputers without compromise.

timing operations and perform time-of-day accumulation.

For sheer performance, there's not a single-chip microcomputer anywhere that can catch our new 8049.

With twice the on-chip memory of the 8048, the 8049 enables you to economically perform complex functions that previously required more costly multi-chip systems. And it's a drop-in replacement for the 8048, so you can upgrade 8048-based products with no redesign.

We've made MCS-48 microcomputers the easiest to use, too. Our 8748, for example, provides on-chip erasable and reprogrammable EPROM. That enables you to beat the ROM turnaround cycle during design and field testing. And its 100-piece prices start at just \$39, making the 8748 economical for low to medium volume production. To ensure maximum flexibility, all members of the MCS-48 family are software compatible.

If you've taken advantage of our high performance multi-chip microcomputers, the 8080 and 8085, you know that Intel delivers the most in-depth and advanced development support. Now you don't have to go without that support, even for your most

## MCS-48 Microcomputers

Model	Program Memory	Data Memory	I/O Lines	Instruc-tions	Package Size
8021	1K Bytes ROM	64 Bytes	21	65	28 Pin
8048*	1K Bytes ROM	64 Bytes	27	96	40 Pin
8748*	1K Bytes EPROM	64 Bytes	27	96	40 Pin
8035*	(External)	64 Bytes	27	96	40 Pin
8049*	2K Bytes ROM	128 Bytes	27	96	40 Pin
8039*	(External)	128 Bytes	27	96	40 Pin

\*Designed for easy expansion of program/data memory and I/O.

budget-minded applications. It starts with our PROMPT™ 48 Design Aid. Then there's Intellec®, the industry's most powerful microcomputer development system, with resident MCS-48 Macro Assembler and ICE™ In-Circuit Emulation with symbolic debugging. Plus applications assistance worldwide, full documentation, training classes, design seminars and a rapidly expanding users' software library.

The more important economy is to you, the more important it becomes for you to evaluate the 8021, 8049 and other members of Intel's MCS-48 economy microcomputer family. They're all available now through your nearest Intel distributor: Almac/Stroum, Component Specialties, Cramer, Hamilton/Avnet, Harvey Electronics, Industrial Components, Pioneer, Sheridan, L.A. Varah, Wyle/Elmar-Liberty and Zentronics. For complete technical information use the reader service card or write: Intel Corporation, 3065 Bowers Avenue, Santa Clara, CA 95051. Telephone: (408) 987-8080.

# intel® delivers.

FOR MORE INFORMATION CIRCLE NUMBER 7

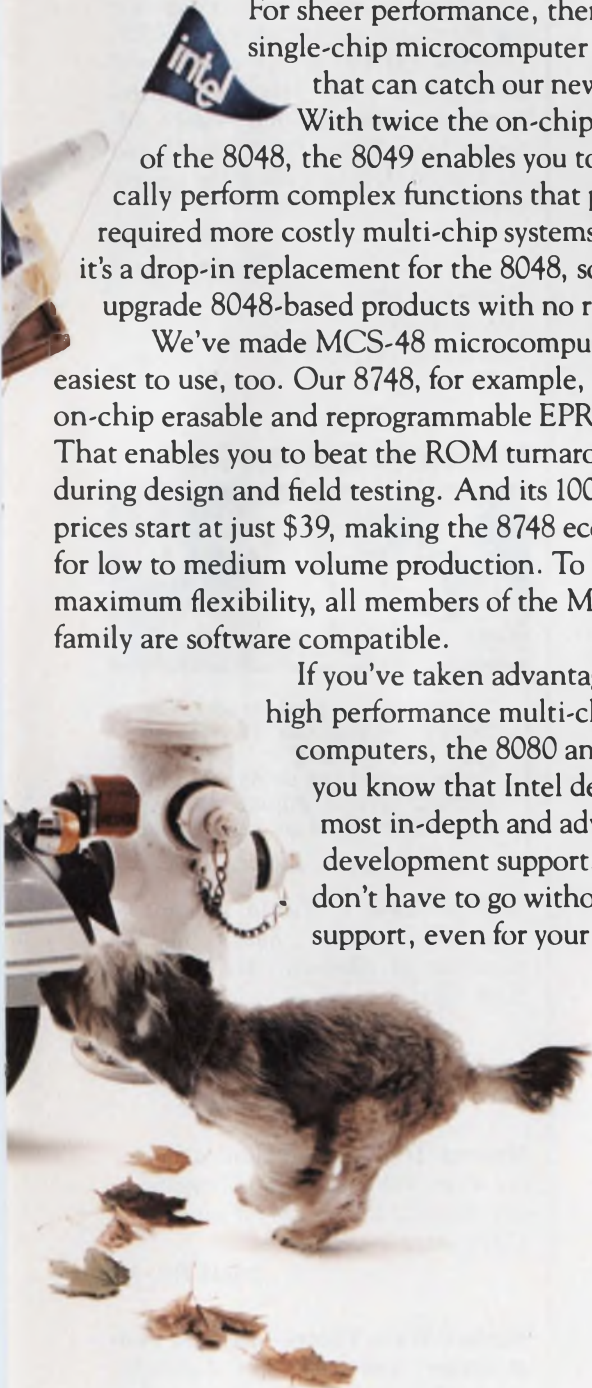

# Protect your expensive switching systems. Prevent down time due to dirty contacts.

## Use MS-230 Contact Re-Nu®



### PURITY COMES FIRST

Our aerosol cleaners have the lowest residual contamination in the industry — some approaching 5-7 parts per million. The general industry range is 50-130 ppm. For only a few dollars per month you can maintain or restore continuity almost instantly to relay and switch contacts. Won't harm insulation. Leaves no residue. Non-conductive, Non-flammable. Contains no lubricant. May be shipped air transport.

For further information, call or write Miller-Stephenson, Chemical Co., Danbury, Conn. 06810 (203) 743-4447

**m s miller-stephenson chemical co., inc.**

Danbury, Connecticut 06810 (203) 743-4447

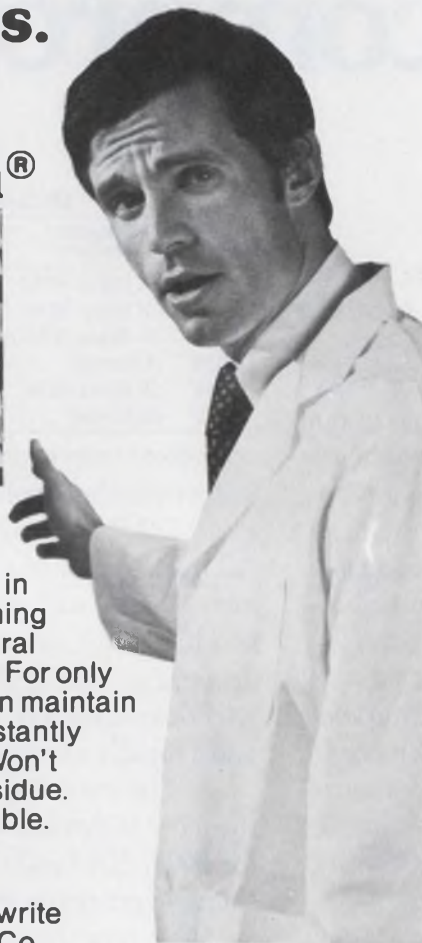

-----  
**miller-stephenson chemical co., inc.**  
 Danbury, Connecticut 06810 (203) 743-4447

ED-3W

- \_\_\_\_\_ Ask our Technical Director for application information
- \_\_\_\_\_ Send \$2 for Trial Unit of MS-230 Contact Re-Nu®
- \_\_\_\_\_ Send literature and prices

My intended use is \_\_\_\_\_  
 Name \_\_\_\_\_ Title/Dept. \_\_\_\_\_  
 Company \_\_\_\_\_  
 Address \_\_\_\_\_  
 City \_\_\_\_\_ State \_\_\_\_\_ Zip \_\_\_\_\_

©Registered trademark.

For Industrial Use Only. Trial Unit must be sent to company address.

LOS ANGELES · CHICAGO · DANBURY, CONN. · TORONTO

CIRCLE NUMBER 83



## Across the desk

(continued from page 7)

industry "secret" about times 10 probes, let it be known that a typical probe is constructed by shunting the 9-MΩ resistor with a capacitor. This configuration, when joined to a 1-MΩ, 10-pF oscilloscope input, forms a compensated voltage divider, and is not the primary determinant of oscilloscope rise time. Once a compensated probe is employed, the bandwidth and rise time depend upon other things, including the amplifiers that drive the CRT. It is not difficult to cite examples of oscilloscopes with virtually identical input characteristics but widely different bandwidths: the TEK 453 and 475A at 60 MHz and 250 MHz, respectively.

Calvin Diller  
 Dennis Feucht

Tektronix, Inc.  
 P.O. Box 500  
 Beaverton, OR 97077

## Misplaced Caption Dept.



If tests on a pilot production item show that our new design just isn't making it, our engineers accept the setback philosophically and adjust the design parameters appropriately.

Sorry. That's Pablo Picasso's "Guernica," which hangs in the museum of Modern Art in New York City.

## New Books

**Modern Digital Communications**—E.J. Foss, Tab Books, Blue Ridge Summit, PA 17214, 308 p. \$7.95 paperback, \$10.95 hardbound.

CIRCLE NO. 501

**Surface Wave Filters—Design, Construction and Use**—H. Matthews, John Wiley & Sons, One Wiley Drive, Somerset, NJ 08873, 521 p. \$29.95.

CIRCLE NO. 502

ELECTRONIC DESIGN 6, March 15, 1978

# Two multi-turn trimmers that will set well with you.

Both our Type RT and MT cermet trimmers combine 20-turns and multi-fingered wipers to give you unexcelled adjustability. Both types: 10 ohms to 2.5 megs  $\pm 10\%$ . Typical TCR is less than  $\pm 35$  PPM/ $^{\circ}\text{C}$ . True quality trimmers at very competitive prices. We have what you need. Our distributors have them when your need is now. Ask for Publication 5237 (RT) or 5241 (MT).

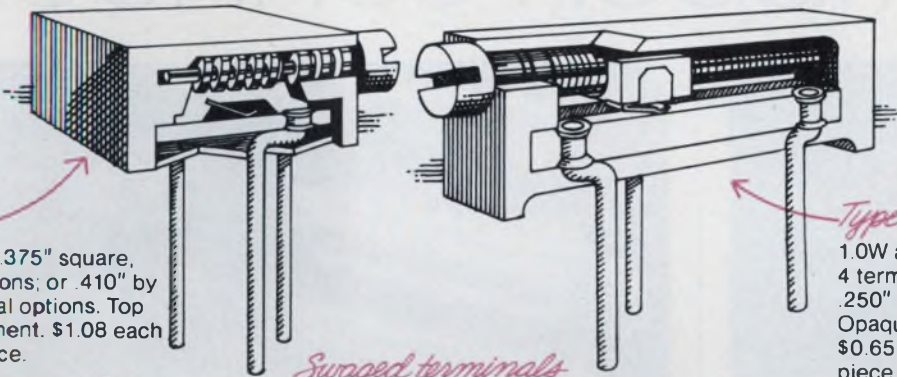

*Type MT*

0.5W at 70°C; .375" square, 3 terminal options; or .410" by .375", 4 terminal options. Top or side adjustment. \$1.08 each 1000 piece price.

*Immersion sealed*

...tested in 85°C water.

*Swaged terminals*

for extra strength and reliable bonding.

*Type RT*

1.0W at 40°C; .750" long, 4 terminal options; choice of .250" or .340" case heights. Opaque or translucent case. \$0.65 or 0.93 each 1000 piece price.

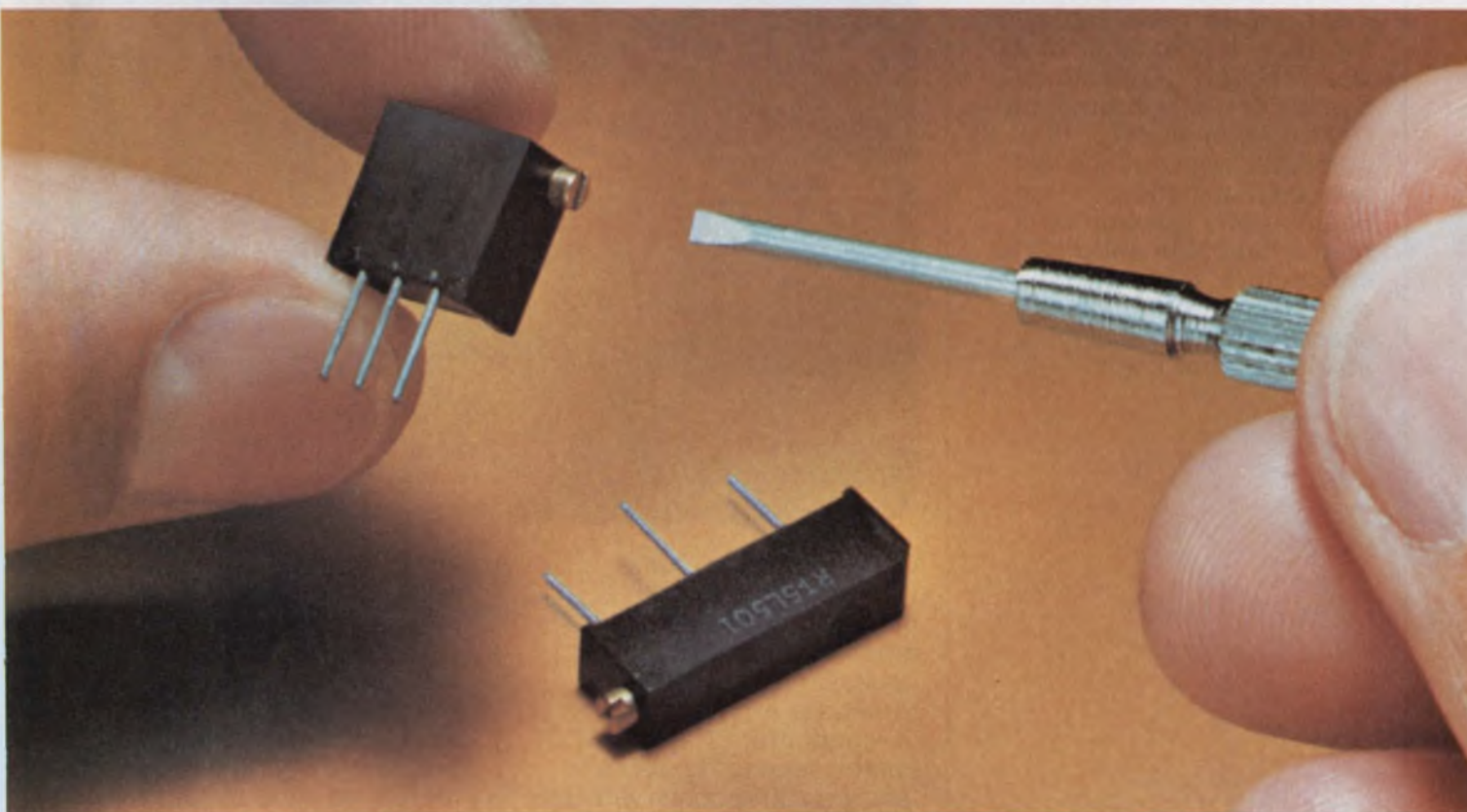

## Quality in the best tradition.



**ALLEN-BRADLEY**  
Milwaukee, Wisconsin 53204

CIRCLE NUMBER 9

# Now you can mass terminate with ribbon connectors...

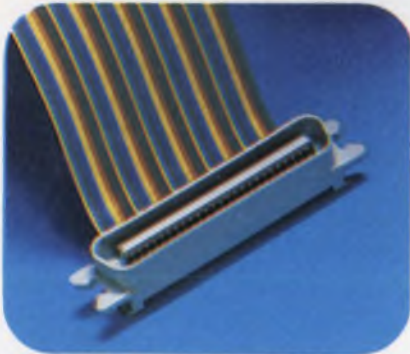

Here's another industry first from 3M that's good news for you: the Scotchflex brand Delta Ribbon Connector System for intra-system or I/O interconnections. In computer applications, in telecommunications, in any place or any way you want to use flat cable and ribbon connectors, this versatile system can do the job at sharply reduced assembly time and labor costs.

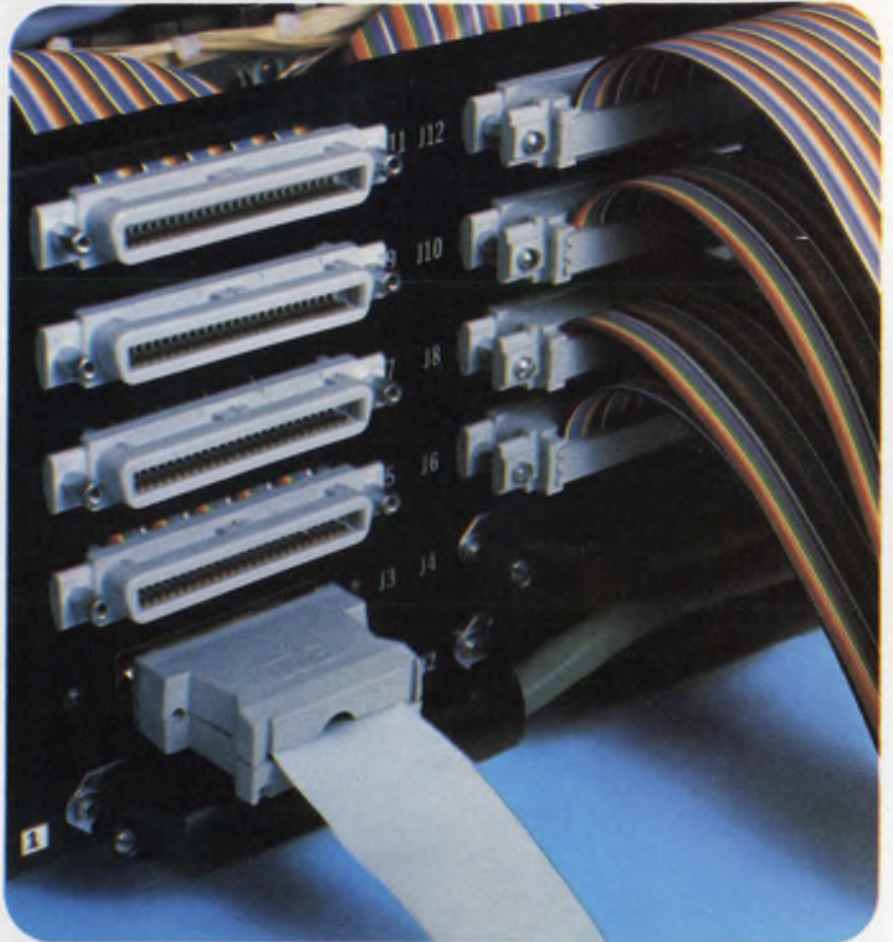

With Scotchflex Delta Ribbon Connectors, no stripping, soldering or other wire preparation is necessary. You can mass terminate a parallel-lay 50-conductor (25-pair) .0425" center-spaced flat cable in less than 30 seconds with one step. That's about ten times faster than other available methods. And thanks to 3M's field-proven, gold-plated beryllium copper U-contacts,

all connections are reliably corrosion-resistant and gas-tight.

After termination, there are more savings. You can buss from point to point without disassembling or breaking existing cables. And there's no need to redesign or rework first generation components. This Scotchflex system mates perfectly with all standard miniature ribbon connectors.

# ..in 30 seconds or less!



There's no costly investment to make in equipment or training. All you need are two locator plates and the Scotchflex manual or pneumatic assembly press. You can start mass terminating assemblies quickly and economically. No special operator skills are required. Rejects and reworking are greatly minimized.

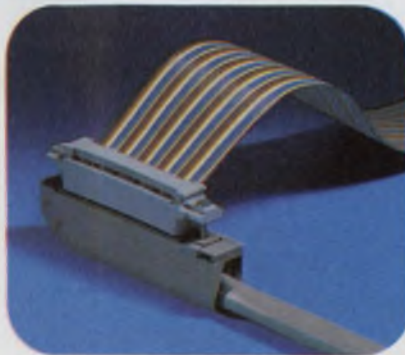

The Scotchflex Delta Ribbon system includes 50-position male and female connectors, plus appropriate bail mount, screw mount and jack screw kits, strain relief clips and dust covers. Color-coded flat cable is available in parallel-lay conductors #28 AWG stranded or #26 AWG solid.



Only 3M offers you so broad a range of flat cable and system components. A nationwide network of stocking distributors. Best off-the-shelf availability. Proven performance. And the unmatched experience of the people who pioneered mass terminations.

"Scotchflex" is a registered trademark of 3M Co.

Scotchflex<sup>®</sup>  
systems  
from 3M.  
The source.



See our  
catalog in EEM,  
page 2256

# ROLM has it all together



## or apart

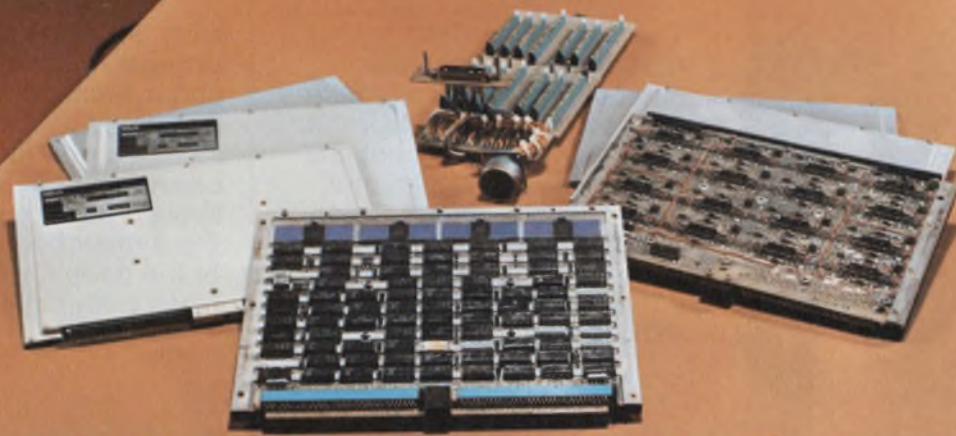

## with the new Micro-Modular Concept

Anyway you want it. In any configuration you need.

For any small Mil-Spec computer system with large performance requirements, you can start with the ROLM® Model 5605 microprocessor. This high speed, single module processor can address 64K of memory and as many as 61 devices.

It uses our semi-conductor or core memory modules. Like the CPU, they're Mil-Spec components ready for severe environments.

Select from a full line of ROLM interfaces ranging from standard I/O buffers to NTDS and communications interfaces.

Tie the whole system together with a custom, or standard, motherboard ready for an enclosure of your design or the ROLM Mil-Spec Half ATR chassis.

While your system is in design & development, your software can be developed on one of the ROLM standard AN/UJK-19 processors. Since all ROLM modules are interchangeable and compatible, processors such as the ROLM 1602A can be used for programming, test and maintenance—without modification!

And your flexibility of selection doesn't stop with hardware. At no added cost you have your pick of extensive, updated, upward compatible software with your programming station.

**We call this the "micro-modular" approach to designing a Mil-Spec computer system.** It puts it all together in a way that makes sense; just the way you want it.

## That's Why We're #1 in Mil-Spec Computer Systems

**ROLM****MIL-SPEC  
Computers**

4900 Old Ironsides Drive, Santa Clara, CA 95050. (408) 988-2900. TWX 910-338-7350.

In Europe: 645 Hanau, Muehlstrasse 19, Germany, 06181 15011, TWX 418-4170.

CIRCLE NUMBER 11



# The HP 2649A is what you make it.

*A controller. It's a natural. Just program the built-in 8080 microprocessor to do your thing, and get it into your system. The HP 2649A has a variety of synchronous, asynchronous, serial and parallel interfaces (including HP-IB, our IEEE Interface Standard 488). This makes it easy to hook up with instruments and peripherals. In short, it's a complete controller system in a single package.*

*A terminal. Terrific! Great editing ability, a choice of keyboards, flexible data communications, and a variety of baud rates make it an excellent fit in an RJE situation. Preprogrammed firmware is available to get you off to a head start.*

*A microcomputer. Why not? The microprocessor gives you a lot of power. Then you can add ROM memory, interface with a disc, control peripherals, and access other systems via a modem. So the HP 2649A acts like a small computer, even if it doesn't look like one.*

*A graphics display station. Sure. You can put a window in your system and see exactly what's going on. Alphanumerics, auto-plot, and full graphics, including Area Shading, Pattern Definition and Rubber-band line, give you the whole picture.*

You can really make a lot with the HP 2649A.

You start with the basics — a CRT, power supply, backplane, I/O cards, MPU, and versatile, modular architecture.

You program

it to do your specific job, and pick only the memory, keyboard, I/O, breadboard, and other modules you need. These include RAM (up to 32K bytes on one module), ROM, and PROM boards, which all simply slip into the chassis.

(There are slots for your own boards as well.) You can also add 220K bytes of mass storage on dual plug-in cartridges.

To top it off, we have documentation, development tools, and a one week training course in programming and customizing the HP 2649A.

So whatever you call it, call your nearest Hewlett-Packard office

listed in the White Pages and ask for complete details. Or send us the coupon. We'll help you make it any way you want it.

HEWLETT  PACKARD

42802HPT6

CIRCLE NUMBER 12

I'm interested in your microcomputer/controller/graphic display station/terminal.

- Have your representative contact me.
- Send me technical literature.
- Send me OEM information.

Name \_\_\_\_\_ Title \_\_\_\_\_

Company \_\_\_\_\_

Address \_\_\_\_\_

City/State/Zip \_\_\_\_\_

Mail to: Ed Hayes, Marketing Manager,  
Hewlett-Packard Data Terminals Division,  
19400 Homestead Road, Dept. 1418, Cupertino CA 95014.

# Our technical coaching makes your job easier.

You'll have a whole team of experts on your side whenever you specify Dormeyer SOLENOIDS, TRANSFORMERS OR CONVERTER/CHARGERS.

For starters, we have a brand new catalog on SOLENOIDS plus a 16-page tech reference guide that shows exactly how to specify laminated, folded frame or tubular type solenoids for commercial applications.

Ditto for our very competitively priced TRANSFORMERS. Our specifying guide lists hundreds of standard open coil channel frame, bracket mount or commercial mount (U/L listed, CSA certified) types available from stock. If your application requires control, high voltage, isolation, auto and high reactance power transformers be sure to request our "Coach's Kit".

When you need fast action on power CONVERTER/CHARGERS, FILTERED CONVERTERS, BATTERY CHARGERS or AC/AC plug-in transformers (all U/L listed or recognized), just give a holler for Dormeyer.

## COACH

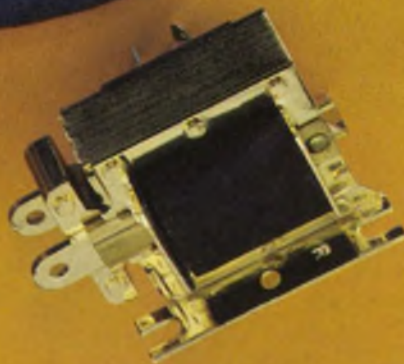

DORMEYER INDUSTRIES, INC., A Division of A. F. DORMEYER MFG. CO., INC.  
3418 N. Milwaukee Avenue, Chicago, IL 60641  
(312) 283-4000 TWX: 910-221-3831

CIRCLE NUMBER 13



# METSHIELD™ Fabric. The first major advance in magnetic shielding in 50 years.



## Now in 40" widths

METSHIELD™ Fabric can help you achieve EMC in field repairs, prototype design, production equipment, and shielded rooms.

Now you have such a shielding. METSHIELD™ magnetic shielding fabric — a wholly new flexible product made from Allied Chemical's METGLAS® amorphous metal alloys.

Because of its exceptional strength and flexibility, METSHIELD fabric retains its full shielding effectiveness during fabrication and use.

This reliability of performance — plus the ease with which METSHIELD fabric can be fabricated — enables you to use magnetic shielding as a preferred method to achieve electromagnetically compatible system designs. And METSHIELD fabric now comes in 40" (1 meter) widths for even greater design flexibility.

Discover how this remarkable material can help meet your shielding needs. Phone John Dismukes at 201-455-4031 or Jack Thorp at 201-455-3306. Or return the coupon.

This is the magnetic shielding product whose time has come.

Increased sales of electronic equipment, a trend toward miniaturization and intensified regulatory considerations have put increased emphasis on EMC.

Consequently, electronics manufacturers need cost-effective magnetic shielding not plagued by fabrication problems and use limitations associated with conventional nickel alloys.

-----  
Check boxes for information on METGLAS® alloys and METSHIELD™ fabric.

- Technical data
- Fabrication
- Grounding and contacting
- Other (specify) \_\_\_\_\_
- Send me sample of METSHIELD fabric

Name/Title \_\_\_\_\_

Company \_\_\_\_\_

City/State/Zip \_\_\_\_\_

Mail to: Metglas Products, Allied Chemical Corporation  
7 Vreeland Road, Florham Park, NJ 07932

-----  
 **Allied  
Chemical**  
Metglas Products

### TMS 4732 32K ROM

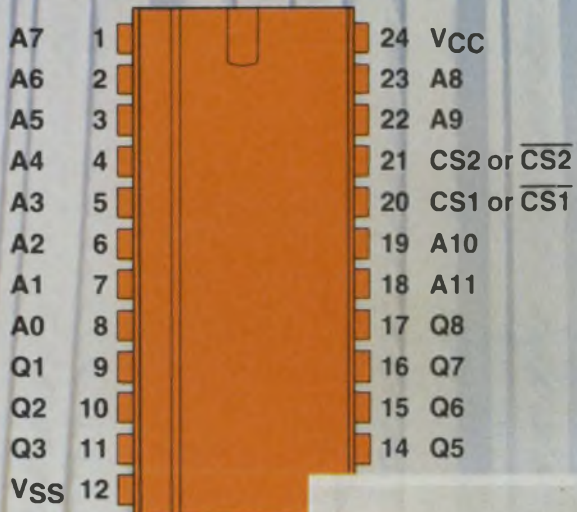

### TMS 2532 32K EPROM

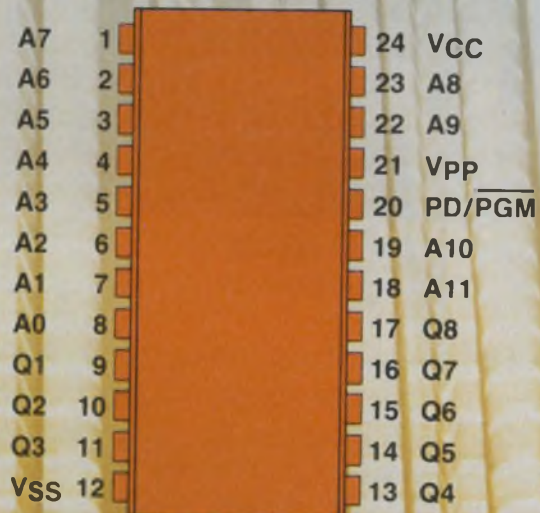

MOVING AHEAD IN MEMORIES

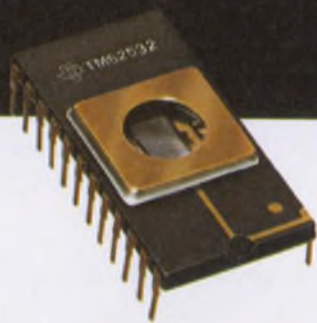

# Introducing the first 32K EPROM.

## Single 5-volt supply. Fully static.

## Biggest ever. From Texas Instruments.

Four 8Ks in a single 24-pin package. Or two 16Ks. TI's new TMS 2532—a 32K 5-volt EPROM (erasable programmable read-only memory). The first and the biggest of its kind.

With applications now demanding more and more memory in the same size space, the new TMS 2532 is both practical and economical. Because TI offers a plug-in 32K ROM for volume production. Because system upgrading is a snap—the TMS 2532 is pin-compatible with 8K and 16K 5-volt models.

In addition, there is less assembly cost. Greater board density. Improved reliability. And, the TMS 2532 is a dollar saver compared to 8Ks and 16Ks.

### Easy programming

Designed for facilitating rapid program changes in high-density, fixed-memory applications, the new TMS 2532 features speedy programming. A single TTL level pulse is all that's needed for simple in-system programming.

Any location can be programmed in any order. Either individually, in blocks, or at random. Which cuts programming time to a minimum. Existing EPROM programmers can do the job.

Erasing is simple, too. All you do is just expose the chip to high intensity ultra-violet light through the quartz window exactly as you would with any other EPROM.

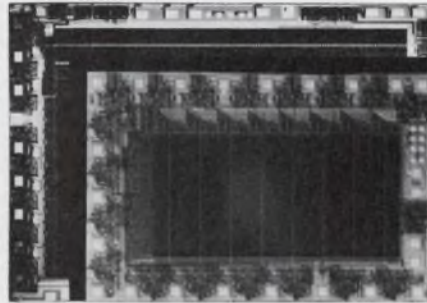

***MORE MEMORY CAPACITY** results from state-of-the-art design techniques that keep the TMS 2532 EPROM chip only slightly larger than an 8K chip (foreground).*

### Fully static operation

Like all EPROMs from TI, the new TMS 2532 continues the fully static tradition that makes designing much easier. There are no clocks. No timing signals. No hassles. Cycle time equals access time.

### Low-power operation

The TMS 2532 also sets new standards in energy saving. At 840 mW maximum power (worst case— $T_A = 0^\circ\text{C}$ ), it uses less power than a 2708. Yet has four times the memory capacity. And when the TMS 2532 is deselected, it automatically assumes a low power mode—50 mW typical.

### Matching 32K ROM

When programming is finalized and you're set for volume produc-

tion, you can readily switch over to TI's TMS 4732, a 32K mask-programmable, production-proven read-only memory.

It's a direct plug-in for the TMS 2532. Note on the illustration that they utilize practically identical pin configurations. In fact, when you order the TMS 4732, merely specify that Pin 20 be active low (CS1) and Pin 21 be active high (CS2) to achieve plug-in compatibility.

### Wide-choice EPROM family

With the addition of the TMS 2532, TI now offers you a broad selection of compatible EPROMs. All available in 24-pin packages. All having speeds of 450 ns. All sharing the same production-proven N-channel process. All having the same basic pin configuration. Which paves the way for increasing memory capacity in the future should your needs so dictate.

This wide-choice EPROM family includes the 8K TMS 2708, the low-power 8K TMS 27L08, and the cost-effective 16K TMS 2716 (see table below). And more members are on the way.

For additional information on the first 32K EPROM, as well as on other family members, write Texas Instruments Incorporated, P. O. Box 1443, M/S 669, Houston, Texas 77001.



## TI's Growing EPROM Family

Device	Complexity	Organization	Operating Supplies	No. of Pins
TMS 2708	8K	1K x 8	+12 V, ±5 V	24
TMS 27L08	8K	1K x 8	+12 V, ±5 V	24
TMS 2716	16K	2K x 8	+12 V, ±5 V	24
TMS 2532	32K	4K x 8	+5 V	24

# TEXAS INSTRUMENTS

INCORPORATED  
CIRCLE NUMBER 15

**MEPCO/ELECTRA**

# GPR 5000X

**RESISTOR...  
ONE SIZE  
ONE STYLE**



## For all general purpose applications

Until now, buying General Purpose resistors meant trading off one requirement to get another—buying 2 or more styles to cover your resistance requirements—giving up board space to get more power dissipation.

**MEPCO/ELECTRA'S GPR 5000X** has changed all that. Now you can get everything you need for all your general purpose applications — automotive, consumer, computer—in just one resistor style, one resistor size. Reduce your resistor inventory.

**MEPCO/ELECTRA GPR 5000X:  
DUAL RATED— $\frac{1}{4}$ W &  $\frac{1}{2}$ W.**

One resistor can be used in both  $\frac{1}{4}$  and  $\frac{1}{2}$ W applications, which means dual power handling capability in the smallest possible size.

**BROADER RESISTANCE RANGE— $10\Omega$  to  $22M\Omega$**   
Widest resistance range for any resistor with comparable tolerance and T.C.'s.

**REPLACES RL07 AND RL20—**  
Perfect replacement for both these MIL styles with the added plus of a broader resistance range, dual rated ... and at a better price.

**CWV—350V Max.**

**STANDARD TOLERANCE—2%**

**STANDARD T.C.— $\pm 200$  PPM**

In the market for a true general purpose resistor that offers "trade-ups" rather than "trade-offs"? Find out about GPR 5000X. For more information ... "Call M/E" at (817) 325-7871. Or write **MEPCO/ELECTRA Inc.**, P.O. Box 760, Mineral Wells, Texas 76067.



CIRCLE NUMBER 16

## Electron beams take aim at Gbyte memory systems

Electron-beam-addressable memories will offer capacities of thousands of megabytes at two to five millicents per bit, thanks to a technique that deflects the beam twice, then passes the beam through an array of lenses. Memory systems storing 256 Mbytes will be available within two years, and gigabyte memories will follow, says Don Smith, who heads the technical side of Micro-Bit Corp., a Lexington, MA, firm that has been studying electron-beam addressable memories for nearly a decade.

An 8-Mbyte system, already developed by Micro-Bit (recently acquired by Control Data Corp. in Minneapolis), incorporates 22 single-deflection tubes—16 for data and six for parallel Hamming-code error correction and detection. But this system is slower than and as expensive as MOS random-access memory and will not become commercially available, explains Smith, who has prepared a paper on electron-beam addressable memories for the IEEE Computer Society International Conference (Compcon '78) in San Francisco.

The next generation of electron-beam addressable memories will use a coarse deflector and a lens/fine deflector array to increase density and drop costs below those of MOS memories, says Smith, adding: "The constraining limitations on single-channel electron optics imposed by deflection can be pushed outward by several orders of magnitude by employing two-stage deflection and an array of lenses known as the 'fly's eye' configuration."

The coarse deflector aims the beam at one of the lenslets in the array, and the fine deflector addresses the memory target area under each lenslet. "By subdividing the deflection into two stages, we can access a much larger target area and the limitations on capacity set by deflection aberrations and deflection voltage inaccuracies can be overcome," claims Smith.

In the double-deflection tube, the

first part of the tube is about 11 in. long and 2 in. in diameter and contains the electron gun, condenser and collimating lenses, and deflection blanker. These are identical to those used in single-deflection tubes, and operate at the same cathode potential—10 kV.

The second half of the tube, about 8 in. long and 4 in. in diameter, includes the coarse deflector, the lens and deflector array, and the silicon target. The coarse deflector is an electrostatic structure, and the array lens consists of three aligned plates, each having a  $32 \times 32$  array of holes plus extra holes around the periphery to preserve field symmetry. Lens tolerances, particularly the roundness of the holes, are tightly controlled to minimize spherical aberrations.

The fine-deflector array consists of two successive arrays of parallel bars at right angles to each other to achieve x-y deflection. Construction stability is important to minimize the memory's sensitivity to vibration, but mechanical tolerances are not particularly stringent because of the nature of the target.

The target is a  $4 \times 4$ -cm slab of silicon that is homogeneous in the plane perpendicular to the beam—there is no structure imbedded in the material. Instead, the target has just four layers: p-type silicon, n-type silicon, an oxide insulator, and a metal front surface. Only two leads, one on each side, are required to write and read data.

In operation, positive charge is normally stored in the oxide layer, and this charge is removed by exposure to the beam. Data storage is represented by charge or no-charge states, or transitions between them, and is nonvolatile.

The writing beam also acts as a reading beam. Signals are capacitively coupled through the oxide to a differential sense amplifier. The MOS target acts as an amplifier because each penetrating electron from the incident beam generates several thousand

electron-hole pairs.

The first double-deflection tubes will have a capacity of 128 Mbits so that a memory system of 22 such tubes will have a 256-Mbyte capacity. Systems four times as large are already in the conceptual stage, according to Smith, who foresees per-bit prices an order of magnitude less than that of similarly large MOS RAM arrays.

### RAM cell promises 64 k with existing rules

A dynamic RAM cell described at the recent International Solid State Circuits Conference promises 64-k dynamic RAMs that can be made with existing fabrication techniques. With this cell, 256-k RAMs should be possible in a couple of years. Today, any RAM larger than 16-k requires special manufacturing techniques.

Each cell, typically  $10 \times 15 \mu\text{m}$ , has internal gain, which means that the sense amplifiers can be simple inverters. Not only that, but dynamic RAMs using these cells will need fewer sense amplifiers than current designs, whose cells have output in the millivolts and require fairly elaborate sense amplifiers. Readout in the new concept is nondestructive, and refresh intervals are expected to be comparable with existing dynamic RAMs.

Access time is limited not by cell speed, but by the multiplexing required to use a limited number of address-input pins for a large address.

The cell concept, called the Stratified Charge Memory, was invented by Dr. Darrell M. Erb, of Mountain View, CA. (PO Box 4113, Zip 94040). Dr. Erb, who is currently self-employed, owns the rights to a forthcoming patent.

Erb's structure is like one transistor with two "gates" in series, one for storing the bit, the other for enabling writing and readout.

An array of Erb's cells contains orthogonal polysilicon row and column electrodes that are simply stripes with straight-sided outlines. The array also has diffused n+ source and drain buses, both running parallel to the column electrodes. Sense amplifiers are connected to the ends of the drain buses. The crosspoint between a row electrode and a column electrode is adjacent to the drain bus, and a bit is stored beneath this overlap.

To store a bit, the column electrode for the selected location is made relatively negative for a ONE, and relatively positive for a ZERO. By properly

biasing the row electrode for that location, holes will be attracted to the oxide-silicon interface beneath the crosspoint to store a ONE. For a ZERO, no holes are attracted.

Changing the bias on the row electrode "traps" the holes, which become surrounded by a positive electric field. Readout doesn't affect this "trapping," so data aren't destroyed.

To read, the row and column electrodes for the selected location are biased to new values. An n-type inversion layer forms under the row electrode, which behaves like a gate enabling writing and readout. The presence or absence of the stored holes under the column electrode has the effect of the other gate and determines whether or not an electron current will flow from source to drain. Current in the drain bus is picked up by the sense amplifiers.

## **$\mu$ C programming easier with ROM interface cards**

Two microcomputer-interface cards, one for printer control and another for communication, are the first to have their on-board intelligence in the form of ROMs. The 256-byte ROMs carry the driver and control software in Basic language. Putting this on-board intelligence into the ROMs simplifies programming, because for most other  $\mu$ C cards to run, a machine-language program must be loaded into the microcomputer itself, or perhaps even written.

The cards, from Apple Computer Inc. (Cupertino, CA), are aimed for use with the Apple II microcomputer. While the intelligent ROM is only a 256-byte device, it appears to the computer to be much larger, because it is linked directly to machine-language routines already in the Apple II monitor.

Both Apple cards do more than simplify programming. In fact some of their features are new to the  $\mu$ C field, according to Apple.

For example, the Parallel Printer Interface control board can handle printers up to 255 characters wide at 5000 characters per second. The Communications Interface board, or modem controller, does more than provide a serial link to allow computers to talk to each other—as most modems and controllers do. With its intelligence, the board permits one Apple computer to take control of another—particularly useful for running remote diagnostic programs.

The Apple printer-control card's ROM has all the card's control and driving software in Basic. This software not only handles the printer timing and interfacing to a wide variety of printers, but also handles all of the interfacing to the Basic language in the  $\mu$ C. So for printing, all a user has to do is tell the card how many columns he wants to have printed, and then type in PRINT.

The Communications Interface card, or modem controller, provides full-duplex operation at 110 or 300 Baud, which is selected by software. The Basic program to control the modems or the Apple II computer is contained in on-board ROM. This feature permits a distributed system—say, in a factory—to bring data to a central location. How? By allowing the user to load and control remote units from a central microcomputer.

## **Dual laser carves out objects of any shape**

A two-laser method of chemical machining does what no conventional machine tool can do—readily produce any pattern or shape required. The method promises to prove useful in precision casting and IC technology, and may even lead to 3-D oscilloscopes.

Two laser beams of different wavelengths are projected into a volume of photoresistant material that reacts only where the beams intersect. After the desired shape is created by the coordinated movement of the beams under computer control, solvents or a vacuum can remove the excess unreacted material. Since the dual-laser system can duplicate a solid object sensed by other lasers, it is called a replicator. It has been patented by Omtec Replication, Berkeley, CA.

"As to its usefulness for ICs, it's all a question of the resolution that can be achieved," says research chemist Dr. Robert Schwerzel of Battelle Memorial Institute. Battelle's Columbus Laboratory is now defining the research necessary to make the concept commercially feasible.

In February, inventor Wyn Kelly Swainson, President of Omtec, executed agreements permitting Battelle to obtain industrial sponsors for the research, which may be under way in a few months.

Castings manufacturers large and small have shown very enthusiastic response, says Schwerzel. The laser approach potentially can do in hours or days the complex pattern-making

jobs that now require months.

The feasibility of a 3-D oscilloscope display was demonstrated in 1971 by Carl Verber, another research chemist at Battelle. Swainson's concept, notes Verber, would add a hard-copy output.

Estimating the ultimate impact of the concept, Arthur C. Clarke, renowned author of science fact and fiction, told the Congressional Clearinghouse on the Future last October about a machine that could make a copy of anything in its three-dimensional form, in all its detail.

"Imagine my astonishment when I learned that the first patent for the replicator had been put out by a company in California called Omtec."

## **Minicomputer emulates most minis or micros**

A new minicomputer can expand a system's performance by being micro-programmed to run the instruction set of practically all mini or microcomputers.

The T-1000 from Dynamic Sciences, Van Nuys, CA, has an architecture specifically designed for efficient emulation. It uses a variable-size microprogrammable memory to store microinstructions, says Earl Kanter, vice-president for corporate development. This, coupled with the T-1000's architecture and interpretive controls, enables it to emulate computers with 8, 12, 16 or 32-bit word lengths.

Operating typically at 300,000 operations per second, the T-1000 is several times faster than a MOS microcomputer. In addition, up to 65,536 words of memory can be directly addressed, and 262,000 words of extended addressing are available. The T-1000 contains 16 full-word (16-bit) registers and operates off a single +5-V supply.

The basic CPU is contained on a single small printed-circuit board, but much more capability is available on additional boards—extra memory, programmed I/O, various interfaces and a series of data option modules, such as memory management and floating-point arithmetic.

To retrofit an existing system and to upgrade its performance, Dynamic Sciences will fit the T-1000 into the card-cage slot of the less-powerful computer being replaced. "We will customize the boards to fit the mechanical requirements of the customer," notes Kanter. Prices start at \$1000 in 100-up quantities.

CIRCLE NO. 315





# Your lights Vs. Our LED Lites.



You could be making a glaring mistake if you're not using Brite-Lites. The LED lamps that really are 25x (50 mcd vs. 2 mcd) or brighter and more reliable than all the rest. They leave other LEDs in the shadows. Brite-Lites are

tested and proven winners time after time in application after application.

**We out-perform good, old fashioned incandescents, too.** Brite-Lites shine with the incandescent-type brightness you need, while giving you solid-state durability. Average lamp life is about 100,000 hours plus, 10 times greater than incandescents.

**Our packages really meet your needs.** Brite-Lites offer you snap-on numbers from 1.6 to 28 volts and 10 to 35 milliamps. All our Lites are available in transparent or translucent red, amber or green.

**We deliver the goods.** There are no guessing games. When you order Brite-Lites, they arrive on time, every time. And they work. There are no empty claims. They're proven facts. We'd like to prove our point against any lamp you're currently contemplating or using. Won't you let us put the Brite-Lite gleam into your applications.

**"The brightest LED lamps in the business."**



**DATA  
DISPLAY  
PRODUCTS**

303 NORTH OAK STREET, INGLEWOOD, CA 90301  
TELEPHONE (213) 677-6166 • TWX 910-328-7205

ECLIPSE S/230

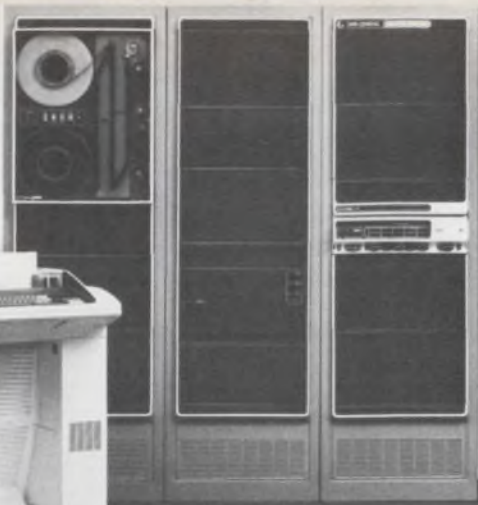

ECLIPSE S/130\*

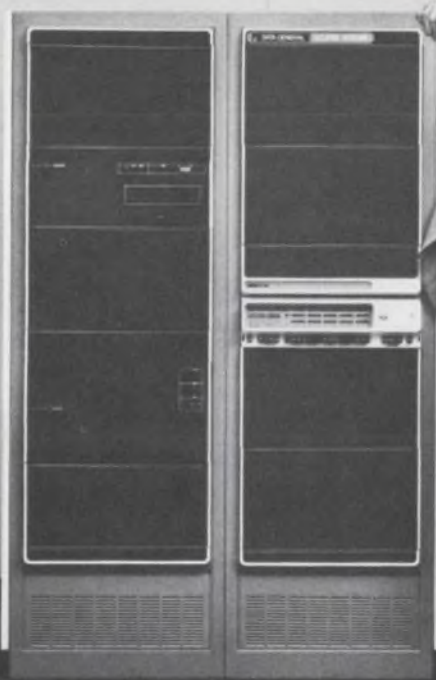

NOVA 3



# **SOMEBODY HAS FINALLY DONE SOMETHING FOR THE MIDDLE CLASS. THE ECLIPSE S/130.**

The ECLIPSE S/130 computer system proves it is still possible to make ends meet. Its performance, on the one hand, approaches that of our super high-speed ECLIPSE S/230. While its price is much closer to the level of our best-selling NOVA 3.

The ECLIPSE S/130 is built around the same powerful architecture as the ECLIPSE S/230. But it has its own unique character. Like our fast micro-coded floating point, efficient character string instruction set, our second-generation WCS microprogramming ability, as well as AOS, our heuristic multiprogramming advanced operating system.

All of which means that even though the ECLIPSE S/130 is in the middle of our family, it's in a class by itself when it comes to performance, features, and power for the money. And if you still think that value is a virtue, the ECLIPSE S/130 system won't let you down. Call (617) 366-8911, Ext. 4735 or write.

 **Data General**

**We make computers that make sense.**

\*The ECLIPSE S/130 System shown includes 128K bytes of memory, floating point instruction set, clock, Dasher\* terminal printer and display, 10 megabyte fixed/removable cartridge disc, 315K byte diskette, and all applicable controls, cabinetry, and cabling. Licensed software available on this configuration are RDOS, FORTRAN IV, optimizing FORTRAN V, and BASIC. Domestic U.S. list price \$42,040, including licensed software. OEM and volume discounts available.

Data General Corporation, Westboro, MA 01581. (617) 366-8911. Data General (Canada) Ltd., Ontario. Data General Europe, 61 rue de Courcelles, Paris, France, 766.51.78. Data General Australia, (03) 82-1361. Data General Ltda., Sao Paulo, Brazil, 543-0138 © Data General Corporation, 1978. ECLIPSE is a registered trademark of the Data General Corporation.

## Minicomputer architecture: advancing, but with caution

Much of the improved data-processing capability of minicomputers stems from architectural changes made possible by advances in semiconductor technology. Yet the basic architectures themselves haven't undergone any tremendous face lifts. For one thing, designers are leery about putting in new devices before their technologies are proven—and that takes time. In addition, manufacturers often cannot get low-enough costs or standardized packaging for new devices.

As a result, minicomputer architecture in several notable cases has not been changed dramatically to improve performance. For sure, minicomputer families are evolving. But each new member first derives benefits from the original architecture, then gains the advantages of improved hardware based on tried-and-true technologies.

### Architecture—do not disturb

For example, Data General's Nova family, designed for the standard minicomputer market, has used the same basic architecture since its inception 10 years ago. This has not prevented advanced features like a hardware multiply and divide, a floating-point processor and an increased memory capacity from being built into the newest members.

Meanwhile, the philosophy at Hewlett-Packard is "to enhance the performance without throwing away the architecture," according to David Carver, Products Manager of the Data Systems Division. Thus, the new HP 1000 Series (HP-21MX) minicomputers are architecturally compatible with machines made way back in 1966, while offering much greater processing power.

Compatibility to Vernon Smith, Senior Vice President at Microdata, means

**Gene Heftman**  
Associate Editor



The Eclipse S/230 uses high-speed semiconductor and core-memory modules. Read cycle time for the Data General mini's 64-kbyte semiconductor memory is 500 ns, while its 32-kbyte core memory cycles in 800 ns.

that "the hardware evolves under the software, so the customer can continue to use the same software package." This is called "software transparency," and to a user it means that while newer members of a machine family offer better performance, their programming is similar to the older models.

Since up to 50% of the development cost of a minicomputer can be tied up in software, sweeping architectural changes that would affect software don't make sense. On the other hand, computer performance is being upgraded by using software in new ways. One of the most recent innovations, user-accessible microcode or microprogramming, provides powerful instructions that replace many normal programming routines. A microprogramming instruction word can be extremely wide—up to 56 bits—and contain several commands that can be executed in one machine cycle.

Not too surprisingly, then, mini-

computers with microprogrammed architecture are becoming more popular than older, hardwired designs. Nevertheless, the basic architectural structures of both types have much in common.

### Microprogramming is coming on

To execute machine code, hardwired and microprogrammed computers begin an instruction cycle the same way. Through the control section, an instruction is fetched from main memory, then loaded into an instruction register.

At this point, paths diverge, with a hardwired computer executing the word via its control logic, and a microprogrammed computer operating on microinstructions located in a special memory called a control store.

The contents of a location in the control store are fed to a microinstruction register, which holds the



1978...  
the year  
of the  
**Gauntlet.**

**BUSSCO.**

We make Bus Bars. And we're better at what we do than anyone else.

We want to talk to you about your Bussing Problems.

Call 213/322-6580 and we'll come to where you are, where ever you are.

Tomorrow.

**BUSSCO ENGINEERING, INC.**

119 STANDARD STREET  
EL SEGUNDO, CA 90245  
PHONE: 213/322-6580



Solderless Bus Strips for Back Panels • Circuit Board Busses • Laminated Bus Bars

(continued from page 26)

control signals until they are ready for execution. Moreover, control signals to allow execution also come from the control store, under the direction of a simple clock that generates the sequence of operations.

Unlike a hardwired controller's instruction set, the instruction set of a microprogrammed minicomputer can be altered by changing the locations of microinstructions in the control store. To do the same thing, a hardwired machine's control section would have to be redesigned radically.

But for high-performance applications, where execution speed is critical, hardwired logic works faster than software. So machines with logic controllers should be around for some time.

Whatever the architecture, minicomputers must operate at increasingly higher speeds to execute the complex programs that result from sophisticated instruction sets. But the burden doesn't have to fall on their CPUs alone. Microcomputers are coming to the rescue.

### Microcomputers share the load

A minicomputer designed for speed has a better chance of achieving higher throughput rates if a microcomputer becomes part of its architecture. By giving up control tasks to a microcomputer, the mini's CPU can perform its primary mission processing data, faster and more efficiently. And the burden of I/O operation, by which a CPU controls and communicates with its peripheral units is shouldered effectively by a microcomputer.

But microcomputers aren't restricted to improving speed. Microcomputers can help minis in the field operate reliably by providing diagnostic capabilities to detect malfunctions in both the CPU and its peripherals. For example, a microdiagnostic unit can test the operation of CPU components, and, with a special code indicated on front-panel LEDs, identify the malfunctioning section. Thus, error diagnosis is taken out of the hands of field-service engineers, which means lower mean time to repair failed equipment and lower service costs.

Microcomputers are just one part of the growing semiconductor arsenal that includes large-scale integrated circuits. With greater levels of gate integration available, features that

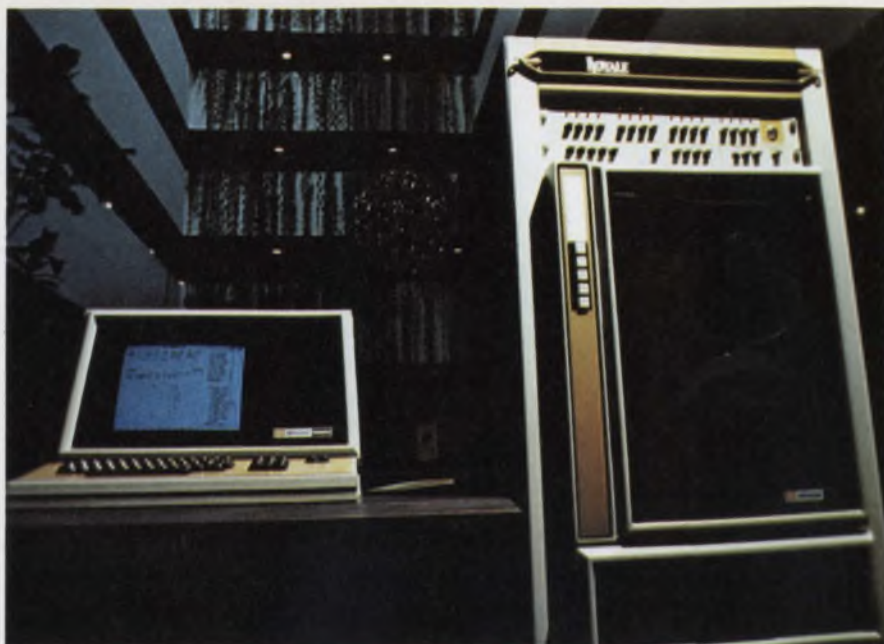

**The Royale, a data management minicomputer,** features a new computer language called ENGLISH. Statements written in dictionary-based form containing verbs, nouns, adjectives and adverbs enable the Microdata computer to identify specific items in a data file.

were previously unheard of can now be built into existing architectures. However, putting LSI to work in mainframes leads to some not-so-obvious problems.

### LSI pros—and cons

LSI devices offer some clearcut reliability advantages on a system level in minicomputers. But many machines still rely on older medium-scale integration to implement control-section logic. For one thing, it's difficult to break the often complex logic of hardwired control sections into blocks that can be implemented with standard LSI devices. And standard LSI in suitable package configurations is not far enough along to be used in architecture.

One way around this problem—although it's far from an ideal solution—is LSI circuits specifically designed to perform the logic functions of the architecture. Unfortunately, procuring such circuits isn't easy. And the custom LSI circuits won't be cost-effective unless an extremely large batch is needed.

Nevertheless, the attraction of LSI, with its potential for reducing both package count and interconnections between circuits, pulls strongly on manufacturers interested in improving overall system reliability.

Where it's difficult to use LSI devices in control logic, LSI memories pose no such problem. Random-access-memo-

ry bit densities have steadily increased from 16 bits in 1970 to the 4-k sizes available today. So memory-oriented microprogramming architectures are gaining popularity. Access times are in the neighborhood of 150 to 300 ns, but newer MOS technologies such as HMOS and VMOS offer the possibility of future RAMs with access times as low as 70 ns.

### Old memories not forgotten

On the mainframe-memory front, meanwhile, established technologies will be hard to overtake.

Most minicomputers today use either core memory, or a combination of both. And there's no mystery behind the reasons. Newly developed charge-coupled devices and bubble memories are not yet price-competitive or, in some cases, not commercially available.

Moreover, minicomputer manufacturers place a premium on component reliability—and CCDs and bubbles don't even have a track record. Couple that with the fact that the reliability of established technologies for disc storage isn't standing still, but is approaching 15,000 hours MTBF.

"Another problem facing replacement memory technologies is that they are chasing a moving target in terms of the minimum memory capacity they

(continued on page 30)

# PIC 1650

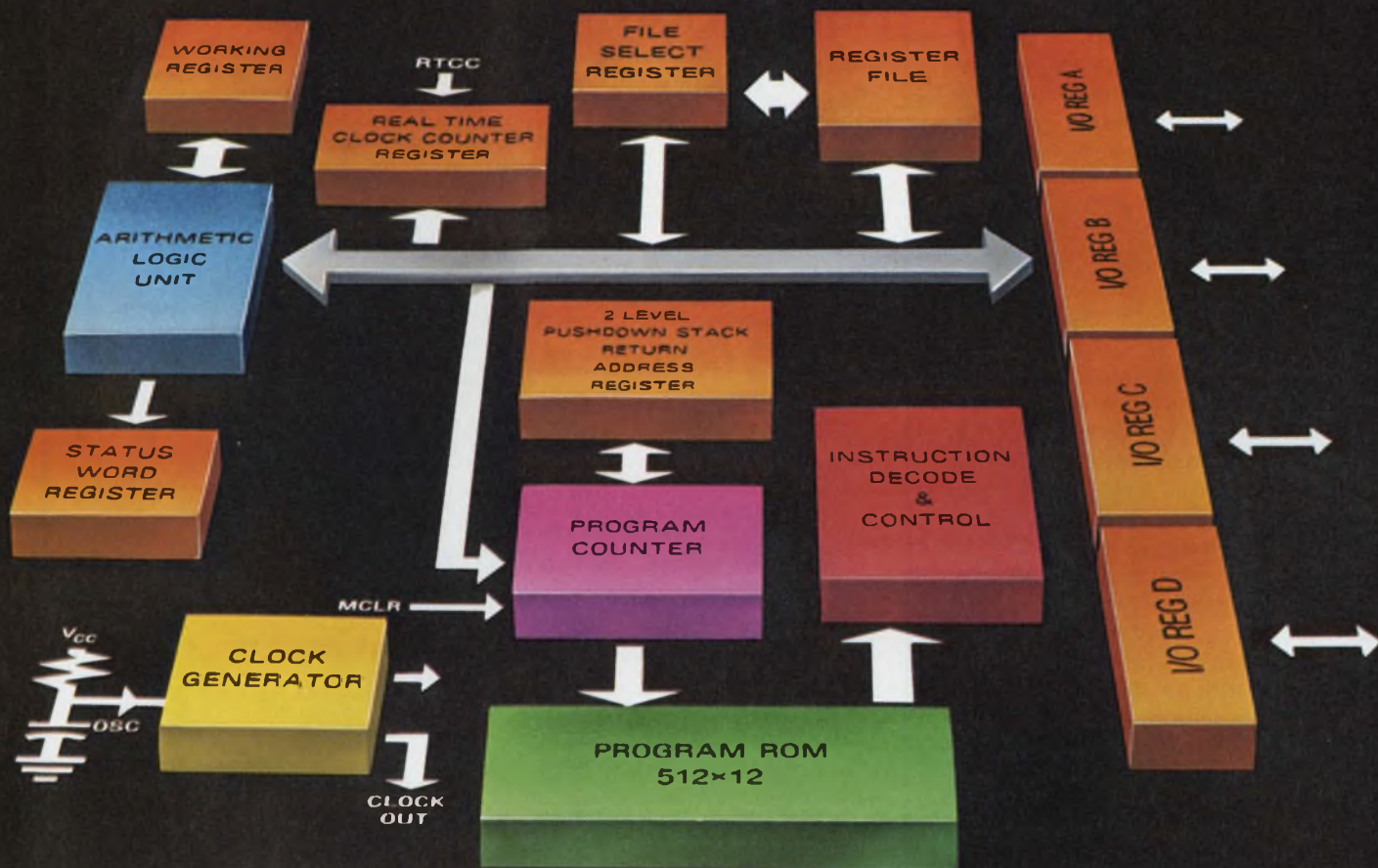

## GI's 8-bit microcomputer...



GENERAL INSTRUMENT  
NEW PIC1650  
LESS THAN  
**\$4.00**  
in quantities of 1000 up

## in a single low cost chip.

Low price is one of many ways you can save with the PIC 1650—Programmable Intelligent Computer. GI's bit-oriented chip also saves on external components, packaging and design time to help you get your product to market faster at lower cost.

There's a programmable 512 by 12-bit ROM on the chip along with four sets of eight TTL compatible input/output lines. Use the I/O as 8-bit data paths or manipulate single bits using a single instruction. The 32 x 8 register file meets RAM requirements and the on-chip oscillator takes

care of timing. All you need for power is a 5-volt supply.

Whatever your stand-alone controller objective may be, PIC 1650 will do it. You can, for example, scan a keyboard, drive a display, control a vending machine or even regulate traffic. And if you need even lower cost, we have the PIC 1655 ... or for higher performance, we have the PIC 1670.

You can depend on GI Microelectronics for full software, hardware and applications support. There are cross assembler/simulator programs and an in-circuit emulation system for efficient program verification and the added flexibility of RAM programming. Write or call General Instrument Microelectronics, 600 West John Street, Hicksville, New York 11802, Telephone (516) 733-3107.

**We help you compete.**

**GENERAL INSTRUMENT CORPORATION  
MICROELECTRONICS**



must replace plus the changing cost of alternate technologies," says Robert Grossman of Data General. Because today's requirements call for sophisticated software and operating systems, the minimum mass memory being ordered is increasing—a trend that will continue. At the same time, the cost per bit of rotating magnetic mass memory is continuing to drop significantly. But CCD add bubble memory costs are roughly proportional to capacity, so increases in minimum memory size makes the cost goals of the emerging technologies harder to achieve.

If cost isn't enough to dampen interest in new memory technology, perhaps the following will: Minicomputer performance can be upgraded by incorporating design techniques into memories that make better use of established technology. Cache memories—fast, bipolar, small-capacity devices that serve as front-ends for the main memory—speed up processing time. The cache contains data that a CPU is most likely to request, and makes the information available faster than if it had come from main memory.

Another reason that caches improve speed performance is that they can read at the same time that the CPU is writing into main memory.

Still, minicomputers have benefited from developments both in basic technology and design innovations. One big result is that minicomputer languages now offer a level of sophistication and data-management capability that grows with the size of memory itself.

## Speak to your computer

The proliferation of languages spoken by new minicomputers would tax the abilities of a linguist. Most machines can now execute operations in well-known high-level languages like Fortran, Basic and Algol.

From Microdata comes the Royale, a data management minicomputer that speaks ENGLISH. While it's not exactly spoken English, users can program the Royale with sentences made up of verbs, nouns, adverbs and adjectives, all stored in dictionary-type files.

Data General's Eclipse family understands a host of high-level languages, including real-time Fortran IV, Extended Basic, Business Basic and Extended Algol. To bring these sophisticated languages to the user, instruction sets have been expanded to include words that are considerably longer than the old 16-bit words.

HP's 21-MX minis use an instruction

word of 32 bits, as does Digital Equipment's PDP 11/34. And among microinstruction words, bit lengths of 48 and 56 bits are not uncommon. But

the old 16-bit word may not be dead yet: Minicomputers still take the longer-bit words and bite them off in 16-bit chunks. ■■

## Need more information?

Not every manufacturer of minicomputers has been cited in this report, nor are the complete product lines of each supplier included. For additional details circle the appropriate number on the reader service card and consult the GOLD BOOK.

ABC Digital Electronics Inc., Automation Dynamics Div., 25 Charles St., Westwood, NJ 07675. (201) 666-2458. **Circle No. 504**

Applied Computer Systems Inc., 77 E. Wilson Bridge Rd., Worthington, OH 43085. (614) 436-3163. **Circle No. 505**

Applied Systems Corp., 26401 Harper Ave., St. Clair Shores, MI 48081. (313) 779-8700. **Circle No. 506**

Astronautics Corp. of America, 907 S. 1st, Milwaukee, WI 53204. (414) 671-5500. **Circle No. 507**

Compucorp, 12312 W. Olympic Blvd., Los Angeles, CA 90064. (213) 820-5611. **Circle No. 508**

Computer Automation Inc., 18651 Von Karman, Irvine, CA 92664. (714) 833-8830. **Circle No. 509**

Computer Electronics Ltd., Shirehill Ind Est Saffron, Waldon, Essex, Great Britain. 0799 27093. **Circle No. 510**

Control Data, P.O. Box 0, Minneapolis, MN 55440. (612) 853-7600. **Circle No. 511**

Control Logic Inc., 9 Tech Circle, Natick, MA 01760. (617) 655-1170. **Circle No. 512**

CSP Inc., 209 Middlesex Tpke., Burlington, MA 01803. (617) 272-6020. **Circle No. 513**

Datacom Inc., Box 278, Fort Walton Beach, FL 32548. (904) 244-6121. **Circle No. 514**

Data General Corp., Rte 9, 15 Tpke. Rd., Westboro, MA 01581. (617) 485-9100. **Circle No. 515**

Datapoint Corp., 9725 Datapoint Dr., San Antonio, TX 78284. (512) 690-7151. **Circle No. 516**

Digital Communications Assoc Inc., 135 Technology Park, Norcross, GA 30092. (404) 448-1400. **Circle No. 517**

Digital Equipment Corp., 146 Main St., Maynard, MA 01754. (617) 897-5111. **Circle No. 518**

Digital Laboratories, 377 Putnam Ave., Cambridge, MA 02139. (617) 876-6220. **Circle No. 519**

Digital Scientific Corp., 11425 Sorrento Valley Rd., San Diego, CA 92121. (714) 453-6050. **Circle No. 520**

Digital Systems Inc., 232 E. Live Oak, Arcadia, CA 91006. (213) 445-6100. **Circle No. 521**

Dynatech R/D Co., Microsystems Dept., 99 Erie St., Cambridge, MA 02139. (617) 868-8050. **Circle No. 522**

Electronic Assoc. Inc., 185 Monmouth Pkwy., West Long Branch, NJ 07764. (201) 229-1100. **Circle No. 523**

Evans & Sutherland Computer Corp., 580 Arapsee Dr., Salt Lake City, UT 84108. (801) 582-5847. **Circle No. 524**

Fabri-Tek Inc., 5901 S. County Rd. 18, Minneapolis, MN 55436. (612) 935-8811. **Circle No. 525**

Ferranti Ltd., Automation Systems, Simonway Wythenshawe, Manchester M22 5LA, Great Britain. 061 437-5391. **Circle No. 526**

Floating Point Systems Inc., P.O. Box 23489, Portland, OR 97223. (503) 641-3151. **Circle No. 527**

Four-Phase Systems Inc., 19333 Vallico Pkwy., Cupertino, CA 95014. (408) 255-0900. **Circle No. 528**

Fujitsu Ltd., 680 Fifth Ave., New York, NY 10019. (212) 265-5360. **Circle No. 529**

GEC Computers Ltd., Elstree Way, Borehamwood, Herts WD6 1RX, England. (UK) 01-953-2030. **Circle No. 531**

General Automation Inc., 1055 S. East St., Anaheim, CA 92805. (714) 778-4800. **Circle No. 532**

GTE Information Systems, 5300 E. La Palma, Anaheim, CA 92807. (714) 524-3131. **Circle No. 533**

Harris Corp., Computer Systems Div., 1200 Gateway Dr., Fort Lauderdale, FL 33309. (305) 974-1700. **Circle No. 534**

Hewlett-Packard, Corporate Div., 1501 Page Mill Rd., Palo Alto, CA 94304. (415) 493-1501. **Circle No. 535**

Hitachi Ltd., 5-1 1-chome Marunouchi Chiyoda-ku, Tokyo 100, Japan. 03-212-1111. **Circle No. 536**

Honeywell Information Systems, 200 Smith St., Waltham, MA 02154. (617) 890-8400. **Circle No. 537**

Hughes Aircraft Co., P.O. Box 90515, Los Angeles, CA 90009. (213) 391-0711. **Circle No. 538**

IBM Data Processing Div., 1133 Westchester Ave., White Plains, NY 10604. (914) 696-1900. **Circle No. 539**

IMSAI Mfg. Corp., 14860 Wicks Blvd., San Leandro, CA 94577. (415) 483-2093. **Circle No. 540**

Interdata Inc., 2 Crescent Pl., Oceanport, NJ 07757. (201) 229-4040. **Circle No. 541**

International Computer Products Inc., 2925 Merrell Rd., Dallas, TX 75229. (214) 350-6951. **Circle No. 542**

Itek, Applied Technical Div., 645 Almanor Ave., Sunnyvale, CA 94086. (408) 732-2710. **Circle No. 543**

LFE Corp., Process Control Div., 1601 Trapelo Rd., Waltham, MA 02154. (617) 890-2000. **Circle No. 544**

Microdata Corp., 17481 Red Hill Ave., P.O. Box 19501, Irvine, CA 92713. (714) 540-6730. **Circle No. 545**

Modcomp, 1650 W. McNab Rd., Fort Lauderdale, FL 33308. (305) 974-1380. **Circle No. 546**

Mohawk Data Sciences, Mktg. Communications, Palisade St., Herkimer, NY 13350. (315) 867-6472. **Circle No. 547**

Monroe Calculator Co., Box 9000R, Morristown, NJ 07960. (201) 540-7636. **Circle No. 548**

National Semiconductor Corp., 2900 Semiconductor Dr., Santa Clara, CA 95051. (408) 732-5000. **Circle No. 549**

Nationwide Electronic Systems Inc., NES Inc., 1536 Brandy Pkwy., Streamwood, IL 60103. (312) 289-8820. **Circle No. 550**

NCR Corp., Dayton, OH 45479. (513) 449-2000. **Circle No. 551**

Omnus Computer Corp., 1751 Langley Ave., Irvine, CA 92714. (714) 751-2960. **Circle No. 552**

Prime Computer Inc., 145 Pennsylvania Ave., Framingham, MA 01701. (617) 879-2960. **Circle No. 553**

Process Computer Systems Inc., 750 N. Maple Rd., Saline, MI 48176. (313) 429-4971. **Circle No. 554**

Qantel Corp., 3525 Breakwater Ave., Hayward, CA 94545. (415) 783-3410. **Circle No. 555**

Raytheon Data Systems, 1415 Boston-Providence Tpke., Norwood, MA 02062. (617) 762-6700. **Circle No. 556**

Rohde & Schwarz, Dept. 5 ZI/G, Muehlendorferstrasse 15, D-8000 Munich 80, W. Germany. (089) 4129-1. **Circle No. 557**

Solid State Systems Inc., 1990 Delk Indl. Blvd., Marietta, GA 30067. (404) 428-1561. **Circle No. 558**

Storage Technology Corp., 2270 S. 88 St., Louisville, CO 80027. (303) 666-6581. **Circle No. 559**

Systems Concepts Inc., 520 Third St., San Francisco, CA 94107. (415) 442-1500. **Circle No. 560**

Systems Engineering Laboratories Inc., 6901 W. Sunrise Blvd., Fort Lauderdale, FL 33313. (305) 587-2900. **Circle No. 561**

Telcon Industries Inc., 5701 NW 31 St., Fort Lauderdale, FL 33309. (305) 971-2250. **Circle No. 562**

Texas Instruments, Digital Systems Div., P.O. Box 1444, MS 784, Houston, TX 77001. (713) 494-5115. **Circle No. 563**

Threshold Technology Inc., 1829 Underwood Blvd., Delran, NJ 08075. (609) 461-9200. **Circle No. 564**

Transnet Corp., 2005 Rte 22, Union, NJ 07083. (201) 688-7800. **Circle No. 565**

Varian Associates, Varian Data Machines, 2722 Michelson Dr., P.O. Box C-19504, Irvine, CA 92713. (714) 833-2400. **Circle No. 566**

Vetrol Data Systems Inc., 2500 13th Ave., Vero Beach, FL 32960. (305) 562-1621. **Circle No. 567**

Wang Laboratories Inc., One Indl. Ave., Lowell, MA 01851. (617) 851-4111. **Circle No. 568**

Wintek Corp., 902 N. Ninth St., Lafayette, IN 47904. (317) 742-6802. **Circle No. 569**



# \$295

U.S. PRICE



## YOUR BEST BUY IN SWEEP FUNCTION GENERATORS

The Krohn-Hite Model 1200 offers linear sweep (up or down) plus sine, square or triangle waveforms from .2Hz to 3 MHz. Features include: 1500:1 tuning dial plus vernier; external VC and CV output; push button control; DC offset control; auxiliary TTL output; separate HI and LO outputs and much more! Take advantage of this price while we're in a generous mood. Call (617) 580-1660 for more details.

# 245

U.S. PRICE



## SECOND BEST

**LESS SWEEP** The new Model 1000 has all the quality features of the 1200 except sweep!

CIRCLE NUMBER 21

# KH KROHN-HITE CORPORATION

Avon Industrial Park, Avon, Mass. 02322 • (617) 580-1660

SALES OFFICES: **ALA.**, Huntsville (205) 534-9771. **ARIZ.**, Scottsdale (602) 994-5461. **CAL.**, San Jose (408) 292-3220. Inglewood (213) 674-6850. **COL.**, Denver (303) 773-1218. **CONN.**, W. Hartford (203) 525-7647. **FLA.**, Orlando (305) 894-4401. **GA.**, Atlanta (404) 455-1206. **HAWAII**, Honolulu (808) 941-1574. **ILL.**, Arlington Hts. (312) 394-3380. **KS.**, Overland Park (903) 384-2710. **LA.**, Lafayette (318) 984-3516. **MASS.**, Wakefield (617) 245-5490. **MICH.**, Southfield (313) 569-4497. **MINN.**, St. Paul (612) 645-5816. **MO.**, St. Louis (314) 731-5400. **N.M.**, Albuquerque (505) 255-2330. **N.J.**, Cherry Hill (609) 482-0059. **N.Y.**, Elmont (516) 488-2100. Rochester (716) 328-2230. Syracuse (315) 437-6666. Vestal (607) 785-9947. **N.C.**, Burlington (919) 227-3639. **OHIO**, Chesterland (216) 729-2222. Dayton (513) 434-8993. **OKLA.**, Tulsa (918) 299-2636. **ORE.**, Portland (503) 297-2248. **TEX.**, Dallas (214) 661-0400. Houston (713) 688-1431. **UTAH**, Salt Lake City (801) 942-2081. **VA.**, Falls Church (703) 573-8787. **WA.**, Bellevue (206) 454-3400. **CANADA**, Montreal Quebec (514) 341-7630. Ottawa, Ontario (613) 235-5121. Toronto, Ontario (416) 445-9900. Vancouver, British Columbia (604) 253-5555. Halifax, Nova Scotia (902) 454-8321. St. John's, Newfoundland (709) 726-2422.

# Airborne TV systems are jammable, but $\mu$ Ps may be part of a solution

Microprocessors may help the Air Force solve the problem of transmitting video signals from its TV-guided airborne vehicles, missiles and gliding bombs without fear of jamming.

The trouble is that for TV pictures to be sent back to earth with techniques that defeat jamming, the 4 or 5-MHz video signals must be squeezed down to a few hundred kHz. But so far, complex mathematical operations needed for such bandwidth compression cannot be performed without extensive hardware. And the airborne system must be small, light, power-stingy and low-cost.

Analog systems developed to minimize bandwidth suffer from analog-multiplier instability. And custom digital systems generally have proven to be power-hungry, expensive, or too slow to process video signals in real time.

But now, for the first time, off-the-shelf microprocessors have been configured for powerful mathematical capability. Moreover, these low-cost devices have been demonstrated to be feasible for the Air Force's airborne TV application (see Fig. p. 34).

Two microprocessors built around

three Advanced Micro Devices 2901 4-bit-slice, low-power Schottky chips are used in a laboratory setup developed for the Air Force by Data/Ware Development Inc. of San Diego to evaluate digital compression-expansion of TV signals. The  $\mu$ Ps provide enough mathematical power and speed to perform the necessary complex TV-signal bandwidth-compression transforms and their inverses in real time.

One of the microprocessors simulates an airborne TV system, in which the signal-compressing takes place. The other  $\mu$ P simulates a ground-site receiving system where the signal is expanded for display on a standard TV monitor.

One advantage this setup has over analog systems is that it is digital. Communications between airborne vehicles and base stations are digital, so the system doesn't require additional hardware for conversion to that form. Moreover, it's more stable.

A PDP-11/40 minicomputer simulates the link between airborne and ground systems. Normally, the compressed airborne video signal is fed to a modulator and transmitter, picked up on the ground by the receiver, and

demodulated for expansion. The microprocessors performing the compression-expansion are tied to the minicomputer's Unibus (see Fig. below). As a result, the minicomputer can control all subsystem operations for evaluating different configurations.

## Redundant data removed

Basically, the TV-picture data are compressed by removing redundant information, explains Richard V. Keeple, vice president of Data/Ware. Keeple is co-author with Ronald A. Belt (USAF Avionics Laboratory, Wright-Patterson Air Force Base) of "Digital TV Microprocessor System," which he presented at the recent National Telecommunications Conference in Los Angeles.

If the compressed video bandwidth can be reduced to some 200 kbits/s, Keeple maintains, the video information can be transmitted over a spread-spectrum link in which the narrowband video is distributed across a broadband spectrum. This makes jamming difficult.

Redundant information in a TV picture can be rejected because it changes

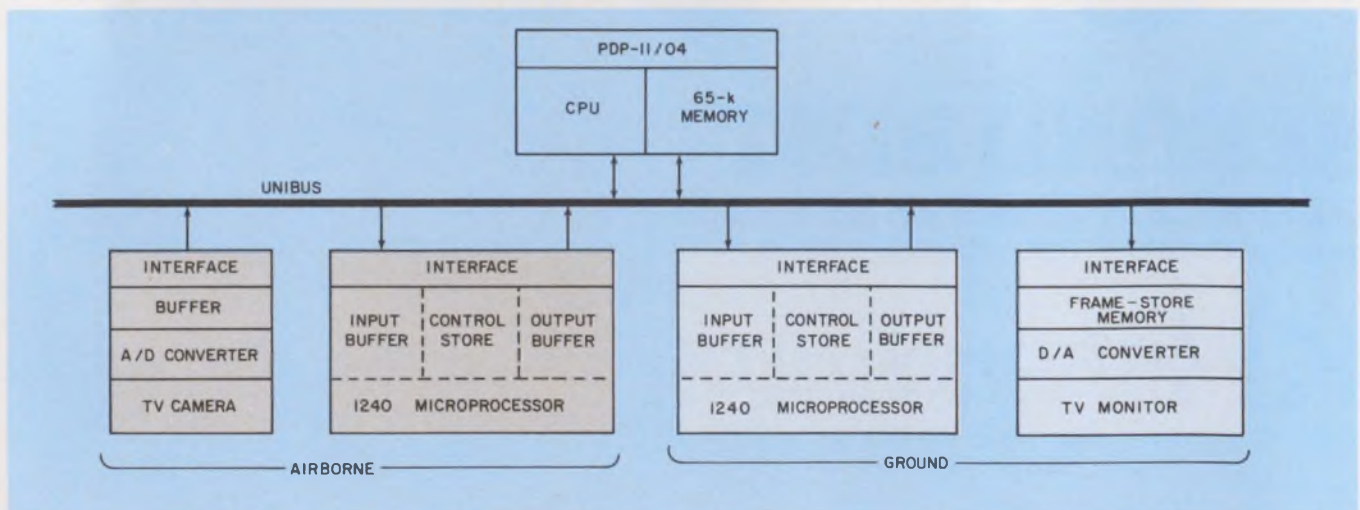

The modems and rf links between the airborne and ground microprocessors are simulated by a PDP-11/40 minicomputer. The DEC machine's Unibus permits a max-

imum transfer rate of 5 Mbytes/s between the processors. This setup allows the mini to control all subsystem operations for evaluation.



# Announcing the successor to the fuse—at low-cost.

## Heinemann Re-Cirk-It protector. Just press the button to reset.

The fuse is passé.

At last there's a modern, reliable way to protect your product—Heinemann's Re-Cirk-It<sup>®</sup> pushbutton circuit protector. It protects like a fuse, is cost-competitive with fuses and fuseholders, but can be quickly reset with just a push of the button.

Re-Cirk-It trips instantaneously on short circuits, and with delay on sustained overloads. It's available in a wide range of current ratings from 0.25A through 10A. And, of course, it's UL-recognized and CSA-approved as a component circuit protector.

There's a good chance today that your product will be used by non-technical personnel who may not know a spent fuse from a dead battery. But when Re-Cirk-It trips, the button pops out, exposing a white band around the pushbutton shaft. So Re-Cirk-It forever ends the frustration of blown fuses, eliminates the danger that your customer will use a wrong size replacement,

and can save you from an expensive, unnecessary service call.

The Re-Cirk-It protector can only be electrically tripped. It can't be turned off, can't be held on against a fault, and there is no confusing mid-position trip-point. It is easily installed, and fits into the same panel space as conventional  $\frac{5}{8}$ "-diameter fuseholders. And it's attractive enough to be placed on a front panel.

If you want more information, request Bulletin KD-4001. But do it now, before you or your customer blows another fuse.

### SPECIAL OFFER

Send us a blown fuse and \$1.00 and we'll send you a 3A or 5A\* Re-Cirk-It to try. Send your request to Heinemann Electric Co., Special Re-Cirk-It Offer, P.O. Box CN 01908, Trenton, New Jersey 08608.

\*Other ratings available under this offer on special request.  
Offer expires December 31, 1978.



# HEINEMANN

**We keep you out of trouble.**



## variable capacitors

... made by Johanson, of course! Quality without compromise is our target in the design and manufacture of capacitors in sizes, mounting configurations and capacitance values to meet every application. Perhaps that's why—for nearly three decades—superior variable capacitors have been synonymous with the name Johanson, where standards of excellence always come first.

Electronic accuracy through mechanical precision.

MANUFACTURING CORPORATION  
Rockaway Valley Road  
Boonton, N.J. 07005  
(201) 334-2676, TWX 710-987-8367

CIRCLE NUMBER 23

very slightly, if at all, from frame to frame. Picture data can be compressed by employing only the frequency changes that occur as the camera scanning beam picks up edges such as lines or rapid variations in light levels.

The information is squeezed down further with transforms of the horizontal and vertical-image frequencies. On the receiving end, the information is subjected to an inverse transform and the picture is reconstructed.

### Transform algorithm helps

The key to the microprocessors' providing the computing power necessary to perform the transforms and their inverse operations is a transform algorithm that is the most efficient to date. It was developed at Data/Ware by P.J. Erdelsky and G.G. Murray.

In the Data/Ware system, the standard TV format is modified so that each field consists of 256 lines of 256 picture elements, or pixels. This means that the horizontal pixels are slightly longer than they are wide, so horizontal resolution is slightly, but not noticeably, lower than the vertical. Since odd and even fields are treated as identical, 256 lines of information are obtained from the 525 lines of the standard TV picture. And gray scales are quantized on a 6-bit level.

To reduce the bandwidth even further, the Data/Ware system employs a frame slowdown that dissects and sends the picture out in vertical stripes 32 pixels wide and 256 pixels high—an eighth of a picture frame—at a time. These stripes are stored in a frame-store memory at the receiving site until the full frame is received. Then the frame is sent to a d/a con-

verter and to the video monitor (see Fig. below). A 32-pixel strip is transmitted during one field period. The slowdown is 8-to-1, but the picture produced at the ground station is acceptable for typical airborne applications. The stripes are processed from left to right, and updated 7.5 times a second.

With Data/Ware's encoding method, each line is processed as it is generated by the TV camera. As the information on one line comes into the microprocessor, a discrete cosine transform is performed on it to extract coeffi-

*(continued on page 38)*



**Complex calculations needed to compress and expand TV signals** are performed by microprocessors (two top card racks) in this laboratory setup. This demonstration system by Data/Ware simulates TV transmission from an airborne vehicle and reception at a ground station.

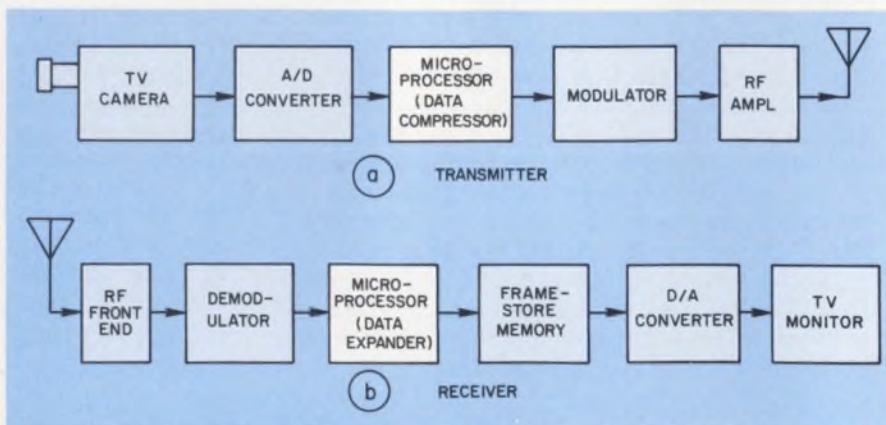

The TV signal from a remotely guided airborne vehicle is compressed by an on-board  $\mu$ P in this Data/Ware system (a). On the ground a second  $\mu$ P expands the video information, stores it, and puts it on a monitor (b).

# Controls your DEC LSI-11\* Moving Head Disc System

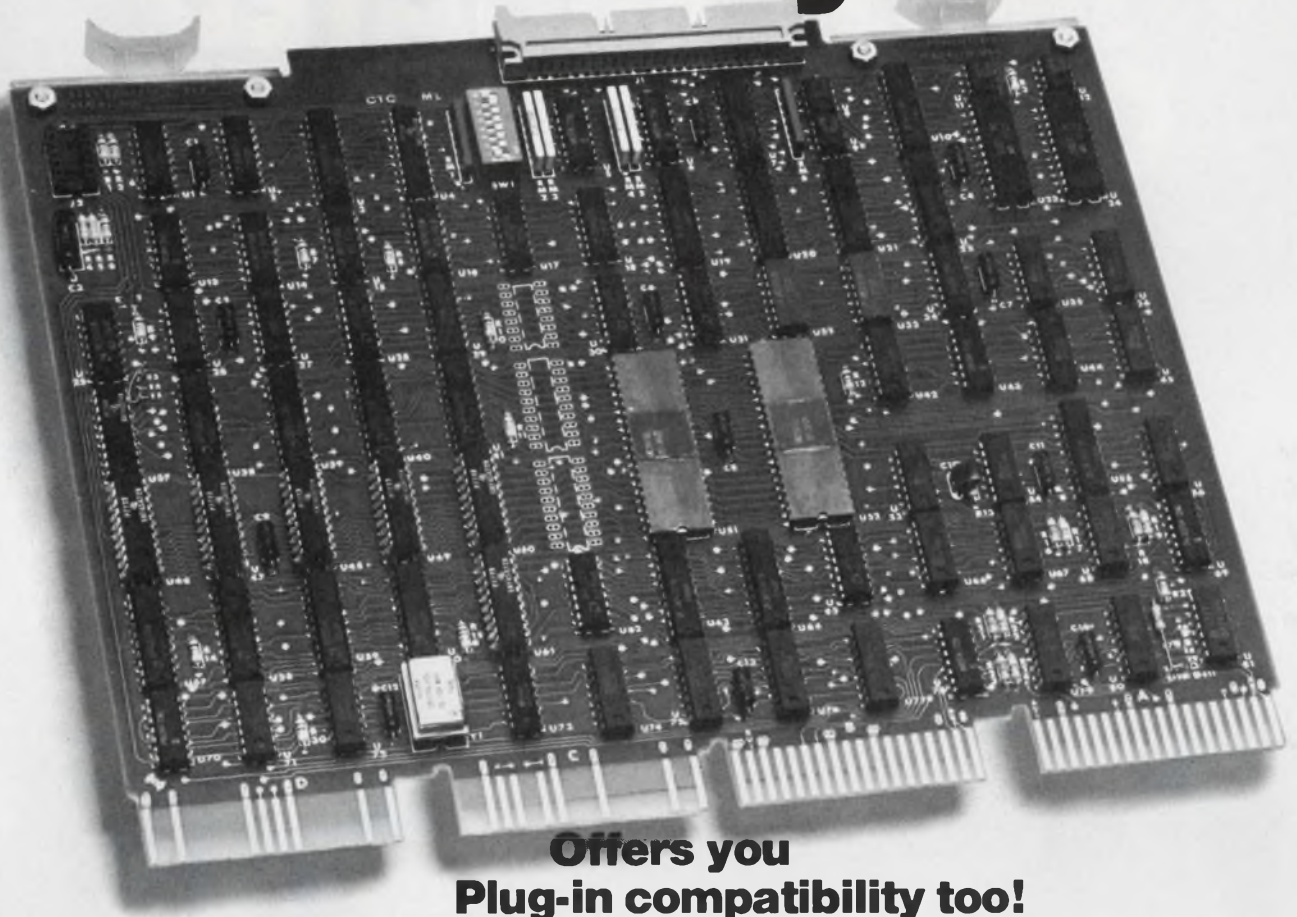

## Offers you Plug-in compatibility too!

Moving Head Disc Controllers are not new. But this one is . . . it's the Model DI-C03. What makes it new is its single quad size, made possible with a bipolar microprocessor and other exclusive Dynus circuitry. The module provides direct interface with your new or existing LSI-11 . . . and it's transparent to DEC's RT-11\* & RSX-11S\* operating systems.

Capabilities offered by the Dynus Controller include control of up to 20 megabytes of online storage • compatibility with standard 2315 or 5540 cartridge drives • storage of 2.5 to 5.0 megabytes per cartridge • DMA transfer rate of 6.4 microseconds per word • an eight word FIFO buffer for DMA latency • and two additional address bits for 128K words of direct addressing for upward compatibility to future LSI-11s.

In addition to complete interface compatibility with the LSI-11, the DI-C03 mates with any industry standard 1500 to 2400 RPM disc drive having 100 or 200 TPI capability.

Write or call for complete details or a demonstration. Discover how easily you can control your DEC LSI-11 Moving Head Disc System.

3198 G Airport Loop Dr., Costa Mesa, CA 92626  
Telephone: (714) 979-6811

\*Trademark Digital Equipment Corp.

CIRCLE NUMBER 24



**THE WORLD'S  
MOST IMITATED  
OEM COMPUTER  
JUST PULLED  
A FAST ONE.**

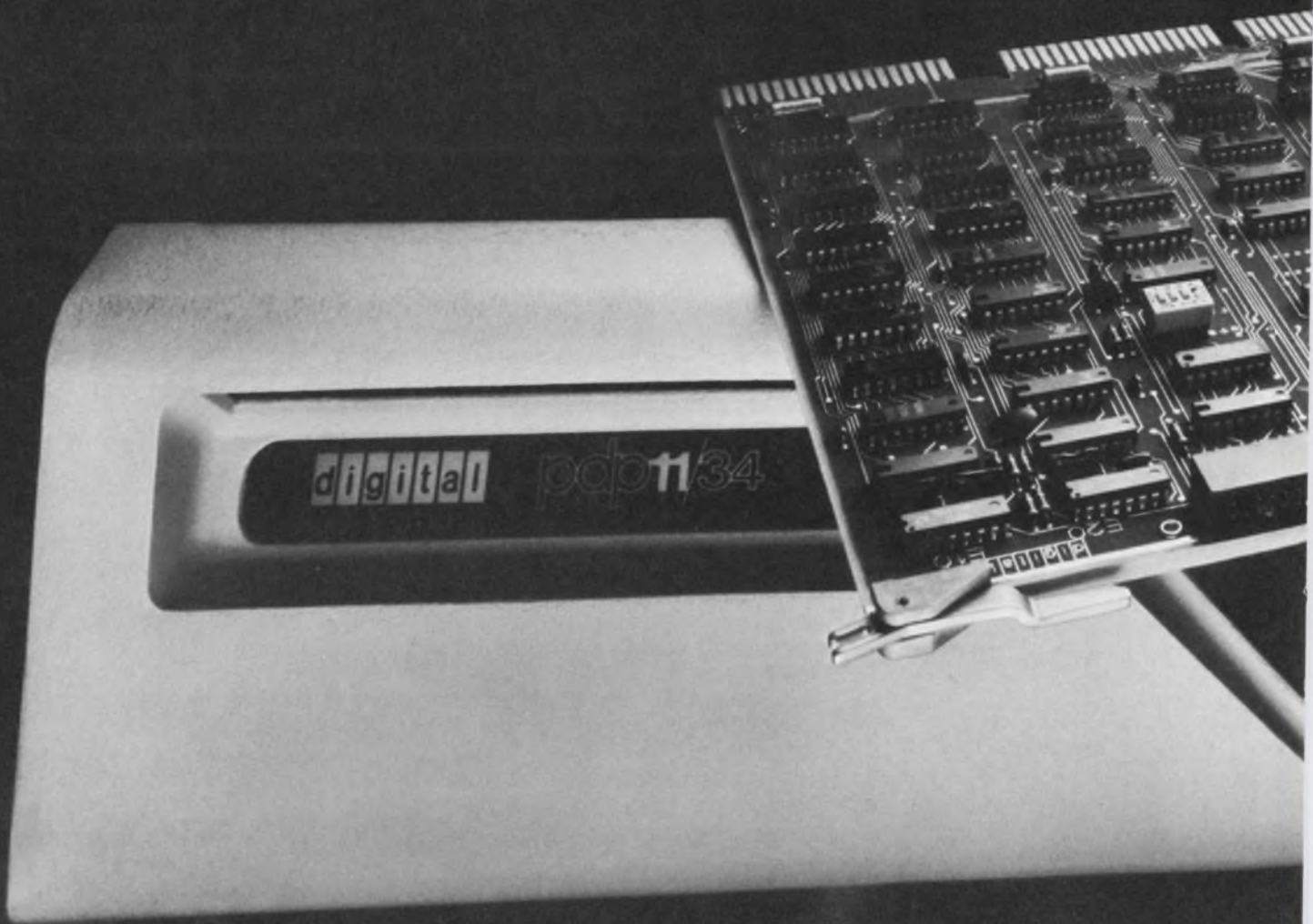



**INTRODUCING THE PDP-11/34  
WITH HIGH-SPEED CACHE.**

The new direct-map cache memory for the PDP-11/34.

2K bytes of high speed RAM. A hit rate of almost 90%. It all adds up to make the fast, powerful PDP-11/34 up to 60% faster. Our new high-speed cache is available in a system now or as a field enhancement.

Deliveries in May.

Will the competition ever cache up?

Call or write: Digital Equipment Corporation, PK3-1/M-86, Maynard, MA 01754. (617) 493-4237. In Europe: 12 av. des Morgines, 1213 Petit-Lancy/ Geneva. Tel. 93 33 11. In Canada: Digital Equipment of Canada, Ltd.

**digital**  
OEM PRODUCTS  
GROUP

CIRCLE NUMBER 25

(continued from page 34)

coefficients of key frequencies. The transform information is saved, and the coefficients obtained from the 32 pixels are stored. This information is compared with (subtracted from) the coefficients generated and stored from the previous line.

After this discrete cosine transform, the frequency-domain coefficients of one TV line-segment are compared with those on the succeeding line by differential pulse-code modulation. The difference obtained for each coefficient is applied to a quantizer table. The output from the quantizer table is a code word to be transmitted. This word can vary from 0 to 4 bits, depending on how much compression is desired.

The over-all bit rate may vary from 1.6 Mbits/s to as low as 200 kbits/s, depending on the contents of the quantizer.

The microprocessor simulating the ground station performs the inverse transforms on the data received, then

sends the reconstituted one-eighth-picture-stripe information to the frame-store memory. The stripes are stored until a complete picture arrives in the memory. The picture is then sent to the TV monitor during retrace so that it doesn't disturb the readout of the frame-store memory as it updates the TV picture.

The transform computations on the 32-line pixels and on the vertical-stripe lines must be executed by 63.5 microseconds less in the ground system. The microprocessors have pipelined architecture and a fast instruction time—150 ns—which is more than adequate for the purpose. And both  $\mu$ Ps operate under microprogram control from a 48-bit wide RAM microstore to which the PDP-11/40 has access.

The microprocessor speed is achieved not only from its pipelined architecture but also from its low-power Schottky elements. Propagation delays have been matched in the system using data latches. And parallel transfers are possible.

The Data/Ware system can not only compress images, but enhance them as well, according to Richard Keeple. This flexibility can be useful in enhancing low-contrast elements like medical X-ray pictures, among other applications. This has already been proved experimentally.

The PDP-11/40 is interfaced with the microprocessors so that various key registers of the subsystem appear as high-speed core-memory locations in the DEC computer. As a result, the minicomputer can directly modify the control-store contents within each microprocessor and directly interrogate or modify the various microprocessor registers. As a result, the  $\mu$ Ps can be controlled directly by the minicomputer for simulation runs.

At present, the microprocessors require about 60 W, which is too much. But a CMOS silicon-on-sapphire equivalent looks like it will be available from at least two companies soon, Keeple says, which would solve the power problem. ■■

## How fast are you driving? That sign on the overpass knows

A radar-operated sign flashes on to warn motorists they're speeding—and tells how fast they're going. But to get the sign's X-band Doppler radar to work reliably from overpasses (see photo) or from overhead sign posts, two major problems had to be overcome: fluctuations in the Doppler returns because of multipath cancellations from cars approaching the sign, and interference caused by bidirectional traffic flow. The sign was developed by John B. Flannery, president of Transportation Safety Associates, North Billerica, MA.

A 100-mW, 10.525-GHz radar mounted in the lower end of the sign measures the speed of approaching vehicles up to 800 feet away. Doppler speed signals of 31.5 Hz per mph are converted by special circuitry into BCD signals that turn on 14-in.-high neon numerals, which display the speed.

### Radar polices drivers

As a vehicle approaches, the radar takes measurements that are stored

and updated every two seconds. If the car's speed is within a preset value, say 55 mph, the sign remains dark—as it does with no traffic. But if the speed exceeds that value by 1 mph or more,

the exact speed is displayed for two seconds, turned OFF for two seconds, and then ON for two seconds in a repetitive cycle.

During the "on" portion of the cycle,

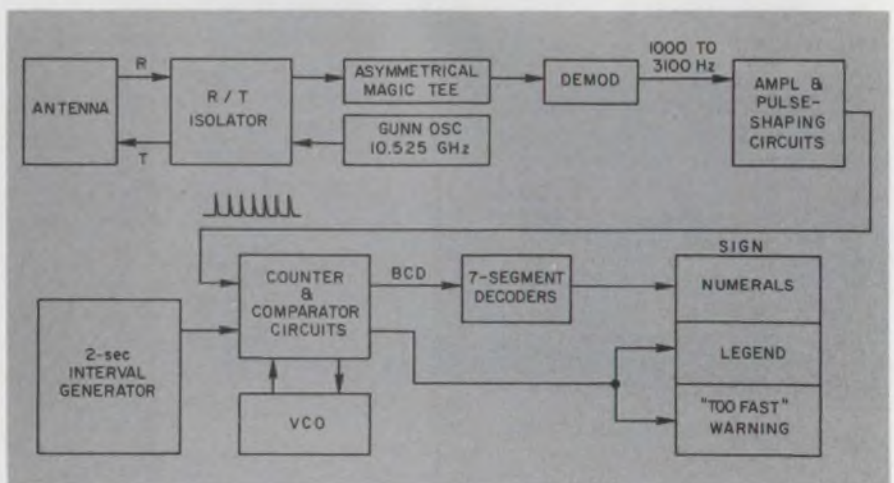

A 100-mW Gunn oscillator provides the CW power for this radar-based speed sign. Doppler signals from approaching cars are selected by the asymmetrical magic tee and passed on to counting and decoding circuits.



# MICRO

DIP SWITCH

# MINI

DIP SWITCH

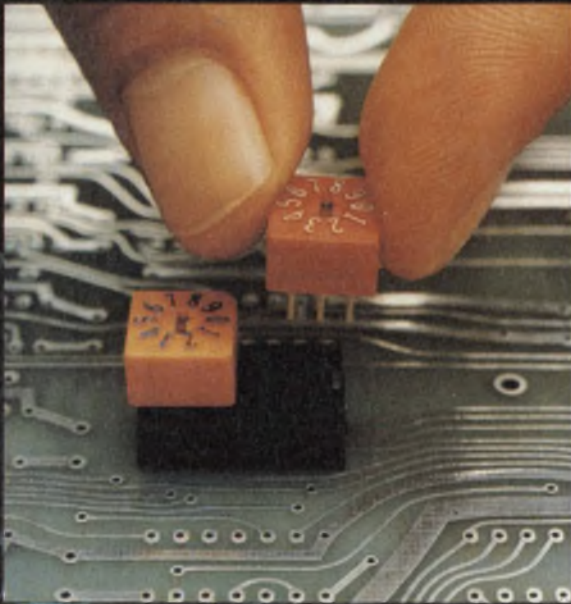

**MICRO-DIP**...10 and 16 position miniature binary coded DIP switch designed to be mounted directly to PC Boards. Ideal for address encoding, pre-setting, PCB programming... every area of digital electronics.

Packaged in a color coded, glass-filled nylon housing with terminals on .100 x .300 centers. It occupies only one half of a standard 14-pin DIP socket.

Screwdriver slot is rotated in either direction to desired setting. Gold contacts protected by dust-seal design.

Positive detenting 10 position BCD, 16 position binary with separate common to not true bits, repeating 1 and 2 pole codes. Guaranteed life of 10,000 detent operations. Operating temperature range of  $-10^{\circ}\text{C}$  to  $+85^{\circ}\text{C}$ , contact resistance of 25 milliohms max. initial.

One year warranty.

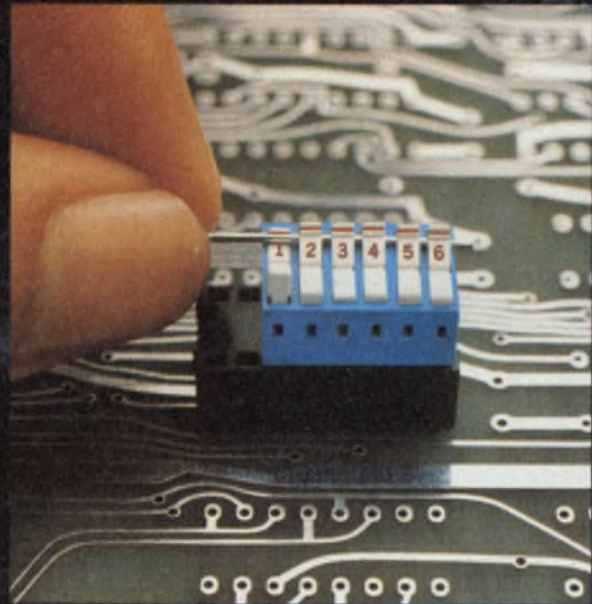

**MINI-DIP**... new from EECO. Form A and C contact arrangements ideal for positive on/off switching and programming.

Easily actuated, positive wiping, gold contacts are packaged in a dust free glass-filled nylon housing.

Interference-fit of terminal pins and one piece housing prevent contamination. Larger cross section pins allow positive insertion into sockets and PC Boards.

New locking design in which .035 diameter locking rod is inserted through rockers, insures against accidental actuations.

Guaranteed life of 50,000 cycles. Operating temperature range  $-10^{\circ}\text{C}$  to  $+85^{\circ}\text{C}$ , contact resistance 25 milliohms max. initial.

Standard .100 x .300 centers allows retrofitting of other major brands of DIP switches. Available in 2-10 station Form A, 1-5 station Form C contacts.

One year warranty.

# EECO

1441 East Chestnut Avenue, Santa Ana, California 92701—Phone 714-835-6000. Distributed in U.S. by Marshall Industries, Hall-Mark, and Schweber. In Canada by RAE and Penryn. Agents throughout the world.

CIRCLE NUMBER 26



A car approaching a radar sign installed in New Hampshire is being clocked at 60 mph, five miles over the legal speed limit.

legends in 8-in.-high neon letters also flash on to tell the driver: "YOUR SPEED IS..." and "REDUCE SPEED."

But the speed readings can be wrong—usually low—if multipath cancellations, or fluctuations in the received microwave energy, aren't corrected. These dropouts are caused by the interference of microwave energy reflected from the road with that reflected directly from an auto.

Besides developing the sign, Flanery came up with the solution to the cancellation problem. To begin with, the speed is determined by shaping the sine-wave Doppler output of the radar receiver and producing a string of pulses with it. These pulses are applied to gating circuits and counted for a specific gating period that is crystal-controlled.

# Your broadest choice is now even broader.



New value and capability in microwave measurement.

HP: MAKING EXPERIENCE COUNT.



When a multipath cancellation causes the Doppler-return pulses to drop out, a voltage-controlled oscillator (VCO) that tracks the Doppler pulses momentarily supplies the missing pulses. When the Doppler pulses reappear, they are compared with the VCO pulses. This comparison takes place at least five times during every two second "off" period. If the rates differ, the display is updated.

### Opposing traffic problems

Another problem had to be solved: What to do where the sign is used over a road whose traffic goes in opposite directions. Doppler signals from the cars going away from the sign can interfere with those approaching it.

Because the Doppler signals (1000 to 3100 Hz) are such a small percentage

of the 10.525-GHz carrier frequency, they cannot be separated by rf frequency filters. Flannery's solution, originally developed for a vehicle collision-avoidance radar, is to use an asymmetrical magic tee that is inserted between the receive/transmit isolator and the demodulator circuits (see Fig.). This proprietary device separates the approaching and receding signals on the basis of phase difference. It rejects the receding signals, and passes the approaching signals on to the demodulator circuits.

The radar sign is usually placed over high-speed lanes of highways, and the antenna beam width is shaped so that the vehicle in that lane will be the only one whose speed is measured. Amplitude gating is incorporated to ensure that the auto closest to the sign is

measured.

The system can measure and display speed from 30 to 99 mph. But, usually the upper limit is set at 75 mph to prevent the hot rodders from checking their speed up to 100 mph. The displayed speed is accurate to  $\pm 1$  mph. Optional outputs are available, such as printers to give the date, time, and speed of the offenders, and counters to measure traffic density.

The sign is being used effectively in several states. At Dulles Airport in Virginia, drivers have maintained slower speeds for up to five miles after passing a sign. In Iowa this slow-down effect has been measured up to 20 miles.

While the radar sign uses the x-band radar it can be updated with the newer Ku band units. ■■

# of counters



New unmatched resolution and versatility in time interval measurement.

## Two new instruments from Hewlett-Packard give you capabilities you've never had before.

### 5342A Microwave Counter

Now, a more useful high-performance microwave counter—and for 20% less than you might expect to pay. Microprocessor-controlled. 18 GHz range. Superior FM tolerance. Amplitude discrimination. For the first time, measure input signal level simultaneously with frequency using just one instrument. And via the keyboard, define your frequency or your power offsets to be added to or subtracted from the measurement. \$4500\*; add \$1000\* for amplitude option.

### 5370A Universal Time Interval Counter

Now, a new standard of time interval measurement with the highest single

shot resolution of any counter,  $\pm 20$  ps. Plus all the features you need to make this resolution meaningful: jittered time base, optimized input amplifiers and automatic calibration. Plus, a keyboard with statistics computation for more complete time interval characterization. All this for \$6500\*

### HP—Your Real Choice In Counting.

Fifteen HP counters span a capability range no other manufacturer even approaches. From the usual, simple, low cost "frequency-only" units to the most sophisticated high speed universal counters with performance that is simply unmatched anywhere.

\*U.S. Domestic price only



Call or write today for our new Electronic Counter Brochure, or call your nearest HP office for applications information.

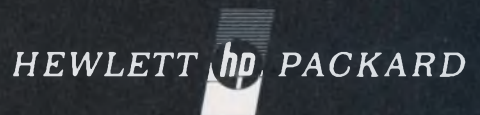

1507 Page Mill Road, Palo Alto, California 94304

For assistance call: Washington (301) 948-6370, Chicago (312) 255-9800, Atlanta (404) 955-1500, Los Angeles (213) 877-1282



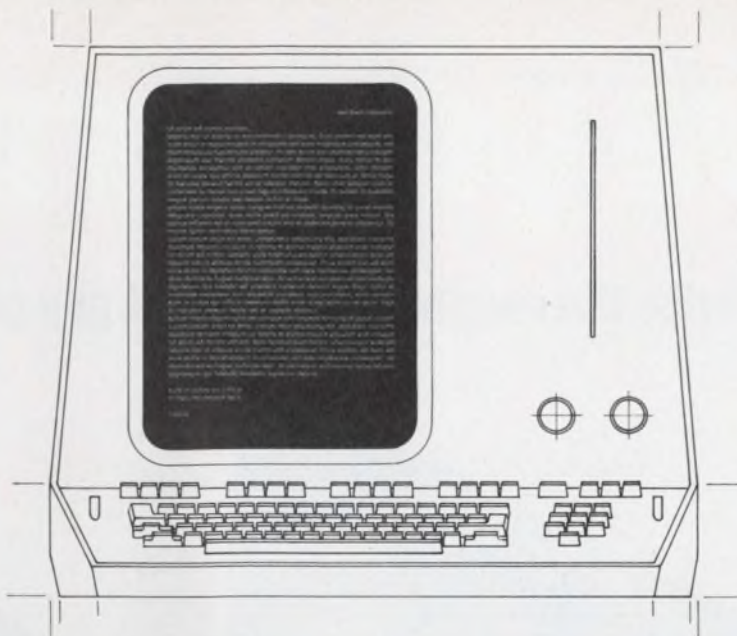

## Display Technology just took a giant step forward.



**MOTOROLA INC.**  
**Data Products**

455 East North Ave., Carol Stream, IL 60187 (312) 690-1400 TWX: 910-252-4404

With the M4408 by Motorola. Like some of our others, it's a 15" raster scan CRT display module, but that's where the similarities end. The M4408 was specifically developed for systems that demand displays of up to 6,300 upper and lower case, clearly readable characters.

With its unique horizontal or vertical mounting capability, the M4408 can display a full typewritten page (96 characters x 66 lines) or a wide page printer format (132 characters x 48 lines...or 43 if you prefer). And those are only two examples. The M4408 is the optimum display for any high performance, high density character application.

The cost? Not much more than conventional 15" 80 x 24 type displays - considerably less when you consider cost per character. And the M4408 doesn't require high speed, expensive logic either.

When you compare features, we think you'll agree that the Motorola M4408 is the price performance winner.

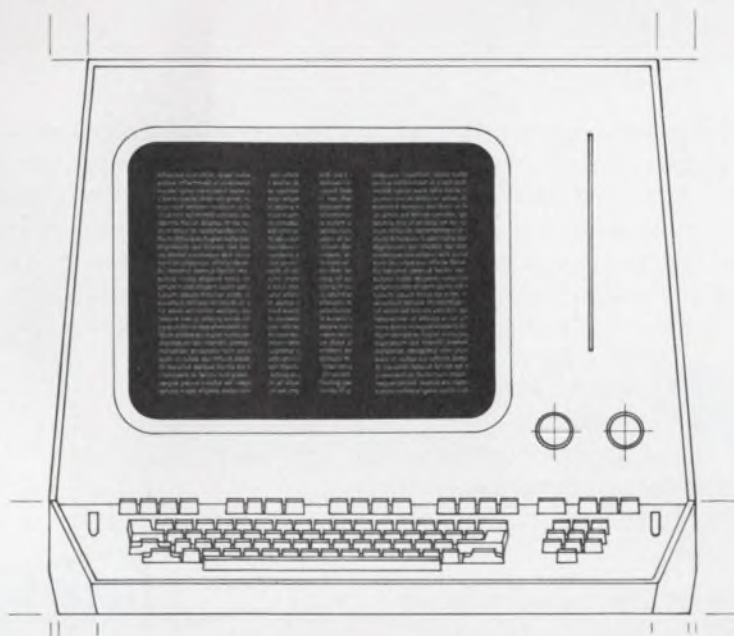

CIRCLE NUMBER 29

# Give your product

with Burroughs SELF-SCAN® II gas plasma displays—

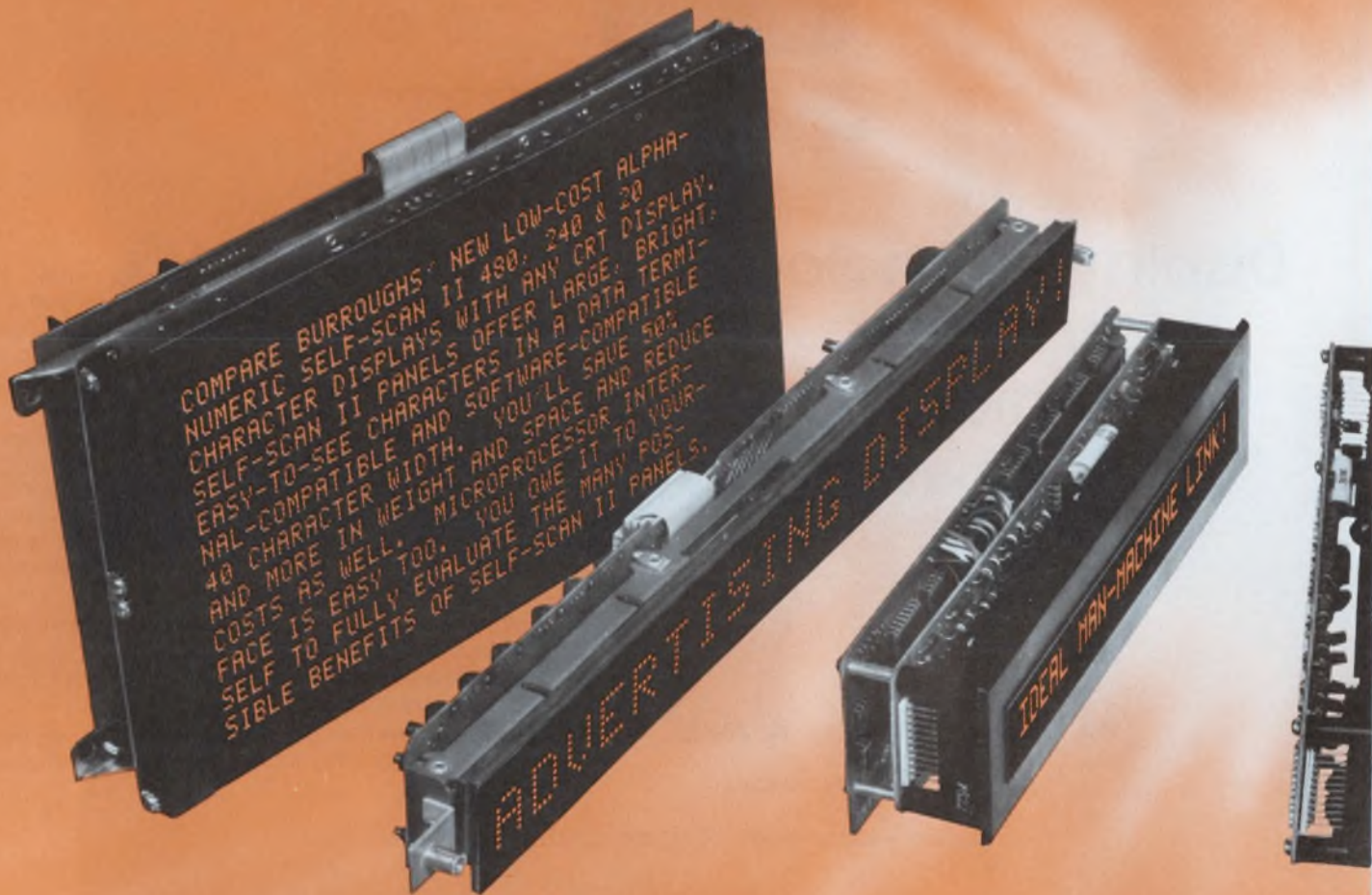

Burroughs SELF-SCAN displays provide bright, easy-to-read alphanumeric readout that will enhance the saleability of your product. Over one-quarter million have been built into everything from word processors to data terminals to paint matching machines.

And now they're easier than ever to use. Optionally available microprocessor-based controllers save you most of the time normally spent to "design-in" a display.

Give your product the visual excitement and dependability of SELF-SCAN displays. You'll benefit from each of these features:

- Thin cross-section (under 2" with electronics) to keep your product's design efficient and low-cost.

- Neon-orange characters are uniformly bright, flicker- and distortion-free, easy-to-read in high ambient light and at night without eye strain.
- Easy interface with microprocessor-based systems.
- Any of over 100 languages can be displayed with many special effects possible (such as word blinking).
- Low power requirements, low heat buildup.

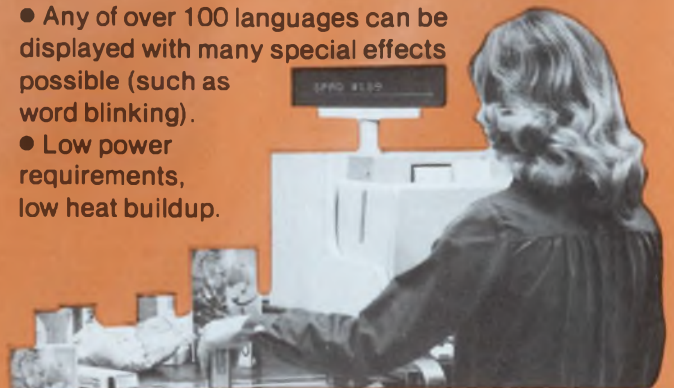

# visual superiority

now available with microprocessor control.

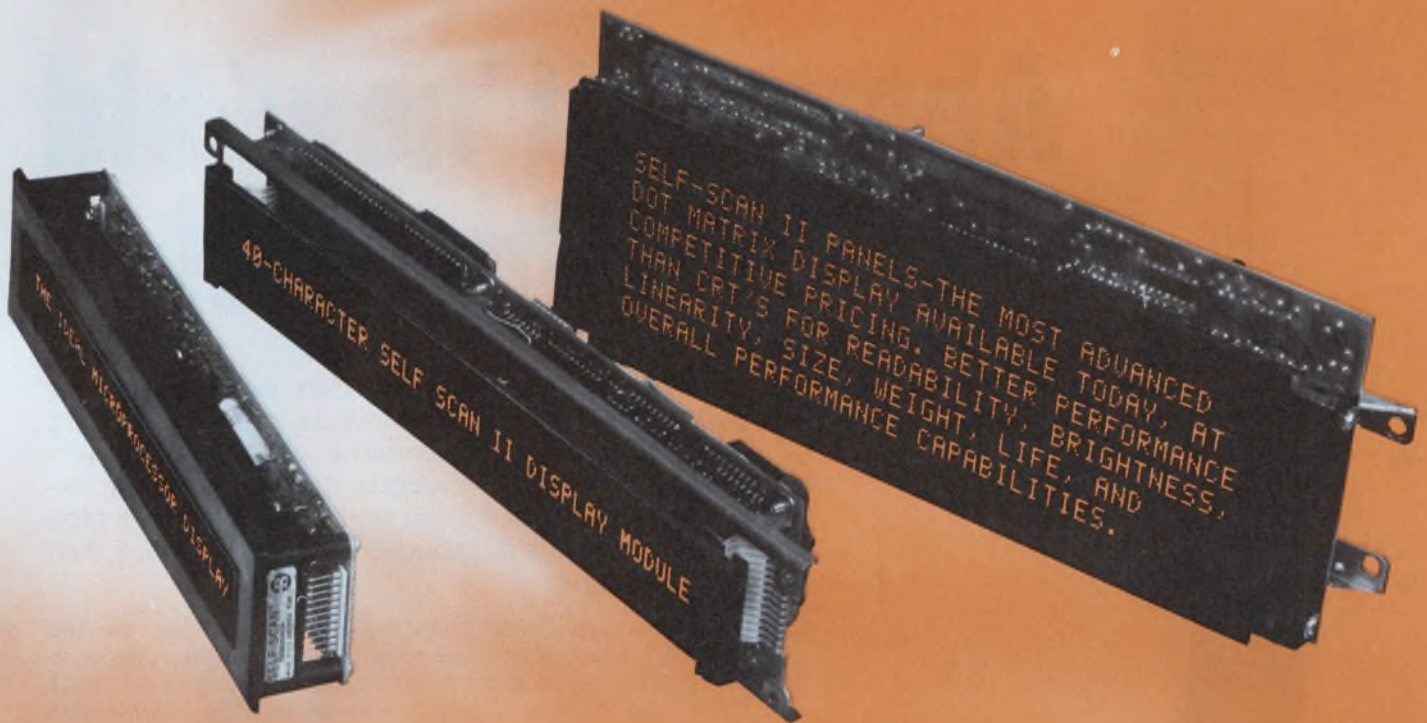

- Fewer connections required than with other displays.
- Long service life even where vibration, temperature and high humidity are present.
- No danger of implosion or X-ray radiation.

**Choose from our complete line.** SELF-SCAN panels are available in both single and multi-line displays with and without memory. Our single-line models, in 16, 20, 32 or 40 characters, are compact, low-cost and extremely dependable. The 20-character panel is stackable and buttable for creating large message panels. Single-line panels range in price from \$112 in 100-unit quantities.

Low-cost SELF-SCAN multi-line displays in 240 and 480-character sizes are rapidly replacing many CRT displays. They give you excellent message readability, big space and weight savings, plus 3 times the life of most CRT's. Prices range from \$311 in 100-unit quantities.



Give your product the visual advantages of SELF-SCAN displays. Write or call for specifications.

Burroughs Corporation, Electronic Components Division, P.O. Box 1226, Plainfield, NJ 07061 or call (201) 757-5000.

Overseas, contact Burroughs ECD International, Buckingham House, The Broadway, Stanmore, Middlesex, England. Telephone 44-9237-70545.

**the first name in displays  
the last word in displays**

## Burroughs



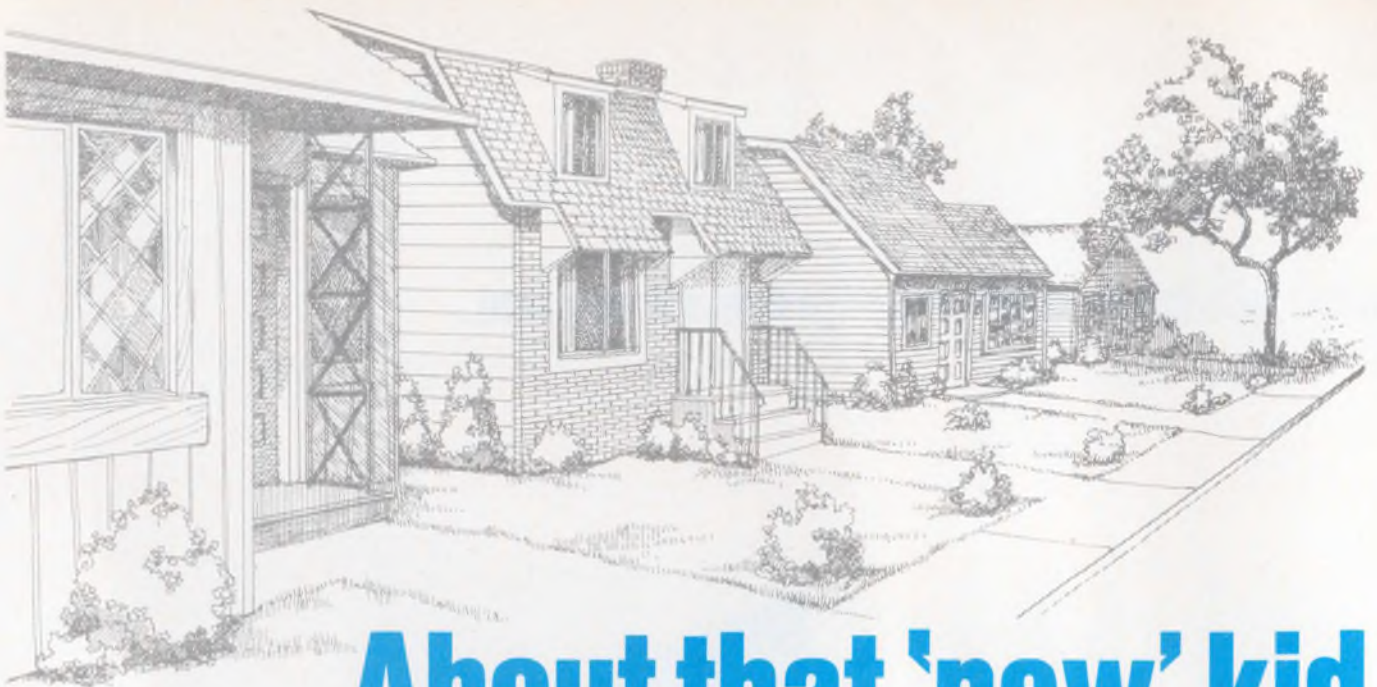

# About that 'new' kid on the block...

Actually, he's not that new. He's been around for quite a while now. Other vendors keep announcing miniature cylindrical ceramic capacitor 'innovations', but Sprague Electric, the pioneer in layer-built ceramics, can state with pride that this type of capacitor was introduced by Sprague more than ten years ago.

Sprague Type 292C MONOLYTHIC® Capacitors are the industry's best-constructed axial-lead capacitors, thanks to MFT\*, a closely-monitored material modification of electrode metal and ceramic reacted with glass. The result—less capacitance change with temperature change, improved stability with life, and improved impedance with frequency characteristic.

These low-cost miniature capacitors feature a dimensionally-precise molded construction and can be ordered taped and reeled for automatic insertion. They are available in body formulations to meet characteristics Z5U (general-application), X7R (semi-stable), and COG (NP0).

For complete technical data, write for Engineering Bulletin 6250B to: Technical Literature Service, Sprague Electric Co., 347 Marshall St., North Adams, Mass. 01247.



Illustrated approx.  
4x actual size



\* Modified Formulation Technology

THE BROAD-LINE PRODUCER OF ELECTRONIC PARTS

CIRCLE NUMBER 32



a  
General  
Cable  
subsidiary



## Cruise missiles will cost over \$8-billion

The air, land and sea-launched cruise missiles proposed by the Defense Department will cost \$8.1-billion, the Department has reported to Congress in its latest Selected Acquisitions Report. The SAR, a quarterly analysis of major weapon-system costs, does not reveal how many cruise missiles will be ordered, but previous estimates have placed their cost at about \$1-million each.

The ship-launched Tomahawk and a variation, the Ground Launched Cruise Missile, will be built by General Dynamics Corp., in San Diego, which is competing with the Boeing Co. in Seattle to build the third type, the Air Launched Cruise Missile. The Tomahawk will cost \$2.4-billion, according to the latest SAR, while the GLCM, to be launched from combat vehicles, will cost \$1.5-billion.

To determine the winner of the Air Force's ALCM, each company will build 18 test missiles for a competitive fly-off in 1979. That program, which is intended to supply strategic cruise missiles to be launched from B-52 bombers, is expected to cost \$4.2-billion. The ALCMs must be operational by early 1980, according to the Defense Department, to fill the gap created when the B-1 bomber was canceled.

The McDonnell Douglas Astronautics division in St. Louis is supplying terrain-contour-matching (Tercom) guidance systems for all the cruise missiles.

## Defense Dept. eyes new high-energy laser for weapons

The Defense Department has begun experimenting with a new "free electron" laser that is believed to be more lethal than conventional lasers. And it wants more money to develop high-energy laser weapons—from \$150-million this year to \$184.1-million in fiscal 1979.

Currently, lasers require a solid or gaseous lasing medium. But the essential physical interactions of the new laser occur within a spiraling, relativistic electron beam.

"This could provide a new option for high-energy lasers, with three times the efficiency previously achieved," according to Dr. William J. Perry, undersecretary for defense research and engineering. Speaking before Congress, Perry went on to say that the free-electron laser would be tunable from ultraviolet to infrared—unlike present systems, which are not continuously tunable.

The Air Force has already demonstrated lasing with the new technique. And if potential weapons based on the new laser prove effective, they could be used to defend ships, aircraft and satellites, according to Perry.

## New ASW helicopter approved for development

Full-scale engineering development of a new antisubmarine warfare (ASW) helicopter has been approved for the Navy by the Defense Department—despite cost overruns that have driven up the price of one to \$18.7-million.

The YSH-60B, also known as the Light Airborne Multi-Purpose System (LAMPS) Mark III, is a variation—with more avionics equipment—of the Army's Blackhawk troop-carrying utility helicopter. One Blackhawk costs \$3.26-million.

Besides antisubmarine warfare, LAMPS is expected to be used for over-the-

horizon targeting for the Harpoon cruise missile and possibly the Tomahawk. The helicopter will carry the new Control Data AYK-14 standard airborne computer and the Texas Instruments APS-124 long-range radar, as well as two torpedoes and 25 sonobuoys. The Federal Systems Division of IBM is the prime contractor and system integrator.

Development was approved by the Defense Systems Acquisition Review Council (DSARC) despite a report to Congress that program costs had jumped from \$2.7-billion to \$3.9-billion. The Navy attributes the increased costs to inflation, additional support requirements and schedule slippage.

The DSARC development decision will permit the airframe contractor, the Sikorsky division of United Technologies Corp. (Stratford, CT), to begin building the first prototypes. The company is already building Blackhawks.

The program will remain in the development phase until the fall of 1981, when the DSARC is scheduled to meet again to rule whether or not the LAMPS should be produced. The Navy is requesting funds for 209 LAMPS helicopters (including five prototypes), and the first flight is scheduled for late 1979.

## Coast Guard seeks new helicopters

The Coast Guard wants a search, rescue and recovery helicopter, and is evaluating proposals from two American and two European manufacturers under a program expected to be worth \$180-million.

Coast Guard officials say they want a helicopter that is already in production in order to eliminate costly research and development, but insist they won't be procuring it "off the shelf." The helicopter must have improved avionics, such as search and weather radars—which current search and rescue helicopters don't have—an area navigation system, and the latest technology autopilot.

One American competitor, the Sikorsky division of United Technologies Corp., is proposing its new S-76 commercial helicopter. The other, Bell Helicopter Co., a Textron division in Fort Worth, TX, is proposing its Model 222. Great Britain's Westland Helicopters is offering its Sea Lynx WG-13 and France's Aerospatiale a version of its Model 365. Whichever helicopter is chosen will have to be modified extensively for the Coast Guard's special requirements, such as the advanced avionics and a hoist for rescue operations.

The Coast Guard expects to make its selection in early 1979 and receive the first fully certified helicopter two years later. Funds for the first 10 have been appropriated in this year's Transportation Department budget, and authority to procure five more is being requested in the fiscal 1979 budget. The Coast Guard expects the procurement to be completed within five years after the initial deliveries.

**Capital Capsules:** Fairchild Space & Electronics Co., Germantown, MD, has been selected to build **the first two Landsat-D earth-resources survey satellites**, to be launched in 1981. The contact, still being negotiated with the National Aeronautics and Space Administration, is expected to be worth \$10.3-million and to include options to produce four additional spacecraft for future programs....**The Air Force now confirms that it plans to buy 20 of the new TR-1 spy planes**, which will fly at 430 miles per hour, with a range of more than 3000 miles and a ceiling described only as "above 70,000 feet." The Air Force will buy them from Lockheed Aircraft Corp., Burbank, CA, as part of its plan to reopen the U-2 production line there (see Washington Report, ED No. 5, Mar. 1, 1978, p. 31). The first six TR-1s will be procured in fiscal 1980, which begins Oct. 1, 1979. To do that, the Air Force plans to seek \$97-million in addition to the \$10.2-million being requested for fiscal 1979.

# Fast Relief for the "Typical Spec" Headache

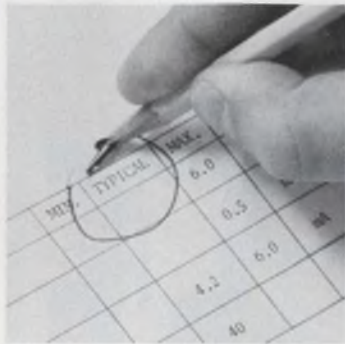

## "Typical Specs" Are a Pain

The next time you're searching through component spec sheets for a characteristic best suited to your design, the word to watch out for is "TYPICAL."

Typical specifications can be devilish creatures. Ask any design engineer who has ever believed in them. When you need answers in black and white, they turn gray and disappear in the fog. Until you determine what the MIN., MAX, or typical value really is, you've got headaches. Headaches not just for you, but for everyone on down the reliability line—from QC to your field service people.

## Curve Tracer A Quick Cure

There's an age-old cure for the headaches caused by typically elusive specifications. It's called a Curve Tracer. TEKTRONIX Curve Tracers aren't new. We introduced our first one in the days of vacuum tubes.

Since then Curve Tracers have performed wonders for semiconductor manufacturers, component evaluators, incoming QC inspectors and reliability engineers.

We prescribe them for design engineers because the earlier you can diagnose a problem, the less of a problem it will be.



## A Picture of Health

If you need to examine a component, it's a good idea to start with its vital signs—current and voltage. And we all know that the best way to understand the voltage/current relationship is to look at a graph.

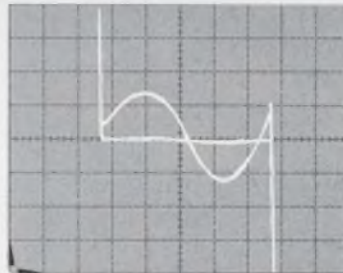

Two Op Amp gain curves at different sensitivities in the storage mode.

TEKTRONIX Curve Tracers graph voltage vs. current in digital and linear ICs, 2- and 3-terminal devices...transistors, diodes, rectifiers, thyristors, optoisolators and more.

At a glance, you can pinpoint parameters such as an Op Amp's offset drift at various loads, or zero in on the *actual* breakdown voltage in a power transistor.

With a Curve Tracer, you can assign *proven* values to several components and select the one that *you know* performs best in the environment you've created. Just think of it as a little preventive medicine to help you and your organization avoid headaches in the future.

## Why Prolong Suffering

Fast relief can be on its way. For detailed information—application notes, specifications, a demonstration and the prices of our Curve Tracers and their Test Fixtures simply call your Tektronix Field Engineer. Or, write:

Tektronix, Inc.  
P.O. Box 500  
Beaverton, OR 97077  
In Europe: Tektronix, Limited,  
P.O. Box 36, St. Peter Port,  
Guernsey, Channel Islands.

**CAUTION**  
TEKTRONIX Curve Tracers are mildly habit-forming. Once you use one, you'll wonder how you ever survived without it.

**Tektronix**<sup>®</sup>  
COMMITTED TO EXCELLENCE

# So put down those aspirins and take one Curve Tracer.

# When you need illuminated switches, or more than illuminated switches...



Dialight is the first place to look. We make just about any kind of illuminated push button switch that anyone could want . . . Single lamp, dual lamp, neon, incandescent, LED lighted, you name it.

Perhaps you're looking for snap action switches with silver or gold contacts, or wiping action switches with gold contacts for low level application.

And if you're looking for rear panel or front bezel mounting switches, switches with momentary or alternate actions, or high quality switches for computer applications, we have them.

You'll find that Dialight switches are not only available at a reasonable price, they're also available with some very attractive features. Lamp removal is from the front so you don't have to remove

an entire switch just to change a lamp. And you never have to use anything more complicated than your fingers for replacement or installation.

Along with outstanding variety and design, you get superior Dialight quality. Most Dialight switches are Underwriter's Laboratory listed and CSA approved.

And Dialight distributors are widely located throughout the United States, Canada and worldwide.

Call or write Dialight today. We'll send you our free switch catalogs so you can select a quality switch that's American made and Dialight guaranteed. **DIALIGHT**  
A North American Philips Company

## Dialight meets your needs.

Dialight, 203 Harrison Place, Brooklyn, N.Y. 11237 (212) 497-7600

CIRCLE NUMBER 35

## The frozen mind

I was discussing power supplies with Charlie the other day. We were arguing the relative merits of linear and switching supplies, and though he knew, or should have known, that I had been studying power supplies for many years, he remained adamant. He had apparently made up his mind years ago and wouldn't budge. He adhered rigidly to his old opinions and seemed unable to accept my facts.

I had a similar problem with Jack, and we weren't even discussing something that affected us professionally. I don't remember what it was that we argued about. It may have been apartheid in South Africa, the Food and Drug Administration, the value of Vitamin E in treating burns, or the relative merits of Chinese and French cuisine. I do remember that Jack was thoroughly rigid and his mind was closed. He had done some reading on the subject and didn't realize that his authors were biased—despite my showing him that, from *my* reading, I knew the facts.

It's sad to relate that my experience with people who confront my facts with their opinions is not limited to Charlie and Jack. Indeed, I've had such experience with dozens of people on dozens of subjects. And though I would expect them, in time, to develop some humility, they still suffer from the illusion that they are right.

I find the problem particularly rampant in our industry. Engineers frequently make design decisions based on insufficiently considered opinions and faulty evidence. And executives make business decisions the same way. That's unfortunate. Things would be lots better if they'd ask me.



We're deeply honored that the American Business Press has conferred on George Rostky, for the third year, its coveted Neal Award Certificate for Editorial Excellence. The Neal Awards are considered the business-press equivalent of Pulitzer prizes. Rostky's award was for the "Best Series of Editorials."

A handwritten signature in dark ink that reads "George Rostky". The signature is fluid and cursive, with a long horizontal flourish extending to the right.

GEORGE ROSTKY  
Editor-in-Chief

# Keep those cards

# & letters coming!

For some, it would be enough to establish industry standards. Like our LM 317.

Or to build an unusually large assortment of "building block" parts.

But, you see, we keep getting telephone calls. And notes on the back of old napkins and such.

"Hey," they'll say, "why don't you make a linear huffle muffle? Boy, could I use that!"

So we did.

## Introducing 3-Terminal Negative Adjustable Regulators.

Per request. The LM 337. Output voltage adjustable from  $-1.2$  to  $-37V$ . 1.5A output guaranteed. Excellent thermal regulation  $-0.002\%/W$ . 100% burn-in, for improved reliability; 100% tested for short circuits and thermal shutdown.

## Introducing 3-Amp Positive Adjustable Regulators.

Per request. The LM 350. Guaranteed 3A output current. A 1.2V to 33V output range. Line regulation typically  $0.005\%/V$ . Load regulation typically 0.1%. And, most critically, 100% electrical burn-in in thermal limit!

## Introducing 2.5V Reference Diodes.

Per request. The LM 336. Guaranteed low temperature coefficient.  $\pm 1\%$  initial tolerance available. And low prices to boot.

## Introducing 3-Terminal Adjustable Current Sources.

Per request. The LM 334. 10,000:1 range in operating current. From 1V to 40V. Accuracy not affected by long wire runs. Also, requires only two wires.

Oh, you're welcome.

National Semiconductor Corporation, MS/520  
2900 Semiconductor Drive, Santa Clara, CA 95051

ED 3/15

Gentlemen: Please respond to the following requests —

- Send me data sheets on your voltage regulators.
- Send me data sheets on your current sources and reference diodes.
- Send me your voltage regulator cross-reference.
- Send me your voltage reference/cross-reference.
- Hey, why don't you make a \_\_\_\_\_

\_\_\_\_\_

\_\_\_\_\_

\_\_\_\_\_

\_\_\_\_\_ . Boy, could I use that!

Name \_\_\_\_\_ Title \_\_\_\_\_

Company \_\_\_\_\_

Address \_\_\_\_\_

City \_\_\_\_\_ State \_\_\_\_\_ Zip \_\_\_\_\_

Telephone \_\_\_\_\_

 **National Semiconductor**

# The big switch

**...is to smaller lighter switchers.**

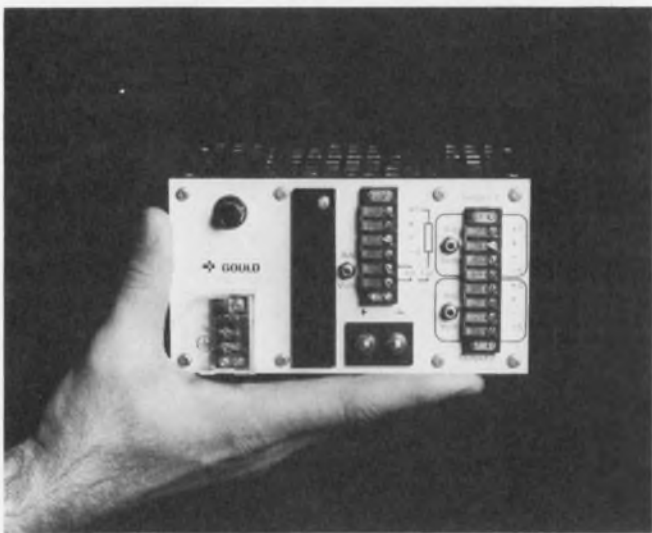

The 200 watt MGT 5-20A: 7" x 6.4" x 3.5" 7.5 lbs

Switching power supplies average about  $\frac{1}{3}$  the size and  $\frac{1}{4}$  the weight of linears. And in many applications that's reason enough to make the switch. But it's not the only reason. Compared to linears, switchers can cut energy consumption in half, generate far less heat, and offer better holdup protection. That's why more than 40,000 Gould switchers are already in use around the world.

Gould offers single and multiple output units with power levels from 8 to 2,250 watts. And custom designs can be provided to meet your exact specifications. You'll be backed by a high volume production capability and worldwide service network that only a \$1.5 billion company like Gould could offer.

For more information or to arrange for an evaluation unit contact Gould Inc., Electronic Components Division, 4601 N. Arden Drive, El Monte, CA 91731. Telephone (213) 442-7755.

**Gould.**  
**The power in switching power supplies.**

 **GOULD**

CIRCLE NUMBER 36

ELECTRONIC DESIGN 6, March 15, 1978



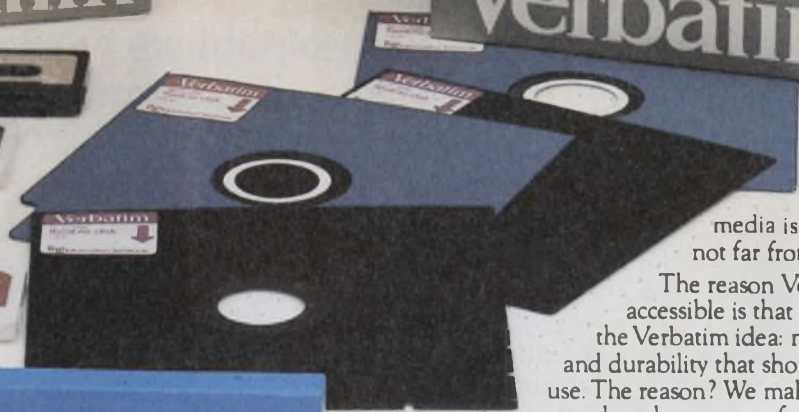

The superb quality of Verbatim™ removable magnetic storage media is now on a dealer's shelf not far from you.

The reason Verbatim is now so accessible is that so many of you like the Verbatim idea: noticeably better quality and durability that show up in tough everyday use. The reason? We make almost everything ourselves, because we found that we could improve on the quality that we were getting from our suppliers.

Being demanding isn't always easy. But it's good for the people who buy and use Verbatim, and it's good for the scores of companies who specify Verbatim for the equipment they make. And we enjoy doing business that way.

For your nearest sales office call toll free:  
**(1) 800-821-7700, Ext. 515**  
 (in Missouri call: 800-892-7655, Ext. 515)

Information Terminals Corp., 323 Soquel Way,  
 Sunnyvale, CA 94086. (408) 245-4400.  
 TWX: (910) 339-9381.



**Ask  
 for it by  
 name.**

# Verbatim™

In the Far East:  
 ITC—Far East  
 404 Roppongi Skyheights  
 3-2-21 Roppongi, Minatoku  
 Tokyo, Japan  
 Telephone: (03) 583-1981  
 Telex: J 47879

In Europe:  
 Information Terminals S.A.  
 Case Postale 296  
 1215 Genève 15  
 Switzerland  
 Telephone: 41(22)34-90-55  
 Telex: 22647 ITGE CH

## Diagnose computer ills

with an analog monitor. It's inexpensive, very easy to build, and does not interfere with computer operation.

When you want to locate and correct computer-system bottlenecks or look for unused capacity, consider using an analog monitor. It doesn't cost much to build and operate, it monitors the system continuously, and its accuracy isn't as limited as that of other methods. For example, digital simulation techniques require a high level of detail to be accurate, and software monitors are limited by their sampling rate.

Like the monitors in an intensive-care hospital ward, an analog monitor measures vital signs—in this case, a computer's. In fact, the charts it produces, even look very much like electrocardiograms or encephalograms.

The analog monitor's measurements are automatically plotted in real time (Fig. 1). You don't need an expensive minicomputer, nor additional analysis on your host computer. Because the plotter records two traces simultaneously, you can also examine Boolean relationships.

These graphs can help the computer designers in locating and correcting system bottlenecks, and similar problems, as will be demonstrated by six case studies.

### A do-it-yourself "encephalograph"

Connect a monitor to your system with a high-impedance, passive probe. It won't affect your "electronic brain's" operation (Fig. 2). Heat-shrinkable tubing (broken lines) protects the external resistors and capacitor.

The selected probe circuit components smooth out high-frequency digital signals. Resistors  $R_1$ ,  $R_2$  and  $R_3$ , along with capacitor  $C$ , form a low-pass filter. If the probe is connected across a low-impedance indicator bulb, the chosen component values provide a time constant of about 15 s, which corresponds to a moving average over approximately one minute ( $4T$

= 58.67 s). A very high output impedance at the test points increases the averaging time to 88 s. If you prefer a faster response, use lower-value resistors or capacitors in the probe (Fig. 3.) Larger component values expand the averaging interval.

Before you assemble the probe, check the ZERO and ONE voltage levels at the connecting points, and use a capacitor rated for the appropriate voltage range. The capacitor in the parts list is rated at 10 V, which is an adequate choice for most applications. You can minimize noise pickup by keeping the probes short and—where feasible—using low-impedance connection points such as indicator bulbs. Test points can be as far as 50 ft from one another, provided you can place the chart recorder midway between them.

To speed up measurements, connect several sets of probes to the host system simultaneously, and connect the chart recorder periodically to different probes. You can leave the probes connected to the "patient" even when you remove the chart recorder at the other end.

### Pick the right recorder

The monitor requires a recorder with high-impedance floating inputs, and zero adjustment as well as sensitivity controls. A Heath-Schlumberger Model SR-206 dual-pen strip-chart recorder or its equivalent works well, because it's versatile, reliable, and reasonably priced. Along its vertical axis the chart is ruled in 5% increments, and chart speed is most convenient at 0.1 in/min.

While the recorder can handle logic levels ranging from millivolts up through several hundred volts, probe-circuit components have to be modified at higher voltage levels. A chart recorder with separate calibration controls and independent floating input for both channels can accommodate both negative (ONE more negative than ZERO) and positive (ONE more positive than ZERO) logic.

To calibrate the monitor, place the chart paper for the correct time reading. If one pen is offset with respect to the other to avoid pen interference, note

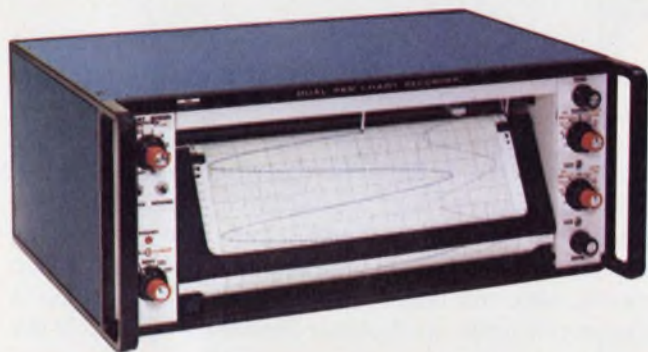
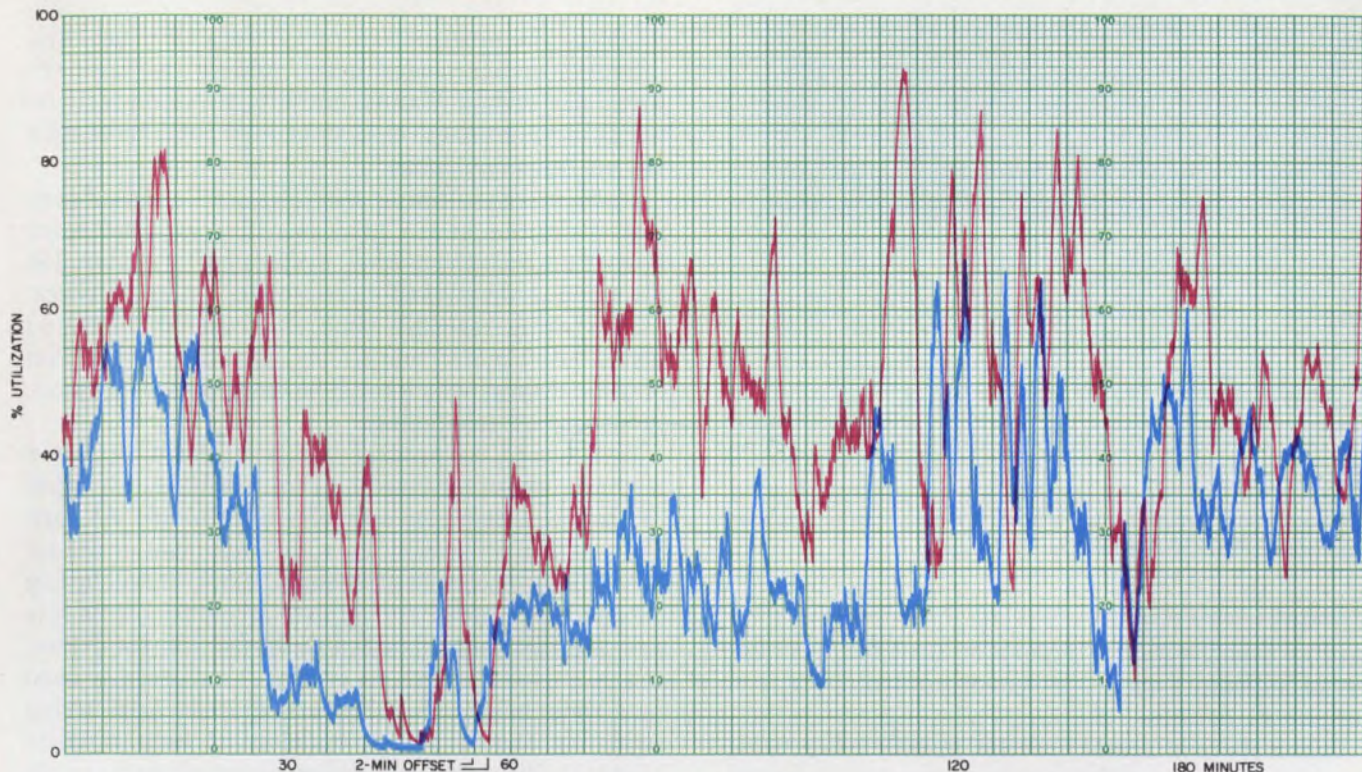

1. A dual-pen strip-chart recorder like this Heath SR-206 is the heart of the described analog monitor. The chart plots total CPU utilization (red) and an application program's contribution (blue) to show supervisor overhead (see also Fig. 4f).

to which pen the time scale applies.

Calibrate the two recording channels separately because they may have to be adjusted for different logic levels (e.g. if the probes go to different parts of a system). First check that the polarity is proper for the probe's electrolytic capacitor by making sure the voltage at the red banana plug is always positive with respect to its black companion. If it isn't, reverse the test clip connections.

Now adjust the null control at logic level ZERO, and then the gain control to full scale with a logic-level ONE input. Chart-recorder drift is usually small enough so recalibration is needed infrequently.

You're now ready to start with the analysis. The monitor probes can frequently be connected directly across indicator bulbs or light-emitting diodes (LEDs). An IBM 370/155 system-control panel contains almost 500 bulbs, and with the help of dial switches they can display the status of approximately 1500 bits of information. It is very likely that some subset of these indicators will satisfy your monitoring needs. If a computer manufacturer has taken the trouble to provide an indicator lamp for a function, you can

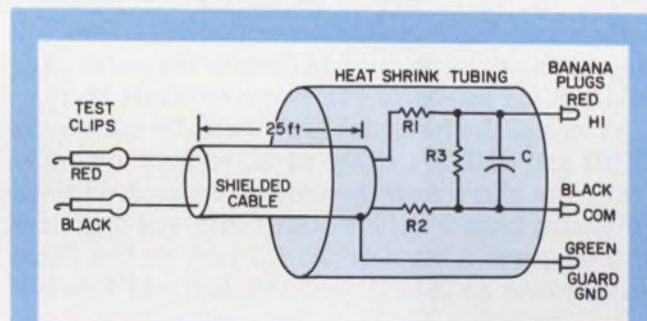

#### Quantity Description

	Micro Grabber test clips (ITT, Pomona, CA)
2	black: model 4233-0
2	red: model 4233-2
6	resistors, 100 k $\Omega$ , 1/4 W, 1% accuracy (Allen Bradley cermet film)
2	tantalum capacitors, 220 $\mu$ F, 10 WVdc (Sprague type CSR-13)
50 ft	2-conductor shielded #22 stranded wire conductor size: (Alpha type 3221) heat shrinkable tubing:
1 ft	3/16 in.
1 ft	1/2 in. (Votrex type FPS)
	banana plugs:
2	red
2	black
2	green

2. The probe schematic and parts list show how easily the analog monitor can be assembled.

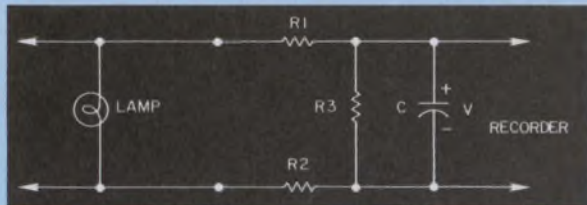

$$T = \frac{(R_1 + R_2)R_3}{R_1 + R_2 + R_3} C$$

If  $R_1 = R_2 = R_3 = 100 \text{ k}\Omega$ ,  $C = 220 \text{ }\mu\text{F}$ :

$$T = 14.67 \text{ s}$$

3. The equation for the monitor's time constant is valid if the test-point impedance is much lower and the recorder impedance much higher than  $100 \text{ k}\Omega$ .

assume that function is important. Look for pertinent signal indicators on the processor, control units, and peripheral devices.

Take a spare indicator bulb and modify it to provide a monitor connection that can be conveniently plugged into one of the front panel indicator sockets: Join the electrical connections from its base to a second "piggybacked" indicator lamp, and attach the probes in-between.

If there is no convenient indicator for the desired signal, you may have to access the host system's backplane or logic gates. Your probe connections will frequently be test points used for troubleshooting, and field service personnel can help you locate them.

As long as the test point impedances for logic levels ZERO and ONE are either equal, or both are under  $2 \text{ k}\Omega$ , the chart scale accurately indicates channel utilization from 0 to 100%. Otherwise, you may have to intersperse a lamp-driver IC, such as the Texas Instruments SN75450B, between host and monitor.

### Put your system on the couch

The six following examples show how the monitor can diagnose system bottlenecks or imbalances.

*CPU waiting for I/O (Fig. 4a):* The negative correlation between CPU and channel readings indicates that the CPU waits for I/O completion before it resumes processing. Simultaneous processor and I/O activity would be much more desirable.

*Excessive overhead (Fig. 4b):* This virtual memory system has a very heavy operating-system overhead and a high paging rate. Turnaround and response times degrade because of contention for real memory and heavy disc activity. Reducing the number of initiators would remove the overload, and increase operating efficiency. Another solution is to disable the system resource management program. Although this program is supposed to optimize system performance by controlling critical resources, it can hog CPU cycles

for itself. So when CPU activity gets extremely high, disabling the program entirely lowers CPU use, and improves system performance. Adding real memory would also reduce channel activity, as would restructuring of programs so that associated portions of code are on the same "page."

*Unbalanced multiprocessor (Fig. 4c):* Periods of very high utilization at any processor in a multiprocessor system degrade the over-all system performance. Job throughput drops and turnaround times increase. Time-sharing response time and batch turnaround would both benefit from a more balanced distribution of the workload, which could be accomplished by more judicious job scheduling.

*Unbalanced multiplexer (Fig. 4d):* Disc multiplexer channels are unbalanced so that the 60% utilization of channel 1 degrades over-all performance. At such high channel utilization, the rotational-position sensor of IBM 3330 discs misses reconnect slots, thus delaying data access for another complete revolution. Data sets and disc packs should be redistributed over the drives, to achieve greater channel overlap. Concurrently used data sets belong on separate drives. And string switching should be implemented to help equalize channel utilization by providing alternate paths to the discs.

*Channel hardware problem (Fig. 4e):* For efficient operation, disc channels disconnect during seek and latency times. The utilization of a block-multiplexer channel is ordinarily much less than the sum of the utilizations of its discs. In the 10-min time span of Fig. 4e, I/O operations are initiated primarily on the monitored disc. Yet channel and disc utilizations almost coincide because the channel is being tied up during seek and latency times. A hardware problem causes this block-multiplexer channel to operate in the selector mode.

*Excessive supervisor overhead (Fig. 4f):* Total CPU utilization is the sum of application and supervisor-state processing. In Fig. 4e, total CPU utilization peaks at 90% (40% application plus 50% supervisor). It is often difficult to determine which—if any—application tasks can be attributed to supervisor processing. So make certain that all definitions are clear, and that you know what CPU time is being charged to which program before drawing conclusions. (The actual recording from which Fig. 4f has been extracted is shown in Fig. 1.)

Effective as analog monitoring is, it does not replace more sophisticated measurement techniques. Digital monitors, for example, are much more expensive, but they can perform logic operations and permit connection of many probes to the host system. While you may end up using a digital monitor, it's only sensible to try the inexpensive analog approach first. The greatest dollar improvements in computer performance often occur early in the project, and analog monitoring can pay big dividends by helping you to find and overcome problems. As a bonus, management gets an early indication whether the computer meas-

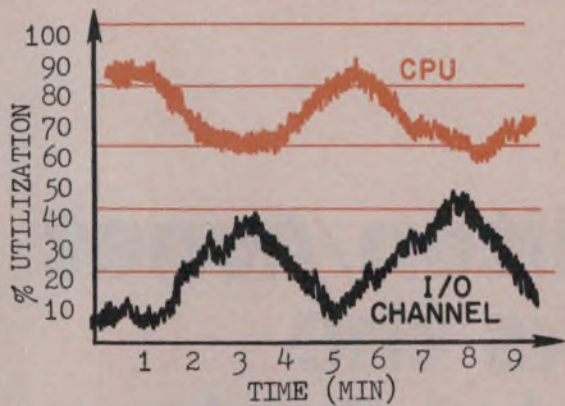

(a)

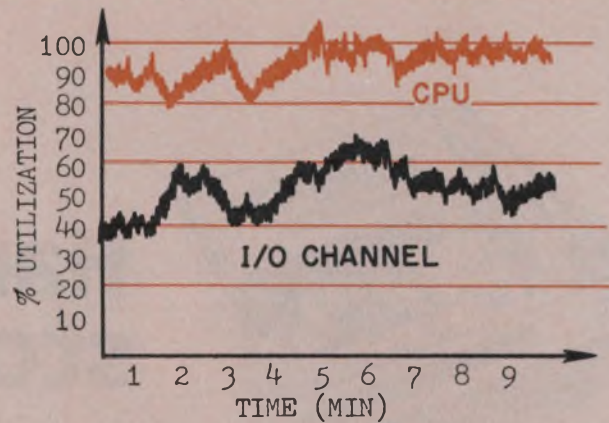

(b)

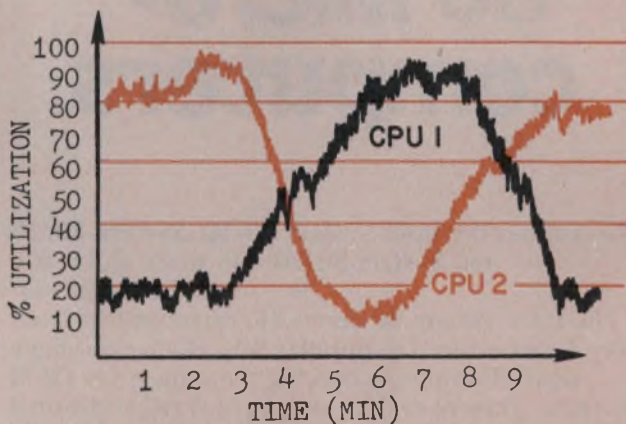

(c)

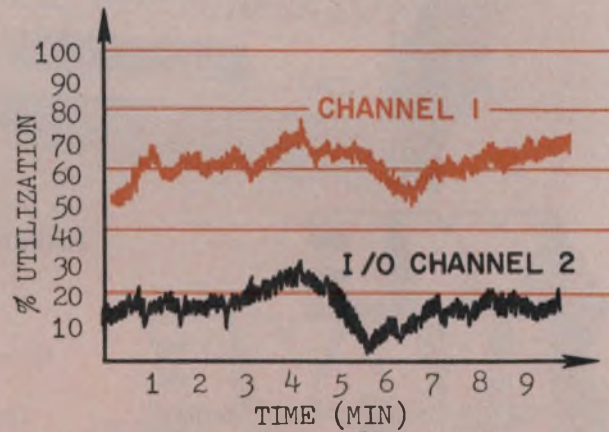

(d)

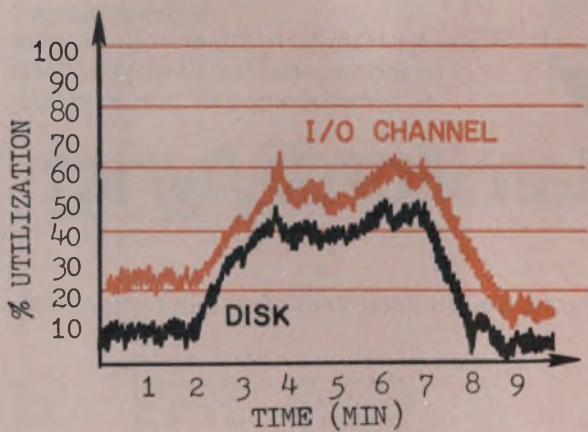

(e)

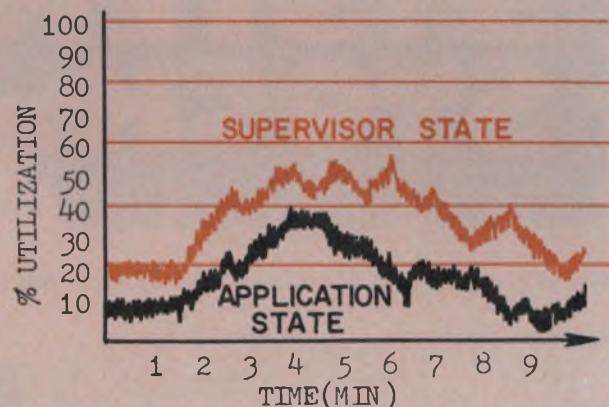

(f)

4. System problems discovered by the monitor include: CPU waiting for I/O (a), excessive overhead (b), un-

balanced multiprocessor (c), unbalanced channels (d), channel hardware (e), and high supervisor overhead (f).

urement program should be extended. ■■

#### Bibliography

Hellerman, H. and Conroy, T.F., *Computer System Performance*, McGraw-Hill, New York, 1975.

Stang, H. and Southgate, R., "Performance Evaluation of Third-Generation Computing Systems," *Datamation*, November, 1969, pp. 181-190.

Svobodova, L., *Computer Performance Measurement and Evaluation Methods: Analysis and Applications*, American Elsevier Publishing Co., New York, 1976.



# Hamilton/Avnet stocks the Intel System 80 Micro-computers.

**WE  
HAVE  
LOCAL  
SYSTEMS  
STOCK.**

Hamilton/Avnet has the Intel System 80/10, System 80/20 and System 80/20-4 in stock and ready for immediate delivery.

The Intel System 80 Series Microcomputers from Hamilton/Avnet utilize the popular SBC 80 Series Single Board Computers making them ideal for OEM applications. They're easy to use, have three additional expansion board slots, an expandable memory capacity, fully programmable I/O and a comprehensive System Monitor for loading, execution and degugging of System 80 Series programs.

Consider Hamilton/Avnet your number one local source for all of your Intel Microcomputer requirements.

**Hamilton Avnet**  
ELECTRONICS   A DIV. OF AVNET, INC.

World's largest local distributor with 35 locations stocking the world's finest lines of system components

**SOUTHERN CALIFORNIA**  
Hamilton, L.A. (213) 558-2121  
Avnet, L.A. (213) 558-2345

**NORTHWEST**  
Mountain View (415) 961-7000  
Seattle (206) 746-8750

**SOUTHWEST**  
San Diego (714) 279-2421  
Phoenix (602) 275-7851

**ROCKY MOUNTAIN**  
Salt Lake City (801) 972-2800  
Denver (303) 534-1212  
Albuquerque (505) 765-1500

**NORTH CENTRAL**  
Chicago (312) 678-6310  
Minneapolis (612) 941-3801  
Detroit (313) 522-4700  
Milwaukee (414) 784-4510

**SOUTH CENTRAL**  
Dallas (214) 661-8661  
Houston (713) 780-1771  
Kansas City (913) 888-8900

**INTERNATIONAL**  
Telex 66-4329  
Telephone (213) 558-2441



**MID CENTRAL**  
St. Louis (314) 731-1144  
Dayton (513) 433-0610  
Cleveland (216) 461-1400

**CANADA**  
Toronto (416) 677-7432  
Montreal (514) 331-6443  
Ottawa (613) 226-1700

**NORTHEAST**  
Boston (617) 933-8000  
Syracuse (315) 437-2641  
Rochester (716) 442-7820

**METROPOLITAN**  
Georgetown (203) 762-0361  
Westbury (516) 333-5800  
Cedar Grove (201) 239-0800

**MID-ATLANTIC**  
Baltimore (301) 796-5000  
Mt. Laurel (609) 234-2133  
Raleigh (919) 829-8030

**SOUTHEAST**  
Miami (305) 971-2900  
Atlanta (404) 448-0800  
Huntsville (205) 533-1170

## Intel from Hamilton/Avnet.



# True RMS to DC isn't a big deal anymore.

The AD536 true RMS to DC converter is a monolithic IC in a 14-pin ceramic DIP. Complete and self-contained. Just plug it in and forget about external trims.

The chip is laser wafer trimmed for maximum accuracy

and stability. That means an accuracy of  $\pm 2\text{mV} \pm 0.2\%$  of reading with high crest factor and excellent bandwidth. And besides the linear DC output, you get a dB output with a 60dB dynamic range for free.

Only \$9.95 in 100s. Now that is a big deal.

For specs and samples call Doug Grant at (617) 935-5565. Analog Devices, P.O. Box 280, Norwood, MA 02062.

 **ANALOG  
DEVICES**

The real IC converter company.

CIRCLE NUMBER 39

Analog Devices, Inc., Box 280, Norwood, MA 02062 East Coast: (617) 329-4700; Midwest: (312) 894-3300; West Coast: (213) 595-1783; Texas: (214) 231-5094; Belgium: 031/37 48 03; Denmark: (02) 845800; England: 01/94 10 46 6; France: 686-7760; Germany: 089/53 03 19; Japan: 03/26 36 82 6; Netherlands: 076/879 251; Switzerland: 022/319704; and representatives around the world.

# Take advantage of powerful instructions in the PIC-1650 microcomputer chip. Its 12-bit instruction size and the register-file architecture make a potent pair.

Based on register-file architecture, the PIC-1650 all-in-one microcomputer uses a 12-bit instruction word, which gives the processor a powerful instruction set. The processor also has an 8-bit arithmetic-and-logic unit, 31 directly addressable 8-bit registers and a 512-word (12-bit size) ROM space.

Programming the PIC-1650 is both easy and economical—all nonjump instructions can be written in a single line, including both operator and operand, and executed in 4  $\mu$ s (assuming the processor operates at a 1 MHz clock). Jump instructions take twice as long. There are 30 basic instructions in the processor's command set—18 arithmetic and logic operations, eight literal functions, and four individual bit operations.

Manufactured with General Instrument's n-channel ion-implant process, the 8-bit PIC-1650 requires just a 5-V supply. Packaged in a 40-pin DIP, the chip has 32 user-defined I/O lines, a clock generator that provides all internal timing, and an 8-bit counter/timer. (The PIC-1650's software-compatible smaller cousin, the PIC-1655, has 20 I/O lines and comes in a 28-pin DIP.)

Besides the 32 I/O lines, there are just eight more lines to connect into a system—and three of those are for power and ground. The other five are for an oscillator input, clock output, counter/timer input, master clear, and an unused pin (Fig. 1).

### Internal workings of the PIC-1650

The 1650's register-file architecture permits simple commands for bit, byte and register transfer operations. The processor's three major sections—the register file, an ALU and the control ROM—are all linked by an 8-bit bidirectional bus (Fig. 2).

The register file is divided into two functional groups that total 31 8-bit registers. The first eight

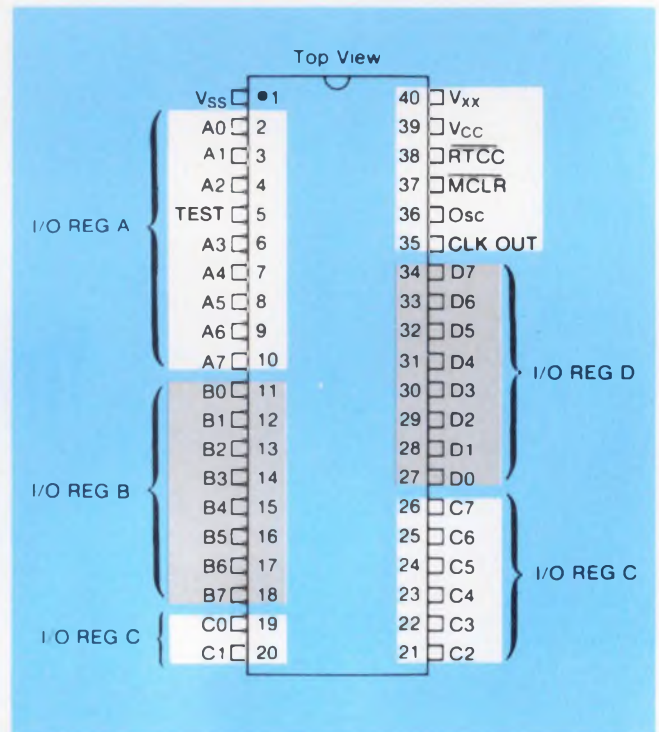

1. There are few control pins on the PIC-1650 microcomputer chip. Of the 40 pins, 32 are I/O lines, each of which can act as either input or output lines.

registers,  $F_1$  to  $F_8$ , are operational registers and the rest are general-purpose registers ( $F_9$  to  $F_{31}$ ). Register  $F_1$  works as the real-time clock/counter and can be incremented by an external signal;  $F_2$  is a 9-bit program counter (the ninth bit comes from one bit of the  $F_3$  register).  $F_3$  is the status-word register;  $F_4$  forms an indirect addressing register; and  $F_5$  to  $F_8$  are I/O registers that function as directly addressable TTL-compatible I/O ports.

The eight operational registers are similar to the general-purpose registers in that they can be loaded, incremented and logically operated on by any instruction servicing any of the registers.

The timer/counter (register  $F_1$ ) can be used to keep track of elapsed time since it can be updated or read via software control. It accepts external pulse inputs

Peter Rush, European Product Manager, Microprocessors and Memories, General Instrument Microelectronics, Regency House, 1-4 Warwick St. London W1R 5WB, England.



## The PIC-1650 instruction set

Even though the PIC-1650's instruction set has only 30 basic commands, there are many features that are hidden because of the large word size. For example, most instructions execute in a 4- $\mu$ s period unless a conditional test is true or the program counter is changed as a result of an instruction. In these two cases, the instruction execution time climbs to 8  $\mu$ s.

There are two addressing modes available to the 1650—direct and indirect. In the direct mode, the address of the register being addressed is contained in the instruction. For the indirect mode, the program instruction contains the address of a register that, in turn, contains the address of the instruction or data to be acted upon. The indirect mode is handy for operations that must be carried out repetitively to data stored contiguously in memory, since only the contents of the indirect register must be incremented to point to another location.

To use the indirect mode, the  $F\emptyset$  file must be accessed (this is the 32-file register). The  $F\emptyset$  register is not an actual register in the processor—however, when  $F\emptyset$  is specified in an instruction, the instruction decode logic interprets the register number as the register pointed to by the file-selector register (F4).

The 30 instructions of the PIC family of microcomputers are in the accompanying table. Various abbreviations used in the table include k to represent an 8-bit constant or literal value, f to represent a file-register designator, and d to represent a destination designator. If d is zero, the result of an operation is placed in the 1650's W register. If d is one, the result is returned to the file register specified in the instruction. If the d operand is omitted, the f register is assumed to be the destination.

When the PIC assembler is used, f and d may be numbers, characters or symbols. Additional abbreviations used in the table include C, which represents the carry bit; Z, which represents the zero bit; and DC, which represents the BCD-digit carry bit.

General file register operations	
Mnemonic	Definition
NOP	No Operation
MOVWF	Move W to f
CLRW	Clear W
CLRF	Clear f
SUBWF	Subtract W from f
DECF	Decrement f
IORWF	Inclusive OR W and f
ANDWF	AND W and f
XORWF	Exclusive OR W and f
ADDWF	Add W and f
MOVF	Move f
COMF	Complement f
INCF	Increment f
DECFSZ	Decrement f, Skip if Zero
RRF	Rotate Right f
RLF	Rotate Left f
SWAPF	Swap halves f
INCFSSZ	Increment f, Skip if Zero
Bit level file register operations	
BCF	Bit Clear f
BSF	Bit Set f
BTFSC	Bit Test f, Skip if Clear
BTFSS	Bit Test f, Skip if Set
Literal and control operations	
RET	Return
RETLW	Return and place Literal in W
CALL	Call subroutine
GOTO	Go To address
MOVLW	Move Literal to W
IORLW	Inclusive OR Literal and W
ANDLW	AND Literal and W
XORLW	Exclusive OR Literal and W

at up to 250 kHz. Keeping track of the program flow, program counter (PC)  $F_2$  automatically increments after each program instruction. It is nine bits wide so that it can address the full 512 words of ROM-based control memory. However, aside from being fed directly to the ROM address inputs, the output of the PC cannot be read by the processor.

Holding all the flag information from logic and arithmetic operations in bits 0 to 2, status word  $F_3$  (Fig. 3) has four more bits allotted for future expansion. The eighth bit is used as bit nine of the PC. Bit 0 stores an arithmetic carry (C) and acts as a link bit on rotate operations. Bit 1 stores the carry-out of the four lower-order bits for decimal arithmetic operations (DC) and is used to simplify operations done with BCD arithmetic. Bit 2 gets set to ONE when the result of an operation is zero (Z). The function of bit 3 has not yet been defined.

Each of the I/O lines on "ports"  $F_5$  to  $F_8$  have a fanout of one standard TTL load, and a sink capability up to 14 mA (which enables them to drive LEDs directly, among other things). However, to provide the high drive, you need a 10-V supply on the  $V_{XX}$  line to turn on the chip's drive transistors.

Since the ports are really registers, they can be directly incremented (to provide a counter output), shifted (to do display scanning), or bit set or tested (to provide single-line logic control or sensing). And, of course, they can be operated on by logic and arithmetic commands.

The 512-word ROM on the chip is custom-programmed at the factory according to the pattern defined by the user during program development. For program development, another chip is available, the PIC-1664, which is a ROM-less version of the 1650. Housed in a 64-pin package, the 1664 has ROM address lines for external use, so that programs can be developed with either fusible-link or ultraviolet erasable PROMs.

You can get more addressing capability. Just make I/O lines function as address lines by using the Bit Set and Bit Clear instructions. Instructions pointed to by the program counter are transferred from either the internal ROM or external PROM via a 12-bit-wide bus to the instruction decode and control section of the processor.

Also in the processor is a two-level push-down stack for storing the current value of the program counter before a subroutine is accessed. The subroutine CALL operation code is contained in the first four bits of the instruction and the address of the subroutine in the other eight bits.

### Programming the processor

Program development can be supported with an assembler that responds to 26 additional instructions (Fig. 4). For instance, the instruction "BTFSC 3, 2"

## Software and hardware support

Type	Description	Cost
Gimini	16-bit development microcomputer based on CP 1600 — General Instrument microelectronics' 16-bit microprocessor	\$2995
PIC assembler	2-pass mnemonic assembler. FORTRAN version available that will run on 16-bit mini computers and large machines	Free with Gimini
PIC simulator	Software simulator of PIC 1650 including mnemonic assembly and disassembly as well as breakpoint and other debug facilities. FORTRAN version available that will run on 16-bit minicomputers and large machines	Free with Gimini
PIC 1664	64-pin version of PIC 1650 with ROM off chip, thus allowing external program to be run from RAM, PROM, or EAROM	\$99
Development System (DB 1650)	Machine-code development system with debug facilities	\$700
PIC field demo system (FD 1664)	PC card with PIC 1664 and PROM sockets. 40-pin plug emulates PIC 1650	\$220

skips on bit 2 of file 3 in the same way as "BTFSC 30, 2" skips on bit 2 of file 30—except that in the first case bit 2 of file 3 is the zero bit of the status register and the operation is the same as a Skip on Zero. As a result, the assembler uses a SKPZ instruction as the equivalent of the "BTFSC 3, 2" command.

Any operation can be performed with any file, except for the program counter, which can be written to but not read. The result of an operation can go either to the referenced file or to a working register. Thus, the assembler instructions like Test File can be generated by a "MOVf f, F" (Move file f, leaving the result in the file rather than in the working register). The assembler mnemonic "TEST f" is interpreted to mean the same as a "MOVf f, F" instruction.

Available software-development aids (see table) include the PIC 1650 assembler, which permits symbolic source programs to be developed. The assembler translates the source program into object code and produces a binary paper tape that, in turn, can be used to generate the ROM mask pattern to program the chip. Two versions of the assembler are available—one is written in Fortran IV and can run on most popular minicomputers and larger systems; the other runs on General Instrument's Gimini development system for the 16-bit CP1600 MP.

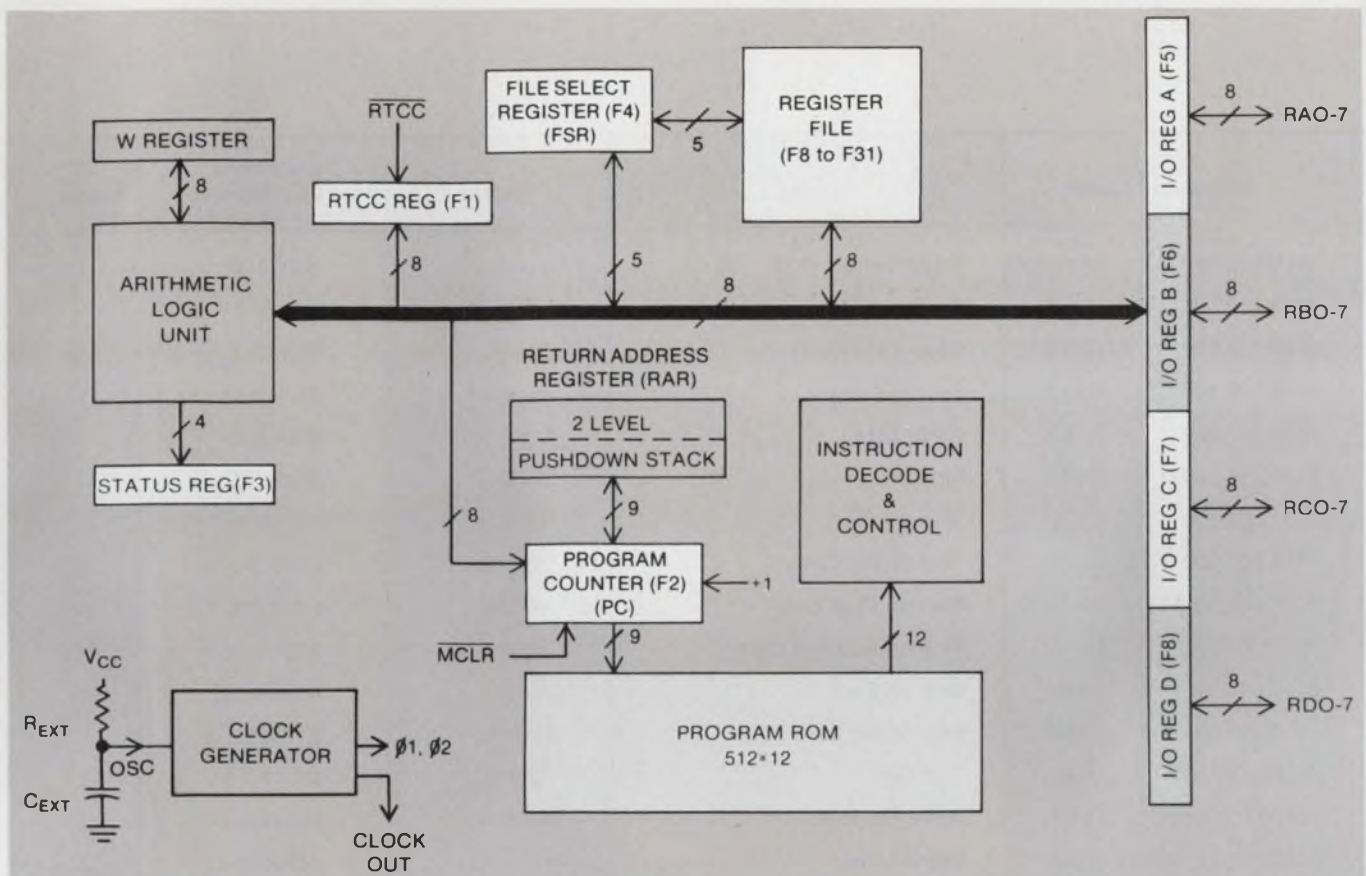

2. Inside the PIC-1650 are 31 randomly accessible registers, an 8-bit counter/timer, storage space for up to 512 words of program memory, an ALU and a clock-generator

circuit. Other versions of the processor are available with more program storage space, fewer I/O lines, or no internal program storage.

Another aid, the PICSIM simulator program, lets you debug programs rapidly by communicating interactively with the processor. Besides simulating the PIC-1650 processor, the PICSIM allows breakpoints to be set and can do comprehensive on-line debugging. It also includes both assembly and disassembly capability to permit programs to be modified at the mnemonic rather than at the object-code level.

PICSIM executes on a Gimini microcomputer with 8 kwords of RAM and a teletypewriter console. It comes as a relocatable load module that can be loaded into the Gimini system with the help of the resident monitor. A Fortran IV PICSIM is also available.

For hardware development, the FD-1664, a printed-circuit card that contains the PIC-1664 chip and provisions for either fusible-link or UV-erasable PROMs, and the DB1650, a fully interactive debug system, are available. The card comes with a ribbon cable that terminates in a 40-pin CIP plug that can plug directly into the socket of a PIC-1650.

The DB-1650 provides in-circuit emulation. Built on a single PC board, the system contains a PIC-1664 with external memory to emulate your processor. A second, preprogrammed, processor on the board, a PIC-1650, acts as the controller. It is programmed with PICBUG, a comprehensive debug program for memory and

(3-7)	(2)	(1)	(0)
not defined	Z	DC	C

3. File register F3 contains all the status information generated by operations in the processor. Four of the eight bits have not yet been assigned for functions.

register examination/modification, single-step tracing, and serial-communications-channel control for communicating interactively with a terminal and paper-tape reader/punch.

### Using the PIC-1650

Developing a routine for the PIC-1650 is the same as preparing a program for any other one-chip microcomputer—start with the flow chart, develop the software, and check out the program before committing yourself to a mask version of the chip. One simple example of a program that the 1650 can handle is an analog-to-digital conversion that provides an 8-bit output. All the hardware you need for the operation is a comparator and a ladder network that must be connected to the processor (Fig. 5a).

Instruction (Octal)	Name	Syntax	Equivalent Operation(s)	Status
0100 000 00011 (2003)	Clear Carry	CLRC	BCF 3, 0	—
0101 000 00011 (2403)	Set Carry	SETC	BSF 3, 0	—
0100 001 00011 (2043)	Clear Digit Carry	CLRDC	BCF 3, 1	—
0101 001 00011 (2443)	Set Digit Carry	SETDC	BSF 3, 1	—
0100 010 00011 (2103)	Clear Zero	CLRZ	BCF 3, 2	—
0101 010 00011 (2503)	Set Zero	SETZ	BSF 3, 2	—
0111 000 00011 (3403)	Skip on Carry	SKPC	BTFS 3, 0	—
0110 000 00011 (3003)	Skip on No Carry	SKPNC	BTFS 3, 0	—
0111 001 00011 (3443)	Skip on Digit Carry	SKPDC	BTFS 3, 1	—
0110 001 00011 (3043)	Skip on No Digit Carry	SKPNDC	BTFS 3, 1	—
0111 010 00011 (3503)	Skip on Zero	SKPZ	BTFS 3, 2	—
0110 010 00011 (3103)	Skip on No Zero	SKPNZ	BTFS 3, 2	—
001000 1 f f f f f (1040)	Test File	TSTF f	MOVF f, 1	Z
001000 0 f f f f f (1000)	Move File to W	MOVFW f	MOVF f, 0	Z
001001 1 f f f f f (1140)	Negate File	NEGF, f,d	COMF f, 1	
001010 d f f f f f (1200)			INCF f, d	Z
011000 0 00011 (3003)	Add Carry to File	ADDCF f, d	BTFS 3,0	
001010 d f f f f f (1200)			INCF f, d	Z
011000 0 00011 (3003)	Subtract Carry from File	SUBCF f,d	BTFS 3,0	
000011 d f f f f f (0300)			DECF f, d	Z
011000 1 00011 (3043)	Add Digit Carry to File	ADDDCF f,d	BTFS 3,1	
001010 d f f f f f (1200)			INCF f,d	Z
011000 1 00011 (3043)	Subtract Digit Carry from File	SUBDCF f,d	BTFS 3,1	
000011 d f f f f f (0300)			DECF f,d	Z
101× kkkkkkkk (5×00)	Branch	B K	GO TO K	—
0110 0000011 (3003)	Branch on Carry	BC K	BTFS 3,0	
101× kkkkkkkk (5×00)			GO TO K	—
0111 0000011 (3403)	Branch on No Carry	BNC K	BTFS 3,0	
101× kkkkkkkk (5×00)			GO TO K	—
0110 00100011 (3043)	Branch on Digit Carry	BDC K	BTFS 3,1	
101× kkkkkkkk (5×00)			GO TO K	—
0111 00100011 (3443)	Branch on No Digit Carry	BNDC K	BTFS 3,1	
101× kkkkkkkk (5×00)			GO TO K	—
0110 01000011 (3103)	Branch on Zero	BZ K	BTFS 3,2	
101× kkkkkkkk (5×00)			GO TO K	—
0111 01000011 (3503)	Branch on No Zero	BNZ K	BTFS 3,2	
101× kkkkkkkk (5×00)			GO TO K	—

if × = 0, address is in page 0.  
if × = 1, address is in page 1.

4. The PIC-1650 assembler can count on these additional commands to simplify substantially programming operations. All these commands are just special cases that

merely extend the normal instruction set, as can be readily seen by examining the equivalent mnemonic codes in the "Equivalent Operations" column.

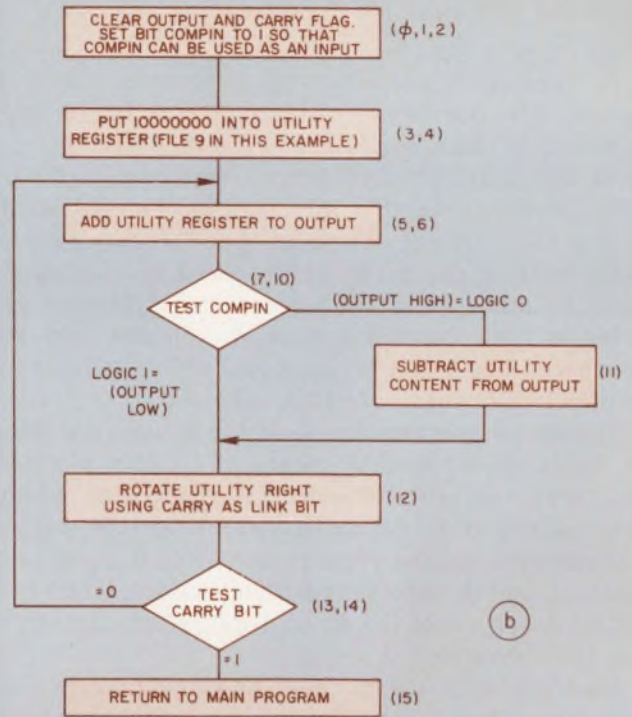
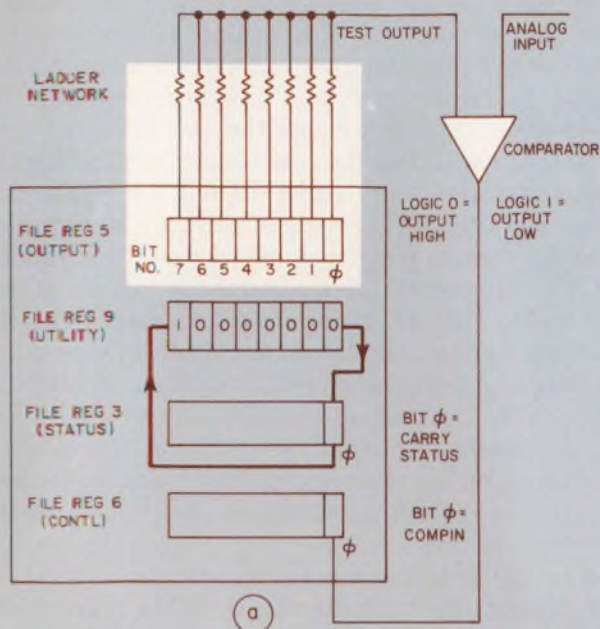

GI PICAL V01G PAGE 1

```

1.      ;8 BIT A TO D SUCCESSIVE APPROXIMATION
2.
3.      ;DEFINITIONS OF WORDS USED IN THE PROGRAM.
4.
5.      F      EQU      1      ;DEST. DESIGNATOR - SEE TEXT.
6.      UTILRG EQU      .9      ;REGISTER 9
7.      OUTPUT EQU      5      ;REGISTER 5
8.      CONTL  EQU      6      ;REGISTER 6
9.      COMPIN EQU      0      ;BIT 0
10.
11.     ;A TO D SUBROUTINE
12.
13.     000 2406 ATOD   BSF      CONTL,COMPIN;BIT SET COMP. INPUT
14.     001 0145      CLRWF   OUTPUT      ;CLEAR OUTPUT, IE: FILE 5
15.     002 2003      CLRC      ;CLEAR CARRY (BIT 0 OF FILE 3)
16.     003 6200      MOVLW   b'10000000';MOVE LITERAL TO W REG.
17.     004 0051      MOVWF   UTILRG      ;MOVE W REG TO UTILREG, FILE 9
18.     005 1011 CYCLE  MOVWF   UTILRG      ;MOVE UTILRG TO W REG
19.     006 0745      ADDWF   OUTPUT,F    ;ADD W REG TO OUTPUT, FILE 5
20.     007 3006      BTFS    CONTL,COMPIN;TEST BIT 0 OF FILE 6
21.     010 5012      GOTO    ENDTST      ;GOTO ADDRESS ENDTST, IE: 12
22.     011 0645      XORWF   OUTPUT,F    ;EXCL. OR W REG WITH FILE 5
23.     012 1451 ENDTST RRF      UTILRG,F  ;ROTATE RIGHT FILE 9
24.     013 3403      BNC     CYCLE      ;BRANCH TO CYCLE IF
           014 5005
25.
26.     015 4000      RET      ;CARRY BIT NOT SET.
27.     015          END      ;RETURN TO MAIN PROGRAM

```

ATOD	0000	R	IN	UR
COMPIN	0000	A	EQ	
CONTL	0006	A	EQ	
CYCLE	0005	R	IN	
ENDTST	0012	R	IN	
F	0001	A	EQ	
OUTPUT	0005	A	EQ	
UTILRG	0011	A	EQ	

8 SYMBOLS  
0 ERR(S)

(c)

5. Using the PIC-1650 to form a successive-approximation a/d converter simply requires a comparator and resistor ladder network (a). The flow chart for the conversion uses a test word that is shifted right one position

every time another bit in the converter's output is filled in (b). Written with the help of the assembler, the program necessary to perform the 8-bit a/d conversion requires just over a dozen instructions (c).

To perform a successive-approximation a/d conversion, the system must be programmed according to the flow chart outlined in Fig. 5b. First, set the most significant bit of the output word equal to ONE, then determine whether this word has an equivalent analog value greater or smaller than the analog value being input. If the test bit gives a word that is smaller than the analog value, the bit remains set. If the word is bigger than the analog value, it is cleared, and the next most significant bit is set and tested—and so on until all eight bits have been determined.

The entire program for digitizing is shown in Fig. 5c. Each bit is tested by means of a utility register ( $F_9$ ), which is initially set to 10000000. The set bit corresponds to the bit under test. After it is tested, the contents of the register are shifted right one position, and the next bit position is tested. When the set bit drops out of the utility register into the carry bit, the conversion is complete.

Each bit is tested in the following manner: The contents of the utility register are added to the output register and a comparison made between the incoming analog signal and the output of the ladder network.

In the conversion program, the first three instructions initialize the PIC-1650 (all instructions are numbered in octal). Instruction 0 sets pin 0 of file control register 6 (called CONTL, COMPIN in the program). This operation is necessary whenever an I/O register is used as an input. If the output were set to 0, the I/O pin would be held at ground by the output latch, regardless of the input value. (This provides a wire-AND capability.)

Instruction 1 sets the contents of register 5 equal to zero, which initializes the trial digitized value. The carry flag, which in this program is used to indicate the end of conversion, is cleared by instruction 2, a Bit Clear command to set bit 0 in register 3 to 0.

Instruction 3 loads the literal 10000000 into the working register, and instruction 4 transfers it from the register into a utility register ( $F_9$ ) where it will be manipulated by a rotate operation. (Any of the available general-purpose registers,  $F_9$  through  $F_{31}$ , could have been selected.)

Before testing the first bit, instruction 5 reads the contents of the utility register back into the working register. The next command adds the contents of the working register to the output register and leaves the result in the output register. A destination-designator bit, *d*, specifies where the result of this operation will be stored. When it is set to ONE, the result is returned to the file register specified in the instruction. When the bit is set to ZERO, the result remains in the working register. If the *d* operand is omitted in the assembler, the result is left in the file register.

Instruction 7 takes advantage of the bit-handling capabilities of the PIC-1650 by testing the comparator's output through an examination of bit 0 in register 6. If the comparator output is ONE, the

bit under test remains set, and the next instruction, a GOTO command, is executed to direct the program flow to instruction 12. If the comparator's output is ZERO, the digitized output is greater than the analog signal to be digitized and the program skips to instruction 11, which resets the test bit.

Instruction 11 does the resetting by subtracting the contents of the utility register from the output register. Since the utility-register contents were loaded into the working register in instruction 5, instruction XORWF performs an Exclusive-OR operation between file register 5 (the output register) and the working register, and leaves the result in the output register (the destination designator bit is set to ONE). The XORWF instruction was used instead of SUBWF, the subtraction command, since the latter would set the carry bit in two's complement arithmetic and would then require an extra clear instruction for the carry bit.

Now the program is ready to test the next bit. In preparation, the contents of the utility register are shifted right one place through the carry bit by means of the Rotate Right command (RRF). Instruction 13 and 14 prepare to finish the conversion program by first checking to see if the carry bit is set. If the bit is not set, the program branches back to instruction 5. If the bit is set, the program is finished and instruction 15 is executed, which returns program control back to a master program.

The a/d-conversion example makes use of direct program addressing. However, the PIC-1650 also has an indirect-addressing capability that can be useful in multigit display multiplexing and other applications. For indirect addressing, the  $F_0$  register must be called; thus, the next instruction will be carried out with the  $F_4$  register as the address pointer.

The file-select register can be used as any of the other registers, except that the three most-significant bits are always set to ONE. For display scanning, the data for each digit or pair of digits could be stored in consecutive locations that aren't addressed directly, but are pointed to by the address stored in the file-select register.

Two special instructions, DECFSZ and INCFSZ (Decrement and skip if zero, and Increment and skip if zero), help keep timing loops short by performing two instructions in the space of one. Also available is a swap instruction (SWAPF), which permits decimal operations to take place by swapping 4-bit sections of the file registers.

Two other important features, the bit set and test operations, are especially useful when used in conjunction with electromechanical operations such as switch closures. The instruction sPcontains operations that can clear a bit, set a bit, skip if the bit is cleared, and skip if the bit is set. When a switch is polled to detect its state, the bit test or skip instructions can divert the program flow. Or, in the case of setting a bit, the processor can be used to turn on a relay, lamp or display segment. ■■

# Amphenol<sup>®</sup> 17-Series rear-release connectors, contacts, and crimpers.

Now with  
insulation-support  
crimp-contact  
back end.

**You asked for it.** With our 17-Series, you can crimp any conductor size from 22 to 26 AWG and also crimp the insulation up to a maximum of 0.050" OD.

**The connectors are 50% less costly to assemble.** Snap several of our crimp Poke-Home<sup>®</sup> contacts in place in the time it normally takes for a single contact inserted with a tool. You can cut labor costs in half.

**The contacts mean big savings for volume users.** With our 15,000-contact capacity reels, you can save a bundle over loose contacts.

**Our high-speed crimpers lower costs even more.** Completely eliminate stripping with our stripper-crimper (up to 1500 terminations per hour). Our semi-automatic crimping machines handle up to 2000 terminations per hour. And our new hand crimp tool makes accurate, identical crimps—time after time.

**Get them all — connectors, reeled contacts, crimpers. And get them now.** For more details, call: Bob Ashley, (312) 986-3673 or write: Amphenol North America Division, Bunker Ramo Corporation, Dept. C38B, 900 Commerce Drive, Oak Brook, Illinois 60521.

The right idea  
at the  
right time.

Hand crimpers  
and semi-automatic  
crimping machine.



**BUNKER  
RAMO**

**AMPHENOL NORTH AMERICA**  
Bunker Ramo Corporation

CIRCLE NUMBER 122

# Accuracy. GOULD/Brush Recorders have it.

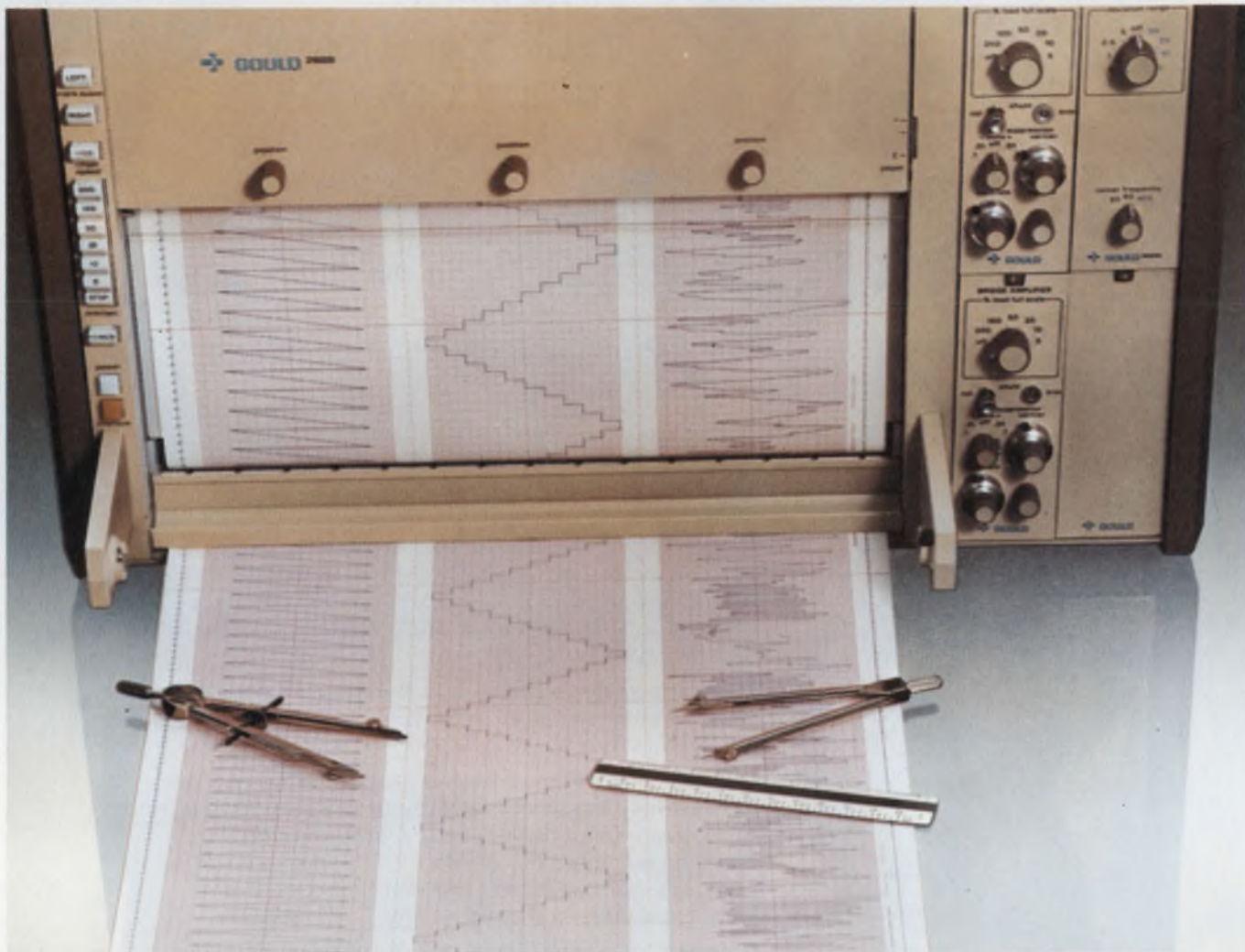

## 99.65% linearity.

Only GOULD Recorders offer you this exceptional accuracy because only GOULD Recorders give you a 100 gm/mm High Stiffness Pen Motor, a non contact METRISITE® position feedback

element having infinite resolution, and a unique servo drive system which anticipates changes in signal amplitude and velocity.

Accuracy is built into every GOULD direct writing recorder.

For more information on the best, write Gould Inc., 3631 Perkins Ave., Cleveland, Ohio 44114. Or Gould Allco S.A., 57 rue St. Sauveur, 91160 Ballainvilliers, France.

For brochure, call Gould toll-free at (800) 325-6400, Ext. 77.  
In Missouri: (800) 342-6600

 **GOULD**  
The product development company

CIRCLE NUMBER 41



# If you're looking for reliability...

AVX is your best choice. AVX molded axial and radial multilayer ceramic capacitors are available to the "S" failure rate level of MIL-C-39014, the

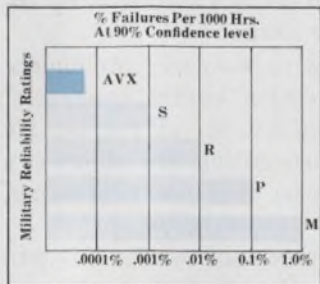

highest established reliability rating for capacitors. In a standard, off-the-shelf capacitor, there is no better assur-

ance of reliability and performance.

But AVX goes even further. In components built in volume for special applications, AVX has designed and delivered capacitors that are ten times more reliable than even the highest military rating. Failure rates of less than .0001% per 1,000 hours at the 90% confidence level has been achieved. For a major telecommunications



program, AVX delivered tight tolerance capacitors with a life expectancy of 345 years.

That's why AVX has

been chosen sole supplier on major military programs. Why AVX capacitors are used aboard critical communications satellites. Why AVX ceramics have replaced mica capacitors in high reliability telecommunications applications.

And it's why you should be talking to AVX if reliability is essential in your products and systems. A system is no more reliable than its components. And few components are more reliable than an AVX multilayer ceramic capacitor.

## ... look to AVX.

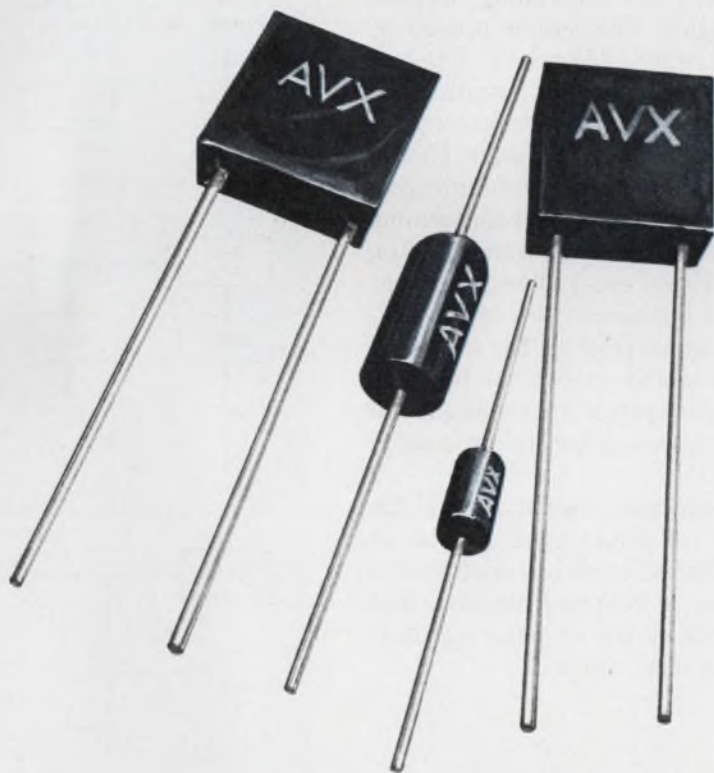

### AVX CERAMICS

AVX Ceramics, P.O. Box 867, Myrtle Beach, SC 29577 (803) 448-3191  
 TWX: 810-661-2252; Olean, NY 14760 (716) 372-6611 TWX: 510-245-2815  
 AVX Limited, Aldershot, Hampshire, GU12 4RG England, Tel: Aldershot (0252) 312131 Telex: 858473

## Multiprocessing boosts microcomputer power dramatically. You can build systems from 8080s and a few other chips. And such systems are expandable, too.

An 8080-based multiprocessor system gives you a powerful architecture when you need fast memory access, enhanced microprocessor performance, extremely large memory, or memory with protected areas. Common memory for all  $\mu$ Ps lets you use the latest, 16-kbit memory circuits, self-correcting codes and memory power back-up. And by letting separate  $\mu$ Ps handle peripherals, you can later increase throughput without redesigning the whole system.

In a conventional mini or microcomputer system (Fig. 1a) the central processing unit (CPU) interacts with peripheral units (PUs) through a peripheral controller (PC). But because  $\mu$ Ps are so inexpensive, they can be used in PCs as well as in CPUs. For example,  $\mu P_p$  is part of the PC in Fig. 1b. This  $\mu$ P works as a controller, by executing a program stored in its own memory, and controlling the peripheral through its I/O ports. The central processor,  $\mu P_c$ , sends data and I/O commands over a data bus to  $\mu P_p$ , which responds by transmitting its status, and data if any are ready. However, the architecture of Fig. 1b suffers at least two serious drawbacks: Memory overhead costs are doubled, and the communication between  $\mu P_p$  and  $\mu P_c$  is complex and time-consuming.

An improved multiprocessing architecture (Fig. 1c), well-known but still not widely used, solves a number of problems. The memory bus serves also as a direct-memory-access (DMA) channel (Fig. 2). The smart PC units execute programs stored in central memory rather than locally. And the system's throughput can be increased by attaching a second "central processor" to the same bus.

In such a multi-microprocessor system, one  $\mu$ P, for instance, can take care of data manipulation or arithmetic functions, while the other one controls the system's I/O. The number of central processors and allocation of tasks depends on the system's purpose, characteristics, and peripheral units.

### Division of labor helps

The tasks to be performed by a system don't depend on how the system is implemented. Before  $\mu$ Ps became popular, intelligence was usually concentrated in the

central processor, which not only manipulated data but also controlled the I/O devices step-by-step because the peripherals were dumb.

In the architecture of Fig. 2, however, intelligence is distributed, and the expression "central processor" is incorrect, unless it's applied to the  $\mu$ P responsible for data handling and task scheduling. The others  $\mu$ Ps are assigned dedicated tasks like file processing, floppy disc control or data transmission.

The data-manipulating processor works on data located in central memory. But when new data are needed, or results must be recorded, the I/O-control

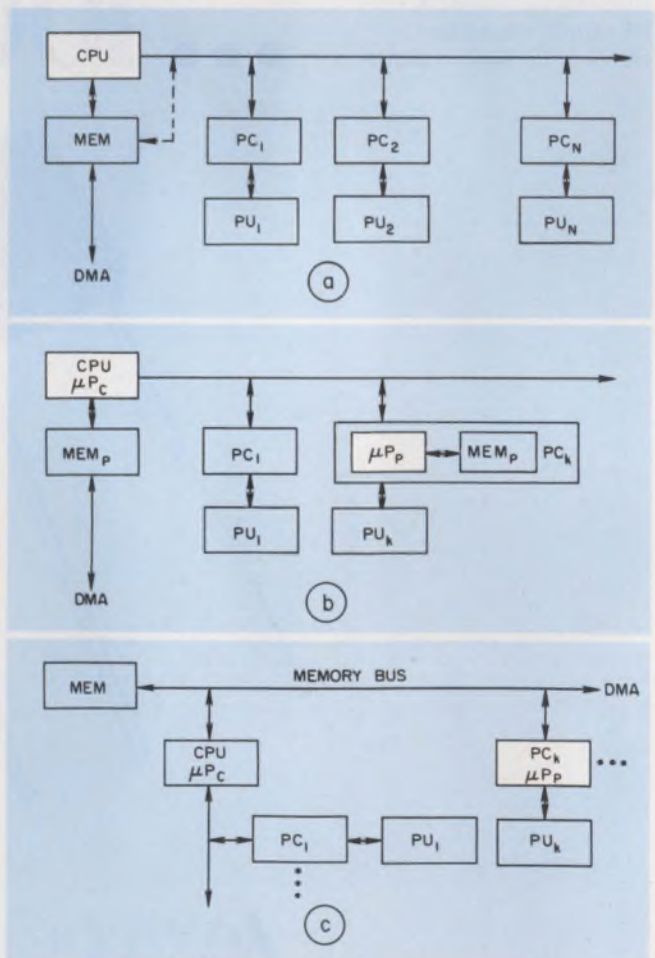

1. Computer architectures have evolved from a central processor with individually controlled peripherals (a), to  $\mu$ P-controlled peripherals with local memory (b) to fast peripherals with direct memory access (c).

processor is awakened and manages the data flow to or from I/O devices. This processor either directly controls slow peripherals, or tells a PC unit what to do by assembling an I/O command. The  $\mu P$  in the PC unit then acts as a controller and handles the peripheral device on the character or bit level.

### Processors communicate by mail

The central memory not only provides program and data storage, but also serves as the communications link between the microprocessors. An assigned part of the memory becomes the "mailbox" where the sending processor places information. The receiving processor then executes the task specified by the message in the mailbox. When the task is completed, the receiving processor responds by leaving a new message.

The simplest way to initiate  $\mu P$  operation is by polling. The receiving  $\mu P$  looks at a mailbox flag, which is either a hardware device (flip-flop) or the content of a memory location. Polling works well if there aren't too many  $\mu P$ s, or if only one of them may initiate an action. But you can get higher efficiency if any  $\mu P$  is allowed to activate any other. For this method, the software must be able to manage priority among processors, as well as multiple requests and queue handling.

The hardware naturally gets to be more complex in this system. Interrupts, though not always desirable, are commonly used to notify the receiving  $\mu P$  that the mailbox contains a message. Several interrupt levels with various priorities must be reserved for interprocessor communication. The microprocessors form a matrix: If N is the number of processors, in theory every  $\mu P$  must have N-1 interrupt levels. In practice, some combinations of sending and receiving  $\mu P$ s never occur, so the number of interrupt levels required is lower.

The processors' ability to prompt each other improves the system's throughput substantially. For example, the contents of a CRT display can be printed out while a file-searching program is in progress. A star or matrix configuration describes the  $\mu P$ s' behavior and the logical data flow. Physically, however, every  $\mu P$  is connected to a common bus.

How many  $\mu P$ s can work together effectively in a

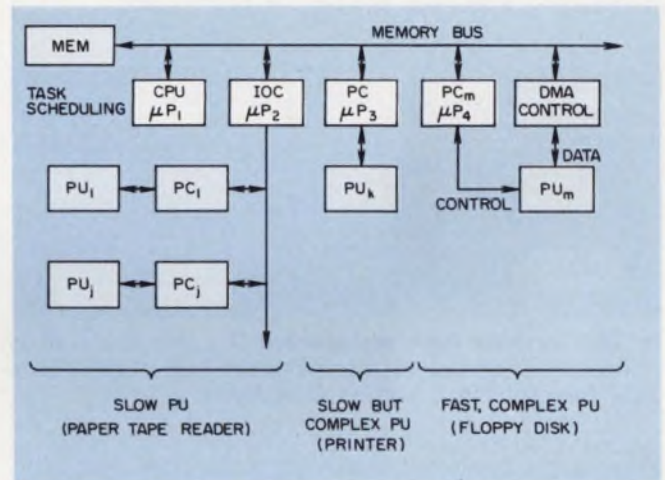

2. In a multimicroprocessor system, intelligence is distributed, but one  $\mu P$  is assigned to task scheduling. Peripherals are grouped by speed and complexity.

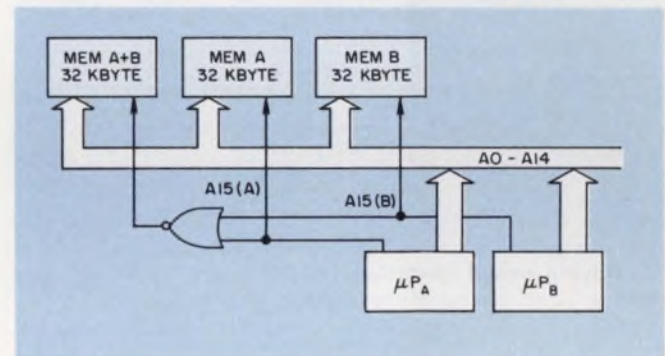

3. When two  $\mu P$ s share CPU functions, each can have its own memory, in addition to the common A+B sector.

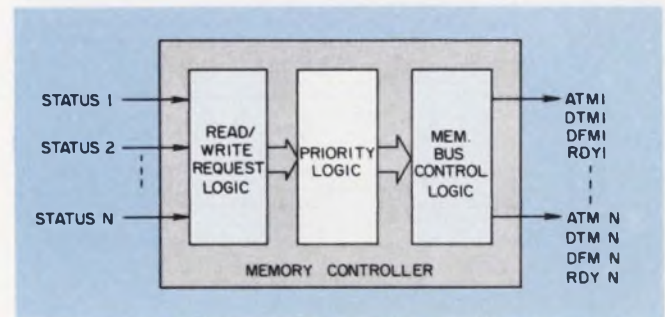

4. A memory controller interprets the status signals and synchronizes the data flow to the processors.

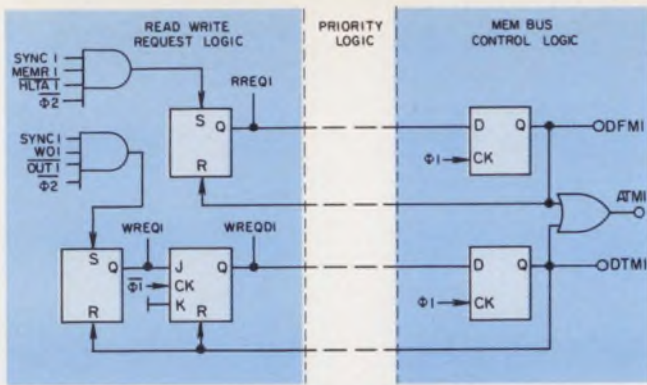

5. The functioning of the memory controller is easier to understand when you bypass the priority logic.

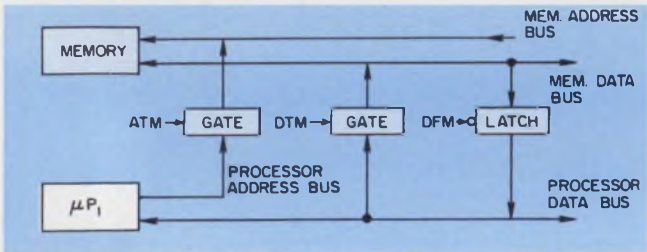

6. With priority logic disregarded (Fig. 5), every  $\mu P$  is connected to central memory with two rows of gates (one gate for each line), and an 8-bit latch.

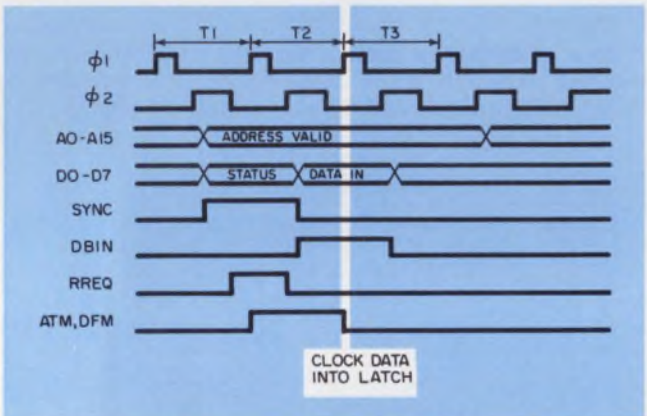

7. During a read operation, the ATM signal gates the data into a latch because the DBIN signal is too late.

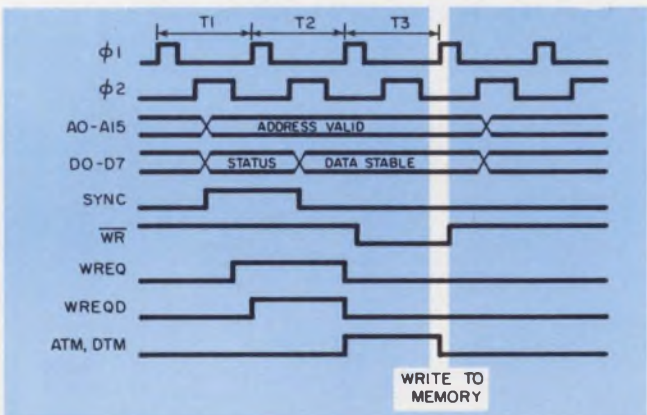

8. Data are written into memory under the control of the DTM signal, which occurs when both address and data are valid.

given system depends primarily on the number of clock cycles per machine cycle. For the 8080A, every instruction needs two to five machine cycles, each consisting of two to five "states," or clock cycles. The first cycle of an instruction is always a fetch cycle, during which the instruction code is read out from the memory. Some instructions access the memory again, when data are written or read.

Statistical analysis of a large number of programs shows that on average 3.5 states elapse for each memory access. That means that, if the memory can be accessed within one state, it can serve at least three  $\mu P$ s without slowing down much. Nonetheless, some speed reduction is unavoidable. If two devices request memory access at the same time, one of them will have to wait.

Connecting more than three 8080s to the same memory bus decreases the average speed of each  $\mu P$ , but because most of the time each  $\mu P$  works independently, the over-all speed of the system is still higher than that of a single-CPU system.

### A trinity of buses

The memory bus combines a data bus, address bus and control bus. The data bus is a two-way, 8-bit-wide data path, but the width of the address bus depends on the size and configuration of the memory. While the number of address lines usually equals the number of address bits, it can be lower or higher. Thus, the addressable memory is virtually unlimited. In Fig. 3, both  $\mu P_A$  and  $\mu P_B$  access 64 kbytes of memory but only their lower halves (memory A+B) overlap. This part holds the common data areas as well as the mailbox. Memories A and B are accessible only by  $\mu P_A$  or  $\mu P_B$ , respectively, and they serve as their program or data storage. A wider address bus not only provides access to a larger memory, it also allows protected areas, accessible to only one  $\mu P$ .

The control bus synchronizes the data flow between memory and processors. Since there is only one memory bus, the processors must obey certain rules when accessing the memory. Each  $\mu P$  is provided with four signals which control when a  $\mu P$ :

1. Must put an address on the address bus (ATM, address to memory),
2. Fetch data from the data bus (DFM, data from memory)
3. Gate out data onto the data bus (DTM, data to memory).
4. Suspend the data bus's activity when the memory bus is busy filling requests from a higher-priority device (RDY goes low).

The control signals are derived from the microprocessors' status signals. The memory-controller network interprets the status signals as memory-access requests and synchronizes the data flow by generating  $ATM_n$ ,  $DFM_n$ ,  $DTM_n$  and  $RDY_n$  (Fig. 4). The suffix n identifies the  $\mu P$ .

If two devices request a memory bus operation at

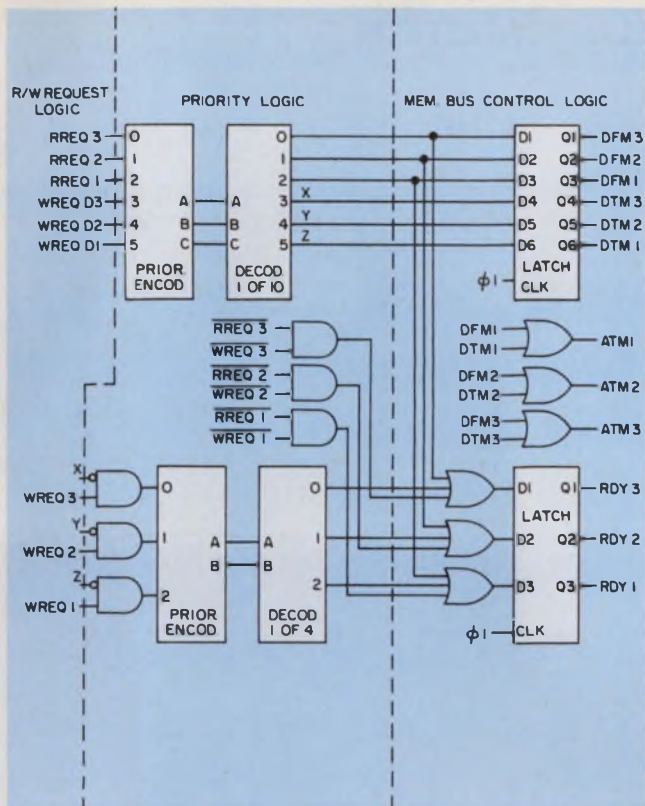

9. In this priority logic for three  $\mu$ Ps, the highest priority is assigned to  $\mu$ P<sub>1</sub>, the lowest to  $\mu$ P<sub>3</sub>.

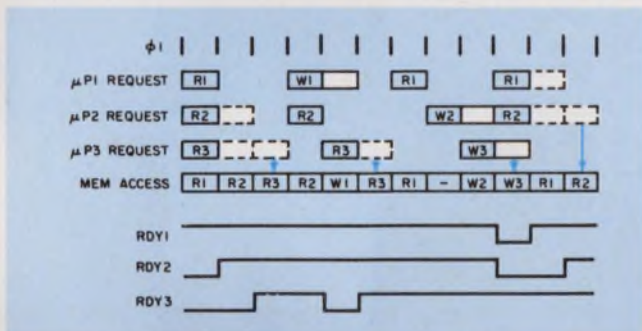

10. Timing for the priority logic of Fig. 9 clearly shows that read (R) and write (W) requests by  $\mu$ P<sub>1</sub> are rarely delayed, while those of  $\mu$ P<sub>3</sub> wait every time. The delay time between request and realization is highlighted.

the same time, the device with higher priority gets immediate service while the other one has to wait. So, analyze your needs thoroughly before you assign priority to different processors.

Priority can be variable or fixed. Variable priority is either "rotating," or assigned by hardware or software in some other way. Fixed priority is easiest to implement, but in some cases more complex arrangements are necessary. A very fast device like a rigid disc requires the highest priority, but only while reading or writing. Head positioning, on the other hand, doesn't depend on immediate memory response, and deserves only low priority.

Very high priority can be used to disable all the other devices. If the read circuits in the disk controller are directly connected to the memory bus under top

priority, you can achieve very high transfer rates, up to 2 Mbytes per second.

### An 8080-based system

Intel's 8080A is not really designed for multi-processing, but by adding a few circuits you can design very powerful architectures with it. While other  $\mu$ Ps are better suited for multiprocessing systems, the 8080A's availability and low price often outweigh its drawbacks.

While neither task allocation nor communication between  $\mu$ Ps depends on the  $\mu$ P model used, you should choose a  $\mu$ P with a suitable number of interrupt levels to avoid complex interrupt-handling hardware outside the  $\mu$ P. The 8080A's interrupt handling capability is fairly good, though some third-generation  $\mu$ P's are better. Communication between  $\mu$ P and memory, on the other hand, is very device dependent, and warrants thorough analysis.

The most crucial part of any multiprocessing system is the memory controller. Its performance must be matched to the system's purpose, speed and projected cost. Usually, it is built from random TTL circuits and some MSI circuits.

The memory controller's main purpose is to time-multiplex the memory bus, making the memory available to all  $\mu$ Ps. Time-multiplexing is done by defining one machine state (clock cycle) as the memory-access cycle, and assigning it to a  $\mu$ P that asks to write or read.

The memory controller contains three blocks: read/write request logic, priority logic, and memory-bus control logic. The R/W request logic interprets the  $\mu$ P's status and generates three signals: RREQ (Read request), WREQ (Write request) and WREQD (Write request delayed).

The memory-bus control logic contains latches and a few gates; it distributes the memory bus control signals to the three-state gates that isolate the  $\mu$ P from the memory bus. Assume for the moment a single- $\mu$ P system which doesn't need priority logic (Fig. 5). The  $\mu$ P runs at full speed, and is never stopped by a low RDY. The interrelationship between the  $\mu$ P and the memory is then as in Fig. 6.

Fig. 7 illustrates the timing of a read operation. The ATM signal gates the address onto the address bus and data is clocked into a latch by DFM's trailing edge. The latch is necessary because the  $\mu$ P's DBIN signal occurs somewhat later. Fig. 8 shows how data to be written pass the DTM gate. The gates are standard three-state bus drivers and the 8-bit latch is an 8212 with three-state output.

Priority logic allows several  $\mu$ Ps to share the same memory bus (Fig. 9). It collects the request signals, determines the highest priority, outputs ATM, DFM or DTM to the selected  $\mu$ P, and stops the others by setting RDY<sub>n</sub> low. In the solution for three processors shown in Fig. 9,  $\mu$ P<sub>1</sub> has the highest priority and  $\mu$ P<sub>3</sub> the lowest. The timing is shown in Fig. 10. ■



**TIME INTERVAL MULTIMETER**  
HEWLETT • PACKARD

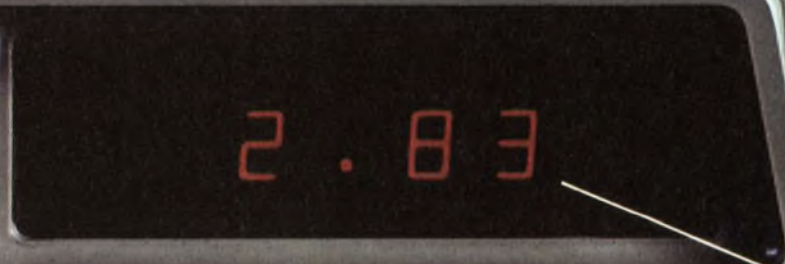

LINE  
OFF ON

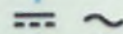

V

A



TYPE (275 MHz)

INTENSITY

**TIME INTERVAL**

START

STOP



**1** You simply set two intensified markers at the desired points using the START and STOP controls.

**2** For maximum accuracy, switch to delayed sweep and use the STOP control to overlap the expanded traces.

SIGNAL  
OVERLAY  
( $\Delta T=0$ )

$\Delta T$   
OFF

CH A  
START

CH B  
START



**1725A OSCILLOSCOPE (275 MHz)**  
HEWLETT • PACKARD

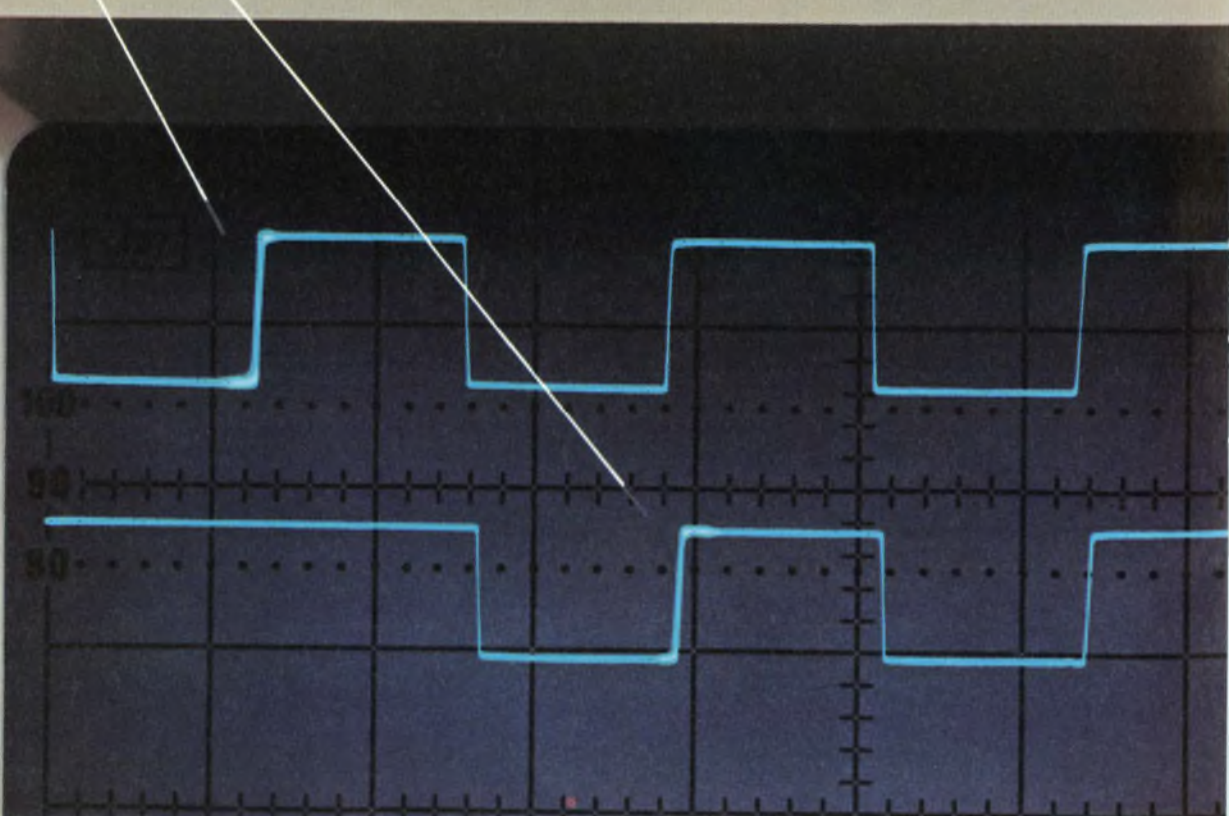

# For improved $\Delta$ -time measurements, plus autoranging AC/DC volts, amps and ohms ...

## HP's the Answer.

Now you can choose from two new scopes with improved  $\Delta$ -time capability: The 200 MHz **1715A** priced at \$3100\* or the 275 MHz **1725A** for \$3450\*. Both offer an optional built-in DMM for direct  $\Delta$ -time readout, plus autoranging AC/DC volts, amps, and ohms.

$\Delta$ -time measurements are now faster with the 1715A and 1725A. They're more accurate because scope and operator errors are significantly reduced. Plus you have switch selection of channel A or B as the starting point for  $\Delta$ -time measurements, often eliminating the need to move probes and simplifying trace overlap for zeroing. But you can still select conventional delayed sweep with the flip of a switch, for brighter low-rep-rate traces and convenient trace expansion.

The optional autoranging 3½ digit DMM is priced at \$325\* factory installed. Or, for easy field installation, there's a kit priced at \$375\*. Another option, HP's "Gold Button" for \$150\*, gives you pushbutton selection of either time domain or data domain when the 1715A or 1725A is used with HP's 1607A Logic State Analyzer.

Like all new high-frequency HP scopes, the 1715A and 1725A have switch selectable 50 ohm or 1 Megohm inputs. And the 1725A, with 275 MHz

bandwidth, is the fastest 1 Megohm-input scope available. That reduces the need for active probes when working with fast logic near maximum fan-out.

The story with both of these scopes is user convenience—from front-panel controls to the minimum of adjustments for servicing. Your local HP field engineer can give you all the details.

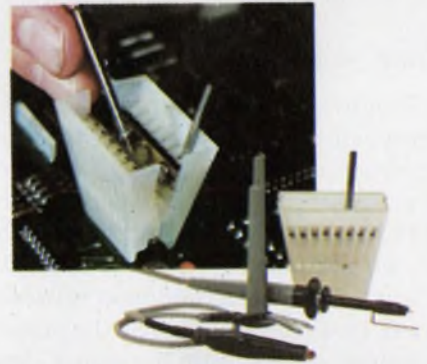

And here's something NEW for scopes. HP's **Easy-IC Probes**. A new idea for probing high-density IC circuits that eliminates shorting hazards, simplifies probe connection to DIPs and generally speeds IC troubleshooting. The probes are standard equipment with these two scopes.

\*Domestic U.S.A. price only



HEWLETT  PACKARD

1507 Page Mill Road, Palo Alto, California 94304

For assistance call Washington (301) 948-6370, Chicago (312) 255-9800, Atlanta (404) 955-1500, Los Angeles (213) 877-1282

087/8A

CIRCLE NUMBER 43

3 Read the time interval directly on the digital display. (Without the DMM option, read the interval directly from the STOP control dial.)

EXT TRIG  
1MO



## Choosing a scope to measure time? Look at some relative pulse-width and delay measurements, and you'll see that wider bandwidth doesn't necessarily mean better results.

When you select an oscilloscope to make time-interval measurements, don't just look for the scope with the widest bandwidth you can afford. Although bandwidth is related to time-interval accuracy, larger bandwidth doesn't necessarily mean more accuracy.

The need to measure time intervals at varying duty cycles and with different logic families places increasing emphasis on resolution and accuracy. Obviously, the more reliable the timing measurements, the faster or more reliable the end system.

### Know your scope's limitations

Bandwidth is certainly a major source of scope errors in timing measurements. But so is time-base accuracy. When rise and fall are considerably slower than a scope's response, errors are negligible and determined primarily by the time base, usually 3 to 6% for standard scopes, 1% for delta-time units and about 0.002% for a time-interval-counter scope. As the transition times approach the scope's response time, however, errors begin to creep in. But to what degree?

Luckily, scopes tend to have many very-high-frequency poles, with the dominant ones determined by the CRT deflection amplifiers. Therefore, a scope can be approximated by a shunt-peaked amplifier. The time-interval accuracy achievable with, say, a 100-MHz unit can be analyzed, along with its induced distortion, with an exponential input signal having different fall and rise times (see box). With that signal, it is easy to vary the transition times, and—as shown by the scope's amplitude response derived in the box—the mathematics is simplified.

To compute the time-interval error of a 100-MHz scope when measuring pulse width, use a pulse with a fixed rise time and a fall time that can be adjusted from one to 10 times the rise time. Select leading-edge rise times corresponding to major logic families: ECL pulse  $t_r$  is 2 ns, so  $t_f$  varies from 2 to 20 ns; Schottky TTL (STTL) pulse  $t_r$  is 4 ns, so  $t_f$  varies from 4 to 40 ns; and low-power Schottky (LPSTTL) rise time is 7 ns, so fall time varies from 7 to 70 ns.

Now compare the actual interval of the input signal,

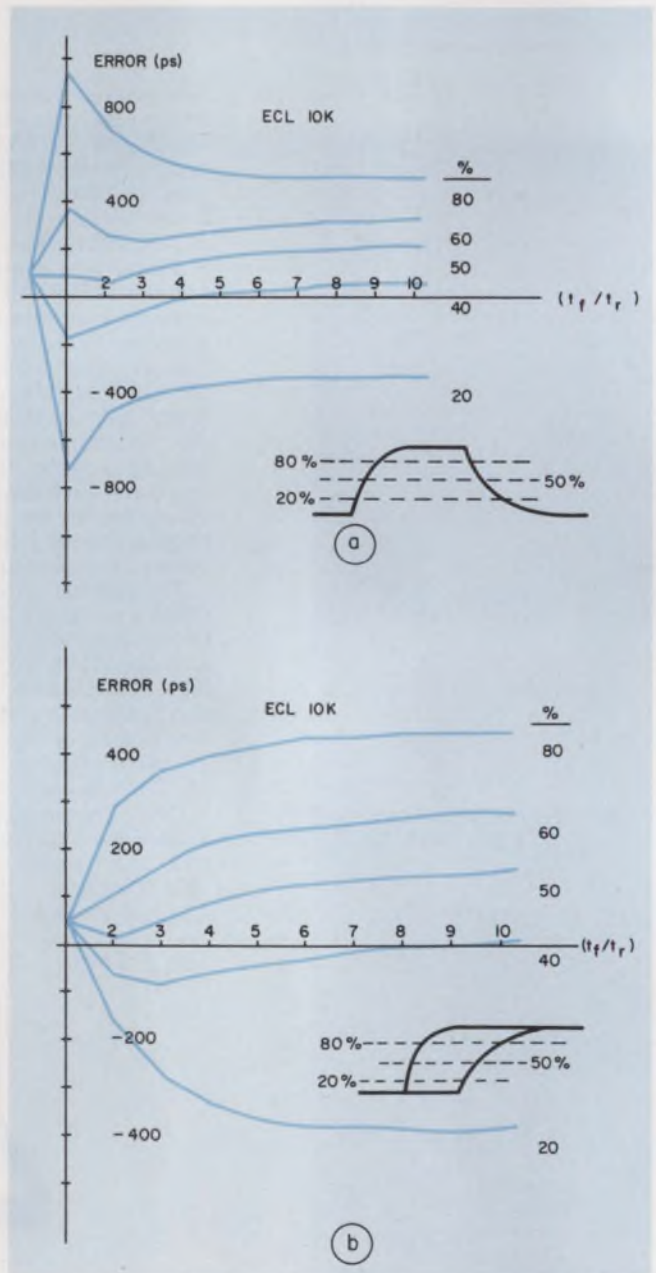

1. Errors in measuring pulse widths on a scope (a) depend on the relative rise and fall times of the pulse and your definition of width. If, for example, an ECL 10 k gate's output pulse has a 2-ns rise and 10-ns fall, and a width of 12.4 ns at the 50% points, the actual width equals  $12.4 - (0.10)$ , or 12.3 ns. At the 20% points, the actual width would be  $12.4 - (-0.46) = 12.86$  ns. Similar propagation-delay errors occur for identical slopes (b).

Walt Fischer, Oscilloscope Engineering Manager, Hewlett-Packard, P.O. Box 2197, Garden of the Gods Rd., Colorado Springs, CO 80901.



## Analyzing the oscilloscope as a shunt-peaked amplifier

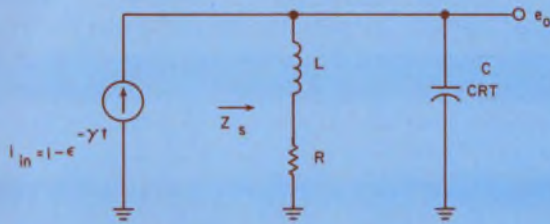

$$Z(s) = \frac{1}{C} \cdot \frac{s + R/L}{s^2 + s \frac{R}{L} + \frac{1}{LC}}; \quad i(s) = \frac{\gamma}{s(s+\gamma)}$$

$$\text{If } K \equiv R \sqrt{\frac{C}{L}}; \quad \tau_o = RC,$$

$$Z(s) = \frac{1}{C} \cdot \frac{s + \frac{K^2}{\tau_o}}{s^2 + s \frac{K^2}{\tau_o} + \frac{K^2}{\tau_o^2}};$$

$$e_o(s) = i(s) \cdot Z(s) =$$

$$\frac{1}{C} \cdot \frac{\left(s + \frac{K^2}{\tau_o}\right) \gamma}{s(s+\gamma) \left[s^2 + s \frac{K^2}{\tau_o} + \frac{K^2}{\tau_o^2}\right]}$$

$$\text{If } a_o \equiv \frac{K^2}{\tau_o}, \quad \alpha \equiv \frac{K^2}{2\tau_o},$$

$$\gamma \equiv \frac{1}{\tau_s}, \quad \beta_o \equiv \frac{2}{\tau_o}, \quad \beta = \frac{K^2}{2\tau_o} \sqrt{\frac{4}{K^2} - 1},$$

$$e_o(s) = \frac{\gamma}{C} \cdot \frac{s + a_o}{[(s+\alpha)^2 + \beta^2] s(s+\gamma)}$$

$$\text{If } K < 2,$$

$$\mathcal{L}^{-1} [e(s)] = e(t)$$

$$e(t) = \frac{1}{C\tau_s} \left\{ \frac{a_o}{\beta_o^2} + \frac{(\gamma - a_o) e^{-\gamma t}}{\gamma[(\alpha - \gamma)^2 + \beta^2]} + \right.$$

$$\left. \frac{1}{\beta\beta_o} \left[ \frac{(a_o - \alpha)^2 + \beta^2}{(\gamma - \alpha)^2 + \beta^2} \right] e^{-\alpha t} \sin(\beta t + \psi) \right\}$$

$$\psi = \tan^{-1} \frac{\beta}{a_o - \alpha} - \tan^{-1} \frac{\beta}{\gamma - \alpha} - \tan^{-1} \frac{\beta}{-\alpha}$$

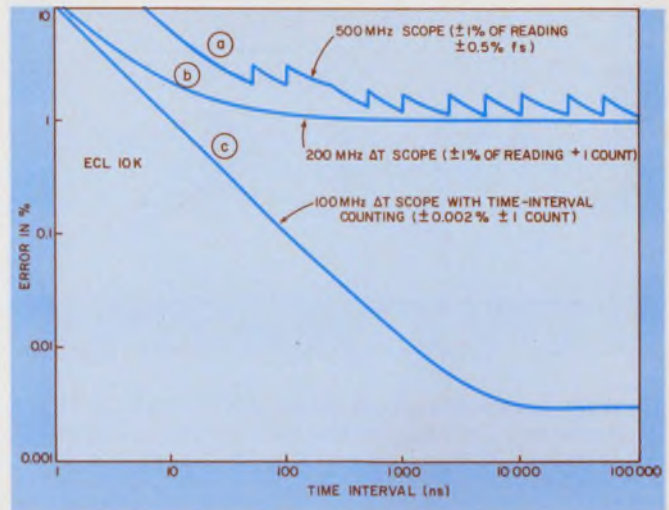

2. Errors contributed by a scope's time base depend on the time interval being measured. Accounting for bandwidth adds more inaccuracy.

measured at the 50% points, with the interval measured on the scope at the 50% points. The difference is the error. Next measure the errors at the 20, 40, 60 and 80% points. The resulting error curves (Fig. 1) reveal slight errors for pulse width and propagation delay, when rise and fall times are different—however, the error is about an order of magnitude less than expected from a 100-MHz scope.

### How the 100-MHz scope stacks up

Measurements made at the 50% points are within  $\pm 150$  ps for ECL 10 k and STTL and within  $\pm 100$  ps for LPSTTL and slower logic families, TTL and MOS. And, if the rise and fall times differ by less than 5:1, the 100-MHz unit can achieve an accuracy of  $\pm 100$  ps on ECL 10 k and STTL as well as LPSTTL.

Since most devices and pulse widths are specified at the 50% points, the 100-MHz scope is entirely satisfactory for timing measurements in logic families up to and including ECL 10 k, and offers accuracies better than  $\pm 200$  ps (Fig. 2). But compare time-base errors, and you'll see that if bandwidth is considered for the 100-MHz scope, you must add 200 ps for ECL 10 k and STTL and 100 ps for LPSTTL (Fig. 3).

Figs. 2 and 3 compare pulse-width measurements on ECL 10 k with bandwidth limitations for 500, 200 and 100-MHz scopes. The 500 and 200-MHz instruments, using an analog time base, provide delta-time measurements while the 100-MHz scope offers a time-interval averaging counter that ties measurement accuracy and resolution to a crystal oscillator.

So what good is a wide bandwidth? In general, it provides more fidelity—important for viewing unwanted narrow pulses and glitches. Obviously, a 1-ns-

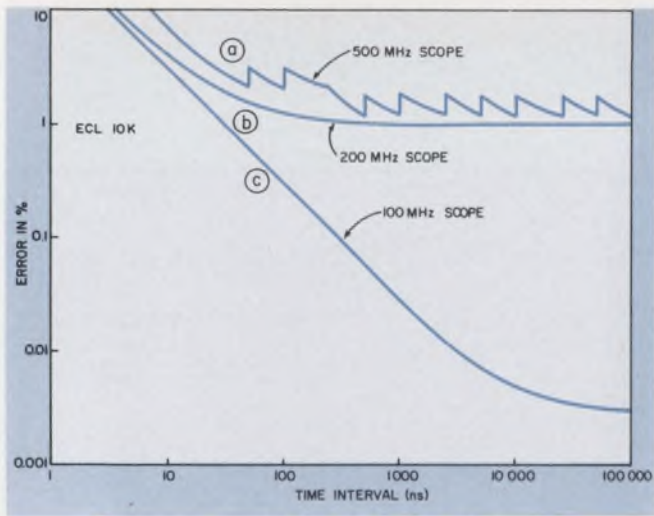

3. When bandwidth errors are added to time-base errors, and intervals are taken at the 50% points, add errors of 50, 150 and 200 ps, respectively, for curves a, b and c.

wide impulse displayed by a 500-MHz scope will have more amplitude than an impulse displayed by a 100-MHz unit. But can your system generate impulses as narrow as that? And will the logic family you're using respond to them?

### Looking at impulses

Most narrow impulses come from system reflections created by poor or unterminated coaxial or printed-circuit connections. See what happens when an ECL gate drives two open, printed-circuit traces, one 15.2 cm (6 in.) long and the other 45.7 cm (18 in.) long. The waveforms are shown in Fig. 4.

The 15.2-cm trace should show a reflection approximately 2 ns after the gate output starts to rise. Because the rise is slew-rate-limited, the reflection returns while the gate output is still rising. The result is a slight slope error on both the 500 and 100-MHz

*(text continued on page 82)*

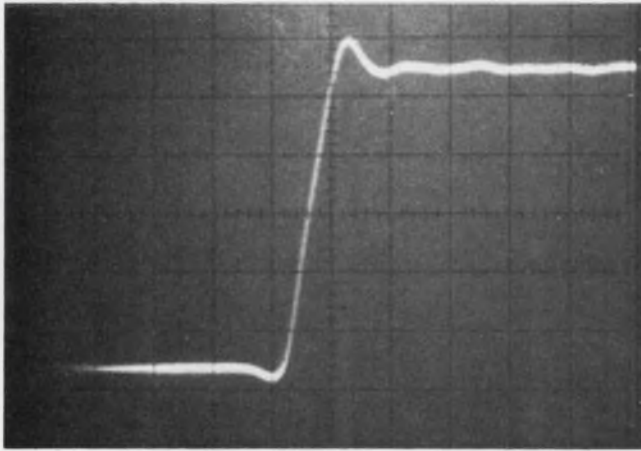

(a)

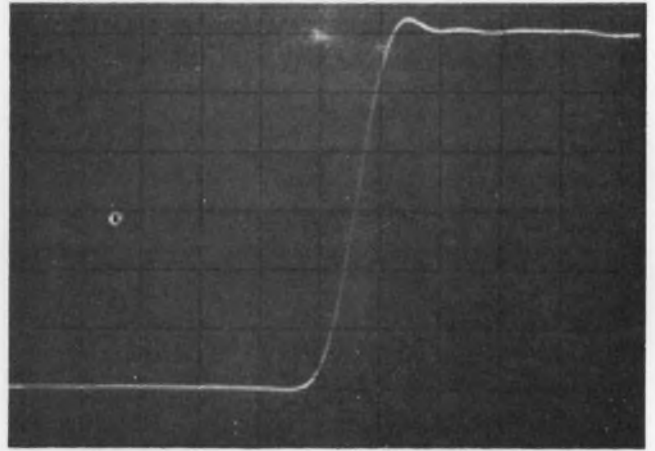

(b)

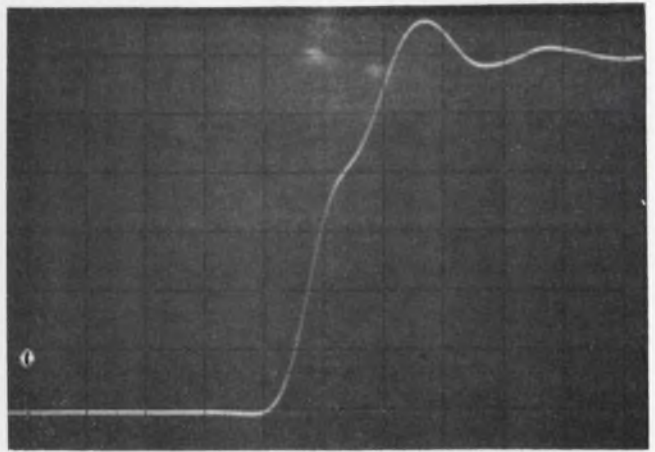
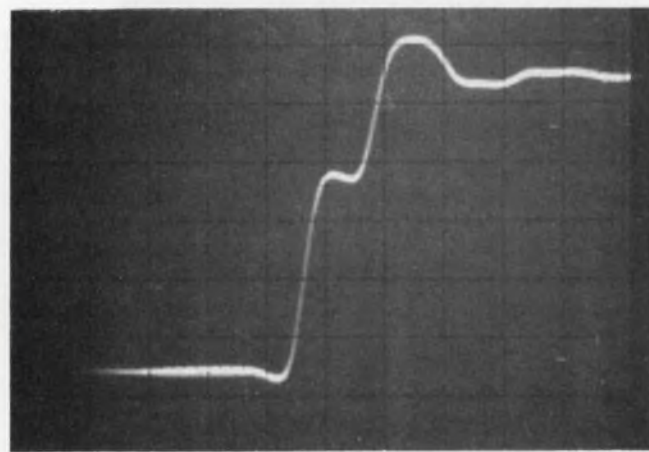

4. See how two scopes of different bandwidths respond to identical pulses generated on ECL-driven, open transmission lines of 15.2 cm (a) and 45.7 cm (b). The response

for a 500-MHz scope is shown on the left, while that for a 100-MHz unit is on the right. Sweep speed is 5 ns/div. Note the reflections.

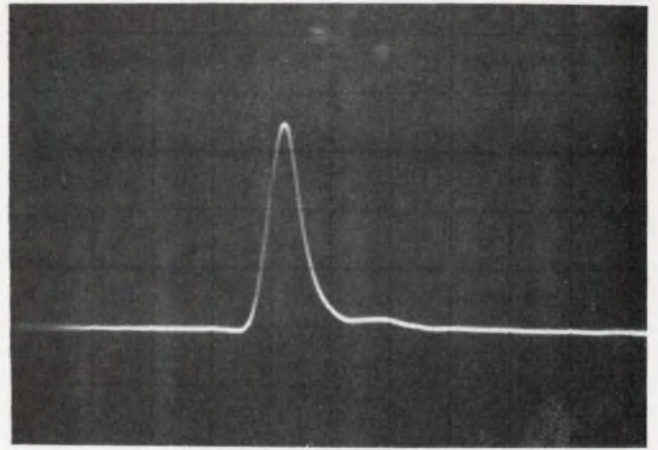
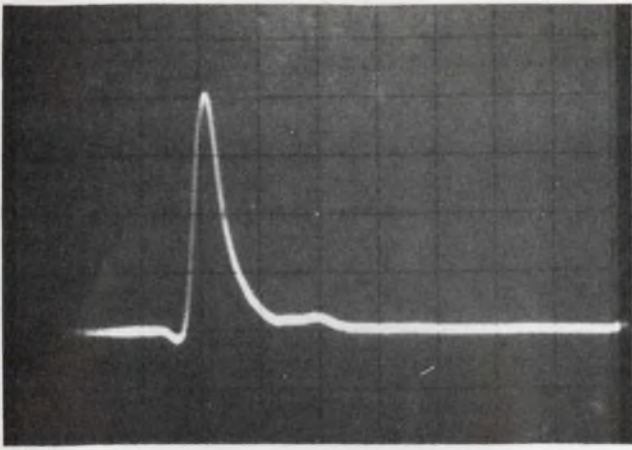

5. **Although an impulse shows up** a bit larger on a 500-MHz scope (left) than it does on a 100-MHz unit (right),

the latter's display is good enough for many purposes. Here an ECL 10 k gate drives a shorted transmission line.

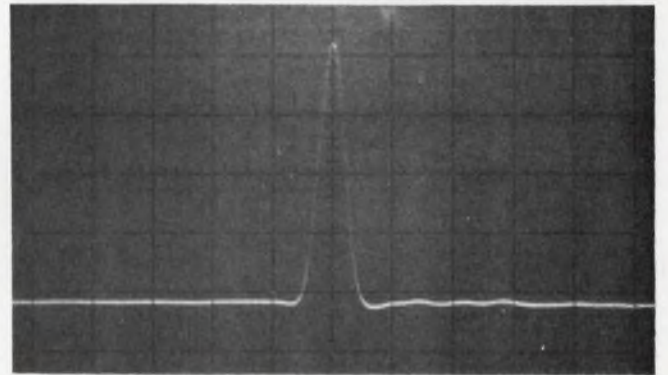
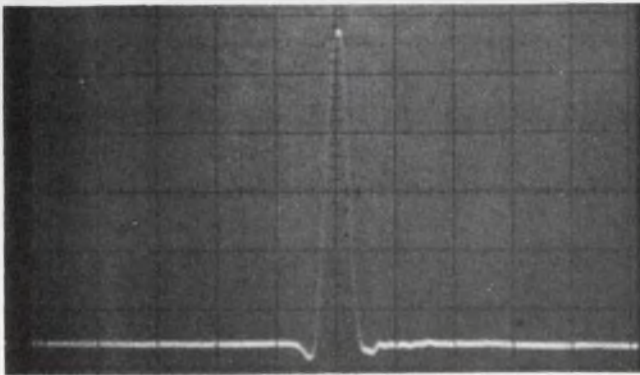

(a)

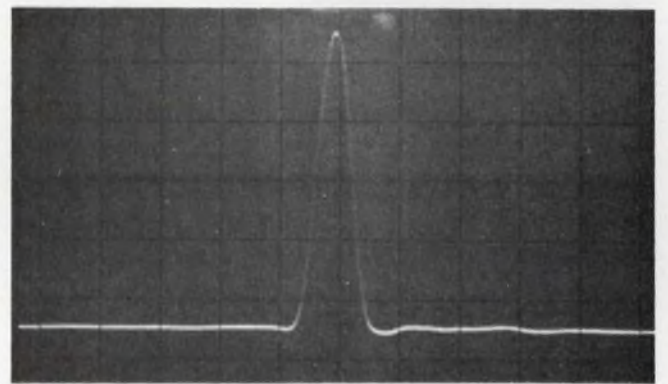
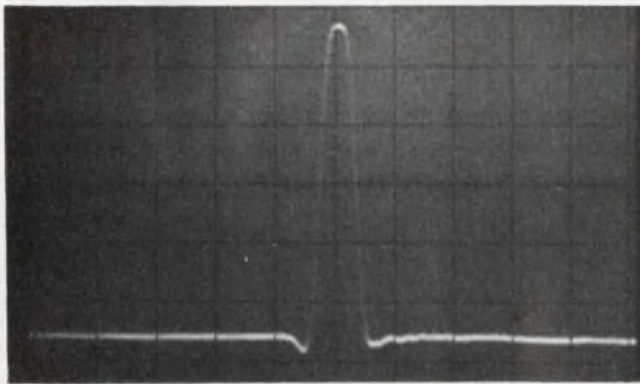

(b)

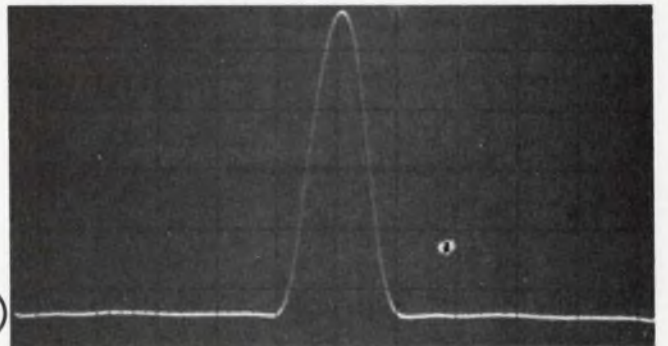
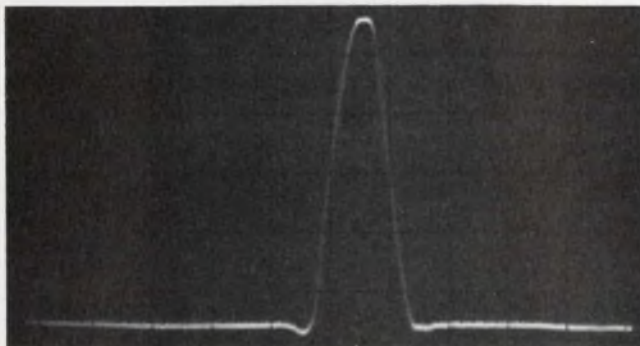

(c)

6. **Bandwidth isn't always crucial for pulse measurements.** 500-MHz displays (left) are of the narrowest

impulse responded to by (top to bottom) ECL 10 k, STTL and LPSTTL. 100-MHz scope photos are at right.

# New! Model ATD



## Adjustable Electronic Time-Delay/Interval Plug-In Relay with Solid-State Circuitry

- Plug-in/Plug-out convenience
- DC polarity protection
- Full 10 amp. loading
- AC or DC voltages
- Timing light
- Fast reset times
- Built-in transient voltage protection
- Repeat accuracy as high as  $\pm 0.75\%$  of setting
- Cycles from 1 sec. to 10 hours
- Competitively priced
- Choice of Knob-adjustable, Lock-Nut or Fixed-time models

For more information, or the name of your nearest Model ATD supplier, write or call:



**LINE RELAYS**

AN ESTERLINE COMPANY

Line Electric Company, U.S. Highway 287,  
Parsippany, N.J. 07054 • (201) 887-8200 • Telex: 13-6494

CIRCLE NUMBER 44

(continued from page 80)

displays. With the 45.7-cm trace, the reflection should occur approximately 6 ns after the gate output starts to rise, and produce a step on the leading edge.

The step is more pronounced on the 500-MHz scope, but the 100-MHz unit, if nothing else, shows that a reflection exists. Notice that the interval between the 10% and 90% points is close enough to indicate the relative delay of the pulse top caused by the reflection.

With a 45.7-cm open trace driven by an STTL gate, the displayed differences between the 100 and 500-MHz scopes are very small. Even if a short impulse were to be generated, the slew rate of the logic limits the amplitude. The resultant distortion, even with ECL 10 k, can be viewed adequately with a 100-MHz scope.

Now consider the shortest impulse that can be generated and still have enough amplitude to pass through the ECL 10 k threshold. The 100-MHz display, even with less amplitude than the 500-MHz, adequately shows the impulse and certainly calls attention to a potential problem (Fig. 5).

### The narrowest observable pulse

To determine a minimum pulse width, rule-of-thumb says to note the transition time of the fastest logic family in your system and increase that number by 100%. For example, ECL 10 k's rise time is approximately 2 ns; therefore, it can generate 4-ns impulses—large enough to pass through the threshold levels of other 10 k components in the system.

Keep in mind that this rule-of-thumb is for minimal output loading, that is, fanouts of one or two. As the fanout increases to 3 or four or six, the transition times can increase to 3 or 4 ns for minimum pulse widths as wide as 6 to 8 ns.

To determine if a logic family can respond to a very narrow input pulse, consider an ECL 10 k gate, which acts as a slew-rate-limited linear amplifier when driven by signals that last only a few nanoseconds. As the input pulse width is varied, the output passes through the threshold level when the input gets to be 3 to 4 ns wide, or approximately twice the transition time.

Therefore, the answers to "Can a system generate extremely narrow impulses?" and "Will the logic family respond?" revolve around the transition-time specifications of the fastest logic family in your system. With ECL 10 k, you will observe impulses of 3 to 4 ns, with STTL, impulses of 4 to 5 ns, and so on.

Trace photos taken on 100 and 500-MHz scopes show displays of ECL 10 k, STTL and LPSTTL impulses for each scope (Fig. 6). The differences in the photos between each scope are so small, you should ask yourself: Is wider bandwidth really worth the additional cost? ■■



MIL-P-50884B

# Flex circuit problems? Next time call Hughes.

You can depend on Hughes when you have flex circuit requirements. Performance-minded people do. Like the people who build high technology products for the Air Force, Army, Navy and NASA. They know that Hughes means reliability.

For example: our three-layer circuit assembly used in the head-up display of a new fighter. It interconnects the power supply with a multi-layer PC mother board. Each layer is silver epoxy shielded for flexibility as well as crosstalk prevention. Nail-head contacts are terminated with high temperature solder. The assembly was designed to solve a tough application problem and maintain a low installed cost.

We can also design, manufacture, terminate and test your total

interconnect system—ready for installation. We're experienced in custom harnesses and assemblies, produced to exact specifications. And, if you need flat cable—flat conductor or round conductor—we're the people to see.

Even if you don't have a flex circuit problem now, remember Hughes. So when you do need reliable flex circuitry, call (714) 549-5701, or write Hughes Connecting Devices, 17150 Von Karman Avenue, Irvine, California 92714.



**HUGHES**

HUGHES AIRCRAFT COMPANY  
CONNECTING DEVICES

CIRCLE NUMBER 241

## The bandwidth of phase-lock loops

for synchronous data transmission should first be wide, then narrow. Solve the dilemma with a modified loop.

If you want to recover the timing signal in synchronous data systems with a phase-lock loop<sup>1</sup> (PLL), you need a filter bandwidth around 10 Hz for good noise rejection. But in the search mode the filter must be wide enough to accommodate the pulling characteristics of the oscillator crystal. This sounds contradictory, but there are three ways to do it:

1. Divide both the input frequency and VCO output-frequency by  $N$ , ahead of the phase comparator (see box for PLL basics). This method reduces noise bandwidth by a factor of  $N$ , and increases the lock range by the same factor. Unfortunately, it also multiplies the steady-state error by  $N$ , and the acquisition time by  $N^2$ , which may be unacceptable.

2. Replace the phase comparator by a phase-frequency comparator that gives different steady-state outputs for input frequencies below, above, and equal to the VCO frequency. However, phase-frequency comparators using digital gates fail to operate satisfactorily if some of the input transitions are missing—i.e. when the input consists of random data.<sup>2</sup> Only very complicated phase-frequency comparators operate satisfactorily with random data.<sup>3</sup>

3. Use variable bandwidth PLLs implemented by digital gates. The normal loop bandwidth is extremely narrow; but once out-of-lock condition is detected, the bandwidth can be made large to help lock the loop as quickly as possible.

### The best of both worlds

To implement the third—and preferred—alternative, you can use a voltage-controlled crystal oscillator, designed to recover the clock signal from a random PCM data channel. To operate properly, the circuit has to meet the following criteria:

- The input data rate must be within the lock-in range of the loop. The filter bandwidth should be large enough so that the lock-in range is essentially determined by the pulling characteristics of the crystal and its associated circuitry.

- The input signal must contain a sufficient number of data transitions per second.

- The input data must be return-to-zero binary.

The oscillator and the integrator filter are designed conventionally. A crystal oscillator is shown in Fig. 1, but an LC oscillator of the same frequency can be used instead. The PLL performance is determined by the loop bandwidth and not by the crystal characteristics.

In Fig. 2, the phase detector operates under steady state conditions.<sup>2</sup> As long as the data input is ZERO, there is no output from the phase detector. When the input is one, gate output A goes high while output B goes low. So the input to the filter is a doublet of current pulses (Fig. 3).

If you ignore component variations and assume the gates' LOW voltage to be ZERO, then the amplitude of the current pulse is given by

$$I = \frac{V/2 - V_d}{R}$$

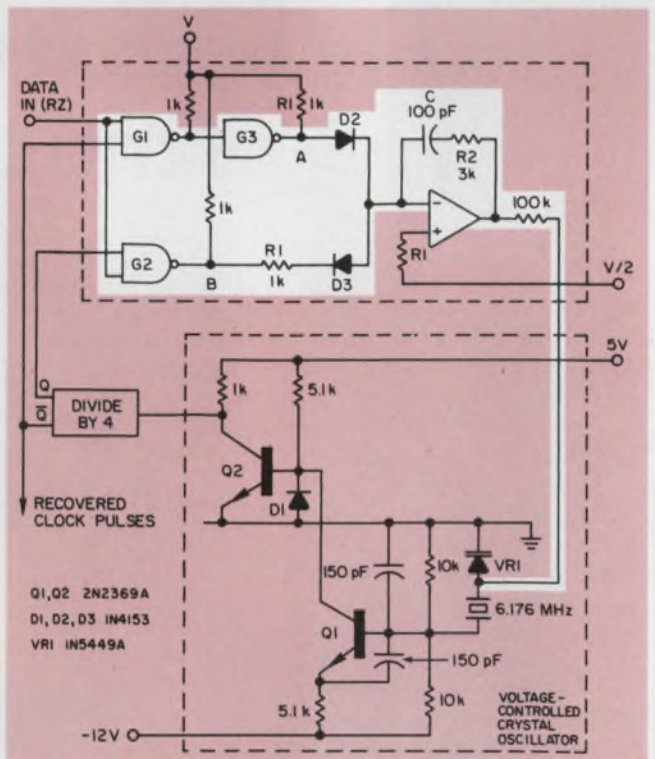

1. A practical PLL circuit uses a crystal-controlled VCO that is fed by a phase comparator and filter. The active filter's bandwidth remains constant.

S. Ghosh, Engineer, TRW Vidar Div., 77 Ortega Ave., Mountain View, CA 94040.

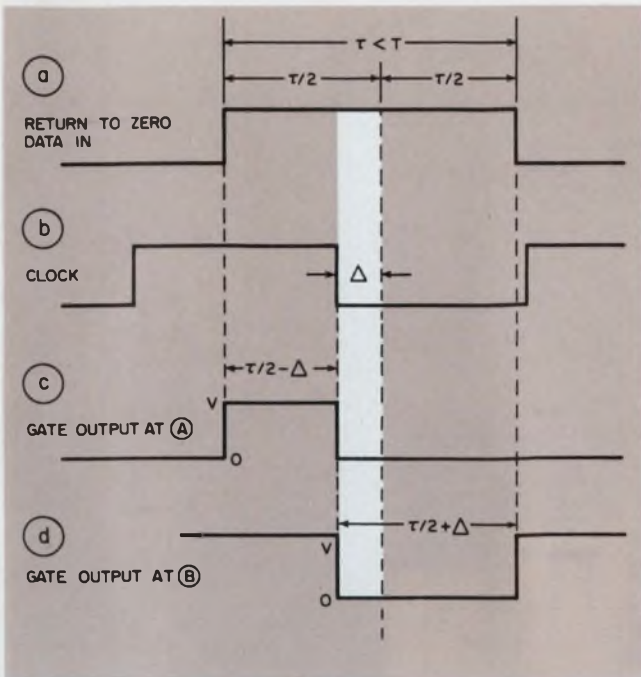

2. A phase detector's output is determined by the status of the NAND gates. The currents are measured at points A and B in Fig. 1 before they are combined.

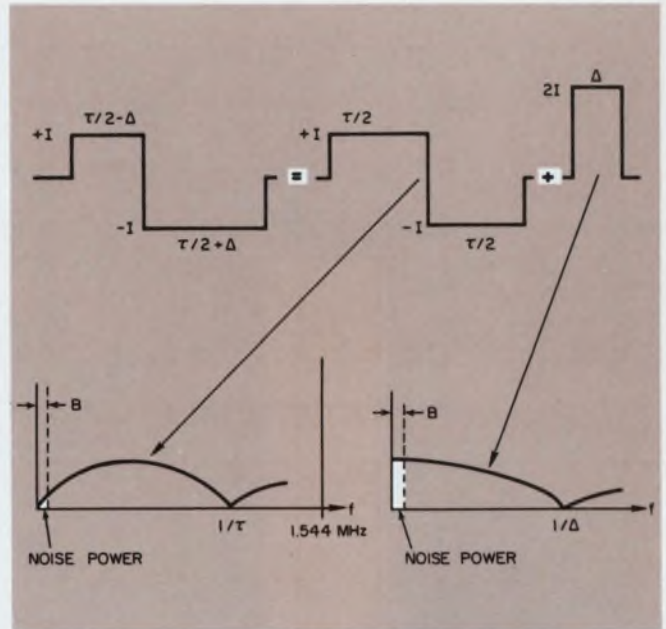

3. The output current from the phase detector is an asymmetrical doublet composed of a symmetrical doublet and a variable pulse (a). Within the filter's bandwidth, the spectrum of the pulse contributes most of the power.

## Loop circuit fundamentals

The basic schematic of a second-order phase lock loop contains a phase comparator, an active filter, and a voltage controlled crystal oscillator. The first basic loop equation is the transfer function:<sup>1</sup>

$$H(S) = \frac{\theta_o(s)}{\theta_i(s)} = \frac{2\rho\omega_n S + \omega_n^2}{S^2 + 2\rho\omega_n S + \omega_n^2} \quad (1)$$

where  $\omega_n$  is the natural frequency and  $\rho$  is the damping factor of the loop. Furthermore,

$$\begin{aligned} \omega_n^2 &= K_o \cdot K_d / \tau_1, \\ \rho &= \tau_2 \cdot \omega_n / 2, \\ \tau_1 &= R_1 C_1, \text{ and} \\ \tau_2 &= R_2 C. \end{aligned}$$

The steady phase error

$$\theta_e = \theta_i - \theta_o = \Delta\omega / K_v, \quad (2)$$

where  $\Delta\omega$  is the difference between input frequency,  $f_i$ , and the free-running frequency,  $f_o$ , of the local oscillator, and  $K_v = A K_o K_d$  is the dc gain of the loop.

A fundamental loop parameter is the noise bandwidth. If the input to the loop has phase noise of uniform density  $\Phi$ , then the output noise power for that input is given by

$$e_{no}^2 = \frac{\Phi_2}{2\pi} \int_0^\alpha |H(j\omega)|^2 d\omega \quad (3)$$

The integral in the equation is defined as the noise bandwidth B of the loop:

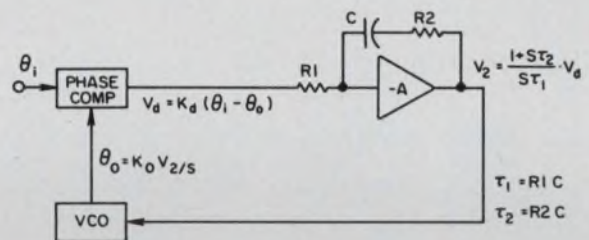

$$\begin{aligned} B &= \frac{1}{2\pi} \int_0^\alpha |H(j\omega)|^2 d\omega \\ &\approx \frac{\alpha}{\omega_n \rho / 2} \end{aligned} \quad (4)$$

The value chosen for  $\rho$  is usually from 0.5 to 1 to ensure good transient behavior of the loop.

Another parameter, equally important, is the lock-in range, given by:

$$\Delta\omega_L = 2\rho\omega_n \quad (5)$$

The lock range indicates the largest difference permitted between  $f_i$  and  $f_o$  at which the loop will lock-in rapidly. Equations 4 and 5 show conflicting requirements: For a wide lock-in range,  $\omega_n$  should be large; on the other hand it should be small for maximum rejection of input jitter.

The problem in designing a phase-locked loop, then, is to keep the noise bandwidth as small as possible, yet maintain a wide lock-in range for the loop.

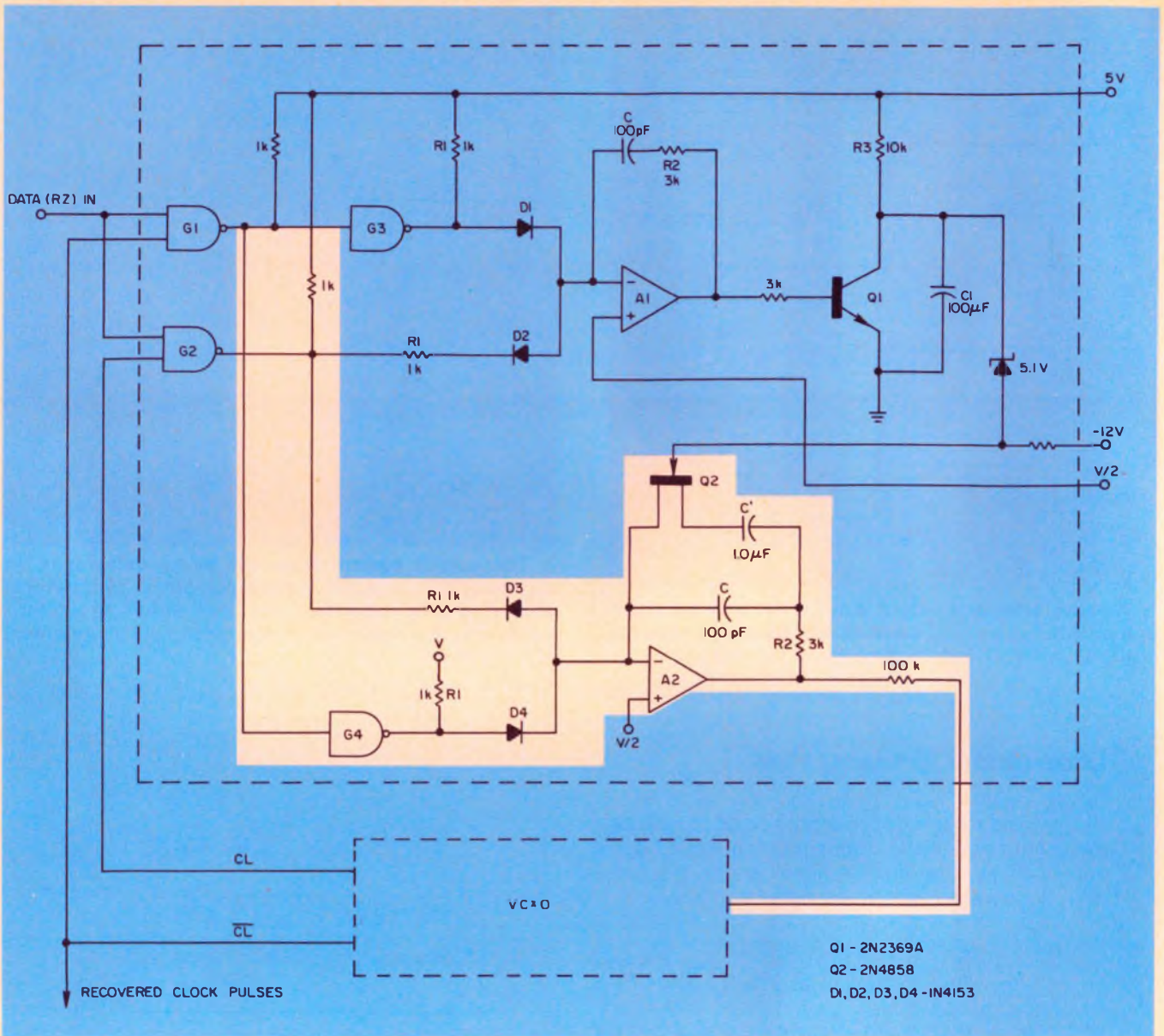

4. A modified PLL circuit controls the VCO through a new gate and filter (highlighted area). The original gates and

filter now serve only to switch a 1- $\mu$ F capacitor, which changes the filter's bandwidth.

where  $V$  is the gate supply voltage for gate B,  $V_d$  is the diode forward drop, and  $R$  is the current-determining resistance.

Normally, the clock transitions should be in the middle of a pulse. If  $\tau$  is the length of the input pulse, and  $\Delta$  the steady-state time deviation from nominal, then the positive current pulse lasts for  $\tau/2 - \Delta$ , and the negative pulse  $\tau/2 + \Delta$ .

You can interpret the asymmetrical doublet to be a symmetrical doublet plus a narrow unipolar pulse with duration  $\Delta$  and amplitude  $2I$ . These narrow pulses produce the correction voltage that maintains lock. Proper servo operation requires that

$$\tau = K_1 T, K_1 < 1,$$

where

$$T = \frac{1}{f_r},$$

and

$$f_r = \text{the data bit rate.}$$

Thus, return-to-zero (RZ) data are needed. If the input data are nonreturn-to-zero (NRZ), they must be converted to RZ by generating a pulse of duration  $\tau$  for every data transition, because NRZ data contain no timing information.<sup>4</sup>

### Reducing the phase error

To predict the steady-state phase error, you first must convert the phase computation ( $\theta_e = \theta_i - \theta_o$ ) to time:

$$\Delta = \frac{T}{2\pi p K_v} \Delta\omega$$

where  $p$  is the probability that ONEs occur.

You can make the phase error as small as you want by increasing  $K_v$ . The equation for  $\Delta$  also shows that the phase error is inversely proportional to the proba-



**Table 1. Performance of three clock extraction circuits**

Parameters	Resonant circuit*	Conventional PLL	Modified PLL
Realizable Q	100	1500	>15,000
Noise BW	15 kHz	1 kHz	<0.1 kHz
Steady state error	12°	≈0	≈0
Long term stability	0.5%	Excellent	Excellent
Necessity for manual alignment during manufacturing	Yes	No	No
Shop cost	\$5	\$6	\$7.50

\*Mistuned by 0.1%

bility of transitions in the input data. If you use an op amp for the integrator, the phase error has to supply only the bias current of the op amp. If the input data were periodic, the power spectrum at the filter input would consist only of discrete lines, namely the harmonics of the bit rate. Random data, however, produce a continuous power spectrum in addition to the discrete lines.

You can separate the continuous spectrum into a component produced by the symmetrical doublet, and one by the unipolar pulses of width  $\Delta$ . The doublet has very little energy in the passband of the loop filter; the output jitter of the PLL is primarily caused by the low-frequency power in the spectrum due to the time error,  $\Delta = K_2T$ .

Over the bandwidth B, the input spectrum is nearly uniform and is proportional to  $K_2^2/f_r$ . The output noise is given by

$$e_{no}^2 \propto \frac{K_2^2}{f_r} B \propto \frac{K_2^2}{Q_e}$$

Variable  $Q_e$  is the "quality factor" of the loop:<sup>5</sup>

$$Q_e = \frac{f_r}{B}$$

The output noise, or jitter, originates from:

1. The randomness of the input data; you can reduce the effect of this source by making  $\Delta$  very small.
2. Modulation of the input phase, hence of  $\Delta$ , due to input timing-jitter; eliminate noise from this source by reducing the noise bandwidth of the loop.

The modified PLL circuit (Fig. 4) has a bandwidth that is wide when out-of-lock, but drastically reduced after lock-in. Two phase detectors and filters operate in parallel: Phase detector 1 senses only the in-lock condition. Phase detector 2, inside the loop, has an associated filter with two time constants, determined by C and C<sub>1</sub>. Capacitor C<sub>1</sub> is switched into the circuit

by FET Q<sub>2</sub> only when the loop is locked in.

Should phase lock be lost, the output of the first filter amplifier is designed to swing from extreme positive to extreme negative. As soon as the output is positive, transistor Q<sub>1</sub> switches on quickly to turn Q<sub>2</sub> off. When the lock is regained, the amplifier output is negative and Q<sub>2</sub> is switched off slowly because of the large time constant R<sub>3</sub>C<sub>1</sub>.

### Balancing the loop

Except for C<sub>1</sub> and its associated circuitry, the two phase detectors and the filters are identical. You may have to adjust one of the current-setting resistors, R<sub>1</sub>, to compensate for bias-current differences in the two op amps.

The time constants of the loop filter may be changed either by adding resistance in series with R<sub>1</sub>, or capacitance in parallel with C. But adding resistance will increase the phase error for any given amplifier bias current. Adding capacitance leads to redistribution of charges in the integrator. But, because the capacitor is switched in very slowly through a FET acting like a time-varying resistor, this should not cause any problems.

Under steady-state conditions, the signal-to-noise ratio at the output of the loop is determined by the input S/N, reduced by the loop bandwidth (which can be as small as you want). However, when the input noise is very large and at low frequencies, the output of the monitoring phase detector may become positive, and switch off C<sub>1</sub>. This will cause sudden output jitter increase, and require a divider chain in front of the phase comparator to reduce the jitter.

To see whether the modified PLL method is worth the trouble, a comparison of three clock extraction methods is made in Table 1, which assumes an input bit rate of 1544 ± 0.25 kb/s, and a required lock range of 300 b/s. "Shop cost" includes hardware (using only commercially available components), and manual alignment for the resonant circuit.

Although Q should be large to minimize noise power, resonant circuits can only realize a Q of 70 to 100. Regular PLLs surpass even the best resonant circuit by a factor of 15, and a modified PLL is superior by at least another order of magnitude. The same ratios are reflected in the noise bandwidth. ■■

### References

1. Gardner, Floyd M., *Phase Lock Techniques*, John Wiley & Sons, New York, 1966, Chapter 2.
2. *Phase Lock Loop Data Book*, MC4344/4044, Motorola, Phoenix, AZ, August, 1973.
3. Bellisio, J. A., "A New Phase Locked Timing Recovery Method for Digital Regenerators," *ICC Conference Records*, June, 1976, p. 10.
4. Bennet, W. R., "Statistics of Regenerative Digital Transmission," *Bell System Technical Journal*, November, 1958, p. 1501.
5. Roza, Engel, "Analysis of Phase Locked Timing Extraction Circuit for Pulse Code Modulation," *IEEE Transactions on Communication*, September, 1974, p. 1236.

# Introducing the King of the Static RAM Family

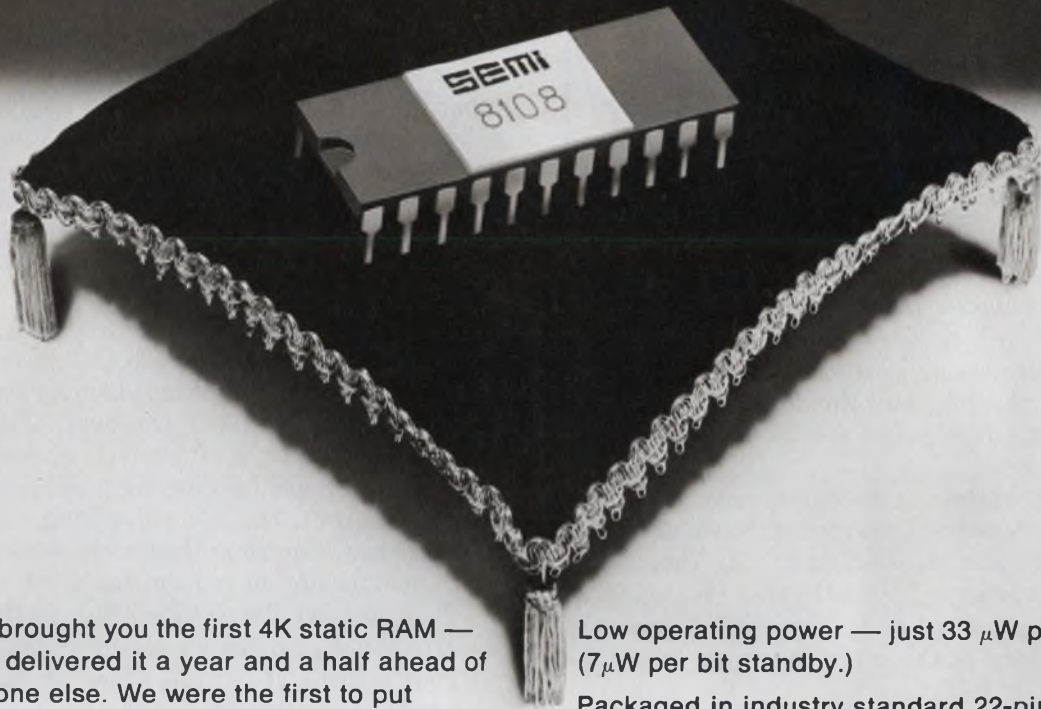

We brought you the first 4K static RAM — and delivered it a year and a half ahead of anyone else. We were the first to put it and its many descendents into volume production.

Now we'd like you to meet the new King of the Static RAMs . . . the 1K x 8, 300 nsec SEMI 8108. Look at his credentials!

A 1K Byte memory system in a single package.

300 nsec access time. The speed you'll need for microprocessor systems.

Low operating power — just 33  $\mu$ W per bit. (7 $\mu$ W per bit standby.)

Packaged in industry standard 22-pin DIP, for a 30% saving in board space over 18-pin 4K devices.

The new King will soon mount his throne to lead you to new design conquests. Call or write us for advance technical information.

## Memory at Work

 **SEMI, INC.**

A subsidiary of Electronic Memories & Magnetics Corp., 3883 N. 28th Ave., Phoenix, Arizona 85107 (602) 263-0202

**ALABAMA:** Gentry Associates, Huntsville 205/534-9771 • **ARIZONA:** EMM, Phoenix 602/263-0202 • **CALIFORNIA:** EMM, Hawthorne 213/644-9881; EMM, Los Alamitos 213/598-8705; EMM, Burlingame 415/692-4251; Varigon, El Segundo 213/322-1120 • **FLORIDA:** Gentry Assoc., Orlando 305/894-4401 • **GEORGIA:** Gentry Assoc., Atlanta 404/455-1206 • **ILLINOIS:** EMM, Des Plaines 312/297-7090 • **MASSACHUSETTS:** EMM, Lexington 617/861-9650 • **MINNESOTA:** EMM, Hopkins 612/933-7115 • **NEW JERSEY:** EMM, Cherry Hill 609/779-7911 • **NEW YORK:** EMM, Melville 516/423-5800 • **TEXAS:** EMM, Dallas 214/231-2539; Young Sales, Dallas 214/341-2900 • **WASHINGTON:** The Thorson Co., Bellevue 206/455-9180 • **CANADA:** Cantec, Ottawa 613/255-0363

# The minifloppy<sup>TM</sup> from number 1

**Proven in 35,000 installations  
and never more affordable.**

When we introduced our minifloppy, we frankly didn't expect the revolution that was about to happen. Now we've delivered 35,000 units and our production experience allows us to pass along a nice 15% price reduction. Naturally, we are flattered by the acceptance the little drive has received (and by all the imitations). There are a lot of good reasons why our minifloppy has been accepted as number 1.

**35 Tracks. A format with a future.** The minifloppy provides fast, random access to the industry accepted 35 recording tracks. This format will help you grow compatibly into double-density and double-sided recording when you are ready. The compact minidiskette<sup>TM</sup> media carries 100 KB of information.

**Reliable Storage.** The Shugart minifloppy drive has the proven mechanical reliability and data integrity of standard flexible disk drives. It reads and writes with the same glass bonded ferrite/ceramic head used in Shugart's standard-sized SA800 flexible disk drives. Die cast construction offers high mechanical integrity.

A DC drive motor with an integral tachometer eliminates AC power requirements. The unique stepping motor actuator uses a direct drive spiral cam with ball bearing V-groove positive indent. This assures perfect head registration every time.

**Data Integrity.** The Shugart minifloppy drive improves error rate by two orders of magnitude compared to cassettes. Soft errors are only one in 10<sup>4</sup>, and seek errors, one in 10<sup>6</sup>. Write protect circuitry prevents loss of recorded information. It's standard with every Shugart SA400.

The minidiskette media is recorded at 20% less density than our standard floppy. This generous safety margin is your assurance of data integrity and the lowest possible media

costs. **Maintainable Performance.**

Simple modular components reduce Mean-Time-To-Repair to minutes. The self-aligning head eliminates the need for head alignment

tools in the field.

**Inexpensive Storage.** Applying affordable floppy technology in a compact size reduces OEM and end user cost. Small drive size (5.75" wide, 3.25" high, and 9.0" deep) reduces total system cost. Low unit weight of three pounds.

Low power consumption. **The SA4400 ministreaker<sup>TM</sup> Controller.** The SA4400 ministreaker controller controls up to three minifloppy drives, providing up to 241.8 kilobytes of on-line data storage.

**Support.** Shugart has made the floppy smaller and product support bigger. We give you more support—systems design, technical service, documentation, and applications help. Two out of three OEM's specify Shugart. They get more experience, more technology, more support.

So talk to number one in low cost disk storage. Talk to Shugart.

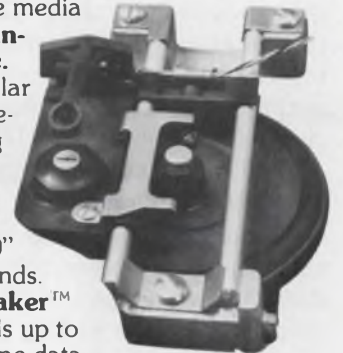

**The Leader  
In Low Cost  
Disk Storage**

 **Shugart Associates**

435 Oakmead Parkway, Sunnyvale, California 94086

Telephone: (408) 733-0100

West Coast Sales/Service: Telephone: (408) 252-6860

Midwest Sales: Telephone: (612) 786-4430

East Coast Sales/Service: Telephone: (617) 890-0808

Europe Sales/Service: 3, Place Gustave Eiffel, Silic 311

94588 Rungis, France Telephone: (1) 686-00-85

## Modulo-N counter speed

is limited by the counter module's propagation delays. But asymmetrical clock inputs can raise the speed substantially.

Because the modulo-N counter has many uses, learning how to push its operating frequency to the maximum can return dividends. The modulo-N counter is found in such important applications as frequency synthesizers, phase-lock loops and many logic-system timing circuits.

Although a bidirectional synchronous counter such as a 74193 has a typical maximum count-frequency rating of 32 MHz, in a modulo-N circuit the frequency is no better than about one-fifth of this value. But you can break through this limitation by using asymmetrical clock inputs.

### Modulo-N circuit revisited

In a simplified modulo-N counter (Fig. 1a), the input clock causes the 74193 modules to count down, toward zero.<sup>1</sup> When zero is reached, a borrow pulse propagates to the last module's borrow output on the negative-going edge of the clock. The borrow pulse then loads the counters with the number N from the data-input bus, and the cycle repeats. The over-all result is an output pulse train of narrow, negative spikes occurring at a frequency of 1/N times the input clock.

Note in the timing-diagram sequence (Fig. 1b) for a single-stage modulo-3 counter that the loading operation quickly resets the borrow pulse to form a sharp spike. However, this simplified timing sequence doesn't contain the information that can tell you the speed limitations of Fig. 1a. The propagation delays detailed in Table 1 must be taken into account. Note the wide spread of delays an individual 74193 counter unit can have.

To determine maximum operating frequency for a symmetrical input clock, examine the negative-going portion of the clock pulse that generates a borrow/load signal. Fig. 2 shows a two-module counter with a set of worst-case propagation delays.

For a counter to perform reliably, the circuit must provide a minimum 20 ns between the trailing edges of the load and a clock signal. The minimum  $T_N$  is (24 + 24 + 55 + 20), or 123 ns. Therefore, for a symmetrical clock signal, the total clock period is 246 ns, which corresponds to a maximum operating fre-

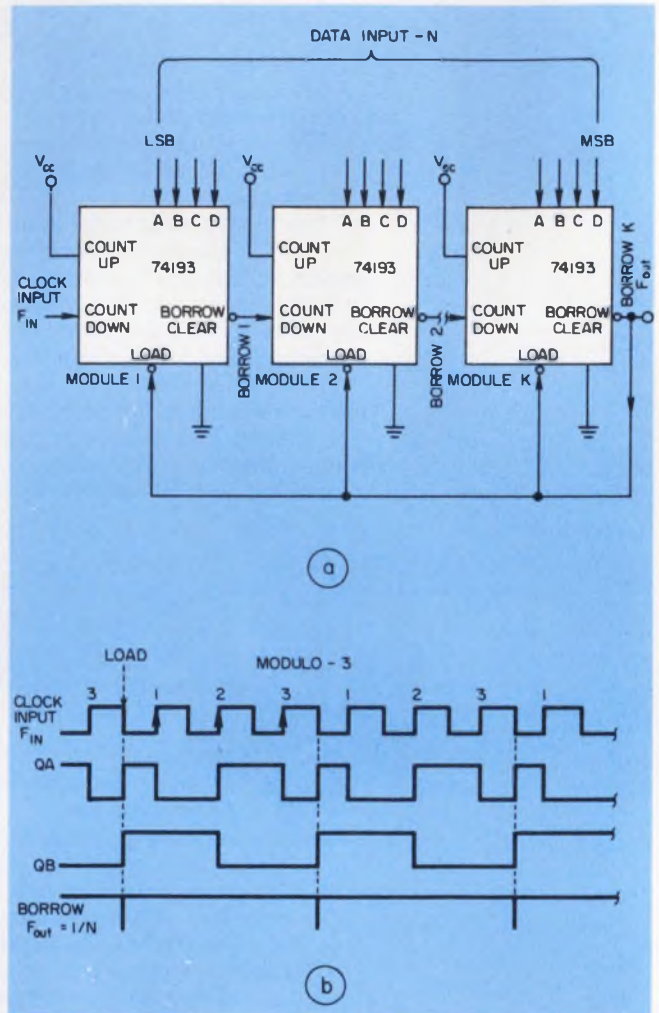

1. The simplified block diagram of a modulo-N counter chain (a) shows how borrow outputs propagate through the chain, when the chain counts down from N and reaches zero. The final borrow-output signal, K, then reloads the counter modules with N, which quickly resets the borrow signal so that the borrow signal is seen as only a narrow spike (b).

quency of 4.07 MHz. Generally, the minimum clock period for any number of counter modules is expressed by the following equation:

$$T = 2[K(T_{PCB}) + T_{PBL} + T_{LC}] \quad (1)$$

where

T = Total minimum symmetrical-clock half-period.

**Table 1. Switching characteristics of a 74193**

Parameter	From input	To output	Min	Typ	Max	Unit
$f_{max}$ (clock)			25	32	50	MHz
$t_{PLH}$ $t_{PHL}$	Count-down	Borrow	8 8	16 16	24 24	ns
$t_{PLH}$ $t_{PHL}$	Either count	Q	13 16	25 31	38 47	ns
$t_{PLH}$ $t_{PHL}$	Load	Q	14 15	27 29	40 40	ns
$t_{PHL}$	QA (output)	Borrow	5	10	15	ns
$t_{PLH}$	Load	Borrow	20	40	55	ns
* $t_w$ (width of any input pulse)			8	15	20	ns
* $t_{LC}$ (time between rise of load and rise of clock)			8	15	20	ns

\*to guarantee operation  
 $t_{PHL}$  = propagation delay for high-to-low level  
 $t_{PLH}$  = propagation delay for low-to-high level

**Table 2. Maximum operating frequency of a symmetrical input clock**

Number of counter modules (K)	Maximum operating frequency (MHz)		
	Minimum delays	Typical delays	Maximum delays
1	13.89	7.04	5.05
2	11.36	5.75	4.07
3	9.62	4.85	3.70
4	8.33	4.20	3.40
5	7.35	3.70	3.14
6	6.58	3.31	2.92

**Table 3. Maximum operating frequency with 20-ns positive clock pulses**

Number of counter modules (K)	Maximum operating frequency (MHz)		
	Minimum delays	Typical delays	Maximum delays
1	17.86	10.42	7.30
2	15.63	8.93	6.21
3	13.89	7.81	5.41
4	12.50	6.94	4.78
5	11.36	6.25	4.29
6	10.42	5.68	3.89

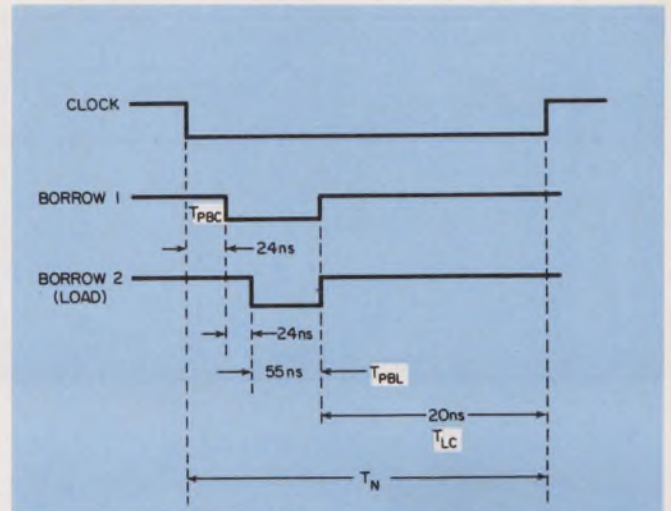

**2. Studying the timing details of the negative clock-signal interval reveals the series of delay times that limit the counting speed of a modulo-N circuit.**

- K = Number of modules.
- $T_{PCB}$  = Propagation delay, high-to-low level, of borrow output with respect to clock input signals.
- $T_{PBL}$  = Propagation delay, low-to-high level, of borrow output with respect to load-input signals.
- $T_{LC}$  = Minimum period between rise of load and rise of clock signals to guarantee operation.

Table 2 shows the results of solving Eq. 1 for minimum, typical and maximum values of the delays, but only the maximum-delay values can guarantee that all counter modules operate.

A test circuit for a one-module, modulo-8 divider built by this author operated properly up to an input clock rate of 13 MHz. From 13.7 to 24.8 MHz, however, the circuit consistently divided by 9. And between 13.0 and 13.7 MHz, the circuit divided by almost anything, with 11 and 15 predominating. The test was repeated for modulo-7 and achieved similar results. The 74193 used in this test apparently was faster than units classified as typical according to Tables 1 and 2.

The modulo-8 test results suggest that you can reliably operate a multimodule circuit in an N+1 mode at frequencies above the maximum. Unfortunately, by the time a minimum delay module starts to operate in an N+1 mode, Table 2 implies that another slower module would operate in an N+2 mode. So don't try to operate above the values in the maximum column in Table 2 for truly reliable performance.<sup>4</sup>

Another note of caution: Frequently, a symmetrical output pulse is required in modulo-N applications. Obviously, you should set the data inputs to N/2 and feed the Borrow/Load output signal to a flip-flop. Note in Table 1, however, that the width of a borrow/load

**Table 4. Maximum operating frequency with maximum circuit delays**

Number of counter modules (K)	Maximum operating frequency (MHz)			
	Symmetrical input	40-ns positive pulses	30-ns positive pulses	20-ns positive pulses
1	5.05	7.19	7.30	7.30
2	4.07	6.14	6.21	6.21
3	3.70	5.35	5.41	5.41
4	3.40	4.74	4.78	4.78
5	3.14	4.26	4.29	4.29
6	2.92	3.86	3.89	3.89

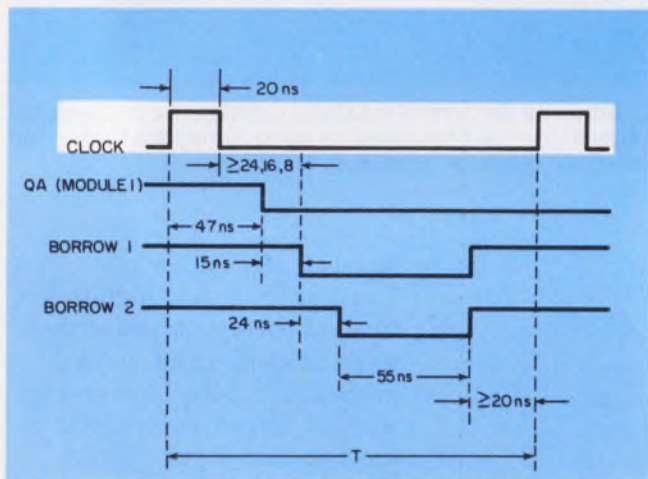

3. An asymmetrical clock signal allows you to operate a modulo-N circuit at a higher frequency than with a symmetrical clock.

pulse can range from 20 to 55 ns. The 20-ns value restricts the choice of flip-flops to high-speed units.

**For still higher frequencies**

But "shaping" the input clock signal can improve speed significantly over the values determined by Table 2 and Eq. 1. The high-level portions of the clock pulses needn't be as wide as the low—merely equal to, or greater than, 20 ns. However, when driving the modulo-N counter with 20-ns positive going pulses, the propagation delay from the QA output to the Borrow output of a module—15 ns max—must be considered. Fig. 3 shows a timing chart for a 2-module counter with a 20-ns positive-going pulse clock input and worst-case delays.

Fig. 3 shows that the total worst-case clock period, T, is (47 + 15 + 24 + 55 + 20), or 161 ns, which is a maximum operating frequency of 6.21 MHz. In general, the minimum clock period for a 20-ns positive-going clock pulse and maximum circuit delays is computed by

$$T_{\max 20} = 137 + (K-1)24 \text{ (ns)}, \quad (2)$$

where

$$137 = 47 + 15 + 55 + 20.$$

A similar analysis for typical and minimum delays results in

$$T_{\text{typ}20} = 96 + (K-1)16 \text{ (ns)}, \quad (3)$$

where

$$96 = (31 + 10 + 40 + 15).$$

Also,

$$T_{\min 20} = 56 + (K-1)8 \text{ (ns)}, \quad (4)$$

where

$$56 = (20 + 8 + 20 + 8).$$

The results of applying Eqs. 2, 3 and 4 are shown in Table 3. Again, only the maximum-delay column will guarantee operation for all modules.

Clock pulses generated by a 74121 one-shot can produce pulses in the 30-to-40-ns range. If used to drive a modulo-N counter, the equations for operating with these one-shot pulse widths are as follows:

For maximum circuit delay in nanoseconds,

$$T_{\max 30} = 137 + (K-1)24,$$

$$T_{\max 40} = 139 + (K-1)24.$$

For typical circuit delays,

$$T_{\text{typ}30} = 101 + (K-1)16,$$

$$T_{\text{typ}40} = 111 + (K-1)16.$$

For minimum circuit delays,

$$T_{\min 30} = 66 + (K-1)8,$$

$$T_{\min 40} = 76 + (K-1)8.$$

Applying these equations with maximum circuit delays, you get the results summarized in Table 4. The values listed guarantee that all the modules will operate. For reliable performance at higher frequencies, you must use faster counters, such as the ECL types, or you can use logic circuits that incorporate look-ahead-borrow techniques. ■

**References**

1. Morris, R.L. and Miller, J.R., *Designing with TTL Integrated Circuits*, McGraw-Hill, New York, 1971, p. 272.
2. "The TTL Data Book for Design Engineers, CC-411" First Edition, Engineering Staff of Texas Instruments, Components Group, Dallas, 1973, p. 333.
3. Some of the specifications were furnished by Ron Natali of Texas Instruments, Stafford, TX.
4. Buhler, O.R., "Stop Counter Errors," *Electronic Design*, Jan. 4, 1977, pp. 104-106.

# In this ever-changing world, Norplex integrity is ever constant.

Today's increasingly sophisticated circuitry demands reliable base materials—with high electrical values, dimensional stability, and consistent performance.

This is why so many makers and users of circuit boards around the world stake their reputations on Norplex base materials. They have complete faith that quality will never vary . . . will always meet, or exceed, all established specifications.

And if they require new product designs, they know their Norplex Technical Service Representative is a qualified consultant in this highly specialized field. And that Norplex will

develop and produce the base materials to their specifications.

No other manufacturer of base materials can offer you the Norplex combination of services that includes research/engineering experience, technical resources, and quality assurance.

At Norplex, integrity is more than a word. It's a state of mind.

Norplex Division, UOP Inc. U.S. operations: LaCrosse, Wisconsin (World Headquarters); Black River Falls, Wisconsin; Franklin, Indiana; Postville, Iowa. European Headquarters: Wipperfurth, West Germany. Pacific Headquarters: Kowloon, Hong Kong.



Norplex laminates  
by **UOP**

## Collect data via pulse-code modulation

in your next data-acquisition system. PCM handles bandwidths of 5 kHz, has a high s/n ratio and permits data manipulation.

In a data-acquisition system, analog signals with bandwidths below 5 kHz are often best handled with pulse-code modulation (PCM) techniques. Above 5 kHz, other ways to handle analog data, such as direct recording and frequency-modulated recording, have their own advantages, depending on the number of channels, the frequency range of the signals and the required accuracy of the recorded data.

Below 5 kHz, however, PCM offers many advantages: data are stored in digital form, thus guaranteeing accurate reproduction of recorded signals; the signal-to-noise ratio is better than 70 dB (about double that of many FM or direct recording methods); and the accuracy of recorded information is within 0.1% (about an order of magnitude better than most other methods).<sup>1</sup>

PCM requires that analog signals be sampled at regular, discrete intervals and that the signal amplitudes be coded into a digital format (Fig. 1). Even though most data-acquisition applications are analog, to maintain accuracy and ease data manipulation, you are better off encoding the data digitally before recording. You also ensure that the desired signals are truly recorded and regenerated. PCM systems are typically 0.1 to 0.025% accurate—or even better, depending on the converter used.

### PCM permits data manipulation

Since the data are stored digitally, a great deal of manipulation and control can be performed via digital techniques. Thus, a complete data-acquisition system, possibly microprocessor controlled, will contain the following features:

- Automatic or manual operation.
- Autoranging for analog inputs.
- Basic accuracy of at least 0.1%.
- Input capacity of at least four channels, but preferably more. (Channel capacity should be expandable.)
- Accurate timing to keep track of data.
- Incremental or continuous recording for good I/O capability.

The circuits that handle and control data flow can

**Stan Yalof**, President, and **Don Gregg**, Principal Engineer, Tetrahedron Associates, 7605 Convoy Ct., San Diego, CA 92111.

be broken down into four major building blocks:

1. Analog-signal handling, which includes the multiplexer.
2. Digitizing, which includes sample/hold amplifier (if used), a/d converter and autoranging circuits.
3. Addressing and timing, which includes clock and parity generation circuits.
4. Recording and transmitting, which includes the tape-drive and line drive circuitry and the motor control.

A basic data-acquisition system is outlined in Fig. 2. Many different companies offer subsystem compo-

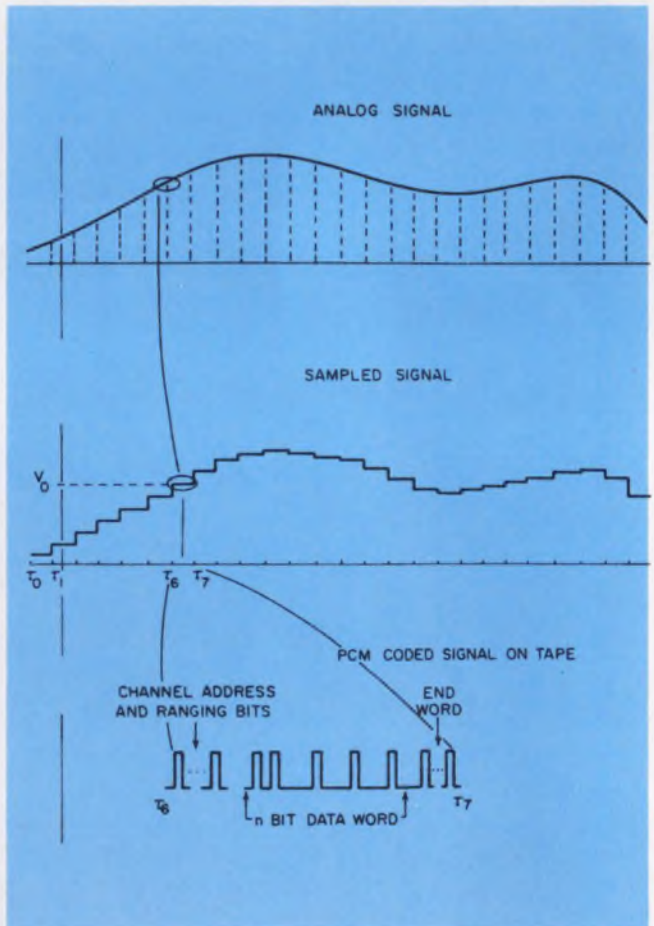

1. **Encoding an analog signal into digital form**, PCM techniques provide the accuracy necessary to guarantee true reproduction of the analog signal when it's played back. Digital encoding also permits the data to be manipulated easily for expansion or compression.





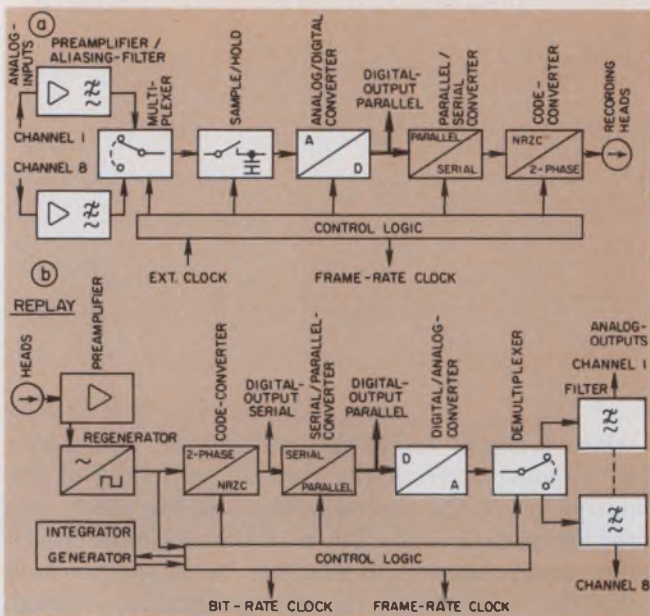

3. Converting the analog input data to serial digital format, the input circuitry of the data-acquisition system (a) multiplexes the inputs, samples them, converts them to digital form, then serializes and encodes the data. To decode the data stored on magnetic tape, the entire recording process must be done in reverse (b).

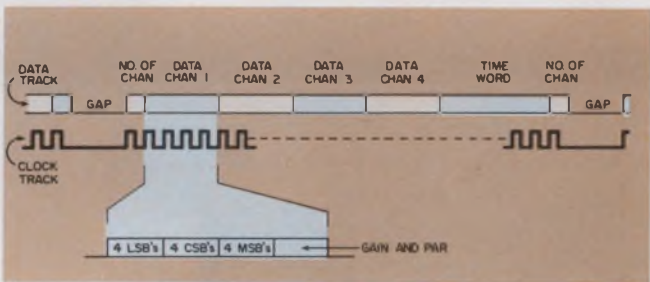

4. One frame of digital data consists of a header to define the number of channels, the time code, a data word from each channel, and an end-of-frame indicator.

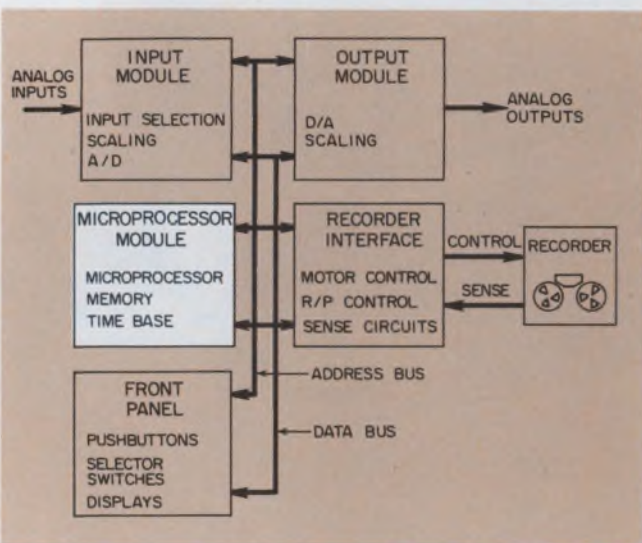

5. Organized around the data and address buses of the microprocessor-based controller, all sections of the data-acquisition system are treated as memory locations to simplify access and reduce hardware.

automatic-ranging code label. Once labeled, the word gets a timing-address code, a parity bit and if necessary, an end-of-word label.

The entire recording process is shown in Fig. 3a. Each completed word is sent on to the recording circuitry where it is placed on tape usually in the form of flux reversals. Again, there are many ways to format data, but one way to keep the circuitry simple is to record four bits at a time and use a separate clock track for timing.

### To recover the data, reverse the process

Recovering data is almost the exact reverse of recording, except that the clock is sensed to synchronize the reading of data (Fig. 3b). Flux reversals on the clock track are sensed and used to synchronize detection and storage of data on each track. If a flux reversal is sensed on a data track, a ONE is stored; if no reversal is sensed, a ZERO is stored—at least, that's the scheme used by Tetrahedron in the Data Manager data-acquisition system.

For data to be read from the tape, the gap between frames must first be sensed. This gap, just an absence of a clock signal over a short section of tape, indicates that no data are stored in that section of the tape and must be used when performing incremental recording. A frame is a complete sweep of all channels recorded on the tape, including the header, time information, channel data and end-of-frame signal (Fig. 4).

Before being passed on to the output circuits, data in each frame are examined to see if the following three questions can be answered affirmatively:

- Is parity met?
- Is the number of channels listed at the beginning the same as the number at the end?
- Is the number of clock pulses correct for the number of channels recorded?

To recover the data you want, use a frame sensor and set the control circuits to capture, say, the third word of every frame.

A microprocessor can perform the timing and control operations for both the data-recording and recovery sequences. For one possible  $\mu$ P-based organization, check Fig. 5. This system is bus-organized and based on a 6800  $\mu$ P, which treats the I/O sections, tape recorder and front panel as memory locations. The control panel for the system (Fig. 6) is also treated as memory—the status of all switches read into the  $\mu$ P control module under software control and the displays that indicate time and other functions can be controlled by the processor as if they were memory locations.

A typical input board for the system contains a 16-channel multiplexer, a digitally controlled amplifier, a high-speed 12-bit a/d converter as well as the necessary gain-control logic and output registers (Fig. 7). A 74LS138, acting as an address decoder, initializes the gain to 1, selects the proper input channel, enables the output data bus and starts the a/d conversion.



6. The front panel for a data-acquisition system typically has control switches to define the number of channels, the scan rate, the step time and many other control functions such as those for the recorder.

With a fast a/d converter, you won't need a sample-and-hold amplifier since the signal to be converted is a relatively slow changing level compared to the a/d conversion time. The correct gain setting is the gain causing the encoded output to have a logic ONE in the most-significant-bit position (not including the sign-bit position).

Determining the correct gain usually takes two steps: First, set the gain to unity and have the a/d converter perform a conversion. Then the higher-order bits of the absolute value of the encoded output are examined by a priority encoder to determine how many binary ( $\times 2$ ) increases in gain are required to make the MSB a logic ONE. The gain setting on the input amplifier is changed by the required amount and the a/d converter then performs another conversion.

The output module operates in the reverse sequence—the digital data from the tape are restored to a full parallel format, then fed into a 12-bit d/a converter (Fig. 8). The converter's output, in turn, feeds a programmable-gain amplifier that provides the desired signal levels. A 74LS138 selects the proper register for accepting data, with the first byte selecting the MSBs and the scaling coefficient. This process is performed for both X and Y outputs, but not for the time scale, which has only the LSB and MSB bytes but no scaling coefficient.

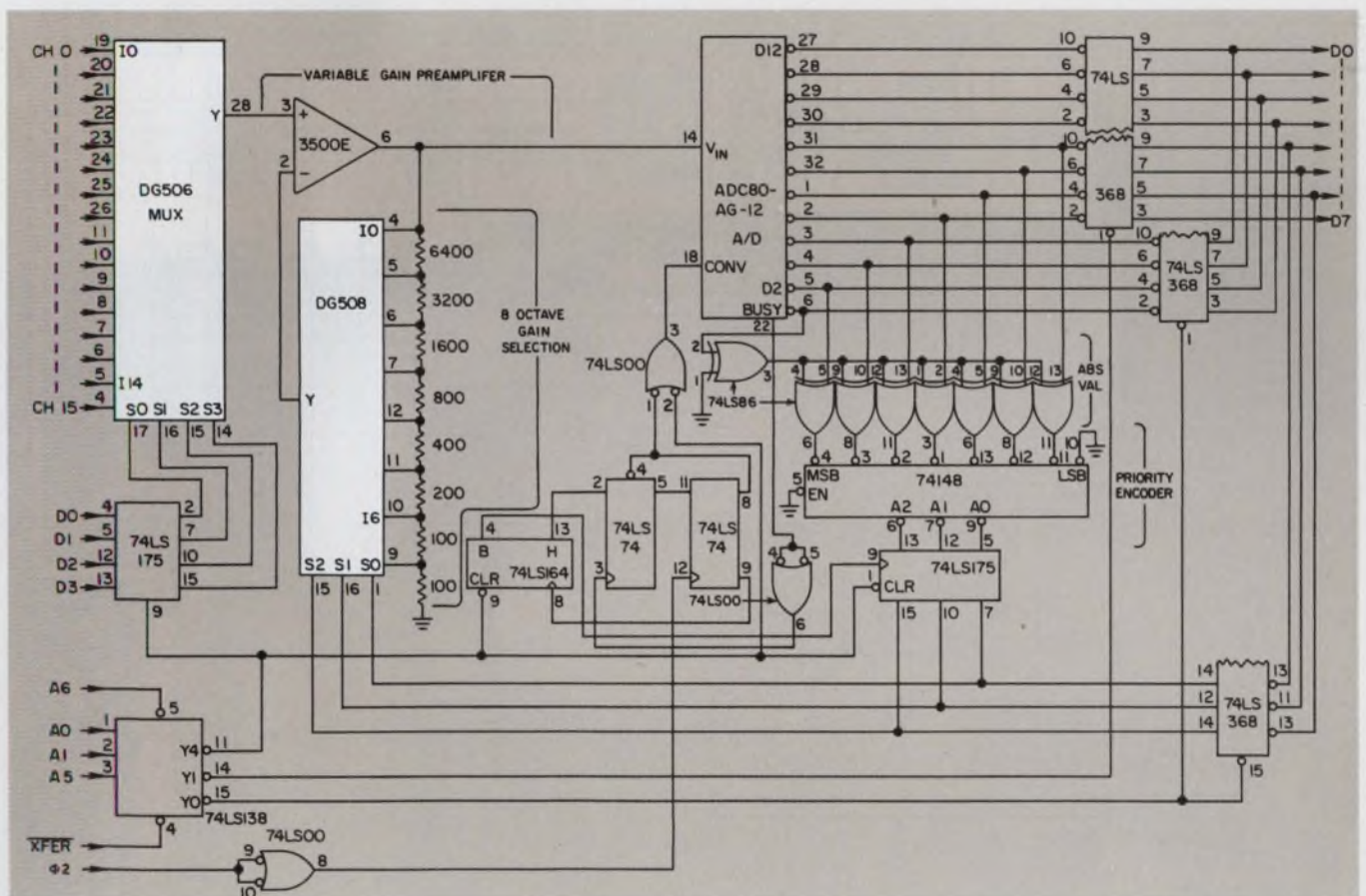

7. Handling analog inputs from microvolts to volts, the 14-channel analog input module contains a program-

mable-gain amplifier, a high-speed 12-bit a/d converter and, of course, the multiplexer.



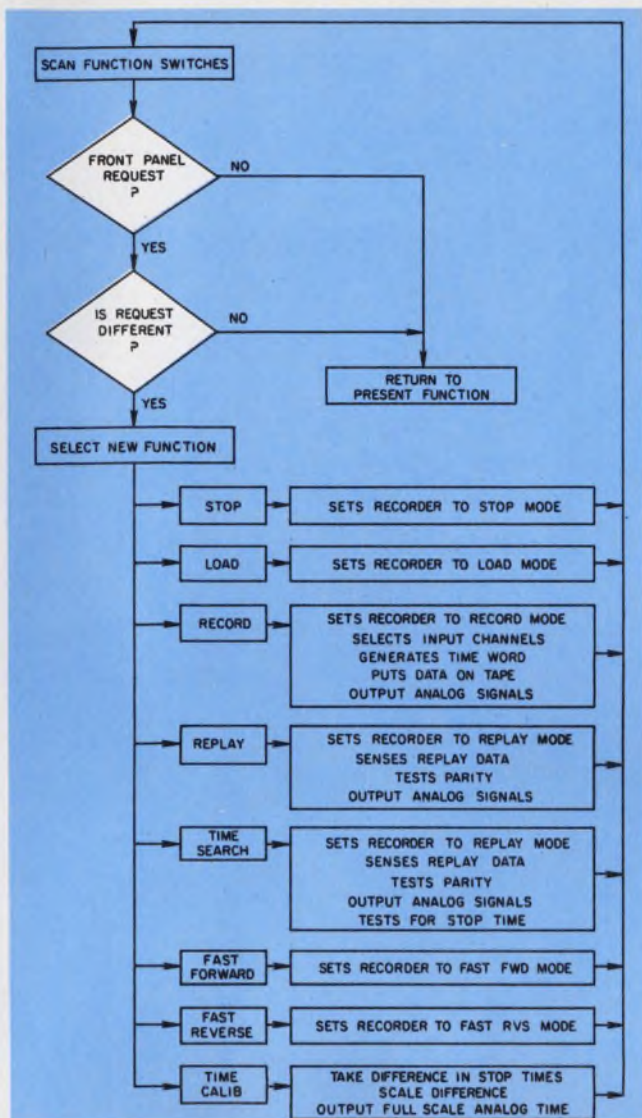

10. To control a data-acquisition system, the 6800-based controller must follow a routine like this one to examine the front panel and follow the commands.

Coordinating all the functions of the data-acquisition system, the  $\mu\text{P}$  control section contains the control memory, the processor, the serial and parallel control lines and all the timing circuitry (Fig. 9).

### A complex task becomes routine

Under ROM control, the 6800-based system performs the complex task of monitoring the front-panel controls and performing the indicated functions (Fig. 10). Each switch and display on the front panel has a unique address and can be accessed by the  $\mu\text{P}$  when an address is loaded onto the address bus. When a switch is accessed the setting is loaded onto the data bus for the  $\mu\text{P}$  to read. When addressing a display, the  $\mu\text{P}$  loads the contents of the data bus into the respective display register that, in turn, feeds a driver.

The system front panel should contain all controls and displays necessary for complete manual operation. On the Data Manager, the front panel is divided

into three primary functions: Record, Replay and Time Search, and three secondary functions: Time Display, Offset and Time Calibrate. The Record function samples the selected number of analog input channels at the selected scan rate, autoranges the sample, digitizes the sample and records the data on tape. The signal is also reconverted into an analog signal that is available on a rear-panel jack.

The Replay function runs the magnetic tape in the direction selected, reads a block of data at the selected replay rate, tests the parity bit, and checks for an error. Then it outputs the data to the converter section for restoration to the analog form, and the time information to the time display. For the Time Search function, which is similar to the Replay, the tape is read at maximum R speed. Replay will stop when the corresponding selected stop time is read from the tape.

Additional control is supplied by the secondary functions. The Time Display shows the time word corresponding to each update of analog output signals. The time word represents the time each sample was taken, in seconds, during a Record operation. Initialization of the time to zero occurs when a Record operation is initiated, and increments occur at the selected scan rate.

To add a voltage offset to an analog signal, the Offset adjustment can be used to set a predetermined level to the output jack. Even time can be scaled—the Time Calibrate function scales the time analog output to the difference between the forward and reverse stop times. This “scaling” permits the operator to fit the data within the selected time interval for a particular recorder. The scaling also sets the reverse stop time to 0 V, and the forward stop time to between +5 and +10 V dc.

The processor section also controls the tape-unit interface. Two sets of signals are fed to the tape mechanism—the basic control sense lines and, of course, the data lines. Control signals activate the stepper motor, tension motors, solenoid and indicator lamps. Signals generated by the mechanism include status flags to the  $\mu\text{P}$  controller (file protect, cartridge in place, solenoid lifted, and end of tape) to help the processor in its decision-making routines.

Information can be collected, collected, and collected. But then what do you do with it? By taking advantage of PCM's high accuracy and reproducibility, data stored in one channel can be compared, scaled and compared, or reproduced at any time and compared with previously collected data without any errors. Fast or slow data can be replayed at either low or high speeds, for time expansion or compression, without sacrificing any accuracy. For example, the stress profile of a tanker ship, taken over several months, versus all pertinent collected variables can be compressed into a single graphic presentation within minutes. ■■

### References

1. Yalof, Stan, “Curb Analog Data Errors with PCM,” *Electronic Design*, June 7, 1974, pp. 124-127.



# ALL UNITRODE MAKES ARE POWER SEMICONDUCTORS. WE HAVE TO MAKE THEM BETTER.

Unitrode makes power semiconductors. Period.

And when a company's income relies totally on only one area of semiconductors, it better make them better than anyone else.

We do.

Take ultra-fast rectifiers. Our UES series gives you the lowest forward voltage drop in the industry: .7V at rating. Plus 15ns forward recovery, 30ns reverse. Plus thermal resistances of 0.6°C/W for the DO-5, 0.8°C/W for the TO-3, and 1.2°C/W for the DO-4. And operating junction temperatures of 175°C. All this performance is available in ratings from 2.5-70A and up to 150V.

Take our unique PIC600 switching regulator power output circuits. A whole power circuit – already designed and built – for less than the price of its individual parts. To save you time in design, breadboarding, and debugging – as well as money.

Take our Barrier™ NPN power switching transistors. Ours give you half the fall times of conventional designs. And three times better  $E_{s/10}$  with ratings up to 400V.

Take our exclusive ChipStrate® thyristors. The revolutionary packaging concept for power SCRs and Triacs that bettered the form factor and lowered the

cost. The line covers 3 to 55A and up to 800V.

Take power PIN diodes. Ours can withstand up to 1000V, with the power to switch up to 5KW thanks to thermal resistance as low as 4°C/W and series resistance as low as 0.2Ω.

Take our JAN-qualified 2N5660 series of state-of-the-art power switching transistors. They give you the best combination of high voltage, fast switching, and low leakage in the industry.

But a better product isn't enough in this business. We have to do a better job of getting it to market.

So with Unitrode you'll never have to pay state-of-the-art prices for state-of-the-art semiconductors. We have one of the most competitive pricing policies you'll find.

Come to Unitrode for your power semiconductor needs.

And find out just how good a power semiconductor company can be.

For our "Semiconductor Selection Guide", circle the reader service number.

For a free copy of our 496-page "Semiconductor Databook", just call or write: Unitrode Corporation, 580 Pleasant Street, Watertown, MA 02172. Tel. 617-926-0404.

Barrier™ is a trademark of Unitrode Corporation

CIRCLE NUMBER 48



UNITRODE

## IN SEMICONDUCTORS, UNITRODE MEANS POWER.

© Copyright Unitrode Corporation 1978

## Multilayer coil design is made easy with a programmable calculator. Not only are AWG numbers provided, but also wire material and tempco can be changed.

Multilayer coil design is laborious when done with tables, charts and complicated formulas.<sup>1,2,3</sup> But now a programmable calculator like the TI-59 can handle the large number of steps needed to provide comprehensive calculations for rectangular and circular multilayer coils. Although the equations (Fig. 1) relating inductance to number of turns, dimensions, wire size, resistance and temperature are complicated, the program makes them easy to implement.

With its 795 steps, the TI-59 program can design a coil of a desired inductance, resistance or number of turns, given its dimensions. Also, the program selects the American Wire Gauge (AWG) number for the wire that will fill the coil's window and yield the maximum inductance possible for a given resistance, or the minimum resistance for a given inductance. In addition, the program can compute temperature effects on resistance and the effect of using wire materials other than copper.

### The program's easy to use

To run the program, just enter the dimensions of the bobbin as in step 3 of the sequence (see table). Enter the known item—the inductance, the number of turns or the resistance—into labels A, B or C, respectively. After a few seconds the calculator displays the first of the three unknowns. The remaining answers are obtained, thereafter, by pressing R/S (steps 4a, 4b or 4c) until you have solved all the unknown parameters, including the AWG number.

Note that circular and rectangular coils have the same sequence, but rectangular calculations are performed with labels \*A', \*B', and \*C'. And when the calculator is connected to a PC-100A printer, all values are printed and identified by name.

Furthermore, you don't have to press R/S to obtain the next answer; R/S is activated automatically as answers are printed. The program "knows" when the calculator is attached to the printer, and consequently doesn't halt after each intermediate answer. This programming sequence, which incidentally can be helpful in other TI-59 programs, is contained in steps

Thomas B. Gross, Consultant, T.A.O. Gross and Associates, Lincoln, MA 01773.

**CIRCULAR COILS**

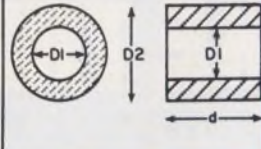

N = number of turns

$$K_n = \frac{1}{1 + 9(r/d) + .32(t/r) + .84(t/d)}$$

$r = (D_1 + D_2)/4$        $t = D_2 - D_1$   
 $D_1$  = inner diameter in cm  
 $D_2$  = outer diameter in cm  
 $d$  = length of coil in cm

$$L = K_n \frac{4\pi^2 r^2 N^2}{d} 10^{-9} \text{ (henrys)}$$

---

**RECTANGULAR COILS**

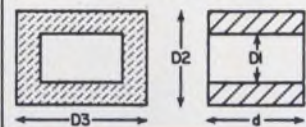

$g = \sqrt{D_2^2 + D_3^2}$   
 $c = D_2 - D_3$   
 $D_1$  = shorter length (cm)  
 $D_2$  = shorter length (cm)  
 $D_3$  = longer length (cm)

$$L = 0.00921(D_2 + D_3)N^2 \left[ \log_{10} \frac{2D_2D_3}{c+d} - \frac{D_2}{D_2 + D_3} \log_{10}(D_2 + g) - \frac{D_3}{D_2 + D_3} \log_{10}(D_3 + g) \right] + 0.004(D_2 + D_3)N^2 \left[ \frac{2g}{D_2 + D_3} - \frac{1}{2} + 0.447 \frac{(c+d)}{(D_2 + D_3)} \right] \text{ (henrys)}$$

---

Wire resistance in ohms at 20 C is

$$R = \rho L/A$$

$L$  = length in cm  
 $A$  = area in cm<sup>2</sup>  
 $\rho$  = resistivity ( $\Omega$ -cm at 20 C)

Resistance of a wire at a temperature other than 20 C is

$$R_t = R_{20} (1 + \alpha (t - 20))$$

$\alpha$  = temperature coefficient of metal at 20 C.

---

The American Wire Gauge number is related to wire cross-sectional area by

$$(\text{AWG}) \approx -10 \left( \log \frac{\text{C.M.}}{100,000} \right)$$

C.M. = cross-sectional area in circular mils

1. **Multilayer-coil inductance equations** for round and rectangular coils are too complicated and time-consuming to solve manually. The work becomes even more difficult if you also calculate coil resistance for any metal at any temperature, and then get answers in AWG numbers. But a calculator makes it all easy.



## Sequence of operations

1. **Partition calculator**  
Enter 2 Press 2nd \*Op 17 Display 799.19
2. **Load both cards:** all four sides
3. **Enter bobbin dimensions** in cm:  
Enter  $D_1$  Press D Display  $D_1$   
Enter  $D_2$  Press 2nd \*D' Display  $D_2$   
Enter  $d$  Press E Display  $d$   
(and for rectangular coils:)  
Enter  $D_3$  Press 2nd \*E' Display  $D_3$
- 4a. **Enter inductance (L)** in henrys:  
For circular coils Press A  
For rectangular coils Press 2nd \*A'  
Display (N)  
\*\*Press R/S Display (AWG)  
\*\*Press R/S Display (OHMS)
- 4b. **Enter number of turns (N):**  
For circular coils Press B  
For rectangular coils Press 2nd \*B'  
Display (L) henrys  
\*\*Press R/S Display (AWG)  
\*\*Press R/S Display (OHMS)
- 4c. **Enter resistance** in ohms:  
For circular coils Press C  
For rectangular coils Press 2nd \*C'  
Display (AWG)  
\*\*Press R/S Display (N)  
\*\*Press R/S Display (L) henrys

°°Performed automatically when used with PC-100A printer

## Program constants and codes

Registers	Contents	Comments
00	0.4	space factor
01	$D_1$	
02	$D_2$	
03	$D_3$	
04	$d$	
05	(used)	
06	(used)	
07	1.	relative resistivity of copper
08	1.724137931	resistivity of copper at 20 C ( $\mu\Omega\text{-cm}$ )
09	0.00393	temperature coefficient of copper
10	20.	temperature °C.
11	16021530.	"D1CM"
12	16031530.	"D2CM"
13	16041530.	"D3CM"
14	27001530.	"L CM"
15	32233036.	"OHMS"
16	55275623.	"(L)H"
17	134322.	"AWG"
18	(used)	
19	(used)	

280 through 289 of the program.

To enter the program into the calculator, you first partition the calculator. In the calculator's notation, 20 registers for data (00 to 19) and 800 registers for the program (000 to 799) appear as 799.19 on the

calculator's display. You obtain this partitioning by pressing keys 2, 2nd, \*Op 17, in that order. A space factor is put into data register 00, and the other constants and alphanumeric codes used in the program are put into registers 07 to 17 (see table of

000	98	ADV	055	12	B	110	01	01	165	91	R/S	220	71	SBR
001	98	ADV	056	71	SBR	111	13	13	166	71	SBR	221	06	06
002	98	ADV	057	03	03	112	91	R/S	167	07	07	222	31	31
003	91	R/S	058	07	07	113	71	SBR	168	62	62	223	81	RST
004	76	LBL	059	65	x	114	05	05	169	81	RST	224	76	LBL
005	13	C	060	71	SBR	115	77	77	170	76	LBL	225	14	D
006	71	SBR	061	04	04	116	81	RST	171	18	C'	226	42	STO
007	03	03	062	17	17	117	76	LBL	172	71	SBR	227	01	01
008	65	65	063	87	IFF	118	17	B'	173	03	03	228	25	CLR
009	53	(	064	07	07	119	71	SBR	174	65	65	229	43	RCL
010	43	RCL	065	00	00	120	06	06	175	43	RCL	230	11	11
011	02	02	066	68	68	121	31	31	176	03	03	231	69	DP
012	33	X <sup>2</sup>	067	91	R/S	122	87	IFF	177	65	x	232	04	04
013	75	-	068	71	SBR	123	07	07	178	43	RCL	233	43	RCL
014	43	RCL	069	05	05	124	01	01	179	02	02	234	01	01
015	01	01	070	54	54	125	27	27	180	65	x	235	69	DP
016	33	X <sup>2</sup>	071	87	IFF	126	91	R/S	181	43	RCL	236	06	06
017	54	)	072	07	07	127	71	SBR	182	04	04	237	91	R/S
018	65	x	073	00	00	128	07	07	183	75	-	238	76	LBL
019	89	π	074	76	76	129	62	62	184	43	RCL	239	19	D'
020	65	x	075	91	R/S	130	81	RST	185	01	01	240	42	STO
021	43	RCL	076	71	SBR	131	76	LBL	186	65	x	241	02	02
022	04	04	077	05	05	132	16	A'	187	43	RCL	242	25	CLR
023	55	+	078	77	77	133	71	SBR	188	04	04	243	43	RCL
024	04	4	079	81	RST	134	03	03	189	65	x	244	12	12
025	65	x	080	76	LBL	135	93	93	190	53	(	245	69	DP
026	71	SBR	081	11	A	136	55	+	191	43	RCL	246	04	04
027	04	04	082	71	SBR	137	53	(	192	03	03	247	43	RCL
028	28	28	083	03	03	138	71	SBR	193	75	-	248	02	02
029	87	IFF	084	93	93	139	06	06	194	71	SBR	249	69	DP
030	07	07	085	55	+	140	59	59	195	03	03	250	06	06
031	00	00	086	71	SBR	141	85	+	196	31	31	251	91	R/S
032	34	34	087	04	04	142	71	SBR	197	54	)	252	76	LBL
033	91	R/S	088	85	85	143	07	07	198	95	=	253	15	E
034	71	SBR	089	95	=	144	32	32	199	65	x	254	42	STO
035	03	03	090	34	IX	145	54	)	200	71	SBR	255	04	04
036	39	39	091	95	=	146	65	x	201	04	04	256	25	CLR
037	55	+	092	22	INV	147	01	1	202	28	28	257	43	RCL
038	71	SBR	093	52	EE	148	52	EE	203	87	IFF	258	14	14
039	03	03	094	58	FIX	149	09	9	204	07	07	259	69	DP
040	56	56	095	00	00	150	95	=	205	02	02	260	04	04
041	87	IFF	096	42	STO	151	34	IX	206	08	08	261	43	RCL
042	07	07	097	05	05	152	95	=	207	91	R/S	262	04	04
043	00	00	098	69	DP	153	58	FIX	208	71	SBR	263	69	DP
044	46	46	099	06	06	154	00	00	209	03	03	264	06	06
045	91	R/S	100	87	IFF	155	22	INV	210	39	39	265	91	R/S
046	71	SBR	101	07	07	156	52	EE	211	55	+	266	76	LBL
047	03	03	102	01	01	157	69	DP	212	71	SBR	267	10	E'
048	07	07	103	05	05	158	06	06	213	03	03	268	42	STO
049	65	x	104	91	R/S	159	42	STO	214	56	56	269	03	03
050	71	SBR	105	71	SBR	160	05	05	215	87	IFF	270	25	CLR
051	04	04	106	95	05	161	87	IFF	216	07	07	271	43	RCL
052	17	17	107	54	54	162	07	07	217	03	03	272	13	13
053	81	RST	108	87	IFF	163	01	01	218	20	20	273	69	DP
054	76	LBL	109	07	07	164	66	66	219	91	R/S	274	04	04

Program Constants and Codes). They are permanently recorded, along with program steps 000 to 794, in banks 1 to 4 of two magnetic cards.

Unless instructed otherwise, the program assumes that the coil is wound with annealed copper having

double-film insulation. Also, the program assumes that the resistance entered is the value at 20 C. But you can easily adjust the program from the keyboard for other types of metal and change the space factor or temperature simply by storing new values in the

275	43	RCL	330	92	RTN	385	06	06	440	55	+	495	85	+
276	03	03	331	53	(	386	25	CLR	441	01	1	496	43	RCL
277	69	DP	332	43	RCL	387	43	RCL	442	00	0	497	01	01
278	06	06	333	02	02	388	17	17	443	00	0	498	54	)
279	91	R/S	334	75	-	389	69	DP	444	95	=	499	55	+
280	53	(	335	43	RCL	390	04	04	445	34	FX	500	04	4
281	02	2	336	01	01	391	54	)	446	65	x	501	54	)
282	00	0	337	54	)	392	92	RTN	447	04	4	502	42	STD
283	69	DP	338	92	RTN	393	53	(	448	55	+	503	18	18
284	07	07	339	53	(	394	42	STD	449	89	π	504	33	X²
285	69	DP	340	71	SBR	395	05	05	450	95	=	505	55	+
286	19	19	341	03	03	396	71	SBR	451	34	FX	506	43	RCL
287	25	CLR	342	31	31	397	02	02	452	54	)	507	04	04
288	54	)	343	65	x	398	80	80	453	53	(	508	55	+
289	92	RTN	344	05	5	399	43	RCL	454	53	(	509	01	1
290	53	(	345	00	0	400	16	16	455	53	(	510	52	EE
291	53	(	346	65	x	401	69	DP	456	42	STD	511	09	9
292	01	1	347	43	RCL	402	04	04	457	06	06	512	55	+
293	85	+	348	04	04	403	43	RCL	458	55	+	513	53	(
294	43	RCL	349	65	x	404	05	05	459	93	.	514	01	1
295	09	09	350	43	RCL	405	52	EE	460	00	0	515	85	+
296	65	x	351	00	00	406	69	DP	461	02	2	516	93	.
297	53	(	352	55	+	407	06	06	462	05	5	517	09	9
298	43	RCL	353	89	π	408	25	CLR	463	04	4	518	65	x
299	10	10	354	54	)	409	03	3	464	54	)	519	43	RCL
300	75	-	355	92	RTN	410	01	1	465	33	X²	520	18	18
301	02	2	356	53	(	411	69	DP	466	55	+	521	55	+
302	00	0	357	43	RCL	412	04	04	467	01	1	522	43	RCL
303	54	)	358	06	06	413	43	RCL	468	52	EE	523	04	04
304	54	)	359	33	X²	414	05	05	469	05	5	524	85	+
305	54	)	360	55	+	415	54	)	470	54	)	525	93	.
306	92	RTN	361	04	4	416	92	RTN	471	28	LOG	526	03	3
307	53	(	362	95	=	417	53	(	472	65	x	527	02	2
308	42	STD	363	54	)	418	71	SBR	473	01	1	528	65	x
309	05	05	364	92	RTN	419	04	04	474	00	0	529	53	(
310	71	SBR	365	53	(	420	85	85	475	94	+/-	530	71	SBR
311	02	02	366	42	STD	421	95	=	476	95	=	531	03	03
312	80	80	367	05	05	422	22	INV	477	22	INV	532	31	31
313	03	3	368	71	SBR	423	58	FIX	478	52	EE	533	55	+
314	01	1	369	02	02	424	69	DP	479	58	FIX	534	02	2
315	69	DP	370	80	80	425	06	06	480	00	00	535	54	)
316	04	04	371	43	RCL	426	54	)	481	69	DP	536	42	STD
317	43	RCL	372	15	15	427	92	RTN	482	06	06	537	19	19
318	05	05	373	69	DP	428	53	(	483	54	)	538	55	+
319	69	DP	374	04	04	429	43	RCL	484	92	RTN	539	43	RCL
320	06	06	375	43	RCL	430	08	08	485	53	(	540	18	18
321	35	CLR	376	05	05	431	65	x	486	04	4	541	85	+
322	43	RCL	377	55	+	432	43	RCL	487	65	x	542	93	.
323	16	16	378	71	SBR	433	00	00	488	89	π	543	08	8
324	69	DP	379	02	02	434	55	+	489	33	X²	544	04	4
325	04	04	380	90	90	435	43	RCL	490	65	x	545	65	x
326	43	RCL	381	95	=	436	05	05	491	53	(	546	43	RCL
327	05	05	382	48	EXC	437	65	x	492	53	(	547	19	19
328	33	X²	383	05	05	438	43	RCL	493	43	RCL	548	55	+
329	54	)	384	69	DP	439	07	07	494	02	02	549	43	RCL

appropriate data registers.

For example, to design a coil wound with aluminum wire, change either the relative resistance in register 07 to 1.64, or the resistivity to  $2.62 \mu\Omega\text{-cm}$  in register 08, but not both. And you can change the temperature in register 10 to investigate the effects of temperature changes.■

### References

1. Welsby, V. G., *The Theory and Design of Inductance Coils*, Macdonald & Co., London, 1960, pp. 42-44.
2. *Circular of the National Bureau of Standards C74*, Washington, 1937, p. 265.
3. "Copper Wire Tables," *National Bureau of Standards Handbook 100*, 1966, pp. 7 and 14.

550	04	04	605	54	)	660	09	9	715	54	)	770	91	R/S
551	54	)	606	33	X <sup>2</sup>	661	93	.	716	28	LOG	771	43	RCL
552	54	)	607	55	+	662	02	2	717	75	-	772	15	15
553	92	RTN	608	89	π	663	01	1	718	43	RCL	773	69	DP
554	53	(	609	65	x	664	65	x	719	03	03	774	04	04
555	25	CLR	610	43	RCL	665	53	(	720	65	x	775	22	INV
556	43	RCL	611	07	07	666	53	(	721	53	(	776	58	FIX
557	17	17	612	65	x	667	43	RCL	722	43	RCL	777	53	(
558	69	DP	613	43	RCL	668	02	02	723	03	03	778	43	RCL
559	04	04	614	08	08	669	85	+	724	85	+	779	03	03
560	53	(	615	55	+	670	43	RCL	725	43	RCL	780	85	+
561	71	SBR	616	01	1	671	03	03	726	19	19	781	43	RCL
562	03	03	617	52	EE	672	54	)	727	54	)	782	01	01
563	39	39	618	04	4	673	42	STD	728	28	LOG	783	54	)
564	55	+	619	95	=	674	18	18	729	54	)	784	65	x
565	43	RCL	620	65	x	675	65	x	730	54	)	785	02	2
566	05	05	621	71	SBR	676	53	(	731	92	RTN	786	65	x
567	54	)	622	02	02	677	02	2	732	53	(	787	43	RCL
568	34	FX	623	90	90	678	65	x	733	04	4	788	05	05
569	65	x	624	95	=	679	43	RCL	734	65	x	789	55	+
570	02	2	625	22	INV	680	02	02	735	53	(	790	71	SBR
571	95	=	626	52	EE	681	65	x	736	02	2	791	06	06
572	71	SBR	627	69	DP	682	43	RCL	737	65	x	792	00	00
573	04	04	628	06	06	683	03	03	738	43	RCL	793	54	)
574	53	53	629	54	)	684	55	+	739	19	19	794	92	RTN
575	54	)	630	92	RTN	685	53	(	740	75	-	795	00	0
576	92	RTN	631	53	(	686	43	RCL	741	43	RCL	796	00	0
577	53	(	632	71	SBR	687	04	04	742	18	18	797	00	0
578	25	CLR	633	03	03	688	85	+	743	55	+	798	00	0
579	22	INV	634	07	07	689	71	SBR	744	02	2	799	00	0
580	58	FIX	635	65	x	690	03	03	745	85	+			
581	43	RCL	636	71	SBR	691	31	31	746	93	.			
582	15	15	637	06	06	692	54	)	747	04	4			
583	69	DP	638	59	59	693	54	)	748	04	4			
584	04	04	639	85	+	694	28	LOG	749	07	7			
585	89	π	640	43	RCL	695	75	-	750	65	x			
586	65	x	641	05	05	696	43	RCL	751	53	(			
587	53	(	642	33	X <sup>2</sup>	697	02	02	752	43	RCL			
588	43	RCL	643	65	x	698	65	x	753	04	04			
589	01	01	644	71	SBR	699	53	(	754	85	+			
590	85	+	645	07	07	700	43	RCL	755	71	SBR			
591	43	RCL	646	32	32	701	02	02	756	03	03			
592	02	02	647	95	=	702	85	+	757	31	31			
593	54	)	648	55	+	703	53	(	758	54	)			
594	55	+	649	01	1	704	43	RCL	759	54	)			
595	02	2	650	52	EE	705	02	02	760	54	)			
596	65	x	651	09	9	706	33	X <sup>2</sup>	761	92	RTN			
597	43	RCL	652	95	=	707	85	+	762	53	(			
598	05	05	653	22	INV	708	43	RCL	763	71	SBR			
599	55	+	654	58	FIX	709	03	03	764	05	05			
600	53	(	655	69	DP	710	33	X <sup>2</sup>	765	54	54			
601	43	RCL	656	06	06	711	54	)	766	87	IFF			
602	06	06	657	54	)	712	34	FX	767	07	07			
603	55	+	658	92	RTN	713	42	STD	768	07	07			
604	02	2	659	53	(	714	19	19	769	71	71			

# The Complete Solution to your F3870 and F8 Design-In Problems

## The Formulator Development System



The Formulator family is designed to allow easy, efficient software development and real time hardware simulation of F8 or F3870 based systems. It is supported by a complete line of functional modules including memory, I/O and simulation cards that plug directly into the Formulator cardframe.

The Formulator can, itself, be used as the system breadboard. It provides microprocessor hardware, plus card slots for breadboarding your system. Thus the entire system may reside within the Formulator or in a combination of external and internal configurations.

## In-Circuit Emulation

To develop, test and debug F8 and F3870 based products, Fairchild offers simulation options that extend the functional features of the micro-

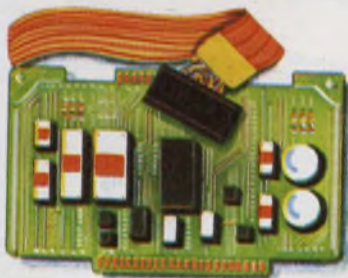

processor from the Formulator to the 40-pin socket on your breadboard. This allows complete ROM firmware development, real-time symbolic debugging of your breadboard and freezing of ROM codes during the breadboard stage.

## PROM Prototypes

The 3870 Emulator is a PROM-based substitute for the F3870 microprocessor. The Emulator measures 5" x 7" and contains two 2708 or 2716 EROMs in place of the F3870 so ROM codes can be verified and easily changed if necessary.



The F3870 Emulator plugs directly into the F3870 40-pin socket in the production prototype via a short cable.

## Powerful and Complete Software

The software consists of an operating system, utility programs and diagnostic routines; a monitor, text editor, assembler and debug package. It includes linking loader and relocating assembler and will operate in interactive or batch mode. The result is an easy to use, reliable, fast and extremely efficient capability for microprocessor based system development.

## The Formulator-Floppy Disk Marriage

An inexpensive plug-in module interfaces the Formulator with up to four plug-compatible ICOM Floppy Disc Drives, providing over one megabyte of storage. If you prefer other Floppies an application note provides the information necessary to modify Drivers for your system.

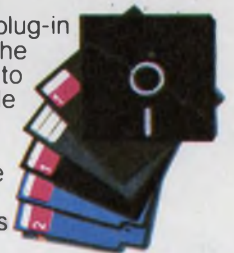

## And That Isn't All

There is a lot more to Fairchild's line of design aids: PCB modules, memory options, PROM programmer, application and peripheral options, design kits, one card micro-computers, software, user's guides and training courses.



No one offers the extensive F8 and F3870 support that you can get from Fairchild. Just ask us about it.

Fairchild Instrumentation and Controls, a division of Fairchild Camera and Instrument Corp., 1725 Technology Drive, San Jose, California 95110 (408) 998-0123, Ext. 220.

**FAIRCHILD**

CIRCLE NUMBER 45

**Total cpu control**  
High level command keys and binary/hexadecimal displays provide complete system control, easy operation.

**Worldwide portability**  
 $\mu$ Scope 820 is fully self-contained, with accessory storage space. Operates on all standard U.S. and worldwide power sources.

**Preprogrammed diagnostics**  
Overlay memory socket enables designers to plug in and execute customized diagnostics for each end product.

**Breakpoint control and trace memory**  
Built-in high level diagnostics speed and simplify isolation of even the most difficult system problems.

**Human engineered**  
Extensive prompting simplifies operation for test and service personnel, minimizes training time

**Interchangeable front panels, personality cards and personality probes**  
 $\mu$ Scope 820 adapts to a variety of microprocessors. Probe plugs directly into system microprocessor socket.

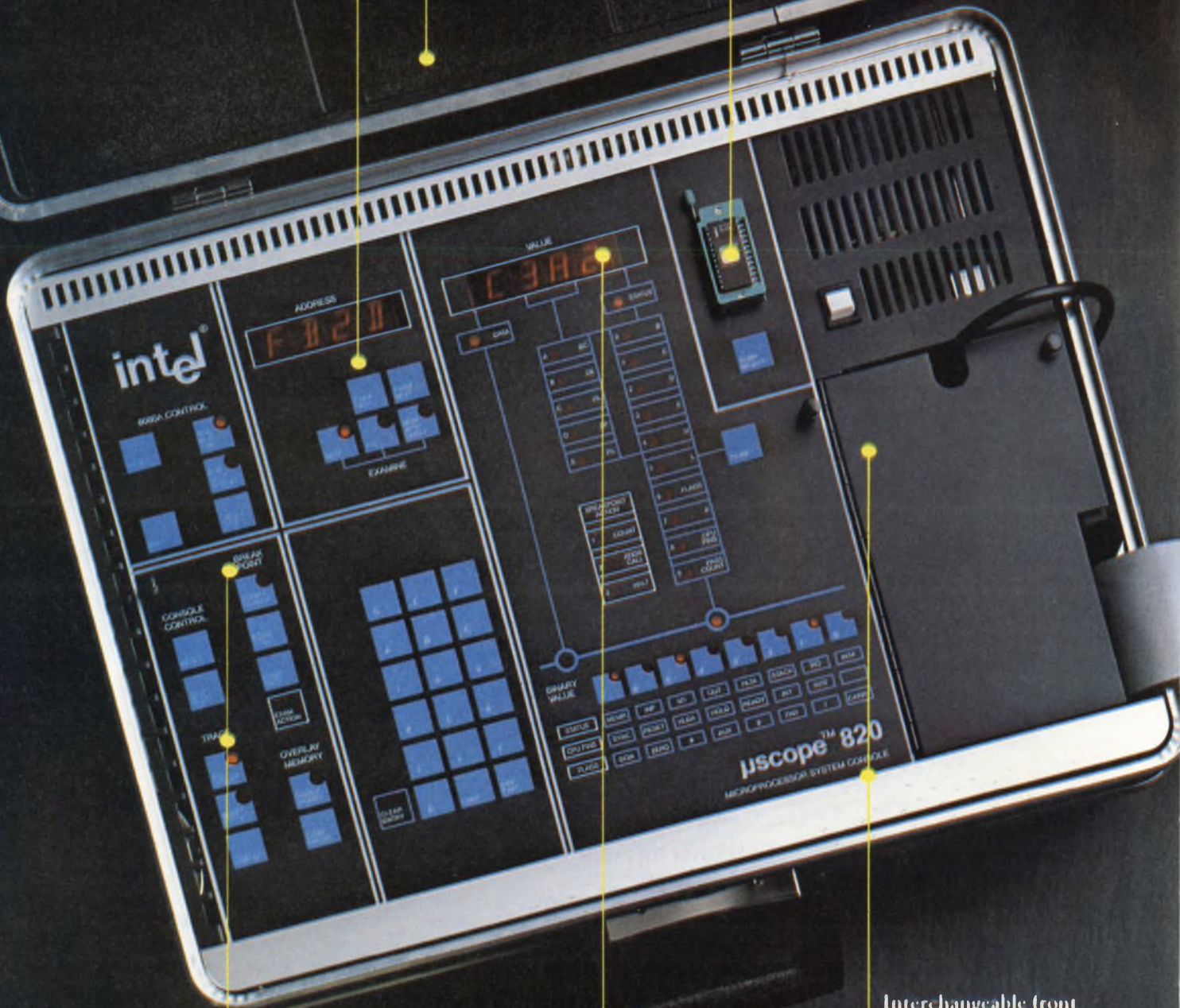

# Intel delivers $\mu$ Scope<sup>TM</sup> 820. Finally, a diagnostic instrument just right for the Age of the Microprocessor.

Troubleshooting microprocessor systems is easier than ever with Intel's new  $\mu$ Scope<sup>TM</sup> 820 Microprocessor System Console. It's a powerful, programmable, fully portable real-time diagnostic instrument. And it's designed specifically to speed and simplify system checkout of your microprocessor-based products.

$\mu$ Scope 820 is really the first test instrument of its kind. It's built around its own microprocessor, to provide a "smart" solution that's highly sophisticated, yet easy to use. Because it's user programmable with interchangeable plug-in ROMs or PROMs, it's like taking a design engineer along on every service call. And because it's fully portable, the  $\mu$ Scope 820 console goes wherever the action is—to the design lab, the production line or into the field.

Unlike logic analyzers, the  $\mu$ Scope 820 console provides a genuine solution for test and service personnel. It provides the same inside look at system operation that you get with a logic analyzer. But the  $\mu$ Scope 820

goes far beyond the mere collection of data. Its internal microprocessor system can actually analyze the data it collects. It does that with diagnostic programs you design specifically for your end product.

Rather than passively watching system operation, the  $\mu$ Scope 820 console lets you execute application programs or diagnostics you develop, in real time or single steps. And it provides full breakpoint capability and a large trace memory.



High level command keys, operator prompting, and binary/hexadecimal display of all system registers, I/O ports and memory give you greater control and make it easier to use than any other test instrument.

Until now the only way to get this kind of diagnostic capability was to use your Intellec<sup>®</sup> Microcomputer Development System. Now we've taken the Intellec features that have proven most useful for field service and production-level system checkout and have packaged them in this self-contained 20-lb attache case. That's portability.

And we've enhanced that portability with a  $\mu$ Scope 820 price of just \$2000,\* complete with personality probe and all accessories. So you can afford to put a  $\mu$ Scope 820 console wherever you need one, and free your development lab instruments to concentrate on development. No longer must you invest in in-house-designed custom test instruments for each of your end products. And the  $\mu$ Scope 820 console will be available with a selection of front panel overlays, "personality" cards and system probes to support a variety of microprocessors.

To get your copy of our  $\mu$ Scope 820 brochure and to arrange for a demonstration right in your lab, contact your local Intel distributor or sales representative. Or write: Intel Corporation, 3065 Bowers Avenue, Santa Clara, California 95051. Telephone (408) 987-8080. In Europe contact: Intel International, Rue de Moulin a Papier, 51-Boite 1, B-1160, Brussels, Belgium. Telex 24814. In Japan contact: Intel Japan, K.K., Flower Hill-Shinmachi East Bldg. 1-23-9, Shinmachi, Setagaya-Ku, Tokyo 154. Telex 781-2846.

**intel delivers.**



\*Domestic U.S. price only, quantities 1-10.

## Quantize the feedback in a/d converters. With microprocessor control, you trade inexpensive program-storage space for crucial speed and accuracy.

If you're designing a microprocessor-based a/d converter, you should try to benefit from quantized feedback. This can provide 18-bit resolution and half-second conversions in a two-chip system. Considering the 14 bits most two-chip systems strain for, or the 16 seconds that some dual-slope converters need, the 500-byte program required for quantized feedback doesn't seem too much of a drawback.

For quantized feedback, a digital control system feeds fixed-charge packets (pulses of reference current) to an integrator. The number of pulses that bring the integrator back to a reference voltage in the presence of the input, is the conversion result.

The fundamentals are illustrated by the simplified schematic of Fig. 1. The processor examines the comparator at intervals and operates the up/down (U/D) switch appropriately. Thus, a current of  $\pm I_r$  is gated to the integrator for a fixed interval. As a result, a specific number of counts can either be added to or subtracted from the counter (U/D switch open or closed, respectively). The flow chart of Fig. 2

**Gary Grandbois**, Precision Monolithics, Inc., 1500 Space Park Dr., Santa Clara, CA 95050. (Formerly Manager of Digital Applications, Siliconix.)

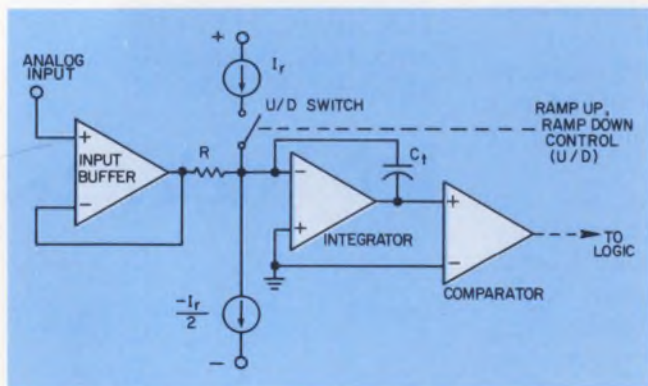

1. The functional components of quantized-feedback systems are a current-to-voltage converter (buffer amplifier), an integrator, a comparator and a switch. With two current sources—one having half the magnitude of the other—a single set of contacts can switch the reference current polarity to measure either polarity input.

describes the quantized-feedback process for one complete measurement interval.

### The integrator sums it all up

Fig. 3a shows the integrator output during a measurement interval. Here, for simplicity, the converter is digitizing a zero voltage input. The waveform implies that eight-count blocks from the counter

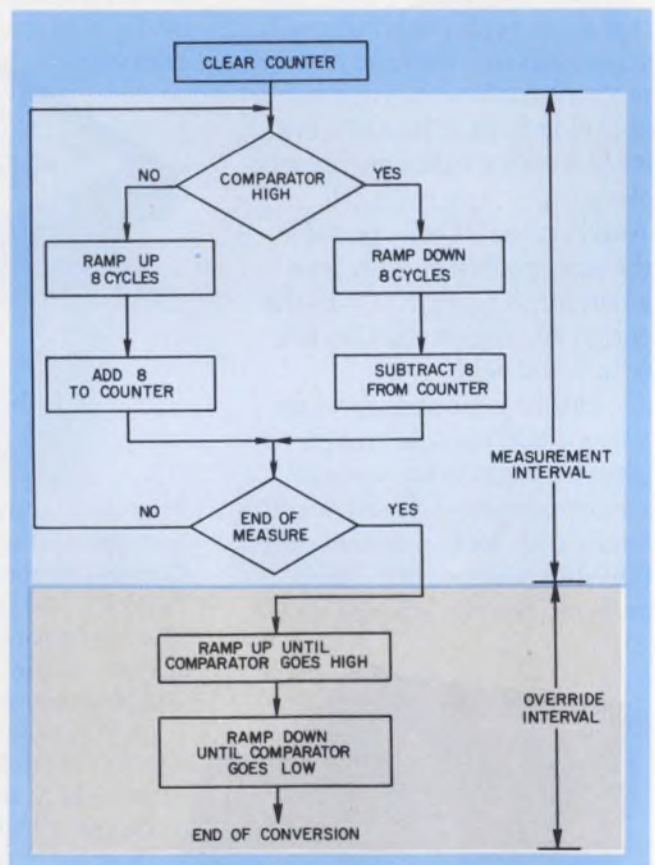

2. In a basic quantized-feedback system, a comparator controls the conversion, which once started, proceeds for eight clock intervals. During the measurement (coarse) interval, eight-count bundles—whose total is proportional to the analog input—are accumulated. This approximation is corrected in the override (fine) interval, during which the comparator always goes from high to low. This eliminates the chance of hysteresis errors.



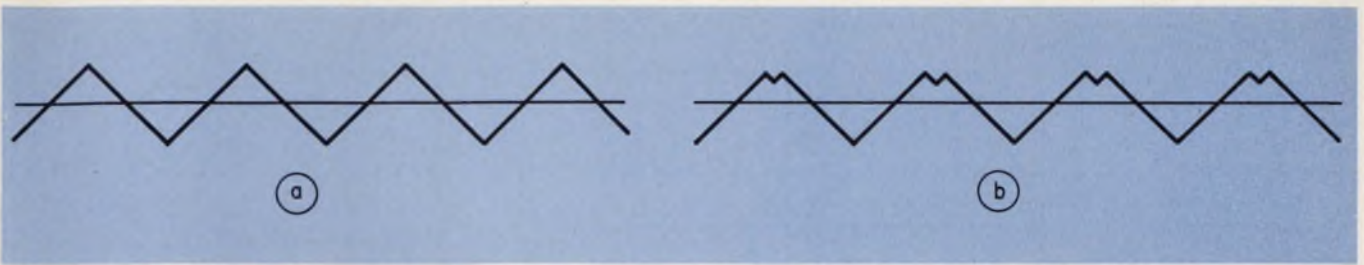

3. **Integrator waveforms for no voltage input** are simple triangles (a) in a 100% duty-cycle (basic) system. An LD120 under F8 control divides each eight-clock-time set into up and down ramps (b) lasting one-and-seven or

seven-and-one clock times each. This 87.5% duty cycle fixes the number of switching transitions and eliminates offset errors that would result from differences in charge injection, turn-on-time and turn-off-time.

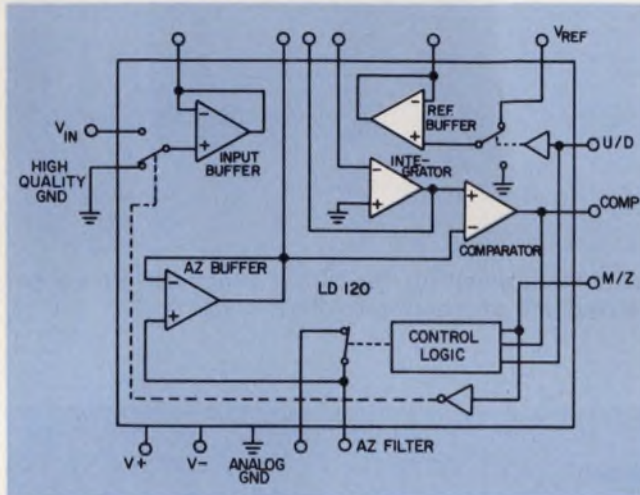

4. **An LD120 chip has all the analog blocks** for quantized feedback: integrator, comparator, voltage-to-current converter and reference switch. Also included: a reference buffer amplifier that lowers tempco, an auto-zero buffer amplifier that nulls offset errors, and analog switches that generate the negative reference with the auto-zeroing.

alternately charge and discharge the integrating capacitor. The integrator keeps adding and subtracting these eight-count blocks from the counter, so the net count ends at zero—corresponding to the input.

The simple system implicit in Fig. 3a uses a 100% duty cycle in each ramp direction. But this simple system has a disadvantage: The number of up or down transitions varies. At the expense of simplicity, if a duty cycle were to contain both an up and down phase, the number of transitions would be constant.

With a constant number of transitions, U/D switching transfers a fixed quantity of charge to the integrator. Also the difference between the turn-on and turn-off times of the U/D switch causes a constant offset. Being constant, charge-switching and transition-time offsets can be nulled automatically.

For example, in the single-chip, LD120 analog processor from Siliconix, offsets are cancelled by an auto-zeroing system. But nonconstant offsets fool the converter's automatic correction system and this makes performance nonlinear.

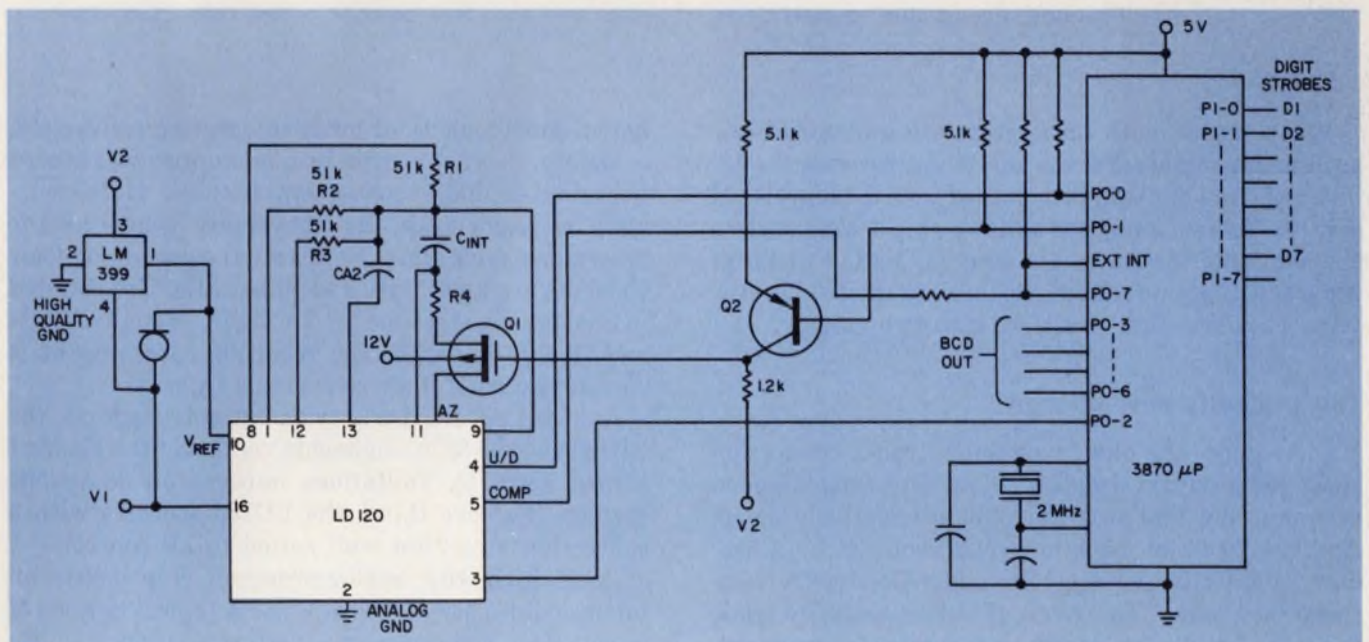

5. **Converting analog inputs to 5 1/2 BCD digits** uses every functional block of the LD120, plus Q<sub>1</sub> for zero-offset

correction. The 3870, a single-chip F8, puts out a single scan of multiplexed data in BCD format.

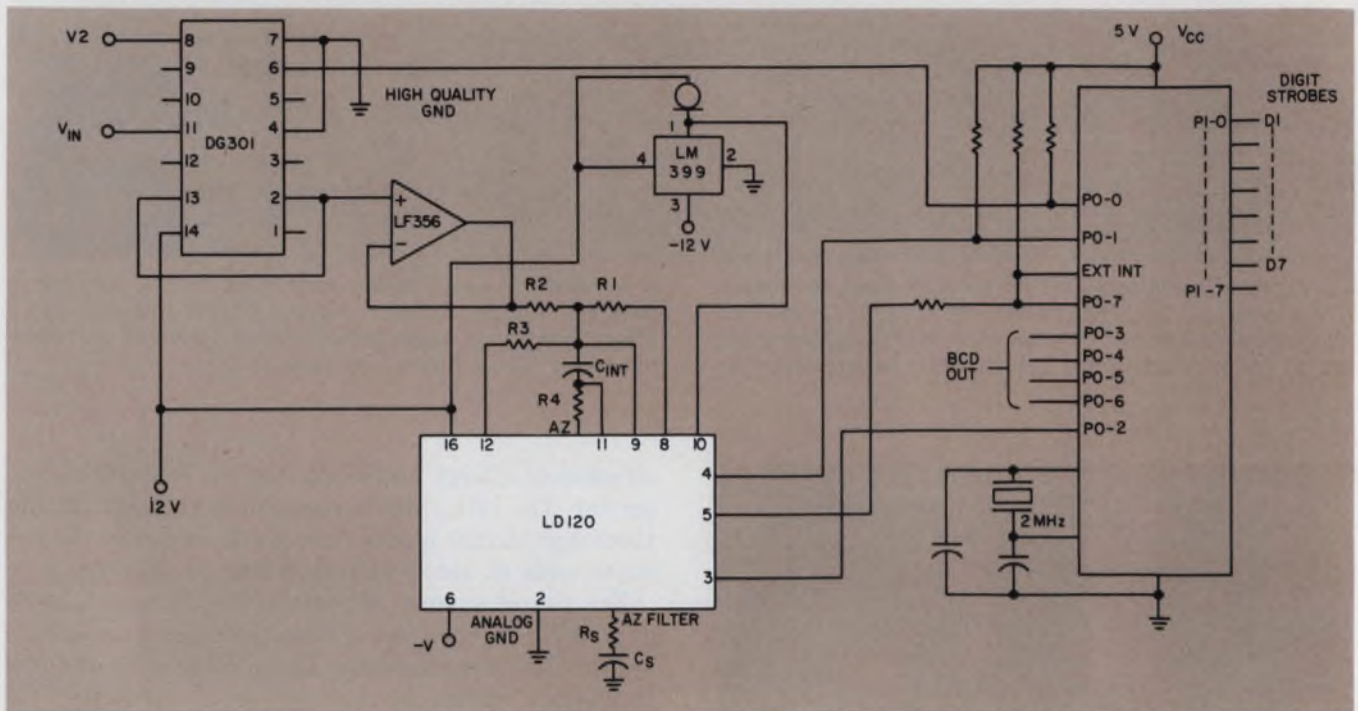

6. This high-performance 5½-digit DVM reduces last-digit jitter by replacing the LD120's input buffer with a lower-

noise BiFET amplifier. The DG301 switch performs auto-zeroing and improves zero-offset correction.

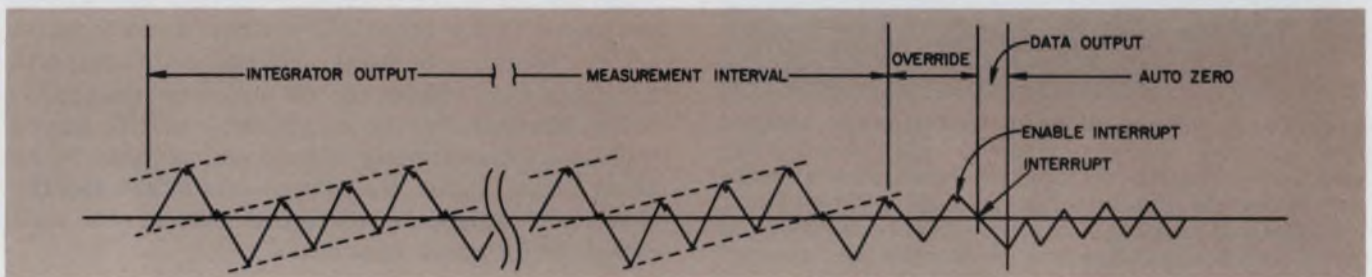

7. In the complete conversion sequence, the analog input is coarsely digitized in the measurement interval. Fine-tuning to the correct number occurs during override as

the integrator ramps down. With an F8 microprocessor, override ends when the processor is interrupted. Digit-scan and auto-zero precede a new conversion start.

When mated with an appropriate microprocessor such as Fairchild's F8, the LD120 can provide the 18-bit resolution and stability needed for a 5½ digit DVM (Fig. 4). Though many one and two-chip a/d converters are available for 2½ to 4½ digit DVMs (10 to 14-bit accuracy), only quantized feedback or dual-slope systems pack 5½-digit precision into two chips.

### The tradeoffs have changed

Dual-slope, the older technique, trades conversion speed for program simplicity. This is no longer a good exchange now that program bytes are relatively cheap. And the 20 to 40 machine cycles required by a 5½-digit Add routine, severely limit dual-slope conversion speed (see table). Therefore, it's often better to trade program length for accuracy and conversion speed. And this is what quantized feedback does—while retaining all the noise-averaging properties and in-

herent monotonicity of other integrating converters.

Mainly, the easy control by a microprocessor makes quantized-feedback converters feasible. Here, software counters take the conversion count at the processor's cycle time. No external counters or logic elements are used. Pulses for integration are counted in groups—six at a time for 3½ digits, 14 for 4½ digits and 78 for 5½ digits. The resulting coarse count is corrected during a short override interval.

A quantized-feedback two-chip set, such as the LD120 and the 3870 single-chip version of the F8, isn't slowed down by limitations imposed on dual-slope systems. For one thing, the LD120 operates with a conversion algorithm well suited to  $\mu$ P control.

In addition, this analog-processor chip boasts an intrinsic linearity of 0.0025% and a typical tempo of 5 ppm/°C. The converter performs zeroing automatically and needs only one reference voltage to accept both positive and negative inputs. All this

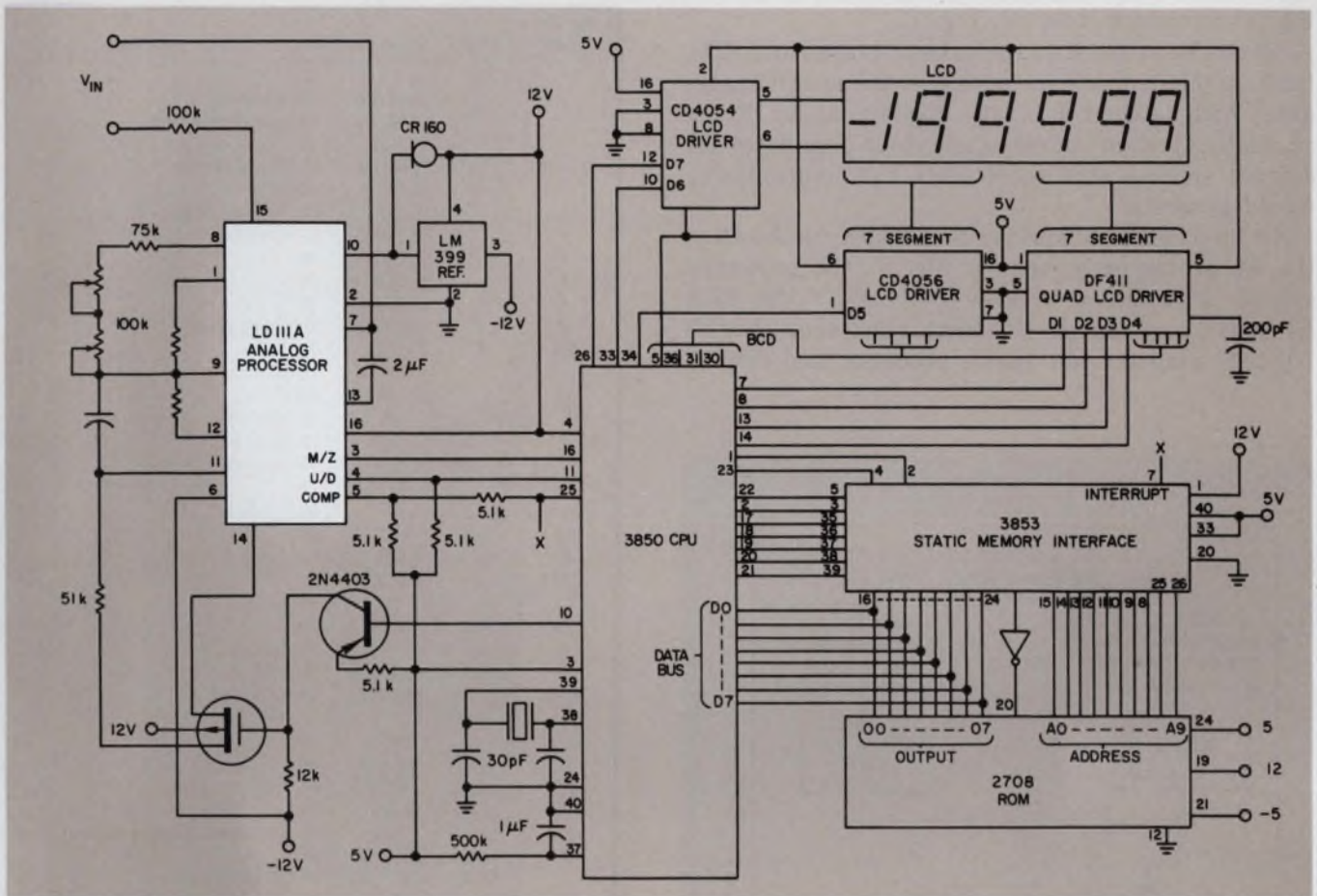

8. Reprogramming this 5½-digit DVM development system is easy. The 2708 ROM can be erased under ultraviolet

light. The system, including the liquid-crystal display, operates from ±5 and ±12-V power supplies.

performance is crammed into one chip, thanks largely to 2-picocoulomb charge-injection input switches.

For control, one simple I/O-oriented microprocessor, either the two-chip F8 or its single-chip counterpart, the 3870, provides the LD120 with a 64-byte internal RAM, a crystal-controllable clock, four 8-bit bidirectional I/O ports and a vectored and maskable interrupt system. Moreover, the 3870 operates from a single +5-V supply and contains 2 kbytes of mask-programmed ROM.

The LD120 does require some additional hardware to interface with the 3870, as shown in Fig. 5. Nevertheless, this DVM system is simple. The MOSFET switch,  $Q_1$ , allows a digital-zeroing period to be added to the software. And external control of the input switch helps simplify the 5½-digit counter's auto-zeroing (AZ) system.

This zeroing routine dedicates an interval every 15 conversions to measuring the system offset with the input switch grounded. Succeeding conversions are corrected by subtracting this measured value.

Zero drift is minimized by combining, in one a/d system, the offset-correction technique and the analog-AZ system. The digital system corrects for such analog-error sources as auto-zeroing system leakage and comparator drift.

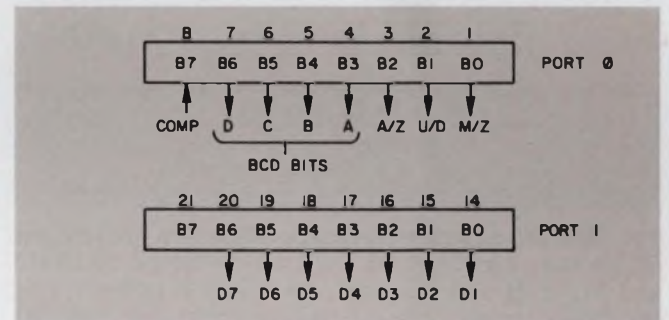

9. Only two of the F8's four I/O ports handle the basic DVM. The two other 8-bit ports and 1500 unused bytes of the 3870 ROM are spare.

Circuit stability is ±1 count on a 2-V scale. A modified circuit (Fig. 6) has less internal noise, hence better performance. An LF356 BiFET op amp replaces the chip's internal buffer amplifier, and lowers the noise to ± one half of the LSB.

#### It's BCD at the display interface

At the output side, the data format from the processor is a strobed single scan of multiplexed BCD, which occurs after each conversion except during the

digital-correction interval (Fig. 7).

When the output data are to be displayed on LEDs, latching the strobed data helps keep the noise manageable. With latched data, the display can be driven statically. And, of course, static drive eliminates the current spiking and interference that multiplexing would generate.

An interface to a liquid-crystal display is shown in the F8 prototype system of Fig. 8. The prototype system is complex because it provides the 2708 EPROM for system development. Fig. 9 shows the F8 I/O-port map for the analog processor and display

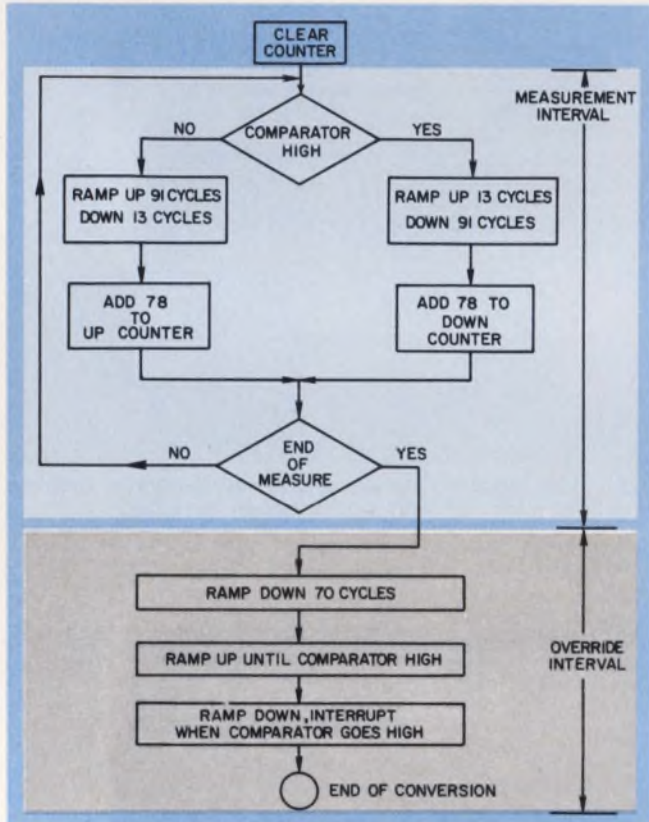

10. This F8 quantized-feedback algorithm retains the 87.5% duty cycle, but the steps are multiplied by 13 (13 and 91, or 91 and 13). The comparator is polled during the measurement interval and generates the interrupt during override, when the final downward ramp occurs.

signals. Since only two of the four available ports are used for the basic DVM, the two additional ports (plus 1500 bytes of ROM) are spares.

Still, software is the key to the converter's operating efficiently. Fortunately, F8 software can closely model the quantized-feedback algorithm used with single-chip analog processors, like the LD 110/111 and LD 120/121, which use 1-of-8 (12.5%) and 7-of-8 (87.5%) duty cycles. The instruction sequence for the 12.5% section of the algorithm takes at least 13 machine cycles. Since the 87.5% section takes 91 cycles, the total operation takes 104 cycles.

The single machine-cycle time of the Increment

Machine cycles	Label	Mnemonic	Hex	Comments
1	Oct:	LR A, 7	47	
		OUT S 0	80	Ramp up
		INS 0	A0	Comparator High
		INC	IF	
3.5/3.0		BM Low	91	Branch if low
			24	
1		LISL 2	6A	Address down
1		LISU 2	62	Counter
1		COM	18	
1		NOP	2B	
1		LR A, 6	46	
2		OUT S 0	80	Ramp down
2.5		LI 78	20	
			78	
3.5		BR DADD	90	
			02	Add 78
1	DAD:	CLR	70	to down
1	DADD:	LNK	19	counter
2.5		AI 66	24	
			66	
2.0		ASD C	DC	
1		LR E, A	5E	
2.5/2.0		BR 7 DAD	8F	
			F9	
2.5		LI F9	20	
			F9	Use up
1	TMD:	INC	IF	rest of
3.5/3.0		BNZ TMD	94	91 cycles
			FE	
2.0		INS 0	A0	
1		LISL 4	66	
2.0		INS 0	A0	
1.0		LIS 01	71	
2.5		ADC	8E	Increment measure interval timer
4		LR Q, DC	0E	
1	MCK:	LR A, QU	02	Measure over
1		INC	IF	
3.5/3.0		BM OVRD	91	If so, branch to override
			21	
2.5/2.0		BR 7, OCT	8F	If not, repeat
			D8	
1	LOW:	COM	18	
1		LISL 2	6A	Address up counter
1		LISU 3	63	
2.5		LI 78	20	
			78	
3.5		BR UADD	90	Add 78 to up counter
			02	
1	UAD:	CLR	70	
1	UADD:	LNK	19	
2.5		AI 66	24	
			66	
2.0		ASD C	DC	
1		LR E, A	5E	
2.5/2.0		BR 7 UAD	8F	
			F9	
1		LIS 01	71	Increment measure interval timer
2.5		ADC	8E	
4		LR Q, DC	0E	
2.5		LI F9	20	
			F9	Use up rest of 91 cycles
1	TMU:	INC	1F	
3.5/3.0		BNZ TMU	94	
			FE	
		NOP	2B	
		NOP	2B	
		LISL 4	6C	
		LR A, 6	46	
		OUT S 0	80	Ramp down
		BR 7, MCK	8F	Branch to measure timer check
			DD	

11. This F8 routine takes 104 machine cycles and adds 78 counts to either the up or the down counter. During the measurement interval, the routine loops 3280 times. All possible branches must take the same time for the program to function properly.

Accumulator instruction fixes the count time. So, the net count is 78 per duty cycle (91 - 13). This measurement routine is shown in the flow chart of Fig. 10, and as you can see, it is much like that in Fig. 2. The principal difference is that in Fig. 10 an up counter and a down counter replace the single counter that performs both addition and subtraction in Fig. 2. In the two-counter system, the up and down counts are subtracted at the end of each conversion (net count equals up minus down). For an F8 program that uses this measurement algorithm, see Fig. 11.

### The errors go out fast

With this algorithm, a measurement interval lasts 3280 duty cycles (341,120 machine cycles) before the

**Table : Dual slope vs quantized feedback for 5½-digit a/d converters with F8 μP control.**

	Quantized Feedback	Dual Slope
machine cycles	1 (increment instruction)	40 <sup>1</sup>
Count Time (μs/count)	2	80
Conversions length (counts)	200 k	200 k
Conversion time (s)	0.5	16
Program length (bytes, approx.)	500	100
Comparator Resolution	1 part in 78	1 part in 200 k

Note 1: Dual-slope counter-increment routine

```

Wait: LI00
      INC      Set carry
      LISL 2
Loop: CLR
      LISU 2
      AI 66
      LNK
      ASD C      add to digits
      LRE C
      BR 7, LOOP
      BR WAIT      wait for interrupt
  
```

override interval starts. The converter's maximum coarse-counting error is 156 counts (2×78). Therefore, the correction that occurs during the override interval is completed in less than 500 μs.

At the end of the override, the down count is subtracted from the up count. The result, the uncorrected count, is then adjusted by a number that represents the offset. The corrected count is then multiplexed out by a Digit Scan routine.

The single Digit Scan output is followed by the AZ interval. During AZ, the U/D line operates at a 50% duty cycle, the input buffer is grounded and the AZ switch closes. Also, the AZ capacitor stores a voltage representing the various amplifier offsets for nulling later. A second reference current is generated, which has the opposite polarity and half the magnitude of

## 5½-Digit DVM Instruction Set for the F8 (HEX)

M0000=2B	74	55	70	54	53	B6	BC
M0008=20	FF	BD	29	01	18	2B	2B
M0010=62	6A	20	02	B0	20	FB	1F
M0018=94	FE	24	69	90	02	70	19
M0020=24	66	DC	5E	8F	F9	63	6A
M0028=70	B0	70	24	49	90	02	70
M0030=19	24	66	DC	5E	8F	F9	39
M0038=A0	22	00	91	EB	72	B0	71
M0040=BE	1B	1F	1F	1F	1F	1F	1F
M0048=1F	1F	1F	1F	1F	1F	1F	1F
M0050=1F	1F	1F	1F	1F	1F	1F	1F
M0058=1F	1F	1F	1F	1F	1F	1F	1F
M0060=1F	1F	1F	1F	1F	1F	1F	1F
M0068=1F	1F	1F	1F	1F	1F	1F	1F
M0070=1F	1F	1F	1F	1F	1F	1F	1F
M0078=1F	1F	1F	1F	1F	1F	1F	1F
M0080=1F	1F	1F	1F	1F	1F	1F	1F
M0088=1F	1F	1F	1F	1F	1F	1F	1F
M0090=1F	1F	1F	1F	1F	1F	1F	1F
M0098=1F	1F	1F	1F	1F	1F	1F	1F
M00A0=1F	1F	1F	1F	1F	1F	1F	1F
M00A8=1F	1F	1F	1F	1F	1F	1F	1F
M00B0=1F	1F	1F	1F	1F	1F	1F	1F
M00B8=1F	1F	1F	1F	1F	1F	1F	1F
M00C0=1F	1F	1F	1F	1F	1F	1F	1F
M00C8=1F	1F	1F	1F	1F	1F	1F	1F
M00D0=1F	1F	1F	1F	1F	1F	1F	1F
M00D8=1F	1F	1F	1F	1F	1F	1F	1F
M00E0=1F	1F	1F	1F	1F	1F	1F	1F
M00E8=1F	1F	1F	1F	1F	1F	1F	1F
M00F0=1F	1F	1F	1F	1F	1F	1F	1F
M00F8=1F	1F	1F	1F	1F	1F	1F	1F
M0100=1F	1F	1F	1F	1F	1F	1F	62
M0108=6A	18	18	90	02	70	19	24
M0110=66	DC	5E	8F	F9	28	01	AA
M0118=70	E5	84	7E	44	E3	94	13
M0120=6A	65	4C	62	5C	64	4C	63
M0128=5E	8F	F7	70	51	28	01	AE
M0130=90	04	28	01	E0	72	B0	71
M0138=50	6A	64	4C	15	12	18	22
M0140=06	B0	40	18	B1	18	13	50
M0148=20	F0	1F	94	FE	4E	12	18
M0150=22	06	59	20	FF	58	B1	49
M0158=B0	40	18	B1	18	13	50	20
M0160=F0	1F	94	FE	48	B1	8F	D4
M0168=44	18	22	06	B0	40	18	B1
M0170=20	F0	1F	94	FE	48	B1	29
M0178=02	52	2B	2B	2A	75	FF	74
M0180=B0	B0	20	F6	1F	94	FE	76
M0188=B0	20	FA	1F	94	FE	26	06

(continued on page 116)

**Three ways  
to get a  
good CRT yoke**

**Call  
Syntronic  
(312) 543-6444**

**Write  
Syntronic**

**Use  
our Yoke  
Selection Guide**

It shows a simplified way to specify the best yoke for your CRT display. Our engineers have developed a unique concept—the yoke energy constant—as a way to estimate yoke inductance and current. From there, it's an easy step to specify a yoke "by the numbers". Try it. Call or write for your copy.\* See for yourself how Syntronic's years of experience can add up to getting a better yoke for your display.

**syntronic**

See us at Booth 440, SID Show  
Syntronic Instruments, Inc.  
100 Industrial Road, Addison, IL 60101  
(312) 543-6444

\*Or see Pages 405 to 408 in EEM

(continued from page 115)

M0190=71	8E	0E	02	1F	91	6E	90
M0198=E7	6A	64	4C	65	5E	8F	FB
M01A0=44	53	20	0F	55	90	D1	2B
M01A8=2B	2B	2B	70	51	54	6A	20
M01B0=66	52	71	58	62	4C	18	63
M01B8=DC	1E	C8	D2	64	5E	49	1E
M01C0=E9	21	02	12	58	8F	EE	70
M01C8=E8	94	15	E1	94	12	6A	64
M01D0=4C	62	5C	63	70	5E	8F	F8
M01D8=44	18	54	71	51	90	D0	1C
M01E0=6A	18	1E	64	1D	70	19	C2
M01E8=DC	1E	65	C2	DC	64	5E	49
M01F0=1E	E9	21	02	59	8F	ED	1C
M01F8=70	6A	54	62	5C	63	5E	8F
M0200=FA	29	01	7B	2A	73	20	2B
M0208=47	B0	A0	1F	91	24	6A	62
M0210=18	2B	46	B0	20	78	90	02
M0218=70	19	24	66	DC	5E	8F	F9
M0220=20	F9	1F	94	FE	A0	6C	A0
M0228=71	8E	0E	02	1F	91	21	8F
M0230=D8	18	6A	63	20	78	90	02
M0238=70	19	24	66	DC	5E	8F	F9
M0240=71	8E	0E	20	F9	1F	94	FE
M0248=2B	2B	6C	46	B0	8F	DD	29
M0250=00	10	35	94	07	72	56	70
M0258=57	90	05	73	56	71	57	29
M0260=01	F8	B5	8A	11	7B	DD	23
M0268=FD	FC	FB	FD	FB	FB	FD	FB

the U/D current through  $R_1$  when the U/D switch is connected to the reference,  $V_{ref}$ .

The U/D duty cycle during AZ is set at 52 machine cycles up and 52 down. Besides generating the negative reference voltage on the AZ capacitor, this duty cycle provides U/D switching transitions at the same rate as during the measurement. Fixing the transition rate, effectively nulls the effects of charge injection due to U/D switching or skew that exists between the U/D turn-on and turn-off delays.

Quantized-feedback can be used in other than precision DVMs. For instance, with minor modifications, the conversion systems for the 5½-digit DVMs in Figs. 5, 6 and 8 can provide a 700- $\mu$ s 8-bit conversion, a 2.5-ms 12-bit conversion, or a 50-ms 4½-digit conversion, respectively. In these conversion systems, the microprocessor can add digital linearization, data reduction and programmed limits. It can also automate ranging and function or multiplexer-addressing. ■■

# Precision can't depend on typical specs.

*PMI's got your number!*

PMI decided long ago to provide circuit designers with the precision they need. And to quote key specs in meaningful MAX. (or MIN.) numbers.

For example: Our OP-05, a direct replacement for 725's, 108A's, and un-nulled 741's, has a MAX. noise spec of  $0.6\mu\text{V}$  p-p, 0.1 to 10Hz. And the data sheet shows that you can depend on the device not to drift more than  $0.5\mu\text{V}/^\circ\text{C}$  (the MAX. spec).

— Long term drift is guaranteed at  $8\mu\text{V}/\text{month}$ . MAX.

—  $V_{os}$  is 0.15mV. MAX.

— Bias current is 2.0 nA. MAX.

— And CMRR, PSRR, GAIN and  $R_{in}$  DIFF are all quoted MIN.

The point is, we know the designer's op amp problems: accuracy and repeatability. That's why we specify exactly what they'll do, MAX.

To check out our precision op amp numbers and ponder the intrinsic simplicity of our monolithics, circle the bingo card or contact us.

Precision Monolithics, Incorporated  
1500 Space Park Drive, Santa Clara, CA 95050  
(408) 246-9222. TWX 910-338-0528.  
Cable MONO.



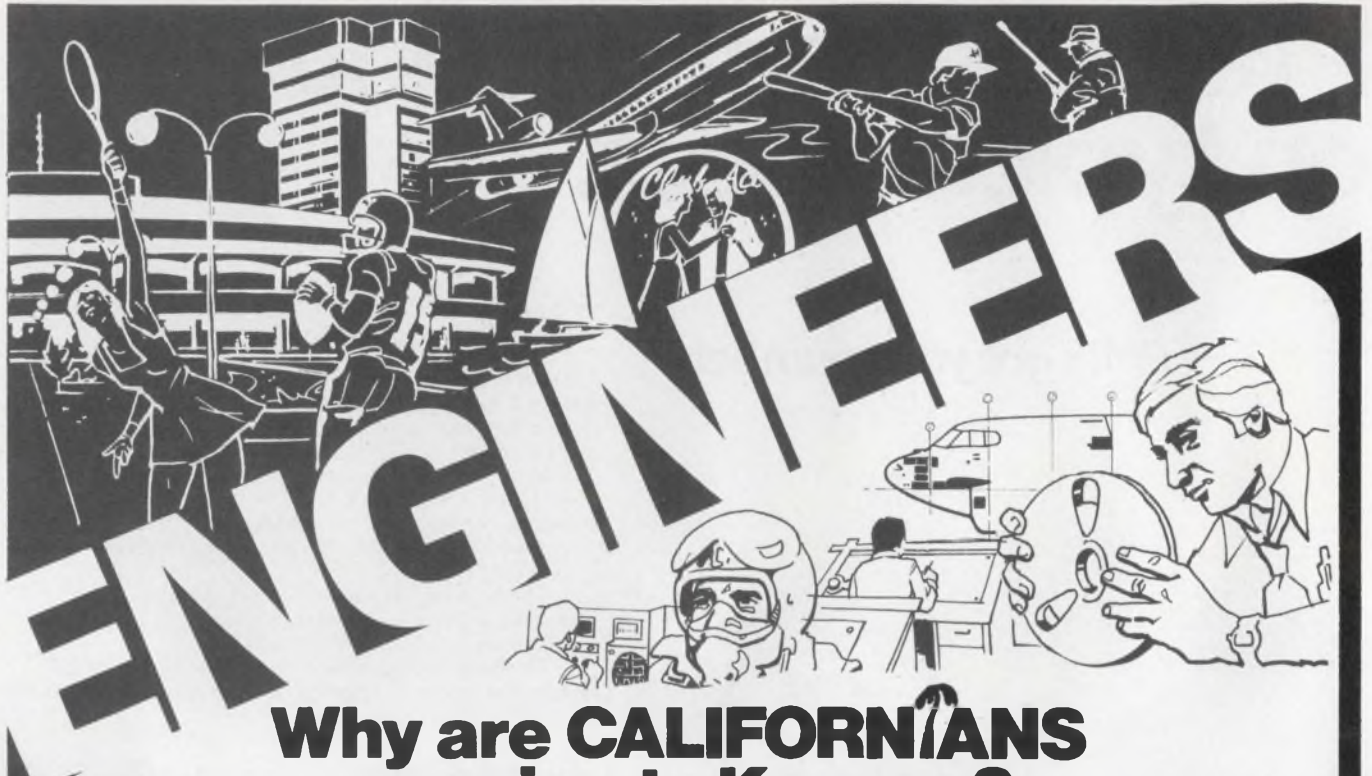

## Why are CALIFORNIANS moving to Kansas?

**OPPORTUNITY...CHALLENGE...ENGINEERING** career openings exist NOW at Boeing Wichita Company on a number of long range programs involving advanced aircraft systems. Staffing is underway for the early phases of a range of projects relating to Air Force bombers and tankers.

Air Launched Cruise Missiles Integration ... Offensive and Defensive Avionics Systems ... Countermeasures Systems ... Electronic Agile Radar Systems ... Electronic Steerable Antenna Systems ... Weapon System Trainers ... Aircraft Winglets ... and Automated Test Equipment. Join these high technology programs now while program assign-

ments are growing. Ask us today just how your experience and background match our many requirements. We think you'll be pleasantly surprised at what we have to talk about.

**AND MIDWEST LIVING**, the kind of friendly neighbor environment you won't find elsewhere, in a Metropolitan area without big city problems is waiting ... for families and families-to-be. Wichita, with an area population of 383,312, has close-to-work living, excellent schools including three universities, smog-free four-season climate and recreational activities, informal atmosphere with ample opportunity for personal expression and growth.

**IMMEDIATE REQUIREMENTS** include the following which call for a BS or higher degree in Engineering, Physics, Computer Science or Math.

- AVIONICS SYSTEMS DESIGN
- AVIONICS SYSTEMS TESTING
- CONTROL SYSTEMS ANALYSIS
- CONTROL SYSTEMS DESIGN (AUTOPILOT)
- ELECTROMAGNETIC COMPATIBILITY
- ELECTROMAGNETIC WARFARE/COUNTERMEASURE
- ELECTROMAGNETIC PULSE ANALYSIS
- ELECTRONIC ANALYSIS
- ELECTRONIC CIRCUIT DESIGN
- HARDWARE/SOFTWARE TESTING
- INSTRUMENTATION TESTING
- NAVIGATION/GUIDANCE/WEAPON DELIVERY
- SOFTWARE SYSTEMS DESIGN/ANALYSIS

Send resume to: Wes Penner, Boeing Wichita Company  
4300 E. MacArthur Road, Wichita, KS 67210  
or Call Collect (316) 687-3057

**BOEING**  
WICHITA COMPANY

An Equal Opportunity Employer M/F



New from Centralab...

# MPS PUSHBUTTON SWITCHES

A new miniature modular building block system that offers microprocessor control designers more of what they need.



To meet the special digital and analog needs of today's  $\mu$ P-based controls, Centralab offers design engineers a whole new system of modular pushbutton switch building blocks. We call it MPS—integrated Modular Panel System. MPS saves PC board and panel area and simplifies front panel design, cuts assembly costs, reduces back-panel space requirements, and meets the digital-analog needs of  $\mu$ P-based controls. Check these space saving, cost-cutting features.

## Simplify front panel interface.

All MPS switches regardless of function, are uniform in size, simplifying design and selection of front panel hardware. They have high volumetric efficiency, occupying .505" x .388" PC board area and require only .608" of space between PC board and front panel.



Cut assembly costs.

MPS switches may be mounted on the front panel, and are designed for automatic wave soldering installation and PC board cleaning. Insert molded terminals prevent flux and solder wicking and contact contamination. Integral PC board stand-offs provide for efficient board cleaning.

## Meet analog and digital needs.

MPS switches are available with momentary, push-push and interlocking actions, with a long-life contact system that switches both digital and analog signals. To accommodate critical signal requirements, housings are high-insulation molded plastic with UL 94V-0 rating.

## Available options.

Optional installations include ganged assemblies, front-panel mounting and wire-wrapping.



All MPS pushbutton switches are built to Centralab's highest quality standards (see specifications at right). They're priced as low as 41 cents in 1,000 quantity. For full technical details, samples and quotation, call (515) 955-3770, or write to the address below.

## Built To Centralab Quality Specs.

MPS Pushbutton Switches combine compact size, low cost and highest quality throughout.

- Silver or gold inlay wiping contacts for long-life and low-contact resistance.
- Less than 2 milliseconds contact bounce.
- SPST, SPDT, DPST, and DPDT switch contacts.
- Printed circuit, DIL socket or wire-wrap terminations available.
- 2.5 to 3.5 oz. actuation force (momentary).
- Choice of button interface—square or blade shaft (shown)—permits use of a variety of Centralab and industry standard buttons and keycaps.
- 10, 15, 20 or 25mm center-to-center spacing.

  
**CENTRALAB**

ELECTRONIC DIVISION  
GLOBE-UNION INC.

P.O. Box 858  
Fort Dodge, Iowa 50501

CIRCLE NUMBER 55

## Make your time generator versatile. You won't have to redesign hardware to change system timing if you start out with a 'universal' timing generator.

Design your timing generator around a ROM and you can change system time sequences without any major redesign of logic or PC boards. Since a ROM can store the bit patterns that make up a timing sequence, it's the only component you'll have to change when your timing must be changed. But the other generator components—gates, counters, flip-flops—remain the same.

To make your timing generator even more flexible, use an electrically alterable ROM, or EPROM, as the memory device. Then you'll only have to change programming to change timing. An EPROM timing generator can even serve as a system debugger, since it can be reprogrammed many times to emulate various time sequences.

Since a universal timing generator can emulate any timing sequence, you can compare operation of a ROM-based circuit with hardwired logic. The comparison, of course, should use the same timing sequence for each generator.

### Back and forth with a ring counter

A hardwired timing generator with a reversible-time sequence is shown in Fig. 1a. This circuit uses a shift register such as the Fairchild 9300 as a twisted-ring counter, a configuration which allows for reversibility of the output pulse sequence. Also included is a dual four-input multiplexer (Fairchild 9309) and SN7400 output-decoding gates.

The decoding gates in Fig. 1a produce only four time pulses, A, B, C and D shown in Fig. 1b. However, you may want to design the generator for many more outputs, thereby increasing the complexity of the decode bus and circuitry. But, then, should timing changes be required, you would spend a lot of time redesigning the decode logic, not to mention cutting up the buses on your PC board.

The 9300 shift register in Fig. 1a is controlled by the state of the Count Forward line. With Count Forward at ONE (+5 V), Parallel Enable,  $\overline{PE}$ , on the shift register is disabled, and the Clock line steps the

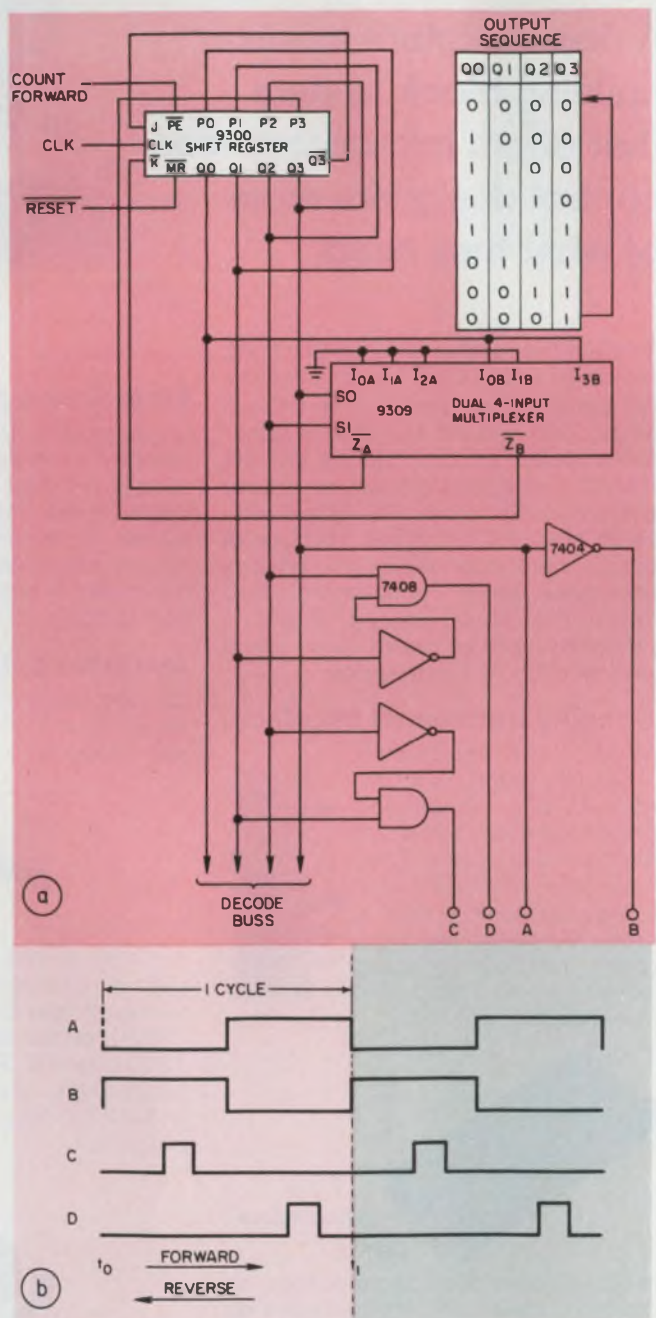

1. Connecting a shift register as a twisted-ring counter allows this timing generator (a) to produce the output sequence, signals A through D in (b). And with a ring counter, the output sequence can be generated in either the forward direction ( $t_0$  to  $t_1$ ) or the reverse ( $t_1$  to  $t_0$ ).

Robert J. Stetson, Engineer, Storage Technology Corp., 10 Clay Ct, Aurora, IL 60538.



the key to instrument stability . . .

# JFD Stab-L™ metalized inductors

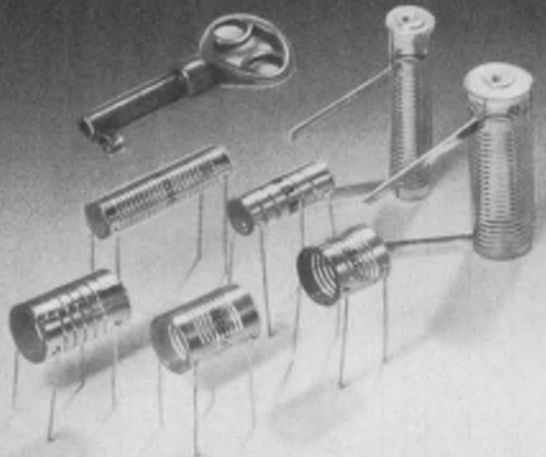

Stab-L precision inductors are specifically designed to provide state-of-the-art tuned circuit stability and performance across the widest possible frequency spectrum and in the most adverse environments. Super-stable glass substrates combined with precision-etched deposited conductors provide typical inductance TC's of better than 10 ppm/°C from -55°C to +125°C. Check some of these other features and see how you can add some extra stability to your tuned circuits.

## FEATURES

- Very low distributed capacitance
- Corrosion resistant conductor plating
- High Q over wide frequency range
- Offered in both fixed and tunable configurations
- 1 Amp current rating
- High self-resonant frequencies

## Typical Specifications

L ± 5% (uH)	Q Min.	at Freq. (MHz)	Min SRF (MHz)	DIMENSIONS (in.)	
				L	D
0.05	135	75	690	.422	.47
0.10	165	75	510	.531	.47
0.20	170	75	380	.781	.47
0.30	210	75	350	.938	.47
0.40	130	75	260	.516	.47
0.50	125	75	240	.578	.47
1.00	140	25	190	.844	.47
2.00	180	25	155	1.281	.47

Intermediate values with similar specifications as well as custom designed units are also available.

## JFD ELECTRONICS COMPONENTS CORPORATION

15th Avenue at 62nd Street □  
Brooklyn, New York 11219  
Phone: (212) 331-1000  
TWX: 710-584-2462

# JFD

CIRCLE NUMBER 56

produce the same timing sequence as its hardwired counterpart, and, in addition, can be easily changed or expanded to fit your needs.

## Off the bus, onto the ROM

A 16-word ROM is the primary component of the firmware timing generator of Fig. 2. "Firmware" refers to the unique program stored in the ROM for generating a particular timing sequence. Except for the ROM, the ICs in this generator are universal, and the output sequence can be easily changed by inserting a new firmware package.

Notice, that this firmware generator has neither a decode bus nor associated logic. This is why it's more versatile than the hardwired version. The ROM and D flip-flops combine to replace the hardwired generator's bus and decoder.

A 4-bit binary counter, such as an SN7493, addresses the ROM by cycling through as many of its 16 states as is necessary to output the programmed locations in memory. Each ROM location contains a unique code, which is delivered to its output lines, DO<sub>1</sub> through DO<sub>4</sub>, and then to the inputs of the D flip-flops. Timing pulses appear at the generator output, Q<sub>0</sub> through Q<sub>3</sub>, when Clock transfers the logic levels on the D inputs to the output.

An SN7420 four-input NAND gate decodes the counter output when the last address count is reached. Any of the 7493's counts can be decoded by connecting its appropriate output lines to the NAND gate via a jumper board. This fires a retriggerable monostable, SN74123, thus resetting the counter to all ZEROs. Then the cycle for generating the timing pulses begins again.

To see how the ROM timing generator emulates the hardwired generator, look at the output sequence of Fig. 3a and the shaded portion of Fig. 2. Outputs Q<sub>0</sub> through Q<sub>2</sub> in Fig. 3a represent the program stored in the ROM. The Count Forward line is at ONE, and the clock steps the 7493 from 0000 to 0111. Two inverters and a NOR gate in the shaded portion of Fig. 2 hold input A<sub>3</sub> of the ROM at ZERO. Therefore, ROM locations from 1000 to 1111 are not addressable, and the generator produces the output pulses shown in Fig. 3b. Notice that they make up the same time sequence as the one shown in Fig. 1b. But to emulate the hardwired generator completely, the ROM generator's time sequence must also be reversible.

At count 1000, the 7420 NAND gate is enabled, and the monostable fires, which resets the counter to all ZEROs. The Count Forward line then switches to ZERO, which makes A<sub>3</sub> high. Now, locations 1000 through 1111 of the ROM can be addressed as the 7493 counts from 0000 to 0111. The program stored in this second group of locations is the exact opposite of the program in the first group. So the timing sequence is repeated, but in reverse order from the original. Thus the hardwired timing generator is emulated completely. ■■

---

# If you think large ATE is the only way to test PC cards, hybrids, logic arrays, memories or microprocessors, you're wrong.

**We'll show you.**

For the kind of money you have available to spend, you're lucky to get "kluged-up" test equipment to look, verify and/or analyze adequately, right? Sure you'd like a programmable, multi-channel generator that stimulates and energizes digital circuitry. But you're not about to lay out a hundred grand-plus for a complex ATE system, either. Right?

Interface Technology is going to show you.

We'll show you a self-contained, low-cost, small digital signal generator/test system for \$10,000 and up. A multi-channel microprocessor-controlled data and timing generator that's programmable with only 16 instructions. A general purpose tester that can generate and record large amounts of digital data; that's interactive, can respond to external stimuli, and make

decisions. A benchtop instrument that can be used rack-mounted as part of a computer-driven system, or as the core of a low-cost stand-alone digital test system.

We'll show you how our multi-channel programmable digital signal generator/test systems can lower engineering development time, and get your product out sooner.

We'll show you how much they can save you on the recurring costs of developing new test equipment and extra hardware. It's been working for Hughes, General Dynamics and Rockwell, and it can work for people like you.

We'll put the whole show on the road, and demonstrate these systems in person. And all you have to do is call collect: (213) 966-1718. Or write us at the address below. We'll show you how wrong you've been about digital circuit testing.

**interface**  
TECHNOLOGY

---

852 North Cummings Road • Covina, California 91724 • (213) 966-1718

CIRCLE NUMBER 57

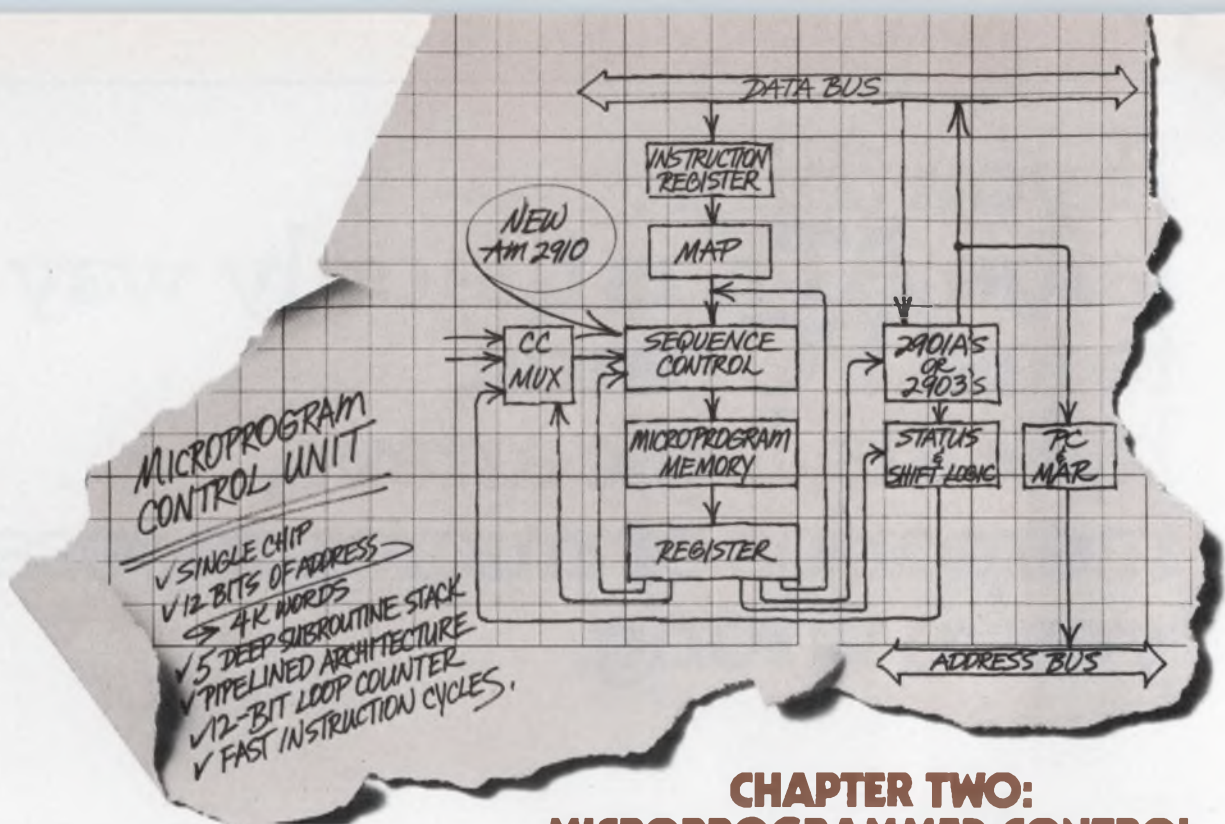

## CHAPTER TWO: MICROPROGRAMMED CONTROL.

Advanced Micro Devices continues its advanced course in microprogrammable microprocessing.

Step by step, function by function, month by month, we'll show you how to build a fast, powerful microprogrammed machine.

And on December 31, 1978, you'll know what we know. As it turns out, that's quite a lot.

At the heart of the microprogrammed machine is a memory and a sequencer.

At a minimum, the sequencer will increment through addresses and branch to other addresses in the memory.

But in more sophisticated architectures, system demands are much higher.

# BUILDING A MICROCOMPUTER, CONTINUED.

## **AM2910: A ONE-PART SOLUTION TO A FOUR-PART PROBLEM.**

Now there's the Am2910, a one-part microprogram sequencer capable of solving a four-part problem.

It provides the ability to step sequentially through memory locations. It can branch on a single cycle to any of several externally specified addresses. It allows you to jump to or return from subroutines up to five levels deep. And it can count iterations of a loop of instructions or a single instruction up to 4096 times. (Just say how much and how many rounds. It not only counts; it branches out when it's finished.)

## **IT WASTES NO TIME GETTING THERE.**

In one part, the Am2910 provides a 12-bit wide address field—enough to address 4096 words of microprogram.

Plus; by combining the Am2910 with our new Am29775 512x8 PROM with built-in output registers, microcycle times of 100 nanoseconds can be achieved. 100 nanoseconds!

If you've got a microprogram control problem in four parts, we've got a solution in one: Am2910.

## **BUILD YOUR LIBRARY, TOO.**

Each of these monthly messages is backed by a ton of theory and applications information. Send in this coupon and we'll send you Chapter Two and tell you how to get the whole book.

Advanced Micro Devices	3/15/78/ED
901 Thompson Place	
Sunnyvale, California 94086	
I want to build a microcomputer this year. Sign me up.	
Name _____	
Title _____	
Mail Stop _____	
Company _____	
Address _____	
City _____ State _____ Zip _____	

## **Advanced Micro Devices**



Multiple technologies. One product: excellence.  
901 Thompson Place, Sunnyvale, California 94086  
Telephone (408) 732-2400

Next, Chapter Three: The CPU.

# LET'S PUT OUR HEADS TOGETHER.

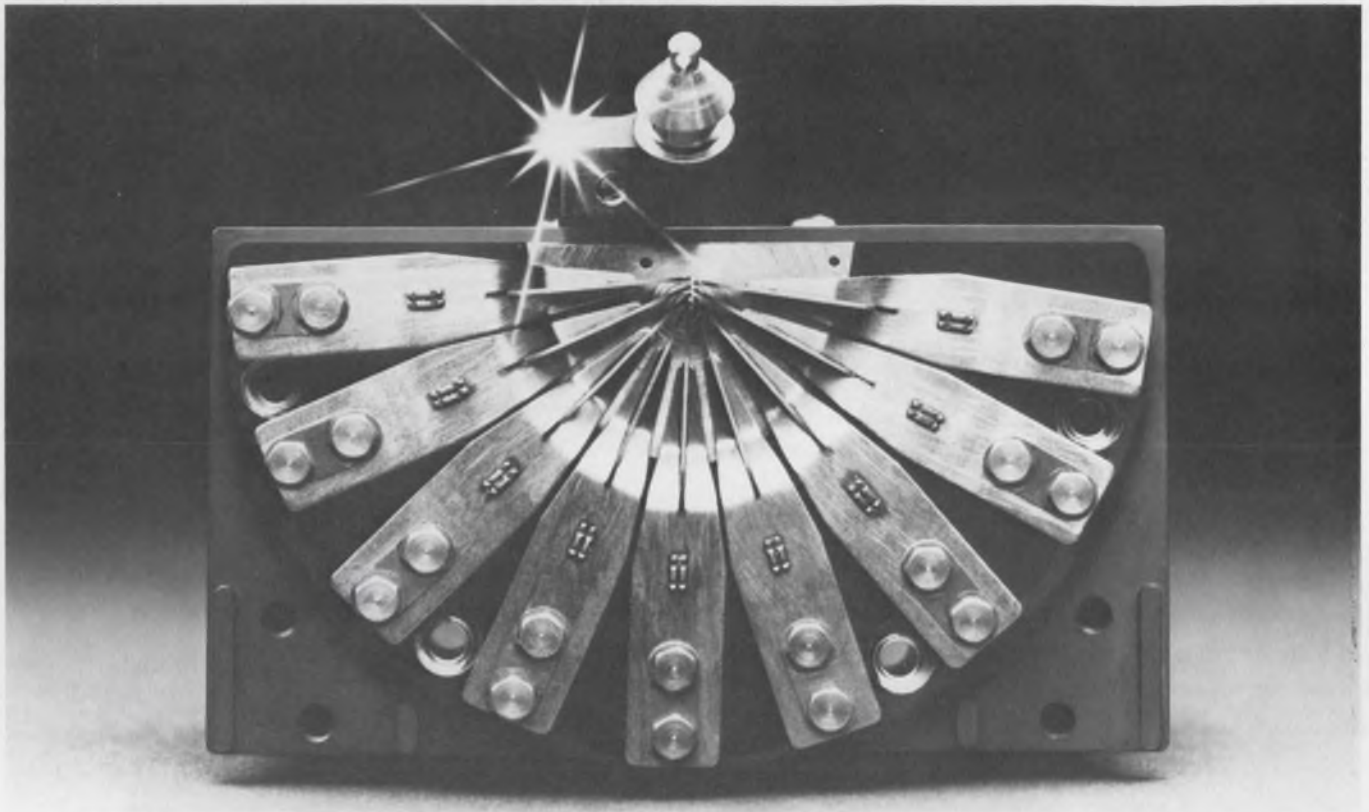

The Facit 4540 Serial Matrix Printer has already made a name for itself with its standard 250 characters a second – all crisp, fullbodied and perfect throughout the 500 million character service life of the printhead. Versatility comes from the rare 9×9 dot matrix, and the Facit 4540 offers a genuine 100% duty cycle and entire elimination of adjustment and lubrication.

The whole secret is in the unique print-head and its microprocessor controlled impact printing mechanism.

Integration of mechanics and electronics has made Facit peripheral data products world famous.

Facit 4540 extends this tradition. So let's put our heads together. To make your systems more efficient, more competitive and more in demand.

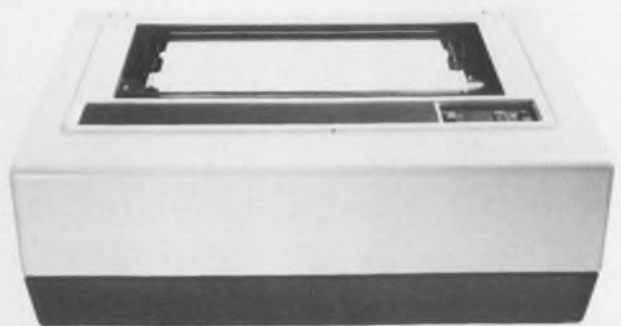

*Facit 4540 Serial Matrix Printer with the unique printhead.*



**FACIT**  
**DATA**  
**PRODUCTS**

FACIT-ADDO INC., 66 FIELD POINT RD, GREENWICH, CONN. 06830. (203) 622-9150. TELEX 96-5998.

CIRCLE NUMBER 59



# TRIMMER SETTABILITY TO 0.01% ...AND NO BACKLASH!

Vishay Bulk Metal<sup>®</sup> resistive elements and latest mechanical improvements raise trimmer technology another notch.

**Settability 0.01% typical, 0.05% max.** The typical settability of Vishay precision trimmers is shown by the red line in the chart below. Multi-fingered wiper over photo-etched redundant current paths on mirror-like planar Bulk Metal resistance element produces an output smoothness (resolution) reflecting a very uniform, non-erratic progression in value. Result: both excellent settability and long-term reliability.

Settability of Bulk Metal<sup>®</sup> trimmers compared with wirewound and cermet

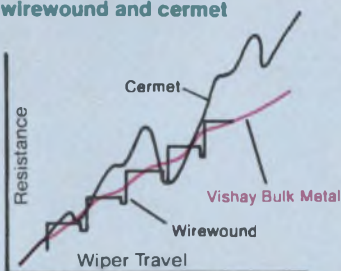

**Setting stability 0.5% max  $\Delta R$  after shock and vibration.** Superior mechanical design keeps settings on value through time and rough service by eliminating stored energy (potential backlash) in the wiper and adjusting mechanism.

**Designed to meet or exceed Mil-R-39035 Char. H requirements.** TCR of 10 ppm/ $^{\circ}\text{C}$  over entire Mil range from  $-55^{\circ}\text{C}$  to  $+150^{\circ}\text{C}$ —that's *five times* tighter than spec. Long-term load-life stability of 1% max  $\Delta R$  after 10,000 hr at rated power and  $85^{\circ}\text{C}$ . Very low noise.

#### Tight backlash control

- 20:1 gear reduction for vernier-like adjusting
- Mirror-smooth surface
- Contact point unaffected by thermal expansion

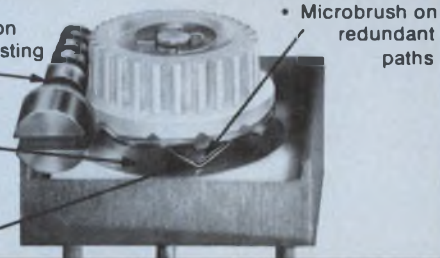

**Other advantages.** Unmeasurable hop-off. Vishay quality (at competitive price) lets you halve your circuit-error budget and buy lower-cost components elsewhere in system.

Pin configurations for 1/4" sq, 3/8" sq, 3/8" rd, 3/4" rect, 1 1/4" rect. Call or write Vishay Resistive Systems Group, 63 Lincoln Highway, Malvern, PA 19355; (215) 644-1300; TWX 510-668-8944.

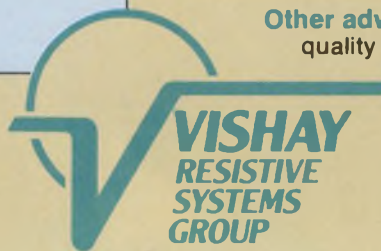

**Passive components aren't necessarily inactive—specify Vishay.**

CHALLENGES TO THE ENGINEER WHO MANAGES

# Lee Wilson of Corning Speaks On Centralizing Engineering

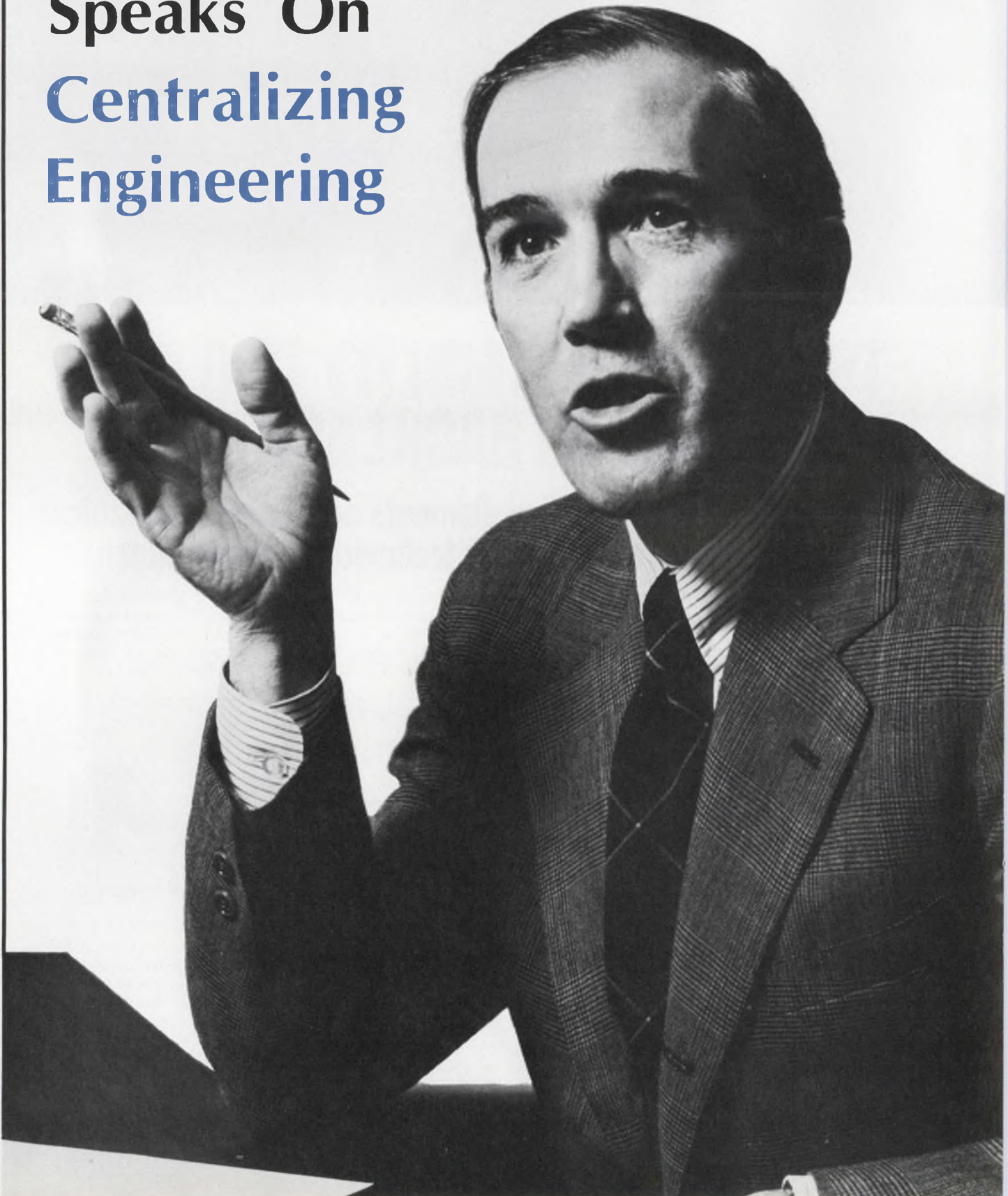

In these days of worldwide markets, there's a popular notion that the way to respond to those markets is to decentralize your engineering—to have your engineers in the local plants, right where the markets are—so you can respond quickly to changing market needs. A further advantage of such decentralization—so the theory holds—is that the engineers can respond to local manufacturing problems quickly and effectively instead of having to overcome communications barriers that geography, national and social differences conspire to create.

Well, we disagree, especially if your business is multinational. We tried that method for a long time, and found that centralization works a lot better. A few years ago our electronic-components business was organized as a domestic and an international business. We had two companies in Europe—Electrosil in Sunderland, England, and Sovcor in LeVesinet, France. Each had a managing director who reported to a general manager, who reported to the area manager for Europe, who reported to the vice-chairman of the company here in Corning, NY, who happened to be the president of our international operations. He reported to our chairman of the board.

---

**So we had two homogeneous businesses, one in Europe and one here, both making components that were largely identical. But product planning, budgeting procedures and almost everything else were different, no matter how hard we tried to coordinate.**

---

And that's understandable, because the European companies had a different boss to satisfy, and he was looking at the components business as just a little piece of Corning's total European business, which includes television bulbs, dinner plates, ophthalmic blanks, Pyrex beakers, and what have you. And that made it really difficult for us to coordinate two distinct sections into what should have been one worldwide business enterprise.

Then we changed the structure so that the European plants now report on a functional basis, rather than a geographical one, just as the plants in the States do. So the two European managing directors, while they have corporate responsibility and are more than just plant managers, also report to the manager of manufacturing of the Electronic Products Division here in New York, as do the U.S. plant managers.

Now we have worldwide programs, not just American or British or French programs. This means we

can centralize our engineering here in Corning. This, in turn, means that we can standardize our manufacturing processes and technologies.

These all came from Corning in the United States originally. But after many years they began to drift apart, with changes being made locally in the equipment and with new designs being developed that were clearly local in character. So we would end up with different processes in Britain, France and the U.S. One plant might be using a vertical cut-off machine, another a horizontal. One might use one kind of laser for spiraling resistors, and another might use a different kind of laser.

Well. . .so what? What's so terrible about having somewhat different processes or machinery in different locations? The answer is that invariably they perform differently. They impart somewhat different product characteristics. Or one set-up is faster than another, or provides higher yield.

Now this could mean that one plant chose equipment better than another did, for whatever historic reason. But without a central point for working on such matters, we might never find out. And that's not merely a problem of operating worldwide. We can find the same problem in different plants in the United States. As a matter of fact, a machine in one plant might perform better or worse than an identical machine in another plant.

What's more, if everybody's using different machinery, nobody can develop improvements that can prove useful to everybody. If you have a decentralized organization, people in one place never know what's been done someplace else that can raise the performance of similar equipment. If you have a central group, even a small one, you can bring all your machines up to the level of the very best one in the corporation. You can develop useful liaison between your division manufacturing engineering and your corporate engineering group.

And that's what we did.

Here in Corning, New York, we established a new position, Division Manufacturing Engineer, and gave that position to a man with broad international experience. He pulls all our programs together, international and national, and decides which ones to focus on with both capital and manpower. By focusing on the best opportunities, we get best total impact.

Now this doesn't mean we don't do any engineering in the individual plants. We do a lot. But we centralize the direction, especially for major programs like cost reduction and product development. Of course we recognize that regional markets have different needs. And that's why there's still lots of engineering in the individual plants. But those regional differences are

## Who is Lee Wilson?



Except for a stint in the Army from 1954 to 1956, Leroy Wilson has been a one-company man. He joined Corning Glass Works as a technical trainee after he got his BS in mechanical engineering from Purdue in 1950. Then he got an over-all view of the company by going through one department after another—manufacturing, then engineering, then sales—before he worked in a branch plant. Then he went into product engineering as a permanent assignment until he went into the Army. When he returned, Wilson went to the Electrical Products Div., where he was given product engineering responsibility for developing the 110-degree television bulb.

A year later, he was selling TV bulbs in Chicago, and three years after that he returned to Corning in New York as sales manager of the Communication Products Dept., where he remained for four years, till 1965.

Then on to Europe as general sales manager for five years, then back to New York as area manager for Latin America and Canada. In 1975 he became vice president and general manager of the Electronic Products Div.

Lee and his wife, Claudie, have two children away at college and three still at home. The couple travel a lot, particularly to Brittany in France. They both dabble in tennis, cross-country skiing and sailing on Keuka Lake, where they have a cottage. And both are avid readers.

less prevalent than you would think because many of our important customers are worldwide customers that manufacture in Europe as well as in the States.

Naturally, some customers have special needs, perhaps to meet local safety requirements or to meet other demands. We make sure the needs of various areas are considered by having engineers from the local plants represented on our central planning task forces. And our engineers visit each other frequently. There are people from France and England here all the time and U.S. people are over there. Interaction is close among all of them.

Of course, for minor changes, say different lead lengths for a component, the local engineers don't have to consult the central organization at all.

---

**But some problems that appear to be merely regional idiosyncrasies and very simple may not be at all.**

---

For example, take a "simple" thing like lead diameter. Some customer wants lead diameters different from the standards you offer. But a difference in lead diameter could affect the way a component holds a lead bend and the way it is inserted into a PC board. So it's wise, even on something apparently trivial, to have local representation on the central organization.

But it's not wise to involve the central organization on matters that can be taken care of entirely locally.

Product definition, for example, must be taken care of locally. We don't have *one* catalog. We have different catalogs in different countries. But as much as we can, we try to standardize products. That's to be expected because, as I said, many of our customers are multinational. A computer manufactured in Detroit is going to be very much the same as one manufactured by the same company in Scotland, so it's going to need the same components. The people in both plants are going to want the same specifications, the same body color and the same markings. They want things to be the same and to look the same.

So we try very much to standardize—starting with the raw materials and manufacturing processes. I think, in the end, you get better quality. And once your standardized processes are tuned up and running well, you can maintain an even higher standard.

If a component is standardized, a multinational systems manufacturer will feel more assured that the one he buys in Europe will be the same as the one he buys in the States. And it's much easier for an

individual customer to qualify different plants making that product.

A European purchaser will feel more confident about qualifying us. He knows, not only that we make the same product elsewhere, but that we make it the same way wherever we make it.

---

**There's also a personal element. If the chief engineer of a major customer in the United States begins to manufacture in Europe, he faces the unwelcome task of finding new vendors in Europe.**

---

We can relieve him of that burden to some extent by letting him know that the vendor he's using here is the same vendor in Europe. Life will be easier for him if he knows that the same people designed the processes for the European and American plants and that the same person has the line responsibility for the quality of engineering in both plants.

Still another advantage to standardization is that if a natural tragedy—say a flood or fire—or a strike shuts down one plant, we can deliver from another plant. Fortunately, we've never had a strike. But a strike by somebody else could also affect us.

There's another advantage to having the same component available from different factories. You can solve problems stemming from local social customs. In France, for example, it's almost impossible to lay off people. You can do it, but it's always very costly. So you have practically zero flexibility in adjusting the size of your work force. And that's becoming more prevalent everywhere.

With standardized components, we can go a long way toward keeping our work force stable. If, for example, the market for resistors suddenly expands in France, and we suspect that the expansion is temporary, we'd be nervous about adding to our French labor force since we couldn't reduce it later.

But we could supply that surge demand from England or someplace else where we have idle capacity. And that can help avoid the old problems of double-ordering, followed by cancellations. This tends further to stabilize the work force, and it reduces capital investment. We're not yet at the stage where we can ship readily from alternative plants, mind you, but that's our direction. It would be impossible if each plant were working on its own.

And there's another point. It's a lot easier to increase the output from another plant to meet surge demand than it is to hire and train new workers.

For all those reasons, we try to standardize, while

trying to recognize and accommodate regional differences. Even if these differences were much stronger, we'd still benefit overwhelmingly from our centralized organization—not only for product planning, but also for developing manufacturing equipment and processes.

Though all our plants got most of their equipment designs from Corning, there was no central group to make sure that each plant used its equipment most effectively. Each plant had its own cost-reduction program and its own process-development activity. The problem, of course, was the old one of everyone wanting to please his own boss. We found that it's much easier if everyone has the same boss.

---

**We tackle this problem by having somebody from the division manufacturing engineering group visit all the plants. He focuses on a relatively small number of objectives. So he can get a great deal done.**

---

If one plant improves a process, our manufacturing engineer can communicate that to all the other plants. He can bring them all up to the highest level.

Another very important advantage of a centrally directed engineering effort, especially for Corning, is access to the central corporate engineering group.

This large and very professional organization can accomplish engineering projects that no plant, or even division, engineering group could do on its own. And with a centralized division engineering group, major projects can be organized and undertaken with the corporate engineers much more easily.

For example, the central corporate engineering group can set up a whole line, get it working smoothly and optimally, then order the same equipment for all the other plants. If we tried to have each plant develop its own equipment, we would end up with an awful lot of duplicate effort.

In addition, our central corporate engineering group can concentrate on developing new equipment and processes without having to worry about keeping a plant running at the same time. Our people in the various plant locations can't do that because their engineers are busy running factories.

Finally, no local plant can bring to bear the level of engineering that we can offer from Corning. We have engineering manpower and resources that no individual plant can afford to carry. We have several hundred engineers in our central engineering group and they have an enormous range of disciplines. ■■

# Remember comstron/adret

# and I'll give you the shirt off my back.

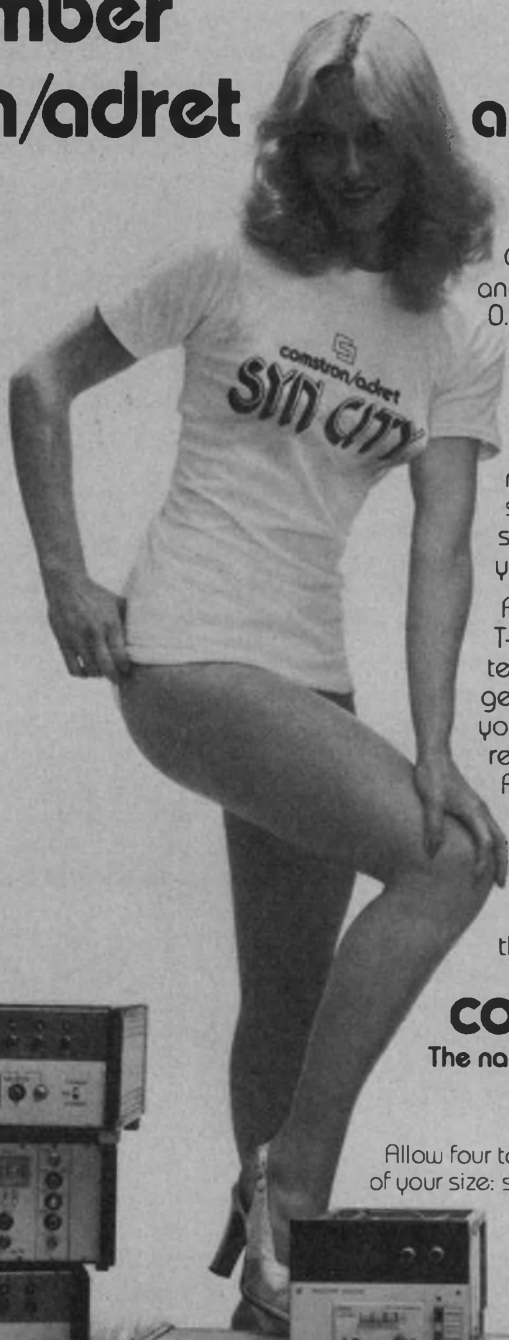

Comstron/Adret offers enough synthesizers and signal generators to be a city in itself. From 0.01 Hz to 1.2 GHz — for bench, lab, and systems, we offer more "syms" than any other company in the world.

Comstron/Adret isn't exactly a household name . . . That's why we're offering memorable t-shirts **free of charge**. You can show the world you know where to get great specs and a great price on any synthesizer you need.

All you have to do to get your free Syn City™ T-shirt is write to us on your letterhead and tell us your synthesizer and/or signal generator application. Along with the shirt, you'll receive our complete catalog. (To receive literature only, please use the Reader Service Number).

Be the first one on your block to get a genuine Syn City T-shirt. They're available only from the company with the largest selection of synthesizers in the world.

## comstron/adret

The name to remember in synthesizers.

Allow four to six weeks for delivery and please inform us of your size: small, medium, large or x-large.



# comstron/adret

200 East Sunrise Highway, Freeport, New York 11520 • (516)546-9700 • TWX 510-225-3699

CIRCLE NUMBER 61

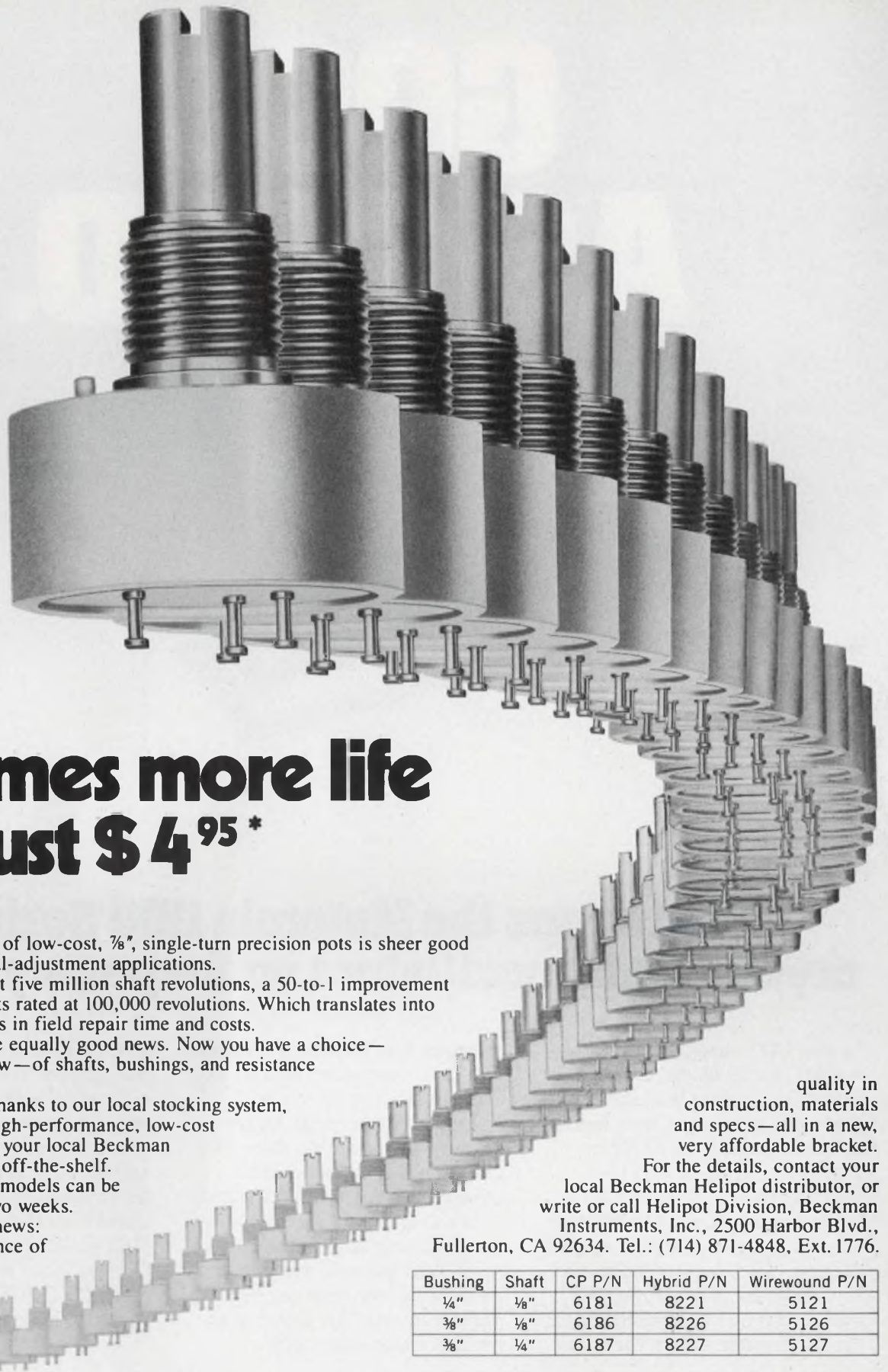

# 50 times more life for just \$4<sup>95</sup>\*

Our new series of low-cost, 1/8", single-turn precision pots is sheer good news for continual-adjustment applications.

They're rated at five million shaft revolutions, a 50-to-1 improvement over short-life pots rated at 100,000 revolutions. Which translates into notable reductions in field repair time and costs.

The options are equally good news. Now you have a choice—see the table below—of shafts, bushings, and resistance elements.

What's more, thanks to our local stocking system, you can get the high-performance, low-cost Model 6187 from your local Beckman distributor—fast, off-the-shelf. Samples of other models can be shipped within two weeks.

That's the big news: Beckman excellence of

\*100-piece quantity  
CP Versions

quality in construction, materials and specs—all in a new, very affordable bracket.

For the details, contact your local Beckman Helipot distributor, or write or call Helipot Division, Beckman Instruments, Inc., 2500 Harbor Blvd., Fullerton, CA 92634. Tel.: (714) 871-4848, Ext. 1776.

Bushing	Shaft	CP P/N	Hybrid P/N	Wirewound P/N
1/4"	1/8"	6181	8221	5121
3/8"	1/8"	6186	8226	5126
3/8"	1/4"	6187	8227	5127

## BECKMAN®

CIRCLE NUMBER 72

# GOOD AS GOLD.

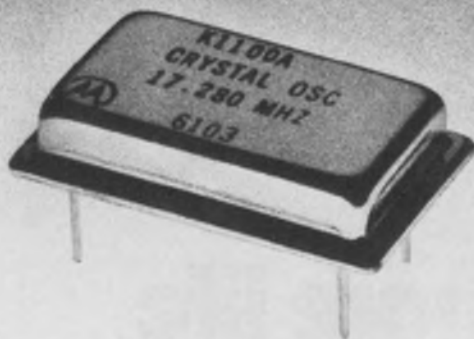

## Gold keeps the Motorola 1100 Series crystal clock oscillators on frequency longer.

In our 1100 series, the Motorola hybrid crystal clock oscillator is best in its class because it performs better and lasts longer — from 250 KHz to 70 MHz with a tolerance of  $\pm 1.0\%$  to 0.0025%.

We ensure that our oscillators stay on frequency by using gold plating. Gold doesn't oxidize as rapidly as most other metals, and oxidation changes the mass on the crystals. When the mass

changes, the frequency changes. You don't want that. Nor do we.

Because dust on a crystal will change the oscillator frequency, we assemble them in a Class 100 Clean Room. The atmosphere is controlled to keep dust out and hold the temperature and humidity at the correct level. And because we demand perfection, we grow our own perfect quartz. The result is an oscillator that stays on fre-

quency longer. All this at a price that's lower than you'd expect.

If only the best is good enough for you, we'll be happy to send you a price list, rep list, and more data than you'll find on any other oscillator data sheet. Call Barney Ill at (312) 451-1000, or write Motorola, Component Products Department, 2553 N. Edgington, Franklin Park, Illinois 60131.



**MOTOROLA INC.**  
**Component Products**

CIRCLE NUMBER 63



# When it comes to VFFV Data Converters, we can serve you the best.



Let designing become simply beautiful for you again. Put our complete family of modular and monolithic VFFV data converters on your side.

We're a small company, true. But we're fussy. And we've gained a reputation for delivering products that live up to specs, fit into cozy spaces, and cost you a lot less money.

For those who live by the numbers, our modular VFFV converters are high-performance, wide

bandwidth units that maintain better than  $\pm 0.005$  to  $\pm 0.02\%$  accuracy up to 1 MHz bandwidth. And our economical, single-power supply monolithics provide  $\pm 0.04\%$  linearity at 1 MHz.

Prices range from \$8.95 to \$179. Put something simply beautiful into your next scheme. Drop a line or call: intech, 282 Brokaw Road, Santa Clara, CA 95050, (408) 244-0500  
TWX: 910-338-0254.

 **intech**  
**function modules**

CIRCLE NUMBER 64

## Constant-current feedback loop improves photodetector performance in optical sensors

Improve your beam-interrupt optical system with a constant-current feedback loop to bias the photodetector, and use both the dc and ac gain of a high-gain op amp in the feedback loop. The circuit (see figure) provides Class-A biasing for the phototransistor, a Motorola MRD 360 Darlington. Not only can you use the circuit for beam-breaking applications, but it's good enough for light-measuring.

A phototransistor is often called upon to distinguish between low-energy light pulses in the infrared region and ambient light, which may be strongly modulated by 60-Hz light sources. With Class-A biasing, the phototransistor's threshold is easily exceeded, which puts ambient light variations and fast rise time light pulses in the phototransistor's linear region. And ac coupling of the signal (via the specially selected  $R_{12}C_5$  combination) helps attenuate 60-Hz components, but not the desired signals.

In the circuit, a dc reference voltage is established at  $A_1$ 's inverting input by voltage divider  $R_8$  and  $R_9$ . Phototransistor  $Q_3$ , a Darlington arrangement, provides dc inverting to hold  $A_1$ 's noninverting input, through feedback, at a voltage which differs from the reference by a very small offset. Constant voltage drops across  $R_6$  and  $R_7$  provide constant Class-A current to the phototransistor. Photon overloading of the photosensitive base of  $Q_3$  is minimized by  $R_{10}$ , a 10-M $\Omega$  resistor. And to control the op amp's dc output to a desired level of pulse clipping,  $R_{10}$  can be a selected value. The photo-Darlington and op amp together

produce a switching time of 25  $\mu$ s.

In addition to the closed-loop circuit between  $Q_3$  and  $A_1$ , the circuit contains a LED pulser, an inhibited trigger circuit and an alarm-horn driver. The pulser consists of  $Q_1$ , a 300-Hz unijunction relaxation oscillator feeding  $Q_2$ , the LED driver. Current pulses through the LED are about 1-A peak with a pulse width of 40  $\mu$ s, giving a duty cycle of about 1%.

After a pulse is detected and amplified, the pulse is capacitively coupled (which rejects 60-Hz modulation) to pulse amplifier  $Q_4$ , and then fed to clamp transistor  $Q_5$ . Since  $Q_5$  clamps the timing capacitor  $C_6$  of the 100-Hz programmable-unijunction oscillator PUT  $Q_6$ , periodic pulses keep  $C_6$  below the firing potential of the PUT. But if the infrared beam is broken for more than four pulse times (about 12 ms),  $Q_6$  conducts, triggering horn-driver  $Q_7$ . A steady stream of pulses inhibits triggering, so the four-pulse feature provides false-signal immunity.

An interrupter-contact-type horn turns off  $Q_7$  after initial triggering, if  $R_{21}$  is large enough. A lower value of  $R_{21}$  would allow  $Q_7$  to latch, and the horn would sound continuously until the circuit is externally opened. A prototype system using a simple flashlight reflector behind the LED can respond at distances to 3.5 ft.

*Al Pshuenich, Senior Application Engineer, Motorola Semiconductor Products, Inc., Phoenix, AZ 85008.*

CIRCLE NO. 311

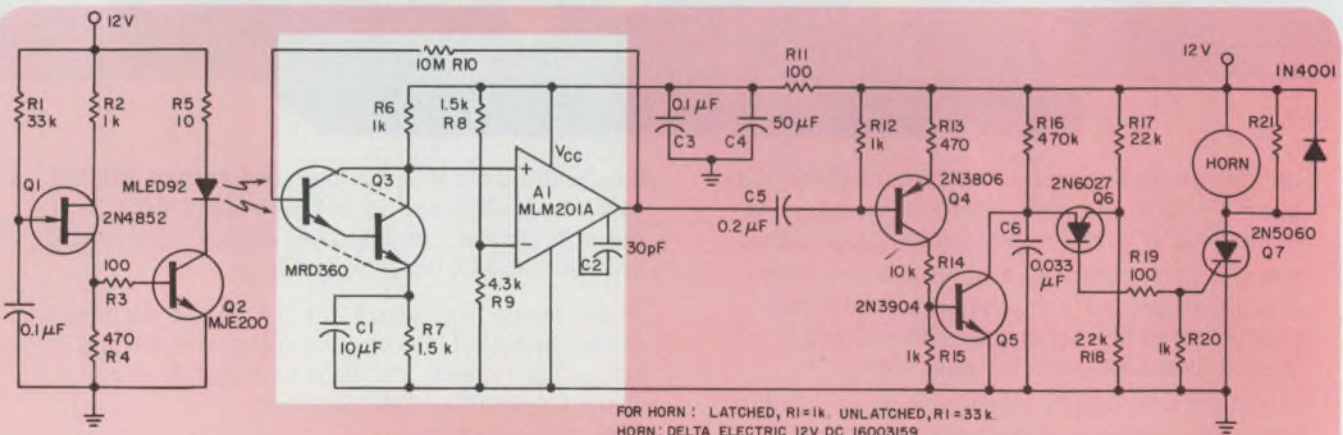

Constant-current Class-A biasing of the phototransistor,  $Q_3$ , allows this optical sensor to operate in a linear region, which improves the

performance of the circuit on fast rise-time pulses. The circuit also includes a LED pulser, inhibited trigger circuit and an alarm-horn driver.



Littelfuse



Littelfuse



Littelfuse



Littelfuse



Littelfuse



Littelfuse



Littelfuse



Littelfuse



Littelfuse

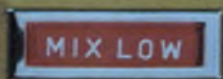

Littelfuse



Littelfuse



Littelfuse



Littelfuse

# We're a whole lot more than fuses.

Everybody knows Littelfuse makes fuses...and a complete line of related devices like fuseholders, fuse clips, fuse blocks, and circuit breakers.

But that's only one side of our story. We're switches, relays, and indicator lights, too.

In fact, our Littelite line includes the widest selection of cartridge lamps and lampholders, sub-miniature and miniature lamp-holders, and Snap-mount Plastic Lites you'll find anywhere. And they're available off-the-shelf from a nationwide network of Littelite distributors.

Switches and Relays? We make all shapes and sizes, designed to fit a variety of applications—from appliances to computers.

To find out what our products can do for yours, just give us a call or send for our Catalog No. GL-77. We can show you a whole lot more than fuses.

1927-1977 **50** YEARS

**LITTELFUSE**

SUBSIDIARY OF  
**Tracor**

800 East Northwest Highway  
Des Plaines, Illinois 60016  
312/824-1188

CIRCLE NUMBER 65

# Field-programmable logic array decodes keyboard without a debounce circuit

A field-programmable logic array (FPLA) can be programmed with hexadecimal code to load keyboard data into an 8-bit processor (Fig. 1). Not only that, but use of the FPLA and a one-shot makes key debounce-circuitry unnecessary.

Each of the FPLA's 16 inputs is assigned a unique key (Fig. 2). When a key is depressed, the FPLA immediately generates the 4-bit hex code (B<sub>0</sub> through B<sub>3</sub> in Fig. 2), and a fifth bit, B<sub>4</sub>, which first passes through time delay R<sub>18</sub>, C<sub>2</sub>, then fires one-shot U<sub>2</sub>. Depending on the state of flip-flop U<sub>6</sub>, the FPLA's contents are loaded into either buffer U<sub>3</sub> or U<sub>4</sub>. The one-shot's trailing edge toggles U<sub>6</sub>, which sets up the empty buffer to be loaded.

An 8-bit hex byte is available on the output lines, ready to input to the processor. Releasing a key presents an all-zeros input to the FPLA, which holds B<sub>4</sub> at ZERO. As a result, the buffers cannot be loaded on a key bounce.

*John A. Glaab, Electronic Systems Engineer, National Aeronautics and Space Administration, Goddard Space Flight Center, Greenbelt, MD 20771.*

CIRCLE NO. 312

82S100 Program																					
Inputs																Outputs					
15	14	13	12	11	10	9	8	7	6	5	4	3	2	1	0	B4	B3	B2	B1	B0	
0	0	0	0	0	0	0	0	0	0	0	0	0	0	0	0	1	1	0	0	0	0
1	0	0	0	0	0	0	0	0	0	0	0	0	0	0	1	0	1	0	0	0	1
2	0	0	0	0	0	0	0	0	0	0	0	0	0	1	0	0	1	0	0	1	0
3	0	0	0	0	0	0	0	0	0	0	0	0	1	0	0	0	1	0	0	1	1
4	0	0	0	0	0	0	0	0	0	0	1	0	0	0	0	0	1	0	1	0	0
5	0	0	0	0	0	0	0	0	0	1	0	0	0	0	0	0	1	0	1	0	1
6	0	0	0	0	0	0	0	0	1	0	0	0	0	0	0	0	1	0	1	1	0
7	0	0	0	0	0	0	0	1	0	0	0	0	0	0	0	0	1	0	1	1	1
8	0	0	0	0	0	0	1	0	0	0	0	0	0	0	0	0	1	1	0	0	0
9	0	0	0	0	0	1	0	0	0	0	0	0	0	0	0	0	1	1	0	0	1
A	0	0	0	0	1	0	0	0	0	0	0	0	0	0	0	0	1	1	0	1	0
B	0	0	0	1	0	0	0	0	0	0	0	0	0	0	0	0	1	1	0	1	1
C	0	0	1	0	0	0	0	0	0	0	0	0	0	0	0	0	1	1	1	0	0
D	0	1	0	0	0	0	0	0	0	0	0	0	0	0	0	0	1	1	1	0	1
E	0	1	0	0	0	0	0	0	0	0	0	0	0	0	0	0	1	1	1	1	0
F	1	0	0	0	0	0	0	0	0	0	0	0	0	0	0	0	1	1	1	1	1
Key release	0	0	0	0	0	0	0	0	0	0	0	0	0	0	0	0	0	0	0	0	0

Note: All outputs are programmed active low.

1. An 82S100 field-programmable logic array is basic to this hex keyboard decoder. Hexadecimal code is programmed into the device; a single one-shot allows debounce circuits to be eliminated.

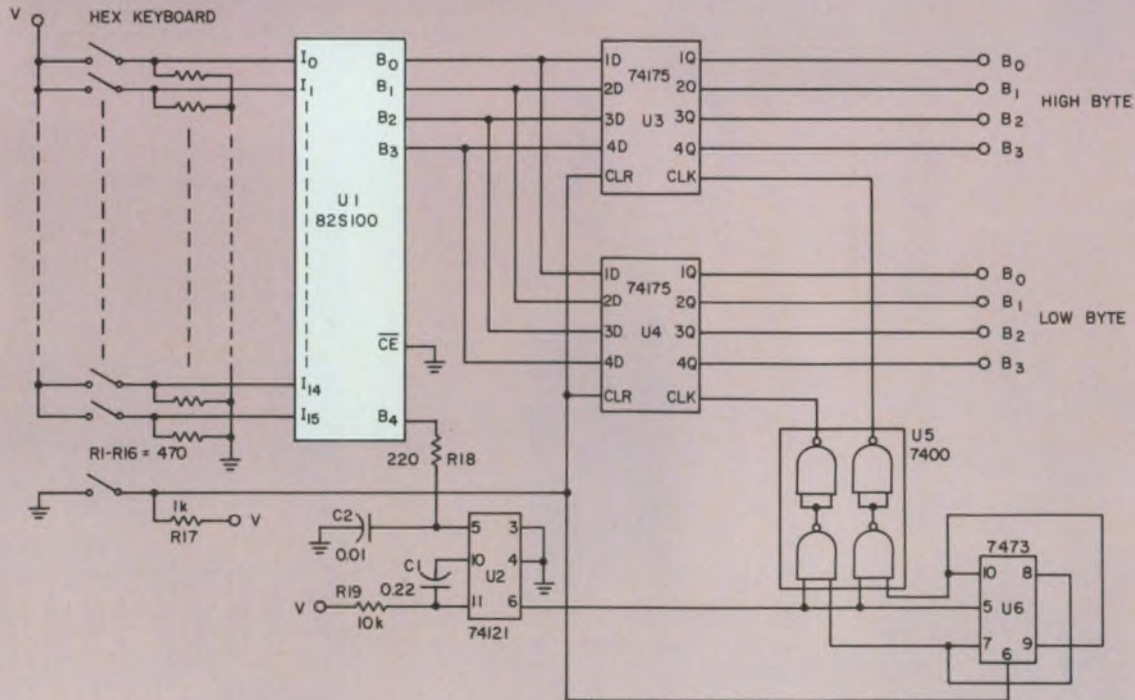

2. Hexadecimal coding of an FPLA provides a unique address to each key on a keyboard. The hex

output code is stored in B<sub>0</sub> through B<sub>3</sub>. A ONE on the B<sub>4</sub> line allows output buffers to be loaded.

# No more square tails in round holes.



## Introducing the wave solder PC connector.

What an electronic design engineer will make-do with in a pinch is astonishing. For example — converting wire wrap\* PC connectors to wave solder.

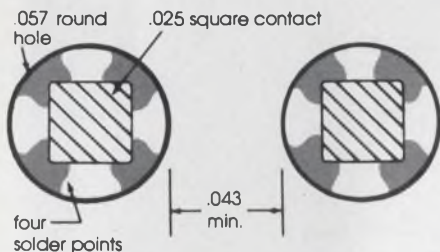

How it's done: you saw off the square .025" tail and push it through a .057" round hole in the PC board. You get only 4 contact points for solder. And there's room for only one tracing between holes. But, so what...it works.

### At last — The obvious answer

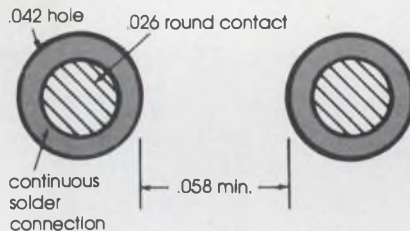

Our own design engineers, not afraid of doing the obvious and simple thing, have done just that. They've taken a series of our PC wire wrap connectors — and given them .026" round tails. Everything else stays the same: the insulator, semi-bellows contacts, pin and row spacing.

### So what?

So — the .026" round pin slips into a .042" round hole in your PC board for an excellent solder connection. So — you can now get multiple tracings between rows.

We have two tail lengths: a .200" short one and a .250" longer one to take the AS400 Solderpak\*\* System. These are available in connectors with contacts on .100", .125" and .156" centers, and in layouts from 6 to 50 positions.

Use our coupon and we'll send you all the details.

**There's more.** There are some things we haven't told you — including materials and other details you need to know. Ask us for the literature.

NAME \_\_\_\_\_

TITLE \_\_\_\_\_ TELEPHONE \_\_\_\_\_ EXT. \_\_\_\_\_

COMPANY \_\_\_\_\_

ADDRESS \_\_\_\_\_

CITY \_\_\_\_\_ STATE \_\_\_\_\_ ZIP \_\_\_\_\_



Viking Industries, Inc./21001 Nordhoff Street, Chatsworth/CA 91311 U.S.A.  
(213) 341-4330/TWX: 910-494-2094

\*A registered trademark of the Gardner-Denver Company. \*\*A registered trademark of the Raychem Corporation.

CIRCLE NUMBER 66

# Improve double-balanced mixer response with an active-circuit design

With four 2N5109 CATV transistors in the active double-balanced mixer of fig. 1, you can use impedance-stabilized feedback in a transformer-coupled configuration. As a result, the mixer has lower intermodulation distortion than conventional field-effect or diode mixers at the same drive level, and a low-noise figure as well as stable gain. The circuit's

10- $\Omega$  emitter resistors reduce the amount of flicker noise. Furthermore, the circuit can achieve a 40-dBm intercept point with a local oscillator drive of 13 dBm. Even a reduced drive of 10 dBm still gives good circuit performance and low distortion.

The available gain of the specialized CATV (community-antenna television) transistors taken to-

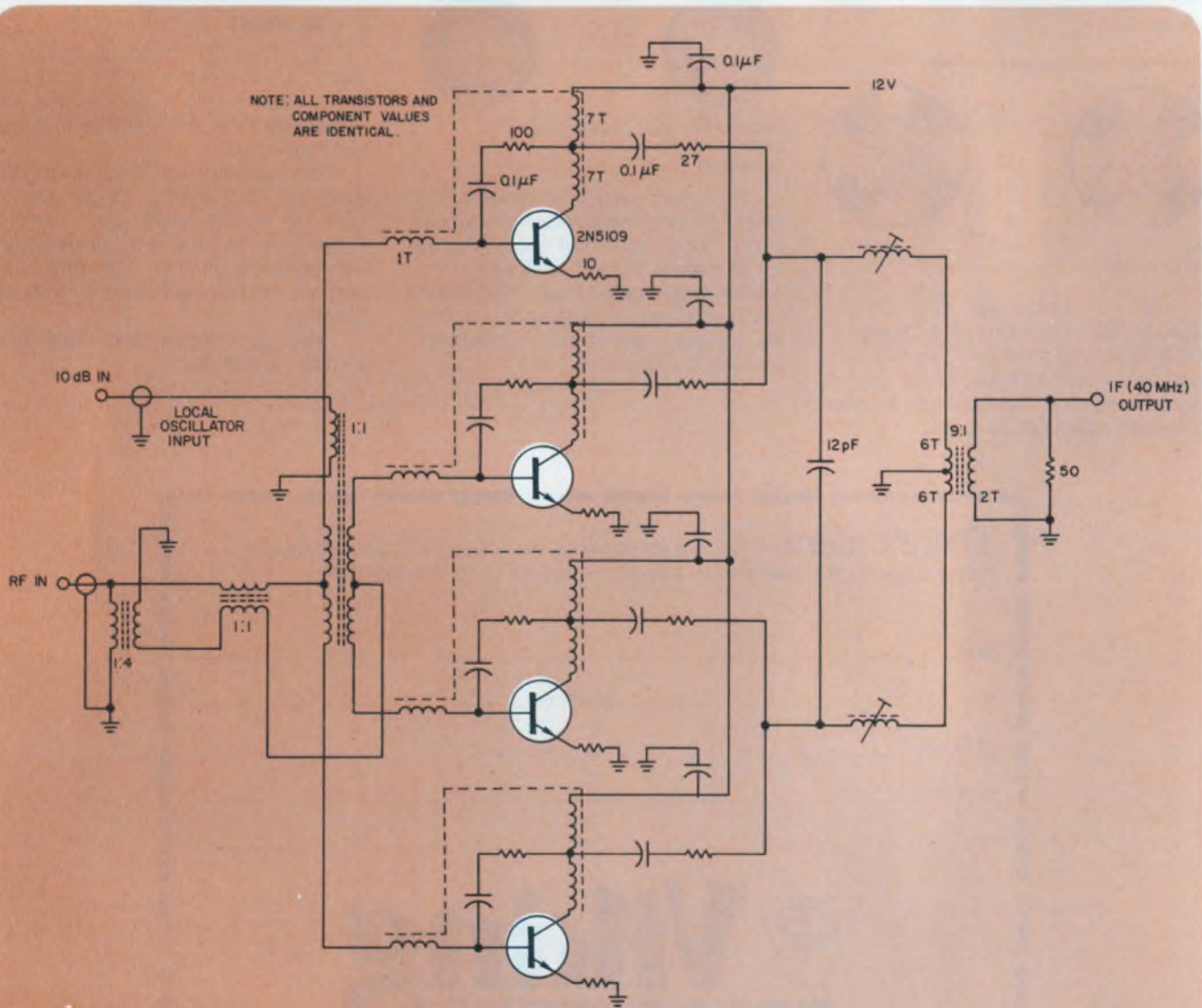

1. An active double-balanced mixer uses 2N5109 transistors for stable gain and low noise.

# If we didn't solve so many of your coax problems we wouldn't be number one.

When it comes to solving knotty coaxial cable problems, it's not surprising that so many design engineers come to Times. We're number one in coax. Which means that there is an excellent chance we have a standard cable to meet your needs perfectly. Times cables are uniform up to 22 GHz and we have constructions suitable for virtually any environmental conditions. We even have cables to meet the new MIL-C-17E specifications, plus Fiber Optic cables.

If you need something unusual, nobody builds as many special cables as Times. Whatever your requirements, Times

can design and produce it: ultra-low noise; high frequency; phase tracking over a broad range of frequencies and temperatures; extra strength; super flexible; buoyant; radiating; you name it.

Times also produces more than 25,000 cable assemblies per year, to exacting specifications. With Times broadband cable assemblies, you're assured of maximum RFI integrity; clean, low resistance connections and exceptionally low VSWR, even at frequencies in the double digit gigahertz range.

To reduce lead time, most cables are readily available from your local Times distributor.

**Send for your free copy of the Times coax "Bible".**



**Times Wire & Cable**

The #1 Coaxial Cable Company

358 Hall Avenue, Wallingford, CT 06492

(203) 265-2361, TWX: 710-476-0763

In Canada: 290 Benjamin Hudon, Montreal (514) 331-2860  
DIVISION OF TIMES FIBER COMMUNICATIONS, INC.

CIRCLE NUMBER 67

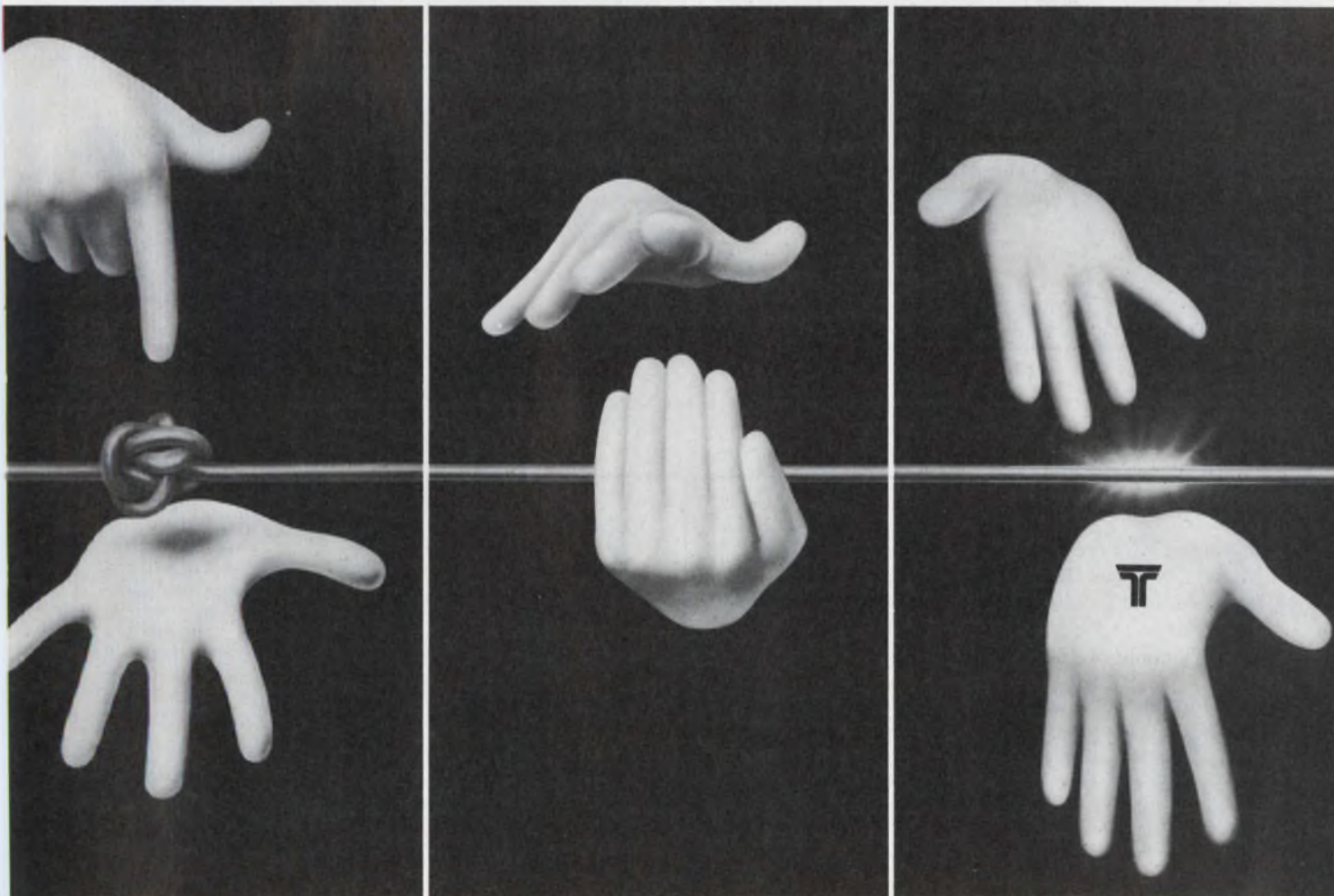

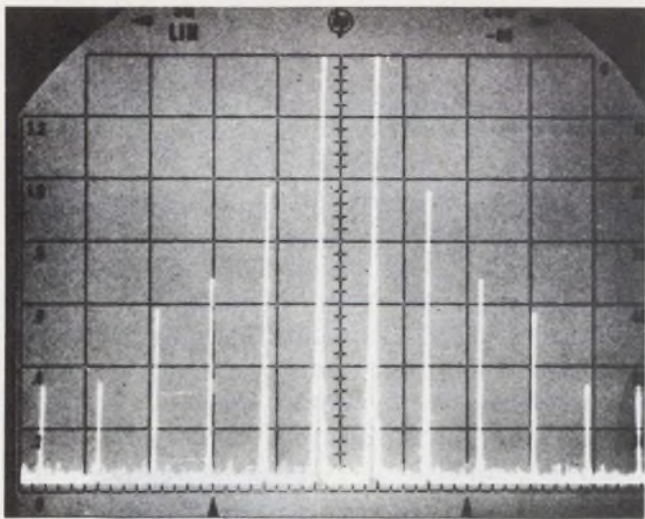

(a)

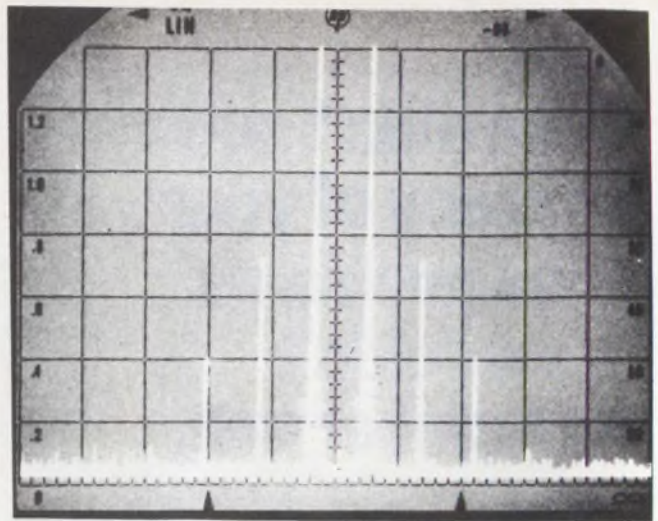

(b)

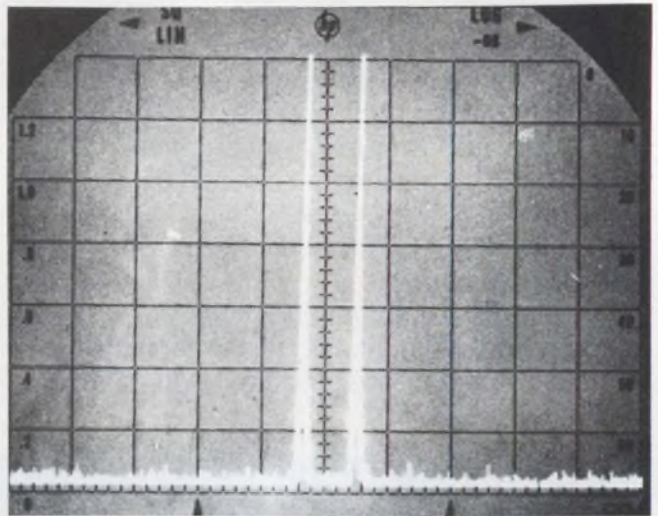

(c)

gether with their low-noise figure and improved gain-bandwidth product allow you to use the impedance-stabilized, current/voltage rf-feedback technique, where previous mixers were passive circuits that used hot-carrier diodes or grounded-gate silicon FETs.

An ordinary double-balanced mixer that uses just four hot-carrier diodes produces the response plot of Fig. 2a. A mixer constructed with a Siliconix quad FET (U 350) generates the plot of Fig. 2b. Note the significant improvement over Fig. 2a—third-order intermodulation distortion is suppressed by 35 dB. However, the circuit of Fig. 1, with CATV transistors, suppresses third-order distortion by 65 dB (Fig. 2c) for about the same component cost as a quad-FET circuit.

*Ulrich L. Rohde, President, Rohde and Schwarz Sales Co., 14 Gloria Lane, Fairfield, NJ 07006.*

CIRCLE NO. 313

**2. Mixer response benefits from active circuits.** A passive, hot-carrier diode mixer's response (a) is improved with a grounded-gate quad FET circuit (b). But the best response occurs when CATV transistors are used as the active elements in the circuit (c).

**IFD Winner of November 8, 1977**

**Raymond K. Ferris**, Supervisor, Program Support, Actron, 700 Royal Oaks Dr., Monrovia, CA 91016. His idea "Constant Bandwidth PLL Tone Decoder Accepts Wide Range of Input Voltages" has been voted the Most Valuable of Issue Award.

Vote for the Best Idea in this issue by circling the number for your selection on the Reader Service Card at the back of this issue.

**SEND US YOUR IDEAS FOR DESIGN.** You may win a grand total of \$1050 (cash)! Here's how. Submit your IFD describing a new and important circuit or design technique, the clever use of a new component or test equipment, packaging tips, cost-saving ideas to our Ideas for Design editor. Ideas can only be considered for publication if they are submitted exclusively to ELECTRONIC DESIGN. You will receive \$20 for each published idea. \$30 more if it is voted best of issue by our readers. The best-of-issue winners become eligible for the Idea of the Year award of \$1000.

ELECTRONIC DESIGN cannot assume responsibility for circuits shown nor represent freedom from patent infringement.



# odds-on choice

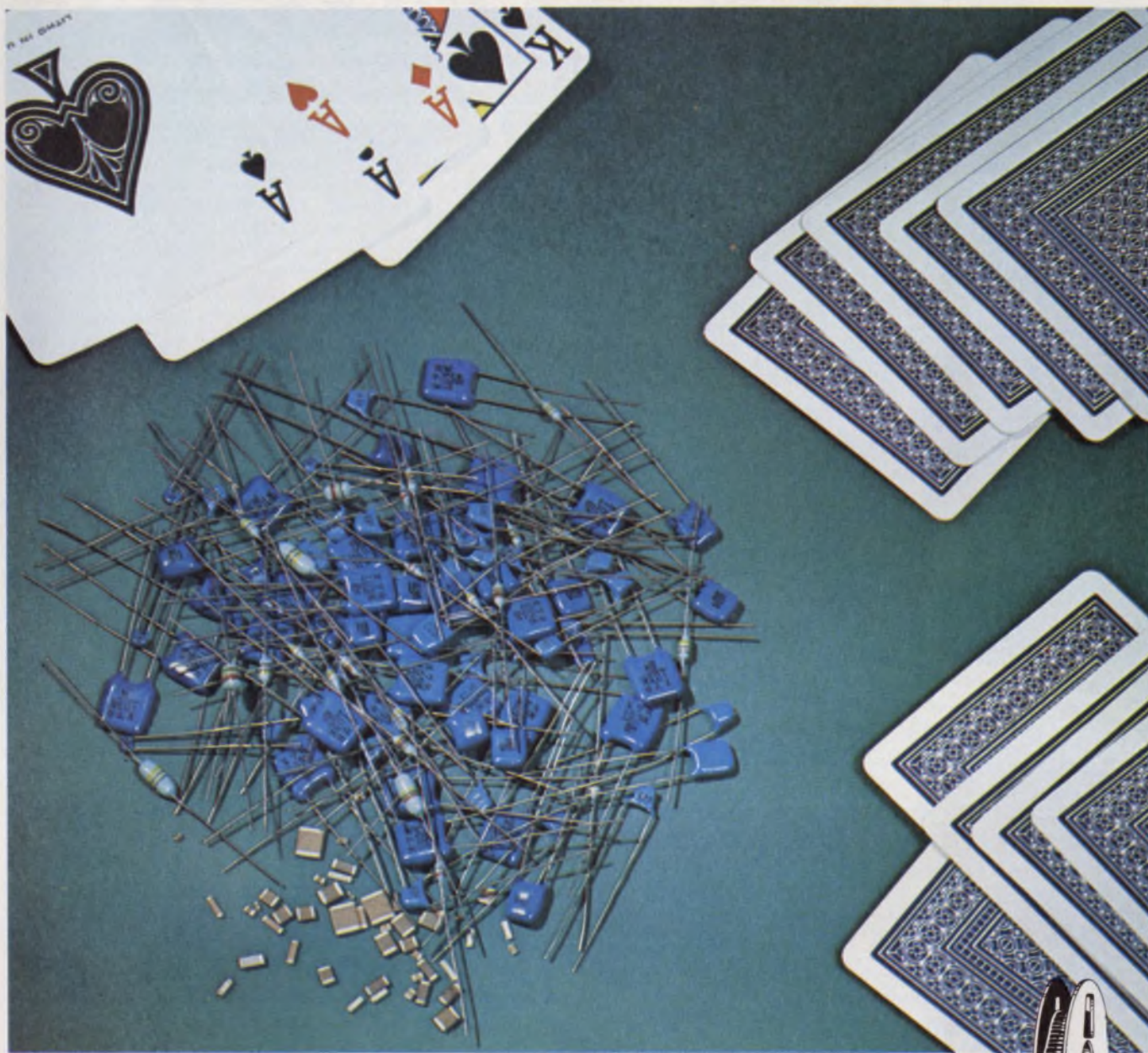

## in monolithic ceramic capacitors

We make more ceramic capacitors than anyone else in the world. That's the Murata capability and know-how that takes the gamble out of monolithic ceramic capacitor specifying. Chips, epoxy coated radials and our new epoxy coated axials are available in virtually every standard capacity and voltage rating. What's more, leaded capacitors are offered in tape and reel configurations for every type of automatic insertion equipment.

Write for complete catalog information to: Murata Corporation of America, 1148 Franklin Road, S.E., Marietta, Georgia 30067. Phone: 404-952-9777.

*first in ceramics*

**muRata**  
CORPORATION  
OF AMERICA

# FOR RENT...NOW...

**$\mu$ scope™ 820, the powerful new portable, fully programmable diagnostic instrument from Intel that's like a design engineer in a briefcase.**

You can use the remarkable new  $\mu$ scope™ 820 Microprocessor System Console to maintain and troubleshoot your microprocessor-based system . . . in the lab, on your production line, at your service facility, or in the field.

Intel's first instrumentation product is packaged in a briefcase you can carry anywhere in the world to obtain total, interactive control over your 8080 or 8085-based system.  $\mu$ scope 820 lets you isolate problems rapidly and complete your system maintenance routines with ease. And you can check out factory, depot, or field upgrade installations thoroughly with preprogrammed system maintenance and exercise routines. Your lab or field support people can use it to quickly verify hardware as well as software field upgrades and changes. And you can use the versatile instrument to tackle system reliability problems on-site — anywhere in the world — with the same instruments you use in your factory.

The  $\mu$ scope™ 820 console has its own microprocessors to provide you with a number of sophisticated troubleshooting techniques. And you can switch from testing a system based on one microprocessor to a different system based on a different microprocessor in minutes.

The new instrument can be used easily by anyone — including your engineering, manufacturing, field support and field service employees. It is an interactive diagnostic tool which employs high-level command keys and extensive operator prompting to simplify operation, minimize operator error and simplify operator training. Because of unique personality probes and front panel overlays, it can be reconfigured in minutes to work with different Intel microprocessors. It's on-the-shelf now at REI, ready to go off-the-shelf for you.

**Rental Electronics, Inc.**  
Another of the AMERICAN companies

**More than 12,871 state-of-the-art instruments . . . off-the-shelf, throughout North America.**

- Tell me more about the  $\mu$ scope 820 now! Call me at \_\_\_\_\_
- Send me a copy of your free illustrated Rental Catalog.
- I might be interested in buying — on a money-back guarantee basis — some of your late-model, well-maintained "previously owned" equipment. Please send me your Equipment Sales Catalog.
- I have a pressing need right now for the following: \_\_\_\_\_

Please phone me immediately at \_\_\_\_\_

NAME \_\_\_\_\_ TITLE \_\_\_\_\_

COMPANY \_\_\_\_\_

ADDRESS \_\_\_\_\_

CITY \_\_\_\_\_ STATE \_\_\_\_\_ ZIP \_\_\_\_\_

PHONE NUMBER \_\_\_\_\_ EXTENSION \_\_\_\_\_

Complete this coupon and return it today to  
REI, 19347 Londelius St., Northridge, CA 91324.

© 1978 Rental Electronics, Inc.

GSA #GS-04S-21963 Neg

**CORPORATE HEADQUARTERS:**  
Palo Alto, CA  
(415) 324-8080

**RENTAL FACILITIES:**  
Northridge, CA (213) 993-RENT  
(7388); Anaheim, CA (714) 879-0561;  
Mountain View, CA (415) 968-8845; Ft  
Lauderdale, FL (305) 771-3500; Des Plaines, IL  
(312) 827-6670; Burlington, MA (617) 273-2770;  
Gaithersburg, MD (301) 948-0620; Oakland, NJ (201)  
337-3757; Cleveland, OH (216) 442-8080; Dallas, TX (214)  
661-8082; Houston, TX (713) 780-7218; Seattle, WA (206) 641-6444

**CANADIAN RENTAL FACILITIES:** (Rental Electronics Ltd.) Rexdale, Ontario (416) 675-7513; Montreal, Quebec (514) 681-9246; Vancouver, BC (604) 684-6623  
**REI SALES COMPANY:** Burlington, MA (617) 273-2777

# FOR RENT...NOW...

Beehive's versatile and easy-to-use B100 and Mini Bee 2 terminals, both available for immediate short-term, low cost rentals today.

If you need a self-contained, feature-filled video display terminal fast, the B100 will fill the bill . . . and it's available today. Beehive International's B100 features both RS232C or current loop interface, has switch selectable transmission rates from 75 to 19,200 bps, and includes cursor control. You'll also like the addressable cursor. The terminal has an easy-to-read 12-inch non-glare screen which is formatted to display 24 lines with 80 characters per line. You can choose upper and lower case characters, too. The B100 has a total page memory of 1920 characters, and the 82-key, ANSI compatible keyboard features auto repeat, 2-key rollover and alpha lock. The addressable cursor lets you directly position by line and column, and an erase mode allows you to erase from cursor to end of line, from cursor to end of memory, and clear. You'll also find operation more efficient because of B100's 11-key numeric pad with decimal and additional function keys. Communications mode is Full Duplex (Echoplex), Half Duplex, and Block (asynchronous 10 or 11-bit word). It's ready for you now.

The low-rental rates on Mini Bee 2 will make you happy if you need a TTY-compatible terminal with cursor control and a detachable keyboard. Beehive's Mini Bee 2 is a stand-alone, operator/computer accessible remote display terminal with a detachable keyboard. You use Mini Bee 2 to transmit and receive data serially through an RS232C interface at any of several preselected transmission rates to a maximum of 9600 baud. Mini Bee 2 has a 12" rectangular monitor which displays 25 lines with 80 characters per line. It has a total page memory of 2000 characters, and each character is generated from a 5x7 dot matrix with two dot spacing between adjoining characters. Communications mode can be full duplex, half duplex, 10 or 11-bit asynchronous word. Mini Bee 2 also features character-by-character transmission, an escape sequence mode for unique CRT functions, and an erase mode. It's also available off-the-shelf from REI immediately.

**Rental Electronics, Inc.**  
Another of the **AMERICAL** companies



More than 12,871  
state-of-the-art instruments . . .  
off-the-shelf, throughout North America.

- Tell me more about B100 and Mini B2 now!  
Call me at \_\_\_\_\_
- Send me a copy of your free illustrated Rental Catalog.
- I might be interested in buying—on a money-back guarantee basis—some of your late-model, well-maintained "previously owned" equipment. Please send me your Equipment Sales Catalog.
- I have a pressing need right now for the following: \_\_\_\_\_

Please phone me immediately at \_\_\_\_\_

NAME \_\_\_\_\_ TITLE \_\_\_\_\_

COMPANY \_\_\_\_\_

ADDRESS \_\_\_\_\_

CITY \_\_\_\_\_ STATE \_\_\_\_\_ ZIP \_\_\_\_\_

PHONE NUMBER \_\_\_\_\_ EXTENSION \_\_\_\_\_

Complete this coupon and return it today to  
REI, 19347 Londelius St., Northridge, CA 91324.

GSA #GS-04S-21963 Neg

© 1978 Rental Electronics, Inc.

Northridge, CA (213) 993-7368  
Anaheim, CA (714) 879-0561  
Mountain View, CA (415) 968-8845  
Dallas, TX (214) 661-8082  
Houston, TX (713) 780-7218  
Burlington, MA (617) 273-2770  
Oakland, NJ (201) 337-3757, Gaithersburg, MD (301) 948-0620  
Des Plaines, IL (312) 827-6670; Ft. Lauderdale, FL (305) 771-3500  
Cleveland, OH (216) 442-8080; Seattle, WA (206) 641-6444

Readale, Ontario (416) 625-7513  
Montreal, Quebec (514) 681-9246; Vancouver BC (604) 684-6623

# abbott

## POWER SUPPLIES

### 2,685 answers to power supply questions.

Answers to better power and thermal efficiency. Answers to size and weight reductions. Answers to available off-the-shelf covered/open frame power supplies and transformers. And price and delivery answers.

These and many more answers can be found in our three product catalogs. And they're yours. Free. Just circle reader card number. Better yet, write or call Abbott. The Power Supply Specialist.



**Power Supply Catalog** — Comprehensive 60-pager describes our full line of 1,573 hi-efficiency, hermetically sealed, single and dual output power supplies and switcher modules. Inputs of 60 and 400Hz and DC are available with outputs from 3VDC to 740VDC, 1 to 250 Watts. Prices start as low as \$174 for 2-4 units.

**Circle Card Number 90**

**Industrial Power Supply Catalog** — Some 279 of our low cost, high quality OEM power modules are detailed in this 16-pager. Includes covered/open frame, AC to DC single, dual and triple output versions, with outputs from 5 to 36VDC, 0.5 to 320 Watts. Plus DC to AC converters with 50 and 60Hz outputs. Priced as low as \$35 for up to 24 units.

**Circle Card Number 91**

**Transformer Catalog** — A 20-pager for the do-it-yourself power supply designer with instructions on how to specify for your custom units. Also covers 833 of our standard military, industrial and miniature pcb power transformers. Included are 60 and 400Hz, single phase input units, with prices starting as low as \$5.10 for up to 9 pieces.

**Circle Card Number 92**

See Power Supply Section 4000, and Transformer Section 5600, Vol. 2, of your EEM catalog; or Power Supply Section 4500, and Transformer Section 0400, Vol. 2, of your GOLD BOOK for complete information on Abbott products.

**abbott transistor**

**LABORATORIES, INCORPORATED**

General Offices  
5200 W. Jefferson Blvd., Los Angeles 90016  
(213) 936-8185 Telex: 69-1398

Eastern Office  
1224 Anderson Ave., Fort Lee, N.J. 07024  
(201) 224-6900 Telex: 13-5332

## GaAsFET may solve NMOS transistor memory problems

Silicon NMOS transistors, when used as nonvolatile-memory storage devices, are hampered three ways. Their data-storage lifetime leaves room for improvement; they are not radiation-hardened; and their access time is relatively slow. But these limitations may be overcome by a nonvolatile GaAsFET transistor, developed at the Dept. of Electrical and Electronic Engineering, University of Newcastle upon Tyne, England.

The new transistor uses a double-oxide gate-insulator structure consisting of aluminum oxide ( $\text{Al}_2\text{O}_3$ ) and gallium arsenide anodic native oxide. The charge is stored at the interface between the two oxides (see Fig.).

The double-oxide structure is made by evaporating 450 Å of aluminum onto the gallium arsenide device and then anodizing through the aluminum layer. The final structure is 700 Å of

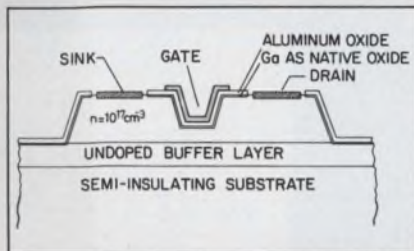

$\text{Al}_2\text{O}_3$ , with some 10 or 20 Å of GaAs underneath the aluminum oxide.

The interfaces between the oxides are charged by three-second pulses as high as 30 V. The ability of the structure to retain charge was measured with the gate disconnected after charging and with the gate grounded and the device operating. With the gate disconnected, saturation current of 5.2 mA decays at the rate of 0.17 mA per decade of time, measured over 2000 minutes.

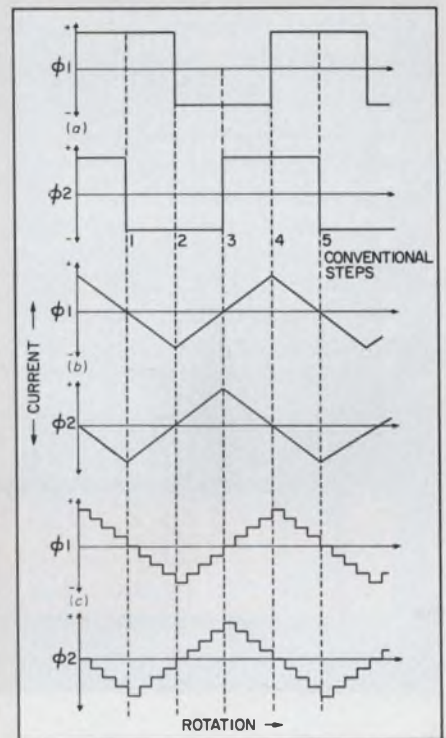

equal staircase steps—whose sizes are obtained by measuring the motor's performance with perfect staircase drive—the nonlinearity can be removed.

## Laser crystal produces high spectral purity

A new semiconductor lasing element has almost ideal characteristics for fiber-optic communications systems. The laser, a neodymium aluminum-borate crystal between 10 and 100  $\mu\text{m}$  long, emits a single spectral line of unusual purity, at 1.06- $\mu\text{m}$ .

The key to the crystal's development is the process used for doping the aluminum compound. By varying the doping, the laser can be tuned to radiate at a wavelength where an optical fiber has minimum absorption loss. As a result, attenuations in the order of 1 dB/km or less are possible.

The doping process is, as yet, being kept secret. The crystal was excited by researchers at the Institute of Applied Physics, at Hamburg University in West Germany, using a krypton gas laser operating at 0.8  $\mu\text{m}$ .

## Stepping motor's angular stability can be increased

With a new technique called "pole interpolation," the angular resolution of a stepping motor can be greatly improved. Indeed, a 200-pole stepping motor can be made to operate with up to 12,800 discrete mini-steps per revolution—and, an angular stability of better than 0.001°.

Developed at Great Britain's National Physical Laboratory, pole interpolation replaces the motor's on-off current pulses with currents of either suitably phased analog waveforms or digitally-generated, modified staircase waveforms.

Conventional two-phase step waveforms are applied to the stator windings as in Fig. 1a. When triangular waves are applied (Fig. 1b), the

motor can be moved continuously between pole positions.

Angular stability depends on the accuracy of the analog waveforms, but these may present design problems. Should that happen, staircase waveforms can be used instead (Fig. 1c). Each step of the staircase represents a stable motor position.

Detailed measurements of the motor's motion have revealed that the angular velocity is not constant as the motor turns—the motor accelerates as it moves away from one conventional pole and decelerates as it approaches the next one. This nonlinearity can lead to unwanted resonances at high stepping speeds.

By using a PROM to generate un-

# The IC Switching Regulator that has everything!

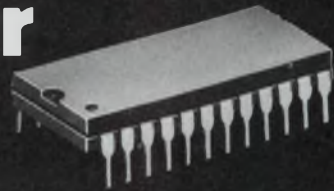

The Ferranti Model ZN1066E Pulse Width Modulator for use in:  
Switching Regulated Power Supplies, Motor Speed Controllers, DC/DC Converters and much more.

## Features:

- High Efficiency
- 0-100% duty cycle control
- Zero overlap of external output transistors guaranteed
- Single ended or complimentary output drive
- Up to 120 mA output drive
- Output frequency adjustable to 500 KHz
- On-chip amplifiers for voltage and current control

- Short circuit protected
- 2.6 V stable reference,  $\pm 50$  PPM/°C
- Soft start capability
- Inhibit and synchronizing inputs
- Major circuit functions externally accessible

better by design



**FERRANTI**  
semiconductors

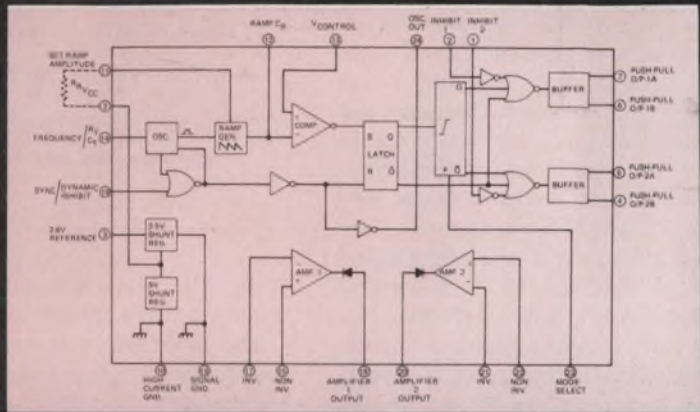

FOR COMPLETE SPECIFICATIONS, CONTACT: FERRANTI ELECTRIC, INC. / SEMICONDUCTOR PRODUCTS  
EAST BETHPAGE ROAD, PLAINVIEW, NEW YORK 11803 PHONE: (516) 293-8383 / TWX: 510-224-6483

CIRCLE NUMBER 71

## If you're into exporting, or about to take the plunge, this could be your market research department.

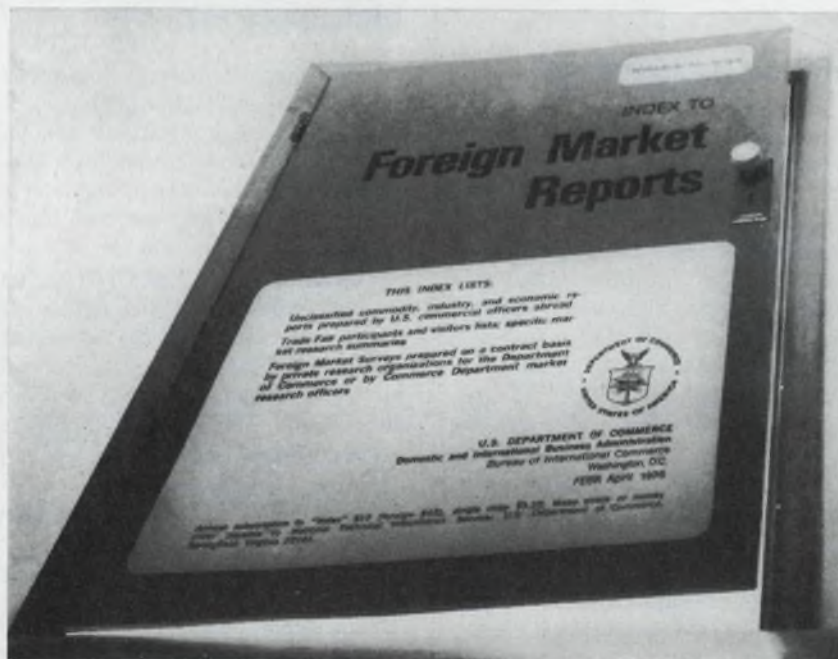

It's your guide to one of the most useful libraries in the world. And it's issued by the U.S. Commerce Department on a monthly basis. Inside, you'll find a list of reports containing a wealth of information for the overseas marketer. Spot news; timely surveys of industrial, commodity, commercial and economic conditions in more than 100 countries; in-depth market research performed by the Commerce Department or private research firms overseas; as well as reports sent to Washington by U.S. Foreign Service Officers. For a free sample, write Secretary of Commerce, U.S. Department of Commerce, BIC-10B, Washington, D.C. 20230.



A Public Service of This Magazine & The Advertising Council

# MINIATURIZED POWER SUPPLIES

## For Logic and Op Amps

With Screw Terminals

Nominal Output Voltage	Output Current Amps.	Regulation		Ripple mv RMS	Price	Model	Case Size
		Load $\pm\%$	Line $\pm\%$				
5	.500	.15	.05	1	\$ 55	5EB50	EB-10
5	1.0	.25	.05	1	75	5EB100	EB-13
5	1.5	.35	.1	1	105	5EB150	EB-13
5	2.0	.25	.05	1	115	5EB200	EB-20
5	2.5	.25	.05	1	130	5EB250	EB-20
$\pm 12$	.100	.05	.05	1	55	DB12-10	EB-10
$\pm 12$	.150	.05	.05	1	65	DB12-15	EB-10
$\pm 12$	.200	.05	.05	1	75	DB12-20	EB-10
$\pm 12$	.300	.05	.05	1	105	DB12-30	EB-13
$\pm 12$	.350	.05	.05	1	110	DB12-35	EB-13
$\pm 12$	.500	.1	.05	1	135	DB12-50	EB-20
$\pm 15$	.100	.05	.05	1	55	DB15-10	EB-10
$\pm 15$	.150	.05	.05	1	65	DB15-15	EB-10
$\pm 15$	.200	.05	.05	1	75	DB15-20	EB-10
$\pm 15$	.300	.05	.05	1	105	DB15-30	EB-13
$\pm 15$	.350	.05	.05	1	110	DB15-35	EB-13
$\pm 15$	.500	.1	.05	1	135	DB15-50	EB-20

PCB Mounting

Nominal Output Voltage	Output Current Amps.	Regulation		Ripple mv RMS	Price	Model	Case Size
		Load $\pm\%$	Line $\pm\%$				
5	.250	.05	.05	0.5	\$ 39	5E25	ES-10
5	.500	.1	.05	1	49	5E50A	EL-10
5	1.0	.2	.05	1	69	5E100	EL-13
5	1.5	.3	.1	1	98	5E150	EL-13
5	2.0	.15	.05	1	110	5E200	EL-20
5	2.5	.15	.05	1	125	5E250	EL-20
$\pm 12$	.025	.1	.05	1	24	D12-03	ES-10
$\pm 12$	.050	.1	.05	1	39	D12-05	ES-10
$\pm 12$	.100	.05	.05	1	49	D12-10A	EL-10
$\pm 12$	.150	.05	.05	1	59	D12-15A	EL-10
$\pm 12$	.200	.05	.05	1	69	D12-20	EL-10
$\pm 12$	.300	.05	.05	1	98	D12-30	EL-13
$\pm 12$	.350	.05	.05	1	105	D12-35	EL-13
$\pm 12$	.500	.1	.05	1	130	D12-50	EL-20
$\pm 15$	.025	.1	.05	1	24	D15-03	ES-10
$\pm 15$	.050	.1	.05	1	39	D15-05	ES-10
$\pm 15$	.100	.05	.05	1	49	D15-10A	EL-10
$\pm 15$	.150	.05	.05	1	59	D15-15A	EL-10
$\pm 15$	.200	.05	.05	1	69	D15-20	EL-10
$\pm 15$	.300	.05	.05	1	98	D15-30	EL-13
$\pm 15$	.350	.05	.05	1	105	D15-35	EL-13
$\pm 15$	.500	.1	.05	1	130	D15-50	EL-20

**Input Voltage:** 105-125 Vac, 47 to 420 Hz, single phase.

**Output Voltage Setting:** Single output models are factory preset to within  $\pm 2\%$  of nominal output voltage, and may be more precisely trimmed to the nominal voltage rating with an external trim resistor. Dual models are set to within  $\pm 1\%$  of their nominal ratings, and are not trimable.

**Polarity:** Either positive or negative terminal of a single output module may be grounded. Dual output modules have a positive/common/negative output terminal configuration.

**Ambient Operating Temperature:**  $-20$  to  $+71^\circ\text{C}$ . (Model 5E150 and 5EB150, 0 to  $+71^\circ\text{C}$ .) No derating required.

**Temperature Coefficient:** 5-volt models,  $.03\%/^\circ\text{C}$ ; dual output models,  $.015\%/^\circ\text{C}$ .

**Impedance:** 0.07 ohm at 1 kHz, 0.2 ohm at 10 kHz (approx.).

**Optional 230 Volt Input:** To order, add suffix "-230" to model number and \$10.00 to price.

**Case Sizes and Weight:**

- EB-10: 3.5" x 2.5" x 1.375" (1 lb)
- EB-13: 3.5" x 2.5" x 1.625" (1 lb 5 oz)
- EB-20: 3.5" x 2.5" x 2.375" (2 lb 1 oz)
- EL-10: 3.5" x 2.5" x 1" (15 oz)
- EL-13: 3.5" x 2.5" x 1.25" (1 lb 3 oz)
- EL-20: 3.5" x 2.5" x 2" (2 lb)
- ES-10: 2.3" x 1.8" x 1" (7 oz)

**Other models available from 1 to 75 volts. Send for complete information.**



Corp., Easton, Pa. 18042 Tel: (215) 258-5441

# **Monolithic Memories announces: a revolution in logic design!**

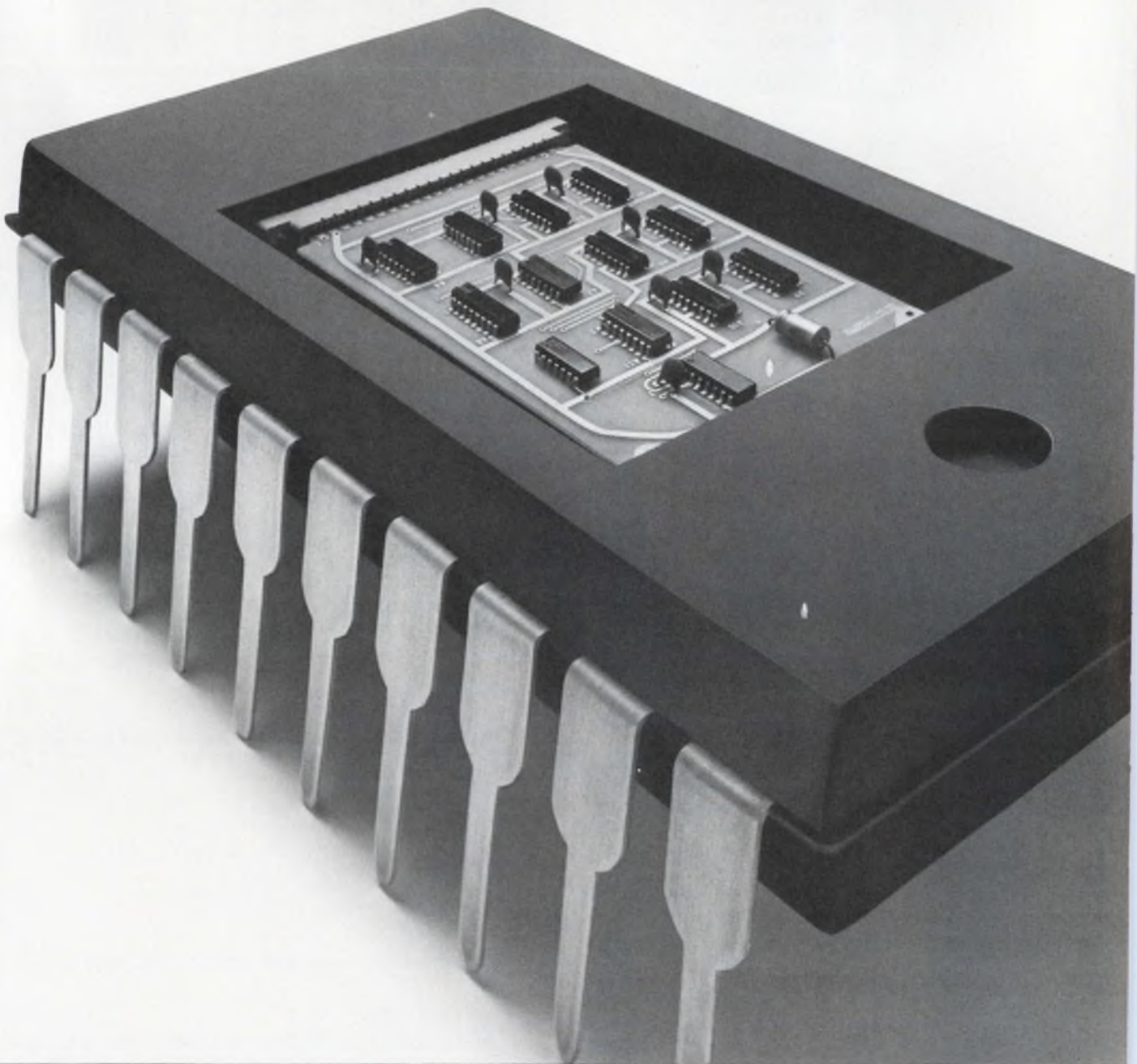



# PAL™ will save you money, space and sweat.

A single PAL16R8 (package shown actual size) can be programmed to perform all the logic functions shown here. Other devices in the PAL family offer comparable efficiencies.

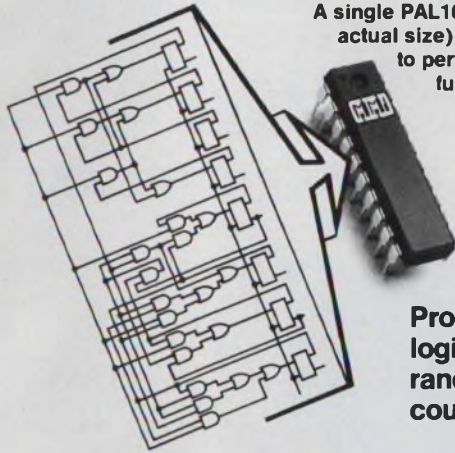

**Programmable PAL logic will reduce random logic chip count by 4-to-1.**

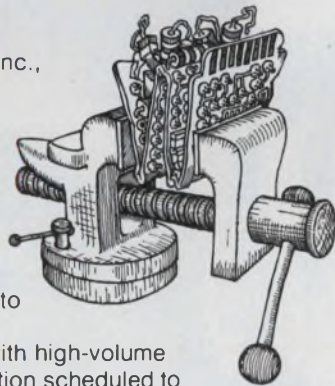

Monolithic Memories, Inc., the company that invented the modern bipolar PROM, soon will bring you PAL (Programmable Array Logic)—a family of monolithic LSI circuits which allows you to program your own logic on a chip, from random gates to arithmetic functions. We

have samples now, with high-volume production scheduled to begin mid-year, and the entire family to be in full production by year's-end.

The fifteen devices in the family will each contain a programming network which interconnects various types of gate arrays, consisting of AND/OR and AND/NOR gates, exclusive-OR gates, registers, optional three-state outputs and feedback connections.

## The PAL family will replace 90% of 7400S/LS Series functions.

When you use PAL, you'll be designing functions on-chip that are ordinarily performed by conventional TTL logic, and realizing tremendous efficiencies of time, space and cost. PAL replaces 9 out of 10 standard functions now provided by ordinary SSI/MSI TTL logic gates and flipflops.

## Use PAL to interface your microprocessor—or maybe even replace it.

To the designer faced with implementing his logic with microprocessors, PAL will offer special blessings. It's ideal for interfacing peripheral devices to any microprocessor system, with minimum time and cost. And for those less complex logic system designs that don't really require a microprocessor, PAL will offer the ideal answer.

## Programmability simplifies design and saves dollars in production.

PAL will let you structure your logic by programming fusible-link connections identical to those used in PROMs. All PAL programming will be handled by standard PROM programmers, simply, quickly and efficiently.

If your PC board layout should prove difficult or awkward, PAL can help. You can program the same logic functions into PAL a number of different ways, thereby eliminating jumper wires and crossed conductors, with substantial improvement in reliability, plus savings in space and power.

PAL's unit cost will be lower than that of microprocessors, custom logic and FPLAs. Compared with conventional TTL logic, you'll save in system cost, because PAL reduces parts inventory as well as parts on your board. It also simplifies production and saves in testing.

Every PAL will be packaged in a 20-pin "Skinny DIP," saving additional board space every time it replaces TTL, microprocessors, FPLAs or custom logic. Result: often you'll get your entire circuit on a single board, resulting in fewer boards per system. Ask for product details from Monolithic Memories, 1165 East Arques Ave., Sunnyvale, CA 94086, or call (408) 739-3535.

## How they stack up. Only PAL offers across-the-board advantages over all other types of logic.

	PACKAGE COUNT	UNIT COST	INVENTORY COST	FLEXIBILITY	SPACE SAVINGS	POWER SAVINGS	SPEED	RELIABILITY	EASE OF PROGRAMMING	DESIGN CYCLE TIME
TTL LOGIC	POOR	GOOD	POOR	GOOD	POOR	POOR	GOOD	FAIR	--	FAIR
FPLA	EXCELLENT	POOR	GOOD	GOOD	EXCELLENT	EXCELLENT	FAIR	GOOD	POOR	FAIR
PAL	EXCELLENT	GOOD	EXCELLENT	EXCELLENT	EXCELLENT	EXCELLENT	GOOD	EXCELLENT	EXCELLENT	EXCELLENT
CUSTOM LOGIC	GOOD	POOR	POOR	POOR	EXCELLENT	EXCELLENT	FAIR	GOOD	--	POOR
MICRO-PROCESSOR	EXCELLENT	POOR	GOOD	EXCELLENT	EXCELLENT	EXCELLENT	POOR	EXCELLENT	POOR	FAIR

**MMI** Monolithic Memories  
Bipolar is our business.

TM—Trademark, Monolithic Memories, Inc.

# Whatever you need in an IC socket... RN has 'em all!

—and with “side wipe” reliability

## PRODUCTION SOCKETS

### NEW! ICL Series

26% lower profile— 150"  
Ideal for high density, high  
volume configurations,  
provides maximum vibration  
resistance. Solder type, single leaf  
“side-wipe” contacts. 8 to 40 contacts.

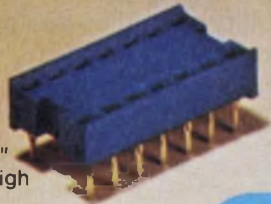

**ICN Series** high reliability general-  
purpose sockets. Low insertion  
force allows automatic IC insertion.  
In solder or wire-wrap. 6 to 64  
contacts. Dual leaf  
“side-wipe” contacts.

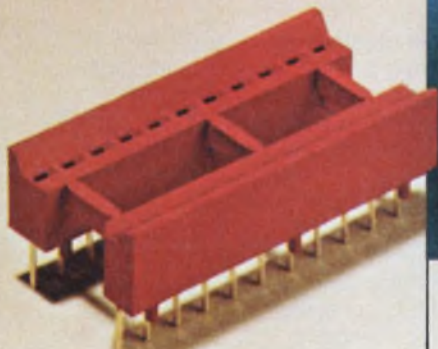

**ICA Series**  
high reliability pin  
socket contacts. Low  
profile in solder  
or wire-wrap.  
8 to 40 contacts.

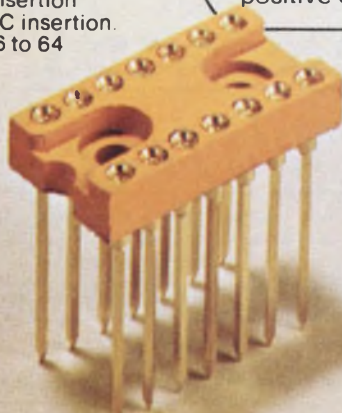

**WRITE TODAY**  
for New RN “Product Selection Guide”...

## BURN-IN, TEST SOCKETS

**TS Series**  
very long contact  
life. Very low insertion  
force. Ideal for in-  
coming inspection. With  
14 to 40 contacts. Also  
strip sockets up to  
21 positions.



**IC Series**  
moderate cost, long life.  
Designed for general test and  
burn-in up to 350°C.  
With 14 to 40  
contacts.

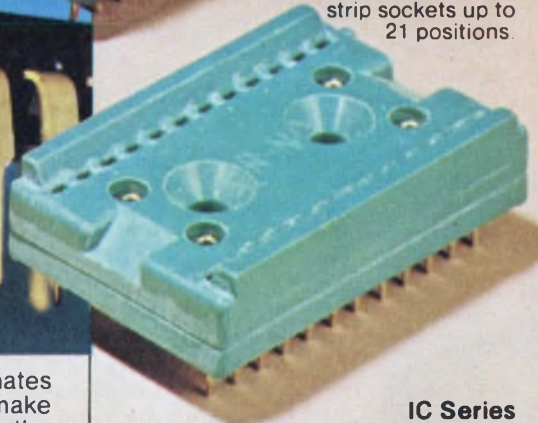

**ICN/S2 Series**  
lowest cost burn-in  
socket available.  
Designed to accept IC  
extraction tool. With 8 to 40  
contacts, with strip sockets  
up to 25 positions.

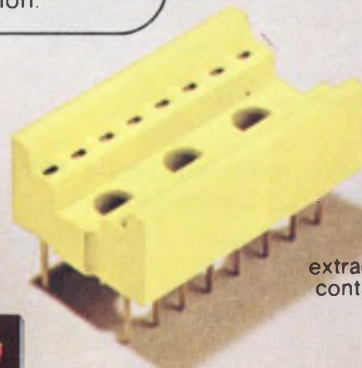

RN HIGH RELIABILITY eliminates  
trouble. “Side-wipe” contacts make  
100% greater surface contact with the  
wide, flat sides of your IC leads for  
positive electrical connection.



... and informative book “What to Look for  
in IC Interconnects.” Free from RN—the  
people who make more kinds of high reli-  
ability sockets than anyone.

# **RN** ROBINSON NUGENT, INC.

ROBINSON-NUGENT, INC. • 800 East Eighth Street • New Albany, Indiana 47150 • Phone: (812) 945-0211  
CIRCLE NUMBER 213

# A "Special" reminder.

We don't stock this one.

We put it together to demonstrate Cutler-Hammer's unique capability to produce custom—and even proprietary—switch "specials" to satisfy virtually any end-product requirement.

We offer "specials". . . toggle, rocker, paddle, rotary, slide, key, lever-lock or pushbutton. Both illuminated and non-illuminated.

. . . ac or ac/dc. For one-hole, flush, sub-panel, snap-in or nest mounting. In all sizes. With special circuits that can be ampere or horsepower rated . . . or both.

. . . with screw, spade, pc, solder lug, wire wrap, wire lead and integrated wire terminations.

For "special" assistance on commercial, industrial and MIL-Spec applications, call your Cutler-Hammer sales office or distributor.

And for the many "non-specials" we *do* stock—write Milwaukee for your copy of our new 144-page catalog.



 **Switch to No.1**

**CUTLER-HAMMER**  
SPECIALTY PRODUCTS DIVISION, Milwaukee, Wis. 53201



CIRCLE NUMBER 214

# We've just terminated your flexcircuit connector cost problems... without sacrificing reliability.

**Burndy Flexlok™ connectors combine  
high-reliability with low-cost design  
to slash installed costs 66%.**

Now, for less than 1¢ per contact, you can enjoy all of the design and production benefits of flexible circuitry and flat cable.\* That's a lot less than the 3¢ to 10¢ you'd normally expect to pay with other connectors.

But Flexlok not only costs less initially, it costs less to install. That's because it comes fully assembled, inspected and ready for soldering and cable insertion. *No separate handling. No loose contacts to assemble. No assembly machines or tools. No special operator training.*

What's more, these savings are all yours without sacrificing reliability. That's because Flexlok connectors feature Burndy's patented GTH™ contact design that delivers gas-tight, high-pressure, good-as-gold contact even under adverse environment. Hard to believe? The proof is in the cost comparisons and performance data shown below.



\*Flat-flat and flat-round types.

# BURNDY CONNECTS

INTERNATIONAL SALES AND MANUFACTURING: BRUSSELS, BARCELONA, PARIS, ROTTERDAM, STOCKHOLM, STUTTGART, TURIN, ZURICH, ST. HELENS (ENGL), TORONTO, SYDNEY, TOKYO, MEXICO CITY, SAO PAULO.

## Here's proof!

### FLEXLOK COST COMPARISON

	GTH Flexlok FC & RC	Clamp Type Pressure Tin	Insulation Displacement	Insulation Piercing	Solder Connections
Piece Price* (per line)	1¢+	2¢-3¢	3¢-5¢	5¢-10¢	5¢-10¢
Special Conductor Preparation	None	Required	None	None	Required
Installation Tooling (Purchase/Rental)	None	Yes	Yes	Yes	Yes
Operator Training Required	None	None	Skilled	Skilled	Skilled

\*In Quantity

†Average price

### FLEXLOK DESIGN FEATURE COMPARISON

Design Simplicity	1 piece	2 pieces or more	2 pieces or more	2 pieces or more	2 pieces or more
Conductor Types Accommodated	Round Flat Flex. P.C.	Flat Flex. P.C.	Round	Round Flat	Round Flat Flex P.C.
Top or Side Entry Available	Yes	No	No	No	No

### FLEXLOK PERFORMANCE DATA

Contact Resistance Test Data		MIN.	MILLIOHMS MAX.	AVG.
Test Group 1	Initial Contact resistance	7.00	7.60	7.26
	After thermal shock	7.10	7.50	7.25
	After durability (5 cycles)	7.10	7.80	7.39
	After moisture resistance (10 days)	7.20	8.70	7.68
	After vibration	PASSED		
	After mechanical shock	8.20	25.20	12.30
	Insulation resistance (megohms X 10 <sup>6</sup> )	.002	9.50	5.26
Test Group 2	Dielectric withstanding voltage No breakdown @ 500V AC	PASSED		
	Initial contact resistance	7.00	7.50	7.25
	After thermal shock	7.20	7.90	7.46
Grp. 3	Ammonium Sulfide exposure (3 min.)	7.20	8.00	7.59
	Initial contact resistance	7.10	7.50	7.25
	After gas tightness	7.00	7.60	7.24

Report No. G7515-755 (Summary) Mated with tin/lead plated flexible printed circuitry.

For details, call or write: Burndy Corporation, Norwalk, Connecticut 06856 (203-838-4444).



Offices in principal cities throughout the United States

CIRCLE NUMBER 215



# Cost efficiency you can put your finger on . . . CORTRON® SOLID STATE KEYBOARDS



Get your hands on a CORTRON Solid State Keyboard, and you'll soon find out why you can't judge all keyboards on initial price alone.

It's after installation that cost efficiency becomes most important. In life expectancy, ability to endure extreme environments, high speed operation without "misses," accuracy, downtime caused by beverage spillages, reliability, serviceability and human engineered features. That's where a CORTRON Solid State Keyboard really pays off.

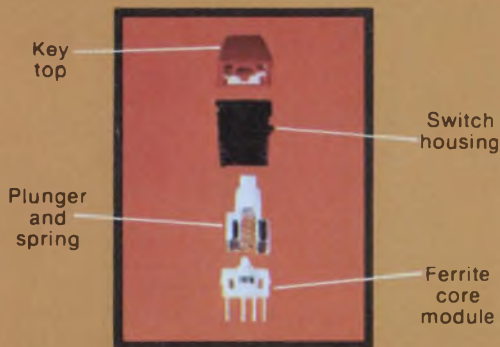

**Unique contactless key switch makes the difference.** Utilizing ferrite core switching technology, the CORTRON Key Switch is mechanically simple (only 4 basic parts!) and has an ultra reliable 100 million cycle life test rating. CORTRON Keyboard Professionals can translate what this can mean to you in cost efficiency terms of MTBF (mean time before

failure). CORTRON has actual customer experience of MTBF in excess of 40,000 hours.

They'll also explain other advantages you'll gain over competitive technologies such as Hall effect, reed switch, and capacitive switching. All in all, you'll find the CORTRON Key Switch offers unusual built-in protection against costly service calls and the hardship of downtime.

**"Human engineered"** keytops and key placement options give CORTRON low profile alpha numeric keyboards the familiar "typewriter feel" that promotes operator productivity and efficiency.

**Nothing left to chance.** CORTRON solid state keyboard materials, components, subassemblies, and final assembly are 100% inspected and tested to assure your specifications are met with plenty of room to spare.

These are just a few of the cost efficiency benefits CORTRON offers you and your customers.



**Cost efficiency you can put your finger on.** For a greater insight into the cost efficiencies attainable with a CORTRON Solid State Keyboard, write or call for details: CORTRON, A Division of Illinois Tool Works Inc., 6601 West Irving Park Road, Chicago, Illinois 60634. Phone (312) 282-4040. TWX 910-221-0275. Toll free line: 800-621-2605.



**CORTRON**  
A DIVISION OF ILLINOIS TOOL WORKS INC.

**THE KEYBOARD PROFESSIONALS**

CIRCLE NUMBER 216

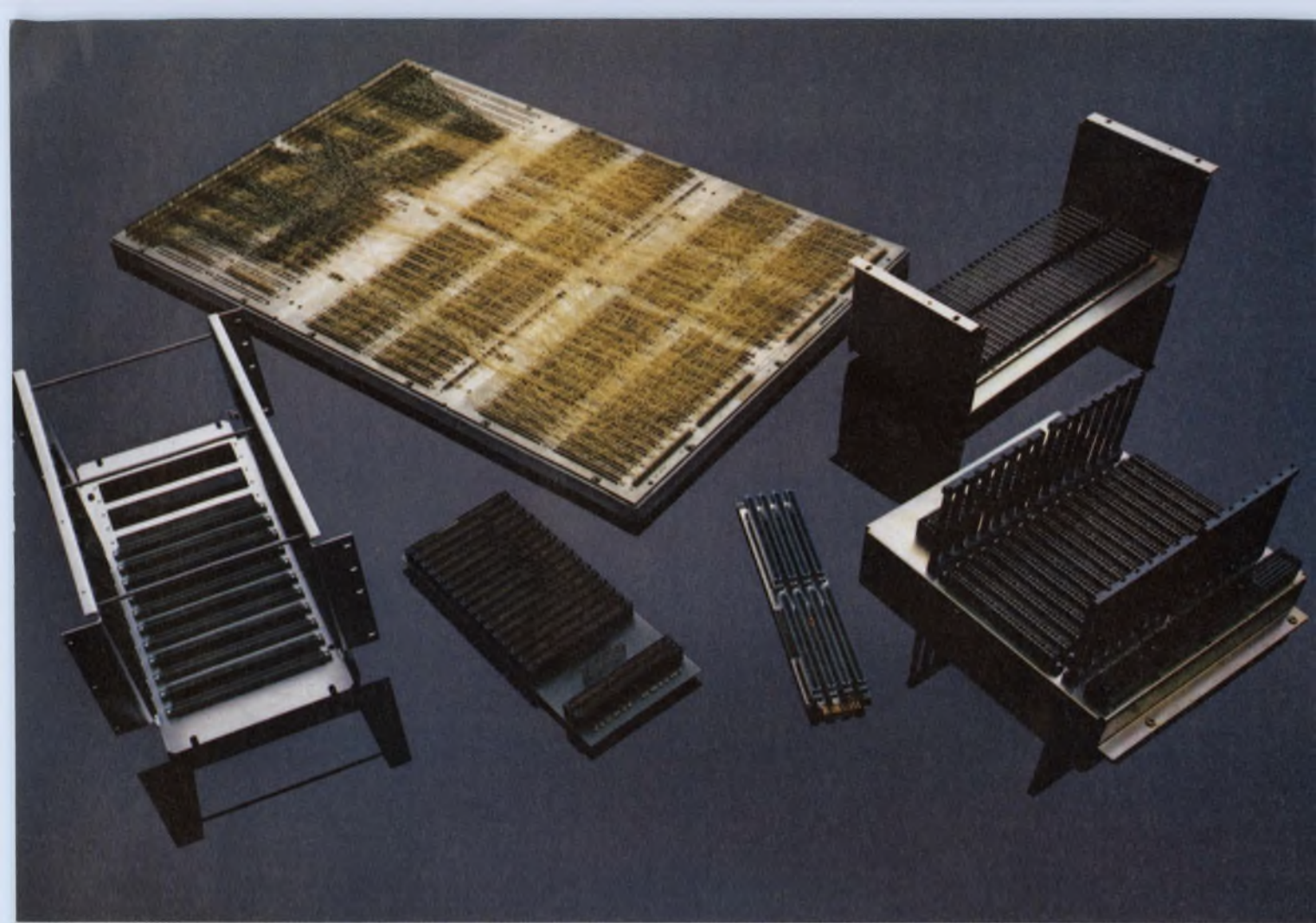

## Our family works behind your back.

Back panel assemblies are an area that puts our family way out in front.

We make assemblies with card-edge connectors on metal frames, soldered-in discrete connectors on PC boards.

And now, press-fit card-edge connectors on printed boards.

We can supply them in bits and pieces for your own assembly, or as a complete package designed to your own specification. We'll even do your wire wrapping and give you a 100% electrical test that assures zero defects.

With our total back-panel capability approach, from contact to wiring, you get single-source responsibility. That alone is a time and money saver.

To take advantage of our ability to design economical high-reliability interconnection systems, call us before you lock-in a design.

GTE Sylvania, CPO, Box 29, Titusville, Pa. 16354. Phone 814-589-7071.

Remember, good interconnection systems run in our family.

**GTE SYLVANIA**

CIRCLE NUMBER 217

# The MC<sup>2</sup> from Pyle gives you more design flexibility than any connector in history.

Until the development of the MC<sup>2</sup><sup>™</sup> (Modular Concept/Multi-Cell) connector system, you either had to design around existing connectors or buy expensive tooling for specialized applications. The former was a nuisance; the latter time-consuming and costly.

We solved the problem by developing a "family" of components consisting of 4 shell sizes and a series of insertable, contact-carrier modules available in a variety

of removable, crimp-type contact sizes and arrangements. You simply insert the appropriate modules into the shells and you have, in effect, designed your own connector. And should you choose to interchange male and female components in the same shell, you can do that, too.

The MC<sup>2</sup> provides you with the capability to design any of 36,936 different connectors.

## But, all connectors are not created circular.

The MC<sup>2</sup> concept can be applied to whatever shape suits your particular purpose. If you will simply tell us what you need to

solve your system-component interconnect problems, we'll come up with the economical answer.

And you and we together will continue to advance the state of the art through design innovation.

Write us for our MC<sup>2</sup> catalogue now, or call our toll-free number.

**DIAL PYLE:**

**800-621-6027\***

*\*Illinois respondents call 312-342-6300.*



**pyle-national  
company**

*A Division of Brand-Rex Company*

**The problem solvers.**

Pyle-National Company, 1334 N. Kostner Ave., Chicago, Ill. 60651. In Canada: Pyle-National of Canada, Ltd., 2560 S. Sheridan Way, Mississauga, Ontario. In Europe: Pyle-National (U.K.) Ltd., The Octagon, 143 Derby Road, Nottingham, England.

CIRCLE NUMBER 218



# Licon has more economical ways to light and control switch action.

If you sat down . . . took the best features of all low cost, low energy lighted pushbutton switches . . . you'd come up with the same thing we did . . . the LICON<sup>®</sup> Series 05 Lighted Pushbutton Switches. These are the switches you asked for.

Here are the ideal LPB switches for office machines, computers, appliances, home entertainment, etc. wherever requirements dictate low level switching, economy and high reliability. The Licon Series 05 Switch is available in momentary and maintained action plus lighted, non-lighted versions. The maintained action style offers "dual indication", light and lens position. Available in both double and single pole styles—single pole N.O., double pole N.O. and SPDT styles. Exclusive design offers smooth, pleasing "feel" plus snap-in bezel mounting that assures rigid retention. These amazing little switches also feature bifurcated, silver plated contacts, .110 quick disconnect or PC board terminals, a rainbow of colored lens cap choices and U.L. Listing.

**05 Series** Switches fit .625 square panel hole size; accept low cost T 1 $\frac{3}{4}$  wedge base lamp. Relamp from front panel. .25 Amp., 125 VAC rating. In addition, all these features are available in a compatible L.E.D. version complete with L.E.D. display lens.

**05-6 Series** Switches mount in a .750 square panel cutout. Use versatile front panel replaceable T 1 $\frac{3}{4}$  flange base lamp. Offered in .25 or 3 Amp versions, 125 VAC rating. Lens barriers are available.

We've got more to talk about too. Ask for full details, contact your local Licon Distributor, or call or write for our Switch Catalog: LICON, 6615 West Irving Park Road, Chicago, Illinois 60634. Phone (312) 282-4040 TWX: 910-221-0275.



**LICON**

A DIVISION OF ILLINOIS TOOL WORKS INC.

For Full Details CIRCLE NUMBER 219  
To Have Salesman Call CIRCLE NUMBER 220

© Illinois Tool Works Inc. 1978

# 8 Bit A to D/D to A Converter - the first priced at only \$4.50\*

The Ferranti Model ZN425E—an 8 bit dual mode analog to digital/digital to analog converter features:

- Single chip monolithic construction
- Typical settling time 1.0  $\mu$ s for 1 L.S.B. step
- 8 bit binary counter, R-2R ladder network and switches
- On-chip precision voltage reference
- Self-contained, precision ramp generator
- TTL and CMOS compatible



better by design

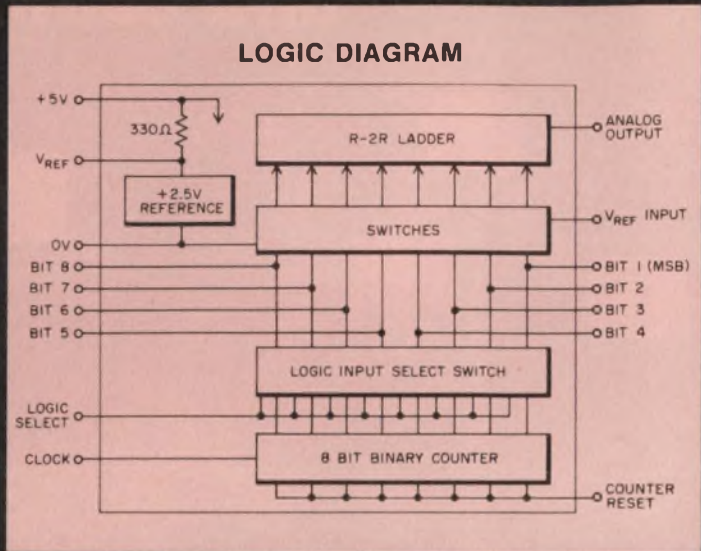

\*1000 piece price

FOR COMPLETE SPECIFICATIONS, CONTACT: FERRANTI ELECTRIC, INC. / SEMICONDUCTOR PRODUCTS  
EAST BETHPAGE ROAD, PLAINVIEW, NEW YORK 11803 PHONE: (516) 293-8383 / TWX: 510-224-6483

CIRCLE NUMBER 221

# CLASSIC

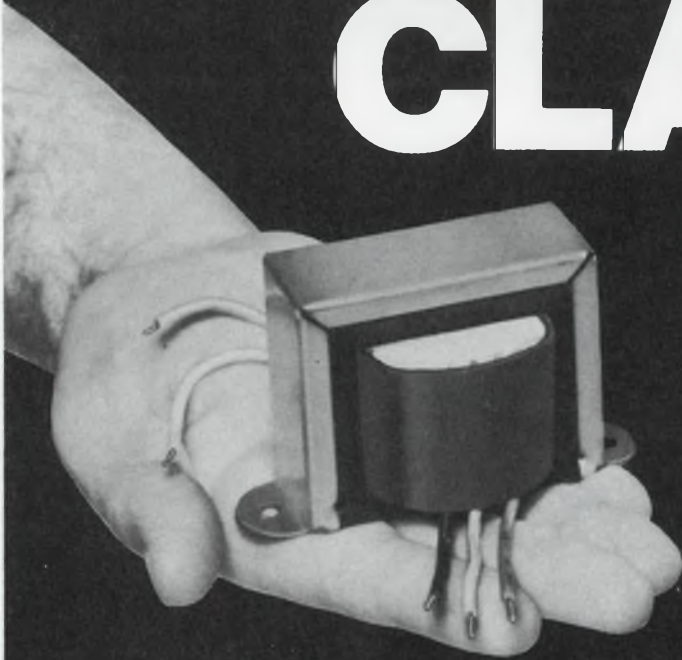

**Essex/Stancor transformers have  
that special quality,  
that classic quality.**

From our miniature transistor transformers to our power transformers, we engineer them for performance and doublecheck them for dependability. And our products are available off-the-shelf from electronic distributors everywhere. For super performance at a basic cost, see your local distributor or write us for our free catalog:

**Essex/Stancor, 3501 W. Addison St.,  
Chicago, IL 60618, 313 / 643-7400.**

**ESSEX  
GROUP**



Subsidiary of  
**UNITED  
TECHNOLOGIES**

CIRCLE NUMBER 222

# Fast Relief

## for digital troubleshooting headaches

Banish those troubleshooting headaches with signature analysis, the new technique from Hewlett-Packard that lets you troubleshoot microprocessor products right down to the faulty component. In production. In the field.

With signature analysis, that enormous floating inventory of expensive boards and modules moving in and out of service can be cut dramatically.

Signature analysis is positive. There is no hit or miss about it. Conceivably you could even eliminate the need to partition your product for modular service.

### A simple concept.

The HP 5004A Signature Analyzer converts lengthy bit streams at any node in the circuit into short, four-digit, hexadecimal "signatures."

Just activate a digital exercise routine in the circuit under test and compare the bit stream signature at each data mode with the known good signatures previously written into your manual.

Digital signal tracing

becomes as simple as analog tracing used to be. But more accurate. So accurate that it catches almost every possible fault, including many that can be detected in no other way. It once again becomes realistic to think of field or production troubleshooting to the component level by technicians.

### Design it in or retrofit.

The savings in service costs and inventory are well worth the effort of designing with signature analysis in mind. In some cases, it could even pay you to "retrofit" by developing a signature manual for your existing equipment.

It's a fascinating—and very workable—concept. Amazingly the price of the HP 5004A Signature Analyzer that makes all this possible is a low \$990\*.

To help you take advantage of this breakthrough we've prepared Application Note 222 — "A Designer's Guide to Signature Analysis." It's yours for the asking. Just contact your nearest HP field sales office or write.

\*Domestic U. S. price only.



HEWLETT  PACKARD

1507 Page Mill Road, Palo Alto, California 94304

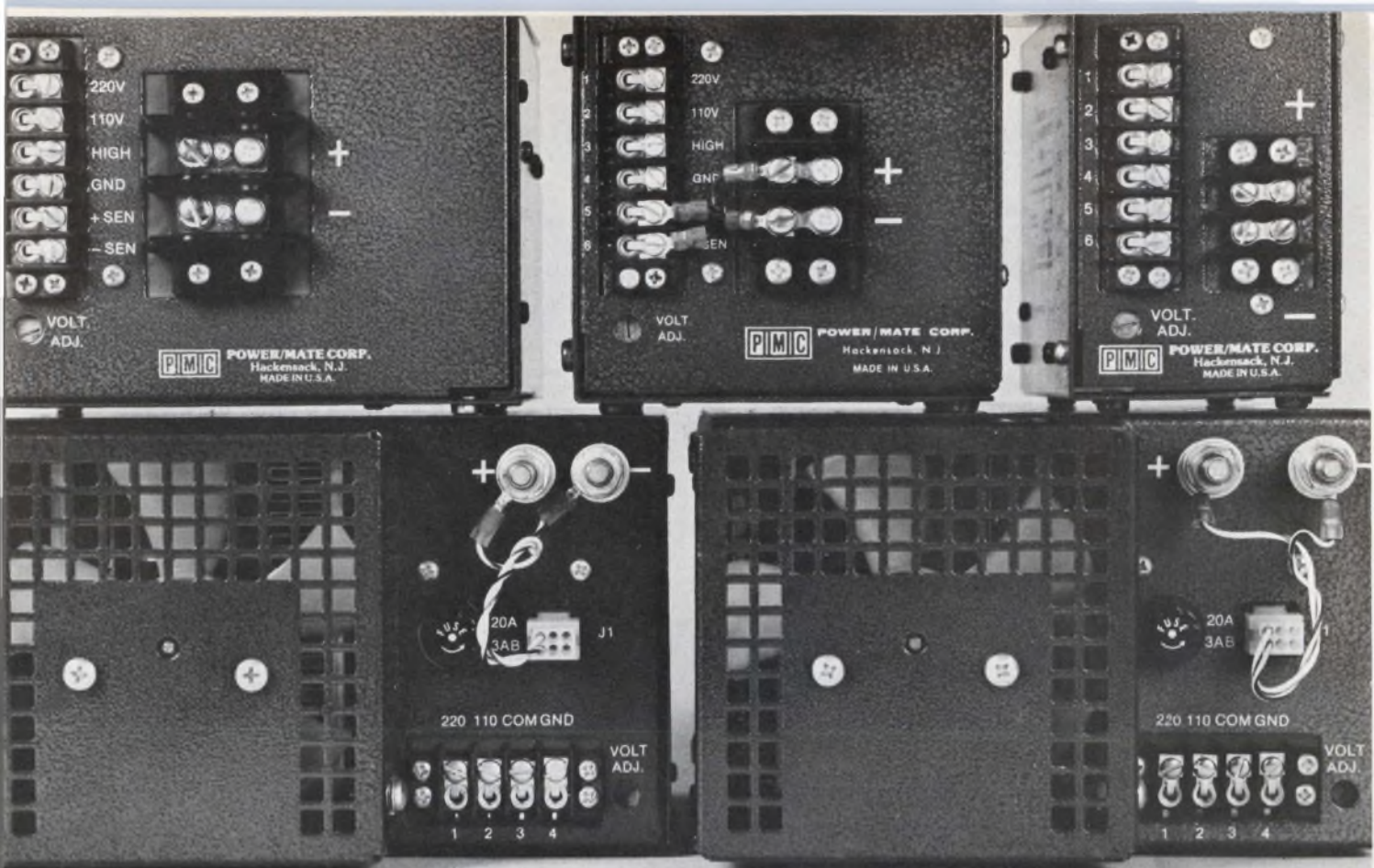

# With 87 different switching supplies to choose from, no wonder people are switching to Power/Mate.

But at Power-Mate we know it's not enough to offer you 87 different switching models in 10 different case sizes.

From 2 volts to 28.

In currents all the way up to 200 amps.

And we know it's not enough to build them to the highest quality standards in the industry.

Standards you've come to expect from Power-Mate.

When you need a switcher fast, your entire business could depend on ours.

So Power-Mate stocks all models

for immediate delivery on every switching model we make from both our East and West Coast plants.

The same goes for our open frame, modular and miniature models, as well as our laboratory supplies.

Whether starting from scratch, updating your system, or in need of emergency service, it's good to keep Power-Mate's name and number in mind.

Because knowing where to get the switchers you want isn't much good, unless you can get them when you want them.



## POWER/MATE CORP.

514 S. River St./Hackensack, New Jersey 07601/(201) 343-6294/TWX (710) 990-5023  
17942 Skypark Circle/Irvine, California 92714/(714) 957-1606/TWX (910) 595-1766

**The world's largest supplier of quality power supplies.**

CIRCLE NUMBER 73

## New products

### True 12-bit CMOS multiplying d/a converter is low-priced

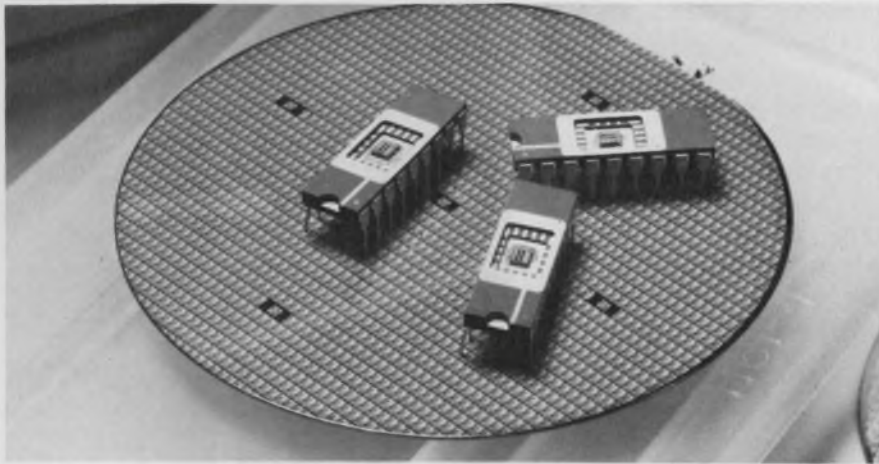

Analog Devices Semiconductor, 829 Woburn St., Wilmington, MA 01887. Jeff Riskin (617) 935-5565. P&A: Stock; see text for price.

Twelve bits for twelve bucks is now available in the first monolithic CMOS multiplying d/a converter to have linearity consistent with its 12-bit resolution. The AD7541 from Analog Devices features a low power consumption (below 32 mW) and nonlinearity error ( $\pm 0.01\%$  of full-scale range at 25 C). In a plastic DIP, and an operating temperature range of 0 to 70 C, the AD7541 goes for \$12 each in quantities of 1000 or more.

The reference-voltage input to the converter may be steady dc of either polarity, or ac of either constant or varying amplitude. This versatility encourages such applications as digitally programmed power supplies, digital-to-synchro converters and digitally controlled attenuators.

The AD7541 contains a precision thin-film R-2R ladder network and CMOS switches. The network is connected—inverted—to generate binary-weighted currents. Each switch sends its current to one of two output current-summing buses; this provides a “push-pull” output. Having both of these outputs available, as well as a reference input that accepts either polarity, permits four-quadrant multiplication to be done with a relatively simple circuit that uses two external

operational amplifiers.

To maintain the AD7541's linearity, the voltages at the output terminals must be kept very close to ground. Op amps at the output(s) must be chosen for low bias current (less than 75 nA, or so) and low offset voltage (less than about 0.5 mV). The digital inputs, which are TTL and CMOS-compatible, are zener-protected, but still require typical CMOS design and handling precautions.

The AD7541 has no digital-input buffer register. Although this complicates microcomputer interfacing, it simplifies the converter, reduces its cost, and increases its versatility.

Two linearities are available:  $\pm 0.01\%$  of full-scale as mentioned, and  $\pm 0.02\%$  of full-scale, which costs less. Both are available in three temperature ranges: 0 to 70 C, -25 to +85 C, and -55 to +125 C. The first range is provided in a plastic DIP, while the latter two come in ceramic DIPs.

Linearity is affected slightly by temperature, and becomes  $\pm 0.012\%$  and  $\pm 0.024\%$  of full-scale over the rated temperature ranges.

Prices for the three temperature ranges, respectively, are \$12, \$16, and \$49 for 0.01% linearity, and \$11, \$15 and \$44 for 0.02%. In addition, the AD7541 is pin-compatible with its less-accurate predecessor, the AD7521, and all versions are in stock.

CIRCLE NO. 301

### Hybrid IC audio amps deliver 25 and 90 W



Sanyo Semiconductor, 1360 Roadrunner Terrace, Sunnyvale, CA 94087. Tsuyoshi Taira (408) 732-7902. P & A: See text.

The STK-075 hybrid IC audio amplifier delivers 15 W into 8  $\Omega$  or 25 W into 4  $\Omega$  at a cost of \$4.80 (1000 quantity). The STK-086 delivers 70 W into 8  $\Omega$  and 90 W into 4  $\Omega$  at a cost of \$16.00. The output has a specified, 0.3%, total harmonic distortion and a 20-Hz to 20-kHz frequency range. Since the device uses a dual power supply, it does not require a speaker coupling capacitor.

CIRCLE NO. 320

### Multiprotocol chip formats data

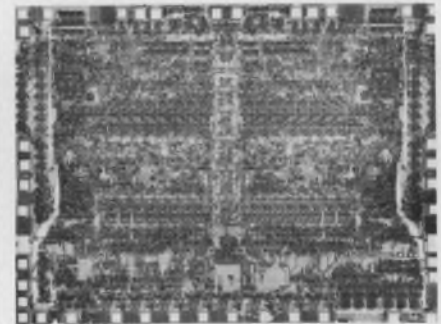

Zilog, 10460 Bubb Rd., Cupertino, CA 95014. Jim Gibbons (408) 446-4666. \$49 (plastic), \$54 (ceramic); stock.

The single-chip Z80-SIO is a serial I/O controller that controls communications peripherals and formats data in data communication networks. The chip works with the interfaces of most 8 and 16-bit processors and supports the “daisy-chain” interrupt structure of the Z80 CPU. Each of the SIO's full-duplex channels has four control lines for most commonly used modems. For systems with 2.5-MHz CPU clock rate, the SIO's data rate goes up to 550 kbits/s, while in a 4-MHz system, it is up to 880 kbits.

CIRCLE NO. 321

# AMP component sockets are sealed with silicone rubber. And can be inserted at up to 7,000 an hour. You can't beat that.

AMP component sockets. They're the ones that come in strip form. You can insert them at high speed and cut your costs. Use a bench press or, for really fast loading, a N/C machine. AMP can furnish the applicator and interface module for compatibility with most N/C machines.

And AMP keeps your product out of trouble by sealing its component sockets with silicone rubber. Which ends solder flux contamination and solder flooding.

Of course, they provide easy pluggability with either rectangular integrated circuit leads or .016 inch-.019 inch diameter leads. Their small head diameters permit .100 inch center-to-center mounting. Our sockets help you save on board costs too, as they seat securely in wide tolerance holes.

For more data on AMP component sockets, ask your AMP Sales Engineer. He's ready to help you in any way possible. Or write or call AMP Incorporated, Harrisburg, PA 17105. (717) 564-0100.

AMP has a better way.

SEE US AT  
ELECTRONIC COMPONENTS  
SHOW, PARIS

**AMP**  
INCORPORATED

CIRCLE NUMBER 74

AMP is a trademark of AMP Incorporated

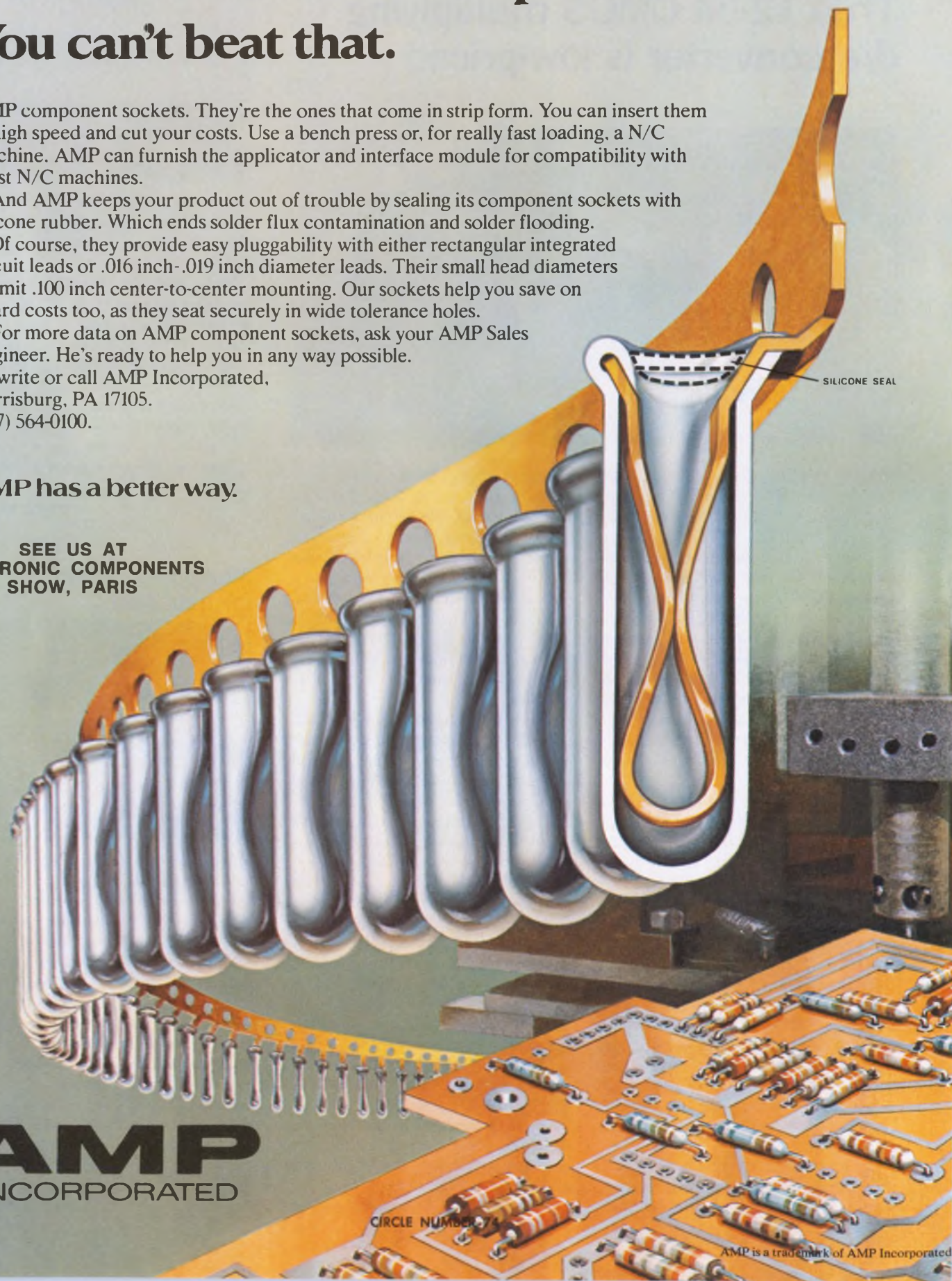

## AMP EUROPE

**Austria** — AMP Austria, Branch of AMP Deutschland GmbH, Markgraf-Ruediger Str. 6-8, 1150 Vienna. Phone: 924191/92

**Belgium** — AMP Belgium, Branch of AMP-Holland B.V., Rue de Brabant 62-66, Brussels. Phone: 322.17.55.17

**Finland** — AMP Finland OY  
Postilokero 3, 00401 Helsinki 40  
Phone: 90/584122

**France** — AMP de France, 29 Chaussée Jules-César, Boite Postale No. 39, 95301 Pontoise France. Phone: 030 82 20, 030 92 30

**Germany** — AMP Deutschland GmbH, Ampèrestrasse 7-11, 607 Langen, B. FFM., West Germany. Phone: (06103) 7091

**Great Britain** — AMP of Great Britain Limited, Terminal House, Stanmore, Middlesex, England. Phone: 01-954-2356

**Holland** — AMP Holland B.V., Papierstraat 2-4 5223 AW 's-Hertogenbosch, Holland. Phone: (073) 125221

**Italy** — AMP Italia S.p.A., Via Fratelli Cervi 15, 10093 Collegno (Torino), Italy. Phone: 785-656

**Spain** — AMP Española, S.A., Apartado 5294, Pedra IV, 491, 495, Barcelona 5, Spain. Phone: 307-75-50

**Sweden** — AMP Scandinavia AB, Datavägen 5, 17500 Jakobsberg, Sweden, Mailing Address: Fack S-175 20 JARFALLA 1, Sweden. Phone: 0758/10400

**Switzerland** — AMP AG, Haldenstrasse 11, 6006 Luzern, Switzerland. Phone: (414) 235421, 235422, 235423

## AMP NORTH AMERICA

**Canada** — AMP OF CANADA LTD., 20 Esna Park Drive, Markham, Ontario, Ph: 416-499-1251

**Mexico** — AMP de Mexico, S.A., Apartado Postal 179, Naucalpan de Juarez, Edo. de Mexico, Phone: Mexico City 576-41-55

**Puerto Rico** — AMP OF CANADA LTD., 677 Calé de Diego, Rio Piedras, Puerto Rico 00924, Phone: (809) 766-2346

**United States** — AMP Incorporated, Harrisburg, Pa. 17105, Phone: 717-564-0100

## AMP SOUTH AMERICA

**Argentina** — AMP S.A. Argentina 4 de Febrero, 76 Villa Zagla — SAN MARTIN, Buenos Aires, Argentina, Phone: 752-4612

**Brazil** — AMP do Brasil Ltda., AV Comendador Martinelli 185, Lapa, Sao Paulo, Phone: 262-4353

## AMP PACIFIC

**Australia** — Australian AMP Pty. Limited, 155 Briens Road, Northmead, N.S.W. 2152 Australia, Mailing Address: P.O. Box 194, Baulkham Hills, N.S.W. 2153 Aus. Ph: 630-7377

**Japan** — AMP (Japan), Ltd., No. 15-14, 7-Chome, Roppongi Minato-Ku, Tokyo, Japan, Ph: 404-7171

Products and services for many specialized industries are provided by the AMPIVERSAL Division. In the United States, this division is known as AMP Special Industries.

For Amp products and services in other countries, write: AMP International Division, Harrisburg, PA 17105, USA.



## ICs & SEMICONDUCTORS

### 200-A transistor turns on/off in 0.5 $\mu$ s

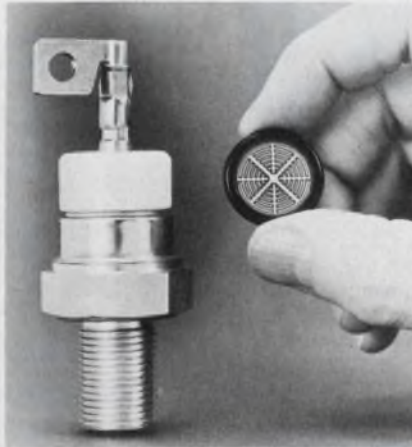

Westinghouse Semiconductor, Youngwood, PA 15697. (412) 925-7272. \$200; 10 to 12 wks.

The D60T is a high-current, high-voltage and fast-switching transistor with turn-on and turn-off times of less than 0.5  $\mu$ s. Rated at 200 A peak, 450 to 550 V, the transistor has a gain of 10 at 50 A.

CIRCLE NO. 310

### High-power SCRs operate at 150 C



International Rectifier, 233 Kansas St., El Segundo, CA 90245. (213) 322-3331. \$44.85 to \$87.65 (100 qty); stock to 4 wks.

The 325PAH series of high-power SCRs are for 150-C operation and have a nominal rms current rating of 510 A. The average current level is 325 A. Peak-reverse voltages are from 500 to 1200 V. The SCRs have a junction operating temperature range of -40 to +150 C and a maximum internal thermal resistance, junction to case, of 0.085 C/W. Packaged in a 1.6-in. diameter "hockey puck."

CIRCLE NO. 322

### 4-bit-slice processors operate at high speed

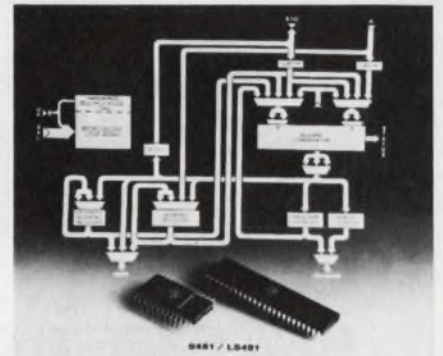

Texas Instruments, P.O. Box 5012, M/S 308 (Attn: S481), Dallas, TX 75222. Rex Meek (713) 491-5115. \$29.25; stock.

The S481 set of 4-bit-slice processors can select and operate on two operands, generate status and store results in a single 100-ns cycle. The chips provide built-in computational algorithms for automatically sequenced iterative, signed or unsigned multiplies and divides and cyclical-redundancy character calculations. The chip set consists of LS/481s, 54S/74S482 4-bit-slice controllers and either the 54S/74S330 or S331 field-programmable logic arrays.

CIRCLE NO. 323

### A/d chip mixes linear and digital

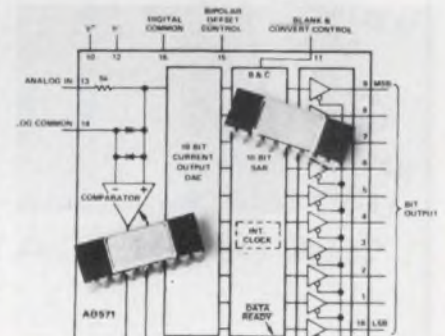

Analog Devices, 829 Woburn St., Wilmington, MA 01887. Jeff Riskin (617) 935-5565. \$24 to \$60; stock.

The AD571 10-bit monolithic a/d converter combines linear and digital circuitry on a single IC chip. The device is a successive-approximation converter and includes a d/a, voltage reference, clock, comparator, successive-approximation register and output buffer on a 120 x 150-mil chip. A complete conversion to 10-bit accuracy is executed in 25  $\mu$ s.

CIRCLE NO. 324

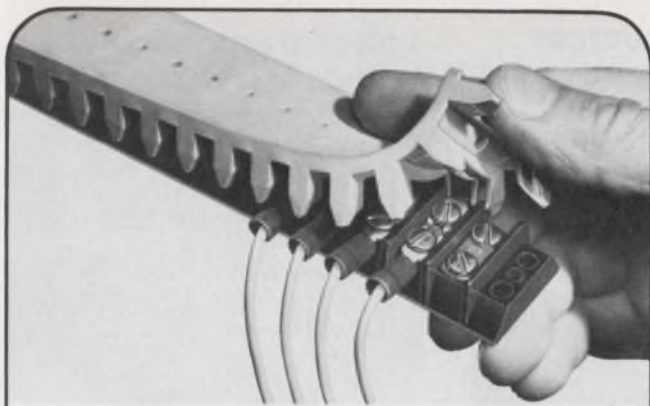

## NEW SAFE-TI CAPS™

Protect your terminal board connections by covering them with Kulka's non-flammable, rubber Safe-Ti Caps™. These unique covers guard against spills, dirt and accidental short circuits from dropped tools. Available in all the popular sizes. Be sure to send for Kulka's free catalog.

# Kulka®

A NORTH AMERICAN PHILIPS COMPANY

520 S. Fulton Ave., Mt. Vernon, NY 10551 Tel: 914 664 4024

CIRCLE NUMBER 75

## NEW! Conductive Emulsion Acrylic Paint

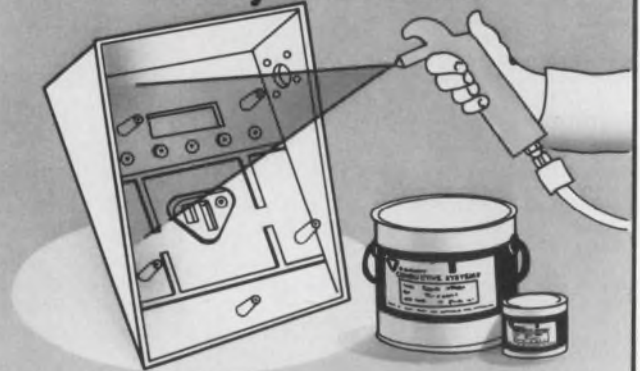

### Conductive Coating Compatible with Solid and Structural Foam Surfaces

- Non-organic water based, silver filled paint
- Compatible with solid and structural foam plastics adversely effected by organic and chlorinated solvents
- Surface-Resistivity: 1.0 ohms/square
- Surface Coverage: 40 ft.<sup>2</sup>/2 mil dry film
- Operating Temperature: -65°F. to +180°F.
- Meets OSHA toxicity restriction requirements

**TECKNIT®** *The Conductive People*

129 Dermody St., Cranford, NJ 07016 • (201) 272-5500  
427 Olive St., Santa Barbara, CA 93101 • (805) 963-1867

CIRCLE NUMBER 242

**FREE!**

## EDMUND SCIENTIFIC

ELECTRONICS  
OPTICS  
SOLAR ENERGY  
MAGNETS  
LASERS



O.E.M.  
COMPONENTS  
LABWARE  
MIRRORS  
SURPLUS

### 164 PAGE CATALOG

- Over 4,000 unusual bargains for science and industry
- In-stock supplies for engineers, experimenters, research labs, hobbyists, etc.
- Order direct and save—buy with complete confidence... every item carries the famous Edmund 30-day money-back guarantee.
- Simply mail this coupon for the newest Edmund catalog.

**RUSH LATEST FREE EDMUND CATALOG**

EDMUND SCIENTIFIC CO.  
Dept. DA06, Edscorp Building, Barrington, N.J. 08007

Name \_\_\_\_\_

Address \_\_\_\_\_

City \_\_\_\_\_ State \_\_\_\_\_ Zip \_\_\_\_\_

CIRCLE NUMBER 243

## 200 MHz DC-Coupled Wideband Amplifier



- 10X fixed, non-inverting gain
- Cascadable to gains of 1000X
- <2 nsec risetime
- 2.5 V/nsec slew rate
- <0.1  $\Omega$  output impedance
- 4 nV/  $\sqrt{\text{Hz}}$  input noise
- $\pm 0.1\%$  integral linearity
- Mounting board also available

LeCroy Research Systems, leading supplier of fast electronics for particle physics research, now offers its unrivaled expertise in high-speed circuits to other original equipment manufacturers. The Model VV1008 Wideband Amplifier, offering excellent linearity, speed, stability, and noise characteristics, is just a sample of LeCroy's creative technology and experience.

LeCroy Research Systems offers a variety of other fast components and is receptive to inquiries regarding custom orders.

Call or write for details.

**LeCroy**  
RESEARCH SYSTEMS

innovators in instrumentation

Headquarters: 700 S. Main St., Spring Valley, N.Y. 10977.  
Offices in: Geneva, Switzerland; Heidelberg, W. Germany;  
Paris, France; Oxford, England.  
Representatives throughout the world.

CIRCLE NUMBER 244

ELECTRONIC DESIGN 6, March 15, 1978



# Another Industry Breakthrough!

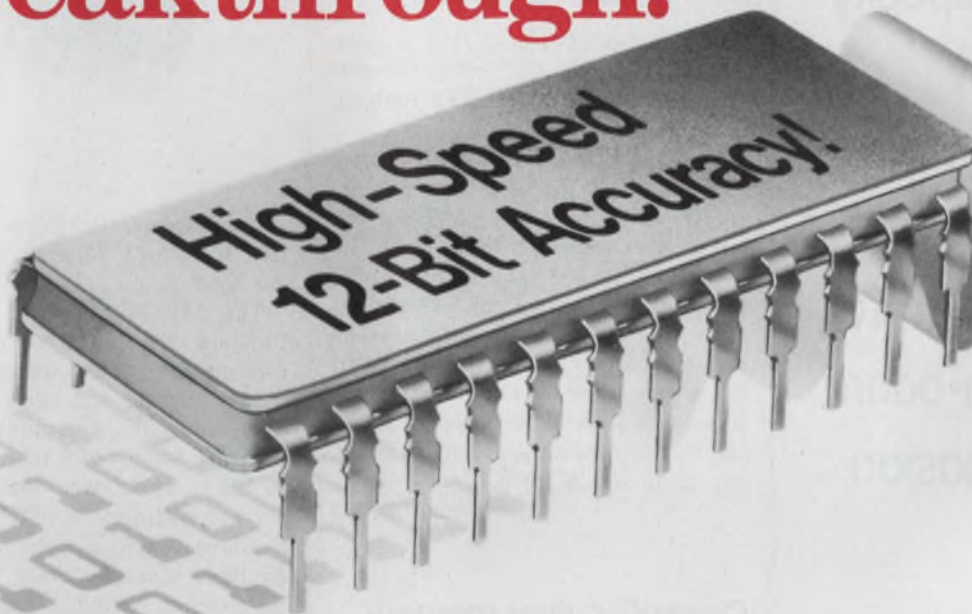

## Introducing... The Harris HI-562 D/A Converter.

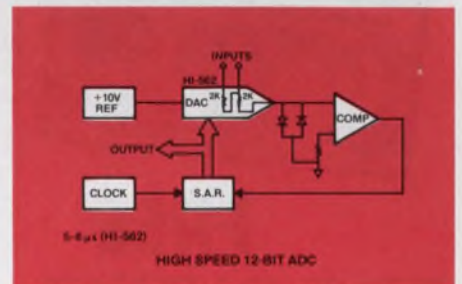
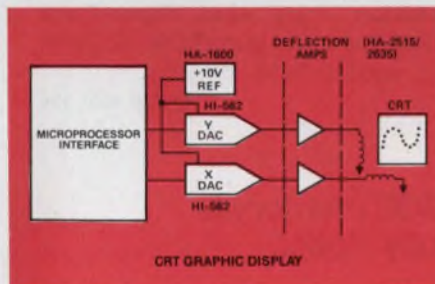
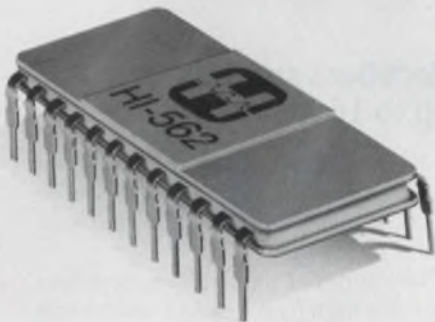

If you've been looking for the right D/A converter to match your brightest design ideas, you can stop looking... it's here... the new Harris HI-562.

The HI-562 is the first monolithic D/A to combine high speed performance and true 12-bit accuracy on the same chip—attained through the utilization of the most advanced laser resistor trimming techniques in the industry. Consider these features:

- Fast Settling: 200 ns to  $\pm 1/2$  LSB
- Excellent Linearity:  $\pm 1/4$  LSB
- Low Gain Drift:  $\pm 2$  ppm/ $^{\circ}$ C
- Fully monotonic over temperature

At only \$29 (100-up), the Harris HI-562 is the cost-effective answer to your most demanding data conversion

design problems. So if you are into A/D converters, CRT graphic displays, process control systems, precision instruments, data acquisition systems, communication terminals... to mention a few... the Harris HI-562 can provide you with the performance, economy, accuracy and design versatility you won't find in any other D/A converter.

Available in a 24-pin DIP, the 562 operates on +5V and -15V supply voltages and a +10V reference.

Check out this new dimension in data conversion. Contact your nearby Harris Semiconductor distributor for evaluation devices. For full details, call the Harris Hot Line, or write: **Harris Semiconductor Products Division, P.O. Box 883, Melbourne, Florida 32901.**

**HARRIS HOT LINE!**  
1-800-528-6050, Ext. 455

Call toll-free for phone number of your nearby Harris sales office, authorized distributor or expedited literature service.

*Harris Technology  
...Your Competitive Edge*

CIRCLE NUMBER 76



**HARRIS**  
SEMICONDUCTOR  
PRODUCTS DIVISION  
A DIVISION OF HARRIS CORPORATION

for those  
 who specify  
 or buy  
 wire wrap  
 panels and  
 cards of the  
 pin-in-board  
 persuasion...



**FREE  
 BROCHURE**  
 28 pages...panels, cards,  
 frames, drawers, prices...

**EECO**

1441 E. Chestnut Avenue • Santa Ana, California 92701  
 (714) 835-6000 • TWX 910-595-1550/Telex 67-8420

DISTRIBUTED BY  
**MARSHALL INDUSTRIES**  
 CIRCLE NUMBER 77

**ICs & SEMICONDUCTORS**

**HV rectifiers have  
 2- $\mu$ s or 250-ns recovery**

*High Voltage Devices, 7485 Avenue 304, Visalia, CA 93277. Ken Corsetti (209) 733-3870. \$6.90 to \$23.93 (100 qty); 1 to 4 wks.*

The KXS and KX Powerstack series of medium (2  $\mu$ s) and fast (250 ns) recovery high-voltage, high-current silicon rectifiers are mini-sized. The body is 0.39 in. long with a max diameter of 0.515 in. Peak inverse voltages are 1.5 to 10 kV with average rectified currents at 50 C of 3, 2.2 and 1.5 A depending on PIV. Max reverse leakage is 1  $\mu$ A at 25 C and 25  $\mu$ A at 100 C. Forward surge current ratings are up to 200 A for 8.3 ms.

CIRCLE NO. 325

**Controller gives memory  
 transfer of 2 Mbytes/s**

*Advanced Micro Devices, 901 Thompson Pl., Sunnyvale, CA 94086. E. Sopkin (408) 732-2400. \$18.25 (100 qty); stock.*

The Am9517 controller has memory-transfer speeds up to 2 Mbytes/s. Four independent channels are available and these can be increased through cascading. Three transfer modes are provided: single word, demand and block. The device is available in molded and ceramic hermetic DIPs.

CIRCLE NO. 326

**MOS memory is  
 fully static**

*Motorola, 3501 Ed Bluestein Blvd., Austin, TX 78721. (512) 928-2600. (100 to 999 qty) from \$12.25, stock.*

The MCM2114 MOS memory is a 1024  $\times$  4-bit static RAM that requires no clocks, no timing strobes, nor refreshing because of fully static operation. Data-out and data-in are of the same polarity and no address set-up time is required. Four speed ranges are offered: 200, 250, 300 and 450 ns. Two power versions are the MCM2114 at 550 mW and the MCM21L14 at 385 W. Two 18-pin packages are available; plastic and lid-seal ceramic.

CIRCLE NO. 327

**Converter can be used  
 a/d or d/a**

JN1E000

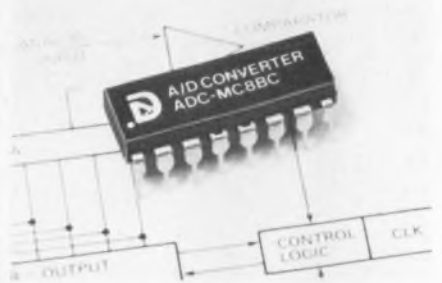

*Datel Systems, 1020 Turnpike St., Canton, MA 02021. Eugene Murphy (617) 828-8000. \$8 to \$14; stock.*

The ADC-MC8B is an 8-bit multi-function d/a converter that can be configured as an a/d, using the internal binary counter and two external ICs. The converter is available in temperature ranges of 0 to 70 C and -55 to 125 C. The device consists of eight current switches, a diffused-resistor ladder network, a precision reference, an 8-bit binary counter and a logic input-select switch. Output settling time is 2  $\mu$ s for a full-scale change. Using the device as a counter-comparator a/d gives a conversion time of 500  $\mu$ s. 14-pin plastic DIP.

CIRCLE NO. 329

**Rectifiers supply  
 up to 16 kV**

*Solid State Devices, 14830 Valley View Ave., La Mirada, CA 90638. Dee Peden (213) 921-9660. \$0.66 to \$7.29 (100 qty); stock to 4 wks.*

Two types of high-voltage rectifiers combine high peak-reverse voltage and moderate current characteristics. An axial-lead series, 1N2372 through 1N2385, has PRVs from 420 V to 10 kV with average rectified currents from 250 mA to 70 mA. Forward voltage drops, at 100 mA, range from 3 V for the 420-V units to 39 V for the 10-kV units. Case dimensions are from 0.5  $\times$  0.363-in. diameter up to 2  $\times$  0.5 in. The ferrule series, 1N1133 through 1N1149, has PRVs from 1.5 kV at 100 mA to 16 kV at 45 mA. Forward drops are 7.5 to 60 V at rated current. The 0.5625-in. diameter cases go from 1.813 to 6.025-in. long.

CIRCLE NO. 328

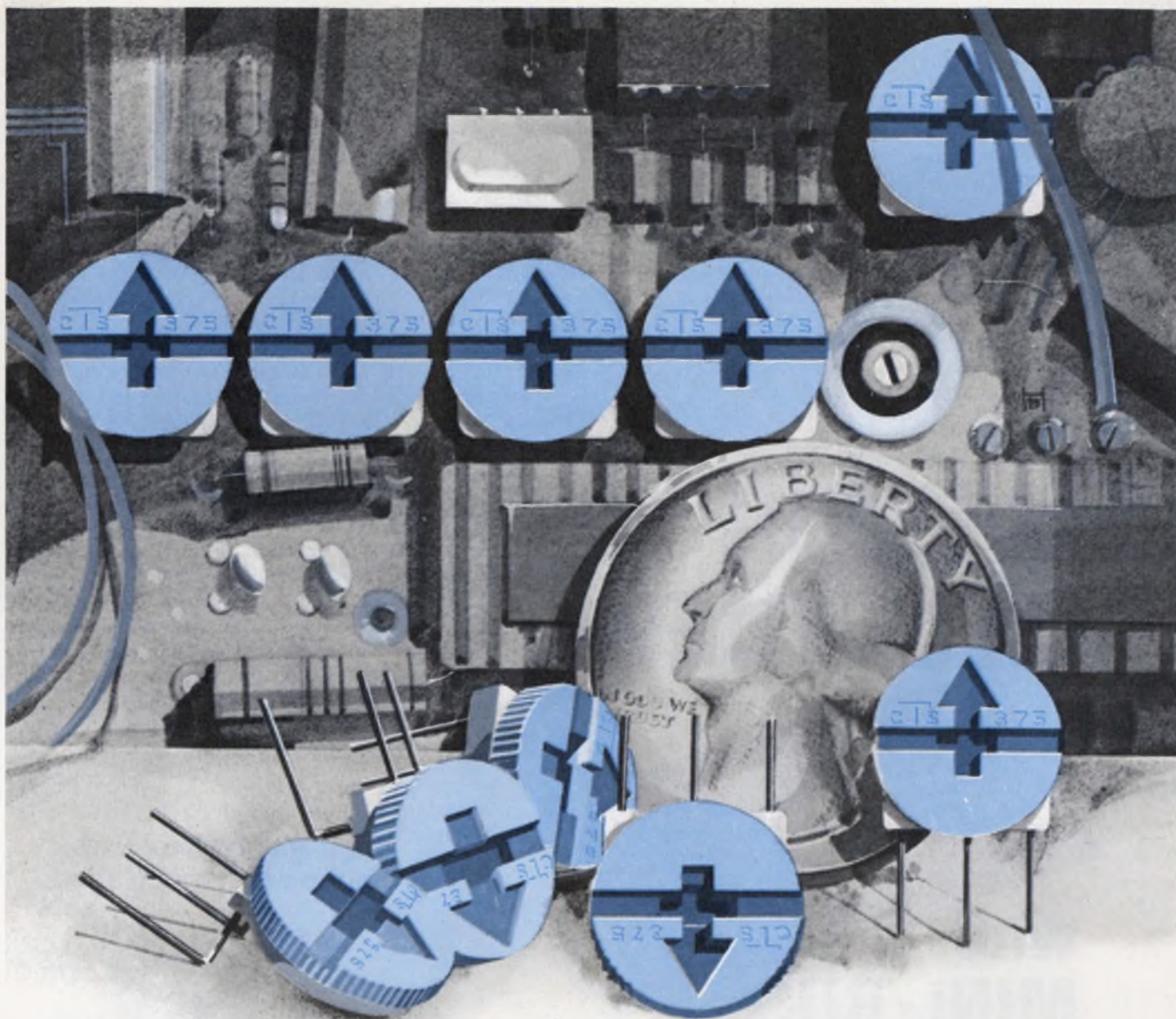

## CTS mini cermet trimmers... low in price, high in performance.

Fantastic! Small  $\frac{3}{8}$ " dia. (10mm), great performance and CTS reliability are only three reasons you should use our NEW series 375 single turn cermet trimmers. The low 25¢ price tag is still another.

CTS 375's, in six popular terminal styles, feature a low  $\pm 100$  ppm/ $^{\circ}$ C standard temperature coefficient—throughout the resistance range. Power rating, 1 watt at  $40^{\circ}$ C;  $\frac{1}{2}$  watt at

$70^{\circ}$ C. CRV of 2%. Settability of .03%.

And the serrated adjustment knob doubles as a dust cover to protect the element from dirt, oil and other contaminants. It's a lot for so little. But you expect that from a company that's put millions into electronics for industry. For complete information, write **CTS OF WEST LIBERTY, INC.**, 6800 County Road 189, West Liberty, Ohio 43357 or phone (513) 465-3030.

**CTS CORPORATION**

ELKHART, INDIANA

A world leader in cermet and variable resistor technology.

CIRCLE NUMBER 78



## ICs & SEMICONDUCTORS Complex-sound generator is I<sup>2</sup>L linear IC

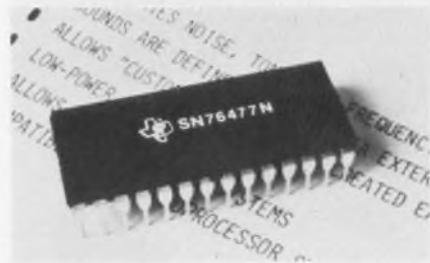

Texas Instruments, P.O. Box 84, M/S 812, Sherman, TX 75090. Lowell Chambers (214) 893-5166. \$1.65 (100 qty); stock.

The SN76477N is a complex-sound generator that can be used to generate the sound of a siren, gun-shot, jet engine, whistle, pin-ball and others. Since it is an I<sup>2</sup>L linear IC with low-power consumption, it is suited for battery powered devices. The IC contains a voltage-controlled oscillator, super-low-frequency oscillator, white-noise generator, noise filter, one shot, mixer and an attack/decay envelope generator. The desired sound is externally programmed through logic and analog inputs. The device is housed in a 28-pin plastic DIP.

CIRCLE NO. 330

## Power transistors handle up to 10 A and 300 V



TRW Power Semiconductors, 14520 Aviation Blvd., Lawndale, CA 90260. John Power (213) 679-4561. \$14.20 to \$45.00 (100 qty); 4 to 8 wks.

The SVT300-3, 300-5 and 300-10 are npn power-switching transistors that feature a minimum dc current gain of 15 at currents of 3, 5 and 10 A. Max collector voltage is 300 V. At 25 C, the SVT300-3 dissipates 116 W; the SVT300-5 and SVT300-10, 146 W. Operating and storage temperature is -65 to +200 C. The transistors are available in TO-3 or TO-61 isolated packages and can be made to meet JAN and JAN-TX military specs.

CIRCLE NO. 331

# MAKING MEMORIES

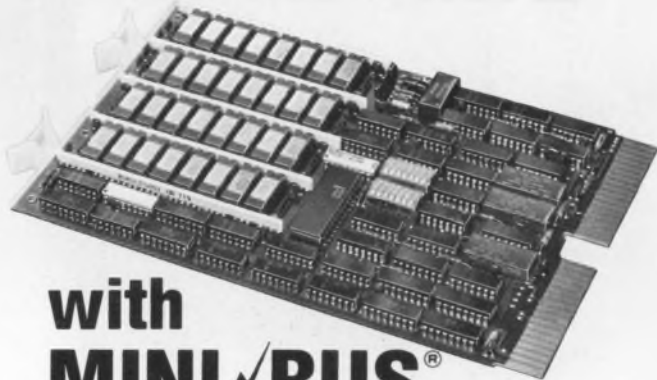

## with MINI/BUS<sup>®</sup> PC BOARD BUS BARS

A high density add-in expansion memory for the DEC LSI-11, MSC 4601, packs up to 32K words of memory in a single option slot. Mini/Bus helps make it all possible, and with a mean time between failures of 100,000 hours.

Monolithic Systems Corporation engineers used Mini/Bus to solve size constraint problems, shorten assembly time, simplify testing, eliminate numerous filter capacitors, and increase reliability.

For more details on how Mini/Bus can handle your design problem, contact the Mini/Bus product specialist at

### ROGERS CORPORATION

Chandler, Arizona 85224  
(602) 963-4584

EUROPE: Mektron NV, Gent, Belgium JAPAN: Nippon Mektron, Tokyo

DEC and LSI-11 are registered trademarks of Digital Equipment Corp.

CIRCLE NUMBER 79



## Voltage regulator uses pulse-width modulation

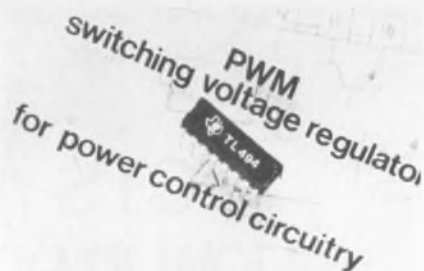

Texas Instruments, P.O. Box 5012, M/S 308 (Attn: TL494), Dallas, TX 75222. Dale Pippenger (214) 238-5908. \$2.88 (plastic), \$3.31 (ceramic); stock.

The TL494 is a switching voltage-regulator IC that provides all the functions required for pulse-width modulation (PWM) control circuits. The chip contains a 5-V regulator, error amplifier, current-limit amplifier, adjustable oscillator, dead-time-control comparator, pulse-steering flip-flop and output-control circuitry. Uncommitted output transistors may be operated as common-collector or common-emitter. The trigger for the pulse-steering flip-flop is derived from the PWM circuit to prevent double pulsing of either output.

CIRCLE NO. 332

# Speed total harmonic distortion measurements.



## With HP's newest distortion analyzer.

Automatic frequency nulling and auto set level features of the 339A Distortion Measurement Set speed your total harmonic distortion measurements (THD). And true-rms detection means accurate measurements as low as 0.0018% (-95 dB) from 10 Hz to 110 kHz. Whether you're testing signal sources or amplifiers, here's how the 339A, priced at \$1,900\*, can help you make quick and precise measurements.

**Speed your set-up.** Just select the frequency of the built-in oscillator and the 339A's "turn signal" indicators show you how to make the proper input range setting. This means you have a low-distortion source for testing high-performance amplifiers and

you tune one instrument instead of two. If you're using an external source, "turn signal" indicators show you which direction to turn frequency controls for quick manual nulling.

**Save test time.** The 339A's auto set level feature automatically sets the 100% reference level, within a 10 dB capture range, every time you change frequency or level. Again, visual indicators show you which way to turn the input range switch if your signal is outside of the capture range. You not only save time, you also minimize operator errors.

Standard features even make the 339A suitable for checking broadcast equipment for FCC compliance. And for measuring frequency response, you can quickly read relative measurements in either percentage or dB.

Contact your local HP field engineer for further details.

\* Domestic U.S.A. price only.

HEWLETT  PACKARD

1507 Page Mill Road, Palo Alto, California 94304

For assistance call: Washington (301) 948-6370, Chicago (312) 255-9800, Atlanta (404) 955-1500, Los Angeles (213) 877-1282

CIRCLE NUMBER 80

## ICs & SEMICONDUCTORS

### Darlington transistors can sustain 400 V when switching

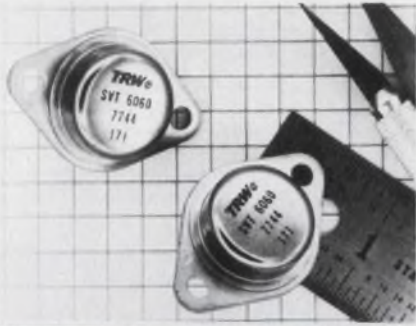

TRW Power Semiconductors, 14520 Aviation Blvd., Lawndale, CA 90260. (213) 679-4561. \$5 to \$6 (100 qty); 4 to 8 wks.

A series of monolithic Darlington transistors, for motor controls and switching power supplies can sustain 400 V. With a rise time of 0.4  $\mu$ s and a fall time of 1  $\mu$ s, the devices are suited for high-speed switching circuits (10 kHz). Three transistors, SVT 6060, 6061 and 6062, have a dc current gain of 30 at 15 A and a peak collector current of 25 A. Junction-temperature range is -50 to +150 C.

CIRCLE NO. 333

# BEGONE CURSED ALIAS

The new Precision 616 cuts clean with programmable ease. 80 dB/octave attenuation slopes and time domain filters superior to Bessel. Up to 16 filter channels, programmable for gain and cutoff frequency. Interfaces with mini, micro or GPIB. Typical

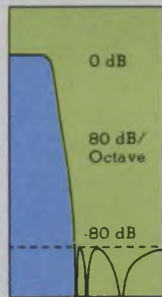

phase match is  $\frac{1}{2}^\circ$ , with worst case of  $2^\circ$ . You get performance that used to require a custom instrument, without paying a custom price. Call Don Chandler, 607-277-3550, or write for complete specs and a demonstration.



**PRECISION FILTERS, INC.**

303 W Lincoln, Ithaca, N.Y. 14850



CIRCLE NUMBER 81

### Dynamic RAM suits low-cost uses

Motorola, 3501 Ed Bluestein Blvd., Austin, TX 78721 (512) 928-2600. From \$5.75 (100 qty); stock.

The MCM4096 is a 4 k  $\times$  1-bit dynamic RAM. All inputs are TTL compatible and the output is three-state TTL compatible. Each of the 64 row addresses requires a memory cycle every 2 ms to refresh the RAM. Max power dissipation is 445 mW in the active mode and 19 mW for standby. Three speeds are available: 250, 300 and 350 ns (max access time). Package types are 16-pin ceramic or frit-seal ceramic.

CIRCLE NO. 334

### 32-k ROM for M6800 bus is fully static

Motorola, 3501 Ed Bluestein Blvd., Austin, TX 78721. (512) 928-2600. \$13.10 (plastic, 250 qty).

The MCM68A332 is a 32,768-bit programmable ROM that is fully static and can be used with bus-oriented systems such as the M6800 or other 8-bit microprocessors. The memory uses a single 5-V supply, dissipates less than 440 mW with an access time and cycle time of 360 ns. The 24-pin package is available in either plastic (P suffix) or ceramic (L suffix).

CIRCLE NO. 335

### SCRs have grounded cathodes

Texas Instruments, P.O. Box 5012, M/S 308 (Attn: TIC101/102), Dallas, TX 75222. Keith Renard (214) 238-3041. \$0.26 to \$0.57 (1000 qty); stock.

The TIC101/TIC102 series of grounded-cathode SCRs are pnpn silicon reverse-blocking triode thyristors with the cathode in electrical contact with the mounting tab. Electrical insulation of the SCR tab is thereby eliminated. Repetitive peak off-state voltages and repetitive peak reverse voltages range from 30 to 600 V. Surge on-state current is to 30 A with up to 600-V capability. Continuous on-state current at or below 80-C case temperature is 5 A dc.

CIRCLE NO. 336

# BergLance™ Wire-Wrapping Posts give a classic performance on the Lowrey Organ.

The BergLance System assures rapid staking of miniature thru-lugs for solid or stranded wire terminations. It's an approach that offers high quality and reliability . . . and is economical, too.

Lowrey likes it, and has used millions of BergLance posts throughout the past decade. Lowrey has found it can rely on Berg Electronics . . . to supply the product and the application machines that precisely meet its interconnection needs.

Berg is experienced. We read interconnection needs like Lowrey reads music. We have the products, the background and the back-up to do the job. Your job. Let's work on it, together. Berg Electronics, Division, E. I. du Pont de Nemours & Co., New Cumberland, Pa. 17070—Phone (717) 938-6711.

 **BERG ELECTRONICS**

CIRCLE NUMBER 82

**We serve special interests—yours!**

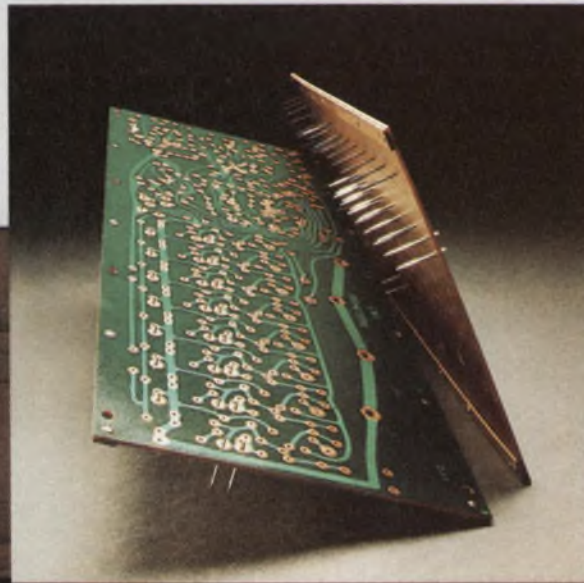

# Some of these components will probably never The others will just come close.

The SR, XL, XK and AV are solid state position sensors featuring almost infinite life. All offer zero speed operation with some up to 100 KHz. ES current sensor utilizes Hall-effect IC and protects against damage from short circuits or overcurrent conditions.

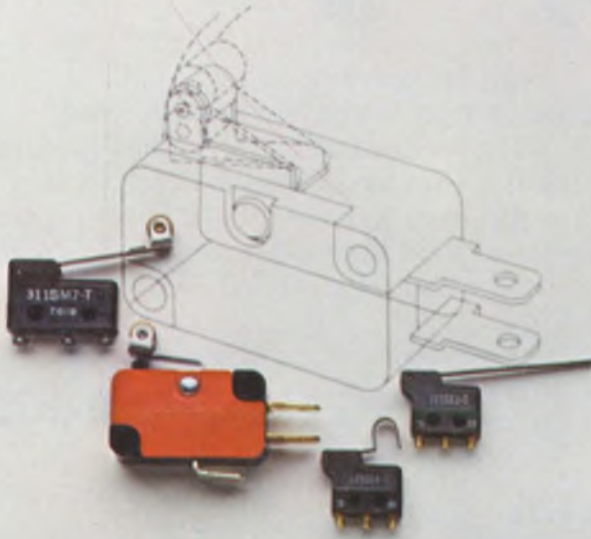

Snap-action V3, SM and SX switches offer wide variety of actuators, electrical capacity and termination.

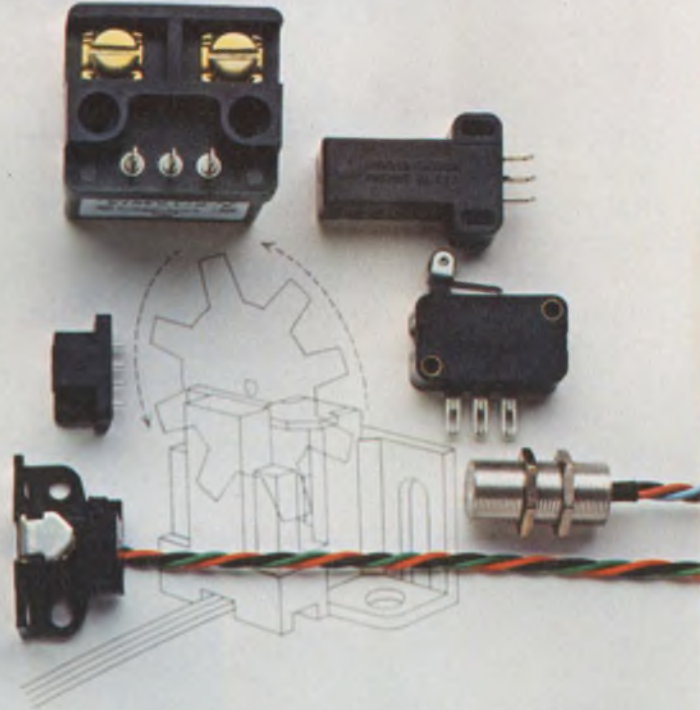

Mercury switches offer hermetic sealing, a variety of electrical capacity and broad temperature ranges at a low cost.

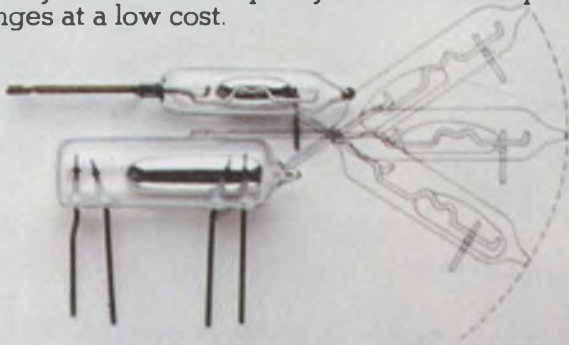

AML manual devices for low installed cost, electrical flexibility and attractive panel appearance. Series 8 miniature manual switches provide small size and wide variety of operators. DM offers inexpensive snap-in panel mount design.



Solid state keyboards provide high reliability no mechanical keyboard can offer. Panel sealed versions also available.





## wear out.

The solid state keyboard, AML lighted push-buttons and sensors you see here will probably never wear out. Because they're all solid state.

Each is based on a Hall-effect integrated circuit. A circuit that's been tested through billions of operations without failing. And proven by performance in thousands of applications.

The precision electro-mechanical components you see here come close. Simply because of the careful way they're designed and put together.

Like the long-life versions of our snap-action V3, SM and SX precision switches. Available in a wide variety of sizes, electrical ratings, terminals, actuators, contact forms and operating characteristics—some tested to a mechanical life of over 10,000,000 operations.

MICRO SWITCH will provide you with field engineers for application assistance and a network of authorized distributors for local availability. Write us for details or call 815/235-6600.

And find out how you can get a component that goes on forever. Or at least comes very, very close.

## MICRO SWITCH

FREEMONT, ILLINOIS 61032

A DIVISION OF HONEYWELL

MICRO SWITCH products are available worldwide through Honeywell International.

## INSTRUMENTATION

# Video monitor takes the lead in resolution and distortion

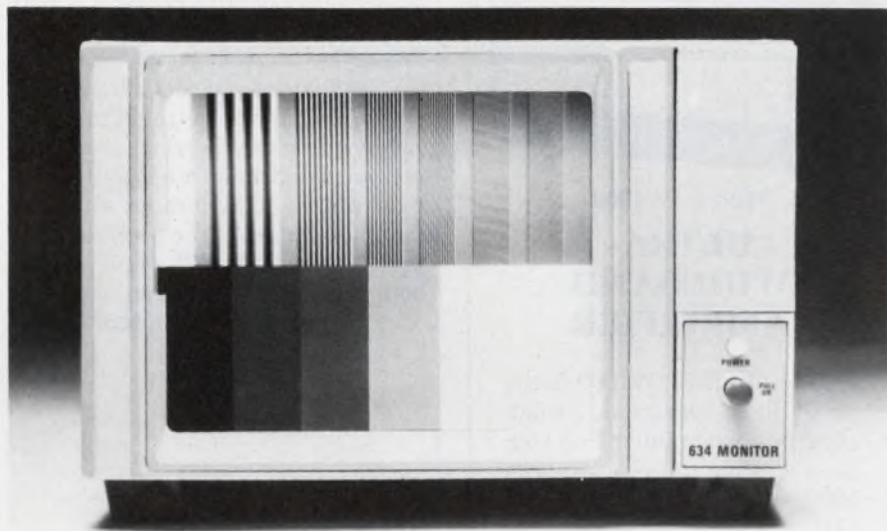

*Tektronix, Inc., P.O. Box 500, Beaverton, OR 97077. Bob Down. (503) 644-0161. P&A: See text.*

Need high resolution, low distortion and uniform brightness in a video display? You can get the best of all three in the Tektronix 634, a 10 × 12-cm, flat-screen monitor.

Resolution is guaranteed to be 1100 lines minimum at a brightness of 100 candelas/m<sup>2</sup> (30 footlamberts). Distortion stays under ±0.5%—without calibration—over a 9-cm circle at the center of the screen, and it remains below 1% elsewhere. And brightness doesn't vary more than 20% over the entire screen.

The best resolution until now was about 800 lines with the Conrac VF-02, a popular 10 × 12-cm display. But even that resolution isn't guaranteed, nor is the VF-02's brightness variation specified. However, the VF-02's distortion is adjustable to 0.5 to 1%.

The maximum brightness of both competing displays is over 150 ft-L.

Tektronix measures the 634's worst-case resolution of 1100 lines—the nominal value is 1400 lines—with the shrinking-raster method at a 60% modulation index. At a 90% index, resolution falls to 840 lines, nominal, and 660

lines, worst case. Distortion is measured with a superimposed, transparent linearity chart, and brightness is read at the center and four corners of the chart by Tek's J-16 photometer.

With the 634's improved performance, the black-and-white range is so wide, you get better gray-scale images than ever before. Moreover, you don't need any calibration time for accurate on-screen image measurements. Also, you get more uniform reproduction of equivalent gray shades over the screen area.

With the Tek unit's modular construction, the various controls for contrast, focus and brightness can be connected at the 634's top or side, or elsewhere in your equipment arrangement. Or functions can be controlled remotely via an optional connector.

The 634 operates from a standard 110 or 220-V line, but unregulated dc operation (21 to 25 V, -21 to -25 V, 8 to 10 V) is available optionally.

The 634 goes for \$1125 (just about a buck a line). If resolution isn't important, you can get a 650-line unit for \$900. Either way, delivery takes 12 weeks.

Tektronix  
Conrac

CIRCLE NO. 302  
CIRCLE NO. 303

# NOW

## 4 Watts Linear 1 to 1000 MHz Only \$2700



### Model 4W1000 ULTRA- WIDEBAND AMPLIFIER

It's fact! Model 4W1000 is the only ultra-wideband, solid-state power amplifier that supplies a minimum of 4 watts of RF power from 1 to 1000 MHz. It's probably all the bandwidth and power you'll ever need.

You can use this versatile, unconditionally stable amplifier with frequency synthesizers or swept signal sources to provide high-level outputs. Applications include RFI susceptibility testing, NMR spectroscopy, antenna and component testing as well as general lab use.

Very likely, the 4W1000 will satisfy all your ultra-wideband power amplifier needs. However, if the 4W1000 offers more power than you need, consider the more economical 1W1000, priced at only \$1,250. For complete information, write or call:

Amplifier Research  
160 School House Road  
Souderton, Pa. 18964  
215/723-8181

**AR** **AMPLIFIER  
RESEARCH**

CIRCLE NUMBER 83

## INSTRUMENTATION

### Pulse generator has true/complement outputs

Dytech, 2725 Lafayette St., Santa Clara, CA 95050. (408) 241-4333. \$385; stock to 4 wks.

The Model 801 pulse generator provides true and complementary outputs with amplitude control from 0 to +10 V. Rise and fall times are 5 ns or less while delays of from 50 ns to 1 s are available. The unit accepts external triggering as well as internal automatic and manual modes and produces pulse-pair bursts over the entire delay range. A single-cycle switch also generates any fixed number of pulses of any pulse width for any duration within the min-max ranges of the generator. The unit accepts DTL, TTL or ac input at both the external and gate inputs.

CIRCLE NO. 337

### Tester locates shorts in multilayer PC boards



Idlewild Associates, Box 41, McMinnville, OR 97128. Larry Lockwood (503) 472-6605. \$275; stock to 2 wks.

A fault finder, called Model 911 Short Sniffer, locates shorted runs buried in multilayer circuit boards. The instrument enables technicians to locate and patch around defective runs and acts as a diagnostic tool to aid in circuit-board failure analysis. The device indicates the direction of shorted conductors as well as pinpointing the location of the short. Indication is by audible clicks that increase in frequency as the short is approached. Meter indication is also provided.

CIRCLE NO. 338

### Thrifty function gen spans 0.1 Hz to 1 MHz



B&K Precision, 6460 W. Cortland Ave., Chicago, IL 60635. (312) 889-9087. \$175; stock.

Model 3010 function generator spans 0.1 Hz to 1 MHz in six ranges, with each range providing linear 100:1 frequency control. The unit generates sine, square, TTL square and triangle waveforms. Frequency generation is by a stable voltage-controlled oscillator (VCO) that can be varied on each range by a front-panel control or the VCO external input. If a 0-to-5.5-V ramp is applied to the VCO, the unit will provide a 100:1 output frequency change. With an audio signal in place of the ramp, the unit will produce a direct FM output. Variable-output, square-wave rise or fall time is 100 ns; TTL square-wave rise/fall time is 25 ns.

CIRCLE NO. 339

### Word generator delivers up to 50 MHz



Tau Tron, 11 Esquire Rd., North Billerica, MA 01862. Jim Hanley (617) 667-3874. \$4400; 6 to 8 wks.

Model MG-3 programmable word generator module has speeds up to 50 MHz. The device contains 1024 bits of RAM, programmable from front-panel controls or via an optional remote bus. The bits are arranged in a matrix of 128 words by 8 bits. An auxiliary ninth channel is used as an additional data channel or auxiliary sync channel. Data outputs may be in either 8-bit parallel or serial, RZ or NRZ-selectable. The output word or bit length in either mode is controllable in integer steps.

CIRCLE NO. 340

# Introducing the Incredible DATALOGGER 2000

... an easy-to-operate... simple to understand...



## DATA INFORMATION CENTER

that speaks your language!

It's incredible but... the Datalogger 2000 can measure 4 parameters that you've chosen... offer 2000 internal alarms... manage your data collection and report it in your language... and still remain 'pushbutton-simple' to operate.

The Digitec DATA INFORMATION CENTER features:

- **Multi-Parameter capability**  
Combine up to 4 of the 38 field interchangeable signal conditioning modules for measuring:
  - Temperature (Thermocouple, Thermistor, RTD)
  - DC Voltage, DC Auto-ranging
  - AC Voltage, True RMS
  - Transmitter output
- **Up to 20 channels internal—expandable to 1000.**
- **±25,000 count display (4¾ digits) of measured data.**
- **Alphanumeric printout.**
- **Exclusive skip-channel capability.**
- **24-hour clock and Julian date.**
- **Internal microprocessor.**
- **Pushbutton programming.**

And these options can make your DATA INFORMATION CENTER even more versatile!

- **Internal alarms**  
Up to 2000 individual set-points.  
4-level limits assignable per channel.
- **English messages**  
6-character message assignable to each limit which eliminates the need for translation codes and look-up tables.
- **Data outputs**  
Isolated BCD.  
Isolated RS-232-C, TTY compatible, with selectable baud rates from 110 to 9600.

From the leaders in data acquisition, the Datalogger 2000 delivers all the traditional Digitec qualities—premium components, designer styling and reliable performance.

For a free brochure that explains how your measuring and collecting of data can be made simple, write or call:

Don Gerdeman, our Datalogger Specialist.

**UNDER \$3000**  
**...it's incredible**

**Digitec** UNITED SYSTEMS CORPORATION

918 Woodley Road, Dayton, Ohio 45403  
(513) 254-6251, TWX (810) 459-1728

United Systems Corp.:  
Precision measurements to count on.

**SPRAGUE  
GOODMAN**

# TRIMMER CAPACITORS

Our only business!



## PISTONCAP® Multi-Turn Tubular

- Low-Loss, Glass or Quartz
- High Stability/High Reliability
- Simple, Long-Life Adjust Mechanism
- Professional / Military Applications, MIL Approved

## CERAMIC Single-Turn

- Compact, Conserves Board Space
- Variety of Mounting Configurations
- Low Cost for Commercial/Industrial Applications

## FILMTRIM\* Single-Turn Film

- PTFE, Polypropylene, Polycarbonate
- Most Stable Trimmer for Size
- Very Wide Capacitance Ranges
- Low Cost for Commercial/Industrial Applications

\*Trade Mark

Tired of broken delivery promises and poor quality? Deal with the trimmer capacitor specialist, for quality products delivered on schedule! Call on us for custom designs too, we deliver!

TRIMMER CAPACITORS — OUR ONLY BUSINESS!

## Sprague-Goodman Electronics, Inc.

(An Affiliate of the Sprague Electric Company)

134 FULTON AVE., GARDEN CITY PARK, N.Y. 11040 • 516-746-1385-TLX: 14-4533

CIRCLE NUMBER 86

# A "LIGHT" TOUCH

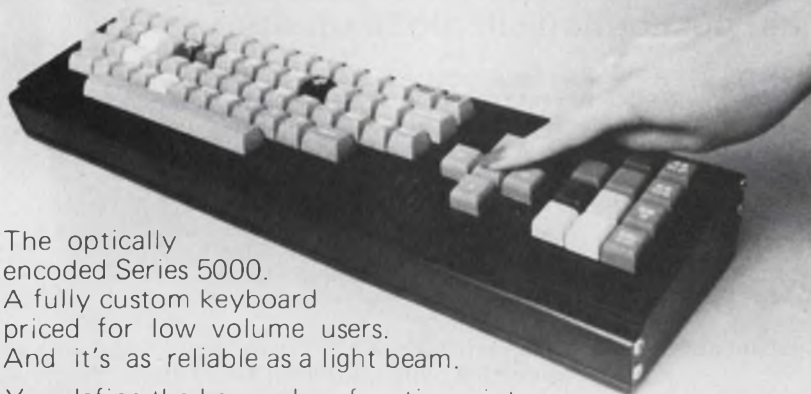

The optically encoded Series 5000. A fully custom keyboard priced for low volume users. And it's as reliable as a light beam.

You define the key codes, functions, interface, key locations and cap markings. If you can make do with a choice of only 2048 different codes, 360 keys or less, n-key lockout, 2-key rollover and logical or non-logical pairing, we'll make it up to you with fast delivery and no NRE or tooling charges.

Series 5000. The most sensible keyboard technology available today. Affordable in any quantity.

**ADI**

APPLIED DYNAMICS INTERNATIONAL  
KEYBOARD PRODUCTS DIVISION  
3800 Stone School Road  
Ann Arbor, Michigan 48104  
Phone: 313-971-7840 Telex: 230238

CIRCLE NUMBER 87

## INSTRUMENTATION

### IC thermal resistance checked in 7 seconds



Sage Enterprises, 1080 Linda Vista Ave., Mountain View, CA 94043. B. Siegal (415) 969-5111. \$5600; 8 wks.

The thermal resistance of ICs can be measured quickly (in accordance with MIL-STD-883A Method 1012) with the THETA 400. Using the forward-biased substrate-isolation-diode junction voltage as the temperature-sensitive parameter, the instrument applies a repetitive pulse that heats the test device. Sensing the change in isolation junction voltage, the device automatically divides the change by the applied heating power to produce a direct full-scale reading of 199.9 C/W. Accuracy of 6% max is made possible by the use of multiwire Kelvin contacts.

CIRCLE NO. 341

### 8-digit freq counter sells for \$135

Continental Specialties, 44 Kendall St., New Haven, CT 06509. (203) 624-3103. \$134.95.

The MAX-100 frequency counter operates from 20 Hz to 100 MHz and reads out on an 8-digit display. The crystal-controlled time base offers 3-ppm accuracy and the counter updates every second. The input is preamplified to work with 30 mV of signal and is diode protected up to 200 V. The display has a 0.6-in. digit height. No range switch is necessary since the least significant digit always represents 1 Hz. The unit can be operated on internal rechargeable batteries or from wall power using a charger.

CIRCLE NO. 342

# How fast can you accurately measure period or frequency of this wave form?



## The old way.

(About 5 minutes)

1. Find a scope and voltmeter
2. Connect signal to scope.
3. Determine proper trigger points.
4. Connect signal to counter
5. Select period or frequency function.
6. Select time base.
7. Set input voltage range.
8. Set input coupling to DC.
9. Connect voltmeter to trigger level output - if counter has output. (If not, good luck.)
10. Set desired trigger level.

## The easy way.

(About 5 seconds)

1. Connect signal to Racal-Dana 9000 counter.
  2. Push **P** or **FA** button.
  3. Push **TL** button.
  4. Push **AU** button.
- The rest is automatic.

## Now it's up to you.

You can continue to struggle along the old way. Or you can find out about the Racal-Dana 9000 Microprocessing Timer/Counter. The patented Auto-Trigger capability makes it the fastest and most accurate instrument in the world for the precision measurement of wave forms. Give us a call and we'll tell you how Racal-Dana systems technology can solve all your measurement problems the easy way.

**RACAL-DANA**  
Others measure by us.

Racal-Dana Instruments, Inc., 18912 Von Karman Avenue, Irvine, CA 92715, Phone: 714/833-1234.

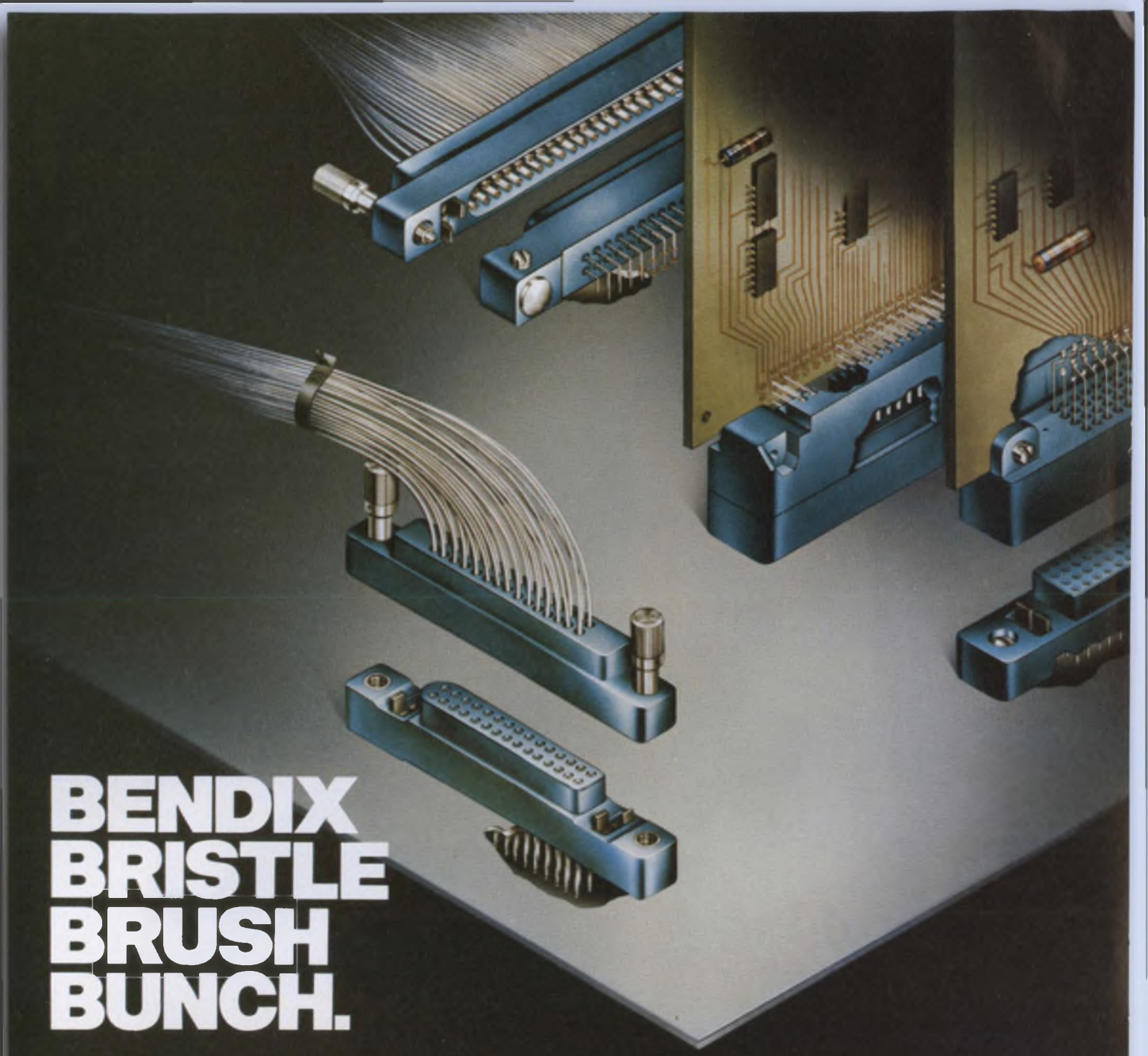

# BENDIX BRISTLE BRUSH BUNCH.

## Opens new horizons for PCB design.

70%-90% Reduction in Mating and Unmating Forces

- simpler board support systems
- fewer damaged boards

### Extended Circuit Count Potential

- up to 400 Bristle Brush contacts per connector

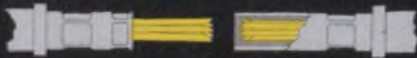

### Extensive Product Line

- mother board, daughter board, input/output, PC receptacle body styles
- 2-, 3-, and 4-row configurations
- 90° and straight PC, solderless wrap, crimp removable, willowy tail terminations

For complete information, contact The Bendix Corporation, Electrical Components Division, Sidney, New York 13838.

**Bendix**

# Featherweight Miniature Panel Mount Thermal Printer



Datel's new model DPP-7 Digital Panel Printer uses only 2 moving parts for OEM reliability. At only 2.3 Lbs. (1,1Kg) it is one of the lightest panel-mounting recording instruments available.

**Includes all electronics.**

The \$475\* single quantity price includes everything required for full parallel BCD/TTL data inputs *plus* an input storage register for multiplexed bus applications *plus* an AC power supply! There are no extra boards to design or bulky cables and power supplies needed. The DPP-7 is ready to use.

**Thermal printing** means no messy inks, banging hammers or twirling print-wheels. Nothing to jam or run out of ink.

**Use** the miniature DPP-7 for simple data logging systems, automatic test fixtures or with a digital panel meter for accurate unattended data measurement.

The **small size** of the DPP-7 makes it ideal for panel-mounting in analytical instruments and compact data systems. Up to six digits and sign may be printed to identify channel number and data.

The DPP-7 uses +5VDC power in a very short 6.2" (158mm) deep version or 100, 115 or 230 VAC power in an 8.7" (221mm) deep version.

\*U.S.A. domestic price only

**DPP-7 QUICK SPECS**

**Printing Rate:**

3 lines per second

**Inputs**

Full parallel BCD  
TTL logic inputs, selectable positive or negative true

**Printouts:**

Six digits and sign, 99 ± 9999  
± 999999 or 9 ± 99999  
(Hexadecimal optional)

**Input Storage**

BCD data must be valid only 1.5 microseconds during print command

**Data Capacity**

9000 lines on 150 foot x 1.75 inch (44.5mm x 45m) thermal paper rolls

**Power Supply:**

Choice of: +5VDC, or 100, 115 or 230VAC, 47 to 440 Hz

**Size Case:**

4.50" wide x 2.72" high  
(115mm x 69mm)

**Depth:**

5V Models  
6.2" (158mm)  
28V, 12V or  
AC Models 8.7"  
(221mm)

**New! Datel's Model DPP-Q7**

Whisper Quiet  
5 Lines/sec.

\$495



COVERED BY  
GSA CONTRACT  
NO. GS-00S-27959

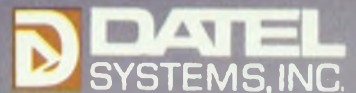

1020 Turnpike St. Canton, MA 02021  
TEL. (617) 828-8000 / TWX- 710-348-0135  
• Santa Ana, CA (714) 835-2751  
• LA Exchange (213) 933-7256  
• Sunnyvale, CA (408) 733-2424  
• Gaithersburg, MD (301) 840-9490  
• Houston, TX (713) 932-1130, 1132  
• Irving, TX (214) 256-4444  
• Tokyo, Japan 793-1031; Osaka, Japan (06) 354-2025 • Andover, UK (0264) 51055 • Paris, Fr. 620-06-74  
• Muenchen, W. Ger. (089) 776095

Send for your FREE Brochure

CIRCLE NUMBER 247

### Data acquisition system measures time intervals

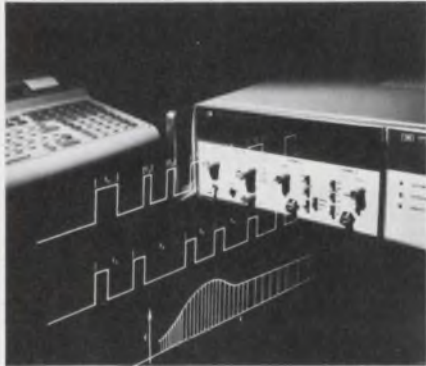

Hewlett-Packard, 1507 Page Mill Rd., Palo Alto, CA 94304. Larry Shergalis (415) 493-1501. \$17,500; 12 wks.

The Model 5391A is a compact data acquisition system capable of high-speed, high-volume measurements of time interval and frequency. Measurements of successive pulse widths or periods as short as 2 ns can be made at rates over 50,000/s. The system measures frequency from 50  $\mu$ Hz to 500 MHz or intervals from 2 ns to 20,000 s in either of two input channels. Up to 8 kbytes of measurement data can be acquired and temporarily stored in the plug-in memory per run. By pressing a single key on the Computing Controller keyboard, all of the specified measurements are automatically made and stored. Pressing another key causes previously-specified statistical analyses to be performed.

CIRCLE NO. 343

### Triggered scope has 20-MHz bandwidth

Leader Instruments, 151 Dupont St., Plainview, NY 11803. Pat Redko (516) 822-9300. \$500.

The LBO-507 oscilloscope has automatic-triggered circuitry and a 20-MHz bandwidth. Pushbutton switches select all functions. Vertical sensitivity is 10 mV/cm, and calibration is in 11 steps, up to 50 V/cm, with variable control. Rise time is 17.5 ns. Sweep speed ranges from 0.5  $\mu$ s/cm to 500 ms/cm in 18 steps. Magnification of  $\times 5$  delivers 100 ns/cm maximum speed. The unit has a 5-in. CRT with an 8  $\times$  10 effective area.

CIRCLE NO. 344

### Transient detector holds spikes

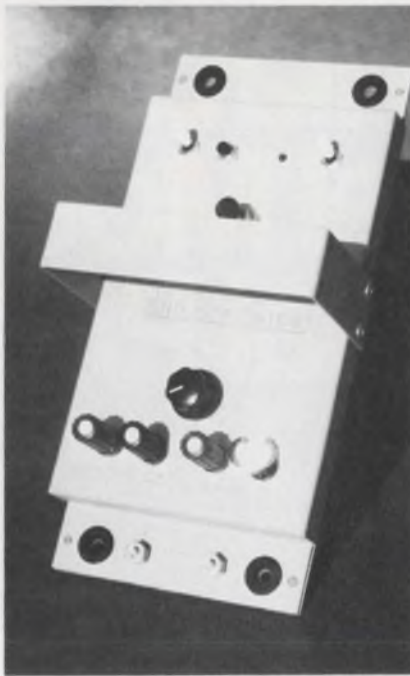

Industrionics, 115 Pleasant St., Millis, MA 02054. Joe Hersey (617) 376-8147. \$125; stock.

The Zap-Trap is a portable battery-operated transient voltage detector that senses and holds voltage spikes for up to 30 minutes with only 10% decay. If necessary, the unit can be operated unattended, with connection made to any dc meter on the 10-V scale. Pulse widths ranging from 2  $\mu$ s to 1.1 ms in both positive and negative directions can be sensed. Voltage range is from 10 to 1000 V, but a special adaptor allows you to detect pulses up to 10 kV. The instrument mounts directly on two 12-V #1463 batteries, or can be powered by 16 C-cells mounted in an optional carrier.

CIRCLE NO. 345

### Freq synthesizer spans 20 to 160 MHz

Syntest, 169 Millham St., Marlboro, MA 01752. (617) 481-7827. \$699; stock to 4 wks.

The SI-160 is a 5-digit frequency synthesizer that provides ECL signals into a 50- $\Omega$  load over the range of 20 to 160 MHz with a resolution of 1 kHz. Temperature stability is  $\pm 1$  ppm from 0 to 50 C. Options include external BCD programming with latching for computer control, sine-wave output at 13 dBm into a 50- $\Omega$  load and a standard RETMA 19-in. rack-mounting adapter.

CIRCLE NO. 346

### Audio gen and monitor checks received signals



International Data Sciences, 100 Nashua St., Providence, RI 02904. (401) 274-5100. \$810; 4 wks.

The Model 8508 audio generator and monitor allows the operator to listen to and measure received analog signals appearing at a modem-telephone line interface. The instrument generates a 1-kHz tone, variable from 0 to -16 dBm, patched into a telephone line. The monitor portion has an audio speaker and a dBm meter to monitor and measure line signals from -20 to +3 dBm. The input signals may be amplified to a level up to 50 dB.

CIRCLE NO. 347

### Logic tester checks general-purpose ICs



E.I.S., 1617 E. 17 St., Santa Ana, CA 92701. Hal Horrocks (714) 541-0445. \$2495; 4 wks.

The Model 500 Functional Logic Tester is a general-purpose IC logic tester that can be used by non-technical personnel. The instrument can be operated manually, testing one device at a time, or can be connected to an automatic handler since it contains built-in interface and control circuitry. Three internal test frequencies are 100 Hz, 250 kHz and 500 kHz. Also available is one external test frequency ranging from 50 kHz to 6 MHz. There is a selection switch for either TTL or CMOS devices. IC packages of 6, 8, 14, 16 and 18 pins can be handled.

CIRCLE NO. 348



# New, 16 Bit Microcircuit D/A Converter

Datel has it...



Two versions to choose from:

#### DAC-HP16BMC

- ▶ 16 Bit Binary Resolution
- ▶ 15 ppm/°C Max. Tempco
- ▶ ± 0.003% Linearity
- ▶ 0 to +10V, ± 5V Output
- ▶ 35 μsec. Settling Time

#### DAC-HP16DMC

- ▶ 4 Digit BCD Resolution
- ▶ 15 ppm/°C Max. Tempco
- ▶ ± 0.005% Linearity
- ▶ 0 to +10V Output
- ▶ 15 μsec. Settling Time

**\$7750\***  
(100's)

Price, both versions: \$119.00\* (1-24)

\*U.S.A. domestic prices only

When high resolution and stability are demanded, Datel's DAC-HP series provides the performance— applications such as precision signal reconstruction, automatic test systems, and ultra-linear ramp generation. DAC-HP's excellent performance results from special low tempco nichrome thin-film resistors, laser trimmed for optimum linearity, and a low tempco zener reference circuit. Operating temperature range is 0 to 70C, with models available for -25 to +85 and -55 to +125C operation.

**DATEL**  
SYSTEMS, INC.

1020 Turnpike Street, Canton, MA 02021  
TEL: (617) 828-8000 TWX: 710-348-0135

Santa Ana, (714) 835-2751, (L.A.) (213) 933-7256 • Sunnyvale, CA (408) 733-2424 • Gaithersburg, MD (301) 840-9490 • Houston, (713) 932-1130 • Irving, TX (214) 256-4444  
OVERSEAS: DATEL (UK) LTD - TEL: ANDOVER (0264) 51055 • DATEL SYSTEMS SARL 620-06-74 • DATELEK SYSTEMS GmbH (089) 77 60 95

CIRCLE NUMBER 180

## INSTRUMENTATION

### Lab rf amplifier yields preset constant level



Instruments for Industry, 151 Toledo St., Farmingdale, NY 11735. Ralph

Logan (516) 694-1414. \$4910; 4 wks.

The Model 2600 rf amplifier is for use where a load may be damaged by excessive power. Either the power or voltage delivered to the load can be maintained at a preset constant level, regardless of impedance changes in the load. In addition, the unit turns itself off if power or voltage reaches a predetermined level. Two meters monitor forward and reflected power. The amplifier covers 0.5 to 35 MHz and is rated at 130 W output. The unit is solid state and operates into any load impedance from a short to an open circuit.

CIRCLE NO. 349

### General-purpose scope handles 15 MHz

Philips Test & Measuring Instruments, Mahwah, NJ 07430. (800) 631-7172. \$875; stock.

Model PM3211 portable, 15-MHz/2-mV oscilloscope features comprehensive triggering facilities. The unit has an 8 x 10-cm screen in a 300 x 135 x 445-mm case. Its weight is 7.5 kg. Triggering can be in "Auto" or level-set modes and multisourced. Channel B can be used as an X input to facilitate X-Y displays, with calibrated attenuation of both X and Y inputs. Channel B can be inverted, and with the ADD function, can display  $A \pm B$ .

CIRCLE NO. 350

### Current probe measures peaks up to 500 A

Tektronix, P.O. Box 500, Beaverton, OR 97077. (503) 644-0161. \$665.

The P6303 probe measures peak pulse currents to 500 A and steady-state currents to 100 A within the frequency range of dc to 15 MHz. A 1 x 0.83-in. jaw accommodates large conductors. Because inductive coupling is used, no electrical contact or circuit break is required. The probe operates as a part of a system with the AM503 current probe amplifier, any TM500 power module and an oscilloscope.

CIRCLE NO. 356

### New technique measures power for fiber optics

Hewlett-Packard, 1507 Page Mill Rd., Palo Alto, CA 94304. John Kane (415) 493-1501. \$500; 5 wks.

The 84801A thermistor sensor, when used with any HP 432 power meter, measures optical power from 1  $\mu$ W (-30 dBm) to 10 mW (+10 dBm) over the wavelength range of 600 to 1200 nm, with an absolute accuracy as low as 7%. Using an optical fiber as its input, the system is a high-efficiency device designed for single-fiber power measurement. Absolute calibration is provided by the calibration factor adjustment on the 432. The power sensor is a thermistor bead that is attached to one meter of fiber-optic "waveguide." The fiber diameter is 200 microns, maximizing the amount of light detected by the sensor and assuring high accuracy of measurement.

CIRCLE NO. 357



### 87% efficiency in a compact 200 watt 400Hz to DC power supply

High wattage power supplies needn't be hot, heavy or bulky. Tecnetics' new 4200 Series packs 200 watts of power in 60 cubic inches of space, and delivers it with up to 87% efficiency. It's accomplished through pulse width modulation techniques, a technology pioneered by Tecnetics.

What did we give up to achieve these impressive specs? Nothing. Just look at

the state of the art features: remote error sensing, full encapsulation, MTBF up to 30,000 hrs. on single output units, EMI filter, overload and short circuit protection, excellent regulation, and environmental specs that meet the requirements of MIL-E-5400.

This impressive power supply series is now available with single and triple outputs to meet a wide variety of military and aerospace power conversion needs. Get full specs on this and over 1000 other AC-DC and DC-DC power supplies by sending for our catalog.

#### 4200 SERIES 200 WATT AC-DC POWER SUPPLIES — 3 PHASE

Output voltage:	5-48 VDC
Output power:	200 - 250 Watts
Frequency:	360 to 440 Hz, 3 phase Y
Dimensions:	6 X 4 X 2.6 inches
Terminals:	Barrier strip, screw type
Weight:	70 ounces, (4.4 lbs.)
Prices: (1 to 9)	Single output — \$750 Triple output — \$900 to \$925

**tecnetics**

The Power Conversion Specialists

P.O. Box 910, 1625 Range Street, Boulder, Colorado 80302 · (303) 442-3837 TWX 910-940-3246

CIRCLE NUMBER 93

# Dial-A-Voltage



SHOWN ACTUAL SIZE

## 0.005% Calibrator only \$450 (SINGLES)

Datel's Digital Voltage Calibrator, DVC-8500 comes in a mini-benchtop package, at a mini-price (\$450 in singles\*), but provides very big performance. DVC-8500 offers 4½-digit resolution and a ±19.999 volt full scale output range with ±1 millivolt accuracy (±0.005% of full scale.)

Use your DVC-8500 to calibrate A/D and D/A converters, DPM's, DVM's, Op Amps, V/F converters, and Data Acquisition Systems. A short-proof, buffered output gives up to ±25mA output current with an LED overload warning signal. The ±1.5 millivolt front panel vernier allows fine tuning of A/D and D/A bit steps.

Included are rear PC sense terminals and a choice of 100, 115, or 230 VAC inputs. A panel mounting kit is optional.

Contact Datel, or your nearest Datel Representative listed in Gold Book or EEM.

\* U.S.A. Domestic Price only.

**D** **DATEL**  
SYSTEMS, INC.

1020 TURNPIKE STREET, CANTON, MASS 02021  
TEL: (617) 828-8000 / TWX: 710-348-0135  
TELEX: 924461

Where can I get an AC-DC or DC-DC switching power supply in a modular, open frame or P.C.B. design, with a 5 year warranty at reasonable cost?

# ETATECH

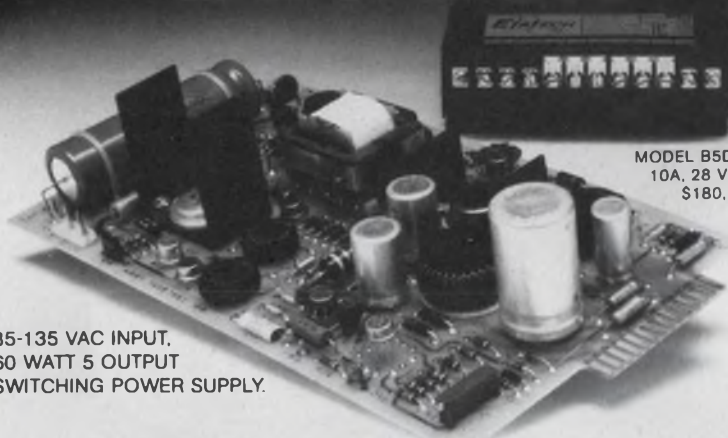

MODEL B5D10, 5V @ 10A, 28 VDC INPUT \$180, 1-99 PCS.

85-135 VAC INPUT.  
60 WATT 5 OUTPUT  
SWITCHING POWER SUPPLY.

187-M W. ORANGETHORPE, PLACENTIA, CA 92670

(714) 996-0981

CIRCLE NUMBER 95

## MICRO/MINI COMPUTING

### 16-bit $\mu$ P outperforms most 8-bit CPUs

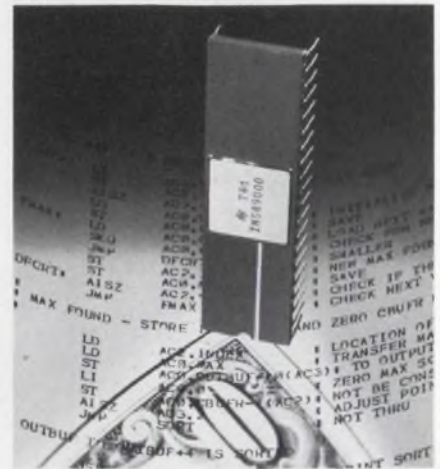

National Semiconductor, 2900 Semiconductor Dr., Santa Clara, CA 95051. Howard Raphael (408) 737-5956. \$10; stock.

The INS8900, a 40-pin, 16-bit microprocessor, sports an interrupt structure, addressing modes and logical capabilities associated with minicomputers. Instruction execution times for most commonly used routines are equivalent to those on advanced 8-bit designs and 10 to 30% faster than on present generation designs, such as the 2- $\mu$ s 8080. The 8900 is a true 16-bit CPU. It uses 16-bit instruction words and 16-bit data words and has a flexible set of 45 instruction types. The chip contains status and control circuitry, conditioned branch-sense circuitry, interrupt logic and a portion of the clock generation circuitry. By adding a ROM and one to four RAMs, a complete microprocessor system can be implemented.

CIRCLE NO. 358

## Double Balanced Mixers 10-1500 MHz

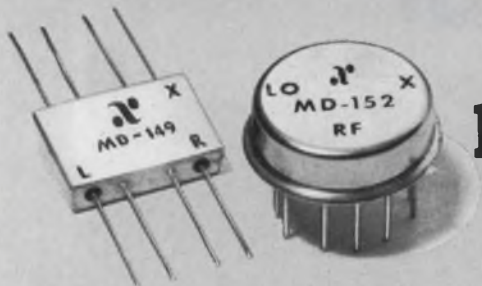

Either Flatpack or TO-8 version provides high performance for applications with Rf signals in the 1000 to 1500 MHz range (e.g., TACAN).

Both Model MD-149 and Model MD-152 are \$39 (1-49 quantity). IMMEDIATELY AVAILABLE FROM STOCK.

6 dB Midband Conversion Loss (typ.)

40 dB Midband LO-RF, LO-IF Isolation (Typ.)

0 dBm Rf Input for 1 dB Compression

DC Offset 10 mV (typ.)

Complete details in ANZAC CATALOG provided as Part 2 of 1977-78 MICROWAVES PRODUCT DATA DIRECTORY



39 Green St., Waltham, MA 02154 (617) 899-1900 TWX 710-324-6484

...the qualitative difference.

CIRCLE NUMBER 96

### Single-chip $\mu$ P has four 8-digit RAMs

Western Digital, 3128 Red Hill Ave., Newport Beach, CA 92663. (714) 557-3550.

The WD/40 microprocessor, for dedicated control uses, has four 8-digit RAM data storage registers and 400 or 512 10-bit words of ROM. The chip directly drives seven-segment displays through a ROM programmable decoder.

CIRCLE NO. 359

## One Mallory THF capacitor can replace up to four CSR types in a switching power supply.

These small, solid-tantalum capacitors give you a per-unit substitution factor as high as one for four and can by-pass 4.5 amp rms at 100kHz. So by using these high ripple performance capacitors you save in space, weight and cost.

Specially designed for low equivalent series resistance, at frequencies from 1 kHz through 1 MHz. They're ideal for high frequency power supply switching, for regulator switching, or for bypassing or filtering unwanted ripple currents.

Because ESR is low, power losses are low. With the solid electrolyte and hermetic seal, long life is inherent. Electrical characteristics are very stable over a temperature range of  $-80^{\circ}\text{C}$  through  $125^{\circ}\text{C}$ . Two case sizes: .29 x .69 and .35 x .79 inches.

Mallory THF capacitors are available in a wide range of ratings: 5.6 to  $330\mu\text{F}$ , 6 to 50VDC.

They're the result of Mallory's engineering program that's finding ways to produce high performance type capacitors at less cost to you.

Just ask your Mallory representative. Available direct, or through authorized Mallory Distributors in U.S. or overseas. Or call Help-Force Headquarters at (317) 856-3731. Mallory Capacitor Company, a division of P. R. Mallory & Co. Inc., Box 1284, Indianapolis, IN 46206.

CIRCLE NUMBER 97

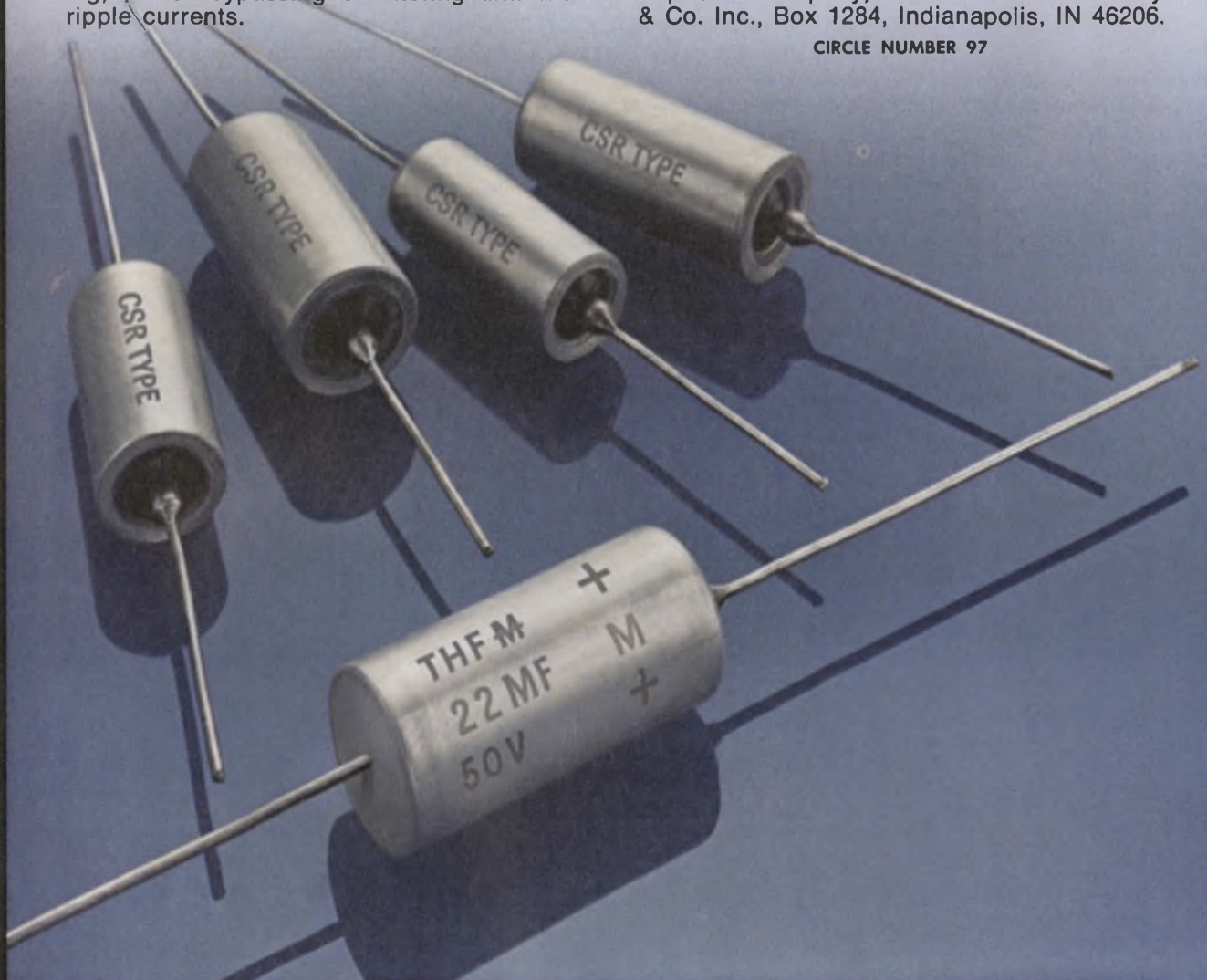

# MALLORY

## MICRO/MINI COMPUTING

### CRT terminal handles 9600-baud data



North Star Computers, 2547 Ninth St., Berkeley, CA 94710. (415) 549-0858. \$995.

Soroc Model IQ 120 is a CRT terminal that can be connected to North Star's Horizon computer and handle data rates up to 9600 baud. The terminal displays 24 lines  $\times$  80 characters and has an addressable cursor, upper and lower-case ASCII character set and a numeric key pad.

CIRCLE NO. 360

### $\mu$ C chip includes 4032 $\times$ 8 bytes of ROM

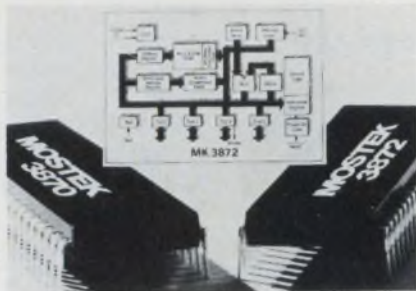

Mostek, 1215 W. Crosby Rd., Carrollton, TX 75006. Jim Vittera (214) 242-0444. See text; 8 to 10 wks.

The 3872 single-chip microcomputer includes 4032  $\times$  8 bytes of mask programmable ROM, 64 bytes of scratchpad RAM and an additional 64 bytes of executable RAM. Supporting the executable RAM is a stand-by power mode for battery backup. The chip requires just a 5 V supply, and includes 32 bits (four ports) of bidirectional I/O; a programmable binary timer and external interrupt capability. The 3872 costs \$25 in 1000-unit quantities with a refundable masking charge of \$3000.

CIRCLE NO. 361

### Data-acquisition system is programmable



Signal Lab, 202 N. State College Blvd., Orange, CA 92668. Bill Chidester (714) 634-1533. \$3495; 4 wks.

UPDAS (user programmable data acquisition system) includes a microcomputer, analog and digital I/O, and the integrating software in a single chassis. The system provides real-time computation in multiple process and control loops. The unit accepts analog and digital inputs; performs real-time computation; outputs in analog and digital form; displays, prints and accepts commands from the front panel. All functions can be programmed by the user.

CIRCLE NO. 362

# Time Delay Relays

More design options with delays of .01 seconds to a year... and more.

Widest choice of timing modes, voltages, mountings, enclosures and contact arrangements. Save design time by selecting a standard P&B time delay relay. Or, we'll make a special for you if your application demands it. All built to P&B's high standards of quality and performance. Potter & Brumfield Division AMF Incorporated, 200 Richland Creek Dr., Princeton, IN 47671. 812/386-1000.

CIRCLE NUMBER 98

# Potter & Brumfield

## Data coupler delivers date, time or messages



*Chrono-Log, 2 W. Park Rd., Haver-  
town, PA 19083. (215) 853-1130.  
\$272/\$312.*

Series 70,000 digital clock/calendars interface with the communications port of a computer, CRT terminal or recording device and deliver date, time and messages with up to 31 ASCII-coded characters. Up to 31 ASCII-coded characters. Up to 16 of these characters can come from variable sources such as digital time and front-panel thumb-switches. The remainder are fixed and stored in a PROM. Each character can include 7 or 8 data bits. Speed can be selected from 75 to 9600 baud.

**CIRCLE NO. 363**

## Cross-assemblers mate with PDP-8 systems

*Sierra Digital Systems, 13905 Ranch-  
eros Dr., Reno NV 89511. (702)  
329-9548. \$400; stock.*

Four microprocessor cross-assemblers have been added to the X8 Series for the DEC PDP-8 minicomputer. The series covers the Z80, 1802, SC/MP and 8048  $\mu$ Ps in addition to the previous 6502, 6800, 8080, F8 and 2650 versions. The cross-assemblers run in 8 kwords of memory under the OS/8 system and are written in PDP-8 assembly language. Pseudo-ops and run-time options provide for conditional assembly and extensive listing control. Generated object code may be output in the  $\mu$ P's standard loader format, or BNPF for ROM generation. The cross-assemblers are distributed in PDP-8 binary format on paper tape, Dectape or DEC floppy diskettes.

**CIRCLE NO. 364**

## Single-board computer ups its ROM capacity

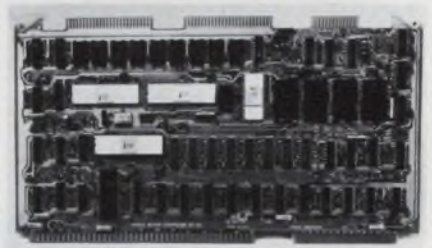

*Intel, 3065 Bowers Ave., Santa Clara,  
CA 95051. Don Schare (408) 987-7253.  
\$495.*

The iSBC 80/10A single-board computer is an enhanced version of the 80/10 and gives up to twice the ROM capability of the older 80/10. With the 80/10A, the user can store the program in either a type 2716, 2048-byte EPROM or smaller 8708 or 2758, 1024-byte EPROM. With the 80/10, the user could only use the 8708.

**CIRCLE NO. 365**

# ...and other solutions to your tough design problems are found in P&B's growing product line.

**AMF**

**Potter & Brumfield**

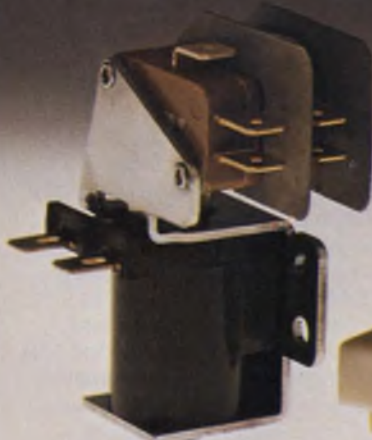

**NEW low-cost S87R industrial relay.** UL recognized. Contacts rated to 20 amps, 277V AC, 50,000 operations at rated load. Contact forms to 2C. Ideal for vending machines, HVAC, home appliances and machine tool controls.

**CIRCLE NUMBER 156**



**NEW T10 PC Board Relay.** Now sealed for flow soldering and immersion cleaning. Only .425" high allowing 0.6" center-to-center spacing. Ideal for high density applications. Choice of 2, 4 and 6 Form C contacts for 0.1 to 3 amp switching @ 28V DC.

**CIRCLE NUMBER 157**



**W58 thermal circuit breaker.** Positive snap action switching up to 35 amps for under \$1.00 in quantity. Exclusive blade design. Pressure actually increases until contacts open... with a "snap." Trip times at 200% of rated load—1 to 4 amp models 10 to 45 seconds, 5 to 35 amp models, 6 to 30 seconds.

**CIRCLE NUMBER 158**

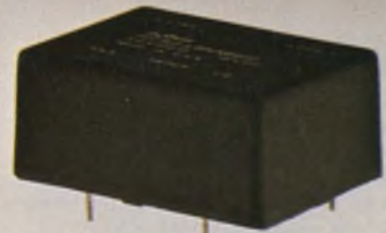

**NEW EAX solid state AC relay.** Thyristor controlled and isolated by pulse transformer circuit. Can be driven directly by logic circuits such as TTL, MOS and HTL. Terminals for 0.1" grid printed circuit board mounting. Rated 1.2 amps, 120V AC.

**CIRCLE NUMBER 159**



Model 178

## Now... the next generation of bench DMMs!

Two New Keithley Models offer uncompromising performance and outstanding value.

- Accuracy 3 1/2's can't match: 0.04% + 1 digit on dc volts and ohms.
- Large, bright, 20,000-count LED display that's quick and easy to read.
- Convenient bench size that won't get "lost" yet doesn't crowd.
- Exceptional reliability.

Model 178 offers functions and ranges for most measurements: 100 $\mu$ V to 1200V dc, 100 $\mu$ V to 1000V ac, 0.1 $\Omega$  to 20M $\Omega$ . At \$199\* it is a remarkable value!

Model 179 is a full-function, multi-feature model offering the same

advantages as the 178. Plus TRMS AC; 10 $\mu$ V Sensitivity; Hi and Lo Ohms; AC and DC Current.

Yet it's still half the price you'd expect. Only \$289\*!

Model 179



### Both models feature designed-in reliability.

Rugged circuits use a minimum of parts—high quality, off-the-shelf parts—carefully assembled and tested by Keithley (we've been making sensitive laboratory instrumentation for more than 30 years.)

Outstanding overload protection and rugged mechanical design keep both

units going even after severe abuse. One-year accuracy specifications minimize recalibration costs. Local assistance keeps downtime to a minimum should service ever be needed.

A battery option, user installable, gets you off "line" for critical measurements or for field use. Nine other accessories add versatility.

Keithley's 178 and 179 are designed, built and supported to provide continuous usability at the lowest total cost of ownership.

Need autoranging, more accuracy or sensitivity? See Keithley's complete line of DMMs.

For complete specifications and immediate delivery on the 178 and 179, call your local Keithley representative (see adjoining list). Or, call or write: Keithley Instruments, Inc., 28775 Aurora Road, Cleveland, Ohio 44139. (216) 248-0400. In Europe: D-800 München 70, Heighofstrasse 5, West Germany. (089) 7144065.

# KEITHLEY

The measurement engineers.

CIRCLE NUMBER 99

\*U.S. domestic price only



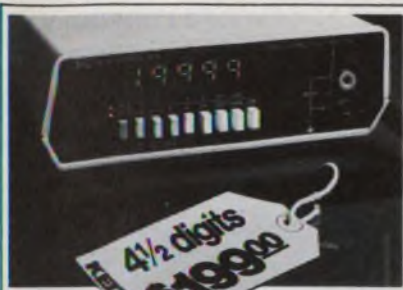

### To order your Keithley DMM:

**ALABAMA:** Huntsville, (205) 883-8660  
**ARIZONA:** Phoenix, (602) 944-9185  
**ARKANSAS:** (214) 231-9489 (Dallas, TX)  
**CALIFORNIA:** Los Angeles, (213) 836-6170  
 San Diego, (714) 226-0305  
 San Francisco (408) 257-8333  
**COLORADO:** Denver, (303) 795-0250  
**CONNECTICUT:** (800) 225-3409, Toll Free  
**DELAWARE:** (609) 871-9341 (Philadelphia, PA)  
**DISTRICT OF COLUMBIA:**  
 (703) 573-8787 (Arlington, VA)  
**FLORIDA:** Ft. Lauderdale, (305) 776-4800  
 Melbourne, (305) 723-0766  
 Orlando, (305) 425-5505  
 Pensacola, (904) 243-6424  
**GEORGIA:** Atlanta, (404) 939-1674  
**IDAHO:** (303) 795-0250 (Denver, CO)  
**ILLINOIS:** Chicago, (312) 585-5485  
**INDIANA:** Indianapolis, (317) 293-0696  
**IOWA:** Cedar Rapids, (319) 365-8071  
**KANSAS:** Kansas City, (913) 492-7020  
 Wichita, (316) 788-0621  
**KENTUCKY:** Lexington, (317) 293-0696  
 (Indianapolis, IN)  
 Louisville, (216) 729-2222 (Cleveland, OH)  
**LOUISIANA:** Baton Rouge, (504) 626-9701  
**MAINE:** (617) 944-6660 (Boston, MA)  
**MARYLAND:** Baltimore, (301) 321-1411  
 South, (703) 573-8787 (Arlington, VA)  
**MASSACHUSETTS:** Boston, (617) 944-6660  
**MICHIGAN:** Detroit, (313) 569-4497  
**MINNESOTA:** Minneapolis, (612) 559-1976  
**MISSISSIPPI:** (504) 626-9701 (Baton Rouge, LA)  
**MISSOURI:** St. Louis, (314) 426-7055  
**MONTANA:** (303) 795-0250 (Denver, CO)  
**NEBRASKA:** (913) 492-7020 (Kansas City, KS)  
**NEVADA:** (213) 836-6170 (Los Angeles, CA)  
**NEW HAMPSHIRE:** (617) 944-6660 (Boston, MA)  
**NEW JERSEY:** North, (201) 368-0123  
 South, (609) 871-9341 (Philadelphia, PA)  
**NEW MEXICO:** Albuquerque, (505) 255-2440  
**NEW YORK:** Metro New York, (201) 368-0123  
 Syracuse, (315) 454-9314 (Paramus, NJ)  
**NORTH CAROLINA:** Durham, (919) 682-2383  
**NORTH DAKOTA:** (612) 559-1976 (Minneapolis, MN)  
**OHIO:** Cleveland, (216) 729-2222  
 Dayton, (513) 434-8993  
**OKLAHOMA:** (214) 231-9489 (Dallas, TX)  
**OREGON:** Portland, (503) 297-2248  
**PENNSYLVANIA:** Philadelphia, (609) 871-9341  
 Pittsburgh, (216) 729-2222 (Cleveland, OH)  
**RHODE ISLAND:** (617) 944-6660 (Boston, MA)  
**SOUTH CAROLINA:** Columbia, (803) 798-3297  
**SOUTH DAKOTA:** (612) 559-1976 (Minneapolis, MN)  
**TENNESSEE:** Oak Ridge, (615) 482-5761  
**TEXAS:** Austin, (512) 451-7463  
 Dallas, (214) 231-9489, Houston, (713) 783-1492  
**UTAH:** (303) 795-0250 (Denver, CO)  
**VERMONT:** (617) 944-6660 (Boston, MA)  
**VIRGINIA:** Arlington, (703) 573-8787  
**WASHINGTON:** Bellevue, (206) 454-3400  
**WEST VIRGINIA:** (216) 729-2222 (Cleveland, OH)  
**WISCONSIN:** Milwaukee, (414) 464-5555  
**WYOMING:** (303) 795-0250 (Denver, CO)

#### CANADA

**BRITISH COLUMBIA:** Vancouver, (604) 732-7317  
**MANITOBA:** Winnipeg, (204) 475-1732  
**ONTARIO:** Toronto, (416) 638-0218  
 Ottawa, (613) 521-8251  
**QUEBEC:** Montreal, (514) 735-4565

#### EUROPE

**FRANCE:** Palaiseau, (01) 928-00-48  
**UNITED KINGDOM:** Reading, Berks.  
 (0734) 861287/88  
**WEST GERMANY:** München, (089) 7144065

Or call Keithley's Toll Free  
 DMM Hot Line (800) 321-0560

**KEITHLEY**  
 The measurement engineers.

## MICRO/MINI COMPUTING

### High-speed RAM is nonvolatile

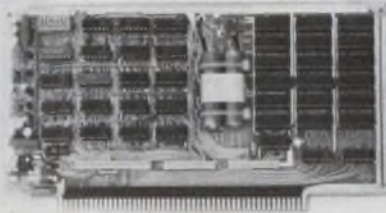

*ElectriCom, P.O. Box 1235, Hawthorne, CA 90250. Pat Patterson (213) 676-6576. \$287.*

Model 4020 nonvolatile high-speed semiconductor RAMs have size and word widths of 2k x 8/9 or 1k x 16/18, which are jumper selectable. Data is maintained for a minimum of three months (six months is typical) after the primary board power is removed. Constructed on a 5 x 10-in. card, the memory has a 450-ns access time, bank selectable by DIP switches within 64 k, phase-programmable operating controls, separate data inputs and outputs that can be bussed together, S100 bus compatibility, on-board address registers for A0 through A9 and LS-type TTL interfacing. On-board NiCd batteries, battery charger and power-state monitors are also included.

CIRCLE NO. 366

### Disc storage unit adds 10 Mbytes to computer

*Diablo Systems, 24500 Industrial Blvd., Hayward, CA 94545. (415) 783-3910. See text: 8 wks.*

Disc-storage capacity of Model 3200 small business computer systems have been increased to 10 Mbytes with the addition of a fixed/removable disc-drive. The Model 3200-14 disc system has a 5-Mbyte fixed disc and an additional removable 5-Mbyte disc cartridge that can be used in place of, or in addition to, the 630,784-byte diskette drives currently available on the computer. The disc subsystem achieves a data transfer rate of 312,000 bytes/s with an average access time of 50 ms. A typical 3200 system with the 1-Mbyte disc drive is priced at \$29,000.

CIRCLE NO. 367

## Data cartridges use 1/4-in. tape



*TAB Products, 2690 Hanover St., Palo Alto, CA 94304. Jim Snyder (415) 493-5790.*

The Model 1040 quarter-inch magnetic-tape cartridge is compatible with the ANSI, ECMA, ISO and IBM standards. Features include ceramic edge guides for extended cartridge life, interchangeability with IBM 5100 and 3M DC300A units, manually operable internal file protection, endless drive belt, roller and hub retaining system that reduces skew and bit-to-bit jitter, a polycarbonate cover and precision-machined metal base.

CIRCLE NO. 368

## 64-k RAM mates with SBC 80/10

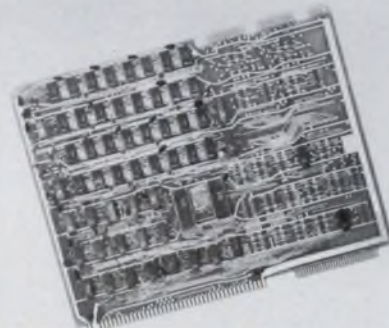

*GSI Systems, 223 Crescent St., Waltham, MA 02154. Ed Letscher (617) 899-6688. \$179; stock.*

The Model 10046, 64-k RAM board is a direct replacement for four SBC 80/10, 16-k RAM boards. Providing 475-ns access and 650-ns refresh times, the board is compatible with a standard SBC 80/10 backplane. The memory can be driven by any 80/10 CPU board, and its 64-k address starts at 0000, page selectable.

CIRCLE NO. 369

## MICRO/MINI COMPUTING

### Unit allows computer to control ac outlets

Mountain Hardware, P.O. Box 1133, Ben Lomand, CA 95005. (408) 336-2495. \$189 (controller), \$149 (remote); stock to 4 wks.

The Introl controls ac devices remotely from any S-100 bus over existing 110-V-ac wiring. The system impresses a code-modulated 50-kHz control on the ac wiring and then decodes the signal at any outlet to switch appliances on and off. A single ac-controller board plugs into the computer bus and connects to the ac interface adapter, which, in turn, is plugged into any 110-V-ac outlet. The controller can address as many as 64 channels remotely. When polled, the remote unit sends a signal back indicating the status of each device.

CIRCLE NO. 370

### ROM/RAM simulator tests software



Electro-Design, 7364 Convoy Court, San Diego, CA 92111. (714) 277-2471. \$1495.

To test software when developing  $\mu$ P systems, the ED5000 simulator can be plugged into any standard ROM or RAM socket to verify new programs under actual operating conditions. Programs entered into its standard 2-k x 8, 45-ns memory can then be edited. Also, programs already stored in PROMs can be loaded into the system. The display serves as a memory map.

CIRCLE NO. 371

### 16 k x 16 core memory plugs into LSI-11 micro



Micro Memory, 9438 Irondale Ave., Chatsworth, CA 91311. (213) 998-0770. \$1181; 3 wks.

The MM-1103/16, 16 k x 16 core memory system plugs directly into the DEC LSI-11 microcomputer. Access time is 400 ns. The memory is plug-compatible with the DEC MMV-11A and may be installed in any location in the LSI-11 chassis. By using slot four of the chassis, two spare slots are provided. The memory has byte control and has module selection in 4-k increments up to 32 kwords.

CIRCLE NO. 372

# An 8½ inch Microprocessor Controlled Impact Printer for just \$345\*

Now that's what we call  
Practical!

Laugh all the way to the bank, OEM's. With both matrix impact print head and built-in microprocessor controller, our DMTP-6uP is a budget printer in price only. In practice, it's one of the greats.

You can print 80-96 columns of both data and text at a fast 110 cps. Turn out up to four copies at once on regular 8½ inch roll paper, even on fan-fold forms and labels. Not only are all needle drivers and diagnostic routines included with the microprocessor, but you can choose the interface function you want — parallel ASCII, RS-232C/I-Loop, or switch-selectable baud rates from 110 to 1200. You even get the economy of easily-replaceable ink rollers and a self-reversing 10-million character life ribbon.

\* \$345 in 100 qts.; single units \$472



All that for \$345\*? It's phenomenal...  
and it's also very Practical.

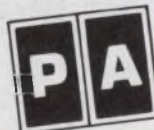

**PRACTICAL AUTOMATION, INC.**  
Trap Falls Road, Shelton, CT 06484  
Tel: (203) 929-5381

# NOW



## A magnetic circuit breaker that proves

# LESS is MORE!



### **Airpax T11 Snap-Action Magnetic Circuit Breaker.**

The Airpax T11 is a single pole, single throw, series trip magnetic circuit breaker that combines power switching and accurate, reliable protection in one aesthetically pleasing package. It features a patented snap-action that assures immediate and positive opening or closing of the contacts. This snap-action results in an increase in operational life of up to 5 times that previously available. It also eliminates possible operator "teasing" of the contacts and minimizes arcing.

**LESS COST.** The T11 costs less than any other magnetic circuit breaker on the market today . . . under \$5.00 in small quantities. Even less as the quantity increases. And the traditional Airpax Five-year warranty.  
**Result: MORE** protection for your money.

**LESS SPACE.** The T11 combines power switching and current protection in one tiny package about 1 cubic inch in size. That's smaller than any other magnetic breaker. In addition, the T11 offers a choice of six attractive paddle handle colors and a variety of mounting hardware.  
**Result: MORE** design flexibility.

**LESS INSTALLATION COST.** The T11 does the job of a power switch, fuse and fuse holder — all in one easy-to-mount unit. This

means only one item to be installed instead of three, less assembly time, and one-third the inventory.

**Result: MORE** Productivity . . . and profit . . . for you.

**LESS SERVICE REQUIRED.** The T11 is immediately resettable to check if a fault has been removed. There's nothing to burn out. Nothing to replace. No annoying service calls.

**Result: MORE** happy customers for you.

**LESS GUESSWORK.** Airpax has a bulletin fully describing the T11 snap-action magnetic circuit breaker, including rating, delays,

complete specifications, and a handy how-to-order chart.

**Result: MORE** information for you.

To get your bulletin, call your local Airpax representative or contact Airpax Electronics, Cambridge Division, Cambridge, MD 21613. Phone: (301) 228-4600. Telex: 8-7715. TWX: 865-9655. Other factories in Europe and Japan.



# AIRPAX™

## THE PRO IN PROTECTION

## Board expands memory and I/O for TI $\mu$ C

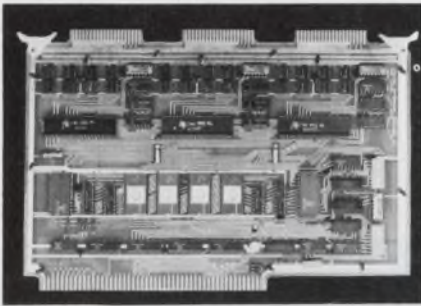

Digital Interface Systems, P.O. Box 1446, Benton Harbor, MI 49022. Mahesh Seth (616) 926-2148. See text; 8 to 12 wks.

The Model 990-110 memory and I/O expansion board is compatible with the Texas Instrument TM990/100M micro-computer. The board provides 2-k, 16-bit words of EPROM (expandable to 4 k), (1-k and 16-bit words of static RAM. Memory addresses are selectable on 1-k boundaries for RAM and 4-k boundaries for EPROM. Also, three TMS 9901 chips for input, output and interrupt lines are provided. Prices range from \$395, for a board with unbuffered inputs and outputs and no memory, to \$635, for a buffered and fully populated board.

CIRCLE NO. 373

## Memory/disc controller meets Euro standards

Zilog, 10460 Bubb Rd., Cupertino, CA 95014. Vince Schlezes (408) 446-4666. \$895.

The Z80-MDC/E is a memory and disc-controller board that meets the standard specs commonly adopted in West Germany, United Kingdom, France and Switzerland. The board provides 12 kbytes of dynamic RAM plus a floppy-disc controller capable of handling up to eight floppy-disc drives. The MDC/E has a strapping option for setting the start address of each 4-kbyte memory page. Also, disc read/write accuracy is ensured by 16-bit cyclic-redundancy-check-code circuitry.

CIRCLE NO. 374

## 8-kbyte static RAM mates with S-100 bus

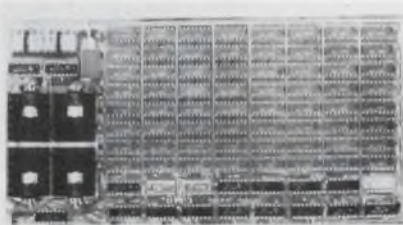

Pacific Digital, 2555 E. Chapman Ave., Fullerton, CA 92631. (714) 992-5540. See text.

The 8KRS is an 8-kbyte static RAM for use on an S-100 bus. The memory is organized as two independently addressable 4-k blocks with address selection by jumper and plug, which can be changed while the board is plugged in. Write protection for the entire board is provided by an on-board toggle switch, and memory disable is via a phantom line. Also, 0, 1 or 2 wait states are plug and jumper selectable. All bus lines are buffered with one LS-type TTL load per line. Prices are \$199.95 for 450-ns-speed units and \$219.95 for 250 ns.

CIRCLE NO. 375

## Single-board computer is disc based



Altos Computer Systems, 4340 Stevens Creek Blvd., San Jose, CA 95129. (408) 244-5766. \$3394.

The Z8000 is a full-sized disc-based business system with all electronics on one plug-in 8 x 12-in. board. The desktop package contains two Shugart floppy discs for IBM compatibility. The system uses the Z80 CPU and the CP/M random access disc operating software together with extended commercial basic.

CIRCLE NO. 376

## Flexible-disc drives store 6.4 Mbits

Pertec Computer, 9600 Irondale Ave. Chatsworth, CA 91311. Neil McElwee (213) 999-2020.

The FD410, 5XO, 511A and 514 are flexible-disc drives that boast a maximum storage capacity of 6.4 Mbits (unformatted). The drives have ferrite read/write heads that are IBM compatible. The disc's positioner uses a three-step track-to-track movement for track-positioning accuracy, and a retractable-head system contacts the recording media only when reading or writing data. The different models offer a selection of interfaces.

CIRCLE NO. 377

## Talk to a computer and it talks back

Digital Group, P.O. Box 6528, Denver, CO 80206. (303) 777-7133. \$595.

With a Votrax voice synthesizer card, you can verbally command your Z80 microcomputer and it will answer. The card plugs into any I/O slot of a Digital Group microcomputer system. Other computers require some extra hardware and software programming. The developed software assumes a Z80 system with at least 18 k of memory, a 1024-character TV and cassette interface card. A high-impedance microphone is required for voice input and an external 8- $\Omega$  speaker for voice output.

CIRCLE NO. 378

## Data cassettes handle short tape lengths

Avdex, 2280 Grand Ave., Baldwin, NY 11510. (516) 546-2272. \$.495 to \$6.35.

The CDC line of data cassettes are loaded with only 1 to 5 min of tape. These cassettes use computer shells, polyolefin slip sheets, machined guide rollers, stainless steel pins, oversized pressure pads and oversized hubs for smooth, uniform tape transport. Extra-short leaders do not come in contact with the recording head, which allows instant-start operation, eliminating lost data.

CIRCLE NO. 379

# Same great name. Same great color.

## And now a neat new way to definitive display performance.

# DOT MATRIX

Consider the new Noritake-Ise dot-matrix line-up—  
9, 10, 16, 20 and 40-character line displays.  
Variety aimed at giving you more design potential.  
Or consider our unique 400-dot graphics display  
with 17m/m depth and low 35V drive rating.  
It's aimed at helping you think low voltage,  
portability and economy all at the same time.

In short, consider Noritake-Ise period  
for dot matrix (or segmental) displays.  
Itrons always help you design more competitively.

**itron**<sup>®</sup>



**DC209A2**

Dimension: 41(H) × 208(W) × 10.5(D)mm Character Size: 9.0(H) × 6.3(W)mm

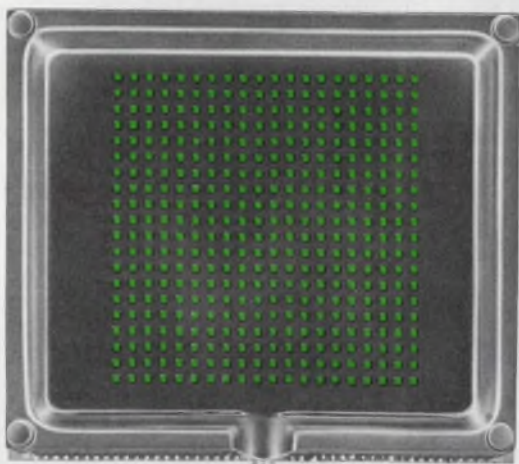

**DM400A1**

Dimension: 114(H) × 130(W) × 17(D)mm



**DC95A2**

Dimension:  
24(H) × 75(W) × 7.2(D)mm  
Character Size:  
5.05(H) × 3.55(W)mm



**FG4806**

Dimension:  
25.5(H) × 56.5(W) × 7(D)mm  
Character Size:  
8.0(H) × 4.2(W)mm

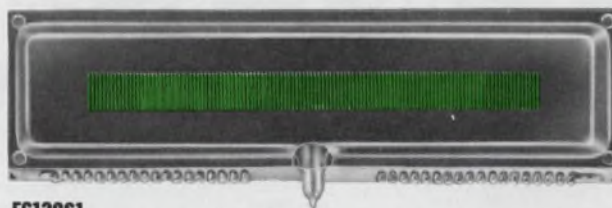

**F6120S1**

Dimension: 39(H) × 138(W) × 12.5(D)mm



**FG209M2**

Dimension: 41(H) × 208(W) × 10.5(D)mm Character Size: 9.0(H) × 5.4(W)mm

## NORITAKE CO., LTD.

Electronics Division  
1-1, Noritake-Shinmachi,  
Nishi-ku, Nagoya Shi,  
Japan  
Phone: NAGOYA  
(052) 561-7111  
Telex: J59738 NORITAKE

Europe Office  
Rue De la presse 3-5 1000  
Bruxelles Belgium  
Phone: 2178360, 2178460  
Telex: 25327, 26962

Noritake Electronics Inc.  
Los Angeles Branch  
22410 Hawthorne Blvd.  
Torrance, Calif  
Phone: (213) 373-6704  
Telex: 230674910

New York Branch  
19C NY MDSE MART  
41 Madison Ave, New York, N.Y. 10010  
Phone: (212) 481-3300  
Telex: 230125469

F.R. Germany  
NEUMÜLLER GmbH B  
München 2,  
Karlstrasse 55  
F.R. Germany  
Phone: 089 (599) 1230  
Telex: 522106

U.K.  
ITT Component Service  
Edinburgh Way Harlow  
Essex, U.K.  
Phone: 0279-3351  
Telex: 81146

Europavia France  
5, Avenue Leon Harmel 92167,  
Antony Cedex, France  
Phone: 666-21 10  
Telex: 42204381

Hong Kong  
Room 1403 Shing Loon Bldg  
24-26 Stanley Street, Hong Kong  
Phone: 5-232420 Telex: HX83151  
Taipei  
72-9 SEC 2, JEN AI RD, Taipei  
Phone: 351-0293 Telex: 11176

Manufacturer:

**ISE ELECTRONICS CORP.**  
P.O. Box 46 Ise-shi,  
Mie-Pref., Japan  
Phone: (0596) 39-1111  
Telex: 4969523

# SPACE·SAVER SPACE·SAVER SPACE·SAVER

The DS-Series  
Switcher from  
Digital Power!

- +Small Size
- +Light Weight
- +High Efficiency

150 Watts in  
90 Cubic Inches

- Brown-Out Protection
- Short Circuit Protection
- Drop-Out Protection
- OVP on All Units
- Exclusive 'Guardian'  
Overtemperature Protection



SINGLE 5v @ 30A	TRIPLE +5v, ± 12v
\$187	\$200
1000 Quantity	

## DIGITAL POWER

2060 The Alameda • San Jose, California 95126 • (408) 246-4337

CIRCLE NUMBER 103

## COMPONENTS

Keyboard allows  
many uses



Cherry Electrical Prod., 3600 Sunset Ave., Waukegan, IL 60085. Frank Amendola (312) 689-7702. \$88.00 (100 qty); 2 wks.

The PRO keyboard, for users who don't want to work around a totally dedicated unit, features an alpha-lock key that changes outputs from typewriter keyboard to teletypewriter code, and also five unassigned keys whose legends you can change. The keyboards daughter-board circuit can be easily piggy-backed. Alterable options that permit rapid customizing of the unit include negative logic, which can be derived by substituting SN7400N ICs for SN7408Ns and three-state positive logic, which can be obtained by using two SN74126Ns. Additional options include CMOS-compatible output, encoded or nonencoded outputs, an automatic repeat function, optional parity bit, varied strobe pulse width, output latch and shift-control mode.

CIRCLE NO. 380

Rocker switches  
are sealed

Cutler-Hammer, P.O. Box 463, Milwaukee, WI 53201. (414) 442-7800.

Commercial environmentally sealed rocker switches resist dust, dirt and liquid contaminants found in harsh environments. The switches are available in either snap-in bezel, flush or sub-panel mounting; in 1, 2 and 4-pole configurations. The switches have flame-retardant mineral-filled melamine bases, die-cast frames, high-impact nylon rockers and screw-type terminals. The units have a seal around the bushing and a seal between the base and frame.

CIRCLE NO. 381

# ION IMPLANTED Tuning Diodes 2 to 500 pF

Design in Implion® hyperabrupt and abrupt tuning diodes which offer superior capacitance swings, reproducibility and reliability. Tailored for octave or linear tuning in communications and test equipment.

Send for our catalog including selection guide and electrical characteristics as well as information on PIN diodes and low voltage avalanche zener diodes or call 617-273-1730.



CIRCLE NUMBER 104

**If you want to turn  
tire kickers into  
car buyers,**

**find a MOS company  
that's really up to speed.**

## **Ford Motor Company did.**

Anyone who buys a 1978 Continental Mark V has come a long way. And this year, a new option lets him know exactly how much further he can go without running out of gas.

A unique "miles-to-empty" display is controlled by a single 3600-transistor microcircuit, designed specially for Ford by AMI. It processes data from sensors in the car's gas tank and transmission, correlating speed and fuel level to estimate the miles remaining.

For the driver, this means an end to

that nervous "can-we-make-it-to-the-next-town" syndrome, and helps him gauge his mpg. Ford, of course, adds another touch of class to a superb automobile—and another selling point to win customers in a highly competitive market.

If you want to get more mileage from your new product, the place to start is AMI. Since 1966, we've developed a variety of ways, using standard or custom circuits, to solve our customers' MOS needs. We have

4, 8 and 16-bit microprocessors ready to program. (The 4-bit S2000 even has a customized I/O.) We can also design a custom circuit for you. Or produce one that you design.

To find out which way is best for you, write to AMI Marketing, 3800 Homestead Road, Santa Clara CA 95051. Or call (408) 246-0330. We'll show you how little it takes to make big ideas work.

**AMI**  
AMERICAN MICROSYSTEMS, INC.

## COMPONENTS

### Audible alarms blast 70 to 86-dB sound alerts



Cybersonic, P.O. Box 151, Glenside, PA 19038. F. Collier (215) 885-2244. \$6.50; stock.

Models of the Bleptone audible signalling device provide a compelling 70-to-86-dB audible alerting signal at 1 meter. All models come with either a 2.5 or 1-kHz (nominal) frequency. Driving voltages are 3, 6 or 24 V dc  $\pm 30\%$ , compatible with DTL, TTL or HTL logic.

CIRCLE NO. 382

### Double-balanced mixers use Schottky diodes



Vari-L, 3883 Monaco Pkwy, Denver, CO 80207. Carol Kiser (303) 321-1511. \$15.95 to \$35.00; stock.

A series of high-level doubly-balanced mixers cover 0.5 MHz to 1 GHz and are designed around beam-lead Schottky diodes. Model CM-1H4 and CM-1H8 cover 0.5 to 500 MHz and are rated at +13 and +17dBm (LO) respectively. Models CM-2H4 and CM-2H8 cover 5 MHz to 1 GHz and are also rated at +13 and +17 dBm. Typical conversion loss is 6 dB and typical isolation is 40 dB. The 1-dB signal compression point for models CM-1H4 and CM-2H4 is +7 dBm. For CM-1H8 and CM-2H8 the compression point is +12 dBm.

CIRCLE NO. 383

### Illuminated switch has multiple legends



Industrial Electronic Engineers, 7740 Lemona Ave., Van Nuys, CA 91405. Helen Sands (213) 787-0311. \$29; 6 to 8 wks.

The Proswitch is a multi-legend, illuminated pushbutton switch with 12 different selectable messages. Up to three lamps can be energized at one time to yield a maximum of 64 possible compound legends. The switch contains 12 lamps, an optical system, a 12-legend film chip, viewing screen and switch. The viewing screen is pivot mounted and doubles as the pushbutton to operate a snap-action switch.

CIRCLE NO. 384

## The Common Denominator Of An Uncommon Company



... is quartz. Then NEL puts 24 years of design experience to work. In addition to our leading position in the low frequency field, we provide broad coverage of high frequency crystals as well as hybrid crystal oscillators. All units are hermetically sealed. We also offer assistance with microprocessor design problems. You'll find our delivery record and customer service are excellent.



For more information send for NEL's FREE design manual/catalog. Write to:



Northern Engineering  
Laboratories, INC.

357 BELOIT ST., BURLINGTON, WI 53105 (414) 763-3591

CIRCLE NUMBER 106

## DIP Switch Line from SMK

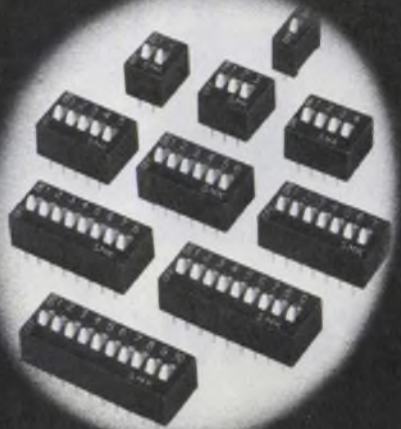

The JS-8722 Series is a complete line of DIP Switches, from 1 to 10 positions, featuring sealed construction to prevent flux contamination during wave soldering. A clip-type wiper design assures positive 2-sided contact to provide excellent shock and vibration characteristics.

Available in SPST configuration, the switches are rated at 24V DC at 300mA switching, resistive load, and will operate from  $-20^{\circ}\text{C}$  to  $+60^{\circ}\text{C}$ .

Typical price for a 4 position DIP Switch in 100 piece quantity would be \$1.16 each.



SMK Electronics Corporation  
of America

118 East Savarona Way Carson, California 90746

Tel: (213) 770-8915

CIRCLE NUMBER 107

ELECTRONIC DESIGN 6, March 15, 1978



# From Crydom... A totally new design in microprocessor interface switches!

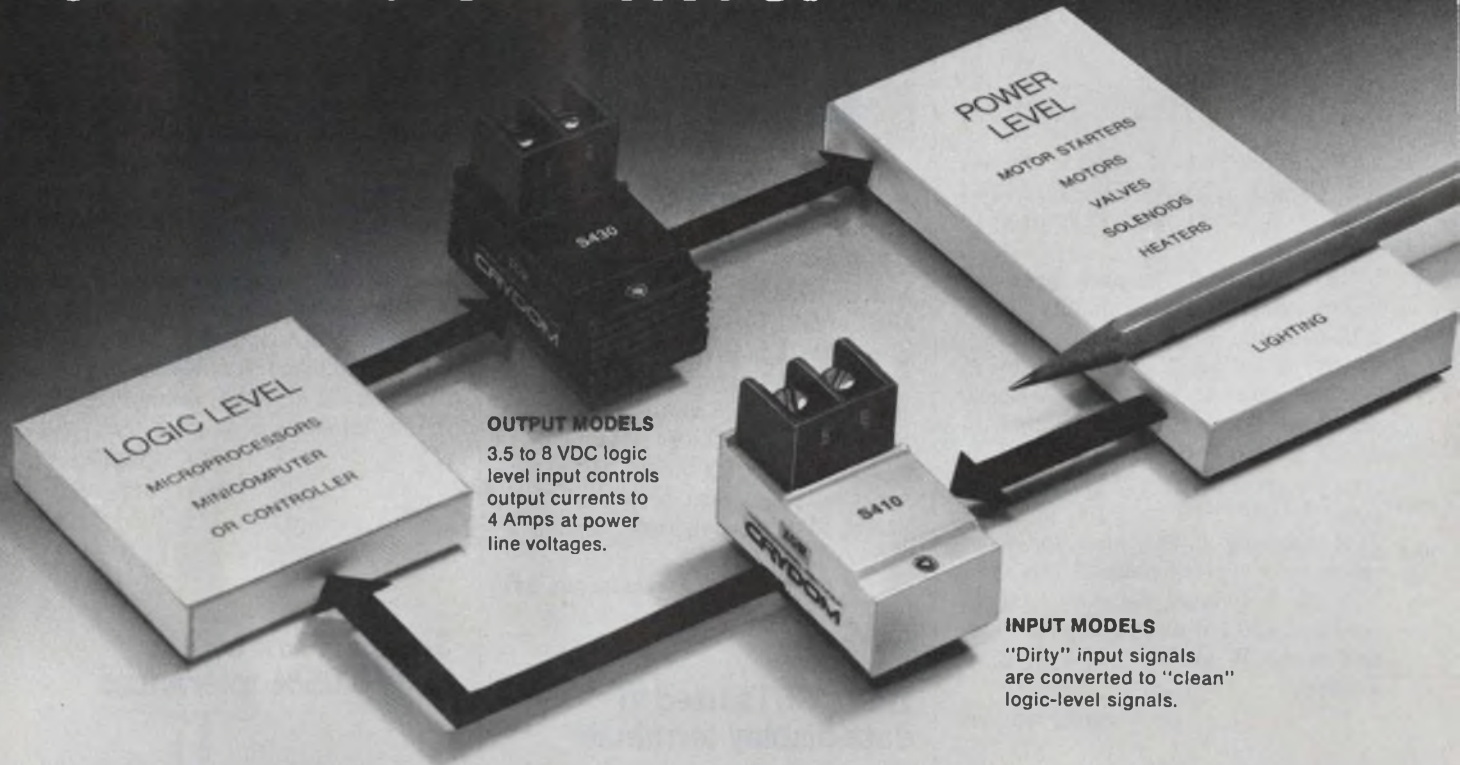

**OUTPUT MODELS**  
3.5 to 8 VDC logic  
level input controls  
output currents to  
4 Amps at power  
line voltages.

**INPUT MODELS**  
"Dirty" input signals  
are converted to "clean"  
logic-level signals.

AC and DC Solid-State Input Switches and companion Output Switches  
that deliver 4 Amps at 40°C, 2.75 Amps at 70°C Ambient . . . without added heat sinks.

Very simply, Crydom's new family of solid-state Input-Output switches give you the highest current capability and highest transient immunity in the industry, with all of the advantages of photo isolation and zero voltage switching. Electrically clean, isolated and noise-free interface switching between logic-level "smart" circuitry and the brawny power level equipment it controls.

But there is much more to the Series 4 design, including models available to NEMA Part ICS-2-230 specifications.

These all-new switches include such quality features as: gold plated logic-level PC board pin terminals; screw-type, color coded power level terminals; and a LED status indicator, all environmentally sealed by solid encapsulation.

Most important, the output devices have their own highly efficient heat radiators, plus a unique and proprietary thermo/mechanical output power construction designed to provide unequalled current handling capability. That's

why the Series 4 output models can handle 4 amps at 40°C and 2.75 amps at 70°C with an extra margin of safety.

And there are other space-saving advantages. Like internal transient suppression in the DC models and internal snubber networks in the AC models. It's all there!

These single-package devices offer you a better and cost-competitive way to switch from logic-level to power levels . . . and vice versa. They're bound to simplify your designs and increase your reliability.

Contact your local Crydom distributor or representative for immediate response to your product and/or technical data needs.

And, find out why it will pay you to switch to — and with — Crydom Series 4 Input/Output devices.

International Rectifier Crydom, 1521 E. Grand Ave., El Segundo, CA 90245. (213) 322-4987. TWX 910-348-6283.

Designs you can profit by . . .

Specifications you can bank on!

INTERNATIONAL RECTIFIER

**IOR** **CRYDOM**  
SOLID-STATE RELAYS

1521 E. Grand Ave., El Segundo, CA 90245 • (213)322-4987

### Resistor network meets MIL-R-83401

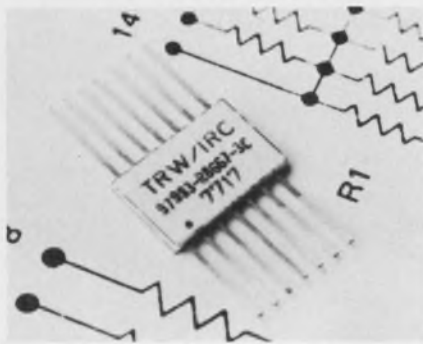

TRW/IRC Resistors, 4222 S. Staples St., Corpus Christi, TX 78411. Bill Wagner (512) 854-4872. \$7.70 to \$8.40 (1000 qty).

TRW's 14-lead flat-pack precision resistor networks now qualify under MIL-R-83401, Style RZ030. Package density is either 7 or 13 resistors in 0.07-in.<sup>2</sup> ceramic sandwich packages. Standard resistance range is 150Ω to 51 kΩ, with 0.1 to 2% tolerance. Four tempcos are offered: ±25 ppm/°C, ±50 ppm/°C and -50 to -150 ppm/°C. TCR tracking is ±5 ppm for most values and current noise is less than -25 dB. Individual resistor elements are rated at 0.1 W and package dissipation is 0.5 W at 70 C, 1 W at 25 C ambient.

CIRCLE NO. 385

### PC relays allow immersion cleaning

Potter & Brumfield, 200 Richland Creek Dr., Princeton, IN 47671. Roy Stewart (812) 386-1000. \$1.74 up; stock.

Immersion-cleanable PC-board relays, Type R50, are rated to 5 A and accept full immersion in cleaning solvents for 2 min. The low-profile relays are available as 1 and 2 A versions for 28 V dc or 120 V ac in SPDT and DPDT models, and as 5-A SPDT model. Standard and sensitive-coil ratings range from 5 to 48 V dc. Sensitive coils can be driven by ICs capable of sinking 80 mA (TTL) and 40 mA (MOS at 12 V dc). The smallest model is 0.46 × 0.595 × 1.09 in.

CIRCLE NO. 386

### DIPs switch 2 to 10 circuits



Waldom Electronics, 4301 W. 69 St., Chicago, IL 60629. (312) 685-1212. See text; stock.

Rocker or lever actuated multi-position DIP switches feature SPDT, SPST or DPST switching for 2 through 10 circuits. The switches handle 30 V dc at 50 mA. Contact resistance is 100 mΩ max at 10 mA and voltage breakdown is 500 V dc. The terminals, on 0.1-in. centers, are tin plated for ease of soldering. A typical price for an 8-circuit SPST switch (type DSL-8) is \$5.55.

CIRCLE NO. 387

### 12-in. CRTs used in data-display terminals



Panasonic, 1 Panasonic Way, Secaucus, NJ 07094. Bill Parkin (201) 348-7271. \$21 (1000 qty); 12 wks.

Two 12-in. cathode ray tubes, the 310JKB4 and 310JLB4 for data display use, feature sharp corner focus and high resolution characteristics. The 310JKB4 offers 100° deflection and 1500-line resolution, and the 310JLB4, 90° deflection and 1200-line resolution. The tubes employ electrostatic focusing, electromagnetic deflection and most standard phosphors are available.

CIRCLE NO. 388

### Keyboard allows typing with one hand



NewO, Palo Alto, CA 94303. Sid Owen (415) 321-7979. \$98; stock to 2 wks.

Writehander is a keyboard on which you can type all 128 ASCII characters with one hand. The typist places four fingers on four press switches and the thumb on one of eight press switches. The four finger-operated switches actuate the four least-significant bits of a seven-bit ASCII code. The thumb then selects a desired character from a choice of eight groups. The keyboard's hemispherical shape comfortably accommodates the hand, and the fingers naturally locate themselves on the switches.

CIRCLE NO. 389

### Sealed RC networks have 0.05% tolerances

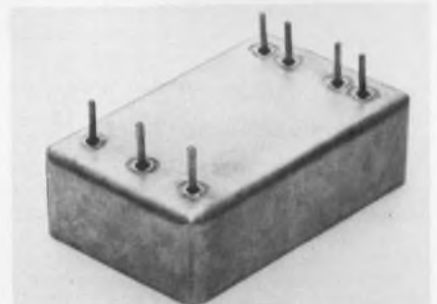

PFC, 100 Community Dr., Great Neck, NY 11022. Tom Cary (516) 487-9320. \$20 up; 8 to 10 wks.

RC networks with tolerances as close as ±0.05% for the RC product come hermetically sealed in metal containers. The accuracy is guaranteed for one year. Variation of the RC product from -55 to 85 C is maintained within ±10 ppm/°C. Several packaging styles are available, including a flat-pack for PC mounting. Two or more networks can be supplied in a single package, with tracking to within 5 ppm/°C.

CIRCLE NO. 390

# Now you can have the $\mu$ P-compatible A/D converter you've been waiting for.



## Without the waiting.

The newest thing you ought to know about our MP-7570 A/D Converter circuit is its immediate availability. That means you can get it—now!

The circuit itself isn't new. It's been around for a couple of years, initially as an Analog Devices part. Its popularity is well-established, which means demand occasionally exceeds supply.

Micro Power's recently expanded production capabilities now provide a volume second-source supply for the 7570. You can design in its unique characteristics and depend on us for the delivery you need.

Functionally, the 7570 is a CMOS 10-bit A/D converter on a single chip. It uses the successive approximation principle and requires only an external comparator, reference and passive clocking components. Ratio-metric operation is inherent in the design, since an ex-

tremely accurate multiplying DAC is incorporated in the feedback loop.

The 7570 has appropriate control inputs and status outputs for convenient interface with most 8-bit or 10-bit microprocessors.

Micro Power's proprietary High-Density CMOS is employed in producing the 7570. This low-power process features an on-chip network of thin-film resistors and silicon nitride passivation to enhance reliability and long-term stability.

Listed in the table are some of the key specs and prices for the 7570 and related CMOS converters. To get more information on these and other linear CMOS products, use the coupon below.



3100 Alfred Street, Santa Clara, CA 95050

### LOW-POWER CMOS CONVERTERS Three-state Logic

Type	Resolution	Non-linearity	Conversion Time	Price (100+)
7570 JD (A/D)	8-bits	N/A	20 $\mu$ sec	\$19.90
7570 LD (A/D)	10-bits	N/A	20 $\mu$ sec	\$42.00
7550 BD (A/D)	13-bits	N/A	40msec	\$24.90
7522 JN (D/A)	10-bits	8-bit	500nsec current settling time	\$13.90
7522 KN (D/A)	10-bits	9-bit		\$16.95
7522 LN (D/A)	10-bits	10-bit		\$26.10

To: Micro Power Systems, Standard Products Division  
3100 Alfred Street, Santa Clara, CA 95050

Please send me technical data on these converter products:  MP7570 A/D  MP7550 A/D  
 MP7522 D/A

I have an urgent requirement. Please have a converter applications specialist phone : ( ) \_\_\_\_\_

Name \_\_\_\_\_

Title \_\_\_\_\_

Company \_\_\_\_\_

Address \_\_\_\_\_

City/State/Zip \_\_\_\_\_

Please also send data on your linear CMOS switches and multiplexers.

ED315

# strip chart recorders

- OEM MODULES
- LOW PROFILE
- PACKAGED UNITS
- PORTABLE DC

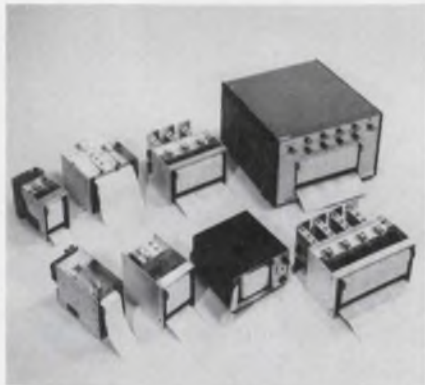

General Scannings thermal writing Strip Chart Recorders are available in a wide range of configurations and performance characteristics to meet virtually every recorder need.

You can select open-loop, velocity feedback or closed-loop operation; continuous roll or fan-feed paper; one to eight channels in channel widths of 20, 40, 50, 80 or 100mm; a variety of chart speeds; and either AC or DC operation.

Recorders can be furnished as modules for use by OEM's or fully packaged.



For complete details, circle readers' service number or write today for our full line Strip Chart Recorder Catalog.



**GENERAL SCANNING INC.**  
150 Coolidge Avenue  
Watertown, MA 02172  
TEL: (617) 924-1010

CIRCLE NUMBER 110

## COMPONENTS

### Miniature switches have four actuator options

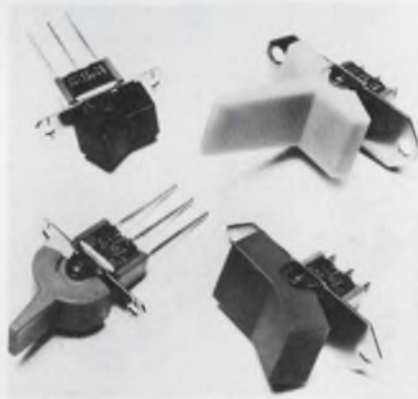

*Dialight, 203 Harrison Pl., Brooklyn, NY 11237. (212) 497-7600. \$1.12 to \$2.68 (1000 qty); stock.*

The 572 series of subminiature rocker and lever-operated switches of fer panel designers a variety of actuator, electrical, mechanical and functional options. The series includes two sizes of rockers, 0.365 × 0.648 in. and 0.595 × 1.036 in.; and two of levers, 0.365 × 0.74 in. and 0.595 × 1.174 in. Molded-nylon actuators are available in black, white and any of seven colors. Other options include six types of terminals, nine different switching functions and standard, low-level or combination standard/low-level contact rating.

CIRCLE NO. 391

### Mini relays latch magnetically

*Gould, 100 Relay Rd., Plantsville, CT 06479. (203) 621-6771.*

MPCL miniature relays latch magnetically and need only 0.6-in. spacing between boards. A permanent magnet provides the armature holding force in the latch position. Two isolated coils (each 5 to 48 V dc, with 500-mW sensitivity at max latch or reset) have identical construction, eliminating the need for polarity reversal for release. A hingeless armature construction ensures a life of more than 10<sup>6</sup> mechanical operations.

CIRCLE NO. 392

### Mini delay timer provides to 900-s delay

*Artisan Electronics, 5 Eastmans Rd., Parsippany, NJ 07054. Alan Seman (201) 887-7100. \$9.00; 2 to 3 wks.*

Model 437 timer is a delay-on pull-in fixed timing device having delays of 0.025 to 900 s. The timer is an axial-lead series device that delays current to a load for a pre-selected time. Available for operating voltages from 6 to 172 V dc, the output is rated at 2 A.

CIRCLE NO. 393

### Capacitors have low ESR for switcher supplies

*Sangamo, P.O. Box 128, Pickens, SC 29671. (803) 878-6311.*

Type 139R thermal-pack aluminum electrolytic capacitors have ESR values as low as 0.003 Ω at 20 kHz, and capacitance tolerance of ±20%. They handle 20-A ripple current at 85 C and 20 kHz and operate from -55 to 85 C with 2000 h of operating life at max temperature.

CIRCLE NO. 394

### Low-profile heat sink fits TO-220 devices

*Thermalloy, 2021 W. Valley View Lane, Dallas, TX 75234. (214) 243-4321. \$0.045 (5000 qty); stock.*

Type 6073 low-profile heat sinks fit TO-220 and Motorola Case 90 and 77 packages. For Case 90 use, heat sinks can be mounted above or below the device. Thermal resistance is 21 C/W in natural convection. Heat sink size is 0.75 × 0.75 × 0.375 in.

CIRCLE NO. 395

### Quartz crystals cover 1-to-60-MHz range

*Marden Electronics, P.O. Box 277, Burlington, WI 53105. Bob Rubach (414) 763-6093. \$1.50 to \$2.75 (1000 qty); stock to 4 wks.*

Precision quartz crystals with wire leads or in plug-in holders cover the 1-to-60-MHz range. Accuracy is 0.002% at 25 C, with a temperature coefficient of 0.002% from -10 to +85 C.

CIRCLE NO. 396



# Intel's 8080A gets JAN approval.

Can't we list  
all 26 of Intel's  
military parts?

No room.

Intel introduces the first JAN-qualified microprocessor, the 8080A. It's available now, and listed in QPL-38510 as M38510/42001BQB.

Now you can build your military projects with the most popular microprocessor ever, and avoid special approval procedures and reliability documentation.

In addition to our JAN-qualified 8080A, Intel's military ic-38510 pro-

gram includes 26 LSI components manufactured in full compliance with the testing and screening requirements of MIL-M-38510D and MIL-STD-883B. For details on the JAN8080A, and our other military products, write Intel Corp., Military Program Manager, 3065 Bowers Avenue, Santa Clara, CA 95051.

**intel delivers.**

Visit us at the Hanover Fair '78  
April 19 through 27, 1978. Cebit-West,  
Hall 18. Booth 1503

## COMPONENTS

### LEDs illuminate pushbutton switches

Dialight, 203 Harrison Pl., Brooklyn, NY 11237. (212) 497-7600. \$1.96 (1000 qty); stock.

Switches and indicator lights in the 554 Series use a 5/8-in.-square, Series 332 caps in which rectangular LEDs are flush-mounted as integral components. The caps can replace incandescent-lamp caps on existing 554 Series units. Seven cap colors and three LED color options give a choice of 21 color combinations. In addition, caps can have hot-stamped or engraved legends. Current-limiting resistors are built into the caps for operation at 5 V dc, 15 mA.

CIRCLE NO. 397

### $\mu$ P crystal line covers 1 to 48 MHz

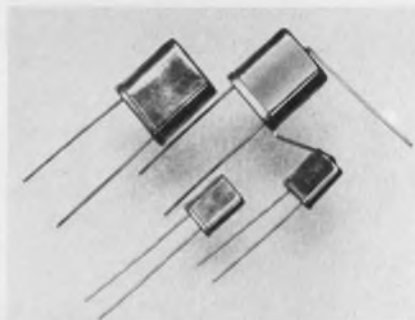

Bulova Electronics, 61-20 Woodside Ave., Woodside, NY 11377. Bob McComb (212) 335-6000. \$6.00 to \$11.75; stock to 6 wks.

Type BU quartz crystals cover from 1 to 48 MHz. The crystals are AT cuts and packaged in hermetically sealed HC-18 holders. Low-frequency units are available also in the HC-33 holders. Frequency tolerance is  $\pm 0.0005\%$  at 25 C and stability from  $-20$  to 75 C is  $\pm 0.003\%$ .

CIRCLE NO. 398

### Pushbutton switches sealed in rubber boots



Standard Grigsby, 920 Rathbone Ave., Aurora, IL 60507. (312) 844-4300. \$0.25.

TL360 miniature pushbutton switches are completely sealed in silicone-rubber boots that prevent contact contamination by water, oil and dust and fluids during cleaning. Just  $0.16 \times 0.36$ -in diameter, the switches mount easily on PC boards.

CIRCLE NO. 399

## PUSHBUTTON SWITCHES

MPG SERIES



Our Mustang Series features a 15/32" bushing size, a SNAP action and a variety of large colored caps. Offered in a choice

of Push On/Off or Momentary in one through 4 poles — 6A @ 125V or 3A @ 250V capability in a miniature size. Molded-In terminals, DAP case & PC types.

Please call or write today for other technical data and prices.

CIRCLE NUMBER 112

## LOCKING TOGGLE



MTL SERIES

Miniature switches with a fool proof Pull-to-Unlock feature for critical or dangerous operation. Attractive anodized aluminum finish toggle. Available in one through 4 pole style. Has all the premium features at no added cost, including Molded-In terminals, gold finished contacts and terminals, etc.

Please call or write today for complete information and prices.

CIRCLE NUMBER 113

**ALCO** ELECTRONIC PRODUCTS, INC.  
1551 OSGOOD STREET, NORTH ANDOVER, MA 01845 U.S.A.

Tel: (617) 685-4371

TWX: 710 342-0552

ALCO DISTRIBUTOR: AUGAT INC.

## A stepper drive system for only \$12.60!

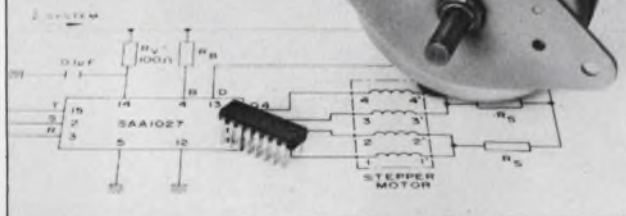

### A quality stepper motor and IC driver that cuts design costs, simplifies circuitry, minimizes space

We've just put the cost of an incremental drive stepping system within reach! And we've simplified your job in doing so. The \$12.60 includes our K82701-P2 12V dc stepper motor and our SAA1027 IC driver in 100 piece quantities, basically all you need for a complete system, if you supply dc voltage and stepping pulse. The motor has a  $7\frac{1}{2}^\circ$  step angle, 200 steps/sec pull-in rate and 6.0 oz-in working torque. If these specs don't suit your proposed application, we have 7 other motors to choose from with pull-in rates and working torque values to satisfy most drive applications.  $15^\circ$  step angles are also available, as are 5V dc models. Any one of the 7 can be driven by the IC driver without the need for discrete power stages. Use of the driver, in fact, cuts the cost and complexity of your circuitry to the bone. It's small in size, low in cost and assures maximum stepping accuracy in conjunction with our stepper motors. Find out more about NAPCC stepper systems.

Write for information today!

NORTH AMERICAN PHILIPS CONTROLS CORP.

Cheshire, Conn. 06410 • (203) 272-0301

Information only #114 Immediate need #115

ELECTRONIC DESIGN 6, March 15, 1978

**LONG SCALE**  
3 1/2",  
4 1/2" Round  
3 1/2" Century



**CENTURY SERIES**  
1 1/2", 2 1/2"  
3 1/2", 4 1/2"



**WIDE-VUE**  
1 1/2", 2 1/2"  
3 1/2", 4 1/2", 8"

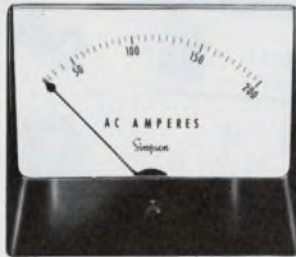

**BOLD-VUE®**  
2 1/2", 3 1/2"



**DIGITAL PANEL METERS**  
Low Cost series 2860  
Deluxe series 2850, 2852



**DESIGNER SERIES**  
3 1/2", 4 1/2"



**RUGGED SEAL**  
(Metal Cased)  
3 1/2", 4 1/2"  
4x6"

# Panel Meters Stock or Special SIMPSON has 'em!

Analog, digital, or Ana-Led®, if it's made, Simpson makes it.  
Over 1500 styles, sizes, ranges. If it's a special, we'll make it for you.

**RECTANGULAR**  
2 1/2", 3 1/2"  
4 1/2"



**ROUND**  
(Commercial and MIL spec)  
2 1/2", 3 1/2"  
4 1/2"



**EDGEWISE**  
3 1/2"



**EDGEWISE Barrel Type**  
1 1/2", 2 1/2"



**STACKABLE EDGEWISE**  
1 1/2", 2 1/2"



**ANA-LED SOLID STATE PANEL METERS**  
Bar or dot display



**RUGGED SEAL**  
3 1/2", 4 1/2"  
4x6"

**EDGEWISE**  
3 1/2"

**CONTACTLESS METER RELAYS**  
single or double setpoint models available in DC microamp, milliamp, millivolt, AC ampere, AC voltage and temperature ranges.



SEE YOUR SIMPSON DISTRIBUTOR  
OR WRITE FOR FULL-LINE CATALOG



**SIMPSON ELECTRIC COMPANY**  
853 Dundee Avenue, Elgin, Illinois 60120  
(312) 697-2260 • Cable SIMELCO • Telex 72-2416



CIRCLE NUMBER 116

## Half the price of other mercury relays—and



## it works in all positions

Our DB relays offer exceptional reliability at extremely low cost (\$1.35 in 10,000 quantities). Self-healing contacts in welded steel package give more than 2 billion bounce-free operations between failures. Contact resistance is stable to 0.015 ohm with loads from nanowatts to 20 watts.

Operation is unaffected by mounting position.

Terminal pin options are available to match most dry reed and mercury wetted relay foot prints.

DB relays are well suited to applications in telephone, modem, data acquisition, and industrial control circuits.

The DB relay offers lower price than mercury relays, and superior performance to dry reeds.

For further information, write or call Fifth Dimension, Inc., 707 Alexander Road, Princeton, NJ 08540; phone (609) 452-1200; TWX 510-685-2387.



**Fifth Dimension Inc.**

Princeton, New Jersey

CIRCLE NUMBER 117

## COMPONENTS

### Linear solenoids use 1.7 to 14.5 W



Canon USA, 10 Nevada Dr., Lake Success, NY 11040. Phil Spector (516) 488-6700. \$0.67 to \$5.00; stock to 10 wks.

A line of 20 models of linear solenoids with maximum continuous power ratings from 1.7 to 14.5 W are available in push, pull or push-pull versions. Both C and D frames are included. Max force ratings at rated power range from 0.30 kg to 7 kg and up to about 13 kg at 10 times rated power for intermittent duty. Stroke length in the largest standard unit is 1.25 in.

CIRCLE NO. 403

### Time-delay relay has delayed-on mode

Master Electronic Controls, P.O. Box 25662, Los Angeles, CA 90025. Shirley Wilkerson (213) 393-3177. \$25.40 (100 qty); stock.

The D10 and D11 solid-state time-delay relays provide a delayed-on mode of operation with fixed, local and remote-adjustable time ranges from 100 ms to 1800 s. Available input voltage ratings are 24, 48, 115, 230 V ac and 12, 24, 48, 110 V dc. Voltages may vary  $\pm 10\%$ . The timers feature polarity and false-output transfer protection. Repeat accuracy is as high as  $\pm 1\%$ .

CIRCLE NO. 404

### Low-pass audio filters allow choice of specs

Sprague Electric, 347 Marshall St., North Adams, MA 01247. (413) 664-4411.

Series JW33-4000 low-pass audio filters are available in a choice of attenuation characteristics (Cauer or Chebyshev), cut-off frequencies (1 to 50 kHz), and operating impedances (250 to 10,000  $\Omega$ ). The filters mount on PC boards on 0.2-in. centers. The max seated height is 0.562 in. Hermetically sealed cases prevent crosstalk and unwanted pickup, and allow operation under extreme environmental conditions.

CIRCLE NO. 405

### Large LED display readable at 33 ft

Hewlett-Packard, 1507 Page Mill Rd., Palo Alto, CA 94304. (415) 493-1501. \$1.80 (1000 qty); stock.

HDSP-3400 series, 0.8-in. numeric displays are readable in bright light at distances to 33 ft. Made from GaAs phosphide, these LED displays come in standard 0.6-in. DIPs that mount on PC boards or plug into standard IC sockets. Models in the series include the 3400 with a common-anode left-hand decimal; the 3401 with a common-anode right-hand decimal; the 3403 with a common-cathode right-hand decimal; and the 3406 with a universal overflow ( $\pm 1$ ) right-hand decimal.

CIRCLE NO. 406

### Solid-state relay boasts $10^{12}$ operations

Solid State Electronics, 15321 Ruyen St., Sepulveda, CA 91343. Ed Politi (213) 785-4473.

The Model SSR-1285-5050 solid-state relay has no moving parts and is capable of over  $10^{12}$  operations. "Contact" rating is 50 V, 50 mA; actuation time is 2  $\mu$ s and dropout time is 5  $\mu$ s. Actuation frequency can be as high as 50 kHz. The relay is epoxy encapsulated and operates from  $-55$  to 125 C.

CIRCLE NO. 407



# Stackpole Ceramag® gives you more of what you buy an inductor core for.

*Transformer designs a la Stackpole toroids  
Contain no air gaps or efficiency voids.*

*Need a good Q? Check our cups and our pots.  
They'll adjust to your problems, be they ohms,  
hertz or watts.*

*Stackpole ferrite cores, both U and E,  
Can take lots of power with a high Curie.*

*Three vowels to remember: Ceramag E's, U's, and I's  
For fluorescent light ballasts and switched mode  
supplies.*

*Our sleeves, baluns, beads help to shut out the sound  
From extraneous EMI that is buzzing around.*

*Stackpole ferrite slugs give car radios strength.  
If you're into perm tuning, we're on your wavelength.*

*And speaking of autos, you will never be sore  
Knowing ferrite core sensors watch your carburetor.  
Showing up "EGR" on your auto dashboard.*

*When it comes to TV's, we've got quite a selection.  
From CRT circuits for info collection  
To round ferrite yokes for TV deflection.*

*For adjustable tuning and good Q circuitry,  
Stackpole threaded cores offer just what you need.  
And without even costing an arm and a knee.*

*If you'd like to devise a test for your peers,  
Our name and address are featured right here.  
We'll send you our folder to make it all clear  
And we never would give engineers a bum steer.  
So send us your name and where you are near.*

*We'll get back to you and we're sure you'll be  
pleased with our Ceramag Bulletin 59-103.*

**Stackpole Carbon Co.  
Electronic Components Div.  
St. Marys, Pa. 15857**

CIRCLE NUMBER 118



**Ceramag. The right ferrite.**

 **STACKPOLE**

## COMPONENTS

### Rotary switches qualify under MIL-S-3786



Cole Instrument, 2034 Placentia Ave., Costa Mesa, CA 92627. Phil Hanson (714) 642-8080.

Type 3600 1-in. enclosed rotary switches are fully qualified under MIL-S-3786. Up to twelve decks of switching are available. Each deck can have one to six poles per deck with 30, 36 or 45-degree steps and 8, 10 or 12 positions. Both shorting and nonshorting contacts that handle 6 A can be combined in the same deck.

CIRCLE NO. 408

### Surge shunts protect solid-state devices



Morel International, 21583 Castleton St., Cupertino, CA 95014. (408) 257-2414. \$0.39 to \$0.42 (OEM).

Carbon-film surge-shunt protectors have a discharge lag of less than 0.1  $\mu$ s when installed across ac input lines. They protect solid-state devices from damage by lightning or high-voltage surges. The protectors can be supplied for high-voltage surges from 180 to 3000 V. For 120-V-ac operation, the shunts are made to arc over at 205 V. They withstand 2000-A impulse currents. Their glass capsules, filled with inert gas, are 5.5-mm diameter by 2-mm long.

CIRCLE NO. 409

### Heat sinks fit plastic SCRs and transistors

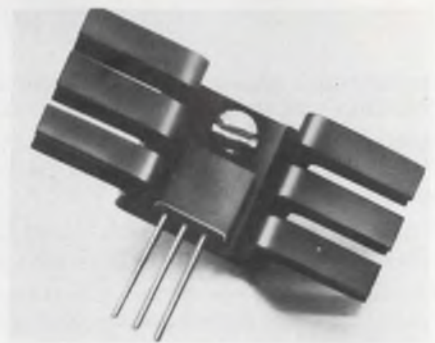

Aavid Engineering, 30 Cook Court, Laconia, NH 03246. (603) 524-4443. Free samples; stock.

A series of low-profile heat sinks for cooling plastic power SCRs and transistors is adaptable for use on PC boards with 0.5-in. spacing between boards. Part numbers 5070 and 5072 have a total height of 0.375 in. Part number 5071 is for high-power use and can be used with either the 5070 or 5072 heat sinks as a cap to provide double-sided cooling of TO-220 devices.

CIRCLE NO. 410



## Due to popular demand MICROPROCESSOR DATA MANUAL is now in book form!

Here is all the information on microprocessor selection and software in one convenient source!

- First appeared in Electronic Design Magazine!
- Over 30 manufacturers represented!

The manual features a complete data page for each microprocessor or family of processors, with complete description of the processor, its family of support circuits, architecture, available software, and the unit's instruction set.

#### Other sections include:

- the pitfalls to avoid when choosing a specific model;
- micro fundamentals and a glossary of terms;
- a report on floppy-disc drives;
- background information on micro selection and software.

Send to: **HAYDEN BOOK COMPANY, INC.**

50 Essex Street, Rochelle Park, N.J. 07662

Please send me MICROPROCESSOR DATA MANUAL (#5114-X, \$7.95) on 15-day examination. At the end of that time, I will send payment, plus postage and handling, or return the book and owe nothing.

Name \_\_\_\_\_

Firm \_\_\_\_\_

Address \_\_\_\_\_

City/State/Zip \_\_\_\_\_

If you send cash with order, publisher pays postage and handling. Same return guarantee. Price subject to change without notice. Offer good in U.S.A. and Canada only.

78-009



## MICROPROCESSOR DATA MANUAL

Edited by Dave Bursky

Make your micro decisions easier! Order your copy today!

# The IMP\* Controller: It doesn't take breaks, It gives them.

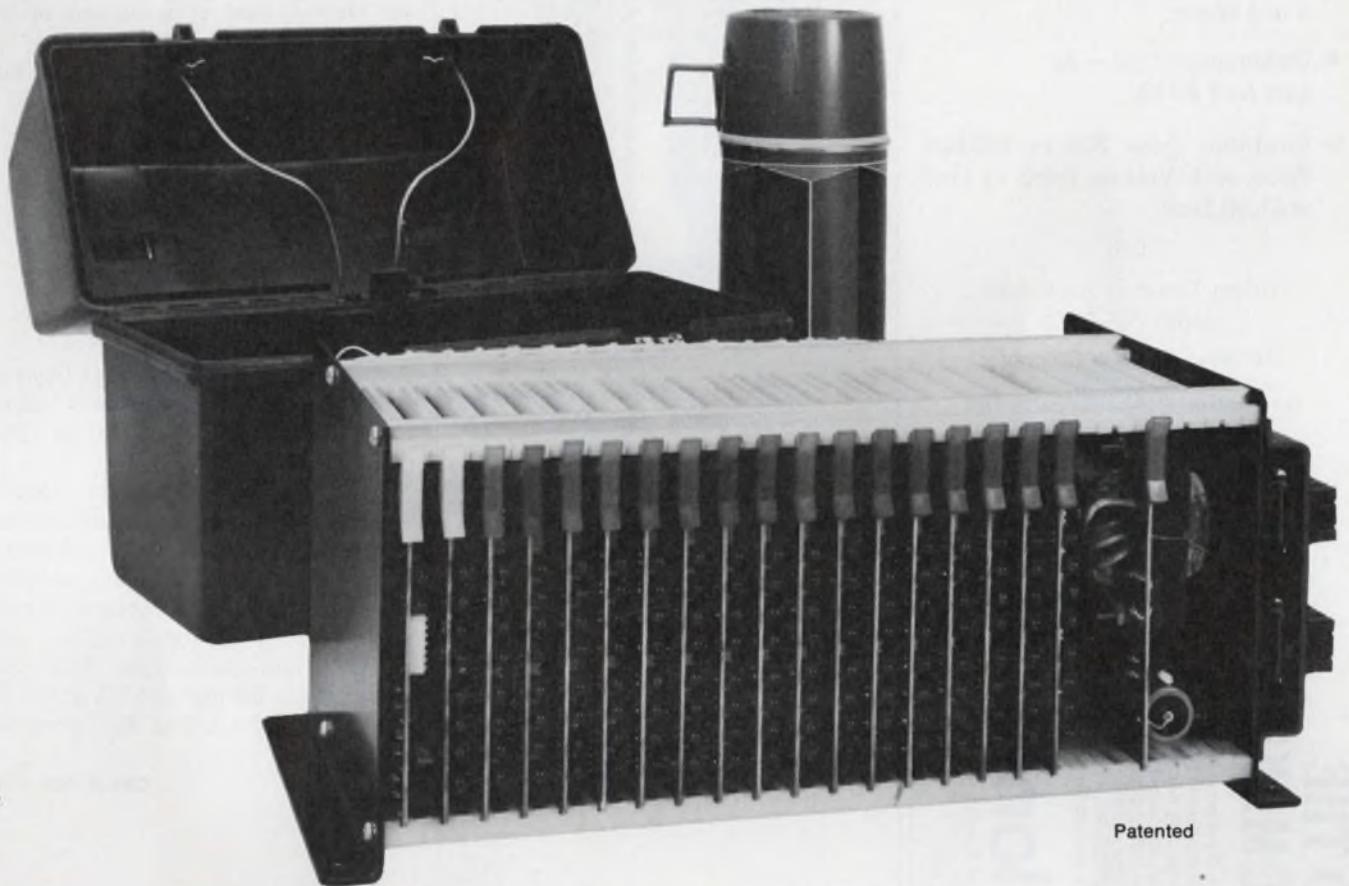

The IMP gives you a break on initial cost, economically accommodating systems from 8 to more than 500 I/O's. It gives you a break in performance too, handling control functions not normally associated with programmable controllers. IMP incorporates patents to give you additional breaks on reliability—more than any other controller. And, if service is necessary,

IMP gives you more good breaks. It can be demounted in minutes. Modular circuit boards are interchangeable and they simply plug in, as does the power supply. Your local ASI representative has spares on hand. Give yourself a break by contacting us today. Write or call and we'll see you get all the facts.

\*Industrial Modular Programmable

asi

**AUTOMATION SYSTEMS, INC.**

LANCER PARK • ELDORIDGE, IOWA 52748 • 319/285-8171

CIRCLE NUMBER 121

# semi CUSTOM CMOS LSI

- Reduce Your Circuit to a Single Chip with One of Our 14 Master-slices.
- Fast Turn Around – Prototypes in 4 to 6 Weeks.
- Development Cost – As Low As \$ 2,150.
- Quantities from 200 to 200,000 Pieces with Volume Prices as Low as \$1.50 Each.

Call

Orhan Tozun or Joe Puhich  
(408) 735-9370

Or Send for New Brochure:

**International Microcircuits, Inc.**  
3004 Lawrence Expressway  
Santa Clara, CA. 95051

CIRCLE NUMBER 119

**INTERFERENCE. WE BUILD THE  
SOPHISTICATED "TROUBLE MAKER."**

Our model 510 Surge Transient Generator provides precise standardized repeatable test signals for determining capabilities, of various equipment, components and systems for possible malfunction or damage caused by line transient surges. (Meets and exceeds IEEE Std. 472, 1974/ANSI C37.90a 1974). Check our reader service card.

**velonex**

560 Robert Avenue  
Santa Clara, Ca. 95050  
(408) 244-7370



CIRCLE NUMBER 120

## COMPONENTS

### Mini power relay switches 15 A



Omron Electronics, 233 S. Wacker Dr., Chicago, IL 60606. Don Nelson (312) 876-0800. \$8.30 to \$9.90; stock.

Model G2H miniaturized power relays meet UL and CSA standards for switching high-capacity ac loads. Rated at 240 V ac with resistive loads of 15 A or inductive loads of 10 A, the relays have DPDT contacts. The units are enclosed in transparent polycarbonate-resin cases and are equipped with an arc barrier that provides a dielectric strength of 2000 V at 50/60 Hz for 1 min.

CIRCLE NO. 411

### Photo scanner detects material at a distance

MEKontrol, 56 Hudson St., Northboro, MA 01532. Dean Percival (617) 393-2451. \$134 (qty discount); stock.

LED proximity scanner, MEK-55-SC85, doesn't need a reflector, but still detects any material at a distance. Its small size—only 3.25 × 3.8 × 1 in.—makes it easily mountable. The sensor is immune to electrical noise and ambient-light and uses a phase-locked-loop circuit built into the amplifier. A choice of plug-in output and timing modules is available.

CIRCLE NO. 412

### Yellow LED arrays readable in sunlight

Plessey Optoelectronics & Microwave, 1641 Kaiser Ave., Irvine, CA 92714. R.G. Millett (714) 540-9934.

The GPD 420 family of GaP solid-state LED arrays are legible in 100,000-lux (lm/m<sup>2</sup>) light levels (equivalent to illumination from direct sunlight above clouds). The displays consist of four, seven-segment digits, each 4-mm high, mounted in a hermetically sealed package. Typical LED intensity is better than 2 mcd at a current of 20 mA/segment.

CIRCLE NO. 413

### Mini toggle switch mounts on PC boards

Alco Electronic Products, 1551 Osgood St., North Andover, MA 01845. Clem Czapinski (617) 685-4371. \$1.20 (100 qty).

A family of miniature toggle switches for use on PC boards can withstand flow-soldering temperatures. Four types are available: upright PC with silver or gold contacts; right-angle PC with side toggle motion; and vertical right-angle types with up-down action. Ratings are 5 A at 125 V ac (silver) or 0.4 VA at 20 V ac or dc max.

CIRCLE NO. 414

### Single/dual-element pots are side actuated

Carter Mfg., Sugar Rd., Bolton, MA 01740. (617) 779-5501. \$10 up; stock.

Series ST477 single and dual-element plug-in wirewound potentiometers are side-actuated and housed in polycarbonate cases. They can be stacked on 1-in. centers and are supplied with matching receptacle boards. The pots have 3-in.-stroke slider action. Resistance values to 100 kΩ are available in a 0.5-W rating, with or without switch and pilot lamp. Basic size is 1 × 0.875 and 6.25 or 4.5 in. long. A pilot lamp provides lighting for the strip.

CIRCLE NO. 415

# AP brought you solderless breadboarding. Now we've added power.

You know the AP name for the development of the first solderless breadboarding devices. First there were ACE All Circuit Evaluators. Then AP's full line of Super Strips, distribution strips and terminal strips.

Now there's POWERACE, the new Power All Circuit Evaluator. Like all AP breadboarding elements, POWERACE accepts all DIP sizes, plus TO-5's and discretes with leads up to .032". But what's most important is its capacity — *twice* that of any other power breadboard manufactured — with 256-5 tie-point ter-

minals and 16-25 tie-point buses.

Plug in to the AP distributor nearest you by calling our Toll-free number: (800) 321-9668.

*Faster and Easier is what we're all about.*



**AP PRODUCTS INCORPORATED**

Box 110 • 72 Corwin Drive, Painesville OH 44077  
(216) 354-2101 TWX: 810-425-2250



CIRCLE NUMBER 123

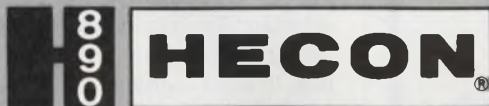

## ...a name you can count on for Electronic Counters.

*A new generation of 3 Electronic Counters to solve  
your high-speed counting and controlling problems . . .*



### The GO 781.100 (Counter-Controller)

Manual, remote and automatic reset. 5 digit LED Display and preset. Counts up to 5,000 cps. Adding and Subtracting Models.



### The GO 781.300 (Totalizer)

Display hold without losing count or built-in count inhibit gate. Compact size and 7 digit LED Display. Electronic or manual reset. Connection for 9v standby battery power supply.

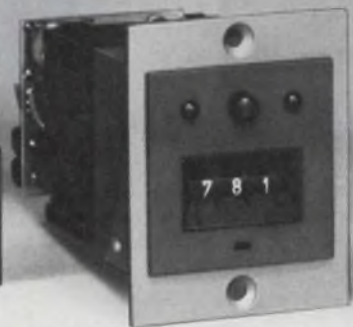

### The GO 781.400 (Controller)

For high-speed controlling requiring frequent reset. Long life expectancy. LED count/output indicators. Manual, remote and automatic reset. Counts up to 5,000 cps.

Manufacturers of: Electronic Counters  
Electromechanical Counters • Mechanical Counters  
Pneumatic Counters • Ticket & Tape Printers

**Hecon Corporation**  
31 Park Road, Tinton Falls, NJ 07724  
(201) 542-9200

**Hecon Canada, Inc.**  
80 Galaxy Blvd., Rexdale, Ontario M9W 4Y8  
(416) 675-3663

Your Hecon Distributor is listed in the Yellow Pages under Counting Machines.

CIRCLE NUMBER 124

# ROYTRON™

## plug-compatible reader/punch

Desktop combination reader/punch with serial asynchronous RS-232C compatible interface. Designed to operate with a terminal device on the same serial data lines or alone on a dedicated serial line. Reader will generate data at all standard baud rates up to 2400 baud.

Punch accepts data at all standard baud rates up to 600 baud continuous or 4800 baud batch, utilizing a 32 character buffer.

Two modes of operation are provided: *Auto Mode* — Simulates Model ASR 33 Teletype using ASCII defined data codes (DC 1, 2, 3 and 4) to activate/deactivate the reader or punch; *Manual Mode* — Code transparent mode. Panel switches control activation/deactivation of reader or punch and associated terminal device.

Tape duplication feature is provided by setting unit to LOCAL mode.



### MODEL 1560-AS

High-speed, compact, with self-contained electronics and power supply. Complete in attractive noise dampening housing.

For full details, write or call us.



Litton

## SWEDA INTERNATIONAL, INC.

OEM Products

34 Maple Avenue, Pine Brook, N.J. 07058/(201) 575-8100

IN U.K. — ADLER BUS. SYSTEMS/OEM PRODS., Airport House, Purley Way, Croyden, Surrey, England

IN FRANCE — SWEDA INTERNATIONAL/OEM, 103-107 Rue de Tocqueville, 75017 Paris, France

CIRCLE NUMBER 125

## Set the Pace with Synchron



### "600" SERIES AC TIMING MOTORS

These motors are designed both for timing and drive applications. Speeds from 600 RPM down to one revolution per week and output torque up to 40 oz. in. rated @ 1 RPM. Available in reversible and double power configurations. For immediate service please call us at -812/385-3415.

## JOIN OUR BOOK CLUB

SYNCHRON® MOTOR CATALOG gives general specifications on AC timing motors, AC clock movements, DC motors and related products manufactured by Hansen Manufacturing Company, Inc. Product literature Broadside and request card will be sent to you along with this catalog.



## Hansen Manufacturing Company, Inc.

SUBSIDIARY OF IMC MAGNETICS CORP.  
PRINCETON, INDIANA 47670

CIRCLE NUMBER 126

## DATA PROCESSING

### Floppy-disc system uses IBM 3740-type diskettes



Sykes Datatronics, 375 Orchard St., Rochester, NY 14606. Bruce Paton (716) 458-8000. See text.

Comm-Stor II is a communications floppy-disc system that uses IBM 3740-compatible diskettes and interfaces with all RS-232 communications devices. The system is  $\mu$ P-based, enabling the user to store and retrieve files by file source. Variable length files give increased file storage capacity and maximum usage of the diskette. Merging files provide the capability of merging and creating new files composed of existing files. The system provides buffering at the terminal and/or modem port to allow commands and data to be stacked. A single drive system lists at about \$3000 and a dual system at about \$4000.

CIRCLE NO. 416

### Mini-controller expands from 1 to 8 displays

Trivex, 3180 Red Hill Ave., Costa Mesa, CA 92626. R.J. Martin (714) 546-7781. \$3950; 6 to 8 wks.

The Model 0712M is a minicontroller that is expandable from one to eight displays and is plug-compatible with IBM's 3271 remote controller. The system operates up to 19.2 kbaud at switch-selectable speeds. The Model 0772M display, used to expand the 0712M cluster, features self-test, OCR wand, light pen, prompting line, cursor position indicator, local display to print, upper and lower case, character indicators in unprotected fields and a 10-key numeric pad.

CIRCLE NO. 417

Digitran  
advances the  
state of the art.  
Again.

# The only thumbwheel switches with optional LED lighting.

Traditional Digitran quality. And half the cost.

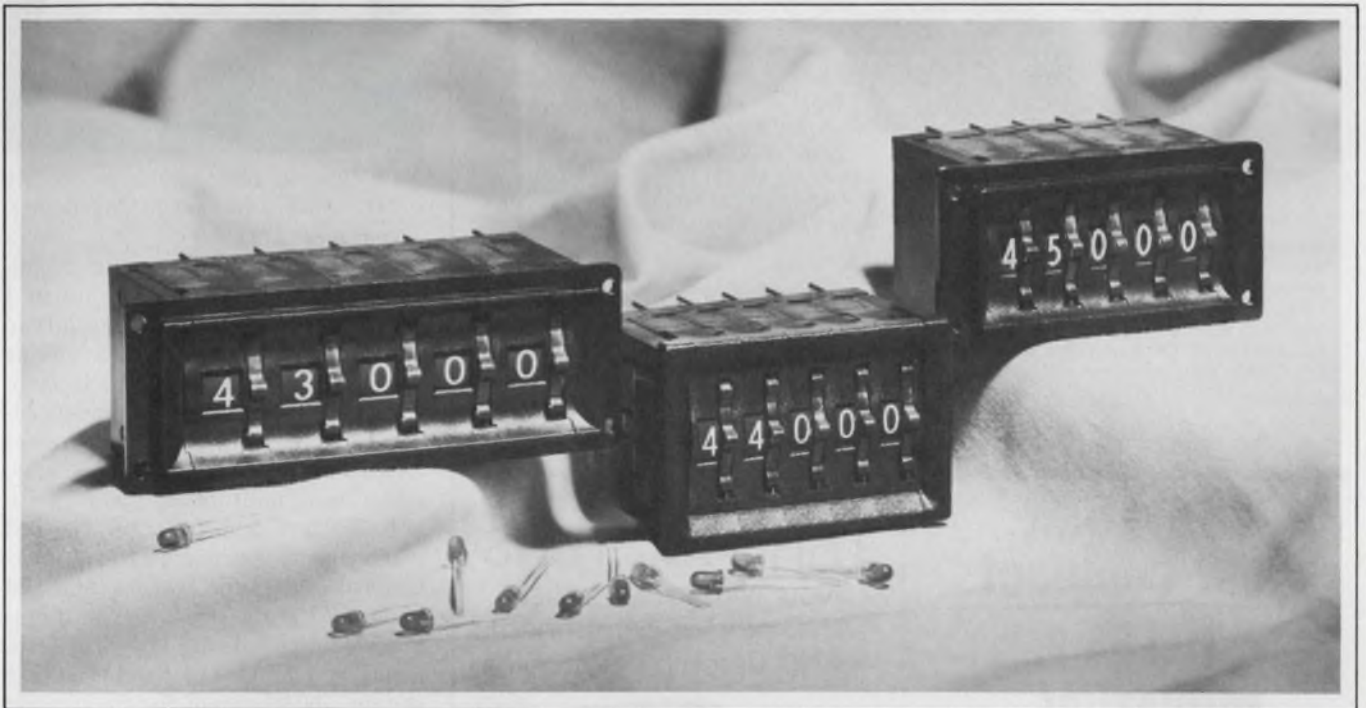

Our innovative line of digital Miniswitches puts it all together at *half* the price of comparable switches. Dependable Digitran quality, snap-together assembly and mini-size—only \$2.25 per module (list)—unlighted.

But don't overlook the unique option: LED lighting that lasts the life of the switches with no maintenance. Only Digitran thumbwheels have it. And the cost is about the same as conventional *unlighted* switches.

Our new Miniswitches are precision molded from highest quality plastic, quickly and easily snapped together for complete design flexibility. No tools, no extra hardware

required. Switches available in three series: 43000, 44000, and 45000, rear mounted or front mounted. They are interchangeable with most conventional .500" (12.7mm) or .315" (8mm) digital switches and may be ordered in most popular codes with direct solder or optional PC mount (pin) terminations.

**Now DIG this:** for more information and prices on our new Miniswitches with optional LED lighting, call our new toll-free number 800-528-6050 (residents of Arizona phone 800-352-0452), Ext. 924, for address and phone number of your nearest representative or distributor.

  
**THE DIGITRAN COMPANY**

A division of Becton, Dickinson and Company 

855 South Arroyo Parkway • Pasadena, California 91105 • Phone: (213) 449-3110 • TWX 910-588-3794.

CIRCLE NUMBER 127



## Data Display: YOUR Way

Ann Arbor makes over 1000 standard RO and KSR display terminal models. Alphanumerics. Graphics. Or both.

We also thrive on *tough* CRT display applications. Unique character sets. Unusual graphics. Difficult interfacing. Custom keyboards. Special packaging. You name it.

Standard or custom, *every* terminal produced is based on a field-proven Ann Arbor engineering concept. DESIGN III desktop terminals to complement any office decor. Compact, rugged Series 200 modular terminals that defy industrial environments. Or barebones board sets for OEMs who prefer to roll their own.

Many companies sell CRT terminals. But Ann Arbor sells creative solutions to CRT display problems, as well.

Probably at lower cost than anyone else in the business.

Contact us at 6107 Jackson Road, Ann Arbor, MI 48103. Tel: 313-769-0926 or TWX: 810-223-6033. Or see our catalog in EEM, Volume One.

**ANN ARBOR**  
TERMINALS, INC

... creating new ways to communicate

CIRCLE NUMBER 128

## USC'S UMI most compact ULTRA MINIATURE CONNECTORS

7 UMI Series -- Standard & Closed-Entry  
MIL-C-28748/7, 8 and others.

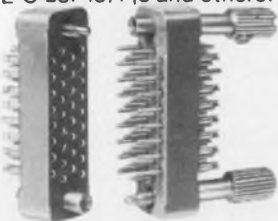

Highest reliability -- proved in Gemini/Apollo flights! 1 of over 20,000 types of connectors. Write or phone for UMI Series catalog -- today!

**U.S. COMPONENTS, INC.**

Leader in advanced engineering & design  
1320 Zerega Avenue, Bronx, N.Y. 10462  
(212) 824-1600 TWX: 710-593-2141  
Cable: COMPONENTS, NYK



CIRCLE NUMBER 129

## TRIPLE TESTED THRIFTMETERS

Now with lower prices  
—AND plug-in components  
—AND unichip electronics



PM-349 \$47  
Lowest priced Thriftmeter.  
PM-350 \$59  
With plug-in components.

Features Include:

- 3-1/2 digits. • Accuracy is  $\pm(0.05\%$  Rdg. + 0.05% F.S.). •  $\pm 0.2V$ ,  $\pm 2V$ ,  $\pm 20V$ ,  $\pm 200V$  or  $\pm 1000V$  range. • Auto zero and autopolarity. • 5 vdc power @ 1 W. • Large 0.3" LEDs. • Small size: 1" H x 2.5" W x 3.25" D. • Protected input. • Unichip construction.



**Non-Linear Systems, Inc.**

Originator of the digital voltmeter.  
Box N, Del Mar, California 92014  
Telephone (714) 755-1134 TWX 910-322-1132

For PM-349 Circle Number 131

For PM-350 Circle Number 47

## DATA PROCESSING

### Multiuser computer has 1-Mbyte memory



Data General, Route 4, Westboro, MA 01581. Howard Steiner (617) 366-8911. \$160,000 to \$395,000.

The M/600 computers contain semiconductor memory capacity up to 1 Mbyte and a demand paging facility to optimize memory use in large on-line applications. A three-level I/O management system features an independent I/O processor with 64 kbytes of local memory, a standard data channel and a burst multiplexer channel with a 10-Mbyte/s transfer rate. The I/O management system provides hierarchical control for low, medium and high-speed peripherals. A typical system would include 512 kbytes of main memory, 4 Mbytes of fixed-head disc storage, 760 Mbytes of disc file storage, two 9-track 1600-bits/in magnetic tape drives, a 600-line/min printer, a 600-card/min card reader, synchronous communications and 32 terminals.

CIRCLE NO. 418

### Modem originates and auto answers

U.S. Robotics, P.O. Box 5502, Chicago, IL 60680. (312) 528-9045. \$160 to \$195; stock.

The USR-300 series of originate and auto-answer modems operate asynchronously, full or half duplex at data rates up to 300 baud. The stand-alone modems are compatible with the Bell 103 and 113 lines. Connection to the public telephone network requires a CBS-1001F data-access arrangement (DAA).

CIRCLE NO. 419



# Specifier's QPL Shopping List.

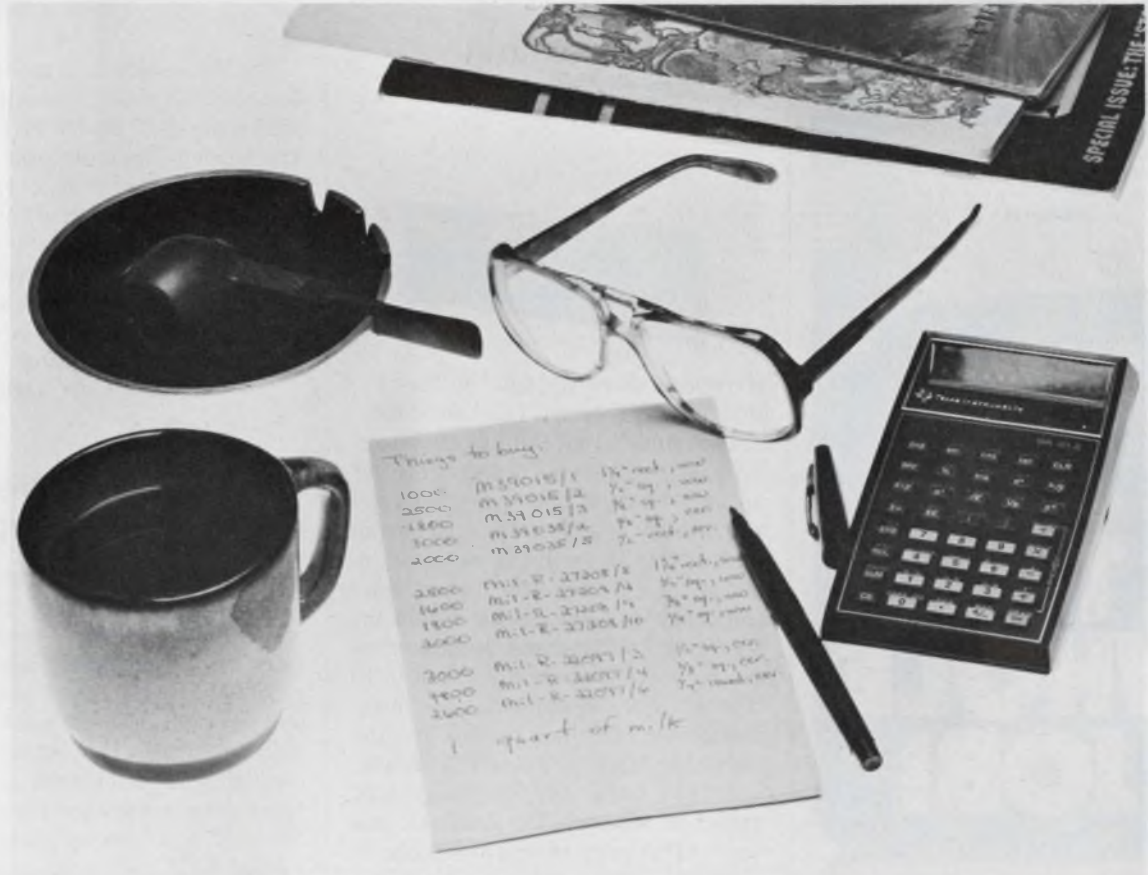

**Shop the Weston Mil-Qualified Trimmer Supermarket for great selection and quality!**

WESTON MIL-QUALIFIED TRIMMERS			
Type	Mil. Spec.	Term.	Description
RTR12	M39015/1	L.P.Y	1 1/4" Rectangular, Wirewound
RTR22	M39015/2	L.P.W.X	1/2" Square, Wirewound
RTR24	M39015/3	L.P.W.X	3/8" Square, Wirewound
RJR24C,F	M39035/2	P.W.X	3/8" Square, Cermet
RJR28C	M39035/5	P	1/2" Rectangular, Cermet
RT12C2	Mil-R-27208/8	L.P.Y	1 1/4" Rectangular, Wirewound
RT22C2	Mil-R-27208/4	L.P.W.X	1/2" Square, Wirewound
RT24C2	Mil-R-27208/9	L.P.W.X	3/8" Square, Wirewound
RT26C2	Mil-R-27208/10	P.W.X	1/4" Square, Wirewound
RJ22C	Mil-R-22097/3	L.P.W.X	1/2" Square, Cermet
RJ24C,F	Mil-R-22097/4	L.P.W.X	3/8" Square, Cermet
RJ50C	Mil-R-22097/6	P	1/4" Round, Cermet

Weston Mil-Qualified Trimmers will meet all your most demanding applications because they're designed and manufactured to the highest government standards for consistently superb performance. For model specifications, check our chart. With 12 Mil-Qualified Trimmers to choose from, we're sure you'll find just what your shopping list calls for. And on the way home, don't forget to stop for that milk!

**SANGAMO WESTON**  
**Schlumberger**

WESTON COMPONENTS & CONTROLS  
A Division of Sangamo Weston, Inc.  
Archbald, Pa. 18403  
Tel. (717) 876-1500  
TWX 510 656-2902  
Telex 83-1873



**RTR12**



**RTR22**



**RTR24**



**RT22C2**



**RT26C2**



**RJ50C**

# WHEN HALF THE POWER



# WILL DO THE WHOLE JOB!

If your application requires only moderate power, ENI's new Model A150 will do the job. All it takes is a laboratory signal generator and you've got a perfect match for RFI/EMI testing, NMR/ENDOR, RF transmission, ultrasonics and more.

Capable of supplying more than 150 watts of RF power into any load impedance, the A150 covers the frequency range of 3 to 35 MHz.

We could mention unconditional stability, instantaneous failsafe provisions and absolute protection from overloads and transients, but that's what you expect from any ENI power amplifier, and the A150 is no exception!

For additional specifications, a demonstration, or a copy of our new, full-line catalog, contact ENI, 3000 Winton Road South, Rochester, New York 14623. Call 716-473-6900 or Telex 97-8283 ENI ROC.

## ENI

The World's Leader in Power Amplifiers

CIRCLE NUMBER 149

## DATA PROCESSING

### Modems operate in satellite FM systems



American Modem, 160 Wilbur Pl., Bohemia, NY 11716. (516) 567-6800.

The Model 1260 QPSK data-over-voice or group-band modems are for use in terrestrial microwave links and satellite FM systems. The modems interface directly with the baseband input of the FM above the highest voice frequency or at any place within the operating FM baseband. Data services can be provided from 1.2 kbaud to 10 Mbaud. The equipment has interchangeable interface options for the use of RS-232, Bell 303 or V35 devices. Operating modes are full duplex, half duplex or simplex. The transmit and receive frequency ranges are 60 kHz to 50 MHz with a minimum carrier-to-noise ratio of 14 dB.

CIRCLE NO. 420

### Journal printer yields 3 lines/s on 40 columns

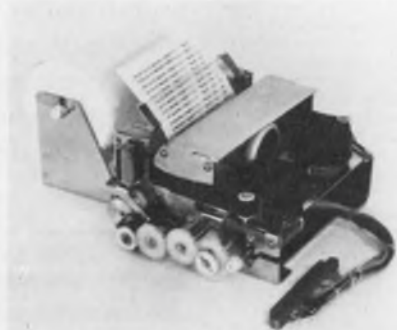

C. Itoh Electronics, 280 Park Ave., New York, NY 10017. (212) 682-0420. \$225.

The Model 512 serial-entry dot-matrix printer prints 3 lines/s on 40 columns. The character set is 64 ASCII. The print-out is 3.5-in. wide friction-fed fan-folded or rolled paper, inked by ribbon or impact. The size is 6 x 7 x 9.6 in.

CIRCLE NO. 421

### Modem mounts directly into teletypewriter

Omnitec Data, 2405 S. 20th St., Phoenix, AZ 85034. (602) 258-8244. \$625; stock.

The Model 4500 data modem mounts directly into a teletypewriter and replaces the Bell Model 101C data set. The modem operates over the DDD telephone network at a rate of 110 baud. The principal mode of operation is two-wire, half-duplex over the dial network. The unit interfaces to the telephone line via a DAA type CBT and provides full auto/answer capability for unattended operation.

CIRCLE NO. 422

### Interactive software creates business reports

Control-Data, Box O, Minneapolis, MN 55440. Ken Thompson (612) 853-3053.

IPS Report Writer is an interactive software package that allows simple reports to be generated quickly using only a few basic terminal commands. More sophisticated reports can be created with minimum effort. Features include command file processing, "what if" and "look up" commands and virtual field and scroll report-writer processing functions.

CIRCLE NO. 423

### Software lets OS/8 talk to remote computers

Menlo Computer Associates, 801 E. Charleston, Palo Alto, CA 94303. (415) 494-3170. See text.

CMU, a software product, permits communications between two OS/8 systems and provides a method for the system to reduce time-sharing service charges. CMU provides full duplex bidirectional terminal communications as well as real-time reception and transmission of OS/8 files with a time-sharing mainframe or another mini-computer. It operates with all PDP-8 systems as well as the PDP-12 and the DECstation-78. All that is required is a minimal OS/8 operating system and an interruptible device handler. The software allows an OS/8 system to perform like a remote terminal with local storage and editing capabilities. The single-system binary license costs \$350, and the binary and source license costs \$700.

CIRCLE NO. 424

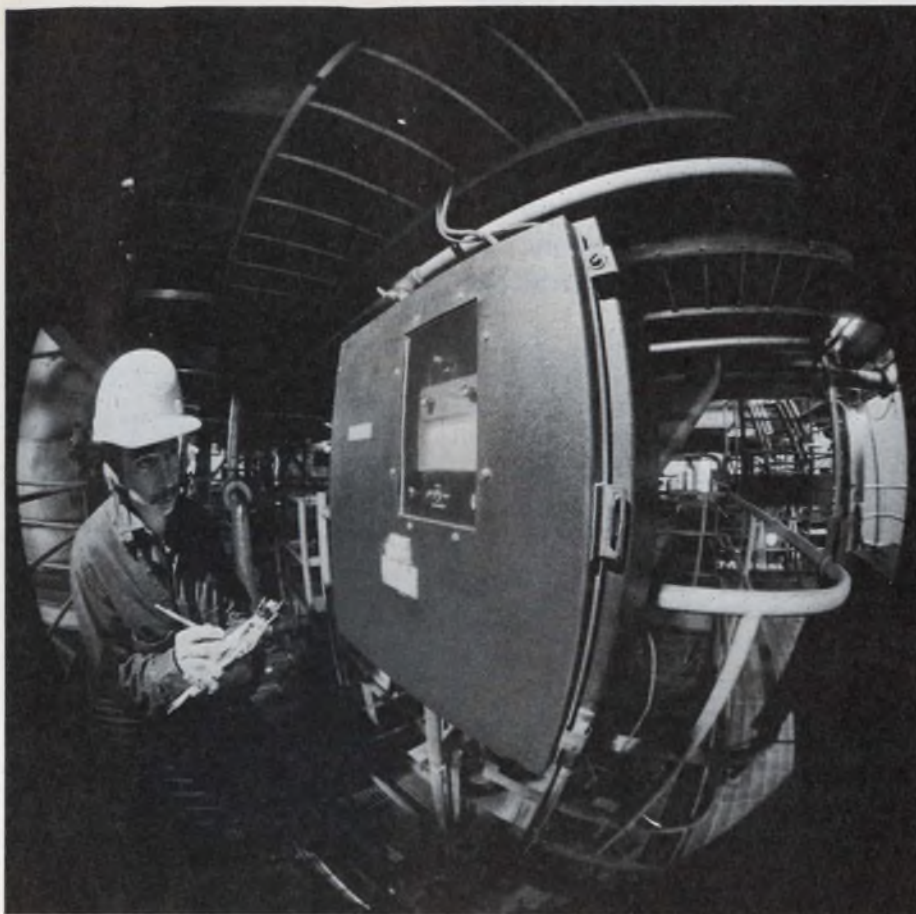

CIRCLE NUMBER 133

## There's a Hoffman enclosure for almost every electronic application you can think of.

One company uses our NEMA 12 enclosures to house water-testing instrumentation. Whatever your electronic application, Hoffman probably offers an enclosure to match it, whether it's for servo controls or sensitive instruments.

Hoffman electronic rack enclosures, consoles, instrument boxes, and a full range of NEMA types are just some of the components in a broad-spectrum 1700-product line. All are quality-built in the materials, finishes, and sizes your application requires.

There's a Hoffman enclosure for almost every electronic application you can think of. Check with your Hoffman distributor, or write directly for specifications — we'll match our enclosures with your thinking any time you like.

For complete data write:  
**HOFFMAN ENGINEERING COMPANY**  
 Division of Federal Cartridge Corporation  
 DEPT ED675, ANOKA, MN 55303

**Hoffman**<sup>®</sup>  
 ELECTRICAL ENCLOSURES

## THE RMP-116 INTRODUCES A NEW DIMENSION TO SOLID STATE SOFTWARE FOR THE PDP-11

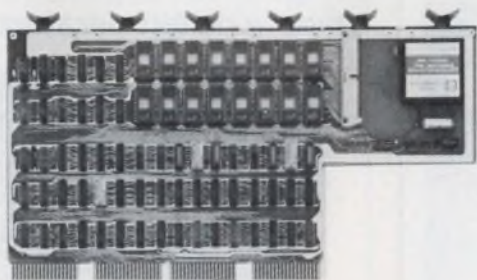

*For the first time you can have*

- Up to 16384 words of Intel 2716 EPROM or equivalent ROM on one small peripheral board.
- Complete on-board programming of the Intel 2716's under computer control.
- Unique and powerful hardware/software system for address space allocation permitting unlimited system expansion.
- Remote station available for added convenience in programming.

Price

RMP-116 \$895\* in quantities 1-9  
 Remote Unit \$250

\*Does not include EPROMs



**DIGITAL PATHWAYS INC.**  
 4151 MIDDLEFIELD ROAD  
 PALO ALTO, CALIFORNIA 94306  
 (415) 493-5544

CIRCLE NUMBER 134

ELECTRONIC DESIGN 6, March 15, 1978

## odds-on choice

## in temperature control and heating

Don't gamble on chancy electro-mechanical contacts. Murata's new solid-state Posistors provide highly reliable stepless temperature control and heating functions in a single, compact package. What's more, they are virtually immune to shock, vibration and dirt. Standard units are designed for 120 or 12 volt operation at up to 300 watts each and may be used in a variety of consumer personal care and industrial products. Write for complete technical information to: Murata Corporation of America, 1148 Franklin Road, S.E., Marietta, Georgia 30067. Phone: 404-952-9777.

**muRata**  
 CORPORATION  
 OF AMERICA

*first in ceramics*

CIRCLE NUMBER 135

# sealed high density miniature switching

for 12 to 60 poles with MIL-R-5757 protection against humidity . . . sand . . . dust . . . moisture . . . corrosion . . . splash . . . explosion . . . built to withstand shock/vibration!

**T-Bar** ENVIRONMENTALLY SEALED  
SERIES  
**831/931**  
RELAYS



12P, ST or DT 24P, ST or DT 36P, ST or DT 48P, ST or DT 52P, ST or DT 60PST

All contacts epoxy sealed in backfilled metal enclosure for ground support or shipboard applications and other hostile environments. Pulse operated magnetic latching available. Simple crimp snap-in contacts fit into single block connectors for easy wiring. 60 circuits switched in a space as small as 2¾" x 1½" x 4½".

Interested? Write or phone T-Bar today for complete facts, prices, quantity discounts.

**T-Bar** INCORPORATED

SWITCHING COMPONENTS DIVISION

141 Danbury Road, Wilton, CT 06897 • Telephone: 203/762-8351 • TWX: 710/479-3216  
CIRCLE NUMBER 136

## MAGNETICALLY SHIELDED TAPE DATA PRESERVERS

Protect your magnetic tapes from degradation and physical damage. Designed for storage, shipment and hand carrying. A wide choice of models and capacities available for standard reels, discs, disk packs, flexible disks and standard cassettes. Immediate shipment from stock.



MAGNETIC SHIELD DIV.



PERFECTION MICA CO.  
740 North Thomas Drive  
Bensenville, Ill. 60106, USA  
Phone 312 / 766-7800  
TWX 910-256-4815

SEND FOR NEW  
TP-5 CATALOG

CIRCLE NUMBER 137

## POWER SOURCES

### Switchers yield four independent outputs

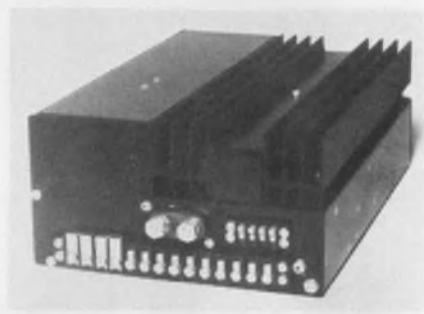

Gould, 4601 N. Arden Dr., El Monte, CA 91731. (213) 442-7755. \$695.

The Model MGQ-300 offers switching-regulated isolated outputs of +5 V at 30 A, -5 V at 5 A and ±15 V at 2 A. Overvoltage and current protection are provided on all outputs. All outputs remain within voltage regulation at full load for 28 ms after the removal of nominal line voltage. The size is 12.25 × 3.9 × 7.5 in.

CIRCLE NO. 427

### Regulated supplies work over wide temperatures



Tecnetics, P.O. Box 910, Boulder, CO 80302. Vern Garrison (303) 442-3837. \$200 to \$365.

The Type 400 compact, low-power, encapsulated, ac to dc regulated power supplies operate at a baseplate-temperature range of -55 to 100 C. Included in the line are units with 3, 6, 10, 15 and 20-W outputs, each with single, dual or triple outputs. Input voltage is 115 V, 400 Hz, single phase per MIL-STD-704A. Regulation is 30 mV, line plus load. The use of military-type parts yields 70,000-h MTBF.

CIRCLE NO. 428

**Need an industrial version  
of our famous DOT and DIT  
military transformer?  
TRW/UTC has a stock answer.**

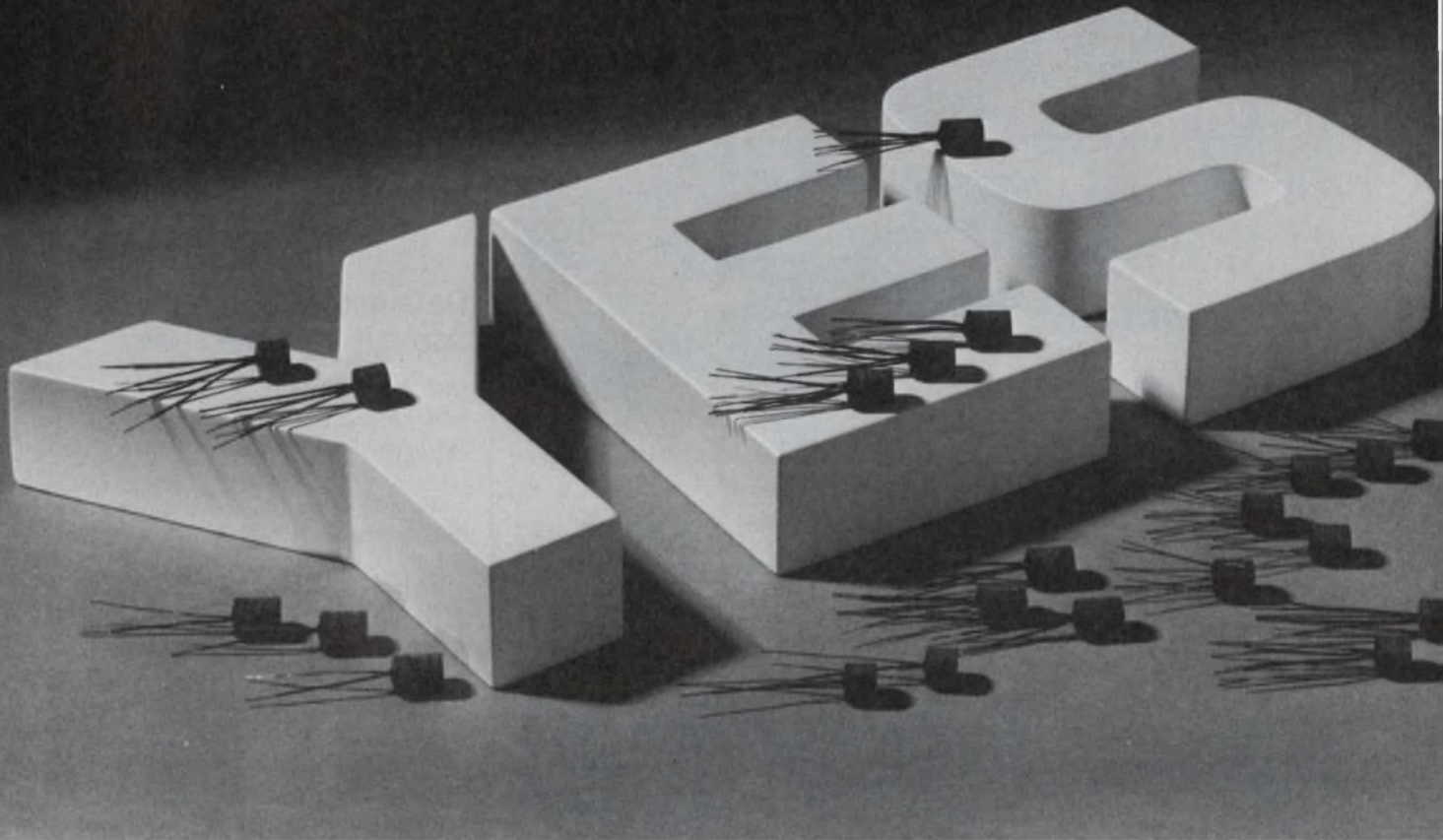

Now industrial users of transformers who need the space/performance of a high grade well tested product can choose from the I-DOT and I-DIT line of audio, signal, pulse or power transformers and inductors.

You see, we relaxed some of the environmental specifications of our prominent line of Mil spec DOT and DIT transformers, but kept the identical excellent electrical performance. Only the cost was reduced.

And the nice part, this industrial counterpart to the world renowned military line is a stock product available now at your authorized TRW/UTC distributor.

The I-DOT family has a frequency response of  $\pm 3$  db, 300 hertz to 20K hertz. The I-DIT has a  $\pm 3$  db, 400 hertz to 100K hertz, and is available both with flexible leads and with uninsulated dumet wire leads for printed circuit board mounting.

Check your authorized TRW/UTC local distributor for immediate off-the-shelf delivery or contact TRW/UTC Transformers, an Operation of TRW Electronic Components, 150 Varick Street, New York, N.Y. 10013. Area code: 212-255-3500.

**TRW UTC TRANSFORMERS**

ANOTHER PRODUCT OF A COMPANY CALLED TRW

CIRCLE NUMBER 138

# WATERS OFFERS the best answer to your servo feedback problem

Designed with computer programmed correction, Waters conductive plastic pots and elements are the answer to your most difficult servo feedback application. They offer long rotational life, low output smoothness, low static noise, and infinite resolution in rotaries from 1/2" to 2" diameters with accuracy to 0.1% terminal linearity. Elements are built to your specifications from 1/2" to 40" in length to almost any resistance value.

Waters customer service team includes an engineering services group which processes every customer inquiry and will consult with you to review existing applications and provide assistance on new ones.

Call Don Russell at (617) 358-2777

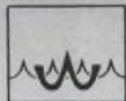

**WATERS  
MANUFACTURING,  
INC.**

Longfellow Center  
Wayland, MA 01778 617-358-2777

CIRCLE NUMBER 139

## VECTORBORD® TENTH/TENTH HOLES MOUNT:

DIPS, SIPS, KLIPS, CHIPS  
PINS, POSTS, POTS, PADS Save Work — Time — Money  
RCs, ICs, PCs, SCs

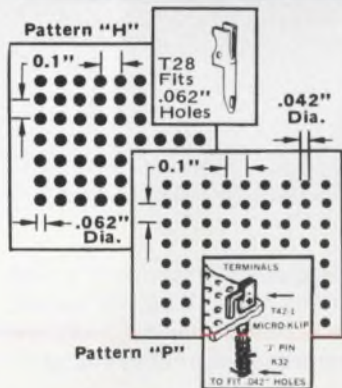

## 8800V MICROPROCESSOR PLUGBORD

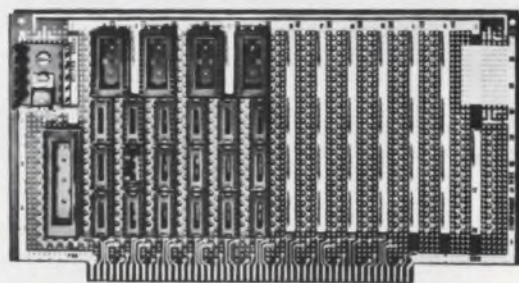

(Component Side with Added Sockets)

Has 100 contacts on .125" centers, is 10" wide by 5.313" high. Has heavy tinned back-to-back buses, overall 0.1" spaced 0.042" hole pattern. Socketed models available.

CIRCLE NO. 430

### WIDE SELECTION OF SIZES AND MATERIALS

**MICRO-VECTORBORD® "P"** — 0.042" holes match DIP leads. Epoxy glass, or glass composite, paper, copper clad. Also 1/64" to 1/16" thick and 10" max. width.

**VECTORBORD "H"** — For larger terminals, leads. Available in epoxy glass sheets 4.8" to 8.5" wide and 8.5" to 17" long. 1/32" and 1/16" thick.

**TERMINALS** — Complete selection of wire wrappable and solderable push-in terminals for 0.042" and 0.062" dia. holes — plus wiring tools available.

**PLUGBORDS** — For solder or wrap wire construction 2.73" to 10" wide and 4.5" to 9.6" long. With holes .1" x .1", .1" x .2", .2" x .2", or loaded with IC sockets.

Send for complete literature

**Vector**

**ELECTRONIC COMPANY, INC.**

12460 Gladstone Ave., Sylmar CA 91342  
(213) 365-9661 — TWX (910) 496-1539



41576

CIRCLE NUMBER 140

## MODULES & SUBASSEMBLIES

### A/d converter delivers high accuracy

Phoenix Data, 3384 W. Osborn Rd., Phoenix, AZ 85021. Srinii Iyer (602) 278-8528. \$2190; 8 to 12 wks.

The Model ADC 1215L analog-to-digital converter has an accuracy of  $\pm 0.004\%$ , a 5.5- $\mu$ s conversion time, 15-bit binary output resolution and  $\pm 0.002\%$  linearity. The a/d converter requires no external reference voltage. Power consumed is 2.2 W. The size is 5 x 4.5 x 0.92 in.

CIRCLE NO. 429

### Data acquisition units come in matched pairs

ILC Data Device, Airport International Plaza, Bohemia, NY 11716. (516) 567-5600. \$255 (amplifier), \$310 (converter); stock to 8 wks.

A matched pair of 8-bit data-acquisition components consists of a hybrid video sample-and-hold amplifier, SH-8518, and a hybrid a/d converter, ADH-8512. The pair is capable of word rates up to 900 kHz. The SH-8518 has a 25-ns acquisition time, a 60-ps aperture uncertainty and a 20-MHz sampling rate. Linearity error is 0.05% and droop rate is 1 mV/ $\mu$ s. The ADH-8512 employs successive approximation with linearity of  $\pm 0.2\%$  and a conversion time of 1  $\mu$ s.

CIRCLE NO. 430

### Op amp in DIP has low offset

Precision Monolithics, 1500 Space Park Dr., Santa Clara, CA 95050. Don Soderquist (408) 246-9222. \$3.25 (100 qty); stock.

The OP-07CP op amp, housed in a plastic DIP, maintains an input-offset voltage below 250  $\mu$ V over an ambient range of 0 to 70 C. Max long-term input-voltage drift is 2  $\mu$ V. Input noise voltage is 0.65  $\mu$ V from 0.1 to 10 Hz.

CIRCLE NO. 431

# For expensive business and commercial computers, talk to DEC®, IBM® or Data General®

**for value-priced  
home or business  
computers,**



H8 Kit \$375.00



H11 Kit \$1295.00

## talk to Heath!®

If you work with computers, you know how much of an asset they are to your business. Fast, accurate data handling, instant retrieval of important information and storage of vital records and statistics are all part of the computer revolution. Computers mean better business, but there's another side to them as well.

Computers can work for, educate and entertain you right in your own home. Because they are true "open-end" machines, the number of ways you can use a computer at home is limited only by your imagination and programming prowess. Computers can also be an important adjunct to your children's education and an introduction to the modern technological world.

Best of all, computers happen to be FUN! There are hundreds of fascinating and challenging games that can stimulate your brain and provide hours of relaxation and recreation. And because the computer can make its own decisions, you can "compete" at any level you program into it.

Heathkit computers are designed to fit right into your home. No matter what your computer application, we have the unit for you. Our H8 is an 8080A-based machine with an "intelligent" front panel that is ideal as a

programming trainer and instruction tool. The powerful H11 is based on the most successful commercial computer in the world, the Digital Equipment Corporation PDP-11. These two computers, along with a complete line of peripherals and I/O devices, make Heath your home computing system headquarters.

Heathkit computer systems provide the documentation you need to get up and running right - complete step-by-step assembly manuals, comprehensive operating procedures and complete and thorough rundowns of software programs. What's more, Heathkit computer systems include the systems software you need to start programming right away. The H8 includes a front panel monitor program, Benton Harbor BASIC, assembly language, text editor and console debugger. The H11 includes editor, relocatable assembler, link editor, absolute loader; debug, executive and dump programs plus BASIC and FOCAL.

Heathkit computer systems are designed to give you home computing at its very best. And since they're backed by Heath's 54-year reputation for honesty, reliability and quality, you know that a Heathkit computer system is one of the best investments you can make!

Prices are mail order net F.O.B., Benton Harbor, Michigan.  
Prices and specifications subject to change without notice.



## HEATHKIT COMPUTERS

**Send for your  
FREE HEATHKIT  
Catalog!**

Read about nearly 400  
top-value electronic kits  
you can BUILD yourself -  
for fun, for satisfaction,  
and for SAVINGS!

Heath Company, Dept. 511-390  
Benton Harbor, Michigan 49022

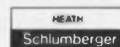

Heath Company, Dept. 511-390  
Benton Harbor, Michigan 49022

Please send me my FREE Catalog.  
I am not on your mailing list.

Name \_\_\_\_\_

Address \_\_\_\_\_

City \_\_\_\_\_ State \_\_\_\_\_

CP-141 \_\_\_\_\_ Zip \_\_\_\_\_

CIRCLE NUMBER 141

## Large-area boards take DIPs and irregular pins

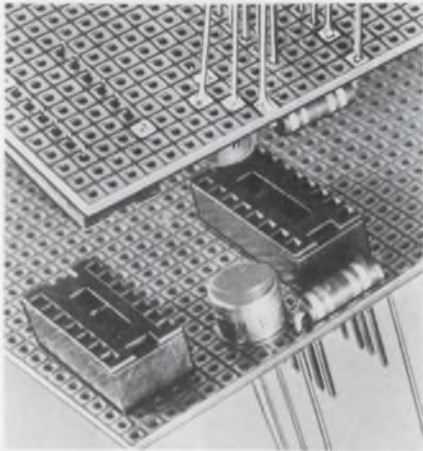

Vector Electronic, 12460 Gladstone Ave., Sylmar, CA 91342. Floyd Hill (213) 365-9661. \$9.96 to \$19.95; stock.

A family of large-area "pad-per-hole" plugboards permit breadboarding of either custom circuits or S-100 bus-compatible boards. All boards have an isolated array of square solder pads surrounding 0.1-in. spaced holes. Two are made without card-edge connectors and may be cut to any desired shape. The 45P80-1 is 4.5 × 8.08 in.; the 106P106-1 is 10.6 × 10.6 in. Model 8801 is compatible with the S-100 bus system, accommodates DIP devices, modules and discrete components. All boards accept DIP packages from 8 to 64 leads as well as special modules with leads spaced on irregular multiples of 0.1 in.

CIRCLE NO. 432

## Epoxy bonds optic fibers, has thermal stability

Epoxy Technology, 14 Fortune Dr., Billerica, MA 01821. (617) 667-3805. \$16.60 (1-lb kit); stock.

Epo-Tek 330 is a two-part epoxy formulated for bundling optic fibers. Thermal stability results in less than 5% weight loss at 300 C. At 2.65 microns, spectral transmission is 84.9% with a 0.0015-in. sample thickness. Pot life is 8 h and the curing cycle is 5 min. Curing is indicated by a change in color from clear amber to bright red.

CIRCLE NO. 433

## Edge connector allows removal of contacts

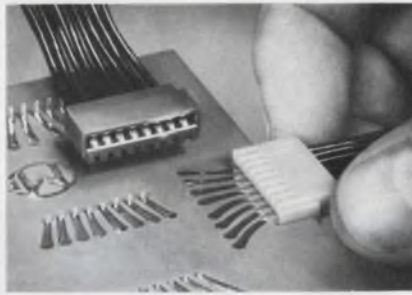

Methode Electronics, 1700 Hicks Rd., Rolling Meadows, IL 60008. (312) 392-3500.

Term-Acon Series 1500 card-edge connectors provide 0.1-in. centers cable-to-board interconnects and allow field contact removal or replacement. The connectors' crimp contacts are rated at 3.5 A and accept board thicknesses of 0.062 in. Connector housing material is 94V-2 or 94V-0. Polarizing features, with or without strengthening flanges for extended PC boards, are available.

CIRCLE NO. 434

## Teflon TO-5 socket installs with 1/4 turn



Sealectro, Mamaroneck, NY 10543. G. Antonion (914) 698-5600. \$0.72 (100 qty); stock to 8 wks.

A Teflon-insulated transistor socket, P/N 027-1700, for four-lead TO-5 transistors installs with only a 1/4 turn in an unchamfered "D" hole in a 0.02 to 0.06-in.-thick chassis.

CIRCLE NO. 308

## Fiber-optic cable uses single large core

Valtec, West Boylston, MA 01583. Rich Cerny (617) 835-6082. \$1/meter; stock.

The general-purpose fiber-optic communication cable, PC10, consists of a single, large-core silica fiber clad in a rugged plastic dielectric jacket. The cable can be used for high-bandwidth optical transmission over distances ranging from a few centimeters to 2 km. The maximum cable attenuation is 20 dB/km at 800 nm. Pulse spreading is 40 ns/km. Over-all diameter is 4 mm.

CIRCLE NO. 435

## Kit mounts TO-220 devices

Thermalloy, 2021 W. Valley View Lane, Dallas, TX 75234. (214) 243-4321. \$0.098 (10,000 qty); stock.

Type 4880 mounting kit for TO-220 devices provides fast, uniform mounting and maximizes thermal performance. Mounting hardware includes a stainless steel 4-40 nut, lock washer, flat washer and 4-40 × 1/2-in. screw. In addition, a polyphenylene-sulphide shoulder washer is provided to fit inside the device tab to electrically insulate the device from the mounting screw. A plastic film provides electrical insulation as well as low thermal resistivity (2.25 C/W).

CIRCLE NO. 436

## Desolder connections with vacuumized wick

Multicore Solders, Westbury, NY 11590. (516) 334-7450. Stock.

A vacuumized wick for desoldering has improved capillarity and shelf-life. The vacuumization technique deoxidizes the copper braid while applying a smooth, adhering coating of noncorrosive flux. To use, place the wick on the connection and apply the soldering iron to the wick. The solder is absorbed almost instantly. Wicks are available in 1/16, 3/32, and 1/8-in. widths, on plastic dispenser spools each 66 in. long.

CIRCLE NO. 309

## Circular connector mates blindly

ITT Cannon Electric, 666 E. Dyer Rd., Santa Ana, CA 92702. R.L. Harmon (714) 557-4700. See text; 15 wks.

The KJL miniature circular connector has a "scoop-proof" feature that eliminates the possibility of contact damage in blind mating use. The connector meets MIL-C-38999 and operates from -65 to 200 C. As many as 58 crimp snap-in contact arrangements take from 3 to 128 contacts in wire sizes 16 through 28. Contacts are of high-conductivity copper alloy with a gold-plated finish. The price of a mated pair (type OF shell) 5-contact plug and receptacle is \$45.54 in lots of 50.

CIRCLE NO. 437



## WE KNOW A LOT ABOUT A LITTLE.

### Silicon-iron alloys, for instance.

Magnetics offers you fast delivery on silicon-iron alloy coils in 1- to 7-mil thicknesses, either coated or uncoated. And we're the only source for 5- and 7-mil nonoriented types. You can count on them for uniformity in magnetic properties—in fact, we make and use them for our own magnetic devices, so they have to be right. In widths to 15".

Our Magnesil catalog tells more. For a copy, write Magnetics, Metals Division, Butler PA 16001.



Magnesil materials provide low core losses.

**Very special specialists in specialty alloys.**



CIRCLE NUMBER 142

## WE KNOW A LOT ABOUT A LITTLE.

### Tape cores, for instance.

When it comes to tape wound cores, we offer thousands of choices—900 sizes, eight materials, seven gauges. Our Supermalloy tape cores feature high permeability and low loss for such applications as precision current and ratio transformers, high-perm inductors, bridge lifters, etc.

We also make bobbin cores from Permalloy 80 and Orthonol<sup>®</sup> ultra-thin tape. These cores are wound on nonmagnetic stainless steel bobbins, with core diameters down to 0.050".

For more information on tape or bobbin cores, write Magnetics, Components Division, Butler PA 16001.



In addition to catalog items, we offer a custom core service.

**Very special specialists in tape wound cores.**



CIRCLE NUMBER 143

FOR INFORMATION CIRCLE NUMBER 144  
FOR INFORMATION AND DEMONSTRATION CIRCLE NUMBER 145

# DMM Sensitivity: Never Have We Packed So Much Of It Into Such a Small Package, ~~\$345 Complete.~~ <sup>now \$295</sup>

No other 4½-digit portable multimeter gives you 10 $\mu$ V DC and AC sensitivity, True RMS AC voltage and current measurement along with unsurpassed  $\pm 0.05\%$  basic DC accuracy, guaranteed for one year—in a truly portable, easy-to-read instrument.

#### Model 248 measures:

Resistance 100m $\Omega$  to 20M $\Omega$   
DC Volts  $\pm 10\mu$ V to  $\pm 1$ KV,  
True RMS AC Volts 10 $\mu$ V to 500V, both DC Current and True RMS AC Current 10 nanoAmps to 2A.

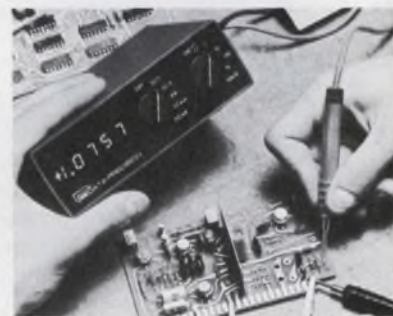

#### Small, Light, Easy-to-Read

Just 1¾" x 5½" x 3½" (4.45 x 13.97 x 8.89 cm) and only 1.3 pounds, the 248 has only 2 controls—Function and Range—and a bright 0.3 LED display for easy viewing.

#### Extras Included

You also get these standard accessories: a rechargeable NiCd battery module, a pair of test leads, line cord with charger, carrying case, and full instruction manual and test data. A full range of optional accessories is also available.

#### Price: \$295\* complete.

For complete information or a demonstration, contact your local Data Precision representative or Data Precision Corporation, Audubon Road, Wakefield, MA 01880, (617) 246-1600. TELEX (0650) 949341.

\*price USA



Shown with optional bench stand.

**DATA PRECISION<sup>®</sup>**  
...years ahead

# New literature



## Test instruments

A 20-page catalog features test instruments, including frequency counters, universal counter-timers, digital volt/multimeters, sweep generators, spectrum analyzers, microwave components and a new instrumentation controller for IEEE bus applications. Systron-Donner, Concord, MA

CIRCLE NO. 441

## PROM matrix

A compact, space-saving, programmable-read-only-memory matrix for switching, testing and programming applications is described in a catalog from the Programming Devices Division. Sealectro, Mamaroneck, NY

CIRCLE NO. 439

## Microwave components

A storehouse of standard and custom components for microwave and electronics engineers, designers and specifiers is detailed in a revised and updated 40-page handbook. Premier Microwave, Port Chester, NY

CIRCLE NO. 440

## Snap-action switches

Operating and dimensional data on hermetically and resiliently sealed snap-action switches are given in a 16-page catalog. Haydon Switch & Instrument, Waterbury, CT

CIRCLE NO. 438

## Indicator lamps and LEDs

Descriptions of LEDs, lamps, lamp-holders and indicators are included in an 88-page catalog as well as the company's complete line of products. Mouser Electronics, Lakeside, CA

CIRCLE NO. 442

## Centrifugal blowers

An 84-page catalog describes an extensive range of centrifugal blowers. The catalog also contains sections on technical notes and standard connection diagrams. IMC Magnetics, Westbury, NY

CIRCLE NO. 443

## Rectifiers

Over 1600 rectifiers, rectifier assemblies, zener voltage regulators, high-voltage rectifiers, Klipvolt surge suppressors and selenium rectifiers are covered in a 20-page catalog. ST-Semicon, Bloomington, IN

CIRCLE NO. 444

## 7-1/2 digit DVM

A 7-1/2 digit precision digital voltmeter that is the only DVM with a displayed scale length of 14-million counts is the feature of an 18-page catalog, whose full-color photos highlight each function and control. Guildline Instruments, Elmsford, NY

CIRCLE NO. 445

## Open-frame switchers

Photos, dimensional drawings, features, and specifications on open-frame switchers are included in a catalog. LH Research, Irvine, CA

CIRCLE NO. 446

## Connectors

A 40-page catalog describes miniature PC-card and cable-to-cable connectors. Featuring a graphic-selector chart, the catalog offers designers photos of actual application-board mountings as well as line drawings, dimensional and specification charts. Methode Electronics, Rolling Meadows, IL

CIRCLE NO. 447

## Assembled instruments

An entire line of electronic test instrumentation is covered and displayed in a 32-page catalog, which carries complete listings of oscilloscopes, laboratory-grade strip and X-Y recorders, power supplies, various signal and function generators, counters, a full line of multimeters (analog and digital), and a complete selection of associated accessories such as probes and interconnecting cables. Heath, Benton Harbor, MI

CIRCLE NO. 448

## Power FETs

The VMOS Power FET brochure covers general VMOS power FET benefits, markets and new design possibilities previously not achievable with bipolar transistors. It works in conjunction with the VMOS Power FET Design Catalog consisting of a device/application selector, data sheets, geometry characteristics, application notes and design aids. Siliconix, Santa Clara, CA

CIRCLE NO. 449

## Transistors

More than 1000 types of transistors are covered in a 28-page catalog. Kertron, Riviera Beach, FL

CIRCLE NO. 450

## Electronic kits

Nearly 400 electronic kits and products are featured in a 104-page catalog. Heath, Benton Harbor, MI

CIRCLE NO. 451

## 12-bit data acquisition

Two complete 12-bit data-acquisition systems, one with eight differential-input channels and one with 16 single-ended input channels, are presented in an eight-page brochure. Datel Systems, Canton, MA

CIRCLE NO. 452

## Automatic testing

A 12-page brochure describes computerized automatic test equipment for functional testing of loaded printed-circuit boards, electronic assemblies, and electromechanical devices. S.I.R. Atlanta, Atlanta, GA

CIRCLE NO. 453

# QUALITY FABRICATION

## Zenamic (Metal Oxide Varistor)

This varistor is fabricated from Metal Oxide and mainly use for absorption of lightning surge, protection of all varieties of semi-conductors, suppression of switching surges and contactor protection. Following types are available.

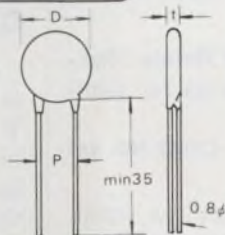

Type No	Z7L	Z10L	Z15L	Z21L
D	Max10	Max13	Max18	Max24
t	Max 8	Max 8	Max 8	Max 9
P	6.8	8.3	8.3	10.8

### Z 10 L 221

Zenamic Element diameter Zenamic voltage Lead type

Code	Diameter	Surge Current	22V at 1mA
7	7φ	8 × 20μ Sec 250A	120V ± 15%
10	10φ	500A	150V at 1mA
15	15φ	1000A	1000V ± 10%
21	21φ	2000A	

#### ISHIZUKA'S ABSORBERS:

- Sic Varistor
- V R D (Bipolarity Zener Diode)
- Gas Tube Arrester
- and Thermistor



### ISHIZUKA ELECTRONICS CORP.

3-16-7, Higashi-Koiwa, Edogawa-ku, Tokyo 133, Japan  
Phone: TOKYO(03)658-5111

CIRCLE NUMBER 146

# EMR Frequency Response Analyzers For Every Application

From the viscous elastic properties of films and fibers, to the frequency response of hydraulic actuators . . . for the open loop response of a servo system with the loop closed, or the frequency response of the Brooklyn Bridge . . . EMR has a Frequency Response Analyzer that is just right for your application.

Take the low-cost, easy-to-use Model 1312. It's ideal for production testing and basic measurements of phase and amplitude to 20 kHz. Or choose the Model 1410, the full capability, single-channel instrument that has become the industry's standard for most engineering applications. Then there's the Model 1172, the ultimate Frequency Response Analyzer featuring all-digital signal processing, fully-isolated dual measurement channels and a computer-type keyboard entry. With the Model 1180 Plotter Interface, you can plot Bode, Nyquist, or Nichols diagrams with a conventional analog XY recorder.

Let EMR solve your frequency response problems . . . call or write for details or a demonstration.

Sangamo Weston, EMR Telemetry Division  
P.O. Box 3041, Sarasota, FL 33578  
813-371-0811

\* SANGAMO WESTON

Schlumberger



**TYPE OF**  
Glass tubular capacitors, temperature range of  $-50^{\circ}$  to  $85^{\circ}$  C, offer continuous operation at  $85^{\circ}$  for 10,000 hours. Standards thru 60 KVDC.



**TYPE LK**  
CP70 style. Unusually good electrical characteristics in a very small unit. Used for filters, bypass and coupling. Temperature range,  $-55^{\circ}$  to  $105^{\circ}$  C, 10,000 hours life at  $85^{\circ}$  C. Standards thru 50 KVDC.

## DUAL DIELECTRIC CAPACITORS



Write for Literature.

Plastic Capacitors, Inc.  
2623 N. Pulaski Road  
Chicago, Illinois 60639  
(312) 489-2229

"Serving industry  
for 25 years"

CIRCLE NUMBER 147

CIRCLE NUMBER 148 ▶



# Vendors report

Annual and interim reports can provide much more than financial position information. They often include the first public disclosure of new products, new techniques and new directions of our vendors and customers. Further, they often contain superb analyses of segments of industry that a company serves.

Selected companies with recent reports are listed here with their main electronic products or services. For a copy, circle the indicated number.

**Gulf + Western.** Manufacturing, natural resources, consumer and agricultural products, apparel, financial services, leisure time, automotive replacement parts and paper and building products.

CIRCLE NO. 459

**Dataram.** Core memories.

CIRCLE NO. 466

**Cubic Corp.** Defense electronics, mass transit, elevator industry/electronic controls, two-way radio communications and medical/industrial equipment.

CIRCLE NO. 460

**Youngwood Electronic Metals.** High-precision metal stampings for semiconductor components.

CIRCLE NO. 461

**Penril.** Data-communications equipment, digital panel meters, test instruments and power supplies.

CIRCLE NO. 462

**Computer Communications.** Equipment and systems for the processing and switching of data.

CIRCLE NO. 463

**Spartek.** Industrial ceramic, plastic and powdered-metal products.

CIRCLE NO. 464

**Tech Ops.** Radiation monitoring, industrial radiographic equipment, solid-state controls and broadcasting.

CIRCLE NO. 465

# Design aids

## D/a, a/d resolution

What resolution (number of bits) a/d is required to resolve 15 mV in 20 V? What is the output-step size of a 14-bit d/a in ppm? The answers to these and other common d/a and a/d-resolution questions can be quickly and conveniently found on a card. Micro Networks.

CIRCLE NO. 454

## Plating process

Easy to use and in full color, a guide lists and describes copper, nickel, electroless nickel, tin/lead, tin, and indium-plating processes. A brief description with suggested applications, operating parameters, and deposit characteristics is given for each of the processes. Sel-Rex Div.

CIRCLE NO. 455

## Magnetic-media guide

A comprehensive magnetic-media-compatibility guide for digital cassettes, disc packs, disc cartridges, discettes and MCST magnetic cards gives an instant cross-reference to hundreds of products by dozens of manufacturers. Wabash Tape Corp.

CIRCLE NO. 456

## Frequency spectra

Using the acoustic noise and vibration of an electric fan as illustrations, an eight-page application note shows how to interpret frequency spectra with the company's Model 444A FFT computing spectrum analyzer. Nicolet Instruments.

CIRCLE NO. 457

## Electromagnetic interference

A three-part kit includes information on electromagnetic-interference shielding and static-discharge theory and formulas, shielding methods and efficiencies, applications and bibliography. TAFE Metallisation.

CIRCLE NO. 458

## Save Your Copies of Electronic Design in handsome library files or binders



Keep your valuable copies neat and organized for ready reference. Each rugged case or binder holds half a year's issues. Richly covered in dark green leatherette and embossed with 16K gold lettering — a handsome and practical addition to your bookshelf or desk.

Mail to: Jesse Jones Box Corp., Box 5120, Philadelphia, Pa. 19141

ED

Please send me: \_\_\_\_\_ Library Cases at \$4.95 each; 3 for \$14; 6 for \$24, postpaid.

\_\_\_\_\_ Binders at \$6.50 each; 3 for \$18.75; 6 for \$36, postpaid.

(Add \$1. each outside U.S.A. to cover additional postage and handling)

Check or money order (U.S. funds) for \$\_\_\_\_\_ enclosed.

Name (Print) \_\_\_\_\_

Title \_\_\_\_\_

Company \_\_\_\_\_

Address \_\_\_\_\_

City/Province \_\_\_\_\_

State/Country \_\_\_\_\_

Zip or Postal Code No. \_\_\_\_\_

Satisfaction guaranteed or money refunded. Allow 5 weeks for delivery

E-Z-PROBES XP AND XPL ■ TEST LEADS AND JUMPERS ■ ADAPTORS

# OUR NEW MICRO TROUBLE SHOOTER SOLVES YOUR IC TESTING PROBLEMS

The XM Micro Hook is designed for difficult IC test connections. Light weight (less than 1 gram) and Finger-eze Hypo Action permit direct hookup to delicate wires where weight and leverage may damage component. Fully insulated to a single contact point for true readings.

**Construction:** One-Piece Beryllium Copper, Gold-Plated Conductor and Hook, made for connections over leads up to .025" diameter. Durable Heat and Chemical Resistant Nylon Body. Stainless Steel Spring. Available preconnected to a wide variety of interface connectors.

**Colors** Red, Black, Blue, Green, Orange, Yellow, White, Brown, Violet and Gray.

### EXCLUSIVE FIELD SERVICING FEATURE

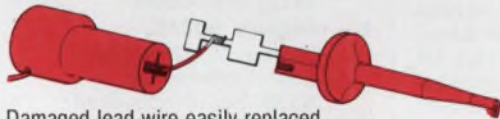

Damaged lead wire easily replaced.

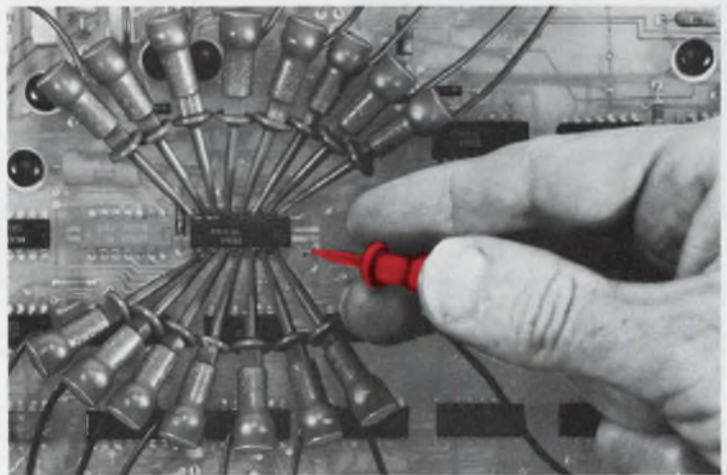

MODEL XM SHOWN ACTUAL SIZE WITH HOOK EXTENDED.

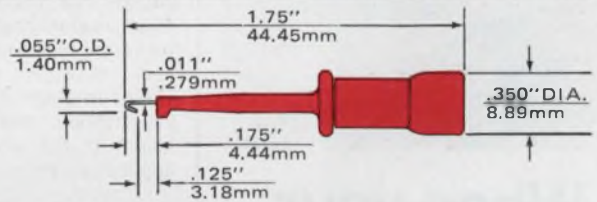

SEND FOR COMPLETE NEW CATALOG AND PRICE LIST

**E-Z-HOOK**  
A DIVISION OF TEKTEST, INC.

114 EAST SAINT JOSEPH STREET  
ARCADIA, CALIFORNIA 91006  
(213) 446-6175 / TWX 910 582 1614

PATCH CORDS ■ COAXIAL JUMPERS ■ E-Z-HOOK CLIP 61-1 AND 61-2

## PROBLEM SOLVER For Electronics Manufacturers

# FOAMEDGE Vinyl Encased Polyurethane Foam

Consider this product as a solution to some of your problems. It comes in diameters from 3/16" to 3", cut to any length.

### Suggested uses include:

- Dust Seals
- Light Seals
- Vibration Dampener
- Airflow Stoppage
- Shock Absorption
- Sound Seals
- Heat Insulation

Perhaps you have your own special need for FOAMEDGE. It is tough and durable, very soft, conforms to shape of irregular surfaces and has lowest K factor of any insulation.

Write For Information and Samples

**TELEDYNE MONO-THANE**

1460 Industrial Parkway, Akron, Ohio 44310  
Phone: 216/633-6100

CIRCLE NUMBER 151

## Electrodeposited bellows contacts



Servometer's gold plated contact springs are actually tiny bellows with one closed end. They can be:

- Mated to diode packages
- Used in blind connections
- Leak tested for use in instruments
- Used to protect fragile crystals from probe damage
- Used to absorb vibration, temperature expansion, or tolerance build-ups.

Available in nine sizes, .037" to 0.245" OD and varying contact pressures from .02 to .3 oz./0.001 in. Special designs can be made to your specifications or standard items can be modified.



FREE SAMPLE and DESIGN CATALOG write:  
Servometer Corporation  
501 Little Falls Road  
Cedar Grove, New Jersey 07009  
(201) 785-4630



Actual Size

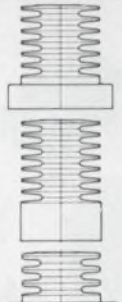

MINIATURE METAL BELLOWS

# SERVOMETER

CIRCLE NUMBER 152

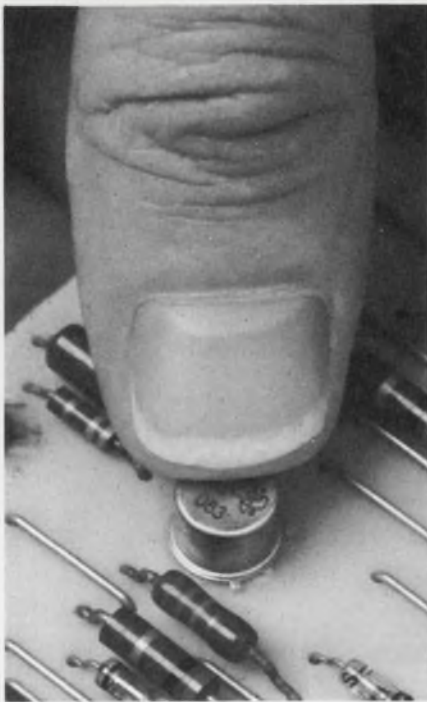

## When your TO-5s flunk the thumb test...

Coolly select one of our 7 efficient low cost TO-5 heat dissipators. For complete specs, thermal dissipating curves, and other helpful information, send for bulletins.



INTERNATIONAL ELECTRONICS RESEARCH CORPORATION  
A SUBSIDIARY OF DYNAMICS CORPORATION OF AMERICA  
135 W. MAGNOLIA BLVD., BURBANK, CA 91502, (213) 849-2481

CIRCLE NUMBER 153

## Electronic Design

ELECTRONIC DESIGN's function is:

- To aid progress in the electronics manufacturing industry by promoting good design.
- To give the electronic design engineer concepts and ideas that make his job easier and more productive.
- To provide a central source of timely electronics information.
- To promote communication among members of the electronics engineering community.

**Want a subscription?** ELECTRONIC DESIGN is circulated free of charge to those individuals in the United States and Western Europe who function in design and development engineering in companies that incorporate electronics in their end product and government or military agencies involved in electronics activities. For a free subscription, use the application form bound in the magazine or write for an application form.

If you do not qualify, paid subscription rates are as follows: \$30.00 per year (26 issues) U.S./Canada/Mexico, \$40.00 per year (26 issues) all other countries. Single copies are \$2.50 U.S. and all other countries. The Gold Book (27th issue) may be purchased for \$30.00 U.S./Canada/Mexico, and \$40.00 all other countries.

If you change your address, send us an old mailing label and your new address; there is generally a postcard for this in the magazine. You will have to requalify to continue receiving ELECTRONIC DESIGN free.

**The accuracy policy** of ELECTRONIC DESIGN is:

- To make diligent efforts to ensure the accuracy of editorial matter.
- To publish prompt corrections whenever inaccuracies are brought to our attention. Corrections appear in "Across the Desk."
- To encourage our readers as responsible members of our business community to report to us misleading or fraudulent advertising.
- To refuse any advertisement deemed to be misleading or fraudulent.

Individual article reprints and microfilm copies of complete annual volumes are available. Reprints cost \$6.00 each, prepaid (\$.50 for each additional copy of the same article), no matter how long the article. Microfilmed volumes cost \$23 for 1976 (Vol. 24); \$30 for 1973-75 (Vols. 21-23), varied prices for 1952-72 (Vols. 1-20). Prices may change. For further details and to place orders, contact Customer Services Dept. University Microfilms, 300 N. Zeeb Rd., Ann Arbor, MI 48106. (313) 761-4700.

**Want to contact us?** If you have any comments or wish to submit a manuscript or article outline, address your correspondence to:

Editor  
ELECTRONIC DESIGN  
50 Essex St.  
Rochelle Park, NJ 07662

## Electronic Design

### Advertising Sales Staff

Susan G. Apolant  
Sales Coordinator

### Rochelle Park, NJ 07662

Robert W. Gascoigne  
Thomas P. Barth  
Stan Tessler  
Constance McKinley  
50 Essex St.  
(201) 843-0550  
TWX: 710-990-5071  
(HAYDENPUB ROPK)

### Philadelphia

Thomas P. Barth  
(201) 843-0550

### Boston 02178

Gene Pritchard  
P.O. Box 379  
Belmont, MA 02178  
(617) 489-2340

### Chicago 60611

Thomas P. Kavooras  
Berry Conner, Jr.  
200 East Ontario  
(312) 337-0588

### Cleveland

Thomas P. Kavooras  
(312) 337-0588

### Los Angeles 90045

Stanley I. Ehrenclou  
Burt Underwood  
8939 Sepulveda Blvd.  
(213) 641-6544

### Texas

Burt Underwood  
(213) 641-6544

### San Francisco

Robert A. Lukas  
465 S. Mathilda, Suite 302  
Sunnyvale, CA 94086  
(408) 736-6667

### England

Constance McKinley  
50 Essex St.  
Rochelle Park, N.J. 07662  
Phone: (201) 843-0550

### Europe

Sanders, W. J. M.  
Raadhuisstraat 24  
Graft-De Ryp, Holland  
Phone: 02997-1303  
Telegrams: Euradteam-Amsterdam  
Telex: 13039-SIPAS

### G. Nebut

Promotion Presse Internationale  
7 ter Cour des Petites Ecuries  
75010 Paris, France  
Telephone: 5231917, 1918, 1919

### Dieter Wollenberg

Erikastrasse 8  
D-8011 Baldham/Muenchen  
Germany  
Telephone: 0 8106/4541

### Tokyo

Haruki Hirayama  
EMS, Inc.  
5th Floor, Lila Bldg.,  
4-9-8 Roppongi  
Minato-ku, Tokyo, Japan  
Phone: 402-4556  
Cable: EMSINCPERIOD, Tokyo



# Imagine what you could do with an RF link so small and yet so versatile.

**Imagine  
the size...** Repco's transmitters and receivers measure only 3.32" square, so no matter how tight the packaging requirement, we've got your link!

**Imagine  
the low cost...** In almost any telemetry application you may consider Repco beats the cost of hard wire hands down. In fact, Repco's low cost RF links could probably be saving money on a job you're designing right now. Why not find out?

**Imagine  
the versatility...**

How could any link so small and so low cost offer so many performance features—Frequencies of 25-50 Mhz, 72-76 Mhz, 132-174 Mhz, 450-470 Mhz • voice, low-speed digital or tone operation • 0.4 to 25 watt Tx output • unique modular circuit design for easy maintenance and design flexibility.

Versatility of applications? We wrote the book on it. And we'll send you a copy free of charge. Write today for Repco's brand new RF links applications book, and we'll also include our latest performance specifications and price list.

 **Repro** Inc.

A subsidiary of Scope, Inc.  
P.O. Box 7065  
Orlando, FL 32854  
(305) 843-8484  
TWX 810-850-0120  
Telex 56-6536

CIRCLE NUMBER 155



# quick ads

New and current products  
for the electronic designer  
presented by their manufacturers.

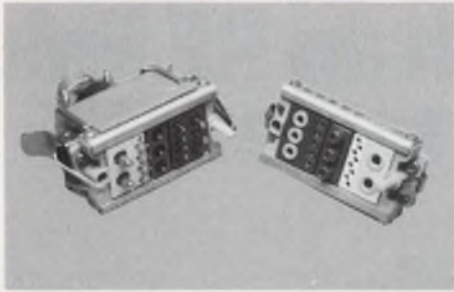

**SOURIAU, INC.** offers a new series designed to enable connectors with a very wide range of custom layouts to be quickly delivered without tooling charge. Modular inserts available with signal, power, coax and high voltage contacts in solder, crimp, PC and wire wrap terminations. Cable to panel and rack to panel types can be made. Request catalog on Series 8140 from SOURIAU, INC., 7740 Lemona Ave., Van Nuys, CA 91405 (213) 787-5341.

MODULAR CONNECTOR SYSTEM 181



**LINE VOLTAGE PROBLEMS? BROWNOUT PROTECTION?** Select from the broad field-proven line of Variac® Automatic Voltage Regulators. Up to  $\pm 20\%$  correction. Regulation accuracy 0.2%. Output current from 8.7A to 85A. Input 50, 60, or 400 Hz (120 or 240V). Single and three phase. Portable, bench, wall and rack models. Militarized versions. GenRad, 300 Baker Ave., Concord, MA 01742 (617) 369-4400.

VARIAC® REGULATORS 184



**ABSOLUTE ENCODER**— $\pm 1$  Part in 3600 System Accuracy, Electro-Magnetic Transducer + LED Display + BCD, Binary, and DC Output—Infinitely Adjustable Scale Factor (0 to 9999)—Hi Noise Immunity—Zero Offset—Single and Multi-Channel Units From \$375/Axis (1 pc.) Other CCC products are Synchro to Digital, Synchro to Linear DC, Digital or DC to Synchro Converters, and Solid State C.T.'s or CDX's. Send for Free Catalog & Application Notes. Computer Conversions Corp., East Northport, N.Y. 11731 (516) 261-3300.

ENCODER 187



**GYRO STABILIZED, 3-AXIS ACCELEROMETER** for precise acceleration measurements free from the disturbing element of earth's gravity vector. Model SA09 has accelerometers on inner gimbal of a vertical gyro which is maintained with a verticality within  $\pm 0.2^\circ$  of local gravity. Wirewound potentiometers provide continuous pitch and roll outputs. Angular freedom of  $\pm 85^\circ$  pitch and  $360^\circ$  continuous roll. 3.13" x 10.0" long, 3.5 pounds. AC/DC. Humphrey, Inc., 9212 Balboa Ave., San Diego, CA 92123. (714) 565-6631

3-AXIS ACCELEROMETER 182

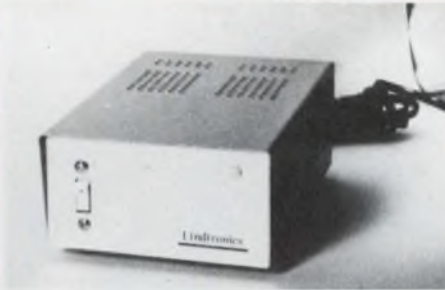

**TRIPLE OUTPUT REGULATED DC SUPPLY**—compact DC supply ideal for micro-processor and memories, Model 477-3 supplies 5V @ 500 ma, +12V @ 100 ma and -5V @ 200 ma regulated outputs, input 110V 60Hz, the unit is enclosed in a compact steel case and complete with AC line cord with fuse. Unit price \$24.00. Lindtronics, P.O. Box 1792, North Brunswick, N.J. 08902.

REGULATED DC POWER SUPPLY 185



Free Catalog contains complete line of Power Supplies from Computer Products, Inc. Miniature encapsulated models from 3.6 to 28V, 25mA to 2A. DC/DC Converters, 5 to 12 Watt models, single and dual outputs. High-efficiency supplies, single and dual output, models to 100 Watts. Attractive OEM discounts. Computer Products, Inc. 1400 N. W. 70th Street, Fort Lauderdale, FL. 33309 305/974-5500

POWER SUPPLY CATALOG 188



**NEW DESKTOP TAPE READER**—all you do is plug this Smart Box in. Up to 300 cps—RS232C, Current loop, parallel I/O—and quality built. State-of-the-art fiber optics, photo transistor read head, dual-sprocket drive. Outstanding for flexibility and simplicity. Low cost. Decitek, 250 Chandler Street, Worcester, MA 01602 (617) 798-8731.

NEW DESKTOP TAPE READER 183

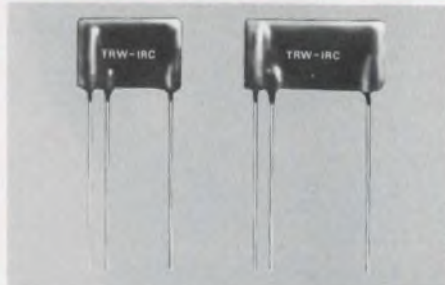

Thick-Film High Voltage Dividers are the latest line of high-voltage resistors from TRW. Each device consists of a high-voltage thick-film resistor circuit deposited on a high alumina ceramic substrate. The circuit can be encapsulated in a high-temperature epoxy coating with printed circuit leads or it can be made as a substrate for customer assembly into an integral high-voltage function. Available in various sizes and configurations. TRW/IRC Resistors, 401 N. Broad St., Phila, Pa. 19108. (215) 922-8900.

HIGH VOLTAGE RESISTORS 186



**ALPHANUMERIC KEYBOARD**, based on screened mylar switch technology, represents lowest cost alphanumeric style keyboard on market today. Standard keyboard consists of 59 keys plus space bar. Encoding and termination, as well as key-top colors and legends, can be produced to customer specification. Technical Bulletin No. 984 provides details. CHOMER ICS, INC., 77 Dragon Court, Woburn MA 01801. (617) 935-4850.

KEYBOARDS 184





**PROGRAMMABLE MOS/CCD DRIVER** plug-in for Tektronix TM-500 series mainframes. Primarily a level shifter, the PI-451 converts a TTL input signal into a  $\pm 25V$  output signal for driving MOS-type devices. Independ. output Hi/Lo levels man. adjustable or voltage prog. Digital programming option also available. Output transition times variable from  $< 2.5ns/V$  to  $> 2.5\mu s/V$ . Max rep-rate  $> 10MHz$  for 10V output and 40pf load. \$324. PLUSE INSTRUMENTS CO., 1536 W. 25th St., San Pedro, Ca. 90732. (213) 541-3204

PROGRAM MOS/CCD DRIVER 190



**Pocket-Size Slide-Switch Resistance Substitution Unit**  
 • Over 11 million ohm values  
 • Only \$58

This aluminum-housed unit is unique in its small size. Half-watt, 1% accuracy resistors provide a range from 1 to 11,111,110 ohms, in one-ohm steps. Designed with three binding posts—one to ground case. Phipps & Bird, P.O. Box 27324, Richmond, Va. 23261 (804) 264-2858

RESISTANCE SUBSTITUTION UNIT 193

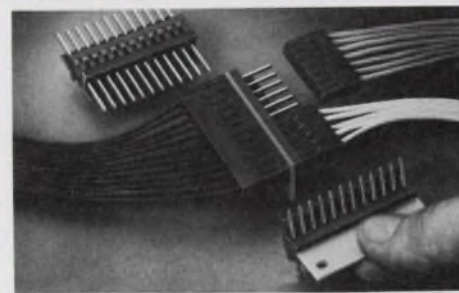

**NEW "DOUBLE-HEADER" MINIATURE CONNECTOR ANSWER TO MYRIAD OF CONNECTION PROBLEMS.** Have dual set of pins that interface with DIFFERENT SIZE crimp contact receptacles. In-line or right angle configurations with screw, rivet or snap-in PC board bulkhead mounts available. Permits identification of each pin with permanent legend on connector. Great for flying interconnects. METHODE ELECTRONICS, INC. 1700 Hicks Road, Dept. PR., Rolling Meadows, Illinois 60008. (312) 392-3500.

DOUBLE-HEADER CONNECTORS 196

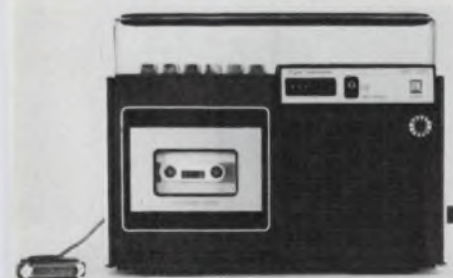

**PROGRAM LOADER . . .** uses computer's existing RS232 terminal port.

. . . A complete storage system . . . up to 109 8-bit characters/sec . . . any line speed 110 to 9600.

. . . Everything including RS232 plug and 48 inch cable in one ultra-compact rugged 5.5 lb. package . . . over 1.5 megabits/cassette.

. . . \$975.00 (USA-only) from DIGITAL LABORATORIES, 600 Pleasant St., Watertown, MA 02172 (617) 924-1680

PROGRAM RECORDER/LOADER 191



**SWITCHING AND LINEAR POWER SUPPLY, POWER CONVERTER DESIGN**, by Abraham I. Pressman. A "how-to-design" book written from a power supply designer's point of view. Provides all the circuits, systems, magnetics, and thermal design skills you need to design a modern power supply system. #5847-0, 384 pp., \$19.95. Circle the Info Retrieval Number to order your 15-day exam copy. When billed, remit or return the book with no obligation. Hayden Book Co., 50 Essex St., Rochelle Park, N.J. 07662. Offer good in USA and Canada only.

194



**Free 1978 Catalog of Recorder Products.** Complete description of all Memodyne incremental and continuous digital cassette recorders, data loggers, transports, universal readers and high speed recording system with illustrations, block diagrams, mechanical dimensions and timing sequences are contained in this new catalog. Accessories, supplies, cassettes and a price list are also included. Write for your free copy! Memodyne Corporation, 385 Elliot Street, Newton Upper Falls, MA 02164 (617) 527-6600

FREE RECORDER CATALOG 197



**TYPICAL AD-MU CRT SHIELDS.** Ad-MU shields designed and fabricated to protect our CRTs from detrimental magnetic fields. As required, single or multi-layers; low, medium or high permeability alloys. They provide structural tube support, easy access to yoke assembly, extra strength in areas subject to shock, vibration, etc. as needed. Your shielding problems end at Ad-Vance's Engineering Dept. Call us. D-VANCE MAGNETICS, INC., 226 E. Seventh St., Rochester, Indiana 46975. (317) 223-3158.

MAGNETIC SHIELDING 192

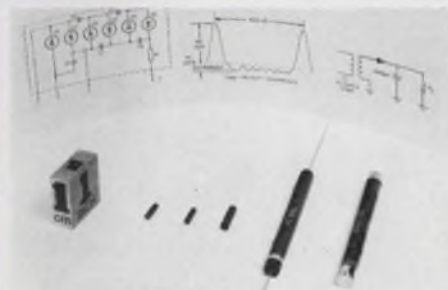

**HIGH VOLTAGE SILICON DIODES FOR CRT'S AND MULTIPLIERS.** Here's the complete, quality line from the world's leader in television diodes. 12,000, 15,000, 22,000 and 30,000 PRV's for 85°C or 100°C ambient temperatures. Long lead versions—22,000, 30,000, and 35,000 KV for B & W and small screen color. Free Samples. ELECTRONIC DEVICES INC., 21 Gray Oaks Ave., Yonkers, N.Y. 10710 (914) 965-4400. TWX 710 560-0021.

CRT RECTIFIERS 195

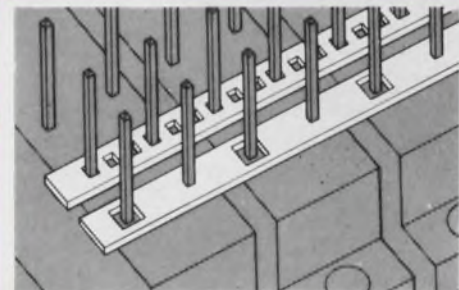

**STRIP/BUS BY ROGERS.** Low Cost Bussing Systems; easy installation, reliable solder joints; greater pin exposure. Write or call for details. Rogers Corporation, Chandler, AZ 85224. Phone (602) 963-4584. (EUROPE: Mektron NV, Ghent, Belgium; JAPAN: Nippon Mektron, Tokyo)

STRIP/BUS 198

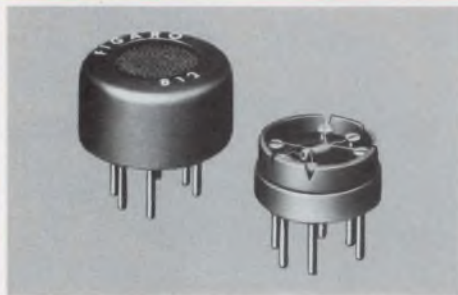

**FIGARO GAS SENSOR TGS** is a gas sensitive semiconductor. When combustible gas is absorbed on the sensor surface, a marked decrease of electrical resistance occurs. Major features of the sensor include high sensitivity, long term reliability and low cost. The applications are: GAS-LEAK ALARM, AUTOMATIC FAN CONTROL, FIRE ALARM, ALCOHOL DETECTOR, etc. Figaro Engineering Inc., North America Office-3303 Harbor Boulevard, Suite D-8, Costa Mesa, Calif. 92626 Tel: (714) 751-4103 Telex: 678396

GAS SENSOR

199



Free New catalog contains over 34,500 quality power supplies from the world's largest manufacturer, Power/Mate Corp. Power Supplies for every application including submodulars, open frame, variorated, encapsulated, laboratory & system. All units UL approved and meet most military and commercial specs for industrial and computer uses. Power/Mate Corp., 514 S. River St., Hackensack, NJ 07601 (201) 343-6294

POWER SUPPLIES

202



**Portable Crystal Clock, Austron Model 12100-01**, is compact, self-contained, self-powered time reference providing stable time outputs at several pulse frequencies. Features digital time of day display and a meter for monitoring oscillator, oven and battery circuits. Standard output pulse is 1 Hz. Any combination of four output pulse rates (.01, 0.1, 1, 2, 10, 10<sup>2</sup>, 10<sup>3</sup>, 10<sup>4</sup>, or 10<sup>5</sup>) can be selected. For complete catalog contact Austron, Inc., 1915 Kramer Ln., Austin, Texas 78758, (512) 836-3523.

TIME AND FREQUENCY CATALOG

205



**LOW COST 2-POLE 10 AMP MINI RELAY.** Series 39. No other like it at the price. Occupies only 2.42" cube. Terminals for PC board, .110 Quick Connect or solder mount. 125V ac 60 Hz or 28V dc. 470 mw sensitivity. 10 amp contacts. 1/4" spacing between surfaces. DPNO (U/L), DPNC or DPDT contacts — TV-5 rating available. Ideal for freezers, vending machines, refrigerators, TV's, ovens. North American Philips Controls Corp., Frederick, MD. 21701. (301) 633-5141.

2 POLE GP RELAY

200

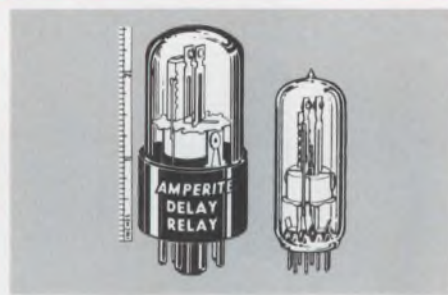

**AMPERITE THERMOSTATIC DELAY RELAYS.** For delays of 2 to 180 seconds. Low cost, long life. Hermetically sealed in glass. Not affected by altitude, moisture or climate changes. Compensated for ambient temperature changes of from -55° to +80°C. Rugged, explosion-proof, long-lived. Standard radio octal and 9-pin miniatures. Prices: Under \$4.00 ea. Send for Bulletin TR-81 . . . also CURRENT REGULATORS under \$3.00 ea. AMPERITE, 600 Palisade Ave., Union City, N.J. 07087. 201-864-9503

203



**400 IDEAS FOR DESIGN, Volume 3**, ed. by Morris Grossman. Brainstorm with the experts! Volume 3 of 400 IDEAS FOR DESIGN contains the best selections from *Electronic Design* that were published between 1971 and 1974. You'll find a wide range of ideas from very complicated to simple, but unique, approaches. #5111-5, 348 pp., \$13.95. Circle the Info Retrieval Number to order your 15-day exam copy. When billed, remit or return book with no obligation. Hayden Book Co., 50 Essex St., Rochelle Park, N.J. 07662.

IDEAS FOR DESIGN

206



**SEIKO MECHANICAL FILTERS FOR CARRIER TELEPHONE SYSTEM.** Center frequencies: 2600Hz and 3825Hz, 3dB Bandwidth; 50Hz, 25dB Bandwidth; 250Hz, Insertion Loss; 5dB Impedance; 30Ω, Size; 1.642(L) x 0.421(W) x 0.555(H) inches. Hermetically sealed, sharp selectivity, good temperature characteristics. Also available from 280Hz to 100kHz. SEIKO INSTRUMENTS, INC., 2990 West Lomita Blvd., Torrance, Ca 90505 (213) 530-3400 Telex: 25-910-347-7307 SEIKOINST TRNC

MECHANICAL FILTERS

201

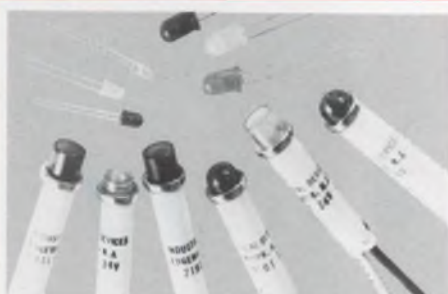

Get free samples of new Super-Brite LED indicator lights from Industrial Devices, Inc., Edgewater, N.J. 07030. Red, green, yellow, 100,000-hr. life. Low ac or dc power-drain, high reliability, shock-resistant. Fit 5/16" holes. Hemispheric or flat-top. Ideal for solid-state and battery. Off-the-shelf for 6, 12, 24 volts.

SAMPLE LED LIGHTS

204

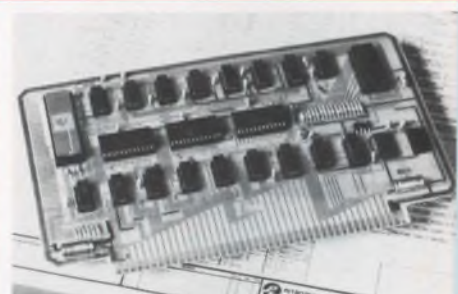

**HARDWARE MATHBOARD—RAM SAVER!** performs logarithmic & trigonometric functions, e<sup>x</sup>, y<sup>x</sup>, multiply, add, divide subtract, etc., etc., 8 digit mantissa, 2 digit exponent, very fast (comparable with in-system software) Compatible with M 6800 Microprocessor KITS AVAILABLE AT \$72.80, \$252. \$555. A - Board, software full instructions B - 'A' and all components, unassembled C - Assembled, inst manual, sftwr. pkg. WOODTRON LTD., PO BOX 4067, STATION "C", CALGARY, ALBERTA, CANADA.

HARDWARE MATHBOARD

20

# SPECIAL

# 2

## RECRUITMENT ADS

FOR THE  
PRICE OF

# 1

### TRANSFORMER ENGINEER

Audio and power design, 4 years minimum experience. Full benefits & pension and profit sharing. Salary open. Reply to:

#### MICROTRAN

P.O. BOX 236  
VALLEY STREAM, NY 11582  
516-561-6050

### ENGINEERS SYSTEMS ANALYSTS/ PROGRAMMERS

Nationwide Professional Fee Paid Positions Salary Range to 35K Call Collect or send resume to K. Schargus or S. Nemser for immediate attention.

Software/Hardware	Analog/Digital
Weapon Systems	Microprocessors
Sonar/Radar	Instrumentation
Electro optics	Test Engineering
Electronic Design	Mechanical Design

#### AMERICAN PERSONNEL SERVICE

240 State Street  
New London, Conn. 06320  
203-442-0395

# recruitment and classified

SPACE	DIMENSIONS		COST	SPACE	DIMENSIONS		COST
	Wide	Deep			Wide	Deep	
One column inch	1-3/4"	x 1"	\$55.	1/4 page (1 col.)	1-3/4" x 10"	Vert.	\$550.
2 col. in.	1-3/4"	x 2"	\$110.		3-1/2" x 5"	Hor.	
1/16 page (1/4 col.)	1-3/4"	x 2-1/2"	\$130.	1/2 page (2 cols.)	3-1/2" x 10"	Vert.	\$1100.
1/8 page (1/2 col.)	1-3/4"	x 5"	\$275.		7" x 5"	Hor.	
				3/4 page (3 cols.)	5-1/4" x 10"		\$1650.
				1 page	7" x 10"		\$2200.

## NUMERICAL CONTROL ENGINEER You're Going To Love Houston! It's Warm, It's Beautiful, It's Growing

In Houston, Texas, NL Atlas Bradford, a growth-oriented division of NL Industries, has an outstanding opportunity for the individual with 3 to 5 years experience as a N/C Engineer. 2 years experience on G.E. 550 TX controls and the ability to trouble-shoot N/C problems to the component level as well as diagnose systems problems are also required. Electronics degree is beneficial.

This position provides an excellent income commensurate with your experience, a generous benefits program that includes a full insurance program, pension plan, educational assistance, and complete relocation assistance, plus outstanding opportunities for both professional and personal growth. In addition, you'll find the lifestyle in Houston to your liking with excellent housing, schools, shopping and many outstanding cultural activities.

Interested candidates possessing the above qualifications should forward their resume and salary history to:

Industrial Relations Department

# NL Atlas Bradford

P.O. Box 15197  
Houston, Texas 77020

All replies held in confidence.

We Are An Equal Opportunity Employer M/F

## U.S. and Overseas Employment with U.S. Foreign Service

The Department of State is recruiting experienced engineers for careers in the field of technical security. Applicants must be willing to accept world-wide assignments. Starting salary range is \$17,231 to \$22,381 plus housing and other appropriate allowances while overseas.

B.S. or M.S. in electrical/electronic engineering, and 3 to 5 years professional experience are required. American citizenship, excellent health and ability to qualify for a high level security clearance are also necessary. Send completed federal employment form SF-171 and resume to:

OFFICER, EMPLOYMENT BRANCH  
EMPLOYMENT DIVISION  
DEPARTMENT OF STATE  
WASHINGTON, D.C. 20520

An Equal Opportunity Employer

## JR. & SR. ELECTRONIC ENGINEERS

If you are a BS, MS or PhD in EE or computer science with 0-7 years experience, we would like to talk to you. You are in desperate demand by electronic firms throughout the country. MAKE YOUR MOVE WHILE YOU ARE STILL YOUNG AND MOBILE.

Predictions indicate 1978 to be the most dynamic year in a decade for engineering employment. NOW IS THE TIME TO LAY THE GROUNDWORK FOR YOUR FUTURE. Don't regard your present position as a temporary holding pattern or a place to wait for a lucky break. Present positions are the action base for future moves.

RCI is a technical search firm with an outstanding reputation representing a broad base of nationwide clients serving the Electronics industry. If you are interested in advancing your career, call us or send your resume or a brief hand written description of your background including present salary and geographic preferences in confidence to:

Search Director-Room D  
**Regional Consultants Inc.**  
213 West 9th Street  
Cincinnati, OH 45202  
513/579-1513

*Representing EEO Clients Only*

## SYSTEMS PROGRAMMERS

- Assembler Language
- New Systems development
- Business applications
- Requires 1-4 years' experience with major operating systems
- Competitive salaries, benefits
- Maryland countryside location

Principals only, please. All inquiries confidential.

Mr. W.T. Myers  
Director of Personnel Management  
Executive Plaza IV  
Hunt Valley, Maryland 21031  
301/667-9211

An Equal Opportunity Employer M/F

**insight**  
DISPLAY DATA CORPORATION

## DYNALECTRON CORPORATION

Dynalectron is seeking candidates for immediate and anticipated openings in the Albuquerque area:

### Electrical Engineer

Must have a MSEE, with a minimum of six years in digital logic design, D/A and A/D, micro-processor systems, minicomputer/display system integration for work on R & D infrared, electro-optics laser instrumentation system, Fortran IV, basic and machine language programming for problem synthesis, diagnostic routine and data processing. Responsibilities to include design, analysis, brass board, packaging, parts and subassembly, specific testing procedures and documentation.

### Electrical Engineer

MSEE with a minimum of six years in analog/servo systems design, continuous and discrete time control systems, positive and negative feedback loop techniques, regulator circuits, power supply, low noise amplifier design, RF techniques, generalized video systems and associated experience in digital interface and data processing techniques. Responsibilities to include design, time domain analysis, brass board, packaging, parts and instruments specifications, testing procedures and documentation.

### Electrical Engineer

BSEE with five years experience in fire control systems for modern aircraft weapon systems

### Mechanical Engineer

BSME with three years experience in an applied research laboratory. Work experience should include gas dynamics, vacuum technology, optics, control instrumentation and high pressure gas systems.

### Systems Safety Engineer

BS in Science or Engineering with eight years experience in Systems Safety Engineering in R & D and testing activities. Experience should include PHA, OHA and FTA.

### Mechanical Technicians

Associate degree is desirable. Minimum of two years experience in high pressure gas handling and/or cryogenic systems as well as pipe or tubing layout ability. Welding, machinist and electrical background is desired.

### Quality Assurance Inspectors

Associate degree desired with a minimum of five years experience in aerospace/aircraft quality control in areas of electro-mechanical systems, cryogenic systems and high pressure tubing. Must be familiar with MIL-I-45208A, MIL-Q-9858A, ASPRVII and ASPRXIV.

Qualified candidates are requested to submit a resume of work history, experience and salary requirements to:

## Dynalectron Corporation



Personnel Department  
P.O. Box 18068  
KAFB Branch  
Albuquerque, NM 87115

U.S. Citizenship Required  
We are an Equal Opportunity Employer M/F

## Recruitment Ads Pull

Constance McKinley  
RECRUITMENT ADVERTISING MANAGER  
ELECTRONIC DESIGN  
50 Essex Street, Rochelle Park, New Jersey 07662

# Come join me at Hughes and be part of the new world of electronics.

It's a good feeling to be in the vanguard of technology with employment stability through dynamic growth and diversification!

For Immediate Openings In:

#### **Circuit Design Engineers**

Experienced in RF, IF, Video, and A/D circuit design for use in Signal Processing in both airborne and space applications.

#### **Digital Logic Design Engineers**

Experienced in design and development of digital circuits using TTL, STTL, ECL and CMOS technologies.

#### **Software Development Engineers**

Experienced in the development of software for special purpose digital processors. Digital hardware background experience desired.

#### **Product Design Engineers**

Experienced in extremely high density physical and thermal designs for airborne and spaceborne signal processing.

#### **Project Engineers**

Experienced in the management of all aspects of a project including management of subcontracts and remote manufacturing facilities.

#### **Digital Module Test Engineer**

Experienced in developing software for automatically testing digital modules.

#### **Digital Associate Engineer (Non MTS)**

Having good rapport with digital logic design, logic schematics and the conversion of these to a computerized interconnect data base.

**Actual Hughes Scientific and Engineering Manpower Growth Curve**

This chart indicates the Company's extraordinary record of growth with stability in the dynamic electronic technology industry

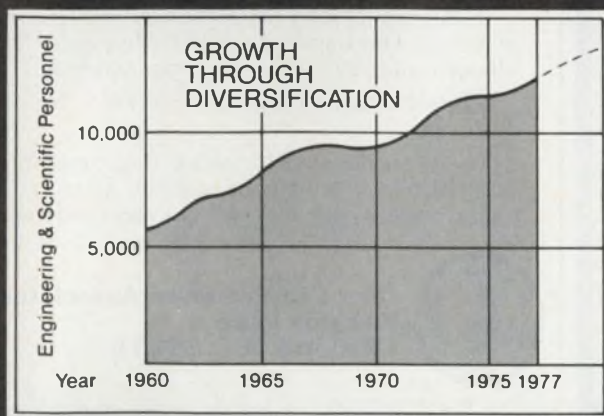

Call now—call collect: Richard Fachtmann, Assistant Manager, Signal Processing Laboratory, (213) 391-0711, Ext. 3904. Or send resume (referencing this ad) to: Professional Employment C, Aerospace Groups, 11940 W. Jefferson Blvd., Culver City, Ca 90230.

## HUGHES

HUGHES AIRCRAFT COMPANY  
AEROSPACE GROUPS

U S citizenship required. Equal opportunity M/F/HC employer

# ELECTRICAL ENGINEERS

## ANALOG

Engineers to design test stands and associated electrical/electronic controls and data acquisition systems. Experience in solid state closed loop analog control systems.

## DIGITAL

Engineers to design the hardware and software of digital computer based equipment used in the testing of high speed rotating machinery and mechanical actuating equipment. Experience in Assembly and Fortran programming of mini-computers is required.

## ANALOG/DIGITAL

Engineers to design control circuits for turbine systems and other high speed machinery. Must have experience in both analog and digital control circuit design.

Sundstrand Corporation's Advanced Technology Group designs, manufactures and markets a variety of aircraft accessory products. Sundstrand offers an excellent benefits package including an extensive medical and dental plan.

We are located in Rockford, Illinois, providing for easy access to Chicago and to the recreational areas of southern Wisconsin.

Send resumes to:

### SUNDSTRAND CORPORATION

Peter L. Arthurs  
4751 Harrison Avenue  
Rockford, IL 61101

An Equal Opportunity Employer. M/F

## SOLID CAREER OPENINGS WITH HEATH Share Our Strong, Continued Growth and Expansion

You know us for our quality Heathkits—and for our reputation for "doing things right." Our progress story goes far back, and prospects are very favorable for the years ahead.

### SOFTWARE DOCUMENTATION WRITER

An effective, proven technical writer needed to write Heathkit computer systems operations manuals and applications procedures. A B.Sc CS or equivalent is required. Candidates must be familiar with LSI-11/PDP-11, software and applications programming, higher level languages, and operating systems, principles and techniques.

### SOFTWARE DEVELOPMENT

#### Broad Assignments

Several positions open requiring demonstrated ability to write operating systems, utilities, interpreters, compiler software; 8080 or PDP-11 systems background helpful. Opportunity to do applications for new personal computers, a rapidly growing product. Calls for BS or advanced degree in CS, or equivalent.

### WRITERS, TRAINING

#### Create Learning Programs

Inviting chance to use your writing, training, or teaching skills and background in electronics. Unusual room to develop courses and individual learning materials. Technical writing or training experience required.

Salaries are competitive, with excellent benefits additional. Our ideal location is a pleasant, small community on Lake Michigan, 90 minutes from Chicago.

Please send resume in confidence, or phone collect to Ken Smith, (616) 982-3673.

HEATH

Schlumberger

### HEATH COMPANY

Benton Harbor, Michigan 49022

An Equal Opportunity Employer M/F



## How Much Are You Worth?

INCOME  $\approx$  OUTGO

In most parts of the country the climate has not been good this winter but the climate has never been better for Engineers, Technical, Scientific and Manufacturing people desiring a change. Do you want more money, better location or better growth potential?

If you are looking for a change, look to IPA to assist you. One hundred and thirty-five agencies with offices from coast to coast are at your disposal.

All positions are Employer Fee Paid. No cost to you ever!

If you are looking for more than your present position offers, send your resume, salary requirements, position objectives and relocation preference to:



**Inter-City Personnel Associates, Inc.**  
P.O. Box 1296  
Charlotte, N.C. 28231

"The buck doesn't stop here; it starts here"

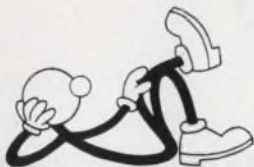

## EFFORTLESS . . .

If you're ready to move on with your career, it can be a lot easier than you expect.

We are the members of



who work extensively with electronics industry leaders. The companies we service have many openings and pay for us to search you out.

Send your resume to the office nearest you. Then sit back and relax while we do the work.

### BURTON PERSONNEL SERVICE

300 Walker Building  
120 Boylston Street  
Boston, Massachusetts 02116  
(617) 482-1950

### ANDERSON-TAYLOR

P.O. Box 21  
Exton, Pennsylvania 19341  
(215) 363-1600

### PETER A. KECHIK & ASSOCIATES, INC.

1420 Renaissance Drive  
Park Ridge, Illinois 60068  
(312) 298-1148

### STAFF DYNAMICS, U.E.

26 Sixth Street  
Stamford, Connecticut 06905  
(203) 324-6191

### CAREER SPECIALISTS, INC.

4600 El Camino Real, Suite 206  
Los Altos, California 94022  
(415) 941-3200

### BRENTWOOD PERSONNEL ASSOCIATES

Electronics Division  
1280 Route 46  
Parsippany, New Jersey 07054  
(201) 335-8700

190 associates internationally

Engineering

# NORTHROP DESIGN ENGINEERING

*great purposes...*  
*greater achievements*

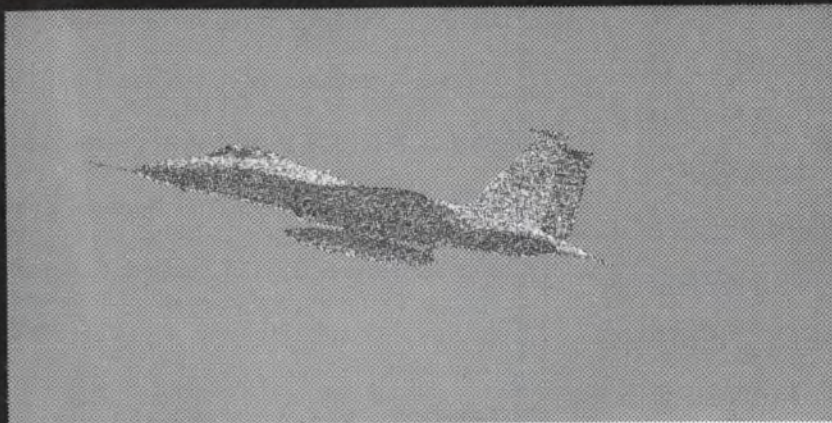

Establishing goals that challenge your ability. . . creates a sound beginning. Advancing beyond those objectives. . . instills pride.

At Northrop Defense Systems Division, a leader in advanced Electronic Countermeasure technology, we provide the guidance and professional freedom necessary for creative problem-solving and maintaining our leadership in the state-of-the-art.

If you are a Design Engineer with the following qualifications and possess a strong drive toward self-fulfillment, we invite you to consider an exciting career at Northrop.

- \*BSEE, familiar with design for AGE test equipment.
- \*Minimum of 5 years experience in Digital Design, using TTL-DTL, MOS and micro-processor in designing and testing computers.
- \*Design of Tuning Unit Analog and digital circuits. Familiarity with RF component interface circuits.
- \*Minimum 5 years experience in analog and/or digital design. Familiarity with microwave components preferred.
- \*PROJECT ENGINEER with analog/digital circuits and microwave components experience.

In addition to the opportunity to join one of the finest engineering teams in the nation, we offer an excellent salary/benefits program. Qualified individuals are invited to send brief letter or resume in confidence, to:

Director—Design Engineering  
Department EM  
**NORTHROP CORPORATION**  
Defense Systems Division  
600 Hicks Road, Rolling Meadows, Illinois 60008  
An equal opportunity employer m/f

# NORTHROP

### YOU REACH ENGINEERS WITH TITLES LIKE THESE:

- Chief Engineer • Development Engineer • Design Engineer • Project Engineer • Electronic Engineer • Engineer-Supervisor • Section Leader • Staff Engineer • Systems Engineer • Test Engineer • Standards Engineer • Master Engineer

## Electronic Design

BRINGS YOU  
THE HIGHEST  
NUMBER OF  
QUALIFIED EOEM  
ENGINEERS AND  
ENGINEERING  
MANAGERS  
ANYWHERE  
... AT THE  
LOWEST COST  
ANYWHERE!

# Power Supply Designers

Explore the rewards and satisfaction of working on new and exciting communications and experimental satellite programs.

**GOES** — NASA's Weather/Environmental Satellite Program

**GMS-2** — Japan's Newest Weather Satellite Program

**SBS** — Privately Owned U.S. Commercial System

**ANIK-C** — Canada's Latest National Communications System

Join the Hughes team of Space & Communications Engineers who are designing high voltage (5 to 10 KV), space qualified high efficiency power supplies for TWTs. Operations with multiple collector TWTs (as loads) present interesting design challenges.

Experience with series and switching regulators, PWM converters and DC-DC converters and BS or MS in EE are desired.

For immediate consideration please call (collect): Mr. G. Kemanis, Asst. Mgr. Communications Labs, at (213) 648-8731 or send your resume to: Professional Employment, Dept. 41-20, P.O. Box 92919, Los Angeles, CA 90009.

## HUGHES

HUGHES AIRCRAFT COMPANY

U.S. citizenship required • Equal opportunity M/F/H/C employer

## We're Seeking Engineers Who Are Special...

At HUTCHINSON we provide a variety of unique products for some of the best known names in the industry—chemically etched and milled parts which are used in computer and medical applications. Our ultra modern facilities are located in a clean air setting just an hour from the vibrant Twin Cities of Minneapolis & St. Paul, and our company growth is reflected by the profile of our engineering staff: aggressive, energetic, innovative. We're currently seeking to build for the future.

**MECHANICAL DESIGN ENGINEER:** The individual we're seeking will hold responsibility for the development and improvement of mechanisms and light machinery. Our ideal candidate must be able to work as an independent project engineer as well as advanced management.

**INDUSTRIAL ENGINEER:** Will involve development of work standards for computerized applications. A BSIE or BSME with five years' related IE production and operating program experience in a sophisticated light manufacturing environment is required.

To apply please submit letter or comprehensive resume with salary history, or call (collect) 612-879-2371.

Verne Meyer



40 W. Highland Park  
Hutchinson, MN 55350

An Equal Opportunity Employer

Engineer

## LOGIC DESIGN ENGINEER

At CRAY RESEARCH INC., we design, build, market and support Super Scale Computers used in scientific applications. We currently have an outstanding opportunity for a Logic Design Engineer.

The candidate we are seeking will have primary responsibilities for covering the specification and design of custom interfaces to the CRAY-1 computer.

Preferred candidates have a BSEE or equivalent experience. A minimum of 2 years' logic design experience, and familiarity with IBM, DEC CDC, I/O design.

This position offers excellent growth opportunities, salary and company benefits. Send resume and salary history in complete confidence to:

Don Hable  
CRAY RESEARCH INC.  
Manufacturing Division  
Industrial Park  
Chippewa Falls, Wisc. 54729

An Equal Opportunity Employer M/F

CRAY  
RESEARCH, INC.



## SEMICONDUCTOR ENGINEERS

Everybody knows that NCR means Computers and Terminals. But, everybody doesn't know that NCR has a Microelectronics Division. Our division of NCR is responsible for designing and developing the unique custom devices used in most NCR systems. We do this because we can do it. We know what LSI is all about; we know how to achieve reliability, and we know what "yield" means.

We developed our own microcomputer chip set that contains electrically alterable ROM's, non-volatile RAM's, SDLC Communications, and direct memory access. And, it operates in a multi-processor environment.

We do all this because we have a competent technical staff, advanced equipment in a modern facility and the backing of a \$2-billion-a-year corporation.

Now we are growing—to do even more. To do this, though, we must add to our staff. We need

- **Design Engineers:** BSEE (MSEE preferred) with 2-3 years experience in digital circuit design including computer aided design.
- **Test Engineers:** BSEE (MSEE preferred) experienced with microprocessors and computer based test systems.
- **MOS Process Engineer:** BS (MS preferred) in Engineering Physics or EE, plus experience in P and N channel. A sound understanding of solid state semiconductor physics for process and device analysis is required for this manufacturing position.
- **QA Engineer:** BSEE plus experience in MOS/LSI technology, innovative and thoroughly grounded in advanced QA techniques and digital circuit design. This is not an ordinary QA responsibility; it requires development skills and experience.

Take the time to explore your career. And spread the word—NCR means complete systems ... and Microelectronics.

Reply in confidence to:

T. F. Wade, Manager  
Personnel Resources  
Microelectronics Division  
NCR Corporation  
8181 Byers Road  
Miamisburg, Ohio 45342

An Equal Opportunity Employer

### MANAGER APPLICATIONS ENGINEERING to \$25,000

Our client is a leader in the commercial electronics field and one of the most dynamic and successful among the 1000 largest industrial corporations.

They seek a marketing minded multi-project, state of the art engineer to direct an application engineering group. This is an exceptional career opportunity for a BSEE to broaden an engineering career through association with sales marketing and project management responsibilities.

Our client is an equal opportunity employer-M/F and pays all employment expenses. Reply in confidence to P. Luttinger.

**W. J. W. Willard Associates, Inc.**  
(agency)

One Lincoln Center Syracuse, New York 13202 (315) 422-5111

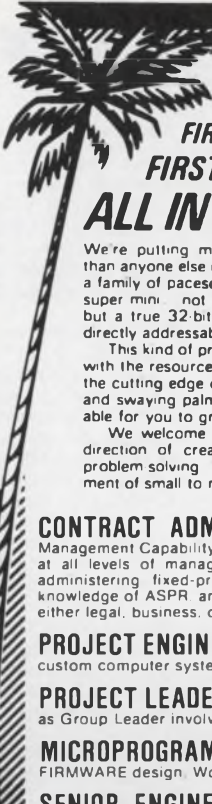

## SYSTEMS ENGINEERING: FIRST IN TRUE 32-BIT MINIS FIRST IN REAL TIME SOLUTIONS FIRST IN CAREER OPPORTUNITY ALL IN FORT LAUDERDALE

We're putting more bytes to work in a real time environment than anyone else in the industry. For almost 2 decades, we've bred a family of pacesetter systems, culminating in the first true 32 bit super mini—not a bridge-the-gap system from 16 bit architecture, but a true 32 bit machine with richer instruction sets and larger directly addressable memory.

This kind of presence means opportunity is here now along with the resources to really make a name for yourself. If being on the cutting edge of technology, surrounded by year round warmth and swaying palms sounds inviting, consider the many ways available for you to grow at Systems Engineering.

We welcome the professional who is highly motivated in the direction of creativity, fresh conceptualization, and imaginative problem solving in state-of-the-art design and software development of small to medium real time systems.

**CONTRACT ADMINISTRATOR** Senior Level. With Program Management Capability. We require experience, ability and effectiveness at all levels of management in negotiating, drafting, enforcing, and administering fixed-price government and industrial contracts and knowledge of ASPR and computer systems. Background is essential in either legal, business, or engineering areas. Some travel.

**PROJECT ENGINEERS BSEE** and experience with job costing of custom computer systems.

**PROJECT LEADER BSEE** and minimum of four years experience as Group Leader involved in job costing for custom computer systems.

**MICROPROGRAMMER** Minimum of one year design experience in FIRMWARE design. Work involves state-of-the-art advanced concepts.

**SENIOR ENGINEERS (DIGITAL)** Four years experience in LOGIC DESIGN. Microprocessor or CPU experience highly desirable. Work involves Custom Systems Group.

**SOFTWARE TECHNICAL INSTRUCTOR** Two or more years teaching computer software courses in industry or academia. Must have knowledge of ASSEMBLY and FORTRAN language.

**MTS PROGRAMMER (DISTRIBUTIVE SYSTEMS)** Must have thorough knowledge of Assembly language programming and some background in FORTRAN. Real Time and inter-CPU COMMUNICATIONS and Data Base experience preferred.

**MTS PROGRAMMER (DATA BASE DESIGN)** D/B Generation software experience for data acquisition and applications programs. Assemblers and FORTRAN required.

**MTS PROGRAMMER (CUSTOMER SERVICE)** Minimum of three years in ASSEMBLY and FORTRAN LANGUAGE. Programming background in Real-time and applications environments. Customer contact experience desired. Some travel.

**TECHNICIANS DIGITAL** I/O and CPU experience desirable. Will work closely with digital design engineers. Two years experience in troubleshooting and testing preferred.

**DESIGNER** Three to ten years experience in electro-mechanical design for a computer manufacturer.

SYSTEMS offers top starting salaries, relocation to beautiful Fort Lauderdale, a full-range benefits program including dental insurance, savings/retirement plan and 100% tuition refund, and the opportunity to work and advance your career in a stable and stimulating professional environment. For immediate and confidential consideration, please forward resume or detailed letter of information, including current annual compensation to:

MR. FRED BRILLANTE, Dept. ED

# SYSTEMS

ENGINEERING LABORATORIES

6901 West Sunnisa Blvd., Fort Lauderdale, Florida 33313

Equal Opportunity Employer Male/Female

### — GET A REPEAT AD FREE!

With our 2 for 1 plan, your net cost in *Electronic Design* is only \$27.50 per column inch, lowest among all the national newspapers and electronics media. You get a total of 165,418 exposures to OEM engineers and engineering managers (not counting 11,668 more among general or corporate managers) at only 33¢ per thousand! You can't beat the price. You can't beat the coverage and you can't beat the quality.

# Advertiser's index

Advertiser	page	Advertiser	page	Advertiser	page
A P Products Incorporated.....	199	Facit-Addo, Inc.....	126	Non-Linear Systems, Inc.....	202
AMP, Incorporated.....	152, 153	Fairchild Systems Technology, A Division of Fairchild Camera and Instrument Corporation.....	107, 16A&B	Noritake.....	183
AVX Ceramics Corporation.....	71	Ferranti Electric, Inc.....	148, 148L	Norpex.....	93
Abbott Transistor Laboratories, Inc.....	146	Fifth Dimension, Inc.....	194	North American Philips Controls Corp.....	192, 220
Acopian Corp.....	148A	Figaro Engineering, Inc.....	220	Northern Engineering Laboratories.....	186
Ad-Vance Magnetics, Inc.....	219	GTE Sylvania.....	148I	Panasonic Electronic Components.....	Cover III
Advanced Micro Devices.....	124, 125	GenRad.....	218	Perfection Mica Company.....	206
Airpax Electronics, Cambridge Division.....	181	*GEC English Electric Valve Co.....	132	*Philips ELA/MCR.....	210, 212, 214
Alco Electronic Products, Inc.....	192	*GEC M-O Valve Co.....	16	Phipps & Birds, Inc.....	219
Allen Bradley Co.....	11	General Instrument Corporation.....	29	Plastic Capacitors.....	213
*Allen Bradley, Electronics Division.....	11	General Scanning, Inc.....	190	Potter & Brumfield, Division of AMF, Incorporated.....	176, 177
Allied Chemical, Metglas Products.....	17	Gould, Inc., Instrument Systems Division.....	70	Power/Mate Corp.....	150, 220
American Microsystems, Inc.....	185	Gould, Inc. Power Supply Dept.....	54	Practical Automation Inc.....	180
Amperite Co., Inc.....	220	Hamilton/Avnet.....	60	Precision Filters.....	160
Amphenol North America Division Bunker Ramo Corporation.....	69	Hansen Manufacturing Co., Inc.....	200	Precision Monolithics Inc.....	117
Amplifier Research Corporation.....	164	Harris Semiconductor, A Division of Harris Corporation.....	155	Pulse Instruments.....	219
Analog Devices, Inc.....	61	Hayden Book Company, Inc.....	*117, 196	Pyle National.....	148J
Ann Arbor Terminals, Inc.....	202	Heath Company.....	209	RCA Solid State Division.....	Cover IV
Anzac Electronics.....	174	Hecon Corporation.....	199	Racal/Dana Instruments.....	167
Applied Dynamics.....	166	Heinemann Electric Company.....	33	Rental Electronics, Inc.....	144, 145
Arnold Magnetics Corp.....	7	Hewlett-Packard.....	15, 40, 41, 76, 77, 149, 159	Repro, Incorporated.....	217
Austron, Inc.....	220	Hoffman Engineering Company.....	205	Robinson Nugent, Incorporated.....	148D
Automation Systems.....	197	Hughes Aircraft Company, Connecting Devices.....	83	Rogers Corporation.....	158, 219
Beckman/Heliport Division.....	133	Humphrey, Inc.....	218	Roim Corporation.....	14
Bendix Corporation, The, Electrical Components Division.....	168	Industrial Devices.....	220	SMK Electronics Corporation of America.....	186
Berg Electronics, Inc.....	161	Information Terminals.....	55	Seiko Instruments Inc.....	220
Boeing Company, The.....	118	Intech Function Modules.....	135	Servometer.....	215
Bourns, Inc., Trimpot Products Division.....	Cover II	Intel Military Div.....	191	Shugart Assoc.....	89
Burndy Corporation.....	148F&G	Intel Memory Systems.....	108, 109	Simpson Electric Company.....	193
*Burr-Brown Research Corporation.....	148	Intel Micro Circuits.....	8, 9	Souriau Inc.....	218
Burroughs Corporation.....	44, 45	Interface Technology.....	123	Sprague Electric Company.....	46
Bussco Engineering.....	27	International Electronic Research Corporation.....	216	Sprague-Goodman Electronics, Inc.....	166
CTS Corporation.....	157	International Microcircuits.....	198	Stackpole Components Company.....	195
Centralab, The Electronics Division of Globe-Union, Inc.....	119	International Rectifier, Crydom Division.....	187	Syntonic Instruments, Inc.....	116
Chomerics, Inc.....	218	Ishiqueta Electronics.....	213	*Systems Industries.....	54
Computer Conversions Corp.....	218	JFD Electronics Corporation.....	122	Sweda International.....	200
Computer Products, Inc.....	218	Johanson Manufacturing Corp.....	34	T-Bar, Incorporated.....	206
Comstron Corp.....	132	Keithley Instruments, Inc.....	178, 179	TRW/IRC Resistors, an Electronic Components Division of TRW, Inc.....	218
Cortron, A Division of Illinois Tool Works, Inc.....	148H	Krohn-Hite Corporation.....	31	TRW/UTC Transformer, an Electronic Components Division of TRW, Inc.....	207
Cromemco.....	42	KSW Electronics Corp.....	184	Tecnetics, Inc.....	172
Cutler-Hammer, Specialty Products Division.....	148E	Kulka Electric Corp.....	154	Tecknit.....	154
Data Display Products.....	23	Lecroy.....	154	Tektronix, Inc.....	49
*DataFlux.....	123	Licon, Division of Illinois Tool Works, Inc.....	148K	Teledyne Mono-Thane.....	215
Data General Corporation.....	24, 25	Lindtronics.....	218	Texas Instruments, Incorporated, Components Group.....	18, 19
Data Precision Corporation.....	211	Littlefuse.....	137	Times Wire & Cable Company.....	141
Datel Systems, Inc.....	169, 171, 173	3M Company.....	12, 13	U. S. Components, Inc.....	202
Decitek, A Division of Jamesbury Corp.....	218	Magnetec, Ins.....	211, 211	U. S. Department of Commerce.....	148
Dialight, A North American Philips Company.....	50	Mallory.....	175	United Systems Corporation.....	165
Digital Equipment Corporation.....	36, 37	Melcher.....	148G	Unitrode Corporation.....	100, 101
Digital Power.....	184, 219	Memodyne Corporation.....	219	Velonix.....	198
Digitron.....	201	Mepec/Electra, Inc.....	20	Victor Electric Wire & Cable Corp.....	208
Digital Pathways.....	205	Methode Electronics, Inc.....	219	Viking Industries, Inc.....	139
Dormeyer Industries, Inc.....	16	Micro Power Systems.....	189	Vishay Resistive Systems Group.....	127
Dyus Inc.....	35	Micro Switch, A Division of Honeywell.....	162, 163	Waters Manufacturing, Inc.....	208
EECO.....	39, 156	Miller-Stephenson Chemical Co., The.....	10	Wavetek Indiana Incorporated.....	1
*EMI Technology, Inc.....	144, 145	Mini-Circuits Laboratory, A Division of Scientific Components Corp.....	2	Weston Components.....	203
EMR Telemetry, Weston Instruments, Inc.....	213	Monolithic Memories, Inc.....	148 B, C	Woodtran.....	220
E-T-A Products Co. of America.....	220	Mostek Corporation.....	4, 5	RECRUITMENT	
E-Z Hook.....	215	Motorola Components Products Dept.....	134	Atlas Bradford.....	221
Edmund Scientific Company.....	154	Motorola Data Products.....	43	Dynelectron.....	222
Electronic Design.....	*133, *137, 214	MuRata.....	205	Hughes.....	223, 226
Electronic Devices, Inc.....	219	MuRata Corporation of America.....	143	NCR.....	227
Electronic Measurements, Inc.....	6	National Semiconductor Corporation.....	52, 53	Northrop.....	225
Electronic Memories & Magnetics Corp.....	88			Sunstrand.....	224
Electronic Navigation Industries.....	204			Systems Engineering.....	227
Essex Group.....	148L				
Esterline Co., Line Electric Co.....	82				
Etatech, Inc.....	174				

\*Advertisers in International Edition

# 4-bit, one-chip micro- computers

Brainy enough  
for anything  
from TV games  
to industrial  
controls.

Block diagram of MN1400  
with on-chip, 1024x8-bit ROM.

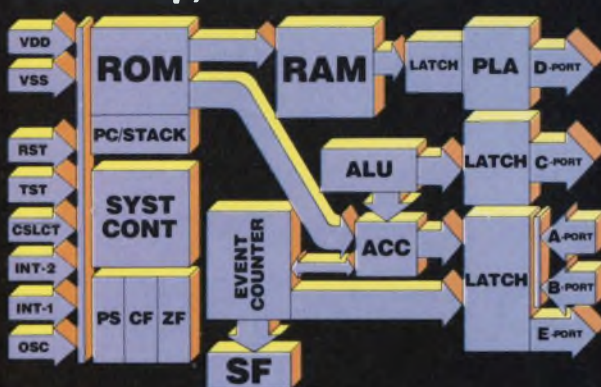

Now Panasonic offers you a whole family of TTL compatible, one-chip microcomputers. So you can choose the combination of features and capabilities that are most cost-effective for your application. From appliances to gas pumps and electronic scales, to copiers, POS and intelligent terminals, tractor controls and countless others.

### Why pay for costly I/O interfacing when Panasonic puts it all on the chip?

Our MN1400 family is ideally suited for control functions with its extensive array of on-chip I/O facilities. There's an 8-bit presetable counter/timer, a clock generator, an arithmetic logic unit, and several input and output ports. Units are available with a self-contained 1024x8-bit ROM and a 64x4-bit RAM memory.

### Still more flexibility and efficiency from Panasonic.

For flexibility, our instruction set contains up to 75 instructions. To give you TTL compatibility, all our family members operate on +5V. And for extra computing speed, we've utilized N-channel E/D MOS construction.

### Panasonic can help you cut development time and costs.

Our Evaluator, the MN1499, can help you design, evaluate and debug programs quickly. In addition, software is available for a number of applications.

### The Panasonic family of one-chip microcomputers.

Package	MN1400 40-Pin Plastic DIP	MN1402 28-Pin Plastic DIP	MN1498 40-Pin Plastic DIP	MN1499 64-Pin Ceramic DIP
Power Supply	+5V	+5V	+5V	+5V
Instruction Cycle Time	10 $\mu$ s	10 $\mu$ s	10 $\mu$ s	10 $\mu$ s
Instruction Set	75	57	68	75
Instruction Memory	Internal 1024 x 8 bits (8192 bits)	Internal 768 x 8 bits (6144 bits)	External 1024 x 8 bits (8192 bits)	External 2048 x 8 bits (16384 bits)
Total on Chip RAM	64 x 4 bits (256 bits)	32 x 4 bits (128 bits)	64 x 4 bits (256 bits)	64 x 4 bits (256 bits)

### 16-bit microprocessors, too.

They're ideally suited for a wide variety of computer peripheral and business machine applications. Designed with minicomputer architecture LOCOS MOSN-channel construction for optimum speed and thrupt efficiency.

For complete information and prices, write to Panasonic Electronic Components, One Panasonic Way, Secaucus, N.J. 07094; or call (201) 348-7269.

**Panasonic**<sup>®</sup>  
just slightly ahead of our time

CIRCLE NUMBER 231

# RCA. Newsmaker in Linear.

## Introducing the next generation of FM-IF system LICs.

RCA's new CA3189 FM-IF system lets you offer FM buyers a whole new world of features. It goes even beyond our milestone CA3089, which still has enough pluses to satisfy most FM-IF system needs.

But maybe you're looking ahead. Designing step-up features into your product line. In that case, the CA3189 is for you. It gives you things like deviation muting built right on the chip.

Programmable RF AGC

threshold. A big 4-6 dB improvement in signal-to-noise ratio. AFC drive circuit. Output signal to drive a tuning meter and/or provide stereo switching logic. All in addition to the features that made our CA3089 so popular. And all at a 3089 price.

**Your distributor has it now.**

The next-generation FM-IF system is already on distributors' shelves. Ready to help you design new performance features into your FM products.

For more information, contact your local RCA Solid State distributor. Or contact RCA Solid State headquarters in Somerville, NJ; Sunbury-on-Thames, Middlesex, England; Quickborn 2085, W. Germany; Ste.-Anne-de-Bellevue, Quebec, Canada; Sao Paulo, Brazil; Tokyo, Japan.

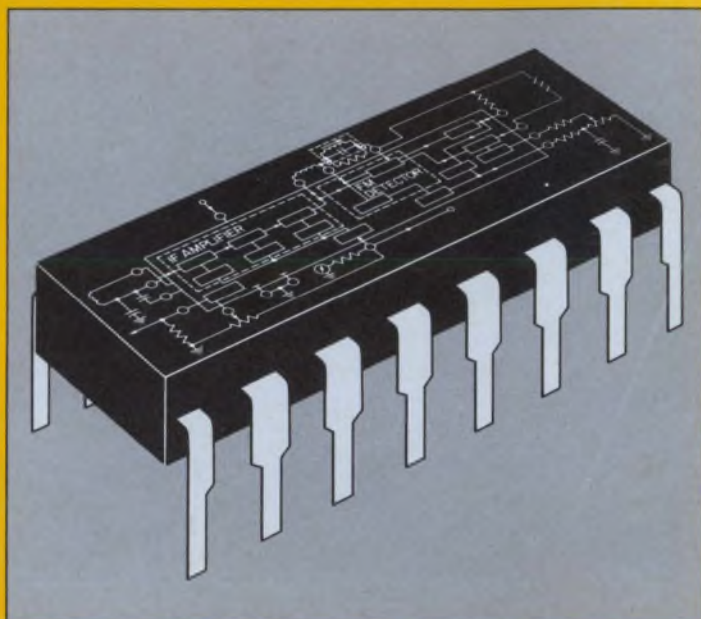

RCA Linear IC experience is working for you.

CIRCLE NUMBER 232

**RCA**