

Zoom in on dc/dc converters.

A magnified look at a converter's output reveals more than pure dc. These devices also spew out noise and spikes—to the power

input lines as well. And unlike conventional ac-to-dc supplies, dc/dc units may refuse to start when the power is first turned on. To learn why, start on p. 70.

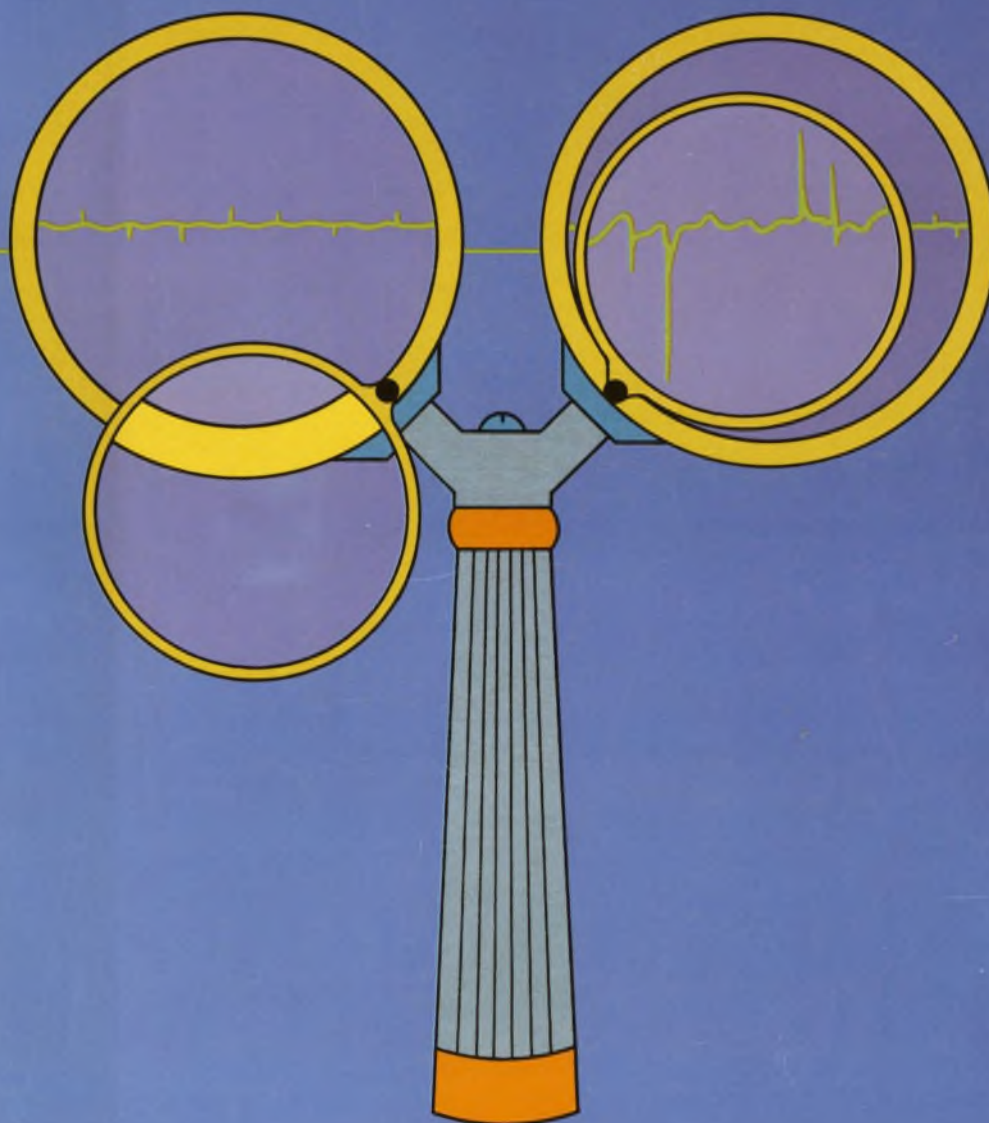



Sellers' markets don't last.

Dependable suppliers do.

Here are four positive steps Dale has taken to help end the seller's market in metal film resistors:

1. INCREASED PRODUCTION: In the past 2½ years Dale has more than tripled its metal film resistor production.

2. BROADENED CAPABILITIES: No one in the industry offers a broader spectrum of film resistors, including: ■ Standard Metal Film styles to MIL-R-10509 and MIL-R-22684 ■ E-Rel styles to MIL-R-55182 and MIL-R-39017 ■ Beyschlag Carbon Film ■ Metal Oxide and High Voltage Resistors ■ Thick Film Networks including MIL-R-83401.

3. STRONGER DISTRIBUTION: Many Dale distributors can ship metal film resistors off-the-shelf in quantity, including RN-55 and RN-60 models.

4. AND SPECIALS, TOO: In the face of record demand, we have continued to respond to customer requests for non-standard parts.

Sellers' markets don't last.

Dependable suppliers do.

Call Dale at 402-371-0080.



DALE ELECTRONICS, INC.
P.O. Box 74, Norfolk, Nebraska 68701
In Canada: Dale Electronics Canada Ltd.
In Europe: Dale Electronics GMBH
8 Munchen 60, Falkweg 51, West Germany
A subsidiary of The Lionel Corporation

Our complete product line can be found in Electronic Design's GOLD BOOK.

SURPRISE!

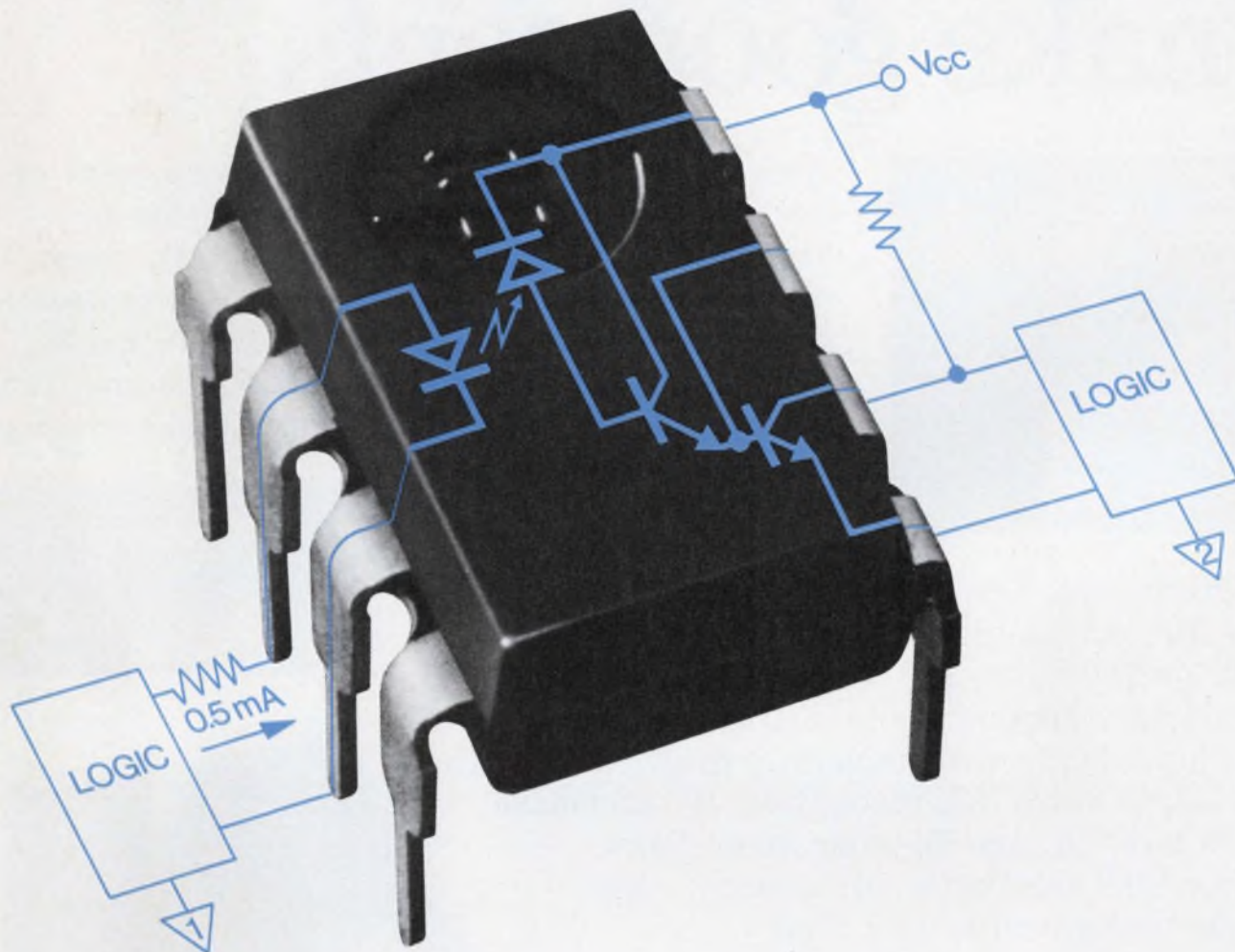

Optical isolation at 0.5 mA input

Now there is a new series of opto couplers from HP that will interface with most logic families. HP's 5082-4370 series isolators can be driven directly from CMOS, MOS, LTTL or TTL.

The unique construction of the 5082-4370 series offers a TTL compatible output voltage with speeds 50 times greater than conventional photodarlington isolators. Current transfer ratio of the 5082-4371 is typically 800% at 0.5mA input current and current transfer ratio of the 5082-4370 is typically 600% at 1.6mA input current.

Select the 5082-4370 for logic and TTL applications; 5082-4371 for CMOS, LTTL and other lower current uses. Performance of both models is guaranteed from 0°C to 70°C.

In 100 quantities, price for the 5082-4370 series starts at \$1.80* each.

For a complete design package on our new 5082-4370, hermetic, dual and high speed isolators contact Hall-Mark, Schweber, Wilshire or the Wyle Distribution Group.

Or write us, we're sensitive to your needs.

*Domestic USA price only

HEWLETT  PACKARD

Sales and service from 172 offices in 65 countries.
1501 Page Mill Road, Palo Alto, California 94304

01407

INFORMATION RETRIEVAL NUMBER 2

Solid state dip relays... make good cents

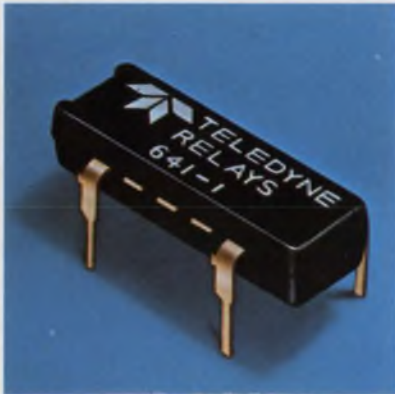

And dollars too, when you're designing point of sale terminals and other business machines. Teledyne's Seren-DIP® relays are totally silent, reliable, long life components that can replace a surprising amount of expensive discrete circuits. Our 641 is a low profile TO-116 DIP; one small PC board holds all you need for control and switching a POS terminal or medium size business machine. But small size can mean big

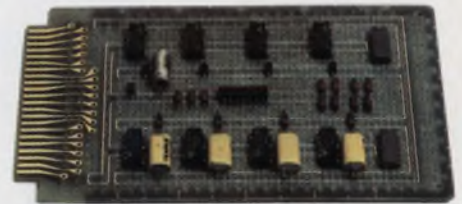

performance. The 641 is a small AC powerhouse: 1 AMP triac output with a 10 AMP surge rating; 140 or 280 volts, AC. It'll easily drive lamps, solenoids, stepping motors, transformers, or any inductive load – without noise or misfire errors. The Teledyne 641 is U.L. recognized. We also make high level DC and Bi-polar Seren-DIPs. Seren-DIP solid-state DIP relays – they make design sense and their dependability and cost effectiveness may help you make POS sales, too. Ask your distributor or call our applications engineers.



 **TELEDYNE RELAYS**

3155 West El Segundo Boulevard, Hawthorne, California 90250
Telephone (213) 973-4545

NEWS

- 31 News Scope
- 36 First OEM electron-beam-pumped semiconductor laser scans flat fields in microseconds.
- 46 A variety of new off-the-shelf speech recognizers let users talk their data into a computer.
- 50 Computerized van will help Navy train for war without leaving port.
- 52 Laser excited by atomic reaction points to new power possibility.
- 55 Washington Report

TECHNOLOGY

- 70 **FOCUS on dc/dc converters:** Pinpoints the headaches and unexpected problems a specifier is sure to run into when he evaluates these deceptively simple devices.
- 88 **Should you use LCD or LED displays** for portable equipment? The choice hinges more on drive and interface requirements than on display appearance.
- 98 **Find the quietest JFETs** by testing them with some simple circuits. Noise comes from internal sources, such as silicon heating and impurities.
- 110 **Need a special power supply?** Look into submodular systems for building blocks that can provide unique voltages at less cost than custom units.
- 116 **Design CMOS commutative filters** that rival quartz. Important features include variable center frequencies, adjustable bandwidth and good dynamic range.
- 122 **Let a computer design memory circuits.** A CAD program prescribes efficient, low-cost hardware for such designs as a digital traffic-light controller.
- 129 **Don't sweat polar to rectangular** coordinate conversion. Use a pencil, ruler and compass with this chart for rapid results with two percent accuracy.
- 134 **Help finish big, creative projects fast,** by cross-fertilizing your staff, hiring key support personnel before the designers and giving engineers freedom to invent.
- 140 **Ideas for Design:** Peak detector provides both the amplitude and a peak-event timing pulse . . . Generate a PSK modulated wave with an all-digital circuit . . . Build a general-purpose power supply with built-in temperature protection . . . A full first pulse is assured in variable-frequency, gated oscillator . . . IC timer, stabilized by crystal, can provide subharmonic frequencies.
- 152 **International Technology**

PRODUCTS

- | | |
|-----------------------------|-----------------------------|
| 155 Power Sources | 176 Microwaves & Lasers |
| 156 Packaging & Materials | 182 Discrete Semiconductors |
| 161 Data Processing | 186 Instrumentation |
| 166 Modules & Subassemblies | 188 Components |
| 172 Integrated Circuits | |

Departments

- | | |
|---------------------------|--------------------------------|
| 67 Editorial: The bargain | |
| 7 Across the Desk | 200 Advertisers' Index |
| 191 Evaluation Samples | 202 Product Index |
| 191 Application Notes | 204 Information Retrieval Card |
| 192 New Literature | |

Cover: Designed and illustrated by Art Director, Bill Kelly

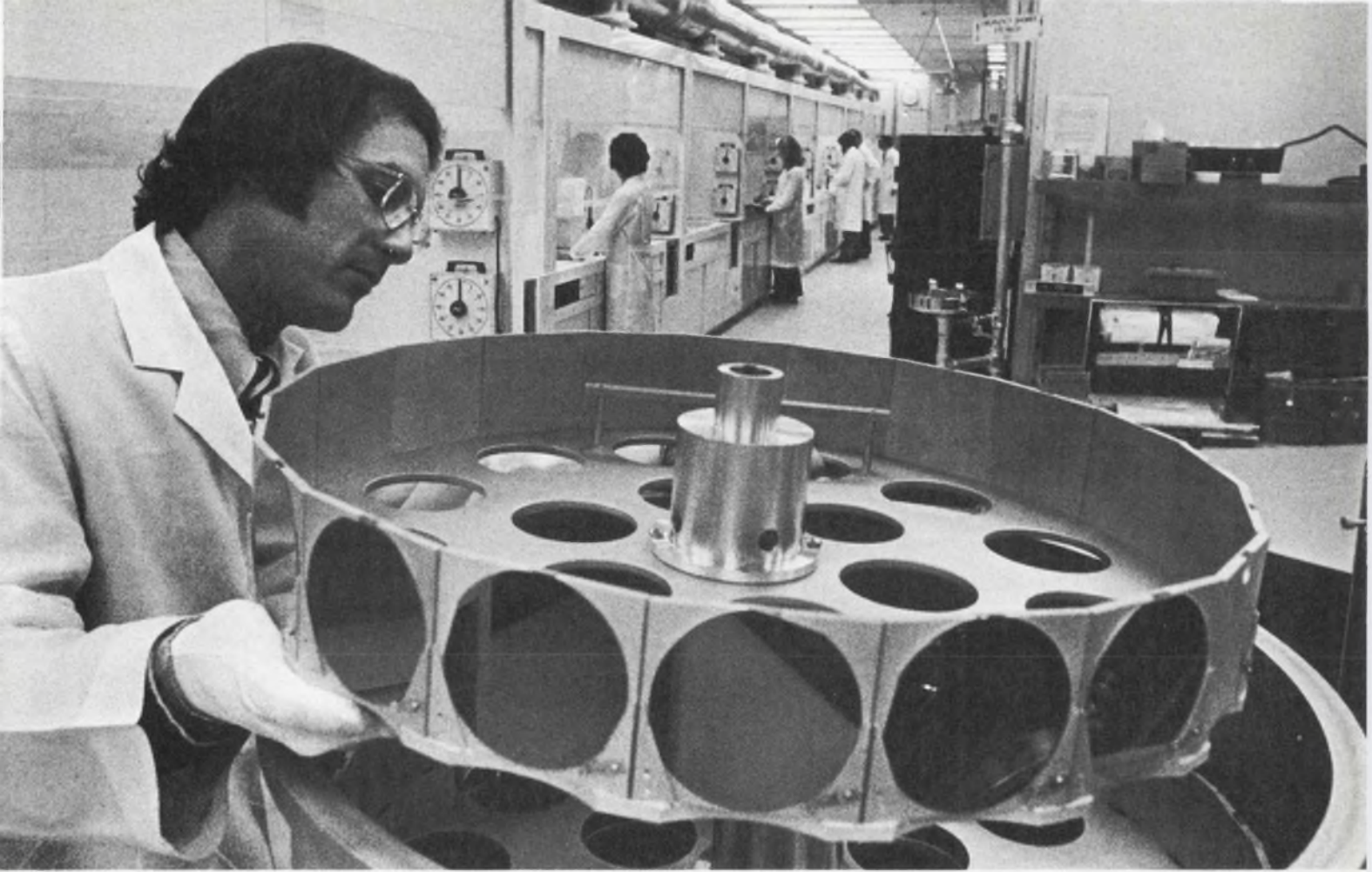

Ion implantation



Automatic
wire
bonding



We're the most modern CMOS facility in the business, and the second biggest producer.

Doesn't that tell you something about quality and delivery?

It should. We're the most modern because we've grown at a phenomenal rate. So our entire facility is the newest and finest and most productive that money can buy. Which means top quality and excellent delivery.

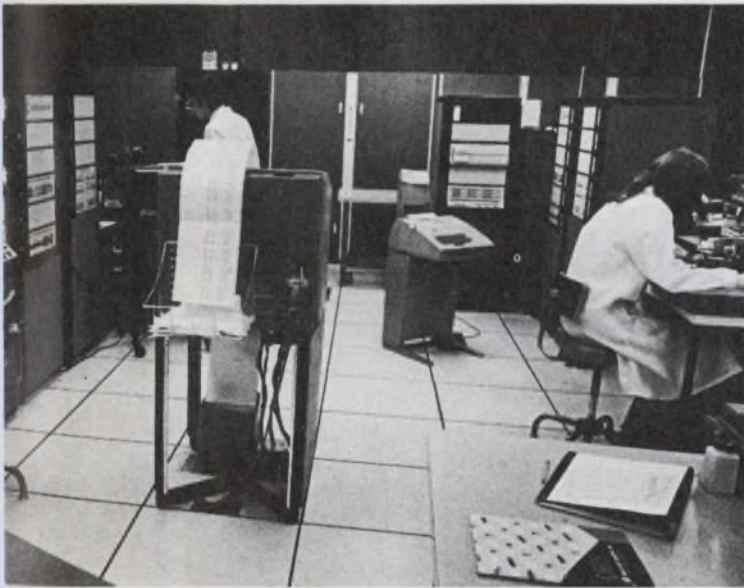

Computer controlled testing

Capacity is up 500% in the last two years alone. So we're a fairly close number two to RCA right now.

And gaining.

How come such growth? Because we specialize in CMOS. The big guy doesn't. We concentrate on high-quality, high-volume production of the most popular types. Anybody's types.

We have a lot more going for you. The prime CMOS facility in the country. The sharpest technical people in the business. And state-of-the-art equipment like a brand new three-inch wafer facility, ion implantation, automatic wire bonding, computer-controlled testing.

So if you want CMOS, and you want consistent quality and availability, talk with us soon. Meanwhile, let us send you our new catalog. Just write "CMOS" on your business card, and mail it to us. Or call our nearest sales office.

East: 215-279-8424

Midwest: 312-437-8343

West: 408-247-9470



SOLID STATE SCIENTIFIC INC.

Montgomeryville, Pa. 18936 / (215) 855-8400 / TWX 510-661-7267

The alternate source that's better than equal.

INFORMATION RETRIEVAL NUMBER 4

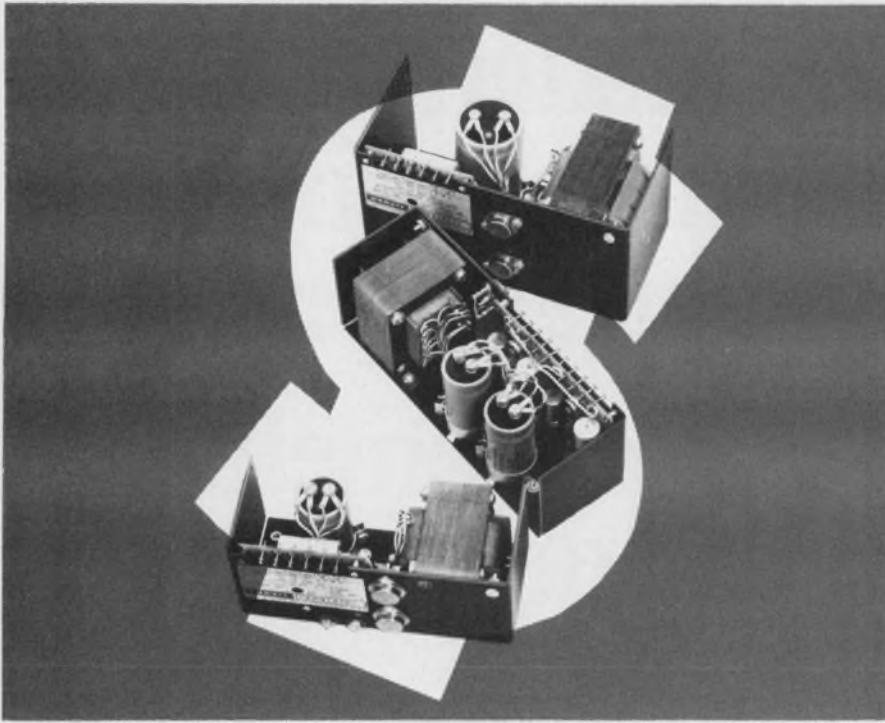

Start Getting Your Money\$worth Out of Power Modules





Now, you can really start getting your moneysworth out of power modules with Abbott's new LOW COST series. Designed to give you 100,000 hours of trouble-free operation (that's 11½ years), these reliable units meet the needs of OEM engineers. Their purchase price is about \$7 per year of service. The model LC series feature:

- 47-420 Hz Input Frequency
- 0.1% Regulation
- +50°C. Ambient Operation
- Single and Dual Outputs
- 1 Day Stock Delivery

These units provide more quality per dollar compared to similar items on the market. See table below for prices on some of our LC models. Many other LC models are listed in our catalog.

If analyzing the many similar power supplies on the market is confusing; if you are concerned about the long-term reliability of those units, then decide on an Abbott power supply for your system. Your best buy in OEM power modules is ABBOTT.

Abbott also manufactures 3,000 other models of power supplies with output voltages from 5 to 740 VDC and with output currents from 2 milliamps to 20 amps. They are all listed with prices in the new Abbott Catalog with various inputs:

60  to DC
 400  to DC
 28 VDC to DC
 28 VDC to 400 
 12-38 VDC to 60 

5V @ 6 Amps	5V @ 10 Amps	12V @ 10 Amps	15V @ 4 Amps	28V @ 1 Amp	±12V @ 1.2 Amps	±15V @ 4 Amps
LC5T6	LC5T10	LC12T10	LC15T4	LC28T1	LLC12T1.2	LLC15T4
\$79	\$89	\$108	\$89	\$79	\$108	\$148

Please see pages 307-317 Volume 1 of your 1974-75 EEM (ELECTRONIC ENGINEERS MASTER Catalog) or pages 853-860 Volume 3 of your 1974-75 GOLD BOOK for complete information on Abbott Modules.

Send for our new 60 page FREE catalog.



LABORATORIES, INCORPORATED
 general offices eastern office
 5200 W. Jefferson Blvd./Los Angeles 90016 1224 Anderson Ave./Fort Lee, N.J. 07024
 (213) 936-8185 Telex: 69-1398 (201) 224-6900 Telex: 13-5332
 INFORMATION RETRIEVAL NUMBER 5

Vice President, Publisher

Peter Coley

Editors

Editorial Offices
 50 Essex St.
 Rochelle Park, NJ 07662
 (201) 843-0550
 TWX: 710-990 5071
 Cable: Haydenpubs Rochellepark
 Editor-in-Chief George Rostky

Managing Editors:

Ralph Dobriner
 Michael Elphick

Associate Editors:

Dave Bursky
 Jules H. Gilder
 Morris Grossman
 Seymour T. Levine
 John F. Mason
 Stanley Runyon
 Edward A. Torrero
 Richard L. Turmail

Contributing Editors:

Peter N. Budzilovich
 Alberto Socolovsky
 Nathan Sussman

Editorial Field Offices

East

Jim McDermott, Eastern Editor
 P.O. Box 272
 Easthampton, MA 01027
 (413) 527-3632

West

David N. Kaye, Senior Western Editor
 8939 S. Sepulveda Blvd.
 Suite 510
 Los Angeles, CA 90045
 (213) 641-6544
 Northe K. Osbrink, Western Editor
 112 Coloma St.
 Santa Cruz, CA 95060
 (408) 426-3211

Editorial Production

Marjorie A. Duffy

Art

Art Director, William Kelly
 Richard Luce
 Anthony J. Fischetto

Production

Manager, Dollie S. Viebig
 Helen De Polo
 Anne Molfetas
 Christopher G. Hill

Circulation

Manager, Evan Phoutrides

Information Retrieval

Peggy Long

Promotion

Manager, Walter G. Salm
 Karen Kerrigan (Reprints)

across the desk

CQ from ED . . . CQ from ED: We hammed it up, all right

"Washington Report in the Sept. 13 issue (ED No. 19, p. 53) foolishly, egregiously, slap-happily and inadvertently referred to noisy Citizen Band operators as "hams." As most designers—and we—know, the word ham has for years referred to amateur radio operators who are tested and licensed by the Government and considered superbly qualified to control the emissions of their radio stations. When cases of interference with the transmissions of others arise, hams can be counted on to cooperate in eliminating the conflict. The "Washington Report" item referred to Citizen Band radio operators, many of whom are not certificated and who frequently contribute to annoying RFI. The Federal Communications Commission is moving to tighten its supervision of CB'ers.

ELECTRONIC DESIGN offers apologies to any hams who might have taken offense at the confusion in identification. We have assigned the sleepy editor of the column to write 100 times: A ham is not a CB'er . . . a ham is not a CB'er . . . a ham

Boy did you goof! . . . That is like comparing ELECTRONIC DESIGN with Playboy. I am not even a radio amateur (ham), but you really shouldn't ever compare a ham with a CB'er.

Everett D. Spidell

Spidell Enterprises
418 Louisiana, SE
Albuquerque, NM

I am certain I will not be the only person to point out to you that your magazine has used the term "ham" interchangeably with "CBer" and "Citizen Band operator." . . . Users of the Citizens Radio Service need only complete a form and pay the fee required, while amateurs, or "hams," are required to show technical competence and the ability to send and receive the Morse Code.

William P. Turner, WA0ABI
5 Chestnut Court
Saint Peters, MO 63376

I was astounded by the faux pas.

Harold H. Fink, WA4KBB
Communications Staff Assistant
Delta Air Lines, Inc.
Continental Colony Parkway
Atlanta, GA 30331

. . . This frequently made error has resulted in unnecessary bad publicity for the radio amateur (ham) fraternity.

Gilbert A. Herlich, W1JMK

Et tu, Brute, Next you'll be filling out minyans with Arabs, because they're Semitic people too, right? May lightning strike your rabbit ears!

John A. Carroll

575 Washington St.
East Walpole, MA 02032

I was appalled. . . This does a great injustice to radio amateurs.

Albert H. Hix, W8BT
860 Alta Rd.
Charleston, WV 25314

Whoeeee! Did you guys ever goof! I'll bet you receive a flood of letters.

(continued on page 10)

Electronic Design welcomes the opinions of its readers on the issues raised in the magazine's editorial columns. Address letters to Managing Editor, Electronic Design, 50 Essex St. Rochelle Park, N.J. 07662. Try to keep letters under 200 words. Letters must be signed. Names will be withheld on request.



OPTRON OPTICALLY COUPLED ISOLATORS

LOW COST "DIP" SERIES
FURTHER EXPANDS
ISOLATOR LINE

OPTRON's addition of a new, low cost 6-pin plastic dual in-line isolator series further broadens its line to provide a coupler for every application.

The new "DIP" series includes six models offering complete interchangeability with popular industry types. It offers a wide range of capabilities to allow you to choose a device most suited to your circuit requirements at the best possible price. The "DIP" series has isolation voltages of 1500 or 2500 volts with a current transfer ratio of 2.0 to 50%.



OPI 102

OPTRON's broad selection of "DIP" and other packages with isolation voltages to 50 Kv now provides the versatility required for maximum electrical and mechanical design flexibility.

1.5 Kv isolation with 60% current transfer ratio. Phototransistor base lead available. Hermetic TO-5 package.

OPI 108



1 Kv isolation and 20% current transfer ratio. 5 μ sec switching time in a welded axial lead hermetic package.

Detailed technical information on these and other OPTRON optoelectronic products . . . chips, discrete components, assemblies, and PC board arrays . . . is available from your nearest OPTRON sales representative or the factory direct.



OPTRON, INC.

1201 Tappan Circle
Carrollton, Texas 75006
214/242-6571

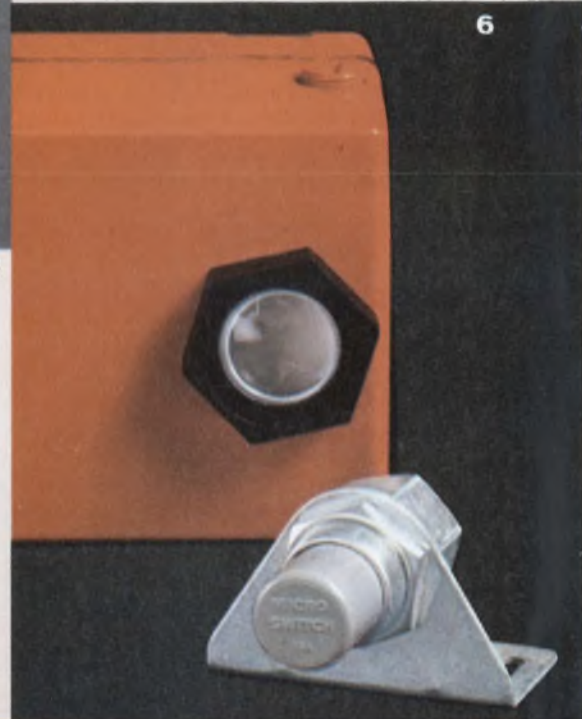
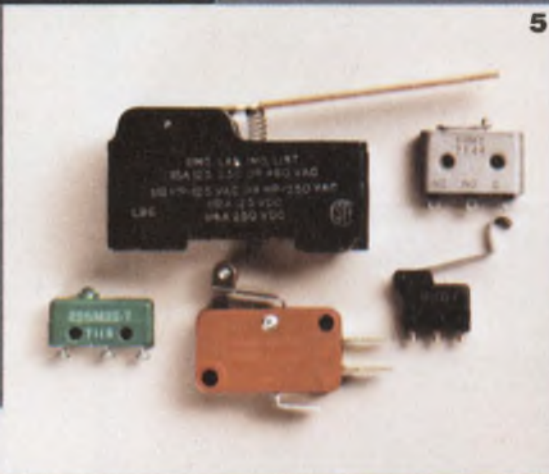
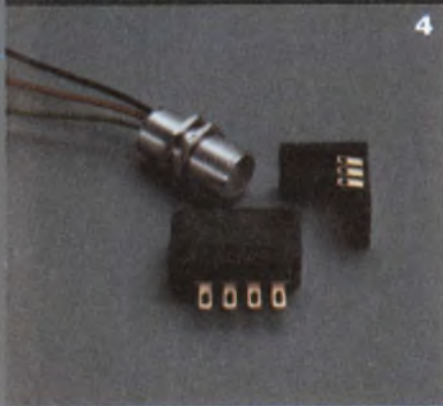
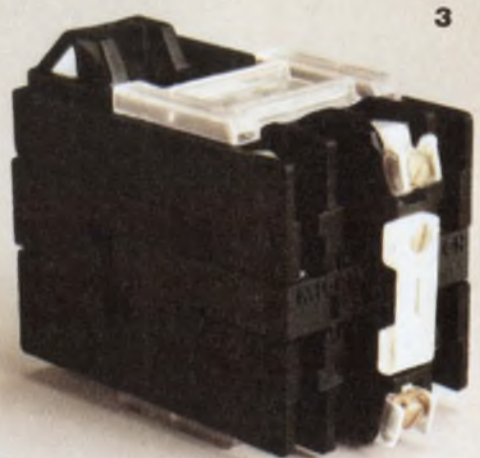
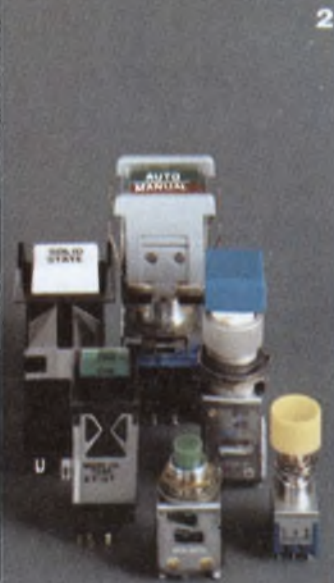

A lot has happened since we invented the snap-action switch in 1932.

1. Limit switches.
2. Pushbutton switches.
3. Industrial relays.
4. Solid-state switches.
5. Precision snap-action switches.
6. No-touch photoelectric and proximity controls.
7. Toggle switches.
8. Industrial manual controls.
9. Solid-state keyboards and DC control motors.

Take advantage of over four decades' experience in solving control problems like yours.

Write for latest literature. Or, for the name and telephone number of your nearest MICRO SWITCH Branch Office or Authorized Distributor, call toll-free 800/645-9200 (in New York, 516/294-0990, collect).

MICRO SWITCH

FREEPORT ILLINOIS 61032

A DIVISION OF HONEYWELL

(continued from page 7)

Alfred E. Schwaneke, WOGS
Route 1, Box 40
Rolla, MO 65401

You have insulted a category of people who probably deserve more credit in electronic pioneering than any other in existence.

Bradley D. Rohrer, K1CTK
4840 Mac Arthur Blvd., N.W.
Washington, DC 20007

You blew it. . . I'm sure you aroused the ire of many readers.

Thomas E. Dewey
Account Executive
Midland Associates, Inc.
4010 West 65th St.
Minneapolis, MN 55435

A konk on your correspondent's head with the Wouff Hong for confusing amateur radio hams with CBers. A swish of the retty-snitch past your editor's ears for letting such an error go by your desks. Even Betsy the Cat would know better.

Forrest E. Gehrke, K2BT
75 Crestview Rd.
Mountain Lakes, NJ 07046

I just about hit the ceiling, I was so mad. As a licensed amateur radio operator, we only can run high power of 1000 W CW or 2000 W PEP and use high and large transmitting and receiving antennas. Citizen operators, who do not take any technical written tests and can only use a max power of 5 W with antennas not over 20 ft high, must in no way be mixed up with amateur radio ham operators.

H. Terraneau, WA6SXR
Teledyne Electronics
649 Lawrence Dr.
Newbury Park, CA 91320

Come on, you guys know better than this!

Jim George, W7AWH
Motorola
Phoenix, AZ

. . . You have made a common error than never ceases to get the hackles up on a legitimate amateur radio operator.

Richard D. Sant, WB6EWE
11703 Mollyknoll
Whittier, CA 90604

I was outraged. . . As an active, licensed amateur (ham) radio operator, I object. . . Hams can legally run up to 1000 W of transmitter power input. Any citizen

can obtain a CB license without any knowledge of radio theory or regulations, but power is limited to 5 W.

Lynn A. Gerig, WA9GFR
Senior Engineer
Magnavox Co.
Fort Wayne, IN 46804

I am confident that every ham that read your Sept. 13 "Washington Report" chuckled over your erroneous caption and text.

William G. Rich, W3PSM/7
P.O. Box 1253
Douglas, AZ 85607

Licensed radio amateurs have a long history and tradition of experimentation and contribution to communications technology that stretches back to the beginning days of radio. . . In contrast, the Citizens Band service has been a thorn in the side of the FCC ever since Class D was initiated.

David A. Beckman, W5MHY
2705 Churchill
Pearland, TX 77581

Along with some 280,000 brother amateurs, I take exception.

Robert G. Ney, WA7VCA
President, Motorola Amateur Radio Club, Phoenix
8231 E. Collidge
Scottsdale, AZ 85251

. . . We have printed forms to send such writers to show the errors of their ways. But gosh, I never thought I'd have to send one to ELECTRONIC DESIGN.

John Huntoon, W1RW
General Manager
America Radio Relay League, Inc.
Newington, CT 06111

Come on man, get with it.
Gil Kowols
Chief Engineer

Anixier Communications Systems
5439 West Fargo Ave.
Skokie, IL 60076

Much heat concerning relative humidity

The article "Are Your Humidity Readings Valid?" (ED No. 16, Aug. 2, 1974, pp. 90-94) is a strong call for the accurate measurement of relative humidity (RH) so test-measurement data will be meaningful. Yet the table on p. 91, which presents relative-humidity temperature as a function of the wet-bulb depression, contains se-

(continued on page 14)

cramer

CRAMER ELECTRONICS, INC.

Your closest distributor is...

NORTHEAST
Cramer Electronics, Inc., Newton, Ma.
Tel. (617) 969-7700
Cramer/Connecticut
Tel. (203) 239-5641
Cramer/International
Tel. (617) 969-7700; Telex-92-2486
Cable-Cramerel
Cramer/Puerto Rico
Tel. (809) 892-1130
Cramer/Italia, Roma, Italy
Tel. 51-393-87 and 51-393-90

METRO-NEW YORK
Cramer/Long Island
Tel. (516) 231-5600
Cramer/New Jersey
Tel. (201) 935-5600

MID ATLANTIC
Cramer/Pennsylvania, Cherry Hill, N.J.
Tel. (609) 424-5993
Cramer/Washington
Gaithersburg, Maryland
Tel. (301) 948-0110
Cramer/Baltimore
Tel. (301) 796-5790

GREAT LAKES
Cramer/Rochester
Tel. (716) 275-0300
Cramer/Syracuse
Tel. (315) 437-6671
Cramer/Binghamton
Tel. (607) 754-6661
Cramer/Cleveland
Tel. (216) 248-8400
Cramer/Canada, Ltd.
Downsview, Ontario, Canada
Tel. (416) 661-9222
Cramer/Detroit
Tel. (313) 425-7000
Cramer/Montreal
St. Laurent P.Q., Canada
Tel. (514) 331-9101
Cramer/Pittsburgh, Monroeville, Pa.
Tel. (412) 252-7410
Cramer/Tri/States, Cincinnati, Ohio
Tel. (513) 771-6441

MIDWEST
Cramer/Chicago
Tel. (312) 593-8230
Cramer/Minnesota
Tel. (612) 835-7811
Cramer/Wisconsin
Tel. (414) 764-1700
Cramer/Texas
Tel. (214) 661-9300
Texas Watts (800) 492-6940

SOUTHEAST
Cramer/Orlando
Tel. (305) 894-1511
Cramer/Hollywood
Tel. (305) 923-8181
Cramer/Huntsville
Tel. (205) 539-5722
Cramer/Winston-Salem
Tel. (919) 725-8711
Cramer/Atlanta, Atlanta, Ga.
Tel. (404) 448-9050

WEST
Cramer/Los Angeles
Tel. (714) 979-3000 and (213) 771-8300
Cramer/San Diego
Tel. (714) 565-1881

NORTHWEST
Cramer/San Francisco
Tel. (408) 739-3011
Cramer/Seattle
Tel. (206) 762-5755

ROCKY MOUNTAIN
Cramer/New Mexico
Tel. (505) 265-5767
Cramer/Arizona
Tel. (602) 267-7321
Cramer/Denver
Tel. (303) 758-2100
Cramer/Utah
Tel. (801) 487-4131

New Resistor LED's from Xciton!

Lucky you! Now Xciton offers a real choice of 24 different resistor LED's. It's the world's widest resistor LED selection with the same high performance in all colors. Red, green, orange or yellow.

Choose direct drive from 5 volt or 12 volt logic supplies with a typical output of 1.6 mcd at 16 mA.

Xciton resistor LED's are available in three lens package styles, with diameters of .125 and .200 inch at these popular prices: 50¢ for Red, 60¢ for all other colors in quantities over 1000.

Please order by correct part number. Each part number is formed by choosing a lens style (XC209, XC5053 or XC22), followed by the voltage (5V or 12V) and ending with the color code (no symbol for red, A for orange, Y for yellow or G for green). Example XC209-5VY.

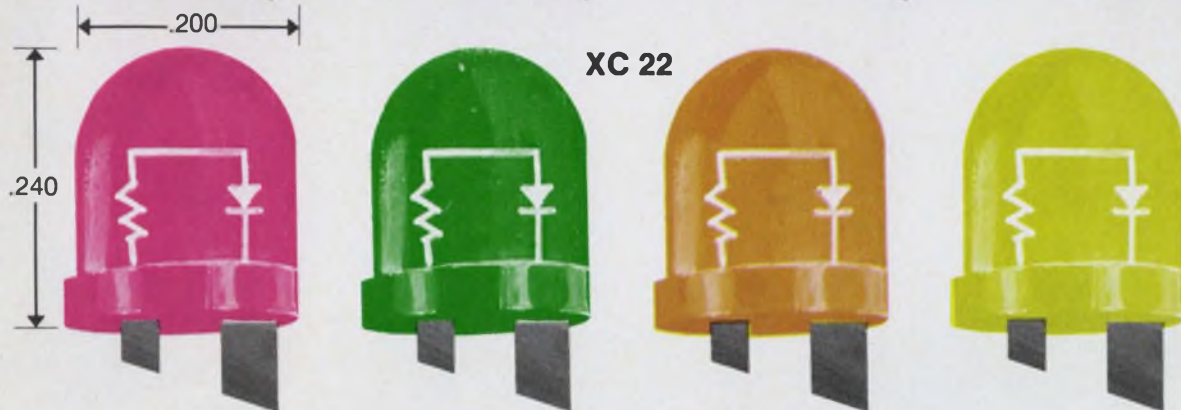
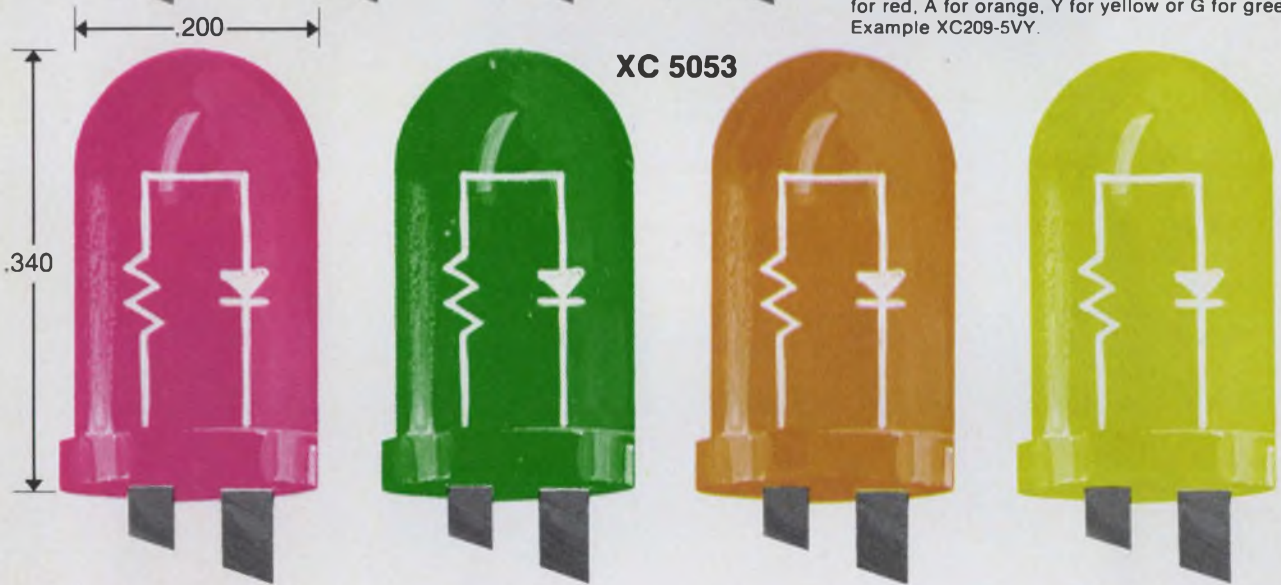
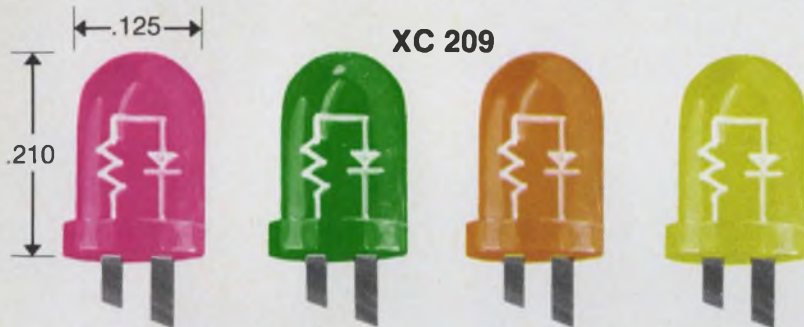

cramer/ Xciton

Cramer: See adjacent list for the Cramer location nearest you.
Xciton Corp., 5 Hemlock St., Latham, N.Y., 12110. Tel. (518) 783-7726. TWX: 710-444-4962

INFORMATION RETRIEVAL NUMBER 8



Introducing Eclipse.
Suddenly a lot of computers don't look so bright.

The most expensive part of a computer isn't the computer anymore.

It's the people who work with it.

So Data General is introducing a family of medium scale computers that cut down on the work people have to do.

Eclipse.

You won't have to clean up the mistakes this computer makes. Eclipse has automatic memory error correction.

You won't have to rewrite complicated instructions every time you need them. Eclipse's microprogrammed architecture includes a comprehensive new set of instructions so powerful they do the work of entire subroutines.

You won't have to lose speed doing special subroutines with software. Eclipse has a Writeable Control Storage Unit that lets you keep them in the hardware.

You won't have to use assembly language to make your programs go fast. Eclipse is so fast it can run high level languages at assembly language speeds. (It has a bipolar memory cache that makes semiconductor memory a lot faster. Plus core and semiconductor memory interleaving for even more speed. And the fastest Floating Point Processor in the industry.)

And even though Eclipse is a brand new computer, you won't have to write a lot of systems software or jury-rig your peripherals. Eclipse is upwards compatible with the Nova line. So all the software and peripherals we've already made can go right to work on the Eclipse.

Write for our brochure. And see how bright an Eclipse can be.

Data General

The computer company you can understand.

• Data General Corporation, Southboro, Massachusetts 01772, (617) 485-9100. Data Gen of Canada Ltd., Hull, Quebec, J8Y3S6, Data General Europe, 116 Rue de la Tour, Paris 75016 France. Data General Australia, Melbourne (03) 82-1361/Sydney (02) 908-1366.

A year ago we introduced 7 new JCM miniature RF coaxial connectors that "do the job for a fraction of SMA prices."

Here, by popular demand, are 8 more.



If you don't require all the electrical performance built into SMA type connectors, why pay for it? Up to 3 GHz for flexible cable assembly and even beyond 6 GHz for semi-rigid assembly, our new JCM series gives you the same electrical performance as the far more expensive SMA types. The series includes connectors for both panel and PC mounting. All are interchangeable and intermateable with the standard, expensive SMA connectors. So you can use them without making any changes . . . and without compromising required performance. There are JCM connectors to accept virtually any miniature size cable, so you don't have to stock a big variety. It's worth looking into, isn't it? All it costs is a stamp.

E. F. JOHNSON COMPANY / Waseca, Minnesota 56093
Please check for technical information or test samples of our new low-cost series 142-0200-001 JCM connectors.

Dept. ED 11

- Please send technical information.
- I desire test samples. Please call me at _____

NAME _____
FIRM _____ TITLE _____
ADDRESS _____
CITY _____ STATE _____ ZIP _____



E. F. JOHNSON COMPANY
INFORMATION RETRIEVAL NUMBER 10

ACROSS THE DESK

(continued from page 10)

rious inconsistencies and built-in errors.

I prepared a graph and found a step-function curve that is inconsistent with the world of reality. Whether the table was prepared by the author or someone else is immaterial. What is important is that the author and your readers be aware of the errors in the table and be referred to valid data available in psychrometric charts in such sources as "Perry's Handbook for Chemical Engineers." I have only pointed out self-consistent errors in the table, and have not checked to see if any of the data are correct with psychrometric charts and tables.

In addition note the following quote on p. 91: "The very pure water behaves as an oxidizing agent and seeks electrons. As verification, note that test-chamber windows pit when high-purity water is used over a long time." This is incorrect; the mechanism by which such surface pitting of glass can occur is a physical process of solvation whereby some of the glass (principally sodium silicate) passes into solution in the water and leaves the surface of the glass roughened.

Also, on p. 92, the author states: "Evaporation. This calls for a large surface area of water, which is held near the evaporating point." An examination of basic physics books and physical chemistry texts will show that the "evaporating point" is not definable. Water will evaporate over the entire temperature range from freezing to boiling. It will also pass directly from the solid state (below the freezing point) to the gaseous (or vapor) phase without first melting and passing into the liquid phase. This evaporation mechanism is called sublimation.

Dr. A. R. Blanck
Rutherford Research Products Co.
P.O. Box 162
Rutherford, NJ 07070.

The author replies

For clarification, I would like to discuss further the three points that Dr. Blanck felt were in error:

(continued on page 16)

SIX NEW SWITCHERS. LET US SHIP YOU SOME.



It's a small celebration to launch six new models in our switching power supply series: five 150 watt units and a 750 watt unit. From us: ACDC Electronics, Inc. Manufacturers of proven, reliable DC power supplies. The new JP switchers offer the latest in technology. Small, cool and efficient, they pack more watts per cubic inch than conventional pass-type supplies. These 20 KHz inaudible switching power supplies operate from a selectable input of 115/220-230 VAC 47-63Hz (100 VAC also available). Overvoltage and overload protection is standard. EMI is minimized by shielding and filtering. Low inrush turn-on for soft start. Units can be paralleled for higher current requirements. Don't miss the boat. Just circle the reader service number. Or if you'd like information on ACDC's complete line of DC power supplies, fill out the coupon or write to us on your company letterhead. We'll send you our 1974 product and application guide.

Name _____

Company Name _____

Address _____

City _____

State _____

Zip Code _____

acdc electronics inc.

Oceanside Industrial Center, Oceanside, CA 92054
(714) 757-1880



To locate your nearest ACDC representative call toll-free (800) 645-9200 (In New York State, Call Collect (516) 294-0990).

INFORMATION RETRIEVAL NUMBER 11

(continued from page 14)

1. The RH chart. Since the table is presented as a list instead of a graph, it does not have the smoothness of "reality." It is, however, the best method to show the relationship for the criticalness of wet-bulb depression accuracy as opposed to temperature effect. Its accuracy, even as a table, is at least 10 times the accuracy of the associated measurement equipment.

2. Glass etching process. My chemical experts say that the glass etch is not pure "solution"; an ion exchange is required before solvation can take place. The word oxidation somehow crept into the text without intention.

3. Evaporation point. The evaporation I am speaking of is a process of passing water in the chamber reservoir to the gaseous state in the chamber air. This evaporation "point" is the temperature at which sufficient evaporation takes place to increase the water vapor in the chamber.

Jerry Kneifel

Reliability Test Lab Manager
Dale Electronics, Inc.
P.O. Box 609
Columbus, NE 68601

Make that symbol an EXCLUSIVE-OR

Every year there are several articles in the trade magazines that illustrate proper logic symbols and expound on their virtues. So why do you use the logic-OR symbol for the EXCLUSIVE-OR function in the article "Combinatorial Logic Circuit Calculates the Absolute Difference of Numbers" (ED No. 14, July 5, 1974, p. 114)?

I trust that this was an oversight by your usually excellent quality-control staff.

Michael Harms

Electronics Engineer
Special Projects Group

Lawrence Berkeley Laboratory
University of California
Berkeley, CA 94720

Ed Note: Do as we say, not as we do—especially when we are wrong—as in this case.

More bits than bytes

ELECTRONIC DESIGN carried the announcement of our new disc controller (see "Disc Controller Handles 400-Mbyte System, ED No. 14, July 5, 1974, p. 128). Although we greatly appreciate the article, it contains a very misleading statement.

Our system can be equipped with 400 million *bits* of disc storage, not 400 million *bytes*. That's quite a difference! Also, the price is \$2500 in small OEM quantities, not in single quantities.

Richard T. Preston
Marketing Manager

Data Systems Design
1122 University Ave.
Berkeley, CA 94702

Ed. Note: Quantity was not quoted in the company's press release. We prefer an exact figure in number of units, since OEM quantity is also subject to interpretation.

Cooling vendor lets off steam

My comments refer to the "Focus on Cooling Electronic Packages" (ED No. 14, July 5, 1974, p. 62-73).

McLean Engineering Laboratories has been in this business for 35 years, and has probably published more technical information on application engineering than other companies. Edwards, of Amphenol, notes in the Focus that motor-life guarantees are usually more sales talk than practical (p. 71). This may be true for new integral pancake-type fans, but it certainly is not true for blowers made by reputable manufacturers.

Blowers use motors of conventional design, which use insulations and all mechanical components that have been reliably time-tested. In addition they cannot be abused in use. The addition of back pressure extends the life of a blower assembly, while it makes the fan motor run hotter and have a shorter life. Failure is normally due more to improper application than to component design.

Three major tradeoffs in fan selection were listed. The careful designer will analyze more trade-

(continued on page 24)

If your
copy of these
Lambda
brochures
is missing
in this issue:

LZ series
LC series
LX series
LY-LV-LW series

or if you
would like more
information
about these
power supplies,
circle number
242
on the reader
service card

 **LAMBDA**
ELECTRONICS CORP.

A  Company

515 BROAD HOLLOW RD. MELVILLE, N.Y. 11746

That's our price for our new 3660J IC Instrumentation Amplifier. Now, if you are building your own, do you know what yours is really costing you? Take a few minutes to add up your costs. Just to match the performance of our new IAs, it would take a well matched pair of op amps, four matched and tracking precision resistors, and at least three more resistors to hook your unit into a circuit. After you design yours, you still have to purchase the parts. Calculate your design and purchasing time, plus all the paperwork. Now, add in your production and testing time, and a little bit for overhead. You might even have to rework your design, and chances are that you'll have to do some tweaking, too. By the time you get through, your costs could be two or three times as high as our price of

\$10.70 in 100's. Then, your parts will probably be spread out all over a PC board that you'll have to make fit somewhere in your system. That's a lot of trouble and money, especially if you need one amplifier per channel. And, what about your performance? Although our 3660J is the lightweight of the new 3660 series, just look at what it has to offer. It lets you adjust the gain from 1 to 1000V/V with a single resistor. At a gain of 1000, it has a guaranteed voltage drift of less than $10 \mu\text{V}/^\circ\text{C}$, a CMR of 96dB, and an input impedance of 20 Megohms. It also offers nonlinearity of 0.1%, a bias current drift of $-2\text{nA}/^\circ\text{C}$, and of course, IC reliability. It's especially useful in applications where size, accuracy, reliability, and economy are your primary considerations. And, just in

case you have an application that demands a lower bias current and a higher impedance, we also have the 3670 FET IC series. These amplifiers guarantee a bias current of -10pA , and an input impedance of $10^{13} \Omega$. The price tag is a little higher than the 3660, but not that much.

Why build your own Instrumentation Amplifiers when the 3660 and 3670 are here now? Try a few of ours and go home on time at night. Burr-Brown, International Airport Industrial Park, Tucson, Arizona 85734. Telephone (602) 294-1431.



You can build your own Instrumentation Amplifiers, but can you do it for less than \$10.70?

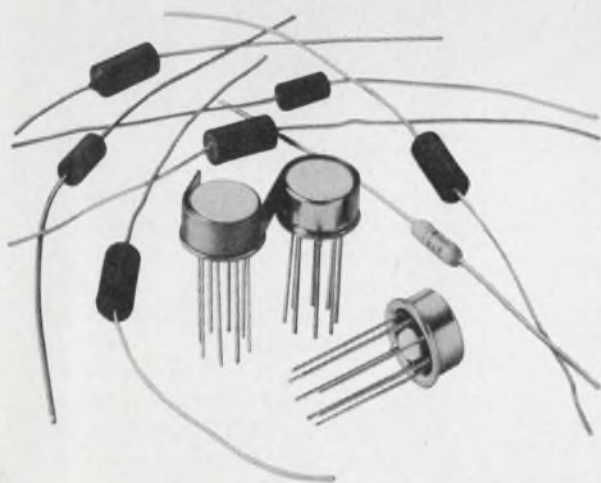

With yours, you start with this.



The 3660 (Low Drift) and the 3670 (FET)... IC Instrumentation Amps from Burr-Brown!

With ours, you start with this.



No Offense

Non-PCB (polychlorinated biphenyl) . . . non-toxic . . . non-polluting. That's new Sprague ECCOL® A-C Capacitors . . . developed for today's ecology-conscious world.

Equipment manufacturers using capacitors with polychlorinated biphenyl impregnants are finding that some nations have prohibited the import of products containing PCB.

ECCOL® capacitors have been designed to meet industry needs for PCB-free capacitors. They exhibit essentially identical electrical performance characteristics to those of long-used askarel capacitors. Their operating life and reliability are also equivalent. Even the size of ECCOL® Capacitors is similar to previous designs, except for a slight increase in case height.

Drawn-case ECCOL® Capacitors are available in a wide range of capacitance values from 1 to 55µF, with four voltage ratings from 300 to 660 VAC.

For complete technical data, write for Engineering Bulletin 4550 to:
Technical Literature Service
Sprague Electric Company
347 Marshall Street
North Adams, Mass. 01247



THE BROAD-LINE PRODUCER OF ELECTRONIC PARTS

ACROSS THE DESK

(continued from page 16)

offs than these before he specifies or selects air-moving equipment. For this reason, our company has over 5000 designed-and-tested models for cooling electronic equipment. New customers place different weights on the desirability of the values of the parameters, and require yet additional models.

I am glad that the article pointed out the need for chamber tests made to code specifications for measurement of the blower performance rather than use of a pitot tube traverse in a downstream pipe. The results will be quite different.

A. Donald Hay
Vice President, Engineering
McLean Engineering Laboratories
Princeton Junction, NJ 08550

Can thermocouples feed high-Z inputs?

In "Report on Sensing Transducers" in the July 19, 1974 issue, you quote Earl McKinley of Omega on pp. 30 and 34 to the effect that thermocouples should work into hi-Z inputs. Are you sure you got this straight? The output impedance of a thermocouple is typically in the 10-to-100-Ω range.

Seymour Verdi
Chief Engineer, Vulcanization
Aborn Rubber Co., Inc.
20 Greene St.
New York, NY

Omega replies

Mr. Verdi is correct in saying that the output impedance of a thermocouple is typically in the 10-to-100-Ω range. The confusion may be with the meaning of the term "hi-Z input."

The hi-Z input referred to was in the input of the readout equipment and not in the input of the extension lead to which the thermocouple was attached.

With low-impedance inputs, the IR drop in the thermocouple circuit becomes quite high, resulting in a low signal that reaches the readout indicator. On the other

(continued on page 28)

Dialight sees a need:

(**Need:** Single source supply for all indicator lights.)

See Dialight.



INCANDESCENT OR NEON MINIATURE AND LARGE INDICATORS

Designed to accommodate either incandescent (2-250V) or neon (105-250V) lamps for panel mounting in 11/16" or 1" clearance holes. Units meet or exceed MIL-L-3661 requirements; all are listed in Underwriter's Recognized Components Index. Wide selection of lens shapes, colors,

finishes and terminations. Many lenses may be hot stamped, engraved or offered with film legend discs. Oil-tight units with unique "O" ring construction make them oil, water and dust tight on the face of the panel. Available off the shelf for prompt delivery.



LED, INCANDESCENT OR NEON ULTRA-MINIATURE DATALITES®

Meet or exceed MIL-L-3661. Replaceable plug-in cartridges for 1.35-125V operation. Indicators mount as close as 1/2" centers; available with red, green, amber, blue, white translucent, light yellow or colorless lenses in wide range of lens shapes, legends and finishes. Off-the-shelf.



INCANDESCENT OR NEON SUB-MINIATURE INDICATORS

Meet or exceed MIL-L-3661. Mounts in 15/32", 1/2" or 17/32" clearance holes. Incandescent for 1.35-28V; neon has patented built-in current limiting resistor. Choice of cylindrical, faceted, convex, flat, square and round lens shapes, colors, finishes, legends. Off-the-shelf.

DIALIGHT

Dialight, A North American Philips Company
203 Harrison Place, Brooklyn, N. Y. 11237 (212) 497-7600

SEND ME FREE INDICATOR LIGHT PRODUCT SELECTOR GUIDE.



Centralab perspectives

FOR USERS OF ELECTRONIC COMPONENTS



CENTRALAB

Electronics Division
GLOBE-UNION INC.

5757 NORTH GREEN BAY AVENUE
MILWAUKEE, WISCONSIN 53201

When Circuit designs shrink, EMI/RFI problems look bigger

**USCC/Centralab's
monolithic ceramic filters
have evolved in phase with
solid state technology and
use of ever higher
frequencies.**

MSI and LSI technology have been shrinking the world of electronic instrumentation, test equipment, systems and computers — enabling (and dictating) the use of higher, faster frequencies/speeds. With active circuit elements in increasingly intimate relationship, electromagnetic and electric fields are straying into unwanted places; sharp filtering has to be an important design consideration.

U.S. Capacitor Corporation, the world's leading innovator of monolithic ceramic capacitors and filters, has tracked circuit speed developments with one set of filter parameters in mind: improved attenuation at increasingly higher frequencies, in state of the art sizes and at *affordable prices*. Ceramic Filter evolution has been accelerated at USCC/Centralab. We've made it happen by basic research in dielectric materials and production-engineering of new manufacturing techniques.

Today's products of this evolution are CERAMOLITHIC®

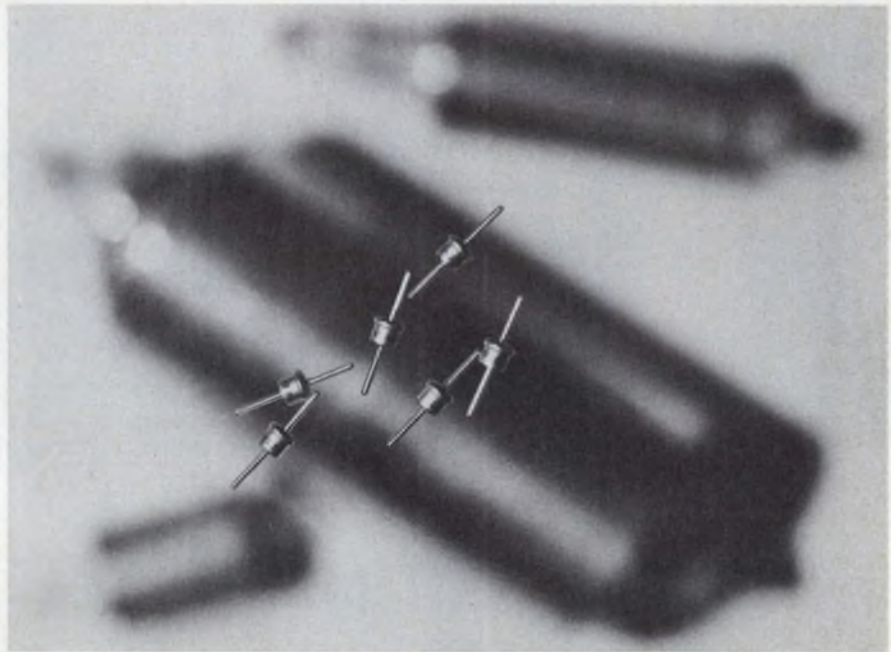

Above is USCC's smallest filter product — the 9900 series feed-thru pictured over larger more costly conventional types.

subminiature EMI/RFI filters like our 3112 — widely used in portable communications and in microwave applications. Or our 9900 series feed-thru's giving better than 70 db at 10GHz in only a .110" x .156" diameter case size — for use in medical electronics and CATV.

Where does filter evolution lead tomorrow? In these pages, in the next couple of months, USCC is going to introduce a whole new concept in ceramic filters — with reliability and pricing in mind.

Meanwhile, our new 1974 filter catalog may be useful. Write for one or call Don Thommen direct, (213) 843-4222 to discuss your filter applications.

At USCC Centralab, the filter evolution is tracking your design requirements; EMI/RFI problems just won't look very big.

USCC **USCC/Centralab** 
Electronics Division • Globe-Union, Inc.
2151 North Lincoln Street • Burbank, California 91504
(213) 843-4222 • TWX: 910-498-2222

Centralab perspective:

Trimmer resistors.



Now, with
new
Snap-Tite[®]
rigid PC mounts.

When you specify the new Snap-Tite rigid mount you can simplify both installation and assembly. Available on both Centralab Series S carbon and cermet trimmer resistors, it lets you snap them into a PC board. Easy. The mount locks the trimmer securely into the board prior to soldering.

Centralab gives you more of the things you want in trimmers. Ceramic bases for higher wattage in a smaller space. Smooth positive adjustment. A variety of choices in mountings, terminations and knobs. And multiple sections too.

Send for Bulletin 1549T so you'll have all the specs.



Centralab perspective:

Transmitter Capacitors

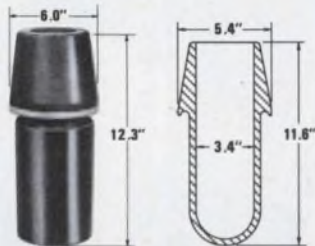

Ceramic
dielectric
insert.

Meet Specs For
Extra Reliability
and Save 50%.

When selecting capacitors for transmitter equipment, Centralab can help. Example: one ceramic dielectric type can replace two vacuum types — increase reliability — yet reduce both weight and cost by 50% or more. The cup type shown, meets specs calling for 6000 pf, 10 kV and current ratings of 100 amps at 500 kHz.

Centralab's line of special capacitors includes header, feed-thru, tubular, slug and water-cooled types — plus custom designs to meet any spec.

All it takes is a call to
Marty Hedrich at
414/228-2033.



CENTRALAB
Electronics Division
GLOBE-UNION INC.
5757 NORTH GREEN BAY AVENUE
MILWAUKEE, WISCONSIN 53201

Centralab perspective:

Pushbutton line switch.



Mounts in any
station.

With Centralab pushbutton switches you can have a line switch that's the same size as a standard six pole module and is interchangeable with other modules in an assembly. For push-ON, push-OFF operation . . . rated 5 amp/125 VAC (CSA).

Other pushbutton switch features include:

- 10, 12.5, 15, 17.5 and 20 mm spacing options.
- Epoxy sealed terminals.
- Interlock/lockout variations.
- 25 button styles and 18 colors.

Write Centralab for
Bulletin 1550.

*Isostat licensed



IF it uses rechargeable
BATTERIES
chances
are...

OTA1



DYNAMIC WALL PLUG-IN CHARGER/CONVERTER

... is the one selected by
the manufacturer as the
'other' unit in the
package.

DYNAMIC'S vast experience and specific
knowledge in the manufacturing of
Wall Plug-in Charger/Converters
has made them the choice
of the great majority.

Call our engineering
staff for full details
relating to your
product.



DYNAMIC INSTRUMENT CORP.

MANUFACTURERS OF POWER CONVERSION AND
BATTERY CHARGING SYSTEMS TO THE
ORIGINAL EQUIPMENT MANUFACTURER

933 Motor Parkway
Hauppauge, N.Y.

11787

516 - 234-2900

ACROSS THE DESK

(continued from page 24)

hand, when the thermocouple looks into a hi-Z load, the IR drop is very low in the thermocouple circuit, resulting in a high signal to the readout.

For example, if the input impedance is the same as the thermocouple resistance, 50% of the signal will be consumed in the thermocouple lead. The higher the input impedance, the greater the ratio of signal-to-lead losses—which is desirable in most cases.

W. Earl McKinley

Vice President, Engineering
Omega Engineering Inc.
Box 4047
Stamford, CT 06907

Beware the needle in acupuncture gear

As a partner in an aborted attempt to market an innovative circuit for use in acupuncture, I must warn your readers of the dangers of dealing in this field.

With the rise of no-fault automobile insurance, the ambulance chasers have turned their attention to medical malpractice cases. In Michigan, liability-insurance costs have driven some doctors out of practice.

Acupuncture equipment can be lethal when misused. Our attorneys advise that the manufacturer and officers of the corporation would be named in any lawsuit that involves such a controversial field. Juries tend to ignore the law book in personal-injury cases. And even if the case is successfully appealed, the legal expenses can be astronomical.

Experimental medical equipment, with its astronomical liabilities, is no place for the evening experimenter or small businessman—unless he is willing to risk the loss of his personal fortune and seek asylum in a foreign country.

Dennis L. Green

20039 Murray Hill
Detroit, MI 48235



made in Georgia, U.S.A.!

Combine Murata's 30-year-old world renown reputation as the leader in ceramic capacitors with its new "Made in Georgia, U.S.A." label and you'll find unexcelled quality, delivery and service. Discs, dipped, molded and chip monolithic multilayers, reduced titanates—Murata has a complete line of everything in the ceramic capacitor field. Write, call or circle the number below. We'll let you know how Murata can solve your ceramic capacitor problems.

muRata

CORPORATION
OF AMERICA

Rockmart, Georgia 30153 • Phone: 404-684-7143 Telex: 54-2999

INFORMATION RETRIEVAL NUMBER 236

BURROUGHS DISPLAYS

CAN TAKE IT!

Burroughs gas discharge display panels are designed to stand up under the toughest operating conditions of shock, vibration, humidity, and temperature extremes ranging from -40° to over $+185^{\circ}$ F. Burroughs display panels are capable of withstanding the real-world conditions so often encountered in automotive, aircraft, instrumentation, consumer, and industrial applications.

SELF-SCAN[®], PANAPLEX[®], and SELF-SCAN BAR GRAPH displays have no moving parts, no internal welds, and require a minimum of external connections (only 8 connections for a dual SELF-SCAN BAR GRAPH, 16 connections for a 16- or 32-character SELF-SCAN display, and 17 connections for a

full 9-digit PANAPLEX display). Gas-discharge technology has proven long life through years of rugged use.

These bright, sharp, clear, high-contrast displays are a pleasing neon-orange color, making them a comfortable display to read, even for extended periods of time.

SELF-SCAN display panels are the ideal man-machine links for displaying 16 to 256 alphanumeric characters for information display systems.

PANAPLEX display panels are for 4 to 16 numeric character applications, and can include arithmetic symbols and alphanumeric characters for systems requiring constant or intermittent display of data, such as calculators, clocks, and recording instruments.

SELF-SCAN BAR GRAPH analog displays present information in analog form with digital accuracy for the measurement and display of speed, torque, temperature, pressure, force, acceleration, and other control or information parameters.

SELF-SCAN, PANAPLEX, and BAR GRAPH display components are attractive, easy to read, compact, versatile, and are ideally suited to the new generation of information display requirements.

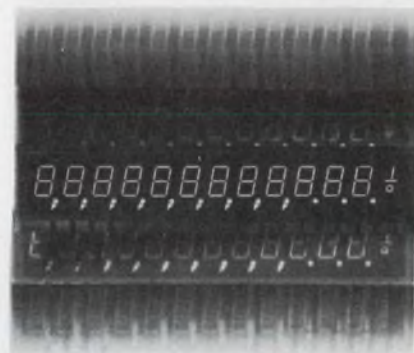

For complete technical details and applications engineering recommendations, write or call Burroughs Corporation, Electronic Components Division, P.O. Box 1226, Plainfield, N.J. 07061 or call (201) 757-3400 or (714) 835-7335 in California.

Burroughs



New amplifier increases s/n ratio of CCD imager

A new concept in semiconductor devices—a distributed floating-gate amplifier—is reported with the latest charge-coupled-device image sensor.

The device, a 190×244 -element array on a 6.15×6.30 -mm silicon chip, has been developed by Fairchild Semiconductor, Mountain View, CA. According to Gilbert F. Amelio, manager of Fairchild's CCD group, the sensor contains in addition to the standard gated-charge integrator-detector-preamplifier—a low-noise, 12-stage distributed floating-gate amplifier.

The idea is based on the property of CCDs that signal charges can be passed under several sensing electrodes with no signal degradation. With the signal-charge sensed repeatedly, the signal-to-noise ratio can be improved, he adds. For the new image sensor, there is a square-root-of-12 increase in the signal-to-noise ratio.

Amelio notes further that there are four functional parts: an input register, a bank of charge amplifiers with floating-gate inputs, an output register and a floating-gate output amplifier.

While the new amplifier makes it possible to get an improved signal-to-noise ratio, it is only capable of handling 10% of the charge of a full well (for more details on how CCDs work, see "3 Years After Birth, CCDs Head for First Commercial Applications," ED No. 1, Jan. 4, 1973, p. 36). Thus as the intensity of the signal gets higher, it is necessary to switch to the more conventional gated-charge detector preamplifier.

Because the 190×244 -sensor provides half the resolution in each direction needed for a TV-compatible device, it seems very likely that the next development from Fairchild will be a 380×488 -element array that is com-

patible with 525-line TV. Since the Fairchild image arrays use an interline transfer organization that substantially reduces the area required for a sensor, Amelio notes that the 380×488 array can be fabricated on a chip with an area of 100 sq. mm. The only other TV-compatible chip developed so far is a 320×512 -element device from RCA, which occupies an area of 242 sq. mm.

Bicolor LED coming with a simpler drive

A major difficulty with single-chip, bicolor LEDs—complex drive requirements—will be overcome with a new bicolor LED expected on the market late this year or early next.

The new Texas Instruments model, according to Karl Stjernquist, international marketing manager for optoelectronics, will have a dc-input range of 10 to 50 mA, which will result in emitted colors of red to green, respectively. With TI's existing bicolor LED, Stjernquist notes, green is obtained with an average input of about 200 mA.

Moreover the higher input current requires special drive circuitry to prevent LED overheating, which would cause the emitted light to shift downward in color. Pulse-generating circuitry must be used to obtain peak current of 600 mA with a 1/2% duty cycle, according to Stjernquist.

Like the existing bicolor LED, the new device will be fabricated from gallium-phosphide and will operate from a single, 5-V supply. It will also appear to be less efficient in red than green.

However, the difference in viewed brightness has more to do with the eye's response than with

the LED, Stjernquist notes. For the same output power, red always appears less bright than green.

The simplified drive requirements have been made possible by improvements in the LED-junction design, Stjernquist explains. With the new model, higher current densities are possible on a smaller chip.

Also, emitted colors vary linearly with the input current. The yellow spectrum, for example, is radiated at around 25 mA. Orange appears at lower currents.

Stjernquist believes that displays using the new LED will be available in the near future. They will provide numerical data plus other information indicated by the color. For example, a numerical readout in red would indicate an unacceptable condition, while one in yellow would imply caution.

Initially the new bicolor LED will be offered in conventional miniature-lamp packages. Although pricing has not yet been set, Stjernquist estimates that the new product will cost about two to three times more than available red LEDs, which are priced at about 10¢ in high volume.

Liquid crystals help spot IC defects

A technique that enables researchers to trace the flow of electron pulses in integrated circuits, and thus quickly locate defects, has been developed with liquid crystals.

Visual inspection, even with very high-powered optical microscopes, gives no indication as to how an IC operates, says Dr. George C. Cody, director of the RCA Physical Research Laboratory, Princeton, N.J., where the new approach was devised. But the liquid crystals reflect or refract light when stimulated by electricity, he notes. Electron microscopes can trace signals in an IC, Cody concedes, but they can cause radiation damage to the device and require time-consuming preparations. Observations of a liquid-crystal-coated IC under a conventional microscope provides significant clues to its operation, the research chief says. Preparation is minimal, 30 to 50 ICs can be pre-

pared in about an hour.

Describing the technique, Cody notes that a surfactant—a material that reduces surface tension—and a drop of nematic liquid crystal are applied to the surface of the IC under investigation. Next the liquid crystal is covered with a thin glass plate. The IC is then placed in a microscope and illuminated with polarized light. The light polarizers are adjusted so no light reaches the eyepiece of the microscope.

When pulses travel through the IC, the electric fields they create rotate adjacent molecules, changing the index of refraction of the liquid crystal. This change in the refractive index allows some light to pass through the polarizers, making the pulses visible. By following the path of the pulses, the investigator can quickly pinpoint most defects and metallization failures.

Since liquid crystals are also heat-sensitive, hot spots caused by shorts can be located in the same way, Cody says.

The new technique, he reports, is quite useful in examining ICs undergoing life testing and in investigating other subtle problems. For example, a device can be examined with and without loads, to determine the effect of loading.

28,244 calls handled by one phone link

A link in the Bell Telephone System's digital communications network that can provide 28,244 simultaneous telephone conversations is undergoing prototype testing over a 2.7-mile range.

The link—the DR-18—is a short-range, 18-GHz microwave system that, for the first time, incorporates transmitting and receiving electronics in the same package as the antenna. The package is placed atop a tower.

"There are no electronics on today's microwave towers," says Richard Slade, supervisor of digital radio systems analysis at Bell Laboratories, Murray Hill, NJ. "The microwave equipment is housed, along with power supplies, in buildings at the tower bases."

Electronics for the new system—eight transmitters and receivers

—provide seven operating channels and one spare, Slade points out. Each channel carries 4032 circuits that are fed by D1 and D3 PCM terminals that service circuits in 24-channel blocks.

The output of these terminals is multiplexed by high-speed digital circuits to produce a stream of 274 Mbits/s.

The volume of the complete DR-18 package is about one-tenth that of present lower-band horn reflector antennas, Slade notes. The reduction in large part, Slade says, because of the availability of solid-state beam-lead devices—both for high-speed logic and microwave integrated circuits.

The basic transmitter power is developed by an Impatt diode in a waveguide cavity, Slade explains. The modulators, as well as the receiving circuits, are made with microwave ICs plus hybrid technology. The transmitted power is about 250 mW.

Power for the system is supplied by local ac lines. For emergencies, batteries are at the tower base. The local ac is stepped down to 24 V and distributed to the eight transmitter-receiver packages, each of which has its own rectifier regulator.

The prototype tests are being conducted at a range near Bell Laboratories' plant in North Andover, MA.

The DR-18's digital transmission rate matches a future millimeter waveguide system and a new digital system—the T4—now under development. The millimeter waveguide system is the Bell System's long-haul transmission medium planned for the 1980s. The waveguide is expected to carry some 250,000 simultaneous conversations.

Wall Street Journal printed via satellite

In an experimental program that forecasts eventual publication and delivery of newspapers on a worldwide basis, the pages of the Wall Street Journal are now being printed via satellite transmission.

For the first tests, a joint program was arranged between Dow Jones & Co., publishers of the Journal and the Communications Satellite Corp. (COMSAT). A digital

data-communications terminal was set up at the Journal's regional typesetting and composing plant in Chicopee, MA. The purpose was to transmit high-resolution facsimile pages of the paper to the printing plant in So. Brunswick, NJ, some 200 miles away.

The Chicopee station transmits at a 50-kbit range in the 6-GHz band with 20 W. A 15-ft paraboloid antenna is used, aimed at the INTELSAT IV communications satellite, which is in synchronous orbit 22,300 miles over the Atlantic Ocean. The facsimile data are relayed by the satellite in a 4-GHz-band down-link to the New Jersey station.

Glenn Jenkins, responsible for the facsimile and wide-band data communications for Dow Jones, says: "From experimental results to date, transmission by satellite will be much less expensive over long distances than is our current use of telephone microwave links. Cost reduction was one of our major objectives for this program."

For commercial purposes Jenkins notes, one Western Union Westar I or II satellites would be used, since INTELSAT IV cannot be used commercially.

A major advance demonstrated by the satellite transmissions has been a reduction in error rates from 1 error in 10^8 bits by use of land circuits, to 1 in 10^{10} bits for the sky link.

"With this low error rate, we can probably run a couple of months without having to retransmit a page," Jenkins says.

Such a low error rate can permit Dow Jones to reduce costs further by elimination of the need for land-link ARQ systems. These systems analyze digital data received and send an automatic request back to retransmit when an error is observed. In addition, Jenkins notes, the time required normally for retransmissions is thus saved.

At the New Jersey site, the receiving antenna, a 15-ft paraboloid, has a G/T gain of 21.6 dB/°K. This compares with 41.7 dB for a standard COMSAT 98-ft paraboloid, according to Neil Helm, assistant manager of applications at COMSAT, Clarksburg, MD. The receiving antenna, which has about a 1° beam width, is more efficient than its larger counterpart.

Power Supply Catalog



the new Reference for Precision DC Power Supplies

Send for your **FREE SYSTRON-DONNER Power Supply Catalog** . . . featuring application notes, power supply terms, photos, easy-to-use selection chart, complete specs, and outline drawings on our complete line of:
laboratory systems, and digital power supplies, and specialty products.

WIDE RANGE LAB & SYSTEM SUPPLIES

Precision Regulation Low Ripple

Volts	Amps	Size	Price	Model
0 to 5	130	R7	\$1150	M7C5-130 OV*
0 to 7	4	O	219	HH7-4
0 to 8	50	R5	795	M5P8-50 OV*
0 to 8	100	R7	945	M7C8-100 OV*
0 to 8	400	R8	1995	M8C8-400 OV*
0 to 15	3	Q	219	HH15-3
0 to 15	30	R5	795	M5P15-30 OV*
0 to 15	50	R5	895	M5C15-50 OV*
0 to 15	80	R7	1095	M7C15-80 OV*
0 to 15	250	R8	1850	M8C15-250
0 to 20	12	H	425	HR20-12C
0 to 20	20	R3	575	RS20-20B
0 to 32	1.5	Q	219	HH32-1.5
0 to 40	2x1 Dual	H	375	DL40-1 (2 outputs)
0 to 40	7	H	425	HR40-7C
0 to 40	10	H	475	HR40-10C
0 to 40	15	R3	575	RS40-15B
0 to 40	30	R5	895	M5C40-30 OV*
0 to 40	50	R7	945	M7C40-50 OV*
0 to 40	100	R8	1850	M8C40-100
0 to 50	1	Q	219	HH50-1
0 to 60	4	H	425	HR60-4C
0 to 60	8	H	475	HR60-8C
0 to 80	12	R3	590	RS60-12B
0 to 80	20	R5	895	M5C60-20 OV*
0 to 80	30	R7	1050	M7C60-30 OV*
0 to 160	0.3	Q	269	HH160-300
0 to 160	3	H	575	HR160-3C
0 to 160	4	R3	695	RS160-4B
0 to 160	8	R5	950	M5C160-8
0 to 160	15	R7	1790	M7C160-15
0 to 320	2	R3	730	RS320-2C

*Overvoltage Protection standard
R3 = 3 1/2" panel height rack
R5 = 5 1/4" panel height rack
R7 = 7" panel height rack
R8 = 8 3/4" panel height rack
H = 5 1/4" panel height half rack
Q = 5 1/4" panel height quarter rack
† = Add \$50 for voltage and current meters

SYSTEM RACKS & SUB RACKS

Precision Regulation Low Ripple Wide Output Slot Adjustment

Power Modules also available in 5 package sizes with compatible rack adapters for use in OEM and systems applications. Ranges from 0 to 210VDC and up to 20 Amps. Complete data available in our NEW 52-page Catalog.

Nominal Voltage	Amps	Size	Price†	Model
5	60	H	\$450	VPH5-60 OV*
5	135	R5	645	VP5-135
8	115	R5	645	VP8-115
±12	2x13 Dual	H	450	VPHD15-13
12	35	H	425	VPH12-35
12	90	R5	645	VP12-90
15	31	H	425	VPH15-31
15	85	R5	645	VP15-85
24	22	H	435	VPH24-22
24	60	R5	660	VP24-60
28	19	H	435	VPH28-19
28	50	R5	675	VP28-50
48	30	R5	675	VP48-30

specialty products

Digitally Adjustable Precision Lab Supply PLS50-1 \$375 0 to 50VDC @ 1 Amp



- 5 dial calibrated output
- Multiversatile remote programming in ohms/volt, volt/volt, analog voltage, current limiting.



Triple Output Lab Supply TL8-3 \$315 0 to 8VDC @ 3 Amps 0 to ±32VDC @ 1 Amp

- Each output independently adjustable
- Automatic Current Limiting
- Ideal for sensitive and critical IC Circuit testing



Digital Power Source Model DPS single output from \$1295 dual output from \$2260 Single or Dual 0 to 50VDC or 0 to 100VDC to 1 Amp Power Supplies for High Speed Automated Test Systems

- Each output digitally programmed independently from computer
- Addressable Memory (16 possible addresses)
- Optional programmed polarity, overcurrent limit, overvoltage protection level
- Optically isolated to reduce ground loops
- Self Verification options — data parity, time delay, overcurrent, equilibration
- Optional integral manual programming and visual display of numerical input data

ASK ABOUT OUR COMPLETE SPECIALS CAPABILITY FOR ALL YOUR POWER SUPPLY NEEDS . . . FROM A MODULE TO A SYSTEM, SINGLE & MULTIPLE OUTPUTS.

Call your local Scientific Devices Sales Office or

TRYGON ELECTRONICS
SUBSIDIARY

SYSTRON DONNER

1200 SHAMES DRIVE ■ WESTBURY, NEW YORK 11590 ■ PHONE (516) 997-6200

Albuquerque, (505) 268-6729; Boston, (617) 894-5637; Burlington, NC (919) 228-6279; Chicago, (312) 297-5240; Cleveland, (216) 835-2270; Denver, (303) 573-9466; Dayton, (513) 298-9904; Dallas, (214) 231-8106; Detroit, (313) 363-2282; Ft. Lauderdale, (305) 721-4260; Hamden CT (203) 248-9361; Huntville, AL (205) 536-1969; Houston, (713) 623-4250; Kansas City, KS (913) 631-3818; Los Angeles, (213) 598-7678; Minneapolis, (612) 544-1616; New York City area (201) 871-3916; Norfolk, (804) 499-8133; Orlando, (305) 841-8180; Philadelphia, (215) 825-9515; Phoenix, (602) 956-5519; Rochester, NY (716) 334-2445; San Antonio, (512) 694-6251; San Diego, (714) 279-6642; San Francisco area (415) 964-4230; Seattle, (206) 454-0900; St. Louis, (314) 842-2535; Washington, DC area (703) 451-6500.

HAYDEN BOOK COMPANY, INC.

50 Essex Street, Rochelle Park, New Jersey 07662



An Open Letter To Manufacturing Managers.

Are you putting off reliable and promising systems innovations because of the money involved? Or the time? Or maybe because of the painful "people problems" you can foresee?

You probably face these problems constantly because as systems technology expands, it demands radically new talents and skills from management.

Recently, professionals from industry, education and government met for the 10th annual symposium co-sponsored by Informatics and UCLA. Their goal? To bring *clarity* and *profitability* to today's new manufacturing methods—for *you*, the *manager*.

Now we have compiled the proceedings into a compact management handbook, called **MANUFACTURING MANAGEMENT SYSTEMS: New Challenges and Profit Opportunities**. As a manager, you couldn't ask for anything more.

This handbook is the symposium and *more*. We've cut away all the extras—the repetitions, the mumblers and the chit-chat—leaving you with the clear and uninterrupted essentials.

The result is an unparalleled, personalized handbook of guidelines, solutions and solid information from some of the nation's most successful industrial leaders.

You'll hear the vice-president in charge of technical affairs at Ford Motor Company tell how an American institution computerized its vast and complex production lines (and battled equally monstrous supplier foul-ups, record problems, etc. along the way).

An executive from a major R & D firm outlines what he has discovered to be the vital managerial skills and essentials for directing progressive operations.

One of Informatic's key men spells out some of the latest and most worthwhile computerized tools available to manufacturers.

The president of a manufacturing firm offers 16 pages of realistic guidelines for handling the sensitive problems of system implementation (without any of the current psycho-social jargon).

There's one corporation president whose share of this handbook is frankly titled "Making Sure You Really Get a Payoff From Your Manufacturing System." It amounts to nothing less than a proven master plan for doing just that.

There are ten sections in all, each one more helpful and informative than the next. Every page is sharp and direct, yet conversational, as if it were being spoken. For the manager, there's a perfect balance of technical information and the wisdom and common sense for using it.

You can now examine, read and use the handbook free, for 15 days, just by circling the information retrieval number shown below. At the end of that time, just send in a check for \$10.50, plus postage and handling, or return the book with no further obligation.

You won't run across many opportunities to hear this kind of straight talk. Try to imagine a symposium where you sit right up front and write down every single word because you know you can use it all.

P.S. Remember—it's easy to order. Just circle the *Information Retrieval No.* shown below!





Circuits missing their mark? Tweak them into spec with our trimmers.

Are tolerance build-ups doing weird things in your circuit designs? Don't worry. It happens in the best of families, and Beckman cermet trimmers straighten it out.

Whatever your packaging problem, you can solve it with the right trimmers from our extensive standard line. With the right shapes, sizes, pin spacings, and resistance values.

Need rectangular trimmers? We have a huge selection. One best-selling line is our $\frac{3}{4}$ " multiturn, sealed series. It's typical in quality and performance of a dozen different rectangular models stocked locally for immediate delivery from your Beckman/Helipot distributor.

But don't be horrified if your boards won't accommodate rectangulars. Also available for

immediate local delivery are our popular $\frac{3}{8}$ " square models, single-turn and sealed. And the low-cost $\frac{3}{8}$ " circular, covered, single-turn types.

Pick from more than three dozen models, each in standard resistance values from 10 ohms to 2 megohms. And in a variety of pin spacings. All with exceptional setability and 100 ppm/ $^{\circ}$ C tempco.

If you need immediate technical literature or the phone number of your local Beckman/Helipot distributor, call toll-free (800) 437-4677.

For a free wall poster featuring the above monstrous illustration, plus our full line of trimmers and specs, write to Beckman/Helipot Division, 2500 Harbor Blvd., Fullerton, Calif. 92634.

Beckman[®]

HELIPOT DIVISION

First OEM electron-beam laser scans flat fields in microseconds

The first electron-beam-pumped semiconductor laser to hit the market resembles a cathode-ray tube. It can electrically sweep the laser beam in two dimensions to provide high-speed random or raster flat-field scanning patterns.

The laser can be used for data retrieval and with light-sensitive materials for a variety of imaging applications. These include microfilm imaging, hybrid microcircuit fabrication, autotype setting, and nonimpact line printers.

The fast sweep speeds obtainable with electronic scanning of the beam—on the order of a few microseconds—are not achievable with any other known technology,

according to the 3M Co., St. Paul, MN, the laser's developer.

Another prime advantage, 3M says, is the beam can be electronically blanked, unblanked or modulated with analog video signals. As a result, the electron-beam laser is able to project pictures or graphic data.

Holographic data retrieved

Retrieval of data in multi-megabit holographic memories has been demonstrated in a 3M prototype archival system—the Megafetch. In this system an array of 1024×1024 microholograms on a four-inch-square holographic storage plate can be accessed in a random fashion or by use of a raster scan. Maximum random-access time between any two microholograms is

20 μ s. Each hologram contains 56 bits of information, with eight bits for parity and checking.

Consequently the storage capacity of Megafetch is 58.7 million bits for the array. The optimum data-transfer rate is in the raster-scan mode—15 Mbits per sec.

In the faceplate of 3M's laser is a 26×26 -mm plate of cadmium sulfide, 30 μ m thick. Both sides of the plate have mirrors that form a Fabry-Perot cavity for lasing action. The sulfide plate is mounted on a sapphire substrate, which forms the tube faceplate.

The cadmium-sulfide plate is bombarded by a 60-kV beam from an electron gun in the opposite end of the laser tube, much as the electron beam from the gun in cathode-ray tubes strikes the faceplate and produces light.

In the case of the electron-beam laser, however, the output is a beam that radiates directly into space from the spot that is hit by the electron beam.

In the present model, according

Jim McDermott
Eastern Editor

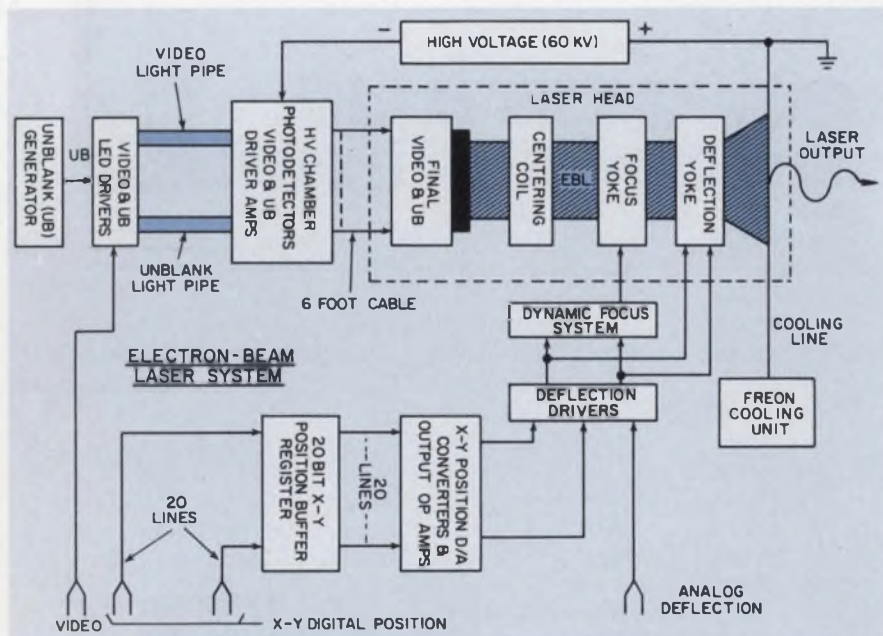

Isolation of ground-level video and unblanking signals from 60 kV on the electron-beam laser tube is provided by use of 9-inch quartz light pipes. The inputs to the light pipes are the outputs of high-speed LEDs.



The electron-beam laser, by 3M, is shown with the optical train that is used for retrieval of holographic data.

1975 CERAMIC CAPS...NOW

MONO-KAP™, MONO-GLASS. Radial. Axial. USCC/Centralab has taken the lead for '75. You can be confident now of short delivery, plentiful supply and competitive pricing on reliable ceramic capacitors from the leader in monolithic technology.

DISCRETE ASSEMBLY

MONO-KAP™ radial-leaded epoxy coated capacitors are reliable performers; they're rugged enough to work in MIL environments. 4.7pF to 10Mfd., 50 to 200 WVDC in a variety of dielectrics and case sizes. Immediate delivery from stock; large volume production orders in *eight weeks* . . . and price competitive.



AUTOMATIC HIGH VOLUME INSERTION

MONO-GLASS axials are glass encapsulated, designed for automatic



PCB insertion; furnished reel-packed for high volume applications. They're available in 50 and 100 WVDC from .01 to 1.0Mfd.; three dielectrics: COG, X7R and Y5V.

Our basic materials research gives you the best in monolithic technology; our productivity engineering guarantees competitive prices and best delivery.

You can design confidently with USCC in 1975 for: calculators, computers, business machines, communications or any volume application using discrete or automatic assembly.

Some manufacturers are still solving problems; we can produce 25 million pieces per month and we're still expanding; at USCC we've got 1975's

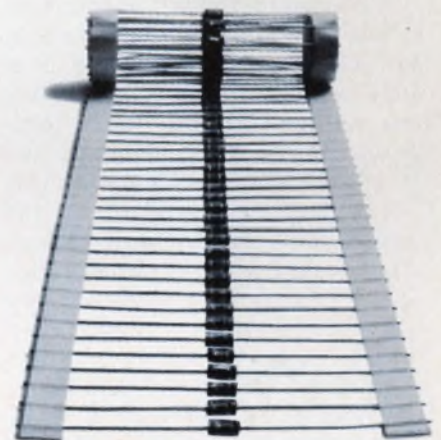

capacitors NOW. Write or call for large quantity quotations or evaluation samples.

Remember, USCC/Centralab.



USCC/Centralab

Electronics Division • Globe-Union Inc.

2151 North Lincoln Street ■ Burbank, California 91504
(213) 843-4222 ■ TWX: 910-498-2222



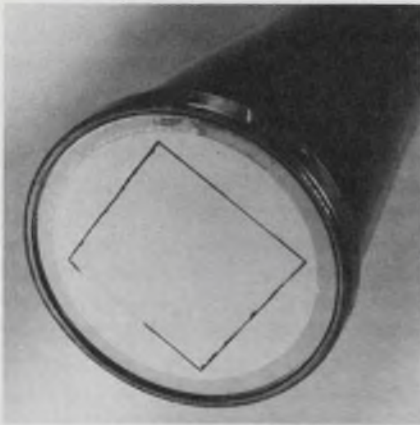

The cadmium-sulfide laser cavity is located on the rear of the sapphire faceplate of the electron-beam tube.

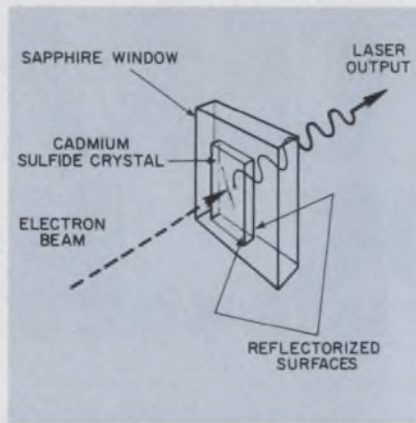

A 30- μm -thick cadmium-sulfide crystal with mirrored surfaces forms the cavity that gives laser action.

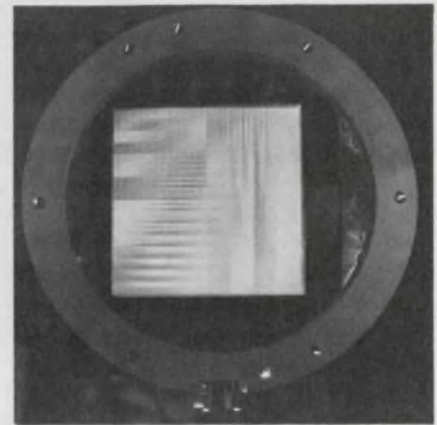

This 1024 by 1024 microholograph array is shown as it is seen through the Megafetch processor lens system.

to Richard Dennison, 3M research specialist on the electron-beam laser, the laser beam varies from 15 to 50 μm in diameter, depending upon the power in that beam. For a 750-mW beam, the spot size is 25 μm , while for 3.5 W the spot increases to 50 μm . The laser efficiency is low—on the order of a few percent.

The electron-beam pumping action is in a 50-ns pulse mode, with the duty cycle for the entire crystal 3% at 3.5-W output. The rise and fall times of the laser emission are less than 10 ns.

With use of 750-mW beam power and a 25- μm spot, the cadmium-sulfide plate can be addressed at 1024 \times 1024 spots—or more than one million discrete beam locations, as has been done in the Megafetch system, Dennison notes.

The half-angle spread of the beam is less than six degrees, and a lens a few inches from the face of the tube is used to collect and collimate the beam. The cadmium-sulfide laser output is a green light with an inherent wavelength of 5150 Å. It can vary plus or minus 10 Å, due to the small variations in the ratios of the elements in the cadmium-sulfide plate.

Dennison points out that as the power output of the plate is increased, the wavelength shifts upwards. For example, at 750-mW peak, the shift is 25 Å, while for 3.5 W the shift is 50 Å.

Lasing action has been produced experimentally from other II-VI semiconductors, such as cadmium selenide and zinc oxide.

The present laser system design, which is being offered to OEM re-

search and design laboratories by the 3M New Business Ventures Div., consists of two units connected by electronic cables and a coolant tube. Cooling is required to keep the cadmium-sulfide plate at a safe operating temperature.

One of the units, the laser head, contains the tube and a window through which the laser beam passes. The head, about 12 \times 12 \times 36 in., can be moved to any desired location, limited only by the cables. The laser head can be oriented in any desired position.

The second or support unit contains power supplies, control circuitry, deflection amplifiers, digital control circuitry and the cooling unit.

Isolation problems solved

Because the laser tube requires 60 kV for operation, isolation problems had to be solved to make the design practical, according to Dennison. To begin with, it was necessary to ground the faceplate, or anode, at the tube end because of the cooling-system piping. As a result, the tube's electron-gun structure operates at the high-voltage level.

Dennison points out that the laser tube is on the end of a six-foot, high-voltage cable that incorporates 50- Ω coax cables carrying driver-amplifier video and unblanking signals from the high-voltage chamber. The final video and unblanking amplifiers are located at the input end of the laser tube at the 60-kV level.

Isolation between the high voltage and the low-level video and

unblanking signals has been provided with two nine-inch quartz light pipes. The inputs to the light pipes, Dennison says, are the outputs of high-speed LEDs that convert low-level video and unblanking signals into optical signals.

The unblanking LED is driven by a 20-V, 200-ns pulse that switches in about 5 ns. The LED output travels through the light pipe to a PIN photodetector diode and to the diode's preamplifier in the high-voltage chamber. The preamp output is fed to line-buffer drivers, which, in turn, drive a 50- Ω line feeding the final unblanking amplifiers in the laser head.

The unblanking signal, which is about 30-ns wide, switches on and off in 5 ns and has a 3.5-V swing into the 50- Ω cable. The signal from this cable drives a high-power, four-transistor, totem-pole unblanking amplifier that has a 140-V swing. This swing is applied to the cathode.

"We're pulse-unblanking the cathode at rates from 2 to 65 kHz, using either internal or external signals," Dennison reports.

The video-input signal, which has a maximum 1-V excursion, is applied to a high-speed op amp that feeds the video LED. In the high-voltage chamber the LED video signal is picked up by a second PIN diode and amplified. The output is applied to a 50- Ω video cable.

At the laser-tube end, the video signal is fed to the final video amplifier to provide a maximum —60-V swing that is applied to the control grid of the tube. ■■

When a life depends on the display you choose...

depend on HP's new 1332A. This improved display gives you the superior picture quality you must have when life is in the balance. It answers your need for higher resolution, better stability, more uniform light-output. And it meets the stringent UL Listing for electronic equipment used in patient care. The 1332A provides a combination of high performance and easy system integration to give OEMs a better display solution for demanding medical-instrument applications. For example:

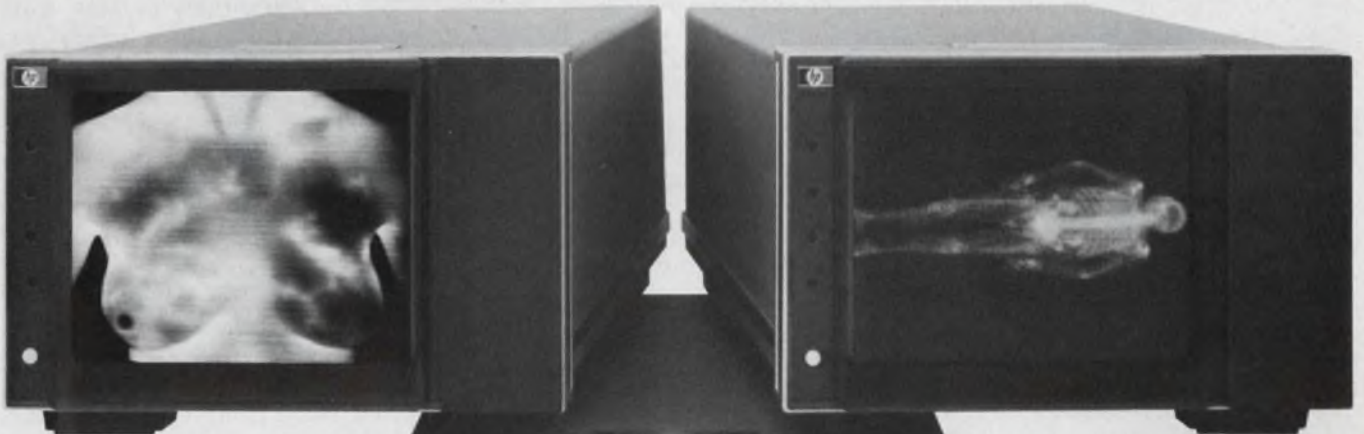

Thermographic breast scan for cancer. Courtesy of Dorex Inc., Los Angeles, CA.

Gamma camera provides full body bone scan for early detection of cancer. Courtesy of Penrose Cancer Hospital, Colorado Springs, CO.

Ultrasound determines dynamic blood flow through the heart. Courtesy of Metrix, Denver, CO.

In Thermography Equipment, HP's 1332A delivers the stable light-output required for making long scans or taking display photographs. Regulated CRT filaments prevent power-line surges from interfering with picture quality. And the 22.5 kV CRT allows more grey shades and assures a bright picture, even at low refresh rates typical in this application.

For Radioisotope Cameras, the 1332A provides superior light-output uniformity for more accurate analysis. Exceptional CRT design maintains the unit's extremely high resolution regardless of intensity level or beam deflection. This, combined with a fast z-axis rise-time means you get sharp pictures that reflect your system's true performance capability.

In Medical Ultrasound Units, where crisp, clear pictures are essential, the 1332A gives sharp focus at all

intensity levels, with any degree of beam deflection. As a result, you get the sharp, high-resolution pictures you need—at high or low intensity, over the entire viewing area. With this display, you get the picture quality needed for accurate diagnoses.

In addition to high performance, the 1332A offers easy system integration. Over 40 standard options, such as phosphor selection, digital blanking, gamma correction, choice of

z-axis rise-time, x- and y-axis deflection factor, control location and more, let you tailor the display to your system's needs. You also get the quality, product safety and after-sales support you expect from a leader in CRT technology. To get more information about the new 1332A Display, just contact your local HP field engineer. Or, write to Hewlett-Packard.

084/7

HEWLETT  PACKARD

Actual photos taken from these systems in use.

Sales and service from 172 offices in 65 countries.
1501 Page Mill Road, Palo Alto, California 94304

INFORMATION RETRIEVAL NUMBER 26

Off-shelf speech recognizers let users talk the data into computer

An automobile production line inspector is checking a car as it comes off the production line to see if it's okay. He wears a microphone. He looks at the car and says: "Carburetor shy, vacuum hose damaged, battery shy . . ." His voice feeds into a speech-recognition system, and seconds later a computer printout states the condition of the car, pointing out faults that have to be corrected.

An airline baggage handler looks at a tag on a piece of luggage, reads the destination or flight number out loud, and a machine automatically routes it to the correct baggage chute.

This new trend in interfacing between man and computer is called voice data entry. At least 20 companies are looking at such speech recognition in the laboratory, but only a handful are offer-

ing commercial equipment. Judging by the acceptance of the systems so far, these companies say the field should grow rapidly.

One concern that is translating spoken language into digital data is Threshold Technology of Cinnaminson, NJ. Its system, the VIP 100, is being used for inspection and quality control at an Owens-Illinois cathode-ray-tube plant, and by United Air Lines, Trans World Airlines and United Parcel for sorting baggage and parcels; by General Motors for assembly-line inspection of cars.

Isolated words recognized

The Threshold Technology system is an isolated-word recognizer—it responds to individual words or phrases, carefully articulated, not to connected speech in which there are no pauses between words.

Research is continuing, says J. Michael Nye, vice president of marketing at Threshold Technology in an effort to develop connected-

speech recognizers, but it may be several years before such systems materialize. The big difficulty is building a device that can determine the beginnings and ends of words in connected speech.

In the meantime isolated-word recognizers—like those offered by Threshold, Scope Electronics of Reston, VA, and Dialog Systems of Cambridge, MA—are filling the gap.

In describing voice-recognition equipment, Nye notes that there are usually three functional subsystems: a preprocessor, a feature extractor and a classifier. The preprocessor in Threshold's VIP 100 is a set of circuits designed to clean up and shape the acoustic signal being received to meet the requirements of the feature extractor.

The preprocessor removes irregularities and produces a normalized speech spectrum. This equal-

Jules H. Gilder
Associate Editor



Voice-controlled system for the handicapped being developed by Scope Electronics for the Veteran's Administration will allow paraplegics to operate typewriters, calculators, telephones and other equipment.



Baggage is routed by voice at United Air Lines' facility at O'Hare International Airport, Chicago.

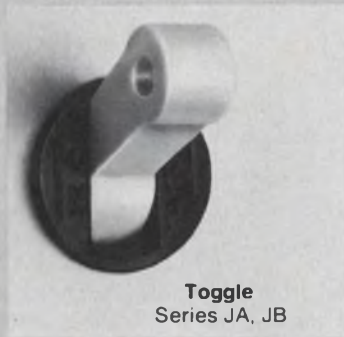

Toggle
Series JA, JB

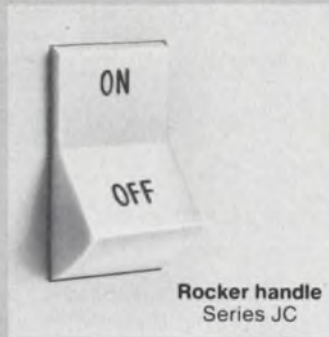

Rocker handle
Series JC



Environmentally sealed
Series JE



Pushbutton
Series JD



**Multipole
companion-trip**
Series JA, JB, JC

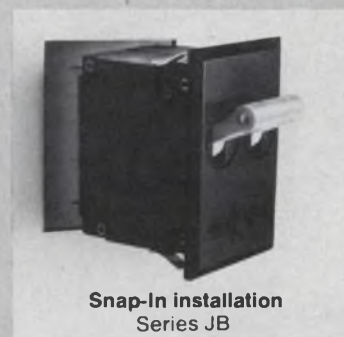

Snap-In installation
Series JB

UP FRONT.

That's where Heinemann Type J breakers look best on your equipment.

If a circuit breaker looks this good, why not put it on your equipment's front panel, where it can double as a power switch? It's an ingeniously simple way to cut component and assembly costs.

To meet the widest possible range of application requirements, Type J breakers are offered in any integral or fractional current rating from 0.020 to 30 amp at 240V 60Hz or 400Hz, or 65V DC. With a choice of four time delays and seven special-function internal circuits. With quick-on or screw terminals. And in one, two, three, or

four poles.

What about delivery? Well, we now have a Quick-Draw procurement program, under which the most frequently specified Series JA breakers are stocked for shipment within a few days of your order, sometimes overnight.

One final point. Though Heinemann Type J breakers are modestly priced, please don't confuse them with breakers of other types. All Heinemann breakers operate on a totally different, hydraulic-magnetic principle that

permits close-tolerance protection with complete freedom from nuisance tripping and other ambient temperature effects. To this day, they're the only circuit breakers good enough to be covered by a five-year warranty.

We'd like you to have our 16-page Bulletin J-3333, which will tell you almost everything you need to know about these breakers. Get it from your nearby Heinemann representative or Heinemann Electric Company, Trenton, NJ 08602. Phone (609) 882-4800.



HEINEMANN

We keep you out of trouble.

INFORMATION RETRIEVAL NUMBER 27

ized filtered speech is then passed through a real-time spectrum analyzer that consists of a bank of 19 active band-pass filters ranging in center frequency from 260 to 7626 Hz. The outputs of the filters are then full-wave-rectified, logarithmically compressed and applied to the feature extractor.

The feature extractor is designed to separate vowel formats, noise bursts and other major features of vocal sound from one another. Once the acoustic features are extracted, they are fed to a minicomputer, where they are compared and classified with stored reference patterns for a vocabulary of words.

To get the reference patterns, the machine is initially put in a training mode, where the user repeats the specific words he is going to use several times. The machine automatically extracts a feature matrix for each repetition of a given word, and a composite matrix is then stored in memory.

For busy hands

Voice-data-entry systems are proving most valuable in applications where the user's hands are normally occupied and it would be cumbersome to use them to enter data on a keyboard. An example is quality-control measurements at the Owens-Illinois TV tube plant in Pittston, PA.

Inspection data are entered orally as the measurements are made by an inspector, and once entered, the data are recognized and visually displayed for verification.

With the advent of hands-free operation, it becomes possible to develop versatile aids for the handicapped. Scope Electronics of Reston, VA, which has been involved in speech recognition for the military, is building a system for the Veterans Administration that would enable paraplegics to use myriad devices, including a typewriter, calculator and telephone.

In the typewriter application, individual letters, and sometimes words, are called out to activate the keys of the machines. The information is displayed on a 16-character readout. This, according to Wally Birdseye, technical applications manager for Scope, makes it possible to change or

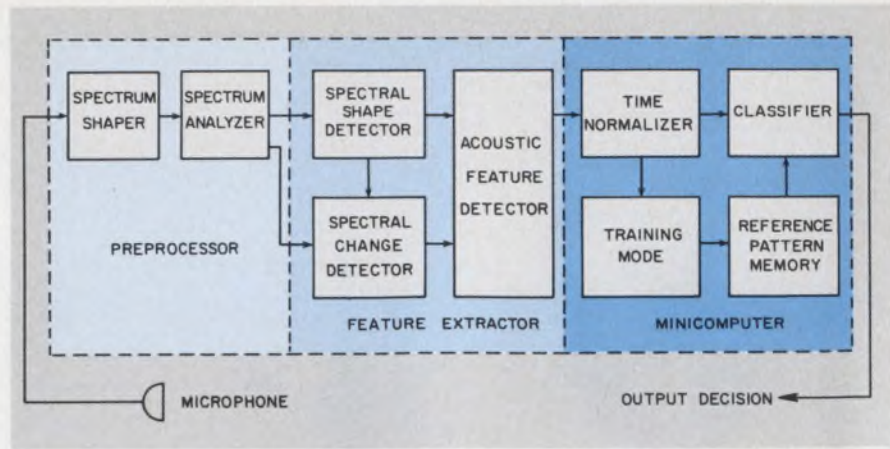

The VIP 100 speech-recognition system, from Threshold Technology, consists of a preprocessor that cleans up the input signal, a feature extractor that separates vocal sounds and a minicomputer that classifies the data.

erase either individual letters or the entire buffer before the information is printed.

The voice-operated typewriter can store a dictionary of frequently used words or phrases, and these entries can be addressed and printed with a single command.

Systems talk back, too

If talking to a computer is useful, why not talk to a computer and have the computer talk back? Scope engineers have come up with a system called VRASS (voice recognition and synthesis system) that does just that. It was developed at the Naval Air Development Center, Warminster, PA, for applications where aircraft crew members are overloaded with controls and displays.

In describing VRASS, Birdseye notes that it provides a communications link between crew members and various displays, subsystems and controls. The system adjusts to individual speaking patterns through a training process, in which a dictionary of control terms is entered via punched cards. As each new item is entered, the vocabulary processing logic asks the operator to repeat an audible synthesis of the command, so the operator's vocal patterns can be recorded. Thus for each dictionary entry there is a synthesis code, the English text and the operator's acoustic reference pattern. The training operation requires only a few seconds for each dictionary entry.

Other features of the VRASS

unit, says Birdseye, include ability to accept multiword sentences—composed of discrete words and phrases—and to provide a system vocabulary of up to 1000 words.

Dialog Systems has designed a voice-data-entry system that doesn't even require training. According to Stephen L. Moshier, president of the Cambridge company, the system can recognize the same words spoken by a wide range of users. The recognition process is based on a technique known as linear predictive coding.

Linear predictive coding, explains Moshier, is a compact way of stating the meaningful characteristics of voice signals. Once the voice signals are converted into digital data, they are fed into a maximum-likelihood processor, which operates on the statistical properties of the sound transform.

The processor compares the spoken word with words in its memory and selects the word that has the highest likelihood of being the one the user pronounced. Once the selection is made, the computer asks the user if it has chosen the correct word. If it has, no problems. If it hasn't, the system requests the user to repeat the word.

This interactive feature ensures that commands have been correctly interpreted by the machine, but along with it come some shortcomings. First, the system response time is lengthened. And, second, the continual questioning of the speaker by the machine can become annoying. ■■

Why SkyCaps are blue on the outside.

So you'll know it's AVX on the inside. A quality monolithic capacitor that delivers the exact capacitance and temperature characteristics specified. Consistently over large quantity orders.

AVX is the quality leader in multi-layer capacitors. Leadership based on innovative design, careful manufacturing, exhaustive testing. And AVX is the technology leader. With more experience in ceramic formulation and precision metallization

than any other capacitor manufacturer.

Sky Caps are immediately available, in volume, from your service-oriented AVX distributor. They're an easy and economical way to build AVX quality inside your products.

AVX: The Insiders

AVX Ceramics Division, P.O. Box 867, Myrtle Beach, S.C. 29577 803-448-3191. TWX 810-661-2252



Sky Cap dipped monolithics are available in the broadest range of sizes and ratings.

Dimensions

Body: 0.1 square to 0.5 square

Leads: Length 1.25 standard (others available)

Space 0.1 to 0.4 standard (others available)

Capacitance: 1.8pf to 4.7mfd

Voltages: 25, 50, 100, 200 VDC

Four temperature characteristics

AVX Distributors:
Cramer Electronics, Inc.
Jaco Electronics, Inc.
Newark Electronics
Texas Instrument Supply
Weatherford Co.

Computerized van will help Navy train for war without leaving port

By late next year or early 1976, the crews on some Navy combat ships will be participating in complex training missions—communicating with friendly craft, tracking and “destroying” enemy surface ships, submarines, missiles and aircraft—while their own ships are tied securely to docks.

The missions will be simulated by a computerized system mounted in a van. Known as Mister (Mobile Integrated Systems Trainer, Evaluator and Recorder), the system is under development by Hughes Aircraft Co., Los Angeles, under a \$4-million contract from the Naval Sea Systems Command. The first prototype is to be ready for evaluation in 18 months.

Equipment in the van is being built around three 16-bit Varian minicomputers, each having 64 kbytes of core memory and about 2 Mbytes of storage memory along with the typical array of tape, disc and other peripherals. Other basic equipment includes two PPI (plan position indicator) scopes, two A (range indicator) scopes and four tactical situation displays—21 in. alphanumeric CRTs—one for each of the three instructor/operators and an auxiliary.

Interface to the shipboard electronics system is via black boxes, weighing about 30 to 40 lb each. The boxes, which plug into the radar, sonar, communications and shipboard computer, generate the rf, i-f, analog and digital signals to simulate inputs and outputs to the front end of each system.

For example, Mister simulates inputs to and outputs from the radar transmitter and receiver, while leaving all the signal processing and control console functions untouched. The interface boxes plug into existing electronics and require no modification of the

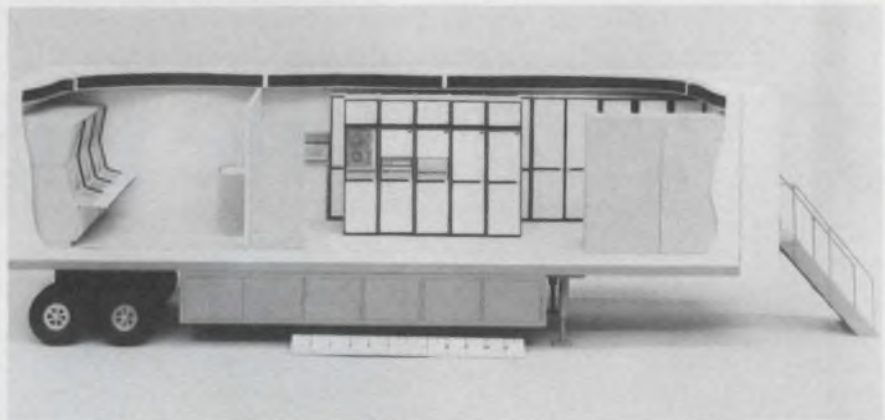

Scale model of Mister (Mobile Integrated System Trained, Evaluator and Recorder) shows probable locations of the system's major components. From left to right are the instructor/operator consoles; computer terminal and printer; power distribution and modems cabinet; maintenance/test complex for carry-on modules and carry-on module storage cabinets. The system is under development by Hughes Aircraft under a contract from the Naval Sea Systems Command.

shipboard systems.

In effect, the Mister van generates a 1000-by-1000-mile battle area in any sea in the world. The radar and sonar crews see the correct coastlines and islands. They also see the sea state—rough or smooth—and other weather effects, such as rain, sleet, fog or clouds.

Mister adds “enemy” and friendly submarines, ships and aircraft—up to 160 active targets. The instructor/operator can either sit passively and allow a preprogrammed exercise to take place or take an active part in the situation—such as playing the part of a friendly aircraft pilot who is responding to instructions received from the ship.

The radar operator on a training ship can use his controls to vary the speed of rotation of his “phantom” antenna, to adjust the operation of his system and change polarization or suppress side lobes so he can acquire and track ships and aircraft under adverse weath-

er or enemy jamming. The sonar operator sees and hears submarines and ship propellers. The electronic warfare crew can hear the pulses of enemy shipboard or missile radar.

Finally the officers and weapons crews can send simulated missiles after aircraft or ships. A “hit” is shown on the radar by a blooming and disintegrating blip.

According to Charles J. Kersch, program manager of Mister at Hughes: “The Navy has needed and wanted such a training aid for years. Not only does it allow the whole combat team on a ship to train into an effective unit, but there is no need to use fuel or fly aircraft to do so.”

One Mister van will be able to interface with two ships of any class—carrier, cruiser, destroyer—during an exercise, and the system is also being designed so that normal telephone links will be able to tie together up to five vans anywhere in the world. ■■

IR's new glass passivated, high voltage Power Transistors and Darlingtons...

Better performance where it really counts.*

The three other largest selling high voltage power transistor lines of today offer you good characteristics. But while a specific device may excel in specs for one parameter, it may be marginal in other equally important characteristics. Not so with IR's new high voltage power transistors. They easily meet or exceed all established specifications. Now you can design a better, more efficient circuit without compromising.

*** High Voltage and High Gain in the same transistor.**

Most others offer you either high voltage or high gain. They can't give you both in the same device. We can. For example: rated to 700V_{CBO} with an I_C from 7 to 10 Amps (pulse), we provide a gain of 30 - 90 at 1 Amp.

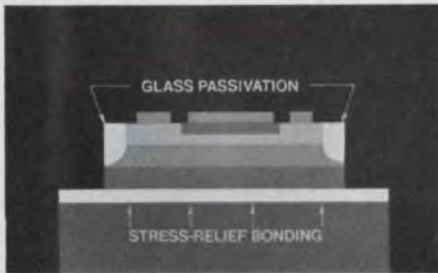

*** Glass Passivation for longer life, better stability.**

IR triple-diffused, NPN mesa structures are the first and only high voltage power transistors with glass passivated

junctions. You'll get longer life and a stability unequalled by the other brands.

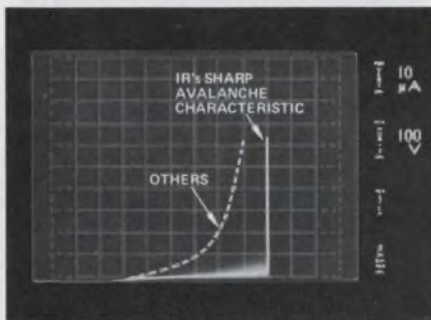

The avalanche curve pictured shows our "sharp" curve and the "soft" curve of the others. Convincing evidence of better junctions that you can operate at full rated specs without a worry.

*** Lower Saturation Voltage for better efficiency.**

IR saturation voltage is lower than the others. Higher efficiency, less power loss, reduced power consumption and system operation at lower power levels are your new advantages. And you won't have to sacrifice switching speeds or voltage capability.

*** "Stress-Relief" Bonding for better resistance to temperature cycling.**

IR's "Stress-Relief" bonding between the chip and mounting surface gives better protection from thermal cycling, gives you an extra margin of safety in thermal design considerations, with a broad safe-area that is more than adequate for any application.

Competitively Priced and Cross-Referenced to the 3 major lines.

IR high voltage power transistors are available in 12 models rated from 300 to 700V_{CBO} with an I_C from 7 to 10 Amps (pulse). Monolithic Darlingtons in 15 models are rated to 600V_{CBO} with an I_C from 15 to 25 Amps (pulse). All are in the standard TO-3 package.

Find IR's equivalent to the devices you're now using, then ask your local IR salesman, Rep or Distributor for complete specs and a test evaluation sample. When you've put it to the test, we think you'll agree. It's better — everywhere that counts.

IR P/N	Delco P/N	RCA P/N	Motorola P/N
IR401	DTS 401		MJ3026 MJ3027
IR402	DTS 402 2N3902		MJ3028 MJ3030 2N3788 2N3902
IR403	DTS 403		
IR409	DTS 409		
IR410	DTS 410	RCA410	MJ410
IR411	DTS 411	RCA411 2N5838 2N5839	MJ411 MJ1800 MJ3029 MJ3430
IR413	DTS 413	RCA413 2N5840	MJ413
IR423	DTS 423	RCA423	MJ423
IR424	DTS 424		MJ424
IR425	DTS 425		MJ425
IR430	DTS 430	2N5239 2N5240	MJ430
IR431	DTS 431	RCA431 2N5240	MJ431 2N5241
Monolithic Power Darlingtons			
IR4040	DTS 4040	Ask for data on IR's 11 additional types.	
IR4045	DTS 4045		
IR4060	DTS 4060		
IR4065	DTS 4065		

Prove our point on your curve tracer...

Get your test sample today.



International Rectifier

...the innovative power people

233 KANSAS ST., EL SEGUNDO, CA 90245, (213) 678-6281

INFORMATION RETRIEVAL NUMBER 29

Laser excited by atomic reaction points to new power possibility

Researchers at Sandia Laboratories have made what is believed to be the first laser to be excited solely by the products of a nuclear reaction. This opens up the possibility that nuclear reactors and lasers can be combined to produce electric power.

David McArthur and Phillip Tollefsrud, the scientists who constructed the experimental laser at Sandia in Albuquerque, NM, report: "The big advantage of using a reactor to produce laser beams is that very large amounts of energy can be delivered to large volumes of laser material. In addition, energy stored in the nucleus of an atom can be released more simply and more efficiently than can the energy in complex power supplies being developed to pump the large, conventionally excited lasers planned for the future."

A 3-mm diam laser beam was produced by exciting carbon monoxide with high-energy fission particles. The particles resulted from irradiation of U-235 with neutrons from one of Sandia's powerful pulsed reactors. Lasing occurred in the 5.1 to 5.6 micron CO region.

A laser pulse energy of 1 to 3×10^{-4} J was measured, corresponding to a peak laser power of 2 to 6 W. Average energy deposited in the gas was estimated to be 200 J per liter over the length of the cavity.

The experimental laser is simple in construction, consisting basically of a metal cylinder lined with a thin coating of enriched uranium (U-235) and filled with carbon monoxide. Mirrors are at both ends of the cylinder, which is placed in an open container of liquid nitrogen to keep the laser gas at a temperature of about -335 F.

The container, with the cylinder inside, is positioned adjacent to the

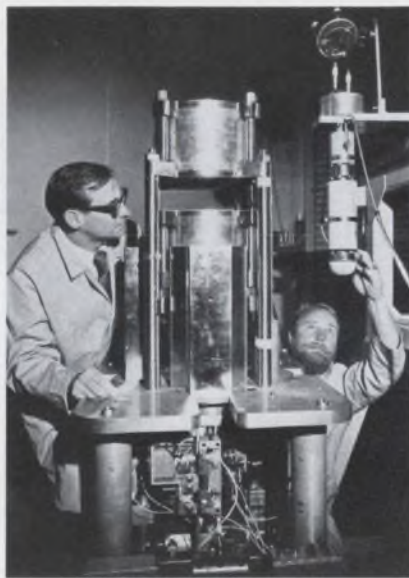

Pulsed nuclear reactor (left) and carbon monoxide laser are worked on by Sandia researchers. Mirror at top of laser reflects the laser beam to exterior detectors.

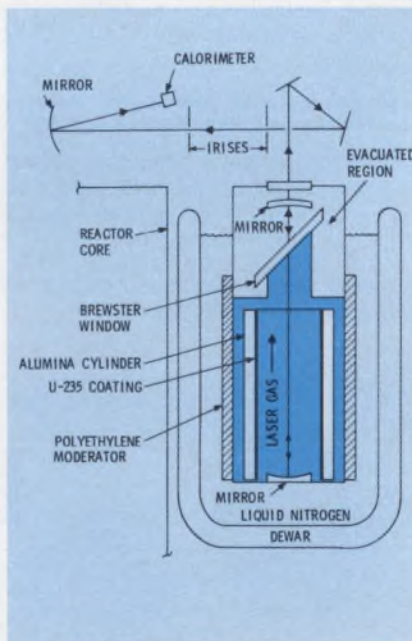

The new laser consists of a cylinder lined with uranium and filled with CO gas. The cylinder is immersed in liquid nitrogen.

reactor core. When the reactor is pulsed, neutrons emerge from the core and strike the uranium coating on the cylinder, producing fission fragments (high-energy atoms) that excite the CO gas molecules. The resulting laser beam is then reflected back and forth between the two mirrors until it is strong enough to pass through the exit mirror, emerging as an intense, highly directional beam.

While the efficiency of the system is low—less than 1%—higher efficiencies are indicated, the researchers note. The experiment, they say, opens the possibility that nuclear reactors and lasers can be combined to produce beams with potential for heating plasmas for conventional magnetic confinement fusion schemes; for imploding targets for laser fusion if short pulses can be obtained; or for extracting energy directly from a fusion reactor in the form of laser light.

"Our experiments are quite preliminary in nature," says Jack Walker, manager of Sandia's Simulation Sciences Research Dept., where the research was conducted. "But early gain data indicate that surprisingly high efficiency might be possible."

"These early results suggest that the efficiency of this pumping scheme could be more than 50%."

Walker summarizes the advantages of a nuclear-laser system by observing that such a system could be relatively independent of external power sources, since the major portion of the laser energy would be stored in the U-235. And the system offers the possibility of pumping a large volume of high-pressure gas uniformly.

Finally, Walker stresses, the reactor appears to be a way to deliver multi-megajoules of energy to a laser media at low cost. ■■

Another technical knockout

the first 100 / 150 W single sideband devices

There's more talk-power available on efficient single-sideband radio and Motorola now introduces state-of-the-art 100 and 150 W units for unprecedented PEPs in your new SSB lineups.

The MRF421 and MRF422 contain the biggest single RF chips in production today.

And that means single-chip ruggedness and consistency.

Each chip incorporates 648 individually-ballasted emitter sites. The geometry was precisely computer-designed for optimized cell placement within the silicon real estate to ensure uniform temperature throughout the chip area.

And that means optimized reliability.



Computer-designed 248 x 140 mil chip

And cooler chips mean improved dynamic linearity and enhanced IMD.

OEM applications help to aid you in building your 12.5 and 28 V single-

SSB type	PEP	G_{pe} dB Min.	V_{cc} V	Package
MRF406	20 W	12 dB	12.5 V	211-03
MRF420	75 W	10 dB	12.5 V	211-02
MRF422	150 W	10 dB	28.0 V	211-04
MRF421	100 W	10 dB	12.5 V	211-04

sideband radio is available through your Motorola rep. And a new Engineering Bulletin, EB-27, is ready to give you the right directions. Get

detailed information on the construction of matching transformers, schematic diagram, printed circuit board and performance. Be first with the first...

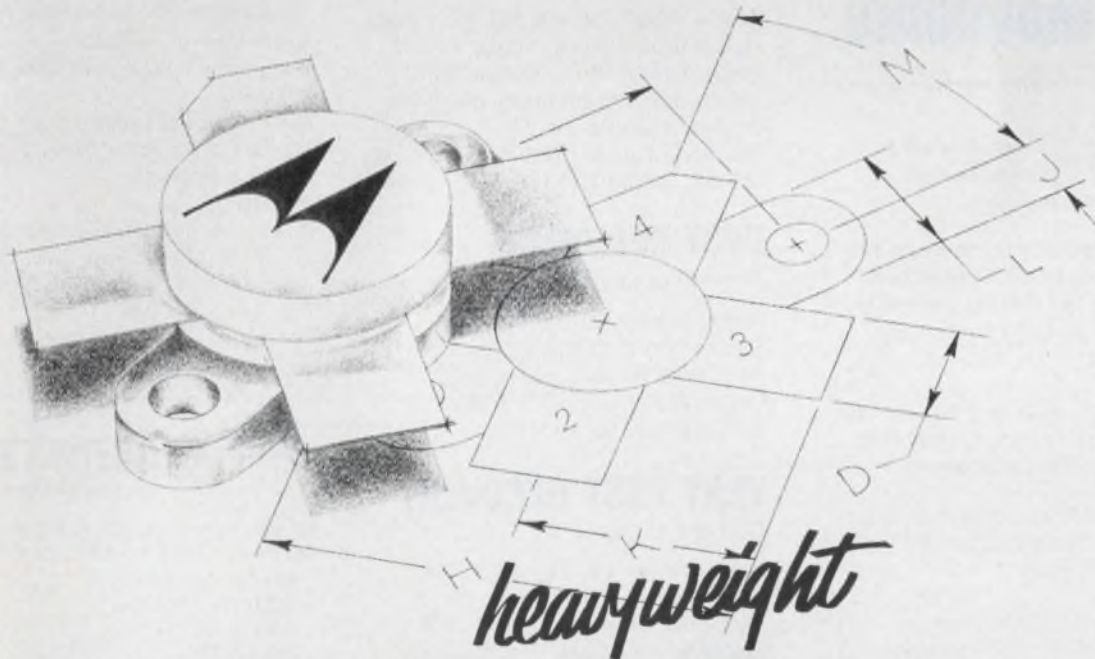

from Motorola, the RF producer.

NEW MINI-METOXILITE SILICON RECTIFIERS

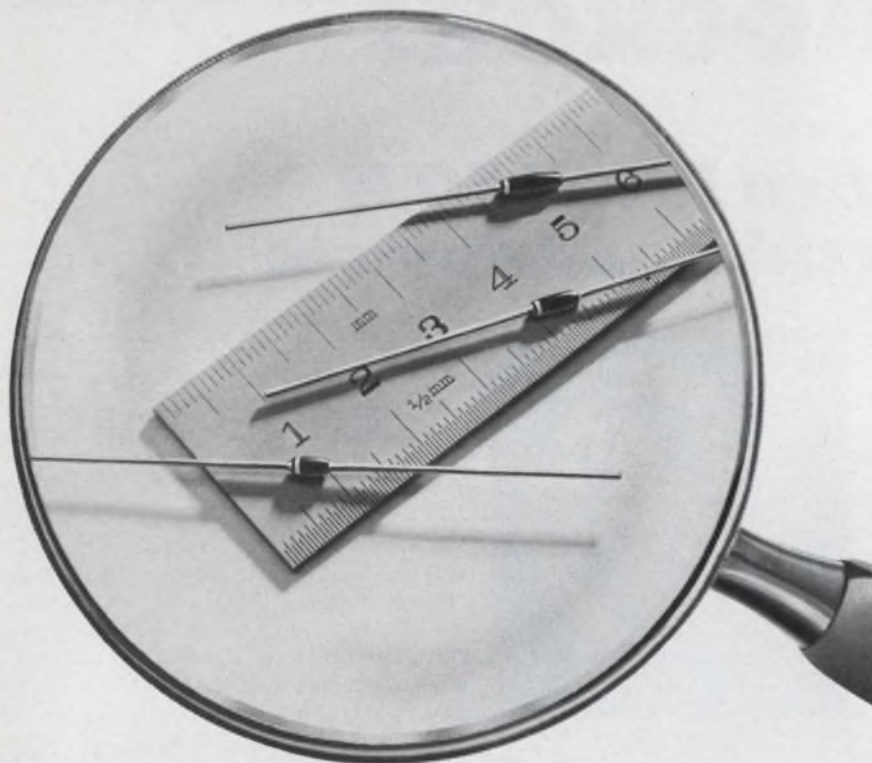

Low-Current Mini-Metoxilite

New low current, Mini-Metoxilite silicon rectifiers are ideally suited for small modular electronic packaging.

Through the application of new design and manufacturing techniques Semtech has produced these Mini-Metoxilite devices to guarantee the ultimate in hermeticity and ruggedness.

The metal oxides, which form the outer case, are fused directly to the high temperature metallurgically bonded assembly.

These devices meet or exceed environmental requirements of current military and space program specifications.

Devices maximum dimensions are:
body — .165" long by .070" in diameter;
leads — 1.25" long by .021" in diameter.

GENERAL PURPOSE

(Trr) 2 μ S (Max.)

Reverse Voltage: 200, 400, 600, 800 & 1000V.
Forward Current: 0.5A @ 55°C.
Reverse Current (Max.): 100nA @ 25°C.
Instantaneous Forward Voltage (Max.): 1.0V.
One Cycle Surge Current: 25A.
Also supplied as JAN, JTX & JTXV.
1N645-1, 1N646-1 & 1N647-1.

FAST RECOVERY

(Trr) 150 ns (Max.)

Reverse Voltage: 100, 200, 400 & 500V.
Forward Current: 0.5A @ 55°C.
Reverse Current (Max.): 250nA @ 25°C.
Forward Voltage @ 0.5A, 25°C (Max.): 1.2V.
One Cycle Surge Current: 12.5A.

VERY FAST RECOVERY

(Trr) 100 ns (Max.)

Reverse Voltage: 100, 200, 400 & 500V.
Forward Current: 0.5A @ 55°C.
Reverse Current (Max.): 250nA @ 25°C.
Forward Voltage @ 0.5A, 25°C (Max.): 1.2V.
One Cycle Surge Current: 12.5A.

High Voltage Mini-Metoxilite Stacks

Semtech's Mini-Metoxilite stacks are the smallest rectifier stacks in the industry to meet or exceed environmental requirements of current military and space programs.

Measuring only .215" long by .070" in diameter (maximum body dimensions) these devices are suitable for all applications where reliability is the primary consideration.

Mini-Metoxilite stacks feature high temperature metallurgically bonded junctions. A coating of metal oxides is fused to the assembly surfaces by proprietary design and manufacturing techniques to guarantee the maximum in hermeticity and ruggedness.

GENERAL PURPOSE

(Trr) 2 μ s

Peak Inverse Voltage: 2000, 3000 & 4000V.
Average Rectified Current: 125MA @ 55°C.
Reverse Current (Max.): 100nA, 25°C.
One Cycle Surge Current: 7A.
Available also . . .
Peak Inverse Voltage: 5000 & 6000V.
Average Rectified Current: 5A @ 55°C.
Reverse Current (Max.): 250nA, 25°C.
One Cycle Surge Current: 5A.

FAST RECOVERY

(Trr) 250 ns (300 ns for 4000 to 6000V)

Peak Inverse Voltage: 1500, 2000, 2500 & 3000V.
Average Rectified Current: 100MA, 55°C.
Reverse Current (Max.): 100nA, 25°C.
One Cycle Surge: 5A.
Available also . . .
Peak Inverse Voltage: 4000, 5000 & 6000V.
Average Rectified Current: 50MA, 25°C.
Reverse Current (Max.): 250nA, 25°C.
One Cycle Surge: 2.5A.

"We're number 1 because we try harder"



SEMTECH
CORPORATION

652 Mitchell Road, Newbury Park, California 91320
(805) 498-2111, (213) 628-5392 / TWX: 910-336-1264

CHICAGO: (312) 352-3227
DALLAS: (214) 253-7644
FLORIDA: (305) 644-5404
NEW JERSEY: (201) 654-4884
SAN FRANCISCO: (415) 328-8025
EUROPEAN SALES HDQ: Bourns AG Zug,
Switzerland (042) 232-242

washington report

New energy agency a victory of sorts

While it alone isn't going to solve the energy problem, the creation of the new Energy Research and Development Administration is a solid first step. The agency is a victory for the nation's technological community, which has long advocated consolidating energy-related research and development in one agency. When President Ford establishes the Energy Research and Development Administration and a Nuclear Regulatory Commission, the Atomic Energy Commission will cease to exist. Its staff and functions will be absorbed by the new agencies, as will many R&D functions now being conducted by other Federal departments.

To manage the programs, estimated at \$2-billion annually for the next decade, Congress specified that the new Energy Administrator and the upper-tier officials be qualified by experience to run such large-scale R&D efforts. This is expected to open more top jobs for engineering managers.

NASA plans a 'smart' robot for space work

The National Aeronautics and Space Administration is developing a "smart" robot for exploratory work on other planets and satellites—one that could perform tasks without need for constant instructions from humans on earth. The robot's brain is to be a computer, which would allow it to make some choices of its own and give it an ability to survive through recognition of danger—whether a crater, a cliff, or whatever. Equipped with TV eyes and laser range finders, the robot would be able to analyze a scene optically, pick up things, do some analysis and send data back to its NASA master.

One assumption of the program is that by the time the robot is ready to go to work in 1985, technology will permit extreme miniaturization of computers. NASA also sees earth applications. Smart robots may be put to work in environments that are hostile to man, such as fighting fires, mining the sea bottoms or operating in radioactive areas. And possibly it could be used in manufacturing to do monotonous jobs that workers don't want anymore.

FTC cracking down on amplifier claims

The Federal Trade Commission is reminding all concerned that new trade regulations concerning power output claims for amplifiers have gone into effect and the agency plans to enforce them vigorously. The FTC says it is going to request each industry member to submit samples of all advertising, including catalogs, specification sheets and owner manuals as evidence of compliance with the new regulations.

What triggered the FTC to send out the reminder was a series of ads that appeared in the October issue of a leading audio magazine. The ads indicated many manufacturers were either (a) trying to use up old ads or (b) hadn't heard of the new rule. The FTC pointed out the glaring violations.

As a second step in the enforcement program, the FTC says it plans to conduct random testing of equipment in the marketplace. Under the tough new rule, for example, is a prohibition against using the omega sign instead of the word ohm in amplifier specs.

A boost for FM radio's future?

The controversial All Channel Radio Bill (H.R. 8266), which would require radios installed in new autos by the manufacturer or dealer to have both AM and FM receiving capability, just might get moving in the coming lame-duck session of Congress. The Senate, by a narrow two-vote margin, passed a bill last June that would require all radios, including those for the home, to have this feature. But the House version, recently reported out of committee for full House consideration, restricts the provision to auto radios.

Yet even this pullback has stirred emotions. Proponents argue that such a requirement will significantly aid the expansion and development of the nation's FM network. About 15 per cent of the new car radios are AM-FM. Major arguments against the bill are that it limits the consumer's freedom of choice, it's inflationary, and it's unnecessary.

Worldwide design data offered

Through a recently concluded agreement, the Commerce Dept.'s National Technical Information Service is going to make it easier for U.S. engineers and scientists to get worldwide design data. The service will now take orders for highly specialized and evaluated engineering data from the Engineering Sciences Data Unit in London. The latter is widely considered the largest and most authoritative collection in the world.

Orders taken by the Commerce Dept. service will be filled directly from London. The basic package is the Data Item, a set of loose-leaf sheets devoted to a single topic. They contain graphical data, equations and tables, together with definitions and terminology, explanatory matter and examples.

Capital Capsules: NASA has Boeing and Rockwell International doing a preliminary study for a quarter-pound thrust rocket powered by solar electric power. Mercury ions would provide a tiny kick, but they should be sufficient to do many tasks over months or years. . . . The U.S. Customs Service has reversed itself on synthetic single-crystal quartz. It had considered it the same as glass, which makes a difference on import tariffs. . . . Companies to develop, fabricate and test ring laser gyros for use in inertial guidance navigation systems are being sought by the Navy. . . . The Air Force plans to demonstrate the effect that a programmable associative processor, performing the signal-processing function of a high PRF radar, will have on the radar's performance. The service is also looking for sources for high efficiency chaff. . . . In a futuristic program, The Air Force plans to develop switches that will permit it to build Hertzian arrays that operate above 1 GHz. The envisioned antenna would be composed of thousands of rf generators operating in concert—thus the need for switch technology. Hertzian generators, used since the late 1880s, are attractive because they give short pulses of high peak power.

The spec sheets tell you what should happen.

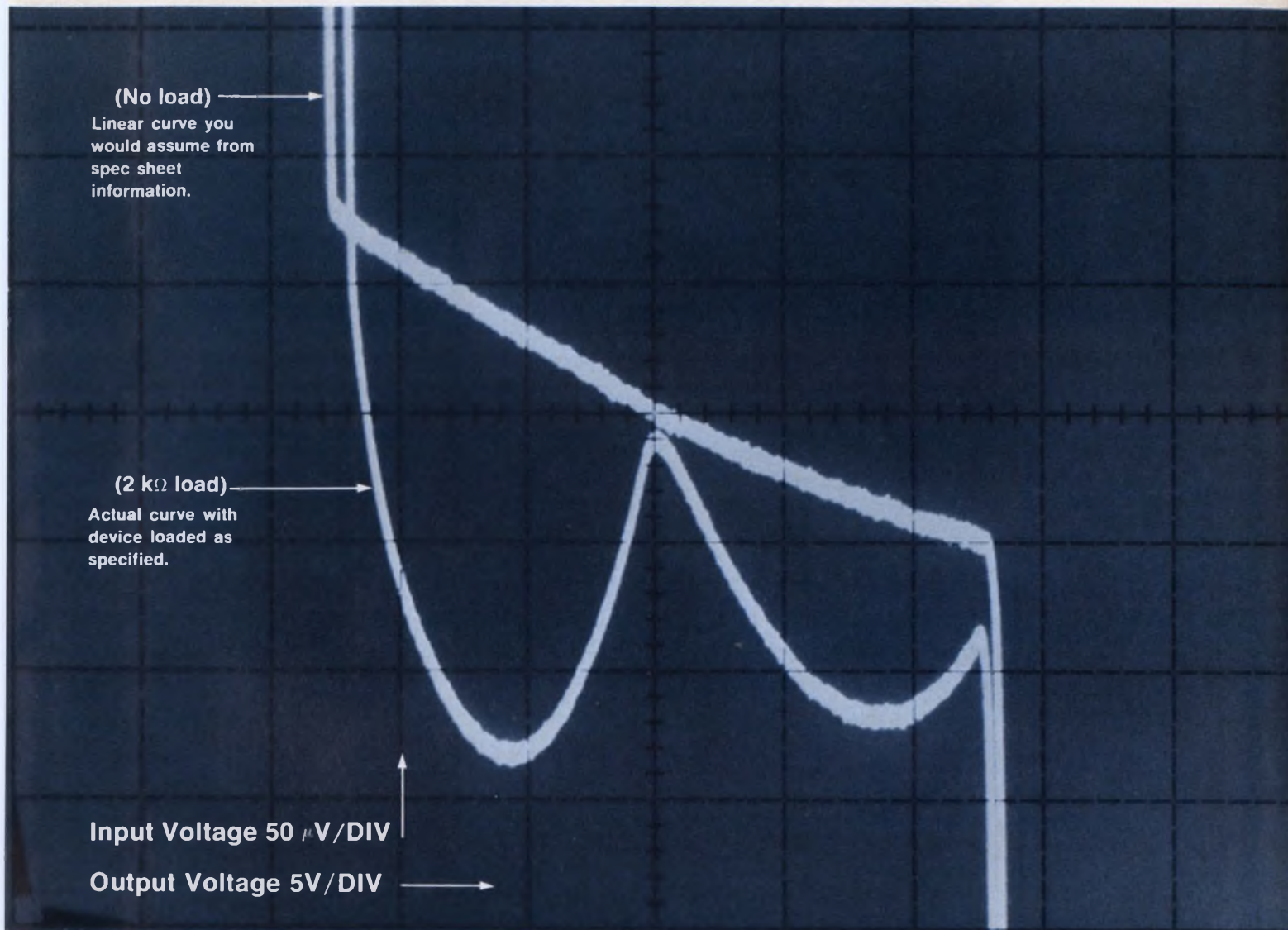

The 577 shows you what did.

When you're designing circuits using linear IC's, you count on spec sheets for the information you need. Generally, gain, CMRR and power supply rejection ratio are given as the ratios of voltage changes measured between discrete points. You assume a "linear" integrated circuit has a linear gain curve (a straight line) with no spurious excursions. But an actual device operating in real-life conditions isn't always linear. Often it produces very irregular curves that may make a big difference in your finished circuit.

These irregular curves are hidden from meters, digital read-outs and go no-go indicators. In fact, a Curve Tracer with its CRT display is the only way to see what is actually happening across the entire operating range of the device you're testing.

The Tektronix 577/178 Curve Tracer will measure and display gain. Offset voltage. Input bias current. Common-mode rejection ratio. And power supply rejection ratio. In addition, the 577/178 displays thermal effects. Popcorn (or flicker) noise. And parameter nonlinearities. And the 577/178 has a storage display to retain curves for comparison or detailed evaluation. Yet it costs only \$3100.

INFORMATION RETRIEVAL NUMBER 32

FOR DEMONSTRATION, 203

To learn about the pitfalls of linear IC performance and measurements write to Tektronix for pamphlets No. A3040, and A3061. For more information contact your local Tektronix Field Engineer, or write Tektronix, Inc., P.O. Box 500, Beaverton, Oregon 97077. In Europe write Tektronix Ltd., P.O. Box 36, St. Peter Port, Guernsey, Channel Islands.



Watch Out.

The volts are out to ruin your computer, maybe your entire system!

Nobody needs to remind you that the erratic demand on electric power these days has created a potential "brownout" condition in just about every major industrial area. Protecting your computer or system from the crazy dips and surges in voltage is critical. A slight dip can cause a computer to drop a few digits, lose parity, distort information, or lose its memory entirely. A surge damages delicate components and ruins printed circuits.

Sola Electric's "brownout insurance" comes in the form of highly reliable constant voltage transformers and Solatron® Voltage Regulators

—in a wide range of specifications. Most are standard units and immediately available for off-the-shelf shipment. And our applications engineering people are ready to help right now —whether you're designing voltage regulation into your equipment or adding protection to an existing system.

Protect yourself. Contact your local Industrial Distributor or the AC Products Group at Sola Electric. Call (312) 439-2800 or write Sola Electric, 1717 Busse Rd., Elk Grove Village, Illinois 60007.



Get brownout "insurance" from SOLA

SOLA ELECTRIC

SB
SOLA BASIC

COMPLETE LOW-FREQUENCY ANALYSIS PACKAGE -

SPECTRUM ANALYZER,
SCOPE,
TRACKING GENERATOR
FOR JUST \$3665.*

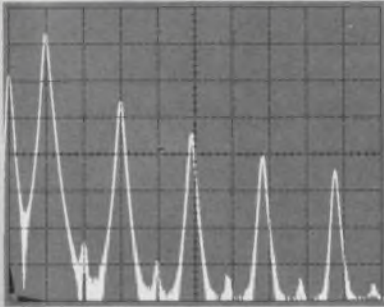

Spectrum analyzer display of square wave harmonics

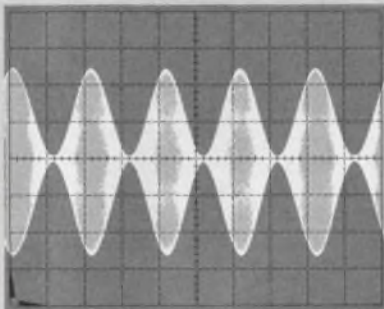

Oscilloscope display of modulated carrier

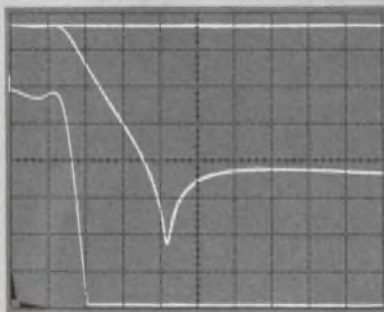

Spectrum analyzer displays of filter response at 10 dB/div and 2 dB/div using built-in tracking generator

You know that a spectrum analyzer displays information as it relates to frequency, somewhat like a scope relates information to time. But unlike the scope, the analyzer has a unique ability to display very low amplitude information even when large amplitude information is present. Analyzer sensitivity to low

amplitude information and ability to separate by frequency allow you to quantify all the components of a complex vibration waveform, or carefully tune the acoustic characteristics of a theatre, or know that an amplifier really meets distortion specs, or that a power supply filter design really works. With a spectrum analyzer and a scope your understanding can be complete in a wide variety of electronic and mechanical events.

Interested? Then tell us about your application. How? Write us, we will respond with application notes—or call your Field Engineer. If you prefer, use the reader service numbers—we will send you data sheets for the instruments in the package.

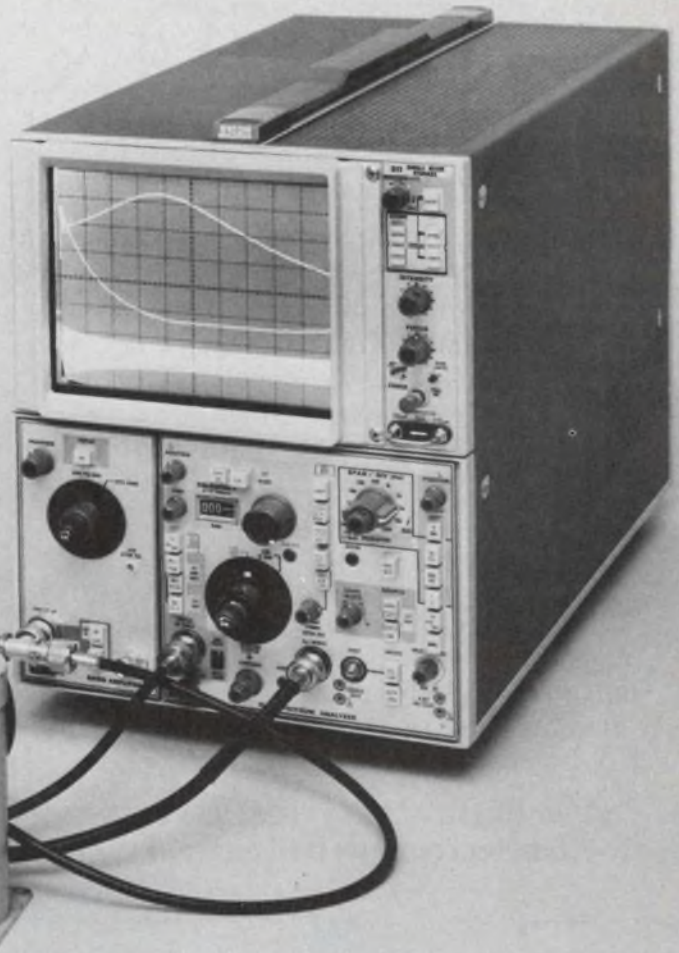

*The package includes: the 0-to-100 kHz 5L4N Spectrum Analyzer (\$2150) with built-in tracking generator, selectable impedance—50 ohm, 600 ohm, one megohm, single ended or differential modes, 20 Hz/div frequency span, 10 Hz and auto resolution. The tracking generator in the 5L4N is a sweeping signal source designed to make response and other tests such as the audio transformer test above. Also included for \$3665 are the 5103N/D11 storage mainframe (\$1175) plus optional 2 MHz scope amplifier 5A15N (\$135) and time base 5B10N (\$205).



Tektronix, Inc., Box 500, Beaverton, OR 97077

INFORMATION RETRIEVAL NUMBER 34

FOR DEMONSTRATION, CIRCLE 204

Three New REED RELAYS from CLARE

Perfect blend of economy and reliability in a dry reed relay

Clare's new 951 dry reed relay is a product of Clare's automated manufacturing process that combines economy with reliability. This epoxy molded PCB relay houses the popular Picoreed capsule which gives you from 100 million operations at signal level loads to 5 million operations at 10 volt-amps. It's an excellent, rugged relay for telecommunications, process control and general electronic applications where reliability and long life is critical. Available in 1, 2 and 4 form A configurations.

951



Longer life than a dry reed; less expensive than mercury wetted contact

851



The new 851 mercury wetted reed relay gives you as much as a billion bounce-free operations, plus switching capabilities from signal level to 50 volt-amperes. The epoxy molded PCB relay is in performance and price, somewhere between the popular dry reed and the more expensive mercury contact relays. And that makes it ideal for applications in telecommunications, computer peripherals, data acquisition and industrial control. Available now in 1, 2 and 4 form A configurations.

A new kind of self-latching reed relay

Clare's new relay is the 961 self-latching PCB dry reed relay which features a unique switch that provides the magnetic memory function without the external biasing magnets

961



found in conventional latching relays.

It is designed to operate on one millisecond pulse, but the pulse duration is limited only by coil heating. Once pulsed, the relay remains in that state until the opposite mode is selected.

Ideal for complex automatic test equipment or telecommunications systems, they're available in 1 to 6 pole configurations and have 5 volt-ampere contact ratings.

Availability? Right now!

All three relays are in production and in stock right now. For full technical specifications contact your nearest Clare Distributor. For more comprehensive application information, contact C. P. Clare & Company, 3101 W. Pratt Avenue Chicago, Illinois 60645 or phone (312) 262-7700.

QUALITY, SERVICE, RELIABILITY

C. P. CLARE & COMPANY a subsidiary of
GENERAL INSTRUMENT CORPORATION



HOW TO BUY OEM MINICOMPUTERS WITHOUT BEING EATEN ALIVE.



MINIVORES
AHEAD
COMPUTERIZE
AT YOUR
OWN RISK

INTRODUCING COMPUTER AUTOMATION'S OEM SURVIVAL SYSTEM:

OEM-unique hardware, software, and support to make computerizing a lot safer.

Meet the Minivores. It's a jungle out there. A tangle of wild, conflicting claims you have to hack your way through. Just to pick a computer supplier.

Which is nothing compared to the profit-gobbling minivores you'll face if you start integrating just any old computer into your product.

Minivoris integratum ineffectus

A voracious feeder that can fold, spindle, and mutilate an engineering budget faster than you can say unemployment. Which, when the overrun starts to approach the GNP, is where you could end up. But not with our OEM SURVIVAL SYSTEM. Integration assistance includes on-board Technical Applications Analysts (hardware and software) who can really make the fur fly.

Minivoris deliveria interruptus

This one can take a big bite out of your bar charts if you've got product and no computers to put in them. To play it safe, move all your milestones to the right about six months. Or buy NAKED MINI's. We maintain a large finished goods inventory. You always get delivery on time or sooner. Guaranteed.

Minivoris informa perplexae

Generally runs amuck, eating up a lot of engineering hours in the ensuing confusion. To finance this fiscal feasting, sell off your subsidiaries. Or outwit with our OEM SURVIVAL SYSTEM. It has all the smarts you need to keep the beasties at bay: Design Guides, "how to" procedures on everything from unpacking to QC sign offs, and total documentation. Plus direct distribution of Engineering Notices, software updates, and Customer Information Bulletins.



MINIVORES
AHEAD
COMPUTERIZE
AT YOUR
OWN RISK

Overnight a pet project becomes a real beast. With your warm body first on the feeding schedule.

How to byte back. Play it cagey. Our OEM SURVIVAL SYSTEM can get you through some mighty tough territory in one profitable piece.

No other mini supplier offers anything like it: OEM-unique hardware and software developed expressly for product computerization. Plus a support-service-integration assistance program so comprehensive other mini manufacturers haven't even figured out how to ape it.

Going great guns vs. going bananas. The whole program is spelled out in our OEM SURVIVAL HANDBOOK. Look over the partial contents on the next page. When you see how much more you get with NAKED MINI's, you won't want to monkey around with anything less.

Minivoris supportica dismalus

(a suborder of *Personnae departus*)

This killer usually times its attack with the signing of the purchase order. Cries for help only antagonize it. Best bet is to keep quiet and hope that curiosity kills the cat. Or play it safe with our OEM SURVIVAL SYSTEM. Internally, we structure a task team of support specialists to parallel every computerization function in your company — everybody has a counterpart to work with to help nip the nasties in the budget.

Minivoris softwarius cashus drainii

Any encounter with this toothy time consumer will cost you at least an arm and a leg. Chalk your completion forecasts on the sidewalk so you don't run out of room. Or buy NAKED MINI's. OEM-unique software packages like our new flexible FORTRAN IV can help keep your milestones off the menu.

Minivoris hardwaria perplexius

Usually conceals itself in a thicket of specifications to await the unwary. Favorite ploy is to camouflage itself as an OEM mini. True nature may remain undiscovered until it bites its victim right in the wallet area. Safe strategy is to avoid his habitat completely. Reroute safari through our neck of the woods where NAKED MINI® families are friendly, compatible, and plug-in interchangeable.



THE OEM SURVIVAL CHECKLIST

Everything you need to turn a perilous expedition into a safe jungle junket. It's all part of our OEM SURVIVAL SYSTEM.

Development Support

PRODUCT DEVELOPMENT:

- Hardware Training
- Technical Documentation
- Design Guides
- Technical Applications Analysts

CONTINUATION ENGINEERING:

- Engineering Notices
- Software Updates
- Customer Information Bulletins
- Product Support Specialists
- Continuation Support
- Engineering Backup

Manufacturing Support

PURCHASING:

- Unique OEM Purchase Agreements

- Adequacy of Supply
- Firm Delivery Commitments

RECEIVING/INSPECTION/TEST:

- Training
- "How To" Procedures
 - Receiving
 - Unpacking
 - Inspection
 - Test

MATERIAL CONTROL:

- Handling/Processing Procedures
 - Factory Repair
 - System Updating
 - Warranty Log Data
 - Incident Reports
 - Packing Procedures

ASSEMBLY AND TEST:

- Diagnostics
- Product Support Specialists

QUALITY CONTROL:

- Ongoing Quality Assurance

Field Engineering

TRAINING:

- Scheduled Hardware and Software Training Classes
- Special Customer Classes
- Training Materials

TECHNICAL AND LOGISTICS SUPPORT:

- Maintenance Documentation
- Provisioning Recommendations

"Please don't feed the Minivores"

 **ComputerAutomation**
Naked Mini_® Division

18651 Von Karman
Irvine, California 92664
Telephone (714) 833-8830



World Leader in Ceramic Capacitors

NAME **3** PRODUCERS OF HIGH VOLTAGE CERAMIC CAPACITORS

If you name ERIE first, you're right on target. For we produce a full line of quality High Voltage Ceramic Capacitors . . . 3kV to more than 30kV . . . in the capacitance value and temperature characteristic to suit your circuit needs. We have all sizes and shapes with the terminal arrangement you want. In fact, you name the application . . . chances are ERIE has a standard unit available. If not, let's talk about it.

You'll find ERIE HV Capacitors in electric utility transformers. Miniature power supplies. CRT displays. Lasers. Lightning arrestors. TV power supplies. Image intensifiers for night vision apparatus. Just about any application where high voltage is involved.

So look to ERIE first. When it comes to High Voltage Ceramic Capacitors, ERIE continues to lead the way. Your letterhead request will get you our new catalog HV/SC-200 . . . or call Customer Engineering at our State College, Pa. plant — 814/237-1431.

ERIE TECHNOLOGICAL PRODUCTS, INC.
Erie, Pennsylvania 16512



INFORMATION RETRIEVAL NUMBER 36

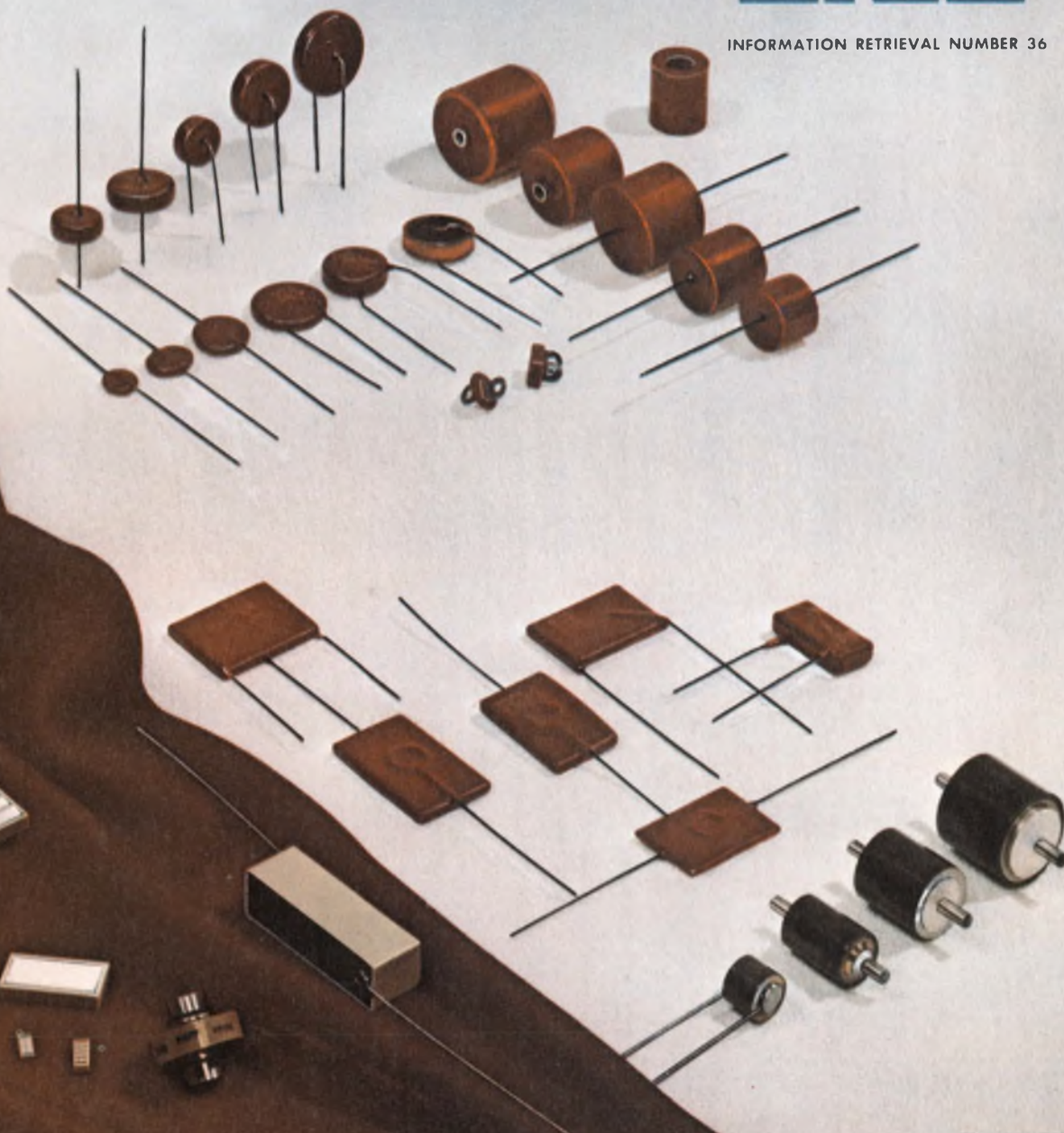

**FREE
REAL ESTATE**
CALL "CONTROLS" AT 714 684 1700

**BOURNS
3850
Series**

**...switch to BOURNS
and get the most
power-for-size in
low-cost panel controls**

Save valuable "real estate" behind the panel . . . switch to BOURNS® unique SPACE SAVER controls design. Extends only ¼" behind your panel, yet handles as much power as bulkier alternatives.

Choose Bourns CERMET CONTROLS for maximum power-for-size optimum stability.

Choose Bourns NEW CONDUCTIVE PLASTIC CONTROLS for low noise and long life. Ideal replacement for bulky carbon controls.

Quality and Service are what you've come to expect from BOURNS . . . the BEST!

Bourns controls are available off-the-shelf at 92 distributor locations nationwide. Standards can be shipped direct from factory stock in 24 hours.

For your custom requirements, call our application engineers for assistance.

**CTS
550**

**ALAN
BRADLEY
"J"**

FREE SAMPLE

Call "CONTROLS" at 714-684-1700 and tell us about your application. We'll send you the Bourns Control that best suits your needs. Pronto.

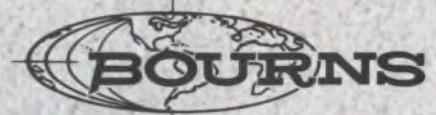

TRIMPOT PRODUCTS DIVISION • 1200 COLUMBIA AVE., RIVERSIDE, CALIF. 92507

INFORMATION RETRIEVAL NUMBER 37

The bargain

Ages ago, long before anybody dreamed of solid-state motor controls, I worked as a sea-going electrician on the S.S. MormacDove (which most of the girls in coastal Brazil called the MormacLove because their English was imperfect). My boss, John, didn't have much formal schooling in matters electrical but he had been sailing as an electrician since the dawn of man—or maybe a little longer.

As chief electrician, John got paid a heck of a lot more than I did. So I felt then that Moore-McCormack, the shipowner, was getting one helluva bargain, since I could run rings around John in electrical theory. Further, I could write a much more literate and readable trip report at the end of each voyage because John's English was, well, not very.

One day in port, one of the forward cargo winches broke down and I had to get it on the air as quickly as possible. As you can well imagine, loading and unloading cargo is the name of the game for freighters. Busted winches are a prime cause of premature baldness among shipping magnates.

So I pulled out schematics and wiring diagrams and started to apply a logical analysis to the problem. ("Let's see, now. It works in Hoist positions 3, 4 and 5 . . . and in Lower Positions 2 and 3. So it's got to be . . .") After about half an hour of my penciling through the circuit diagrams, John walked into the winch house, pointed to one component on a 5 × 10-foot array, and grunted, "Check that relay!" And of course, the problem was precisely "that relay."

Later, when I asked John if his intuition had been working overtime, he told me that it was very simple. It seems that 20 years earlier he had worked on another ship, one of whose winches had been broken down in an identical manner. The cause then was "that relay." Throughout our trips together, over and over again, John would pinpoint troubles ten times faster than I could—always because 20 years ago, or 30 years ago, or whenever, he had been on a ship that had suffered precisely that ailment.

When I think of John, I often wonder how smart are the managers in our industry who have a standing rule for hiring engineers: "Always hire the bright young kids out of school. We can get them a heck of a lot cheaper."



GEORGE ROSTKY
Editor-in-Chief

surround it
with something special





Safety. Reliability. Long-haul performance. Cost. They all have an effect on your product's design parameters and capabilities.

Belden has a custom design capability in wire, cable, and cord that can help you meet the most demanding performance for your products. We've helped solve some extraordinary problems. Can provide definitive data and answers on flex life, oil resistance, electrical characteristics, aging that can cope with practically any environment your specific job criteria calls for.

Talk to your Belden specialist about it. He understands design requirements. Can give you straight answers on cable or cord design feasibility. What modifications are possible. What the trade-offs are. The costs involved. We haven't perfected that "fancy" jacketing yet, but can improve the wire, cable, or cord package you need to meet the most challenging electrical, physical and thermal applications you might be faced with.

If you need answers right now, phone:

(312) 887-1800, Transportation Division

(312) 681-8920, Electrical Division

(317) 966-6681, Electronic Division

Or write Belden Corporation, P. O. Box 386, Geneva, Illinois 60134.

H-2-3

BELDEN 

INFORMATION RETRIEVAL NUMBER 234



FOCUS

on
DC/DC
converters

Dc/dc converters have all the problems of traditional ac-to-dc power supplies—and then some.

The “then some” arises because every converter must first change the primary dc input power to ac, then proceed along conventional lines to arrive at the final dc output level or levels. It’s a lot easier to convert ac to clean dc than vice versa. Many a dismayed user learns this as he battles to keep converter noise, spikes, ripple and electromagnetic interference from invading both his load and his prime source.

To avoid such noise (and other problems) at the hardware stage—where at best the solution is makeshift—gird up to battle at the specification and selection stage. Get a copy of PY1-1972, the NEMA standard for dc power supplies, and learn its terminology.

Know your application backwards and forwards before you buy. Read converter data sheets as you would a marriage contract—especially the second time around. Check up on your vendor to make sure he can deliver a reliable product—next year as well as this. But before you do anything, analyze thoroughly both your load and primary source.

Put the ends before the middle

To select a converter solely for its rated steady-state voltages and currents is to court danger. What you really have to know is how the unit performs under all expected load conditions and also under all input source conditions.

First: Is the source a battery? A rectified-and-filtered line? A combination of each? Or some other supply? You must know this to determine the source’s capacity to deliver not just

the steady state but peak and transient currents as well. If the source supplies other loads besides the converter, this must be taken into account to determine how the combined load affects the source.

For example, during start-up a battery’s terminal voltage can plunge drastically and stay down for 10 s or more. Conventional ac-to-dc regulated supplies may ignore a low line. But converters are touchy when it comes to input: If the level is too low, they simply refuse to start. Of course, once the battery voltage comes up to normal, the converter will turn on. But if the converter’s load includes semiconductor mem-



Compact dc/dc converters, such as these from Datal Systems, come in 2 × 2 × 0.4-in. cases, or smaller.

Stanley Runyon,
Associate Editor

ory, say goodbye to your data.

Consequently you've got to pin down the expected total input variations, both static and transient, and specify a converter that can handle the total range. Remember that less obvious factors—such as temperature—can also assault the level of the prime source. Since most converters can tolerate only about a $\pm 10\%$ input variation, each factor can be significant—especially with low (5 V) source levels.

Converter in-rush currents can cause other headaches. If the source level first drops upon in-rush, then rockets up and overshoots upon recovery, what happens to other loads on the source line? With logic loads, perhaps you'll get an unwanted ONE or ZERO; with sensitive circuits—pht. Another gloomy possibility: Can the prime source voltage reverse its polarity? If so, better make sure the converter (and any other load) is protected.

On other unhappy occasions, the source itself may need protection: Converters can kick back energy into the source. Just how much and under what conditions are two things you'd like to know.

No less important to a converter's performance is what the unit sees at its delivery end—the load characteristics. Factors to take into account are these: Is the load resistive or re-

active? What are the magnitudes? Is the load fixed or variable? If variable, what are the load's regulation requirements? How does the load react to ripple, spikes and transients? These and other questions must be answered before a converter can be specified.

Regulation (stabilization is the preferred word in the NEMA definitions) is one area that poses particular problems—particularly since vendors generally oversell regulation and designers tend to overspecify it. Because a designer may not quite know what his final load will look like, or because he leaves the converter design for the last minute, he buys tight regulation to "play it safe." But that 0.01% regulation spec costs lots extra and may be totally unnecessary.

First, many loads don't vary, so why spec a tight regulation? Second, some loads, such as op amps and CMOS circuitry, aren't affected by nominal shifts in the excitation level—these don't need close regulation either. And don't forget that such items as drift, tempco, external components and distribution busses can all team up to swamp out tight regulation.

Arguments against unnecessarily close regulation apply to all power supplies but take on added significance with dc/dc converters. Since many converters will draw power from a prime source that's already well-regulated, why buy

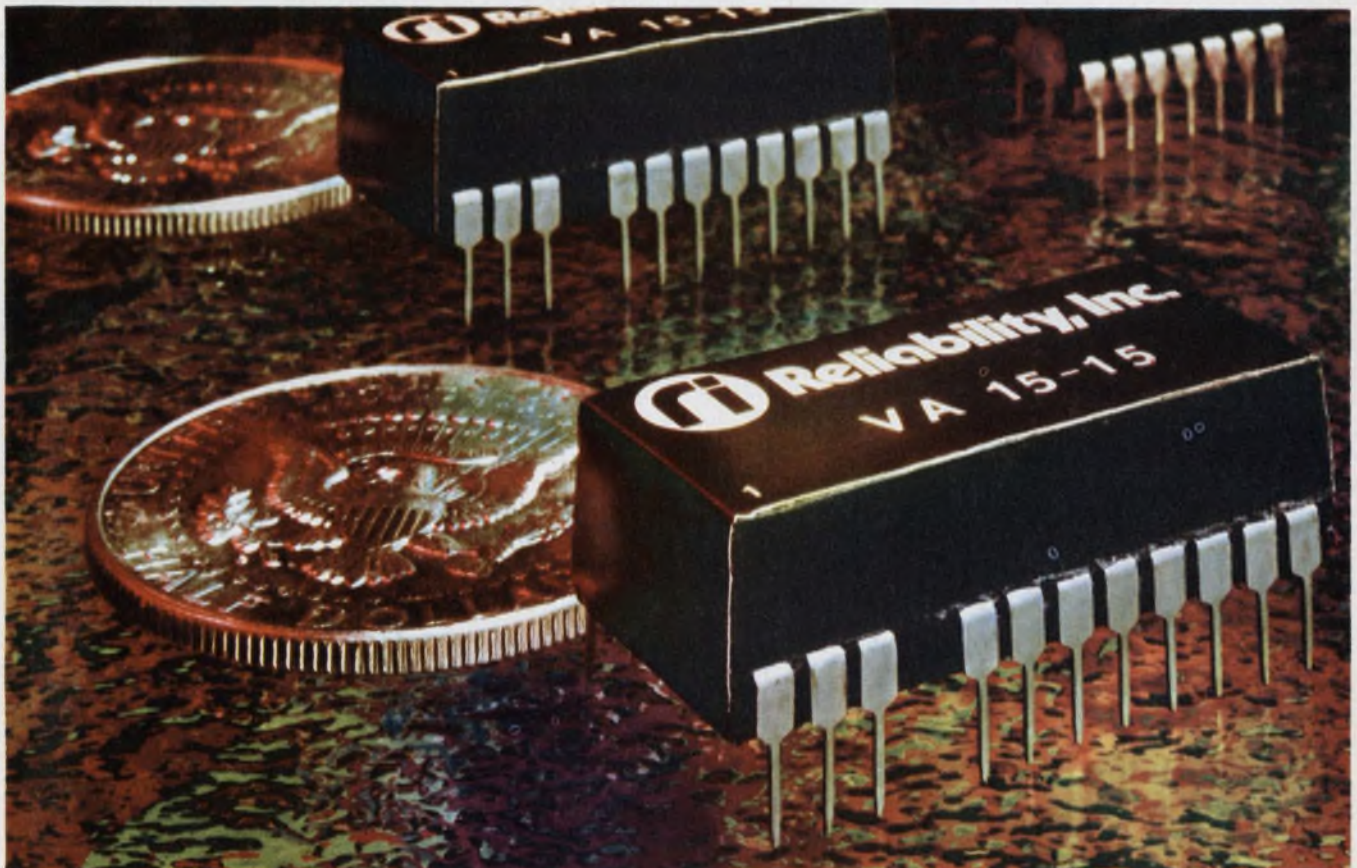

Occupying less than one third cubic inch of volume, these Reliability, Inc., power sources deliver 1 W in either

single or dual outputs. The units can be mounted in standard IC sockets.

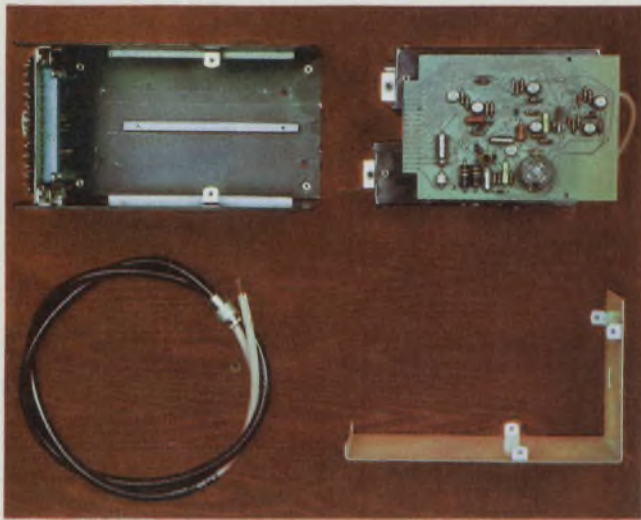

Super regulation (0.001%) and outputs to 30 kV mark the SRM Series from Spellman High Voltage Electronics.

more regulation in the converter? Or why buy a regulated converter at all? Though this sounds logical, remember that the converter is interposed between the load—where the regulation is desired—and the prime source. Any impedance between source and load will cut into the regulation figure. Just how much, of course, depends on the converter.

When you do evaluate a converter's regulation specs, watch out for plus-and-minus signs that make the spec look twice as good as it really is. Look for figures specified over a limited range—like half to full load, instead of no load to the full amount. And check for line-regulation specs that don't spell out the load current. Line regulation should be measured for the worst case—presumably at full load and maximum line change.

Extra tight regulation not only costs more but usually goes hand in hand with larger package sizes. And it opens the door a bit wider for the converter's arch enemy: heat dissipation.

High tempco brings short tempers

Always a villain in electronic equipment, heat can be especially brutal in energy sources, which operate at relatively high power levels. At best, heat worsens performance or shortens life (aluminum electrolytics fail three times faster at 75 C than at 65). At worst, heat can destroy the converter.

Left unchecked, heat pushes circuit temperature up and up until semiconductor junctions fuse, coatings melt and resistors crack like so many walnuts in a vise. The object then is to get rid of the heat, and at a rate fast enough to avoid damage or deterioration of performance. Better, perhaps, is to dissipate as little heat as possible—in short, to select a converter that's as

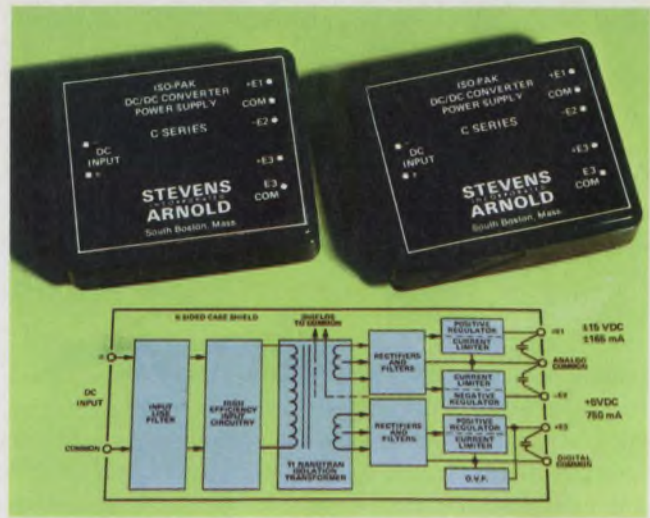

High isolation and low noise characterize the Stevens-Arnold Iso-pak C Series, which offers up to triple outputs.

efficient as possible. Unfortunately this may not be easy to do.

While the basic definition of efficiency is simple—it's the ratio of power out to power in—comparison of competing converters for efficiency isn't. This is because one vendor lists a figure for efficiency that covers the basic converter but conveniently "forgets" to include the losses in the regulator, bleeder resistors, filters and the like. These losses can be substantial.

Another vendor states efficiency at just one point—full load; and still another over a range of half to full load. Since efficiency varies with input voltage, output current, temperature and other factors, and since the variations are non-linear, competing units can't be directly compared.

Converters that are self-oscillating, rather than driven, are especially sensitive to input voltage variations, which affect switching frequency. When the frequency goes up, so do core and switching losses. The result: Efficiency plunges.

Naturally, to put their best foot forward, vendors will often list the maximum efficiency the unit can achieve. But at what combination of output currents, input voltages and temperature is left to your imagination.

With the increased use of portable equipment and uninterruptable power supplies to protect against brownouts and blackouts, efficiency has gained in importance. Both types of equipment operate from batteries, and, of course, the better the efficiency, the longer the battery will last. But with low or unlisted efficiency, the converter itself may not last.

It's time to beware when a converter boasts a high output power in a compact package size but doesn't bother to mention such items as efficiency,

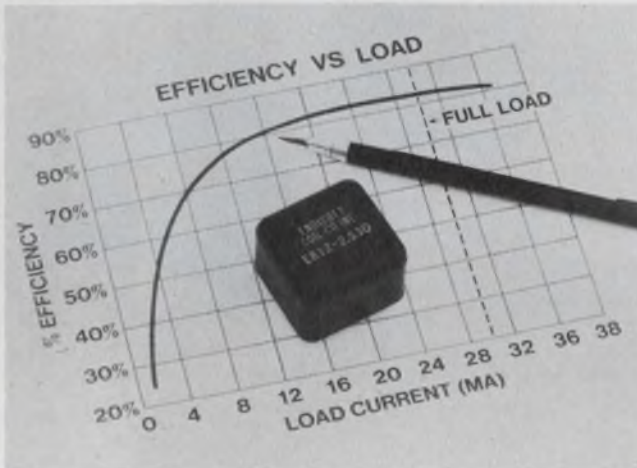
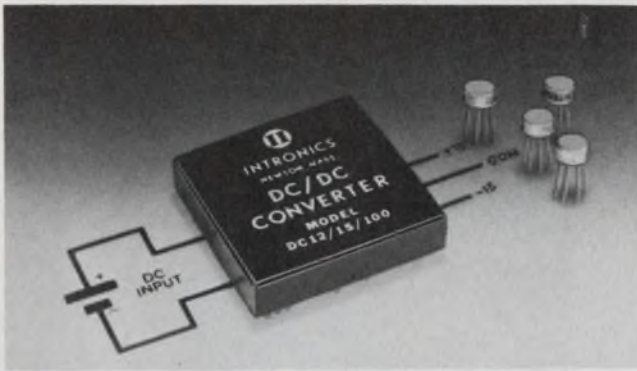

Small modular converters with special features are available for a variety of applications. Typical are those from (clockwise from top left) Intronics (high isolation), Hybrid Systems (continuous, six-sided copper shielding), Burr-Brown (fast transient response), and Endicott Coil (high voltage for glow-type displays).

temperature rise and derating or heat-sink requirements.

You can be sure the full-load efficiency is low if you can't find it anywhere on the data sheet. This means the unit will run hot—perhaps hot enough to cause trouble. But since the vendor doesn't tell you how to mount or cool the unit, or what the allowable temperature rise is, you've got to either guess or ignore the situation and hope for the best.

(Note that reduced efficiency at half or light loads isn't necessarily bad. It's really the amount dissipated that counts, and this will depend on how much standby power the converter draws at zero or light loads.)

Even when a unit is fully specified for heating, designers so often consider the converter last in their equipment designs that there's seldom room to follow the vendor's cooling instructions. Or because a selected converter is highly efficient, designers assume mistakenly that the unit's internal heat isn't significant. But it may be.

For example, a 600-W converter that's 85% efficient must still dissipate about 106 W—no small amount. But note that another converter with the same power rating and only 15% less efficient (still considered highly efficient) must dissipate a whopping 257 W—over twice as much as the first unit.

Just how a converter should be specified for its temperature characteristics is another problem. One vendor gives derating curves as tempera-

tures elevate; another claims his converter doesn't have to be derated because it runs cool. Still others state a surface temperature-rise coefficient ($\Delta t/\Delta W$) and an operating temperature range but don't give exact cooling instructions (could it be because only a wind tunnel at the North Pole can do the job?).

Another problem: Does "temperature" include the ambient? Where is it measured—inside the converter, at the surface or above it? Or maybe at the heat sink? Find out.

Still another problem is the tempo of the output. When it's listed, tempco is usually an average figure, measured at two temperature extremes (again, which temperature is measured?). But tempco isn't necessarily linear. So between the chosen measuring points, the coefficient can wander up or down almost as it pleases. To make matters worse, variations in load and line voltage can also shove tempco around until it looks like the bouncing ball in a movie sing-along.

The culprits here are thermals—internal gradients between case and component, from component to component and from the case to the mounting surface or to the surrounding air. Any change can redistribute the gradients—and vary the output.

In short, there's no easy or one right way to pin down the temperature effects and cooling requirements of a converter. One thing is certain, though: These can't be ignored safely.

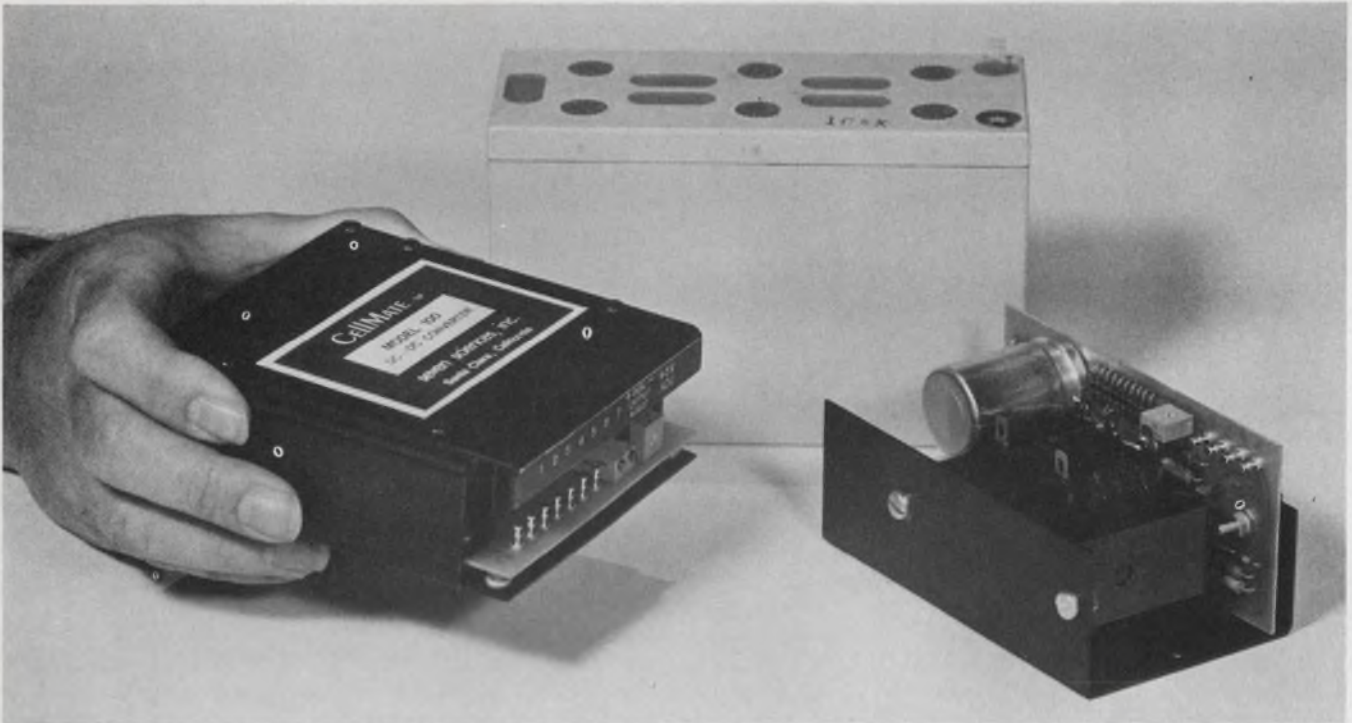

Packaged in a 4-1/2 x 4 x 1-1/2-in module, the Model 100 from CellMate accepts a 10 to 15-V input and de-

livers up to 20 W at its triple outputs. The unit is protected at both its input and output.

The bliss that is born of ignorance soon evaporates in still another converter area: dc outputs that aren't.

The search for a perfect straight line

Despite the modifier in front of its name, no converter delivers a pure dc level. Along with the dc you can expect to find ripple, noise and other assorted hash. And this will be true no matter how pure the input level.

The unwanted outputs can be traced mainly to the switching techniques used, first, to convert the incoming dc to ac and then, in some converters, to provide regulation. Of course, you don't pay directly for the unwanted departures from dc, but you pay a high price in extra time and trouble.

Even if you can't avoid the extras, you'd still like to know how much of each kind to expect. And converter vendors will usually tell you. (Like "painless" dentists, "noiseless" converters are to be avoided.)

So you confidently plug in that "low-ripple" or "low-noise" unit, throw the power on and—instead of what you expected, you find yourself hooking up a scope to find out what went wrong. What probably happened is this:

That 1-mV rms ripple or noise spec was true enough. But what the rms spec didn't show was a hefty switching spike—narrow enough not to contribute to an rms measurement, but packing enough energy to do damage or to foul up logic

circuits. Moral: With ripple, look for a peak-to-peak spec, not rms. Of course, unless ripple or noise is some simple periodic waveform (which excludes spikes), the pk-pk spec can't be found by simple multiplication of the rms value by a constant. So ask the vendor how he arrived at the figure.

While you're asking, ask what bandwidth was used to measure the noise. Though NEMA specifies a 20-Hz-to-10-MHz bandwidth for PARD (periodic and random deviations), the standard isn't widely followed. One reason may be that the narrower the BW, the smaller the noise spec. Other tricks to reduce rated noise: Lower the line voltage or reduce the load. Watch for them.

If the circuit being powered by the converter contains sensitive elements or operates at very low levels, then the noise spec becomes doubly important. In this case high-frequency pulse equipment with even greater BWs may be needed (some spikes have nanosecond widths).

After you've checked the output noise specs, turn the converter around and look at it from the source's point of view. What you see may surprise you.

When it comes to noise, converters are neatly symmetrical—they inject a pk-pk current into the source as well as the load. Depending on the amount, your source may not care. But what if other loads—which do care—are powered by the source? Ironically enough, the "other" loads can conceivably be a series of identical converters—all spewing garbage onto the prime bus.

To keep the noise current—called reflected input-ripple current or spike feedback current—off the power line (or at least to minimize it), vendors design converters with input filters. Symmetrical filters work both ways—they stop noise from getting into or out of the converter.

Reflected input-ripple current should be specified as a pk-pk value. Again, the value will depend on how it's measured: Instrument BWs, terminations, cable types and lengths, inductance (if any) of the sampling resistor—all play a role.

Converters that operate from batteries, and which have a battery charger hanging on the line, may need an input filter to keep 120-Hz ripple (from the charger) from getting into the converter. If the ripple does get in, it can pass through to the converter's load or heat a capacitor within the converter.

Since an input filter adds to a converter's cost, and since it cuts into efficiency, don't expect to find one in every converter. Of course, you can always add an input filter. Indeed, it's considered good engineering practice to drop an LC decoupling filter between the prime dc source and the converter (and not just converters but all switching-mode power equipment—regulators, dc/ac inverters, etc.). When you do this, watch out for a pitfall.

Because the dynamic input impedance of a converter can become negative under certain conditions, the possibility exists for external impedances to interact with this negative impedance. You can easily guess what happens then: The system breaks out into neat but rather disturbing, oscillations. In fact, even without the filter, the right combination of source and other load impedances can touch off oscillations during start-up or converter load changes. Solution: Shuffle the impedances at the input terminals or add damping networks.

Tagging along with the output noise voltage and the reflected input-ripple current is still a third noise contribution—common-mode current. This consists of current spikes or other hash that flow between the supposedly isolated input-common and output-common terminals.

Problems start when the noise current finds a path back to the source from the converter's load (ground loop) and the load is, say, a differential op amp (which proceeds to saturate) or some other low-level analog circuit (which can't distinguish the noise current from a legitimate input). You can always stick a capacitor across the common terminals, but this usually degrades the isolation impedance even more.

Common-mode current can also hamper the measurement of output noise voltages. So don't forget to use high-frequency probes with short (less than an inch) ground clips.

Noise conducted along input and output lines



Sorensen's STM line operates from 100 to 150 V dc or from the standard ac line. The unit is intended for uninterruptible power systems.

can certainly be a problem. But even when a converter bristles with filters at every port, noise can still reach out to plant a spiky kiss on the power or load lines. How? By radiation.

The switching technique used to convert the incoming dc level also converts the unit into a neat transmitter. Consequently unenclosed, plastic-encased or epoxy-encapsulated units are usually surrounded by electromagnetic, and even electrostatic, noise fields.

When the converter is used in or near sensitive, wideband equipment (mobile radio, for instance), shielding will probably be needed. Alternately you can buy a unit completely enclosed in a metal can. If you do, make sure the unit is surrounded on all sides and that the shield is unbroken. Remember that aluminum doesn't provide magnetic shielding; cold-rolled steel will give about 6-dB worth. And, of course, metal cases should be grounded for electrostatic shielding.

Vendors use other techniques to keep the converter "clean"—for example, shielded transformers and special switching frequencies. But when it comes to EMI, the best precaution is to try a unit in its intended application.

A converter's switching frequency may be important for other reasons. Since the higher the frequency, the tougher the design problems, some vendors stick to frequencies below 20 kHz. But audio frequencies bring their own set of problems: audible noise that is not only annoying but can cause mechanical resonances; vibrations that

conceivably can be converted to electric noise by a component that inadvertently acts like a vibration transducer.

So when a converter with attractive specs also carries a too-good-to-be-true price tag, ask the vendor, "What's the switching frequency?" Another thing you might ask: "For that price, do I get any protection?"

Protection is a must

Practically every power supply needs some protection against accidents at the load terminals—shorts, transients, reversed polarities and the like. A dc/dc converter will probably need protection at its input terminals as well.

Look at what can happen during turn-on, for instance. Because of the fat filter capacitor sitting at the input, or perhaps because of the vendor's base-drive design, a surge of current rushes into the converter when the power is turned on. But can the regulated supply that drives the converter—the prime source—handle the in-rush?

What you'd like to know—and probably don't—is the source's transient response. Can the source overshoot and, as a result, hurt itself? Will the source take the converter down, and possibly some other loads as well?

You say you don't have to worry because your source is current-limited? Agreed. When the converter asks the source to dump current quickly, the source responds by going into limiting. No one gets hurt—but the converter never turns on either.

And you can't remove an input capacitor—at least not without making the converter even more vulnerable. Power-line spikes can then slip in without interference and knock the converter down for the count. If the leads between the power source and converter are long—which implies high inductance and, consequently, even higher spikes—it's a knockout.

Input protection doesn't stop with spikes. All kinds of things can happen, especially in complex systems with many interconnected supplies, converters and loads. One supply can decide to turn on just a shade faster than all the others. If that supply happens to be the one with the greatest power rating, it can dump a hefty current into the lines. If an unsuspecting—and unprotected—converter just happens to be sitting in the wrong place—pow.

If the converter survives, the prime source can come up with still another weapon: It waits for the right transient; then unexpectedly the supply quickly reverses its polarity and renders the coup de grace to the converter.

So input protection can be vital. And it must accommodate a number of possible faults. What



High-voltage units from Velonex operate under severe thermal, shock and vibration conditions.



High efficiencies (to 75%) from low input voltages (3 to 4 V) mark the Adaptive Systems Model 212.



You can parallel these 5-V units (Series 4000) from RO Associates to get thousands of amps.

output protection may also be needed is another story.

The types of output protection for dc/dc converters are similar to those for most power supplies—by and large some form of current limiting is used to prevent converter damage from short circuits and overloads (high-voltage converters may use other techniques). But because of the switching techniques used within the converter, more failure modes exist. Consequently protection is more difficult and subject to more problems.

Thus it may not be enough to state that a converter is short-circuit-protected. You may need to know just how it's protected. For instance, suppose a battery-operated converter uses straight current limiting to handle overloads. When a fault occurs, the unit goes into limiting and no damage occurs. But wait. In the current-limited mode, the converter can still draw appreciable current from the battery. There goes your low-power, long-life design.

To get around the problem, you can opt for

foldback protection, in which both voltage and current are cut back simultaneously upon a fault. In effect, the converter shuts down, and so does power dissipation.

But don't relax. With foldback, after the short or fault is cleared, the converter may decide it likes a life of leisure: It may refuse to start, and remains latched or partly latched down. To get the converter going, you'll have to turn off the prime source or disconnect it from the converter.

So you do this cheerfully, then throw the power on to get back to normal operation. What happens? Nothing. A bit more switch flipping and wire jiggling, and finally something happens all right—the system breaks out into oscillations. What's the problem? Probably that large capacitive load that your foldback-protected converter doesn't like and the vendor forgot to tell you about.

Some converters won't restart after a fault if they see even a small current coming back from the load. And restart can bring other headaches, so ask the vendor these questions as well: How much energy is stored in the converter's output filter? Does a restart voltage transient occur when a short is removed? Will the converter restart if the fault is still present? No less important: How does the converter respond to changing loads? In short, what's its transient response?

Disturbed by transients?

When a converter's load changes, so does its output. What you're often not told is how. Or if settling and other transient specs are given, the listing is vague—like “settles to 0.01% in so many microseconds.” The question in this case is: To 0.01% of what and for what load change?

Or perhaps you'll see: “Response or recovery time equals 10 μ s.” What does that mean? Only the Shadow knows. Of course, you can always speculate as to the meaning: If by “10 μ s” the vendor means that his unit will return to its nominal output voltage within that time after a load change, that sounds pretty good (and the vendor hoped you'd feel that way). But then it occurs to you, “Hey, what happens during that 10 μ s?”

Well, if the load change consists of a step decrease in current, the output voltage could zoom up, pause momentarily at a substantial peak, then plunge to its original level. Remembering that 10 μ s can be a lifetime to a fast-logic load, you can see that the key word here is “substantial.” Similarly a step increase in load current can result in an undervoltage transient, which can harm loads sensitive to such a condition.

What the transient-response problem boils down to is this: When a load demands an abrupt

change in current, it's the converter's dynamic-regulation characteristics that will determine the course of events. Since dynamic regulation is tough to pin down, many vendors solve the problem by ignoring it—something you may not be able to do. (And don't ignore the fact that converters can have transient problems on the input side too.)

Not all vendors sidestep the problem. Many do give measurement figures for transient performance. But since the test method usually varies from manufacturer to manufacturer, you can't safely compare competing units. One way out, however, is to think in terms of the NEMA standard, which does give definitions and test methods for transient behavior. If you insist on speaking NEMAese, then perhaps converter vendors will have no choice but to go along. Though the standard isn't perfect, at least everyone will be speaking the same language.

A converter's dynamic regulation tells you how the unit responds to short-term disturbances. But relatively long-term characteristics may be equally or more significant—a converter's stability, for example.

Any variation in a converter's output level within the frequency range of dc to 20 Hz (the lower PARD limit) is considered drift (exclusive of temperature effects). Some vendors spec drift. Many don't. If it's important, find out what the manufacturer means when he refers to “short-term” or “long-term” drift.

Another converter spec that's often critical—in for example, in medical applications—is isolation. A perfectly isolated converter has absolutely no direct path between input and output—its input-to-output impedance is infinite. Of course, practical units have some leakage; the trick is to find out where and how much.

Isolation is generally specified (when you can find it) in terms of an equivalent capacitance and resistance plus a figure for breakdown voltage. Less than 10-pF input/output capacitance is generally required for biomedical use.

Other converter specs assume greater or lesser importance, depending on the application. But regardless of which are important to you, don't make the mistake of overspecification.

Mistakes and tradeoffs

Converters suffer from two maladies common to all power supplies: overspecification and the stick-it-where-it-will-fit syndrome.

In the former case, designers order performance far in excess of what they really need as a safety factor (some vendors say “ignorance factor”). In the latter case, the converter isn't thought of until the day before shipment, and then a mad scramble starts to find a unit that

fits whatever odd-ball space is left.

Among the most common fertile areas for such mistakes are these:

- **Regulation:** Far and away the most over-worked converter spec, regulation is ordered by habit instead of need—a costly error.

- **Current rating:** Not enough is allowed for peak-level demand or too much is specified on a continuous basis to meet a brief peak demand.

- **Size:** Peculiar form factors asked for to meet available space bring additional costs and result in cooling problems.

- **Input/output range:** Output adjustment range is frequently overspecified—adjustments of greater than about $\pm 5\%$ generally lead to larger sizes and larger heat sinks. Wide input range is tough to get—better try to limit source excursions.

- **Operating Band:** Designers assume that regulation, ripple, tempco and stability tolerances will offset one another. But they probably won't—best to spec total operation-band tolerance and hold the vendor to a worst-case spec.

Sure to pop up in the search for the right converter are the names of 100 or 200 vendors who offer hundreds of models in a variety of inputs, outputs, power ranges and package styles.

Some vendors specialize. For example, Ad-

vanced High Voltage Co., Bertan Associates, Endicott Coil Co., Sierra Systems, Spellman High Voltage Electronics, and the Velonex Div. of Varian all offer units with high output voltage—to the hundreds of kilovolts region.

But by and large, most converter vendors offer units that fall in the miniature, low-power classification—modular units intended mostly for PC-mounted applications. Among the more prominent are such vendors as Adaptive Systems, Analogic, B.H. Industries, Burr-Brown, Datel Systems, ERA Transpac, Hybrid Systems, Intronic, Reliability, Inc., Semiconductor Circuits and Stevens-Arnold.

For higher-output units, look into the lines offered by CellMate Div. of Seven Sciences (which offers a 20-W triple-output unit that measures only $4\frac{1}{2} \times 4 \times 1\frac{1}{2}$ in.), and those of such prominent power-supply outfits as ACDC Electronics, North Electric (Electronetics Div.) RO Associates, Sola Electric, Sorensen, Technipower and Wilmore Electronics.

If you want to build your own, Microtran and others carry a line of dc/dc-converter transformers which come with suggested schematics. Or you can get a custom house—such as Design Automation or Prototype Transformer Corp.—to design one for you. ■■

Need more information?

The products cited in this report don't represent the manufacturers' full lines. For additional details, circle the appropriate information retrieval numbers. For data sheets and for more vendors, consult ELECTRONIC DESIGN'S GOLD BOOK.

ACDC Electronics, Oceanside Industrial Ctr., Oceanside, CA 92054. (714) 757-1880. (D. W. Purkey). **Circle No. 401**
Aaron-Davis Co., 1720 22nd St., Santa Monica, CA 90404. (213) 829-1834. (R. A. Walden). **Circle No. 402**
Acme Electric Corp., 205 Water St., Cuba, NY 14727. (716) 468-2400. **Circle No. 403**
Adaptive Systems, Inc., P.O. Box 1481, Pompano Beach, FL 33060. (305) 942-4000. (Weldon Vlasak). **Circle No. 404**
Advanced High Voltage Co., Inc., 14532 Arminta Ave., Van Nuys, CA 91402. (213) 997-7222. (Michael Alexander). **Circle No. 405**
American Time Products, 6120 Woodside Ave., Woodside, NY 11377. (212) 335-6000. (Robert R. Ansell). **Circle No. 406**
Analogic, Audubon Rd., Wakefield, MA (617) 246-0300. (Bernard Gordon). **Circle No. 407**
Arnold Magnetics, 11520 W. Jefferson, Culver City, CA 90230. (213) 870-7014. (R. Pizer). **Circle No. 408**
Astro-geo-Marine, Inc., P.O. Box 5526, Oxnard, CA 93030. (805) 485-3128. (J. E. Fenole). **Circle No. 437**
B.H. Industries, 2218 Cotner Ave., Los Angeles, CA 90064. (213) 479-8278. (Raymond Quiring). **Circle No. 409**
Bertan Associates, Inc., 180 Miller Pl., Hicksville, NY 11801. (516) 433-3110. (L. Bertan). **Circle No. 410**
Burr-Brown Research Co., International Airport Industrial Park, Tucson, AZ 85706. (602) 294-1431. (T. Fern). **Circle No. 411**
CellMate Div. of Seven Sciences Inc., 933 Kifer Rd., Sunnyvale, CA 94086. (408) 735-0200. (Leonard Azar). **Circle No. 412**
Computer Products, Box 23849, Fort Lauderdale, FL 33307. (305) 974-5500. **Circle No. 413**
Data Translation, Inc., 109 Concord St., Framingham, MA 01701. (617) 879-3595. **Circle No. 414**
Datel Systems, Inc., 1020 Turnpike St., Canton, MA 02021. (617) 828-8000. (Jack Gallagher). **Circle No. 415**

Design Automation, 809 Mass. Ave., Lexington, MA 02173. (Nathan O. Sokal). **Circle No. 416**
ERA Transpac Corp., 311 E. Park St., Moonachie, NJ 07074. (201) 239-3060. (Paul Greco). **Circle No. 417**
Endicott Coil Co., 24 Charlotte St., Binghamton, NY 13905. (607) 797-1263. (S. Foides). **Circle No. 438**
Hybrid Systems, 87 Second Ave., Burlington, MA 01803. (617) 272-1522. (William D. Miller). **Circle No. 418**
Intronics, Inc., 57 Chapel St., Newton, MA 02158. (617) 332-7350. (Richard Sakakeeny). **Circle No. 419**
LRC Inc., 101 Digital Dr., Hudson, NH 03051. (603) 883-8001. **Circle No. 420**
Mil Electronics Inc., 176 Walker St., Lowell, MA 01854. (617) 453-4142. (Bruce Eldridge). **Circle No. 421**
North Electric Co., P.O. Box 688, Galion, OH 44833. (419) 468-8100. (Jerome D. Neff). **Circle No. 422**
Nova Electric Mfg. Co., 263 Hillside Ave., Nutley, NJ 07110. (201) 661-3434. (Ken Niowitch). **Circle No. 423**
Powercube Corp., 214 Calvary St., Waltham, MA 02154. (617) 891-1830. (J. Prestidge). **Circle No. 424**
Reliability, Inc., 5325 Glenmont, Houston, TX 77036. (713) 666-3261. (Bob Miller). **Circle No. 425**
RO Associates, 3705 Haven Ave., Menlo Park, CA 94024. (415) 322-5321. (Robert H. Okada). **Circle No. 426**
Semiconductor Circuits, Inc., 306 River St., Haverhill, MA 01830. (617) 373-9104. (John T. Parent). **Circle No. 427**
Sierra Systems, Inc., 650 Vaqueros, Sunnyvale, CA 94086. (408) 733-1040. (William F. Doherty). **Circle No. 428**
Sola Electric Div., Sola Basic Industries, 1717 Busse Rd., Elk Grove Village, IL 60007. (312) 439-2800. (R. G. Tucker). **Circle No. 429**
Sorensen Co., Unit of Raytheon Co., 676 Island Pond Rd., Manchester, NH 03103. (603) 668-4500. (Ken Lent). **Circle No. 430**
Spellman High Voltage Electronics, 1930 Adee Ave., Bronx, NY 10469. (212) 671-0300. (Michael A. Civin). **Circle No. 431**
Stevens-Arnold, Inc., 7 Elkins St., South Boston, MA 02127. (617) 268-1170. (E. Stevens). **Circle No. 432**
Tecnetics Inc., Box 910, Boulder Industrial Park, Boulder, CO 80302. (303) 442-3837. (Bern Garrison). **Circle No. 433**
Technipower, Inc., Benrus Center, Ridgefield, CT 06877. (203) 438-0333. (Albert R. Saenz). **Circle No. 434**
Velonex Div. of Varian, 560 Robert Ave., Santa Clara, CA 95050. (408) 244-7370. (Elliott Rudee). **Circle No. 435**
Wilmore Electronics, Box 2973, W. Durham St., Durham, NC 27705. (919) 489-3318. (J. L. Harris). **Circle No. 436**

TRW connects with Celanex. At 1/3 the cost of DAP

Based on a very thorough material comparison, Cinch Division of TRW Electronic Components now molds these printed circuit edge connectors, shown below, in flame-retardant Celanex SE-O—replacing DAP and glass-filled phenolics. Why? Celanex cuts molded insulator costs by a whopping 2/3. And insulator properties in Celanex are equivalent or better.

Fact is, for electrical/electronic connectors, glass-filled Celanex thermoplastic polyester combines all the advantages of DAP and phenolics. With none of their disadvantages.

Celanex is faster cycling than all thermosets. By far. Easier to mold in thin-walled sections. And Celanex scrap can be re-ground and reused. Another cost-saving.

Celanex is rigid, for support of the printed circuit board. It will withstand severe shocks to thin-wall parts. It's dimensionally and electrically stable at elevated temperature and humidity. And it resists strong chemical solvents and cleaning solutions.

Maybe Celanex has so much going for it because Celanese was the first to market a thermoplastic polyester. We have more ex-



perience and far greater depth of data to offer you. It's yours for the asking. Celanese Plastics Company, Dept. X-602, 550 Broad Street, Newark, New Jersey 07102.

Celanese Plastics Company is a division of Celanese Corporation. Canadian Affiliate: Celanese Resources, Ltd. Export: Amcel Co., Inc., and Pan Amcel Co., Inc., 522 Fifth Ave., New York 10036.

Celanex: the original thermoplastic polyester

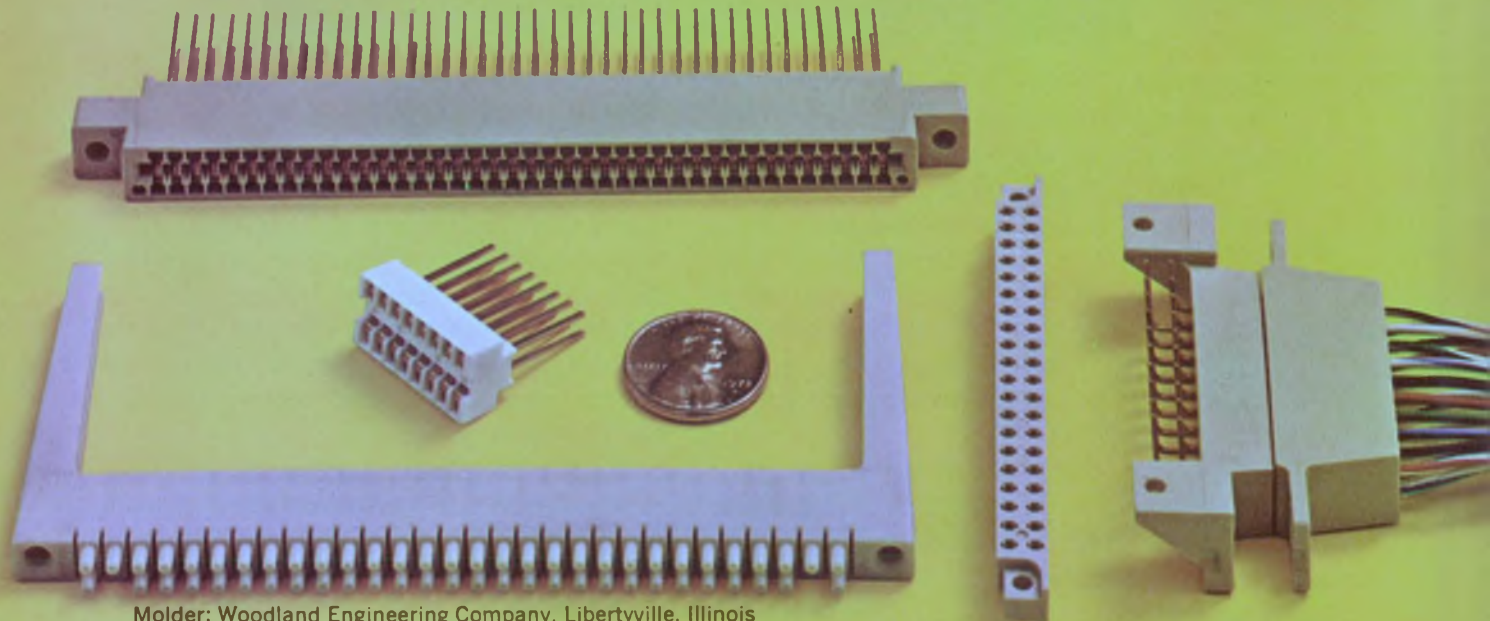

Molder: Woodland Engineering Company, Libertyville, Illinois

INFORMATION RETRIEVAL NUMBER 39

For built-in reliability, design with "Scotchflex" Flat Cable/Connector Systems.

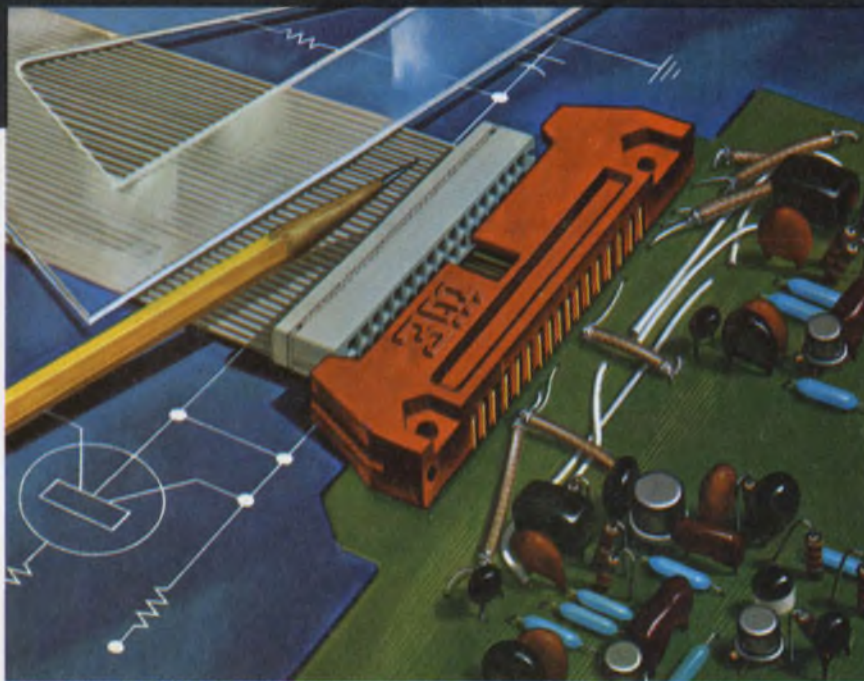

"SCOTCHFLEX" IS A REGISTERED TRADEMARK OF 3M CO.

"Scotchflex" Flat Cable and Connectors can offer you trouble-free packaging for your next generation equipment.

There's built-in reliability for your circuit inter-connects. Our flat, flexible PVC Cable has up to 50 precisely spaced conductors. The gold plated U-contacts are set into a plastic body to provide positive alignment. They strip through the insulation, capture the conductor, and provide a gas-tight pressure connection.

Assembly cost reductions are built-in, too. "Scotchflex" Connectors make up to 50 simultaneous connections without stripping or soldering. No special training or

costly assembly equipment is needed.

Off-the-shelf stock offers you flat cable in a choice of lengths and number of conductors from 14 to 50. Connector models interface with standard DIP sockets, wrap posts on .100 x .100 in. grid, or printed circuit boards. Headers are available to provide a de-pluggable inter-connection between cable jumpers and printed circuit boards (as shown). Custom assemblies are also available on request.

For full information on the "Scotchflex" systems approach to circuitry, write to Dept. EAH-1, 3M Center, St. Paul, Minn. 55101.

3M
COMPANY

WHEN DIP RELAYS ARE CALLED FOR, CALL FOR US



You can call on us for help in solving any relay-related problem. That's how we built our reputation in the first place. We took on the toughest applications problems you could hand us. And we solved them — with innovative engineering, advanced production techniques, tight

quality control. We still invite your custom business, though our standard product lines will meet most any need.

If you have an application that calls for DIP packages, for instance, you'll be interested in our complete line of form A, B and C DIP reed relays. They are contained in the standard 14-pin DIP package capable of insertion in standard 14-pin DIP sockets or automatic insertion in P.C. boards. Available in either 3 or 10 watt form A and form B contacts, and 3 watt form C contacts, they can be driven directly by TTL logic, and provide total isolation between input and output circuits. The hermetically sealed reed switch contacts provide millions of trouble free operations.

Elec-Trol DIP reed relays are available with 8 or 14 terminals, with or without internal clamping

diode across the coil, and with optional electrostatic shielding and contact run-in. (The internal lead frame serves as a magnetic shield.) Epoxy encapsulation yields high shock and vibration immunity and provides total protection to coil and reed switches in hazardous environments.

If you'd like specific technical information, call or write us at the address below. Ask for our DIP Reed Relay Catalog No. 103. We'll send it by return mail.

ELEC-TROL INC.

26477 North Golden Valley Road
Saugus, California 91350
Telephone: (805) 252-8330
(213) 788-7292 TWX 910-336-1556

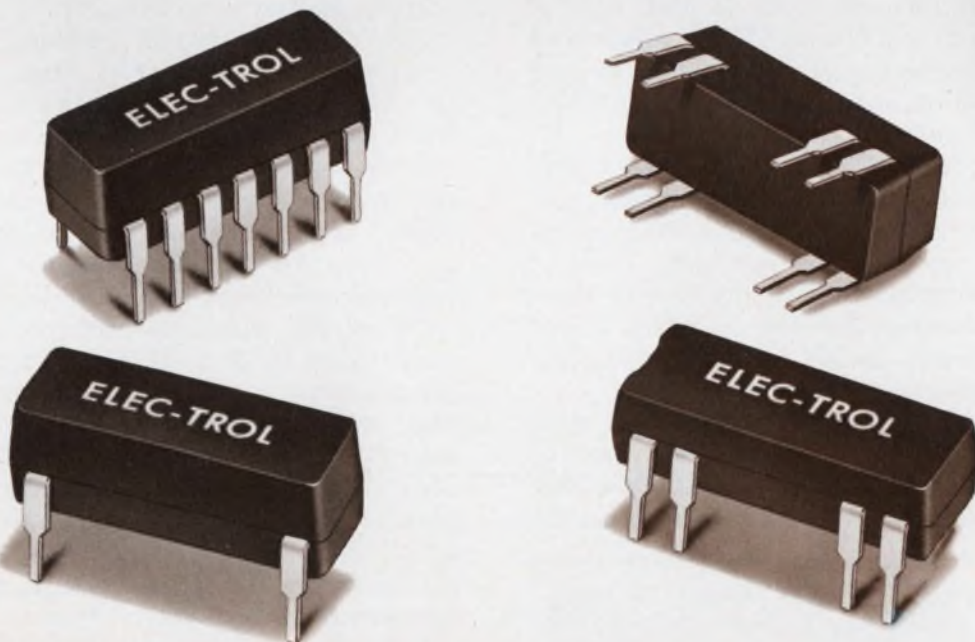

INFORMATION RETRIEVAL NUMBER 41

Should you use LCD or LED displays

for portable equipment? The choice hinges more on drive and interface requirements than on display appearance.

Two important technologies, LEDs and LCDs, are being used for the display of alphanumeric data in compact portable systems.

Light-emitting diodes (LEDs)—semiconductor devices—emit visible monochromatic light. Liquid-crystal displays (LCDs)—using organic liquids contained in transparent glass packages—modify the transmission or reflection of ambient light.

Both types of display offer the advantage of low power consumption, allowing use of battery supplies. And small package sizes are available. Hence both are finding their way into such applications as hand-held calculators, digital wrist watches and pocket-sized digital multimeters.

However, the selection of one display over the other can present a difficult choice. In some cases, a particular display's appearance might be the deciding factor. But often drive and interface requirements determine which display to use.

The tradeoffs with each display

LED displays offer solid-state reliability, relatively low price and low-voltage operation—1.7 to 3.4 V. However, segment-drive currents range from a low 250 μ A up to 5 mA in digit sizes of 0.1 to 0.5 in. Since display brightness varies directly with segment current, the goal of long battery life requires some compromise in visibility under direct-sunlight conditions.

LCDs don't generate light; therefore they have extremely low power requirements. Segment currents are in the nanoampere-to-microampere region. Though excellent for sunlight viewing, LCDs require supplementary light sources when used under low-ambient lighting conditions. And because of hermetic sealing, package prices for LCDs somewhat exceed those for LEDs.

Major disadvantages of LCDs arise from their drive requirements. Pure rectangular-wave ac signals from 3 to 24 V must be used to ensure acceptable lifetimes. Multiplexing—commonly



1. Built-in secondary magnification, as shown for the DL-95 LED display of a nine-digit calculator, can be used to cut drive-current requirements.

used with LEDs—is difficult with LCDs because of their slow speed of response, which worsens at temperatures close to freezing.

LCDs are generally larger and bolder than LED displays. Under most ambient lighting conditions, however, filtered red LEDs offer superior contrast against a background.

How these and related tradeoffs affect display selection can be seen from some typical applications. For example, with hand-held calculators, which generally use an eight or nine-digit read-out, the main consideration is the lowest possible total system cost. LEDs provide the most appropriate display because of their low cost per digit. And multiplex capability minimizes interconnections and interface-circuit complexity.

The digital watch has different requirements, since today it is more an expensive piece of jewelry than a mass-produced consumer item. Ideal criteria would be minimum power dissipation, clear visibility in both bright sunlight and a darkened room, and a large digit with high-quality, aesthetically pleasing appearance. Both LCD and LED displays are used about equally since each satisfies these criteria, although with different compromises.

Small digital multimeters also choose both dis-

David A. Laws, Product Marketing Manager, and Roger R. Ady, Senior Applications Engineer, Litronix, Inc., 19000 Homestead Rd., Vallco Park, Cupertino, CA 95014

play technologies. Probe-mounted readouts with control switches, such as those used on the Model 167 from Keithley (Cleveland, OH) or the HP 970A instruments from Hewlett-Packard, favor LEDs because of their small package size. The Danameter multimeter (Dana Labs, Irvine, CA) uses LCDs because of the large character height and continuous display of the parameter being measured.

Portable terminal systems present another important area of new applications for low-power

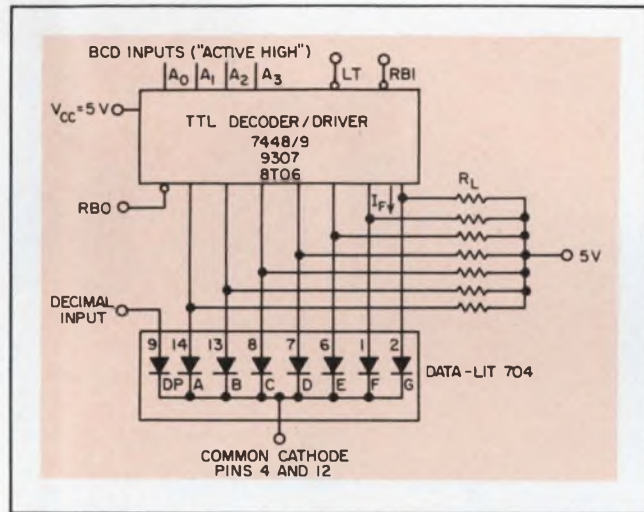

2. Dc drive signals are provided by a decoder-driver. Newer drivers, such as Signetics' 8T75 or Fairchild's 9368, contain current sources on the chip.

alphanumeric displays. Devices are becoming available for both person-to-person—the MCM telephone link from Micon (Oakland, CA) for the deaf—and man-to-machine communications—the HT-2 hand-held computer terminal from Termitex (Nashua, NH). Both systems use LED displays because of their high-speed multiplex capability.

LEDs emit several colors

Light-emitting diodes can be produced with many different semiconducting materials. The most efficient devices developed to date are all based on gallium compounds. A forward-biased pn junction formed in GaAs emits infrared radiation at 900 nm.

The introduction of phosphorous to form GaAs₍₆₀₎P₍₄₀₎ provides visible red light at 650 nm. A gradual increase in the concentration of phosphorous produces orange and yellow colors. Finally at GaP₍₁₀₀₎, green light is emitted.

Current materials technology has reached the point where red, yellow and green devices can all be produced at similar brightness levels, as perceived by the human eye, under equal drive conditions. However, raw materials and fabrica-

tion methods for green and yellow devices cost two to three times more than red.

Most display devices are formed by light-emitting bars arranged in seven or nine-segment patterns. Two types of displays are produced—monolithic and hybrid. A monolithic display has all segments diffused in a common-cathode configuration on one GaAsP chip. It requires little assembly labor, offers excellent alignment and brightness matching between segments and has a continuous nonsegmented appearance.

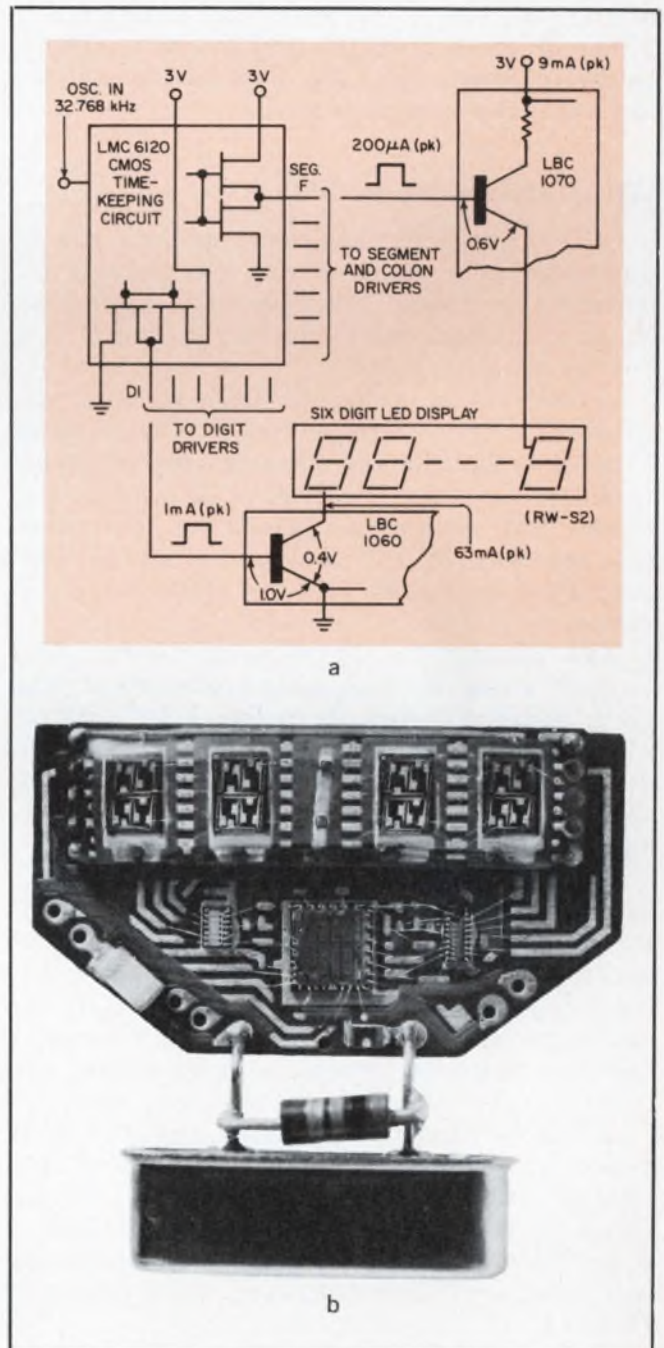

3. LED watch circuit employs ion-implanted CMOS control IC (LMC 6120) for low power (a). The IC performs time-keeping and multiplex-drive functions. In typical watch modules, the drive and interface circuitry form a compact package with the LED readout (b).

At character sizes above 0.1 in., however, material costs become excessive and hybrid digits are produced. In this case, a separate rectangular die is used to form each of the seven segments. As labor costs increase and material costs decrease, the trend is in favor of larger monolithic devices.

In use, the red-LED display is placed behind a filter window to protect the device and improve contrast. Ambient light contains very little red, so a red filter can be used to provide excellent contrast enhancement with zero background clutter. Since yellow or green narrowband filters are difficult to produce, significant separation of yellow or green from the background is difficult to obtain. Hence red LED displays are expected to remain the most popular.

LED packaging: dice to DIPs

LED displays for low-power systems can be purchased as a semiconductor die, suitable for mounting in hybrid microelectronic assemblies, or as a conventional component packaged in a DIP or on a PC board.

In the case of a die, the LED supplier provides either tested chips or wafers. The customer must establish internal microelectronic-assembly facilities, including die-attach wire bonding and in-line test equipment. Monolithic dice allow easy matching of brightness and electrical characteristics, and many different styles are available.

Most common are 70-mil seven-segment, and 100-mil seven or nine-segment characters. The ninth segment centers the numeral "1," and for watches, it provides alphanumeric capability to display the day of the week. Fourteen and 16-segment devices are also available for ASCII-alpha compatibility.

Packaged displays generally come in modular form specifically designed for the watch, calculator or other function. A typical watch-display package consists of a small, rectangular multilayer ceramic substrate with bump contacts designed for reflow soldering. The four digits and colon are protected by a clear epoxy encapsulant that could also be used to add some magnification.

Calculator displays of eight or nine digits are generally mounted on a larger board designed for edge or pin-solder connection to the main circuit board. Up to two times magnification is frequently provided by a clip-on plastic lens to minimize both cost and drive-current requirements (Fig. 1).

Driving LEDs is easy

Drive requirements for a LED are very simple: The selected segment is switched into a circuit

Table. Compare drive requirements for GaAsP LEDs

Character Height (inches)	Device Type	Typical Litronix Part No.	Average Segment Drive Current (mA)
0.1	Magnified Monolithic	DL-95	0.3
0.1	Monolithic	DL-5175	1.0
0.12	Hybrid	DL-5176	2.0
0.16	Magnified Monolithic	DL-44M	1.0

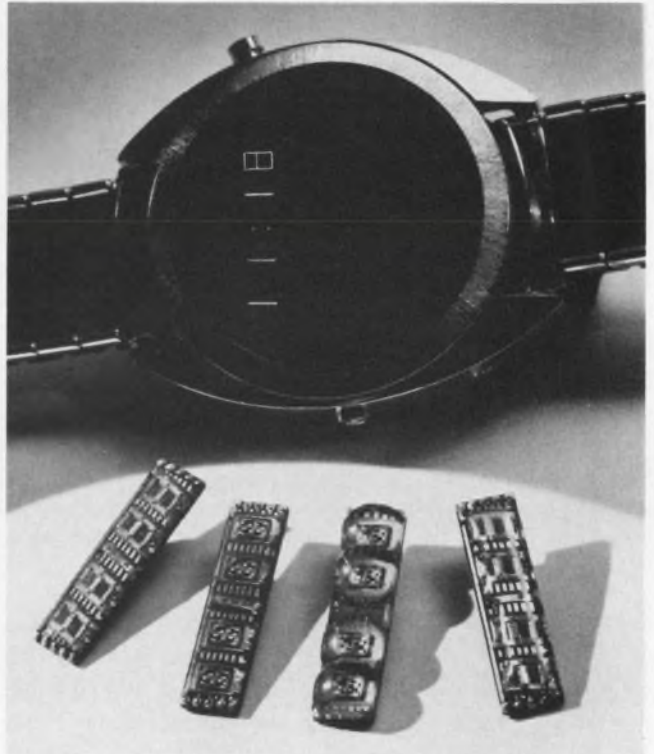

A set of LED displays from Litronix illustrates typical drive-current/segment requirements. The photo shows different package styles for the DL-5175 series.

containing sufficient voltage to overcome the forward diode drop—1.7 V for red GaAsP.

Also the LED's brightness varies directly with forward current. Hence some form of current limiting is needed to set the required level (Fig. 2). The limiting can be provided by the driving circuit, as in the case of many MOS and TTL circuits designed for use with LEDs.

Component cost can be reduced in multiple-digit arrays by time sharing, or multiplexing, one set of decoder-drivers across all digits. This technique is commonly employed in most MOS chips to reduce pin count, wiring, interconnect and PC-board area.

In multiplexed operation, each digit receives successively a pulse of current. Under these conditions, GaAsP devices exhibit a "super linearity" that combines with the eye's response as a peak

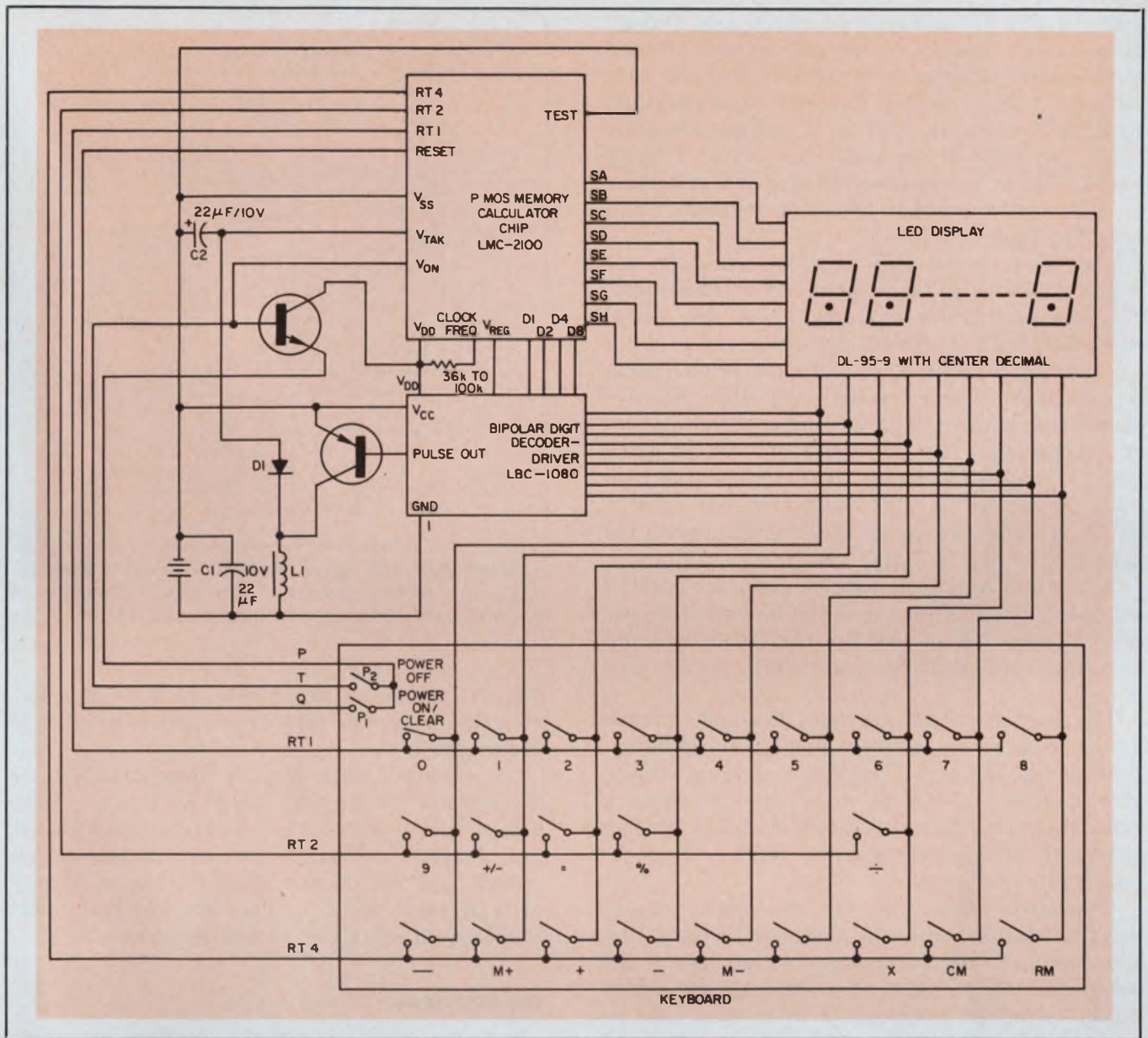

4. Calculator employs multiplexing techniques with LED display. The external, discrete components provide the

voltage regulation necessary for battery-saving features of automatic power-up and power-down.

detector to provide an improved apparent brightness level. This pulse enhancement is a side benefit of multiplexing that is frequently exploited.

The combinations of pulse width, duty cycle and peak current are determined by the drive available from the MOS chip, the display size and the desired brightness level. Typical indoor, ambient-viewing drive requirements for GaAsP LED digits appear in Table I.

Systems that require absolute minimum power dissipation, such as a digital watch, employ low-threshold, ion-implanted, CMOS circuits. When combined with a LED display, the watch can operate from two silver-oxide batteries for about 12 months of normal usage. For example, Fig. 3 shows the circuitry for a digital watch. The time-keeping circuit (the Litronix LMC 6120) has an enhancement-mode output structure with

a p-channel transistor to the supply and n-channel to ground. The output is enabled when the p-channel device is ON. In that state, the output sees an effective 1-k Ω impedance in series with 3 V.

The LED display normally operates on a 12.5% duty cycle, when displaying hours, minutes and seconds, with about 1-mA average current per segment. Hence the peak segment current required is 8 mA, and the digit driver must be able to sink seven times this current.

To minimize voltage drop, the digit driver in Fig. 2 is operated in saturation. A typical driver, the device has a $V_{CE(SAT)}$ of 0.4 maximum. With V_F of 1.6 V across the LED, a balance of 1.0 V remains for the segment driver and CMOS-segment output.

Early watch designs have used discrete pnp

segment drivers because of their low voltage drop. In the absence of low-cost monolithic pnp arrays, later designs have turned generally to a high-gain npn emitter-follower configuration, such as the one in Fig. 2, to reduce assembly costs. The eight-driver array has a V_{BE} of about 0.6 V. Gain of the emitter-follower is a minimum of 120, which ensures adequate segment drive with low base currents.

The circuitry of Fig. 2 doesn't require external resistors, so board area can be minimized. The segment driver contains monolithic 100- Ω current-limiting resistors for the segment lines and a 200- Ω resistance for the colon (which must be driven at a lower current). All other resistive elements are provided by the internal impedances of the devices. The resistance of a silver-oxide battery ranges from 1 to 10 Ω ; that of the bulk material of the GaAsP display extends from 6 to 12 Ω ; and the saturation resistance of the digit driver is 2 to 7 Ω .

A similar approach can be used to build a calculator. In this case, power dissipation is less critical, so a PMOS chip having lower cost and improved output-drive capability can be employed.

The higher output currents available permit direct segment drive of the display and elimination of the external transistor driving array. Fig. 4 shows a typical drive scheme using a calculator chip. Current provided to the display is typically 400 μ A per segment average on a one-out-of-nine duty cycle.

Calculator chips like the one used provide several features that can maximize battery life. For example, the clear-function key turns the calculator ON in place of a slide switch, which might be moved accidentally in a brief case or pocket. Also automatic power down after 15 min of nonuse eliminates battery drain. Should the cell voltage fall below 3.3 V prior to the full 15-min delay, the calculator will also be shut off. This ensures that the NiCd batteries are never subjected to a damaging reverse voltage.

The chip's low-voltage oscillator gates ON following a single key closure. The oscillator signal goes through a second gate to a fly-back up-converter, whose output is sensed and used to control this gate for voltage regulation.

As the converter voltage rises, it passes a threshold level sensed internally as the "ON" condition, which sets a "system fail" detector circuit. The converter output continues to rise to the regulated level, which then becomes the supply voltage for the calculator portion of the chip.

To turn the calculator off, the converter voltage is temporarily shorted, bringing its value below the "ON" threshold. The "system fail" circuit senses this transition and turns "OFF"

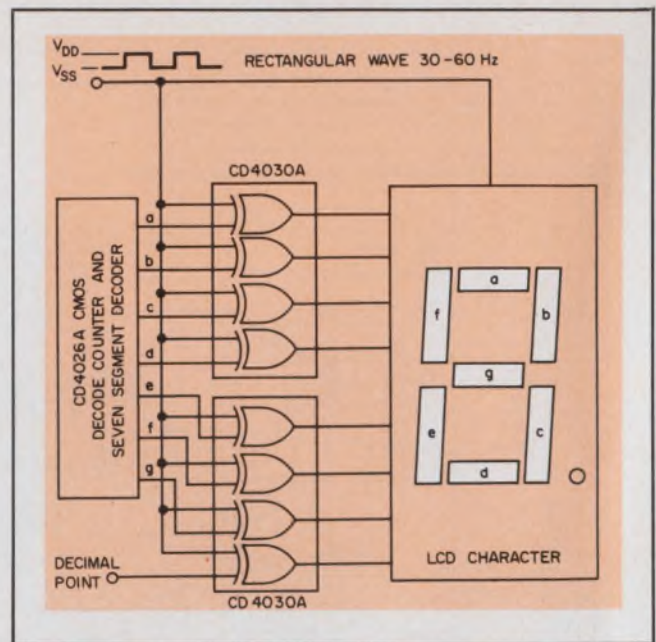

5. Single-digit LCD drive uses 4000-series CMOS circuits. The rectangular-wave drive signal eliminates a dc component, thereby extending display lifetime.

the low-voltage-oscillator gate. In turn, this disables the converter and causes the calculator to power down.

An internal clock circuit, monitored by an accumulator on the chip, resets each time a keyboard input is made. If no inputs are introduced, the accumulator reaches its limit in about one minute and the display then flashes at a duty cycle of about 25%. No data are lost and power is conserved up to the 15-min shutdown time.

The LCD story

In LCD displays, a layer of either dynamic-scattering or field-effect liquid-crystal solution is hermetically sealed between two precision glass plates. Electrodes are screened onto the inside glass surface in a seven-segment pattern.^{1,2}

With dynamic-scattering material, application of an electric field causes domains of crystals to be formed. The domains reflect light at the boundaries, and scatter the incident beam. Inactivated areas remain transparent. Activating field-effect (or twisted-nematic) materials rotate the plane of light polarization that passes through the display. Suitable orientation of polarized screens can therefore be used to extinguish light selectively.

Both types of display are available in transmissive or reflective versions. Low-power applications favor the reflective mode because it relies solely on externally generated illumination. Dynamic-scattering devices offer lowest cost, best contrast and widest viewing angle, but suffer

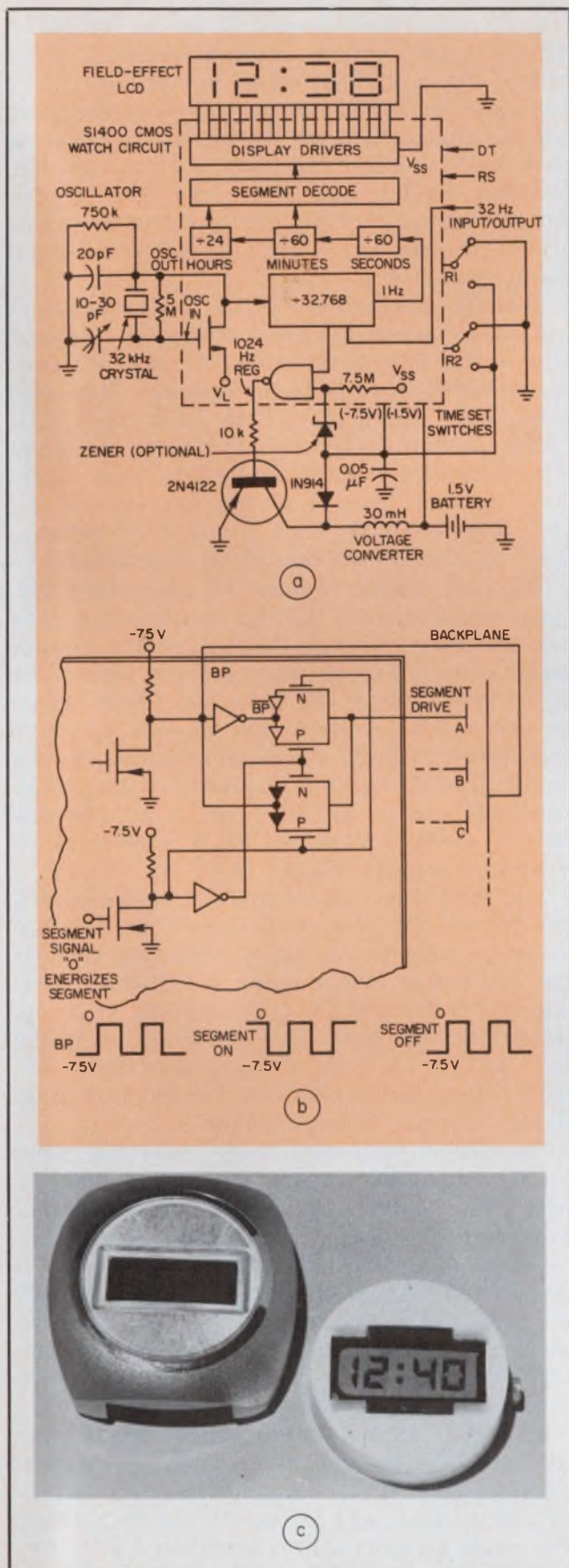

6. Single-chip LCD watch system employs an AMI S1400 silicon-gate CMOS circuit (a). The CMOS circuit performs level shifting and provides segment drive (b). A photo of the watch (c) exhibits the sharp contrast possible with field-effect LCDs.

disadvantages of short lifetimes and background clutter from the rear mirror in the reflective mode.

Field-effect types offer operating voltage down to 3 V compared with 10 to 15 V for dynamic-scattering, and an order-of-magnitude lower power dissipation. The disadvantages are higher price, narrower viewing angle and low contrast factor.

LCDs come in modular forms aimed at specific functions such as clocks, watches or instruments. All digits are screened onto a sheet of glass, which has a connector pattern brought out to the edge.

A plug-in socket with pointed gold-connector pins should be employed to obtain good electrical contact to the screened material. Soldering cannot generally be used. Differences in the expansion coefficient of the glass plates and the frit or plastic seal could cause cracking and leakage problems.

LCDs don't like dc drives

Liquid-crystal displays are high-impedance, low-current devices. The ideal display would be a perfect insulator, but practical devices are leaky capacitors with time constants of about 1 ms at room temperature.

The most important consideration when designing drive circuitry is that LCDs cannot tolerate dc potentials for an extended period of time. A rectangular ac waveform with no dc component must be generated to prevent destruction of the display by electrolysis.

The stringent constraint on the drive circuitry results in increased circuit complexity. A number of standard 4000-series CMOS small-scale-integration drivers are available to supply the appropriate waveforms (Fig. 5). However, LCDs are most suited for use with MOS/LSI circuits, since the special drive circuitry can be accommodated without recourse to additional circuits.

Most LCDs operate in the 3-to-15-V range. Display manufacturers are developing units that operate at 1.5 V, but none are yet producing them in volume. In most battery-powered applications then, either several batteries or a voltage up-converter must be used. In watches, CMOS circuits usually operate from a single 1.5-V cell. The output buffers are driven internally with a level shifter, so LCD drive voltages can be applied to the buffer only. The drive voltage is usually generated by a fly-back up-converter.

To operate an LCD, apply a rectangular waveform, with an amplitude exceeding the display threshold, to the display backplane. Apply simultaneously a similar waveform, 180° out-of-phase with the first, to the appropriate segment.

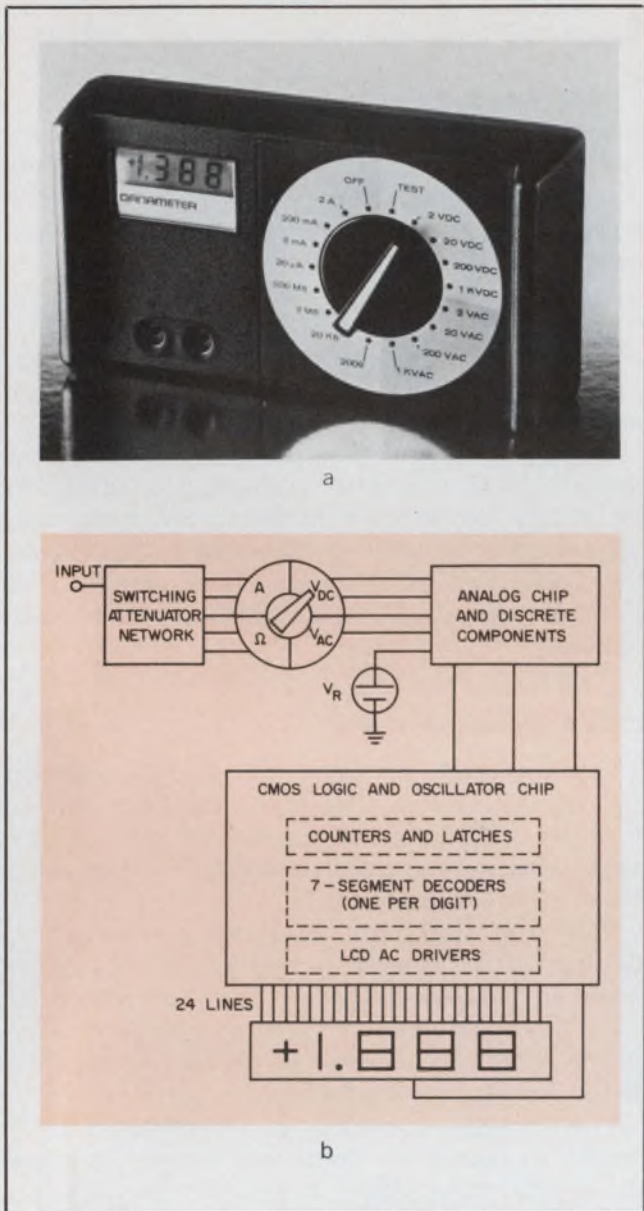

7. Digital multimeter with LCD from Dana Labs (a) consists of micropower, custom analog and CMOS/LSI chips (b).

Then at any given instant there is sufficient operating potential across the liquid-crystal material to activate the display. The polarity of this potential alternates at the display frequency.

The waveform frequency selection represents a tradeoff between low power consumption and display flicker. Since the loading effects of capacitance are more significant than the effects of resistance, the operating frequency should be chosen as low as possible without an offensive display flicker being produced. Typically, values range from 30 to 60 Hz.

To deactivate the displays, simply change the phase of the second waveform to be that of the backplane waveform. The net potential on the display becomes zero, and the display blanks off.

Multiplexing can't be used economically with LCDs because of their slow speed and capacitive

characteristic. As a result, LCDs are generally limited to applications requiring readouts of up to four digits, such as clocks or watches.

Digital electronic watches represent the most popular application for LCDs. Early watches have used two-chip CMOS sets, such as the 5801 oscillator/divider, and either the 5201/2 (for dynamic-scatter LCDs) or 5201-2/02-2 (field-effect) decoder-driver circuits, all from Intel, Santa Clara, CA.

Recently single-chip, CMOS, LCD-watch circuits have become available. A typical chip system, in Fig. 6, uses the S1400 series of divider/driver CMOS circuits from American Microsystems, Santa Clara, CA. Both LED and LCD-CMOS counter-divider circuits require about the same supply current—typically 2 to 4 μA . However, the total average display current for the LCD is so low—only 1 μA for all 3-1/2 digits—that the display can remain on permanently.

The 7.5-V supply required for field-effect displays comes from a 1024-Hz up-converter. The external zener-reference diode gates the up-converter output through the regulator input. The 25 driver outputs of the S1400 are CMOS transfer gates and inverters that provide both BP (backplane) and $\overline{\text{BP}}$ ac rectangular waveforms for the display. Up to a maximum of 12-V peak amplitude can be provided (Fig. 6b). In this case, a pk-pk voltage of 7.5 V alternates in polarity across the display at 32 Hz.

The Danameter digital multimeter employs a two-chip set of bipolar analog and CMOS digital ICs to provide a low-cost portable replacement for the familiar analog VOM. A reflective field-effect LCD from ILIXCO (Cleveland, OH) operates from the same regulated 6-V line as the logic, so that one year of operation from a 9-V radio battery can be obtained. The block diagram of Fig. 7 shows the basic system.

The analog chip obtains its reference from a mercury cell, and the chip contains a two-pole active filter, buffer and voltage converter. Only four additional external discrete components are required. The low-power, CMOS/LSI digital chip contains an 8-kHz clock oscillator as well as counting and control logic. Data to be displayed are stored in an array of latches on command from the analog chip. A seven-segment format displays the data.

Generation of an ac driving waveform ensures adequate LCD lifetime. One output line is provided for each of the segments, polarity indicator and decimal point of the 3-1/2-digit readout. The entire system requires less than 1 mW. ■■

References

1. Tannas, L. E., "Liquid Crystal Displays are Great—But . . .," *Electronic Design*, July 5, 1974, p. 76.
2. Wasserman, P., "Which LCD is Best?" *Electronic Design*, Aug. 2, 1974, p. 76.

if it's a meter or meter relay,

Stock or Special...

Simpson

makes it.

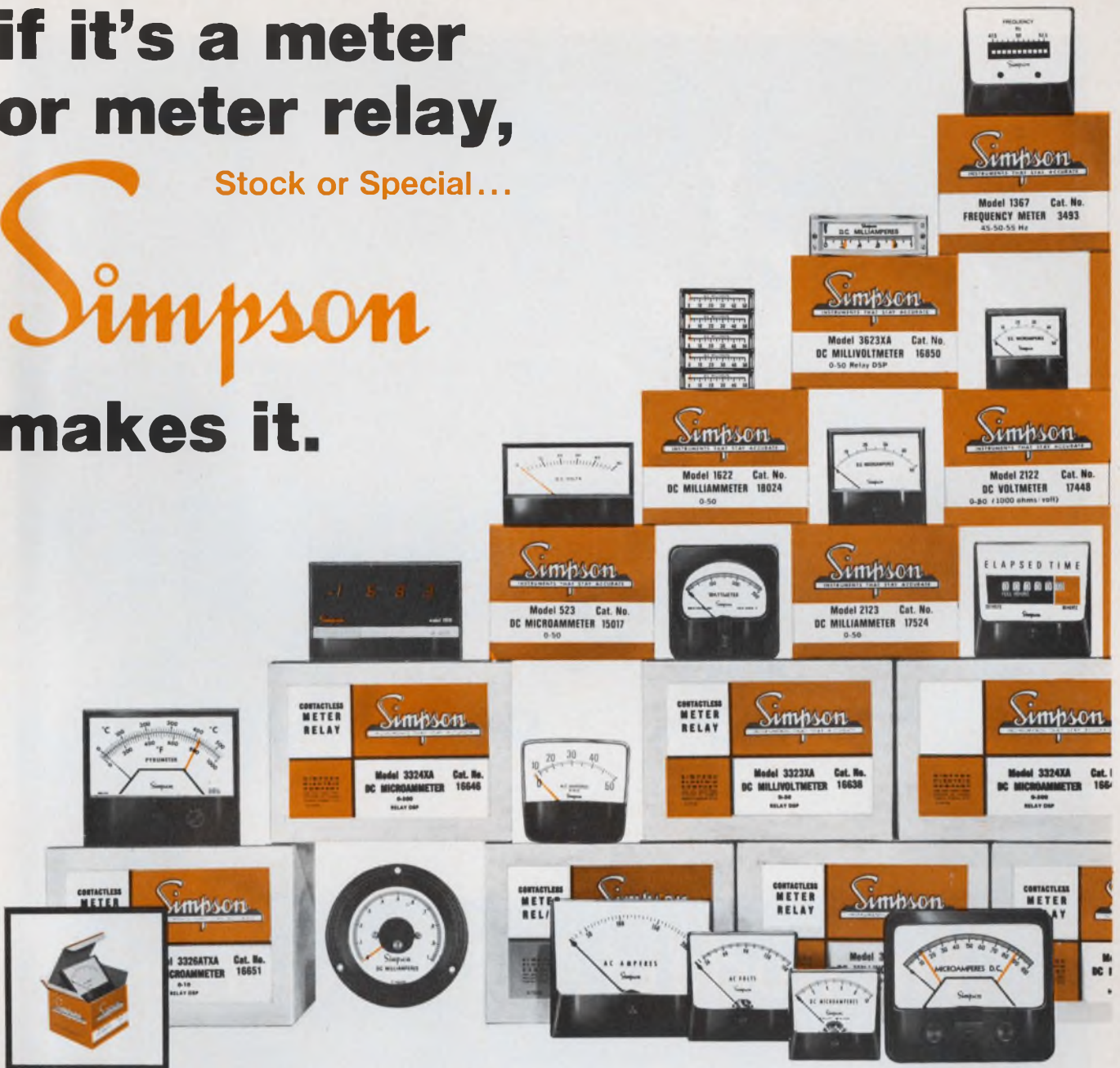

Stock:

Simpson distributors nationwide stock over 1,500 types, ranges, styles and sizes of panel meters, relays and controllers. They're all listed in Catalog 4200. Write for your free copy.

Special:

Need a special or unusual meter? Let Simpson help you custom design it. Send us your specs and we'll send you a quote. But check our catalog first—that "special" may be a standard Simpson stock item.

Get off-the-shelf delivery from your local electronics distributor.



SIMPSON ELECTRIC COMPANY

853 Dundee Avenue, Elgin, Illinois 60120
(312) 695-1121 • Cable: SIMELCO • Telex: 72-2416

IN CANADA: Bach-Simpson, Ltd., London, Ontario

IN ENGLAND: Bach-Simpson (U.K.) Limited, Wadebridge, Cornwall

IN INDIA: Ruttonsha-Simpson Private, Ltd., Vikhroli, Bombay

KATY INDUSTRIES



ELECTRICAL EQUIPMENT GROUP

INFORMATION RETRIEVAL NUMBER 42

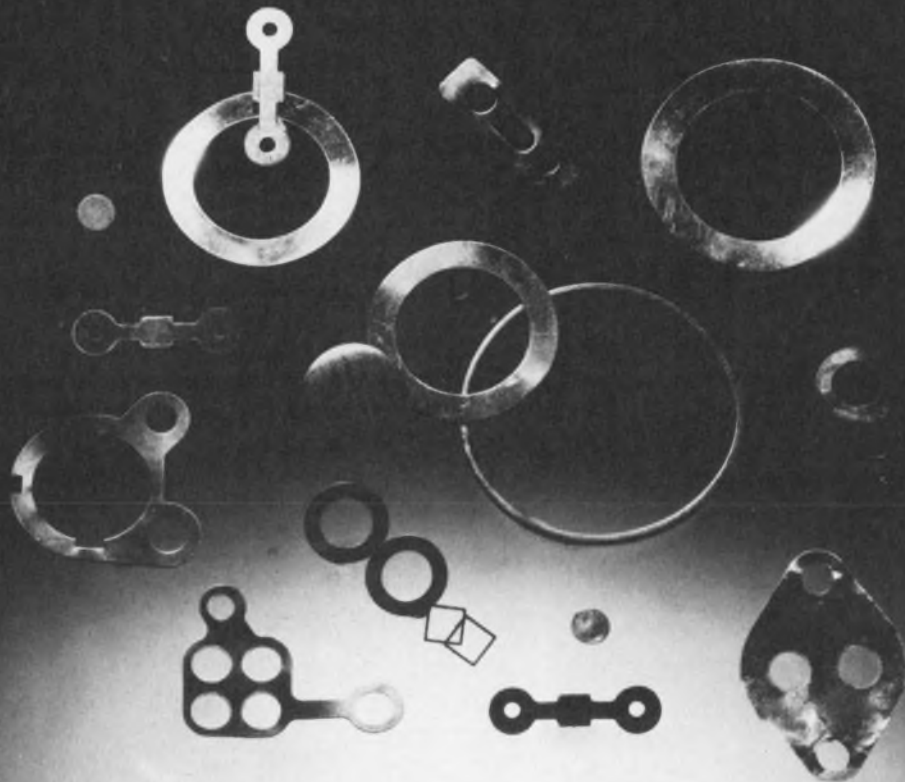

The world of Alpha preforms

Stop relying on operator skill and judgement for solder-joint reliability.

Switch to preforms — for automatic prelocation of engineered amounts of solder and/or flux, plus heating flexibility.

Results: reduced production costs and superior solder joints.

There should be off-the-shelf Alpha tooling for your job from the thousands of different preforms we've manufactured in the last 20 years. If there isn't, we'll custom-design a new preform.

- Stampings in geometric or irregular configurations, including solder-coated base-metal stampings.
 - Solid-metal spheres from 0.003 in. to 0.100 in. diameter.
 - Formed-wire rings, loops, coils or segments. Flux-coated, flux-filled, or uncoated. In a choice of w-w rosin fluxes in nonactivated, mildly activated, fully activated, or super activated formulations.
 - In many alloys for soldering or brazing.
 - Because we offer every type of preform — for every soldering and brazing application — depend on your Alpha sales engineer for objective recommendations.
- Phone or write for full information.

alphametals Inc.

56 Water Street, Jersey City, N. J. 07304 (201) 434-6778 Chicago, Santa Fe Springs



The case for Liquid Crystal Displays

Dynamic Scattering or Field Effect

Liquid Crystal Displays; light emitting diodes; incandescent and fluorescent displays and "Nixie" tubes are becoming solidly established in circuit design as the trend to digital readout continues. The design engineer faces an unusually formidable task in determining the type of display most suitable and practical for his product. We make liquid crystal displays — dynamic scattering and field effect.

The display of the future? Our displays are as sandwiches of two glass plates, spaced typically about .0005" apart with a nematic liquid crystal solution between them and hermetically sealed at the perimeters.

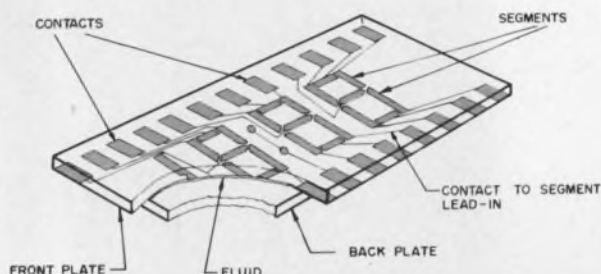

How they work. When the liquid is not electrically excited, its long cigar-shaped molecules are parallel to one another in a position perpendicular to the plates. The liquid appears transparent. When an electric current is applied, ion activity of the molecules leads to turbulence causing the liquid to scatter incident light. Depending on the type of nematic liquid used, either a dynamic scattering or field effect display results.

Dynamic scattering. We use a nematic liquid crystal solution in our dynamic scattering displays. This nematic liquid crystal is conductive, has negative dielectric anisotropy, and is oriented in either a homeotropic or homogeneous alignment. In either case the liquid is clear in the absence of an electric field. When an electric field is induced, the molecules scatter, giving the visual effect of a frosted piece of glass.

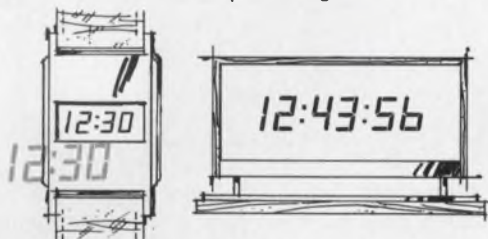

Field effect. These displays also utilize a nematic liquid crystal but with a different molecular orientation. The molecules are arranged in a helical stack, like a spiral staircase. The liquid is also sandwiched between two polarizers which are at right angles with each other. When current is applied the molecules rotate 90° so that they become perpendicular to the front polarizer. Light that passes through them is not rotated and therefore is absorbed by the rear polarizer. The result is a dark image on a light background. The image also can be reversed — light on dark.

Producing an image — digital or other — simply requires a conductive surface the shape of the desired image on the front glass plate. Current flowing from the conductive image through the liquid crystal to the common ground back plate causes the liquid to change from clear to a frosted appearance in the current-carrying areas.

The images almost always are in the form of seven segments formed on the front glass with transparent oxide and each with its own electrical lead. Energizing the proper segments produces the desired numerals. Lead-ins connect the segments to external contacts on the sandwich (display).

Consider the advantages. Liquid crystal displays have a number of distinct advantages. Simplicity is the reason for several of these. The elements are few and passive — very little can go wrong with an LCD and this means reliability and long life. Simplicity means low cost too — lower than that of most similar displays. Packaging costs are low because LCD's can be driven directly by MOS and C/MOS circuits. Very narrow character widths are possible and still provide a good viewing angle — 60 degrees in many cases.

Low power consumption makes LCD's a logical choice where power limitations rule other displays out. They do not generate light as do other displays so use no power for that purpose. Watch type field effect LCD's use only 3μW. for example with all segments energized at 7 Volts.

LCD's offer the greatest flexibility of any display type. Several standard displays, dynamic scattering or field effect, are immediately available from Hamlin's stock. Special displays with virtually any type of image can be produced with surprisingly low preparation or "tooling" cost. Because of the LCD's simplicity, lead time on specials is only a matter of weeks.

DYNAMIC SCATTERING

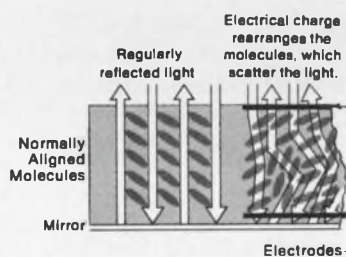

FIELD EFFECT

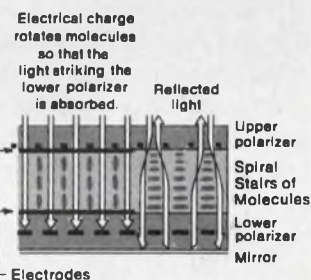

A few limitations. LCD's have limitations too. Operating temperature range is one. Liquid crystals slow down and may even cease to function at temperatures below 0°C. Above 50-60°C, crystals go into solution and will not function properly. But extremes do not damage LCD's. Once the temperature returns to normal, operation is automatically resumed.

LCD's are somewhat difficult to read under low ambient light conditions. (Side or back lighting can remedy this.) Visibility under medium to high ambient light conditions is excellent.

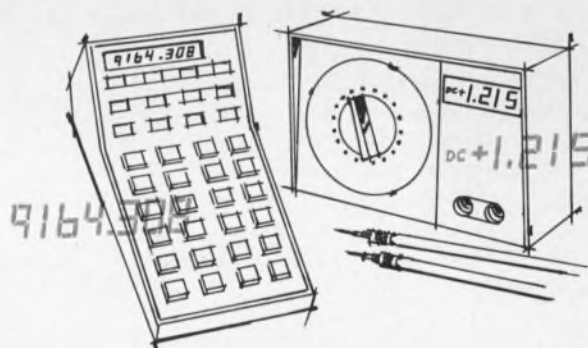

Conclusion. In the majority of display applications, MOS and C/MOS compatibility, reliability, flexibility and low power requirements are important considerations. No other display can match the liquid crystal display on these jobs. They could be the display of the future.

And that's the case for the LCD. For specifications, and application data, write Hamlin, Inc., Lake Mills, WI 53551 • 414/648-2361. Or dial toll-free 800-645-9200 for name of nearest representative. (Evaluation samples are available at moderate cost.)

HAMLIN
INCORPORATED

INFORMATION RETRIEVAL NUMBER 44

Find the quietest JFETs by testing them with some simple circuits. Noise comes from internal sources, such as silicon heating and impurities.

Junction FETs are preferred to bipolar transistors for most audio frequency applications because of their lower noise current (\bar{i}_N). But how do you pick the quietest JFET reasonably fast and without undue effort?

You can do it with a series of simple formulas and easy-to-build test circuits that identify and characterize the audio-frequency noise.

The geometry of the junction field-effect transistor—whether annular, square, star-shaped, or whatever—is also a factor in device noise, by virtue of its effect on gate capacitance, current and resistance. So when you select a second-source supplier, be sure that he uses the same geometry.

For analysis of noise characteristics, represent the JFET by assuming an ideal noise-free device with external voltage and current noise sources, \bar{e}_N and \bar{i}_N (Fig. 1).

The noise factor, F , is a figure of merit of a transistor referred to the resistance of a generator. To calculate noise factor, add a source resistance, R_G , with a thermal noise voltage of \bar{e}_T to the circuit.

The noise factor can then be defined in any of the following ways:

$$F = \frac{\text{total available output noise power}}{\text{output noise power due to } R_G \text{ thermal noise}}$$

$$F = 1 + \frac{\text{output noise power due to JFET,}}{\text{output noise power due to } R_G}$$

$$F = 1 + \frac{\text{noise power of JFET referred to input}}{\text{noise power at input due to } R_G}$$

The thermal noise voltage¹ across R_G can be found from

$$\bar{e}_T = \sqrt{4kTR_G B}$$

where k equals 1.38×10^{-23} joules/°K, T is temperature in degrees Kelvin and B is the bandwidth in hertz. Thus the noise power due to R_G is $4kTB$. Referring the noise power of the JFET back to the input, you get

$$\frac{\bar{e}_N^2}{R_G} + \bar{i}_N^2 \times R_G.$$

When expressions for noise power of the

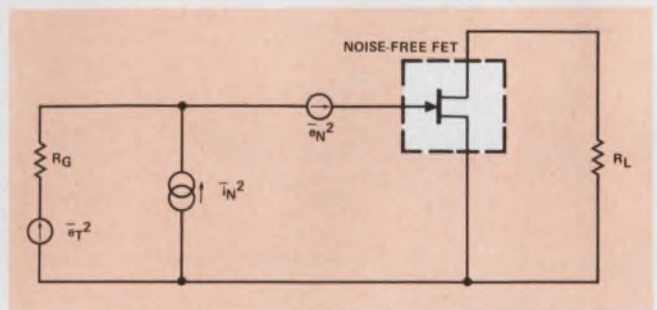

1. The noisy JFET can be represented by a noise-free JFET and external sources of noise.

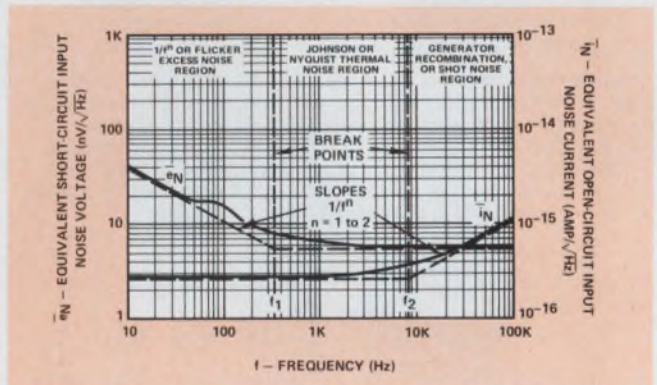

2. Within the audio-noise spectrum, JFET voltage and current-noise characteristics are frequency-dependent.

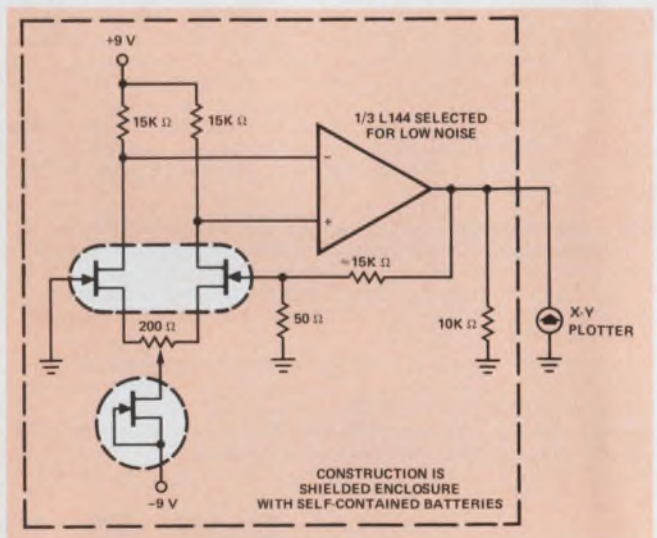

3. A shielded test box must be built to measure popcorn or burst-type noise voltages.

F. Bruce Watson, Applications Engineer, Siliconix, 2201 Laurelwood Rd., Santa Clara, CA 95054.

JFET and R_G are substituted into the equation for noise factor,

$$F = 1 + \frac{\overline{e_N^2} + \overline{i_N^2} R_G^2}{4kTR_G B}$$

The noise figure (NF), expressed in dB, indicates the presence of added noise power from the JFET or another active device. A reference, usually the generator resistance, R_G , helps to standardize the NF and provide a common base for comparisons:

$$NF = 10 \log_{10} (F)$$

Thus the NF for the JFET can be written as

$$NF = 10 \log_{10} \left(1 + \frac{\overline{e_N^2} + \overline{i_N^2} R_G^2}{4kTR_G B} \right) \text{ dB}$$

But when the JFET noise is expressed in terms of NF, it depends directly on the value of generator resistance. Thus the use of the equivalent external noise sources, $\overline{e_N}$, $\overline{i_N}$, remains the best way to quantitatively express the noise characteristics of the JFET.

Examine JFET characteristics

JFET voltage and current-noise characteristics are frequency-dependent within the audio noise spectrum (Fig. 2). The equivalent short-circuit noise voltage $\overline{e_N}$ (except in the $1/f^n$ region), is defined² as

$$\overline{e_N} = \sqrt{4kTR_N B}, \quad (1)$$

where R_N , the equivalent resistance for the noise, is approximated by $0.67/g_m$. The $\overline{e_N}$ (except in the $1/f^n$ region) closely approximates the equivalent thermal noise voltage of the FET's channel resistance.

In the $1/f^n$ region, $\overline{e_N}$ becomes

$$\overline{e_N} = \sqrt{4kR_N B (1 + f_1/f^n)},$$

where n varies between 1 and 2, and is usually device and lot-oriented.

The characteristic bulge in the graph of $\overline{e_N}$ in the $1/f^n$ region exists, to some extent, with all JFETs. The breakpoint or corner frequency, shown as f_1 in Fig. 2 is lot and device design-oriented and varies from about 100 to 1000 Hz.

Since $\overline{e_N} \propto 1/\sqrt{g_m}$, it can be lowered by a factor of $1/\sqrt{N}$ —if N devices with matched electrical characteristics are connected in parallel.

For example, let $N = 2$, $\overline{e_{N1}} = \overline{e_{N2}}$, and g_{m1}

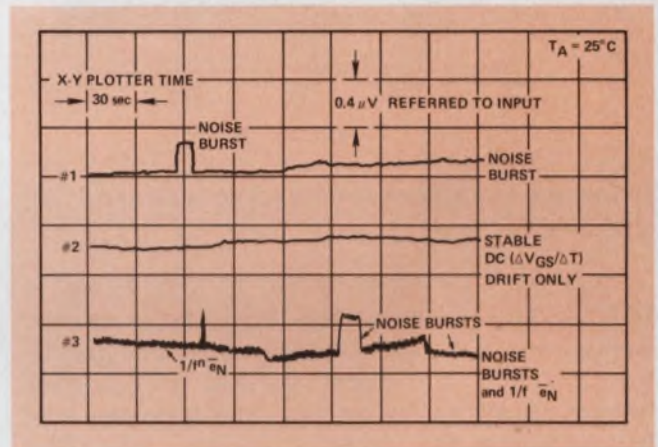

4. Burst, or "popcorn" noise, occurs in JFETs and is believed to come from contaminants in the oxide and intermittent contacts in aluminum-silicon interfaces.

$= g_{m2}$. You then get $g_{m(\text{total})} = 2g_{m1}$ or $2g_{m2}$. This value of g_m can be substituted into Eq. 1 to give $\overline{e_{N(\text{total})}}$ equal to $(1/\sqrt{2}) (\overline{e_{N1}})$.

Another alternative, for achieving a low value of $\overline{e_N}$, is to use a JFET with a large gate area. Empirically, $\overline{e_N}$ is inversely proportional to the square of the gate area and independent of g_m .

The equivalent open-circuit input-noise current, $\overline{i_N}$ (in the shot-noise region shown in Fig. 2) is generated by thermal reverse current in the gate channel junction. The current is defined as

$$\overline{i_N} = \sqrt{2qI_G B}, \quad (2)$$

where q is the magnitude of an electron charge, I_G is measured dc operating gate current in amperes, and B is the bandwidth in Hz. This expression is accurate only when the measured gate current stems from bulk-device conductance.

At high frequencies, such as in the shot-noise region, $\overline{i_N}$ can be approximated as the Nyquist thermal noise current generated by a resistor³:

$$\overline{i_N} = \sqrt{\frac{4kTB}{R_p}},$$

where R_p is the real part of the gate-to-source input impedance. The breakpoint of corner frequency, shown as f_2 in Fig. 2 is lot and design-oriented and can vary from about 5 to 50 kHz.

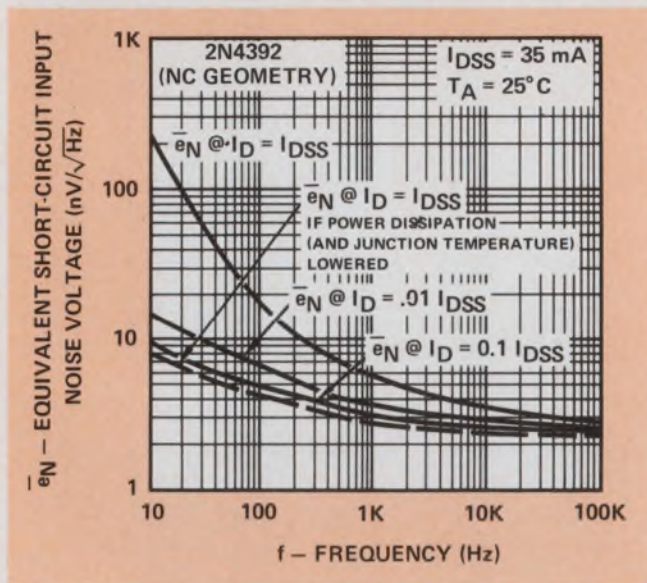

5. Changes in the drain current create variations in the noise voltage, \bar{e}_N .

"Popcorn," or burst noise, is also found in JFETs. This random-burst input noise current maintains a constant average amplitude for its duration, and is usually confined to repetition frequencies of 10 Hz or less. The seriousness of the popcorn-noise problem depends upon the amplitude of the burst, its duration and its repetition rate. The origins of popcorn noise are not completely identified, but are believed to come from intermittent contact in aluminum-silicon interfaces and from contamination in the oxidation processes.

You can build a test circuit to measure popcorn noise in differential JFET amplifiers (Fig. 3). This noise is usually measured for a single sample rather than on a production-line basis, since the test is a lengthy process.

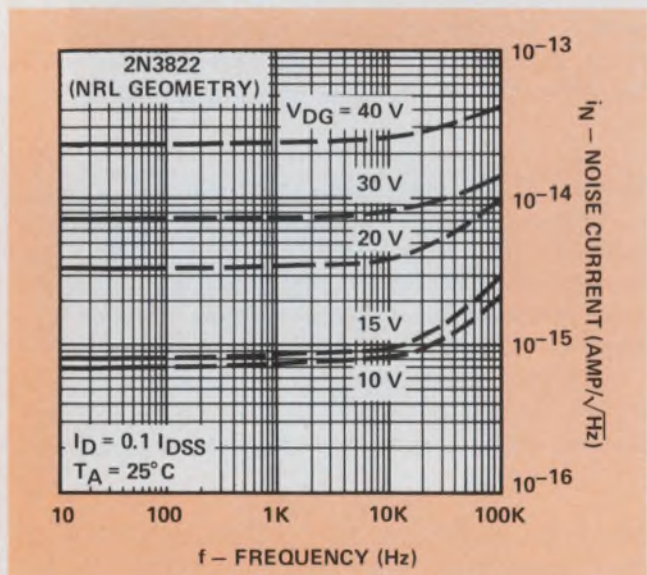

6. If the drain-to-gate voltage is maintained below the gate-current breakpoint, noise current remains constant.

No correlation between $1/f^0$ noise at 10 Hz and popcorn noise has been found yet in JFETs. However, if the amplitude of the burst is large and occurs frequently, the $1/f$ noise voltage, \bar{e}_N , is masked, and hence difficult to evaluate at 10 Hz. Fig. 4 shows plots for three transistor samples measured in the test circuit.

Unlike the bipolar transistor, where \bar{e}_N and \bar{i}_N characteristics vary directly with changes in collector current, similar characteristics in the JFET vary only slightly as the drain current changes. This holds true as long as the drain-source voltage is greater than the pinch-off voltage.

The \bar{e}_N in JFETs will be the lowest if you operate the device at zero gate-source voltage, where the transconductance is highest. Unfortunately this holds only when the total dissipation capability of the device is much greater than the actual power dissipated.

The curves in Fig. 5 show the changes in \bar{e}_N as the drain current varies. Note that the lowest value of \bar{e}_N doesn't occur at $V_{GS} = 0$ on this sample, due to the high power dissipation. This also results in a rise in the junction temperature at the operating point.

The optimum (lowest) value of \bar{i}_N in depletion-mode JFETs also occurs at $V_{GS} = 0$. Actually, very little change occurs when the operating point is moved, provided the drain-gate voltage is maintained below the gate-current breakpoint and the power dissipation is kept at a low level (Fig. 6).

In designing any JFET circuit, pay special attention to the drain-gate voltage, to help minimize the gate current under operating conditions. The critical drain-gate voltage can range from 8 to 40 V, depending upon the device design⁴. Gate operating current should not be considered equal to the gate reverse current in linear-amplifier applications. The reverse current is only an indication of reverse-biased junction leakage under nonoperating conditions (Fig. 7). Device designs with a high g_m to C_{iss} ratio have low breakpoint voltages (typically 10 V) while low-ratio devices have higher breakpoints (typically 20 to 30 V).

Temperature also affects noise voltage

So far, all equations show a temperature dependence for \bar{e}_N and \bar{i}_N . Both terms are proportional to the square root of temperature. From Eq. 2, it follows that \bar{i}_N varies with I_G and that I_G halves for each temperature drop of 10° . In Eq. 1, \bar{e}_N follows the effects on TR_N ; thus when g_m increases, \bar{e}_N decreases (Fig. 8).

The g_m relationship can vary by 0.2 to 1%/°C. The g_m slope depends upon the basic JFET design and the proximity of the drain-current oper-

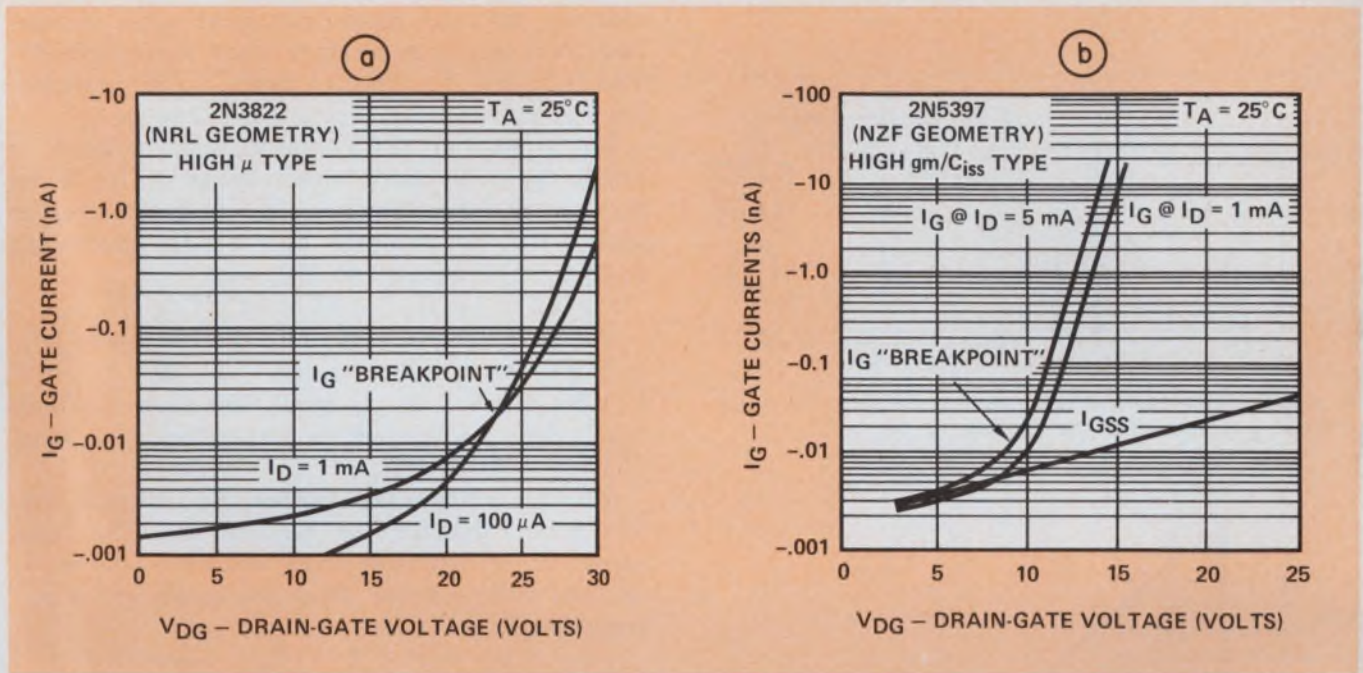

7. The reverse gate current in a JFET is an indication only of junction leakage under nonoperating conditions.

ating point to I_{DZ} , the zero temperature-coefficient point. Low-temperature applications for JFETs include charge amplifiers⁵, where a high g_m to C_{iss} ratio is required.

By definition, \bar{e}_N and \bar{I}_N are referred to the input of the device under test. The simple test circuit in Fig. 9 can help measure \bar{e}_N . The procedure is as follows:

1. Set the tunable filter to required f_{low} and f_{high} .
2. Adjust the oscillator to mean center frequency ($f_{mean} = \sqrt{f_{low} \times f_{high}}$).
3. Set V_{osc} to 100 mV, with switch 1 in position 1, and compute $V_{in1} = 10^{-1} \times 10^2 / 10^6 = 10 \mu V$.
4. Measure V_{out1} and compute the over-all gain as $A_v = \frac{V_{out1}}{V_{in1}} = \frac{V_{out1}}{10 \mu V}$.
5. Set switch 1 to position 2, and measure V_{out2} .
6. Compute V_{in2} , the equivalent short-circuit input noise voltage \bar{e}_N , by use of A_v from step 4. $V_{in2} = \frac{V_{out2}}{A_v} = \bar{e}_N$ in volts over the bandwidth f_{low} to f_{high} .

Alternatively, you can use a noise analyzer like the QuanTech Model 2173, with its accompanying filter, Model 2181. The analyzer has provisions to measure \bar{e}_N and to determine the NF with various values of R_G . The measuring system has a constant gain of 10,000. The analyzer can record output noise between 10 Hz and 100 kHz, with the scale shown being the output divided by 10,000.

The recorded output then becomes the output noise referred to the input. The equivalent band-

width for test purposes is 1 Hz.

There are cases where the test circuit or the noise analyzer is not adequate to measure \bar{e}_N at certain frequencies over restricted bandwidths in the $1/f^n$ region. The rms noise over a bandwidth from f_{low} to f_{high} , where there is a $1/f^n$ characteristic over the entire range, can be computed from

$$e_N = (e_{N \text{ known}}) \left(f_{\text{known}} \times \ln \left[\frac{f_{\text{high}}}{f_{\text{low}}} \right] \right)^{1/2}$$

This equation is represented graphically in Fig. 10. If you pick $\bar{e}_N = 70 \times 10^{-9} V/\text{Hz}$ at 10 Hz, you can find the noise—in, say, the band from 4.5 to 5.5 Hz. After substituting these

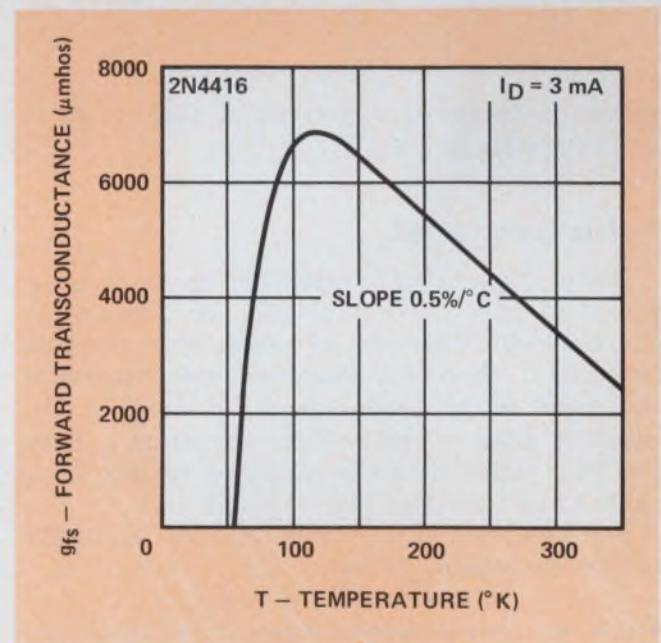

8. As the transconductance increases, \bar{e}_N decreases and follows the temperature effects on g_m .

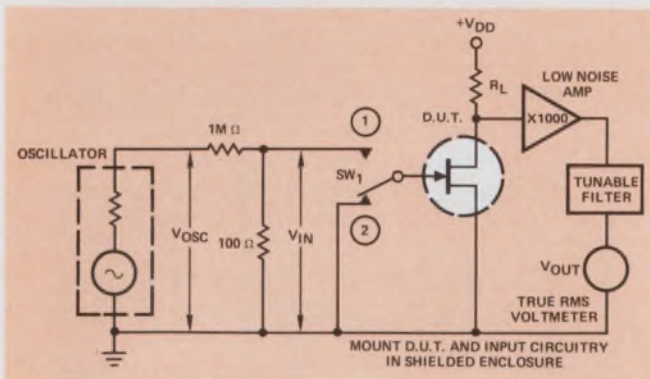

9. Another shielded test box can help measure the noise voltage, e_N , and refer the reading to the input.

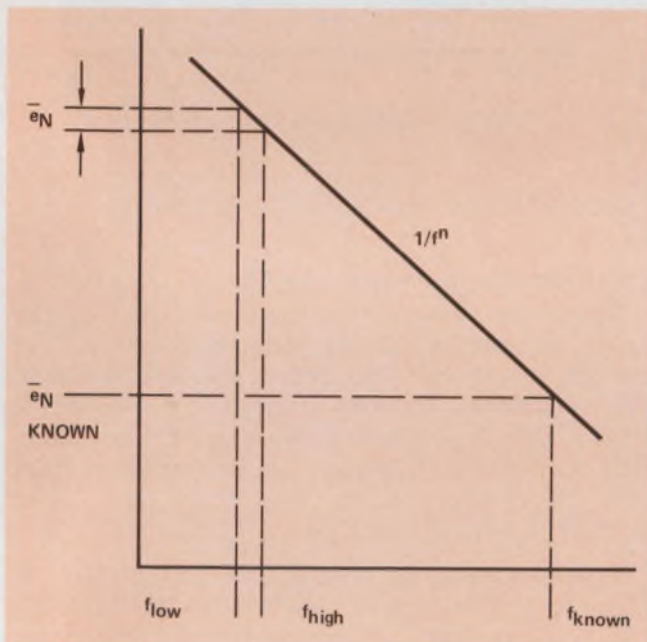

10. Rms noise over a restricted bandwidth can be picked off the graph of frequency vs noise voltage.

values in the equation, you get \bar{e}_N equal to $99.16 \times 10^{-9} \text{V}/\sqrt{\text{Hz}}$ at 4.975 Hz (f_{mean}).

Finding noise current

Below frequency f_2 (noted in Fig. 2) \bar{i}_N is assumed to have a constant-level, or white-noise, characteristic. This can be correlated to the gate current, I_G . Since the measured gate current is the result of all conductances at the gate, the resulting gate current and the computed \bar{i}_N from the bulk material can be assumed to take on a value equal to or less than $\sqrt{2qI_GB}$.

The total equivalent input noise of the JFET can be approximated⁶ by

$$\bar{e}_{ni}^2 = \bar{e}_T^2 + \bar{e}_N^2 + \bar{i}_N^2 R_G^2,$$

where \bar{e}_T^2 is the thermal noise of the generator resistance squared and \bar{e}_{ni}^2 is the total noise referred to the input squared. This approximation

assumes that the equivalent total noise voltage and the current generators vary independently. The equation also implies that \bar{i}_N^2 can be calculated if all the other factors are known.

But in MOS or JFETs the R_G must be large, to detect the anticipated small value of \bar{i}_N . When R_G is very large, however, \bar{e}_T^2 is much greater than $\bar{i}_N^2 R_G^2$. For example, over a 1-Hz bandwidth at 25 C, if R_G equals 100 MΩ, then

$$\bar{e}_T^2 = 4kTR_G = 1.63 \times 10^{-12} \text{V}/\sqrt{\text{Hz}}.$$

The anticipated value of \bar{i}_N then becomes $10^{-15} \text{A}/\sqrt{\text{Hz}}$. And $\bar{i}_N^2 R_G^2 = 10^{-30} \times 10^{16} = 10^{-14} \text{V}/\sqrt{\text{Hz}}$. Thus $\bar{i}_N^2 R_G^2$ is much less than \bar{e}_T^2 , finding i_N by this method is impractical for most JFETs or MOSFETs.

You can improve this method. Substitute a low-loss mica capacitor for resistor R_G . The mica capacitor, by definition, does not have equivalent thermal noise voltage. Thus the equation for \bar{e}_{ni}^2 simplifies to

$\bar{e}_{ni}^2 = \bar{e}_N^2 + \bar{i}_N^2 \times X_C^2$ (X_C = capacitive reactance), or

$$\bar{i}_N = \frac{(\bar{e}_{ni}^2 - \bar{e}_N^2)^{1/2}}{X_C}$$

When a 10-pF capacitor is used in the test circuit up to a 100-Hz frequency limit, a correlation of from 80 to 90% can be obtained, compared with the calculated \bar{i}_N from gate current readings. At frequencies above 100 Hz, direct computation of \bar{i}_N by the capacitor method becomes unwieldy, because the capacitive reactance decreases rapidly.

One method⁷ to find \bar{i}_N at higher frequencies is to measure the real part of the gate-source impedance, R_p , of the JFET. When R_p is measured at various frequencies, the equivalent short-circuit input-noise current, \bar{i}_N , can be computed as a function of frequency. One convenient instrument for doing this is the Hewlett-Packard 250A RX meter. The unit can measure R_p accurately up to 200 kΩ.

Since R_p increases as frequency decreases, the low frequency limit is determined by the point at which R_p reaches 200 kΩ. In typical JFETs this is about 2 MHz and \bar{i}_N between this point and 100 Hz must be extrapolated. ■■

References

1. Nyquist, H., "Thermal Agitation of Electric Charge in Conductors," *Physics Review*, 32, 1928, p. 110.
2. Van der Ziel, A., "Thermal Noise in Field-Effect Transistors," *Proceedings of the IRE*, Vol. 50, August, 1962, pp. 1808-1812.
3. Fitchen, F., and Motchenbacher, C., "Low Noise Electronic Design," John Wiley & Sons, 1973, pp. 103-107.
4. MacDonald, C., "Behavior of FET Gate Current," Siliconix, Inc., Santa Clara, Calif. Application Tip, April, 1969.
5. Radeka, V., "Field-Effect Transistors in Charge-Sensitive Amplifiers," National Academy of Sciences, National Research Publication 1184.
6. Op. cit., "Low Noise Electronic Design," pp. 30-31.
7. Op. cit., "Low Noise Electronic Design," pp. 103-107.

FUJI**COMPONENTS FOR CUSTOMER'S SYSTEM**

WANTED

For partners to manufacture ADD-ON memories and OEM systems with us.
OEM System ————— **RAM CARD 8K × 18** —————

FUJI memory system cards, power supplies, and drawers have a wide range of applications as OEM processor components. Large inventory assures off-the-shelf delivery. We also manufacture and design add-on memory and OEM system use interfaces and logic design incorporation with our better-half. Since we supply memory, power supplies and other components as hardware specialist; we are looking for partners to cooperate with us in the field service, maintenance.



MB2000	65KB max.
MB2100	131KB max.

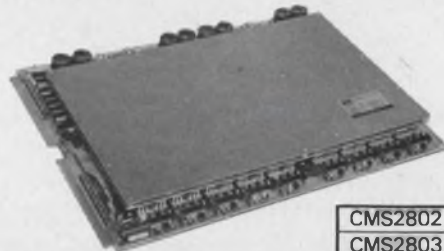

CMS2802	650ns
CMS2803	850ns

CMS2802 and CMS2803 have been specifically developed as the core memory of electronic computers and designed to feature compact size high performance and low price. Moreover, since a byte control function is incorporated as standard, they can also be used as 9 bits wordlength as well as 18 bits. CMS2802 is compatible to EMM micro 3000 and CMS2803 to AMPEX1885.

FUJI ELECTROCHEMICAL CO.

Head Office:
Hamagomu Bldg., 5-36-11, Shinbashi, Minato-ku, Tokyo, Japan TEL: 434-1271

Overseas Office: New York TEL: (212) 532-5630
Los Angeles TEL: (213) 620-1640
Düsseldorf TEL: (211) 89031

JOHN TSUKIKAWA
SAM. YOSHINO
TAD. KOMURO

INFORMATION RETRIEVAL NUMBER 45

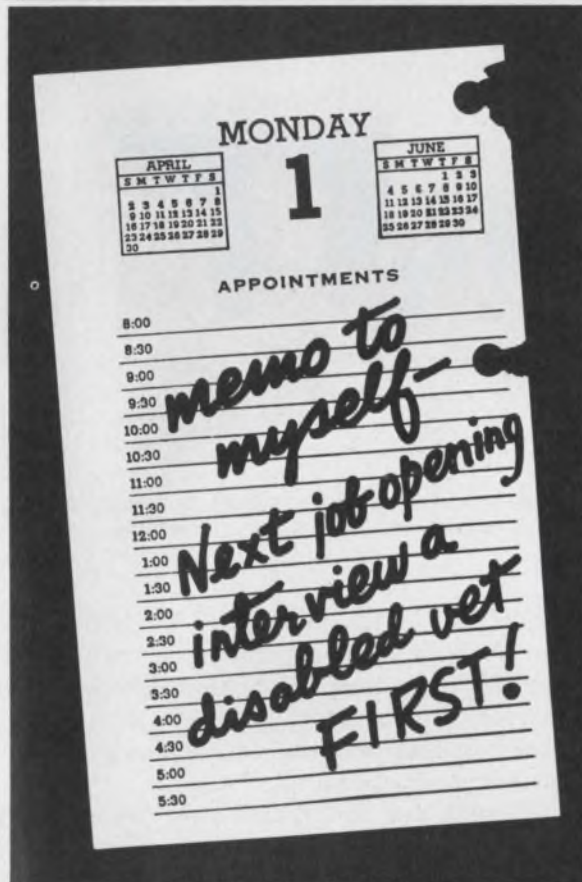

The President's Committee on Employment of the Handicapped
Washington, D.C. 20210

LOOKING FOR A DISTRIBUTOR NEAR YOU?

Electronic Design's GOLD BOOK lists 5,700 distributors with access both alphabetic, by distributor name, and geographic by location.

When you need
information . . .

**Electronic Design's
GOLD BOOK
IS THE PLACE
TO LOOK**

Need a special power supply? Look into submodular systems for building blocks that can provide unique voltages at less cost than custom units.

If you need a couple hundred units of a special power supply and the standard catalogs can't help, look into submodulars.

For a few thousand units, it might pay to go custom. But below a few hundred—and especially if you need more than three or four different outputs—the price of custom soars and the submodular supply wins (Fig. 1).

A submodular dc power supply consists of a number of off-the-shelf submodules, all built to a common high-density outline. Individual modules are selected and combined to form a specified power supply (Fig. 2). The completed supply contains a driving submodule and a number of mutually isolated regulator submodules, which provide each of the specified dc outputs.

Though almost any requirement can be met with standard submodules (within the output voltage and power ranges of the manufacturer's product line), submodules can be modified slightly to obtain still other outputs or characteristics.

It's a relative 'sleeper'

The advantages of submodulars haven't been widely exploited by most system designers—perhaps because the supply's aerospace origin seems to set it apart. This is in spite of some impressive cost, availability and performance benefits.

The submodular power supply gains its price advantage because a special unit can be made with no engineering costs—only the small cost to assemble the submodules into the finished package. And an order for a submodular supply can usually be filled within half a week.

By contrast, nonrecurring engineering (NRE) costs make a custom-built power supply expensive for a small number of units. For a standard catalog supply, the NRE costs might be distributed over thousands of units and are therefore insignificant per unit.

Typically, a \$500 supply carries its share of a \$5000 NRE burden. For a big supply selling for

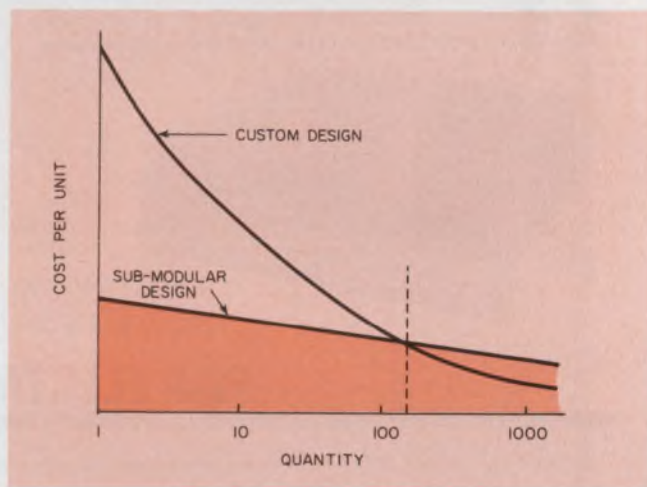

1. With special power supplies, it doesn't pay to go custom unless large quantities are needed.

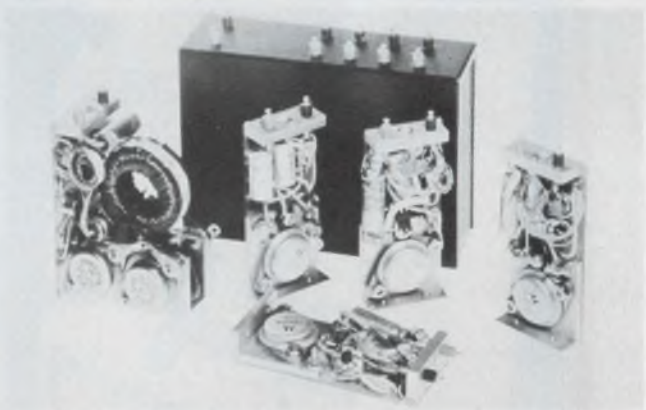

2. A typical submodular supply is formed from various input drivers and regulating submodules.

\$5000, the NRE cost will be about \$50,000. Obviously if these expenses are borne by only a hundred units the cost per unit can be intolerable. Delivery can be a problem, too; it usually takes three or four months for delivery of the first custom production unit.

If costs are distributed over many units and all other factors are equal, the choice of supplies may be made solely on a cost-per-unit basis.

For less than 100 units, the submodular supply appears to be the best choice, based on cost alone.

Ron Pizer, Vice President, Arnold Magnetics Corp.,
11520 W. Jefferson Blvd., Culver City, CA 90230.

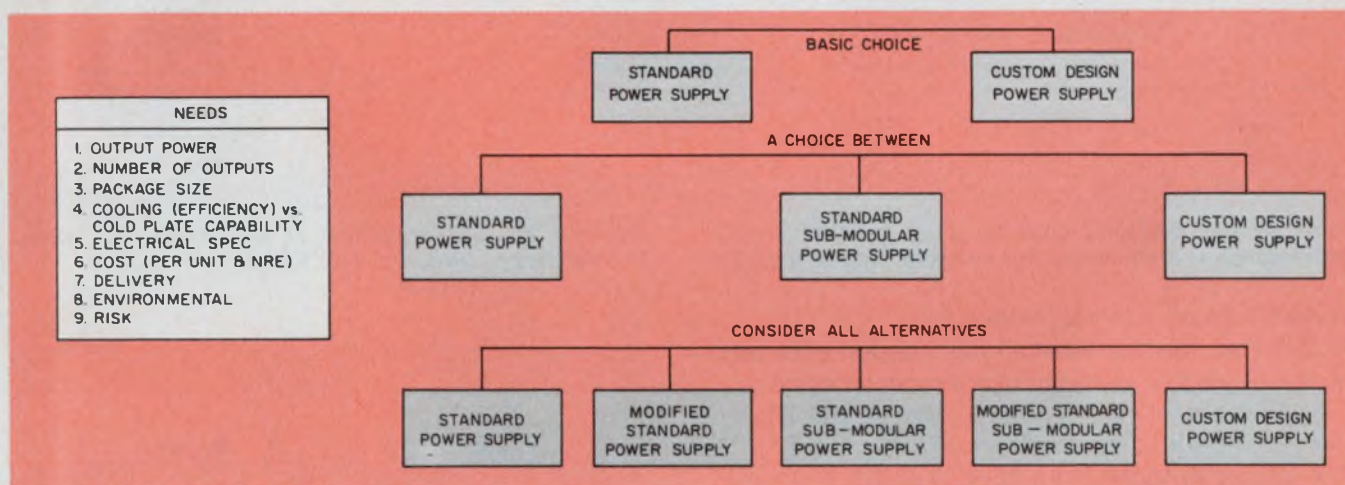

3. To select a power supply consider all alternatives, not just standard or custom units. Submodulars offer many

advantages. Or sometimes a simple modification of a standard or submodular unit will do the job.

But even when the submodular's unit cost is higher than the custom's, its speedier delivery or certain of its characteristics may tip the choice in its direction.

If the designer's project calls for many supplies—and lower unit cost ultimately justifies a custom supply—the designer often can keep his project moving with less risks if he uses submodulars for the development stage and initial production runs, then phases in the custom units when the design is frozen and the custom supply is ready for delivery.

However, before you go either way—custom or submodular—take another look at your needs. You may not need a special after all.

Rethink your design

For example, if you need a number of outputs—like ± 15 , ± 12 and ± 5 V,—it's possible to get the lower voltages with a couple of zeners. This simple change can put you back in the catalog—and back within your budget and schedule. Sometimes a second look may even eliminate a special dc-voltage requirement.

Often a designer who is insecure, or who doesn't know what he needs, will specify super-tight regulation and ripple "just in case." But

that extra 0.5% of regulation can bump him out of the catalogs and into the "special" category, and that 25% pad in power requirements can have the same results. Moral: Pin down your needs and save money.

If a standard catalog supply does come close to your requirements, your first move should be to a telephone. If the vendor can modify the unit to fit—with just simple component changes—the problem may be solved.

But if the modification requires any engineering or redesign and fabrication of PC boards or packages, you're almost back to the custom supply: It's going to cost a lot of money, and it won't be available for many weeks. Fig. 3 shows the custom supply as one of the designer's choices.

Another consideration: Though it's expensive to make a late change in a custom supply, it costs relatively little to modify or substitute one of the building blocks in a submodular supply.

Of course, other characteristics of the submodular supply can influence the designer, such as compactness and efficiency. It's usually a cooler-running unit than a custom supply, takes less room and consumes less power. The submodular is conduction-cooled and usually bolted to a metal plate in the equipment drawer; so you

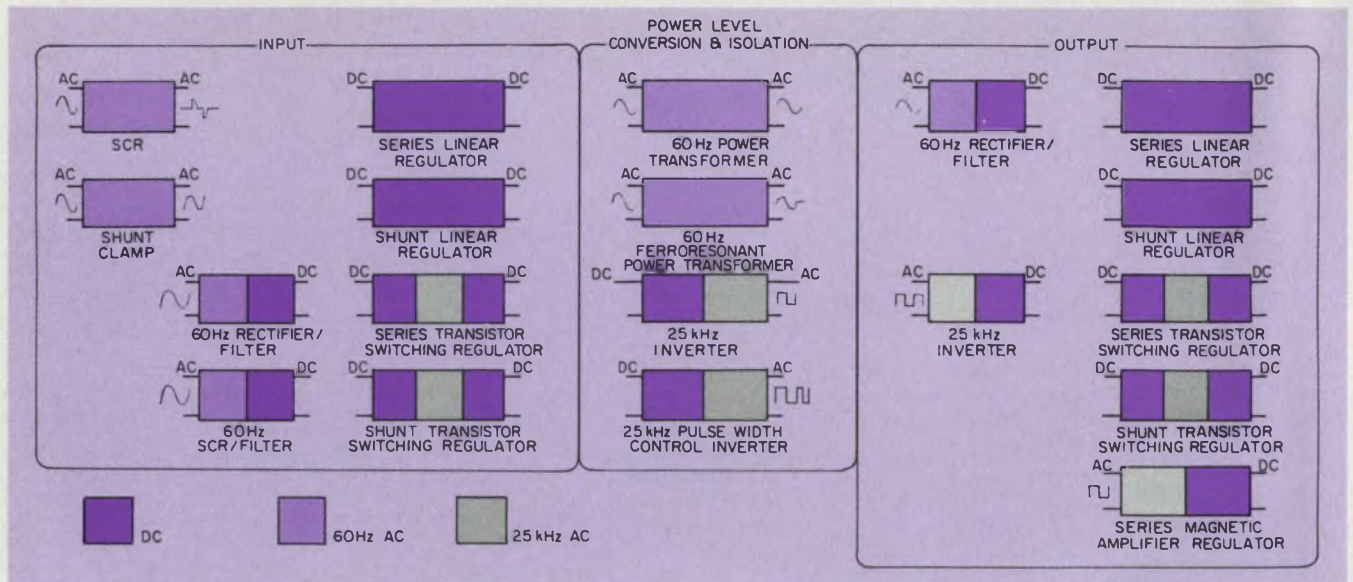

4. In general, tradeoffs must be made between supply performance and efficiency. For example, choose a series

regulator for tight regulation at the expense of power. For efficiency, choose a 1% switching regulator.

probably won't need a cooling fan.

You can select a submodular supply with any of the following performance characteristics:

- Ac inputs at 115 V and 60, 400 or 500 Hz.
- Dc inputs at 12, 28, 48 or 115 V.
- Power outputs from 25 to 500 W.
- Regulation (line or load) from 0.1 to 1.0%.
- Short-circuit and overvoltage protection.
- Efficiencies as high as 87%.

Efficiency vs performance

A number of approaches are used to get the best tradeoffs of efficiency and performance for each supply (Fig. 4). In general, most driving submodules are switching converters that operate at about 25 kHz. The 115-V, 400-Hz drivers are usually simple power transformers. In all driving submodules separate output secondary windings are used to drive and isolate the regulator submodules.

A series regulator is generally used for medium power output, with regulation to 0.1%. This tight regulation results from a tradeoff with efficiency, which is somewhat lower than that of the other regulators. The switching regulator, used for medium-power applications at lower voltages (below 30 V), regulates to 1.0%, but at an efficiency about 15% greater than that of the series-pass circuit (typically 80% vs 65%).

Magnetic-amplifier regulators yield both high efficiency and tight regulation, with high output current. For example, a 6-V-dc, 20-A unit regulates to 0.2% at 80% efficiency. And a 100-V, 10-A unit can regulate to 1.0% at 87% efficiency. This means about 200 W less heat compared with a typical custom supply with the same voltage and power ratings.

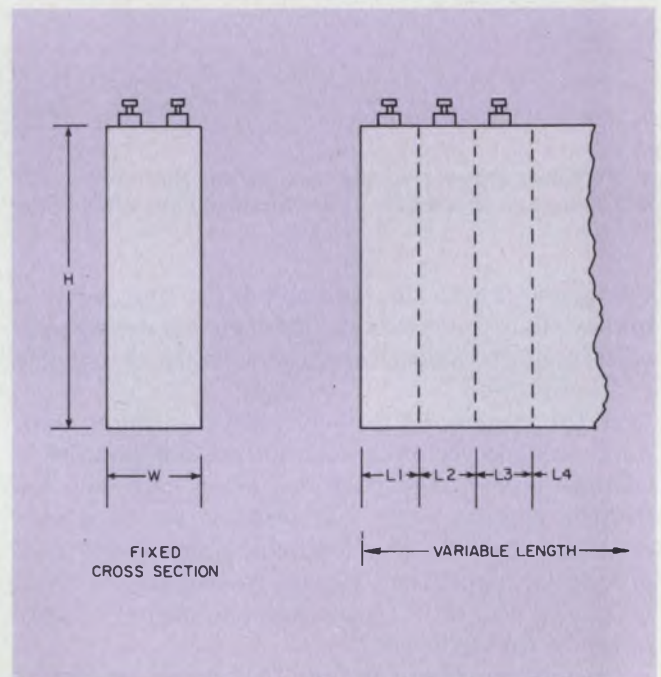

5. One advantage of submodules is the fixed cross-section of each module. Only the length varies.

All submodules in a family are usually of the same height and width; they differ only in depth. Only length varies as the various submodules are stacked side by side (Fig. 5). The manufacturer draws from stock the pre-tested submodules and mounts them on a heat sink, drilled to accommodate the external interconnections.

The mounted submodules are then connected internally, installed in an enclosure and potted, if desired. The supply is tested twice: once after submodule interconnection and again before shipping. ■■

Save Space. Save Weight. Increase Reliability.

Paralleling transistors doesn't pay —not when an inherently rugged single device can do the job far more reliably, using much less space, weight, and at lower total system cost. That's why PowerTech's unique single-chip NPN silicon high-power transistor is the *one way to go*.

Used alone, our space-saving single-chip device eliminates multiple failure sources while reducing the environmental testing costs inherent in parallel arrays. Because of their simplicity they're available off-the-shelf—pre-rated, pre-tested and inventoried to meet virtually any hi-rel JAN and JAN-TX hi-current requirements without custom prices and long

custom waits. For information, application assistance, and free design guide call Sales Engineering, PowerTech, Inc., 9 Baker Court, Clifton, N.J. 07011; (201) 478-6205.

Type #	(pk.) I_c	V_{ce0}	($h_{fe} = 10$) $V_{ce}(\text{sat}) @ I_c$
JAN-TX 2N5926	90A	120V	0.6V @ 50A
PT-7511	90A	200V	0.6V @ 50A
JAN-TX 2N5927	120A	120V	0.6V @ 70A
PT-6502	200A	80V	0.7V @ 100A
PT-9502*	500A	80V	0.5V @ 300A

350 Watt Power Rating
*625 Watt Power Rating
Guaranteed SOAR

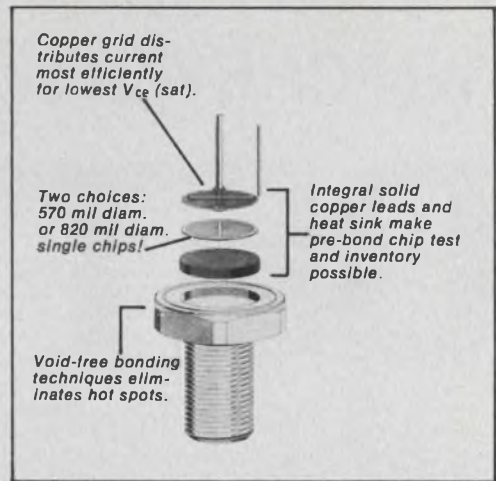

TO UNPARALLEL IS TO SAVE:

Silicon transistors
to 500 amps with
lowest $V_{CE}(\text{sat})$



PowerTech, Inc.
"BIG IDEAS IN
BIG POWER"

"See us at our booth Number 600 Electronica '74"

INFORMATION RETRIEVAL NUMBER 46

WHICHEVER WAY YOU LOOK AT IT...

BETTER BY

Electronic Design's

BOOK GOLD

1974-75 Master Catalog & Directory

Vol. 1

Electronic Design's

BOOK GOLD

1974-75 Master Catalog & Directory

Vol. 2

Electronic Design's

BOOK GOLD

1974-75 Master Catalog & Directory

Vol. 3

Digitec 6100 Series Digital Recorders



Five specially modified designed specifically for production, laboratory and O.E.M. applications.

- 6110 — 10 column capacity
- 6120 — 18 column capacity
- 6130 — 18 column plus integral events counter
- 6140 — 18 column plus integral crystal clock
- 6150 — 18 column plus events counter and crystal clock

These five digital recorders offer a wide variety of features that will enable you to find the recorder that will give you the most accurate and reliable data recording and storage capabilities of 10 or 18 column capacity, an integral crystal clock, and an integral events counter.

To perfect convenient data processing, these recorders have programmable single or double spacing, and an integral printing and autoadvance mechanism which data is available. More recording capacity can be achieved by recording decimal with no loss of a character group.

Other important standard features include a printing rate of up to 270 lines per second, TTL, RS-232C, and RS-422C interfaces for system interfacing, and an optional logic probe connector can be with either one or negative logic.

Externally loaded tape (no heat, without requiring electronic components). These digital recorders use standard bonded paper. This allows them to be used as an external printer to feed paper without any special circuit. A special sensor records printing when it is low, protecting the print drum and the character integrity on the print drum.

All Digitec Digital Recorders are equipped with integrated IC's and feature, incorporating state-of-the-art results for better high reliability, and more cost-effectiveness. These are particularly true in the appearance of advanced on the technological and strong they feature.

Specification of Character Patterns

101	102	103	104	105	106	107	108	109	110
111	112	113	114	115	116	117	118	119	120
121	122	123	124	125	126	127	128	129	130
131	132	133	134	135	136	137	138	139	140
141	142	143	144	145	146	147	148	149	150
151	152	153	154	155	156	157	158	159	160
161	162	163	164	165	166	167	168	169	170
171	172	173	174	175	176	177	178	179	180
181	182	183	184	185	186	187	188	189	190
191	192	193	194	195	196	197	198	199	200

See the Manufacturer's Direct

MORE THAN TWICE THE NUMBER OF EDITORIAL DIRECTORY PAGES THAN OTHER INDUSTRY SOURCES

EVERY MEASURE

Last fall we promised you that *Electronic Design's* GOLD BOOK would be better by every measure, quantitative and qualitative. Now you can see for yourself. The facts are clear. *Electronic Design's* GOLD BOOK . . .

- Is the largest, most complete, most comprehensive one-step purchasing and reference tool ever produced in this industry.
- Contains more information and data for the specifier/purchaser; more useful listings, more detailed listings; more directory pages; more catalog pages, divided into more product classifications than ever assembled.
- Is far and away the best electronics directory in the world.
- Is the first major industry directory to go abroad in quantity, totaling 13,200.

Here are the statistics:

EDITORIAL	The other industry directory	Electronic Design's GOLD BOOK	
PRODUCT DIRECTORY	195 pages	469 pages	+274
TRADE NAME DIRECTORY	19	28	+ 9
MANUFACTURERS DIRECTORY	200	341	+141
DISTRIBUTORS — Alpha	14	39	+ 25
— Geo	15	40	+ 25
Total Editorial	443	917	+474
ADVERTISING	2752	2820	+ 68

The combination of *Electronic Design* and its GOLD BOOK constitutes the most useful technical information package ever provided to engineers in this industry. You'll refer to these pages again and again to save time and simplify product search, sourcing, selection, specification and purchase.

ELECTRONIC DESIGN'S GOLD BOOK

Design CMOS commutative filters with Q_s that rival quartz. Important features include variable center frequencies, adjustable bandwidth and good dynamic range.

When signal processing requires Q_s above 500, only commutative filters rival quartz. And both the bandwidth and center frequency of the commutative filter are simple to change. While some crystal filters do offer switch-selectable dual bandwidth, their center frequency remains fixed.

Implementation of commutative filters with CMOS offers numerous design advantages. CMOS switches consume little power and have low leakage current (in the off state). Simple logic circuitry can switch input resistances, which, in turn, selects the bandwidth. Readily available CMOS countdown circuitry permits selection of the clock rate to vary the center frequency. And CMOS offers inherently good noise immunity.

Both types of commutative filters—series and shunt—operate in a similar fashion (Fig. 1). A timing circuit controls switch closures: two at a

time for the series and one at a time for the shunt filters. Each switch, or pair of switches, is closed for one fourth of the period of the pass-band center frequency.

One of the four capacitors is always switched into the circuit—each for a quarter cycle of the input signal. Each capacitor charges to the average value of a particular quarter cycle. And the output thus has four discrete levels.

Filter has multiple passbands

If the input-signal frequency lies outside the filter passband, the average voltage across each capacitor, when integrated over many cycles of the input signal, approaches zero. The exception occurs for input frequencies that are harmonics of the filter center frequency. And the filter's frequency response resembles that of the basic low-pass filter (R_{in} and the four capacitors). But this response is moved to the center frequency and also to the harmonics of the center frequency.

Dennis W. Feller, Research Engineer Associate, University of Texas at Austin, Applied Research Laboratories, Austin, TX 78712.

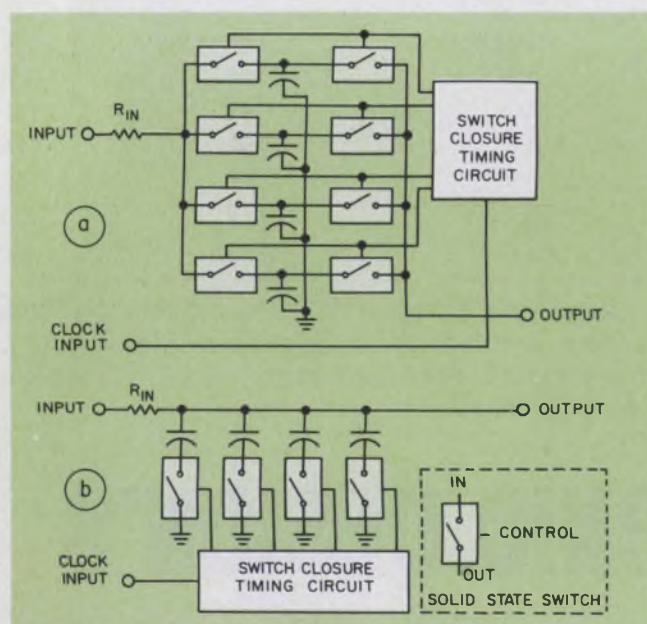

1. Commutative filters achieve large Q and bandpass operation through sequential grounding of capacitors. The two basic forms are series (a) and shunt (b).

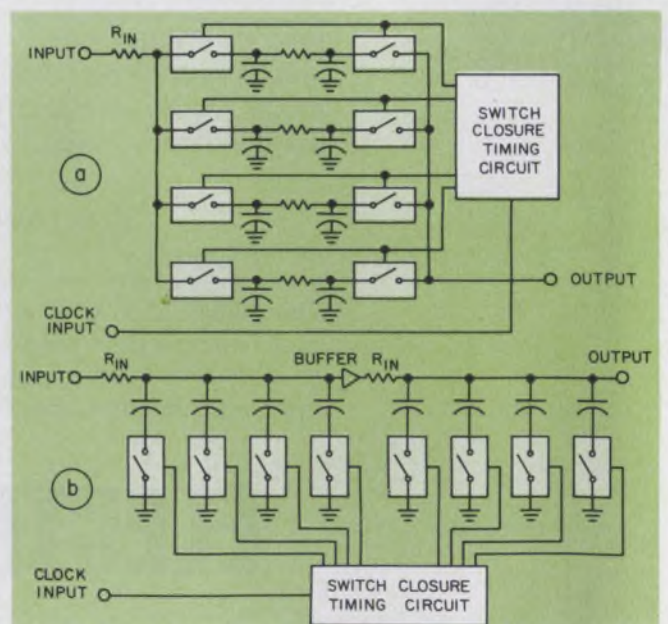

2. The series filter (a) uses more components than the shunt type (b) for multiple poles. The series shape is controlled with additional RC low-pass circuits.

Although the series filter uses more components than the shunt, you can easily change the frequency-response shape with the addition of extra RC poles to each section (Fig. 2a). With the shunt filter, you must cascade two or more units (Fig. 2b) to change the shape.

For multipole filters, the shunt units may require more components than the equivalent series filter. For example, both units have 12-dB/octave rolloffs as their low-pass equivalents (Fig. 2). But the shunt unit uses fewer components; it is

A signal-processing example

A multimode sonar system transmits CW pulses of various center frequencies and pulse widths. The optimum receiver filter bandwidth has to be the inverse of the pulse width. Several crystal filters can provide the different center frequencies and bandwidths. But only one commutative filter, with external control of bandwidth and center frequency, is needed.

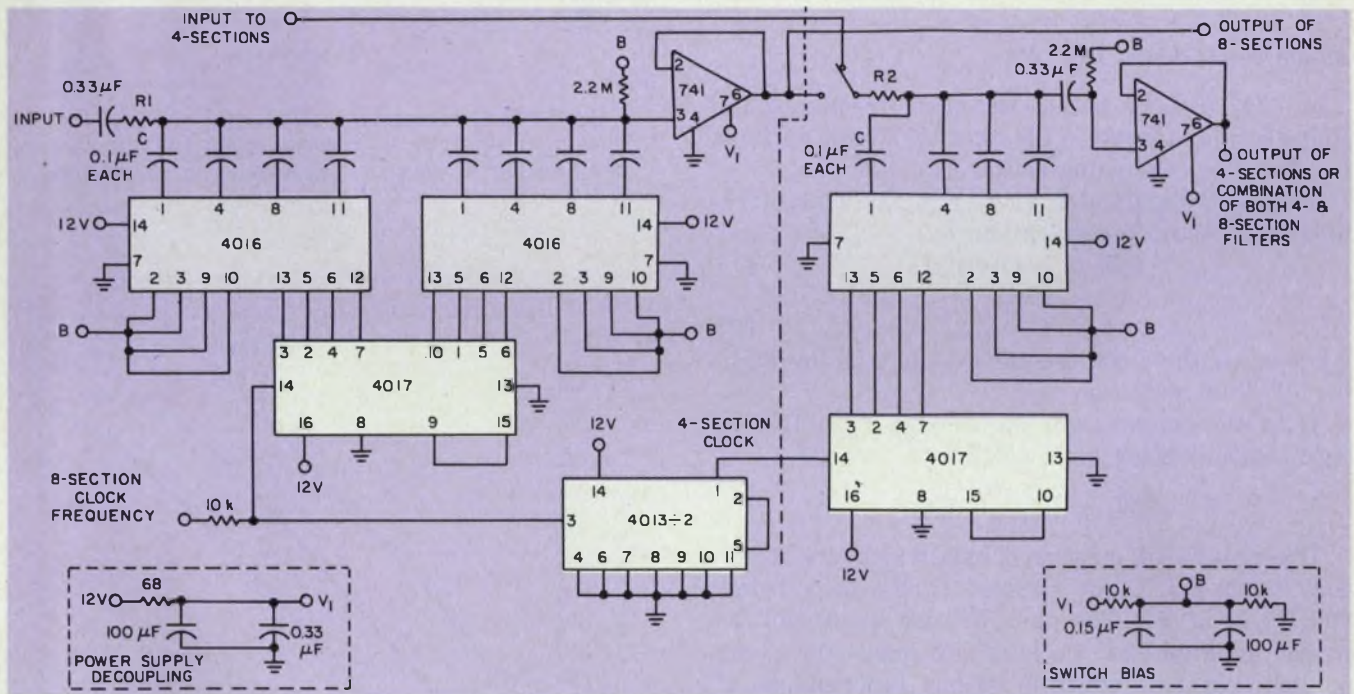

3. CMOS switches and counters are good building blocks for practical commutative filters.

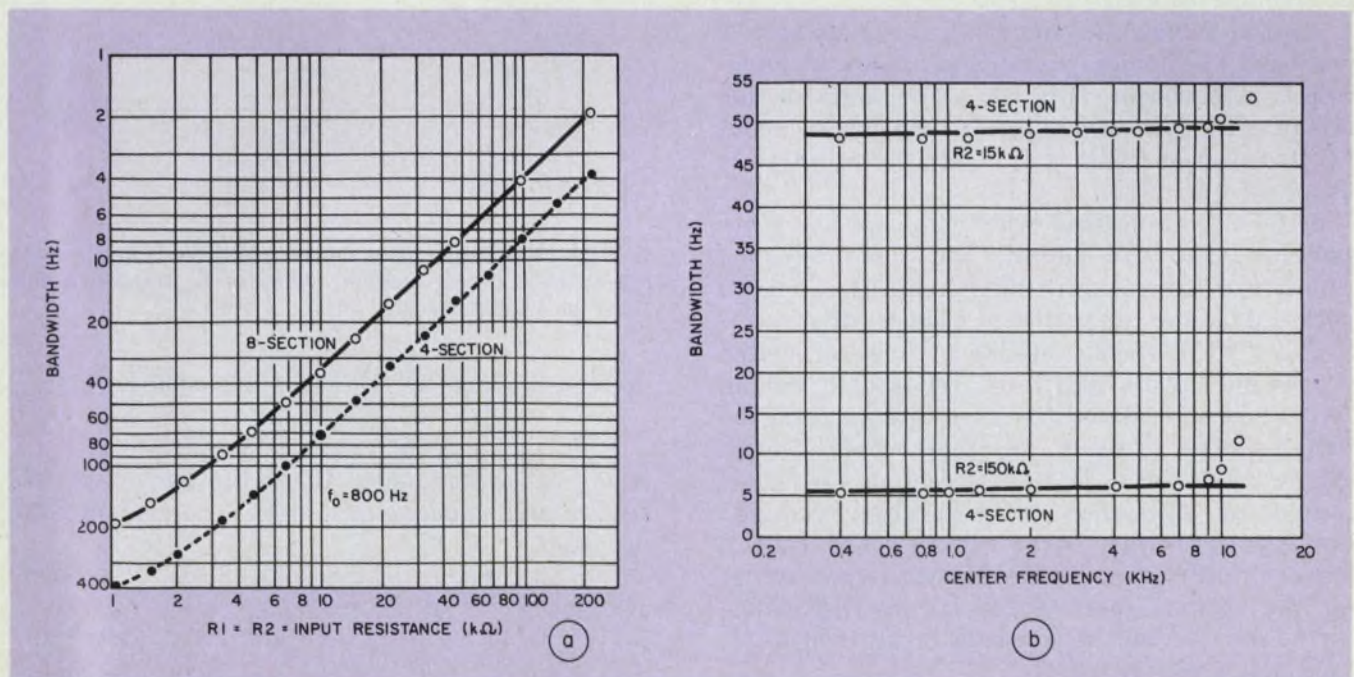

4. Bandwidth varies inversely with input resistance (a) but is independent of center frequency (b).

therefore selected for further design analysis.

An eight-section commutative filter, built with two cascade shunt sections, illustrates the various design tradeoffs. The circuit requires a clock frequency of eight times the center frequency. Also it can operate as a four-section unit (Fig. 3).

The 4017 counter closes the 4016 bilateral switches in sequence for a period of one clock cycle. All switches are connected to one half the supply voltage. This bias enables the switches to operate within their linear region and also permits pk-pk signal input swings that approach the supply voltage.

Single clock drives two filters

A 4013 divider halves the clock frequency for four-section operation, so that all filter sections are tuned to the same center frequency.

The 3-dB bandwidth (Hz) and the center frequency of the filter are given by

$$BW = 1/(n\pi RC) \quad (1)$$

and

$$f_o = f_c/n, \quad (2)$$

where f_c is the clock frequency and n is the number of filter sections.

With the components shown and $R_1 = R_2$, the eight-section filter bandwidth is

$$BW_8 = \frac{4 \times 10^5}{R_1} \text{ Hz.}$$

The results of measured bandwidth are in accord with Eq. 1 for narrow bandwidths below 100 Hz (Fig. 3). The plots become nonlinear for wider bandwidths because of passband harmonics. The bandwidth is largely independent of center frequency (Fig. 3b). Insufficient slew rate of the 741 op amp accounts for the nonlinearity at frequencies above 10 kHz.

As the bandwidth increases or Q decreases, passband harmonics overlap and reduce the band-reject attenuation (Fig. 5). The eight-section circuit with a bandpass Q of 4.2 provides about 14-dB rejection; with a Q of 50, the rejection is about 42 dB.

Self noise, generated when the capacitors are switched into the circuit, can limit dynamic range. For example, one filter had a Q of 30,000 with a dynamic range of less than 60 dB.

The 4016 IC switch—unlike a transistor switch—does not have a saturation voltage but has an “on” resistance. Capacitive feedthrough from the switch-control signals to the switch inputs causes the noise. With transistors, noise is caused by differences in saturation voltage.¹ Furthermore either stray circuit-board capacitance or differences in feedthrough capacitance for the various gates of the IC are responsible for noise. (No self noise would result if all feedthroughs were identical).

An analysis of the circuit shows that the noise

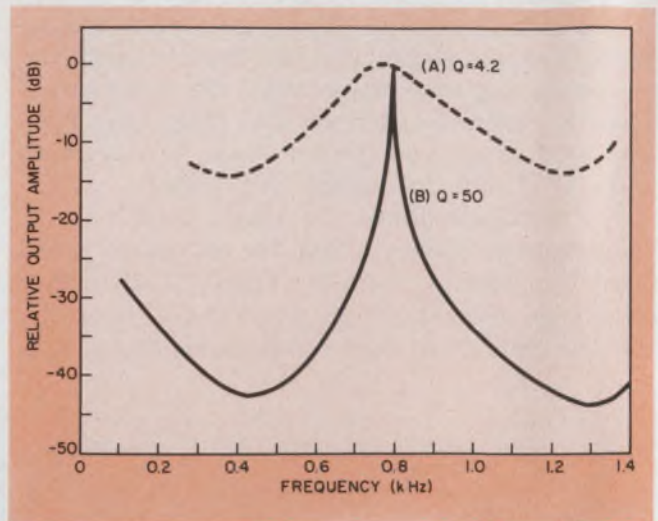

5. Band-reject attenuation decreases sharply for low values of Q as shown by the curves for the eight-section filter. Overlap of passband harmonics is responsible.

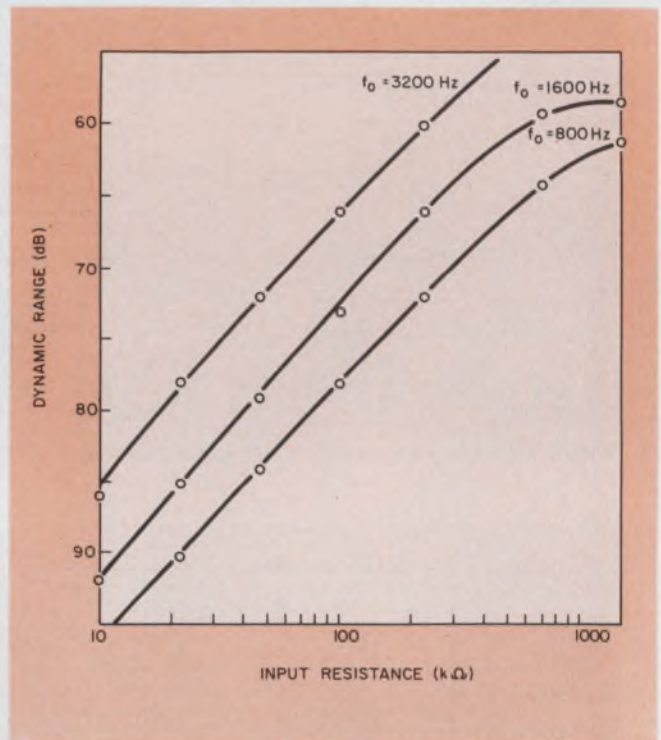

6. High clock frequencies increase self noise and reduce the dynamic range. Smaller values of R_{in} decrease self noise in a given design.

voltage is given by the following equation:

$$V_n = \Delta C V_c f_c R_{in}; \quad (3)$$

$$= \Delta C V_c (nf_o) R_{in}$$

where ΔC = maximum difference among switch feedthrough capacitances, and, V_c = control voltage step.

For an input resistance of 100 kΩ, $f_o = 1600$ Hz, and $V_c = 12$ V the noise level is about 5 mV pk-pk, or 72 dB below the 12-V pk-pk output. The value of ΔC is around 0.4 pF for the eight-section filter.

As shown in Eq. 3, the self noise increases with frequency and input resistance. Conversely, both factors decrease dynamic range (Fig. 6). For high-frequency or high-Q applications, decrease the input resistances and use larger capacitors.

Trimmer capacitors or resistors can help reduce self noise. Proper adjustment of the capacitors matches control-signal feedthrough among the switches (Fig. 7a). The trimming resistors compensate for unequal feedthrough by letting you adjust the discharge (Fig. 7b). But there are some detrimental effects: The impedance of the auxiliary components must be large enough so they do not alter the filter characteristic. The extra components waste space, and adjustments can be tedious.

Commutative filters also generate outputs at harmonics of the selected passband frequency. Although several articles discuss passband harmonics,^{1,2} there is still the matter of sampling

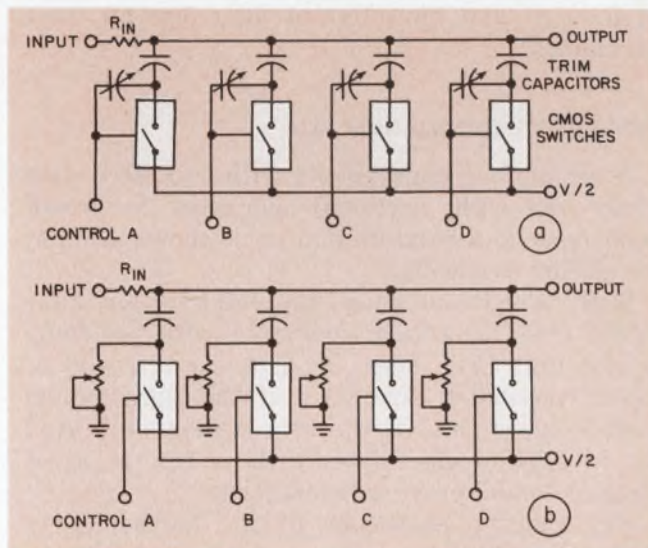

7. Self noise caused by capacitive feedthrough can be reduced with capacitive balance (a) or compensated for with auxiliary discharge paths (b).

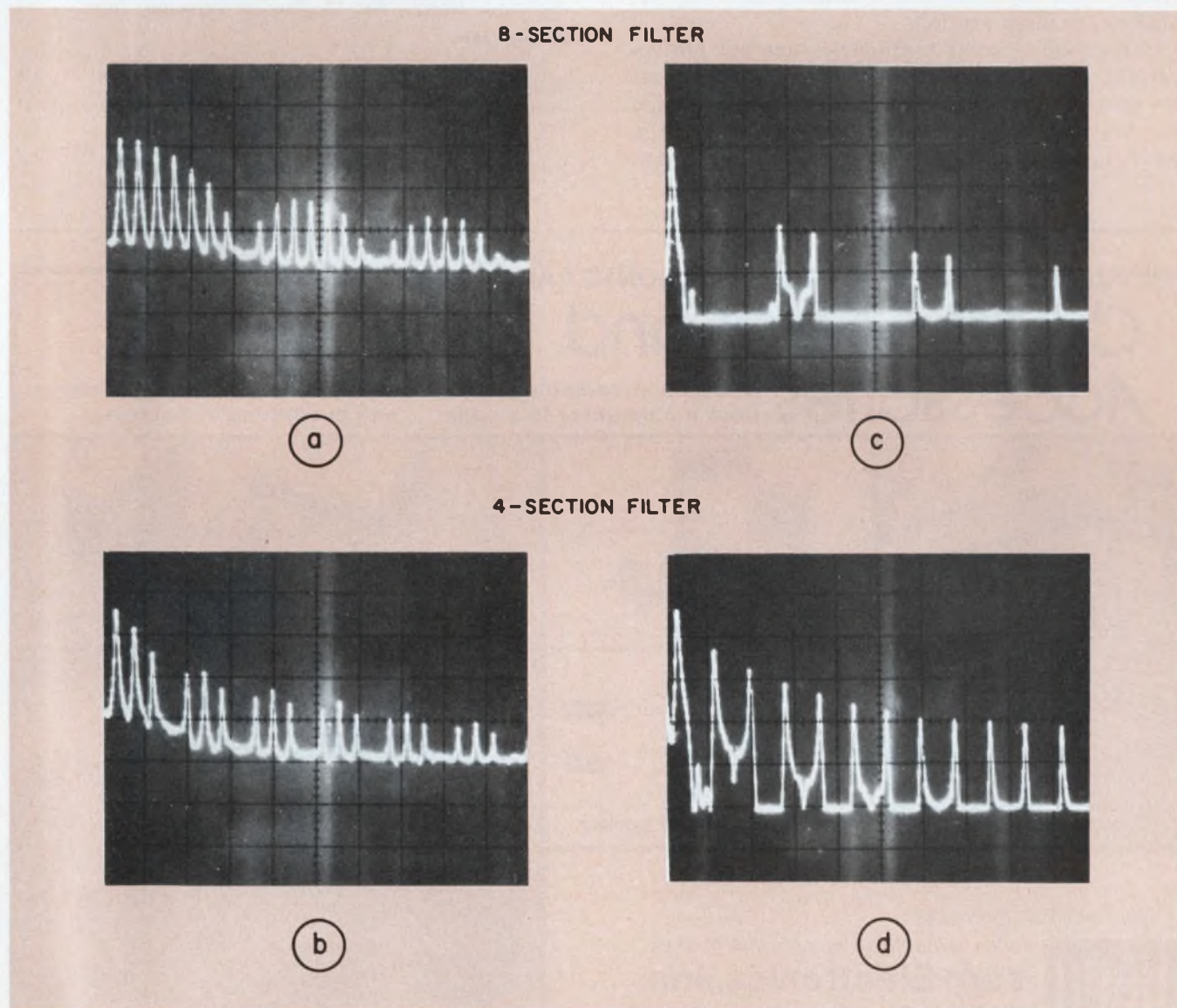

8. Fewer sections means less harmonic content for broadband inputs. The eight-section filter (a) is thus less effective than the four-section one (b). The opposite

is true (c,d) with band-limited inputs. All filters are tuned for 800 Hz. The display scale is 2 kHz/div horizontal and 10 dB/div vertical.

harmonics³ and the effect of filter size on these harmonics.

Harmonics influence filter size

A set of four experiments with two filter sizes (four and eight sections) subjected to broadband noise and band-limited noise shows some of the design tradeoffs.

With broadband noise, the eight-section filter shows little advantage compared with the four-section unit (Fig. 8a,b). In fact, the intensity of second passband harmonics of the eight-section filter exceeds that of the four-section unit. And for broadband use, filters with as few as three sections could prove advantageous.

The relative amplitude of the harmonics in dB is given by

$$A_h = 10 \log_{10} \left[\frac{\sin(kn)}{kn} \right]^2,$$

where k is the passband number and n is the number of filter sections.

If the input-signal frequencies are cut off before the second passband harmonic, the filter output spectrum is equivalent to that of a sampled sine wave. With input noise limited to 1.2 kHz, the eight-section filter reduces the harmonic con-

tent more than the four-section unit does (Fig. 8c,d). The center frequency is 800 Hz; for a sine wave sampled eight times per cycle, the harmonic content is as follows:

fundamental	-0.45 dB
even harmonics	none
3rd and 5th harmonics	none
7th harmonic	-17.3 dB
9th harmonic	-19.5 dB.

These are the values that correspond to the display in Fig. 8c.

Thus for prefiltered inputs to the commutative filter, additional filter sections reduce the harmonic content of the output and may eliminate the need for output filters. ■■

References

1. Harden, W. R., "Digital Filters with ICs Boost Q without Inductors," *Electronics*, July 24, 1967, p. 91.
2. Vale, C., "A Novel Approach to Wave Filters," *EDN*, June, 1967.
3. Kaufman, M., "Get Notch Qs in the Hundreds," *Electronic Design*, No. 16, Aug. 2, 1974, pp. 96-101.

Bibliography

- Ranks, E., and Sandberg I. W., "An Alternative Approach to the Realization of Network Transfer Functions: The N-path Filter," *Bell System Technical Journal*, Vol. 39, No. 5, September, 1960, pp. 1321-1350.
- Visel, Thomas A., "Narrowband Digital Filter Achieves High Qs," *Electronics*, Nov. 22, 1973, p. 118.

VERO ... A COMPLETE ELECTRONIC PACKAGING CAPABILITY

Circuit boards and Accessories

A total and versatile packaging capability for every application from a connector to a case ... and everything in between!



Circuit Boards & Connectors



VeroBox® Small Enclosures



Multi-Purpose Plastic Boxes



P.C. Card Handles & Ejectors



D-I-P Sockets

We make your job easier ...

VERO Call or write today for more information:
Vero Electronics, Inc.
 171 Bridge Road, Hauppauge, N.Y. 11787
 Tel.: 516-234-0400 TWX: 510-227-8890
 In Canada Call: EPS, 613-389-1025



Terminal End Socket Pins

FMC

Syntron Semiconductor Sales Organization

ARIZONA

Fryco, Engineering Reps.
Scottsdale
(602) 945-3281

CALIFORNIA

Carl E. Holmes Co.
Los Angeles
(213) 256-2255

COLORADO

Gossard & Associates
Denver
(303) 985-0602

FLORIDA

L. Haas Co., Inc.
North Miami Beach
(305) 949-9143
(305) 949-5157

ILLINOIS

Syntron Chicago Sales Co.
Hinsdale
(312) 325-3250

INDIANA

Seawood Sales, Inc.
Montgomery
(513) 793-6702

MARYLAND

Callas Electronics, Inc.
Baltimore
(301) 744-7711

MASSACHUSETTS

Garrettson Co., Inc.
Needham
(617) 449-2640

MICHIGAN

L. H. Dickelman
Detroit
(313) 255-3300

MINNESOTA

Northport Engineering Inc.
St. Paul
(612) 698-3841

MISSOURI

Harlan J. Weisler & Associates
St. Louis
(314) 428-3934

NEW JERSEY

Syntron Newark Sales Co.
Hasbrouck Heights
(201) 288-1845

NEW YORK

J. Lazor Associates
Penfield
(716) 473-8337

NORTH CAROLINA

Jake Rudisill Associates, Inc.
Charlotte
(704) 377-6901

OHIO

Allen Nace Co., Inc.
Brecksville
(216) 526-4323

PENNSYLVANIA

W. Reeves Associates, Inc.
Media
(215) 566-6709

TEXAS

Palatine Sales, Inc.
Richardson
(214) 231-9489

WASHINGTON

Bergford & Associates
Olympia
(206) 866-2001

WISCONSIN

Syntron Semiconductor Sales Co.
Milwaukee
(414) 273-6773

Syntron Power Thyristors

Syntron Thyristors (SCRs) are diffused, three junction, semiconductor units designed for medium and high power solid state control applications.

Available in the popular standard JEDEC configurations from 25 amps rms to 850 amps rms with V_{BO} ratings to 1600 volts and transient ratings to 2000 volts, these Thyristors exhibit the same reverse voltage avalanche characteristics found in all Syntron silicon diodes.

In a single element application, they can be used for direct conversion and continuous control of AC to DC power requirements or they can be used as a DC switch to initiate current flow.

Rigid quality control and years of field testing have made Syntron Thyristors among the most reliable devices available for solid state power control.

For detailed information, contact:

FMC Corporation
Semiconductor Products
Operation
Homer City, Penna. 15748
(412) 479-8011

FMC Special
Products

Let a computer design memory circuits.

A CAD program prescribes efficient, low-cost hardware for such designs as a digital traffic-light controller

Last of three articles

Computer-aided design (CAD) takes the sweat out of design of digital networks that have memory. This contrasts with manual design which involves reduction of Karnaugh maps, and in which both design time and the probability of error increase rapidly with the number of input and feedback lines. A seven-variable or higher map discourages even the most eager designer.

The CAD program is written for sequential circuits that have the basic configuration of Fig. 1. Use of clocked D-type flip-flops for the memory greatly simplifies the design of the combinational, or gate, part of the network. Input data are derived from a state table. The table doesn't have to be optimum; powerful subroutines simplify and minimize the functions.

First, the computer reduces the number of memory states required. Then memory-state codes are assigned. The assignment rules lead to a good solution for many different types of sequential circuits. Finally, the functions for the network combinational logic are minimized and simplified. Hardware is implemented directly from the printout.

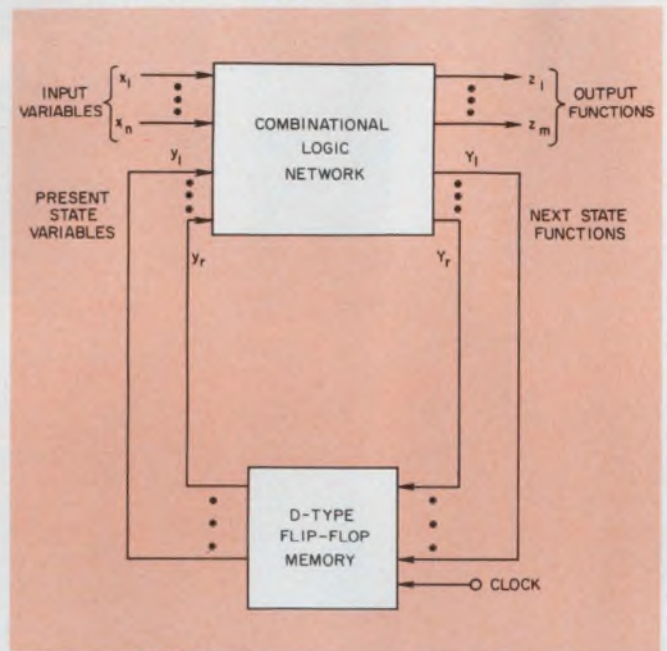

1. The CAD program is written around this model of a sequential network. AND/OR gates combine external inputs and flip-flop outputs to produce outputs and next-state flip-flop inputs.

Designing a traffic-light controller

Let's use the program to design a digital controller for a city traffic light at the intersection of a main thoroughfare and a side street. We want maximum flow on the thoroughfare. Therefore the green light for the side street must have the shorter duration—20 seconds shorter during the day and 40 seconds shorter at night (Table 1).

Our job is to come up with a low-cost hardware design. To start with, of course, we'll need a photocell and clock pulses. The photocell output line, x , is high ($x=1$) during the day and low at night ($x=0$). The clock interval is five seconds—the lowest common denominator of the specified time intervals. And since the patterns repeat after one minute, our base cycle extends

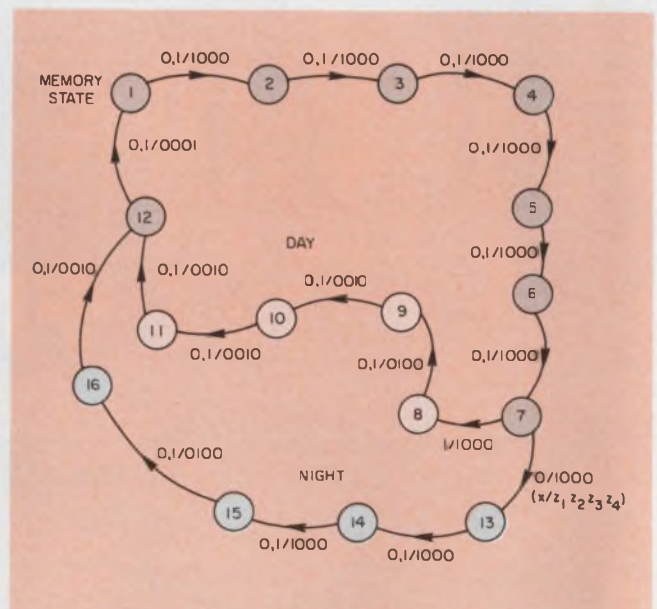

2. State diagram for the controller has two loops, one for day and one for night operation.

S. G. Shiva & H. Troy Nagle Jr., Electrical Engineering Dept., Auburn University, Auburn, AL 36830.

for 12 clock pulses. How many outputs will we need? From Table 1, we see that when the side-street light is green or yellow, the main-street light is red—and vice versa.

We can write a pair of Boolean equations for signals on the main and side streets, as follows:

$$RED_2 = GREEN_1 + YELLOW_1 \quad (1)$$

$$RED_1 = GREEN_2 + YELLOW_2 \quad (2)$$

We need only four output lines from the controller to operate the lights. In the notation of Fig. 1 these are

$$GREEN_1 = z_1,$$

$$YELLOW_1 = z_2,$$

$$GREEN_2 = z_3,$$

$$YELLOW_2 = z_4.$$

How many memory states? Certainly, no more than 24, since there are 12 clock pulses and no more than two possibilities for each, day and night. From the arrangement in Table 2, we see that we can get by with fewer than 24 states. Day or night, there are identical outputs for the first seven clock periods when GREEN₁ is on. The outputs begin to differ on the eighth pulse.

So if we assign memory states one through 12 to the day condition (x=1), the first seven states at night (x=0) are the same as for day operation. The eighth through 11th day states differ from the night states. But the 12th state is identical for day or night operation.

We've assigned 16 different states. We could have avoided even this bit of reasoning. Even if we assigned 24 states, the computer has a minimization routine, and, further, it will turn out that even our 16 states are too many. Fig. 2 shows the data rearranged in a state diagram. The controller sequences in the direction of the arrows from state to state (numbered circles).

		INPUTS			
		1	2		
PRESENT STATE	1	2/9	2/9	NEXT STATE /PRESENT OUTPUT	
	2	3/9	3/9		
	3	4/9	4/9		
	4	5/9	5/9		
	5	6/9	6/9		
	6	7/9	7/9		
	7	13/9	8/9		
	8	9/5	9/5		
	9	10/3	10/3		
	10	11/3	11/3		
	11	12/3	12/3		
	12	1/2	1/2		
	13	14/9	14/9		
	14	15/9	15/9		
	15	16/5	16/5		
	16	12/3	12/3		

3. A state table presents data in integer form for subsequent transfer to data-entry cards.

Table 1. Traffic-light timing

Time period	Main street	Side street
Daylight to sunset	Green: 35 s Yellow: 5 Red: 20	Red: 40 s Green: 15 Yellow: 5
Sunset to daylight	Green: 45 s Yellow: 5 Red: 10	Red: 50 s Green: 5 Yellow: 5

Table 2. The controller sequence is based on day or night operation

Clock pulse	Starting time (sec)	Daylight					Night				
		Memory state	z ₁ Green ₁	z ₂ Yellow ₁	z ₃ Green ₂	z ₄ Yellow ₂	Memory state	z ₁ Green ₁	z ₂ Yellow ₁	z ₃ Green ₂	z ₄ Yellow ₂
1	0	1	1	0	0	0	1	1	0	0	0
2	5	2	1	0	0	0	2	1	0	0	0
3	10	3	1	0	0	0	3	1	0	0	0
4	15	4	1	0	0	0	4	1	0	0	0
5	20	5	1	0	0	0	5	1	0	0	0
6	25	6	1	0	0	0	6	1	0	0	0
7	30	7	1	0	0	0	7	1	0	0	0
8	35	8	0	1	0	0	13	1	0	0	0
9	40	9	0	0	1	0	14	1	0	0	0
10	45	10	0	0	1	0	15	0	1	0	0
11	50	11	0	0	1	0	16	0	0	1	0
12	55	12	0	0	0	1	12	0	0	0	1

Table 3. Codes for circuit outputs

z_1 z_2 z_3 z_4	Code
0 0 0 1	2
0 0 1 0	3
0 1 0 0	5
1 0 0 0	9
Don't-Care	0

Pairs of numerals adjacent to the arrows show the input/output condition. For the transition from state 5 to 6, for example, code 0,1/1000 means that for both photocell conditions, ONE and ZERO, output $z_1z_2z_3z_4 = 1000$, so that the main-street light is red and the side-street light green (based on Eqs. 1 and 2). The two loops for day and night show up clearly on the diagram.

Set up a state table

To prepare the data for computer processing set up a state table (Fig. 3). In this format, inputs and outputs are in decimal form, equal to the value of the binary-code representation plus one. For each present state and input combination, enter the NEXT STATE/PRESENT OUTPUT values. Thus the first line in Fig. 3 can be read as: "The present state is 1 and the next state 2 for both $x=0$ and $x=1$. The present output is 1000 in both cases."

We can now prepare the data-entry cards for the computer, using Table 3 for the decimal equivalents of the binary-coded output combinations. As seen in the state table, only output codes 2, 3, 5 and 9 occur. There are no don't-care conditions in this example. Don't-care conditions, if they do occur, allow more freedom in network design. And the program takes advantage of them to simplify the network equations. The final hardware is reduced correspondingly.

Four data cards are prepared (Table 4). The first card lists the number of inputs, $N=2$, and of memory states, $L=16$. The NEXT STATES

PRESENT STATE	NEXT STATES		OUTPUTS	
	$x = 0$	$x = 1$	$x = 0$	$x = 1$
1	2	2	9	9
2	3	3	9	9
3	4	4	9	9
4	5	5	9	9
5	6	6	9	9
6	7	7	9	9
7	13	8	9	9
8	9	9	5	5
9	10	10	3	3
10	11	11	3	3
11	12	12	3	3
12	1	1	2	2
13	14	14	9	9
14	15	15	9	9
15	11	11	5	5

4. The computer produces a reduced state table, in which only 15 memory states, rather than 16, are needed.

are listed in order of occurrence on the second card and the corresponding outputs on the third card. Finally the input codes are entered in order of occurrence on the fourth card.

Printout verifies entries

The state table, as read from the data cards, is printed out first. Key-punching errors can be quickly identified and eliminated. Now the memory-state minimization subroutine can be run. A reduced state table for the traffic controller results (Fig. 4). Only 15 states are required.

Now a code will be assigned to each memory state (Fig. 5). The subroutine follows rules that produce good solutions.

The next printout section contains the Boolean functions for the next-state and output signals, Y_i and z_i . Listed for each function are the min-terms and don't-cares (in integer format) and the essential and other prime implicants needed to construct the logic network. The user can have either the true functions, their complements or both printed out. These functions for Y_i and z_i are in the form

Table 4. Format for data-entry cards

Data card	Card Columns									Comments	
	1 2	3 4	5 6	7 8	9 10	11 12	13 14	15 16	... 8		
1	2	16									N, L
2	2	2	3	3	4	4	5	5	...		Next states
3	9	9	9	9	9	9	9	9	...		Outputs
4	1	2									Input codes

State Number	Assignment (Decimal Code)	Assignment (Binary Code)			
		y_1	y_2	y_3	y_4
1	1	0	0	0	1
2	2	0	0	1	0
3	3	0	0	1	1
4	4	0	1	0	0
5	5	0	1	0	1
6	6	0	1	1	0
7	7	0	1	1	1
8	8	1	0	0	0
9	9	1	0	0	1
10	10	1	0	1	0
11	0	0	0	0	0
12	11	1	0	1	1
13	12	1	1	0	0
14	13	1	1	0	1
15	14	1	1	1	0

5. The computer assigns a decimal code to each memory state prior to minimization of the logic functions.

$$f(x, y_1, y_2, y_3, y_4), \quad (3)$$

where the flip-flop output lines, y_i , and the photocell output line, x , are the combinational logic inputs. We need four y lines to code 15 memory states, and there is a corresponding Y next-state input line to the memory for each y . To illustrate, for the next-state function, Y_4 , we get this print-out in binary form:

THE ESSENTIAL PRIME IMPLICANTS ARE

- 0 - - 0
 - - - 0 0
 - 1 - 1 1

OTHER PRIME IMPLICANTS ARE

NONE

The Boolean function Y_4 is the sum of the essential and other prime implicants:

$$Y_4 = -0--0 + ---00 + -1-11. \quad (4)$$

The product terms, in the order x, y_1, y_2, y_3, y_4 , have these variables:

- variable omitted
- 1 variable present
- 0 complemented variable present

$$\text{Thus } Y_4 = \bar{y}_1 \bar{y}_4 + \bar{y}_3 \bar{y}_4 + y_1 y_3 y_4. \quad (5)$$

The remaining next-state and output functions generated by the CAD program are:

$$Y_3 = y_3 y_4 + \bar{y}_1 y_3 \bar{y}_4 + \bar{y}_1 y_2 \bar{y}_4 \quad (6)$$

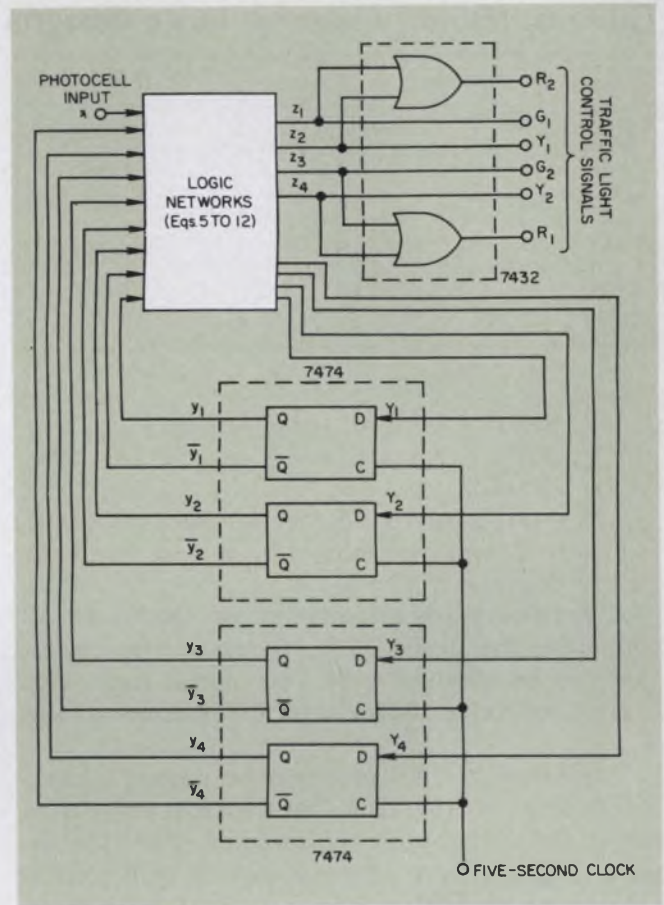

6. Block diagram of the traffic controller, shows use of D flip-flops and a five-second clock.

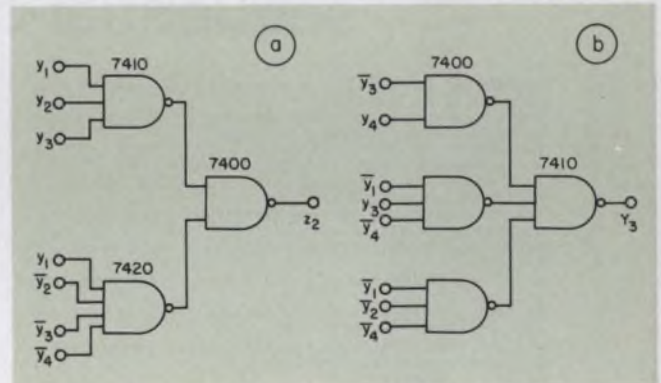

7. Ordinary logic gates are used for the combinational section of the controller. Variable z_2 controls the yellow light at the main street (a) and Y_3 is a next-state input to a flip-flop (b).

Table 5. Computer time/memory requirements

Type of Circuit	Number of		Execution time (seconds)	Computer used	Memory (kbytes)
	States	Inputs			
Incompletely Specified	12	2	1.77	IBM 370/155	68
Incompletely Specified	5	2	0.42	IBM 370/155	66
Incompletely Specified	16	8	6.59	IBM 370/155	112
Completely Specified	10	4	1.09	IBM 370/155	85

Table 6. Memory use for large designs

Number of		Memory
States	Inputs	(kbytes)
31	2	80
31	4	97
31	8	137
31	16	240

$$Y_2 = \overline{y_2} \overline{y_3} + \overline{y_1} \overline{y_2} y_3 y_4 + \overline{y_1} y_2 \overline{y_4} + \overline{x} y_1 y_2 \quad (7)$$

$$Y_1 = y_2 y_3 y_4 + y_2 y_3 y_4 + y_1 y_3 \quad (8)$$

$$z_4 = \overline{y_1} y_3 y_4 \quad (9)$$

$$z_3 = \overline{y_1} \overline{y_2} \overline{y_3} \overline{y_4} + y_1 \overline{y_2} \overline{y_3} y_4 + y_1 \overline{y_2} y_3 \overline{y_4} \quad (10)$$

$$z_2 = \overline{y_1} y_2 y_3 y_4 + y_1 y_2 y_3 \quad (11)$$

$$z_1 = \overline{y_1} y_4 + y_1 y_3 + y_2 y_3 \quad (12)$$

A hardware implementation of Eqs. 5 to 12 completes the design. Fig. 6 shows one circuit that can be obtained with 7400 series logic. Fig. 7 gives gate circuits for typical functions, z_2 and Y_3 .

The complete CAD program for sequential networks runs on the IBM 360 and 370 computers under the Fortran IV G compiler. For this design package, your program library will consist

of the programs and subroutines listed at the end of this article and those listed in the previous two articles (Oct. 11 and Oct. 25). The only program to be omitted is REED, which appears in the first article.

Table 5 shows computer execution time and memory requirements to design various types and sizes of networks. Incompletely specified networks (with don't-cares) take more time to design than those that are completely specified, but they generally result in simpler hardware. It takes less than seven seconds to design an incompletely specified network with 16 memory states and eight input combinations. ■■

The first article in the series discussed the simplification of combinatorial logic and appeared in the Oct. 11 issue. The second article in the Oct. 25 issue dealt with the reduction of state tables.

References

1. Nagle, H. T. Jr., Carroll, B. D. and Irwin, J. D., "An Introduction to Computer Logic," Prentice-Hall, 1975, Chap. 7 and 9.
2. Shiva, S. G., and Nagle, H. T. Jr., "A Computer-Aided Procedure for Complete Design of Sequential Machines," Project THEMIS, Tech. Report No. AU-T-26, Auburn University, March, 1973.

Additional subroutines for sequential-circuit design

```

SUBROUTINE SUBADJNS,IY,L,N,NUMBER,ISTATE,IASSGN,ISI,
11ADJCN,IALLAD,INPUT,KL)
C
C FORTRAN SOURCE PROGRAM FOR APPLYING STATE-ASSIGNMENT
C ALGORITHM TO A SEQUENTIAL MACHINE.
C
C L=NUMBER OF STATES IN MACHINE
C
C N = NUMBER OF INPUTS IN MACHINE
C
C IY = NUMBER OF STATE VARIABLES USED IN THE DESIGN
C
C NS IS THE NEXT STATE FUNCTION
C
C NUMBER = 2**IY-1 = DECIMAL REPRESENTATION OF THE
C HIGHEST STATE ASSIGNMENT POSSIBLE.
C
C IADJCN(I,J) IDENTIFIES WHICH STATES I AND J ARE
C ADJACENT.
C
C ISTATE(I) STORES (IN DECIMAL) THE STATE ASSIGNMENT FOR
C STATE I.
C
C IASSGN(J) IDENTIFIES DURING CALCULATION WHICH STATE
C ASSIGNMENTS J HAVE BEEN USED.
C
C INTEGER IASSGN(16),ISI(16),ISTATE(16),IADJCN(16,16),
C INSI(8,16),IALLAD(16),INPUT(16)
DO 12 I= 1,NUMBER
12 IASSGN(I) = 0
DO 13 I = 1,L
ISI(I) = 0
ISTATE(I) = 0
DO 13 J = 1,L
IADJCN(I,J)=0
13 CONTINUE
DO 14 I = 1,N
IALLAD(I) = 1
DO 14 J = 1,L
IF(NS(I,J).EQ.0) GO TO 14
NSI = NS(I,J)
ISI(NSI) = ISI(NSI) + 1
14 CONTINUE
LRGSTN = ISI(1)
LARGST = 1
DO 15 J = 2,L
IF(LRGSTN.LT.ISI(J)) GO TO 16
GO TO 15
16 LARGST = J
LRGSTN = ISI(J)
15 CONTINUE
DO 5 I = 1,N
IF(NS(I,1).EQ.0) GO TO 17
NSJ = NS(I,1)
DO 18 J=2,L
IF(NS(I,J).NE.NSJ) GO TO 17
18 CONTINUE
GO TO 5
17 IALLAD(I) = 0
CONTINUE
DO 19 I = 1,N
IF(IALLAD(I).EQ.1) GO TO 19
DO 26 J = 1,L
DO 26 K = 1,L
IF(NS(I,J).NE.NS(I,K)) GO TO 26
IF(NS(I,J).EQ.0) GO TO 26
IF(IADJCN(J,K).EQ.1) GO TO 26
IF(IJ.EQ.K) GO TO 26
IF(NS(I,J).EQ.LARGST) GO TO 26
IADJCN(J,K) = 1
26 CONTINUE
19 CONTINUE
MAKE ADJACENT ASSIGNMENTS TO STATES ADJACENT TO THE
STATE MOST OFTEN TRANSFERRED TO (THE INITIAL REFERENCE
STATE).
DO 4 IA = 1,L
IF(IADJCN(LARGST,IA).EQ.0) GO TO 4
DO 1 I = 1,NUMBER
IF(IASSGN(I).EQ.1) GO TO 1
DO 2 J = 1,IY
JNONE = J-1
IF(I.EQ.2**JNONE) GO TO 3
GO TO 2
3 ISTATE(IA) = I
IASSGN(I) = 1
GO TO 4
2 CONTINUE
1 CONTINUE
4 CONTINUE
CHOOSE AS THE NEW REFERENCE STATE SOME STATE ALREADY
HAVING AN ASSIGNMENT. MAKE ADJACENT ASSIGNMENTS TO
STATES ADJACENT TO THIS REFERENCE STATE. USE ALL
STATES HAVING ASSIGNED CODES ONCE AS THE REFERENCE
STATE UNTIL ALL STATES ARE ASSIGNED CODES.
21 ICHANG = 0
DO 24 I = 1,L
ISI(I) = 0
ISI(LARGST) = 1
DO 6 JA = 1,L
IF(ISTATE(JA).EQ.0.OR.ISI(JA).EQ.1) GO TO 6
ISI(JA) = 1
DO 7 JB = 1,L

```



```

IF(IADJCN(JA,JPI,EO,0) GO TO 7
IF(IISTATE(JB),NE,0)GO TO 7
IF(JR,EO,LARGST) GO TO 7
DO 9 I = 1,NUMBER
IF(IASSGN(I),EO,1) GO TO 9
ICHECK = IEXOR(ISTATE(JA),I)
DO 10 JI = 1,IY
JMNONE = JI-1
IF(ICHECK,EO,2*(JMNONE) GO TO 11
GO TO 10
11 ISTATE(JB) = I
IASSGN(I) = 1
ICHANG = 1
GO TO 7
10 CONTINUE
9 CONTINUE
7 CONTINUE
6 CONTINUE
IF(ICHANG,EO,1) GO TO 21
DO 49 I=1,L
IF(I,FO,LARGST,OR,ISTATE(I),NE,0)GO TO 49
DO 41 I=1,L
DO 42 IJ=1,N
IF(NS(IJ,I),NE,1)GO TO 42
IPOINT=IJ
DO 43 IK=1,N
IF(NS(IK,I),EO,0)GO TO 43
IF(NS(IK,I),FO,1,OR,ISTATE(NS(IK,I)),EO,0)GO TO 43
ICHECK=IEXOR(INPUT(IJ),INPUT(IK))
DO 44 IL=1,KL
IF(ICHECK,EO,2*(IL-1))GO TO 45
44 CONTINUE
C NOT ADJACENT INPUTS
GO TO 43
45 ICHECK=ISTATE(NS(IK,I))
DO 46 IM=1,NUMBER
IF(IASSGN(IM),EO,1)GO TO 46
IPOINT=IEXOR(ICHECK,IASSGN(IM))
DO 47 IN=1,IY
IF(IPOINT,EO,2*(IN-1))GO TO 48
47 CONTINUE
C NOT ADJACENT
GO TO 46
48 ISTATE(I)=IM
IASSGN(IM)=1
GO TO 21
46 CONTINUE
43 CONTINUE
42 CONTINUE
41 CONTINUE
49 CONTINUE
C IF SOME STATES NOW REMAIN WITHOUT CODES, ASSIGN SOME
C UNUSED CODE TO AN UNASSIGNED STATE AND USE THIS STATE
C AS THE NEW REFERENCE STATE
DO 8 I = 1,L
IF(I,EO,LARGST,OR,ISTATE(I),NE,0) GO TO 8
DO 22 J = 1,NUMBER
IF(IASSGN(J),FO,1) GO TO 22
ISTATE(I) = J
IASSGN(J) = 1
GO TO 21
22 CONTINUE
8 CONTINUE
200 WRITE(6,200)
FORMAT('0',10X,'STATE ASSIGNMENT')
DO 23 I = 1,L
23 WRITE(6,100) I,ISTATE(I)
100 FORMAT(' ',10X,I3,8X,I3)
RETURN
END

```

```

SUBROUTINE FUNGENIN(L,IY,INPUT,NSI,M,I,ISTATE
1,INSET,KL,KKL,II,IA,NSDNT,LITCNT,CONSI,CONSJ)
C SUBROUTINE TO GENERATE AND MINIMIZE THE BOOLEAN
C FUNCTIONS FOR NEXT STATE AND OUTPUT VARIABLES.
INTEGER NSI(8,16), ISTATE(16),M(8,16),INPUT(16),INSET(16)
INTEGER IA(16)
DIMENSION NSDNT(256)
DIMENSION TRAY(16),ICONS(10,8),COUNT(10)
DIMENSION NUM(200),IR(256),MINAX(256)
INTEGER C(256),D,MIN(256),DONT(256),MINT(256),EMP
INTEGER DIF,PRIM(256),PRIMJ(256),ESEN(200),ESENJ(200)
INTEGER LITCNT(16),CONSI(16),CONSJ(16)
INTEGER ESARY(100,8),MASK(8),MATCNT(10)
INTEGER ONE,ZERO,DASH,WAIT(10)
COMMON/COM2/C
COMMON/COM3/ID1
DATA DASH/1M-/
COMPUTE NEXT STATE DONTCARES WITHIN THE STATE TABLE
ID1=1
IDNT=0
ID=0
DO 70 I=1,L
DO 70 J=1,N
IF(NS(I,J),NE,0)GO TO 70
ID=ID+1
NSDNT(ID)=ISTATE(I)+(2**IY)*(INPUT(J)-1)
70 CONTINUE
IF(L,EO,2**IY)GO TO 74
LL=L+1
IX=2**IY
DO 72 I=1,IX
IA(I)=0
DO 501 I=1,L
501 IA(ISTATE(I)+I)=1
DO 502 I=LL,IX
IP=I
DO 503 J=1,IX
IF(IA(IJ),EO,1)GO TO 503
IP=J
IA(IJ)=1
GO TO 504
503 CONTINUE
504 ISTATE(I)=IP-1
502 CONTINUE
COMPUTE THE NEXT STATE AND OUTPUT DONTCARES
C OUTSIDE THE STATE TABLE
IY=(2**IY)-1
DO 73 I=LL,IX
DO 73 J=1,N
ID=ID+1
IDNT=IDNT+1
NSDNT(ID)=ISTATE(I)+(2**IY)*(INPUT(J)-1)
DONT(IDNT)=ISTATE(I)+(2**IY)*(INPUT(J)-1)
73 CONTINUE
74 IF(N,EO,2**KL)GO TO 76
IN=N+1
KKL=2**KL
DO 82 I=1,KKL
INSET(I)=0
82 CONTINUE
DO 83 I=1,N
83 INSET(INPUT(I))=1
IY=2**IY
DO 77 I=1,KKL
DO 77 J=1,IY
IF(INSET(I),EO,1)GO TO 77
IDNT=IDNT+1
ID=ID+1
NSDNT(ID)=ISTATE(I)+(2**IY)*(I-1)
DONT(IDNT)=ISTATE(I)+(2**IY)*(I-1)
77 CONTINUE
COMPUTE OUTPUT DONTCARES WITHIN THE STATE TABLE
76 DO 79 I=1,L
DO 79 J=1,N
IF(LW(I,J),NE,0)GO TO 79
IDNT=IDNT+1
DONT(IDNT)=ISTATE(I)+(2**IY)*(INPUT(J)-1)
CONTINUE
79 CALL ARANG(NSDNT,ID)
CALL ARANG(DONT,IDNT)
C ORDER OF THE FUNCTION IORDER=IY+KL
IORDER=IY+KL
COMPUTE MINTERMS FOR NEXT STATE VARIABLES
WRITE(6,300)
300 FORMAT('1)BOOLEAN FUNCTIONS FOR STATE VARIABLES')
DO 3 J=1,IY
IYY=IY-J+1
WRITE(6,220)IYY
220 FORMAT('0)BOOLEAN FUNCTION FOR Y',I1)
ICNT=0
DO 4 IJ=1,N
DO 4 K=1,L
IF(NS(IJ,K),EO,0)GO TO 4
IF(AND(ISTATE(NS(IJ,K)),2**(J-1)),NE,2**(J-1))
GO TO 4
ICNT=ICNT+1
MIN(ICNT)=ISTATE(K)+(2**IY)*(INPUT(IJ)-1)
4 CONTINUE
CALL ARANG(MIN,ICNT)
CALL MINIM(MIN,ICNT,NSDNT,ID,IORDER,LITCNT,CONSI,CONSJ)
3 CONTINUE
C FORM MINTERMS FOR OUTPUT FUNCTIONS
WRITE(6,301)
301 FORMAT('1)BOOLEAN FUNCTIONS FOR OUTPUT VARIABLES')
DO 8 K=1,II
IIK=II-K+1
WRITE(6,302)IIK
302 FORMAT('0)BOOLEAN FUNCTION FOR Z',I1)
ICNT=0
DO 9 J=1,N
DO 9 I=1,L
IF(LW(I,J),EO,0)GO TO 9
IW=W(I,J),I-1
IF(AND(IW,2**(K-1)),NE,2**(K-1))GO TO 9
ICNT=ICNT+1
MIN(ICNT)=ISTATE(I)+(2**IY)*(INPUT(J)-1)
CONTINUE
CALL ARANG(MIN,ICNT)
CALL MINIM(MIN,ICNT,DONT,IONT,IORDER,LITCNT,CONSI,CONSJ)
8 CONTINUE
RETURN
END
SUBROUTINE ARANG(MIN,K)
C THIS SUBROUTINE ARRANGES K ELEMENTS IN ARRAY MIN
C INTO THEIR ASCENDING ORDER
DIMENSION MIN(256)
DO 1 I=1,K
DO 1 J=1,K
IF(MIN(I).GT,MIN(J))GO TO 1
MT=MIN(I)
MIN(I)=MIN(J)
MIN(J)=MT
1 CONTINUE
RETURN
END

```

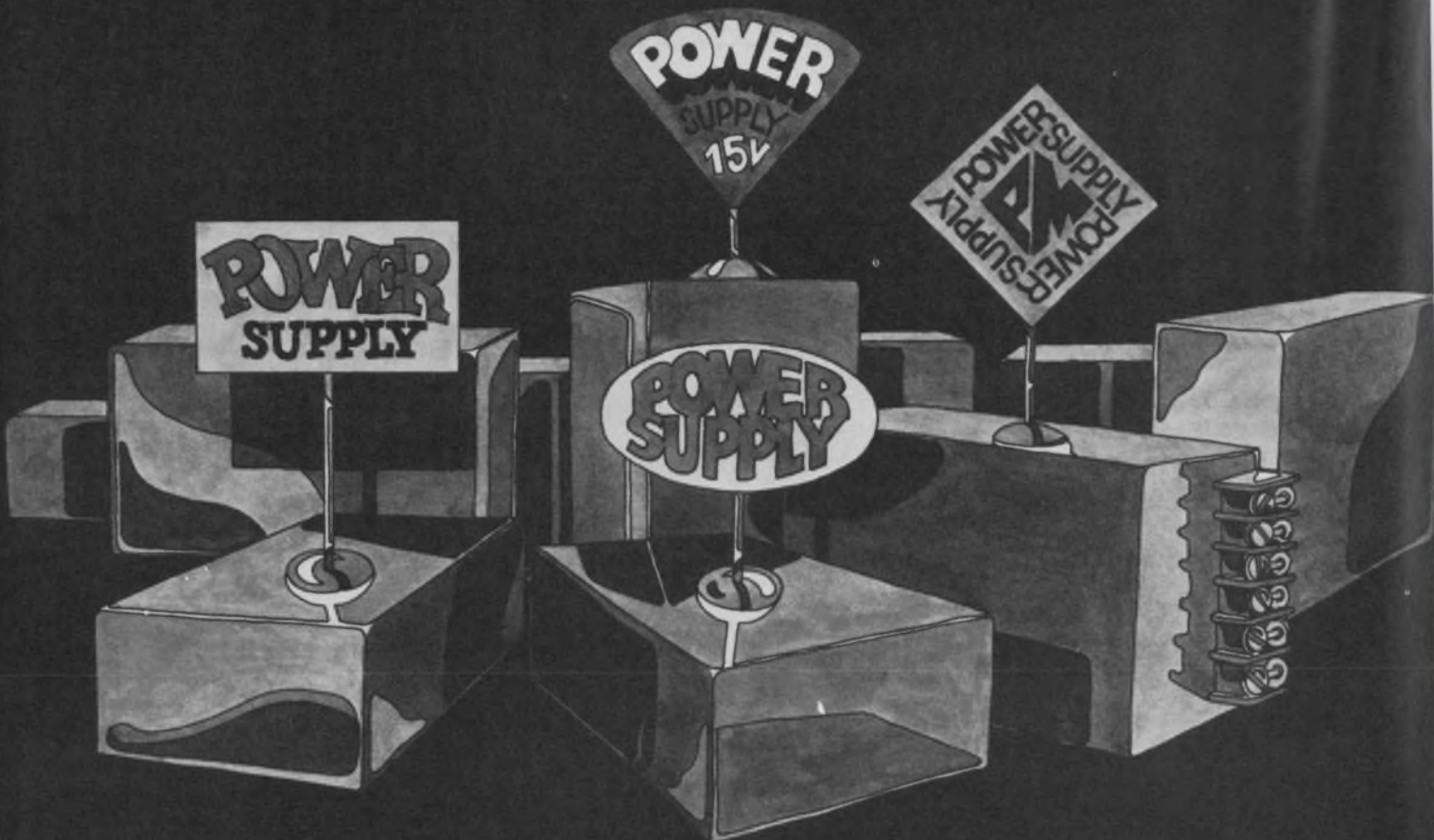

“You see one, you’ve seen them all.”

Some engineers have a funny attitude about power supplies.

That is, until they have to use one.

Then, if it doesn't perform, or if it blows under heavy loads, that attitude changes. Either they think encapsulation is a mistake, or they make their own, or they pay more attention to what power supplies they buy.

Only then do they stop saying power supplies are all alike.

Computer Products' packaged power modules are all alike. But that's as far as the similarity goes.

We triple test every module through production. Our final tests find very few faulty modules. You won't find any. Our return rate is less than 1%.

That's why we confidently offer a TWO YEAR warranty. That's why most encapsulated power supplies in use today are ours. And, our engineering department is always looking for new improvements to make our power supplies even more reliable. Like our high power PM 500 series with the saw cut. A simple saw cut through the metal case that keeps heat away from the vital components in the unit.



So, before you buy theirs, look at ours.
It's good for your attitude.



Computer Products, inc.

1400 NW 70 Street, Fort Lauderdale, Florida 33309. (305) 974-5500 TWX (510) 956-9895

Distributors: Indianapolis 317-899-2890/Dallas 214-341-8311/Los Angeles 213-877-5518
Canada 416-751-2371/Seattle 206-454-9332/Sunnyvale 408-735-9040

INFORMATION RETRIEVAL NUMBER 51

Don't sweat polar to rectangular coordinate conversion. Use a pencil, ruler and compass with this chart for rapid results with two percent accuracy.

Need to convert admittances in rectangular coordinates to impedances in polar coordinates? Why waste time with tedious calculations when a few motions with a pencil, ruler and compass on a chart yield speedy answers with two-percent accuracy. In addition, the SWR (standing-wave-ratio) of a transmission line can be easily found by use of the chart.

Converting rectangular to polar form

Consider the circuit shown in Fig. 1a, with an admittance Y of 20 millimhos $-j44.6$ millimhos. Admittance Y , as shown in (b), is the hypotenuse of the triangle having conductance G as the base and susceptance B as the altitude. To convert this value of rectangular admittance to polar form, merely follow these three steps by use of the chart shown in Fig. 2:

1. Locate point A that corresponds to $G = 20$ millimhos and $B = 44.6$ millimhos.
2. Insert the point of a compass at the origin, and set the other end of the compass at point A. Swing the compass from point A to the intersection of the conductance axis, point B.

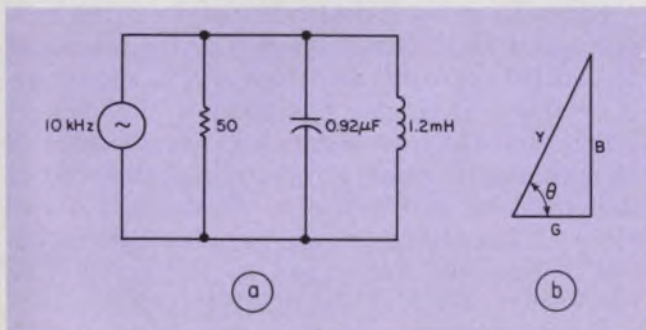

1. A typical parallel circuit (a) is used for the conversion example, $X_c = 17.3 \Omega$, $X_L = 75.4 \Omega$, $R = 50 \Omega$. In millimhos, $B_c = j57.8$, $B_L = -j13.3$, $G = 20$, $B_{\text{eq}} = 44.5$. As shown in (b), admittance Y is the hypotenuse of a triangle having conductance G as the base and susceptance B as the altitude.

3. Take a ruler and draw a line perpendicular to the X-axis from point B until it intersects the impedance scale at point C. The impedance of the network is found to be 20.4Ω .

To find the phase angle, draw a straight line from the origin through point A to the intersection of the graph's outer edge, point D. The phase angle can now be read as slightly greater than 65° or 65.8° . Thus $Z = 20.4 \Omega / 65.8^\circ$.

If the susceptance $(\pm)jB$ is negative, as in the example used, the phase angle will be positive. If the susceptance B is positive in rectangular admittance form, the phase angle is negative. This reversal of sign results because admittance and impedance are reciprocals of each other; when exponents are brought from one side of a fraction bar to the other, their signs change.

Changing polar to rectangular coordinates

When polar coordinates are given and admittance in rectangular form is desired, only three simple steps are required once again. Consider the impedance value of 20.4Ω with a phase angle of 65.8° .

1. From point C (20.4Ω) on the impedance scale, draw a line parallel to the vertical axis until it intersects the X axis at point B.

2. With the compass point at the origin and the other end at point B, draw an arc to intersect the susceptance axis at point E.

3. Using a ruler, draw a straight line from the origin to the graph's outer edge through the point representing the given phase angle of 65.8° (point D). The arc and this straight line intersect at point A, the admittance value in rectangular form. The susceptance and conductance components for point A can be read by referring to the vertical and horizontal axes, respectively.

Finding SWR is a snap

Maximum power transfer from an ac source to a load is achieved when the load impedance matches the characteristic impedance Z_0 of the transmission line connecting the source to the

Vaughn D. Martin, Senior Engineering Writer, ASW Section, Magnavox Co., 1415 Dividend Rd., Fort Wayne, IN 46808.

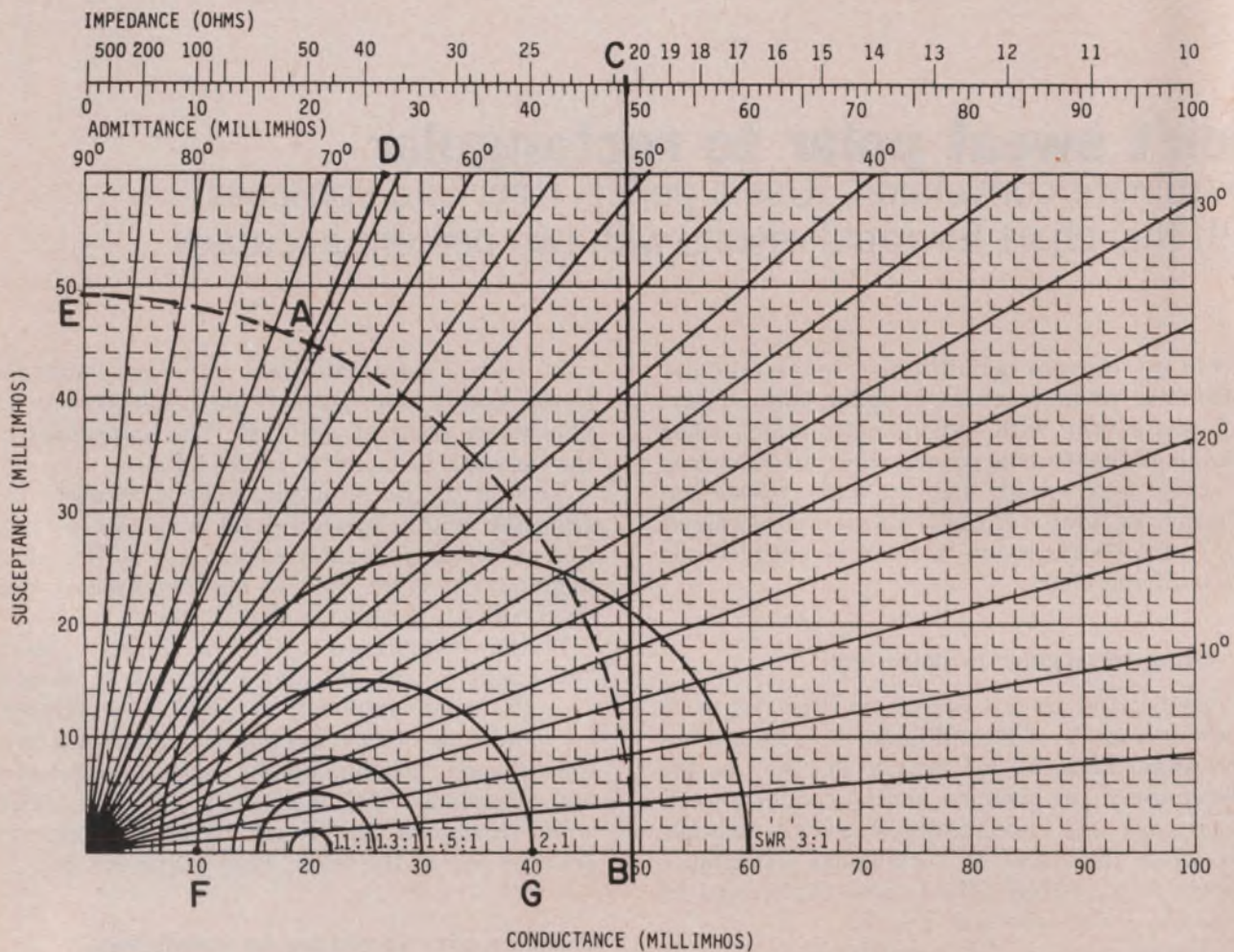

© VAUGHN D. MARTIN, 1974

2. Rectangular to polar coordinate conversion is simple with this chart. SWR is also found conveniently with

$Z_0 = 50 \Omega$, represented by the semicircles extending from the 20-millimho point on the conductance axis.

load. If the load impedance is less than Z_0 , it will resemble a short circuit; if the load impedance is higher than Z_0 , it will resemble an open circuit. The ratio of mismatch is called the standing-wave-ratio (SWR). For example, if $Z_0 = 50 \Omega$ and the load is 25Ω , the mismatch and SWR would be two. If the load is 100Ω , again the mismatch and SWR would be two.

If the SWR is known to be two, is the load greater or smaller than Z_0 ? If the load is less than Z_0 , it resembles a short and a voltage minimum will appear at the load with voltage increasing as measurements are made back to the source. The opposite takes place if the load impedance is greater than Z_0 .

Smith charts are generally used to find SWR, but the chart shown in Fig. 2 offers an alternate approach. The semicircles extending from the 20-millimhos point of origin on the conductance axis are SWR circles for a 50- Ω transmission line.

For a Z_0 of 50Ω and a $100\text{-}\Omega$ load, the mismatch and SWR would be two. The reciprocals of 50 and 100Ω are 20 and 10 millimhos, respectively. Starting from the 20-millimhos conductance origin, find the load resistance's conductance of 10 millimhos at point F, one terminating end of the circle for an SWR of 2. What about a load of 25Ω ? This would be represented by 40-millimhos conductance, and would appear at point G, the other terminating end of SWR = 2.

But loads are not always purely resistive, and here's where the chart is handy. Let's use the previous example's value of 20.4Ω for load impedance, shown at point A in Fig. 2. Put the point of the compass at the graph's origin and the other end of the compass at point A. Strike an arc that cuts the X, or conductance, axis at point B. This point represents an SWR of about 2.5, since it is midway between SWR circles 2 and 3. ■■

Way to go

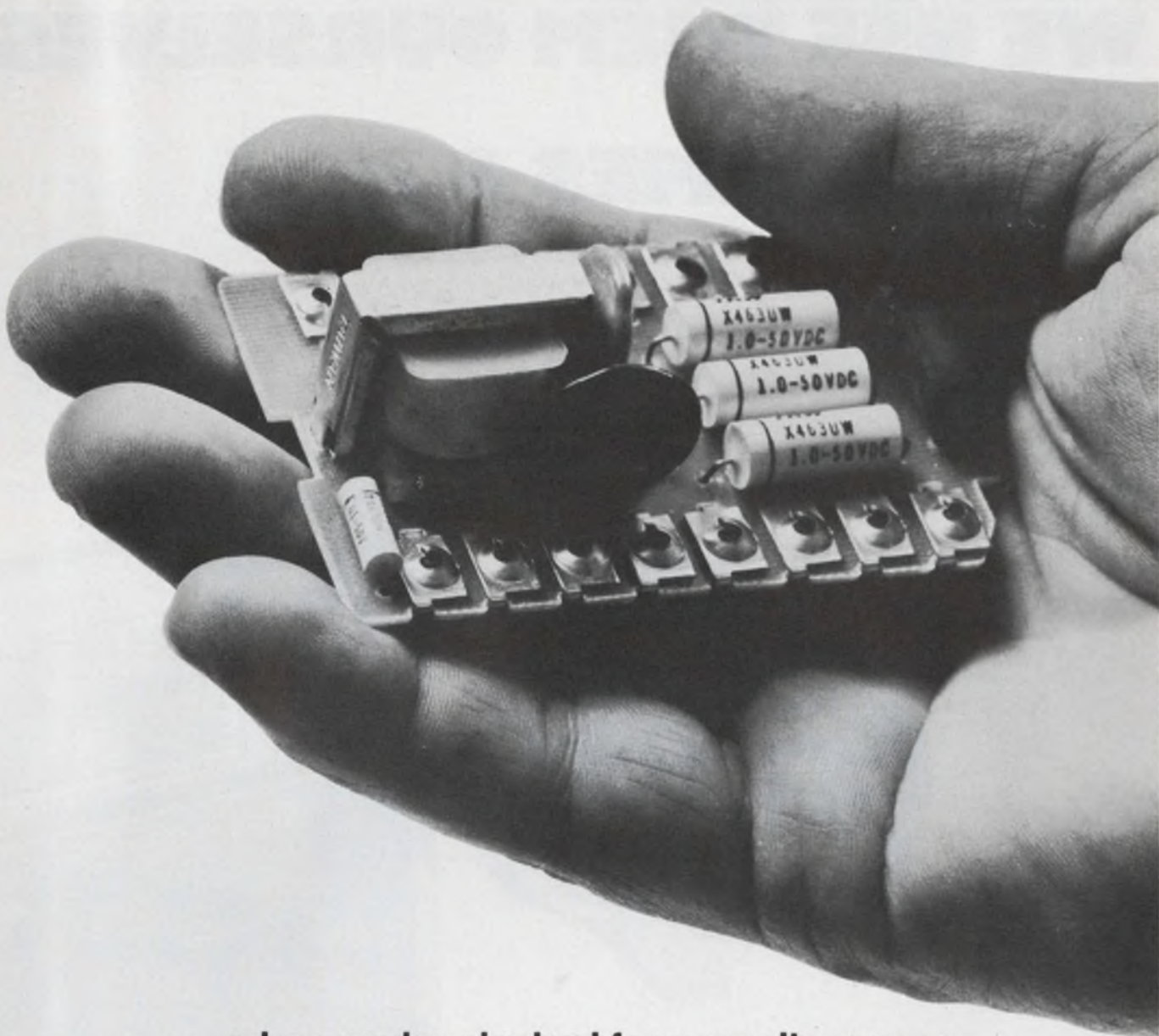

...when you're pinched for capacitor space

Way to go is with TRW X463UW metallized *polycarbonate* subminiatures. These capacitors give you the size and weight savings you expect with a metallized dielectric, *plus* the improved electrical performance of polycarbonate.

For example. Less than 1.5% capacitance change from -55°C through $+125^{\circ}\text{C}$ (with no voltage derating). Dissipation factor of less than 0.3% at $+25^{\circ}\text{C}$ and 1 KHz. IR of 60,000 megohm x mfd minimum at $+25^{\circ}\text{C}$. Stability 2-3 times better than polysulfone in humidity and shelf life tests.

Capacitances from .001 to 10.0 mfd (higher for special applications)—in 50, 100, 200 and 400 vdc. Real "problem solvers," these—for precision circuitry demanding real stability combined with smallest possible size.

Write for catalog or application engineering assistance. TRW Capacitors, an Electronic Components Division of TRW, Inc., Box 1000, Ogallala, Neb. 69153. (308) 284-3611.

TRW CAPACITORS

INFORMATION RETRIEVAL NUMBER 52



**OUR POWER
SEMICONDUCTORS
ARE SO GOOD
WE USE THEM OURSELVES.
20,000 TIMES A DAY.**

That's the rate at which Delco Electronics supplies a variety of products for GM cars.

Under one roof we design and manufacture complete systems, including the power semiconductors that help make those systems work. This can mean a lot to you. Here's why:

We know the requirements and standards that must be met to produce over 20,000 systems a day. We know what it means to deliver on time, to meet our own production schedules. And we know the importance of component quality in assuring reliability of the end product.

Our semiconductor devices are used

in the Delco AM radios, AM/FM radios and stereo tape systems we produce for GM cars. They are also used in the GM High Energy Ignition systems, I.C. voltage regulators, alternators, and in the new combination front seat/shoulder belt interlock systems you find in all the 1975 GM cars.

And all the capabilities that go into Delco semiconductors can work for you, too.

There are select distributors with stock on hand strategically located coast to coast. For the distributor nearest you, phone

your closest Delco Electronic regional sales office: Kokomo, Ind. (317) 459-2175, Van Nuys, Calif. (213) 988-7550, Union, N.J. (201) 687-3770.

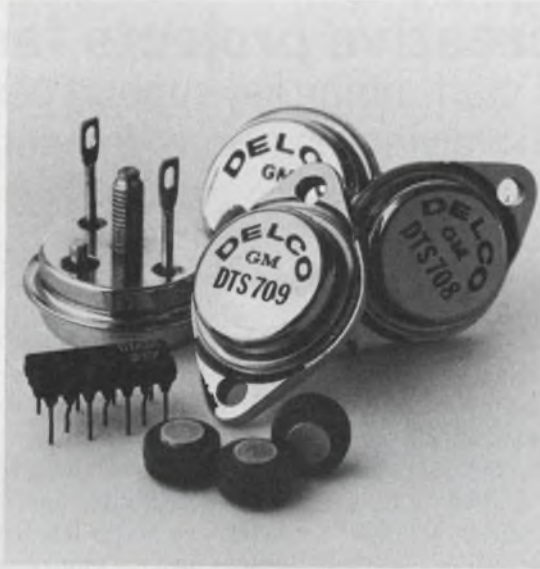

your closest Delco Electronic regional sales office: Kokomo, Ind. (317) 459-2175, Van Nuys, Calif. (213) 988-7550, Union, N.J. (201) 687-3770.

DELCO ELECTRONICS



Help finish big, creative projects fast, by cross-fertilizing your staff, hiring key support personnel before the designers and giving engineers freedom to invent.

You've heard of creative engineering. How about creative managing?

Recently, as a new manager, I had a big project to finish in a short time. I realized that with 40 new semiconductor devices to complete in a year, I couldn't rely exclusively on the standard ways of technical management. In setting up a CMOS design group, I knew I had to be flexible and adaptable and build my management methods on each new situation as it came up. In other words, I had to use creative management to produce creative products.

Armed with the adage, "Not doing more than the average is what keeps the average down," I decided to correct those mistakes that I had experienced as an engineer on past projects. Most of the errors were made in these areas:

- Staffing.
- Coordination.
- Operation.

For creative staffing, cross-fertilize

The most common mistake I think project managers make in design groups is trying to pick up experienced talent in the particular field of the project design. That's a mistake, because the engineers you pick tend to be limited in perspective, leaving little chance for cross-fertilization within the group. Quite often these people just don't have the broad perspective that's needed to generate new ideas. They're used to doing things in a particular way.

So I try to cross-fertilize ideas in the IC design game. I hired a digital systems man, a bipolar linear IC design man, a communications engineer with PC-board experience, a military designer and an R&D engineer. That's quite a hodgepodge, but in retrospect, I've found it to be a very creative group.

IC design is such an art form that when project managers have to get a product out in a hurry, they naturally look for people who have done the job before. This may help to assure

satisfactory productivity, but it will sacrifice creativity. I've found that you can still have a very productive group with inexperienced people in the field, because IC design can be quickly learned when you put a lot of emphasis on well-structured training.

I organized the project so we could learn as we went, hiring engineers who seemed to be the type who could learn fast and from one another. Each design engineer was responsible for designing his own group of ICs.

Whom to hire when

In staffing the group, I tried to avoid another problem that I'd experienced as a past project member—where to put the stress when hiring.

Many managers place all their emphasis on hiring engineers, often to the detriment of the whole department. I put a lot more emphasis than is normal on selecting the leaders of the support personnel—the leader of the drafting group and the leader of the technicians. I had them trained before I completed the hiring of the engineering staff.

In some companies engineers are trained, but they have no support. It's an extremely frustrating situation for the engineer. He ends up doing the work of a draftsman or a technician, because those people aren't trained properly. They were hired late in the cycle, and they have little experience.

But I wanted my support leaders trained in the same philosophy that I wanted to direct the group. I wanted the leaders to establish the mode of operation for their subsequent groups.

One fallout benefit of hiring support people first is that it gives you a larger selection of engineers. You can sometimes hire a good engineer who hasn't had too much experience, knowing that the support groups will be able to help him along until he learns.

I've seen delays in time mount against a project while the manager tries to find that one key engineer who's going to make his project successful. It's better to look for people with basic

Bernard Schmidt, Product Manager, CMOS Special Products, Motorola, Phoenix, AZ 85251.

Bernard H. Schmidt, Jr. and the Motorola Semiconductor Products Division



Since graduating from Pennsylvania State with a BSEE in 1967, Bernie Schmidt has been employed by Motorola, working his way up from engineer trainee to his present position as product manager CMOS Special Products. In the past seven years his career path has included stopovers as design engineer, project engineer, section manager (CMOS standard product design) and manager CMOS Design where he created the largest CMOS standard product line in the industry, a notable feat. From 1967 to 1970 Schmidt also found time to earn a MSEE at Arizona State, where he's presently working toward an MBA.

Versatile, Schmidt has been granted three patents in CMOS technology and he has written half a dozen articles for in-house and trade publications.

His employer, the Motorola Semiconductor Products Division (SPD), opened its first major research and manufacturing facility in 1950, in Phoenix, Arizona, its present home. In 1955 the Division opened the 52nd Street research and manufacturing facilities, one of the largest in the industry. SPD is now regarded as a leading supplier of both discrete and integrated circuit devices.

In its relatively short history, Motorola Semiconductor Products Inc., has tallied a number of industry achievements: it introduced the industry's first silicon and germanium epitaxial transistors; the first commercial Mesa transistor; the TO-3 diamond package; and the first rectifier specifically for automotive alternators. Motorola has contributed significantly to the development of linear as well as digital integrated circuit, i.e. Emitter Coupled Logic had its main thrust here.

engineering ability and count on the training function and experience on the job to make them productive.

Just remember that often you can get the job done with less experienced people than you think you need.

Don't be a 'do-it-yourself' hero

Good timing, coordination and organization are the result of good communications. If anything, over-communicate, so everyone is pulling together.

I've found, on a crash program, that there's too much time spent just trying to communicate

in an unorganized manner. Make effective use of the monthly summary memo; document your work and keep everyone informed. Be sensitive to requests for information; use them as feedback to improve your communication system.

Some managers try to do the entire job themselves, failing to realize that they're successful if they do their own job well. There's no need for the manager to duplicate his staff's work. If he brings them together in one major team effort, he's got it made.

Other managers try to do everything in their own department, with the result that when they come out with the product, the other groups who have to make it or service it or sell it don't even

know what it is.

There are obvious advantages in communicating whatever you're doing to all the others involved outside your department. I set up an elaborate system of documentation—monthly summary reports and design reports. Each step in the design cycle had some sort of documentation, but not necessarily written reports by the engineer doing the project; it may have been just a monthly status schedule.

If you don't keep everyone informed, you will spend a lot of time answering inquiries from these outside people about problems and schedules that they should have been told about.

Because it was a crash effort, I was under very close top-management scrutiny. But as I look back on it, I felt independent of that pressure. Why? Because in keeping all of the corporate teams together—marketing, applications, field sales people, production, everyone in the loop—I felt that the project was under control.

I used a total team approach, with interdisciplinary group meetings and thorough interdepartmental documentation.

Producing patentable ideas for products

If left alone, an engineer will spend a lot of time doing things that someone else has already done. Establish the policy that the engineer can-

not proceed with the design until he has an analysis of his competition and has had a thorough marketing applications review and agreement. Knowing this allows him to work on new things.

Knowledge of production costs will also give the whole group a perspective of where it is at and where its technology is. It allows the group to proceed from there to a higher level, and it keeps the members from spending their time on things that may already have been done.

The manager must constantly reinforce the creative urge of his engineers. When there's a creative challenge, I've found that you can manage the project better by actually scheduling inventions. Ask your staff to come up with a number of patentable ideas. It's very difficult to program invention, but it does force the engineer to look over whatever he's done to consider whether it's patentable or whether it's to follow up on an idea that he hasn't fully developed.

We ask each engineer twice a year to present a patentable idea. In looking back over their prior work and in thinking about it, most come up with new ways of using what they've done, and they rework it into a product. There were five patent disclosures in one year that came out of the CMOS design group, and they ended up in products that helped us scoop the competition. ■■

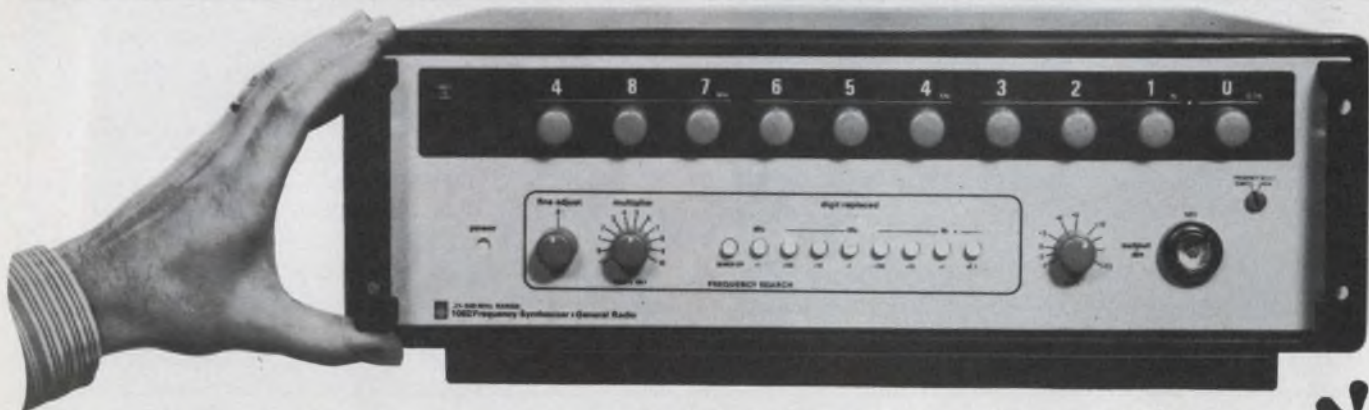

5 BILLION FREQUENCIES*

*Almost — General Radio's new 1062 Frequency Synthesizer can actually deliver 4,999,900,000 different frequencies. . . .

over a broad range of 10 kHz to 500 MHz
in steps as small as 0.1 Hz, remotely programmable

with the purity of a high-quality crystal oscillator
(spurs > -80 dB, phase noise > -60 dB, stability to $< 1 \times 10^{-9}$ per day)

at the speed needed for flicker-free digital sweep displays
($< 100 \mu\text{s}$ per step or about 10 times faster than comparable synthesizers)

and the capability for the toughest applications —
fully programmable output from 100 mV to 1V rms

into 50 Ω , programmable search-sweep, am, fm and pm standard, only 5 1/4-inch panel height

Write or call for applications assistance to:



General Radio

300 BAKER AVENUE, CONCORD, MASSACHUSETTS 01742

NEW YORK (N.Y.) 212 964-2722, (N.J.) 201 791-8990 • BOSTON 617 646-0550 • DAYTON 513 294-1500
CHICAGO 312 992-0800 • WASHINGTON, D. C. 301 948-7071 • ATLANTA 404 394-5380
DALLAS 214 234-3357 • LOS ANGELES 714 540-9830 • SAN FRANCISCO 415 948-8233
TORONTO 416 252-3395 • ZÜRICH (01) 55 24 20

GR COMPANIES • Grason-Stadler • Time, Data • Techware Computing Co.

1K/4K PROGRAMMABLE RAM TESTER FOR UNDER \$10,000!

**Now! For a limited time only--through
November 30, 1974.**

**This turnkey
Production/
Engineering System
at a special low price
which includes:**

- The MD-100 Microprogrammable Pattern Generator
- One Personality Card for any commercial 1K or 4K RAM (See lists)
- A Device Test Program including worst-case test patterns and multiple voltage iterations

1K MOS RAM's

- INTEL 1103, 1103-1, 1103A, 2102, 2105 • MOSTEK 4006, 4008, 4009, 6028, 6029 • AMS 6002, 7001
• EA 1500, 1501 • INTERSIL 7552
• NATIONAL 1103 • AMI 2103, 2102
• SIGNETICS 1103 • AMD 2102
• And Others



**Macrodata's MD-100
is the world-wide
standard for memory
testing. Over 350 in
use throughout the
world.**

Additional MD-100 System Features:

- Operation by unskilled operators
- Expandability for testing ROM's, PROM's, Shift Registers, UAR/T's
- Expandability for testing RAM cards, up to 65K x 16

4K MOS RAM's

- TI TMS 4030 • MOTOROLA 6605
• MOSTEK MK4096 • INTEL 2107, 2107A, 2107B • AMI S6103 • MIL 7112 • And Others



Fill out this coupon and mail it immediately, or call us on one of these MD-100 Hot Lines — East Coast — (516) 543-8600; Midwest — (312) 297-8746; Northern California — (408) 735-9560; Southern California — (213) 887-5550; Munich, Germany — (0811) 34 56 00; Tokyo, Japan — (03) 985-5266. There is a full 90-day warranty on all hardware.



Macrodata Corporation, 6203 Variel Avenue, Woodland Hills, Ca. 91364, Phone: (213) 887-5550, Telex: 65-1345

MACRODATA

Name _____ Title _____

- I'm ready to buy. Bring one out.
 Please reserve a Model MD-100 for me at the sale price until you bring one out to demonstrate.
 I need more information. Send a brochure.

Company _____

Address _____ Phone _____

City _____ State _____ Zip _____

LOOKING FOR RESISTORS OR CAPACITORS?

ERIE

TRW CAPACITORS

MALLORY

**E. F. JOHNSON
COMPANY**

JFD



CUSTOM



**AVX
FUJITSU LIMITED**

**UNITED
CHEMI-CON**

**NIPPON
CHEMI-CON**

**UNION
CARBIDE**

SPRAGUE

GENERAL ELECTRIC



CENTRALAB

MRE

**CORNING
ELECTRONICS**

LOOK FIRST IN Electronic Design's GOLD BOOK

IT'S ALL THERE Under CAPACITORS, for example, you'll find source information listed in the following categories in the PRODUCT DIRECTORY (each listing gives *complete* manufacturer's name, street address, city, state, zip and phone for your convenience in contacting suppliers): • CHIP CAPACITORS • FIXED CAPACITORS — AC&AC MOTOR; AIR; CERAMIC; CERAMIC CHIP, CERAMIC TEMPERATURE COMPENSATED; ELECTROLYTIC — ALUMINUM, (TANTALUM FOIL, SOLID, & WET-SLUG); FEEDTHROUGH; FILM, TEMPERATURE COMPENSATED; GAS FILLED; GLASS; HIGH TEMPERATURE; LABORATORY STANDARD; METALIZED PAPER; MICA; MICA PAPER; OIL-FILLED; PAPER; POLYCARBONATE; POLYESTER; POLYPROPYLENE; POLYSTYRENE; PRECISION; TFE; HIGH ENERGY • VARIABLE CAPACITORS — AIR, (INCLUDES TRIMMER); CERAMIC; FILM; GAS; GLASS OR QUARTZ TRIMMER; HIGH TEMPERATURE; LAB TYPE; MICA; MOTOR-DRIVEN; TEMPERATURE COMPENSATED, AND VACUUM.

YOU'LL FIND 235 CATALOG PAGES ON RESISTORS AND CAPACITORS

Volume 2 of *Electronic Design's* GOLD BOOK provides page after page of catalog information and specs for resistors and capacitors. Twenty-five capacitor manufacturers are represented, including 24 pages from Sprague, 20 pages from Corning, 12 pages from USCC Centralab and so on. Twenty-three manufacturers are represented for fixed or variable resistors. Scan these pages before you contact a supplier. You can nearly always save valuable time, perhaps locate the exact item you need — and that goes for each one of the 52 product categories cataloged in two full volumes of *Electronic Design's* GOLD BOOK. These pages are **READY WHEN YOU ARE**, 2,820 of them, right at your fingertips for immediate reference.



REMIND YOUR ADVERTISING MANAGER

If your company has catalog pages in *Electronic Design's* GOLD BOOK, don't forget that 91,000 copies are in circulation with 13,200 overseas (11,000 in Europe). Your advertising manager should refer engineers to your pages at every opportunity, especially in current advertising campaigns.

ideas for design

Peak detector provides both the amplitude and a peak-event timing pulse

The analog peak detector in Fig. 1 can analyze transient or repetitive waveforms. The circuit measures a signal's peak amplitude during a selectable time period and also provides a logic-level output that coincides with the detection of each new peak (Fig. 2). Input signals with slew rates to $4 \text{ V}/\mu\text{s}$ are accurately handled.

Though the circuit resembles a classical two-amplifier peak detector, it differs in that the first circuit element, IC₁, is a high-speed differential voltage comparator with an internal logic strobe. The logic state of the output of the comparator depends on the sign of the difference of the comparator's two inputs and on the status of the strobe.

If the amplitude of the analog input signal is greater than that of the output of op-amp IC₂, the output of IC₁ switches to a logic HIGH (+3 V), when the peak-enable line is HIGH. The IC₁ HIGH output charges capacitor C₁ through diode CR, and a 100- Ω resistor until the output

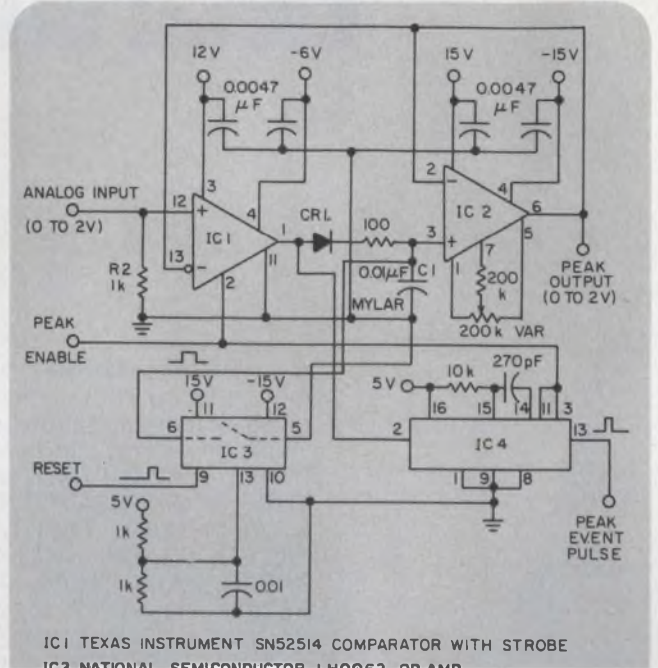

POWER FOR YOUR IC'S OR OP AMPS

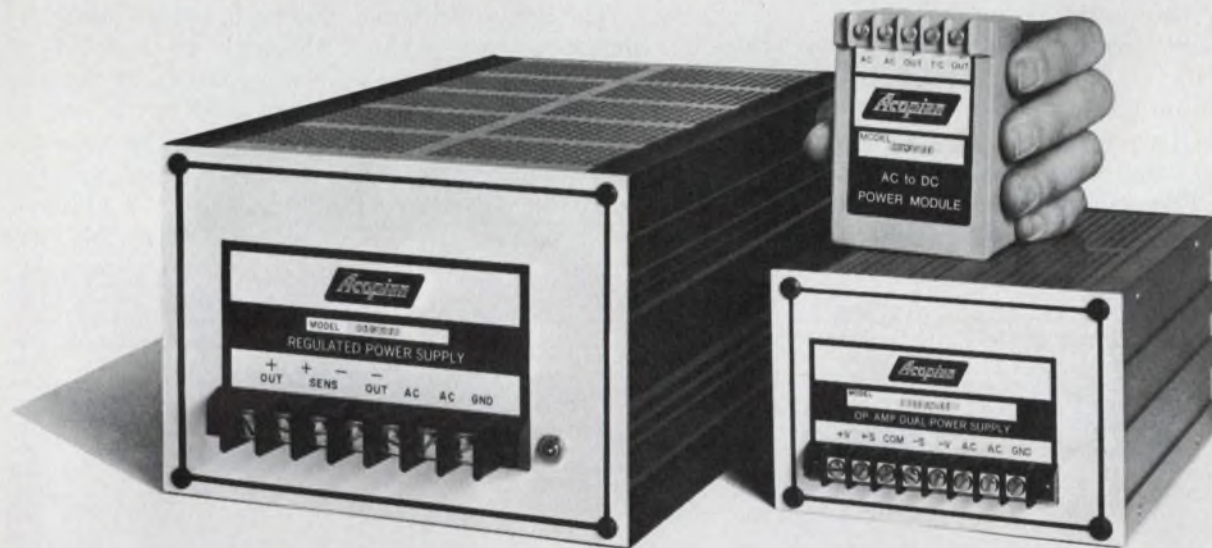

ALL MODELS U.L. RECOGNIZED

5 VOLTS

OUTPUT CURRENT AMPS	SIZE INCHES	PRICE	MODEL
.5	3.5 x 2.5 x 1.4	\$55	5EB50
1.0	3.5 x 2.5 x 1.6	75	5EB100
2.0	3.5 x 2.5 x 2.4	115	5EB200
2.5	3.5 x 2.5 x 2.4	130	5EB250
5.1	3.4 x 5.1 x 6.6	150	A5MT510
9.0	3.4 x 5.1 x 9.3	180	A5MT900
12.0	3.4 x 5.1 x 13.3	200	A5MT1200
22.0	5.1 x 7.4 x 11.3	270	A5HT2200
32.0	5.1 x 7.4 x 16.0	320	A5HT3200

±15 VOLTS

OUTPUT CURRENT AMPS	SIZE INCHES	PRICE	MODEL
.1	3.5 x 2.5 x 1.4	\$55	DB15-10
.15	3.5 x 2.5 x 1.4	65	DB15-15
.2	3.5 x 2.5 x 1.4	75	DB15-20
.4	3.4 x 5.1 x 5.1	85	TD15-40
1.0	3.4 x 5.1 x 5.1	125	TD15-100
1.6	3.4 x 5.1 x 6.6	150	TD15-160
2.5	3.4 x 5.1 x 9.3	160	TD15-250
4.5	3.4 x 5.1 x 13.3	225	TD15-450
8.5	5.1 x 7.4 x 11.3	299	TD15-850

Line/Load Regulation: $\pm 1.1\%$ or better; Ripple: 1.5 mv or less; Input: 105-125 VAC

Three day shipment guaranteed. Complete details on these plus a comprehensive line of other power supplies and systems are included in the Acopian 73-74 catalog. Request a copy.



Corp., Easton, Pa. 18042. Telephone: (215) 258-5441.

INFORMATION RETRIEVAL NUMBER 56

Generate a PSK modulated wave with an all-digital circuit

Only a few CMOS digital ICs are needed to produce a differentially coherent, four-phase, phase-shift-keying (PSK) modulator. The circuit accepts synchronous data, 2 bits at a time (di-bit), and it needs a data clock that runs at the di-bit data frequency and a counter clock at 16 times the carrier frequency. The phase of the output is shifted either 0, 90, 180, or 270 degrees relative to the phase of the previous di-bit signal interval as a function of the input di-bit.

The carrier waveform is synthesized by the sequential scanning of a resistor network that is sinusoidally weighted. Two CD4051 analog multiplexers do the scanning. One multiplexer provides the positive and the other the negative portions of the output.

The multiplexers sequence through their states at a rate of 16 times the carrier frequency. A 74C163 counter, which runs at the 16-times rate between positive edges of the data clock, counts in modulo 16 and addresses the multiplexers sequentially. The weighted resistors produce a step

approximation of a sine wave at the multiplexer circuit's output.

A di-bit (2-bits) is sampled at each positive edge of the data clock. These bits feed into the CD4008 adder to form an index number (see table) whose value corresponds to one of the phase changes. And the index number is added to the existent state of the counter via the adder. The result of the addition presets the counter at the next positive edge of the counter clock. The presetting action causes the phase of the output signal to shift 0, 90, 180 or 270 degrees in accordance with the value of the added index number.

The steps in the output signal can be removed with a low-pass filter.

The same technique can be extended easily to generate eight-phase PSK with an input of 3 bits at a time. However, the resolution of the output waveform should be increased by the use of additional weighted resistors and multiplexers.

John R. Tracy, Litton Systems, Data Systems Div., 8000 Woodley Ave., Van Nuys, CA 91409.

CIRCLE No. 312

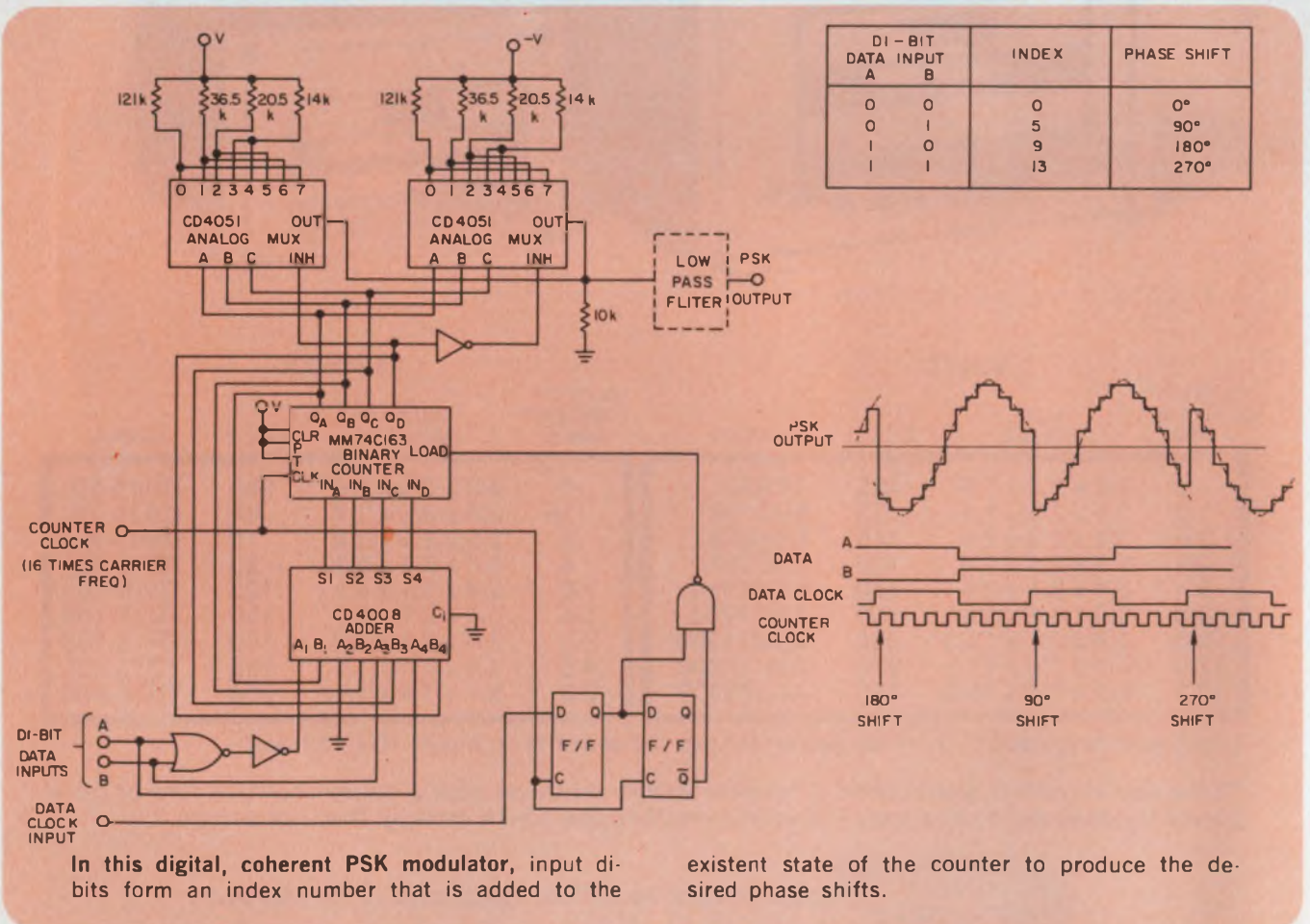

Topaz Ultra-Isolation Transformers will solve your power line noise problems. We guarantee it.



Pete Jorgensen, Magnetics Production Manager at Topaz, was asked recently why the performance of Topaz Ultra-Isolation Transformers is so exceptional. He answered by saying, "Because we have people who have been winding and shielding transformers for 10 years, and they do it unusually well."

Topaz Ultra-Isolation Transformers protect electronic equipment from noisy power lines and protect clean power lines from noise-generating equipment. The unique Topaz box shielding techniques and the meticulous care taken during manufacturing guarantee the effectiveness of Topaz transformers.

Common-mode noise is attenuated by more than 1,000,000 to 1. Effective capacitance between windings is less than 0.0005 picofarads.

So if power line noise is your problem, write or phone. We'll prove that Topaz Ultra-Isolation Transformers will solve your problem. We guarantee it — or your money back.

Or your money back.



Other Products • Uninterruptible Power Systems • Inverters • Frequency Changers • AC Line Regulators

Topaz is also a major supplier of **custom** power conversion equipment. Contact us.

TOPAZ

ELECTRONICS 3855 Ruffin Road, San Diego, California 92123 • Phone: (714) 279-0831. TWX (910) 335-1526

Build a general-purpose power supply with built-in temperature protection

A constant-voltage/constant-current power supply, suitable for laboratory or general use, can be built with discrete transistors only in the series-pass circuit; the control circuit uses standard ICs. And a special-purpose temperature-sensing IC, an LX5600, protects the whole unit. The circuit provides up to 25 V at a maximum of 10 A. Both the output voltage and current are adjustable down to zero. Voltage and current regulation is better than 0.01%.

Seven monolithic LM395 transistors are the pass elements. They each act as a 2-A current and thermally limited, high-gain power transistor with complete overload protection. Only 10 μ A is needed to drive the base of a pass element. Thus the need for external biasing and protection circuitry is eliminated. In addition, only two control op amps are needed, one for voltage control and the other for current control.

In constant-voltage operation, a reference voltage is fed from the LX5600 temperature-transducer IC via potentiometer R_1 through a high-frequency filter into the noninverting input of the LM308 op amp. The output of the LM308 drives the seven paralleled LM395s as

by the ratio of R_{10} to R_7 . A separate LM395 is driven from the negative power supply lead (pin 4) of the LM308 to provide a 2-A output-current sink capability, so the supply can be quickly programmed even with large capacitive loads. Switch S_1 can introduce an output capacitor to reduce the output impedance when the supply is in the constant-current mode. Capacitors C_3 and C_1 provide frequency compensation. Resistor R_{11} , capacitors C_5 and C_6 , and network R_{15} and C_9 suppress high-frequency oscillations.

When the circuit is used in the constant-current mode, the LM101A overcomes the constant voltage loop to control the output. Output current is sensed in R_8 and compared with the voltage between V^+ and the arm of R_2 . Resistor R_2 is connected across an LM113 low-voltage reference diode to provide 0-to-1.2-V reference for 0-to-12-A output.

When the output current is below the set level, the LM101A output is positive and reverse biases D_3 . In this condition the LM308 controls the output. However, when the current increases to the control point, the output of the LM101A swings negative and passes through D_3 to limit

There's nothing new about a 2N3055 but there's a **powerful** difference in this one.

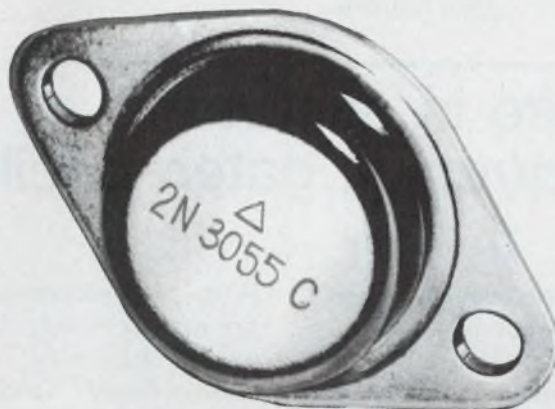

**That's why we call ours the 2N3055C*
*“C” designates it as the Cadillac of power transistors.**

Compare the specs below and see at a glance why Sensitron's upgraded version of the workhorse 2N3055 . . . the 2N3055C . . . is your best bet for a wide range of power transistor applications.

Parameter	Conventional 2N3055	RSM Sensitron “Cadillac” 2N3055C
Chip size	140-175 mil ²	210 mil ²
P _D	115 W @ 25°C case temp.	150 W @ 25°C case temp.
I _{Cmax}	15 A	30 A
BV _{EBO}	7V	10V
BV _{CEO}	60 V	120 V
BV _{CER}	70 V	130 V
I _{CEX}	@ 100 V < 5 mA	@ 120 V < 1 mA
h _{FE}	20 @ 4 A	25 @ 4 A
h _{FE}	5 @ 10 A	10 @ 8 A
V _{CE (sat)}	1.1 V @ 4 A	0.75 V @ 4 A
V _{CE (sat)}	8.0 V @ 10 A	3.0 V @ 10 A
SOAR	60 V @ 1.9 A	70 V @ 2.15 A

Write or call for more information or applications assistance on the 2N3055C and other RSM Sensitron single diffused power transistors.

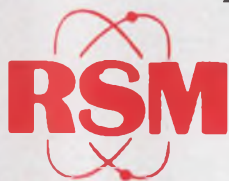

Sensitron Semiconductor

A DIVISION OF RSM ELECTRON POWER, INC.
221 West Industry Court • Deer Park, N.Y. 11729
Telephone 516-586-7600 • Telex 96-7737

INFORMATION RETRIEVAL NUMBER 58

equal to the positive supply. Diode D_2 clamps the output of the LM101A when it is not regulating and decreases the time required to switch from voltage to current operation.

Though the power transistors protect themselves against thermal overload, excessive temperatures can still damage other components in the supply. A special LX5600 temperature-transducer IC, in addition to supplying the voltage reference, protects the entire supply against overheating. Divider resistors R_{16} and R_{17} set the limit points at 100 C and if the supply's temper-

ature exceeds this level, the LX5600 output saturates the LM101A current-control amplifier and turns off the power. The temperature-transducer's output can change state with less than 0.1 C change in temperature.

All LM395s should be mounted on the same heat sink to ensure good current sharing. A large heat sink is necessary, since 300 W is dissipated under worst-case conditions.

Robert C. Dobkin, National Semiconductor, 2900 Semiconductor Dr., Santa Clara, CA 95051.

CIRCLE NO. 313

A full first pulse is assured in variable-frequency, gated oscillator

An improved gated, variable-frequency oscillator circuit uses the delay inherent in a gate to provide a full first pulse. The circuit allows a TTL level to gate strings of pulses that have a preadjusted repetition frequency. With several circuits, each operating at a different frequency, you can synchronize various parts of your logic system with one gating signal. The pulse widths remain the same throughout the range of frequency adjustments.

With power-on and the circuit reset, the pin-1 outputs of one-shots OS_1 and OS_2 are HIGH and the line labelled "prime" is LOW. When this priming signal goes HIGH, the oscillator circuit's output goes HIGH and stays HIGH until the output of OS_1 goes LOW.

The 74H11 between the priming signal and input to OS_1 , delays triggering of the one-shot and assures that the first oscillator pulse is full width. The timing of the one-shots determines the time between the oscillator output pulses.

With the components shown, the pulse widths are approximately 45 ns and the maximum frequency attainable is about 14 MHz. The pulse widths depend upon the delays in the one-shots and 7404 inverters that couple the one-shot inputs.

The duration of the LOW output OS_1 , depends on the time constant, R_1C_1 . When the output of OS_1 goes HIGH again, the oscillator output goes HIGH and OS_2 fires after an inverter delay. When one-shot OS_2 resets, it retriggers OS_1 after a delay through the 7404, and the one-shot cycle repeats. The LOW time of OS_2 depends on R_1C_2 . Oscillations are sustained as long as the priming signal level is HIGH.

Potentiometer R_1 controls the frequency of the output pulses. It can be set so that the last pulse is not sliced by the drop of the prime level.

C. Karabatsos, International Business Machines Corp., Kingston, NY 12401.

CIRCLE NO. 314

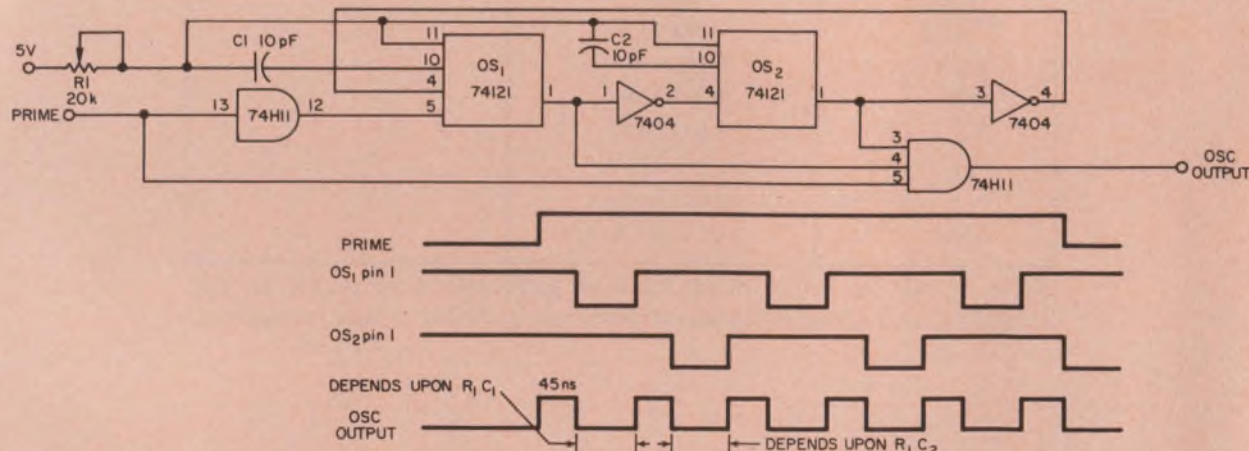

In this variable-frequency, gated oscillator, control-resistor R_1 sets the frequency and adjusts for

generation of a full last pulse. A maximum frequency of about 14 MHz can be attained.

IF WE CAN'T MAKE YOUR MINICOMPUTER SYSTEM DO MORE WORK FOR LESS MONEY, NOBODY CAN.

When we introduced the SPC-16, we promised it would be the world's most powerful, versatile, cost-effective family of minicomputers.

It was. It still is.

The SPC-16 isn't the lowest priced hardware you can buy. But it will give you the lowest cost solution.

Through advanced systems architecture, simplified interfacing and a powerful instruction repertoire, the SPC-16 allows you to minimize programming, interfacing and memory costs no matter what size your system is.

Six mighty minis.

The SPC-16 family consists of six minicomputers offering a choice of three memory cycle times (800ns, 960ns and 1440ns), memory expansion to 128K using efficient 16K boards, and two different packaging configurations.

If you build a system around the SPC-16, it will do more work for less money than any other system you could build.

And that translates into more profits.

We know it for a fact. In the past few years, we helped a lot of OEMs get the edge on their competition by designing our product into their products. We helped a lot of end users solve a lot of tough, tight-budget applications. And, we produced some cost-effective systems of our own.

Two hard working systems.

Take RTOS II for example. It's a multi-programming system offering real-time event driven foreground processing concurrent with background job development and computation.

You couldn't buy a better price/performance solution for applications such as process control, data acquisition, laboratory research, material handling, communications or overall manufacturing automation.

We also built a powerful disk-based general purpose system around the SPC-16. DBOS II lets you do more computation with less memory, in far less time, at a lower price than any system on the market. It offers both scientific and commercial languages and a combination of interactive and batch operation.

This system is perfect for service centers, research and development groups and system house dedicated applications.

That's the short form.

To really appreciate how much power we can deliver for your money, write for our book "The Value of Power." It will give

you the facts to back up our claim: If General Automation can't make your system do more work for less money, nobody can.

Write General Automation, 1055 South East Street, Anaheim, California 92805. Or call (714) 778-4800. In Europe, write General Automation, S.A., 24 rue du Sergent Bauchat, 75012 Paris, France. Telephone (1) 346/7973. In Canada, write G.A. Computer Ltd., 880 Lady Ellen Place, Ottawa K1Z5L9, Ontario. Telephone (613) 725-3626.

POWERFUL MINICOMPUTERS BY GENERAL AUTOMATION

INFORMATION RETRIEVAL NUMBER 59

IC timer, stabilized by crystal, can provide subharmonic frequencies

A simple circuit change converts the 555 IC timer from an RC to a stable crystal-controlled oscillator.

The figure shows the timer with component values for operation with a 100-kHz crystal. The crystal is placed between the external RC series circuit and the IC's comparator terminals. The charge/discharge paths for C remain the same as before, but the control signal to the comparators is now through the crystal. This forces the circuit to oscillate at the crystal frequency or one of its subharmonics.

The values of R and C are selected so that with the crystal shorted out oscillation will still be in the vicinity of the crystal frequency— $f \approx 1.46/RC$. But the R and C values can vary by 25% or more without the crystal oscillator's frequency being affected. However, the charge/discharge amplitude of C changes to accommodate the selected R and C values. This action keeps the frequency constant.

If you double the RC time constant, the oscillations shift to half the crystal frequency. Other changes produce corresponding subharmonics— $1/3$, $1/4$, $1/5$, etc.—of the crystal frequency.

The trimmer capacitor across the crystal allows precise but small adjustment of the frequency. And the resistor across the crystal provides a dc path for the comparator inputs to ensure that the oscillator will start when dc power is first applied.

Jack Althouse, Palomar Engineers, P. O. Box 455, Escondido, CA 92025. CIRCLE NO. 315

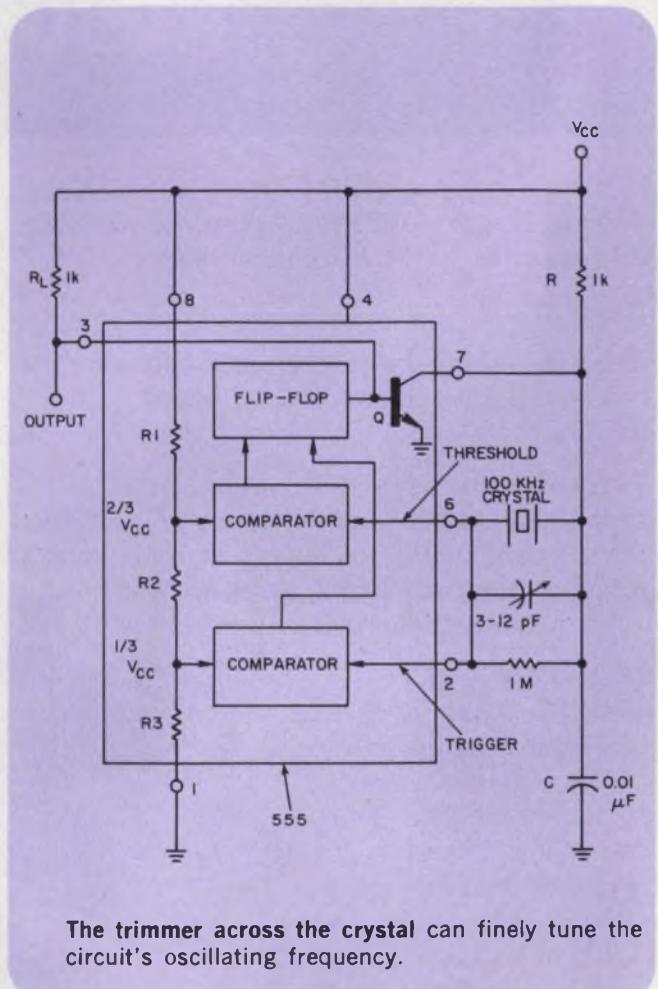

The trimmer across the crystal can finely tune the circuit's oscillating frequency.

IFD Winner of July 5, 1974

B.D. Wallace, Instrumentation Program, University of California, Santa Barbara, CA 93106. His idea "Low Power at Ohmmeter's Probes Allows Safe Usage on Most Sensitive Components" has been voted the Most Valuable of Issue Award.

Vote for the Best Idea in this issue by circling the number of your selection on the Information Retrieval Card at the back of this issue.

SEND US YOUR IDEAS FOR DESIGN. You may win a grand total of \$1050 (cash)! Here's how. Submit your IFD describing a new or important circuit or design technique, the clever use of a new component or test equipment, packaging tips, cost-saving ideas to our Ideas for Design editor. Ideas can only be considered for publication if they are submitted exclusively to ELECTRONIC DESIGN. You will receive \$20 for each published idea, \$30 more if it is voted best of issue by our readers. The best-of-issue winners become eligible for the Idea of the Year award of \$1000.

ELECTRONIC DESIGN cannot assume responsibility for circuits shown nor represent freedom from patent infringement.

SIEMENS

Dickson has a big new name: Siemens

Dickson Electronics Corporation has merged with Siemens Corporation as the Siemens Components Group. This means that Dickson Zener diodes, TC Zeners, tantalum capacitors and Dickson microelectronic products will now carry the Siemens brand, along with such quality products as Siemens capacitors, diodes, ferrites, flash tubes, surge voltage protectors, relays, switches, electro-optic products, microwave components and other semiconductors. Headquartered in Scottsdale, Arizona, the Components Group will provide local service through an existing organization of Group sales offices, representatives and stocking distributors.

For the phone number of your Siemens Components Group sales office, PHONE TOLL FREE 800-645-9200 (in New York call collect 516-294-0990).

Call us, today, But call us Siemens.

Siemens Corporation
Components Group

P.O. Box 1390, Scottsdale, Arizona 85252
(602) 947-2231 TWX 910-950-1292 Telex 667-406

INFORMATION RETRIEVAL NUMBER 60

Electronic Design's GOLD BOOK IS READY



VOLUME 1 DIRECTORIES

• PRODUCT DIRECTORY

Want to know who makes a given product? *Electronic Design's* GOLD BOOK is the first place to look. Manufacturers are listed under almost 5,000 product headings or cross references. You'll find everything an electronics manufacturer would require — components, computers, hardware, test equipment, instrumentation, systems and services — they're all there, from "Abrasives" through "Zone Boxes."

Knowing only a name or state isn't much help if you or your secretary want to contact several manufacturers at once for information or a quote. That's why *Electronic Design's* GOLD BOOK repeats each manufacturer's full name, street address, city, state, zip and phone number every time the manufacturer is listed.

• MANUFACTURERS DIRECTORY

You'll find 7,528 manufacturers listed in *Electronic Design's* GOLD BOOK — more than twice the number contained in "the other industry directory." In addition to complete address and phone number, whenever provided by the company you'll also find:

TWX

TELEX

CABLE ADDRESS

FACSIMILE EQUIPMENT
(make and call number)

800 (TOLL-FREE) NUMBER

QPL DESIGNATION

FEDERAL STOCK CODE NUMBER

NUMBER OF EMPLOYEES

NUMBER OF ENGINEERS

DOLLAR VOLUME

KEY OFFICIALS

SALES OFFICES

FOREIGN OFFICES

U.S. AND FOREIGN REPS

U.S. DISTRIBUTORS

• DIRECTORIES OF DISTRIBUTORS

Want to find a distributor near your town? Use the geographic Directory of Distributors. Access is by State, then City. 5,700 distributors are listed. The same distributors are also listed alphabetically for your convenience, often with additional information about their business volume, key personnel, etc.

• TRADE NAME DIRECTORY

If you've heard the trade name, but can't remember who makes it, here's the place to look. Over 4,600 industry trade names are included. Listing includes brief description of item and company name.

**TOTAL DISTRIBUTION: 91,000 — 13,200 COPIES OVERSEAS,
INCLUDING 11,000 COPIES IN EUROPE**

WHEN YOU ARE



VOLUMES 2 & 3 CATALOGS

- 520 CATALOG PAGES ON ICs AND SEMICONDUCTORS
 - 300 CATALOG PAGES ON INSTRUMENTS
 - 290 CATALOG PAGES ON POWER SUPPLIES
- 210 CATALOG PAGES ON WIRE AND CONNECTOR PRODUCTS
 - 150 CATALOG PAGES ON SWITCHES

Volumes 2 and 3 of *Electronic Design's* GOLD BOOK are filled with manufacturers' technical data and product catalogs — a gold mine of information for the engineers, engineering and purchasing managers of this industry. Products are classified by related families and are organized in 52 product categories, over 2,800 catalog pages in all.

Volume 2 contains *Components and Materials*; Volume 3 contains *Equipment, Hardware, Panel Components, Power Supplies, Tools and Production Equipment, Engineering Aids*, and *"Company Profiles and Capabilities."*

Electronic Design's GOLD BOOK is READY WHEN YOU ARE. Keep it on hand for product search, sourcing, or for instant technical and specifying data. It puts the entire electronics industry at your fingertips.

Electronic Design's GOLD BOOK is the largest, most complete, most comprehensive one-step purchasing and reference tool ever produced in this industry. Its PRODUCT DIRECTORY contains more than twice the number of editorial pages than the other industry directory; almost 50% more pages of TRADE NAMES; half again the number of pages in its MANUFACTURERS DIRECTORY; almost twice the number of pages in its DISTRIBUTORS DIRECTORIES. It's far and away the biggest and best electronics directory in the world.

BETTER BY EVERY MEASURE

	The Other Industry Directory	<i>Electronic Design's</i> GOLD BOOK	
Total manufacturers	3,165	7,528	+ 4,363
Direct product codes	2,250	2,925	+ 675
Cross-reference product codes	985	1,874	+ 889
Total product codes	3,235	4,799	+ 1,564
Overseas circulation	Nil	13,200	+ 13,200

Computer system keeps 100 busses on schedule

A computer-based management system to improve the service and efficiency of bus networks—still the main form of public transportation in most cities of the world—has been produced by Thomson-CSF in France.

Known as the Sygal system, it has been tested in Marseilles. Vehicle positions are pinpointed on the bus routes, comparisons of bus running times are made with schedules and timetables, and the number of passengers on board is counted. This information can be displayed on a console in a central control station.

Sygal uses a cyclic vehicle interrogation-response procedure for control of about 100 busses. Each vehicle is interrogated every 20 to 30 seconds. If the bus travels at 30 km/h (fast for city travel), interrogation occurs every 250 meters. The interrogation rate can be increased to once every 100 meters.

When a bus receives a message identified by its address code, it

replies with readings of on-board sensors. One sensor indicates the wheel revolutions turned, which gives distance covered. Another sensor output is the algebraic sum of the passengers who board and get off at each stop, which gives passenger load. In large and medium-sized cities, the bus can be located to within 20 meters, and the passenger load computed to between 5 and 7% accuracy.

Communications support is via vhf radio-telephone. Controllers can send "speed up," "slow down," "wait" or "overtake" commands to bus drivers to keep the system on schedule. The commands are displayed by lamps on service boxes in the busses. The voice links can also be used for special instructions.

The Sygal system can be tied to a central traffic-light control system. Then lights can be held on green to allow a bus to pass through a busy intersection to keep it on schedule.

CIRCLE NO. 319

D_2 because of the shorting effect of the line. When the input polarity reverses, D_2 recovers earlier than D_1 , and a positive pulse from the input voltage appears across D_2 and the load.

The pulse traverses the line and is reflected back to D_2 with a delay that depends on the length of the line. The pulse charges D_2 positively. Further reflections take place, and each time the pulse returns to D_2 , more positive charge is added, with the pulse voltage decaying on each reflection.

During this time a second input pulse is obtained across D_2 . Because of the charge already stored in D_2 , the second impulse gives rise to a higher charge at D_2 than for the first period. But when the input polarity goes positive again, D_1 is the first to recover, isolating the load from the source. As a result, no pulse appears at the output now. Depending on the decay time of the reflected pulse, the output frequency can be reduced to fractions of the input frequency.

Capacitive loading lifts MW-antenna response

A new type of capacitive loading reduces monopole antenna end reflections in the 1.1-to-2.3-GHz range substantially below those of an unloaded unit.

Developed at the University of Belgrade in Yugoslavia, the design uses a tapered capacitive structure originally produced for thin-wire monopoles and dipoles. The end loading consists of 15 brass cylinders with an outer diameter of 6 mm and an inner diameter of 5 mm, all mounted on a dielectric rod. The cylinder lengths vary from 2 to 30 mm in steps of 2 mm.

To avoid the partial reflection of the standing wave by the gaps between the cylinders, the gaps are made small—about 0.1 mm. The gap capacitance is about 1.2 pF. The antenna produced with this construction is essentially of the standing-wave type.

At frequencies of greater than 2.3 GHz, this nonreflecting structure is expected to be more efficient than the lower-frequency version. The efficiency of the lower-frequency unit might be raised by an increase in the gap capacitances.

Frequency divider uses step-recovery diodes

A simple wideband frequency-divider circuit that uses step-recovery diodes has been developed at the Electrical Engineering Dept. of the Middle East Technical University, Ankara, Turkey. Experimental divide-by-two circuits operating over input-frequency ranges of 160 to 320 MHz and 880 to 1800 MHz have been produced.

A short-circuited transmission line is added to a pulse-generator circuit in parallel with the shunt diode. Use is made of the multiple reflections occurring in the shorted

line. When the input signal is negative, the diodes are forward-biased, and the charge is stored. Diode D_1 has more charge than

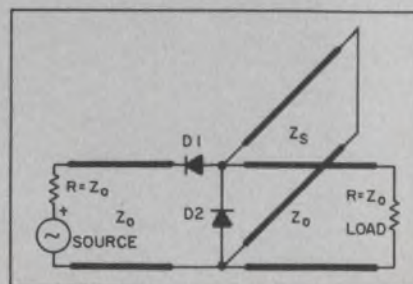

NEW! DYNAMIC DELAY LINE

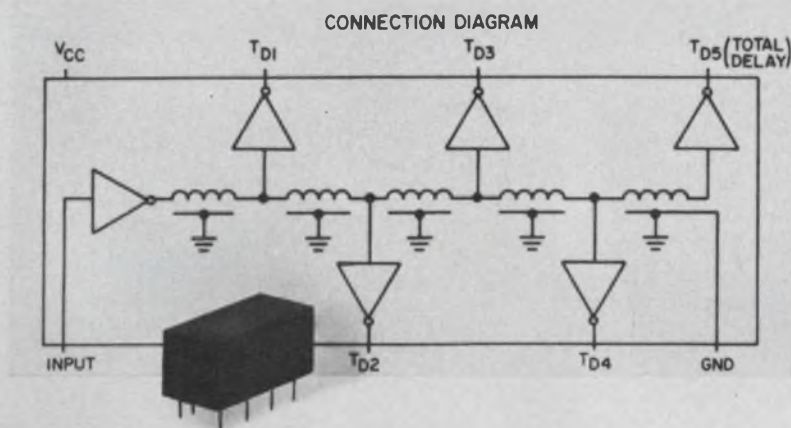

- For super high-speed T²L, standard T²L, and DTL.
- Fan out capability=10.
- Three compatible lines: 25-, 50-, and 100-ns delays; can be cascaded without deterioration of rise time, any number, any combination.
- Rise time= ≤ 1 ns (25- and 50-ns delays); ≤ 2 ns (100-ns delay).
- 14-pin DIP (8 pins used).

Call Bill Chamberlin at 215-426-9105. Or write for details.



Technitrol, Inc.

TECHNITROL, INC.

1952 E. Allegheny Avenue, Philadelphia, PA 19134.

Specialists in pulse transformers and completely transfer molded, welded DIP delay lines under 3/16" high—to 250 ns.

Crank up this high-performance machine and you'll have 30 MHz at your command. Enough frequency for about any test situation you can name.

Of course top end isn't everything. The Wavetek 164 has the sophistication to maneuver smoothly on anybody's test bench.

You can shift to any of nine

different waveforms in continuous, triggered or gated modes. Drop to 3 μ Hz and then run up the entire range in 1000 to 1 sweeps or discrete 10% steps. You can even adjust rise-and-fall times with the unique trapezoidal waveform.

The price is \$1,095*. A bit more than average. But a few minutes at the controls will convince you

that the Model 164 is no average function generator.

*F.O.B. San Diego, wheels optional at extra cost.

WAVETEK®

P.O. Box 651
San Diego, California 92112
Tel. (714) 279-2200, TWX 910-335-2007

**Thirty million
Hertz
puts you
in the driver's seat.**

new products

Two-output inverter is phase-lockable



Avionic Instruments, 943 Hazelwood Ave., Rahway, NJ 07065. (201) 388-3500. 1A1000: \$1900 FOB factory; avail. latter part of year. Other models 3 wks.

A new 1000-VA static inverter, the 1A1000, provides 400-Hz ac power and has two outputs: 115 V ac and 26.5 V ac. The unit is qualified to the latest U.S. Government specifications; namely, FAA approved TSO-C73, RTCA DO-138 and MIL-E-5400 Class 2. The unit is said to attain 73% minimum efficiency and to provide 150% power capability for five minutes to accommodate large start-up loads. The unit measures 10 × 6 × 12.68 in. and weighs 24 lb.

CIRCLE NO. 250

Pocket-sized unit detects ac-line faults

Data Architects, Inc., 460 Totten Pond Rd., Waltham, MA 02154. \$79.95.

LINEALERT is a pocket-sized ac power monitoring device that detects power transients. It plugs directly into the ac outlet to be monitored. The device is preset at the factory to illuminate indicator lamps if any of the monitoring thresholds are exceeded. Thresholds are high-voltage transients exceeding ±260-V peak for at least 500 μs, decreasing to less than 100 μs at ±325 V, low-voltage transients below 100-V rms for at least 100 ms, and outages for at least one cycle.

CIRCLE NO. 251

5-V OEM supply sells for \$26.95

Advanced Power, 1621 S. Sinclair St., Anaheim, CA 92806. (714) 997-0034. \$26.95; stock.

APS5-3 is a 5-V dc, 3.0-A economy power supply that uses an IC regulator. The unit operates from any 115/230 V ac, 50-to-60 Hz one-phase power source and provides ±0.1% regulation for ±10% ac line change and ±0.1% for ±50% dc load change. The unit weighs 2 lb. Ripple and noise is 5 mV pk-pk. The convection-cooled operating temperature is 0 to 65 C (derated above 40 C), and the tempco is 0.03%/°C. Response time is 50 μs or less. The unit features automatic foldback current limiting.

CIRCLE NO. 252

Nickel-cadmium battery offers 20 cells



Marathon Manufacturing Co., 1900 Marathon Bldg., P.O. Box 61589, Houston, TX 77061. February.

CA-400, 40-Ah nickel-cadmium aircraft battery provides 20 cells for increased starting power with cooler engine starts. The unit weighs 84 lbs and packs 20 cells into the standard package size of 10-1/2 × 9-11/16 × 10-1/4 in. The CA-400 is designed for engine starting from extreme sub-zero temperature conditions to 165 F and can be stored in any state of charge without interim trickle charging. No price available at press time.

CIRCLE NO. 253

Hv unit provides four outputs for CRTs



Keltron, 225 Crescent St., Waltham, MA 02154. (617) 894-0525. \$68 (25)

Model 601.5 has all of the voltages required to operate a small CRT tube and features +1.5 kV for the anode, 6.3 V for the heater, -1.5 kV for the cathode and -1.5 kV floating supply for blanking. Input power is unregulated 24 V dc. Line and load regulation is 1% on each of the outputs. Maximum power output is 5 W. Other features include: short-circuit, arc and overload protection; silent, repairable unit; and a one-year warranty.

CIRCLE NO. 254

12-V, 240-mA module regulates to 0.02%



Analog Devices, Rte. 1 Industrial Pk., P.O. Box 280, Norwood, MA 02062. (617) 329-4700. \$69; stock.

Model 921 ±12 V dc, 240-mA modular power supply features 0.02% maximum line and load regulation. The unit offers current limiting short-circuit protection. Rms ripple and noise are limited to a maximum of 0.5 mV and tempco is 0.015%/°C maximum. The supply is specified from 0 to 70 C and is packaged in an encapsulated epoxy module measuring 3.50 × 2.50 × 1.25 in. Weight is only 18 ounces.

CIRCLE NO. 255

GENERAL ELECTRIC'S 69F MIL TYPE TANTALUM WET SLUG CAPACITOR...



Four series to choose from:

69F — Unique patented double O-ring elastomer seal, with proved superiority over other elastomer seal designs.

69F2000 — Provides two-to-three times more capacitance in the same case size, with the patented double O-ring elastomer seal.

69F3000 — Glass-to-metal hermetic seal. Fully qualified to MIL-C-3965/24, Style CL66/67.

69F4000 — Glass-to-tantalum hermetic seal. Fully qualified to MIL-C-39006/9C, Style CLR65.

Same quality features in all four:

- High Volumetric Efficiency — for minimum size and weight.
- Low Leakage Current — for timing applications.
- Broad dual rated temperature range — from -55 C to +85/125 C.
- Thixotropic gelled electrolyte — for maximum stability throughout extreme temperature ranges.

For more information on these, or any other General Electric capacitors, call your nearest GE sales office, or write Section 430-52, Schenectady, N. Y. 12345.

MAKE SOMETHING OUT OF IT!

GENERAL  ELECTRIC

INFORMATION RETRIEVAL NUMBER 63

PACKAGING & MATERIALS

Shield and conductor crimp simultaneously



Hughes Connecting Devices, 500 Superior Ave., Newport Beach, CA 92668. (714) 548-0671. \$2.70 (5000 up); 2-3 wks.

Conventional contacts for coaxial cables require two crimps with two tools. In addition, contact assemblies are generally supplied as separate components—outer housing, inner contact, one or two spacers, crimp ring—which must be put together by the user. The new Hughes 16-gauge contact is pre-assembled prior to shipment from the factory. To crimp, a properly stripped coaxial cable is inserted into the contact and the combination is then crimped—shield and conductor—in one step, with a special self-aligning tool. The simultaneous-crimp contacts can be used with a large variety of coaxial cables. And they can be mixed with power contacts in Hughes standard MRS connectors.

CIRCLE NO. 256

Semicon-device holder aids in testing

Sandia Laboratories, Albuquerque, NM 87115. (505) 264-1253.

A protective carrier for handling semiconductor devices solves the problem of testing beam-lead semiconductors as small as 0.002-in. thick and 14-mils square. Leads can be 1/2-mil thick, 3-to-4-mils wide and protrude 4-to-5 mils beyond the body. The carrier is made of transparent plastic with a metalized circuit pattern and a cover clamp. The system is semi-automatic, but has the potential for complete automation.

CIRCLE NO. 257

Jumpers speed panelboard assembly

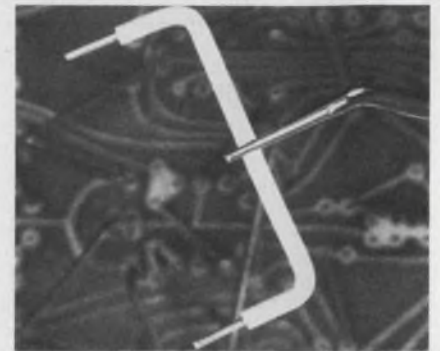

Manger Electric Co., Inc., W. Henry St., Stamford, CT 06904. (203) 348-7761.

Faster panelboard assembly is possible with preformed jumpers made on Manger machines. The new machinery cuts, strips and forms accurate jumpers. The center-to-center preformed leads have tolerances of only $\pm 1/64$ in. in lengths of 1/4 to 3 in. Exposed strip dimensions, which are controlled to a $\pm 1/32$ in., are sufficiently accurate to be used as standoffs or stops. Stranded or solid wire from 30 to 14 AWG with almost any type of insulation can be precision stripped and formed without nicking or scraping the conductor.

CIRCLE NO. 258

Beam compass scribes circles to 72 inches

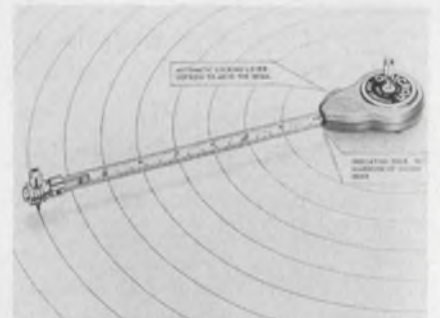

Hunter Associates, 792 Partridge Dr., Somerville, NJ 08876. (201) 526-8440. \$12 (unit qty).

Model No. 1260 beam compass uses a flexible steel tape. When the tape is retracted, the compass is no larger than an ordinary tape measure, but it can rule accurate circles and arcs to 72-in. radius. It is also helpful in straight line layout with parallel dimensions. The unit is calibrated with both inch and metric dimensions.

CIRCLE NO. 259

Triple Output Laboratory Power Supply for Digital and Analog Applications

0-32 VDC, 0-1A
0-32 VDC, 0-1A
0-6 VDC, 0-5A



From seconds to hours... ...no one does it better

CRAMER ELAPSED TIME INDICATORS

Competitively priced in all quantities...
a complete line that meets all ETI industrial
requirements... stock or custom. Send for
our new Elapsed Time Indicator
Selector Guide. It's free.

CONRAC CORPORATION

INFORMATION RETRIEVAL NUMBER 132

CRAMER DIVISION Mill Rock Road, Old Saybrook, Connecticut 06475 • Telephone (203) 388-3574 — Telex 966-453



Terminal test clips fit into tight places

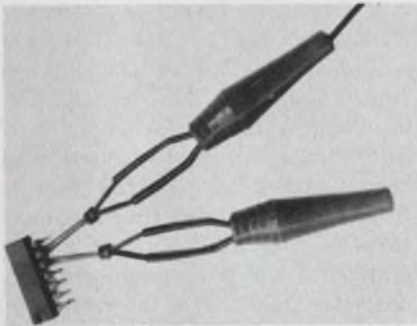

SPI/Electronics, 875 N. Virgil Ave., Los Angeles, CA 90029. (213) 666-1188. stock.

A new type of miniature, test, terminal clip, the 101 series, works on extremely small PC boards and ICs. The unit's positive grip "eagle nose," a normally closed test clip, has a quick-disconnect feature and a fully insulated gripper. Standard gripper clips are available in black and red. They are also furnished in white, blue, green and yellow coded colors. The test clips accept both cable and banana plug leads.

CIRCLE NO. 260

Convert barrier strips to thermocouple use

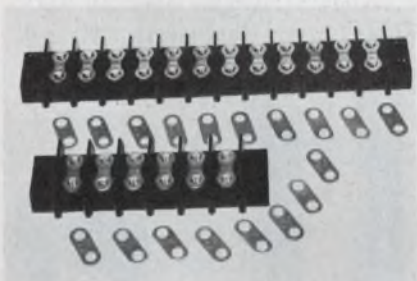

Omega Engineering, Inc., Box 4047, Stamford, CT 06907. (203) 359-1660. \$5 pkg. of 20.

Omega has found a way to convert barrier-type terminals into thermocouple-compensated positions with its new thermocouple-alloy terminal lugs. These lugs are supplied in the form of tie-bars which enable the user to jump the barrier-type terminal strip with any of a dozen different types of thermocouple compensating alloys. The lugs are available in packages of 20, in many different materials. They include chromel, alumel, iron, constantan and copper, as well as compensating alloys for the platinum/rhodium and tungsten/rhenium thermocouple series.

CIRCLE NO. 261

How can you resist a 400% improvement in feedback stability?

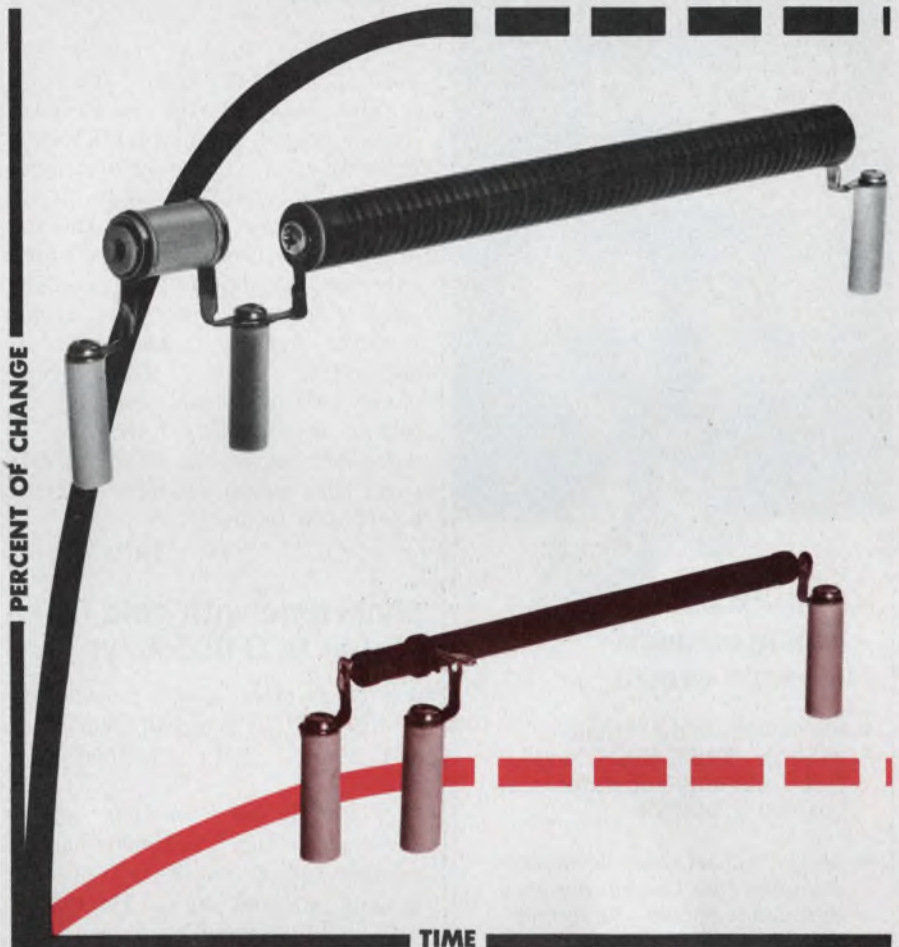

So beautifully done!

With DIVIDER-MOX resistors, the effects of T-C matching, V-C, self-generated heat, and other control variables are minimized by a unique manufacturing process.

Precision is % allowable change over operating temperature range; DIVIDER-MOX resistors give 0.5% stability at 10% power dissipation over a temperature range of -55° to 125°C .

And, along with precision and stability you also get size advantages as well . . . DIVIDER-MOX resistors are about $\frac{1}{2}$ as large as the equivalent resistance carbon film.

Resistance ranges available from 25K to 2000 Megs with maximum power ratings up to 10W at 30kV. Customers may specify divider ratios in the range of 300:1 to 10,000:1.

Victoreen...where else can you get so many accurate ohms for your money:

VICTOREEN INSTRUMENT DIVISION
VLN Corporation
10101 Woodland Avenue
Cleveland, Ohio 44104



INFORMATION RETRIEVAL NUMBER 64

Grayhill quality in 1/4 amp lighted switches



- Self-cleaning wiping contacts for logic circuits
- Momentary and alternate actions—SPST, SPDT, and DPDT circuitry—operates in any position or attitude.
- Shown actual size—decorator-designed for compact panels—wide color choice—matching unlighted switches and indicator lights.
- Choice of mountings— front panel bezel, sub-panel or bushing.

Not all lighted push-button switches are created equal! Grayhill's low-level lighted switches are designed for applications where *switch* quality is what really counts. They out-perform butt contact or snap action switches... yet offer the style and appearance options you need, competitively priced. Write for complete technical data on these switches, and consult EEM for data on other Grayhill switches.



561 Hillgrove Avenue • LaGrange, Illinois 60525
(312) 354-1040

PACKAGING & MATERIALS

Feel setting with preset torque driver



Mountz, Inc., 1080 N. 11th St., San Jose, CA 95112. (408) 292-2214.

Once you set the toggle-joint mechanism of Mountz' LTD torque screwdrivers, you need not read the scale again. The toggle movement is easily felt when the desired torque is reached. The unit's external torque setting is made easy with a vernier scale. Other features include: sealed external calibration screws, wide torque range in each model size and excellent repeatability. Accuracy is $\pm 3\%$ of the setting. Eight models cover the range of torques from 0.1 to 180 in.-lb.

CIRCLE NO. 262

Nichrome with gold layer stable to 0.005%/yr

Analog Devices, Route 1 Industrial Park, P.O. Box 280, Norwood, MA 02062. (617) 329-4700. See text.

A family of two-film coated substrates, the AD19000 series, consists of a nichrome resistive coating covered by a 150-micro-inch gold conductive layer. Surface finishes of either 3 to 4 or 5 to 10 microinches are available. A backside gold-conductive coating is optional. Sheet resistivities can range from 50 to 500 Ω /square, noise may be specified to -50 dB, power densities to 50 W/in.², long term stability to 0.005%/year at 25°C and substrate sizes are available from 0.025 to 3.50 in.² The substrates come precut or prescribed in three material classifications: MIL, commercial and prototype. The AD-1922 is a high-precision substrate with 250 Ω /sq sheet resistivity, 25 ± 2 -mil substrate thickness, 5 to 10 microinches of surface finish and a gold back-side coating. The substrate is priced at \$3.60/in.² in 100-in.² quantities. Delivery is from stock. User designed films can be fabricated upon request.

CIRCLE NO. 263

Surfactant improves etching process

3 M Company, P.O. Box 33600, St. Paul, MN 55133. (617) 733-9853.

A new member of the Fluorad fluorochemical specialties line, FC-93, reduces the surface tension of acid etches to improve both surface wetting and bubble release. Reject rates are thus reduced through the elimination of air entrapment, which may cause an undesirable mask over a portion of the surface to be etched. FC-93 is highly surface active in both acid and alkaline solutions, and has excellent chemical and thermal stability. As a result of this stability, etching-solution life is extended beyond that achieved with conventional surfactants. For convenience of use, FC-93 is supplied as a 25% solution. At the recommended use level range of 0.04 to 0.4%, surface tension of a typical oxide etch solution is as low as 19.0 dynes/cm. The same concentrations of FC-93 reduce the surface tension of a typical aluminum etch to as low as 19.4 dynes/cm.

CIRCLE NO. 264

Phone plugs adapt to BNC and banana plugs

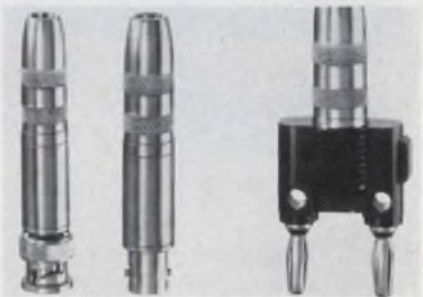

ITT Pomona Electronics, 1500 E. Ninth St., Pomona, CA 91766. (714) 623-3463.

Three phone-plug test adapters provide interconnections between standard two-conductor phone plugs and BNC receptacles (Mod. 4043), BNC plugs (Mod. 4026), or standard 3/4-in. spaced double-banana plugs (Mod. 4044). Two conductor phone-plug jacks on all three adapters accept standard 1/4-in. dia \times 1-3/16 in. long phone plugs. Models 4043 and 4026 are all-metal construction for maximum shielding. Banana plugs feature cross holes in their bodies for side stack-up connections.

CIRCLE NO. 265

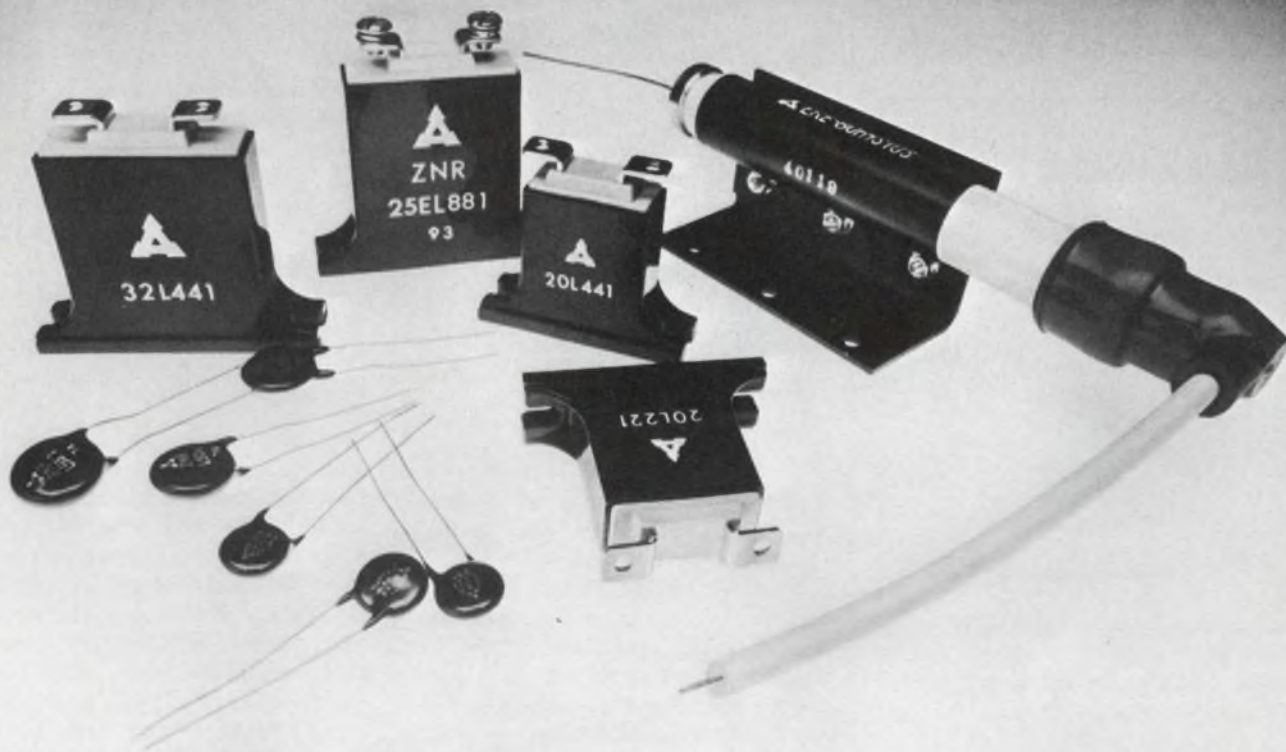

Three basic reasons to specify Panasonic ZNR's.

1. Panasonic ZNR's greater nonlinearity coefficient gives your design unique protection against repeated high-voltage surges. ZNR's extremely fast response time is in the order of 40 nano-seconds. Unlike the zener diode, ZNR clamps and shunts energy. ZNR's protect your circuit by limiting both surge and pulse voltages from either transients or lightning. ZNR's maintain circuit integrity by preventing reverse leakage and stabilizing DC currents.

2. Panasonic ZNR's come in a wide range of ratings to match your design. Disc-type ZNR's range from 33V to 1800V at 1MA. They give you superior voltage stabilization and surge absorption for semiconductor circuits. In higher voltages, stacked-type ZNR's range from 6KV to 26KV. Ideal for voltage stabilization of high-voltage power supplies and inputs to CRT's.

3. Panasonic ZNR's have a bilateral and symmetrical VI characteristic curve. This gives your circuit clamping protection in either direction.

Superior surge protection. Wide range of voltage ratings to match your design requirements. Clamping protection in either direction. Consider the Panasonic ZNR for your next circuit design or system.

All are readily available. All at a reasonable price. All made with the kind of quality that delivers high performance. It's what you expect from Panasonic. For more information on Panasonic's ZNR's, fill out the coupon.

Matsushita Electric Corp. of America,		ED-2
Industrial Division, 200 Park Avenue, N.Y., N.Y. 10017		
<input type="checkbox"/> Please send ZNR literature.		
<input type="checkbox"/> Please have representative call.		
Name _____		
Title _____		
Company _____		
Address _____		
City _____	State _____	Zip _____

Panasonic Electronic Components
our technology is all around you

YOUR NEW STALWART RUBBER MATERIALS GUIDE IS READY.

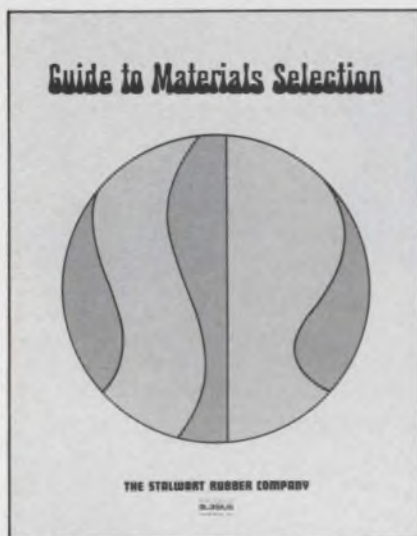

Your complimentary copy of our 14-page Stalwart Rubber "Guide To Materials Selection" is hot off the presses and waiting for you.

The Guide lists today's 18 most commonly used elastomers with hundreds of characteristics suitable for thousands of industrial uses. It's full of ideas to fit your designs and save you money.

Every day over 20,000 copies of past editions make buying rubber parts easier for designers and engineers all over the country. Our latest edition makes it easier still.

So clip and send the coupon today. It's free.



THE STALWART RUBBER COMPANY

160 Northfield Road Bedford, Ohio 44146

Subsidiary of
BLASIUS
INDUSTRIES, INC.

Send a free copy of your newest
"Guide To Materials Selection" to:

Name _____

Title _____

Company _____

Address _____

City _____ State _____

Zip _____

INFORMATION RETRIEVAL NUMBER 67

PACKAGING & MATERIALS

Power housing available in standard kits

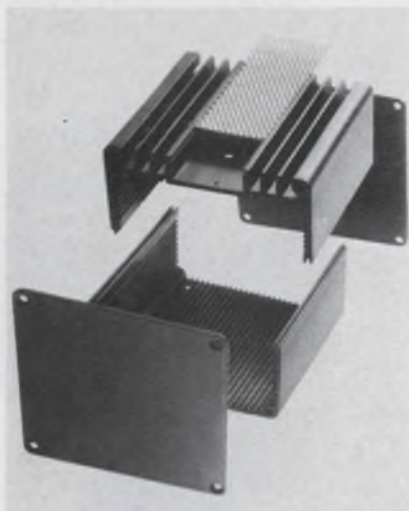

Techmar Corp., 2232 S. Cotner Ave., Los Angeles, CA 90064. (213) 478-0046. See text.

New SH series off-the-shelf kits and parts for subassembly housing of power amplifiers and power supplies interlock with tongue-and-groove joints and accept 0.062-in.-thick PC boards in its internal grooves. Material is black-anodized aluminum. Parts for 45 configurations available in stock include nine with integral heat sinks. Over-all dimensions range from 2 x 3 x 4 to 8 x 8 x 4 in. Warranty allows the customer to return the first shipment for any reason and get full credit to \$150. Kit prices range from \$7.74 to \$27.63.

CIRCLE NO. 266

DIP magazines available in six configurations

Clover Industries, 600 Young St., Tonawanda, NY 14150. (716) 693-1331.

Aluminum conductive magazines handle DIP ICs with 0.3 and 0.6-in. lead spacing. Standard magazine length for the 0.3-in. center DIP is 23-1/2 in. and for the 0.6-in. center DIP it's 21 in. Custom lengths are available to requirements. Six standard frame configurations can meet most specifications for process handling and testing equipment. Custom designed configurations are readily available. The magazines load and unload rapidly, ship at low cost and lend themselves to recycling.

CIRCLE NO. 267

Feedthroughs handle vacuum or 75 psi



Sparrell Engineering Research Corp., 112 Front St., Marblehead, MA 01945. (617) 744-8011.

Prewired vacuum feedthroughs, with standard 1/2 or 3/4-in. National Pipe pretreated threads, permit immediate installation of multiple electrical conductors or thermocouples through vacuum and pressure enclosures. Standard feedthroughs are available with up to 16 wires with wire sizes from 8 to 24 gauge. Copper wires are used for electrical signal and power applications and matched wire pairs are available for common thermocouples. The feedthroughs handle vacuums down to 5 x 10⁻⁶ torr, and they may also be used for moderate pressures to 75 psi.

CIRCLE NO. 268

Plastic filter matches green color of LEDs

Panelgraphic Corp., 10 Henderson Dr., West Caldwell, NJ 07006. (201) 227-1500. Stock.

Chromafilter Green 48 is a mar-resistant, anti-reflection, plastic filter spectrophotometrically matched to LED readouts for improved contrast and readability. Resolution as far as 1-in. from the display remains distinctly intact. The filter is unaffected by a variety of chemicals and solvents and can be easily cleaned with ammoniated cleaning compounds. Chromafilter can be produced in any size and thickness, and can be formed, molded and machined to any shape. The filter is available in 0.030-in. thick rigid vinyl and 1/16 and 1/8-in. acrylic sheets, or formed and fabricated to customer specifications. It is available at a fraction of the cost of conventional MIL-C-675A inorganic anti-reflection coatings, and exceeds all appropriate military and governmental specifications, such as FAA spec E-2481 for resolution.

CIRCLE NO. 269

DATA PROCESSING

Small mag tape system uses little power



Micro Communications Corp., 680 Main St., Waltham, MA 02154. (617) 899-8111. See text.

Separate read and write units each $1 \times 2.875 \times 5$ -in. emphasize the small size of this tape-loop storage system. An ordinary mailing envelope easily contains the thin continuous-loop cartridge. The cartridge stores about 300 kbits, operates at 1.25 in/s and provides 800 bit/in. density. Data interfaces are TTL. CMOS, used throughout the design, keeps power down to 0.33 W for read or write operations. Each unit costs \$150 in quantity orders. An evaluation kit with read unit, write unit and five tape cartridges costs \$299.

CIRCLE NO. 270

Document scrambler works automatically



Datotek, Inc., 13740 Midway Rd., Dallas, TX 75240. (214) 233-1030.

To send sensitive facsimile information securely, let the DF-300 scramble them with one of its user-selectable 16M code families. The unit operates with standard facsimile machines on commercial links. The DF-300 uses digital timing circuitry that acquires and maintains synchronization even under poor operating conditions. The scrambled text appears as an equal but random mixture of "salt and pepper" dots. Operation is fully automatic.

CIRCLE NO. 271

RFI/EMI filters. Made a better way to give you more.

Two big families of low-pass feedthrough types. The "55 Series" of standard suppression filters—the "25 Series" of miniatures and subminiatures. Each in a variety of configurations—solder flange, sleeve/conductor, sleeve/eyelet, bolt-in.

They're the direct result of our up-to-date, proven technology.



Featuring rugged one-piece sleeve construction that distributes inductance, capacitance and resistance over the filter. A truly integrated assembly—no lumped elements to cause internal resonance—made possible by a unique ferrite-titanite composition. High-temperature solder to eliminate risk of solder reflow and pin dropout.

No beads, no low-temperature solder—for consistency of electrical specifications within each series.

For data, contact:
AMP Capatron Division,
Elizabethtown, Pa. 17022.
(717) 367-1105.



AMP

INCORPORATED

free The "NEW LOOK"
1975
LAFAYETTE
ELECTRONICS
CATALOG

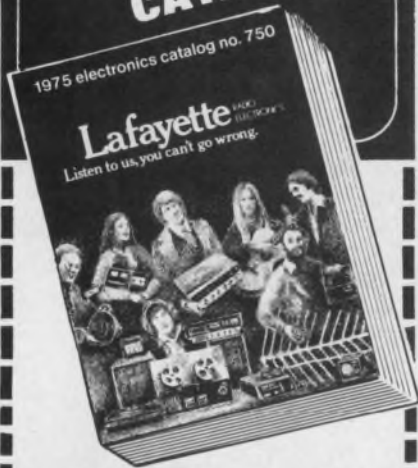

NEW! Larger Page Size
NEW! More Full Color
NEW! Easy-Read Type

SAVE ON LAFAYETTE
 PRODUCTS PLUS BEST
 MAJOR BRAND NAMES

The catalog you **NEED** if you're interested in electronics! Filled with colorful, accurate, interesting descriptions of all the latest electronics products, plus the "bits and pieces" you need to keep everything in top shape. It's the "energy saving" way to shop too—order by mail from your easy chair!

Lafayette

Listen to us, you can't go wrong.

Mail this coupon today **FREE!**

DEPT. 45114

Lafayette Radio Electronics
 111 Jericho Tpk., Syosset, LI, NY

Send me your **FREE** 1975 Catalog

Name Apt.

Street

City State

Zip

Send a 1975 Catalog to my friend

Name Apt.

Street

City State

Zip

DATA PROCESSING

Microprocessor lets terminal massage data



Texas Instruments, P.O. Box 1444, Houston, TX 77001. (713) 494-5115. \$4925.

With its built-in microprocessor, the Model 742 terminal can generate forms, check data for type, size, and range, as well as perform arithmetic operations. A user-oriented language, dubbed TICOL, lets the user program the localized processing and format the data. As with most intelligent units, the terminal can batch prepared data then transmit it unattended to a central site at rates up to 1200 baud. Other features of the unit parallel those of the manufacturer's—Silent 700 Series dual tape cassettes, 30 char/s printer and ASCII keyboard.

CIRCLE NO. 272

TTY-style keyboards are also expandable

Key Tronic Corp., Bldg. 14AA, Spokane Industrial Park, Spokane, WA 99216 (509) 928-8000. \$145; stock.

In addition to its standard Teletype keyboard, Key Tronic Corporation offers a new range of ASR33 code compatible keyboards with optional calculator pad and video display control keys. The ASR33 section can be easily field-expanded to include the optional features by adding additional key switches. Keyboard features include quad-level ASCII outputs, positive or negative logic, pulsed strobed two-key rollover, internal repeat, and low power consumption. The design uses single-board construction and easy-to-insert reeds for quick maintainability in the field.

CIRCLE NO. 273

Simplified terminal works with computers



VMF Industries, 216 N. Fehr Way, Bay Shore, NY 11706. (516) 242-3939. \$900 (50 quan).

Where a simplified terminal will do, the TR-10 offers a 10-key numeric section, buffered 32-character display and 10 customer-coded keys. In addition the unit provides 110 to 1200 baud ASCII transmission and connections for RS-232-C interfaces or 20 mA current loops. Further utility is provided by the unit's ability to operate in a half-duplex polled environment. Options include interface to external peripherals and double line displays.

CIRCLE NO. 274

Touch-Tone coupler pressed on mouthpiece



Metroprocessing Corp. of America, 60 Prospect St., White Plains, NY 10606. (914) 949-0890. See text; stock.

The FT-1020P Push-On Acoustic Coupler, for use with the manufacturer's line of portable Touch-Tone Terminals can be pressed onto the phone mouthpiece in less than a second and fits current handsets. The original FT-1211U Universal Coupler, with elastic strap, is still available for use with Trim-Line handsets or with older model phones. The 12-button and the 16-button terminals may be ordered with either or both types of coupler. Prices of complete terminals start at \$175. The couplers are also available separately. The price: \$15 for the push-on unit and \$30 for the universal unit.

CIRCLE NO. 275

Augat gives you eight.

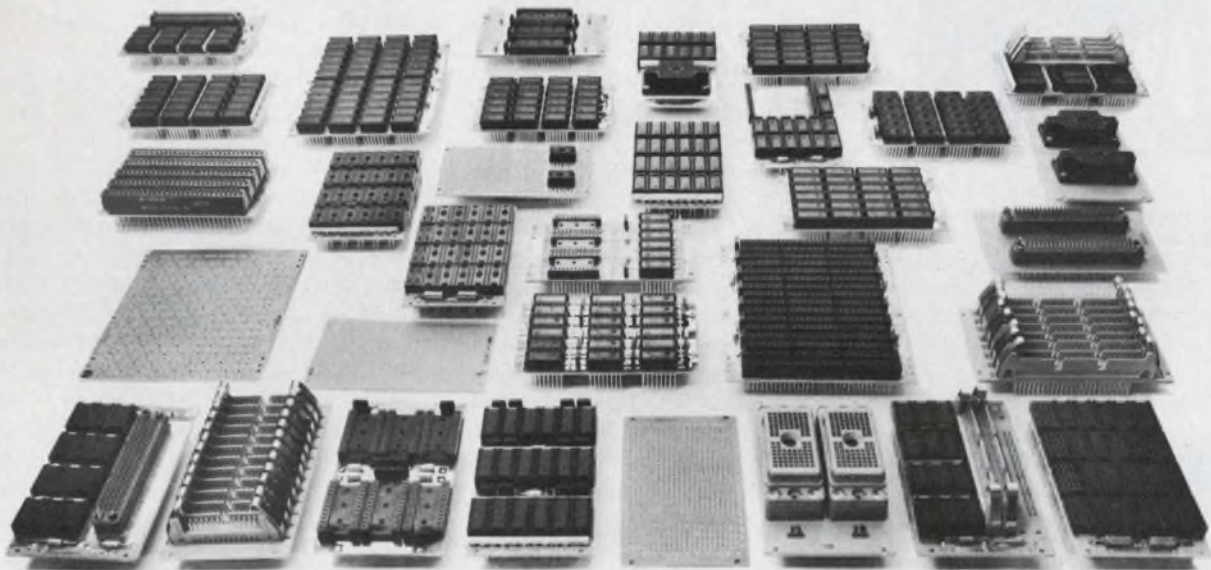

EECO gives you this.

Eight socket boards may be all that most designers need. Augat thinks so.

We don't.

We've got eight boards of our own to match Augat's. And we don't stop there.

Our other 24 boards are also needed. They provide off-the-shelf solutions to real design and packaging problems. However rare.

They give you more options and more design freedom. With

low-cost types, low-noise power distribution types, custom power-pin connection types, I/O connector types, and matrix and special types. And power supplies; fixed and swing-out frame assemblies; drawers; cabinets; and wire wrapping services.

They all make up our 2-D Dual-in-Line Socket Board line. Most of which can be ordered right out of our catalog.

Try us. We'll see you through.

EECO

1441 East Chestnut Avenue
Santa Ana, California 92701
Phone 714/835-6000
Also from G. S. Marshall Company nationwide.

FREE SOCKET BOARD AND PACKAGING
HARDWARE CATALOG!
We'll send it to you if you'll send us the
information below.

Name _____
Position _____
Company _____
Address _____

INFORMATION RETRIEVAL NUMBER 70

Kiss Noise Good- bye

The higher a counter's sensitivity and the wider the frequency measuring range, the more noise is superimposed on signals, right? Wrong. Not with high-input sensitivity/wide frequency range counters from T.R.I. You get noise-free measurement of even weak signals.

Model: 5108
Frequency Counter \$950

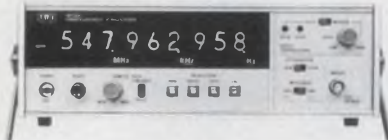

DATA PROCESSING

Converter distributes 32 analog channels

Datel Systems, Inc., 1020 Turnpike St., Canton, MA 02021. (617) 828-8000. \$1360; 60 days.

The System DDS-32, a 32-channel d/a and distribution system, takes both data and address words from a computer I/O bus and presents the stored data word as an analog signal at the output channel selected by the address word. The system consists of up to 32 separate d/a converters with their associated input registers. The 8, 10 or 12-bit parallel data inputs are bussed to all registers, while the address word selects into which register the data word is to be stored. Another mode of operation allows for the sequential distribution of the data words to the d/a converters. Control logic for interface to most minicomputers is provided. The analog outputs are expandable, in increments of one, up to 32 channels, and the channels may be updated at a rate of 500 kHz.

CIRCLE NO. 276

Microcomputer package invites modular growth

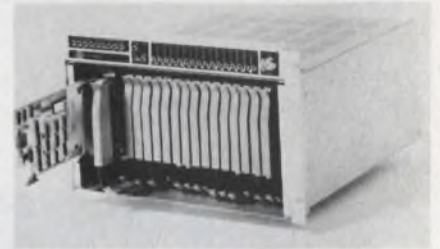

Process Computer Systems, G-4025 S. Center Rd., Flint, MI 48507. (313) 744-0225. \$2995 in single qty; 60 to 90 days.

The MicroPac is a microcomputer that uses the Intel 8080 CPU. The unit is ready to interface with analog or digital instrumentation, communications devices or a host computer. The standard MicroPac includes the Intel CPU packaged on a self-contained logic module and 5k bytes of memory (4k random access, 1k read only). With a capacity of 256 plug-in modules, the computer can be ordered for address ranges to 65 kbytes of memory and is available with a real time clock. In addition to the standard MicroPac model, PCS offers the new microcom-

Interface lets PDP-8 handle eight data lines

Computer Interface Systems, Box 58, Piscataway, NJ 08854. (201) 463-8279. \$1980; 60 days.

A single board combines line interfaces, multiplexer and PDP-8/E series interface and handles eight asynchronous data lines. Each serial channel is buffered with jumper selection of word length, parity and stop-bit. Data rates range from 50 to 9600 baud. And the board occupies but one I/O slot.

CIRCLE NO. 280

Floating-point system speeds Nova Fortran IV



Floating Point Systems, 3160 S.W. 87 Ave., Portland, OR 97225. (503) 297-3318. See text; 60 days.

FPS faster FORTRAN IV, a newly introduced system package based upon the FP-09 Floating-Point Processor, is being offered to Data General Nova users to speed Fortran throughput without large hardware investments. The FP-09 Floating-Point processor, with its stack-oriented command set, replaces software subroutine calls with hardware in-line code execution of Fortran IV floating-point REAL and COMPLEX arithmetic. The unit performs a single or double precision REAL add in 6.7 μ s, compared with 102 to 152 μ s for software execution. The FP-09, built on two Nova-compatible circuit cards, will plug inside any Nova series CPU. Run-time library software includes 94 scientific subroutines, which use the floating-point hardware to provide fast computation of trigonometric and other math functions. The Fortran package can be used on any Nova-based system with TTY and 12K or more of core memory. Speed is said to approach that of Data General's Fortran 5. It is priced at \$4500 for the FP-09 Floating-Point Processor, plus a one-time charge of \$500 for system software.

CIRCLE NO. 281

With MINI BUS[®]

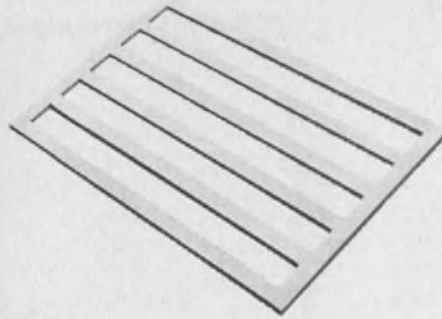

It's the PC card bus bar that saves space on a PCB. Saves money too. Makes board design and layout easier.

all these DIPs



How can you put 36 DIPs on a 30 sq. inch board without using costly multi-layer PCBs?

go on a 5" x 6" 2-sided PCB

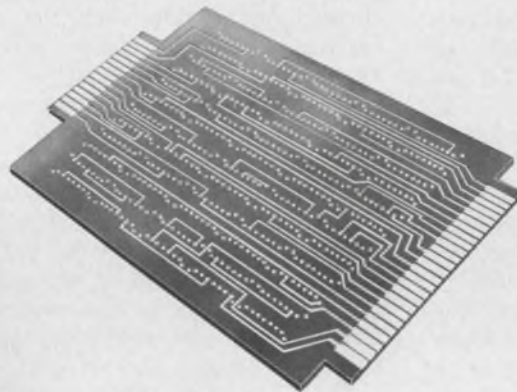

Take Voltages and Grounds **off the board** with MINI/BUS. Use all the board geometry for interconnecting DIPs.

like this

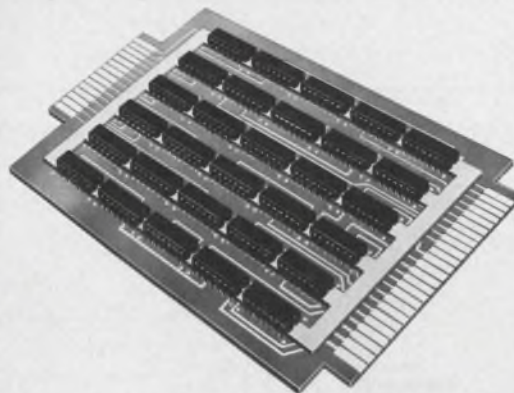

With MINI/BUS, you'll save design and layout time. You'll save space on the board. And **you'll save money** — up to half the cost of a typical 4-layer PCB.



Rogers Corporation Chandler, Arizona 85224 Phone: (602) 963-4584

Represented in Canada by LLOYD A. MEREDITH,
1560 Watersedge Road, Clarkson, Ontario L5J 1A4 Phone: (416) 533-2367

INFORMATION RETRIEVAL NUMBER 72

D/a converters deliver an accurate 12 bits

Analog Devices, Route 1 Industrial Pk., P. O. Box 280, Norwood, MA 02062. (617) 329-4700. AD562K: \$39 (100 up); stock.

The AD562 12-bit d/a converter is housed in a hermetically sealed 24-pin DIP. Accuracy of the AD562 is claimed to be better over temperature than any other existing 12-bit d/a converter, including modular and hybrid converters costing many times more. This accuracy is established initially at 25 C by a total error of $\pm 1/4$ LSB maximum referred to full scale. Temperature stability is assured by a differential non-linearity TC of 1 ppm of full scale range/ $^{\circ}$ C, which guarantees monotonicity over a 100-C temperature variation. A gain TC of 3 ppm of FSR/ $^{\circ}$ C maximum is a further indication of the AD562s stability with temperature variations. The power-supply sensitivity of gain is guaranteed to be 1 ppm of FSR/% maximum for the -15-V-dc supply. The AD562 is also fast; its current output settles to $+1/2$ LSB in less than 1.5 μ s with the addition of a single external resistor and capacitor. Available in versions for either binary or BCD input coding, the DAC also has two internal scaling resistors and a bipolar offset resistor which, when used with a suitable amplifier, allows the user to program five output voltage ranges: 0 to 5, -2.5 to 2.5, 0 to 10, -5 to 5 or -10 to 10 V.

CIRCLE NO. 282

S/d converter tracks at rates up to 5760 $^{\circ}$ /s

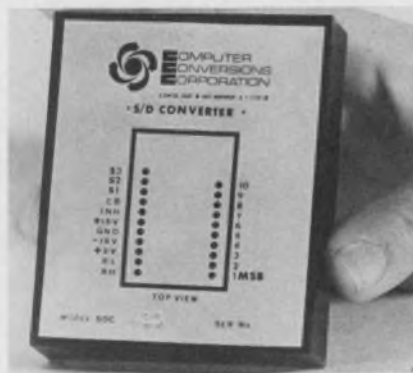

Computer Conversions Corp., 6 Dunton Ct., East Northport, NY 11731. (516) 261-3300. Under \$400; 4 wk.

A series of 10-bit synchro-to-digital converter modules can track at input rates up to 5760 $^{\circ}$ /s with no added error. The modules are 2.6 x 3.1 x 0.82 in. and are designed to be mounted on PC boards. They convert synchro or resolver inputs of 11.8 or 90 V, 400 Hz, or 90 V, 60 Hz., into 10-bit parallel binary outputs representing angle with an accuracy of ± 30 min of arc. There is no accuracy degradation over the operating temperature range, $\pm 10\%$ amplitude and frequency variations and $\pm 5\%$ power supply variations. The converters have isolated reference and synchro inputs and provide complete synchronization to a computer. Part SDC410 requires a 26 or 115 V ac reference input and +15 V dc at 65 mA, -15 V dc at 40 mA, and +5 V dc at 375 mA. Operating temperature ranges are 0-to-70 or -55-to-+85 C.

CIRCLE NO. 283

Solid-state timer mounts in junction box

Syracuse Electronics Corp., P.O. Box 566, Syracuse, NY 13201. (315) 488-4915. \$6 to \$9 (large qty.); 8 wk.

The Series SCS solid-state timer can mount through a junction box knock-out. The device fastens securely by use of a single 0.75 in. conduit fitting locknut. This delay-on-make timer differs from most timers in several ways. For one, the timer body remains outside the junction box. The SCS also eliminates mounting brackets along with the necessary fastening screws. Further in place of quick-connect or screw terminations that are common with other timing devices, the timing module comes with 6-in. long, 18 AWG stranded wire terminations. The timer has a repeat accuracy of $\pm 2\%$ (typical), rapid reset with a 50 ms maximum during and after time out and a reliability rating of over 100 million operations. Time delays are available from intervals as brief as 100 ms up to intervals as long as 8 minutes (factory-fixed or potentiometer-adjustable, remotely). The SCS, a normally open device, comes in any voltage value from 24 to 230 V ac and from 24 to 110 V dc. Maximum power consumption is 3 W, and the load rating for ac is 1 A rms max, 40 mA min. at 25 C; for dc, 1 A at 25 C. Built-in circuitry protects the SCS module against voltage transients up to 400 V (for one full line cycle, repetitive), surges up to 15 A and inverse voltages (for dc units).

CIRCLE NO. 284



ANALOGY

INTECH'S 3020 TRIPLE LED/LAMP FLASHER IC TO THE RESCUE. THREE INDEPENDENT LAMP DRIVERS, EACH WITH 100 mA CAPABILITY. EACH DRIVER HAS TWO TTL-COMPATIBLE INPUTS. VARIABLE FLASHING AND DUTY CYCLE 5 TO 15V SUPPLY AND LOW STANDBY.

intech INCORPORATED
(408) 244-0500
1220 COLEMAN, SANTA CLARA CA 95050

Digivue® - a better way to look at it.

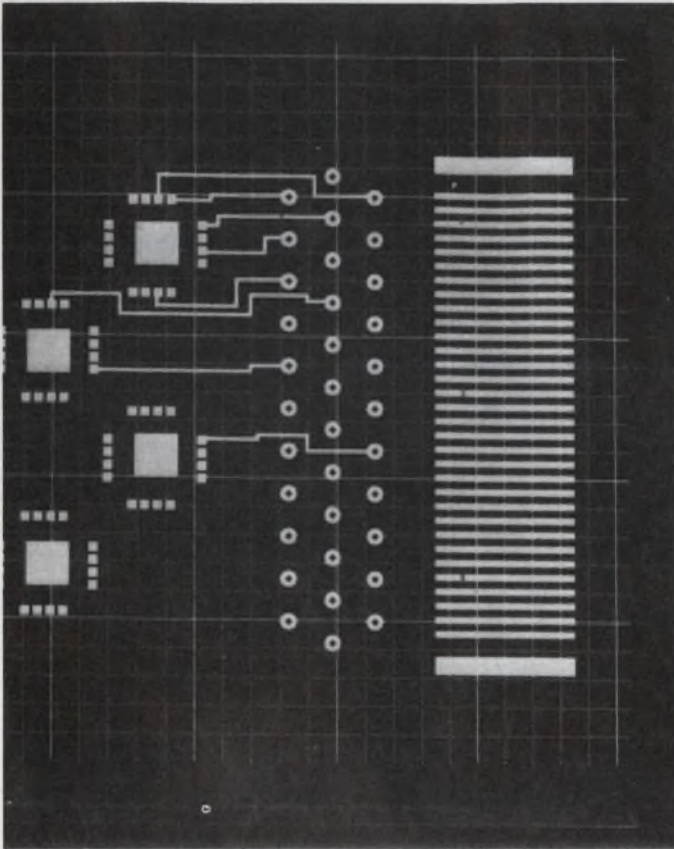

Unretouched time exposure of data displayed on a Digivue unit. Note high contrast picture, precise graphics.

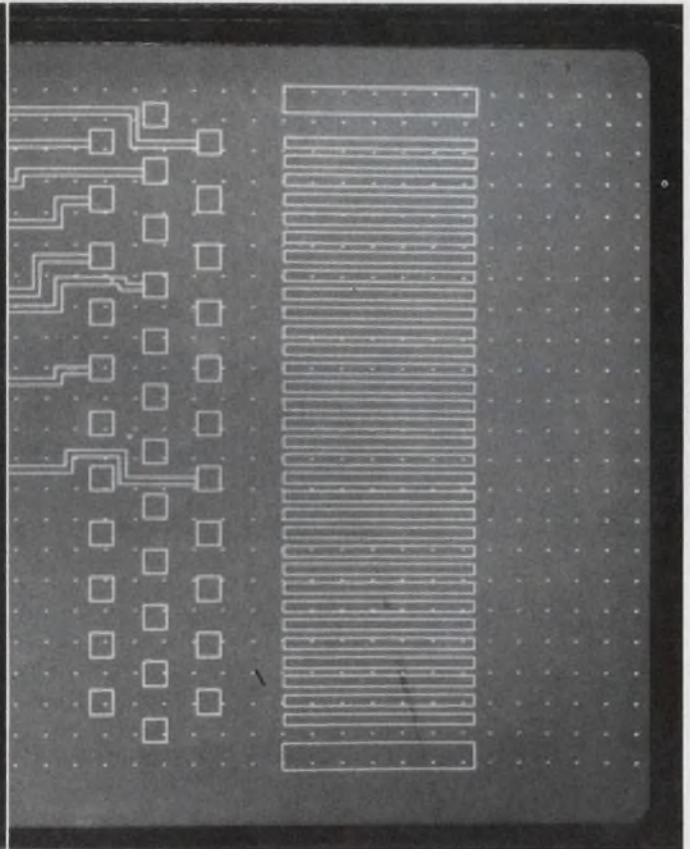

Unretouched time exposure of same data displayed on a CRT. Note lack of contrast in CRT image.

When your customers spend a lot of time looking at data displays and computer terminals, the advantages of Digivue plasma display units over CRT's become clear.

Very simply, Digivue display/memory units are better to look at. Digivue units present a flicker-free high contrast display for more precise readings and reduced chance of eye fatigue.

And Digivue units make it easier to use what's on the screen. Inherent memory is a feature of every unit. Digivue images appear on a thin, flat panel—which allows you to design compact components. The 512-60 models offer hard copy and rear projection capabilities, too. All of which gives you a product with more features to sell.

Sure, Digivue display/memory units currently cost more than CRT's. But they're worth a lot more to your customer, because they do a lot more.

For an informative booklet about Digivue display/memory units call (419) 242-6543, Ext. 66-415, or write Electro/Optical Display Business Operations, Owens-Illinois, Inc., P.O. Box 1035, Toledo, Ohio 43666.

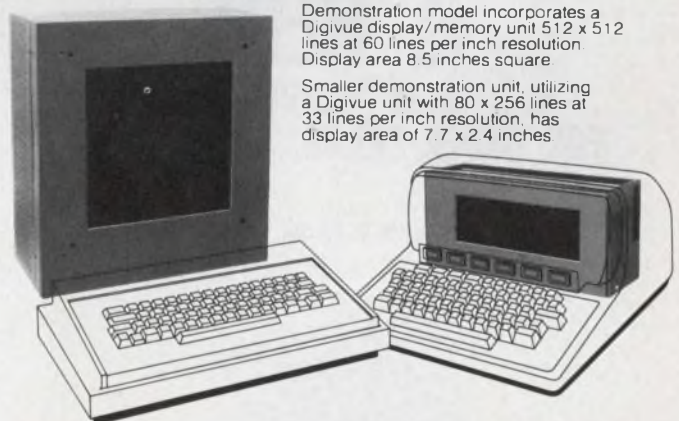

Demonstration model incorporates a Digivue display/memory unit 512 x 512 lines at 60 lines per inch resolution. Display area 8.5 inches square.

Smaller demonstration unit, utilizing a Digivue unit with 80 x 256 lines at 33 lines per inch resolution, has display area of 7.7 x 2.4 inches.

OWENS-ILLINOIS

Toledo, Ohio

Thermocouple box adjusts to many types

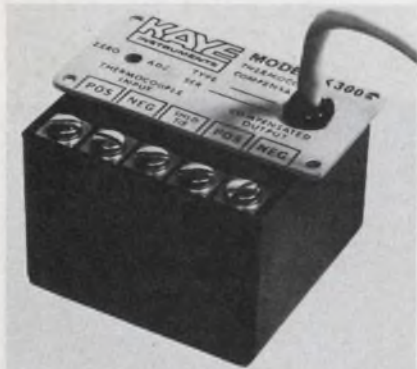

Kaye Instruments, 15 DeAngelo Dr., Bedford, MA 01730. (617) 275-0300. \$145; 3 to 4 wk.

An electronic thermocouple compensator, the Model K300, provides single channel, ac powered operation. The unit has an adjustment potentiometer that permits the user to trim the compensator output to match a specific thermocouple. The compensator is available for thermocouple types E, J, K, R, S and T.

CIRCLE NO. 285

Sample-and-hold amp droops only 0.3 mV/ms



Micro Networks, 5 Barbara Lane, Worcester, MA 01604. (617) 753-4756. From \$55 (1 to 24 pcs.); 2 to 4 wk.

The MN343 is a complete sample/hold amplifier housed in a 14-pin DIP. The unit provides a droop rate of less than 0.3 mV/ms and acquisition times of less than 10 μ s. The MN343H, full MIL range version, provides a typical droop rate of 20 mV/ms at +125 C. Thus, the unit can hold a sample for 50 μ s and lose only 1 mV, which, when paired with a 12-bit a/d converter is less than $\pm 1/2$ -bit on a 10-V range. Other features of the MN343 include aperture time of 60 ns, a peak amplitude transient (glitch) of -80 mV and gain error of $\pm 0.02\%$ max at 25 C.

CIRCLE NO. 286

Telephone line tester works remote or up front

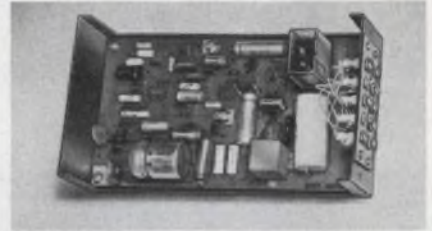

TM Systems, Inc., 25 Allan St., Bridgeport, CN 06604. (203) 366-4571. About \$100.

Model 321 loop back unit tests lines directly from a telephone office or the remote end of a line. The unit is activated with a test tone through protective circuitry to prevent false operation. Loop back test on a two-wire circuit provides for a high impedance dc termination of 600 Ω , a test tone from the remote point, removal of the customer terminated equipment during test and the automatic restoration of the circuit upon completion of the test period. Several four-wire versions of Model 322 are available with or without amplification.

CIRCLE NO. 287

ECONOMICAL PROGRAMMING IS HERE

A 10 x 10 MATRIX BOARD FOR UNDER \$15.00, SINGLE QTY.

AVAILABLE FROM STOCK

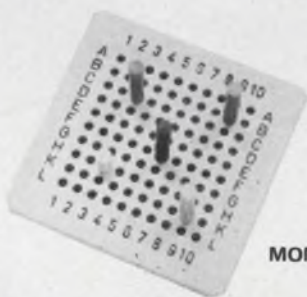

MONOMATRIX



ONE OF THE PURDY GROUP OF COMPANIES

770 Airport Blvd • Burlingame, Ca 94010 (415)347-8217

INFORMATION RETRIEVAL NUMBER 75



The Quick Way to select
HEAT SINKS
New!

astrodyne's easy to use Natural Convection HEAT SINK catalog provides data for more than 80 basic designs. Low power units for cap mounting on TO-5, TO-9 and TO-18's or for circuit board use, a wide selection of patented "T-fin" and standard heat sinks and high power units including compression type sinks for "hockey-puck" thyristors are illustrated with dimensions and performance graphs.

for your free Natural Convection Heat Sink catalog see your Astrodyne representative or write:



astrodyne, inc.

SUBSIDIARY OF ROANWELL CORPORATION
353 MIDDLESEX AVENUE / WILMINGTON, MASSACHUSETTS 01887

(617) 272-3850 TWX 710 347-0704

INFORMATION RETRIEVAL NUMBER 76

D/s converters accept 14-bit logic inputs

Singer Kearfott Div., 1150 McBride Ave., Little Falls, NJ 07424. (201) 256-4000. \$450; stock to 60 days.

The Trigac VI 14-bit digital-to-synchro-resolver converters have transformation ratio variations less than 2% as a function of angle. The units (C70 4773 series) are designed to drive loads to 100 Ω . The resolvers are fully compatible with the company's line of synchro amplifiers which provide up to 5 VA power capacity for driving high-powered torque repeaters. The converters are packaged in a 2.6 \times 3.1 \times 0.82 in. case and are optionally available in hi-rel versions including MIL-883 Class B components, operating temperature ranges of -55 to +125 C and CMOS compatibility.

CIRCLE NO. 288

Proximity detector works with three probe styles

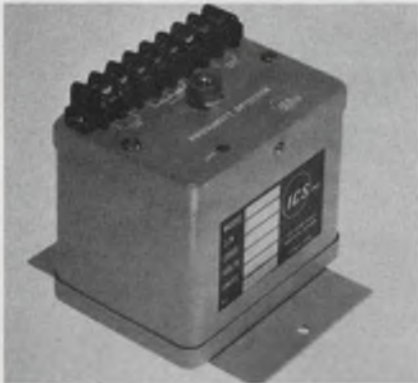

Instrumentation and Control Systems, Inc., 129 Laura Dr., Addison, IL 60101. (312) 543-6200. Approx. \$90; 2 wk.

The Model PD proximity detector is an inductive sensing system which detects ferrous and nonferrous metals without actual contact. Three basic style sensors are available: The slot, probe and ring. Gap spacing can vary from 0.0625 to 0.375 in. The sensors are available in 10:1 ranges from 1 to 5000 ppm. Input power requirement is 100 to 130 V ac, 60 Hz. The sensor is available with relay or static output. Critical alignment between sensor and metal is not required. Sensor size is 3.75 \times 2.75 \times 2.75 in. and system weight is 1.5 lb.

CIRCLE NO. 289

Having a little pull in the right places is what Ledex® Solenoids are all about

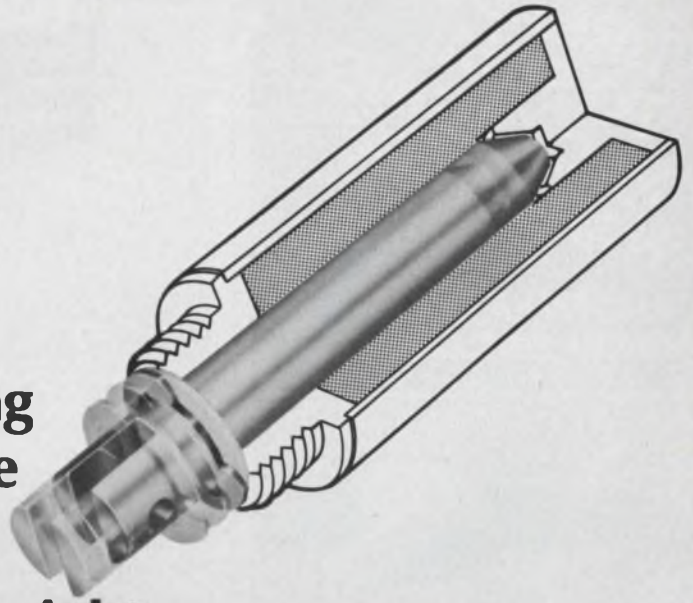

Get that extra pull or push right when you need it with a compact Ledex solenoid.

We have catalogued over six dozen standard models for immediate delivery. But, our specialty is providing the exact solenoid to fit your requirements . . . strokes, forces, speeds, mountings, etc.

Quality to you means long term dependability. Ledex tubular solenoids provide that because of exacting construction features that include a heavy duty plunger stop that keeps the pole faces from taking a beating at the end of the power stroke. The shaft is electroless nickel plated for smoother operation and longer bearing life. When you are making professional decisions, specifying Ledex push/pull solenoids, rotary solenoids, stepping switches, rotary switches, and push button switches can make a dramatic difference in your end product.

Send now for this complete reference book of application fundamentals, specifications, types and sizes of both Ledex straight pull and push/pull solenoids.

Toll free number for name of your nearest representative: 800-645-9200.



LEDEX INC.

123 Webster Street
Dayton, Ohio 45401
(513) 224-9891



**FROM
BREADBOARD
TO FINAL
PACKAGING
HARDWARE...**

**ALL AVAILABLE
FROM ONE SOURCE**



**★ ADHESIVE BACKED
CIRCUIT SUB-ELEMENTS**

*(Over 200 Pre-Drilled component mounting
patterns available "off-the-shelf.")*

**★ EPOXY GLASS BOARD
MATERIALS**

- 76 Standard "Off-the-Shelf" Boards.
- Including Unclad, Copper Clad, Cut & Peel Copper Clad, Pre-etched "X-Y" Pattern and Plated thru Hole Copper Clad.

MODULES & SUBASSEMBLIES

**Sequencer/controller
replaces control logic**



*Datel, 1020 Turnpike St., Canton,
MA 02021. (617) 828-8000. \$79;
4 wk.*

The Model SCL-CM is a micro-power data acquisition controller for up to 16 analog data channels. The unit will interconnect an external multiplexer, a/d converter, sample and hold and power supply for complete system control. In its simplest configuration the user need only provide the a/d conversion start-clock pulse and take the data out when the SCL-CM returns the a/d converter's end-of-conversion signal. The SCL-CM

**Active low-pass filters
use resistive tuning**

*Frequency Devices, Inc., 25 Locust
St., Haverhill, MA 01830. (617)
374-0761. From \$29 (100-up);
stock to 3 wk.*

The 738/748 series of resistively tunable low-pass filters has 16 models with two-pole Butterworth and Bessel transfer functions. The models cover the frequency ranges of 1 Hz to 20 kHz and 1 Hz to 50 kHz in four overlapping bands. Each model is externally tunable and has a 500:1 tuning range (200:1 for the 738 series). Specifications include passband insertion loss of 0.02 dB, 3% cutoff frequency accuracy, $10^9 \Omega$ input impedance and 1Ω output impedance. Offset voltage is less than ± 2 mV (adjustable to zero), offset drift is $\pm 20 \mu\text{V}/^\circ\text{C}$ and output noise is less than 75 μV .

CIRCLE NO. 292

**Instrumentation amp
draws only 1.25 mW**



THE MAXI KEYBOARD FAMILY

Shopping for keyboards? Don't buy more — or less — than you need. Maxi can supply keyboards to your mechanical and electronic requirements, in standard or custom configurations.

Economy? Our 3100 Series encoded keyboard with mechanical contacts is priced as low as the \$50.00 range in quantity. Dual bifurcated gold contacts have a life of over 10^7 operations under load.

Need the option of glass reed switching? The Maxi 2700 Series keyboard combines low cost and high reliability. All reeds are pre-tested before assembly, and switch modules are machine-adjusted for accurate operating point.

Special key actions? The Maxi 1800 Series keyboard offers more action options than any other keyboard on the market. Interlatch and lockout, accumulative latch, solenoid hold and release to name a few. Even illuminated buttons if you need them. Its metal frame construction makes the 1800 Series the strongest keyboard of the market.

The Maxi keyboard line includes double-shot and engraved buttons in a variety of sizes and colors. Encoding is another flexible Maxi option. Specify USASCII, EBCDIC or special codes in up to nine bits. The Maxi keyboard family has a member exactly suited to your needs. Call or send your specs for a firm quote on cost and delivery.



THE

(See Maxi in EEM)

Maxi-SWITCH CO.

9697 East River Road • Minneapolis, Minnesota 55433 • (612) 755-7660



INFORMATION RETRIEVAL NUMBER 79

THE SPACE SAVER WITH 10 AMP CAPABILITY

The RU 110 series is a new miniature low profile relay with an unusually high rated breaking capacity of 10 amps at 2200 VA. The 1 Form C relay contact is rated @ 6 amps, 250 VAC continuous duty. Dimensions: 1 1/8" long x 3/4" wide x 1/2" high, in clear dust cover for PCB mounting. Coil voltages range from 5-110 VDC. The relay can be operated in any position.

Call or write for catalogs and complete specifications.



1140 Broadway
New York, N.Y. 10001
(212) 683-0790

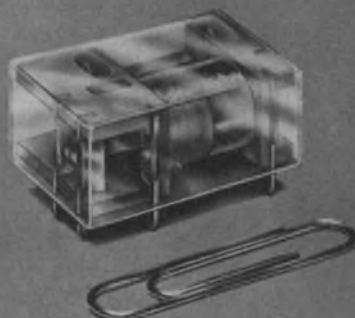

Immediate
Delivery

INFORMATION RETRIEVAL NUMBER 80

ELECTRONIC DESIGN 23, November 8, 1974

THE 25 YEAR METERS...



10/20/50/100 A AC: \$130.00

YEW's Precision Portables!

95% of all YEW precision portables that are returned for calibration certification are within original specifications, even after 25 years of use. We have even had instruments dating back 50 years within original specifications. *That is long term reliability* and that is why YEW is the world's largest manufacturer of precision portables.

Add taut band 0.5% accuracy, high quality and low cost, fast service, a vast selection of models and 25 years from now, you'll be glad that you tried a YEW portable. Prices start at \$120.00.

1% Portables also available. Prices start at \$50.



Yewtec Corporation
1995 Palmer Ave., Larchmont, N. Y. 10538
Telephone: 914 834-3550

60 Years of Measuring and Recording Instrumentation

INFORMATION RETRIEVAL NUMBER 81

INTEGRATED CIRCUITS

Detectors convert light to voltage

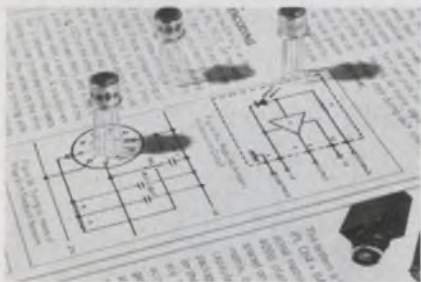

Integrated Photomatrix Inc., 1101 Bristol Rd., Mountainside, NJ 07092. (201) 233-7200.

Each of the IPL 16 series of analog-light detectors consists of a 1-mm diameter photodiode integrated on a single chip with a MOS buffer amplifier. Devices have a low-noise characteristic of $NEP = 2 \times 10^{-13} \text{ W}/\sqrt{\text{Hz}}$ and high sensitivity of $220 \text{ mV}/\mu\text{W}$ per cm^2 . They also have a fast response of less than $1 \mu\text{s}$, and operate over a bandwidth of up to 400 kHz.

CIRCLE NO. 294

IC forms digital radio-alarm timer

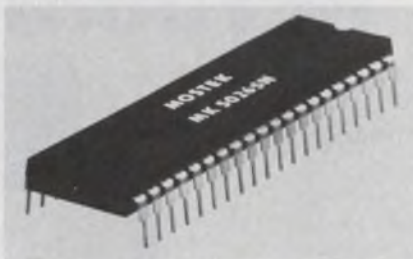

Mostek Corp., 1215 W. Crosby Rd., Carrollton, TX 75006. (214) 242-0444. \$4.80 (1000).

The MK 50265 MOS/LSI clock circuit can be used to build a digital radio-alarm clock timer with the addition of power supply, display and standard interfacing components. The new unit allows four or six-digit multiplexed display, AM/PM indication and 24-hour alarm setting with "snooze" function. Other features include power failure indication and intensity control. Operation is from 50 Hz (12-hour operation) input. The MK 50265N comes in a 40-pin plastic package.

CIRCLE NO. 295

Timers drive any logic

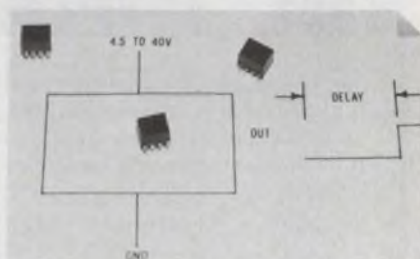

Timers Unlimited, P.O. Box 526, Saugus, CA 91350. (805) 252-8592. \$4.50 (1000); stock to 30 days.

The PT 200 series of hybrid power-on timers provide a delayed, clear logic pulse following the application of input power. Supply voltages of 4.5 and 40 V make the unit compatible with standard logic families. Packaged in mini-dips, the timers require no external components and have a large fanout capability—sink currents are 50 mA. Packaged height is 0.325-in. above the seating plane and delays from 10 ms to 10 s are available.

CIRCLE NO. 296

"CANNON® ZERO FORCE DL CONNECTORS GAVE OUR COSTS A CUT, and me a boost."



"No wonder. The combination of a 10,000 cycle life and lower cost than other rectangular connectors made Cannon Zero-force DL's the easy choice for a tough application. It's all told here in 'Secrets of Connector Success.' Get yourself a copy, and save some wear and tear."

Contact ITT Cannon Electric, International Telephone and Telegraph Corporation, 666 East Dyer Road, Santa Ana, CA 92702. (714) 557-4700.



INFORMATION RETRIEVAL NUMBER 82

PHOTO ETCH™ PRINTED CIRCUIT KIT

Makes circuits THREE WAYS

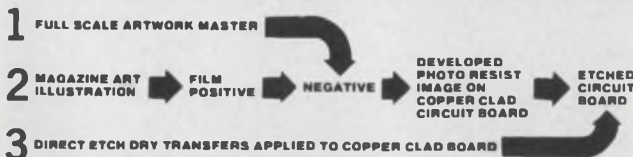

NO CAMERA DARKROOM FILM CUTTING TRACING **USES DATAK'S POS-NEG PROCESS**
The revolutionary photographic way that makes PERFECT printed circuits from original art or a printed page.

KIT CONTAINS: 5' x 6' steel printing frame, 4 sheets 5' x 6' photocopy film, yellow filter, chemicals for 1 pint film developer and 1 pint film fixer, 5' x 6' copper clad board, 3' x 4', copper clad board, spray can of photo etch resist, 1 pint resist developer, 2 sheets 8 1/2' x 11' layout film, 1 roll 3/16" printed circuit tape, 1 roll 1/32" printed circuit tape, 8 sheets dry transfer direct etch PC patterns including diodes, transistors, round can and flat pack IC's, DIP IC's, edge card connectors, lines, circles, logs, etc. 1/2 to anhydrous ferric chloride to make 1 pint etchant, instructions.

- ER-4 COMPLETE PHOTO ETCH SET \$24.95
- ER-2 PC patterns and tapes—refill 3.39
- ER-3 1/4 pound dry etchant—refill 1.25
- ER-5 6 sheets photocopy film—refill 3.39
- ER-6 Film process chemicals—refill 1.79
- ER-7 Photo resist spray, 2.5 oz.—refill 2.95
- ER-8 Resist developer, 16 oz. can—refill 2.95

AT YOUR DISTRIBUTOR OR DIRECT

the **DATAK** corp.
65 71st St. • Guttenberg, N. J. 07093

INFORMATION RETRIEVAL NUMBER 83

ELECTRONIC DESIGN 23, November 8, 1974

70-V/ μ s op amps have 15-MHz BW

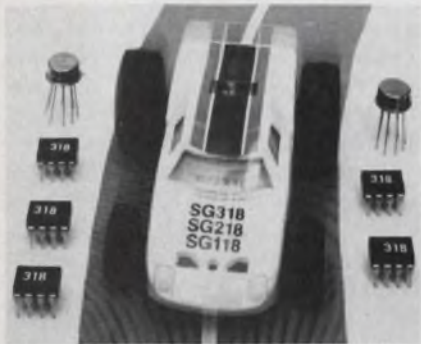

Silicon General Inc., 2712 McGaw Ave., Irvine, CA 92705. (714) 556-1600. \$2.60 to \$22.95. (100); stock.

Slew rates to 70 V/ μ s and bandwidths of 15 MHz are combined in the SG118/218/318 high-speed internally compensated op amps. Supply current drain is only 5 mA. Other characteristics include 2-mV offset voltage, 6-nA offset current and 120-nA bias current. Voltage gain is typically 200,000 and the supply voltage can range from ± 5 to ± 20 V. The op amps are identical to like-numbered units first introduced by National Semiconductor.

CIRCLE NO. 297

CMOS up/down counter guarantees 1.5-MHz rate

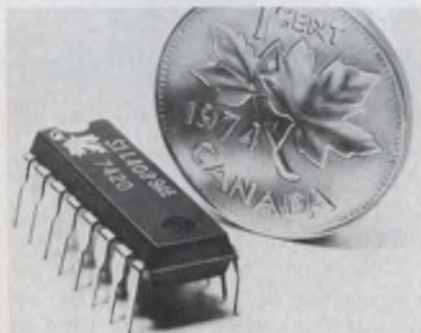

Siltek International Ltd., Bromont, Quebec, Joe 1LO, Canada, \$3.80 (1000); stock.

A CMOS binary or BCD-decade presetable up/down counter, the SIL4029A, permits multiple devices to operate in the parallel-clock mode at a guaranteed clock rate of 1.5 MHz with 50-pF loads. The output transition time with $V_{DD} = 10$ V and $C_L = 50$ pF is typically 70 ns. The unit comes in a 16-lead package, and versions operate over commercial or MIL-temperature ranges.

CIRCLE NO. 298

Give your circuits a break

When you specify Kulka, you are specifying terminal blocks which are second to none in terms of quality, design, workmanship and durability. What's more, you will have the most comprehensive sales and distribution network in the industry. So give your circuits a break. Make contact with Kulka.

Kulka

A NORTH
AMERICAN
PHILIPS
COMPANY

Kulka Electric Corp., 520 South Fulton Avenue, Mount Vernon, New York 10551

MOVE IT?



NEW "V-PAC"* POWER SOURCES for PORTABLE & AUTOMOTIVE ELECTRONICS

Use your 12v DC source to operate most IC types, including MOS, linear and TTL's. Get isolation, with single or dual voltage sources, positive and/or negative polarities.

Select from sources which provide DC voltages from -6 to +15, at one watt. You can use "V-PAC" sources on the same PC card as ICs, use standard 24 pin 1C plug or solder mount. Use less than .3 cubic inch volume per unit.

Call or write now for full technical specifications. Ask for the "V-12" data.



Reliability, Inc.

5325 Glenmont
Houston, Texas 77036
713-666-3261
TWX: 910-881-1739

*Trademark, Reliability, Inc.

INFORMATION RETRIEVAL NUMBER 85

INTEGRATED CIRCUITS

ICs link instruments

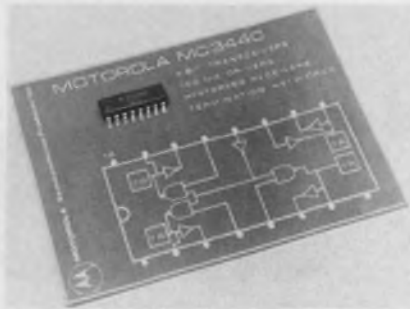

Motorola Semiconductor Products, Inc., P.O. Box 20924, Phoenix, AZ 85036. (602) 244-6900. \$2.15 (100-999).

General-purpose interface-bus transceivers—the MC3440, MC3441 and MC3443—provide the common bond to link a variety of test instruments together. These circuits contain four drivers and receivers arranged to permit bi-directional flow of digital data between various instruments. All feature receiver input hysteresis for noise rejection, open-collector driver outputs for wired-OR connections, TTL drive levels and internal termination resistors in the MC3440 and MC3441.

CIRCLE NO. 299

Decade divider operates at 1.2 GHz

Plessey Semiconductor, 1674 McGaw Ave., Santa Ana, CA 92705. (714) 540-9979.

Doubling the capability of the next-highest-frequency decade divider available, the company offers a 1.2-GHz decade divider intended for frequency synthesis in navigation equipment for TACAN, and distance-measuring-equipment applications. The new IC can be triggered by a sine wave at frequencies as low as 100 MHz. Input range is 400 mV to 1.2 V pk-pk for a sine wave. The clock input is self-biasing, and is controlled by a MECL III-compatible clock-inhibit input. Outputs are fully compatible with MECL II and with ECL-10-k circuits using external resistors. Packaged in a standard 14-pin DIP, the unit dissipates only 500 mW.

CIRCLE NO. 300

4-bit ALU processes in 9 ns

Advanced Micro Devices, Inc., 901 Thompson Pl., Sunnyvale, CA 94086. (408) 732-2400. Am54S/74S181: \$10.78 to \$45; AM54/74181: \$5.99 to \$10.65 (100 up).

The Am54S/74S181, functionally equivalent to a like-numbered 4-bit ALU from TI, can handle 4-bit numbers in 9 ns and 16-bit numbers in 17 ns. The Schottky-TTL unit can perform 16 arithmetic operations including add, subtract, double and compare, and it offers a full look-ahead carry scheme for arithmetic operation of longer words. A companion circuit, the Am54/74181 (a functional equivalent of the Am9341) can handle 4-bit numbers in 19 ns and 16-bit numbers in 11 ns.

CIRCLE NO. 301

4096-bit NMOS RAM costs \$12

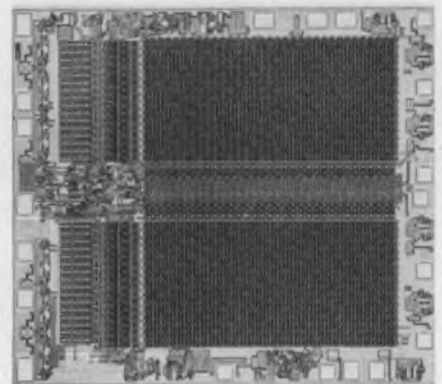

Intel Corp., 3065 Bowers Ave., Santa Clara, CA 95051. (408) 246-7501. P&A: See below.

The company's 4096-bit n-channel RAM enters the market with a price tag of only \$12 in 100-up quantity. Called the P-2107A-8, the new RAM comes in a 22-pin DIP and is available from stock. It has a maximum access time of 420 ns, read-cycle time of 690 ns and write cycle time of 970 ns. The IC is a fully decoded, single clocked, TTL-compatible design that operates on standard power supplies of +5, -5 and +12 V. Standby power dissipation is 2 mW and active power is 11 mW. The low standby power allows a typical storage array of 32 kilobytes to operate with an average power dissipation of about 4 W.

CIRCLE NO. 302



**POLYESTER FILM TYPE
ELECTROLYTIC TYPES
CERAMIC DISC TYPES**

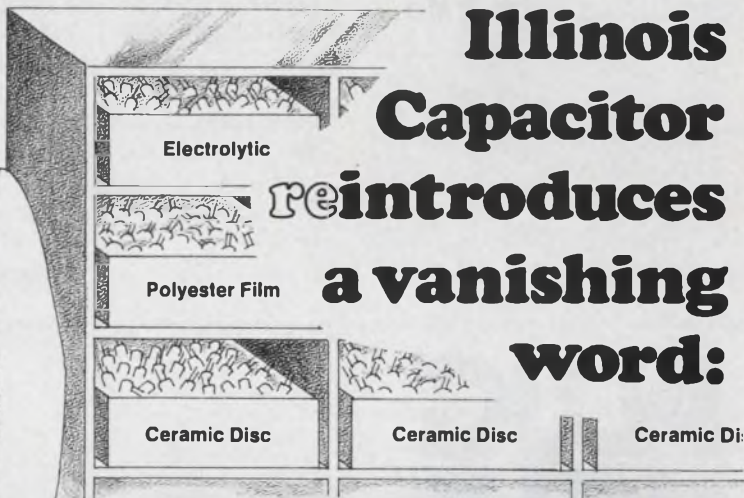

**Illinois
Capacitor
reintroduces
a vanishing
word:**

STOCK

ILLINOIS CAPACITOR SALES CO.

6284 W. Oakton • Morton Grove, Illinois 60053
(312) 967-6270 • Telex: 72-4361 • Cable: ILLCON Morton Grove

INFORMATION RETRIEVAL NUMBER 86

*Add thermocouple
inputs directly
to your computer!*

DIGISTRIP

**the all-new
DIGITAL DATA SYSTEM**

Solves your thermocouple to computer problems. Digistrip automatically conditions and scans up to 15 thermocouples or other low-level analog signals and converts them to digital data for direct computer interface.

Transmits TTY, RS232, or serial by character ASCII data from remote locations. Accuracy to 2µV or 0.1°F. All this for as little as \$110. per channel! Call or write today for FREE Digistrip brochure.

Keye ... the industry standard for accuracy



15 DeAngelo Drive
Bedford, Massachusetts 01730
(617) 275-0300

"CANNON® MICRO-MINIATURE CONNECTOR CAPABILITIES GOT US OUT OF OUR BOX, and me into a corner office."

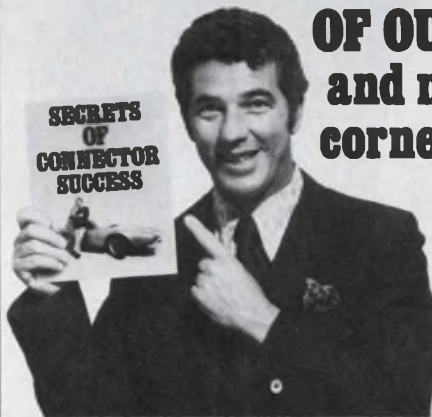

"Cannon showed us how their custom miniature connector assemblies could do the job better—and for less—than we could ourselves. Read about it in 'Secrets of Connector Success'—and get ready to move up."

Contact ITT Cannon Electric, International Telephone and Telegraph Corporation, 666 East Dyer Road, Santa Ana, CA 92702. (714) 557-4700.

CANNON ITT

INFORMATION RETRIEVAL NUMBER 88

Vhf log-periodic antenna has high gain



The Antenna Specialists Co., 12435 Euclid Ave., Cleveland, OH 44106.

(216) 791-7878.

For the vhf range, a log periodic antenna—Model ASP-810—offers a minimum 8.1-dB forward gain across a 26-MHz bandwidth, from 148 to 174 MHz. VSWR is less than 1.5:1 across the entire bandwidth, and the antenna's front-to-back ratio is greater than 20 dB. The antenna has a 500-W power-handling capability and it provides dc grounding for lightning protection.

CIRCLE NO. 303

Special klystrons power 50-80-GHz range

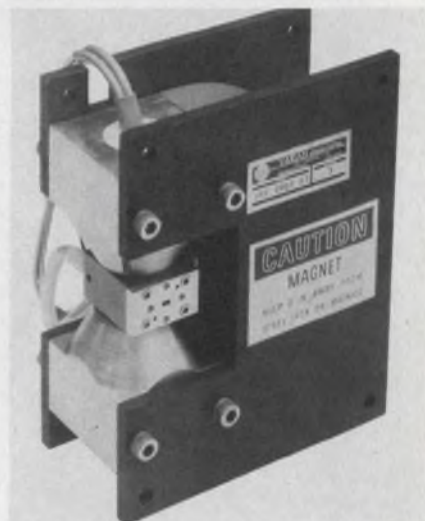

Varian, 611 Hansen Way, Palo Alto, CA 94303. (415) 493-4000. \$8000 to \$10,000; 120 days.

Extended interaction klystron oscillators provide typical output powers of 20 to 45 W for the 50-to-80-GHz frequency range. For example, Model VKE-2401A, which comes fixed tuned, and Model VKE-2401B, which is trim-tuned, have a typical frequency of 60 GHz and typical output of 50 W. The mechanically tuned VKE-2401C and the motor-tuned VKE-2401D have a typical frequency of 75 GHz and a typical output power of 20 W.

CIRCLE NO. 304

PLUG UGLY.™

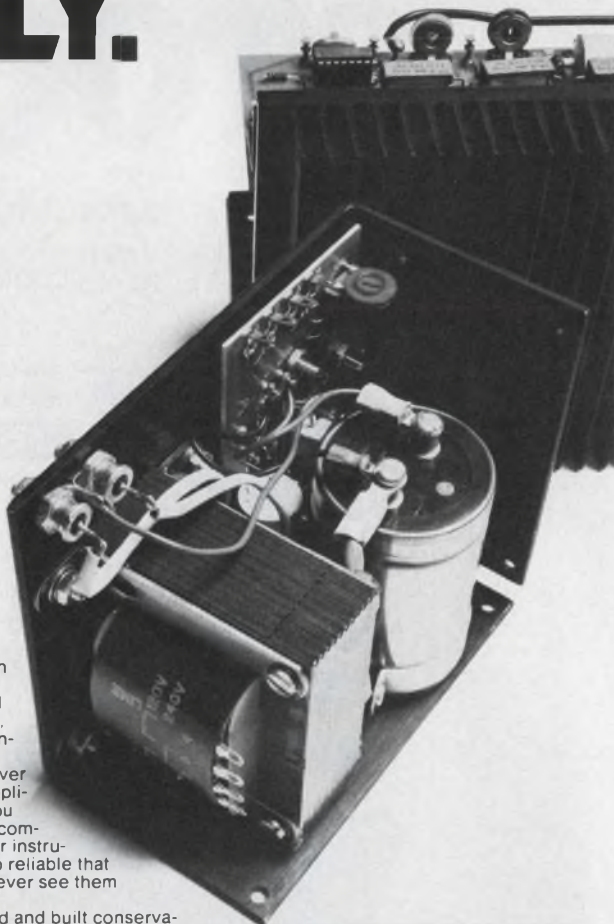

\$49 (unit qty.)
5V, 6A

They're not much to look at

Because instead of fancy front panels, we designed our standard open-frame dc power supplies to cover 90% of your OEM applications. And once you plug them into your computers, peripherals or instrumentation, they're so reliable that chances are you'll never see them again.

They're designed and built conservatively, so you get full rated power all the way up to +55°C. Regulation, ripple and noise are specified by the book. And with no expensive options, you can now get your dc power for as little as 60¢/W (unit qty).

If you've looked at the competition, we know that has to be a sight for sore eyes.

For more info, use the bingo card or call 714/979-4440. Or call your local Cramer or Newark distributor and get UGLY today.

OPEN-FRAME OLV SERIES: 4-28 Vdc, 15-250 W

STANDARD FEATURES: Choice of 16 voltages, adjustable ±5%
Currents to 50A, no derating to +55°C, ±0.1% IC regulation
±0.1% ripple and noise. Remote sensing/programming
Spike suppression. Foldback current limiting. 120/240 Vac,
50/60 Hz inputs

OPTIONS: OVP crowbar PRICES: \$29.00 to \$219 (unit qty.)

Elexon Power Systems

Get UGLY wherever you are: New England: Coakley, Boyd & Abbott 617/444-5470 □ Upstate N.Y.: Kehoe Component Sales 315/524-2491 □ N.Y.-Metro: New Jersey: Ed Glass Assoc. 201/592-0200 □ Penn. Del.: So. N.J.: T.O.E. Sales 215/348-2212 □ Va.: S.C.: Md.: N.C.: Component Sales Inc. 301/484-3647 □ Kentucky: Ohio: Ind.: Frank J. Campisano Co. 513/662-1616 □ Michigan: Wiliani-Pitcher Inc. 313/271-4600 □ No. Carolina: Component Sales Inc. 919/782-8433 □ Ga.: Ala.: BJR Manufacturing Reps. 205/881-3565 □ Florida: Orba, Inc. 813/894-0687 □ Ill.: Wisc.: Iowa: Balhorn & Welch 312/889-5011 □ Minn.: N. & S. Dakota: Lew Cahill & Assoc. 612/646-7217 □ Mo.: Kansas: K & M Sales Co. 816/471-2355 □ Colo.: Utah: J. S. Heaton Co. Inc. 303/758-5130 □ Texas: La.: Carter Assoc. Inc. 214/276-7151 □ Okla.: Ark.: Hugh J. Daly Co. 918/627-4159 □ Arizona: J. S. Heaton Co. 602/264-7887 □ New Mexico: J. S. Heaton Co. 505/293-3900 □ Wash.: Ore.: Blum & Associates 206/782-1600 □ N. Calif.: J. S. Heaton Co. 415/369-4671 □ S. Calif.: RLS Associates 714/644-7497



© Copyright 1974 Eipac, Inc.

Dual-mode technique simplifies filters

Frequency Engineering Laboratories, Farmingdale, NJ 07727. (201) 938-9221.

A family of tunable filters boast multicavity response characteristics with only half the number of stages normally required for the equivalent response. Using the dual-mode technique in TE₁₁₁-mode cylindrical cavities, the DU-MODE filters offer a 2-pole response for each physical cavity used. For example, a 2-cavity device exhibits a 4-pole response and a 3-cavity device exhibits a 6-pole response. Covering selected segments of the 4.4-to-11.0-GHz range, the single-knob bandpass filters feature 3-dB bandwidths from 10 to 50 MHz and 2-pole through 6-pole selectivity.

CIRCLE NO. 305

Video amp complements photomultiplier tubes



Pacific Photometric Instruments, 5745 Peladeau St., Emeryville, CA 94608. (415) 654-6585. \$150; 2 wks.

Amplifiers designed for use with photomultiplier tubes are offered in the Model 2A44 series. The video amplifier features a noninverted gain of 100 and operation from dc to 50 MHz. With the new amps, photomultiplier current of 1 μ A is amplified to 5 mV across a 50- Ω load; the resulting output remains linear to 1 V. The amplifier also can handle sine wave or pulse inputs, and it operates from \pm 15-V supplies.

CIRCLE NO. 306

Omni antennas cover broad band



Tecom Industries Inc., 9000 Owensmouth Ave., Canoga Park, CA 91304. (213) 341-4010.

A family of five antennas, covering frequencies in the range of 0.25 to 40 GHz, consists of slant-linear polarized biconicals packaged in hermetically sealed, foam-filled radomes (MIL-E-16400). The omnidirectional antennas have an elevation beamwidth of 45 to 50 degrees centered about the horizon.

CIRCLE NO. 307

Module programs laser for 99 resistor trims

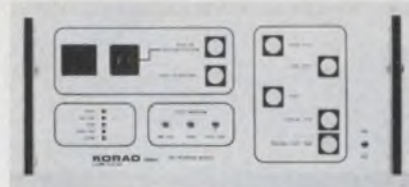

Hadron Inc., 2520 Colorado Ave., Santa Monica, CA 90404. (213) 829-3377.

With a program module for the company's Model KRT laser resistor trimmer, up to 99 resistors can be trimmed automatically. A single module interfaces to a carousel-type substrate handler and trims up to 24 resistors. But with the addition of "slave" program modules, the higher number can be achieved. Use of the module doesn't require software expertise.

CIRCLE NO. 308

MEAN AND UGLY.™



\$79 (1-9) 3 outputs

Our OEM dc supplies have always been stark, but now they're twice as ugly (also 3x).

Because instead of working up a new color scheme, we've combined two and three of them on a single chassis to make them an even better buy for your computers, peripherals and instruments.

We've taken out redundancies, but they still offer the widest range of voltages you can get in a modular dc supply. Still deliver all the power we promise across the full temperature range (even with 50 Hz inputs). And still include all the features you need as standards, not expensive options.

So that now if you check us out against the competition, they're liable to tell you that we're not just ugly.

We're downright mean.

For more info, use the bingo card or call 714/979-4440. Or call your local Cramer or Newark distributor and get UGLY today.

MULTIPLE OUTPUT OLV/TLV SERIES: 1st output: 5 V at 3-15 A. OVP standard. 2nd and/or 3rd outputs: each 4-28 V, 8-15 W. OVP optional. All outputs isolated, may be used as positive or negative supplies.

STANDARD FEATURES: Choice of 18 voltages, adjustable \pm 5%. Currents to 15 A, no derating to $+55^\circ\text{C}$ \pm 0.1% regulation. \pm 0.1% ripple and noise. Remote sensing/programming. Spike suppression. Feedback current limiting. 120/240 Vac. 50/60 Hz inputs.

OPTIONS: Enclosure. **PRICES:** \$29 to \$151 (1-9)

Elexon Power Systems

Get UGLY wherever you are: New England: Coakley, Boyd & Abbott 617/444-5470 Upstate N.Y.: Kehoe Component Sales 315/524-2491 N.Y.: Metric New Jersey: Ed Glass Assoc. 201/592-0200 Penn. Del.: So. N.J.: T.O.E. Sales 215/348-2212 Va.: S.C.: Md.: N.C.: Component Sales Inc. 301/484-3647 Kentucky, Ohio, Ind.: Frank J. Campisano Co. 513/662-1618 Michigan: Villani-Pitcher Inc. 313/271-4600 No. Carolina: Component Sales, Inc. 919/782-8433 Ga.: Ala.: BJR Manufacturing Reps 205/881-3589 Florida: Orbe, Inc. 813/894-0687 Ill.: Wisc.: Iowa: Balhorn & Welch 312/889-5011 Minn.: N. & S. Dakota: Lew Cahill & Assoc. 612/646-7217 Mo.: Kansas: K & M Sales Co. 816/471-2355 Colo.: Utah: J. S. Heaton Co., Inc. 303/758-5130 Texas: La.: Carter Assoc., Inc. 214/276-7151 Okla.: Ark.: Hugh-J. Daly Co. 918/827-4159 Arizona: J. S. Heaton Co. 602/264-7887 New Mexico: J. S. Heaton Co. 505/293-3900 Wash.: Ore.: Blum & Associates 206/782-1600 N. Calif.: J. S. Heaton Co. 415/389-4871 S. Calif.: RLS Associates 714/644-7497



ELPAC © Copyright 1974 Elpac, Inc.

INFORMATION RETRIEVAL NUMBER 90

Flat packs hold phase shifters

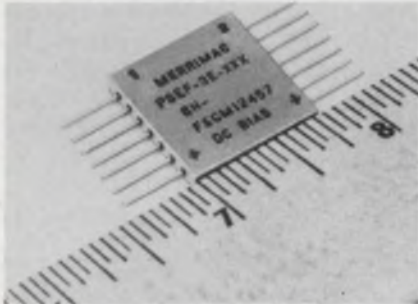

Merrimac Industries Inc., 41 Fairfield Pl., West Caldwell, N.J. 07006. (201) 228-3390.

Miniature, flat-pack electronically controlled phase shifters cover the 10-to-500-MHz frequency range. The new units have a center-frequency phase-shift range of 0 to -180° and they spec 10% bandwidths. Three standard models offer center frequencies of 30, 60 and 160 MHz. Other features of the PSEF-3E series are an insertion loss of 1.2 dB maximum, 0.8 dB typical, and a VSWR of 1.6:1 maximum with 50- Ω impedance.

CIRCLE NO. 320

Laser product allows controlled-mode tuning

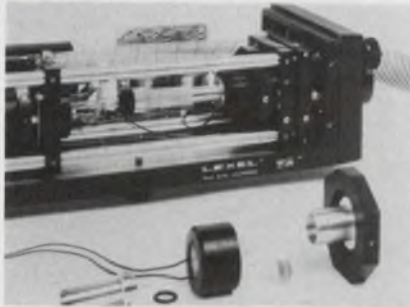

Lexel Corp., 928 E. Meadow Dr., Palo Alto, Calif. 94303. (415) 328-3466. \$750; stock.

Temperature-controlled single-frequency Etalon assembly, for use with the company's ion lasers, allows single longitudinal-mode operation for applications requiring long coherence length and very narrow line width, such as holography and interferometry. The Model 503 assembly has a surface parallelism of better than 0.5 arc seconds and a free spectral range of 9.4 GHz. Etalon temperature regulation is ± 0.01 C, and conversion efficiency ranges from 50% to 75%.

CIRCLE NO. 321

Efficiency of uhf tetrodes reach 50%



Thomson CSF, Groupement Tubes Electroniques, 8 rue Chasseloup-Laubat 75737, Paris, Cedex 15, France.

Using proprietary fabrication techniques, the TH 491H uhf-TV tetrode delivers a peak-video output of 20 kW with only 5.5-kV high voltage required. The tetrode draws just 40-kW average from the dc power source, for an overall efficiency of 50%. The TH 491H operates over the 470-to-860-MHz range.

CIRCLE NO. 322

HUNT: THE CASE PLACE



Need thyristors (triacs and SCR's) in a variety of cases? You can get 'em all at the case place. Write Hunt for a brochure, or call toll-free 800-645-9200.



HUNT ELECTRONICS

2639 Mañana, Dallas, Texas 75220
(214) 350-5571

oem

A CAMBION® Double "QQ" Product Line

As often as you want, too. The design of the jack and the materials from which it is produced give it the strength to be cycled more than 50,000 times (we've done it) without appreciable change in contact resistance.

And we didn't just do it once "in the lab."

We have tens of millions of these jacks out, in use by customers. ID's range from .016" to .080". And are available in different shapes and types for mounting components, patching, plugging, or whatever you have in mind.

All CAMBION cage connectors are standard, immediate delivery items. You can have them fast in whatever number you want. That's the CAMBION Double "QQ" approach, the quality stands up as the quantity goes on. Ask for a sales engineer or a catalog. Cambridge Thermionic Corporation, 445 Concord Avenue, Cambridge, Mass. 02138. In Los Angeles, 8703 La Tijera Blvd. 90045.

This cage jack was built for recycling!



INFORMATION RETRIEVAL NUMBER 92

ELECTRONIC DESIGN 23, November 8, 1974

INFORMATION RETRIEVAL NUMBER 91

J-band amp outputs 50 W

Teledyne MEC, 3165 Porter Dr., Palo Alto, Calif. 94304. (415) 493-1770. 6 months.

Designed for ECM applications, the M2716 amplifier provides 50 W of rf power in J band. The unit operates from 12 to 18 GHz with a gain of 54 dB, and it can be installed in a 3-1/2-inch, external ECM pod. It includes built-in blanking capability for "look-through" mode cw jamming. Prime power for this MIL-E-5400 Class 2 HPA is 115 V ac, 400 Hz, single phase, 350 VA. The amplifier measures 2-1/2 x 3 x 24-in. and it weighs just 15 lbs. Cooling is by conduction.

CIRCLE NO. 323

FM antennas rated at 1 kW per bay



Phelps Dodge Communications Co., Rt 79, Marlboro, N.J. 07746. (201) 462-1880.

Two 1000 W per bay, FM broadcast antennas come circularly and horizontally polarized. Called CP-1000 and HP-1000, the new antennas fill the gap between an educational series rated at 200 W per bay and the standard antenna series rated at 5000 W per bay. The antennas are parallel fed so that a two-bay antenna is rated at 2 kW and a three-bay at 3 kW.

CIRCLE NO. 324

TWT produces 20 W at X-band

English Electric Valve Co., Ltd., Chelmsford, Essex, CML 2 QU, England.

The company's latest TWT yields 20 W over the 10.7-to-13.2-GHz frequency range. Called the N1093, the TWT has a saturation output of 30 W, nominal gain of 43 dB and a noise factor of 25 dB. AM/PM conversion is 2 degree/dB.

CIRCLE NO. 325

A complete line of CUSTOMIZED ROTARY CERAMIC SWITCHES ...

For RF and POWER APPLICATIONS

RSC switches are available in a variety of switching models. RSC high precision, quality built units are designed for applications requiring long life maintenance-free service. Types include shorting and non-shorting, single and multi-deck, up to 18 pole positions. Features include, 10 to 100 amp current carrying capacity, 20° to 90° detents, 2000 to 24000 volts flashover and corrosion-proof construction.

Write for catalog no. 960 and complete information.

RADIO SWITCH CORPORATION

Rt. 79, Marlboro, N. J. 07746

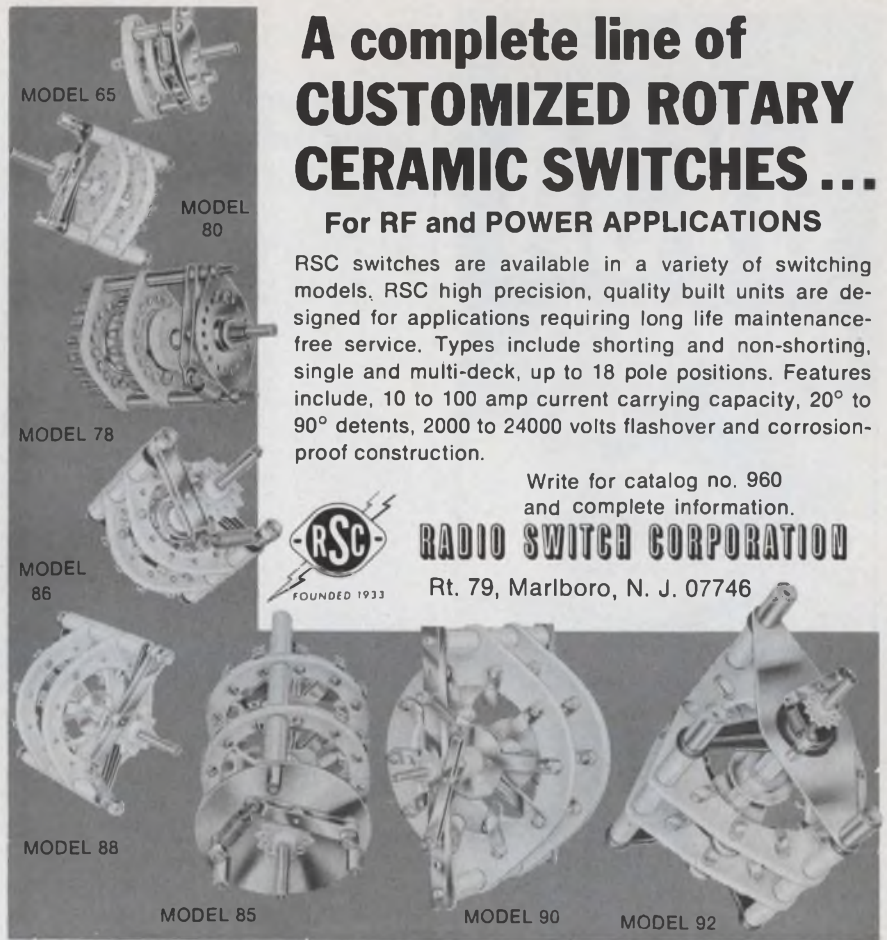

INFORMATION RETRIEVAL NUMBER 94

WHO MAKES WHAT & WHERE TO FIND IT

Volume 1 of **Electronic Design's GOLD BOOK** tells all. And, when you look up an item in its **PRODUCT DIRECTORY** you'll find each manufacturer listed **COMPLETE WITH STREET ADDRESS, CITY, STATE, ZIP AND PHONE.** Save time. There's no need to refer elsewhere to find missing information.

IT'S ALL THERE in **Electronic Design GOLD BOOK**

DIRECT FROM STOCK

5V3A

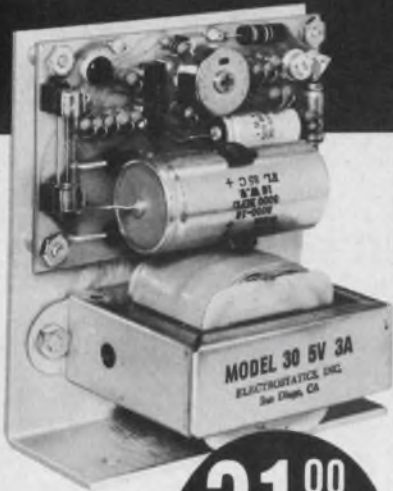

31⁰⁰
(1-9)

\$23.70 - 100 pcs.

Excellent regulation

MICROWAVES & LASERS

Active antennas boast reduced size

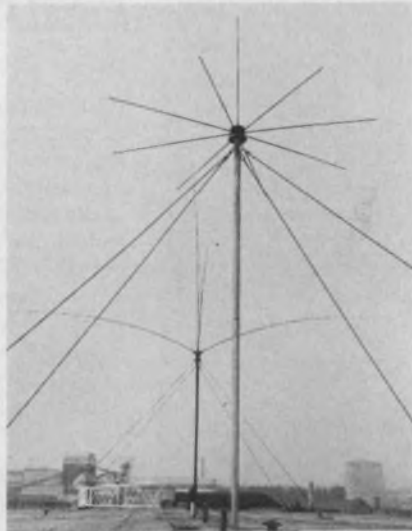

*Rohde & Schwarz, Pressestelle,
8000 Munchen 80, Muhldorfstrabe
15, Germany.*

Active receiving antennas for the 1.5-to-30-MHz frequency range are reportedly only 1/3 as large as corresponding passive antennas with the same sensitivity. The HE001 active vertical antenna has a height of only 1.5 m, and the

Power filter has 0.035-dB loss

*Wavecom, 9036 Winnetka Ave.,
Northridge, CA 91334. (213) 882-
3010.*

Model C-115 transmit-reject filter achieves loss as low as 0.035 dB while operating at a continuous power level of 10 kW and providing stopband attenuation as high as 100 dB. Other specifications include a 3.7-to-4.2-GHz passband, 5.9-to-6.4-GHz stopband and maximum VSWR of 1.1:1. The unit's over-all length is 18 in. and it doesn't require special cooling.

CIRCLE NO. 328

Combiners, couplers aid antenna sites

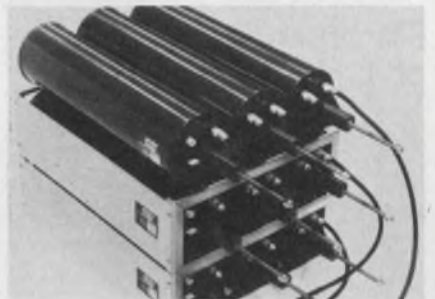

YIG filter spans 26.5-to-40-GHz band

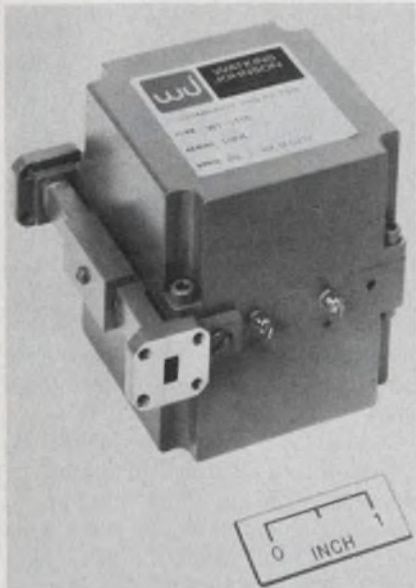

Watkins-Johnson Co., 3333 Hillview Ave., Palo Alto, CA 94304. (415) 493-4141.

Model WJ-5196 YIG filter, covering the 26.5-to-40-GHz frequency band, can be used as an electronically tunable preselector in superheterodyne or TRF receivers. The filter has a maximum insertion loss of 6 dB, minimum 3-dB bandwidth of 75 MHz and minimum off-resonance isolation of 35 dB. The unit measures 2.8 × 2.8 × 2.9 in., weighs 70 oz and has a 40-MHz/mA tuning sensitivity.

CIRCLE NO. 330

Yagi antennas list 7, 9-dB gains

The Antenna Specialists Co., 12435 Euclid Ave., Cleveland, OH 44106. (216) 791-7878.

Three and five-element Yagi antennas are designed primarily for point-to-point communications in the 138-to-174-MHz range. The new antennas feature bandwidths of greater than 5 MHz and VSWRs of less than 1.5:1. The 3-element array, Model ASP-816, has a forward gain of 7 dB and is rated for wind velocities up to 189 mph. The 5-element array, Model ASP-817, has a forward gain of 9 dB and a 145 mph wind-velocity rating. Gain and wind ratings are in accordance with E.I.A. Standard RS-329.

CIRCLE NO. 331

Mixer/preamp spans Ka band



SpaceKom, Inc., 212 E. Gutierrez

St., Santa Barbara, CA 93101. (805) 965-1013.

Model BFK-20u mixer/preamplifier employs stripline-waveguide hybrid fabrication to cover all of Ka band. Over-all noise figure is 7 dB maximum from 26.5 to 40 GHz and 6 dB maximum from 28 to 38 GHz. The unit has an i-f bandwidth of 10 to 500 MHz and a gain of 30 dB. LO power is 5 mW nominal.

CIRCLE NO. 332

This Christmas give your car a Mark Ten B Capacitive Discharge Ignition. You and your car will enjoy it all year.



The Mark Ten B keeps your car in tune. That means increased mileage, less maintenance and a better running car. A well-tuned car also decreases emission contaminants. All this adds up to more driving enjoyment for you. Mark Ten B, the perfect gift—for cars—and their owners.



DELTA PRODUCTS, INC.

P.O. Box 1147, Dept. ED
Grand Junction, Colo. 81501
(303) 242-9000

Here's my Christmas order. Please rush!

Please send me free literature.

Enclosed is \$ _____ Ship ppd. Ship C.O.D.

Please send: _____ Mark Ten B assembled @ \$64.95 ppd. _____ Mark Ten B Kit @ \$49.95 ppd. 12 volt negative ground only • _____ Standard Mark Ten, assembled, @ \$49.95 ppd.

_____ 6 Volt: Neg. Ground Only _____ 12 Volt: Specify _____ Pos. Ground _____ Neg. Ground • _____ Standard Mark Ten Deltakit' @ \$34.95 ppd. (12 Volt Positive or Negative Ground Only)

Car Year _____ Make _____

Name _____

Address _____

City/State _____ Zip _____

INFORMATION RETRIEVAL NUMBER 96

LED lamps handle max 40-mA forward current

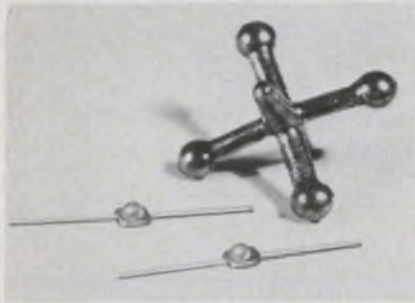

Dialight, 203 Harrison Pl., Brooklyn, NY 11237. (212) 371-8800. From \$0.17 (1000-up); stock.

The 521 series of GaAsP lamps is intended for high volume usage in array and indicator light applications. Available are the 521-9185 red non-diffused, 521-9186 red diffused, and 521-9195 red diffused. Maximum ratings are: forward dc current, 40 mA; reverse voltage, 3 V; power dissipation, 80 mW (derate 1.1 mW/°C above 25 C); and storage and operating temperature range, -55 to 100 C.

CIRCLE NO. 333

Tuning diodes have max capacitance of 33 pF

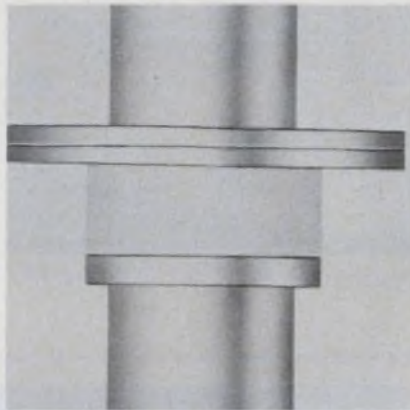

MSI Electronics, 34-32 57 St., Woodside, NY 11377. (212) 672-6500. \$9.50 (100-up). 2 wk.

The LP 1014 through LP 1038 series tuning diodes are in low-loss, low-inductance packages. The series starts with a minimum capacitance of 1.7 pF at 4 V, and the range of types extends to capacitance values of up to 33 pF at 4 V. The capacitance ratios from 0-to-25-V reverse bias are as high as 4.7:1, with a figure-of-merit of up to 1000 at 4-V bias and 50 MHz.

CIRCLE NO. 334

Red LED lamp provides wide viewing angle



Monsanto, 3400 Hillview Ave., Palo Alto, CA 94304. (415) 493-3300. \$0.33 (1000-up); stock.

A red LED lamp, the MV50104, is 0.19-in. (4.82 mm) in diameter, but only 0.285-in. (7.24 mm) high. An additional feature is the extra-long, 0.69-in. (17.5 mm), lead length. The MV50104 has a typical luminous intensity of 2 mcd at 20 mA and a wide ($\pm 35^\circ$) viewing angle between the 50% intensity points. The lens is made of red epoxy, is fully flooded and partially diffused. The LED is a direct replacement for the FLV110 lamp manufactured by Fairchild.

CIRCLE NO. 335

QUALITY YOU CAN PUT YOUR FINGER ON!



GET POSITIVE CONTROL... EVERY TIME!

Designed to save you money in the "long run" and you'll get more control in less space! Available in bi-directional and uni-directional models in all standard coded outputs with a wide variety of custom features. Choice of six colors opens up a whole new world in control panel design. Keep control... write for complete catalog.

Janco
CORPORATION

3111 WINONA AVE., BURBANK, CALIF. 91504
PHONE 213-845-7473 • TWX 910-498-2701

WHO ME? AN AUTHOR?

If you have solved a design problem, developed a new circuit, gained experience in depth in a specific technical area, why not share your knowledge with *Electronic Design's* 232,000 readers. Do your professional image a favor and earn some extra money at the same time. Send for our 12 page AUTHOR'S GUIDE. It covers criteria for acceptability, form, length, writing tips, illustrations, and payment for articles published.

Contact: George Rostky,
Editor-in-Chief

Electronic Design

50 Essex Street, Rochelle Park, New Jersey 07662

Epoxy packages hold dual JFETs

Siliconix Inc., 2201 Laurelwood Rd., Santa Clara, CA 95054. (408) 246-8000. 88¢ to \$2.45 (100); stock.

Monolithic matched dual FETs are offered in epoxy packages. The E410 family of n-channel dual JFETs is intended for low and medium frequency small-signal differential amplifiers requiring matched gate-source voltage, high common-mode rejection ratio and low output conductance. Characteristics of the E410 family include $|V_{GS1} - V_{GS2}|$ of 10 mV max, CMRR of 70 dB min, $\frac{\Delta V_{GS1} - V_{GS2}}{\Delta T}$ of 10 $\mu\text{V}/^\circ\text{C}$ and $g_{oss} = 5 \mu\text{mho}$ max at $I_D = 200 \mu\text{A}$.

CIRCLE NO. 336

Power transistors made for medium power use

RCA Solid State Div., Box 3200, Somerville, NJ 08876. (201) 722-3200. From \$0.47 (1000 up).

Three series of power transistors, the RCA29/SDH, RCA31/SDH and RCA41/SDH are intended for medium-power switching and amplifier applications. The SDH units are single-diffused home-taxial-base versions of the RCA29, RCA31 and RCA41 epitaxial-base series, respectively. They are supplied in the JEDEC TO-220AB package. The RCA29/SDH, RCA29A/SDH, RCA29B/SDH and RCA29C/SDH transistors have V_{CEO} ratings of 40, 60, 80 and 100 V, respectively. The turn-on time for each type is typically 2.3 μs and the turn-off time is typically 6 μs . Minimum beta for each type is 15 when measured at a collector current of 1 A. The RCA31/SDH, RCA31A/SDH, RCA31B/SDH and RCA31C/SDH transistors have similar V_{CEO} ratings and switching speeds, but have a beta of 10 when measured at a collector current of 3 A. The RCA41/SDH, RCA41A/SDH and RCA41B/SDH transistors have V_{CEO} ratings of 40, 60 and 80-V, respectively. Each type typically has a turn-on time of 3.2 μs and a turn-off time of 3.7 μs . Minimum beta for these types is 15 when measured at 3 A.

CIRCLE NO. 337



See me* for off-the-shelf savings on this and other Tele-Dynamics power supplies...

5-28 Vdc modular power supplies

- Stock delivery • Low cost
- Same performance as Lambda LM

Tele-Dynamics Series HR modular supplies are offered in 30 models in 5 case sizes, all interchangeable with Lambda LM and similar units.

Output: 5-28 Vdc, 1.3-20 A. **Ripple:** 1 mV rms.

Regulation: $\pm 0.05\%$ line, $\pm 0.05\%$ load.

Input: 105-125/210-250 V, 47-63 Hz.

Unit price: \$113 to \$256.



TELE-DYNAMICS DIVISION OF **AMBAC**
WANLASS POWER SUPPLIES AND
LINE CONDITIONERS

525 Virginia Drive, Fort Washington, PA 19034 • (215) 643-3900

Career opportunities for power supply engineers—an equal opportunity employer M/F

*110 STOCKING DISTRIBUTOR LOCATIONS

- Allied • Arrow-Angus • Cramer • Newark • Olive Radio • Philadelphia Electronics • Pioneer Standard • RPS Electronics • Ralph's • Stark • Sterling (Calif.) • Summit • Testco • T. I. Supply • Zack • Texas Instruments, Ltd. (Europe) • Tisco (Europe)

Call toll-free (800) 645-9200 for the one nearest you. In N.Y. State, call collect (516) 294-0990.

© TELE-DYNAMICS

6050

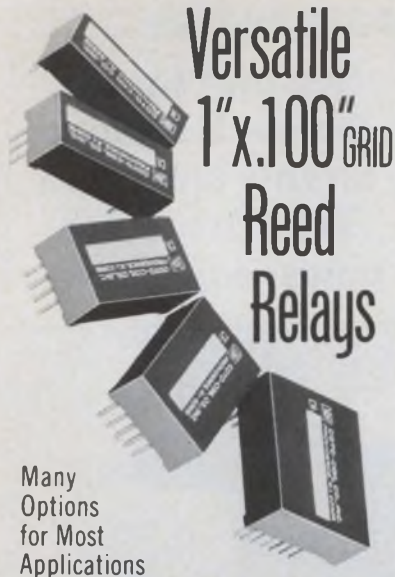

Versatile 1" x .100" GRID Reed Relays

Many
Options
for Most
Applications

New CR-2000 Series utilizes the popular 1" x .100" grid pattern, with 1 to 6 poles and a variety of options and contact forms for almost any application. Reliable low-level switches may be conditioned by special run-in and dynamic testing. Models can be epoxy-encapsulated or simply encased for added economy. Ask for Bulletin MR 11.1 for full details.



**COTO-COIL
COMPANY, INC.**
59 Pavilion Ave.
Providence, R. I. 02905
Tel: (401) 467-4777

INFORMATION RETRIEVAL NUMBER 98

Circuit Savers

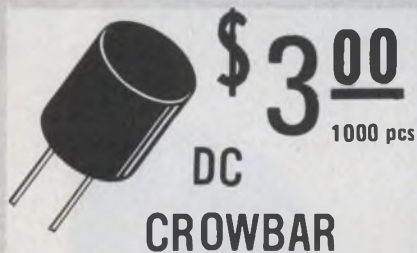

Here's positive low cost protection for your IC's, transistors, power supplies and pc cards.

The LVC-1A crowbar switches to a short circuit whenever the voltage across it exceeds a specified level.

Any trip voltage level between 4.7V and 200V \pm 10% can be selected. The unit will handle a peak current of 50 Amps (8ms) and 3A continuously. MIL Temperature range. Call Mike Coyle for applications assistance.

Full line of protection modules for every hi-lo voltage/current requirement. Write or call for Catalog 749.

279 Skidmore Road
Deer Park, New York 11729
Telephone: 516 - 586-5125

MCG Electronics

See Gold Book vol 2, p. 1277.

INFORMATION RETRIEVAL NUMBER 100

DISCRETE SEMICONDUCTORS

Color sensitive diodes deliver 0.5 A/W

Innotech, 181 Main St., Norwalk, CT 06851. (203) 846-2041. 25-up prices: F: \$25, L: \$17; 2 wk.

The PD050F and PD050L photodiodes have a guaranteed minimum-spectral response of 0.5 A/W maintained from 0.62 through 0.85 μ m wavelengths. These photodiodes have an essentially flat response through the visible region and remains high into the blue-violet region. The current output is linear with light and the response remains linear through more than seven decades. The PD050F is packaged in a flat glass TO-18 windowed case, while the PD050L is in a TO-18 lens windowed case. Chips are also available. The chip size is 0.05 \times 0.05 in. with a sensitive area of 0.045 \times 0.045 in. Dark current is 20-nA typical at 25-C and 20-V bias. NEP is 4 \times 10⁻¹³ W min. measured at a 0.8- μ m wavelength.

CIRCLE NO. 338

L-band power transistors deliver up to 0.5 W

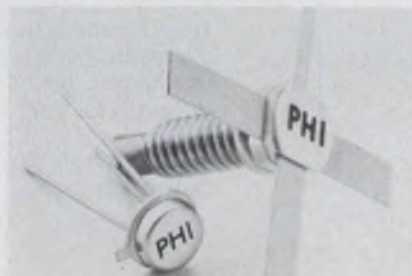

Power Hybrids, 1742 Crenshaw Blvd., Torrance, CA 90501. (213) 320-6160. PH8193: \$13.50, PH-8110: \$27 (for 100 pc. lots); stock.

Two medium power microwave transistors are characterized for oscillator and class A linear service. Both transistors are gold metalized, emitter ballasted and fully characterized from 500 MHz to 2.5 GHz. The PH8193 is housed in a TO-46 hermetic package and can produce 300 mW of oscillator power at 1.75 GHz with a bias voltage of 17 V. The PH8110 is packaged in a common-emitter isolated-stud stripline hermetic package and is rated for 0.5 W output at 2.3 GHz and 18-V bias.

CIRCLE NO. 339

Red, green and yellow LEDs get JEDEC numbers

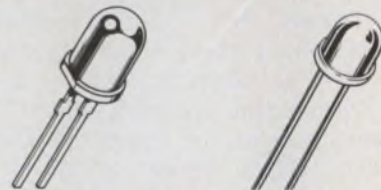

Motorola Semiconductor, P.O. Box 20912, Phoenix, AZ 85036. (602) 244-3466. From \$0.35 (100 up).

Available in red, green and yellow, the 1N5909 through 1N5912 series of visible LEDs offers the user the design advantage of JEDEC registered parts. The operating and storage temperature range for the devices covers -40 to +100 C. The 1N5909 miniature panel mount LED and the 1N5910 standard panel mount are GaAsP devices that operate at a peak wave length of 660 nm and provide a minimum axial luminous intensity of 0.3 mcd at a forward current of 20 mA. The viewing angles of the 1N5909 and 1N5910 are 75° and 100°, respectively, when referenced to the 50% luminous intensity levels of the spatial radiation patterns. The 1N5911 and 1N5912 are GaP devices that emit green and yellow light, respectively, at peak wave lengths of 560 nm and 575 nm. Axial luminous intensity, of both units, is 0.3 mcd, minimum at a forward current of 25 mA. The viewing angle of these devices is 90°. The JEDEC registered series is available in plastic packages, the color of each package corresponding to the emitted wave length of each device. A light-scattering diffusant material is incorporated in the plastic.

CIRCLE NO. 340

Pulsed power transistor delivers 250 W

Communications Transistor, 301 Industrial Way, San Carlos, CA 94070. (415) 591-8921. \$195 (unit qty); stock.

A pulse power transistor, type CD2196, for uhf radar applications delivers 250 W of pulse power at 430 MHz. The CD2196 has a 1 ms pulse width (10% duty cycle), very high gain (7 dB minimum at 40 V) and saturated output power capability in excess of 300 W.

CIRCLE NO. 341

High frequency JFETs have new packages

Siliconix, 2201 Laurelwood Rd., Santa Clara, CA 95054. (408) 246-8000. 100-up prices: J310: \$0.79, U316: \$6.45; stock.

Two new package options are available for the U310 n-channel JFET family. The epoxy J310 series with the flat-lead TO-92 package is intended for use with automatic PC board assembly techniques. With the ceramic stripline U316 series, the communications designer has available a FET package designed for use at frequencies of 500 MHz or higher. J310 and U316 series electrical characteristics include high power gain of 10 dB at 450 MHz in the common-gate configuration. The noise figure is 3.4 dB typical at 450 MHz and dynamic range is greater than 100 dB. The transconductance, g_{fs} , is 12,000 mho at 450 MHz.

CIRCLE NO. 342

Germanium transistors handle high power

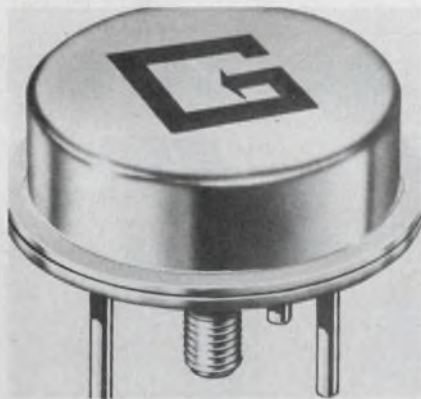

Germanium Power Devices Corp., P.O. Box 65, Shawsheen Village Station, Andover, MA 01810. (617) 475-5982. From \$4 to \$19, 6 to 8 wk.

A series of industrial pnp germanium power transistors has peak current capabilities of 65 A and can handle voltages of up to 80 V. The series is available in the standard TO-68 package (65 A: SDT 1861-2) which is all metal and hermetically sealed. The devices are from the 2N2730-to-32 family and have applications in computer peripherals, communications equipment, inverters and converters, audio amplifiers and battery operated equipment.

CIRCLE NO. 343

Opto-isolator combines LED and CdS cell

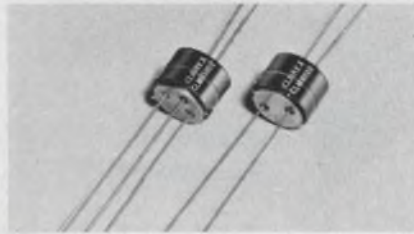

Clairex, 560 S. Third Ave., Mount Vernon, NY 10550. (914) 664-6602. CLM8500: \$4.15, CLM8500/

2: \$5.25 (1 to 99).

The CLM8500 and the CLM8500/2 are LED photoconductive isolators. The CLM8500 combines a CdS hermetically sealed photocell and a LED. The CLM8500/2 combines a dual CdS element hermetically sealed photocell and a LED. The dual output, balanced over a wide range of input currents, is suited for applications requiring isolated two-channel control.

CIRCLE NO. 344

Optical Encoders



Designer's Choice

Now you can select the Optical Encoders you need for your instrument and control design from one source — *THETA*. All of Theta's Incremental, Absolute, and OEM Naked Encoders are designed for heavy industrial use at economical prices. All these encoders use LED light sources and integrated electronic circuits for extended service life.

Theta, a leading supplier of industrial control systems, has firsthand knowledge of the problems of shock, vibration, and electrical transients.

- **The Decittrak® OEM Naked Encoder** is the lowest-cost digitizing device available anywhere. It is easily assembled into existing equipment and is available with either unidirectional or bidirectional outputs from 1 to 2000 counts per revolution.
- **Decittrak® Incremental Encoders** produce bidirectional outputs in either a sine wave, square wave, or pulse format. They are ideally suited to digitize linear or rotary motion for display and control. Ranges are available to 2000 counts per revolution.
- **Decittrak® Absolute Encoders** are the ultimate in digitizing devices. The outputs are BCD coded with measurement ranges up to 999999. Power outages or extreme electrical noise do not affect its operation. Through the use of state-of-the-art components, Theta is able to offer these units at prices competitive with brush-type encoders.

Have a system requirement? Theta has an extensive line of plug-in control and display modules. If it's very special, Theta will design a custom system, too. Contact Theta today for more information.

Theta **INSTRUMENT CORP.**

Specialists in Digital Automation
Fairfield, New Jersey 07006
Phone: 201 - 227-1700

INFORMATION RETRIEVAL NUMBER 101

FM signal generator gives internal counter



Gaw Co., Inc., 141 Algonquin Pkwy., Whippany, NJ 07981. \$1540; approx. 6 wks.

Model 1012 FM signal generator features digital-frequency readout, eight frequency ranges, low-frequency output for i-f alignment, internal-external modulation, dc-coupled, double-trace sweep modulation, and automatic output leveling. Also included is an external counter (20 MHz), electronic fine tuning and double shielding. Residual FM is less than 100 Hz.

CIRCLE NO. 345

3-MHz synthesizer resolves 1 Hz



Real Time Systems, Inc., 598 Broadway, Norwood, NJ 07648. (201) 768-6500. \$1995; stock to 8 wks.

Model 35 coherent frequency synthesizer covers zero to 3 MHz with a resolution of 1.0 Hz over the entire range. A second range, which provides a frequency resolution of 0.01 Hz, is also available. Frequency accuracy and stability is $2 \times 10^{-8}/^{\circ}\text{C}$. Output is 1 V rms into a 50- Ω source. The unit uses direct digital techniques. Frequency programming is with either binary or BCD coding at TTL-compatible levels. Programming delays are in the order of 1 μs or less. Model 35 provides sine waves, triangular waveforms and a TTL-compatible pulse.

CIRCLE NO. 346

Transient recorder gives 10-bit resolution



Physical Data, Inc., 5160 N. Lagoon Ave., Portland, OR 97217. (503) 283-5116. \$2975.

A new single-channel transient recorder provides sample rates as high as 2 MHz with 10-bit resolution. Unlike other units, the 514A provides a "split memory" mode that permits two sequential recordings (as in a baseline subtraction application), where both can be played back simultaneously. Among the unit's features are: four-digit thumbwheel resolution to set pre and post-trigger delay, dual time base that permits switched time base recording, and a special auto-plot mode that causes the 514A to automatically reproduce its stored data once and then rearm itself to wait for a new trigger.

CIRCLE NO. 347

Power Supplies



With Built in Overvoltage Protection
5 1/2 x 4 x 15 1/8 Deep

\$149.00

MOD	VOLTS	AMPS	MOD	VOLTS	AMPS
86-201	3.5-4.5	10	86-206	14-16	6
86-202	4.5-5.5	10	86-207	17-19	6
86-203	5.5-6.5	9	86-208	19-21	5
86-204	9-11	8	86-209	23-25	4.5
86-205	11-13	7	86-210	27-29	4.5

Rack Adapter



MOD. 86-211 — \$69.00

Up to four power supplies can be mounted in one rack adapter. Mating connector and barrier terminal strips on rear apron of rack adapter facilitate system assembly.

Power supplies contain test jacks, voltage adjust, line switch, pilot lamp and line fuse on front panel.

REQUEST BULLETIN PS-201

115 Marine St., Farmingdale, N.Y. 11735 • (516) CH 9-2336

VOLTEX

INFORMATION RETRIEVAL NUMBER 102

TRANSFORMERS AUDIO POWER



NEW!

PLUG-IN
PC POWER

TELEPHONE
COUPLING

DC-DC
CONVERTER

STUDIO
BROADCAST

← REQUEST NEW
CATALOG # 741

COMMERCIAL / MIL

COMPLETE LINE OF STOCK TRANSFORMERS
IMMEDIATE DELIVERY FROM DISTRIBUTORS



MICROTRAN

COMPANY, INC.

145 E. Mineola Ave., Valley Stream, N.Y. 11582

INFORMATION RETRIEVAL NUMBER 103

ELECTRONIC DESIGN 23, November 8, 1974

Meter measures noise figure and gain

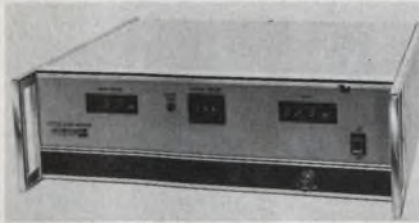

Ailtech, 815 Broad Hollow Rd., Farmingdale, NY 11735. (516) 595-6471. \$3295 U.S. only.

Model 7380 simultaneously measures noise figure and gain of an rf amplifier or receiver. The new instrument operates at an i-f frequency selectable between 10 and 100 MHz. BCD outputs are available for each parameter with a resolution of 0.1 dB. The instrument has a 50-dB signal-level range with a nominal sensitivity of -100 dBm. Customer selected i-f and input impedances are available. Noise-figure measurements are made with an accuracy of 0.15 dB with the new solid-state noise sources. A new noise technique is also used to measure the true gain of the device under test to an accuracy of ± 1 dB.

CUSTOM ELECTRONICS' MICA CAPACITORS: short on DELIVERY long on RELIABILITY

That describes our CMR type capacitor, ideal for "potted-in" applications where minimum size and low per-unit cost are important. All our dielectric is screened before production to avoid failure in the field.

Installation No.	Cap.	WVDC	TYPICAL UNITS:			1 to 10 Qty. Price
			L	x W	x T Max.	
CMRIA102104K	0.1 μ f	1,000	2.062"	x 1.425"	x 0.200"	\$8.05
CMRIA302104K	0.1 μ f	3,000	2.562"	x 1.620"	x 0.270"	9.25
CMRIA103103K	0.01 μ f	10,000	2.562"	x 1.800"	x 0.350"	8.80

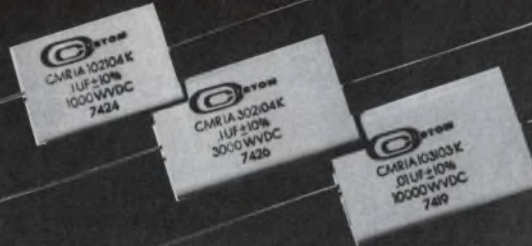

FREE: Descriptive TechniTip, includes Mica Sample. Write:



CUSTOM ELECTRONICS, Inc.

4 Browne St., Oneonta, N.Y. 13820
PH: (607) 432-3880 TWX: 510-241-8292

INFORMATION RETRIEVAL NUMBER 104

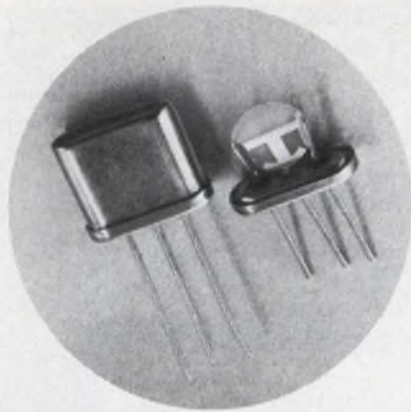

175 MHz MONOLITHIC OVERTONE CRYSTAL FILTERS?

YES!.. FROM BULOVA

We're offering, right now, monolithic crystal filters covering the range from the upper limits of the fundamental frequencies all the way to the fifth overtone — 30 MHz to 175 MHz. We've made a breakthrough in manufacturing techniques that enables us to produce these crystal filters for the complete overtone range, and we've developed computer programs that enable us to design them efficiently and speedily. If you are looking at the VHF frequencies you undoubtedly would be interested in filters which will:

Save space (they're packaged in 3-pin, HC-18 cans 0.380" high);

Simplify circuit design, and
Cut production expenses.

If you are in a rush call 212-335-6000, Ext. 744 or write:

FREQUENCY CONTROL PRODUCTS
Electronics Division Bulova Watch Co., Inc.
62-10 Woodside Avenue, Woodside, N.Y. 11377

Of course we're still interested in your requirements for other crystal filters, for crystals and for crystal oscillators

INFORMATION RETRIEVAL NUMBER 106

COMPONENTS

PC-board relays come in 1/6 crystal cases

Westinghouse Air Brake Co., Aerospace Dept., Pittsburgh, Pa. 15218. (412) 242-5000. 4 to 6 wks.

A family of 1/6-crystal-case, microminiature, rotary relays, which feature 0.1-in. grid-spaced terminals, includes two SPDT members, Models 900 and 930, and two DPDT members, Models 901 and 931. All are hermetically sealed to meet or exceed applicable performance requirements of MIL-R-5757. Models 901 and 931 are low-profile, 0.405-in.-high versions of Models 900 and 930, respectively. The relays are available with coil voltages of 6, 12, 26.5, 48 and 76 V. They have an operating temperature range from -65 to 125 C, and they can withstand 100-G shock for 6 ms. Contact rating ranges from dry-circuit applications to 1-A max., and mechanical life expectancy at rated load ranges from 100,000 to 150,000 operations.

CIRCLE NO. 350

Solid-state flasher handles 18 to 36 V dc



Applied Electro Technology Inc., 2220 S. Anne St., Santa Ana, Calif. 92704. (714) 556-6570.

A solid-state flasher unit provides more than 10-million cycles of trouble-free operation over 18-to-32-V-dc and -65-to-160-F ranges. The unit weighs only 7 oz. and power consumption is only 1 W maximum. A completely transistorized control circuit is used. The only moving parts are the relay contacts rated at 0.5 A for lamp or inductive loads. The unit is potted, and stud-type terminals with barriers are provided.

CIRCLE NO. 351

Delay lines to 1000 ns packaged in DIPs

Rhombus Industries, Inc., 22119 S. Vermont Ave., Torrance, Calif. 90502. (213) 325-7440. From \$7.25 (1-9); stock.

Electromagnetic delay lines in DIP configurations include mini, standard, low-profile and double DIPs with eight to 34 leads. And all except the double DIPs are available in flatpack configurations. Specification highlights for the series include: tap capabilities from 500 ps to 25 ns, tap stabilities to ± 250 ps, delays from 5 ns to 1000 ns, rise time ratios from 5:1 to 30:1, frequency capabilities to 300 MHz, operating temperature range from -55 to 125 C, temperature coefficient of 70 ppm/ $^{\circ}$ C, and standard impedances of 50, 75 and 100 $\Omega \pm 5\%$. All units are designed to meet applicable portions of MIL-D-23859 and are capable of meeting the environmental requirements of MIL-STD-202 for moisture resistance, vibration, shock, humidity and life.

CIRCLE NO. 352

Liquid crystal display uses 1/2 μ W/segment

Industrial Electronic Engineers, Inc., 7720-40 Lemona Ave., Van Nuys, Calif. 91405. (213) 787-0311. \$21.30 (100 up); stock.

New field-effect liquid-crystal displays are offered in both reflective, Model 1650-01, and transmissive, Model 1550-01 P or N, configurations and in a 3-1/2-decade array with seven-segment, 0.43-in.-high characters, \pm sign, individual left-hand decimal points for each digit and a colon for digital clock and counter applications. In addition, the transmissive models are available in either positive (dark characters/clear background) or negative (translucent characters against a dark field) versions. These nematic distortion displays offer several significant advantages over other liquid crystal arrays: low power of 1/2 μ W/segment at 10 to 15 V ac, 30 to 1000 Hz, fast switching time of 40 to 50 ms; high-contrast ratio of 25:1; long life of 20,000 h at 12 V ac; and broad operating temperature range of -10 to 65 C.

CIRCLE NO. 353

Conductive-plastic pots are 1/4-in thin

Bourns Inc., 1200 Columbia Ave., Riverside, Calif. 92507. (714) 684-1700. \$0.80: 3858A (500 up); stock.

Bourns' new Models 3851 and 3858 conductive-plastic resistor controls provide a $\pm 1\%$ contact-resistance variation, a tolerance of $\pm 20\%$ and independent linearity of $\pm 10\%$. Their heatsink shaft design helps in the unit's rated 70 C. The potentiometers have a thin 1/4-in. behind-the-panel profile. They are available in a wide variety of shaft, bushing and terminal styles, including a snap-in style, which reduces installation time and cost. Resistance range is 1 k Ω to 100 k Ω and rotational life is 100,000 cycles.

CIRCLE NO. 354

Inclinometer shows ± 10 -degree tilt



Robinson-Halpern, One Apollo Rd., Plymouth Meeting, Pa. 19462. (215) 825-9200. \$195 (unit qty).

Model 685A inclinometer is rugged, has internal voltage regulation, a static error band of $\pm 0.25\%$ and measures deflection of ± 10 degrees from a horizontal reference. It can be used in road graders and other mobile machinery such as cranes and cherry pickers and provides stable performance over a temperature range of -10 to 175 F. The unit is capable of withstanding 50-G shock, and the vibration error is 1/2% for 1-1/2 G in the sensitive axis and 4 G in the perpendicular axis. The unit's output is ± 0.5 -V full scale with a 9-to-30-V-dc supply voltage. The unit weighs 6 oz and measures 1.5 \times 1.75 in. It uses an inductive transduction element, which eliminates problems often encountered with potentiometer inclinometers.

CIRCLE NO. 355

Polystyrene capacitor is self-healing

TRW Capacitor Div., Box 1000, Ogallala, NE 69153. (308) 284-3611. 4-6 wks.

A new self-healing polystyrene capacitor replaces conventional foil electrodes with a more reliable carrier film, metallized on both sides. The capacitor has a tubular tape-wrap endfill configuration, with a

minimum 0.175-in. dia. and 0.625-in. length. It ranges between 0.001 and 0.015 μ F at 100 V with a $\pm 1\%$ tolerance. Values through 1.0 μ F are available in larger standard sizes. Values up to 4.0 μ F $\pm 1\%$ are available on special order. Its negative TCC of -50 ppm/ $^{\circ}$ C remains relatively linear over 0 to 70 C. Any self-healing that occurs in the capacitor has no adverse effect on electrical properties.

CIRCLE NO. 356

industries' largest selection of SCR Phase Controlled Power Supplies

CALL TOLL FREE 800-631-4298



E/M has expanded its former 2.5, 5.0 and 10.0 kw SCR Models to now include 27 new models with power ratings of 600w, 1200w and 2000 watts. All models are 0.1% regulated in both the voltage and current mode of operation with automatic crossover. Remote programming and sensing are standard on all models as well as forced air cooling and automatic over-temperature protection. The three lower power ratings are all single phase input, while the three higher power ratings are all three phase input. As expected, E/M has maintained its position of providing the highest power output per mechanical volume in the industry for equipment of this type. Front panel heights being 3 1/2" on 600w, 5 1/4" on 1200w, 7" on 2000w and 2500w, 8 3/4" on 5000w and 12 1/4" on 10,000w models.

Volts	600w		1200w		2000w		2500w		5000w		10,000w	
	Amps	\$	Amps	\$	Amps	\$	Amps	\$	Amps	\$	Amps	\$
0-6									600	2200		
0-7.5	85	500	125	850	200	1000	300	1400				
0-10	60	500	100	850	150	1000	250	1400	500	2200		
0-20	30	425	50	750	90	900	125	1300	250	1800	500	2700
0-30							100	1300	200	1800		
0-40	16	425	30	750	50	900	60	1300	125	1700	250	2500
0-50											200	2700
0-60	11	425	20	750	35	900						
0-80	8	425	14	750	25	900	30	1300	60	1700		
0-100											100	2700
0-120							20	1300	40	1700		
0-150	4	425	7	750	13	900						
0-160							15	1300	30	1700	60	2500
0-250							10	1300	20	1800	40	2700
0-300	2	450	3.5	850	6	1000						
25-500							5	1600	10	2200	20	2700
10-600	1	450	1.5	850	3	1000						

SEE EEM VOL. 1-673-675 FOR ADDITIONAL PRODUCT INFORMATION

ELECTRONIC MEASUREMENTS INC.

405 ESSEX ROAD, NEPTUNE, NEW JERSEY 07753
Phone: (New Jersey) (201) 922-9300 • (Toll-Free) 800-631-4298
Specialists in Power Conversion Equipment



INFORMATION RETRIEVAL NUMBER 107

COMPONENTS

Small motors feature governor speed control



Mabuchi Motors America, 314 Fifth Ave., New York City, NY 10001. (212) 279-9034.

The new Model RF510G motor is available with an internal or external electronic governor, and it is housed in a shielding-can to minimize electrical noises. The motor measures 1.417-in. dia and 1.320-in. long with internal governor, or 1.165 in. with external governor. Motors are available in several armature windings to provide a wide range of speed and torque requirements. First models to be released will be for a 6-V rating with a working range of 4.5 to 7.5 V dc and 13 V with a working range of 10 to 16 V dc.

CIRCLE NO. 357

Linear switch provides 11 positions

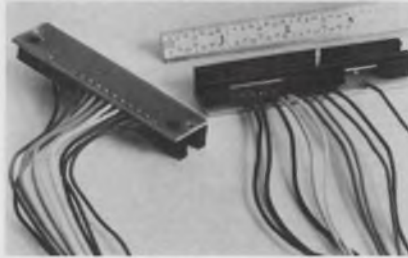

Sonitronic, Inc., 32-02 Linden Pl., Flushing, NY 11354. (212) 939-8300.

A linear-slide selector switch with 11 discrete positions, called the Swift-Action, features fast, snap-action that does not stall in intermediate positions. The actuation force is a minimum of 10 oz with 0.150 in. of travel between positions. Contacts are rated at 20 V dc max with a current of 1 to 10 mA. The capacitance between the common and switching circuits is 60 pF max. Tested life of the switch is 25,000 cycles min. Heavy-deposit gold contacts assure positive switching.

CIRCLE NO. 358

Trimmer potentiometers provide low profile

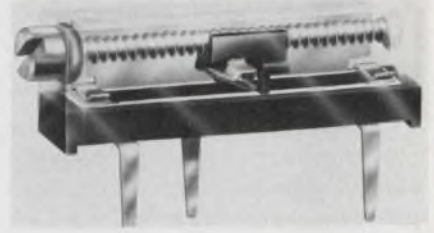

Dale Electronics Inc., P.O. Box 609, Columbus, NE 68601. (402) 564-3131. Typical: \$0.99 (1000 up).

Dale Electronics' 700 Series low-profile trimmer potentiometers offer a choice of cermet or wirewound elements in a 0.25-H × 0.75-L × 0.165-W-in. package and an all-metal screw for 25-turn adjustability. A one-piece clutch prevents overtravel damage. The trimmers dissipate 1 W at 70 C and provide standard TCs of 100 ppm for cermet models and 50 ppm for wirewound models. They are available in a resistance range of 10 kΩ to 50 kΩ for wirewound models and 10 Ω to 2 MΩ for cermet models.

CIRCLE NO. 359

**end
costly
power
interruptions**



Whatever the cause, power problems cost plenty . . . in terms of time and dollars lost. You can end those power problems and associated losses with the complete, dependable line of power protection equipment from ACD Co. Ruggedly designed, solid state equipment for a variety of applications.

- UPS (Uninterruptible Power Supply) Systems--125VA to 5KVA
- Static Inverters--125VA to 5KVA
- Frequency Changers
- Static and Hybrid Switches
- Battery Floating/Charging Systems . . . and many more products

SEND FOR FREE CATALOG AND APPLICATIONS ASSISTANCE

ADVANCE CONVERSION DEVICES COMPANY **ACDCO**
109 EIGHTH STREET, PASSAIC, NEW JERSEY 07055 Phone (201) 778-0707

INFORMATION RETRIEVAL NUMBER 108

**KING-SIZE
CHARGING
POWER
IN A
COMPACT
CONVERTER**



THAT'S WHAT YOU GET IN A DORMEYER—the UL listed line of converter/chargers that offers the widest selection for all applications from calculators and small appliances to radios and toys.

Put Dormeyer safety and dependability into your products. Add buyer confidence.

Choose from the most complete line of in-stock plug-in units available: AC-DC power converters or converter/chargers . . . AC-DC filtered converters . . . AC-AC low voltage transformers . . . nickel-cadmium chargers.

Request bulletin and quote.



DORMEYER INDUSTRIES

A Division of A. F. Dormeyer Mfg. Co., Inc.
3414 N. Milwaukee Ave., Chicago, Ill. 60641
Factories: Chicago, Ill., Kentland and Rockville, Ind.
Telephone: 312-283-4000

SOLENOIDS, CONVERTER/CHARGERS, TRANSFORMERS, COILS

INFORMATION RETRIEVAL NUMBER 109

ELECTRONIC DESIGN 23, November 8, 1974

evaluation samples

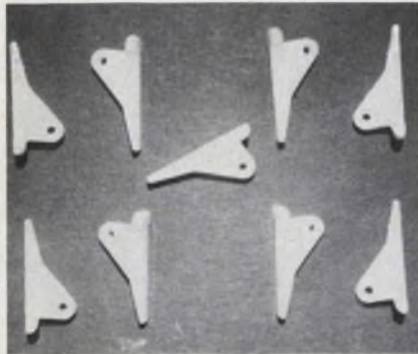

PC card ejector

Nylon card ejectors are supplied with an attachment pin and can be used with 1/16-in. PC cards. They come in a natural color. Letterhead requests only. JOLO Industries, 11861 Cardinal Circle, Garden Grove, Calif. 92643.

INQUIRE DIRECT

Manual-motor controls

A UL-recognized manual-motor control has power input ratings through 38 A at 2 hp. Designated the MC 390 motor control, it offers single and double-pole switching with indexing from two to 12 positions in steps of 45, 51.42, 60, 72, 90 and 180 degrees. Oak Industries, Switch Div.

CIRCLE NO. 360

Molded nylon washers

Washers ranging in size from 0.1 in. to 1.5 in. O.D. can be made at no tooling charge providing the customer purchases a \$100 minimum order. Thickness varies from 0.02 to 0.125 in. Micro Plastics.

CIRCLE NO. 361

Vinyl laminates

A durable, thick, vinyl, polished or glare-free material can be laminated to two sides of reference material. Size of material that may be covered ranges from 2 x 3 in. to 21 x 25 in. with minimum thickness of 25 mils. Letterhead requests only. Plastics, 633 Davisville Rd., Willow Grove, Pa. 19090.

INQUIRE DIRECT

application notes

Oscilloscope guide

Features of UV and other direct-writing instrumentation are detailed in a general guide. SE Labs, Middlesex, England.

CIRCLE NO. 362

Thick-film resistors

The often-asked question "What happens to thick-film resistor performance when substituting substrates from different vendors?" is answered in a two-page bulletin. Thick-Film Systems, Santa Barbara, CA

CIRCLE NO. 363

Power transformers

The design of power transformers made with pot and E cores through the use of sinusoidal excitation is described in a paper. The article offers curves for determining the size of the core to be used, test applications and specifications. Siemens, Iselin, NJ

CIRCLE NO. 364

Magnetic shielding

How to eliminate stray magnetic fields that affect the performance of electronic components and circuits is the subject of a bulletin. The bulletin contains design formulas, graphs and tables of material properties and simplifies the selection of material, design of the shield and testing. Magnetics, Butler, PA

CIRCLE NO. 365

Understanding CMOS

A 80-page programmed text, "Understanding CMOS," is structured as a self-teaching aid to familiarize engineers with CMOS technology. It contains six chapters on such topics as fundamentals and features, basic circuits and characteristics, standard RCA circuits, packaging and specifications, design considerations and custom circuits and LSI. The booklet contains a six-page glossary. The cost of this book is \$2.00. RCA, Box 3200, Somerville, N.J. 08876.

INQUIRE DIRECT

RELIABLE CONTACT PROTECTION

Superior

Quality



Imported from famed KONTAKT CHEMIE

WEST GERMANY

Kontakt 61 is ideal for high and low frequency contacts vulnerable to oxidation. A superior cleaning, lubricating and anti-corrosion agent, Kontakt 61 reduces mechanical abrasion of all contact surfaces by several orders of magnitude, thereby immeasurably increasing their service life. Kontakt 61 is free of silicones and inorganic acids... perfectly safe on all types of plastics, metals and insulating materials. Excellent contact is secured at the points after a Kontakt 61 application. Kontakt 61 is available in bulk plastic containers by the liter and in 6 ounce and 16 ounce spray cans.

In addition to its use in the manufacture of new equipment, Kontakt 61 is a reliable aid in maintenance servicing and repair departments.

Call or send for catalog and price information on this and 15 other formulations. Liberal quantity discounts.

REGMO DATA CORPORATION

Authorized United States Distributors

612/925-3800

6992 Oxford St., Mpls., MN 55426

INFORMATION RETRIEVAL NUMBER 110

new literature

**PRECISION
MADE
PINS**

MANUFACTURERS
OF JACKS
PINS AND
TERMINALS.

HUNDREDS
OF CONFIG-
URATIONS
IN STOCK

MATERIAL: BRASS; 00-B-626
FINISH: GOLD PLATE

.051
.045
.120
.025
.020
.070
.020 DIA. PIN
.460
.010R

SEND
FOR
CATALOG

**CONCORD
ELECTRONICS
CORPORATION**
37 GREAT JONES STREET
NEW YORK, N.Y. 10012
(212) 777 6571 • TWX 710 581 4930

INFORMATION RETRIEVAL NUMBER 111

IC POWER SUPPLY 5 volts at 1 amp

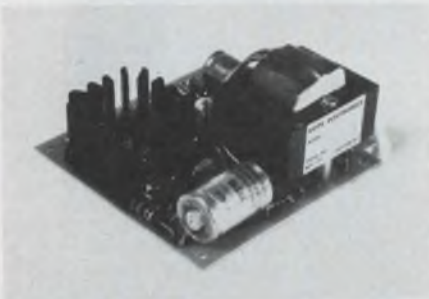

DELIVERY FROM STOCK

1-9 QUANTITY **\$3300**

- Input 117 V \pm 10% — 60 to 400 CPS
- Output Adjustable \pm 10% at 1 amp
- Line Regulation 0.1%
- Load Regulation 0.5%
- Ripple and Noise <1 MV peak to peak
- Short Circuit Proof
- Over Voltage Protection

HOPE ELECTRONICS

Box 773, Clifton, New Jersey 07013
Phone (201) 777-3522

Contact us for Your Custom Requirements

Oscillators • Amplifiers • Modulators
Attenuators • Sweep Generators • Filters

INFORMATION RETRIEVAL NUMBER 112

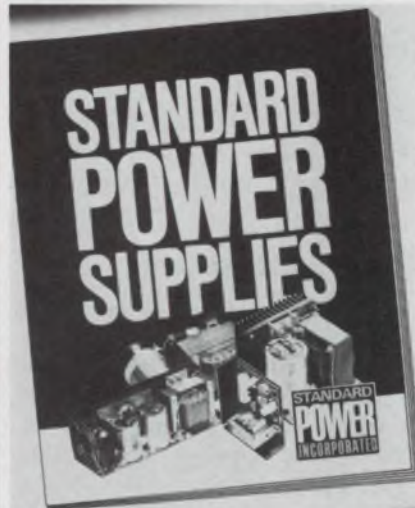

Power supplies

This illustrated 24-page power-supply-catalog describes 45 new products, and includes prices and dimensional drawings of all models. The new models include 20 additional multiple-output supplies, high-power models, and of particular interest, units that provide power for the newest in semiconductor electronics developments. All units are stocked for delivery by 60 distributor locations nationwide, listed on the catalog's back page. Standard Power, Santa Ana, CA

CIRCLE NO. 366

Termination systems

An eight-page brochure describes a fast and reliable way to terminate wires to connectors. Raychem, Menlo Park, Calif.

CIRCLE NO. 367

Brushless dc motors

Miniature brushless dc motors are highlighted in a 12-page brochure. Typical applications as well as operating and design principles, features, circuits for speed control, reversal and dynamic braking, performance curves and specifications and a description of the Hall generator and electronic commutators with which these motors can be equipped are included. Siemens, Iselin, N.J.

CIRCLE NO. 368

Mini-rotary switches

Series 26000 10-position sub-miniature rotary switch for flow solder or plug-in applications is featured in a data sheet. Mechanical, electrical and environmental specifications as well as dimensional drawings are included. The Digi-tran Co., Pasadena, Calif.

CIRCLE NO. 369

Emitters and isolators

Solid-state gallium-arsenide and indium-gallium-arsenide emitters, optically coupled isolators and gallium-arsenide and gallium-aluminum-arsenide laser diodes are covered in a six-page brochure. RCA Commercial Engineering, Harrison, N.J.

CIRCLE NO. 370

Tubular capacitors

A data sheet features type WMF polyester film dielectric, film encased tubular capacitors. Performance data, electrical specifications, mechanical characteristics and environmental information is presented in both chart and graph form. Cornell-Dubilier, Newark, N.J.

CIRCLE NO. 371

Steam electric system

A booklet describes a steam electric evaluating and recording system. The system uses the company's 4400 process computer and a standard programming package to monitor and control nuclear and fossil-fueled power plants. Honeywell Process Control Div., Phoenix, AZ

CIRCLE NO. 372

Active filters

The state-variable active-filter handbook deals with active-filter design methods. The 56-page book is complete with tables, formulas and worksheets and costs \$5.95. Kinetic Technology, 3393 De La Cruz Blvd., Santa Clara, Calif. 95050.

INQUIRE DIRECT

Temperature controller

An indicating 100 Series controller, Model 32190, offering 4-to-20-mA output, automatic reset and automatic rate, is described in a catalog. Thermo Electric, Saddle Brook, N.J.

CIRCLE NO. 373

Laser-based system

An eight-page brochure describes a laser-based system for scribing wafers. The brochure includes a nomogram which shows typical wafer diameter and die size. Quantronix, Smithtown, N.Y.

CIRCLE NO. 374

Converters

Electrical, mechanical and price data on modular a/d, d/a and v/f converters, op amps and power supplies are contained in a six-page catalog. Dynamic Measurements, Winchester, Mass.

CIRCLE NO. 375

Surge arresters

An eight-page, two-color brochure describes the need for surge protection in electronic equipment. The brochure details the use of two-electrode and three-electrode gas tube surge arresters, and it is illustrated with drawings, photos and artwork. Telecommunications Industries, Copiague, N.Y.

CIRCLE NO. 376

Generators

A six-page fold-out catalog describes 31 different models including function generators, phase generators, frequency synthesizers and complex waveform synthesizers. The catalog contains a model capability cross-reference chart and prices. Exact Electronics, Hillsboro, Ore.

CIRCLE NO. 377

Instruments

"News from Rohde & Schwarz" describes the design, function and uses of a wideband power sweep generator. The 44-page edition includes articles on precision sound level meters, high-power coaxial rf switches and a small vhf direction finder. Rohde & Schwarz, Munich, West Germany.

CIRCLE NO. 378

Cylindrical connectors

General-purpose cylindrical connectors—designed to meet and exceed performance requirements of MIL-C-0026482 (Navy) and MIL-C-83723B (Air Force)—are described in a catalog. The 16-page publication contains specifications, dimensional drawings and cross-sectional views of the Merlin I connectors. Amphenol Connector Div., Broadview, Ill.

CIRCLE NO. 379

Lock-in amplifiers

"Your Guide to Lock-in Amplifiers" covers topics such as what are lock-in amplifiers used for, how a lock-in works, why use a lock-in, how good is noise rejection, and what can go wrong in a lock-in amplifier. A full-page chart presents critical performance features and another chart presents 100 applications. Ortec, Oak Ridge, TN

CIRCLE NO. 380



High Regulation High Density Hybrid

DC-DC dual output power supply

- tecnetics HR series highly regulated three watt, dual output hybrid power supply features high density packaging, 4w/in.³ and a low profile, 0.4 inches high.
- 5V in and $\pm 15V$ out and $\pm 100mA$
- Regulation: Line (LL to HL) 0.02% max.
Load (NL to FL) 0.05% max.
Temperature 0.015%/°C max.
- Dimensions 1.89 x .984 x 0.4 inches
- Hermetically sealed
- Input-output isolation
- Short circuit and overload protected
- Low output impedance, both static and dynamic

Availability: Three to four weeks

Price: \$95

(Also available in unregulated HC series)

Write or call for more details on specifications, applications and the new 1974 catalog from tecnetics.

tecnetics The Power Conversion Specialists

P. O. Box 910 1625 Range Street, Boulder, Colorado 80302
(303) 442-3837 TWX 910-940-3246

Why Decitek's low cost 100 cps Sam tape reader is so accurate and reliable.

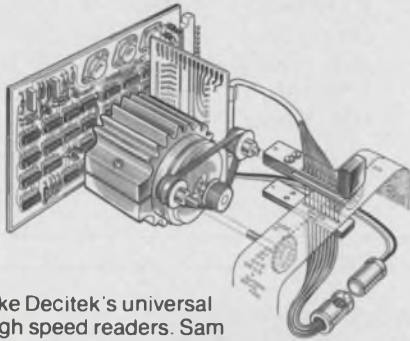

Like Decitek's universal high speed readers. Sam has our patented dual sprocket drive that starts, steps and stops accurately every time, eliminates tape wear. A highly stable fiber optic-photo transistor array reads 5, 6, 7, and 8 level advanced and center feed hole tapes interchangeably without adjustment. For more features that make Sam more than a match for any other low cost reader, write for our brochure.

When reading matters

DECITEK

A DIVISION OF JAMESBURY CORPORATION

250 CHANDLER STREET, WORCESTER, MASSACHUSETTS 01602. U.S.A. (617) 798-8731



INFORMATION RETRIEVAL NUMBER 115

NEW LITERATURE



Tubing products

A 52-page tubing catalog contains descriptions, applications and specifications on 38 tubing products. Alpha Wire, Elizabeth, NJ

CIRCLE NO. 381

PC card frames

A 56-page catalog covers PC card frames, including circuit boards, connectors and accessories. Vero Electronics, Hauppauge, NY

CIRCLE NO. 382

V/f converters

A catalog details 27 types of modular voltage and current-to-frequency converters, including differential input, optically coupled output and low-power modules. Application data include selection guide by resolution and v/f-converter-based data-acquisition systems. Dynamic Measurements Corp., Winchester, MA

CIRCLE NO. 383

MOS ICs

A MOS integrated circuit catalog contains over 500 pages of design and application information on standard MOS products, including clocks, calculators and memories. National Semiconductor, 2900 Semiconductor Dr., Santa Clara, Calif. 95051.

INQUIRE DIRECT

TALK TO THE
CHRISTIE

for all you ever wanted to know about **high current DC POWER SUPPLIES**
BATTERY CHARGERS
Call HERM RUDMAN toll-free
(800) 421-2058
IN CALIFORNIA CALL COLLECT (213) 750-1151
SINCE 1929
CHRISTIE
ELECTRIC CORP
3412-A W 67TH ST. • BOX 60020
LOS ANGELES, CALIFORNIA • 90060
(213) 750-1151 • TWX 910-321-3887

SUBSCRIBER SERVICE For prompt service include the addressed label when writing about your subscription.

CHANGE OF ADDRESS

NEW ADDRESS	name	company	division/department	company address	city	state	zip

If you're moving, please let us know six weeks before changing your address. If you have a question, place your magazine address label here and clip this form to your letter.

MAIL TO: ELECTRONIC DESIGN Circulation Dept. Hayden Publishing Co., Inc., 50 Essex Street, Rochelle Park, NJ 07662

INFORMATION RETRIEVAL NUMBER 116

IC devices

Commercial and military-grade integrated-circuit devices are featured in a 12-page catalog. The catalog is divided into five sections: high-speed, low-power CMOS ICs; RAMs; multiplexers; SOS wafer and design kits; and specialty products. Inselek, Princeton, NJ

CIRCLE NO. 387

Microprogramming manual

A 114-page manual—a complete reference source for microprogramming the HP 21MX mini-computer series—is written for persons who already have considerable experience in assembly language programming. Throughout its six chapters, the manual offers diagrams, illustrations and tables and gives detailed examples of how users can speed up over-all execution time of their software by microprogramming repetitive routines. Hewlett-Packard, Palo Alto, CA

CIRCLE NO. 388

Synchro conversion

"Synchro Conversion Handbook," a comprehensive reference source, is direct, concise and well-supported with appropriate illustrations. While the handbook shows a cover price of \$3.95 per copy, the company is making it available to qualified engineers—those who are actively engaged in synchro conversion—at no charge. ILC Data Devices, Airport International Plaza, Bohemia, NY 11716

INQUIRE DIRECT

Electronic instrumentation

Consisting of 68 pages, a two-color catalog combines both the DigiTec and Monsanto lines in one volume. The book has a separate section for digital voltmeters, multimeters and panel meters, one for time and frequency measurement, another for calibration and signal sources, the fourth for temperature measurement and the fifth for data-acquisition systems and components. United Systems Corp., Dayton, OH

CIRCLE NO. 389

Don't Forget!

TUNABLE BANDPASS FILTERS

YOU CAN AFFORD!

Operating from 50 KHz to 2 GHz (nominal octave ranges), these are flexible, versatile and economical tools for electronic prototype development and other laboratory work. 15% bandwidths range from 1% to 1%, 3% and 5%.

CIR-Q-TEL Models FBA/7, 21 and 23 are available in diameters from $\frac{1}{4}$ " to $1\frac{1}{8}$ " and in length from $3\frac{1}{4}$ " to 14 ", depending on complexity. Manually tunable 2, 3, 4 and 5 resonator models are standard, with nominal Butterworth and transitional Butterworth Thompson amplitude responses.

CALL COLLECT and talk to one of our applications/design engineers. We'll gladly discuss your needs and quote specs, prices and delivery dates by phone.

CIRQ-TEL
INCORPORATED
10504 Wheatley Street, Kensington, Md. 20795
Superior Products . . . by Design

INFORMATION RETRIEVAL NUMBER 117

At Last. A Data Acquisition System In a Single Module.

Save time and money . . . translating analog data into digital words. Data Translation's DATATM is a line of fully integrated data acquisition system modules that outperforms clusters of modules . . . and all at lower cost.



Imagine, for \$395 in 100's you get a complete system that includes:

- 16 Channel Multiplexer
- High Performance Differential Amplifier
- High Speed Sample/Hold Amplifier
- 12-Bit A/D Converter
- All Control and Programming Logic

DATA TRANSLATION
INC

109 CONCORD STREET, FRAMINGHAM, MA 01701

Call us at 617/879-3595 for a complete set of applications data. Or call your local representative below.

205-539-4411	303-934-5505	904-243-6424	504-366-5766	215-925-8711	919-489-1546	713-688-9971
602-947-7841	305-425-5505	305-723-0766	301-953-3724	505-299-7658	216-585-8421	214-231-2573
213-938-2833	305-776-4800	404-939-1674	314-997-1515	201-569-2230	615-584-2614	703-527-3262
415-941-4410		913-649-4000		716-334-2445		206-454-0900

INFORMATION RETRIEVAL NUMBER 118

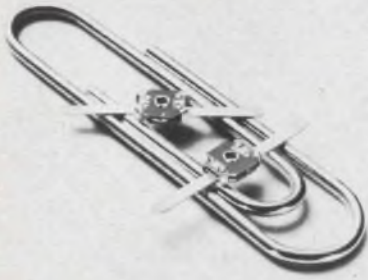

Thin-Trim variable capacitors provide a reliable means of adjusting capacitance without abrasive trimming or interchange of fixed capacitors. Series 9401 has high Q's and a range of capacitance values from 0.2-0.6 pf to 3.0-12.0 pf and 250 WVDC working voltage. Johanson Manufacturing Corporation, Boonton, New Jersey (201) 334-2676.

INFORMATION RETRIEVAL NUMBER 601

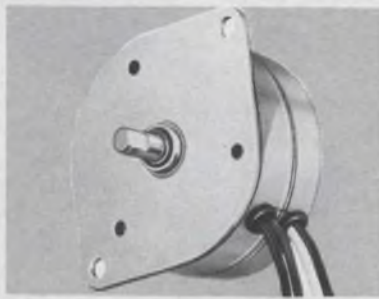

PM Synchronous Motor. Low cost motor provides torque to 10 oz-in at 300 RPM rotor. Electric reversibility, instant start/stop, quiet operation, and compact size—2-1/4" dia. x 1-1/8" long. For computer peripherals, control devices, chart drives, etc. ECM Motor Co., 1301 E. Tower Rd., Schaumburg, Ill. 60172. 312/885-4000.

INFORMATION RETRIEVAL NUMBER 604

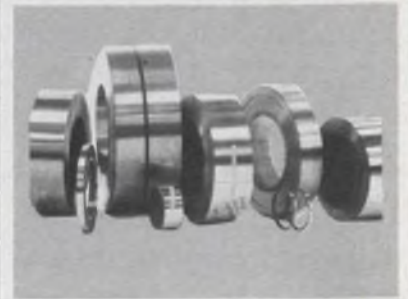

ELECTRONIC ALLOY HEADACHES? WE HAVE THE SOLUTIONS! Come to Magnetics for fast action on high quality magnetic, electronic, expansion or custom alloys. Complete, integrated facilities include vacuum or air melting; powder metallurgy; hot or cold rolling; precision flattening, slitting, annealing etc. Magnetics, Butler Pa. 16001.

INFORMATION RETRIEVAL NUMBER 607

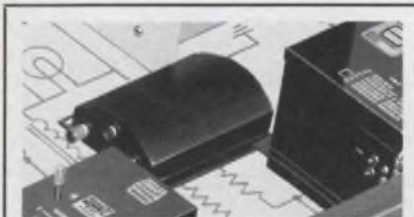

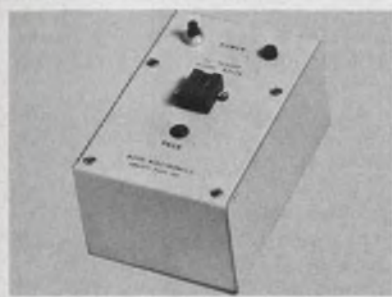

IC Tester. Test the SN74121, 74122, 9600, 9601, 9603 Monostable Multivibrators Automatically. Simple high speed GO NO-GO testing of pulse width accuracy. Completely self contained, does not require scope or external equip. Models BO121 and BO122 Priced at \$98. Boyd Electronics 1998 Southgate Way, Grants Pass, OR. 97526 (503) 476-9583.

INFORMATION RETRIEVAL NUMBER 610



LSI modem operates at 4800 BPS over worst-case dial-up telephone circuits. Digital MOS/LSI design with internal general purpose processor. Incorporates 110 BPS reverse channel. Design utilized computer simulation to verify automatic equalization and to optimize digital implementation. 16841 Armstron Ave., Irvine, Calif. 92705. (714) 557-5252

INFORMATION RETRIEVAL NUMBER 613

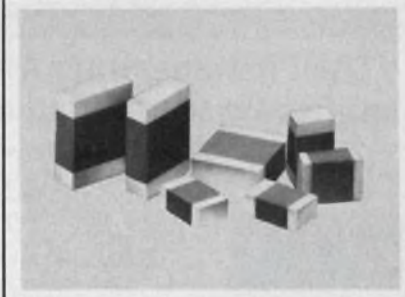

HIGH Q MULTILAYER CAPACITORS feature very high quality factors at microwave frequencies. Offered in three standard sizes: .050 x .040, .080 x .050, .125 x .095. Capacitance values from 0.1 pf to 1000 pf with close tolerance and voltages to 1000 VDCW. Johanson/Monolithic Dielectrics Div., Box 6456, Burbank, Ca. 91510, (213) 848-4465.

INFORMATION RETRIEVAL NUMBER 616

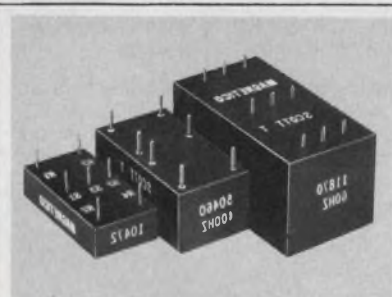

Scott T Transformer. 11870: 60HZ, 90v, L-L in. 1.1x2.1x1.1. 50460: 400HZ, 90v, L-L in. 7/8x1-5/8 x11/16. 50642: 400HZ, 11.8v, L-L in. 7/8x1-5/8-11/16. 10472: 400-HZ, 11.8v, L-L in. 3/4x1-1/2x3/8. All with 6v RMS sine & cosine output. MAGNETICO, INC., 182 Morris Ave, Holtsville, N.Y. 11742 516-654-1166.

INFORMATION RETRIEVAL NUMBER 611



Free catalog of 34,500 power supplies from the worlds largest manufacturer of quality Power Supplies. New '74 catalog covers over 34,500 D.C. Power Supplies for every application. All units are UL approved, and meet most military and commercial specs for industrial and computer uses. Power Mate Corp. (201) 343-6294.

INFORMATION RETRIEVAL NUMBER 614

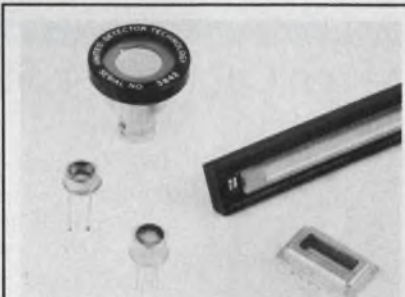

UDT offers a complete line of silicon photodiodes. Schottky for large area and enhanced UV responsivity, planar diffused for low noise and extended responsivity, photops (detector/amplifier combinations), special arrays and detectors to customer specifications. United Detector Technology, 2644 30th St., Santa Monica, Ca. 90405 (213) 396-3175.

INFORMATION RETRIEVAL NUMBER 617

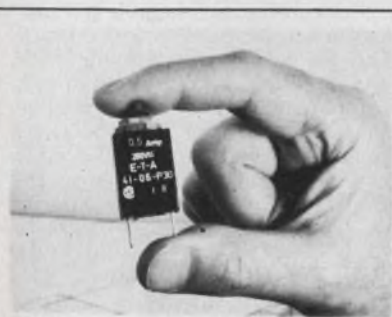

Overcurrent Protector, manual reset eliminates fuse replacement. Convenient panel mounting. 15 fractional ratings from 0.1 to 3 amp. Other models up to 400 amp. Trip-free and fool-proof, UL and CSA approved. High quality, low cost \$1.20 ea. in 1000 lots. E-T-A Products Co. of America, 7400 N. Croname Rd., Chicago, Ill. 60648. Tel: (312) 647-8303. Telex: 253780.

INFORMATION RETRIEVAL NUMBER 612



IM-LITE Lamp Assembly
THE LOWEST COST LAMP ASSEMBLY
IN THE INDUSTRY

- 10,000 Hour Life
- UL/CSA Leads
- Wide Range of Voltage and Current
- Incandescent and Neon
- No Tools Required for Installation
- Lens Press Fits in Panel
- Lenses in Full Range of Colors
- Tamper Proof Housings

IMTRONICS INDUSTRIES, LTD.
813 2nd St., Ronkonkoma, N.Y. 11779
(516) 981-3434

INFORMATION RETRIEVAL NUMBER 615

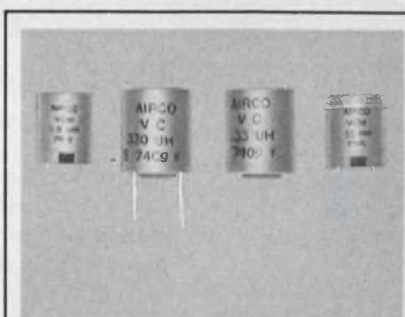

Variable Inductors Versacoil® VCM Shielded Series 0.1 to 100,000 uh VC Unshielded Series 0.1 to 4700 uh Unique unitork design provides uniform torque, no more broken cores. Available stock. Airco Electronics, P.O. Box 547 Bradford, Pa. 16701 814-362-5536.

INFORMATION RETRIEVAL NUMBER 618

The First Spectrum Analyzer-Calculator Simplifies Noise & Vibration Analysis in Real Time

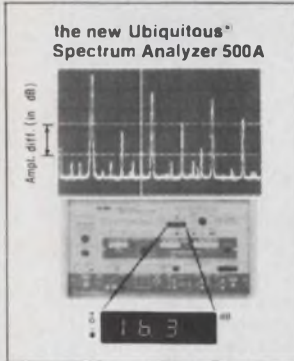

New Ubiquitous® UA-500A is world's first combination 500-line spectrum analyzer-averager that automatically **calculates** (computes): absolute frequency & amplitude in dB or % of full scale; relative amplitude above and below your calibration signal; frequency deviation from your chosen reference frequency; frequency in Hz and CPM (cycles/min.) for ease in reading RPM; which peaks are harmonically related by isolating them from others with harmonic markers or eliminating all else from the CRT display. Applications simplified include: machine diagnosis, rotating machine analysis, noise source identification, mechanical signatures, underwater acoustics, and noise reduction. Built-in dual memory averager allows comparison of past & present data. Small, portable, only 8¾" high. Highest speed: real-time 100% analysis to 10kHz. Thirteen ranges from 0-10Hz to 0-100kHz providing analysis bandwidths of .02Hz to 200Hz (also 0-5mHz direct input). Simplest to use.

Nicolet Scientific Corp. (formerly Federal Scientific Corp.)
245 Livingston St., Northvale, New Jersey 07647
(201) 767-7100. TWX: 710-991-9619

Demo, circle No. 170
Lit., circle No. 171

Giant Free Catalog! 4,500 Unusual Bargains



New 164-page catalog! Packed with 1,000's of hard-to-find buys in Optics, Science, Electronics. Loaded with optical, scientific, electronic equipment available from stock. Rare surplus buys. Many "one-of-a-kinds". Ingenious scientific tools. Components galore: lenses, prisms, wedges, mirrors, mounts, accessories. 100's of instruments: pollution test equipment, lasers, comparators, magnifiers, microscopes, projectors, telescopes, binoculars, photo attachments, unique lighting. Shop, save by mail! Request free Catalog "DA".

CIRCLE NO. 172

Edmund Scientific Co.

America's Largest Science-Optics-Electronics Mart
300 Edscorp Bldg., Barrington, New Jersey 08007 (609) 547-3488

New Kepco Power Supply Catalog and Handbook



Kepco, Inc. has published a new 1974 Power Supply Catalog and Handbook. In 130 pages, there are schematics and mechanical drawings of more than 30 power supply designs, encompassing several hundred separate models. The Kepco Catalog and Handbook includes applications material on high speed-fast programming models, digital control systems, measurements and power supply combinations. A comprehensive glossary is also included.

CIRCLE NO. 173

KEPCO, INC.

131-38 Sanford Avenue, Flushing, N.Y. 11352
(212) 461-7000

ELECTRONIC DESIGN's function is:

- To aid progress in the electronics manufacturing industry by promoting good design.
- To give the electronic design engineer concepts and ideas that make his job easier and more productive.
- To provide a central source of timely electronics information.
- To promote communication among members of the electronics engineering community.

Want a subscription? ELECTRONIC DESIGN is sent free to qualified engineers and engineering managers doing design work, supervising design or setting standards in the United States and Western Europe. For a free subscription, use the application form bound in the magazine. If none is included, write to us direct for an application form.

If you do not qualify, you may take out a paid subscription for \$30 a year in the U.S.A., \$40 a year elsewhere. Single copies are \$1.50 each.

If you change your address, send us an old mailing label and your new address; there is generally a postcard for this bound in the magazine. You will have to requalify to continue receiving ELECTRONIC DESIGN free.

The accuracy policy of ELECTRONIC DESIGN is:

- To make diligent efforts to ensure the accuracy of editorial matter.
- To publish prompt corrections whenever inaccuracies are brought to our attention. Corrections appear in "Across the Desk."
- To encourage our readers as responsible members of our business community to report to us misleading or fraudulent advertising.
- To refuse any advertisement deemed to be misleading or fraudulent.

Microfilm copies are available of complete volumes of ELECTRONIC DESIGN at \$19 per volume, beginning with Volume 1, 1961 through Volume 20. Reprints of individual articles may be obtained for \$2.00 each, prepaid (\$.50 for each additional copy of the same article) no matter how long the article. For further details and to place orders, contact the Customer Services Department, University Microfilms, 300 North Zeeb Road, Ann Arbor, Michigan 48106 telephone (313) 761-4700.

Want to contact us? If you have any comments or wish to submit a manuscript or article outline, address your correspondence to:

Editor
ELECTRONIC DESIGN
50 Essex Street
Rochelle Park, N.J. 07662

A GOLD MINE OF INFORMATION & DATA

- **520** CATALOG PAGES ON ICs & SEMICONDUCTORS
- **300** CATALOG PAGES ON INSTRUMENTS
- **290** CATALOG PAGES ON POWER SUPPLIES
- **210** CATALOG PAGES ON WIRE & CONNECTOR PRODUCTS
- **150** CATALOG PAGES ON SWITCHES
- **2800** CATALOG PAGES ALL TOLD IN 52 PRODUCT CATEGORIES

Electronic Design's GOLD BOOK puts the entire electronics industry at your fingertips. Use it for product search, selection, specification and purchase. It's the most thorough industry master catalog & directory ever compiled.

When you need Information . . .
Electronic Design's

**GOLD
BOOK
IS THE PLACE
TO LOOK**

Electronic Design

Advertising Sales Staff

Tom W. Carr, Sales Director

Rochelle Park, N.J. 07662

Robert W. Gascoigne
Daniel J. Rowland

(Recruitment, Quick Ads, Classified)

50 Essex Street
(201) 843-0550
TWX: 710-990-5071

Philadelphia

Thomas P. Barth
50 Essex Street
Rochelle Park, N.J. 07662
(201) 843-0550

Boston 02178

Gene Pritchard
P.O. Box 379
Belmont, Mass. 02178
(617) 489-2340

Chicago 60611

Thomas P. Kavooras
Berry Conner, Jr.
200 East Ontario
(312) 337-0588

Cleveland

Thomas P. Kavooras
(Chicago)
(312) 337-0588

Los Angeles 90045

Stanley I. Ehrenclou
Burt Underwood
8939 S. Sepulveda Boulevard
Suite 510
Los Angeles, Calif.
(213) 641-6544

San Francisco 94022

Jerry D. Latta
P.O. Box 1248
Los Altos, Calif.
(415) 965-2636

London, Amsterdam, Tokyo, Seoul

John Ashcraft
12, Bear St.
Leicester Square
London WC2H 7AS England
Phone: 01-930-0525

W. J. M. Sanders
John Ashcraft & Co.
Herengracht 365
Amsterdam C., Holland
Phone: 020-24-09-08

Haruki Hirayama
Electronic Media Service
5th Floor, Lila Bldg.,
4-9-8 Roppongi
Minato-ku, Tokyo, Japan
Phone: 402-4556
Cable: Electronicmedia, Tokyo

Mr. O-kyn Park, President
Dongbo International
Corporation
1.P. O. Box 4010
Seoul, Korea
Phone: 28-1911
Cable: Dongbo Seoul

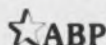

VIDEO AMPS

C-COR

**VIDEO Amplifiers
are the most
versatile!**

DC and AC Coupling
Laboratory or Modular
Single or Multiple Output

FOR EXAMPLE

MODEL	4392	3567	3334
BW	DC to 20 MHz	DC to 20 MHz	DC to 20 MHz
Gain	6 to 20dB	20dB	X1 to X100
			in steps
Z In/Out	50/5 ohms	1k/50 ohms	50/50 ohms
Output	+32dBm into 50 ohms	+19dBm scope preamp	+21dBm into 50 ohms

For a complete amplifier catalog
call, wire, or write:

C-COR
Electronics, Inc.

60 Decibel Road
State College, PA 16801
814-238-2461
TWX 510-691-1933

Call Toll Free 800-458-3751

INFORMATION RETRIEVAL NUMBER 119

PIEZOELECTRIC TUNING FORK

**LOW PRICE
HIGH RELIABILITY**

TYPE : TFQ 697.5Hz~1492.5Hz



20^L × 8.0^H × 6.5^W mm

TYPE : TFD 360Hz~2000Hz



32^L × 7.8^H × 7.8^W mm



IWATA ELECTRIC CO., LTD.

Mansei Bldg. Rm. 36 1-16, 1-Chome
Soto-Kanda, Chiyoda-ku, Tokyo 101, Japan

INFORMATION RETRIEVAL NUMBER 120

recruitment
and
classified ads

SAME DAY SHIPMENT
Minis & Peripherals
PRINTERS
Some "BRAND NEW"
DATA PRODUCTS

2440—700 LPM
2470—1250 LPM
MOHAWK DATA SCIENCES
4320—300 LPM
4330—380 LPM
CONTROL DATA CORP.
9322—200 LPM
9352—600 LPM

ALSO CENTRONICS, POTTER,
A. B. DICK, IBM, HIS, UNIVAC
617-261-1100

Send for Free Report
"Maintenance of Computers"

**AMERICAN USED
COMPUTER CORP.**
P.O. Box 68, Kenmore Sta.,
Boston, MA 02215

member
COMPUTER DEALERS ASSOCIATION

INFORMATION RETRIEVAL NUMBER 210

KEEP

Electronic Design's

GOLD BOOK

HANDY



When You Call

Save time when you contact suppliers. Check their catalog pages first in *Electronic Design's* GOLD BOOK. Maybe the information you need is right at your fingertips.

**advertiser's
index**

Advertiser	Page
ACDC Electronics, Inc.	15
AMP, Incorporated, Capatron Division	161, 196
AVX Ceramics Corporation	49
Abbott Transistor Laboratories, Inc.	7
Acopian Corp.	141
Addmaster Corporation	179
Advance Conversion Devices Company	190
Airco Electronics	197
Alpha Metals, Inc.	96
Arnold Magnetics Corp.	196
Astrodyne, Inc.	168
B & H Industries	196
Ballantine Laboratories, Inc.	204
Beckman Instruments, Inc. Helipot Division	35
Belden Corporation	68, 69
Bourns, Inc. Trimpot Products Division	66
Boyd Electronics Co.	197
Buckbee-Mears Company	196
Bulova Frequency Control Products	188
Burr-Brown Research Corporation	23
Burroughs Corporation	30
C-Cor Electronics, Inc.	199
Cambridge Thermionic Corporation	178
Celanese Plastics Company	79
Centralab, The Electronics Division of Globe-Union, Inc.	26, 27
Christie Electric Corp.	194
Cir-Q-Tel	195
Circuit Stik, Inc.	170
Clare & Co., C. P.	60
Columbia Research Labs, Inc.	201
Computer Automation, Inc.	61, 62, 63, 64
Computer Products, Inc.	128
Concord Electronics Corporation	192
Coto Coil Company, Inc.	184
Cramer Electronics, Inc.	10, 11
Cramer, Division of Conrac	156B
Custom Electronics, Inc.	187
Dale Electronics, Inc.	Cover II
Data General Corporation	12, 13
Data Translation, Inc.	195
Datak Corporation, The	172
Datel Systems, Inc.	196, Cover II
Delco Electronics, Division of General Motors Corporation	132, 133
Delta Products, Inc.	181
Dialight Corporation	25
Dormeyer Industries, Inc.	190
Dynamic Instrument Corp.	28
ECM Motor Co.	196
EECO	163
E-T-A Products Co. of America	197
Elmund Scientific Co.	198
Efratom California, Inc.	201
Elec-Trol, Inc.	87
Electronic Design	182
Electronic Measurements, Inc.	189
Electrostatics, Inc.	180
Elxon Power Systems	176, 177
Erie Technological Products, Inc.	65

Advertiser	Page
FMC Corporation	121
Fuji Electrochemical Co.	109
General Automation, Inc.	147
General Electric Company	156
General Radio Company	136
Gold Book, The	114, 115, 138, 139, 150, 151
Grayhill, Inc.	158
Hamlin, Inc.	97
Hayden Book Company, Inc.	34, 154B
Heinemann Electric Company	47
Hewlett-Packard	1, 45
Hope Electronics	192
Hunt Electronics	178
Hycom	197
ITT Cannon, A Division of International Telephone and Telegraph Corporation	172, 175, 204
Illinois Capacitor Sales Co.	175
Intronics Industries Ltd	196
Intech, Incorporated	166
International Rectifier	51
Interswitch	168
Iwata Electric Co., Ltd.	199
Jamesbury Corp., Decitek Division	194
Janco Corporation	182
Johanson Manufacturing Corp.	196
Johanson Monolithic Dielectrics Div.	197
Johnson Co., E. F.	14
Kay Instruments	
Kepeco, Inc.	198
Kulka Electric Corp.	173
Lafayette Radio Electronics	162
Lambda Electronics Corp.	16, 17 thru 22, 39 thru 44, 81 thru 86, 103 thru 108
Ledex, Inc.	169
3M Company	80
MCG Electronics	184
Magnético, Inc.	197
Magnetics, Inc.	196
Macrodata Corporation	137
Maxi-Switch Co.	171
Micro Switch, A Division of Honeywell	8, 9
Microtran Company	186
Mini-Circuits Laboratory	203
Motorola Semiconductor Products, Inc.	53
MuRata Corporation of America	29

Advertiser	Page
Nicolet Scientific Corp.	198
Optron, Inc.	7
Owens-Illinois, Inc.	167
Paktron, Division Illinois Tool Works, Inc.	204
Panasonic Matsushita Electric	159
*Philips Industries Electronic Components and Materials Division ..	27
*Philips Industries,	34, 35
Power Design	154A
Power/Mate Corp.	197
Power Tech, Inc.	113
Princeton Electronic Products, Inc.	202
RSM Sensitron Semiconductors	145
RCA Solid State	Cover IV
Radio Switch Corporation	179
Reader Service Card	204A, 204B
Reed Devices, Inc.	204
Reliability, Inc.	174
Regmo Data Corporation	191
Rogers Corporation	165
Schrack Electrical Sales Corp.	171
Semtech Corporation	54
Siemens Corporation Components	

NEW PIEZOELECTRIC CRYSTAL
ACCELEROMETERS
 CONTROL ALL **VIBRATION-SHOCK**

PROBLEMS

Self-generating these accelerometers instantaneously provide an electrical output proportional to the vibration or shock. The total isolation from the case, and newly discovered composition of the seismic element, results in a stability and almost infinite life for the most severe industrial or test applications. The basic sizes shown are of the 600, 300 and 200 Series.

Call or Write:

COLUMBIA RESEARCH LABS., INC.
 Woodlyn, Pa. 19094 Phone: (215) 532-9464



 **columbia** first for
 transducers and control



If your graphic CRT terminal has

- Grey Scale
- Electronic Zoom
- Selective Erase
- High Brightness

(and Tektronix software compatibility)
IT CAN ONLY BE A
Princeton 801

The complete graphic terminal with unique flexibility and low cost.

Vectors, Verbs, and Video. Stores and displays — flicker-free — vectors and alphanumerics from the computer or keyboard, and video from a TV camera or similar source, in any combination.

Software Compatible. Are your applications written for Tektronix? No problem. A small, no-cost software package from Princeton Electronics interfaces the 801 to the Tektronix software.

Grey Scale. In grey-scale mode, the 801 accepts a high-resolution image (1,024 by 1,024 points) with 32 discrete levels of grey.

Flicker-Free. A unique silicon target image-storage memory, the PEP Lithocon II™, gives the 801 its remarkable versatility. The flicker-free CRT display is refreshed from the Lithocon target for more than an hour with no loss of image quality and no further computer time.

Selective erase. Any element in the display can be erased, and a new element displayed — giving the 801 the maximum in flexibility and responsiveness.

A word about delivery: Ours — 60 days. Theirs — 6 months.

Options include joystick cursor control and zoom magnification.

Write or call.



**PRINCETON
ELECTRONIC
PRODUCTS, INC.**

P.O. Box 101, North Brunswick, N.J. 08902
Telephone: (201) 297-4448

product index

Information Retrieval Service. New Products, Evaluation Samples (ES), Design Aids (DA), Application Notes (AN), and New Literature (NL) in this issue are listed here with page and Information Retrieval numbers. Reader requests will be promptly processed by computer and mailed to the manufacturer within three days.

Category	Page	IRN	Category	Page	IRN
Components			manual (NL)	195	388
brushless dc motors (NL)	192	368	processor, floating pt	165	281
capacitor, monolithic	49	28	scrambler, facsimile	161	271
capacitors	24	13	storage, cassette	161	270
capacitors	131	52	terminal data entry	162	274
capacitors	175	86	terminal, intelligent	162	272
capacitors	204	128	Discrete Semiconductors		
capacitors, ceramic	29	236	diodes, color sensitive	184	338
capacitors, ceramic	37	25	diodes, light emitting	184	340
capacitors, mica	187	104	diodes, tuning	182	334
capacitors, polystyrene	189	356	displays	45	26
capacitors, tantalum	156	63	emitters and isolators (NL)	192	370
delay lines, DIP	188	352	indicator lights	25	14
display, liquid crystal	188	353	isolator, opto	185	344
displays, liquid crystal	97	44	isolators	7	6
filters, RFI/EMI	161	68	JFETs, uhf	185	342
filters, ceramic	34	21	JFETs, dual	183	336
filters, crystal	188	106	LEDs	11	8
flasher, solid-state	188	351	LEDs, discrete	182	333
ignition system	181	96	lamp, LED	182	335
inclinometer	189	355	power semiconductors	133	53
keyboards	171	79	power thyristors	121	50
mini-rotary switches (NL)	192	369	rectifiers	54	31
motors, small, dc	190	357	single sideband devices	53	30
optical encoders	185	101	thyristors	178	91
potentiometer, trimmer	190	359	transistor, power	185	343
potentiometers	189	354	transistor, pulse power	184	341
relay	171	80	transistors, L-band	184	339
relays, DIP	2	3	transistors, power	183	337
relays, DIP	87	41	transistors, silicon	113	46
relays, reed	60	35	zeners	149	60
relays, reed	194	115	Instrumentation		
relays, 1/6 crystal case	188	350	communications		
resistors	35	22	instruments (NL)	194	385
resistors	157	64	counters	164	71
resistors, metal-film	11	245	curve tracer	57	32
solenoids	169	77	DPM/counter	111	246
surge arresters (NL)	193	376	frequency synthesizer	136	54
switch, linear	190	358	function generator	154	62
switches	9	232	generators (NL)	193	377
switches	182	97	instruments (NL)	193	378
switches, ceramic	179	94	lock-in amplifiers (NL)	193	380
switches, lighted	158	65	meter	171	81
switches, pushbutton	35	23	meters	95	42
terminal blocks	173	84	noise-figure meter	187	348
thermocouple	175	87	noise generator	187	349
transformers	143	57	RAM tester	137	55
transformers	186	103	signal generator	186	345
			synthesizer	186	346
			temperature controller (NL)	193	373
Data Processing			transient recorder	186	347
CRT terminal	202	123	voltmeters, rms	204	126
cable TV systems (NL)	194	384	Integrated Circuits		
computers, medium-scale	13	9	arithmetic logic unit	174	301
converter, d/a	164	276	CMOS	5	4
coupler, acoustic	162	275	CMOS	IV	247
data-acquisition system	195	118	clock circuit	172	295
flexible disc drive (NL)	194	386	counter, CMOS	173	298
interface, computer	164	277	decade divider	174	300
interface, data	165	280	detectors, light	172	294
keyboard	162	273			
memory, disc	164	279			
microcomputer	164	278			
microprogramming					

Category	Page	IRN
IC devices (NL)	195	387
LED/lamp flasher IC	166	73
op amp	173	297
RAM	174	302
timers	172	296
transceivers	174	299
Microwaves & Lasers		
amplifier, J-band	179	323
amplifier, video	177	306
antenna, log periodic	176	303
antennas	177	307
antennas, FM	179	324
antennas, active	180	326
antennas, yagi	181	331
combiners, couplers	180	329
filter, power	180	328
filters	176	305
filters, YIG	181	330
klystrons	176	304
laser-based system (NL)	193	374
laser calorimeter	180	327
laser products	178	321
mixer/preamp	181	332
module, laser program	177	308
phase shifters	178	320
TWT	179	325
tetrodes	178	322
Modules & Subassemblies		
amplifier, s/h	168	286
amplifier, instrument compensator,	170	293
thermocouple	168	285
controller, a/d	170	290
converter, d/a	166	282
converter, d/s	169	288
converter, s/d	166	283
converters (NL)	193	375
detector, proximity	169	289
filters, bandpass	195	117
filters, low pass	170	292
instrumentation amps	23	12
oscillator, clock	170	291
tester, phone-line	168	287
timer, solid-state	166	284
Packaging & Materials		
adapters, phone plug	158	265
beam-compass	156	259
bus	165	72
chemical, surfactant	158	264
circuit boards, g-p	170	78
circuit boards and accessories	120	49
cleaning and lubricating agent	191	110
connectors	172	82
connectors	175	88
connectors	204	125
connectors	187	105
contact, coax cable	156	256
cylindrical connectors (NL)	193	379
flat cable/connector systems	80	40
headers, feedthrough	160	268
holder, semicon-devices	156	257
housing kits	160	266
jacks	178	92
light filter, green	160	269
lugs, thermocouple	157	261
machine, preformed jumper	156	258
magazines, DIP IC	160	267
matrix board	168	75
PC kit	172	83
pins	192	111

Category	Page	IRN
preforms	96	43
resistors, film	158	263
rubber material guide	160	67
socket boards	163	70
terminal strips	204	127
test clips	157	260
thermoplastic polyester	79	39
torque screwdriver	158	262
wire, cable, cord	69	234

Category	Page	IRN
Power Sources		
battery	155	253
CRT supply	155	254
charger/converters, plug-in	28	17
circuit breakers	47	27
fault monitor	155	251
inverter	155	250
modular supply	155	255
open-frame	155	252
power modular equipment	6	5
power protection equipment	190	108
power sources	174	85
power supplies	15	11
power supplies	16	240
power supplies	128	51
power supplies	141	56
power supplies	176	89
power supplies	177	90
power supplies	180	95
power supplies	186	102
power supplies	189	107
power supplies	193	113
power supplies, dc	194	116
power supply	192	112
voltage regulators	58	33

new literature

brushless dc motors	192	368
cable TV systems	194	384
communications instruments	194	385
converters	193	375
cylindrical connectors	193	279
electronics catalog	162	69
emitters and isolators	192	370
generators	193	377
IC devices	195	387
instruments	193	378
laser-based system	193	374
lock-in amplifiers	193	380
microprogramming manual	195	388
mini-rotary switches	192	369
PC card frames	194	382
power supplies	192	366
steam electric system	192	372
surge arresters	193	376
temperature controller	193	373
termination systems	192	367
tubing products	194	381
tubular capacitors	192	371
v/f converters	194	383

application notes

magnetic shielding	191	365
oscilloscope guide	191	362
power transformer design	191	364
thick-film resistors	191	363

evaluation samples

manual motor controls	191	360
molded nylon washers	191	361

DOUBLE-BALANCED MIXERS

Great Value at

\$7.95
500 piece quantities.

\$9.95 in quantities of 1 to 49 pieces

DC-500MHz
6dB conversion loss
40dB isolation
EMI shielded case



A breakthrough in technology and high production volume enables Mini-Circuits Laboratory to offer these new products at an unprecedented low price.

In today's tough competitive market can you afford not to use these remarkably low priced and high performance units?

Ruggedness and durability are built in the SRA-1. These new units are packaged within an EMI shielded metal enclosure and hermetically sealed header. They use well matched hot-carrier diodes and uniquely designed transmission line transformers.

We invite you to convince yourself. Place your order now and check our delivery, product performance and reliability.

Mini-Circuits Laboratory

837 Utica Avenue, Brooklyn, N.Y. 11203
(212) 342-2500
A Division Scientific Components Corp.

*FRANCE: S.C.I.E., *31, rue George-Sand, Palaiseau 91, France *GERMANY: AUSTRIA, SWITZERLAND: Industrial Electronics GMBH, *Klüberstrasse 14, 6000 Frankfurt/Main, Germany *UNITS IN STOCK

ENGLAND: Dale Electronics: Dale House, Wharf Road, Frimley Green, Camberley, Surrey. JAPAN: Denisho Kaisha, Ltd.: Eguchi Building, 8-1, 1-Chrome, Hamamatsucho, Minato-Ku, Tokyo.

*UNIT IN STOCK.

INFORMATION RETRIEVAL NUMBER 124

203

"CANNON'S PRESS-T-MATE CONNECTORS GOT US CONNECTIONS AT HALF THE

COST, and me congratulations all around!"



"Because PRESS-T-MATE eliminates the cost of wire wrapping and the disadvantages of soldering, it saved us a bundle. See why in 'Secrets of Connector Success.' It's a 'how to' book for 'can do' guys like us."

Contact ITT Cannon Electric, International Telephone and Telegraph Corporation, 666 East Dyer Road, Santa Ana, CA 92702. (714) 557-4700.

CANNON ITT

INFORMATION RETRIEVAL NUMBER 125

SPACE-SAVING BARRIER TERMINAL STRIPS FOR P. C. BOARDS

Resilient break resistant U.L. grade material.

Backstop contains wires, protects components from field wiring.

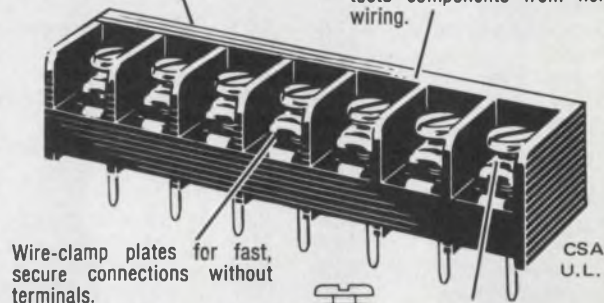

Wire-clamp plates for fast, secure connections without terminals.

CSA U.L.



Screws in raised position, saves 50% wiring time.



Featuring Right Angle mount option.

3 sizes available from Distributor stock:

- #4-40 screws, pins on .325" centers
- #6-32 screws, pins on .375" centers
- #8-32 screws, pins on .4375" centers

WRITE FOR CATALOG 200

RDI/Reed Devices Inc.

21W183 Hill Avenue • Glen Ellyn, Il. 60137

Tel: 312/858-2050 • Telex: 72-1527

In Canada: Renfrew Electric, Toronto • Tel: 416/461-3511

INFORMATION RETRIEVAL NUMBER 127

Look to Ballantine for TRUE RMS Voltmeters



- True RMS • Battery Option
- 100 μ V to 300 V
- 2 Hz to 20 MHz (Usable to 50 MHz)
- 1% Mid-Range Accuracy
- Fast Response
- Fully Overload Protected

From \$665



Ballantine Laboratories, Inc.
P.O. Box 97, Boonton, New Jersey 07005
201-335-0900, TWX 710-987-8380

INFORMATION RETRIEVAL NUMBER 126

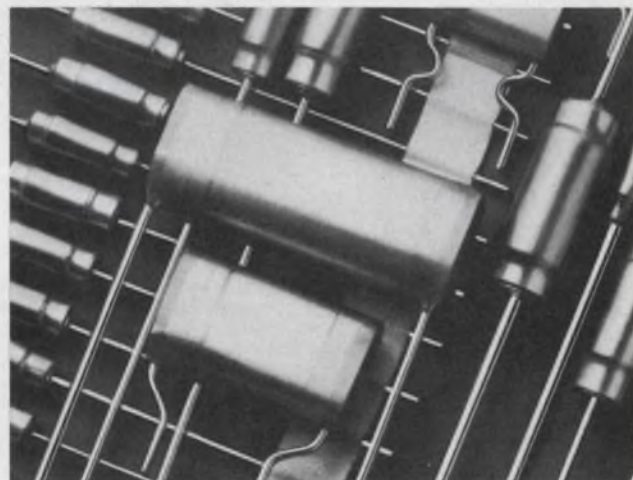

Two remarkable film capacitor types. Only from Paktron.

Axial lead polyester and polypropylene Micromatic® capacitors. Self-encased—wound on their own leads. Radial lead Filmatic® capacitors with Rippleweld® lead attach process. Modern plants in Vienna and Lynchburg, Virginia. For free catalog, write:

PAKTRON, Division Illinois Tool Works Inc.,
900 Follin Lane, S. E., Vienna, Virginia 22180.
Phone (703) 281-2810. TWX 710-833-0682.



iLW PAKTRON

innovators in film capacitors

The Innovative Electronic Group of ITW...

PAKTRON • LICON • EMCON © ILLINOIS TOOL WORKS INC. 1974

INFORMATION RETRIEVAL NUMBER 128

ELECTRONIC DESIGN 23, November 8, 1974

Another Datel
Two-for-One
Sale

Whose Digital Panel Meter
can you count on?

DATEL'S



\$99 DPM/Counter

We've put them together. A 3-digit panel meter and high speed counter. And much more, all for \$99.00, single quantity. This compact, 2-card, low parts-count DPM has easy-to-read .43" High LED digits. A counter input and gate with 0's reset not found on other DPM's lets you create frequency and period meters and tachometers. A wealth of special controls and full BCD outputs makes the DM-3000 ideal for systems use.

ALL FOR \$99 !!!!

QUICK SPECS

Input:
0 to +999mV
Drift:
100 ppm/°C max.
Power:
+5VDC
Output:
Full parallel BCD
Speed:
0 to 250 samples/second
using internal or
external clock.
Counter:
0 to 10MHz count rate
Display:
Red 0.43" High LED 7-bar
Built-in 5V at 5mA short-proof
supply for external circuitry
Selectable leading zero
suppress, display blank,
short cycle
Optional 500kHz \pm .02% crystal
oscillator for accurate
frequency and period
measurement.

Use the DM-3000 as:

- 3-digit DPM
- 4-wire slaved display
- Tach. period or frequency meter
- 0 to 10MHz general purpose counter with selectable full count.

DATEL
SYSTEMS, INC.

1020 Turnpike Street, Canton, Mass. 02021
• TEL. (617) 828-8000 • TELEX 924461
• TWX 710-348-0135

Direct Offices

Santa Ana, Calif. (714) 835-2751
Sunnyvale, Calif. (408) 733-2424
Muenchen, W. Germany 089/78 40 45
Paris, France 603-06-74
Basingstoke, U. K. (0256) 66721
Tokyo, Japan 499-0631

A major breakthrough in op amps...

MOS/FET, Bipolar and CMOS on the same chip.

It's the low-cost CA3130 from RCA. An accurate, easy-to-work-with op amp from the people who first combined PMOS and bipolar technologies in the CA3100T.

Even with three technologies on a single chip, the new CA3130 is simplicity itself. Which is why it costs only \$0.75 at 1K (premium versions are also available). Among its principal features (values shown are typical):

General Purpose

High open loop voltage gain: 110 dB
Low input offset voltage: 8mV
Low input current: 5pA
Input offset current: 0.5pA

FET input

Very high input impedance: 1500 M Ω

Wideband

Unity gain crossover frequency: 15 MHz
High slew rate: 10 V/ μ s
Fast settling time: 1.2 μ s

Micropower

2.5 mW at 5V supply voltage

High current

22 mA output

A voltage swing to within 10 millivolts of either rail on a single power supply is now possible for the first time because of the CMOS output stage.

Available in 8-lead TO-5 ("T") or 8-lead dual in-line ("S") packages off the shelf from your RCA Solid State distributor. Call him or write RCA Solid State, Box 3200, Somerville, N.J. 08876. Phone (201) 722-3200, Ext. 3142.

RCA Solid State

A full house in Linear ICs

INFORMATION RETRIEVAL NUMBER 247

