

Electronic Design 6

VOL. 19 NO.

FOR ENGINEERS AND ENGINEERING MANAGERS

MARCH 15, 1971

RECEIVED
MAR 17 1971
CALMA CO

Take a peek at the IEEE show without moving from your desk. Start with the technical sessions and listen to the latest in your specialty, whether it's LSI or minicomputers. Then take a tour of the exhibit aisles and check the specs on the new op amps, or maybe that spectrum analyzer. Hurry! The show starts on p. S2.



Introducing: "The Portables" from HP



Shown: 1701A delayed-sweep version

They make your budget seem bigger.

HP's new dual-channel, portable scopes make slim budgets look fatter. At only \$1850, our delayed-sweep model, the 1701A, weighs in at \$200 less than the competition, which adds up to a 10% savings for you. (Our non-delayed-sweep model, the 1700A, is even lower — \$1680.)

The 1701A weighs less in pounds, too — 24 as compared to 28 — which makes it easy to carry around in the field. But the 1701A is no "light-weight" in its performance. It gives you all the necessary capabilities for digital field service work.

Its 10 ns/div sweep time and <10 ns rise time (35 MHz) let you measure T²L pulse timing and propagation delay.

And its simple-to-use delayed sweep allows expansion of complex waveforms, for easy observation on the large 6 x 10 cm screen.

Another advantage is the 1701A's low power requirement. This HP breakthrough eliminates the need for fans (or even vent-holes), which means that dust and moisture are kept out of the circuits. It also assures extreme reliability, as all components are operating at less than 20% of rated capability. And, this low power requirement allows battery operation in the field — a capability you get with no other scope in this class. (Internal battery pack, \$200 extra.)

For further information on "The

Portables" — HP's new 1700 Series scopes — contact your local HP field engineer. Or write Hewlett-Packard, Palo Alto, California 94304. In Europe: 1217 Meyrin-Geneva, Switzerland.

Scopes are changing.
Are you?

081/7

HEWLETT **hp** PACKARD

See at IEEE Show

Monolithic Memories bipolar 1024 bit field programmable ROM

Introducing the industry's first 1024 bit bipolar programmable Read Only Memory. Because you program it in your own facility, you save expensive masking charges and time delays for new bit patterns. With programming time cut to minutes, you won't be sitting there with an idle system waiting six weeks or more for parts. And, think how happy *your customer* will be if you replace a ROM in the field in minutes.

MMI field-programmable ROM's are easy to program. A low 20mA applied to the proper leads, using *any* test equipment, and your ROM is programmed. If you don't have test equipment, we'll sell you a portable field-programmer at nominal cost that can be plugged into any common electrical outlet. Or, have your MMI distributor program them for you the same day.

Sooner or later you'll need that programmed ROM in production quantities. That's where our MM6200 ROM comes in.

Only MMI offers pin for pin compatibility and interchangeability between our 1024 programmable ROM (MM6300) and a 1024 bit mask-programmable ROM (MM6200). Both are bipolar; both organized as 256 words by 4 bits, have an access

time of 50 nsec and low power dissipation of 0.35 mW/bit.

Both have full address decoding on the chip, are directly DTL/TTL compatible and have open collector outputs

for easy memory expansion. And they come in a standard 16 pin ceramic dual in line package.

The programmable ROM, MM6300, is available from stock at below 7¢ a bit in 100 unit quantity. The MM6200, with a four week turn around time, is priced at less than 2¢ a bit in 100 lots. Pick a winner, call, TWX, telex or write today.

Monolithic Memories

Monolithic Memories, Inc., 1165 East Arques Avenue, Sunnyvale, Ca 94086
(408) 739-3535 TWX: 910-339-9229 Telex: 356-301

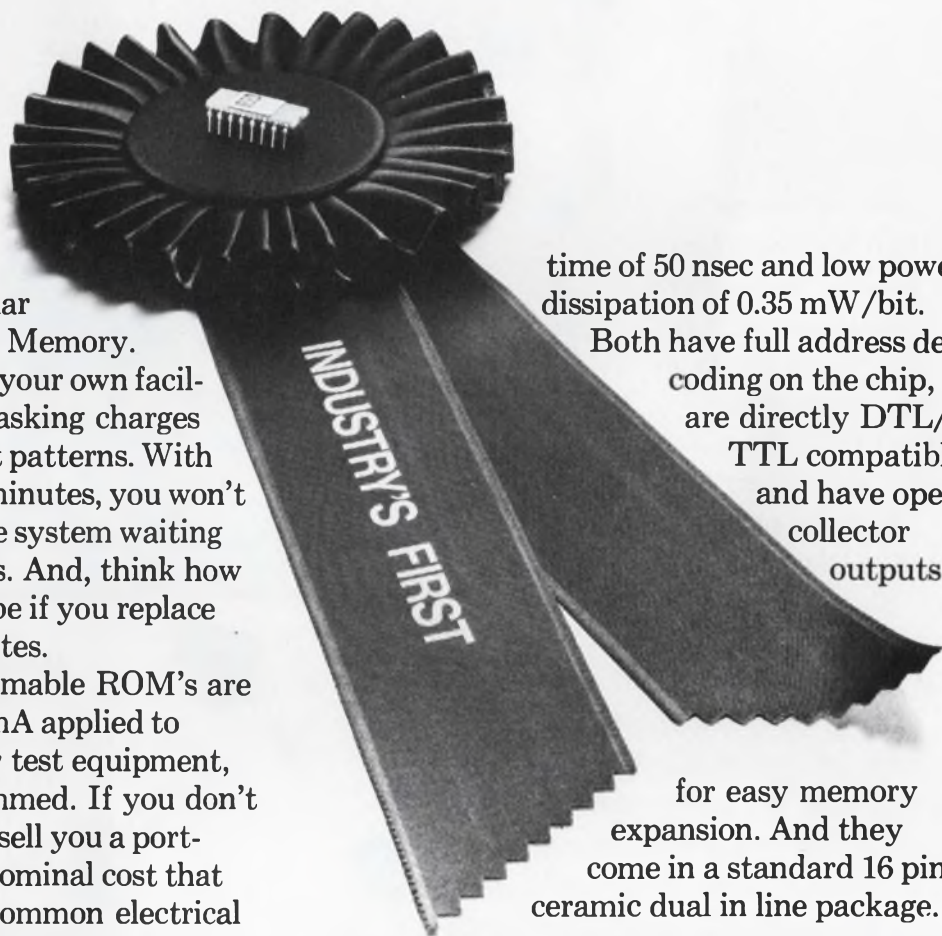

LED Test Instrument

The human eye is the best test instrument for selecting visible LED's. Brightness and uniform radiation from device to device are two criteria Litronix LED's can match against all other emitters.

There are other criteria — package strength and design, reliability and cost — our LED's have those benefits too.

The RL-50 second source for the MV-50, packs all these advantages in a tiny, strong axial-lead package. We didn't invent it, but we make it a little brighter and stronger. It can be mounted flat, with leads soldered across terminals or on the edge of the PC card.

Our Red-Lit 2 is a plastic LED



with a red diffused lens and comes with a panel mounting clip. It's also available with water clear, white diffused or red clear lens.

Both these LED's operate off TTL/DTL logic levels and consume next to nothing in power.

We have lots of other low cost discrete LED's as well — all available from stock.

If you call or write us, we'll send you a free sample of the RL-50 or

the RL-2 with the panel clip. Put it to the eyeball test. We'll also

tell you about our opto-isolators, infrared

emitters and seven segment displays and send you

a copy of our product guide.



The bright guys

litronix

NEWS

- 21 **News Scope**
- 25 **At the Solid-State Circuits Conference**—Medical electronics stirring, and the IC prognosis looks excellent.
- 28 **2 new semi memories** offering immunity to volatility problems.
- 30 **Billions in U. S. shipbuilding** open big field for electronic innovation. Shipyard business is booming after 25-year slump.
- 36 **GE promises 'exciting' displays with LED** fabrication process.
- 38 **Europe outpacing U. S. in use of ICs** in consumer products.
- 40 **10-trillion-bit memory** promised, but not many experts believe it.
- 42 **Technology Abroad**
- 45 **Washington Report**

-
- S1 **IEEE '71**—A special section devoted to this year's big show

TECHNOLOGY

- 66 **Don't be fooled by multiplier specs.** They don't always say what they mean. Study this model to learn what the errors really are.
- 74 **Cut delay times with look-ahead carry** in high-speed ripple adders. The time saved may well be worth the cost of a few more gates.
- 80 **Design a 1200-bit/s FSK modulator** for data transmission over ordinary telephone lines. Use either acoustic coupling or a direct connection.
- 86 **Your product will get rave notices** if your creativity has been directed, says this management counsel. Here's how engineers can measure the pulse of the marketplace.
- 90 **Ideas for Design**

PRODUCTS

- 101 **ICs & Semiconductors:** MOS analog switches can operate in 90 ns.
- 102 **ICs & Semiconductors:** Line driver/receivers simplify data interface.
- 104 **Components:** Low-cost phase-control circuit can be used as a lamp dimmer.
- 110 Instrumentation
- 113 Data Processing
- 116 Modules & Subassemblies
- 120 Microwaves & Lasers
- 121 Packaging & Materials
- 136 Product Index

Departments

- 65 **Editorial:** The minicomputer—slide rule of the 70s.
- 7 Letters
- 13 Designer's Calendar
- 122 Evaluation Samples
- 124 Design Aids
- 126 Application Notes
- 128 New Literature
- 131 Bulletin Board
- 134 Advertisers' Index
- 136 Information Retrieval Card

Cover: Illustration by Stephen Brown

ELECTRONIC DESIGN is published biweekly by Hayden Publishing Company, Inc., 850 Third Avenue, New York, N.Y. 10022. James S. Mulholland, Jr., President. Printed at Brown Printing Co., Inc., Waseca, Minn. Controlled circulation postage paid at Waseca, Minn., and New York, N.Y. Copyright © 1971, Hayden Publishing Company, Inc. 82,501 copies this issue.

The Magn

HP's got a great new idea in counters: buy one that just fits your specific application — without paying for extras you'll never use. Yet make your choice from a family of six counters with a wide range of unique features, at prices so low you'll wonder how we did it.

You'll get all the things you expect from our 5326 and 5327 family of counters: totalizing, frequency, ratio, period and time interval measurements, in a range of 50 MHz or 550 MHz.

In addition, they let you perform tasks no counters could handle before.

For instance, you can now do IC logic timing testing simply and economically with 15 picosecond resolution. HP's unique time interval averaging mode makes it possible! (Request HP Application Note 129 for the story.) Price is just \$1195 for a 50 MHz unit and \$1795 for the 550 MHz model with this powerful time interval capability.



ificent Six.

For just \$355 more you can get a counter with a DVM built in. So you can do things like measure rise times more rapidly, simply and accurately than with a scope. And you can check external dc voltages with it, too. Add a \$60 HP 11096A Probe if you need rf voltage measurements.

Want programming capability? Our options will permit remote control of all front panel functions, including trigger levels and attenuators.

Computer interface is easy and costs less than ever.

Suppose you just want the basics? Our frill-free models will supply them with trouble-free, simple operation. They'll cost you \$950 for 50 MHz, \$1495 for 550 MHz.

Your HP field engineer has the 5326/27 data sheet that tells the complete story about these precise new counters. Or write to Hewlett-Packard, Palo Alto, California 94304; Europe: 1217 Meyrin-Geneva, Switzerland.

02102



See them in action
at I.E.E.E.

HEWLETT  PACKARD

Counters that promise a lot and deliver it all.

**This
Sweet
MICROVOLT
MULTIMETER is
SENSITIVE to $1\mu\text{V}$,
STABLE within $2\mu\text{V}/\text{day}$
and easy on the budget at
\$545**

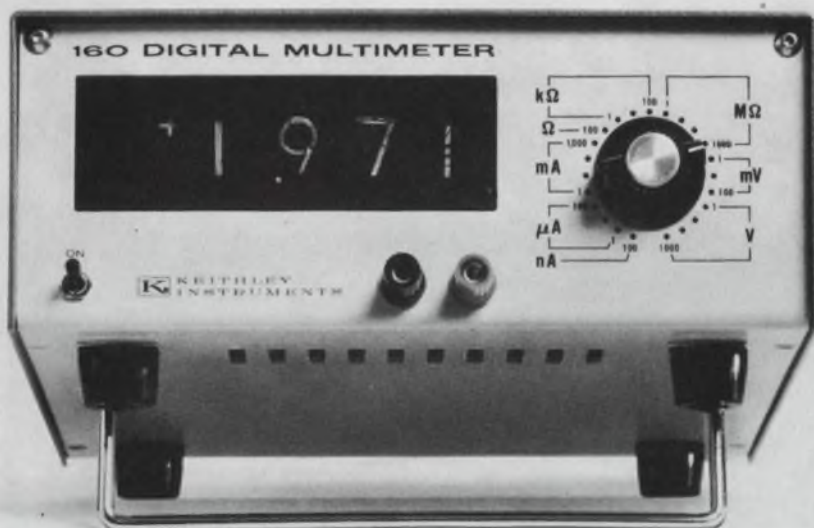

Users call it "the-how-sweet-it-is-meter".
But it's really the Model 160 that . . .

- MEASURES WITH DIGITAL ACCURACY
 - Voltage** — $1\mu\text{V}$ to 1000V
 - Current** — 0.1 nA to 2A
 - Resistance** — 0.1Ω to 2000 M Ω
- 100% OVERRANGING
- ANALOG and OPTIONAL BCD OUTPUT
- MANY MORE SWEET PERFORMANCE FEATURES

SEND FOR FULL DETAILS AND YOUR FREE "HOW SWEET IT IS" BUTTON



**KEITHLEY
INSTRUMENTS**

U. S. A.: 28775 Aurora Road, Cleveland, Ohio 44139
Europe: 14, Ave. Villardin, 1009 Pully, Suisse

Publisher

Peter Coley

Editors

New York Office
850 Third Ave.
New York, N.Y. 10022
(212) 751-5530
TWX: 710-581-2874
Cable: Haydenpub

Editor: Frank Egan
Managing Editor: Ralph Dobriner
Managing Editor: Raymond D. Speer
Microelectronics, Steven A. Erenburg
Computers, Raymond D. Speer
Microwaves, Michael J. Riezenman
Circuits, Lucinda Mattera
Management, Richard L. Turmail
News, John N. Kessler
Military-Aerospace, John F. Mason
New Products, Roger Allan
Copy, Marion Allen

Field Offices

Massachusetts
Jim McDermott
P.O. Box 272
Easthampton, Mass. 01027
(413) 527-3632

West Coast
David Kaye
2930 Imperial Highway
Inglewood, Calif. 90303
(213) 757-0183

Washington
Don Byrne
1425 N St. NW
Washington, D.C. 20005
(202) 667-6568

Editorial Production

Dollie S. Viebig

Art

Art Director, Clifford M. Gardiner
Assistant, William Kelly
Rita Jendrzejewski

Production

Manager, Thomas V. Sedita
Helen De Polo
Kathleen McConkey
Leslie Stein

Circulation

Manager, Nancy L. Merritt

Information Retrieval

Peggy Long

letters

We're taxed with a slip on airline taxation

We were very interested in the Washington Report item in the Nov. 22, 1970, issue (ED 24, p. 41), which states that the airlines want a bigger say in R&D by the FAA.

We think it is important that the users of the airspace and the airports have a stronger say in the research and development work, and, certainly, we do not quarrel with the airlines' attempts toward this end.

However, in reporting this item, it was pointed out that the airlines are seeking this as a result of paying higher taxes since the passage of the Airport and Airways Development Act. I think this might be very misleading to many of your readers. The airlines were relieved of much taxation by this new act. They pay absolutely no federal tax on gasoline or jet fuel. Prior to this act, there was a federal tax on gasoline used by the airlines. The airlines are taxed for the weight of each aircraft in use, but simultaneously with the enactment of this new tax, the airlines were permitted to round off fares to the next highest dollar, which not only recovers the tax but provides increased income over and above the amount paid for the weight of the aircraft.

The airline passenger and freight shipper are being taxed more heavily than in the past. But I think you will agree there is a great deal of difference between a customer paying a tax for which the airlines are merely a collecting agent, and the airlines themselves paying the tax.

C. Spence

Vice President, PR
Aircraft Owners and
Pilots Association
Washington, D. C.

World survival calls for new goals

Sir:

The letter from Charles A. Cady in the Dec. 6, 1970, issue (ED 25, p. 7) raises more questions than it answers. Although there may be no final answers to the problems posed by the article, "How Do We Compete with 'Japan, Inc.'?" (ED 19, Sept. 13, 1970, p. 100), and Mr. Cady's discussion, we must work out better solutions than have been proposed.

What Mr. Cady seems to suggest for the U. S. is a "partnership" between government, industry and labor for "a common goal, for the common good," such as seems to prevail in Japan.

The "common goal" in Japan, as I understand it, is to supply the world's population with transistor radios, tape recorders, TV sets and small cars. When government, industry and labor in the U. S. and France, Great Britain, Italy, West Germany, et al) unite for the same "goals," who buys all the "goodies" produced in ever greater quantities? And what about the needs of the world's people for the common necessities—such as clothing, shelter, cooking utensils and sanitary facilities? Where will the raw materials for these needs come from if most of them go into the making of "goodies"?

Goals for the common good of national groups became invalid with the coming of the Space Age. World survival calls for international goals. The real answer would seem to be internationalization of all world production facilities and rationing of all world resources, rather than further "nationalization" of economies.

Isadore Wolf

790 Kimball Ave.
Yonkers, N. Y.

Exactly your speed.

Servo-Tek's Speed Indicating System takes the precise rotational speed of your application and displays it on an easy-to-read meter. And it tells you repeatedly and accurately even on the most delicate machinery. A temperature-compensated low torque d-c generator and a taut-band meter movement assure a maximum error of less than 1% of full scale reading. Use it as a watchdog on any industrial application where sensitive speed indication is necessary. The attractive design of our Model ST-926 modernizes any application and comes in a standard version or tailor-made with bi-directional indication, special scales and ranges, and with color coding for multiple readouts.

SERVO-TEK PRODUCTS COMPANY
1086 Goffle Road, Hawthorne,
New Jersey 07506.

SERVO-TEK

PRODUCTS COMPANY

*For complete specifications
write for our colorful
technical sheets.*



Electronic Design welcomes the opinions of its readers on the issues raised in the magazine's editorial columns. Address letters to Managing Editor, Electronic Design, 850 Third Ave., New York, N.Y. 10022. Try to keep letters under 200 words. Letters must be signed. Names will be withheld on request.

If you're reed-switching 5-10 V, 5-10 ma loads

(as in keyboards and IC packages),

there's a good, small but growing company
making good, small reed switches
you should know about:

GENERAL REED

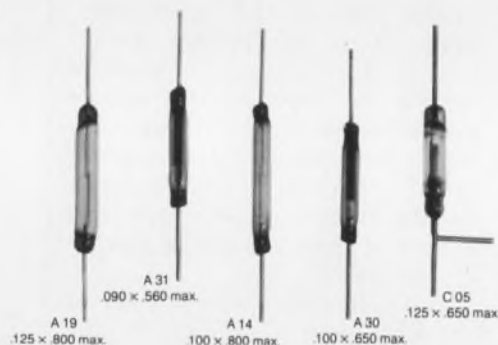

In the last seven years, General Reed has designed and produced many millions of high-quality, miniature magnetic reed switches of Form A and Form C types. Expansion of our manufacturing, including the installation of over 1000 sq. ft. of Class 3-4 clean room facility, has now increased our capacity to deliver *highly reliable* snap-action reed switches *in quantity*, at competitive prices, to meet your requirements. Many standards can be shipped immediately from stock, specials in as little as three days depending on the characteristics you need. General Reed quality assurance techniques include on-line testing of electrical characteristics . . . production in controlled clean room areas . . . heat-treating in controlled atmospheres for precise control of magnetic and mechanical properties . . . mechanical run-in of at least 100,000 operations for all switches . . . microscopic inspection for all Form C switches.

To achieve low and *stable* contact resistance throughout the operating life, General Reed selects from over 50 different combinations of noble contact plating materials specially developed to match a wide variety of specific load requirements. This capability alone offers significant advantages in difficult minimum-current switching applications, such as keyboards and other solid-state circuit interfaces, where erratic contact resistance has been a frequent problem.

Low bounce, long life and relatively high immunity to vibration, shock and temperature extremes are characteristic trademarks of General Reed switches. Call or write the Sigma stocking distributor near you for full details - or contact General Reed Division, Sigma Instruments, Inc., 170 Pearl St., Braintree, Mass. 02185 / Tel. (617) 843-5000.

GENERAL REED

DIVISION OF SIGMA INSTRUMENTS INC.

INFORMATION RETRIEVAL NUMBER 6

INFORMATION RETRIEVAL NUMBER 7 ►

Room for improvement.

Until now, most rack and panel and I/O connectors came with contacts spaced at .150". Or wider.

Which meant that your dense forest of .100" center connections had to spread out whenever it came to an R/P connector.

Or your standard .125" center automatic-wire-wrapping grid had to lengthen stride to accommodate an I/O connector.

No more.

Our new crimp-and-insert mini-Varilok™ contact fits easily, with no sacrifice of electrical or mechanical integrity, into .100" or .125" center plugs and receptacles.

R/P connectors with mini-Varilok contacts on .100" centers (Series 8026) are less than half the size of their .150" counterparts. They're suitable either for the rigors of military service or the air-conditioned comfort of a computer room. And they have all the options you'll need: 33-contact connectors with plastic covers; 75-or 117-contact connectors with metal covers;

cable clamps; jackscrews; polarizing hardware.

For I/O applications you can use the same connectors, mating them with modular receptacles (Series 5540). The receptacles—a keyed connector-center module, contact modules, and polarizing hardware modules—have Varicon™ contacts, ready for wire-wrapping. Your choice of 33, 75, or 117 contacts on .100" centers, 55 or 79 contacts on .125" centers.

When you're ready, you'll find all these connectors, all ready, at your Elco distributor. In the meantime, to get your copy of our new 1971 R/P and I/O connector guide, write us at Elco, Willow Grove Division, Willow Grove, Pa. 19090. Elco, Huntingdon Division, Huntingdon, Pa. 16652. Elco, Pacific Division, 2200 Park Place, El Segundo, California 90245.



Improvements.



ELCO .100"/.125" square grid input/output, rack & panel and plate connectors

Send for your 1971 Design Handbook

MEET OUR MINI- FAMILY.



Small links in making a stronger system.

Weinschel's advancements in the subminiaturization of microwave components are reflected in its increasing number of such devices. ✚ Mini-Components are big in Performance and Reliability, and low in Price. ✚ Mini-Components feature time proven, quality resistive films and stainless steel Type WPM connectors which mate nondestructively with SMA connectors.

Subminiature Fixed Attenuators—

Models 3M and 4M—dc to 12.4 GHz and dc to 18 GHz ranges, respectively—have a 2 W power rating and flat broadband response, and are small size (1.2" to 20 dB; 1.85" to 60 dB)—ideal for high-performance systems.

Model 9 Mini Pad has a dc to 26.5 GHz range with flat response. Measuring 1¼" long by ¼" in diameter, power rated at 2 W, and available up to 30 dB, it offers a unique combination of performance and size suitable for many ECM applications. WPM-2 connectors have improved life and repeatability.

Model 21, a dc to 18 GHz medium-power unit rated at 8.75 W in 3 dB value down to 5 W in 20 dB value, is only 1.52" long. Having excellent performance, it is suitable for all medium-power applications.

Mini Step Attenuators—Model 9000 series, available in 5 frequency ranges (includes dc to 18 GHz) and 5 attenua-

tion ranges (to 99 dB in 1 dB steps), measures only 1.62" in diameter by 1.13 to 3.30" in length (varies with attenuation range). A size perfect for mounting in compact areas. Features are flat frequency response, 2 W power rating, and repeatability of better than 0.05 dB. They will make your system a Step Ahead in performance and reliability.

Mini Power Divider—Model 1515 accurately divides power over dc to 18 GHz range. Rated at 1 watt CW input. Power division is nearly constant 6 dB (within ± 0.5 dB to 18 GHz).

Terminations and Mismatches—Models 1406 thru 1408, Mini-Terminations and Model 1412, Mini-Mismatches operate to 18 GHz. They are perfect for applications which require low SWR or SWR be precisely known for calibrating equipment. Units are rated at 0.5 W input and are less than 0.60" long. Terminations are available

in two types: precision with extremely low SWR, and general purpose with a low price.

For detailed information on ✚ Mini-Component Family, contact your local representative, or call:



Tomorrow's Microwave
Technology Today

WEINSCHEL ENGINEERING

Gaithersburg, Md. 20760 Tel: (301) 948-3434 TWX: 710-828-9705

VISIT US AT BOOTHS 3632/3634—THE 1971 IEEE CONVENTION, MARCH 22-25 IN NEW YORK CITY.

If you judge computer power
by cycle time,
lots of luck.



You'll need it. There's a big difference between raw cycle time and "getting-the-job-done" time. If you select a mini-computer based solely on the first parameter, you're invariably going to have trouble with the second one. That's why, ever since we first hung out our shingle, we've built all our computers with one guiding philosophy in mind: computers should work smart, not hard. Instead of resorting to raw cycle time for their speed, they should offer built-in features that assure fast program execution. That's true computer speed. True computer power. Thanks to this philosophy,

we've put together the best 16-bit computers on the market. Not "one of the best." The best. Bar none. With our Models 116 and 216, you get the kind of features that "get the job done" fast: 122 basic instructions (over 500 with Microcoding), three Direct Memory Channels, Hardware Multiply/Divide, and Vectored Priority Interrupts. Just to name a few. For full details on these powerful, but easy-to-apply computers, write us today.



COMPUTER AUTOMATION, INC.
895 West 16th Street • Newport Beach, California
92660 • Phone (714) 642-9630 • TWX 910-596-1377

A new cost-saver...

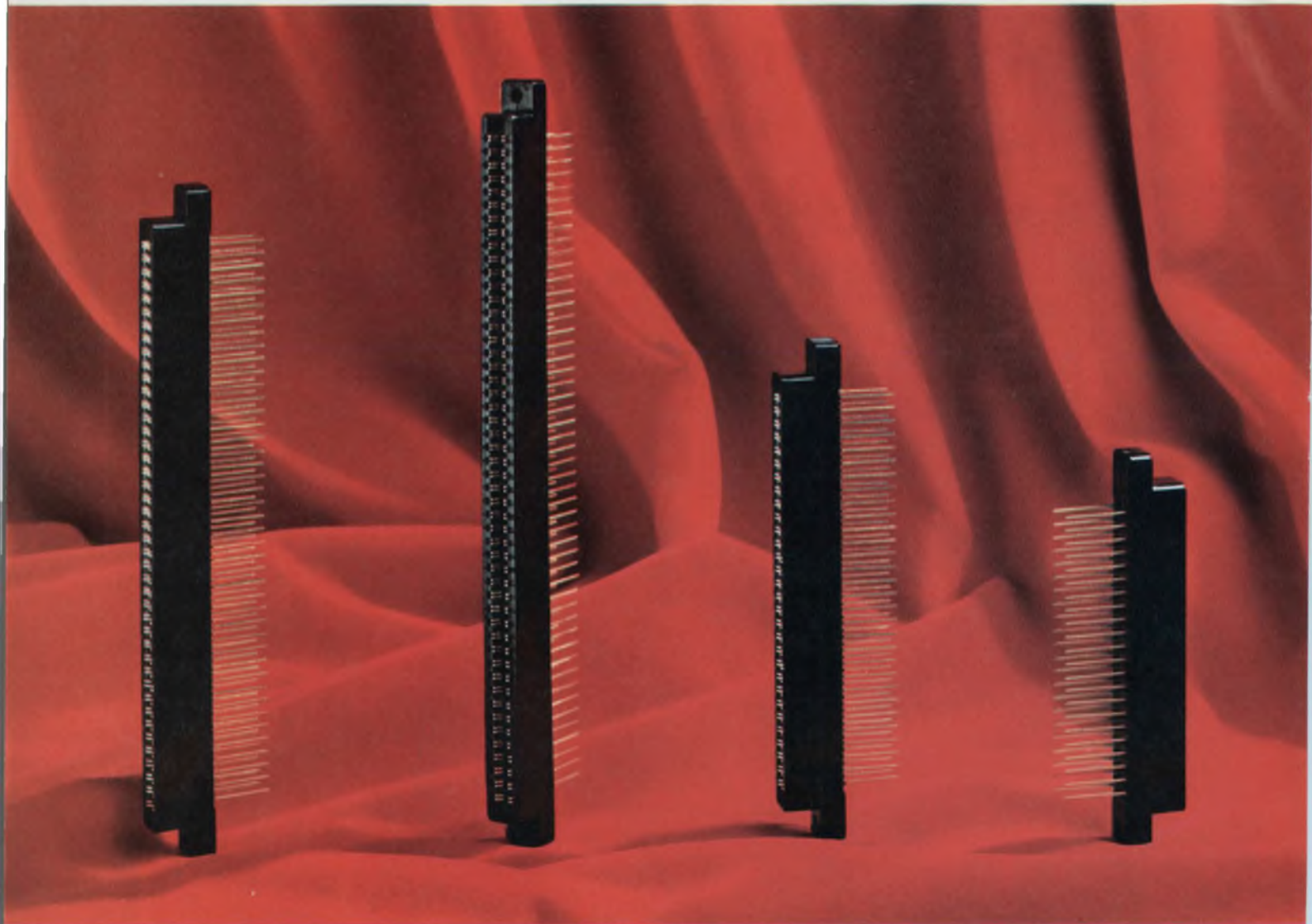

to wrap your wires around.

Here's a new family of miniature pc connectors from Amphenol for wire wrapping applications. They cost you less because we've engineered new industrial grade materials into these connectors, yet retained all the same features found in military connectors.

Contact spacing is on a .100 X .200, or .125 X .250 grid and the connectors are available in 22-, 30-, 43- and 50-position models with either grid spacing.

These new 225 Series connectors have bifurcated bellows contacts for smooth, positive, 2-point mating action no matter how irregular the board

surface. The bellows exert firm pressure on the pads even under extreme vibration and shock conditions. You get thousands of insertions and withdrawals without a failure.

We can also give you this new low-cost connector with solder terminations on .156 centers. And there's a QPL version to MIL-C-21097B, too.

Call your Amphenol salesman or distributor; he'll show how inexpensive it is to wrap your wires around a great connector. Or write us. Amphenol Industrial Division, The Bunker-Ramo Corporation, 1830 South 54th Avenue, Chicago, Illinois 60650.



AMPHENOL
THE BUNKER-RAMO CORPORATION

designer's calendar

APRIL 1971						
S	M	T	W	T	F	S
				1	2	3
4	5	6	7	8	9	10
11	12	13	14	15	16	17
18	19	20	21	22	23	24
25	26	27	28	29	30	

April 12-15
National Telemetry Conference, (Washington, D. C.) Sponsor: IEEE. H. B. Riblet, Johns Hopkins Univ., 8621 Georgia Ave., Silver Spring, Md. 20910.

CIRCLE NO. 407

April 13-16
INTERMAG, International Magnetism Conference (Denver, Colo.) Sponsor: IEEE. Bernard F. DeSavage, U. S. Naval Ordnance Laboratory, Silver Spring, Md. 20910.

CIRCLE NO. 408

April 28-30
SWIEEEO, Southwestern IEEE Conference & Exhibition (Houston Tex.) Sponsor: IEEE. W. J. Groves, Texas Instruments, Inc., P. O. Box 66027, Houston, Tex. 77006.

CIRCLE NO. 409

MAY 1971						
S	M	T	W	T	F	S
						1
2	3	4	5	6	7	8
9	10	11	12	13	14	15
16	17	18	19	20	21	22
23	24	25	26	27	28	29
30	31					

May 10-12

Electronic Components Conference (Washington, D. C.) Sponsors: IEEE, EIA. R. D. Allan, EIA, 2001 Eye St., Washington, D. C. 20006.

CIRCLE NO. 410

NEW FROM POWER/MATE CORP. THE mini/mate SERIES

FROM
\$15

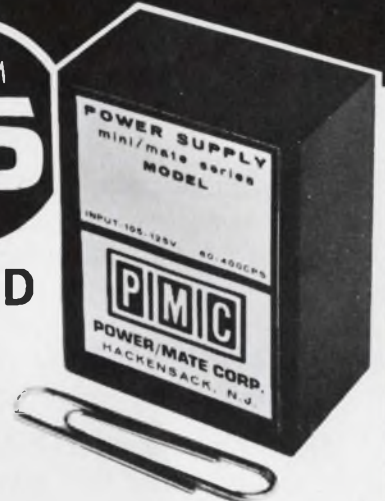

a complete
line of LOW PRICED
MINIATURE
POWER SUPPLIES

119 MODELS
VOLTAGE OUTPUT TO 48 VDC
CURRENT OUTPUT TO 2 AMPS.

The Mini/Mate series provides a new level of performance, quality, and reliability, previously unattainable, plus they are a pin for pin replacement for other manufacturers supplies. The new series is particularly appropriate for use in modern designs which make use of linear and digital integrated circuits, operational amplifiers, decimal displays and other related semi-conductor circuitry.

All Mini/Mates may be printed circuit board or chassis mounted. The output of all Mini/Mates may be trimmed to precisely adjust the DC voltage to your circuit needs.

THE MINI/MATE SERIES IS A CROWD PLEASER THAT GIVES YOU . . .
PERFORMANCE . SELECTION . PRICE . DELIVERY

119 MODELS WITH OUTPUT VOLTAGES FROM 3.6 TO 48 VDC & CURRENT TO 2 AMPS.
* * FIVE YEAR WARRANTY * *

CREATED BY POWER/MATE . . . the leader in DC Power Supplies. Big power, small power and in between . . . POWER/MATE CORP. is your "one-stop-source" for all power supply needs. After all, PMC offers you the widest choice of power supplies anywhere.

QUANTITY DISCOUNTS AVAILABLE . . . SEND FOR



FREE FULL LINE CATALOG
Giving . . . Specifications, Model Nos. and Prices.

POWER MATE GIVES YOU
SAME DAY SHIPMENT
PIMC

POWER/MATE CORP.

514 S. RIVER STREET, HACKENSACK, N. J. 07601
Phone (201) 343-6294 / TWX 710-990-5023

"Choosing the right digital voltmeter"

Product Manager, Charles Newcombe gives you some inside tips on choosing the appropriate digital voltmeter for your task.

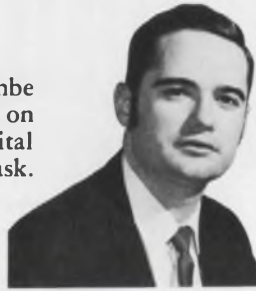

"The single most important point to remember in choosing a digital voltmeter is *credibility*. That is, you must have confidence in the measurements made. When a Fluke voltmeter records a measured volt, you know you have received an accurate reading . . . you can believe, brother.

"Next, get yourself a DVM with the accuracy and stability needed for a given job. Fluke digital voltmeters are available in seven different models with certified guaranteed accuracies down to 0.004% and sampling rates up to 400 per second. Fluke voltmeters are so stable they seldom require recalibration more than once a year. And they are designed to work in a wide range of environmental conditions. As a matter of fact, Fluke off-the-shelf DVM's meet or exceed many military specifications.

"Get yourself a DVM that won't always be out of service for maintenance or repair. Fluke DVM's use our unique recirculating remainder analog-to-digital conversion circuitry. It uses far fewer components than other methods. So, as the parts count goes down, the reliability goes up. And as a bonus feature, power drain is low, so we can give you true battery portability.

Our DVM's are burnout proof, which is just another neat little trick to minimize downtime.

"Don't handicap yourself with digital voltmeters that can't be updated in the field as your needs change. Fluke meters let you drop-in circuit boards at anytime to expand measurement capabilities or tailor the instrument to systems application. Our wide range of options includes such things as millivolts (with 1 microvolt resolution), 4 wire ratio, AC-AC ratio and 4 terminal ohms. Isolated digital or printer output, and isolated remote control with memory were designed for direct computer interface—not just add on adaptability.

"Buy a new voltmeter with all the circuit refinements and convenience features that make it a genuine pleasure to use. Fluke meters give you autopolarity, autoranging, pushbutton function and range selection, and floated and guarded circuitry. All Fluke DVM's have an extra digit for 20 to 60 percent overranging.

"Don't fall for the price fallacy. When we introduced Fluke digital voltmeters a few years back, we offered them at a price that curled our competitor's hair. We did it by engineering the complexity out of the instrument. We did it by not taking the 'me too' path.

"We've got a full measure of new information on the complete line of Fluke DVM's. We'd like to send you a copy. Call us here at the factory, or better yet, contact your nearby Fluke man."

Here's one of our two new voltmeters. The Model 8200A is a fast systems DVM featuring 400 samples per second, 60% overranging, autoranging and remote programming. Accuracy is 0.01%. Prices begin at \$995.



Here's the other, the new Model 8400A with the big accuracy spec, 0.004% for 90 days, 0.01% per year. Base price is \$2450.



Fluke, Box 7428, Seattle, Washington 98133. Phone: (206) 774-2211. TWX: 910-449-2850/In Europe, address Fluke Nederland (N.V.), P. O. Box 5053, Tilburg, Holland. Phone: (04250) 70130. Telex: 884-50237/ In the U. K., address Fluke International Corp., Garnett Close, Watford, WD2, 4TT. Phone: Watford, 27769. Telex: 934583.

THE QUALITY AND PERFORMANCE COUNTER LINE



Featuring the Model 101B MULTI-FUNCTION COUNTER

- 5-50 MHz counting range
- 50 mV, RMS sensitivity
- 1 μ s time interval resolution
- Frequency, totalize, period average, ratio and time interval modes
- BCD output
- 4½ x 7½ x 9 inch case
- FCC type-approval NO3-174

101B 7 digit.....\$815

101B 5 digit.....\$695



PRINT OUT

with the Model 511A digital printer, compatible with most counters. Compact (only 4½ inches high), 21 columns at up to 3 lines per second, auto zero suppression, BCD input and a price of only \$1195.

For more information on any of these priced-to-fit instruments, call or write:

Monsanto
Electronic Instruments
620 Passaic Avenue
West Caldwell, New Jersey 07006
(201) 228-3800

Select the Counter
that suits your needs.

- 100B, 40 MHz Counter-Timer.....\$575
- 101B, 50 MHz Counter-Timer.....\$695
- 103A, 20 MHz Counter-Timer.....\$420
- 104A, Variable Time Base C/T.....\$795
- 105A, 512 MHz Counter-Timer.....\$1550
- 106A, Up Down Counter-Timer.....\$775
- 107A, Computing Counter.....\$1250
- 109A, Dual Limit Counter.....\$975
- 110B, 150 MHz Counter-Timer.....\$1585
- 114A, 150 MHz Freq. Counter.....\$995
- 120A, 512 MHz Auto/Programmable C/T.....\$2195
- More coming.

Monsanto

INFORMATION RETRIEVAL NUMBER 13

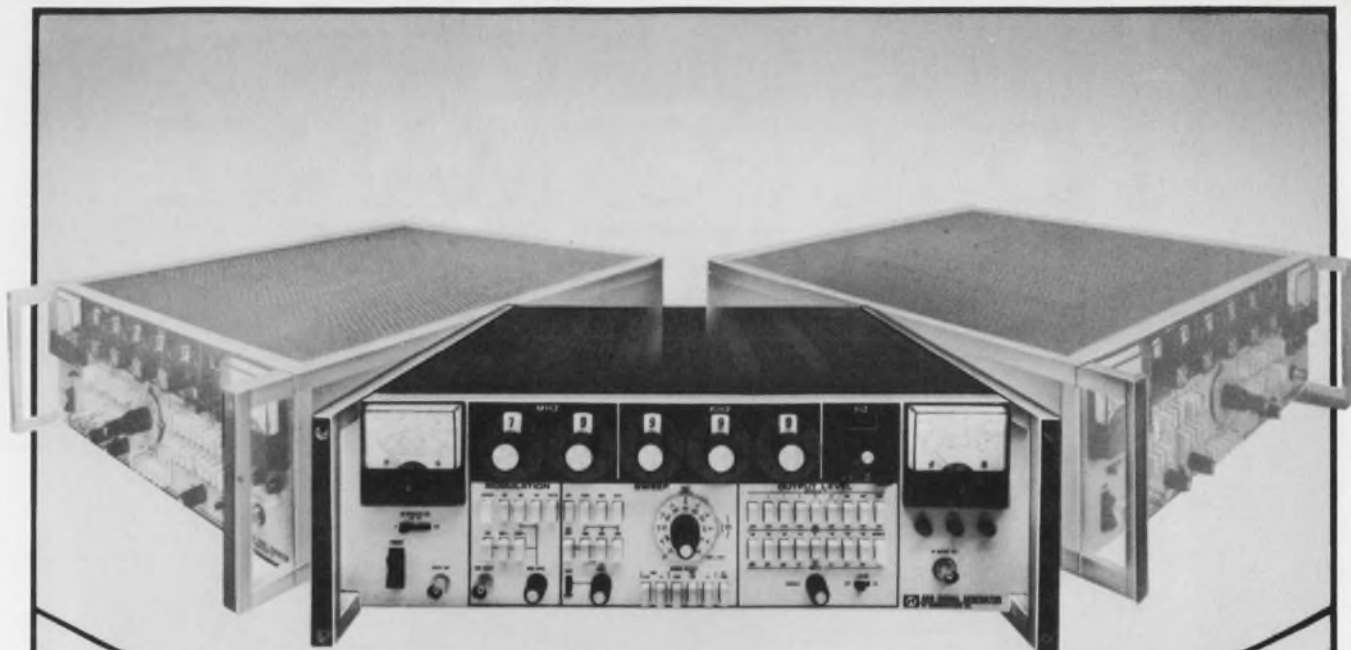

A triple threat for - \$3,576

In one instrument package...
**Signal Generator • Sweeper
 Frequency Synthesizer**

Applications:

**Automated Test Systems
 General Lab
 Military & Government**

Model RF-808 Generator/Sweeper offers the benefits of three different instruments . . . all for \$3,576. Covering the frequency range of .05 MHz to 80 MHz in 1 KHz steps, the RF-808 combines generator and sweeper versatility with synthesizer accuracy and programmability.

The RF-808, 5¼ inches high, can be rack-mounted with panel adapter.

Features include:

- Frequency settable to 1 Hz resolution
- Remote programming
- Digital frequency setting
- High signal power output
- FM, AM and pulse
- Automatic or manual sweep
- Stability 5 parts in 10⁹ per day
- Solid state

Write today for free literature on the RF-808 . . . and on the RF-815 Power Amplifier, tunable from 10 MHz to 500 MHz, and the RF-805 80 MHz wideband Power Amplifier. Accessories include: 10-watt Impedance Transformers, 20-watt 2-way Power Combiners, 40-watt 4-way Power Combiners, Filters, Splitters, etc.



RF COMMUNICATIONS, INC.

Electronic Instrumentation Operation • Phone: 716 - 244-5830 • TWX: 510 - 253-7469
 1680 University Avenue • Rochester, N. Y. 14610 • A Subsidiary of Harris-Intertype Corporation

See Us At IEEE Booth No. 3308

SEMICONDUCTOR NEWSBRIEFS

PUBLISHED BY MOTOROLA SEMICONDUCTOR PRODUCTS INC.

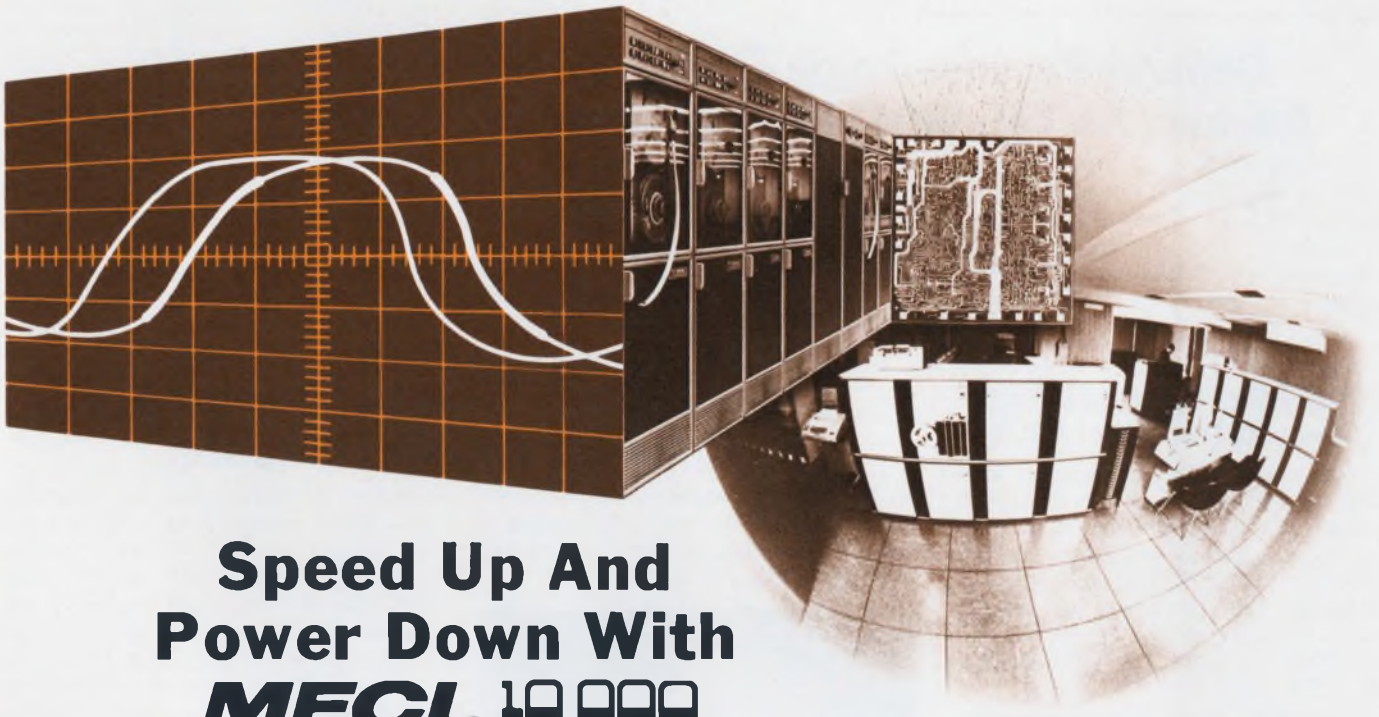

Speed Up And Power Down With **MECL 10,000**

Introducing MECL 10,000 logic — a new logic family to try on your computer for size. Planned to be strong in complex function circuits, MECL 10,000 logic is characterized by high speed operation (typically 2 ns propagation delay per gate), low power (25 mW dissipation per gate), and toggle frequency to 150 MHz.

Prime application areas are large and small computer central processing units as well as high-speed peripherals, plus high-speed digital communications, telemetry systems, and instrumentation. System designers in these areas will discover that the 10,000 series is tailored for their use, for example:

- Slow rise and fall times (3 ns edge speed) so that conventional system layout can be used.
- Minimal change in system operating characteristics over a $\pm 10\%$ supply and 0 to 75°C temperature variation. Expensive power supply regulation is not required.
- Wired-OR capability plus availability of complementary outputs simplify design, minimize package count.
- Low noise and crosstalk generation.
- Easy transmission-line driving especially for twisted pair and 50Ω cable.
- Compatibility with MECL III for higher speeds where required.

MECL 10,000 functions now available include the MC10109, a dual 4-5 input OR/NOR and the MC10119 3-3-3-4 input OR-AND gates; the MC10131 dual D master-slave flip-flop, and the

MC10181 4-bit arithmetic unit, capable of 16 arithmetic functions and 16 logic operations.

Additional MECL 10,000 devices to be added in 1971 include 11 gate functions, 2 line receivers, 5 more complex functions, and additional memory elements such as a dual D latch, a dual J-K master-slave flip-flop, a 64-bit RAM, a 256-bit fusible link ROM, a 4-bit universal counter, 4-bit universal shift register, and others.

MC10109, MC10119 and MC10131 are supplied in 16-pin dual in-line ceramic packages at 100-up prices of \$2.00, \$2.50 and \$7.00 respectively. MC10181 is available in 24-pin dual in-line plastic at the 100-up price of \$20.00.

MECL 10,000 invites comparison — you'll find we eliminated the alternatives.

For details, circle 211



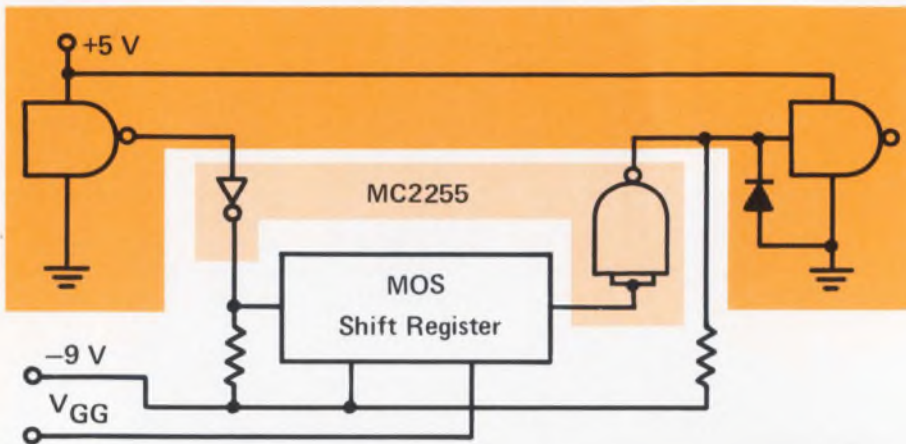

General Purpose Logic Element Doubles As TTL-MOS-TTL Interface

Two new MOS general purpose logic elements are ready to serve on your breadboard or in your system. The low-threshold MC2255L and its high-threshold mate, MC1155L, are P-channel enhancement mode devices that can pro-

vide a variety of NAND, NOR and functional gate configurations.

Through straightforward external connections, you can obtain the single or dual 3-input NOR, the inversion, the 2-input NAND, the Exclusive-OR, the

For details, circle 212

2-wide 4-2 input AND-OR-INVERT or nearly any simple function you need. In addition, because of its low-threshold characteristics and its flexible configuration, the MC2255 can interface *both* ends of a MOS circuit. A single MC2255 can, for example, translate levels from TTL to MOS and back to TTL (see illustration).

The logic elements are essentially comprised of a three-input NOR section and a three-input NAND section with all useful gate, drain and source connections brought out for full logic flexibility. Each device has low input capacitance for fast switching and low drive current requirements. Typical NOR capacitance is 2.5 pF per input and typical NAND capacitance is 3.5 pF per input. Input and output leakage for both is a low 1.0 μ A (max), and all inputs are diode protected. And, as an added feature, gain ratios are indicated on the data sheet.

Both logic elements are available now from your Motorola distributor in the 14-pin, dual in-line, black ceramic package for the 100-up price of \$4.40 each.

Quad Gates Up Logic Design Power Of Low-Power MRTL

Your logic design options for low-power systems are greater now that quad-2-input AND, NAND, and OR gates have been added to Motorola's plastic-packaged mW MRTL — intrinsically a NOR logic family. The new devices are the MC9723P/MC9823P AND, the MC9724P/MC9824P NAND, and the MC9725P/MC9825P OR gates.

The MRTL family of resistor-transistor logic offers the industry's broadest selection of low-cost circuits. Plastic-packaged mW MRTL is for your use in medium-speed, low-power systems where maximum economy is paramount. With their low, 12 mW power dissipation, the new quad gates are ideally suited for use in medical electronics and portable, battery-operated equipment where low power drain is essential.

The quads come in two temperature ranges: the MC9700 devices for the +15 to +55°C range and the MC9800 devices for the 0 to +75°C range. Each is supplied in a rugged 14-pin, dual in-line plastic package (TO-116). Ceramic packaging is available on request.

Pricing in 1k to 4999 quantities is low — just \$1.05 — MC9723P/MC9823P, \$1.15 — MC9724P/MC9824P, and \$0.95 — MC9725P/MC9825P.

For details, circle 213

Get Best High Frequency Performance At Any Gain With MC1748 Op Amp

In the many applications where the MC1741 would be the perfect op amp if only it weren't internally compensated, the MC1748 is the answer!



The MC1748 lets designers trade internal compensation for optimum circuit performance.

Why? Because it *is* an MC1741 — less compensation.

You get the same output short-circuit protection, the same offset voltage null capability, the same wide common-mode and differential voltage ranges, provid-

ing input protection up to 30 V, the same low power consumption, and virtually the same specs. The difference is that now you can tailor your design for the optimum slew rate/high frequency performance at the required gain.

But that's not all. Compared to the former industry standard noncompensated op amp, which required 2 capacitors plus a resistor, the MC1748 is compensated with a single 30 pF capacitor at unity gain. And the input overvoltage protection permits operation as a voltage follower with a 24 V p-p swing or as a large input swing voltage comparator.

The MC1748 is dandy for use as a summing amplifier, integrator, inverting or non-inverting amplifier, unity-gain voltage-follower, or in any general purpose application for a differential input, class AB output amplifier.

Packaged in the TO-99 eight-pin metal can and in 100-up quantities, the -55 to +125°C version — MC1748G — is priced at \$3.85. The commercial temperature range MC1748CG — 0 to +75°C — is \$1.25 in like quantities.

We've given you the answer — MC-1748 — now put the question to your Motorola dealer. He'll pass the test.

For details, circle 214



Count-Latch-Decode-Drive MC4050 Puts It All Together

Drive your seven-segment displays the CLD way! Use the MC4050 Counter-Latch-Decoder, that combines the func-

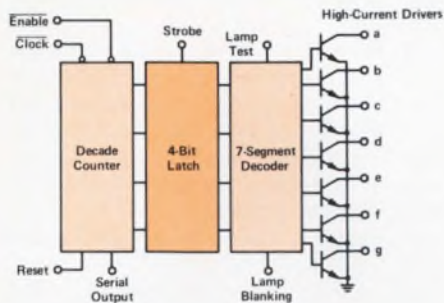

tions of an NBCD counter, a four-bit latch, and a seven-segment decoder/driver on one monolithic, MSI chip.

A unique circuit design is combined

with standard, two-layer metal processing to bring you the most economical, compact means yet for driving your seven-segment incandescent and LED displays.

MC4050 CLD features include:

- A counter Reset input that turns off the CLD's output driver transistors permitting automatic suppression of leading zeroes in your readout *without* extra wiring.
- A lamp blanking input that permits control of display brightness.
- A lamp testing input that allows verification of all segments.

The MC4050 has a typical maximum toggle frequency of 35 MHz, sustains at least 15 volts, and provides up to 40

mA sink capability for displays.

In terms of cost reduction, one MC4050 accomplishes the function of three devices bringing immediate savings of over 30% per display. This, coupled with reduced wiring costs, reduced use of board space and better display system reliability means the MC4050 is *the* answer to your display interfacing applications.

Available now in 0° to 75°C (MC4050) and soon in -55° to +125°C (MC4350) ranges, the devices are packaged in both ceramic (suffix L) and plastic (suffix P) 16-pin dual in-lines. 100-up prices are \$9.00 for the MC4050P and \$11.70 for MC4050L devices. Check your local distributor and put it all together.

For details, circle 215

1024-Bit RAM And 2240-Bit ROMs Lead Motorola's MOS Memory Parade

MCM1173L Provides Low Cost, Medium Speed On-line Memory Capability

Beat core and plated wire size and cost in your mini-computer and main-frame bulk storage with Motorola's MCM1173L 1024-bit MOS read/write memory.

It's 1024-word by 1-bit organization provides maximum word capacity, and bit expansion is simply a matter of connecting additional MCM1173L's in parallel.

Low address-line capacitance of 2.5 pF (typ) improves systems speeds and, with the output circuits' high ON/OFF current ratio, simplifies bipolar interfacing. Drive power requirements are low compared to other high-threshold MOS, and power dissipation is way down at 50 μ W/bit. Access time is specified at 400 ns and cycle time at 800 ns. No separate chip select clock signal is required to refresh stored information. The package is a 24-pin dual in-line ceramic. Pricing is attractive . . . \$28.00 in 100-999 quantities.

MCM1130 Series ROMs Provide 64 USASCII Characters In 5 x 7 Matrix

The MCM1131L and MCM1132L column-select character generators are standard variations of the MCM1130 2240-bit read only memory. Both are programmed with the standard USASCII code and provide 64 characters in a 5 x 7

Motorola's P-MOS process thriftily utilizes silicon achieving LSI component densities today in new products for memory and logic designs. Typical are the MCM1173-L, 1024-bit RAM and the MCM1130, 2240-bit ROM.

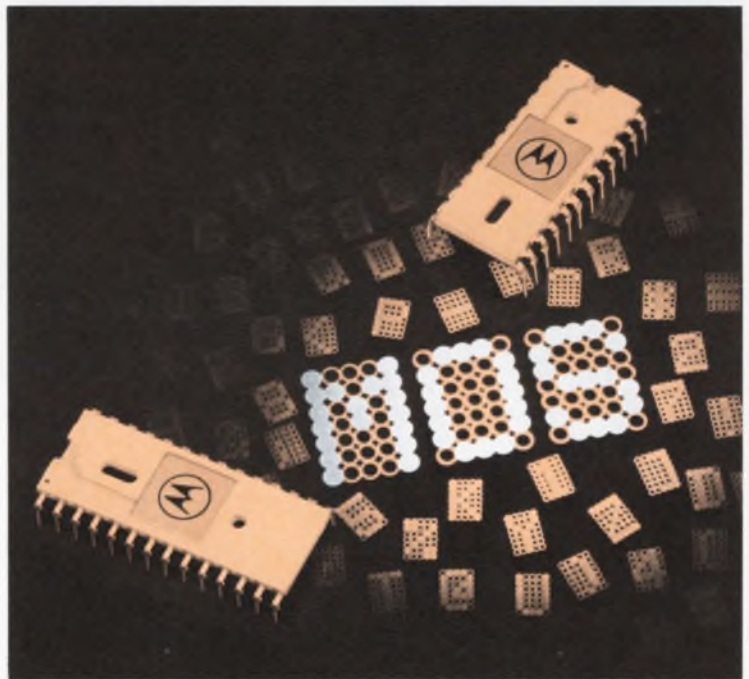

matrix. The MCM1131L is supplied in a 24-pin ceramic package with seven address inputs to select a particular character, five column select inputs and a chip enable input. The 1132L is in a 28-pin ceramic package with six address inputs, five column select inputs, a chip enable input and is a plug-in replacement for the TMS4103JC.

Both character generators are TTL compatible, offer a maximum access time of just 500 ns, provide static operation and "wired-OR" capability for expansion, and sink 2.0 mA (min) with open drain output buffers.

In 100-999 quantities, prices are MCM1131L - \$14.60, and MCM1132L - \$16.20.

For details, circle 216



New MINI-L Voltage-Variable Capacitance Diodes Offer Economical, Reliable Tuning

It may be true that you can't please everyone, but here's a chance to titillate two: your customer and your industrial stylist. Just feature compact, "locate it anywhere" solid-state tuning and band-switching in your new models by using Motorola's new voltage-variable capacitance and PIN diodes in the unique new MINI-L case.

Three new voltage-variable capacitance devices — the MV3140-42 and two new PIN diodes — MPN3401, 02 — plus



Voltage-variable and PIN diodes in a rugged new MINI-L package bring economy to tuning and bandswitching jobs.

a low inductance, plastic package designed for high-volume stripline assembly make it all possible. The per-

fect matching of voltage/capacitance characteristics so essential to using sets of VVC diodes for VHF and UHF tuning is guaranteed by precision computer control of testing and device selection.

Check these outstanding characteristics:

- MV3140-42 30 V silicon EPICAP voltage-capacitance diodes for general frequency control and tuning and featuring minimum Q values specified at VHF and UHF frequencies and available in sets matched to $\pm 1.5\%$ or 0.1 pF (whichever is greater) at all points along the specified tuning range.
- MPN3401-02 35 V silicon PIN diodes for VHF band-switching plus general-purpose switching and attenuator circuits. The diodes use a rugged PIN structure with wire-bond construction for optimum reliability, exhibit a low series resistance at 100 MHz of 0.34 ohms (typ) at $I_F = 10$ mA dc and provide design selectivity with both 1 and 2 pF devices.

In addition to the economy it brings through stripline fabrication, the new MINI-L package is rugged and, by means of a ridge on the cathode end, offers convenient polarity identification for automatic handling.

In 100-up quantities, MPN3401-02 both sell for 35¢, MV3140 for 80¢, MV3141 for 55¢ and MV3142 for 40¢.

For details, circle 217

MC1594L – The Self-Regulated Multiplier

Motorola's new monolithic IC four-quadrant multiplier, the MC1594L/1494L Multiplier "Plus" heralds the second generation of these basic analog building blocks.

The new multiplier earns its "Plus" accolade two ways: it's easier to use than the familiar industry standard MC1595/1495, and it offers a new, high level of performance. A built-in current and voltage regulator reduces the effects of power supply fluctuation lowering the number of external components required. The regulator controls all constant current sources on the monolithic chip and provides plus and minus 4.3 V regulated voltages to bias the offset adjust potentiometers. Interaction between the pots during adjustment is eliminated along with changes in offset voltage caused

by supply variation and the need for four external resistors. At the multiplier outputs, a differential current converter provides a single-ended output current reference to ground.

The linearity of 0.5% max (X or Y) for the MC1594 sets a new standard of excellence for monolithic multipliers and the MC1494 is a low 1.0% max (X or Y). Because it handles input and output voltages of ± 10 V with ± 15 V supplies, the "Multiplier Plus" is easier for the designer to use. And, power supply sensitivity is improved to a typical 30 mV/V.

The MC1594/1494L is available now from your Motorola distributor at 100-up prices of \$12.00 and \$8.00 respectively. A detailed 14-page specifications/applications sheet is available.

For details, circle 218

RF Power Goes Gigahertz!

The rarified stratosphere of multiwatt, gigahertz capability has been reached by a new series of high climbing and rugged RF power transistors — the new 2N5923-25 family!

Boasting 1 to 10 W power output at 1 GHz, the units are designed for amplifier and varactor driver applications from 600 MHz to 1 GHz. They fit right into industrial/military point-to-point microwave, transponder, telemetry, transmitter and ECM equipment.

Ruggedness under mismatch conditions? You bet!

These overlay devices inherently resist load mismatch, permitting simpler circuit designs since special protection need not be employed. And multiple emitter construction ensures excellent, HF performance while stripline opposed-emitter packaging furnishes lower lead inductance, better broadband capability.

They'll cost you less, too — the 2N5925, 10 W device, for example, is \$54.00, 100-up . . . \$6.00 less than comparable industry units! Similar savings are reached with the others.

As for performance, how's 5 dB minimum power gain at 1 GHz; 35% minimum efficiency at 1 GHz; -65 to 200°C operating temperature capability?

And when you get the data sheets, take a close look at the way we blueprint performance . . . completely! We spec everything from impedance parameters to efficiency. You're assured "worst case" design considerations through min-max



The moon is no limit when you use the new 2N5922-25 GHz power transistors in your communications applications.

ratings where they count: power out, efficiency, power gain, etc.

Motorola RF . . . not just more megahertz — more communication!

For details, circle 219



Devices that emit, detect, isolate, and display are offering revolutionary new ways to perform old functions — and are lighting the way to completely new ones. Where reliability immeasurably better or switching a thousand times faster or display in a much smaller space than the old way is needed — look to optoelectronics for your answer.

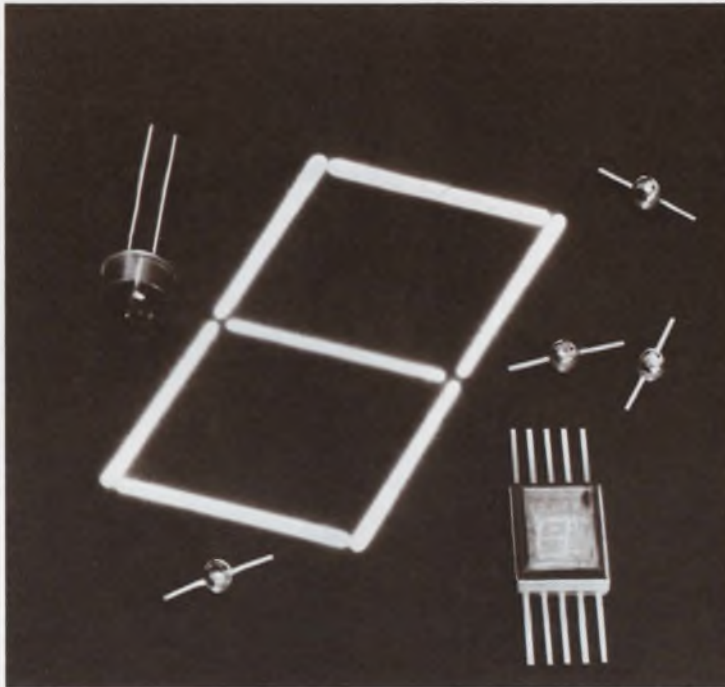

Opto Picture Brightens With 7-Segment Display, New LEDs

For those of you designing desk calculators, instruments, film annotation devices, portable equipment and general digital readouts, here are new solid-state lights.

The new, low-cost, 7-segment, MOR33 displays the numerals 0 thru 9 plus the letters A, C, E, F, H, J, L, P and U. Its bright red, 400 fL-@-20 mA-per-segment

output assures medium-range visibility and its wide, 150° single-plane viewing angle offers excellent sighting flexibility.

In multiple device use, a string of compact, MOR33's affords a 16-digit display in only 4" of width. The MOR33's input signal requirements are compatible with IC decoder/drivers like the new MC4050 (see story p. 3) and its life

For details, circle 220

3 dB Quadrature Coupler Hikes RF Reliability

In your UHF designs, any one of the following is worthwhile: greater power than you can get from an individual solid-state amplifier, assurance of broadcast continuity, isolated feed and combining ports plus matched input.

The new MIC5830,31 miniature 3 dB quadrature couplers give you all three.

Mismatching of transmitter outputs is now no problem because the application of a signal at any of the coupler's 4 ports results in equal signals at opposite ports with the adjacent port remaining isolated. Minimum isolation is 20 dB. Insertion loss is low as 0.25 dB max. affording greater coupler power. Phase balance is $\pm 1.5^\circ$ max. furnishing smaller combining losses and less distortion.

In critical applications where transmission continuity must be maintained,

such as police radios, the MIC5830 couplers maintain transmission capability should one of the "combined" RF output transistors fail.

Efficiency in higher frequency designs, such as broadband military and ECM equipment is also heightened through elimination of passive components which constrict bandwidth. Usable frequency of the new series ranges from 225 to

expectancy far exceeds that of older-type readouts. Visibility is realized with inputs as low as 1 mA, 1.65 V per segment.

Narrow-beam light emission is the keynote advantage of the new MLED-60/90 infra-red (9,000) Å, Micro-T light-emitting diodes. They're lensed for high, on-axis power output (350 and 550 μ w @ 50 mA input signal) providing a greater signal to coupled silicon detectors. 1000-up prices of \$0.99 and \$0.85 make the subminiature units ideal for card and tape readers.

The MRD60/90 diodes can also be used for industrial processing and control in light modulators, shaft or position encoders, optical switching and logic circuits.

Still working "in the red?" The MLED630 RED LED offers 1,100 fL typical brightness @ 50 mA input current and a wide 120° field of view. It's cased in the popular, TO-18 type package with a unique molded plastic lens for durability and long life and . . . it's very low cost — only 69¢, 1000-up!

Use it compatibly with RTL, DTL, and T²L for low-drive-current (200 fL @ 10 mA) applications requiring high visibility, low drive power, fast response time . . . and economy!

Device	Design Advantages	Price 1 k-up
MOR33 7-Segment Display	1) Compact, solid-state reliability 2) 400 ft. @ 20 mA/segment brightness 3) RTL, DTL, T ² L compatible	\$5.80
MLED60/90 IR LED	1) Choice of 350/550 μ w power output 2) Unique, molded, narrow-beam lens 3) Spectrally-matched to silicon	\$0.99/ 0.85
MLED630 Red LED	1) 1,100 ft brightness @ 50 mA 2) Popular, plug-in TO-18 type case 3) All-around design applications	\$0.69

Type	Frequency Range (MHz)	Impedance (Ohms)	Isolation (dB)	Amplitude Bal (dB)	Phase Bal (Dge)	Insertion Loss (dB)	VSWR
MIC5830	225-400	50	20 min	± 0.5 max	± 1.5 max	0.25 max	1.2:1 max
MIC5831	450-512	50	20 min	± 0.5 max	± 2.5 max	0.35 max	1.2:1 max
MIC5830A	225-400	50	20 min	± 0.7 max	± 3.0 max	0.30 max	1.2:1 max

For details, circle 221



NEW PRODUCT BRIEFS

ADDER AND NIXIE DRIVER

— *Up MECL II System Capabilities*

Now, you can decode and drive your displays the complete MECL way through application of the MC1045 decoder-nixie™ driver. The MC1045 accepts four-line BCD code and converts that code to select one of its ten outputs. And, in addition to gas-filled display tubes the MC1045 can drive low-current, high-voltage relays.

Use the MC1059 dual full adder for a variety of applications including the common arithmetic unit with ripple carry adders and those with look-ahead carry adders. With its typical ripple propagation delay of 7.0 ns for two bits, ripple carry is now practical for many applications. The MC1059 provides the AND, NAND, Exclusive NOR, SUM and CARRY OUT functions requiring only Augend (A) and Addend (B) inputs with the CARRY input.

Both devices are available in 0°C to +75°C (MC1000 series) and -55°C to +125°C (MC1200 series) temperature ranges in either plastic (suffix P) or ceramic (suffix L) dual in-line packages. 100-up prices are \$3.71 for the MC1045P and \$5.57 for the MC1059P.

For details, circle 222

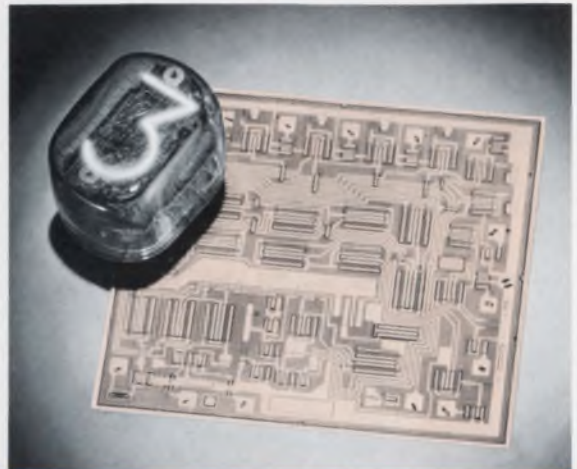

ULTRA-FAST, LOW-VOLTAGE SWITCH

— *For Your Computer Logic Circuits*

If you're among the many designers who need a very high-speed, low-voltage switch for computer logic circuits, here are four.

Two of these new PNP silicon Annular transistors — called the MM4208 and 4209 — are spec'd like the 2N4208 and 2N4209 but provide a lower minimum $V_{BE(sat)}$ of 0.7 Vdc versus 0.8 Vdc for the 2N parts. And the MM4208A and MM4209A, in addition to the lower minimum $V_{BE(sat)}$, offer a higher BV_{CEO} of 15 V to give you greater design flexibility.

Switching times for all four transistors at $I_C = 50$ mAdc are $t_{on} = 15$ ns (max), $t_{off} = 20$ ns (max). Their current-gain bandwidth product is high, $f_t = 1300$ MHz (typ) at $I_C = 10$ mAdc.

The new switches are supplied in the TO-18 metal case for the following 100-up prices: MM4208 — \$2.50, MM4209 — \$4.50, MM4208A — \$3.00, and MM4209A — \$5.00.

For details, circle 223

SWITCHING CHARACTERISTICS

Parameter	Symbol	Typical	Max	Unit
Turn-On Time ($V_{CC} = 3.0$ Vdc, $I_C = 50$ mAdc, $I_{B1} = 5.0$ mAdc)	t_{on}	—	15 (max)	ns
Turn-Off Time ($V_{CC} = 3.0$ Vdc, $I_C = 50$ mAdc, $I_{B1} = I_{B2} = 5.0$ mAdc)	t_{off}	—	20 (max)	ns
Storage Time ($V_{CC} = 3.0$ Vdc, $I_C = 10$ mAdc, $I_{B1} = I_{B2} = 10$ mAdc)	t_s	17 (typ)	20 (max)	ns

LOW-COST AUDIO POWER AMPLIFIER

— *100 mV In — A Full Watt Out*

For low-cost phonograph, TV, and radio designs where you're driving a 16 ohm load and need 100 mV or less sensitivity, the MFC6070 audio power amplifier will provide a full watt — no heat sinking required ($T_A = 55^\circ\text{C}$.) It has excellent hum rejection and low-distortion — typically 1% at 1 W — and can be operated from half or full wave supplies with a minimum of filtering.

The MFC6070's tough, six-lead plastic Case 643A, economical by virtue of high-volume stripline encapsulation, is adaptable to your automatic insertion equipment. And, its short-circuit proof outputs (short-term — 10s, typ) offer virtually goof-proof testing.

At the 100-up price of only \$1.19, the MFC6070 is the audio amplifier to drive your 16-ohm load — economically!

For details, circle 224



ECONOMICAL, TRANSIENT-PROTECTED, DUAL-GATE MOSFETS

— *Designed for VHF Applications*

MFE120-122 — hermetic N-channel MOSFETs with features you'd expect only in much higher-priced devices. They're diode-protected across both gates against damaging transient overvoltages for added reliability. And, for your amplifier/mixer applications, these depletion mode transistors give you 50 dB minimum AGC control, 1% typical cross-modulation distortion with 100 mV of unwanted signal, low feedback capacitance and high power gain.

Excellent as an RF amplifier to 105 MHz, the MFE120 has two separate channels, each with an independent control gate for cascade use. The MFE121 is an outstanding VHF amplifier usable to 200 MHz. And the MFE122 mixes RF with guaranteed frequencies of 104 and 244 (optimum I_{DSS}).

The new series uses the Motorola-developed silicon-nitride passivation that ensures long-term stability under high-temperature and reverse bias conditions. Design them into communications equipment, IF strips and color demodulators now — get more FET for less.

For details, circle 225

Type	G_p (min) dB @ f	NF (max) dB @ f	I_{DSS} (max) mA	Y_{fs} μmhos	$V_{DS(sat)}$ V (max)	Price 100-up
MFE120	17 @ 105	5 @ 105	2-18	8-18	20	91c
MFE121	17 @ 200	5 @ 60	5-30	10-20	20	93c
MFE122	15 @ 104 12 @ 244	5 @ 200	2-20	8-18		88c



NEW LITERATURE BRIEFS



MOS Polycell LSI Manual Bursts Seams—Second Edition Issued

Scarcely four months after beginning operation, Motorola's Polycell LSI design team has created so many new basic building blocks for the Polycell Library that a second edition of the MOS Polycell LSI brochure nearly double the size of the first was necessary.

To the original 88-page manual with its 28 high-threshold, medium-power (MH series) MOS elements has been added 12 new MH functions and a new section of 26 high-threshold, low-power (ML series) MOS Polycells. In its 170 pages, the second edition now offers 66 building block functions to the users of the MOS LSI design facility.

Where maximum accuracy, minimum time and lowest cost are essential requirements of that custom design you're contemplating, Motorola's MOS LSI design facility can help you achieve your goals. At your disposal is a staff of skilled logic designers who utilize the Polycell library and the design facility to quickly help you realize your system requirements in LSI. Prototype parts can be delivered in just 10-15 weeks and non-recurring design costs are considerably below those of other methods.

In the MOS LSI design system, your design requirements are soon transformed into a production run through development of a custom logic design by utilizing a complement of sophisticated computer-aided design programs and drawing upon the logic building blocks in the Polycell Library. Each cell represents the diffusions and interconnections needed to implement a particular logic function and has been extensively characterized in terms of electrical performance. Design costs are minimized by a well defined, yet flexible customer/Motorola interface that allows varying degrees of customer participation in the design process.

To obtain more detailed information, write on your company letterhead for the fully descriptive second edition of the "MOS POLYCELL LSI" manual to: Motorola Semiconductor Products Inc., P.O. Box 20912, Phoenix, Arizona 85036.

Tear Along Perforated Line and Drop in Mail (No Postage Required)

Please PRINT clearly (To expedite your literature we may have to use this as a return mailing address)

NAME

TITLE

COMPANY NAME

DIVISION

DEPARTMENT

COMPANY ADDRESS (Street or P. O. Box)

CITY

STATE

ZIP CODE

SEMICONDUCTOR NEWSBRIEFS

Please circle the Reader Service number of item(s) you are interested in receiving from NEWSBRIEFS No. 11-71:

E.D.						
211	212	213	214	215	216	217
218	219	220	221	222	223	224
225	226	227				

List Application Notes you wish to receive below (by number):

_____	_____	_____
_____	_____	_____
_____	_____	_____

Do you wish a Motorola Representative to contact you?

VISIT PHONE . . . Phone No. _____ Area Code _____

NOTICE: Requests for literature on items described in this publication cannot be honored after June 1, 1971.

Linear Consumer IC Data Folder

Having trouble getting data sheets for some 88 op amps, linear/digital interface circuits, high and low frequency circuits, multipliers, modulators, detectors, regulators, plus microwave devices and special-purpose circuits into your folder? We are! So, to make it easier for you (and us) we've made a folder and hardware available for your linear consumer device data sheets.

For a copy, circle 226



FOLD HERE

Semiconductor NEWSBRIEFS No. 11-71
Motorola Semiconductor Products Inc.
P. O. Box 20924
Phoenix, Arizona 85036

POSTAGE WILL BE PAID BY

BUSINESS REPLY MAIL
No postage stamp necessary if mailed in the United States

FIRST CLASS
Permit No. 2565
PHOENIX
ARIZONA



FOLD HERE

For Fast Action!

... on delivery of literature for items described in this publication — fill out this coupon, fold as indicated and drop in the mail.

(NO POSTAGE IS REQUIRED)

SEAL HERE

(Please use tape — do not staple)

Motorola Semiconductor Products Inc., P. O. Box 20924, Phoenix, Arizona 85036

SEMICONDUCTOR
newsbriefs

© Motorola Inc. 1971

The circuitry shown external to Motorola products is for illustrative purposes only, and Motorola does not assume any responsibility for its use or warrant its performance or that it is free from patent infringement.

MECL, mW, MRTL, MINI-L and EpiBase used in this publication are trademarks of Motorola Inc. NIXIE is a trademark of the Burroughs Corporation.

NOTE: If Motorola's Literature Request Coupon is missing, use magazine's standard Reader Service Card.

NEW LITERATURE BRIEFS



April/May/June Master Selection Guide And Price List Nearly Ready

As you read this, the Master Selection Guide and Price List for April/May/June is being prepared, will soon go to the printers, and will be available after April 10th.

This handy compendium is published quarterly and quarterly it gets fatter, reflecting the most complete, yet ever-growing array of semiconductors in the industry.

In its pages, the Master Selection Guide and Price List combines under one cover all the selector guides and price lists for all 17 major semiconductor categories. It provides quick, convenient reference to new devices and price changes as well as standard Motorola policies including: pricing and ordering; device, test, package and hardware options; price adders and device mixing. And you get current prices for over 14,000 solid-state products from Motorola.

For details, circle 227



Our 5000 and 7500 permeability Ceramag[®] ferrite materials can pack a terrific amount of inductance into a small size.

And the higher the perm, the fewer turns required. Results. Lower distributed capacity. Material savings. Improved performance.

Ceramag[®] 24H offers the designer a true 5000 permeability. New, Ceramag[®] 24K is also a true 7500 permeability. Both materials hold their permeability over a wide range of sizes.

Ceramag[®] 24H and 24K are production materials, ready for immediate use in your design. Stock available in some sizes.

Precisely engineered, Stackpole ferrite materials are produced by exact processing, density checks, rigid kiln controls and accurate sintering. You get more out of Stackpole Ceramag[®] materials simply because we put more into them.

Study the characteristics of 24H

	$\frac{L}{N^2}$ (nh) TOROID SIZE: 0.230" O.D. 0.120" I.D. 0.060" L.	MAXIMUM PERMEABILITY	SATURATION FLUX DENSITY @ 1.5 OERSTED	RESIDUAL MAGNETISM	COERCIVE FORCE	CURIE POINT	TEMPERATURE COEFFICIENT OF μ_0	
							-25° to 25° C.	25° C. to 75° C.
CERAMAG [®] 24K	1485	9700	4100	700	0.05	175	+1.000	-0.450
CERAMAG [®] 24H	990	6900	3800	850	0.1	175	+0.700	-0.450
2500 PERM REFERENCE	495							

and 24K, then consider how you might use these ferrites.

For more information, samples and applications, contact:

Stackpole Carbon Company,
Electronic Components Division,
St. Marys, Pa. 15857. Ph: 814-834-1521. TWX: 510-693-4511.

Disaccommodation factor for both materials is 1.4×10^{-6} , typical.



STACKPOLE
Electronic Components Division

Producing high quality Ceramag[®] ferrite components for the home entertainment, industrial electronics and computer industries for over twenty-two years.



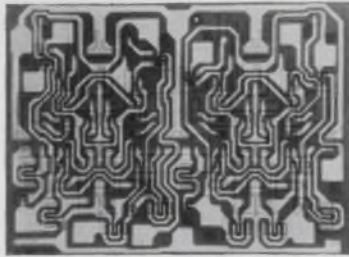

DIGITAL IC CHIPS

Series 74 and 74H: full line of standard circuits, high speed circuits, and complex arrays. TTL logic for all of your digital system designs. Delivered in plastic "egg-crate" trays.



LINEAR IC CHIPS

High gain op amp chips for integrators, summing amplifiers, and amplifiers with operating characteristics as a function of external feedback components. Set new standards for price/performance.



TRANSISTOR CHIPS

Small signal chips (10 to 600mA) and power chips (0.5 to 30 amps). High performance with economy. Silicon planar epitaxial transistors. 100% D-C probe tested. Guaranteed to an LTPD of 10%.



CERAMIC CAPACITOR CHIPS

Both Monolithic® and Single-Wafer chips in unusually large selection of capacitance values and body codes. Make it easy for you to meet budget/performance requirements for thick-film hybrid circuits.

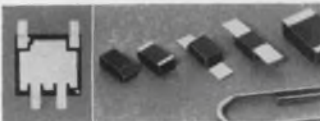

TANTALUM CAPACITORS

TANOX® Beam-Leaded Tantalum Thin-Film Capacitors and DOMINO® Molded Solid-Electrolyte TANTALEX® Capacitors offer board choice of sought-for mechanical features, electrical characteristics, and capacitance values. Compatible with assembly techniques used for active device chips.

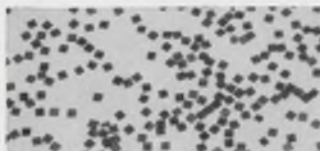

METANET® RESISTOR CHIPS

Precision noble metal resistor chips made to your requirements. Available as networks or discrete resistors.

Almost Everything You Need To Make Hybrids

Because Sprague Electric makes more types of chips and packages than any other source can offer, our extensive experience in this field assures that they're made well.

For technical data on the specific products in which you are interested, fill out and mail the coupon below.

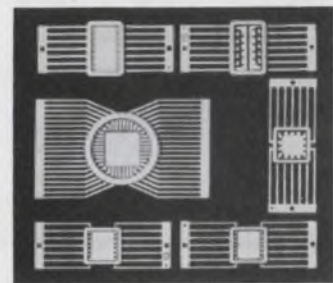

PACKAGES

Hermetic flatpacks of every description carried in stock. From 3/16" x 3/16" to 1" square. Radial and plug-in types. With base material choice of glass, ceramic, metal, or metallized ceramic. From 6 to 60 leads. Also custom made to meet specialized needs.



ASSEMBLY EQUIPMENT

The most sophisticated equipment available in the industry. Made by Micro Tech, a Sprague subsidiary. Thermocompression wire bonders and chip attachers especially designed for rapid, accurate hybrid circuit assembly. Handle all types of substrates and packages up to 2" square.

SPRAGUE ELECTRIC CO., Tech. Lit. Sec.,
347 Marshall St., North Adams, Mass. 01247

MAIL technical literature describing the following:

- | | |
|--|---|
| <input type="checkbox"/> Digital IC Chips | <input type="checkbox"/> Tantalum Capacitors |
| <input type="checkbox"/> Linear IC Chips | <input type="checkbox"/> Metanet Resistor Chips |
| <input type="checkbox"/> Transistor Chips | <input type="checkbox"/> Packages |
| <input type="checkbox"/> Ceramic Capacitor Chips | <input type="checkbox"/> Assembly Equipment |

Name.....
Title.....
Company.....
Street.....
City.....
State..... Zip.....



highlighting

THE ISSUE

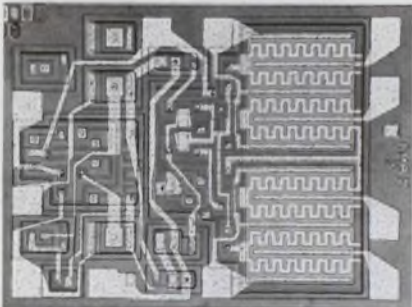

By using a combination of Schottky diodes, bipolar and MOS field-effect transistors, a series of analog switch/drivers achieve ON and OFF operating speeds of 90 and 350 ns, respectively. These speeds are reportedly three times faster than those of any other available units.

In addition, the switches dissipate only 80 mW and keep their ON resistances low—over a range of 25 to 300 Ω depending on the analog signal level used, which can vary over ± 10 V.

Page 101



Multiplier errors are bad enough, but add a lack of standards for multiplier specifications, and the design engineer can get very confused indeed.

Since dramatic reductions in price, combined with better performance, have made multipliers an attractive solution to many signal-processing problems, isn't it time you learned how to compare competitive devices properly? Probably your best bet is to study the relationship between multiplier specifications and the errors to which the devices are subject.

Page 66



"Technology for a Better World" is the theme chosen by the IEEE for this year's show and no where is this more evident than the technical program which features such sessions as: Electricity in the City, Technology and Privacy, Redirecting Electro-Technology for a Better World, Interaction of Technology and Society, Design Objectives for Transportation Systems and finally, Computer Art and Music. Despite the obvious interest in civionics, the practical side of the program has not been neglected. Program sessions covering technical applications are more numerous than ever before. In fact, the special technical applications sessions offered at the Coliseum have been increased from seven in 1970 to 28 for 1971.

Page 52

PANEL DISPLAY IT

now it's possible

We've done the hard work— by making the first commercially available panel display subsystem for use in your application. Burroughs new SELF-SCAN panel display subsystem provides 256-character alphanumeric panel display capabilities and all necessary electronics — *drivers, memory, timing and character generation* — in a compact module.

And because SELF-SCAN panel display technology reduces electronics by 90% and cuts display thickness to less than 1½ inch, you get unprecedented flexibility and cost advantages for display applications.

The easily-read characters used in this unit are formed of dots on .040" centers, with eight 32-character rows in a 5 x 7 dot matrix format. Application versatility is designed-in with options including visual cursor, tab controls and expanded memory capability. The 256-character unit shown is available for off-the-shelf delivery; 64- and 128-character subsystems available soon. Units with only display and driver electronics are also available. Write or call for additional information: Burroughs Corporation, Electronic Components Division, Box 1226, Plainfield, N. J. 07061 (201) 757-3400.



(Size 5.5 x 11 x 1.4)

256-Character **SELF-SCAN™** Panel Display Subsystems

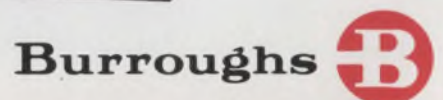

Petitioners demand change in IEEE priorities—now

If the petition now being circulated nationally by members of the IEEE is implemented, the basic objectives and emphasis of that organization will shift from promoting scientific and educational activities to advancing the economic well-being of its members.

If signed in sufficient numbers, the petition (which will be printed in an upcoming issue of *ELECTRONIC DESIGN*) will require the IEEE Board of Directors to place a constitutional amendment before the membership for their decision by ballot.

The petitioners, headed by Drs. Victor Galindo and James W. Duncan of TRW, Redondo Beach, Calif., contend that "positive action must be taken now to modify the purpose of the IEEE so that it functions in the economic interests of its members as well as functioning for the advancement of the science and technology of electrical engineers."

At IEEE headquarters, a spokesman told *ELECTRONIC DESIGN* that the February 1971 report from Dr. James Mulligan published in *IEEE Spectrum* answered the points that are being raised in the petition. Mulligan's report deals with reduction in membership dues for unemployed IEEE members, arrangements with the National Society of Professional Engineers (NSPE) whereby IEEE members can obtain copies of legislative information for a fee of \$15, and the availability of educational materials.

But Galindo contends that affiliation with NSPE "for a fee of \$15 is equivalent to a magazine subscription. And a lobbying organization without voting rights is equivalent to political rights enjoyed by citizens in the USSR."

"The 1971 IEEE Board of Directors has in effect told us," says Galindo, "'Don't bother us with

your economic problems, go join NSPE or something.'"

Galindo wants to see the IEEE establish an Economic Activities Board with power to:

- Publish an impartial evaluation of employers in *IEEE Spectrum*.
- Provide a job placement service.
- Initiate "portable" services—pension plans and other fringe benefits that would carry over from corporation to corporation.
- Attempt to have engineers hired on a contractual basis.
- Formulate a program to influence government action.

Broad security system devised for the home

A new solid-state security system not only protects the home against burglars and fire; it also provides a means of sounding an alarm in case of sudden illness or an accident.

Developed by Westinghouse Security, Inc., Pittsburgh, the system relies on a computer in a central control panel. Information from sensors placed at strategic points in the home is fed into the computer to detect a breach in security—fire, smoke, or loss of the heating system, say. Emergencies are signaled to the computer by means of a pushbutton.

When any of the various sensors indicates an alarm condition, the computer scans a hard-wired memory, creating coded dialing pulses that simulate a telephone output. These pulses are sent over a telephone line to a communications center that serves several homes or an entire apartment building.

At the center, the information is decoded, and the type of emergency

and its location are displayed for an attendant, who can summon help. This information plus the location and time of the alarm are printed out on a paper tape as a permanent record.

Each control station in the home or apartment also has an emergency voice contact with the communications center.

False alarms are minimized through a lock-and-key arrangement at the dwelling's master control panel and at entry doors that activate or deactivate the system, as well as by means of a test circuit over which the homeowner can check the system at any time.

An across-the-line battery provides more than 24 hours of service in case of local power failure.

Aluminum gaining favor as electrical conductor

The use of aluminum wire for electrical purposes in the U. S. is increasing over twice as fast as copper, according to Howard L. Cook, electrical staff engineer of the Aluminum Association, New York City. Shipments of aluminum insulated or covered wire and cable rose 4.6% in 1970, he reports.

Cook predicts that if this growth continues, along with expected increases in the shipment of aluminum bus, strip and foil conductors, aluminum will be the principal electrical conductor metal within a few years.

Conference promises 'firsts' in liquid crystals

The spring conference of the Society for Information Display will feature a number of "firsts," particularly in the field of liquid crystals.

Those who attend the May 4-6 meeting in Philadelphia will hear papers on what is believed to be the first liquid-crystal display with a memory that can be addressed by an X-Y matrix and liquid-crystal displays that can be placed directly on an IC chip. (See "Liquid Crystals: Material With a Hot Future," *ED* 19, Sept. 13, 1970, p. 76.)

A team of researchers from Xerox Corp., Rochester, N. Y., will demonstrate a laboratory display

that uses cholesteric (rather than the more conventional nematic) liquid crystals, which can be addressed by using driving circuits to access a matrix (X-Y) of columns and rows. The display, according to Dr. James H. Becker, principal scientist at Xerox, "will be at least a 5-by-7 dot pattern, and we may show some much bigger ones."

There are two main advantages in using cholesteric liquid crystals instead of nematic crystals: cholesterics have a "memory"; once the display is turned on, it will stay turned on, even when the electric field is removed. With nematic liquid crystal displays, which operate by applying an electric current, the display disappears as soon as the current is switched off.

The second advantage of the cholesteric liquid crystals is their very sharp threshold. This means that such displays can be accessed with an X-Y matrix. This greatly reduces the number of drivers needed to form any character, according to Becker.

The alphanumeric liquid-crystal display, composed of an integrated MOS shift register, will be presented by J. Borel and J. Robert of LETI, Grenoble Gare, France. The memory and addressing circuit in this display are covered with a thin layer of nematic liquid crystal.

Bipolar IC size cut 40% with Fairchild process

Bipolar ICs may soon be no bigger than MOS devices, with the use of a new semiconductor structure announced by Fairchild Camera and Instrument Corp., Mountain View, Calif.

The new structure, called Isoplanar, will make possible a 40% reduction in size, according to Dr. James M. Early, vice president of research and development.

High speed—up to now the major advantage of bipolar digital ICs—will still be retained with the Isoplanar construction, Early says. The company plans to introduce sometime after June a 256-bit Isoplanar RAM with an access time of 80 ns and power dissipation of 2 mW/bit. The chip size will be 78 by 84 mils.

The announcement by Fairchild comes shortly after announcements of faster MOS devices with speeds similar to bipolar ICs—by Varadyne Semiconductor, Cupertino, Calif., with its field-shield process—and of a double-diffused MOS process—by Signetics Corp., Sunnyvale, Calif.

The Isoplanar process uses a selectively grown thermal oxide to replace the conventional diffused sidewall isolation between devices. But since this oxide is an insulator, there is no need to separate it from the transistor base. This allows the transistor size to be reduced accordingly, Fairchild says.

Skin effect proposed to heat oil pipelines

A new, electromagnetic skin-effect method of heating steel pipelines may prove valuable in moving oil from arctic wells to refineries.

Invented by Dr. Donald F. Othmer, professor of chemical engineering at the Polytechnic Institute of Brooklyn, N. Y., the method keeps electric current on the inside surface of pipes.

As Dr. Othmer explains it, power at a frequency from 10 to 1000 Hz would be applied to the pipelines by power stations some 50 miles apart. Because of the skin effect, most of the current flows on the inside of the pipe.

The professor notes that the outside of a 1-inch-thick pipe would have a current less than one billionth that of the inner surface. As a result, the voltage drop on the outside would be less than 1 μ V per mile.

18% rise forecast in 71 for computer business

The revenues of U. S. computer companies are expected to exceed \$14.5-billion this year, up 18% over 1970, according to the International Data Corp. in New York City, market researchers.

The forecast looks for worldwide shipments of new computers to reach \$8.43-billion, up 16% over 1970. The research firm notes that U. S. spending on computer-related items was up 13% in 1970 and

should increase 15% more this year.

Over half the U. S. users contacted in a survey reported that the state of the economy would have no effect on their buying plans.

Power needs outrunning supply, expert warns

"We have reached a situation in which the nation's electrical energy demands are growing at a rate almost faster than the power industry is capable of meeting."

So says S. David Freeman, director of the energy policy staff in the U. S. Office of Science and Technology. Consumption of electric power is increasing five times as fast as population growth, he reports.

Speaking before a seminar on science and public policy at the National Academy of Sciences in Washington, Freeman warned of more brownouts in metropolitan areas. He called for broad conservation of energy and new sources of power.

Freeman described the major reasons for the present power crisis as follows:

- A demand in electrical power that has far exceeded the expectations of the Federal Power Commission and the power industry.

- Poor reliability of new power plants—500 kW to 1000 kW or larger. A recent study by Edison Electric Institute revealed that in the first three years, the average availability of these units barely exceeded 60%.

- Delay in availability of nuclear power plants, which represent a sizable percentage of new plant construction.

- Opposition by environmentalists—though their effect will be mostly long-range.

Freeman suggested the development and use of more efficient forms of generating electricity. These would include: the liquid-metal cooled fast breeder reactor and other advanced reactors; magnetohydrodynamics, fuel cells and solar energy.

Freeman believes that in many parts of the U. S. the heating load could be supplied by solar energy supplemented by other furnaces. ■

They're new, Molex edge connectors. For printed circuit boards. Terminals crimped to wires automatically. We have straight-in and right-angle types. With and without mounting ears. It's another giant step by Molex in helping create high-speed, low-cost devices that simplify circuitry. Reliable? You bet. The connector has bifurcated terminals that provide solid contacts. Yet you can slip the connector on and off many times without damaging printed circuits. And it's not a preloaded unit. Carries only contacts required. From nine to twenty-two.

If you want to save assembly time, steps and money, take a close look at this new Molex edge connector. For free samples, write or you can make connections by calling (312) 969-4550.



M155A

**MOLEX PRODUCTS
COMPANY**
Downers Grove, Ill. 60615

HOW LOW CAN WE GET?

We looked at the competition, then built a better potentiometer, the Model 3006, a low cost cermet unit for PC board use.

Here's how we did it:

GAVE IT MORE POWER

$\frac{3}{4}$ watt at 70°C

MADE IT SURER

superior setability: longer element, 15 turns and 16 independent wiper contacts to make sure

SEALED IT TIGHTER

to Mil-R-22097

BUILT IT LOWER

only $\frac{1}{4}$ " off the board

PRICED IT LOWER

only 81¢ in 25,000 piece quantity, much lower for more

Send for full data on the 3006, and we'll send along dramatic proof of how tough a little unit it really is.

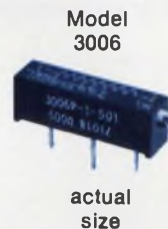

At the Solid-State Circuits Conference

Medical electronics stirring, and IC prognosis is excellent

Medical electronics, though growing, has been a relatively small field so far, but many in the industry believe that the time may be ripe for a broad, dramatic advance in applications. Among the optimists may be the IEEE, which for the first time devoted part of its recent International Solid-State Circuits Conference to discussions of how integrated-circuit technology could be applied to biomedicine.

Typical of developed devices described at the Philadelphia conference were these:

- A microprobe containing integrated buffer amplifiers that can record the electrical activity of single neurons in the brain.
- A telemetry transmitter for electrocardiogram monitoring whose total power consumption is 180 microwatts.
- A piezoresistive pressure sensor consisting of a silicon chip with an active diaphragm 1.2 mm in diameter and 5 microns thick.
- A receiver fabricated on a single silicon chip that can disconnect an implanted device from its power source on command.

An IC probe developed

The recording of electric potentials in the brain is becoming increasingly important in neurophysiology and the microprobe with integrated-circuit amplifiers, developed by Kensall D. Wise and J. B. Angell of Stanford University, solves a serious problem that conventional stainless steel or tungsten electrodes cannot deal with effectively: the presence of stray capacitance between the electrode and the recording amplifiers.

The new device can do this be-

cause the entire probe is fabricated with silicon IC technology. The electrode is made of gold with a silicon supporting carrier. Silicon dioxide is grown over the entire probe and then etched away to uncover only the gold tip. In this way the silicon chip containing the two buffer amplifiers can be placed directly behind the probe and connected to it with beam leads.

The use of integrated junction FET source followers by Wise and Angell is typical of medical applications where a device is intended for use in the body. Such devices generally require a high input impedance, a low output impedance, low noise and a low supply voltage.

The buffer amplifiers for the microprobe operate with a common 2.5-V drain supply, the gate of each junction FET is connected to its corresponding electrode, and

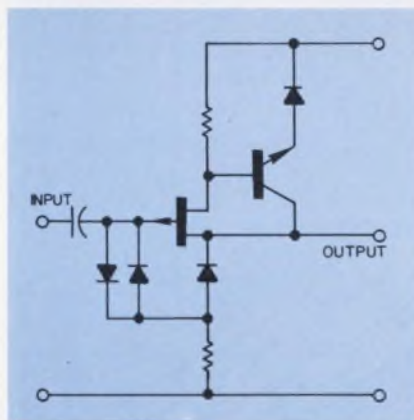

Circuit diagram of active electrode used in a micropower telemetry system developed at Case Western Reserve University. Diodes supply bias to the input and also maintain high impedance. Drain resistance is adjusted to select the proper operating point for the amplifier.

each source is connected to a common output lead. The input impedance is greater than 10^8 ohms at 1 kHz, and the output impedance is less than 500 ohms.

Transmitting microwatt signals

Dr. Wen H. Ko, professor of electrical engineering at Case Western Reserve University, Cleveland, and three colleagues—E. T. Greenstein, J. Hyncek and D. Conrad—developed the EKG telemetry transmitter. A pulse-width modulated transmitter, it was made with hybrid and monolithic ICs. It requires 180 μ W at 2.6 V. The range of the unit, which transmits electrocardiographic signals, is up to 20 feet without the use of an external antenna (see "The Patient Comes First in Telemetry," ED 24, Nov. 22, 1970, p. 48.)

A FET is used in the active electrode unit in the transmitter design to provide a high input impedance and a noise voltage of less than 0.5 μ V/Hz at 10 Hz. The transmitted carrier is detected by a pulse-modulated receiver. To reduce electrical interference, the receiver output signal is processed through a noise discriminating circuit.

Ko told the conference that low-power sources were critical in biomedicine, particularly in implanted or patient-carried devices. Low-power designs offer safety and convenience factors (the units are smaller and lighter), and longer battery lifetime.

IC sensor fits in catheter

Using integrated-circuit technology, a team of researchers at Stanford University developed the

tiny piezoresistive pressure sensor, which can be used in biomedical instrumentation, such as cardiovascular catheterization.

The device consists of a circular silicon chip with an outer diameter of 1.6 mm, and an active diaphragm 1.2 mm in diameter and 5 microns thick. The supporting rim is 50 microns thick—the thickness of the original substrate. Four resistors are diffused into the diaphragm area and are interconnected to form a bridge.

The chip can be mounted in the tip of a small catheter, which provides reference pressure to the back of the diaphragm and electrical connections to the external signal processing circuitry. The work was performed by S. Samaun, K. D. Wise, E. D. Nielsen and J. B. Angell, all of Stanford University.

The tiny command receiver that can disconnect an electronic implant from its power source was described by Peter H. Hudson of the Electronic Components Laboratory, Army Electronics Command, Fort Monmouth, N. J., and James D. Meindl of Stanford University.

The command receiver, according to Hudson, can extend the operating lifetime of an implanted telemetry package to the shelf life of its battery. The receiver is fabricated entirely on a single silicon

chip. It consists of an rf amplifier, an AM detector and an audio amplifier. The unit has a sensitivity of better than $15 \mu\text{W}$ and is designed to operate from a single 1.35 mercury cell.

Solid-state advances noted

In the keynote address to the conference, Dr. Dennis W. Hill of Britain's Royal College of Surgeons told listeners in the University of Pennsylvania's Irvine Auditorium in Philadelphia that solid-state circuitry was being used in cardiac pacemakers, myoelectrical prostheses, surgical lasers, patient monitoring equipment, computers and biological amplifiers, transducers and probes.

Dr. Hill noted that solid-state circuitry was particularly valuable in devices that must operate inside the body or be carried on the body in an inconspicuous fashion.

The most dramatic advances, he said, have occurred in cardiac pacemakers. The simplest types pace the heart at a fixed rate. The more sophisticated equipment is triggered by the heart's natural pacemaker when it is ineffective in triggering the heart itself.

While not directly concerned with the design circuits, the packaging of implantable devices was

considered to be of crucial importance in the success of medical implants. At an evening panel discussion on medical devices, Robert Huber, director of the Solid State Electronics Laboratory at General Instrument Corp., Salt Lake City, said that conventional passivation techniques, such as silicon nitride, could not be used in the body because of attack by sodium ions. He said that in experiments with animals, small aluminum implants, while not creating an infection at the skin surface, were completely absorbed after three to six months.

Other materials associated with solid-state technology, such as copper, nickel and magnesium—could be cancer-producing, according to Dr. Allan K. Ream of the Medical Devices Applications Program at the National Institutes of Health in Washington. Dr. Ream said that the body's defenses might diminish or block entirely the performance of a device if it was not packaged properly in a biologically inert material.

According to Dr. Huber, even RTV Silastic, while excellent for packaging some electronic components, is permeable to water and to salt in the body.

With the trend toward the use of nuclear-powered pacemakers, packaging problems have become even more severe, according to Dr. Hill. What is needed, he said, is lightweight, effective shielding and refined heat-removal techniques.

Dr. Robert M. Berger, director of the Research Triangle Institute, Durham, N. C., pointed to the need for transducers and sensors that can measure skin color, muscle tone and interior areas, such as the inside of the eye. He said that high-impedance amplifiers in biomedical probes were needed to help localize brain damage. And he saw the need to replace the physician's ear with more sensitive phonocardiographs that would help diagnose defects in the heart and lungs.

"The old data we have collected," Dr. Berger said, "includes temperature, pulse rate, EEG and EKG." What is needed, he continued, are computers that can be fed a number of inputs from body measurements and come up with a determination of the cause and nature of an illness. ■■

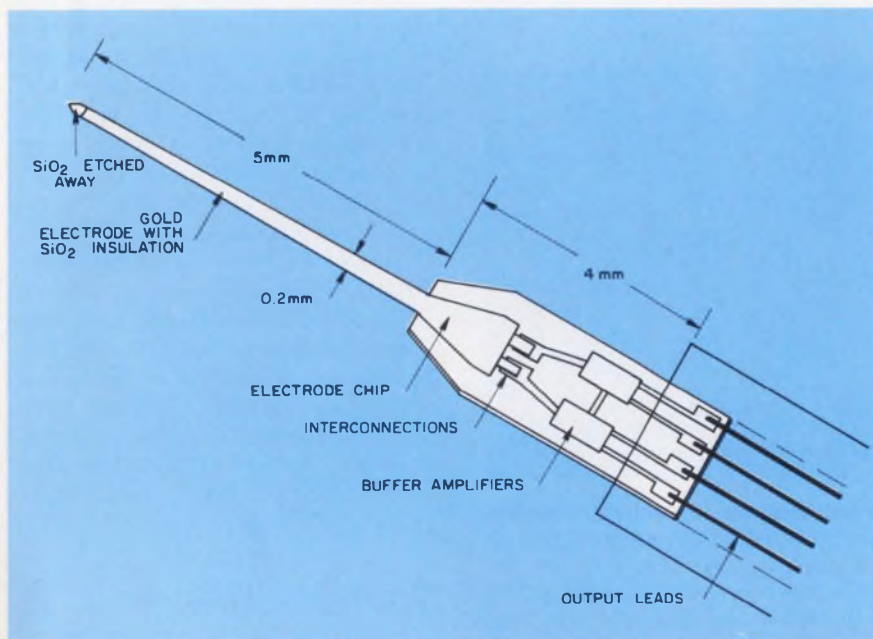

Microprobe with integrated amplifiers was fabricated with IC technology and can be used to record biopotentials in single neurons.

More JAN approved devices

Six more SCRs, two transistors, and four more rectifiers have joined the ranks of JAN approved products from UNITRODE. For fast action on these or any other JAN products listed below, call Sales Engineering collect at (617) 926-0404, Unitrode Corporation, 580 Pleasant St., Watertown, Mass. 02172.

TYPES	DESCRIPTION	MIL. SPECS.
JAN & JANTX 2N3027-32	SCRs — 5 TO 500mA DC CURRENT — TO-18 PKG	MIL-S-19500/419
JAN & JANTX 2N4150	SWITCHING TRANSISTOR 10 AMP 80 VOLT TO-5 PKG.	MIL-S-19500/394
JAN & JANTX 2N2151	POWER TRANSISTOR 5 AMP 100 VOLT TO-59 PKG.	MIL-S-19500/277
JAN & JANTX 1N5186, 7, 8, & 90	FAST RECOVERY RECTIFIERS 3 AMPS TO 600 VOLT	MIL-S-19500/424

from  UNITRODE

More than 60 existing JAN devices

TYPES	DESCRIPTION	MIL. SPECS.
JAN & JANTX 1N4245-47	MIL. GEN. PURPOSE RECTIFIERS — 1 AMP	MIL-S-19500/286
JAN & JANTX 1N4942-46	FAST RECOVERY RECTIFIERS — 1 AMP	MIL-S-19500/359A
JAN & JANTX 1N3611-14	RECTIFIERS — 2 AMPS	MIL-S-19500/228
JAN & JANTX 1N4954-90	ZENER DIODES 5 WATTS 5% TOLERANCE	MIL-S-19500/356
JAN 2N1870A-74A	SCRs — 200 VOLT 1.25 AMP	MIL-S-19500/198
JAN & JANTX 2N2323-29	SCRs — 400 VOLT 1.6 AMP	MIL-S-19500/376
JAN 1N5597 & 5600	HIGH VOLTAGE STACKS	MIL-S-19500/404

from  UNITRODE



At the solid-state circuits conference

2 new semi memories offering immunity to volatility problems

Volatility—a major problem when semiconductor memories are considered for use in computer systems—may no longer be a problem.

In a paper presented at the Solid-State Circuits Conference, Dr. I. T. Ho of the IBM Components Div., Hopewell Junction, N. Y., described a random access read/write memory (RAM) that contains a suppressed, nonvolatile, read-only image. The read-only image reappears each time the memory powers up and has virtually no effect on the original RAM capabilities.

At the same session, Dr. D. Frohmann-Bentchkowsky of Intel Corp., Mountain View, Calif., described the construction and operation of a new electrically alterable read-only memory (ROM).

Neither of these two devices provides the perfect answer for the designer looking for a substitute for the nonvolatile storage capabilities of magnetic core memories. But both of these memories give the designer a lot more flexibility in computer microprogramming applications than he had before.

Dr. Ho referred to the IBM dual memory as a latent-image memory, or LIM. "In hardware," he explains, "a LIM cell is a conventional flip-flop that has been intentionally made asymmetric. When power is on, the cell operates as a RAM, and its ROM image is suppressed. When power is tuned off and on again, the predetermined asymmetry will appear and the information now in the cell will be that of the ROM image."

This technique can be demonstrated on a diode-coupled cell, as shown in Fig. 1. The ROM latent image is added to the cell by an additional Schottky barrier diode from the P⁺ isolation wall to one of the collectors. The additional diode can be added to the lefthand transistor to represent a 1 or to the

righthand transistor to represent a 0.

When power is on, the P⁺ isolation wall is negatively biased. When the ROM image is required, power should first be turned off and then a positive pulse applied to the substrate. Before the pulse ends, V_i is applied and the predetermined preferred state of the ROM appears.

As an alternate configuration, Dr. Ho suggested connecting the additional Schottky barrier diode to separate lines instead of to the P⁺ isolation wall. These added

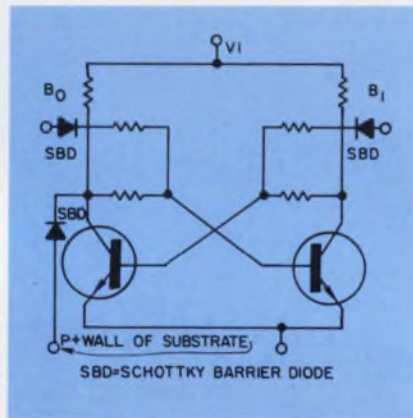

1. Flip-flop, with an extra diode attached to one of the collectors, can serve alternately as a RAM and a ROM. When power is applied, the cell initially settles to its preferred state.

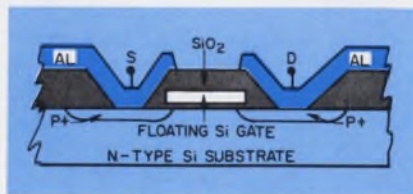

2. Avalanche injection transfers charge to the floating silicon gate to program the new Intel ROM. The stored program is erased by exposing the memory to ultraviolet light, or to X-rays when packaged.

lines, rather than the substrate, will then be pulsed when the ROM image is called for.

For other RAM cells that do not contain Schottky barrier diodes in their original configuration, the latent-image concept can be implemented by unbalancing the collector-substrate capacitance of the two transistors. The two half cells then have different time constants. When power is first applied, the cell will set to its preferred state.

"Computer simulation shows that a 20% difference in these two capacitors would be sufficient to guarantee a predetermined preferred state," Dr. Ho says.

The Intel ROM is a fully decoded 2048-bit device, implemented with what Dr. Frohmann-Bentchkowsky called a "novel MOS-charge storage transistor as the basic nonvolatile memory element; it is fully TTL-compatible and can be operated in both the static or dynamic decoding and sensing mode."

The storage element is a floating gate avalanche injection metal oxide semiconductor device. It is a P-channel silicon gate MOSFET in which no electrical contact is made to the silicon gate (Fig. 2).

The operation of the memory depends on charge transport to the floating gate by avalanche injection of electrons. Charge can be transferred if an avalanche injection condition is reached in either the source or drain junction. With an applied junction voltage of -30 V, avalanche injection begins, and negative electron charge accumulates on the gate. When the voltage is removed, no discharge path is available for the accumulated electron, since the gate is surrounded by silicon oxide, a very-low-conductivity dielectric.

Once programmed, the memory can be erased by ultraviolet light (before packaging) or by exposure to X-rays. ■■

Three-week delivery* from Heinemann? Don't make me laugh.

**Call your Heinemann representative
and start grinning.**

*Two- to three-week delivery applies to Series JA and AM12 circuit breakers on up to 100 poles per order; Series AM1 breakers, up to 35 poles; single-pole SM breakers, up to 25; C or PJ overload relays, up to 10.

SEE US AT THE IEEE SHOW, BOOTH #2634

Billions in U.S. shipbuilding open big field for electronic innovation

One revolution under way in the United States today that no one is quarreling with is the prosperous and forward-looking upheaval in the nation's shipyards. Business is booming after a 25-year slump—for both merchant and military ships. And the old ship-building techniques are being replaced by new methods.

"We are entering a totally new era," says Nick Milakovich, vice president of Litton Ships Systems, a division of Litton Industries in Pascagoula, Miss. "The opportunities in the domestic shipbuilding market and the need to lower costs have thrust the American shipbuilder into one of the greatest industrial, scientific and technological revolutions ever to occur in a major industry."

He adds: "The electronics industry can play a major role in assisting us toward further automation."

A multitude of opportunities

Interest is high in numerically controlled machines for cutting, burning and contouring metal. Numerical control is taking over in machine shops where the many giant components that go into a ship—propellers, shafts and condensers, for example—are built. But needed also, shipbuilders say, is the following electronics:

- Automated equipment to handle materials.
- Industrial robots.
- A device to look inside pipes and tell whether they are clean.
- Improved measurement devices, with opportunities for lasers.

■ Ultrasonics to perform non-destructive testing of materials, especially small, portable ultrasonic units.

The competition is wide open and is starting to attract what might appear as some unlikely candidates. The Picker Corp. of Cleveland, for instance—primarily a medical equipment manufacturer—is converting some of its products for shipyard use.

But, by and large, domestic electronics companies have barely placed a foot in the door to

this new market. The shipbuilding industry in this country was in the doldrums for so long that few American companies bothered to keep in touch. Meanwhile machine builders and electronics concerns in northern Europe and Japan, where shipbuilding never lagged, kept apace. As a result, most of the big, automated equipment found in U.S. shipyards today comes from Scandinavia, the Netherlands and West Germany.

Two electronically controlled automatic welders from Hebe of



Story and photographs by
John F. Mason, News Editor

Sweden, for example, went into operation last month at Bethlehem Steel Corp.'s Sparrows Point (Md.) shipyard. The electronic console for the huge, \$1.5-million machines was unwrapped for a visitor from ELECTRONIC DESIGN, and it was an impressive piece of equipment (if hard to follow at first glance, since all the dials, meters, labels and instructions were in Swedish).

'We need U. S. industry'

"Before buying these machines," said W. C. Brayton, assistant to the general manager of the Sparrows Point yard, "we talked with U.S. manufacturers, and they went to Europe to see what the equipment was like. When they saw how far advanced it was, they figured it was pointless to try to duplicate it, so they just made some reciprocal trade agreements and came home."

But now, Brayton continued, "we need U.S. industry."

"By adopting assembly-line techniques—conveyor handling, automatic holding devices and welding processes—we hope to reduce labor costs more than 50%," the shipyard executive explained. "Instead of a half dozen ship fitters using sledgehammers and wedges, we're moving toward electronically controlled hydraulic devices."

The demand for domestic shipbuilding has come about because the Nixon Administration became alarmed on noting that the U. S. was No. 10 among world shipbuilders (and going down); that the U. S. merchant fleet carried less than 7% of U. S. cargoes in 1968, and that by 1982, with no improvement in the fleet, it would carry less than 3%; that American users of ships ordered 145 new vessels, or \$1-billion worth, from foreign yards last year.

The result was the Merchant Marine Act of 1970, under which the Government will subsidize 30 merchant ships a year instead

of 10. And the incentive to automate came with a full set of teeth. At present the Government will pay 55% of a ship's cost to the shipyard, calculating that this enables the yard to compete with foreign prices. But within six years the Government expects U. S. yards to cut costs sufficiently to operate with subsidies as low as 35%. Only automation can achieve this.

Military contracts available

Military business also looks good. The U.S. fleet is getting older, and the Soviet fleet is becoming newer, larger and more in evidence all over the world. Litton Industries is now working on a potential \$2.4-billion contract to build a fleet of destroyers. And two companies have recently received contracts to build 12 high-speed attack submarines—the Newport News (Va.) Shipbuilding and Dry Dock Co. and General Dynamics Corp.'s Electric Boat Div.



Eventually this gantry will use a computer-made tape, instead of an operator, to pick up steel panels from barges that come up the Pascagoula River to Litton's yard in Mississippi. It will be programmed to put them in the right piles.

Shipyards in the U. S. have come to life. They are buying new equipment and looking for new ways to meet the shipbuilding challenge of the 70s. Obstacles are foreign competition and lack of familiarity with shipbuilders' needs. Bethlehem Steel's yard in Sparrows Point, Md., (left), for example, welcomes the electronics industry's help.



Position holding and welding gantry in the panel shop at Litton in Pascagoula, Miss., assembles stiffeners and T beams into flat panels. The large console (left) controls the gantry and the welding heads. The small one controls the materials passing through the station. Ogden Engineering Corp., Schereville, Ind., built the system.

in Groton, Conn. The cost is an estimated \$1.9-billion.

On an average, Navy Secretary John H. Chafee says, \$3.5-billion will be needed every year for the next 10 years to build new ships and to modify old ones, making a total for the decade of \$35-billion.

All shipyards have many procedures in common. Raw steel plates arrive by rail, barge or ship, and all are picked up by giant cranes and stacked in a storage area.

At Litton the gantry crane,

called Big Bertha, consists of a 360-foot-long beam supported at either end by 55-foot vertical structures on tracks. A magnetic boom moves back and forth along the beam, picking up plates—often 13 feet by 56 feet and weighing five to six tons—from a barge on the Pascagoula River. It moves back to a designated lane and then the entire gantry moves forward on its tracks and places the panel in one of 265 piles.

Big Bertha is run by an operator now, but Filippo Cali, Litton's

director of engineering, foresees the day when the crane will be numerically controlled.

"If it begins work at 2 a.m., we'd have enough panels in the right piles by the time the men come to work to supply the fabrication shop all day long," Cali says, adding that the problem is not hardware but making the software foolproof. "A 5-ton plate in the wrong pile can cause tremendous trouble," he notes.

From the storage piles, the panels are picked up by cranes and placed on a conveyor belt, which is controlled by an electronic console—both Litton and Bethlehem Steel at Sparrows Point use a console built by Vianova of Denmark. The console directs the panels through a room containing a rotary shot-blast machine, to clean them, then a drying room, a painting room, a drying oven and then a plate shop for cutting, forming and, later, welding.

Very little cutting or burning is done manually.

One burning machine at Sparrows Point is guided by a photoelectric cell that follows a plan laid alongside the machine. But the big emphasis now is on numerically controlled (NC) machines.

"In the past three years we've installed about \$750,000 in NC equipment," says George Constantine, machine shop manager at the Avondale Shipyard, a large com-



All dials and labels on this electronic console for an automatic welding system (background) must be translated from Swedish to English. Bethlehem Steel bought the \$1.5-million system from Hebe of Sweden:

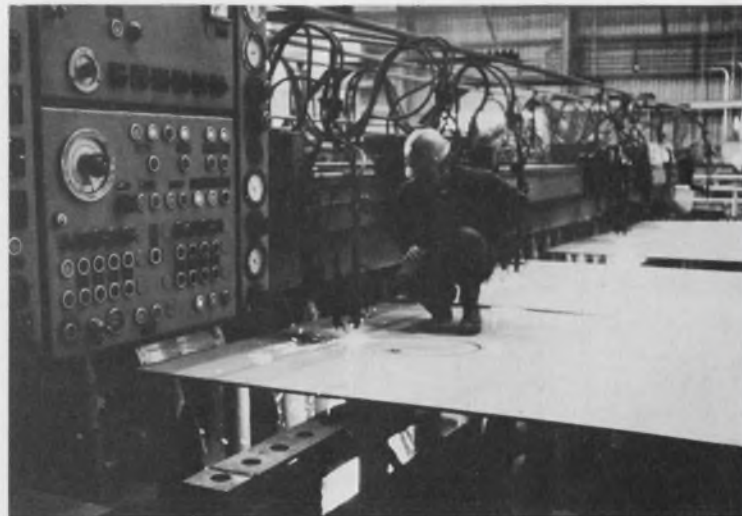

An operator checks a numerical-control burning machine at Avondale Shipyard in New Orleans. Officials say that NC machines have increased efficiency 750%. In the past three years Avondale has spent \$750,000 for NC equipment.

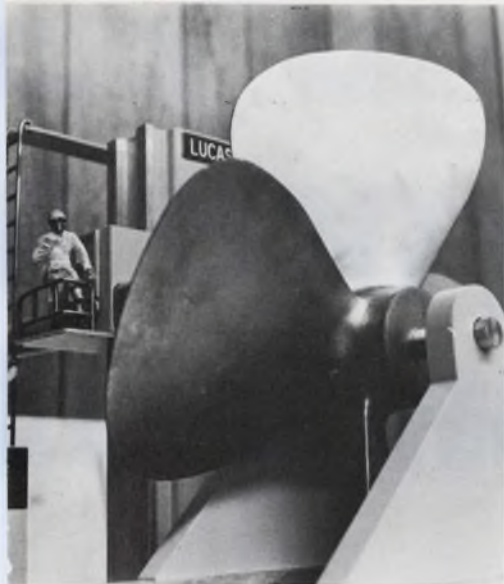

A numerically controlled milling machine, like this model, will take a 150-ton cube of steel and sculpture a ship's propeller. It's being made by Lucas of England.

plex about a mile and a half up the river from the Port of New Orleans. Avondale has just spent \$38-million for modernization. The yard has one NC machine on order now from Joseph Lucas, Ltd., of Birmingham, England that will cost \$500,000. It will be a horizontal boring mill in three axes—34 feet in the X axis, 17 feet and 10 inches in the Y axis and 70 feet in the Z axis. When it is delivered in a year, it will perform full contouring in all three axes and will be driven by a General Electric Mark Century 7500 series computer.

"The machine is going to be terrific," Constantine says. "It will take a 150-ton cube of steel and, by directions from a punched tape, sculpture a propeller."

As for direct numerical control (DNC) for shipbuilders—NC directed by a computer instead of a tape—Avondale's Constantine says:

"I think DNC has got to be in everybody's future, but it's our opinion that any piece of NC equipment must be versatile. We want to be able to operate it manually, semi-manually—that is, with data fed into it manually, by tape and by computer. We don't ever want to be caught short if one system is knocked out."

Litton's Cali is not so optimistic. "DNC wouldn't pay in our

industry," he contends. "It's a great advantage when you are producing a lot of pieces quickly—500 of these parts, 1000 of these—but with big steel panels the tape hardly moves. It's a slow operation. We don't need DNC."

The Hunter's Point Naval Shipyard in the San Francisco Bay area, however, is said to be considering buying a DNC system in the near future. (See "DNC: The new assembly line boss," ED 22, Oct. 25, 1970, p. 38.)

Of the other product opportunities that are wide open in the shipbuilding industry, automated material-handling, is urged by C. W. Bowman, a sales manager of General Electric's Marine and Defense Facility Sales Operation in Schenectady, N. Y.

"They could use equipment that automatically goes to a tier and row in a warehouse and pulls out an article," he says.

Litton's Milakovich sees a real role for industrial robots.

One product that would find ready acceptance, says Litton's Cali, is "a device that would enable us to see inside a pipe and tell us how clean it is.

"We need this badly for pipes from eight inches in diameter down to half-inch pipes," he reports. "We spend a lot of money purging our systems because of dust and paint that gets into pipes."

Avondale's Constantine says that his company's linear measurement rod is good to 100,000th of an inch but that ultimately lasers might be used. Several companies speak of the possibility of using lasers instead of theodolites for aligning equipment on a ship.

Laser welders are not considered practical at this time, "although with newer or more exotic materials, we might need the higher quality welding that lasers could provide," Brayton says.

Testing by sound

Radiography is still used widely for testing materials, but ultrasonics is moving in as the main nondestructive testing device in many yards.

"We are going to use ultrasonics exclusively on our big

Navy contracts," says Litton's director of quality assurance, Phil Scordino. "Ultrasonics gives us the flexibility to work during the day hours and with people on the job; you can't do that with radiography.

"Ultrasonics also gives us greater definition. You note more defects than you do with radiography—which gives you more control. We can pick up defects at any depth or angle.

"We like small units that can be carried out on the job. We also want a recorder that gives a digital interpretation, which would preclude any subjective opinion the operator might inject."

An ultrasonic flaw detector that does come with a recorder has been built by Krautkramer Ultrasonic, Inc., of Stratford, Conn. When the recorder is attached to the top of the detector, a three-inch CRT display and a chart recording can be observed at the same time.

Needed: aids to welding

"We'd like to be able to evaluate the soundness of a welded joint by looking at it on a screen," Scordino says. "We're trying now to develop ways to do this applying the principle of closed circuit television.

"An aid we do have now that we like is an infrared device that we can simply point at a casting being welded and read the temperature."

Infrared is also useful in detecting porosity or slag because these do not absorb as much heat as a good weld does.

The Picker Corp. in Cleveland makes X-ray tubes for nondestructive testing in shipyards and sells a TechOps radiation camera, built by Technical Operations, Inc., of Burlington, Mass. The cameras use iridium or cobalt isotope sources.

Michael Leipner, general manager for Picker's industrial division, believes that by next year the company will be able to build equipment for automatic inspection. A medical tube mount will be converted for X-raying expansion joint hinges and other small fabricated parts in nearly inaccessible places in a shop. ■■

When you've going for your s than silicon gat

...you ought to more than silico

First off, there's the breadth of our shift register line. We've been building hard-working, reliable shift registers since 1967 and, right now, we're into four different types: long dynamic registers, data buffers, long static registers and short static registers.

All very much *systems* oriented. All TTL/DTL bipolar compatible. All available off-the-shelf.

We match the process to the product, whether it's silicon gate, process 100, or whatever. Right now, we have more than 30 second generation devices of all types. Including 11 never before announced.

DYNAMIC SHIFT REGISTERS

MM4001/MM5001	Dual 64 bit
MM4006/MM5006	Dual 100 bit
MM4007/MM5007*	20-100 bit programmable
MM4010/MM5010*	Dual 64 bit accumulator
MM4015/MM5015	Triple 60 + 4 bit accumulator
MM4016/MM5016	500/512 bit
MM4017/MM5017*	Dual 500/512 bit
MM4018/MM5018	Triple 64 bit
MM4100/MM5100	144/156 bit
MM4102/MM5102	Dual 71 bit
MM4105/MM5105	Quad 64 bit buffer memory
MM4106/MM5106	Dual 70 bit

STATIC SHIFT REGISTERS

MM4040/MM5040*	Dual 16 bit
----------------	-------------

got more shift registers

E...

talk about n gate.

MM4050/MM5050	Dual 32 bit
MM4051/MM5051	Dual 32 bit split clock
MM4052/MM5052	Dual 80 bit
MM4053/MM5053	Dual 100 bit
MM4054/MM5054*	Dual 64/72/80 bit (silicon gate, on chip clock)
MM4081/MM5081	10 bit serial to parallel register driver (70V out- put breakdown)

MM4000 series devices - 55°C to +125°C
MM5000 series devices - 25°C to +70°C

Incidentally, our shift register line is backed up by an ever-growing stack of Application Notes and MOS Briefs, yours for the asking.

Finally, no National shift register ad would be complete without listing our line of hybrid and monolithic clock drivers.

CLOCK DRIVERS

NH0007	Single phase, DTL compatible
NH0009	Two phase, DC coupled
NH0012	Single phase, high speed
NH0013	Two phase, AC coupled
NH0025	Two phase, low cost
NH0026	Two phase, fast rise time

As we're prone to say at the end of our ads, if you'd like more information, just write, phone, TWX or cable us today. National Semiconductor Corporation, 2900 Semiconductor Drive, Santa Clara, California 95051. Phone (408) 732-5000. TWX (910) 339-9240. Cable: NATSEMICON.

*Available soon.

National.

At the solid-state circuits conference

GE promises 'exciting' displays with LED fabrication process

A new process for fabricating display panels with light-emitting diodes has been developed that reduces drastically the number of interconnections on the display surface and minimizes the number of external wires.

The development "promises to have exciting and far-reaching effects on display panels for computers, data-handling terminals and, eventually, even information-retrieval units for the home," according to the General Electric Research and Development Center in Schenectady, N. Y., where the panel was developed.

As with conventional LED panels, the diodes are clustered and activated in various combinations. They can be lighted to form the 64 standard computer characters: numerals, letters and symbols, GE says.

To form a character, 35 of the diodes are combined in a rectangular array, five rows across by seven rows down. The resulting character is an eighth of an inch high—nearly twice the size of newspaper print. When individual diodes are activated, their light spreads out slightly so that the numeral or letter appears solid.

Interconnections reduced

Each 35-element array is built with only six interconnections, as opposed to a conventional LED display's 70, and 12 external wires instead of the usual 36.

The reduction in external leads was accomplished by using matrix (row and column) addressing. The number of interconnections on the display panels and the chip alloying and lead-bonding operations were reduced by using a monolithic approach.

The devices are fabricated by

placing 2000 diodes on a single flat wafer of gallium phosphide.

"This is the first time," Barnett says, "that any complex gallium phosphide device, with electrically isolated regions of both p and n conductivity types on the same substrate, has been made with planar geometry."

The development of a monolithic matrix-addressable array of light-emitting devices was never accomplished before because there was no n-type diffusant available. The solution was found by using a liquid-phase epitaxial growth of the gallium-phosphide, which provided a viable alternative to the n-type diffusions.

"Essentially," Barnett explains, "we etch grooves into the wafer and then grow in gallium phosphide containing an n-type dopant." The wafer is then cut into 35-element arrays and strung out to form



An array of 35 GE light-emitting diodes, enlarged 60 times. Developers of new fabrication for the array are (clockwise) Frederick K. Heumann, Allen M. Barnett and Simeon V. Galginaitis.

a display panel."

The prototype arrays that GE has built emit red light, although green-emitting diodes can be made by changing the dopant—the pre-arranged combination of impurities added to the material.

The array operates on a time-shared basis, with each emitter being activated in a pulsed mode. The prototype matrix operates on 2 to 3 V and has an average brightness of 50 foot-lamberts at an average current of 1 milliamp when operated at 120 Hz.

Larger displays promised

Looking beyond the 64-character array, GE says that a panel capable of displaying 200 characters simultaneously, made up of 7000 diodes, can be fabricated. It would require 1200 interconnections on the display surface, Barnett says. Future variations of the same technique, GE says, will reduce the interconnections to 200, compared with the 14,000 interconnections (7000 die bonds plus 7000 wire bonds) required in a panel fabricated by the best competitive process presently in use.

"Such panels will find applications in portable two-way communications gear, automobile and aircraft consoles, computers and data-handling terminals," says GE's vice president for research and development, Arthur M. Bueche.

"Ultimately," he adds, "a low-cost home display unit the size of a book could function as an electronic information service, providing instant stock market reports, weather forecasts, news bulletins and even store prices. Such a unit might even be connected to a central computerized library, giving access to millions of different volumes." ■■

Belden the Special "Specials" specialist

Here's what to do when cable catalog specs just won't do the job: Dial Area Code 317 ■
Then dial 966-6681 ■ You'll get action ■ From a man who devotes full time to solving
engineered cable problems ■ A Belden specialist that "lives"
with your design parameters from engineering through the
actual production run ■ Cables for underwater-under-
ground devices . . . extra-high voltage and pulse ap-
plications . . . medical instrumentation . . . low-level
signal interference problems . . . unusual environ-
mental conditions . . . he's tackled them all ■
Phone now. 8-5-0

DIAL (317) 966-6681

BELDEN



... new ideas for moving electrical energy

At the Solid-State Circuits Conference

Europe outpacing U.S. in use of ICs in consumer products

Unlike the market in the U. S., approximately 20% of all integrated circuits sold in Europe this year will be linear ICs for consumer applications, Dr. G. Lorenz, director of Valvo, GmbH, Hamburg, Germany, told the Solid-State Circuits Conference.

In an invited paper at the Philadelphia meeting, the German executive said IC technology was improving the reliability and performance of European TV and radio sets. And costs are "coming down rapidly," he reported—"the competition is very hot."

"More than 50% of all TV and radio manufacturers in Europe are already using linear ICs in production quantities," Lorenz told the conferees. "In Germany, the number is closer to 100%."

By contrast, only 2% of the total IC market in the U. S. this year will be linear devices for consumer use, according to Sirio A. Sconzo, manager of consumer circuits marketing for Texas Instruments, Inc., Dallas. Sconzo made

his comments in an interview after the Solid-State Circuits Conference had closed. He told ELECTRONIC DESIGN:

"The IC consumer electronic market in Europe is much larger because of their lower military and defense spending."

In addition, he noted, European manufacturers started using ICs earlier than the U. S. for the home entertainment market. Color TV became available later in Europe, and the set makers were able to go directly with ICs. European TV sets will average almost twice as many ICs per set than U. S. sets this year, Sconzo said.

Before any manufacturer will switch to ICs there must be clear technical and commercial advantages. Generally the use of an IC must result in an over-all cost reduction, compared with the price of discrete components that it replaces. But there are two other commercial reasons that are peculiar to Europe, Lorenz told the conference.

The first is a labor shortage. "This problem is especially true in Germany, where there are now 2 million foreign workers," the German executive said. "These workers can be hired only on long-term contracts. This limits the flexibility of the manufacturers to changes in the market."

The other reason for IC popularity in Europe, Lorenz continued, is that the consumer there is very quality-minded. "He wants minimum service costs, and he's willing to pay a little more," the German said.

Products that can guarantee longer life as well as easier service have been introduced, even at higher prices, he noted, and in cases like these the manufacturer will consider using ICs.

As an example of this improved performance, Lorenz mentioned a voltage regulation problem in varicap-tuned TV receivers. Varicap tuners are used almost exclusively in Germany today. A relatively simple circuit using a zener diode and resistors could be used, but temperature stability would be a problem. With IC technology, the TAA-550 voltage regulator was developed. It has a very low dynamic resistance. Frequency stability within the tuner is maintained to smaller than 100 kHz.

One of the biggest problems with IC acceptance by the circuit designer is the need for flexibility along with complexity. According to Lorenz, the real breakthrough will occur only if there is an optimum compromise between complexity and flexibility for the customer. A set of seven ICs for the video portion of a color TV set that will provide the designer with this flexibility is available in Europe and is already in use, he said. ■■

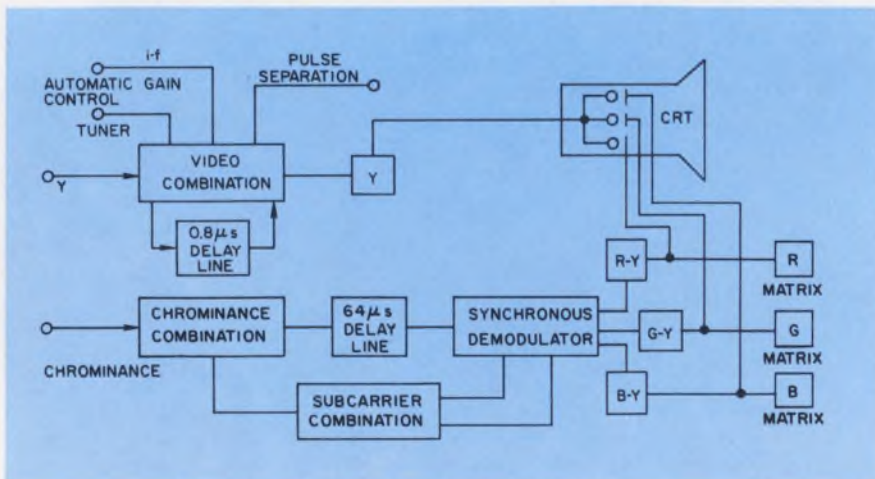

Seven ICs give the designer flexibility to use the color-difference method (shown) or red-green-blue for color TV output circuits.

Our ruggedized 316 minicomputer has a certified thick skin.

An independent testing lab certified that our 316 meets MIL Specs for shock, vibration, EMI, inclination, altitude, temperature, and humidity.

And because it meets MIL Specs, it works wherever you work. It works in airborne applications. (It weighs less than 90 pounds.) It works near seismic explosions. It can ride out storms at sea and the 24-hour punishment of an oil rig. And it can easily handle the vibrations of a production line.

Our ruggedized 316 minicomputer is compatible with all our ruggedized Series 16 computers. And, it's the lowest priced ruggedized minicomputer that's certified to meet MIL Specs.

Which proves that the beauty of our 316 computer isn't just skin deep.

Write: Honeywell
Information Systems (MS 061),
200 Smith Street, Waltham,
Massachusetts 02154.



Sculpture by Jack N. Rindner

The Other Computer Company:
Honeywell

At the solid-state circuits conference

10-trillion-bit memory promised, but not many experts believe it

In what was probably the most controversial session of the Solid-State Circuits Conference, Dr. Frank Marchuk, president of Computer-General, Inc., Anaheim, Calif., said his small company was going to deliver within 60 days a computer with a 10-trillion-bit (10^{13}) memory and operating speeds approaching the speed of light.

Marchuk found nobody on the panel who believed such a development was possible at this time. Besides Marchuk, the panel members were L. K. Anderson of Bell Telephone Laboratories, Murray Hill, N. J.; A. Kozma, Radiation, Inc., Ann Arbor, Mich.; W. J. Poppelbaum, University of Illinois, Urbana; J. Rajchman, RCA Laboratories, Princeton, N. J.; and J. L. Reynolds, IBM, Poughkeepsie, N. Y.

Marchuk would not describe the details of the system, other than to say that it consisted of a multi-laser array whose outputs were directed into beam-splitters to form 100 beams. These, he said, are directed at hologram memory plates, which form an array 66 by 120

inches. Each bit, he said, is contained in an area equal to 0.63 microns. Access times for 10 or 100 bits, "depending on the bits needed at the input-outputs" are 40 ns for a full read/write cycle, he reported.

One panel member said that if Marchuk's computer was "for real," "I might as well retire now because I would be working on these problems for the next 10 years."

Another said that Marchuk's computer was "like manufacturing a car that could run for a year on a flashlight battery."

But some of the conference—mostly in government and banking—took Marchuk's claims seriously. A member of the National Security Agency appeared at the panel session and asked for further background and details. And after the conference, Marchuk met in Washington with officials of NASA.

Two problems with such a large memory system using holographic techniques are said to be:

- Registration must be near-perfect with such optical systems.
- Deflection schemes must oper-

ate at heretofore unachievable speed with great accuracy.

Marchuk said that "one Computer General 100 computer would replace 50 IBM-360 machines." (He did not specify which model of IBM's line). He also pointed out that Nippon Telephone and Telegraph was working on a system "very similar" to that being developed by his company.

Japanese in the running

In a recent news article the Nippon Telephone and Telegraph system was described as a holographic memory with bit density 100,000 times greater than that of existing magnetic drums and tapes. The readout speed was reported to be 1000 times faster than that of conventional memories.

When systems like these are marketed, Marchuk said, computer software costs will be reduced 40 to 60% over those for present systems and "will be capable of operating with such internal flexibility that the language of software, as we know it today, will be drastically altered." ■■

And, now, subnanosecond MOS circuitry

The tradeoffs between MOS and bipolar technology got a little closer with RCA's development of subnanosecond switching speeds for complimentary MOS inverters. The silicon was grown on a sapphire substrate.

A paper presented at the Solid-State Circuits Conference by Edward J. Boleky of RCA's David Sarnoff Research Center in Princeton, N. J., attributed the high speed obtained with the inverter to the fabrication of short channel-length CMOS silicon-on-sapphire (SOS) transistors. Boleky said

that by using polycrystalline silicon gate electrodes in the CMOS transistors rather than aluminum gates, RCA was able to reduce the channel spacing between the source and the drain regions to 5 microns.

A 25-stage ring oscillator was used to evaluate the switching performance of the 5-micron-channel, CMOS/SOS silicon-gate inverters. With a 15-V supply voltage, a stage delay of 0.55 ns was measured. With a 5-V supply, the delay was 1.8 ns.

Using the switching data obtained from the ring oscillator,

Boleky predicted that the worst-case stage delay of a three-input, three-output CMOS/SOS NAND gate would be 2.8 ns. The RCA devices are fabricated in 1-micron-thick films of n and p-type single crystal silicon, grown on a sapphire substrate.

Because of the excellent insulating properties of sapphire, the thinness of the silicon and the etching away of all silicon not needed in the circuit, almost all junction capacitances found in conventional MOS ICs are eliminated, according to Boleky. ■■

Current News

ACOPIAN 5-VOLT POWER SUPPLIES NOW AVAILABLE FROM 50 ma TO 32 AMPS!

Shipment in just three days

Wide choice of case sizes and mountings



3-DAY SHIPMENT RECORD REMAINS UNBROKEN

Redundancy—says Acopian—is good good

5-Volt 20 Amp Power Supply Fits Standard Mounting Racks

How Special Are Acopian Customers

Good News For IC System Designers!

If you design IC systems . . . need a high performance 5 volt power supply between 50 milliamps and 32 amps . . . and can't afford to gamble on uncertain delivery . . . this latest Acopian announcement may be the best news you've had in a long, long time. Because now you can get a power supply in the configuration, current rating and operating specifications you need, with built-in Acopian quality and guaranteed shipment in three days.

Choose from among: Encapsulated power supplies—both single and dual—for direct mounting on PC boards. Low profile units for use where space is really limited. Plug-in units in both single and dual outputs. Rugged higher wattage supplies in extruded aluminum cases for powering entire IC systems. Special purpose power supply assemblies for just about anything.

See for yourself what all the excitement is about. Send for your own

free copy of **Current News** today. Write or call Acopian Corp., Easton, Pa. 18042. Telephone: (215) 258-5441. And remember, Acopian offers 92,000 other power supplies, each shipped with this tag . . .



ME-2



SCANBE'S NEW DUAL INLINE SOCKETS

- ◆ Accepts flat or round leads
- ◆ Tapered entry channels
- ◆ 3 level wire wrap

At first glance, Scanbe's new ME-2 Dual Inline Sockets may appear to be like all others. Appearances can be deceiving. Our new ME-2 includes many exclusive features and offers Scanbe's quality, precision and performance. When it comes to customer benefits, Scanbe's ME-2 socket is a leader not a follower.

Also, custom P.C. board designs using ME-2 sockets to fit your application, software programs and wire wrap services can complete your hardware system from one source...Scanbe. Write or call for catalogs, price and delivery.

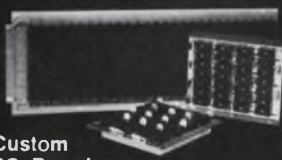

Custom
PC Board



MANUFACTURING CORP.
A CANOGA COMPANY
3445 Fletcher Avenue
El Monte, California 91731
Phone: (213) 579-2300

INFORMATION RETRIEVAL NUMBER 26

technology abroad

A novel form of heat sink for dual, in-line ICs has been developed by engineers at Texas Instruments, Ltd., Bedford, England. The sink, capable of dissipating 3 W, consists of a radial array of aluminum vanes that clip onto the IC body, giving it the appearance of a porcupine. The sink is crimped onto the lead-frame extension. A special copper-coated Kovar lead frame was developed to improve the heat transfer from the clip to the vanes.

A new, flat-screen, alphanumeric liquid-crystal display has recently been demonstrated by scientists at Siemens Research Laboratories in Munich, Germany. The display, similar to those developed in the United States, is a thin-film of liquid-crystal material sandwiched between two glass plates. The letters and numerals are deposited as transparent conductive films on the inner surface of each plate. When a voltage is applied between the conductive patterns, the display becomes visible as a changed color that shows up in ambient light, or as an opaque area that is visible by back-lighting. Siemens engineers believe that displays of this kind will ultimately replace TV tubes.

A hybrid microelectronics frequency synthesizer that weighs only 12 ounces and provides a total of 1721 channels is being produced for military manpack sets by A/S/ Akers Electronics Horten, Norway. Operating in the 27-to-70-MHz band the synthesizer consumes but 1.1 W and measures only 1.6 by 2.4 by 3.2 inches.

A complete solid-state camera package, including a lens system, a 50-element light-sensitive integrated circuit array and the necessary driving and readout circuits has been developed by Integrated Photomatrix of Dorchester, Dorset, England. Intended for applications such as width monitor-

ing or optical character recognition, the heart of the package is a 50-element, light-sensitive, MOS array. When the array is exposed to light, a charge builds up on each element that is proportional to the light striking it. On command from a clock signal, each charge is transferred into a shift register and read out serially.

A lifting magnet that releases its load when power is applied has been developed by scientists at the Wallsend Research Station of the British Ship Research Association. This feature has made it possible to design large lifting magnets without having to include a stand-by battery system in case of local power failure. The new prototype design uses a large ferrite permanent magnet with a lifting power of one ton. To pick up or release a load, the magnetic force of the ferrite magnet is neutralized, by application of an opposing field generated in a surrounding coil. A current of 1.2 A at 200 V reportedly gives such complete neutralization that the magnet will drop a paper clip. When the power is turned off, the permanent magnet locks onto the material being lifted.

Microwave control of 9000 miles of urban and suburban gas lines is serving more than a million customers in southeast England. A Pye Telecommunications microwave system monitors gas temperatures and pressures at 100 unattended stations and also commands changes in gas distribution when necessary. The microwave equipment operates at 7 GHz, carrying up to 240 data channels, and also at 1.5 GHz, providing up to 24 channels. The network is designed for unattended operation with automatic channel switching in case of failures within the system. The master control complex, situated at Potters Bar, Hertfordshire, uses two Honeywell computers, along with peripheral equipment by Plessey.

INFORMATION RETRIEVAL NUMBER 27 ►

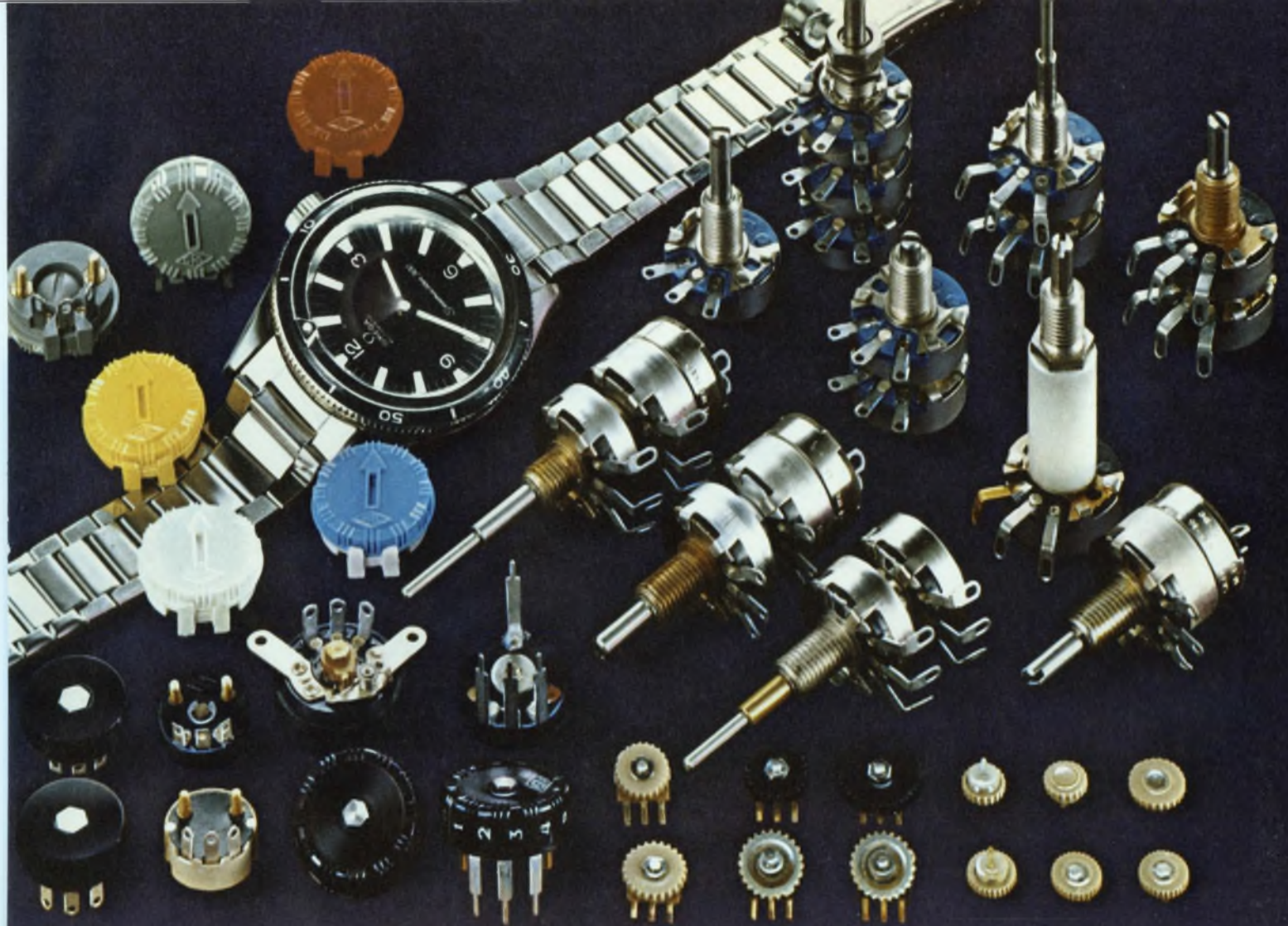

a little something special for everybody

Centralab designs miniature potentiometers to meet unique and exacting applications

Throughout our more than 20 years of experience in the development of miniature industrial potentiometers, we've found that many special purpose designs soon establish an array of standard applications. Today, Centralab pots are relied upon for test and measurement instrumentation, communications, medical equipment and other exacting applications.

Many of your present requirements might be satisfied by our

standard models which meet the following design parameters:

Wattage ratings: 1/10 to 2 watts

Temperature range: -55°C to 120°C

Resistance range: 4 ohms to 10 megohms

Size: 5/32" to 5/8" diameter

Carbon composition resistance. Bushing mounted units also available with wirewound resistance.

Some models provide switching capability.

Our miniature potentiometers represent just a small share of our entire capability, which includes custom designs for a wide variety of unique applications.

Simply tell us what you need. We'll customize a potentiometer to your mechanical and electrical specifications with your economics in mind. For additional information, write: Centralab Electronics Division.

CENTRALAB PRODUCTS ARE MARKETING THROUGH CENTRALAB INDUSTRIAL DISTRIBUTORS AND INTERNATIONALLY THROUGH GLOBE-UNION INC. - INTERNATIONAL DIVISION.



CENTRALAB

Electronics Division
GLOBE-UNION INC.

5757 NORTH GREEN BAY AVENUE
MILWAUKEE, WISCONSIN 53201

Siemens



No one knows ferrites like a ferrite user. We produce and use more quality ferrites than anyone.

Siemens, a world leader in the design and manufacture of sophisticated telecommunications and computer systems, has also become the world's leading producer of linear, memory and microwave ferrites. Ferrites that are performance and reliability engineered to meet our demanding

system requirements.

Siemens pioneered T38 with permeabilities of 10,000, T9 and T10 high-density ferrites for recording heads, SM6 and M6 filter inductors for high packing densities, 12 mil extended temperature cores, plated wire memories and CVB7 microwave material.

Siemens design engineers are ready to assist you in solving your ferrite problems.

Siemens Corporation, 186 Wood Avenue South, Iselin, N.J., 08830. (201) 494-1000. Siemens. A three billion dollar name in quality products. **SIEMENS**

washington report

DON BYRNE, WASHINGTON BUREAU

AFL-CIO to seek import ban

The AFL-CIO will meet here late next month in a renewed effort to limit imports of TV and radio sets and other electronic products made overseas by foreign subsidiaries of U. S. manufacturers. At a recent executive council meeting, union economists said that almost 400,000 jobs had been lost in four years in the United States because of competition from imports. The April meeting is expected to come up with a demand that Congress limit the flow of U. S. capital overseas and repeal tax credits and subsidies for American companies that manufacture abroad.

Air Force will test portable weather station

The Air Force has awarded a \$1.4-million contract for the prototype of an electronic package designed to give even the smallest, crudest tactical airstrip its own weather station. The prototype, to be built by SDM Corp. of Woburn, Mass., is described as of modular construction, "in which different combinations of modules can be formed to provide tailored weather support to a variety of tactical elements." The equipment has a forecasting module, weather-communication module, radio-communication module and an easily shaped shelter unit that can be adapted to whatever size needed. If tests, expected to be completed next spring, are successful, 30 of the units will be ordered, with an option for 30 more.

Defense contractors may be under the gun again

A new round of criticism of defense contractors is expected as a result of the latest Selected Acquisition Report prepared by the Pentagon for the Senate Armed Services Committee. The reports, which were ordered by the Senate last year to keep track of overruns in defense contracts, are supposed to be filed quarterly, but the current one was due last Sept. 30. Reportedly Lockheed's S-3A antisubmarine warfare aircraft will show an overrun, while the Navy's Mark 48 torpedo will show a drop in costs of almost a billion dollars, due to a reduction in spares, training torpedoes and over-all procurement numbers. Meanwhile the General Accounting Office is reported to have prepared a critical report on over 140 weapon systems, their overruns and profits to their makers.

U. S. lets contracts for tracked air-cushion service

The Dept. of Transportation has let contracts of \$100,000 each to the LTV Aerospace Corp. in Dallas and Rohr Corp. of Chula Vista, Calif., for the preparation of plans for a tracked air-cushion vehicle that would link Dulles International Airport with Washington, D. C.

The vehicle is to be powered by an electric linear-induction motor. Both the vehicle and the motor have been developed under previous programs

operated by the Federal Railroad Administration. The Dept. of Transportation, which has long been pushing the concept of air-cushion vehicles, sees the 13.5-mile Dulles-Washington line as an achievement that can later be applied to mass-transportation problems around the country. The line is expected to be in operation by May, 1972.

Previous programs have been explored in Kansas City and Los Angeles, but they were dropped for various reasons.

Air-traffic-control system getting bigger and slower, say airlines

The nation's air-traffic-control system will nearly double in scope in the next decade, says a leading engineer of the Air Transport Association, but it will be a less efficient system than it is today. Siegbert B. Poritzky, associate director for systems engineering of the ATA, says that there are currently 27,000 air-traffic controllers and that this figure will increase to 46,000 by the end of this decade. But, he adds, "FAA admits that increasing the number of controllers and decreasing the size of air-traffic-control sectors does not really mean improvement, but in fact creates a less efficient ATC system."

Citing the need for a coordinated R&D program and deployment of equipment derived from the R&D, Poritzky says that "it is a terrible indictment of the Government that not a single major ATC study has been carried through to implementation—and by our count there have been at least nine such studies."

"Coming at the rate of every 2.5 years, the usual pattern has been for implementation work to be started and then be suspended because of the succeeding study," the engineer noted.

Army radar may be used in city riots

The Army hopes to beef up its foliage-penetration radar sufficiently to penetrate brick and cinder-block walls. If successful, the sensor would be used to look for snipers inside buildings during civil disorders. The radar would operate at less than 250 MHz and respond to moving targets only. The foliage-penetration radars being studied were built by the University of Syracuse and Aerospace Research, Inc. The work is under way at the Land Warfare Laboratory, Aberdeen, Md.

Capital Capsules: The White House has eased the economy pressure on the Defense Dept., and defense officials now say they expect to lose only 20,000 employees this year and 10,000 the next. Original job cutback estimates last year totaled about 30,000, and then the figure soared to 100,000. **Rising unemployment all over the country was reported as the reason for the White House backoff. . . .** A suburban Maryland bank has teamed up with NASA to provide "space derived information" to customers. The bank will submit patron requests for technical research information to NASA's Regional Dissemination Centers. After selecting the information from among 700,000 research abstracts and related files, NASA will advise the bank patron on what is available and how much it will cost to procure it. . . . The Defense Dept. has reportedly allocated \$60-million to \$70-million to improve and expand the **Caeser Underwater Listening System**—the sensor array built along the Atlantic and Pacific approaches to detect Russian submarines. **Recent Russian naval incursions into the Carriibbean have shown that the sensor fence has a hole in it, and the Navy will attempt to close this.** Work will take place along the Gulf Coast.

SAVE // GAIN

\$\$\$ // performance

over any other 50-MHz, plug-in oscilloscope.

50-MHz oscilloscope with:

5-mV dual-trace amplifier and delaying sweep	\$2200
5-mV dual-trace amplifier and single time base	1900
5-mV single-trace amplifier and single time base	1650

AND LOOK AT THESE BONUSES:

- 3 plug-in compartments and mainframe mode switching
- 6-1/2-inch CRT — 50% larger than 8 x 10 cm CRT's
- time bases have 5 ns/div sweep rate
- amplifiers and time bases accurate within 2%
- high writing-rate CRT gives a brighter trace

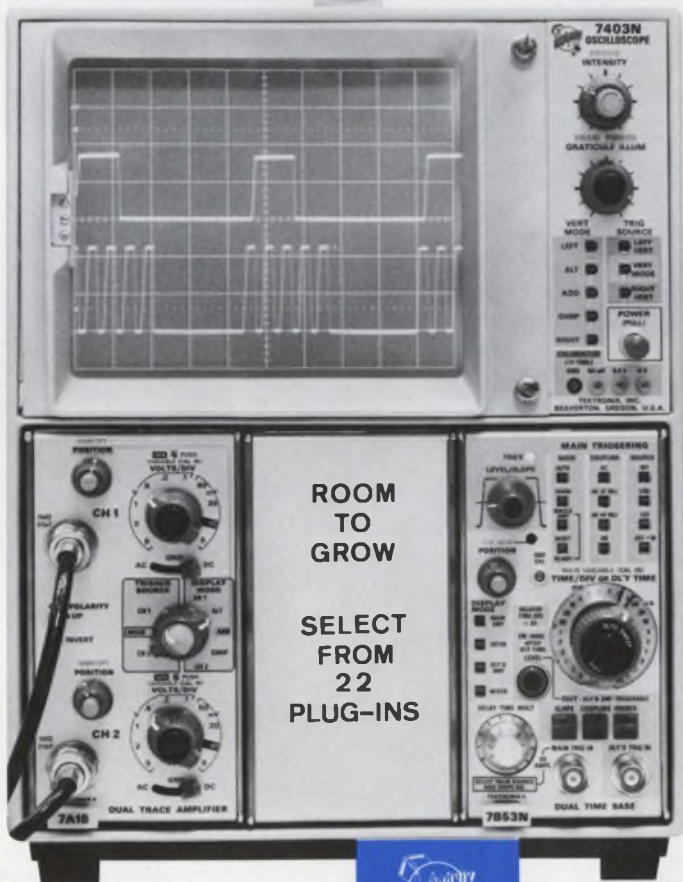

If you wish, select a plug-in for the second vertical compartment to give you 10 μ V/div at 1 MHz or 1 mV/div at 55 MHz or 1 mA/div at 55 MHz or another dual-trace unit for 4-trace capability, etc., etc. Plug-in prices start at a low \$250. Call your nearby Tektronix field engineer today for a demonstration.

7403N Oscilloscope	\$950
7A18 Dual-Trace Amplifier, Option 1	\$500
7A15 Single-Trace Amplifier	\$250
7B53N Dual Time Base	\$750
7B50 Time Base	\$450

U.S. Sales Prices FOB Beaverton, Oregon

Available in U.S. through the Tektronix lease plan.

TEKTRONIX®

committed to technical excellence

See The Tektronix Display at IEEE Booths 3520 - 3527

In MOS/LSI, a speck of dust looks like an epidemic.

If you can keep the dust down to 100 or fewer particles (1/10 of a micron in size) for every million parts of air, you've got a room rated Class 100.

And it takes this kind of dust-free, contamination-free environment to help make a good MOS/LSI product. Because the less dust there is, the more good products you can produce. And that's the name of the game: more good MOS/LSI devices. Fewer rejections. Higher yields. Less cost for the custom MOS/LSI user.

At our new custom MOS/LSI manufacturing facility in San Diego, we have a giant fabrication and assembly area rated Class 100. There's a built-in laminar air flow system that's designed around some simply but strategically placed return air vents. They virtually suck scrubbed clean air down from the force fed ceiling air filters through the bench work areas. So the entire room is dust free — and stays dust free.

This one-of-a-kind contamination control system was expensive, but it helps make our new facility the finest of its kind in the world. And it helps us produce more good products. And remember, in MOS/LSI, that's the name of the game.

Stop by and see it for yourself. Or write for our new facilities brochure. Mr. David A. Beadling, Director of Marketing, Garrett Micro-Circuits Corporation, 16701 West Bernardo Drive, San Diego, California 92127.

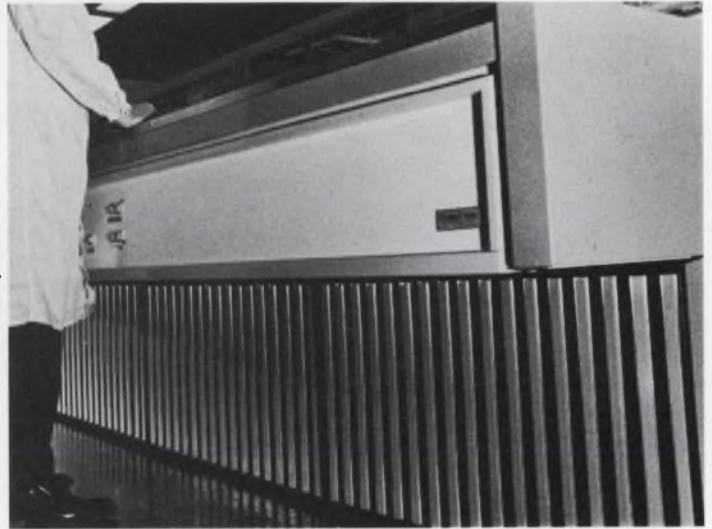

Garrett

MICRO-CIRCUITS CORPORATION

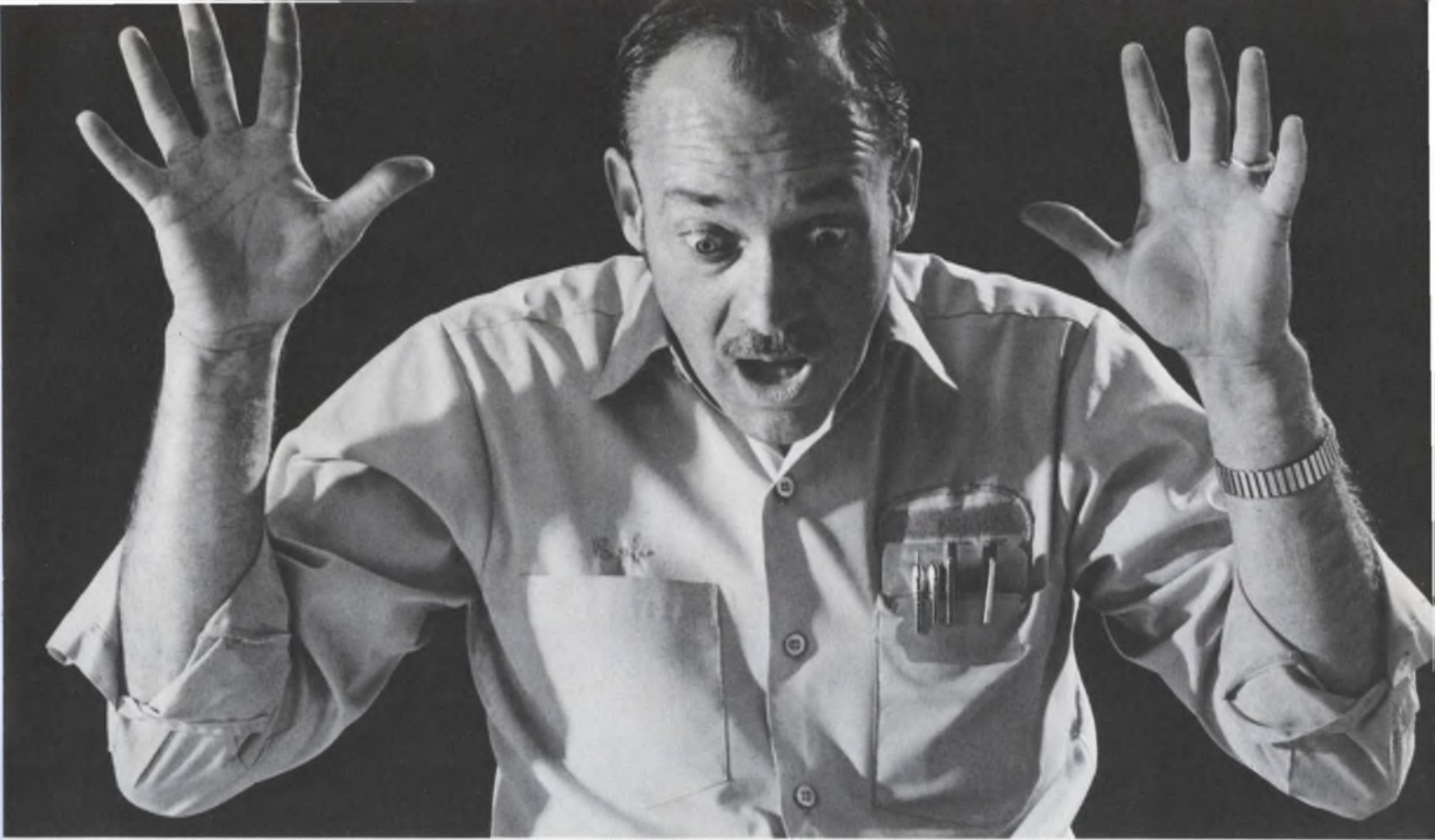

**The following page
carries an important message
from Weston for anyone
who ever dropped
a precision instrument...**

NO
POSTAGE STAMP
NECESSARY
IF MAILED IN THE
UNITED STATES

POSTAGE
WILL BE PAID
BY
ADDRESSEE

BUSINESS REPLY MAIL
First Class Permit No. 392, Newark, N.J.

WESTON INSTRUMENTS
614 Frelinghuysen Ave.
Newark, New Jersey 07114

Next time, make sure it's a Weston "drop-proofed" VOM.

Model 660 General-Purpose VOM. Thirty-five ranges: 250 MV to 5000 VDC @ 20,000 ohms/volt; 2.5-5000 VAC; 2.5-250 VAC "output"; 50 μ a to 10 Amps DC; 0-20,000,000 Ohms; plus five DB ranges. Basic accuracy: 2% DC, 3% AC.

Model 661 High-Accuracy VOM. Same as above, with mirror scale and accuracy to 1% DC, 2% AC.

Model 662 VOM with Full Overload Protection. Incorporates externally resettable overload relay and fuse to protect all circuits except 10 Amp DC against 220 volt overloads.

Now you can have a VOM with all of the features of the most advanced instruments — plus "drop-proofed" protection. Weston 660 series VOMs are warranted in writing to work after accidentally being dropped five feet. Not only does the new Weston VOM utilize the latest high-impact type plastics, it's also the smallest precision multimeter on the market. Yet it costs no more than other instruments. All five models feature a custom taut-band mechanism, self-storing handle, polarity reversal switch, temperature compensation, flush-mounted controls, externally replaceable fuse and diode meter protection. All models are supplied complete with leads and batteries, and measure 7" x 5" x 2 1/4".

Model 663 High-Accuracy VOM with Full Overload Protection. As above, but with mirror scale and accuracy to 1% DC, 2% AC.

Model 666 High Impedance VOM. A "drop-proofed" VOM with 10 megohm input impedance for semiconductor testing. Four push-button selected modes and 37 ranges measure 100 MV to 1000 VDC, 100 MV to 1000 VAC, 1 μ a to 30 ma DC, 1 μ a to 30 ma AC, "normal" and "low-power" resistance in seven steps to 1000 Megohms. Basic accuracy: 2% DCV, 3% ACV, 3% DC Current, 4% AC Current.



It bounces.

- Enter my order for a new Weston drop-proofed VOM. P.O. # _____
- Model 660, \$68.00 Model 661, \$76.50 Model 666, \$132.50
- Model 662, \$101.50 Model 663, \$110.00
- Send complete information on the Weston 660 Series.

NAME _____ TITLE _____
(Please print)

COMPANY _____

ADDRESS _____

CITY _____ STATE _____ ZIP _____

Drop this handy reply card
in the mail today!

WESTON®
WESTON INSTRUMENTS
614 Frelinghuysen Ave., Newark, N.J. 07114

QUALIFIED TO MIL. C-55302.

Government Designation	Burndy Part Number
M55302/1-03	UPC2A17P4
M55302/1-04	UPC2A23P4
M55302/1-05	UPC2A28P4
M55302/2-03	UPC2A17R4
M55302/2-04	UPC2A23R4
M55302/2-05	UPC2A28R4
M55302/4-02	UPC2B17P4
M55302/4-03	UPC2B25P4
M55302/4-04	UPC2B33P4
M55302/4-05	UPC2B41P4
M55302/6-02	UPC2B17R4
M55302/6-03	UPC2B25R4
M55302/6-04	UPC2B33R4
M55302/6-05	UPC2B41R4
M55302/7-01	UPC3B13P4
M55302/7-02	UPC3B25P4
M55302/7-03	UPC3B37P4
M55302/7-04	UPC3B49P4
M55302/7-05	UPC3B61P4
M55302/8-01	UPC3B13R4
M55302/8-02	UPC3B25R4
M55302/8-03	UPC3B37R4
M55302/8-04	UPC3B49R4
M55302/8-05	UPC3B61R4
M55302/19-01	UPC2A41P-4
M55302/20-01	UPC2A41R-4
M55302/21-01	UPC3B92P4
M55302/22-01	UPC3B92R4

The current Mil E-5400L specifies the use of two-piece printed circuit type connectors for airborne military applications. At the same time, recent additions to Mil STD-454, requirement 10, specifically call out the Mil C-55302 connector series. Burndy has them in stock, ready for delivery. Just call your nearest Burndy electronic distributor or Burndy Sales Office.

 **BURNDY**
Norwalk, Connecticut



THE BURNDY UPC.

INTERNATIONAL SALES HEADQUARTERS & MANUFACTURING FACILITIES: CANADA / ENGLAND / BELGIUM / MEXICO / BRAZIL / JAPAN / Sales Offices in Major Cities

70-32

INFORMATION RETRIEVAL NUMBER 31



Norden Encoders perform for you!

Look at these new 1971 additions to Norden's line. More are on the way.

	Total Count	Revolutions for Full Count	Diameter"	Model Number
NEW! Optical Absolute	10,000	50	2.25	OADC-23/4/BCDQ-200L
NEW! Optical Absolute	1,000	1	2.25	OADC-23/3/BCD-1000L
NEW! Optical Incremental: Series now available with shaft seal—permits drenched operation.				
NEW! Contact Size 11	8,192	32 or 64	1.06	ADC-11/13/BNRY-256L
NEW! Contact Size 11 Altitude Reporting Encoder	1,280	16	1.06	ADC-11-ALT-1280
NEW! Contact Size 11	10,000	100	1.06	ADC-11/4/BCDX-100
NEW! Contact Size 11	3,600	36	1.06	ADC-11/4-36/BCDX-100
NEW! Rugged Industrial Grade Optical Incremental Encoders				
All available with quadrature and internal squaring circuit options	4,000	1	3.500	OADC-35/4000/INC
	3,000	1	3.500	OADC-35/3000/INC
	2,500	1	3.500	OADC-35/2500/INC
	2,000	1	3.500	OADC-35/2000/INC
	1,200	1	3.500	OADC-35/1200/INC
	1,000	1	3.500	OADC-35/1000/INC
	600	1	3.500	OADC-35/600/INC
	400	1	3.500	OADC-35/400/INC
	200	1	3.500	OADC-35/200/INC
Optical Incremental Encoders				
All available with index marker, quadrature outputs and internal squaring circuit options. Other counts on special order	500	1	2.250	OADC-23/500/INC
	512	1	2.250	OADC-23/512/INC
	1,000	1	2.250	OADC-23/1000/INC
	1,024	1	2.250	OADC-23/1024/INC
	2,000	1	2.250	OADC-23/2000/INC
	2,048	1	2.250	OADC-23/2048/INC
IC-Compatible Encoders. For direct interface with TTL & DTL circuits				
Binary	128	1	1.750	ADC-ST7-BNRY-E/L
	8,192	64	1.750	ADC-13-BNRY-E/L
	524,288	4,096	1.750	ADC-19-BNRY-E/L
Binary-Decimal Code				
	100	1	2.250	ADC-ST2-BCD/L
	1,000	10	2.250	ADC-3-BCD/L
	10,000	100	2.250	ADC-4-BCD/L
	100,000	1,000	2.250	ADC-5-BCD/L
	1,000,000	10,000	2.250	ADC-6-BCD/L
	360	1	2.250	ADC-3-36BCD-E-360L
	3,600	10	2.250	ADC-4-36BCD-E-360L
	36,000	100	2.250	ADC-5-36BCD-E-360L
	360	1	3.250	ADC-ST3-36-BCD/L
	3,600	36	2.250	ADC-4-36-BCD/L
	36,000	360	2.250	ADC-5-36-BCD/L
	360,000	3,600	2.250	ADC-6-36-BCD/L
External Logic V-Scan Binary Encoders				
	128 or 256	1	1.750	ADC-7/8-BNRY-XB
	8,192 or 16,384	64	1.750	ADC-13/14-BNRY-XB
	524,288 or 1,048,576	4,096	1.750	ADC-19/20-BNRY-XB
Single Turn Gray Code Encoders				
Available with various levels of RFI suppression	256	1	1.066	ADC/11/8/GRAY
	256	1	1.750	ADC-ST8-GRAY
	512	1	2.250	ADC-ST9-GRAY
	1,024	1	3.062	ADC-ST10-GRAY
Multiturn Gray Code Encoders				
Available with various levels of RFI suppression	1,024	4	1.062	ADC-11/10GRAY256
	1,024	16	1.062	ADC-11/10GRAY 64
Low Cost Magnetic Noncontacting Encoders				
Incremental	128	1	1.750	MADC-18/128/INC
Binary	128(V scan)	1	1.750	MADC-18/7/BV
Binary	8,192(V scan)	64	1.750	MADC-18/13/BV
Binary	524,288(V scan)	4,096	1.750	MADC-18/19/BV

For more information and detailed specs, write Norden, Att: Components Dept., Helen Street, Norwalk, Conn. 06856. Phone (203) 838-4471. TWX: 710-468-0788.

Norden DIVISION OF UNITED AIRCRAFT CORPORATION

New third generation op amps.



Exotic, but never neurotic.

No more paying a premium for sticky performance problems. Signetics' new third generation linear offers optimum performance without the usual penalties.

New 537 precision op amp. At last, a "super" op amp that's finally practical. Permits a full range of input signals without blowing up. Standard pinout like 748, 101, etc. Drives 2K load as any op amp should.

New 536 FET input op amp. Very high input impedance — now much easier to apply. Combines high gain and large signal AC performance with extremely low input offset voltage and bias current. Can be provided with 7.5mV offset voltage.

New 533 micro power op amp. The bonus: the 533 fits existing designs (pinouts, voltage swings, compensation). Operates from supplies as low as $\pm 1V$.

Delivery now from your Signetics distributor or salesman. Along with our 528 sense amp and 531 high slew rate op amp. All true third generation linear devices that let you perform — and expand — existing functions without neurotic hang-ups. 

Signetics

Signetics-Linear
811 E. Arques Avenue
Sunnyvale, Calif. 94086

Show me Signetics counts
in linear.

Rush me third generation
information package
on 533, 536, 537, 528 and 531.

Name

Title

Company

Address

City

State

Zip

Telephone

SIGNETICS CORPORATION—A SUBSIDIARY OF CORNING GLASS WORKS

To get
 “hooked” on
 our
 “bellowform”
 connector,
 you’ve
 got to see
 their
 connector.

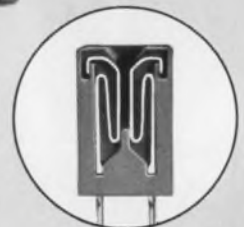

Cross Section Shows How a Continental Contact Hooks on Top of Connector Molding for Permanent Grip.



Nothing holds more firmly than Continental's "Bellowform" contacts... because they hook on top for a permanent grip on the molding. The absolute end to loose connections. Choose from a wide variety of printed circuit connectors with .025" square terminations on .100" or .125" contact spacing; and .045" square terminations with .156" or .200" contact spacing. For connector contacts that can't loosen — because they're "hooked" in — call or write for our free 80-page Printed Circuit Connector Manual.



See EEM and VSMF Directories for Distributor or Sales Representative Nearest You

CONTINENTAL CONNECTORS

Continental Connector Corporation / Woodside, New York 11377 / 212-899-4422

**MORE AIR FLOW
THAN ANY OTHER
AXIAL FLOW FAN
OF THE
SAME SIZE!**

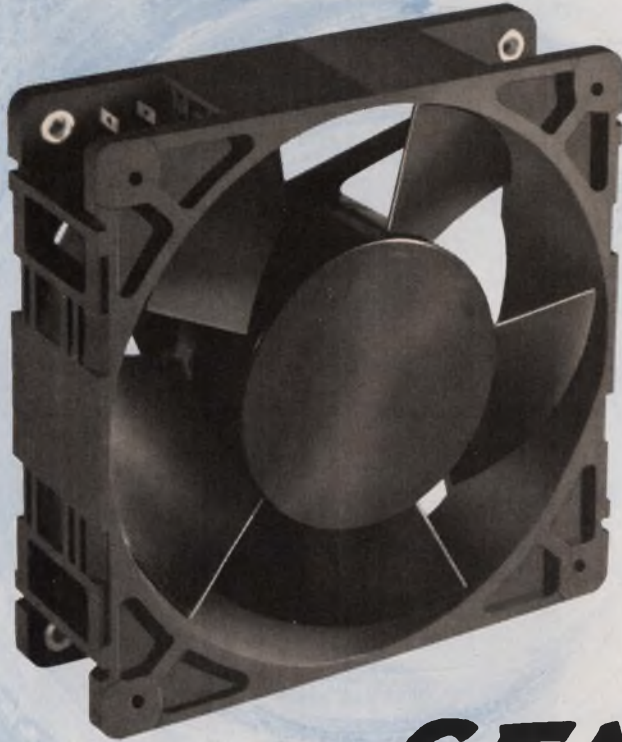

CENTAUR ^(TM)

FEATURES

- A new breakthrough in the science of aerodynamics
- Compact — 4 11/16" square and ONLY 1 1/2" deep
- Lightweight — only 1.2 lbs.
- Quiet — as low as 40 db (SIL) on 60 Hz power
- Economically priced
- U.L. Yellow Card Recognition (File No. E31293)
- Impedance protected

New aerodynamic principles by Rotron permit the Centaur fan to achieve greater aerodynamic efficiencies than ever before from axial flow fans — and with low acoustical disturbance and compact size.

The Centaur with its computer designed five-bladed impeller molded of high impact polycarbonate is precisely matched to a powerful shaded pole motor — available with either oil-impregnated sleeve bearings or precision ball bearings lubricated for life. The recommended operating ambient temperature is -40°C to $+55^{\circ}\text{C}$ with sleeve bearings, and -40°C to $+72^{\circ}\text{C}$ with ball bearings. The motor is mounted to a spider of die cast aluminum which is in turn assembled to a venturi of high temperature resistant black phenolic.

The Centaur will deliver 120 cfm of air, free delivery operating at 115 volts, 60 Hz, or 100 cfm free delivery at 230 volts, 50 Hz making it possible for the design engineer to select a fan to deliver the same cfm on European power sources as Muffin fans or Sentinel fans at 60 Hz power used in the U.S.A.

The Centaur is designed to be physically interchangeable with the Muffin fan or the Sentinel fan.

For complete technical details write today to Rotron Incorporated, Woodstock, N.Y. 12498.

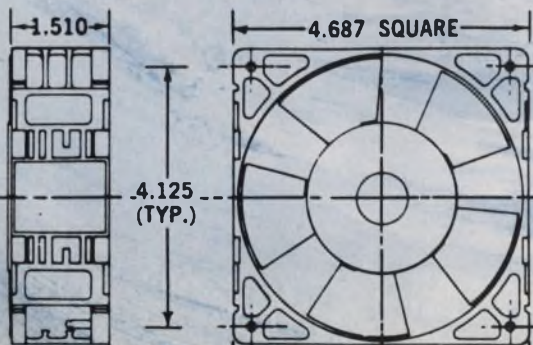
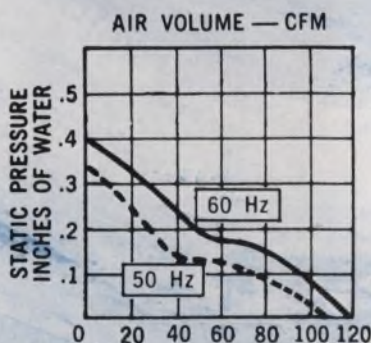

QUICK

One of these dependable,

OPERATING

easy-to-install Simmons fasteners

FASTENERS

may be exactly what you need

FOR

to solve your fastening problem.

ELECTRONICS

Standard Simmons panel fasteners, latches, pressure hinges, hole plugs and other devices have proved themselves in thousands of varied electronics applications. Most are immediately available from stock in various sizes and capacities, and all can be adapted to your special needs. Quickly. Economically.



Write for this 36-page catalog. Complete data on Simmons' quality quick-operating fasteners.

SIMMONS

FASTENER CORPORATION

1746 North Broadway, Albany, New York 12201

MINI-Q-LOCK — quick-operating fastener for miniaturized electronics applications where space and weight limitations are important. ▼

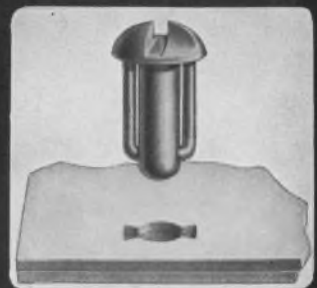

SPRING-LOCK — one-piece blind rivet for removable panels and control covers; self-adjusts to various panel thicknesses. Locks, unlocks with a ¼-turn.

QUICK-LOCK — for removable panels and access doors; locks or opens with a 90° turn. Works with curved sheets or slightly misaligned holes. ▼



HOLE PLUGS (plastic) permit fast, secure, snap-in installation in round, square or unusual-shaped holes. Not affected by climate or temperature.

LINK-LOCK — ideal for latching where heavy locking pressure is required. High impact resistance. Available in medium and heavy duty. ▼

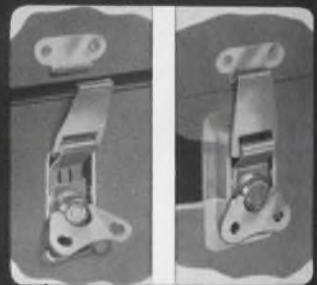

RECESSED LINK-LOCK — minimum protrusion, pressure-tight seal. Can be bonded with adhesive or riveted to any sheet, sandwich material or plywood.

HINGE-LOCK — rugged pressure hinge provides strong seal on hinge line of gasketed cases. (Matched hardware with Link-Lock fasteners.) ▼



HOOK-LOCK — springless, positive-locking latch lies flat on mounting surface; high closing pressure and load-carrying capacity. Impact and shock-proof.

THE ONLY ENVIRONMENTALLY SEALED SWITCH WITH A ONE-PIECE SEAL.

Check it out.
Cutler-Hammer's new MIL-S-3950 switch line offers more designed-in reliability:

- A patented sealing process produces an exclusive-design seal of molded silicone rubber.
- Completely environmentally sealed. Tight enough to pass a mass spectrometer leak test.
- Improved dielectric capability because the one-piece seal is bonded to the lever, bushing, and the inside of the aluminum frame.
- Terminals that are molded into base without use of elastomers.
- No "O" rings to distort or age, and leak.
- A self-extinguishing Melamine base for increased arc resistance under contaminated conditions.
- Back-wired terminals with molded-in identification.
- A positive detent feel.
- A truly reliable momentary return action.
- Complete line including standard bat levers and lever-lock toggles in one, two, and four poles. Standard and special circuits.

- 25 MS configurations in stock for immediate delivery.
- Priced to meet many demanding commercial applications, too.

Cutler-Hammer's new MIL-S-3950 switches are a fitting companion line for our MIL-S-8834 positive-action switch line. For complete data and fast, helpful service, contact the Cutler-Hammer Sales Office or Stocking Distributor near you.

CUTLER-HAMMER
SPECIALTY PRODUCTS DIVISION Milwaukee, Wis. 53201



INFORMATION RETRIEVAL NUMBER 37

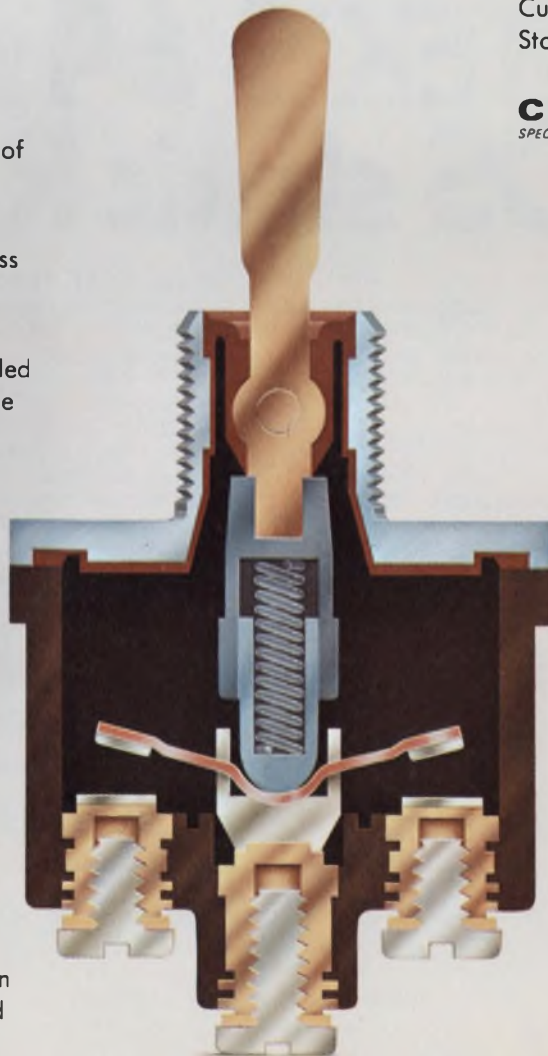

Switch
to No. 1

More than just switches;
prompt availability,
field help, innovation,
quality assurance, too.

The perfect part to fit
your buffer memory needs
...fully stocked on distributors' shelves!

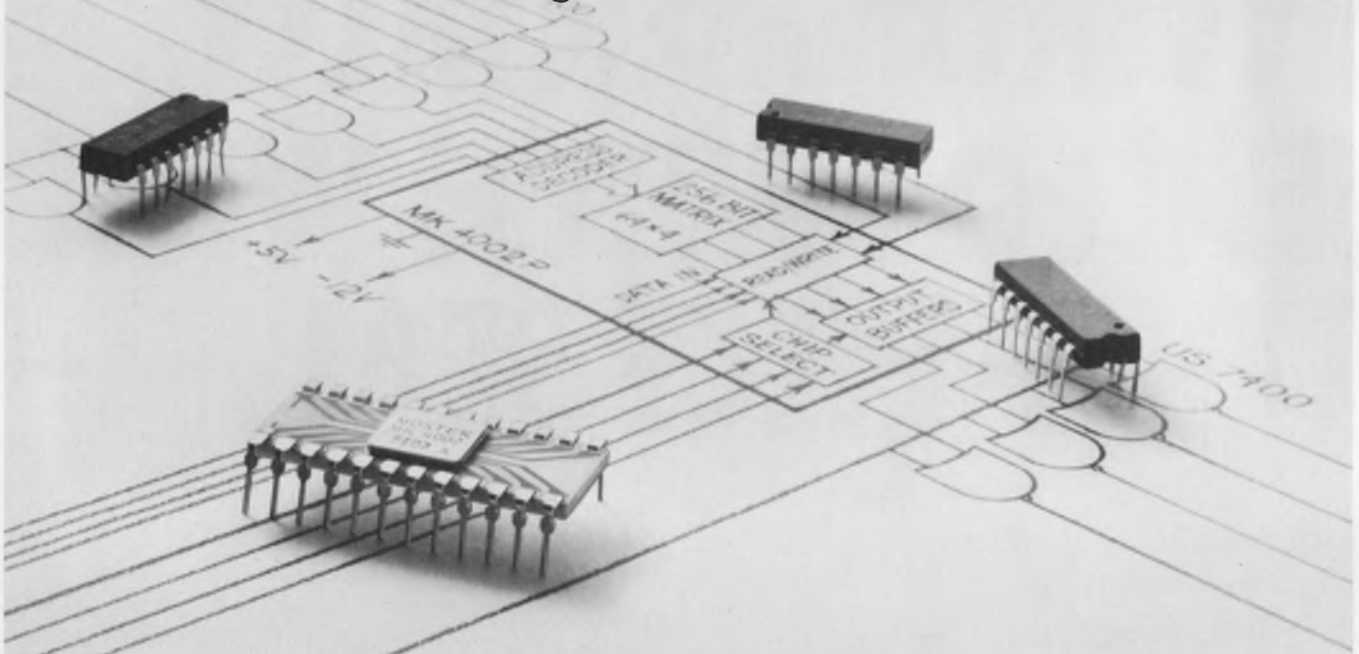

MOSTEK'S 64x4-bit MOS static RAM

Don't buy more bits than you need for those small buffer memory applications. MOSTEK's MK 4002 P 256-bit static RAM is organized as 64,4-bit words. Perfect for such requirements as data acquisition; key-to-tape and tape-to-printer buffers; in short, any application where you need temporary storage of data.

Don't get the idea that the 4002 is any slouch in performance, though. Access time is less than one microsecond . . . even up to +75°C. Memory operation is static so no refresh clocks are required. And power dissipation is low, typically less than 200mW.

Plus, MOSTEK's exclusive low-threshold ion-implantation process gives you full TTL/DTL compatibility . . . no need for external components or interface circuitry. We even put pull-up resistors on the chip for driving from TTL gates . . . and all four out-

puts have a TTL fan-out of 1. If your system requirements grow, additional packages are easily wire-OR'd thanks to the four chip-select inputs.

Got the message? MOSTEK makes it easy for you to use MOS. Call today for information and fast delivery of all the MOS components you need to Gordon Hoffman at our home office (214) 242-1494, or contact your nearest Sprague Electric Company office or representative.



An affiliate of Sprague Electric Company
1400 Upfield Drive
Carrollton, Texas 75006

BOURNS MAKES WIREWOUND, CERMET AND CARBON POTENTIOMETERS!

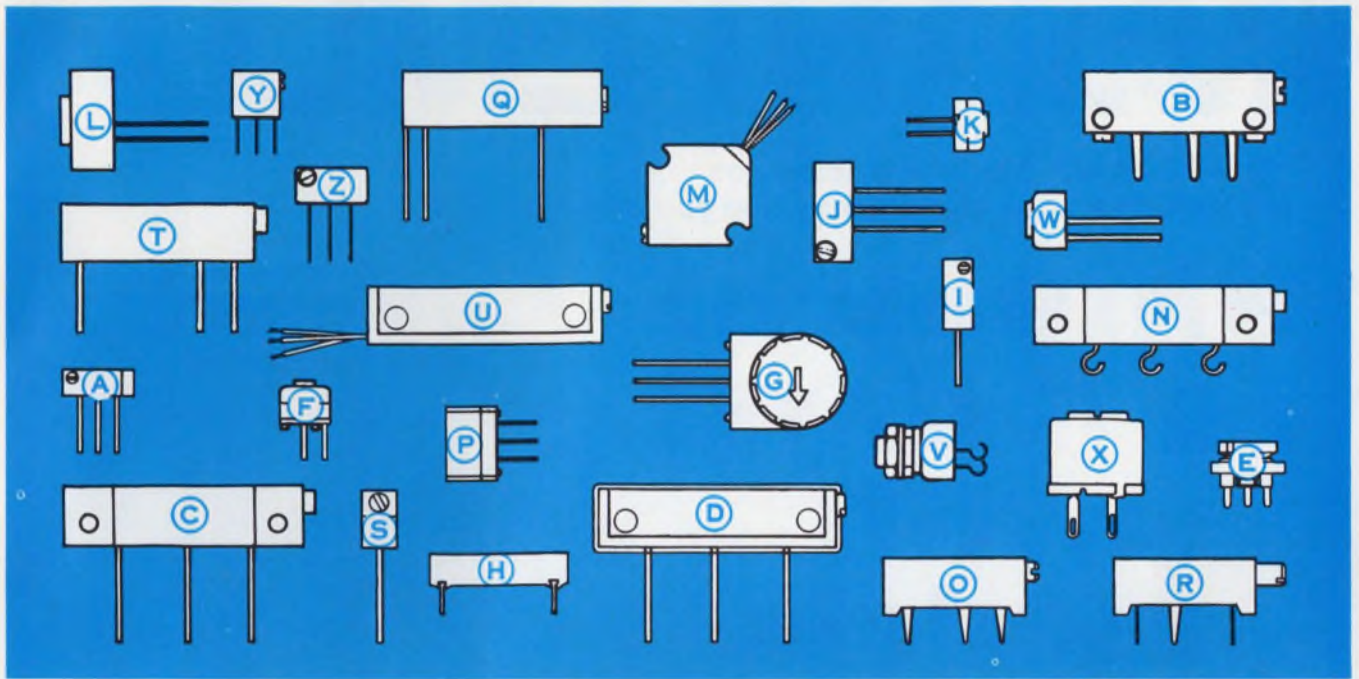

BE A WINNER... FIND THE WIREWOUNDS

Give up? We'll give you a few hints. In selecting potentiometers it's the performance that counts. When you need *high power, stability, low tempco* and *price*, wirewounds may be your best bet. Six best bets are described below and illustrated above — among a wide assortment of Bourns po-

tentiometers. We challenge you to match the six correct potentiometers to the six descriptions. To the first 250 who submit winning entries we will send a deck of Bourns first quality playing cards. All entries will receive a packet of information on wirewounds and the correct answer. Try your skill.

The key to winning is matching identification letters with descriptions below. If you're handy with words, the six correct letters should make you win.

MODEL 3260

Very tiny 1/4" square; 0.2 watt at 70°C; high temp. to 175°C; qualified as RT26.

MODEL 3005

E-Z-TRIM® 3/4" rectangle for small places; 1 watt at 40°C; temp. to 125°C; sealed; very inexpensive.

MODEL 260

We'll give you a lead; 1 1/4" rectangle; metal cover, 1 watt at 70°C; high temp. to 175°C; self-locking adjustment for stable setting.

MODEL 3300

A 5/16" dia. single turn; 1/2 watt at 70°C; high temp. to 175°C; excellent shock and vibration stability.

MODEL 3290

Thin 3/8" square; 1 watt at 70°C; high temp. to 175°C; qualified as RT24. Edge mounting version is very popular.

MODEL 3057

1 1/4" rectangle; 1 watt at 70°C; high temp. to 150°C; temp. stability to 1/2%; sealed. Some users specify solder lugs.

CLIP THIS COUPON AND SEND IT TO:

WIREWOUND CONTEST



1200 COLUMBIA AVE., RIVERSIDE, CA. 92507

My winning words are

--	--	--

--	--	--

with wirewounds.

NAME _____

TITLE _____ COMPANY _____

ADDRESS _____

CITY _____ STATE _____ ZIP _____

Bourns factory, representative and distributor personnel and their families are ineligible.

Contest closes April 30 (ED 371)

INSTANT EMCOR

"Off-the-Shelf" Modular Enclosures
are ready for your equipment when you are!

**Shipment
in 3 days!
... 69
models
in stock.**

From the company that pioneered the modular enclosure concept comes another service first — INSTANT EMCOR! 69 assemblies offer more variety than you probably need to satisfy your enclosure requirements: for housing electronic, electrical, mechanical, hydraulic or electro-mechanical equipment. Specify EMCOR I for ball-cornered design, EMCOR II for the more contemporary squared corner look.

Sixty-nine assemblies in all: 28 vertical; 6 slope front; 14 desk and counter height; 6 turret; 5 instrument; 6 low silhouette; 4 steel work/writing top.

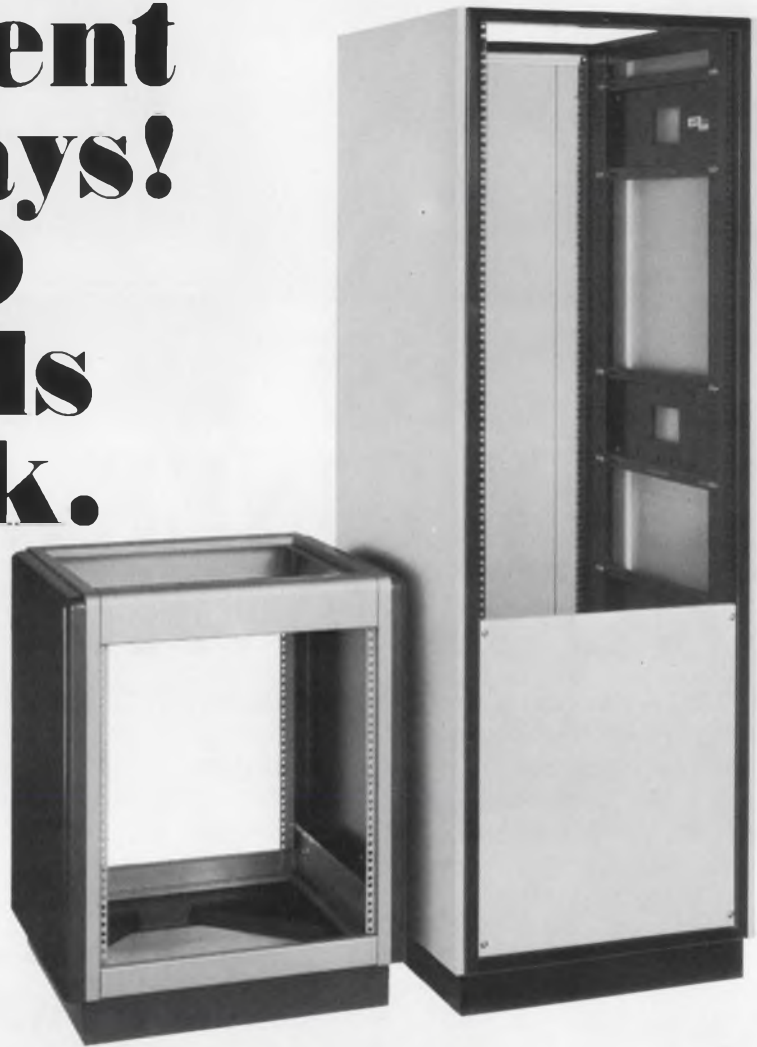

Emcor accessories offer virtually unlimited assembly combinations

Also available on 3 day shipment are thousands of accessories — doors, drawers, shelves, chassis guides, plain, louvered and perforated panels, caster dollies and all miscellaneous items — let you meet almost any equipment housing need and allow unlimited expansion or modification of enclosure frames.

Instant Emcor gives you the benefits of versatility available only with standardized enclosure frames and components. If color selection is not critical but speed is, order INSTANT EMCOR!

WRITE today for complete information and name of nearest representative or
CALL (312) 264-8314



Ingersoll Products 1000 W. 120th St., Chicago, Ill. 60643

DIVISION OF BORG-WARNER CORPORATION



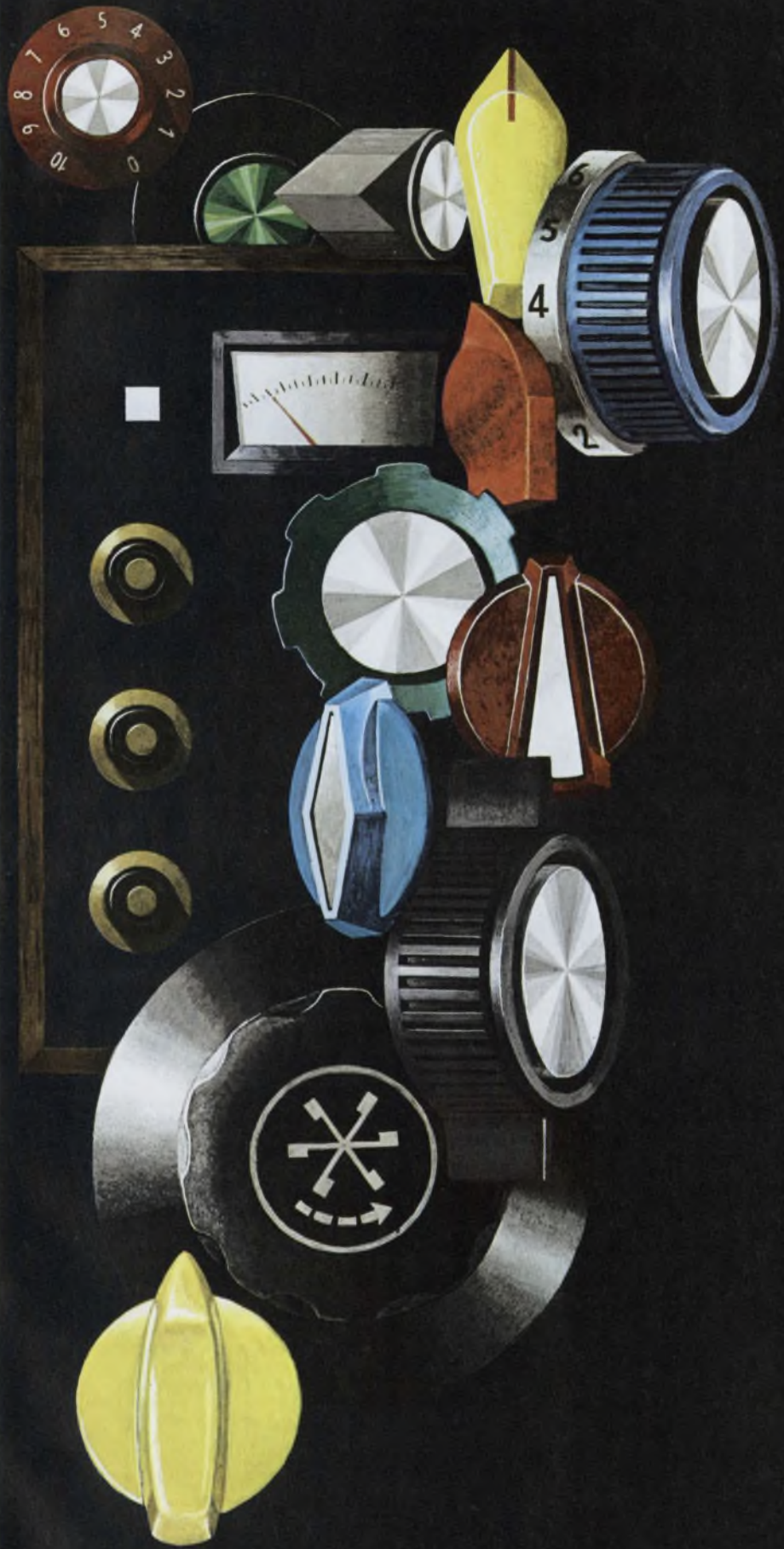

Rogan Control Knobs For Quality Control

From electronic test equipment to appliances . . . from communications equipment to amplifiers . . . to almost every type of electrical application required today. Rogan offers the added advantage of *unlimited color possibilities*—molded material, or decorative inlays. It's the Rogan Knob that is selected when quality is the specification—and pricing the consideration. It's the Rogan name that makes the Rogan knob the designers' No. 1 choice in knobs.

Write today for new full color catalog or see us in Sweets or Thomas Micro catalog. Outline your requirements for quotation and free knob sample.

Rogan
BROTHERS, INC.

8019 N. Monticello Ave. Skokie, Illinois 60076

Phone: (312) 675-1234

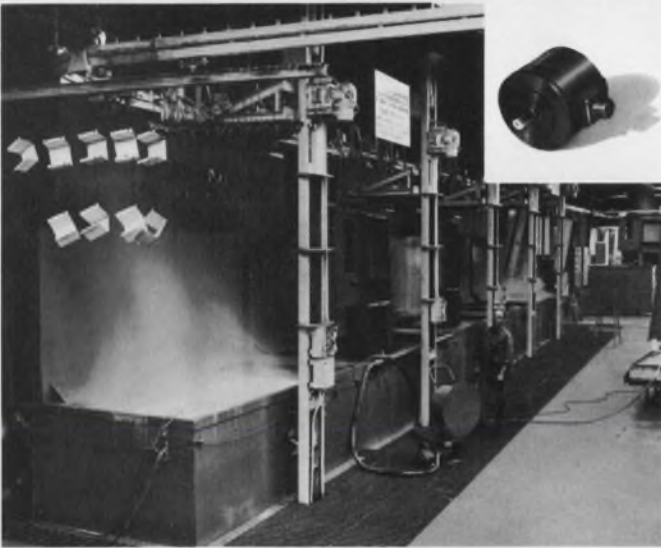
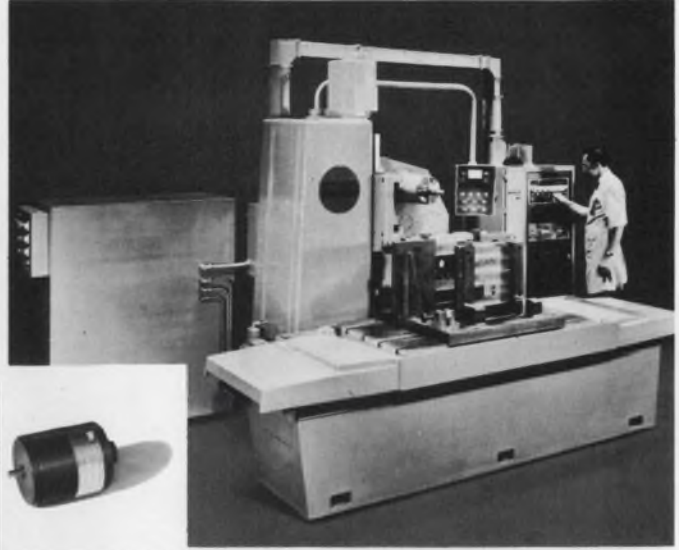

WE'VE ALREADY SOLVED MANY OF YOUR ENCODER PROBLEMS.

For over ten years, Data Tech has been solving industry's problems in precision measurement, numerical control feedback, instrumentation, design and display. Our solutions are technically sound, economical and offer years of reliable repetitive system operation. Wherever encoder technology makes good sense – our technical skills and years of experience are available to you.

Typical OPTECON™ Encoder Applications –

1. Measurement Laboratory Digitizing
2. N/C Machines and Readouts
3. Severe Industrial Environment Operations
4. Heavy-Duty Punch-Press Operation

™ – Trade Names describing Data Technology, Inc., series of Optical Encoders

Write for **OPTECON™**
Publication 1-601 and
Application Notes.



New **SUPERCON™** Offers High Performance:
Frequency: 125 KHz Max.
Accuracy: 3 arc min.
Resolution: to 2500 cycles/turn
Speed: up to 3000 RPM
Drive Capability: up to 400 feet
WRITE FOR PUBLICATION 1-700 for complete information.



DATA TECHNOLOGY, INC
65 GROVE ST., WATERTOWN, MASSACHUSETTS 02172 / 617 • 924-1773

A new pushbutton line has come to light.

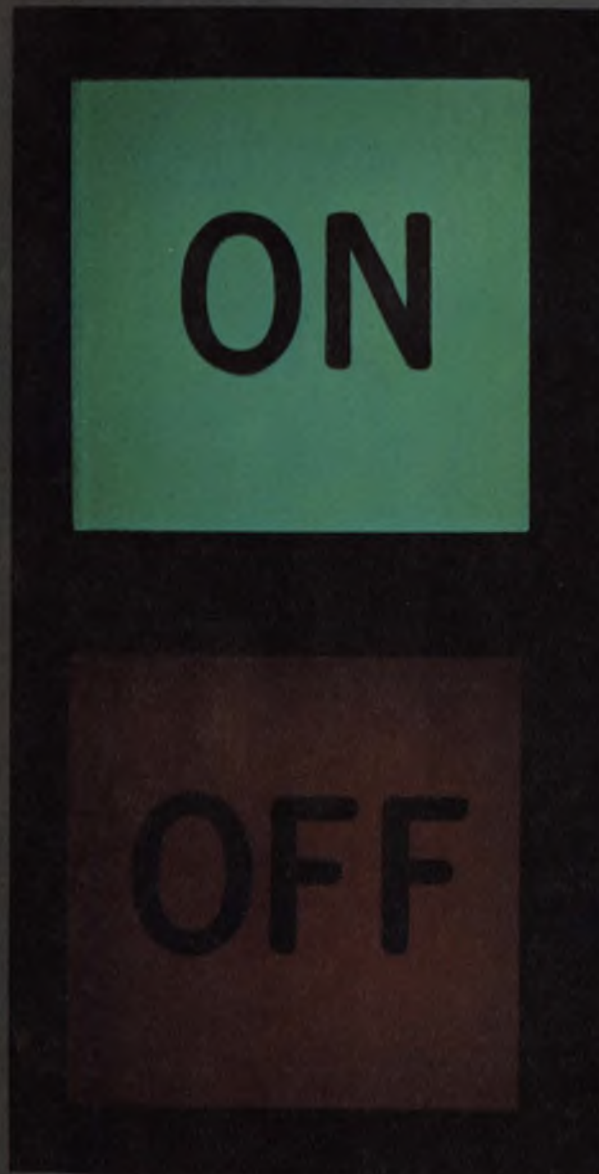

Announcing a medium-priced line of quality lighted pushbuttons and indicators. Our new Series 3.

A complete line with a choice of options that never seems to stop. For example:

Choose from low energy, electronic-duty reed switches with form A circuitry. Or from 5-amp, double-break power switches with a variety of circuit options.

Choose from strip, matrix or individual mount. Each with front relamping or replacement. And with two lamps and $\frac{3}{4}$ " mounting centers.

Choose from five lighted display colors and from momentary or two-level alternate-action.

It all adds up to versatility. The kind that makes the Series 3 ideal for computer peripheral equipment, business machines, instrumentation equipment, communications systems, control panels. Or, maybe a job you're working on that requires a lighted pushbutton or indicator.

For more information, call your MICRO SWITCH Branch Office or Authorized Distributor (Yellow Pages under "Switches, Electric"). Or write for Product Sheet Series 3.



MICRO SWITCH

FREEDPORT, ILLINOIS 61032
A DIVISION OF HONEYWELL

How do you tie together 4 million square miles of land, 3 oceans and the ionosphere?

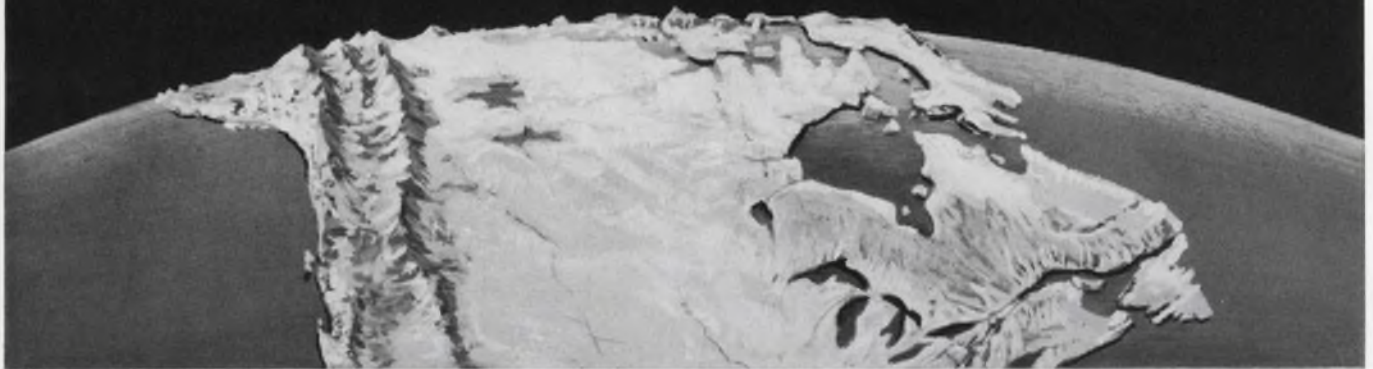

CANADA does it electronically

The Canadian electronics industry has to tackle the big jobs—in communications alone, a 17,000 mile broadband system provides for message, broadcast and television transmission across Canada and into the far north. And no less than eighteen countries are using Canadian designed and manufactured microwave relay systems, many of them important military installations.

Not only does the Canadian electronics industry handle the big jobs, but it also specializes in short runs! Today new methods of miniaturization are being

developed, particularly in the field of integrated circuits.

Twelve leading Canadian electronics manufacturers will be exhibiting a broad spectrum of specialized electronic products at the **Institute of Electrical & Electronic Engineers Conference and Exhibition (IEEE) in The New York Coliseum, March 22-25.**

Visit the display . . . find out how Canadian installation services, training programs and maintenance are tailored to fit any need anywhere.

Canadian companies exhibiting are:

SIMTEC INDUSTRIES LTD.
Montreal 445, Quebec

BOWMAR CANADA LIMITED
Ottawa 15, Ontario

MICRO-COM ELECTRONICS LTD.
Winnipeg 4, Manitoba

NAUTICAL ELECTRONIC
LABORATORIES LIMITED
Halifax County, Nova Scotia

ELECTRONIC CRAFTSMEN
Waterloo, Ontario

SANDTRON ELECTRONIC
INDUSTRIES LIMITED
Oakville, Ontario.

INGRAPHICS LTD.
Steinbach, Manitoba

EPITEK ELECTRONICS LTD.
Ottawa 12, Ontario

GENERAL PRECISION
INDUSTRIES LIMITED
Montreal 114, Quebec

COMPUTER METAL REG'D.
Montreal 376, Quebec

MICROSYSTEMS INTERNATIONAL
LIMITED

Ottawa 14, Ontario

MID-CANADIAN INVESTMENT
CASTINGS LTD.
Georgetown, Ontario

Write for your free copy of "Canada in the World of Electronics"
Deputy Consul General (Commercial), Canadian Consulate General
680 Fifth Avenue, New York City, N.Y. 10019



THE Honeywell STYLELINE 4000 SERIES



Newest in cabinetry, Honeywell Styleline 4000 Series offers maximum designer selectivity.

The Honeywell crafted, 14-gauge steel frames with new extended side panels, aluminum trim, and durable vinyl finishes, provide appearance and marketability factors that every cabinet designer should consider.

Take a positive step forward for your next cabinetry requirements . . . send for our free Styleline 4000 Factbook. Honeywell may be able to add the finishing touch.

COMMUNICATE WITH HONEYWELL, WABASH, INDIANA 46992 • Phone (219) 563-2161

- More Exclusively Unique Features
- Six Exciting Coordinated Vinyl Colors
- Patented Frame-Corner Construction
- New Extended Side Panels
- New Aluminum Trim
- Vinyl Inserts For The Trim
- Extensive Accessory Availabilities
- Full Line . . . Straight, Slope & Wedge

CABINET DESIGNERS FACTBOOK

Comprehensive 52-page book available no charge to complement your cabinet design and specifying knowhow.



Complete price sheets provide total information. Available with Honeywell Series 4000 Factbook on request.

INFORMATION RETRIEVAL NUMBER 45

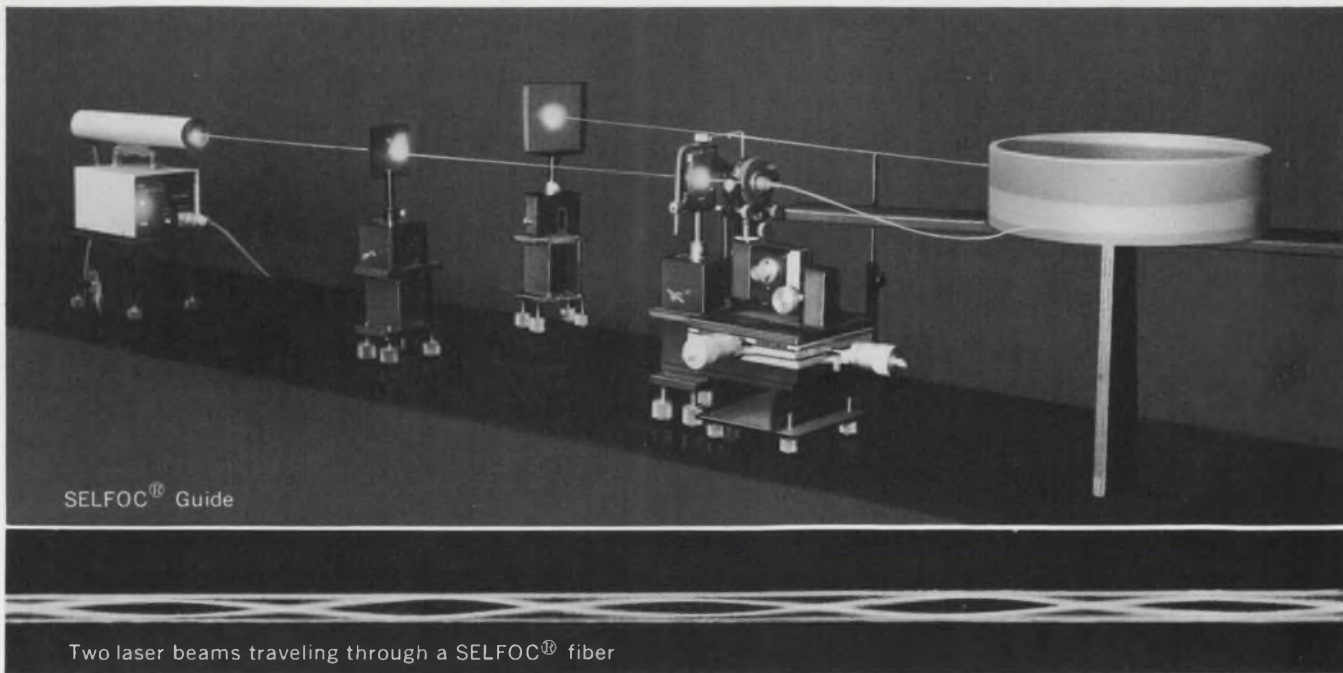

SELFOC® Guide

Two laser beams traveling through a SELFOC® fiber

Tying light beams in knots for tomorrow's communications

Leading laser beams around corners may well be one of the keys to the next generation of communication systems. NEC has the problem licked.

Our new SELFOC®* system, still in the development stage, incorporates two exciting breakthroughs in laser technology. Developed in cooperation with Nippon Sheet Glass Co., it employs a special low-attenuation light-focusing fiber with a refractive index that decreases parabolically toward the periphery. This SELFOC® guide is thus perfectly suited for use as an optical transmission line, carrying laser beams in any direction it is bent.

The SELFOC® laser is just as revolutionary. Using a similar active glass fiber it amplifies weak laser beams, so it's ideal as an optical repeater. It also produces a continuous series of ultra-short (pico-

second) optical pulses, raising information volume to unheard of levels.

Just another example of how NEC is in front for tomorrow's communications.

Whether it's satellite station or telephone switching equipment, TV and radio broadcast or microwave and carrier transmission systems, data processing, radar or other electronics equipment or components, Nippon Electric is a world leader in products for today, innovation for tomorrow.

NEC plans to exhibit a selection of its electronic products, including the SELFOC, at the March IEEE Show in New York (Booth Nos. 2000/2002/2004). We look forward to seeing you there.

* Trademark registered in four countries including Japan



SELFOC® Laser

NEC AMERICA INC. Suite 4321, Pan Am. Bldg., 200 Park Avenue, New York, N.Y. 10017 Tel. New York (212) 661-3420 Cable Address: "NIPPELECO NEWYORK" Telex Address: NIPPELCO 234936 NEW YORK

Chicago Office: Room 410, 500 North Michigan Avenue, Chicago, Illinois 60611 Tel. Chicago (312) 828-9494/5 Telex Address: 910-221-2101 NIPP ELEC CGO

Los Angeles Office: Suite 924 Airport Century Bldg., 9841 Airport Boulevard, Los Angeles, California 90045 Tel. (213) 776-5923/4 Cable Address: "NIPPELECO LOS ANGELES CALIF" Telex Address: 910-328-6574 NIPPON ELC LA

Washington D.C. Office: Suite 508, Crystal Mall Bldg., 1, 1911 Jefferson Davis Highway Arlington, Virginia 22202 Tel. 703-920-8228/9 Telex Address: 710-955-0651 NIPP ELEC WASH

**Products for today—
Innovations for tomorrow**

NEC
Nippon Electric Co., Ltd.
Tokyo, Japan

Main Products: electronic computers, data communication systems, telephone systems, carrier transmission equipment, radio communication systems, radio & television broadcasting equipment, satellite communications equipment, electrical household appliances, other applied electronic equipment, and electronic components.

Fuseholders!!!

Another Industry 1st Pioneered by Littelfuse

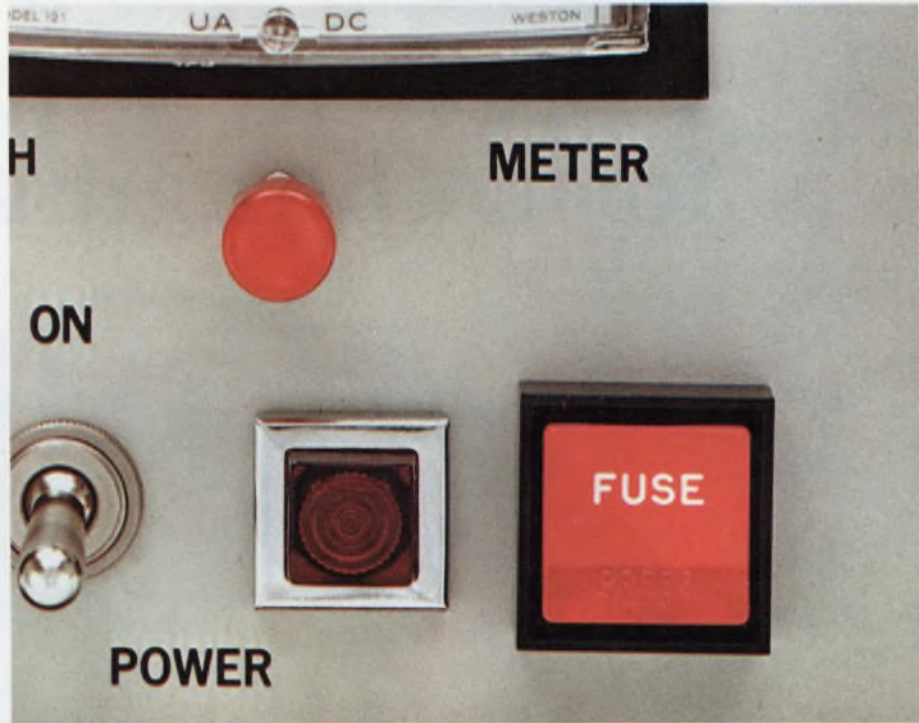
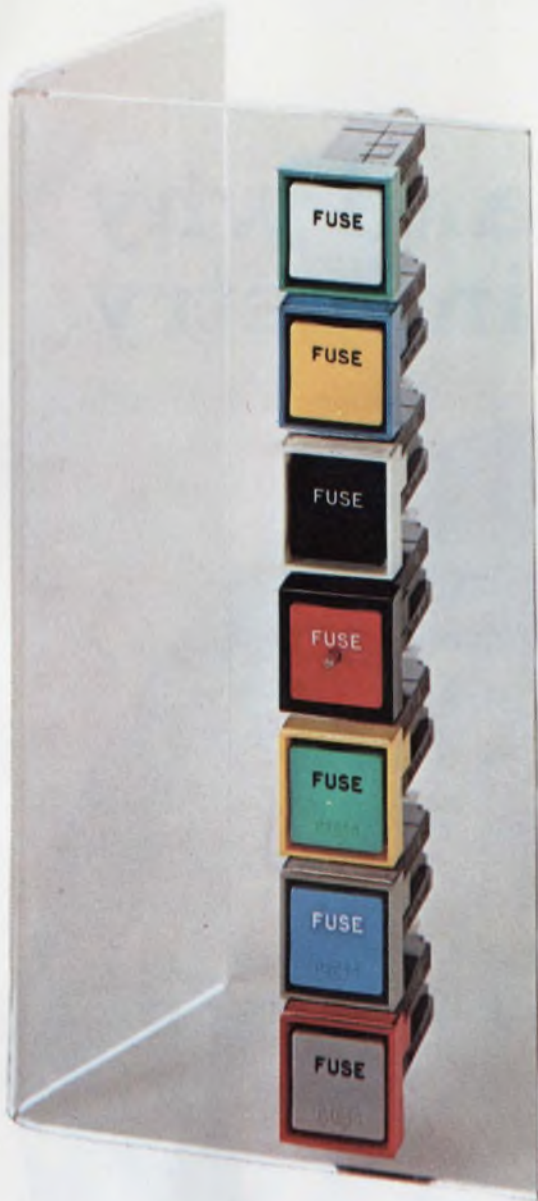

Yes! These new low profile fuseholders with attractive square caps and bezels are for front panel installation on instruments, computers, aircraft, marine, business and general electronic equipment.

Seven standard colors are available for caps and bezels. Mix or match for 49 different combinations. Order a million and we'll custom color for you at no extra charge.

Up front mounting makes installation and servicing a snap. To replace the fuse, press the cap and it snaps open, insert a new fuse and press the cap back. Snap! It's closed and locked securely.

No tools are needed for installation. No mounting hardware. No inaccessible terminals to solder behind the panel.

Recognized under the component recognition program of Underwriters Laboratories to 250V-15amps max. for standard 3AG and 8AG fuses.

Write, wire or call.



LITTELFUSE

800 E. Northwest Highway, Des Plaines, Illinois 60016
312-824-1188 TWX 910-233-3598 Subsidiary of Tracor

INFORMATION RETRIEVAL NUMBER 121

IEEE '71

Practical how and why for a changing industry



This year's IEEE International Convention and Exposition in New York City is stressing the practical side of electronics—more than ever before. In addition to 56 technical and socio-technological sessions at the New York Hilton, 28 special technical applications sessions are being offered at the New York Coliseum. The latter deal with such practical subjects as LSI testing, the what and how of minicomputers, computer-assisted manufacturing, multilayer boards, new connector developments, the application of microwave semiconductors, IC reliability, assembly techniques, pollution control and other timely subjects.

The regular technical sessions are more oriented toward long-range R&D and designed to keep the nonspecialist engineer abreast of the state of the art. They deal with such subjects as the future of global satellite communications, optical communications, digital high-speed ICs, micro-electronic interconnections and packaging, and advances in high-power, long-wavelength lasers.

The IEEE expects about 45,000 engineers at the show March 22-25. This would be a slight drop from the nearly 48,000 who attended last year. The general economic decline in the industry has also cut the number of exhibitors. This year there are about 400 exhibits, compared with 589 in 1970.

Two special evening sessions are scheduled. The Monday evening highlight (March 22) is

“Role of the IEEE in the 70s,” particularly timely in view of the serious impact of the business recession on electronics. The Tuesday evening keynote session (March 23) emphasizes the theme of the convention, “Redirecting Electro-Technology for a Better World.” A panel of experts is discussing how the nation's technical resources can be best applied to advance the American standard of living.

David Packard, Assistant Secretary of Defense, is the guest speaker at the annual IEEE banquet Wednesday evening (March 24). The IEEE Medal of Honor is being presented at this affair to Dr. John Bardeen, co-inventor of the transistor.

Once again, a science film theater is part of the show. This year a concerted effort is being made to coordinate the subject matter of the theater with the technical content of the program. Films will portray Apollo 13, magnetic bubble memories, integrated electronics, sea drilling projects and other subjects.

One innovation this year is the opening of four Tech-Talk Centers in the exhibit areas at the Coliseum. These are quiet lounge areas where engineers can meet in a “more relaxed atmosphere.” In the past those attending the show have been hard-put to find a place where they might have a quiet chat with colleagues or an interchange of ideas with exhibitors. Tech-Talk Centers should solve this problem.

Design trends in major engineering areas as reflected in the technical papers	S4
Microwaves	S4
Computers	S6
Communications	S7
Aerospace	S9
Civionics	S10
Microelectronics	S12
Electro-Optics	S14

Complete guide to technical papers listed by engineering subject . . .	S18
Outstanding new products	S30
Modules & Subassemblies	S30
Instrumentation	S40
Microwaves & Lasers	S50
ICs & Semiconductors	S53
Data Processing	S54
Packaging & Materials	S56
Components	S58

Technical highlights of show

"Technology for a Better World" is the theme for this year's IEEE show, and nowhere is this more evident than in the technical program, which features such sessions as: Electricity in the City, Technology and Privacy, Redirecting Electro-Technology for a Better World, Interaction of Technology and Society, Design Objectives for Transportation Systems, and Computer

Art and Music. Despite this obvious interest in civionics, however, the practical side of the program has not been neglected. Program sessions covering technical applications are more numerous than ever before. In fact, the special technical application sessions offered at the Coliseum have been increased from seven in 1970 to 28 for 1971. Here's a sampling of the key papers:

Microwaves: Solid-state devices are ready, willing and able

Solid-state microwave technology has advanced tremendously in the last five years and is ready for practical application, yet engineers appear reluctant to use the new devices in systems designing. If lack of familiarity is the reason, this year's IEEE show should prove a boon: At least four technical sessions and one technical application session are devoted entirely to microwave semiconductors.

Among the major conclusions to emerge from the sessions are these: Bulk-effect devices, although more costly than their avalanche counterparts, offer better noise performance and operation over much wider bandwidths. Avalanche

diodes, on the other hand, excel in cw power production and dc-to-rf efficiency.

Session 5G, "Recent Advances in Gunn and Impatt Devices," is devoted completely to an elucidation of the state of the art in four important device areas: Gunn, Impatt, LSA and Trapatt diodes. The session begins with four technical papers and follows them with a panel discussion by the authors on the merits of the various devices for particular applications.

The others are under the Gunn

At the moment it seems that the bulk-effect (Gunn and LSA) devices have a performance edge, according to Fred Sterzer of RCA's David Sarnoff Research Center, Princeton, N. J. Sterzer, who is speaking on "Progress in Gunn Devices" at the session, says, "The combination of power output, bandwidth and noise figure that has been achieved with stable linear, negative resistance reflection transferred electron amplifiers (TEAs) cannot be matched by any other type of solid-state amplifier." He also points out:

"Transferred electron oscillators (TEOs) have produced the highest power output obtained so far from a single solid-state device at microwave frequencies (6 kW at L-band). They can be electronically and mechanically tuned over larger

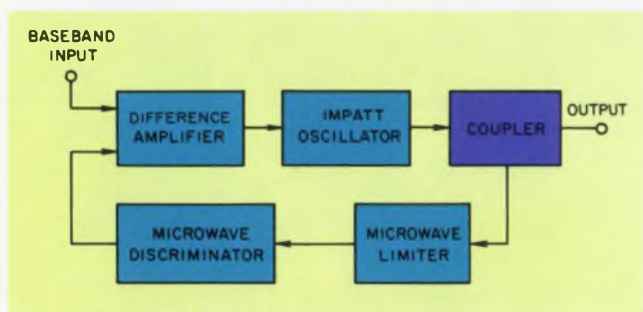

This FM modulator uses feedback to reduce FM noise, improve frequency-deviation linearity and establish long-term stability. The experimental circuit, which uses a germanium diode, is described in Session 4CJ.

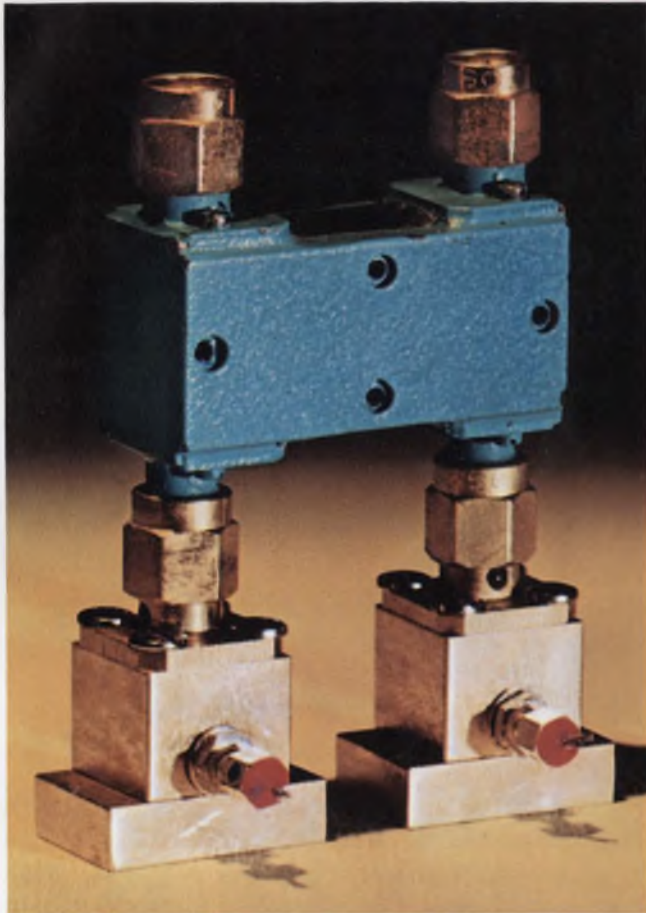

Two-stage circulator-coupled Gunn diode amplifier, developed at RCA's laboratories in Princeton, N. J., features low noise and wide bandwidth (Session 5G).

frequency ranges than other types of solid-state oscillators (4 to 12 GHz, for example), and well-designed TEOs have exceptionally low AM and FM noise."

The drawbacks of the transferred electron devices are threefold: They require extremely pure and uniform gallium arsenide—hence, they are expensive; they have poor thermal characteristics and are thus limited in cw power; and they have fairly low conversion efficiencies, which adds further to their cw power problems.

Almost a diametrically opposite situation arises when the Impatt and Trapatt diodes are examined. Here it is possible to use silicon, which is a lot cheaper than GaAs, and Trapatt efficiencies as high as 75% have been reported, according to S. M. Sze and R. M. Ryder of Bell Telephone Laboratories, Murray Hill, N. J., whose paper is titled "Avalanche Diodes for Microwave Generation."

Typically, silicon Impatt diodes operate with efficiencies on the order of 8 to 9%, while transferred electron devices are limited to around 2 to

3%. Some double-drift silicon structures have obtained 15% efficiency while producing 1 W at 50 GHz. And the power record is held by a GaAs Impatt diode that produced 3 W of cw power at 6 GHz with an efficiency of about 15%.

The trouble with the avalanche (Impatt and Trapatt) devices is that they are noisy. A typical TEA noise figure at C or X-band is about 15 dB, while the corresponding figures for avalanche diodes are 40 dB for the silicon units and 25 dB for the GaAs.

To prepare for Session 5G, microwave engineers may want to attend Session 4CJ, "Applications of Present-Day Microwave Semiconductors." This session reviews recent developments, but its emphasis is on applications to practical microwave systems. The session deals with transistors as well as microwave diodes, and it covers the areas of frequency stabilization, noise reduction, modulator design and other transmitter and receiver design topics.

A particularly useful paper in this session is "Application of Avalanche Diodes to Communication Systems" by J. W. Gewartowski of Bell Laboratories in Murray Hill. Several techniques for overcoming the noise problems associated with avalanche diodes are described, including the use of cavities in local-oscillator applications and the use of feedback in a transmitter output stage (see illustration). The output stage uses an Impatt diode oscillator whose bias current is modulated by the baseband input signal. Feedback is employed to reduce FM noise and improve modulation linearity. In the experimental work he describes, Gewartowski obtained 300 mW at 6 GHz using a germanium transistor.

Phased-array applications are waiting

An important area in which solid-state microwave devices may find wide application is phased-array radars. In his paper "Active Distributed Solid State Arrays for Military Communications and Radar Systems," A. G. Kramer of the Raytheon Co., Bedford, Mass., discusses the operations that must be performed by the components of a phased array and indicates which are suitable for solid-state devices. At present, Kramer points out, their low efficiency makes solid-state devices unsuitable for transmitter applications.

"However," he says, "recent trends in microwave devices offer the promise of enhanced efficiency, and thus system size and weight performance comparable to tubes. When this is achieved, the enhanced reliability of distributed, solid-state transmitters will make their use mandatory in military systems." ■■

Computers: If you think they're smart now, wait till you hear them gab

For a long time computers have been answering questions vocally—at times with more animation and naturalness than many recordings we now hear on the telephone. And in the future, according to speakers in Session 2F, "Voice Response from Computers," they will talk even more.

IBM's W. D. Chapman of Research Triangle Park, N. C., describes the company's two existing systems in his paper, "Techniques for Computer Voice Response." The earlier IBM 7770 system generates messages from words that are stored on a magnetic drum and is capable of serving up to 48 lines simultaneously. It has a maximum vocabulary of 128 words stored in analog form.

The later IBM 7772 audio response unit uses pitch-excited vocoder synthesizers, one for each output line. Speech is stored in compressed digital form in the computer-system disc files instead of in the response unit. A 1000-word vocabulary covering a variety of business applications is delivered with the unit in digital card or tape form, and special words are available on order. Up to four synthesizers may be installed in one unit to handle up to eight output lines on a queued basis.

Replacing human speech

In the works, Chapman says, are techniques to replace the human speaker as the source for speech with synthetically generated sounds. The reason is to minimize the storage space that speech data requires and to reduce the computing time for generating messages. Also, synthetic speech is a necessary step toward converting printed or machine-readable text into speech.

In general, the synthesized speech is formed by using a set of several hundred stylized units called "diphones" to characterize generally the basic dynamic qualities of speech. These units are concatenated and modified with a set of rules to give an intended message the appropriate sentence melody, stress and continuity.

If the technique is successful, the result will sound like a human. If it isn't, it will sound like the recordings used on certain pay telephones to advise you that your time has run out.

In "A Voice for the Laboratory Computer," a paper by F. S. Cooper, R. C. Rand, R. S. Music and I. G. Mattingly, all of Haskins Laboratories, New Haven, Conn., the authors discuss the combinations of techniques that may be used in generating voice responses. Storing messages as



Computer-driven printers are among the topics under discussion in Session 3E, "Graphics Display and Hard Copy." The session is concentrating on "state of the art" rather than long-range developments.

speech waveforms is simple, they say, but it makes heavy demands on memory capacity—roughly 50,000 bits per second of stored speech. The method is useful, however, when a very limited set of words will suffice for all messages.

Another method suitable for whole messages, or for messages composed of smaller fragments, is to store the control parameters that will enable a synthesizer to generate the speech waveforms. There are considerable advantages to this method, the authors say. Storage requirements are reduced by a factor in the range of 10 to 50, and there is more flexibility in composing realistic sentences, since stress and intonation can be imposed on a composite spectral "skeleton."

The disadvantages are that special hardware is needed to synthesize the speech; that the parameters are not related in a simple way to either the speech waveform or the message in its normal written form; that a substantial amount of processing is required to derive the parameters or to revise them when the message set is to be changed.

A third method is synthesis by rule. It is a two-stage process. The first converts a written

English sentence into a phonetic transcription, and the second converts the transcription into control parameters for a synthesizer.

Other improvements, IBM's Chapman says, include more sophisticated audio response systems that will be able to store long messages both in voice and synthetic forms. They will be fed into the computer in printed form. This will, of course, require the computer to generate the voice message from a basic knowledge of speech-generated mechanisms.

Jonathan Allen of the Massachusetts Institute of Technology, in "Speech Synthesis from Unrestricted Text," discusses the problems of taking typed text, putting it into a machine and having it respond audibly.

There are two directions in which these machines can go, right now, Chapman says. For business applications, small vocabularies will suffice—short, terse messages, numbers of simple answers, bank balances, telephone numbers and inventory information. The other direction is to supply long descriptive answers, such as how to administer a drug. Thousands of words might be required, and they would have to be connected to give a coherent reading.

Where a larger vocabulary is required, low data-rate coding will be called for. ■■



"Quad IV" is the title of this laminated marble structure, produced with the help of a computer by Robert Mallary, associate professor of art at the University of Mass. (Session 1C).

Communications: A look at future instead of the usual hardware

In a turnabout from previous meetings, this year's IEEE coverage of the communications field is diverting the emphasis from hardware design to problems of the near future and far future: the development of international and domestic satellite systems, as well as optical-system communications.

One problem inhibiting worldwide implementation of the International Satellite (Intelsat) System is politics, according to Dr. J. Martin Braverman, a member of the staff of the Institute for Defense Analysis, Arlington, Va., organizer and chairman of Session 1A on "The Future of Global Satellite Communications."

He points out that Intelsat was set up under interim agreements between 63 countries, in which each country owns its own ground stations. Under the present agreement, the United States' Communications Satellite Corp. (Comsat) owns 52% of Intelsat. And at present many of the member companies are somewhat sensitive as to why a U. S. company should have control of

system procurement policy—where the money for the system will be spent.

Because the system can't grow without the cooperation of the many nations concerned, a paper in Session 1A, "Establishing the Permanent Intelsat," by Abbott Washburn of the U. S. Dept. of State discusses how this goal might be achieved.

Although great strides have been made in using present Intelsat satellites—all Apollo spaceship communications and TV are relayed to the United States from Australia through the system, for example—even greater service is envisioned from these relay stations in the sky. The expansion of Intelsat service can be accomplished in two ways, according to John L. Hult, a member of the Rand Corp., Santa Monica, Calif. In a Session 1A paper on "Future Communication and Television by Satellite," he points out that expansion of the satellite bandwidth capabilities and higher effective transmitted satellite power can reduce earth-station cost,

minimize the adverse affect of local ground-station interference, and thus permit placement of the ground station near a communication center, rather than some distance away in an interference-free region.

As for selection of future operating frequencies, Hult says that the greatest potential in satellite-to-satellite spectrum capacity lies in the use of signals above 16 GHz. However, he cautions that down-link propagation characteristics make it advisable to develop the spectrum below 16 GHz first.

The UHF band is preferred for the down link, for both area coverage and for small-system terminals, Hult notes. On the other hand, if the higher microwave frequencies are used for the down-link, the system capacity decreases and the system cost—particularly for the ground station—increases rapidly.

Domestic satellite uses cited

A sizable number of telecommunications systems planned or developed in recent years require wideband, low-cost communications links for their exploitation, according to Todd G. Williams, manager of advanced terminal requirements for Philco Ford, Palo Alto, Calif. Williams, chairman and organizer of Session 8A, "Domestic Satellite Communications for the United States," points out that one of these new systems will be a domestic satellite network, designed for such purposes as these:

- Biomedical networks.
- Law-enforcement communications.
- Aeronautical communications.
- Educational and industrial TV.
- High-speed facsimile.
- Data-processing systems.

Several domestic satellite communications systems have been proposed and in Session 8A a five-man panel discusses informally the impact that some of these systems would have on society, the telecommunications industry and the potential user. One area in which domestic satellite communications might have its greatest cultural impact is in Alaska. Bringing reliable telecommunications and TV service to hundreds of remote communities not now served could alter the cultural and economic development of that state.

Laser communications look promising

The tremendous bandwidth and channel capacity of laser communication systems have been well known for years, but implementation still seems a long way off. A major limitation on ground-to-ground or even sky-to-ground optical communication is in the attenuation and dispersion of laser beams by the earth's atmosphere,



Laser color television projector, from General Telephone & Electronics Laboratories, produces pictures off the air with a single multicolor laser, single modulator and single scanner (Session 3E).

plus unreliability during bad weather. But a promising new application is proposed by Dr. Henry H. Plotkin, head of the optical systems branch, NASA Goddard Space Flight Center, Greenbelt, Md.

In his Session 2C paper on "Satellite Communication at Optical Frequencies," Plotkin explains that future space missions—particularly low-altitude earth-resources satellites—will greatly increase data-rate requirements beyond those now handled by microwave systems. Data from the earth-resources satellites will include inputs from color photography, high-resolution spectrophotometry, infrared mappers, meteorological balloons, remote buoys and other sources. Plotkin notes that to provide real-time global coverage, data will be relayed from the low-altitude resources satellite to high-altitude synchronous relays before being transmitted to a central ground station.

To provide channel capacities of hundreds of megabits over system distances of 40-km maximum will require exceptionally high transmitted power plus unusually large spaceborne antennas at each terminal in the link.

As a less costly and simpler alternative, Plotkin proposes to use optical communication systems that employ carbon-dioxide lasers radiating at 10.6 micrometers, or Neodymium laser systems operating at 1.06 or 0.53 micrometers.

With the micrometer-sized wavelengths, very high antenna gains can be obtained with physically small optical antennas, thus greatly reducing the size and weight over comparable microwave equipment.

Plotkin includes systems using the CO₂ and Neodymium lasers, because of their advanced state of development and because they represent two classes into which future systems will fall—namely, optical heterodyne receivers for the 10.6 wavelength and direct detection by photomultipliers at 1.06 or 0.53 micrometers. ■■

Space: Electronics for missions to Venus, Mars and orbit stations

Exploration of distant planets by unmanned craft and observation of the earth and stars from manned orbiting stations call for improved electronic design. Typical problems are power to operate the stations, high-volume communication, guidance, components that will operate for years and ultra-miniaturization.

These challenges of the 1970s are described in a number of IEEE papers dealing with space that crop up in four or more sessions.

Unique characteristics of the Pioneer spacecraft that is scheduled to fly past Jupiter in early 1972 are described in "The Pioneer Spacecraft Flyby of Jupiter," Session 4D. The paper is by William J. Dixon and Edgar G. Wheeler of TRW Systems, Redondo Beach, Calif., and Ralph W. Holtzclaw of NASA's Ames Research Center at Moffett Field, Calif.

Four radioisotope thermoelectric generators (RTG) are used in the spacecraft as the primary source of electrical power, each of which converts 5 to 6% of the heat released from plutonium dioxide fuel to electrical power. RTG power output is greatest at 4.2 V, the authors say. Then, for distribution, an inverter boosts this to 28 V. RTG life is degraded at low currents. Therefore, the authors say, voltage is regulated by shunt dissipation of excess power. The units weight 118 pounds.

The periodic maintaining of the earth-pointing attitude is another unique feature, the authors say. On command, an on-board digital phase processor synchronously demodulates (at the 0.08-Hz spin rate) the signal received by a conically scanning antenna. It abstracts phase information to control the pulsing of correcting precession thrusters, and amplitude information to terminate the maneuver at threshold.

Mars mission described

Two Viking spacecraft are scheduled to take off for Mars in 1975, arrive in 1976, orbit the planet and then land. A paper describing the mission is presented in Session 4D by E. A. Brummer and W. F. Cuddihy of NASA's Langley Research Center, Hampton, Va., and W. Mielziner of the Martin Marietta Corp., Denver. Entitled "The Viking 1975 Mission: Electronic System Challenges for an unmanned Mars Landing," the paper focuses on problems the lander will encounter rather than the orbiter, because the lander must be designed to accommodate more rigid space limitations.

High volumes of data will be relayed from the lander at rates up to 16,000 bits a second and at distances as great as 380×10^6 km. At this distance the round-trip signal time is 42 minutes, ruling out any real-time control from earth. An on-board computer will conduct the investigations, manage the data, point and program the high-gain antenna and monitor the systems. In addition it will provide guidance and control for a multimode entry through the tenuous Mars atmosphere. All equipment that lands on Mars must be heat-sterilized, including 90 pounds of NiCd batteries.

The guidance, control and sequencing computer requires minimization of power consumption because of the limited source of regenerated power on board the lander and because the computer must be on-line continuously. Only 5.2 W of average power after landing can be allocated. To accomplish this goal, low-power TTL and P-MOS circuit technology are currently being studied.

Maximum software flexibility to permit reprogramming as new knowledge of Mars is gained is also required. The memory is currently sized at 12,000 25-bit words. A completely redundant system within a weight limit of 45 pounds is the design goal.

Data storage will be provided in two forms: a tape recorder with a capacity of 4×10^7 bits and a static memory with a capacity of 2×10^5 bits. Due to the sterilization requirements, a great deal of work has been done on the tape recorders. A prototype using phosphor bronze tape electroplated with nickel-iron, however, has been operated 480 hours after sterilization at 135° for 300 hours.

Because of its low power consumption and over-all size, plated wire is a candidate for the static data storage memory as well as for the computer.

For communication, an operating frequency in the uhf region (around 400 MHz) has been chosen, using PCM-FSK transmission with a power of 30 W after landing. Data rates as great as 16,000 bits per second are provided.

The lander's S-band system uses considerable redundancy and flexibility. Commands can be received over an omni-directional antenna or over the high-gain antenna—a 30-inch-diameter dish. PCM-PSK-PM block-coded data will be transmitted to earth at rates of 250 or 500 bits per second, depending on the range. A 30-W TWT rf amplifier is used.

Sterilization will have an impact on electronics

designers, the authors say. Wet tantalum capacitors, so widely used for space applications because of their small size and weight, are prone to imperfections in the oxide coating of the tantalum slug; sterilization aggravates this problem, causing them to fail. This problem is being worked on and may be solved by improved manufacturing processes or by using alternate capacitors if circuit designs can be constrained—ceramic capacitors below 5 microfarads or solid tantalum capacitors with a series resistor.

Solder connections that are under stress tend to become weak under the elevated sterilization temperatures, thereby creating imperfect connections. This problem will have to be overcome by using different techniques that do not depend upon the solder to carry stress forces.

Mariner problems discussed

Several problems are being encountered in designing Mariner Venus/Mercury '73—the last of the Mariner series and the first spacecraft expected to visit and send back data from two planets and the interplanetary medium in between. Some of the problems are discussed in "Mariner Venus/Mercury '73—the First Multi-planet mission," a paper in Session 4D by John R. Casani of Jet Propulsion Laboratory in Pasadena, Calif.

The variation in solar intensity causes large changes in solar panel temperature, and thus the panel voltage output, the authors say. There is more variation, in fact, than the existing power conversion equipment can handle. Of the several possible solutions, the one regarded best at this time is tilting the solar panels from the direction normal to the sun, which has the effect of hold-

ing both the voltage and power output nearly constant.

Data techniques in space

Turning from unmanned to manned space flight, a discussion on "Centralized Data Management Techniques for the Space Shuttle," is presented in Session 3C by H. S. Ed Tsou and Berry S. Tolken, TRW Systems, Redondo Beach, Calif.

A centralized data management system will be used to perform data acquisition, distribution, monitoring and control for the data transfer between the central computer complex and the subsystems, and also among subsystems.

Excluding special processing for engine control and display generation, the over-all processing requirements can be met by a general-purpose computer with a memory capacity of 65,000 32-bit words and a processing speed of 2- μ s add time and 8 μ s multiply time, the authors say. The data transfer requirement on a data bus, excluding engine trend and payload data, can be met with a data rate of 250,000 bits per second.

In "Space Station Adaptive Control" in Session 1D, by Jerry M. Mendel, McDonnell Douglas Astronautics Co., West Huntington Beach, Calif., three adaptive control techniques are discussed: adaptive random optimization, model reference and invariant pole placement.

In the invariant pole placement technique, which the authors consider the most promising, feedback gains are adjusted so the closed-loop system's characteristic equation is matched to that of a reference model. Hence the closed-loop system's poles will not move; they will be invariant, provided bending frequencies and parameters can be identified accurately. ■■

Civionics: An even better living through new electro-technology

Electronics will, in the next 10 years, improve the environment, upgrade education, better physical and mental health and make the lives of people more productive and satisfying, both at work and during leisure hours.

That's the optimistic view of Dr. A. M. Bueche, vice president of R&D, General Electric Corp., Schenectady, N. Y., a speaker at the keynote panel session, "Redirecting Electro-Technology for a Better World." Bueche envisions this by 1980:

- New kinds of energy-producing and energy-storage systems, together with new power-controlling techniques, that will make possible a cleaner environment, as well as quiet and efficient electric vehicles.

- A combination of new microminiature electronics, new computers and software, and new communication techniques that will make it possible to tie the home into vast information networks. Through these links, goods and groceries will be ordered and bills paid. Educational infor-



Blood-pressure and blood-flow measuring instruments, along with a radio telemetry transmitter, were implanted

in this giraffe in an experiment by Scripps Clinic and Research Foundation. (Session 4G).

mation will be readily retrieved, consumer and voter opinions will be sampled, and new forms of entertainment and art will be provided.

- A variety of new light sources, including vastly improved solid-state lamps, that will promote safety and productivity. Artificial lighting will also be used much more widely by the agricultural industry.

- Manufacturing plants that will be automated so flexibly that they will be able to shift rapidly from one product line to another. A part of this automation will be the development of machines with far greater artificial intelligence than we have today.

Solar power system envisioned

New electric power sources will be vital to prevent a deterioration of the earth's environment, according to W. A. G. Voss of the Dept. of Electrical Engineering, University of Alberta, Canada. In a Session 2C1 paper on "Advanced Applications of Microwaves to Propulsion and Power Transmission," Voss estimates that electric power demands will increase steadily to at least 1700 gigawatts by the year 2000, at which time nuclear sources will provide half of the world's

power and fossil fuels the other 50%. But both of these power sources contribute to an ever-growing pollution of land, water and air.

There is only one pollution-free power source, Voss contends—the sun. He proposes to use solar energy to operate a microwave-generating station in outer space, with provisions for beaming the microwave power to earth.

To energize the space microwave generators, an enormous blanket of solar cells—measured in many square miles—would be unfolded in space in the proper attitude to point directly at the sun. The dc power, generated by the myriad of cells, is estimated to be sufficient to operate a microwave amplatron tube capable of producing about 8 MW at 1 GHz. The power transmitted to earth would be amplified by an electromagnetic lens at the transmitter in space, as Voss envisions it, or perhaps by some type of phased array. With this proposed system, the earth station should receive some 500 MW of microwave energy, Voss says.

The long-range, free-space transmission efficiency of this solar power system has been estimated at over 80%, and rectification of the microwave power to high-voltage dc at the earth station could be accomplished with an efficiency

of 80 to 90% with the use of arrays of Schottky-barrier diodes.

Harnessing such solar energy could lead to development of world areas now inhibited by lack of power. Voss points to South America as an example. The solar power that would be available for that continent, he says, would be sufficient to fill all needs for several decades. And with plenty of power, the full industrialization of these regions could follow.

Relief of urban traffic jams can come through the construction of new mass-transportation systems (see "Designing Tomorrow's 8:05 Express," ED 1, Jan. 7, 1971, p. 72). But problems abound in system development.

For high-speed ground transportation systems, studies have shown that propulsion through wheels is inadequate at speeds over 180 mph. One proposal advanced by the Office of High Speed Ground Transportation of the U.S. Dept. of Transportation is a linear induction motor—essentially one which is turned inside out and flat-

tened lengthwise. The primary is a short section mounted on the vehicle and the secondary is a flat conductor running the length of the track.

Characteristics of 4000-hp linear motors to drive both tracked and air-cushion vehicles are described by O. G. Farah and R. K. Lay of the Mitre Corp., McLean, Va., in their session 8F paper entitled: "Power Conditioning Unit for Linear Induction Motor Thrust and Speed."

Electronics for optimum art

A portent of the future enrichment of life with advanced electronic systems is found in today's growing rapport between artists and technical people, according to Robert Mallery, associate professor of art at the University of Massachusetts, Amherst. He sees the computer "optimizing" the creative talents of artists and musicians through an artistic variant of "computer-aided design," in his Session 1C paper on "Synergistic and Cybernetic Aspects of Computer Art." ■■

Microelectronics: Why they rave about semiconductor memories

Six months ago there were no computers for sale with semiconductor memories. Since then at least three manufacturers have announced a variety of computers that use different types of semiconductor memories, employing both bipolar and MOS technology.

MOS seems to be favored for most memory applications. But IBM is using bipolar devices for the mainframe memory in its new 370/145 and System 7 computers.

A session at the IEEE show that may be one of the most interesting for designers has been organized by Dr. Robert N. Noyce, president of Intel Corp., Mountain View, Calif. Session 2B, "User's Point of View of Semiconductor Memories," is attempting to present answers to questions that once called for speculative answers but now can be based on practical experience.

Lawrence Seligman, senior engineer at Data General Corp., Southboro, Mass., presents a practical paper on "Choosing Memory Technologies for a Minicomputer Family." He concentrates on the immediate prospect for semiconductor memory, rather than on aspects that will emerge over the next several years. According to Seligman, "An analysis of the major factors in selecting a minicomputer memory technology indicates that the core memory technology is today the better

choice when the two technologies directly compete."

The major advantages of core include cost, well-known reliability and nonvolatility.

For high-performance small computers, core memories are not available, and semiconductor memories are the natural choice, Seligman says. As the technology evolves, he expects to see semiconductor memories introduced in the lower-performance, lower-cost systems.

"In the long run," he says, "semiconductor memories look more reliable, but we don't have enough life test data yet."

The all-MOS computer—or almost

While Seligman speaks as an engineer working for a manufacturer that has been producing minicomputers with core memories for some time, Cloyd E. Marvin, vice president for corporate development at Four-Phase Systems, Inc., Cupertino, Calif., represents a company that brought out its first product last fall. In his paper, "MOS/LSI Throughout," Marvin describes how his company went about designing a general-purpose, business-oriented computer and display system that was made almost exclusively with MOS/LSI.

According to Marvin "The use of semiconductor memory devices promises simplicity of design and low cost, both currently and into the future."

The System IV/70, as described by Marvin, has the computing power of an IBM 360/30 in storage and functional capacity, and is packaged in a desk top unit. The mainframe memory is composed of 1024-bit random-access-memory (RAM) chips designed in-house. At that level of complexity, the costs associated with the packaging and testing of the finished unit allow manufacturing costs to be comparable to ferrite core mainframe memories, Marvin says.

IBM decided to go a different route as far as mainframe memories are concerned. John K. Ayling of the IBM Components Div., Hopewell Junction, N. Y., discusses the four-chip, 512-bit bipolar memory module that IBM is incorporating in its new 370/145, System 7 and other computing products. IBM had previously used smaller semiconductor memories for high-speed buffers.

In his paper, "Monolithic Main Memory is Taking Off," Ayling contends that the time is ripe for semiconductor main memories in small and intermediate size CPUs. In addition semiconductor memories are competitive in the areas of writeable control storage, where the need is to match the performance of arithmetic and logic units.

How many ways can you make an MOS-IC?

Over 30 U. S. companies are selling MOS devices manufactured from almost as many different processes. N channel, enhancement mode, silicon gate, aluminum-oxide, self-aligning, nitride and ion implantation are the names of some of

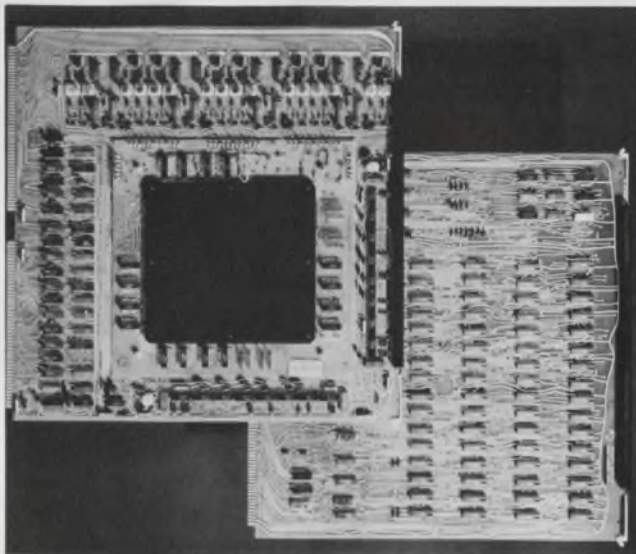

Memory selection for minicomputers involves a choice between a core memory system (top board) and a semiconductor memory (bottom board). Both types shown here are used by Data General Corp.

the processes used. In addition to the basic types, there are many variations for starting resistivity, junction depth, gate thickness, etc.

Dr. J. Leland Seely, corporate technical director of General Instrument Corp., Hicksville, N. Y., explains the main characteristics of each process as he leads off Session 4B, "Advances in MOS Technology," with a paper entitled "A Survey of MOS Process Technologies."

"It is not surprising how much process proliferation has taken place, with this number of companies all searching for a new breakthrough in MOS processing," Dr. Seely says. "This wild proliferation of processes causes many problems, both for the user and product vendor."

In the rush to keep up with the latest "in" process, sufficient documentation, quality control and life testing may not be done to insure reliability. The sheer number of different processes and the rapidity with which they and the products made from them are changing lead to confusion among users.

But where will it end? "Solutions to the problems are not obvious, but most probably the laws of economics will prevail and the proliferation will become self-limiting," according to Seely.

Linear ICs have not been forgotten

Simpler, less-expensive functions, more complex subsystems and low-cost, flexible consumer products are the three trends that W. G. Howard Jr. of Motorola Semiconductor Products, Inc., Phoenix, Ariz., sees in "New Product Trends in Linear Integrated Circuits" (Session 5 CH, "Using Integrated Circuits").

The development of simple, modest-performance building-block circuits makes possible a new generation of IC products, according to Howard. This will lead to electronic systems "where large numbers of very inexpensive linear circuits are used, in much the same manner as digital gates are used to realize logic functions," he says.

Howard uses op amps as a prime example. Historically they were the first widely used linear ICs to appear. And the development efforts have been traditionally concentrated on improving performance—higher gain, lower input current and offset voltages.

But the fact is, Howard says, that in applications such as active filter systems, simple warning and control circuits for automobiles and appliance control circuitry only modest op amp performance is required. In keeping with the need for simplicity, many of these applications require amplifiers that operate from a single supply voltage rather than the split supplies now needed for nearly all IC op amps.

Howard describes the operation of what he calls the "simplest possible operational ampli-

fier." This circuit, which operates from a single supply, gives an open loop gain of 3000 to 4000 with an input current of typically 60 nA. Since the circuit is so simple, the device may easily be internally compensated with 3 pF and the total die area of the complete circuit is small enough that quad or even hex op amps are now feasible.

In discussing more complex monolithic subsystems, Howard emphasizes the digital-analog interface of digital data acquisition and transmission systems. "A/d conversion systems of significant accuracy (6 bits and up) are too complicated to be realized monolithically," he says. "However, substantial parts of the converter may

be integrated."

The emergence of special-purpose modules to perform large portions of complicated system functions is the precursor of more complex linear IC products, Howard asserts. These products will, he says, in all likelihood, be modular to retain flexibility in several systems of the same type, yet be specifically aimed at particular system functions, such as a/d conversion.

Performance characteristics of many of the newly developed interface circuits that have become available in the last year are discussed by William D. Whittekin of Texas Instruments, Inc., Dallas, in Session 7B. ■■

Electro-Optics: LEDs lead the way in a variety of new applications

Displays of light-emitting diodes are now in ready supply at reasonable cost. But the number of ways in which the diodes can be arranged to provide the alpha or numeric characters, and the methods by which they can be driven, mean that the design of decoding and driving circuitry must be carefully considered. The possibilities are discussed in Session 4E on "Electroluminescent Diode Displays and Associated Circuits."

It is possible, for example, to have a much larger number of display leads and much more complicated driving circuits than are really necessary. This means excessive cost and size.

David J. Giuliana, an applications engineer with Hewlett-Packard, Palo Alto, Calif., and author of "Matrix Addressing and Partitioning Schemes for EL Diode Arrays," points out that the LED displays are matrixes interfaced with circuits that provide more than one function. The data to be displayed comes from some information source in a form that normally must be processed by a decoder. The decoder translates the data into a logic format suitable for a given type of display. The decoder output feeds the driving circuits that provide the necessary voltage and current levels for activating portions of the matrix at any one time.

Diode arrays are usually organized in a rectangular matrix that may be addressed by either a single-coordinate or dual-coordinate method. With the single-coordinate method, one address line is needed for each discrete diode in the matrix. For example, a 5-by-7 matrix would require 35 lines.

The dual-coordinate system acts like an X-Y selection setup, in that one set of lines selects the horizontal coordinate and another the vertical coordinate of the diode being addressed.

Single-coordinate systems are generally used with on-board decoder/drivers for numerical data display, whereas dual-coordinate systems are used in time-shared, multiplexed (strobed) displays of both alpha and numeric data.

Another type of solid-state display, and one that promises to give LEDs competition, is liquid crystals, says Dr. Richard A. Reynolds, manager of the display technology branch of the Advanced Technology Laboratory at Texas Instruments, Dallas. His viewpoint is confirmed in a Session 8CH paper, "Liquid Crystals," by Dr. Linda T. Creagh and Dr. Allan R. Kmetz, both members of the TI technical staff.

"The direction our research has taken is emphasizing the development of low-voltage crystals," Reynolds says. "Principal advantages lie in the low-voltage required, as well as the negligible power needed to operate the display. Display numerals, or characters, can also be driven directly by MOS circuits without the interfacing complications of LED devices."

Because these liquid-crystal displays are compatible with 12-V battery sources, Reynolds points out that a potential mass market is in new types of automobile dashboard displays for monitoring the various operating functions.

A number of other companies besides Texas Instruments should have this type of display in production by the end of 1971, Reynolds believes. And the cost for an eight-digit readout should be about \$8, he adds.

Another advantage of liquid crystals lies in the fact that large characters—1/2 to 1 inch or greater—can be produced with essentially no difference in cost, whereas with LEDs, both the cost of the materials and the fabrication increase dramatically with sizes above 1/4 inch. ■■

P&B Solid State Hybrid Relays.

We get them by mating semiconductors and relays. You get a whole new range of switching options.



For example, you can interface semiconductor logic circuits with inductive loads like motors, solenoids, contactors. You can use inputs as low as 5 microwatts to switch 7 ampere loads. All with the isolation normal with relays. Wide choice of package sizes and terminations, too.

EBT Solid State Hybrid Relay. A solid state AC switch controlled by a reed relay. It switches 7 amperes rms, 60 Hz at 25°C ambient. Operate time: 2 milliseconds. Coil voltages range from 6 to 48V DC.

EBA Sensitive Solid State Hybrid Relay. Similar to the EBT but with sensitivity as high as 12 microwatts. Available for 12, 18 or 24V DC. Built-in polarity protection. Switching is bounce-free.

KUA Amplifier-Driven Relay. Standard sensitivity: 60 microwatts. DPDT contacts will switch 5 amperes at 28V DC or 120V 60 Hz, 80% PF. Features continuous duty operation, built-in polarity protection.

KUR Alternate, Direct-Action, Impulse Relay. Single coil, DPDT relay has permanent magnet in parallel with normal flux path plus solid state flip-flop circuit. Results? A relay with both permanent memory and alternate action features controlled from a single DC source. Contacts rated 5 or 10 amperes remain in last position without power.

JDA Amplifier-Driven Reed Relay. Low profile Dual Thin-Line reed relay has sensitivity as high as 5 microwatts (96 mw standard). Designed to operate in association with integrated circuits, in particular the output of DTL and TTL logics in current sourcing mode. High input/output isolation. Contact arrangements: 2 Form A and 4 Form A.

JDB Solid State/Reed AC Switch Ideal for interfacing solid state circuits intended to control 120V 60 Hz loads such as fractional HP motors, solenoids, contactors. Seated height: .275". 1 Form A contacts will switch 1.7 amperes at 25°C ambient.

P&B solid state hybrids are available from leading electronic parts distributors. For complete information, call your P&B representative or Potter & Brumfield Division of AMF Incorporated, Princeton, Indiana 47570. Telephone: (812) 385-5251.

AMF
POTTER & BRUMFIELD

P&B performance. Nothing else comes close.

We give you more
of what you need;
quality.



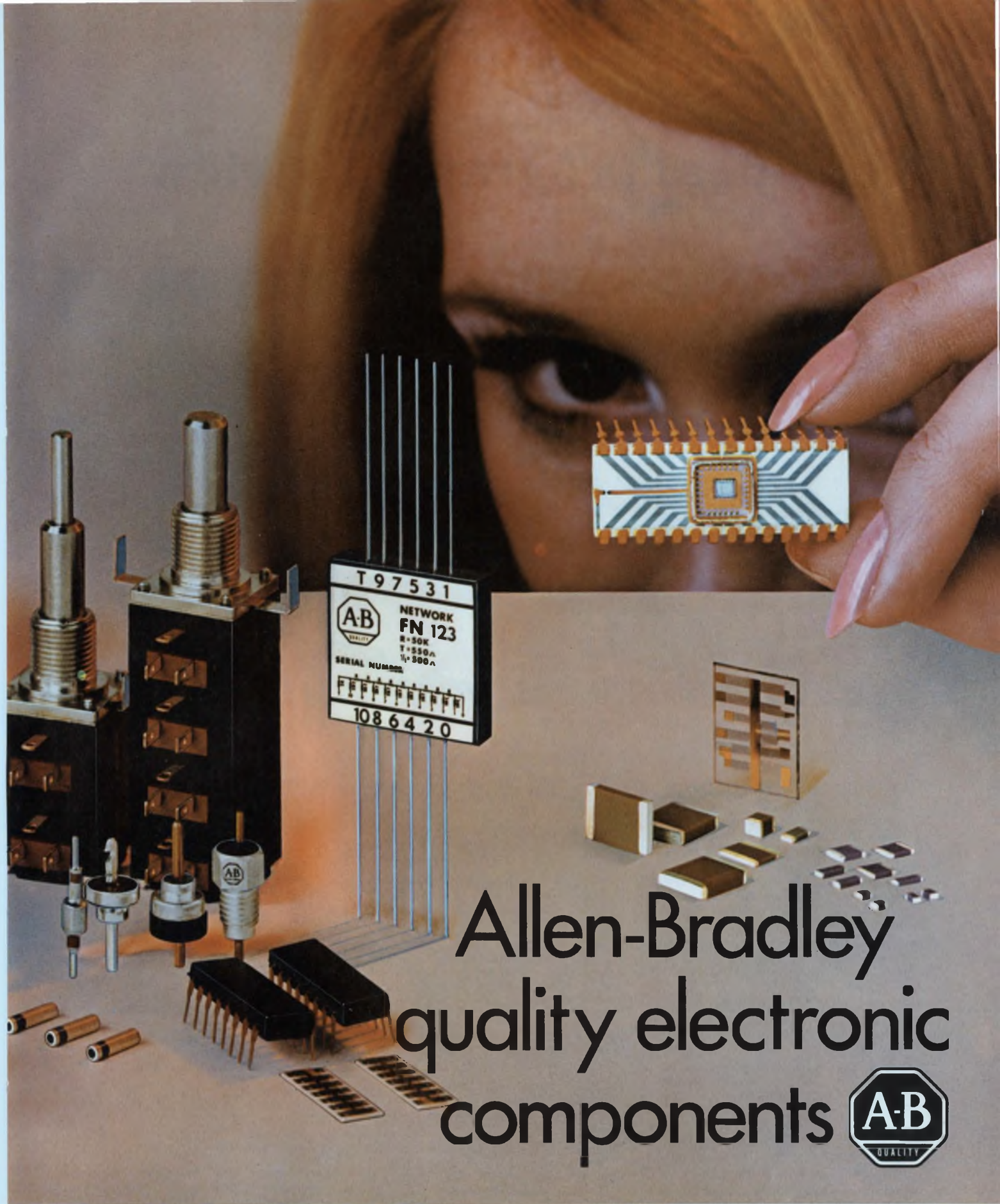

Allen-Bradley quality electronic components



You know our resistors, billions produced with unexcelled quality. This same tradition extends to precision thick and thin film networks, RFI filters,

hard and soft ferrites, chip capacitors, pots and trimmers, hybrids, optoelectronic devices, even large scale integrated circuits.* Quality is Allen-Bradley's

contribution to the marriage of mass production and advanced technology. Call your nearest A-B electronic specialist. Allen-Bradley, Milwaukee, Wis. 53204.

*LSI devices produced by an Allen-Bradley affiliate, MOS Technology, Inc., Valley Forge, Pa.

Technical program in review



This year's IEEE show will offer the visiting engineer a choice of 82 technical sessions.

Avionics and Aerospace

Establishing the Permanent INTEL-SAT—The Hon. Abbott Washburn, Dept. of State, Washington, D. C. (1A.1/Mon./a.m./T)

The Future Trends in Satellite Technology—W. L. Pritchard, Communications Satellite Corp. Lab., Clarksburg, Md. (1A.2/Mon./a.m./T)

Utilizing Satellites in the Commercial Telecommunications Network—J. R. Rae, AT&T, New York, N.Y. (1A.3/Mon./a.m./T)

The Future of Communications and TV by Satellite—John Hult, The Rand Corp., Santa Monica, Calif. (1A.4/Mon./a.m./T)

Space Station Adaptive Control—J. M. Mendel, McDonnell Douglas Astronautics Co., Huntington Beach, Calif. (1D.1/Mon./a.m./SS)

Satellite Communications at Optical Frequencies—H. Plotkin, Goddard Space Flight Center, NASA, Greenbelt, Md. (2C.3/Mon./p.m./SN)

Planetary Imaging and Topographic Mapping by Radar Interferometry—S. H. Zisk and A. E. E. Rogers, MIT, Westford, Mass. (2G.1/Mon./p.m./R)

Impact of ATC Automation on Data Acquisition System Requirements—

N. A. Blake, Federal Aviation Administration, Washington, D. C. (2G.3/Mon./p.m./R)

Airborne Multifunction Array Radar—Michael Briana, Raytheon Co., Bedford, Mass. (2G.4/Mon./p.m./R)

The Digital Future of the Ground Based Phased Array—S. J. Rabinowitz, RCA, Moorestown, N. J. (2G.5/Mon./p.m./R)

Landing System Requirements for Large Space Vehicles—D. L. Mellen, Honeywell, Minneapolis, Minn., and H. L. Ehlers, North American Rockwell, Downey, Calif. (3C.1/Tues./a.m./SN)

Space Computer Technology—Harrison Garrett, NASA, Huntsville, Ala. (3C.4/Tues./a.m./SN)

Technology for Data Transmission via Satellite—Andrew Werth, COMSAT Labs., Clarksburg, Md. (3F.3/Tues./a.m./G)

Demands of Future Unmanned Planetary Missions—Paul Tarver and R. S. H. Toms, NASA, Washington, D. C. (4D.1/Tues./p.m./SS)

The Pioneer Spacecraft Flyby of Jupiter—W. J. Dixon, R. W. Holtzclaw, Ames Research Center, Moffett Field, Calif., and E. G. Wheeler, TRW, Redondo Beach, Calif. (4D.2/Tues./p.m./SS)

Mariner Venus/Mercury '73—The First Multi-Planet Mission—J. R. Casani, Jet Propulsion Lab., Pasadena, Calif. (4D.3/Tues./p.m./SS)

The Viking 1975 Mission: Electronic System Challenges for an Unmanned Mars Landing—E. A. Brummer, W. F. Cuddihy, NASA, Hampton, Va., and Walter Mielziner, Martin Marietta Corp., Denver, Colo. (4D.4/Tues./p.m./SS)

Grand Tour Spacecraft Avionics Challenges—R. F. Draper, Jet Propulsion Lab., Pasadena, Calif. (4D.5/Tues./p.m./SS)

Recent Developments on Observations of the Earth and Atmosphere from Satellites—William Nordberg, NASA, Greenbelt, Md. (7G.1/Thur./a.m./R)

Automatic Data Analysis Techniques for Earth Resources Information Systems—R. B. MacDonald, Purdue Univ., W. Lafayette, Ind. (7G.2/Thur./a.m./R)

Earth Resources Aerospace Systems for the '70s—A. B. Park, NASA, Washington, D. C. (7G.3/Thur./a.m./R)

Domestic Satellite Facilities for the Nationwide Telephone Network—R. F. Latter, AT&T, New York, N. Y. (8A.3/Thur./p.m./T)

Technical papers are grouped in these categories

Avionics and Aerospace
 Communications
 Components
 Computers and
 Computer-Aided Design
 Electro-optical

Materials, Interconnections
 and Packaging
 Microelectronics
 Microwaves
 Urban Engineering (Civionics)

Code to abbreviations

Session locations in the New York Hilton are:

E — East Ballroom
 G — Gramercy Suite
 M — Mercury Ballroom
 MH — Murray Hill Suite
 N — Nassau Suite
 R — Regent Room
 RG — Rhineland Gallery
 South
 SN — Sutton Ballroom North
 SS — Sutton Ballroom South
 T — Trianon Ballroom

All Technical Application Sessions
 C — Coliseum

Numerals refer to sessions and to papers in a session—for example, 8F.5 is paper 5 of session 8F.

The hours for the technical application sessions, Monday through Thursday are: 10:30 a.m. to 5:00 p.m.

Economics and Regulation of Domestic Satellite Communication—W. H. Melody, Univ. of Pennsylvania, Philadelphia, Pa. (8A.4/Thur./p.m./T)

Domestic Satellite Communications in Alaska—Philip Schneider, RCA, New York, N. Y. (8A.5/Thur./p.m./T)

Applications and Social Impact of Domestic Communications Satellite—E. M. Van Vleck, NASA, Moffett Field, Calif. (8A.6/Thur./p.m./T)

Labs., Clarksburg, Md. (3F.3/Tues./a.m./G)

Multiplexing in the Real World Today—R. W. Sanders, Computer Transmission Corp., Los Angeles, Calif. (3F.4/Tues./a.m./G)

A Private Line Digital Data Service—Paul Muench, AT&T, New York, N. Y. (4F.1/Tues./p.m./G)

Plans for a Nationwide Digital Transmission Network for Data—R. G. DeWitt, Western Union Telegraph Corp., Mahwah, N. J. (4F.2/Tues./p.m./G)

Digital Transmission and the Evolving Nature of Data Processing—D. E. Gourley, Data Transmission Corp., Vienna, Va. (4F.3/Tues./p.m./G)

Computer Network Design—Howard Frank, Network Analysis Corp., Glen Cove, N. Y. (4F.4/Tues./p.m./G)

An Experiment in Addressed-Block Data Transmission Around a Closed Loop—J. R. Pierce, Cecil Coker, and W. J. Kropfl, Bell Telephone Labs., Murray Hill, N. J. (4F.5/Tues./p.m./G)

Computer Communications—An Overview—Al Hartung, XDS, El Segundo, Calif. (5A.1/Wed./a.m./T)

Interfacing Communications Lines with a Computer—J. W. Conway, Honeywell, Framington, Mass. (5A.2/Wed./a.m./T)

Criteria for Systems Organization and Hardware Design of a Data-Communications Processor—Richard Barton, General Electric Co., Charlottesville, Va. (5A.4/Wed./a.m./T)

Panel Discussion: Interconnection with the Telephone Network—R. M. Alden, United Utilities, Inc., Kansas City, Mo.; C. H. Elmendorf, AT&T, New York, N. Y.; J. L. Wheeler, Xerox Corp, Rochester, N. Y.; Sang Whang, International Communications Corp., Miami, Fla.; M. P. Beere, Tymshare, Inc., Palo Alto, Calif.; and J. F. Holmes, Business Equipment Manufacturers Association, Washington, D. C. (6A/Wed./p.m./T)

Domestic Satellite Communications as Part of the Record and Data Network—Robert Garbarini, Western Union, New York, N. Y. (8A.1/Thur./p.m./T)

Domestic Satellite Communications as a Multipurpose Telecommunications Entity—John Martin, COMSAT Corp., Washington, D. C. (8A.2/Thur./p.m./T)

Communications

Establishing the Permanent INTELSAT—The Hon. Abbott Washburn, Dept. of State, Washington, D. C. (1A.1/Mon./a.m./T)

The Future Trends in Satellite Technology—W. W. Pritchard, Communications Satellite Corp. Lab., Clarksburg, Md. (1A.2/Mon./a.m./T)

Utilizing Satellites in the Commercial Telecommunications Network—J. R. Rae, AT&T, New York, N. Y. (1A.3/Mon./a.m./T)

The Future of Communications and TV by Satellite—John Hult, The Rand Corp., Santa Monica, Calif. (1A.4/Mon./a.m./T)

Progress in High Data Rate Optical Communications—T. S. Kinsel, Bell Telephone Labs., Murray Hill, N.J. (2C.1/Mon./p.m./SN)

Outdoor Optical Transmission Experiments—H. J. Schulte, W. C. G. Ortel, and B. G. King, Bell Telephone Labs., Holmdel, N. J. (2C.2/Mon./p.m./SN)

Satellite Communications at Optical Frequencies—H. Plotkin, Goddard Space Flight Center, NASA, Greenbelt, Md. (2C.3/Mon./p.m./SN)

Communication Through Optical Scattering Channels—R. S. Kennedy, MIT, Cambridge, Mass. (2C.4/Mon./p.m./SN)

Alphanumeric and Graphical Communications Terminals—Henry Burkhard, U. S. Army Electronics Command, Fort Monmouth, N. J. (3E.2/Tues./a.m./MH)

Multiplexing for Computers—Samuel Estes, IBM, Research Triangle Park, N. C. (3F.1/Tues./a.m./G)

Synchronizing and Multiplexing in a Digital Transmission Hierarchy—J. W. Pan, Bell Telephone Labs., Holmdel, N.J. (3F.2/Tues./a.m./G)

Technology for Data Transmission via Satellite—Andrew Werth, COMSAT

Domestic Satellite Facilities for the Nationwide Telephone Network—R. F. Latter, AT&T, New York, N. Y. (8A.3/Thur./p.m./T)

Economics and Regulation of Domestic Satellite Communication—W. H. Melody, Univ. of Pennsylvania, Philadelphia, Pa. (8A.4/Thur./p.m./T)

Applications and Social Impact of Domestic Communications Satellite—E. M. Van Vleck, NASA, Moffett Field, Calif. (8A.6/Thur./p.m./T)

Components

Panel Discussion: How Components May Affect Computer Systems—Gerald Estrin, Univ. of Calif., Los Angeles, Calif.; A. S. Hoagland, IBM, Yorktown Heights, N. Y.; J. H. Pomerehne, IBM, Armonk, N. Y.; J. A. Rajchman, RCA, Princeton, N. J.; and Rex Rice, Fairchild Semiconductor, Palo Alto, Calif. (4A/Tues./p.m./T)

Modular Design for Advanced Assembly—Darwin Inman, Zenith Radio Corp., Chicago, Ill. (2CH.1/Mon./p.m./C)

Computer-Controlled PC Assembly with a Modular Approach—J. S. Hohl, Universal Instruments Corp., Binghamton, N. Y. (2CH.2/Mon./p.m./C)

Computer-Controlled PC Assembly System—Leonard Prednis, National Electro-Mechanical Systems, Inc., Binghamton, N. Y. (2CH.3/Mon./p.m./C)

Advanced Beam Lead Chip Handling—R. O. Birchler, Texas Instruments, Inc., Dallas, Tex. (2CH.4/Mon./p.m./C)

Reaction of Gold Alloys and Electroplates in Hostile Environments—W. H. Abbott, Battelle Memorial Institute, Columbus, Ohio (2CK.1/Mon./p.m./C)

- The Design of Separable Connectors—R. H. VanHorn, Bell Telephone Labs., Columbus, Ohio. (2CK.2/Mon./p.m./C)
- Use of Soft-Gold Overplate on a Contact Tab Surface—D. W. Hogan, R. J. Krajnyak, and H. Hildebrandt, IBM, Endicott, N. Y. (2CK.3/Mon./p.m./C)
- Cross-Talk Analysis of Digital Interconnection System—R. Harwood and E. Reyner, AMP, Inc., Harrisburg, Pa. (2CK.4/Mon./p.m./C)
- Development of Wideband, Tunable VHF Circulators—Irving Rubinstein, Airborne Instruments Lab., Melville, N. Y. (3CJ.1/Tues./a.m./C)
- Applying the YIG Filter to Tunable Microwave Systems—N. P. Albrecht, Watkins-Johnson Co., Palo Alto, Calif. (3CJ.2/Tues./a.m./C)
- Advances in Ferrite Phase Shifter Technology: New Possibilities for the System Designer—C. R. Boyd, Jr., Microwave Applications Groups, Chatsworth, Calif. (3CJ.3/Tues./a.m./C)
- Ferrite Components for MIC Modules—B. R. Savage, J. L. Brediger, D. R. Taft, Sperry Rand Corp., Clearwater, Fla. (3CJ.4/Tues./a.m./C)
- ## Computers and Computer-Aided Design
- Bipolar Memories—M. R. Barber, Bell Telephone Labs., Murray Hill, N. J. (1B.1/Mon./a.m./M)
- Static MOS Memories—P. H. Bardell, Jr., IBM, Hopewell Junction, N. Y. (1B.2/Mon./a.m./M)
- Complementary MOS Memories—H. S. Muller, RCA, Somerville, N. J. (1B.3/Mon./a.m./M)
- Dynamic Refresh Memories—J. A. Karp, Intel Corp., Mountain View, Calif. (1B.4/Mon./a.m./M)
- Monolithic Main Memory Is Taking Off—John Ayling, IBM, Hopewell Junction, N. Y. (2B.1/Mon./p.m./M)
- A User's Look at MOS RAMS for Main Memory—D. K. Lauffer and Peng Lim, NCR, San Diego, Calif. (2B.2/Mon./p.m./M)
- MOS/LSI Throughout—C. E. Marvin, Four-Phase Systems, Cupertino, Calif. (2B.3/Mon./p.m./M)
- Choosing Memory Technologies for a Minicomputer Family—Lawrence Seligman, Data General Corp., Southboro, Mass. (2B.4/Mon./p.m./M)
- Semiconductor Memory Design—Richard Woelkers, Ampex, Culver City, Calif. (2B.5/Mon./p.m./M)
- Computer Voice Response Using Low Bit-Rate Synthetic Speech—L. R. Rabiner and R. W. Schafer, Bell Telephone Labs., Murray Hill, N. J. (2F.1/Mon./p.m./G)
- Techniques for Computer Voice Response—W. D. Chapman, IBM, Research Triangle Park, N. C. (2F.2/Mon./p.m./G)
- Voice Response Using Monotone Synthetic Speech—B. Gold and T. Bialy, MIT, Lexington, Mass. (2F.3/Mon./p.m./G)
- A Voice for the Laboratory Computer—F. S. Cooper, T. S. Rand, R. S. Music, and I. G. Mattingly, Haskins Labs., New Haven, Conn. (2F.4/Mon./p.m./G)
- Minicomputer Architecture—Description and Design—C. G. Bell, Carnegie-Mellon Univ., Pittsburg, Pa. 3A.4/Tues./a.m./T)
- Space Computer Technology—Harri-son Garrett, NASA, Huntsville, Ala. (3C.4/Tues./a.m./SN)
- Computer-Driven Printers, Technology and Trends—D. E. Damouth, Xerox Corp., Rochester, N. Y. (3E.1/Tues./a.m./MH)
- Multiplexing for Computers—Samuel Estes, IBM, Research Triangle Park, N. C. (3F.1/Tues./a.m./G)
- Panel Discussion: How Components May Affect Computer Systems—Gerald Estrin, Univ. of Calif., Los Angeles, Calif.; A. S. Hoagland, IBM, Yorktown Heights, N. Y.; J. H. Pomerene, IBM, Armonk, N. Y.; J. A. Rajchman, RCA, Princeton, N. J.; and Rex Rice, Fairchild Semiconductor, Palo Alto, Calif. (4A.1/Tues./p.m./T)
- Computer Network Design—Howard Frank, Network Analysis Corp., Glen Cove, N. Y. (4F.4/Tues./p.m./G)
- Computer Communications—An Overview—Al Hartung, XDS, El Segundo, Cove, N. Y. (4F.4/Tues./p.m./G)
- Interfacing Communications Lines with a Computer—J. W. Conway, Honeywell, Framingham, Mass. (5A.2/Wed./a.m./T)
- A Systems Approach to Front-End Software—L. L. Sando, COMCET, Roseville, Minn. (5A.3/Wed./a.m./T)
- Criteria for Systems Organization and Hardware Design of a Data-Communications Processor—Richard Barton, General Electric Co., Charlottesville, Va. (5A.4/Wed./a.m./T)
- Efficiency Considerations of Several Communications Executives—S. R. Amstutz, Honeywell, Framingham, Mass. (5A.5/Wed./a.m./T)
- The Present and Future of Moving Media Memories—D. T. Best, UNIVAC, Blue Bell, Pa. (5F.1/Wed./a.m./G)
- Semiconductor Memory—T. R. Finch, Bell Telephone Labs., Murray Hill, N. J. (5F.2/Wed./a.m./G)
- Magnetic Memories—Present Status and Future Trends—Rabah Shahbender, RCA, Princeton, N. J. (5F.3/Wed./a.m./G)
- How LSI Is Affecting Logic Design—R. A. Henle, IBM, Armonk, N. Y., and G. A. Maley, IBM, Hopewell Junction, N. Y. (5F.4/Wed./a.m./G)
- Delay and Communication in Computer Networks—Leonard Kleinrock, Univ. of California, Los Angeles, Calif. (6D.2/Wed./p.m./SS)
- From Computer Networks to Gas Pipelines—Large Scale Network Design—H. Frank, Network Analysis Corp., Glen Cove, N. Y. (6D.3/Wed./p.m./SS)
- Computer Systems as Instructional Aids—John Morrissey, John Morrissey Associates, Inc., New York, N. Y. (8G.1/Thur./p.m./R)
- Refinements in Computer Enhanced Microwave Testing—Stuart Yellen, Computer Metrics Testing, Rochelle Park, N. J. (1Cl.1/Mon./a.m./C)
- Solution to Building Minicomputer Systems—J. J. Mohan, Abate and Mohan Associates, Inc., Ridgewood, N. J. (3CH.3/Tues./a.m./C)
- Minicomputers and Environmental Resources—Stanford Hovey, Data-graphics, Inc., Allison Park, Pa. (3CH.4/Tues./a.m./C)
- Application of Computers to LSI Testing—S. Sampson, Bell Telephone Labs., Naperville, Ill. (5CJ.1/Wed./a.m./C)
- ## Electro-optical
- Progress in High Data Rate Optical Communications—T. S. Kinsel, Bell Telephone Labs., Murray Hill, N. J. (2C.1/Mon./p.m./SN)
- Outdoor Optical Transmission Experiments—H. J. Schulte, W. C. G. Ortel, and B. G. King, Bell Telephone Labs., Holmdel, N. J. (2C.2/Mon./p.m./SN)
- Satellite Communications at Optical Frequencies—H. Plotkin, Goddard Space Flight Center, NASA, Greenbelt, Md. (2C.3/Mon./p.m./SN)
- Communication Through Optical Scattering Channels—R. S. Kennedy, MIT, Cambridge, Mass. (2C.4/Mon./p.m./SN)
- Underwater Optical Communication—Why Not?—E. V. Hoversten and R. Lerner, M. I. T. Cambridge, Mass. (2C.5/Mon./p.m./SN)
- Light-Emitting Diodes—A Survey—R. W. Ahrons, Opcoa, Inc., Edison, N. J. (4E.1/Tues./p.m./MH)
- Circuit Applications and Fabrication of Monolithic Solid-State Displays—Raymond Hunt, Sr., Monsanto, Cupertino, Calif. (4E.2/Tues./p.m./MH)
- Addressing and Coding Schemes for Mosaic Displays—D. J. Giuliani, Hewlett-Packard, Palo Alto, Calif. (4E.3/Tues./p.m./MH)
- Organization of Alphanumeric Electroluminescent Diode Displays—Walter Rosensweig, Bell Telephone Labs., Murray Hill, N. J. (4E.4/Tues./p.m./MH)
- Panel Discussion: LED Arrays—Their Technology and Associated Circuits—R. W. Ahrons, Opcoa, Inc., Edison, N. J.; Raymond Hunt, Sr., Monsanto, Cupertino, Calif.; D. J. Giuliani, Hewlett-Packard, Palo Alto, Calif.; Walter Rosenweig, Bell Telephone Labs., Murray Hill, N. J.; H. C. Borden, American Micro-Systems, Inc., Santa Clara, Calif.; and Dominick Richiuso, General Instruments, Hicksville, N. Y. (4E.5/Tues./p.m./MH)
- Application of the Charge Coupled Device Concept to Image Sensors—W. J. Bertram, Bell Telephone Labs., Murray Hill, N. J. (5C.1/Wed./a.m./SN)

The toughest lighted switches.

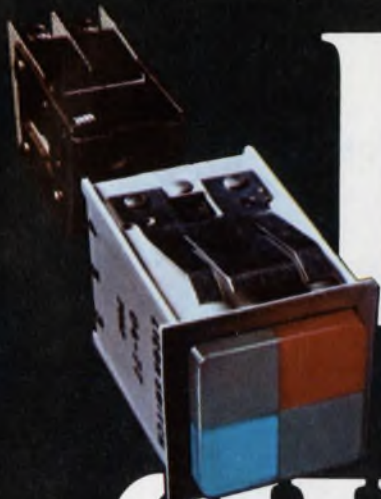

*Because every one is based on Licon's
incredibly reliable (up to 20 million
mechanical cycle) Butterfly switch.*

From the tiny inexpensive Type 01-700 to the four-lamp Type 04, every Licon® lighted switch incorporates one or more Licon Butterfly® switches. Thus the ultimate in double-break switches becomes the basis for one of the broadest lines of lighted switches available. Choose the indicating function required... one; two or four lamps... lens cap configuration... screen color and engraved legend. Name your switching

action... momentary, maintained, solenoid-held, indicator light only, or multi-circuit control. Select your mounting style... flange, barrier, bezel, bezel-barrier, horizontal or vertical, single-switch or multiple in matrix. Meet Mil Specs. In every choice, installation and servicing is fast and easy. Because ultra-reliable switching is our business. Test light the line yourself. Call your local Licon distributor or representative for a

lighted demo in your office. Or call or write for a Licon Switch Catalog. **Licon, Division Illinois Tool Works Inc., 6615 W. Irving Park Road, Chicago, Illinois 60634. Phone (312) 282-4040. TWX 910-221-0275.**



itw LICON

- Applications for Solid-State Line Scanners—Observations from the Perspective of the Designer—R. H. Dyck, Fairchild R&D, Palo Alto, Calif. (5C.2/Wed./a.m./SN)
- Characteristics and Limitations of Light-Sensing Arrays Based on LSI Technologies—W. F. List, Westinghouse Advanced Technology Lab., Baltimore, Md. (5C.3/Wed./a.m./SN)
- Interrogation Limited Performance of IR Sensor Arrays—R. D. Stewart, General Electric Co., Syracuse, N. Y. (5C.4/Wed./a.m./SN)
- A Comparison of Systems and Technologies for Solid-State Image Sensors—P. K. Weimer, RCA, Princeton, N. J. (5C.5/Wed./a.m./SN)
- A Review of Tube-Type Video Imaging Devices—E. I. Gordon, Bell Telephone Labs., Murray Hill, N. J. (6C.1/Wed.p.m./SN)
- Design and Fabrication of Silicon Diode Array Targets—L. H. Von Ohlsen, Jr., Bell Telephone Labs., Reading, Pa. (6C.2/Wed./p.m./SN)
- Low Light-Level Performance of Silicon Diode Array Devices—R. L. Rodgers, III, RCA, Lancaster, Pa. (6C.3/Wed./p.m./SN)
- Performance of Silicon Vidicons—F. L. Skaggs, Texas Instruments, Inc., Dallas, Tex. (6C.4/Wed./p.m./SN)
- Pulsed CO₂ Lasers—W. B. McKnight and G. J. Dezenberg, U. S. Army Missile Command, Huntsville, Ala. (7C.1/Thur./a.m./SN)
- CW Electrical CO₂ Lasers—J. W. Davis, United Aircraft Research Labs., East Hartford, Conn. (7C.2/Thur./a.m./SN)
- Chemical Lasers—T. A. Cool, Cornell Univ., Ithaca, N. Y. (7C.3/Thur./a.m./SN)
- High-Power HE & DF Chemical Lasers—T. A. Jacobs, Aerospace Corp., Los Angeles, Calif. (7C.4/Thur./a.m./SN)
- Gas Dynamic Lasers—E. Gerry, AVCO, Everett, Mass. (7C.5/Thur./a.m./SN)
- Optical Parametric Oscillators—A. Ashkin, Bell Telephone Labs., Holmdel, N. J. (8B.1/Thur./p.m./M)
- Tunable Semiconductor Lasers—E. D. Hinkley, MIT, Lexington, Mass. (8B.2/Thur./p.m./M)
- Tunable Raman Lasers—C. K. N. Patel, Bell Telephone Labs., Holmdel, N. J. (8B.3/Thur./p.m./M)
- Tunable Dye Lasers—D. J. Bradley, Queen's Univ., Belfast, Northern Ireland. (8B.4/Thur./p.m./M)
- Approaches to Multichip Interconnect—Dave Richardson, Fairchild R&D, Palo Alto, Calif. (5B.2/Wed./a.m./M)
- Multilevel Interconnections for Complex ICs—James Cunningham and Barney Carbajal, Texas Instruments, Houston, Tex. (5B.3/Wed./a.m./M)
- MOS/LSI Packing—Problem or Opportunity?—R. C. Platzek, North American Rockwell Corp., Anaheim, Calif. (5B.4/Wed./a.m./M)
- Interconnection Problem Areas—R. A. Glass, T. G. Maple, and R. D. Wales, Lockheed Palo Alto Research Lab., Palo Alto, Calif. (5B.5/Wed./a.m./M)
- Equipment for Total Soldering Systems—W. L. Ferris, RCA, Plymouth, Mich. (1CK.1/Mon./a.m./C)
- Some Automated Soldering Techniques Used in Automotive Electronics—G. M. Wagner, GMC, Kokomo, Ind. (1CK.2/Mon./a.m./C)
- Ultrasonic Soldering—Stanley Frolic, Westinghouse, Pittsburgh, Pa. (1CK.3/Mon./a.m./C)

Want to write technical articles?

If you do, then don't miss session 7D, "What engineers should know about trade magazines." One of the speakers at this session is Frank Egan, Editor of ELECTRONIC DESIGN. He, together with the other speakers, will outline the ABC's of trade magazines, and offer many valuable tips to engineers on how to get technical articles accepted and published. (7D/Thur./a.m./SS)

Artwork Compensation, Tooling and Realistic Tolerances in Electrochemical Processing—R. A. Jones, RCA, Camden, N. J. (4CK.1/Tues./p.m./C)

Matching of Electrochemical Processes for a Variety of Sequences of Such Processes—R. J. Dietz, Maine Research Corp., Lisbon, Me. (4CK.2/Tues./p.m./C)

Method of Analysis of Photo Tooling Tolerances and Their Effect on Manufacturing Yield—Howard Martin, Systematic Design, Inc., Garland, Tex. (4CK.3/Tues.p.m./C)

Process Changes, Interactions and Reliability—Jane Partridge, MIT, Cambridge, Mass. (4CK.4/Tues./p.m./C)

Ceramics for Microelectronics—L. E. Ferreira, Coors Porcelain Co., Golden, Colo. (5CK.1/Wed./a.m./C)

Multilayered Ceramics—J. J. Cox, Jr., E. I. duPont de Nemours and Co., Wilmington, Del. (5CK.2/Wed./a.m./C)

Ceramics for Microwave Applications—Martin Caulton, RCA, Princeton, N. J. (5CK.3/Wed./a.m./C)

Ceramic Substrates for Thin-Film Circuits—D. E. Peters and D. A. Rott,

Western Electric Co., Inc., Allentown, Pa. (5CK.4/Wed./a.m./C)

Hermetic Package Sealing—Samuel Goldfarb, RCA, Somerville, N. J. (6CJ.1/Wed./p.m./C)

Glass Passivation of Integrated Circuits by Chemical Vapor Deposition of Oxide Films—G. L. Schnable, Philco-Ford Corp., Blue Bell, Pa. (6CJ.2/Wed./p.m./C)

Reliability of Thick-Film Modules in Automobile Environments—G. L. Thomas, GMC, Kokomo, Ind. (6CJ.3/Wed./p.m./C)

Microelectronics

Bipolar Memories—M. R. Barber, Bell Telephone Labs., Murray Hill, N. J. (1B.1/Mon./a.m./M)

Static MOS Memories—P. H. Bardell, Jr., IBM, Hopewell Junction, N. Y. (1B.2/Mon./a.m./M)

Complementary MOS Memories—H. S. Muller, RCA, Somerville, N. J. (1B.3/Mon./a.m./M)

Dynamic Refresh Memories—J. A. Karp, Intel Corp., Mountain View, Calif. (1B.4/Mon./a.m./M)

Monolithic Main Memory Is Taking Off—John Ayling, IBM, Hopewell Junction, N. Y. (2B.1/Mon./p.m./M)

A User's Look at MOS RAMS for Main Memory—D. K. Lauffer and Peng Lim, NCR, San Diego, Calif. (2B.2/Mon./p.m./M)

MOS/LSI Throughout—C. E. Marvin, Four-Phase Systems, Cupertino, Calif. (2B.3/Mon./p.m./M)

Choosing Memory Technologies for a Minicomputer Family—Lawrence Seligman, Data General Corp., Southboro, Mass. (2B.4/Mon./p.m./M)

Semiconductor Memory Design—Richard Woelkers, Ampex, Culver City, Calif. (2B.5/Mon./p.m./M)

MST-4, A High-Speed Circuit Application—R. R. Wilcox, IBM, Poughkeepsie, N. Y. (3B.1/Tues./a.m./M)

Schottky-Clamped TTL—J. W. Kronlage, Texas Instruments Inc., Dallas, Tex. (3B.5/Tues./a.m./M)

Impact of Large Scale Integration on The Selection of Redundancy Techniques—G. C. Vandling, IBM, Owego, N. Y. (3C.2/Tues./a.m./SN)

A Survey of MOS Process Technologies—J. L. Seely, General Instrument Corp., Hicksville, N. Y. (4B.1/Tues./p.m./M)

Low Power Circuit Design Using P-Channel MOS—J. H. Kerins, American Micro-Systems Inc., Santa Clara, Calif. (4B.2/Tues./p.m./M)

Performance Characteristics of Low-Voltage COS/MOS Devices—E. E. Moore, RCA, Somerville, N. J. (4B.3/Tues./p.m./M)

Ion-Implanted MOS-LSI Circuits—H. G. Dill and P. J. Coppen, Hughes Aircraft Co., Newport Beach, Calif. (4B.4/Tues./p.m./M)

A 4000-Bit TTL Compatible Static MOS ROM—Vahe Sarkissian, National Semiconductor Corp., Santa Clara, Calif. (4B.5/Tues./p.m./M)

Materials, Intercommunications and Packaging

Interconnections and Hybrid Circuits—T. J. Matcovitch, Drexel Univ., Philadelphia, Pa. (5B.1/Wed./a.m./M)

Low cost reliable film caps.



As typified by this line of broad value/voltage, axial lead, metalized wrap and fill types.

Paktron employs the most highly mechanized film capacitor plant in the country to insure economy, availability and consistent quality throughout its entire line of film capacitors. Which includes a selection that virtually guarantees the ideal and economical choice for almost any application. Choose from the Paktron® film foil and metalized Mylar*, polypropylene, and metalized polycarbonate parts. Epoxy

coated, wrap and fill, molded and epoxy dipped construction. Radial and axial leads. Special close-tolerance types, temperature stable types and extra compact shapes like low-profile and wafer thin models. All designed to advance the universal trend to miniaturization and the current state of solid-state electronics. For samples and data on the finest in quality domestic capacitors, contact

your Paktron representative, or call or write:
**Paktron, Division
Illinois Tool Works
Inc., 1321 Leslie
Ave., Alexandria,
Virginia 22301.
Phone (703) 548-
4400. TWX
710-832-9811.**

*A DuPont Registered Trademark

 **PAKTRON**

The Innovating Electronic Group of ITW... PAKTRON • LICON • ELECTRO MATERIALS



- Interconnections and Hybrid Circuits—T. J. Matcovitch, Drexel Univ., Philadelphia, Pa. (5B.1/Wed./a.m./M)
- Approaches to Multichip Interconnect—Dave Richardson, Fairchild R&D, Palo Alto, Calif. (5B.2/Wed./a.m./M)
- Multilevel Interconnections for Complex ICs—James Cunningham and Barney Carbajal, Texas Instruments, Houston, Tex. (5B.3/Wed./a.m./M)
- MOS/LSI Packing—Problem or Opportunity?—R. C. Platzek, North American Rockwell Corp., Anaheim, Calif. (5B.4/Wed./a.m./M)
- Interconnection Problem Areas—R. A. Glass, T. G. Maple, and R. D. Wales, Lockheed Palo Alto Research Lab., Palo Alto, Calif. (5B.5/Wed./a.m./M)
- Semiconductor Memory—T. R. Finch, Bell Telephone Labs., Murray Hill, N. J. (5F.2/Wed./a.m./G)
- How LSI is Affecting Logic Design—R. A. Henle, IBM, Armonk, N. Y., and G. A. Maley, IBM, Hopewell Junction, N. Y. (5F.4/Wed./a.m./G)
- Ion-Implanted Resistors and MOSFETs in Integrated Circuits—J. D. Macdougall, Sprague Electric Co., North Adams, Mass. (6B.2/Wed./p.m./M)
- Experiences in the Use of Projection Photolithographic Exposure—J. R. Mathews, Bell Telephone Labs., Reading, Pa., and P. A. Raetsch, Western Electric Co., Reading, Pa. (6B.3/Wed./p.m./M)
- A Complete Integrated Circuit I-F. System for Color and B&W TV—R. T. Peterson and Seymour Reich, RCA, Somerville, N. J. (7B.1/Thur./a.m./M)
- Interface Circuit Trends—W. D. Whittakin, Texas Instruments Inc., Dallas, Tex. (7B.2/Thur./a.m./M)
- Monolithic Voltage Regulator: Present Trends—T. M. Frederiksen, Motorola, Phoenix, Ariz. (7B.3/Thur./a.m./M)
- Designs for I.C. Op Amps—R. C. Dobkin, National Semiconductor Inc., Santa Clara, Calif. (B.4/Thur./a.m./M)
- A Description of LSI Componentary Used in Digital Systems—Rex Rice, Fairchild Corp., Palo Alto, Calif. (7F.1/Thur./a.m./G)
- Array Logic and LSI—Harold Fleisher, IBM, Poughkeepsie, N. Y. (7F.2/Thur./a.m./G)
- Universal Logic Implementations—S. S. Yau, Northwestern Univ., Evanston, Ill. (7F.3/Thur./a.m./G)
- Partitioning for LSI: On the Trade-off Between Logic Performance and Circuit-to-Pin Ratio—R. L. Russo, IBM, Yorktown Heights, N. Y. (7F.4/Thur./a.m./G)
- Digital Bipolar Integrated Circuits—B. T. Murphy, Bell Telephone Labs., Murray Hill, N. J. (5CH.1/Wed./a.m./C)
- Linear Bipolar Integrated Circuits—W. G. Howard, Motorola, Phoenix, Ariz. (5CH.2/Wed./a.m./C)
- MOS Integrated Circuits—R. L. Luce, Philco-Ford Corp., Blue Bell, Pa. (5CH.3/Wed./a.m./C)
- Low Threshold Voltage CMOS Integrated Circuits—T. G. Athanas, RCA, Somerville, N. J. (5CH.4/Wed./a.m./C)
- Computer-Aided Integrated Circuit Design—C. S. Meyer, Motorola, Phoenix, Ariz. (5CH.5/Wed./a.m./C)
- Application of Computers to LSI Testing—S. Sampson, Bell Telephone Labs, Naperville, Ill. (5CJ.1/Wed./a.m./C)
- LSI Testing—A Manufacturing Reality—M. O'Shea, Fairchild Semiconductor, Mountain View, Calif. (5CJ.2/Wed./a.m./C)
- Test Pattern Generation and Fault Diagnosis—R. Marlett, Teradyne, Boston, Mass. (5CJ.3/Wed./a.m./C)
- Practical Aspects of LSI Testing—M. Lee, Motorola, Phoenix, Ariz. (5CJ.4/Wed./a.m./C)
- Testability as a Design Criterion—A. E. Pound, American Micro-Systems, Santa Clara, Calif. (5CJ.5/Wed./a.m./C)
- An Overflow of Hybrid Integrated Circuit Reliability Problems and Solutions—W. E. Leyshon and R. E. Warr, General Electric Co., Syracuse, N. Y. (7CJ.1/Thur./a.m./C)
- Reliability of Epoxy Transistors and Integrated Circuits and Silicone Transistors—Yoshio Yatagai, Sony Corp., Atsugi-Shi, Kanagawa-Ken, Japan (7CJ.5/Thur./a.m./C)
- Computer-Aided Design and Layout of Hybrid Integrated Circuits—D. Katz, Bell Telephone Labs, Whippany, N. J. (8CI.1/Thur./p.m./C)
- The Evolution from Hybrid to Monolithic Technology at IBM—W. Graff, IBM, Hopewell Junction, N. Y. (8CI.2/Thur./p.m./C)
- Thin-Film Hybrid Manufacturing—W. B. Reichard, Western Electric Co., Allentown, Pa. (8CI.3/Thur./p.m./C)
- Discrete Device Attachment to Hybrid Integrated Circuits—W. H. Leiderbach, RCA, Inc., Indianapolis, Ind. (8CI.4/Thur./p.m./C)
- Laser Trimming of Thick-Film Resistors—R. Picton, GMC, Kokomo, Ind. (8CI.5/Thur./p.m./C)

Microwaves

- ALCOR—A High-Sensitivity Radar with One-Half Meter Range Resolution—M. Axelbank, W. W. Camp, V. L. Lynn and J. Margolin, MIT, Lexington, Mass. (2G.2/Mon./p.m./R)
- Impact of ATC Automation on Data Acquisition System Requirements—N. A. Blake, Federal Aviation Administration, Washington, D. C. (2G.3/Mon./p.m./R)
- Airborne Multifunction Array Radar—Michael Briana, Raytheon Co., Bedford, Mass. (2G.4/Mon./p.m./R)
- The Digital Future of the Ground-Based Phased Array—S. J. Rabinowitz, RCA, Moorestown, N. J. (2G.5/Mon./p.m./R)
- Progress in Gunn Devices—Fred Sterzer, RCA, Princeton, N. J. (5G.1/Wed./a.m./R)
- Impatt Diodes for Generating Microwaves—S. M. Sze and R. M. Ryder, Bell Telephone Labs., Murray Hill, N. J. (5G.2/Wed./a.m./R)
- Progress in the Development of High Pulse Power LSA Oscillators—L. F. Eastman, Cornell Univ., Ithaca, N. Y. (5G.3/Wed./a.m./R)
- Recent Advances in High-Power GaAs IMPATT Oscillators—Chung Kim and W. G. Matthei, Raytheon Co., Waltham, Mass. (5G.4/Wed./a.m./R)
- Paradise—Phased Array Radars and Diverse Integrated Semiconductor Elements—M. C. Vosburgh, Institute for Defense Analyses, Arlington, Va. (6G.1/Wed./p.m./R)
- Design Considerations for X-Band Phased Array Radar Modules—G. C. Bandy and E. V. Farinholt, Texas Instruments Inc., Dallas, Tex. (6G.2/Wed./p.m./R)
- Array Modules for Airborne Coherent Radar—R. J. Bauer, Westinghouse Electric Corp., Baltimore, Md. (6G.3/Wed./p.m./R)
- Product Design of a High-Power S-Band MIC Module for Phased Arrays—F. E. Vaccaro, E. E. Bliss, D. Ziegler and R. P. Lorentzen, RCA, Harrison, N. J. (6G.4/Wed./p.m./R)
- Broadband Gigahertz Integrated Power Amplifier—Octavious Pitzalis, Jr., and R. A. Gilson, U. S. Army Electronics Command, Fort Monmouth, N. J. (7E.1/Thur./a.m./MH)
- Wideband Microwave Amplification Using Transferred Electron Devices—B. S. Perlman and L. Chainulu Upadhyayula, RCA, Princeton, N. J. (7E.2/Thur./a.m./MH)
- Wideband Microwave Transistor Power Amplifiers—E. F. Belohoubek and Adolph Presser, RCA, Princeton, N. J. (7E.3/Thur./a.m./MH)
- Distributed Unidirectional Microwave Amplification—M. E. Hines, R. N. Wallace and S. F. Paik, Microwave Associates, Inc., Burlington, Mass. (7E.4/Thur./a.m./MH)
- High-Power GaAs Avalanche Diode Amplifier—C. W. Lee and W. C. Tsai, Raytheon Co., Murray Hill, N. J. (7E.5/Thur./a.m./MH)
- A Microwave Integrated Circuit Converter for a 2.0-12.4 GHz Receiver—Raymond Waugh, Applied Technology, Inc., Palo Alto, Calif. (8E.1/Thur./p.m./MH)
- L-Band TR Module for AN/PRC 95—Roger Weber and James Chapman, Texas Instruments, Dallas, Tex. (8E.2/Thur./p.m./MH)
- Microwave Integrated Circuit Signal Processor Using YIG Multiplexers—Raymond Jones, Westinghouse Electric Corp., Baltimore, Md. (8E.3/Thur./p.m./MH)
- Hermetically Sealed Broadband Mixer Assembly—W. J. Dwyer, III, Microwave Associates, Inc., Burlington, Mass. (8E.4/Thur./p.m./MH)
- Refinements in Computer Enhanced Microwave Testing—Stuart Yellen, Computer Metrics Testing, Rochelle Park, N. J. (1CI.1/Mon./a.m./C)

0.47pf-15mfd in many "mini" styles

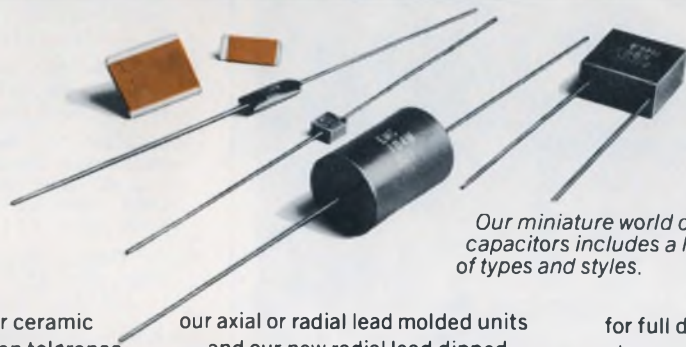

Our miniature world of ceramic capacitors includes a huge range of types and styles.

Whatever your multilayer ceramic capacitor need – precision tolerance for critical application or high volumetric efficiency for general purpose use – Electro Materials can deliver. At competitive prices. Select Electro Materials® layered ceramic chips from a wide range of styles, voltages, temperature ranges, capacitance values and end terminations. The same holds true for

our axial or radial lead molded units ... and our new radial lead dipped models. Many styles available in rectangular or tubular shapes. We'll help you match the right ceramic capacitor to your specific project. And because of advanced technology and high volume production, we can pass along substantial savings to you. See for yourself. Contact your local Electro Materials representative

for full details. Or phone or write:
**Electro Materials,
Division Illinois
Tool Works Inc.,
11620 Sorrento
Valley Road, San
Diego, Calif. 92121.
Phone (714) 459-
4355. TWX 910-
322-1130.**



itw ELECTRO MATERIALS

The Innovating Electronic Group of ITW... ELECTRO MATERIALS ■ PAKTRON ■ LICON

heat & serve



That's all it takes with solder preforms from The Indium Corporation of America.

A little heat and our high-purity, low-melting preforms serve your needs exactly . . . whether you have automated soldering or simply need *exact* amounts or shapes of solder everytime.

Our solder preforms — made from Lead, Tin, Silver, Indium, Cadmium, Gallium, Antimony, Bismuth, Copper, Aluminum, Nickel and/or Germanium — are available in any size, weight, shape, composition and tolerance to *your specifications*.

And we deliver. So, call on The Indium Corporation, or write for our comprehensive new Solder Preform Selector.

We're your low-melting metals gourmet.



INDIUM CORPORATION OF AMERICA

1676 LINCOLN AVE. • UTICA, N.Y. 13503

TELEPHONE 315/797-1630 • TWX 510-242-0288

IEEE '71

Microwave Attenuation Measurement System RF Series Substitution—Wilbur Larson, National Bureau of Standards, Boulder, Colo. (1C1.2/Mon./a.m./C)

A New Approach to Provide Crystal Accuracy Frequency Control to Swept Frequency Microwave Measurements—Jose Herrero, Singer Co., Palo Alto, Calif. (1C1.3/Mon./a.m./C)

Application of the Automatic Network Analyzer to Microwave Transistor Amplifier Design—J. R. Knapp, R. E. Byrns, G. A. Coniver, General Electric Co., Syracuse, N. Y. (1C1.4/Mon./a.m./C)

Development of Wideband, Tunable VHF Circulators—Irving Rubinstein, Airborne Instruments Lab., Melville, N. Y. (3CJ.1/Tues./a.m./C)

Applying the YIG Filter to Tunable Microwave Systems—N. P. Albrecht, Watkins-Johnson Co., Palo Alto, Calif. (3CJ.2/Tues./a.m./C)

Advances in Ferrite Phase Shifter Technology: New Possibilities for the System Designer—C. R. Boyd, Jr., Microwave Applications Group, Chatsworth, Calif. (3CJ.3/Tues./a.m./C)

Ferrite Components for MIC Modules—B. R. Savage, J. L. Bediger and D. R. Taft, Sperry Rand Corp., Clearwater, Fla. (3CJ.4/Tues./a.m./C)

Solid-State Devices in Modern Microwave Military Systems—A. G. Kramer, Raytheon Co., Bedford, Mass. (4CJ.1/Tues./p.m./C)

Microwave Power Transistors Come of Age—Ronald Lessnick, Microwave Semiconductor Corp., Somerset, N. J. (4CJ.2/Tues./p.m./C)

Low Noise Microwave Mixers—D. H. Steinbrecher, MIT, Cambridge, Mass. (4CJ.3/Tues./p.m./C)

Application of Avalanche Diodes to Microwave Communication Systems—J. W. Gewartowski, Bell Telephone Labs., Murray Hill, N. J. (4CJ.4/Tues./p.m./C)

Gunn Device Applications—Fred Rosenbaum, Washington Univ., St. Louis, Mo. (4CJ.5/Tues./p.m./C)

Ceramics for Microwave Applications—Martin Caulton, RCA, Princeton, N. J. (5CK.3/Wed./a.m./C)

Urban Engineering (Civionics)

The Urban Region and Its Organization—C. D. Loeks, Mid-Hudson Patterns for Progress, New Paltz, N. Y. (2D.1/Mon./p.m./SS)

The Suburban Area and Its Development Needs—Carl Mays, Hudson River Valley Commission, Tarrytown, N. Y. (2D.2/Mon./p.m./SS)

The Inner City and Its Service Needs—R. A. Speaks, Model Cities Administration, New York, N. Y. (2D.3/Mon./p.m./SS)

Electricity Needs and Solutions in the Future—Alexander Kusko, Alexander Kusko, Inc., Needham, Mass. (2D.4/Mon./p.m./SS)

Urban Problems—Transportation, Pollution—J. H. Hollomon, MIT, Cambridge, Mass. (4K.1/Tues./p.m./E)

Implementing the Technological Attack on Rehabilitation and Medical Problems—J. G. Linvill, Stanford Univ., Stanford, Calif. (4K.2/Tues./p.m./E)

Consumer and Industrial Electronics—A. M. Bueche, General Electric Co., Schenectady, N. Y. (4K.3/Tues./p.m./E)

Opportunities and Pitfalls—The Hon. E. E. David, Office of Science and Technology, Washington, D. C. (4K.4/Tues./p.m./E)

Problem-Focused Education at the Technology-Science Interface—A. O. Converse, Dartmouth College, Hanover, N. H. (5E.1/Wed./a.m./MH)

Impediments to Societal Problem Solving—What Must Happen Before We Can Succeed?—Gabor Strasser, Office of Science and Technology, The White House, Washington, D. C. (5E.2/Wed./a.m./MH)

National Laboratories and National Needs—D. J. Rose, Oak Ridge National Lab., Oak Ridge, Tenn. (5E.3/Wed./a.m./MH)

Informed or Novice: The Engineer in Technology Transfer—J. D. Palmer, Union College, Schenectady, N. Y. (5E.4/Wed./a.m./MH)

University Responses to the Social Aspects of Technology—E. B. Skolnikoff, MIT, Cambridge, Mass. (5E.5/Wed./a.m./MH)

Research and Development Goals and Programs in the Department of Transportation—H. H. Richardson, U. S. Dept. of Transportation, Washington, D. C. (8F.1/Thur./p.m./G)

Role of Transportation Systems Center in the R&D Program of DOT—W. C. Dunlap, Transportation Systems Center, Cambridge, Mass. (8F.2/Thur./p.m./G)

Linear Motor Propulsion and Power Conditioning—John LaFrance, Mitre Corp., Alexandria, Va. (8F.3/Thur./p.m./G)

High-Speed Electric Power Collection—Rodney Lay and Mathews Guarino, Mitre Corp., Alexandria, Va. (8F.4/Thur./p.m./G)

The Accommodation of Anomalous Events in Synchronous Transportation Networks—Richard Boyd, TRW, McLean, Va. (8F.5/Thur./p.m./G)

Development of a Five-Year Federal Plan for Instrumentation R&D—H. J. Hal and R. R. Bertrand, ESSO, Linden, N. J. (1CH.1/Mon./a.m./C)

Spectroscopic Instrumentation for Air-Pollution Monitoring—Philip Hanst, NAPCA, Raleigh, N. C. (1CH.2/Mon./a.m./C)

Design Criteria of Process Emission Analysers—A. Grunt and Paul Testerman, TRW, Redondo Beach, Calif. (1CH.3/Mon./a.m./C)

Data Acquisition for Air-Pollution Monitoring Systems—J. B. Tommerdahl, Research Triangle Institute, Research Triangle Park, N. C. (1CH.4/Mon./a.m./C)



Would you believe they'll do the job for a fraction of SMA prices?

Until now you've had to buy SMA connectors built to MIL specification. And pay the price. There just wasn't any other kind.

Johnson has changed that. With this new series of JCM miniature RF coaxial connectors. Up to 3 GHz you get the same electrical performance as with the expensive SMA types. Only we don't overbuild them. That way we don't have to charge as much for them.

We make 7 types—for panel and PC mounting and for flexible cable assemblies. All are interchangeable and intermateable with the standard, expensive SMA connectors. So you can use them without making any changes . . . and without compromising required performance. And JCM connectors accept virtually any size cable, so you don't have to stock a big variety. It's worth looking into, isn't it? All it costs is a stamp.

E. F. JOHNSON COMPANY / Waseca, Minnesota 56093

Please send technical information and test samples of your new low-cost series 142-0200-001 JCM connectors. Specify model #: _____

NAME _____

FIRM _____

TITLE _____

ADDRESS _____

CITY _____

STATE _____

ZIP _____



E. F. JOHNSON COMPANY

Visit our booth at IEEE: #2506 & 2508

INFORMATION RETRIEVAL NUMBER 128

**Reliability is 756 little dents
and one big one.**





The big squeeze.

The heelpiece and frame are the backbone of our Class H relay. The slightest squiggle or shimmy out of either and the whole relay is out of whack.

756 tiny dents on the heelpiece, plus one big one on the frame, make sure this'll never happen.

They're the result of planishing, a big squeeze. Planishing is an extra step we go through in forming the pieces to add strength and stability by relieving surface strain. It also makes the parts extra flat.

This takes the biggest press in the industry and the biggest squeeze. Both exclusively ours.

A different kind of coil.

The heart of a relay is the coil. If ours looks different, it's because we build it around a glass-filled nylon bobbin. It costs us more, but you know how most plastic tends to chip and crack.

Also, moisture and humidity have no effect on glass-filled nylon. No effect means no malfunctions for you to worry about. No current leakage, either.

The coil is wound on the bobbin automatically. No chance of human error here.

We didn't forget the solder.

We use a solderless splice. That's because solderless splice connections are sure-fire protection against the coil going open under temperature changes, stress, or electrolysis.

A solderless splice is more expensive to produce, so it's usually found only on the most reliable relays. AE is the only manufacturer to use this method on all of its relays.

Finally, we wrap the whole assembly with extra-tough, mylar-laminated material. A cover is not really necessary here; but why take chances?



Springs and other things.

We don't take any chances with our contact assembly, either. Even things like the pileup insulators (those little black rectangles) get special attention. We precision mold them. Other manufacturers just punch them out.

It makes a lot of difference. They're stronger, for one thing; and because they're molded, there's no chance of the insulators absorbing even a droplet of harmful moisture. Finally, they'll withstand the high temperatures that knock out punched insulators.



Then there are the contact springs. Ours are phosphor-bronze. Others use nickel-silver. Our lab gave this stuff a thorough check, but found nickel-silver too prone to stress-corrosion. Atmospheric conditions which cause tarnish and ultimately stress corrosion have almost no effect on phosphor-bronze.



Two are better than one.

Our next step was to make sure our contacts give a completed circuit every time. So we bifurcate both the make and break springs.

Each contact works independently to give you a completed circuit every time.

Edge-tinned contact springs save you the job of solder tinning them later. Also, edge-tinning enables you to safely use the same relay with sockets or mounted directly to a printed circuit board. A simple thing, but it takes a big chunk out of the inventory you have to stock.

Etc. Etc. Etc.

There's a lot more to tell about what makes our Class H relay reliable. Now we're waiting to hear from you. GTE Automatic Electric, Industrial Sales Division, Northlake, Illinois 60164.

GTE AUTOMATIC ELECTRIC

IEEE '71 Products

FET-input op amp slashes price to \$9.75

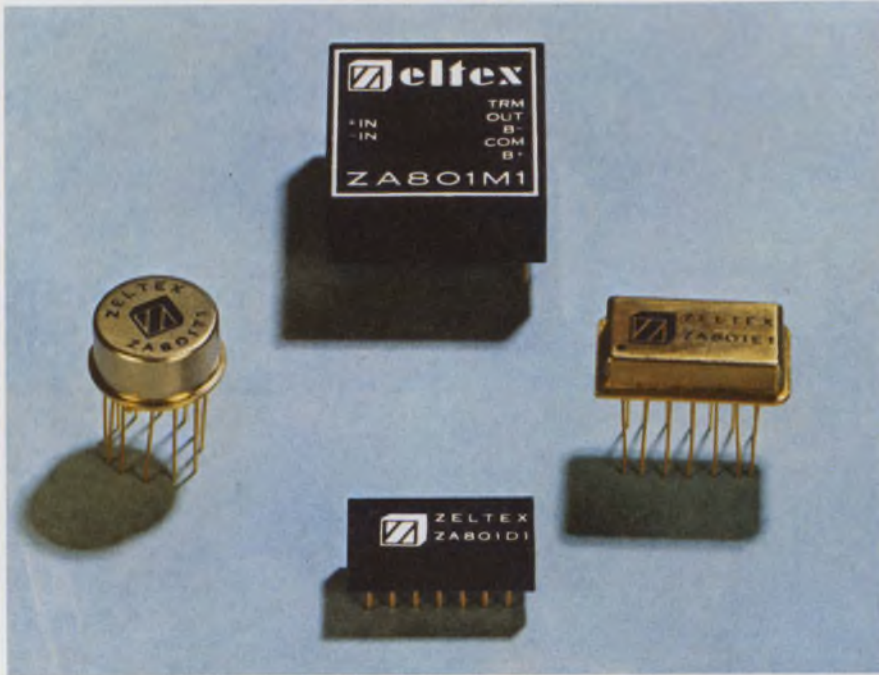

Zeltex, Inc., a sub. of Redcor Corp., 1000 Chalomar Rd., Concord, Calif. Phone: (415) 686-6660. P&A: see text; stock.

Priced at a low \$9.75 (1 to 9 quantities), a new operational amplifier gives circuit designers high-performance characteristics such as a low input bias current of 25 pA, input impedance of $10^{11} \Omega$, voltage drift with temperature of $50 \mu\text{V}/^\circ\text{C}$ and common-mode rejection of 10,000:1.

In addition, the ZA801M1 op amp has an open-loop gain of 100,000, a 4-MHz bandwidth, full-power response up to 100 kHz and an output of $\pm 10 \text{ V}$ at 7 mA.

The ZA801M1 is ideal for use as a buffer, since it permits full-scale operation ($\pm 10 \text{ V}$) while maintaining its rated accuracy of 0.01%.

Its rated voltage drift of $50 \mu\text{V}/^\circ\text{C}$ is specified over a temperature range of -25 to $+85^\circ\text{C}$. For better drift characteristics, the ZA801M2 or the ZA801M3 are also available, with voltage drifts of 20

and $5 \mu\text{V}/^\circ\text{C}$, respectively.

Except for higher prices because of the better voltage drift characteristics, the ZA801M2 and ZA801M3 are identical to the ZA801M1 in performance. The former costs \$19 (1 to 9) and the latter \$45 (1 to 9).

The ZA801M1 comes in a tiny module, measuring 1 by 1 by 0.4 in. with 0.25-in. high leads. Three other packaging configurations are also available. These include a dual-in-line epoxy-filled version (ZA801D1) costing \$30, a dual-in-line hermetically sealed version (ZA801E1) costing \$35 and a TO-8 model (ZA801T1) that costs \$35. Prices are for 1 to 9 quantities.

Additional performance specifications of the ZA801 amplifiers include on open-loop output impedance of $1 \text{ k}\Omega$ at dc, a maximum input offset voltage of $\pm 10 \text{ mV}$, a storage temperature range of -55 to $+125^\circ\text{C}$ and power-supply requirements of $\pm 15 \text{ V}$ at 3 mA.

Booth No. 2208 Circle No. 351

Fiber-optic readout drains but 160 mA/digit

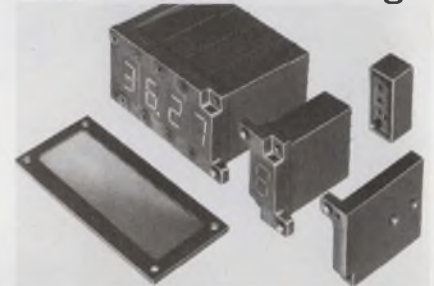

Alco Electronic Products, Inc., Box 1348, Lawrence, Mass. Phone: (617) 686-3887. P&A: \$14.95; stock.

The MS-2520 incandescent modular fiber-optic readout with eight T-1 lamps for each digit module drains only 160 mA/digit. Each module has a phenolic segment fiber plate and eight bundles of optical fibers. Lamps are rated at 2.5 V and 20 mA. Lamp life expectancy is over 30,000 hours. Each MS-2520 readout is supplied with lamps and sockets without a decoder/driver unit.

Booth No. 2224 Circle No. 285

Tiny electric counters are 1 by 1.6 by 2.2 in.



Durant Digital Instruments, 622 Cass St., Milwaukee, Wis. Phone: (414) 271-9300. Price: from \$12.

The new low-cost ME miniature electric counter family features units weighing just 3 oz each and measuring just 1 by 1.593 by 2.187 in. Flexible plug-in accessories permit close stacking, ease of installation and mating with standard sockets. Speeds are rated to 1000 counts/min. Units are available with 4, 6, or 7-digit displays with pushbutton reset or non-reset.

Booth No. 2728 Circle No. 346

...what you see...is what you get !

5 Volts/50 Amperes in a 5x6x7 Power Supply

CEC's sophisticated switching regulator and magnetics technology, gleaned from extensive space age power conversion development programs, culminates in our Model 550... a 250 watt, 210 cubic inch, RFI-free power supply.

This truly miniature, light weight, 75% efficient power supply solves the size, weight and thermal problems of today's systems, while substantially eliminating the invariably troublesome RFI associated with switching regulators. Other specifications include • $\pm 1\%$ line and load regulation • 50 millivolts peak-to-peak ripple including all noise and spikes • 50 microseconds recovery time to within 1% with 10 amperes step load. Unique design techniques enable parallel operation without elaborate interconnections. -30°C to $+55^{\circ}\text{C}$ without derating. No cooling required.

If the Model 550 sounds like the answer to your power supply requirements, please call or write for detailed information on the many additional features you get...but don't see.



for detailed information write or call today
COMPUTER ENERGY CORP

399 Smith Street, Farmingdale, New York 11735

Telephone: 516-293-4182

FET op amp pair offers 1 $\mu\text{V}/^\circ\text{C}$ drift and 0.1 pA bias

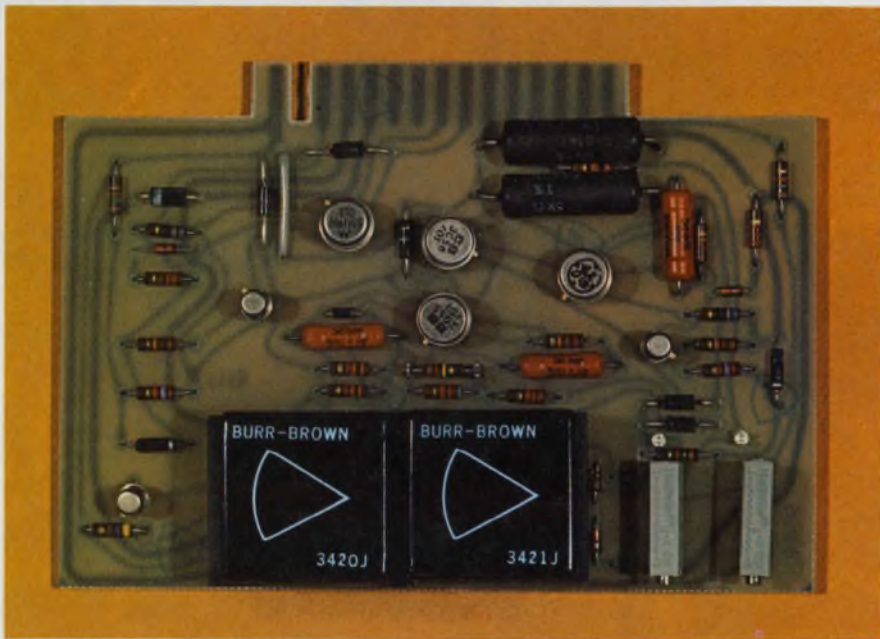

Burr-Brown Corp., International Airport Industrial Park, Tucson, Ariz. Phone: (602) 294-1431. P&A: see text; stock.

Two new high-performance FET-input operational amplifiers achieve drastic reductions in the major sources of operational amplifier errors—voltage drift and bias current—with one model (3420L) offering a maximum voltage drift of $\pm 1 \mu\text{V}/^\circ\text{C}$, and another (3421) featuring a bias current of only 0.1 pA.

The 3420L, in addition to its low voltage drift, has a bias current of just 10 pA maximum. This low bias current insures negligible offset voltages for source impedances up to 1 M Ω .

Other performance characteristics include a slew rate of 6 V/ μs , small-signal bandwidth of 1 MHz, open-loop gain of 120 dB and a rated output of ± 10 V at +10 mA.

The 3420's input stage consists of a monolithic FET pair, selected for very close thermal tracking and very low noise. Secondary sources of voltage drift have been minimized by the use of high-stability resistors and careful attention to reducing thermal gradi-

ent effects.

The 3420L costs \$75 (1 to 9) and is the lowest in voltage drift among three versions, each having a different voltage drift. The 3420K has $\pm 2 \mu\text{V}/^\circ\text{C}$ of voltage drift and costs \$65 (1 to 9), while the 3420J has $\pm 5 \mu\text{V}/^\circ\text{C}$ of voltage drift and costs \$55 (1 to 9).

The other half of the new FET op amp team is the 3421, whose low bias current of 0.1 pA is specified at 25 $^\circ\text{C}$. This very low bias current is realized by the use of selected monolithic FET pairs and an input stage which maintains a constant voltage drop across the input FETs. At 70 $^\circ\text{C}$, bias current is 2 pA.

Characteristics include open-loop gain of 100 dB, a slew rate of 0.5 V/ μs , a small-signal bandwidth of 750 kHz and a rated output of ± 10 V at ± 10 mA. Common-mode rejection is 100 dB and input impedance is $5 \times 10^3 \Omega$.

Three versions of differing voltage drifts are available. The 3421L drifts $\pm 10 \mu\text{V}/^\circ\text{C}$ and costs \$66 (1 to 9). The 3421K drifts $\pm 20 \mu\text{V}/^\circ\text{C}$ and costs \$46 (1 to 9). Finally, the 3421J has $\pm 50 \mu\text{V}/^\circ\text{C}$ of drift and costs \$36 (1 to 9).

Booth No. 2501 Circle No. 352

Plug-in PC supplies start from \$14

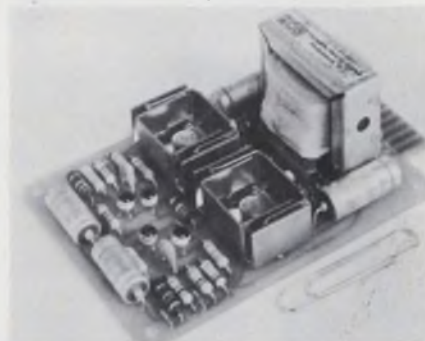

Power/Mate Corp., 514 S. River St., Hackensack, N. J. Phone: (201) 343-6294. P&A: from \$14; stock.

A new line of low-cost regulated PC plug-in dc power supplies, designated the Card/Pac series, starts in cost from \$14. Line regulation is 0.01% and no-load to full-load regulation is 0.05%. Ripple and noise are 1 mV rms. Available voltages are from 3 to 50 V dc at 25 mA to 1 A from a single PC card. Temperature coefficient is 0.02%/ $^\circ\text{C}$.

Booth No. 2239 Circle No. 290

Constant-current supply is $\pm 0.01\%$ regulated



Syntronic Instruments, Inc., 100 Industrial Rd., Addison, Ill. Phone: (312) 543-6444. P&A: \$90; stock.

Model 212-10030 constant-current supply has precise current regulation of $\pm 0.01\%$ over a wide range of temperatures and loads. Convenient front-panel current adjustment is accomplished by a 10-turn indicating dial resettable to 0.1% accuracy. Output voltage is 16.5 V at 500 mA. Current range is 0 to 1 A.

Booth No. 2629 Circle No. 338



The case for uncanny capacitors.

Our molded case aluminum electrolytic capacitors are replacing epoxy case and cardboard tubular capacitors as fast as we can make them because they are better than either.

For one thing, they have better electrical and chemical characteristics. They're more impact resistant too. Because they are precision molded, case dimensions and lead placement are uniform. This makes them ideal for automated production—and they have excellent solderability. And, they cost less than other container-case capacitors.

We make three types of molded aluminum

electrolytic capacitors—the MTA axial lead, the MTV for printed circuit board mounting and the MFP for multisection printed circuit boards. All may be used for FM and AM radio, hi-fi, stereo, TV, transistorized equipment and similar electronic applications.

Specify Mallory molded aluminum electrolytic capacitors. They'll provide long life and good electrical-temperature characteristics over a temperature range of -30°C to $+65^{\circ}\text{C}$ and $+85^{\circ}\text{C}$.

Available from authorized Mallory distributors, or write to Mallory.

MALLORY

MALLORY CAPACITOR COMPANY

a division of P. R. MALLORY & CO. INC.

3029 E. Washington St., Indianapolis, Indiana 46206; Telephone: 317-636-5353

Electrical and electronic components • sequence timers • metallurgical products • batteries

Buying Power?



Here's the new, single source for all your power needs.

- Mil Spec DC Modules
- Wide Range DC Modules
- Slot Voltage DC Modules
- IC Logic Modules
- Full-Range Lab Supplies
- Inverters, Frequency Changers
- High-Voltage Supplies
- AC Regulators
- Full Technical Data
- Full Specifications
- Mechanical Data
- Model Types
- Prices & Availability

Ask for Your Free Catalog #157 Today!



ERA TRANSPAC CORPORATION

67 Sand Park Road, Cedar Grove, N. J. 07009
(201) 239-3000

A subsidiary of
Electronic Research Associates, Inc.

MODULES & SUBASSEMBLIES

Hybrid \$20 voltage regulator handles 85 W in 2.5-in.³ case

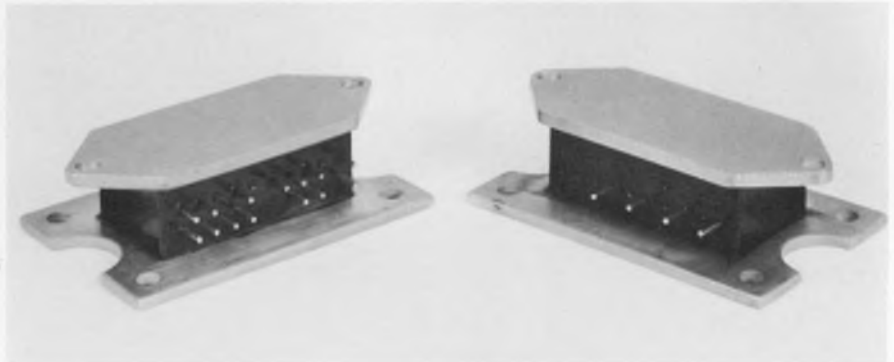

Lambda Electronics Corp., 515 Broad Hollow Rd., Melville, N.Y. Phone: (516) 694-4200. P&A: \$20; 4 to 6 wks.

Representing a breakthrough in size, cost and performance, a new hybrid dc voltage regulator can handle 85 W of power in a package that is truly compact—it occupies just 2.5 cubic in. of space.

Called LAS-2000, it provides 0.2% regulation for both line or load for any dc power supply with an output voltage from 5 to 28 V and current from 5 to 2 A. And it can do this economically—a \$20 unit price is being quoted for 100-lot quantities.

Size reduction was achieved by the use of thick-film and integrated circuits on two hybrid substrates—one for the control circuit and the other designed for the power circuits.

The construction's key feature is the thermal isolation achieved between the heat-sensitive elements and the heat-generating power elements. Careful attention was paid to heat flow problems by treating thermal parameters as electrical analogs.

This thermal isolation results in low thermal drift characteristics for changes in power levels. The temperature coefficient is specified as 0.02%/°C.

The LAS-2000, which is 0.7-in.-high, replaces all discrete components in a conventional voltage regulator—diodes, resistors, ca-

pacitors, transistors and circuit boards—to allow a power-supply builder to achieve simplicity in his design.

To the power supply builder, this means lower production costs, i.e. lower engineering costs, simpler incoming inspection, smaller and simpler parts inventory and lower manufacturing costs.

Additional characteristics of the LAS-2000 regulator are short-circuit and overload protection, positive regulation and an electrically isolated case.

A thermal cutout is also provided so that if the unit exceeds a temperature of 200°C, its circuit will open. This is especially important for cases where external cooling methods are used, such as blower fans, which can fail.

The basic unit has four pins (input and output terminals) and is available in 22 models ranging from 5 to 28 V and 5 to 2 A. All are rated at 85 W.

A second version, which has 14 pins, has all the features of the four-pin model plus the following: remote sensing, remote programming, dual tracking, negative regulation with transformer isolation, and high-power output operation as a driver for series regulators (up to 50 A).

The 14-pin version is expected to cost approximately 10% more than the cost of the LAS-2000 four-pin unit.

Booth No. 2305 Circle No. 353

Dual-output supplies cover 0 to 32 V dc

PIC Design Corp., 477 Atlantic Ave., E. Rockaway, N. Y. Phone: (516) 593-6470. Price: from \$143.

New dual-output dc supplies are available with or without tracking in incremental voltages of 5 to 32 V adjustable to $\pm 5\%$ (narrow range) and voltages of 0 to 7 V (wide range). Outputs are adjustable independently or simultaneously.

Booth No. 1512 Circle No. 261

Modular power supplies range to 50 V at 30 A

Dynage, Inc., 1331 Blue Hills Ave., Bloomfield, Conn. Phone: (203) 243-0315. Availability: stock.

A new series of modular power supplies comes in models with adjustable outputs from 0 to 7, 0 to 15, 0 to 30, and 0 to 50 V dc. Current ratings are as high as 30 A. All voltages will be available in each of five case sizes, all of which are 3-1/2-in. high.

Booth No. 2500 Circle No. 280

Regulated 6-V supply runs on a battery

Deltron, Inc., Wissahickon Ave., N. Wales, Pa. Phone: (215) 699-9261.

The BA6-1 0.01% regulated power supply features a variable 0 to 6-V output at 0.1 A from a self-contained Ni-Cd battery that can be recharged indefinitely. It has a built-in charger and operates at full load for 8 hours. Recovery is 25 μ s and noise is 25 μ V rms.

Booth No. 2409 Circle No. 250

1.6-in.³ d/a converter has 3-digit BCD input

Varadyne Systems, 1020 Turnpike St., Canton, Mass. Phone: (617) 828-6395. P&A: \$59; stock.

Model DAC-59 1.6-in.³ d/a converter will accept a 3-digit BCD word and convert it to an analog voltage of 9.99 V in less than 25 μ s. Its overall accuracy is $\pm 0.1\%$ and temperature coefficient is ± 30 ppm/ $^{\circ}$ C. All digital inputs are compatible with TTL/DTL levels.

Booth No. 3508 Circle No. 283

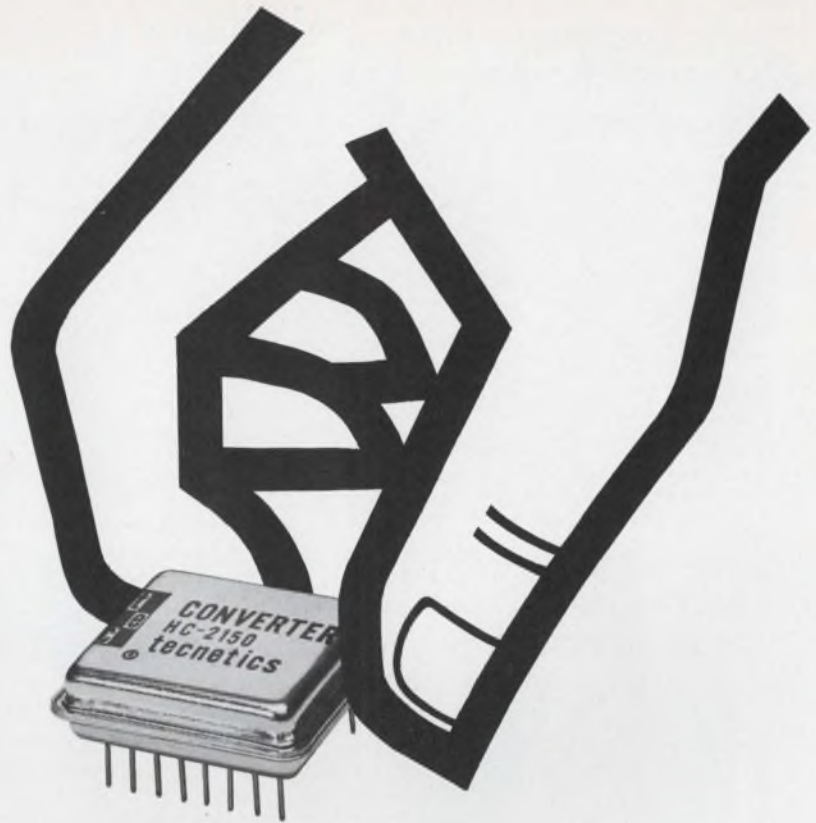

Tecnetics converter

Best little thing that ever happened to circuits

Looking for more design flexibility in your portable instruments or sophisticated systems? Then take a long hard look at our new series of 3 watt hybrid microelectronic DC-DC converters.

These Tecnetics converters were designed especially for on-card mounting in point-of-load applications. Which means you are now able to design without a large, bulky, highly regulated, multi-output central power supply. You can buss a single voltage around your circuit . . . and then convert it to other voltages as needed. And end up with more flexibility, better circuit or system performance, as well as greater reliability.

Tecnetics 3 watt DC-DC converters are available in cold welded metal packages to resist shock, vibration and other environmental conditions.

The specifications

Input voltage: 5, 12 or 20VDC nominal operating

Input power:	Less than 4W typ. @ full load, 2W typ. @ half load.
Output power:	3 watts maximum (2W for 5V and 12V models below 10V out)
Isolation:	300 VDC
Single outputs:	All popular outputs available from 5 to 300 volts for all inputs.
Dual outputs:	$\pm 12, \pm 15, \pm 18, \pm 25$ Volts

Tecnetics, Inc., the innovator in power supplies, also manufactures a complete line of regulated DC-DC converters, hybrid components and custom transformers.

For more information on power conditioning products, call 303-442-3837, see EEM, or write: Tecnetics, Inc., P. O. Box 910, Boulder, Colorado 80302.



DIELECTRIC MATERIALS CHARTS



Charts in full color contain data on all important materials used by electrical and electronic engineers.

INFORMATION RETRIEVAL NUMBER 91

HEAT SHRINK BOOTS FOR RFI CONTROL



ECCOSHIELD® HS is a line of heat shrink boots and tubing -- electrically conductive -- shield up to 100 db for EMI/EMC applications.

INFORMATION RETRIEVAL NUMBER 92

SPECIFIER'S GUIDE TO INDUSTRIAL ADHESIVES



New ECCOBOND® booklet and fold-out wall chart gives specifications and use criteria for a broad line of industrial/electrical adhesives, epoxies and others. Send for FREE copy.

INFORMATION RETRIEVAL NUMBER 93

Emerson & Cuming, Inc.



CANTON, MASS.
GARDENA, CALIF.
NORTHBROOK, ILL.
Sales Offices
in Principal Cities

EMERSON & CUMING EUROPE N.V., Oevel, Belgium

MODULES & SUBASSEMBLIES

Data acquisition system fits in a 2.4-in.³ module



Varadyne Systems, 1020 Turnpike St., Canton, Mass. Phone: (617) 828-6395. P&A: from \$990; 30 days.

A complete data acquisition system is now available in a 2.4-in.³ module that weighs less than 16 oz and interfaces with most popular minicomputers in use today.

The DAS-16 is able to achieve this small size for a complete system due to its use of MOS circuits and clever packaging techniques.

Contained within this small module are an eight or sixteen-channel multiplexer, a sample-and-hold amplifier, an a/d converter, a system sequencer that includes all necessary control and interface logic and an LED readout that displays the multiplexer address and the a/d output value.

The DAS-16 employs random and sequential addressing to enhance system flexibility. Individual channels may be sampled at rates that are consistent with their particular bandwidth.

The DAS-16 is available with input ranges of 0 to +5 V and 0 to +10 V, and ± 5 or ± 10 V at an input impedance of 100 M Ω . Overall accuracy is $\pm 0.025\%$ with a temperature coefficient of ± 25 ppm/ $^{\circ}$ C.

No adjustments are needed when it is operated over the temperature range of 0 to +70 $^{\circ}$ C. Its long-term stability is specified at better than $\pm 0.01\%$ per year.

Output coding can be binary or BCD with word lengths of 8, 10

and 12 binary bits or 3 BCD bits. The maximum system throughput rate ranges from 0.2 to 100 kHz, depending on which DAS-16 series is used and on the output coding.

Series E units have maximum throughput rates of 2, 0.8, 0.2, 2 and 0.2 kHz for 8, 10 and 12 binary and 2 and 3 BCD bit coding, respectively.

Series L units have maximum throughput rates of 50, 30, 25, 50 and 30 kHz for 8, 10 and 12 binary bit and 2 and 3 BCD bit coding, respectively.

Series M units have maximum throughput rates of 100, 60, 50, 100 and 60 kHz for 8, 10 and 12 binary, and 2 and 3 BCD bit coding, respectively.

Input control lines consist of one line for each of the following functions: device select, random or sequential, convert command, reset and strobe. Four lines are for channel addressing.

The device-selected signal inhibits all input commands, allowing the system to be multiplexed with other peripherals that are tied into the computer.

For real-time data logging, the DAS-16 system can be interfaced with printers, paper-tape punches solid-state or core memories and magnetic tape recorders.

The multiplexer and sequencer may be expanded optionally to 24 or 32 channels by an expander module. This increases the channel select input to 5 lines.

Booth No. 3508 Circle No. 354

We sewed these famous labels together to give them added strength.



You know these names. By joining the capabilities of these fine instrumentation companies with ours, we achieved something more than the sum of the parts (and became the nation's fourth largest maker of test instruments.) Now, working together, we can—we will—give you even more value and better

service than ever. And, because we're working together, the products that carried these respected labels now come to you worldwide under a single name—Singer. You can depend on it for the same reasons your grandmother did. Singer Instrumentation, 250 Crossways Park Drive, Woodbury, N.Y. 11797.

SINGER

INSTRUMENTATION

SPECTRUM ANALYZERS • SIGNAL GENERATORS & SWEEPERS • NOISE AND FIELD INTENSITY METERS • NETWORK ANALYZERS • SYNCHRO/RESOLVER COMPONENTS & SYSTEMS
• MOBILE COMMUNICATIONS TEST EQUIPMENT • BROADBAND DIGITAL & ANALOG VOLTMETERS • ELECTRICAL STANDARDS • MICROWAVE ATTENUATORS & COMPONENTS

High energy silicon for the 70's.

Switching Regulator

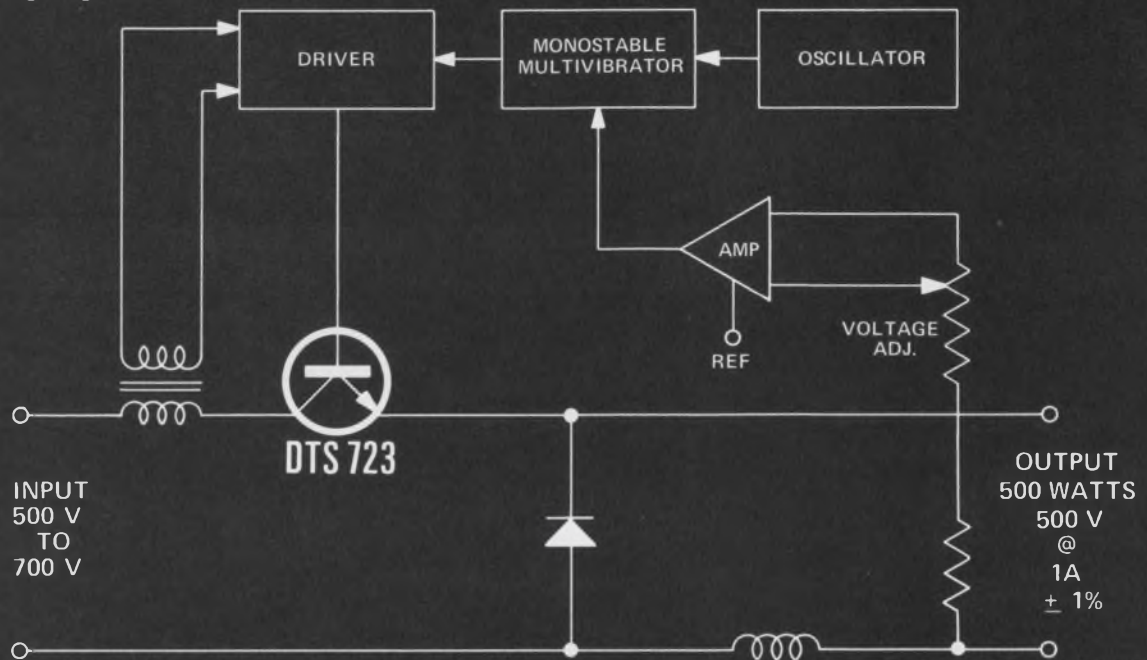

DC Regulator

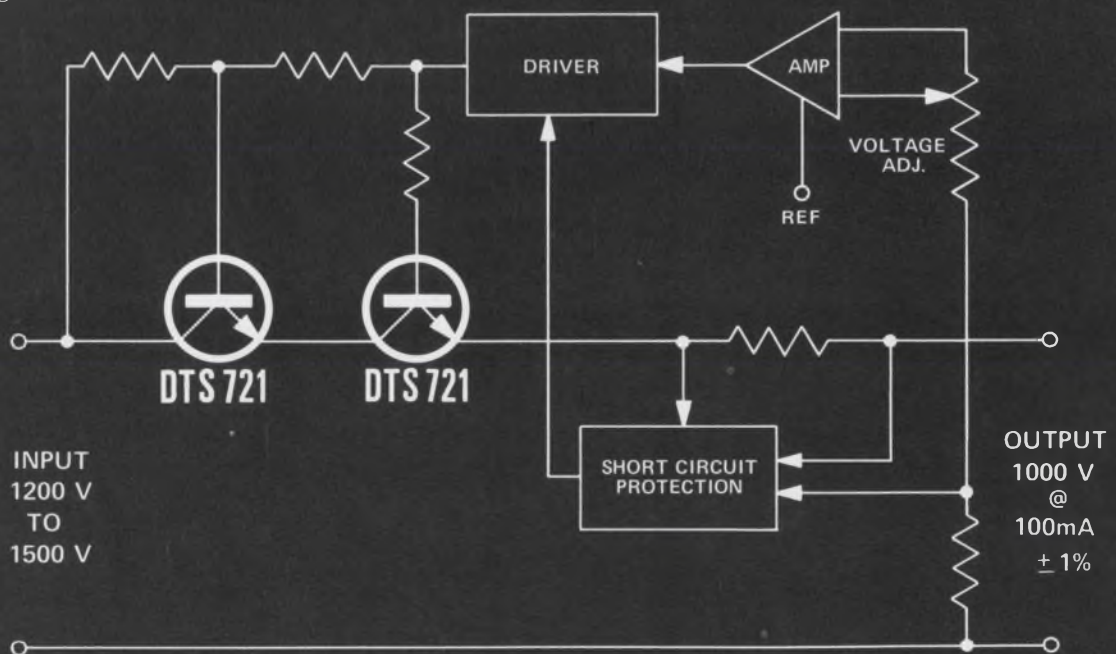

	V _{CEX}	V _{CEO}	V _{CEO} (sus)	I _C (cont)	h _{FE} @ I _C min/max V _{CE} = 5.0V	P _T
DTS-721	1000V	1000V	800	3A	20/60 @ 150 mA	50W
DTS-723	1200V	1000V	750	3A	2 min @ 2.5 A	50W

Delco announces two new 1000-volt transistors for high power regulators in small packages.



Our new DTS-721 and DTS-723 1000-volt silicon transistors permit you to design solid state circuits for industrial applications with capabilities previously reserved for tubes. Now you can think small.

These two new silicon devices were developed specially for instrumentation and power supply builders, as well as for computer and military applications. They can operate from DC inputs of 1200 volts to 1500 volts. With 1% regulation at full load.

In a switching regulator, they can operate directly from a 220-volt line or from rectified 440-volt single or polyphase sources.

Both devices are NPN triple diffused, packaged in Delco's solid copper TO-3 cases. They are mounted to withstand mechanical and thermal shock because of special bonding of the emitter and base contacts.

The DTS-721 and DTS-723 have been proven by

application tests from production lots by prospective users with stringent reliability requirements.

And their energy handling capability is verified by Delco Pulse Energy Testing.

These new high voltage silicon transistors make it possible for you to take advantage of reduced size, weight and component costs in designing circuits—and get far greater reliability.

The circuits shown are explained in detail in our application notes nos. 45 and 46.

Call the Kokomoans or your Delco Distributor for more information.



Delco Electronics

DIVISION OF GENERAL MOTORS CORPORATION, KOKOMO, INDIANA

Available from these Delco distributors:

ALA., BIRMINGHAM • Forbes Distributing Co., Inc. (205)-251-4104
ARIZ., PHOENIX • Cramer/Arizona (602)-263-1112 • Sterling Electronics (602)-258-4531
CAL., LOS ANGELES • Kierulff Electronics, Inc. (213)-685-5511 • Radio Products Sales, Inc. (213)-748-1271
CAL., PALO ALTO • Kierulff Electronics, Inc. (415)-968-6292
CAL., SAN DIEGO • Milo of California, Inc. (714)-232-8951
COLO., COLORADO SPRINGS • Walker Electronics (303)-636-1661
COLO., DENVER • Cramer/Denver (303)-758-2100 • Denver Walker Electronics (303)-935-2406
FLA., MIAMI • Mountain Electronics Subsidiary of Avnet, Inc. (305)-634-4556
FLA., WEST PALM BEACH • Mountain Electronics, Subsidiary of Avnet, Inc. (305)-833-5701
ILL., ROSEMONT (Chicago) • F-J-R/Kierulff (312)-678-8560
ILL., SKOKIE (Chicago) • Merquip Electronics (312)-282-5400
IND., INDIANAPOLIS • Graham Electronics Supply, Inc. (317)-634-8486
MD., BALTIMORE • Radio Electric Service Co. (301)-823-0070
MASS., NEWTON • The Greene-Shaw Co., Inc. (617)-969-8900
MICH., ROMULUS • Harvey/Detroit (313)-729-5500

MINN., MINNEAPOLIS • Stark Electronics Supply Co. (612)-332-1325
MO., KANSAS CITY • Walters Radio Supply, Inc. (816)-531-7015
MO., NO. KANSAS CITY • ECI Semiconductors, Inc. (816)-221-2400
MO., ST. LOUIS • Electronic Components for Industry Co. (314)-647-5505
N.J., CLIFTON • Eastern Radio Corporation (201)-471-6600
N.M., ALBUQUERQUE • Cramer/New Mexico (505)-265-5767 • Sterling Electronics (505)-247-2486
N.Y., BINGHAMTON • Harvey/Federal (607)-748-8211
N.Y., NEW YORK • Harvey/New York (212)-582-2590
N.Y., WOODBURY • Harvey/New York (516)-921-8700
OHIO, CINCINNATI • United Radio, Inc. (513)-761-4030
OHIO, CLEVELAND • Pattison Supply (216)-441-3000
OHIO, DAYTON • F-J-R/Kierulff (513)-278-9411
OKLA., OKLAHOMA CITY • Radio, Inc. (405)-235-1551
OKLA., TULSA • Radio, Inc. (918)-587-9123
PENN., PHILADELPHIA • Almo Electronics (215)-676-6000
PENN., PITTSBURGH • RPC Electronics (412)-782-3770
S.C., COLUMBIA • Dixie Radio Supply Co., Inc. (803)-253-5333

TEXAS, DALLAS • Adleta Electronics Company (214)-742-8257
TEXAS, FORT WORTH • Adleta Electronics Co. (817)-336-7446
TEXAS, HOUSTON • Harrison Equipment Co., Inc. (713)-224-9131
UTAH, SALT LAKE CITY • Cramer/Utah (801)-487-3681
VA., RICHMOND • Meridian Electronics, Inc., a Sterling Electronics Company (703)-353-6648
WASH., SEATTLE • Kierulff Electronics, Inc. (206)-763-1550
WASH., TACOMA • C & G Electronics Co. (206)-272-3181
CANADA, ONT., SCARBOROUGH • Lake Engineering Co., Ltd. (416)-751-5980
ALL OVERSEAS INQUIRIES:
General Motors Overseas Operations
Power and Industrial Products Dept.,
767 Fifth Avenue, New York, N.Y.
10022. Phone: (212)-486-3723.

Regional Headquarters. Union, New Jersey* 07083, Box 1018 Chestnut Station, (201)-687-3770 ■ El Segundo, Calif. 90245, 354 Coral Circle, (213)-772-5181
■ Chicago, Illinois* 60656, 5151 N. Harlem Avenue, (312)-775-5411 ■ Kokomo, Ind. 46901, 700 E. Firmin, (317)-459-2175 Home Office
■ Office includes field lab and resident engineer for application assistance.



Wideband analyzer simplifies measurement



Systrom-Donner Corp., 888 Galindo St., Concord, Calif. Phone: (415) 682-6161.

A new solid-state calibrated spectrum analyzer with a 10-Hz to 64-MHz range features an automatic optimum-resolution circuit to simplify measurements of AM, FM, cw and single-sideband signals. The model 726 system consists of four sections: the 800S spectrum analyzer, the 710S display unit, the 806 50-kHz to 56-MHz converter and the 7127 audio two-tone generator.

Booth No. 3510 Circle No. 251

Light, portable scope operates to 75 MHz

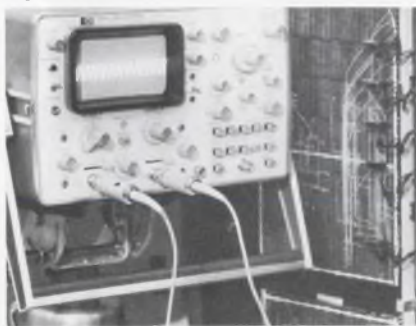

Hewlett-Packard Co., 1501 Page Mill Rd., Palo Alto, Calif. Phone: (415) 493-1501. P&A: \$2050 (add \$200 for battery pack); stock.

Weighing 35 lb (includes battery and cover) the 1707A dual-trace portable scope designed for portable applications such as computer servicing has delayed sweep, 6 by 10-cm display, 25-W consumption and 75-MHz response. It runs for 4-1/2 hours on a rechargeable battery, has sweep speeds down to 10 ns/div. and vertical-channel sensitivity of 10 mV to 5 V/div.

Booth No. 3400 Circle No. 357

High-speed current amp resolves 10 fA to 1 mA



Keithley Instruments Inc., 28775 Aurora Rd., Cleveland, Ohio. Phone: (216) 248-0400. P&A: \$796; 60 days.

The 427 current amplifier with decade-selectable gains from 10^{11} to 10^4 V/A features current resolution from 10^{-14} to 10^{-3} A. Its output voltage is ± 10 V at 1 mA and output resistance is 1 Ω . Minimum adjustable rise time is from 1 to 330 ms with low noise ranging from 4×10^{-13} to 10^{-10} A. Zero suppression and input overload protection are built-in.

Booth No. 3301 Circle No. 291

0.6-GHz sweep/marker provides 1 V into 50 Ω



Kay Elemetrics Corp., 12 Maple Ave., Pine Brook, N. J. Phone: (201) 227-2000. P&A: \$1195; 4 wks.

The new 160A sweep/marker generator provides a 1-V rms output into 50 Ω over 1 to 600 MHz. It features continuously variable sweep widths and center frequency and a multi-turn center-frequencies control for the fine setting of narrow sweeps. Other features are line-lock, variable-repetition rate, cw, manual and external modulation and switchable blanked retrace capabilities.

Booth No. 3302 Circle No. 281

Transient recorder mixes sweeps

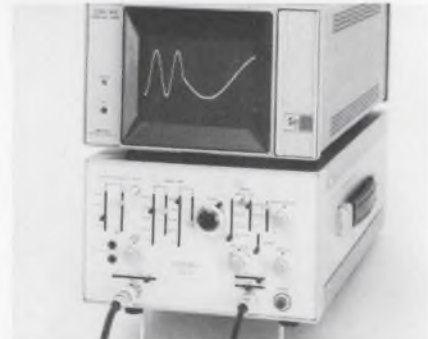

Biomation Corp., 1070 E. Meadow Circle, Palo Alto, Calif. Phone: (415) 321-9710. P&A: \$2950; 60 days.

The model 802 transient recorder allows mixed-sweep capability of two time bases and can vary a scope's sweep from 500 μ s to 20 s. Its bandwidth is 500 kHz and sensitivity is 50 mV to 50 V full scale. Triggering can be external or from the input signal. The trigger signal can be received before, during or after the signal to be recorded has occurred.

Booth No. 2733 Circle No. 264

Systems voltmeter is 0.004% accurate



John Fluke Mfg. Co., Inc., Box 7428, Seattle, Wash. Phone: (206) 774-2211. P&A: \$2450; 60 days.

A new systems-compatible digital voltmeter, the 5-digit 20% over-range 8400A, offers guaranteed accuracies of 0.004% for 90 days and 0.01% for 1 year without calibration. The basic unit features five dc voltage ranges—0.1, 1, 10, 100 and 1 kV. Options include seven resistance ranges from 10 Ω to 10 M Ω and four ac voltage ranges from 1 V to 1 kV with 0.05% accuracy to 10 kHz.

Booth No. 3600 Circle No. 294

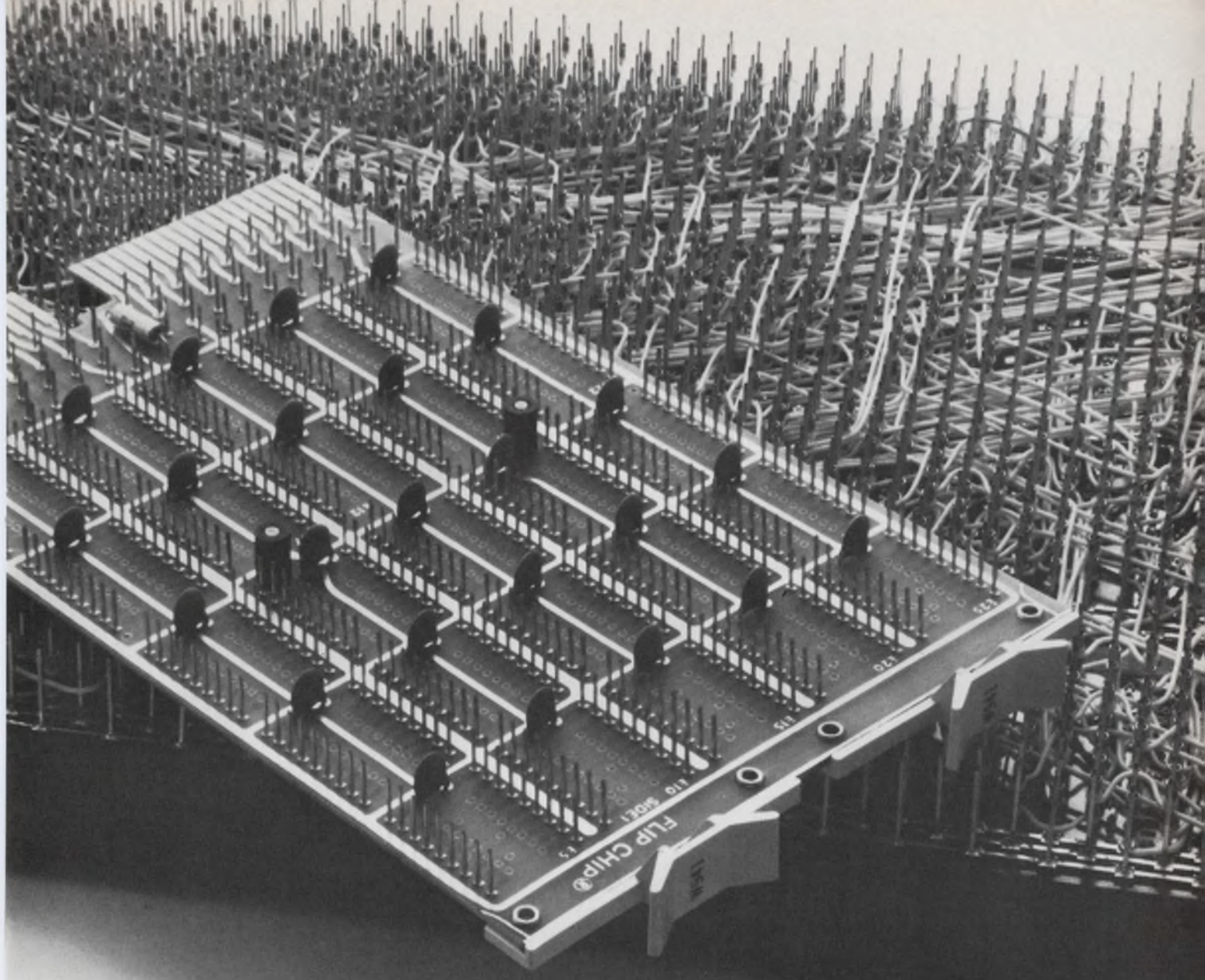

Sometimes, wrapping up takes a little knowhow.

Digital can provide its customers with automatic, computer-controlled wire wrapping services. Automatic wire wrapping is faster and much less expensive than either soldering or wire wrapping by hand and greatly reduces the chance of human error. And, of course, it eliminates all those nasty little problems associated with soldering.

We've got other production services, too. And hardware if you need it. And pieces of modules, all the way up to a module itself. And modules in combination with other modules, all the way up to a computer itself.

And if need be, we'll manufacture a module to your idea.

Frankly, we don't think you'll have to go that far. DIGITAL

has over 300 standard modules to pick from, and we think we have the fields of digital logic pretty well covered. Positive logic. Negative logic. Fast logic. Noise-immune logic. All these are already done.

But if you need something we don't have as standard, we'll make it for you. The engineering and design knowhow, the production design skills, and the manufacturing facilities that have already produced millions of modules – they're all available.

Doing it yourself has some pitfalls. Remember what happened last time?

Digital Equipment Corporation, Main St.,
Maynard, Mass. 01754, (617) 897-5111



Write.

See us at IEEE Booth 2348-2549.

digital

If you can't stand
the heat ...

stay out
of the
kitchen!



Here are components that stand the heat ... and the cold (-55°C to $+125^{\circ}\text{C}$) without voltage derating. The dissipation curve is as flat as a pancake ... and the other specs are out of this world. Maybe your recipe calls for

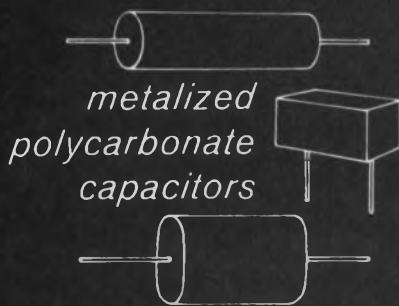

Try Standard's PC2-E (Rectangular Epoxy) and PC2-W (Wrap and Fill).

Send for Catalog and complete details.

Standard

CONDENSER CORPORATION

Dept. ED-3

1065 West Addison Street
Chicago, Illinois 60613 • (312) 327-5440

INFORMATION RETRIEVAL NUMBER 137

S42

INSTRUMENTATION

Three portable scopes range up to 150 MHz



Tektronix, Inc., Box 500, Beaverton, Ore. Phone: (503) 644-0161. P&A: \$1225, 2050, \$3050; 1st to 2nd quarter 1971.

Three new portable Sony/Tektronix scopes reach out to 150 MHz. The 324 is an 8-lb (includes batteries) 10-MHz scope with 10 mV/div. and sweeps from $0.2 \mu\text{s}$ to 0.2 s/div. The 453A 60-MHz dual-trace scope has 20 mV/div. and sweeps from 10 ns to 5 s/div. The 454A 150-MHz dual-trace scope has 20-mV/div. and sweeps from 2 ns to 5 s/div.

Booth No. 3520 Circle No. 295

Tri-waveform generator spans 0.2 Hz to 2 MHz



Wavetek, Box 651, San Diego, Calif. Phone: (714) 279-2200. P&A: \$395; 30 days.

Model 131A oscillator/voltage-controlled generator includes sine, square and triangular-wave outputs into 50 and 600 Ω over the range of 0.2 Hz to 2 MHz. Other features include a 20-V pk-pk output, a 1000:1 external voltage control ratio, a 60-dB output attenuator and a dc offset control that allows the signal ground to be raised above or below chassis ground.

Booth No. 3441 Circle No. 255

Digital error detector checks PCM pulses



Marconi Instruments Ltd., Englewood, N. J. Phone: (201) 567-0607.

The new digital error detector model TF2801 detects the errors in a pulse-code modulation signal consisting of a train of bipolar pulses. It produces an output pulse for every error that occurs, indicating it on a meter. Errors are indicated for both positive and negative swings. This four-digit instrument also has single and balanced 75- Ω inputs.

Booth No. 3211 Circle No. 302

Plug-in-card counters field expand to 3 GHz



Systron-Donner Corp., 888 Galindo St., Concord, Calif. Phone: (415) 682-6161.

The new series 6050 frequency counters includes four basic models with field-expandable measurement ranges up to 3 GHz. The four models measure up to 50, 200, 500 and 3000 MHz each. The first three models are expandable up to 3000 MHz with the simple insertion of the proper printed circuit card. The fourth is the model 6053.

Booth No. 3510 Circle No. 252

JUST ARRIVED



**A whole new family of 4½ digit
LED readout **DVMs** with guarded
inputs, more ranges . . .
and amazingly lower prices.**

LED displays are 7 bar segment, light-emitting diodes with a 100 year half-life. All instruments in this new family have basic $\pm .02\%$ accuracy and are systems compatible with BCD outputs. The Digital Millivoltmeter has resolution of 1 microvolt.

4 range Digital Voltmeter \$525
4 range Voltmeter Auto-ranging \$625
6 range Digital Millivoltmeter \$795
Digital Multimeter AC, DC, Ohms \$695

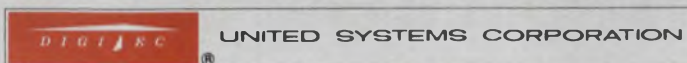

918 Woodley Road • Dayton, Ohio 45403 • (513) 254-6251
Representatives throughout the world
For complete specifications, request new catalog.

OPERATING SYSTEMS DEVELOPMENT FOR DESIGN . . . DIAGNOSTIC . . . FIELD AND SUPPORT PROGRAMMING ANALYSTS

Automatic Electric Laboratories Incorporated has immediate permanent career opportunities for experienced computer programmers to join our technical staff in the research, design and development of new computer controlled electronic telephone switching systems. We are a leading producer of switching equipment for the independent telephone industry. Consider the following factors in addition to the positions available.

STABILITY . . . The telephone communication industry in itself requires steady long term development to service the general public, industry, government and commerce. Our industry is the lifeline to man's need to interact with his fellow man.

GROWTH . . . The number of Automatic Electric plants have more than doubled in the past five years. Our ten year forecast requires us to double our production of existing equipment.

CHALLENGE . . . To build computer controlled systems with an outage of no more than 1½ hours of total time over a period of 30 years! This equipment must be capable of handling on-line functions such as computer talk, man-machine talk, international conference calls, etc. These systems must be capable of interfacing with all communication systems in existence today and in the future.

OPPORTUNITY . . . To develop computer programming projects in support of real-time special computer systems . . . researching applications of digital computer technology to the development of telephone switching systems . . . analyze, design and develop the software/hardware techniques required for sophisticated electronic switching networks . . . software/hardware testing of prototype and field systems . . . develop call processing software (real-time) . . . design software architecture for the control of electronic systems.

Immediate positions available are as follows:

DIAGNOSTIC PROGRAMMERS . . . Responsible for the development of real-time call processing programs for a stored program controlled telecommunication office. Must have two or more years experience in software design of real-time control systems plus knowledge of automata theory, computer design and logic circuits.

SYSTEM DESIGNERS . . . Responsible for the design of a common control for an electronic switching system (designing and generating diagnostic programs for a processor and 1/0 hardware). Must have several years experience in the design of electronic digital hardware using I.C.s.

MAINTENANCE PROGRAMMERS . . . Responsible for fault isolation and localization of maintenance software design involving all facets of program design including analysis, specification, coding and lab testing. Must have two or more years experience in software/hardware design of a computer controlled system (machine or assembly language level) with knowledge of logic and digital circuit design and assembly language programming.

SUPPORT PROGRAMMERS . . . Responsible for the development of the field or engineering support programs on commercial data processing machines and able to direct a group of programmers who have either hardware or software backgrounds. Must have several years of experience working on the development of real-time on-line computing or message switching systems and knowledge of maintenance programming and logic design.

FIELD ENGINEERS . . . Responsible for setting up of field tests and evaluation of computer controlled switching systems. Must have several years experience with compiler and assembler level languages in applications programming (design through documentation). Knowledge of hardware design and testing is essential.

SALARY OPEN! Salary will be commensurate with experience and qualifications. Applicants should submit a detailed resume outlining applicable experience, education, salary history and goals. Resumes will be held in strict confidence. Send to:

Russell DeRose
Professional Employment

GTE AUTOMATIC ELECTRIC LABORATORIES
INCORPORATED

A Part of General Telephone & Electronics

400 North Wolf Road

Northlake, Illinois 60164

An Equal Opportunity Employer

INSTRUMENTATION

**50/550-MHz counters
sell for \$950 to \$2150**



Hewlett-Packard, 1501 Page Mill Rd., Palo Alto, Calif. Phone: (415) 326-7000. P&A: \$1795, \$2150, \$1495, \$950; March, 1971.

Four new 50 and 500-MHz counters are available within the price range of \$950 to \$2150. The 550-MHz 5327A has 100-ps resolution in time-interval measurements by averaging. The 5327 adds a DVM to measure dc voltages and trigger level settings. The 5327C is a multi-function 550-MHz counter. The 5326C is a 50-MHz counter. Booth No. 3400 Circle No. 267

**Function generators
cover 0.3 Hz to 3 MHz**

Interstate Electronics Corp., Box 3117, Anaheim, Calif. Phone: (714) 772-2811. Price: \$295 to \$495.

Four new low-cost function generators covering the range of 0.3 Hz to 3 MHz feature sine, square, and triangular-wave outputs with variable pulse widths and sweeps. Series 30 units have outputs of 10 V pk-pk into 50 Ω.

Booth No. 3212 Circle No. 260

**Dual-trace scope
has two delay lines**

Phillips Electronic Instruments, 750 S. Fulton Ave., Mount Vernon, N. Y. Phone: (914) 664-4500. P&A: \$1350; 30 days.

The PM3210 is a 25-MHz dual-trace scope with delay lines in both of its channels for accurate X-Y measurements at frequencies to 5 MHz with only 2 degrees of phase-shift error. Input capacitance is 15 pF and sensitivity is 1 mV.

Booth No. 3222 Circle No. 305

If you need cool, accurate, reliable DPMs ... Buy Triplett

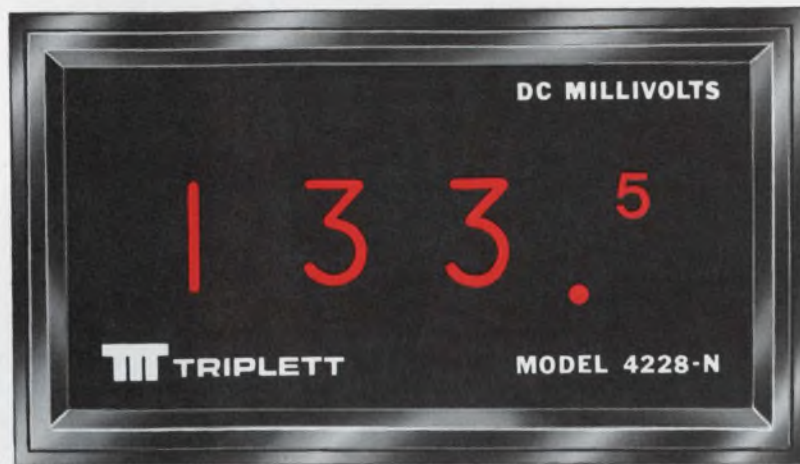

Model 4228-N

actual size

\$140

1. 2¾ digits — Provides double the accuracy (0.25% of reading \pm ½ digit) and double the resolution at lower cost.
2. Instantaneous Response — 16-millisecond display rate with 60 times per second sampling rate.
3. Fool-proof Numeral display blurs beyond over-range and with negative polarity.

Designed for OEM applications as well as R&D, production, quality control, maintenance and education use, Triplett's line of digital panel meters combine compactness, convenience and capability with characteristic Triplett accuracy and quality.

To 2 Watts power consumption (for reduced heat and increased reliability) and positive over-range and reverse polarity indications, Triplett's Model 4228-N adds a unique (patent pending) 2¾-digit display that effectively doubles the accuracy and resolution of 2½-digit instruments . . . at the cost of 2½-digits. Accuracy is \pm 0.25% of reading \pm 1 digit.

Model

4235-F \$240

1. 3½ digits with auto-polarity.
2. Low Power Drain — provides low operating temperature and long-lived reliability.
3. Single-plane, Seven-bar Readout — for accurate, wide-angle readability.

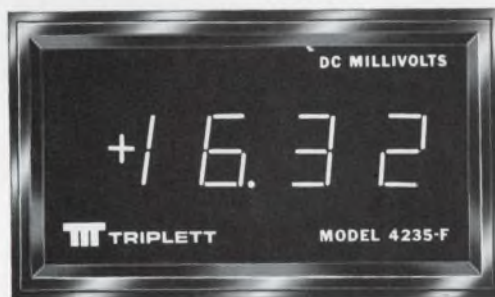

The Model 4228-N is a real value at \$140, so call your local Triplett Sales/Service/Modification Center or Triplett sales representative right now. Either will also be pleased to demonstrate two companion products: Triplett's Model 4225-N at \$125 which merely omits the neon lamp "1" (thus reading to 995) and offers \pm 0.50% \pm 1 digit accuracy; and the Model 4220-N at \$110 — a 2-digit instrument (reading to 99) with \pm 1% \pm 1 digit accuracy.

Mounted in the same size case and boasting the same low power consumption and positive over-range indication, Triplett's 3½-digit Model 4235-F adds auto-polarity

(with polarity indication) display hold capability, high input resistance (from 10 to 1,000 megohms depending on range) and a 3½-digit single-plane seven-bar fluorescent display. For many users, the wide-angle viewing capability — enhanced by a green, circularly-polarized viewing window that eliminates confusing internal reflections — will make the 4235-F the obvious choice.

Boasting a voltage accuracy of \pm 0.10% (current \pm 0.15%) of reading \pm 1 digit, Triplett's Model 4235-F sells for \$240. Its companion, the 3-digit Model 4230-F, is \$220. More information, or a free demonstration of both models, is available from your Triplett Sales/Service/Modification Center or your Triplett sales representative. Triplett Corporation, Bluffton, Ohio 45817.

TRIPLETT

Manufacturers of the World's most complete line of V-O-Ms.

ATTENUATORS

Standard In-Line



Miniature In-Line



Standard Rotary



Miniature Rotary

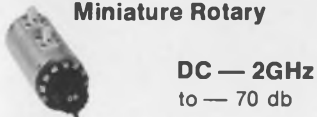

Tandem Rotary



Cam-Operated Rotary



In-Line Coaxial



Miniature Programmable



Microwave Programmable



Customerized Attenuators

DC — ?GHz
to — ? db

(to your specifications)

KAY

Elemetrics Corp

formerly Kay Electric Company

Maple Avenue
Pine Brook, N. J. 07058
(201) 227-2000

INSTRUMENTATION

\$975 dual-trace scope has 25-MHz response



Tektronix, Inc., Box 500, Beaverton, Ore. Phone: (503) 644-0161. P&A: \$975; 2nd quarter, 1971.

The new Telequipment, (Tektronix's British subsidiary) D67 dual-trace scope offers a 25-MHz bandwidth, 10-mV sensitivity and delaying sweep for \$975. Other features are 3% measuring accuracy, a vertical-signal delay line and a rectangular 5-in. CRT which has an 8 by 10-cm display. Sweep rates are from 2 s/cm to 0.2 μ s/cm (40 ns with X5 magnifier).

Booth No. 3520 Circle No. 257.

Versatile electrometers simplify measurements

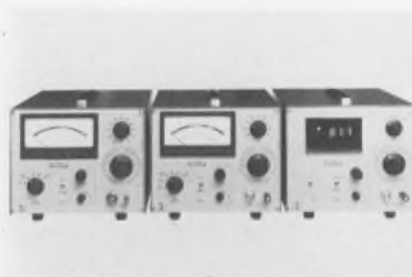

Princeton Applied Research Corp., Box 565, Princeton, N. J. Phone: (609) 924-6835. P&A: \$615, \$675, \$995; 90 days.

A new line of multi-purpose, multi-range electrometers permit precise and stable measurements of low-amplitude dc voltages, currents and charges without significant source loading. The line consists of the model 134 ac-line powered electrometer, the model 135 battery-powered electrometer, and the model 136 digital-display electrometer.

Booth No. 3314 Circle No. 339

Selective voltmeters work 30 to 1000 MHz



Rohde & Schwarz Sales Co., Inc., 111 Lexington Ave., Passaic, N. J. Phone: (201) 773-8010.

Types USU1 absolute and USU2 relative voltmeters are two new selective voltmeters for the 30 to 1000-MHz range. Type USU1 has a full-scale voltage range of 10 μ V to 3 V and automatic lock-in to ± 1 MHz. Its bandwidth can be switched from 0.2 to 2 MHz. The USU2 has fullscale sensitivity of 30 μ V to 30 mV. Both voltmeters operate according to the superposition principle.

Booth No. 3315 Circle No. 343

Four-digit voltmeter samples at 400/s

John Fluke Mfg., Box 7428, Seattle, Wash. Phone: (206) 774-2211. P&A: \$995; stock to 60 days.

The 8200A 4-digit voltmeter has a sampling rate of 400/s, 60% overranging, 0.01% accuracy, auto-ranging and remote programming. Other features are 1-ms sample-and-hold, fifth-digit overrange, a four-pole filter, four dc ranges (0 to 1100 V) and 1- μ V resolution.

Booth No. 3600 Circle No. 293

FM/AM source/sweeper spans 10 kHz to 0.5 GHz

Marconi Instruments, 111 Cedar Lane, Englewood, N. J. Phone: (201) 567-0607.

The model 2008 combines the facilities of an FM/AM generator with those of a sweeper over the frequency range of 10 kHz to 510 MHz in 11 ranges. Each range may be swept over its entire span and full modulation may be retained in the swept mode.

Booth No. 3211 Circle No. 272

MORE SWITCH FOR THE MONEY.

NOW YOU CAN SPECIFY PRACTICALLY ANY CUSTOM PUSHBUTTONS ON SWITCHCRAFT'S DW "Multi-Switch®"

There's almost no limit to the variety of pushbuttons you can use on this space-saving, multiple-station pushbutton switch. It has a newly designed "Cross-Rib" actuator located on each module

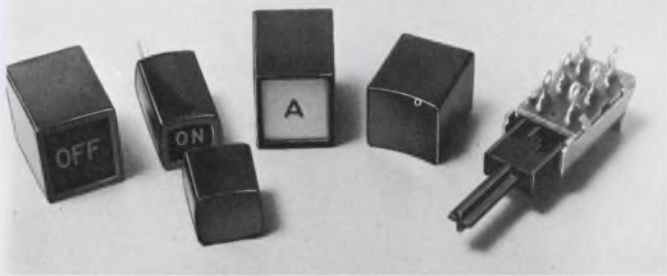

that makes the switch more versatile than ever.

The "Cross-Rib" actuators conform to industry standards and are furnished $\frac{3}{4}$ " and $1\frac{1}{16}$ " long to accommodate different size pushbuttons. They solve many operator-machine interface problems

when used with Switchcraft non-illuminated "Dual," "Showcase," concave or convex face, rectangular, round or square pushbuttons, or the unique "Glo-Button" that achieves simulated illumination.

MORE QUALITY FOR THE MONEY.

In a nutshell, the Series 70000, 71000 DW "Multi-Switch®" is an economical 1 to 18 station switch, that offers up to 4 PDT switching per station; Interlock, All-Lock, Non-lock or Push-lock/ Push-release functions, plus an almost unlimited variety of electromechanical and electrical accessory options. These switches are adaptations of the Switchcraft Series 65000 DW "Multi-Switch®" switches that

are noted for their simplicity, economy and reliability.

SWITCHCRAFT FORUM

Join the SWITCHCRAFT FORUM by sending us a request on your company letterhead. Just give us details

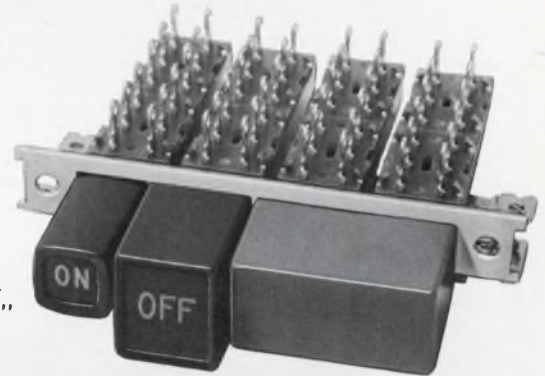

on your application, function and the circuitry required.

We'll forward a free sample of the Series 70000 DW "Multi-Switch®" plus our "FORUM FACTS on 'Multi-Switch®' SWITCHES" handbook that's loaded with specifications and application information. Your name will also be added to our TECH-TOPICS mailing list. Over 12,000 design engineers find the application stories in this technical publication extremely useful in their work.



SWITCHCRAFT, INC.
5529 N. Elston Avenue
Chicago, Illinois 60630



SWITCHCRAFT
INC.

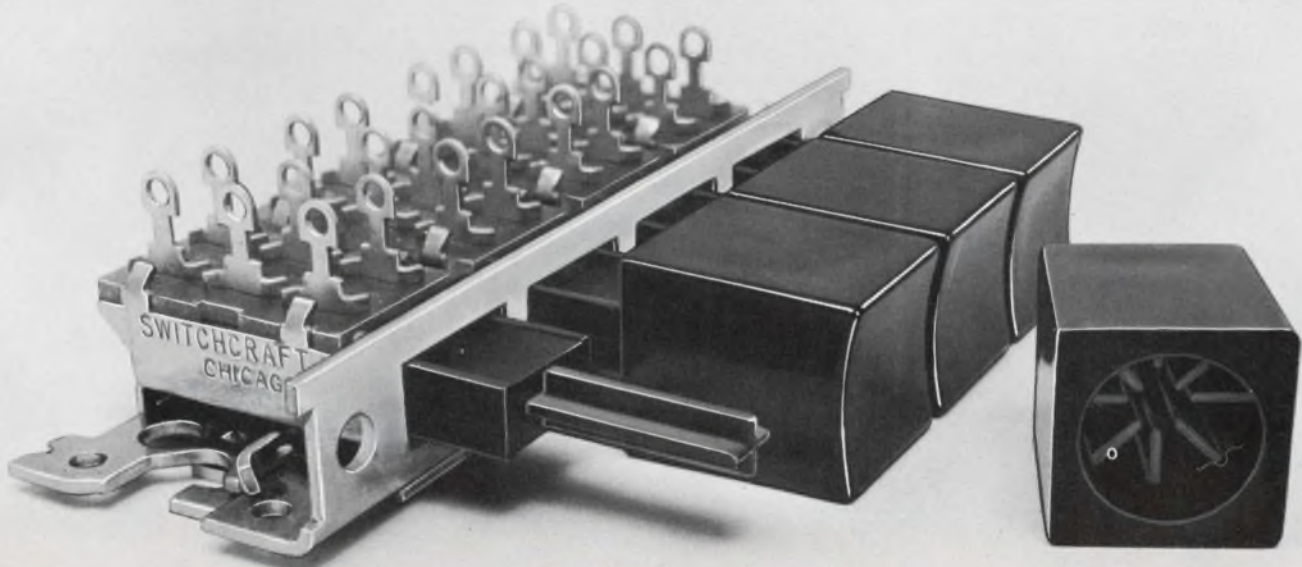

SPACE SAVERS...



JMT Series
Basic

LFH Series
Flat Handle

LL Series
Lever Lock

MPC Series
Printed Ckt

15 Series
15/32\"/>

... The Only Complete Line Of U.L. Listed Sub-Miniature Toggle Switches With Full 5 Amp. Rating At 125 VAC, Inductive.

For openers, there are more than 100 standard models in this U.L. listed family of single-pole, double-throw, double-pole, double-throw, and 2 circuit double-throw switches in several series and circuit configurations. Plus many other U.L. listed models with external variations in levers, bushings and terminals to customers' own specifications.

To back them up, there are some 80 standard models of 3- and 4-pole, double-throw switches in corresponding series and circuitry, not counting specials.

All are manufactured in New Haven, Conn., by J-B-T Instruments, Inc., and have virtually the same trouble-free characteristics as J-B-T Government quality standard size toggles in spite of drastic reduction in size and weight. For instance, single-pole types are 1/4\"/>

For full details, send for your copy of Catalog MT-40, or better yet, pick up your copy at the Show where you can handle the actual switches and feel the smooth action.



J-B-T INSTRUMENTS INC.

NEW HAVEN, CONNECTICUT 06508

(203) 772-2220

Booth 2621 at the IEEE Exposition March 22-25, 1971

INFORMATION RETRIEVAL NUMBER 143

INSTRUMENTATION

50-channel data logger costs \$4475 complete



Hewlett-Packard, 1501 Page Mill Rd., Palo Alto, Calif. Phone: (415) 326-7000. P&A: \$4475; 60 days.

A complete 50-channel data-logging system that operates at 1000 channels/s can be purchased for just \$4475. The 2070A system is only 7-in. high in a standard rack and includes the 3480 DVM, the 5055A 10-column digital recorder and the 3485A scanner which plugs into the DVM. The basic system costs \$2675 to which can be added plug-in options.

Booth No. 3400 Circle No. 268

8-channel recorder uses no ink

Mechanics For Electronics, Inc., 340 Fordham Rd., Wilmington, Mass. Phone: (617) 658-5500. P&A: \$3975; 30 to 45 days.

The model M28C/M28CR portable inkless recorder with 100-Hz response uses a thermal recording system to record eight 4-cm-wide channels. It has multiple chart speeds, an event/timer marker and a seven-step attenuator.

Booth No. 3104 Circle No. 278

Programmable source is DTL/TTL compatible

Chronetics, Inc., 500 Nuber Ave., Mount Vernon, N. Y. Phone: (914) 699-4400. P&A: \$4000 (1012), \$3250 (1012/P); stock to 30 days.

Model 1012 10-Hz to 9.99-MHz (single pulse) pulse generator has programmable inputs that are DTL/TTL compatible with most minicomputers. Program response is 1 μ s to 6 ms. Without front-panel controls it is the 1012/P.

Booth No. 3303 Circle No. 271



LIQUID RIVET

One drop bonds almost anything to almost anything for almost forever. We call it Eastman 910[®] Adhesive. It works with metals. With plastics. With rubber. With glass. With bonds that are often stronger than the materials being bonded.

It works without heat. Without solvents. Without pressure. Without catalysts. And without a lot of waiting. Philco-Ford uses Eastman 910 to bond aluminum to aluminum. Cessna uses it to bond rubber to acrylic plastic. Bendix uses it to bond steel to brass. For more information, call your Eastman representative. Or write Eastman Chemical Products, Inc., Kingsport, Tennessee.

You may find that Eastman 910 bonding is a lot easier than what you're doing now. More economical. Maybe even quieter.

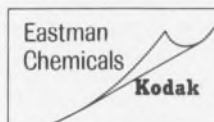

INFORMATION RETRIEVAL NUMBER 144

Wideband synthesizer resolves down to 1 Hz



General Radio, 300 Baker Ave., Concord, Mass. Phone: (617) 369-4400.

The new 1168 frequency synthesizer offers 1×10^{-9} /day stability and 1-Hz incremented output from 10 kHz to 160 MHz. The fixed-frequency output of the 1168 can be externally phase modulated up to ± 3 radians from dc to 300 kHz or ± 1 radian at a 1-MHz modulation. Output is 100 mV to 1 V rms into 50 Ω , accuracy is ± 1 dB and harmonics are down 25 dB.

Booth No. 3500 Circle No. 350

12.4-GHz power meter measures down to 1 nW

Boonton Electronics Corp., Route 287 at Smith Road, Parsippany, N. J. Phone: (201) 887-5110. P&A: \$1100; April 1, 1971.

The new model 42AD 3-1/2-digit rf power meter for the range of 200 kHz to 12.4 GHz measures 1 nW to 10 mW with an overload of 0.3 W cw. It has a display period of 250 ms, but may be triggered every 10 ms for BCD.

Booth No. 3606 Circle No. 259

High-accuracy generator covers 10 Hz to 10 MHz

Green Electronic and Communication Equipment, Ltd., Interstate Div. of B.A.C. (U.S.A.) Inc., 399 Jefferson Davis Highway, Arlington, Va. Phone: (703) 684-4735.

The TG1800 digital signal generator with high calibration accuracy offers five-decade control of 700,000 output frequencies from 1 Hz to 10 MHz. Its calibration accuracy is 1 part per million.

Booth No. 3231 Circle No. 286

A single capable source for both lamps and fiber optic light guide systems

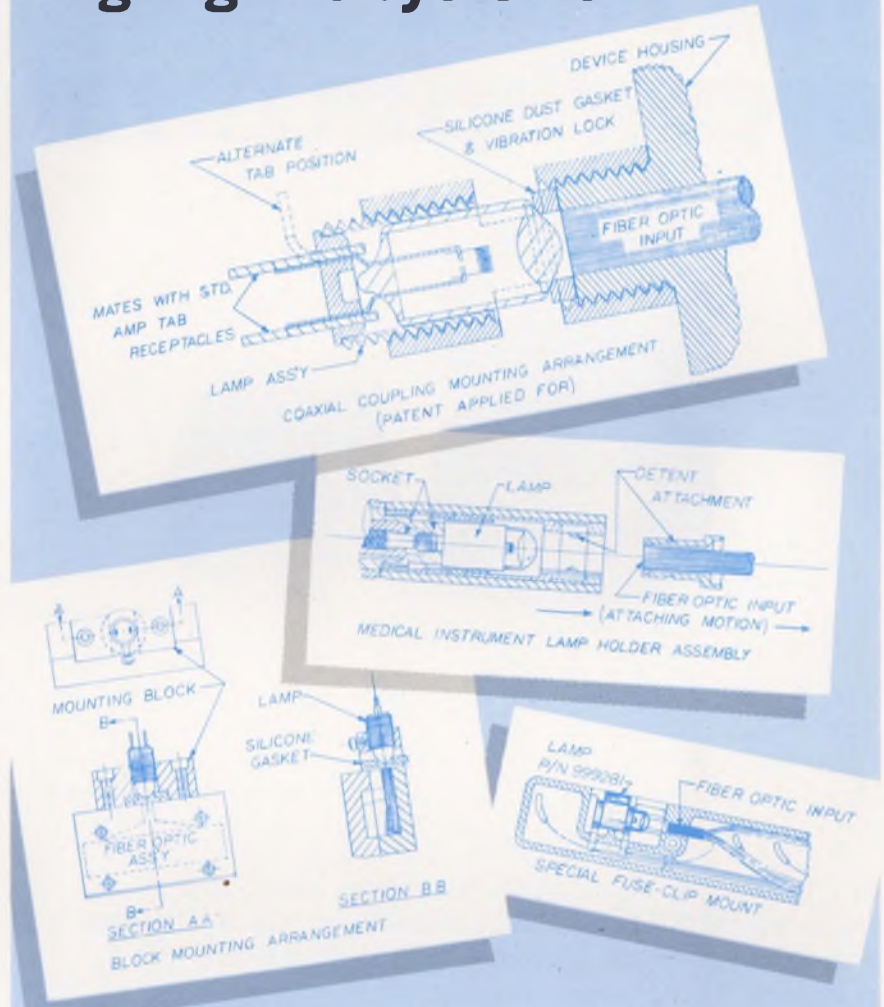

There are obvious advantages in speed, cost and often in efficiency of the ultimate system in having one source produce both miniature lamps and fiber optic assemblies. Welch Allyn has that capability.

We are major suppliers of fiber optics and incandescent illumination sources to principal computer manufacturers and other light guide users.

In addition to our standard lamp designs, we have recently developed a new family of customized miniature vacuum lamps for fiber optic and photo-sensitive device applications with selectable lens-filament combinations and basing for optimum utilization of energy.

Our lamp-fiber optic systems are designed for maximum efficiency and are often less costly than standard multiple-lamp systems.

Phone or write for more information

WELCH ALLYN, INC.
Skaneateles Falls, N.Y. 13153
(315) 685-5788

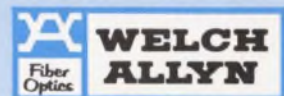

If you overpower our DC torquers you won't overwhelm them.

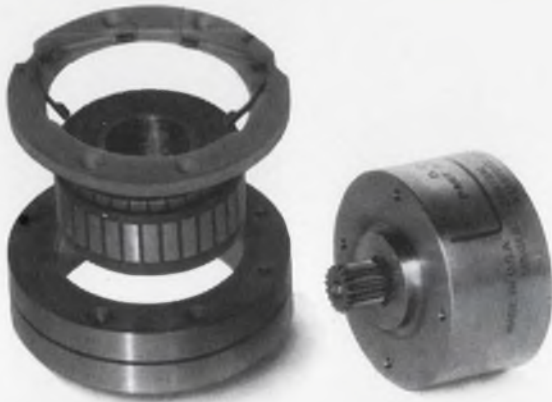

We have a new family of DC torquers—cased and uncased—which can be supplied with almost any feedback elements you might choose. Like potentiometers. Synchros. Tachometers. And more.

For their torque-to-size ratio, these units are as small as you'll find anywhere. But they can take it real big.

Even if you should accidentally give them momentary over voltages of 150%, you won't degrade them beyond their already tight specifications.

We also produce a large range of other DC rotating devices. Size 8 and 9 pm DC motors. Limited rotation DC torquers. Inside out DC torquers. Many types of feedback elements. A whole family of electromagnetic indicators.

When you need DC rotating devices, don't spin your wheels. Come to the source. Kearfott.

Write for our brochures today. Kearfott Division, Singer-General Precision, Inc., 1150 McBride Avenue, Little Falls, New Jersey 07424.

SINGER
KEARFOTT DIVISION

INFORMATION RETRIEVAL NUMBER 146

MICROWAVES & LASERS

VSWR bridge families span 50 kHz to 124 GHz



Wiltron Co., 930 E. Meadow Circle, Palo Alto, Calif. Phone: (415) 321-7428. Price: \$395, \$140, \$595.

Seven new families of VSWR bridges, some with rf outputs proportional to VSWR, some with built-in detectors and others for different frequency ranges span 50 kHz to 12.4 GHz. Directivity is over 50 dB to 4 GHz and over 36 dB to 12.4 GHz. Typical units are the 63N50 (10 MHz to 3 GHz), the 67FF75 (10 MHz to 1 GHz), and the 64A50 (3 GHz to 8 GHz).

Booth No. 3329 Circle No. 287

Wattmeter module adjusts phase to 90°



RFL Industries, Inc., Boonton, N. J. Phone: (201) 334-3100. Price: \$995.

Model 5058 wattmeter calibration module is designed for use with two model 829G calibration standards to enable calibration of four-terminal wattmeters from 0.05 to 14 kW with power factor adjustable from unity to zero (phase angle 0 to 90 degrees). The module includes all necessary shunts and multipliers, phase-shifting networks and controls.

Booth No. 3321 Circle No. 347

500-MHz beam tetrode dissipates 250 W

M-O Valve Co., Metropolitan Overseas Supply Corp., 468 Park Ave. South, New York, N. Y. Phone: (212) 686-2120.

The CCS1 conduction-cooled beam tetrode is intended for use as a power amplifier up to 500 MHz with an anode dissipation of 250 W. The new unit's conduction cooling eliminates moving parts and achieves greater reliability.
Booth No. 2144 Circle No. 301

Portable power meter spans 0.01 to 12.4 GHz

Narda Microwave Corp., 75 Commercial St., Plainview, N. Y. Phone: (516) 433-9000. P&A: \$320 (includes 1 mount); 6 wks.

The new model Mini hand-size 1.5-lb rf power meter which works on a 9-V transistorized battery operates from 10 MHz to 12.4 GHz. It sizes up to 1.75 by 4.625 by 2.625 in. and measures 10 μ W to 100 mW or -20 to +20 dBm at 3% accuracy.
Booth No. 3530 Circle No. 348

Small rfi/emi filters are rated 2 A and 100 V

RF Interonics, 100 Pine Aire Dr., Bay Shore, N. Y. Phone: (516) 231-6400.

The new line of single and dual-circuit Micro-Filters are subminiature rfi/emi filters rated for a maximum of 2 A and 100 V dc. They are available in both single-circuit (series 4000) and dual-circuit (series 4100) models. Many configurations are available.
Booth No. 2400 Circle No. 256

High-power varactors work at 5 to 13 GHz

Siemens Corp., 186 Wood Ave. South, Iselin, N. J. Phone: (201) 494-1000. P&A: approx. \$100; 2 to 4 months.

BXY15E and BXY15CA are new high-power charge storage varactors for the frequency range of 5 to 13 GHz. The varactors consist of diodes on a common silicon substrate with many mesas connected by low-inductance strips.
Booth No. 2528 Circle No. 297

What You Should Know About...

Miniature High Voltage Resistors

new Mini-Mox resistors offer 100 ppm TCR plus low noise characteristics

If you are responsible for design of high-voltage, highly-stable miniaturized electronic networks and equipment, the new Mini-MOX resistor can be a life saver. Mini-MOX resistors have all the ingredients you need to cook-up new designs for ultra-critical applications. For instance, Mini-MOX resistors are a fraction the size of conventional types; they meet or exceed MIL-R-10509-F for environmental parameters . . . 100 ppm or less; stability better than $\pm 2\%$ for 2,000 hours at full load; low-voltage coefficient less than 5 ppm/volt, measured between 100 volts and full-rated voltage; in addition, typical quantech noise at 20 megohms is less than 0.5 microvolt/volt.

All these characteristics combine to provide extremely-rugged and highly-stable resistor configurations that are virtually immune to environmental extremes. Available off-the-shelf in a wide range of resistance values, Mini-MOX resistors are ideally-suited for high-voltage applications where long-term stability and power-to-size ratios are critical.

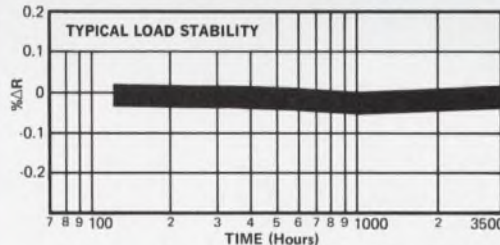
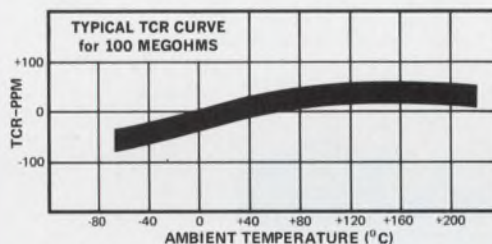

Model	Resistance	Rating @ 70°C	*Max. Oper. Volts	Length Inches	Diameter Inches
MOX-400	1-2500 megs	.25W	1000V	.420	.130
MOX-750	1-5000 megs	.50W	2000V	.790	.130
MOX-1125	1-10,000 megs	1.00W	5000V	1.175	.130

Write for complete Technical Data Sheet on Mini-MOX Resistors: Victoreen Instrument Div. of VLN Corp., 10101 Woodland Avenue, Cleveland, Ohio 44104. Telephone: 216/795-8200



Expertise in high voltage

DMA 557

**More wafers
per furnace load.
Longer furnace tube life.**

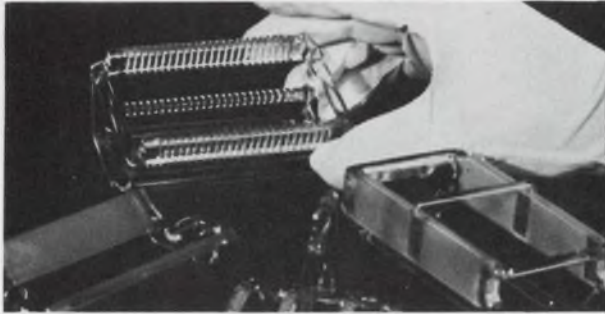

Newly designed carrier boats from Amersil are a marked improvement over slotted plate and slotted rod carriers for low and high temperature diffusion applications. This construction provides more secure wafer spacing for uniform diffusion.

For details on the above and our complete line of new spring boats and carriers to raise wafer output, write today to: Amersil, Inc., 685 Ramsey Ave., Hillside, N. J. 07205.



An Equal Opportunity Employer

207B

INFORMATION RETRIEVAL NUMBER 148

SPDT DPDT 3PDT 4PDT

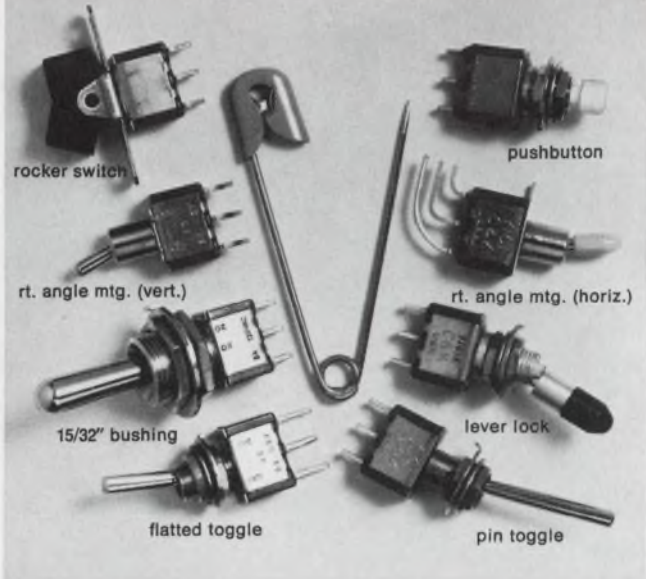

8 tiny, new additions to our family.

There they are – in a proud family portrait. And like all C&K subminiature switches, they're competitively-priced and Made-in-America. Ask for our new catalog.

C&K COMPONENTS, INC.
103 Morse Street, Watertown, Massachusetts 02172
Tel: (617) 926-0800
See us at the IEEE Show. Booth #21-39

INFORMATION RETRIEVAL NUMBER 149

TERMINAL BLOCKS

CURTIS

**INSULATED FEED-THRU
GFT SERIES**



**RATED: 20 Amps.
300 Volts**

Versatile, compact GFT Series eliminate costly insulating and mounting procedures to meet UL and CSA requirements. Fully insulated inserts give 1/4" solder terminal to ground clearance on 1/8" thick chassis.

SURFACE TERMINALS: 3/8" center-to-center spacing of #6 or #8 screws take up to #12 AWG wire.

INTERNAL CONNECTIONS: Variations include turret-type solder posts, printed circuit pin (.062 dia.), #6-32 screws, or turret-type posts with axial #53 taper pin receptacle.

AVAILABLE: 1-18 bright tin plated terminals per block with end mounting positions or flush ends with Tinnerman nut mounting.

FREE! Full details, descriptions and prices in Curtis 24-page illustrated catalog.



CURTIS DEVELOPMENT & MFG. CO.
3236 N. 33rd St., Milwaukee, Wis. 53216

See us at Booth 2138, IEEE Show and Booth 4332, Design Engineering Show.



INFORMATION RETRIEVAL NUMBER 150

S52

ON THE MOST WANTED LIST



ALIAS MINI & MAXI

Real names: **TH-Jr. and TH-65.** Smallest and largest members of the "Tenney Gang" of reach-in, temperature-humidity chambers. Easily identified by the Tenney Vapor-Flo® humidity generation system and the fully hermetic, all-welded Hermeticool® refrigeration system.

Known to cover a temperature range of 0°F to 200°F and a humidity range of 20% to 95% RH. Noted for responsive performance. Praised for ease of operation and high reliability.

Can be found serving in evaluation or manufacturing of products sensitive to temperature and humidity environments. For details on Mini, Maxi and all the Gang in-between, call or write today:



1090 Springfield Rd., Union, New Jersey 07083 • (201) 686-7870
Western Division: 15721 Texaco St., Paramount, Calif. 90723



619A

INFORMATION RETRIEVAL NUMBER 151

ELECTRONIC DESIGN 6, March 15, 1971

Modified DTL ICs improve noise margins

AEG-Telefunken Corp., 570 Sylvan Ave., Englewood Cliffs, N. J. Phone: (201) 568-8570.

The new DTLZ integrated circuits are modified DTL ICs that use zener diodes instead of the normally used voltage-dropping diodes to achieve high noise margins and small temperature drifts. They are part of the FP family of ICs and are designed for industrial use.
Booth No. 2127 Circle No. 270

Monostable flip-flop ignores interference

Siemens Corp., 186 Wood Ave. S., Iselin, N. J. Phone: (201) 494-1000.

The FZK101 is an interference-free monostable flip-flop. It can be used for delaying and shortening pulses by means of external connections and is triggered by the edges of positive or negative pulses. Its threshold voltage is 6 V.
Booth No. 2528 Circle No. 340

Video i-f amp IC has 60-dB gain

Siemens Corp., 186 Wood Ave. South, Iselin, N. J. Phone: (201) 494-1000.

The TBA 440 IC includes a video i-f amplifier whose gain can be controlled within a range of 60 dB to considerably simplify TV receiver circuits. The TBA 440 handles all the functions between tuner output and video stage and replaces 60 discrete TV components.
Booth No. 2528 Circle No. 298

Silicon solar cells are 12.5% efficient

AEG-Telefunken Corp., 570 Sylvan Ave., Englewood Cliffs, N. J. Phone: (201) 568-8570.

Telesun silicon solar cells are high-efficiency energy converters with efficiencies as high as 12.5%. This efficiency is reported to be about 20% higher than that of standard silicon solar cells which is 10 to 11.5%.
Booth No. 2127 Circle No. 336



THE FIRST MONOLITHIC DUAL TRACKING REGULATORS CAME FROM SILICON GENERAL...

The SG1501/2501/3501 regulators give you **simultaneous positive and negative outputs**, $\pm 15V$ or adjustable from $\pm 8V$ to $\pm 23V$, balanced to within 1%, with 4 mV line and 5 mV load regulation and with 100 mA output capability.

NOW THE FIRST INTERNALLY COMPENSATED "ULTIMATE" OP AMP — THE SG118/218/318...

Here's 108 performance with 30 pF internal compensation: 2 nA max. input bias current, 200 pA offset current, 300 μA supply current and interchangeability with 108 types.

AND THE UNCOMPENSATED SG108/208/308...

With or without compensation, SG has the plug-in replacement for your LM108 requirements, including high performance "A" selections, at money-saving prices.

AND THE SG109/209/309 FIVE-VOLT REGULATORS

The 109's provide local regulation at currents to more than one amp, with current limiting and thermal shutdown protection. Both solid header TO-5 and TO-3 power packages are available.

USING LM LINEAR IC's?

In addition to innovations such as the SG1501 and the SG118, we make theirs: LM100/200/300, LM101/201, LM101A/201A/301A, LM102/202/302, LM105/205/305, LM107/207/307, LM108/208/308, LM108A/208A/308A, LM109/209/309, and the LM110/210/310. The LM104/204/304, LM106/206/306 and LM111/211/311 are coming. We also manufacture the $\mu A710$, 711, 723, 733, 741, 747 and 748, the MC1595/1495, MC1596/1496 and equivalents to the CA3046 and CA3054. Call collect or write today for more data.

Silicon General

THE LEADER IN LINEAR

7382 Bolsa Avenue, Westminster, California 92683, 714/892-5531



SILICON GENERAL DISTRIBUTORS: ARROW ELECTRONICS, INC. — New York 516/694-6800, Ohio 216/464-2000, BODELLE COMPANY, INC. — Chicago, Ill. 312/468-1016, GERBER ELECTRONICS — Dedham, Mass. 617/329-2400, GREENE-SHAW COMPANY, INC. — Newton, Mass. 617/969-8900, HARVEY RADIO COMPANY — Woodbury, L.I., N.Y. 516/921-8700, N.Y., N.Y. 212/582-2590, Clifton, N.J. 201/473-8558, INDUSTRIAL COMPONENTS, INC. — Minneapolis, Minn. 612/927/9991, INDUSTRIAL ELECTRONICS ASSOCIATION — Palm Beach Gardens, Fla. 305/622-2626, KIERLUFF ELECTRONICS — Phoenix, Ariz. 602/273-7331, Albuquerque, N.M. 505/247-1055, Palo Alto, Calif. 415/968-6292, San Diego, Calif. 714/278-2112, Denver, Colo. 303/343-7090, Seattle, Wash. 206/763-1550, K-TRONICS-WESCO — Los Angeles, Calif. 213/685-9525, OSS-MANN COMPONENT SALES CORP. — Rochester, N.Y. 716/422-3290, PYTTRONIC INDUSTRIES, INC. — Baltimore, Md. 301/539-6525, Cheverly, Md. 301/322-3740, Montgomeryville, Pa. 215/643-2850, Philadelphia, Pa. 215/242-6700, Pittsburgh, Pa. 412/931-0915, Harrisburg, Pa. 717/233-6591, Raleigh, N.C. 919/833-7552, REPRESENTATIVES: ALA 205/772-9237, ARIZ 602/253-6104, CALIF 714/892-5531, 415/349-1266, COLO 303/798-8439, CONN 203/239-0212, FLA 305/622-1468, 305/622-1730, ILL 312/286-1500, IND 317/359-9283, 219/432-5591, 317/453-6868, IOWA 319/362-8155, MD 301/825-0001, MASS 617/862-8230, MICH 313/342-3242, MINN 612/927-9991, MO 816/763-3624, 314/872-3183, N.M. 505/268-3941, N.Y. 716/442-3290, 914/338-5505, 315/454-4477, 607/785-9949, N.Y. CITY 516/741-8966, OHIO 216/241-4880, 513/298-0662, OKLA 405/721-4617, PA 215/248-3377, 412/922-3890, TENN 615/968-4195, TEX 214/233-5591, 713/729-1233, WASH 206/767-4330 — ATHENS Tel: 727-719, COPENHAGEN Tel: 2771, GENNEP Tel: 45239, HASSETT Tel: 011-25467, LONDON Tel: 24443, MONTREAL 514/735-5775, MILAN Tel: 639-751, MUNICH Tel: 05-22-106, PARIS Tel: 62-630 F, STOCKHOLM Tel: 08/756-65-53, TEL-AVIV Tel: 033-638, TOKYO Tel: 4208, ZURICH Tel: 52028.

Data distributor controls 240 channels



Hewlett-Packard, 1501 Page Mill Rd., Palo Alto, Calif. Phone: (415) 326-7000. P&A: see text; 5 wks, 8 wks.

A new digital data distributor allows a single computer output to control up to 240 channels for automatic test and control systems.

The 6936A Multiprogrammer expands one parallel, 16-bit computer output into 15 separate and individually addressable 12-bit output channels. Fifteen additional control channels can be added to the system by connecting a model 6937A Extender.

Up to 15 Extenders can be added to the 6936A system so that a single 16-bit computer output can control as many as 240 12-bit channels. No changes in computer hardware or software are necessary.

Plug-in output cards in each of the 240 channels provide outputs in the form of resistances, dc voltages, contact closures or TTL logic levels in any combination.

A variation of the 6936A Multiprogrammer, designated the 6936S, has been combined with the 1800-series programmable pulse generator to form a system for computer control of pulse parameters.

The Multiprogrammer accepts one 16-bit word at a time from a computer and directs it into the indicated control channel and sets the corresponding generator pulse parameter.

Parameters include height, width, polarity, risetime, falltime, offset repetition rate and trigger delay. Each can be controlled in 30 μ s.

Basic price for the 6936A Multiprogrammer is \$1200. An Extender costs \$750 and a typical output card is \$350. The 6936S/1900-series system costs \$5950.

Booth No. 3400 Circle No. 355

16-register calculator is field-expandable



Wang Laboratories, Inc., 836 North St., Tewksbury, Mass. Phone: (617) 851-7311. P&A: \$2700 to \$4200; 3 months.

The 500 programmable calculator can be field-expanded from 16 registers with 64 program steps to 192 or 320 steps, with the capability of extending up to 56 storage registers under manual-print or cassette programmable control. With the optional cassette, the 500 automatically cascades blocks and executes a program of 16,000 steps.

Booth No. 2721 Circle No. 269

Touch calling keyset includes tone generator



GTE Automatic Electric, Inc., 400 N. Wolf Rd., Northlake, Ill. Phone: (312) 562-7100. P&A: \$19.95; stock.

A new 12-button keyset for touch-calling applications has a one-transistor tone generator that produces different combinations of tone frequencies to encode each of its ten digits and two control symbols. Type D-840000-A has two variable tank circuits—one for a low group of four and another for a high group of three frequencies.

Booth No. 2615 Circle No. 289

Software programs speed circuit design

Telcomp. Corp. of America, 50 Moulton St., Cambridge, Mass. Phone: (617) 491-1850.

Five new computer programs are available for circuit design. They are AMCAP (microwave circuit analysis), IMPACT (nonlinear circuit analysis) and ACAP (nonlinear circuit analysis). They also include MIFIL (microwave filter design) and SYNFIL (filter synthesis).

Booth No. 2826 Circle No. 265

Thrifty keyboard switch has 1-ms contact bounce

Chicago Switch, Inc., 2035 Wabansia, Chicago, Ill. Phone: (312) 489-5500.

The new low-cost 34 series keyboard switch in lighted and unlighted versions features long life of 25 million actuations and 1-ms contact bounce. Bifurcated contact resistance is 20 m Ω . Actuation force varies from 1-1/2 to 2 oz.

Booth No. 2432 Circle No. 304

Hard-copy recorder speeds out graphics

Alden Electronic & Impulse Recording Equipment Co., Inc., Westboro, Mass. Phone: (617) 366-8851. P&A: \$2400; stock.

The new 600 Push-to-Print graphic recorder provides instant hard-copy paper records from data and graphic CRT display terminals. Utilizing the Flying-Spot technique, CRT recordings can be generated at 30 lines/s.

Booth No. 2715 Circle No. 335

Instrument peripherals enhance interfacing

Weyfringe Ltd., Longbeck Rd., Marske, Redcar, Tesside, England.

A line of low-cost instrument peripherals include a digital comparator and timer and a scanner. The comparator is pre-set on thumbwheel switches. It compares at 350/s. The timer allows two external functions to be automatically controlled with accuracy. The scanner accepts 10 analog inputs.

Booth No. 3409 Circle No. 299

**What happened when
Marconi combined
a signal generator with
a frequency sweeper?**

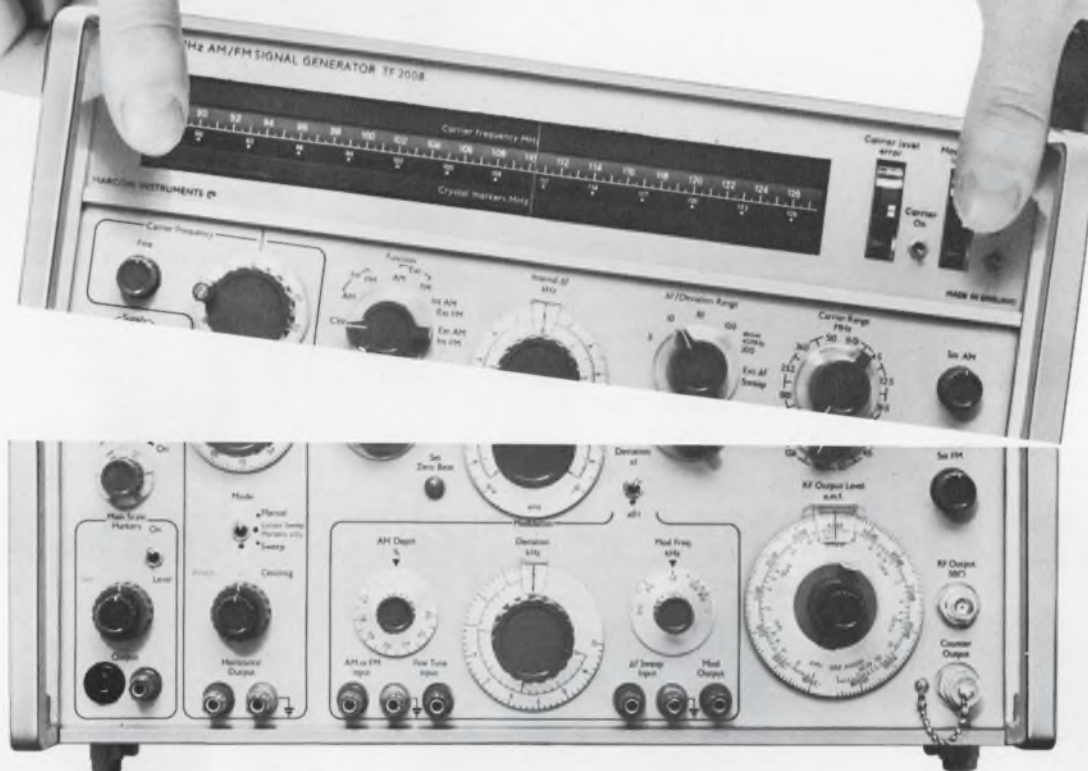

**they developed the
Dynamic Transmission Simulator**

Marconi gives you a Sweeper and Generator in our new Dynamic Transmission Simulator, Model 2008 . . . a complete test source for all measurements in the LF/MF/HF and VHF ranges and beyond.

This remarkable new instrument offers many unique features . . . exceptionally wide frequency range starting in the VLF Band (10KHz) and going up to UHF (510MHz) in eleven ranges each with a 1 to 1.5 cover . . . internal or external sweep adjustable to entirely span any tuning range . . . full

FM and AM capabilities which can be retained in the swept mode. Write for detailed specifications.

Dynamic Transmission Simulator Model TF 2008

- Frequency range: 10 kHz to 510 MHz; stability 5 p.p.m.
- Direct reading incremental frequency control.
- Built-in frequency sweeper.
- Crystal calibrator also provides marker outputs.
- Remote fine-frequency control facilities.
- Modulation facilities retained in both sweep and remote-control modes.



111 CEDAR LANE □ ENGLEWOOD, NEW JERSEY 07631
TELEPHONE: (201) 567-0607

SEE US AT IEEE-BOOTH # 3211-3217.

726

Coaxial connectors mate with ease



Sealectro Corp., 225 Hoyt St., Mamaroneck, N. Y. Phone: (914) 698-5600. P&A: \$2 to \$7; stock to 3 wks.

New Kwik-Konnect coaxial rf connectors feature a lock ring whereby the connectors are merely pushed together and automatically lock for quick and easy mating. Low VSWR figures include 1.20:1 to 12.4 GHz and 1.30:1 to 18 GHz. Voltage rating is 400 V rms and impedance is 50 Ω. They are available in cable jacks and plugs, right-angle plugs and bulkhead receptacles.

Booth No. 2128 Circle No. 254

Wire-wrap boards mix multi-pin ICs

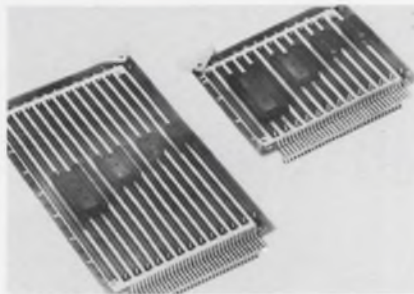

Cambridge Thermionic Corp., 445 Concord Ave., Los Angeles, Calif. Phone: (213) 776-0472.

Two new wire-wrap boards have been added to the series 715 line to allow the user to mix 14, 16, 24 and 36-pin IC sockets in any desired arrangement. The boards contain all holes for mounting and no sockets. Input/output is accomplished with a combination of 70 wire-wrap pins and 70 edge connections. Sizes of the boards are 4.5 by 4.5 in. and 4.5 by 9.25 in.

Booth No. 3222 Circle No. 288

Aluminum knobs fit 1/8-1/4-in. shafts

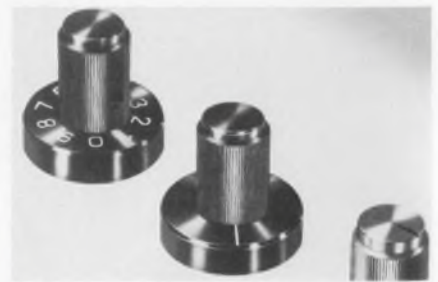

Alco Electronic Products, Inc., Box 1348, Lawrence, Mass. Phone: (617) 686-3887. P&A: 49¢ (no skirt), 60¢ (plain skirt), 72¢ (engraved skirt); stock.

The new KB series of machined-aluminum knobs fill the requirements for rotary switches having 1/8 and 1/4-in.-dia shafts. They have 0.63-in.-deep shaft holes and 0.55-in. straight knurl bodies. They are available with plain 0.997-in. skirts or with skirts having engraved 0 to 9 numerals with 36-degree spacing.

Booth No. 2224 Circle No. 253

Pssst...all muscle and no fat makes



75ips Transport

Faster throughput with higher transfer rates for 30% less than you've been paying. Tape is accelerated to 75ips with negligible velocity transients or overshoot. Vastly superior servo system delivers gentle positive tape control, excellent stability, controlled start/stop operation. 7 and 9 track, 800cpi NRZI and 9 track 1600cpi phase-encoded formats. 10 1/2 inch reel. Circle No. 191



45ips Transport

It does everything any other transport can do. Better. For \$3150. (In quantities of 100 for read-after-write) Or \$2930 in read/write. Other low prices for 72 read-only, multi-format models. 10 1/2 inch reel. No vacuum. Negligible velocity transients or overshoot. Tape speeds from 12.5 to 45ips. In 7 and 9 track, 800cpi NRZI. Also 9 track, 1600cpi phase-encoded formats. Circle No. 192

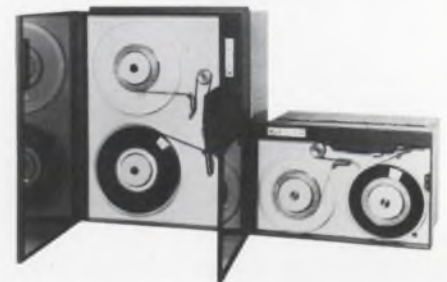

Incremental Transports

Prices reduced on all 28 models, including Incremental Write, Incremental Write/Synchronous Read, Synchronous Write and Synchronous Read models. 8 1/2 inch and 10 1/2 inch reels, complete with data electronics and control logic. Write step rates to 1000 char/sec.; synch. read rates from 1 1/2 to 25ips. 7 and 9 track, with standard 800/556/200cpi data densities. All IBM 360 compatible. 45 day delivery. Circle No. 193

PC board comparator inspects rapidly



Ragen Precision Industries, Inc., 9 Porete Ave., N. Arlington, N. J. Phone: (201) 997-1000. P&A: \$1990; stock.

The new PCI-608 Blinc Inspection Comparator System for PC boards contains an illumination system that visually identifies the location and nature of board errors. An approved master board is inserted on one side and production units are compared one by one on the other side. Fixed mirrors and switching lights are used. Booth No. 1309 Circle No. 277

Wire-wrap modules simplify logic design

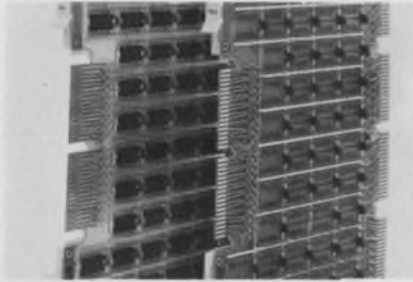

Digital Equipment Corp., 146 Main St., Maynard, Mass. Phone: (617) 897-5111. Price: \$40 to \$140.

Eight new wire-wrap module boards serve as basic building blocks upon which engineers can design their own logic functions. Series W900 modules accommodate 14, 16 and 24-pin dual-in-line packages with or without sockets. Up to 50 ICs can be accepted on some boards. Boards are double-sided and 8-1/2 in. wide with quad heights. Half-size versions are available.

Booth No. 2348 Circle No. 356

Dense packaging system can house 720 DIPs

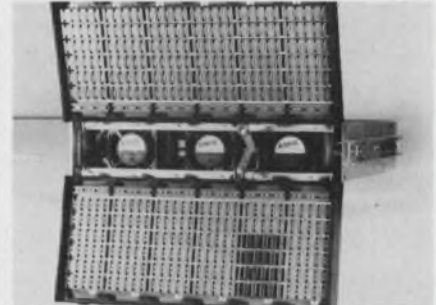

IFE Div. of Plastic Mold & Engineering Co., 25 Tripps Lane, E. Providence, R. I. Phone: (401) 438-3315. Price: \$45 to \$385.

Featuring slide-mounted drawers designed for rack mounting, new SD300 modular packaging systems have capacities from 30 to 720 DIP sockets and include tilt-open mounting frames for access to sockets and wiring planes. They are self-cooled and have a maximum drawer height of 5-1/4 in. (720-socket model).

Booth No. 2342 Circle No. 263

PEC your best tape transport buy.

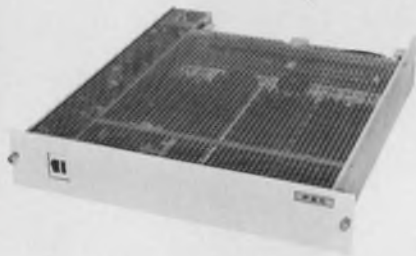

Data Formatters

Two-to-one better than anything in its class. With these, system designers can utilize the same simplified controller for both 1600cpi and 800cpi 10 1/2 inch and 7 inch reel transports. Choice of 7 and 9 track, 800cpi NRZI — or 9 track, 1600cpi phase-encoded ANSI and IBM compatible formats. Each formatter can handle up to 4 PEC tape transports of same speed and interface configuration. Also PEC's new combination 800/1600cpi data formatters. Circle No. 194



7" Reel Transport

Higher data density in an ultra-compact 7 inch reel unit that racks in an 8 3/4 inch space. Tape speeds to 12.5ips, data transfer rates to 20K char/sec. 7/9 track NRZI or 9 track phase-encoded. Read-after-write and write/read models. Prices start at under \$2000 in OEM quantities. Tape loading is extremely fast and simple. Circle No. 195

PEC delivers high performance products free of frills at prices that are free of padding. We're hardnosed about basic design. Our policy is, if it could hinder data reliability one bit, leave it out. (We eliminated the need for vacuum components in our new 45ips and 75ips tape transports and passed the savings on to you.)

And that makes it possible for you to choose your transport from over 300 PEC models in 3 reel sizes, available with fast delivery from our modern plant.

For a sample of best buys, check these new PEC products. And write Peripheral Equipment Corporation, 9600 Irondale Ave., Chatsworth, Calif. 91311. (213) 882-0030.

PEC

150/350-MHz CRTs cut length to 11.5 in.

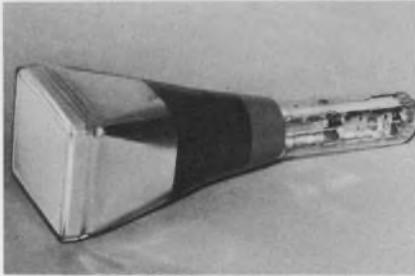

Thomson-CSF Electron Tubes, Inc., 50 Rockefeller Plaza, New York, N. Y. Phone: (212) 489-0400. P&A: \$335 (F8071); 1 to 2 months.

Two new CRTs are the 150-MHz F8071 with a short 11.5-in. length and the 13.5-in.-long OEE1108 with an operating frequency up to 350 MHz. The former attenuates 0.2 dB at 150 MHz, has 4-V/cm deflection and displays over 6 by 10 cm. The latter has 1.5-V/cm deflection and displays over 8 by 10 cm. Booth No. 2223 Circle No. 276

Tiny solid-state switch handles 5 amperes

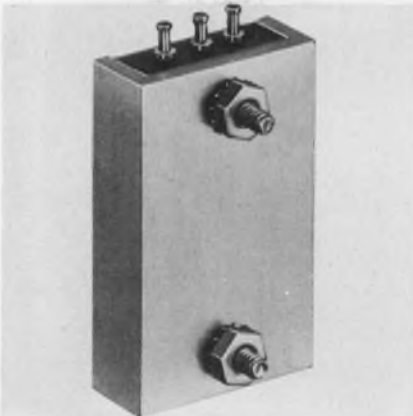

Grayhill, Inc., 561 Hill Grove Ave., LaGrange, Ill. Phone: (312) 354-1040. P&A: \$13.35; 2 to 10 wks.

Unlimited life, no contact bounce and constant performance are features of a new 2-1/4 by 1-1/4 by 1/2-in. solid-state switch capable of handling 5 A at 115 V ac or at 6 to 48 V dc. Series 70 switch is turned on and off by a 0.2-mA control current (ac version). ON and OFF resistances are 0.2 Ω and 20 k Ω (ac version) or 1.6 k Ω (dc version), respectively.

Booth No. 2214 Circle No. 284

Magneto-resistor unit measures magnetic field

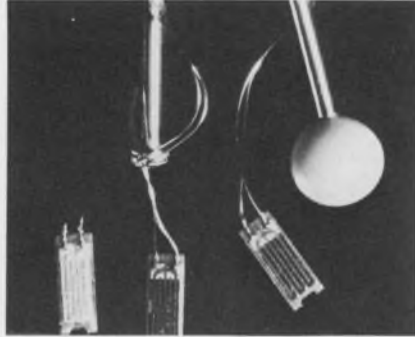

Siemens Corp., 186 Wood Ave. South, Iselin, N. J. Phone: (201) 494-1000.

Magnetically pre-biased to 3 to 4 kilogauss, a new encapsulated component with a magneto resistor determines the polarity and magnitude of an externally applied magnetic field by its change of resistance. The pre-bias magnetic field allows the magneto resistor to operate in a linear manner. The device measures 4 by 4 by 2 mm and has a temperature coefficient of $-0.7\%/^{\circ}\text{C}$.

Booth No. 2528 Circle No. 303

Bright red GaAsP LEDs emit 1500 foot-lamberts

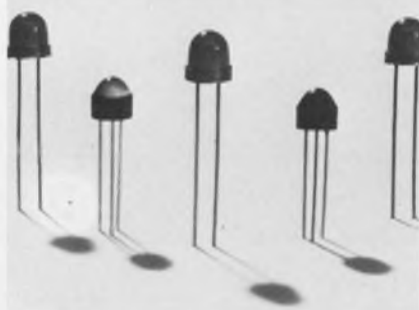

Dialight Corp., 60 Stewart Ave., Brooklyn, N. Y. Phone: (212) 497-7600. P&A: \$1.55; 6 to 8 wks.

Diode-lites are new GaAsP LEDs that emit red light of 1500 foot-lamberts at 20 mA. Its ratings include forward dc current of 50 mA at 1.8 V, power dissipation of 100 mW and an operating temperature range from -40 to $+100^{\circ}\text{C}$. An external resistor is to be used in series with the LED. Its value depends on the selected operating voltage.

Booth No. 2523 Circle No. 345

Brushless tachometer has 0.1% linearity

Vibrac Corp., Alpha Rd., Chelmsford, Mass. Phone: (617) 256-6581.

Designed for computer peripherals, a new brushless dc tachometer with a 7-V-dc/1000-rpm output has 0.1% linearity and rms ripple of 2% of the dc voltage. Uni-Flux's output impedance is 400 Ω and ripple frequency is 18 times the shaft speed. Drive torque is 0.2 oz-in. and speed is 15,000 rpm.

Booth No. 2207 Circle No. 306

Stable resistors have 100-ppm TC

Victoreen Instruments Div. of VLN Corp., 10101 Woodland Ave., Cleveland, Ohio. Phone: (216) 795-8200.

New Mini-Mox metal-oxide-glaze resistors with a stability of $\pm 2\%$ for 2000 hours at full-load current have a temperature coefficient of 100 ppm up to 500 M Ω . They range in value from 1 to 10,000 M Ω at power ratings from 1/4 to 1 W and tolerances of 1 to 10%.

Booth No. 2220 Circle No. 342

Interference suppressor simulates LC functions

Birch-Stolec, Ltd., Windmill Rd., Ponswood Industrial Estate, Hastings, Sussex, England.

A new device integrates the functions of inductance and capacitance in a single component to suppress electrical interference from thyristors and triacs by the absorption of energy. It is rated up to 250 V 50/60 Hz, and up to 15 A rms. Cut-offs are 5 to 50 kHz.

Booth No. 2526 Circle No. 300

Semiconductor diodes respond to magnetics

AEG-Telefunken Corp., 570 Sylvan Ave., Englewood Cliffs, N. J. Phone: (201) 567-8570.

AMY10 magnetic diodes are semiconductor devices which change their internal resistance as a function of an external magnetic field. By altering the magnetic field, electrical signals are obtained from non-electrical quantities.

Booth No. 2127 Circle No. 337



The one that shouldn't get away.

There's a great catch out there for the wise buyer of power supplies. If you've been angling for a way to get top performance at a very competitive price, then hook onto NJE.

The NJE attitude toward power supplies can be expressed in just four letters: Q.I.P.P. Quality. Interchangeability. Price. Performance. An outstanding example of Q.I.P.P. is the RS line of Modular/Rack System, Slot Power Supplies—90 different models and 9 sizes that match or exceed anything else on the market.

And they cost less!

For a new RS catalog—describing the line from small, low power configurations to large, high power configurations—call or write today.

NJE CORPORATION
Electronic Development & Manufacturing

Kenilworth, New Jersey 07033 / (201) 272-6000
TELEFAX: FFP • TWX: (710) 996-5967

A subsidiary of  Corporation

SEE US AT BOOTH #2232-34



behind
every
successful
key

there's a coil

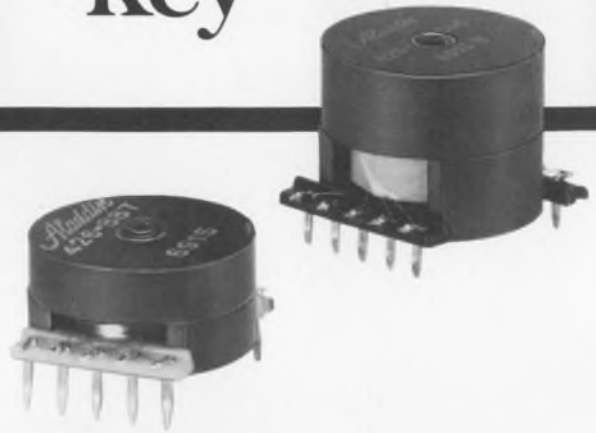

Data lovers, how do these frequencies grab you?

600Hz	1200Hz	2025Hz
697Hz	1209Hz	2050Hz
770Hz	1270Hz	2150Hz
852Hz	1336Hz	2200Hz
941Hz	1477Hz	2225Hz
1070Hz	1633Hz	2250Hz
1098Hz	1950Hz	2350Hz

Applications:

As fixed and adjustable inductors for low frequency filters. As transformers for tone frequencies used in push button telephone oscillator circuits and data sets; coupling and impedance matching applications.

Features:

High and low profile units, p/c mounting, fine tuning, tuning adjustment at least $\pm 3\%$ from nominal, TC matches polystyrene capacitors, high Q — custom designs, impregnated coils, for extreme environments.

data coils by **Aladdin**



Transformers, Inductors, Filters, Pulse Transformers? We've got those too!

Aladdin Electronics shows you more than 20,000 different magnetic components in the new Aladdin *Encyclopedia of Capabilities*—a real Supermarket in Print for designers. Unique double binder shows Applications and Configurations . . . makes it easy for you to select components by telling us the performance characteristics you want. If you'll write on your letterhead (telling us a few things about yourself and your company please), we'll send you a FREE COPY of the Encyclopedia.

ALADDIN ELECTRONICS
A Division of Aladdin Industries, Inc.
703 Murfreesboro Road
Nashville, Tennessee 37210

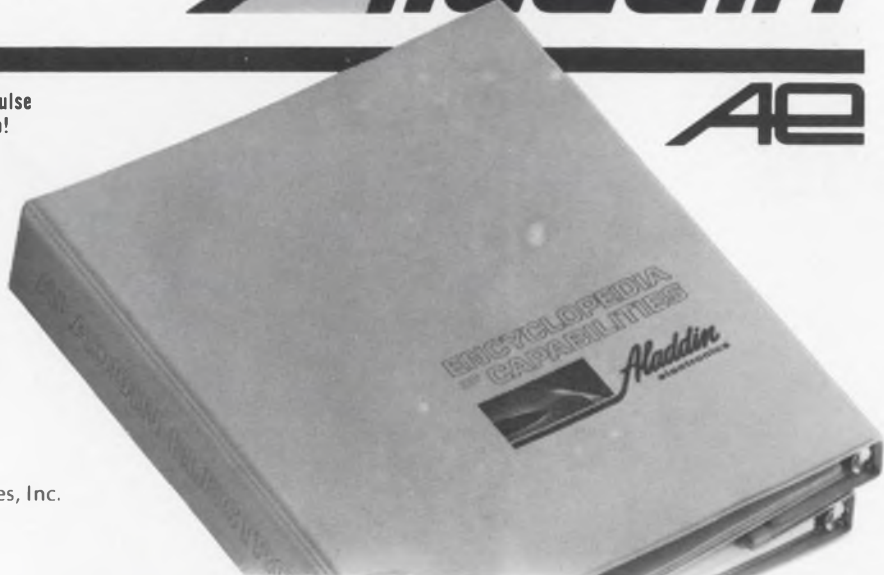

The minicomputer —slide rule of the 70s

For hundreds of years, the slide rule has been the “trademark” of the engineer. It is his constant companion during schooling and on the job, as familiar to him and as much a part of him as a thing of metal, wood and plastic can ever be.

But in the 70s the engineer has a new trademark—a new, much more powerful calculating tool to master as a student, a new companion in his work and a new component for his systems—the minicomputer.

Roughly speaking, the minicomputer includes a central processor, provision for internally storing a program that can be altered by the user, and at least 4-k bits of memory in which programs and data can be stored and altered under program control. It includes input/output capability for communication of commands, instructions and results, is relatively small in size—perhaps approaching portability—and costs \$25,000 or less.

And it is rapidly finding application in every area of engineering. The number of minicomputer installations in the United States is expected to grow from the 23,000 of 1970 to 145,000 in 1975.

The designer of the 70s will use the minicomputer as an everyday tool in computation, modeling and control. He will employ it as a design, analysis and synthesis aid, a laboratory development appliance, a process or communications controller.

He must know what a minicomputer is capable of as a design aid and as a system component, what its limitations are in each case and what fields of use it is best suited for. He must be prepared to choose intelligently from the over 130 minicomputer products now available and select peripheral devices from an even greater array. And he must understand the problems of programming and be thoroughly aware of the economic tradeoffs to be made.

The engineer who ignores these considerations and the importance of the mini, who fails to learn how to use the machine efficiently, does so at his own peril. Technical obsolescence comes fast in the electronics industry.

To introduce the designer to the world of minicomputers and to help him specify and use minicomputer products, ELECTRONIC DESIGN will present a special technical series, “The Minicomputer and the Engineer,” beginning in the April 15 Issue. Watch for it.

RAYMOND D. SPEER

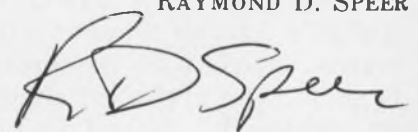

Don't be fooled by multiplier specs.

They don't always say what they mean. Study this model to learn what the errors really are.

First of three articles

The day of monolithic and modular analog multipliers is upon us. Dramatic reductions in price—especially for the new IC versions, combined with improvements in performance, make the device an attractive solution to many signal-processing problems.

Unfortunately, there are no established standards for multiplier specifications, nor is there much consistency among the various definitions used by the manufacturers of these products.

How, then, can an engineer intelligently compare multipliers in selecting one for a particular application? His best approach is probably to study the relationship between multiplier specifications and the actual errors to which the devices are subject. Then he will not only be able to interpret a manufacturer's spec sheet in a meaningful manner, he will also be able to ask the questions best calculated to give him an accurate assessment of a multiplier's accuracy.

The major factors that contribute to the inaccuracy of an analog multiplier are:

- Output offset.
- Feedthrough—both low and high-frequency.
- Nonlinearity.
- Scale-factor variations.
- Temperature drifting of all these factors.

In addition, the frequency response of the multiplier, which is different for small and full-power signals, must also be considered in calculating over-all accuracy. Finally, in those applications where the phase difference between the input and output signals is important, this parameter must also be known as a function of frequency.

To study the sources of the five major types of errors listed, it is helpful to represent a real multiplier as an ideal multiplier with error sources attached to its inputs and its output (Fig. 1). The equivalent circuit includes dc offset voltages V_1 , V_2 and V_3 , nonideal amplifiers

A_1 and A_2 and ideal amplifier A_3 .

A reasonably accurate model can be constructed if it is assumed that, apart from frequency-response considerations, the input amplifiers cause errors primarily because of their nonlinearity, finite input impedance and gain drift with temperature. It should also be assumed that the offset voltages have initial values at room temperature that will drift with changes in temperature, supply voltage and time.

Notice that the model of Fig. 1 has provisions for the application of three external voltages to cancel the effects of the dc offsets, at least at room temperature.

If voltages v_x and v_y are applied to the multiplier's X and Y inputs, respectively, the output voltage, v_o , is clearly seen to be given by

$$v_o = a_1 a_2 a_3 v_x v_y + a_1 a_3 V_2 v_x + a_2 a_3 V_1 v_y + a_3 V_1 V_2 + V_3 \quad (1)$$

The last two terms of this equation constitute the output-offset error because they produce a dc output even when $v_x=v_y=0$. This is the quantity that should be found on a manufacturer's data sheet under the heading "Output Offset." Typically, the offset can be adjusted to zero at room temperature by varying E_3 . But it will still vary with temperature and supply-voltage changes, so those drift-rate data should also be supplied.

In some multipliers the output offset is internally trimmed to eliminate the need for an external adjustment.

Consider the feedthrough phenomenon

With either input set to zero the output of an ideal multiplier is, of course, zero. However, for a real multiplier, we can see that when one of the inputs is zero there is an error term, in addition to the output offset, that varies as a direct function of the nonzero input. For the case $v_y=0$, this feedthrough error is equal to $a_1 a_3 V_2 v_x$. Although usually called feedthrough, this type of error is sometimes called null suppression.

To go further, we should recall that the input amplifiers are not ideal—they have nonlinearities. The output of A_1 is not really equal to $a_1 v_x$,

Ray Stata, President, Analog Devices, Inc., Rte. 1 Industrial Park, P. O. Box 280, Norwood, Mass. 02062.

The multipliers are coming

Multipliers can do a lot more than merely multiply two signals. They make good modulators, demodulators, automatic level controllers, phase detectors, trigonometric manipulators, and a host of other useful circuits limited mainly by the imaginations of their users.

They haven't been used very much in the past because of their high cost. But now that several manufacturers are producing low-cost IC units, we may expect to see them boom in much the same way that op amps boomed after the 709

was introduced.

In this first article of a three-part series, we begin with a treatment of multiplier specifications. The second article will describe a variety of practical applications. And the third will concentrate on what may be the most significant single application of analog multipliers: the synthesis of arbitrary transfer functions.

This last application opens up the possibility of linearizing any device whose transfer function is continuous and free of hysteresis.

for example, but is actually a power series, $a_{11}v_x + a_{12}v_x^2 + a_{13}v_x^3 + \dots$. Thus, the feedthrough error is more accurately described by $a_3V_2(a_{11}v_x + a_{12}v_x^2 + \dots)$.

This nonlinearity means that, for sinusoidal input signals, the feedthrough error will include harmonic distortion components as well as the fundamental frequency. Because of the harmonics, specifying the feedthrough error can be a problem. Feedthrough is measured by zeroing one input, applying a low-frequency sinusoid to the other input and observing the peak-to-peak ac signal at the output. Since the fundamental component varies directly with the input signal and the distortion components do not, it is difficult to completely describe the error. The approach used by most manufacturers is simply to specify the total error for a full-scale input.

Many multipliers have provisions for nulling the feedthrough error by an external pot adjustment. This is functionally illustrated in the equivalent circuit of Fig. 1 where a fraction of the input signal, E_1 , is subtracted from the output of amplifier A_1 , to cancel the fundamental component of the feedthrough signal. Notice,

however, that the distortion components are not canceled by this adjustment, and these remain as an irreducible null signal.

Remember that Fig. 1 is only a mathematical model used to describe multiplier performance, and as such it may not physically correspond to the circuitry by which the feedthrough adjustment is actually made. In most cases a dc potential is applied to the feedthrough adjustment terminal where it acts as an electronic gain control.

At high frequencies the effect of capacitance coupling between the input and output dominates the feedthrough performance. Above some corner frequency the feedthrough error increases with frequency at 6 dB per octave. Since capacitive coupling is linear, the high-frequency feedthrough error is dominated by the fundamental.

Nonlinearities can't be nulled out

For the general case where signals are applied to both inputs, the nonlinearities of the two input amplifiers interact to produce a series of intermodulation products. Ideally, if feedthrough

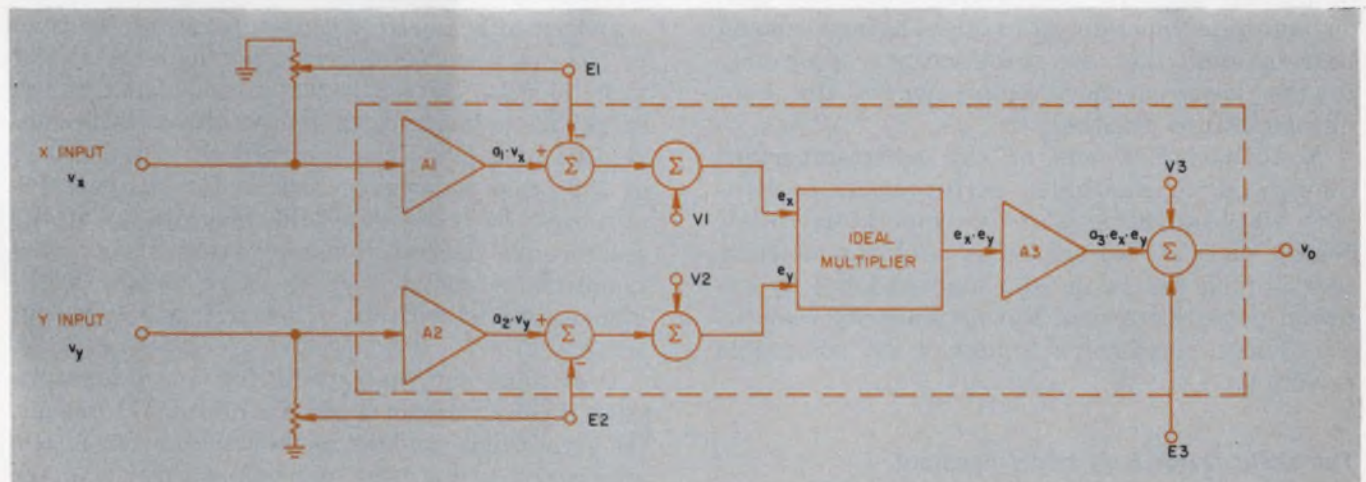

1. Nonlinearities are assigned to the input amplifiers in this multiplier model, while the frequency response is assumed to be limited by the output amplifier. The

effects of offset voltages V_1 , V_2 and V_3 , can be nulled at room temperature, but they will still be subject to drifting with temperature, supply-voltage changes and time.

and offset errors are ignored, the output voltage should be given by $v_o = a_1 a_2 a_3 v_x v_y$. Actually, the output is given by

$$v_o = a_3 (a_{11} v_x + a_{12} v_x^2 + \dots) (a_{21} v_y + a_{22} v_y^2 + \dots),$$

which becomes

$$v_o = a_{11} a_{21} a_3 v_x v_y + a_3 a_{11} v_x (a_{22} v_y^2 + a_{23} v_y^3 + \dots) + a_3 a_{21} v_y (a_{12} v_x^2 + a_{13} v_x^3 + \dots) + \text{higher-order terms.}$$

The first term of this equation is the ideal response, the second is the Y-nonlinearity and the third is the X-nonlinearity. (We assume that the higher-order terms are small enough to be neglected.) The nonlinearities are measured and specified independently on each of the inputs by alternately applying a full-scale dc signal to one input and a low-frequency full-scale ac signal to the other. A distortion analyzer could be used to measure either total harmonic distortion or the amplitude of the distortion components.

Note that the contribution of the feedthrough term in measuring nonlinearity is negligible because the offset factor that multiplies the feedthrough terms is small compared with the factor that multiplies the nonlinearity terms—that is, $a_3 a_{11} v_x \gg a_3 V_2$ when v_x is a full-scale voltage.

A more common way to measure nonlinearity is shown in Fig. 2. Here the ac output is nulled against the ac input, and the scale factor is adjusted to minimize the error voltage. The residual peak-to-peak error voltage is then a measure of nonlinearity referred to a best straight line. The rms value of this error signal is, of course, a measure of the total harmonic distortion.

In the model of Fig. 1, we have assumed that the output amplifier is ideal. However, above some frequency this amplifier will begin to contribute distortion. In transconductance-type multipliers the output amplifier is an op amp with local feedback. At higher frequencies, distortion increases because of reduced loop gain in the output op amp. In interpreting published data on multiplier nonlinearities, the engineer should bear in mind that the specifications apply only to the low-frequency region where the nonlinearities are constant.

Nonlinearity is one of the most important limitations on multiplier performance, particularly when operating at room temperature. Other errors such as output offset and fundamental feedthrough can be substantially reduced by external pot adjustments. But nonlinearity remains as a basic, irreducible limitation on achievable accuracy.

The scale factor isn't really constant

The scale factor or gain of the multiplier, $a_1 a_2 a_3$, is internally adjusted in most multipliers to calibrate the ac ratio of the output to input

signals to some convenient value, usually $v_x v_y / 10$. This calibration is made at a low frequency, roughly 50 Hz, with full-scale peak-to-peak ac on one input and full-scale dc on the other input. Because of the nonlinearities, the scale factor will vary slightly from quadrant to quadrant when measured in this way. It is, therefore, expressed as the average scale factor for the four quadrants. Also note that, since feedthrough contributes an ac error at the output, the setting of the external feedthrough null pots will affect the calibration of the multiplier. Most multipliers provide for the addition of an external pot, usually as an attenuator at the input, to calibrate or further trim the scale factor.

Self-heating effects are present to at least some degree in essentially all amplifiers. This phenomenon shows up as a shift in the amplitude response, usually around 10 to 100 Hz. The shift can be as much as 0.5% in some modular multipliers—particularly high-frequency units where a lot of dissipation is required for speed. So watch out when using a multiplier at high frequencies if it has been calibrated at dc or some low frequency.

Another anomaly introduced by self-heating is a long tail on the transient response settling time. This leads to the surprising fact that a 5-MHz multiplier may take 100 ms to settle to within 0.5% of its final value.

Temperature drifting is a big problem

With multipliers, as with op amps, temperature stability is often a serious problem. All of the errors discussed so far are subject to change with temperature. Thus, while external pots can be used to minimize offset, feedthrough and scale-factor errors at room temperature, the big question is: "How fast do errors accumulate as temperature changes?"

Output-offset drift with temperature tends to be the main source of error, particularly at low signal levels. But scale-factor and feedthrough errors also change with temperature. It is convenient to express these errors as a percentage of full scale per degree Celsius for comparative purposes; however, since the magnitudes of the feedthrough and scale-factor errors are proportional to the signal level, they are usually negligible compared with the offset drift at low output levels.

It is apparent that specifying over-all multiplier accuracy is not a simple matter. Moreover, the errors that are significant will vary from one application to the next, depending upon whether the signals are ac or dc or a combination of both. Each error source is independently specified, but some of the errors actually cancel each other

This statement is the worst-case limit of error, without external trim, at rated power-supply voltages, at room temperature—including: scale-factor error; output offset; nonlinearity; and feedthroughs. Do not duplicate! Also note that this figure is *less* than the raw sum of its four components. Finally, note that it (like all the percentages on this page) is a percent of *full scale*.

With both inputs at zero—usually trimmable, and often negligible, compared with output signals of interest.

Feedthrough is measured with full signal on the open channel: if this is more signal than you will ever apply, reduce this effect accordingly, in your error calculations.

Vector (quadrature) errors are a measure of the output phase shift. Since amplitudes combine vectorially, the contribution to magnitude error is negligible.

Noise is measured with both inputs at zero signal and zero impedance—that is, shorted. If you filter, you may reduce the noise level significantly.

This specification, like several of the others on this page, is sometimes omitted by multiplier manufacturers... for the usual sordid commercial reasons, we suspect. Check...Check...Check!

MULTIPLICATION CHARACTERISTICS

Output Function	X Y/10
Error, with Internal Trim	±1% max
Error, with External Trim	±0.7%
Avg vs. Temp (All Errors)	±0.05%/°C
Avg vs. Supply (All Errors)	±0.05%/%

SCALE FACTOR

Initial Error	0.5%
Avg vs. Temp	0.03%/°C
Avg vs. Supply	0.03%/%

May not be significant, if you plan to use an over-all system scale-factor trim.

OUTPUT OFFSET

Initial at 25°C	±25 mV
Avg vs. Temp	±2 mV/°C
Avg vs. Supply	±1 mV/%

NONLINEARITY

X Input (X=20 V p-p, 50 Hz, Y=±10 V)	0.6% max
Y Input (Y=20 V p-p, 50 Hz, X=±10 V)	0.3% max

This is peak deviation from best straight line, expressed as a percent of full-scale output. If you are filtering out, or are insensitive to, harmonics, you may be justified in ignoring part of this.

FEEDTHROUGH

X=0, Y=20 V p-p, 50 Hz With External Trim	±25 mV max ±8 mV
Y=0, X=20 V p-p, 50 Hz With External Trim	±50 mV max ±35 mV

BANDWIDTH

-3dB	5 MHz min
Full Power Response	2 MHz min
Slew Rate	120 V/μsec min
1% Amplitude Error	300 kHz min
1% Vector Error (0.57°)	50 kHz min
Differential Phase Shift ($\theta_x - \theta_y$)	1° @ 1 MHz

Amplitude error is for worst-case input combination yielding full output, both X and Y being sine waves at the specified frequency.

Small Signal Rise time 10-90%	50 nsec
Small Signal Overshoot	5%
Overload Recovery	0.15 μsec

Transient properties may not be significant—but, if they are, they can swamp all other considerations.

OUTPUT NOISE

5 Hz to 10 kHz	0.5 mV rms
5 Hz to 10 MHz	2.5 mV rms

OUTPUT CHARACTERISTICS

Voltage, 1 k Ω Load	±11 V min
Current	±11 mA min
Load Capacitance	0.01 μF max

INPUT RESISTANCE

X Input	10 k Ω ±5%
Y Input	11 k Ω ±2%

INPUT BIAS CURRENT

Each Input	+ 100 nA
------------	----------

Check the effect of bias current on your zero-signal condition. If it is appreciable (due to high source resistance) it can be trimmed out... unless the source resistance varies!

MAXIMUM INPUT VOLTAGE

For Rated Accuracy	±10.5 V
Maximum Safe	±16 V

WARM UP

To Rated Specifications	1 s
-------------------------	-----

POWER SUPPLY

Rated Performance	±(14.8 to 15.3) Vdc
Operating	±(14 to 16) Vdc
Quiescent Current	±12 mA

TEMPERATURE RANGE

Rated Performance	-25°C to +85°C
Operating	-25°C to +85°C
Storage	-55°C to +125°C

Be careful when you read a spec sheet. As the annotations indicate, the data doesn't always say what it seems to say. Specs may be misleading if all of the pertinent conditions under which they were determined are not clearly called out.

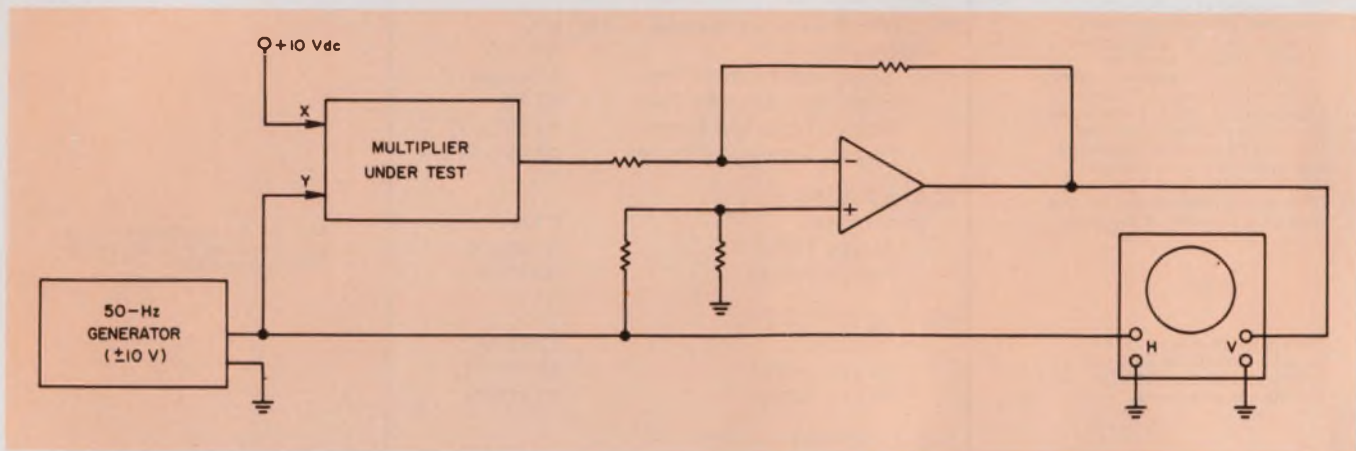

2. The Y-input nonlinearities are displayed as a function of v_y when this test setup is used. The differential ampli-

fier subtracts the fundamental from the multiplier output and applies only the distortion to the scope.

when they are combined. Therefore, an rms sum of the pertinent errors will often give a better indication of over-all accuracy than would a simple summation of the individual errors.

For applications in which two dc signals are multiplied, the best way to specify accuracy is to combine all of the errors and to specify a total combined dc error, which is defined as the Dc Multiplication Accuracy. To measure the combined dc error, first adjust the output-offset, feedthrough and scale-factor pots for minimum error. Then construct a matrix by recording the output voltage for various combinations of input voltages throughout the input voltage range. The total error is determined by comparing the actual readings with the ideal output.

While Dc Multiplication Accuracy is the most convenient and least ambiguous specification of errors, it is also a time-consuming and therefore expensive test to perform. It can become prohibitively expensive if the accuracy is to be measured as a function of temperature.

Measuring the frequency response

Frequency (dynamic) response is measured and specified by applying full-scale dc to one input and ac to the other, and then observing the ac component of the output. There are three types of dynamic response errors that must be considered, depending on the application: small-signal response, large-signal response and vector, or phase, response.

One measure of multiplier dynamic performance is the frequency at which the output amplitude decreases by 3 dB from its low-frequency value. This measurement must be made with a relatively small output amplitude that does not exceed the slewing rate of the multiplier.

Another measure of performance is large-

signal or full-power response. This is the maximum frequency at which the rated output voltage swing can be obtained without introducing more than 3% of distortion caused by slew-rate limiting. By this definition, full power response, f_p , is related to slewing rate, S , by $(dE_o/dt)_{max} = S = 2\pi f_p E_o$ where E_o is the rated peak output voltage.

For some applications, the instantaneous (sometimes called absolute) error between output and input signals may be of primary concern. In this case, vector errors due to phase shift accumulate much more rapidly as a function of frequency than do amplitude or scalar errors. This follows since a phase shift of only 0.57° will cause a vector error of 1% whereas the amplitude error is only 0.005% at this phase shift. ■■

Test your retention

Here are questions based on the main points of this article. Their purpose is to help you make sure you have not overlooked any important ideas. You'll find the answers in the article.

1. Nonlinearities in the input amplifiers contribute to two types of errors. What are they?

2. Why is it possible for a 5-MHz multiplier to take 100 ms to settle to within 0.5% of its final value?

3. How does the composition of the feed-through error signal change with increasing frequency?

A very uncomplicated new OEM recorder with just one thing going for it...

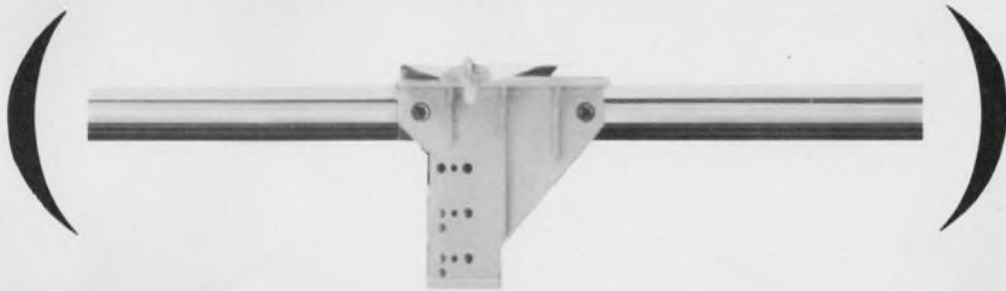

You'll like what you see in our new approach to dedicated OEM strip chart recorders. First, we eliminated all those complicated moving parts from the writing mechanisms. No more pulleys, cables and slip clutches. Instead, there's just one simple moving part—the slider/pen assembly. That's because a linear servo motor keeps the pen going magnetically ... and very reliably.

When you see the HP Model 7123, you'll notice how the low power servo system makes the recorder smooth, precise and trouble-free. You could drive it off scale around the clock without noise or danger.

Even with all that, you've got a lot more going for you with the 7123. Like a swing-out chart paper drive for quick reloading and reinking. The viewing/writing area is slanted so you can make notes right at the disposable pen tip. And you can work without worrying about a lot of circuit adjustments. They're simply not needed anymore.

Since it's an OEM machine from the ground up, the 7123 has options

for everybody. Select any chart speed and voltage span in English or Metric scaling. In all, nearly 50 options will customize the recorder exactly to a specific application.

You'll probably be most intrigued by an option we call electric writing. Normally, the ink system works like a cartridge fountain pen. But electric writing is designed for people who don't even want to mess around with that. A highly stable electrosensitive paper that gives you a crisp, clear trace without ink.

Available in full rack or half rack versions, the 3½ inch high 7123 makes totally unattended operation a reality. Simplicity, reliability, precision and even electric writing. With all that going for you, you can turn it on Friday and forget about your work all weekend.

To see the uncomplicated new 7123 and its matching price and OEM discount schedule, call your nearest HP sales office. Or write, Hewlett-Packard, Palo Alto, CA 94304; Europe: 1217 Meyrin-Geneva, Switzerland.

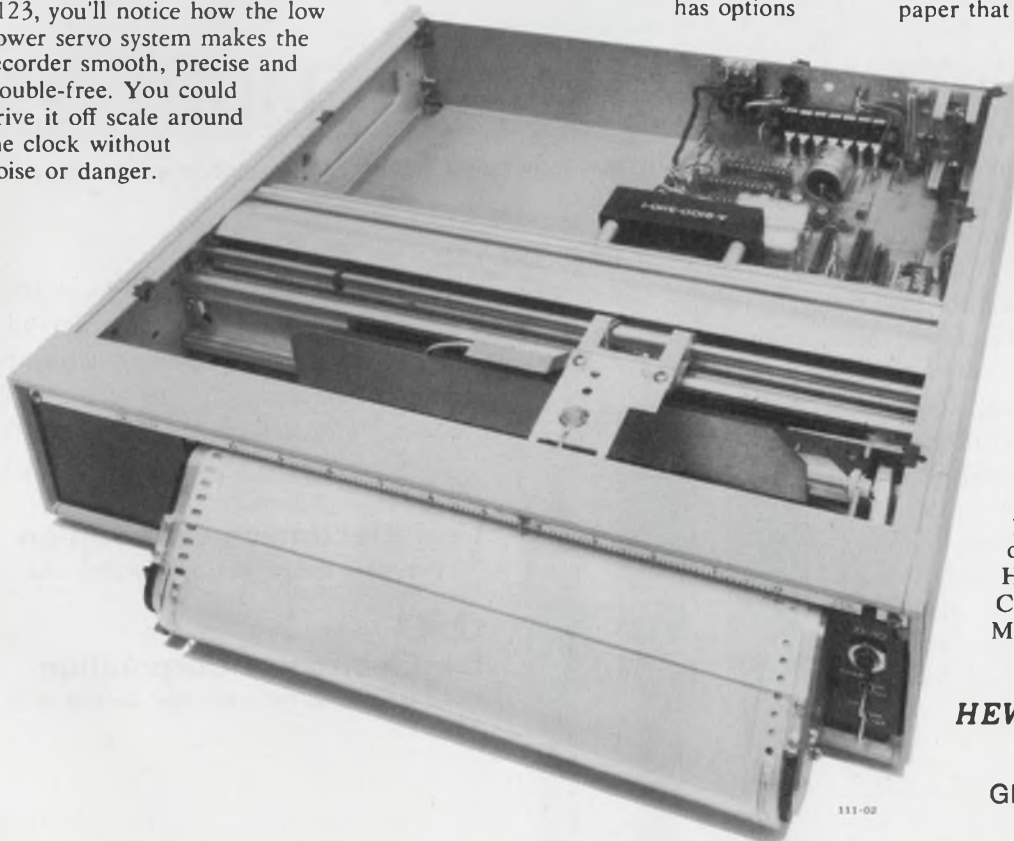

HEWLETT  PACKARD

GRAPHIC RECORDERS

111-02

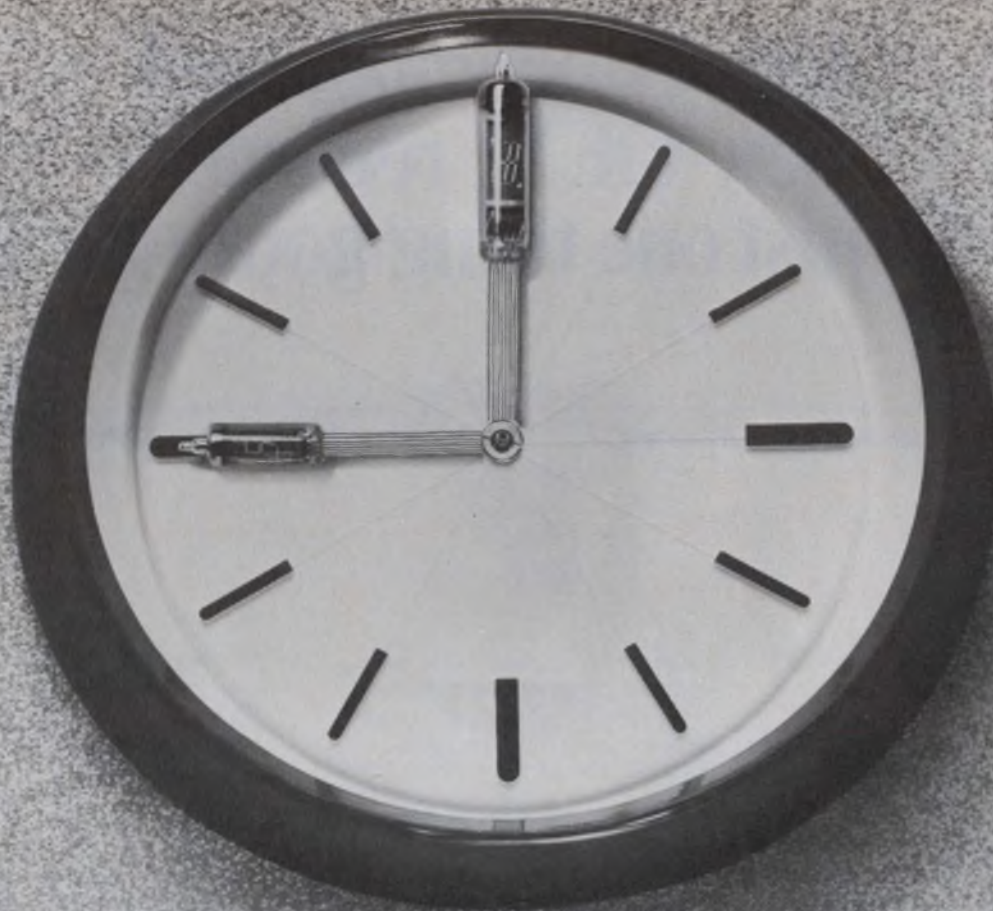

IT'S TIME... TO SEE THINGS IN A NEW LIGHT

When multi-faceted display problems dictate 9 to 9 work days, it's high time you saw things in a new light, on a single plane with no "dancing" digits and with no eye strain.

Legi DG 12C numerical indicator tube segments are an eye-easy phosphor green for a readout as bright and clear as day, legible at distances over 35 feet.

These tubes offer low-voltage, low current drain, and high stability advantages so definitive and pack a performance punch so large, you can't afford not to afford to examine full particulars. They fit to the "T" perfectly portable and circuit-board mounting applications and are available at mass production prices. Look at these important particulars, then write for comprehensive data

that show display tube performance in an entirely new light:

LEGI DG 12C

Filament voltage at 95 mA 0.85 volts \pm 10%

Phosphor segments & control grid 20 Vdc

Brightness 80 foot -lamberts

Operating temperature -10° to $+70^{\circ}$ C

* Dynamic life expectancy 200,000 hrs.

U.S. PATENT 3508101

Legi Sole U.S. Distributor:

Legi Electronics Corporation

3118 West Jefferson Blvd. Los Angeles, California 90018 U.S.A.
Phone: RE 3-4508, 733-9105



Manufacturer:

Ise Electronics Corporation

P.O. Box 46, Ise City Mie Pref., Japan Phone: Mie (059627)-26

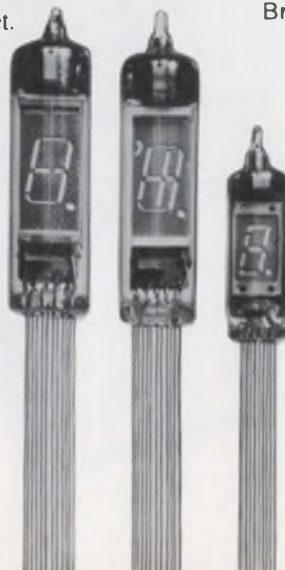

DG 12H

DG 10A

INFORMATION RETRIEVAL NUMBER 48

NEW EL-MENCO Transmitting Dipped Micas take only 1/6 the space, yet cost less than conventional types.

NEW in the industry—El-Menco TDM43 Transmitting Dipped Mica Capacitors are unequalled in small size and low cost for their ratings. Compared to conventional types with similar characteristics, they require only one-sixth as much space... save you 83% of the volume previously required. The superior coating transmits heat more efficiently, so you can use a smaller size for a given rating.

Specify these high-quality TDM43 Capacitors wherever better performance and long, reliable life are critically important... and where space and weight are at a premium. For medium power, moderate-to-high voltage service, TDM43's can be used in tuned amplifier tank circuits, for DC blocking in high frequency amplifiers, in high frequency filter networks needing high Q and RF current capabilities, and in timing circuits requiring a high degree of stability.

Check the table below for representative values among the many standard TDM43 units available... or call or write Electro Motive if you have a special application or one in which pulse conditions are present. Technical literature available on request.

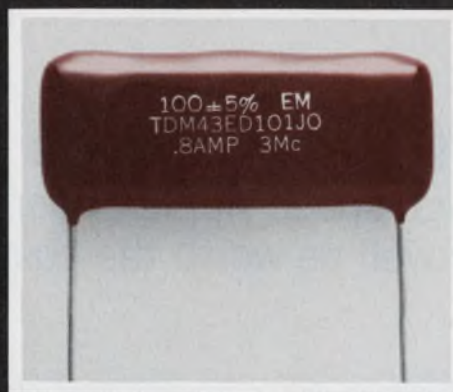

Typical TDM43 Capacitor, actual size

Ideal for high frequency circuits, in military, communication, and industrial portable and airborne equipment... equivalent to RTM 63 in EIA spec. TR-109.

Typical Values Available—TDM43 Transmitting Dipped Mica Capacitors

Capacitance Value in pF	60 Hz Peak W.V.	Characteristic	Rated Current in amps. at Freq. of				Max. Dimens. in Inches		
			3.0 MHz	1.0 MHz	0.3 MHz	0.1 MHz	L	W	T
47	1500	C	0.50	0.10	0.07	0.03	2.010	.850	.220
1200		F	4.90	3.80	1.20	0.42	2.010	.850	.230
2700		F	5.90	5.80	2.20	0.90	2.010	.850	.230
3300	1000	F	6.10	6.20	2.60	1.10	2.010	.850	.230
5600		F	6.50	7.30	4.10	1.80	2.010	.850	.240
9100		F	6.80	8.10	5.50	2.40	2.020	.860	.260
10,000	750	F	6.90	8.40	6.40	2.70	2.020	.860	.260
15,000		F	7.00	8.90	7.80	3.30	2.030	.870	.280
20,000		F	7.10	9.20	8.30	3.50	2.040	.880	.310
22,000	500	F	7.20	9.40	8.80	3.70	2.030	.870	.300
30,000		F	7.20	9.60	9.30	3.90	2.040	.880	.320
36,000		F	7.30	9.80	9.70	4.10	2.040	.890	.340
39,000	250	F	7.30	9.90	10.0	4.20	2.050	.890	.350
68,000		F	7.40	10.3	10.9	4.50	2.050	.900	.370
100,000		F	7.40	10.5	11.5	4.70	2.070	.910	.440



The Electro Motive Mfg. Co., Inc.

WILLIMANTIC, CONNECTICUT 06226

Dipped Mica • Molded Mica • Silvered Mica Films • Mica Trimmers & Padders
Mylar-Paper Dipped • Paper Dipped • Mylar Dipped • Tubular Paper

West Coast Manufacturers contact:

COLLINS & HYDE CO., 900 N. San Antonio Rd., Los Altos, California 94022
5380 Whittier Blvd., Los Angeles, California 90022

ALSO SOLD NATIONALLY THROUGH ARCO ELECTRONIC DISTRIBUTORS

INFORMATION RETRIEVAL NUMBER 49

Cut delay times with look-ahead carry

in high-speed ripple adders. The time saved may well be worth the cost of a few more gates.

Propagation delays consume most of the time used to perform binary addition in ripple-carry parallel adders. The add time can be significantly reduced by using a method known as look-ahead carry addition.

The basic principle of look-ahead addition is to examine a number of inputs and simultaneously produce the proper carry term. The application of the carries to the adder block then produces the proper sum bits.

Break the input into groups

In simple block form, the look-ahead adder is shown in Fig. 1. Note that a group of input bits, A and B, is applied to a carry logic block, together with the initial carry input. If 100% look-ahead carry were accomplished, then the carry logic block would produce all the carries, which would then be used by the sum logic blocks to produce the sum outputs. The look-ahead carry block is comprised of several multi-input logic gates. Although it is possible to calculate all the carries and sums of a look-ahead carry adder in just two steps, a large number of inputs within the look-ahead gating structure is required. For large adders of more than 16 bits, this direct method can be prohibitive unless MSI functions are used. Only a small increase in delay time is incurred by going to a multilevel look-ahead carry structure as shown.

At the lower or zero level a carry logic block produces the carry outputs for a number of adder stages, say four, which we will call a group. The carry output of this zero-level group is then applied to another carry logic block at the next or first level that computes the carries for the fifth through the eighth adder stages. The first level look-ahead carry block requires the carry-out of the fourth stage as one input and so must wait for the zero-level carry block output.

However, by this method all of the carries are produced for the total adder structure in a num-

ber of time periods proportional to the number of levels. These carries are then used by the sum blocks to produce the final addition sums. The sets of logical operations are performed during different time periods so that in the last time period all sums and carries are available. This requires the preparation, in sequence, of intermediate logic quantities used to produce the final logical variables.

For a discussion of look-ahead carry addition, it is useful to define two terms:

$$G_k = A_k \cdot B_k \quad (1)$$

$$\text{and } P_k = A_k \cdot \overline{B_k} + \overline{A_k} \cdot B_k = A_k \oplus B_k \quad (2)$$

The symbol for a carry output bit generated at the k-bit position is G_k . The carry is produced only when there is an input on both the A_k and B_k lines. P_k is the symbol for a carry output bit at the k-bit position that is produced only if there is an input on the A_k or the B_k lines and a carry is present from the previous stage. At the k-bit position a carry bit will be generated according to the equation:

$$C_k = G_k + P_k \cdot C_{k-1} \quad (3)$$

where C_{k-1} is a carry from the previous stage, group or section.

We may now write the equation for the carry output of this stage, group, or section in terms of the carry input to the look-ahead carry adder as:

$$C_k = G_k + P_k G_{k-1} + P_k P_{k-1} G_{k-2} + \dots + P_k P_{k-1} P_{k-2} \dots P_1 G_0 \quad (4)$$

where $G_0 = C_{in}$ (initial carry input).

By examining the terms of the above carry equation, we see that except for the first, second, and last, each term consists of a generate factor (G) and the product of propagate factors (P). Basically, the equation defines the following operation: A carry is formed at the output of a particular stage if the stage in question generates a carry; or if the previous stage generates a carry and the original stage propagates that carry; or if the second from the previous stage generates a carry and both the previous and original stages propagate that carry, etc. The final term in the equation shows that a carry will be produced by the over-all adder if an initial carry input is present and all stages propagate it.

Jon M. DeLaune, Applications Engineering, Motorola Semiconductor Products Inc., 5005 E. McDowell Rd., Phoenix, Ariz. 85036.

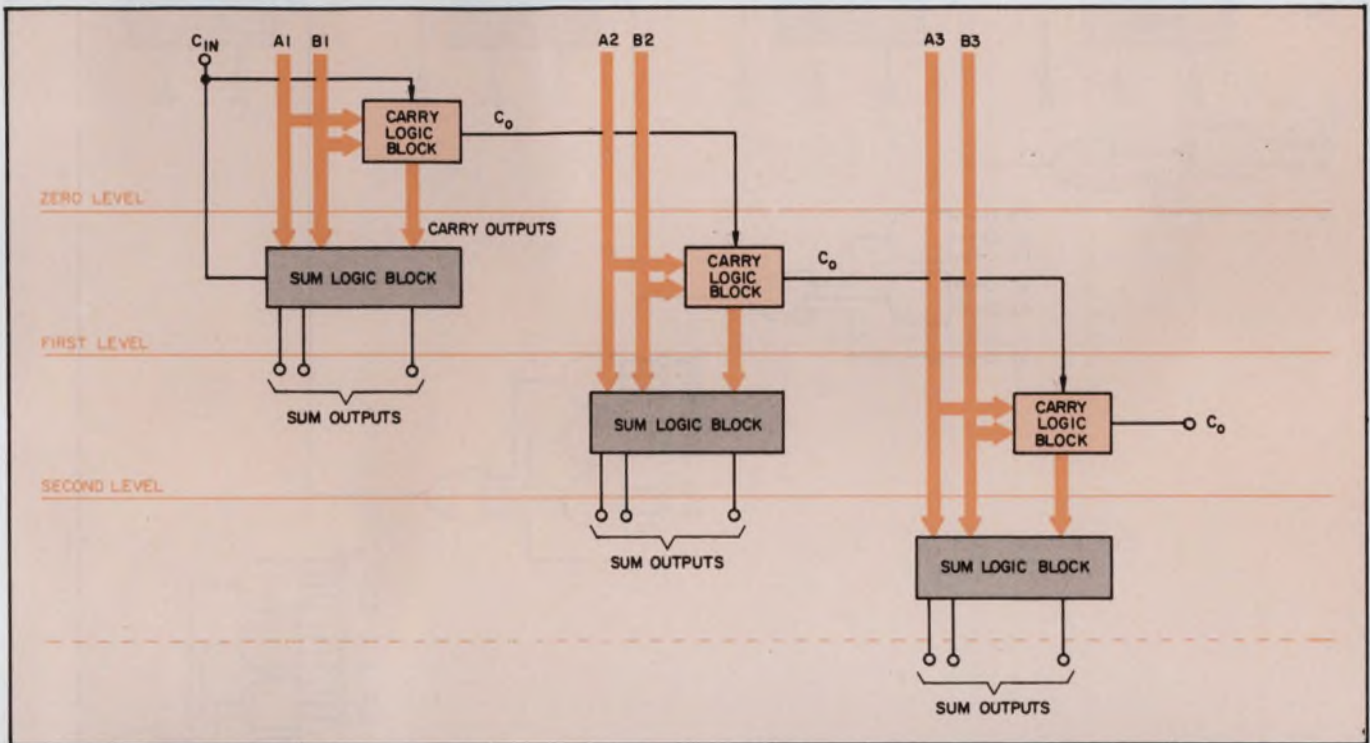

1. The basic principle of look-ahead carry is to examine a number of inputs to each counter stage and then simultaneously produce the proper carry term. A_1 and B_1

may be single bits or a group of bits. The complexity of the sum and carry blocks is determined by the number of bits examined at a given time.

The logic required to form a 4-bit look-ahead adder, using the general form of carry equation, is illustrated in Fig. 2. Fast-carry adders that will produce the generate and propagate factors, in addition to the sum and carry outputs, are available. It can be seen that the number of adder stages for which a zero-level look-ahead logic can be used will depend either upon the maximum fan-in or the inputs available to the gates of the logic family used in the implementation.

There are many ways in which a look-ahead carry logic system can be arranged. The method used by the designer depends upon three factors: (1) the size of the adder system, (2) the speed requirements of the system, and (3) the maximum number of integrated circuits allowed.

A look-ahead carry adder capable of adding any desired number of bits can be implemented

by various design methods. As an example we'll show a modification of the look-ahead carry logic given in the previous section. Ripple carry is used between adder bits within each group and look-ahead carry between each group. Because TTL and ECL adders possess high ripple-carry speed, a reduction in parts count can be achieved with this method at a small sacrifice in speed. Using ripple carry within groups would present a problem if the normal group look-ahead carry logic were used.

This can best be explained by the following example, using groups of four adders per look-ahead section. The equation for the third group input carry can be written as:

$$C_2 = C_{in} \cdot P_A \cdot P_B + G_A \cdot P_B + G_B \quad (5)$$

where C_{in} is the initial carry input; P_A , P_B are the propagate terms; and G_A , G_B are the generate terms. Now, consider adding the following two

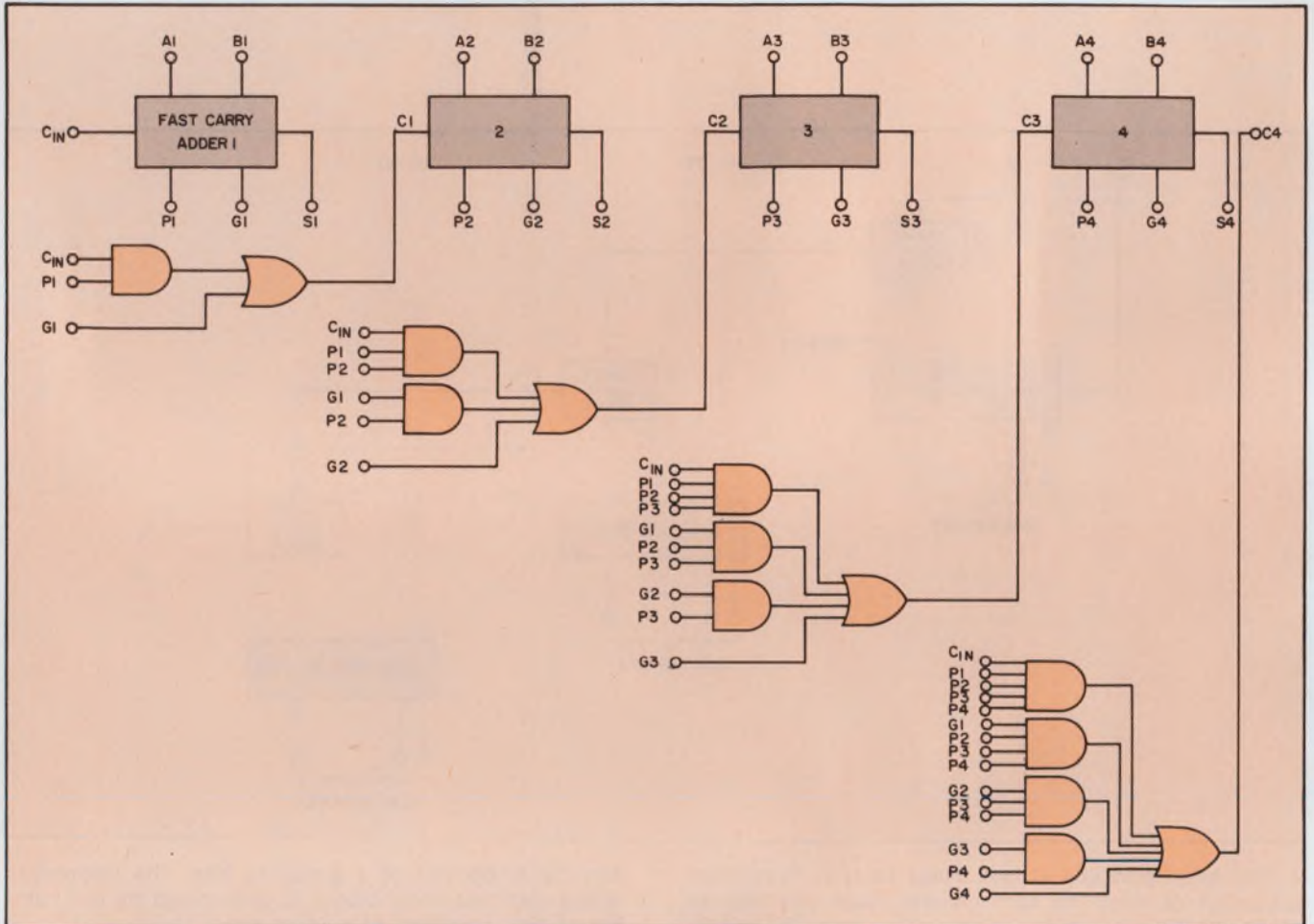

2. The number of gates required to form this four-bit look-ahead adder depends on the fan-in capability of the logic family used. Trade-offs between speed and size

can be made in large adders to keep the number of gates from becoming prohibitive. MSI functions can be used to lower the parts count.

8-bit words.

$$\begin{aligned} A_1 &= 11111111 \\ B_1 &= 00000001 \\ C_2 &= \overline{10000000} \end{aligned}$$

If the logical 1 level in the least significant bit position of the augend (B_1) were dropped to a logical 0 level, $C_2 = 0$ would be yielded only after four ripple delays plus two gate delays. The look-ahead carry logic equations, however, can be rewritten to eliminate this ripple delay problem. For example, the carry equation for the third group of four adders can be rewritten as:

$$C_2 = C_{in} \cdot P_A \cdot P_B + G_A \cdot \overline{P_A} \cdot P_B + G_B \cdot \overline{P_B} \quad (6)$$

Now, as soon as the B_1 bit drops to a 0 level, the propagate term P_A in the above equation

changes to a logical 1 level in two gate delays, and the term $G_A \cdot P_A \cdot P_B$ goes to a logical 0 level after three gate delays.

A significant reduction in delay time results from using this method. The scheme is unique in that a carry-in (C_{in}) is cleared out of the adder system in a minimum amount of time. The 16-bit TTL look-ahead carry adder illustrated in Fig. 3 uses two 2-bit adders per ripple block. The following equations describe the operation of this look-ahead carry circuit.

$$C_1 = C_{in} P_A + G_A \overline{P_A}, \quad (7)$$

$$C_2 = C_{in} P_A P_B + G_A \overline{P_A} P_B + G_B \overline{P_B}, \quad (8)$$

$$\text{and } C_3 = C_{in} P_A P_B P_C + G_A \overline{P_A} P_B P_C + G_B \overline{P_B} P_C + G_C \overline{P_C}, \quad (9)$$

where

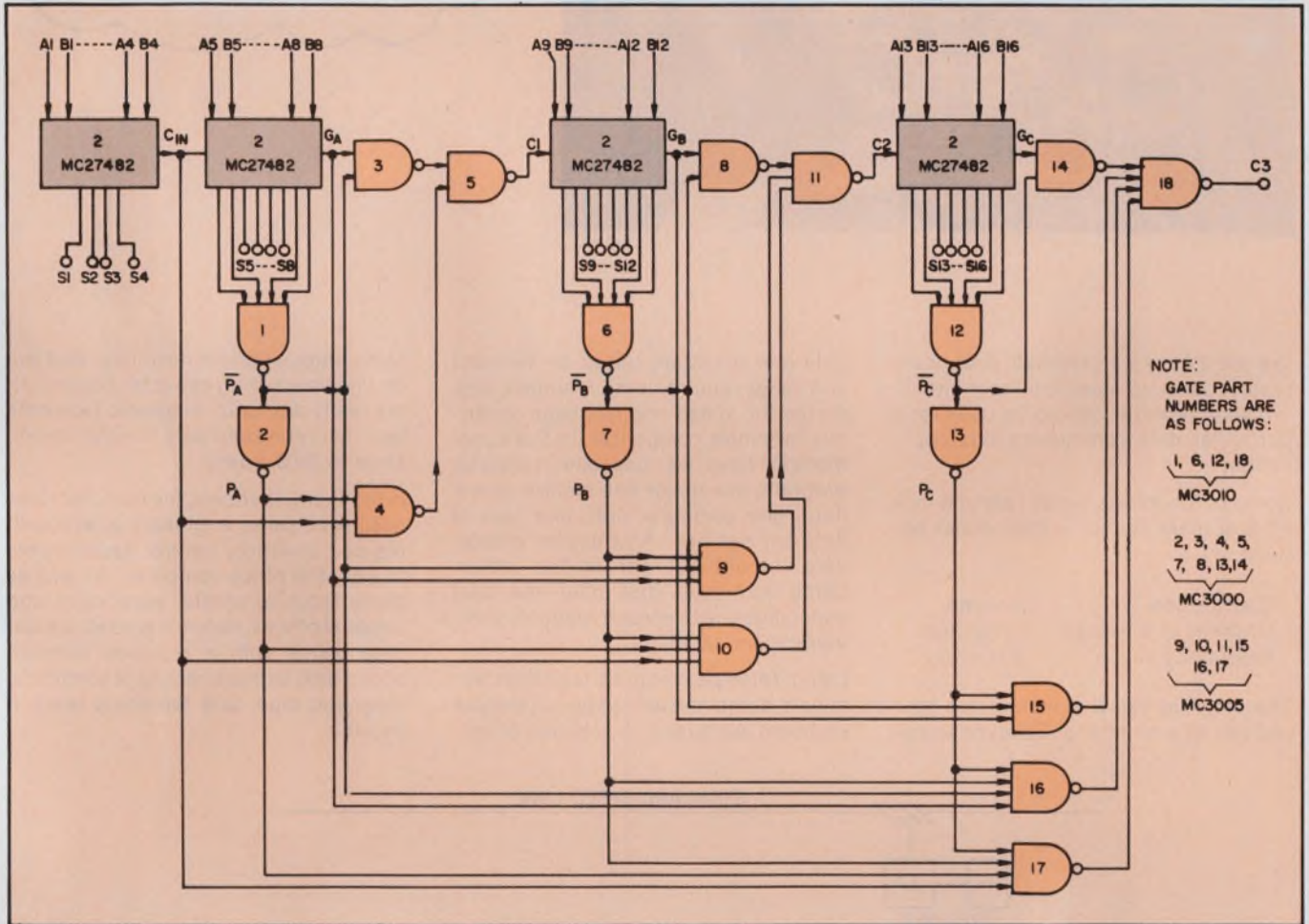

3. This 16-bit TTL look-ahead carry adder uses a modification of the basic look-ahead-carry logic to reduce the parts count. Ripple carry is used between adder bits

within each of the four groups and look-ahead carry is used between each group. A typical add time obtained with this method is 78 ns assuming 6 ns gate delays.

$$P_A = (A_5 \oplus B_5) \cdot (A_6 \oplus B_6) \cdot (A_7 \oplus B_7) \cdot (A_8 \oplus B_8), \quad (10)$$

$$\begin{aligned} \text{and } G_A = & (C_{in}) \cdot (A_5 \oplus B_5) \cdot (A_6 \oplus B_6) \\ & \cdot (A_7 \oplus B_7) \cdot (A_8 \oplus B_8) \\ & + (A_5 \cdot B_5) \cdot (A_6 \oplus B_6) \\ & \cdot (A_7 \oplus B_7) \cdot (A_8 \oplus B_8) + (A_6 \cdot B_6) \\ & \cdot (A_7 \oplus B_7) \cdot (A_8 \oplus B_8) + (A_7 \cdot B_7) \\ & \cdot (A_8 \oplus B_8) + (A_8 \cdot B_8). \quad (11) \end{aligned}$$

P_B , P_C , G_B and G_C are determined in a similar manner.

In operation, the input data is entered in parallel into the augend and addend bit inputs. Now the adders in each group take this information and produce the generate terms (G_A , G_B and G_C) in a time interval equal to four ripple-carry

delays. Within the same time interval the propagation terms, P_A , P_B and P_C , are formed.

Next, both the generate and propagate terms are applied to the look-ahead carry gating section. This gating section forms all carry inputs, (C_1 , C_2 and C_3), for the adder groups except C_{in} , which was formed after the first four ripple delays.

After all carries have been formed they are applied to the carry inputs of each adder group. Once this occurs, the sum outputs are updated in four ripple delays. Total time requirement for the addition of 16 bits is equal to twice the adder-group ripple delay, plus two gate delays. A typical 16-bit add time of 78 ns can be obtained with TTL logic using this method. ■■



...try a Teletype® 37
...and look
into mag tape!

We don't have a crystal ball. And rarely resort to mystic means in recommending what terminal should be used for a particular data communications application.

Some of the things, we at Teletype look at, that make the job a little easier are these:

Distribution	Volume
Urgency of message	Language
Frequency of use	Accuracy

The diagram below demonstrates how you can fit a number of Teletype terminals

into a system based on function and usage requirements. Magnetic tape makes the speed and language of various terminals compatible. In this hypothetical case we use one computer program, one major line control procedure, one computer port, one type of data set per link. And deliver greater data through-put per on-line dollar. Using terminals that offer the best capabilities within each station's communication situation.

Using Teletype magnetic tape terminals, combined with various Teletype keyboard send-receive sets, you obtain

some unique system flexibility. And the on-line time saving aspects of operation are really dramatic. Magnetic tape data terminals can keep data flowing on-line at up to 2400 wpm.

In the example shown, the manufacturer has linked sales, engineering, accounting and inventory control departments to a central office computer. As well as manufacturing plants, warehouse and regional offices. He's covered all critical data points with a common medium speed link, using a variety of terminals. Magnetic tape data terminals make it possible.

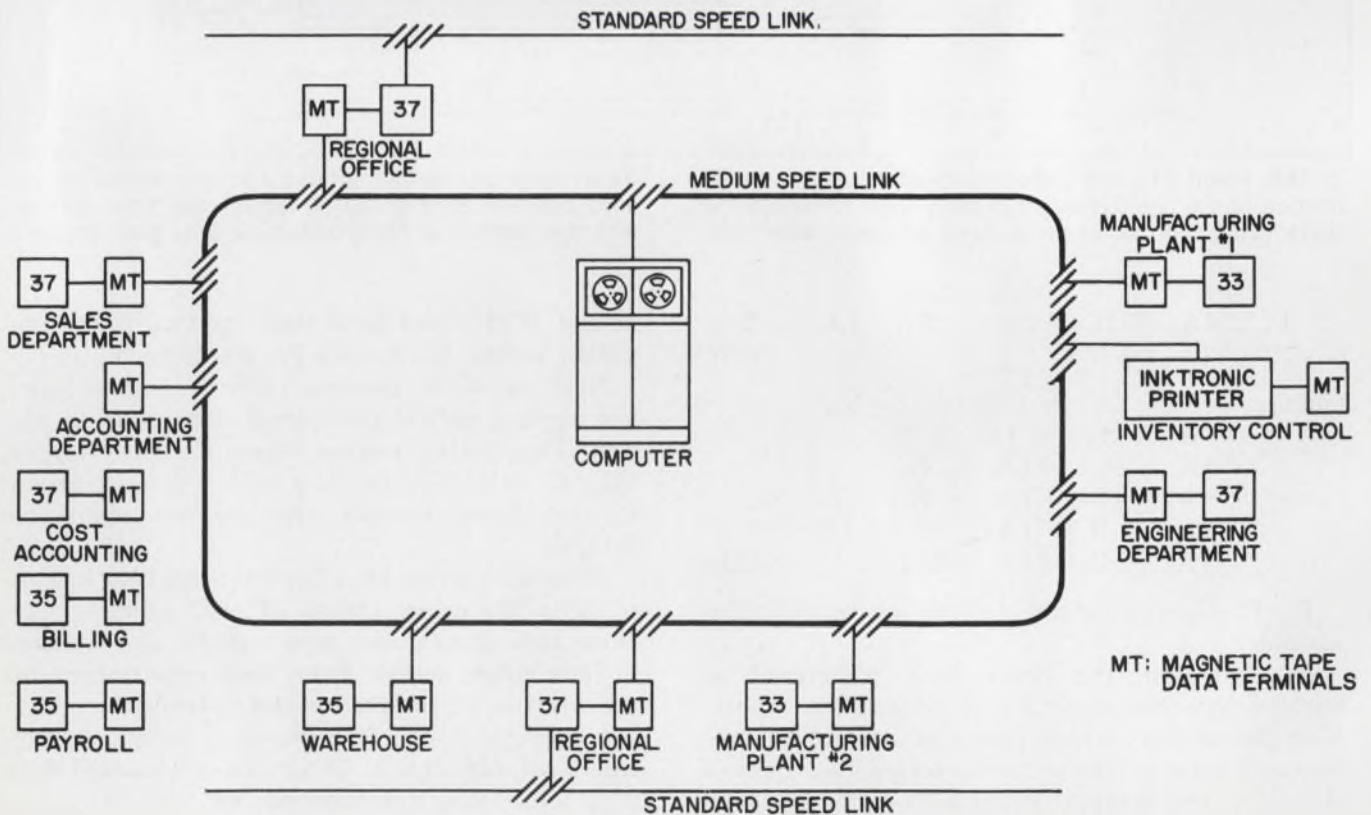

DATA COMMUNICATIONS

equipment for on-line, real-time processing

Routine aspects of the system are maintained in standard speed links. Branch offices are tied into the regional office terminals on standard speed networks. Regional offices batch routine branch office data on one magnetic tape. Transmit the data to the central office processor at one time. Saving a number of additional computer port requirements.

Since data generated at manufacturing plants is urgently needed, but volume is low, low-cost model 33 terminals are used here. The warehouse data volume is higher, but not complex, so a heavy-duty model 35 is working here.

Volume requirements are heaviest in the accounting department. Cost accounting, payroll, billing and invoice payment functions generate data all day long. Here magnetic tape is prepared off-line at various terminals. And an on-line stand-alone magnetic tape terminal is used to transmit data to and receive data from the central processor.

Sales and engineering departments are equipped with Teletype 37 terminals. But for different reasons.

This terminal offers engineering people some unique format flexibility. Half-line and full-line forward and reverse line feed can be used to communicate complex equations and engineering formulae to the processor. It is possible to add special graphic engineering symbols to the normal compliment of letters, numbers and punctuation marks found in the typebox (up to 32).

The sales department uses the model 37 for order processing. It has on-line vertical and horizontal tab set control, and form feed platen (optional) which makes data transmission and reception on multiple copy business forms easy and economical.

At the inventory control point, this manufacturer has an urgent need to obtain printed page copy of large volumes of inventory items. Magnetic tape is used to feed data to the processor and a Teletype Inktronic® KSR set receives data and prints page copy on-line up to 1200 words per minute.

As you can see, Teletype's modular terminal design allows you to use vari-

ous units as building blocks to meet the most demanding system needs. Teletype also has the station and error control accessories necessary for more efficient and economical data communications operations. Since cost is a very important part of the mix, Teletype offers greater terminal capabilities on a price/performance basis than any other manufacturer.

If you're involved in designing a teleprocessing, time-sharing, remote batch or computer switched system; looking into a multi-point private line, point-to-point private line or switched data communications network; talk to Teletype about terminals. For ideas, equipment and understanding, you'll find no better source. Anywhere.

Teletype data communications equipment is available in send-receive capabilities of up to 2400 words per minute. If you would like specific information about any of the equipment described here, write: Teletype Corporation, Dept. 89-16, 5555 Touhy Ave., Skokie, Ill. 60076.



model 33 series: An extremely low-cost 100 wpm terminal line. Uses ASCII. The most widely used terminal in time-sharing systems today.



model 35 series: A rugged, heavy-duty line of 100 wpm terminals. Uses ASCII.



model 37 series: One of the most versatile heavy-duty terminal lines going. Generates all 128 characters of ASCII. Operates at 150 wpm. Prints in upper and lower case.



Inktronic® data terminals: A unique electronic, solid state terminal. Prints up to 1200 wpm. Forms characters through electrostatic deflection (no typebox). ASCII compatible.



magnetic tape data terminals: Use compact reusable tape cartridges. Operate on-line at up to 2400 wpm, and connect "locally" to lower speed Teletype terminals using ASCII.



Stuntronic™ accessories: Electronic solid state terminal logic devices offering many control options. Such as, automatic station control, error detection and correction capabilities.

Teletype is a trademark registered in the U.S. Pat. Office

machines that make data move



INFORMATION RETRIEVAL NUMBER 50

Design a 1200-bit/s FSK modulator

for data transmission over ordinary telephone lines. Use either acoustic coupling or a direct connection.

Digital data transmission over ordinary telephone lines requires a modulator at the sending end that will convert the stream of data pulses to a form that is easily transmitted and will also couple to the telephone line. An approach that is suitable for use on voice-grade telephone lines is frequency-shift keying, or FSK modulation.

A data rate of 1200 bits/s is a practical limit for FSK on voice-grade lines. The modulator must operate at this rate and should be suitable for hard-wiring to the telephone line as well as acoustic coupling through a telephone handset. A modulator with this dual operating capacity can be used in offices, labs and at remote sites.

Audio modulation is necessary

A stream of square dc pulses, as generated by teletypewriters or other computer equipment, cannot be transmitted on telephone lines because of their limited frequency response. Therefore, FSK modulation, in which a pulse or MARK is transmitted at one audio tone and a SPACE at another tone, is used. A third tone may be required to respond to automatic dialing equipment.

The first step in modulator design is to determine the audio tones to be used in the transmission. The combination of frequencies is arranged to provide a center frequency of 1700 Hz to match the center frequency of the standard Bell System model 202C demodulator.

The other parameter of interest is the deviation ratio, r_d , which at 1200 bits/s, is defined as

$$r_d = (f_s - f_m) / 1200$$

where f_m = MARK frequency in Hz, and f_s = SPACE frequency in Hz.

According to Bennett and Davey¹ discontinuities disappear from the spectral density characteristic when the deviation ratio is equal to $2/\pi$ or 0.636. These two constraints, r_d equal to 0.636 and center (average) frequency equal to 1700 Hz, lead to the following two equations:

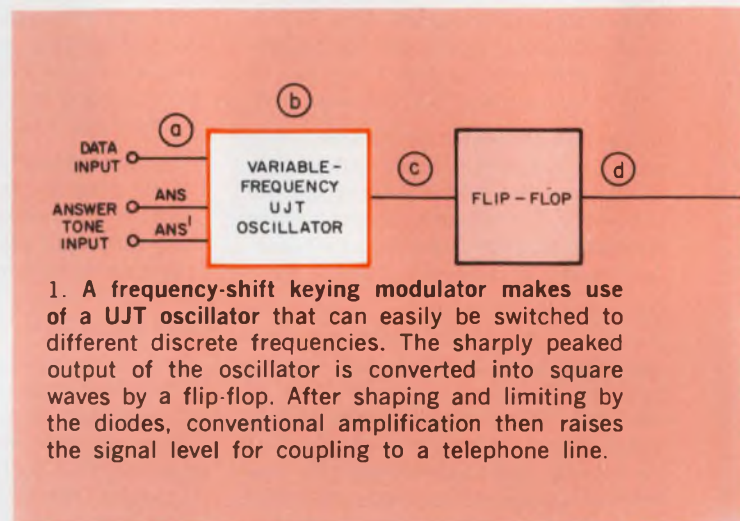

1. A frequency-shift keying modulator makes use of a UJT oscillator that can easily be switched to different discrete frequencies. The sharply peaked output of the oscillator is converted into square waves by a flip-flop. After shaping and limiting by the diodes, conventional amplification then raises the signal level for coupling to a telephone line.

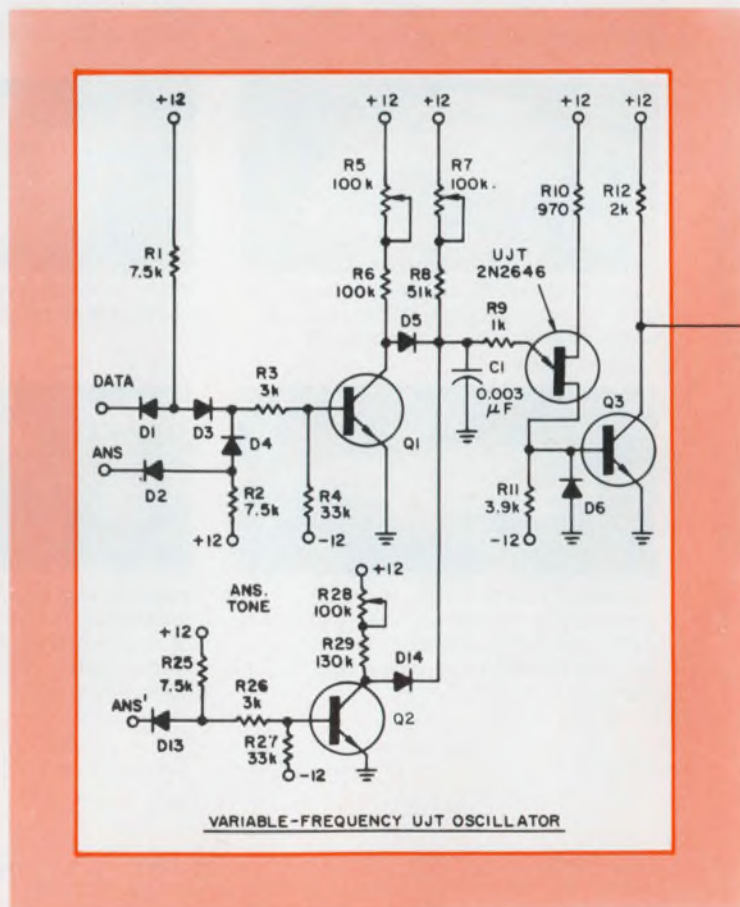

Frank Marino, Senior Staff Engineer, Digitronics Corp., Albertson, N. Y. 11507.

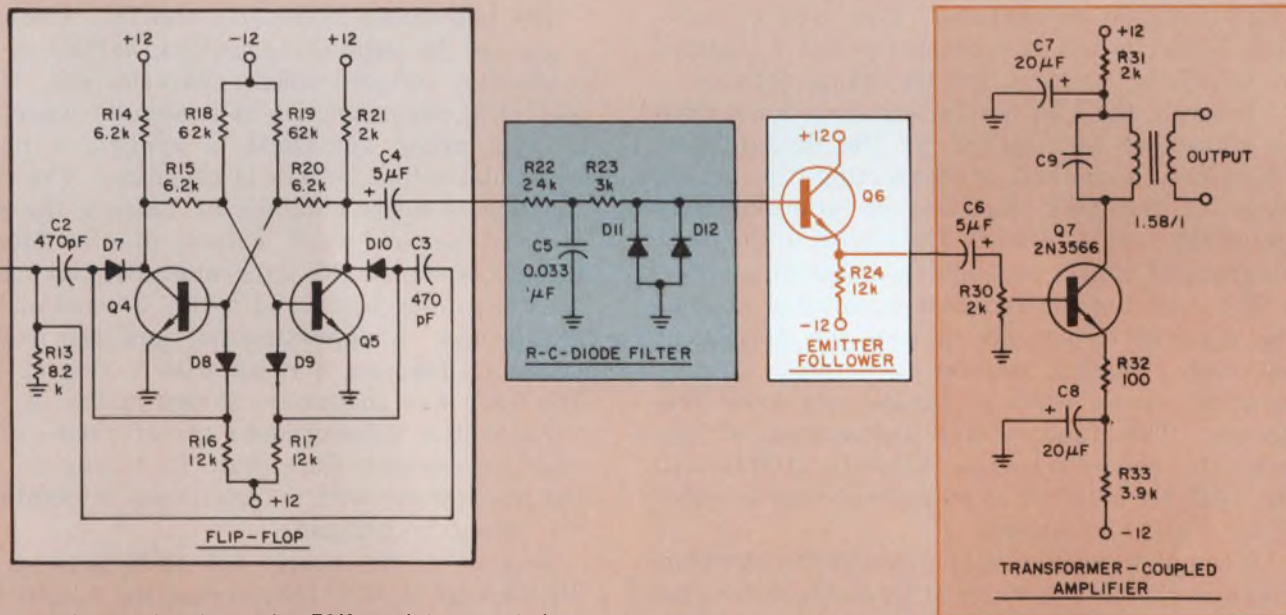
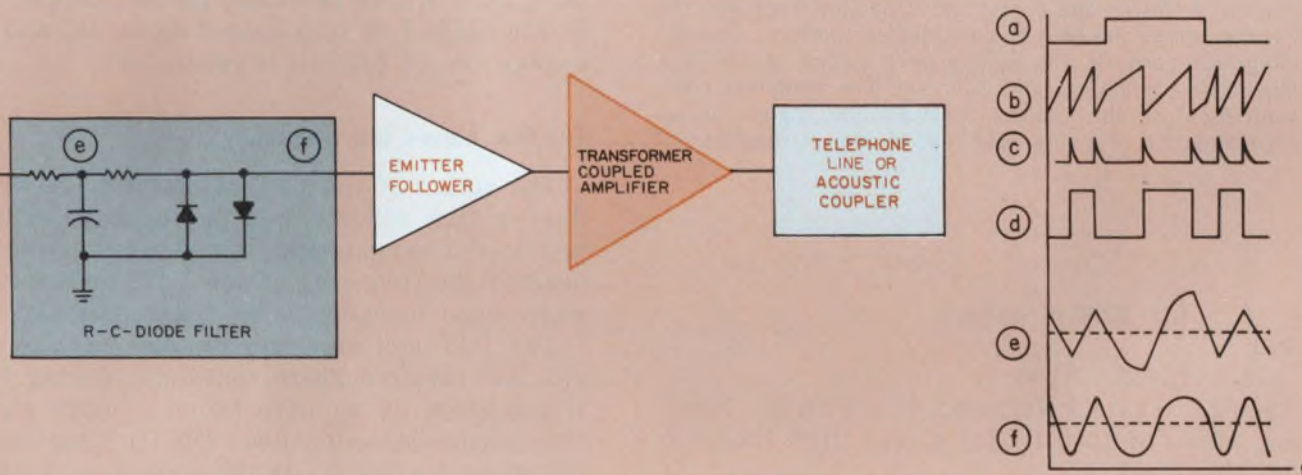

2. The input signals to the FSK modulator switch transistors Q_1 and Q_2 to control the frequency of the UJT relaxation oscillator. The data signal may be present or absent (MARK or SPACE), but either ANS or ANS' is always present. The capacitor across the output transformer, C_{11} , is $0.03 \mu\text{F}$ for direct access to a telephone line, or $0.05 \mu\text{F}$ for use with an acoustic coupler.

UNLESS OTHERWISE NOTED:
 ALL DIODES ARE TCRSU0125
 ALL RESISTORS ARE 1/4 WATT
 ALL TRANSISTORS ARE 2N3565

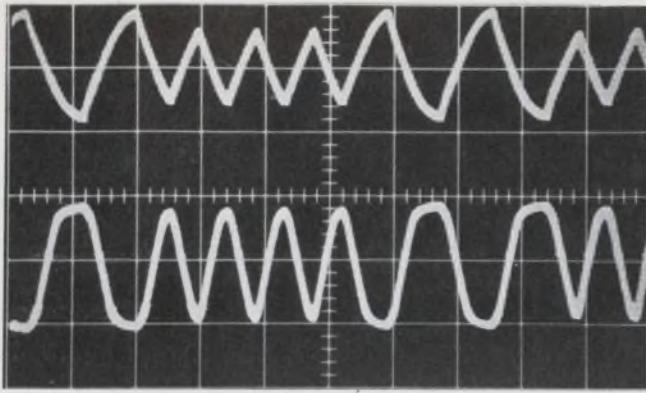

3. The effects of the RCD filter are shown by the photographs of the voltage across the capacitor (top) and the voltage across the back-to-back diodes (bottom). The RC integrator converts the square-wave output of the flip-flop to an oscillating ramp function. The nonlinear characteristics of the diodes converts the signal to an approximation of a sine wave free of even harmonics.

$$(f_s - f_m) / 1200 = 0.636$$

and

$$(f_s + f_m) / 2 = 1700.$$

Then $f_m = 1318.4$ Hz, and $f_s = 2081.6$ Hz. Nominal values of 1300 Hz for f_m and 2100 Hz for f_s are thus used.

An important requirement for a circuit to be used in commercial applications is that it be cost-competitive. One way to design a low-cost keyable oscillator is to use a unijunction transistor (UJT) relaxation oscillator. This type of oscillator is stable, and its frequency is easily changed by switching resistors into its timing network.

However, the UJT oscillator output is not close to sinusoidal as required by the demodulator. Therefore, a method of converting the output wave of the UJT oscillator to approximately sinusoidal form is needed. The circuit in the block diagram of Fig. 1 accomplishes this aim.

The output of the oscillator is adjusted to twice the required frequencies because the subsequent one-stage flip-flop counter generates a symmetrical square wave at one-half its input frequency. The fundamental frequencies of the generated square waves are 1300 Hz, 2100 Hz and the 2025 Hz required as an answer tone by automatic dialing equipment.

A complete schematic diagram of the circuit is given in Fig. 2. The states of Q_1 and Q_2 determine the relaxation frequency of oscillation. With Q_1 and Q_2 conducting because both a positive data signal and ANS' (the inverse of the automatic answering signal) are present, the MARK frequency is determined by C_1 , R_7 , and R_8 . Under these conditions, resistor R_5 and R_6 , and R_{28} and R_{29} , are isolated from capacitor C_1 by back-biased diodes D_5 and D_{14} .

With Q_1 cut off during a SPACE interval and Q_2 conducting, R_5 and R_6 are applied in parallel with R_7 and R_8 while R_{28} and R_{29} remain isolated by back-biased diode, D_{14} . In this case, the SPACE frequency is generated.

Transistor Q_2 is kept in its conducting state during transmission of data because the signal ANS' is positive. In the automatic answering mode, however, ANS is positive, and ANS' switches to zero. Under these conditions, Q_1 is conducting and Q_2 is cut off. The frequency of oscillation is then determined by C_1 and the series-parallel configuration of resistors R_7 and R_8 , R_{28} and R_{29} . In this case, the resistors R_5 and R_6 are isolated by back-biased diode, D_5 , and the answer tone of 2025 Hz is generated.

Flip-flop halves the frequency

The output of the UJT oscillator triggers the flip-flop that follows it. This one-stage counter produces a symmetrical square-wave output at one-half the frequency of the UJT oscillator. Its wave shape, however, is far from sinusoidal.

The UJT oscillator and flip-flop circuits provide the required phase continuity during FSK transmission of an asynchronous input signal. The resistor-capacitor-diode (RCD) filter retains this phase continuity. At the same time the filter produces a waveform that is sufficiently close to sinusoidal and eliminates unwanted harmonics without sacrificing good transitional response at the 1200 bits/s rate.

The two silicon diodes, D_{11} and D_{12} , which are connected in parallel opposition, exhibit a logarithmic voltage-current characteristic. If an oscillating ramp function or triangular waveform of appropriate amplitude is applied, a nearly sinusoidal output voltage is generated. The ramp function is easily obtained by passing the symmetrical square wave output of the flip-flop through a simple RC integrator. By making R_{22} relatively large compared to R_{23} a constant-current source is approximated, and the voltage across C_5 becomes a ramp with a slope of I/C . The filter waveshapes are shown in Fig. 3.

An emitter follower and a transformer-coupled amplifier complete the circuit. By tuning the output transformer with C_9 , additional smoothing of the output is obtained.

Because of the nearly 2:1 shift between the MARK and SPACE frequencies, the output voltage developed across C_5 would tend to be larger for the lower MARK frequency than for the SPACE frequency. The constants of the RCD filter are so chosen that the diodes provide a peak-limiting function during the generation of the MARK frequency. This results in a MARK frequency at the final output, which is less sinusoidal than the SPACE frequency but of

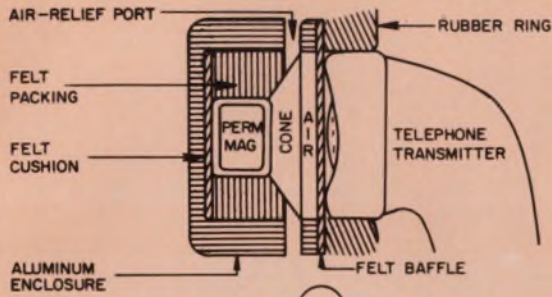

(a)

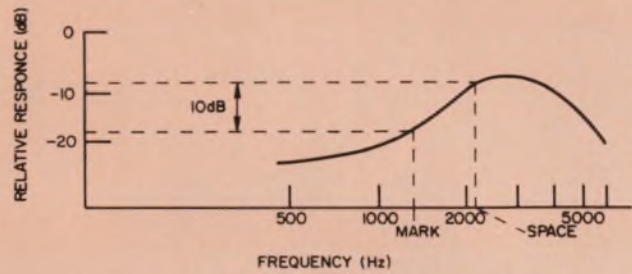

(b)

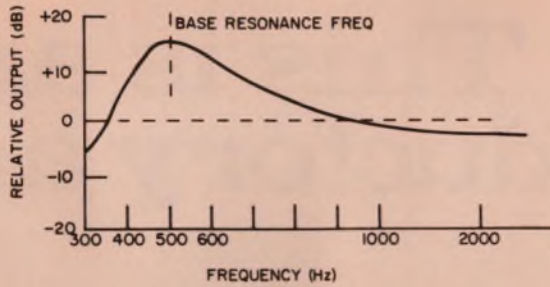

(c)

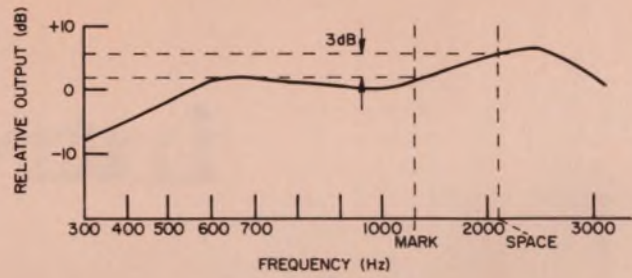

(d)

4. An acoustic coupler requires careful mechanical design to insure proper signal transfer to the telephone handset (a). A telephone microphone, however, has a poor frequency response (b) for this application so that a speaker should be chosen

whose response (c) complements the microphone. Over-all response (d) of speaker and microphone is usually not flat, but a 10-dB or greater difference between MARK and SPACE frequencies can be reduced to 3 dB.

equal amplitude. The significant harmonics contained in the final output, however, are primarily odd due to the symmetry and phase continuity that is inherent in this modulation scheme.

Odd harmonic distortion is less deleterious in FSK transmission than is even harmonic distortion because the symmetry of the received waveform is more important to the Bell System's 202C demodulator than is deviation from a pure sine-wave.

If the output of the modulator is to be fed directly into a telephone line using a Direct Access Arrangement (DAA), an attenuator must be used to adjust the power level. The attenuator network is fed from the output transformer whose 600- Ω level matches the telephone line. In addition, R_{30} can be adjusted to set the output level.

Acoustic coupler is an alternative

An acoustic coupler, to couple the FSK modulator into a telephone handset through a small loudspeaker, is a very useful device, particularly for remote data transmission away from a fixed installation. For example, a salesman can use a battery-powered acoustically coupled modulator from a motel room with no need to make wired connections to the telephone line.

If an acoustic coupler is to be used in place

of DAA, other problems—the response of the telephone microphone and the tightness of coupling between loudspeaker and microphone—must be considered. A diagram showing how the mechanical coupling problem is solved is presented in Fig. 4a. The frequency response of the carbon granule microphone that is universally used in telephone transmitters is shown in Fig. 4b. This response peaks at about 3 kHz, and there is close to a 10-dB difference in the response at the MARK and SPACE frequencies.

The first step in smoothing the response, is to choose a permanent-magnet loudspeaker whose response complements that of the carbon microphone. Fortunately, a 2.5-inch-diameter speaker (Fig. 4c) has a cone resonance at around 500 Hz, well below the microphone peak. When this speaker is coupled to a telephone microphone, the over-all response of Fig. 4d results. The difference between MARK and SPACE frequency response is now 3 dB.^{2,3} Tuning capacitor C_0 across the primary of the output transformer can be adjusted to make the response flat over the range of 1300-2100 Hz. ■■

References

1. Bennett and Davey, *Data Transmission*, McGraw-Hill Book Co., New York, 1965, pp. 327-332.
2. Wolf, E. and Marino, F., "Acoustic Transmission System," *National Electronics Conference Proceedings*, Vol. 24, 68CP531-COM, 1968.
3. Wolf, E. and Marino, F., "Acoustic Transmission System," *IEEE Transactions on Communications Technology*, Vol. COM-17, No. 6, December, 1969.

**This is an
introductory ad.**



F-100

R-410 SERIES

C-110

If you've never seen an ad quite like this before, it's because you've never seen products quite like this before in the United States.

While these data systems are just now being introduced in this country, they're part of the entire TEAC line of instrumentation products that have more than made their mark in business and industry around the world over the past decade.

So this debut is anything but presumptuous or precipitate. It's part of a planned program as precise and uncompromising as the products themselves.

TEAC's commitment has

always been to become thoroughly involved with our customer's problems and needs before, during and after the purchase of our products. Competent field and factory service and a comprehensive parts inventory are a critical part of this philosophy.

By way of introduction, the six products shown below illustrate our point.

Newest addition to the TEAC line of data recorders is the R-70 Cassette Data Recorder which includes both FM and direct electronics and operates from either self-contained power supply or external AC/DC.

Flexibility in analog data

recording is reflected in the wide variety of configurations available in the truly portable R-200 and the IRIG compatible R-250 as well as the transportable R-410 series.

The C-110 Real Time Digital Correlator and the F-100 Spectrum Analyzer team up to provide rapid signal analysis.

As we said in the beginning, this is an introductory ad. We can't hope to give all the details here or anticipate your questions.

So, if you'd like more details on the exciting world of TEAC, send for our new twelve-page, four-color brochure. Just write or call Ken Williamson, Director of Marketing, Technical Products, TEAC Corporation of America, 2000 Colorado Avenue, Santa Monica, California 90404. Telephone (213) 394-0240.

There's a good reason to go **TEAC**®

R-250 SERIES



R-200 SERIES



R-70 SERIES



Your product will get rave notices

if your creativity has been directed, says this management counsel. Here's how engineers can measure the pulse of the marketplace.

This is the first of two articles on how to convert ideas into marketable electronics products. It offers a four-point plan to help you direct your creativity. The second article will detail the development of a specific product from inception through sales presentation.

Each day on the Bayshore Freeway—the “electronics highway” of the San Francisco Bay Area—the pink cement mixers of Kaiser Sand and Gravel Co. pound back and forth. On their rotating barrels, in huge black letters, is the slogan: “Find a need and fill it.”

This is an appropriate slogan for the creative electronics engineer to affix to his office wall. The 70s will bring the message home loud and clear—engineering creativity alone may not sell. The increasingly competitive nature of the electronics business demands “directed creativity.”

After many years of adolescence, the electronics industry is face to face with maturity. Its position today is characterized by consolidations, mergers and a reduction in new ventures. How are you facing this maturity?

As industry matures, so does the marketplace for its output. More knowledgeable, experienced and economically aware consumers are buying—or not buying—your products. Many consumer industries have recognized this interplay for years and have allotted major portions of their marketing budgets for research to determine just what the customer will or will not buy. Now the electronics industry must follow.

Find out what sells

Can you, as a designer, develop a fuller awareness of what sells? Can a program be established in your company to assist you in gaining this awareness? To prove that the answer in both instances is yes, let's look at three successful examples of directed creative design.

In the earlier days of the semiconductor industry, the engineer who was inclined to use digital

integrated circuits in his system design faced a packaging problem. His choice was between the old standard multi-lead TO-5 and the ceramic flat package. Both provided some benefits to the user, but both also had considerable drawbacks. The TO-5 configuration was limited in the number of leads it could provide. The ceramic flat package had ribbon leads on 50-mil centers, and this meant that expensive multi-layer boards or other custom printed-circuit boards were required. Repair was difficult, if not impossible.

The packaging engineers of the semiconductor industry went to work, and the dual-in-line package was born. Easy insertion in low-cost, standard, two-sided printed-circuit boards and ease of repair are major benefits of the DIP package.

This is a classic example of “directed creativity”—the DIP remains the most widely accepted IC package in the industry today.

Consider the problem today's computer designer faces when he chooses a technology for buffer or microprogramming memory applications. For years, the principal technology was ferrite cores.

But, it became apparent that there were significant potential improvements with semiconductor memory. Many semiconductor manufacturers invested heavily in R&D in the memory field. Today the system designer can choose from a variety of bipolar or MOS memories that offer improvements in bit-density, size, weight, speed and power consumption over ferrite cores. And semiconductor memories promise to compete in cost and reliability.

In a sense, this case of directed creativity has given rise to a new industry segment that has significant growth potential over the next few years. A milestone was reached for semiconductor memory manufacturers when IBM announced the 370/145 series of computers with a semiconductor mainframe memory.

Perhaps one of the most dramatic examples of directed creativity is at your fingertips each time you travel on the jumbo Boeing 747 jetliner. Airlines are normally loaded with bundles of cabling for such things as radios, flight indicators and entertainment systems. The cabling is heavy, and it reduces the range and economy of operation.

Several companies, recognizing this problem, have developed electronic multiplexers, replacing as many as 10 to 20 wires with a single wire strand. The initial development has been on the 12-channel seat entertainment systems in airliners, but the technology is applicable to monitoring fuel and hydraulic systems, flight controls, navigational aids, etc. The multiplexer is apt to become one of the most widely used subsystems on commercial or military aircraft of the future.

The objective, then, is to design in such a manner that the final product will gain market acceptance. Find a need and fill it.

Measuring market pulse by plan

How can the creative engineer measure the pulse of the marketplace? Here is a simple plan:

■ *Travel with the salesmen.* The design engineer should not be isolated from the field sales force. Face-to-face technical exchange between the component or subsystem supplier and the systems house customer can reveal many needs that require filling.



■ *Participate in the field.* One regional manager we know makes it a practice always to invite engineers to participate in office or quarterly sales meetings. The action is sometimes as simple and unstructured as a roundtable discussion with sales engineers on customer needs. This manager



also has the engineer lecture field personnel on products or technology, to simulate a customer in practice selling situations. Or he has him judge in contests in which salesmen compete to name the most features and benefits of a product. In brief, the engineer can make a tremendous contribution to the sales force and gain knowledge and exposure—all he has to do is participate.

■ *Exchange ideas.* The communications gap between product marketing personnel and research and development engineers is often sizable. It is important that product status meetings include not only the sponsoring marketing group but also responsible development engineers. It is here that ideas get filtered. Are the customer requests reasonable? Are we conscious of their needs? Do we have the capacity to respond? Profiles of the competition and pricing strategies also evolve. It is critical that the engineer have a voice in answering these questions.

■ *Keep an open mind.* A cardinal sin of marketing is failure to recognize that the customer almost always has an alternative to fill his need. There are several reasons for this failure. First is the "N. I. H." factor—"not invented here." Because our company didn't design the competitive product, we're reluctant to admit that it can do the job as well as our own. Sound familiar? A second reason is simply failure to listen to the customer. The engineer or marketing man who asks questions and listens to the answers will soon learn in which direction to direct his creativity.

A third reason is that companies—even industries—often become fixated upon one technology. For many years, the railroad companies worked to improve methods of rail travel. Simultaneously entirely new methods of transportation in the form of airplanes and trucks began to take away their business. The railroads assumed that they were in the "railroad business"; in reality they were in the business of "transporting" people and things from point to point. Their failure to recognize this has contributed significantly to their present problem. The engineer must always be willing to consider that the answer to any need could lie with more than one technology.

Test the game plan

That's the four point plan. Face-to-face technical exchange. Marketing involvement for the engineer. Elimination of the communications gap

between product marketing and personnel and R&D engineers. And an open-mind policy.

Let's see how this four-point plan might work in practice. Assume you are an engineer charged with the design of the input/output section of a next-generation minicomputer. Why not try this approach before any aspect of the design is committed to paper?

First, spend several days in the field with your sales force. Let your customers tell you what they like and dislike about available I/O systems. Do they have a particular accessing problem? Can they get the information out when they want it and in the form they want it? Let them do the talking.

In the evening meet with the sales force and discuss broader customer problems. Build a data base.

When you have enough external inputs, discuss them with your product marketing or applications group. They will be able to contribute a national outlook and provide a sounding board for the inputs you now have. During all of these steps maintain an open mind about any new ideas. Wait until you have all the inputs before putting the filtering process into effect. What might seem like the most far-out idea can have merit. A cargo plane the size of the 747 probably seemed far out to the railroad industry and most everybody else only a short time ago.

Perhaps you are now asking yourself, "This is all fine for the development engineer with a specific idea of product concentration, such as the minicomputer or a component line. How about me? I'm a research engineer—basic processes, materials and things of that sort are my area of responsibility. How does the four-point plan apply to me?"

It still has merit. The steps are the same, but some of the interplay within each step might be different. The fact that the customer has needs and problems remains the same. The distance between his practical need and your research is obviously greater. There are many steps and a substantial time lag between his need for an amplifier with a greater bandwidth and your work on a new diffusion technique, but you may still be able to come up with some new thoughts from his comments, or perhaps check out work you already have under way.

The most critical step of the four-point plan as it applies to the research engineer is the relationship with the product marketing group. It is here that the general trends of the marketplace can be discussed and opinions can be gathered on the value of research in certain marketable areas.

The plan is applicable to any phase of engineering. Follow it, and you'll find yourself designing products that sell. ■■

new

4th GENERATION OP AMP.

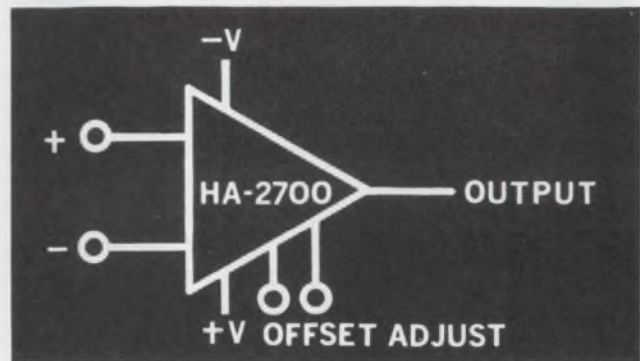

OFF-THE-SHELF DELIVERY

Operates at very low power levels without compromising large signal response or output drive capability.

- Slew Rate — 20V/ μ s
- Input Offset Voltage — 0.5mV
- Power Dissipation — 2.5mW at ± 15 V
- Open Loop Gain — 2.0×10^6 at $R_L = 2K$
- Input Bias Current — 5.0nA
- Power Supply Range — ± 5.5 V to ± 22 V
- Built-in Short Circuit Protection
- Offset Null Capability
- Internally Compensated

The HA-2700 is available in the TO-99 package at \$10.20* (0°C to +75°C), \$16.20* (-25°C to +85°C) and \$24.00* (-55°C to +125°C)

*100 to 999 unit price.



HARRIS

SEMICONDUCTOR

A DIVISION OF HARRIS-INTERTYPE CORPORATION

P. O. Box 883, Melbourne, Florida 32901 (305) 727-5430
DISTRIBUTORS: HARVEY/R & D ELECTRONICS—Lexington, Mass (617) 861-9200/R. V. WEATHERFORD CO.—Albuquerque (505) 265-6112, Anaheim (714) 547-0891, Dallas (214) 231-6051, Denver (303) Enterprise 165, Glendale (213) 849-3451, Palo Alto (415) 321-5373, Phoenix (602) 272-7144, Pomona (714) 623-1261, San Diego (714) 278-7400, Seattle (206) 762-4200/SEMICONDUCTOR SPECIALISTS INC.—Chicago (312) 279-1000, Detroit (313) 255-0300, Minneapolis (612) 884-8132, Kansas City (816) 452-3900, St. Louis (314) 428-6100, Dallas (214) 358-5211, Indianapolis (317) 243-8271, Pittsburgh (412) 781-8120, Dayton (513) 278-9455



**IN STOCK
RELIABLE
LOW COST**

The Harris family is designed to solve your problems

When you need to — convert to binary or decimal codes, convert voltage to current pulses, interface with modems, transmit and receive over a party line, encode a keyboard or restore current pulses to voltage pulses — Call Harris.

DIGITAL I.C.'s

- Keyboard Encoder**
Adapt to any Binary code
HD-0165
- Line Driver/Receiver**
Meets EIA RS-232-C
Interface specification
HD-1488, HD-1489
- Party Line Transmitter/Receiver**
Compatible with DTL
and TTL Logic
HA-245, HA-246
- Diode Matrix**
Easily customized to
specific pattern
7 configurations

When you need to — amplify, buffer, compare, multiplex, convert D to A or anything else in analog signal processing — Call Harris.

LINEAR I.C.'s

- Op Amp**
General Purpose/
Low Power
HA-2700
Wide Band
HA-2620, HA-2625
High Slew Rate
HA-2500, HA-2510, HA-2520
Low Noise
HA-2909
High Impedance
HA-2600
- 8-Bit D/A Converter**
Monolithic/Guaranteed Accuracy
HI-1080
- 10-Bit Ladder Network**
Low Cost, High Accuracy
HI-0910, HI-1010
- 16-Channel Multiplexer**
J-FET/Bipolar
HS-1000

When you need to — convert a code, microprogram a computer, store information and recover it quickly — Call Harris.

MEMORY I.C.'s

- 64 x 8 PRØM™**
Field Programmable
HROM-0512
- 256 x 1 PRØM™**
Field Programmable
Very high speed
HROM-1256
- 16-Bit RAM**
High speed
HARAM-0016
- 64-Bit RAM**
High speed, fully decoded
HARAM-0064



**HARRIS
SEMICONDUCTOR**

A DIVISION OF HARRIS-INTERTYPE CORPORATION

P. O. Box 883, Melbourne, Florida 32901
Please send me more information on the
Harris Off-the-shelf I.C.'s checked below.

- Memories
- Linear Circuits
- Digital Circuits

NAME _____ TITLE _____

ADDRESS _____

CITY _____ STATE _____ ZIP _____

PHONE _____

DISTRIBUTORS: HARVEY/R & D ELECTRONICS—Lexington, Mass (617) 861-9200; R. V. WEATHERFORD CO.—Albuquerque (505) 265-6112; Anaheim (714) 547-0891; Dallas (214) 231-6051; Denver (303) Enterprise 165; Glendale (213) 849-3451; Palo Alto (415) 321-5373; Phoenix (602) 272-7144; Pomona (714) 623-1261; San Diego (714) 278-7400; Seattle (206) 762-4200; SEMICONDUCTOR SPECIALISTS INC.—Chicago (312) 279-1000; Detroit (313) 255-0300; Minneapolis (612) 884-8132; Kansas City (816) 452-3900; St. Louis (314) 428-6100; Dallas (214) 358-5211; Indianapolis (317) 243-8271; Pittsburgh (412) 781-8120; Dayton (513) 278-9455.

SALES OFFICES: P. O. Box 883, Melbourne, Florida 32901 (305) 727-5430; Lexington, Massachusetts (617) 237-5430; Frederick, Maryland (301) 662-5400; Palos Heights, Illinois (312) 448-9110; Albuquerque, New Mexico (505) 268-3549; Palo Alto, California (415) 321-2280; Dallas, Texas (214) 231-9031; Long Beach, California (213) 426-7687; Norwalk, Connecticut (203) 853-3646; EXPORT SALES, DAGE CORPORATION, STAMFORD, CONNECTICUT.

RADIATION MICROELECTRONICS HAS CHANGED ITS NAME TO **HARRIS SEMICONDUCTOR**

INFORMATION RETRIEVAL NUMBER 95

ideas for design

Blank out insignificant zeros in your digital readouts

It is usually desirable, in digital instruments, to omit the unnecessary zeros in the displays. A six-digit readout, for example, would read "120" instead of "000120."

Any standard BCD counting decade can easily be modified to include this blanking function without making any changes in its decoding network. All that must be done is to start each decade's counting sequence from one of its normally wasted states instead of from zero.

As an example, suppose that the BCD decade has an 8-4-2-1 counting sequence as shown in the table. Normally, the decade counter is reset to 0 at the beginning of each counting sequence. As successive pulses are applied, the counter follows the states listed in the table until it reaches 9. At that point it goes back to 0.

If the same counting sequence is maintained except that one of the unused states (labeled X in the diagram) is used as an initial state, then

a blanked display is obtained. The BCD logic circuitry must be modified so that the first input pulse causes a transition from the initial state to the state 1 (0001). From then on, the counter must follow the sequence of a normal 8-4-2-1 counter: 1, 2, 3, . . . 8, 9, 0, 1, . . .

In the example shown in the diagram, the code 1010 was chosen as an initial state. The first input pulse must cause a transition from the 1010 state to the 0001 state. From then on, the standard counting sequence shown in the table is followed.

The blanked BCD decade counter is described by the following logic equations:

$$A_J = 1, A_K = 1, B_J = \overline{AD}, B_K = A + D = \overline{\overline{AD}}, C_J = C_K = AB, D_J = ABC \text{ and } D_K = A + B = \overline{\overline{AB}}$$

As can be seen from the circuit diagram, only three additional gates need to be added to the standard BCD decade: OR₁, OR₂ and AND₁.

Dipl. Eng. Vasile Catanescu, and Dipl. Eng. Decebal Poenaru, Institute for Atomic Physics, P. O. Box 35, Bucharest, Romania.

VOTE FOR 311

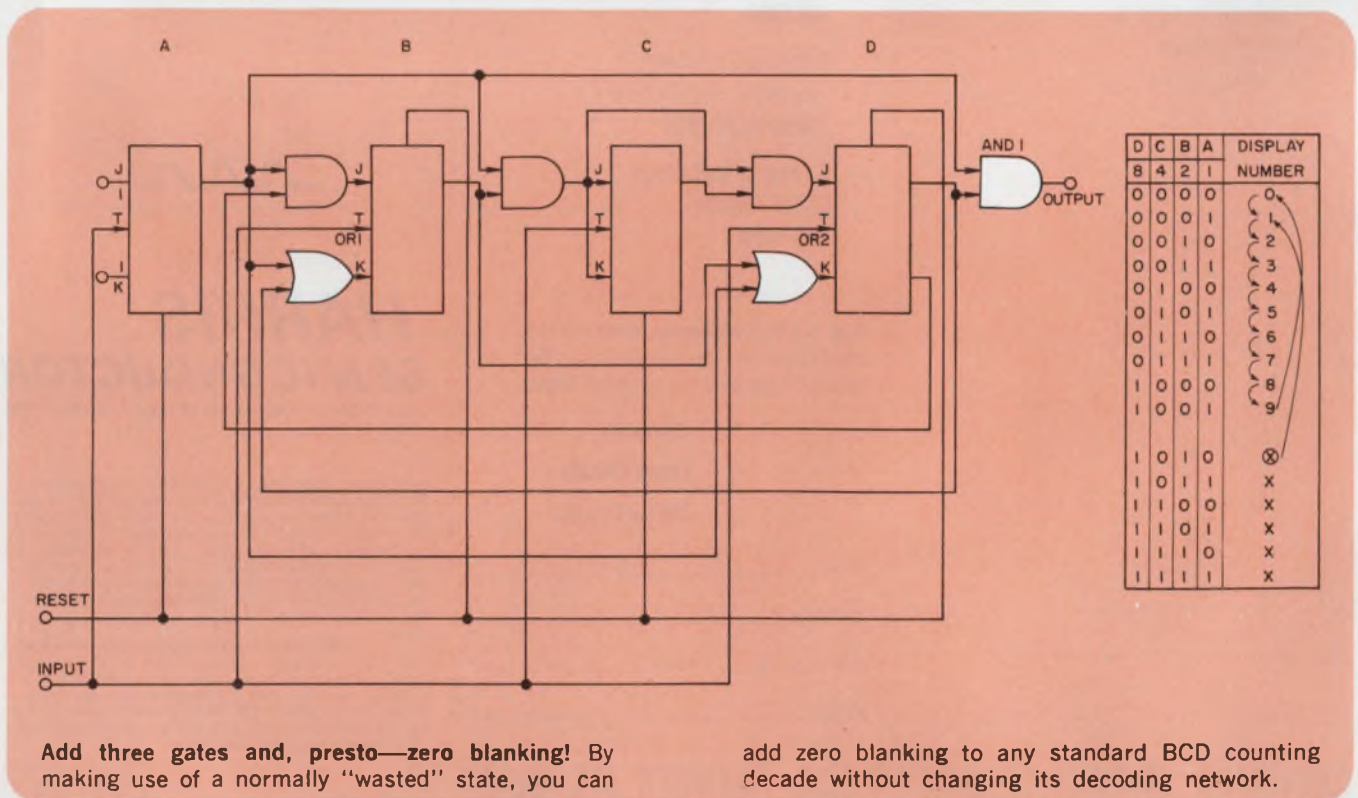

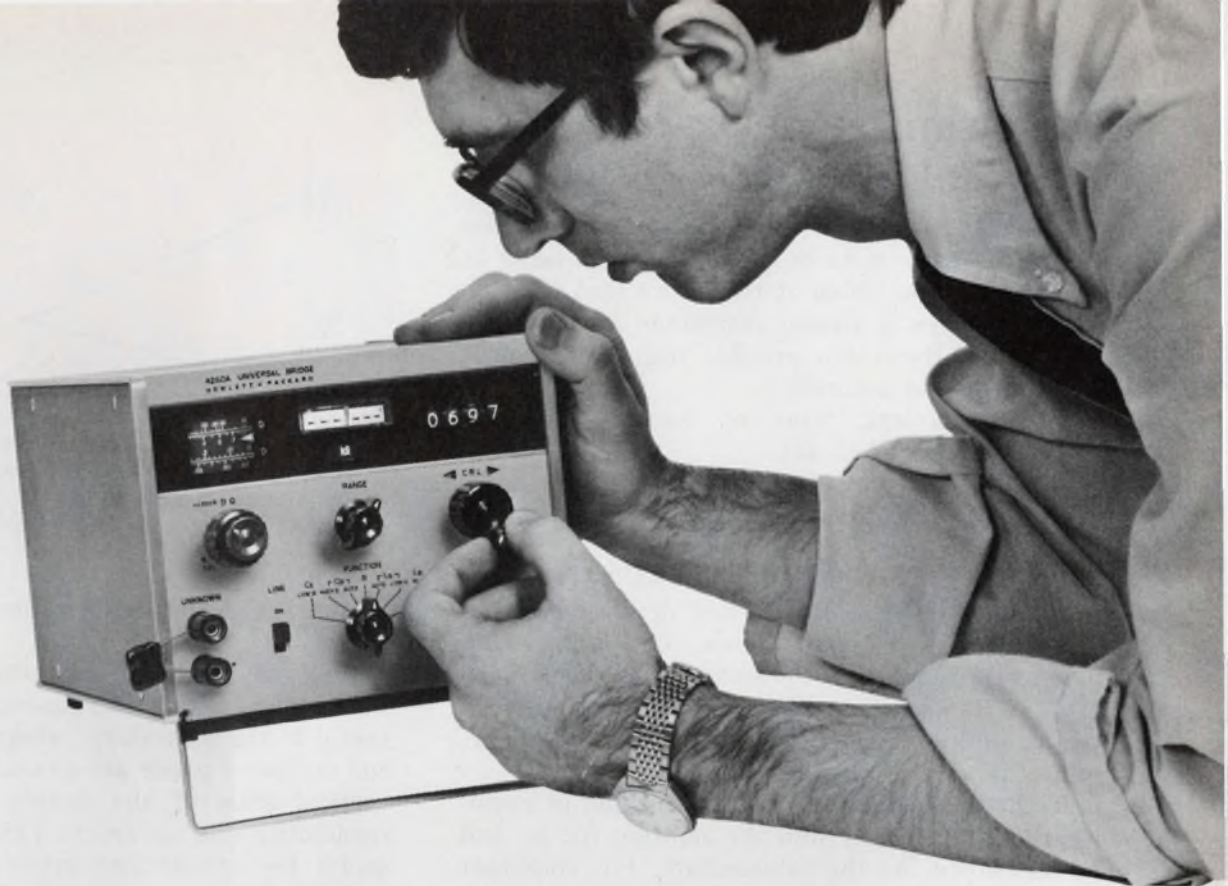

No. 5: The Monomatic Bridge

Gone are the days of the "knobby" universal bridge. No more hard-to-read, interacting controls and annoying multiplier scales.

With HP's 4260A Universal Bridge, you get a direct, in-line digital readout with automatic decimal and units indication — plus a unique auto-balance system that allows "monomatic" (one-operation) use. No more two-handed struggles; just set your scale, turn one feather-touch crank... and the figure you're seeking appears in seconds, in digits.

To aid in selecting the proper scale and in fine-balancing the bridge, the 4260A has a unique neon-arrow

indicator system that tells you whether you're up-scale or down—as well as a null-meter for final adjustment.

With the 4260A, you can measure C from 1 pf to 1000 μ f, R from 10 m Ω to 10 M Ω , and L from 1 μ H to 1000 H. Accuracy is $\pm 1\%$ +1 digit on the middle ranges. Yet the 4260A costs only \$595.

The 4260A is just one of HP's family of "Useables" — easy-to-use instruments for testing components. For further information on the 4260A, or on any of the "Useables," contact your local HP field engineer. Or write Hewlett-Packard, Palo Alto, California 94304. In Europe: 1217 Meyrin-Geneva, Switzerland.

HEWLETT  PACKARD

09 1/10

COMPONENT-TESTING INSTRUMENTS YOU CAN USE

The Useables:



No. 1: 4342A Q Meter, No. 2: 4270A Automatic Capacitance Bridge, No. 3: 4328A Milliohmmer, No. 4: 4329A High Resistance Meter, No. 5: 4260A Universal Bridge, No. 6: 4470B Transistor Noise Analyzer.

Use a simple graphic technique to solve for parallel resistors

Often, it is necessary to rapidly determine the values of resistors to be connected in parallel or to determine the value of resistance that must be shunted across a known resistance to achieve a new value. Here is a graphic technique that is both quick and accurate.

The equivalent value of two resistors in parallel is expressed as:

$$R_T = R_1 R_2 / (R_1 + R_2).$$

Thus, if $R_1 = 7.5 \text{ k}\Omega$ and $R_2 = 4.7 \text{ k}\Omega$, then $R_T = 2.88 \text{ k}\Omega$.

To solve this equation graphically first plot the values of R_1 and R_2 . Then draw lines from the "origins" to these points. The intersection point (i), represents the value of R_T (about 2.9 k Ω). If R_T and R_1 are known, then merely work the graphical construction backwards to determine the value of R_2 .

If three resistors are to be connected in parallel, then graphically find the solution for R_1 and R_2 as before. At the intersection, (i), construct a vertical line passing through (i). Graph R_3 as shown, drawing a line from the new "origin" at the bottom of the vertical line to the point representing R_3 . The intersection of lines from (i) and

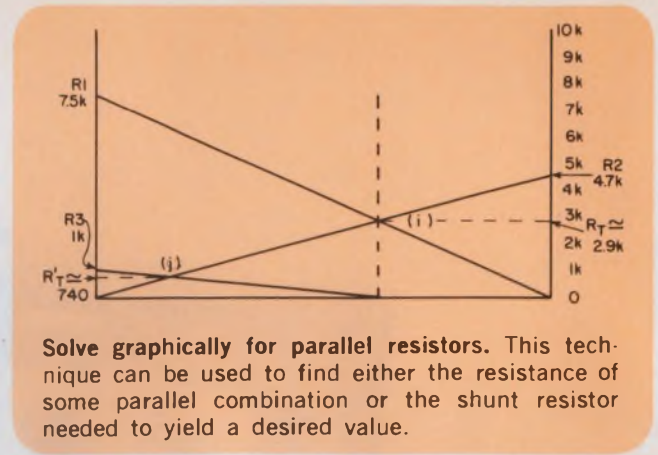

Solve graphically for parallel resistors. This technique can be used to find either the resistance of some parallel combination or the shunt resistor needed to yield a desired value.

R_3 , at (j) determine the value of R'_T (about 750 ohms).

This graphical approach works very well, even with crude hand-drawn figures, and is especially useful in the laboratory, where only a pencil and odd scraps of paper are available. Expanding the vertical scale of the graphs greatly increases readability and accuracy. This technique is also useful for calculations involving paralleled air-core inductors.

Michael Coyle, MCG Electronics, 279 Skidmore Rd., Deer Park, N. Y. 11729.

VOTE FOR 312

Regulated dc voltage source also supplies constant current

Starting with an unregulated dc voltage of $28 \pm 4 \text{ V}$, a low-power voltage/current regulator can provide 12 to 20 V of regulated dc output voltage with load currents up to 10 mA, as well as a constant current of 0 to 10 mA at the same time. Both the regulated voltage and the regulated current can be separately adjusted.

Constant-current diode D_1 provides initial starting current for transistor Q_1 , and breakdown current for zener diode D_2 . More current is provided to D_2 through R_4 to make D_2 a stable reference voltage source. If Q_2 's base current is assumed to be much smaller than the current through R_3 , then the voltage across R_2 becomes constant.

By adjusting R_1 , the output voltage can be brought to the desired value:

$$V_{out} = V_{R2} (R_1 + R_2) / R_2$$

To get the constant-current output, transistor Q_3 and resistor R_3 are added to the voltage regulator circuit. The current through R_3 is constant and is equal to:

$$I_{R3} = [V_{D2} - (V_{BE})_3] / R_3$$

I_{R3} is also the emitter current for Q_3 . Since $I_C = \alpha I_E$, the collector current of Q_3 will be con-

stant for any single value of R_3 . The desired current can be obtained by choosing the proper value for R_3 .

By carefully selecting D_2 for temperature coefficient, the V_{BE} temperature variations of Q_2 and Q_3 can be canceled, or a diode compensation technique may be used.

Kashmiri L. Khatter, Electronic Engineer, Systems Div., Dynasciences Corp., 9601 Canoga Ave., Chatsworth, Calif. 91311.

VOTE FOR 313

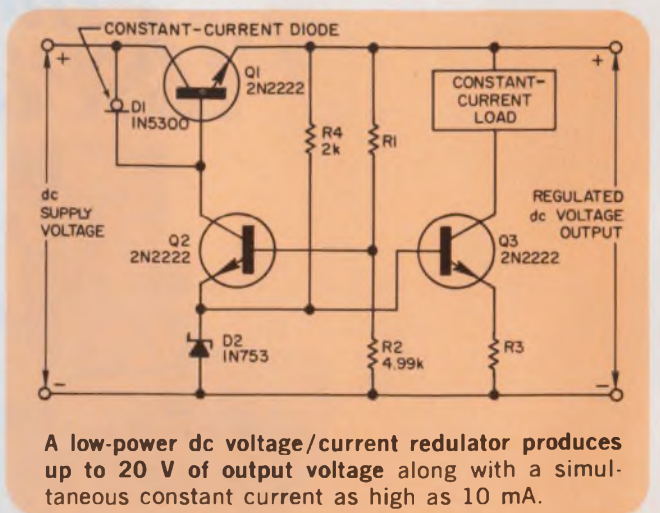

A low-power dc voltage/current regulator produces up to 20 V of output voltage along with a simultaneous constant current as high as 10 mA.



this



**protects
equipment
against
voltage
surges**

Electronic equipment is constantly running the risk of being "zapped" . . . by lightning, short circuits, switching of inductive components, etc. These ceramic gas filled arresters, from Signalite, offer maximum protection against voltage surges. They are low priced (under \$1.00) . . . reduce maintenance and down time . . . withstand shock and vibration. Some of the more vital statistics are listed, but for complete details, contact Signalite.

**Guaranteed 50
discharges . . .
200 typical**

**Fast response . . .
40 kv/ μ sec. wavefront**

**High temperature
capability with true
follow-on capability**

**Rugged ceramic
construction . . .
no glass**

Low cost . . . under \$1



**AVAILABLE UPON
REQUEST**

Detailed Data Sheet . . .
on Signalite Subminiature
Low Voltage Ceramic Gas
Filled Surge Arresters.



**The Broadest Line of Spark Gaps In
The World . . .** are described in the
Signalite "300" Spark Gap brochure . . .
including definition of terms,
characteristics of gap operation and
application information.

Signalite



**DIVISION OF
GENERAL INSTRUMENT**

1933 HECK AVE., NEPTUNE, N.J. 07753
(201) 775-2490

Solve static saturation in your astable multi

Conventional free-running multivibrators will always fail to oscillate if they become trapped in the stable state when both transistors are saturated. This can be caused by a load transient, or it can happen during the power turn-on transient, if both transistors have a high gain with the circuit RC time constant. A simple circuit modification, requiring no additional components, can prevent this static saturation.

The grounded-emitter circuit shown gives a saturated ON output level of about 0.1 V. It will not lock up, with both transistors saturated, because the base current of the ON transistor causes a reverse voltage to appear across the collector-base junction. This is due to the voltage drop on the collector-base resistor. Being unsaturated, the multivibrator will oscillate, regardless of power-supply voltage risetime, if the gain around the loop is greater than one. Oscillation will start from any disturbance, like the shot noise of transistor current. Once oscillating, the transistors saturate during the entire ON half-cycle if the resistance ratio of the base-to-collector resistors is sufficiently low. This ratio is less than 3.7 in the design shown.

For the values given in the diagram, the oscillating frequency is 420 kHz, and the period is

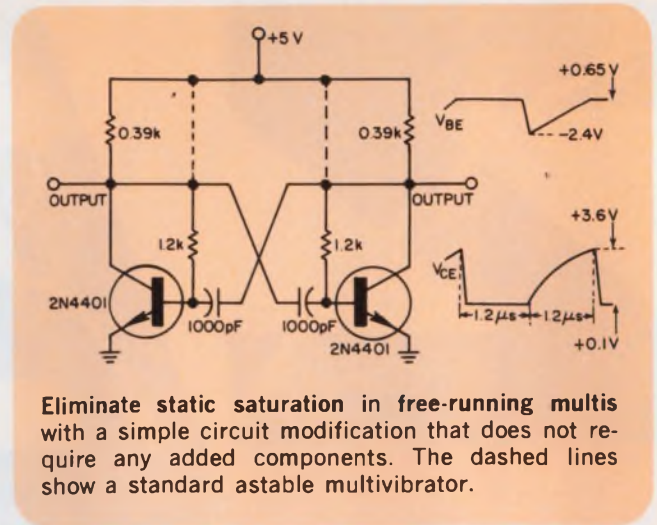

Eliminate static saturation in free-running multivibrators with a simple circuit modification that does not require any added components. The dashed lines show a standard astable multivibrator.

proportional to the sum of the two capacitors. Diodes should be inserted in series with the transistor emitters if the power-supply voltage is larger than device emitter-base reverse voltage rating. This adds about 0.7 V to the ground output level if silicon diodes like the 1N914 are used, or 0.4 V if hot-carrier diodes like the Hewlett-Packard 5082-2800 are used.

Edward D. Pinkham, Senior Engineer, and Nathan O. Sokal, President, Design Automation, Inc., 809 Massachusetts Ave., Lexington, Mass. 02173.

VOTE FOR 314

Use latching inverters to control pulse width

Logic design often makes it necessary to generate a pulse of specified length from a dc-level input. A circuit that will do the job consists of inverters A, B, D and F.

These generate a positive-going pulse, whose length is determined by the capacitor and the associated inverter pull-ups as long as the input is high. If the input becomes low before the circuit's cycle is completed, the output pulse will have a shorter duration than desired.

The same basic circuit can be made compatible with an input pulse of short duration by the addition of inverter E. This makes the output-pulse width independent of the input-pulse width. With the latching arrangement shown, a very narrow input pulse can be used to generate an output pulse of much greater duration.

As the output begins to go high, inverter E changes states and latches the input at point X to the low condition. The circuit will remain in this condition until the capacitor integrates to the threshold of inverter F.

When inverter F switches to the low state, the output pulse is terminated, and inverter E unlatches the input at point X. The circuit is now ready to accept the next input pulse.

Regis C. Farrell, Engineer Associate, Raytheon Data Systems, 2700 South Fairview St., Santa Ana, Calif. 92704.

VOTE FOR 315

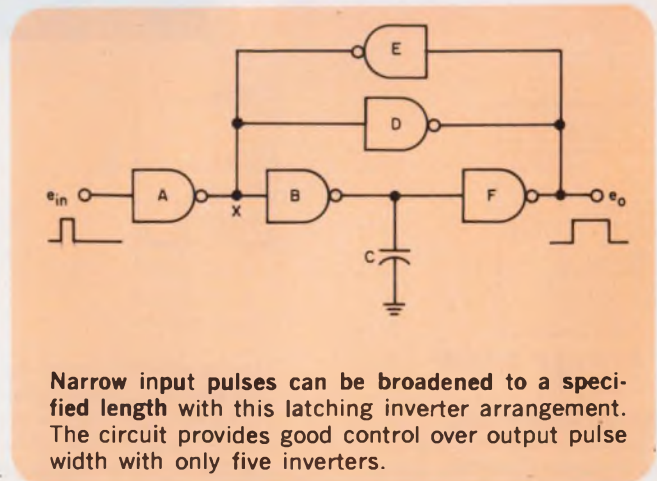

Narrow input pulses can be broadened to a specified length with this latching inverter arrangement. The circuit provides good control over output pulse width with only five inverters.

OUR ANGLE: angle position indicators that do more and cost less

SHOULDN'T YOU TAKE A NEW READING ON THIS COST-PERFORMANCE ANGLE?

For better ways to measure synchro and resolver data, North Atlantic offers the best of both worlds: budget prices for the popular API-8025; superior performance and increased capability of the new 8525. • Both are interchangeable without any mechanical or wiring modifications. North Atlantic's solid-state 8525 offers an accuracy of 0.05° (3 minutes). Following a 180° step input, it synchronizes a five-digit NIXIE readout in $\frac{1}{2}$ second flat. And it tracks at up to 1000° per second. Where cost can be traded against performance, the proven electromechanical API-8025 . . . a recognized indus-

MODEL 8525



MODEL 8025

try workhorse . . . is available with its 6 minute accuracy, 25° /second slew speed, and many options. • Input of the 8525 is any 60 or 400Hz resolver/synchro data from control instrumentation. The patented servo design eliminates all inertia and improves dynamic performance many times over. Its digital outputs are especially suited to the computer-oriented requirements of today's automatic test systems. The 8525 . . . priced at \$1885 . . . and the API-8025 priced at \$995 actually cost less because they perform more functions per dollar. And with greater reliability. ®

For complete information on the cost-performance angle, please write or phone now.

ON DISPLAY at IEEE—Booths 3108-3110

NORTH ATLANTIC
industries, inc.

200 TERMINAL DRIVE, PLAINVIEW, NEW YORK 11803
cable: noatlantic / twx: 510-221-1879 / phone: (516) 681-8600

Protect regulated series supply with only four components

A circuit that protects against short circuits or overloads for series-regulated power supplies can be built with only a single transistor and three resistors. The circuit often allows the power supply to come back to its normal operating conditions automatically, after the fault has been cleared.

Good current fold-back is achieved because the reverse bias on the base-emitter of Q_1 is made proportional to the output voltage. Q_1 is a silicon switching transistor, and R_s , R_1 , and R_2 are selected so that Q_1 is reverse-biased by about 0.3 V, when the supply is delivering full output current to the load. This ensures that under normal conditions Q_1 is really in cutoff.

The value of R_s is chosen so that Q_1 is ON when the supply is overloaded to the desired limit, for example, 120% of the full-load value. Q_1 then conducts and removes the base drive of Q_2 , thus limiting the output current.

Once the current is limited, any further attempt to increase the load current will decrease the output voltage. Overloading quickly reduces the reverse bias on the base-emitter circuit of the

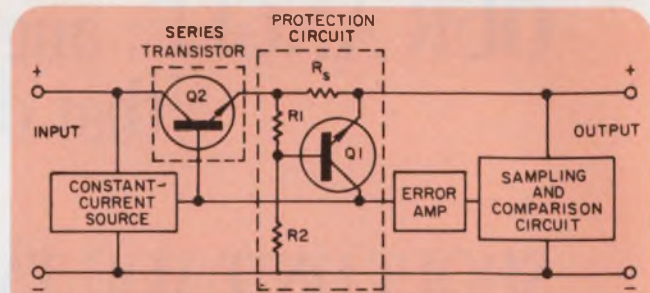

A protection circuit for series-type regulators guards against both short circuits and overloads. A switching transistor and three resistors are all that are required to do the job.

series transistor, lowering the current limit proportionally and the current folds back.

This protection circuit can be designed to limit the output current to about 20% of the full-load value with a "dead short" across the output, and the supply can operate with this short indefinitely. Care should be taken, however, to be sure that the power dissipation in the series transistor does not go above its safe limit when the supply is overloaded.

T. Lakshminarayana, Power Reactor Instrumentation Div., Electronics Corporation of India, Ltd., Hyderabad 40 (AP) India.

VOTE FOR 316

Low-cost circuit indicates line failure

Often in automatic electronic systems, such as burglar alarms, it is desirable to have an indicator built in to indicate past temporary power-line failures. This is often accomplished with a drop-out relay or some other awkward electromechanical device.

The simple circuit shown here indicates line drop-out with a few dollars' worth of parts. It has no arcing contacts, its components are inherently reliable, and it consumes very little power.

Basically, this circuit is a dc supply consisting of the bridge rectifier and C_1 . Across this supply is R_1 in parallel with the series combination of R_2 and an NE2 lamp, all in series with the SCR. When the SCR is conducting, most of the current flows through R_2 —enough to provide the minimum holding current for the SCR. Also, approximately 1 mA flows through R_5 and the NE2, causing the lamp to glow.

If the line should fail and then be restored, the SCR would be left in the OFF state, and the NE2 would not be lighted. The SCR can be turned on again by the reset pushbutton switch, S_1 , which discharges C_2 across the gate-cathode junction of the SCR. The ratio of R_1 and R_2 determines

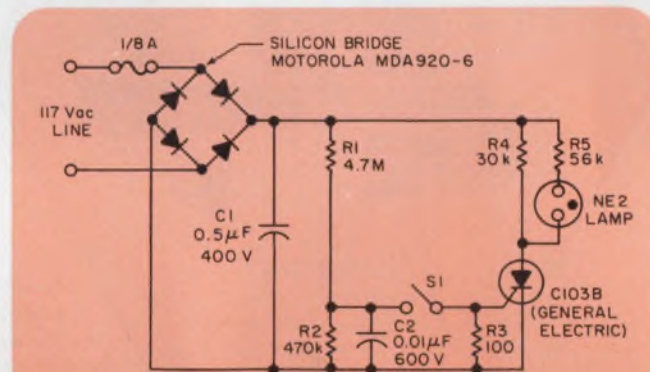

Failure of the ac line extinguishes the NE2 lamp. The lamp will stay off, even after power is restored, until the reset pushbutton, S_1 , is depressed.

the voltage to which C_2 charges, and the large value of R_1 prevents excessive gate current from damaging the SCR if the pushbutton is held down manually. R_3 is made small to prevent false triggering of the SCR.

The size of C_1 determines the number of cycles of 60-Hz drop-out required to trip the system. A minimum size of about 0.3 μF was found to be adequate.

Henry Olson, Research Engineer, Stanford Research Institute, 333 Ravenswood Ave., Menlo Park, Calif. 94025.

VOTE FOR 317

when
it
comes
to
power
supplies



HEWLETT **hp** PACKARD

wrote the books...

... Definitions, principles of operation, load connection, remote programming, performance measurements ... it's all here and more in this 140 page **Power Supply Handbook** ... yours for the asking. Write for your copy.

PLUS...A NEW Power Supply Selection Guide...

This 36 page selection guide lists over 100 power supplies and makes it easy to find and select the right one for your specific application ... Includes ratings, performance, features, prices, options, etc. **For Your Copy Check Number 320.**



HEWLETT **hp** PACKARD

POWER SUPPLIES

100 Locust Avenue, Berkeley Heights New Jersey 07922 • (201) 464-1234

Single differential amplifier shifts phase full 360 degrees

A single differential amplifier (Fairchild's model $\mu A733$), a few resistors and a capacitor provide a simple unity-gain phase-shift network allowing 0 to 360-degree variations. A distinct advantage is the absence of a transformer.

The differential input and output of the amplifier give the normal transformer action required. Phase shifts of 0 to 180 degrees are available with the switch in position 1, and 180 to 360 degrees with the switch in position 2, as shown in Fig. 1.

The combination of R_a , R_b , R_c and the $\mu A733$ yield a unity-gain low-output-impedance amplifier. The equivalent circuit of the network itself is shown in Fig. 2.

With the switch in position 1:

$$\begin{aligned} \text{as } R \rightarrow 0 \quad e_o &= e_i / 0^\circ \\ \text{as } R \rightarrow \infty \quad e_o &= e_i / -180^\circ \end{aligned}$$

Therefore, by varying R , a phase shift of 0 to -180° can be obtained. With the switch in position 2:

$$\begin{aligned} \text{as } R \rightarrow 0 \quad e_o &= e_i / -180^\circ \\ \text{and as } R \rightarrow \infty \quad e_o &= e_i / -360^\circ \end{aligned}$$

Although a full-180-degree phase shift cannot be obtained practically, it is possible to come very close. Also, in order to avoid driving a pure capacitive load, it is necessary to use a small re-

sistance ($20 \Omega \leq R_1 \leq 50 \Omega$), making it impossible to achieve true zero-degree phase.

When designing the circuit, only two preliminary decisions must be made: What value of R_1 should be used, and what maximum (Θ_{\max}) and minimum (Θ_{\min}) angles should be obtained?

Since

$$-\Theta_{\min} = -2 \tan^{-1} \omega CR_1$$

$$\text{or } \tan(\Theta_{\min}/2) = \omega CR_1$$

then

$$C = [\tan(\Theta_{\min}/2)] \omega R_1 \quad (1)$$

Also

$$\Theta_{\max} = -2 \tan^{-1} \omega CR_T$$

$$\text{where } R_T = R_1 + R_2 + R_3,$$

$$\text{or } \tan(\Theta_{\max}/2) = \omega CR_T.$$

Therefore,

$$R_T = [\tan(\Theta_{\max}/2)] \omega C \quad (2)$$

Substituting Eq. 1 into Eq. 2:

we find $R_T = R_1 [\tan(\Theta_{\max}/2)] / \tan(\Theta_{\min}/2)$.

Because R_T depends only on R_1 , Θ_{\max} and Θ_{\min} and not upon ω , it is not necessary to adjust R_T for various operating frequencies; it is necessary only to adjust C . This network has been successfully operated into the 10-MHz region. R_2 provides coarse phase adjustment, and R_3 provides fine phase adjustment.

William Fletcher, Assistant Professor of Electrical Engineering, Utah State University and William Harris, Electrical Engineer, Utah State University, Logan, Utah 84321.

VOTE FOR 318

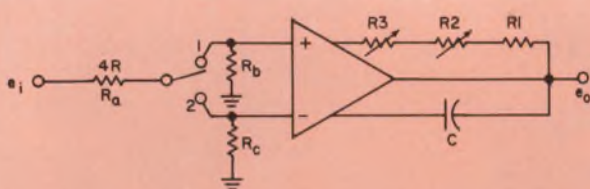

1. A variable phase-shift network offers 0 to 360-degree signal control using only one differential amplifier, a capacitor and resistors.

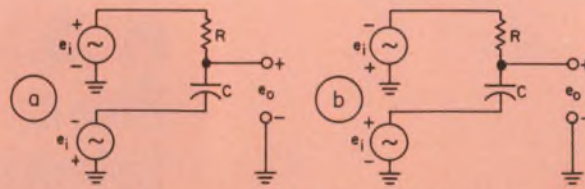

2. The equivalent circuit of phase-shift network shows switch in position 1 (a) or switch in position 2 (b).

IFD Winner for November 22, 1970

Paul C. Krueger, Electronic Consultant, 20 Wabash Ave., Wharton, N. J. 07885. His Idea "Transistor Protects Sensitive Meter Movements" has been voted the Most Valuable of Issue award.

Vote for the Best Idea in this Issue.

VOTE! Go through all Idea-for-Design entries, select the best, and circle the appropriate number on the Reader-Service-Card.

SEND US YOUR IDEAS FOR DESIGN. You may win a grand total of \$1050 (cash)! Here's how. Submit your IFD describing a new or important circuit or design technique, the clever use of a new component or test equipment, packaging tips, cost-saving ideas to our Ideas-for-Design editor. You will receive \$20 for each accepted idea, \$30 more if it is voted best-of-issue by our readers. The best-of-issue winners become eligible for the Idea Of the Year award of \$1000.

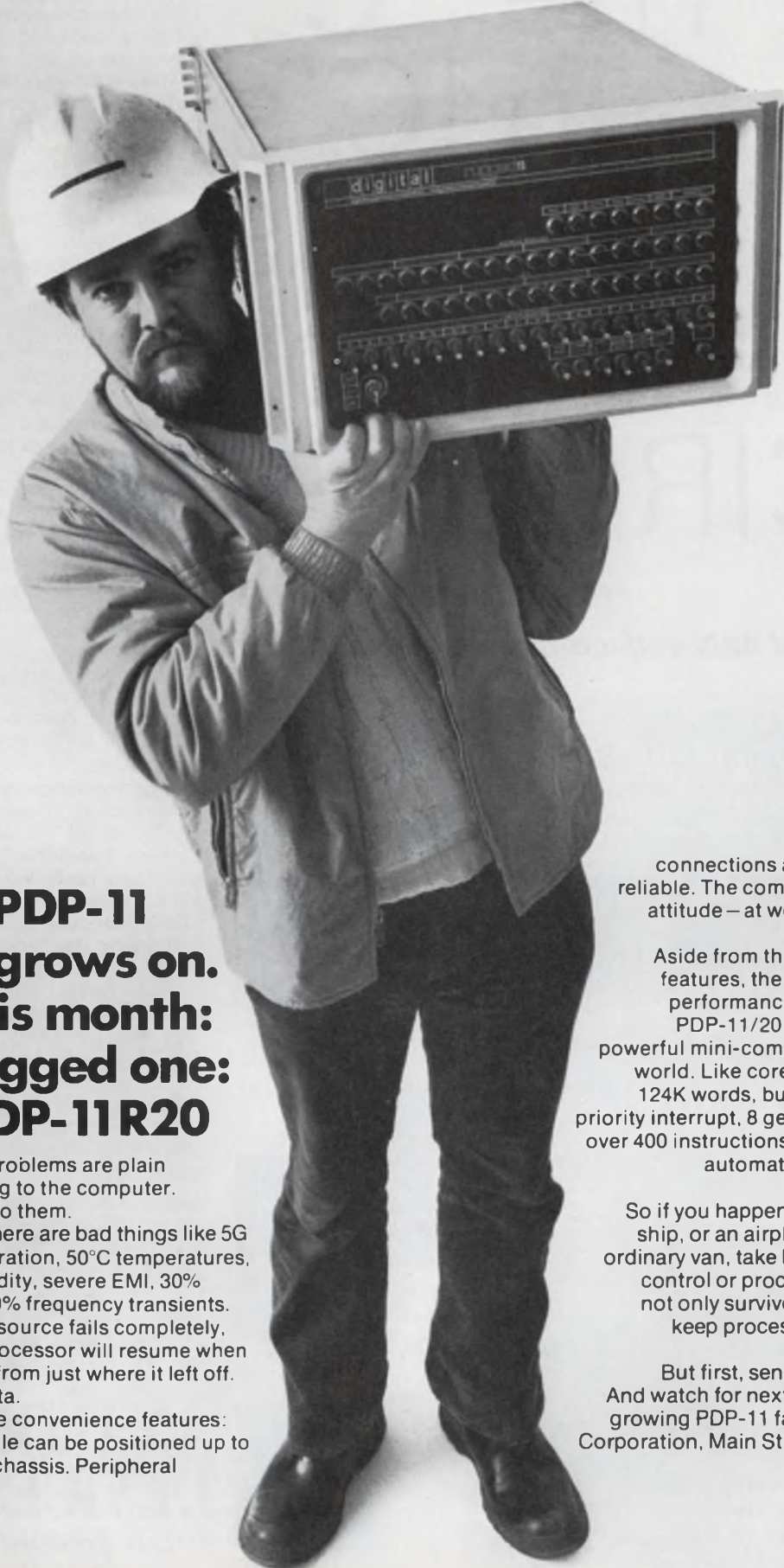

**The PDP-11
family grows on.
This month:
The rugged one:
PDP-11R20**

Some computer problems are plain impossible to bring to the computer. PDP-11R20 goes to them.

Goes where there are bad things like 5G shocks, 500Hz vibration, 50°C temperatures, 95% relative humidity, severe EMI, 30% voltage swings, 10% frequency transients. Even if the power source fails completely, the PDP-11R20 processor will resume when the power does — from just where it left off. You won't lose data.

Then there are convenience features: The control console can be positioned up to 200 feet from the chassis. Peripheral

connections are MIL type — quick and reliable. The computer will operate in any attitude — at weird angles, even upside down if it comes to that.

Aside from these and other protective features, the 11R20 is the same high-performance 16-bit computer as the PDP-11/20 and possesses the most powerful mini-computer architecture in the world. Like core memory expandable to 124K words, built-in multi line and level priority interrupt, 8 general purpose registers, over 400 instructions, direct memory access, automatic power fail and restart.

It goes on and on.

So if you happen to have an ocean going ship, or an airplane, or a tank, or just an ordinary van, take PDP-11R20 to where the control or processing problem is. It will not only survive the environment, it will keep processing in the environment for a long time.

But first, send for the complete story. And watch for next month's addition to the growing PDP-11 family. Digital Equipment Corporation, Main St., Maynard, Mass. 01754. (617) 897-5111.

digital

The "C" in IC's stands for CIRCUITS

—therefore the AD530...

the first and only self-contained IC multiplier.

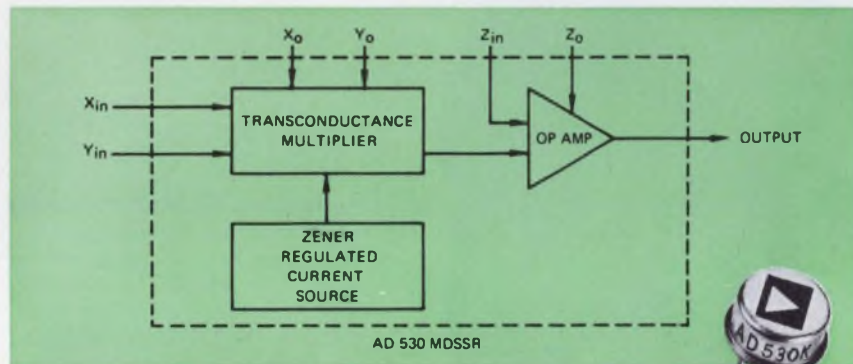

$$\sum \left\{ \begin{array}{l} \text{Linearity} \\ \text{Offset Voltage} \\ \text{Feedthrough} \\ \text{Scale Factor} \end{array} \right\} \leftarrow \text{Accuracy} = \left\{ \begin{array}{l} 1\% \text{ Max. } \dots (\text{AD530K}) \\ 2\% \text{ Max. } \dots (\text{AD530J}) \end{array} \right.$$

PERFORMANCE PARAMETERS

LINEARITY (X INPUT)	0.5%
LINEARITY (Y INPUT)	0.2%
FEEDTHROUGH (X = 0)	0.5%
FEEDTHROUGH (Y = 0)	0.3%
OUTPUT VOLTAGE ($R_L = 2K\Omega$)	$\pm 10V$
FULL POWER BANDWIDTH	500 KHz
SLEW RATE	40V/ μs
SUPPLY CURRENT	4 mA
OFFSET VOLTAGE VS. SUPPLY VOLTAGE	100 mV/V
SCALE FACTOR VS. SUPPLY VOLTAGE	2%/V
OFFSET VOLTAGE VS. TEMPERATURE	0.2 mV/ $^{\circ}C$
SCALE FACTOR VS. TEMPERATURE	0.04%/ $^{\circ}C$
OVERALL ACCURACY VS. TEMPERATURE	0.05%/ $^{\circ}C$



Now that the glamour has worn off the integrated circuit, it's become increasingly clear that more than semiconductor know-how alone is needed to further advance the state of the art. Truly outstanding integrated circuits require exceptional processing skills, including thin-film technology, laser trimming, computer-controlled testing . . . the whole "fourth generation" arsenal . . . and must begin with outstanding circuit design.

One I.C. manufacturer has put it all together, Analog Devices . . . Circuit Specialists. Our new microcircuit facility is one of the very few that is equipped for large-volume fourth-generation processing. It is staffed by the most experienced linear processing and circuit design team ever assembled.

Here's a specific example: The AD530 Multiplier/Divider/Squarer/Square Rooter. The first and only MDSSR that combines the output op amp with a zener regulated current source and transconductance multiplier, all on a single chip . . . a completely self-contained circuit. With four simple trim pots you get performance unmatched by any other I.C. multiplier, and rivalling that of the black boxes.

The performance of the AD530 is not external component limited. The specs of the AD530 are not external component complicated. Check the performance:
AD 530K accuracy, 1% max.
AD5305 accuracy, 2% max.
Full-power bandwidth, 500kHz
Check the ease of operation: write for our Multiplier Engineering Manual that removes the complexities and problems for multiplier use. And while you're at it, get our Fourth Generation Analog I.C. Brochure on the AD530 and six other stunners. Write for them and *join the fourth generation* . . . you can't beat it.

Analog Devices, Inc., Route 1 Industrial Park, P.O. Box 280, Norwood, Mass. 02062. Evaluation units? Certainly! Immediately! Call Stan Harris at (617) 329-4700; TWX (710) 394-6577; and he'll send you up to 5—the 100 piece price.

**ANALOG
DEVICES**
Circuit Specialists

new products

Fast MOS analog drivers switch on in just 90 ns

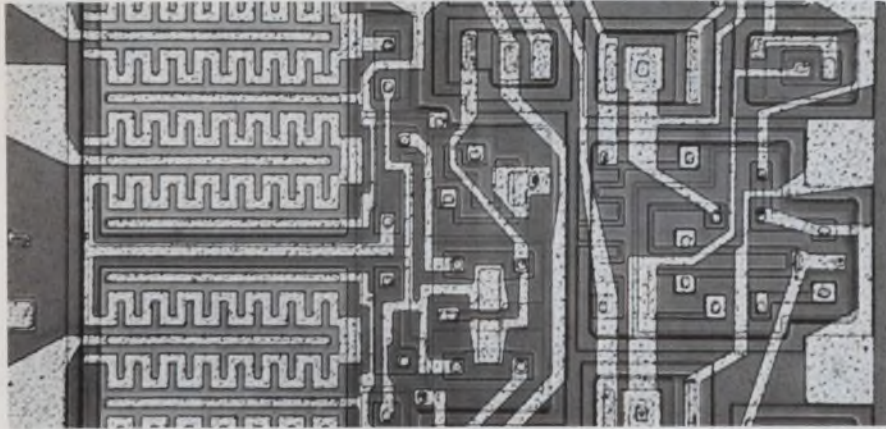

Siliconix, Inc., 2201 Laurelwood Rd., Santa Clara, Calif. Phone: (408) 246-8000. P&A: see text; stock.

Using Schottky diodes, bipolar transistors and MOS FETs, a new series of monolithic MOS analog switch/drivers provide typical switching speeds of 90 ns (ON) and 350 ns (OFF).

The DG171 exhibits typical ON resistance of 25 to 70 Ω , depending upon the analog signal level. The DG175 has 50 to 140 Ω of ON resistance. The DG176 ranges in ON resistance from 100 to 300 Ω .

Other features include compatibility with an analog voltage level of ± 10 V, low power dissipation of 80 mW maximum, excellent open-switch isolation for signals up to 20 MHz (-68 dB at 1 MHz and

-40 dB at 20 MHz in 100- Ω circuits) and TTL compatibility.

When operated with +10, -20 -V supplies, the maximum analog signal range is ± 10 V. However, typical rf or small-signal switching applications with signals up to ± 5 V are adequately handled with +5-V, -15 -V supplies.

These devices, particularly the low-resistance DG171, are well suited for use in high-speed rf/i-f or video-switching applications, such as radar signal processing.

For example, with ± 1 -V rf signals, the DG171 introduces only 2 dB of insertion loss in 100- Ω circuits and only 4 dB of insertion loss in 50- Ω circuits.

All the devices are available in military grades (suffix A) that are processed to MIL-STD 883, Notice 2 (less burn-in) as standard parts. Industrial grades are also available (suffix B) to operate over -20 to $+85^\circ\text{C}$.

The DG171 and DG175 are both available in TO-100 round cans. The DG176 comes in TO-86 flatpacks or in a TO-116 dual-in-line package.

Unit prices for quantities of 100 to 999 are: DG171AA (military, TO-100), \$11.90; DG171BA (industrial, TO-100), \$5.95; DG175-AA, \$15.90; DG175BA, \$7.95; DG176AL (TO-86) and DG176AP (TO-116), \$29.90; DG176BL, \$14.95; and DG176BK (ceramic, TO-116), \$11.95.

CIRCLE NO. 358

TTL one-shot multi resets and retriggers

Fairchild Semiconductor, 464 Ellis St., Mountain View, Calif. Phone: (415) 962-3563. P&A: \$2.30; stock.

The 9600 is a new retriggerable, resettable one-shot TTL multivibrator. It offers systems designers the flexibility of controlling pulse width either by lengthening pulses, by retriggering or by shortening pulses with its reset function.

CIRCLE NO. 359

Plastic MOSFETs come down to 52¢

Motorola Semiconductor Products, Inc., Box 20912, Phoenix, Ariz. Phone: (602) 273-6900. P&A: 54¢, 56¢, 52¢ (1000 units).

Three new dual-gate MOSFETs are available within a 50¢ price range. The MPF120-122 units are 244-MHz 52¢ plastic flatpacks, MPF120 are 105-MHz 54¢ plastic flatpacks and MPF121 are 200-MHz 56¢ flatpacks.

CIRCLE NO. 360

Dual monostables draw just 14 mA

Advanced Micro Devices Inc., 901 Thompson Place, Sunnyvale, Calif. Phone: (408) 732-2400. Price: \$5.25 to \$18.

Two new low-power dual monostable multivibrators, the Am26-L02 and the Am96L02, require only one-fourth the power of conventional units—14 mA at 5.5 V. The one-shots can be triggered either on the rising or falling edge of an input signal.

CIRCLE NO. 361

Quad core driver can carry 500 mA

Sprague Electric Co., Functional Electronic Circuits Operation, 347 Marshall St., North Adams, Mass. Phone: (413) 664-4411.

A new quad high-current core driver consists of four high-speed npn silicon transistors with breakdown voltages of 50 V and a maximum operating current of 500 mA.

CIRCLE NO. 362

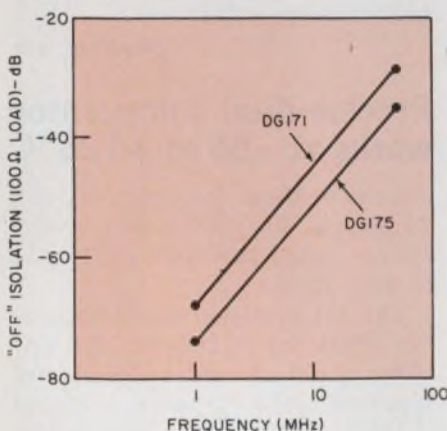

MOS analog switches isolate signals to -68 dB (DG171) and -74 dB (DG175) at 1 MHz.

Line driver/receivers ease data interface

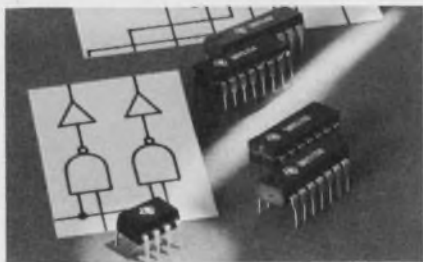

Texas Instruments, Inc., 13500 N. Central Expressway, Dallas, Tex. Phone: (214) 238-2011. P&A: from \$2.70, \$5.40; stock.

Two new modem interface ICs, the dual line driver SN75150 and the quad line receiver SN75154, which meet EIA RS-232C specifications, allow modems to receive and transmit digital information with a minimum number of IC packages.

The SN75150 dual line driver dissipates only 200 to 300 mW and has current-limited outputs for short-circuit protection to ± 25 V. Output voltage levels are ± 6 V and are designed to drive capacitive loads greater than 2500 pF.

The driver is available in an 8-pin dual-in-line package (suffix P). It can also be purchased in a 14-pin dual-in-line ceramic (suffix J) or plastic package (suffix N).

The SN75154 quad line receiver can be operated from either the ± 12 -V supply normally used for telephone lines, or a +5-V supply for DTL/TTL compatibility, without any additional components.

Its features include a 3 to 7-k Ω input resistance, built-in hysteresis for increased noise immunity and an active pull-up on the output for more symmetrical switching speeds.

It is available in 16-pin ceramic and plastic dual-in-line packages. Both line driver and receiver ICs are characterized for operation over the temperature range of 0 to +70°C.

Applications include time-sharing computer services; data processing equipment; short, single-line point-to-point transmission; and level translators. The SN75154 receiver can function as a Schmitt trigger in computer applications, as well.

CIRCLE NO. 363

Tone-decoder chip uses phase-locked loop



Signetics Corp., 811 E. Arques Ave., Sunnyvale, Calif. Phone: (408) 739-7700.

Employing a phase-locked-loop design, the model 567 tone decoder has a current-sinking capability of up to 100 mA when a sustained frequency within its detection band is present at its self-biased input. A saturated transistor output permits the device to drive TTL elements directly. The center frequency is adjustable from 0.01 Hz to 500 kHz. The detection bandwidth is also variable.

CIRCLE NO. 364

Tiny 3-dB coupler has 1/4-dB insertion loss

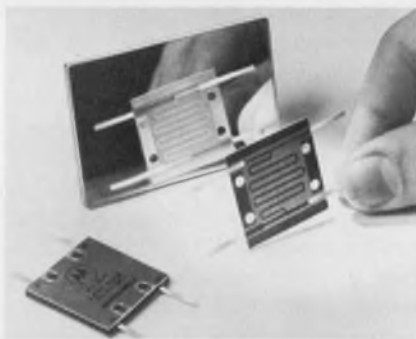

Motorola Semiconductor Products, Inc., Box 20912, Phoenix, Ariz. Phone: (602) 273-6900. Price: \$12.

Multiple-device combining, transmission continuity and mismatch isolation are claimed to be three performance advantages to the uhf designer afforded by the new tiny MIC5830-31 3-dB quadrature coupler. Insertion loss is as low as 0.25 dB and phase balance is ± 1.5 degrees maximum. Usable frequency ranges from 225 to 400 MHz and 450 to 512 MHz.

CIRCLE NO. 365

800-V thyristor SCRs accept 35-A loads

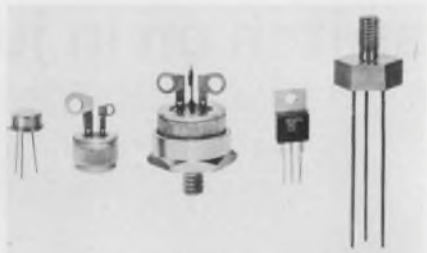

ECC Corp., 1011 Pamela Dr., Euless, Tex. Phone: (817) 267-2601.

A new full line of unilateral power thyristor SCRs features load current ratings from 0.8 to 35 A and voltage ratings from 30 to 800 V. The new line of thyristors have two gate-sensitivity ranges from 1 to 10 mA and 1 to 25 mA. They are available in 10 device packages, seven of which have an electrically isolated tab or case. Non-isolated packages include TO-5, 1/2-in. press-fit and stud types.

CIRCLE NO. 366

96-bit shift register moves data at 2 rates

Ragen Semiconductor, Inc., 53 S. Jefferson Rd., Whippany, N. J. Availability: stock.

Offering a static storage capability of 96 bits, the model MS618 complementary-MOS variable-length shift register can be used as a first-in/first-out buffer so that information can be loaded and extracted concurrently, at different instantaneous rates.

CIRCLE NO. 367

Precise dual comparator works at -55 to +125°C

Advanced Micro Devices, Inc., 901 Thompson Pl., Sunnyvale, Calif. Phone: (408) 732-2400. P&A: \$12 to \$20; stock.

The 111 precision dual comparator offers input bias of 150 nA, offset of 20 nA and a differential input of ± 30 V over -55 to +125°C. It also has a power dissipation of 120 mW at 125°C. The 111 can drive 50-V 50-mA loads.

CIRCLE NO. 368

40 Watt 12.5 Volt

VHF COMMUNICATIONS POWER TRANSISTORS

FEATURING

- Infinite VSWR Capability
- Reliable Output Power at 175 MHz
- Nichrome Emitter Resistors



MT75 CASE

Solitron's new series of VHF RF Power Transistors were designed for FM Mobile, Marine and Radio Telephone Applications, and offer maximum design flexibility. A high gain pre-driver (such as SRD8B212) is less demanding on power supplies. The rugged output units (SRF5B215 and SRD5B216) provide 25W and 40W of reliable power and feature infinite VSWR as well as overvoltage protection. Low input Q makes these RF transistors ideal for broadband applications. They are packaged in the MT 75 case for optimum performance and convenience. Contact us today for engineering application assistance and write for our free catalog of semiconductor and microwave products.

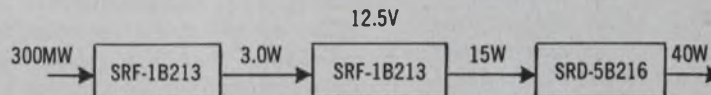

DEVICE	FREQUENCY	Vcc	POWER OUT	GAIN (DB)	Z in (ohms)	Zo* (conjugate) ohms
SRD-8B212	175MHz	12.5V	2.0W	10.0	3.5 + j 2.0	33.0 + j 6.0
SRF-1B213	175MHz	12.5V	15.0W	7.0	2.5 + j 3.0	8.5 + j 5.5
SRF-5B215	175MHz	12.5V	25.0W	5.0	2.0 + j 1.0	5.0 + j 1.0
SRD-5B216	175MHz	12.5V	40.0W	4.5	1.0 + j 2.5	3.5 - j 1.25

Dial 1-800-327-3243 for a "No Charge" telephone call and further information

Solitron

DEVICES, INC.

1177 BLUE HERON BLVD. / RIVIERA BEACH, FLORIDA / (305) 848-4311
TWX: (510) 952-6676

Solitron is next door to you

in Baltimore (301-243-9960); Canoga Park, Calif. (213-883-3822); Chicago (312-824-8127); Dallas (214-341-1180); Needham, Mass. (617-444-1152), and Tappan, N.Y. (914-359-5050).

EUROPE: Solidev Ltd., Tubbs Hill House North Entrance, London Road, Sevenoaks, Kent, England. TEL: (0732) 57541-2-3

ISRAEL: A E.L. Israel Ltd., 51 Hayarkon Street, Bene Baraq. TEL: 78-21-41

JAPAN: Matsushita Electric Trading, 5 Chrome Kawamachi, Hegashi - Ku, Osaka, TEL: (06) 202-1221 or World Trade Centre Bldg., No. 5, 3-Chrome, Shibahamamatsu-cho, Minato-Ku, Tokyo, TEL: (03) 435-4501

There is a difference in Heath Dynamics' Quartz Crystal Filters!

Heath Dynamics specializes in the design and manufacture of the highest quality Quartz Crystal Filters and Discriminators for the Communications Industry.

Our facility is completely new, inside and out, fully staffed and equipped with the most modern mechanical and electronic test measuring devices.

We employ the assistance of one of the largest time sharing computers available.

Heath Dynamics' area of specialization includes the manufacture of miniature and sub-miniature filters in the range of 10 thru 32 Mhz. Bandwidths may be from .025% thru .35% in the smallest packages and may range up to 2.0% in the larger ones.

We manufacture direct replacement filters for all the current monolithic designs using our half lattice configuration which yield lower insertion loss, lower ripple and greater ultimate rejection. Yet our filters cost less and faster delivery is guaranteed!

All Heath Dynamics' crystal filters designed and manufactured to your particular specifications meet Mil F. 18327.

In short, we want your business and we'll act like it. Do us both a favor and send us your print or specification for a quote. If you have any questions just write or call us... we're here to serve you.



**heath
dynamics, inc.**

6050 n. 52nd avenue
glendale, arizona 85301
(602) 934-5234

subsidiary of
Heath International, Inc., Richmond, Mich.

COMPONENTS

Phase-control device is a low-cost lamp dimmer

General Electric Co., Semiconductor Products Dept., Auburn, N. Y. Phone: (315) 253-7321. P&A: see text; 2nd quarter, 1971.

A new device acts to simplify ac phase-control circuitry. It is primarily designed for economical use as a lamp dimmer but can also be used for motor-speed control.

The device, the ST-4, triggers triacs (bi-directional thyristors) in hysteresis (i.e. snap-on) free-phase control circuits, using a minimum-parts circuit.

This triggering function formerly required seven components and an rfi filter. The ST-4 can do this same triggering with only four components and an rfi filter.

This results in appreciable savings in both package size and assembly costs. The ST-4 is housed in a two-lead TO-98 can and is estimated to cost from 50 to 55¢ each, in 1000-lot quantities.

The device contains only four transistors, four zener diodes and two resistors (see illustration).

The principle of the ST-4 hysteresis-free operation is the conversion of the phase-angle shift, resulting from a capacitor's discharge into a triac gate, into a dc voltage shift across the capacitor. This is provided by the asymmetrical, bilateral conduction characteristics of the ST-4.

CIRCLE NO. 369

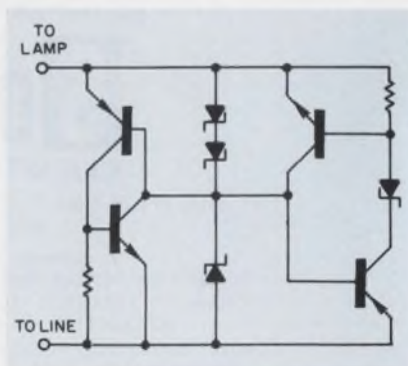

The ST-4 lamp-dimmer circuit uses only four transistors, four zener diodes and two resistors.

Stripline resistors withstand 1 kW peak

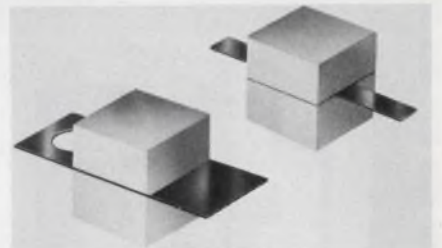

Solitron/Microwave, Filmohm Div., 37-11 47th Ave., Long Island City, N. Y. Phone: (212) 937-0400. P&A: \$50; 1 to 6 wks.

A new series of stripline beryllium-oxide resistors can dissipate powers of 100 W average and 1 kW peak. Standard resistivities are 50, 75, and 100 ohms. The resistors are clamped between the ground planes of the strip transmission line using existing ground plane bolts; the center conductor is then usually soldered to the strip.

CIRCLE NO. 370

Dual-in-line modules contain 17 resistors

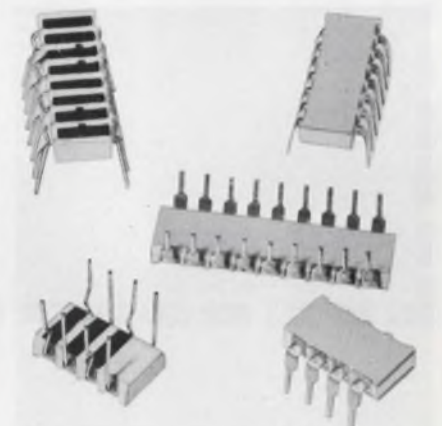

CTS of Berne, Inc., 406 Parr Rd., Berne, Ind. Phone: (219) 589-3111. Price: 35¢ to 55¢.

Series 760 dual-in-line modules house up to 17 cermet resistors. These new resistor networks offer power capabilities of up to 2 W at 70°C. They feature 0.1-in. lead spacing, a low profile, a wide resistance range, and a standard $\pm 5\%$ resistance tolerance. They are supplied in 18-pin flat-lead packages.

CIRCLE NO. 371

Photomechanical reproduction of precision parts is our business

We invented it!

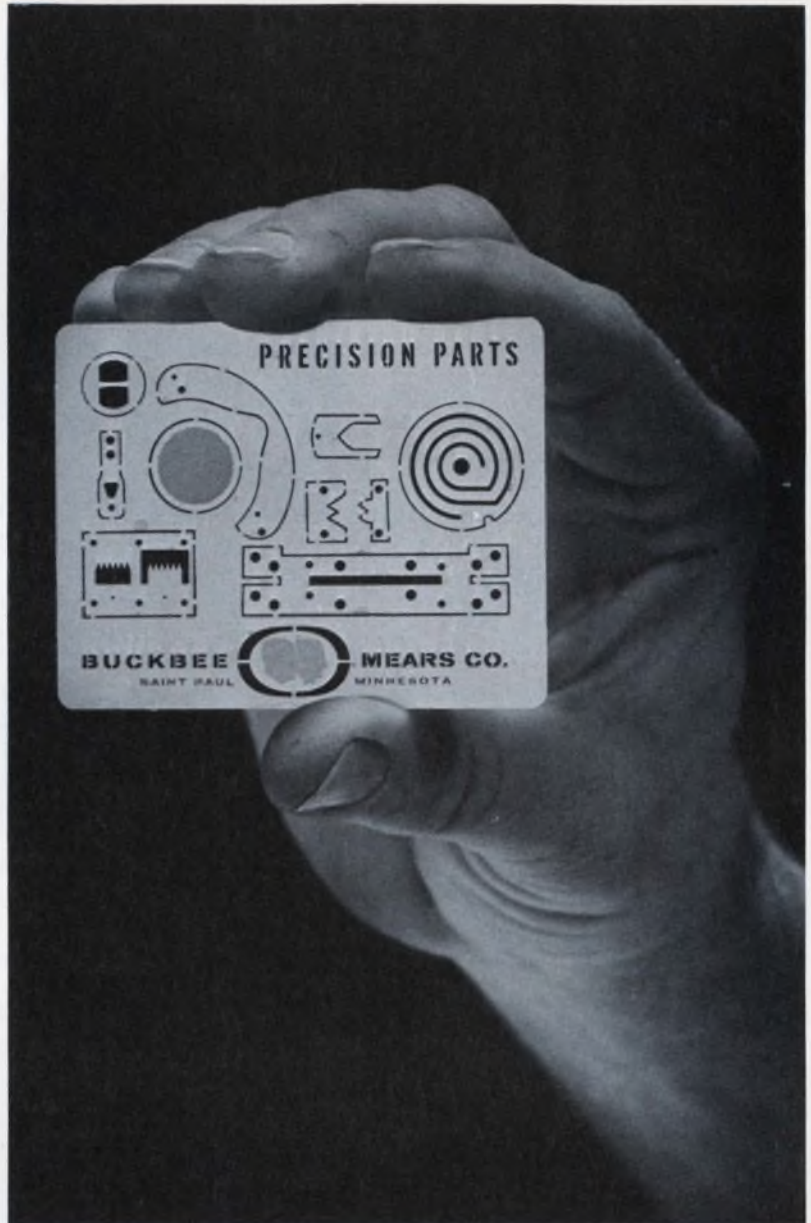

We began precision etching of metal and glass parts for the military during World War II. Today we're the world's largest producer of photo etched metal, glass and electroformed parts. Our new computer-directed automatic plotter is accurate to .001" or better, and it can draw in an hour what would take a draftsman days to do. It's economical, too, because there are no costly dies to make.

METAL ETCHING: We etch round, square, oval or straight holes or lines to tolerances of $\pm .0001$. Currently we are producing shaver grills, hemispheric domes, springs, micro component parts and curved surfaces too complicated for die stamping. We etch mesh, precision circuitry, core loading mats and print out rollers. More than 70 materials have been etched in our plant.

ELECTROFORMING: Our mesh screens go down to four million holes per square inch with accuracy.

Line width tolerances of ± 2 microns are common. Typical production ranges from five to 2,000 lines per linear inch. We electroform copper, nickel, silver and gold. A few standard products include evaporation masks, pin hole apertures, micro-mesh sieves, electron microscope grids, optical wedges, zone plates and a variety of micro-miniature parts.

GLASS ETCHING: We use the same photomechanical techniques in glass etching to provide calibrations and other configurations to tolerances of $\pm .0001$. Straight and cross rulings, calibrated dials, concave and convex reticles, scales, prisms and encoder discs are some of the items we produce in volume.

FREE SAMPLE CARD: The metal card shown on the illustration above contains samples of etched parts we can produce. If you would like one, drop a note to Bill Amundson, Industrial Sales Manager, on your letterhead.

PRECISION METAL AND GLASS ETCHING • ELECTRO FORMING • AUTOMATED DESIGN



SAINT PAUL, MINNESOTA 55101

BUCKBEE-MEARS COMPANY

INFORMATION RETRIEVAL NUMBER 60

Thermistor kit eases design problems

Fenwal Electronics, Inc., 63 Fountain St., Framingham, Mass. Phone: (617) 875-1351. Price: \$19.95.

The G500 thermistor kit contains six standard Uni-Curve interchangeable precision thermistors with resistivities of 3, 5, 10, 30, 50 and 100 k Ω and 25 $^{\circ}$ C. Accuracy of the units is $\pm 0.2^{\circ}$ C over a temperature range of 0 to 70 $^{\circ}$ C.

CIRCLE NO. 372

Second-source LED can dissipate 75 mW

Litronix, Inc., 1900 Homestead Rd., Cupertino, Calif. Phone: (408) 257-7910. P&A: \$1.60; stock.

An infrared light-emitting diode, the IR-Lit 60 (second source for the ME60), offers a power dissipation of 75 mW and a dc forward current of 50 mA. The device can produce an intense narrow-band of radiation that peaks at 900 nm.

CIRCLE NO. 373

Tilting Hg switches come in handy kit

Kahl Scientific Instrument Corp., P. O. Box 1166, El Cajon, Calif. Phone: (714) 444-5944.

The model 8701 engineering kit contains seven tilt-actuated mercury switches that permit the use of a variety of mechanical movements to control electrical circuits. The samples range from vertical and horizontal-inclination types to rotation-sensitive styles.

CIRCLE NO. 374

Match-box attenuators are 2 by 2 by 1/2 in.

MDC Instruments, Inc., 11822 W. Jefferson Blvd., Culver City, Calif. Phone: (213) 391-8308. Price: \$9.50 (L-pad), \$15 (ladder).

Six new Min-Dek attenuators that measure only 2 by 1 by 1/2 in. include four L-pad types with attenuation ratios from 10 to 1000. Two ladder types have fixed inputs of 600 Ω and a maximum attenuation range of 100 dB.

CIRCLE NO. 375

Visible LED costs just 49¢

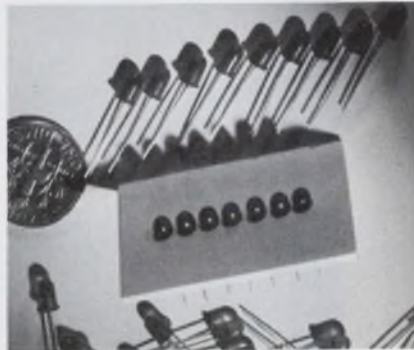

Texas Instruments Inc., Components Group, P. O. Box 5012, Dallas, Tex. Phone: (214) 238-2011. P&A: 49¢; stock to 6 wks.

Designated the TIL209, a visible light-emitting diode is priced at 35¢ in quantities of 25,000 and at 49¢ for quantities of 100 to 4999. The device is housed in a molded red plastic package with an integral dome-shaped lens. An epoxy filler in the lens permits the LED to emit a diffused light from the entire lens area.

CIRCLE NO. 376

Tiny low-cost timers turn green to indicate



Raytheon Co., Industrial Components Operation, 465 Centre St., Quincy, Mass. Phone: (617) 479-5300. P&A: \$1; 90 days.

Inexpensive miniature timers indicate a wide range of preset elapsed times by a vivid color change. The units, which resemble flashlight bulbs, are filled with an electrolyte whose color changes from yellow to green when a current-time product of 6000 micro-ampere-hours has expired. Elapsed times of 50 to 1000 hours can be indicated with 3% accuracy.

CIRCLE NO. 377

Metal-film resistors meet MIL-R-10509

Mepco, Inc., Morristown, N. J. Phone: (201) 539-2000. Price: 3.5¢ to 18¢.

Two new metal-film resistors are designed to meet military specification, MIL-R-10509—one is the MR54 for military applications and the other is MR52 for industrial use. For both units, resistance ranges from 10 ohms to 1 M Ω . All resistors are conformal coated.

CIRCLE NO. 378

Economy servomotor develops high torque

Axial Corp., Magnedyn Div., 5580 El Camino Real, Carlsbad, Calif. Phone: (714) 729-7191. Price: \$39.50.

Costing only \$39.50, a 3-in.-diameter dc motor produces 100 oz-in. of torque performance to bring high-torque performance to precision servo applications, and yet has a weight of only 23 oz.

CIRCLE NO. 379

Miniature capacitors yield up to 100 nF

Vitramon, Inc., P. O. Box 544, Bridgeport, Conn. Phone: (203) 268-6261. P&A: 28¢ to 60¢; stock.

Capable of withstanding 525 $^{\circ}$ F for 60 s, new miniature axial-lead ceramic capacitors offer standard capacitances from 10 through 100,000 pF in NPO and general-purpose dielectrics. Dimensions range from 0.2 by 0.065 by 0.065 in. to 0.016-in.-diameter by 1.25-in. long.

CIRCLE NO. 380

Power ceramic chips boost capacitance by 5

Monolithic Dielectrics, Inc., P. O. Box 647, Burbank, Calif. Phone: (213) 848-4465. P&A: from 0.07¢; stock to 2 wks.

Intended for use in hybrid, high-voltage, and rfi/emi applications, a new line of NPO ceramic chip capacitors reportedly offer five times the capacitance of other competitive designs. Temperature coefficient is less than ± 20 ppm/ $^{\circ}$ C.

CIRCLE NO. 381

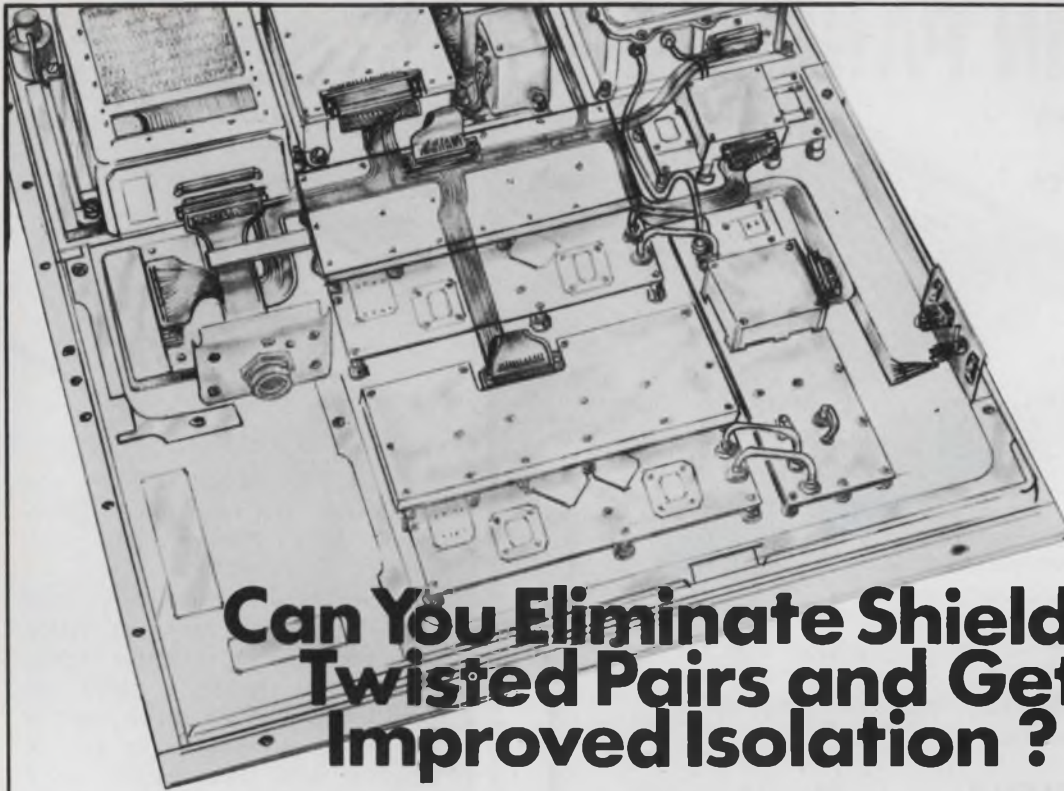

Can You Eliminate Shielded Twisted Pairs and Get Improved Isolation ?

**Yes, with
Teledyne
Electro-Mechanisms'
Flexible Etched
Cable!**

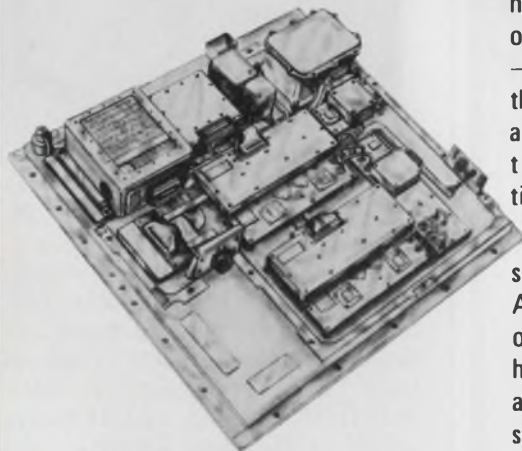

 **TELEDYNE
ELECTRO-MECHANISMS**
29 Crown Street
Nashua, N.H. 03060

The new AN/APN-200 Doppler Ground Velocity Sensor for the Navy S-3A Antisubmarine Patrol Aircraft has several design improvements that, says its manufacturer, "...we think gives the Navy the best and most reliable Doppler navigation system ever."

The new DGVS has among its many improvements a new etched flexible cable interconnect that has no shielded twisted pairs but meets or exceeds its signal isolation criteria — quite a feat when you consider that the harness carries lo-level audio and 6-MHz serial data in a 36-pulse train having 15-nanosecond rise times.

Early in the breadboard phase, designers realized that the AN/APN-200 package weight was dangerously close to its design limit. After harness spares and other contingency allowances had been made, available space and weight envelopes were used up. Because a traditional wire harness would result in further weight and space penalties and also hamper service and repair proce-

dures, designers turned to flexible etched cabling.

Although etched flexible cabling is accepted as an efficient interconnect technique where weight and space are critical, engineers were not sure that the required degree of isolation could be achieved with flexible cable.

In eleven weeks we designed and fabricated an etched flexible harness that exceeds every engineering specification. Isolation of sensitive lines is almost perfect, and because of the harness' totally engineered efficiency, package weight has been reduced by three pounds.

The finished system harness is virtually invisible and occupies only a fraction of the available growth space between subassemblies. Assembly and test economies make the flexible etched harness less costly than a traditional harness.

We have solved countless other interconnection problems like this one. Write for our free Design Guide — it's full of good ideas and contains design and fabrication tips that can help you with your own particular interconnection problem.

PLUG IN PANELS

STANDARD RACKS,
BACK PANELS
AND ENCLOSURES
AVAILABLE

For 14 and 16 Lead DIP's

60 patterns-standard catalog items.
Also available in universal style for LSI.

Mates with Augat's 120 contact edge connector. Wire wrap termination on .100 inch centers.

High density IC patterns with power and ground planes connected to each pattern.

Machined contacts assure high reliability and retention.
Complete wire wrap service.

IC PACKAGING PANELS

Request Catalog 266

AUGAT
INC.

TEL: 617-222-2202
31 PERRY AVE., ATTLEBORO, MASS. 02703



INFORMATION RETRIEVAL NUMBER 62

UNIVERSAL

GREATER FLEXIBILITY —
ACCEPTS ALL I. C.
PACKAGES

Point to point
wiring saves time,
space and money

Available in multiples of 9 row sections
up to 54 rows, as standard catalog item.
Each 9 row section accepts 3 plugs for interfacing
or input-output connections.
Double sided board with power and ground planes connected to
additional wire wrap terminations outside of contact row.
Changes and replacements made at component level.
Complete wire wrap service.

IC PACKAGING PANELS

Request Catalog 266

AUGAT
INC.

TEL: 617-222-2202
31 PERRY AVE., ATTLEBORO, MASS. 02703

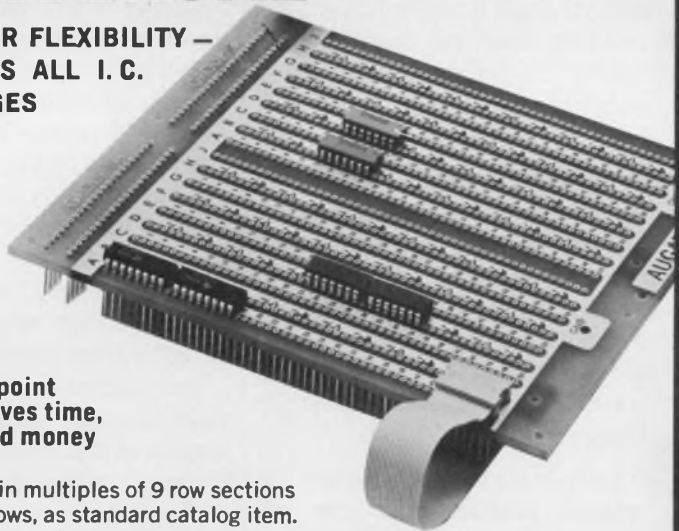

INFORMATION RETRIEVAL NUMBER 63

COMPONENTS

Indicator lights simplify mounting



Industrial Devices, Inc., Edgewater, N. J. Phone: (201) 943-4084.

Mirror-finish chrome-plated steel bezels permit fast easy installation of a new line of indicator lights. Series 2640 Omni-Glo lights use neon lamps with a built-in resistor for service to 250 V, or can be supplied with incandescent lamps for low-voltage operation. Their nylon housing easily snap-fits into a 1-in.-diameter hole. The units have an average operating life of 10,000 hours.

CIRCLE NO. 382

Hall-effect switches widen operating range

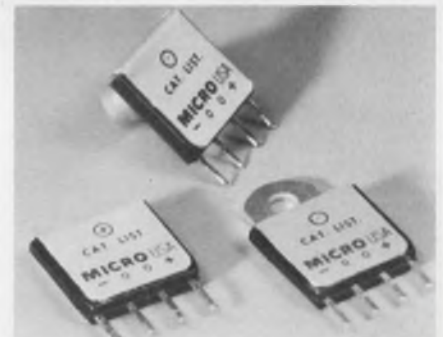

Micro Switch Div., Honeywell, Inc., 11 W. Spring St., Freeport, Ill. Phone: (815) 232-1122.

Three new Hall-effect solid-state switches with magnetic-flux concentrators and improved mountings can operate at greater distances than was previously possible. Models 1SS2, 1SS3, and 1SS4 are silicon integrated circuits that produce a switching action when a magnetic field is applied. They are said to have practically unlimited life.

CIRCLE NO. 383

1-A rotary switch mounts on PC board

Grayhill, Inc., 561 Hillgrove Ave.,
La Grange, Ill. Phone: (312) 354-
1040. P&A: \$5.60; stock.

A new 1-A rotary switch, model
42, features terminals designed for
direct mounting on printed circuit
boards. The unit is rated to make
and break 1-A resistive loads at
115 V ac. Its life expectancy is
100,000 cycles of operation.

CIRCLE NO. 384

Thick-film resistors give 1000 M Ω /in.²

Airco Speer Electronics, Packard
Rd. at 47th St., Niagara Falls,
N. Y. Phone: (716) 285-9381.

Mutli-megohm tapped resistors
on flat substrates employ thick-
film resistor compositions that
provide values as high as 1000
megohms per square inch. Primari-
ly intended for high-voltage circuit
applications, the units are reported
to offer good voltage and tempera-
ture stability.

CIRCLE NO. 385

Ten-turn potentiometer features 3/4-in. length

Spectrol Electronics Corp., 17070
E. Gale Ave., City of Industry,
Calif. Phone: (213) 964-6565.

A new 10-turn wirewound poten-
tiometer measures just 7/8 in. in
diameter and only 3/4 in. in length.
Model 534 is said to have a rugged
integrated construction with no
glued joints, superior stop
strength, and a high power rating.

CIRCLE NO. 386

Precision metal-film resistors hold 5 ppm/°C

TRW Inc., IRC Burlington Div.,
Box 887, Burlington, Iowa. Phone:
(319) 754-8591. P&A: 40¢ to
\$1.96; stock.

AR series of ± 1 to $\pm 0.02\%$
metal-film resistors features tem-
perature coefficients of ± 15 , ± 10
and ± 5 ppm/°C. They come in 4
sizes: 1/20 W (50 Ω to 50 k Ω),
1/10 W (50 Ω to 100 k Ω) 1/8 W
(50 Ω to 225 k Ω) and 1/4 W
(50 Ω to 499 k Ω).

CIRCLE NO. 387

the Giant Killer strikes again...



New Heath SM-105A

\$350.00*

ASSEMBLED
& TESTED

- 10 Hz to over 80 MHz range
 - 5-digit LED readout
 - Advanced design — new Texas Instruments 74S Series superspeed Schottky TTL
 - Wide range input without adjustment
 - 1 megohm input
 - Crystal clock
- Send for free SM-105A spec sheet...
and watch the giants fall!

SM-105A SPECIFICATIONS — Sensitivity: 100 mV RMS to 50 MHz; 250 mV RMS, 50 MHz to 80 MHz. Frequency Range: 10 Hz to 80 MHz. Input Impedance: 1 Megohm shunted by less than 15 pF. Overload: 50 V RMS from 10 Hz to 15 MHz; from 15 MHz to 80 MHz derate linearly at 0.8 V RMS/MHz from 50 V RMS. Maximum DC input is ± 50 V. Time Base: 1 MHz ± 2 Hz. 0° C to 40° C ambient, ± 10 ppm. Readout: Five 7-segment light-emitting-diode displays. One single light-emitting-diode for overrange. Overrange: Flashing, 40 ms on, 60 ms off. Power Requirements: 120/240 VAC, 12 watts. Dimensions: 9 3/8" D x 6 3/4" W x 2 1/4" H. Net Weight: 3 1/2 lbs. Shipping Weight: 6 lbs.

FREE HEATH SCIENTIFIC INSTRUMENTATION CATALOG

Investigate these and other
new ideas in Spectroscopy,
Digital Instrumentation, Lab
Equipment and Test Equip-
ment. Send for your FREE
catalog now.

HEATH COMPANY, Dept. 520-28
Benton Harbor, Michigan 49022

 **HEATH**
a Schlumberger company

Please send free Heath Scientific Instrumentation Catalog

Name _____

Address _____

City _____

State _____

Zip _____

*Mail order prices; FOB factory.

Prices & specifications subject to change without notice. EK-296

INFORMATION RETRIEVAL NUMBER 64

DVMs and DMMs sport LED displays



United Systems Corp., 918 Woodley Rd., Dayton, Ohio. Phone: (513) 254-6251. Availability: 4 to 8 wks.

Now available is a new family of LED-readout voltmeters, millivoltmeters, multimeters, and thermocouple thermometers. The instruments feature guarded inputs, full 4-1/2-digit displays and BCD outputs as standard equipment. The basic dc accuracy of the voltmeters and multimeter is 0.02% of reading. The voltmeters are available with autoranging and resolutions of 1 μ V.

CIRCLE NO. 388

21-range DMM boasts a \$195 price



Esterline Angus Div. of Esterline Corp., Box 24000, Indianapolis, Ind. Phone: (317) 244-7611. P&A: \$195.50; stock.

Priced at \$195.50, the DM3550 digital multimeter has 21 switch-selectable measurement ranges: eight ac voltage and current, eight dc voltage and current and five resistance ranges. It measures in 10-mV and 10- μ A steps at an accuracy of 1% with 10% of overrange on all scales. A decimal point positions automatically.

CIRCLE NO. 389

Quad-output supply delivers 0.1 to 36 V

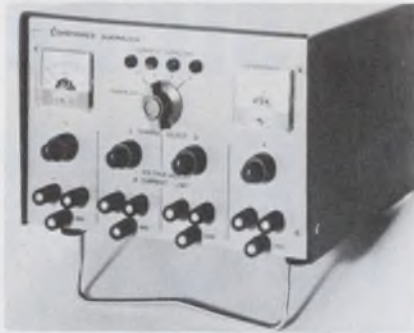

Computer Measurements, Inc., 1645 W. 135th St., Gardena, Calif. Phone: (213) 532-9752. P&A: \$395; stock.

Actually four completely independent and isolated power supplies on one compact half-rack package, the CPS 400-1 power supply features four separate outputs that are adjustable from 100 mV to 36 V. The outputs can be either positive or negative, and each one has a 1-A capacity. Adjustable current limiting, 0.05% regulation, and less than 5 mV of ripple and noise are other features.

CIRCLE NO. 390

\$390 pulse generator has output for ICs



Data Dynamics Div., 240 Humphrey St., Englewood, N. J. Phone: (201) 567-5300. P&A: \$390; stock.

Designed specifically for use with integrated circuits, the model 5109 10-MHz pulse generator, which sells for \$390, offers three separate outputs. Each of the outputs has a nominal risetime and falltime of less than 4 ns. One is a positive output, the second is a negative output, and the third is an IC-compatible output for TTL, RTL and DTL ICs.

CIRCLE NO. 391

Regulated supplies produce 5 to 42 A

Alpha Scientific, sub. of Systron-Donner Corp., P.O. Box 2044, Oakland, Calif. Phone: (415) 635-2700. Price: \$420 to \$695.

Rated at 5 to 42 A, a complete line of medium-current dc power supplies provide a voltage regulation of 0.01% and a current regulation of 0.05%. Series 3550 units have a maximum ripple of 1 mV rms and 10 mV peak.

CIRCLE NO. 392

Recorder accessory records off-scale data

Cahn Instruments, 7500 Jefferson St., Paramount, Calif. Phone: (213) 634-7840. Price: \$495.

The Automatic Range Expander enables strip-chart recorders to record off-scale data. It automatically returns the recorder pen to zero when it begins to go off scale and counts and displays the number of times such displacements occur.

CIRCLE NO. 393

Digital ohmmeter can resolve 10 $\mu\Omega$

General Oceanology, Inc., Dynacontrol Div., 27 Moulton St., Cambridge, Mass.

Measuring resistance with a voltage as low as 5 mV, a new digital ohmmeter features a dynamic range of 10 $\mu\Omega$ to 20 M Ω . Model R-104 has a 4-1/2-digit readout and 100% overranging. Its sampling rate is 2 or 10 readings per second.

CIRCLE NO. 394

Logic function tester expands with needs

Membrain, Ltd., 344a Holdenhurst Rd., Bournemouth, England.

Designed to check digital function modules and printed circuit cards, the model MB 1000 logic function analyzer provides a method of functional testing that can grow with the complexity of larger and more densely packaged future circuits. It uses simple English-language software programming.

CIRCLE NO. 395

Worldwide Service and Prompt Delivery for Quartz, Lucalox® and Electronic Glass Products



Fused Quartz is produced by General Electric with the most complete and advanced technical resources available today. Ample evidence of our capability is this 7,645 pound ingot of clear fused quartz. Along more conventional lines, GE offers Type 124 quartz for application in the semi-conductor industry, in reflective optics, and for optical flats. Type 124 features economy in combination with

high purity, plus prompt delivery of large size ingots. Another GE product, Type 125, is produced in smaller sizes for applications requiring excellent optical properties and is free of large bubbles. Both Types 124 and 125 are General Electric specialties. For laboratory applications, General Electric Type 204 clear fused quartz tubing is available in three and four-foot lengths from stock.

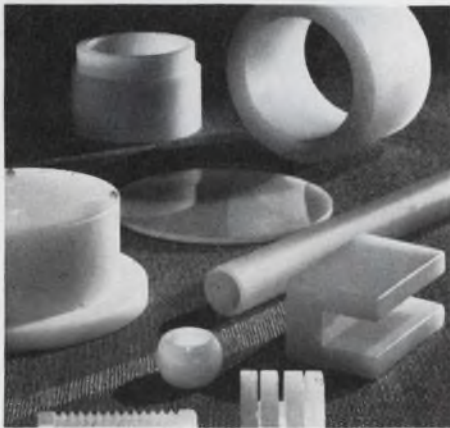

Lucalox®, a highly versatile polycrystalline alumina ceramic, has an extensive number of applications in the chemical, electronic, microwave and high temperature fields. Readily fabricated to complex specifications, Lucalox applications include use as insulators . . . guides . . . microwave windows . . . bearings . . . gyros. Lucalox has high dielectric strength, purity, plus transmission capabilities of up to 90% of total light in the visible spectrum. Standard tubing, rod, plates and discs are available from stock.



Electronic Glass from General Electric is available in a wide variety of shapes. Applications for the electronic and associated industries include TV repair necks



. . . electronic tubing . . . tubing blown miniature bulb blanks . . . subminiature radio tube blanks . . . receiving tube blanks . . . beads and brazing pellets . . . electronic tube flares . . . pressed ware . . . re-draw tubing. General Electric research and technical representatives are always ready to work with customers on specific applications. And at General Electric we welcome new challenges.

WORLDWIDE SERVICE. For sales and application assistance, contact your nearest regional office:
CALIFORNIA, Los Angeles . . . (213) 723-2541
CALIFORNIA, San Jose . . . (408) 298-4126
MASSACHUSETTS, Boston . . . (617) 332-6200
NEW JERSEY, Newark . . . (201) 824-5200
OHIO, Cleveland . . . (216) 266-4001
CANADA, Toronto . . . (416) 537-4481

Write for illustrated technical literature.
LAMP GLASS DEPARTMENT
GENERAL ELECTRIC COMPANY
24400 Highland Road
Richmond Heights, Ohio 44143

GENERAL  **ELECTRIC**

INFORMATION RETRIEVAL NUMBER 65

NEW VACTEC VACTROLS

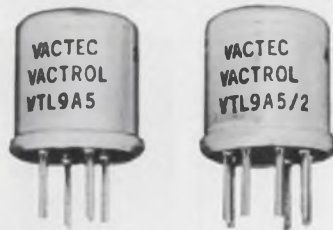

GENERAL PURPOSE PHOTON ISOLATORS

Both single and dual cell units are available in combinations with incandescent or neon lamps in a low cost aluminum case.

New Vactec Vactrols provide a wide range of control in the on-off mode or in proportional control circuits. Applications include photochoppers, DC isolators, noiseless switching, automatic gain controls, audio limiting and compression, SCR and Triac firing, audio effects, computer interfacing, and others.

MAXIMUM RATINGS

Maximum case dissipation (5)	400 mW — derate 10 mW/°C above 35°C — case
Maximum cell power	200 mW — derate 4 mW/°C above 25°C — case
Isolation voltage	500V
Thermal resistance — case to ambient	40°C/W
Ambient temperature	-40°C to + 75°C

SPECIFICATIONS @ 25°C

Part Number	LAMP		PHOTOCELL RESISTANCE — OHMS (3)		Cell Volts (max)
	Volts	mA	ON	OFF	
			Light Adapted (max)	(min)	
INCANDESCENT TYPES					
VTL9A1	1.5	50	400	10 ⁷	100
VTL9A2	6.0	40	60	10 ⁷	100
VTL9A3	10	14	250	10 ⁷	100
VTL9A4	10	22	300	10 ⁷	100
VTL9A5	10	22	1500	10 ⁷	200
VTL9A9	6.0	40	200	10 ⁷	300
VTL9A10	10	14	800	10 ⁷	300
VTL9A11	12	25	600	10 ⁷	300
NEON TYPES EXTERNAL RESISTOR REQUIRED					
VTL9B6	125 VDC*	1.5	300	10 ⁶	200
VTL9B7	125 VDC*	1.5	800	10 ⁷	300
VTL9B8	80 VDC*	.3	2000	10 ⁷	300

*Breakdown V.

For complete details and specifications, write for new Bulletin VTL 9 today!

Vactec manufactures a complete line of hermetic Vactrols with LED's or standard lamps. ALL Vactec production, including Vactrols, CdS & CdSe cells, and photovoltaic cells is confined entirely within the United States. Advanced mechanized techniques provide highest quality at prices competitive with other manufacturers anywhere in the world.



VACTEC, INC.

2423 Northline Ind. Blvd.
Maryland Heights, Mo. 63043
Phone (314) 872-8300

INFORMATION RETRIEVAL NUMBER 66

INSTRUMENTATION

50-MHz scope system sells for \$2200



Tektronix, Inc., Box 500, Beaverton, Ore. Phone: (503) 644-0161. P&A: \$2200; stock.

The 50-MHz 7403N mainframe with the 7B53N time base and the 7A18 amplifier plug-ins offers a 6-1/2-in. CRT, 5-mV dual-trace, delaying and mixed sweep and 2% accuracy for a \$2200 price. A third plug-in compartment is also included. The scope has vertical-mode switching and versatile triggering. Sweeping is available at a 5-ns rate. The R7403N is a rackmount version.

CIRCLE NO. 396

Three-MHz generator phase-locks 0 to 360°



Microdot, Inc., Instrumentation Div., 220 Pasadena Ave., S. Pasadena, Calif. Phone: (213) 682-3351.

A new 3-MHz waveform generator with triggered/phase-locking capability features 0 to 360 degrees of phase-locking. The Model F240A has a front-panel meter which indicates the phase angle relationship of the output signal to an external standard. When it is phase-locked with a frequency standard, the F240A will produce sine, square, triangle, ramp and offset sine waves.

CIRCLE NO. 397

Remote-control decoder responds to Touch-Tone

Bramco Controls, div. of Ledex Inc., College & South St., Piqua, Ohio. Phone: (513) 773-8271. Price: \$415 to \$540.

Able to be remotely controlled, the model MD47C multi-function decoder is designed to respond to each of the twelve audio tone signals used in standard pushbutton Touch-Tone telephones. Switching is accomplished by relays.

CIRCLE NO. 398

\$3000 CRT display is interactive

Lear Siegler, Inc., Electronic Instrumentation Div., 714 N. Brookhurst St., Anaheim, Calif. Phone: (714) 774-1010. Price: \$3000.

Available in two versions, the model 7700 interactive CRT display terminal can present 1000 characters (40 characters per line, 25 lines) or 2000 characters (80 characters per line, 25 lines). Both versions are self-contained.

CIRCLE NO. 399

Calculator programmer expands problem solving

Cintra, Inc., 1089 Morse Ave., Sunnyvale, Calif. Phone: (408) 731-3630. P&A: \$1495; 30 days.

A new programmer can handle looping, branching, editing and storing of programs for use with the Scientist 909 and Statistician 911 computing calculators. The combination of the 909 or 911 and the 926 allows the solution of most scientific problems.

CIRCLE NO. 400

Modem test set eases data testing

International Data Sciences, Inc., 100 Nashua St., Providence, R. I. Phone: (401) 274-5100.

The new model 1200 modem test set tests both synchronous and asynchronous modems, multiplexers and digital transmission systems. It features bit or block-error counting, a bias distortion meter, an independent transmitter and receiver data-rate capability.

CIRCLE NO. 401

Mil-Spec reliability

in a speck of a solid tantalum capacitor



New Nytronics subminiature solid tantalum capacitors.

We put our MIL-type manufacturing know-how to work to bring you these subminiature solid electrolyte tantalum capacitors. They're produced with the same rigid specs, the same uniform quality as our MIL types. Mylar casing and epoxy end-fill assure excellent outer insulation. We can deliver them in both cylindrical (CMS) and rectangular (RMS) configurations. They're ideal for high density packaging, thick or thin film applications. Available with radial or axial leads.

Capacitances range from .001 to 220 microfarads with voltage ranges up to 50 VDC.

Write for catalog sheets. Or call (803) 393-5421.



Nytronics, Inc.

THE QUALITY LINE OF STANDARD COMPONENTS

ORANGE STREET, DARLINGTON, S. C. 29532 • (803) 393-5421 • TWX 810-665-2182

INFORMATION RETRIEVAL NUMBER 67

1 / %
AMERICAN MADE

Tolerance
SCHAUER
1-Watt
ZENERS

**Immediate Shipment
Low Prices**

ANY voltage from 2.0 to 18.0

Quantity	Price each
1-99	\$1.07
100-499	.97
500-999	.91
1000-4999	.86
5000 up	.82

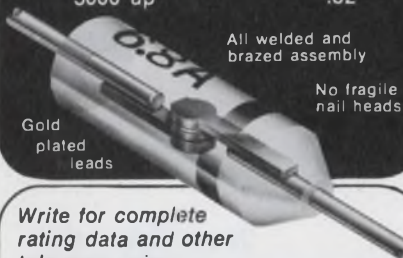

All welded and
brazed assembly

No fragile
nail heads

Gold
plated
leads

Write for complete
rating data and other
tolerance prices.

**Buy the kit-
Save
a lot**



Kit contains a 51-piece assortment of SCHAUER 1% tolerance 1-watt zeners covering the voltage range of 2.7 to 16.0. Three diodes of each voltage packaged in reusable poly bags. Stored in a handy file box. Contact your distributor or order direct.

A \$54.57 value for
ONLY \$24⁵⁰

Semiconductor Division

SCHAUER
Manufacturing Corp.

4511 Alpine Ave. Cincinnati, Ohio 45242
Telephone: 513/791-3030

DATA PROCESSING

**Picture monitor
performs to 6 MHz**

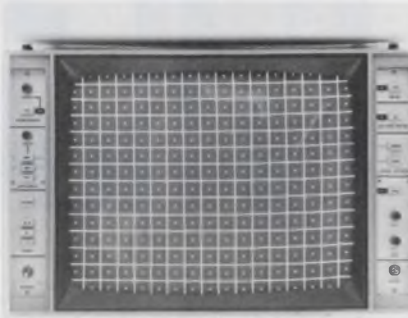

Tektronix, Inc., P. O. Box 500, Beaverton, Ore. Phone: (503) 644-0161. Availability: Third quarter/1971.

Besides unity interlace for optimum display resolution, a new monochrome picture monitor features a flat response to 6 MHz at full picture drive. Model 630 also offers dc-coupled deflection circuits for a bounce-free raster. All supplies are regulated to assure stability of the picture display, and there is a switchable chroma filter.

CIRCLE NO. 402

**Microfiche viewer
costs as low as \$80**



Stromberg DatagraphiX, Inc., Box 2449, San Diego, Calif. Phone: (714) 283-6531. P&A: \$145; May, 1971.

The compact 17-lb model 1400 microfiche viewer has a single-unit price of only \$145 and can be bought for as low as \$80 (1000-unit lots). It comes in two models: one for 24X fiche; the other for 42X fiche. The screen size is 9 by 11-3/4-in. and comes in a choice of blue or gray colors. The viewer's projection lamp and supporting circuitry are located in a slide-out drawer.

CIRCLE NO. 403

**Miniature computer
retails at just \$3250**

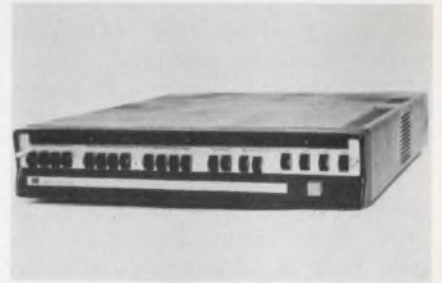

Microdata Corp., 644 E. Young St., Santa Ana, Calif. Phone: (714) 540-6730. Price: \$3250.

A small and inexpensive but powerful micro-computer, the Micro 400, is a programmable general-purpose unit priced at \$3250 for a 1k core configuration. The new computer weighs 23 lbs and is provided with extensive software support packages which include an assembler, Teletype, an editor, loaders and processor and I/O diagnostics. Available are 123 basic and 50 optional instructions.

CIRCLE NO. 404

**Alphanumeric display
shows graphics too**



ITT Data Equipment and Systems Div., East Union Ave., East Rutherford, N. J. Phone: (201) 935-3900. P&A: \$9000; Second quarter/1971.

The Graphscope is a graphic-plus-alphanumeric display system costing less than \$9000. Graphic or alphanumeric operation is selected by simple program keys. In addition, alphanumeric and graphical information can be displayed simultaneously. There can be up to 16 graphs per screen; each graph can display 74 points.

CIRCLE NO. 405

relays... general purpose, sensitive, miniature, mechanical and magnetic latching

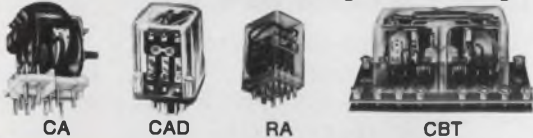

stepping switches...



NEW
RTM miniature
— 2 pole,
10 or 12
position



RT rotary
— 1, 2, &
4 pole

accessories...

plugs, sockets and dust covers



HIGH QUALITY • LOW COST • IMMEDIATE DELIVERY
SEND FOR FREE CATALOGS



1140 Broadway, New York, New York 10001 Tel: (212) 683-0790

INFORMATION RETRIEVAL NUMBER 69

New! FAIR-LINE* Series
MODULAR ENCLOSURES

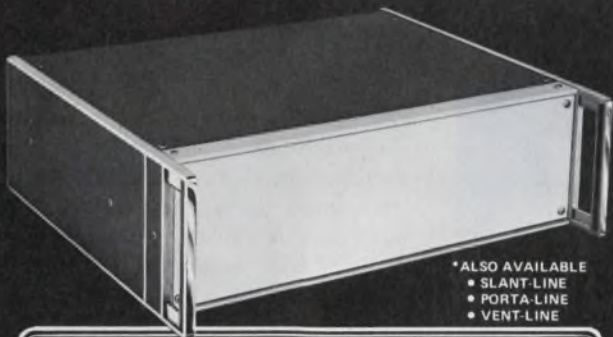

* ALSO AVAILABLE
• SLANT-LINE
• PORTA-LINE
• VENT-LINE

30 DAY FREE EVALUATION

Program is available for prototype planning.
Contact us for information on this service.

67
MODELS

IT'S A PROVEN FACT!
A "CADILLAC" ENCLOSURE
WILL SELL MORE OF YOUR PRODUCTS

The new FAIR-LINE SERIES features identical flat front and rear panels and NEW LOWER PRICES. Highly polished, chrome plated, rugged die cast aluminum side frames and vinyl clad aluminum covers are examples of our standard practices which will provide you with SUPERBLY CRAFTED ENCLOSURES.

ALL THIS AND DELIVERIES FROM STOCK !!!



T.D.J. COMPANY INC.

1172 Morena Boulevard • San Diego, California 92110 • Telephone (714) 276-5920

INFORMATION RETRIEVAL NUMBER 70

ELECTRONIC DESIGN 6, March 15, 1971

laser
aerospace
copying
metrology
optical
component
sighting
aligning
focusing
lens

For optimal performance, you don't just prescribe a lens, you require a custom-designed lens sub-system, expertly designed by a specialist team accustomed to laser standards of exactitude and quality-control.

Laser Optics' team of engineers and physicists has earned one of America's proudest reputations in the fields of coated laser lens and filters.

Let this accomplished team design and supply your special lens sub-system. Our initial response to your inquiry is based on a free computer-assisted feasibility and preliminary design study. Each further step is based upon the highest professional standards of performance and responsibility.

LASER OPTICS, INC.
Mill Plain Road, Danbury, Conn. 06810



INFORMATION RETRIEVAL NUMBER 71

115

Mastech T/D* Test Sets Are Not Something Else. Just Better.



MODEL 2610 DCP

- ACCURATE TESTING AT MODERATE COST •
- OPERATING RANGE 1000 V, 10 AMPS •
- DIRECT DIGITAL READOUT—ANY TEST PARAMETER •
- DATA LOGGING OUTPUTS, TYPE SELECTION CLASSIFIER (SORT TO 20 CATEGORIES) •
- DESIGNED FOR USER AND MANUFACTURER, CAN BE INTERFACED WITH MECHANICAL EQUIPMENT FOR COMPLETELY AUTOMATED SYSTEMS.

Shown are 2 of several models. Other Mastech transistor/diode test sets offer 300 V, 1 amp. or 600 V, 10 amp. range with 6, 12, 18 or 24 test positions.



CARD READER MODEL

Further versatility is provided with card readers, slave and master multiplex stations and full line of test fixtures. Equipment is fully warranted. Contact Mastech for complete information, and visit our booth #3219.

IEEE 71
EXHIBITOR

*TRANSISTOR/DIODE

MASTECH INC.



478 E. BRIGHTON AVE. SYRACUSE, N.Y. 13210
TELEPHONE (315) 478-3133

INFORMATION RETRIEVAL NUMBER 72

MODULES & SUBASSEMBLIES

Segmented LED display has 0.6-in. numbers

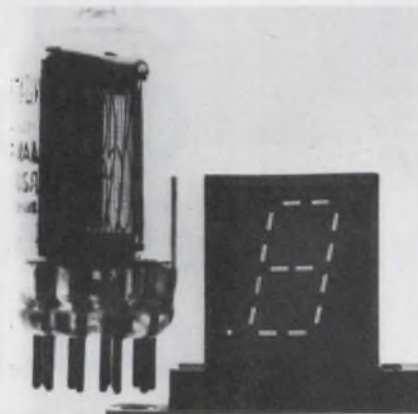

Litronix, Inc., 19000 Homestead Rd., Cupertino, Calif. Phone: (408) 257-7910. P&A: \$24.75; stock.

Said to be the largest LED display presently available, the Data-Lit 6 LED numeric indicator features a character height of 0.6 in. This seven-segment device has two gallium-arsenide-phosphide bars per segment. It operates with a forward voltage drop of 3.4 V and a luminance of 500 foot-lamberts at 20 mA. Its common-mode construction is compatible with most standard decoders.

CIRCLE NO. 406

Dc/dc converter gives 15 V at 30 mA



Novatronics, Inc., P.O. Box 878, Pompano Beach, Fla. Phone: (305) 942-5200. Price: \$25.

Operating from 26 V dc, the model 4A2020 dc/dc converter provides ± 15 -V dc outputs with a current capability of 30 mA. Regulation for the unit is better than ± 0.1 V dc from no load to full load with a ripple content of less than 0.1 V pk-pk. It is an epoxy-encapsulated unit measuring only 1-7/16 by 1-3/16 by 1 in. There are five leads for PC-board mounting.

CIRCLE NO. 411

Regulated 15-W supply costs \$24.95

Wanlass Electric Co., 2165 S. Grand Ave., Santa Ana, Calif. Phone: (714) 546-8990. P&A: \$24.95; stock.

Model DPS-1 power supply provides a 5-V 3-A output regulated at $\pm 1\%$ and filtered to 0.3% rms for \$24.95. It operates from 105 to 125 V, 47 to 63 Hz and measures just 4-in. wide by 4.5-in. high by 2.5-in. deep.

CIRCLE NO. 412

Dual card supplies regulate line to 0.01%

Faratron Corp., 290 Lodi St., Hackensack, N. J. Phone: (201) 488-1440. P&A: \$28; stock.

New plug-in card dual-output power supplies provide regulation of 0.01% for line variations from 105 to 125 V ac. Load regulation is 0.5% for no-load to full-load changes. Outputs are from ± 5 to ± 28 V dc at up to 200 mA per output. Ripple is 1 mV rms.

CIRCLE NO. 413

Decoder/driver modules include counters

Fabri-Tek Micro-Systems, Inc., 1150 N. W. 70th St., Fort Lauderdale, Fla. Phone: (305) 933-9351.

Using hybrid construction, the FTD-1000L series decoder/drivers combine BCD to 7-segment units with quad latch memories, decade latch and up/down counters. They drive LED readouts with 15-V 30-mA outputs.

CIRCLE NO. 414

Sine/cosine generator has $\pm 0.1\%$ accuracy

General Magnetics, Inc., 135 Bloomfield Ave., Bloomfield, N. J. Phone: (201) 743-2700. P&A: \$93; 3 to 4 wks.

A new two-quadrant sine/cosine function generator with excellent temperature stability has accuracy at 25°C of $\pm 0.1\% + 0.6\% \times V_{in}/10$ V. Over the -25 to $+85^\circ\text{C}$ range, an accuracy of $\pm 0.25\% + 0.75\% \times V_{in}/10$ V is provided.

CIRCLE NO. 415

Thermostats in any shape.



H. A. Wilson thermostatic bi-metals are being used in literally thousands of different configurations.

The many varieties of thermometal available, coupled with Engelhard's engineering expertise and experience in customer applications makes the uses of these metals almost limitless.

These metals change shape with temperature and, when constrained, build up force with temperature change. They can be rolled to any thickness, formed into almost any shape, plated, brazed or welded.

Our engineering know-how and manufacturing facilities surpass those of anyone in the field. For information and/or technical assistance call or write the H. A. Wilson Technical Service Department (201) 686-6600.



ENGELHARD INDUSTRIES DIVISION
 ENGELHARD MINERALS & CHEMICALS CORPORATION
 2655 U. S. ROUTE 22, UNION, NEW JERSEY 07083
An Equal Opportunity Employer

INFORMATION RETRIEVAL NUMBER 73

The power supply you plan to build is built!



\$99 each

OTHER MODELS 3 to 50 V available

It's on the shelf, ready for immediate delivery from Electrostatics. With specs proven in service. Low cost. Brief specs on our Model 200:

- 5V 15A DC Power Supply
- Input 105-125V, 47-420 Hz
- Regulation: Line 0.01%
Load 0.1%
- Ripple: 500 μ V max.
- Temp: -20 to +71°C
- Foldback current limiting
- Size: 5.5" W x 5" H x 10.8" L

(\$114 with overvoltage protection)

For full information call Robert McCartney, Manager of Application Engineering, (714) 279-1414. Or circle the number below for our latest data sheet.

Electrostatics, inc.

7718 Clairemont Mesa Blvd., San Diego, California 92111

DEPT. 112

INFORMATION RETRIEVAL NUMBER 74

ELECTRONIC DESIGN 6, March 15, 1971

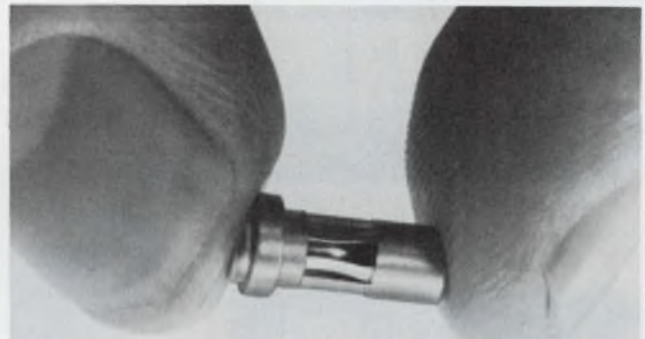

it takes guts to be a good connector

The kind that can hold without appreciable change in contact resistance through 50,000 cycles and more. And that's the kind of guts you get with CAMBION cage jacks. Permanently swaged inside a precisely machined brass body, these beryllium copper cages come in jacks ranging from .016"-.080" in a wide variety of shapes and types for mounting components, patching, plugging. Complete range of mating pins also available. Our latest catalog has a complete selection - it's free for the asking.

The next time a salesman tries to sell you a connector, ask to see the insides - it isn't caged, it's not a CAMBION.

Cambridge Thermionic Corporation, 445 Concord Ave., Cambridge, Mass. 02138. Phone: (617) 491-5400. In Los Angeles, 8703 La Tijera Blvd. 90045. Phone: (213) 776-0472.

Standardize on

CAMBION

The Guaranteed Electronic Components

INFORMATION RETRIEVAL NUMBER 75

117

Your best choice in enclosures

- oil and dust tight
- EMI/RFI shielded
- rigid one-piece construction
- available from stock



Consoles in versatile stock design, 50" x 24" x 23", with gasketed front and rear doors. Options include rack angles, swing-out and stationary subpanels and writing desk. **Consolelets** are offered in eleven stock sizes for desktop mounting of remote controls. Floorstand optional.

All units are heavy gauge steel with all-welded seams, easily shielded.



NEMA 12 units in stock sizes up to 90" x 36" x 24". Rigid 12 gauge steel with all-welded seams, gasketed doors front and/or rear. Oil and dust tight. Options include several interior panel arrangements, rack angles and shielding.

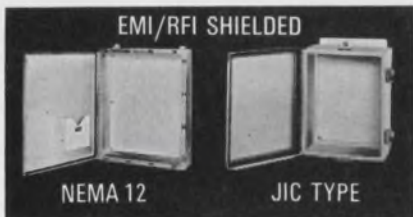

Heavy gauge steel boxes with hinged doors, all cadmium plated. Oil and dust tight, fully shielded. Interior mounting panels and terminal block kits optional. Shipment from stock, all sizes.



For mounting controls where oil, dust and water are not a problem. One-piece heavy gauge steel construction, finished in gray prime. Flush latches. Interior panels for mounting components. Wide size range in stock.

Hoffman

HOFFMAN ENGINEERING COMPANY
Division of Federal Cartridge Corporation
Anoka, Minnesota, Dept ED-434

ELECTRICAL ENCLOSURES

INFORMATION RETRIEVAL NUMBER 76

MODULES & SUBASSEMBLIES

10-bit d/a converter comes in 16-pin DIP

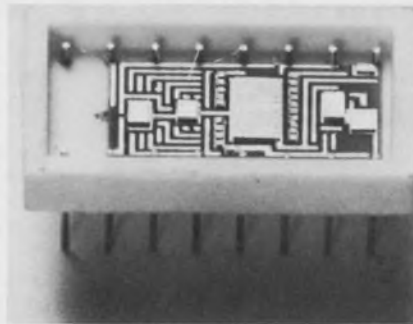

Micro Networks Corp., 5 Barbara Lane, Worchester, Mass. Phone: (617) 756-4635. P&A: \$79; stock.

Supplied in a 16-pin dual-in-line package, a 10-bit digital-to-analog converter occupies less than one-tenth the board space commonly required by similar d/a modules. Model MN310 is a complete multi-chip converter that includes monolithic switching networks, a precision thin-film resistor network, an operational amplifier and an internal reference.

CIRCLE NO. 416

Crystal oscillator works from 5 V dc



McCoy Electronics Co., div. of Oak Electro/Netics Corp., Mount Holly Springs, Pa. Phone: (717) 486-3411.

A new temperature-compensated crystal oscillator can be operated from a single voltage source of 5 V dc rather than the two-voltage-source system required for most conventional units. Model MC380A2 is available in four standard tolerance and temperature ranges and can also be custom designed. It is a 2 by 1.5 by 0.5-in. package.

CIRCLE NO. 417

Analog modules generate 3-D graphics

Optical Electronics, Inc., Box 11140, Tucson, Ariz. Phone: (602) 621-8358. P&A: \$345 to \$3025; stock.

Designated the 6100 series, a new set of analog modules generates three-dimensional graphic displays. They produce geometric and aerial perspectives, interposition, movement parallax, depth of focus and stereo when required.

CIRCLE NO. 418

Frequency converters provide dc outputs

Solid State Electronics Corp., 15321 Rayen St., Sepulveda, Calif. Phone: (213) 894-2271.

The normalized Freqmeters are solid-state units which linearly convert a frequency to a proportional dc voltage. Four models are: 410KF (0 to 100 Hz), 420KF (0 to 1 kHz), 430KF (0 to 10 kHz) and 440KF (0 to 100 kHz).

CIRCLE NO. 419

8-bit storage register transfers in 100 ns

Analogic Corp., Audubon Rd., Wakefield, Mass. Phone: (617) 246-0300. P&A: \$42; 2 to 3 wks.

With 8-binary-bit capacity MP-1608-SR Regpac register transfers in 100 ns 3.5 V \pm 1 V at 1 mA (ON) and 0.25 V \pm 0.25 V at 15 mA (OFF). It is DTL/TTL compatible and is designed for parallel-in/parallel-out applications.

CIRCLE NO. 420

Second-source display comes in a DIP

Litronix, 1900 Homestead Rd., Cupertino, Calif. Phone: (408) 257-7910. P&A: \$18.75; stock.

The Data-Lit 10, a pin-for-pin replacement for the Monsanto MAN-1 seven-segment display, comes in a dual-in-line package. Its character height is 1/4 in. and it displays all numerals and nine letters. Brightness is 350 foot-lamberts at 20 mA.

CIRCLE NO. 421



Switches. ▲
1-4 poles, 2-12 positions.
15 grams of excellence.

This 15 gram Series 51 switch from Grayhill, offers you an unprecedented choice of poles and positions.

The mini rotary also gives you a choice of adjustable, or fixed stops. Solder, or PC terminals.

The flexible Series 51 is only one of a number of Grayhill miniature rotaries. All have been proved for reliability, by a length-

ening list of customers in many different applications.

Like to know more? Write or phone for our latest general engineering catalog. Grayhill, Inc., 565 Hillgrove Ave., La Grange, Ill. 60525, (312) 354-1040.

Grayhill

... the Difference Between Excellent and Adequate

INFORMATION RETRIEVAL NUMBER 77

Who ever heard of a line of Plug-in delay/interval Timers that is reliable, economical and interchangeable for as low as **\$27.90?**



You just did.

It's our new Series GP which is completely interchangeable with over 80% of today's most widely used plug-in delay/interval timers. The GP is designed for easy installation in stan-

dard 3-inch diameter panel holes.

Delivery is stock to 6 weeks, depending upon quantity. Consult us for further information and the GP Bulletin 310. Call 201-887-2200.

SINGER
INDUSTRIAL TIMER DIV.

Industrial Timer Division, U.S. Highway 287, Parsippany, N.J. 07054 201/887-2200

INFORMATION RETRIEVAL NUMBER 78

ELECTRONIC DESIGN 6, March 15, 1971

PROVEN RELIABILITY—
SOLID-STATE POWER INVERTERS,
over 260,000 logged operational hours—
voltage-regulated, frequency-controlled,
for missile, telemeter, ground support,
135°C all-silicon units available now—

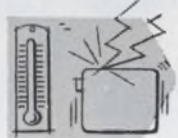
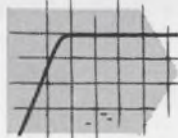
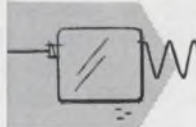
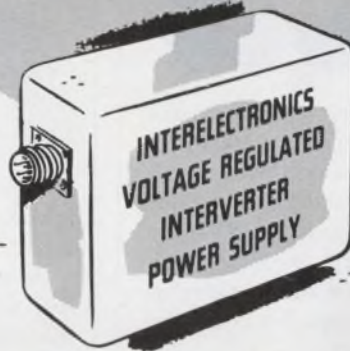

Interelectronics all-silicon thyatron-like gating elements and cubic-grain toroidal magnetic components convert DC to any desired number of AC or DC outputs from 1 to 10,000 watts.

Ultra-reliable in operation (over 260,000 logged hours), no moving parts, unharmed by shorting output or reversing input polarity. High conversion efficiency (to 92%, including voltage regulation by Interelectronics patented reflex high-efficiency magnetic amplifier circuitry.)

Light weight (to 6 watts/oz.), compact (to 8 watts/cu. in.), low ripple (to 0.01 mv. p-p), excellent voltage regulation (to 0.1%), precise frequency control (to 0.2% with Interelectronics extreme environment magnetostrictive standards or to 0.0001% with fork or piezoelectric standards.)

Complies with MIL specs. for shock (100G 11 mlsc.), acceleration (100G 15 min.), vibration (100G 5 to 5,000 cps.), temperature (to 150 degrees C), RF noise (1-26600).

AC single and polyphase units supply sine waveform output (to 2% harmonics), will deliver up to ten times rated line current into a short circuit or actuate MIL type magnetic circuit breakers or fuses, will start gyros and motors with starting current surges up to ten times normal operating line current.

Now in use in major missiles, powering telemeter transmitters, radar beacons, electronic equipment. Single and polyphase units now power airborne and marine missile gyros, synchros, servos, magnetic amplifiers.

Interelectronics—first and most experienced in the solid-state power supply field produces its own all-silicon solid-state gating elements, all high flux density magnetic components, high temperature ultra-reliable film capacitors and components, has complete facilities and know how—has designed and delivered more working KVA than any other firm!

INTERELECTRONICS CORPORATION
550 U. S. Route 303, Congers, N. Y.
Telephone: 914 ELmwood 8-8000

INFORMATION RETRIEVAL NUMBER 79

monolithics: the facts

Monolithic crystal filters are becoming a popular topic of discussion these days. Since we've been making them longer (since 1967) and making more of them (over a quarter-million last year), we'd like to clear up a few misconceptions about the state-of-the-art.

- 1. Monolithics are expensive—**Wrong. They cost less than conventional crystal filters. And, their low cost/high performance has brought reality to many "someday" applications.
- 2. There are no standard models—**Wrong again. PTI has over 20 standards at the 10.7 MHz frequency alone. Plus a big selection of standards at other popular frequencies.
- 3. There isn't enough variety of packaging—**PTI offers several models in flatpack, upright mount and P.C. assembly. We've got more on the drawing board.

If you're now using standard crystal filters, or if you've been holding off because of cost, size or performance, we'd like to show you how monolithics can do the job better for less. Drop us a line and we'll send our new fact sheet.

For off-the-shelf or custom models, if you have questions about monolithics, we've got the answers.



Plezo Technology Inc.

2400 Diversified Way
Orlando, Florida 32804
305-425-1574

The standard in monolithic crystal filters

MICROWAVES & LASERS

Laser optics kit has \$40 price tag



Metrologic Instruments, Inc., 143 Harding Ave., Bellmawr, N. J. Price: \$40.

A new laser optics experiment kit, which sells for \$40, includes materials for constructing a Michelson interferometer. Complete with a detailed easy-to-follow instruction manual, the kit allows laser light to be projected onto walls and large screens so that complex phenomena can be shown graphically. The equipment includes diffraction slides, a hologram, lenses, prisms and polarizing filters.

CIRCLE NO. 422

Optical isolator is IC-compatible

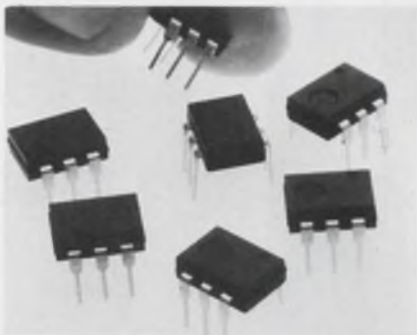

Fairchild Camera and Instrument Corp., Microwave and Optoelectronics Div., 2513 Charleston Rd., Mountain View, Calif. Phone: (415) 961-1391. Price: \$5.90.

Packaged in a six-lead plastic DIP, a new optically coupled isolator is compatible with integrated circuits at both input and output terminals. Model FPLA820 typically provides a 50% current transfer ratio, greater than 1500 V of voltage isolation, a low input-to-output capacitance, and a 3- μ s switching speed.

CIRCLE NO. 423

GaAs avalanche diodes deliver 4 W at X band

Raytheon Co., Micro State Products, 130 Second Ave., Waltham, Mass. Phone: (617) 899-8080.

Microminiature GaAs avalanche impatt diodes delivering cw power outputs of up to 4 W at C and X bands are conservatively rated with dc-to-rf efficiencies of 8%. The new diodes in power levels of 1 W perform typically at 12% efficiency with some as high as 15%.

CIRCLE NO. 424

TO-5 power dividers start at \$25 each

Relcom, 2329 Charleston Rd., Mountain View, Calif. Phone: (415) 961-6265. P&A: \$25 to \$55; stock.

Costing as little as \$25, a line of miniature reactive power dividers operate over the frequency range of 10 to 600 MHz. The units are packaged in a 0.24-in.-high TO-5 metal can and weigh less than 1.2 grams.

CIRCLE NO. 425

90-V rf diodes have Qs of 350

Teledyne Crystalonics, 147 Sherman St., Cambridge, Mass. Phone: (617) 491-1670. P&A: \$4.50; stock.

Varactron high-Q rf diodes feature 90-V dc minimum breakdown and Qs (at -4 V) as high as 350. VA5139 through VA5143 diodes are packaged in DO-7 cases. They are identical to their EIA 1N equivalents except for their 90-V ratings.

CIRCLE NO. 426

S-parameter test set characterizes stripline

Hewlett-Packard, 1501 Page Mill Rd., Palo Alto, Calif. Phone: (415) 326-7000. P&A: \$5000; 30 days.

The circuit elements of high-frequency stripline circuits can be accurately characterized by a new S-parameter test set, the proper stripline test fixture, and an appropriate network analyzer. Characterization from 500 MHz to 12.4 GHz is possible.

CIRCLE NO. 427

Vacuum solder puller stresses eye safety



Consell, Nutmeg Ridge, Ridgefield, Conn. Phone: (203) 438-6718. P&A: \$10; stock.

A new self-contained vacuum tool permits fast efficient desoldering of components from PC boards or terminal strips. The solder vacuum features a captive plunger rod that, after loading, remains in the same position when the tool is fired, thus eliminating the risk of eye injury. The tool cleans itself automatically when it is reloaded, an operation that is done with one hand.

CIRCLE NO. 428

PC board kit accepts DIP ICs

Vero Electronics, Inc., 171 Bridge Rd., Hauppauge, N. Y. Phone: (516) 234-0400. P&A: \$29.95; stock.

The MC-10 PC board kit is designed for molded DIP ICs. All boards are pierced on a 0.1 by 0.1-in. matrix. The kit has 4 boards, 500 terminal pins, a reproducible design sheet, a pin insertion tool and a 32-contact edge connector.

CIRCLE NO. 429

Test-point jack rates 6500 V rms

Sealectro Corp., Circuit Components Div., 225 Hoyt St., Mamaroneck, N. Y. Phone: (914) 698-5600.

A new press-fit test-point jack designated #014-1546 is rated for 5.5 A at 6500 V rms flash-over. It has a height of 0.615 in. and color-coded Teflon insulation. The insulation is 0.2-in. long and 0.218-in. in dia.

CIRCLE NO. 430



Printact®

Plugs into your PC board... mates with plated conductors

The unique design concept of the Printact magnetic latching and non-latching relays provides <math>< 5.0\mu\text{v}</math> thermal EMF, 45-65 db cross talk isolation, <math>< 0.5\text{ms}</math> contact bounce and other custom features as standard at no extra cost. The single moving part is the pivoting armature with series break contacts held by a permanent magnet eliminating return springs, mechanical linkage and pig-tail connections thus assuring reliable performance for many millions of cycles.

For a sample and/or data, write or call 212-EX 2-4800

Printact Relay Division, Executone, Inc., Box 1430ED, Long Island City, N.Y. 11101
INFORMATION RETRIEVAL NUMBER 81

MAGNETIC RELAY
with
Custom Features

- Low Thermal EMF
- 45-60db Isolation
- Low Contact Bounce
- Encapsulated Coil
- Bifurcated Contacts

\$165 IN ONLY 5,000 LOTS

Available with 6, 12 or 24 VDC coils (0.5 watt G series, 1.0 watt LD series) in 2, 3 and 4 pole configuration. Series break swingers permit each pair of fixed contacts to be etched with common (Form C) or isolated (Form A plus Form B) switching between make and break circuits.

Send for catalog, 2X and 4X artwork stick-on contact patterns and Technical Notes PR262-D, which assist in simplifying PC board artwork, fabrication and procurement.

STRESS RELIEVED AND WEATHERPROOFED

BNC Cable Assemblies

These new cable assemblies feature polyethylene collars which are injection molded directly onto cable jacket and connector body. The resulting encapsulation offers two outstanding advantages:

STRESS PROTECTION against failure from excessive bending, flexing, twisting;

WEATHERPROOF SEAL between cable and connector.

Available in various lengths and RG58C/U, RG59B/U, or RB62A/U. Connectors have non-tarnish finish and conform to MIL-C-39012. Write for specifications, prices, and delivery.



POMONA ELECTRONICS CO., INC.

1500 East Ninth Street, Pomona, California 91766 • (714) 623-3463

INFORMATION RETRIEVAL NUMBER 82

P.C. CARD BUS BARS



Eliminate the need for multi-layer P.C. Boards, and reduce noise with a low inductance high capacitance P.C. Card Bus Bar.



COMPONENTS. INC.
1239 University Ave.
Rochester, N. Y. 14607

INFORMATION RETRIEVAL NUMBER 83

It's roomy
It's rugged
It talks to computers

It's Supermeter!



Our new Model 2330 is the all-things-to-all-people panel meter. On top of such standard features as hold, TTL, BCD output, 1000 megohms input resistance, and auto-zero, you can get isolated BCD, ohms, 60 db normal noise rejection with 3-pole active filter, ratiometer, wrong-polarity indication, VAC, "second source" features, and there's a bipolar version.

Add those three inches of extra space in the back of the rugged, sealed aluminum case for such things as existing analog circuitry or what-have-you and you get the most versatile panel meter going. And you get it for \$169. Write, call, or circle for complete details today. Digilin, Inc., 1007 Air Way, Glendale, California 91201. Telephone (213) 242-1200.

See us at IEEE

digilin
DIGITAL INSTRUMENTS

INFORMATION RETRIEVAL NUMBER 84

evaluation samples

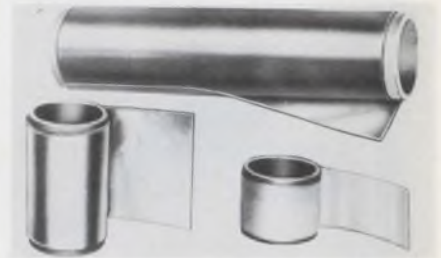

Teflon-fused materials

Lamalok is a new process that produces materials of Teflon fused to aluminum, copper, steel, stainless steel, nickel, nylon paper, glass fiber or foil. Materials are available in rolls up to 36-in. wide in any combination of thickness up to 15 mils. Rolls may be slit to as little as 1-in. wide or in any width up to 36 in. Lamalok materials can also be produced in sheet form in any combination of thickness up to 1/4 in. They are suitable for use in applications up to 600°F. Sample swatches of the materials are available free of charge. Lamart Corp.

CIRCLE NO. 431



ID arrows

Three sizes of pressure-sensitive identification arrows for use in production operations are now available. The 1/4, 3/8, and 3/4-in. arrows can be affixed permanently, repositioned or removed, without adhesive transfer. They are mounted on a quick-release backing paper for protection and cleanliness and are individually die-cut out of paper or vinyl in six standard colors. Four fluorescent colors, in paper only are also offered. Free samples and information are available. By-Buk Company.

CIRCLE NO. 432

RUBBERIZED ABRASIVES

DEBURR SM-O-O-TH POLISH



COMPLETE KIT \$750

CONTENTS: 8 tapered edge wheels 3/8" dia. x 3/32"; 16 cylinder points 1/4" dia. x 3/8" long; 16 bullet points 3/32" dia. x 1" long; 8 bullet points 1/4" dia. x 3/8" long; 8 straight wheels 1/4" x 1/4" x 1/8" hole; 16 straight wheels 3/8" x 1/4" x 1/8" hole; 8 straight wheels 1" x 3/8" x 1/8" hole; 2 wheel mandrels 1/4" shank; 2 point mandrels 1/4" shank. For use at speeds up to 25,000 RPM.

\$7.50 BUYS IT ALL — 80 piece introductory Kit 777 equally assorted in 4 grit textures: coarse, medium, fine and extra fine. **TRY IT** — Cratex Rubberized Abrasives improve the surface while preserving critical workpiece dimensions by its unique cushioning action. **FINISH THE JOB** — to your most exacting specifications — often in a single operation. **SEND FOR KIT 777** — or your **FREE SAMPLE** and catalog illustrating the full Cratex product line and its applications.

CRATEX® RUBBERIZED ABRASIVES

1600 Rollins Road • Burlingame, Calif. 94010
Sold through leading industrial distributors

INFORMATION RETRIEVAL NUMBER 85

**PATENTED*
DESIGN**

SELF-LOCKING
ALL-NYLON
HEAD



**NEW PAN-TY®
ONE-PIECE
CABLE TIES**

* U.S. Patent No. 3,537,148.
Other pending patent appli-
cations in U.S. and abroad.

FREE SAMPLES

PANDUIT CORP.

Tinley Park, Ill. 60477 • Phone: 312-532-1800 • Telex 25-4560

Visit Panduit at IEEE Show Booth 1213.
INFORMATION RETRIEVAL NUMBER 86

now...you
can test
digital
IC's...



**economically...
to manufacturer's specs**

New Kurz-Kasch Model IC-590 is the first economically priced digital IC analyzer for accurate testing in the lab, shop, inspection, production, field or any other location.

The Model IC-590 is a completely portable, battery powered digital IC tester for use in conjunction with published IC specification sheets for static and dynamic testing of all 14 and 16 pin dual in-line IC modules of the DTL and TTL, 5 and 15 volt families. Flat pack and TO-5 modules may also be tested by using appropriate adapters. Price \$169.95.

A unique sister Model IC-591 is also available. It comes complete, as IC-590 above, internal power supply for highly regulated 5 volt, 1 amp operation and adapter cable for firing-up complete card units containing as many as 15 or more mounted IC's. Price \$295.00.

For complete technical data,
write or call now: Tom Barth,
Marketing Manager

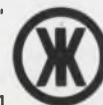

ELECTRONICS DIVISION
Kurz-Kasch, Inc.

1421 S. Broadway,
Dayton, Ohio 45401

(513) 223-8161

INFORMATION RETRIEVAL NUMBER 87

WHY IS THIS THE BEST

PIEZOELECTRIC

ACCELEROMETER EVER MADE

FOR VIBRATION & SHOCK
FROM .001G TO 20,000G's?

Because the model 902 accelerometer is self generating and provides electrical output directly proportional to vibration or shock. Even in extremely rough environments with a stability and ease of operation like no other accelerometer can. The high capacitance of this unit permits readout directly from a scope or meter without auxiliary amplifiers. Call or write COLUMBIA RESEARCH LABS., MacDade Blvd. & Bullens Lane, Woodlyn, Pa. 19094. Phone (215) 532-9464.

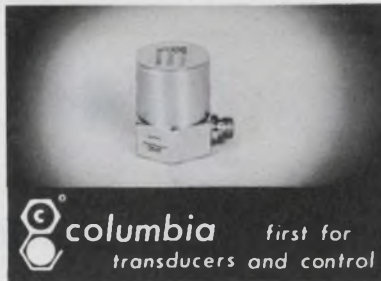

columbia first for
transducers and control

INFORMATION RETRIEVAL NUMBER 101

design aids



Adhesives selector

A new Eccobond adhesives selector chart is available in the form of a folder suitable for notebook or wall mounting. This folder describes 17 non-conducting and 9 electrically conductive adhesives. Many of the adhesives listed have an epoxy base, but vinyl, cyanoacrylate and silicone are represented. Characteristics such as composition, preparation, pot life, color, cure temperature and bond strength are also included. The folder is well illustrated with application photographs. Emerson & Cuming, Inc.

CIRCLE NO. 433

New Micro-Miniature Form C Reed Relays



Only
.290 OD!



- The First FORM C Micro-Min. Relay Available!
- Measures .435 x .290 OD, only 0.03 cu. in.!
- Min. Overall Length with Bent Leads .600
- High Speed 100 microsec. Operate Time (ex. Bounce)
- Stock Voltages 3, 6, 12 and 24
- Leads or Pins. Also Available with Form A.

Special voltages, resistances, electrostatic and/or magnetic shields available. Write for new Bulletin MR-9.2.



COTO-COIL COMPANY, INC.
59 Pavilion Avenue, Providence, R. I. 02905
Tel: (401) 941-3355

INFORMATION RETRIEVAL NUMBER 102

1MHz HIGH PRECISION PACKAGED CRYSTAL OSCILLATOR

- LOW COST
- READY SUPPLY

TYPE:
TCO-8D... 2×10^{-8}
TCO-9D... 2×10^{-9}
TCO-9E... 5×10^{-9}

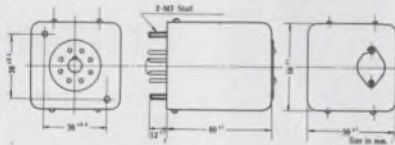

These oscillators feature a 4MHz, 3rd overtone cold-weld vacuum-sealed high-stability crystal element having a Q above 1,500,000, 4:1 frequency division by means of IC, continuously controlled constant temperature oven, new construction, and high reliability components. Extremely fine frequency adjustment to the order of 10^{-6} ~ 10^{-8} is possible with a single trimmer.

TOYOCOM
TOYO COMMUNICATION
EQUIPMENT CO. LTD.

EXPORT DEPARTMENT
TORANOMON BLDG.
18 SHIBA TORANOMON
MINATO-KU TOKYO JAPAN
CABLE: EXPORTOYOCOM TOKYO

INFORMATION RETRIEVAL NUMBER 103



Portable eraser

A new cordless rechargeable electric eraser for draftsmen that weighs less than 9 oz has an average speed of 3800 to 4500 rpm. The Pacer uses standard 7-in. round erasers and will run for at least a half hour before its nickel-cadmium batteries need recharging. It has a plug-in charging system and hangs on a hook which also serves as a caddy for the charger cord and plug when not in use. The unit has a high-impact thermoplastic housing. Pierce Corp.

CIRCLE NO. 434

The Stripper

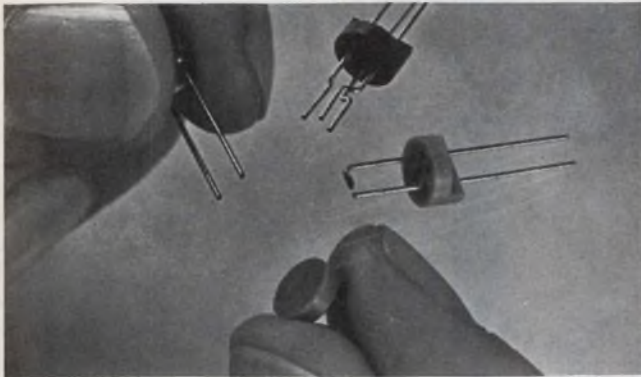

Encapsulate LEDs, photocells, and other discretes on lead wires securely positioned in plastic . . . then strip away the plastic. Fast, efficient, low cost. Save up to 50% compared to other methods.

Lead wires can be flattened, bent, or twisted to form club leads or other configurations. Two, three, or more leads per header. Off the shelf or special designs. Prices: \$3.00 to \$5.00 per 1,000 in standard shapes.

Write or call for data on plastic headers. Lamp Metals and Components Department, General Electric Company, 21800 Tungsten Road, Cleveland, Ohio 44117. Telephone: (216) 266-3942.

GENERAL  ELECTRIC

INFORMATION RETRIEVAL NUMBER 104

FREE

BUTTite SPACERS **SAMPLES**



from tremendous stocks of over

1000 DIFFERENT STANDARDS!

IMMEDIATE DELIVERY!

#4 bolt size to 1" diameter
3/16" to 4" in length

Square ends, burr-free edges!

Send for literature and free samples . . .

CEM COMPANY, INC.

52 SCHOOL STREET, DANIELSON, CONN. 06239

See us at Design Engineering Show Booth #4631

INFORMATION RETRIEVAL NUMBER 105

ELECTRONIC DESIGN 6, March 15, 1971

counting/timing application?

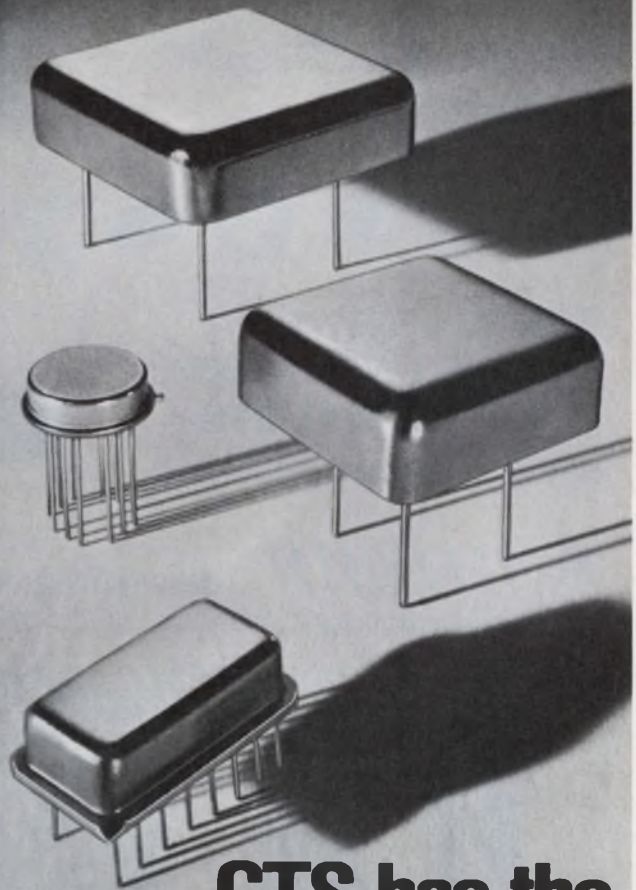

CTS has the oscillator you need.

Maybe it will be packaged in a standard can like our JKTO-77 and JKTO-78. Or our new JKTO-79, T0-8 package with a crystal-controlled hybrid microcircuit. Perhaps you'll need our low profile JKTO-73 for dual-in-line applications. In short, we have the right crystal oscillator for you.

And because these economical miniature oscillators are CTS designed and manufactured you can count on great operating characteristics. For example: Frequency Range: 20 KHz to 20 MHz; Stability: $\pm 50 \times 10^{-6}$; Operating Temperature: -55°C to $+125^{\circ}\text{C}$; Input: $+5\text{V DC} \pm 10\%$; Output: Square to drive TTL logic. (Other stabilities and temperature ranges are available.)

You get fast delivery on any CTS oscillator—at a price as likeable as the quality. For complete information write: CTS Knights, Inc., Sandwich, Illinois 60548. Phone: (815) 786-8411.

CTS CORPORATION
Elkhart, Indiana



INFORMATION RETRIEVAL NUMBER 106

125

PRECISION ENGINEERED DEFLECTION YOKES

FROM SYNTRONIC
ENGINEERS



FOR ALL CRT'S.
CONSULT SYNTRONIC
YOKE SPECIALISTS

SERVICE • ENGINEERING • EXPERIENCE

syntronic INSTRUMENTS, INC.

100 Industrial Road, Addison, Ill. 60101 • Phone 312, 543-6444



INFORMATION RETRIEVAL NUMBER 107

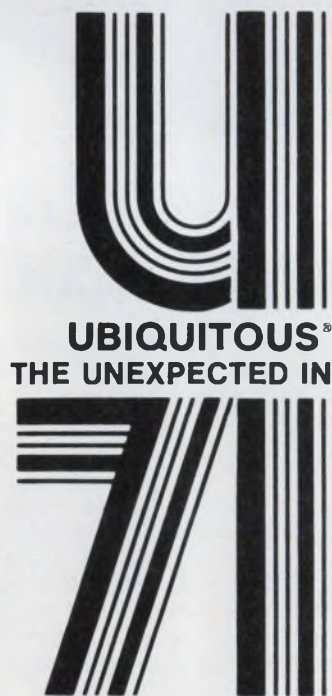

UBIQUITOUS®
THE UNEXPECTED IN

FOR REAL-TIME ANALYSIS

Watch Electronic Design's "Design Data" section for announcements of new literature.

To be put on our mailing list, attach this to your letterhead and mail to
FEDERAL SCIENTIFIC

Federal Scientific Corp., a subsidiary of
Elgin National Industries, Inc.,
615 West 131 St., New York, N.Y. 10027.

INFORMATION RETRIEVAL NUMBER 108

126

Apollo

New Products!!

Extra bright display!
Readable at a distance,
even under direct sunlight.

7 Segment Incandescent
Digital Readout Tube
DA-1300 Series



● 12 Great Features:

- 1 Low Voltage—Low Current Operation
- 2 Compatible with IC Decoder/Driver
- 3 AC and DC operation
- 4 Brightest fully adjustable display
- 5 Unlimited filtered color selection
- 6 Best visibility
- 7 Excellent contrast to dark background
- 8 Produces numeric, alphabetic and symbol display
- 9 Single plane provides wide viewing angle
- 10 Unsurpassed reliability—rigid construction
- 11 Sub-miniature size
- 12 Long operating life

● For more information, please write to:

Apollo
CORPORATION

5-1, TOGOSHI 6-CHOME
SHINAGAWA TOKYO 141, JAPAN
TELEPHONE 786-2005
CABLES: APOLLOHAGITA TOKYO

INFORMATION RETRIEVAL NUMBER 109

application notes

Shaft encoders

The popular eight-page "A Primer on Shaft Encoders" has been reprinted and is again available. The Primer, 10-minute reading time, is designed to familiarize engineers with shaft encoders — what they are, how they operate, the tasks they can take. The fully illustrated booklet performs and their unique advantages on to explain the relative merits of optical vs brush techniques and absolute vs incremental encoders. Theta Instrument Corp.

CIRCLE NO. 435

Constant-current sources

A new application report discusses how to use a dc constant-current source for resistance and semiconductor device measurements and component testing. Applications showing how constant current simplifies these measurements are explored in detail. Desirable characteristics of constant-current sources, and practical approximations to such sources are among other topics included in this 32-page booklet. Hewlett-Packard.

CIRCLE NO. 436

Computers

Methods of measuring a computer system's effectiveness and suggesting improvements are set forth in a 20-page brochure. It explains the measurement approach and basic measurement techniques, and gives a background in computer systems. System Development Corp.

CIRCLE NO. 437

Magnetic diodes

Magnetic diodes, which are magnetic-sensitive semiconductor devices that change their internal resistance as a function of an external magnetic field, are discussed in an application report. It details their structure and gives examples of applications. AEG-Telefunken Corp.

CIRCLE NO. 438



A conventional typewriter with input/output—how about that?

Not bad, is it? Will fill a long-felt need and has all these advantages:

- Availability of all facilities of a conventional electric typewriter, e.g. red ribbon selector as well as upper and lower case
- Complete echo check of typewriter print-out
- Full code flexibility
- Ready access to the established, worldwide Facit service organization.

There is further interesting information on the new Facit 3851 in this publication.

Facit 3851 - the conventional typewriter with input/output



For further information, contact
 in US: Facit-Odhner Inc., 501 Winsor Drive, SECAUCUS, New Jersey
 outside US: Facit AB, Albygatan 102, 171 84 Solna, Sweden

INFORMATION RETRIEVAL NUMBER 110

THERMOCOUPLE/TEMPERATURE PROBES

INDUSTRIAL • AIRCRAFT/MISSILE • SPECIAL PURPOSE



* BARE WIRE

* INSULATED

* GROUNDED

* RADIATION SHIELD

* SIZES FROM 1/16" O.D.

* ASPIRATED

* COMBINATION TEMPERATURE AND PRESSURE PROBES

United Sensor offers a complete line of Thermocouple/Temperature Probes and Rakes to suit most applications. Over seventeen types to choose from — many in stock.

Request Catalog S-7 describing more than 170 models with specifications, prices and special purpose capabilities.



& CONTROL CORPORATION
 A Subsidiary of UNITED ELECTRIC CONTROLS CO.
 85 SCHOOL STREET
 WATERTOWN, MASS. 02172
 Telephone: 617 926-1000

INFORMATION RETRIEVAL NUMBER 111

ELECTRONIC DESIGN 6, March 15, 1971

limiter/detector MODULES

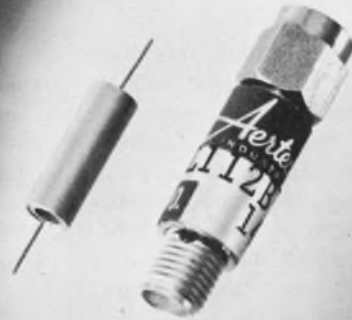

Aertech's standard selection of hermetically sealed modules is available from stock. If the standards don't quite do the job, we can design to your requirements; that includes limiter and detector modules combined, with or without connectors.

The devices advertised here are examples of our capability. We're designing others right now, possibly one of them is just right for your ECM, surveillance, communications, navigation, instrumentation and other receiver applications.

LIMITER MODULES

STANDARD MODEL NUMBER	FREQUENCY (GHz)	MAXIMUM INSERTION LOSS (dB)	MAXIMUM VSWR	PEAK POWER ⁽¹⁾ (WATT)
A9L112	1.4	0.8	1.3:1	100
	4-8	1.2	1.5:1	
	8-12	1.8	1.7:1	

NOTE: (1) 10 μ sec 0.5% Duty Ratio; 1W, C.W.

DETECTOR MODULES⁽¹⁾

STANDARD MODEL NUMBER	FREQUENCY (GHz)	MINIMUM T_c ⁽²⁾ (dBm)	MAXIMUM VSWR	MINIMUM VOLTAGE SENSITIVITY ⁽³⁾ (mV/ μ WATT)
A9D204	2.4	-55	2:1	2.0
A9D408	4.8	-55	2:1	2.0
A9D816	8-16	-53	2.5:1	1.5

NOTE: (1) At 100 μ A Bias
 (2) 2 MHz Video Bandwidth
 (3) Higher sensitivities may be realized at reduced bias

For further information on these devices or other semiconductors, contact your local Aertech representative, or write us directly.

Aertech
INDUSTRIES

825 STEWART DR. • SUNNYVALE • CALIF. 94086
 (408) 732-0880 • TWX 910-339-9207

INFORMATION RETRIEVAL NUMBER 112

127

new literature



Relays

A new 24-page catalog lists over 550 different relays. They include electro-mechanical, solid state hybrid, reed, time-delay, general-purpose, hermetically sealed, power, coaxial and telephone-type relays. Also included are IC compatible, low-cost PC-mounting and miniature latching reed relays. Magnecraft Electric Co.

CIRCLE NO. 439

Semiconductor fuses

A two-page bulletin describes special fuses for semiconductor protection. Carbone-Ferraz, Inc.

CIRCLE NO. 440

Machined components

Machined components such as precision slip clutches, couplings, drag brakes and jaw clamp gears are described in a new 24-page catalog. Machine Components Corp.

CIRCLE NO. 441

Connectors

A full line of rectangular and environmental rack-and-panel connectors are featured in a new catalog. Amphenol Connector Div. Bunker-Ramo Corp.

CIRCLE NO. 442

Power drives

A comprehensive manual contains listings of precision power drives such as gearheads, motors and tachometers. MPC Products Corp.

CIRCLE NO. 443

IC sockets

Sockets for testing and packaging ICs and components are shown in a catalog. Augat Inc.

CIRCLE NO. 444

Electronics courses

A new 24-page electronics-courses brochure describes practical approaches for training of employees in industry. It shows how unique methods teach workers quickly and economically the specific electronics knowledge they need and explains how full-time employees can be trained on their own time, at home, or on company time. Cleveland Institute of Electronics.

CIRCLE NO. 445

Photo-electric relays

A 54-page booklet describes a range of photo-electric-cell-operated controls, photo-electric counting equipment, projectors and receivers, retroreflective photo-relays and the applications of photo-electric-cell-operated relays. Hird-Brown America.

CIRCLE NO. 446

Frequency converter

A four-page brochure describes a two-wire frequency-to-current converter. The booklet is amply illustrated with drawings, graphs and photos. G. W. Dahl Company Inc.

CIRCLE NO. 447

Potentiometers

A new eight-page short-form catalog lists a broad line of precision potentiometers, trimmers, turns-counting dials and miniature switches. Spectrol Electronics.

CIRCLE NO. 448

Lighted modules

A new switchlight systems guide to control and indicating devices is available. It includes a design guide to lighted display modules. Clare-Pendar Co.

CIRCLE NO. 449

Semiconductor dice

A complete line of semiconductor dice and wafers is described in a 16-page brochure. Intersil, Inc.

CIRCLE NO. 450

Computer microfilm

Written in a non-technical style with flow charts and graphic artwork, a new primer booklet explains the concept behind COM (computer-output-microfilm) systems, how they operate, who can use them, and the various economies they realize over impact printing. The publication also contains a glossary on COM terminology. Stromberg Datagraphix Inc.

CIRCLE NO. 451

Dc power supplies

Finding the right power supply is simple by using the tables contained in a new dc power supply selection guide. General and special-purpose supplies are listed by voltage and current output in this 36-page booklet. Hewlett-Packard.

CIRCLE NO. 452

Components

A 36-page catalog with over 400 new items lists jacks, plugs, switches, connectors, molded cable assemblies and audio accessories. All components listed are described and illustrated. Switchcraft, Inc.

CIRCLE NO. 453

Alumina terminals

Complete lines of alumina terminal bushings and ceramic-to-metal seals are described in a 16-page booklet. Victoreen Instruments Div. of VLN Corp.

CIRCLE NO. 454

Masking materials

Pressure-sensitive tapes and masks, tape materials, custom-die cut materials and masking aids are contained in a new catalog. By-Buk Company.

CIRCLE NO. 455

Pulse transformers

A new eight-page catalog lists a series of general-purpose pulse transformers. The Potter Co.

CIRCLE NO. 456

DIP/IC hardware

A complete family of DIP/IC packaging hardware utilizing a modular building-block approach is described in a new catalog. Standard Logic, Inc.

CIRCLE NO. 457

Capacitors

A six-page condensed catalog of capacitors features expanded porcelain, ceramic and chip capacitor lines. Vitramon Inc.

CIRCLE NO. 458

Switches

A new catalog features comprehensive coverage of explosion-proof rotary switches. It contains a fold-out switch-selector chart with detailed descriptions. A S M Corp.

CIRCLE NO. 459

YAG lasers

A six-page bulletin describes a series of YAG (yttrium aluminum garnet) laser systems. The systems include power supplies, cooling systems and laser resonators. Quantronix Corp.

CIRCLE NO. 460

Logic power supplies

A four-page data sheet describes a wide range of highly regulated dc power supplies for op amp, a/d and d/a converters and various forms of IC logic. Analog Devices.

CIRCLE NO. 461

IC tester

A 12-page brochure describes an IC tester that handles automatic, semi-automatic and manual testing of 16-lead digital circuits. Microdyne Instruments, Inc.

CIRCLE NO. 462

MOSFETs

A line of MOS insulated-gate FETs are described in a new product guide. RCA.

CIRCLE NO. 463



The advertisement for Industrial Electronic Engineers (IEE) features several electronic components and displays. At the top left, a large black display unit shows the text "TRANSFER PUMP FROM TANK #5" and a large numeral "5". To its right is a smaller component with labels "LT DEP", "WIND ONLY", "HELP REC", and a large numeral "24". Below the large display is a cylindrical component labeled "IEE nimo" and the numeral "5". In the center, a stack of three components is shown: the top one has "OK TO START", "+", "3", and "7/8"; the middle one has "TEMP SHOCK STATION", "7", "OIL OVER TEMP WARNING PUMP #", and "4"; the bottom one is partially visible. At the bottom left is a component with "DISPLAY DATA", "2", ".3", and "M". To its right is a small component showing "-5 C". The IEE logo is in the bottom right corner.

GETTING THE MESSAGE ACROSS!

That's our job at IEE and, we've been at it for close to two decades. Whatever your message: Letters, words, numerals, colors, etc., you tell us and we'll put it all together, and, in any size—subminiature, standard or jumbo 3" high displays. For every type readout we also have a compatible I.C. or hybrid Driver/Decoder series with a wide range of features and options. When it comes to "man to machine communications" and demanding display requirements contact IEE. After all, one message certainly deserves another.

Industrial Electronic Engineers, Inc. 7740 Lemona Ave., Van Nuys, Calif.
Telephone: (213) 787-0311 • TWX 910-495-1707

STABILITY & QUALITY

High quality capacitors unrivalled in the precision, dependability and compactness. Quality is recognized by ever wider use in measurement equipment, computers, and automatic controllers. "LEAF" the matter of capacitors to MATSUO ELECTRIC CO.



MATSUO

METALLIZED POLYESTER FILM CAPACITOR - "TYPE FNX-H"

Specifications:

Operating Temperature Range: -40°C to $+85^{\circ}\text{C}$
Standard Voltage Rating: 100, 200, 400, 600 VDC
Standard Capacitance Value: .1 MFD to 10 MFD.
Standard Capacitance Tolerance: $\pm 20\%$ (available $\pm 10\%$)



MATSUO'S other capacitors include:

Solid Tantalum Capacitors: MICRO-CAP for hybrid ICs, Type TAX hermetically sealed in metallic case, Type TSX encased in metallic case and sealed with epoxy resin, Type TSL encased in metallic case and sealed with epoxy resin. **Polyester Film Capacitors:** Type MFL epoxy dipped, Type MFK epoxy dipped, non inductive, Type MXT encased in plastic tube, non inductive.

For further information, Please write to
Manufacturers and Exporters

MATSUO ELECTRIC CO., LTD.

Head Office: 3-5, 3-chome, Sennari-cho, Toyonaka-shi, Osaka, Japan
Cable: "NCCMATSUO" OSAKA Telex: 523-4164 OSA
Tokyo Office: 7, 3-chome, Nishi-Gotanda, Shinagawa-ku, Tokyo

INFORMATION RETRIEVAL NUMBER 114

NEW LITERATURE

Thermistor beads

Product bulletin TB-3 describes a new series of bead-type thermistors made of small ellipsoids of thermistor material sintered on two fine lead wires. Thermometrics, Inc.

CIRCLE NO. 464

Telephone coupler

A new originate/automatic-answer acoustic telephone coupler is described in a four-page brochure. Omnitec Corp.

CIRCLE NO. 465

Keyboards

Two series of keyboards in standard and custom configurations are detailed in a brochure. Maxi-Switch Co.

CIRCLE NO. 466

Microwave products

A new catalog describes microwave power tubes and products such as traveling-wave tubes, klystrons, oscillators and amplifiers. Sperry Rand Corp.

CIRCLE NO. 467

Connectors

A 33-page handbook displays eight basic connector series for computer and industrial applications. Gorn Connector Div. of Positronic Industries.

CIRCLE NO. 468

Semiconductor devices

Fifty-one diode types and nineteen semiconductor modules are listed in a short-form catalog. Aertech Industries.

CIRCLE NO. 469

Data acquisition

How to build an automated data recording system is the subject of a 20-page booklet. Hewlett-Packard Co.

CIRCLE NO. 470

Computer-aided design

A 22-page brochure describes computer-aided design and automated manufacturing services. Data Technology Corp.

CIRCLE NO. 471

ELFIN[®] NEON INDICATORS

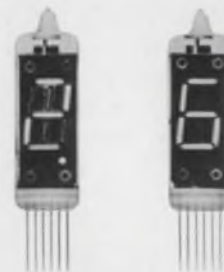

1. Single Plane
2. Brighter Display
3. Wide Viewing Angle
4. Smallest in Size
5. Low Power Consumption

OKAYA ELECTRIC INDUSTRIES CO., LTD.
Yasuda Bldg., 8-3-1 chome, Shibuya-ku,
Tokyo, 150 Japan

INFORMATION RETRIEVAL NUMBER 115

The cure for cancer



There is no doubt
that sooner or later research
will find the ultimate cure
for cancer.

We can help make it sooner.

If you help us.

Give all you can to
the American Cancer Society.

Fight cancer with a checkup and a check.

THIS SPACE CONTRIBUTED BY THE PUBLISHER

bulletin board

of product news
and developments



A new 1/4-in. video tape-recording systems has been introduced by Akai, America, Inc., of Compton, Calif. Model VT-100 is self contained, weighing less than 20 lbs and operates from two 6-V rechargeable batteries up to 40 minutes. Retail prices of the system is \$1295.

CIRCLE NO. 472

A new process for manufacturing wired PC boards known as Infobond has been announced by Inforex, Inc., of Burlington, Mass. The process reportedly eliminates expensive pins and plug sockets used on conventional boards and is said to cost 30% less per termination than present wire-wrap techniques.

CIRCLE NO. 473

The Signetics UTILOGIC II line of logic circuitry has been expanded by 50% with the introduction of twelve new products. They include a shift register, a BCD decade, a binary counter/storage element, two AND gates, a flip flop, three NAND drivers, a detector, a NOR gate and a hex inverter.

CIRCLE NO. 474

Fairchild Semiconductor has added eight 54/74 devices to its line of second-source TTL/MSI ICs. They are two dual-clock up/down counters, a BCD-to-decimal decoder, an excess-three-to-decimal decoder, an excess-three-gray-to-decimal decoder, a four-bit full adder, a four-bit right/left shift register and a five-bit shift register.

CIRCLE NO. 258

Design Data from Manufacturers

Advertisements of booklets, brochures, catalogs and data sheets. To order use Reader-Service Card.
(Advertisement)

Experi/Board: From Schematics to Electronics in Minutes



Circuit Accessories Co. has introduced a new method of breadboarding, "Experi/Board." CAC's "Experi/Board" is introduced and suddenly all other methods of breadboarding are obsolete. For integrated circuits or discrete components, the engineer can't find a faster way to bring his ideas from schematics to electronic realities than with "Experi/Boards." The new "Experi/Boards" are offered in 24 different sizes and models. The four page catalog covers complete specs, model numbers, mechanical dimensions and prices. "Experi/Boards" are shipped from stock. Write, call or TWX for your free catalog.

CIRCLE NO. 172

Circuit Accessories Co.

514 S. River Street
Hackensack, New Jersey 07601
(201) 343-6294 TWX: (710) 990-5023

Get Detailed Analysis Of Spectra To 0.02 Hz Bandwidth

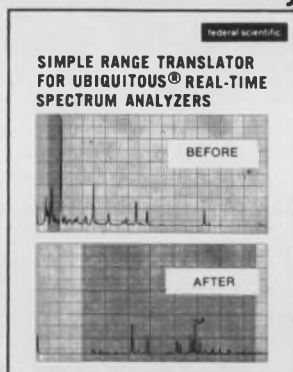

New 30A Range Translator selects narrow bands of frequency, translates them down so they can be analyzed by a Ubiquitous® Low Frequency Real-Time Spectrum Analyzer. (Special version feeds FFT computer inputs, etc.) Selects bands with widths of 20 kHz, 10 kHz, 2 kHz, 1 kHz. Up to 7 ranges supplied, the lowest 10 Hz. Ideal for expansion of small sections of spectrum for detailed analysis. With 500-line UA-6B Analyzer on 10 kHz scale, nominal bandwidth is 0.02 Hz. Customize: you can order even one range. Inexpensive low frequency oscillator can be used; or up to 10 precision oscillator steps can be integral to 30A.

CIRCLE NO. 173

Federal Scientific Corporation

a subsidiary of Elgin National Industries, Inc.
615 West 131st Street, New York, N. Y. 10027

Instant Circuit Boards!™



Engineers at CIRCUIT-STIK, INC., have developed a complete family of circuit sub-elements and circuit materials designed to work together producing "INSTANT PROTOTYPE CIRCUIT BOARDS." Individual circuit boards can be assembled and tested from engineering sketches the same day. CIRCUIT-STIK's sixteen page catalog describes circuit sub-elements and materials that are pre-drilled, pre-plated, fluxcoated, and have pressure sensitive adhesive substrates ready for mounting and soldering of electronic components. (U. S. Patent #3,538,389 and other patents pending)

SEND FOR YOUR FREE CATALOG AND SAMPLES

CIRCLE NO. 174

Circuit-Stik, Inc.®

1518 West 132nd Street, Gardena, California 90249
Telephone (213) 532-1450

IEEE SHOW—MARCH 22-23-24-25, BOOTH #1219

ELECTRONIC DESIGN's function is:

- To aid progress in the electronics manufacturing industry by promoting good design.
- To give the electronic design engineer concepts and ideas that make his job easier and more productive.
- To provide a central source of timely electronics information.
- To promote two-way communication between manufacturer and engineer.

Want a subscription? ELECTRONIC DESIGN is sent free to qualified engineers and engineering managers doing design work, supervising design or setting standards in the United States and Western Europe. For a free subscription, use the postfree application form inside the back cover. If none is included, write to us direct for an application form.

If you do not qualify, you may take out a paid subscription for \$25 a year in the U.S.A., \$35 a year elsewhere. Single copies are \$1.50 each.

If you change your address, send us an old mailing label and your new address; there is generally a prepaid postcard for this inside the back cover. You will have to requalify to continue receiving ELECTRONIC DESIGN free.

The accuracy policy of ELECTRONIC DESIGN is:

- To make reasonable efforts to ensure the accuracy of editorial matter.
- To publish prompt corrections whenever inaccuracies are brought to our attention. Corrections appear at the end of the Letters column.
- To refuse any advertisement deemed to be misleading or fraudulent.

Microfilm copies are available of complete volumes of ELECTRONIC DESIGN at \$19.00 per volume, beginning with Volume 9, 1961. Work is now in process to complete the microfilm edition of Volumes 1-8. Reprints of individual articles may be obtained for \$2.00 each, prepaid (\$.50 for each additional copy of the same article) no matter how long the article. For further details and to place orders, contact the Customer Services Department, University Microfilms, 300 North Zeeb Road, Ann Arbor, Michigan 48106; telephone (313) 761-4700.

Want to contact us? If you have any comments or wish to submit a manuscript or article outline, address your correspondence to:

Editor
ELECTRONIC DESIGN,
850 Third Avenue,
New York, N.Y. 10022.

Digital Controls Handbook



WATERTOWN, MASSACHUSETTS — CGS/Datametrics is pleased to announce the availability of a new handbook entitled "Digital Controls for Industry" which describes a series of Digital modules and instruments for accurately measuring, displaying, and controlling any measured parameter such as pressure, load, temperature, flow, position, velocity, acceleration, or voltage for on line monitoring and control. The techniques employed offer ease of linearization to provide output signals directly proportional to input parameter. The handbook serves as a valuable aid for engineers engaged in process control and instrumentation, automotive safety, and test cell monitoring. Direct requests for Technical Handbook "Digital Controls for Industry" to Mr. Phil Micciche.

CIRCLE NO. 175

CGS/Datametrics

a division of CGS Scientific Corporation, 127 Coolidge Hill Road
Watertown, Massachusetts 02172, Telephone (617) 924-8505

Centron Precision Drafting Aids Catalog



The latest catalog in pressure-sensitive precision component matched artwork symbols and drafting aids. Completely opaque pre-cut symbols are printed on pressure sensitive .0015" matte acetate film accurate to $\pm .001$ ". Featured are choices in packaging to the user which affords greater convenience and cost savings. Donut pads are offered in both roll and strip form and precision tape is packaged in air-tight zipper bags to preserve freshness even after use. SEND FOR YOUR FREE CATALOG AND SAMPLES.

CIRCLE NO. 176

Centron Engineering, Inc.

1518 W. 132nd Street
Gardena, California 90249

IEEE SHOW - MARCH 22-
23-24-25. BOOTH #1219

How To Write Technical Articles



A guide for the engineer-author, "How to Write Articles for Electronic Design" shows how easy it is to write for publication—once the engineer knows what to write and how to write it. The Author's Guide includes a complete run-down of the types of articles published by Electronic Design—plus detailed instructions on how to prepare technical articles and short special features. A MUST for every "would-be-writer" in the electronics industry. Send for your complimentary copy by circling the number to the right.

CIRCLE NO. 177

Electronic Design

850 Third Avenue
New York, N.Y. 10022

Manufacturers

Advertisements of booklets, brochures, catalogs and data sheets. To order use Reader-ServiceCard (Advertisement)

Plastic Parts



CUSTOM production to your specs from patented low-cost tooling. Any size, any quantity in Nylon, Delrin, other thermoplastics. Let us quote. We have 20 years experience.

STANDARD gears, racks, bearings, sprockets, pulleys, washers, insulators, many other components available quickly from stock tools. Over 2,500 items described in our 48-page catalogue. Write today for a free copy.

CIRCLE NO. 178

Nylomatic

28 Nolan Ave., Morrisville, Pa. 19067

FIBERGLASS EPOXY TUBING

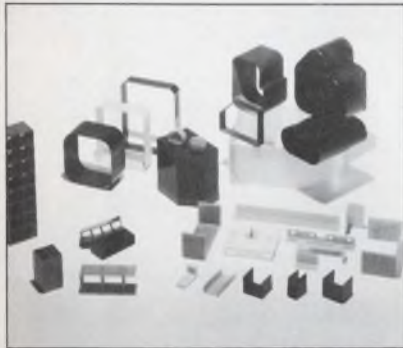

A line of fiberglass laminated epoxy angles, channels and special shapes allows freedom of prototype design for electronic encapsulating forms, display devices, chassis mounts, structural members and coil forms. Many sizes and shapes are available without additional tooling costs. Shapes are available in paper phenolic (105°C), glass epoxy (155°C), and glass silicone (180°C). Samples and literature are available. Stevens Tubing Corp.

CIRCLE NO. 179

Stevens Tubing Corporation

128 North Park Street
East Orange, New Jersey 07019

ENGINEERS' RELAY HANDBOOK

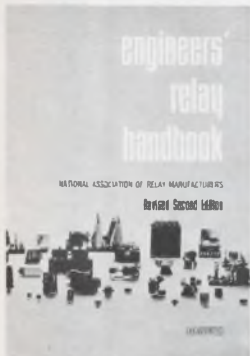

Reflecting the latest advances in the technology, the Revised Second Edition of this authoritative guide answers the needs of all who use, buy, specify, or trouble-shoot relays. Sponsored and prepared by the **National Association of Relay Manufacturers**, the handbook presents complete, illustrated coverage of relays, inspection testing, life testing, military specifications, and standardized definitions. 368 pages, 7 $\frac{3}{8}$ x 10 $\frac{1}{8}$, illustrated, \$13.95. Circle the reader-service number below for 15-day examination copies.

CIRCLE NO. 180

Hayden Book Company, Inc.

116 West 14th Street
New York, N. Y. 10011

Electronic Design

Advertising Sales Staff

Keith Aldrich
Sales Manager

New York 10022

Robert W. Gascoigne
Samuel M. Deitch
Daniel J. Rowland
850 Third Avenue
(212) Plaza 1-5530
TWX: 867-7866

Philadelphia 19025

Mort Sullivan
P.O. Box 126
Dresher, Pa.
(215) 884-6880

Boston 02154

Joseph F. Palmer
1268 Main Street
Waltham, Mass.
(617) 894-2700

Chicago 60611

Thomas P. Kavooras
Berry Conner, Jr.
200 East Ontario
(312) 337-0588

Cleveland

Thomas P. Kavooras
(Chicago)
(312) 337-0588
(call collect)

Los Angeles 90303

Stanley I. Ehrenclou
2930 Imperial Highway
Inglewood, Calif.
(213) 757-0183

San Francisco 94022

Jerry D. Latta
95 Main Street
Los Altos, Calif.
(415) 941-3084

London W. 1

For United Kingdom and Holland
Brayton C. Nichols

For Eastern Europe

Peter Kehr
44 Conduit Street
Tel: REGent 4714

Verviers, Belgium

For Continental Europe
Andre Jamar
1, Ru Mallar, 1
(087) 253.83 Telex 41563

Tokyo

Haruki Hirayama
Electronic Media Service
5th Floor, Lila Bldg.,
4-9-8 Roppongi
Minato-ku
Phone: 402-4556
Cable: Electronicmedia, Tokyo



advertiser's index

Advertiser	Page	Advertiser	Page	Advertiser	Page
Acopian Corporation	41	Garrett Micro-Circuits Corporation..	48	Okaya Electronics Industries Co., Ltd.	130
Aerotech Industries	127	General Electric Company, Lamp Glass Dept.	111	Paktron Division, Illinois Tool Works, Inc.	C23
Aladdin Electronics, A Div. of Aladdin Industries, Inc.	S60	General Electric Company, Lamp Metals & Components Dept.	125	Panduit Corp.	123
Allen-Bradley Co.	S16, S17	General Reed, Division of Sigma Instruments, Inc.	8	Peripheral Equipment Corporation	S56, S57
Amersil, Inc.	S52	Grayhill, Inc.	119	Piezo Technology, Inc.	120
Amphenol, The Bunker-Ramo Corporation	12	Harris Semiconductor, A Division of Harris Intertype Corporation	88, 89	Pomona Electronics Co., Inc.	121
Analog Devices, Inc.	100	Hayden Book Company, Inc.	44, 133	Potter & Brumfield Division of AMF Incorporated	S15
Apollo Corp.	126	Heath Company	109	Power/Mate Corp.	13
Augat, Inc.	108	Heath Dynamics, Inc.	104	Printact Relay Division, Executone, Inc.	121
Automatic Electric Laboratories, Inc.	S44	Heinemann Electric Company.....	29	RCA Electronic Components and Devices	Cover IV
Automatic Electric Company	S28, S29	Hewlett-Packard	Cover II, 4, 5, 71, 91	RF Communications, Inc.	16
Belden Corporation	37	Hewlett Packard, New Jersey.....	97	Rotron, Incorporated	53
Bourns, Inc.	24, 57	Hoffman Engineering Company.....	118	Rogan Brothers, Inc.	59
Buckbee Mears Company	105	Honeywell, Inc.	63	Scanbe Manufacturing Corp.	42
Burdny Corporation	49	Honeywell Information Systems.....	39	Schauer Manufacturing Corp.	114
Burroughs Corporation	20	ISE Electronics Corporation	72	Schrack Electrical Sales Corp.	115
C & K Components, Inc.	S52	Indium Corporation of America	S26	Servo Tek Products Company.....	7
CGS Scientific Corp., Datametrics Division	132	Industrial Electronic Engineers, Inc.	129	Siemens Corporation	44
CEM Company, Inc.	125	Ingersoll Products Division of Borg Warner Corporation.....	58	Signalite Division of General Instruments	93
CTS Corporation	125	Institute of Electrical & Electronic Engineers' Conference	62	Signetics-Linear	51
Cambridge Thermionic Corporation.....	117	Interelectronics Corporation	119	Silicon General, Inc.	S53
Centralab, the Electronics Division of Globe-Union, Inc.	43	J-B-T Instruments, Inc.	S48	Simmons Fastener Corporation.....	54
Centron Engineering, Inc.	132	Johnson Company, E. F.	S27	Singer Company, The Instrumentation Division	S37
Circuit Accessories Co.	131	Kay Electric Company.....	S46	Singer-General Precision, Inc. Kearfott Division	S50
Circuit Stik, Inc.	131	Keithley Instruments, Inc.	6	Singer, Industrial Timer Div.	119
Columbia Research Labs	124	Kurz-Kasch, Inc.	123	Singer, Line Electric Div.	135
Computer Automation, Inc.	11	Laser Optics, Inc.	115	Solitron Devices, Inc.	103
Computer Energy Corp.	S31	Licon, Division Illinois Tool Works, Inc.	C21	Sprague Electric Company	18
Continental Connector Corporation.....	52	Littlefuse	S1	Standard Condenser Corporation.....	S42
Coto Coil Company, Inc.	124	Litronix, Inc.	2	Stackpole Carbon Company	17
Cratex	123	Mallory Capacitor Company.....	S33	Stevens Tubing Corporation.....	133
Curtis Development & Mfg. Co.	S52	Marconi Instruments Division of English Electric Corporation.....	S55	Switchcraft, Inc.	S47
Cutler-Hammer	55	Mastech, Inc.	116	Syntronic Instruments, Inc.	126
Dale Electronics, Inc.	Cover III	Matsuo Electric Co., Ltd.	130	TEAC Corporation	84, 85
Data Technology, Inc.	60	MicroSwitch, A Division of Honeywell	61	T. D. J. Company, Inc.	115
Delco Electronics, Division of General Motors Corporation.....	S38, S39	Mil Electronics, Inc.	135	Tecnetics, Inc.	S35
Digilin, Inc.	122	Molex, Incorporated	23	Tektronix Inc.	47
Digital Equipment Corporation.....	S41, 99	Monolithic Memories, Inc.	1	Teledyne Electro Mechanisms.....	107
ERA Transpac Corporation	S34	Monsanto Company	15	Teletype Corporation	78, 79
Eastman Chemical Products, Inc.	S48	Mostek Corporation	56	Tenney Engineering, Inc.	S52
Elco Corporation	9	Motorola Semiconductor Products, Inc.	16A—H	Toyo Communication Equipment Co. Ltd.	124
Eldre Components, Inc.	122	NJE Corporation	S59	Triplett Corporation	S45
Electro Materials, A Division of Illinois Tool Works, Inc.	S25	National Semiconductor Corporation	34, 35	United Sensor Corporation.....	127
Electro-Motive Mfg. Co., Inc., The ..	73	Nippon Electric Company, Ltd.	64	United Systems Corporation.....	S43
Electronic Design	132	Norden Division of United Aircraft Corporation	50	Unitrode Corporation	27
Electrostatics, Inc.	117	North Atlantic Industries, Inc.	95	Vactec Inc.	112
Emerson & Cuming, Inc.	S36	Nylomatic Corporation	133	Victoreen Instrument Division	S51
Engelhard Industries Division, Engelhard Minerals & Chemicals Corporation	117	Nytronics, Inc.	113	Weinschel Engineering	10
Executone, Inc., Printact Div.	121			Welch-Allyn, Inc.	S49
Facit-Odner, Inc.	127			Weston Instruments, Inc.	48 A-B
Federal Scientific Corporation.....	126, 131				
Fluke Mfg. Co., Inc., John.....	14				



DC to DC POWER SUPPLIES

- ▶ NEARLY 1,000 STANDARD MODELS TO CHOOSE FROM
- ▶ HIGH VOLTAGE—LOW VOLTAGE
- ▶ METAL CASE—EPOXY CASE
- ▶ PRINTED CIRCUIT PINS—SOLDER TERMINALS
- ▶ UP TO 20 WATT PACKAGES
- ▶ REGULATED—UNREGULATED
- ▶ UNITS QUALIFIED TO MIL SPECS.
- ▶ DELIVERY FROM STOCK TO 2 WEEKS



MIL MIL ELECTRONICS, INC.
 SEND FOR FREE CATALOG
 HUDSON, N.H. 03051
 TEL. (603)889-6671

INFORMATION RETRIEVAL NUMBER 116

"IT'S GOOD BUSINESS
 TO HIRE THE HANDICAPPED."

ISN'T THAT A GREAT IDEA, SNOOPY?



THE PRESIDENT'S COMMITTEE ON EMPLOYMENT
 OF THE HANDICAPPED, WASHINGTON, D. C.

How to save on relays

A quotation from Line Electric includes lots of values that add to the total savings possible.



For instance:

Line makes on-time deliveries to meet your production line schedules. Line offers excellent engineering help free. Line maintains the highest manufacturing standards in the industry.

Add these values together and you get all-round savings on your relay purchases. Not to mention the headaches you can avoid.

Won't you check us out and see how much better you can do at Line? Send for free copy of our new 1970 catalogue containing all the most frequently used industrial type relays. We guarantee you'll learn something to your advantage.



In a hurry, call (201) 887-8200 and ask for Relay Sales Manager. We like to do business by phone.

SINGER
 LINE ELECTRIC DIV.

Line Electric Division, U.S. Highway 287, Parsippany, N. J. 07054 201/887-8200
 INFORMATION RETRIEVAL NUMBER 117

We'll go to extremes

extremes

We'll go to extremes to solve your resistive problems

Call Dale when you need to cut development and delivery time on non-standard resistors. Our design file contains more than 4,500 "specials"—all pre-engineered and ready for production. It includes everything from the most powerful and precise wire-wounds to the industry's widest range of metal film values to tiny thick and thin film chips and microcircuits. If we have not already produced what you need, we're ready to assign a special engineering task force to the job. Call today. The difficult resistive function you're looking for—and the package to put it in—are waiting for you at Dale.

*Dale's new **Functional Guide To Non-Standard Resistors** is a must for every design file. Phone 402-564-3131 or write for your copy today!*

DALE ELECTRONICS, INC.
1300 28th Avenue,
Columbus, Nebr. 68601
In Canada:
Dale Electronics Canada, Ltd.
A subsidiary of
The Lionel Corporation

A Functional Guide to
Non-Standard Resistors

DALE

Large jet aircraft equipped with RCA 400 Hz triacs are making aviation history

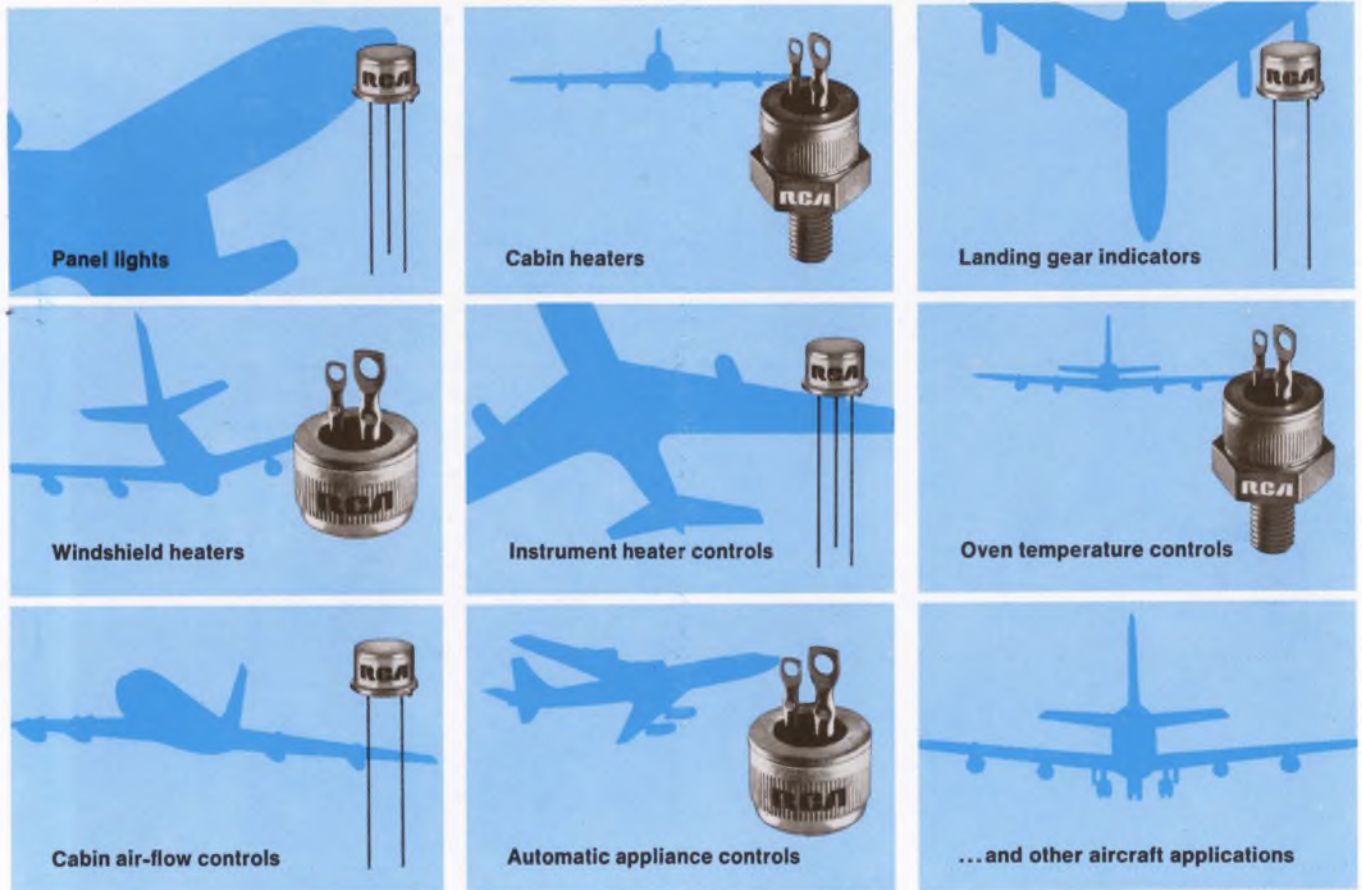

Today, in the jet age of aviation, strong demands are placed on "super" new designs. Now, more than ever, systems designers of aircraft controls recognize the need for these designs which must feature reduced weight and increased reliability. To achieve this, designers are relying on RCA 400 Hz triacs for aircraft control applications. You will find RCA 400 Hz triacs in some of the newest and biggest aircraft — operating windshield and instrument heaters, and controlling panel lights, cabin air flow, lamp intensity, cabin heaters, and landing-gear systems.

Examine your circuit designs against the following table, to see where the superior quality, reliability and high performance of RCA 400 Hz triacs can help you. Then call your local RCA Representative or your RCA Distributor for further details. For technical data, write: RCA, Commercial Engineering, Section 57C-15/UR7, Harrison, N.J. 07029. International: RCA, 2-4 rue du Lièvre, 1227 Geneva, Switzerland, or P.O. Box 112, Hong Kong.

Type Number	Rating I _T (RMS) (A)	Package	Voltage* V _{DRM} (V)	Gate Trigger Current I _{GT} (max.) mA	Modes
40769	0.5	3-lead modified TO-5	200	10	all
40771	0.5	3-lead modified TO-5	200	25 40	I ⁺ , III ⁻ I ⁻ , III ⁺
40773	2.5	2-lead modified TO-5	200	25 40	I ⁺ , III ⁻ I ⁻ , III ⁺
40775/ 40777	6.0	press-fit/ stud**	200	80	all
40779/ 40781	10.0	press-fit/ stud**	200	80	all
40783/ 40785	15.0	press-fit/ stud**	200	80	all
TA 7646/ TA 7648	25.0	press-fit/ stud**	200	80	all
TA 7650/ TA 7652	40.0	press-fit/ stud**	200	30	all

*All above devices are also available in 400-V versions.

**On special request, these units are available in isolated stud.

RCA Thyristors