

Electronic Design 12

VOL. 18 NO.

FOR ENGINEERS AND ENGINEERING MANAGERS

JUNE 7, 1970

In Britain and on the Continent electronics is changing the form of technology in basic industry. Moiré fringes, thyristors, and fluorescence are being used

along with CAD software and ICs. The need for electronic innovations is challenging the skills of European designers. For details see report on p. 24.

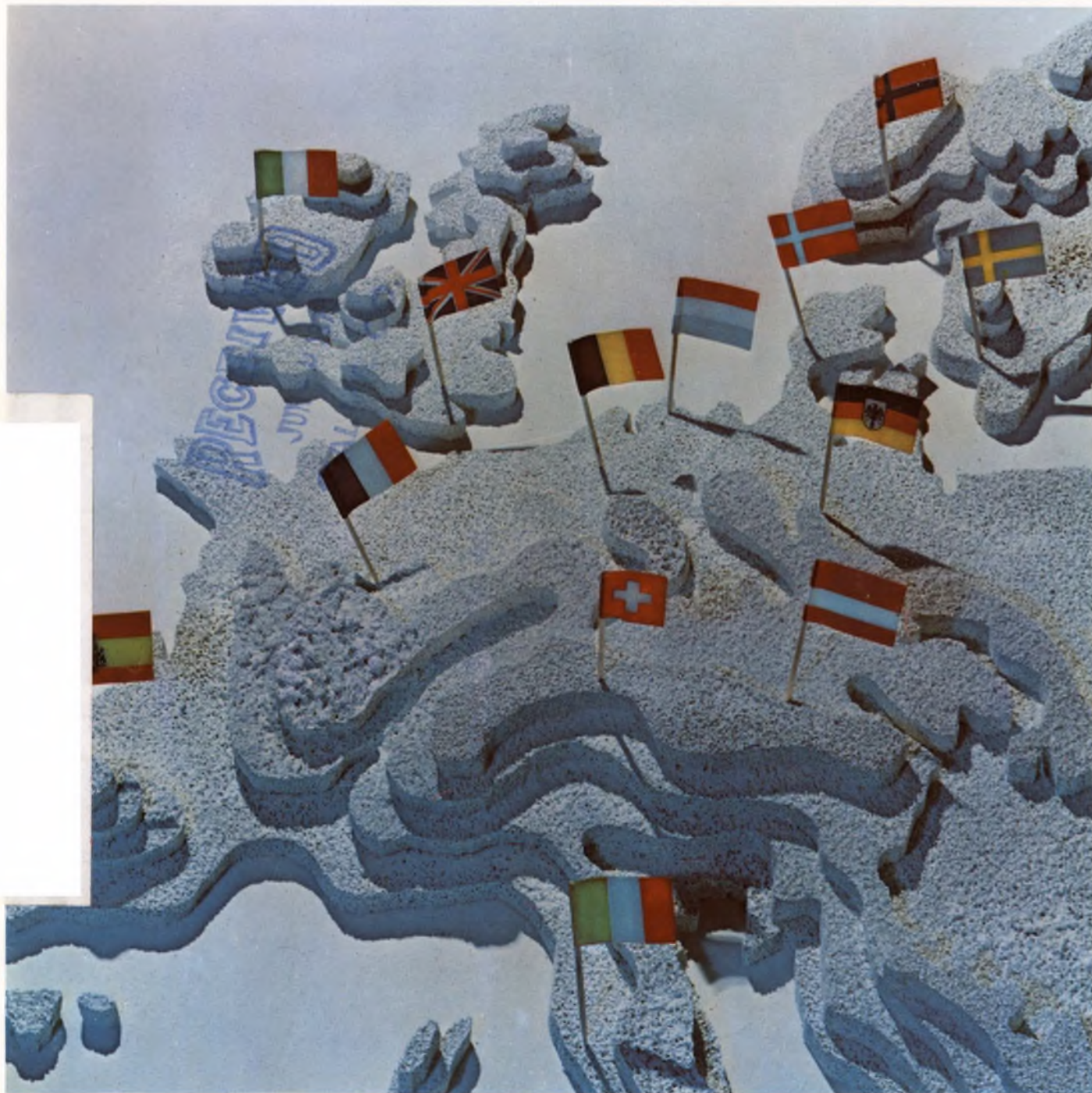



Exclusive HP
CRT Deflection System

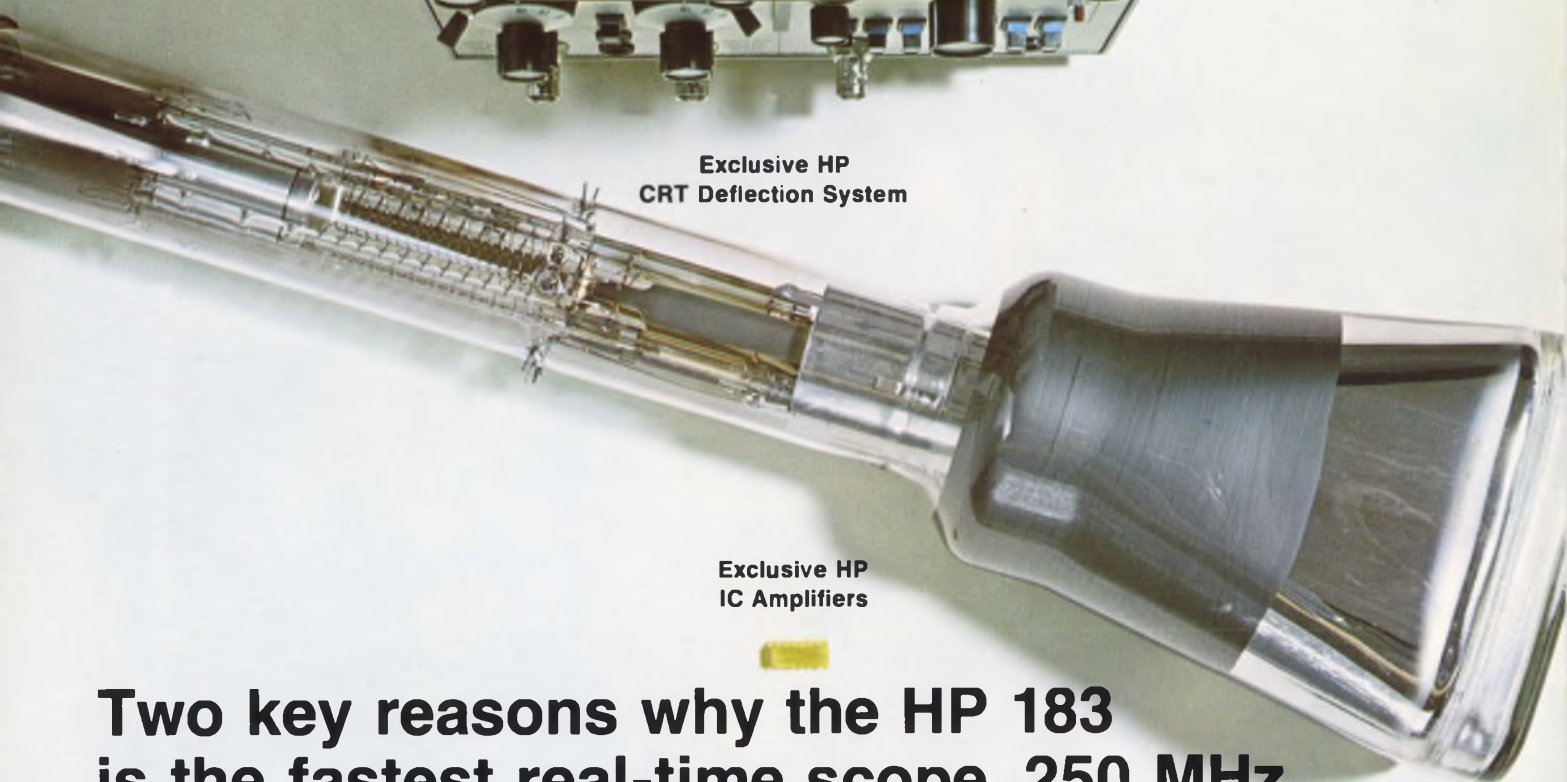

Exclusive HP
IC Amplifiers

Two key reasons why the HP 183 is the fastest real-time scope, 250 MHz ...today's performance champ!

080/7

Here is today's undisputed leader in scope performance: DC to 250 MHz bandwidth, 10 mV sensitivity, less than 1.5 ns risetime, 4 cm/ns writing speed and 11 compatible plug-ins.

Here are some of the tasks performed by this new, DC-to-VHF real-time window—display intermittent pulse trains with nanosecond risetime, capture fast transients, take a look at amplitude-modulated carriers ahead of a detector.

This is a **big jump in real-time waveform displays**. HP's technical leadership, covering a wide area of disciplines, has made it possible. An in-house IC capability has produced **monolithic transistor arrays** for the vertical amplifier—key factor in achieving **good transient response with 250 MHz bandwidth** and high-fidelity reproduction of waveforms.

Use of micro-circuitry also has reduced the number of high frequency calibration adjustments—to only two for the vertical amplifier, instead of typically up to 30 or 40.

HP's step-ahead CRT technology produced a unique CRT to display fast signals. It utilizes two transmission lines for the vertical deflection system. They provide distributed deflection of the electron beam, **giving the CRT a cutoff frequency well beyond 500 MHz**. Other features of this exclusive CRT are a low deflection factor, high brightness and fast writing speed.

Because the vertical deflection system of this CRT is directly accessible to the vertical plug-in, the **183A mainframe can accept any of the 180 series plug-ins**—to make it a true, general-purpose scope. Since the 183A is **not mainframe limited** you can take advantage of HP innovations in higher frequency plug-ins as they become available.

This is the year of the big change for the oscilloscope industry. You'll be making a buying decision that you will have to live with for some time to come. It stands to reason that the step-ahead thinking exemplified in the HP 250 MHz scope also exists in all HP scopes. **If you are not now convinced** Hewlett-Packard is best, try a side-by-side comparison with any other scope. Call your HP field engineer to arrange a comparison.

The HP 183 is only one of a family of high performance scopes—including sampling and storage. Write, Hewlett-Packard, Palo Alto, California 94304. Europe: 1217 Meyrin-Geneva, Switzerland. Price, HP 183A with 250 MHz plug-ins: \$3150.

HEWLETT  PACKARD

OSCILLOSCOPE SYSTEMS

Suppose you wanted an Automatic RLC Bridge

that could measure up to $2\text{ M}\Omega$ resistance, 2000 H inductance, and 0.2 F capacitance, plus equivalent series resistance and leakage current. A bridge with 5-digit resolution for reactance and resistive readouts, automatic decimal point and units of measurement; a 20-measurements-per-second capa-

bility; 120-Hz and 1-kHz test frequencies; 5-terminal connections to preserve a basic 0.1% accuracy; a built-in 0 to 3-V bias or external bias to 600 V; optional remote programmability and data output.

And prices that start at \$4,215. (in U.S.A.)

Where could you possibly find such a bridge?

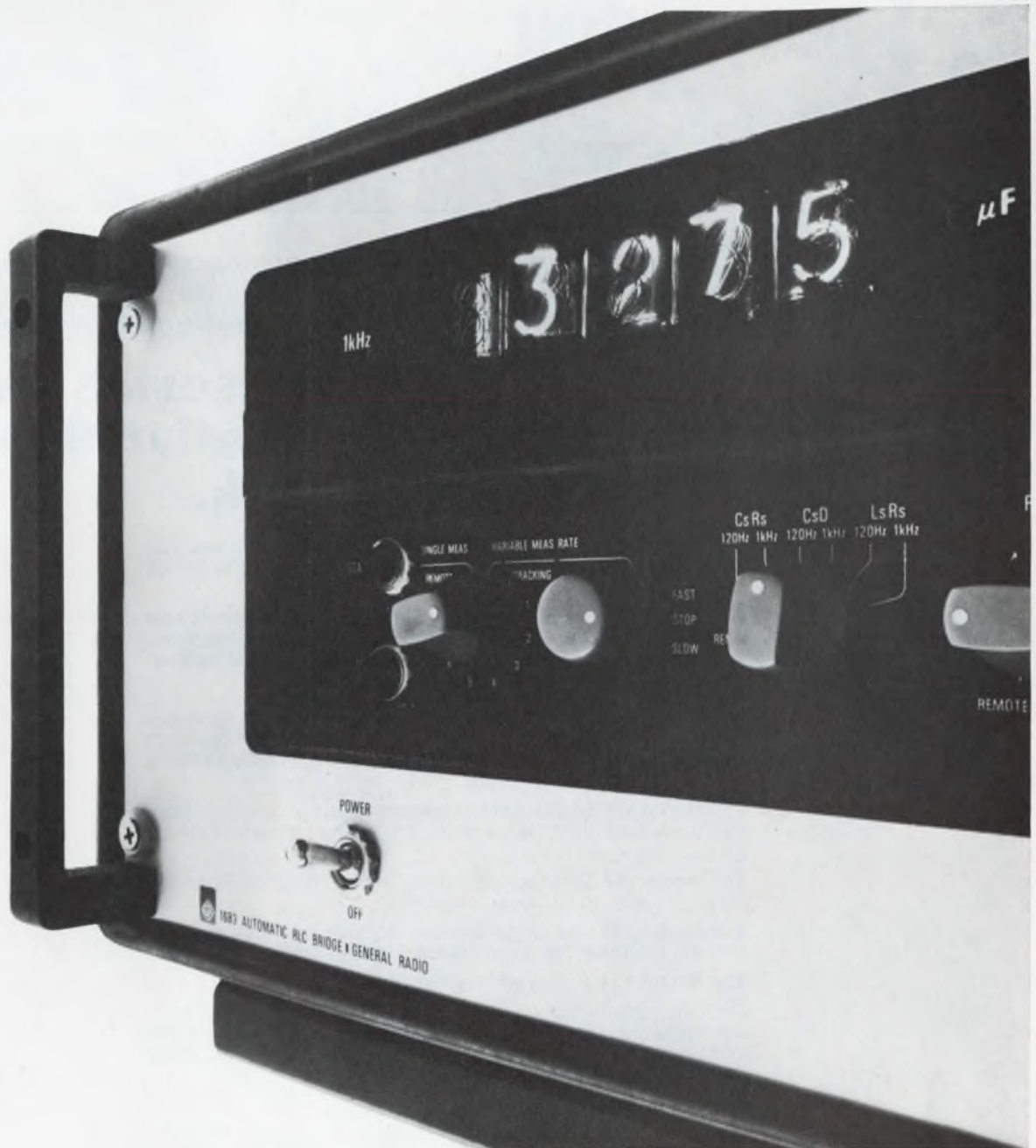

1683 Automatic RLC Bridge by **GENERAL RADIO**

West Concord, Mass. 01781 Tel: (617) 369-4400 Europe: Postfach 124, CH 8034 Zurich, Switzerland



INFORMATION RETRIEVAL NUMBER 2

GUARANTEE

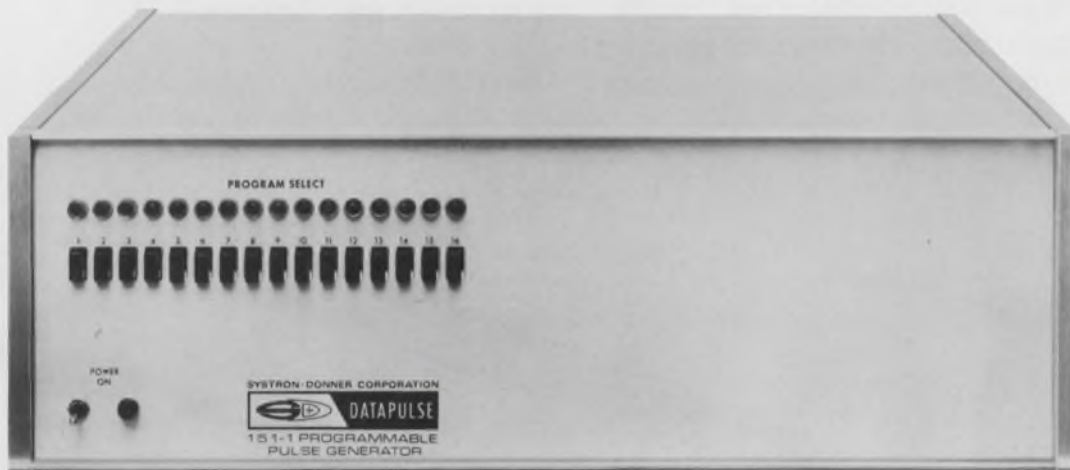

If your new Datapulse 150 series pulse generator doesn't pay for itself in 90 days, we'll take it back.

If your pulse generator just sits on your work bench and you reach over now and then to turn a knob or two—the Series 150 is not for you.

But, if you're like everybody else, your pulse generator is part of some test set-up. You perform several different tests and you repeat them several times. **You can't afford anything else.**

HERE'S WHY!

Rep Rate to 50 MHz—Delay and Duration from 10 nanoseconds to 10 milliseconds—Pulse Amplitude to ± 10 volts with top and baseline anywhere from + to -10 volts—Transitions take less than 5 nanoseconds.

The Model 151 sets all parameters with **one punch** of a button. You pocket all the dollars you used to spend for manual set-up time.

The Model 152 does the same thing—and transition times are variable out to 10 microseconds.

The Model 153 sets all parameters from digital input information if you already have a semi-automatic or automatic system.

The Model 154 adds variable transitions again.

Optional automatic sequencing and/or parallel manual control round out the picture to give you a choice of 16 different units. Let one of them pay for itself in your test set-up. After that, the time saved is pure profit.

Prices start as low as \$1,000.

For more information, address Datapulse Division, Systron-Donner Corporation, 10150 W. Jefferson Blvd., Culver City, California 90230. Phone 213-836-6100 or TWX 910-340-6766.

DATAPULSE
DIVISION

SYSTRON  DONNER

NEWS

- 21 **News Scope**
- 24 **The automation revolution sweeps Europe**
European companies are setting process-control standards for the world. Their goal is to automate major industries by the year 2000.
- 30 **New progress in ferroelectric ceramics**
Improved electro-optic material and novel image device show promise in memory and display devices.
- 33 **Laser with energy to burn may power satellites from the ground.**
- 36 **Major advances predicted for thin-film ICs**
Specialists at components conference see better materials and processes increasing circuit yields.

TECHNOLOGY

- 70 **Yes, redundancy increases reliability . . . but how much?** Here's how to calculate the reliability improvement for redundant op amps, or RAMPS.
- 80 **Build better source followers 10 ways,** using these graphical designs that simplify the biasing calculations.
- 86 **Try using VCOs as discriminators.** This technique eliminates the need for separate designs in some systems and improves performance.
- 90 **Needed: a quality design for living . . .** A management professor discusses what social commitment should mean to the engineer.
- 96 **Ideas for Design**
- 106 **Six-month index to Product Source Directories**
- 107 **Product Source Directory: Frequency Synthesizers**

PRODUCTS

- 111 **Modules & Subassemblies:** Modular converters boost specs, drop prices.
- 116 **ICs & Semiconductors:** Hybrid-compatible transistors take 117 W at 25°C.
- 122 **Instrumentation:** Dc supply with dual output offers two-mode operation.
- | | |
|---------------------------|------------------------------|
| 126 Data Processing | 133 Microwaves & Lasers |
| 129 Components | 135 Tools & Engineering Aids |
| 132 Packaging & Materials | 152 Product Index |

Departments

- 69 **Editorial:** Why not give your Congressman some lessons in engineering?
- | | |
|------------------------|----------------------------|
| 13 Designer's Calendar | 138 Annual Reports |
| 43 Letters | 140 Application Notes |
| 48 Sidelights | 142 New Literature |
| 136 Evaluation Samples | 147 Product Bulletin Board |
| 137 Design Aids | 150 Advertisers' Index |

Information Retrieval Service Card inside back cover

Cover: Designed by Art Director Clifford M. Gardiner and photographed by Henry Ries.

ELECTRONIC DESIGN is published biweekly by Hayden Publishing Company, Inc., 850 Third Avenue, New York, N.Y. 10022. James S. Mulholland, Jr., President. Printed at Brown Printing Co., Inc., Waseca, Minn. Controlled circulation postage paid at Waseca, Minn., and New York, N.Y. Copyright © 1970, Hayden Publishing Company, Inc. 82,501 copies this issue.

Don't
miss our
big production
number.

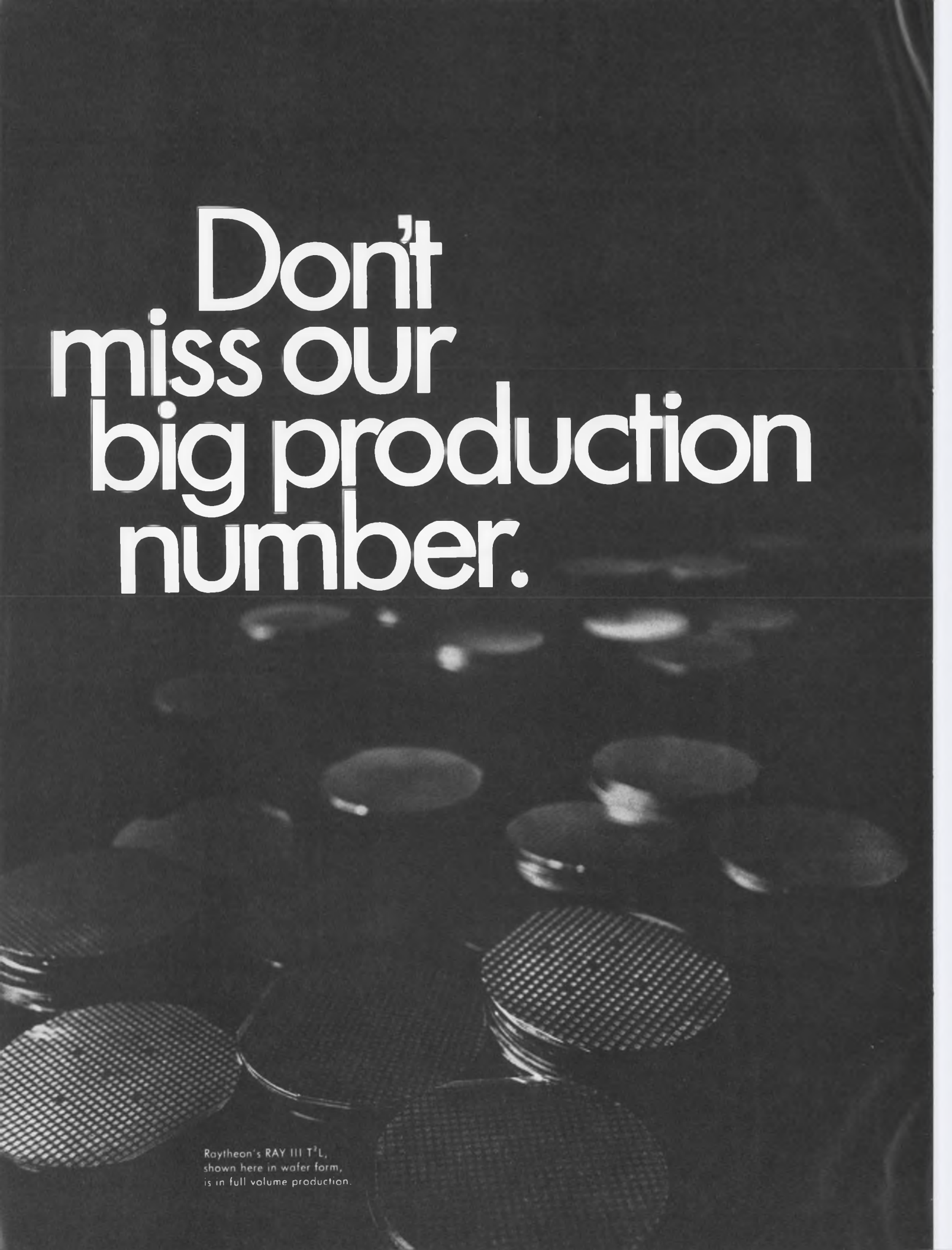

Raytheon's RAY III T³L,
shown here in wafer form,
is in full volume production.

**Starring RAY III
and a cast of 28**

Raytheon's RAY III
T²L is now in
volume production.
With 28 separate
functions, it's the market's
fastest saturated logic.



RG3180 Dual 4-Input NAND Expander	RG3440 2-Wide 2-Input AOI Gate, Split Outputs
RG3200 Expandable Single 8-Input NAND Gate	RG3450 4-Wide 2-2-3-4 Input AOI Gate
RG3240 Dual 4-Input NAND Gate	RG3380 Hex Inverter
RG3260 Single 8-Input NAND Gate	RG3390 Dual 4-Input AND Gate, Split Outputs
RG3220 Quadruple 2-Input NAND Gate	RG3400 Quad 2-Input AND Gate
RG3320 Triple 3-Input NAND Gate	RG3410 Quad 2-Input NOR Gate
RG3420 Dual 4-Input NAND Gate, Split Outputs	RF3200 AND-Input JK Flip Flop
RG3430 Single 8-Input NAND Gate, Split Outputs	RF3210 OR-Input JK Flip Flop
RG3210 Expandable 2-wide, 4-Input AOI Gate	RF3120 Dual JK Flip Flop (Separate Clocks)
RG3230 4-Wide 2-2-3-3 Input AOI Expander	RF3130 Dual JK Flip Flop (Common Clock)
RG3250 Expandable 4-Wide, 2-2-2-3 Input AOI Gate	RF3220 Triple Flip Flop, Sep. Neg. Edge Clocks
RG3270 2-Wide, 4-Input AOI Expander	RF3230 60 MHz Dual-D Flip Flop
RG3300 Expandable 3-Wide, 3-Input AOI Gate	RF3240 Triple Flip Flop, Com. Pos. Edge Clock
RG3310 Dual 2-Wide, 2-Input AOI Gate, One Side Expandable	RF3250 5 Channel Selector Flip Flop

Catch the main feature

This third-generation T²L is designed for new sockets needing higher logic speeds, or for upgrading existing systems.

Either way you pay no design penalties.

At all temperatures it's nearly twice as fast (with 5 nanosecond gate delays, 9 ns flip flops) as 54H/74H, SUHL II and RAY II. But it takes no more power. Still only 22 mW per gate from a 5 volt supply.

And RAY III is function-compatible with all second-generation logic, pin-compatible with most. It gives you improved noise immunity, plus input clamping diodes.

All types come in hermetic or plastic DIP's, or in flatpacks, and operate from -55° to +125°C. (Also available from 0° to +75°C.)

We wrote the script

Send for our comprehensive data book, "RAY III," with logic diagrams and schematics, electrical characteristics, test data and application notes on the whole line.

All from the company that gets the ideas and produces them.

Raytheon Semiconductor,
Mountain View, California.
(415) 968-9211.



See it now at
your neighborhood
Raytheon distributor

Alabama
Huntsville
Cramer/Huntsville, Inc.
(205) 536-4493

Arizona
Phoenix
Avnet
(602) 272-6821

California
Culver City
Avnet
(213) 836-7200

Inglewood
Liberty Electronics
(213) 776-6252

Los Angeles
Kierulff Electronics
(213) 685-5511

Mountain View
Avnet
(415) 961-7700

Mountain View
Elmar Electronics
(415) 961-3611

Palo Alto
Kierulff Electronics
(415) 968-6292

San Carlos
Intermark Electronics
(415) 961-5222

San Diego
Avnet
(714) 279-1550

Colorado
Denver
Avnet
(303) 623-6255

Connecticut
North Haven
Cramer Electronics
(203) 239-5641

Florida
Fort Lauderdale
Cramer/Florida, Inc.
(305) 566-7511

Fort Lauderdale
Hallmark of
Fl. Lauderdale
(305) 563-3271

Orlando
Hallmark
Electronics Corp.
(305) 855-4020

Palm Beach Gardens
Industrial Electronics Assoc.
(305) 848-8686

Georgia
Atlanta
Cramer/Atlanta, Inc.
(404) 451-5421

Illinois
Rosemont
Hallmark Electronics
(312) 299-6602

Schiller Park
Pace/Avnet
(312) 678-6310

Kansas
Prairie Village
Avnet
(913) 362-3250

Maryland
Baltimore
Cramer/Baltimore, Inc.
(301) 354-0100

Baltimore
Radio Electric Service
Company of Baltimore
(301) 823-0070

Rockville
Cramer/Washington, Inc.
(301) 424-2700

Rockville
Pioneer Washington
Electronics
(301) 427-3300

Silver Springs
Radio Electric
Service Company
(301) 588-5140

Massachusetts
Burlington
Avnet
(617) 272-3060

Newton
Cramer Electronics
(617) 969-7700

Michigan
Detroit
Avnet
(313) 538-1000

Minnesota
Bloomington
Cramer Electronics
(612) 881-8678

Minneapolis
Avnet
(612) 920-5866

Missouri
St. Louis
Hallmark Electronics
(314) 521-3800

New Jersey
Jersey City
KRS Electronics, Inc.
(201) 435-3600

Pennsauken
Cramer Pennsylvania
(215) 923-5950

New Mexico
Albuquerque
Avnet
(505) 265-7926

Albuquerque
Century Electronics
(505) 265-7837

New York
Baldwin, L.I.
Hamilton Electro Sales
(516) 223-8000

East Syracuse
Cramer/Eastern, Inc.
(315) 437-6671

Elmhurst
Cramer/Esco, Inc.
(212) 478-4000

Great Neck, L.I.
Time Electronics Sales
(516) 487-0100

South Rochester
Cramer/Rochester
(716) 275-0300

Westbury, L.I.
Avnet
(516) 333-5800

North Carolina
Raleigh
Cramer/Raleigh, Inc.
(919) 876-2371

Ohio
Cincinnati
Cramer/Tri-States, Inc.
(513) 771-6441

Cleveland
W. M. Pattison
Supply Co.
(216) 441-3000

Pennsylvania
Hatboro
Avnet
(215) 052-6900

Pittsburgh
Cameradio Company
(412) 391-4000

Texas
Dallas
Avnet/Contact Electronics
(214) 638-2850

Utah
Salt Lake City
Cramer/Hyer
(801) 487-3681

Washington
Seattle
Avnet
(206) 623-8824

Seattle
Kierulff Electronics
(206) 763-1550

Wisconsin
Milwaukee
Hallmark Electronics
(414) 476-1270

Canada
Montreal
Avnet Electronics
of Canada, Ltd.
(514) 381-9127

Ottawa
Wackid Radio & Television
Labs, Ltd.
(613) 728-1821

Toronto
Avnet Electronics
of Canada, Ltd.
(416) 789-1838



New USCC Ceramolithic® chips put more capacitance in smaller sizes

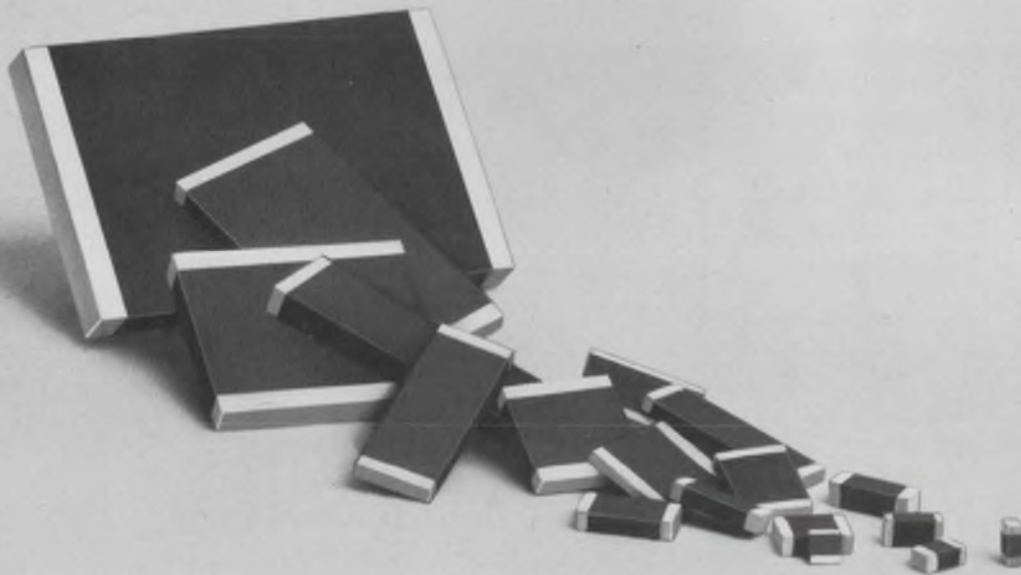

USCC has found the way to increase capacitance values in every monolithic chip size. Reliable values to solve hybrid circuit design problems with. It's our exclusive Ceramolithic® construction. Starting with the smallest chip, only .050" x .050" x .040", you'll discover new, important maximum capacitance values in all 18 configurations. For complete information, phone or write USCC or contact your local USCC sales representative.

Ceramolithc® Chip Capacitor Specifications: Capacitance range: 10 pF to 3.3 Mfd. Voltage ratings: 50, 100 and 200 WVdc. Dielectrics: W and NPO. Temperature range: -55°C to 125°C. End terminations: noble metal and special combinations. Meets applicable requirements of MIL-C-11015 and MIL-C-39014.

To know chip capacitors is to use them

New, 36-page guide and checklist tells what to look for in choosing monolithic chip capacitors. USCC has compiled the most comprehensive "how to" manual ever published on practical considerations for selecting and using monolithic chip capacitors. Featured are all important criteria needed by engineers and engineering designers to specify the proper chip capacitor for every application. For your free copy, write to the USCC Engineering Department.



U.S. Capacitor Corporation, 2151 No. Lincoln St., Burbank, Calif. 91504, Phone: (213) 843-4222. TWX: 910-498-2222.



Need high stability and low noise
in trimming your circuitry?

The CTS Answer Man offers two new Cermet Rectilinear Trimmers

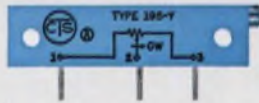
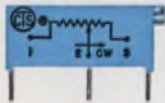

CTS Series 190 and 195 trimmers give you what you need: high stability and low noise. Settability is unusually easy—better than $\pm 0.025\%$. Noise is very low—on the average, $\pm 0.5\%$. Moreover, there's maximum stability in resistance after setting—no matter how severe the environment. Choice of 3 terminal configurations in each series. Price? Delivery? Highly satisfactory.

The CTS Answer Man is your man at CTS. He's more than a salesman—he'll quarterback your product requirement through the multi-resources of CTS. At his fingertips: broad production facilities, the latest technologies, plus 10 years of Cermet product experience. You can bet he'll come up with an answer every bit as good as our trimmers.

Trimmers. Potentiometers. Selector switches. Crystal products. Thick-film hybrid circuits. Cermet resistor modules. Loudspeakers. CTS makes them all in 10 U.S. and 8 foreign plants. And the CTS Answer Man stands ready to fit them to your application. To learn more, write:

CTS CORPORATION
Elkhart, Indiana



The Malco reputation wasn't built on dating and marriage counseling. But it was built on broad product lines of precision mating, interconnecting techniques with virtually unlimited tooled parts for superior circuit distribution regardless of your electronic packaging application.

This unique system has been named —

MALCO/MATES. However, it does more than supply you with the highest-quality and quick delivery of parts and equipment you need. It was designed to bring your organization and the Malco people together in a mutually satisfying relationship. You'll be surprised how much easier our sales and engineering staff can make your job. Consult us today.

The entire **MALCO/MATE** family will be at the **NEPCON Show—Booth 4209:**

AUTO/MATES (Automatically Applied)

Crimp Type Wire Connectors

Tabcons® (flat blade receptacles)

Pinons (pin receptacles)

Wrapons (wrapost receptacles—
for .045" or .025" square or .030"
x .060" or .020" x .030"
rectangular wraptails)

Rings & Spades

Printed Circuit Hardware

Pins

Wraposts

PLATE/MATES (Hi Reliability, Logic
Distribution Plate Connectors)

**Fork and Blade Interconnection
Systems**

Wasp®

Mini-Wasp®

CARD/MATES (Plate Type and
Standard P.C. Edge Connectors)

Cardec

Card Receptacles

RACK/MATES (Accessory Rack and
Panel Products)

Rack & Panel I/O Connectors

Flat Cable Connectors

Power Buss Strips &

Jumper Clips

Card Guide Systems

MOD-MATES (Modular Interconnection
Designs)

Modu-Con

Dip Mate



MALCO®

MALCO MFG. COMPANY INC

5150 W. ROOSEVELT RD.

CHICAGO, ILLINOIS 60660

PHONE (312) 287-8700

We Solve Your Mating Problems.



Amperex Electro-Optics Capability
extends far beyond the
Plumbicon* TV Camera Tube...



...guess
who's become a
leading supplier of
Instrument Cathode Ray Tubes!

In addition to the well-known line of Plumbicon TV Camera Tubes, the electro-optics capability of Amperex is reflected in its position of leadership in instrument cathode ray tubes. The type range is broad and includes mono-accelerator tubes, post-deflection accelerator tubes and high frequency tubes. There are also monitor, flying spot scanner and projection tubes.

The so-called "medium priced" CRT's are especially noteworthy in terms of value:

- they are precision made
- the rectangular types give the best ratio of usable to actual screen area
- their electrical and physical axes coincide
- some have built-in, high-contrast, edge-lighted graticules covering the entire scanned area
- they have remarkably high vertical and horizontal sensitivities, typically 4 V/cm 'Y' and 16 V/cm 'X' for an anode voltage of 10 kV and a gun voltage of 1500 V
- they are capable of oscilloscope deflection system bandwidths up to 50 MHz
- and they can be had in various phosphors to meet specific applications

To obtain further information or to discuss your individual requirements on Amperex CRT's, contact us by mail or phone: Electro-Optical Devices Division, Amperex Electronic Corporation, Slatersville, Rhode Island 02876. Telephone: 401-762-3800.

Amperex[®]

TOMORROW'S THINKING IN TODAY'S PRODUCTS
A NORTH AMERICAN PHILIPS COMPANY

Zero-In On 3A To 20A Economy With Rugged, New Silicon Power Complements!



The most spec for the least money!

That's the big story in back of these 20 new 3, 5, 8, 12 and 20 A silicon power transistors . . . spec'd to give you the option of choosing the exact current-gain level you need for a variety of industrial designs without having to "specialize."

They handle power up to 200 W . . . and they're complementary!

That means you can design circuit-simplified audio/servo amplifiers with no need for output transformers and associated labor of installation. And, in dc-coupled pulse generators, the series can provide both positive and negative pulse outputs when used as PNP/NPN pairs.

The 2N5867-86, 60-80 V family gives you your choice of capability vs. price, too — because it has gain spec'd at 3 points within each individual current category. The 12 A, 2N5879-82 group, for example, furnishes minimum beta of 35 at 2 A and 5 at 12 A plus a complete gain range of 20-100 at 6 A. Two saturation voltages characteristics ($V_{CE(sat)}$ & V_{BE}) are given at 7 and 12 A, too, providing a broad picture of high efficiency operation in your design . . . and ensuring more "usable power" even up to junction temperatures of 200°C!

Motorola's exclusive EpiBase* fabrication process further inherent economy by furnishing more low-cost ways to replace germanium types while maintaining long-term reliability and stability in the most demanding applications.

Set your sights on the 2N5867-86 series for relay and solenoid drivers, inverters, converters, and audio/servo amplifiers . . . Box 20912, Phoenix, Arizona 85036 — get all the silicon power you need for the exact price you want to pay — today!

**...ON THE MOVE
IN SOLID-STATE
POWER!**

Type		I _c (Cont) A	P _D W	h _{FE} @ I _c (min/range)	V _{CE(sat)} @ I _c V	Rise & Fall Time μs	PRICE, 100-UP	
PNP	NPN						PNP	NPN
2N5867 2N5868	2N5869 2N5870	3	87½	35 @ 0.3A 20-100 @ 1.5A 5 @ 3A	1 @ 2A 2 @ 3A	1.0 @ I _c (max) 2	\$1.35 1.75	\$1.25 1.60
2N5871 2N5872	2N5873 2N5874	5	100	35 @ 0.5A 20-100 @ 2.5A 5 @ 5A	1 @ 4A 2 @ 5A		1.60 1.95	1.40 1.75
2N5875 2N5876	2N5877 2N5878	8	150	35 @ 1A 20-100 @ 4A 5 @ 8A	1 @ 5A 3 @ 8A		2.45 2.85	1.70 2.00
2N5879 2N5880	2N5881 2N5882	12	160	35 @ 2A 20-100 @ 6A 5 @ 12A	1 @ 7A 4 @ 12A		3.70 4.20	2.70 3.00
2N5883 2N5884	2N5885 2N5886	20	200	35 @ 3A 20-100 @ 10A 5 @ 20A	1 @ 15A 4 @ 20A		4.10 4.50	3.75 4.25

*Trademark of Motorola Inc.



MOTOROLA
Silicon Power Transistors

Here's a quick plug for micro-systems.

The A-MP Chevron Shaped Connector plugs in, plugs out and interchanges to give you connection flexibility in your most mini-micro applications.

This connector has contacts on straight centers of .050". Or staggered centers of .025". Because of their special design, the contacts are very tolerant of misalignment and very redundant in their connection.

The receptacle contacts have an outside diameter of .030". Inside there are two spiral springs that redundantly grasp every pin.

The connector housings are dimensionally identical for both pin and receptacle contacts. (A foresight for versatility's sake.) They are available with contoured edges that correspond to the staggered pattern of the contacts. Which means you can fit the housings together and maintain even contact spacings.

For application versatility, the connectors can be mounted for either perpendicular or parallel card mating in addition to the standard in-line card-to-card applications. There's also a version for ribbon cable that opens many cable-to-card or cable-to-cable possibilities, or for transmission cable to match 75 ohm impedance.

That's our plug for micro-systems. But it's not all you'll need to know about it. For more information on the A-MP Chevron Connector write:

**Industrial Division,
AMP Incorporated, Harrisburg, Pa. 17105.**

AMP
INCORPORATED

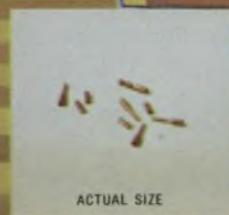
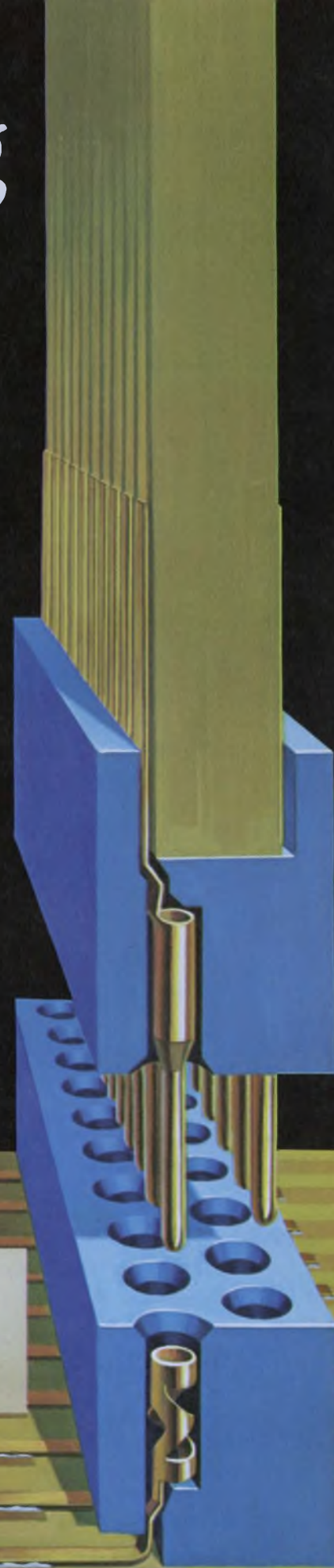

New! MULTI-COMP[®] Assemblies...

UP TO 28 FILM RESISTORS INSIDE A DIP PACKAGE LIKE THIS

UP TO 10 CERAMIC CAPACITORS INSIDE A DIP PACKAGE LIKE THIS

UP TO 4 TANTALUM CAPACITORS INSIDE A DIP PACKAGE LIKE THIS

UP TO 4 PULSE TRANSFORMERS INSIDE A DIP PACKAGE LIKE THIS

UP TO 8 DELAY LINE TAPS INSIDE A DIP PACKAGE LIKE THIS

NETWORK COMBINATIONS OF THE ABOVE INSIDE A DIP PACKAGE LIKE THIS

COMPATIBLE WITH IC PACKAGES. PIN SPACING FITS STANDARD 100-MIL GRID.

Now get multiple components in dual in-line packages!

- Single package form for your wiring boards.
- Compatible with automatic insertion equipment.
- High packaging density.
- Facilitate purchasing, inspection, storage, installation—Fewer parts to handle.
- Easier board layout.
- Improve appearance of circuit boards—Everything lines up neatly, compactly.
- Fully molded for protection against moisture and humidity.
- Ideal for use in data and signal processing systems where repetitive patterns exist.

Write for Engineering Bulletin 22,500 to Technical Literature Service, Sprague Electric Company, 347 Marshall Street, North Adams, Massachusetts 01247.

THE BROAD-LINE PRODUCER OF ELECTRONIC PARTS



Sprague and ® are registered trademarks of the Sprague Electric Co.

Designer's Calendar

JULY 1970						
S	M	T	W	T	F	S
			1	2	3	4
5	6	7	8	9	10	11
12	13	14	15	16	17	18
19	20	21	22	23	24	25
26	27	28	29	30	31	

For further information on meetings, use Information Retrieval Card.

July 14-16

International Electromagnetic Compatibility Symposium (Anaheim, Calif.) Sponsor: IEEE. Jim Senn, Lectro Magnetics, Inc., 6056 W. Jefferson Blvd., Los Angeles, Calif. 90016.

CIRCLE NO. 451

July 21-23

Conference on Nuclear & Space Radiation Effects (San Diego, Calif.) Sponsor: IEEE. Richard Thatcher, Battelle Memorial Inst., 505 King Ave., Columbus, Ohio 43201.

CIRCLE NO. 452

AUGUST 1970						
S	M	T	W	T	F	S
						1
2	3	4	5	6	7	8
9	10	11	12	13	14	15
16	17	18	19	20	21	22
23	24	25	26	27	28	29
30	31					

Aug. 25-28

Western Electronic Show & Convention (WESCON), Los Angeles). Sponsors: IEEE, WEMA. WESCON Office, 3600 Wilshire Blvd., Los Angeles, Calif. 90005.

CIRCLE NO. 454

Aug. 30-Sept. 2

Electronic Materials Technical Conference (New York City). Sponsor: AIME. A Reisman, IBM Corp., P.O. Box 218, Yorktown Heights, N.Y. 10598.

CIRCLE NO. 453

Simpson's Goof-Proof 260-5P



the
VOM
they
can't
burn
out!

- **All Ranges Protected** except for 10 Amp, 1 kV, and 5 kV ranges. Even takes line voltage on the Rx1 range without damage!
- **Button Pops Out to Indicate Overload.** Lets operator know instantly that an overload is present. Does not require massive overloads to activate.
- **Cannot be re-set While Overload Is Present.** The 260-5P's protective circuits are truly defeat-proof.
- **New Shock-Proof Taut Band Movement** cannot develop error-causing friction from rough treatment. Self-shielding, too.

GOOF-PROOF 260-5P VOM

Complete with test leads and operator's manual. **\$97⁰⁰**

Simpson
INSTRUMENTS THAT STAY ACCURATE

GET "OFF THE SHELF" DELIVERY
FROM YOUR LOCAL
ELECTRONIC DISTRIBUTOR.



SIMPSON ELECTRIC COMPANY

5200 W. Kinzie Street, Chicago, Illinois 60644 • Phone (312) 379-1121

EXPORT DEPT.: 400 W. Madison Street, Chicago, Illinois 60606. Cable Simelco
IN CANADA: Bach-Simpson Ltd., London, Ontario
IN INDIA: Ruttonsha-Simpson Private Ltd.

International House, Bombay-Agra Road, Vikhroli, Bombay

INFORMATION RETRIEVAL NUMBER 12

How to save on relays

A quotation from Line Electric includes lots of values that add to the total savings possible.



For instance:

- Line makes on-time deliveries to meet your production line schedules.
- Line offers excellent engineering help free.
- Line maintains the highest manufacturing standards in the industry

Add these values together and you get all-round savings on your relay purchases. Not to mention the headaches you can avoid.

Won't you check us out and see how much better you can do at Line? Send for free copy of our new 1970 catalogue containing all the most frequently used industrial type relays. We guarantee you'll learn something to your advantage.



In a hurry, call (201) 887-8200 and ask for Relay Sales Manager. We like to do business by phone.

SINGER
LINE ELECTRIC CO.

Line Electric Company, U. S. Highway 287, Parsippany, N. J. 07054 201/887-8200

INFORMATION RETRIEVAL NUMBER 13



Leave my power supply system alone! You can get your own in only 9 days from Acopian.

"I tried struggling through that old power supply system catalog. It was like a jigsaw puzzle, hunting for the pieces I needed for my new power system. There had to be a better way.

"Then I remembered the Acopian hotline. I called it. I told them the DC voltages and currents I wanted. Discussed panel size. Meters. Switches. And other accessories.

"They gave me a firm price. Right on the phone. It was a lot less than I expected. I had our buyer phone in the P.O. And Acopian designed,

built, tested and shipped it in nine days. Completely wired.

"So go order your own Acopian power system . . . It's easy!"

HOW TO ORDER ACOPIAN POWER SYSTEMS

- Call Acopian collect
- Tell us the outputs and accessories you need
- Get a firm price
- Shipment of completely wired system will be made in 9 days.

For immediate service, call the Acopian hotline: (215) 258-5441. For literature, write Acopian Corp., Easton, Pa. 18042. And remember, Acopian also offers 82,000 different DC power modules, every one shipped with this tag . . .



OUR ANGLE: High Speed Accurate and Automatic Angle Position Indicators

WHAT'S YOUR ANGLE?



MODEL 545/100

If you're converting synchro/resolver data to digital format, you need both speed *and* accuracy to keep pace with today's data explosion. Only one converter meets both these requirements without compromise. And for under \$4K. . . . North Atlantic's Model 545/100.

The solid-state Model 545/100 converts both resolver and synchro data with 0.01° accuracy and resolution. And continuously digitizes input angle data at $20,000^\circ$ per second in the face of real-life noise, harmonics and quadrature levels. BCD output is available at the rear connector. Conversion can be stopped by a data freeze command. If multiplexed signals are your bag, acquisition time is less than 30 ms.

Options? Other models offer many options, including 0.001° resolution with 10 arc-second accuracy; data frequencies from 60Hz to 2.4kHz, binary output, small size.

No matter what your conversion problem, if you require ultra-fast, ultra-accurate tracking, contact your North Atlantic sales engineering representative today. He'll show you a better angle.

**IN
A**

NORTH ATLANTIC
industries, inc.

200 TERMINAL DRIVE, PLAINVIEW, NEW YORK 11803
cable: noatlantic / twx: 510-221-1879 / phone: (516) 681-8600

WIN BIG

Let



Deal you a

FULL HOUSE
of capability

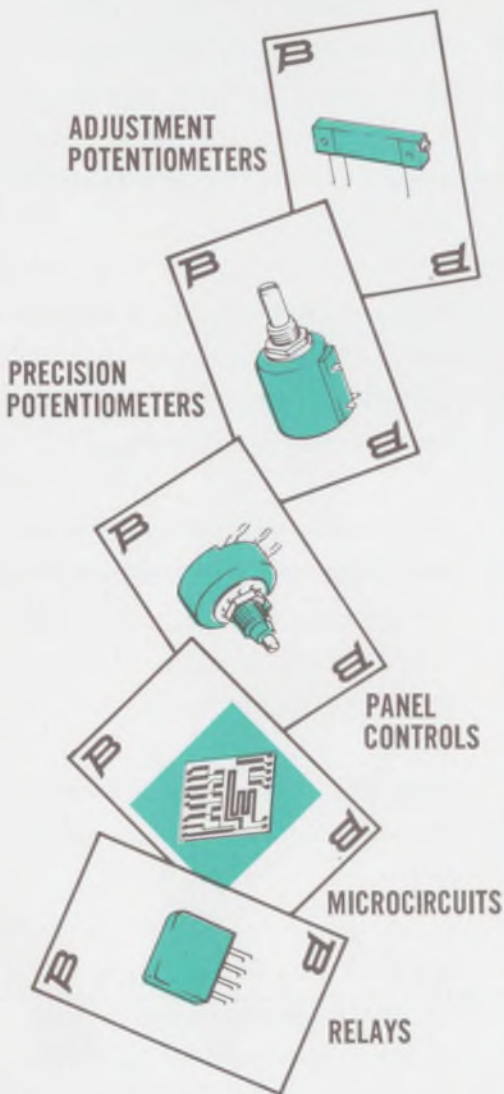

Take a card. Send for any or all of these brand new 1970 brochures from Bourns.

Deal yourself a winning hand. Send for any or all of these winning combinations. There is no obligation. No sales engineer will call.

- | | |
|---|--|
| <input type="checkbox"/> Adjustment Potentiometers and Panel Controls | <input type="checkbox"/> Microcircuits |
| <input type="checkbox"/> Precision Potentiometers | <input type="checkbox"/> Relays |

Name _____
 Company _____ Bldg. _____ Mail St. _____
 Street _____
 City _____ State _____ Zip _____

Please print clearly for fast, sure delivery!

Deal yourself a winning hand. Send for any or all of these winning combinations. There is no obligation. No sales engineer will call.

- | | |
|---|--|
| <input type="checkbox"/> Adjustment Potentiometers and Panel Controls | <input type="checkbox"/> Microcircuits |
| <input type="checkbox"/> Precision Potentiometers | <input type="checkbox"/> Relays |

Name _____
 Company _____ Bldg. _____ Mail St. _____
 Street _____
 City _____ State _____ Zip _____

Please print clearly for fast, sure delivery!

Deal yourself a winning hand. Send for any or all of these winning combinations. There is no obligation. No sales engineer will call.

- | | |
|---|--|
| <input type="checkbox"/> Adjustment Potentiometers and Panel Controls | <input type="checkbox"/> Microcircuits |
| <input type="checkbox"/> Precision Potentiometers | <input type="checkbox"/> Relays |

Name _____
 Company _____ Bldg. _____ Mail St. _____
 Street _____
 City _____ State _____ Zip _____

Please print clearly for fast, sure delivery!

STAND PAT

With



*Every Hand's
A Winner!*

ADJUSTMENT POTENTIOMETERS:

Widest selection on market: smallest, most reliable; complete lines of cermet, wirewound and carbon; more models on DESC's QPL than any other manufacturer.

PANEL CONTROLS:

A new sensation; complete line of single-turn potentiometers with cermet resistance elements for top performance.

PRECISION POTENTIOMETERS:

Widest selection of standards in the industry; outstanding custom capability; versatile new line of single-turns — the B-LINE™.

MICROCIRCUITS:

Thick film hybrid circuits — R, R-C, ladder and active circuits.

RELAYS:

Outstanding line of sub-miniatures; smallest 2 amp units on market; 1 amp Trimpack PC models with lowest profiles in industry.

POSTAGE
WILL BE PAID
BY
ADDRESSEE

NO POSTAGE
STAMP NECESSARY
IF MAILED IN THE
UNITED STATES

BUSINESS REPLY CARD
First Class Permit No. 327, Riverside, California



1200 COLUMBIA AVE.,
RIVERSIDE, CALIF. 92507

POSTAGE
WILL BE PAID
BY
ADDRESSEE

NO POSTAGE
STAMP NECESSARY
IF MAILED IN THE
UNITED STATES

BUSINESS REPLY CARD
First Class Permit No. 327, Riverside, California



1200 COLUMBIA AVE.,
RIVERSIDE, CALIF. 92507

POSTAGE
WILL BE PAID
BY
ADDRESSEE

NO POSTAGE
STAMP NECESSARY
IF MAILED IN THE
UNITED STATES

BUSINESS REPLY CARD
First Class Permit No. 327, Riverside, California



1200 COLUMBIA AVE.,
RIVERSIDE, CALIF. 92507

The hybrid circuit: if you don't like what we make, we'll make what you like.

We're not proud.

We've designed many different standard hybrid microelectronic modules in what we think is the optimum package type for each one.

But, if they don't suit your system, we'll gladly change the package or the circuit to suit your needs.

Our off-the-shelf line spans the spectrum from digital to video. It includes a video amplifier, memory and clock drivers and translators, gated high-power drivers and a 30-MHz IF amplifier.

All of them are our own design and if they meet your needs, we are both ahead of the game.

If they don't, that's where our experience and advanced hybrid techniques come into play. We can translate your design into a hybrid microelectronic module quickly, easily, *and* economically, because we don't have to waste time getting familiar with the problems.

Show us your system requirements. We'll come up with the right hybrid circuit to fill the bill.

That way we'll have a circuit we both like.

For more information, see your local representative. Sylvania Electronic Components, Hybrid Microelectronics, Waltham, Mass. (617) 893-9200, ext. 2400.

SYLVANIA
GENERAL TELEPHONE & ELECTRONICS

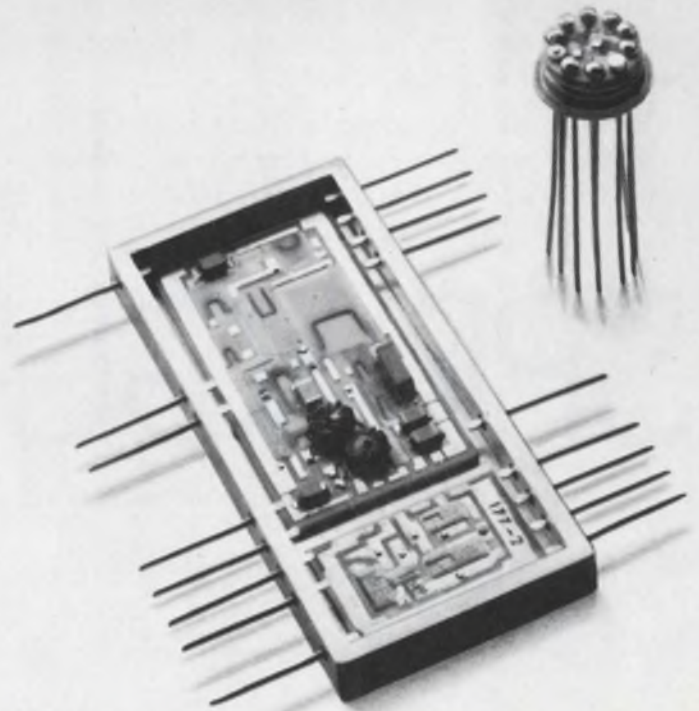



NEW NAME IN THE OP AMP GAME

There's a new name in the game for the best low-cost general-purpose IC op amp. Sprague 2139. Available now.

Plug the new Sprague 2139 into sockets where you've had the 1539, 741, 101 or the 709. Improved performance! Available now!

The Sprague 2139 comes in 8-lead TO-5 (TO-78) cans, and in chip form for building hybrids. Available now. And it's coming soon in plastic DIP.

Get the facts on the Sprague 2139, the new

THE SPRAGUE 2139	
FAST SLEW RATE	34 V/ μ s @ 100 gain
LOW NOISE	20 nV/(Hz) ^{1/2}
VERY LOW TEMP. DRIFT	\pm 0.2 nA/ $^{\circ}$ C
HIGH COMMON-MODE REJ. RATIO	20 V p-p @ 20 kHz

standard for price/performance factor. Write for Engineering Bulletin 27108 to Technical Literature Service, Sprague Electric Co. 347 Marshall Street, North Adams, Mass. Or Circle the reader service number below.

SPRAGUE 2139

SPRAGUE ELECTRIC CO., SEMICONDUCTOR DIV., WORCESTER, MASS. 01606 (617) 853-5000

ALA. Huntsville, no charge call operator, WX4000 ARIZ. Phoenix (602) 279-5435 CALIF. Burlingame (415) 347-7701 Los Angeles, Bell Tel., (213) 870-0161, Gen. Tel., (213) 391-0611 San Diego (714) 278-7640 COLO. Denver (303) 756-3611 CONN. Trumbull (203) 261-2551 DC. Washington (202) 244-6006 FLA. Orlando (305) 831-3636 ILL. Schiller Park (312) 678-2262 IND. Indianapolis (317) 253-4247 MASS. Newton (617) 969-2520 North Adams (413) 664-4411 MICH. Jackson (517) 787-3934 MINN. Minneapolis (612) 335-7734 MO. St. Ann (314) 291-2500 N.J. Cherry Hill (609) 667-4444/(215) 467-5252 Wayne (201) 696-8200 N.M. Albuquerque (505) 265-1579 N.Y. Melville (516) 549-4141 Syracuse (315) 437-7311 N.C. Winston-Salem (919) 722-5151 OHIO Chagrin Falls (216) 247-6488 Dayton (513) 223-9187 Cincinnati, no charge call operator, Enterprise 3-8805 TEX. Richardson (214) 235-1256 WASH. Seattle (206) 632-7761.



155-0132

Highlighting

THE ISSUE



Europe may be trailing the U. S. in basic electronic design, but it can still give Americans lessons in applications. Probably nowhere is this more apparent than in industrial process control.

From simple digital readouts to complete computer control of processes, European manufacturers are automating at a rapid pace. Their goal: complete automation of all major industries by the year 2000.
Page 24



Consisting of over 65 individual modules, the Modupac series of analog-to-digital and digital-to-analog signal conditioning circuits makes new breakthroughs in performance, miniaturization and price.

The a/d converters offer capacities of 8 to 15 bits at costs from \$180 to \$2400.

Besides multiplying types, the d/a converters include complementing designs for all the a/d converters.

Page 111

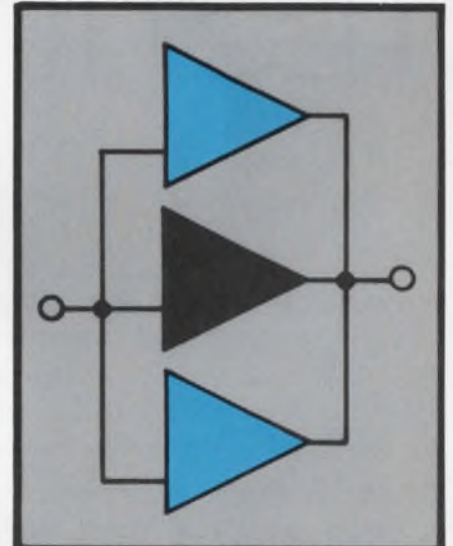

When good op-amp reliability is not enough—when you need ultra-high reliability—special summing circuits can be the answer. A redundant amplifier (RAMP) connection of several op amps can continue to operate satisfactorily, even after one or more of the amplifiers fails.

But exactly how much is the reliability increased? And what about interconnections? Author William H. Huber shows how a designer can conveniently compare, in a quantitative way, the reliability of a given RAMP with its nonredundant counterpart.

Page 70

NEW AUTO-POLARITY FET V-O-M SPEEDS TESTING

You've probably imagined the convenience and time-saving you'd enjoy if you could just clip one of the V-O-M leads to ground or to the chassis, and have your meter always read upscale regardless of the polarity of any other terminal you touched.

No need to imagine it any more . . . you can see it and try it right now at your Triplet distributor. Called the Triplet Model 602, it's probably the most convenient V-O-M ever built. Its convenience goes well beyond the auto-polarity feature, though . . . to AC and DC measurements from 10 mV to 1000 V in 8 ranges at 11 megohms DC and 10 megohms AC input resistance . . . AC and DC from 0.02 to 1000 mA in 4 ranges . . . resistances from 0.2 ohms to 1000 megohms in 6 ranges. And with an accuracy of 3% on voltage measurements, and a rugged suspension-type meter movement, the Model 602 has what it takes to make your job easier.

This great new V-O-M is only **\$100** suggested USA user net. For more information, or for a free, no-obligation demonstration, call your local Triplet distributor or your Triplet sales representative. Triplet Corporation, Bluffton, Ohio 45817.



The World's most complete line of V-O-M's . . . choose the one that's just right for you.

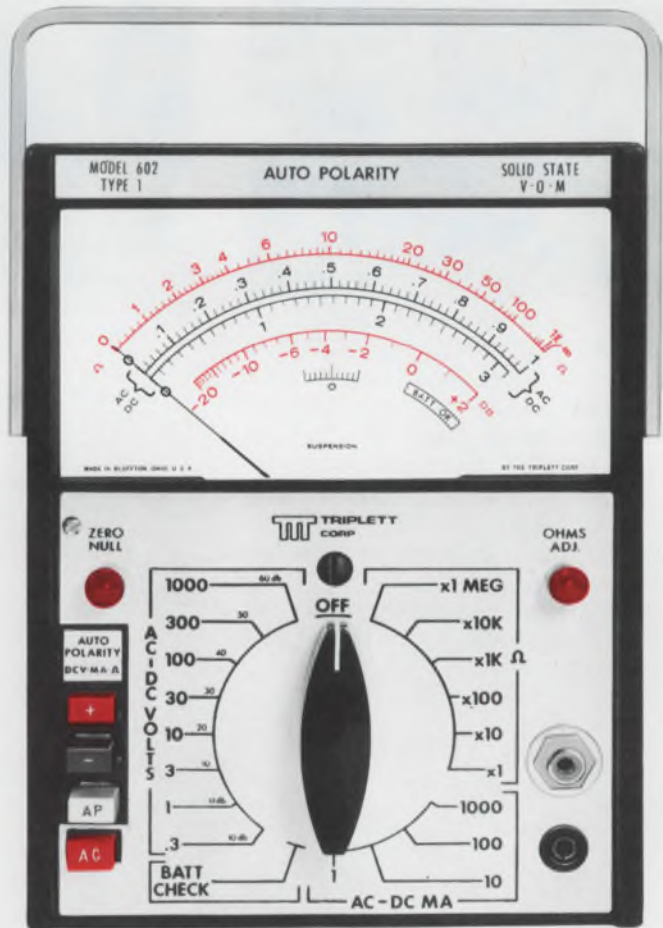

1. Auto Polarity . . . convenient and time-saving; creates memory and suppressed scale.
2. High sensitivity (.3V AC and DC) at constant 11 megohms input resistance.
3. Simplified scale with only 2 arcs for 24 AC/DC ranges.

News Scope

IEEE chief sees industry facing tough pull in 70s

Because of a change in national priorities, "it's going to take a lot more hard work to succeed in the 70s than it did in the 60s, for both companies and individuals," Dr. John V. N. Granger, president of the IEEE, told delegates to the International Microwave Symposium.

In a keynote address to the symposium in Newport Beach, Calif., Granger said that national priorities had shifted from the aerospace and military efforts of the 60s to such goals as:

- Stopping the war in Asia.
- Slowing inflation.
- Improving the quality of urban life.
- "Saving" the environment.
- "Providing new opportunities for the poor.

That, in a nutshell, Granger said, is why there is a slump in the electronics industry at present.

The IEEE president said he had no doubts that electronics technology had a major role to play in meeting these goals, but he added that he wasn't at all sure that the industry, as presently constituted, was set up to do the job. Present methods of management and financing, for example, may not be "relevant" to the social and economic problems of the 70s, he said.

Noting that the phenomenal growth of the electronics industry in the 60s took place under massive Government support, Granger said companies could not count on ever seeing its like again. For example, he said, NASA was spending over \$10-million a day on the programs that took the country from the first space flight of Alan B. Shepard Jr. in 1961 to the moon landing in 1969.

Those days are over, Granger said. Defense Dept. spending is down 24% in the last year, he noted. And factory output is down 10% in the last nine months. Few-

er new military aircraft will be purchased this year than in any year since 1939, he went on. And forecasts predict a 25% drop in new hirings of electrical engineers this year.

This is not a temporary slump due to a small cyclical technical economic factor, Granger said. "This is the real thing—a change in our national priorities."

Space-shuttle contracts won by California firms

Contracts for the preliminary design of a reusable space shuttle have been awarded by NASA to North American Rockwell's Space Div. in Downey, Calif., and the McDonnell Douglas Astronautics Co. in Huntington Beach, Calif.

The space shuttle, which is to ferry astronauts to and from earth-orbiting satellites, should be operational in 1977 or 1978, according to NASA. Each contract is worth \$8-million.

Total expenses for the program have been estimated by the space agency at between \$5.6-billion and \$6-billion. The shuttle is considered a key element in achieving planned interplanetary space flight.

(See "Designing for the Coming Space Station Era," ED 25, Dec. 6, 1969, p. 24).

New electron microscope can "see" heavy atoms

A new scanning electron microscope has enabled scientists to "see" for the first time single heavy atoms—such as uranium and thorium.

Designed and built by University of Chicago physicist Albert V. Crewe under a contract with the

Atomic Energy Commission, the new 25,000-volt instrument is not as powerful as many electron microscopes in use today. But it is said to have far higher contrast.

A unique feature of the new instrument is its electron source, a tiny tungsten point that can focus a beam of electrons only 5 angstroms in diameter. The beam is scanned across an object or specimen and the electrons scattered from the specimen generate an image on an oscilloscope.

3-way struggle looming for No. 2 computer spot

After IBM, who's No. 2 in the computer industry?

The recent move by Honeywell and General Electric to merge a good part of their computer operations seems likely to touch off a three-way battle. Honeywell and GE who plan to form a new company that would combine Honeywell's present computer operations and GE's business computer interests, have their sights on the No. 2 market spot. But so do Univac and RCA.

An RCA representative says his company's shipments of computer equipment are projected to be "slightly more than 7% of the industrywide total." "In the last five years, no other company [except IBM] has achieved this percentage of the market," he adds.

Univac's executive vice president for worldwide marketing and services, George H. Geick, says: "We are not in any way endorsing the assumptions being made about Honeywell's ascendancy to No. 2 position in worldwide computer markets. Our sales projections show Univac continuing to hold the No. 2 position, even after considering the effect of the proposed merger."

The computer market in 1969, as reported in dollars by the International Data Corp. of Newtonville, Mass., was shared by five companies as follows:

IBM	69 %
Univac	6.7%
Honeywell	4.2%
GE	4.0%
RCA	3.6%

The Honeywell-GE computer agreement must still be approved

News Scope

CONTINUED

by the Government and the boards of directors of the two companies. A new company would be set up, with Honeywell owning 81.5% of the stock and GE 18.5%. GE would receive 1.5-million shares of Honeywell common stock together with notes totaling \$110-million.

GE's time-sharing services, computer communication equipment and process computer business are not included in the negotiations. GE's board chairman, Fred J. Borch, emphasized that GE's business-computer customers would "continue to be serviced fully in terms of sales and service."

Lasers show promise as computer memories

Laser "mini-array" computer memories have been batch-fabricated and show promise of achieving higher bit densities and faster access times in mass storage than is now possible with conventional magnetic-induction techniques.

The bit density should jump by an order of magnitude, according to John C. Marinace of the IBM Research Div. in Yorktown Heights, N. Y., where the experimental device was built.

Each array is a gallium arsenide bar, containing 20 lasers, each of which can be switched to eight positions—a total of 160 positions. Each laser is 0.008-inch long and 0.0005-inch wide. They are spaced 0.004-inch apart.

The device stores information via highly localized laser heating of thin film to raise the temperature to a spot above its ferromagnetic Curie temperature. When such a spot cools in the presence of an external bias field, it takes on the magnetization direction of the field's polarization. The magnetization direction is later detected by the rotation of the laser beam produced by the ferromagnetic Kerr effect.

Arrays of individually addressable miniature lasers acting as counterparts of conventional mag-

netic induction heads serve effectively in this technique. In a high-power cw operation, the same lasers furnish the light that changes polarization corresponding to stored information.

Initial testing indicates that the arrays are both efficient and long-lasting, Marinace says.

Sensors would inflate car-crash cushions

Deceleration sensors based on inertial guidance technology may solve a safety problem for the automobile industry: the need for reliable crash-sensing electronics to trigger inflatable air cushions without explosive noise.

The cushions would inflate in milliseconds and keep riders in the car from slamming into the dashboard.

The use of deceleration sensors to inflate the cushions was suggested by the AC Electronics Div. of General Motors, Milwaukee, at the International Automotive Passive Restraints Conference. The conference was held at the General Motors proving grounds in Milford, Mich.

Typical time from initial shock to full cushion inflation ranges from 40 to 60 ms with deceleration sensors, according to Trevor O. Jones, automotive safety products director of AC Electronics. He pointed out that the sensors could be made "fail safe" to prevent inadvertent inflating of cushions.

Expansion plan cheers cable-TV industry

Proposed regulations to let the cable-TV industry expand rapidly into the top 100 markets in the country could be the start of large cable networks in the U. S., industry spokesmen say.

The Federal Communications Commission proposal has been praised by Irving Kahn, chairman and president of TelePrompster Corp. in New York, as "an historic move forward in American communications policy."

Under the FCC plan, cable-TV companies could transmit to their subscribers in the 100 markets sig-

nals from television stations around the country. Transmission of such distant signals has, until now, been barred by disagreement over the fees that cable-TV operators should pay for the privilege.

At present cable-TV doesn't offer much more than the stations that set owners might pick up directly off the air. The industry feels that reception of distant signals is a necessity before large numbers of new consumers will buy their service.

The FCC has suggested that Congress be asked to pass a law requiring most cable TV operators to pay 0.7% of their gross income to the copyright owner for each distant signal. To aid educational stations, cable-TV operators would have to pay 5% of their gross income to the Corporation for Public Broadcasting, which oversees production of educational programming.

To protect UHF television stations from loss of advertisers, such advertising would be carried without charge.

To protect cable TV systems from exorbitant city franchise fees, 2% of the system's gross income would be the top fee.

New terminal displays radar, computer data

A compact modular display terminal has been unveiled by the Air Force at the Rome Air Development Center, Griffiss Air Force Base, Rome, N. Y. The terminal was produced by Motorola's Government Electronics Div., Scottsdale, Ariz.

Designed to meet the needs of the Army, Navy and Air Force, the 16-inch terminal weighs less than 100 pounds. By changing electronic and mechanical modules, it can be used as radar display, computer readout or graphic terminal.

In the radar mode, vector velocity, range, elevation and identify of targets are displayed, making the terminal adaptable for civilian air traffic control.

As a graphic terminal, the unit can be used for data management. An area commander can be kept up to date and new data can be inserted via an interactive probe as the tactical situation changes.

TRY TO MATCH THIS

for size and reliability

you can't!

For their size, Type BB resistors pack a tremendous power dissipating ability. Rated 1/8 watt at 70°C in a 0.0004375 cu. in. volume.

And miniaturization has not reduced reliability. Tests prove it. They satisfy the highest level—the S level—of the latest MIL-R-39008 Established Reliability Specifications in all resistance values.

The key is hot molding—the Allen-Bradley way. A-B developed and built the machines. Only A-B uses them. They're fully automatic. Built-in precision control. A high degree of uniformity. Predictable performance from resistor to resistor—year after year.

For immediate delivery at factory prices call your authorized A-B industrial electronics distributor. Or write Marketing Dept., Electronics Division, Allen-Bradley Co., 1201 South Second St., Milwaukee, Wis. 53204. Export Office: 1293 Broad St., Bloomfield, N.J., U.S.A. 07003. In Canada: Allen-Bradley Canada Limited.

© Allen-Bradley Company 1969



Exclusive

Only A-B Type BB
RCR05 meets MIL-R-39008
ER (established reliability)
for 1/8-watt resistors
at the S level.
Shown actual size.



ALLEN - BRADLEY
QUALITY ELECTRONIC COMPONENTS

Europe may be trailing the U.S. in basic electronic design, but it can still give Americans lessons in applications. Probably nowhere is this more apparent than in industrial process control.

From simple digital readouts to complete computer control processes, European manufacturers are automating at a rapid pace. Their goal: complete automation of all major industries by the year 2000. And they are doing it largely with American components and equipment.

By using American computers and their own software and interfaces, for example, some European companies are setting process-control standards for the world. A re-

John N. Kessler got this story by traveling to France, Germany, England, Scotland and Wales and visiting a broad range of industrial plants.

cent tour of plants in Britain and the Continent shows such progress as this:

■ Imperial Smelting Corp. in Avonmouth, England, has constructed the most highly automated nonferrous-metals smelting plant in the world.

■ SNIAS (formerly Sud Aviation) in Toulouse, France, is using a computer automated checkout program for the Concorde and is

the first to market such a system to airlines.

■ Renault in Rueil, France, is designing cars by specifying numerical coordinates for a computer-controlled drafting and model-sculpturing system.

■ One of the world's most advanced control systems is being installed at a Steel Co. of Wales' cold-rolling mill in Port Talbot.

■ In Longannet, Scotland, an electronic mining system is belt-linked via an underground tunnel to a power-generating station.

To achieve this progress, Europeans are leaning heavily on American computers from Control Data Corp., Digital Equipment Corp., Honeywell, and IBM. But

The Automation Revolution Sweeps Europe

John N. Kessler
News Editor

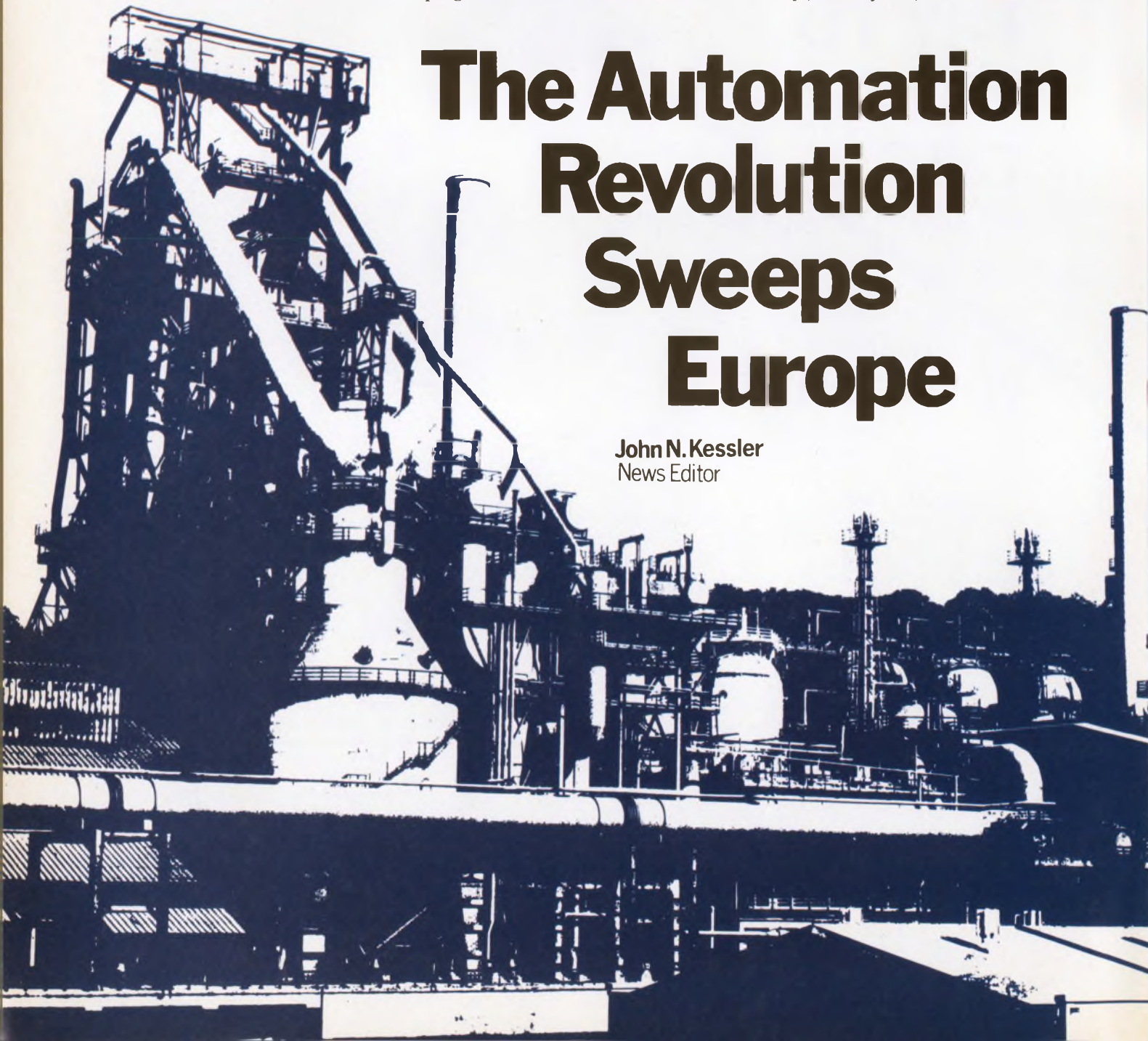

large European electronics concerns, such as Siemens and Imperial Computers, Ltd., are developing a class of general-purpose computers that can readily meet the needs of most large process-control operations.

At the Siemens plant in Karlsruhe, Germany, Dr. Helmut Bachmayer, relaxing in a private dining room, tells a visitor: "Process-control computers will increase at a rate of 50% a year for the next 10 years in Germany."

Bachmayer estimates that there are now 600 process-control computers in Germany, of which 340 are in industry and the rest being used for scientific purposes. "Today there are about 4000 process

control computers in Europe," he says. "By 1980 there will be 22,000 in Europe and 55,000 in the rest of the world."

The Siemens System 300 may be used in nearly all process-control applications. Depending on which of the four available processors are connected, memory cycle times vary between 33 and 1.5 μ s and memory capacities between 4096 and 16,384 words. All four processors can be time-shared and operated by up to 23 user programs. The system is highly flexible and is said to "permit optimum tailoring of equipment configurations to problem requirements and easy system expansion in line with growing processing requirements."

The chief applications for Siemens process-control computers include these:

- Power generating stations—to reduce the flow of data, preserve it for later evaluation, monitor measured values, detect incipient faults, perform fault diagnosis and maintain supervisory logs.

- Blast furnaces—to increase over-all effectiveness by controlling steam, oxygen, CO, and CO₂ and H₂ concentrations and monitoring temperature, humidity, pressure and oil flow.

- Chemical, petroleum, plastics, and textile plants—to perform automatic analyses of gases or organic substances, monitor manufacturing processes and automatically test components.

- Cement works—to control blending of raw materials for optimum mix by interfacing with an X-ray spectrometer.

Direct digital control, too

Most of these are analog systems. But one of the few direct digital control (DDC) systems for basic industry is installed in the Imperial Smelting Corp. plant at Avonmouth, England, a short distance up the Severn River from Bristol. This is the world's largest blast furnace for the combined smelting of zinc and lead. It has, the company says, "a cross-sectional area of 292 square feet." Every 24 hours it produces 400 tons of zinc, 200 tons of lead bullion, 750 tons of sulphuric acid and 500 tons of phosphoric acid. The furnace and the sintering plant are con-

trolled by a GEC-Elliott Automation 4120 computer, which has a capacity of 32,000 24-bit words and a readout time of 2 μ s.

At the control console, the operator receives all the information he needs to run the entire plant. He can perform all control functions without leaving his seat. Information is input to the control console on three typewriters: one for process data, one for alarm conditions and one for weights and constituents.

The control system starts with a mile-long conveyor belt from the Avonmouth docks. Here the feed rates are precisely controlled from a number of storage bins onto a moving belt. The technique typifies the use of simple electronics in process-control interfaces. A constant-weight instead of a constant-volume system was used. Four strain gauges are bonded to each load cell and connected to form the arms of a Wheatstone Bridge. These cells, attached to the rollers of the feed belt, produce a change in electrical resistance with weight, and this changes the output voltage. The signal from the load cell, through an amplifier and servo motor, controls the feed-gate aperture.

The computer controls the entire sequence of operations involved in mixing the ores prior to sintering, charging the furnace, monitoring temperature, pressure, flow rate, pH, humidity and acid strength, as well as the weight of materials.

E. I. Lowe, director of the Control Engineering Dept. at Imperial Smelting says: "Until recently, most process-control equipment was pneumatic. We were one of the first to go to electronic systems."

The great advantage of direct digital control, he says, is that "advanced methods of control can be developed that you can't do with conventional computers."

Resistance thermometers, gas chromatographs, self-sensing potentiometers (to convert pressure drops to electric signals) are used to provide digital inputs for some of the 300 measurements, 80 control loops and 800 contact closure signals in the system.

Automated drafting is another aspect of process control. These techniques have been used for several years to design the hulls of



ships and the bodies of automobiles. But the UNISURF drawing and sculpturing machine at the Renault Research Div. in Rueil is somewhat different from previous systems: Most other machines translate hand-drawn curves and the surfaces of a model into a numeric form. UNISURF derives its curves directly by machine. The system is based on the fact that a cube can be transformed into any parallel-piped if certain linear equations are solved.

A small computer, developed by Compagne Internationale pour l'Informatique CII, does the solving. The operator, communicating with the computer through a control console or typewriter, describes the coordinates of four points, which define a curved area within a cube. The curve is traced on a drawing table, and a punched tape for the milling machine can be produced simultaneously. Once a satisfactory design is achieved, models can be automatically milled from soft materials, such as wood, plastic or

aluminum. The machine will eventually be used to construct master models, but it is not expected that press tools will be machined in this way.

In Toulouse, the Concorde—Europe's supersonic commercial transport—is undergoing tests. Its electronic and pneumatic systems and components are checked out on ATEC (Automatic Test Equipment Complex), a system developed two years ago by Sud Aviation, since renamed SNIAS (Société Nationale Industrielle Aérospatiale). Already 20 checkout systems have been purchased by airlines for testing DC-8s and 9s, 707s, 727s, 737s and 747s.

The basic machine is a Control Data Corp. 1700 computer, with 10 to 12 test stations time-shared with it. This is a core-memory machine expandable to about 65,000 16-bit words. SNIAS developed the software—an automatic test-oriented language (ATOL). There are 50 ATOL programs for Concorde and 30 for nonsupersonic planes. Roger

Coppee, chief sales engineer at SNIAS, says that ATEC is the first aircraft automatic checkout system to use a computer.

Automation with safety

The small village of Hayange, France, close by the Luxemburg border, is dominated by the factories of Wendel-Sidolor, a steel plant with the largest hot-rolling mill in Europe.

Here the basic business is to produce a variety of steel beams, each weighing four tons or more. Walking through the plant, a visitor has to watch his step. Yellow-hot steel beams pop out of furnaces and slither along the factory floor, guided by rollers embedded in concrete.

"Steel-making," says a company representative, "is a rough business—a slowdown of a four-ton beam can break down equipment. Automation with complete safety is difficult, unless you build in certain delays."

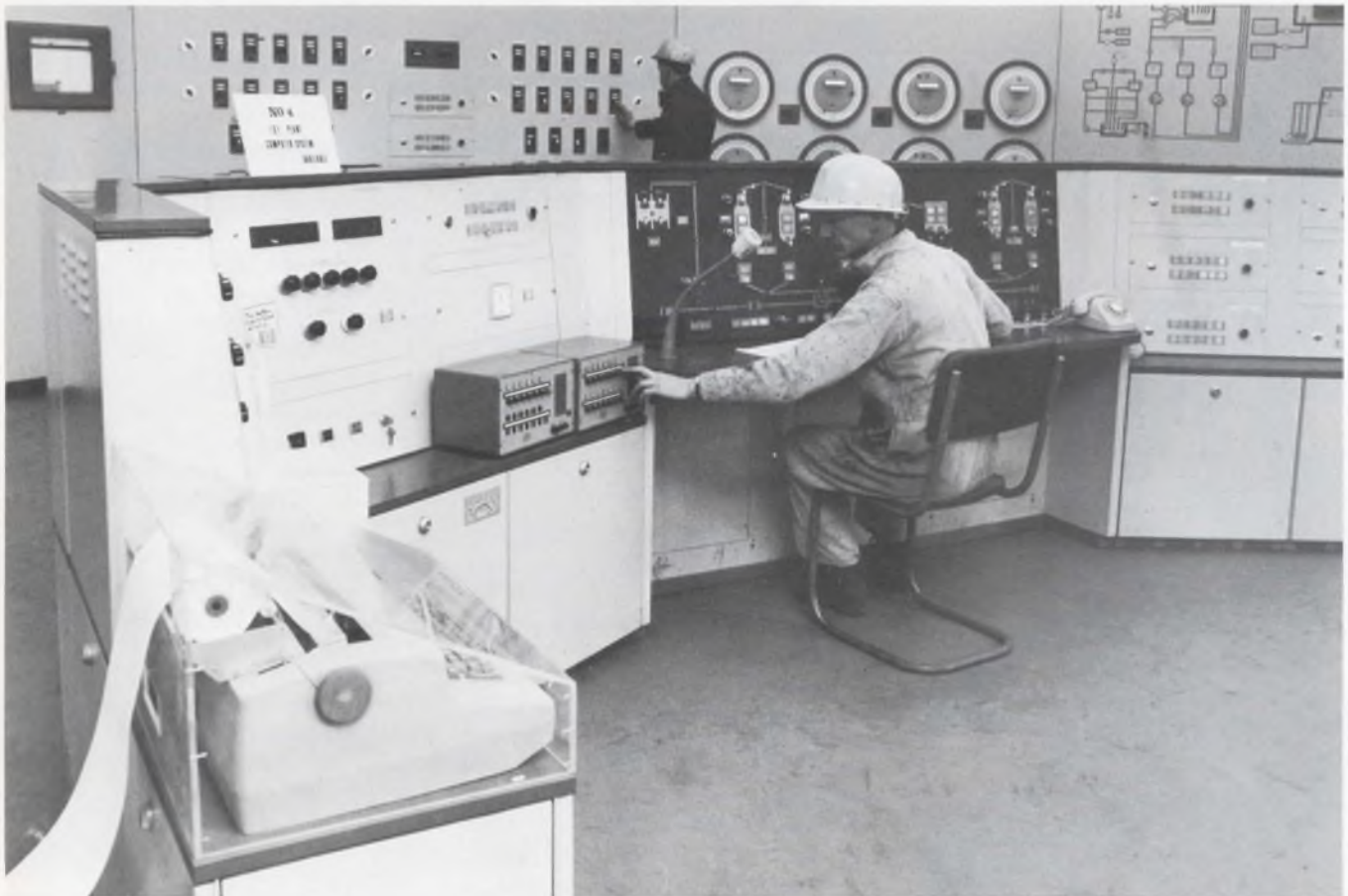

Direct digital control for a zinc blast furnace at Imperial Smelting Corp., Avonmouth, England, uses an Elliott 4120 computer and interface equipment. The operator sits in front of a "mimic" display of the entire smelting process

and controls the sequence of mixing the ores prior to sintering, charging the furnace, monitoring the temperatures, pressures, flow rates, pH, humidity and acid strength, as well as the weight of the materials.

Computers are being used to perform control functions in five basic manufacturing areas:

- Blast furnaces.
- Hot rolled products.
- Sintering.
- Cutting.
- Adding of choke (CaO) to pig iron.

Wendel-Sideler has two IBM 1800 machines that monitor the heat balance in the company's blast furnaces. The air temperature, humidity and quantity of produced gases must be analyzed and regulated. This is done by controlling the amounts of fuel, O₂, CO and CO₂ that go into the furnace. The basic purpose of such control is to maintain a specific level of silicon in the steel, so the silicon can be eliminated later on.

The IBM equipment is said to be too big for the work that must be done, and the company is installing a Model 10010 computer, made by CII, which is said to be one-third the cost of the IBM machine.

Hot-rolling typically consists of taking an ingot of heated steel and pushing it between four "rolls" to obtain the desired shape. The separation between the rolls is controlled by a set of screws. The spacing is critical and is related to the grade of steel being shaped. Usually seven or eight passes are sufficient to form a beam. Wendel-Sideler has developed a computer program that permits an operator to select a card that describes the grade of steel to be used and the shape of the finished product. The card is inserted in the computer, and the computer automatically controls the space between the rolls for each pass.

The operator sits at his console in a small room about 20 feet above the blooming, roughing and finishing stands. (A bloom is an ingot of unprocessed steel.) Infrared cells follow the product and determine how fast it is moving at each point in the process; this information is read out by the computer memory and displayed to the operator along with the spacing of the rolls.

A ferromagnetic gauge inside the blooming stand measures the tensions between the rolls. As a bloom is inserted between the rolls, the gauge senses the change in magnetic flux across the ap-

paratus and automatically adjusts the separation of the rolls. A TV camera is set up at each stand so the operator can see both sides of a beam as it is being processed. If something goes wrong, the operator can reroute the beam without endangering the continuation of the rest of the system.

Doppler-effect radar is being used to calculate the precise length of a beam before it is cut. Plans for the future include automation equipment for finishing and straightening the beams.

Another highly advanced process-control system is being installed by the Steel Co. of Wales at its Abbey Works cold-rolling mill in Port Talbot. The basic purpose of this equipment is to control the thickness of sheet steel as it moves forward, backward and vertically between rolls.

The mill being automated consists of five stands, with each stand reducing the steel sheet to a thinner dimension. The process involves extraordinarily complicated interactions dependent on:

- The tension of the steel.
- The roll separating forces.
- The thickness of the steel.
- The speed of the rolls.
- The relative speed of the rolls.

While the computer can set the references for the roll speed, the tension and the thickness of the steel through use of automatic control loops, it must also monitor the processing.

The operator sits in a "pulpit" control room above the five stands. He feeds the computer the "identity" for the coil to be processed (its thickness, width and composition) and the computer does the rest—detecting the steel as it enters the rolls and automatically setting up the control functions for it. Digital readouts on the operator's console denote the position of the screws controlling the separation of the rolls. Potentiometers measure the tensions of the steel, and six X-ray thickness gauges also have their readouts displayed on the operator's console.

On the north bank of the Firth of Forth in Scotland, the Longanet power station devours 12,000 tons of coal a day. Its appetite is palliated electronically by a Ferranti Argus 400 computer. This latest system in process control in

mining and power generation went into operation last month. The computer controls a main underground conveyor system that runs five and a quarter miles. Coal is fed directly into the furnaces from underground bunkers in four nearby mines. Each bunker contains 700 tons of coal, the hourly capacity of the main conveyor belt.

The input/output equipment includes logging printers, digital displays, pen recorders, tape readers and editing sets for program tapes and an operator's console. Compared with the average process plant, the degree of control is minimal. Only five control loops are needed to control the bunker output and the belt speed. Because the quality of the coal from each of the mines can vary considerably, it is essential to measure continuously the composition of the fuel assure homogeneity. Electronic sensors are used to monitor underground gases, the condition of the conveyor belts, water-pumping equipment and ventilation.

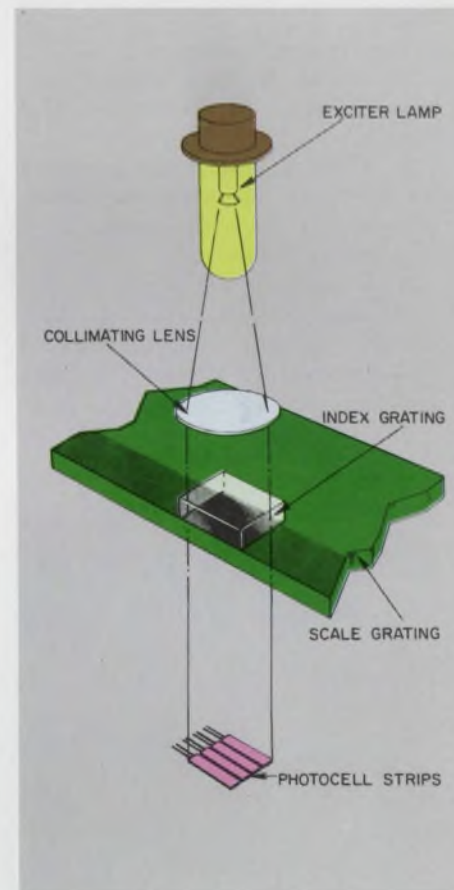

Moire fringe systems convert small linear motion into greatly magnified optical signals. This system can detect 0.0001-inch imperfections.

In the Longanet scheme, 33 outstations—most of them underground—are connected by two-wire telephone circuits to the computer. Pat Wimbush, sales manager at Ferranti in Dalkeith, Scotland, suggests that the computer system could also handle manpower deployment, timekeeping, wage preparation, materials consumption, stock control and geological prediction.

The most fundamental step in process-control operations, whether they involve monitoring, measuring or manufacturing, is to reduce the operations to numbers and place them on a paper tape or any storage medium. According to Wimbush, this area—numerical control—is where Ferranti has pioneered.

Fringe patterns developed

Ferranti has developed a technique of using moiré fringe patterns that can be used in standard digital readout systems or in numerically controlled machines. One such machine can inspect manufactured items in three dimensions and detect 0.0001-inch imperfections.

The system consists of:

- A scale grating—with a precise number of lines per unit length.
- A glass index grating—with an identical line structure superimposed on the scale grating.
- A light source.
- A group of photocells.

A moiré fringe pattern is produced when the index grating is superimposed on the scale grating and the line structure of one is at

a slight angle to the other. The angle is set to make the width of the fringe cover the width of the index grating. As the grating is moved linearly, a slight motion is converted to a greatly "magnified" optical signal (fringe). This is converted to an electric signal by the photocells and fed into a digitized electronic counter. Outputs from the counters are recorded on a printout. The scale can be changed to obtain millimeter readouts.

Demand for nucleonic instruments

In the area of on-line measurement Nuclear Enterprises in Edinburgh is finding an increasing market for nucleonic instruments compatible with computers. According to Dr. Robert Pringle, managing director, the company has the largest research and development group in this field in Europe.

Radioisotope instruments developed at Nuclear Enterprises are used to determine:

- Coating thickness and mass per unit area.
- Density.
- Level.
- Composition.

There are also instruments to determine pressures and torques. Typical applications include measuring the densities of slurries in ore-processing and cement plants, or the densities of such liquid foods as fruit juice, condensed milk or syrup; measuring the thickness of metal, plastic, paper, cloth coating—even the thickness of photographic emulsions; and determining amounts of food in the can-

ning industry or amounts of grain syrup in whiskey.

Traditionally forges that process metal ingots have been open furnaces. But induction heating lends itself to electronic process control and creates a much cleaner working environment. An inductor furnace consists basically of a magnetic field set up by alternating current in a coil. When any conductor is placed within such a coil, eddy currents are produced in the material, causing it to heat.

Motor alternators have been used to convert the dc inputs. But for practical induction heating, the frequency and voltage of the electrical supply must be variable to accommodate different sizes of ingots with varying magnetic properties. Silicon-controlled rectifiers (thyristors) have heretofore been used to provide this switching function.

But now the Burwelco, Ltd., Uskside Works in Wales has performed a kind of turnabout in the industry and increased efficiency by doing so. It has replaced the SCRs with tube devices—deuterium thyratron tubes.

The new system has an efficiency of 95% within the frequency range of 2.5 to 6 kHz. A capacitor bank in the circuit forces commutation of the dc from one tube to the other when the nonconducting tube is triggered. The control electronics consist of eight printed-circuit boards.

Furnaces vary in power capacity from 300 kW to 2000 kW and produce between 900 kg/hr to 6000 kg/hr respectively. And John Owen, director of the company, says that furnaces with greater power capacities are now being developed.

What lies ahead in European industrial automation? According to a survey and forecast by Parsons & Williams, engineering consultants in Copenhagen, complete automation of all basic industry will probably be achieved by the year 2000. And the forecast goes on to state that the development of control units and highly complex instruments will be more important in industrial process control than the development of computers. This is the very area where Europeans are most competitive with American electronics. ■■

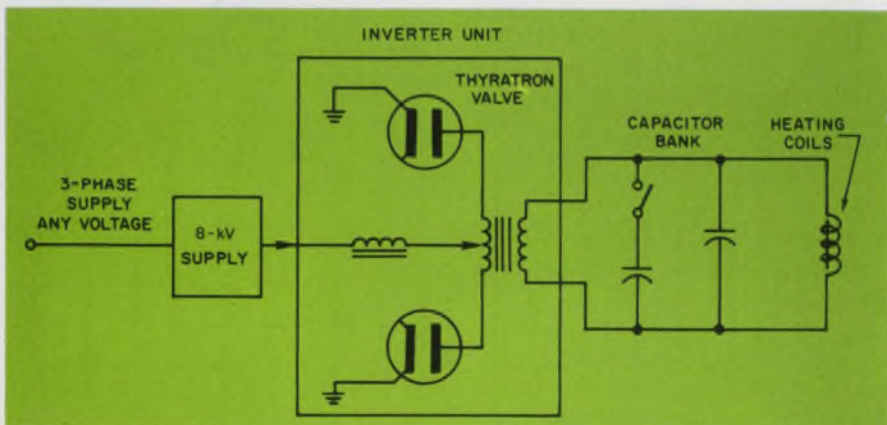

Two deuterium thyratron tubes have replaced SCRs in new induction heating furnace. Heating is produced by eddy currents set up in magnetic material. Capacitor bank forces commutation of the dc.

NEW from UNITRODE
INDUSTRIAL ZENERS

**Armored in glass...
 5 times the surge
 protection of plastic**

20¢

**High-volume production economies mean
 typical Unitrode fused-in-glass reliability
 in 1 Watt and 5 Watt families
 at the price of plastic.**

Order your free samples today.

- 1 Watt family starts at 20¢ each in 100 K lots. Comparably low prices on 5 Watt and smaller quantities.
- Fills the need for quality zeners in the 750 mW to 5 Watt range.
- Voltage range from 6.8 to 200 Volts.
- Smallest size and weight in the industry.
- Low impedances to insure sharp knees.

IN STOCK READY TO DELIVER NOW • WRITE ON YOUR LETTERHEAD FOR FREE SAMPLES AND DATA SHEETS

TOUGH AS ALL GET OUT FROM THE INSIDE OUT
 With the silicon die metallurgically bonded between terminal pins of the same thermal coefficient, the hard glass sleeve is fused to the entire outer silicon surface. Result — a voidless monolithic structure.



For Fast Action call Bud Anderson collect . . . today!

A product of the wide ranging semiconductor technology of

UNITRODE



580 Pleasant St., Watertown, Massachusetts 02172 (617) 926-0404

INFORMATION RETRIEVAL NUMBER 20



1N4736 Series — 1 Watt
 UZ8706 Series — 1 Watt

Actual Size

UZ4706 Series — 5 Watt
 UZ4806 Series — 5 Watt

Actual Size

New progress in ferroelectric ceramics

Improved electro-optic material and novel image device show promise in memory and display systems

Ralph Dobriner, Managing Editor



Dr. Gene Haertling looks at a projected view of a new transparent ceramic. Varying the voltages between electrodes (dark bands) changes the birefringence. This causes polarized white light shining through the material to be converted into colored light.

Since the discovery of the unusual electro-optic properties of polycrystalline ferroelectric ceramics several years ago, their application to information storage and display devices has been limited, largely by materials problems. Now it appears that practical devices are on the way with the development of a new transparent ceramic composition—lead lanthanum zirconate titanate—and the construction of experimental ferroelectric picture devices. Both advances were described at last month's meeting of the American Ceramic Society in Philadelphia.

What are the special optical properties of ferroelectric ceramics?

A property unique to these materials is that they become bire-

fringent when voltage is applied and that this characteristic can be changed by increasing or decreasing the voltage.

Birefringence means that the material has a different refractive index for light waves polarized parallel to the material's polarization direction than for light waves polarized perpendicular to this direction.

A voltage across the material, or a portion of it, establishes an electrical polarization vector in which the minute dipoles within the material are poled or switched to align along this vector.

When plane-polarized white light enters a poled ceramic plate only one color will emerge from the analyzer (see Fig. 1). If, on the other hand, the incident light is of a

single color, birefringence can change the amount of light transmitted.

By modifying the birefringence through application of additional positive or negative voltage pulses, it is possible to cause other colors or light intensities to pass through the analyzer.

By application of extremely precise pulses, the material is able to produce all colors in the spectrum. Typical switching speed is 100 μ s; however, faster switching is possible with higher voltages.

Switching the small areas

Both coarse and fine-grained ferroelectric ceramics have the property that localized areas as small as 25 microns can be poled or switched independently without affecting the light-transmission characteristics of the surrounding area. The locally switched areas are stable with time (i.e., nonvolatile), but they can be "erased" by switching them back to their original orientation. Each locally switched area can function as a light shutter, valve, or spectral filter depending on the switching mode, material and nature of the incident light.

Despite their attractive characteristics, the application of ferroelectric ceramics to practical devices has been limited by the poor transparency of the basic material, the relatively low black-white contrasts achieved in displays and difficulty in producing the colors blue and violet.

New ceramic solves problems

These problems appear to have been solved by a new ceramic that in thin slices (up to 0.25 mm thick) is so transparent that it resembles glass.



It's new. Our Molex 1820 Switch. You can use one, or a gang of them, for an infinite variety of applications. Its lighted push button can be wired to light independently of the switch. And there are colors galore. But what's really nice is price. About seventy cents in quantity.

It's a good example of the Molex creative approach to design problems. And the ability to design reliability and ease of assembly into a product without letting costs run wild due to over-engineering.

The 1820 is really one you have to see to believe.

And we would like to show it to you. For a free sample of our new switch, write or phone (312) 969-4550.



(Ceramics, continued)

Developed by Gene H. Haertling, supervisor at Sandia Laboratories' Ceramics Research Div., Albuquerque, N.M., and described at the Philadelphia meeting, it is said to be the first transparent ferroelectric ceramic ever produced.

The material is made by mixing conventional lead zirconate-lead titanate with about 4 per cent by weight of lanthanum. The new ceramic, Haertling says, provides greater contrasts in black-white image displays (1000 to 1 compared to 100 to 1 for the older ceramic), a greater range of colors for displays and lower switching voltages.

He predicted that, as a display device, the ceramic could be plated with electrodes so that it contains 500 or more lines of information per vertical inch. Images generated by a ceramic display would probably be made up of a number of

dotted lines, rather than (as in television) several hundred continuous lines.

Each of the 500 lines could contain 500 or more "dots," each representing a type of visual information. Thus, the array of cells forms a grouping of 250,000 individual particles of information that could be converted to an electrooptic memory by equipping each cell with a simple photodetector that converts light to electrical voltage. The information state—that is, the relative transparency or opacity of the memory cell—would be determined by reading the voltages produced by each photodetector.

BTL designs a "ferpic"

Experimental image storage and display devices using fine-grained ferroelectric ceramics were described at the Philadelphia meeting by A. H. Meitzler, a researcher at Bell Telephone Laboratories, Mur-

ray Hill, N. J.

Meitzler described the principles of operation of the ferroelectric picture devices, which he calls "ferpics," by referring to Fig. 1.

As shown in Fig. 1(a) a voltage applied to a thin, transparent plate of lead zirconate-lead titanate establishes an electrical polarization vector, aligning (poling) minute dipoles within the material along this vector. In this condition (L-state) the plate exhibits uniform birefringence for polarized light that is normally incident. An image is stored by switching at least a portion of the dipoles in the areas where the plate is illuminated to a direction perpendicular to the plane of the plate (T-state).

The required perpendicular switching field can be obtained by means of the arrangement shown in Fig. 1(b). The ceramic plate is coated on both sides with a photoconductive film and sandwiched between transparent electrodes. In front of the ferpic is placed a high-contrast transparency illuminated by a beam of collimated incident light. When voltage is applied to the transparent electrodes, the high impedance of the dark photoconductive regions prevents the field inside the ceramic from reaching a value that would produce a significant amount of switching.

In the illuminated regions, however, the impedance of the photoconductor is reduced, and the field in the ferroelectric device increases to the point where appreciable domain switching is produced. This causes the ceramic underlying the illuminated areas to be switched to the T-state.

In this way a stored image is obtained as a spatial modulation of the birefringence of the ceramic.

The image can be made visible by inserting a ferpic between a polarizer and analyzer as shown in Fig. 1(c). The image can be erased, either by poling the sample in the plane (L-state) or by thermally depoling the material.

Meitzler says that this device and similar experimental ferroelectric picture devices built at Bell Laboratories have demonstrated a resolution of about 50 lines/mm in 50 μm -thick ceramic material, and that they had been able to hold the image with no apparent change for several months. ■■

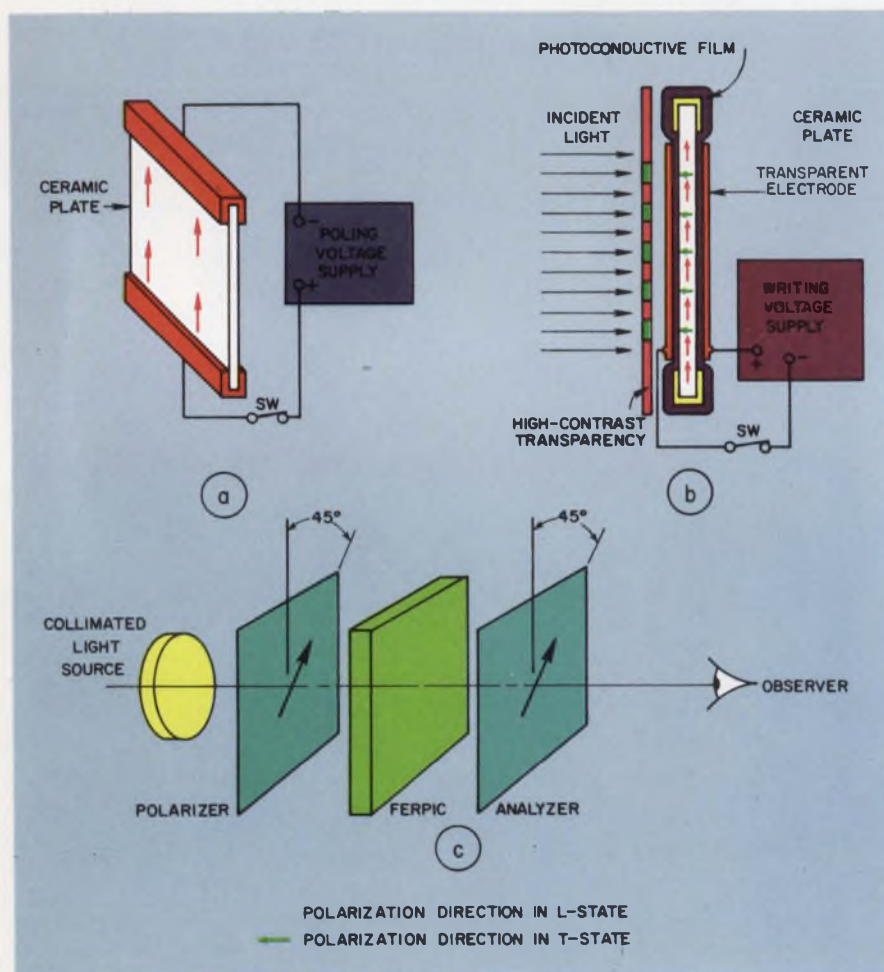

An experimental ferroelectric picture device ("ferpic") is shown in construction and operation: (a) poling the ceramic plate, (b) storing the image, and (c) observing the recorded image.



MOS AND BIPOLAR COMPATIBILITY—FACT OR FICTION

Now that MOS has been accepted into the design engineers bag of tricks, its compatibility with other forms of logic is the main issue. In the beginning, MOS and bipolar devices were not compatible at all; negative power supplies of 27 and 13 volts, threshold levels of -3 to -6 volts, slower speed, electrically fragile, etc. Sometimes the objections are more against MOS than the compatibility of the two families. Now, process refinements and design expertise have minimized these differences. Any designer that wants to intermix devices can do it if he really chooses. When linear circuits were first made available, the objection was that -6 and +12 volts or ±15 volts were not standard power supplies, MOS can use these same supplies if we manipulate the data sheet requirements.

LEVEL TRANSLATION

There is only one thing to remember about working with any logic element: it doesn't matter what the supply voltages are as long as the absolute magnitude across the device is maintained. A TTL element can operate between 25 and 30 volts or -10 and -5 volt busses because there are only 5 volts across the device. The only restriction is that the ground pin, being the reference point, must always be *more* negative than the V_{CC} pin.

This freedom of power supply levels is also a feature of MOS integrated circuits. Since it is normal procedure to bias the ground pin, it has been renamed the V_{SS} pin. It is the reference point and, for the P channel technology, must always be more positive than any other pin. Let's review why this is true. Consider the structure of an MOS device. A cross sectional view shows two diffused junctions in an N-type substrate. A channel is

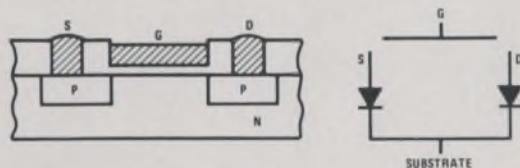

induced between these two junctions to cause operation. The electrical symbol shows the device to be no more than two diodes with a common cathode. The junctions are used merely as contact points for the Source and Drain. If forward biasing occurred without current limiting, the junctions would be destroyed. As long as the substrate remains more positive, the diodes never become forward biased. The gate is electrically isolated by a thin oxide layer.

Process innovations, as stated before, have provided the designer with a method of achieving compatibility between MOS and bipolar IC's. The use of 1-0-0 crystal orientation silicon has yielded threshold voltages in the -1.8 to -2.5 volt range. These levels allow operation with +5 and -12 volt power supplies. Typical voltage levels for several different design configurations are shown below.

SHIFT REGISTER OPERATION

Most all low threshold voltage devices have characteristics like those shown under "existing register voltages" below. The National Semiconductor dynamic and static registers numbered MM400/500 through MM407/507, for example, fit this category. Newer designs such as the MM4015/5015, MM4050/5050, MM4051/5051 and many more to come will be designed with the "newer designs" logic levels shown.

	OUTPUT LEVELS		INPUT LEVELS		POWER SUPPLIES			
	V_{IL}	V_{IH}	V_{OL}	V_{OH}	V_{DD}	V_{GG}	V_{SS}	V_o
Existing register voltages	-2.5	-7.0	-1.5	-8.0	-10	-16	GND	0 to -16
Newer designs register voltages	-2.5	-4.0	-1.5	-6.0	-10	-16	GND	0 to -16

These voltage values can be shifted to any convenient level as long as all voltages are shifted by the same potential. To make the "newer designed" registers shown above operate in a bipolar system, the levels can be shifted positive by +5.0 or +10.0 volts with the following results.

V_{IL}	V_{IH}	V_{OL}	V_{OH}	V_{DD}	V_{GG}	V_{SS}	V_o
-2.5	-4.0	-1.5	-6.0	-10	-16	GND	0 to -16
+2.5	+1.0	+3.5	-1.0	-5	-11	+5	+5 to -11
+7.5	+6.0	+8.5	+4.0	GND	-6	+10	+10 to -6

Since these power supply voltages shown are nominal supplies, the device could operate satisfactorily between +5 and -12 volts, standard power supply values. This example shows that the popular misconception that MOS operates on negative voltages should be put to bed. They can be operated in the manner indicated: +5 and -12 volts, or +10 and -6 volts. A resistive pull-up on the input and a current sinking resistor on the output provides bipolar compatibility as shown. Second generation shift register designs such as the MM5050 will eliminate the resistors.

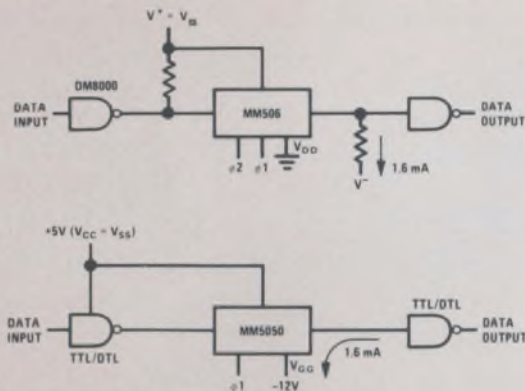

This form of interface can even be used to improve the operating frequency of MOS devices. When the MOS shift register is driving TTL, the total signal swing from a logic "0" to a logic "1" is reduced, hence the delay time is minimized. A long serial delay line, consisting of 1 MHz operating frequency shift registers, can be made to operate at 2.0 MHz by this method.

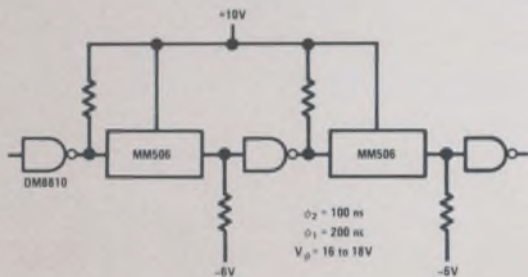

COST PROJECTIONS

Improved circuit design and process innovations are continually pushing aside objections to the MOS/bipolar hybrid system. The cost advantage and systems size reduction realized by utilizing long MOS shift registers in memory applications have come of age. Long shift registers compete favorably in price with magneto-strictive and glass delay lines. Price projections show 1970 pricing for long registers to achieve a penny a bit. The price coupled with the handling ease and smaller size of MOS registers will make replacement of delay lines a necessity during 1970.

READ ONLY MEMORY OPERATION

The read only memory designs have been made around ± 12 volt operation. The rules, however, remain the same. MOS transistor threshold voltage is between -1.8 to -3.0 volts and bipolar compatibility is again maintained. The series 54/74 or DM8810 devices have the ability to hold off 12 volts on their output. The DM8810 Quad Gate and DM8812 Hex Inverter have an output break-

down specified at 14 volts. The interface between these elements is again a pull-up resistor on the input and a current sinking resistor on the output as shown.

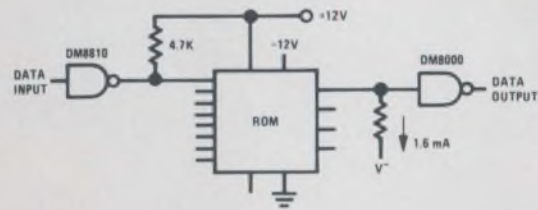

Application briefs have been written to describe a character generator system or a delay line application that mixes the two worlds. By using a ROM for micro-programming, code conversion, character generation, table lookup and so forth, a system becomes fewer and fewer components. In fact, any random logic function that can be expressed in a truth table can be programmed into a ROM. Just try it.

CLOCK DRIVERS

The shift registers must be clocked and the clock must be generated from some source that will provide clock pulse amplitudes of 10 to 18 volts. Clock drivers that provide proper level translation have been developed by National. The NH0007 is a single phase clock driver capable of driving about 800 pF of clock line capacitance at 1.0 MHz and the NH0009 and NH0013 are two phase clock drivers capable of driving 1600 pF per line at 1.0 MHz. Another driver, the NH0012 has been developed for those clock driver applications requiring 10.0 MHz operation. The limiting parameter for these devices is power dissipation. The NH0007 is in a TO-5 can and is capable of dissipating about 300 milliwatts of power. The NH0009, NH0012 and NH0013 are in TO-8 cans and are capable of dissipating about 1.5 watts of power. The transient power for the driver is a function of speed, voltage amplitude, and load capacitance. The drive capability must be restricted so that the maximum power rating is observed. To calculate the power dissipated, the AC power is given by $P_{AC} = CV^2f$. The standby power is a small percentage of the total power dissipated. For further details, refer to MOS Brief 9.

CONCLUSION

Our goal is to provide complete systems capability. We have achieved this with the availability of our MOS product line; bipolar logic for data manipulation, and MOS shift registers and read only memories for memory and micro-programming applications.

National Semiconductor Corporation

2900 Semiconductor Drive, Santa Clara, California 95051

(408) 732-5000 / TWX (910) 339-9240



3-70 PRINTED IN U.S.A.

Satellites may get power from laser on the ground

Power to operate future satellites may be transmitted from the ground, if a newly developed laser proves as feasible in operation as it appears promising.

The laser is capable of drenching a 10-foot solar collector on a satellite 200 miles high with thousands of kilowatts of infrared energy.

The laser is a high-power combustion-driven, gasdynamic cw or pulsed instrument developed by the Avco Corp.'s Everett (Mass.) Research Laboratory.

Besides beaming power to satellites, the laser is expected to find application in high-information-rate optical radar and communications. Industrially, it can be used for cutting, welding or brazing large metal and ceramic structures.

"One advantage of the laser," says Edward T. Gerry, one of the inventors of the gasdynamic laser, "is that it is very nearly diffrac-

tion-limited—that is, the beam spreads in angle at the minimum rate theoretically possible."

The laser, which has a power output of 6 kW, resembles a rocket motor, with inward facing mirrors on opposite sides of the exhaust (see diagram). The motor burns fuel in a combustion chamber and expands products of combustion through a converging-diverging nozzle to accelerate gas to supersonic exhaust velocity.

Similarly the gasdynamic laser burns fuel in a combustion chamber to thermally excite a gaseous mixture of carbon dioxide and nitrogen, which is then rapidly cooled by expansion through an array of small converging-diverging nozzles. This expansion alters the configuration of molecules in the chamber, which results in a coherent beam. The beam is then focused out through a hole in a mirror array. ■■

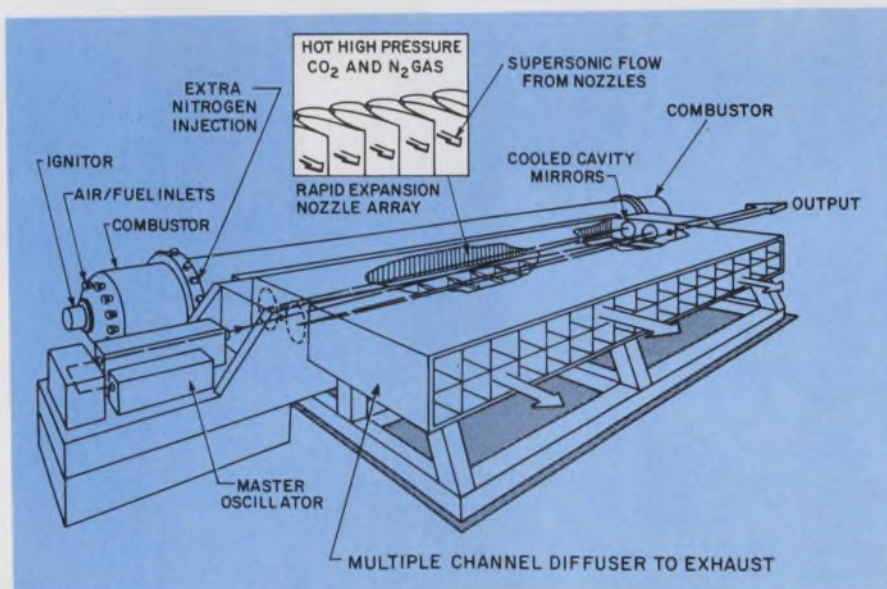

In this open-cycle gasdynamic laser, a CO_2 beam from a master oscillator is amplified in the laser cavity to yield high-power output. A fuel-air mixture is first ignited in combustors at each end of a cylindrical reservoir. The hot, high-pressure CO_2 and nitrogen gas mixture then is rapidly expanded through the nozzle array into the laser cavity, where a photon beam is generated between the mirror arrays at opposite ends of the cavity. The laser beam, now more than 1000 times more powerful, passes through a hole at one end of the cavity.



Alone in its class

Johanson products stand alone as a symbol of leadership. Even an unpracticed eye can see the differences between a Johanson capacitor and its counterpart.

Such things as ultra-high Q (useable at microwave frequencies) . . . ultra-high stability ($0 \pm 15 \text{ PPM}/^\circ\text{C}$) . . . and "sizes" for hybrid and microcircuit as well as for conventional applications . . . these and other integral design advances attest superiority.



Model 5801
(actual size)

Send for a complete Johanson catalog. Let a Johanson product help your product be a leader!

Johanson

Johanson Manufacturing Corporation
Rockaway Valley Road, Boonton, N.J. 07005
(201) 334-2676 • Telex: 13-6432

**Reliability is 756 little dents
and one big one.**





The big squeeze.

The heelpiece and frame are the backbone of our Class H relay. The slightest squiggle or shimmy out of either and the whole relay is out of whack.

756 tiny dents on the heelpiece, plus one big one on the frame, make sure this'll never happen.

They're the result of planishing, a big squeeze. Planishing is an extra step we go through in forming the pieces to add strength and stability by relieving surface strain. It also makes the parts extra flat.

This takes the biggest press in the industry and the biggest squeeze. Both exclusively ours.

A different kind of coil.

The heart of a relay is the coil. If ours looks different, it's because we build it around a glass-filled nylon bobbin. It costs us more, but you know how most plastic tends to chip and crack.

Also, moisture and humidity have no effect on glass-filled nylon. No effect means no malfunctions for you to worry about. No current leakage, either.

The coil is wound on the bobbin automatically. No chance of human error here.

We didn't forget the solder.

We use a solderless splice. That's because solderless splice connections are sure-fire protection against the coil going open under temperature changes, stress, or electrolysis.

A solderless splice is more expensive to produce, so it's usually found only on the most reliable relays. AE is the only manufacturer to use this method on all of its relays.

Finally, we wrap the whole assembly with extra-tough, mylar-laminated material. A cover is not really necessary here; but why take chances?

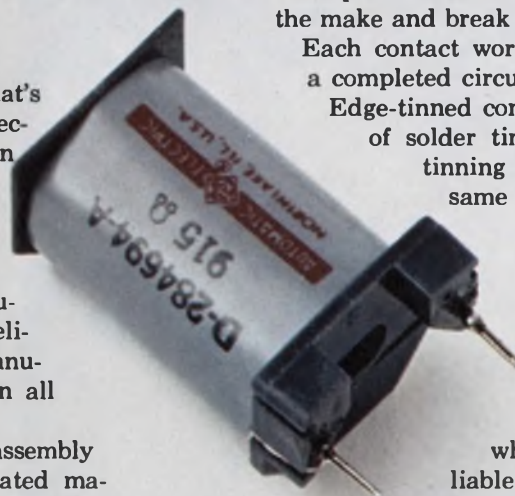

Springs and other things.

We don't take any chances with our contact assembly, either. Even things like the pileup insulators (those little black rectangles) get special attention. We precision mold them. Other manufacturers just punch them out.

It makes a lot of difference. They're stronger, for one thing; and because they're molded, there's no chance of the insulators absorbing even a droplet of harmful moisture. Finally, they'll withstand the high temperatures that knock out punched insulators.



Then there are the contact springs.

Ours are phosphor-bronze. Others use nickel-silver. Our lab gave this stuff a thorough check, but found nickel-silver too prone to stress-corrosion. Atmospheric conditions which cause tarnish and ultimately stress corrosion have almost no effect on phosphor-bronze.



Two are better than one.

Our next step was to make sure our contacts give a completed circuit every time. So we bifurcate both the make and break springs.

Each contact works independently to give you a completed circuit every time.

Edge-tinned contact springs save you the job of solder tinning them later. Also, edge-tinning enables you to safely use the same relay with sockets or mounted directly to a printed circuit board. A simple thing, but it takes a big chunk out of the inventory you have to stock.

Etc. Etc. Etc.

There's a lot more to tell about what makes our Class H relay reliable. Now we're waiting to hear from you. Automatic Electric Company, Northlake, Ill. 60164.

AUTOMATIC ELECTRIC

SUBSIDIARY OF GENERAL TELEPHONE & ELECTRONICS

INFORMATION RETRIEVAL NUMBER 23

Major advances predicted for thin-film ICs

Specialists at components conference see better materials and processes increasing circuit yields

Roger Allan
New Products Editor

Breakthroughs in thin-film technology, predicted at the 1970 Electronic Components Conference, are expected to increase the use of these components in hybrid integrated circuits.

The use of thin-film components is limited at present because of material shortcomings. Present circuit production yields are said to average about 80%. With expected improvements in materials and processes, this figure should rise to 90%, specialists say.

At the conference, sponsored in Washington, D.C., by the IEEE and the Electronic Industries Association, several papers by engineers and scientists in the thin-film industry predicted the following developments in technology:

- A ninefold increase in resistance per unit area over the next

two years, and a fortyfold increase over the next five to 10 years.

- A tenfold increase in the amount of capacitance per unit area over the next five to 10 years.

- Better substrate materials and interconnections through the use of plug-in ceramics, leading to more complex, low-cost RC networks.

- Improved processing techniques, leading to higher component resolutions and temperature stabilities.

"In the next two to three years we can expect thin-film tantalum resistors to rise from the current 12.5 ohms per square to 110 ohms per square, and in the next five to 10 years to 500 ohms per square," said Dr. David McLean, director of the components laboratory at Bell Telephone Laboratories, Allentown, Pa. (see table on p. 38).

"We can also expect thin-film capacitors with thinner and more perfect dielectrics to give high

yields and with an expected tenfold increase in capacitance per unit area in the next five to 10 years.

"Thin-film capacitors at present have constituted a yield problem when fabricated in high-capacitance values. However, with continued development of materials and process control, it has been possible to obtain yields as high as 90% in pilot productions using a 50-V test."

So far as substrates are concerned, McLean foresaw improvement in their material composition and surface properties with the use of multilayer ceramic substrates that plug into each other. He also looked for an increase in density per circuit.

The plug-in feature would decrease the need for printed-wiring boards, he said.

Higher density simulated

To illustrate the point on higher circuit densities, McLean, along with W. H. Orr and R. J. Moore of Bell Laboratories, designed and developed a 24-circuit tone generator on a ceramic substrate measuring 3-3/4 by 4-1/2 inches (below). The generator used thin-film passive elements for precision and accuracy and silicon active elements for amplification.

Using predicted component-size reductions, the three researchers worked out a redesign by computer and obtained a simulated ceramic substrate of the same size as the original one, but with 216 circuits on it. A calculated reduction in component area by a factor of 10 yielded a circuit area reduced by a factor of nine.

"This miniaturization was not achieved for the sake of miniaturization, but for greater circuit throughput for production equipment and larger numbers of circuits per batch, resulting in economy of labor, handling, processing and testing," McLean reported.

Another paper, by Dr. George Moschytz, supervisor of the active

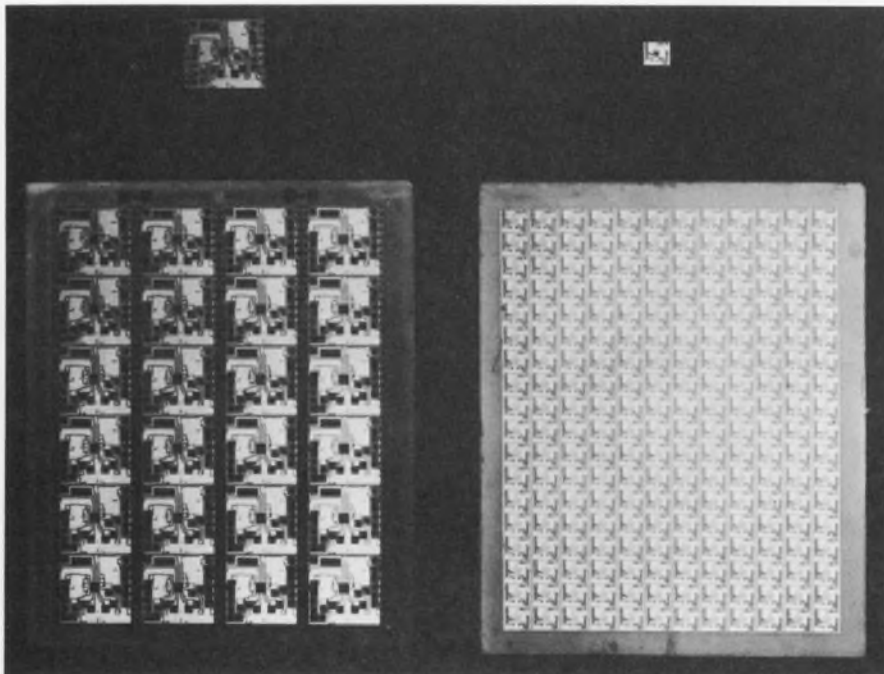

Using present technology, tone generator (left) has 24 circuits on a standard substrate. With future technology, the same substrate (right) has 216 of the same circuits based on predicted component miniaturization.

How the Wizard of Barnes foiled Benny the DIP.

ONCE UPON A TIME there was a clever little electronic bug whose name was Benny the DIP. He got this name because he liked to rob computer folks of time and money. "I like my job," said Benny.

"I can lie down on a PC card, put my 14 (and sometimes 16) feet right into an overly hot tub of solder and Zap! — out goes my electronic function — isn't that fun?" "No it isn't," said the wise old Wizard.

"It's time you grew up and recognized responsibility." "Never," said the bug. "I'm going to grow long hair, and go and fight the computer establishment." With that, the Wizard waved his wand and magic created a

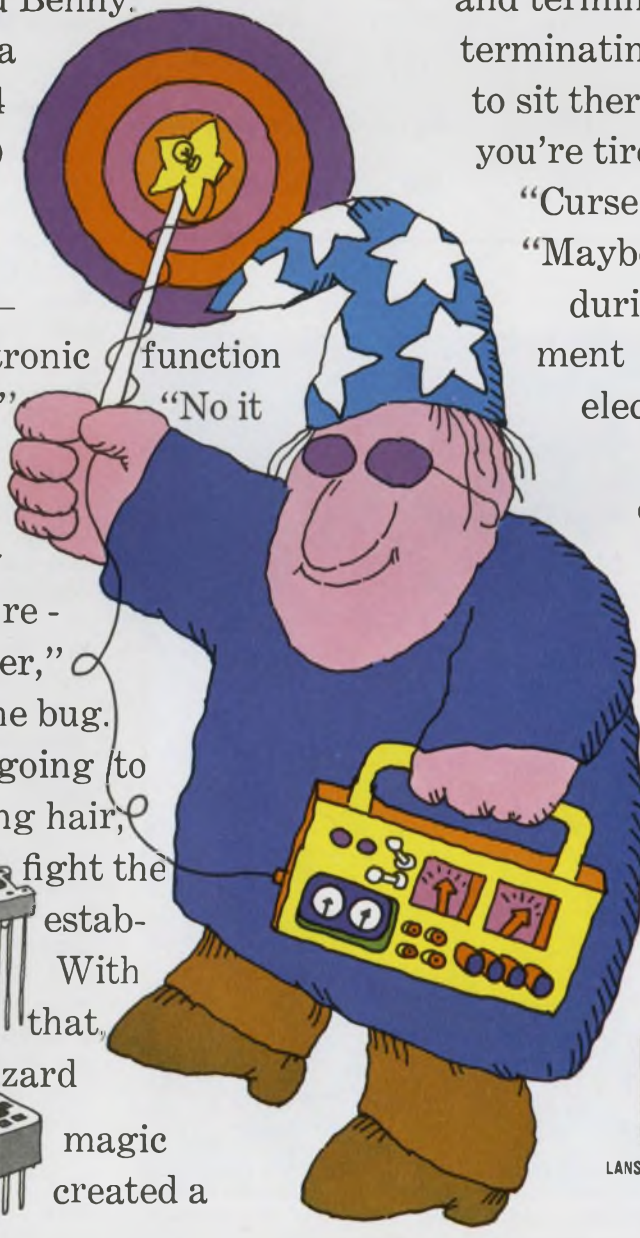
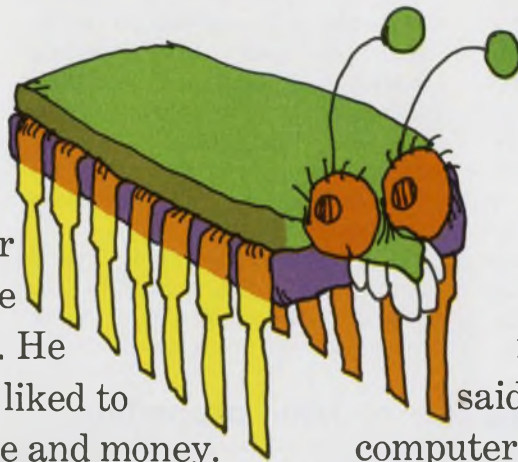

magic socket. "There," said the Wizard, "Now the computer people can plug you in and terminate the socket without terminating you. You'll just have to sit there and work. And when you're tired, you'll be replaced."

"Curses!" exclaimed the bug, "Maybe I can cause problems during handling and shipment or 'turn on' with static electricity." "Sorry, bug," said the Wizard, "I've created magic carriers and test contactors to stop that, too." "Foiled again," said the bug. "Why don't you go pick on Flat Packs?" "I already have," said the wise old Wizard. Moral: Never bug a Wizard.



LANSLOWNE, PA. 18050 ■ (215) MA 2-1525

(thin film, continued)

filter group, data communications laboratory, Bell Telephone Laboratories, Holmdel, N.J., showed the versatility and economy of using thin films in hybrid active RC networks.

"High-Q linear active filters have continued to defy monolithic silicon implementation," Moschytz said, "and in all likelihood they will continue to do so for some time. This is because of the wide variations of silicon integrated-circuit components with tempera-

ture and aging, and because the required component stability of active frequency-selective networks is much higher than that of passive networks.

"It is no wonder then that most active filters considered for, or in, production today use a hybrid integrated-circuit approach with a combination of monolithic silicon gain elements and thin-film or thick-film components that give the necessary gain and frequency stabilizations."

The feasibility of this hybrid approach and the versatility and economy of using thin films, Moschytz went on, is demonstrated

by an "all-purpose, hybrid IC second-order active filter building block" that he constructed (below). The gain elements are monolithic silicon and the control elements thin films. The circuit contains several scribe points that can be opened or closed in any combination to give any desired filter function on the same integrated circuit—that is, bandpass, bandstop, all-pass, low-pass and high-pass.

"These scribe points," Moschytz noted, "could be manipulated through a computer program by an unskilled operator, to give the desired filter function. This technique of getting several filter functions on the same substrate reduces the cost per circuit, while at the same time it gives us the accuracies and RC temperature coefficients of ± 30 to ± 40 ppm/ $^{\circ}$ C that characterize thin-film components."

Improved processing seen

W. K. Morritz of the microelectronics engineering laboratories at Allen-Bradley Co., Milwaukee, reported on technological gains when chromium/cobalt was used to produce complex thin-film resistor networks. High-temperature stability and improved performance were reported.

"The need for bridging the gap between analog and digital information has produced more demanding requirements for precision voltage division," Morritz said. "A new and better approach to these requirements was sought. Based on 12 years of experience in producing thin-film, chromium/cobalt, discrete precision resistors on flat substrates, a technology was developed for producing multiple, complex thin-film, precision, integrated resistive networks on a single substrate."

These high-precision, highly stable complex networks were produced by Morritz with photographic and photo-resist techniques that gave line-width resolution of more than 100 microns. The photographic system was a precision, step-and-repeat camera that was used within a controlled-temperature environment. The resulting resistor networks contained resistors that tracked to one another with temperature coefficients of less than 1 ppm/ $^{\circ}$ C. ■■

Table. Thin-film tantalum resistor properties

Time scale	Sheet resistivity (Ω /square)	Line width (mils)	Resistance per area (Ω /mils ²)	Probability of achievement
Now (1970)	100	2.0	12.5	Established
2 years (1972)	500	1.5	110	Nearly certain
5 to 10 years (1975 to 1980)	1000	1.0	500	Probable

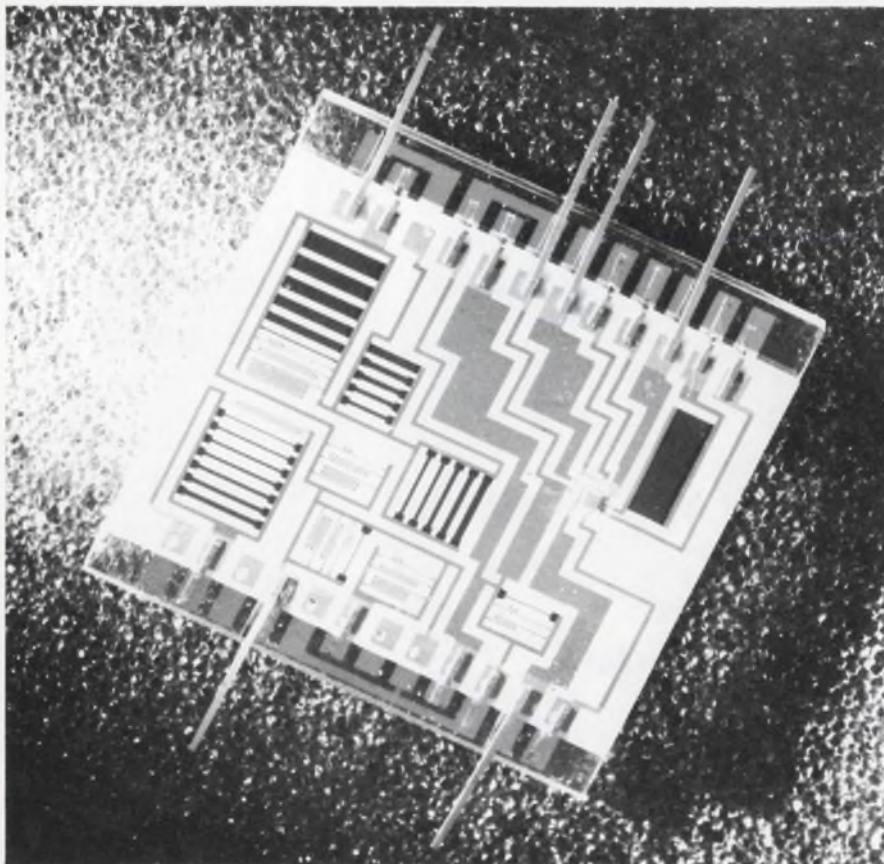

All-purpose second-order filter building block uses thin film components. Scribe points on the circuit allow the selection of any filter function.



Need a function generator? Don't waste your money!

Make sure you get the function generator that best fits your needs... in both price and capability. It's that simple.

Or at least it sounds simple. Then you sit down to make a list of all your technical requirements... present and future. Next you try to match those requirements against all of the instruments available. Finally, you make trade-offs of specific performance features versus X dollars saved.

When you are all done, hopefully you wind up with a function generator that has the best performance/price ratio for your particular needs and budget.

But there is an easier way!

HP manufactures, sells and services a complete line of function generators with a long history of proven performance. Even the newest function generators take advantage of HP's experience and conform to the high quality standards you have come to expect in any HP instrument.

To get all the information you need to determine exactly what you want in a function generator... just turn to page 267 of your 1970 HP catalog. You get more than just a list of products, you get the background information you want to determine your specific needs.

If you need a low-cost general purpose function generator, pay special attention to the HP 3310A. This one does so much that it's actually more than just a function generator.

You not only get the usual sine, square and triangle functions—but both positive and negative going pulses and ramps. Add dc offset, a frequency range of 0.0005 Hz to 5 MHz, all solid-state reliability and a price tag of only \$575 and you will see why we say this one is more than just an ordinary function generator. You save both money and space.

With the HP 3310A you can test and demonstrate the response of differentiator and integrator circuits. Use the triangle output to show how a

sine wave may be synthesized. Use the ramps to demonstrate the action of a comparator circuit.

You can even use a combination of pulses and ramps to simulate the action of a mechanical function to an analog computer. This is a function generator with such potential that you'll be using it for more applications than any other signal source you now own.

If you need more information, just call your local HP field engineer. He will be glad to help you solve any measurement problem you may have. Or, write to Hewlett-Packard, Palo Alto, California 94304. Europe: 1217 Meyrin-Geneva, Switzerland.

090/4

HEWLETT  PACKARD
S I G N A L S O U R C E S

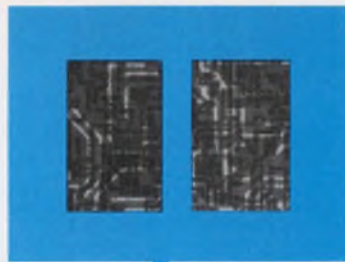

7-Bit Parallel-To-Serial Converter
(2 MC7495's)



Sequential Readout
Storage Buffer
(utilizes 63 MC7491A's
for storage)

MC
1582

REGISTER

Shift a bit, store a bit, improve performance, reduce package count, increase system flexibility — familiar terms when you're concerned with data transmission. Now Motorola offers two versatile TTL shift registers that provide a variety of storage capabilities and system configurations. For instance, apply the MC7491A 8-BIT SHIFT REGISTER as a shift counter. Any pattern of ones and zeros may be set into the MC7491A and then shifted to provide a divide-by-N function. Or, use the MC7491A to form delay lines, and to act as buffers in computer systems when interfacing is required between modules operating at different speeds. The MC7495 4-BIT UNIVERSAL SHIFT REGISTER is capable of both serial and parallel operation. As such, the MC7495 meets requirements for serial to parallel and parallel to serial data converters, ring counters, and parallel arithmetic processors.

The two registers are ideal choices for data

CHECK THESE 54/74 MSI CIRCUITS

Available Now

MC7441A	BCD-To-Decimal Decoder Driver
MC7442	BCD-To-Decimal Decoder
MC7443	Excess-3-To-Decimal Decoder
MC7444	Excess-3-Gray Code-To-Decimal Decoder
MC7446	Seven Segment Decoder
MC7447	Seven Segment Decoder
MC7475	Quad Latch
MC7480	Gated Full Adder
MC17482	2-Bit Full Adder
MC27482	2-Bit Full Adder w/Excl. OR Outputs
MC7490	Decade Counter
MC7491A	8-Bit Shift Register
MC7492	Divide-By-Twelve Counter
MC7493	4-Bit Binary Counter
MC7495	4-Bit Universal Shift Register

Coming Soon

MC7445	BCD-To-Decimal Decoder Driver
MC7448	Seven Segment Decoder
MC7449F	Seven Segment Decoder
MC7470	Edge Triggered J-K Flip-Flop
MC7483	4-Bit Full Adder
MC7494	4-Bit Shift Register
MC7496	5-Bit Shift Register
MC74121	One-Shot Multivibrator
MC74150	16-Bit Data Selector
MC74151	8-Bit Data Selector
MC74192	Decade Up/Down Counter
MC74193	Binary Up/Down Counter

— where the priceless ingredient is care!



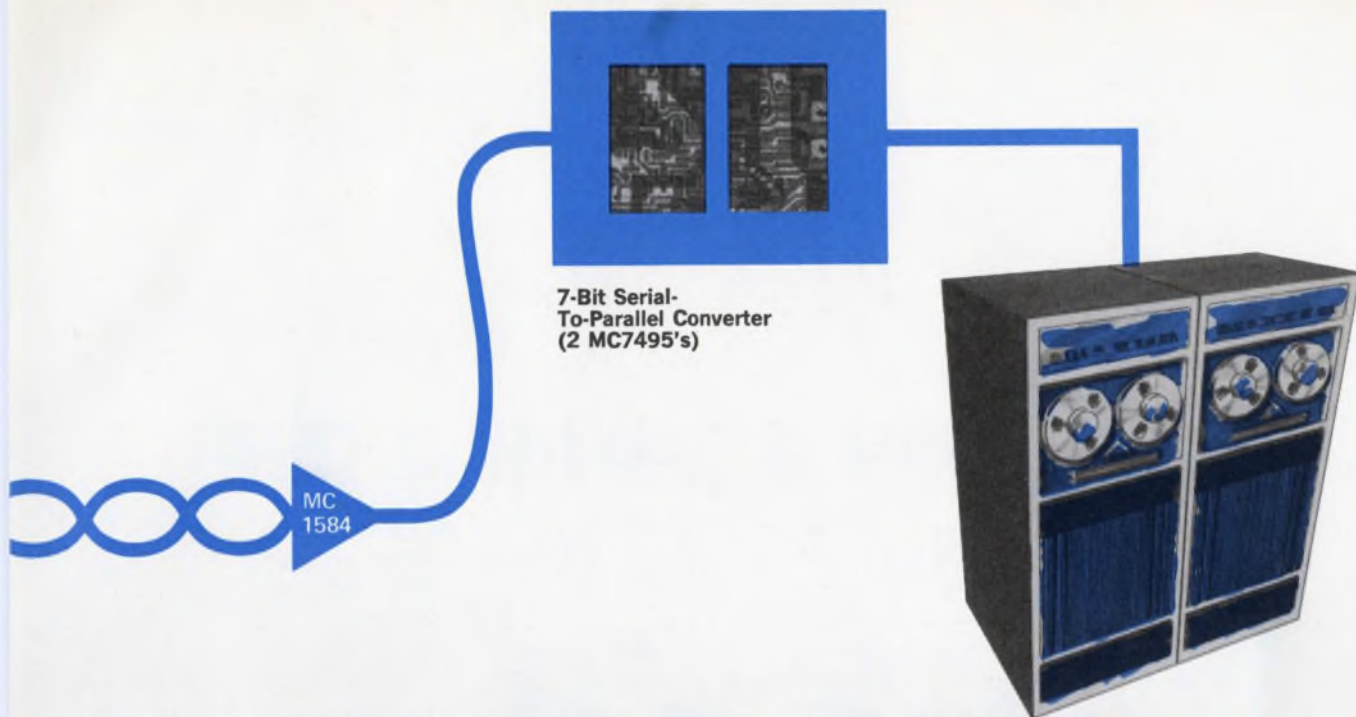

HERE FOR DATA

transmission in teletype-computer interface systems. In these systems, each character on the teletype keyboard is expressed in a 7-bit ASCII code for transmission to the computer. As each teletype key is depressed the 7-bit code for that character is presented at the inputs to the storage buffer. The buffer, utilizing MC7491A's for storage, accumulates the ASCII coded characters until an end of transmission signal is received. Next the 7-bit words are converted to serial by the 7-bit parallel-to-serial converter which is comprised of two MC7495's.

The serial data is applied to the MC1582 DUAL LINE DRIVER and transmitted over a twisted pair to a MC1584 DUAL LINE RECEIVER. To be interpreted by the computer, the data is converted to parallel by two MC7495's in a serial-to-parallel mode. For computer-modem interfacing an RS-232C Line Driver/Receiver pair is

substituted for the MC1582 and MC1584 circuits. Typically these would be the MC1488L QUAD LINE DRIVER and its companion, the MC1489L QUAD LINE RECEIVER.

If you are concerned with data transmission and the application of shift registers, you'll find our MTTL Designer's Note on the MC7491A and 7495 useful. This note describes numerous applications for the devices including the teletype-computer interfacing system briefly detailed above. Just write to us at P. O. Box 20912, Phoenix, Arizona 85036 and ask for MOTOROLA TTL DESIGN KIT #2. Register now for data and increase the logic design capability of your system.

MOTOROLA 5400/7400 TTL

INFORMATION RETRIEVAL NUMBER 26

more than a power supply

You get more than a power supply when you specify this or any Hewlett Packard power supply. An international network of 220 sales/service offices are at your disposal . . . the most comprehensive service manuals detailing every aspect of the supply from theory and operation to troubleshooting . . . protection circuitry including an internal overvoltage "crowbar" to safeguard delicate loads, standard on this Low Voltage Rack (LVR) Series. OUTPUTS: 10V @ 20, 50, or 100A; 20V @ 10, 20, or 50A; 40V @ 3, 5, 10, 30, or 50A; 60V @ 3 or 15A. RIPPLE AND NOISE: typically 200 μ V rms, 10mV p-p. Remote Programming and lots more. Prices start at \$350.

and you can customize it with these options . . .

- 10-Turn Output Voltage and Current Controls
- Chassis Slides
- 3-Digit Graduated Decadial for Voltage or Current
- 115V, 208V, or 230Vac Inputs
- 50Hz Input.

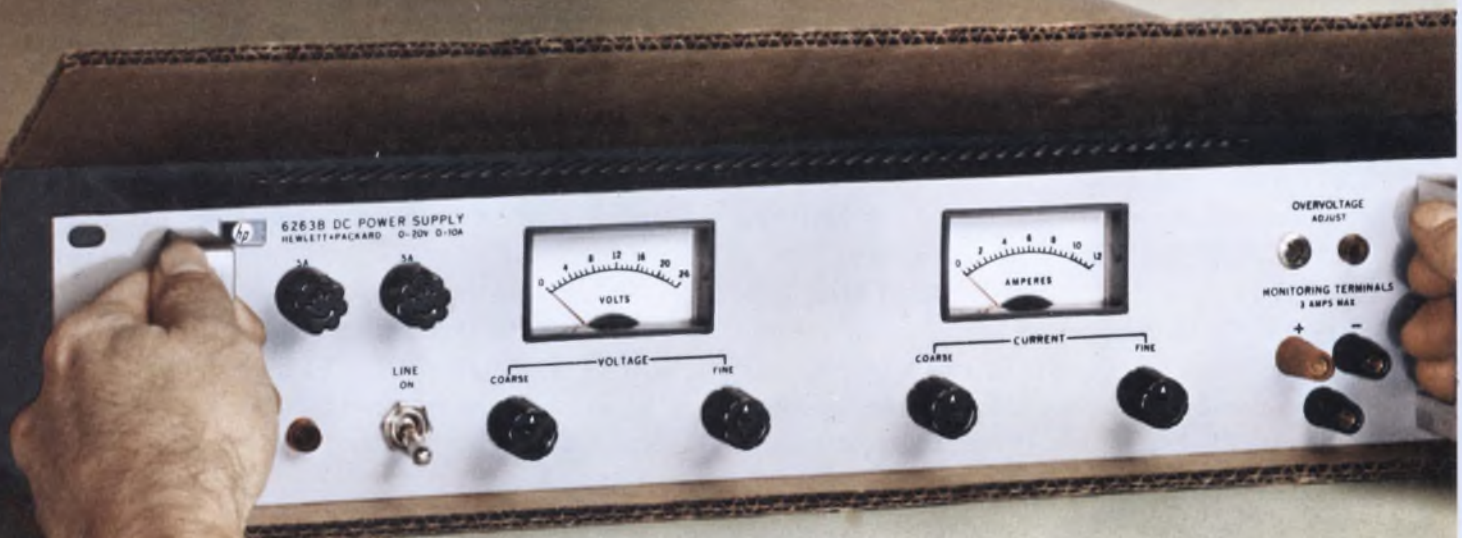

HEWLETT  PACKARD

POWER SUPPLIES

Over 100 power supplies are described in the 1970 HP Electronics Catalog. Write for your copy.

hp DC POWER

From 10 μ V to 4000V

From 1 μ A to 2000A

From \$90 to \$3,500

From manual to computer controlled.



LOW COST SUPPLIES

Compact laboratory power supplies can be stacked or rack mounted. Choose from 6 well-regulated models: 10V @ 1A; 25V @ .4A; 50V @ .2A. Three Constant Voltage/Current limiting models — \$90. Three Constant Voltage/Constant Current models — \$115.

Constant Voltage/Constant Current with Automatic Crossover, Remote Programming, Remote Sensing, Auto-Series or Parallel, Optional Internal Over-voltage "Crowbar"



MEDIUM POWER / TRANSISTOR REGULATED

Precisely regulated. Programming speeds as fast as 500 μ s. 20 models: 7.5V @ 3 or 5A; 10V @ 10A; 20V @ 1.5, 3, 5, or 10A; 30V @ 1A; 40V @ .75, 1.5, 3, or 5A; 60V @ 1 or 3A; 100V @ .75A; 160V @ .2A; 320V @ .1A. \$144 to \$395.



MEDIUM POWER / SCR REGULATED

8 models: 20V @ 15 or 45A, 40V @ 10 or 25A; 60V @ 5 or 15A, 120V @ 2.5A; 600V @ 1.5A. \$360 to \$550.

HIGH POWER/SCR REGULATED

12 Models: 4V @ 2000A; 8V @ 1000A; 18V @ 500A; 36V @ 300A; 64V @ 150A; 110V @ 100A; 220V @ 50A; 300V @ 35A; 600V @ 15A. \$1275 to \$3500.

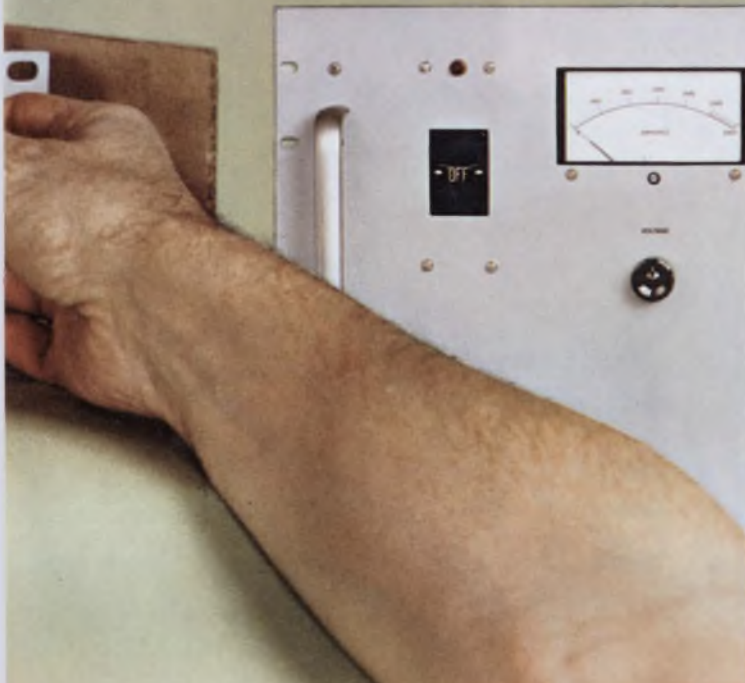

Letters

Correcting the record on APG-59 radar

Sir:

We would like to point out an error in your March 1, 1970, issue. A report appearing on page 35 ("Navy Is Seeking Better Electronics") states: "The Westinghouse APG-59, installed in the F-4J, must be removed from the aircraft every time it is adjusted or repaired."

This is not true. The radar remains on the slide rails on the aircraft during maintenance. To get at the radar, the hinged radome on the front of the aircraft is opened like a door and the radar pulled forward on slide rails. In this position, the entire radar is in the open, with access to all its test points and line-replaceable units, while remaining mechanically and electrically connected to the aircraft.

H. D. Lawton

Program Manager, AWG-10
Westinghouse Electric Corp.
Aerospace Div.
Baltimore

ELECTRONIC DESIGN referred the above comment to the Navy's Point Mugu missile range in California, which had furnished the information for the report. The following reply was received:

Mr. Lawton is entirely correct. I have followed the Westinghouse APG-59 for several years and can attest that the radar can indeed be serviced on the aircraft and ordinarily is never removed except for major modification or overhaul.

I am at a loss to explain the error. Apparently I confused the nomenclature, as many equipments and systems do have to be removed for service.

I offer Westinghouse my sincerest apologies and also apologize to any of your readers who may have been misled.

L. P. Melancon

Pacific Missile Range
Point Mugu, Calif.

Change your mind at the snap of a cam.



NEW FROM YOUR GUARDIAN ANGEL: LEVER SWITCHES WITH SNAP-IN CAM INSERTS

This latest miracle from your Guardian Angel lets you change switch actuator positions instantly . . . at any time. Any combination of **off**, **momentary** or **locked** actuator positions is as easy as inserting a pair of "programmed" molded plastic cam inserts. A snappy little chore that takes maybe 20 seconds.

The new Guardian Lever Switches offer more than versatility. They are available in non-illuminated or illuminated with color coding. Up to 4 pole, double throw per station with switches arranged in any desired form to provide needed circuitry. (Now do you believe there's a Guardian Angel watching over Engineers?)

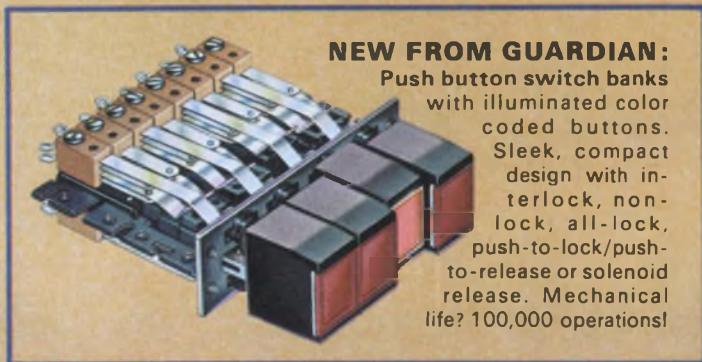

NEW FROM GUARDIAN:
Push button switch banks with illuminated color coded buttons. Sleek, compact design with interlock, non-lock, all-lock, push-to-lock/push-to-release or solenoid release. Mechanical life? 100,000 operations!

*Talk to your GUARDIAN ANGEL
at the WESCON SHOW*



**GUARDIAN
ELECTRIC**

MANUFACTURING COMPANY
1550 W. Carroll Ave., Chicago, Illinois 60607

Washington Report

DON BYRNE, WASHINGTON BUREAU

SST program faces critical fight in congress

Opponents of the program to construct an American supersonic transport are lining up for what may well be the life-or-death showdown on the project. Joint Economic Committee of Congress head, Sen. William Proxmire (D-Wis.), a long-time foe of the aircraft, has just completed hearings in which the expected gaggle of opponents testified. But Administration witnesses, in a show of candor rare to the SST effort since it started over seven years ago, did little to support the request for \$290-million in SST funds for this fiscal year.

They told the committee that the SST might be too risky to attract private capital and might thereby require Government involvement of almost \$4-billion instead of the planned \$1-billion. They also admitted there had been a \$76-million overrun in R&D costs; that the aircraft might not be profitable if banned from overland flights because of sonic booms, and that the runway noise of an SST might equal that of 50 jumbo jets taking off at once.

Following the hearings, William M. Magruder, head of the SST program, held a press conference to rebut nearly everything the program's detractors had said. He is "absolutely confident," he said, that the two SST prototypes will be tested on schedule without any cost overruns, and that they will be only "three to four times" noisier than subsonic jets.

Meanwhile, the Russians report that their TU-144 SST has successfully flown at twice the speed of sound, 1336 mph.

CATV expansion expected to be fought

It's a safe bet that the Big Three television networks are oiling their heavy legal artillery to block any move to expand the cable-television industry (also known as CATV, for Community Antenna Television). Such expansion has been proposed by the Federal Communication Commission in a confidential staff memorandum that was somehow "leaked."

The memo directed the FCC staff to come up with a plan for lifting the ban on piping network TV from distant cities into the country's 100 largest markets. (See News Scope, p.22)

Comsat offers satellite traffic-control system to airlines

The Communications Satellite Corp. (Comsat) has proposed a communications systems to the Federal Aviation Administration and the airlines that, if accepted, could mean a \$55-million, two-ocean voice and data network within two years of the letting of contracts. The system would employ dual-frequency satellites stationed in synchronous orbit. They would provide both uhf and vhf voice and data communications for aircraft flying the Atlantic and Pacific.

Comsat sees a chance for the FAA to expand its crowded air-traffic-control capability and for NASA to conduct extensive tests in an operational environment. The annual charge for both bands over both oceans would come to \$19-million.

Meanwhile Textron's Bell Aerospace Div. has received a contract from NASA to help determine the feasibility of using a relay satellite for air traffic control. The experiment, called PLACE (position location aircraft communications equipment), will involve a combination of existing ground stations and synchronous-orbit satellites for navigation and communication over the North Atlantic. Traffic-control officials predict a load of 250 aircraft over the Atlantic during peak hours by 1980. The NASA contract calls for \$590,000 to develop the transmitting and receiving system and the test-bed aircraft, and \$75,000 to study ways of using existing satellite ground stations in the network.

Jumbo jets pose new grief for air traffic control

Instead of authorizing a three-mile separation between jumbo jets and following aircraft—a tightening up that seemed possible due to the good performance of precision radars and beacon transponders—the wake turbulence left by the big planes requires other aircraft to stretch out the separation to five miles.

Recent experiments by NASA, FAA and Boeing revealed that, contrary to prevailing thought, the wing-tip vortices do not spread out and diffuse aloft; they remain in trail. In fact, the most violent reaction occurs at a distance of three miles. The roll strength, it was found, gets as high as 140 feet per second.

Making the ruling all the more imperative are the five wake-turbulence accidents, two of them fatal, that have occurred over the past six months.

Tariff Commission hears labor and industry on 807

Witnesses for industry and labor are testifying here for and against Item 807 of the U.S. Tariff Code, but most sources feel that the electronics industry will not be affected by any change in the legislation. As it stands, 807 exempts from duty the value of U. S. components shipped overseas, assembled into a product there, and returned to the States. Duty must be paid only on the value-added by foreign labor. Nathaniel Goldfinger, representing the AFL-CIO, says 807 encourages the spread of U. S.-based foreign subsidiaries. But George D. Butler, president of EIA, testified that if 807 is repealed, 220,000 U. S. workers would be adversely affected, and \$100-million in exports and balance of payments would be lost.

Capital Capsules: The Dept. of Transportation plans to staff the former NASA Research Center at Cambridge, Mass., with about 425 persons, or just a fraction more than half the number NASA employed . . . A high official of one of the prime aerospace companies, which is also an airframe builder, is speculating aloud that his concern will have to become much more of an electronics manufacturer. "The vehicle doesn't mean a damn any more. it's the systems that count" . . . The deadline for comments on the FCC's proposed rule-making on computer-communications relationships, due in mid-May, has been postponed until mid-June. The proposals would allow the data-processing industry to communicate between customers without federal regulation, and would permit communications common carriers with more than \$1-million in annual operating revenue to sell data-processing services.

Allen-Bradley cuts space requirements with new sealed type Z cermet trimmers

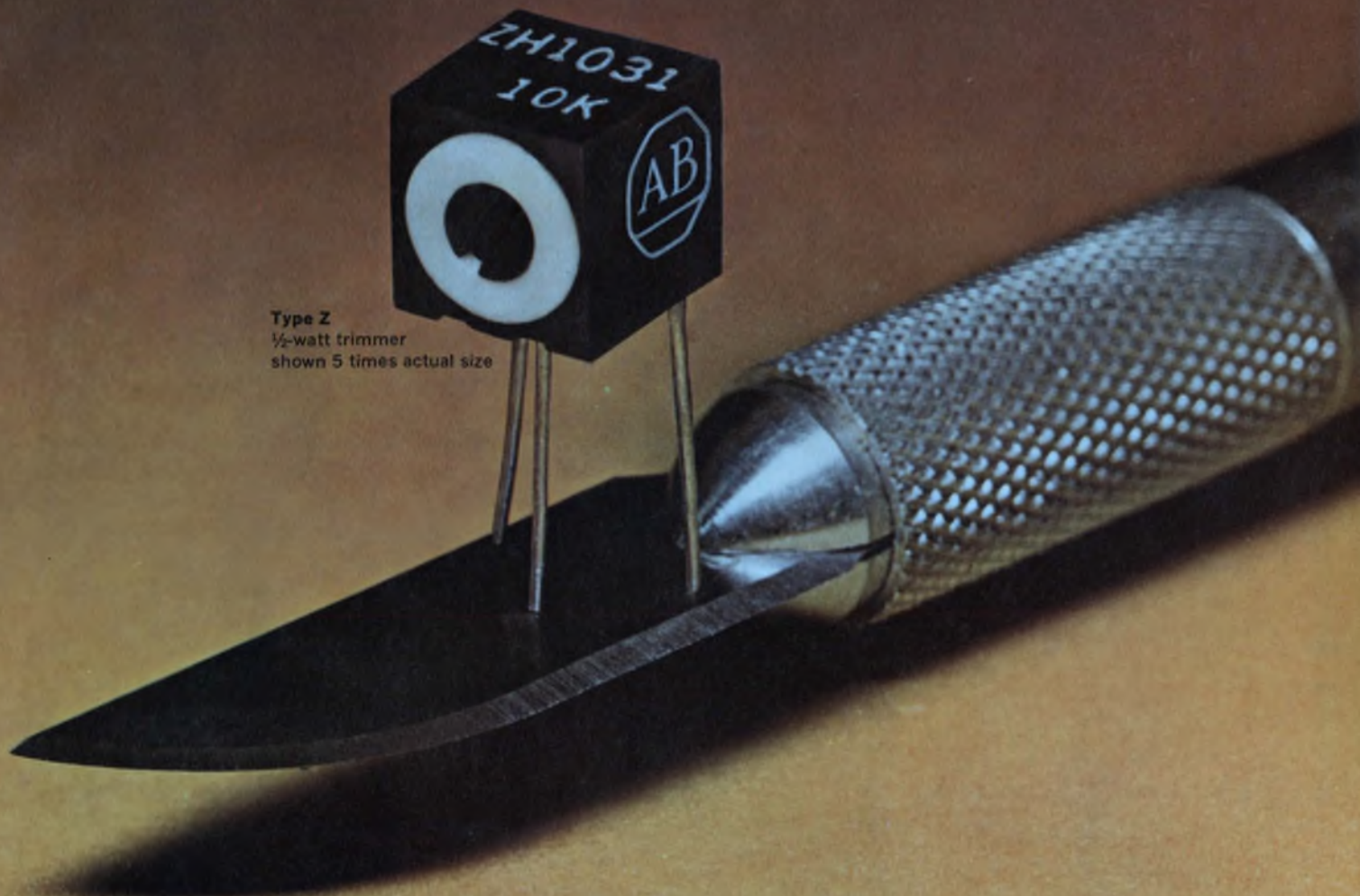

Type Z
1/2-watt trimmer
shown 5 times actual size

this latest addition to the Allen-Bradley line of cermet trimmers...the type Z...affords high performance in an especially compact package

The cermet material — an exclusive formulation developed by Allen-Bradley — provides superior load life, operating life, and electrical performance. For example, the full load operation (1/2 watt) for 1000 hours at 70°C produces less than 3% total resistance change. And the temperature coefficient is less than ± 250 PPM/°C for *all* resistance values and throughout the *complete* temperature range (-55°C to $+125^{\circ}\text{C}$).

The Type Z is ruggedly constructed to withstand shock and vibration. The unique rotor design ensures smooth adjustment and complete stability under severe environments. The leads are permanently anchored and bonded. The connection exceeds the lead strength — opens cannot occur. Leads are weldable.

The enclosure is *SEALED*. It is both dust-tight as well as watertight and can be potted. Mounting pads prevent moisture migration and also post-solder washout. You can get immediate delivery at factory prices from your authorized A-B industrial electronics distributor. Or write: Marketing Dept., Electronics Div., Allen-Bradley Co., 1201 S. Second St., Milwaukee, Wis. 53204. Export Office: 1293 Broad St., Bloomfield, N. J., U. S. A. 07003. In Canada: Allen-Bradley Canada Limited.

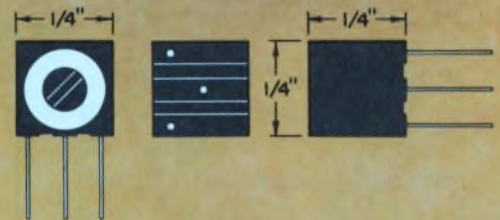

SPECIFICATIONS SUMMARY

- Adjustment:** Horizontal or vertical.
- Temperature Range:** -55°C to $+125^{\circ}\text{C}$.
- Resistances:** 50 ohms through 1 megohm.
Lower resistances available.
- Tolerances:** $\pm 20\%$ standard, $\pm 10\%$ available.
- Resolution:** Essentially infinite.
- Rotational Life:** Less than 2% total resistance change after 200 cycles.
- Rotation:** 300° single turn.
- End Resistance:** Less than 3 ohms.



ALLEN-BRADLEY
QUALITY ELECTRONIC COMPONENTS

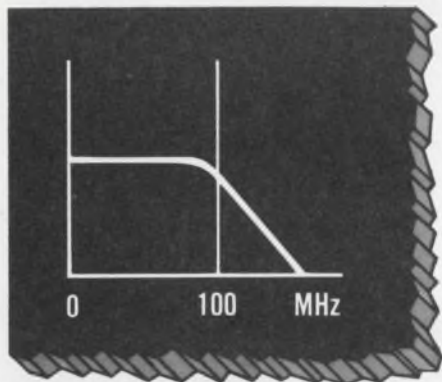

VIDEO SOURCE FOLLOWER

Problem: You want a zero offset source follower, operating from DC to 100 MHz.

Solution: One Siliconix 2N5912 and two matched resistors as shown.

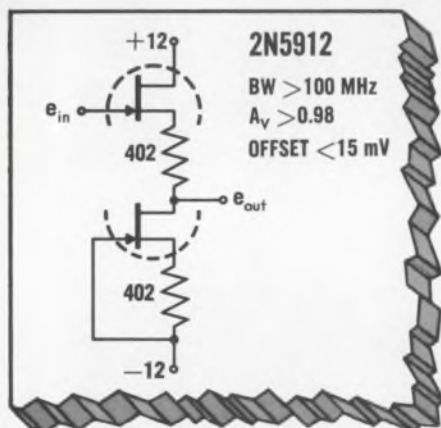

Half the device acts as a current generator for the source follower. Since the FETs are matched to less than 15 mV, $V_{GS1} = I_D R_1 = I_D R_2 = V_{GS2}$ and near zero offset is achieved.

We have more applications information on this and other FETs. Just write or call!

Siliconix
incorporated

2201 Laurelwood Rd. • Santa Clara, Calif. 95054
(408) 246-8000 Ext. 201 • TWX: 910-338-0227
In Europe: Siliconix Limited, Saunders Way, Sketty, Swansea, Great Britain

What the guidebooks didn't tell Jack

Do you want to pass European border guards in a hurry? Pull up in front of a car with pretty girls in it and "they'll always detain them and let you go through," says ELECTRONIC DESIGN's sales rep in Paris. If your hosts let their lunch get cold, pick up a fork—any fork—and start eating; they were politely waiting for you to begin. And "bitter" means beer in England.

News Editor Jack Kessler brought back these and other valuable tips for travelers from his two-weeks' tour to observe the state of the electronics industry in Europe and Great Britain. (See story on p. 24.)

But Jack found himself to be no ordinary traveler; in fact, he was given the red-carpet treatment in Edinburgh where he visited Ferranti and Nuclear Enterprises. At Nuclear, the American flag was raised in his honor. And his hosts at lunch were the heads of the electrical engineering and industrial engineering departments at the University of Edinburgh. He was guest of honor at another "lunch" in a French village. It started off with whiskey to accompany salmon, caviar and capers. Vodka followed. After an entree featuring ribs of wild boar came champagne, then cheese, then more champagne. A dessert of meringue encasing ice cream, coffee, and Armagnac topped off the meal. The party proceeded—at 2 p.m.—to demonstrate to Jack the workings of a steel mill.

But Jack had one disappointment at the Renault factory near Paris. He was all primed to speak French and had his questions formulated in that language—only to be greeted in impeccable English with "Good to see you, Mr. Kessler. I've got your itinerary here."

Art director builds a continent



A novel representation of Europe and the British Isles forms the cover of Jack Kessler's story. Art Director Cliff Gardiner works here on the Styrofoam model he designed and made. Where will he spot the Union Jack?



THE WAVEMAKERS

in every sense of the word

and we'll prove it!

We're challenging you to use our amazing new Model 4200 Test Oscillator in your own lab, on your own projects for 10 days without obligation. We're sure you'll be quick to recognize its superior performance, ease of operation, reliable accuracy, and unmatched value. The consistent half watt power output over the 10 Hz to 10 MHz range plus an internal impedance of 50 ohms means you can drive loads without overloading. Add excellent frequency response of 0.025 db and a distortion factor of 0.1% and you've got a versatile, high performance test oscillator that can't be beat.

Yes, Krohn-Hite, innovators in oscillator design for over twenty years, is making waves again!



First Class
Permit No.
30358
Boston, Mass.

Business Reply Mail

Krohn-Hite Corporation
580 Massachusetts Avenue,
Cambridge, Massachusetts 02139

KROHN-HITE MODEL 4200, 10 Hz TO 10 MHz, TEST OSCILLATOR

- Frequency Range: 10 Hz to 10 MHz
- Power Output: 1/2 watt
- Maximum Output: 10 volts rms
- Frequency Response: 0.025 db
- Harmonic Distortion: 0.1%
- Frequency Accuracy: 2%
- Internal Impedance: 50 ohms
- Auxiliary Output
- External Synchronization
- Amplitude Stability: 0.02%



A low priced, solid state laboratory or production signal source featuring unusual flatness and ease of operation normally found in instruments selling at twice the price. The high power output signal of the Model 4200 delivers full voltage to the load over the entire frequency range. An infinite resolution dial and push-button multiplier provide rapid and continuous frequency tuning. In short, the Model 4200 is a broad range, versatile test oscillator destined to set new standards in performance and value.

KROHN-HITE MODEL 4100A, 0.01 Hz TO 1 MHz PUSH-BUTTON OSCILLATOR

- Frequency Range: 0.01 Hz to 1 MHz
- Power Output: 1/2 watt
- Harmonic Distortion: 0.02%
- Frequency Accuracy: 0.5%
- Amplitude Stability: 0.002%
- Frequency Response: ±0.05 db
- Internal Impedance: 50 ohms
- Square Wave Risetime: 20 ns
- External Synchronization



A medium priced, solid state, general purpose Oscillator that produces sine and square waves simultaneously from 0.01 Hz to 1 MHz with 1/2 watt of power into 50 ohms. Frequency calibration is within ±0.5% and push-button tuning permits ±0.1% frequency repeatability. 50 ohm internal impedance minimizes output voltage drop due to loading, specifically at higher frequencies where unavoidable capacitive loading limits the usefulness of higher impedance oscillators. The Model 4100A is an ideal laboratory and production instrument for a variety of applications where outstanding performance offers increased measurement speed and accuracy.

Yes, Krohn-Hite, the leader in variable filters, is fast becoming a leader in oscillators. Krohn-Hite has designed and manufactured a complete line of signal generating equipment to meet and, in many cases, exceed your project requirements. Each offers high performance features that you'd normally expect to cost a great deal more. Here's a brief rundown of the soon-to-be famous, never-to-be forgotten Krohn-Hite line. For further information on any of the instruments or complete details on our challenging Free Trial offer, simply fill in the attached postpaid reply card. We guarantee an answer by return mail.

OSCILLATORS

Frequency Range	Osc. Model*	Freq. Acc. %	Power (mw)	Impedance (ohms)	VRMS (Open Circuit)	Quad. Output	Add'l. Wave-Forms	Freq. Resp. (db)	Dist. %	Approx. Ship. Wt. lbs/kgs	Price
0.001 Hz to 100 kHz	4024	0.5	125	200/600	10	Yes	⌋ ⌋	0.01	0.01	24/11	\$1200
0.001 Hz to 100 kHz	4025	0.1	125	200/600	10	Yes	⌋ ⌋	0.01	0.01	24/11	\$1950
0.01 Hz to 1 MHz	4100A	0.5	500	50	10		⌋ ⌋	0.05	0.02	21/10	\$ 550
0.1 Hz to 100 kHz	4000	0.5	125	200/600	10	Yes	⌋ ⌋	0.01	0.01	18/9	\$ 850
0.1 Hz to 100 kHz	4001	0.1	125	200/600	10	Yes	⌋ ⌋	0.01	0.01	18/9	\$1450
10 Hz to 10 MHz	4200	2	500	50	10		~ (FIXED)	0.025	0.1	21/10	\$ 350

*Add suffix "R" for rack mounting.

PROGRAMMABLE OSCILLATORS

Frequency Range	Osc. Model	Freq. Acc. %	Max. Volts	Output Impedance	Dist.	Square Wave	Prog. Amp.	Approx. Ship. Wt. lbs/kgs	Price
0.1 Hz to 100 kHz	4030R	0.5	10 RMS	200/600	0.01%	optional	optional	27/13	\$1495
0.1 Hz to 100 kHz	4031R	0.1	10 RMS	200/600	0.01%	optional	optional	27/13	\$2145
0.1 Hz to 1 MHz	4131R	0.1	10 RMS	50	0.02%	yes	no	30/15	\$1375
0.1 Hz to 1 MHz	4141R	0.1	10 RMS	50	0.02%	yes	yes	30/15	\$1585
1 Hz to 1 MHz	4130R	0.5	10 RMS	50	0.02%	yes	no	27/13	\$1075
1 Hz to 1 MHz	4140R	0.5	10 RMS	50	0.02%	yes	yes	27/13	\$1285

- Yes, I accept your challenge to try the fabulous Model 4200 Test Oscillator. Send me complete details at once.
- Send me complete specifications on Model(s): _____
- Send me a copy of the complete K-H Catalog.
- Wow! You've aroused my interest and I can't wait. Please have your representative call me for an appointment.

NAME _____ TITLE _____

COMPANY _____

DIVISION _____ PHONE _____

STREET _____

CITY _____ STATE _____ ZIP _____

Here's your chance to put Krohn-Hite, the Wave-makers, to work for you. Accept our challenge and you'll never settle for less. Just fill in the attached post-paid card and we'll see that you get all the details on the Krohn-Hite Free Trial Offer by return mail. Then, you too can be a wavemaker.



KROHN-HITE CORPORATION

580 Massachusetts Ave., Cambridge, Mass. 02139
Telephone: 617/491-3211 TWX: 710-320-6583

OVERSEAS SALES OFFICES: BELGIUM, C. N. Rood s. a. DENMARK, SC Metric A/S; FRANCE, Antares; GERMANY, Nucletron Vertriebs-GMBH; HOLLAND, C. N. Rood n. v.; ITALY, Dott. Ing. Mario Vianello; SWEDEN, Teleinstrument; ISRAEL, R. D. T. Elect. Eng. Ltd.; JAPAN, Shoshin Shoji Kaisha, Ltd.; AUSTRALIA, Sample Electronics (Vic.) Pty., Ltd.; G. B., B & K Inst. Ltd. Printed in U.S.A.

cure your logic testing headaches



Mellonics offers new automated diagnostic tools for detecting functional logic faults in sequential digital circuits. These computer programs have already cured test headaches in dozens of circuits, some with more than 400 logic elements.

Specifically, we have programs for: **Logic Simulation** which certifies design correctness; **Test Sequence Validation** which verifies that all potential func-

tional faults in a logic design will be detected by your test procedure; **Automatic Test Sequence Generation** which produces a test procedure assuring that all testable functional faults in a logic design will be detected.

These services are economical and easy to use with guaranteed full data security. For more information contact Test Systems Marketing.

MELLONICS SYSTEMS DEVELOPMENT DIVISION
LITTON INDUSTRIES

1001 WEST MAUDE AVE., SUNNYVALE, CALIFORNIA 94086 (408) 245-0795



Process more information faster and cheaper with HP hot carrier diodes.

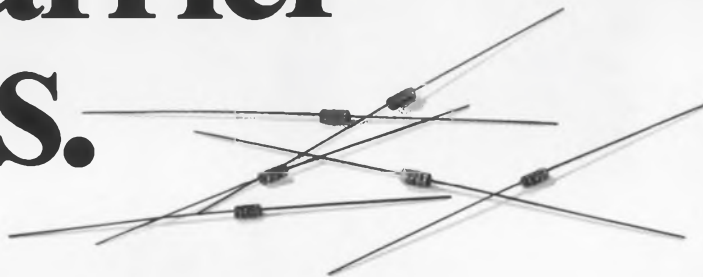

Now you can think about circuit switching speed in terms of picoseconds instead of nanoseconds, for digital logic systems, data handling and peripheral equipment and other applications where you're designing circuits for mixing, clipping, clamping, A/D conversion, gating and sampling.

These low-cost hybrid Schottky diodes are fully passivated, have a 0.4 V threshold voltage, have

100 picosecond switching speed and 1.0 mV/degree C temperature coefficient. They'll withstand temperatures from -55° to 200° C and breakdown voltages up to 70 V. In fact, their near-ideal combination of forward voltage/current characteristics adds up to better-than-PN-junction performance at volume user prices. And they're newly EIA registered.

INFORMATION RETRIEVAL NUMBER 31

Check your HP sales office for prices, which are as low as 32¢ each in 100,000 quantities for the HP 5082-2800. Ask about specs and prices on the HP 5082-2810 and 2811, too.

.01008

HEWLETT  PACKARD

SOLID STATE DEVICES

INFORMATION RETRIEVAL NUMBER 32 ►

The Competition And Us.

More than an open and closed case.

Three fine rotary switches. Two competitors'. And ours.

The open deck rotary switch on the right is probably the most versatile type switch available today. It is simple. Functional. And very inexpensive.

However, an open switch is highly susceptible to contamination, damage, even tampering. It must be handled carefully. Both in production and in end use.

At Stackpole, we've designed a *totally enclosed* rotary for only pennies more and without sacrificing flexibility. And tough as they come.

To the left is a closed type rotary often considered as top-



of-the-line. Rugged. Well made. Expensive.

Unfortunately it is severely limited. No interconnection of adjacent terminals or decks is possible.

The slots through which riveted terminals protrude in this so-called closed rotary prevent total enclosure. Permit looseness. Stackpole molds contacts and terminals right into the switch body. Everything's

rigid. Tight. We call it "Environment proof." And it costs a lot less.

That leaves the Stackpole Series 100 rotary switch. Front and center. A totally new concept in rotary construction. Decks interconnect internally. Adjacent terminals may be interconnected internally or externally. At no extra cost.

Another feature is compactness. Note the shorter build-up in length. Then there's the wear compensating dual-ball detent. Rotation is precise. Positive.

Compare. Send for a sample. Made to your specifications in 2 to 3 days. Production quantities in 2 to 3 weeks. For data, quotation or samples, contact: Stackpole Components Company, P.O. Box 14466, Raleigh, N.C. 27610.

Right in the middle is value. Stackpole rotary switches.

Now in two sizes

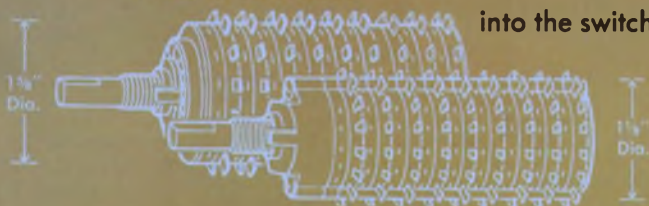

Also the leading producer of quality slide and rocker switches and linear potentiometers.

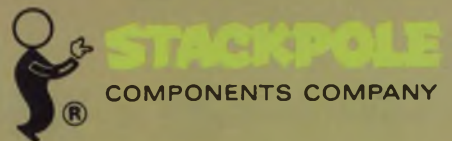

MINIATURE POWER RESISTORS

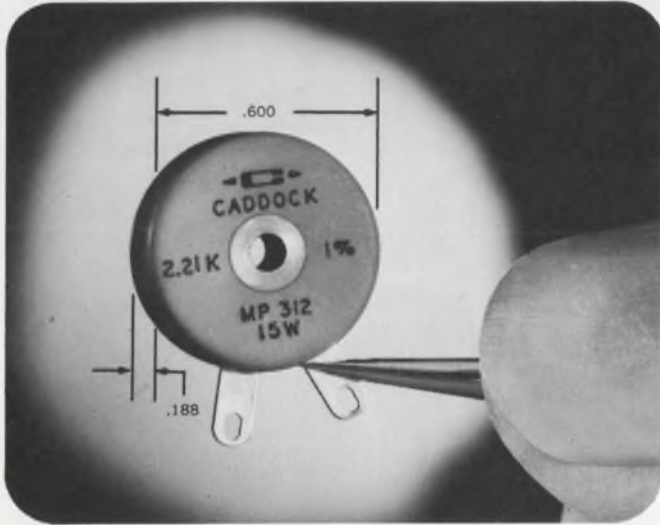

CHASSIS-MOUNT TYPE • NEW LAMINAR DESIGN • LOW PROFILE • 50% REDUCTION IN SIZE AND WEIGHT • COMPLETELY NON-INDUCTIVE • T.C.: 50 PPM/°C • RESISTANCE TOLERANCE: ±1%

Model No.	Power Rating†	Max. Voltage	Diel. Str.	High Temp. TC‡	Resistance Range	Terminals
MP311	15 Watts	300	600	50	50Ω-200K	12" Min Teflon Leads 26AWG 7x34
MP312	15 Watts	300	600	50	10Ω-200K	Gold Plated Solder Lugs

†Power rating based on chassis mounting—MP311 and MP312 on 6"x4"x2"x.040 aluminum chassis

‡TC: 50ppm/°C Referenced to 25°C, ΔR taken at +150°C and +275°C. (Low temp. TC will be nominally -85ppm/°C at -55°C. See typical R-T curve.)

Resistance Tolerance: ±1% standard (Other tolerances on special order.)
Insulation Resistance: 10,000 Megohms, dry, Method—Mil-R-18546D, para. 4.6.8.

Solderability: Per Mil-R-18546D, para. 3.7, para. 4.6.4.
Terminal Strength: Per Mil-Std-202, Method 211, Cond. A (Pull Test), 5 lbs., and Cond. B (Bend Test), Max. ΔR, .2% or .2Ω, whichever is greater.

Thermal Shock: Per Mil-R-18546D, para. 4.6.9, max. ΔR, .5% or .2Ω, whichever is greater.

Momentary Overload: 2 times rated power or 1.5 times max. allowable working voltage, whichever gives the lower power, for 5 seconds. Max. ΔR, .5% or .2Ω, whichever is greater.

Moisture Resistance: Mil-Std-202, Method 106B, less steps 7a and 7b, max. ΔR, .5% or .2Ω, whichever is greater.

Life: Per Mil-R-18546D, para. 4.6.12, 1,000 hrs. Max. ΔR, .1% or .2Ω, whichever is greater.

Shock, Medium Impact: 50G, per Mil-Std-202, Method 205, Cond. C.
Vibration, High Frequency: Per Mil-Std-202, Method 204, Cond. B. Max. ΔR, .2% or .2Ω, whichever is greater, through shock and vibration sequence.

DERATING CURVE

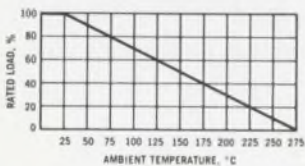

TYPICAL R-T CURVE

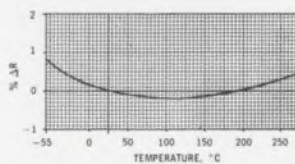

CADDOCK  **ELECTRONICS**

3127 Chicago Ave., Riverside, Calif. 92507 • Telephone: (714) 683-5361

INFORMATION RETRIEVAL NUMBER 33

SPDT DPDT 3PDT 4PDT

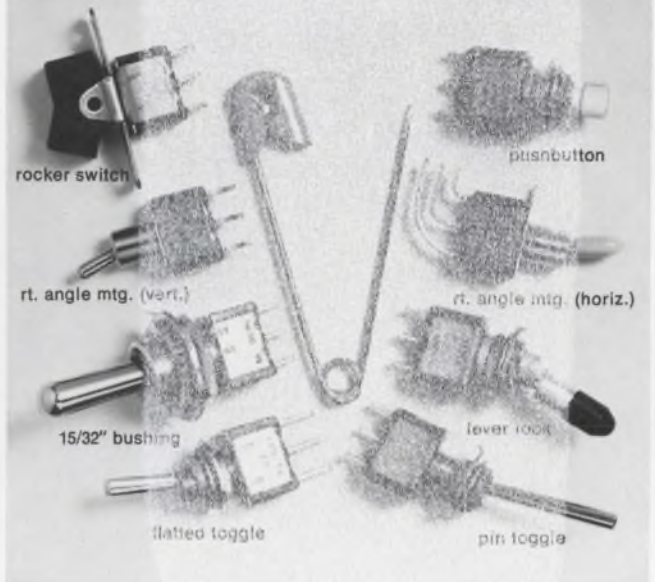

8 tiny, new additions to our family.

There they are—in a proud family portrait.

And like all C&K subminiature switches, they're competitively-priced and Made-in-America.

Ask for our new catalog.

C&K COMPONENTS, INC.

103 Morse Street, Watertown, Massachusetts 02172

Tel: (617) 926-0800

INFORMATION RETRIEVAL NUMBER 34

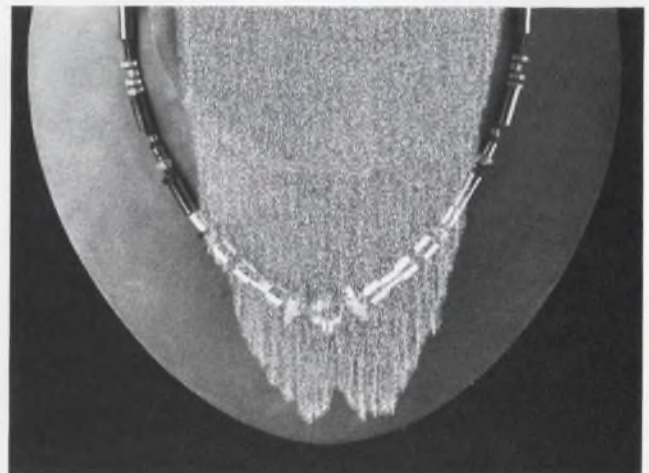

Precision Ring Jewel Necklace from the Classic Collection of R. H. Bird, Waltham.

The beauty of Bird Ring Jewels lies in their versatility. These stunning gems offer optimum design flexibility and superior performance in a wide variety of industrial applications.

Bird Ring Jewels are used in gauges, indicators, watches, clocks, gyroscopes, and aerospace instruments. They're available in glass or sapphire, set or unset, in five dramatic configurations: Straight Hole; Olive Hole; Bombe; Single Cup; and Double Cup.

With over a half-century of precision jewel-making experience, R. H. Bird is one of the nation's most respected industrial jewelers. For more information about Ring Jewels, or our stunning array of other precision industrial jewels, ask for our showcase catalog.

Bird Precision Jewels

1 Spruce Street, Waltham, Mass. 02154. (617) 894-0160.

INFORMATION RETRIEVAL NUMBER 35

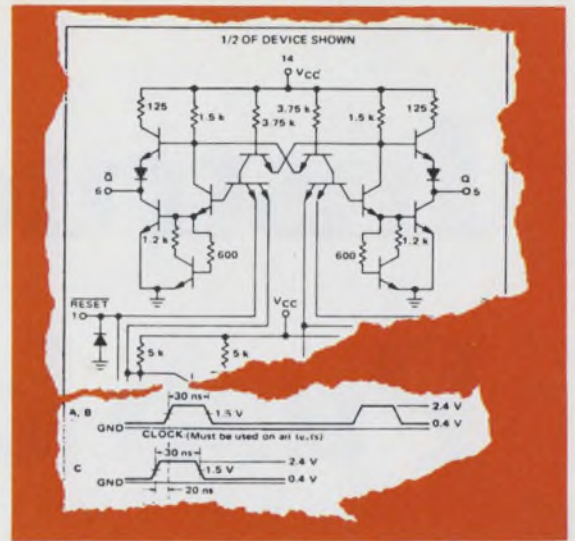
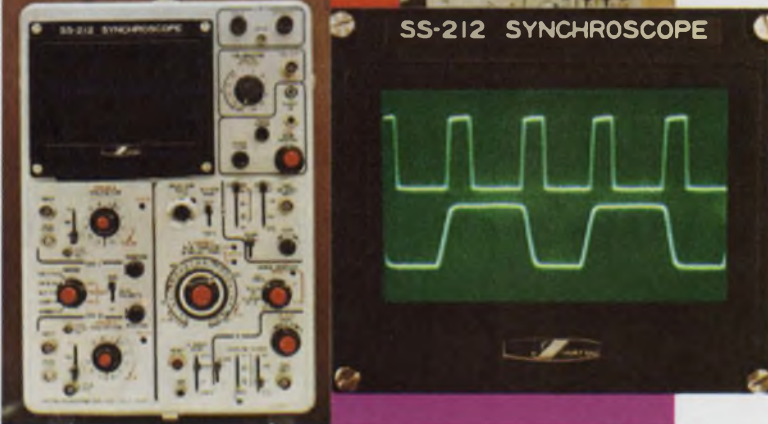
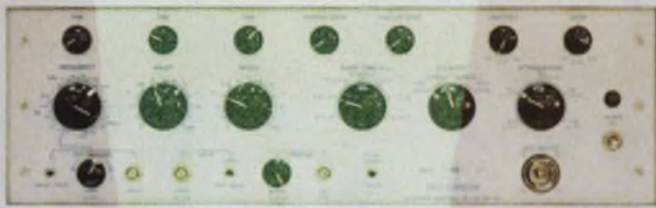

E-H the logical solution

The E-H Research Laboratories, Inc., America's leading designer and manufacturer of pulse generators and other measurement instruments, has teamed up with the Iwatsu Electric Company, Ltd., Japan's foremost manufacturer of oscilloscopes. Together they make an ideal team to solve any of your logic problems.

For example, the **E-H 137 pulser** is an ideal stimulus source offering a source impedance of 50 ohms, fast, ultra-clean, adjustable leading and trailing edge ramps, all the output levels you need for TTL and ECL logic and 100 MHz pulse repetition frequency.

Team this up with the **Iwatsu 212 oscilloscope** and you've got a team that'll perform to your utmost satisfaction for years to come. The Iwatsu 212 is the ideal wide-band scope featuring bandwidth in excess of 200 MHz, with sweep speeds and writing rate to match. One MΩ input impedance matches directly with the impedance level of circuitry under test. This is the only 200 MHz bandwidth oscilloscope featuring 1ns/cm and delayed sweep in one instrument. Big, bright 6x10 cm display is another feature.

These are only two instruments from a broad line of E-H and Iwatsu instrumentation exclusively available from E-H. So whatever your logic problems are, contact an E-H representative today for the most logical solution.

E-H **E-H RESEARCH LABORATORIES, INC.**

515 Eleventh Street • Box 1289, Oakland, California 94604 • Phone: (415) 834-3030 • TWX 910-366-7258
 In Europe: E-H Research Laboratories (Ned) N.V., Box 1018, Eindhoven, The Netherlands, Telex 51116
 In Japan: Iwatsu Electric Company, Ltd., 7-41, 1-Chome Kugayama Sugunami-Ku, Tokyo 167, Japan

INFORMATION RETRIEVAL NUMBER 36

Instructions: Push button and count to 1,000.



That'll give you some idea of the wide variety of PB Pushbuttons we have. The secret is interchangeable parts. Pushbutton modules. Switch modules. Facenuts. Colored Buttons. The combinations literally range in the thousands.

This variety in our PB, and the easy-to-assemble Series 6, gives you the opportunity to customize your panel design. To make it the way you want it. To do it economically.

When you need variety in unlighted pushbuttons, choose the one with a cast of thousands. The MICRO SWITCH PB or Series 6.

For more information, call your MICRO SWITCH Branch Office or Authorized Distributor, or write for Catalog 51.

MICRO SWITCH

FREEPORT, ILLINOIS 61032
A DIVISION OF HONEYWELL



did you know?

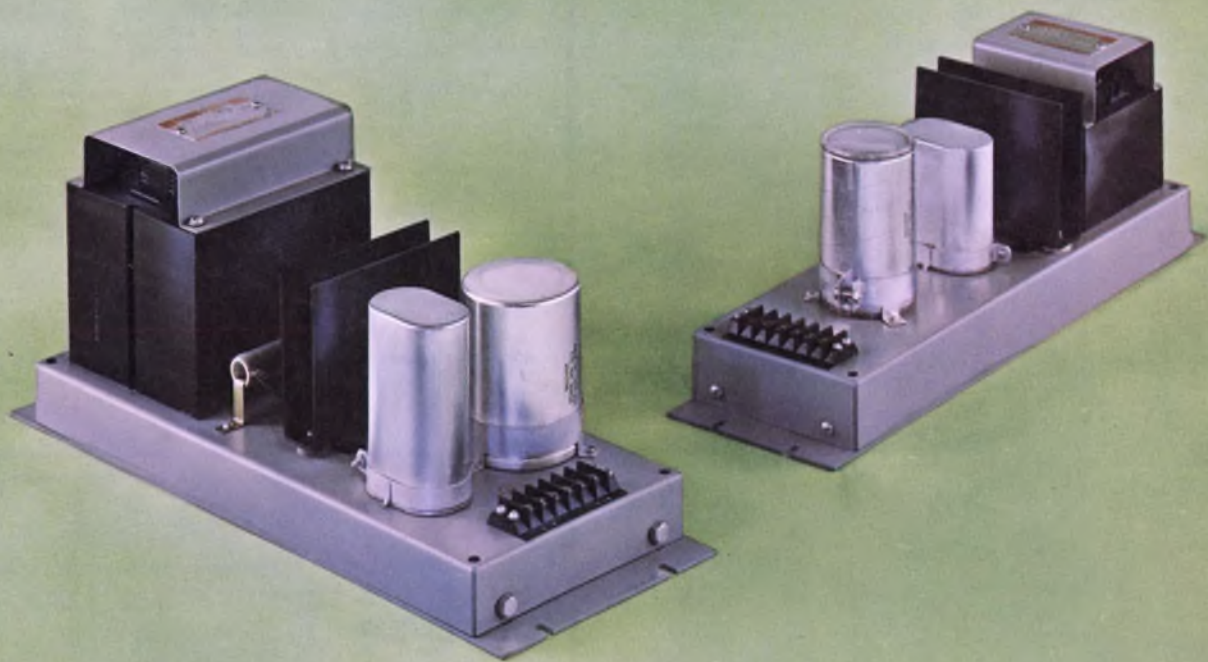

General Electric **REGULATED DC POWER SUPPLIES**
maintain DC load voltage precisely*...
precisely, precisely, precisely, precisely, precisely,
precisely, precisely...

Send in this coupon for free bulletin giving complete details on GE Regulated DC Power Supply features, ratings and application data; or see your GE sales representative today.

* Maintains $\pm 1\%$ output voltage for a variation in input voltage of $\pm 15\%$.

GENERAL  ELECTRIC

Section 413-36
General Electric Company
Schenectady, New York 12305

Please send me free bulletin GEA-7353B on
Regulated DC Power Supplies.

NAME _____

COMPANY _____

TITLE _____

ADDRESS _____

CITY _____ STATE _____ ZIP _____

E/M Leads In 5 Significant Specifications Power Supplies

TYPICAL EXAMPLE 10-KW	WATTS PER CU. IN.
E/M	2.15
CHRISTIE	1.07
SORENSEN	.96
H-P	.96

SIZE (CU. IN.)	WEIGHT	Mv/ RIPPLE	CONSTANT CURRENT REGULATION
4,655	365	5	0.2% Total
11,221	400	30	1.5% Total
10,374	485	160	0.4% Total
11,221	420	220	1.0% Total

(Data compiled from the latest available specification sheets)

Focusing Coils for Accelerators
Burn-in & Life Testing Semiconductors
CW Lasers
Capacitor Forming & Aging
General Purpose

Write today for your free Quick-Selector Guide to our complete line of power supplies offering detailed specifications, application notes, accessories and prices.



**ELECTRONIC
MEASUREMENTS INC.**
405 Essex Road, Neptune, New Jersey 07753

INFORMATION RETRIEVAL NUMBER 39

NPO CHIP CAPACITORS



MDI offers 1000 pF In a standard chip .100" x .050" x .050"

Search no more! They're here! These NPO ceramic multilayer chip capacitors offer the highest capacitance volumetric ratio, coupled with the lowest dissipation factor (less than 0.01% typ.) and highest insulation resistance (greater than one teraohm @ 25°C, and 50,000 megohms @ 125°C). Because they also meet applicable portions of MIL-C-11015 and MIL-C-39014 you can depend on these NPO chip capacitors where reliability and performance really count. Also available in kits . . . for further information call direct and ask for Jim Waldal.

Monolithic 
Dielectrics Inc.

P.O. Box 647 • Burbank, Calif. 91503 • (213) 848-4465

INFORMATION RETRIEVAL NUMBER 40



OIL TIGHTS

**MODULAR
SWITCHES
and
INDICATORS**

with Color-coded
Circuitry!

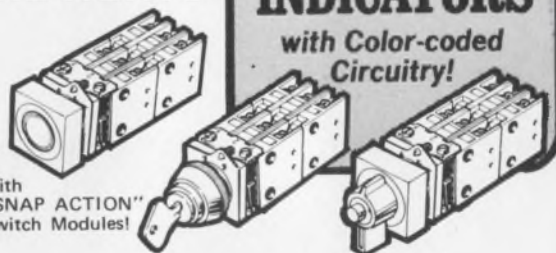

With
"SNAP ACTION"
Switch Modules!

Specify literally millions of different units from a few basic parts! Up to six color-coded modules per component. Switches may be activated by pushbuttons (flush or mushroom heads) or by selectors (knobs, levers, wings or keys) . . . with or without indicator light or auxiliary pushbutton for test conditions. Ratings: 10A-300V continuous . . . 6A-300VAC interrupt . . . 1/2A-125VDC resistive interrupt. Max. making current 60A . . . dielectric withstanding voltage 2500VAC. Mech. life over 1,000,000 operations. Available as finished components or modules or sub-assemblies. Write for Bulletin 32.



**ELECTRO SWITCH
CORP.**

Weymouth Massachusetts 02188
Telephone: 617/335/5200 TWX: 710/388/0377

INFORMATION RETRIEVAL NUMBER 41

Top
of any
line



Most accurate, most versatile 5-digit multimeter — period.

Here's the finest, most advanced measuring instrument available. It's Cimron's Model 6853 Digital Multimeter, the truly new five digit DMM that offers versatility and reliability unobtainable until now.

Years of building standard multimeters, and years of engineering costly modifications to fit special applications, have resulted in the most complete measurement capability ever put into a single, compact instrument.

With DC accuracy up to 0.001%, the 6853 gives you six DC ranges (100 Nanovolts to 1100V); nine

ohms ranges (10 Microhms to 100 Megohms); four AC ranges (1V to 1100V); DC and AC ratios plus much, much more. Auto ranging, remote programmability, five print options, out-of-range indication and automatic desensitization to name just a few.

Because all options are standard plug-ins for the basic instrument, Cimron has eliminated the need for special modifications or external units in virtually any measurement or systems application.

We invite you to compare our "Customer Concern" construction,

advanced design, unsurpassed expandability and long list of other exclusive features. They make the new 6853 Digital Multimeter the "top of the line" at Cimron. That means the top of any line — period.

And if you buy millivolts you get ohms free. Call (714 276-3200) or write Cimron, Department D-144, 1152 Morena, San Diego, California.

the hot line of DMM's

CIMRON



CIMRON DIVISION

LEAR SIEGLER, INC.

The ZA801 is a low-cost FET-input op amp. It comes in four different packages. It has a DC gain of 100,000, ± 10 volts output, and a full-power frequency response of 200 kHz. Voltage drift is $50 \mu\text{V}/^\circ\text{C}$ and input bias current is 25 picoamps. In quantity, price is as low as \$11.90.

Why four different packages? We had the idea that designers might like to get to know one op amp well, then use it whenever they could — without having to think about package density. So we put the ZA801 in a TO-8 can, a plastic DIP, a hermetically-sealed DIP, and a modular flat pack.

We're the first to offer this idea of total package capability. The competition will undoubtedly copy us. But before they can get the first one off the ground, we'll have another — and then another.

This sort of answers the question, "Hey Zeltex, what have you done for me lately?"

SPECIFICATIONS

DC Gain (at rated load, min.)	100,000
Minimum output	$\pm 10\text{V}$ @ 5 mA
Unity Gain (min.)	4 mHz
Full-power output frequency (typ.)	200 kHz
Maximum voltage drift	$50 \mu\text{V}/^\circ\text{C}$
Common mode rejection ($\pm 10\text{V}$) (typ.)	10,000:1
Input Bias Current (max.)	25 pA
Input voltage noise (10 Hz to 10 kHz)	$3 \mu\text{V rms}$

QUANTITY PRICES

ZA801M1 Modular Flat Pack	\$11.90
ZA801D1 Plastic DIP	22.00
ZA801E1 Hermetically-sealed DIP	34.00
ZA801T1 TO-8 can	28.00

All four ZA801 packages are available from stock. Call your Zeltex rep for evaluation samples.

To receive a ZA801 data sheet, plus information about the complete line of Zeltex FET-input amplifiers, circle the reader service number below, or write



A SUBSIDIARY OF REDCOR CORP.
1000 Chalomar Road, Concord, California 94520
Phone (415) 686-6660

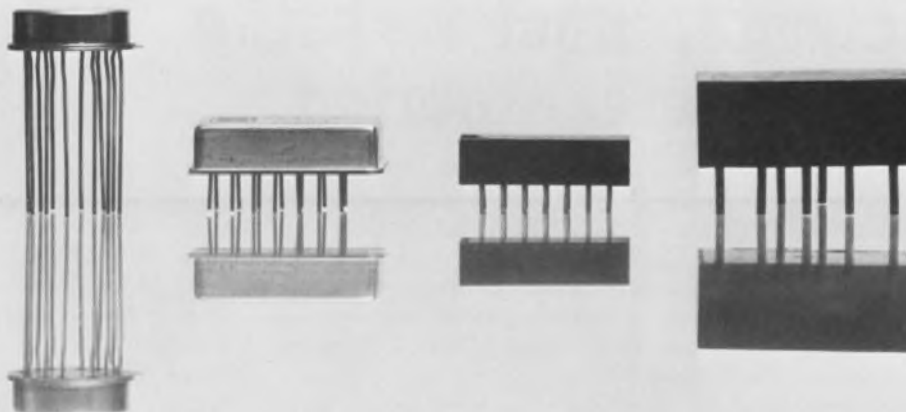

These are the ZA801

Introducing the DATA-PAC family: Compatible from logic modules to minicomputers.

If you build digital systems, make life easy for yourself. Look into Honeywell's DATA-PAC family of digital products.

There are logic modules. Core memory systems. Controllers. Minicomputers. Analog interface modules. Hardware. Power Supplies. Accessories.

Every DATA-PAC product is compatible logically, electrically, and mechanically. Which lets you do something unique: pick precisely the items you need,

join them, attach the cables . . . and go.

You use common documentation. You don't have to select or design different power supplies and interfaces. You get your system together quickly, easily, economically. And just the way you planned it.

Our new DATA-PAC Family Brochure gives you all the facts. Write for it today. But whatever you do, consider the alternative: Honeywell, Computer Control Division, Framingham, Massachusetts 01701.

The Other Computer Company:
Honeywell

HONEYWELL INTERNATIONAL—Sales and Service offices in all principal cities of the world. Manufacturing in Australia, Canada, Finland, France, Germany, Japan, Mexico, Netherlands, Spain, Taiwan, U.K. and U.S.A.



60 dB Stop band rejection

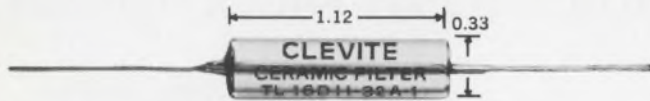

in a mil spec
ceramic filter for
less than \$15.

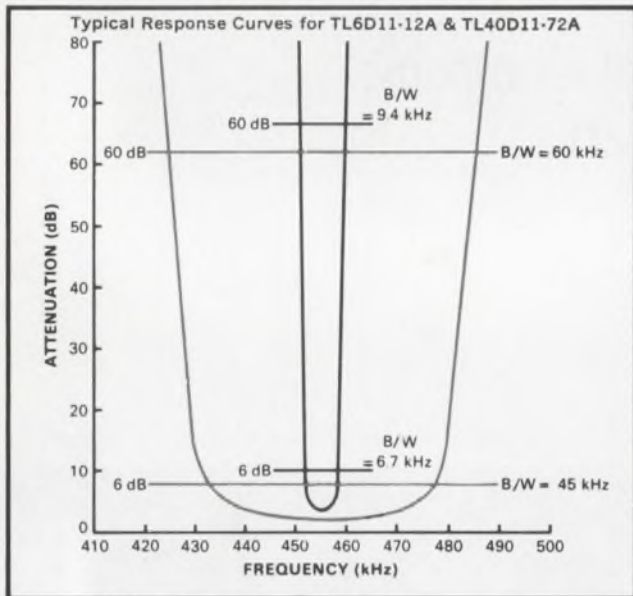

Here's the smallest (less than 0.1 cu. in.), most rugged fixed-tuned filter of its kind on the market today!

Clevite's 11-disc miniature filter is packaged in a hermetically-sealed cylinder, exceeds all military environmental specifications, is ideal for transistorized i-f amplifier circuitry in AM and FM sets plus many other applications that call for a fixed-tuned filter. Stop band rejection: 60 dB. Center frequency tolerance: ± 2 kHz to ± 3 kHz. Stability: within $+0.2\%$ for 5 years; within 0.2% from -40°C to $+85^\circ\text{C}$. Impedance (in and out) 2000 ohms for B/W less than 12 kHz; 1000 ohms for broader bandwidths.

Following models standard at 455 kHz.

Model Number	B/W	
	min. @ 6 dB	max. @ 60 dB
TL6D11-12A	6 kHz	12 kHz
TL10D11-20A	10 kHz	20 kHz
TL16D11-32A	16 kHz	32 kHz
TL20D11-38A	20 kHz	38 kHz
TL30D11-57A	30 kHz	57 kHz
TL40D11-72A	40 kHz	72 kHz

PRICES: 1—\$25 ea; 25—\$20 ea; 100—\$17.50 ea; 500—\$15 ea; 1000—\$13.75 ea; 2500—\$12 ea.
(Prices subject to change without notice)

Send order or request for Bulletin 94029 to: Piezoelectric Division, Gould Inc., 232 Forbes Rd., Bedford, Ohio 44146, U.S.A. Or: Brush Clevite Company, Limited, Southampton, England.

GOULD CLEVITE

INFORMATION RETRIEVAL NUMBER 45

If Quality is Important
If Service is Important
If Pricing is Important
SCHRACK DELIVERS
Immediately From New York Stock

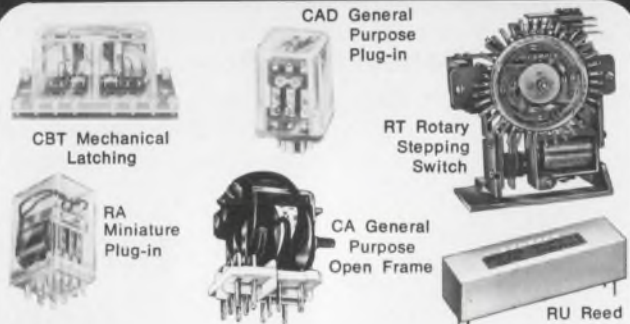

Schrack relays meet specifications far in excess of those required by the most exacting standards — and are priced much less.

Schrack has available a complete line of sockets, plugs and dust covers for custom modular construction to suit all your requirements — including accessories.

Send for complete catalogs today

SCHRACK ELECTRICAL SALES CORP.
1140 Broadway, New York, New York 10001

INFORMATION RETRIEVAL NUMBER 46

PRECISION POWER WIRE WOUND AND
HEAT SINK RESISTORS ON "DESIGN-CALL"

FROM

OMTRONICS
MANUFACTURING, INC.

2408 Leavenworth Street
Phone (402) 348-9500

Omaha, Nebraska 68105
TWX 910 622 8820

WRITE FOR OUR CATALOG AND NAME OF OUR
LOCAL REPRESENTATIVE



INFORMATION RETRIEVAL NUMBER 47

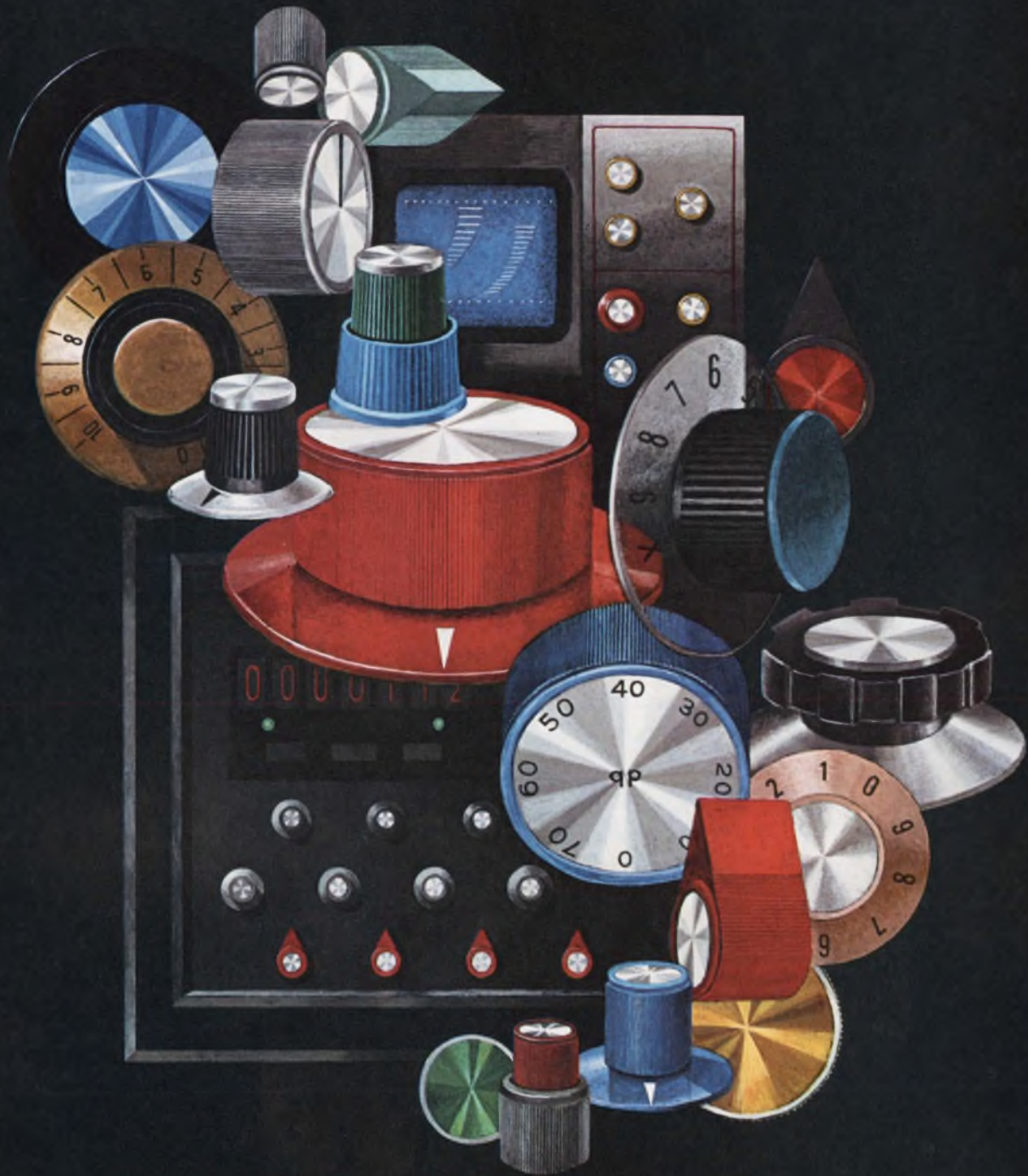

RELIABILITY

Sets the pace in product performance — quality — service. And, when it comes to control knobs and dials, the reliable name is Rogan . . . the pace-setter of the knob industry since 1939.

Outline your requirements for quotation and free knob sample. Write for free color catalog.

Rogan
BROTHERS, INC.

8019 N. Monticello Ave. Skokie, Illinois 60076
Phone: (312) 675-1234



**when
this
cannon
fires,
a lot of
things
happen**

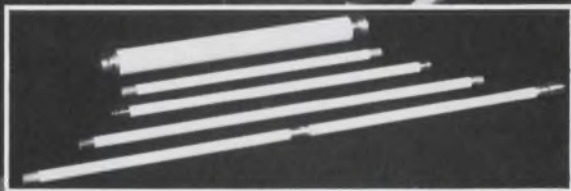

- ◎ **HIGH CURRENT DENSITY—OVER 1000 A/CM² IN VACUUM**
- ◎ **POWER DENSITY UP TO 200 WATTS/CM OF DISCHARGE LENGTH**

- ◎ **3000 TO 4000 WATTS POWER DISSIPATION**
- ◎ **HIGH DENSITY, HIGH TEMPERATURE ELECTRICAL DISCHARGE COOLED TO 110°C IN 0.213" THICKNESS**

That's pretty tough on the supporting insulator - but BERLOX[®] beryllia takes it in stride . . . which is why Perkin-Elmer uses BERLOX as the capillary tube - the "cannon" - of a c/w argon gas laser for reconnaissance systems.

The high thermal shock resistance of BERLOX withstands high temperature, high density discharge at near vacuum to a coolant at 110°C through 0.213" radius; thermal conductivity is 3.0 watts/cm²/°C - second only to that of copper, silver and gold - and far superior to that of any other electrical insulator. BERLOX is inert, and has immeasurably low sputtering rates.

Not everybody makes lasers, or needs laser support tubes. But the thermal conductivity and thermal shock resistance which enables BERLOX to operate indefinitely under laser conditions make it a material to consider for high performance, high reliability electronic, electrical and electromechanical applications.

What is Berlox[®]?

Berlox is a technical ceramic, manufactured by National Beryllia Corp., from beryllia (BeO) beryllium oxide. In addition to excellent physical and electrical properties of interest to designers, BERLOX has the unique ability to transfer heat as efficiently as aluminum metal and many electrical conductors, while acting as a highly efficient electrical insulator (350 VPM dielectric strength; dielectric constant of 6.7 at room temperature; loss tangent .0002 at room temperature).

It is used in such applications as electronic assemblies, heat sinks, thermocouple insulation, electro-magnetic windows, substrates, ceramic-to-metal seals.

When the last word in design is cost effectiveness, take a long, hard look at BERLOX. You can start now by requesting a detailed chart of properties from

b National Beryllia
CORP
Haskell, N. J. 07420
Telephone 201 • 839-1600

12371

Cutler-Hammer extends its Rockette Switch line with the first totally illuminated rocker.

Totally visual indication of operation. It's Cutler-Hammer's new illuminated Rockette Switch. Another example of how we go just a little further to meet your design and functional needs.

The little *extras* that are part of every Cutler-Hammer Rockette Switch, like the entirely translucent rocker, are what has made us Number 1. The switches people specify when designing commercial appliances and business machines—because quality equipment demands the best.

Our 9 rocker shapes, each in a

wide variety of colors, offer the finest in design flexibility and distinctive appearance. And, the legend is hot stamped.

AC-rated. AC/DC. Printed circuit terminations. Single pole. Two pole. Four pole. Dry-circuit capability, or up to 20 amps. 125 and 250 volt service. Single-, double-, and triple-throw contacts. You name it.

So, on the next piece of quality equipment you design, brighten it with a Rockette Switch from Number 1. Call your Cutler-Hammer Sales Office or Stocking Distributor. Or write for new full-line catalog LD-110-217



Quality switches for quality equipment. Check with your distributor for our Rockette Line of switches. AC. AC/DC. Low energy. Dry circuit. Up to 20 amps.

CUTLER-HAMMER
SPECIALTY PRODUCTS DIVISION, Milwaukee, Wis. 53201



Enlightenment.

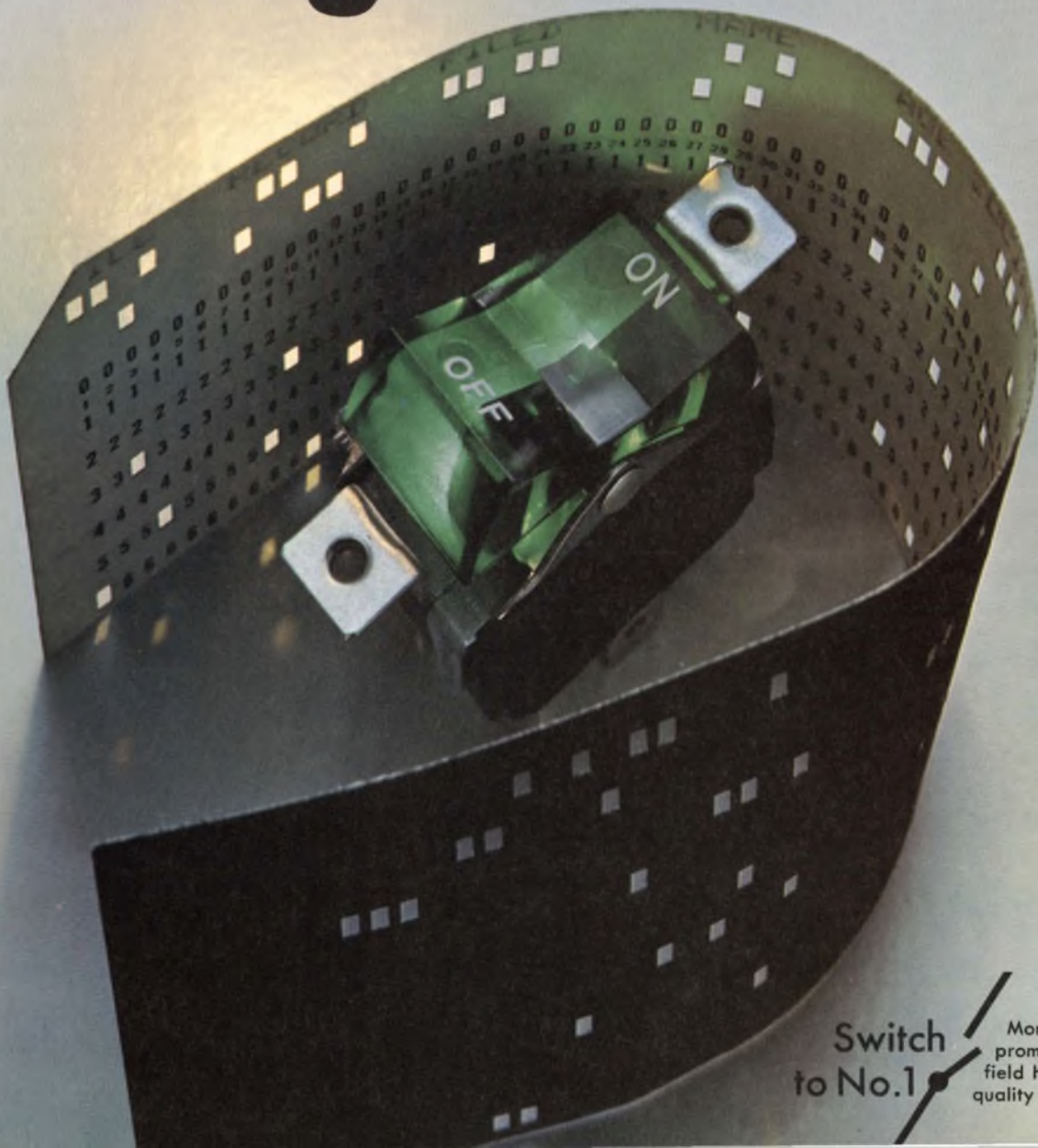

Switch
to No. 1

More than just switches;
prompt availability,
field help, innovation,
quality assurance, too.

*we're
BIG...*

*on
small*
**REED
RELAYS**

Wheelock probably has the reed relay you're looking for. Write for catalog describing the Wheelock Big Family of Small Relays

Wheelock

SIGNALS, INC.

273 Branchport Ave.
Long Branch, N. J. — 201-222-6880

INFORMATION RETRIEVAL NUMBER 51

the Transducers

A complete lineup of pressure, force, velocity and displacement transducers. Wanted everywhere for their reliability and adaptability. Hewlett-Packard engineering and quality control assure that they stand up under strictest examination. Get a line on The Transducers. Write Hewlett-Packard, Palo Alto, California 94304; Europe: 1217 Meyrin-Geneva, Switzerland.

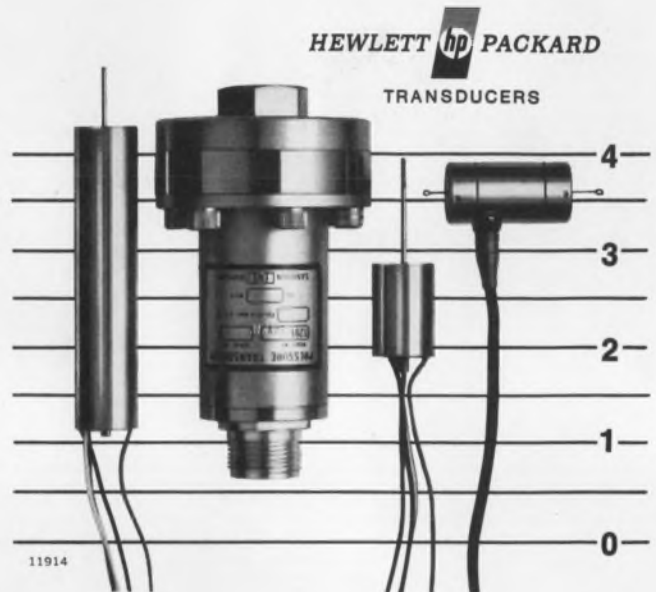

INFORMATION RETRIEVAL NUMBER 52

**"IT'S GOOD BUSINESS
TO HIRE THE HANDICAPPED."**

ISN'T THAT A GREAT IDEA, SNOOPY?



**THE PRESIDENT'S COMMITTEE ON EMPLOYMENT
OF THE HANDICAPPED, WASHINGTON, D. C.**

Our
 2N5592 JFET
 has
 33% lower
 1/f noise
 than
 our
 2N5593.

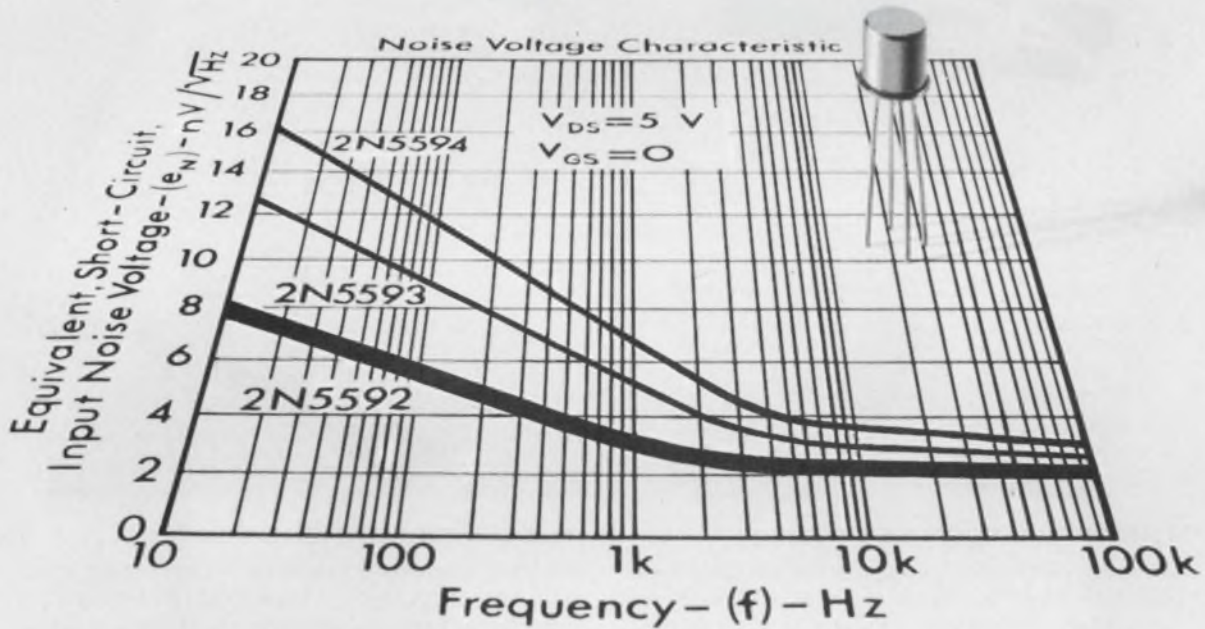

How low can we get?

Only time will tell. Because we're designing an entire family of N-Channel JFET's around a new manufacturing process. And one of the nicest things about this process is that it has low-noise as a natural characteristic. In fact, the 2N5592 is the lowest-noise device of its type. (Maximum noise is $10 \frac{nV}{\sqrt{V}}$ at 10 Hz.) Output admittance is also very low, typical γ_{os}

is $1 \mu\text{mho}$. And since it's an N-Channel JFET, you know what kind of gain to expect. (Around $4500 \mu\text{mhos}$.) What's more, 2N5592 is available right now. Bet you didn't expect that.

Soliton Devices, Inc., P. O. Box 1416,
 San Diego, California 92112.
 Telephone 714/278-8780.
 TWX 910-335-1221.

Soliton DEVICES, INC.

NOW! A SUPERMARKET IN PRINT FOR MAGNETIC COMPONENTS

Here is your key to 20,000 components—without a single ambiguity, irrelevant specification, or the sort of interminable list of “part numbers” that makes life easy for manufacturers, but hell for the designer.

Here is a functional approach to component selection:

- The *relevant* parameters for specifying a

- component to *perform a particular function*
- The formulae and test circuits for computing electrical values within the circuit
- The available package configurations.

Here's what we need to know to have a mechanically and electrically correct sample on its way within 48 hours following your phone call! (It's *that* easy.)



THE APPLICATION SECTION

We give you detailed information on circuits which perform various functions (such as SCR Triggers, Sine Wave Demodulators, Pulse Gates, etc.) complete with circuit diagrams, magnetic component functions within the circuit, the *relevant* parameters for which we need values to select or design a component for you, and a listing of available configurations that could be used for each application.

THE TEST CIRCUIT SECTION

Gives you all necessary formulae, test circuits, and definitions to help you measure or compute all parameter values.

The Aladdin Encyclopedia of Capabilities is Free to qualified design and purchasing personnel (write on your letterhead, giving us a few facts about yourself please), or may be purchased for \$3.95 by anybody who wants to see the greatest innovation in components selection in a dozen years or more.

THE CONFIGURATIONS SECTION

We show you over 30 standard Aladdin configurations (or “packages”)—including photographs, dimensional drawings, terminal information, an exploded view showing the core construction of each component (together with possible variations), and detailed design parameter ranges. You can determine how big a package is needed from the parameter values your functional performance requirements dictate. This section is your key to over 20,000 Aladdin designs!

THE PRICE RANGE SECTION

You can do rough cost estimating on the spot, and choose the configuration that most closely matches your cost limitations.

Aladdin
ENCYCLOPEDIA OF CAPABILITIES

Aladdin Electronics • Nashville, Tennessee 37210

AE



Miniature
price
tags.

KMC announces the biggest technical breakthrough in the history of high quality semiconductors.

KMC has just cut prices, on all products, by up to sixty percent.

A triumph of miniaturization.

These price cuts mean that you can now get the same high quality semi-conductors you expect from KMC, at prices you wouldn't.

No cutting corners.

About a year ago, KMC was purchased by Harvard Industries. Among other things, Harvard brought in highly sophisticated production machinery, substantially increasing yields and reducing many of the operations which had held our prices up. Result: We realized vast reductions in our costs with no reduction in our quality. We now pass these savings along to you.

The cynics asked why.

Outsiders asked us: "But engineers have always bought your products. They were *willing* to pay high prices for high quality. Business is booming. Why knock a good thing like your prices?"

We were steadfast.

The highest quality is now available at competitive prices. We think this move will result in a general upgrading of all semiconductor applications.

Write us about your application.

If you're designing with semiconductors, write us about it. You can now get the cream of semiconductors at prices that won't milk you dry.



KMC SEMICONDUCTOR CORPORATION

a subsidiary of Harvard Industries, Inc.

Parker Road, Long Valley, New Jersey 07853.
(201) 876-3811, TWX (510) 235-3350



Now there's a multiplexer
as dependable as an ICC modem.

The MC-70.

It operates without constant monitoring,
so you won't see lots of colored lights.

The advantages are inside,
with many special features that
save communication costs.

You won't be dazzled — just impressed.



Send for our new data sheet.



International Communications Corporation
7620 N.W. 36th Avenue, Miami, Florida 33147
Telephone 305 + 691-1220 TWX 810-848-6588
a milgo company

In Europe —



Reading, Berks, England

Publisher

Hugh R. Roome

Editors

New York Office
850 Third Ave.
New York, N.Y., 10022
(212) 751-5530

Editor: Frank Egan
Managing Editor: Ralph Dobriner
Managing Editor: Raymond D. Speer
Microelectronics, Steven A. Erenburg
Computers, Milton J. Lowenstein
Circuits, Don Mennie
Microwaves, Michael J. Riezenman
Management, Richard L. Turmail
News, John N. Kessler
Military-Aerospace, John F. Mason
New Products, Roger Allan
New Products, Lucinda Mattera
Directory Manager, Greg Guercio
Copy, Marion Allen

Field Offices

Massachusetts

Jim McDermott
P.O. Box 272
Easthampton, Mass. 01027
(413) 527-3632

San Francisco

Elizabeth de Atley
2051 Wellesley St. (Suite D)
Palo Alto, Calif. 94306
(415) 321-7348

Los Angeles

David Kaye
2930 Imperial Highway
Inglewood, Calif. 90303
(213) 757-0183

Washington

Don Byrne
1425 N St. NW
Washington, D.C. 20005
(202) 667-6568

Editorial Production

Dollie S. Viebig
Richard D. Grissom

Art

Art Director, Clifford M. Gardiner
Assistant, William Kelly
Rita Jendrzewski
Lynn Thompson
JoJo Miskimmon

Production

Manager, Thomas V. Sedita
Helen De Polo
Kathleen McConkey
Leslie Stein

Circulation

Manager, Nancy L. Merritt

Information Retrieval

Genate Piccinetti

EDITORIAL



Why not give your Congressman some lessons in engineering?

Is a Congress full of lawyers really capable of dealing with the increasingly complex technical problems that face our society today?

Not only are our lawmakers largely unknowledgeable about such diverse problems as pollution control, the evaluation of controversial defense projects, rf spectrum management and high-speed transportation, they are also under constant pressure from lobbyists to favor special interests. These lobbyists are often a Congressman's sole source of "facts." With the resources of large institutions behind them, they frequently succeed in convincing legislators that as is dc, if it suits the goals of their employers.

A good first step toward changing this situation has been proposed by Rep. Emilio Q. Daddario (D-Conn). His bill would create an Office of Technology Assessment under the Comptroller General of the United States (see Washington Report, ED 10, May 10, 1970, p. 40). The new office would convene special panels to assess different approaches to national technical problems.

This is fine as far as it goes. But the office would only report on problems that are assigned to it. It would not provide Congress with unbiased day-to-day technical consultation.

What can be done to fill this need? It's pretty unrealistic to think we can elect a large number of engineers to Congress. And it probably wouldn't be a good idea to do so even if we could.

But why can't we, as technically competent citizens, try to educate our governmental representatives in technical areas? All it would take as a start is some clear thinking by engineers followed by the composition of a few letters.

Every time you read about a technical or semi-technical debate in Congress and find yourself saying, "Don't those fatheads realize . . .," regard it as an invitation to tell them.

We engineers have long been an extremely conservative, quiet, uninvolved group. Isn't it time for a change?

MIKE RIEZENMAN

Yes, redundancy increases reliability . . .

but how much? Here's how to calculate the reliability improvement for redundant op amps, or RAMPS.

When good op-amp reliability is not enough—when you need ultrahigh reliability—special summing circuits can be the answer. A redundant amplifier (RAMP) connection of several op amps can continue to operate satisfactorily, even after one or more of the amplifiers fails.¹

The gain available from the extra op amps is used to overcome the effect of a failure in an op amp or in an interconnection—the penalty being decreased dynamic range and accuracy of the output signal. A RAMP will operate with a single input or with redundant inputs (Fig. 1). If redundant transducers are used, for example, the RAMP can even compensate for a failure in one or more of the transducers.

Is redundancy for your design?

But exactly how much is the reliability increased? And what about interconnections? The addition of redundant elements to a circuit or system provides acceptable operation in the presence of failures, but the redundant elements themselves cause additional failure modes.

This, plus the fact that component failures reduce the available dynamic range of the RAMP,¹ (which may also be classified as a failure) makes the decision of when to use the RAMP configuration a difficult one. It cannot be based on a surface inspection or intuition.

The designer must have a convenient means of comparing, in a quantitative way, the reliability of any given RAMP to that of a nonredundant counterpart. He must have a quick method of determining, before he makes any detailed design effort, the number of RAMP amps required to achieve a given reliability increase over a nonredundant configuration. With this information, he can decide whether or not he can “afford” this degree of reliability.

And in assessing the RAMP's reliability characteristics, he must consider the probability of failure and the mean life characteristics, and determine the RAMP's dynamic range with failures and

the mission or operating life required (see box). The application of the various reliability formulas to the RAMP configuration is straightforward. In the expression for the binomial distribution function (Eq. 7), for instance, N is the number of amplifiers in the RAMP, K is the number of nonfailed RAMP amplifiers, R_e is the probability of success for any RAMP amplifier, F_e is the probability of failure for any RAMP amplifier, and R_N is the probability of K nonfailed amplifiers out of a total of N RAMP amplifiers.

In the case of the RAMP, however, the item of interest is not the probability of exactly K successes but rather the probability of K or more successes. Equation 7 is easily modified to accomplish this as follows:

$$R_r = \sum_{x=K}^N \frac{N!}{x!(N-x)!} R_e^x F_e^{(N-x)} \quad (8)$$

where R_r is the net RAMP reliability.

Equation 8 now gives the net success probability R_r of a RAMP consisting of N amplifiers, K of which must be nonfailed for proper operation. For example, a RAMP consisting of three amplifiers must have two nonfailed amplifiers for proper operation, and thus $N = 3$, $K = 2$, and

$$R_r = 3R_e^2 F_e + R_e^3.$$

Evaluate the success probability

The “basic element” of the RAMP is the general amplifier shown in Fig. 2. The RAMP is formed by connecting three or more of these amplifiers at their output terminals (the reliability of the interconnect is lumped with the reliability of the basic element). The probability density function for the circuit of Fig. 1 is assumed to be exponential. Hence

$$R_e = e^{-\lambda t}, \text{ and} \quad (9)$$

$$F_e = 1 - e^{-\lambda t}, \quad (10)$$

where R_e is the reliability of the “basic element” (Fig. 3), and λ is the “basic element” failure rate for the RAMP.

The reliability of a RAMP consisting of N basic

William H. Huber, Member of the Technical Staff, TRW Systems, Redondo Beach, Calif.

amplifiers of Fig. 1, with K or more amplifiers non-failed, is obtained from Eq. 8 as

$$R_r = \sum_{x=K}^N \frac{N!}{X!(N-X)!} R_e^x (1-R_e)^{N-x} \quad (11)$$

Equation 11 requires, of course, that the Bernoulli trial criteria be satisfied, so that: each amplifier in the RAMP must either be failed or non-failed (no degradation); the success probabilities

for the amplifiers in the RAMP are equal; the failures of the basic amplifiers in the RAMP are independent. It should also be recalled that K in Eq. 11 must always represent a majority of the total number of RAMP amplifiers.

The comparison of reliability between the RAMP and a nonredundant counterpart is based upon the following definition:

System r (with reliability R_r) is G times as reliable as system e (with reliability R_e) when,

$$R_r^G = R_e \quad (12)$$

where G is the "reliability gain." In other words, the probability of successful operation of G system r 's is the same as the probability of successful operation of a single system e . If R_r and R_e of Eq. 12 are replaced with $(1-F_r)$ and $(1-F_e)$ the result is

$$(1-F_r)^G = (1-F_e)$$

Then

$$1 - GF_r + \frac{G(G-1)}{2} F_r^2 - \frac{G(G-1)(G-2)}{6} F_r^3 + \dots = (1-F_e) \quad (12a)$$

If F_r is sufficiently small, the terms containing powers of F_r greater than 1 can be neglected without significant error. Then

$$(1 - GF_r) \doteq (1 - F_e)$$

and

$$F_e/F_r = F_{rr} = G \quad (13)$$

For most electronic systems, F_r is sufficiently small so that F_{rr} is a good approximation to the reliability gain G . Consequently, for the remainder of this article, the failure probability ratio F_{rr} will be designated as the RAMP reliability gain G .

If $F_{rr} = G = 10$, one can then say that system r is ten times as reliable as system e . To compare the RAMP's reliability to that of a non-redundant counterpart a plot of the ratio $F_e/F_r = G$ as a function of mission life λ , is used.

Using Eqs. 9 and 11, the failure probability ratio F_{rr} is:

$$F_{rr} = \frac{1 - R_e}{1 - R_r}$$

$$F_{rr} = \frac{1 - e^{-\lambda t}}{1 - \sum_{x=K}^N \frac{N!}{X!(N-X)!} e^{-X\lambda t} (1 - e^{-\lambda t})^{N-X}} \quad (14)$$

The number of failed RAMP amplifiers, M (discussed in reference 1), is related to the K of Eq. 11 by the formula:

$$M = (N - K)$$

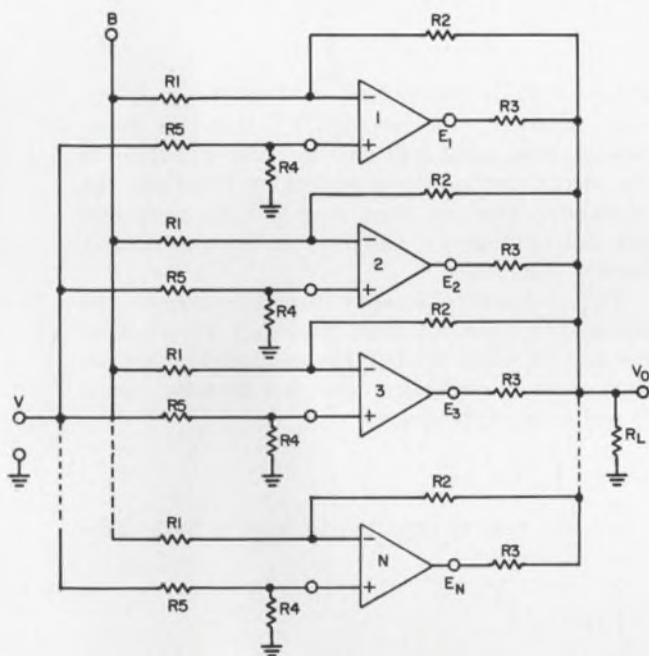

1. The single-input RAMP operates with all op-amp inputs tied together and supplied from a single source. It compensates only for internal op-amp or interconnection failures. The range and accuracy of compensation depend on the number of op amps used.

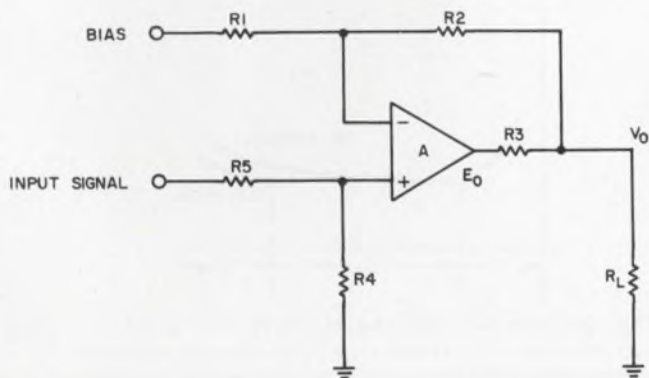

2. The basic element of the redundant amplifier (RAMP) is common operational amplifier.

Know the language of reliability

If an experiment, Δ , is repeated n times under uniform conditions and a particular event E is observed to occur in f of the n trials; then the ratio f/n is called the "relative frequency" of E for the first n trials of Δ . As n increases, the ratio f/n will be observed to approach a constant value (this characteristic is called 'statistical regularity'). The probability P of an event E is thus taken to mean that if the experiment, Δ is repeated a sufficiently large number of times the relative frequency ratio f/n for the event E will almost certainly approach the value P .

The probability P of an event is a number between 0 and 1 ($0 \leq P \leq 1$). Since the event must either occur or not occur

$$P(E) + P(\bar{E}) = 1,$$

where $P(E)$ is the probability of the event "E" and $P(\bar{E})$ is the probability of the event "not E".

Nearly every discussion of reliability in systems involves the equipment failure rate λ .

λ_b (repairable) is the ratio of the total number of failures incurred by a sample of units to the total accumulated operating time of the units for a fixed test duration T . Failures are repaired or replaced immediately. Thus, if a sample of N units is operated under identical conditions for a time, T , and a number of failures, F , are observed to occur, λ_b is computed as F/NT . Notice that, since failures are repaired or replaced immediately, the total accumulated operating time is given by the product of the number of units under test N and the test duration time T . Also, it should be recognized that many unit may not fail during the test interval T ; this time must also be included in the total time accumulated.

λ_c (unrepairable) is the ratio of the total number of failures incurred by a sample of units to the total accumulated operating time of the units with no repairs or replacements. The test is continued until all units have failed. The operating time for any unit is that time from the initiation of the test until the failure of the unit. Thus, for a sample of units, N , λ_c is computed as

$$N / \sum_{i=1}^N t_i,$$

where t_1 is the operating time of unit 1, t_2 is the operating time of unit 2, and t_N is the operating time of unit N .

Observations of a number of different electrical and mechanical systems have resulted in a common "classic" life characteristic curve¹ that has three distinct regions as shown in the figure. These regions are the burn-in or debugging period T_1 (generally 50-200 hours for electronic equipment), the normal operating period, often called the "life expectancy" T_2 , and the fatigue or wearout region T_3 .

If the probability of a successful event is

represented by $R(t)$, and the probability of an unsuccessful event (failure) is represented by $F(t)$, then

$$R(t) + F(t) = 1, \text{ and} \\ R(t) \cdot F(t) = 0,$$

where

$$+ = \text{logical "or" and} \\ \cdot = \text{logical "and."}$$

The failure probability can be defined as^{3,7}

$$F(t) = \int_0^t f(t), \quad (1a)$$

and the success probability as

$$R(t) = 1 - \int_0^t f(t), \quad (1b)$$

where $F(t)$ is the failure probability distribution function (the probability that an item, new at time zero, will fail by time t), $R(t)$ is the success probability distribution function (the probability that an item, new at time zero, will not fail by time t), and $f(t)$ is the probability density function.

The probability density function defines the probability that an item will fail in a given interval of time. Thus, the probability that an item, new at time zero, will fail between times t_1 and t_2 is expressed as

$$P = \int_{t_1}^{t_2} f(t).$$

Since the item is expected to have a finite lifetime, of course,

$$\int_0^{\infty} f(t) = 1.$$

Differentiating Eq. 1b yields

$$f(t) = -\frac{dR(t)}{dt} = -R'(t). \quad (2)$$

The mean-time-to-failure, or mean-time-between-failures, μ , is defined as the mean value (first moment about $t = 0$) of $f(t)$. Thus, μ

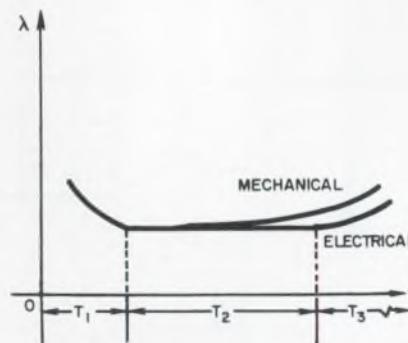

The characteristic failure-rate curve for electrical and mechanical systems has three distinct regions corresponding to the burn-in or debugging, normal operating, and fatigue or wearout periods.

represents the MTTF or MTBF, depending upon which definition of λ is used (λ_c or λ_b):

$$\mu = \frac{\int_0^{\infty} tf(t)}{\int_0^{\infty} f(t)}$$

$$\mu = \frac{\int_0^{\infty} -tR'(t)}{1} \quad (3)$$

Accepted statistical methods are readily available for modifying λ to obtain any desired λ confidence limits.³

A number of basic density functions, representing various types of physical systems and life characteristic regions, are described in the literature,^{3,4,5} but the exponential density function has been found to most often describe the failure probability rate for electronic equipment.⁴

This exponential density function is given by

$$f(t) = \lambda e^{-\lambda t}, \quad (4)$$

where t = time, and λ = failure rate.

From Eq. 1 it is seen that

$$F(t) = \int_0^t \lambda e^{-\lambda t}, \quad (5)$$

so that $F(t) = 1 - e^{-\lambda t}$,
and $R(t) = 1 - F(t)$,

so that $R(t) = e^{-\lambda t}$, (6)

The derivations presented thus far pertain, of course, to nonredundant systems. To compare the reliability of the RAMP to a nonredundant counterpart, a density distribution function that is applicable to the RAMP configuration (which is essentially a "majority voting" system), is required.

The binomial distribution function is applicable to majority voting systems. It is a discrete function, derived from a set of Bernoulli trials and characterized by the following¹:

- for each trial, the result is either a success or a failure;
- the probability of success for each trial is the same;
- each trial is independent of all others.

The function is of the form

$$R_K = \frac{N!}{K! (N-K)!} R_e^K F_e^{(N-K)}, \quad (7)$$

where N is the number of trials, K is the number of successes, R_e is the probability of success for any given trial, and R_K is the probability of K successes in N trials. This equation gives the probability R_K of obtaining K successes from N trials where each trial has the same success and failure probabilities R_e and F_e . Since the independent variable K has a discrete value (0, 1, 2, . . .), R_K can have only a certain set of discrete values and thus is a discrete function of K .

Plots of Eq. 14 for values of N from $N = 3$ to $N = 8$ are shown in Fig. 3. Recall that the values of M must be discrete and are limited to values that provide that K be a majority of N . If required, plots of the type shown in Fig. 3 can easily be constructed, from Eq. 14, for values of N greater than eight.

Separate curves for each allowable value of M are required, since it may not always be possible (from a dynamic range consideration) to allow the absolute maximum number of RAMP element failures (from a majority voting consideration) to occur. That is, with $N = 5$, two RAMP element failures ($M = 2$) can occur while still providing a majority of nonfailed elements ($K = 3$). However, the RAMP dynamic range is reduced to approximately two-tenths of the nonfailed value. With $N = 5$ and $M = 1$, the RAMP dynamic range changes to six-tenths of the nonfailed value. Thus the dynamic range considerations may be the constraining factor in determining the allowable number of RAMP element failures. As a result of this contingency, all possible M values are plotted for each value of N considered.

On the basis of Fig. 3 the following general conclusions can be drawn concerning the relative reliability G of the RAMP:

- G is heavily dependent upon time.
- G is heavily dependent upon the number of allowable RAMP element failures.
- In every case (for $\lambda > 0$) there exists a time beyond which the RAMP is less reliable than its nonredundant counterpart ($G < 1$).

Notice that the basic element of the RAMP is merely a nonredundant amplifier. Since the nonredundant circuit is needed whether or not the RAMP design is used (if the RAMP design is used, the nonredundant amplifier is merely repeated N times) no additional design effort is required to consider the RAMP configuration. Also, once the "element" design (Fig. 2) is completed, the associated failure rate λ can be determined for use in Fig. 3.

Assume, for example, that the circuit of Fig. 2 represents the "basic element" of the RAMP. The failure rates for the components within the element are:⁶ for resistors (film), $\lambda_1 = 10 \times 10^{-9}$ /hr; for IC amp, $\lambda_2 = 150 \times 10^{-9}$ /hr.

If component failures are assumed to be independent, the total element failure rate is:

$$\lambda_{tot} = 5\lambda_1 + \lambda_2$$

(the load resistor of Fig. 2 is not a part of the RAMP basic element). Then

$$\lambda_{tot} = 2 \times 10^{-7}/\text{hr.}$$

For a mission life (time period) of five years, then, the corresponding λt is

$$\lambda t = 0.009$$

$$\lambda t = 2 \times 10^{-7} \times 5 \times 365 \times 24$$

In practical applications the RAMP amplifiers will probably be more complex than the simple

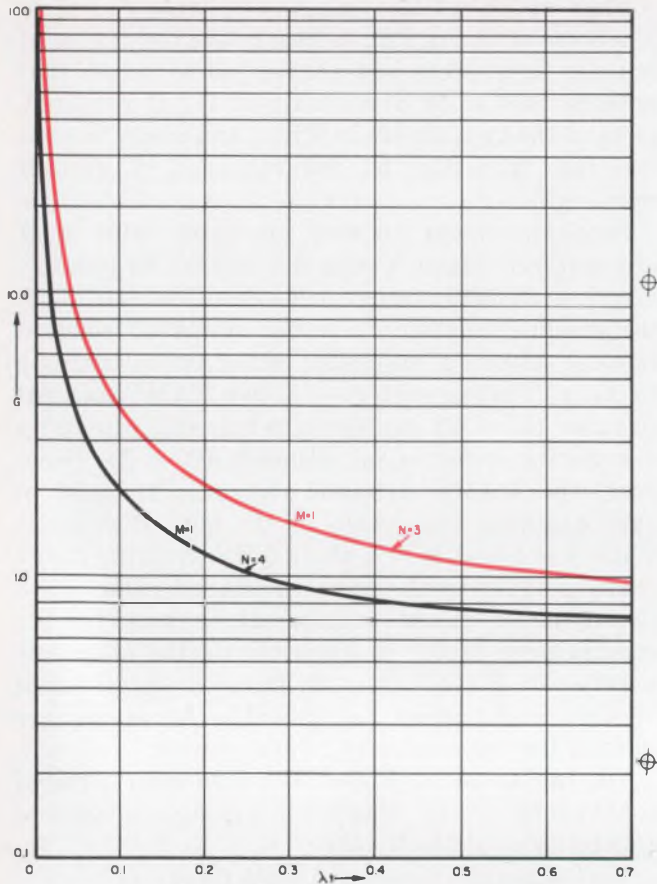

3. The relative reliability G of the RAMP decreases with increasing mission life λt and with increasing number of failures M . Shown are plots of G for $N = 3$

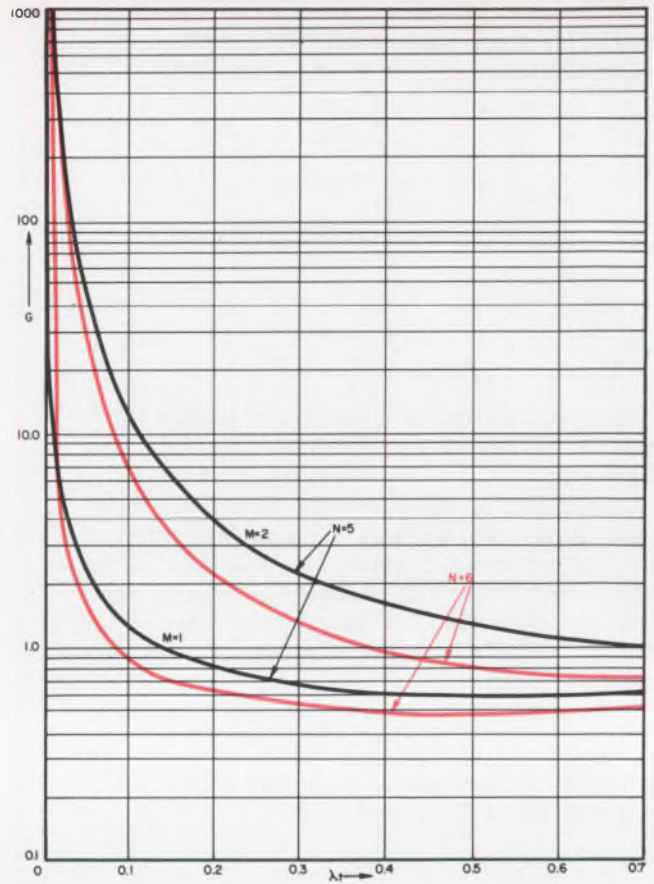

through 8, which can be used to directly determine the RAMP reliability gain G for any given values of M and λt . G is heavily dependent on time, and in every case

circuit of Fig. 2. The reliability analysis presented is valid, however, for any value of λ .

To provide a realistic working value of λt for purposes of discussion here, assume a "basic element" failure rate of 4×10^{-7} /hr and a mission life of approximately five years. Then,

$$\lambda t = 4 \times 10^{-7} \times 5 \times 364 \times 24$$

$$\lambda t = 0.0175$$

For computational ease, let $\lambda t = 0.02$.

The absolute (true) RAMP reliability number for any value of λt can be obtained by dividing the value of G into the nonredundant failure probability number $(1 - e^{-\lambda t})$ and subtracting this ratio from one. Since the designer is usually more interested in the reliability advantage (gain) attainable with the RAMP than the actual reliability number (at least for the initial design trade-off considerations) the reliability gain is a more useful parameter. The true RAMP reliability R_r can be plotted directly from Eq. 11 for any values of N and M , if it is needed. Recall that when a reliability number is specified for a given time period this number represents the minimum reliability number existing over the entire time interval (assuming operation within the life expectancy range T_2 , see figure in box). This is due, of course, to the fact that the reliability number decreases monotonically with time ($e^{-\lambda t}$ for nonredundant circuits).

dant circuits).

The curves of Fig. 3 can be used to directly determine the RAMP reliability gain G for any given values of N , M , and λt .

Suppose that we want to know the reliability gain and the absolute RAMP reliability for a RAMP with $N = 5$, in which (because of dynamic range considerations) one failure is allowed ($M = 1$), and the "mission life" (λt) is 0.02. From Fig. 3, $G = 5$ and

$$R_r = 1 - \frac{(1 - e^{-0.02})}{G} = 0.9960$$

If the "mission life" was 0.14, $G = 1.0$; and the RAMP would be exactly as reliable as the nonredundant counterpart.

As previously mentioned, the loss in RAMP dynamic range associated with RAMP element failures may be a constraining factor in using the RAMP design. It is, in any case, an important consideration in assessing any RAMP design.

The output voltage of a RAMP with N amplifiers (configured as in Fig. 1), M of which have failed is given by¹

$$V_o = \frac{(N - M)(R_1 + R_2)E_D + NR_3B + M(R_1 + R_2)E_F}{[R_3(R_1 + R_2)/R_L] + N(R_1 + R_2 + R_3)} \quad (15)$$

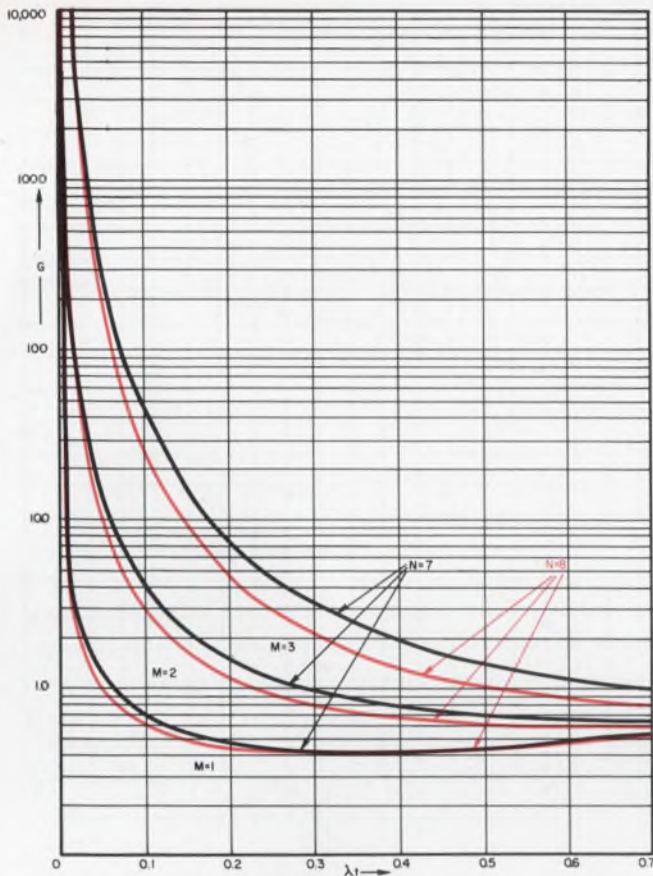

there exists a time beyond which the redundant amplifier configuration is less reliable than a single op amp. Values of M , of course, must be discrete.

where E_D is the linear voltage range of the non-failed op amps, E_F is the failure voltage of the M failed op amps and B is a dc voltage used for level shifting.

If Eq. 15 is normalized to the nonfailed RAMP output range ($M = 0$),

$$\delta = 1 - \frac{M(R_1 + R_2)(E_D - E_F)}{N[(R_1 + R_2)E_D + R_3B]} \quad (16)$$

where δ is the normalized output range.

As discussed in Ref. 1, the dynamic range of the RAMP is a function of its element components. If we assume a RAMP element configuration (Fig. 2) in which

$$R_1 + R_2 = 80 \text{ k}\Omega, R_3 = 1 \text{ k}\Omega, R_L = 2 \text{ k}\Omega,$$

$B = 4 \text{ V dc}$, $E_F = \pm 9.5 \text{ V dc}$, and $E_D = \pm 7.5 \text{ V dc}$, then

$$\delta = 1 - (2.27 M/N). \quad (17)$$

If Eq. 17 is plotted as a function of N , a family of curves is obtained relating δ to N for all allowable values of M (Fig. 4).

The three salient design constraints associated with the RAMP configuration are, of course, the mission life, the reliability number required, and

the dynamic range required. Once these have been determined (the first two are usually fixed by contractual agreements), the curves of Figs. 3 and 4 can be used to determine whether or not the RAMP configuration can fulfill specified requirements. The necessary values of N and M can also be determined, allowing the designer to decide if he can "afford" the reliability advantages offered by the RAMP.

This procedure is best illustrated with an example. Assume, for instance, that the required mission life λt is 0.02, the reliability number required is $R \geq 0.9970$, and the necessary dynamic range is $\delta \geq 0.25$ (normalized).

The nonredundant design (satisfying gain and frequency characteristic requirements) is assessed at $R_e = e^{-0.02} = 0.9802$. Clearly the nonredundant design does not satisfy the reliability requirement. The RAMP configuration (using the nonredundant design as the RAMP "basic elements") is then considered. The reliability gain G is calculated as:

$$G = \frac{(1 - 0.9802)}{(1 - 0.99700)} = 6.6$$

The reliability gain G , from Fig. 3, is plotted as a function of the number of RAMP basic elements N for the given "mission life" of $\lambda t = 0.02$ (Fig. 6). To consider the dynamic range requirements, the corresponding normalized RAMP dynamic range is written (from Fig. 4) for each combination of N and M values. A horizontal line is then drawn on Fig. 5 at $G = 6.6$, and a search is made for δ values equal to or greater than 0.25. This search reveals the following possibilities:

- $N = 4, M = 1, \delta = .41$, and $G = 8.5$;
- $N = 7, M = 2, \delta = .36$, and $G = 76$;
- or $N = 8, M = 2, \delta = .44$, and $G = 50$.

To keep the system cost down, we want to minimize the number of RAMP amplifiers, N , and our choice is a RAMP with $N = 4$, which allows one failure ($M = 1$). This choice yields a circuit which, for the specified mission life, possesses the following characteristics:

reliability number: $R_r = 1 - \frac{(1 - 0.9802)}{8.5} = 0.9977$
 RAMP dynamic range: = 0.41

If the dynamic range requirement is reduced to $\delta \geq 0.20$ and Fig. 4 is searched ($G > 6.6$) for the minimum values of N and M providing a δ greater than or equal to 0.20, the result is:

$$N = 3, M = 1, \delta = .24, \text{ and } G = 18.$$

Thus the RAMP choice is $N = 3$ with one failure allowed ($M = 1$). The resulting circuit characteristics in this case are:

$$\text{reliability number} = 1 - \frac{1 - 0.9802}{18} = 0.9989$$

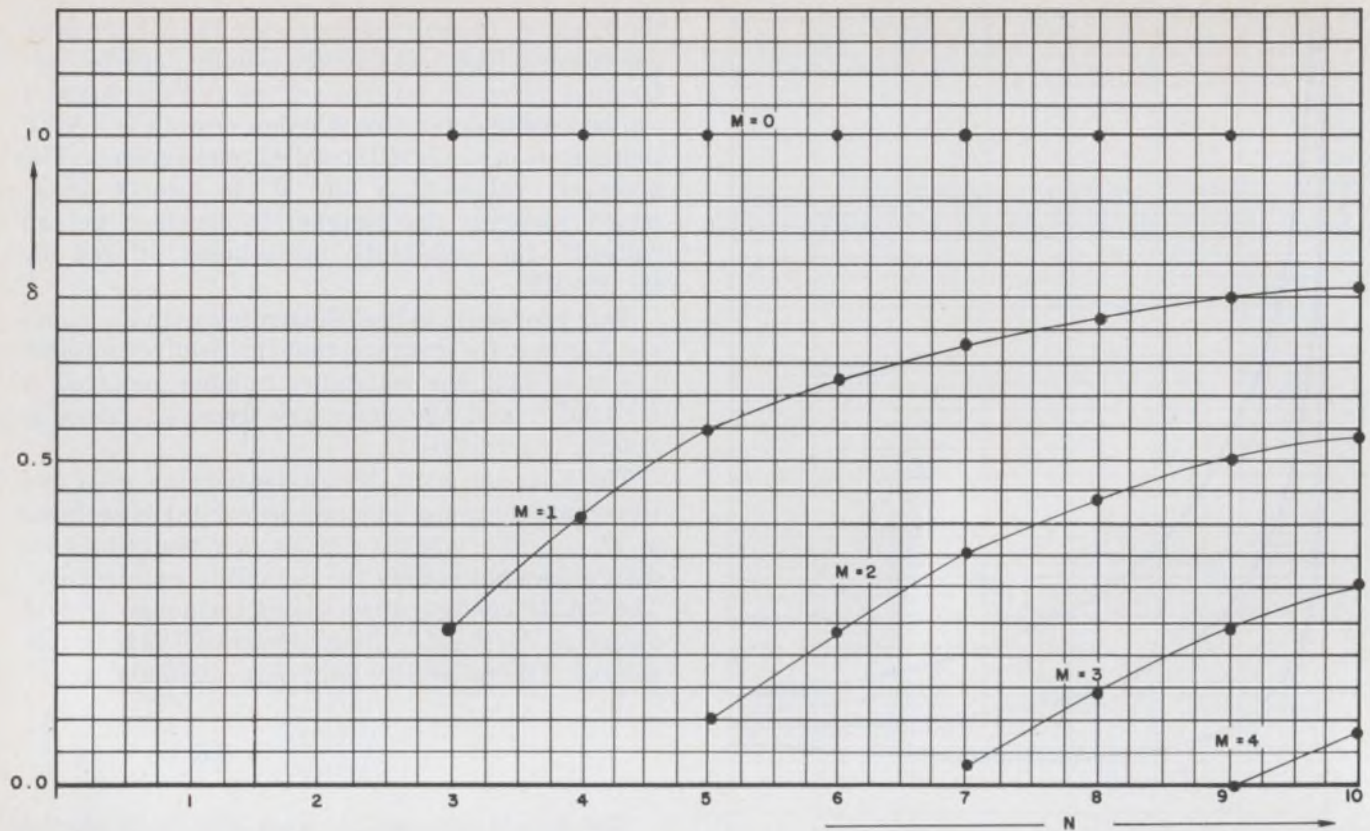

4. The normalized dynamic output range δ of the five-op amp RAMP decreases as the number of failures M increases, each point on the plot representing a possible

operating condition. The δ for a RAMP with one failure ($M=1$) can be increased by increasing N , the number of redundant op amps in the circuit.

RAMP dynamic range = 0.24

Once N and M are determined, of course, a more accurate (free of the interpolation errors of Figs. 2 through 4) value for the RAMP reliability number R_r can be computed by substituting the specified λt value into the proper R_r equation from Table 1.

Note that the development of Fig. 5 is for convenience of analysis only. The information obtained from it can be obtained directly from Fig. 3 by applying the mission life λt , reliability gain G , and dynamic range δ requirements to these curves. In this case, each M -curve corresponds to a particular δ value determined from Eq. 17 or Fig. 4. Each of the graphs in Fig. 3 must be searched (at the specified mission time) for points possessing both the required reliability gain and the required dynamic range.

The size and cost of a RAMP consisting of more than four or five op amps is probably prohibitive if the RAMP is constructed from discrete components. But the present and projected availability of custom IC's could make possible RAMP's with five or more op amps, at reasonable prices, in packages of rather modest dimensions. With this capability the reliability advantages of the RAMP become greatly enhanced. In the case of the

previous example, Fig. 5 shows that, for $N = 4$ and $M = 1$, a reliability gain of 8.5 is achieved with a dynamic range of 0.41. Now, if a RAMP with $N = 8$ were available, a reliability gain of 50 ($M = 2$) would be achievable with no further loss in dynamic range (0.44).

Mean life characteristics can be deceptive

To find the MTTF of a nonredundant system ($R_c = e^{-\lambda_c t}$), Eq. 3 provides

$$\mu_c = \int_0^{\infty} t \lambda_c e^{-\lambda_c t} dt \quad (18)$$

which, when integrated, yields the familiar result

$$\mu_c = \frac{1}{\lambda_c} = \text{MTTF} \quad (19)$$

To find the MTTF of the RAMP configuration, both N and M must first be specified to provide a reliability number $R_r(t)$. The general expression for the RAMP MTTF is provided in the literature as:⁷

$$\mu_r = \frac{1}{\lambda_c} \sum_{K=(N-M)}^M \left(\frac{1}{K} \right) \quad (20)$$

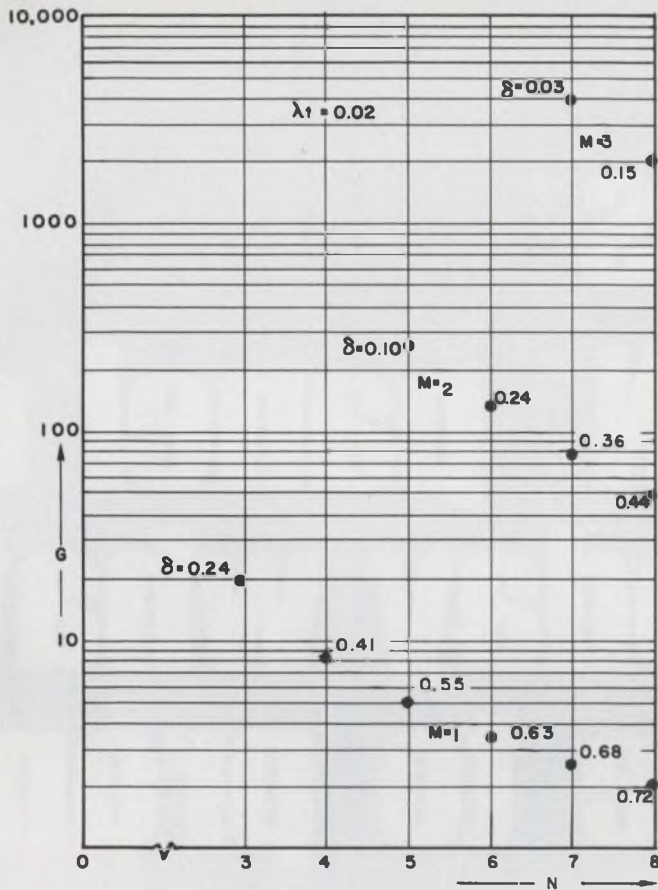

The reliability G of the RAMP for a given mission life decreases as the normalized RAMP output range increases for a given number of failures M .

where λ_c is the failure rate of the nonredundant (basic element) amplifiers comprising the RAMP. Evaluating Eq. 20 for a RAMP with $N = 3$ and $M = 1$ gives,

$$\mu_r = \frac{0.83}{\lambda_c} = \text{MTTF}. \quad (21)$$

A comparison of Eqs. 19 and 21 reveals that the MTTF of the RAMP is *less than that of the nonredundant circuit!* However, Fig. 4a indicates that the RAMP is indeed more reliable than the nonredundant circuit for $\lambda_c < 0.7$. This paradoxical result points out a common misconception about the meaning of the MTTF (or MTBF).

Mean life figures can be deceptive

Values of MTTF (or MTBF) are meaningful in assessing reliability *only when the type of distribution for which the "mean life" has been computed is also specified.*⁷ For example, the reliability of a nonredundant system $R_o = e^{-t/\mu_c}$ can be assessed only when *both* the "mean life" μ_c and the type of distribution (exponential) are specified.

The common practice of evaluating and comparing system reliabilities through mean life values

is most probably a result of the fact that designers usually deal with nonredundant systems *possessing the same (exponential) distribution.*

Since the RAMP distribution is binomial and not exponential, direct comparisons of MTTF or MTBF for a RAMP and a nonredundant system are not meaningful. This explains the paradox of the RAMP with a lesser MTTF and greater reliability number than the nonredundant circuit. ■■

References:

1. W. H. Huber, "Boost Reliability in Your Op-Amp Circuit" and "Dodge Transducer Failures With a RAMP," *ELECTRONIC DESIGN*, ED 14, July 4, 1968, p. 62 and ED 15, July 18, 1968, p. 70.
2. J. M. Wiesen, "Mathematics of Reliability," Sixth National Symposium on Reliability and Quality Control in Electronics, pp. 110-120, New York, Institute of Radio Engineers, 1960.
3. TRW Systems Group, "Reliability Manual," Part II RDM, Sections 1, and 2, and 3.
4. D. R. Earles, M. F. Eddins, "Reliability Engineering Data Series, Reliability Physics," pp. 5, 11, 16-21, Avco Corp. RAD Div., Wilmington, Mass., 1962.
5. Gryna, McAfee, Ryerson, Zwerling, *Reliability Training Text*, pp. 12-13, New York, Institute of Radio Engineers, 1960.
6. TRW Systems Group, "Electronic Components Handbook," Chapt. 8, Section IIa, p. 6; Chapt. 9, Section IIw, p. 3.
7. W. H. Von Alven, *Reliability Engineering*, pp. 138-139, 247, Prentice-Hall, Inc., Englewood Cliffs, N.J., 1964.

Bibliography:

- Jimerson, B. D., "Guidance and Control Electronics Reliability Improvement Study," TRW Systems Group Document No. 99900-6127-R000, 7 February 1967.
- O'Hern, E. A., "The Potential of Monitorless Control Systems of High Redundancy Efficiency," SAE/NASA Aerospace Vehicle Flight Control Conference, Los Angeles, Calif., July 1965.

Test your retention

Here are questions based on the main points of this article. Their purpose is to help you make sure you have not overlooked any important ideas. You'll find the answers in the article.

1. *What is the RAMP reliability gain G ?*
2. *The relative reliability G of the RAMP, as compared with nonredundant amplifiers, depends heavily on two things. What are they?*
3. *If the number of failed op amps M is held constant and the number of redundant amplifiers N is increased, what happens to the dynamic range of the RAMP?*
4. *If the number of failed op amps M is 2, and the number of redundant amplifiers is increased, what happens to the reliability gain of the RAMP?*

Burroughs SELF-SCAN™ panel displays deliver today what don't dare to promise for the future

SELF-SCAN alphanumeric displays* available today.

16/18 characters – 110 x 7 matrix (770 Light Emitting Dots on 0.030 mil centers) \$150.00 per alphanumeric display* in 1000 quantity lots. Prototypes for evaluation \$600.00 each.

16/18 characters – 110 x 7 matrix (770 Light Emitting Dots on 0.060 mil centers) \$133.00 per alphanumeric display* in 1000 quantity lots. Prototypes for evaluation, \$600.00 each.

256 characters – 8 rows of 32 characters each (8000 Light Emitting Dots on 0.040 mil centers) alphanumeric display* Price on request.

To order: Write Burroughs Electronic Components Division
P.O. Box 1226, Plainfield, New Jersey 07061 (201) 757-3400.

*Complete with drive circuitry, character generator and bezel



Only Burroughs manufactures NIXIE™ tubes and



isplays
others
ise

SELF-SCAN™ panel displays

THE ONLY DOT MATRIX SYSTEM with these advantages

LESS THAN ONE CONNECTION

for each 35 dot character displayed. 1/10 the drivers and associated circuitry of any equivalent display.

LOWEST COST TODAY for display, circuitry, and packaging. Costs forecast for the future are significantly lower than any equivalent display.

RELIABILITY AND BRIGHTNESS comparable to industry standard NIXIE® tubes, plus the inherent advantages of a high-contrast, single-plane readout.

DELIVERY TODAY complete with electronics and contemporary, stylized packaging. Available in quantities.

WIDE SELECTION OF AVAILABLE display configurations, dot sizes and readout formats.

No other product, existing now or promised for the future, offers the advantages and features available NOW in SELF-SCAN panel displays.

Burroughs



Build better source followers 10 ways.

Here are graphical designs, covering almost every practical configuration, that can simplify the biasing calculations.

Too little knowledge of biasing methods for FET amplifiers sometimes keeps engineers from making maximum use of FETs in circuit designs. The common-drain amplifier, or source follower, is a particularly valuable configuration; its high input impedance and low output impedance make it very useful for impedance transformations between FETs and bipolar transistors.

By considering 10 circuits, which represent virtually every source-follower configuration, the designer can obtain consistent circuit performance despite wide device variations.

There are two basic connections for source followers: with and without gate feedback. Each connection comes in several variations (Fig. 1). Circuits 1a through 1e have no gate feedback; their input impedances, therefore, are equal to R_G . Circuits 1f through 1k employ feedback to their gates to increase the input impedance above R_G .

Before getting into the details of bias-circuit design, note several general observations that can be made about the circuits of Fig. 1:

- Circuits a, d and f can accept only positive and small negative signals, because these circuits have their source resistors connected to ground. The other circuits can handle large positive and negative signals limited only by the available supply voltages and device breakdown voltage.

- Circuits c, d, e, h, j, and k employ current sources to improve drain-current (I_D) stability and increase gain.

- Circuits d, e and k employ FETs as current

Editor's Note: In the last issue (ED 11, May 24, 1970, "Liberate Your FET Amplifier," p. 78) James S. Sherwin discussed the biasing of common-source FET amplifiers. Here he extends the application of limiting transfer characteristics to the biasing of source-follower circuits. A set of limiting transfer characteristics consists of the two FET transfer curves that represent the extremes of behavior for a given type of FET.

James S. Sherwin, Applications Manager, Siliconix Inc., Santa Clara, Calif.

sources. In circuit d, Q_2 must have a lower pinch-off voltage, V_{P1} , and a lower zero gate-voltage drain current, I_{DSS} , than Q_1 .

- Circuits e, g, h and k employ a source resistor, R_S , which may be selected to set the quiescent output voltage equal to zero.

- Circuits e and k use matched FETs. R_S is selected to set I_D near the specified low-drift operating current. The input-output offset is zero.

Biasing without feedback is simple

The no-feedback circuits of Fig. 1 (circuits 1a through 1e) use simple biasing techniques (see the earlier article). Circuit 1a is a self-bias configuration; the voltage drop across R_S biases the gate (which draws essentially zero current) through resistor R_G . Since no gate-to-source voltage, V_{GS} , can be developed when $I_D=0$, the self-bias load line passes through the origin (Fig. 2). For the 2N4339 FET, whose limiting transfer characteristics are used throughout this article, the quiescent drain current is seen to lie between about 0.25 and 0.55 mA when a 1-k Ω source resistor is used. The quiescent output voltage lies between +0.25 and +0.55 V.

Circuit 1b is another example of source-resistor biasing with a $-V_{SS}$ supply added. The advantage over circuit 1a is that the signal voltage can swing negative to approximately $-V_{SS}$. Two bias lines are shown in Fig. 3, one for $V_{SS} = -15$ V and the other $V_{SS} = -1.6$ V. For the first case, the quiescent output voltage lies between +0.18 and +0.74 V. For the second, it lies between +0.3 and +0.82 V.

The bias load line for circuit 1c is just a horizontal line ($I_D = \text{constant}$). The quiescent output voltage is between +0.15 and 0.7 V for $I_D = 0.3$ mA.

Circuit 1d is similar to 1c except that the $V_{GS} = 0$ output characteristic of FET Q_2 is used as a current source. As seen in Fig. 4, Q_2 does not supply constant current when its V_{DS} gets very small. This technique should therefore be used only to bias FETs whose V_{P1} is significantly

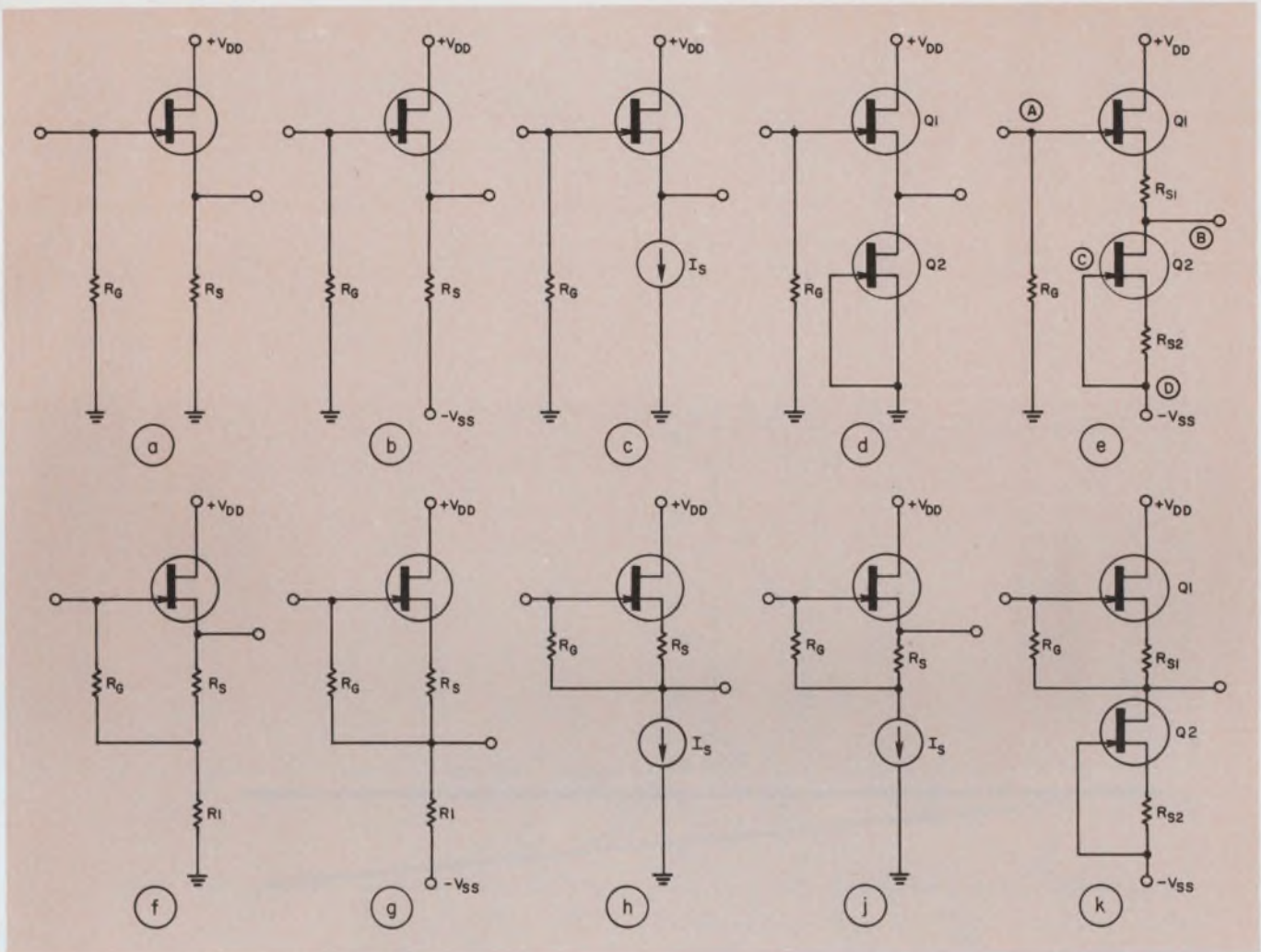

1. Virtually every practical source-follower configuration is represented in this collection of ten circuits. The con-

figurations in the top row do not employ gate feedback; the corresponding ones in the bottom row do.

higher than the equivalent V_T of the current-source FET diode.

A pair of matched FETs is used in the circuit of Fig. 1e, one as a source follower and the other as a current source. The operating drain current (I_{DQ}) is set by R_{S2} , as indicated by the load line of Fig. 5. The drain current may be anywhere from 0.20 to 0.42 mA, as shown by the limiting transfer characteristic intercepts; however, $V_{GS1} = V_{GS2}$ because the FETs are matched.

Since $I_{D1} = I_{D2}$ and $V_{GS1} = V_{GS2}$, choosing $R_{S1} = R_{S2}$ will ensure that the voltage from point A to B equals the voltage from point C to D (Fig. 1e). This source follower, therefore, exhibits zero or near-zero offset. If the FETs are temperature-matched at the operating I_D , the source follower will exhibit zero or near-zero temperature drift.

Biasing with feedback increases Z_{in}

Each of the feedback-type source followers (Fig. 1f through 1k) is biased by a method simi-

(continued on page 84)

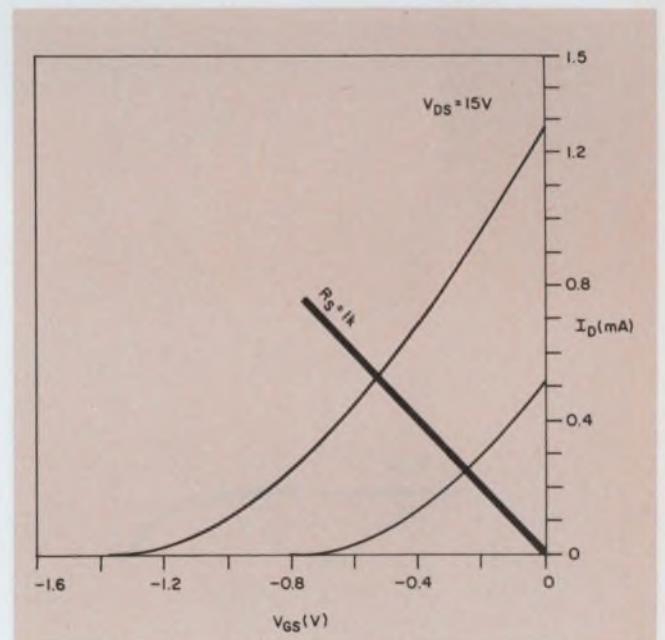

2. Self biasing (Fig. 1a) uses the voltage dropped across the source resistor, R_S to bias the gate. The load line passes through the origin and has a slope of $-1/R_S$.

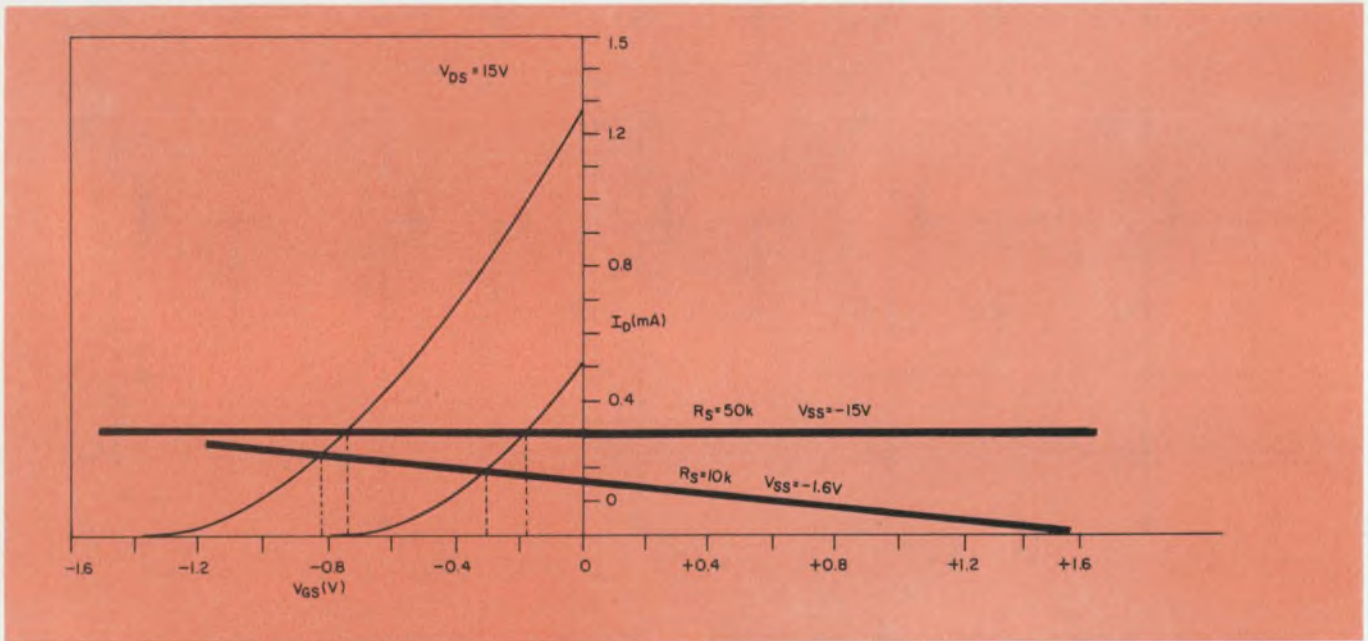

3. Adding a V_{SS} supply to the self-bias circuit (Fig. 1b) allows it to handle large negative signals. The load line's

intercept with the V_{GS} -axis is at $V_{GS} = -V_{SS}$. Bias lines are shown for $V_{SS} = -15$ V and $V_{SS} = -1.6$ V.

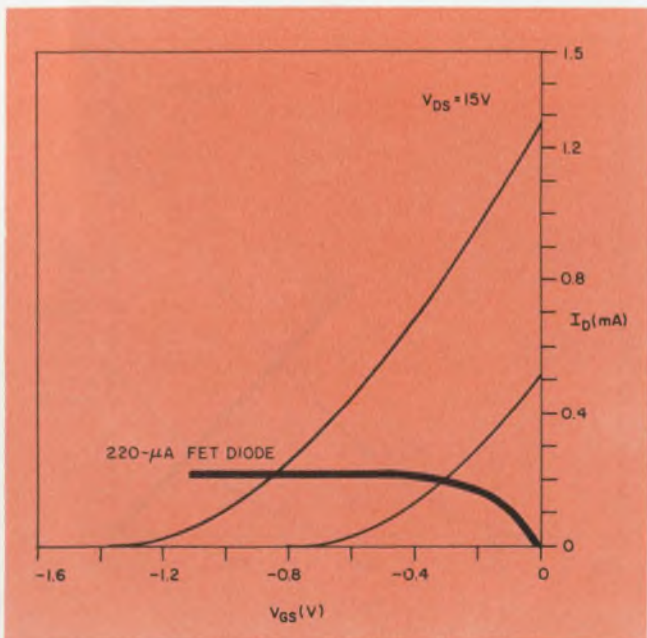

4. FET Q_2 doesn't behave like an ideal current source when its V_{DS} gets very small (Fig. 1d). Therefore, Q_1 should have a significantly larger V_p than Q_2 does.

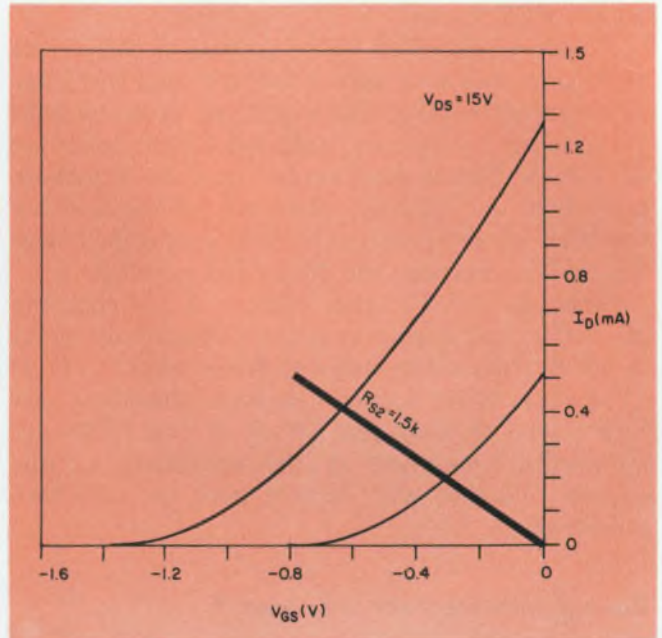

5. This load line is set by R_{S2} and Q_2 which acts as a current source (Fig. 1e). If its components are properly matched, the circuit will have zero or near-zero offset.

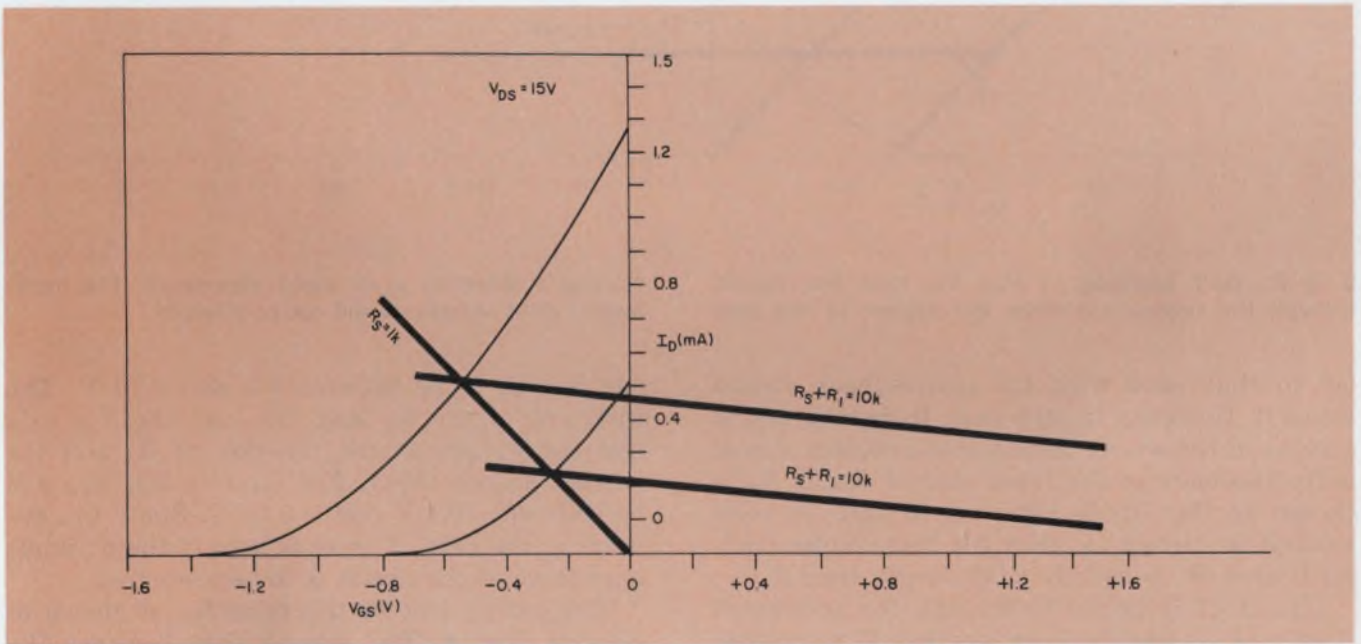

6. The bias load line is set by R_S but the output load line is determined by $R_S + R_L$ when gate feedback is employed

(Fig. 1f). The feedback V_{fb} is determined by the intercept of the $R_S + R_L$ load line and the V_{GS} axis.

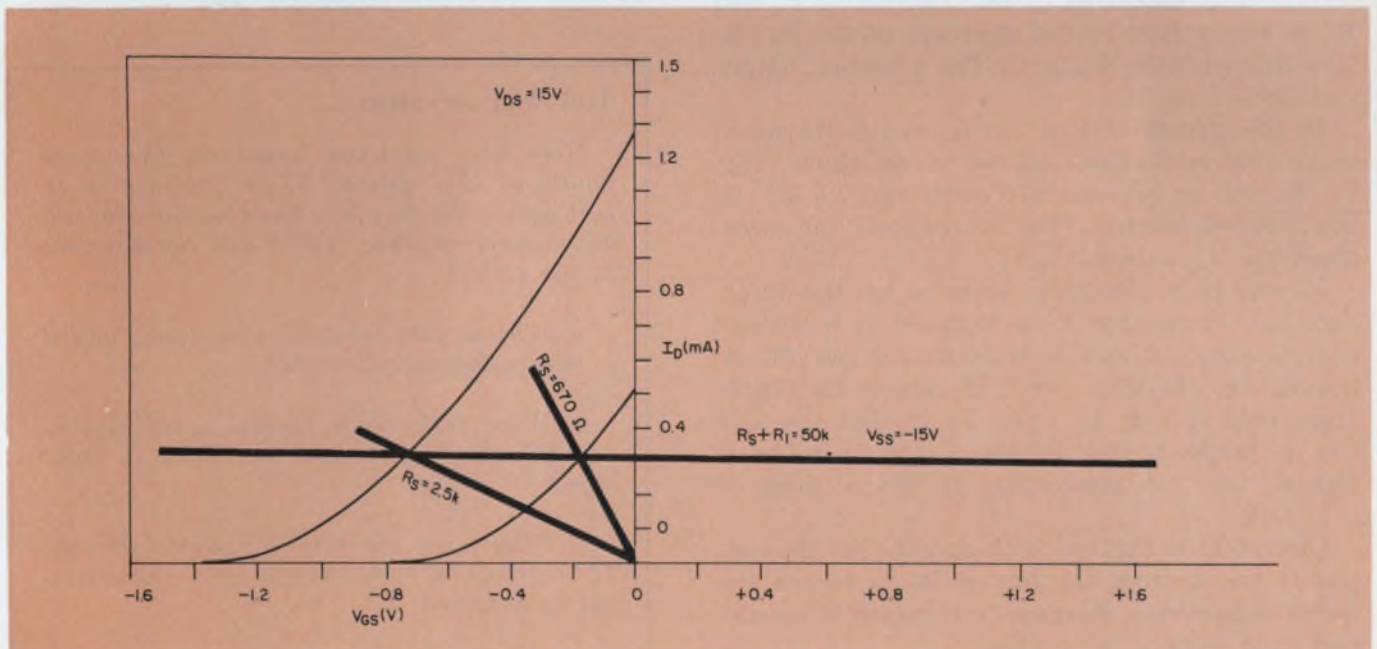

7. R_S can be trimmed to provide zero offset at some point between 670 ohms and 2.5 k Ω (Fig. 1g). The source load line intercepts the V_{GS} axis at $V_{SS} = V_{GG} =$

-15 V. Note that this load line is not perfectly flat. It has a slope of $-1/50k$, because the current source is not perfect; it has a finite impedance.

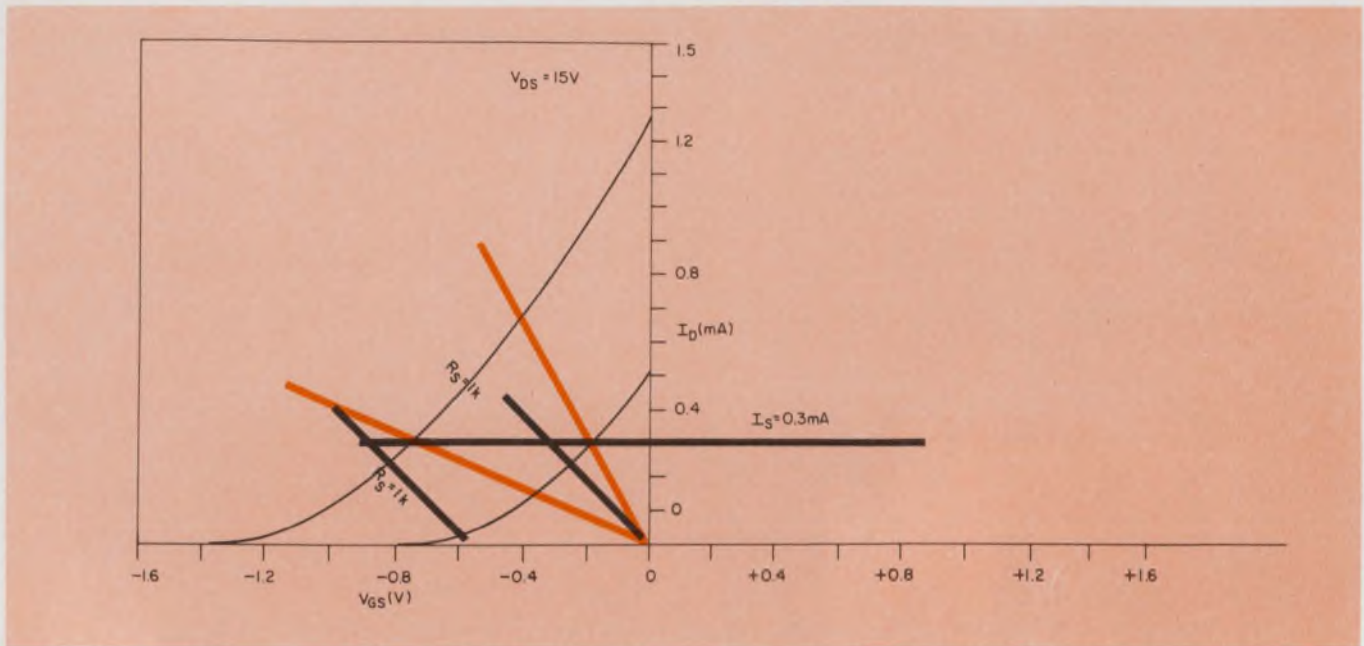

8. If R_s isn't trimmed so that the load line passes through the origin, a voltage will appear at the gate

causing a reduction in dc input impedance. The incremental input impedance will not be affected.

lar to that used with the nonfeedback circuit above it. However, in each case, R_G is returned to a point in the source circuit that provides almost unity feedback to the lower end of R_G . If R_s is chosen so that R_G is returned to zero dc volts (except in circuit f), then the input/output offset is zero. R_1 is usually much larger than R_s .

Circuit 1f is useful principally for ac-coupled circuits. R_s is usually much less than R_1 to provide near-unity feedback. The bias load line is set by R_s (Fig. 6). The output load line, however is determined by the sum of $R_s + R_1$. The feedback voltage V_{FB} , measured at the junction of R_s and R_1 , is determined by the intercept of the $R_s + R_1$ load line with the V_{GS} axis. The quiescent output voltage is $V_{FB} - V_{GS}$.

In the circuit of Fig. 1g, R_s can be trimmed to provide zero offset. As the curves show (Fig. 7), R_s will be between 670 ohms and 2.5 k Ω . R_s is much less than R_1 . The source load line intercepts the V_{GS} axis at $V_{SS} = -V_{GG} = -15$ V.

Circuit 1h is almost the same as 1g; the difference is that resistor R_1 is replaced by a current source. Since an ideal current source has infinite impedance, the bias curve of circuit 1h differs from that of Fig. 1g (Fig. 7) in that the load line is perfectly flat. In Fig. 7 the load line is almost, but not quite, flat; it has a slope of $-1/50$ k.

Circuit 1j is similar to 1h except that the output is taken from the top of R_s to reduce the output impedance. R_s must be trimmed if the circuit is to work at all properly.

In Fig. 8, the constant-current load line represents a 0.3-mA current source, and the effect of a 1-k Ω source resistor is shown. The offset volt-

age is seen to lie between 0.2 and 0.75 V. The intercept of the R_s load line and the V_{GS} axis sets the voltage at the junction of R_s and the current source (V_{FB}). For $R_s = 1$ k Ω , V_{FB} will be between -0.1 V and $+0.45$ V. Since V_{FB} appears at the gate, it must be zero if the dc input impedance of the circuit is to be preserved.

This can be done by trimming R_s , as shown in color in Fig. 8. The biasing then becomes the same as for circuit 1h.

Biasing for circuit 1k is identical to that for circuit 1e (Fig. 5) except that feedback is added to raise the input impedance. ■■

Test your retention

Here are questions based on the main points of this article. Their purpose is to help you make sure you have not overlooked any important ideas. You'll find the answers in the article.

1. Why is gate feedback sometimes added to source-follower circuits?

2. What desirable property do the matched-FET circuits (1e and 1k) have in common?

3. Why must the source resistor of Fig. 1j be trimmed even though zero offset cannot be obtained?

4. What is the major difference between a FET constant-current source and an ideal current source?

TI's quiet revolution in TTL

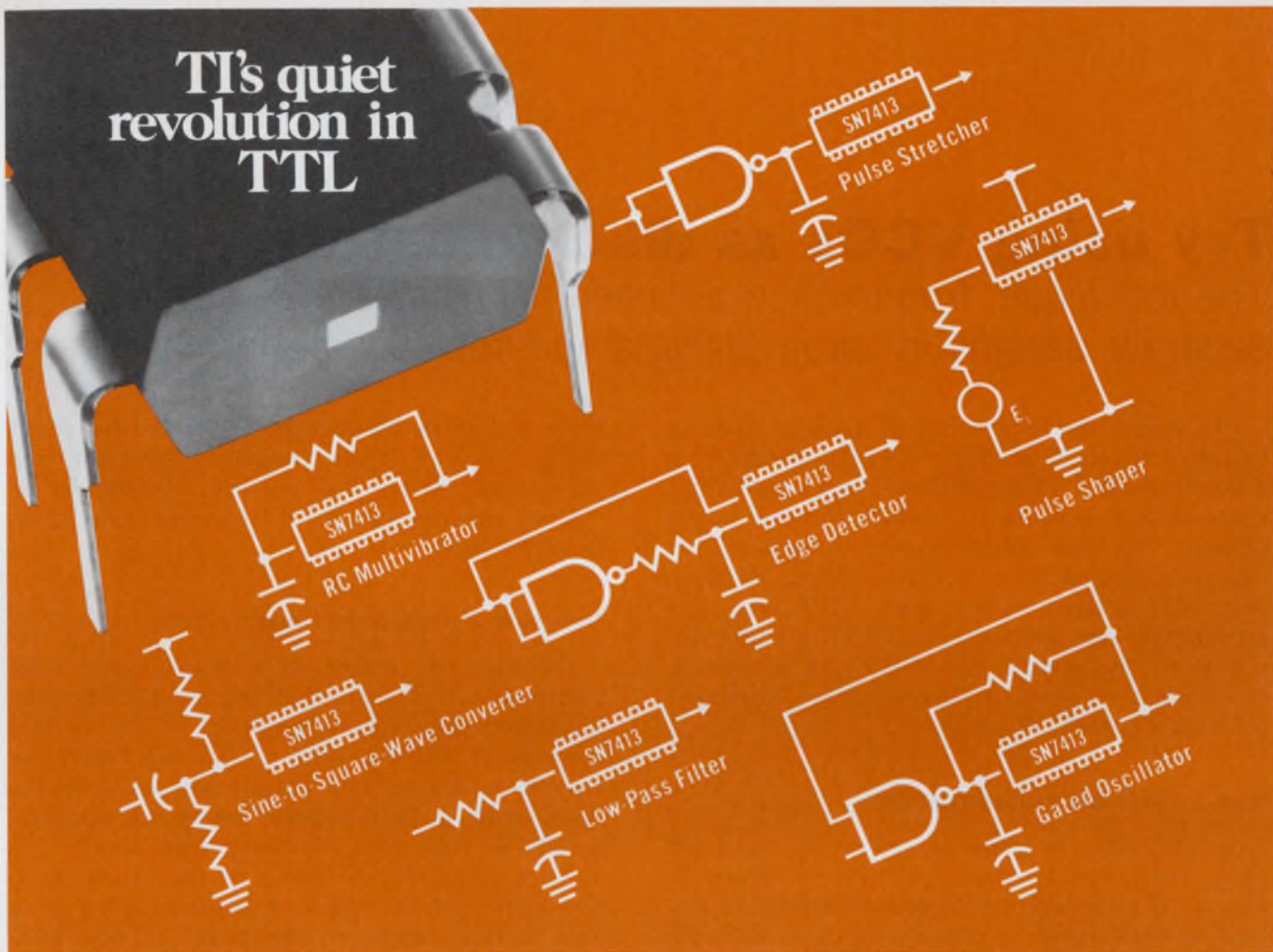

The only Schmitt trigger that works this hard for so little money is TI's new SN54/7413.

You can now perform any of these Schmitt-trigger functions (and more) with a single, inexpensive TTL device. Forget multiple discrete components—just plug in TI's new SN54/7413. It combines two 4-input Schmitt-triggered positive NAND gates in integrated circuit form.

And the bargain price lets you use it whenever, wherever you need to square up non-compatible waveforms. The SN7413 in TI's reliable plastic dual-in-line package costs only \$1.65, 100-999 quantities. Immediately available from TI or from your nearest authorized TI Distributor.

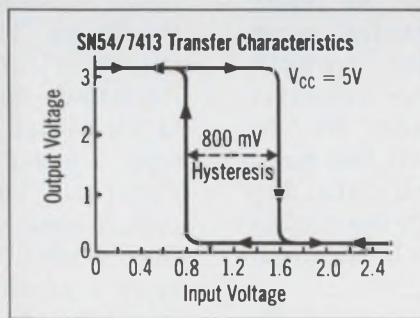

Unmatched stability

Each gate has different input threshold levels for positive and negative going signals. Hysteresis—the difference between the two threshold levels—is typically 800 mV, producing an unusually

high noise immunity that remains virtually unchanged over a wide temperature range. Hysteresis shifts less than three percent from -55° to $+125^{\circ}\text{C}$.

You can handle noisy pulses without false triggering, regardless of operating temperature. The Schmitt trigger fires reliably with input rise and fall times slower than one volt per second.

For our new Schmitt trigger application report, Bulletin CA-152 circle 290 on the Reader Service Card or write Texas Instruments Incorporated, P.O. Box 5012, M.S. 308, Dallas, Texas 75222.

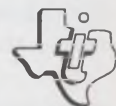

TEXAS INSTRUMENTS

INCORPORATED

Try using VCOs as discriminators.

The technique, frequently overlooked, eliminates the need for separate designs in some systems and improves performance.

Phase-lock techniques can be used to make a voltage-controlled oscillator (VCO) function as a discriminator. This technique, long used in fm-fm telemetry, is often overlooked for other applications. Yet the advantages are obvious: It eliminates the need for separate designs in many electronic systems where both VCOs and discriminators are used together. With a slight addition to the circuit, the VCO can become a discriminator with a temperature coefficient identical to the VCO itself.

How a phase-locked loop operates

A VCO that is phase-locked to an incoming pulse repetition frequency (PRF) is shown in Fig. 1. The operation of a phase-locked loop can best be understood by considering it as a standard servo loop. The three loop elements are the phase detector, the loop filter and the VCO. With the circuit in the out-of-lock condition, the phase detector acts as a frequency mixer, whose output is filtered so that only the frequency difference between the two inputs appears in the control loop.

With different input frequencies, the phase detector will move along its transfer curve (Fig. 2), producing a low-frequency, sawtooth voltage output. This sawtooth voltage will drive the VCO along its transfer curve, until its output is equal to the input frequency. At this point the phase difference between the input signal and the VCO will generate a dc voltage in the control loop that will maintain the VCO at the input frequency.

The time required for the loop to reach equilibrium is determined by the loop filter (R1, R2, C1).^{1,2}

When lock has been achieved, the output from the phase detector is an asymmetrical square-wave with a dc component dependent on the

phase difference between the VCO and the input signal. As the input frequency deviates, the phase also varies. The resulting change in dc voltage changes the VCO frequency and maintains the lock.

Designing a phase-locked discriminator

Consider the design of a phase-locked loop discriminator. Assume that the input PRF to be monitored has a center frequency of 150 Hz and a spread of ± 50 Hz. With a -15 volt supply for the phase detector, its output will be a square wave with a peak-to-peak swing of approximately 14 volts with an average dc level of -7 volts. A phase shift of 180 ± 90 degrees between the VCO and the input is considered to be a safe locking range, so the range of the VCO drive voltage will be -7 ± 3.5 V.

The required sensitivity of the VCO can be determined by dividing the frequency deviation desired, in this case ± 50 Hz, by the voltage change corresponding to a phase change of ± 90 degrees. In this example, a sensitivity of at least 14.3 Hz/V is required, but to allow an over-range capability, we will choose 20 Hz/V for the design. This sensitivity gives a 5-V change in output for a 100-Hz change in input. An important consideration is the amount of PRF in the output signal. If the output is to be read from a meter only, the amplitude of the output ripple can be a significant percentage of the peak-to-peak output signal, and a simple buffer can be used. However, in applications that require a continuous analog output, a reasonable level of ripple would be 0.1%, or 5 mV with a 5-V peak-to-peak output. To meet this requirement, an active filter with a bandpass gain of unity and an attenuation of 70 dB at 100 Hz should be used in the output.

A circuit (Fig. 3) using the phase-lock technique is being used to calibrate and periodically check a set of VCOs with an output frequency range of 100-200 Hz. A conventional bistable multivibrator is used as the phase detector. The VCO in the loop is similar to that of the analog-to-frequency converter.³

P. Bruce Uhlenhopp, Electrical Engineer, Environmental Science Services Administration, Boulder, Colo., and Larry G. Smeins, Electrical Engineer, Ball Brothers Research Corp., Boulder.

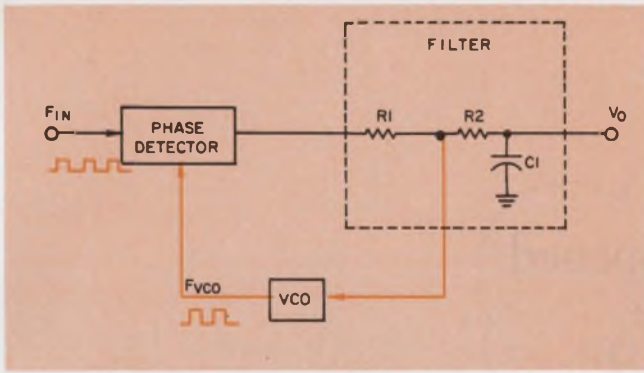

1. The basic loop configuration of the discriminator uses a VCO to provide feedback to the phase detector.

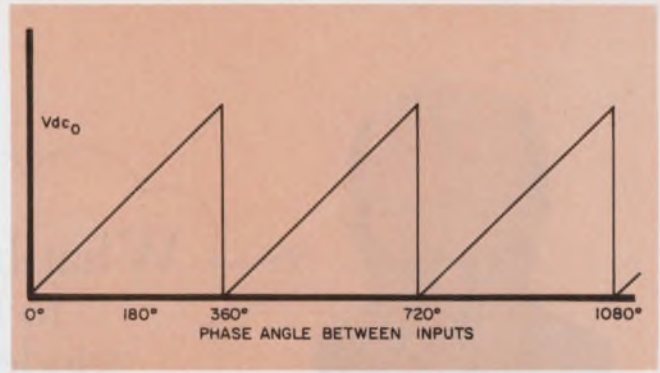

2. The average value of the phase detector output varies linearly over a full 360° range.

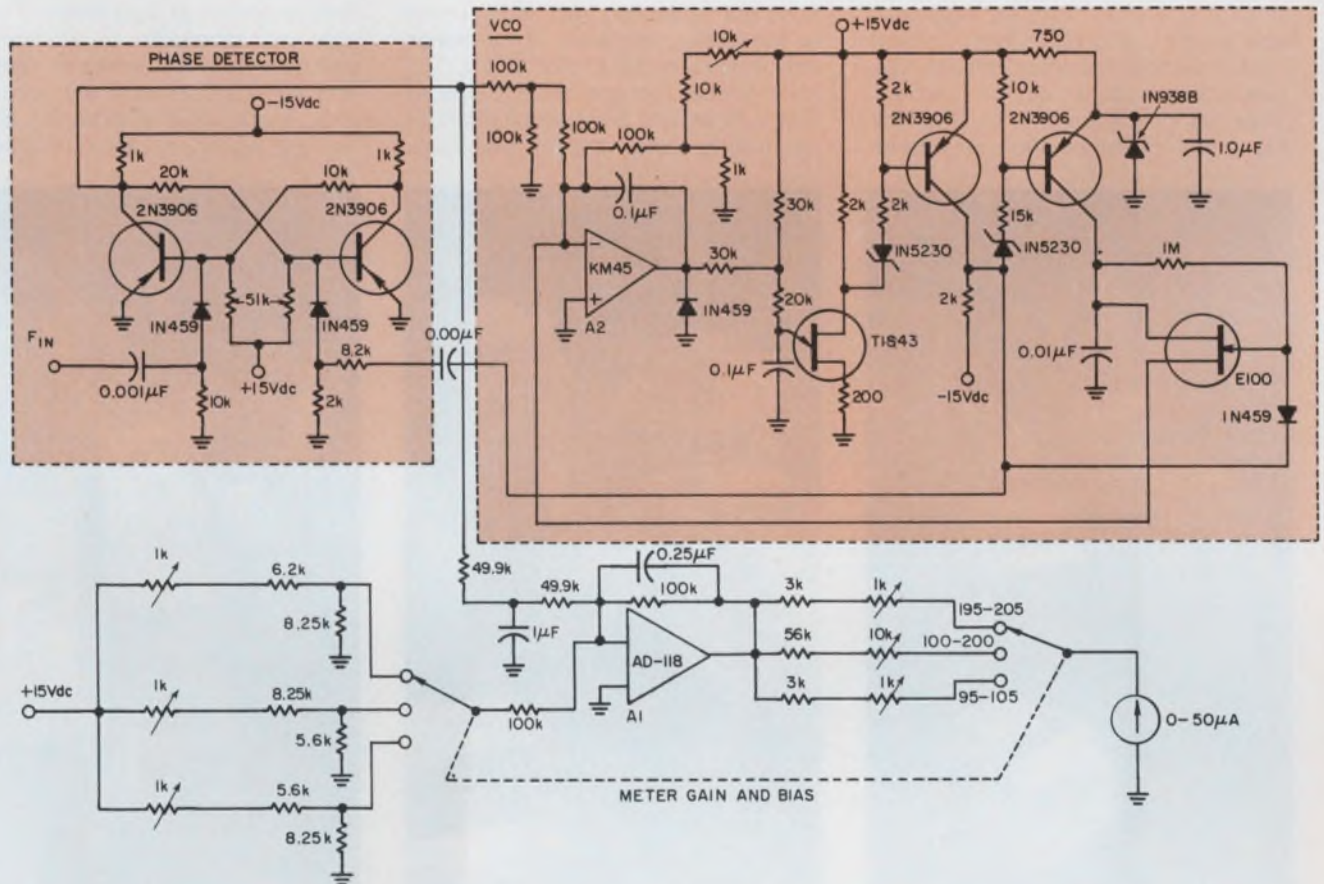

3. VCOs are calibrated with this discriminator circuit which operates from 95 to 205 Hz. Full-scale meter deflection for any portion of the total range is obtained by biasing and varying the meter gain.

3. VCOs are calibrated with this discriminator circuit which operates from 95 to 205 Hz. Full-scale meter deflection for any portion of the total range is obtained by biasing and varying the meter gain.

The low-pass network normally found in the control loop is not necessary in the circuit shown because the op-amp integrator in the VCO input provides essentially the same action.

The RC time constant of the integrator is analogous to R1-C1 of Fig. 1 and will determine how fast the VCO can reach the lock condition and respond to changes in the input frequency. It should also be noted that the transfer characteristics of the phase detector and the VCO are inverted from the curve shown in Fig. 2. This does not affect the circuit operation, since the feedback is still negative and provides a stable

equilibrium point. The addition of bias and a change in gain can be used to obtain a full scale meter indication for any reasonable portion of the frequency range. The operational amplifier A1 and associated circuitry provide the necessary gain and bias for the ranges of 100-200 Hz, 95-105 Hz and 195-205 Hz. ■■

References

1. *Phase Lock Techniques*, Floyd M. Gardner, John Wiley & Sons Inc., New York, 1966.
2. Lew Jr., Wasyl M., "A Primer on Phase-Locked Loops," *Electronic Design*, July 20, 1964.
3. Ben Yaakov, "Analog-to-Frequency Converter is Accurate and Simple," *Electronic Design*, July 4, 1968.



What happened to the model 19?

You're looking at some of the Teletype® basics used in building a data communications system. Printer, keyboard, tape sending and receiving combinations in a variety of speed capabilities. Teletype's modular design concept gives you the opportunity to extract the best terminal combination for system

needs today, and refine, add to, subtract and adapt as system modifications are called for. Just as important as the basics, are some of the things not obvious in the photos below. The logic devices, options and accessories that add almost limitless possibilities for making things happen exactly as

your system requires. We have some solid state logic devices that provide precise control of data traffic. That enable your computer to automatically poll data from a number of terminals and feed each terminal with processed data. There are error detection, correction and signal regeneration options to



model 33 series: An extremely economical 100 wpm terminal line. Has 4-row keyboard, uses 8-level ASCII code. The most widely used terminal in time-sharing systems today.



model 35 series: A rugged, heavy-duty line of 100 wpm terminals. Uses ASCII. Units in foreground are self-contained paper tape punch and paper tape reader.



Telespeed™ equipment: A line of high-speed tape-to-tape terminals capable of sending and receiving at speeds of 750, 1050 (shown above), or 1200 words per minute.

DATA COMMUNICATIONS

equipment for on-line, real-time processing

keep data flowing faultlessly. Options such as pin-feed platens and form feed controls that make it possible to fill multiple copy business forms on-line. And many, many more. What did happen to the model 19? Believe it or not, there are still some of these old, die-hard terminals around. And that's

another advantage your data communications dollar buys when you specify Teletype equipment. It lasts. Moves data reliably, economically, for a long time. On a price/performance basis, Teletype equipment is in a class by itself.

Teletype data communications equipment is available in send-receive capabilities of up to 2400 words per minute. If you would like specific information about any of the equipment described here, write: Teletype Corporation, Dept. 89-17, 5555 Touhy Ave., Skokie, Ill. 60076.



model 37 series: One of the most versatile heavy-duty terminal lines going. Generates all 128 characters of ASCII. Operates at 150 wpm. Prints in upper and lower case.

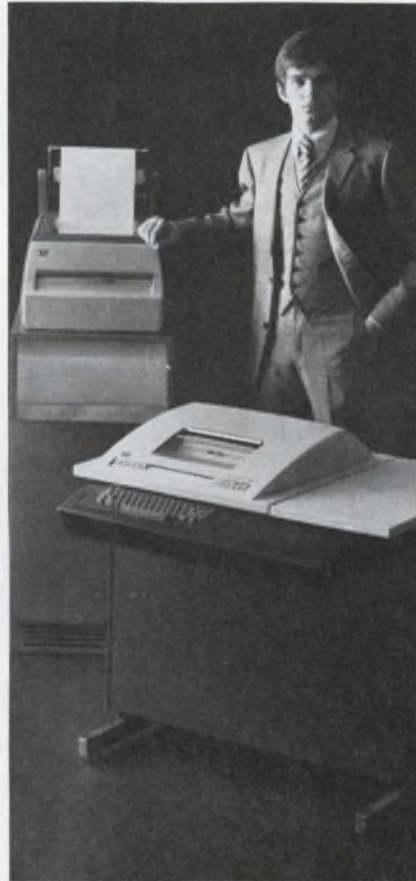

Inktronic® data terminals: A unique electronic, solid state terminal. Prints up to 1200 wpm. Forms characters through electrostatic deflection (no typebox). ASCII compatible.



magnetic tape data terminals: Use compact reusable tape cartridges. Operate on-line at up to 2400 wpm, and connect "locally" to lower speed Teletype terminals using ASCII code.

Teletype is a trademark registered in the U.S. Pat. Office

machines that make data move



Needed: a quality design for living.

This professor of management examines the question of what social commitment should mean to the engineer.

Social commitment and the engineering profession are like tenants who share the same apartment building but don't know each other very well. They are strangers because other problems have been left to doctors, nurses, clergymen and social workers—those "helping professions" that try to assist people in "adjusting" to the world about them. Yet the engineers and scientists who create technology have a great responsibility to society. What, exactly, should social commitment mean to the professional engineer?

The answer is tied to occurrences at three interrelated levels:

- Events that are currently reshaping our society.
- Events that shape the psychological climate of our engineering-based organizations.
- Events that affect the perceptions, values and motivations of the individual engineer.

Balance sheets of the 20th century

Eric Sevareid in an article for *Look* magazine made the observation: "This country is the vast experimental laboratory in human relations for the 20th century; it is in a sense defining and creating the 20th century for much of the world." And what kind of world is this 20th century model? How say the balance sheets?

Balance sheets reflect your point of view. If you're a member of the engineering profession, you can point with pride to the electronic computer that produces the maps for this century's decision-making, and to all the other intricate feats of technology that have eased our lives.

But the disadvantaged, the rebellious youth, the social critics are reacting quite differently. Their balance sheets for social progress have little to do with computers and other advanced forms of technology. And many of the revolutionary acts by these groups are a direct attack against what they feel is a soulless, military-industrial bureaucracy; they feel that it is run by heartless technocrats who try to impose the

model of machine efficiency on the human spirit.

So society finds itself in a dilemma. While our technologies have created a more convenient and efficient world, they have not created a better world.

Efficiency and quality at odds?

But there is an important and subtle connection between the ethic of efficiency and the notion of a better life. Take, for example, the current interest in ecology: we are painfully learning that the pollution of our air and water is often the undesirable by-product of an engineered method of production that met the test of rational efficiency. But this test may have been viewed from the perspective of a particular organization's interest in profits and its position in the marketplace.

Another glaring example of how rational efficiency can work at cross-purposes with our desired quality of life is the application of traditional industrial engineering principles—like those of Frederick Taylor (19th century American engineer and scientist) and Henry Ford—to the organization of human effort.

Breaking a complex job down into its simplest component parts and assigning men to work on a small subsection of the total job appears to have many advantages. The skill required for any particular job is automatically reduced. So is training time. This type of organization also lends itself to tighter production controls and more precise "management."

As Taylor put it in an early paper called "The Principles of Scientific Management," "It is only through the *enforced* standardization of methods, *enforced* adaptation of the best implements and working conditions and *enforced* cooperation that faster work can be assured." A visit to any office or factory will attest to the impact of Taylor's ideas on the organization of work.

But engineering principles should be altered to meet a changing society.

Here the engineer comes face to face with an important fact: Implicit in all engineering decisions is a value orientation about what is best for the firm and what is best for society. So social commitment may not start with asking

Dr. Eugene J. Koprowski, Associate Dean, University of Colorado Business School, Denver Center, and Associate Professor of Management and Organization.



KOPROWSKI: “. . . The engineers and scientists who create technology may have a far greater responsibility to society than those ‘helping professions’ who try to assist men in adjusting to it.”

how an engineer can apply his unique expertise to solving social problems, but by asking how his technological world view has contributed toward creating many of these problems.

Certainly, the engineering profession alone is not responsible for such complex social ills as poverty, the pollution of our environment or the alienation of man from his work, but it has helped create the technologies that are at least in part connected to what is happening in our society.

Unlike many other professionals, the engineer is usually a member both of a technical team and of a larger organizational enterprise. Social commitment in this context becomes a knotty issue. Can an engineer who helps design guidance systems for atomic warheads—but in his spare time works to clean up pollution in his city—be said to act in a socially committed way?

Or what about the engineering manager of a firm producing smog-control devices who organizes his production line in a way that fragments work and insults the creativity and intelligence of men and women who turn out the final product?

Perhaps these questions seem unfair, but they do illustrate that the posture of an individual engineer toward social responsibility is intri-

cately interwoven with the products of the firm he works for and in the methods that firm uses to produce them. Once an engineer becomes a manager or is responsible for policy-level decisions, these questions must be considered in terms of social commitment.

King Profit and the token commitment

How the engineer responds to his private reading of societal problems and his firm's commitment to them plays a critical role in determining how he will react. Unfortunately, most engineers are captives of a highly rigorous, highly technical education. Engineering schools tend to stress “how” and “why.”

Explanations for “why,” when given, are couched in the proofs of formal mathematical logic or in terms of economic theory. But these are not the only yardsticks for decision-making, although they may be the most appropriate ones for certain types of societies in certain stages of evolution.

In our particular society it is becoming evident that the quantity ethic may need to be replaced by a quality ethic. And part of this quality ethic must include aesthetic considerations as well as short-range utility considerations.

It is equally possible that we have reached that point in time when engineers must begin experimenting with designing work around a human rather than a machine model, and these designs should include opportunities for human growth and the utilization of creative capacities.

All of this brings us back to the original question: What should social commitment mean to the professional engineer? Looking at events from the societal level it is clear that affluence, a youth culture, and dazzling advances in technology have greatly influenced human values and human priorities. The engineer must realize, however, that the traditional models for efficiency must be reappraised before technology can be applied in a constructive way to help solve our broader social problems.

The profit motive still rules the day. And the role of the engineer in this drama should be to accommodate the social trends and shifts in human priorities. It is not enough, for example, to build a better designed automobile. It's also necessary to build a safer one.

Finally, the forces that shape the perceptions, values and motivations of individual engineers must be changed. This can be done by bringing pressure to bear on professional schools of engineering to broaden their curricula to include the study of art, aesthetics, ecology, philosophy, history and contemporary social problems.

A firm makes a commitment

This still leaves the question of what an organization can do to actually involve engineers in helping to solve the various critical problems. The model I will present is in part based on my experiences with a number of industrial firms and in part on theoretical considerations. It is a fictitious case, liberally salted with real happenings.

The "Testex Corp." is a large national firm manufacturing various types of high-quality electronic testing equipment. It has an excellent reputation in the industry and has grown rapidly since it was founded shortly after World War II. Approximately 65% of the more than \$170-million in sales is in the general industrial market and not tied to government contracts.

Because of its reputation for having an alert innovative management, Testex has, through the years, managed to attract and retain an engineering staff of unusually high quality. In the late 1960s, however, the situation began to deteriorate.

The new crop of graduating engineers was becoming more selective. Many of them were asking embarrassing questions in their campus interviews like, "What percentage of minority group members does Testex employ?" and "To

what extent is the corporation involved in war-related product development?"

Turnover was also increasing at an alarming rate, and one study showed that the engineers who were leaving were generally the brightest, most creative in the organization.

Things reached a climax when a delegation of six engineers, all of whom were recent college graduates, asked for a meeting with the executive vice president. During the meeting they pointed out that they were originally attracted to Testex because of its advertising in various professional journals that expressed an enthusiasm for broad social issues that went beyond profit making. Once on the job, they found that little, if anything, was being done by the company to meet its social obligations.

Another cluster of complaints had to do with the work itself. As one member of the delegation put it, "Most of the projects I've worked on in the last year a high school draftsman could handle."

The VP listened carefully and reflected on the fact that these same six men represented the cream of his new engineering crop. After the group presented its case, the VP asked if there were any constructive suggestions. At this point the young men seemed to flounder, and one of them even implied that to find answers to these questions was not their responsibility.

When the six left the VP's office, he sensed a twinge of indignation and hostility toward the group. He reflected on the top salaries these men were getting, the company's profit-sharing program and the excellent retirement benefits. He shook his head in silent disbelief, and headed for the suburbs and a very dry martini.

But early the next morning he saw things in a somewhat different light. These young men were serious and concerned. The company couldn't afford to lose them. On his scratch pad he had written "social responsibility" and "boredom."

The traditional way to handle these problems would have been to consult with the appropriate staff departments and conjure up some new "programs" that would attempt to placate this disgruntled group. Unfortunately, the staff departments had not been coming up with anything too imaginative lately, and substantial changes were required if the firm was to revitalize its sagging image.

Strategies as important as direction

The VP did some reading and some talking. He even spent part of a day with a local college professor who was doing research on organizational development. The more he read and the more he talked, the more he became convinced



KOPROWSKI: "Perhaps we have reached that point in time when engineers must begin experimenting with designing work around a human rather than around a machine model."

that social responsibility and boredom were just different sides of the same coin. The world was changing and so were the people. He was beginning to feel grateful to the six young men who raised these questions.

A number of things the college professor said made sense to him. One remark particularly stuck in his mind: "The strategies for change that you employ are as important to your organizational development as the direction of those changes. Change by enforcing a staff-developed program seldom creates real change."

On the college professor's advice, the VP called the six young men in for a follow-up meeting. He told them the company was both anxious to fulfill its social responsibilities and to provide challenging jobs. He asked them to serve as the nucleus for two special task forces to recommend:

1. How Testex might become involved in helping solve social problems and still discharge its basic responsibilities to stockholders.

2. Ways for making jobs more meaningful through job enrichment and other new strategies coming out of the behavioral sciences.

Both the social-responsibility and the job-enrichment task forces were given a specific budget to bring in any outside expertise that might be necessary. The VP was careful to point out that the goal of the task forces was to help change the organization rather than merely to submit an idealistic treatise on what should be done. Step-by-step implementation strategies were to be developed along with appropriate re-

source allocations and priorities.

About a year later the following luncheon conversation took place between the VP and the college professor.

Professor: Then something actually did happen? I mean more than just paperwork?

VP: Much more. There were four spin-off projects from the social-responsibility task force alone. One had to do with setting up a recruiting center right here in our black ghetto. Another involved training programs for minority group members. Two others involved developing new products to help fight pollution, both of which look very promising. The job-enrichment task force is moving more slowly, but the problems are tough ones and we are generating a lot of enthusiasm for viewing work from a different angle.

Professor: What has happened to those original six young men?

VP: There was an unexpected pay-off. All but one became project managers of spin-off projects.

Professor: What do you think all of this means in terms of what you've learned about social responsibility?

VP: Hmm. That's a tough one to answer. Maybe it means that social responsibility starts at home. We did something with those six young men we would have never thought of doing ten years ago. In a way we gave them an opportunity to take some risks and to live out their commitment through responsible action . . . And you know what? It may be contagious. ■■

Instrument Clinic

where skilled surgery adapts Westinghouse stock models to meet special needs.

Westinghouse Instrument Service Centers (28 of them) are superbly equipped to adapt stock panel or switchboard instruments to fit your special requirements.

They can provide special scales and calibrations, suppressions and expansions. They can change ratings and responses. Almost anything you want.

Modifications are made in factory-approved shops using factory-approved methods. The original Westinghouse warranty remains in effect.

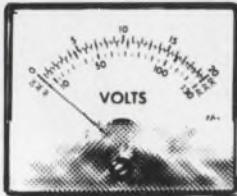

Service Centers also stock nominal quantities of standard panel, switchboard and portable instruments. You get fast delivery.

To find out more, contact any Center listed on the next page. Or write Westinghouse Electric Corporation, Box 868, Pittsburgh, Pa. 15230. 4-43019

You can be sure...if it's Westinghouse





MARYLAND

- Instrument Specialties, Inc. 3100 Washington Blvd. Baltimore, Md. 21230 (301) 644-0200

MASSACHUSETTS

- The Mancib Co. A St. at Middlesex Tpk. Burlington, Mass. 01803 (617) 272-9450

MICHIGAN

- Ram Meter, Inc. 1100 Hilton Rd. Ferndale, Mich. 48220 (313) 547-1000

NEW JERSEY

- Bryam Laboratories 535 S. Orange Ave. Newark, N.J. 07103 (201) 375-3198

NEW YORK

- A&M Instruments, Inc. Community Dr. Great Neck, N.Y. 11022 (516) 487-0330
- Electrical Instrument Laboratories, Inc. 932 Hertel Ave. Buffalo, N.Y. 14216 (716) 876-0880

NORTH CAROLINA

- Electro-Tech Inc. 5141 Belhaven Blvd. Charlotte, N.C. 28214 (704) 392-7451

OHIO

- Weschler Electric Corp. 4250 W. 130th St. Cleveland, Ohio 44135 (216) 251-4609

OKLAHOMA

- Tri-State Instrument Labs, Inc. 3242-44 E. 15th St. Tulsa, Okla. 74112 (918) 936-0489

PENNSYLVANIA

- Sunshine Scientific Instrument, Inc. 1810 Grant Ave. Philadelphia, Pa. 19115 (215) 673-5600
- EIL-Unitec Industries, Inc. 2366 Holiday Park, Rte. 286 Pittsburgh, Pa. 15239 (412) 327-4450

TENNESSEE

- Electro-Tech Inc. 217 Cumberland St. Memphis, Tenn. 38112 (901) 452-2181

TEXAS

- Border Machinery Co. 1710 E. Paisano Dr. El Paso, Texas 79986 (915) 533-7565
- Nelson Electronics Laboratories, Inc. 4751 Gulf Freeway Houston, Texas 77023 (713) 923-6606
- Nelson Electronics Labs, Inc. 1717 Dallas N. Parkway Plano, Texas 75074 (214) 235-1217

VIRGINIA

- Miller Magnetics 924 W. Little Creek Rd. Norfolk, Va. 23505 (703) 423-8381

WASHINGTON

- Eicher-Richards Co. 2727 N.E. Blakely St. Seattle, Wash. 98195 (206) 523-7888

ALABAMA

- Electro-Tech Inc. 106 Jordan Lane Huntsville, Ala. 35805 (205) 539-3718
- Electro-Tech Inc. 63 Sidney Phillips Dr. Mobile, Ala. 36607 (205) 479-5405

CALIFORNIA

- Metermaster 5646 Jillson St. Los Angeles, Calif. 90022 (213) 685-4340
- Miller Magnetics 1730 Canal Ave. Long Beach, Calif. 90813 (213) 437-0934
- Kierluff/Metermaster 8797 Balboa Ave. San Diego, Calif. 92111 (714) 278-2112

COLORADO

- Meter-Master Instrument Corp. 1165 S. Cherokee St. Denver, Colo. 80223 (303) 722-5766

CONNECTICUT

- The Mancib Co. Randolph at Rte. 9 Middletown, Conn. 06457 (203) 347-5629

FLORIDA

- Electro-Tech Inc. 307 27th St. Orlando, Fla. 32806 (305) 423-5589

GEORGIA

- Electro-Tech Inc. 3020 Commerce Way Hapeville, Ga. 30054 (404) 767-8761

ILLINOIS

- Meter Makers, Inc. 1111 W. Armitage Ave. Chicago, Ill. 60614 (312) 549-5252

LOUISIANA

- Industrial Instrument Works 3305 Tchoupitoulas St. New Orleans, La. 70115 (504) 895-5621

Ideas For Design

Pulse stretcher remembers level of narrow spike

Accurate determination of narrow pulse levels must circumvent the inaccuracies inherent in standard test techniques. Measurement systems where a capacitor is charged through a diode or emitter follower transistor cause an error due to the voltage drop across the junction. Comparator methods, where a capacitor is charged incrementally until the pulse height is reached, cannot measure a single pulse or follow rapid variations in pulse height. Other methods demand that the storage capacitor charging time be less than one pulse width to allow level comparison. This proves very difficult with narrow pulses.

The solution is the two-stage pulse stretcher where a stretch of 10^8 times can be easily achieved, together with cancellation of the V_{be} voltage drop. V_{out} and V_{in} are compared by the op amp (741) through the emitter followers Q_1 and Q_2 . The op amp pumps current into C_2 until the voltage at the Q_2 emitter is equal to the voltage at the Q_1 emitter. Before C_2 has been fully charged, V_{in} (pulse) may be removed, but its level will be remembered by C_1 until C_2 is completely charged.

This circuit will remember the level of a single pulse down to 20 ns in width. The circuit works from a few hundred millivolts to 5 V, and the output voltage can be reset by means of a shunt transistor or resistor across C_2 .

The circuit may be optimized for wider pulses or pulse trains by making

$C_1 < [(pulse\ width) (V_{line})] / [(V_{in\ max}) (R_1)]$.
In this case, R_2 and R_3 may be reduced and C_2 increased to improve the response to low level

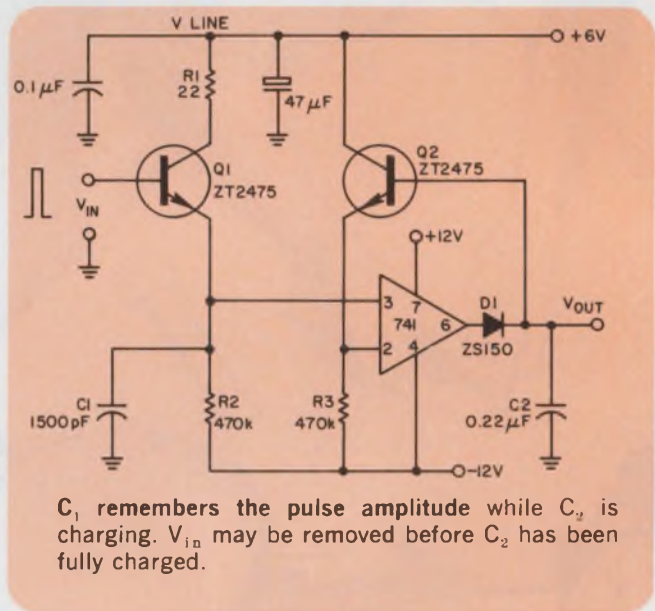

C_1 remembers the pulse amplitude while C_2 is charging. V_{in} may be removed before C_2 has been fully charged.

pulses while maintaining the output hold time. Since

$$V_{in} - V_{be\ Q1} = V_{out} - V_{be\ Q2}$$

Q_1 and Q_2 may be matched with advantage. The stretching performance may be further improved by driving a larger C_2 from an emitter follower after D_1 and reducing R_2 and R_3 . The C_2 voltage across may be sampled at low impedance by using an op amp connected as a unity gain voltage follower.

Ian D. Crawford, Design Engineer, Ferranti Ltd., Edinburgh, Scotland

VOTE FOR 311

Simple transistor checker boasts speed and versatility

This instrument is basically a go-no-go device that serially tests the quality of the base-emitter (BE) junction and the base-collector (BC) junction of any transistor. It will accept either a pnp or an npn device in the same test socket without any selective switching. The test results

are read out on the zero-center microammeter, with the junction to be tested selected by switch S_1 .

When any transistor is inserted into the test socket, the meter will either immediately deflect or it will not. If no deflection occurs, the junction

There isn't another like it. A 1/4-inch, single-pole, six position, 28-vdc. Helipot switch for PC boards.

Beckman INSTRUMENTS, INC.

HELIPOT DIVISION

Fullerton, California 92634

INTERNATIONAL SUBSIDIARIES: AMSTERDAM; CAPE TOWN;
GENEVA; GLENROTHES, SCOTLAND; LONDON; MEXICO CITY;
MUNICH; PARIS; STOCKHOLM; TOKYO; VIENNA



Model 374H \$3.00 (1-9 pieces)

Model 374 \$2.75 (1-9 pieces)

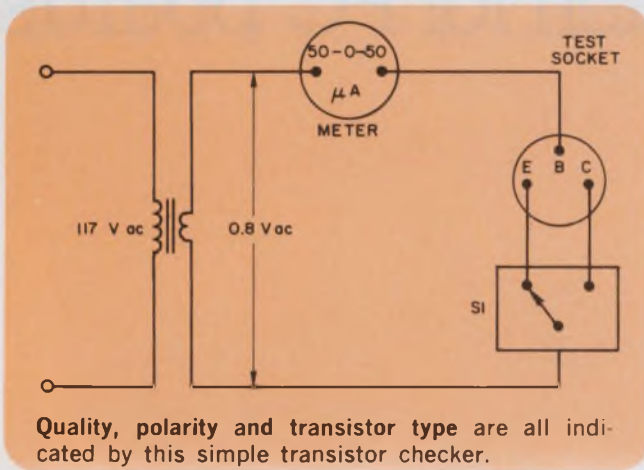

under test is considered defective; that is, it is either open or shorted. If the junction is good, the meter will immediately deflect to one side or the other of zero, depending on whether the device under test is an npn or a pnp.

The magnitude of deflection will depend on whether the device is silicon or germanium. The forward voltage drop across an Si junction is greater than that across a Ge junction; therefore, the meter deflection will be greater for a good Ge junction.

A complete check will require about 5 seconds, or the time it takes to insert a device in the test socket, read the meter, flip switch S₁ to the opposite position and read the meter again.

In other words, the instrument will determine the quality, polarity, and material of a transistor, all at the flip of a switch.

William Hinds, Design Engineer, University of Missouri, Columbia, Mo.

VOTE FOR 312

Slide rule improves VTVM resolution

Most VTVMs employ a scale switching factor of 10 dB, which is equal to a voltage ratio of 3.162277---. Generally the scales range from 0 to 1.0 and 0 to 3.0 (actually 3.2 in many instances). The 0-1 scale usually contains about 100 divisions, with only 30 or so in the 0-3 range. When equal resolution is required on both scales, a more precise value of deflection in the 0-3 range can be

obtained by reading the 0-1 scale and dividing by 3.162277---. A 12-inch slide rule can perform this division with adequate precision. Greater accuracy is possible from preparation of a conversion table for all positions on the VTVM 0-1 scale.

George, J. Maki, Instrumentation Engineer Hughes Aircraft Co., Goleta, Calif.

VOTE FOR 313

Linear sweep generator uses zener diode

A variation of the familiar bootstrap integrator is illustrated in the figure. A zener diode is used for level shifting—replacing the conventionally used device, a capacitor of large value. Operation is therefore realized from dc to 100 kHz, depending on the capacitor chosen.

Basically, Q₁ is an emitter follower that buffers the capacitor C voltage. D₁ shifts the level of the capacitor voltage and applies it to R₂. Since the voltage is then stable across R₂, a constant charging current, I, is supplied to C, resulting in a linear ramp. The four-layer (Shockley) diode, D₂, is used to reset the capacitor when the output voltage exceeds a predetermined level. The saturation voltage of D₂ offsets the base-emitter drop of Q₁, and thus the sweep output starts at 0 V.

The design consists of selecting R₁, R₂ and

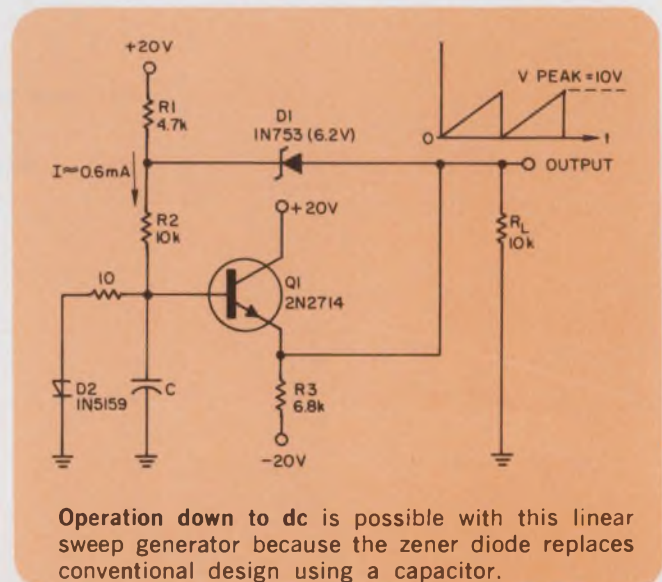

COMPETITIVE PLUG-IN PLASTIC		SYLVANIA CERDIP
TYPE	(100-999) Price	(100-999) Price
7400N	1.06	.85
7402N	1.06	.97
7410N	1.06	.85
7420N	1.06	.85
7430N	1.06	.85
7440N	1.15	.97
7450N	1.06	.85
7451N	1.06	.85
7453N	1.06	.85
7454N	1.06	.85
7460N	.95	.77
7472N	1.47	1.31
7473N	2.42	2.15
7474N	2.11	1.88

We're out to knock the plastic package flat on its back. And as you can see from the comparative pricing table that's exactly what we're doing.

However, since exact competitive prices are always changing, we suggest that you check the competition yourself to get the full story.

And while you're checking, remember the advantages that our 7400N line offers. We guarantee* the hermeticity of every Cerdip package to 1×10^{-7} cc/sec, 2% AQL. We have tapered leads for easier socket insertion.

Our superior Cerdip package isolates the bonding wires and there

is no problem of wire breakage because of differing coefficients of expansion, as can happen in plastic packages. In addition, we use an all aluminum wiring system, so you don't have to worry about "purple plague."

With our full line of 14 devices available at your distributor, right now, why struggle along with plastics? We match them penny for penny, and surpass them where it counts—reliability.

Sylvania Electronic Components, Semiconductor Division, Woburn, Mass. 01801.

SYLVANIA
GENERAL TELEPHONE & ELECTRONICS

Cerdip packages at plastic prices.

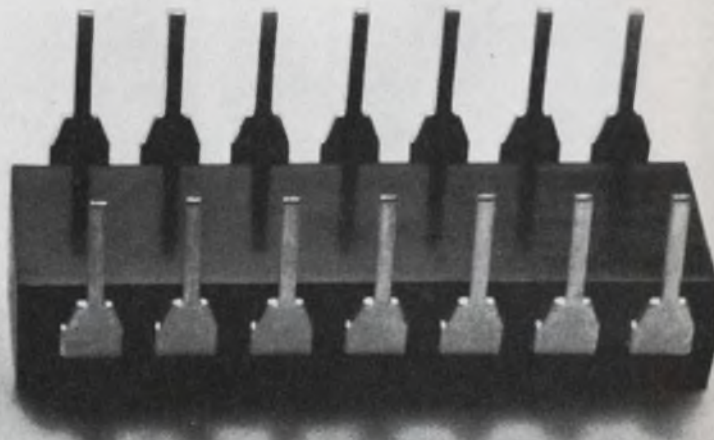
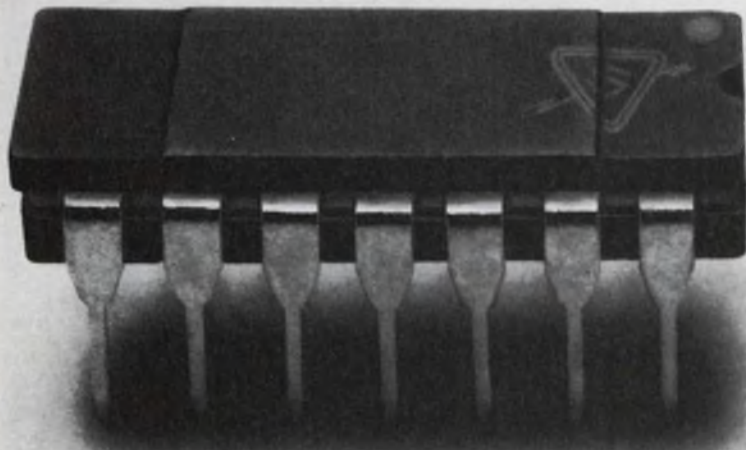

That's why you need 9th-sourcing in 7400N TTL.

*These integrated circuits are guaranteed to substantially conform to Sylvania's applicable specifications and be delivered free of defects in materials and workmanship. If they are defective in such respects, at Sylvania's election, Sylvania will either repair, replace or grant a credit at invoice prices if defective integrated circuits are returned to the factory pre-paid within one year.

R_3 after the other parameters have been specified, so that Q_1 and D_1 operate in their active regions and charging current is large compared to the Q_1 base current. There is an optimum choice of component values that will yield the best linearity for a given output swing.

Linearity is about $\pm 1\%$ for the circuit shown. Operation is assured over a wide range of com-

ponent tolerances, supply voltages, and temperature variations. Assuming that I is constant, the frequency can be calculated. For $I \approx 0.6$ mA, $V_{peak} = 10$ V, then

$$f = I / (C V_{peak}) = (60 \times 10^{-6}) / C$$

Dennis R. Morgan, Engineer, General Electric Co., Syracuse, N.Y.

VOTE FOR 314

Schmitt trigger program uses standard resistor values

There is always a need for a quick design for Schmitt trigger circuits. Here is a program, written in BASIC, for use on a time-shared terminal. It has been written to eliminate redundant design calculations and can be stored on paper tape for easy entry into the computer.

In Fig. 1, the values of R_1 , R_2 , R_3 , and R_4 can be determined once the following are specified: V_{CC} , the voltage supply available; UTP, the upper voltage trip point; LTP, the lower voltage trip point; V_{be} , the base-to-emitter voltage drop of the transistor; and Z , the impedance of the relay or load being switched.

Once the values are calculated, the designer may insert the nearest common commercial values and note the effects of these values on the UTP and the LTP in a conversational mode. The program is listed in Fig. 2.

Figure 3 gives a computer calculation for a typical Schmitt trigger and the results of cor-

recting these values with commercial components.

Anthony C. Caggiano, Design Engineer, Ridge, New York.

VOTE FOR 315

```

10 PRINT
20 PRINT"INPUT: UTP, LTP, VCC, VBE";
30 INPUT U,L,V1,V2
40 PRINT"SPECIFY THE LOAD IMPEDANCE IN OHMS";
50 INPUT Z
60 PRINT
70 LET R1=Z*(U-V2)/(V1-U+V2)
80 LET R2=R1*(V1-L+V2)/(L-V2)
90 LET R3=10*R1
100 LET R4=R3*V1/U -R3-R2
110 LET I=(U-V2)/R1
120 LET P=INT(10000*I*I*Z)/10
130 PRINT"YOUR VALUES IN OHMS ARE:"
140 PRINT"R1","R2","R3","R4"
150PRINT INT(100*R1)/100,INT(100*R2)/100,INT(100*R3)/100,INT(100*R4)/100
160 PRINT
170 PRINT"POWER IN MILLIWATTS DISSIPATED BY Z IS ";P
180 PRINT
190 PRINT"ENTER NEAREST COMMERCIAL VALUES FOR R1,R2,R3,R4 (IN OHMS)"
200 INPUT A,B,C,D
210 PRINT
220 PRINT"THIS WOULD MAKE THE UTP ": C*V1/(B+C+D)
230 PRINT"AND THE LTP ": V2+A*V1/(A+B)
240 PRINT
250 PRINT"TO TRY OTHER COMMERCIAL VALUES, TYPE 1; ELSE TYPE 0";
260 INPUT 0
270 IF Q=1 THEN 180
280 END
    
```

2. The conversational design of a Schmitt trigger is performed by this BASIC program.

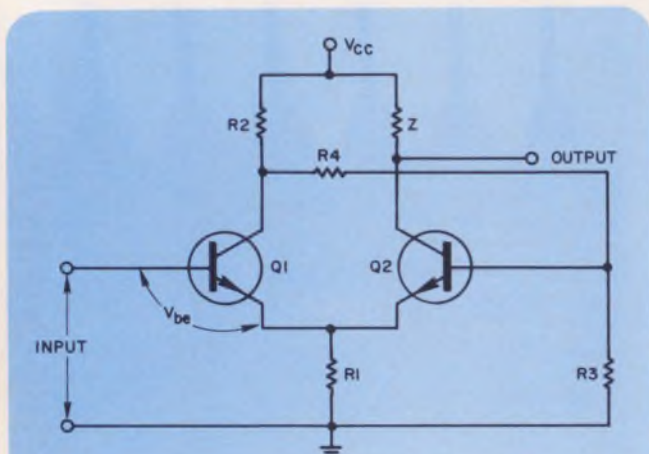

1. This Schmitt trigger circuit can be fully specified by means of the program in Fig. 2.

```

RUN
INPUT: UTP, LTP, VCC, VBE? 4,2.6,12,.6
SPECIFY THE LOAD IMPEDANCE IN OHMS? 750

YOUR VALUES IN OHMS ARE:
R1      R2      R3      R4
296.51  1482.55  2965.11  4447.67

POWER IN MILLIWATTS DISSIPATED BY Z IS 98.6

ENTER NEAREST COMMERCIAL VALUES FOR R1,R2,R3,R4 (IN OHMS)
? 300,1500,2700,4500

THIS WOULD MAKE THE UTP 3.724138
AND THE LTP 2.6

TO TRY OTHER COMMERCIAL VALUES, TYPE 1; ELSE TYPE 0? 1

ENTER NEAREST COMMERCIAL VALUES FOR R1,R2,R3,R4 (IN OHMS)
? 300,1500,3000,4500

THIS WOULD MAKE THE UTP 4
AND THE LTP 2.6

TO TRY OTHER COMMERCIAL VALUES, TYPE 1; ELSE TYPE 0? 0
    
```

3. A typical example of trigger-circuit design is shown here. Note the conversational entry of commercial resistor values.

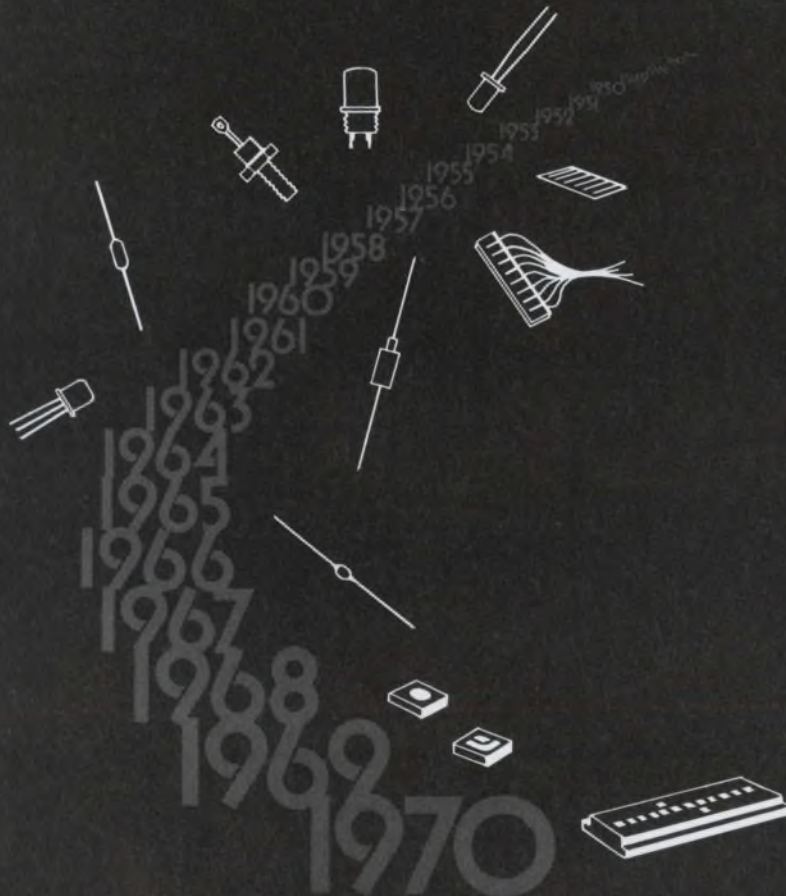

next...

even more exotic products than those we've developed over the last sixteen years. We're the original silicon semiconductor house. We made the first silicon diodes, the first zeners, temperature compensated devices, passivated mesa zeners, the first silicon tunnel and uni-tunnel diodes and the first thick-film opto-hybrids. We pioneered diffusion techniques and led the way in product miniaturization. We developed the silicon solar cell, and have supplied millions for space applications and for electro-optical systems.

Today, we're working on thick-film microcircuits, improved phototransistors, solid state varactors, beam lead semiconductor chips, punch-through voltage regulators, photo-coupled gallium arsenide isolators and microwave subsystems . . . for tomorrow's needs. Awareness, imaginative engineering and manufacturing capabilities will keep us leading our industry in the years ahead. Call us for your needs in . . .



**CENTRALAB
SEMICONDUCTOR**

Division • GLOBE-UNION INC.
4501 NORTH ARDEN DRIVE
EL MONTE, CALIFORNIA 91734

zeners, temp.-compensated devices, tunnel diodes, rectifiers, scr's, semiconductor chips, hi-rel hybrids and photovoltaic products

INFORMATION RETRIEVAL NUMBER 63

Voltage regulator is a current source or sink

Many times it is desirable for a voltage source to be able to sink current, as well as supply it, while maintaining a constant output voltage. An inexpensive and reliable circuit for doing this is shown here.

In the circuit, V_1 is the unregulated input voltage, zener diode CR_1 establishes the output voltage E_o , R_1 limits the current through CR_1 , and C_1 provides filtering action. Diodes CR_2 and CR_3 provide temperature compensation for the base-emitter drops of emitter followers Q_1 and Q_2 . Transistor Q_3 is connected in a complementary-symmetry configuration with Q_2 , while CR_4 , R_2 and R_3 provide proper biasing for Q_3 . R_1 limits power dissipation in Q_3 and establishes the maximum current that the supply can sink.

In operation, the output voltage is fixed at the voltage across CR_1 . If the output voltage tries to rise, the base-emitter junction of Q_3 becomes forward-biased, causing it to conduct and sink

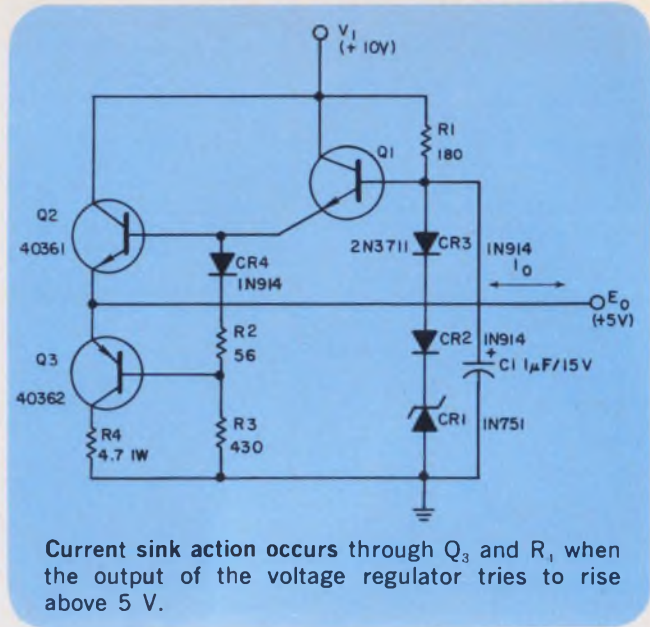

current through R_1 . For the circuit values shown, the output voltage is 5 V, and the supply can sink up to 100 mA of current.

Ronald S. Conero, Design Engineer, Lear Siegler, Inc., San Diego, Calif.

VOTE FOR 316

Noise spikes trigger random-pulse generator

The circuit illustrated meets the need for a TTL logic level pulse generator with random-pulse spacing in the tens of microseconds to milliseconds region. A practical, yet inexpensive, solution to this problem is to use the higher-level spikes from a noise source to trigger a monostable multivibrator.

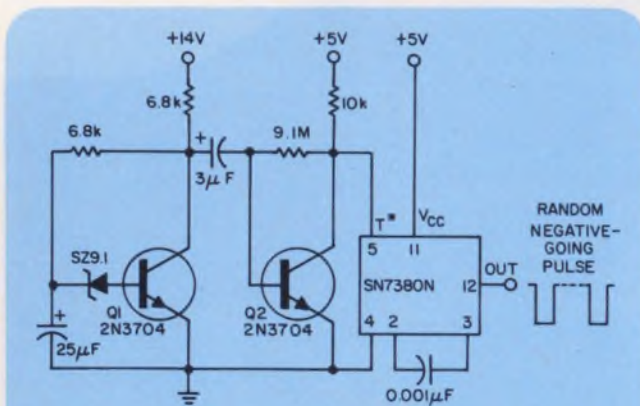

Random negative pulses from the monostable multivibrator are triggered from a combination noise generator/amplitude discriminator.

A Schauer SZ9.1 zener diode feeding the base of Q_1 (2N3704 transistor) forms an excellent broad spectrum noise generator. The second stage, Q_2 , is biased so that only the higher level noise spikes will drive it to saturation. The amplitude discriminator output feeds the negative transition trigger, input T^* , of an SN7380N monostable multivibrator. The 0.001 μF capacitor between pins 2 and 3 was selected to give 6- μs pulse width output.

The output rate can be controlled by varying the noise generator's supply voltage.

Roy J. Krusberg, Marshall W. Williams, Design Engineers, University of Georgia, Athens, Ga.

VOTE FOR 317

VOTE! Go through all Idea-for-Design entries, select the best, and circle the appropriate number on the Reader-Service-Card.

SEND US YOUR IDEAS FOR DESIGN. You may win a grand total of \$1050 (cash)! Here's how. Submit your IFD describing a new or important circuit or design technique, the clever use of a new component or test equipment, packaging tips, cost-saving ideas to our Ideas-for-Design editor. You will receive \$20 for each accepted idea, \$30 more if it is voted best-of-issue by our readers. The best-of-issue winners become eligible for the Idea Of the Year award of \$1000.



Left: Cross-section (enlarged 70 diameters) of plated hole through typical 8-plane Collins etch-back circuit board.

Enlargement below: Note absence of "nailheading" of inner circuit planes at drilled hole. Outer layer on plated hole is 0.0004-inch solderable tin plating.



EXPAND YOUR MARKETS WITH COLLINS ETCH-BACK BOARDS

Collins multilayer planar circuits meet the critical new government specifications for physical and electrical integrity.

These new etch-back circuits — offering unmatched performance and reliability at lower cost — help you expand your government and commercial markets... and help you serve those markets better.

Using Collins highly-automated, computer-controlled design and production facilities, you avoid the cost of establishing your own production capabilities for high-density multilayer circuits. Input to Collins facilities is available through data terminals in Boston and Los Angeles or directly to Collins in Dallas.

Collins new etch-back planar circuits are examples of the engineering and manufacturing excellence achieved at Collins through use of the C-System, a computer-controlled system which integrates design and production — as well as other management control functions — into a single network.

For complete information on how Collins etch-back planar circuits can improve your market position, contact Collins Radio Company, Dept. 300, Dallas, Texas 75207. Phone: (214) 235-9511.



COMMUNICATION / COMPUTATION / CONTROL

INFORMATION RETRIEVAL NUMBER 64

THE PRACTICAL REFERENCE SHELF

FUNDAMENTALS OF INTEGRATED CIRCUITS

Lothar Stern

A practical guide to integrated circuits — their theory, manufacture and applications. This book offers complete discussion of the various techniques of integrated circuit fabrication and their strong influence on circuit design and performance. From a marketing viewpoint, it compares the relative qualities of the numerous IC's devised to date in terms of economics and logistics.

The book covers basic semiconductor principles, monolithic integrated circuits, thin-film circuits and their characteristics, hybrid and other integrated structures. There is also discussion of packaging, design and layout principles, and LSI. A volume in the *Motorola Series in Solid-State Electronics*. 208 pages, 7 x 10, illustrated, cloth cover.
#5695 \$8.95

LEVEL-HEADED LETTERS

Dr. Dugan Laird and Joseph R. Hayes.

Will help the executive to write better letters, faster. In practical, down-to-earth style, this book shows how to find the real reasons for writing; provides a simple plan for organizing ideas logically and psychologically, and points out ways to get affirmative responses from readers. Shows how to avoid cliches, verbiage and how to inject an air of informality into letters. Key feature is the programmed learning section on painless grammar. 134 pages, 6 x 9.

Paper cover, #5032 \$3.50
Cloth cover, #5033 \$4.95

PROJECT ESTIMATING BY ENGINEERING METHODS

Paul F. Gallagher.

A practical approach to attaining consistently accurate estimates by summarizing many general practices and introducing specific methods proven valuable in various kinds of work. Five methods of estimating are discussed, the fifth of which combines the two most important developments in the field: standard hours and the learning curve. To insure complete understanding, full coverage is given to construction and use of learning curves. Nearly 100 pages of learning curve tables appear in the appendix. 344 pages, 8½ x 11, illustrated, cloth cover.

#5018 \$15.00

PRACTICAL PA GUIDEBOOK: HOW TO INSTALL, OPERATE AND SERVICE PUBLIC ADDRESS SYSTEMS

Norman H. Crowhurst

A practical guide covering all aspects of the subject. The book shows how to select and install the appropriate equipment, covers routine operation and maintenance of the finished system. Special attention is given to solving the problems encountered in providing successful service. 136 pp., 6 x 9, illus., paper.

#0778 \$4.45

THEORY AND APPLICATIONS OF TOPOLOGICAL AND MATRIX METHODS

Keats A. Pullen.

The dependence of electrical circuit theory on topology (theory of line graphs) is of growing importance because line graphs for networks represent their flow patterns. Application of topological methods has lagged behind the use of matrix methods only because of minor application problems. This volume resolves these problems in a logical and understandable way. 100 pages, 5½ x 8½, paper cover.

#0300 \$2.50

INDUSTRIAL STROBOSCOPY

Gilbert Kivenson.

A comprehensive description of the history, development and use of stroboscopy in industry, commerce and research. Stroboscopy for analysis and measurement has spread to many specialized areas of science and engineering, such as high-speed cinematography, photometry, radiometry, torsional vibration and other areas. This book discusses the state of the art today and areas of further usage. 284 pages, 6 x 9, illustrated, cloth cover.

#5045 \$9.95

DESIGN OF LOW-NOISE TRANSISTOR INPUT CIRCUITS

William A. Rheinfelder.

Design engineers and others interested in low-noise circuit design will find this book a real time saver. Gives a multitude of labor saving graphs and design curves for the practical circuit designer. Simple derivations of all important formulas help the reader obtain a deeper insight into the fundamentals of practical low-noise design. 128 pages, 6 x 9, illustrated, cloth cover.

#5014 \$6.50

WAVEFORM MEASUREMENTS

Rufus P. Turner.

Complete how-to information on the various techniques of electrical waveform measurement—from troubleshooting to signal synthesis. Book details procedures for the isolation and measurement of a single harmonic from a multisignal mixture, measurement of total distortion, calculation of harmonic values from heights of the wave patterns, etc. 96 pages, 5¾ x 8¼, illustrated, paper cover.

#0775 \$2.95

UNDERSTANDING SILICON CONTROLLED RECTIFIERS

Saul Heller

A compact, illustrated guide to the capabilities and operation of the versatile SCR and the triggering circuits associated with these devices. Throughout the book, schematic diagrams illustrate the application of the various SCR's as static switches, phase-control switches, inverters, choppers, etc. Emphasis is placed on choosing the right SCR to do a given job. 134 pages, 5¾ x 8¼, illustrated, paper cover.

#0782 \$3.95

TRANSISTOR AND DIODE NETWORK PROBLEMS AND SOLUTIONS

Harry E. Stockman.

This two-way reference demonstrates the practical application of theory and serves as sourcebook of step-by-step mathematical solutions to practical problems. With schematic situations covering the entire field of transistor and diode networks, the reader develops effective techniques by comparing his own solution methods with the author's. 352 pages, 6 x 9, illustrated.

#5694 \$9.95

TRANSISTOR AND DIODE LABORATORY COURSE

Harry E. Stockman

Structured on engineering concepts and facts, this new course first provides a groundwork in transistor technology. Two-part theory viewpoints are applied continuously to give the work an engineering slant. The balance of the experiments deal with more intricate transistor networks, such as the theory and operation of multivibrators, and the concept of parametric action. 128 pages, 7¼ x 10, illus.

#5671 \$3.95

REVIEW ANY OF THESE BOOKS FOR 10 FULL DAYS — FREE!

HAYDEN BOOK COMPANY, INC. 116 W. 14 St., N. Y., N. Y. 10011

Please send me the books circled below, on a 10-day free examination. At the end of that time I will remit payment, plus postage, or return the books without obligation.

5695	0778	5014
5694	5032	0775
5671	5033	0782
5018	0300	5045

Payment enclosed (Hayden pays postage). Same return privilege.

Name _____

Firm _____

Address _____

City _____ State _____ Zip _____

On all overseas orders, payment in U.S. dollars must be enclosed. Publisher pays postage with same return privilege.

ED-270

Sylvania introduces a new 40-lead, glass-ceramic, sandwich-type, unitized, hermetically sealable large scale integrated circuit package.

(whew.)

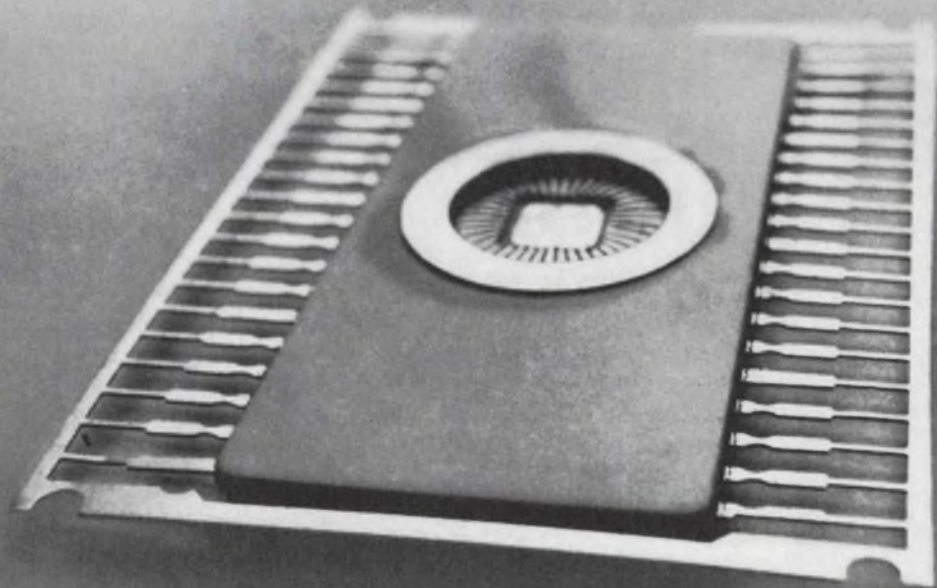

Here is the first glass-ceramic package in the IC major leagues. And that, friends, marks the beginning of the end of the LSI package shortage. Write to: Sylvania Precision Materials, Parts Division, Warren, Pa. 16365. Or telephone: 814-723-2000. Ask for Bill Williamson.

SYLVANIA
GENERAL TELEPHONE & ELECTRONICS

6-month index to Product Source Directories

This index covers all Product Source Directories published in ELECTRONIC DESIGN since November 1969.

For each product category the index lists both the issue in which the particular Directory was published and the number designation of the table(s) that list the product category. (The

number designation appears at the upper right of all Directory tables.) For each addendum, table numbers are followed with a letter.

Thus, the index can be used whether you file complete issues of ELECTRONIC DESIGN or whether you clip the individual Directories and file them in a loose-leaf binder.

Product	Table number(s)	Issue
Digital voltmeters (ac)	3	ED 24, Nov. 22
Digital voltmeters (dc)	1-2	ED 24, Nov. 22
Field strength meters	31	ED 26, Dec. 20
Frequency counters	4-7	ED 24, Nov. 22
Frequency counter extenders	8	ED 24, Nov. 22
Frequency meters (coaxial)	61	ED 5, March 1
Frequency meters (waveguide)	62-63	ED 5, March 1
Function generators	80	ED 11, May 24
Minicomputers	76	ED 9, April 26
Multitesters	65-66	ED 7, April 1
Oscillators	77-79	ED 10, May 10
Oscilloscopes (general purpose)	9-10	ED 24, Nov. 22
Oscilloscopes (main frame)	12	ED 24, Nov. 22
Oscilloscopes (sampling)	11	ED 24, Nov. 22
Oscilloscopes, horizontal amplifier (delay)	17	ED 24, Nov. 22
Oscilloscopes, horizontal amplifier (time base)	16	ED 24, Nov. 22
Oscilloscopes, vertical amplifier (single trace)	13	ED 24, Nov. 22
Oscilloscopes, vertical amplifier (dual trace)	14	ED 24, Nov. 22
Oscilloscopes, vertical amplifier (four trace)	15	ED 24, Nov. 22
Power supplies, ac (amplitude regulated)	72-73	ED 8, April 12
Power supplies, ac (frequency regulated, adjustable-frequency)	69-71	ED 8, April 12

Product	Table number(s)	Issue
Power supplies, ac (frequency regulated, fixed-frequency)	67-68	ED 8, April 12
Power supplies, dc (constant current)	43-45	ED 4, Feb. 15
Power supplies, dc (high current)	39-42	ED 4, Feb. 15
Power supplies, dc (high voltage)	46	ED 4, Feb. 15
Power supplies, dc (high voltage, addendum)	46a	ED 8, April 12
Power supplies, dc (klystron)	75	ED 8, April 12
Power supplies, dc (laboratory type)	47-49	ED 4, Feb. 15
Power supplies, dc (modular)	50-60	ED 4, Feb. 15
Power supplies, dc (modular, addendum)	60a	ED 5, March 1
Power supplies, dc voltage reference)	74	ED 8, April 12
Pulse generators	32-34	ED 1, Jan. 4
Random noise generators	64	ED 6, March 15
Signal generators	35-36	ED 2, Jan. 18
Slotted lines	37-38	ED 3, Feb. 1
Spectrum analyzers	19-20	ED 24, Nov. 22
Spectrum analyzers (plug-in)	18	ED 24, Nov. 22
Squarewave generators	81	ED 11, May 24
Sweep generators	26-30	ED 25, Dec. 6
Sweep generators, addendum	30a	ED 6, March 15
Vacuum-tube voltmeters (ac)	23-25	ED 24, Nov. 22
Vacuum-tube voltmeters (dc)	21-22	ED 24, Nov. 22

Product Source Directory

Frequency Synthesizers

This Product Source Directory covers Frequency Synthesizers.

For each table the instruments are listed in ascending order of one major parameter. The column containing this is color-coded white.

The following abbreviations apply to all instruments listed:

ina—information not available

n/a—not applicable

req—request

PM—Phase Modulation

Unless otherwise specified, the power requirements for all instruments listed are 105-125 Vac.

Manufacturers are identified by abbreviations. The complete name of each manufacturer can be found in the Master Cross Index below.

Abbrev.	Company	Info. Ret. No.
Dana	Dana Labs 2401 Campus Dr. Irvine, Calif. 92664 (714) 833-1234	461
EMR	EMR Instruments County Line Rd. Hatboro, Pa. 19040 (215) 672-1240	462
FEL	Frequency Engineering Labs P.O. Box 527 Farmingdale, N.J. 07727 (201) 938-9221	463
Fluke	John Fluke Mfg. Co. Box 7428 Seattle, Wash. 98133 (206) 774-2211	464
GR	General Radio Co. 22 Baker Ave. W. Concord, Mass. 01781 (617) 369-4400	465
H-P	Hewlett-Packard Co. 1501 Page Mill Rd. Palo Alto, Calif. 94304 (415) 326-7000	Contact local sales office
Kay	Kay Elemetric Co. Maple Ave. Pine Brook, N.J. 07058 (201) 227-2000	466
Micro-Power	Micro-Power Inc. 25-14 Broadway Long Island City, N.Y. 11106 (212) 726-4060	467

Abbrev.	Company	Info. Ret. No.
Monsanto	Monsanto Electronic Instruments 620 Passaic Ave. W. Caldwell, N.J. 07006 (201) 228-3800	468
RF	RF Communications 1680 University Ave. Rochester, N.Y. 14610 (716) 244-5830	469
R&S	Rohde & Schwarz 111 Lexington Ave. Passaic, N.J. 07055 (201) 773-8010	470
Schomandl	Schomandl c/o Rohde & Schwarz 111 Lexington Ave. Passaic, N.J. 07055 (201) 773-8010	471
Spectra	Spectra Electronics Inc. 915 Linda Vista Ave. Mountain View, Calif. 94040 (415) 964-4170	472
TMC	Technical Material Corp. 700 Fenimore Rd. P.O. Box 142 Mamaroneck, N.Y. 10543 (914) 698-4800	473
Wavetek	Wavetek 9045 Balboa Ave. San Diego, Calif. 92123 (714) 279-2200	474

Manufacturer	Model	FREQUENCY				Selection	Switching Speed μ s	Spurious Signals dB	Harmonic Signals dB	OUTPUT		Type of Modulation	Type of Synthesizer Direct, Indirect	Misc Features	Price \$
		Min. Hz	Max. MHz	Increments Hz	Stability %					Min. V	Max. V				
H-P	5102A	0	0.1	0.01	3×10^{-7} /day	p	20	-90	-35	0.3	1	FM	Direct, Dual range	ps	7200
GR	1161	0	0.1	0.01	$2 \times 10^{-7}/^{\circ}\text{C}$	a	200	-70	-40	0	2	AM/PM	Direct	abct	3680-4990
Schomandl	ND99K	0	0.11	0.01	5×10^{-8}	ina	n/a	-80	-40	0.2	1.5	n/a	Indirect	h	3690
GR	1162	0	1	0.001-1000	$2 \times 10^{-7}/^{\circ}\text{C}$	a	200	-80	-40	0	2	AM/PM	Direct	abct	3680-4990
H-P	5103A	0	1	0.1	3×10^{-9} /day	p	20	-70	-35	0.3	1	FM	Direct, Dual range	ps	7800
Wavetek	157	10 ⁻⁶	1	y	0.005	ina	100	n/a	-36	0.001	10	FM	ina	sy	2995
Schomandl	NDIM	300	1.1	0.1	5×10^{-8}	ina	n/a	-80	-40	0.2	2.7	n/a	Indirect	h	4030
Monsanto	3100A	0.01	1.3	0.01	ina	ina	20	-47	-45	-70 dB	2.23	AM/FM	Direct	s	3950
Monsanto	3100A/D16	0.01	1.3	0.01	ina	ina	20	-47	-45	-70 dB	2.23	AM/FM	Direct	s	4650
Monsanto	310B	0.01	1.3	0.01	ina	ina	5 ms	-70	-40	-70 dB	2.23	AM/FM	Direct	s	4950
Spectra	SE-1200	dc	1.999999	1	1×10^{-8}	digital	40	-90	-35	1	2	n/a	Indirect	cs	2000
EMR	FSD2	0	2	0.01	3×10^{-9}	a	20	-100	-40	0	2	n/a	Indirect	a	req
TMC	LFE-2	10k	2	100	0.0001	ina	manual	-60	-55	0	250mW	cw	Direct		11,300
Dana	7020	dc	11	1	1×10^{-9}	a	10	-70	-30	10 ⁻⁹	1	PM, FM	Indirect	ab	5895
Dana	7010	dc	11	1	1×10^{-9}	a	10	-70	-30	0.1	1	phase	Indirect	ab	5375
Fluke	633A	dc	11	0.1	1×10^{-8}	k	25	m	-35	0.75	1.25	FM	Direct	ckm	7790
Dana	7030	0.01	11	0.01	10^{-9}	a	10	-70	-30	0.1	1	PM/FM	Indirect	ab	6395
GR	1163	30	12	0.01-100	$2 \times 10^{-7}/^{\circ}\text{C}$	a	200	-60	-30	0	2	AM/PM	Direct	abct	3980-5290
TMC	MMX-2	1.6M	30	100	0.0001	ina	manual	-60	-55	0	250mW	cw	Direct		12,200
Schomandl	ND25M	20M	30	10	5×10^{-8}	ina	n/a	-80	-40	0.1	0.1	n/a	Indirect		4540
Schomandl	ND30M	300	31	0.1	5×10^{-8}	ina	n/a	-80	-40	0.05	1	n/a	Indirect		4870
EMR	SS830	300	32	0.01	3×10^{-9}	rotary	n/a	-80	-40	0	1.3	f	Indirect	dfg	6375
EMR	F530	300	32	0.01	3×10^{-9}	rotary	n/a	-80	-40	0	1.3	f	Indirect	df	4395
Fluke	644A	50	40	0.1	1×10^{-8}	k	25	-90	-30	0.75	1.25	FM	Direct	ck	10,900
		dc	0.1							0.09	0.11				
R & S	SMDH	0	50	0.002	1×10^{-9}	ina	20	-100	-30	0.1 μ	2.5	AM/FM	Direct	s	10,990
H-P	5100B/5110B	0	50	0.01	3×10^{-9}	p	20	-90	-30	q	q	FM	Direct	pqrs	12,500
Fluke	645A	50	50	0.01	1×10^{-8}	k	20	-100	-30	0.9	1.1	AM/FM	Direct	ck	13,500
		dc	0.1							0.09	0.11				
GR	1164	10k	70	0.1-100	$2 \times 10^{-7}/^{\circ}\text{C}$	a	200	-60	-30	0.2	2	AM/PM	Direct	abct	5885-7195
RF	RF-808	50k	80	1000	5×10^{-9}	a	2000	-80	-30	0.1 μ	10	f	Indirect	acfs	2980
Schomandl	ND100M	300	100	1	5×10^{-8}	ina	5 ms	-80	-34	0.05	1	FM	Indirect	cht	5440-6520
Schomandl	MS100M	10k	100	0.1	5×10^{-8}	ina	10 ms	-80	-30	0.3 μ	1	AM/FM	Indirect	cht	6460-7650
Kay	101A	50k	110	ina	20 ppm	v	26 ms	-30-50	-30	0	1	FM	Indirect	v	2495
EMR	FSD120	0	120	0.1	3×10^{-9}	a	100	-80	-35	0	2	AM/PM	Indirect	ade	req
EMR	F551500	106M	156	0.01	3×10^{-9}	manual	n/a	-70	-26	1	1	none	Indirect	b	4870
GR	1165	10k	160	100	1×10^{-9}	a	50 ms-200	-60	-30	0.1	1	PM	Direct	asu	u
EMR	FSM530	300	470	0.01	3×10^{-9}	rotary	n/a	-80	-26	0	2	f	Indirect	df	10,845
EMR	FSM500	27M	470	1 MHz	3×10^{-9}	rotary	n/a	-80	-26	0	2	f	Indirect	dfj	5550
EMR	FS500	27M	470	1 MHz	3×10^{-9}	rotary	n/a	-80	-26	0	2	n/a	Indirect	dh	4950
H-P	5105A/5110B	100k	500	0.1	3×10^{-9}	p	20	-70	-40	-6dBm	+6dBm	FM/PM	Direct	prs	14,100
R & S	SMDV	1M	500	w	w	ina	20	-80	-20	2 μ	2	AM/FM	Direct	w	4950
R & S	XUC	470M	1000	5000	1×10^{-9}	ina	n/a	-80	-34	0.5 mV	3	n/a	Direct	x	6990
EMR	FS1	0	1200	0.01	3×10^{-9}	rotary	n/a	-80	-40	0	2.5	n/a	Indirect	b	2950
EMR	FS01500	850M	1550	0.01	3×10^{-9}	manual	n/a	-80	-26	-140 dBm	15dBm	n/a	Indirect		9700
EMR	FS2	0	2000	0.01	3×10^{-9}	rotary	n/a	-80	-40	0	2.5	n/a	Indirect	b	2950
Fel	700B	1.2G	2400	1	1×10^{-9}	a	50-5000	-70	-20	1 mW	1 mW	n/a	Direct	an	req
EMR	FSX3000	100	5000	0.01	3×10^{-9}	rotary	n/a	-70	n/a	1	1	n/a	Indirect	bi	4870
Micro-Power	300A	1G	12,400	10k	1×10^{-8}	a	ina	-65	-20	30mW	50mW	ina	Indirect	as	req

- a. Selection, manual or remote.
- b. Output voltage, rms.
- c. Also sweep mode.
- d. Output voltage, emf.
- e. Also pulse modulation.
- f. Type of modulation, AM/FM/PM/pulse.
- g. Two tone single sideband synthesizer.
- h. Battery operated.
- i. Also frequency meter.
- j. Also frequency deviation meter and frequency meter.
- k. Frequency selection, front panel or remote 10 line. Option A605 at S1495 for remote BCD.
- m. Spurious signals, dc-4MHz, -90 dB; 4-6.5 MHz, -80 dB; 6.5-11 MHz, -60 dB.
- n. Frequency increments, 1 Hz through 1 GHz. Direct nixie readout of programmed frequency, 1 Hz, 10 Hz, 100 Hz, 1 kHz and 10 kHz optional.
- o. 100 Hz, 1 kHz and 10 kHz optional.
- p. Pushbutton switch.
- q. Output, 1V rms \pm 1 dB, 100 kHz-50 MHz; 1V rms +2 dB, -4 dB, 50 Hz-100 kHz into 50 Ω resistive load. 15 mV rms minimum open circuit from 100 kHz down to dc. The 5110B is a synthesizer driver capable of driving up to four 5100B or 5105A synthesizers. When one 5110B drives several synthesizers, the cost per output is reduced substantially.
- r. Remotely programmable.
- s. Units are modular in construction, price depends on requirements, check with manufacturer.
- t. Price, master unit \$5900.00. Slave unit \$5300.00. Stability, long term. Selection, thumbwheel and vernier. Swept frequency synthesizer. Basic unit plus 6 voltage controlled oscillator plug-ins at \$295 each.
- u. Requires a low frequency synthesizer as vernier and frequency standard. Will extend the range of any 30 MHz synthesizer to 500 MHz. When used with the ND25M, stability 5×10^{-8} /mo, when used with SMDH, stability 1×10^{-9} /day.
- v. Increments to 1 Hz with ND25M and ND30M. Output attenuator for synchronization of microwave sources included.
- w. 5 digits with ranging.
- x. 5 digits with ranging.
- y. 5 digits with ranging.

Even when Anna finishes her cleaning chores at night our new Microwave Variable Persistence Display is still going strong. This new storage display coupled with the proven advantages of our Model SPA-3000 Wide Dispersion Analyzer form an unbeatable team.

- Minimal interaction between persistence and brightness controls.
- A long term storage capability . . . up to 3 hours with negligible loss.

- An ability to measure low PRF pulse spectra or long term oscillator stability.
- Virtually no blooming.
- A display that will average responses varying in amplitude . . . can record the varying spectra that result from high RPM rotating fire-control radar systems.
- Not just another variable persistence display made for an oscilloscope . . . This one's designed for our SPA-3000 and other spectrum analyzers.

- Multi-sweep integration that will detect coherent signals in random noise.

The Singer Company, Electronic Products Division, 915 Pembroke Street, Bridgeport, Conn. 06608.
In Europe contact: Singer Sewing Machine Company, Instrumentation Division, P.O. Box 301, 8034 Zurich, Switzerland. Telephone: (051) 47 25 10.

New Microwave Spectrum Analyzer Display lasts and lasts and lasts and



SINGER
INSTRUMENTATION

Look who has the popular new size at a popular price.

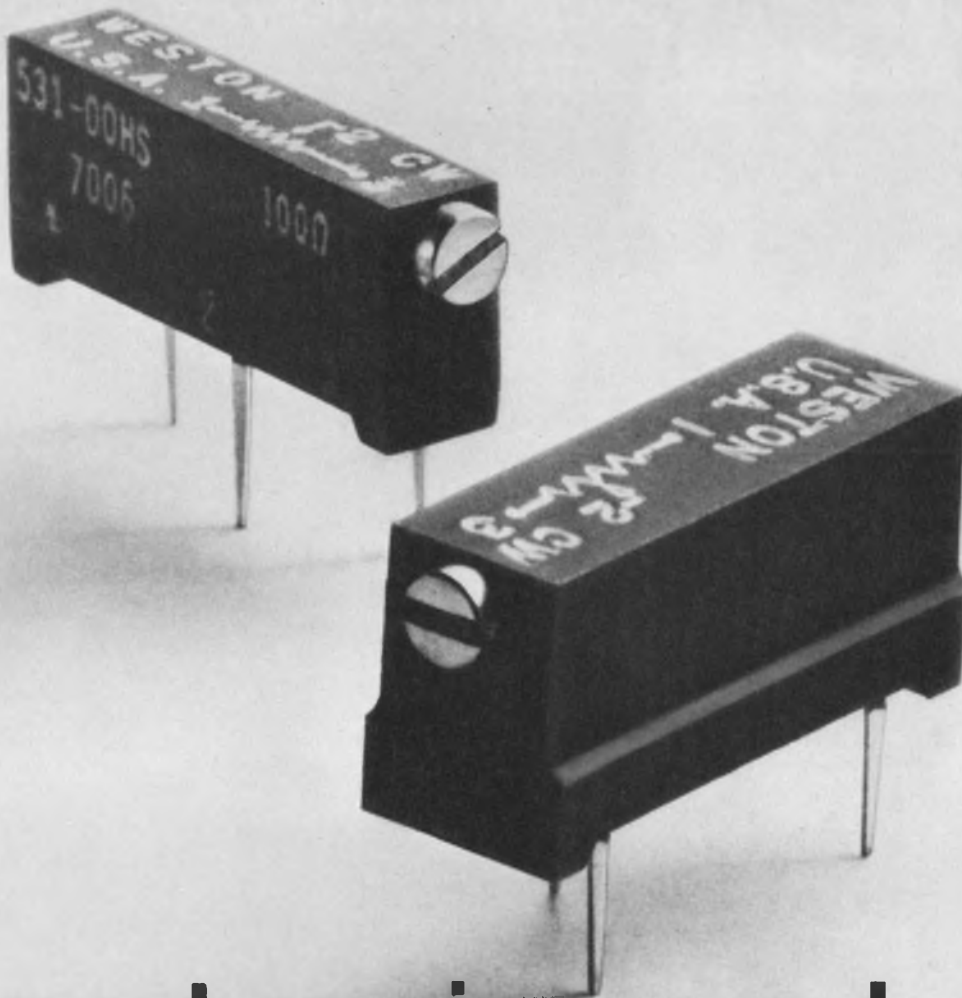

Cermet or wirewound.

Now it's no longer necessary to settle for less than the best.

These popular new Weston $\frac{3}{4}$ " rectangular series 530-533 combine the famous features of our Squaretrim® potentiometer line—high quality, wide temperature range, precision tolerance, low noise, 15 turn adjustability with slip clutch protection—in a case size that's rapidly becoming industry's number one choice. In addition to standard models,

sealed equivalents are available for protection against water, cleaning solvents, flux and encapsulating compounds. Units are priced as low as \$1.30*.

Cermet series 532 and 533 come in standard resistance values to one megohm. Those who prefer wirewounds may order series 530 and 531 in standard values from 10 ohms to 35K. Both cermet and wirewound models are available with tab mounting

centers of either .10" or .20".

However you choose, you're clearly a winner with Weston's 530-533 rectangular trimmers. Write or phone today for sample units and complete data.

WESTON COMPONENTS
DIVISION, Archbald, Pennsylvania
18403, Weston Instruments, Inc.

a Schlumberger Company

WESTON®

*100 quantity unit price for standard models.
100 quantity unit price for sealed models is \$1.63.

New Products

A/d and d/a signal conditioning modules set new standards in performance and price

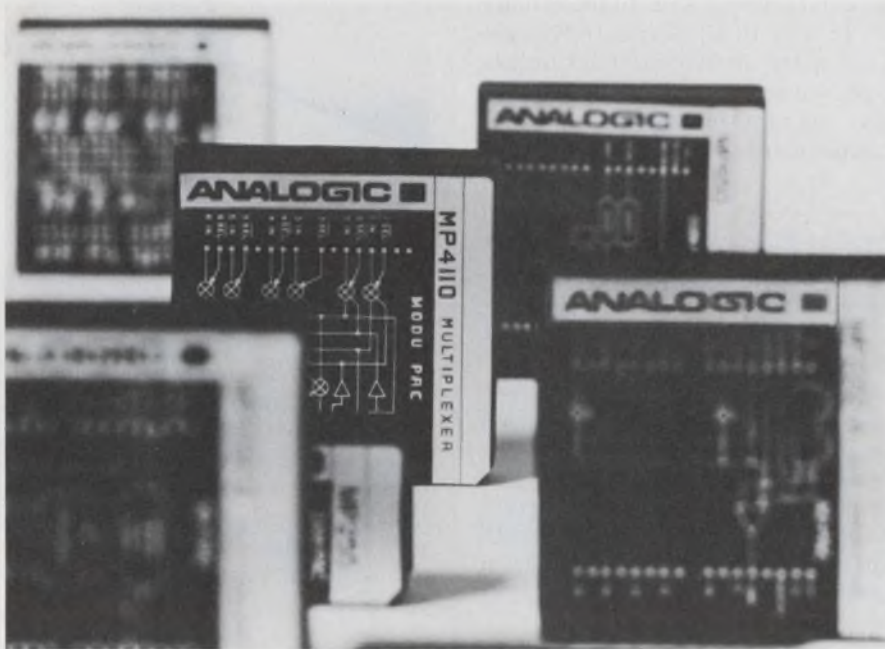

Analogic Corp., Audubon Rd., Wakefield, Mass. Phone: (617) 246-0300. P&A: see text; stock to 4 wks.

Consisting of over 65 individual modules, the Modupac series of analog-to-digital and digital-to-analog signal conditioning circuits make new breakthroughs in performance, miniaturization and price. The new line includes: a/d converters (Adpacs), d/a converters (Dacpacs), multiplexers (Muxpacs), sample-and-hold circuits (Sampacs), storage registers (Regpacs), amplifiers (Ampacs), voltage references (Refpacs), control units (Tropacs), power supplies (Pwrpacs), and interface elements (Midpacs).

The a/d converters offer capacities of 8 to 15 bits at costs from \$180 to \$2400. Model MP2600 (\$180) is a 12-bit integrating-type converter with an accuracy of 0.05%. It has a differential front end and is compatible with both DTL and TTL circuits. Model MP2715 (\$2400) is a precision high-speed 15-bit Adpac.

Another high-speed converter,

the MP2212, can handle 12 bits with 0.01% accuracy for only \$495. It operates at speeds of 0.8 μ s per bit. The MP2208, which is supplied as two modules, provides 8-bit capacities for just \$250.

Besides multiplying types, the d/a converters include complementing designs for all the a/d converters. They too cover from 8 to 15 bits, but vary in price from \$59 to \$795.

Model 1808, which sells for \$59, handles 8 bits with a conversion accuracy of $\pm 0.025\%$ of full scale. This unit boasts a slew rate of 10 V/ μ s and a 5- μ s settling time to one-half the least significant bit.

At the other end of the scale is the MP1715 high-speed 15-bit d/a converters for \$795. It has an accuracy of $\pm 0.01\%$ and a linearity of $\pm 0.003\%$. Settling time to one-half the least significant bit is 500 ns without an amplifier and 1.5 μ s with an amplifier.

Another converter in this group is the MP1812 12-bit module selling for just \$89. It can slew 10 V/ μ s and is accurate to $\pm 0.025\%$ of full scale. Also included are the

12-bit 0.01% model MP1612DA for \$150, and the 12-bit multiplying model MP1008 for \$200.

The multiplexers, competitively priced at approximately \$150 to \$200, include both single-ended and differential units, for either high or low-level signals. A variety of operating speeds, plus a MOSFET design with a high interchannel impedance are available.

Offering aperture times of less than 50 ns, the sample-and-hold modules give a low droop of 0.01% at price tags of only \$150 or \$200. The storage registers handle 8, 12 or 16 bits for \$50, \$60 or \$95.

Ampac amplifiers consist of: fast-settling followers; 10, 100 and 150-V inverters; differential units; and a low-level programmable-gain device. Prices for these modules range from \$50 to \$600.

The control units include the MP4100D counter/register/decoder (\$90) for multiplexer programming of 64 or 80 channels. A phase-lock oscillator, model MP610, is also available (\$150) for improving low-level signal-to-noise ratios in a/d converter systems.

Other modules in this group are timing generators, code translators, a strobe distributor for sequential control, and an AND/OR logic unit with 12 two-input gates.

All Modupacs are packaged in one of three basic module sizes — 1 by 2, 2 by 2, or 2 by 4 in. Height is either 0.39 in. for 1/2-in. board centers or 0.8 in. for 1-in. board centers.

The units are electromagnetically and electrostatically shielded on all six sides. This means that they can be mounted side-by-side without inter-module interference.

Modupacs have 0.025-in. gold-plated pins spaced on 0.1-in. centers for direct mounting into 16-pin dual-in-line IC sockets. In addition, signal and power terminal arrangements are standard so that adjacent Modupacs can be easily interconnected.

CIRCLE NO. 250

D/a 12-bit converters resolve to 10 bits

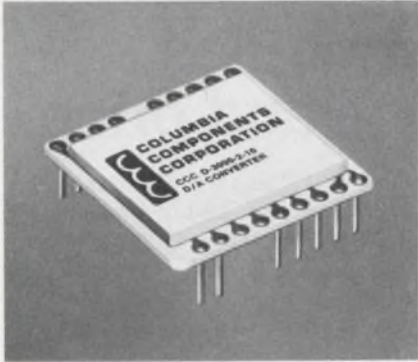

Columbia Components Corp., 60 Madison Ave., Hempstead, N.Y. Phone: (516) 483-8200. P&A: from \$195; stock.

Capable of driving a 50-Ω cable at full output, a new series of hybrid thick film d/a converters provides units with 10-bit resolution at accuracies of 8 or 10 bits binary or 12 bits BCD. Series D-3000 devices settle in 100 ns (8-bit units), have outputs of 5 V at 100 mA and operate in a wide range of temperatures.

CIRCLE NO. 251

High-current booster zeroes bias externally

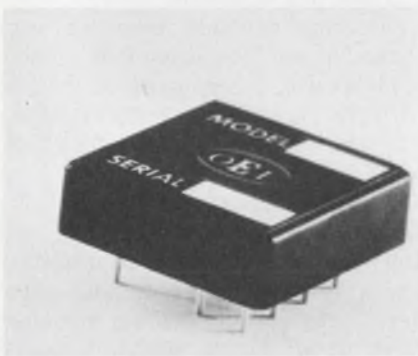

Optical Electronics Inc., Box 11140, Tucson, Ariz. Phone: (602) 624-8358. Price: \$55.

Featuring an output of ±10 V at ±100 mA, the model 9693 current booster and voltage follower allows its bias current to be adjusted to zero with an external potentiometer. It is designed for two modes of operation: as a current booster inside a feedback loop with an operational amplifier and as a stand-alone voltage follower. Input impedance is 10-MΩ.

CIRCLE NO. 252

Stable bipolar op amp drifts only 15 μV/°C



Zeltext, Inc., 1000 Chalomar Rd., Concord, Calif. Phone: (415) 686-6660. P&A: \$20; stock.

Featuring bipolar input, a new differential amplifier in a dual-in-line package boasts an input voltage drift of 15 μV/°C. The Model ZA101D1 features a common-mode rejection ratio of 50,000:1 and a 4-MHz frequency response at unity gain. Other specifications include dc gain of 5 × 10⁴, input noise of 2 μV rms and a slew rate of 6 V/μs.

CIRCLE NO. 253

High-current op amp gives 20 mA at 250 kHz

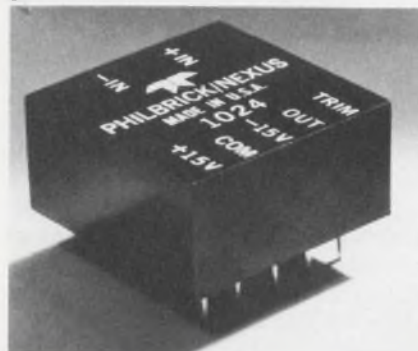

Philbrick/Nexus Research Co., A Teledyne Co., Allied Dr. at Rte. 128, Dedham, Mass. Phone: (617) 329-1600. P&A: \$15.50; stock.

Featuring a slew rate of 15 V/μs, the model 1024 operational amplifier delivers an output current of ±20 mA into a 500-Ω load at frequencies as high as 250 kHz. Other features include a low input bias current of ±50 nA, a ±10-V common-mode voltage range and a common-mode rejection ratio of 20,000:1.

CIRCLE NO. 254

High-CMRR FET op amp trims offset externally



DDC, a Div. of Solid State Scientific Corp., 100 Tec St., Hicksville, N.Y. Phone: (516) 433-5330. P&A: from \$60; stock to 2 wks.

Offering a high common-mode rejection ratio of 10,000:1 at ±10-V input levels, model H50 hybrid FET operational amplifier in a TO-8 can provides a provision to externally trim offset voltages to zero. Initial offset is 2 mV (trimmable to zero), voltage drift is 5 μV/°C, initial bias current is 5 pA and full-output frequency is 130 kHz.

CIRCLE NO. 255

A/d 10-bit converters operate in only 1 μs



Datel Systems Corp., 943 Turnpike St., Canton, Mass. Phone: (617) 828-1890. P&A: \$595 to \$990; stock to 2 wks.

The ADC-H series of a/d converters utilizes the successive approximation conversion technique for word rates of 1 μs (model ADC-H10B) to 250 ns (model ADC-H4B) with word lengths from 4 to 10 binary bits. Full-scale input is ±5 V with optional ranges of +5, +10 and ±10 V at an input impedance of 2 kΩ. Overall accuracy is ±0.1%.

CIRCLE NO. 256

tektronix® expands the 7000 series



New Three-Plug-In Mainframe New Dual Time Base Plug-In

A third mainframe and a fifth time base are added to the growing 7000-Series. The **NEW 7503 THREE-PLUG-IN OSCILLOSCOPE** offers bandwidths up to 90 MHz, depending on the plug-in selected. The **NEW 7B52 Dual Time Base** features four sweep modes: Main, Intensified, Delayed, and Mixed. The Mixed Sweep is **CALIBRATED**, allowing you to **MEASURE . . . not just MONITOR**.

Simultaneous measurements can be made by multiple plug-ins with widely different features. Some of the features of the fourteen plug-ins currently available are: dual-trace, 75 MHz at 5 mV/div (four-trace, 75 MHz with two units) • differential, 100,000:1 (100 dB) CMRR at 10 μ V/div • differential comparator, 75 MHz at 1 mV/div and comparison voltage accurate to 0.1% • random or sequential sampling, 25-ps risetime (depending upon the sampling head) • two single-trace amplifiers, 90 MHz at 5 mV/div • current amplifier, 75 MHz at 1 mA/div.

For faster and easier measurements, Auto Scale-Factor Readout, which is exclusive to Tektronix, labels the CRT with time/div, volts or amps/div, invert and uncal symbols, and automatically corrects for 10X probes and magnifiers. All the data is on the CRT, where you need it, for faster measurements with fewer errors. And, looking into the future, the readout system is designed to meet needs other than of today's plug-ins.

The CRT display above is just one example of the flexibility and measurement ease that is **YOURS** when you use an oscilloscope that features Auto Scale-Factor Readout and dual vertical amplifier plug-ins. Pulse width, period, amplitude, and aberrations are all quickly measured in **ONE** display by applying the same signal to both amplifiers. With the 7B52 Time Base in the **MIXED** mode, two different

sweep speeds are displayed simultaneously—the first 4 div at 100 μ s/div, the last 6 div at 10 μ s/div (the delay time multiplier control can be rotated to start the faster sweep at any point on the main sweep). The DC offset feature of the 7A13 Differential Comparator Amplifier is used to obtain the bottom trace. With a deflection factor of 100 mV/div, the pulses are effectively 100 divisions high, giving the resolution needed to detect aberrations and precisely measure pulse amplitude of -9.91 V (accurate to 0.1%).

For even greater versatility, 2 four-plug-in mainframes are available, the 7704 (150-MHz) and 7504 (90-MHz) Oscilloscopes. The 7000-Series does not require a full complement of plug-ins, you can start with only one horizontal and one vertical plug-in and add more as your measurement requirements change. When your plans call for the purchase of a new oscilloscope, evaluate the Tektronix 7000-Series . . . it's **EXPANDABLE**.

Your Tektronix field engineer will gladly demonstrate the complete **VERSATILITY** of the New Tektronix 7000-Series Oscilloscope System, in **YOUR** lab with **YOUR** signals. Contact him locally or write: Tektronix, Inc., P. O. Box 500, Beaverton, Oregon 97005. See your 1970 Tektronix catalog for complete specifications.

Prices of instruments shown:

7503 — 90-MHz, Three-Plug-In Oscilloscope	\$1775
7A16 — 90-MHz, Single-Trace Amplifier	600
7A13 — 75-MHz, Differential Comparator Amplifier	1100
7B52 — Dual Time Base	900

U.S. Sales Prices FOB Beaverton, Oregon

Available through our new leasing plan.



Tektronix, Inc.
committed to technical excellence

diversified components

*Prices shown are single lot.
Inquire about quantities.

Proximity Switch Assembly

Encased magnet actuates a reed switch to within 1" ctrs. Rated 500 μ A, 60 VDC. **RS-24-NO.**



CIRCLE 191

2.85*

Low-Current Readout

Compact 7-Segment readout features low-drive requirement. Plug-in mount. 2.5V @ 20 ma. per segment. With socket. **MS-250A.**

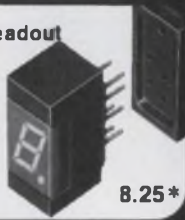

CIRCLE 192

8.25*

110V Neon Indicator

With built-in NE2H hi-intensity lamp & series resistor for 110V. Unique retainer allows front or rear panel mounting. 6" leads. Plastic housing, 1 1/2" long. **BIM-B-3.**



CIRCLE 193

59¢*

Magnet Push Button Keyboard Switches

Magnetic repulsion, momentary types use ceramic magnets & reed switches that eliminate springs. Metal case N.O. **MSPM-101C.**



CIRCLE 194

3.90*

Remote Control Relay

For safe, shock-free remote control circuit operations. Standard octal base plug-in; clear plastic cover. **FRP-104.**



CIRCLE 195

5.45*

Mini Mosaic Displays

Single plane incandescent devices display 0-to-9 numerals and some letters by lighting up a combination of line segments thru a matrix. **MSM-5**



CIRCLE 196

8.25*

Immediate Deliveries on Above Items

ALCO®

ELECTRONIC PRODUCTS, INC.
Lawrence, Massachusetts 01843

MODULES & SUBASSEMBLIES

Power supply module regulates to 0.1%



CIRCLE NO. 257

Electronic Arrays, Inc. Systems Div., 9060 Winnetka Ave., Northridge, Calif. Phone: (213) 882-9610.

The Model 8000 character generator card converts a 64-character subset of the ASCII code to the corresponding 5 by 7 dot matrix for each character. Each character is five dots wide by seven dots high. It is TTL compatible and contains registers, level shifts, a read-only memory and all clocking and timing circuits.

CIRCLE NO. 258

Philbrick/Nexus Research, A Teledyne Co., Allied Dr. at Route 128, Dedham, Mass. Phone: (617) 329-1600. P&A: \$48; stock.

A new low-cost 5-V 0-to-500-mA power supply for DTL and TTL logic provides line and load regulation of 0.1% and 0.2%, respectively, from line voltages of 105 to 125 or 205 to 230 V ac. It is protected against short circuits for any duration and operates over the temperature range of -35 to +85°C without derating.

Character generator converts ASCII code

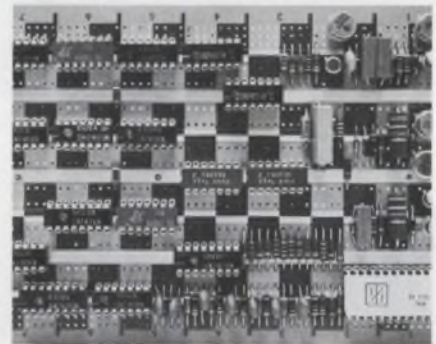

Miniature logic supply measures but 2.25 in.³

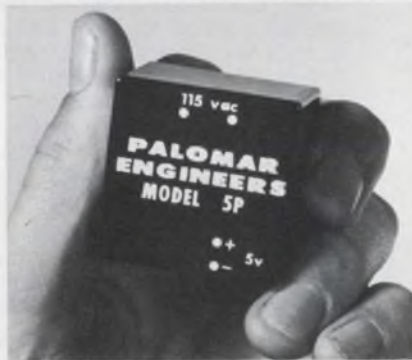

CIRCLE NO. 259

Palomar Engineers, Box 455, Escondido, Calif. Phone: (714) 747-3343. P&A: \$62.50; 2 wks.

Providing an output of 5 V at 500 mA, a new miniature power supply for digital logic circuitry measures only 1-1/2 by 1-1/2 by 1 in. Model SP1 requires an input of 115 V ac at 50 to 400 Hz. Its regulation is $\pm 0.15\%$ and ripple is 4 mV rms. The output is accurate to $\pm 1\%$ and is short-circuit proof and current-limited. The unit is designed for PC board mounting.

Analog Devices, Inc., 221 5th St., Cambridge, Mass. Phone: (617) 492-6000. P&A: \$54; stock.

Featuring 0.05% linearity and a common-mode rejection ratio of 80 dB, a new FET-input differential operational amplifier displays an input impedance of $10^{12} \Omega$. The model 603 low-cost amplifier has input current and voltage drifts of 5 pA/°C and 15 μ V/°C, respectively. Gain-bandwidth is 1 MHz, linear common-mode input is ± 8 V and output is ± 10 V at ± 5 mA.

CIRCLE NO. 260

Low-cost FET op amp boasts $10^{12}\text{-}\Omega$ impedance



Hybrid 12-V regulator adjusts output to $\pm 1\%$

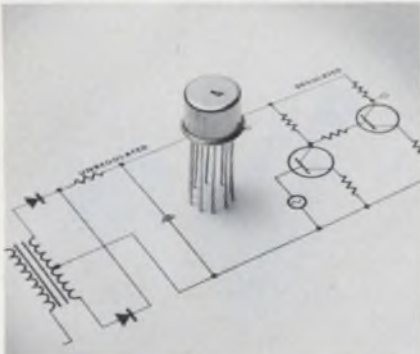

Dickson Electronics Corp., P.O. Box 1390, Scottsdale, Ariz. Phone: (602) 947-2231. P&A: \$23 to 28; 4 wks.

The DVRI00 is a 12-V hybrid IC voltage regulator whose output voltage is internally adjusted to ± 5 or $\pm 1\%$. It accepts load currents to 1000 mA and features adjustable internal over-current protection. With a minimum of external components, output voltages of 12 to 40 V and load currents to 3 A can be obtained.

CIRCLE NO. 261

Building-block elements form logic packages



Digital Applications Corp., 9170 Independence Ave., Chatsworth, Calif. Availability: stock.

A complete packaging concept called RLA (rapid logic applications) provides all the elements necessary to produce digital systems quickly and economically. These building blocks feature low cost, high packaging density, high reliability and flexibility so that any digital system from the simplest to the most complex can be made with minimum engineering.

CIRCLE NO. 262

There are other 10Amp Relays like these...

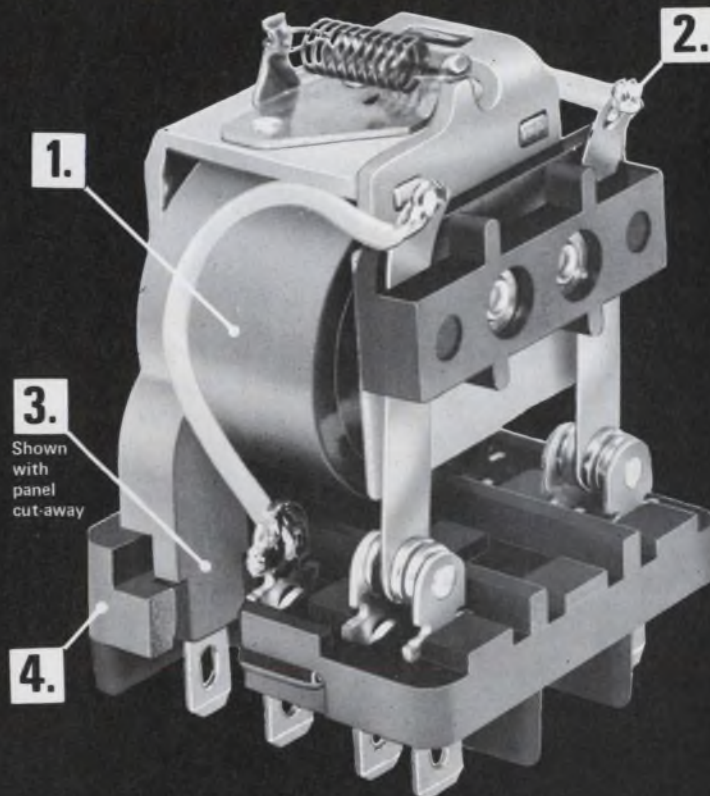

Two Models:
160 without cover
165 with Lexan dust cover

but not with these Exclusive Features...

1. Molded nylon coil for stronger terminals, fungus and moisture resistance, cleaner appearance.
2. Fewer solder joints for more reliable construction.
3. Coil terminates in panel for extra strength, eliminates coil terminal breakage.
4. Frame locked into panel for superior rigidity.

Other features include blade-type terminals for higher current-carrying capacity, 5 & 10 amp contact ratings; SPDT, DPDT, 3PDT contact configurations.



Model 165 with Lexan dust cover.



Optional nylon mounting sockets.

1431

DELTROL CONTROLS

2745 So. 19th St., Milwaukee, Wis. 52315, Phone (414) 671-6800, Telex 2-6871

Exactly your speed.

Servo-Tek's Speed Indicating System takes the precise rotational speed of your application and displays it on an easy-to-read meter. And it tells you repeatedly and accurately even on the most delicate machinery. A temperature-compensated low torque d-c generator and a taut-band meter movement assure a maximum error of less than 1% of full scale reading. Use it as a watchdog on any industrial application where sensitive speed indication is necessary. The attractive design of our Model ST-926 modernizes any application and comes in a standard version or tailor-made with bi-directional indication, special scales and ranges, and with color coding for multiple readouts.

SERVO-TEK PRODUCTS COMPANY
1086 Goffle Road, Hawthorne,
New Jersey 07506.

SERVO-TEK

PRODUCTS COMPANY

For complete specifications
write for our colorful
technical sheets.

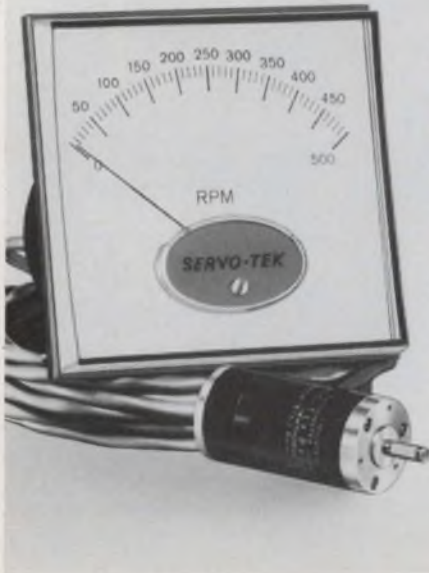

INFORMATION RETRIEVAL NUMBER 70

ICs & SEMICONDUCTORS

Transistor chips for 60¢ dissipate up to 117 W

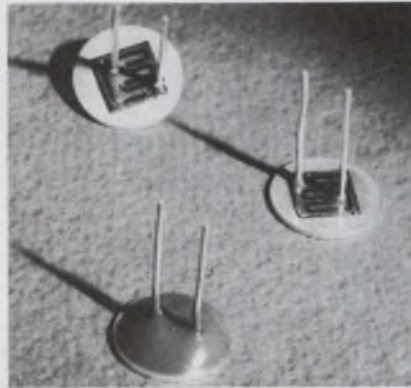

Power Physics Corp., Industrial
Way West, P.O. Box 626, Eaton-
town, N. J. Phone: (201) 542-1393.
P&A: 60¢ to \$1.35; 30 days.

At a disc temperature of 25°C, series CH transistor chips can dissipate power levels as high as 117 W. Especially designed for compatibility with hybrid circuits, these silicon npn devices are intended for low-cost power amplification and switching.

Each chip consists of a large single diffused mesa die mounted on a collector disc. Nickel-plated copper leads are bonded to the base and emitter contacts and the entire unit is coated with a protective silicone varnish.

The resulting assembly provides the hybrid circuit designer with a low-cost and power-oriented silicon mesa transistor option.

Series CH3055, CH3226 and CH3232 feature minimum collector-to-emitter voltages of 60, 35, and 60 V, respectively, at 25°C and at 200 mA of collector current.

Current gains range from 20 to 50, 20 to 50 and 12 to 35, respectively. Maximum collector-to-base voltage ratings are 100, 35, and 80 V, respectively.

All three series feature maximum collector currents of 15 A, maximum base currents of 7 A, a gain-bandwidth product of 0.8 MHz, emitter-base and collector-base currents of 5 mA.

The maximum operating temperature is 200°C and the maximum temperature the chip will withstand when mounted is 300°C. The single diffused silicon power transistor is usually mounted on a nickel-plated copper disc.

CIRCLE NO. 263

Pnp power transistors carry up to 100 amperes

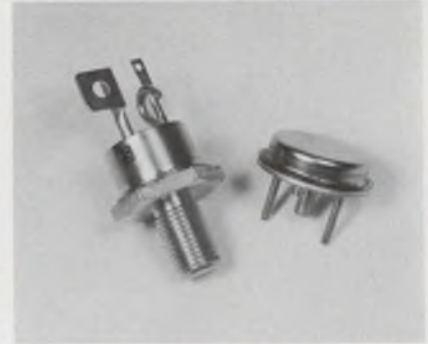

Solitron Devices, Inc., Semiconduc-
tor Div., 1177 Blue Heron Blvd,
Riviera Beach, Fla. Phone: (305)
848-4311. Availability; stock.

A new line of high-reliability epitaxial planar pnp power transistors with breakdown voltages up to 1000 V features collector currents to 100 A. Series SDT3600 (TO-68 case) and SDT3900 (TO-114 case) silicon units include a saturation voltage of 1.5 V, current gain of 10, under 10 μ A of leakage current and rise and fall times of 2 μ s at 100 A.

CIRCLE NO. 264

Read-only memory packs in 2560 bits

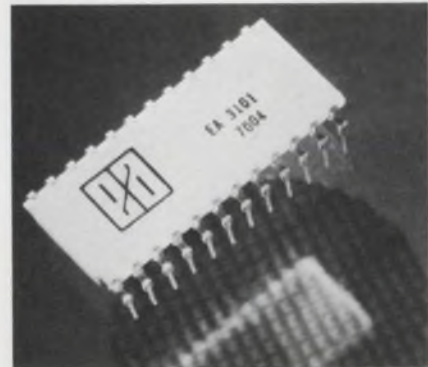

Electronic Arrays, Inc., 501 Ellis
St., Mountain View, Calif. Phone:
(415) 964-4321. P&A: \$83.50;
stock.

Designated EA 3101, a new MOS enhancement-mode p-channel monolithic read-only memory packs a capacity of 2560 bits organized as 256 words at 10 bits per word. It contains both ASCII-to-Selectric-line and Selectric-line-to-ASCII code conversions. A two-phase clock is used and an output inhibit control allows the use of multiple wire-OR'd configurations.

CIRCLE NO. 265

High-gain photo SCRs trigger on low levels

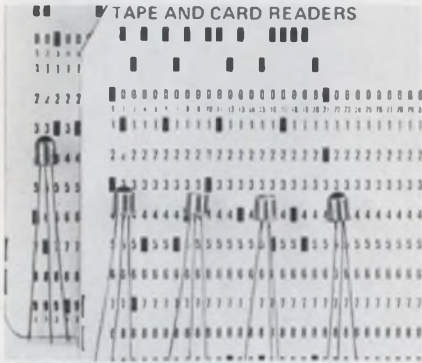

Unitrode Corp., 580 Pleasant St., Watertown, Mass. Phone: (617) 926-0404. P&A: from \$2.05; stock.

Incorporating light trigger intensities of 10 foot-candles and 50 foot-candles, respectively, are two new round-lens and flat-lens photo SCRs. They have high gains, a 300-mA dc continuous-current rating, a 5-A surge rating and a dv/dt of 50 V/ μ s. Operating temperature range is from -65 to $+125^{\circ}\text{C}$. Units are hermetically sealed in TO-18 cases.

CIRCLE NO. 266

Interface logic line turns back noise

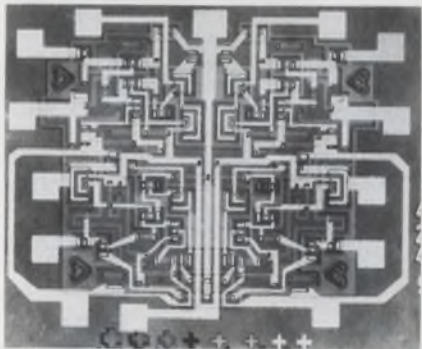

Sylvania Electric Products Inc., Semiconductor Div., Woburn, Mass. Phone: (617) 933-3500. P&A: \$5.90 to \$12.45; stock.

Designed to interface TTL or DTL ICs to interconnecting lines is a new family of circuits providing quality digital data transmission in high-noise environments. The series, types SS334 through SS345, consists of a single-ended quad logic level driver for transmission of digital signals and two receivers—a single-ended and a dual differential unit.

CIRCLE NO. 267

simplicity



NOW... FROM GTI. 3 HIGH-QUALITY PACKAGE SEALERS.

- FP-VP-1M
LABORATORY AND PILOT FLAT PACK SEALER
- FP-VP-17
PRODUCTION FLAT PACK SEALER
- FP-VP-11
LSI PACKAGE SEALER

All are built with sophisticated solid state circuitry. You have complete control over the sealing atmosphere, location of heat, time at temperature, and rate of anneal and heat-up.

In the lab sealer, any stage can be suspended or bypassed for experimental purposes.

In the production sealer, you get laboratory precision at production rates (with three to ten independently monitored sealing heads).

And the LSI sealer can seal both medium scale and large scale integration packages. If this is the kind of flexibility you want, write or call your nearest GTI Sales Engineer, or call Major St. John — at (714) 546-0411, GTI Corporation, Dix Division, 1399 Logan Avenue, Costa Mesa, California 92626.



ATLANTIS- ALMOST FOUND



FOUND- A LOW LOSS CAPACITOR THAT MEANS IT

Plato wrote—"Yonder is a real ocean and the land surrounding it may be called... a continent. Now in this land of Atlantis there existed a confederation of Kings which held sway over the many islands and parts of the continent... over Libya as far as Egypt, and over Europe as far as Tuscany." In a less poetic, but still romantic, age—ours, underwater archeologists utilize the newest oceanographic techniques to search for the lost Atlantis. It is surely there. But your search for the perfect low loss capacitor can be ended in one week. It's the ATC 100 Series with low VSWR and IL. $Q = 10,000$ for a 10 pF capacitor @ 100 MHz, thus its equivalent series R = .159 Ohms, and self resonance above C-Band (extremely low inductance). Range: 0.1 pF to 1000 pF in .1" x .1" x .1" case; 7 lead styles including stripline, microstrip, pellet. Your Atlantis Found.

BIBLIOGRAPHY
Chapin, Henry "The Search For Atlantis" Crowell Collier Press 1968. Velikovsky, Immanuel "Worlds In Collision" Macmillan Co. 1950. Plato "The Collected Dialogues, Including The Letters" Random House 1961.

**American
technical
ceramics**

1 NORDEN LANE, HUNTINGTON STATION, N. Y. 11746
516/271-9600 • TWX 510-226-6993

INFORMATION RETRIEVAL NUMBER 72

ICs & SEMICONDUCTORS

Power 0.3-MHz diodes switch in just 15 ns

TRW Semiconductor Div., 14520
Aviation Blvd., Lawndale, Calif.
Phone: (213) 679-4591.

A new family of extremely high-speed power rectifiers permit efficient operation at frequencies in excess of 300 kHz at switching speeds as fast as 15 ns. Two types are available: SVD-4000 which consists of a completely isolated quad with ratings of up to 300 V and 15 A per diode, and SVD-2000 which is a dual diode with ratings of up to 300 V and 30 A per diode.

CIRCLE NO. 268

IC multivibrator reps out to 10 MHz

Raytheon Co. Semiconductor Div.,
350 Ellis St., Mountain View,
Phone: (415) 968-9211.

Providing complementary de-level-sensitive inputs and optional retriggering lockout, a new retriggerable monostable IC multivibrator furnishes a repetition rate of 10 MHz. The RF9601 (military version) and RF8601 (commercial version) provide an output pulse that can be predetermined from 50 ns to infinity by the use of an external resistor and capacitor.

CIRCLE NO. 269

MOS integrated circuit controls TV rasters

Hughes Aircraft Co. MOS Div.,
500 Superior Ave., Newport Beach,
Calif. Phone: (714) 548-0671.
Price: \$15.

The HSUB0525 is an MOS integrated circuit that digitally controls horizontal and vertical raster generation for television receivers. It takes a 1.08-MHz crystal oscillator signal and divides the frequency to produce accurate and stable horizontal, vertical, and composite blanking pulses. Use of this unit eliminates variable resistors and potentiometers.

CIRCLE NO. 270

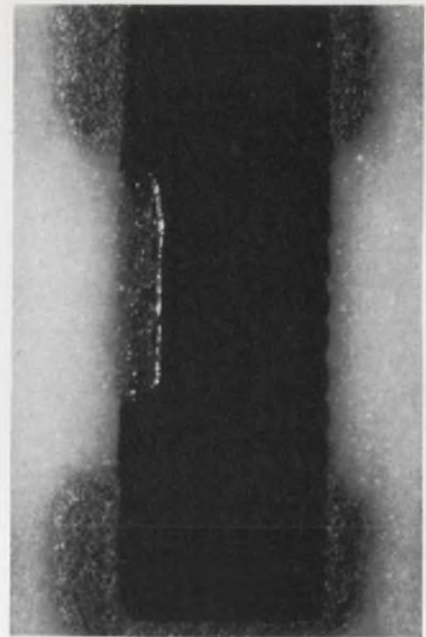

Through thick and thin.

A better IC trim.

Raytheon's SS-218 laser IC trimmer is a self-contained system that trims thick (as shown above) and thin film resistors, capacitors and other deposited materials. It is faster and provides better tolerances than abrasive trimmers. Accuracy is better than 0.1% from 1 ohm to 11 megohms.

The SS-218 operates manually and at pulse rep rates from 1-20 pps with output energy variable to 100 mj at 10 pps and to 50 mj at 20

The SS-218 comes with Yttrium-Aluminum-Garnet laser head, power supply, remote-control operating console, closed-cycle cooler, shielded viewing microscope, micrometer X-Y positioner, automatic resistance measuring bridge, and circuit probes.

For information and applications assistance, contact Raytheon Company, Laser Advanced Development Center, 130 Second Ave., Waltham, Mass. 02154.
Tel. (617) 899-8080.



RAYTHEON

Driver/receiver ICs interface coax cables

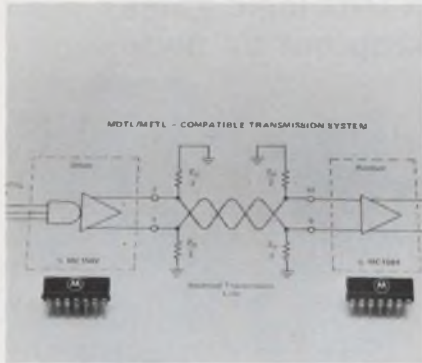

Motorola Semiconductor Products Inc., Box 20924, Phoenix, Ariz. P&A: \$7.50 to \$8.75; stock.

Five new monolithic dual line driver/receivers, MC1580L through MC1584L, satisfy the requirements of driving and receiving digital data in coaxial or twisted-pair transmission lines. They feature high input and output impedances of 5 to 12 k Ω at 10 MHz, propagation delays from 18 to 40 ns and a common mode input voltage range of ± 4 V.

CIRCLE NO. 271

IC computer interface boasts 97¢ price

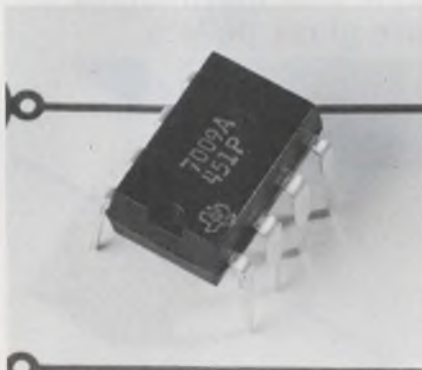

Texas Instruments Inc., 13500 N. Central Expressway, Dallas, Tex. Phone: (214) 238-2011. P&A: 97¢ per 100; stock.

Providing two independent channels, a new IC for computer system interface costs under one dollar in 100-piece quantities. Designated SN75451P, it features internal connection of each output gate with its corresponding transistor base. This allows it to be encapsulated in an eight-pin molded package for added economy and ease of assembly.

CIRCLE NO. 272



Extra short, extra long, regular

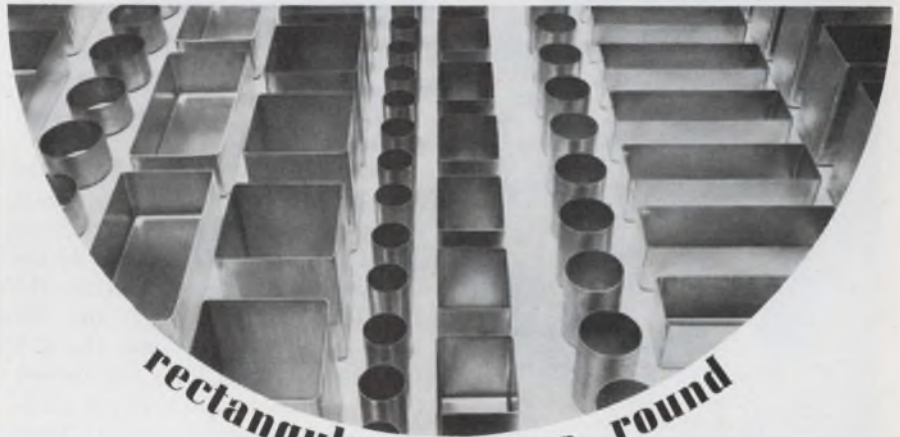

rectangular, square, round

Moorlee has the long and short of it in the box and cover business

You can figure on getting what you want from Moorlee. We have cataloged more tooled sizes and shapes in aluminum boxes and covers than anyone else in the business. Anyone!

Over 200 more sizes in rectangular or square boxes and covers than the manufacturer with the next largest selection. Over 250 more sizes in round boxes and covers. All availa-

ble with the right price and with the right delivery. With no tooling around.

We have complete facilities, too, for all secondary operations as well as for custom tooling. Plus over 25 years experience.

Get hold of our new Catalog. It's all arranged so you can find the right size and shape fast. Send for your free copy and smile.

Moorlee can fit you.



Moorlee Manufacturing Company
120 WEST SLAUSON AVE., LOS ANGELES, CALIFORNIA 90003

INFORMATION RETRIEVAL NUMBER 74

MACRO SPECS. MICRO PRICE.

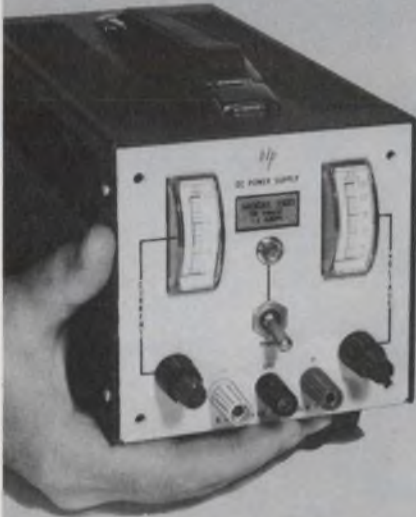

**The Packer 3500 Bench
Supply Gives You Both!
Forty Watts With
.005% Regulation...
Less Than 100 μ v Ripple...
At Prices As Low As \$120**

Six models from 0-6V at 0-5A to 0-120V at 0.3A let you match your needs exactly. All models have constant current or constant voltage output, resistance or voltage programming, remote sensing, may be operated in series or parallel.

And all models have floating output, free from spikes or overshoot on turn-on, turn-off or short removal... current regulation of 0.1%... temperature coefficient better than 0.01%... come in space-saving one-third rack and dual versions in half-rack sizes.

If you're looking for **both** specs and price, check out the Packer 3500. Complete data on request.

B. L. PACKER CO.

5-05 BURNS AVENUE,
HICKSVILLE, N.Y. 11801
(516) 433-4470

blp

INFORMATION RETRIEVAL NUMBER 75

ICs & SEMICONDUCTORS

Four MOS logic arrays simplify circuit design

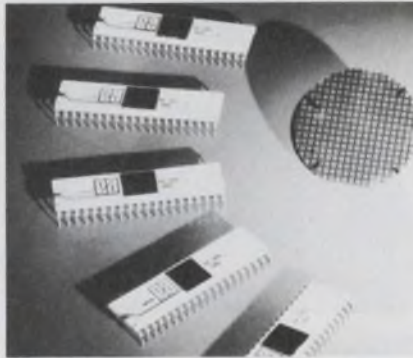

Electronic Arrays, Inc., 501 Ellis St., Mountain View, Calif. Phone: (415) 964-4321. P&A: \$22 to \$37; stock.

A family of four basic DIP MOS arrays makes possible off-the-shelf design of many types of electronic circuits. The family consists of the EA 1800 universal logic array, the EA 1801 control array, the EA 1802 register array and the EA 1803 carry array. They feature low power of 180 to 200 mW per package and propagation delays from 150 to 500 ns.

CIRCLE NO. 273

Zener 1-W glass diodes cover 6.8 to 100 V

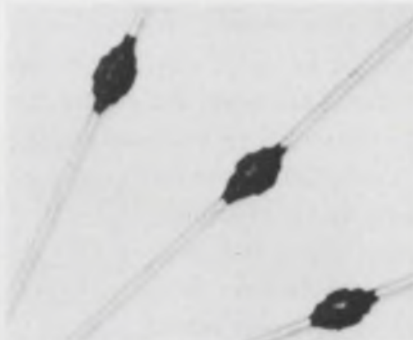

Unitrode Corp., 580 Pleasant St., Watertown, Mass. Phone: (617) 926-0404. P&A: from 71¢; stock.

Types 1N4736 through 1N4764 are a family of industrial fused-in-glass 1-W zener diodes with voltage ratings ranging from 6.8 to 100 V. Their unique construction offers proven reliability and a surge rating five times greater than plastic zeners. Because they are fused-in-glass instead of plastic, humidity and moisture environments present no problem.

CIRCLE NO. 274

NAND logic gates keep out dc noise

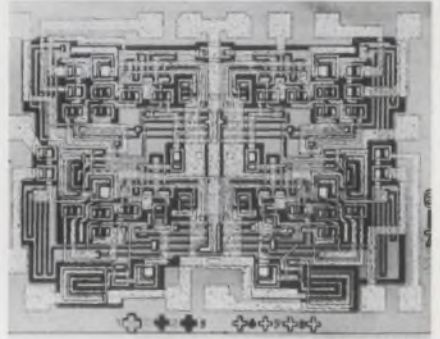

Sylvania Electric Products Inc., Semiconductor Div., 100 Sylvan, Woburn, Mass. Phone: (617) 933-3500. Price: \$3.05, \$2.75, \$3.20.

Models SG393, SG394, and SG395 are monolithic digital high-threshold logic circuits designed to perform NAND gating functions in high-noise environments. SG393 is a quad dual-input NAND gate, and SG394 and SG395 are dual four-input NAND gates. Their dc noise immunity is 15 times that of TTL circuits when operating with an 11.4 to 12.6-V supply.

CIRCLE NO. 275

Low-cost thermistors are glass pellets



Fenwal Electronics Inc., 63 Fountain St., Framingham, Mass. Phone: (617) 872-8841.

Designed for temperature compensation of relays and generators are low-cost thermistor pellets sealed in glass diode-type enclosures. Type PB, PA, and PP units are available in standard resistance values (at 25°C) of 2 k, 5 k, 10 k, 20 k, 50 k, 100 k, 200 k and 500 k Ω , and 1 M Ω . They offer many of the advantages of the glass-coated bead or glass-probe thermistor.

CIRCLE NO. 276

Npn 8-A transistors resist radiation

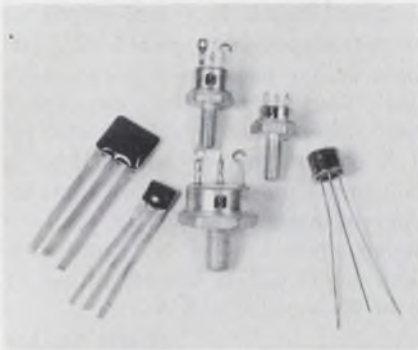

Solitron Devices, Inc., Semiconductor Div., 1177 Blue Heron Blvd., Riviera Beach, Fla. Phone: (305) 848-4311.

Two new series of npn silicon power transistors for radiation resistance feature collector currents of 5 A (series BR200) and 8 A (series BR 300). The unity-gain crossover frequency is 400 and 300 MHz, respectively. Both series accept collector-to-emitter voltages of 100 V and show current gains greater than 15.

CIRCLE NO. 277

Dual n-channel JFETs track within $5 \mu\text{V}/^\circ\text{C}$

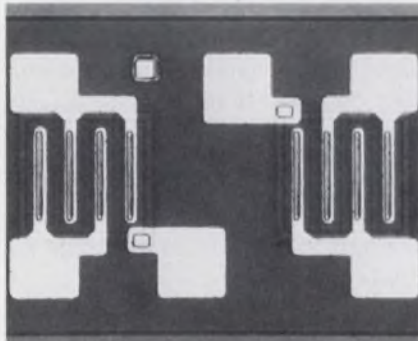

Intersil Inc., 10900 N. Tantau Ave., Cupertino, Calif. Phone: (408) 257-5450. P&A: \$3.20 to \$14.50; stock.

Designated as IMF3954 through IMF3958 is a new series of monolithic dual n-channel JFET chips with tracking to within $5 \mu\text{V}/^\circ\text{C}$. The chips are similar in electrical specifications to the popular 2N-3954 through 2N3958 chips but cost 40 to 60% less. Other features are improved temperature tracking over a range of drain currents.

CIRCLE NO. 278

You get a lot less capacitor for your money...

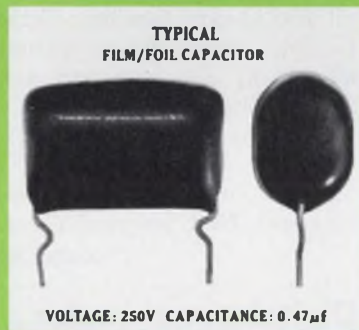

...from Amperex

Until you've seen the Amperex C280 line, you have not seen the smallest fixed film capacitors that the industry has to offer. Now you can get the Amperex C280 series of metallized film capacitors without premium for their miniaturized dimensions and metallized construction. They are competitively priced for radio, TV and other general purpose and consumer electronic applications. Available in off-the-shelf, production quantities, the C280 series encompasses a full range of capacitance values at working voltages of 250, 400 and 630 VDC. There is no additional charge for formed crimped leads.

For further information on the entire C280 line, including metallized polyester and metallized polycarbonates, write: Amperex Electronic Corporation, Component Division, Dept. C, Hauppauge, New York 11787... or phone 516-234-7000.

Amperex®

TOMORROW'S THINKING IN TODAY'S PRODUCTS
A NORTH AMERICAN PHILIPS COMPANY

Military Power

ERA supplies it off the shelf!

ERA CERTIFIED MIL SPEC POWER MODULES FULLY MEET OR EXCEED:

MIL-E-4158, MIL-E-5400, MIL-E-16400,
MIL-E-5272, MIL-T-21200, MIL-E-4158

- no engineering or prototype costs
- checked, approved and certified
- minimum cost for single or quantity orders
- fast delivery
- 77 proven and tested models
- repairable 75°C silicon types
- encapsulated types
- hundreds of variations in each group

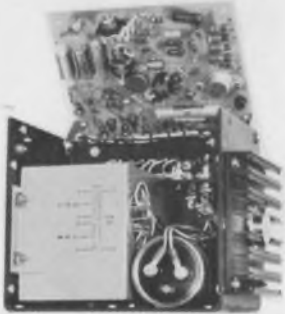

Satisfy your most exacting military requirements with off-the-shelf certified ERA Mil Spec DC power modules. Choose from 77 stock models. Proven designs... no engineering or prototype costs AND, you get certification from one of America's leading independent testing laboratories.

Write for free informative booklet describing tests and results along with the ERA catalog.

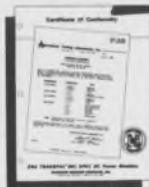

ELECTRONIC RESEARCH ASSOCIATES, INC.

67 Sand Park Road, Cedar Grove, N.J. 07009 • (201) 239-3000

SUBSIDIARIES:

ERA Acoustics Corp. • ERA Dynamics Corp.
Astrocom Inc. • The Magitran Company

INFORMATION RETRIEVAL NUMBER 77

INSTRUMENTATION

Dual 50-W power supply operates in two modes



General Dynamics, Electronics Div., Dynatronics Operation, P.O. Box 2566, Orlando, Fla. Phone: (305) 838-6161.

The model 6228B is a dual-output dc power supply with two 50-W outputs in one package that can operate independently, or can track each other. Each 0-to-50-V at 0-to-1-A output can be operated as a constant-voltage or as a constant-current supply. Each has its own independent overvoltage protection. The model 6227B has an output of 0 to 25 V at 0 to 2 A.

CIRCLE NO. 279

Hewlett-Packard, 1501 Page Mill Rd., Palo Alto, Calif. Phone: (415) 326-7000. P&A: \$450; 6 wks.

Model 6228B is a dual-output dc power supply with two 50-W outputs in one package that can operate independently, or can track each other. Each 0-to-50-V at 0-to-1-A output can be operated as a constant-voltage or as a constant-current supply. Each has its own independent overvoltage protection. The model 6227B has an output of 0 to 25 V at 0 to 2 A.

CIRCLE NO. 279

Portable IC card tester checks all digital ICs



Digital panel meter consumes just 6 W



Weston Instruments, Inc., a Schlumberger Co., 614 Frelinghuysen Ave., Newark, N.J. Phone: (201) 243-4700.

Occupying less than seven square inches of panel space, a new digital panel meter cuts power consumption to less than 6 W with its novel time-sharing circuitry. Model 1294 is a bipolar 4-1/2-digit instrument with a sensitivity of 10 μ V on its 100-mW range. Accuracy for the unit is $\pm 0.05\%$ of reading, ± 1 digit, $\pm 10 \mu$ V.

Occupying less than seven square inches of panel space, a new digital panel meter cuts power consumption to less than 6 W with its novel time-sharing circuitry. Model 1294 is a bipolar 4-1/2-digit instrument with a sensitivity of 10 μ V on its 100-mW range. Accuracy for the unit is $\pm 0.05\%$ of reading, ± 1 digit, $\pm 10 \mu$ V.

CIRCLE NO. 281

Philips Electronic Instruments, 750 S. Fulton Ave., Mt. Vernon, N.Y. P&A: \$2775; 30 days.

Variable-sampling scope has 1.7-GHz bandwidth



Displaying continuously variable control of sampling speeds of 10, 100 and 1000 samples/cm is the new PM3400 dual-trace oscilloscope with a vertical-amplifier rise time of 200 ps (bandwidth of 1.7 GHz). It provides continuously variable sampling and eliminates external triggering. Manual and one-shot scanning at 5 to 60 seconds/sweep are possible.

CIRCLE NO. 282

Sweeper/counter combo marks as it sweeps



Kay Elemetrics Corp., 12 Maple Ave., Pine Brook, N. J. Phone: (201) 227-2000. P&A: \$1295; 4 wks.

Combining a 115-MHz counter and a variable marker to count and mark its output while it is sweeping, the 8323A sweeper generator provides settability and readability of $\pm 0.25\%$ of sweep width. Three independent variable markers mark and count any point in the sweeper range of 100 seconds/sweep to 100 sweeps/second either vertically or horizontally.

CIRCLE NO. 283

Low-cost logic probe checks levels in colors



AP Inc., 72 Corwin Dr., Painesville, Ohio. Phone: (216) 357-5597. P&A: \$35; stock.

Indicating with a green light for logic level 0 from 0 to 0.6 V and a red light for logic level 1 at 2.4 V and above, a new low-cost logic probe permits testing of DTL, TTL and other logic systems. Pulses as narrow as 30 ms at rates of 30 pulses/s can be detected. It has two probes, one male and one female, and draws a maximum power of 60 mA at 5 V from the circuit under test.

CIRCLE NO. 284

WE'VE GOT A BETTER WAY TO MAKE PRINTED CIRCUITS!



MERCURY



GEMINI



APOLLO



New techniques developed to make circuit boards more reliable.

The Printed Circuits Operation of CDC used a unique etch-back technique for producing reliable multi-layer circuitry for the Mercury project. Its success is indicated by the fact that the same techniques were used in the Gemini and Apollo projects without design change . . . millions of inter-facial connections with no known failures.

Designs ranged from double-sided circuitry to complex 15-layer circuit boards . . . using sequential laminating, extra fine line width and spacing, and plated slots and edges . . . and were used for systems control telemetry, hi and low level multiplexer, command module telemetry, LEM flight control system, and the seismograph experiment.

The Mercury-Gemini-Apollo program demonstrates our capability for the design and production of high quality circuit boards. Hundreds of other projects use our circuit boards in many phases of civilian and military equipment. We've got a better way to make printed circuitry.



F-104

Developed new technique to produce circuit boards with more reliable plated-thru holes.



C5

We introduced circuit boards that had the highest density circuitry ever used before on a production basis.



F-111

New industry technique was used to produce multilayer circuit boards with an internal heat sink.



PHOENIX

Required new techniques for manufacturing heat sinks and insulation by chemical milling.



707

Reliable circuit boards in high volume at low cost were produced for this project.



POSEIDON

Developed new technology for sequential laminating multi-layer circuit boards with aluminum backbone.



This design and production experience can work for you . . . CALL US NOW.

CONTROL DATA
CORPORATION

CONTROL DATA CORPORATION
PRINTED CIRCUITS OPERATION
7800 COMPUTER AVENUE
MINNEAPOLIS, MINN. 55435
PHONE: (612) 927-5681

Function generators span 0.5 mHz to 10 MHz



Interstate Electronics Corp., sub. of A-T-O, Inc., P.O. Box 1137, Anaheim, Calif. Phone: (714) 772-2811.

Four new function generators, models F52 through F55, operate over the frequency spectrum of 0.0005 Hz to 10 MHz and produce outputs of variable-width pulse, sine, square, triangle, ramp, and fixed-duty-cycle pulse waveforms. A continuously variable offset as well as analog voltage control over frequency and pulse duty cycles are standard features.

CIRCLE NO. 285

Eight-digit counter is fully programmable



Dana Laboratories, Inc., 2401 Campus Dr., Irvine, Calif. Phone: (714) 833-1234.

Measuring frequencies up to 500 MHz, model 8134 counter/timer forms a complete systems interface for computerized checkout and control systems. All controls of this eight-digit instrument, including attenuator setting, trigger level, input coupling, function, and measurement time can be programmed with BCD codes. Remote programming inputs and BCD outputs are TTL compatible.

CIRCLE NO. 286

Waveform generator uses VCO as source



Exact Electronics, Inc., P.O. Box 160, Hillsboro, Ore. Phone: (503) 648-6661. P&A: \$495; stock to 30 days.

Operating over the frequency range of 0.1 Hz to 3 MHz, model 126 two-in-one waveform generator features a voltage-controlled frequency source and an internal linear sweeping source. The unit produces sine, square, triangle, ramp, pulse and sync waveforms. It can operate in any one of six modes: run, gate, triggered, burst, pulse and sweep.

CIRCLE NO. 287

**What Sam Colt did to the arms industry...
Tetra is doing to the memory business**

Here is Tetra's line of compact, high quality MEMORY SYSTEMS. One of these should fit your application.

ALPHA 10.2	ALPHA 12.2	ALPHA 10.3	ALPHA 12.4
1024 x 10	4096 x 10	2048 x 12	4096 x 12 to 20
1024 x 9	4096 x 9	1024 x 12	2048 x 12 to 20
1024 x 8	4096 x 8	512 x 12	1024 x 12 to 20
512 x 10	2048 x 10	256 x 12	16384 x 12 to 20
512 x 9	2048 x 9	1024 x 24 to 48	8192 x 12 to 20
512 x 8	2048 x 8	512 x 24 to 48	4096 x 24 to 40
1.5 usec full cycle	1.75 usec full cycle	1.5 usec full cycle	1.75 usec full cycle

Call collect! We'll ship you a prototype the same day!

Of the people who have actually mass produced memories, Tetra's doing it best! Mass production gives the obvious advantages of price, maintainability, and consistent quality... plus immediate delivery.



7309 WASHINGTON AVE. SO.
MINNEAPOLIS, MINN. 55435
PHONE (612) 941-5450

**Low-cost display scope
plots 0.005 to 50 V/cm**

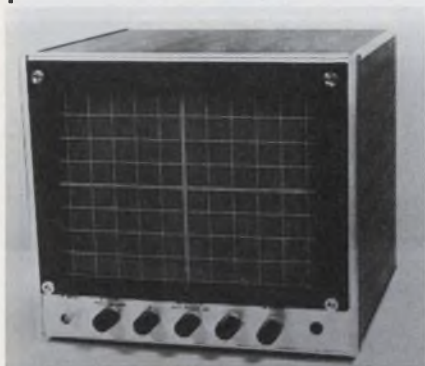

Telonic Industries, Inc. 21282 Laguna Canyon Rd., P.O. Box 277, Laguna Beach, Calif. Phone: (714) 494-9401. P&A: \$395; stock.

Incorporating a bright 11-in. screen marked with 2-cm squares for easy clear viewing is a new low-cost display oscilloscope with variable sensitivity from 5 mV/cm to 50 V/cm. This is provided by dc-coupled solid-state vertical and horizontal amplifiers. Model 101 can display all types of swept frequencies and measurements.

CIRCLE NO. 288

**Low-cost FET-input VOM
shows input of 11 MΩ**



Dynascan Corp., 1801 W. Belle Plaine Ave., Chicago, Ill. Phone: (312) 327-7270. P&A: \$99.95; stock.

Measuring voltage, current and resistance, the B&K 176 low-cost FET VOM has an input impedance of 11 MΩ. It measures dc and ac rms voltages from 0.5 to 1500 V full scale in 8 ranges at accuracies of ±2% and ±3% of full scale, respectively; ac pk-pk voltages from 1.5 to 5000 V in 8 ranges and resistance from 1 Ω to 1 GΩ full scale.

CIRCLE NO. 289

Now choose either

PLASTIC

or

GLASS

FIBER OPTICS

from

WELCH ALLYN

For minimum cost (as in disposable products) or for maximum bundle flexibility, check the advantages of fiber optics assemblies or systems made with Welch Allyn's newly developed *plastic* fibers.

For high precision work, where infra-red light transmission is important, or where fiber optics are exposed to high heat, our *glass* fibers are normally still preferable.

COORDINATED FIBER OPTICS/LAMP SYSTEMS

Glass or plastic, your fiber optics system will have maximum optical performance with custom-built, precision Welch Allyn miniature lamps.

Ask us about your glass or plastic fiber optics assemblies or lamp/fiber optics systems.



Welch Allyn, Inc., Skaneateles Falls, N. Y. 13153 Tel (315) 685-5788

FLEX KEY[™]

a new concept
in
KEYBOARDS

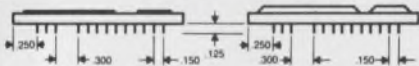

A beautifully simple, proprietary* structure comprised of a "button" surface, a conductive elastomeric membrane, an aperture film, and a printed circuit board . . . sealed together into an integrated module which provides:

- VERY LOW COST (AS LITTLE AS \$5.80 IN QUANTITY)
- BOUNCELESS OPERATION
- LONG LIFE (ORDER OF 50 MILLION CYCLES)
- NO MECHANICAL WEAR OR DEGRADATION
- DIRT AND MOISTURE PROOF
- SPACE AND WEIGHT SAVING
- SIMPLE INSTALLATION

FLEX KEY is compatible with DTL, TTL, and MOS logic interfaces. Evaluation units available from stock: \$9.95 (1-24) for DK-1L; \$12.95 (1-24) for DK-1M

*U.S. & Foreign Patents Pending

FLEX KEY[™]

CORPORATION

1277 MAIN ST., WALTHAM, MASS. 02154

(617) 891-1320

DATA PROCESSING

Graphics system runs four displays



Tektronix, Inc., P.O. Box 500, Beaverton, Ore. Phone: (503) 644-0161. P&A: \$7850; third quarter, 1970.

Besides the ability to drive as many as four display devices, a new graphic display system features zooming, augmenting, scaling, and multiple software and interrupt controls. Model T4005 also has status controls, and positioning controls that offer two methods for setting a portion of the display. The unit can be interfaced to most computers.

CIRCLE NO. 291

Sixteen-bit computer is just 1-3/4-in. high

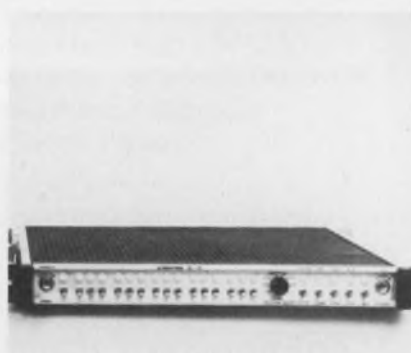

Datamate Computer Systems, Inc., P.O. Box 310, Big Spring, Tex. Phone: (915) 267-6353. P&A: from \$5900; August, 1970.

Measuring only 1-3/4 by 19 by 20 in., a new 16-bit digital computer is said to have a computational power that far surpasses its small size. Model 70 is designed for on-line data acquisition, control and monitoring, time sharing, automatic testing, and instrumentation, data concentration and educational applications.

CIRCLE NO. 292

power grows where Faratron goes...



All Faratron modules provide the ultimate in reliability and ruggedness. Designed especially for OEM systems employing the latest semiconductor devices. The FR series Power Supplies are available in six case sizes. Output voltage of 3 to 150 VDC available in each case size.

All units feature remote sensing and programming, plug in regulator board, adjustable overload protection with automatic recovery, and a unique self cooling heat sink especially designed to permit reliable operation at 71°C with currents up to 34.0 amperes.

Additional specifications include: line regulation, 0.01% (105-132 VAC); load regulation, 0.01% (no load-full load); ripple, 0.5 mv rms (3 mv peak to peak); temperature coefficient, 0.02%; and response time of 20 microseconds.

PRICE RANGE \$105.00-\$345.00.

For additional information contact . . .

FARATRON CORP.

290 Lodi Street, Hackensack, N. J.

(201) 488-1440



CRT display terminal can vary data rate



Hazeltine Corp., Little Neck, N.Y.
Phone: (212) 321-2300. Price:
\$2995.

Intended to serve a wide range of computer operating environments, a new desktop CRT display terminal provides selectable transmission rates as well as full and half-duplex operation. Model 2000 features a flicker-free 1998-character display, and offers both split-screen and flexible editing capabilities, including character and line insertion and deletion.

CIRCLE NO. 293

Minicomputer with bus mixes memory types



Computer Development Corp., 3001
S. Daimler St., Santa Ana, Calif.
Phone: (714) 557-9720. Price:
from \$3490.

In addition to low cost, a new minicomputer, model 200, features a universal bus that provides an asynchronous memory interface, permitting various sizes, speeds and types of memory to be used. This intermixing of more than one kind of memory in a single computer provides corresponding control of processor speed and instruction execution time.

CIRCLE NO. 294

Our B 5000 series. It's cheaper than a chip.



If you're into hybrids or miniaturized circuits, standard power transistors are too large.

Yet chips are too delicate and require assembly and handling procedures that cost you time and money.

Enter Solitron's mesa-construction silicon NPN B 5000 series.

The smallest power transistor available for hybrid use this side of a transistor chip, yet unlike a chip—it's rugged and reliable.

In the end, it's less expensive.

Solitron DEVICES, INC.

256 OAK TREE ROAD, TAPPAN, NEW YORK
PHONE (914) 359-5050/ TWX: 710-576-2654/ TELEX: 13-7346

SCHAUER

1%

tolerance

1 WATT ZENERS ARE A REAL BUY!

ANY voltage from 2.0 to 16.0
at the industry's **LOWEST
PRICES!**

Quantity	Price each
1-99	\$1.07
100-499	.97
500-999	.91
1000-4999	.86
5000 up	.82



THE HI-RELIABLE!

No fragile nail heads.
Silicon junction aligned between two, parallel, offset tantalum heat sinks . . . great lead tension strength.

All welded and brazed assembly.

High pressure molded package.

Gold plated nickel-clad copper leads.

Write or phone for Form 68-4 for complete rating data and other tolerance prices.

Semiconductor Division

SCHAUER MANUFACTURING CORP.

4511 Alpine Avenue
Cincinnati, O. 45242
Ph. (513) 791-3030

DATA PROCESSING Eight-bit computer carries \$3000 tag



Monitor Data Corp., 17805 Sky Park Drive, Irvine, Calif. Phone: (714) 540-4812. Price: \$3000.

Including its central processing unit, a new eight-bit 1.6- μ s general-purpose minicomputer sells for less than \$3000 in quantities of 25. The MD708 features a 1024-word eight-bit core memory, power supply, control panel, and a desk or rack cabinet. Its memory is expandable to 65k words. I/O interfacing and all the standard peripherals are available.

CIRCLE NO. 295

Calculator trio stress versatility



Singer Co., Friden Div., 2350 Washington Ave., San Leandro, Calif. Phone: (415) 357-6800. P&A: \$935 to \$1495; stock.

Three new electronic calculators include: the 1166 for \$935 with a mini-CRT display; the 1154 for \$1095, which gives fast answers plus a printed record; and the 1152 programmable printing calculator with a direct square-root function for \$1495. The 1166 calculates in milliseconds and always displays two calculation factors.

CIRCLE NO. 296

Cassette recorder pulls just 150 mA



Compucord Inc., 225 Crescent St., Waltham, Mass. Phone: (617) 891-0080.

Drawing only 150 mA while in operation, a new battery-operated industrial-grade digital cassette recorder offers true bit-by-bit incremental capability. The Computette 1100DC writes at speeds up to 400 steps per second, and rewinds at speeds of 30 inches per second. Its packing density is 200 bits per inch. The 5 by 4 by 2-in. unit weighs only 30 ounces.

CIRCLE NO. 297

Compact calculator handles 12 digits



Canon U.S.A., Inc., 64-10 Queens Blvd., Woodside, N.Y. Phone: (212) 478-5600. Price: \$750.

Comparable in size to a small portable typewriter, a new desktop electronic calculator is a 12-digit machine that weighs only 8-1/2 pounds and measures 10-1/2-in. wide by 13-in. deep. Besides a standard memory system, model 121 also has a constant memory for constant multiplication and division. The unit can perform both positive and negative automatic accumulations.

CIRCLE NO. 298

FAREWELL

In case you haven't noticed, Fairchild has modified a long-standing posture against "second sourcing" (last month's editorial "Farewell NIH" pretty well spelled this out).

A one-sentence summary of our new position would read like this:

If a linear circuit — any linear circuit — is worth making, we're going to make it, regardless of its point of origin.

Got the point? Fine. Now hear this:

EDITORIAL

Fairchild doesn't make "The Super" Op Amp. Here's why:

There has never been, isn't now, and probably never will be a *true* ultimate op amp.

Ideal op amps exist only in textbooks. They can't cut the mustard in the real world of systems design where trade-offs like slew rate vs. power consumption or common mode rejection vs. input current make the critical difference.

Then there's dollars. Cost vs. performance. A \$60 or a \$28 or even a \$15 super-beta, or FET, or high-gain, or whatever-you-call-it op amp simply isn't going to make it past an experienced designer very often (except as a tinkerer's toy). Who wants to live with the dual problem of paying too much in order to lose design flexibility?

Smart engineers want options. They want to meet many different system requirements. And there's only one answer to this type of requirement:

A complete family of op amps.

Not just one or two devices which are obsoleted quickly by higher priced "A" versions. Not a "complete line" of three or four circuits. Modern systems can't be built with just a hammer and a saw. It takes a complete tool kit.

We offer a true family of op amps. A tool kit of fifteen separate circuits. At the base of our family is a solid core of low cost general purpose op amps to meet 80% of your system's requirements. On top of these, we have a complete set of complementary special purpose amplifiers designed for various combinations of low input currents, high accuracy, high speed, low power, temperature stability or high CMRR.

It's conceivable, we admit, that some day in the future there will be a true, ultimate, universally useful, supercalifragilistic op amp. We're looking for it inside Fairchild. And outside Fairchild. If we find it, we'll build it. And if we do, you can count on not having to compromise either system design or cost/performance to use it.

Op Amp Digest

Below you'll find the Fairchild op amp family. A circuit for every application. A trade-off for every system. A price for every parts list. Everything except a "super op amp" (see cover editorial to find out why). You can order additional information via the reader service numbers listed below.

μ A715 – High Speed Op Amp
 100 V/ μ S Unity Gain Inv. Slew Rate
 300 nS Settling Time
 65 mHz Bandwidth
 70 nA Offset Current
 Reader Service Number 211

μ A725 – Instrumentation Op Amp
 0.5 μ V/ $^{\circ}$ C Voltage Drift
 128 dB Voltage Gain
 120 dB Common Mode Rejection
 0.6 pA/V \sqrt Hz Input Noise Current
 Reader Service Number 212

μ A727 – Temperature Stabilized Preamp
 2 pA/ $^{\circ}$ C Offset Current Drift
 0.6 μ V/ $^{\circ}$ C Offset Voltage Drift
 300 M Ω Input Resistance
 2 nA Offset Current
 Reader Service Number 213

μ A735 – Micropower Op Amp
 100 μ W Power Consumption
 500 pA Offset Current
 10 M Ω Input Resistance
 Wide Supply Voltage Range
 Reader Service Number 214

μ A739 – Dual Low Noise Op Amp
 2.0 dB Noise Figure
 86 dB Voltage Gain
 \pm 13 V Output Swing
 Wide Bandwidth
 Reader Service Number 215

μ A740 – FET Input Op Amp
 10¹² ohms Input Impedance
 80 pA Input Bias Current
 6 V/ μ S Slew Rate
 Internal Frequency Compensation
 Reader Service Number 216

μ A741 – General Purpose Internally Compensated Op Amp
 200,000 V/V Voltage Gain
 Short Circuit Protected
 Latch-up Proof
 \pm 30 V Differential Input Voltage
 Reader Service Number 217

μ A747 – Dual Internally Compensated Op Amp
 Short Circuit Protected
 Latch-up Proof
 \pm 30 V Differential Input Voltage
 200,000 V/V Voltage Gain
 Reader Service Number 218

μ A748 – General Purpose Externally Compensated Op Amp
 Short Circuit Protected
 Latch-up Proof
 \pm 30 V Differential Input Voltage
 200,000 V/V Voltage Gain
 Reader Service Number 219

μ A749 – Dual General Purpose Op Amp
 92 dB Voltage Gain
 20 mHz Bandwidth
 Latch-up Proof
 Short Circuit Protected
 Reader Service Number 220

μ A777 – Precision Op Amp
 30 nA Input Bias Current
 1.5 nA Input Offset Current
 Low Offset Voltage and Current Drift
 Short Circuit Protected
 Reader Service Number 221

SAVE
\$6.05

Bargain Corner

SAVE
\$6.05

Keep your eyes peeled for this space. Almost every month it will carry glad tidings of new prices. Here's one for openers:

Four Quadrant Analog Multiplier

μ A795C – was \$12.00 now \$5.95*

(Don't miss new prices on μ A742 TRIGAC – see facing page)

SAVE
\$6.05

*Price based on 100 pieces.

SAVE
\$6.05



Hot Off the Press

You can take it with you. We've just published an all-new Fairchild Linear Condensed Catalog. It's pocket sized so that you can lug it around with you. For a free copy, use reader service card number below:

Reader Service Number 222

WIN
\$100

Win Fame and Fortune

WIN
\$100

Fill in this box.
(Your circuit here)

By now you ought to be down to the final strokes of preparing your entry in our recently announced Linear Applications Contest. Here are the rules, remember?

1. Get all the facts on a Fairchild Linear IC.
2. Design the world's greatest application for it.
3. Send to: Fairchild Linear Contest, P.O. Box 880A Mountain View, California 94040.

WIN
\$100

All entries will be judged by the editors of EEF Magazine. Every month, they will select the most imaginative application and give us the designer's name. We'll publish the winning design and give the winner \$100 upon publication. Ready. Set. Design!

WIN
\$100

TRIGAC PRICE REDUCTIONS THREAT TO MECHANICAL SWITCHES & RELAYS.

New prices on Fairchild's μ A742 "TRIGAC" make replacement of

troublesome electro-mechanical components a reality. Countless

applications are now economical (oven and room temperature controls, ON-OFF motor controls, level detectors, fan controls, etc.).

New μ A742 Prices:
@ 100 was \$4.95 now \$2.35.
Special new 1000 piece price \$1.95.
Immediate shipment available from stock.

μ A742 "TRIGAC"—Powerful Solution to Power Control Problems

Electrical Performance/Features

- Operation directly from DC or AC 50 Hz to 440 Hz (24 VAC to 440 VAC).
- Bridge Sensing with adjustable Hysteresis.
- Minimizes RFI with Resistive or Inductive Loads.
- Large Output Pulses — 1 Ampere Peak.
- Minimum external components required.
- High Noise Immunity.
- No electrolytic capacitors required for most applications.

The μ A742 Zero-crossing AC Trigger performs all the signal-processing required to provide precision control of large loads by small

sensors, while eliminating RFI problems by switching at the zero-crossings of the load current. Additional features are the internal provision for time-proportioning and dead-band control, plus an internally regulated supply for operation directly from the power line. One ampere output pulses trigger even large thyristors directly. Half-cycle firing with resultant DC in the load is prevented by special internal logic design.

Here's an example of what the "TRIGAC" can do:

3 PHASE ZERO-CROSSING DUAL-THRESHOLD TEMPERATURE CONTROLLER 208 V 3 ϕ 60-

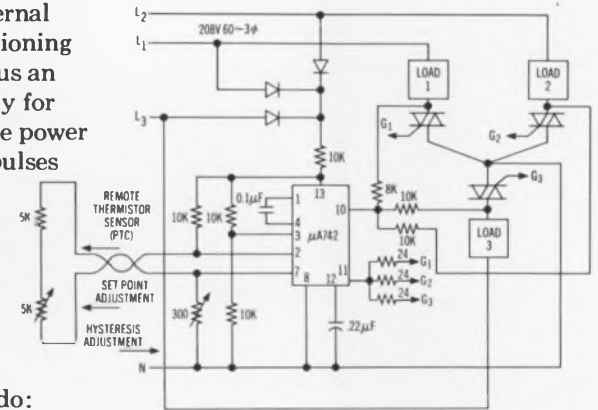

Micropower Exists— μ A735

Minimizing power drain, weight and space gives design engineers ulcers (how come the system power supply designer is the last one to know you've overrun the allotted system power consumption?).

Here's good news. Relief exists: The μ A735 micropower operational amplifier uses only 100 μ W at \pm 3.0 volts.

Systems such as space vehicles, aircraft, and portable medical equipment will benefit from the use of the μ A735 by shrinking bulky batteries. It gives you low quiescent currents. It also gives you versatile, accurate and cool operation without the customary design tradeoffs.

In addition, the μ A735 simplifies design of high impedance instrumentation circuits due to its extremely low input currents.

Here are some typical device specifications:

input offset current	500 pA
input bias current	5.0 nA
input offset voltage	1.0 mV
supply voltage range	\pm 3 volts to \pm 18 volts
power consumption	100 μ W
open loop voltage gain	20,000
input impedance	10 m Ω
noise	.5 pA / $\sqrt{\text{Hz}}$

Smart engineers who like to minimize component count, can now take advantage of a new simplified frequency compensation scheme that applies over the entire supply voltage range of the μ A735.

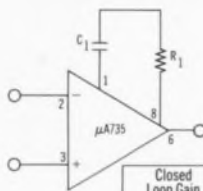

Closed Loop Gain	C ₁	R ₁
1	20nF	110 Ω
10	2nF	1.1k Ω
100	680pF	11k Ω

Most engineers like to eliminate those large, expensive, hard-to-find capacitors that hog space and dollars. Here's a nifty little application which will avoid large capacitors in low frequency, active filter design. And with very low supply current drain!

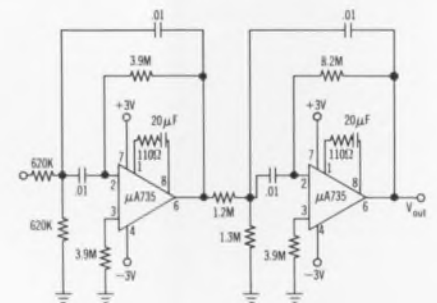

This circuit has a center frequency at 10 Hz, 12 dB rolloff with -3 dB points at 6.5 Hz and 14 Hz. The μ A735 lets you use small capacitor values and large resistors for frequency shaping at a few Hz, due to the μ A735's low input offset current.

The new price is low, too —

μ A735 -55°C to $+125^{\circ}\text{C}$ \$30.00 @ 100
 μ A735B -20°C to $+85^{\circ}\text{C}$ \$22.50 @ 100
 μ A735C 0°C to $+70^{\circ}\text{C}$ \$15.00 @ 100

See? Micropower does exist; alive and in quantity at your Fairchild distributor.

High-speed plotter minimizes commands



Omega-t Systems, Inc., 300 Terrace Village, Richardson, Tex. Phone: (214) 231-5121.

Combining solid-state control circuitry with an analog recorder, the Fasplot plotter can rapidly (10 inches per second) draw a straight line in any direction with a minimum number of commands. The unit has an automatic segmenting mode that may be selected for either the X or Y axis. This enables the plotter to quickly create graphs composed of preset equal increments.

CIRCLE NO. 340

General Electric Co., Telecommunication Products Dept., P.O. Box 4197, Lynchburg, Va. Phone: (703) 846-7311.

Allowing efficient utilization of peripherals and terminals associated with complex information systems, the TDM-330 short-haul data set lets printers, readers, plotters and even minicomputers operate at their rated speed. The unit provides transmission speeds of 2400, 4800 or 9600 bits per second over four-wire circuits.

CIRCLE NO. 341

Fast data modem matches peripherals



Atlantic Scientific Corp., Plainview, N.Y.

Truly a full computer interface, the model 1003 data terminal can operate unattended for 24 hours while transmitting in any desired language to a computer. In addition, the unit performs the functions of data collection and storage, and accounting and verification. It uses a seven-channel tape cartridge to send up to 150 characters per second. The cartridge can store 100,000 characters.

CIRCLE NO. 342

Data terminal works unattended



Baganoff Associates, Inc., 6809 W. Florissant Ave., St. Louis, Mo. Phone: (314) 383-2432. Price: \$290/month.

The RDT (Random Data Telecom) is a complete time-sharing telemetry system designed to transform any test facility into a complete data processing center. The unit, which is housed in two compact portable cabinets, transmits acoustically over ordinary voice-grade telephone lines. It accommodates from 1 to 80 analog signals simultaneously.

CIRCLE NO. 343

Telemetry system is data center



Portable printer mates with Teletype



Computer Devices, Inc., 167 Albany St., Cambridge, Mass. Phone: (617) 492-4455. P&A: \$1800; 30 days.

Designed primarily for time-sharing and minicomputer applications, a portable multiple-copy printer is directly compatible with the Teletype model 33 in code, format and keyboard. Model 1010 includes: an integral acoustic coupler, a simplified impact printing mechanism that needs no standby power and prints three copies, and internal storage of fan-folded paper.

CIRCLE NO. 344

Memory peripherals handle discs or tape



Data Systems Design, 1122 University Ave., Berkeley, Calif. Phone: (415) 849-1102. Price: \$7000 to \$11,000.

Two new series of peripheral memory subsystems—one for disc cartridge and the other for magnetic tape storage—are now available for use with a number of minicomputers. The series 130 disc cartridge memories contain a microprogrammed controller. The series 140 magnetic tape memories incorporate IBM-compatible synchronous-write/synchronous-read tape transports.

CIRCLE NO. 345

COMPONENTS

Transistor transformer is a ten-lead flatpack

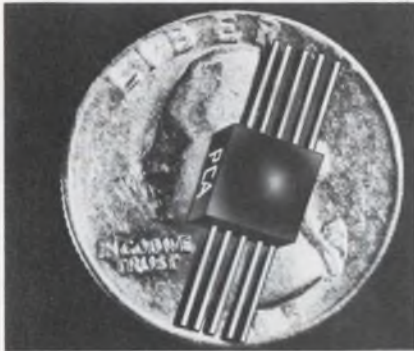

PCA Electronics, Inc., 16799 Schoenborn St., Sepulveda, Calif. Phone: (213) 892-0761. P&A: \$15; 2 to 6 wks.

Designed to drive transistor switches such as those used in computer memory circuits, a new temperature-stable transformer comes in a flatpack configuration. Its operational stability covers the temperature range of -35 to +105°C and it contains three windings with ratios of 1:1:1. It has ten gold-plated ribbon-style leads.

CIRCLE NO. 346

Current sensors react in 40μs

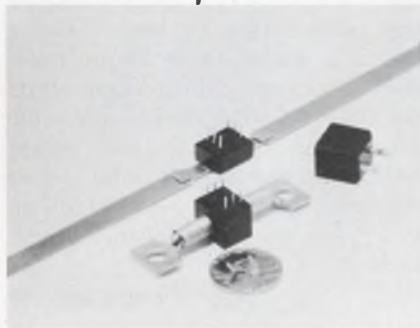

Hudson Corp., Box 867, Manchester, Vt., Phone: (603) 669-8570. P&A: \$26 to \$40; stock to 3 wks.

A new line of magnetically sensitive high-speed transistors that put out a voltage analog of the currents they sense respond with speeds up to 40 μs. Series HM-2000 sensors are available to measure ac or dc currents in three ranges: 0.05 to 2, 2 to 50 and 50 to 4000 A. They operate from ±5 to ±15 V dc and dissipate less than 700 mW of power.

CIRCLE NO. 347



Simpson's new 2700.

Versatile Digital System:

- New, fast warm-up*
- 4½ digits
- 0.05% accuracy
- 5 plug-in function modules

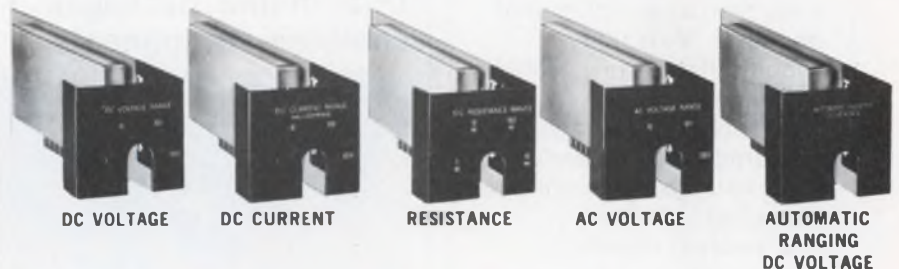

- Automatic Polarity Selection
- Built-in Self Calibration
- 100 Microvolt Resolution
- Optional BCD output
- IC Modular Design for reliability

2700 DIGITAL SYSTEM \$615⁰⁰
complete with DC voltage range module, test leads, and operator's manual

AVAILABLE "OFF-THE-SHELF" AT ELECTRONIC DISTRIBUTORS STOCKING SIMPSON INSTRUMENTATION PRODUCTS.

Simpson ELECTRIC COMPANY



5200 W. Kinzie Street, Chicago, Illinois 60644 • Phone (312) 379-1121
Export Dept: 400 W. Madison Street, Chicago, Illinois 60606. Cable Simelco
IN CANADA: Bach-Simpson Ltd., London, Ontario • IN INDIA: Ruttonsha-Simpson Private Ltd., International House, Bombay-Agra Road, Vikhroli, Bombay

INFORMATION RETRIEVAL NUMBER 85



The 10.7 MHz Flatpack—solves sticky filter problems

You name it and Comline® Flatpack integrated crystal filters have got it. **Size?** Less than one-sixth that of standard. **Versatility?** Mounts flat for low profile (.22 in.) or on edge for minimum board space. **Performance?** Beautiful! Two, four, six and eight-pole response. Monolithic and tandem monolithic construction for maximum stopband attenuation. **Price?** Unbeatable! Six-pole flatpack — \$22.82, 1-4 pcs. Much, much less in production quantities.

Standard Comline Flatpack bandwidths—13 and 30 kHz. Other bandwidths on request. Conventional 10.7 MHz filter packages also available.

Pi

Plezo Technology Inc.

2400 Diversified Way
Orlando, Florida 32804
305-425-1574

a subsidiary of Walter Kidde & Company, Inc.



COMPONENTS

Chip resistor line covers 10 Ω to 5 MΩ



Tecnetics, Inc., Box 910, Boulder, Colo. Phone: (303) 442-3837. P&A: \$10.95; stock.

The Limitran is a new component in a DO-13 case similar in size and action to a zener diode but able to handle surges as high as 600 V. When installed across the input of a power supply it limits transients and protects voltage-sensitive circuits. If transient duration is abnormally long, the Limitran fails by shorting, thus continuing circuit protection.

CIRCLE NO. 349

Dual-in-line packages combine components

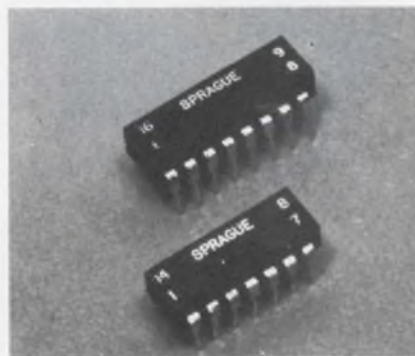

Wilbrecht Electronics, 240 Plato Blvd., St. Paul, Minn. Availability: stock to 4 wks.

Designed to mount on printed circuit boards is the model 500 miniature slide switch measuring only 0.5-in. long. Built to last, its base is made of phenolic material and its housing is stainless steel. The use of precious metal contacts and a positive wiping action results in a contact resistance of only 20 mΩ over an expected life of 250,000 cycles.

CIRCLE NO. 351

Kulite Semiconductor Products, Inc., 1039 Hoyt Ave., Ridgefield, N.J. Phone: (201) 945-3000.

A new line of thick-film resistors measuring 0.1 by 0.05 in. spans the resistance range of 10 Ω to 5 MΩ with standard tolerances of ±1, ±2, ±5 and ±10%. They exhibit low noise, low shunt capacitance and low drift. Temperature coefficient of resistance is as low as 50 ppm. A wide variety of termination materials are available for wire bonding or soldering.

CIRCLE NO. 348

Transient suppressor limits 600-V surges

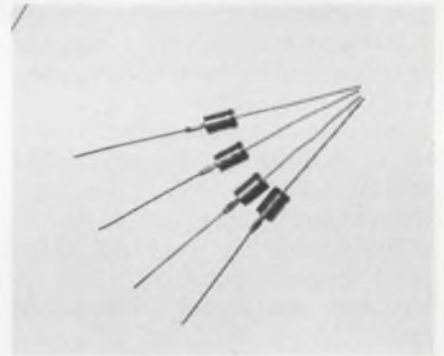

Sprague Electric Co., 347 Marshall St., North Adams, Mass. Phone: (413) 664-4411.

Up to 28 film resistors, 10 ceramic capacitors, 8 delay lines or any combination of these can be had in a single 14 or 16-pin dual-in-line package. Multi-Comp units are fully molded and are compatible with automatic insertion equipment used for TO-116 dual-in-line packages. They can also accept up to 4 pulse transformers in a single package.

CIRCLE NO. 350

PC board slide switch is only 0.5-in. long

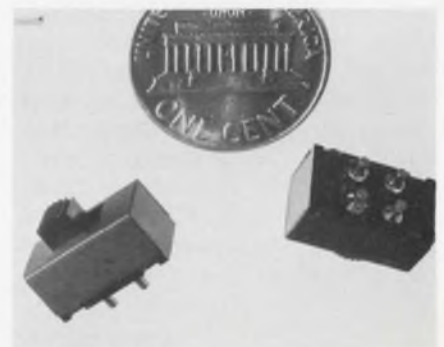

Multi-turn PC trimmer is a scant 1/4-in. high

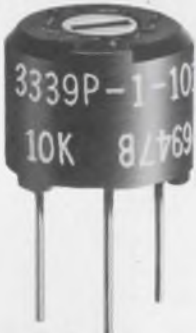

Bourns Inc., Trimpot Products Div., 1200 Columbia Ave., Riverside, Calif. Phone: (714) 684-1700. Price: \$1.46.

Model 3339 is a printed-circuit board cermet trimmer whose diameter is 0.3 in. and height is only 0.25 in. Its precise wiper setting is assured by a unique drive mechanism that permits four mechanical turns to traverse its element. Resistances range from 10 Ω to 1 M Ω with a maximum contact resistance variation of 3 Ω or 3%, whichever is greater.

CIRCLE NO. 352

Solid-state devices increase isolation



Vactec Inc., 2423 Northline Industrial Blvd., Maryland Heights, Mo. Phone: (314) 432-4200. Price: from \$4.20.

Designated as VTL2C, a new series of hermetically sealed isolators combines a light emitting diode and a photoresistor to provide high input-to-output isolation. Since these TO-5-cased devices have no filaments to burn out, they offer virtually unlimited lifetimes. Applications include photochoppers, linear isolators, noiseless switching and turning on SCRs and triacs.

CIRCLE NO. 353

The SSL Explosion!

Solid State Lamp technology is booming. GE offers you the most complete data available today.

Everything about solid state lamps — technology, applications, product variety, prices — is changing almost day to day. How to keep up? Here's how, with the most complete up-to-the-minute information available on SSL's (previously known as light emitting diodes). Clip the coupon and start catching up today. With each order placed now for either of the SSL Manuals, you also will get free all new SSL application bulletins issued during 1970.



1 **GE's Complete Two-Part SSL Manual:** Covers theory, characteristic and applications, with 108 pages of diagrams, graphs and circuit applications. The most complete source of new and revised SSL data available anywhere. (Price \$2.00)

2 **GE SSL Application Manual Only:** 48 pages, 59 SSL circuit and application ideas, 22 of which have never been published before. (Price \$1.00)

3 **Infrared SSL Bulletins:** Fully describes GE's 9 gallium arsenide emitters. Shows mechanical and electrical specifications, including characteristic curves. For card and tape readers, photoelectric systems, optoelectronics devices. (Free)

4 **Visible SSL Bulletins:** Has complete mechanical and electrical data on GE's duo of SSL indicators... the SSL 3 green. And the plastic encapsulated SSL 22 red, the most visible red SSL available today. (Free)

5 **Photon Coupler Bulletins:** For electrical isolation and high speed switching. The new PC4-73 gallium arsenide SSL with a NPN planar silicon photo-darlington amplifier, the first of its kind, has the highest transfer ratio (125%) of any coupler on the market today. And the PC15-26, a gallium arsenide SSL coupler with a NPN planar silicon photo-transistor. Both isolate up to 2500 volts. (Free)

Check information you need and mail to: General Electric Company, Miniature Lamp Department, #382-ED, Nela Park, Cleveland, Ohio 44112.

Name _____

Company _____

Address _____

City _____ State _____ Zip _____

GENERAL  ELECTRIC

for
STABILITY
in signal
generating
equipment

... We Offer a
Wide Selection of...

- CRYSTAL CONTROLLED FM GENERATORS
- CRYSTAL CONTROLLED AM GENERATORS
- TUNEABLE FM GENERATORS
- NARROW RANGE SWEEPERS

General High
Quality...

- COMPLETELY SOLID STATE
- RUGGED
- HIGH RELIABILITY
- FOR LABORATORY AND PRODUCTION LINE



Model 71-1 AM Signal Generator



Model 61 FM Signal Generator



Model R38 FM Signal Generator
Crystal Controlled

**RADIO
RESEARCH CO.**

189 MT. PLEASANT AVENUE
ROCKAWAY, NEW JERSEY 07866
phone: (201) 627-1754

INFORMATION RETRIEVAL NUMBER 88

PACKAGING & MATERIALS

Insulating epoxy works for hybrids

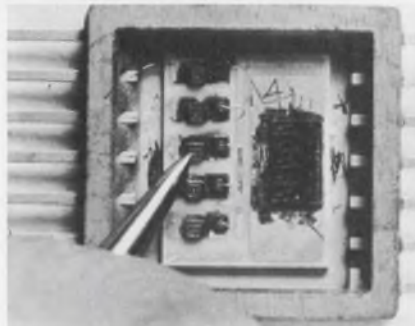

Epoxy Technology, Inc., 65 Grove St., Watertown, Mass. Price: \$15/kit.

A new two-component epoxy compound aids in hybrid circuit fabrication by providing a bonding and coating material with high insulating resistance in thin films. Epo-Tek H54 has a built-in color indicator that causes the material to turn from its natural amber to a deep red, as curing progresses. Applications include the bonding of active and passive components.

CIRCLE NO. 354

Terminal strip bends to job



Electrovert, Inc., 86 Hartford Ave., Mount Vernon, N.Y. Phone: (914) 664-6090.

Especially designed to fit curved surfaces, a flexible 12-pole terminal strip can be cut easily with a sharp knife to the required number of terminal points. Type ESK is rated for 20 A at 300 V and will accept conductors up to AWG #12. Mounting holes to accommodate 1/8-in. bolts are molded into the terminal strip body, thereby eliminating the need for drilling.

CIRCLE NO. 355

Fiber-optics kit eases experiments

Poly-Optics, Inc., 1815 E. Cornegie Ave., Santa Ana, Calif. Phone: (714) 546-2250. P&A. \$50; 30 days.

A new experimenter's kit containing 50,000 feet of synthetic fiber-optics permits the scientist and the engineer to determine fiber-optics applications feasibility through his own in-house testing. Kit EK-50 includes: a 7-V 3-W incandescent light source with a 120-V transformer, 10 feet of three different sizes of jacketed commercial-grade light guides, and a 72-in. 1/4-in.-diameter bundle of five different-size bulk fiber-optics.

CIRCLE NO. 356

IC heat dissipators boost powers by 300%

International Electronic Research Corp., 135 W. Magnolia Blvd., Burbank, Calif. Phone: (213) 849-2481. Price: 40¢ or 51¢ in quantity.

Two new series of heat dissipators for integrated circuits packaged in TO-3 and TO-8 cases are said to increase power levels by 300% or more. Series UP units are available in one size with three different heights; the larger series HP units are available in two sizes with the same height. All of the dissipators are made of aluminum.

CIRCLE NO. 357

Two-part adhesive bonds in one minute

Emerson & Cuming, Inc., Canton, Mass. Phone: (617) 828-3300. Price: \$8 for 2-lb kit.

Eccobond PDQ is a two-part epoxy adhesive that cures in less than one minute at room temperature after mixing. The bond which develops almost instantaneously has a tensile strength of 900 psi for a 1-in. overlap on aluminum to aluminum. The new epoxy can be used with many materials, including metals, glasses, ceramics, most plastics, and various combinations of these.

CIRCLE NO. 358

Hybrid microwave ICs shrink case sizes

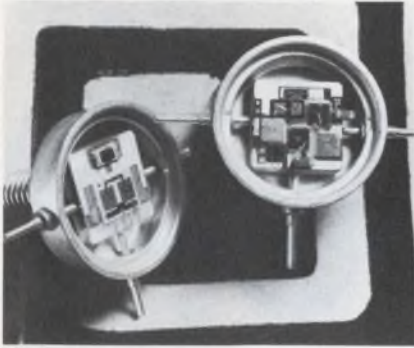

RCA Electronic Components, 415 S. 5th St., Harrison, N.J. Phone: (201) 485-3900.

Two new developmental ICs, TA7702/7703 power amplifier and TA7747/7748 three-port hybrid power combiner/divider, miniaturize circuit size with a radial-lead package 0.625-in. in dia and 0.2-in. high. The amplifier delivers 16 W at 350 MHz with a 6 dB of gain. The combiner/divider isolates from 10 to 40 dB and has a loss of 0.25 dB from 225 to 400 MHz.

CIRCLE NO. 359

Rf 150-MHz transistor delivers up to 75 W



Kertron Inc., 7516 Central Industrial Dr., Riviera Beach, Fla. Phone: (305) 848-9606. P&A: \$81; 2 to 3 wks.

Designed for 28-V operation, a new rf transistor delivers an output of 75 W at frequencies up to 150 MHz. The 3TE611 has an rf gain of 7 dB and is available in an MT-62A package. A built-in desirable feature includes a low-inductance package for better broadband capability. The use of nichrome resistors improves stabilization.

CIRCLE NO. 360

Voltage-tuned filters cover 50 to 400 MHz



Telonic Industries, Inc., Box 277, Laguna Beach, Calif. Phone: (714) 494-9401. Availability: stock.

Series TVF voltage-tunable bandpass filters cover a frequency range of 50 to 400 MHz with tuning voltages from 2 to 60 V. Models are available in two and four-section versions depending on the attenuation characteristics desired. All filters show a typical Chebyshev response.

CIRCLE NO. 361

Lapping and Polishing?

Hyprez makes it easy

"Hyprez makes it easy" . . . we offer a complete family of Diamond Compounds for every purpose, to cover simple as well as critical tolerances. We've earned our reputation in the field of diamond technology, by developing the first successful series of commercial Diamond Compounds. Here are our credentials:

- **W, OS, and FORMULA "L"** Diamond Compounds . . . long the leader in their field.
- **New Aerosol Diamond Compounds** . . . for finishing operations that require very uniform dispersion of diamonds.
- **New Aerosol Lubricants** . . . for lapping and polishing operations.
- **Slurry Compounds** . . . for automatic metered amounts of diamond compound and lubricants with the Mini-Miser Spray Unit.
- **Diamond Die Compounds.**
- **Kemet Lap Materials** . . . a new concept in lapping materials.
- **Lapping and Polishing Accessories** . . . a wide variety.

For consistent quality, insist on Hyprez Diamond Compounds. We offer a selection as well as a solution. Ask for a copy of our full-line catalog No. H100A.

HYPREZ DIVISION
ENGIS EQUIPMENT COMPANY
8035 Austin Ave., Morton Grove, Ill. 60053 • Phone 312-966-5600



Engis

YOKE SPECIFYING PROBLEM?

**ASK AN
EXPERT...**

**A SYNTRONIC
DEFLECTION
YOKE SPECIALIST**



Since we make more types of yokes than anyone else, it's natural enough for our team of experts to know more about yoke design, application engineering, and quality control.

Specifying can be a challenging problem, and with this in mind, we put our experience at your disposal. Don't hesitate to call or write us when you're puzzled as to the right deflection yoke for your display.

syntronic **INSTRUMENTS, INC.**
100 Industrial Road, Addison, Illinois
Phone: Area 312, 543-6444

INFORMATION RETRIEVAL NUMBER 90

**Roper
Whitney
wants you
to be
strong**



**... but it isn't
necessary**

Roper Whitney tools are a pleasure to use. Operation is easy and without strain—you don't have to be strong to exert great power. You can design with freedom: prototypes, breadboards, custom chassis, or produce low volume cabinets and panels. With Roper Whitney tools you can swiftly and powerfully punch any shape hole, shear, notch, rip, rivet and bend sheet metal or light plate and angle iron for custom framing. Manual punching power from 2 to 30 tons can be yours.

NEW 56-page Roper Whitney Catalog 70A illustrates and describes hundreds of hand tools from scratch awls to clip punches and hand seamers. Twenty pages of punches and dies are included along with prices for all items. We're holding your **FREE** copy for you . . . We'll send you 70B on power equipment too.



ROPER WHITNEY, INC.
Formerly Whitney Metal Tool Co.
2833 Huffman Blvd., Rockford, Ill. 6110

INFORMATION RETRIEVAL NUMBER 91

MICROWAVES & LASERS

**Low-profile DIP mixer
measures 0.21-in. high**



Elcom Systems, Inc., 151 W. Industry Court, Deer Park, N.Y. Phone: (516) 667-5800. P&A: \$12 to \$24; stock to 30 days.

Designed to plug into a 14-pin dual-in-line socket or mount directly to a PC board, a new low-profile double balanced mixer measures 0.21-in. high by 0.5-in. wide by 0.79-in. long. The DBM-500PC has an rf range of 2 to 500 MHz and an i-f range from dc to 500 MHz. Isolation is from 15 to 50 dB between all ports.

CIRCLE NO. 362

**Vhf/uhf 250-mW diodes
measure 0.16-in. long**



MSI Electronics Inc., 34-32 57 St., Woodside, N.Y. Phone: (212) 672-6500. P&A: \$8.60; 2 wks.

Series SQ1212A through SQ1232A vhf/uhf tuning diodes are miniature devices with 0.015-in. leads and cases 0.16-in. long. They dissipate 250 mW to handle most tuning diode applications. With an inductance of 3 nH and a capacitance of 0.2 pF, their self-resonant frequency is 25% higher than larger size diodes that offer the same characteristics.

CIRCLE NO. 363

Ultrasonic handgun goes to workpiece



Dymo Products Co., P.O. Box 1030, Berkeley, Calif. Price: \$174.95.

Claimed as the world's first electric labelmaker, the Tapewriter 2310 prints letters up to 0.35 in., both upper and lower case, and extended letters. It has four interchangeable horizontal embossing wheels, plus one vertical embossing wheel. Special characters and chemical symbols are included. The unit is equipped with a dual track for both 3/8 and 1/2-in. labeling tape.

CIRCLE NO. 365

Chartmaking kit gives pro results



Thomas & Betts Co., 36 Butler St., Elizabeth, N.J. Phone: (201) 354-4321. P&A: \$28; stock.

Completely self-adjusting, a new wire stripper allows wires of different popular diameters to be stripped consecutively without changing or adjusting the tool's stripping jaws. In addition, there is no need to position the wire. Model ABMK-1 accommodates wire diameters from AWG #30 through #12, having either copper or aluminum conductors.

CIRCLE NO. 367

Dukane Corp., Ultrasonics Div., 103 N. Eleventh Ave., St. Charles, Ill. Phone: (312) 584-2300.

A new general-purpose hand-held ultrasonic gun allows ultrasonic energy to be taken directly to the workpiece or fluid being processed. The transducer is housed in a probe attached to the generator by a connecting cable. The unit may be used with all the convenience of a soldering iron. Both 100 and 300-W models are available with a variety of probe tips.

CIRCLE NO. 364

Electric labelmaker prints varied output

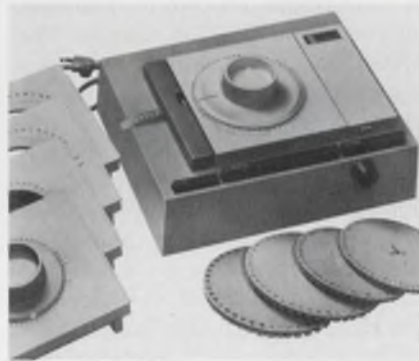

Devoke Co., 1015 Corporation Way, Palo Alto, Calif. Phone: (415) 964-3883. Price: \$37.

Containing materials for rendering six 16 by 20-in. charts, Chart-fax chartmaking kit allows statistics to be converted into colorful charts and graphs in either bar or line techniques. Rub-off type sheets permit transfer of printed copy a complete word at a time. Chart-board grids come in three different patterns for plotting a wide range of situations.

CIRCLE NO. 366

Wire stripper adjusts itself

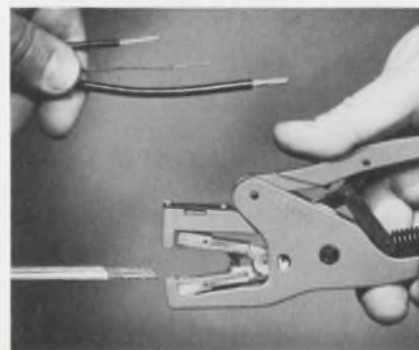

better switch



- **HIGHER RATINGS:**
10 amps @ 125 VAC
- **LONGER LIFE:**
250,000 operations
- **HIGHER IMPACT:**
New metal case
- **MEETS IEC SPECS:**
5A/250 VAC — 10A/115 VAC
- **LOWER PRICES (SPDT):**
1.95 ea., 1.17 lots of 100
- **U/L OPTIONAL:**
Write for details
- **SPDT AND DPDT TYPES:**
With 1/4" or 15/32" bushings
- **IMMEDIATE DELIVERY**

A new series of miniature toggle switches with a cylindrical metal case where reliability is a prerequisite in the smallest size possible. All metal construction and high impact insulation allows use under all environmental conditions.

Alco-switch	Bush-ing	Type	One-24	500-999
MCT-110D	1/4	SPDT	1.95	.98
MCT-220N	15/32	DPDT	2.55	1.28
MCTG-110D	1/4	SPDT	1.95	.98
MCTG-220D	15/32	DPDT	2.55	1.28

Write for other quantity prices

ALCO®

ELECTRONIC PRODUCTS, INC.
Lawrence, Massachusetts 01843

JFD PISTON TRIMMERS

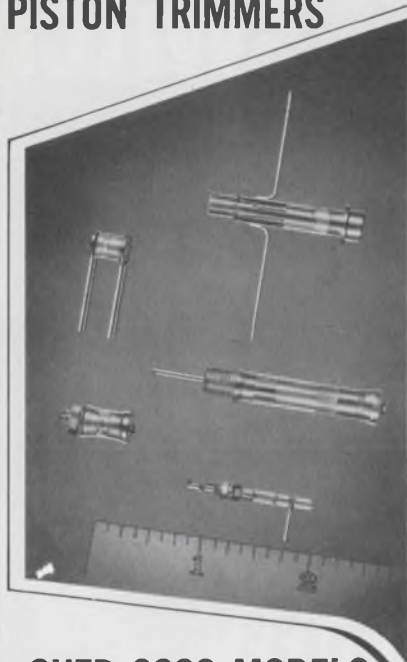

OVER 3000 MODELS

JFD offers the industries largest selection of Piston Trimmer capacitors to meet every circuit requirement. More than 3000 standard and special designs assure exactly the right component for every application.

The Miniature Telescopic Capacitor Series — offers a variety of glass and quartz dielectric materials in a wide range of capacitance values. For example: the VC10GWY is available from .8 to 4.5 pf for printed circuit mounting. Body length is only 5/16". Another example is the NVC 24G panel mount — available in a 1 — 38 pf capacitance range. Body length measures 1-19/32".

The Max-C High Range Miniature Telescopic Capacitor Series — utilizes an embedded electrode for greatly increased capacitance range. Models are available from 10 pf — 250 pf sizes ranging from 17/64" — 1-61/64" in body length. The Max-C series offers a wide variety of sealed and unsealed models.

Beyond this is an immense array of standard and special units covering almost every requirement: from minute diameters for space considerations to heavy walled units for high voltage applications.

More JFD Piston Trimmers meet or exceed present military specifications, than any other brand.

JFD JFD ELECTRONICS CORP. / COMPONENTS DIVISION

15th Avenue at 62nd Street
Brooklyn, New York 11219
Phone 212-331-1000

SUBSIDIARY OF RIKER-MAXSON CORPORATION

"See us at the WESCON Show Booth 1324 and 1325."

Evaluation Samples



Pushbutton switch

A new-style pushbutton switch which normally retails from \$5 to \$6 is available free on loan for 30-days as an evaluation sample. The switch has a 3/4-by-1-in. prism cap that displays legends in color when switched ON or OFF, without the need of electrical power. This is done with snap-in changeable color bands that glare through the prism cap in bright colors. The switch also contains a lamp in the cap for conventional electrical illumination. Marco-Oak Industries.

CIRCLE NO. 368

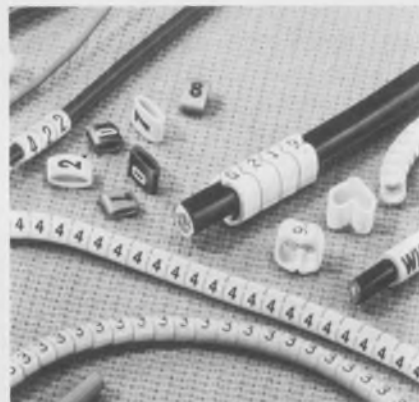

Wire marker sleeves

Free samples of new black-on-white wire marker sleeves printed with individual letters and numbers are available. Sleeves come in four types: clip-on, expandable, tension grip and slip-on versions. Multi-digit codes may be built by combining several markers. Custom sleeves may be obtained in several lengths, in either blank styles or with any code in many colors. The sleeves accommodate wires and cables up to 4 inches in diameter. W. H. Brady Co.

CIRCLE NO. 369

Pulling down the cost of lighting up an instrument



For a high-reliability light source, the Tung-Sol baseless cartridge lamp is about as simple as you can get. Elimination of cemented-on bases removes two potential failure sources while lowering cost. There are no anchors to generate noise and no soldered connections. Design permits use of an inexpensive clip-type mounting bracket which achieves low silhouette. Can be supplied in 6 v. and 12 v. types. Complete information and application assistance available. Write for catalog A-21. Tung-Sol Division, Wagner Electric Corporation, 630 W. Mt. Pleasant Avenue, Livingston, N.J. 07039; TWX: 710-994-4865, Phone: (201) 992-1100; (212) 732-5426.

TUNG-SOL® BASELESS CARTRIDGE LAMP

TUNG-SOL—WHERE BIG THINGS
ARE DONE WITH SMALL LAMPS

© Trademark TUNG-SOL Reg. U.S. Pat. Off. .
and Marcas Registradas

INFORMATION RETRIEVAL NUMBER 94
ELECTRONIC DESIGN 12, June 7, 1970

Design Aids

Semiconductor guides

Two new charts give cross reference numbers for semiconductor devices manufactured by various firms. The first is a four-page operational-amplifier cross-reference guide listing interchangeability information on 174 competitive amplifiers. The second is an 11-by-15-1/2-in. chart with cross-references for 48 competitive low-power DTL devices. Teledyne Amelco Semiconductor.

CIRCLE NO. 370

Hybrid design chart

A new chart for thick-film hybrid circuits contains design guidelines, packaging information and data on active devices, substrate materials, capacitors and commercially available inks. Listed are typical parameters of key hybrid materials which are given visual representations to afford the user a comprehensive source of information. The chart folds to a convenient 8 by 11 in. for filing or reopens to 15 by 22 in. for wall mounting. Sylvania Products Inc.

CIRCLE NO. 371

Rotary switch chart

A two-color rotary-switch wall chart guide is available to assist design engineers. It contains specifications on micro-miniature, miniature, standard rotary and totally enclosed pushbutton switches. It also includes special electrical products such as external ammeter shunts, bonding jumpers, bus bars and flexible bus assemblies. The chart gives data for each switch model on such things as indexing, the maximum number of positions, electrical specifications, the number of available poles and decks, and general engineering and dimensional information. Janco Corp.

CIRCLE NO. 372

SENSITIVE MERCURY WETTED CONTACT RELAYS

Ultra-reliable, highest quality Sensitive Relays with mercury wetted contacts are ideal for critical applications, such as digital and analog computers, telecommunication systems, multiplex, industrial control equipment and power control devices. New type MWK (center off—SPST) is ideal for multiple channel switching.

ELECTRICAL (Type AWCM):

- Contact Arrangements: Form C and D
- Insulation Resistance: 1000 Megohms minimum
- Current Rating: Up to 2 amps or 500 VDC
- Contact Resistance: 50 milliohms maximum
- Life: 1 billion operations
- Contact Bounce: NONE
- Contact Rise Time: 10 nano seconds or less
- Operating Speed: To 200 operations/second

PACKAGING (Type AWCM):

- Environmental Protection: Hermetically sealed contacts, potted metal case
- Shielding: Internal shielding available
- Shock and Vibration: Withstands all normal handling/transportation effects
- Mounting: Printed Circuit

Advanced manufacturing methods and stringent quality control procedures assure highest quality. Many types available directly from stock. Engineering and applications assistance available. Surprisingly short delivery schedules.

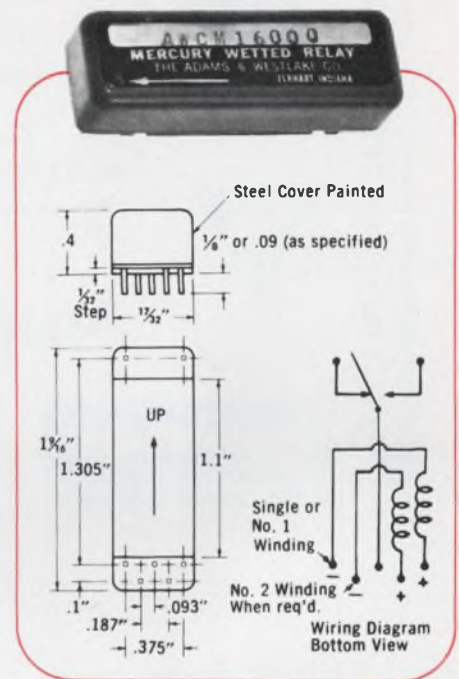

MERCURY DISPLACEMENT RELAYS

Time delay and load relays meet the toughest, most demanding switching applications. Non-adjustable time delay relays offer contact forms A and B with delays up to 1/2 hour, current ratings to 15 amps. Load relays switch from 30 to 100 amps with contact forms A and B.

DRY REED RELAYS

Miniature, intermediate, and standard sizes offer A and B contact forms with from 1 to 4 poles of switching. Typical life is 20×10^6 operations (rated load) or 500×10^6 operations (dry circuit).

USE READER-SERVICE NUMBER FOR COMPLETE INFORMATION



THE ADAMS & WESTLAKE COMPANY

Elkhart, Indiana 46514 • (219) 264-1141 • TWX (219) 522-3102 • TELEX 25-8458 • Cable ADLAK

SUBSIDIARY OF
ALLIED PRODUCTS CORPORATION

Annual Reports

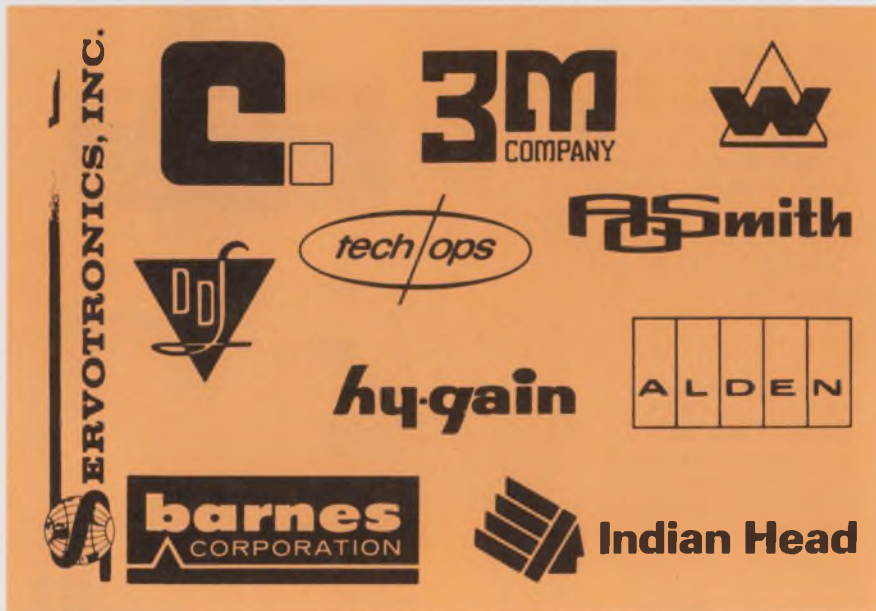

Alden Electronic & Impulse Recording Co., Inc., Alden Research Center, Westboro, Mass.

Facsimile transceivers, recorders and meteorological instruments.
1968: revenues, \$3,434,128; net earnings, \$113,387.

1969: revenues, \$3,916,234; net earnings, \$78,396.

CIRCLE NO. 373

Barnes Corp., Lansdowne, Pa.

Integrated circuit sockets, carriers, contactors, breadboards and test handlers, for processing and communications equipment.

1968: net sales, \$2,287,652; net income, \$226,330.

1969: net sales, \$3,661,201; net income, \$300,992.

CIRCLE NO. 374

Chalco Engineering Corp., 15126 S. Broadway, Gardena, Calif.

Tape readers and handling equipment, ac-to-dc power supplies and aircraft subassemblies.

1968: sales, \$2,008,964; net earnings, \$143,691.

1969: sales, \$2,063,825; net earnings, \$72,177.

CIRCLE NO. 375

Data Design Laboratories, 7925 Center Ave., Cucamonga, Calif.

Computer software and hardware, PC boards, aircraft parts and oceanographic research.

1968: sales, \$5,282,229; net income, \$283,356.

1969: sales, \$5,519,523; net income, \$336,930.

CIRCLE NO. 376

Hy-Gain Electronics Corp., Highway 6 and Stevens Creek, Lincoln, Neb.

Antenna systems for citizens' band and military fields.

1968: revenues, \$4,742,701; net earnings, \$88,083.

1969: revenues, \$4,647,200; net earnings, \$86,017.

CIRCLE NO. 377

Indian Head, 111 W. 40 St., New York, N.Y.

Microfilm information systems, glass, metal, textile and automotive products.

1968: net sales, \$369,531,000; net income, \$12,072,000.

1969: net sales, \$435,469,000; net income, \$13,417,000.

CIRCLE NO. 378

Minnesota Mining and Manufacturing Co., 3M Center, St. Paul, Minn.

Copying systems, magnetic tapes and home-entertainment products.

1968: total sales, \$1,465,720,000; net income, \$166,933,000.

1969: total sales, \$1,631,266,000; net income, \$179,410,000.

CIRCLE NO. 379

Servotronics Inc., 3901 Union Rd., Buffalo, N.Y.

Servos and control systems.
1968: net sales, \$3,676,443; net income, \$345,014.

1969: net sales, \$5,179,334; net income, \$526,351.

CIRCLE NO. 380

A. O. Smith Corp., P.O. Box 584, Milwaukee, Wis.

Electric motors and controls, metering systems, metal powders, plastics and automotive products.

1968: sales, \$372,797,673; net earnings, \$11,642,613.

1969: sales, \$354,518,304; net earnings, \$14,559,501.

CIRCLE NO. 381

Technical Operations, Inc., Northwest Industrial Park, Burlington, Mass.

Electro-optical analytical and radiographic equipment.

1968: net sales, \$11,538,000; net income, \$571,000.

1969: net sales, \$12,105,000; net income, \$131,000.

CIRCLE NO. 382

Weldotron Corp., 907 Frelinghuysen Ave., Newark, N.J.

Packaging materials and machinery, electronic controls, and audio/visual equipment.

1968: total income, \$5,557,008; net income, \$212,532.

1969: total income, \$7,354,592; net income, \$305,801.

CIRCLE NO. 383



MAIL COUPON FOR GIANT FREE CATALOG!

EDMUND SCIENTIFIC CO.
300 Edscorp Building, Barrington, N. J. 08007
Please send Free Giant Catalog "DA"

NAME _____
COMPANY _____
ADDRESS _____
CITY _____ STATE _____ ZIP _____

FREE CATALOG!

**148 PAGES • MORE THAN 4000
UNUSUAL BARGAINS
SCIENCE • OPTICS • SPACE**

Speed your work! Improve quality! Cut development and production costs! Completely new edition loaded with on-the-job helps, quality control aids, unique items available nowhere else. 148 easy-to-read pages packed with new products, charts, diagrams, illustrations. A treasure house of optical and scientific equipment available direct from stock for industry, research labs, design engineers, experimenters, hobbyists.

AMERICA'S GREATEST ONE-SOURCE MARKET PLACE
Hard-to-get surplus bargains. Ingenious scientific tools. Thousands of components: lenses, prisms, wedges, mirrors, mounts, accessories of all descriptions. Hundreds of instruments: lasers, comparators, magnifiers, microscopes, projectors, telescopes, binoculars, photo attachments, black light equipment and the largest selection of unique lighting items in the country.

ORDER DIRECT WITH ABSOLUTE CONFIDENCE
Edmund ships more than 5,000 orders monthly to the country's largest industrial. Every item completely guaranteed. You must be satisfied with any purchase or return it in 10 days for your money back. Shop the catalog of America's largest Science-Optics-Space Mart. Send for your free copy today. Absolutely no obligation. Request FREE catalog "DA".

EDMUND SCIENTIFIC CO., 300 Edscorp Bldg.
Barrington, New Jersey 08007

INFORMATION RETRIEVAL NUMBER 96

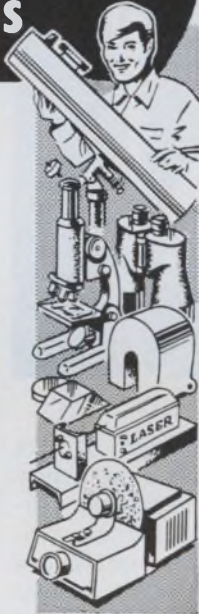

SWITCH/INDICATORS

Super-compact 5 & 15 amp models.

Alternate or momentary action. Push-on, push-off power switch mounts in a 3/8" hole on centers as close as 3/8" (5 amp model) and 3/4" (15 amp). Minimum life: 100,000 cycles.

Independent, isolated incandescent lamp (neon optional). Match other TEC-LITE indicators for panel design harmony. Switch contact rating: 5 or 15 amps at 115 VAC, 60 Hz or 28 VDC resistive. Available in 14 lens colors. As low as \$3.85 in quantities of 100 - 499.

For more information on PBL-PBS switches — or our complete line of display/control products and systems — write: TEC, Incorporated, 6700 So. Washington Avenue, Eden Prairie, Minnesota 55343. (612) 941-1100.



INFORMATION RETRIEVAL NUMBER 97

ELECTRONIC DESIGN 12, June 7, 1970

**Oak
Versatility**



Now! One new exclusive switch replaces seven. You can easily eliminate tedious design engineering problems—just use versatile Multidex® switches. They're available in thousands of variations...are smaller than the switches they replace...yet provide more contacts (up to 36) at no additional cost. Crisp Detenting... the patented Unidex™ detent offers uniform "feel" for long life in choices from 10° to 36° throw. Meets MIL-S-3786, SR32 requirements.

Superb Insulation... molded diallyl phthalate meets MIL-M-14 requirements and guarantees electrical continuity between mounting and housing. Glass-alkyd insulation available on request. Special contacts and clips... Oak-pioneered, double-wiping, self-cleaning contacts assure trouble-free operation. Special AF clips with large windows speed wiring.

What's more, Multidex switches meet commercial and military environmental requirements. Special options available on request. For full details, write today for Bulletin SP-324.



OAK MANUFACTURING CO.

A Division of OAK ELECTRO/NETICS CORP.
Crystal Lake, Illinois 60014
PHONE: 815-459-5000 TWX: 910-634-3353

INFORMATION RETRIEVAL NUMBER 98

Application Notes

A/d converters

A comprehensive 22-page handbook includes four sections devoted to a/d converters. One section provides basic converter theory for successive-approximation and dual-slope integrating types and includes typical circuits and definitions of key parameters. Another section describes a wide variety of applications for such devices. Two more sections describe a new line of ultraminiature a/d converters and include comprehensive mechanical and electrical specifications. Datel Systems Corp.

CIRCLE NO. 384

Multiplier applications

A detailed 12-page multiplier applications manual offers complete data on the operation and applications of multipliers. It includes basic multiplier operation, block diagrams, error curves, and details of connecting multipliers for multi-quadrant operations. Applications data includes operation of multipliers in squaring, voltage-controlled function generators, automatic-gain control, phase detection and suppressed-carrier modulation. Zeltex, Inc.

CIRCLE NO. 385

The Hall effect

"The Hall Effect and its Applications" is the title of a booklet that explains the theory of the Hall effect phenomena and how it can be put to practical application through the media of Hall generators. It illustrates various configurations of Hall generators available and of typical applications circuitry. It also explains the use of an experimental kit (cost \$6.50 plus 50¢ for handling) that is available for those who wish to explore the application of the Hall effect to their area of interest. F. W. Bell, Inc.

CIRCLE NO. 386



D/a converters

A thorough treatment of d/a converters is contained in a new 88-page converter handbook. Discussions are included for the various techniques of performing d/a conversion, the relative advantages and disadvantages of each technique, types of electronic switches and definitions of specifications. Also provided is an extensive coverage of applications information. Circuit diagrams, oscilloscope photos, and tables and charts providing useful information are contained in the handbook. Hybrid Systems Corp.

CIRCLE NO. 387

Power thyristors

The state of the art in power thyristor technology is dealt with, in two parts, in an extensive publication. The first part concerns itself with present and future developments of power converter devices and auxiliary circuitry. The second part involves a discussion of two interesting techniques in providing regulated power. These two techniques are a method of audible suppression in a soft commutation chopper circuit and another method of marrying triacs to ferroresonance in power supply transformers. International Rectifier Semiconductor Div.

CIRCLE NO. 388

Resistor identification

A quick easy-to-understand guide to the nomenclature and scope of 12 of the most popular military resistor specifications is contained in a military resistor identification manual. It is designed to simplify the identification of individual resistors and to aid in understanding of the specifications under which they are classified. It discusses the scope of each specification and breaks down the part numbers involved into basic alphanumeric components for further explanation. Dale Electronics, Inc.

CIRCLE NO. 389

Microwave terminations

Information on selecting and specifying terminations for microwave applications is contained in an eight-page application note. It defines terminations, shows where they are used, gives the known types, and discusses the effect of tapering lossy materials. Tabular and graphical information along with pertinent equations are included. The tabular data shows coaxial and waveguide terminations and dummy loads. Narda Microwave Corp.

CIRCLE NO. 390

Glass memories

The use of glass digital memory modules in high-speed buffers for computer terminals and other data transmission systems is described and illustrated in an application note. Covered are several forms of addressing, such as continuous data input, non-synchronous and synchronous random word rates, and parallel channel operation. Diagrams illustrate the memory functions in a variety of systems. Steps in considering and selecting memory configurations for various applications are discussed. Corning Glass Works.

CIRCLE NO. 391

TRW Semiconductors control velocity

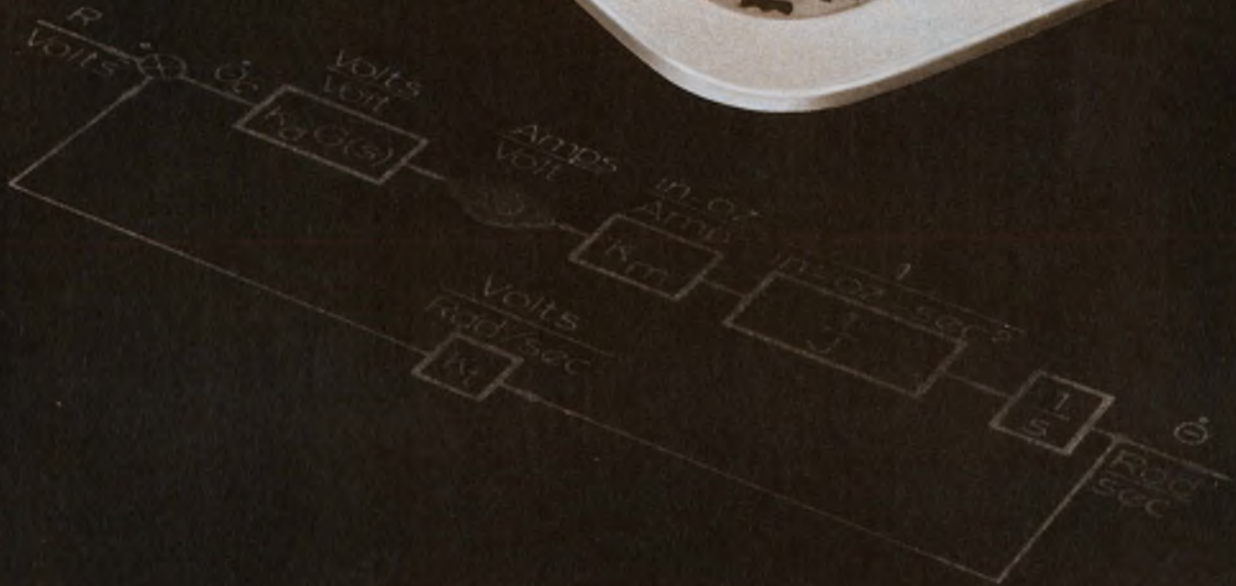
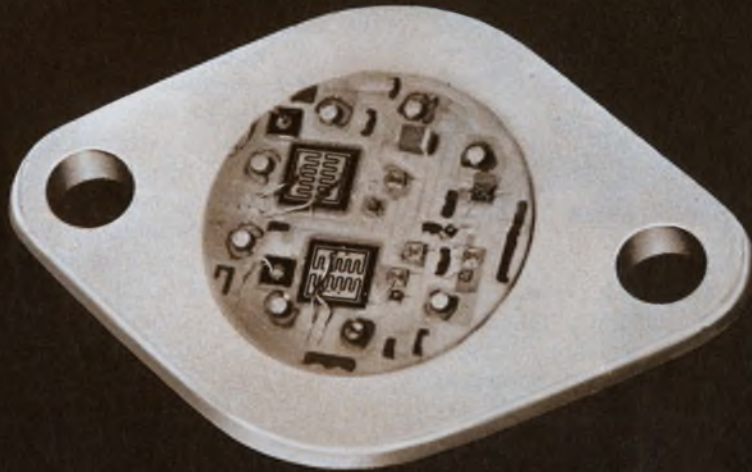

8-64

10,000 to 1 Range... G_m to 10 Amp/Volt... 0.1% Accuracy

The new TRW hybrid pulse-width modulated amplifiers deliver 400 watts from a single TO-3 package ... or a kilowatt from a "kit" of three. The PWM amplifier simplifies design by eliminating the motor electrical time constant. This means less design and assembly time and greatly reduced power dissipation problems.

Type MCB/MCC 1000 series amplifiers provide 90 to 95% efficiency, precision control and fast response. Space saving is 8:1

over equivalent discrete-component designs.

The hybrid switching amplifier allows delivered motor current to be controlled from an input voltage, independent of changes in load impedance or power supply variations. Such control is desirable since motor torque and rate of velocity change are proportional to delivered current.

Available from 5 to 50 volts DC, currents to 20 Amps and switching rates to 40 kHz.

For details and application assistance contact TRW Semiconductor Division, 14520 Aviation Blvd., Lawndale, Calif. 90260. Phone: (213) 679-4561. TWX: 910-325-6206.

TRW®

New Literature

Linear integrated circuits from Texas Instruments



Linear ICs

Eighteen computer system interface circuits, including ten sense amplifiers, two memory drivers, and six line circuits are described in a 16-page publication. It explains the advantages of using these ICs for interfacing with a variety of systems such as ECL, DTL, MOS, TTL, and analog. Information on two new linear ICs—a multi-purpose peripheral driver and an operational amplifier—is also included. Texas Instruments Inc.

CIRCLE NO. 392

SCR inverters

All of the necessary specifications, characteristics, parameters and ratings needed to select and apply SCRs for inverter applications are contained in a new 48-page handbook. It is loaded with typical characteristic curves, and includes pertinent design equations and discussions. A preliminary section is devoted to explaining how to use the handbook. International Rectifier Semiconductor Div.

CIRCLE NO. 393

High-power op amps

A comprehensive catalog and selection guide on high-power operational amplifiers is available. Detailed specifications on units from 20 W to 2 kW are provided, along with frequent references to available technical notes on specific applications. Also included are prices and dimensional data. Torque Systems, Inc.

CIRCLE NO. 394

Control handbook

Hardware specifications, application notes and product information for industrial and other control applications are contained in the new 288-page Control Handbook. It is written for specifiers, designers, manufacturers or users of electronic or mechanical logic. It includes an introduction to solid-state logic and chapters on industrial control logic, machine controllers, industrial data acquisition and control systems and numerical control products. Digital Equipment Corp.

CIRCLE NO. 395

Thick-film guide

In ten pages of fact-filled instructions, a manual outlines successful techniques for high-yield production of cermet circuits. Seven pages are devoted to thick-film resistors and three to conductors. Also included are a graphic presentation of an acceptable firing envelope and a viscosity-vs-temperature curve. A short section on thick-film theory is presented, followed by a discussion of printers, viscosity effects, substrate variation and conductor-resistor interface. Electro Materials Corp. of America.

CIRCLE NO. 396

Transformers

Technical information on transformers, magnetic devices and power sources in a wide range of fields is available in a new catalog. It includes a general description of rectifier, plate-supply, test-equipment, air and oil-cooled, filament and voltage-regulating transformers. Also included are saturable reactors, inductive elements, power sources and high-power magnetic amplifiers. Information on applications, ordering, pricing and delivery is also given. Light Electric Corp.

CIRCLE NO. 397



Data converters

A variety of data conversion modules for data interfacing and acquisition applications are described in a brochure. Capsule listings indicate the salient features and show system block diagrams of the various types of data converters. Described are encapsulated modular d/a, a/d, digital-to-synchro and synchro-to-digital converters. Also described are accessories such as multiplexers, sample-and-hold circuits, and control transformers. DDC, A Div. of Solid State Scientific Devices Corp.

CIRCLE NO. 398

Trimming pots

A full product line of trimmers and related products including multi-turn potentiometers and turns-counting dials are described in a new catalog. Trimmers range from 1/4-in. round to 1-1/4-in. rectangular units, and include military-approved, general-purpose wirewound and cermet-element types. Complete specifications are included. Fairchild Controls, a division of Fairchild Camera and Instrument Corp.

CIRCLE NO. 399

Operational amplifiers

A six-page foldout short-form catalog selects 12 widely used operational amplifiers giving full specifications and brief application suggestions. It is divided into six amplifier groups: low-cost, FET-input, ultra-low-drift chopperless, fast-settling, high-stability chopper-stabilized and varactor bridge types. Analog Devices, Inc.

CIRCLE NO. 400

Most engineers know ADC Products has designed over 3000 different filters.



But do you know... ADC Products makes 19,897 different transformers, 2,863 different jacks, plugs, jack panels and allied components, plus power supplies, solid state relays, pre-wired jack fields and even complete telecommunications systems?



One of the finest, most knowledgeable filter design departments in the country is just one reason why ADC Products has designed and built 3,512 different custom filters . . . to date. Another reason is the use of computer design and analysis techniques to help optimize design and performance. At ADC Products, state-of-the-art design is an everyday thing, and we can show you the 3,512 designs to prove it!

But modern techniques extend beyond design. Every filter is built by modern methods using the newest materials and the latest techniques in a high-reliability manufacturing program. Why not see if this kind of capability can go to work on your problems? Write ADC Products today for more information and a free guide to filter design.



ADC PRODUCTS
A DIVISION OF MAGNETIC CONTROLS CO.

4900 West 78th Street, Minneapolis, Minnesota 55435
(612) 929-7881

INFORMATION RETRIEVAL NUMBER 100



**INDUSTRY'S FIRST
MINIATURE CIRCULAR
multi-coax
CONNECTOR**

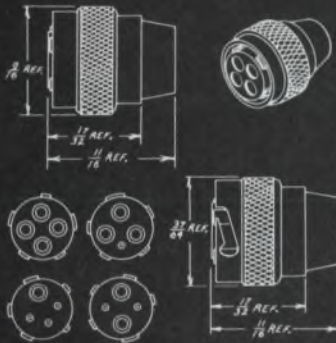

Meet Navajo: Introducing industry's first circular miniature multi coaxial connector offering 4 coax, 3 coax 1 power pin, 2 coax 2 power pin, all for RG196/U cable. 1 coax 3 power pin for RG196/U or RG188/U versions; all in 1/2" maximum diameter shell size. Five key polarization, contacts and shell gold over nickel plating, female contacts closed entry design. Power contact solder pots accept maximum No. 20 wire, connectors are 7/16-28 threaded or 3 pin bayonet coupling design. A wide choice of receptacle mounting configurations are available to best accommodate your own design requirements. Include the Navajo Series in your next design where miniaturization and reliability are requirements. Ted Manufacturing Corporation manufactures the broadest possible line of coaxial cable connectors in all popular mating characteristics and specializes in prompt engineering modification to suit your individual design requirements.



MANUFACTURING CORPORATION
11415 Johnson Drive
Shawnee Mission Kansas 66203
Phone-913 631-6211

NEW LITERATURE

**TTL Catalog Supplement
from Texas Instruments**

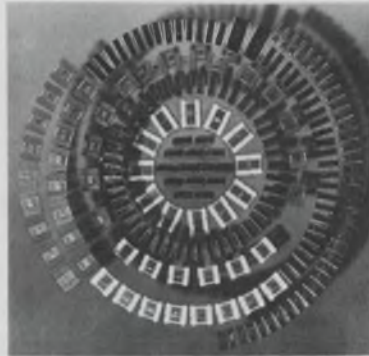

TTL ICs

A TTL IC catalog supplement of 196 pages provides data on 25 recently announced TTL ICs. These include 14 medium-scale and 11 small-scale-integrations circuits. Contained are comprehensive data sheets for 19 ICs in the 54/74 standard family of circuits. Information on flatpack, plastic and ceramic dual-in-line packages augments each specification sheet. Texas Instruments Inc.

CIRCLE NO. 401

Integrated circuits

Integrated circuits by the score are condensed in a 20-page catalog. It describes voltage regulators, clock drivers, ladder and hybrid switches and power amplifiers. Circuit diagrams, tables or characteristics, and other descriptive material are provided for each device. Outline dimensions for each device package are included. General Instrument Corp.

CIRCLE NO. 402

Conversion modules

Updated specifications on modules needed to construct a wide variety of multiplexers, a/d and d/a converters, sample-and-hold circuits, data distributors and other functions are contained in a catalog. All modules including their power supplies are encapsulated and are sold with a lifetime warranty. Redcor Corp.

CIRCLE NO. 403



Solid-state choppers

A comparative data profile contains 23 different models of a line of solid-state electronic choppers. Characteristics of both germanium and silicon units are compared and tabulated. These are used as synchronous demodulators to convert an ac signal to dc and are capable of linearly switching or chopping voltages over a wide dynamic range. Descriptions, curves, features and applications are discussed. Solid State Electronics Corp.

CIRCLE NO. 404

Transistor chips

A line of silicon planar transistor chips are described and illustrated in a four-page, two-color short form catalog. Graphs and dimensional drawings show the operating curves and geometries of all standard silicon transistor chips rated from 0.5 to 30 A. A table of electrical characteristics for standard npn and pnp units is also included. Features, absolute maximum ratings and quality-assurance provisions are covered. Pirgo Electronics Inc.

CIRCLE NO. 405

Solderless terminals

A 32-page catalog contains complete descriptions, electrical and mechanical specifications, and dimensional data for an entire product line of over 500 solderless electrical terminals. These include straight and right-angle receptacles, tabs, insulating sleeves, quick disconnect splices, multi-position connectors, and special-purpose items. Terminals described can be crimped individually, or applied automatically at rates up to 11,400 per hour. AMP Inc.

CIRCLE NO. 406



Switches

Thumbwheel, lever-actuated and pushbutton rotary switches are featured in a new easy-to-use catalog. This concise 48-page catalog leads switch specifiers through a step-by-step procedure in selecting the proper series and type number. Detailed electrical, mechanical, and installation data are provided. A complete section of truth tables designate the electrical output configurations of the specific types of many switches available. The Digi-tran Co., a division of Becton, Dickinson and Co.

CIRCLE NO. 407

Microwave devices

Descriptions, specifications, photographs, and prices of a complete line of microwave instruments and waveguide and coaxial components are detailed in a 12-page short-form catalog. Typical applications and features are described and a list of domestic and foreign sales offices is also shown. PRD Electronics, Inc.

CIRCLE NO. 408

Power supplies

Detailed information on eleven separate lines of standard power supplies is given in a 32-page power supply catalog and engineering manual. It includes modular, system, laboratory and special purpose supplies for operational amplifiers and integrated circuits. A complete family of accessories and options, including rack adapters, meter panels, crowbars, over and under-voltage detectors, and other related items, are also detailed thoroughly. Deltron, Inc.

CIRCLE NO. 409

Everything's clearer with the flat one!

Letters! Digits! Symbols! Equations! All varieties of data are displayed as undistorted images on Zenith Flat-Face Metal CRTs. Ideal for light pen operations, alphanumeric and analog presentations — they're even available with a rear port for optical chart projection. When you need CRTs, face up to the flat one. Write for details.



ZENITH RADIO CORPORATION
THE RAULAND DIVISION

5616 W. JARVIS AVE. • CHICAGO, ILL. 60648 • 312-647-8000

INFORMATION RETRIEVAL NUMBER 101

If your equipment calls for custom-designed protection...

Give us your out-of-the-ordinary container requirement—and we'll meet it. Precisely. In the shortest possible time. Because we have everything it takes to do the job. Sandwich construction materials. Off-the-shelf components. Standard hardware. Over 30 years of experience in the manufacture of cases and containers. The result? Complete equipment protection against shock, vibration, and environmental hazards. Built to all required MIL specifications. We also make custom molded and standard fiberglass and ABS thermoplastic containers and cases. Call or write for our standard price lists and comprehensive design manuals.

Skydyne will "contain" it for you.

Skydyne, Inc.

River Road, Port Jervis, N. Y. 12771 • (914) 856-6655

Subsidiary of **b+p** Brooks & Perkins, Inc.



INFORMATION RETRIEVAL NUMBER 102

VITREOSIL[®] INDUSTRIAL WARE



Whether you're concentrating, evaporating, or crystallizing acid solutions . . . or melting, sintering, or heat treating metals, Thermal American VITREOSIL Industrial Ware is your best bet.

VITREOSIL is exceptionally resistant to thermal shock (having a coefficient of expansion of: 0.45×10^{-6}), chemical reactions at high temperatures, has high dielectric strength, high purity, and extreme resistance to catalytic action. It is available in the forms of crucibles, dishes, trays, tanks, retorts, pots, tubes and pipes, and can also be fabricated in other configurations for specific requirements. It is light in weight and suitable for operating temperatures between 1000°C and 1300°C.

For complete technical and application data, write or phone.

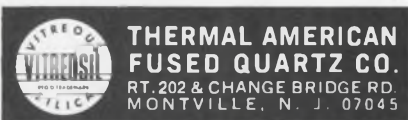

INFORMATION RETRIEVAL NUMBER 103

NEW LITERATURE



Computer language

FOCAL, an easy-to-learn computer conversational language for a variety of engineering applications, is described in a 32-page soft-cover catalog. FOCAL explains in simplified terms how small computers are programmed to solve such problems as square roots, sinusoidal expressions and series evaluations. Digital Equipment Corp.

CIRCLE NO. 410

Clips

A complete line of electric clips and insulators for quick, temporary electrical connections is described in an eight-page brochure. The line includes miniature, alligator, completely insulated, crocodile and general purpose clips. It also includes heavy-duty test and battery clips, welding ground clamps, plier-type clips for automotive batteries, and twin-ended test and needle clips. Specifications and illustrations are given for each clip type. Mueller Electric Co.

CIRCLE NO. 411

Minicomputer report

The entire special 1970 Spring Joint Computer Conference section of the April 26 issue of ELECTRONIC DESIGN, which includes the directory on minicomputers, is now available. The section also includes a special 10-page report on minicomputers, plus the conference's complete product highlights and features. Hayden Publishing Co., Inc.

CIRCLE NO. 412



Converters

Designed to fit in any standard file cabinet, a comprehensive 14-page jacket catalog contains detailed electrical and mechanical information on a new line of ultraminiature a/d and d/a converters. Eight series containing 32 models are described with accessories. Hardware described forms the basic building blocks for many forms of data systems. Recipients of this jacket catalog are placed on a mailing list and are insured of automatic updating as new technical literature becomes available. Datel Systems Corp.

CIRCLE NO. 413

Image and display tubes

A full line of image, storage and display tubes is shown in a new 26-page catalog. Included are vidicon, esicon and image converter and intensifier tubes with high-speed shutters and for use in ultraviolet, infrared and X-ray regions. Also included are memory, readout and storage tubes, CRTs and photocells. Specifications and characteristics curves are completely covered. Thomson-CFS Electron Tubes Inc.

CIRCLE NO. 414

Power supplies

Nine new lines of dc power supplies are introduced in a catalog supplement. Described are a series of high-efficiency, low-ripple power modules designed to power TTL, ECL, DTL, RTL and HTL levels. A series of dc power modules, for powering transistor circuitry, relays, motors, lamps and solenoids is also introduced. Other products include a low-cost dual-output supply for operational amplifiers. Lambda Electronics Corp.

CIRCLE NO. 415

Product Bulletin board

On license from CBS, Motorola has introduced an EVR (electronic video recording) teleplayer for the commercial/industrial market. The system uses special dual-track prerecorded film in cassettes, which can be played back with any standard TV receiver. A flying spot scanner reads the film images. One film track contains black-and-white information and the second carries color information; there are also two sound tracks. Expected cost is \$795.

CIRCLE NO. 416

Fortin Laminating Corp. has introduced an epoxy-glass copper-clad tunnel mat laminate that allows the fabrication of a complete plated-wire memory tunnel structure with conventional printed circuitry techniques. Word-line copper planes can be extended to the area adjacent to the tunnel structure, permitting matrixing circuitry to be employed as an integral part of the structure.

CIRCLE NO. 417

Planar triodes (type ML-7815/AL) from Machlett Laboratories, Inc., a Raytheon subsidiary, now carry a warranty of 3000 hours due to an improved cathode design. Normal life for this tube type is reportedly under 500 hours. The triode uses a phormat cathode, which has a porous layer of nickel deposited on its metal base. The cathode is then sprayed with a triple-carbonate coating, resulting in a spongy area that gives uniform emission, fast heat transfer, and reduced arcing.

CIRCLE NO. 418

A newly developed television transmitting system, known as Sound-in-Vision, is to be manufactured under license from the British Broadcasting Corp. by Pye T.V.T. Ltd., Cambridge, England. The system combines the pulse-code modulated sound signal with the video signal so that both can be transmitted simultaneously along the same channel. This reduces the number of lines or links required, besides lowering operat-

ing costs. Applications will include international transmissions, direct or by satellite, and closed-circuit television.

CIRCLE NO. 419

High-speed strobe lights and solid-state construction highlight the emphasis on reliability for the Systems 30 desktop electrostatic copier, recently announced by Sage Systems Corp. The unit, which will sell for \$1695, can produce as many as 30 copies a minute. It uses specially prepared paper that is fed from a roll in order to reduce the possibility of paper jams. Each roll can make up to 795 letter-size documents.

CIRCLE NO. 420

The Inspector is an off-line computer tape cleaner/evaluator that can operate on a 2400-ft reel of 1/2-in. tape in just 5.3 minutes. Base price of the unit, which is manufactured by Graham Magnetics Inc., is \$6250.

CIRCLE NO. 421

Price changes

Utilogic II industrial and commercial logic circuits from Signetics are selling for up to 38% less than before. The new prices range from 69¢ to \$2.38; old prices were 95¢ to \$3.85.

CIRCLE NO. 422

Weston Instruments Div., Weston Instruments, Inc., has reduced the price on its model 1241 digital volt-ohmmeter from \$325 to \$289.

CIRCLE NO. 423

Series 1090 magnetic tape encoders from Keymatic Data Systems Corp. now range in price from \$7590 to \$9570, reflecting reductions of approximately 25%.

CIRCLE NO. 424

Reflecting price cuts as large as 57% for quantity orders, Fairchild's μ A742 Trigac, a zero-crossing ac trigger circuit, now costs \$3.20 for 1 to 24. Formerly, the unit sold for \$7.45.

CIRCLE NO. 425

INFORMATION RETRIEVAL NUMBER 104 ►



One of the
unique qualities
of Electro Cube
is to produce
non-standard
packages readily

electro cube
capacitors

We also make 4,000 or more standard capacitors with wound dielectrics. If case style is a problem, ask. We'll help. Electro Cube, Inc., 1710 South Del Mar Road, San Gabriel, California 91776. (213) 283-0511

ELECTRONIC DESIGN's function is:

- To aid progress in the electronics manufacturing industry by promoting good design.
- To give the electronic design engineer concepts and ideas that make his job easier and more productive.
- To provide a central source of timely electronics information.
- To promote two-way communication between manufacturer and engineer.

Want a subscription? ELECTRONIC DESIGN is sent free to qualified engineers and engineering managers doing design work, supervising design or setting standards in the United States and Western Europe. For a free subscription, use the postfree application form inside the back cover. If none is included, write to us direct for an application form.

If you do not qualify, you may take out a paid subscription for \$25 a year in the U.S.A., \$35 a year elsewhere. Single copies are \$1.50 each.

If you change your address, send us an old mailing label and your new address; there is generally a prepaid postcard for this inside the back cover. You will have to requalify to continue receiving ELECTRONIC DESIGN free.

The accuracy policy of ELECTRONIC DESIGN is:

- To make reasonable efforts to ensure the accuracy of editorial matter.
- To publish prompt corrections whenever inaccuracies are brought to our attention. Corrections appear at the end of the Letters column.
- To refuse any advertisement deemed to be misleading or fraudulent.

Microfilm copies are available of complete volumes of ELECTRONIC DESIGN at \$19.00 per volume, beginning with Volume 9, 1961. Work is now in process to complete the microfilm edition of Volumes 1-8. Reprints of individual articles may be obtained for \$2.00 each, prepaid (\$.50 for each additional copy of the same article) no matter how long the article. For further details and to place orders, contact the Customer Services Department, University Microfilms, 300 North Zeeb Road, Ann Arbor, Michigan 48106; telephone (313) 761-4700.

Want to contact us? If you have any comments or wish to submit a manuscript or article outline, address your correspondence to:

Editor
ELECTRONIC DESIGN,
850 Third Avenue,
New York, N.Y. 10022.

Improved 500-Line Analyzer Reads Peak Automatically



For on-line studies of noise, vibration, radar, underwater signals. The peak of a varying frequency component is automatically tracked by new UA-6B Ubiquitous® Real-Time Spectrum Analyzer — a constant readout can be produced regardless of frequency drift or variation; for direct plotting of amplitude vs rpm for a rotating machine, & long-term monitoring of single frequencies. Also 1000-line power spectral density analysis & improved hi-temp performance to 130°F. 40 kHz max. range, continuous input and output level monitoring, 5 mHz direct input, built-in capability for expansion into a real-time correlation & cross-PSD system. Send for catalog.

Federal Scientific Corporation
a subsidiary of Elgin National Industries, Inc.
615 West 131st Street, New York, N. Y. 10027

171

1970 Electronic Components Drafting Aids Catalog



Free Catalog! Free Samples! Exciting innovations in pressure-sensitive electronic component drafting aids and methods are detailed in the new 1970 edition of the combined Bishop Technical Manual and Catalog 104A.

68 illustrated pages of over 15,000 multi-pad configurations, symbols, tapes, sequential reference designations plus hundreds of time-and-money-saving hints in making artwork for PC boards. Includes instructions for using the industry's only red and blue tape system for making two-sided boards in perfect registration. Send now for free Catalog 104A and free samples.

Bishop Graphics, Inc.
7300 Radford Avenue
North Hollywood, California 91605
(213) 982-2000 Telex: 674672

172

Self-clinching, Floating Fasteners



PEM self-clinching, floating fasteners, with and without self-locking threads permit up to 1/32" adjustment for misalignment of mating holes. Easily squeezed into punched or drilled holes in metal panels as thin as .040". They provide permanently mounted threaded holes with high torque and push-out resistance, and a patented feature of the PEM floater brings the threads through the retainer shank to minimize gaps associated with other makes. Non-locking fasteners are available in thread sizes #2 to 1/4", and self-locking fasteners are available in thread sizes #4 to 1/4". Send for Free Bulletin

Penn Engineering & Manufacturing Corp.
Box 311
Doylestown, Pa. 18901

173

Manufacturers

Advertisements of booklets, brochures, catalogs and data sheets. To order use Reader-ServiceCard (Advertisement)

NEW RELAY SOCKET ASSEMBLIES CATALOG



The new Curtis line of printed circuit snap-in track-mounted relay socket assemblies is completely illustrated in this new 2-color, 6 page catalog. Variations include RS8 octal relay sockets, as well as RS11 and RS15 with eleven and fifteen pin relay sockets. Complete dimensional drawings and list prices are included. All units snap in or pop out vertically from prepunched vinyl track and feature Curtis barrier terminal blocks. CSA approved. Send today for your free copy.

Curtis Development & Mfg. Co.
3236 North 33rd Street
Milwaukee, Wisconsin 53216

174

PRECISION CARBON FILM RESISTORS



High Voltage . . . High Frequency . . . High Megohm . . . complete specifications for 120 devices and "The Case for Carbon Film" are presented in this new 1970 resistor catalog. Resistors are offered in 15 basic styles, ranging from .25 to 100 watts, with over 100 special variations available. Resistances range from 10 ohms to 100 Terohms and tolerances from $\pm 1\%$. Applications include those requiring high resistances, voltage capability from 250 to 125,000 V, and high frequency or pulse circuits. Send for free catalog and engineering data.

Resistance Products Company
914 South 13th Street, Harrisburg, Pa. 17104
(717) 236-5081

175

FILTER SYSTEMS AND DESIGN



A new book on the fundamental concepts of electrical filters is now available on free ten-day examination. The book is Filter Systems and Design: Electrical, Microwave, and Digital by Yale Jay Lubkin, Lubkin Associates, Inc. (c. 224 pp, 125 illus, \$11.50) To get your copy, just circle reader service number below. If not satisfied return book and pay nothing.

Addison-Wesley
Publishing Company, Inc.
Reading, Massachusetts 01867

176

Electronic Design

Advertising Sales Staff
Keith Aldrich
Sales Manager

New York 10022
Robert W. Gascoigne
Thomas P. Barth
Samuel M. Deitch
850 Third Avenue
(212) Plaza 1-5530
TWX: 867-7866

Philadelphia 19066
William C. Repetto
P. O. Box 206
Merion Station, Pa.
(215) MA-3-5888

Boston 01945
Joseph F. Palmer
14 Peter Hobart Drive
Hingham, Mass.
(617) 742-0252

Chicago 60611
Thomas P. Kavooras
Berry Conner, Jr.
200 East Ontario
(312) 337-0588

Cleveland
Thomas P. Kavooras
(Chicago)
(312) 337-0588
(call collect)

Los Angeles 90303
Stanley I. Ehrenclou
W. James Bischof
2930 Imperial Highway
Inglewood, Calif.
(213) 757-0183

San Francisco 94022
Arthur R. Shields, Jr.
95 Main Street
Los Altos, Calif.
(415) 941-3084

London W. 1
For United Kingdom and Holland
Brayton C. Nichols
44 Conduit Street
Tel: REGent 4714

Verviers, Belgium
For Continental Europe
Andre Jamar
1, Rue Mallar, 1
(087) 253.83 Telex 41563

Tokyo
Haruki Hirayama
Electronic Media Service
Rm. 601, Daini Miyauchi Bldg.
6-8-14, Roppongi,
Minato-ku
Phone: 402-4556
Cable: Electronicmedia, Tokyo



Micro-Miniature Reed Relays

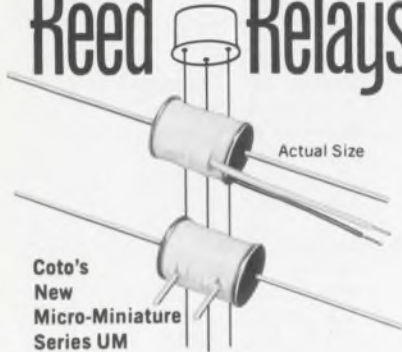

Coto's
New
Micro-Miniature
Series UM

- Extremely small size: .400" x .300"OD
- Occupies less than 0.03 cu. in.
- Ultra-high speed 100 Microseconds operate time excluding bounce
- Stock voltages 3, 6, 12 and 24 volts
- Available with either leads or pins with 0.2" spacing

Special voltages, resistances, electrostatic and/or magnetic shields available. Write for new Data Sheet MR-9.1



COTO-COIL COMPANY, INC.
59 Pavilion Avenue, Providence, R. I. 02905
Tel: (401) 941-3355

INFORMATION RETRIEVAL NUMBER 105

LARGEST AND MOST
DIVERSIFIED STOCK OF

RELAYS

IN THE WORLD!

We also stock MICROSWITCHES®

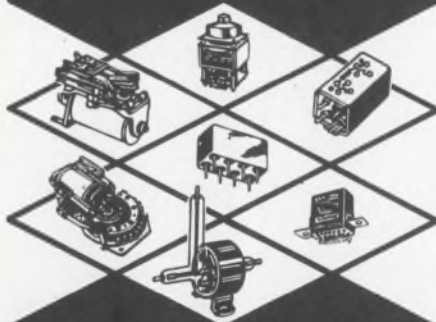

Faster Delivery / Lower Prices
All Types / Most Makes

SEND FOR
CATALOG ED

Universal RELAY CORP.

42 White St., New York, N. Y. 10013
(212) 925-6900 • TWX 710-581-4461

INFORMATION RETRIEVAL NUMBER 106

Advertisers' Index

Advertiser	Page	Advertiser	Page
ADC Products, A Division of Magnetic Controls Co.	143	Malco Manufacturing Company, Inc.	8
AMP, Incorporated	11	Mellonics Systems Development Division of Litton Industries	49
Acopian Corp.	15	MicroSwitch, A Division of Honeywell	54
Adams & Westlake Company, The	137	Molex Products Company	31
Addison-Wesley	149	Monolithic Dielectrics, Inc.	56
Aladdin Electronics	66	Moorlee Manufacturing Company	119
Alco Electronic Products, Inc.	114, 135	Motorola Semiconductor Products, Inc.	10, 40, 41
Allico	64B	National Beryllia Corporation	62
Allen-Bradley Co.	23, 47	National Semiconductor Corporation	32 A-B
American Technical Ceramics	118	North Atlantic Industries, Inc.	16
Amperex Electronic Corporation	9	Oak Manufacturing Co.	139
Amperex Electronic Corp., Electronics Division	121	Omnitronics Manufacturing, Inc.	60
Automatic Electric Company	34, 35	Packer Co., B. L.	120
Barnes Corporation	37	Penn Engineering & Mfg Corp.	148
Beckman Instruments, Inc., Helipot Division	97	Philips Electronic Components and Materials Division	64 A
Bird Precision Jewels	52	Piezo Technology, Inc.	130
Bishop Graphics, The	148	RCA Electronic Components and Devices	Cover IV
Bourns, Inc.	16A-B	Radio Switch Corporation	132
Burroughs Corporation	78, 79	Raytheon Company, Microwave and Power Tube Division	118
C & K Components, Inc.	52	Raytheon Company, Semiconductor Operation	4, 5
CTS Corporation	7	Resistance Products Company	149
Caddock Electronics	52	Rogan Brothers, Inc.	61
Centralab, the Electronics Division of Globe-Union, Inc.	101	Roper Whitney, Inc.	134
Collins Radio Company	103	Schrack Electrical Sales Corp.	60
Control Data Corporation	123	Servo-Tek Products Company	116
Coto Coil Company, Inc.	150	Schauer Manufacturing Corp.	128
Curtis Development & Mfg. Co.	149	Siliconix Incorporated	48
Cutler-Hammer	63	Simpson Electric Company	13, 129
Dale Electronics, Inc.	Cover III	Singer Company, The, Electronic Measurements Division	109
Deltrol Controls	115	Skydyne, Inc.	145
E-H Research Laboratories, Inc.	53	Solitron Devices, Inc.	65, 127
Edmund Scientific Company	139	Sprague Electric Company	12, 18
Electro Measurements, Inc.	56	Stackpole Components Company	51
Electro Cube, Inc.	147	Sylvania Electronic Components, Hybrid Microelectronics	17
Electro Switch Corp.	56	Sylvania Precision Materials, Parts Division	105
Electronic Design	151	Sylvania Electronic Components Semiconductor Division	99
Electronic Research Associates, Inc.	122	Syntronic Instruments, Inc.	134
Engis Equipment Company	133	Systron-Donner Corporation	2
Fairchild Semiconductor, A Division of Fairchild Camera and Instrument Corporation	128 A-B-C	TEC Incorporated	139
Faratron Corporation	126	TED Manufacturing Corporation	144
Federal Scientific Corp.	148	TRW Semiconductors, a Subsidiary of TRW, Inc.	141
FlexKey Corporation	126	Tektronix, Inc.	113
GTI Corporation	117	Teletype Corporation	88, 89
General Electric Company	55	Tetra Corporation	124
General Electric Company, Miniature Lamp Dept.	131	Texas Instruments Incorporated, Components Group	85
General Radio Company	1	Thermal American Fused Quartz Co., Inc.	146
Gould Inc., Piezoelectric Division	60	Triplett Corporation	20
Guardian Electric Manufacturing Company	44	Tung Sol Division, Wagner Electric Corporation	136
Hayden Book Company, Inc.	104	U. S. Capacitor Corporation	6
Hewlett-Packard	Cover II, 39, 50, 42, 43, 64	Unitrode Corporation	29
Honeywell, Computer Control Division	59	Universal Relay Corp.	150
International Communications Corporation	68	Welch-Allyn, Inc.	125
JFD Electronics Corp./Components	136	Westinghouse Electric Corporation	94, 95
Johanson Manufacturing Company	33	Weston Instruments, Components Division	110
KMC Semiconductor Corporation	67	Wheelock Signals, Inc.	64
Krohn-Hite Corporation	48 A-B	Zeltex, Inc.	58
Lear Siegler, Inc., Cimron Division	57	Zenith Radio Corporation	145
Line Electric Company	14		

now you can reach
more engineers
and reach them
faster...

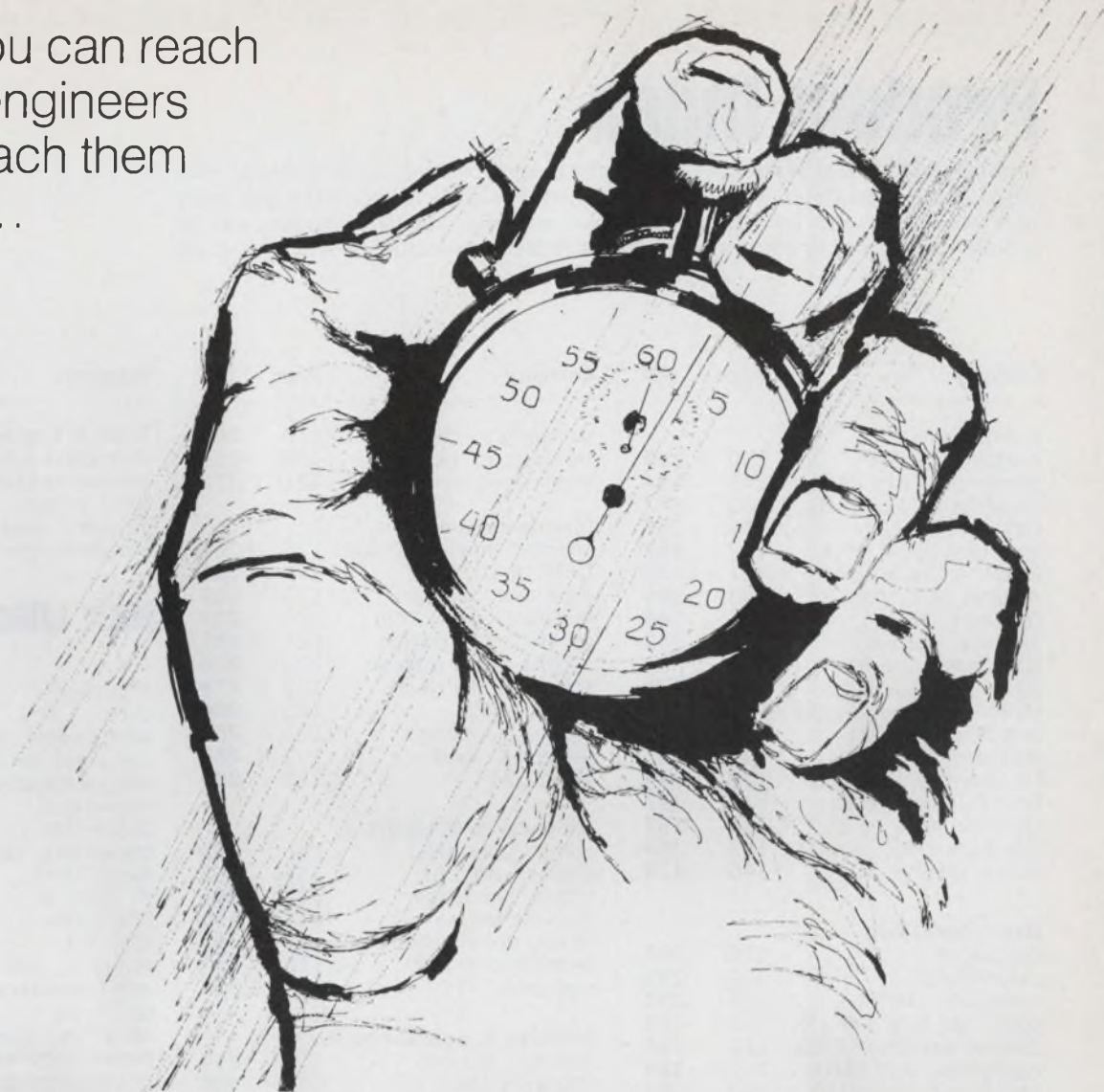

Electronic Design's *NEW*

FAST CLOSE FORM

Marketing and salespeople can't specify your products... engineers can. Products don't move through distributors until they are specified by engineers. Now there's a way to reach *more** EOEM engineers and reach them *faster*. It's Electronic Design's new FAST CLOSE FORM—right up front in the News Section. You can get out your new product story, your price announcements or delivery and distribution information, quickly, while they're still hot. Closing date for film positives is only 24 hours before press time... 48 hours before the issue mails. You save 3 full weeks over normal closing. The form will accept full pages or spreads in b&w or 2-color; premium is only \$150 per insertion. Call your Electronic Design representative today for complete information.

*Electronic Design has 72,271 EOEM engineers and engineering managers—53,372 more than Electronic News... 37,998 more than Electronics. Source: December, 1969 BPA and ABC Publisher's Statements.

ELECTRONIC DESIGN FAST CLOSE SCHEDULE

(Post on your production bulletin board)

ISSUE DATE	REGULAR CLOSING	FAST CLOSE		ISSUE DATE	REGULAR CLOSING	FAST CLOSE	
		ORDER IN N.Y. OFFICE	FILM POS. AT PRINTER			ORDER IN N.Y. OFFICE	FILM POS. AT PRINTER
June 7	May 4	May 22	May 25	Sept. 27	Aug 24	Sept. 11	Sept. 14
June 21	May 18	June 5	June 8	Oct. 11	Sept 8	Sept. 25	Sept. 28
July 5	June 1	June 19	June 22	Oct. 25	Sept. 21	Oct. 9	Oct. 12
July 19	June 15	July 3	July 6	Nov. 8	Oct. 5	Oct. 23	Oct. 26
Aug. 2	June 29	July 17	July 20	Nov. 22	Oct. 19	Nov. 6	Nov. 9
Aug. 16	July 13	July 31	Aug. 3	Dec. 6	Nov 2	Nov. 20	Nov. 23
Sept. 1	July 27	Aug. 14	Aug. 17	Dec. 20	Nov 16	Dec. 4	Dec. 7
Sept. 13	Aug. 10	Aug. 28	Aug. 31				

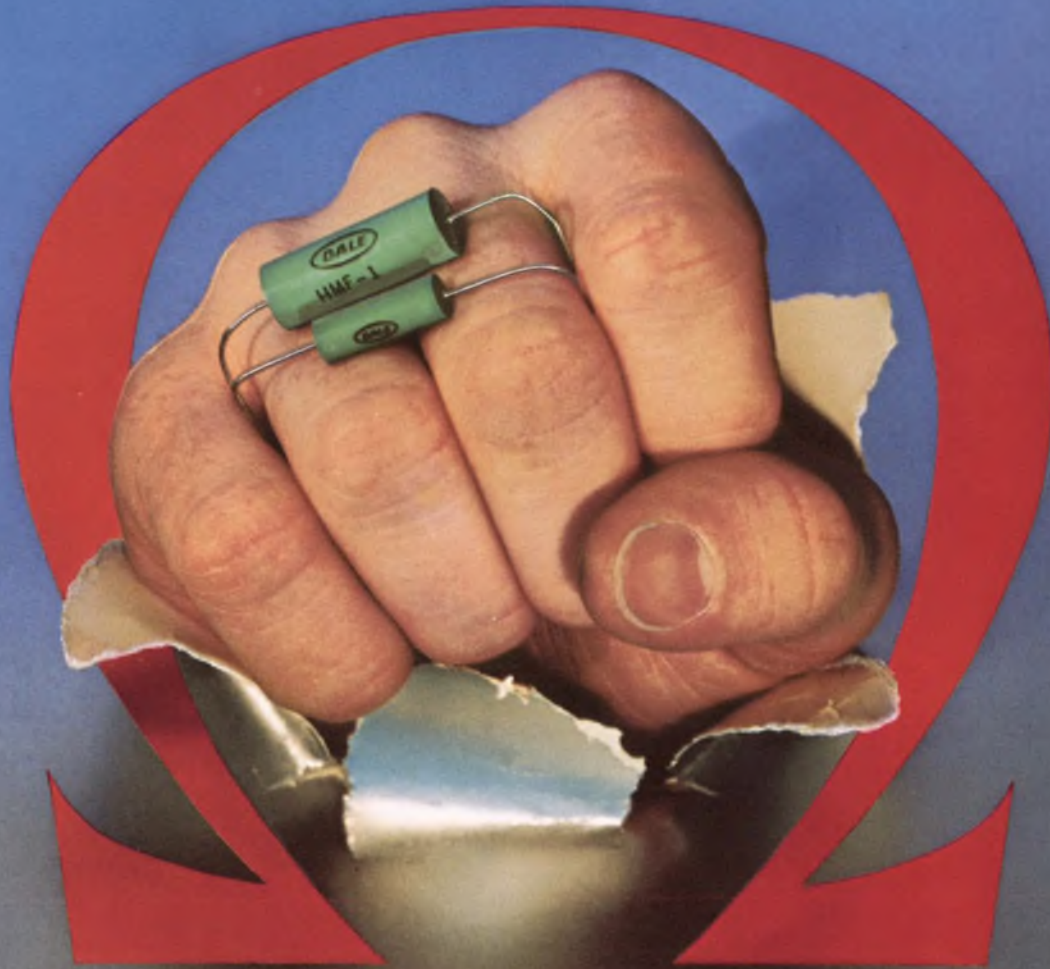

Dale breaks metal film value barriers

**Exclusive new
LMF/HMF Resistors
go as low as 1 Ohm...
and as high as 50 Megohms!**

Now you can use low-priced Dale Metal Film Resistors in more applications than ever. New LMF and HMF Series let you extend the use of high stability metal film parts to your lowest and highest resistance requirements. This Dale breakthrough gives you design and performance uniformity you've never had before. T.C.'s are no longer a problem — packaging is easier, too. The price: Competitive with the non-precision carbon film parts you previously had to use in low and high value situations. Check the specifications at right, then ask Dale for details on the industry's broadest and most useful line of metal film resistors.

Phone 402-564-3131 today
or write:

DALE ELECTRONICS, INC.

1328 28th Avenue
Columbus, Nebraska 68601
In Canada: Dale Electronics Canada, Ltd.
A subsidiary of The Lionel Corporation



SPECIFICATIONS

RESISTANCE		T.C.	
LMF	1-9.9 ohms	HMF	100K-50M
	5-30 ohms		100K-50M
	10-30 ohms		100K-30M
	15-30 ohms		100K-5M
			150 PPM
			100 PPM
			50 PPM
			25 PPM

Tolerance: 1% standard. Special tolerances and T.C.'s available.

Applicable Mil Specifications: MIL-R-10509
(Char. C, D, E), MIL-R-22684 (RL-07, RL-20).

Power Rating:

LMF — 1/10, 1/8, 1/4, 1/2 watt.

HMF — 1/20, 1/10, 1/8, 1/4, 1/2, 3/4, 1 watt.

Per Char. C & E 125° C rating. MIL-R-10509.

FLAME RETARDANT COATINGS

are standard on all Dale 1/10 thru 1/2 watt conformally-coated metal film resistors.

These resistors have excellent color stability when subjected to short time overloads and prolonged high temperature operation. They have withstood 100 times rated power for as long as 10 minutes without exhibiting flame.



New IC Switch from the Triac Leader

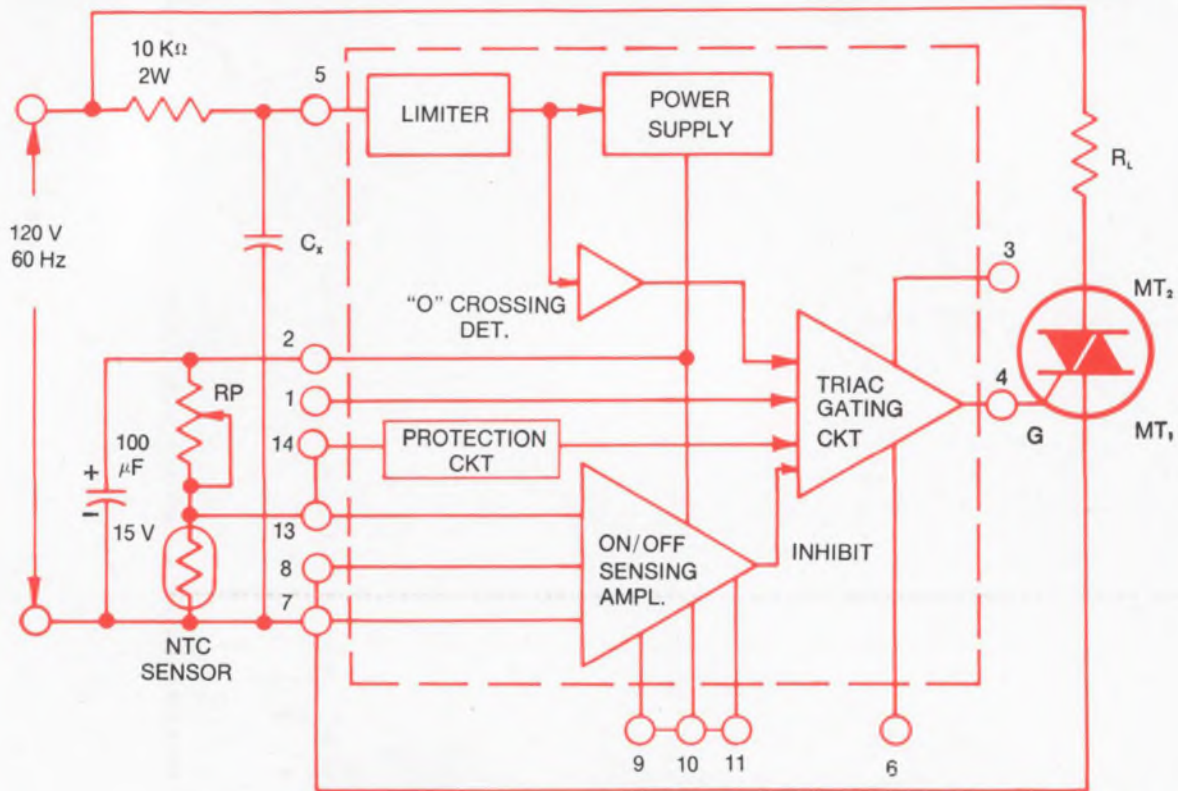

RCA-CA3059 Zero-Voltage Switch for New Economy, New Simplicity in Thyristor Trigger Circuits \$1.95 (1000-unit level)

Here's RCA's economical, new approach to Thyristor triggering—the CA3059 monolithic zero-voltage switch, at \$1.95 (1000 units). For efficient triggering of Triacs and SCR's with current ratings to 40 amperes—in applications such as electric heating, motor on/off controls, one-shot controls, and light-flashing systems—CA3059 offers these important new design advantages:

- Triggers Thyristors at zero-voltage crossing for minimum RFI in applications at 50, 60, 400 Hz.
- Self-contained DC power supply with provision for supply of DC bias current to external components.
- Built-in protection against sensor failure.
- Flexible connection arrangement for adding hysteresis control or proportional control.
- External provisions for zero-current switching with inductive loads.

- On/off accuracy typically 1% with 5 kΩ sensor; 3% with 100 kΩ sensor.
- Triacs in RCA's 2.5—40 Amp, 100—600 Volt series, Types 40693—40734, are selected to operate over the entire CA3059 temperature range.
- 14-lead DIP pkg. for -40°C to +85°C operation. For further details, check your local RCA Representative or your RCA Distributor. For technical data bulletin, file no. 397, and Application Note ICAN4158, write RCA Electronic Components, Commercial Engineering, Section 52-F-1/CA0014, Harrison, N.J. 07029. In Europe, contact: RCA International Marketing S.A. 2-4 rue du Lièvre, 1227 Geneva, Switzerland.

RCA Integrated
Circuits