

# Electronic Design 23

VOL. 14, NO.

THE MAGAZINE OF ESSENTIAL NEWS, PRODUCTS AND TECHNOLOGY

OCTOBER 11, 1966

**Computer-aided design**—exciting challenge to electronic engineers. From an amplifier to a feedback system, here is how this new technology has been applied to solve

typical design problems. Also included is a table of available computer programs that will help you to put this powerful design technique to work (turn to p. 54).





**HI-FI**



Transistor output; matches any PP transistor to 4, 8, 16  $\Omega$  speaker. Primary 48, 36, 12  $\Omega$  C.T.; 20  $\mu$  to 20 KC; 40 watts.

**MINIATURE MIL TYPE**



Metal case hermetically sealed to MIL-T-27B. Gold Dumet leads spaced on 0.1 radius, for printed circuit application.

**CHOPPER**



Magnetic shielded plus electrostatic shield for voltage isolation of  $2 \times 10^6$ . Primary 200K C.T. to within 0.1%. Secondary 50K.

**HIGH POWERED AUDIO**



Low distortion 2.5 KW output transformer, PP 450 TH's 18,500 ohms C.T. to 24/6 ohms, 20 KV hipot. 520 lbs.

**CATHODE FOLLOWER OUTPUT**



Provides equal voltages to 5 loads. Primary inductance maintained to 5% with 20% change in DC unbalance and 30% change in AC voltages.

**"SPECIAL" CUSTOM BUILT AUDIO TRANSFORMERS TO YOUR SPECIFICATIONS**

**HI-FREQUENCY CARRIER TO MIL-T-27B**



Electrostatically shielded, humbucking, +30 dbm level. Within .5 db 250 cycles to 110 KC. 600/135:600 centertapped to .1% tolerance.

**HYBRID TRANSFORMER**



Two transformers each 600  $\Omega$  primary, 40K  $\Omega$  C.T. secondary 250 cycles to 5 KC within 1/4 db. 40 db isolation over band.

**MICROMODULE**



Life tested per micromodule specs.: no failures. 10K  $\Omega$  C.T. to 10K  $\Omega$ , 100 mw from 400  $\mu$  to 20KC.

**SUBMINIATURE MOLDED TRANSFORMER**



Grade 3 with printed circuit leads for transistor application. 150  $\Omega$  to 150  $\Omega$  at 10 dbm level. Size 1/2 x 1/2 x 1/2"; weight 5 grams.

**BOLOMETER TRANSFORMER**



Primary 10 ohms, secondary 530K ohms, 230:1 ratio, response from 1/2 cycle to 25 cycles. 120 db magnetic shielding, plus full electrostatic shielding.

**ULTRA-MINIATURE**



Electrostatically & magnetically shielded output transformer 1/4 D. x 1/4" H. Pri. 15K CT, Sec. 8K CT; max. level 50 mw; audio range response. To MIL-T-27B, grade 4.

Exceptional quality and reliability is provided in all UTC designs. Over 30 years of engineering knowledge and experience substantiated by extensive field performance assure the highest quality and most reliable components in the industry. Complete environmental testing facilities are incorporated to prove out new designs. Full analysis and evaluation of materials are conducted in UTC's Material and Chemical Laboratories. Rigid quality control measures coordinated with exhaustive statistical findings and latest production procedures results in the industry's highest degree of reliability. Range covered in Audio Transformers is from 0.1 cycles to 400 MC . . . microwatts to 50 KW.

**MILITARY AND COMMERCIAL TYPES FOR EVERY PHASE OF THE ELECTRONICS ART**

- POWER TRANSFORMERS
- AUDIO TRANSFORMERS
- INDUCTORS
- PULSE TRANSFORMERS
- ELECTRIC WAVE FILTERS
- LUMPED CONSTANT DELAY LINES
- HIGH Q COILS
- MAGNETIC AMPLIFIERS
- SATURABLE REACTORS
- REFERENCE UNITS

Write for catalog of over 1,300 UTC TOP QUALITY STOCK ITEMS IMMEDIATELY AVAILABLE from your local distributor.



**UNITED TRANSFORMER CO.**

DIVISION OF TRW INC. • 150 VARICK STREET, NEW YORK, N. Y. 10013

# Check your application against each performance feature of the new 463A Precision Amplifier

- 1. 0.01% gain accuracy and stability—80 db dynamic range
- 2. Wideband application—dc-1 MHz

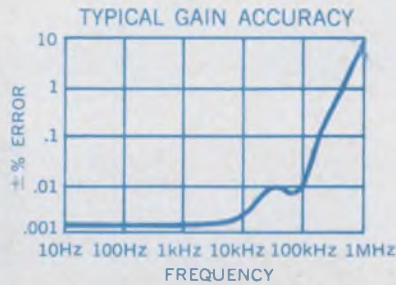

- 3. 0.01% ultra-low distortion
- 4. 100 v rms out, 5 watt continuous power
- 5. Front-panel overload indicator, reset button
- 6. All solid-state

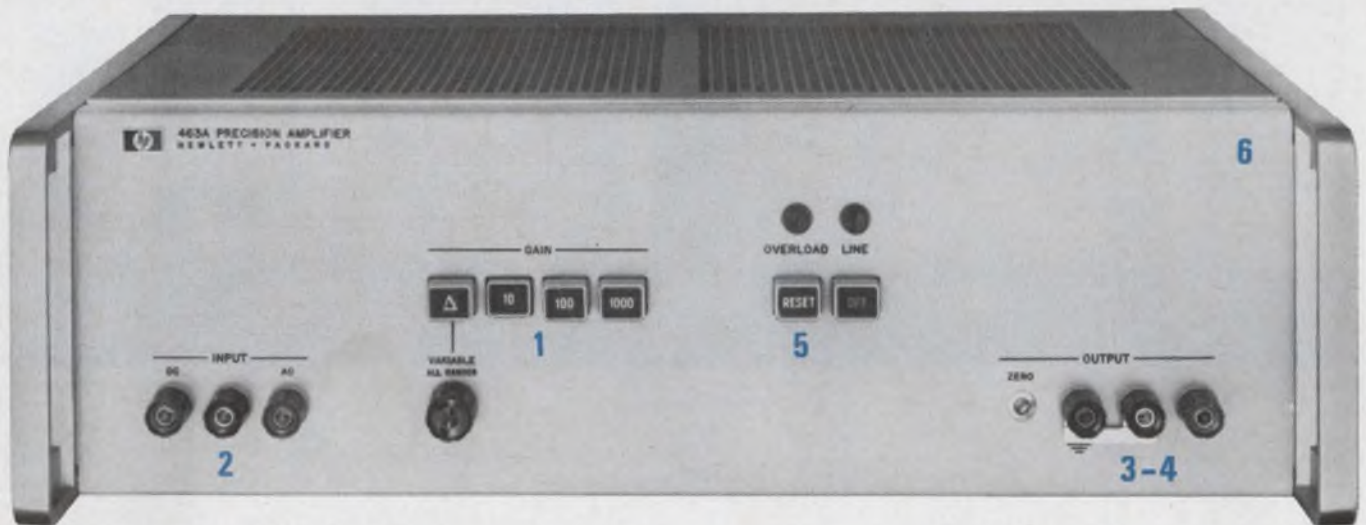

The Hewlett-Packard 463A Amplifier has totally unique benefits for almost every application—calibration system work without introducing error, ac and dc measurements with thermocouples or differential voltmeters, amplification of stable solid-state oscillators, driving magnetic memory cores, data acquisition amplification, bridge measurements, very low frequency amplification for biomedical, servo, geophysical applications, in-system amplification (BNC rear-panel terminals).

Adjustable gain is also provided with a range of 0 to 100% of

selected gain. The 463A meets the most critical demands of wide-range, low-distortion amplification. Ideal as a preamp for the hp 741A AC/DC Differential Voltmeter, DC Standard and 3440A/3445A DVM and Range-Unit Plug-in, for making low-level measurements. Hewlett-Packard 463A, \$590.

Call your Hewlett-Packard field engineer for complete specifications, related to your particular amplifier need. Or write Hewlett-Packard, Palo Alto, California 94304, Tel. (415) 326-7000; Europe: 54 Route des Acacias, Geneva.

*Data subject to change without notice. Price f.o.b. factory.*

**HEWLETT *hp* PACKARD**  
An extra measure of quality

ON READER-SERVICE CARD CIRCLE 2



No, it's not the start of a price war. We're simply demonstrating that our new solid-state Model 616A frequency meter costs about half the price of any other comparably performing instrument now available. But, since the 616A is so versatile, who needs two of them anyway? This clever little instrument, with all silicon semiconductor insides, gives you direct frequency measurement through the entire 225 Mc telemetry band, and as high as 12 gigacycles with one plug-in. That's because we cunningly built in the prescaler.

But Hewlett-Packard and Beckman didn't. Theirs is a plug-in to a counter, and the total cost is twice that of our 616A. Then they sell you a second

plug-in to measure above 400 Mc. Speaking of plug-ins... the 616A comes well equipped! Slip in a frequency converter or other special CMC frequency extender plug-ins, and your frequency measurements can soar to 1,000 Mc, 3,000 Mc, and even a phenomenal 12 gigacycles! Or, with our time interval plug-ins, measure time from .1  $\mu$ sec. to 1 sec., or 1  $\mu$ sec. to 10 sec.

Not only is the Model 616A half the price, but notice, it's half-rack size too! One reason is because, like others in the 600-Series, it features



an advanced "mother board" technique. Lost are excess size, weight, and components; gained are new shape, reliability, and ease-of-maintenance. Button it up with its front cover and this rugged 28-pound wizard goes right out in the field.

All this for just \$2,185. Interested? Then send now for the complete specs. And, if you're new at comparing our specs to high-powered H-P and big, bad B, you can earn a glorious Crusading Engineers' medal which reveals to everyone that you had the guts to look at somebody else for a change. It's also a great conversation opener for sweet young things you want to dazzle at your next T. G. I. F. party!

12973 Bradley · San Fernando, California · Phone (213) 367-2161 · TWX 213-764-5993

COMPUTER MEASUREMENTS COMPANY IS A LEADING DESIGNER AND MANUFACTURER OF ELECTRONIC INSTRUMENTATION TO COUNT, MEASURE, AND CONTROL.

Speed Inquiry to Advertiser via Collect Night Letter  
ON READER-SERVICE CARD CIRCLE 3

## NEWS

- 13 News Scope
- 17 **NASA spurs unity in computer-aided design**  
Compiles library of its programs as a first step toward ending duplication.
- 20 New spectrograph cuts process time.
- 21 **And now . . . inertial guidance in a suitcase**  
Portable system aligns navigation platform in carrier aircraft in seconds.
- 24 Audio/video system checks into hospitals.
- 26 Navy gets three-axis laser gyro.
- 28 Silicon improves efficiency of light-emitting diodes.
- 31 Washington Report
- 33 Laser may switch high RF power.
- 40 Letters
- 51 **Editorial: Engineer's black box complements MD's black bag.**

## TECHNOLOGY

- 54 **Staff Report: Computer-aided design**
- 56 **Here's a powerful design program** that allows the designer to use Laplace transform techniques to check circuit performance.
- 62 **Simplify feedback system design** by using a digital computer to perform the tedious steps required by manual techniques.
- 70 **Need a circuit design program? Why not custom-tailor one to fit your needs?** Here's an example that shows you how it can be done.
- 76 **Check design program availability** with this listing of computer programs developed for the design and analysis of electronic circuits.
- 84 **Avoid variable-load problems** by fitting the amplifier dissipation to the changing drive needs of your system.
- 90 **Demodulate the error signal** in FM modulators with a differential network for very stable and broadband operation.
- 96 **Convert complex numbers** to absolute values and angles graphically. The approach is very useful in analyzing transfer functions and complex impedances.
- 103 Ideas for Design
- 110 **Bits and Pieces:** A technical editor's miscellany.

## PRODUCTS

- 132 **Semiconductors:** Power FET 'on' resistance drops to new low of 4 $\Omega$ .
- 136 Microelectronics
- 140 Test Equipment
- 150 Microwaves
- 154 Power Equipment
- 158 Production Equipment
- 160 Systems
- 166 Components

## Departments

- 118 Book Reviews
- 202 Design Aids
- 204 New Literature
- 212 Reprints
- 214 Advertisers' Index
- 216 Designer's Datebook

## BOURNS® BUSHING MOUNT POTENTIOMETERS

Diameter (In.)	Model No.	Turns	Resistance <sup>①</sup> Ω	Tolerance (%)	Linearity (%)	Power (Watts)	Maximum Operating Temp. Range (°C)	Humidity (MIL-R-12934)	Shock (G)	Vibration (G)	Case Length (In.)
1/2	3700	10	100-100K	± 5	± 0.25	1.0 at 70°C	-65 to +125	Yes	100	20	1
	3707	10	100-100K	± 5	± 1.0	1.0 at 40°C	-55 to +105	③	50	10	1
7/8	3500	10	100-250K	± 3	± 0.20	2.0 at 70°C	-65 to +125	Yes②	100	20	1
	3501	10	1K-500K	± 5	± 0.50	2.0 at 70°C	-55 to +125	Yes②	100	20	1
	3507	10	100 to 100K	± 5	± 0.50	2.0 at 25°C	-55 to +105	③	50	10	1 1/4
	3510	3	50-100K	± 3	± 0.30	1.0 at 70°C	-65 to +125	Yes②	100	20	3/4
	3520	5	50-100K	± 3	± 0.30	1.5 at 70°C	-65 to +125	Yes②	100	20	1 1/4
	3530	1	25-50K	± 3	± 0.50	1.0 at 70°C	-65 to +125	Yes	50	15	1/2
1 1/16	3430	1	50-100K	± 3	± 0.50	1.5 at 70°C	-65 to +125	Yes	50	15	3/4
	3438	1	100-50K	± 20	± 1.0	1.0 at 40°C	-15 to +80	③	15	10	3/4
1 13/16	3400	10	100-500K	± 3	± 0.15	5.0 at 40°C	-65 to +105	Yes	50	10	1 3/4
2	3410	1	50-100K	± 3	± 0.30	4.0 at 70°C	-65 to +125	Yes	50	15	3/4
3	3440	1	100-150K	± 3	± 0.25	6.0 at 70°C	-65 to +125	Yes	50	15	3/4

## BOURNS KNOBPOT® POTENTIOMETERS

3/4	3600	10	100-100K	± 5	Accuracy <sup>①</sup> % ± 0.50	1.5 at 25°C	-65 to +85	③	50	10	1
1 1/4	3640	10	100-100K	± 3	± 0.10	2.5 at 25°C	-65 to +85	③	50	10	1 1/2
1 1/4	3650 DIGITAL READOUT	10	100-100K	± 3	± 0.10	2.5 at 25°C	-65 to +85	③	50	10	1 1/2
1 1/4	3660 LABPOT™	10	100-100K	± 1	± 0.10	2.5 at 25°C	-65 to +85	③	N/A	N/A	N/A

① Accuracy of Readout vs Output (Including Linearity)  
 ② Moisture Resistance per Method 106, MIL-STD-202 Available.

# BOURNS PRECISION POTENTIOMETERS

"A complete in-stock, in-depth line of proven standards and capability to adapt any model for special requirements."

## BOURNS® SERVO-MOUNT POTENTIOMETERS

Diameter (In.)	Model No.	Turns	Resistance <sup>①</sup> Ω	Tolerance (%)	Linearity (%)	Power (Watts)	Maximum Operating Temperature Range (°C)	Humidity (MIL-R-12934C)	Shock (G)	Vibration (G)	Case Length (In.)
1/2	3750	10	100-100K	±5	±0.25	1.0 at 70°	-65 to +125	Yes	100	20	1 3/8
	3550	10	100-250K	±3	±0.20	2.5 at 70°C	-65 to +125	Yes	100	20	1 3/8
	3551	10	1K-500K	±5	±0.50	2.0 at 70°C	-55 to +125	Yes	100	20	1 3/8
	3560	3	50-100K	±3	±0.25	1.5 at 70°C	-65 to +125	Yes	100	20	1 3/8
7/8	3570	5	50-100K	±3	±0.25	2.0 at 70°C	-65 to +125	Yes	100	20	1 3/8
	3580	1	25-50K	±3	±0.50	1.0 at 70°C	-65 to +125	Yes	50	15	3/4
1 1/16	3480	1	50-100K	±3	±0.50	1.5 at 70°C	-65 to +125	Yes	50	15	3/4
2	3450	10	100-500K	±3	±0.15	5.0 at 70°C	-65 to +125	Yes	50	10	2 1/4
	3460	1	50-100K	±3	±0.30	4.0 at 70°C	-65 to +125	Yes	50	15	3/4
3	3490	1	100-150K	±3	±0.25	6.0 at 70°C	-65 to +125	Yes	50	15	3/4

## 1" TURNS-COUNTING DIALS

## 1/2" TURNS-COUNTING DIALS

Model No.	Shaft Diameters (In.)	Brake	Body Finish	Part No.	Description
H-491	3/32, 1/8, 1/4	No	Clear	H-351	10-Turn, clock-dial readout. Accepts 1/8" or 3/32" Dia. shafts.
H-492	3/32, 1/8, 1/4	Yes	Clear	H-353	Adapter for shaft extensions
H-493	3/32, 1/8, 1/4	No	Black	H-354	Turns Counting Dial with brake
H-494	3/32, 1/8, 1/4	Yes	Black	H-355	Snap-on Color rings* *Per FED. STD. 595

③ Steady State Humidity per Method 103, MIL-STD-202.

① Lower and High Resistance Values than those shown are available in most models.

ON READER-SERVICE CARD CIRCLE 4

Take stock in twenty years of product reliability

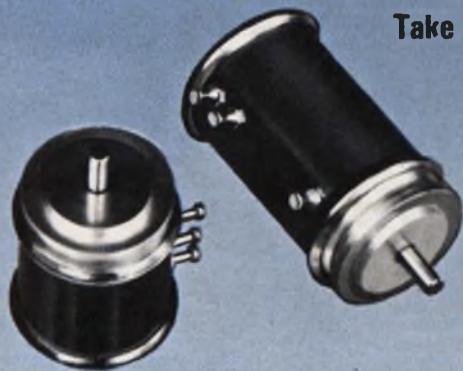

BOURNS, INC., TRIMPOT DIVISION  
1200 COLUMBIA AVE., RIVERSIDE, CALIF.  
PHONE (714) 684-1700 · TWX: 714-682 9582  
CABLE: BOURNSINC

TRIMPOT® AND PRECISION POTENTIOMETERS—RELAYS—MICROCOMPONENTS: TRANSFORMERS, INDUCTORS, RESISTORS AND CAPACITORS

## MICROCIRCUIT MODULES

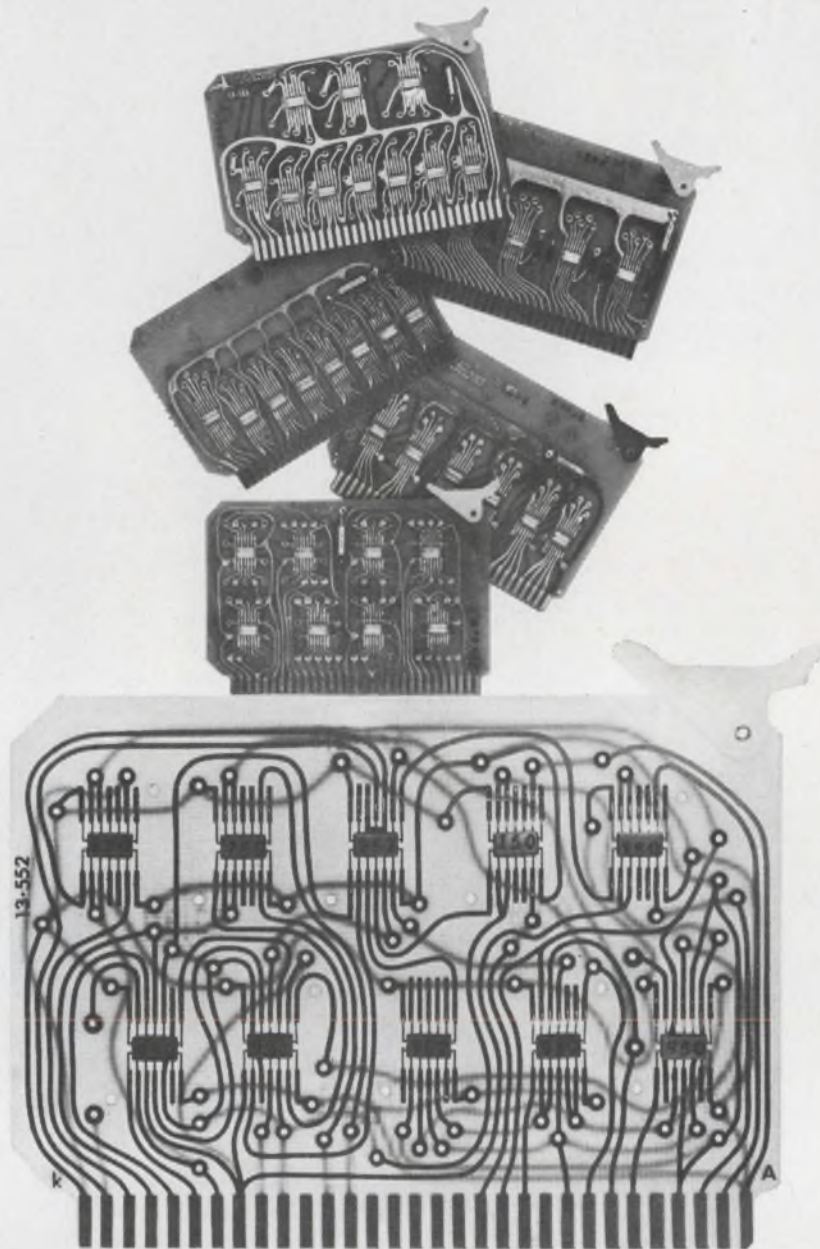

# HIGHEST DENSITY

...and simplified Gating Rules Reduce Costs

The ADC 13-Series features unique function grouping, simplified gating rules and a 62 pin connector which permits the highest density per board. This means more functions per board — fewer boards required — less wiring — less noise problems — less cost. The 13-Series offers the most economical logic implementation as well as field proven performance ■ The ADC 13-Series further expands (more than 30 new modules) the most complete line of logic modules available. ■ The 100 kc - 10



Series, with germanium semi-conductors, is simple, economical and reliable. The 1 mc 11-Series using silicon semiconductors, is ideal for high performance applications and the 11G-Series meets all applicable MIL/NASA specifications.

ADC offers free logic implementation service for competitive evaluation and application assistance. ■ *Write for new short form catalog and obtain a free logic design handbook.*

**ADC** DIGITAL PRODUCTS DIVISION **canoga** ELECTRONICS CORPORATION  
8966 Comanche Avenue, Chatsworth, California 91311, Tel. (213) 341-3010, Twx (910) 494-1214

ON READER-SERVICE CARD CIRCLE 5

ELECTRONIC DESIGN 23, October 11, 1966



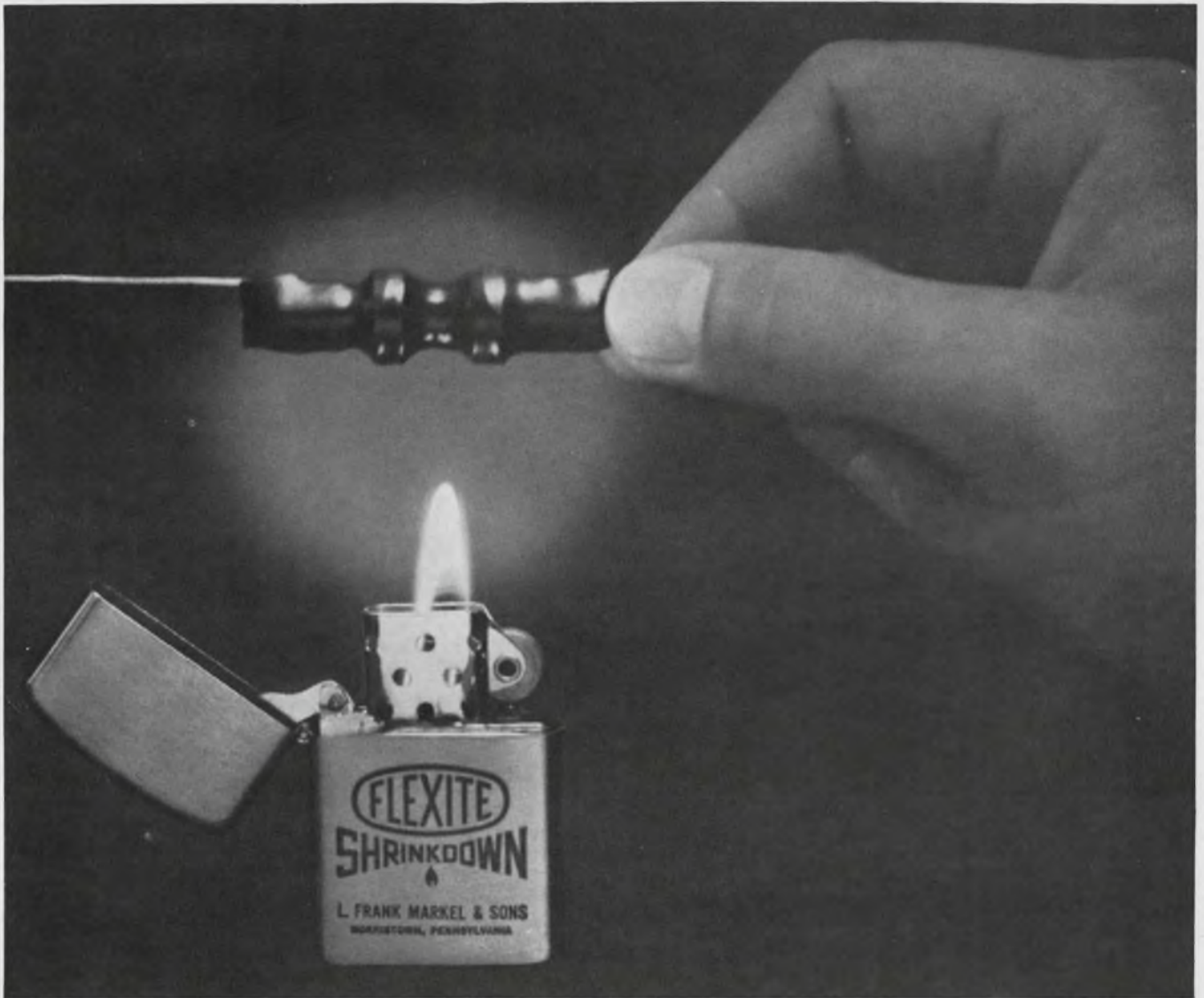

## *Ingenious uses for a* **hot idea!**

You design engineers are coming up with all sorts of ingenious uses for Flexite Shrinkdown plastic tubing.

Three years ago, Markel Shrinkdown was introduced as a better, more easily applied insulation for electrical components, connections and assemblies of irregular shapes. It still is . . . only more so!

But new uses, in countless applications, are being discovered every day. For instance: to bind things together—add strength and rigidity—seal against leaks—identify wires and parts—protect against abrasion, wear and breakage—resist corrosion, heat and moisture—keep out dirt, water, grease and chemicals—cover rough or sharp protrusions—prevent vibration—reduce noise—improve appearance—and so on ad infinitum.

Put your ingenuity to work. See where a skin-tight sheath of tough, flexible, heat-resistant plastic would improve performance, prolong life or cut the cost of your products.

There are four types of Shrinkdown to meet your requirements. One is of Teflon\*, for use at temperatures

up to 250°C. Two have shrinking temperatures under 200°F for use where higher heat would injure components. All have excellent electrical characteristics . . . meet military and commercial specifications. All shrink 50% in diameter—less than 10% in length.



To stimulate your thinking, we'll be glad to send you our "Hot Idea" experimental sample kit of Markel Flexite Shrinkdown Tubings. No cost—no obligation—just write.

\*DuPont Trademark



**L. FRANK MARKEL & SONS**  
 Norristown, Pa. 19404 • Phone: 215/272-8960  
**INSULATING TUBINGS AND SLEEVINGS**  
**HIGH TEMPERATURE WIRE AND CABLE**

ON READER-SERVICE CARD CIRCLE 6

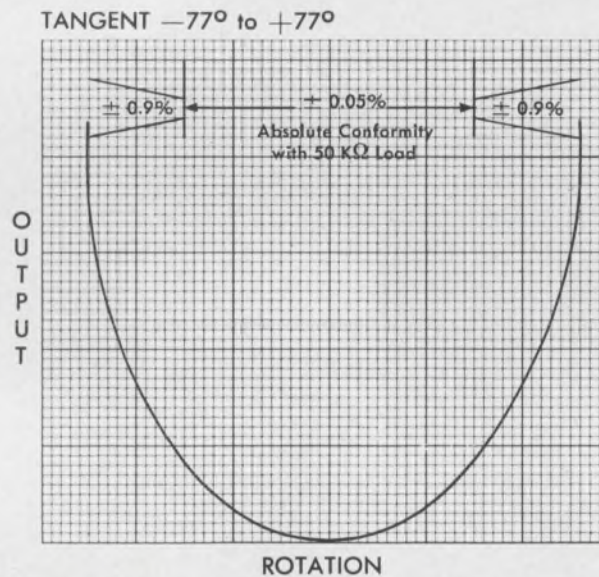
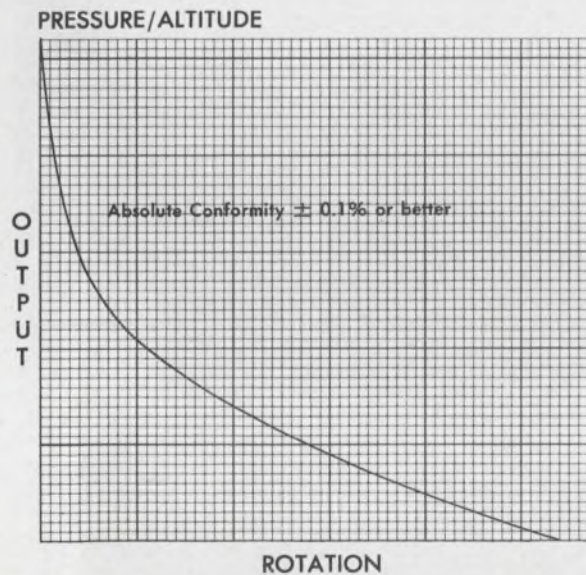
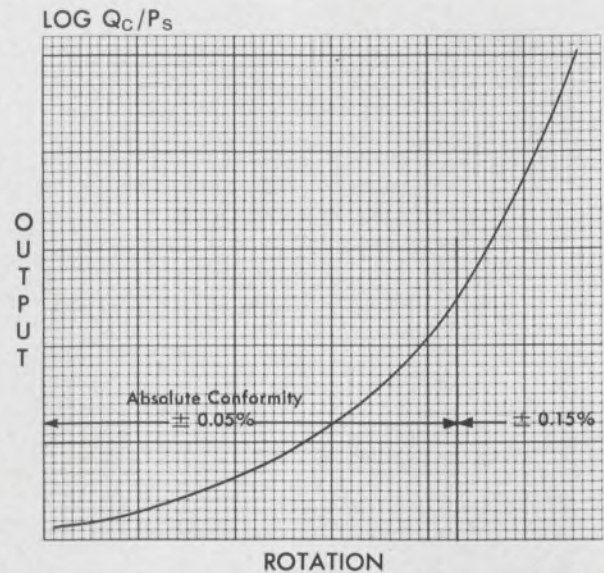
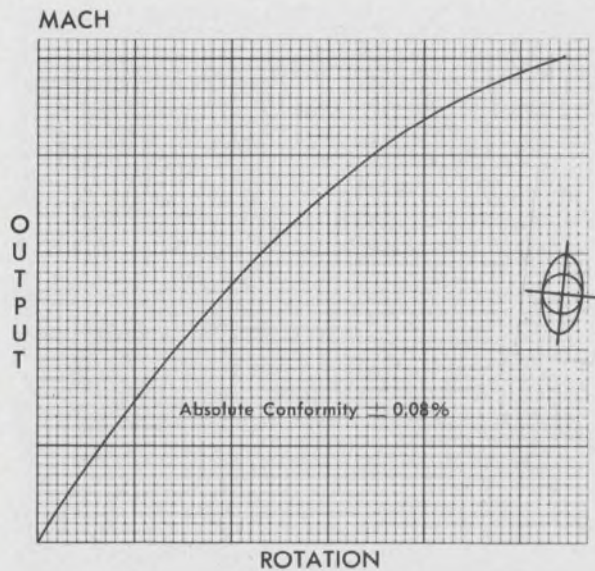

## OUR POTS CAN THROW A WICKED CURVE

If you require a precise non-linear voltage output, we have the answer. A Vernistat a.c. Potentiometer with a permanent wave.

Take a look at some of the useful curves produced by Size 11 Series 4 Vernistats.

Suppose you need a function generator or some other non-linear control. Remember there's a precise mechanism available for the job. It's called Vernistat.

As for reliability—rotational life tests indicate that Vernistat a.c. Potentiometers are "run-in" where conventional units experience serious degradation.

All Vernistat a.c. Potentiometers feature:

- Reliability and long life
- High input and low output impedance
- Low quadrature output
- Small loading error
- Continuous rotation in a multiturn unit.

We'll be glad to assist with any problem of pot design. Call or write to Electronic Products Division, Perkin-Elmer Corporation, 768 Main Avenue, Norwalk, Connecticut 06852.

**PERKIN-ELMER**

ON READER SERVICE CARD CIRCLE 7

ELECTRONIC DESIGN 23, October 11, 1966

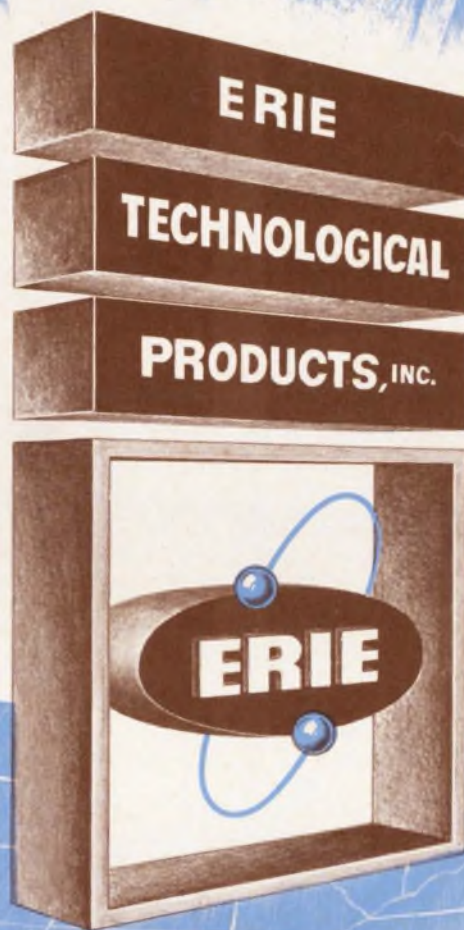

***A Growing Force in the World of Electronic Components***

SUBMINIATURE CAPACITORS • EMI FILTERS • SEMICONDUCTORS • THICK FILM INTEGRATED CIRCUITS •

ERIE, PENNSYLVANIA • OFFICES IN MOST PRINCIPAL CITIES •

ON READER-SERVICE CARD CIRCLE 8

**New from Sprague!**

**LOW  
COST  
HERMETICALLY  
SEALED**

**SEPT<sup>®</sup>**

**SILICON  
EPITAXIAL  
PLANAR  
TRANSISTORS**

**NOW AVAILABLE IN PNP TYPES!**

NPN TRANSISTORS		
Type No.	Application	Features
TN53-TN54	high voltage switch	$BV_{CEO} = 45V$ (min.), $BV_{CBO} = 75V$ (min.), $f_T = 100$ (min.)
2N4383-2N4386 (TN55-TN58)	low level switch	wide-band noise figure = 2 db (typ.), $h_{FE} = 100$ at 10 mA
TN59-TN64	high speed switch	$f_T$ up to 100 mc, $h_{FE}$ up to 100 at 150 mA
TN79-TN80	chopper	$V_O < 500$ mV at $I_B = 5$ mA, $R_S < 20 \Omega$ at $I_B = 5$ mA
TN81	power amplifier	600 mW $P_{OUT}$ at 50 mA, typical gain of 9 db

PNP COMPLEMENTS
2N4412-2N4413 (TQ55-TQ56) Low Level, Low Noise (complement of TN55, TN56)
TQ59-TQ60 General Purpose, High Gain (complement of TN59, TN60)
TQ61-TQ62 High Speed Switch (complement of TN61, TN62)



TO-5 CASE

**Hermetically-Sealed TO-5 and TO-18 Metal Cases  
for Superior Moisture Resistance  
and Power Capability**



TO-18 CASE

*For complete information, write to Technical Literature Service, Sprague Electric Company, 347 Marshall Street, North Adams, Mass. 01247*

**SPRAGUE COMPONENTS**

TRANSISTORS  
CAPACITORS  
RESISTORS  
INTEGRATED CIRCUITS  
THIN-FILM MICROCIRCUITS

PULSE TRANSFORMERS  
INTERFERENCE FILTERS  
PULSE-FORMING NETWORKS  
TOROIDAL INDUCTORS  
ELECTRIC WAVE FILTERS

CERAMIC-BASE PRINTED NETWORKS  
PACKAGED COMPONENT ASSEMBLIES  
BOBBIN and TAPE WOUND MAGNETIC CORES  
SILICON RECTIFIER GATE CONTROLS  
FUNCTIONAL DIGITAL CIRCUITS



\*Sprague\* and \*S\* are registered trademarks of the Sprague Electric Co.

# News

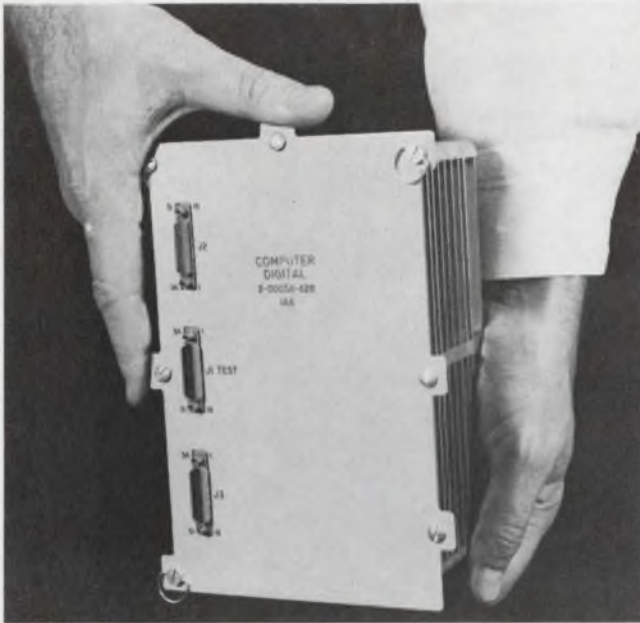

**Portable inertial guidance system** rapidly aligns aircraft navigation platform. Page 21



**Solid-state spectrograph** prints taped sound pictures in a matter of seconds. Page 20

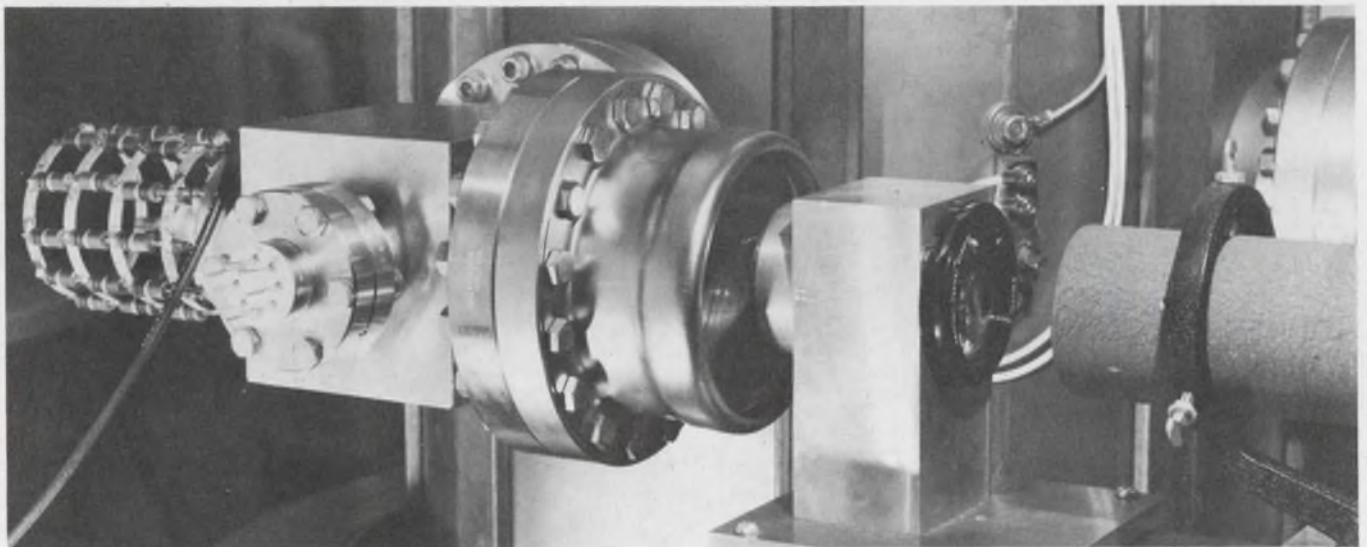

**A laser beam** may be used to trigger a high microwave power switch. The gaseous plasma

created by an ionization process in the beam is used as a transmission path. Page 33

## Also in this section:













**Computer-aided design** experiences growing pains . . . Page 17

**Audio/visual system** checks with hospitals . . . Page 24

**News Scope**, Page 13 . . . **Washington Report**, Page 31 . . . **Editorial**, Page 51

# All from Sprague!

## TWELVE OF OUR MOST POPULAR METALLIZED CAPACITOR TYPES

SPRAGUE TYPE	Case And Configuration	Dielectric	Temperature Range	Military Equivalent	Engineering Bulletin
 <b>680P</b>	hermetically-sealed metal-clad tubular	metallized Metfilm* 'A'	-55 C, +85 C	no specification	2650
 <b>431P</b>	film-wrapped axial-lead tubular	metallized Metfilm* 'E' (polyester film)	-55 C, +85 C	no specification	2445
 <b>155P, 156P</b>	molded phenolic axial-lead tubular	metallized paper	-40 C, +85 C	no specification	2030
 <b>218P</b>	hermetically-sealed metal-clad tubular	metallized Metfilm* 'E' (polyester film)	-55 C, +105 C	CH08, CH09 Characteristic R	2450A
 <b>260P</b>	hermetically-sealed metal-clad tubular	metallized Metfilm* 'K' (polycarbonate film)	-55 C, +105 C	no specification	2705
 <b>121P</b>	hermetically-sealed metal-clad tubular	metallized paper	-55 C, +125 C	no specification	2210C
 <b>118P</b>	hermetically-sealed metal-clad tubular	metallized Difilm® (polyester film and paper)	-55 C, +125 C	CH08, CH09 Characteristic N	2211D
 <b>143P</b>	hermetically-sealed metal-clad "bathtub" case	metallized paper	-55 C, +125 C	no specification	2220A
 <b>144P</b>	hermetically-sealed metal-clad "bathtub" case	metallized Difilm® (polyester film and paper)	-55 C, +125 C	CH53, CH54, CH55 Characteristic N	2221A
 <b>284P</b>	hermetically-sealed metal-clad rectangular case	metallized paper	-55 C, +105 C	no specification	2222
 <b>283P</b>	hermetically-sealed metal-clad rectangular case	metallized Difilm® (polyester film and paper)	-55 C, +125 C	CH72 Characteristic N	2223
 <b>282P</b> (energy storage)	drawn metal case, ceramic pillar terminals	metallized paper	0 C, +40 C	no specification	2148A

For additional information, write Technical Literature Service, Sprague Electric Company, 347 Marshall St., North Adams, Massachusetts 01247, indicating the engineering bulletins in which you are interested.

\*Trademark

### SPRAGUE COMPONENTS

CAPACITORS  
TRANSISTORS  
RESISTORS  
INTEGRATED CIRCUITS  
THIN-FILM MICROCIRCUITS

PULSE TRANSFORMERS  
INTERFERENCE FILTERS  
PULSE-FORMING NETWORKS  
TOROIDAL INDUCTORS  
ELECTRIC WAVE FILTERS

CERAMIC-BASE PRINTED NETWORKS  
PACKAGED COMPONENT ASSEMBLIES  
BOBBIN and TAPE WOUND MAGNETIC CORES  
SILICON RECTIFIER GATE CONTROLS  
FUNCTIONAL DIGITAL CIRCUITS



'Sprague' and ® are registered trademarks of the Sprague Electric Co.

## New X-ray unit shows 3-D internal views

A new development in X-ray technology affords the physician a three-dimensional view of the inside of his patient. Stereofluoroscopy gives a live view of the heart, liver and other internal organs such that their contour and depth may be seen at a glance.

This technique allows the physician to make more accurate and speedier investigations and simultaneously cuts the time that the patient is exposed to the possibly destructive radiation.

The new system, called Stereo Fluoricon by its maker, General Electric's X-ray Dept., Milwaukee, is an improvement of existing methods of enhanced two-dimensional fluoroscopy. It can be used in normal artificial light and is based on the use of a dual-beam X-ray tube that irradiates the patient from two slightly different angles. An optical polarizing arrangement superimposes left and right images on a mirror so that they appear as a sin-

gle three-dimensional image to the human eye.

The system is particularly valuable for locating foreign objects within the body and placing catheters within the heart. A heart catheter is a long, fine, highly flexible tube that is inserted in an artery at the wrist and snaked all the way to the heart. The procedure is used to inject X-ray-opaque dye into the heart for analysis of heart function. It is also employed to examine the composition of cardiac blood for aeromedical studies of pilots' reactions under conditions of acceleration and stress.

Fluoroscopy is based on the ability of X-ray radiation to illuminate a fluorescent screen. The patient is placed between the X-ray tube and the viewing screen and bursts of radiation project negative images of internal structures onto the screen. These can be viewed directly or filmed for later study.

This process was vastly improved

about 15 years ago with the introduction of the image intensifier tube which enhanced the image through application of electron microscope optics. Image brightness was increased as much as 6000 times. The patient could be viewed in a normally lit room. The technique was also safer because the X-ray energy level could be lowered and radiation dosage decreased.

The GE unit now introduces the third dimension into fluoroscopy. The two X-ray beams that it uses are two inches apart and are triggered alternately at 60 hertz. Because of their separation, each beam produces a slightly different image. After enhancement by an intensifier, the images are passed through the polarizing system and flashed successively onto the viewing mirror. The flashing rate is fast enough for the composite to appear as a continuous stereoscopic image.

Optional extra equipment makes it possible to vary depth perception. Altering the firing rate of the dual X-ray tube increases or decreases the angle of convergence so that the perception of depth can be increased or decreased.

## NASA funds may be cut by one billion dollars

One billion dollars will definitely be cut from NASA's budget this fiscal year, it is reliably reported. Leslie Carpenter, a highly respected and well-informed special writer for the *Washington Star*, contends that President Johnson has before him right now a proposal that will certainly reduce NASA's funds by that amount some time during the remaining ten months of Fiscal 1967.

The proposal, he reports, was submitted to the President by his economic advisers, who believe that NASA can better stand such a cut-back than any other government agency. Carpenter claims that both the President and his aides feel that the reduction in funds will delay a lunar landing by only a year or so.

## Sodium-sulfur battery to power electric car

A new type of battery said to be lightweight, cheap and powerful enough to propel a "subcompact" car has been unveiled by Ford Mo-

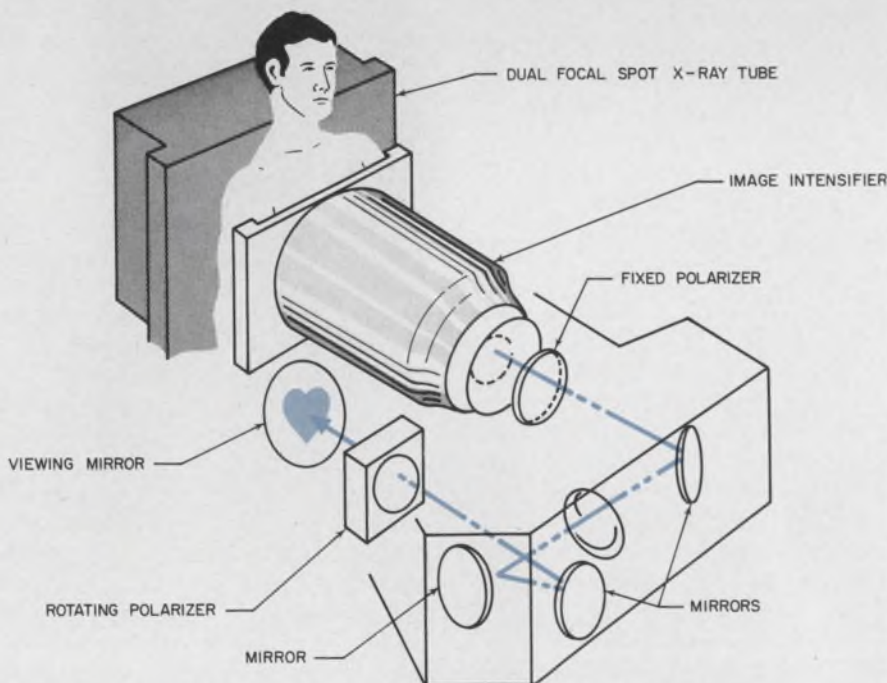

X-ray looks inside the body in 3-D

tor Co. researchers (see ED 13, May 24, 1966, pp. 17-22).

The battery contains liquid sodium and liquid sulfur separated by a crystalline ceramic sleeve. The production model will be a sealed unit that can be recharged with ordinary household current, a Ford spokesman said.

A major feature of the battery is the ceramic sleeve, which is made from aluminum oxide and beta-alumina. The selective qualities of this composition allows only the sodium ions to pass through, and interact with the liquid sulfur.

Because the battery is sealed and the action between the chemicals is a relatively simple process, the new battery is said not to suffer from the deterioration that occurs in conventional batteries.

Within 10 years, Ford said, they will be able to produce a 5- to 10-kW battery weighing 50 to 100 lb capable of powering a small car 150 to 200 miles at 40 miles per hour.

## Zenith demonstrates laser TV system

Zenith Radio Corp. has announced development of an experimental laser TV system that is said to produce large pictures with a sharpness and detail approaching that of conventional TV pictures.

An unusual feature of the display system is that horizontal scanning of the laser beam is accomplished by an ultrasonic deflection cell. The cell directs acoustic waves of varying frequency to intercept the laser beam and deflect it across the screen 15,750 times per second.

The system consists of a 50-mW, helium-neon laser source (producing a black and red picture on the screen). A first ultrasonic diffraction cell for intensity modulation. A second diffraction cell that acts as a horizontal deflector, and a ver-



Checking the weather

tical deflector. These perform essentially the same function as a conventional TV receiver.

## 16-lb weather station operates on batteries

A 16-pound portable weather station that operates on four conventional flashlight batteries has been delivered to the Army for use in the field.

The all solid-state unit, manufactured by Cambridge Systems, Inc., of Newton, Mass., can be put into operation by one man within the space of five minutes.

Also to be made available commercially, the station measures basic weather variables, including wind speed, direction, barometric pressure, temperature, dew point and precipitation levels.

Designated the AN/TMQ-22, the device will aid Army meteorologists in providing tactical weather.

## It may be hard to pass the buck

The Pennsylvania State University, University Park, Pa., has begun tagging some of the wild animals in the woods of central Pennsylvania with tiny radio transmitters.

Deer—bucks, does and fawns—are first shot with tranquilizer-tipped needles and then outfitted with bright plastic collars that contain the minute devices. The entire collar, containing transmitter, circular antenna and battery, weighs less than a pound.

The electronic tagging is a university project called Radio Deer.

Its aim is to learn more about the movement of the wildlife.

When the tagging is completed, graduate students will track the deer. Each student will carry a shoulder-strap receiver as he trudges through the chilly autumnal woodland. A handheld loop antenna will zero in on the animal and the student will pinpoint its whereabouts on a map for future study. The students will keep in touch with one another with walkie-talkies.

## Atom power urged for ocean living

A nuclear generator that would be placed 1200 feet below the ocean surface and supplying up to a million watts of power for a small underwater community has been suggested by B. D. Pritchard, vice president of R&D for T.M.C. Systems, Springfield, Va. The company has been studying the feasibility of such a project.

The reactor would provide electricity for protein farming and would operate equipment for mining the large reserves of mineral deposits known to exist under the seas. Sheltered inhabitants of the underwater community, Pritchard says, would receive enough generated power to live for extended periods without coming to the surface.

The reactor and generator would be contained in its own module and connected by cable to fully equipped community modules, providing living and recreational facilities. A floating platform would provide communication with the outside.

## Airline installs portable radios

A hand-held vhf radio that permits an airline pilot to talk directly to a control tower or rescue plane without relying on the aircraft power system has been developed. The two-channel unit is being placed aboard all United Airlines planes.

The wet-cell battery that powers the unit will last up to 20 years without recharging, says the radio manufacturer, Granger Associates of Palo Alto, Calif.

Development of the radio is said to be significant in that previously an aircraft with electrical failure lost all communications.



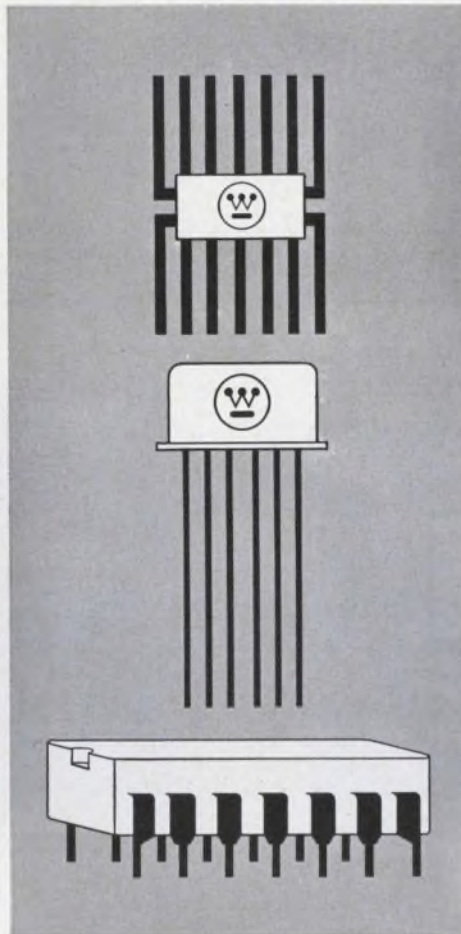

# Workhorse DTL

Four reasons why Westinghouse WC 200 IC's are a clear first choice for trouble-free computer and control systems.

The Westinghouse DTL line has been designed into so many successful computer and control equipments that it has won the supreme endorsement: It is being second-sourced by four major integrated circuit producers.

Reasons? First — reliability. WC 200 series designs have been proved by 5 million hours of life testing since their introduction in 1962 and have been continually improved since then. Major users report a 20 to 1 improvement in system reliability over previous discrete-component circuits. Just try to find any other digital line backed by such massive proof of reliability!

Second reason — speed. WC 200's six volt design with or without built in collector resistors increases speed and flexibility, keeps power dissipation down. And the use of the single-stage JK flip-flops rather than a master-slave arrangement makes WC 200 inherently fast.

Third reason — the greatest versatility in commercial DTL. Circuits are available in all 3 industry accepted packages. The line includes 15 gate circuits with 1 to 6 gates per package in a variety of input arrangements, 2 RS flip-flops, 2 JK flip-flops, 1 pulse binary counter, plus diode expanders and a large variety of interface circuits.

Fourth reason — immediate local availability at competitive prices. Behind the Westinghouse WC 200 line are both the most advanced IC plant in the industry and the longest production experience in integrated DTL. Result: high yields, and the greater production, increased reliability, and lower costs that you would expect to go with them.

These should be all the reasons you need to investigate WC 200 series DTL now. For immediate delivery, call your Westinghouse electronic distributor. For technical data, write Westinghouse Molecular Electronics Division, P.O. Box 7377, Elkridge, Maryland 21227.

You can be sure if it's Westinghouse

J-09134



ON READER-SERVICE CARD CIRCLE 11

# Solve Your Noise Problems...

*fish out those elusive weak signals from gooey backgrounds of noise*

... Since our first "solve-your-noise-problems" advertisements ran, we've sold a lot of PAR Lock-In Amplifiers and helped to solve a lot of noise problems. **But** — we couldn't help everybody . . .

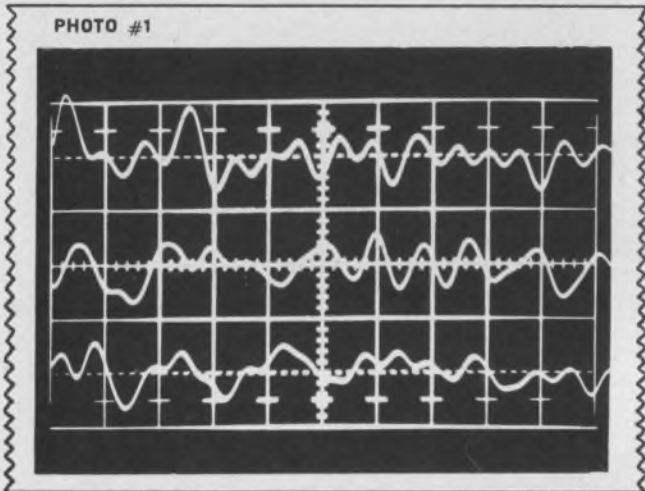

Three traces of a repetitive 50kHz signal buried in noise. Time: 10  $\mu$ sec/cm

certain applications require "fishing out" a faithful reproduction of the waveform of the desired signal and the lock-ins just didn't quite do this.

Heretofore — if the frequency was low, and the customer had lots of money, some sort of reproduction could be obtained with Brand X and similar types of complicated and expensive types of signal averaging machines.

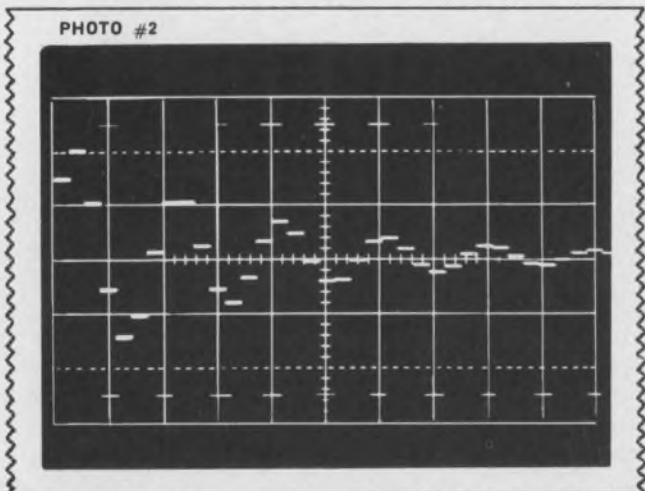

Output of Brand X at max. sweep with similar shaped waveform as signal input. As Brand X did not work with the 50 kHz signal, the input frequency had to be reduced to 5 kHz. Time: 100  $\mu$ sec/cm

See us at ISA Booth 1437

**NOW** — good news for searchers for small signals — the PAR team has again broken the noise barrier.

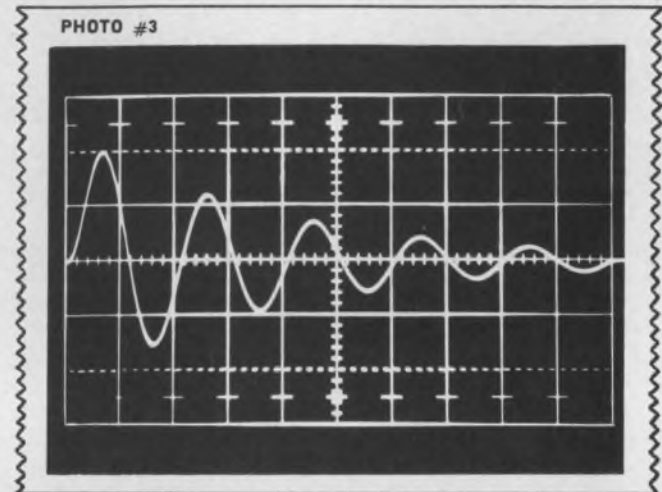

Output of PAR TDH-9 Waveform Eductor with the noisy 50 kHz signal shown in Photo #1 as input. Time: 10  $\mu$ sec/cm

Using an entirely new principle (an old PAR dodge), the PAR TDH-9 Waveform Eductor offers much faster speeds, much higher frequency response, all at a much lower cost! In the Waveform Eductor, special active filters combine the latest in field-effect and high-speed-switching techniques to get information into and out of information storage channels in nanoseconds. Thus, you can put 100 separate channels across one cycle of a 10 kHz signal or, on slower signals, these narrow channels can be used to study portions of the waveform in great detail for unexcelled resolution.

You can purchase a PAR Waveform Eductor for only \$4,200 and, of course get, for free, application help from the world's foremost noisy signal processing specialists.

**TDH-9 Specification Summary:**

- Averaging Time—1 to 100 sec
- Averages up to— $10^9$  separate scans
- Sweep Duration—100  $\mu$ sec to 11 sec
- Operates from —0.1 Hz to 100 kHz
- Outputs—Fixed and variable for oscilloscopes and/or recorders.



**PAR Model TDH-9 Waveform Eductor**

Write for Bulletin #126 to:

P  
A  
R

**PRINCETON**

**APPLIED RESEARCH CORP.**

Dept. E., Princeton, N. J. Tel. (609) 924-6835

# NASA spurs unity in computer-aided design

**Compiles library of its programs as a first step toward ending overlap among programs in field.**

**Peer Fossen**  
West Coast Editor

For a newcomer to the fertile field of electronics, computer-aided design has been growing more like a weed than a healthy seedling. With an estimated 2000 programs in use, wasteful and costly duplication of effort have abounded. The trouble: the lack of a clearinghouse for designers to locate and evaluate programs.

This picture emerged from the Institute on Modern Solid-State Circuit Design, held Sept. 15-16 at the University of Santa Clara, Calif. But for participants at the institute there was also good news: the first steps are being taken to correct the trouble. The most significant of these is a NASA survey of computer programs for circuit analysis and design. NASA is compiling a library of its programs and is making the contents available to industry

for a nominal fee.

The present information gap, speakers at the institute emphasized, exists not only between competing electronic companies but also between Government agencies and even different divisions of the same company.\*

A preliminary report on the NASA survey, being conducted by the agency's Electronics Research Center (ERC) at Cambridge, Mass., was presented by Dr. John Staudhammer of Arizona State University and Dr. William W. Happ, chief of the Design Criteria Branch at the NASA center. They stressed the value of setting up "standardization and qualification procedures to assure the usefulness and reliability of a program."

Their report noted that several hundred programs had so far been

\*See ED 4, June 7, 1966, p. 31 and ED 20, Aug. 3, 1966, pp. 34-36.

provisionally encoded and that specific information on individual programs would be made available through NASA's COSMIC project.

Under COSMIC, the Computer Center at the University of Georgia, Athens, is compiling the library of verified NASA programs. Apart from NASA's Cambridge center, the main sources of information for COSMIC are NASA's Marshall Space Flight Center, Huntsville, Ala., and the Manned Space Flight Center in Houston.

## Macroprogram distributed

NASA/ERC offered institute participants its "macroprogram," Network Analysis for Systems Application, confusingly abbreviated to NASA. Richard Carpenter of NASA/ERC said that the program was based on the "dichotomy" implied in the flowgraph associated with any active network. This dichotomy, Dr. Happ explained, was what distinguished flowgraph, cut-set and similar approaches to solid-state circuit design from node- or loop-analysis and like algebraic approaches. It stemmed from the fact that "to describe a passive element a decision . . . *must be made*: Is the element *either* a voltage-controlled current source or a current-controlled voltage source."

Carpenter described the NASA program based on this as particularly useful to circuit designers and reliability analysts with access to a medium-size or desk computer or to a time-sharing outlet. The final form of NASA was expected to become available more widely later through the COSMIC project.

## Balanced program was presented

The participants' consensus was that the formal portions of the institute afforded a good balance between academic and design-oriented lectures.

The two basic trends of the institute became apparent from the outset. The first day's formal program consisted of two main sessions on models of active elements and methods of circuit analysis. Five papers

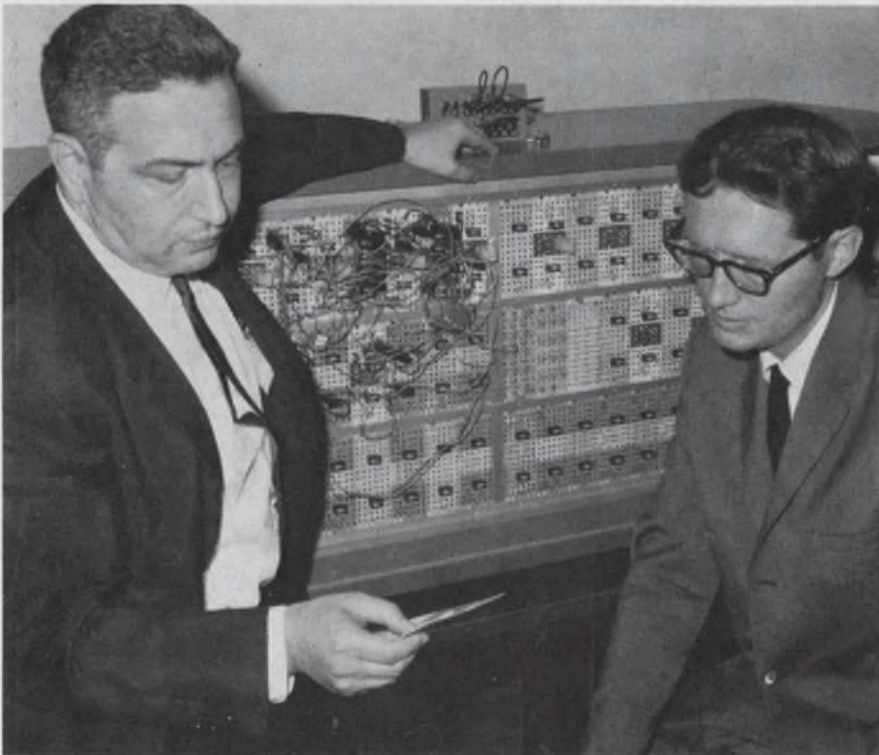

**Dr. Dorf (right) explains a circuit, simulation program, set up on the University of Santa Clara's Systron-Donner 80 analog computer, to Dr. Happ.**

**(computer design, continued)**

were presented. On the second and last day several practically oriented papers were heard.

Perhaps the most compelling paper given was "Inductorless Filters" by H. J. Orchard, of Lenkurt Electric Co., San Carlos, Calif. Orchard stated that the production of inductorless filters with RC active networks led to circuits that were very much more sensitive to component tolerances than conventional LC filters. An alternative and apparently optimum solution, according to Orchard, is merely to replace each inductor in a conventional doubly loaded LC filter with a gyrator-capacitor combination.

**Iterative method disapproved**

Both the next two speakers spoke against the usefulness of computer-aided design by iterative methods.

Dr. G. Temes, of Ampex Corp., Culver City, Calif., flatly warned against such methods in a paper, "Iterative Optimization Techniques." He said: "It is like brain surgery and should be used only after everything else has been tried. The iterative methods should only see use if no 'classical' synthesis technique is available to solve the design problem." One reason that he adduced was that the iterative methods take from 10 to 100 times longer than direct circuit synthesis.

Dr. E. A. Huber, of Sylvania Electric Co., took a less vigorous stand against iterative methods by suggesting that perhaps an approach involving both science and

art should be considered for computer-aided circuit design.

Dr. Richard Dorf of the host university's Electrical Engineering Dept. also came out strongly for the direct synthesis approach. Speaking on the topic, "Sensitivity," he said: "Going into computer-aided design is going to mean quite a bit of effort in some direction on the part of any company or individual. It is therefore necessary to think out, before starting, whether to go the route of building a large block of analysis programs or to try to develop design programs in themselves."

**No obvious choice exists**

To judge from the informal portions of the institute, there is no clear-cut answer to which route to choose. The trend seemed to be for companies not concerned with the cost of computer time to become more involved in analysis programs while engineers designing with an eye to the profit and loss statement favor direct synthesis.

It was Dr. Temes who best summed up the divergence of views when he said at an informal evening session: "This institute has brought together two groups interested in computer-aided circuit design: those who know how to design and go ahead and do it; and those who don't know how to design and go the guess-and-analyze route. They are both very competent groups, but they need to get together!"

**Other issues remain undecided**

The informal sessions also

brought out a number of other questions for which there are as yet no ready answers. These included:

- Why isn't more done to simplify computer languages?
- How do you persuade a design engineer who is "afraid" of the computer to use this important tool?
- Why is there not greater implementation of those programs and ideas that are available?

The legal problems of computer-aided design also exercised participants in the institute, particularly industry's idea of copyrighting computer programs. It has been customary for computer programmers to exchange information on an informal basis. They now see the possibility of copyrighting as a threat to this practice.

A spokesman for one firm deeply involved in computer-aided design gave his views in this fashion: "Anyone with a specific problem can just call his buddy at the company next door, and his buddy can in most cases help him out, either by steering him in the right direction, or by offering a program he already has on hand. Usually a deal of this sort ends up in a 'horse-trade' situation without anyone losing on the deal, least of all the general industry and the public.

"Now, if the legal and patent people become involved through copyrighting—and they see the litigation that is possible as a result—this lower-level horse-trading will be closed up tighter than a drum. The net result will be a tremendous duplication of effort all round, increased manpower demands and higher cost." ■ ■

## Latest in typesetting: Magnetic-tape "print shop"

A new automatic typesetting system being offered by International Business Machines is, in effect, a one-man print shop on magnetic tape.

The system consists of four units—a recorder for storing copy on magnetic tape, a tape reader, a console control station, and a composer that produces the justified copy—but only one operator is needed to perform the complete direct-printing process.

The four units can store and print about 4000 words—equivalent to a solid page of newspaper copy. The magnetic tape makes it possible to produce the printed copy automatically in any composition format desired.

The copy is first typed on a modified IBM typewriter. The typing action records all printing-machine functions, such as type selection, capital shift, paragraphing, spacing and tabulating in code on the tape.

A 100-foot-long tape can store the 4000 words. The operator can erase any errors by automatically backspacing and typing over them.

After removal from the recorder, the tape is placed in the reading unit. Type style and the system instructions are selected on its control panel.

The composer then composes camera-ready copy, according to the format instructions, at speeds up to 14 characters a second. ■ ■

**ONLY 3C OFFERS**

**30 DAY DELIVERY**  
**ON THE HOTTEST COMPUTER**  
**IN THE \$28,500 PRICE RANGE**

DDP-116 computers are now operational in over 50 installations including communications, data acquisition, hybrid and other real-time control applications. Specifications include: 16-bit word, 1.7 $\mu$ sec cycle, expandable 4096-word memory and keyboard with paper tape I/O unit.

Software is a proven factor! The compact DDP-116 offers as many as 134 subroutines in its ASA FORTRAN IV library. Also, it is compatible with the DAP assembler and desectorizing loader. A/D and D/A subsystems, a full peripheral line and special purpose systems capability are available to extend the flexibility of the basic DDP-116.

Write for full details, or telephone today to test operate the DDP-116 at a selected 3C regional office nearest you.

**DDP-116**

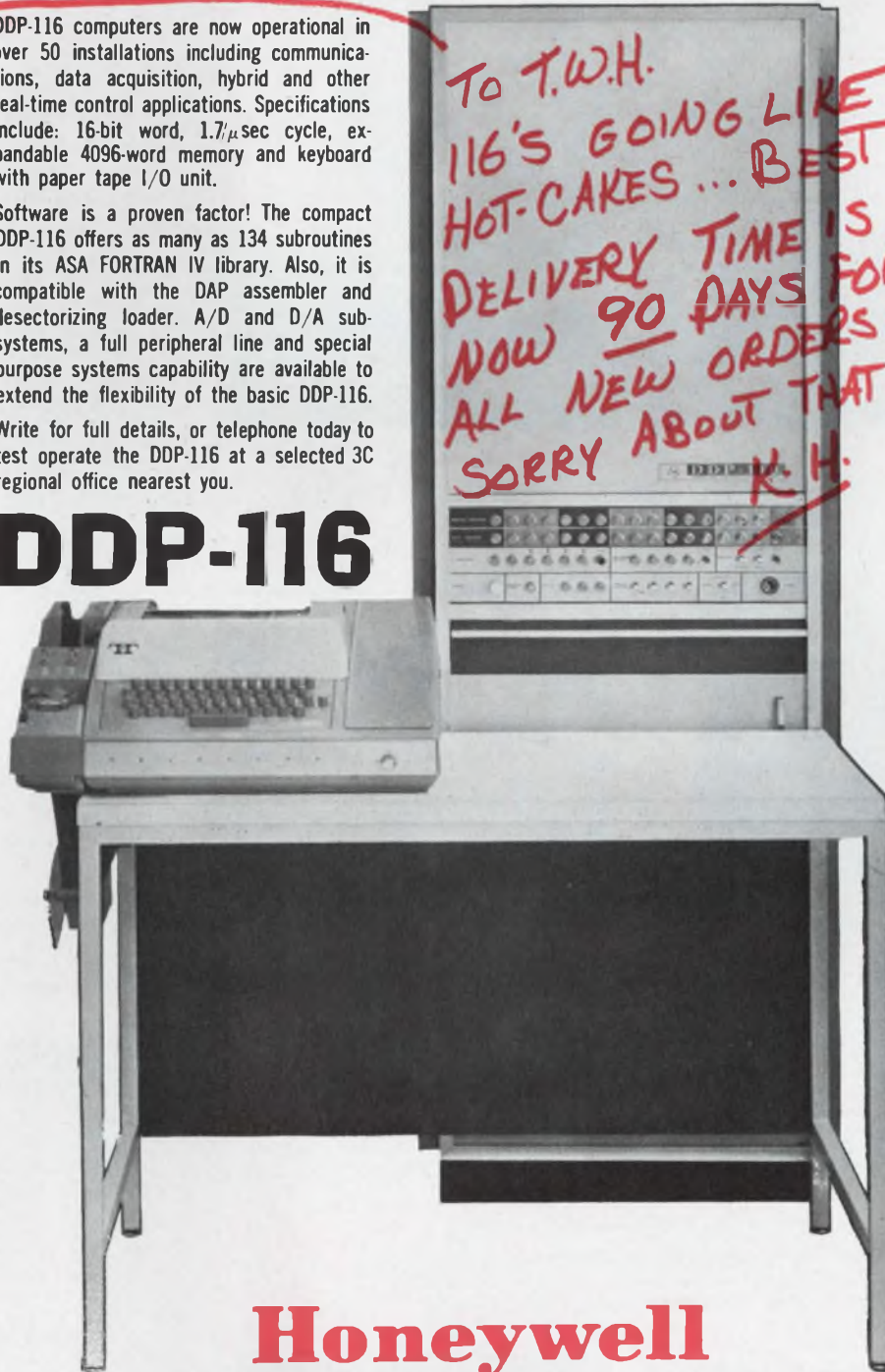

**Honeywell**

 **COMPUTER CONTROL DIVISION**  
OLD CONNECTICUT PATH, FRAMINGHAM, MASSACHUSETTS

**SEE US AT FJCC**

Speed Inquiry to Advertiser via Collect Night Letter  
ON READER-SERVICE CARD CIRCLE 13

# New from Sprague!

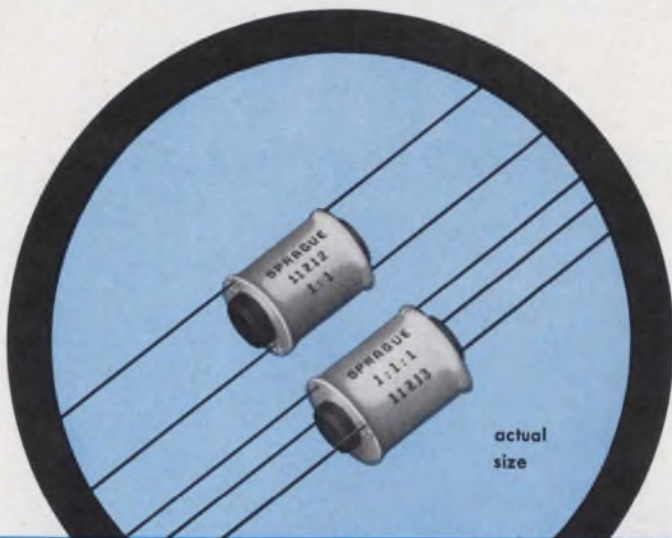

## TRIGATE\* PULSE TRANSFORMERS... the industry's lowest-cost SCR triggers!

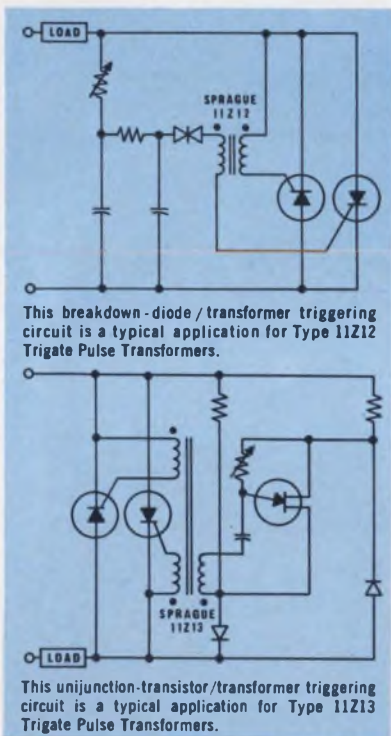

### Dependable enough for industrial equipment, yet priced for high-volume commercial applications

Here's good news for designers of appliances; lighting controls; air-conditioning and heating controls; industrial controls. You can actually cut costs while upgrading your present method of SCR triggering!

Type 11Z Trigate\* Pulse Transformers offer these unique features:

1. Balanced pulse characteristics and energy transfer from primary to secondary and tertiary windings.
2. Minimum saturation effect to allow operation where increased pulse widths are required.
3. Fast pulse rise time and increased current capability to prevent SCR *di/dt* failure.
4. Increased energy transfer efficiency.

Designed for operation over the temperature range of  $-10^{\circ}\text{C}$  to  $+70^{\circ}\text{C}$ , Trigate Pulse Transformers are available in 2-winding and 3-winding configurations for half-wave and full-wave applications. Turns ratios include: 1:1, 1:1:1, 2:1, 2:1:1, 5:1.

For complete information, write for Engineering Bulletin 40,003 to the Technical Literature Service, Sprague Electric Co., 347 Marshall St., North Adams, Mass. 01247

\*trademark

### SPRAGUE COMPONENTS

PULSE TRANSFORMERS  
CAPACITORS  
TRANSISTORS  
RESISTORS  
THIN-FILM MICROCIRCUITS  
INTEGRATED CIRCUITS

INTERFERENCE FILTERS  
PACKAGED COMPONENT ASSEMBLIES  
FUNCTIONAL DIGITAL CIRCUITS  
MAGNETIC COMPONENTS  
CERAMIC-BASE PRINTED NETWORKS  
PULSE-FORMING NETWORKS



\*Sprague\* and ® are registered trademarks of the Sprague Electric Co.

## NEWS

### New spectrograph cuts process time

"Pictures" of sounds are printed directly from standard magnetic recording tape in 80 seconds with a solid-state spectrograph developed by Bell Telephone Laboratories.

Sound spectrographs have long been used in research. They can analyze speech, diagnose heart disease or malfunctioning jet engines, or check communications equipment.

Earlier spectrographs took five minutes to produce a spectrogram, and an intermediate step was required: the taped data had to be transferred to plated drums or metal loops. With direct printing from mylar tape, the new model has better fidelity and lower background noise, according to Bell.

In operation, the spectrograph scans the tape in narrow bands of successively higher frequencies. Information from each scan is transferred to electrically sensitive paper, resulting in a graph of frequency and amplitude. For an analysis of frequencies up to 7000 cps, the tape is scanned 400 times. Lower frequencies are printed at the bottom of the spectrogram paper and higher frequencies at the top. Sound intensity is indicated by light and dark shading, and time is read from left to right. Each spectrogram represents 2.4 seconds of sound.

The designer of the machine is Anthony J. Presti, an engineer member of Bell's Acoustics Research Dept. at Murray Hill, N. J. ■ ■



High-speed spectrograph, developed at Bell Telephone Laboratories, works directly from standard magnetic tape.

# And now . . . inertial guidance in a suitcase

**Portable system aligns navigation platform in carrier aircraft in seconds, instead of 30 minutes or more.**

**Neil Sclater**  
East Coast Editor

Inertial-guidance platforms, wonderful for navigating, are lazy about getting started. They must be warmed slowly and coaxed into working position. This poses a problem on the pitching, rolling deck of an aircraft carrier, with only minutes available for take-off preparations under combat conditions.

Engineers at the Arma Div., American Bosch Arma Corp., Garden City, N. Y., say this is a good place to use their Master Reference System, an inertial navigator in a suitcase. By feeding essential carrier position and speed data into the portable system and transferring it, as needed, to the aircraft, sailors can set up airborne platforms for flight in about 60 seconds.

At present, alignment of the platform usually takes about 30 min-

utes, and, under adverse conditions, it can stretch as long as 80 minutes. A cable running between the plane and the ship's inertial navigation system is ordinarily used to feed such reference signals as latitude, longitude, velocity and the ship's heading into the aircraft navigation system.

Arma's portable system, not intended for flight, includes a complete sensing platform, a digital computer and an electronic control—all mounted in a case weighing less than 100 pounds. The system is being completed under a contract from the Grumman Aircraft Engineering Corp. of Bethpage, N. Y.

Arma engineers say that miniaturization was possible because of the use of two-degree-of-freedom fluidless gyros and a compact digital computer, constructed largely of monolithic integrated-circuit modules.

The portable system consists of two major sections: the reference unit/transfer fixture and the electronics unit.

The reference unit and transfer fixture, containing the stabilized platform, is attached directly to the outside of the aircraft through access holes. This action connects the aircraft's inertial unit to the portable transfer cable. When the

transfer fixture is properly mounted, the autocollimator, mounted on the reference unit, lines up with a mirror on the aircraft's unit. The operator observes the autocollimator output on a null meter and manually reduces any misalignment in azimuth between the two units to less than 1.0 minutes of arc.

The electronics unit is placed on the deck near the operator and is connected by cable with the reference unit and transfer fixture. It has a self-contained power supply.

The reference unit-transfer fixture weighs only 25 pounds, light enough to be carried by one man. More than 40% of the total 100-pound weight of the system is in the carrying case and combination battery and battery charger.

The reference unit contains the three-axis stabilized platform, which carries two 2-axis gyros and two inertial quality accelerometers whose sensitive axes are leveled and aligned to north and east. The transfer fixture is used to orient the azimuth axes of the portable platform and that of the aircraft navigator in order to permit rapid transfer of azimuth synchro signals.

The electronics of the system include a digital computer, analog-to-digital converter, power supplies, battery and other circuitry for navigation computation, gyro drift auto-compensations, mode control and data display.

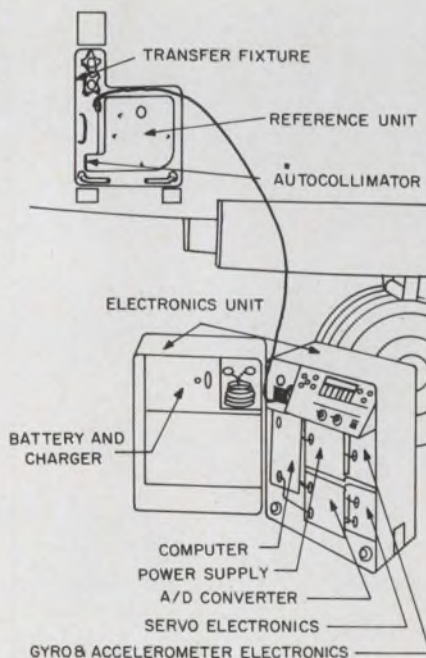

**Master reference system** shown in working position. Arma system, used on aircraft carriers, will transfer position and speed from ships' inertial navigator to aircraft.

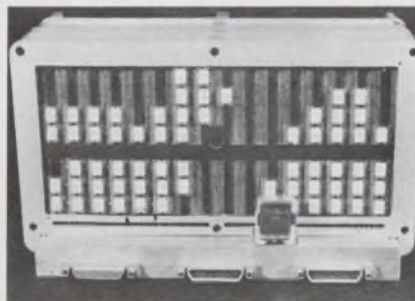

**Digital computer** weighs less than 5 lbs and requires 25-W power. It is made up of eight plug-in card assemblies; 3 logic, 1 input/output, 4 memory electronics plus a plug-in memory stack. Outside dimensions are approximately 7 in. by 4 in. by 3 in.

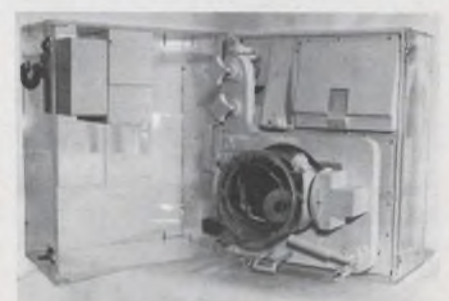

**Master Reference System** mock-up showing components in storage position. The L-shaped unit (right foreground) is reference unit/transfer fixture that is lifted out and attached to the aircraft. The platform is contained within the 8-in. sphere.

(suitcase guidance, *continued*)**Gyros: One or two degrees of freedom. Which is best?**

In an inertial navigation system, motion must be controlled about three axes. The designer generally has two options: three single-degree-of-freedom-gyros (SDF) or two two-degree-of-freedom gyros (TDF). The advantages and disadvantages of both approaches have been debated by many people. So far the debate is a stand-off.

In terms of attainable performance in systems, both appear equivalent. In simple terms, it is largely a matter of two relatively costly TDFs as against three SDFs whose individual cost is slightly less.

Most gyro manufacturers tend to fall into one or the other of these camps. Single-degree-of-freedom proponents include the Instrumentation Laboratory at Massachusetts Institute of Technology, Honeywell, A.C. Spark Plug Division of General Motors and Nortronics. Arma Corp is in the two-degree-of-freedom camp along with Litton Industries and the Autonetics Division of North American Aviation. Some, like General Precision, Inc. and Sperry Gyroscope Co. cover both sides.

Dr. Bernard Litman, program manager at Arma, says that the use of two gyros and only two accelerometers along with advanced IC circuitry permitted the company to obtain the desired characteristics in a suitcase-sized package.

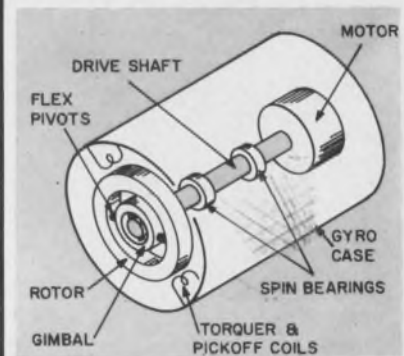

The two-degree-of-freedom gyro used in the Arma Master Reference System is shown in this simplified drawing.

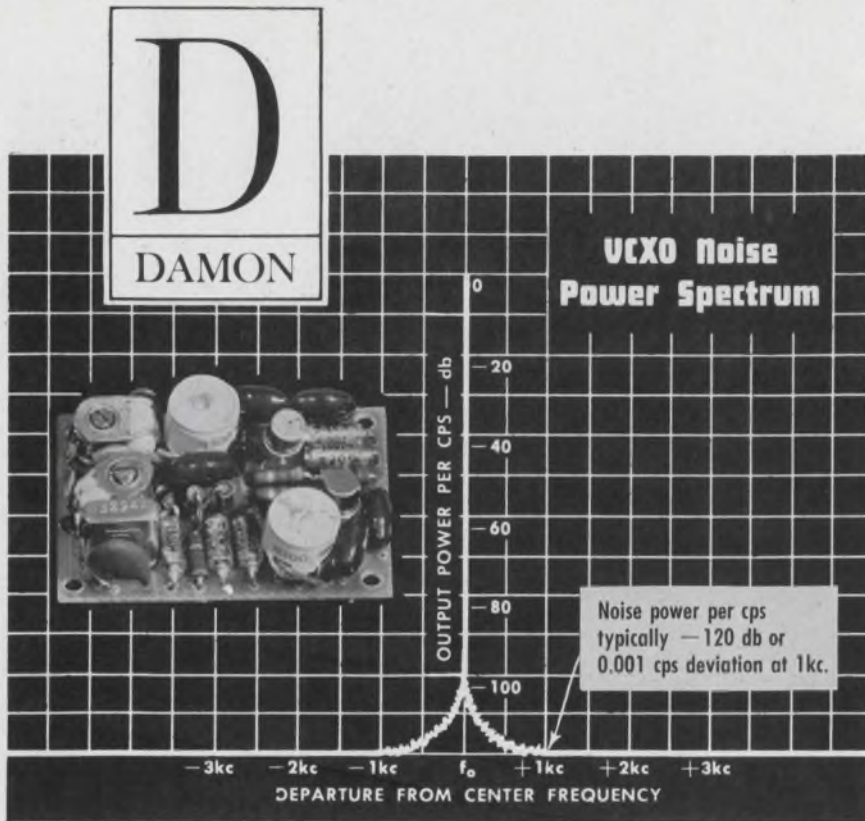

# Low Noise VCXOs (Voltage Controlled Crystal Oscillators)

## for an Important Reduction in Phase Jitter

Another FIRST from DAMON . . . Low Noise VCXOs with extremely low phase-jitter ( $-120$  db or  $0.001$  cps deviation at  $1$  kc.) This excellent short term stability is typified in the VCXO output spectrum illustrated, above.

Damon Low Noise VCXOs may now be inserted into systems as simple components with no auxiliary compensating circuitry. Only a source of power and a control signal are required.

Applications include: Doppler Radar (CW, CW-FM, FM and Pulse Doppler); Phase Locked Receivers and Transmitters; Doppler Simulation and Compensation; Frequency Synthesizers and other applications requiring electronic frequency control with crystal stability and extremely low phase jitter.

Write for Data on Low Noise VCXOs

## DAMON ENGINEERING, INC.

240 HIGHLAND AVENUE, NEEDHAM HEIGHTS 94, MASS.

(617) 449-0800

Speed Inquiry to Advertiser via Collect Night Letter  
ON READER-SERVICE CARD CIRCLE 15



The calibration alignment and navigation computations are performed by the digital computer.

Alignment of the portable system is accomplished by use of the ship's inertial navigation system for leveling and self-gyrocompassing for azimuth. The local vertical reference is obtained by comparing the ship's velocity outputs, modified by relative velocity computations, with the integrated outputs of the reference-unit accelerometers. Differences in the match of velocity signals yields an error signal to torque, or force, the platform to a matched position. Modified gyrocompassing is used to accomplish north alignment. Platform misalignment in azimuth is corrected by compensating for tilt, as determined by the difference between the north accelerometer and the ship's north signal.

Transfer alignment is made after the transfer fixture is attached to the aircraft and electrical interconnections are made. Azimuth transfer is done with synchro signals.

The computer is a simple, general-purpose microcircuit unit that has a wired-in program memory. It is organized for whole-number, single-address serial operation with an 18-bit word length. With a computation speed of 225 bits per second, the computer includes 1792 words of random-access magnetic core memory for operational programs and constants, plus 256 words of scratch-pad memory. With the exception of parts of the memory and clock pulse generator, the electronics of the entire unit is made up of transistor-transistor logic IC modules.

The A/D converter is used to convert reference-data analog velocity and synchro signals to a usable form for the digital computer. It also uses monolithic ICs similar to those in the digital computer.

Dr. Bernard Litman, the system's program manager, said that while the concept was being developed primarily for carrier-based aircraft, it could be adapted for use with land-based planes or missiles, where the alignment time for the inertial navigator was critical. ■ ■

*basic measuring tools from*

**HEWLETT  
PACKARD**



## *hp 3439A Plug-in Digital Voltmeter*

versatile, 4-digit DVM—for only \$950

accuracy better than  $\pm 0.05\%$  of reading  $\pm 1$  digit,  $\pm 15^\circ\text{C}$  to  $\pm 40^\circ\text{C}$   
with line voltage variation of  $\pm 10\%$

5% overranging, high ac rejection (30 db at 60 Hz)

signal common floatable up to 500 v dc from chassis ground

automatic ranging

### *Use it for:*

mv to kv dc autoranging voltage measurements: thermocouple, bridge measurements, production and maintenance testing

$\mu\text{a}$  to a dc current measurements: power supply currents, collector and base currents, leakage currents

mv to kv ac voltage measurements: average responding (rms with hp 3440A), servo measurements, turns ratios

ohms to megohms resistance measurements

programmable ac, dc voltage ranges

Plug-in capability makes this DVM an economical bench instrument with a wide range of uses. The basic instrument, priced at \$950, offers high accuracy, dc isolation, speed (readings in a fraction of a second), ac rejection, economy, reliability. Plug-ins permit manual range selection 10 v to 1000 v full scale (3441A); automatic range selection with remote range feature (3442A); measurement ranges 100 mv to 1000 v full scale, with automatic and remote ranging (3443A); voltage (100 mv to 1000 v), current (100  $\mu\text{a}$  to 1 amp) and resistance (1000  $\Omega$  to 10 M $\Omega$ ) measurements (3444A); ac/dc measurements, 10 v to 1000 v full scale with manual, automatic

and remote ranging (3445A), and remote function and/or ranging (3446A). Plug-ins priced from \$40 for the manual ranging unit (required) to \$525 for the ac unit and \$575 for the multi-function unit.

Your Hewlett-Packard field engineer will give you a demonstration of the voltmeter and the plug-ins most useful for your application. Just give him a call. Or write for complete specifications to Hewlett-Packard, Palo Alto, California 94304, Tel. (415) 326-7000; Europe: 54 Route des Acacias, Geneva.

*Data subject to change without notice.  
Prices f.o.b. factory.*

**HEWLETT**  **PACKARD**  
An extra measure of quality

908



3439A with 3445A plugged in

ON READER-SERVICE CARD CIRCLE 16

# Audio/video system checks into hospitals

## Systems engineering results in simple yet flexible system for TV, intercom and patient monitoring.

Hospital patients in many parts of the country are now using television for both audio and visual communication with their nurses as well as for private entertainment. The system has been developed specifically for hospital use by Bell Hospital Systems of Bridgeport, Conn.

Actually, the system is two systems in one. SteriVision, as one is called, provides the patient with his own television receiver. The other, SteriCall, allows the patient to use his TV set for remote communication with his nurses. Both systems operate from a single coaxial line at the patient's bedside.

### Systems engineering used

SteriVision was designed to eliminate as nearly as possible all the objectional aspects of conventional hospital TV. This required not only that the patient be borne in mind, but also the doctors, nurses and hospital administrators.

The end result is a system that includes the following:

- Master antenna system
- Amplifier system
- Mixing system
- Broadcast system
- Power and stand-by power system
- Receiver
- Receiver positioning system
- Power and signal cabling

The master antenna system is an array that has a separate tuned element for each TV station broadcasting in the area. The antenna signals are fed to the amplifier system, which contains a separate transistorized amplifier for each station received. Each amplifier is tuned to pass the signal of only one TV station. During installation the gain of the amplifiers is adjusted so that all deliver the same output signal level. The outputs of the amplifiers are combined into a single composite signal in the mixing system. This signal is distributed throughout the

hospital by a coaxial cable.

The broadcast system consists of one or more FM tuners, tuned to local radio stations. Their outputs are sent over the same coaxial wire as the television signals, and are heard on unused channels on the patients' TV sets.

The coaxial wire also carries 12-volt dc power to power the TV receivers. A special network built into the room outlets separates the dc power from the RF signal and allows inclusion of a power circuit breaker in the outlet. The dc power comes from a 12-volt supply that operates from commercial power. A stand-by battery source is automatically switched into operation should the commercial power fail.

The receivers used for the SteriVision system are commercially available units with 5-inch screens. Modifications to the sets include removal of the power supply, which is not needed, and removal of the speaker. The patients listen in using disposable headsets.

The specially designed receiver positioning system allows the receiver to be positioned within four feet of any bed post. The receiver "floats" at the end of a positioning arm; it can be tilted in any direction and swiveled through 360 degrees.

### SteriCall complements SteriVision

The SteriCall system uses the TV receiver and circuits of the SteriVision system, plus additional intercom and signaling equipment. A master station at the nurses' desk and a station at the patient's bed allow the patient both to signal and talk to the nurse. A kinescope at the master station permits the nurse to be seen on the patient's TV screen as they talk. If desired, the patient's TV receiver and the nurses' kinescope can be interchanged, so that the nurse can monitor a patient constantly without leaving her desk. ■ ■

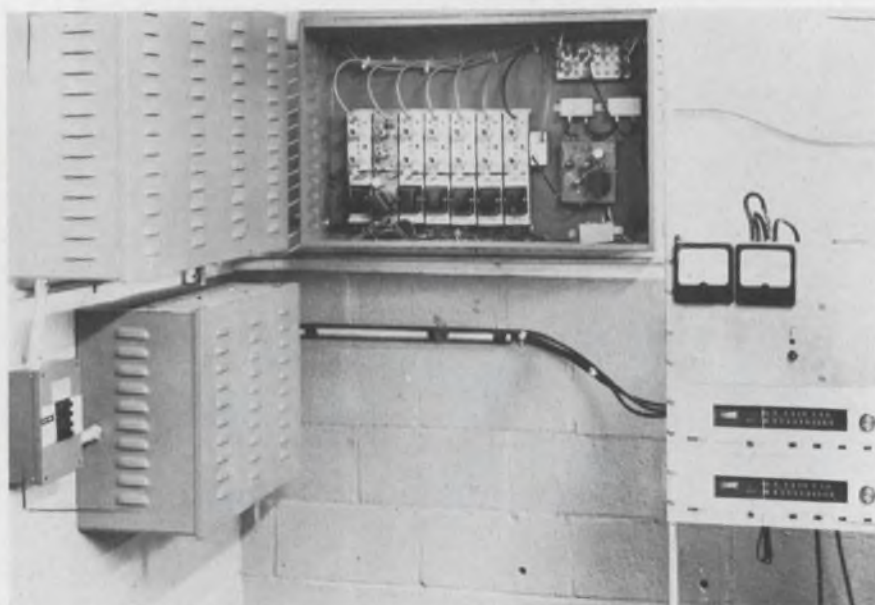

Head end of SteriVision system includes master antenna console (left) atop stand-by power console, and open console (center) containing signal amplifiers for each TV channel. At lower right are the broadcast system FM tuners.

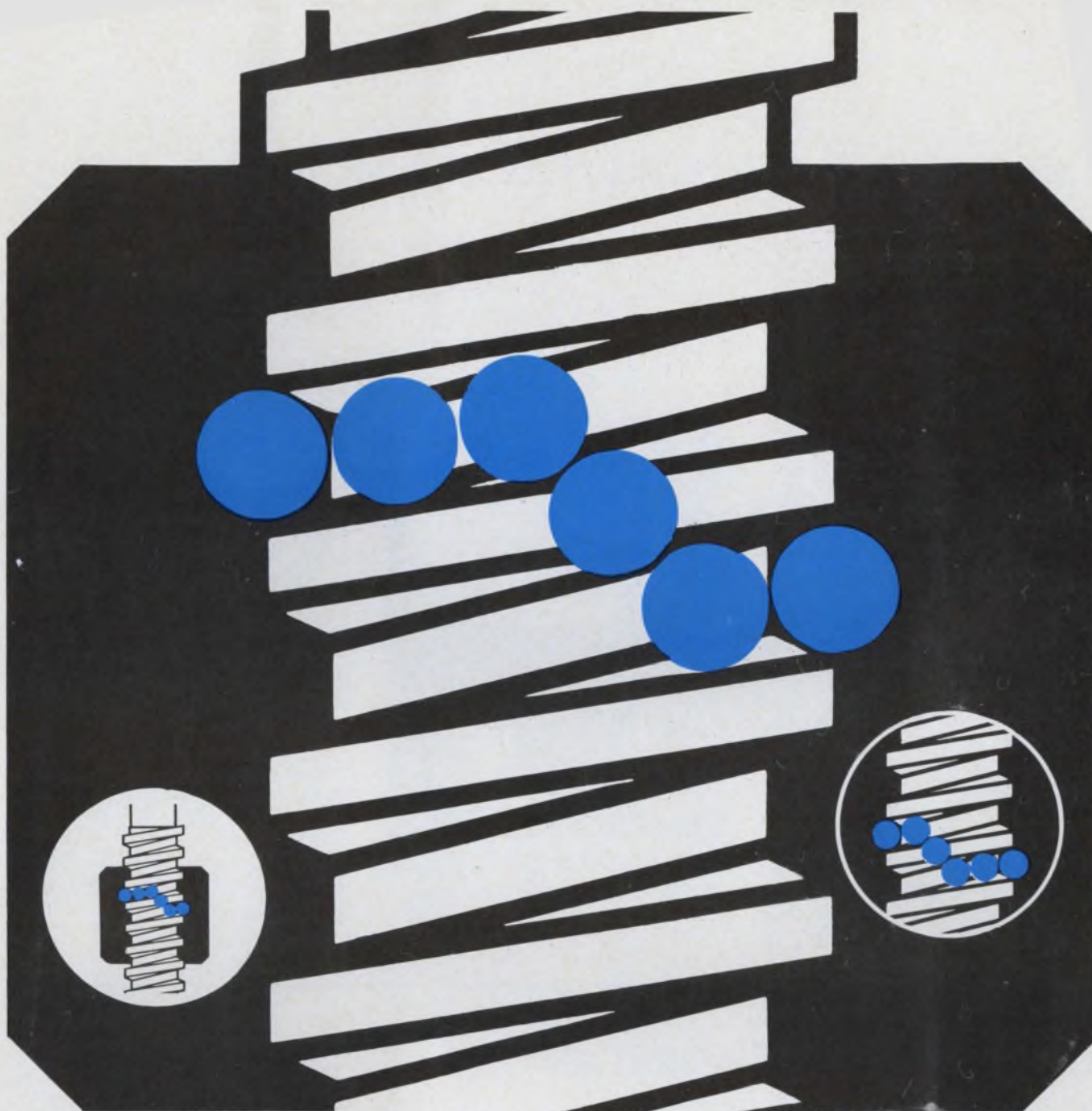

## Kidde Ballscrews

### SIZE AND WEIGHT PROBLEM SOLVERS

Kidde Ballscrews do more than solve friction problems of prime movers and drives. They can solve size and weight problems, too—and meet the demands for high efficiency transfer of motion and power. Here's why:

Their compact design results in smaller envelope dimensions. Weight is reduced because external tubes and fittings are eliminated. Kidde designs allow optimum usable power, due to extremely high efficiencies.

To solve these major problems, Kidde has designed a

wide range of Ballscrew sizes—from units less than 1" long to 32 foot custom assemblies. From 6" diameters down to 1/8"; sizes 3/16" to 1-1/2" (with various lead) are stocked.

Learn how Kidde Ballscrews can become your problem solver. Write for your free copy of "Standard and Precision Ballscrews." Walter Kidde & Company Inc., 675 Main Street, Belleville, New Jersey 07109.



ON READER-SERVICE CARD CIRCLE 17

ELECTRONIC DESIGN 23, October 11, 1966

## Laser gyroscope measures Navy's roll, pitch and yaw

A three-axis laser gyroscope has been delivered to the Navy's Ordnance Test Station, China Lake, Calif. The Navy is conducting a series of tests to determine the gyroscope's ability to sense a ship's roll, pitch and yaw precisely. The unit was designed and built by Honeywell's Military Products Div., Minneapolis.

Several companies have been active in the development of laser gyros—Sperry Gyroscope and Autonetics, to name two. The big problem to be combated is a phenomenon known as "lock-in," a tendency of the gas in a laser tube to lase in phase. This prevents the laser from measuring extremely slow rotation rates.

The laser gyroscope works by measuring the beat rates between two waves that propagate in opposite directions within the same rectangular or triangular tube. When the laser is not rotating, there is no beating and the waves traveling in each direction in the tube are indistinguishable. When the tube

starts to rotate, the effective path length of one wave lengthens by the distance that the laser moves during the time it takes the wave to travel around the tube. Similarly,



**Three-axis laser gyroscope** uses mechanical biasing to keep beams from locking in phase at very low rates of rotation.

the effective path length of the wave that propagates in the opposite direction shortens by the same amount. At low angular velocities, however, the two path lengths differ very slightly and the two waves tend to lock on to each other.

Honeywell overcomes this problem by mechanically biasing the lasers. They vibrate the lasers to keep them moving and prevent the waves from locking in phase. Sperry Gyroscope of Great Neck, N. Y., has been working on a method of optical biasing. It uses Faraday biasing cells that provide a false signal to give the effect of moving the ring. Its working unit is due to be ready within a few months.

The Honeywell unit has measured as small a rate of angular rotation as 0.1 degrees/hour, according to the company. It reports that it has maintained this fineness of measurement during runs of more than an hour. Sperry anticipates similar results. ■ ■

## Electronically controlled pellet gun shoots back at Army marksmen



The marksman stalks his quarry.

Riflemen just don't behave the same when their targets fire back at them, according to human engineers at the Army's Aberdeen, Md., Proving Ground.

Wearing headgear that contains a fan for ventilation and electrodes to measure heartbeat, the riflemen fire at targets that appear at random and return their fire. The targets are electronically controlled to pop up and down, and an electronically controlled BB gun shoots at the marksmen. The BB gun has a sawed-off barrel and rests behind sandbags. It is powered by CO<sub>2</sub> cartridges.

Recorders register the times of target appearances, the number of shots fired by the riflemen, the number of shots fired by the sawed-off BB gun, and the number of hits scored by the riflemen. No record is kept of the number of hits.

The vital organs of the human marksmen are protected by pads but the BBs sting when they hit unprotected areas. Even when they miss, the BBs strike a plywood backstop, making a loud clack. The BB gun fires at the shooters every half second.

The threat of return fire places the soldier under much greater stress than he encounters when he fires at passive targets, according to the human engineers. In fact, they say, the stress persists even when the gun doesn't fire back. ■ ■

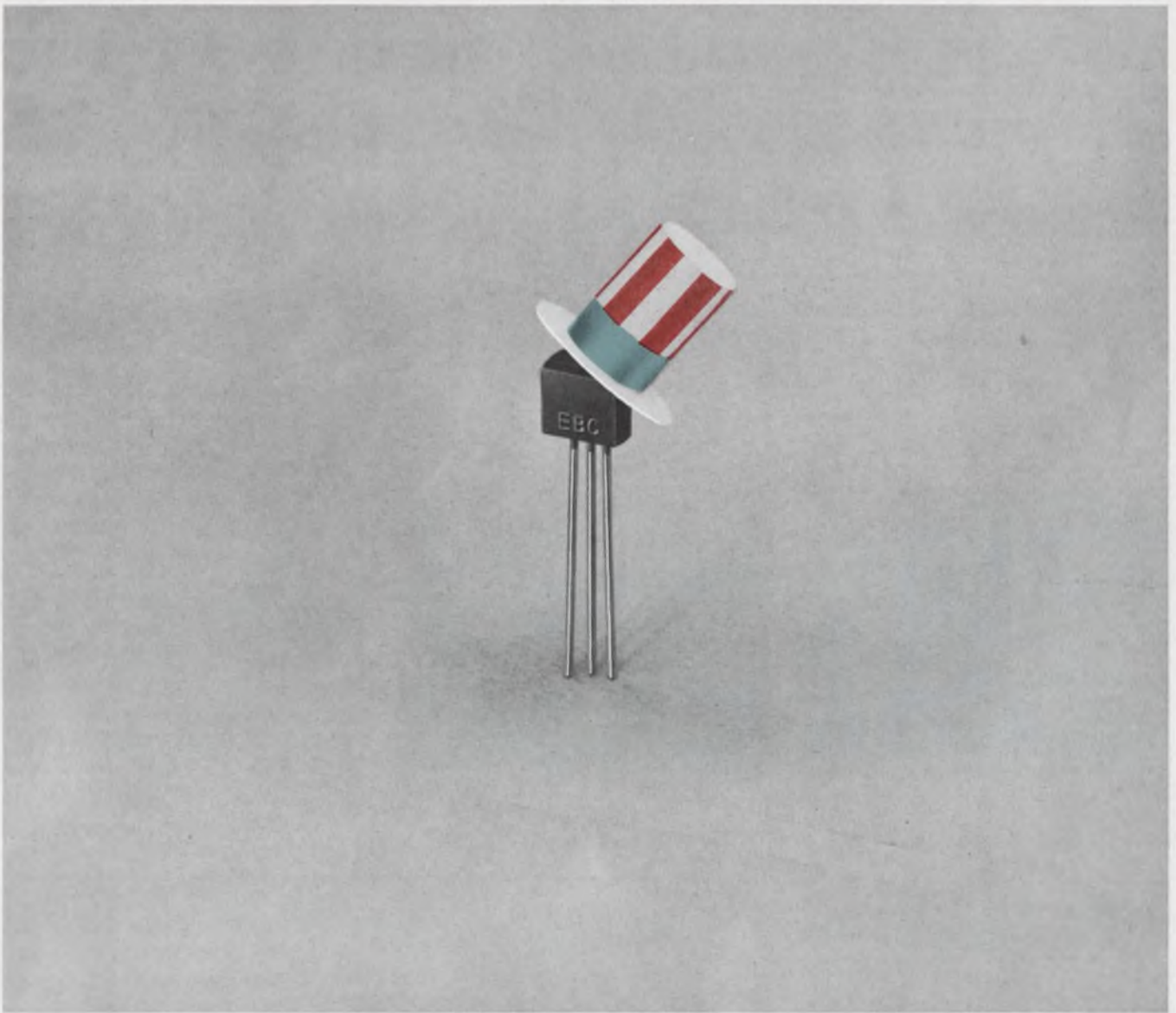

## A NATIVE-BORN SON

We like to mother our UNIBLOC\* plastic-packaged transistors all the way through production. Call us overprotective, say we're spoiling them if you want, but it doesn't add a thing to the cost — only to the quality. Besides, that's the way we like to do business; and, we're sure, the way you like us to do business, too!

We make our UNIBLOC-packaged transistors in high volume, right here in Phoenix, Arizona —

plastic semiconductor center of the world! We don't use low-cost foreign labor to make them inexpensive. No frequenting of border towns, either, just to be close to home.

Here at home, we can give close engineering supervision during manufacture; and, when they are completed, we have our complete huge Quality Control facility right at hand for all quality testing.

It's the kind of care only a mother could give.

\*Trademark Motorola Inc.

*- where the priceless ingredient is care!*



**MOTOROLA**  
**Semiconductor Products Inc.**

MOTOROLA SEMICONDUCTOR PRODUCTS INC. • P. O. BOX 955 • PHOENIX, ARIZONA 85001 • (602) 273-6900 • TWX 910-951-1334  
Speed Inquiry to Advertiser via Collect Night Letter  
ON READER-SERVICE CARD CIRCLE 18

## Silicon increases diode light output

Silicon dopant in the active regions of gallium-arsenide electroluminescent diodes has tripled their light-producing abilities. They have typical efficiencies of about 6 per cent, as compared with 1 to 2 per cent in earlier zinc-doped versions.

Scientists at the International Business Machines Corp., developers of the new technique, report that the key to the diode's per-

formance is the use of silicon as both an n- and p-region dopant.

According to the IBM scientists, light emitted by the new devices has lower frequency than that from zinc-doped diodes. They also say that another characteristic—lower internal light absorption—is the probable reason why light output is improved in silicon-doped diodes.

The solution regrowth technique

used to fabricate the diodes calls for close temperature range and cooling cycle control. Silicon is incorporated on the gallium sites of a 40-micron thick layer. Silicon is then incorporated on arsenide sites, where it acts as an acceptor.

After the structure has been formed, the p side is reduced to a thickness of 50 to 60 microns, and external zinc diffusion forms an ohmic contact.

Light emission occurs across the entire 50-micron thickness of the p layer, rather than over the typical 2 to 3 microns in zinc-doped diodes. The width of the recombination regions is believed to be another reason for the high efficiency of the diodes. But it also causes the relatively long turn-on time of about 200 ns.

The energy peak of the light from the diodes at room temperature is at 9300 Å. This emission is virtually independent of current through the diode.

The research was supported in part by the Army Electronics Command, Ft. Monmouth, N. J. ■ ■

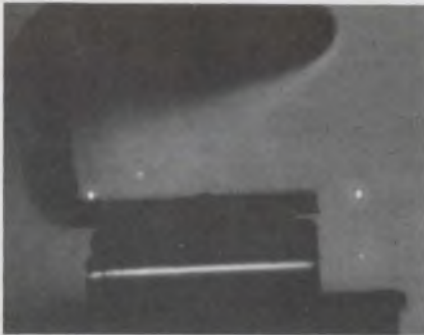

Light from a gallium-arsenide electroluminescent diode doped with zinc offers about 1 to 2 per cent efficiency (left). Light-producing ability is tripled when silicon is used as the active dopant (right).

## Fluidic integrated DDA the size of a cube of sugar

An integrated fluidic differential digital analyzer one inch square by 6/10 inch can solve relatively simple differential equations.

Little balls move up and down in cylindrical holes so that the operator can follow counting and adding operations visually.

The unit is fabricated from many thin sheets of beryllium copper that have etched channels for the flow of fluid (in this case air). The unit contains 132 individual devices that are interconnected by passageways that run through and across the layers.

The main advantage of the miniaturization of fluidic devices is the resulting improvement of response speed. The operating rate of fluidic devices is seriously limited by the total pathlength. The fluid must travel considerably less than the speed of sound.

This device was developed by Martin-Orlando for the Harry Diamond Research Labs, Washington, D. C. ■ ■

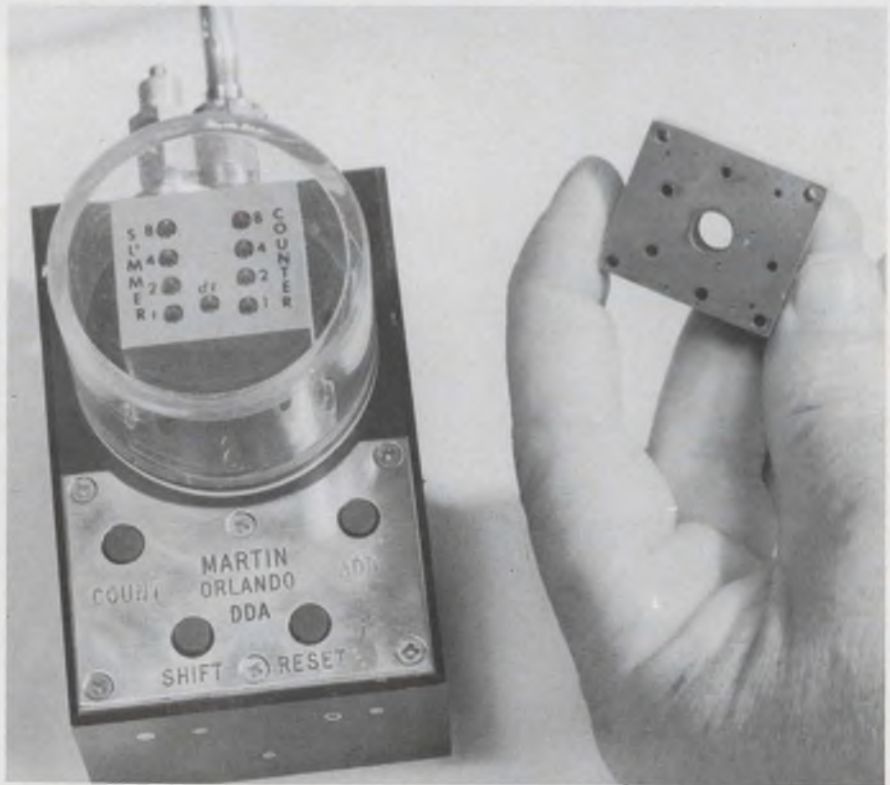

Digital differential analyzer can calculate areas under simple curves.

# NAND logic is old hat.

We've invented SDS Natural Logic for our T Series integrated-circuit modules. It's a comprehensive set of gating structures that permit the terms of any Boolean logic equation to be converted directly into hardware.

Now you won't have to manipulate equations to make them fit the restrictions of NAND or NOR gates. With Natural Logic the hardware fits the equations without unnecessary inversions.

So you won't need nearly as many circuits to build your logic system. Your system will cost you a lot less. It will be faster and more reliable. It will be easier to mechanize. And it will take up less room.

Naturally.

**Scientific Data Systems**

1649 Seventeenth Street, Santa Monica, California  
Offices in principal cities throughout the world



With NAND logic you are stuck with only this, no matter what the equations call for.

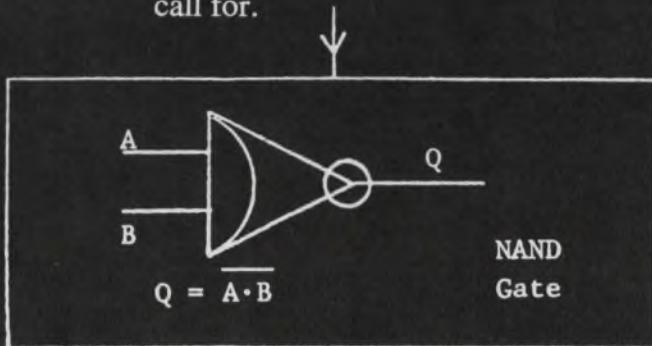

With T-Series NATURAL logic you have all these to choose from at a lower price per circuit.

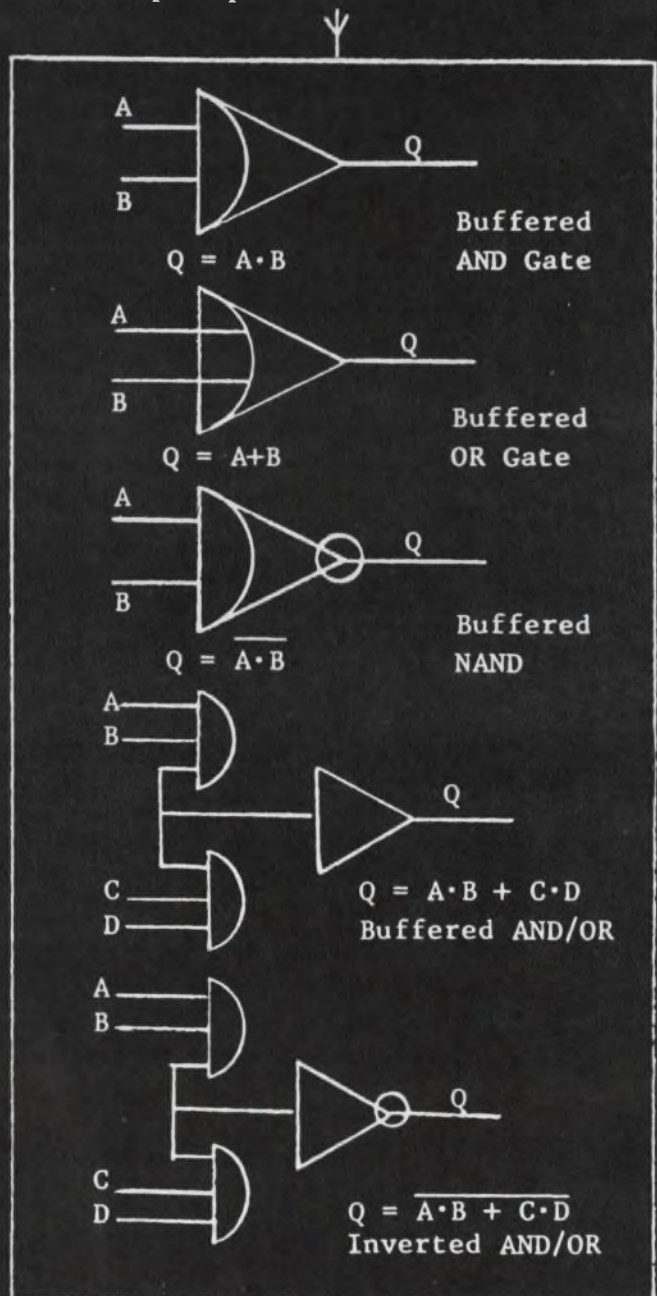



### SWITCH TO THE SWITCH WITH THE MOST STABLE TRIGGERING VOLTAGE

Try a new G-E Silicon Unilateral or Silicon Bilateral Switch. SUS's and SBS's are kind of like 4-layer diodes except that they are actually planar integrated circuits rather than "stacked" structure devices.

How do they differ? The SUS switches on in only one direction whereas the SBS—actually two SUS's integrated on the same pellet—switches in either polarity . . . and with exceptionally good symmetry. Both feature triggering voltages in the 6- to 10-volt range that are virtually unaffected by temperature changes.

SUS's and SBS's are excellent devices for triggering SCR's and bi-directional thyristors (Triac's). Light dimmer and speed control circuits are naturals for them, as are simple ring counters that can be designed to count up to 50 kHz. **Circle Number 811** on the Reader's Service Card if you'd like more product and application facts.

### WHAT'S THIS? A 40¢ POWER TRANSISTOR?



Actual size G-E D27 device

That's just what you get when you specify new G-E 2N4054 through 2N4057 devices . . . from 150 to 300 volts in G.E.'s newest compact, silicon economy package for prices as low as 40 to 59¢ (in lots of 100,000 or more). Looking for industrial uses? Try these new NPN transistors as high-voltage differential and operational amplifiers . . . or as Nixie† Tube drivers . . . or as high-voltage power supplies. Operating temperature ranges from -55 to +150 C. Beta is between 30 and 90 at 50 milliamps, 10 volts. And the new transistors can amplify up to 25 Megahertz.

What about commercial applica-

† Trademark of Burroughs Corporation.

### Over 400 pages on the industry's broadest SCR line

Everyone needs a standard reference manual. And this is the one when you're looking for facts about Silicon Controlled Rectifiers. Already G.E.'s well-known SCR Manual is in its Third Edition, and over half its content is previously unpublished application information.

Use the G-E SCR Manual to look up useful circuit and application information. Special related devices are covered in detail, too . . . devices such as G.E.'s light-activated SCR. And there's a special chapter on the reliability aspects of SCR's.

If you haven't already gotten one for yourself, order your copy now. The price is just \$2.00. **Circle Number 813** on the Reader's Service Card.

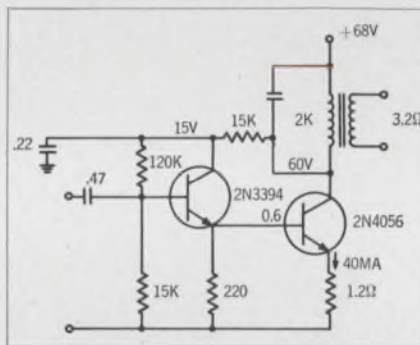

3/4 watt output (100 mv input) TV audio circuit using new 2N4056 transistor

tions? Look how easy it would be to mount this package in a printed circuit board! No extra hand-soldered leads to waste assembly time. You can use them to deliver 1 watt to the loudspeaker of TV receiver Class A audio output stages, phonographs, tape recorders, intercoms or radios. **Circle Number 812.**

#### G-E 2N4054 Series Minimum Electrical Ratings

	2N-4054	2N-4055	2N-4056	2N-4057
V <sub>CE</sub> (I <sub>C</sub> = 10ma) volts	300	300	240	180
V <sub>CE0</sub> (I <sub>C</sub> = 1.0ma) volts	300	250	200	150
V <sub>EB0</sub> (I <sub>E</sub> = 100µa) volts	7	7	7	7
I <sub>C</sub> ma	100	100	100	200
P <sub>T</sub> (70 C case temperature) watts*	4	4	4	4
h <sub>FE</sub> (I <sub>C</sub> = 50ma, V <sub>CE</sub> = 10v)†	30	30	30	30
V <sub>CE(SAT)</sub> (I <sub>E</sub> = 2.5ma) volts	2.5	2.5	2.5	2.5

\* Derate 50 mw/°C increase in case temperature above 70 C.  
† Pulsed conditions at 2% duty cycle 300 µsec pulse width.

More information on all G-E semiconductor products—one more example of General Electric's total electronic capability—can be obtained by calling your G-E engineer/salesman or distributor. Or write to Section 220-41, General Electric Company, Schenectady, N. Y. In Canada: Canadian General Electric, 189 Dufferin St., Toronto, Ont. Export: Electronic Component Sales, IGE Export Division, 159 Madison Ave., New York, New York.





### ESRO may become U.S. market

U.S. aerospace manufacturers may find a market for their products in the European Space Research Organization (ESRO). ESRO requires that contracts be spread evenly among participating nations—of which the U.S. is not one. But the working-level ESRO scientists are impatient to buy U.S. hardware and look forward to the organization's easing its restrictions. They believe that their modest budget—\$280 million over eight years—would go further in the U.S. than in Europe. They say that in the U.S. they would be able to buy what they want off the shelf, whereas in Europe they will not only have to wait longer for the goods but also pay for their development.

European scientists, shopping around Washington recently for free ideas, claimed that ESRO's budget was enough to give European industry no more than a nibble at an exciting technology. State Dept. officials remain close-mouthed about the situation, referring only to NASA's programs of international cooperation. Commerce Dept. spokesmen, however, are more sanguine about what may become a much enlarged market for U.S. aerospace firms. Privately they concede that the ESRO governments may more readily relax their rules if the State Dept. stays out of it. Meanwhile, Commerce Dept. officials are not reluctant to show the Europeans what U.S. companies have to offer at low prices.

Some "Made in U.S.A." hardware will soon be on view at the newly inaugurated launching site near Kiruna, Sweden, 100 miles above the Arctic Circle. It will be brought there, however, by individual teams of participating nations, who will be using the facilities on a tenant basis. A West German team, for instance, will conduct a program with U.S. Nike-Apaches, considered far more effective for the money that the Germans

# Washington Report

S. DAVID PURSGLOVE,  
WASHINGTON EDITOR

paid for them than their European counterparts—Britain's Skylark and France's Centaur. It is these nonetheless that ESRO would have to buy to conduct a program of its own.

### Big opening for oceanics in Europe

The Commerce Dept. is promoting Europe's mushrooming underwater programs as an important market for U.S. manufacturers of oceanic equipment. At the same time, The Bureau of International Commerce (BIC) is spreading word in Europe of the terrific products that U.S. firms have for sale. As a further boost, BIC is sponsoring an exhibition of U.S.-made ocean equipment and instrumentation at the U.S. Trade Center in Frankfurt, West Germany, Nov. 2 through 9. The Commerce Dept. is urging U.S. companies—mostly electronics-oriented—to send products and representatives. BIC has tagged the week-long show "a rare opportunity to establish liaison with policy-making and purchasing agents of marine exploration groups" in Europe. It has prepared a comprehensive study of the European oceanics market available to interested manufacturers.

BIC's study calls Europe a "prime market for marine equipment and services" and implies that it has outstripped the U.S. as a sales field. For its part, the Commerce Dept. says: "In Europe private and government groups are heavily involved in well-budgeted oceanographic studies; many of these organizations have gone beyond the basic research stage on to commercial enterprises." It adds: "The results of marine research are being applied to many areas, including fishing, marine meteorology, oil/gas exploration, ocean mineral development, salvage operation and corrosion metallurgy."

BIC's study describes the West German

# Washington Report

CONTINUED

market in detail as an example of the potential in Europe. It also spotlights the market in the U.K. and touches on eight other countries.

## Auto safety agency in first gear

A new National Traffic Safety Agency has begun to function, but its operation is still on a very limited scale and is likely to remain so for some time to come. Its administrator, Dr. William J. Haddon, a physician formerly involved with New York safety programs, has not yet been confirmed by the Senate, although no hitch is anticipated. Nor have any funds been made available so far for the agency, which is expected to be transferred into the domain of a proposed new Transportation Dept.

Meanwhile Dr. Haddon and his assistant, Dr. Robert Brenner, have set up shop in a temporary, partitioned-off section of the Commerce Dept. Building on Federal Triangle, Washington, D. C. Their staff at present is miniature, but they are expected to borrow additional personnel from existing agencies whose functions they will take over. Some Bureau of Public Roads people, who have been engaged on the National Driver Register and on safety in highway design, may be assigned to the agency on loan, for instance.

The agency, set up under legislation that came out of this summer's hearings on automobile safety, is within the purview at the Commerce Dept. of Alan Boyd, Under Secretary for Transportation and former Federal Aviation Agency Administrator. Boyd and his staff have made no secret of their commitment to electronics in highway safety, driver education and testing, and other areas where the new agency will have competence. Should a new Transportation Dept. be set up, Boyd is looked upon as its most likely first chief.

## EIA to hear aerospace role in cities

The National Institute of Public Affairs has chosen the fall conference of the Electronic

Industries' Association as the forum at which it will make public its report on the "California aerospace experiments." Those were contracts awarded last year, under which five major aerospace companies applied their military-space-systems approach to the solution of urban and social problems. The report, sponsored by the Ford Foundation, is expected to praise the experiments. The White House is expected to use it to back up an order to government agencies that the advanced technology and systems management must be applied, wherever possible, in fulfilling Federal contracts in urban development, transportation, pollution control, housing, education and other nonspace, nonmilitary fields.

Officials of both the Aerospace Industries' Association and the National Security Industrial Association admit privately that it is a feather in the electronic industry's cap that the EIA meeting in San Francisco, Oct. 17-20, was chosen for formal presentation of the report. They view the choice as an indication that the report will come out in favor of electronic firm's recent moves into such rapidly growing nontechnical areas as highway safety, crime control, high-speed ground transportation and pollution abatement.

## EIA ready to play new parts

The pat on the back that the electronic industry anticipates at San Francisco will not catch the EIA unprepared. The association has made a number of studies analyzing various areas of Federal activity and their potential for the industry.

In August, John Sodolski, staff manager of the EIA Requirements Committee, put out a 6,000-word analysis of one such area—medical electronics. It took particular notice of new hospital systems and the role of all levels of government in them, as well as of such predictable items as remote biosensors and cardiac pacers. Sodolski told EIA members: "The Federal Government has increasingly been funding programs directed at what it considers to be major national problems of an economic and social nature." He added: "The Federal Government is in the process of spending, or planning to spend, billions of dollars in areas such as transportation, education, crime prevention, water and air pollution and medical facilities, among others."

# Fast, convenient direct reading measurements of impedance and phase angle 500 kHz to 108 MHz...



## THE 4815A RF VECTOR IMPEDANCE METER

This new Vector Impedance Meter is a versatile instrument that provides fast, direct reading measurements of impedance and phase angle over the frequency range from 500 kHz to 108 MHz. It is continuous tuning over this frequency range, and does not require balancing or data interpretation. Thus, it is an extremely useful tool for the evaluation of the complex impedance of both active circuits and components. The convenience of probe measurement, ease of operation, and direct reading features make the instrument equally useful for laboratory, receiving inspection or production line measurements.

The 4815A is a convenient and powerful measuring tool for any application involving measurements over a band of frequencies or in-circuit measurements. It may be used to determine the self-resonance point of capacitors, the series and parallel resonance points of crystals, or the characteristics of high frequency transformers and transducers. Price: \$2650 f.o.b. factory. For complete specifications, contact your local Hewlett-Packard field engineer or write Hewlett-Packard, Rockaway Division, Green Pond Road, Rockaway, N. J. 07866; Europe: 54 Route des Acacias, Geneva.

### Advantages:

- Fast, continuous tuning from 500 kHz to 108 MHz
- Provides data directly in impedance and phase angle, 1 ohm to 100K ohms 0 to 360°
- Convenient probe for in-circuit measurements
- Analog outputs permit permanent data recording
- Self calibration check provides measurement confidence
- Low-level test signal minimizes circuit disturbance

HEWLETT  PACKARD  
An extra measure of quality

ON READER-SERVICE CARD CIRCLE 201

# scope—And in a 30-Pound Package!



## Step-Ahead Electrical Performance

- Solid triggering capability to 90 MHz, as shown above.
- New horizontal amplifier permits linear 5 nsec/cm sweep speed.
- Maximum stability with 100% solid state circuitry.
- Premium components—capacitors, potentiometers and metal film resistors.
- FET input amplifiers for exceptionally low drift, quick 15-second warm-up.
- Operates on 115 or 230 volts, 50-1000 Hz, only 95 watts—convection cooled.
- New hp CRT design permits 3 v/cm drive; therefore, vertical amplifier is smaller, lower power. Amplifier drives CRT vertical deflection plate directly. These features provide extended bandwidth capability.
- DC coupled Z axis input.
- New etched circuit delay line for clean pulse response—minimum weight and size.

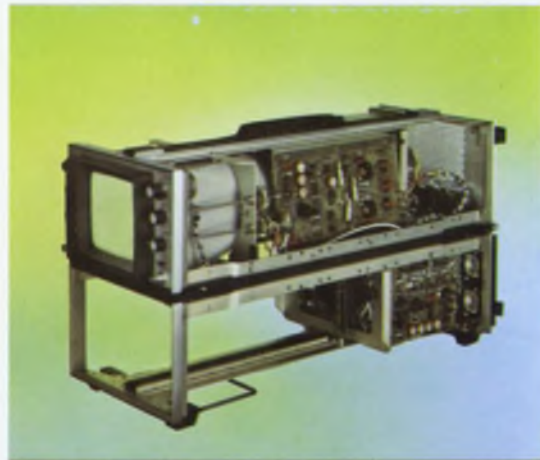

## Rugged Design for Use Anywhere

- Aircraft-type frame construction for maximum ruggedness with minimum weight.
- Easy-to-get-at circuits—covers snap off.
- Conveniently-grouped controls are easier to see, easier to operate.
- Operates with confidence at  $-28^{\circ}\text{C}$  to  $+65^{\circ}\text{C}$ , 95% relative humidity to  $40^{\circ}\text{C}$ , 15,000 feet.
- Withstands shock and vibration—built for portable use.
- Scope with plug-ins weighs only 30 pounds.
- 8" x 10" cabinet, or 5 $\frac{1}{4}$ " x 19" rack mount models.

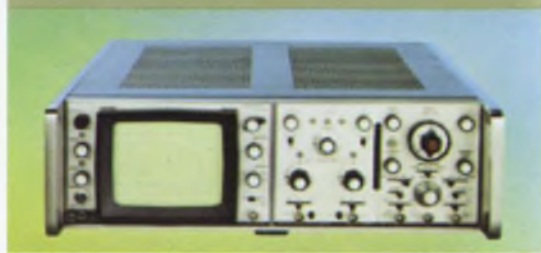

**HEWLETT**  **PACKARD**  
An extra measure of quality

Get the BIG picture! Write or call for your demonstration, today! Hewlett-Packard, Palo Alto, California 94304, Tel. (415) 326-7000; Europe: 54 Route des Acacias, Geneva. Price: hp Model 180A Oscilloscope, \$825.00; hp Model 180AR (rack) Oscilloscope, \$900.00; hp Model 1801A Dual Channel Vertical Amplifier, \$650.00; hp Model 1820A Time Base, \$475.00; hp Model 1821A Time Base and Delay Generator, \$800.00, f.o.b. factory.



**SEE MORE!**

## **NEW 180A OSCILLOSCOPE**

Get Big Picture Displays,  
Plug-In Versatility,  
100% Solid State Circuitry,  
Superior Performance,  
In a New 30-Pound Package  
For Field, Laboratory and  
Production Applications

**HEWLETT**  **PACKARD**  
*An extra measure of quality*

**DO MORE!**

# More Performance Than Any Other Scope



## Large Area 8 x 10 cm CRT

- New design breakthrough offers a shorter, high-frequency CRT with picture area from 30% to 100% greater than any other high-frequency scope. Accurate measurements are easier to read and view.
- Deflection plates require only 3 v/cm drive—allows extended bandwidth capabilities.
- 12 kv accelerating potential produces bright, easy-to-see traces, even at 5 nsec/cm sweeps.
- Snap-off bezel for easy installation of new hp contrast filters or special graticules.
- Beam finder for rapid location of trace.
- Internal graticule calibrated in centimeters eliminates parallax error; flood guns allow variable background illumination for optimum contrast of graticule and trace.

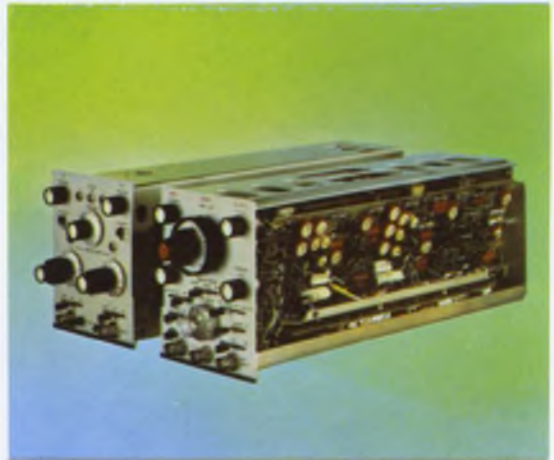

## Plug-In Versatility

- Now 1801A dual channel vertical amplifier
  - dc to 50 MHz bandwidth (all ranges). 7 nsec rise time.
  - 5 mv/cm to 20 v/cm range.
  - A + B, and A — B operation.
  - internal trigger on Channel B in ALT and CHOP modes for time correlation of traces.
- Now 1821A time base and delay generator
  - triggering to 90 MHz.
  - sweeps from 1 sec/cm to 10 nsec/cm.
  - easy-to-use delayed sweep.
  - mixed sweep for slow/fast sweep display.
  - bright line automatic triggering.
- Now 1820A time base
  - triggering to 90 MHz.
  - sweeps from 2 sec/cm to 5 nsec/cm.
  - variable holdoff locks-in complex waveforms.
  - bright line automatic triggering.
- More plug-ins to come—for extended capabilities.

## ACCESSORIES



1118A Testmobile, \$95.00

197A Camera, \$475.00

10176A Flexible Viewing Hood, \$7.00

10166A Panel Cover, \$25.00

10167A Carrying Cover, \$20.00

10004A 3½-foot 10:1 Divider Probe, \$35.00

10110A BNC Male to Binding Post Adapter, \$5.00

10360A Camera Adapter for hp 196A/B Camera, \$15.00

10361A Camera Adapter for Tektronix C12 Camera, \$15.00

10362A Camera Adapter for Tektronix C27 Camera, \$15.00

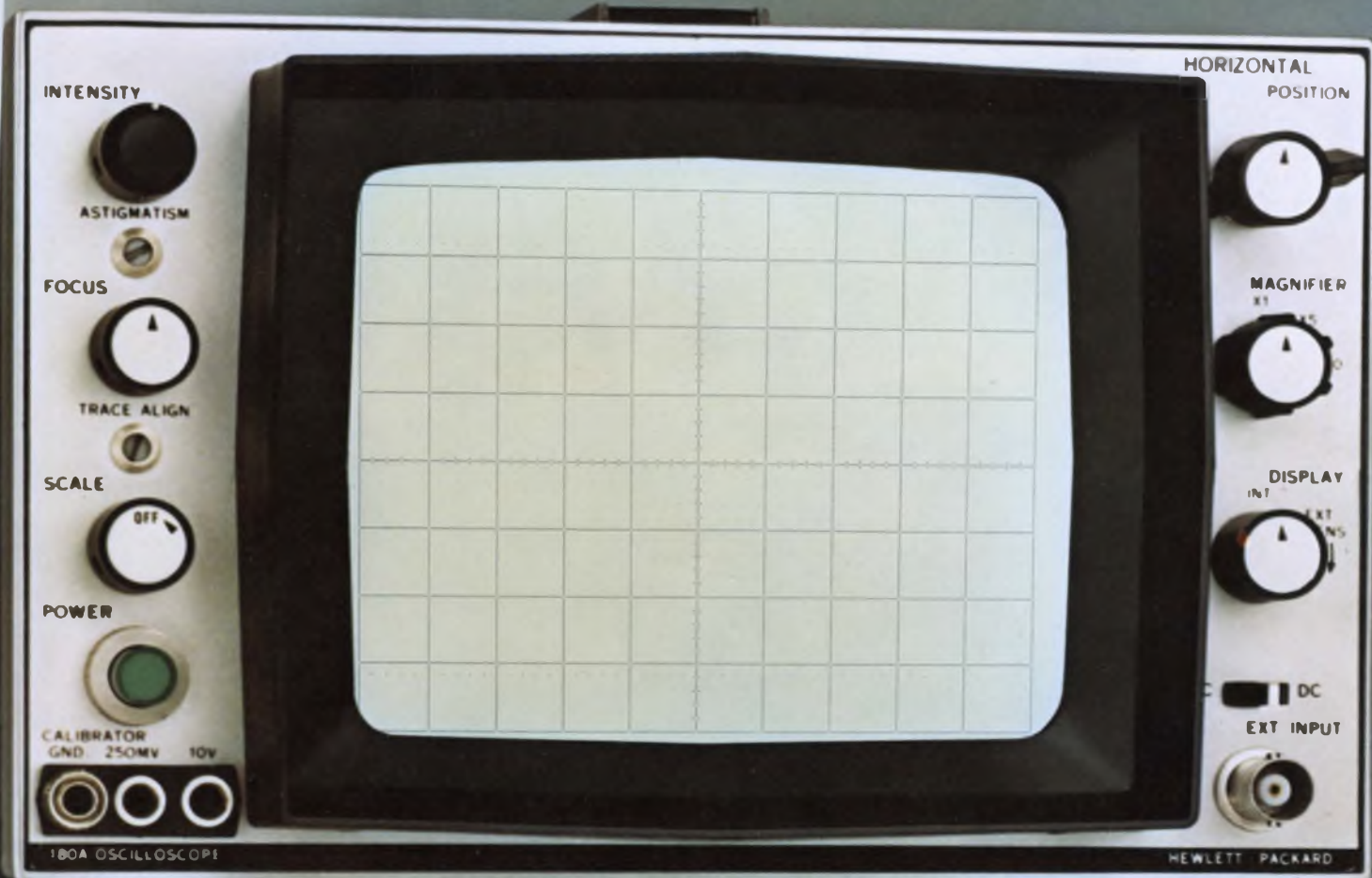

ACTUAL SIZE

# GOOD BYE **DOWN TIME**

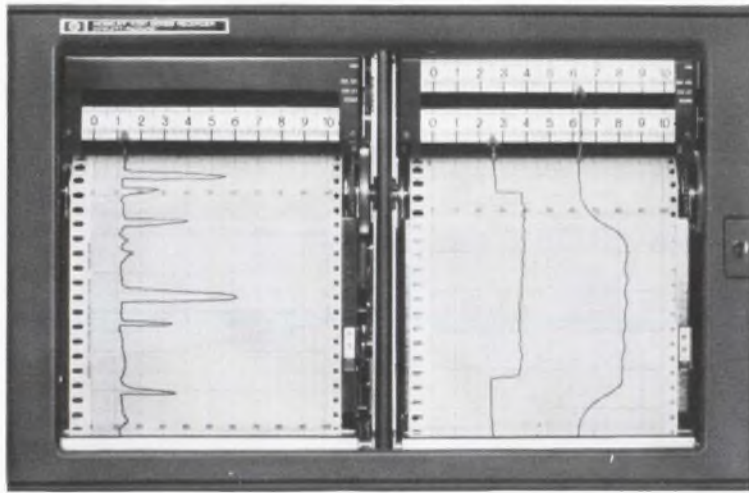

these new  
strip-chart  
recorders take  
the downtime  
out of  
industrial  
recording

Four new strip-chart recorders are now available from Hewlett-Packard; 6-inch one or two pen models and 11-inch one or two pen models. Design techniques including solid-state circuits and precision reference allow reliable, trouble-free operation. True modular design makes possible rapid interchange of modules on line with minimum downtime. Oversized inkwells and disposable pen tips provide inexpensive writing convenience. (Or you can have inkless writing on inexpensive electrosensitive paper for long-term unattended monitoring applications.)

The modular design also lets you order a low-cost recorder that is tailor-made to fit your application. You have a choice of sensitivity and speed.

As options you can use up to 6 limit switches, electric pen lift, event markers, and retransmitting pots. Other options include air purge, individual-remote pen lift, remote chart drive, electric writing, and jump speed chart drives. Two 6-inch instruments may be mounted side by side in a single 19-inch relay rack.

Standard features include guarded and floating inputs with high CMR and solid-state construction with zener reference. The

removable chart magazine tilts out 45° for easy notations and front loading.

It all adds up to recorders that stay on the job, not the repair bench.

Call your Hewlett-Packard field engineer for complete information. Or write Hewlett-Packard, Palo Alto, California 94304, Tel. (415) 326-7000; Europe: 54 Route des Acacias, Geneva. *Data subject to change without notice. Prices f.o.b. factory.*

#### SPECIFICATIONS

**Sensitivity:** Choice from 1 mv to 100 v full scale  
**Chart Speed:** Choice from 0.5 in/hr to 10 in/min  
**Accuracy:** 0.25% with 0.5 second balance time  
**Input Impedance:** Potentiometric 1 mv to 100 mv; constant 1 MΩ above 100 mv

Prices:	6-Inch Recorders	11-Inch Recorders
Single pen:	5701A . . . . \$ 825.00	5703A . . . . \$ 995.00
Dual Pen:	5700A . . . . \$1325.00	5702A . . . . \$1895.00

**HEWLETT  
PACKARD**  **MOSELEY  
DIVISION**

ON READER-SERVICE CARD CIRCLE 203



## Laser may switch high RF power

The laser is being considered for triggering a high-microwave-power switch. Metal within a vacuum would be used to ionize metal at precise intervals, and the plasma formed would be used as a transmission path.

The investigation is being conducted at the Cornell Aeronautical Laboratory, Buffalo, N. Y. under the sponsorship of the Rome Air Development Center, Griffiss AFB, N. Y. Preliminary research by Dr. A. S. Gilmour of the Cornell laboratory has shown that a precisely controlled laser beam creates a gaseous plasma when it is focused on one of the electrodes of a switch within a vacuum chamber. High current through the switch

is conducted on the plasma, and conduction is maintained in the resulting arc until the power source is discharged. Dr. Gilmour said that with the use of a ruby laser approximately 10 megawatt pulses 1 to 10 microseconds in duration had been produced. He believes the concept can be applied to power switching in ultra-high-power radar modulators where precise pulses are required from a single power source and power levels are too high for existing pulse-forming network switching tubes.

Cornell laboratory engineers point out that the experimental switch is one of the first applications of the laser as a component of electronic circuitry. ■ ■

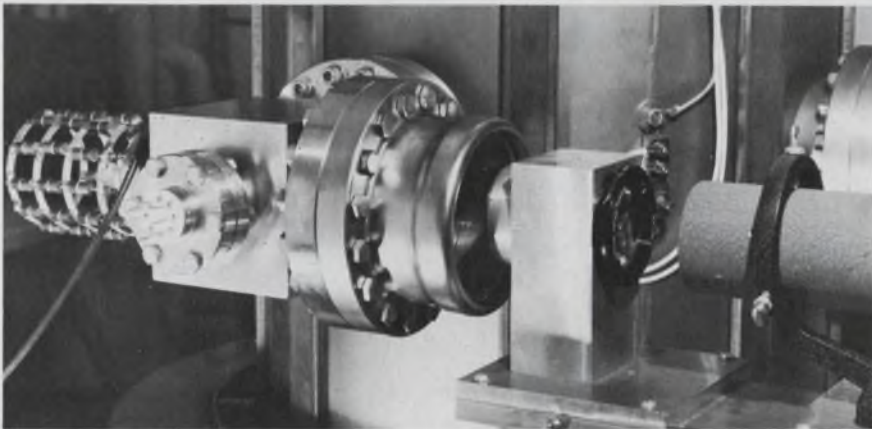

Experimental laser-actuated switch has possible application in high-power radar transmitters. Ruby laser beam at right is focused on electrodes in the vacuum chamber. The resulting plasma switches the power.

## Robot chemist performs laboratory tests

An electronic robot is now able to perform many ordinary chemical laboratory tests that formerly had to be done by technicians.

Solid-state sequential logic circuitry controls various solenoid-triggered air valves, liquid pumps and indexing mechanisms for sliding racks and a rotating tray that hold test tubes. As the robot operates, probing pipettes dip into test tubes and suck up preset amounts of the sample; plastic tubes carry drops of reagent to be mixed with

the sample. Test tubes and pipettes are then promptly washed, dried and re-washed to ensure that residual droplets of reagents or samples do not contaminate later tests. The machine evaluates the chemical by comparing its light transmission with that of a control sample. The output is digital, and it is printed on a paper tape.

The Robot Chemist was designed by Warner-Lambert Pharmaceutical Co., Richmond, Calif., to dupli-

(continued on p. 36)

## Tube cutting headache?

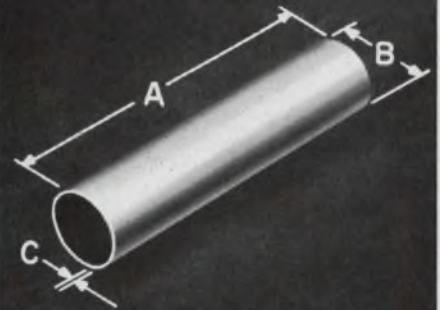

	A	B	C
Max. Dim.	7"	.500"	
Min. Dim.	.125"	.090"	.014"

## Forget it!

## Let Art Wire do it.

Tubing cut to precise spec is another of those maddening jobs that are best farmed out and forgotten. Art Wire can probably do the job a lot faster than you can. Our Automatic machines are already set up. At less cost, too, considering down-time and overhead.

Nice thing about it is that Art Wire takes over the problems, as well. Delivery, quality control and high-volume production are our worry, not yours.

Any non-ferrous metal tubing cut to dimensions shown above. Send us a part or a print. Phone 201-621-7272 if you're in a hurry.

We do wire forming and small part stamping, too. Bulletin 501 shows what we can do. Ask for it.



## ART WIRE & STAMPING CO.

17 Boyden Place, Newark, N. J. 07102

**If you think  
you've seen  
low-priced  
multi-function  
plastic dual in-line  
integrated circuits . . .**



Box 955, Phoenix, Arizona 85001



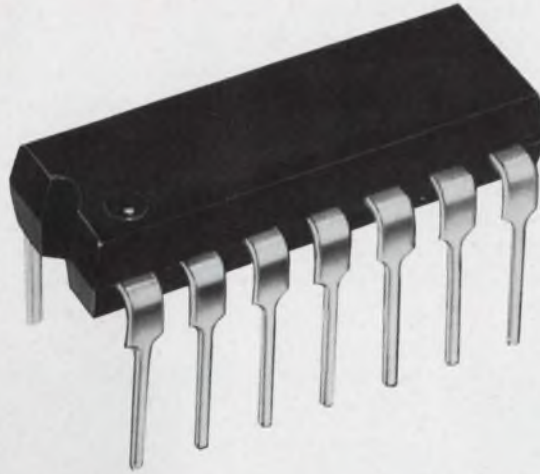

... Think again.

*Multi-  
functions*

**MRTL\* - MC700P Series**

**One-999 1000-4999**

Dual 3-Input Gate (MC715P) .....	\$1.00	\$ .75
Quad 2-Input Gate (MC717P) .....	1.08	.81
Dual 3-Input Gate (MC718P) .....	1.00	.75
Dual 4-Input Gate (MC719P) .....	1.08	.81
J-K Flip-Flop (MC723P) .....	1.35	1.00
Quad 2-Input Gate (MC724P) .....	1.08	.81
Dual 4-Input Gate (MC725P) .....	1.08	.81
Dual Buffer (Non/inverting) (MC788P) .....	1.35	1.00
Hex Inverter (MC789P) .....	1.08	.81
Dual J-K Flip-Flop (MC790P) .....	2.00	1.50
Triple 3-Input Gate (MC792P) .....	1.20	.90
Triple 3-Input Gate (MC793P) .....	1.20	.90
Dual Buffer (MC798P) .....	1.35	1.00
Dual Buffer (MC799P) .....	1.08	.81

**MDTL\* - MC830P Series**

Dual 4-Input Gate (MC830P) .....	1.55	1.15
Clocked Flip-Flop (MC831P) .....	3.00	2.25
Dual Buffer (MC832P) .....	1.65	1.25
Dual Expander (MC833P) .....	1.35	1.00
Dual Power Gate (MC844P) .....	1.65	1.25
Clocked Flip-Flop (MC845P) .....	3.00	2.25
Quad 2-Input Gate (MC846P) .....	1.65	1.25
Clocked Flip-Flop (MC848P) .....	3.00	2.25
Triple 3-Input Gate (MC862P) .....	1.65	1.25

\*Trademark of Motorola Inc.

**CALL YOUR MOTOROLA DISTRIBUTOR  
RIGHT NOW!**

**MOTOROLA Semiconductors**

*- where the priceless ingredient is care!*

Speed Inquiry to Advertiser via Collect Night Letter  
ON READER-SERVICE CARD CIRCLE 21

**BRUSHLESS  
SYNCHROS  
DON'T HAVE  
THESE  
TROUBLE-MAKERS**

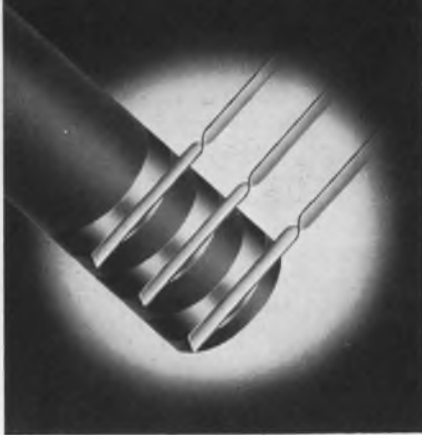

**OR THESE TROUBLES:**

Brush wear • Arcing • RFI emission  
• Contact bounce • Bearing contamination from brush-wear particles • Brush friction error

We left out all these synchro problems by leaving out the brushes. Rotary transformers couple signals into rotors without contact. Result is far longer synchro life — which can exceed 10,000 hours — with performance equal to the best of brush types.

Patented Harowe brushless synchros are available for all common functions, in sizes 5, 8, 10, and 11 as standard; larger sizes as special. All types meet applicable requirements of MIL specs. Request complete data from —



Servo, Stepper &  
Synchronous Motors  
Motor Generators • Synchros  
Resolvers • Pancakes • Gearheads

**HAROWE SERVO CONTROLS, INC.**

20 Westtown Road  
West Chester, Pa. 19380  
(215) 692-2700

ON READER-SERVICE CARD CIRCLE 22

**NEWS**

(Robot, continued)

cate precisely the step-by-step procedures of a working technician. By changing reagents, cycle times, and the order of procedure, the user should be able to adapt the robot to any future tests.

Though this is the first such machine that physically imitates the motions of a human technician, it is not the first automatic testing de-

vice for laboratory use. A company called Technicon has produced for some time a machine called the Autoanalyser. It can run up to 12 tests simultaneously, with a minimum of mechanical moving parts. Its heart is a set of plastic tubes that carries samples one after another through each tube. The samples are separated in the tubes by air bubbles. ■ ■

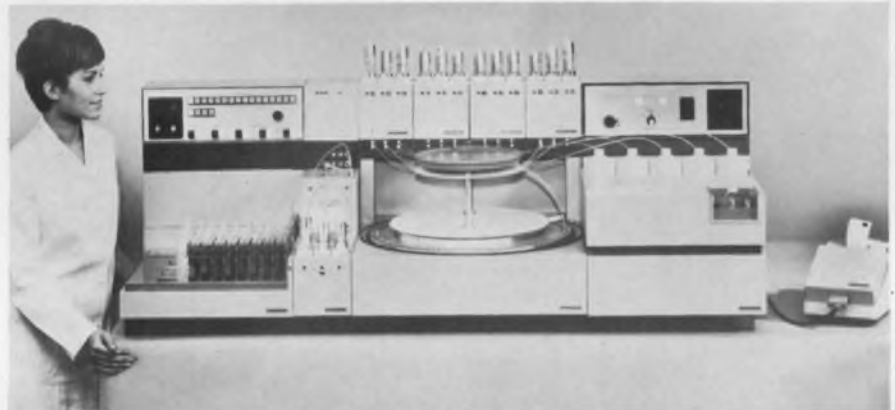

Electronic robot chemist duplicates the work of a laboratory technician.

**For metal rips in space, an electron welder**

What does an astronaut do after the hull of his spacecraft has been torn by a jagged meteorite somewhere out in space?

Well, he might find a nine-pound electron-beam welder just the thing for an emergency repair. One has recently been developed by the Hamilton Standard Div. of United Aircraft Corp. for NASA, and successfully tested under conditions like those 73 miles up.

The welder, with a 1.5-kW beam power, can join titanium, aluminum and other metals up to one-quarter-inch thick. It is designed to operate off an on-board power supply. Only 10 inches long and 3.5 in diameter, the gun fires tightly packed electrons at a velocity of 50,000 miles a second. The operator holds it flat on the metal, where it rides along the weld seam on metal rollers. A shield around the welder muzzle protects the operator from the splatter of molten metal and radiation: he checks the welding through windows in the shield. ■ ■



Astronaut uses electron-beam gun to weld stainless steel in chamber that simulates conditions 380,000 feet up.

ON READER-SERVICE CARD CIRCLE 23 ➤

# Two sets of our switches meet quietly in space.

When Gemini 6 caught up with Gemini 7 late in 1965, the programmed approach to space exploration was proved. Our skilled Astronauts, the NASA team, McDonnell, and America's aerospace industries had passed a major milestone on our way to the moon.

Cutler-Hammer people are especially proud of this achievement. Many of our positive-action switches are employed on each Gemini vehicle.

We earned our part in Gemini—and every manned space vehicle before it—based on almost half a century of experience. Dating back to 1920 when we created the first line of switches especially for airborne use. Today, nearly everything that flies uses Cutler-Hammer positive-action switches.

Our leadership is built on reliability. Through painstaking design and manufacture. Proved by exhaustive in-process inspection and 100% final testing.

Whatever your aerospace project, get the Cutler-Hammer switch and power relay story before firming up design. Many standard items are available from our Distributors' shelves. For specials—and full application support—call your nearby Cutler-Hammer Sales Office.

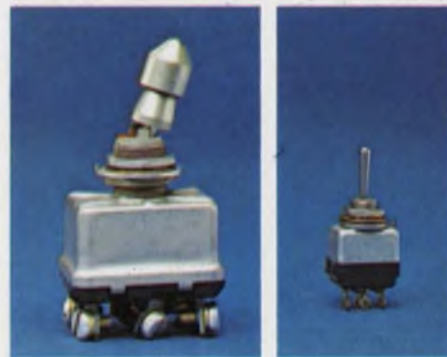

There are Cutler-Hammer positive-action switches, miniature and standard size, for almost everything that flies.

**CUTLER-HAMMER**

Milwaukee, Wisconsin 53201





**The Fairchild 704A  
broad-band X-Y scope  
gives you a clearer,  
sharper picture.**

**It gets rid of jitters  
and of parallax problems.  
It is stable and reliable.  
And it is ten times more  
sensitive than any other  
scope of its kind.**

**Get the full picture in our  
new brochure.**





## A-to-D converter

10 bit parallel binary output  
10 microseconds conversion time

Model ADC-10<sub>ic</sub> is a plug-in Analog-to-Digital Converter with a 10 volt input range and contains a Clock, Reference Supply, Resistor Network and Comparison Amplifier.

Also available

## D-to-A converter

10 bit strobed parallel binary input  
1 microsecond settling time  
(same size as A-to-D converter)

Model DAC-10<sub>ic</sub> is a Digital-to-Analog Converter and contains a Storage Register and high-speed Strobe System, Internal Reference Supply, Resistor Network and output Operational Amplifier.

Variations are available in input and output ranges, converting speeds, number of bits, and triggering modes.

Pastoriza also provides compatible Sample-and-Hold and Multiplexing Cards and Auxiliary Readout Equipment with self-contained power supplies to facilitate matching these units to OEM and system applications.

Write for A-to-D and D-to-A Converter literature.

**PASTORIZA**  
ELECTRONICS, INC.

385 Elliot St., Newton Upper Falls, Mass. 02164  
(617) 332-2131

ON READER-SERVICE CARD CIRCLE 25

# Letters

## Editorgrams are our guidelines

The editorial staff of ELECTRONIC DESIGN is grateful to you readers for the steady flow of Editorgrams into our offices. Suggestions, criticism, praise—these brief comments help us to put together a magazine that corresponds as closely as possible to your interests. Of course, we cannot act on every suggestion, but whenever an obviously useful or telling point is made and whenever a number of requests for a specific type of article are received, we do our best to follow through. So keep them coming. They cost you only a few minutes of time; to us they are invaluable.

Here, for instance, is a couple of suggestions that we have taken up:

"If you put the issue number at the bottom of the page with the date, it would be easier to find an article listed in your semiannual index of articles, which catalogs by issue number only."

*(Note: The number is being included at the foot of each page of every issue from ED 22, Sept. 27, 1966, onwards.)*

\* \* \*

"How about printing 'Index Issue' on the binding so that those of us who file ED can find the index more easily?"

*(Note: 'Index Issue' will appear on the cover spine of the year-end issue and all subsequent numbers that contain a semiannual index of articles.)*

### Topics for articles proposed

Many readers come forward with suggestions for articles that they would like to see. Here are some recent ones:

\* \* \*

From Montreal, Canada: "I'd like to see articles on broadband phase detectors, phase-lock receivers and phase-locked loop FM detectors."

\* \* \*

From Flensburg, West Germany: "Tunnel diode applications in microwave circuits."

\* \* \*

From Mountain View, Calif.: "I'd like to see something on nanoamp, high-impedance, 75-megohm voltage sensors using unipolar transistors and FETs."

\* \* \*

From La Spezia, Italy: "More about low-noise amplifiers, filters (active and passive) and linear circuits in general."

\* \* \*

Such Editorgrams are grist to our mill, for they are the key to the contents of future issues. If you feel that you are able and willing to write articles for us to publish on such subjects as those suggested above, or on any other timely topic of immediate interest to design engineers, we shall be very happy to send you our author's guide. This outlines our editorial requirements, sketches the best way to put your article together and tells you how to go about submitting an article idea to us. For your copy of "How to Write Articles for ELECTRONIC DESIGN," check the box at the bottom of the Editorgram at the back of this issue.

### Past articles draw praise

Along with the suggestions, comments and occasional brickbats come plaudits:

"I especially like 'Rid mixers of spurious signals' (ED 19, Aug. 16, 1966, pp. 210-216) because of its new approach and the expanded data that ED made available."

\* \* \*

"The article on mixer spurs was very timely because I am involved in the design of local oscillators and mixers at present."

\* \* \*

"Your Wescon information was very useful and helped me to plan my visit."

\* \* \*

"Your editorial, 'The quest is on for the perfect micronym' (ED 17, July 19, 1966, p. 43), was first-class

*(continued on p. 44)*





## SUCCESSFUL STEPS TO COMPUTER AIDED GRAPHIC DESIGN

Take a giant step with Benson-Lehner's new family of graphic digitizing and reduction systems. Now, for the first time, you can build a system to fit your current requirements or your future needs — easily, efficiently and economically.

With the Large Area Record Reader (LARR-V), digitizing of engineering drawings, plans, and maps with output to punched paper tape or punched cards is quickly accomplished. For high volume jobs, an IBM compatible 556 bpi magnetic tape output is available.

For precise printed circuit artwork, the field proven Graphic Artwork Reduction Digitizer (GARD) system has unequalled capabilities. The GARD is adaptable for use with all coordinatographs or the LARR-V.

GARD output is directly usable for numerical control, computer or drafting systems. Resolutions of .001", .010", .050", .100", .250" and .500" are standard. Grid offset, absolute and incremental outputs, and special commands are all included with GARD.

For computer aided design — simple or complex — rely on Benson-Lehner for proven systems every step of the way.



**benson-lehner** corporation 14761 CALIFA STREET, VAN NUYS, CALIFORNIA • 781-7100

ON READER-SERVICE CARD CIRCLE 26



## Better styling by design with Alcoa Aluminum

Electronic equipment looks better and sells easier when it's designed with aluminum, Alcoa® Aluminum.

That's why designers everywhere use aluminum for styling cabinets, racks, decks, frames, panels, housings, grills, inserts or trim—practically any place where permanent good looks are important.

Aluminum gives the designer more to work with—more colors, more textures, more forms—in virtually any size or configuration. It can be easily and accurately fabricated by stamping, forging, extruding or casting; easily joined

by welding, brazing, soldering, or by various mechanical production systems.

Striking textures can be developed by mechanical finishing, such as embossing or coining, with surfaces ranging from smooth lustrous to rough matte. Subtle colors can be added by using any one or a combination of techniques—chemical, electrochemical, paint, enamel, lacquer, porcelain enamel, or Vynalate\* Sheet (a permanently bonded laminate of aluminum sheet and vinyl). And, aluminum is naturally light, uncommonly strong and cor-



rosion-resistant. Its applications are unlimited. That's why it's called "the designer's ally."

For your demanding design applications, particularly where the problem is one of cost and competitive styling, change for the better with Alcoa Aluminum. Call your nearest Alcoa sales office or write: Aluminum Company of America, 1780-K Alcoa Building, Pittsburgh, Pennsylvania 15219.



\*Trademark of Aluminum Company of America



**ALCOA**

**Change for the better with Alcoa Aluminum**

ON READER-SERVICE CARD CIRCLE 27

The  
"constant"  
in the formula  
for core  
design

**PERMACOR®**  
powdered iron cores



There are many "variables" between concept and use. One company which is a constant is **PERMACOR**. If you have a design problem, our engineers can help you solve it. If you have a production problem, we can help solve that, too. We have a full line of stock cores, and facilities for any custom core design and production. This is part of the reason why we are the number one producer of powdered iron cores. Write for the full story.

**PERMACOR®**

A Division of Radio Cores, Inc.  
9540 Tulley Ave.,  
Oak Lawn, Ill. 60454  
Phone: 312-422-3353

LETTERS

(continued from p. 40)

because humor is essential to a readable technical magazine."

\* \* \*

One last Editorgram gave us pause to reflect for a moment. An "Atoms Scientist" in upstate New York told us: "Change your magazine's name to 'Electrons Design' " Well . . . it's an idea!

**Polyurethane protects devices against moisture**

Sir:

I enjoyed your article, "Electronics needed for guerrilla warfare" [ED 17, Aug. 2, 1966, pp. 36-47]. One of the areas that stood out as a problem is the protection of electronic components and circuitry from moisture.

Here at Kennedy Space Center and Cape Kennedy we have a similar problem. We do not have quite the same degree of humidity as Viet Nam, but, in addition, we have the salt and sand problem.

We have developed a family of thin-film polyurethane conformal coatings which can be easily and economically applied to printed-circuit boards and terminal boards. The coating does not appreciably change electrical properties, but almost entirely seals the units from the detrimental environmental conditions which render many printed circuits useless. The coatings are covered by the Kennedy Space Center specification KSC-C-183, and KSC-QPL-183-1.

The Department of Defense, as well as NASA, has been doing work for several years on both epoxy and polyurethane coatings. Both materials in very thin coatings (2 mils or less) seem to have very little effect on the Q-factor and other electrical properties. Both protect the equipment from moisture and fungal attack and add terrifically to its handling characteristics. For example, six commercially built boards were vibrated to more than 50 G from 0 to 2000 Hz while plugged in and operating. They should easily withstand parachute drops and rough handling without damage.

Polyurethane was chosen because it is more elastic and is very wear-resistant. Epoxy, by comparison, is

rigid, and in thicker coatings (above 2 mils) tends to crack solder joints and components under varying heat loads. Some of the thick polyurethane coatings have also caused like problems.

The thin coatings are so thin that they have very little heat insulative effects and should reduce the cooling required of other sealed modules. Since the coatings are thin, replacement of components is no problem. Repair or touch-up of the coating is simple.

The biggest advantage of these coatings to the manufacturer is reduction in labor, material, and facilities costs. Masking is almost eliminated, and by using the "Ferris-wheel technique" one person can coat a large number of boards in a short time without expensive spray guns, vacuum chambers, or banks of ovens.

Using this new family of coatings, off-the-shelf commercial equipment can be easily, quickly, and economically protected to withstand the stringent environmental conditions of Vietnam.

J. M. Fisher  
NASA Office of Quality Assurance  
John F. Kennedy Space Center  
Cape Kennedy, Fla.

**Devices stave off power surges**

Sir:

I read with extreme interest your interview, "Electronics needed for guerrilla warfare," in which Chief Warrant Officer Carl Sellers referred to the problems of power surges and generators.

ATI Industries has been marketing for over two years a solid-state device that protects electronic equipment from overvoltage surges and transients. The device, known as the Solid-state Circuit Protector (SCP), has a triggering response time of 500 ns or less, and is available with automatic reset, therefore eliminating the need for any fuse or circuit breakers.

SCPs have also been developed for undervoltage protection as well; for instance, should the line or generator voltage drop below a preset voltage, the SCP switches to emergency battery operation. The SCP

(continued on p. 47)



## Johnson brings you a long line of connectors

No matter what kind of application, Johnson's long line of jacks and plugs will supply your design needs. Whether it's military or commercial, whether it's sub-miniature or standard, there's a rugged polyamide insulated or un-insulated connector for your job. Johnson has a full line of tip and banana plugs, tip jack and sleeve assemblies, metal-clad and rapid mount tip jacks, dual banana plugs and the unique, patented Johnson binding post in three sizes. Insulated connectors color coded to federal color standards. Voltage breakdown ratings up to 11,000.

Get complete information on JOHNSON'S full line of connectors. Write today on company letterhead for free, detailed Johnson components catalog.



**E. F. JOHNSON COMPANY**  
WASECA, MINNESOTA 56093



HERE'S A CONNECTOR FOR YOUR PROJECT, CONSTRUCTED OF TOUGH, LOW LOSS POLYAMIDE FOR RELIABLE PERFORMANCE UNDER ADVERSE CONDITIONS. TURN PAGE FOR DETAILS.



**Look to Johnson for  
all your component needs**

## CONNECTORS

**SUB-MINIATURE INSULATED TYPES** — Designed for printed circuit applications. Operating voltages to 1500 volts RMS . . . 5 amperes current carrying capacity . . . contact resistance less than 2 milliohms. Capacitance between two adjacent jacks less than one pf at 1 Mc. 10 colors available. Test-Point Strip/Handle — rapid-mounting polyamide body contains 12 test points each rated at 5 amps., maximum current capacity. Operating voltage 1500 volts RMS at sea level, 350 volts RMS at 50,000 feet. Contact resistance less than 2 milliohms.

**STANDARD INSULATED CONNECTORS** — A complete line of connectors molded of tough, low-loss, shock-proof polyamide in 10

colors meeting Fed. Std. 595. Tip, Banana and Dual Banana Plugs; Tip and Banana Jacks; Metal-Clad Tip Jack, Military; Jack and Sleeve; Binding Posts.

**RIB-LOC TERMINALS** — A new line of miniature, one-piece, insulated terminals with a unique serrated conical design, which resists loosening and turning. Provides an inexpensive approach to convenient press-in type terminals. Six colors conforming to Federal Color Standard No. 595. Terminal styles include single and double turret feed-thrus and stand-offs, .040" dia. tip plug and mating jack for .040 plug.

## CAPACITORS

**MACHINED PLATE TRIMMER AND TUNER TYPES — U, UA, UB, U-LC, V, AND W** — Available in both printed circuit and chassis mounting types. U types available in differential and butterfly printed circuit mounting types in addition to single section types. V and W capacitors available in single section type only. Maximum capacities of up to 54 pf. Tuners consist of a machined plate trimmer and high Q air wound silver plated inductor, in resonant frequencies of 100 to 750 Mc.

**SOLDER PLATE TYPES** — Type M: Capacity values to 30 pf. Voltage ratings to 1250 volts peak. Available in single section, differential and butterfly types.

Type S: Capacity values to 100 pf. Voltage ratings to 3000 volts peak. Available in single section, differential and butterfly types.

Type K: Capacity values to 150 pf. Voltage ratings to 3800 volts peak. Available only in single section types. May be furnished in production quantities in full compliance to MIL-C-92A.

Type R: Capacity values to 340 pf. Voltage ratings to 4400 volts peak. Available only in single section type.

Type L: Capacity values to 200 pf. Voltage ratings to 3500 volts peak. Available in single section differential, butterfly and dual section types.

**SPACER TYPES** — Type C: Capacity values to 1500 pf. Voltage ratings to 13,000 volts peak. Available in single section and dual section types.

Type D: Capacity values to 1700 pf. Voltage ratings to 9000 volts peak. Available in single section and dual section types.

**STAKED PLATE TYPES** — Type E: Capacity values to 1000 pf. Voltage ratings to 4500 volts peak. Available in single section and dual section types.

Type F: Capacity values to 400 pf. Voltage ratings to 3000 volts peak. Available in single section and dual section types.

## TUBE SOCKETS, INSULATORS, PILOT LIGHTS AND HARDWARE

**ULTRA HIGH FREQUENCY SOCKETS** — Continuous heat resistance to 500°F. with low loss, glass filled silicone base and heat treated beryllium copper contacts. Low inductance screen bypass capacitor available for VHF and UHF operation.

**KEL-F SERIES** — Molded of low dielectric loss-factor Kel-F plastic — designed for use with a wide selection of high power transmitting tubes.

**STEATITE WAFER TYPES** — Available in 4, 5, 6, 7, and 8-pin standard socket types, as well as Super Jumbo 4-pin types. Also giant 5 pin, and 7 pin Septar and VHF Septar Sockets.

**SPECIAL PURPOSE TYPES** — Includes sockets for special purpose tubes.

Note: For detailed specifications, request Socket Standardization Booklet 536 on your company letterhead.

**INSULATORS** — Low loss, high-voltage breakdown in either steatite or porcelain. Complete line includes Thru-panel Bushings and Insulators, Antenna Strain and Feeder Types, Cone and Stand-off Insulators, Lead-in Bushings and Feed-Thru Bowl Assemblies.

**PILOT LIGHTS** — Over 47 separate assemblies. Continuous indication neon types, models for high and low voltage incandescent bulbs, standard or wide angle glass, and lucite jewels. Specials, including types meeting military specifications, also available in production quantities.

**PANEL BEARINGS** — For use on 1/4" shafts and panels up to 3/8" thick. **CRYSTAL SOCKETS** — For low capacity, high voltage and high temperature operation. Glazed steatite, Grade L-423 or better. DC-200 impregnated. **RF CHOKES** — High quality construction. For 1.7 to 30 Mc range.

Johnson also offers a complete line of heavy-duty RF components for broadcast transmitting, RF heating, antenna phasing and other commercial applications.

Equipment in this line includes fixed and variable inductors, antenna phase sampling loops, isolation filter inductors, feed-thru bowl insulators, static drain chokes, RF contactors, and heavy duty make-before-break switches.



**E. F. JOHNSON COMPANY**  
W A S E C A, M I N N E S O T A 5 6 0 9 3

## LETTERS

(continued from p. 44)

would eliminate line surges from ever entering areas where electronic equipment is used.

ATI has available on request its standard SCP Catalog that shows available ranges of its devices.

John S. White, Sr.  
Dir. of Communications Products  
ATI Industries  
Los Angeles

## Guerrilla detectors are in production

Sir:

After the pleasure of reading "Electronics needed for guerrilla warfare," I felt compelled to write regarding the statement, "Sensitive metal detectors planted around the perimeter of the camp might have alerted the Americans and saved the village" [p. 36].

Texas Instruments, Inc., does in fact manufacture a device now in use in Vietnam for this and other tactical action programs. It is called the Model SID-X-150A Seismic Intrusion Detector, and it signals an alarm when activated by persons, animals or machines moving within the detection range of either a single hidden seismometer or an array.

The unit, in its present configuration, is compact, light in weight and can be installed as much as a mile from a control point. This makes it ideal for use for perimeter protection of areas such as those described in the article. Seismometers can be installed in the ground or attached directly to fences, buildings or bridges, or even placed in water.

The SID-X-150A sensors operate in the subaudio frequency range from about 15 to 30 Hz and the electronic circuit converts the elastic wave motion of a man, animal or moving vehicle into a distinctive audible sound. Furthermore, the operator, after a short training period, can easily identify the source of these characteristic sounds. Six size-D dry-cell flashlight batteries power the unit; under normal use the average life of the batteries is four months. This power supply, although quite inexpensive compared with some complex systems

now in use, provides reliable service in jungle warfare.

Frank Lord  
Manager of Merchandising  
Science Services Div.  
Texas Instruments, Inc.  
Dallas, Tex.

*Note: A copy of a brochure describing this equipment was forwarded to the Green Berets. Ed.*

## Full-wave rectifier tubes are in push-pull

Sir:

In your interesting article relating to electronics in Vietnam, I should like to call your attention to some inaccurate comments on page 44 about a high-voltage power supply.

The comment begins: "This is full-wave rectification, the two tubes are in parallel." This is incorrect, for in a common full-wave rectifier (not bridge) the tubes are in fact in push-pull.

It adds: "So when one goes, it throws the full load on the other tube." This also is false. In a full-wave rectifier circuit, the duty cycle on each tube is 50%. Only one tube is conducting at any one time. With one tube removed from the circuit, the duty cycle is still 50% on the remaining tube. It does not throw the full load to the other tube.

Arnold J. Carmody  
Engineer  
Electronic Design Co.  
Fairport, N. Y.

## Professionalism is a state of mind

Sir:

Anent Miss Dekany's editorial of July 5 ["An ill wind blows for the baccalaureate," ED 16, p. 35], there are three points that I would like to state briefly. One is that "professionalism" is more a state of mind, or attitude, than a matter of formal education. Usually, increasing the formal education does not change a student's basic attitudes.

Second, much good engineering work can be done and is being done by men who stopped at the bachelor's degree. It would be unfair to exclude them from professional status, particularly when so many men

**Need a small 1, 5 or 10 mc crystal oscillator for use in synthesizers, timing systems, counters, communication systems, time-code generators, tape systems, or some other small black box?**

Think **TRACOR**<sup>®</sup>



Shown half actual size

TFA 766

Volume 19.1 in.<sup>3</sup>  
That's about the size of it.

For further information:  
TRACOR, Inc.  
General Sales Office  
6500 Tracor Lane  
Austin, Texas 78721  
Phone: 512-926-2800



**SULZER  
DIVISION**

REPRESENTATIVES IN PRINCIPAL CITIES

We are looking for EE's, ME's and Physicists for design consultation or systems development in ASW and undersea problems—experience in penetrations aids—design studies, tests, analysis and reports on electronic and mechanical systems. Your reply strictly confidential.

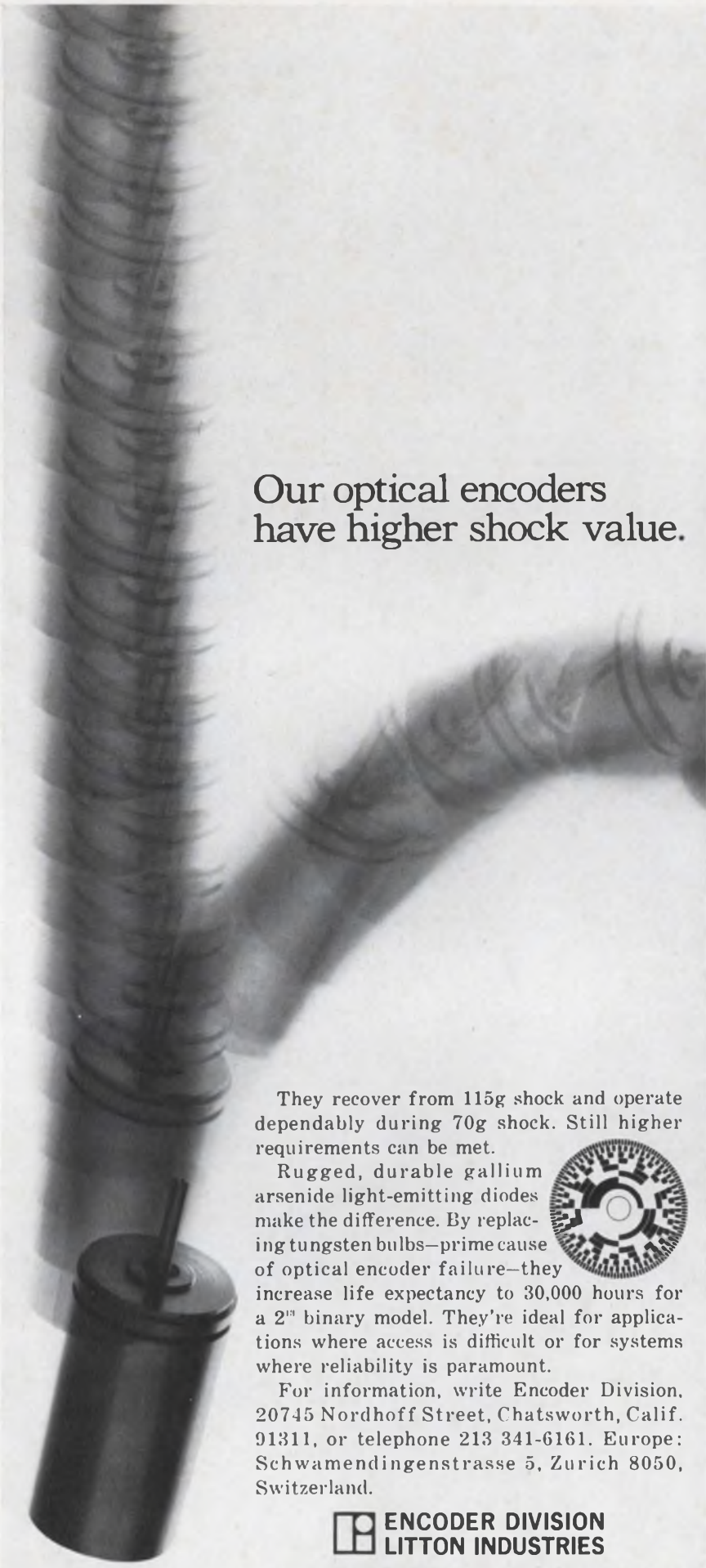

## Our optical encoders have higher shock value.

They recover from 115g shock and operate dependably during 70g shock. Still higher requirements can be met.

Rugged, durable gallium arsenide light-emitting diodes make the difference. By replacing tungsten bulbs—prime cause of optical encoder failure—they increase life expectancy to 30,000 hours for a 2" binary model. They're ideal for applications where access is difficult or for systems where reliability is paramount.

For information, write Encoder Division, 20745 Nordhoff Street, Chatsworth, Calif. 91311, or telephone 213 341-6161. Europe: Schwamendingenstrasse 5, Zurich 8050, Switzerland.



**ENCODER DIVISION  
LITTON INDUSTRIES**

ON READER-SERVICE CARD CIRCLE 32

## LETTERS

with graduate degrees are not really using them. It would be more to the point to revise the undergraduate curriculum, eliminating the superfluous and outdated material, and making it into a course that was truly professional.

Last but not least, I think that professional status should include a certain amount of practical experience. A recent graduate, whether bachelor or master, is far from being a true professional. My idea of a professional engineer is a man with at least a bachelor's degree and five years of applicable experience. Incidentally, I have a master's, so my feelings on the subject are not sour grapes.

Alex Richardson  
Sr. Member Tech. Staff  
ITT Federal Labs.  
Nutley, N. J.

## Accuracy is our policy

In "Stabilize gain in a dc amplifier," ED 19, Aug. 16, 1966, p. 180, Fig. 1 ("Open-loop gain . . .") a solder dot was omitted at the junction of  $R_2$ ,  $R_L$ ,  $E_0$ , and the emitter of  $T_2$ .

In "Cure switching system noise," ED 19, Aug. 16, 1966, pp. 186-189, the following corrections should be made.

Equation 1, p. 186, should be amended to read:

$$Z = [(R + j\omega L)/(G + j\omega C)]^{1/2},$$

inserting the square root.

In the Table, p. 187, the remarks applying to single wire near a ground plane, the entire second sentence ("Can be fabricated with multilayer printed wiring") should be deleted.

The captions for Figs. 2 and 3, p. 188, should be switched, so that that under Fig. 2 applies to Fig. 3 and that under Fig. 3 to Fig. 2.

The entire paragraph, beginning "Decoupling capacitors can be located . . ." at the foot of column 1, p. 188, and ending ". . . to supply transient currents" at the top of column 2, should be deleted.



**DESIGNERS 1985**

**THE DESIGNER: Lester Beall Inc.**

**THE DESIGN: Supermarket Check-Out/Packaging Unit**

**THE TRACING MEDIUM: Bruning Five Hundred**

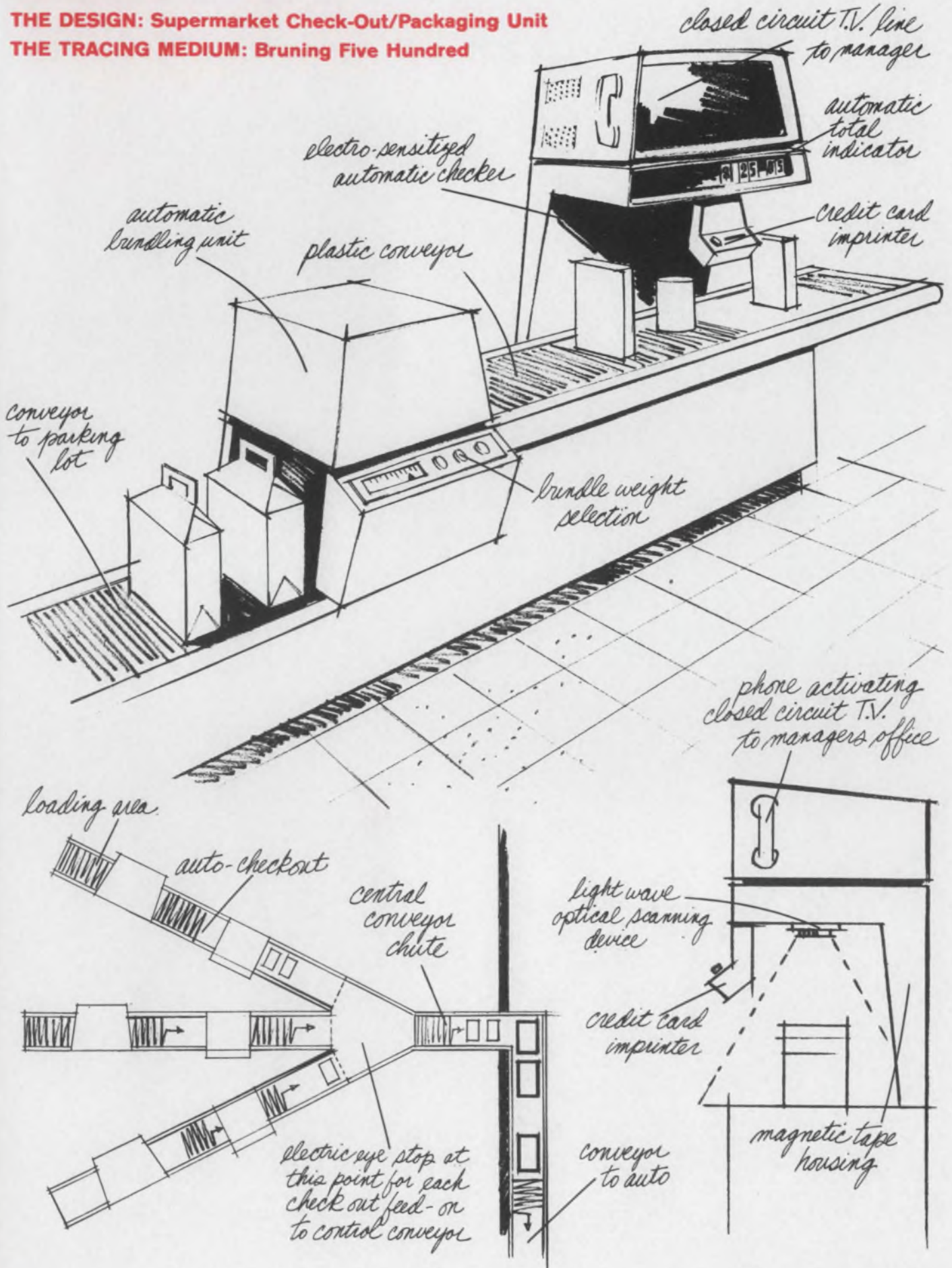

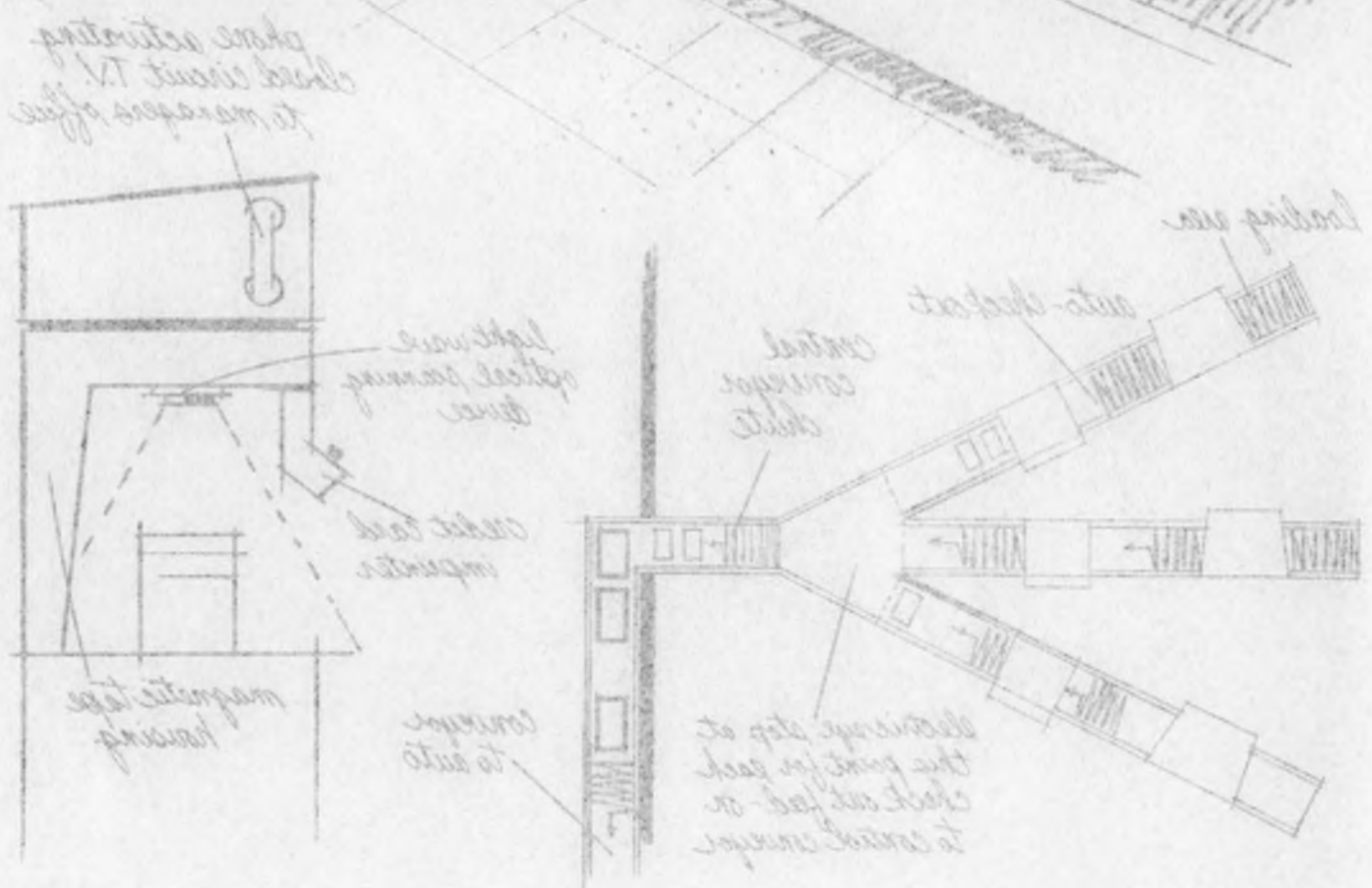
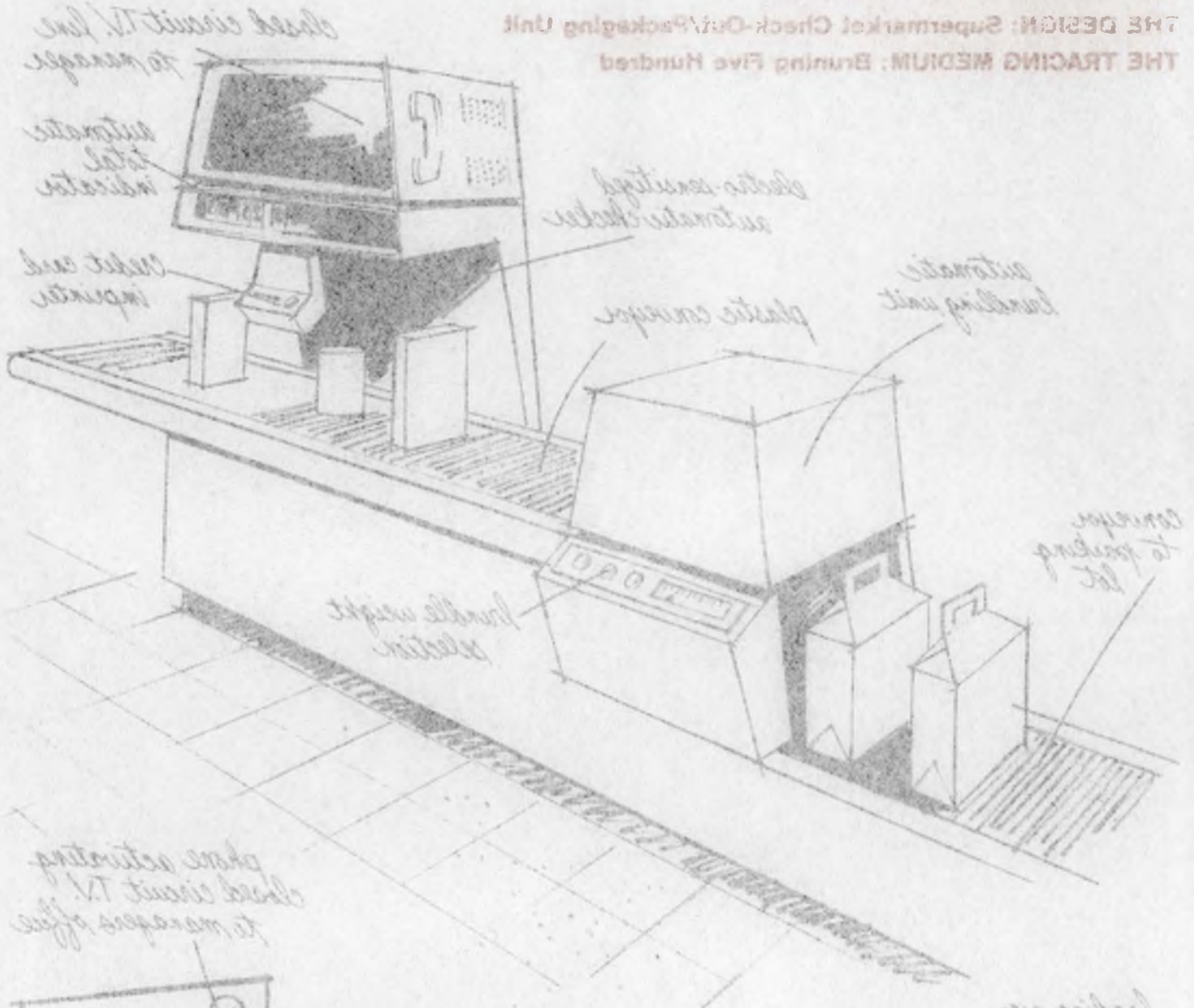

THE DESIGNER: Lester Beall Inc. has designed corporate identity programs, packages, brochures and displays for some of the nation's leading manufacturers.

THE DESIGN: Supermarket Check-Out/Packaging Unit. Shopper sets the machine in operation by inserting her credit card. After the card is scanned (and approved), the customer receives an order number tag, and the conveyor is set into motion. The optical scanner totals items as they pass under it. If the customer has any questions concerning her purchases, she can stop the machine and have TV communication with store personnel by lifting the phone. The totalled items are conveyed directly into a packaging unit where they are enclosed in plastic containers marked with the customer's order number. Customer now may pick up a small order, or let the order be transported by a central conveyor to an exterior pickup point.

THE TRACING MEDIUM: Bruning Five Hundred. By 1985 there will undoubtedly be improvements in this fine tracing paper, as a logical result of Bruning's endless program of product development. One thing will not change: the superb quality of Bruning Five Hundred for its time. That quality will be uniform, sheet after sheet, roll after roll, year after year.

Have you tried it yet? No? Then you're living in the past. Call your Bruning man for a sample of Five Hundred. And if you'd like additional copies of the Check-Out/Packaging Unit design and others included in this series, simply write Designers 1985, Charles Bruning Company, 1800 W. Central Road, Mt. Prospect, Ill. 60058.

Bruning is a U.S. Reg. Trademark of A. M. Corp.



**TRW**  
gives you...

**THE MOST  
EFFICIENT  
5 AMP  
SWITCHING  
TRANSISTORS  
IN SPACE**

**SPEED: 80MHz      GAIN:  $50h_{FE}$  @ 1A      SATURATION: 1V @ 5A**

Every characteristic the designer needs for top performance airborne inverters and switching regulators are combined in the new TRW 2N4305—2N4312 power transistors...high frequency...high gain...low collector saturation voltage.

Another plus factor in this outstanding new series is operating voltage characteristics as high as 120V.

Available in TO-5 packages. Available in Low Profile Isolated Stud packages. Available NOW from authorized distributors everywhere!

For detailed technical information write TRW Semiconductors Inc., 14520 Aviation Blvd., Lawndale, Calif. 90260. Phone: 679-4561. TWX: 910-325-6206. Cable TRWSEMICON / Telex: 67-7148.

**TRW SEMICONDUCTORS**

ON READER-SERVICE CARD CIRCLE 33

**Co-Publishers**

James S. Mulholland, Jr.  
Robert E. Ahrensford

**Editorial Director**

Edward E. Grazda

**Editor**

Howard Bierman

**Managing Editor**

Robert C. Haavind

**Technical Editors**

Joseph J. Casazza  
Rene Colen  
Maria Dekany

**News Editors**

Frank Egan  
Roger K. Field

**East Coast Editor**

Neil Sclater

**West Coast Editors**

Ralph Dobriner  
Peer Fossen

**Copy Editor**

Peter Beales

**New Products Editors**

David Surgan  
Genevieve Adee

**Washington Editor**

S. David Pursglove

**Editorial Production**

Dollie S. Viebig  
Mary Lou Goldstein

**Art Director**

Clifford M. Gardiner

**Art Assistant**

William Kelly

**Technical Illustrators**

Lewis D. Hill  
Cheh Nam Low  
Douglas Luna

**Production Manager**

Thomas V. Sedita

**Asst. Production Manager**

Helen De Polo

**Production Assistants**

Bernard Wolinsky  
Robert M. Henry

**Circulation Manager**

Nancy L. Merritt

**Reader Service**

Diane Pellechi

## EDITORIAL



## Engineer's black box complements MD's black bag

Electronic designers can be proud of their accomplishments in just about every phase of modern society from home entertainment to mass education. But nowhere is this pride more justifiable than in the area of medical electronics. If Hippocrates was the father of medicine, electronic technology is proving a most worthy stepfather.

The reasons for the growing accommodation between electronics and medicine are many. To some extent, it is a case of the "art" of medicine having a need and the "science" of electronics having the means. This is proven by the fact that many techniques now widely used for measuring various bodily processes of the sick would be impossible by other than electronic means. Another reason is that the doctor-to-population ratio in the United States has been steadily declining, while the public demand for medical services has been steadily increasing. As a result, both doctors and hospitals have had to increase their efficiency drastically to serve their increasing patient loads. Electronic instrumentation and data-processing equipment have allowed them to do this, in many cases with resounding success.

Despite the present widespread use of medical instrumentation, its full potential is still far from fully exploited. This is partly because of the relatively high cost of development and the tendency of many physicians to look on the engineers' "gadgets" with a mixture of wariness and disdain. But the biggest obstacle is the lack of widespread cross-pollination of ideas between the engineering and medical communities. Effective exchange between the two groups is essential if electronic technology is to do all it can for medicine. A good example of what can be done is the bio-medical transfer program of NASA's Technology Utilization Division. Under this program, a NASA team of biological and physical scientists seek out medical problems that might be solved by aerospace-technology developments. And already NASA has solved many such biological problems.

The market for medical instrumentation and data-processing equipment is expected at least to triple by 1975. But where will the ideas, the innovations and the designs for all this equipment come from? The explosive growth will require designers who also know something about the biological sciences. Unless the educational community makes some adjustments, new engineering graduates will not be the answer. At present only a handful of universities offer extensive biomedical engineering programs.

It is probable, therefore, that many designers now devoting their talents to space telemetry, industrial instrumentation and the like will find themselves in years to come designing medical equipment and systems. It might behoove all of us, then, to learn just a little more about the needs and requirements of our doctor friends. Anyone who thinks a pacemaker is a driver at a harness track had better start now.

FRANK EGAN

# Unexcelled 30 ohm FET Switch

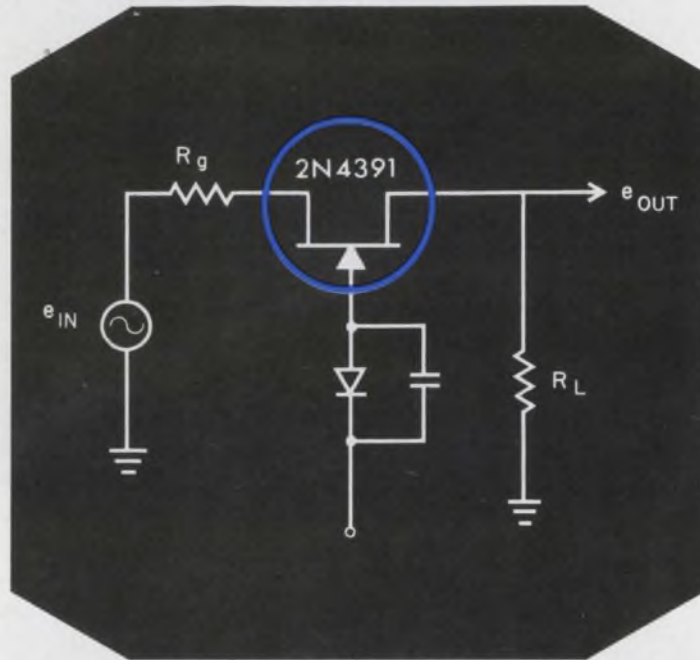

## Unequaled Performance/Price

### COMPARE!

	2N4391	2N4392	2N4393	2N4091	2N4092	2N4093	Units
ON Resistance, $R_{ON}$	30	60	100	30	50	80	ohms
Leakage, $I_{D(OFF)}$	100	100	100	200	200	200	pA
Capacitance, $C_{iss}$	3.5	3.5	3.5	5.0	5.0	5.0	pf
Capacitance, $C_{iss}$	14	14	14	16	16	16	pf
Turn On Time, $t_{on}$	10	10	15	15	15	20	nsec
Turn Off Time $t_{off}$	15	30	40	40	60	80	nsec
Price, 1-99	9.50	7.80	9.00	18.00	16.50	9.70	\$

Another advancement from the leader in Field Effect Transistor technology — UNION CARBIDE ELECTRONICS. Select the performance/price for your application and call your UCE distributor today.



UNION CARBIDE CORPORATION 365 Middlefield Road, Mountain View, California 94041 TWX: 910-379-6942; Telephone: (415) 961-3300

Speed Inquiry to Advertiser via Collect Night Letter  
ON READER-SERVICE CARD CIRCLE 34

# Technology

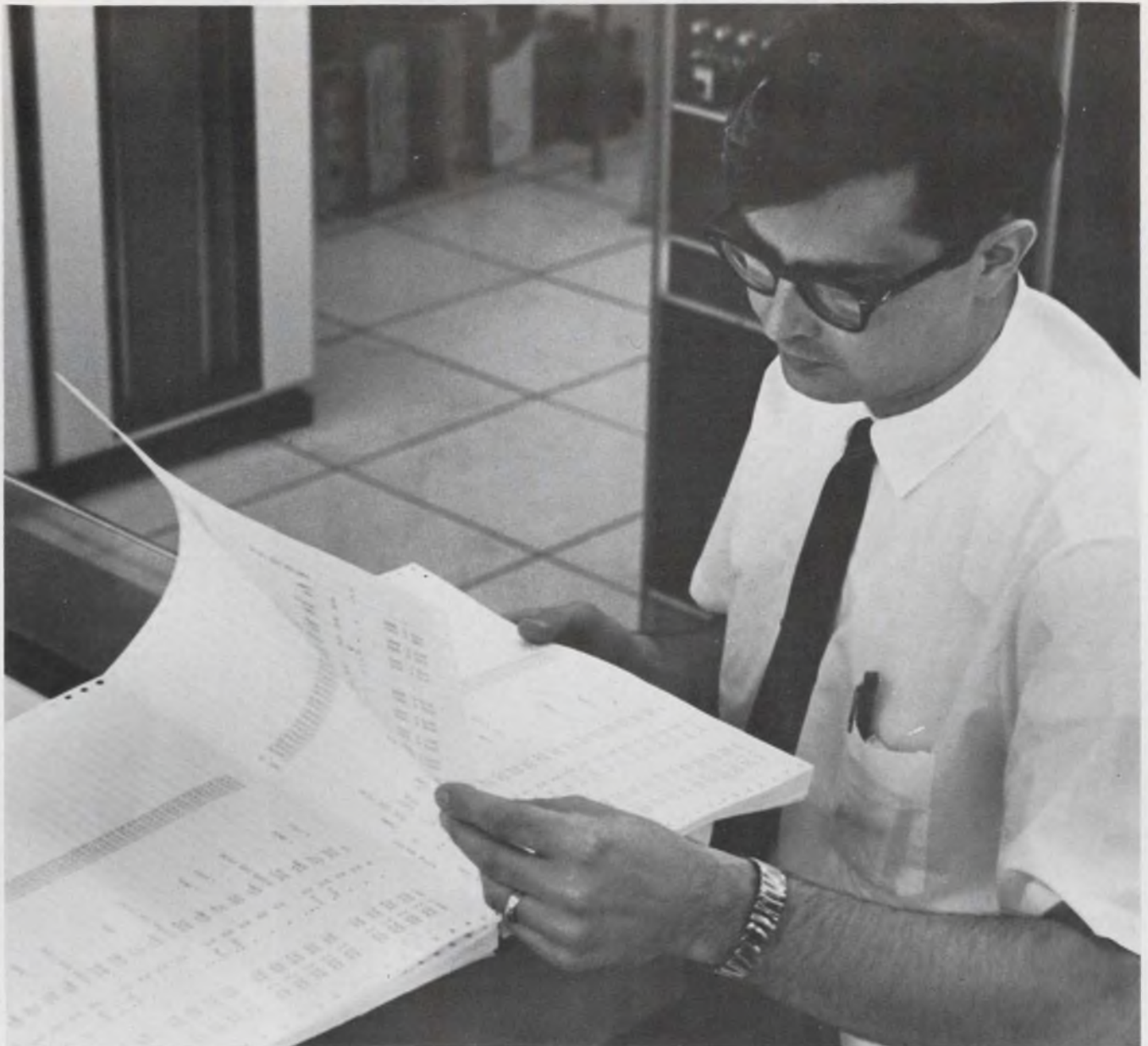

**Computer-aided circuit design** may well have a more far-reaching impact on the tasks of

design engineers than any single development since the advent of the transistor. Page 54

## Also in this section:

**Avoid variable-load problems** in the design of power amplifiers. Page 84

**Demodulate the error signal** in FM modulators for stable, broadband operation. Page 90

**Convert complex numbers** to absolute values and angles graphically. Page 96

**Bits and pieces:** an editor's pie. Page 110

# COMPUTER-AIDED DESIGN

Are computers really a designer's best friend?  
Read this series and decide for yourself.

Edited by **Joseph J. Casazza**, Technical Editor





Far-reaching in its implications and promise, computer-aided design is already being used in many sectors of the electronics industry. Although still young, this exciting technology is growing rapidly.

Indications of its growth are evident in the conference sessions (WESCON, 1966) and seminars (University of Wisconsin in May and the University of Santa Clara, Calif., last month) devoted exclusively to the topic. So, too, is the birth of small, informal user groups (see *Design Directions*, ED 20, Aug. 30, 1966, pp. 34-36). The message for the electronic designer is clear: Don't ignore this powerful new technology.

Using the digital computer as a design tool gives the engineer an opportunity to put classical techniques to work with virtually none of the usual manual drudgery. But before the computer will do his bidding, the engineer must perform a few preliminaries. Here are some of them:

- Learn to communicate with the computer. At present this means, at the very least, a working knowledge of FORTRAN (FORmula TRANslation) programming. Ideally, some day we may all be able to write our instructions on the computer's graphic-input tube screen, but much development still remains to be done before this becomes the established practice.

- Learn to state the problem properly. This is vital, if useful and intelligible data are to be obtained from the computer. The approach to a problem must be refined to weed out waste motion, unrealizable specifications, etc. Although most computer programs will let the user know when he has made an error, the wise design engineer can save himself considerable time and strain by ensuring that initial problem statements and formulations are correct.

- Try to find out what others in the field are doing. This is especially important because of the newness of computer-aided design. There is still little communication between users, because of the difficulty of establishing who and where they are. This problem should dwindle as more conference sessions are held and as more information is

published in engineering journals.

The four articles presented in this special section are designed to give the reader an insight into computer-aided design. The articles are broad in scope, dealing with feedback system design, circuit design by both large- and medium-scale computers, and the circuit-design programs that are currently available.

Throughout the articles there runs the common theme that computer-aided electronic design is practical and has tremendous potential.

The reader need not be a programmer to understand the material, which is written by experts in the field. A casual acquaintance with FORTRAN is certainly helpful but not essential. Once familiar with the capabilities and simple use of such design programs as BASIC, LISA and AMPLI, many designers should be motivated to increase their knowledge of those programming methods that will be of greatest use to them.

Many improvements can be anticipated in computer-aided design in the near future. Perhaps the two most significant developments today are:

- Increased use of time-shared computer systems, enabling relatively small engineering organizations to take full advantage of the modern digital computer.

- Lower cost and greater availability of graphic input/output consoles that allow engineers to communicate with a computer in terms of actual schematic symbols and graphs.

With much new territory to explore, virtually everyone in the industry will eventually feel the effects of the digital computer's contribution to electronic design.

JJC

### Free reprints available

You may obtain a single reprint of the entire special section on computer-aided design by circling 309 on the Reader Service Card.

# Here's a powerful design program

that allows the designer to use Laplace transform techniques to check circuit performance.

High-speed computing methods can be applied to complex problems in linear circuit analysis and design with little effort on the part of the engineer. Through a new experimental computer program called LISA (Linear System Analysis Program), the engineer can draw on the useful s-plane, or pole-zero, techniques, without getting lost in a maze of algebraic or programming details.

Laplace transform methods, although powerful tools in linear theory, have been limited in practice by tedious manual calculations and the need for severe approximations to make solutions tractable. In recent years, the digital computer has been applied to remove these restrictions.<sup>1</sup>

LISA was developed as a result of experiments conducted with various programs aimed at solving a matrix equation with terms that are functions of the complex frequency variable  $s$ . Other techniques were developed to manipulate transfer functions to obtain solutions in the real-frequency and time domains. To support these methods, programming routines were written, such as those needed to generate matrix equations from a node description of the circuit.

Success with these methods led to the organization of these programs into a tool that can aid the engineer both in analysis and design. LISA, an integrated package of programs connected by a common, easy-to-use language, is the result.<sup>2</sup>

## LISA is simple and flexible

The LISA language permits the user to describe his problem in familiar engineering terms, and the simple programming commands can be learned without specialized training in computer techniques. This language is suitable for terminal (i.e., teletypewriter) as well as card input.

The design engineer can apply the program to problems expressed in terms of equivalent circuit diagrams, transfer functions and matrix equations. In addition, basic two-block feedback control systems can be described. Results may be requested as poles and zeros, frequency and transient responses, root locus or sensitivity.

With these alternative forms of input and output, the engineer can apply LISA to a variety

of problems, ranging from electronic circuit applications and heat flow to mechanical and servo-mechanism design problems.

For electronic circuit applications, the program can determine the effects of parameter and topological changes on various parts of the circuit. This characteristic of LISA encourages the engineer to experiment freely with design alternatives. During early design stages, for example, the engineer may want to alter the circuit configuration and examine root locations. At a later stage, his interest may turn to the effect of dominant components. At any time in the development of the design, he can easily jump from the s-plane to the frequency or time domain.

LISA is written in FORTRAN IV for the IBM 7090/94 computer. Although the program is still experimental, it incorporates methods that are general in approach and can be adapted to other types of computers and programming languages.

The flexibility of LISA can be demonstrated through applications that start with an equivalent circuit diagram. The engineer enters the circuit description as values of R, L, C, mutual inductance, initial conditions, independent current sources, and voltage- or current-dependent current sources. The dependent sources are used for active device models such as the  $\Pi$  or T transistor circuits.

From this information, the program automati-



Author Johnson studies print-out resulting from a design problem being executed on a digital computer.

Edward T. Johnson, Senior Associate Engineer, IBM, Systems Development Div., San Jose, Calif.

cally sets up the nodal matrix equation in the complex frequency variable  $s = \sigma + j\omega$ . In addition, the engineer defines the functions required by the problem. These may be voltages, voltage ratios, currents, current ratios, impedances, admittances, determinants, cofactors, or any of the common three-terminal, grounded, two-port parameters.

The program can then compute one or more of the following:

- Poles and zeros.
- Variations of the poles and zeros to component variations.
- Locus of roots over a range of values for any component.
- Time response to various driver functions.
- Bode response over a range of frequencies.
- Sensitivity of a function to component variations at a given frequency.

Answers appear as numerical listings or, if applicable, in the form of plots.

The above computations can be approached in several ways.

### LISA offers three solutions

Three methods of solving the circuit matrix equation for the unknown function are possible with LISA. Each has its advantages and limitations. The engineer's choice will depend on the relative importance of these factors and the characteristics of his design.

■ The first method, POLY, is used to compute polynomial coefficients and find the roots. Calculating speed is an advantage of this method, but coefficient round-off error and overflow problems limit its use to approximately 12 nodes. This method will be illustrated by a design example.

■ TRFN, another method, finds the roots directly from the proper determinants by iteration without even forming the coefficients. Round-off error and overflow are considerably reduced at the

cost of increasing the computing time in comparison with POLY speeds. TRFN accommodates approximately 25 nodes.

■ The third method, called ACCA, works only in the  $s = j\omega$ , or real-frequency, domain, and roots are not found. However, the method is fast and accurate, and both the Bode response and sensitivity can be computed for circuits containing up to 50 nodes. The ACCA method computes the unknown function for dc circuits by using a single value of  $\omega$ .

These three alternative methods make it possible for the engineer to check the accuracy of one set of computations against another.

### Design problem shows LISA in action

A typical design problem for an emitter-follower circuit illustrates how LISA operates in practice. The engineer starts with a circuit diagram, selects the hybrid- $\Pi$  as the transistor model for this circuit, and completes the equivalent circuit (Fig. 1). For convenience, the base resistance and generator resistance are combined. In this example, a Norton equivalent circuit is substituted for the voltage source, and  $V_G(s)$  is set equal to 1 or to the impulse function. Nodes on the equivalent circuit are numbered for reference, starting with 0 for ground. Symbolic names, such as V1, A or GND, can be used as alternative methods of referring to the nodes.

The engineer assigns values to the circuit components. In this case, he selects scaled values with the following units:

R in k $\Omega$	V in volts	t in ns
L in $\mu$ H	I in mA	$\omega$ in Grad/s
C in pF		

His objective, in this case, is to find the poles and zeros, the magnitude and phase response over a specified frequency range, and the transient response for a given driver function.

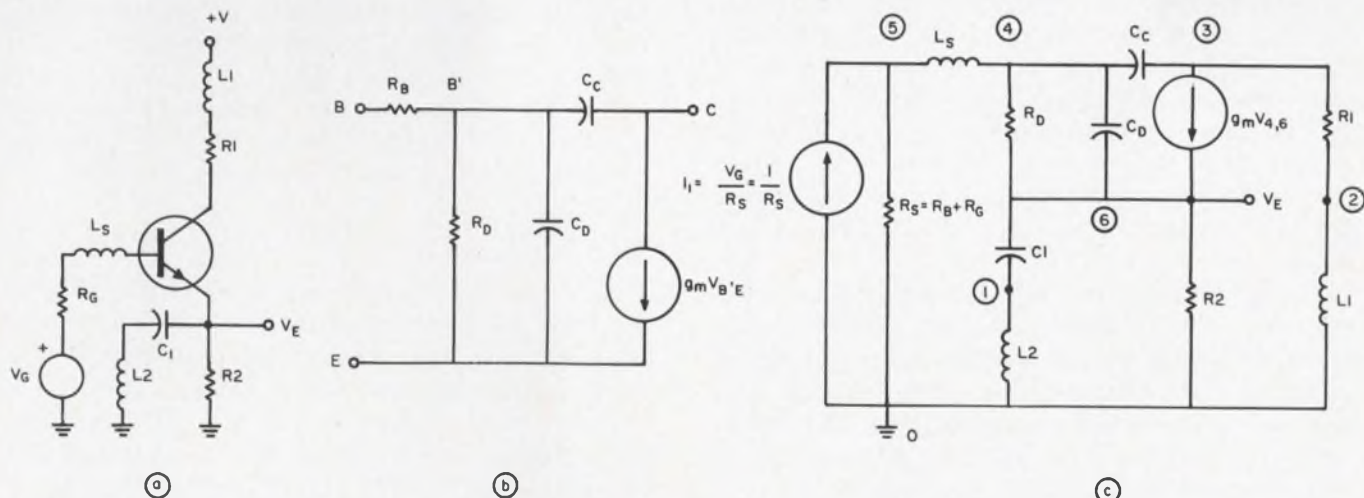

1. Emitter-follower (a) serves as design example to demonstrate the performance of LISA. The Hybrid

$\Pi$  transistor model (b) is used to develop the emitter-follower's small-signal equivalent (c).

All the program statements required to solve this problem are shown in Table 1. When punched cards are the method of input, each statement represents an individual card. All data are entered in free format—that is, a particular type of information, such as a command word or number, does not have to be restricted to specified columns. The data can appear anywhere on the card, with commas separating the items. The free-format style of LISA reduces the possibility of input errors, is more convenient to use, and allows the program to be readily adapted to input devices other than punched card.

LISA commands (TITLE, COMPUTE, etc.) are placed at the beginning of a statement as shown in Table 1. The TITLE command (Table 1, line 000), for example, is followed by a heading for the output listing. The next command, NOTE (line 001), can be used by the engineer for special reminders, such as the selected scale units. The third command, READ, CIRCUIT, introduces 12 descriptive statements about the circuit (lines 002 through 014). Each component is listed by name with its connection nodes and assigned values.

At this point in the program, LISA sets up the nodal matrix equation:

$$Y(s)V(s) = I(s),$$

where  $Y(s)$  is the nodal admittance matrix,  $V(s)$  the unknown node voltage vector, and  $I(s)$  the vector of the sources plus the initial conditions.

The engineer next enters the DEFINE command and describes the unknown transfer function. LISA accepts an unknown function as a FORTRAN-like statement, using the general form:

$$\text{DEFINE, name} = K*[\pm V(i_1) \pm V(i_2)]*S^Z/\text{denominator},$$

where the name is a function term selected by the user;  $K$  is a constant;  $Z$  is the name of a circuit resistor, capacitor, or inductor;  $S$  is the complex frequency variable; and  $V(i_1)$  and  $V(i_2)$  are circuit voltages at nodes  $i_1$  and  $i_2$ . The denominator is identical in form to the numerator, and the two parts are separated by a slash.

For this problem, he assigns the name MS to the function and defines it as the voltage at node 6 (line 015). The engineer can include additional functions by submitting separate DEFINE statements.

The program allows any degenerate (i.e., simplified) form of this expression. Consequently, voltages, voltage gains, currents and a variety of functions can be described in terms of node voltages and circuit resistors, capacitors, and inductors. In addition, a three-terminal, grounded, two-port function is defined by the statement:

DEFINE. PORTS=input node, output node.  
Unknown functions can be referred to merely by

Table 1. Statements for emitter-follower analysis

```

000 TITLE .  EMITTER FOLLOWER ANALYSIS
001 NOTE .  SCALE IS K-OHM,UH,PF,NSEC,GIGA-RAD/SEC,VOLT,MA
002 READ .  CIRCUIT
003      R1, 2, 3 = .15
004      L1, 2, 0 . .1
005      R2, 6, 0 . .2
006      C1, 6, 1, 15
007      L2, 0, 1, .06
008      RD, 4, 6 . .49
009      CD, 4, 6 . .60
010      CC, 3, 4, 2.68
011      TGM, 3, 4, 6, 155.1
012      LS, 4, 5, .001
013      I1, 0, 5, 20
014      RS, 0, 5, .05
015 DEFINE. MS = V(6)
016 COMPUTE . POLY, MS
017 COMPUTE . BODE, MS
018 DATA . FREQUENCY = 20, 3, .001, RPS
019 PLOT
020 LABEL .  EMITTER FOLLOWER - W = GIGA-RAD/SEC, T = NSEC, MS
021 READ .  DRIVER
022      STEP, 0, 1.0
023 DATA .  TIME = 0, 80, .25
024 COMPUTE . TRANSIENT, MS
025 PLOT
026 EXIT

```

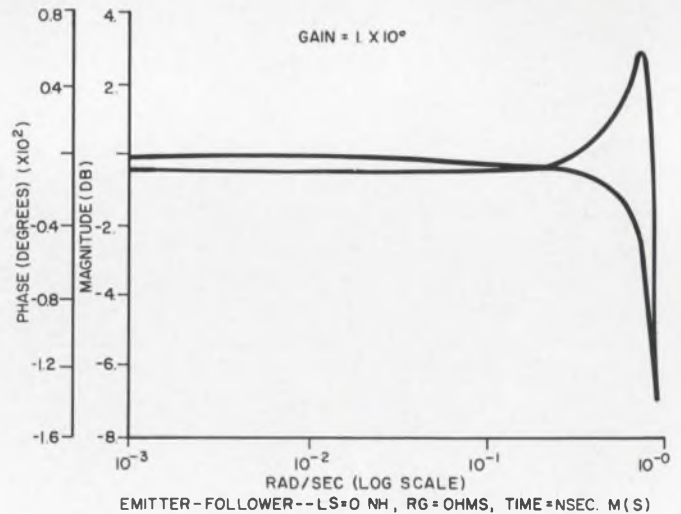

2. Frequency response is plotted by the computer using data shown in Table 3. The curve shows the Bode response of MS obtained for  $s=j\omega$ .

their assigned names or by their implied two-port names in statements that initiate computing steps. Any of the common two-port names, such as Z11, Y21, or H22, may be given.

For the emitter-follower problem, the decision to compute the function MS has many advantages. Because  $V_G(s)$  is set to the impulse function, MS becomes:

$$MS = V_E(s)/V_G(s) = V_E(s)/1 = V(6) = N(s)/D(s).$$

This function, therefore, represents a voltage ratio for the Bode response, or a voltage for the transient response; and its denominator is the characteristic function for stability studies.

With the command, COMPUTE, POLY, MS, the computer calculates the poles and zeros of the function MS. Output from this computation (Table 2) lists the pole and zero coefficients in descending order and shows the roots. The results,

**Table 2. Computer prints out emitter-follower's poles and zeros for MS**

ETJ AMP-BW-1-4		LS INCLUDED , MADE SMALL		SCALED	
DENOMINATOR	DEGREE = 9	1.60799999999928D 06	4.171993738775469D 08	2.156315857551004D 09	
		5.24698516D090700D 09	7.556823347392045D 09	4.316465464852453D 09	
		3.614467120183749D 09	0.	0.	
		0.			
ROOTS	REAL PART	IMAG PART	ITNS	TEST	
	0.	0.			
	0.	0.			
	0.	0.			
	-1.108414643865605D-01	8.346869397855932D-01	8	1	
	-1.108414643865604D-01	-8.346869397855932D-01	1	1	
	-1.177269124880819D 00	1.822899288566771D 00	8	1	
	-1.177269124880819D 00	-1.822899288566771D 00	1	1	
	-2.648344951440168D 00	0.	2	1	
	-2.54227780808097D 02	0.	2	1	
ETJ AMP-BW-1-4		LS INCLUDED , MADE SMALL		SCALED	
X ( 6 )	DEGREE = 8	3.21599999999996D 08	1.324674775510202D 09	2.820745496598634D 09	
		4.614677188208595D 09	2.737124625850357D 09	3.492018140589646D 09	
		0.	0.	0.	
ROOTS	REAL PART	IMAG PART	ITNS	TEST	
	0.	0.			
	0.	0.			
	0.	0.			
	0.	1.054092553390536D 00	8	1	
	0.	-1.054092553389473D 00	1	1	
	-7.500000000000129D-01	1.780124513505184D 00	8	1	
	-7.500000000000129D-01	-1.780124513505184D 00	1	1	
	-2.619013605442175D 00	0.	2	1	

after cancellation, are:

$$MS = N(s)/D(s) = 0.8(s-z_1)(s-z_2)(s-z_3) / (s-p_1)(s-p_2)(s-p_3)(s-p_4),$$

where

$$\begin{aligned} p_1 &= -0.1108 \pm j0.8346 & z_1 &= -0.75 \pm j1.780 \\ p_2 &= -1.177 \pm j1.822 & z_2 &= \pm j1.054 \\ p_3 &= -2.648 & z_3 &= -2.619 \\ p_4 &= -254.2 \end{aligned}$$

By computing MS in the s-plane, the engineer has immediate information on stability at his disposal. In Table 2 for example, the poles are all in the left half plane, indicating the circuit is stable. The designer can relate MS to the real-frequency domain by setting  $s=j\omega$ , or he can shift to the time domain by applying residue methods to obtain the inverse of the transform.

The statement COMPUTE, BODE, MS now directs the computer to provide the magnitude and phase of MS over the frequency range given on the DATA card. This card specifies a range of 20 points per decade over three decades, starting at  $\omega = 0.001$  Grad/s = 1 Mrad/s. A variety of other point ranges could have been specified, such as 80 points per decade over 10 decades. Computation in Hz is optional. Table 3 shows a partial listing of the results. The PLOT and LABEL commands produce a Bode plot (Fig. 2).

The engineer enters the transient driver with

the READ, DRIVER command. He asks for just the step response, beginning with  $t = 0$  and with unit height (1.0). LISA actually allows seven basic Laplace transform drivers: impulse, step, ramp, sine, cosine, sinh and cosh. These drivers can be super-imposed to obtain a variety of pulse shapes, which can be periodic.

The DATA, TIME statement supplies the starting time (0 ns), the ending time (80 ns) and the time step (0.25 ns) for the transient response computation. COMPUTE, TRANSIENT, MS and PLOT commands produce a listing of results (Table 4) and a plot of MS vs time (Fig. 3) for the step driver. Since residue methods are used, the partial fraction expansion can also be obtained. Computing time is fast in comparison with numerical integration methods.

The problem ends with the EXIT card. This statement is deferred, however, if the engineer wants to study circuit changes immediately.

### Design changes can be evaluated

Let us assume the engineer wants to study the effects of various parameter combinations on stability. With a few more statements, he increases the values of LS and RS and computes the results for each change.

The only statements required to do the additional computation are:

**Table 3. Frequency response calculated and printed out using LISA**

FREQUENCY	PHASE (DEG)	MAGNITUDE (DB)	MAGNITUDE	LOG FREQUENCY (F/FO)
10.000E-04	-0.024	-0.299	9.661E-01	0.
1.120E-03	-0.026	-0.299	9.661E-01	0.049
1.260E-03	-0.030	-0.299	9.661E-01	0.100
1.410E-03	-0.033	-0.299	9.661E-01	0.149
1.580E-03	-0.037	-0.299	9.661E-01	0.199
1.780E-03	-0.042	-0.299	9.661E-01	0.250
2.000E-03	-0.047	-0.299	9.661E-01	0.301
2.240E-03	-0.053	-0.299	9.661E-01	0.350
2.500E-03	-0.059	-0.299	9.661E-01	0.398
2.820E-03	-0.066	-0.299	9.681E-01	0.450
3.160E-03	-0.074	-0.299	9.661E-01	0.500
3.550E-03	-0.083	-0.299	9.661E-01	0.550
4.000E-03	-0.094	-0.299	9.661E-01	0.602
4.470E-03	-0.105	-0.299	9.661E-01	0.650
5.000E-03	-0.118	-0.299	9.661E-01	0.699
5.620E-03	-0.132	-0.299	9.661E-01	0.750
6.300E-03	-0.148	-0.299	9.661E-01	0.799
7.080E-03	-0.166	-0.299	9.661E-01	0.850
7.950E-03	-0.187	-0.299	9.661E-01	0.900
8.900E-03	-0.209	-0.299	9.661E-01	0.949
10.000E-03	-0.235	-0.299	9.661E-01	1.000
1.120E-02	-0.263	-0.299	9.662E-01	1.049
1.260E-02	-0.296	-0.299	9.662E-01	1.100
1.410E-02	-0.332	-0.299	9.662E-01	1.149
1.580E-02	-0.372	-0.299	9.662E-01	1.199
1.780E-02	-0.419	-0.298	9.662E-01	1.250
2.000E-02	-0.470	-0.298	9.663E-01	1.301
2.240E-02	-0.527	-0.298	9.663E-01	1.350
2.500E-02	-0.588	-0.297	9.663E-01	1.398
2.820E-02	-0.664	-0.297	9.664E-01	1.450
3.160E-02	-0.744	-0.296	9.665E-01	1.500
3.550E-02	-0.836	-0.296	9.665E-01	1.550
4.000E-02	-0.942	-0.294	9.687E-01	1.602
4.470E-02	-1.053	-0.293	9.688E-01	1.650
5.000E-02	-1.179	-0.292	9.670E-01	1.699
5.620E-02	-1.326	-0.290	9.672E-01	1.750
6.300E-02	-1.487	-0.287	9.675E-01	1.799
7.080E-02	-1.673	-0.284	9.679E-01	1.850

**Table 4. Print-out shows circuit's transient response**

T	F(T)	T	F(T)	T	F(T)	T	F(T)
0.	8.00000E-01	1.0000E 01	9.49459E-01	2.0000E 01	1.00293E 00	3.0000E 01	9.56528E-01
2.5000E-01	6.19049E-01	1.0250E 01	9.74720E-01	2.0250E 01	9.98314E-01	3.0250E 01	9.55336E-01
5.0000E-01	5.25573E-01	1.0500E 01	9.98217E-01	2.0500E 01	9.92570E-01	3.0500E 01	9.54672E-01
7.5000E-01	5.03912E-01	1.0750E 01	1.01904E 00	2.0750E 01	9.86005E-01	3.0750E 01	9.54538E-01
1.0000E 00	5.32764E-01	1.1000E 01	1.03643E 00	2.1000E 01	9.78947E-01	3.1000E 01	9.54909E-01
1.2500E 00	5.91753E-01	1.1250E 01	1.04985E 00	2.1250E 01	9.71726E-01	3.1250E 01	9.55741E-01
1.5000E 00	6.64887E-01	1.1500E 01	1.05892E 00	2.1500E 01	9.64663E-01	3.1500E 01	9.56973E-01
1.7500E 00	7.41496E-01	1.1750E 01	1.06350E 00	2.1750E 01	9.58051E-01	3.1750E 01	9.58531E-01
2.0000E 00	8.15593E-01	1.2000E 01	1.06364E 00	2.2000E 01	9.52151E-01	3.2000E 01	9.60329E-01
2.2500E 00	8.84508E-01	1.2250E 01	1.05957E 00	2.2250E 01	9.47178E-01	3.2250E 01	9.62277E-01
2.5000E 00	9.47440E-01	1.2500E 01	1.05171E 00	2.2500E 01	9.43293E-01	3.2500E 01	9.64282E-01
2.7500E 00	1.00430E 00	1.2750E 01	1.04061E 00	2.2750E 01	9.40604E-01	3.2750E 01	9.66255E-01
3.0000E 00	1.05500E 00	1.3000E 01	1.02691E 00	2.3000E 01	9.39160E-01	3.3000E 01	9.68114E-01
3.2500E 00	1.09911E 00	1.3250E 01	1.01135E 00	2.3250E 01	9.38956E-01	3.3250E 01	9.69784E-01
3.5000E 00	1.13587E 00	1.3500E 01	9.94709E-01	2.3500E 01	9.39930E-01	3.3500E 01	9.71204E-01
3.7500E 00	1.16436E 00	1.3750E 01	9.77753E-01	2.3750E 01	9.41978E-01	3.3750E 01	9.72327E-01
4.0000E 00	1.18372E 00	1.4000E 01	9.61233E-01	2.4000E 01	9.44950E-01	3.4000E 01	9.73121E-01
4.2500E 00	1.19336E 00	1.4250E 01	9.45833E-01	2.4250E 01	9.48669E-01	3.4250E 01	9.73567E-01
4.5000E 00	1.19309E 00	1.4500E 01	9.32156E-01	2.4500E 01	9.52932E-01	3.4500E 01	9.73672E-01
4.7500E 00	1.18322E 00	1.4750E 01	9.20694E-01	2.4750E 01	9.57528E-01	3.4750E 01	9.73445E-01
5.0000E 00	1.16454E 00	1.5000E 01	9.11818E-01	2.5000E 01	9.62239E-01	3.5000E 01	9.72915E-01
5.2500E 00	1.13824E 00	1.5250E 01	9.05766E-01	2.5250E 01	9.66857E-01	3.5250E 01	9.72122E-01
5.5000E 00	1.10585E 00	1.5500E 01	9.02644E-01	2.5500E 01	9.71189E-01	3.5500E 01	9.71114E-01
5.7500E 00	1.06912E 00	1.5750E 01	9.02424E-01	2.5750E 01	9.75063E-01	3.5750E 01	9.69946E-01
6.0000E 00	1.02989E 00	1.6000E 01	9.04955E-01	2.6000E 01	9.78338E-01	3.6000E 01	9.68679E-01
6.2500E 00	9.90039E-01	1.6250E 01	9.09977E-01	2.6250E 01	9.80908E-01	3.6250E 01	9.67371E-01

CHANGE, CIRCUIT, VALUE

LS = 0.05636

COMPUTE, POLY, MS

CHANGE, CIRCUIT, VALUE

LS = 0.2

COMPUTE, POLY, MS

CHANGE, CIRCUIT, VALUE

RS = 0.1

COMPUTE, POLY, MS

These statements produce computations similar to those seen in Table 2. The results are illustrated in a sketch (Fig. 4) showing the movement of the dominant poles. The critical pole moves to the  $j\omega$  axis, then into the right half plane as LS increases. Adding more base resistance stabilizes the circuit.

Many other alternatives could be tried. For example, the engineer could direct the program to compute the locus of the roots over a range of values for RS with the statements:

COMPUTE, LOCUS, MS

DATA, LOCUS = RS, 0.075, 0.1, 0.125, 0.15

PLOT

This input would produce the desired computations and a root-locus plot of the poles and zeros for the selected values of RS. With this information, the engineer could establish the proper design values for stability and other design criteria.

Or, he might determine the effects of component variations on the roots with the statements:

COMPUTE, SENSITIVITY, MS

DATA, SENSITIVITY = 0.05, RS, LS, TGM

These statements will result in new listings of the roots which reflect a 5% increase in the value of RS, LS, and TGM, each taken individually. The word ALL can be used if every component is to be varied. The sensitivity at a single frequency may also be found with similar statements.

To illustrate how the user directs LISA to change his circuit topology, let us assume that he removes  $C_c$  in Fig. 1, and computes the new roots. The statements required for this addition are:

CHANGE, CIRCUIT, TOPOLOGY, REMOVE  
CC

COMPUTE, POLY, MS

To make further topological changes, ADD and SHORT options are available. The ADD option allows new components to be connected to the original circuit description. Following this command, these components are listed in the same manner as those shown in Table 1.

The SHORT option allows the connection of floating nodes caused by the removal of components, or the option can be used actually to short out components connected to adjacent nodes. Ambiguity is avoided in a change of this type if the nodes are originally assigned symbolic names rather than numbers.

These design capabilities of LISA allow many

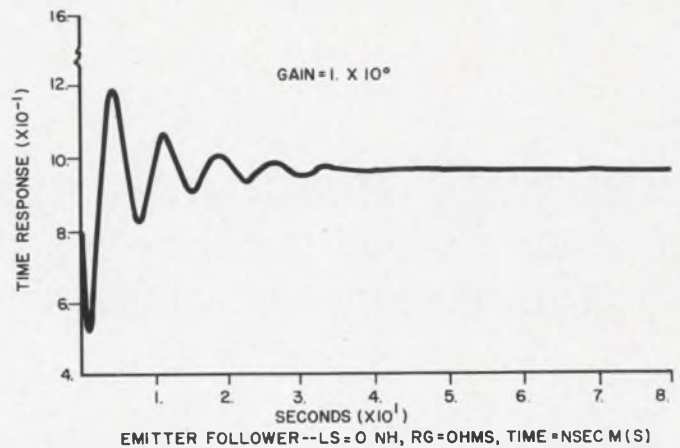

3. The computer provides transient response to unit-step driver in graphic form as well as in the form of the print-out shown in Table. 4.

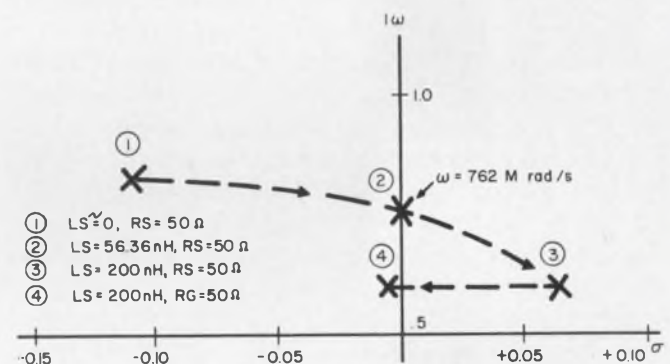

4. Effects of parameter variations on circuit stability are easily observed with LISA. With only a few statements, the designer can obtain data needed to sketch the movement of dominant poles as both LS and RS are varied.

variations to be made easily in the original circuit, with the result that the effects of certain components may be determined with minimal effort.

For the emitter-follower design, the roots found by the POLY method can be checked against TRFN results. Or, they can be checked indirectly by comparing the magnitude and phase listing produced by ACCA with the results from the poles and zeros for  $s = j\omega$ .

Many of the device and parameter studies allowed by this program would be difficult or impossible to perform on the bench within a reasonable period of time. By taking over the burden of calculation, LISA permits the engineer to concentrate his abilities on the creative aspects of his job. ■ ■

#### Acknowledgment:

I want to thank Dr. K. L. Deckert, program leader, for his guidance and significant contributions to all phases of the LISA program.

#### References:

1. F. F. Kuo, "Network Analysis by Digital Computer," *Proc. of IEEE*, LIV, No. 6 (June, 1966), pp. 820-829.
2. K. L. Deckert and E. T. Johnson, "LISA—A Program for Linear Systems Analysis" (Paper presented at WES-CON, Aug. 23, 1966).

# Simplify feedback system design

by using a digital computer to perform the tedious steps required by manual techniques.

Next time you're designing a linear feedback system, let a digital computer do the "dog-work" for you. The computer-aided design procedure to be described will deliver more accurate results in less time than standard graphical techniques.

The conventional method of finding the closed-loop response of a linear feedback system is tedious and open to human error. With this method the gain and phase of the sections (low pass, integration, lead-lag, etc.) of the system must be plotted and added graphically. This composite, open-loop response must then be mapped into a Nichols chart to find the corresponding closed-loop response. The computer-aided technique, however, does the required graphical plotting, adding and Nichols mapping precisely and swiftly and then presents the results in both tabular and graphical form.

## Defining the problem

Many linear feedback systems can be expressed in the form given in the block diagram of Fig. 1. Here  $E_1$  is the input signal,  $E_0$  is the output signal, and  $A(s)$  is a complex function of frequency  $\bar{\omega}$  representing the open-loop transfer function of the system. When the feedback loop is closed by subtracting  $E_0$  from  $E_1$  at the summing point shown in Fig. 1, the closed-loop transfer function is:

$$E_0(s)/E_1(s) = A(s)/[1 + A(s)]. \quad (1)$$

If the open-loop response is known in both gain and phase at a given frequency, Eq. 1 can be used to calculate the closed-loop response at that frequency.

A convenient form of expression for  $A(s)$  is the product of a series of first- and second-order transfer subfunctions. Here each subfunction directly represents one of the series of single- and/or double-pole sections from which the over-all transfer function is constructed. A list of the more useful single- and double-pole sections together with their respective transfer subfunctions is given in Fig. 2.

Frederick R. Shirley, Engineer, Electronic Design Dept., Sanders Associates, Inc., Nashua, N. H.

If a transfer function is composed of  $N$  sections of the types given in Fig. 2, and if the gain of each section is expressed logarithmically in dB, then the total gain  $M$  of the transfer function is:

$$M_{dB} = \sum_{n=1}^N 20 \log_{10} |A_n(s)|. \quad (2)$$

Similarly, if the phase of each section is expressed linearly (in degrees), then the total phase  $\phi$  of the transfer function is given by:

$$\phi_{deg} = \sum_{n=1}^N \angle A_n(s). \quad (3)$$

With the relations of Eq. 2 and 3, the imaginary (I) and real (R) parts of the open-loop transfer function may be expressed:

$$I = 10^{(M/20)} \sin \phi. \quad (4)$$

$$R = 10^{(M/20)} \cos \phi. \quad (5)$$

Therefore the gain ( $M'$ ) and phase ( $\phi'$ ) of the closed-loop transfer function may be expressed:

$$M'_{dB} = M - 20 \log_{10} [(R+1)^2 + I^2]^{1/2}. \quad (6)$$

$$\phi'_{deg} = \phi - \tan^{-1} [I/(R+1)]. \quad (7)$$

Equations 6 and 7 form a particularly useful expansion of Eq. 1 because they express the desired closed-loop solution directly in terms of the standard transfer subfunctions of Fig. 2. These equations form the basis for the computer program used to solve a linear feedback system.

## The computer program is BASIC

A computer program for calculating the closed-loop transfer function of the feedback system (Fig. 1) is shown in Table 1. The program is written

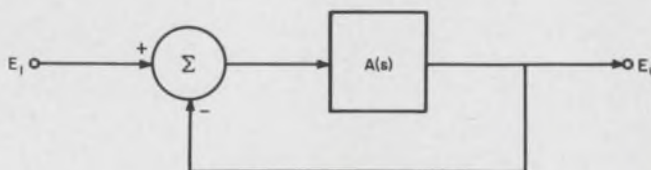

1. Feedback system transfer function equations are developed by means of the block diagram shown. Many linear feedback systems can be represented in this way.



in BASIC (Beginner's All-purpose Symbolic Instruction Code), which is a simplified language used on the Dartmouth teletype time-sharing system. This type of time-sharing system is particularly advantageous to the engineer, because it allows complete control of all aspects of the programming procedure directly from the teletype keyboard.

The input format for BASIC requires a line number (0 to 99999) followed by a command word at the beginning of each typed line. The computer interprets each line as an individual statement, and reorders these according to increasing line number. Some of the BASIC command words which are used in the program of Table 1 are listed alphabetically in Table 2.

The program of Table 1 is composed of the following seven parts:

1. Instructions to the user.
2. Data setup.
3. Calculation of the individual section frequency responses.
4. Calculation of the open-loop response.
5. Calculation of the closed-loop response.
6. Print-out of the tabular data.
7. Print-out of the graphical data.

The instructions to the user are contained in

lines 10 through 44. These statements explain briefly the purpose of the program and the required input format for the user's specific problems. In the execution of the program the computer ignores these statements on every line prefixed with the command word "REM".

The data setup is contained in lines 100 through 420. Line 100 is blank (i.e., it line-feeds the print-out one line). Line 110 requests preliminary information on the user's problem—the central frequency and decade range he is interested in, and the number of sections in his open-loop transfer function. Line 115 causes a question mark to be typed, and waits for three numbers to be entered on the teletype by the user. These three numbers are then defined as C, D, and L1 in the succeeding computations in the program. Lines 120-130 form an error routine which prevents the solution of a problem of more than 50 sections, which is the maximum program length—a limit imposed by the available memory room in the computer. Lines 150-190 reserve extra memory room for the variable arrays F (frequency computation points), A (open-loop phases), M (open-loop gains), B (individual section phases), and N (individual section gains). Lines 200 and 210 define the constants  $\pi$  and  $\ln(10)$  which are used in converting radians

SECTION	TYPE OF TRANSFER FUNCTION	POLE ORDER	POLE-ZERO LOCATIONS	GAIN RESPONSE	PHASE RESPONSE
1	LOW PASS	(1)			
2	$\frac{1}{s}$ LOW PASS	(1)			
3	HIGH PASS	(1)			
4	$\frac{1}{s^2}$ HIGH PASS	(1)			
5	INTEGRATOR	(1)			
6	DIFFERENTIATOR	(1)			
7	CONSTANT	(0)			
8	STABLE	(2)			

2. Here are the transfer functions usually encountered when dealing with linear feedback systems. Also shown

are the pole-zero, gain, and phase characteristics of each function.

**Table 1. BASIC program aids linear feedback design**

```

10 REM THIS PROGRAM COMPUTES AND GRAPHS THE CLOSED LOOP RESPONSE OF A
12 REM FEEDBACK SYSTEM WITH UP TO 50 SECTIONS, WHERE EACH SECTION CON-
14 REM TAINS EITHER A STABLE 2ND ORDER POLE (DAMPING FACTOR >= 0), OR
16 REM ANY 1ST ORDER POLE. COMPUTATION IS DONE AT 31 LOG-SPACED FREQ.
18 REM POINTS OVER A 2, 4, OR 8 DECADE RANGE.
20 REM WHEN ASKED "CENTRAL FREQ., DECADES, NO. OF SECTIONS?" ENTER
22 REM 3 NUMBERS: C,D,L--WHERE C IS THE CENTRAL FREQ. OF INTEREST; D IS
24 REM THE NUMBER OF DECADES TO BE COVERED; AND L IS THE TOTAL NO. OF
26 REM SECTIONS.
30 REM WHEN ASKED "TYPE, FREQ., GAIN: NO. N?" ENTER 3 NUMBERS: N1,
32 REM N2,N3--WHERE N1 IS THE TYPE OF THE NTH SECTION (1=LOWPASS, 2=
34 REM 1/LOW, 3=HIGHPASS, 4=1/HIGH, 5=INT., 6=DIFF., 7=CONST., 8=2ND
36 REM ORDER); N2 IS ITS CRITICAL FREQ.(HZ); AND N3 IS ITS GAIN (DB)/
38 REM OR DAMPING FACTOR (FOR B).
40 REM TO ELIMINATE THE INDIVIDUAL DATA ENTER EDIT DEL 3080-3180.
42 REM TO ELIMINATE ALL TABLE DATA ENTER EDIT DEL 3010-3180,3200,3705
44 REM F. SHIRLEY, SANDERS ASSOC., NASHUA, N.H., 7/8/68
100 PRINT
110 PRINT "CENTRAL FREQ., DECADES, NO. OF SECTIONS";
115 INPUT C,D,L1
120 IF L1 <= 50 THEN 140
125 PRINT "TOO MANY SECTIONS. TRY AGAIN WITH 50 OR FEWER."
130 GO TO 110
140 PRINT "TYPE, FREQ., GAIN (DB):"
150 DIM F(31)
160 DIM A(31)
170 DIM M(31)
180 DIM B(3,50)
190 DIM N(3,50)
200 LET P = 3.14159265
210 LET E = 2.30258509
220 FOR L = 1 TO 0/2
230 FOR J = 1 TO 31
240 READ F(J)
250 LET F(J) = F(J)*C
260 NEXT J
270 NEXT L
280 DATA .100, .117, .138, .158, .185, .215, .251, .293, .341, .398, .464
281 DATA .541, .631, .738, .858, 1.00, 1.17, 1.38, 1.58, 1.85, 2.15
282 DATA 2.51, 2.93, 3.41, 3.98, 4.64, 5.41, 6.31, 7.38, 8.58, 10.0
290 DATA .01, .0138, .0185, .0251, .0341, .0464, .0631, .0858, .117, .158, .215
291 DATA .293, .398, .541, .738, 1.00, 1.38, 1.85, 2.51, 3.41, 4.64
292 DATA 6.31, 8.58, 11.7, 15.8, 21.5, 29.3, 39.8, 54.1, 73.8, 100
300 DATA .001, .0018, .0025, .004, .0063, .01, .018, .025, .04, .063, .1, .18, .25
301 DATA .4, .63, 1, 1.8, 2.5, 4.6, 6.3, 10, 18, 25, 40, 63, 100, 180, 250, 400, 630, 1000
350 FOR J = 1 TO 31
360 LET A(J) = 0
370 LET M(J) = 0
380 NEXT J
400 FOR L = 1 TO L1
410 PRINT "": "NO.": L;
420 INPUT T, K, G
450 FOR J = 1 TO 31
501 IF T = 1 THEN 1100
502 IF T = 2 THEN 1200
503 IF T = 3 THEN 1300
504 IF T = 4 THEN 1400
505 IF T = 5 THEN 1500
506 IF T = 6 THEN 1600
507 IF T = 7 THEN 1700
508 IF T = 8 THEN 1800
520 PRINT "INCORRECT POLE TYPE. TRY AGAIN."
530 GO TO 410
1100 LET B(0,J) = -ATN(F(J)/K)*180/P
1110 LET N(0,J) = 20*LOG(SQR(1/(1+(F(J)/K)^2)))/E + G
1120 GO TO 2000
1200 LET B(0,J) = ATN(F(J)/K)*180/P
1210 LET N(0,J) = -20*LOG(SQR(1/(1+(F(J)/K)^2)))/E + G
1220 GO TO 2000
1300 LET B(0,J) = ATN(K/F(J))*180/P
1310 LET N(0,J) = 20*LOG(SQR(1/(1+(K/F(J))^2)))/E + G
1320 GO TO 2000
1400 LET B(0,J) = -ATN(K/F(J))*180/P
1410 LET N(0,J) = -20*LOG(SQR(1/(1+(K/F(J))^2)))/E + G
1420 GO TO 2000
1500 LET B(0,J) = -90
1510 LET N(0,J) = 20*LOG(K/F(J))/E + G
1520 GO TO 2000
1600 LET B(0,J) = 90
1610 LET N(0,J) = 20*LOG(F(J)/K)/E + G
1620 GO TO 2000
1700 LET B(0,J) = 0
1710 LET N(0,J) = G
1720 GO TO 2000
1800 LET X = F(J)/K - SQR(1-G^2)
1810 LET Y = F(J)/K + SQR(1-G^2)
1820 LET B(0,J) = -(ATN(X/G) + ATN(Y/G))*180/P
1830 LET N(0,J) = 20*LOG(SQR(1/((X^2+G^2)*(Y^2+G^2))))/E
2000 LET A(J) = A(J) + B(0,J)
2020 LET M(J) = M(J) + N(0,J)
2030 NEXT J
2040 FOR I = 1 TO 31 STEP 15
2050 LET B((J+14)/15, L) = B(0,J)
2060 LET N((J+14)/15, L) = N(0,J)
2070 NEXT J
2080 NEXT L
3000 PRINT
3020 PRINT "": "OPEN LOOP": "": "CLOSED LOOP"
3030 PRINT "FREQUENCY": "PHASE": "GAIN": "PHASE": "GAIN"
3040 PRINT "HERTZ": "DEGREES": "DECIBELS": "DEGREES": "DECIBELS"
3050 PRINT
3060 FOR L = 1 TO L1
3070 PRINT "SECTION NO.": L; "":
3080 FOR J = 1 TO 31 STEP 15
3090 PRINT F(J), B((J+14)/15, L), M((J+14)/15, L)
3100 NEXT J
3110 NEXT L
3120 PRINT
3200 PRINT "COMPOSITE FREQUENCY RESPONSE:"
3210 FOR J = 1 TO 31
3220 LET X = 10*(M(J)/20)
3230 LET I = X*SIN(A(J)*P/180)
3240 LET R = X*COS(A(J)*P/180)
3250 LET A2 = A(J) - ATN(1/(R+1))*180/P
3260 LET N(0,J) = M(J) - 20*LOG(SQR((R+1)^2 + 1^2))/E
3300 LET A2 = A2 + 180
3310 LET A2 = A2 - 180
3320 IF M(J) >= 0 THEN 3400
3330 IF A2 - A(J) <= 90 THEN 3700
3340 GO TO 3310
3400 IF A2 <= 90 THEN 3700
3410 GO TO 3310
3700 REM
3705 PRINT F(J), A(J), M(J), A2, N(0,J)
3710 NEXT J
10000 FOR J = 1 TO 6
10010 PRINT
10020 NEXT J
10025PRINT "CLOSED LOOP GAIN (DB)"
10030PRINT "-20 -10 -5 0 5 10"
10040PRINT "+-----+-----+-----+-----+-----+-----"
10100 FOR J = 1 TO 31
10110 LET W = INT(2*N(0,J) + .5) + 40
10130 FOR L1 = 0 TO 1
10140 FOR L = 0 TO 4
10150 LET V = W - 8*L - 30*L1
10160 IF V < 0 THEN 11000
10170 IF V > 5 THEN 11000
10200 IF V < 5 THEN 10300
10210 PRINT "":
10220 GO TO 12000
10300 IF V < 4 THEN 10400
10310 PRINT "":
10320 GO TO 12000
10400 IF V < 3 THEN 10500
10410 PRINT "":
10420 GO TO 12000
10500 IF V < 2 THEN 10600
10510 PRINT "":
10520 GO TO 12000
10600 IF V < 1 THEN 10700
10610 PRINT "":
10620 GO TO 12000
10700 PRINT "":
10720 GO TO 12000
11000 IF L < 4 THEN 11100
11010 PRINT "":
11020 GO TO 12000
11100 IF L < 3 THEN 11200
11110 PRINT "":
11120 GO TO 12000
11200 IF L < 2 THEN 11300
11210 PRINT "":
11220 GO TO 12000
11300 IF L < 1 THEN 11400
11310 PRINT "":
11320 GO TO 12000
11400 PRINT "":
12000 NEXT L
12010 NEXT L1
12015 PRINT "": F(J)
12020 NEXT J
12025 PRINT
12030PRINT "
12050PRINT "
99999 END

```

and Napierian logarithms (the computer's natural units) to degrees and decibels (the desired print-out units).

In lines 220-301 the computer uses input information C and D to generate 31 logarithmically spaced frequency-computation points. The nested J-loop from 230 to 260 reads the first 31 numbers in the data block (i.e., the data in statements 280-282), multiplies each number by C, and sets the resulting 31 numbers equal to F (J). The over-all L-loop from 220 to 270 operates the J-loop 1, 2, or 3 times depending on whether the value of D is 2, 4, or 6, respectively. If D is equal to 2, the frequency points are determined by the first data block (280-282); if D is equal to 4, the frequency points are recomputed according to the second data block (290-292); and if D is equal to 6, the points are recomputed again according to the third data block (300-301).

In lines 350-380 the initial value of the open-loop phase and gain are set equal to zero in preparation for later computation.

In lines 140, 410 and 420 additional information is requested from the user. For each section in the user's open-loop transfer function, the computer requests the type T, critical frequency K, and gain (or damping factor if T=8) G.

The calculation of the *frequency response for each section* is accomplished in lines 400-1830. Lines 501-508 route the computation of the individual-section phase and gain to one of nine locations: to the appropriate formula pairs in lines 1100-1830 if T is one of the section-type codes given in Fig. 2, or to the error routine in lines 520-530 if T is incorrectly defined. The nested J-loop from 450 to 2030 calculates the phase and gain of the individual section at the 31 frequency-computation points, and the over-all L-loop from 400 to 2080 repeats these calculations for each section in the user's transfer function.

The formula pair for a low-pass section (lines 1100-1120) is typical of the eight sets of formulas in the 1100-1830 calculation portion of the program. In line 1100, B (O, J) is the phase  $\phi(\omega)$  of the section for the Jth frequency value, F(J) is the Jth value of frequency, K is the critical frequency  $\omega_c$ , P is  $\pi$ , and ATN is the arc-tangent function evaluated in radians. Therefore line 1100 is equivalent to:

$$\phi(\omega)_{deg} = -[\tan^{-1}(\omega/\omega_c)_{rad}](180/\pi). \quad (8)$$

Similarly in line 1110, N(O, J) is the gain  $M(\omega)$  of the section for the Jth frequency value, E is the natural logarithm of 10, SQR is the square-root function, and LOG is the natural logarithm function. Therefore line 1110 is equivalent to:

$$M(\omega)_{dB} = 20 \ln\{[1 + (\omega/\omega_c)^2]^{-1/2}/\ln 10\} + G_{dB}. \quad (9)$$

The *calculation of the open-loop frequency response* is accomplished in lines 2000 and 2020. The

Table 2. Commands used in feedback design program.

COMMAND	MEANING
DATA	Stores numerical data
DIM	Reserves memory room
END	Terminates all computation
FOR...TO...STEP	Sets up an iteration loop
GO TO	Alters the order of computation
IF...THEN	Allows a computation decision
INPUT	Requests numerical data
LET	Solves a numerical equation
NEXT	Terminates an iteration loop
PRINT	Prints output data
READ	Enters numerical data
REM	Allows remarks to be ignored

open-loop phase and gain at the Jth frequency value are set equal to their previous values plus the phase and gain of the Lth section. Here it is seen that the initial zero-setting of A(J) and M(J) in lines 350-380 is required to define the starting phase and gain values as zero. After the over-all L-loop (400-2080) has been performed the required L1 times, the values of A(J) and M(J) are the desired sums of the phases and gains of the individual sections according to Eq. 3 and 2.

The *calculation of the closed-loop frequency response* is accomplished in lines 3210-3410. Lines 3230, 3240, 3250, and 3260 are directly equivalent to Equations 4, 5, 6, and 7 respectively. However, there is an ambiguity in the closed-loop phase  $A_2$  by a multiple of 180 degrees because of the cyclical property of the arc-tangent function. This ambiguity is resolved in lines 3330-3410 by comparison of the close-loop phase with the open-loop phase according to the value of the open-loop gain. For a stable feedback system, if the open-loop gain is non-negative, the closed-loop phase must lie between +90 degrees and -90 degrees, and if the open-loop gain is negative, the closed-loop phase must lie within + and -90 degrees of the open-loop phase. Therefore, in line 3300 the closed-loop phase is made too large by a multiple of 180 degrees. Then, if the open-loop gain is non-negative, it is reduced 180 degrees at a time in lines 3310, 3320, 3400 and 3410 until it is between + and -90 degrees. Or, if the open loop gain is negative, it is reduced in lines 3310, 3320, 3330, and 3340 until it is within + and -90 degrees of the open-loop phase.

*Print-out of the tabular data* is accomplished in lines 2040-3710. As a means of checking the results, it is convenient to have the print-out divided into two portions: a preliminary print-out giving spot values of the frequency response of each individual section, and a primary print-out giving the open-loop and closed-loop frequency responses of the system. In lines 2040-2070 three values of the phase and gain of the individual sections are stored, and in lines 3060-3110 these values are printed out. Then, in line 3705 the open- and

closed-loop system responses are printed out. The REM statement (line 3700) is to provide a forwarding location for lines 3330 and 3400 which is not a PRINT statement such as line 3705. This allows the same flexibility in bypassing the print-out as described in lines 40-42, when only the graphical data are desired by the user. The EDIT DEL statement temporarily removes the indicated line-number blocks from the program.

*Print-out of the graphical data is accomplished*

in lines 10000-12050. Lines 10000-10020 space the graph 6 lines down from the tabular data, and lines 10025-10040 and 12015-12050 print the axes, scales and labels. Line 10110 defines the variable W such that, as the closed-loop magnitude varies from -20 dB to +10 dB, W varies in nearest integer steps from 0 to 60 (i.e., in half-dB steps across the graph grid). Because the BASIC language subdivides each print-out line into six-character regions, it is convenient to define another

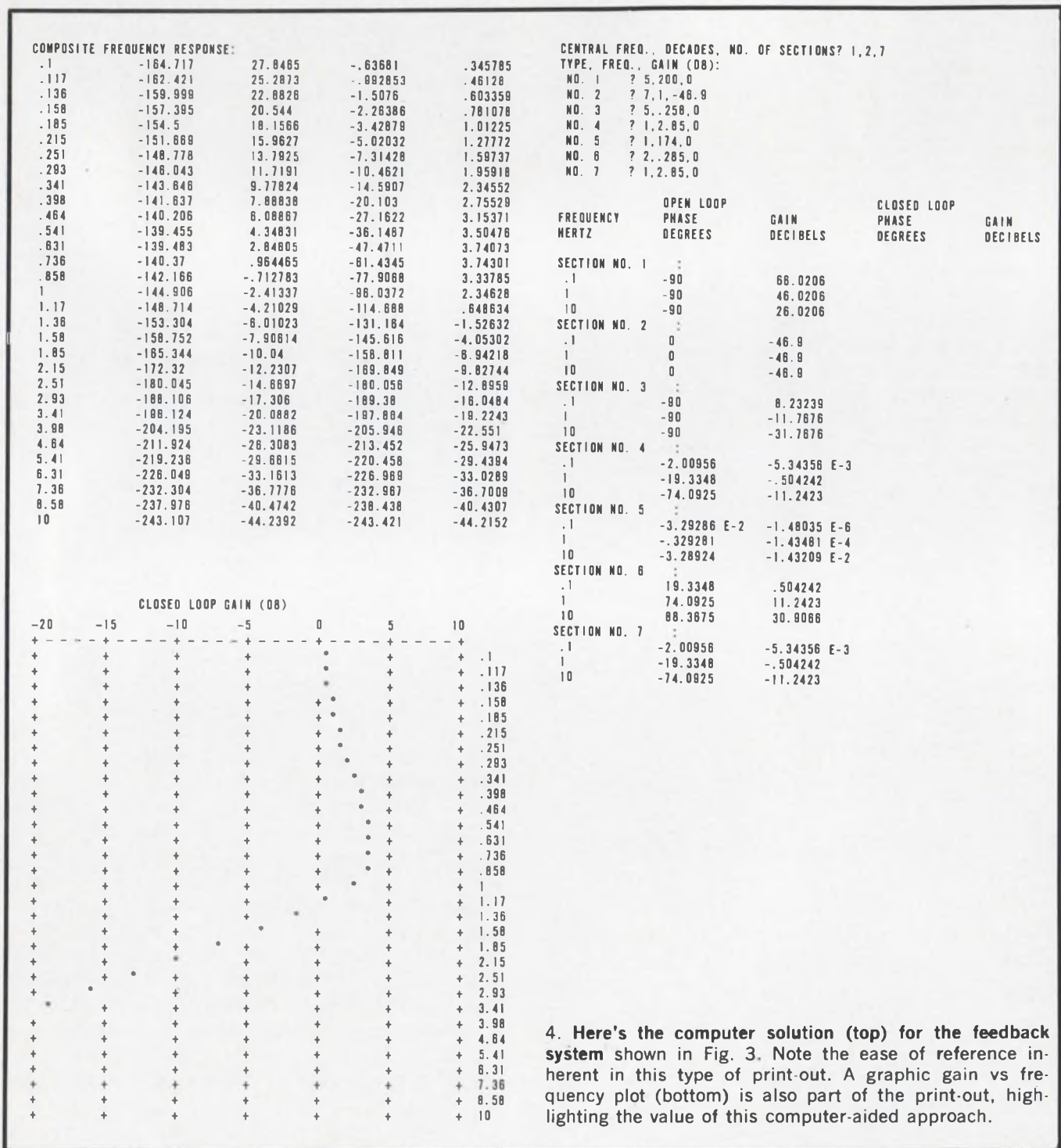

4. Here's the computer solution (top) for the feedback system shown in Fig. 3. Note the ease of reference inherent in this type of print-out. A graphic gain vs frequency plot (bottom) is also part of the print-out, highlighting the value of this computer-aided approach.

variable  $V$  in line 10150 which divides  $W$  into ten 6-character groups. The nested L-loop (10140-12000) and the over-all L1-loop (10130-12010) print one graph line in ten groups, with the print-out for each determined by the value of  $V$ . If  $V$  is between 0 and 5 for a particular group, a graph point (an asterisk) is plotted at the correct location by lines 10160-10720. If  $V$  is not between 0 and 5 for that group, then a graph grid (a plus sign) is plotted where required by lines 11000-11400.

### Sample design illustrates technique

A typical feedback-system (Fig. 3) design problem will serve to demonstrate the computer-aided approach. The specifications for this second-order phase-locked loop are that it have a minimum bandwidth of 1 Hz and an attenuation at 10 Hz of at least 40 dB. With the aid of the computer program of Table 1, the theoretical frequency response of the system can be calculated from the circuit parameters of Fig. 5. In particular, the gain and phase margins of the open-loop transfer function, and the 3-dB bandwidth, 10-Hz attenuation, and resonant rise of the closed-loop transfer function can be precisely determined.

In order to express the system of Fig. 3 in suitable computer format, the open-loop transfer function must be broken down into a series of transfer subfunctions, each of which corresponds to one of the sections of Fig. 2.

The first section is an integrator (type 5), composed of the phase detector and VCO, with the transfer subfunction:

$$A_1(s) = (200 \text{ Hz/V}) (1 \text{ V/rad}) (2\pi \text{ rad/s}) = 400\pi/s. \quad (10)$$

The second section is a constant (type 7), composed of the input and output resistive dividers, with the transfer subfunction:

$$A_2(s) = (8.2 \text{ K}/384.2 \text{ K}) (2.2 \text{ K}/10.4 \text{ K}) = 0.00451. \quad (11)$$

The third section is another integrator (type 5), composed of the 56-k $\Omega$  and 560-k $\Omega$  resistors and the 1.0- $\mu$ F capacitor in the operational amplifier cir-

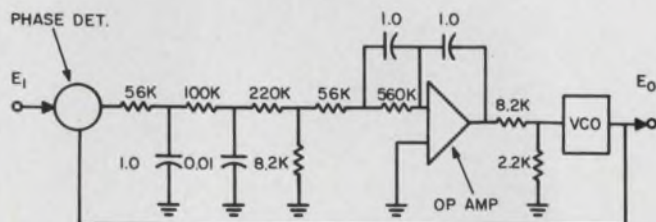

VCO = VOLTAGE-CONTROLLED OSCILLATOR

3. Using this sample feedback system, the design technique discussed in the text can be demonstrated.

cuit, with the transfer subfunction:

$$A_3(s) = 1/(0.616 \text{ M}) (1.0 \mu\text{F}) (s) = 1.62/s. \quad (12)$$

The fourth section is low-pass (type 1), composed of the first 56-k $\Omega$  series resistor and 1.0- $\mu$ F capacitor to ground, with the transfer subfunction:

$$A_4(s) = 1/[1 + 0.056 \text{ M}/(1.0 \mu\text{F}) (s)] = 1/(1 + 0.056/s). \quad (13)$$

The fifth section is another low pass (type 1), composed of the 100-k $\Omega$  series resistor and the 0.01- $\mu$ F shunt capacitor to ground, with the transfer subfunction:

$$A_5(s) = 1/[1 + (0.100 \text{ M}/0.01 \mu\text{F}) (s)] = 1/[1 + (10/s)]. \quad (14)$$

The sixth section is a reciprocal low pass (type 2), composed of the second series 56-k $\Omega$  resistor and the 1.0- $\mu$ F capacitor at the operational amplifier input, with the transfer subfunction:

$$A_6(s) = 1 + [0.056/(1.0 \mu\text{F}) (s)] = 1 + (0.056/s). \quad (15)$$

The last section is a low pass (type 1), composed of the 560-k $\Omega$  resistor and 1.0- $\mu$ F parallel capacitor at the operational amplifier input, with the transfer subfunction:

$$A_7(s) = 1/1 + [0.560 \text{ M}/(1.0 \mu\text{F}) (s)] = 1/[1 + (0.56/s)]. \quad (16)$$

The gain of each of these sections is zero except for section 2, which has a gain of -46.9 dB. The critical frequency in Hz of the integrator sections is the zero-gain frequency, which is 200 for section 1 and 0.258 for section 3. The critical frequency of the constant section is immaterial and is arbitrarily set equal to 1 for section 2. The critical frequencies for the low-pass and reciprocal low-pass sections are the 3-dB corner frequencies, which for sections 4, 5, 6, and 7 are 2.85, 174, 0.284, and 2.85 Hz, respectively.

The computer solution to the problem of Fig. 3 is shown in Fig. 4. Here a two-decade frequency range centered at 1 Hz is selected as the frequency range of interest, and the over-all open-loop transfer function is divided into the seven sections of Eq. 10-16. The preliminary print-out of the individual section data may be used to check the computer calculations of Eqs. 10 through 16 at the 0.1-, 1- and 10-Hz frequency points. The print-out of the composite frequency response shows that the open-loop gain and phase margins are 14.6 dB and 40 degrees, and that the closed-loop 3-dB bandwidth, 10-Hz attenuation, and resonant rise are 1.5 Hz, 44.2 dB, and 3.74 dB, respectively. And for the engineer who likes his data in graphical form, the final print-out gives a Bode plot (dB gain vs logarithmic frequency) of the closed-loop transfer function. ■ ■



# TEST THE BEST... WITH 50

## *before you buy...try TI's new*

Our proposition is simply this:

We'll give you 50 molded TI integrated circuits with each order of 1000 units or more placed before November 1, 1966.

Do anything you like with these samples... hammer them... test to destruction... wire into your circuits... soak in boiling water... compare with any others. Prove to yourself that they're best — by test!

**Money-back guarantee**—If you're still not convinced that TI molded integrated circuits do your job better than any competitive types available, just return the unused circuits. We'll give you full credit for them. This offer is good for 60 days from date of any order placed before November 1, 1966.

**Offer includes popular series** — Devices included in this offer are the popular digital circuits from the 930-type DTL and Series 74 TTL families shown below right. Series 74 TTL is first choice of many designers for new equipment. Circuits in this line typically are 48% faster, have 25% higher fan-out and 15% better noise margin than DTL... at competitive prices.

Whether your system design calls for DTL or TTL circuits, you'll find a wide selection of single and multiple gates and flip-flops available. With either series, high-speed logic is now available to you at lower prices per function than ever before.

**Rugged design proved by test** — TI molded integrated circuits offer outstanding durability. The rugged, high-density package is molded from the same encapsulant used in millions of SILECT™ transistors and is backed by over 2,000,000 actual hours of test. Resistance to impact, heat and moisture are further borne out by successful testing to the following rigorous schedule: *Thermal Shock* — MIL Std. 750, Method 1056A; *Temperature Cycling* — MIL Std. 750, Method 1051, *Moisture Resistance* — MIL Std. 202C, Method 106B, *Hydropressure* — 3% JOY, 110 PSI for four hours.

**Exclusive features save you money** — You realize big reductions in total manufacturing costs with TI molded integrated circuits because they are specifically designed for use in automatic handling, assembly and test facilities. Exclusive features such as the positive index notch, pretinned leads and side-mounted lead design make it possible. Even the cartridge-type shipping container lends itself to automated production line use.

**Fast delivery** — Deliveries of TI molded integrated circuits are prompt... prototype shipments can typically be made within days. And TI's high production rates assure *continued* availability to meet your most critical production schedules.

To obtain your 50 free evaluation samples immediately, just place your order with any TI sales office or authorized TI distributor.

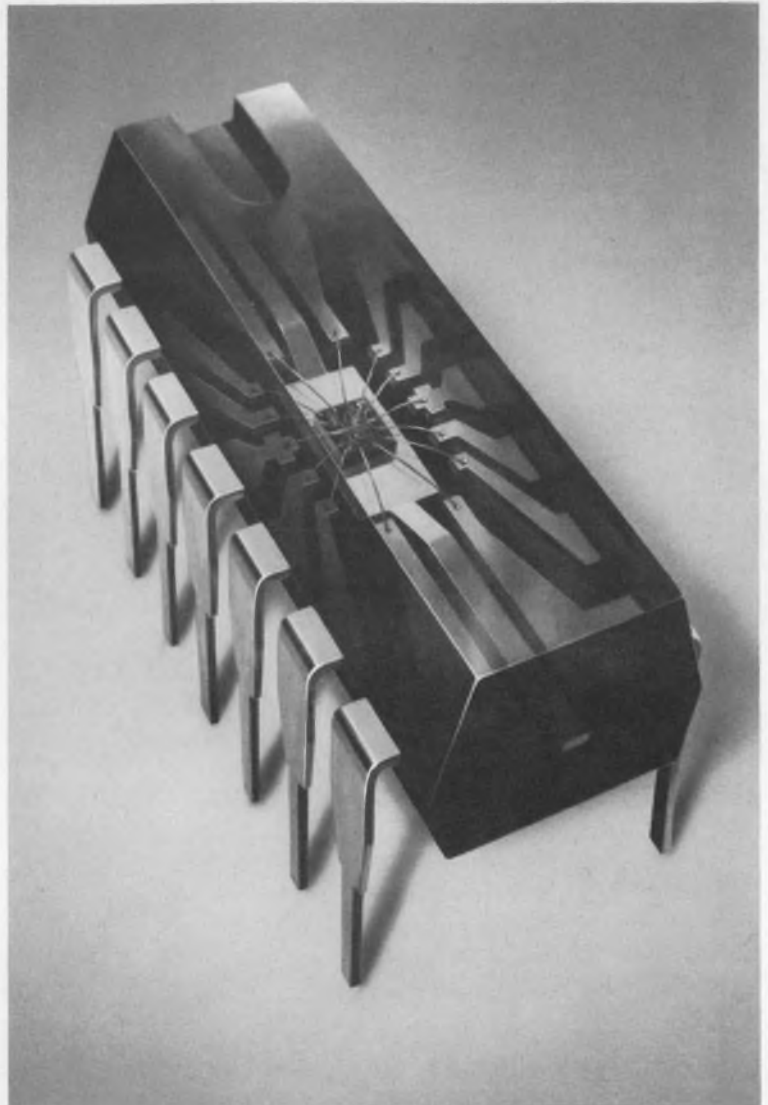

### All these devices are included—

	<b>Series 74 TTL</b>				
	<b>0° to 70°C Operating Temp.</b>				
SN7400N	Quad 2-input NAND Gate	SN7460N	Dual 4-input expander		
SN7410N	Triple 3-input NAND Gate	SN7470N	Single-phase Flip-flop		
SN7420N	Dual 4-input NAND Gate	SN7472N	Master-slave J-K Flip-flop		
SN7430N	3-input NAND Gate			<b>930 Type DTL</b>	
SN7440N	Dual 4-input NAND "power" Gate			<b>0° to 70°C</b>	
SN7450N	Expandable Dual AND-OR-INVERT Gate	SN15830N	Dual 4 Nand Gate		
SN7451N	Dual AND-OR-INVERT Gate	SN15831N	RS/JK Flip-flop		
SN7453N	Expandable 2-input 4-wide AND-OR-INVERT Gate	SN15832N	Dual 4 Buffer		
SN7454N	2-input 4-wide AND-OR-INVERT Gate	SN15833N	Dual 4 Expander		
		SN15844N	Dual 4 Power Gate		
		SN15845N	RS/JK Flip-flop		
		SN15846N	Quad 2 Nand Gate		
		SN15850N	Pulsed AC Flip-flop		
		SN15851N	One Shot		
		SN15862N	Triple 2 Nand Gate		

# FREE SAMPLES FROM TI

## *molded integrated circuits*

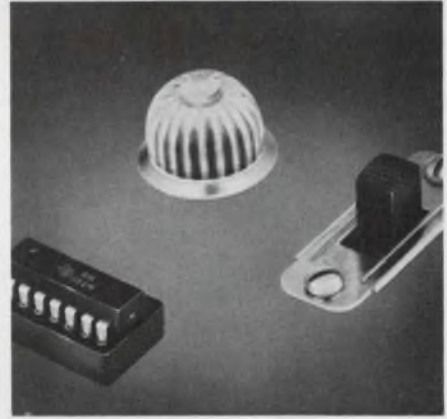
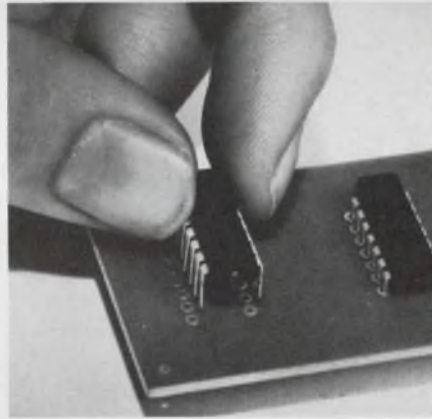
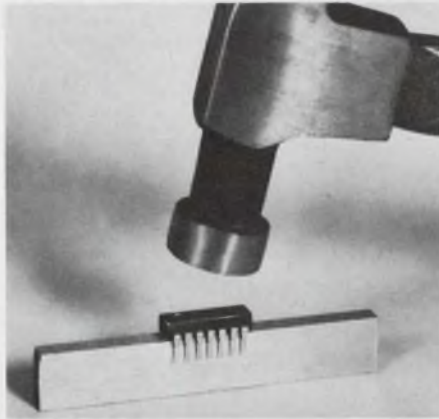
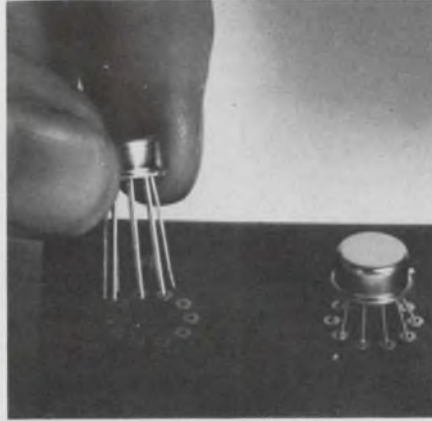
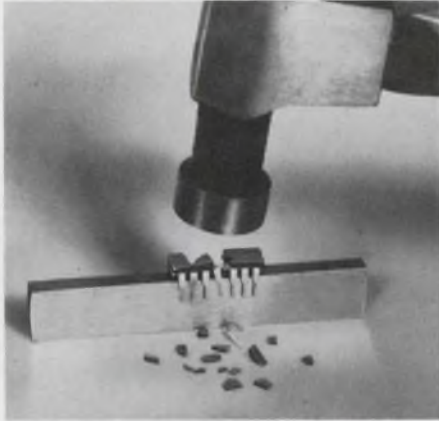

**RESISTS SHOCK . . .** TI molded integrated circuits resist impacts that would smash metal packages and shatter ceramic packages as shown in top photo. You benefit from fewer failures in handling accidents and greater reliability in service. The solid molded construction gives extreme resistance to acceleration, vibration and shock as proven in actual test (see opposite page).

**EASY TO ASSEMBLE . . .** TI molded integrated circuits are ideal for mechanized assembly, including automatic insertion and wave soldering. Faster, easier handling cuts total manufacturing costs. You realize big savings because of the in-line rigid lead pattern and convenient indexing notch. These features simplify assembly when compared with transistor-type circular lead packages.

**RESISTS DAMAGE . . .** You also realize savings from fewer rejects while achieving higher end-product quality because TI molded integrated circuits have outstanding durability. For instance, they'll hold up to heat that would induce failures in many competitive devices. Result: fewer assembly rejects due to high soldering temperatures.

**SEE THESE TESTS FOR YOURSELF! CALL YOUR TI SALES ENGINEER**



**TEXAS INSTRUMENTS**

**INCORPORATED**

13500 N. CENTRAL EXPRESSWAY  
P. O. BOX 5012 • DALLAS 22, TEXAS

SEMICONDUCTOR PLANTS IN BEDFORD, ENGLAND • NICE, FRANCE • FREISING, GERMANY • DALLAS, TEXAS

ON READER-SERVICE CARD CIRCLE 35

# Need a circuit design program? Why not custom-tailor one to fit your needs? Here's an example that shows you how it can be done.

There are a number of excellent computer programs for circuit analysis now available to the general user.\* They have been well documented and work within their defined scope of operation. However, as these programs are major systems best run on larger-scale computers, the total time required is often so excessive as to be impractical for the typical engineering user. Furthermore in using these programs, the engineer tends to lose touch with his circuit because generally he does not know the programmed algorithm, the step-by-step procedure followed by the computer for the circuit analysis.

This particular problem tends to be compounded by the fact that any single circuit problem is usually worked on by an entire programming group. This may well lead to further frustrations through lack of communication and end up in the frequently heard complaint by the engineering user that the program is "no good"; it doesn't solve his particular circuit problem. The fact is that frequently some input requirement or other detail has been either garbled or omitted entirely.

In the light of all these problems, the authors saw a need for a circuit-design program that would:

---

\*PREDICT—Given a simple topological description, the program solves for the transient response of large, nonlinear electrical circuits. Its output includes listings of computed responses and machine-plotted graphs. It requires initial conditions for capacitors and inductors. Written in FORTRAN II and FAP, it is available for use on the IBM 7090/7094 Series with the approval of the Air Force Weapons Laboratory.

NET-1—From topological circuit description and control statements the program performs a dc steady-state and transient-response analysis of a large class of electrical circuits composed of conventional elements. The program has a built-in Ebers-Moll model for nonlinear devices with provision to alter parameters at check-out. Written in FAP, the program is available for the IBM 7040/44 and 7090/94 Series.

ECAP—The program performs ac-dc and transient analysis of electrical circuits, given a topological description. Many features are available for the dc portion. It is written in FORTRAN II for the IBM 1620.

---

Fred R. Decker, Manager, and Augustine J. Welling, Senior Engineer, Design Analysis Section, Honeywell EDP Division, Waltham, Mass.

- Be capable of running on a number of different small-scale computers, so that it would be readily available to many users as well as be efficient in terms of running time.

- Demonstrate the features and operation of larger circuit-design programs.

To this end an algorithm was developed to generate a program called AMPLI (Program for Analysis of Amplifier Circuits). AMPLI omits a number of the elaborate automatic-input-setup features found in the major program systems. It has been our experience that the engineering user has no problems in defining these and that the saving in programming effort and time is justified.

In brief, then, the AMPLI algorithm was developed to obtain the frequency response of an electrical circuit composed of conventional circuit elements. The engineering user must define the topological hook-up, including element values and the equivalent circuit model for transistors, and the frequencies of interest. The program in turn develops node voltages which can be used to calculate frequency response, including gain and phase angle. The actual computer program can be readily developed from the detailed algorithm described here by use of one of the higher-order program languages (i. e., those languages closer to plain English), such as FORTRAN II or IV, as opposed to machine language.

## Matrix is heart of AMPLI program

The essential information needed by an ac analysis program consists of:

- Control parameters.
- Circuit parameters (independent and dependent).
- Parameter interconnections.

The *control parameters* needed for input to the program are the number of circuit nodes, the number of circuit branches and the number of frequency points at which calculations are to be made. These can be read into the computer on one punched card.

*Independent circuit parameters* include a listing



of the passive components and independent sources by branch. That is, the value of resistance, inductance, capacitance, source voltage per branch and source current per branch—all of which are put on one card. The direction of branch-current flow has been purposely omitted at this point.

In the large, generalized programs, current direction information is included with the passive elements by indicating the initial and final nodes of a branch. This information is used in the program to generate the node incidence matrix  $A$  (see Table 1).

Information on feedback and *dependent circuit parameters* (which result from branch interactions and include controlled sources) covers any interaction between the various branches. Two such interactions are mutual inductance and the  $\beta_{ib}$  factor in the collector branch of a grounded emitter, for example. The direction of the induced disturbance is important and care has to be exercised lest erroneous results occur. Feedback information can be put directly in the  $Y$  circuit admittance matrix or order  $n$  where  $n$  equals the number of circuit nodes.

Finally, in AMPLI, *parameter interconnection* information is treated as a separate entity and read into the program. Since the matrix contains only 0, +1, and -1 elements, a FORTRAN format of 40 F2.0 can be used. The result is 40 element locations per card, but only the +1 and -1 elements need be punched. (One card was needed for the circuit problem used later in this article.)

The central program task involves solution of the matrix equation  $(A'YA)e = A'(I - YE)$ , which represents the circuit node equations. Vectors  $I$  and  $E$  contain the values of the independent sources in each branch. Circuit connectivity information is contained in matrix  $A$ , while  $A'$  is the transpose of  $A$ . All remaining circuit information is contained in circuit admittance matrix  $Y$ .

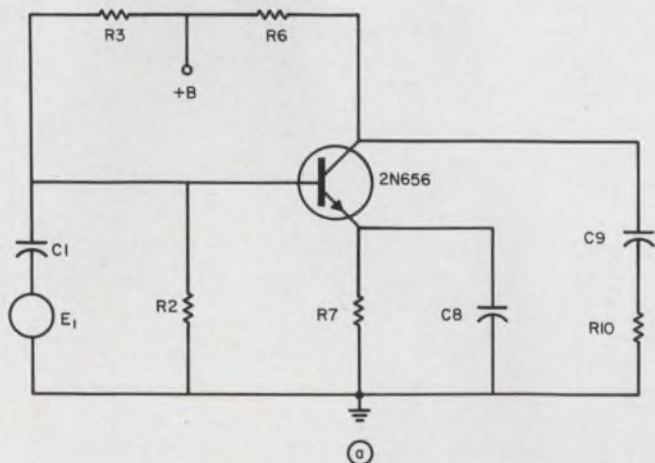

**Analysis of single-stage amplifier (a) demonstrates AMPLI's capabilities.** The equivalent circuit (b) is shown

**Table 1. Explanation of matrix notation**

$A$ —node incidence matrix, a matrix containing circuit connectivity information. Elements are 0, +1, -1. The rows of the matrix correspond to circuit branches and the columns correspond to circuit nodes. If a branch current,  $i$ , is oriented away from, towards or not connected to a given node  $j$ ; then  $A(i, j) = (+1, -1, 0)$ .

$A'$ —the transpose of  $A$ . Rows and columns are interchanged.  $A'(j, i) = A(i, j)$ .

$A'YA$ —circuit nodal admittance matrix contains the coefficients of  $e$  (node voltages) in circuit nodal equations.

$(A'YA)^{-1}$ —the inverse of the circuit nodal admittance matrix. Sometimes referred to as the circuit solution matrix, since the solution of  $e = (A'YA)^{-1} [A'(I - YE)]$ .

This information may be considered to be divided into two parts: independent and dependent factors. The independent factors are the values of the circuit passive components and lie on the diagonal of  $Y$ . Off-diagonal elements of  $Y$  contain feedback or dependent information, if any.

Once the individual matrices and vectors are set up, straightforward matrix multiplication develops the circuit nodal admittance matrix  $A'YA$  and the circuit source vector  $A'(I - YE)$ . Inverting  $A'YA$  with a suitable matrix inversion subroutine and matrix multiplication develops the node voltages:  $e = (A'YA)^{-1} [A'(I - YE)]$ . In actual practice,  $Y$  would be divided into real and imaginary parts:  $1/R$  and the real terms of feedback would be contained in  $Y_R$ ;  $\omega C - 1/\omega L$  and the imaginary feedback terms would be contained in  $Y_I$ .  $A'Y_R A$  and  $A'Y_I A$  would be the results and would require an inversion routine capable of handling a complex matrix.

Once the node voltages are calculated for one frequency, output-to-input ratios can be generated

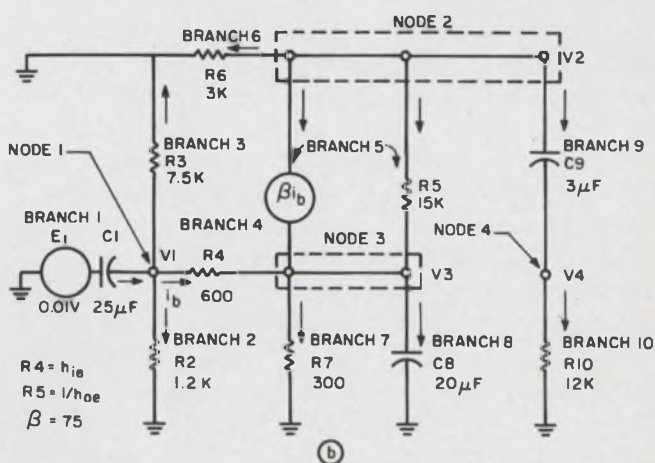

labeled with branch and node numbers which are required for data input to the computer.



Table 2. FORTRAN statements for amplifier analysis

TITLEAMFIER	590 CONTINUE	270 DO 280 J1=2,NN	57
DIMENSION R(70),RI(70),ELL(70),HI(70),H(70),	CALL INVERT(B,A,N,D,D1)	280 B(11,J1-1)=B(J,J1)	58
C(70,25),CT(25,70),XAR(70),AI(70),ZR(70),ZI(70),	DO 14 I=1,LKNO	B(11,NN)=0.	59
BR(25,70),A(25,25),BS(25,70),B(25,25),XVORT(25),	VORT(1)=0.0	GO TO 310	60
VOIT(25),HH(70),HC(70),FBR(25,25),VMAG(25),	DO 14 J=1,LKNO	290 TPE=B(J,I)	
WW(35)X,FBI(25,25)	VORT(1)=A(I,J)*ZR(J)+B(I,J)*ZI(J)+VORT(I)	DO 300 J1=2,NN	
PRINT 797	14 CONTINUE	300 B(11,J1-1)=B(J,J1)-TPE*P(J1-1)	
797 FORMAT(34H TRANSISTOR AMPLIFIER DESIGN CHECK//)	DO 15 I=1,LKNO	B(11,NN)=TPE*P(NN)	
READ 1,N,NBR,LKNO,KW,NX	VOIT(1)=0.0	310 CONTINUE	64
1 FORMAT(511D)	DO 15 J=1,LKNO	CALL OVERFL(KK)	
READ 2,((C(I,J),J=1,LKNO),I=1,NBR)	VOIT(1)=B(I,J)*ZR(J)-A(I,J)*ZI(J)+VOIT(I)	GO TO (15,140),KK	
2 FORMAT(4DF2.0)	15 CONTINUE	140 DO 320 J=1,NN	65
PRINT 3,((C(I,J),J=1,LKNO),I=1,NBR)	DO 411 I=1,LKNO	320 B(NN,J)=P(J)	66
3 FORMAT//9H C MATRIX,/(4F5.1)	VMAG(I)=SQRT(VORT(I)**2+VOIT(I)**2)	330 K(NN)=IP	67
DO 5 I=1,NBR	411 CONTINUE	I=I+1	
DO 5 J=1,LKNO	VIN=VORT(1)**2+VOIT(1)**2	IF(I-NN)431,431,350	
5 CT(J,I)=C(I,J)	VRT=SQRT(VORT(NX)**2+VOIT(NX)**2)	350 CONTINUE	
READ 4,(R(I),ELL(I),H(I),AR(I),AI(I),I=1,NBR)	EG=VRT/SQRT(VIN)	DO 410 I=1,NN	71
4 FORMAT(5E15.7)	DBG=(20.0*ALOG(EG))/(ALOG(10.0))	DO 400 J=1,NN	72
READ 82,(WW(I),I=1,KW)	IF(VOIT(NX)) 22,99,22	11=K(J)	73
62 FORMAT(4E20.7)	22 IF(VORT(NX)) 24,999,23	400 P(I1)=B(I,J)	74
READ 81,((FBR(I,J),J=1,LKNO),I=1,LKNO)	23 ANG=ATAN(VOIT(NX)/VORT(NX))*QW	DO 410 J=1,NN	75
READ 61,((FBI(I,J),J=1,LKNO),I=1,LKNO)	GO TO 80	B(I,J)=P(J)	76
61 FORMAT(4E20.7)	24 ANG=(3.14159-ATAN(VOIT(NX)/VORT(NX)))*QW	RETURN	77
QW=180.0/3.14159	GO TO 80	420 DO 810 I=1,NN	
DO 63 I=1,KW	99 ANG=0.0	12=N1-I	
WW(I)=3.14159*2.0*WW(I)	GO TO 80	PE=0.	
63 CONTINUE	999 ANG=90.0	DO 450 I1=1,12	
DO 888 I=1,KW	80 CONTINUE	TPE=A(11,I)**2*B(11,I)**2	
W=WW(L)	PRINT 89,(VORT(I),VOIT(I),I=1,LKNO)	IF(PE-TPE)460,450,450	
DO 56 I=1,NBR	89 FORMAT//23H VOLTAGE OUTPUT BY NODE/(2E20.7)	460 PE=TPE	
IF(R(I)) 57,58,57	PRINT 33	IP=11	
57 RI(I)=1.0/R(I)	33 FORMAT//10B, 10H FREQUENCY, 7B, 13H VOLTAGE	450 CONTINUE	
GO TO 56	GAIN, 12B, 8H DB GAIN, X8B, 12H PHASE ANGLE//	IF(PE)19,19,480	
58 RI(I)=0.0	PRINT 34, W, EG, DBG, ANG	PER=B(IP,1)/PE	
56 CONTINUE	34 FORMAT(4E20.7)	PEI=A(IP,1)/PE	
DO 7 I=1,LKNO	888 CONTINUE	E=D*B(IP,1)-D1*A(IP,1)	
DO 7 J=1,NBR	902 STOP	D1=D*A(IP,1)+D1*B(IP,1)	
BR(I,J)=CT(I,J)*RI(J)	END	D=E	
7 CONTINUE	SUBROUTINE INVERT(B,A,N,D,D1)	IF(MOD(IP,2))470,470,481	
DO 12 I=1,LKNO	DIMENSION B(25,25),K(25),P(25),A(25,25),PI(25)	470 D=0	
DO 12 J=1,LKNO	NN=IABS(N)	D1=D1	
A(I,J)=0.0	D=1.0	481 DO 600 J=2,NN	
DO 12 K=1,NBR	D1=0.	P(J-1)=B(IP,J)*PER-A(IP,J)*PEI	
A(I,J)=BR(I,K)*C(K,J)+A(I,J)	N1=NN+1	PI(J-1)=B(IP,J)*PEI+A(IP,J)*PER	
12 CONTINUE	CALL OVERFL(KK)	P(NN)=PER	
DO 6 I=1,LKNO	DO 30 I=1,NN	PI(NN)=PEI	
ZR(I)=0.0	30 K(I)=1	IP=K(IP)	
ZI(I)=0.0	IF(N)420,430,430	12=0	
DO 6 J=1,NBR	430 I=1	DO 500 J=1,NN	
ZR(I)=CT(I,J)*AR(J)+ZR(I)	431 CONTINUE	11=J-12	
ZI(I)=CT(I,J)*AI(J)+ZI(I)	12=N1-I	IF(12)510,510,520	
6 CONTINUE	PE=0.	510 IF(K(J)-IP)530,540,530	
DO 66 I=1,NBR	DO 120 I1=1,12	540 12=1	
IF(ELL(I)) 67,68,67	TPE=ABS(B(11,I))	GO TO 500	
67 HI(I)=1.0/(ELL(I)*WW(L))	IF(PE-TPE)100,120,120	520 K(11)=K(J)	
GO TO 66	PE=TPE	530 PER=B(J,1)	
68 HI(I)=0.0	100 IP=11	PEI=A(J,1)	
66 CONTINUE	110 IP=11	DO 550 J1=2,NN	
DO 76 I=1,NBR	120 CONTINUE	B(11,J1-1)=B(J,J1)-PER*P(J1-1)+PEI*PI(J1-1)	
HC(I)=H(I)*WW(L)	IF(PE)16,16,10	550 A(11,J1-1)=A(J,J1)-PER*PI(J1-1)+P(J1-1)*PEI	
76 CONTINUE	17 Q1=0.	B(11,NN)=PEI*PI(NN)-PER*P(NN)	
DO 77 I=1,NBR	16 Q=0.	A(11,NN)=P(NN)*PEI-PI(NN)*PER	
HH(I)=HI(I)+HC(I)	15 N=0	500 CONTINUE	
77 CONTINUE	RETURN	CALL OVERFL(KK)	
DO 9 I=1,LKNO	10 PE=1./B(IP,1)	GO TO (15,560),KK	
DO 9 J=1,NBR	Q=Q*B(IP,1)	DO 570 J=1,NN	
BS(I,J)=CT(I,J)*HH(J)	IF(MOD(IP,2))130,130,160	B(NN,J)=P(J)	
9 CONTINUE	130 D=0	A(NN,J)=PI(J)	
DO 13 I=1,LKNO	160 DO 170 J=2,NN	K(NN)=IP	
DO 13 J=1,LKNO	170 P(J-1)=B(IP,J)*PE	610 CONTINUE	
B(I,J)=0.0	P(NN)=PE	DO 580 I=1,NN	
DO 13 K=1,NBR	190 IP=K(IP)	DO 590 J=1,NN	
B(I,J)=BS(I,K)*C(K,J)+B(I,J)	12=0	11=K(J)	
13 CONTINUE	DO 310 J=1,NN	P(I1)=B(I,J)	
DO 690 I=1,LKNO	11=J-12	PI(I1)=A(I,J)	
DO 690 J=1,LKNO	IF(12)180,180,340	DO 580 J=1,NN	
A(I,J)=A(I,J)+FBR(I,J)	180 IF (K(J)-IP) 260,250,260	B(I,J)=P(J)	
B(I,J)=B(I,J)+FBI(I,J)	250 12=1	A(I,J)=PI(J)	
	GO TO 310	RETURN	
	340 K(11)=K(J)	19 I=NN+1	
	260 IF(B(J,1))290,270,290	GO TO 17	
		END	99

The final circuit nodal admittance matrix  $A'YA$  can be considered as the superposition of two matrices. If, initially,  $Y$  contained only diagonal elements (independent parameters), the resulting  $A'YA$  plus a feedback matrix would yield the final nodal admittance matrix. Both the initial

$A'YA$  and the feedback matrix would be square, with an order corresponding to the number of circuit nodes. The circuit nodes correspond to the rows of the so-called feedback matrix while the circuit nodes' voltages correspond to the columns. From the example, feedback from branch 4 to

branch 5 results in element values of  $\pm 75/600$  in locations 2,1, 2,3, 3,1 and 3,3, both in the feedback matrix and the final  $A^1YA$ .

Bilateral feedback between two branches affects two off-diagonal elements in  $Y$  and results in eight elements in  $A^1YA$  if neither branch has a ground. In general:

Feedback is:	and circuit has:	then the number of elements of $Y$ affected is:	and results in $A^1YA$ elements:
Unilateral	No grounds	1	4
Unilateral	1 ground	1	2
Unilateral	2 grounds	1	1
Bilateral	No grounds	2	8
Bilateral	1 ground	2	4
Bilateral	2 grounds	2	2

An admittance value for an independent, passive, ungrounded component appears in four locations in the  $A^1YA$  matrix. A component connected between nodes 2 and 3 will appear in positions 2,2, 2,3, 3,2 and 3,3. This is just another way of looking at the nodal equations, but it can be helpful in visualizing the nodal admittance matrix.

The transistor  $y$ -parameter equivalent circuit may also be used rather than the active model shown in the example. This is useful when transistor high-frequency effects cannot be ignored. A small, flexible program can handle this problem since it is mostly a question of reading in parameter values or devising a simple function describing  $y(f)$ . Obtaining the transistor  $y$ -parameters as a function of frequency, however, is not easy.

To summarize, the algorithm employed in AMPLI will permit the user to develop a computer program to simulate the frequency response of a transistor amplifier circuit. Given an amplifier circuit, the program will generate a frequency analysis with no circuit equations required; the engineer need provide only the circuit mapping, component values and frequencies of interest. Aside from conventional circuit element values, the transistor model with associated parameters is required. Mapping is covered by the connectivity or branch node incident matrix as described.

Next, for each frequency specified, a set of simultaneous equations is set up for each circuit node. Following matrix inversion, the unknown voltages are solved for. Then by equating the first and last node voltage, the over-all gain in dB can be readily determined.

#### AMPLI is easily modified

In its present form the algorithm could easily be augmented or revised. For example, it would be possible to use any transistor model of interest. Phase angle calculations could be added to the program. Sensitivity analysis could also be added

along with a provision for statistical analysis. At this point it would be possible to suggest a large variety of features and output modes. However, these are best dictated by actual user requirements.

Conversion of the algorithm described here to a computer program can be readily accomplished by any program applications group, or, for that matter, by the engineer himself, provided that he has some programming background. The simplicity of the method is demonstrated by the fact that the algorithm was converted to a computer program (FORTRAN II) of less than 150 statements for a computer that included matrix inversion subroutine as shown in Table 2.

Following exploitation of the ac analysis, the engineer would most likely proceed to a dc steady-state analysis, and subsequently a time-domain or transient analysis. But at this point the user might be well advised to use one of the major program systems cited earlier in this article.

Finally, what of the computer programs for circuit analysis that are becoming increasingly available to engineering users? Program distribution centers, exchange groups, both government- and industry-funded, have been set up or are in the process of being set up. These hold great promise for the future.

However, we believe that the engineering user cannot depend entirely on outside sources for circuit analysis programs. Our reasons for this include:

- Compatibility of program languages.
- Incomplete program documentation.
- System operation details.

Also the user, by developing his own competence in this field, will be in a stronger position to evaluate the various program systems offered as well as tackle such undertakings as adding program features or revising the program. ■ ■

#### Bibliography:

- Automated Digital Computer Program for Determining Responses of Electronic Systems to Transient Nuclear Radiation, PREDICT Circuit Analysis Program.* ("U.S.A.F. Technical Documentary Reports," No. WL TDR-64-62, Vol. 11.) Kirtland A.F.B., N. M.: Research and Technical Div., U.S.A.F. Weapons Lab., Aug., 1964, revised Sept., 1965.
- IBM 1620 Electronic Circuit Analysis Program (ECAP).* White Plains, N. Y.: IBM Corp., Data Processing Div., Application Program 1620-EE-02X, 1965.
- Bashkow, T. R. "The A Matrix, New Network Description," *IRE Trans. on Circuit Theory*, IV (Sept., 1957), 117-120.
- Branin, F. H., Jr. "A New Method for Steady-State ac Analysis of RLC Networks," *IEEE International Convention Record*, XIV, Part 7 (Mar., 1966), 218-233.
- . *Machine Analysis of Networks.* ("IBM Technical Notes," No. 00.490.) Poughkeepsie, N. Y.: IBM Development Lab., 1961.
- Malmberg, A. F., et al. *NET-1 Network Analysis Program.* Los Alamos, N. M.: Los Alamos Scientific Lab., Oct., 1962.
- Southworth, R. W., and DeLeeuw, S. L. *Digital Computation and Numerical Methods.* New York: McGraw-Hill Publishing Co., 1965.

# VALUE ENGINEERED FOR LOWER COST THRU SIMPLIFIED DESIGN

4 New 1/2" x 13/32"

**High Performance Trimmers with Solder or Pin Terminals**

Infinite resolution. Excellent high frequency performance characteristics. No catastrophic failures.

These four new additions to the extensive CTS trimmer line have many applications in High Performance Industrial and Military fields: computers, instruments, medical electronics, communications equipment, electronic machine controls, aerospace electronics, microwave transmission, etc.

Series 330



80¢

in production quantities  
Priced lower than comparable wirewound trimmers.

Series 330P



85¢

- Proven Reliable CTS Carbon-Ceramic Resistance Element
- Far Exceeds Environmental Performance Spec of MIL-R-94B, Char. Y
- ± 8% Humidity Stability
- 100 Ohms to 2.5 Megohms
- 3/8 Watt @ 70°C Derated to Zero Load @ 150°C
- Grounded Construction Available on Model 330

Series 330 Has Solder Terminals. Series 330P Has Pin Terminals on .100" Grid Configuration and Standoffs to Insulate Metal Cover From P. C. Board.

Write for Data Sheet 2330A

Series 630



\$1.50

in production quantities  
Priced lower than comparable wirewound trimmers.

Series 630P



\$1.60

- Famous CTS CERMET™ Resistance Element
- Extreme Stability Under Severe Environmental Conditions
- ± 4% Humidity Stability
- 20 Ohms to 2.5 Megohms
- 1/2 Watt @ 85°C Derated to Zero Load @ 150°C
- Low Noise—Long Life
- Extreme Overload Capacity
- Grounded Construction Available on Model 630

Series 630 Has Solder Terminals. Series 630P Has Pin Terminals on .100" Grid Configuration and Standoffs to Insulate Metal Cover From P. C. Board.

Write for Data Sheet 3630A



Founded 1896

**CTS CORPORATION**  
Elkhart, Indiana

Sales Offices and Representatives conveniently located throughout the world.

**Principal Products**

Variable Resistors  
Selector Switches  
Loudspeakers  
Trimming Potentiometers  
Microminiature Components  
& Circuit Packages  
Crystals, Filters,  
Oscillators & Ovens

**Subsidiaries**

CTS of Asheville, Inc., Skyland, N. C.  
CTS of Berne, Inc., Berne, Indiana  
CTS of Paducah, Inc., Paducah, Ky.  
Chicago Telephone of California, Inc.,  
South Pasadena, Calif.  
CTS of Canada, Ltd., Streetsville, Ontario  
CTS Microelectronics, Inc., Ridgefield, Conn.  
CTS Research, Inc., Lafayette, Ind.  
CTS Knight, Inc., Danmitch, Ill.

ON READER-SERVICE CARD CIRCLE 36

# Check design program availability

with this listing of computer programs developed for the design and analysis of electronic circuits.

Granted the availability of a digital computer, the design engineer who intends to use the machine as a design tool must have the necessary "software" (computer program).

To obtain the right software, he must either write his own program or adapt an existing one to his needs.

The first of these alternatives is not always possible, and may not even be desirable. The second is generally the better choice. A representative list of existing computer programs follows.

The programs are arranged in the Table alphabetically, by company or institution. The availability of each program is indicated at the end of each description by one of three letters:

(A) Supply your own blank tape, and the program will be written on it at no charge. Instruction manuals are usually available either at no cost or for a small fee.

(B) The program is available on an exchange basis.

(C) Availability is subject to individual negotiation.

Where possible, a description of the program's capabilities has been provided, together with those computers on which the program may be run.

If a design engineer does not have computer facilities at hand, he may turn to such companies as Design Automation of Lexington, Mass., which will perform batch processing of circuit-analysis problems.

## Present programs are not perfect

While a number of powerful and useful programs are available, the relative novelty of computer-aided design implies that a large amount of development work must still be done. Some of the improvements that can be expected in the foreseeable future are:

- Better nonlinear models and more flexible means of insertion. For example, MOS-FETs are not at present properly modeled for transient analysis for

a large class of circuits.

- Faster computer running time for frequency analysis problems.

- Partitioning of long computer programs into distinct segments, any of which may be selected from tape or disk files. This reduces the computer core memory requirement, NET-1, for example, a 30,000-word program, is divided into nine such segments. In this time-sharing age, a bulky program occupying the core memory of a computer could reduce the computer's availability for time-shared activities to nil.

- Simpler inputs and outputs, and cheap, simple graphical displays. The aim is to make the computer as easy for an engineer to operate as possible.

- Automatic circuit parameter variation.

In the meantime the electronic designer still has available to him a sizable package of computer programs that will help him to conceive and develop better designs. ■ ■

## Bibliography:

Branin, F. H., Jr. *Dc Analysis Portion of PE TAP—A Program for Analyzing Transistor Switching Circuits*. ("IBM Tech. Report," No. TR 00.11000.701.) Poughkeepsie, N. Y.: IBM Dev. Lab.

———. "Dc and Transient Analysis of Networks Using a Digital Computer," *IRE International Convention Record*, X, Part II (1962), 236-256.

Brooks and Long. *A Program for Computing the Transient Response of Transistor Switching Circuits—PE TAP*. ("IBM Tech. Report," No. TR 00.11000.700.) Poughkeepsie, N. Y.: IBM Dev. Lab.

M. Dertouzos and Therrien. *CIRCAL: On-Line Analysis of Electrical Networks*. ("Electronic Systems Lab. Report," No. ESL-R-248.) Cambridge, Mass.: M.I.T.

Katzenelson. "An Algorithm for Solving Nonlinear Resistive Networks," *B.S.T.J.*, XLIV (Nov., 1965), 1605-1620.

Kopp, C. *Review, Application and Evaluation of Computer Methods for Circuit Reliability Analysis*. (USN Contract N164-10516.) Crane, Ind.: U.S. Naval Ammunition Depot.

Kuo, F. F. "Network Analysis by Digital Computer," *IEEE Proc.*, LIV (June, 1966), 820-829.

Malmberg, Cornwell and Hofer. *NET-1, Network Analysis Program, 7090/94 Version*. ("Publications of the Clearing House for Federal Scientific and Technical Information, National Bureau of Standards, U.S. Department of Commerce," No. LA 3119.) Washington, D. C.: Government Printing Office.

Rader, C. M. "Study of Vocoder Filters by Computer Simulation," *J. Acoust. Soc.*, No. 36 (1964), p. 1023A.

D. M. Sheppard, Barone and Harris. "A Computer-Aided Method for Checking and Making Monolithic Integrated Circuit Masks." Paper delivered at Tech. Session 1, Wescon '66, Los Angeles.

---

John Dumanian, Aerospace Technologist, NASA Electronics Research Center, Cambridge, Mass.

Company	Program	Description
Autonetics 3370 Miraland Ave. Anaheim, Calif. R. S. Miles		The following programs are written in Fortran II and are programmed for the IBM 7094. At present they are being rewritten in Fortran IV in one consolidated large program for insertion in the IBM 360 computer. Later another revision will be made into the PL1 language.
	MANDEX WORST CASE METHOD	Performs ac steady-state and/or dc worst-case analyses. It uses circuit equations and requires nominal values and end-of-life limits on parts. It can handle 75 input parameters, 40 output variables and a 40 x 40 matrix. The types of circuits which can be handled are Class-A amplifiers, power supplies, logic circuits (for each state), comparators, switches, flip-flops, etc. (C)
	MOMENT METHOD	Statistical-type program that, when given the mean and variance of individual components, gives the mean and variance of the circuit outputs. The program uses circuit or matrix equations. (C)
	MONTE CARLO METHOD	Statistical program that predicts the output variable for dc, ac or transient inputs. It uses circuit or matrix equations or circuit transfer function. The distributions of all the electronic components must be supplied. The outputs are described by 20-cell histograms. (C)
	VINIL METHOD	Uses piecewise linear equivalent circuits as models and requires drift data. It presents the transfer characteristics (max & min), output characteristic (max & min) and the input characteristic (max & min). It also calculates the stress ratios for failure rate prediction and indicates parameter settings for the worst-case conditions, for digital and linear circuits. (C)
	PARAMETER VARIATION METHOD	Determines the one-at-a-time and two-at-a-time allowable parameter variation before a circuit fails to function. Circuit or matrix equations are used and the nominal value of parameters is required as well as their per cent change. Output schmo plots determine the safe operating zone. (C)
	SPARC	Performs dc analysis (AEM-1), ac analysis (AEM-2), transient analysis (AEM-3) on the Recomp 11 computer. Equivalent circuit equations or matrices must be prescribed as well as the mean and $\pm 3\sigma$ ( $\sigma$ = standard deviation) components of the circuits. (C)
	SCAN DC	Performs linear and nonlinear static analysis of circuits, with the equations of the circuits presented in matrix form and the components specified by the mean and $3\sigma$ values. The output gives nominal solutions and partial derivatives of unknowns with respect to knowns, worst-case values, and the probability of the unknowns being outside specified values. This program permits a more realistic type of statistical analysis than that done by purely worst-case methods as statistical correlations and the averaging effect of random variation in parameters. (C)
	SCAN AC	Performs linear, sinusoidal, dynamic analysis when complex variable equations of circuits are presented along with the mean and $\pm 3\sigma$ values of the components. Families of frequency response curves can be indicated as well as the $\pm 3\sigma$ values of the unknowns versus frequency. (C)
	SCAN TRANSIENT	Performs linear and nonlinear transient analysis given differential equations describing the circuit and data describing components. The output is the system time response. (C)
CODE	Writes the node voltage equations given a topological description of the circuit and the parameter names and node equations. All circuits except those containing transformers or controlled voltage sources can be handled. (C)	

(table continued on p. 78)

*Applications of Linear Programming to Circuit Optimization.* ("Autonetics Publication," No. EM 1063-16.) Anaheim, Calif.: Autonetics, April, 1963.

*Description of Five Computer Methods of Circuit Analysis.* Ibid., No. 558-D.

*Design by Worst-Case Analysis.* Ibid., No. 552-A-2, Aug. 1, 1961.

*Introduction to Network Analysis Using Line Graphs and Flow Graphs.* Ibid., No. T4/956/3111, Aug. 10, 1964.

*Nonlinear Circuit Modeling.* Ibid., No. X5-1779/3111, Oct. 19, 1965.

*Proceedings of the Second Design Aids Symposium.* Ibid., No. 558-A-14, Sept., 1963.

*Reliability Analysis of Electronic Circuits.* Ibid., No. DDC # AD461-303.

*Reliability Analysis of Electronic Circuits.* Ibid., No. X5-1841/33, Oct., 1955.

*Survey of Studies and Computer Programming Efforts for Reliability, Maintainability and System Effectiveness.* ("Defense Documents Center Publication," No. AD-622676.) Washington, D. C.: Government Printing Office, Sept., 1955.

*SYCATE, A Digital Computer Program.* Ibid., No. 558-D-2, Dec., 1962.

*Theoretical Basis for a Statistical Transient Analysis Computer Program.* Ibid., X5-1089/3111, July 8, 1965.

(continued from p. 77)

Company	Program	Description
Bell Telephone Laboratories Murray Hill, N.J. B. J. Karafin	BLODI (Block Diagram Compiler)	Simulates sampled-data systems that are made up of filters, limiters, detectors and other functional blocks which are employed in speech compression systems, television transmission systems, and radar. (C)
	BLODI B	An improved version that will allow the user to define new blocks based on the previously defined types, to code separate, interacting simulation programs, and to define simulation subroutines by symbolic arguments. This as well as other Bell Laboratories programs are being rewritten in the PL1 language. (C)
	CODE-MANDEX	Gives the steady-state ac and/or the dc worst-case from a topological description of a circuit with the nominal values and end-of-life limits of components. The worst-case value of the output variable is compared with the allowable value. (C)
	SPADE	Performs frequency analysis and displays poles and zeros on an s-plane plot. The program requires a set of Laplace-transformed differential equations and nominal parts data. All linear circuits can be analyzed with this program. (C)
	DEE	Performs linear transient analysis given a set of Laplace-transformed differential equations or a rational polynomial in s and the nominal parts data. The maximum degree of matrix-element polynomials is five. The maximum degree of the transfer-function denominator is 23 and the numerator degree must be less than the denominator. The poles and zeros of output variables, the partial fraction expansion and the time response of the outputs are plotted for all circuits. (C)
	SYCATE	Performs failure-mode analysis, given the dc node voltage equations, nonlinear component switching expressions, application curves over operating regions, nominal and drift parameter data, and the range of permissible test-point voltages. This is, at present, a program of limited capability, for it can handle only eight transistors, 12 diodes, and 75 resistors and sources. The output is a table of test-point voltage readings vs failure modes. Any digital or analog circuit that fits can be analyzed. (C)
Bendix Corp. North Hollister Road Teterboro, N.J. Neil V. Hilsen	TRANSFER FUNCTION AND FREQUENCY RESPONSE	Input data are the nodal admittance of the specified circuit if it contains active elements. If the circuit is strictly passive, only the parameters are required. The program yields the transfer functions at any or all points in the circuit, along with the poles, zeros, and frequency response of these functions. The circuit can also be modified for design considerations (worst-case analysis, etc.). The maximum circuit dimensions are 27 nodes and 60 branches. The maximum order of output polynomials is 25. The maximum number of frequencies in each frequency response is 50. The programing is written in FORTRAN II. (C)
	INVERSE LAPLACE TRANSFORM AND TIME RESPONSE	Input data are the numerator and denominator polynomials in the s-domain along with increments of time for the time response. The program yields the inverse Laplace transform in the time domain and the time response. Also available is the time-delayed response. This consists of evaluating the function at a running time and at a delayed time, and then taking the difference. The maximum order of the input polynomials is 25. The time response can be analyzed in a total of four separate sections, each with its own time increments. The program is written in FORTRAN II. (C)
	GATE ASSIGNMENT	Assigns logic elements to flat-packs (modules) with the option of minimum, fixed number, or maximum interconnections between logic elements on the modules. (C)
	LOAD (Load Factor Analysis)	Assures the loading integrity of the circuit elements. Each logic element (gate, flip-flop, etc.) is analyzed for compatibility between load-factor and drive-factor relationships. If an incompatibility is found, additional circuitry is provided either to split the load or help drive the load. If additional circuitry is insufficient, an error message suggests further study or re-design. (C)
	LOGIC DIAGRAM	Generates a tape which contains instructions for a Calcomp or Gerber plotter. The plotter will draw a logic diagram of the switching network which has been synthesized by the NETS program. Military standard 806B symbols are used and drawings prepared in A, B, C or D size. (C)



Company	Program	Description
	TIMING ANALYSIS	Determines the internal states of the switching network for each time interval. Input stimuli and timing data are required inputs. A truth table will be printed out and a timing diagram will be plotted. (C)
	MODULE ASSIGNMENT	Assigns modules to logic cards with the option of minimum, fixed numbers, or maximum interconnections between modules on the logic card. (C)
	PATH ROUTING	Defines the location of paths used to connect module pins to module pins or module pins to terminal pins. In addition, the locations of feed-through holes are determined. (C)
General Electric P.O. Box 2500 Daytona Beach, Fla. E. W. Burdette	COMPILER	Receives input logic equations in the form of the BCD card images, converts these equations to a form usable by the computer, and generates lists (tables in core memory) containing these equations and associated data for use by the NETS program. (C)
	NETS (Network Synthesis)	Processes the compiled form of Boolean equations and reduces them to logical elements which are then assigned to a family of integrated circuit modules. (C)
International Business Machines Greenbelt Space Flight Center Greenbelt, Md. Roger Cliff	ASAP (Automated Statistical Analysis Program)	Performs Monte Carlo analysis on dc currents and voltages of circuits containing transistors and diodes. ASAP handles 50 dependent nodes (other than ground or those connected to a voltage source) and 40 diodes plus transistors. The program, which is a large one, operates on the IBM 7090/94. (C)
	ECAP (Electronic Circuit Analysis Program)	Performs ac-dc and transient analysis of electrical circuits given a topological description of the circuit. Many features are available for the dc portion. Written in FORTRAN II for the IBM 1620. (A)
	PREDICT	Yields the dc and transient response of a general network in a radiative environment. Written in FORTRAN II and FAP (FORTRAN Assembly Program), it permits an optional selection of two integration routines: one is a Runge-Kutta method which yields $\pm 0.01\%$ accuracy; the other is a trapezoidal method which yields $\pm 1\%$ accuracy but with greater numerical stability. The components R, L, C, M are functions of current, voltage or time, and, if the dependence of the sources is allowed to be linear or nonlinear, active devices may be presented. The program is written in FORTRAN II for the IBM 7094 and UNIVAC 1107 computers. It differs from IBM ECAP program in that it does not employ piecewise linear models. SCEPTRE, a newer FORTRAN IV version of this program, is due to be completed in the fall of 1966. (A)
Jet Propulsion Laboratory 4800 Oak Grove, Pasadena, Calif. W. J. Thomas	TAG (Transient Analysis Generator)	A NET-1-like program that performs dc and transient analysis. TAG is written in FORTRAN II and FAP for the IBM 7094. It can handle 100 nodes and 2 or 3 transistors with nonlinear modeling capability. Subroutines such as plotting control and program can be called for by FORTRAN commands. The preprocessor portion generates a FORTRAN program for reuse. It possesses dependent variable stops. Another unique feature is that it employs K. Lock's algorithm for minimum round-off errors.
Los Alamos Scientific Laboratory Los Alamos, N.M. Allan F. Malmberg	NET 1 (Network Analysis Program)	Performs nonlinear dc steady-state and transient analysis for any circuit which can be built from R, L, C, M, voltage sources, junction transistors and junction diodes. Maximum of 200 nodes. Input is circuit schematic. Nonlinear device models are built into the program. Device parameters are fed in from library tape or as a part of the input. Available on IBM 7040, 7044, 7090, 7094 machines. Written in FAP language. (A)
	NET 2	Under development. It will perform all of NET 1 functions plus ac steady-state, Monte Carlo and variational studies, sensitivity analysis. It will include additional nonlinear devices. (A)
Massachusetts Institute of Technology Cambridge, Mass. Prof. M. Dertouzos	CIRCAL I (Circuit Analysis Program)	Can handle linear and nonlinear resistors, linear storage elements, voltage and current sources which are arbitrary functions of time. At present, approximately 8 nodes and 12 branches can be handled.
	CIRCAL II	An expansion of CIRCAL I, is capable of accommodating additional elements with faster solution times. (A)

(table continued on p. 80)

(continued from p. 79)

Company	Program	Description
<b>Norden</b> Div. of United Aircraft Norwalk, Conn. Martin Goldberg (NORNAP) Arnold Spitalny (CADIC)	NORNAP (Norden Network Analysis Program)	A nonlinear dc analysis program which is an extension of the dc portion of IBM's ECAP. A nonlinear Ebers-Moll model is set up automatically for transistors and diodes; operating points are determined by iteration of the nonlinear equations. List programs are now being developed or in occasional use. Derating analysis and failure effect analysis routines are being added to NORNAP. (B)
	CADIC (Computer Aided Design of Integrated Circuits)	A man-machine system for rapid design of diffusion and interconnection patterns of new integrated circuits. Experimental version is not available for IBM 7094. CADIC is being converted to IBM 360 with 2250 Display. (C)
<b>Sylvania Electronic Systems</b> West P.O. Box 205 Mountain View, Calif. E.A. Huber Phyllis J. Grossberg	FALEN (Frequency Analysis of Linear Electrical Networks)	Performs with up to 40 nodes. The frequency functions to be calculated are defined by choosing from a prepared set of equations and listing the variables to be used in these equations. Subroutines are used to describe the frequency functions and transistor models; these subroutines may easily be changed to describe models or functions not presently provided. The desired frequency functions are computed in the program by generation of the admittance matrix and partial inversion of it to obtain the voltage needed in the specified equations. The program is written in FORTRAN IV for the IBM 7094. (C)
<b>University of Michigan</b> Ann Arbor, Mich. Alan B. Macnee	FACTOR	Finds roots of polynomials with real coefficients. (A)
	TCHDEL	Finds roots of all-pole transfer function to give a Tschebyscheff approximation to a constant low-pass group delay for a specified percentage ripple. (A)
	RATTCH	Finds zeros of the Tschebyscheff rational function for a specific set of poles. (A)
	LAPLAC	Calculates the step and impulse response of a specified rational function that has simple poles. (A)

## You've read the series — what do you think?

Now that you've had a chance to look at a sample of what a computer can do for the electronic designer, what do you think about the prospects of this new area of technology? **ELECTRONIC DESIGN** would like to know.

Not only are we interested in your opinions on the future of computer-aided design, but we also want to know more about what you may be doing with it. What programs are you using? What computers? What problems are you having? This is the kind of information that we think will be interesting and helpful to all design engineers. We'd be glad to look over article proposals or outlines as well as Ideas for Design in this field. We'd also be interested to know what specific areas of computer-aided design you'd like to see covered in articles.

**ELECTRONIC DESIGN** believes that the use of computers as a design aid will continue to expand and will affect an increasing number of design engineers. We intend to keep our readers abreast of the latest developments in this technology. We will be able to do this better with your help. Address your correspondence to:

Computer Editor  
**ELECTRONIC DESIGN**  
 850 Third Avenue  
 New York, N. Y. 10022

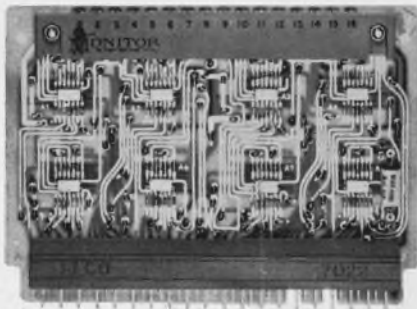

# Where's the error in this IC Logic Card schematic?

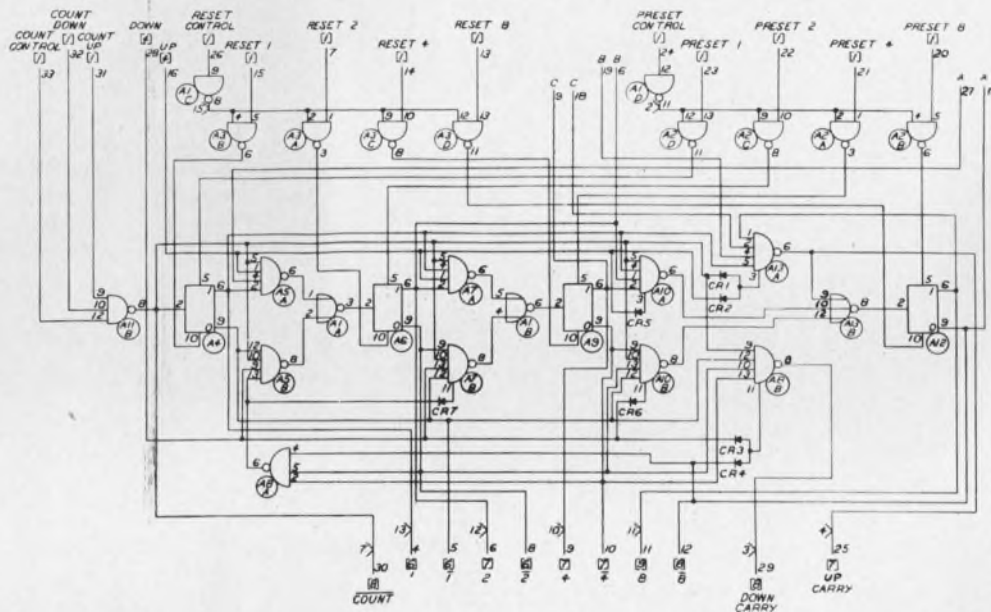

This is an almost-accurate schematic of our MONILOGIC Type C54 Four-Bit Up-Down Counter . . . the only IC Logic Card Up-Down Counter that's *fully buffered* . . . the one that takes the place of *two or three* cards of competing lines.

Note the low fan-in requirements and high fan-out capacity. Note how the C54 operates in either a binary or BCD mode. Note, if you can, the one error this schematic contains.

Find it and we'll gladly send you a prize. Admittedly, since it's a relatively minor error, the prize is proportionately small. But there is a way you can gain a *major* reward: if you're not yet using the C54 and other MONILOGIC types in your data systems, you're making mistakes of major magnitude.

Earn the prize of systems that are simpler to design, less costly to produce, easier to test and maintain. Spec use-proven MONILOGIC into your next data instrument or system.



PHONE 215-646-8100  
TWX 215-646-9399

FORT WASHINGTON, PENNSYLVANIA  
A SUBSIDIARY OF *Epco*

*(All corrected schematics should be sent to Harold Lorber, our Product Sales Manager. If Harold doesn't ship your prize fast enough . . . tell Tom Cowgill, our VP of Sales.)*

ON READER-SERVICE CARD CIRCLE 37

# Now **2** oscilloscopes offer unique advantages of Tektronix split-screen bistable storage

1 **NEW TYPE 549 DC-TO-30 MHz with sweep delay and > 5 cm/μs writing speed; accepts letter and 1-series plug-ins**

2 **EXISTING TYPE 564 DC-TO-15 MHz accepts 2 and 3 series vertical and time-base plug-ins**

The exclusive Tektronix split-screen, bistable storage feature is now available in two oscilloscopes, the new DC-to-30 MHz Type 549 and the familiar DC-to-15 MHz Type 564.

Both offer the unique capability for simultaneous storage and conventional oscilloscope operation, plus general purpose convenience and plug-in versatility. These features add up to the kind of value you can expect from Tektronix.

**Tektronix Bistable Storage Offers**  
**Contrast of a stored trace independent of viewing time**  
**Brightness of a stored trace independent of viewing time**  
**Brightness of a stored trace independent of writing speed**

Storage Scope		Type 549	Type 564	Type 564 Mod 08
Brightness		2.5 ft. L	6 ft. L	2 ft. L
Writing Speed	Normal	0.5 cm/μs	25 cm/ms	100 cm/ms
	Enhanced	> 5 cm/μs	> 125 cm/ms	500 cm/ms
Contrast Ratio		> 4:1	2:1	2:1
Erasure		split screen full screen remote/Auto	split screen full screen	split screen full screen
Display Area		6 cm x 10 cm	8 cm x 10 cm	8 cm x 10 cm

■ **3 display modes**—(1) split-screen combination of storage/conventional displays, (2) full-screen storage, or (3) full-screen conventional displays.

■ **saves film**—extended viewing times of stored displays permit detailed waveform analysis in many instances without photography.

■ **simplifies trace photography** — once initial camera setting has been determined, no further camera adjustments are necessary, regardless of conditions under which future stored traces are obtained.

■ **beam locate**—locate pushbutton offsets beam into a non-store area on left edge of display, permitting precise vertical positioning of beam before signal is stored.

■ **adapts easily to various applications**—accepts major plug-in lines for such applications as multi-trace, low-level differential, sampling, spectrum analysis, others.

■ **Type 549 automatic erase**—can be selected for periodic or after sweep operation with selectable viewing times from 0.5 second to 5 seconds. In addition, Erase-and-Reset pushbutton—which permits erasing display and rearming single sweep—can be controlled remotely, if desired.

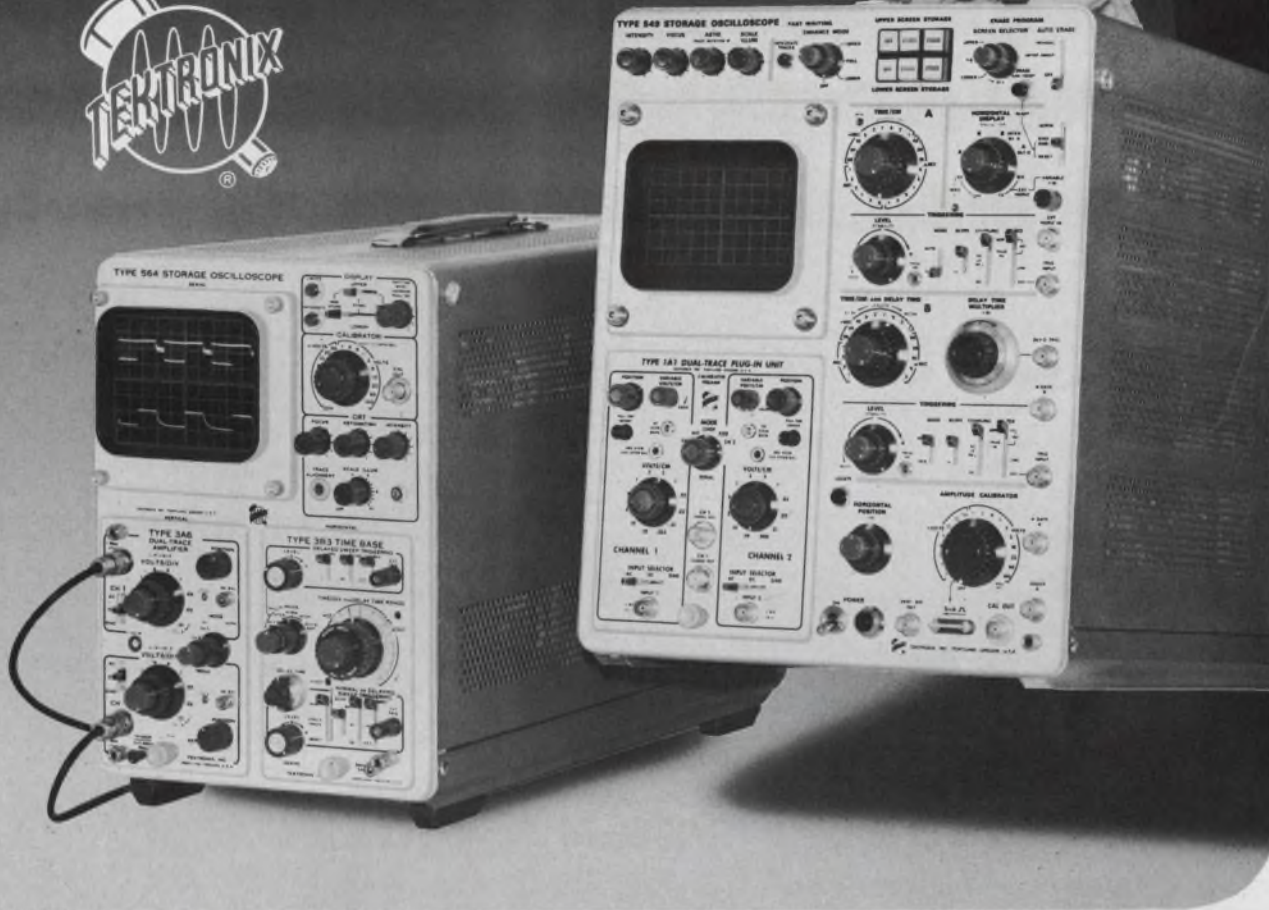

## TYPE 564

**Storage time** — Bistable Storage provides a stored display for up to one hour.

**Erase time** — 250 ms full cycle at normal operating level.

Type 564 Storage Oscilloscope . . . . . \$875  
 Size is 13½" high by 9¾" wide by 21½" deep; net weight is 33 pounds.  
 Uses 2-series and 3-series plug-ins.

Rack Mount Model RM564 . . . . . \$960  
*(same performance specifications, yet occupies only 7" standard rack height)*  
 (Bandwidth DC-to-15 MHz with Type 3A5 Plug-in)

### Plug-ins illustrated

Type 3B3 Time-Base Unit . . . . . \$585  
*(normal and delayed sweeps — 0.5 μs/cm to 1 s/cm, calibrated sweep delay — 0.5 μs to 10 sec, single sweep, 5X Magnifier, full passband triggering, flexible, easy-to-use — simplified trigger logic)*

Type 3A6 Dual-Trace Unit . . . . . \$540  
*(Dual-Trace—10mV/cm at DC-to-10 MHz, 5 display modes)*

U.S. Sales Prices, f.o.b. Beaverton, Oregon

## TYPE 549

**Storage time** — Bistable Storage provides a stored display for up to one hour. When applications require maximum writing speed, viewing times of 20 minutes or less are recommended.

**Erase time** — 200 ms maximum, complete cycle.

**Time base features** — **Sweep Delay** — from 1 microsecond to 10 seconds. **Sweep Range** — 5 s/cm to 0.1 μs/cm (Time Base A) and 1 s/cm to 2 μs/cm (Time Base B). X5 Magnifier extends fastest sweeps to 20 ns/cm (Time Base A) and to 0.4 μs/cm (Time Base B). **Single Sweep** — manually, automatically, or remotely. **Full Passband Triggering** — with flexible, easy-to-use facilities, and **Simplified Trigger Logic** — with lever control of trigger functions.

Type 549 Storage Oscilloscope . . . . . \$2,375  
 Size is 17" high x 13" wide x 24" deep; net weight is ≈ 67 pounds.  
 Uses letter and 1-series plug-ins.

Type 1A1 Dual-Trace Plug-In Unit (illustrated) . . . . . \$600  
*(Dual Trace — 50 mV/cm at DC-to-30 MHz\*, 5 mV/cm at DC-to-23 MHz\*. Single Trace — 500 μV/cm at 2 Hz-to-14 MHz. 5 Display Modes, front panel signal output)*

\*When used in Type 549.

**For information on how Tektronix can solve your measurement problem with a storage oscilloscope, call your Tektronix field engineer.**

**Tektronix, Inc.**

# Avoid variable-load problems by fitting the power amplifier dissipation accurately to the changing drive needs of the system that you design.

An important consideration in the design of power amplifiers is frequency-dependent load variations; yet they are frequently ignored by many designers. If they are not taken into account, the amplifier may deliver too little drive over one part of the band and too much over the rest. Load variations can cause inefficient operation and possibly destructive overstresses on components—particularly transistors.

Proper design will overcome these problems. The load can be matched to the amplifier at a precise point in the band so as to keep the transistor dissipation to a minimum. The amplifier dissipation can then be analyzed over the entire band. This can be achieved by use of the load-amplifier power dissipation relationships described in this article. A Class-B power amplifier is used in the discussion since this type of amplifier is usually employed in driving high-power complex loads.

## Admittance loop opens analysis

A piezoelectric transducer can be taken as a representative example of a varying load. The equivalent circuit of the transducer is shown in Fig. 1a.  $R_0$  and  $C_0$  are the static values of electrical resistance and capacitance, respectively;  $L_m$  and  $C_m$  are electrical equivalents of the transducer mass and stiffness, respectively;  $R$  is the radiation resistance of the transducer.

If an admittance loop (susceptance vs conductance as a function of frequency) is plotted for this circuit, the curve shown in Fig. 1b is obtained. An admittance circle is used because the transistorized driver closely approximates a constant-current source. This makes a Norton equivalent circuit for the configuration more useful in the analysis.

Transducers are usually operated near resonance at the point  $f_r$  on the admittance curve. A nominal susceptance,  $B_0$ , can be tuned out by

means of an inductor. This will have the effect of shifting the curve down so that  $f_r$  and  $B_0$  will intersect the horizontal axis at  $G_0$  as shown in Fig. 2. A typical admittance vector  $Y$  is also shown.

Variations in frequency about the resonance point give rise to a phase-shift,  $\phi$ . Of equal importance is the fact that the real part of the admittance,  $G$ , will also change along with the total admittance,  $Y$ . These variations place severe limitations on the associated Class-B push-pull power-amplifier driver.

## Load changes increase dissipation

If the amplifier unit is treated as a current-amplifying type (Fig. 3), the power dissipation can be analyzed as a function of the load impedance variations. Variations in output voltage swing as the load impedance changes, and variations in phase angle between voltage and current must be taken into consideration. Note that the output voltage (Fig. 4), as reflected back to the transistor collector, is capable of swinging from  $V_{cc}$  to ground for full collector output swing.

While the collector is swinging from the supply toward ground, the transistor's output current

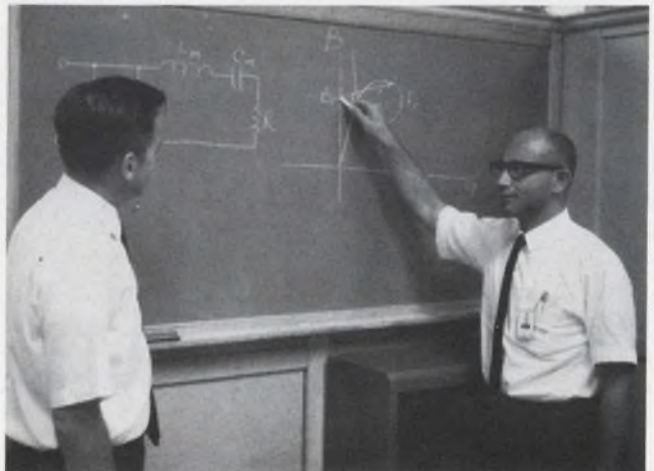

Variation of conductance with frequency puts limitations on the power amplifier driver, Author Bram points out to a colleague.

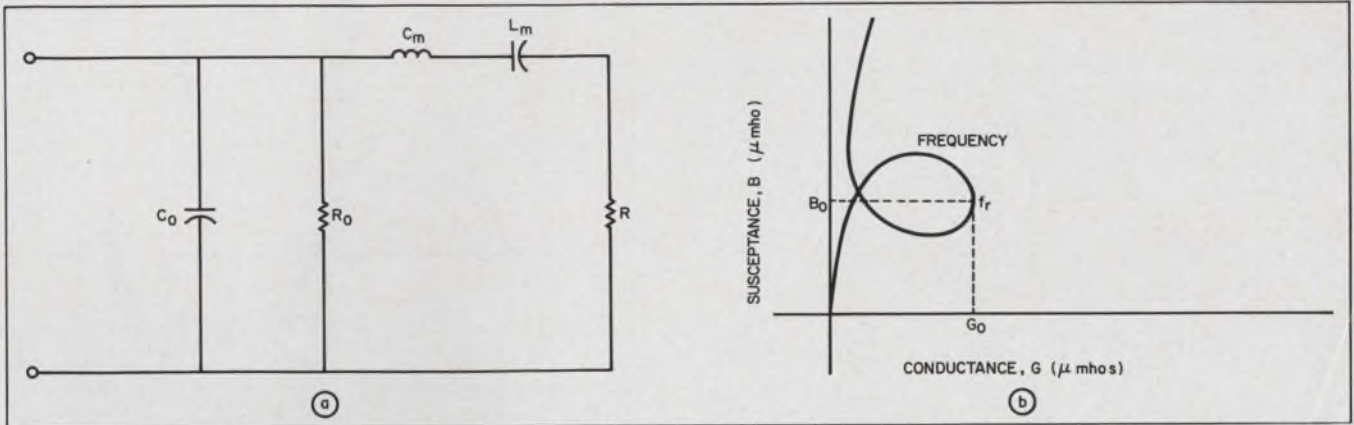

1. **Piezoelectric transducer**, representative of varying-load for Class-B power amplifiers, has this equivalent circuit (a). Parameters  $R_0$  and  $C_0$  represent static resistance and capacitance;  $L_m$  and  $C_m$  are equivalents of transducer

mass and stiffness, respectively;  $R$  is transducer radiation resistance. Admittance loop (b) shows how susceptance,  $B$ , and conductance,  $G$ , vary with frequency. Transducers are usually operated near resonance; point  $f_r$ .

goes from zero to a maximum current,  $I$ , for that stage. The dissipation in that half of the output stage is then the integral of the instantaneous voltage-current products for that half-cycle. During the other half-cycle a similar dissipation occurs in the other half of the output stage. Hence, the total power dissipation in the output stage is twice the dissipation for one half of the sine-wave cycle.

Also,  $V_{cc}$  can be reflected back to the output side of the output transformer. It can thus be used with output voltage and current swings in an expression for the total output power of the amplifier. This expression may be written in terms of the maximum-to-actual-rms ratios (voltage and current) for the amplifier dissipation. This will ultimately result in an expression for output stage dissipation which is dependent solely upon:

- The ratio of actual to maximum output voltage,  $V_{ratio}$ .
- The ratio of actual to maximum output current,  $I_{ratio}$ .
- The division of  $V_{ratio}$  by  $I_{ratio}$ .
- The phase angle between output current and voltage.

It should be noted that this expression does not take into account losses in the output transformer. These losses must be added to the collector dissipation loss to obtain a total dissipation figure for the output transistors.

### Integration yields dissipation figure

An expression for the dissipated power in the transistors can be derived from Fig. 4 by taking the integral of the instantaneous voltage-current product (over one cycle):

$$P_d = (2/2\pi) \int_0^{2\pi} n 2^{1/2} I_o \sin \omega t [V_{cc} - (2^{1/2}/n) V_o \sin(\omega t + \phi)] d\omega t. \quad (1)$$

In Eq. 1,  $\omega = 2\pi f$  and is the frequency in radians

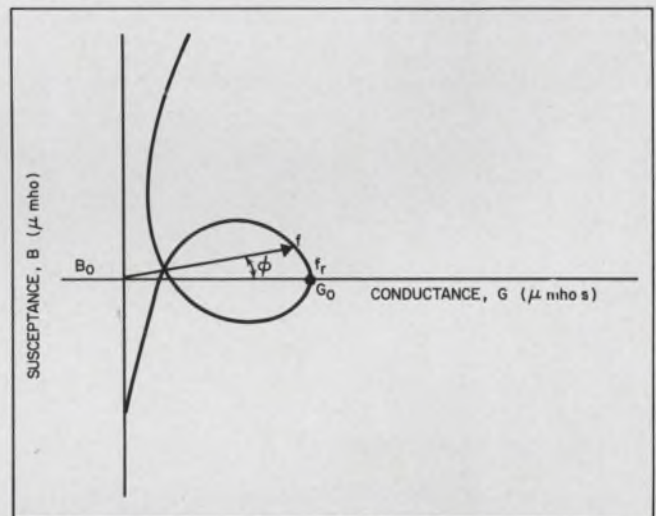

2. **Nominal susceptance** of transducer,  $B_0$ , can be tuned out with an inductor. This shifts the admittance loop (see Fig. 1b) so that resonant frequency point  $f_r$  intersects the horizontal axis at  $G_0$ , the nominal conductance. Vector  $Y$  represents a typical total admittance value at a frequency  $f$ .

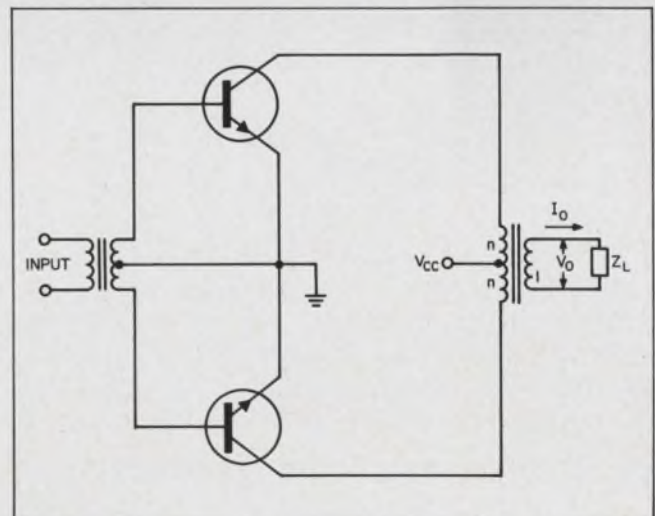

3. **Power amplifier** is a push-pull, Class-B, current-amplifying type. As load impedance changes, power dissipation levels are modified.

per second;  $V_o$  is the rms output voltage;  $V_{cc}$  is the collector supply voltage;  $I_o$  is the rms output current;  $n$  is the turns ratio from half of the primary to the secondary; and  $\phi$  is the phase angle between output voltage and output current.

Since this is a Class-B, push-pull amplifier, the term  $2^{1/2} n V_{o(max)}$  is made equal to  $V_{cc}$ . Here  $V_{o(max)}$  is the maximum rms output voltage. Therefore Eq. 1 may be rewritten:

$$P_d = (2/\pi) I_o V_{o(max)} \int_0^\pi \sin \omega t [1 - k \sin(\omega t + \phi)] d\omega t, \quad (2)$$

where  $k = V_o/V_{o(max)}$ .

Using the substitution  $\sin(\omega t + \phi) = (\sin \omega t)(\cos \phi) + (\cos \omega t)(\sin \phi)$  and expanding yields:

$$P_d = (2/\pi) I_o V_{o(max)} \quad (3)$$

$$\int_0^\pi (\sin \omega t - k \sin^2 \omega t \cos \phi - k \cos \omega t \sin \omega t \sin \phi) d\omega t.$$

Integrating, evaluating and simplifying Eq. 3 produces:

$$P_d = (1.273 - k \cos \phi) I_o V_{o(max)}. \quad (4)$$

Using the identities  $V_{o(max)} = n V_{cc}/2^{1/2}$  and  $V_o = I_o/|Y|$  gives:

$$P_d = [1.273 - 2^{1/2} I_o \cos \phi / (n V_{cc} |Y|)] n I_o V_{cc} / 2^{1/2}. \quad (5)$$

Equations 4 or 5 can be used to calculate the output stage dissipation.

#### Step-by-step design example

This is how the relationships are used in an actual system. Assume the following parameters are given:

- Power amplifier output — 100 W
- Supply voltage — 28 V
- Admittance at resonance — 10,000  $\mu$ mhos
- Admittance at the band — 7000  $\mu$ mhos  
extremities  $20^\circ$

The maximum value of  $V_o$  occurs at the edge of the band where the admittance is at a minimum. Thus:

$$V_{o(max)} = (P/Y_{min})^{1/2} = (100/0.007)^{1/2} = 119 \text{ V}. \quad (6)$$

Consequently,  $n$  may now be computed:

$$n = 2^{1/2} V_{o(max)} / V_{cc} = 2^{1/2} (119/28) = 6.04. \quad (7)$$

At resonance, to supply 100 watts into an admittance of 10,000  $\mu$ mhos requires one ampere. At the band edge, the current required by the 7000- $\mu$ mhos load for 100 watts is 0.858 A. Therefore the dissipated power at resonance may be computed from Eq. 5:

$$P_d = [1.273 - 2^{1/2} (1) (1) / (0.01) (6.04) (28)] \quad (8)$$

$$(1) (6.04) (28) / 2^{1/2} = 51.9 \text{ W}.$$

The dissipated power at the band edge is likewise computed:

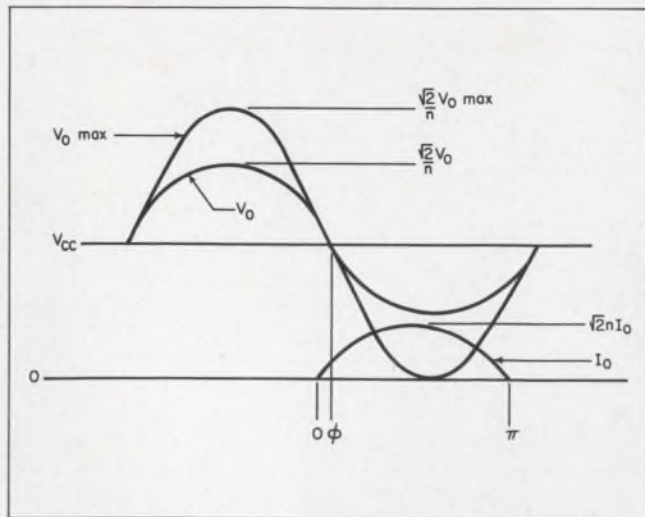

4. Amplifier collector waveforms for the circuit of Fig. 3 show Class-B operation. Here  $V_o$  is the rms output voltage,  $I_o$  the rms output current and  $n$  the turns ratio.

$$P_d = [1.273 - 2^{1/2} (0.858) (\cos 20^\circ) / \quad (9)$$

$$(0.007) (6.04) (28)] (0.858) (6.04) (28) / 2^{1/2} = 31 \text{ W}.$$

If one were to design the amplifier just for operation at resonance, the resulting  $V_{o(max)}$  value would be:

$$V_{o(max)} = (100/0.01)^{1/2} = 100 \text{ V}. \quad (10a)$$

This in turn yields:

$$n = 2^{1/2} (100) / 28 = 5.06. \quad (10b)$$

Therefore, the dissipated power, computed from Eq. 4 would be:

$$P_d = (1.273 - 1 \cos 0^\circ) 100 (1) = 27.3 \text{ W}. \quad (10c)$$

From this example it can be seen that the required dissipation varies according to whether the amplifier is designed for proper operation at the band edge or at resonance. If the amplifier is designed to operate at the band edge, at resonance the dissipation is almost double what it would be for a single frequency design at resonance.

Moreover, the dissipation does not include output transformer losses. These must be added to the output transistor losses to obtain a complete result. Also, the expression for power dissipation derived above (Eqs. 4 or 5) is for the entire output stage. So, when the dissipation of each half of the push-pull stage is being calculated, the result should be divided by two.

When computing the maximum dissipation in the output stage, realize that maximum dissipation does not occur at the point of maximum output in a Class-B stage. This fact is made obvious by Eq. 5—by differentiating it with respect to  $I_o$ , equating the expression to zero, and then solving for  $I_o$ . Doing this shows that the maximum dissipation occurs at 63.7 per cent of the maximum voltage drive for conditions of maximum impedance and zero phase-angle. ■ ■



# RECTIFIERS



## IRC expands rectifier line





### Wide choice of MIL and industrial devices

Now, IRC is offering an even larger selection of silicon rectifiers. These devices are immediately available from stock to fill the vast majority of your MIL and industrial requirements. Most IRC rectifiers are also available in reverse polarity.

- Ratings from .045 to 250 amps, and 50 volts to 100 Kv
- MIL types meet all performance and environmental requirements of MIL-S-19500
- Subminiature, high-voltage types to 4000 volts

- 100 and 250 amp controlled avalanche units for industrial use
- Fast recovery types—200 nsec—in five package choices

If you specify or buy silicon rectifiers, you should know about the money-saving advantages of IRC's silicon rectifier line. For new semiconductor catalog, prices and samples, write: IRC, Inc., Semiconductor Division (formerly North American Electronics), 71 Linden St., West Lynn, Massachusetts 01905.

 <p><b>ZENER DIODES</b></p> <p>MIL and industrial regulator types, silicon reference diodes, 1-watt DO-7, and solid construction Poly-Sil packaging.</p>	 <p><b>AXIAL LEAD RECTIFIERS</b></p> <p>AR16 thru AR24 replaces 363 JEDEC devices for 50 to 1000 V/.25 to 1A needs. Costs less than stud-mounted types.</p>	 <p><b>SCR's</b></p> <p>MIL and industrial devices, including fast-switching types. Choice of power ratings and package shapes.</p>	 <p><b>SPECIAL ASSEMBLIES</b></p> <p>Rectifier stacks, potted bridges and high voltage assemblies. Available in prototype or production quantities.</p>
---	--	--	--



Speed Inquiry to Advertiser via Collect Night Letter  
ON READER-SERVICE CARD CIRCLE 39

More than 500 scientists have one or another of the PDP-8 family computers in their laboratories. Physicists, chemists, life scientists, social scientists, mathematicians. For such a small family of machines, that's an enormous family of users.

There are good reasons, of course.

Scientists like to talk to each other. They like to exchange programs and ideas with other scientists — not accountants.

Then, too — scientists like to be able to change their minds. Family-of-8 computers are approachable, variable, easy to talk to, personal machines. They are easy to re-instruct half-way through an experiment, and they respond. For those who know how an investigation will begin — but not necessarily how it will end — they are ideal.

That's also why so many scientific instrument and systems makers build in one of the Family-of-8. That, and the proven reliability, and the price.

Lastly, there are PDP-8 type computers for almost all types of investigations and for greatly varying budgets. All use the same set of instructions. All use the extensive PDP-8 programs. When we say they are compatible machines, we don't just mean format compatibility. We mean programs. All instructions. Without exception and without modification.

It started with the PDP-8 itself, the most popular computer ever made for the scientific community. 4K memory, expandable. 12 bit word. 1.5  $\mu$ sec cycle time. Fortran. Approachable. 30-day delivery of basic machines is now possible. \$18,000. A ruggedized, portable version is also available, and, of course, expanded versions, too.

The new \$10,000 PDP-8/S is a near cousin. We call it the SMALL-8 because of its compact size. But it has the same general purpose, same real-time on-line computation, same size memory, same size word, same instructions as the PDP-8. Same Fortran. Same everything, in fact, except physically smaller, slower (36  $\mu$ sec add time), and less expensive.

The LINC-8 is an ingenious combination of two computers: the famous MIT inspired LINC, and the PDP-8. Two complete software packages. Built-in A to D conversion. Built-in oscilloscope display. Dual magnetic tape unit. Relay buffer. It is a completely integrated laboratory data handling system. \$38,500.

The DISPLAY-8 is a display terminal to large computers. It is the only standard display terminal with a built-in small computer as an integral part. The PDP-8 is the buffer to a large machine or a generator for the display when on its own. The DISPLAY-8 proves how easy it is to use small computers on the business end of time sharing. \$55,000 to \$150,000.

And modules. DIGITAL is one of the world's leading suppliers of logic modules, each electrically, physically, and logically compatible with each other — and with each DIGITAL computer. For interfacing. Many scientists consider this an important reason for buying DIGITAL'S computers. Module prices start at \$4.75.

A 350-page handbook describes the 101 FLIP CHIP™ modules and what you do with them. A 500-page Small Computer Handbook contains a computer primer and full descriptions of the Family-of-8 computers. Write for either, or both.

And if you have bigger problems than these, we have bigger answers. PDP-9. PDP-9M analyzer. And the soon-to-be-here PDP-10.

## **PDP-8 computer family: approachable, friendly, personal. \$4.75 to \$150,000.**

**digital**  
COMPUTERS • MODULES

DIGITAL EQUIPMENT CORPORATION, Maynard, Massachusetts 01754; Telephone: (617) 897-8821 • Cambridge, Mass. • New Haven • Washington, D.C. • Parsippany, N.J. • Rochester, N.Y. • Philadelphia • Huntsville • Pittsburgh • Chicago • Denver • Ann Arbor • Houston • Los Angeles • Palo Alto • Seattle • Carleton Place and Toronto, Ont. • Reading, England • Paris, France • Munich and Cologne, Germany • Sydney and West Perth, Australia • Modules distributed also through Allied Radio



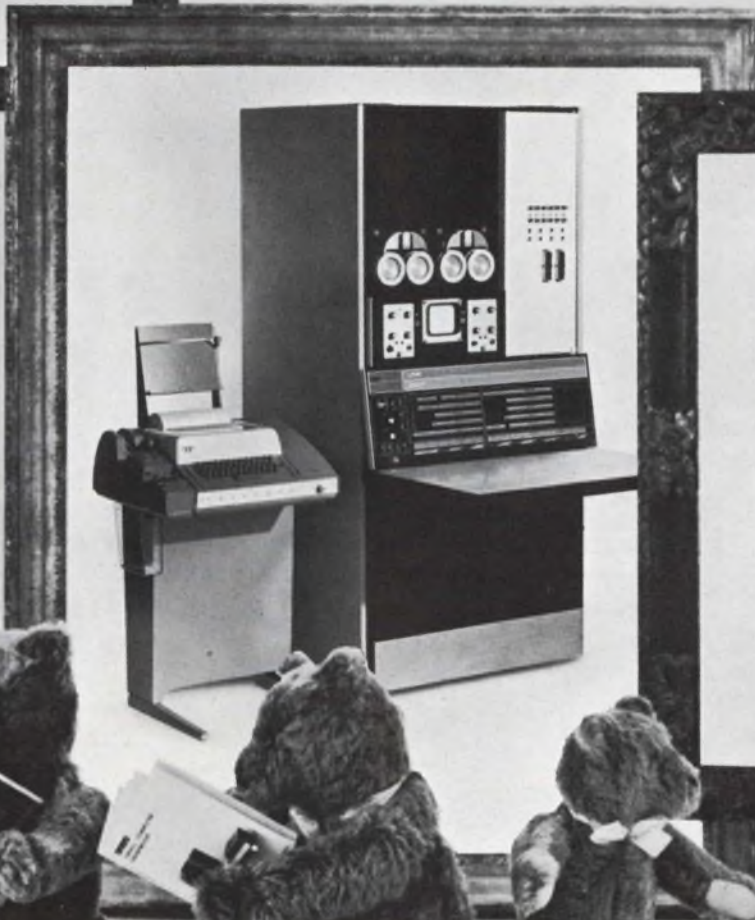
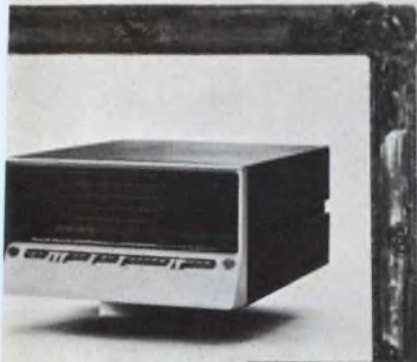

ON READER-SERVICE CARD CIRCLE 40

# Demodulate the error signal in FM modulators with a differential network for very stable and broadband operation.

A clever approach to automatic frequency control combines the basically contradictory requirements of stability and wide bandwidth in FM modulators. The design makes the sampling rate independent of the lowest modulating frequency by removing the modulation from the error signal. The result is a modulator with a frequency stability of from 0.005 to 0.001% and a frequency response from dc to 1 MHz.

The conventional automatic frequency control loops used to stabilize voltage-controlled oscillators (VCO), give only an order of magnitude better stability than the oscillator itself. The reasons for this are:

- Use of crystal discriminators for a reference source.
- Drift of dc amplifiers.
- Low loop gains of 20 dB or less.

Mixing techniques improve the stability but create spurious problems and cannot meet wide deviation requirements. At best they tend only to approach the stability of the crystal mixer oscillator.

In a basic afc scheme, shown in Fig. 1, a crystal reference oscillator and a VCO are alternately gated into a frequency discriminator by a gate controlled by the sampling generator. The output of the discriminator has a dc component that represents the center frequency of the discriminator. It also has an ac component, which is a square

wave at the frequency of the sample rate, and its peak-to-peak amplitude represents the frequency error between the two oscillators. The dc component is blocked in the ac loop amplifiers. A synchronous detector determines the polarity and magnitude of the error to be corrected by the gain of the loop. In this manner the frequency instability of the discriminator and the drift of the dc amplifiers are eliminated.

The system is limited by the fact that the sampling rate must be about one-tenth of the lowest modulation rate—otherwise errors will be introduced into the loop at low modulation frequencies.

A modified version of this chopper technique allows the sampling rate to be independent of the lowest modulation frequency and, in fact, extends the frequency response down to dc.

## Remove modulation from error signal

A differential amplifier removes the modulation from the error signal in the FM loop. This step makes the switching rate of the gate generator independent of the system's low-frequency response. The modified block diagram is shown in Fig. 2. Here, as in the basic system, the reference oscillator and the voltage-controlled FM oscillator are alternately gated into the frequency discriminator.

The simple waveforms of Fig. 3 illustrate the manner in which the modulation is removed from the error signal. The two inputs to the differential network are the audio input to the modulator and the sampling output of the discriminator. (The

**Richard Brounley**, Project Engineer, Electronic Communications, Inc., St. Petersburg, Fla.

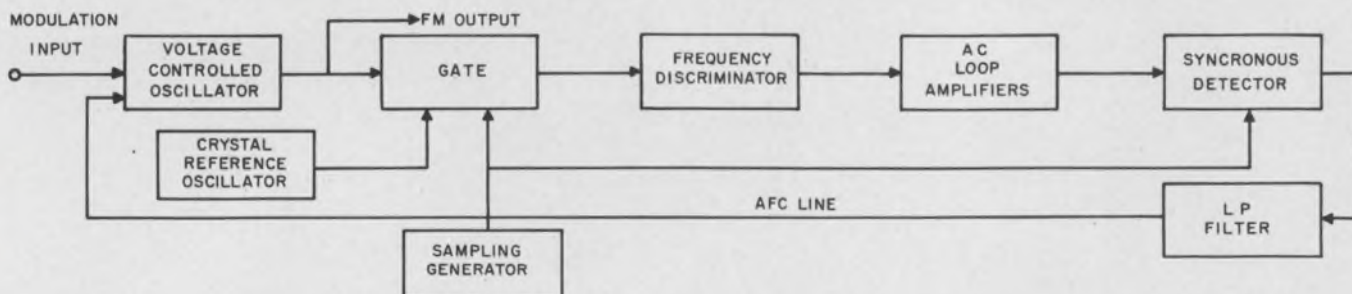

1. Conventional afc setup illustrates a gating technique that eliminates the effects of drifting dc amplifiers and

the unstable discriminator. However, its sampling rate is limited by the modulation rate.

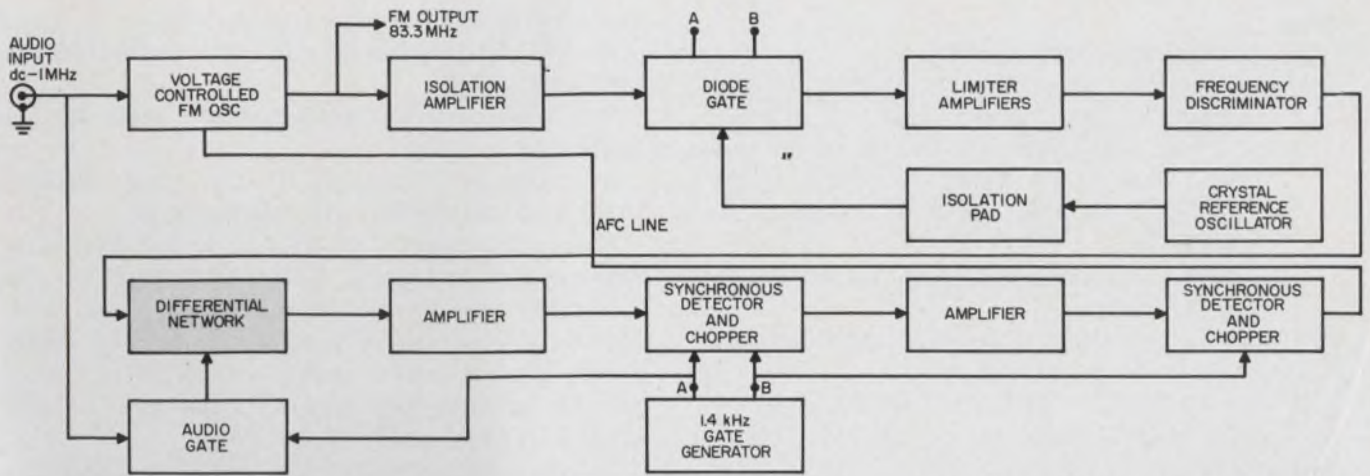

2. **Modified chopper scheme** makes the sampling rate independent of the lowest modulating frequency and

extends the frequency response to dc. The modulation is removed from the error signal in the FM loop.

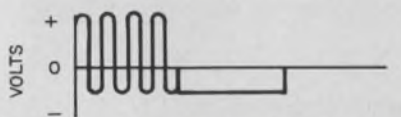

DISCRIMINATOR OUTPUT TO DIFFERENTIAL NETWORK

(a)

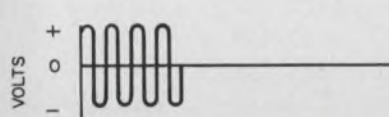

AUDIO INPUT TO DIFFERENTIAL NETWORK

(b)

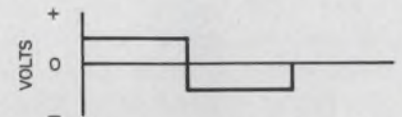

FREQUENCY ERROR OUTPUT FROM DIFFERENTIAL NETWORK

(c)

3. **The two inputs to the differential network** (a and b) yield the ac error signal (c). The discriminator's output

(a) displays the frequency of each oscillator in terms of a dc voltage as it is gated into the limiter-discriminator.

audio gate passes the audio signal during the time the FM oscillator is being sampled.) The differential network is adjusted so that the algebraic difference between the two signals is zero, which essentially eliminates the effect of modulation on the signal from the discriminator.

Once the modulation has been removed from the error signal, it is amplified and fed into a synchronous detector and a chopper that filter it and reconvert it to an ac signal.

Then a final synchronous detector and low-pass filter provide the correction voltage, proportional to the error signal, to the FM oscillator. The gain of the loop is nominally set at 60 dB and will, therefore, reduce the open-loop error of the FM oscillator by a factor of 1000:1.

### Limiting gives rise to frequency errors

Ideally, the frequency is unaffected by discriminator drift owing to the ac coupling. However, imperfect limiting induces a frequency error that does depend on the discriminator drift.

The effect of imperfect limiting may be illustrated with Fig. 4. No frequency error will be produced when the loop is closed, if both oscillators and the zero point of the discriminator are all the same frequency ( $f_0$  in Fig. 4) when the loop is open.

However, if the center frequency of the discriminator drifts, a square wave is generated when the loop is open. Since the closed loop sees this as a

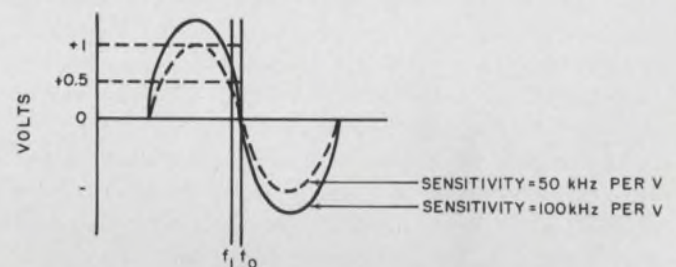

4. **Inadequate limiting** introduces drift-sensitive frequency errors. The error is the result of discriminator drift, not of the difference in amplitudes.

difference in frequency between the two oscillators, the frequency of the FM oscillator will be changed.

This process may be illustrated with a numerical example. Assume that one oscillator produces a discriminator sensitivity of 100 kHz per volt and the other, 50 kHz per volt. If the discriminator drifts, the frequencies of the two oscillators may be represented by  $f_1$  in Fig. 4. As a result, a square-wave voltage of 0.5 V peak-to-peak is generated. Since the closed loop detects this as a 50-kHz frequency drift of the FM oscillator, the oscillator's frequency will be changed by 50 kHz. Therefore the drift of the discriminator must be minimized by extremely good limiting and by reduced level variation between the two oscillators. The error generated by the drift of the discriminator can be expressed in the following form:

$$fe = \Delta f VE/L, \quad (1)$$

where

$f_e$  = frequency error (hertz),

$\Delta f$  = discriminator sensitivity (hertz/volt),

$V$  = expected discriminator drift ( $\pm$ volts),

$E$  = difference between input levels of the two oscillators =  $(E_1 - E_2)/E_1$ , where  $E_1$  is the higher input level and  $E_2$  is the lower input level,

$L$  = degree of amplitude-variation reduction by limiters.

Typical numbers for a developed modulator are:

$\Delta f = \pm 500,000$  hertz/volt,

$V = \pm 0.5$  volt ( $-28^\circ\text{C}$  to  $+85^\circ\text{C}$ ),

$E = (1 - 0.8)/1 = 0.2$ ,

$L = 300$  to  $1$ , or  $50$  dB.

Therefore,  $f_e = \pm 166$  hertz.

At 83 MHz, this error results in an additional frequency tolerance of about  $\pm 0.00025\%$ . Because of the high-gain afc loop, the corrected free-running oscillator frequency error is also about  $\pm 0.00025\%$ . The total worst-case tolerance of the modulator is the sum of these two errors plus the reference oscillator error of  $\pm 0.0015\%$ , or  $\pm 0.002\%$ .

#### 50-dB isolation is advisable

If the outputs of the two oscillators are not fully isolated during the error-sampling time of the loop, frequency errors can occur. The beat interference between the two oscillators appears superimposed on the error signal before being detected by the synchronous detector (Fig. 5).

If the interference is not large enough to saturate the loop amplifiers, very little frequency error results. It is even possible to phase-lock the FM oscillator and the reference oscillator.

If the interference does saturate the loop amplifiers, a frequency offset appears and leads to a symmetrical control of the FM oscillator's frequency drift.

Adequate interference suppression may be

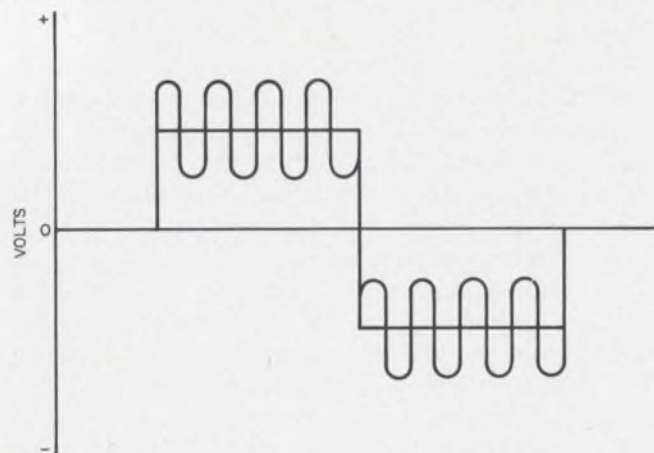

5. Insufficient isolation between the FM and the reference oscillator causes a beat signal to appear superimposed on the error signal. This beat influences the detector and so introduces frequency errors.

achieved through the following steps:

- Provide adequate decoupling between the two oscillators.

- Ensure at least 50-dB on-to-off ratio for the diode gate.

- Isolate by at least 50 dB the other coupling paths and be careful with packaging.

Since telemetry systems characteristically require low incidental FM, the output of the modulator must have switching currents and beat-interference effects reduced or completely eliminated. This is again primarily an interference problem and requires essentially the same consideration as that discussed above.

Isolation between the FM oscillator and the diode gate must be maintained or the impedance change of the gate will be reflected as incidental FM. About 80-dB isolation is needed to decrease this incidental to a value below the normal oscillator noise.

#### The beat from imperfect cancellation

The beat effect discussed here is not the same as the beat interference already mentioned. It is the beat between the modulation frequency and the gate generator rate. This beat would not exist if perfect cancellation were possible, but in practical operation it is always present in some degree. It is caused by an odd number of half cycles of the modulating frequency at the output of the differential network during the FM sample time. The average value of these odd half cycles changes at a rate which is equal to the difference between the two frequencies and thus creates this beat effect. The effect can occur when the modulating frequency is near the sample rate or any of its odd harmonics.

The amplitude of the beat is a function of the difference between the modulation and gate generator rates, the peak deviation, the low-pass filter bandwidth and the degree of cancellation achieved ahead of the loop amplifiers. With a cancellation of 40 dB, the beat is only about 1% of the peak deviation with a low-pass filter having a time constant of five seconds. The beat can increase to 10% of the peak deviation, when the degree of cancellation drops with temperature variation. The odd harmonics and subharmonics have a lower average value for their odd number of half cycles, and the beat effect is considerably less than at the sample rate.

The best solution is to use a time constant of about 200 seconds in the low-pass filter. This restricts the modulation frequency range for which the beat can occur to within a few cycles of the sample rate. Unfortunately, this makes the turn-on time about two minutes, because the capacitor in the low-pass filter must charge from zero to a positive bias voltage on the afc varactor

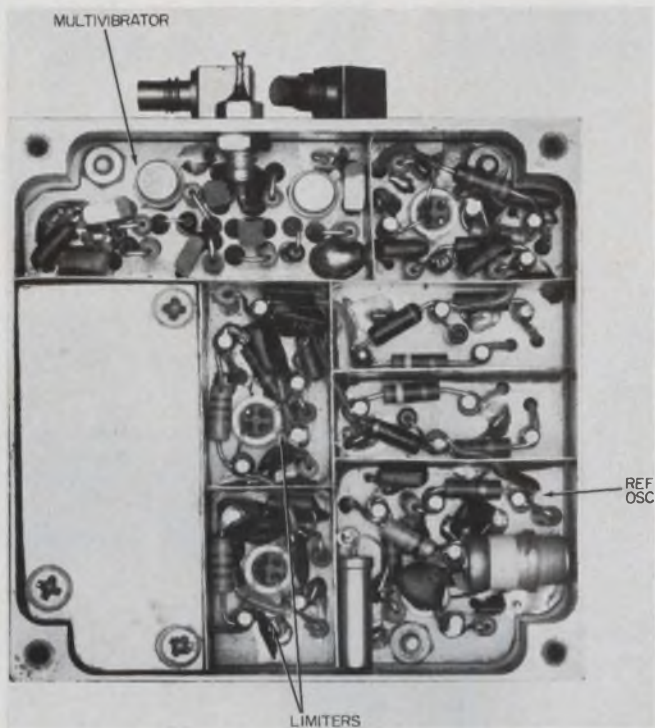

6. Modulator, built according to the circuit of Fig. 2, performs as a frequency source for telemetry transmit-

diode. This problem has been solved by shunting a silicon diode across the series resistor in the low-pass filter. The shunt diode permits the low-pass filter capacitor to charge very quickly during initial turn-on. Thereafter it acts as a peak detector with a long discharge time constant. No beat interference of any consequence is then observed or measured under any operating condition.

#### Other sources of errors

If the amplifier ahead of the synchronous detector and chopper circuit becomes saturated during the FM oscillator time period because of imperfect cancellation, a frequency offset can occur. Therefore, the levels of the system must be established so as to prevent this.

Any square wave, introduced at the sample rate into the loop by the audio gate, the synchronous detectors, loop amplifiers, and so on, will result in frequency errors. The degree of error depends on the magnitude of the square wave and the point at which it occurs in the loop. For instance, a particularly sensitive point is at the input to the first-loop amplifier. For this reason the audio gate employs a simple insulated gate field-effect transistor series switch which has virtually no leakage to the output from the switching voltage on the gate.

A modulator, built according to the design approach described (Fig. 6), has been operating as an integral part of a modularized S-band telemetry transmitter capable of delivering 5 watts of average power.

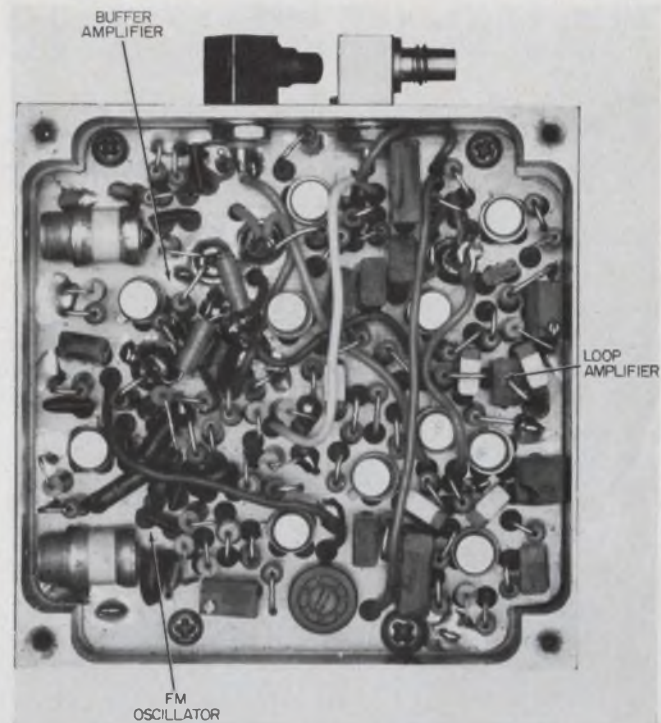

ters in both the vhf and uhf regions. The frequency of the gate generator is set at 1.4 kHz.

The frequency of the gate generator is set at 1.4 kHz to minimize the size of the audio components. This selection also allows very high loop gain because of the wide separation between the cutoff frequency of the low-pass filter at the output of the loop, and the loop carrier or sampling rate.

The reference oscillator uses a fifth overtone crystal at 83.3 MHz and is typically stable within  $\pm 0.0015\%$  over a temperature range of  $-28^\circ\text{C}$  to  $+85^\circ\text{C}$ . No temperature compensation techniques are needed to achieve an over-all stability of  $\pm 0.002\%$  from the modulator over the same temperature range in production quantities. Center frequency is unaffected by modulation at deviations up to  $\pm 100$  kHz and with rates from 1 hertz to 1 MHz. The dc response and hence the center frequency is affected by the degree of cancellation held over temperature and is specified at  $\pm 1.5$  dB.

With the above parameters, the frequency at which the beat is of significance is  $1.4 \text{ kHz} \pm 25$  hertz; the maximum beat occurs at 1.4 kHz, where it is a dc voltage whose magnitude depends on the phase of the two frequencies.

The frequency stability of the S-band transmitter is  $\pm 0.002\%$ , its frequency response is from dc to 1 MHz ( $\pm 1.5$  dB loss). The transmitter operates with a distortion of 1% and an incidental FM of  $\pm 5$  kHz. The deviation is  $\pm 2$  MHz and the temperature range is from  $-28^\circ\text{C}$  to  $+85^\circ\text{C}$ . ■ ■

#### Acknowledgement:

The author wishes to express his gratitude to Mr. Neville Downs and Mr. Ralph Looney for their assistance in developing the modulator.

# Announcing the Brush Mark 250, first strip chart recorder for the perfectionists of the world.

Meet the fastest, most accurate strip chart recorder on record: The new Brush Mark 250. When you read about all the features you'll know why we call it the first recorder for the perfectionists of the world!

**1 Unmatched frequency response.**

Flat to 10 cycles on full 4½" span! Useful response to 100 cycles. Nobody has a strip chart recorder in the same league.

**2 Wide selection of signal conditioners.**

Choose from 21 interchangeable preamps. Use one today; plug in a different one when your recording requirements change.



**3 Crisp, clean rectilinear writing.**

Patented, pressurized inking system puts smudge-proof trace into the paper not just on it.

**4 Contactless, non-wearing feedback system.**

Same one used in our multi-channel Mark 200 recorders. (No slide wires!) Accuracy? Better than ½%!

**5 Multiple chart speeds.**

Push-button choice of twelve . . . from 5 inches/second to 1/10 of an inch/minute (up to 8 days of continuous recording).

**6 Portable or Rack mounting.**

And either way you get the exclusive new dual position writing table.



**7 Removable chart paper magazine.**

Great for desk top record reviews. Man-sized manual winding knobs let you roll chart forward and back. Chart reloading is a cinch.



See what we mean? The Mark 250 is for the perfectionists of the world. Ask your Brush Sales Engineer for a demonstration. Or, write for chart sample and specifications. Clevite Corporation, Brush Instruments Division, 3633 Perkins Ave., Cleveland, Ohio 44114.

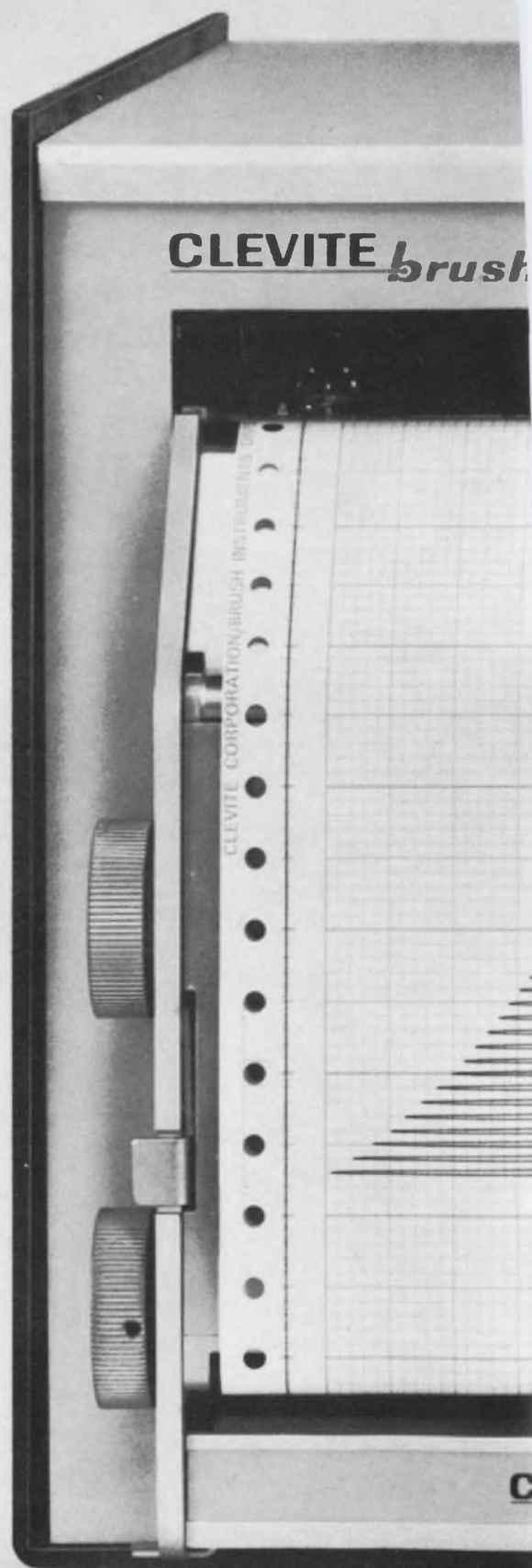

Shown approx. 76% of actual size with 1 μv preamplifier RD 4215-70; event markers optional.

**CLEVITE**  
—brush INSTRUMENTS DIVISION



MARK 250

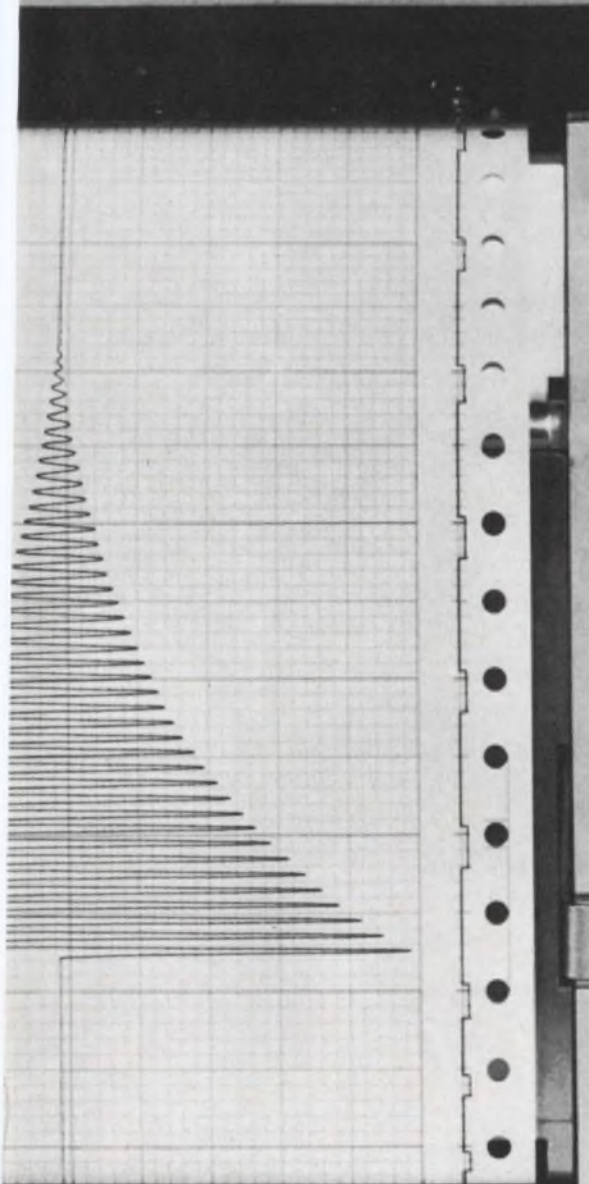

chart speed  
inches/sec

inches/min

5

2

1

.5

.2

.1

stop

paper  
F  
E

power

D.C. AMPLIFIER

sensitivity

1 2 5 10 20 50 100 200 500 1000 off

microvolts/div

x 1 x 1000

zero suppression vernier

range

off mv

sensitivity

pen position

x 1

brush

interlock warning

VITE brush

# The Brush Mark 250

First recorder for perfectionists

ON READER-SERVICE CARD CIRCLE 248

# Convert complex numbers to absolute values and angles graphically. The approach is very useful in analyzing transfer functions and complex impedances.

A simple, graphical approach provides quick, accurate answers in calculations of the magnitudes and angles of transfer functions and complex impedances.

Consider the circuit shown. Its complex impedance,  $Z_i$ , is equal to  $R + sL2$ . The transfer function has the form:

$$\frac{e_o}{e_i} = \frac{R + sL2}{R + s(L1 + L2)} = \frac{Z_i [R - s(L1 + L2)]}{R^2 + |s(L1 + L2)|^2} \quad (1)$$

To illustrate the use of the graph, assume that  $R$  is equal to 3 and both  $|sL1|$  and  $|sL2|$  are equal to 10. To find the magnitude and the angle of  $Z_i$ :

- Put 3 on either scale A or B; draw a horizontal line (line *a*); read off 9 from scale C.

- Do the same for 10; read off 100 from scale C (line *b*).

- Add 100 and 9; mark the point for 109 on scale C; draw a horizontal line and read off the intersection from scale A or B (line *c*). The value at this point, 10.7, is the magnitude of  $Z_i$ .

- Put 3 on scale A and 10 on scale C; read off the angle of  $Z_i$ :  $\theta = 73^\circ$  (line *d*).

The transfer function is found in a similar man-

ner. The procedure is repeated for  $R - s(L1 + L2) = 3 - j20$ . The result is  $20.2 / -81.5^\circ$ . The value of  $R^2 + |s(L1 + L2)|^2$  is 409.

The numerator of Eq. 1 is a product of two terms— $10.7 / 73^\circ$  and  $20.2 / -81.5^\circ$ . To perform the multiplication:

- Put 20.2 on scale A and 10.7 on B; connect these two points; read off the value at the intersection with C: 217 (line *e*).

- Put 217 on scale C,  $40.9^*$  on A; connect these two points; read off the value at the intersection with B: 5.3 (line *f*). The correct answer is  $5.3 (10)^{-1}$ .

The angle of the transfer function is simply the sum of the two angles:  $73^\circ - 81.5^\circ = -8.5^\circ$ . Hence:

$$e_o/e_i = 0.53 / -8.5^\circ. \quad \blacksquare \blacksquare$$

\*Numerical values exceeding the ranges of the scales may be divided or multiplied by factors of 10.

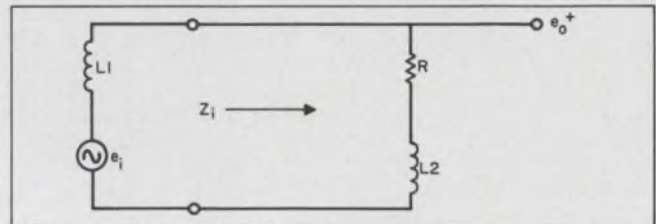

Simple RL circuit is used to illustrate the graphical approach to transfer functions and complex impedances.

Thac Mac, Research and Development Engineer, Allen-Bradley Co., Milwaukee

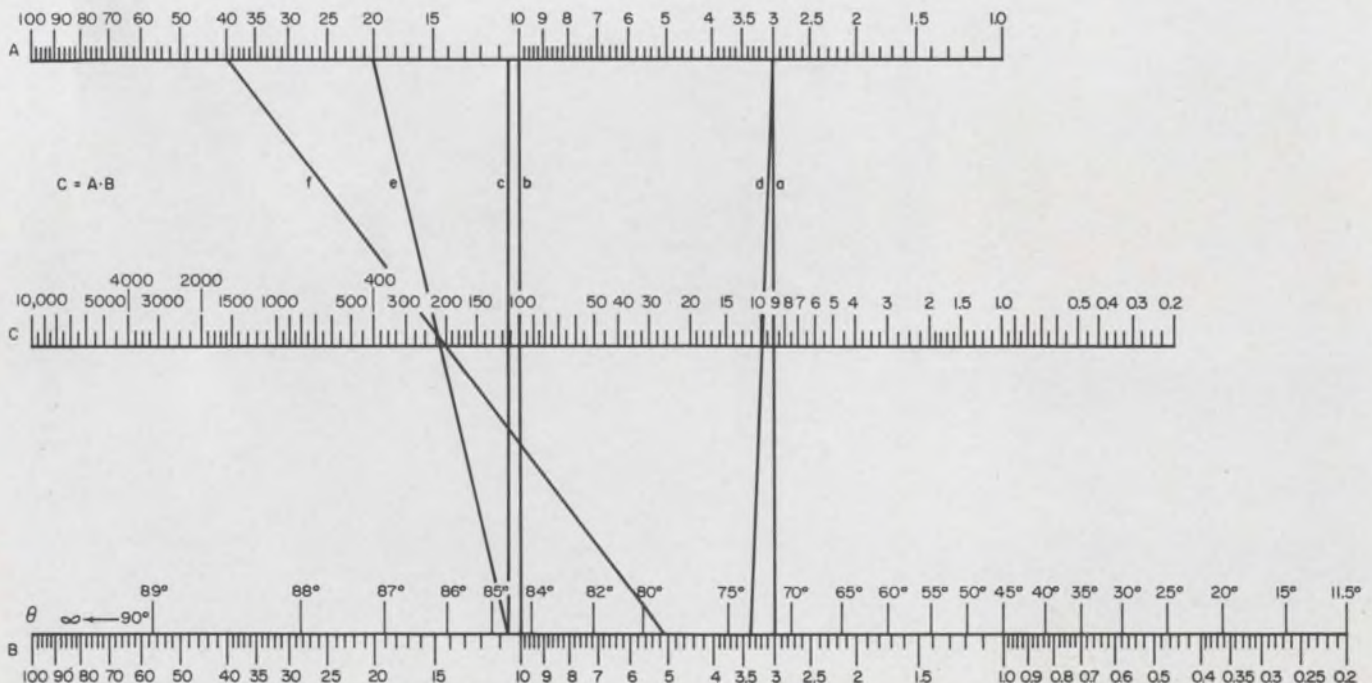

# PROGRESS REPORT

## Precision **ALSiMAG** CERAMICS *without grinding*



Alumina  
Counter Bore .295 ± .002  
I.D. .249 ± .003  
Length Ground .150 ± .002



Alumina  
O.D. .418 ± .002  
Length .600 ± .005



Alumina  
.241 ± .002 Square  
Camber .003  
Counter Bore .008 Minimum



Zircon  
Center Hole I.D. .258 - .259  
Grinding on 5° Angle leaving  
.258 - .259 dimension  
.032 ± .005 long

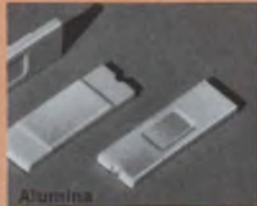

Alumina  
Length .760 ± .005  
Thickness .050<sup>+</sup>.005  
- .000  
Counter Bore Depth .008<sup>+</sup>.003  
- .000



Alumina  
O.D. .800 ± .005  
Boss O.D. .400 ± .005  
Counter Bore Depth .020<sup>+</sup>.005  
- .000



Steatite  
Length .500 ± .003  
Shank O.D. .235<sup>+</sup>.000  
- .005  
Hole .139<sup>+</sup>.006  
- .000



Alumina  
O.D. .604 ± .005  
I.D. .510 ± .005  
Thickness .040 ± .005  
Wall Thickness .047 ± .0015

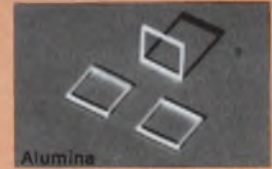

Alumina  
O.D. .250 Square  
Wall Thickness .015 ± .002  
Thickness .018 ± .001



Zircon  
Thickness .030 ± .002  
I.D. .060 ± .001  
Two Holes .020 ± .002  
Hole Center .054 ± .002  
O.D. .273 ± .001 Ground



Alumina  
O.D. .220 ± .002 Square  
Thickness .030 ± .002  
Counter Bore Depth .025<sup>+</sup>.005  
- .000  
Counter Bore Dia. .175 ± .002



Steatite  
O.D. .636 ± .007  
Thickness .046<sup>+</sup>.002  
- .000  
Hole .042<sup>+</sup>.002  
- .000



Alumina  
Diameter .027 ± .002  
O.D. .153 ± .003  
Width .044 - .003



Steatite  
Length .220 ± .005  
Rib Width .026 ± .001  
Overall Width .101 ± .001



Alumina  
Thickness .032 ± .002

Many of the technical advances in microminiatures and integrated circuitry are based on technical ceramics produced in volume to close tolerances. The growth in the use of these precision ceramics has been so constant that our production facilities have again been more than doubled, re-equipped and moved into specially designed climate-controlled areas.

More than ten years of growth in this field have given us a lot of know-how. We have not been able to meet all the requirements of all designs but our batting average continues to rise. One recent design which we cannot illustrate was an ALSiMag 614 alumina ceramic .277" (+ .000, - .004) square and with a thickness of .043" ± .003 with an array of holes with a diameter of .012" ± .001 on .023" HC (leaving a .011" wall between holes).

Marked progress has been made in two other areas. Note the tolerances on the four hole tube illustrated in the lower left. This gives an idea of precision attainable in extruded ceramics. Progress also is being made on precision metallizing. Metallize patterns are screened with lines as thin as .007" and as close as .007". Much closer tolerances are practical with our photoetch process.

If you will give us details of your requirements we will be glad to work with you on prototypes for your evaluation. Precision ALSiMag microminiature ceramics may be the key to design advances in your products.

Parts illustrated approximately actual size.

## American Lava Corporation **3M**

PHONE 615 265-3411, CHATTANOOGA, TENN. 37405

A SUBSIDIARY OF **3M** COMPANY

For service, contact American Lava representatives in Offices of Minnesota Mining and Manufacturing Company in these cities (see your local telephone directory): Atlanta, Ga. • Boston: Needham Heights, Mass. • Chicago: Bedford Park, Ill. • Cleveland, Ohio • Dallas, Tex. • Laurens, S. C. • Los Angeles, Calif. • Metropolitan New York: Ridgefield, N. J. • Up-State New York and Canada: Baldwinsville, N. Y. • Philadelphia, Penn. • Roanoke, Va. • St. Louis: Lees Summit, Mo. • South San Francisco, Calif. Troy, Michigan • 3M International: c/o American Lava Corporation, Chattanooga, Tenn. 37405, U.S.A., Phone 615/265-3411.

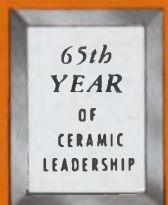

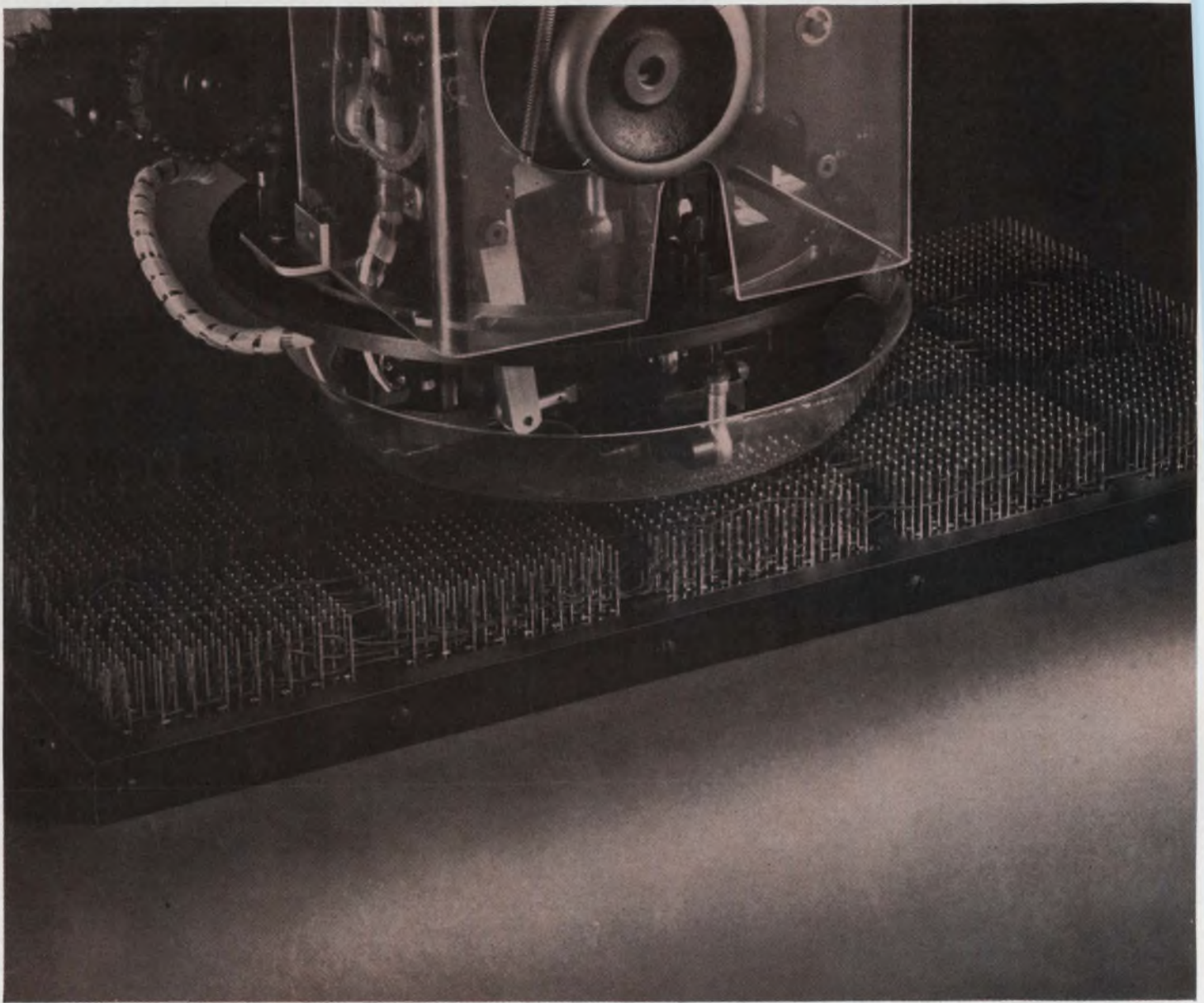

## Everything you could ask for in production wiring ... **TERMI-POINT**\* wiring devices

For dense point-to-point wiring applications TERMI-POINT tooling and products offer you an automatic, solderless, wrapless, weldless technique for wiring computer panels as well as industrial control and communications equipment.

This technique consists of a fine grain phosphor bronze clip which secures the wire firmly to a post, utilizing the spring "memory" of the metal clip. Wires can be bulk or pre-cut, solid or stranded—even enameled or tinsel! Best of all, the gas-tight, reliable connections may be serviced without electrically disturbing other connections on the same post using only lightweight hand tools! And the entire wire lead need not be replaced, just the clip, saving half the servicing time.

For automated production, you merely program the TERMI-POINT automatic wiring machine to suit your requirements. This remarkable machine routes wires in the pre-set programmed pattern and cuts, strips, and terminates both ends of the lead in seconds. Programs are punched on economical 8-column paper tape. In addition, several types of manual TERMI-POINT tools are available for servicing, testing or limited production. A variety of TERMI-POINT clips and post sizes are offered, including .022" x .036" posts which provide grid densities of .100". In fact, TERMI-POINT products are under development which would reduce this grid size even more.

The complete line of TERMI-POINT products includes printed circuit connectors, transition

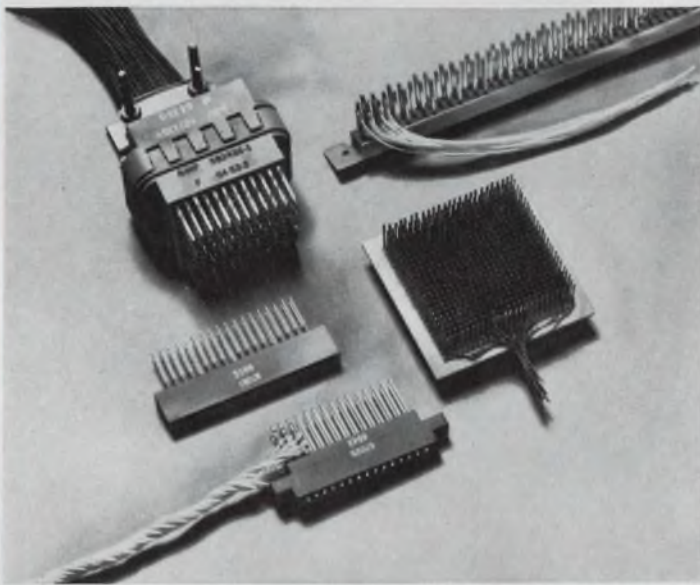
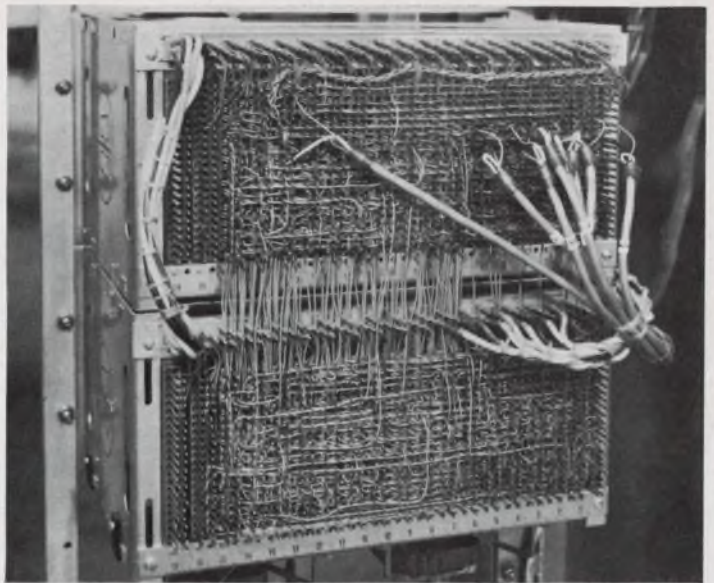
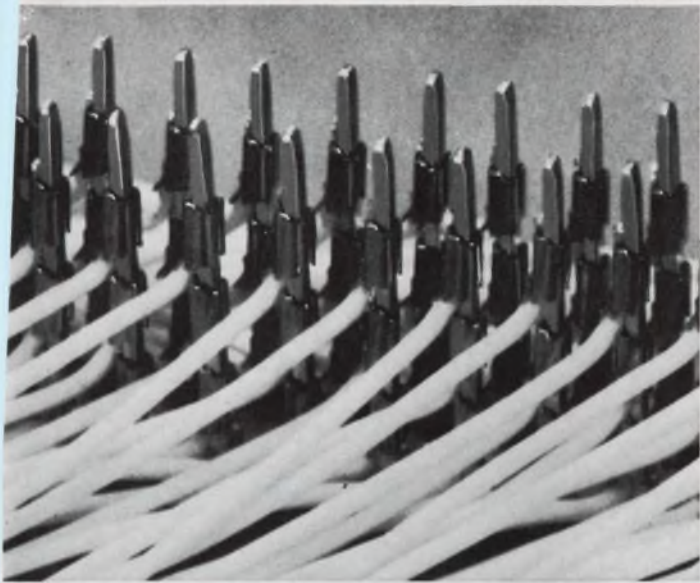

blocks, bus bars, cable connectors, junction blocks, relay blocks, and other devices. Furthermore, large-scale wiring of these products may be accomplished by mounting them on a panel and programming the TERMI-POINT machine for high-speed automatic wiring.

Besides the speed, density, and versatility of this wiring method, it offers an unusual degree of reliability. The reason for this is AMP's special post presents relatively large contact surfaces which are wiped clean by the wire held by the TERMI-POINT clip as the post is terminated. The resulting connection is highly resistant to the effects of corrosion, vibration, and temperature extremes. It is held with a high retention force which exceeds the yield strength of the wire itself, yet the post plating remains undamaged and the wire may be used again.

**No other wiring method offers this combination of advantages!**

With TERMI-POINT clips and tools, your wiring facilities will never become outdated, because unlike other automated methods, there is no

inherent limitation in density with TERMI-POINT wiring devices. In addition, AMP accepts total responsibility for the performance of the TERMI-POINT products, the technique and your completed terminations. You can save considerable time and capital investment by allowing us to wire your panels or circuit boards to your specifications.

If you plan to enlarge or improve your present wiring facilities, we suggest a comparative study of this new technique at your earliest convenience. Write or call today for a demonstration; or ask for information about the TERMI-POINT products which interest you most. Find out how this versatile new method can boost your future production!

\*Trademark of AMP INCORPORATED

**AMP**  
**INCORPORATED**  
 Harrisburg, Pennsylvania

A-MP\* products and engineering assistance are available through subsidiary companies in: Australia • Canada • England • France • Holland • Italy • Japan • Mexico • Spain • West Germany

Speed Inquiry to Advertiser via Collect Night Letter  
 ON READER-SERVICE CARD CIRCLE 43

# Eliminate switch contact bounce with this simple logic design

When a mechanical switch is used as an input to a digital system, contact bounce will almost always be present. Many times it is necessary for the input signal from the switch to produce a single one-clock-period-long pulse which is used by the digital system to initiate a sequence of events. When contact bounce is present, however, several pulses may be generated, or possibly a pulse may be generated that is longer than the specified one clock-period. In either case, a number of difficulties may ensue. The use of RC networks on the switch contacts tends to reduce contact bounce, but it never fully or reliably eliminates the problem.

Logic techniques can be used to generate a pulse one clock-period long regardless of any contact bounce present. This approach allows a number of switches to time-share a single bounce-suppression circuit.

The logic mechanization diagram is shown in Fig. 1 and the waveforms are shown in Fig. 2. The switches  $SW_1 \dots SW_n$  in Fig. 1a contain three sets of contacts which are the break-before-make type. As shown in Fig. 2, these switches have contact bounce; however, since the normally closed contact (NC) is broken before the normally open contact (NO) is made, the contact bounce on the NC side stops before contact bounce on the NO side starts. In the waveforms of Fig. 2 a logic "one" (or "true") is indicated when the waveform is low and a logic "zero" (or "false") is indicated when the waveform is high. Similarly, in Fig. 1, a logic "one" is present when a signal level is at ground and a logic "zero" when the signal level is at  $B+$ .

In order to allow the switches to share the single bounce suppression circuit shown in Fig. 1b, the first set of contacts of  $SW_1 \dots SW_n$  in Fig. 1a is connected together to produce a "true" signal for as long as all the switches remain released. The logic equation for this condition is:  $NC = NC_1 \cdot NC_2 \cdot \dots \cdot NC_n$ . The second

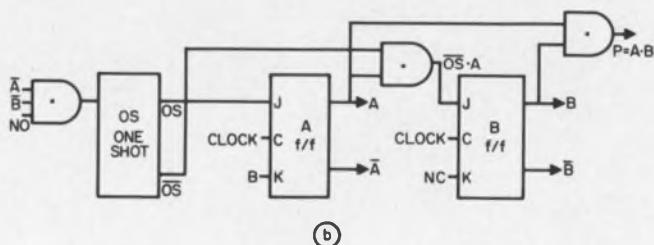
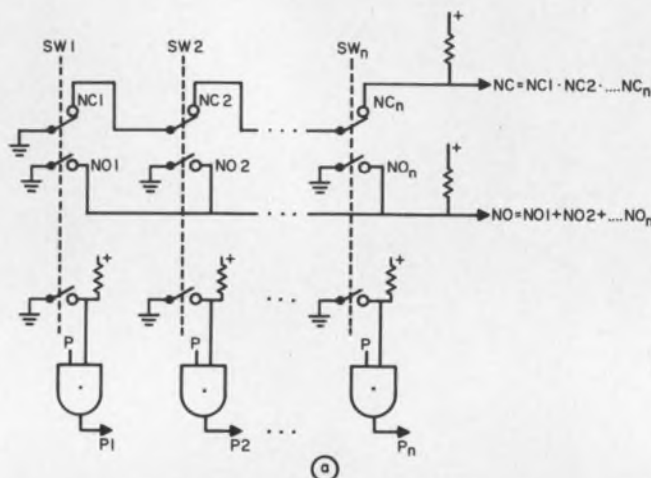

1. Contact bounce can be eliminated using the logic circuitry shown. Pulse P, shown in (a), is generated by the circuits shown in (b).

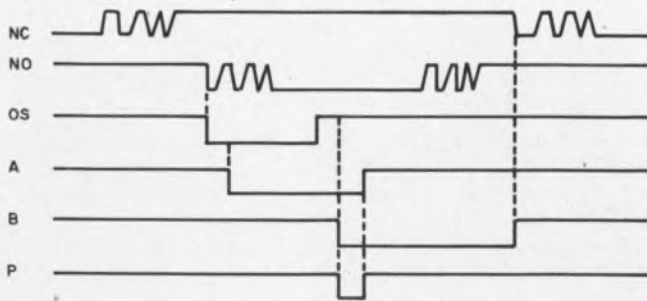

2. These waveforms result when any switch is depressed.

set of contacts is connected to produce a "true" signal when any of the switches are depressed. The logic equation is:  $NO = NO_1 + NO_2 + \dots + NO_n$ . When any of the switches is depressed, a one-shot pulse (OS) is initiated. This pulse, which is about 15 ms long (depending on the switch in use), lasts long enough to eliminate any contact bounce coming from the NO contact

**VOTE!** Circle the Reader-Service-Card number corresponding to what you think is the best Idea-for-Design in this issue.

**SEND US YOUR IDEAS FOR DESIGN.** Submit your IFD describing a new or important circuit or design technique, the clever use of a new component, or a cost-saving design tip to our Ideas-for-Design editor. If your idea is published, you will receive \$20 and become eligible for an additional \$30 (awarded for the best-of-issue Idea) and the grand prize of \$1000 for the Idea of the Year.

## Low Profile, MPC Package, Standard Size, Printed Circuit Reed Relays

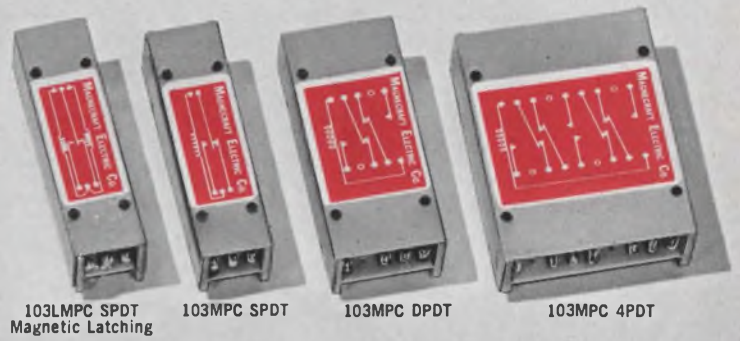
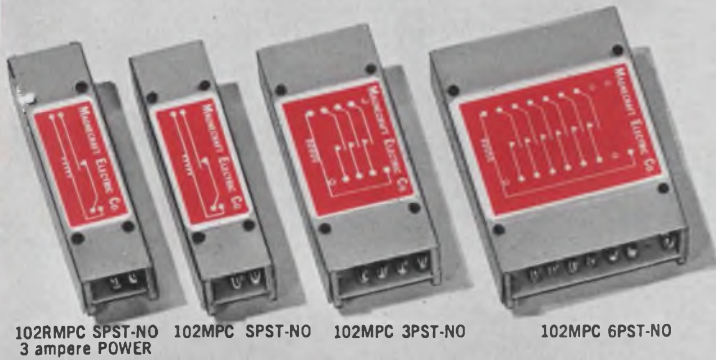

## Encapsulated, Standard Size, Printed Circuit

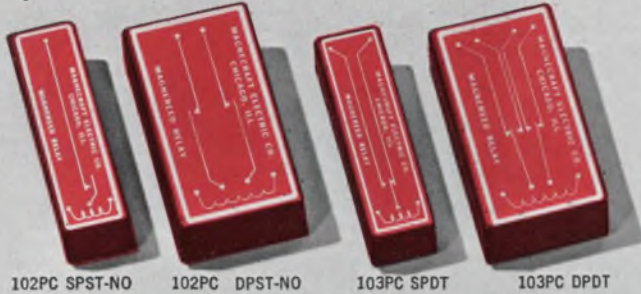

## Miniature Printed Circuit Reed Relays

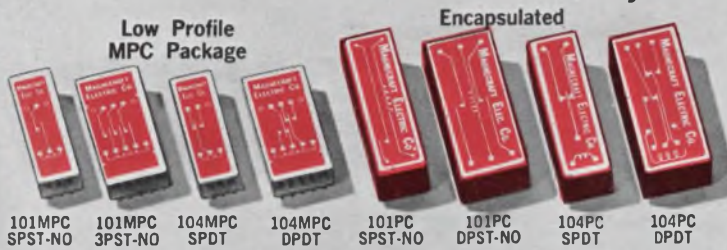

## Mercury-Wetted Printed Circuit Reed Relays

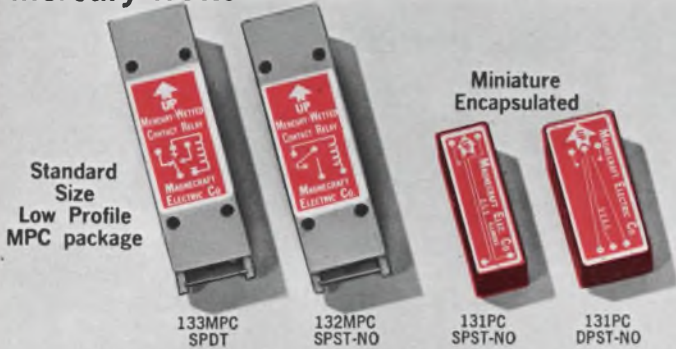

## Plug-in Mounted Standard Size



## High Voltage Reed Relays Switch up to 5000 Volts



# Take a GOOD Look

The pictures show the greatest selection of Mercury-Wetted and Dry Reed Relays STOCKED in DEPTH by any manufacturer—available in your area through MAGNECRAFT AUTHORIZED DISTRIBUTORS.

These OFF-the-SHELF relays and other MAGNECRAFT Reed Relays are cataloged in two brand new MAGNECRAFT publications:

### The new MAGNECRAFT STOCK RELAY CATALOG 267

gives complete information on MAGNECRAFT RELAYS in STOCK for immediate delivery and available through local MAGNECRAFT DISTRIBUTORS. We mean COMPLETE information; clear illustrations that provide visual size comparison, specifications, wiring diagrams, dimensions, prices—information that enables you to select MAGNECRAFT STOCK RELAYS with assurance.

### The new DESIGNERS' REED RELAY HANDBOOK & CATALOG

by MAGNECRAFT gives you the most complete information on Reed Relays ever available in one cover. Discusses—

- Principles of Operation
- Styles and Characteristics
- Application Information
- Testing Procedures
- How to Specify.

Includes Designers' Specification Data on the whole extensive line of MAGNECRAFT Mercury-Wetted and Dry Reed Relays.

Both publications mailed promptly on request. Write, phone or circle the inquiry number NOW.

## MAGNECRAFT ELECTRIC CO.

5575 North Lynch Chicago, Ill. 60630  
 Phone 312-282-5500



## Dry Reed Relays with Axial Leads

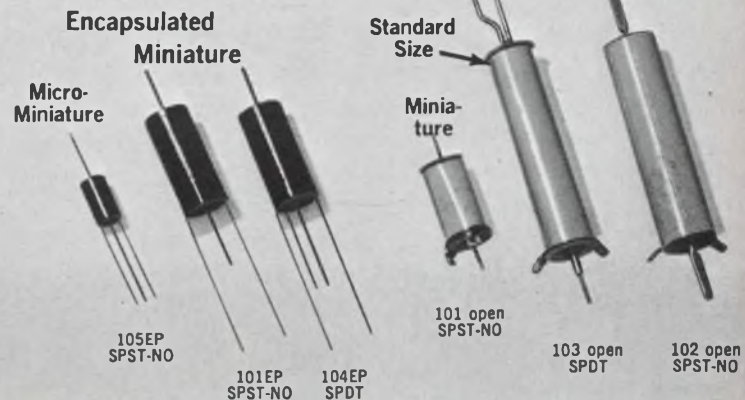

closure. After this time period has elapsed, a pulse, *P*, is produced by the circuitry shown in Fig. 1b. *P* is then "ended" with the third set of *SW*<sub>1</sub> . . . *SW*<sub>*n*</sub> contacts to produce output pulses *P*<sub>1</sub> to *P*<sub>*n*</sub>, which select one of *n* possible sequencing operations. Since only one of the switches is depressed, only one of the output pulses will go "true" and, consequently, only one of *n* possible operations can be selected.

The logic equations producing *P* after a switch is depressed and the NO output reaches a true steady state are as follows:

$$\begin{aligned} OS &= NO \cdot \bar{A} \cdot \bar{B} & BJ &= OS \cdot A \\ AJ &= OS & BK &= NC \\ AK &= B & P &= A \cdot B \end{aligned}$$

The waveforms are shown in Fig. 2. A one-shot (*OS*) Fig. 1b, is initiated when any NO contact is made. The *A* f/f (*A* flip-flop) is set by *OS*. (The set side of the *A* f/f is indicated as *AJ*.) Then, after the time period generated by *OS* is finished, the *B* f/f is set and *P* goes "true." *P* remains "true" until one clock-time later when the *A* f/f is reset by *B*. The  $\bar{B}$  term prevents the one-shot from being reinitiated by contact bounce from the NO contact when the switch is released. When the switch is released, its NC contact is made and the *B* f/f is reset, enabling the process to begin again.

Norton Markin, Senior Engineer, Bendix-Pacific, North Hollywood, Calif.

VOTE FOR 110

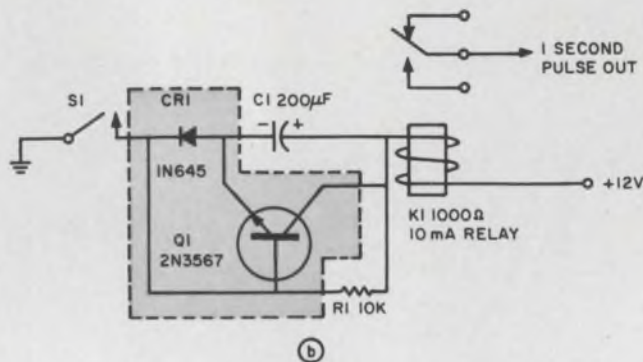
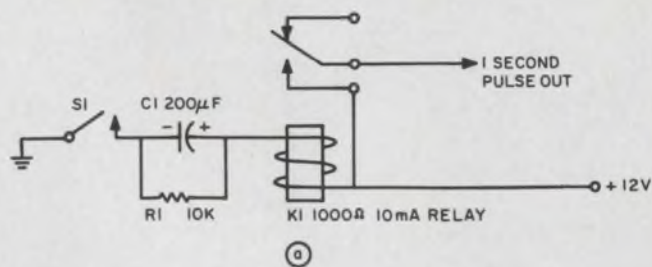

Improved operation can be obtained from the simple pulsing circuit (a) by the addition of a transistor-diode combination (b) which allows greater variation of pulse widths.

seeing a resistor of  $R1/h_{fe}$  across it. For all practical purposes, the circuit is ready immediately for another timing cycle.

This arrangement may be used to advantage in isolated or floating circuits, since no external power source is required.

Elbert S. Kennedy, P. E., Leawood, Kan.

VOTE FOR 111

## Transistor-diode combination improves pulser operation

An inexpensive transistor-diode combination increases the ability of a simple pulsing circuit to generate pulses of varying widths.

A frequently used pulsing circuit is shown in (a). Pulse characteristics are determined by *C1* and *K1*. Often only a form-A (i.e., spst normally open) contact is available at *S1* for actuation, so that circuit reset is accomplished by paralleling *C1* with *R1*. The reset time, determined by *C1* and *R1*, may be made less by reducing *R1*, but this is possible only when the value of *R1* is greater than that resistance value which will hold *K1* operated and prevent delivery of the required pulse.

An inexpensive way to overcome this problem appears in (b). Operation of *S1* reverse-biases *Q1*, owing to the drop across *CR1*, and *C1* is essentially shunted by *R1*, which is too large to hold *K1*, after *C1* is charged. When *S1* is opened, *CR1* is reverse-biased, allowing *R1* to deliver base current to *Q1* from its collector potential. *Q1* conducts and rapidly discharges *C1* as if it were

## Square-wave generator uses IC NAND gate

With one IC NAND gate and a couple of passive components, a small square-wave oscillator may be built to work in the 1-hertz-to 5 kilohertz range. Since this clock generator is physically compatible with integrated logic circuits, it is easy to locate it close to the logic circuitry and alleviate pulse degeneration problems.

Distortion limits the frequency of this design (Fig. 1a), but within the range the waveform is fairly good with a rise of time of less than 100 ns. With an added buffer or drive stage at the input point (pin 1), however, it should be possible to extend the operating frequency even higher than 5 kHz.

For very low frequencies, electrolytic capacitors can be used reliably. Two miniature 47-µF capacitors were used in parallel to achieve a 1-Hz pulse.

The charge time for *C* (*T<sub>c</sub>*) is dependent on the values of *R1*, *R2*, *R3*, the source impedance of the



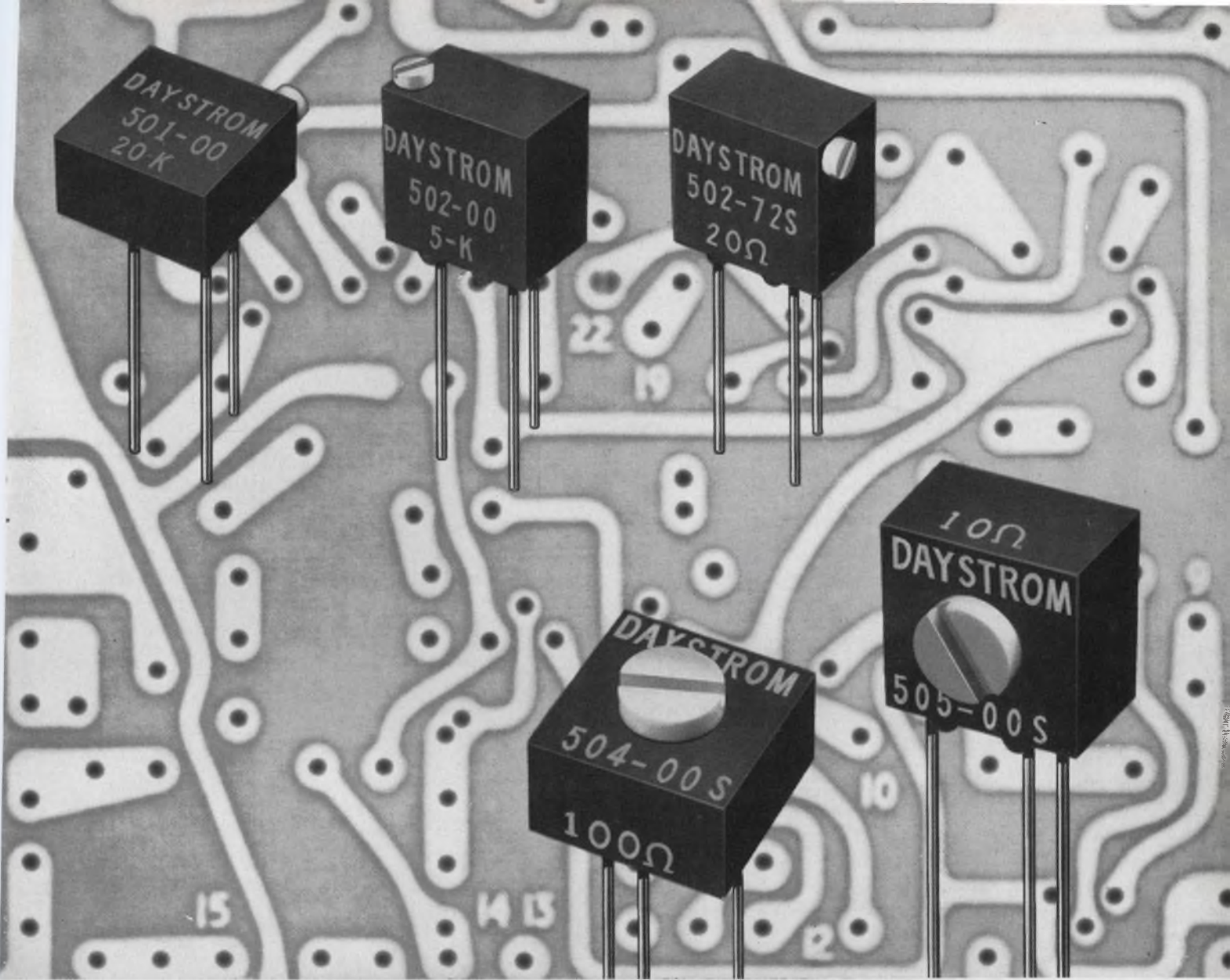

## **Savings across the board just took a new turn**

*Single turn potentiometers have just been added to the Daystrom Squaretrim® family. New models 504 and 505 are fully adjustable with just one turn. Models 501 and 502 are 15-turn types. They all clear up to 80% more PC board space—at no extra cost. But the trim .02 cubic inch size is only one reason why these commercial 500 Series pots are proving so popular. They also feature Weston's exclusive wire-in-the-groove design, and all these performance extras:*

**Convenience** 5 different configurations with adjusting screw on top, side or end • **Tolerance**  $\pm 5\%$  • **Adjustability** 15 turns or single turn • **Slip Clutch** eliminates wiper damage, cuts production delays • **Suregard™ Terminations** (controlled solder) for better protection against vibration, shock and humidity—no pressure taps • **Superior Resolution** 0.125% or less • **Wide Range**  $10\Omega$  to  $20K$  • **High Power** 0.6 watt in still air at  $70^\circ C$  • **Wide Temperature Range**  $-55^\circ C$  to  $150^\circ C$  • **Low Temperature Coefficient** 70 ppm max. • **Low Noise**  $100\Omega$  max. ENR • **Small Size**  $\frac{5}{16}$ " x  $\frac{5}{16}$ " x  $\frac{3}{16}$ ".

**Weston Instruments, Inc. • Weston-Archbald • Archbald, Pa. 18403**

**WESTON®** prime source for precision... since 1888

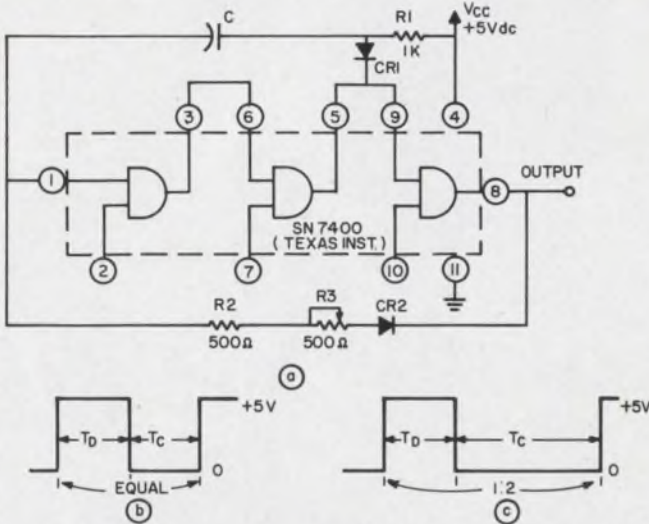

1. Square-wave generator (a) uses charge and discharge paths of capacitor C as timing elements. With R3 shorted, the output is symmetrical (b). As R3 is increased, the symmetry is affected and the pulse is slowed down (c).

NAND gate output (pin 8), and the resistance of CR2. Potentiometer R3 provides a 2-to-1 frequency change for any specific capacitor. However, since it operates only on the charge path, it affects the symmetry of the output. In Fig. 1b, with R3 shorted out, the output is symmetrical. In Fig. 1c, with R3 all the way in, the OFF time of the pulse is twice as long as the ON time. The discharge time for C ( $T_D$ ) is determined by the value of source impedance of the NAND gate output (pin 5) and the input impedance (pin 1).

C. Joseph Buttemeier, Senior Engineer, Litton Guidance & Controls Systems Div., Woodland Hills, Calif.

VOTE FOR 112

## Balanced load, tight regulation with SCR-Zener circuit

Balancing the load on a multiphase power source is achieved easily with this straightforward rectifier-voltage regulator circuit. Intended primarily for use as a preregulator for three-phase power sources, not only does the circuit serve as the main system rectifier but the SCRs (2N689) are also used for regulation. Finer regulation can be obtained by following this circuit with a series-type regulator.

When the upper terminal of the secondary of T1 (as viewed in the diagram) becomes sufficiently positive with respect to its lower terminal, Zener diode D7 breaks down to provide a reference potential at the junction of current-limiting resistor R7 and diode D7. This reference voltage is

applied through direction-determining diode D1 and current-limiting resistor R1 to the gate electrode of silicon-controlled rectifier SCR1. Since SCR1 is switched ON when its control voltage is less than its gate voltage and is switched OFF when its control voltage is greater than its gate voltage, the upper rectifier circuit A tends to keep the voltage across its output capacitor, C1, at a constant value. Each of the SCR rectifier circuits, B and C, which are energized by the secondary windings of T2 and T3, respectively, charges its respective output capacitor, C2 or C3, in a similar manner. The three capacitors in series discharge through the load resistor providing a regulated output voltage.

The load across the individual phases of the polyphase source may be balanced by adjustment of the output time constant of the SCR circuits by means of varying the values of either their respective output capacitors or their respective series resistors R4, R5 and R6, or both, for a given load resistance.

The main advantage is that the power drawn from each phase of the primary source is the same, and thus a balanced load is achieved. A secondary advantage is that the power drawn is about the same at low-line voltage as at high-line voltage. (The circuit was originally designed to handle a 60% swing in line voltage, [145 V-270 V]). In other words, the circuit is almost a constant power input device independent of line voltage.

Other advantages are: three-phase equalization

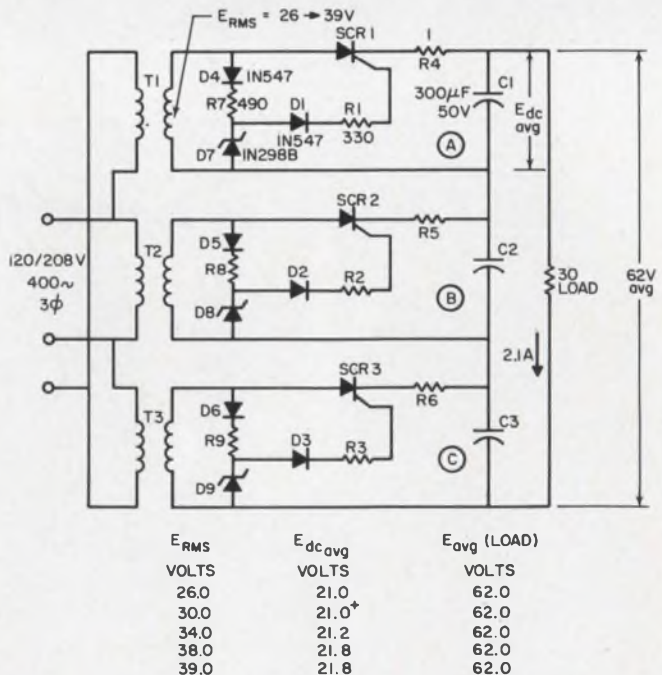

Good output voltage regulation is easily obtained with this circuit. The voltages shown indicate the effectiveness of this multiphase rectifier-regulator. All single phase circuits use the same values of components.

# ITT 2N3375s are 100% factory tested to give you $P_{OE}$ of more than 5 watts @ 400 MHz

28V CLASS B POWER OUTPUT VS FREQUENCY

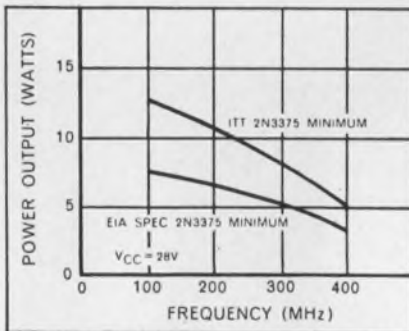

Every ITT 2N3375 gives you 66% more  $P_{OE}$  than EIA specs demand. The secret lies in ITT's unusually close control of resistivity, combined with interdigitated construction.

Order ITT 2N3375s today. They're on your distributor's shelf for immediate delivery.

**ITT**  
SEMICONDUCTORS

ITT SEMICONDUCTORS IS A DIVISION OF THE INTERNATIONAL TELEPHONE AND TELEGRAPH CORPORATION  
FACTORIES IN WEST PALM BEACH, FLORIDA, PALO ALTO, CALIFORNIA, LAWRENCE, MASSACHUSETTS, HARLOW AND FOOTSCRAY, ENGLAND, FREIBURG AND NURENBERG, GERMANY

ON READER-SERVICE CARD CIRCLE 46

IDEAS FOR DESIGN

of phase loading using a minimum number of parts for a maximum change in the three primary voltage; capacity to feed reasonably high current loads; and the facility of the single-phase version to be adapted inexpensively to regulate dc for any electronic application requiring a maximum change in the primary ac voltage (transmitters, receivers, test equipment, etc.).

*Daniel Rosenthal and Herbert E. Hawlk, Design Engineers, RCA, Camden, N. J.*

VOTE FOR 113

## Diode bridge saves wires in motor-reversing systems

Two, not four, wires are needed to reverse the rotation of a motor, if a diode bridge is employed.

Often, small shunt or series dc motors are used for remote-controlled equipments. To change the direction of rotation, the conventional circuit

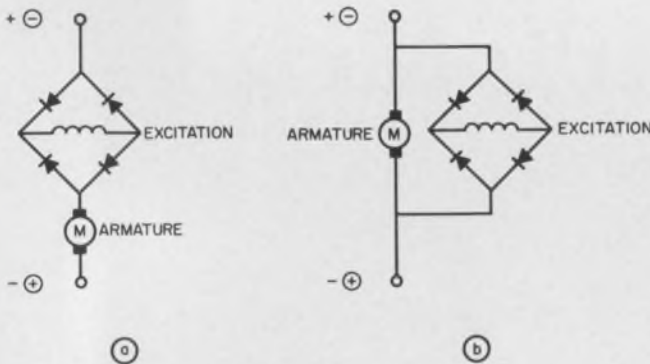

Only two wires are needed to reverse the rotation of a series motor (a) or a shunt motor (b) when a diode bridge is employed.

requires four leads—two for the armature with a fixed polarity and two to stop polarity of the excitation.

With a diode bridge (see schematic) only two wires are necessary. When the polarity of these two wires is changed, the armature current changes direction, but not the excitation current. The motor, however, will reverse its direction of rotation.

*Gottfried Irminger, Design Engineer, Wettlingen, Switzerland.*

VOTE FOR 114

## One-sided flip-flop uses only one SCR

A one-sided flip-flop, driven by a switch-generated trigger, can easily be built with a single SCR. Its current-handling capability is reasonably

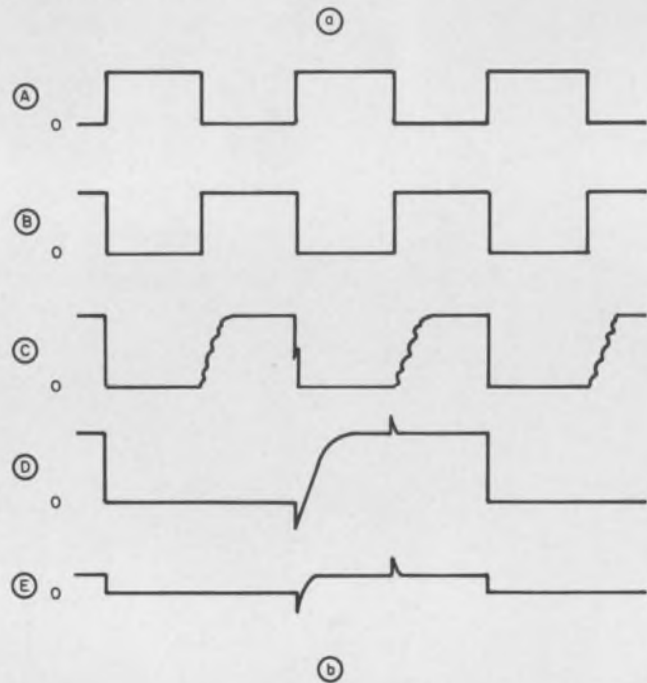
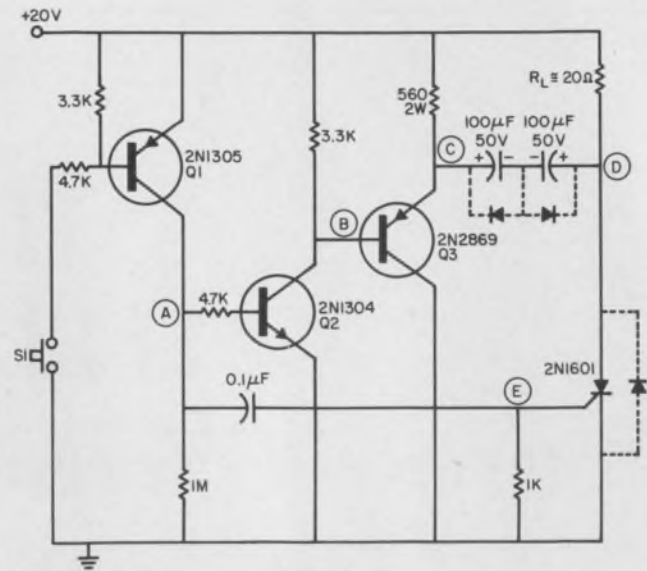

One-sided flip-flop uses SCR and three bipolar stages (a). Output frequency (at D) is half that of input frequency (b). Optional diodes (dotted) may be used for peak clipping and reset of electrolytics.

large; its components are inexpensive.

In the circuit (see schematic) the SCR is being commutated; Q3 is a charging stage, and Q1 and Q2 provide the triggering-buffering functions. The optional diodes (shown dotted) may be added to clip negative spikes and to reset the back-to-back electrolytics.

Output current capabilities may be further increased by using "bigger" SCR and Q3 stages. This, however, entails larger commutating capabilities and less emitter resistance in Q3. A further liability is the possible degradation of the frequency response. Circuit action is initiated by grounding the base-leg of Q1 by way of switch S1.

*Jack H. Still, Project Engineer, American Lava Corp., Chattanooga, Tenn.*

VOTE FOR 115

# Whose dual in-line 930 DTL?

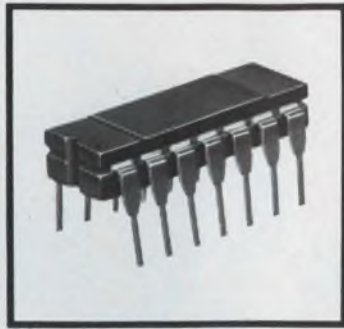

**ITT**



**OTHERS**

**Only your  
purchasing agent knows  
for sure!**

ITT offers all series 930 DTL circuits in a dual in-line package. Circuits manufactured by ITT are identical to and perfectly interchangeable with the other leading brand.

If you're convinced that dual in-line packaging is your answer — if you want

the lower component insertion cost, heavier leads and all-ceramic construction that only dual in-line can give you, evaluate ITT.

You can order any series 930 DTL in dual in-line today! Call your ITT distributor or factory representative.

**ITT**  
SEMICONDUCTORS

ITT SEMICONDUCTORS IS A DIVISION OF THE INTERNATIONAL TELEPHONE AND TELEGRAPH CORPORATION  
FACTORIES IN WEST PALM BEACH, FLORIDA; PALO ALTO, CALIFORNIA; LAWRENCE, MASSACHUSETTS; HARLOW AND FOOTSCRAY, ENGLAND; FREIBURG AND NURENBERG, GERMANY

ON READER-SERVICE CARD CIRCLE 47

# Adage makes the fastest A-to-D converter on the market

8 bits at 1 Mc, 1  $\mu$ s conversion time (Model VT7-AB)  
14 bits at 200 Kc, 4  $\mu$ s conversion time (Model VT13-AB)

Adage has been making solid-state analog-to-digital converters, and compatible sample-and-hold amplifiers, multiplexers, and D-to-A converters, since 1957 — longer than anyone else. We like to think our record of performance is also unmatched.

May we send you literature describing our products — or an applications engineer to help you with your problem? Write Leon Dall, Product Manager, Adage, Inc., 1079 Commonwealth Ave., Boston, Mass. 02215, (617) 783-1100.



*Adage*  
INC

ON READER-SERVICE CARD CIRCLE 48

ELECTRONIC DESIGN 23, October 11, 1966

# ARNOLD IS



## **TAPE WOUND BOBBIN CORES**

**Standard Cores of 4-79 Mo-Permalloy and Deltamax  
on Ceramic or Stainless Steel Bobbins . . .**

engineered for use in sophisticated data processing systems, high frequency magnetic amplifiers, static inverters, timing circuits, shift registers, ring counters, pulse transformers and as static magnetic memory elements. All tapes are rolled on a beta-ray controlled Sendzimir mill in standard gages of 1, 1/2, 1/4 and 1/8 mil and slit to standard widths of 0.031, 0.0625, 0.125 and 0.250. Cores are wound on semi-automatic machines, then annealed at extremely high temperatures in specially designed dry hydrogen atmosphere furnaces to obtain the final magnetic properties. Arnold maintains complete control over all phases of fabrication. Melting, processing, rolling and slitting of raw materials (nickel iron) to winding, annealing and final test are all "in-plant" functions.

Write for Catalog TC-108B.

 **ARNOLD**  
SPECIALISTS IN MAGNETIC MATERIALS

THE ARNOLD ENGINEERING COMPANY, Main Office MARENGO, ILL.  
BRANCH OFFICES and REPRESENTATIVES in PRINCIPAL CITIES

Speed Inquiry to Advertiser via Collect Night Letter  
ON READER-SERVICE CARD CIRCLE 49

# Bits and Pieces

*Wisdom and levity, well-developed fruits of frustration, will rarely be found, except in bits and pieces. . . .*

## Esoteric obscurity

The present report is an admonitory expostulation by a panel of eminent psychologists who have been designated to conduct an investigation into the feasibility of implementing an optimal increment in the degree of obfuscation in defense reports. It has been averred in cognizant circles that recognized techniques have circumstantiated that the degree of operational utility envisioned for certain ancillary defense projects is minimal, if not altogether supposititious. To obviate the possibility of a budgetary recession, it seems to be indicated that means should be devised to make the appreciation of the inherently nonutilitarian nature of the aforementioned projects as recondite as possible.

Heretofore the panel has convened only a minimal number of times, but considerable progress has already been made toward elaboration of procedures and establishment of basic principles. Recapitulation of its work demonstrates that seven fundamental principles of obfuscation obtain:

- Utilization of Anglo-Saxon language units of deficient letter count should be deprecated insofar as more suitable polysyllabics of Latin or Greek origin can be substituted.

- Euphuistic periphrasis and employment of complex and compound syntax should be encouraged, since it has been determined by a study of behavioristic signifies that, when the reader observes ambiguities in the relation between verbal form classes, a comparatively high parameter of confusion results.

- Fustian recourse to archaic and obsolescent word forms will

inculcate an impression of erudition and scholarship.

- Excessive verbosity in the form of concatenations of sonorous phrases of negligible import is highly commended.

- The passivity of verbal voices is an auxiliary ploy that engenders opacity.

- Infusion of alphabets other than roman, interspersed with technological nomenclature which should be neither semantically defined nor elucidated by terminological redundancies, will promote turbidity.

- **Never write as you speak!** People might just be able to understand you, and then you're really in trouble. After all, what *are* you trying to say?

V. D. Landon  
Princeton, N. J.

## Managing change

How are your managerial instincts? Success demands dynamism, dynamism begets change and change creates resistance. Do you give conscious thought to this problem when you institute changes? As stated by Dr. Gordon L. Lippitt, president of Leadership Resources, Inc., here are some of the reasons why people resent change:

- When purpose is not clear. Mystery and ambiguity cause anxiety.

- When they are not involved in the planning. On the other hand, we're all usually ready to follow our own suggestions.

- When the change is made for purely personal reasons. Loyalty is great, but action requires a purpose and a goal.

- When habit patterns are ignored. A group of people who eat lunch together will resent changes that alter their relationship.

- When there is fear of failure. For instance, if penalties for non-fulfillment are implied or stated—demotion, loss of job, etc.

- When there is poor communication. Though a change may affect only one or two persons out of a group of ten, all members of the group need to be advised in order to maintain group cooperation.

- When excessive work pressure is involved. Often these pressures are the result of short-sighted work plans.

- When the rewards for changing are, in human terms, outweighed by the costs.

- When there is no obvious benefit from the change. There is always the attitude, typically human, that is reflected by the question, "Why rock the boat?"

(continued on p. 112)

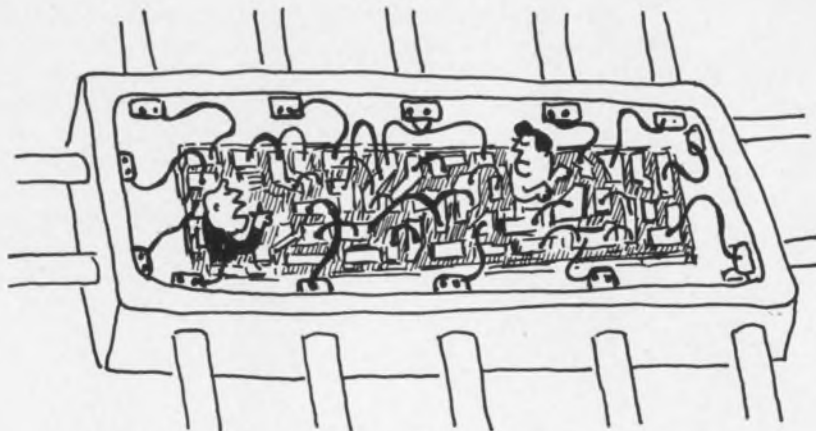

"Hey Joe, you sure you wired the emitter to R1?"

Have you got a contribution? We'll compensate. Be it a letter, commentary, puzzle, cartoon, or cartoon idea, send it along to: RC, Electronic Design, 850 Third Ave., New York, N. Y. 10022.



# CAREER INQUIRY – confidential

Respond to the career opportunities advertised in this issue. Fill out and send us this handy resume. **Electronic Design** will do the rest – neatly typed copies of this form will be mailed to the companies of your choice, indicated by the circled Career Inquiry Numbers at the bottom of this page.

23

Name Home Phone

Home Address (Street) City State ZIP Code

Age U.S. Citizen Security Clearance  
 Yes  No

Prime Experience	Secondary Experience

Desired Salary Availability Date

**Employment History – present and previous employers**

Company	City, State	Dates	Title
		to	
		to	
		to	

**Education – indicate major if degree is not self-explanatory**

Degree	College	City, State	Dates
			to
			to
			to

**Additional Training – non-degree, industry, military, etc.**

---



---



---

**Professional Societies**

---

**Published Articles**

---

- Career Inquiry Numbers:**
- |     |     |     |     |     |     |     |     |     |     |
|-----|-----|-----|-----|-----|-----|-----|-----|-----|-----|
| 900 | 901 | 902 | 903 | 904 | 905 | 906 | 907 | 908 | 909 |
| 910 | 911 | 912 | 913 | 914 | 915 | 916 | 917 | 918 | 919 |

**ELECTRONIC DESIGN**  
 850 Third Avenue  
 New York, New York 10022

# Bits and Pieces

CONTINUED

*Next time you're thinking of making some changes, keep these points in mind and see if the waves made by your changes can't be reduced to ripples.—RC*

**If you learn, you earn.** This is particularly true in the engineering profession, according to a study by the National Society of Professional Engineers.

The study, based on a survey of 1960 engineering graduates from the University of Illinois, found that without exception the increase in an engineer's salary is more dependent on education than experience.

The survey showed that the 319 engineers who took jobs immediately after graduation now average \$818 a month. The 66 with master's degrees in a technical field earn an average \$893 a

month, while three with doctorates average \$900.

**"Although** advanced sophistication and circuits may lead to efficient instruments, their basic measuring principles must be soundly founded. Most of these were conceived a half-century ago."

Teradyne, Inc.  
Boston, Mass.

**"... professors,** preoccupied with their personal prestige and fortified by their intellectual competence, are inclined to look down their noses at the most pedestrian efforts of the working Industrial Engineer. Without detracting from their important role in developing the minds of our youth, I think educators are generally out of place in the industrial world. Their theories, some quite obscure, have not been honed and sharpened by contact with the realities of running a profitable business. There is something about the generation of action . . . that requires a realistic bed-rock approach not in harmony

with lofty pronouncements or impressive equations.

**"If these idealists** had to work with people rather than ideas, they would soon find a variety of reactions that defies a precise, mathematical-oriented solution . . . They have a place in the field but in the average plant which can support an Industrial Engineering department of, say, twenty engineers, the right proportion would be, in my opinion, one technically competent theorist to nineteen aggressive, take-charge, shirtsleeve type of operator who will set some realistic objectives and get them done."

*Taken from "The Emerging Role of the Industrial Engineer," a paper by R. H. Bavier, of Bavier, Bulger and Goodyear, management consultants, this statement appears particularly appropriate within the electronics industry, where a good many engineers and engineering managers would sympathize with Mr. Bavier. The complete paper appears in the August/September issue of the IEEE Engineering Management Newsletter.—RC*

Fold here, staple and Mail.

FIRST CLASS  
Permit No. 725  
New York, N. Y.

**BUSINESS REPLY MAIL**

No Postage Stamp Necessary if Mailed in the United States

POSTAGE WILL BE PAID BY

# ELECTRONIC DESIGN

READER SERVICE

850 THIRD AVENUE

NEW YORK, NEW YORK 10022



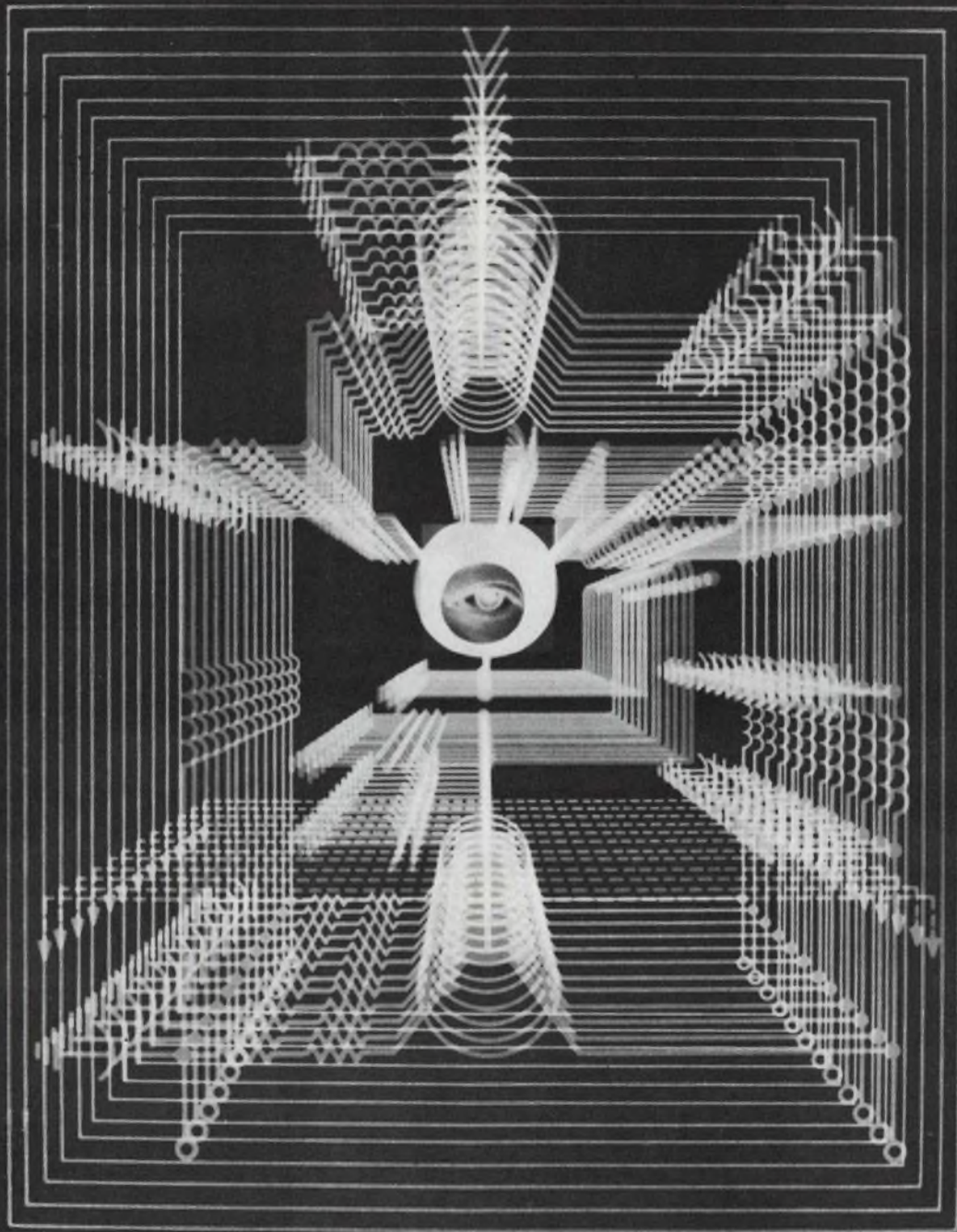

*Look into the vehicles of opportunity at Lockheed...for circuit designers.*

Opportunity broad enough to interest every circuit designer, that's the sweep of electronics assignments at Lockheed. Big, wide-ranging programs that extend from deep sea to deep space. And with ever-growing commitments comes an increasing need for new concepts and major technical advances in flight controls, communications, antennas and state-of-the-art electronics checkout equipment in both spacecraft and fleet ballistic missiles. In addition to its major vehicle programs... Agena, Poseidon, and Polaris, Lockheed is involved in deep submersibles; unique advanced land vehicles; information systems for states and hospitals; and many other technically alluring programs. For complete information, write Mr. R. C. Birdsall, Professional Placement Manager, P.O. Box 504, Sunnyvale, California. Lockheed is an equal opportunity employer.

## **LOCKHEED**

**MISSILES & SPACE COMPANY**

A DIVISION OF LOCKHEED AIRCRAFT CORPORATION

**ON CAREER-INQUIRY FORM CIRCLE 900**

# DISCOVER THE WIDENING WORLD OF WESTON



**WE HELP  
NORTH AMERICAN  
CONTROL APOLLO  
IN FLIGHT**



**WE HELP THE  
NAVY PUT THE  
PUNCH IN THE  
F4D FIGHTER**

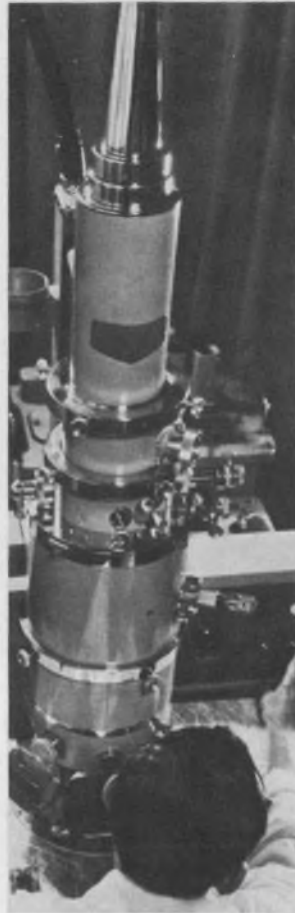

**WE HELP  
THE AIR FORCE  
WITH THIN-FILM  
RESEARCH**



**WE HELP YOU  
ENJOY  
TASTIER BAKERY  
PRODUCTS**

In this age of constant change, one thing doesn't change: America's reliance, since 1888, on Weston for precision measurement.

At this very moment, thousands of Weston products, programs and projects are playing a vital role in protecting our way of life and in our enjoyment of its fruits.

For example, 30 Weston instruments and devices will be aboard NASA's Apollo spacecraft when it takes its history-making orbit around the earth. A revolutionary new azimuth package, encompassing specially designed Weston generators, motors and synchros, gives F4D pilots unprecedented accuracy; it automatically computes target speed, then sets and locks the guns on target.

Weston electron microscopes enable Air Force researchers to probe the basic structure of semi-conductors and thin metallic layers. And Weston bi-metal thermometers make sure that every "Jane Parker" bakery product of A&P is tastier and fresher.

This is but a minuscule part of the activities of our six integrated divisions, which are hard at work keeping pace ...and sometimes setting it...with the diversified needs of industry and government.

Engineers, scientists and professional personnel looking for new challenges are invited to discover the widening world of Weston. And to widen their personal worlds at the same time.

Write in confidence to Corporate Personnel Manager

## WESTON

INSTRUMENTS, INC.

614 Frelinghuysen Avenue, Department E.D.-3, Newark, New Jersey

### PLANTS AND DIVISIONS

Weston-Newark  
Newark, N.J.

Weston-Archbald  
Archbald, Penna.

Weston-Poughkeepsie  
Poughkeepsie, N.Y.

Weston-Transicoil  
Worcester, Penna.

Weston-Rotek  
Watertown, Mass.

Weston-Boonshaft & Fuchs  
Hatboro, Penna.

**Weston • Prime Source for Precision . . . Since 1888**

An Equal Opportunity Employer

ON CAREER-INQUIRY FORM CIRCLE 901

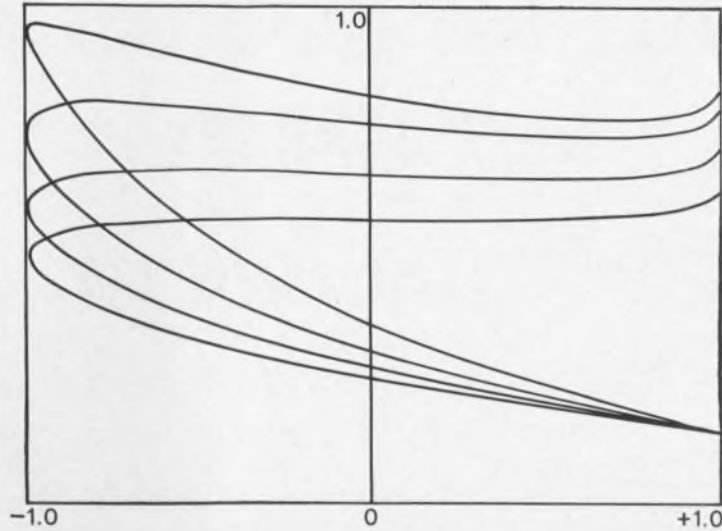

## 3 new ways to see your engineering shape up on IBM's 1130 computer

You get computer output in graphic form when you use any of these three IBM programs.

1. IBM 1130 Continuous System Modeling Program (CSMP) provides electrical engineers with a versatile tool for analyzing control systems and solving dynamic simulation problems.

Simple block-diagram language lets you describe the control system. The computer does the analysis. Automatically. You see the results in plotted form.

2. IBM 1130 Data Presentation System is a special program to give you computer output in the form of graphs. Use it to plot results of your transient analyses, frequency spectra, parameter

studies, or any other task. This program yields a finished graphic report, including labels and scales.

3. IBM 1130 Numerical Surface Techniques and Contour Map Plotting is a program you may use for visual displays of electrical and magnetic fields. It can take field data in equations or points, smooth them if desired, and produce contour maps.

These easy-to-use programs, and others, let you concentrate on problems—not programming. IBM provides the FORTRAN language to help you write your special programs. In addition, there are more than 120 computational programs for solving equations, evaluating functions, inverting matrices, and many

other requirements relating to electrical engineering design.

The IBM 1130 is built with your needs in mind. You can find out just how it can work for you. Call your local IBM sales office or send the coupon.

IBM Data Processing Division, Dept. 735-3  
112 East Post Road, White Plains, N. Y. 10601

Please send me more information on the use of computers in electrical engineering.

Name \_\_\_\_\_

Title \_\_\_\_\_

Company \_\_\_\_\_

Address \_\_\_\_\_

City \_\_\_\_\_ State \_\_\_\_\_ Zip Code \_\_\_\_\_

**IBM**<sup>®</sup>

# THE UNIVAC 1108 JOINS OUR GROUP NEXT JANUARY

## ***WHY DON'T YOU JOIN US NOW?***

Scientific Computing equipment currently in use includes:

IBM 360/50—IBM 7094—UNIVAC 418—CDC 3300—IBM 360/30

The UNIVAC 1108 will be incorporated in our system in January, 1967

### **OPENINGS AT ALL LEVELS**

*for*

#### **SCIENTIFIC PROGRAMMERS**

Engineering applications on C-130, C-141, and C-5 cargo aircraft, VTOL/STOL development, and the JetStar airplane. Problems to be solved are in the areas of: Structural Analysis, Aerodynamics, Loads, Dynamics & Flutter, Flight Simulation, Statistical Design of Experience, and Numerical Control.

#### **SYSTEMS PROGRAMMERS**

Work is in progress on system design and development of:

1. Computer Graphics Project
2. Real-time Data Acquisition and Monitoring Systems
3. Remote Access Computing Facility

BS degree in mathematics or engineering and minimum one year's experience with one or more large-scale digital computers for entry-level openings. We are also seeking personnel with several years programming experience and/or advanced degree to fill higher-level technical and supervisory positions.

Send complete resume, including current salary, to: Charles E. Storm, Professional Employment Manager, Lockheed-Georgia Company, 834 West Peachtree Street, Atlanta, Ga. 30308, Dept. 1011-ED.

## **LOCKHEED-GEORGIA COMPANY**

*A Division of Lockheed Aircraft Corporation*

An equal opportunity employer

University surveys indicate:

# STARTING SALARIES OF ENGINEERS ARE DECEPTIVELY HIGH

By James M. Jenks



**T**WO SEPARATE STUDIES of the salaries made by college graduates appear to contradict the commonly held belief that engineers today make out better financially than their classmates who major in non-technical subjects.

Both surveys were conducted by large universities. The first polled graduate engineers; the second, company executives. And both resulted in identical findings! That is, the average engineer today — despite a deceptively high starting salary—climbs fast but not far.

The need for technically trained men in recent years has exceeded the supply to such an extent that companies have been forced to bid for their services—to actually set-up “recruiting” offices on college campuses all over the country. Thus, starting salaries have gone up and up. But the income ceiling for these technically-trained men is lower than that for managerial personnel.

*Despite the substantial head start engineers have, the differential in money earned over a ten-year period averages out at \$7,000 more for the management man.*

And from the tenth year on, the administrator’s salary obviously outstrips that of the engineer by a wider and wider margin.

This, of course, is not to say that engineering students would be wise to shift to the study of business administration—or that working engineers face a bleak future. Quite to the contrary, the continuing growth of technology means that men with technical backgrounds are as ideally qualified for the highest rewards industry has

to offer—if they also have a knowledge of the underlying principles of business.

### FREE...“FORGING AHEAD IN BUSINESS”

If you want to avoid the thorny barriers to success — if you’re ambitious, determined to move up fast — send today for the Institute’s 32-page descriptive booklet, “Forging Ahead in Business.”

It explains what a man must know today to make \$20,000 or more a year . . . what he must do to accumulate this knowledge. It tells why men of equal ability fare so differently in the race for better jobs and bigger salaries. It analyzes the causes of failure . . . the reasons for success. And it outlines an executive-training program which is so complete and so scientific that each day subscribers are brought a little closer to a mastery of business procedures.

There’s no charge for “Forging Ahead in Business.” And no obligation . . . other than the obligation to read it thoughtfully, and decide for yourself whether the training it describes is meant for you. To obtain your complimentary copy, simply fill out and return the coupon. It will be mailed to you promptly.

### ALEXANDER HAMILTON INSTITUTE

235 East 42nd Street, New York, New York 10017

ALEXANDER HAMILTON INSTITUTE  
Dept. 719, 235 East 42nd Street  
New York, New York 10017

Please mail me, without cost or obligation, your 32-page book, “Forging Ahead in Business.”

Name .....

Firm .....

Name .....

Business .....

Address .....

Position .....

Home .....

Address .....

Zip Code

ON CAREER-INQUIRY FORM CIRCLE 903

# Book Reviews

introduction to nuclear physics | harald engel

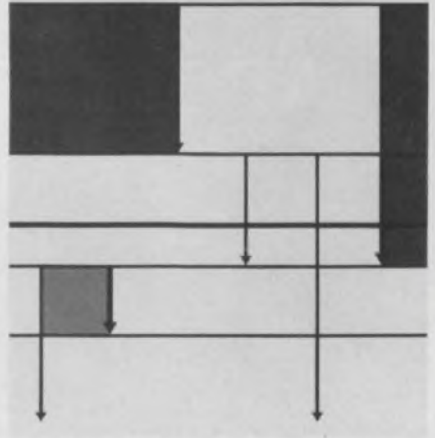

## Nuclear physics

Such topics as two-body problems, proper ties of stable nuclei, nuclear models, disintegration of unstable nuclei, nuclear reactions, nuclear power and elementary particles are covered in this book on low-energy physics.

For a given topic the experimental facts are presented first, followed by theory. Experiment and theory are then compared. For example, the Hofstadter experiment which measures the nuclear radius using high-energy electron scattering or diffraction is described. The experimental results are likened to those of the less complex Rutherford experiment in which nuclei are bombarded with alpha particles. Then the formula for distribution of the charge density in the nucleus and theory are given and compared to Hofstadter's experimental results.

The recent and typical experiments chosen to illustrate the various theories are not necessarily historical firsts. In organizing the material for this book no attention is paid to the historical development of the subject.

Some knowledge of electricity and magnetism and elementary wave mechanics is helpful for a full understanding of the book. One appendix contains a brief but thorough review of wave mechanics



# 1000<sub>vdc</sub> STANDARD\*

COMPARE  
performance  
. . . . value

EDC's High Voltage Reference Source Model VS-1000-NR, is the only all-solid-state high precision printed circuit 6-decade dc portable standard with . . .

- Absolute Accuracy .....  $\pm 0.01\%$  or  $\pm 1$  mv (NBS traceability)
- Output Voltages .....  $\pm 1111.110$  vdc (full scale)
- Stability .....  $\pm 0.001\%$  (short term — 8 hrs)
- Output Current ..... 10 ma
- Delivery ..... from stock
- Price ..... \$995

Model VS-1000-NR has: automatic recovery . . . short-circuit and overload protection . . . output as well as measuring capability . . . direct reading . . . ready to use within 30 sec (no balancing or zeroing). Designed for production line and laboratory applications — for use as a voltage source and a potentiometer measuring device. Fits standard rack, weighs only 20 pounds, guaranteed for one full year including calibration and stability.

\*Other models from 1  $\mu$ volt.

**ELECTRONIC  
DEVELOPMENT  
CORPORATION**



423 WEST BROADWAY · BOSTON 27, MASSACHUSETTS  
Tel: 617 268-9696

ON READER-SERVICE CARD CIRCLE 50



# MONOLITHIC FIVE-CHANNEL SWITCH

**Low leakage, Planar II MOS, requires no transformer:** The Fairchild  $\mu$ M3400 is the first in a new line of monolithic, Hi-Rel, Planar II MOS switching circuits. It is immediately available from stock at a cost of only \$8.00 per channel. The device consists of five MOS-FET channels, integrated on a single chip, and can be used for selecting inputs to a computer, telemetry system, or other signal routing applications. In such applications it requires no transformer (unlike alloy junction or dual emitter transistors) thereby saving space and weight, as well as reducing costs and improving reliability.

**FAIRCHILD**  
SEMICONDUCTOR

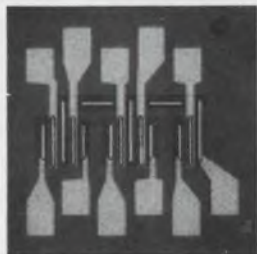

#### Features:

- ±10V input range
- Planar II MOS stability
- Low leakage
- 250nsec. on/off speed
- Zero offset voltage
- 55°C to +125°C operation
- 14 lead, 1/4" by 3/8" flat pack

#### Typical Specifications:

Input signal range	.....	±10V
Channel ON resistance	.....	1.0kohm
Channel OFF resistance	.....	10 <sup>11</sup> ohm
Input leakage current	.....	0.005nA
Output leakage current	.....	0.005nA
Gate input capacitance	.....	3.6pf
Output capacitance	.....	12pf

Planar is a patented Fairchild process.

FAIRCHILD SEMICONDUCTOR / A Division of Fairchild Camera and Instrument Corporation ■ 313 Fairchild Drive, Mountain View, California (415) 962-5011 ■ TWX: 910-379-6435

ON READER-SERVICE CARD CIRCLE 51

# NEW TORQUE MOTOR DRIVER

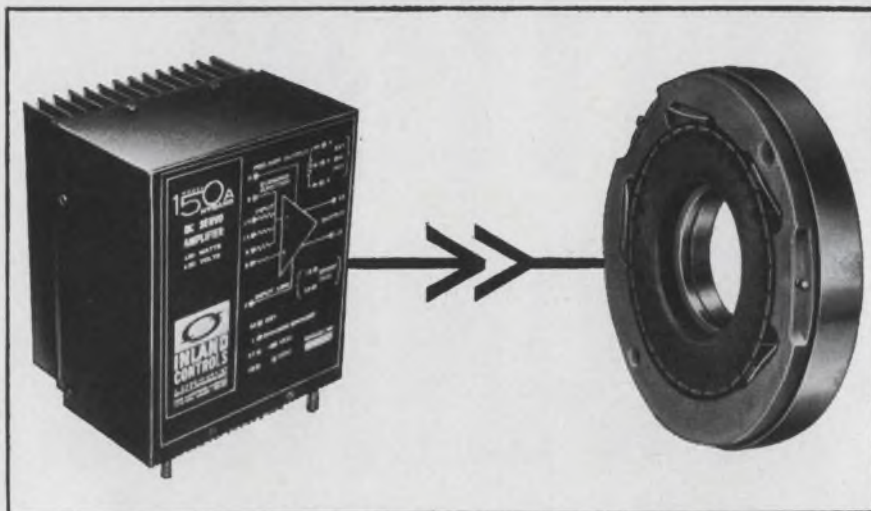

## Cut costs and time with off-the-shelf HYBAND DC Servo Power Amplifiers by INLAND

Inland Controls specializes in the design and manufacture of reversible polarity, wide bandwidth DC servo power amplifiers that help you:

- ELIMINATE design and development **costs**
- ACCELERATE delivery **schedules**
- AVOID motor/amplifier interface **problems**

Ranging from 50 watts to 3000 watts, these amplifiers, designed specifically for driving Inland Motor\* DC torque motors, are available in either compact modular design or standard rack-mounted design. Current-limiting, short-circuit protection, multiple summing inputs, high gain preamplifier and provisions for servo compensation networks are built-in standard features of the HYBAND amplifiers.

To avoid your interface problem entirely, why not let Inland Controls supply guaranteed match-

ing amplifiers, or complete amplifier and torque motor blocks? We can do this and satisfy your most demanding needs. Don't let interface and transfer function problems get you down . . . call on the INLAND team and relax . . . our amplifiers offer proven and outstanding compatibility, reliability and availability.

A CONDENSED SELECTION GUIDE giving detailed information on HYBAND dc servo power modular and rack mounted amplifiers is now available and we'll be happy to send you a copy. All of the amplifiers described in this guide are manufactured for general sale and are available off-the-shelf. MIL-SPEC versions are available on special order.

Or, if you prefer, a demonstrator kit designed to illustrate exactly how these amplifiers operate in a closed loop servo system can be shown in your plant at your convenience. All it takes is a call or a letter from you.



**INLAND  
CONTROLS**

A SUBSIDIARY OF  
**KOLLMORGEN**

342 WESTERN AVENUE • BOSTON, MASSACHUSETTS 02135  
Telephone: 617 254-0442 TWX: 710 330-0143

\*Inland Motor Corporation  
is also a subsidiary of Kollmorgen

ON READER-SERVICE CARD CIRCLE 52

## BOOK REVIEWS

for those uncertain of their proficiency in this subject. Other appendices cover ion-beam focusing and dispersion in electric and magnetic fields, barrier penetration, time dependent perturbation theory and matrix diagonalization.

A number of problems are given at the end of each chapter. One or two problems in each section considered more difficult are intended as "term problems."

*Introduction to Nuclear Physics.*  
Harald A. Enge (Addison-Wesley Publishing Co., Inc.: Reading, Mass.). 582 pp. \$12.75.

—Genevieve Adee

## Test probes

This is an introductory book intended to provide a basic background to modern electronic probes and their uses. It explains how they operate and what they can be expected to do. It provides information about the circuitry, construction, basic functions, and applications of the most common types of test probes found in the field today. You will find illustrations to guide you in improving your knowledge of test equipment.

*ABC's of Electronic Test Probes,*  
Rudolf F. Graf, (Howard W. Sams & Co., Inc., Indianapolis, Ind.) 128 pp. \$2.25

## Switching theory

The techniques and theory for the design and analysis of switching circuits are given in two volumes. Their theoretical framework explains the switching theory from both engineering and mathematical points of view.

Volume 1 covers extensively functional decomposition, multiple output design, the application of techniques developed for relay-contact networks, cubical representation and the connection of Boolean algebra to group and lattice theory.

Topics in Volume 2 include regular depressions, incompletely specified sequential machine state minimization, and asynchronous and speed independent circuit theory.

*Switching Theory.* Raymond E. Muller (John Wiley & Sons, Inc.: New York). 2 vols.

**This one  
MOS array  
is every  
bit as  
good  
as 32  
integrated  
circuits.  
(And it costs less.)**



## **Meet our pL5216 MOS shift register.**

It has 32 bits, arranged in a flexible dual-16 sequence. It costs \$44.60 (in lots of 50-199). Or, about \$1.39 a bit. And it meets military environmental requirements.

Meets mil specs for \$1.39 a bit?

Naturally! *This* shift register is MOS.

Compatibility can easily be achieved with any integrated circuits you plan to use in your system. (Much as we'd like to see you convert all the way to MOS.) Power supply range is from -12 V to -20 V; clocks -22 V to -27 V. Frequency range is from 10 kHz to 1 MHz minimum.

Since all bits are stored in individual registers

under direct control, bits cannot be lost due to wide temperature variations.

Our MOS shift register and its companion unit—the pL4G01 dual 4-input gate—are widely tolerant. They can be used in: memory elements, counters, arithmetic units, frequency dividers, numeric filters, digital differential analyzers.

Call for the name of your nearest distributor. **Philco Microelectronics Division Sales Offices:** 2920 San Ysidro Way, Santa Clara, California (408-245-2966) / 999 North Sepulveda, El Segundo, California (213-772-6226) / 594 Marrett Road, Lexington, Mass. (617-862-6000) / Benson Manor, Suite 114B, Washington Lane, Jenkintown, Pa. (215-885-0430) / 1215 Drew Street, Clearwater, Florida (813-446-0124) / 815 Connecticut Avenue, N. W., Washington, D. C. (202-965-0903).

**Microelectronics Division** | **PHILCO**  
SANTA CLARA, CALIF. • LANSDALE, PA. • SPRING CITY, PA. • SUBSIDIARY OF *Ford Motor Company*

Speed Inquiry to Advertiser via Collect Night Letter  
ON READER-SERVICE CARD CIRCLE 53

# Waters



**DUMMY  
LOAD/WATTMETER**  
Mod. 334 .. \$89.95



**REFLECTOMETER**  
Mod. 369 .. \$115



**"LITTLE DIPPER"® RF DIP  
OSCILLATOR**  
Mod. 331 .. \$129.75



**WIDE  
RANGE  
ATTENUATOR**

Model 371-1 UHF .. \$27.95  
Model 371-2 BNC .. \$29.95  
Model 371-3 N .. \$37.95



**PROTAX Mod. 375** .. 6 position rear  
mounted axial connectors .. \$13.95  
**PROTAX Mod. 376** .. 5 position side  
mounted radial connectors .. \$12.50

... when you're  
working with  
**RF** ... designing  
... developing ... testing  
... checking ... switching

We've the unique theory at Waters that reliable products are somewhat difficult to produce without reliable test equipment. So we manufacture reliable test equipment, particularly in the field of radio frequency. Interested? Your inquiry will bring full data.

**DUMMY LOAD/WATTMETER** ... Non-inductive and oil-cooled with direct reading of output to 1000 watts at 52 ohm load. Operates from 2 to 230 megacycles; VSWR less than 1.3:1 up to 230 mc. Calibrated scales provide accurate readings at 0-10, 0-100 and 0-1000 watts.

**REFLECTOMETER** ... Measures forward and reflected power in RF watts simultaneously on a unique double meter. Covers 30 to 230 megacycles at 52 ohms on two separately set forward scales of 200 and 1000 watts (20 and 200 watts reflected) to insure accurate readings. Comes complete with directional coupler and interconnecting cable.

**"LITTLE DIPPER"® RF DIP OSCILLATOR** ... Fully transistorized RF dip oscillator performs as grid dip oscillator, absorption wave meter and signal generator for field use. Operates 2 to 230 megacycles with 7 overlapping plug-in coils. Compact and lightweight.

**WIDE RANGE ATTENUATOR** ... Provides stepped attenuation to 225 mc at 50 ohms from 0 to 61 db in 1 db steps. Used with receivers, signal generators, converters and other low level frequency equipment. Available with UHF, BNC and Type "N" connectors.

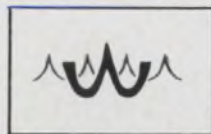

**WATERS**  
MANUFACTURING INC.  
WAYLAND, MASSACHUSETTS

## COAXIAL SWITCHES

Waters makes a Coaxial Switch for every RF switching need! Built with internal ceramic switch and silver plated conductors, each switch rates at 1000 watts and comes with markable escutcheon plate and knob. Our new PROTAX models for antenna switching ground entire antenna systems automatically when equipment is not in use. (Operate to 150 mc)

<b>SELECTOR SWITCH Mod. 325</b> .. Single pole, six position, 7 UHF Connectors .. \$12.95	<b>ANTENNA TRANSFER SWITCH Mod. 341</b> .. Single pole, double throw, 3 UHF connectors .. \$11.45
<b>TRANSFER SWITCH Mod. 330</b> .. Double pole, double throw, internally strapped, 4 UHF connectors .. \$11.45	<b>RADIAL SELECTOR SWITCH Mod. 370</b> .. Single pole, five position, 5 UHF connectors in radial position .. \$12.95
<b>DUAL TRANSFER SWITCH Mod. 351</b> .. Double pole, double throw, 8 UHF connectors .. \$12.95	

## BOOK REVIEWS

### Crystal growth and structure

A book on crystals, their growth and structure is one in a series of Westinghouse Search Books. It describes the arrangement of molecules, atoms and electrons within various crystals and other solids and discusses how the lattice formations determine physical and chemical properties. Imperfections in crystals are examined, and diagrams and illustrations show crystal formation.

*Crystals: Perfect and Imperfect.* A. Bennet, D. Hamilton, A. Maradudin, R. Miller and J. Murphy (Walker and Company: New York). 237 pp. \$5.95.

### Basic microwave principles

An explanation of the principles underlying modern microwave technology begins with wave phenomena, considering electromagnetic waves both in free space and interacting with matter. A discussion of reflection, refraction and diffraction provides the basis for the introduction of antenna theory and a description of antenna types.

Treatment of the transmission line theory and the effects of obstacles and apertures in waveguides is provided, as is a consideration of microwave component design. Mathematical aids are included where needed, but a knowledge of calculus is not required.

*Basic Microwaves.* Bernard Berkowitz (Hayden Book Company, Inc.: New York). 167 pp. \$5.95.

### Power supplies

Methods and circuits for controlling power supply outputs, including the latest innovations are included in this book. Contains numerous diagrams for open-loop regulated supplies, closed-loop regulators, and open-loop circuits using zener diodes. Written for anyone who designs and services regulated power supplies.

*Design and Operation of Regulated Power Supplies,* Irving Gottlieb (Howard W. Sams & Co., Inc., Indianapolis, Ind.) 144 pp. \$3.25

# SIGNETICS- FOR ONE-STOP SHOPPING IN DTL OR TTL CIRCUITS IN DUAL IN-LINE PLASTIC PACKAGES



for military GSE and Industrial/Commercial applications.

Now you can choose from four circuit families in two temperature ranges for military ground systems, industrial and commercial systems. Only Signetics offers this wide a selection of trade-offs in speed, power, overall performance and price.



Fill your needs from these four circuit families — all available in Signetics low cost Plastic Package.

MILITARY GSE	NE 100 A	NE 400 A	NE 800 A
	DTL 0-70° C	Low Power TTL 0-70° C	High Speed TTL 0-70° C
INDUSTRIAL	ST 600 A	ST 400 A	ST 800 A
	DTL 0-70° C	Low Power TTL 0-70° C	High Speed TTL 0-70° C
COMMERCIAL	SP 600 A	SP 400 A	SP 800 A
	DTL 15°-55° C	Low Power TTL 15°-55° C	High Speed TTL 15°-55° C



A subsidiary of Corning Glass Works, 811 East Arques Avenue, Sunnyvale, California. Tel. (408) 739-7700 TWX: (810) 339-9220

ON READER-SERVICE CARD CIRCLE 55

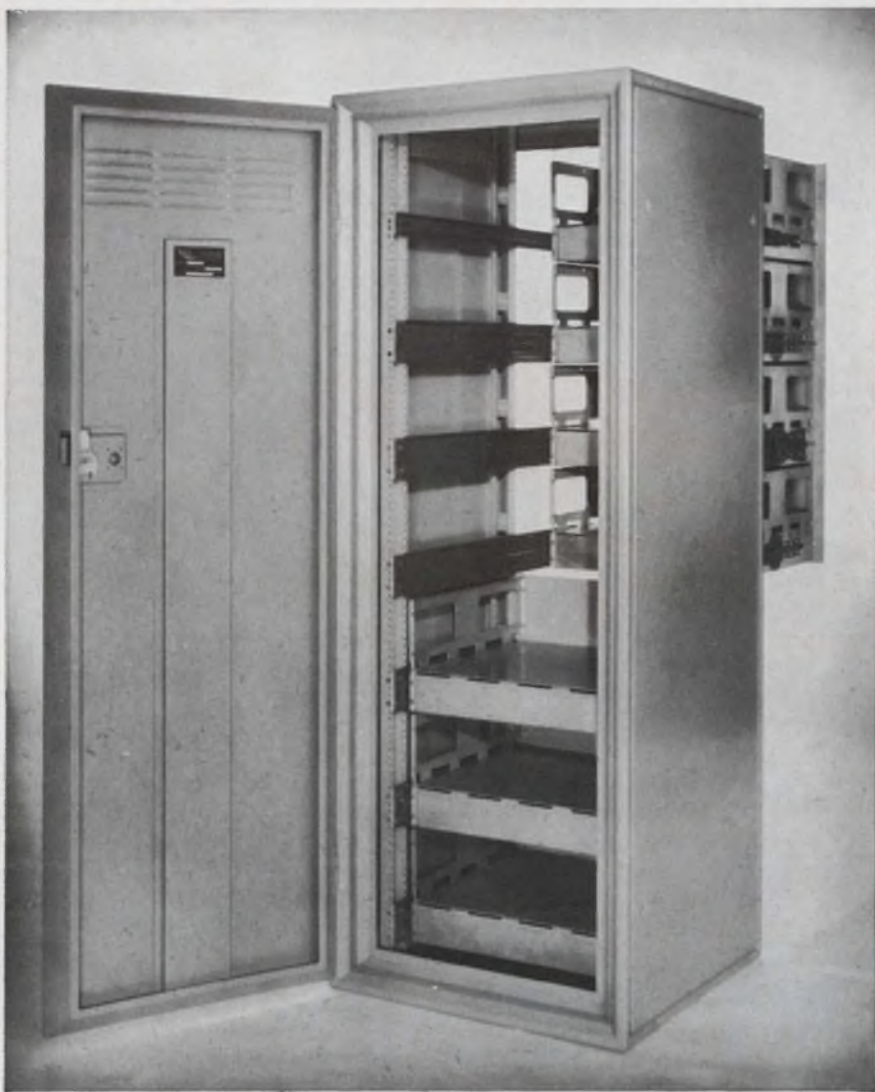

## How much Engineering goes into an Electronic Cabinet?

Countless hours of engineering have resulted in a line of electronic cabinets which meet and exceed all requirements for:

- **VERSATILITY**—simplifies inspection and provides interchangeability between standard models.
- **STRENGTH**—vertical frame posts of unique cross section construction provide exceptional strength.
- **AVAILABILITY**—Vent-Rak's Indianapolis facilities offer a central geographic location to reduce shipping time.

### DELIVERY IS GOOD TOO!

For information on Vent-Rak's complete line of electronic packaging components, write:

525 SOUTH WEBSTER AVENUE  
INDIANAPOLIS 19, INDIANA

ON READER-SERVICE CARD CIRCLE 56



## BOOK REVIEWS

### Bibliographical guide

This second volume of *Electronics* is a bibliographical guide from 1959 to December 1964. It lists directly the major works in the literature of electronics: the authoritative textbooks, the survey articles, reports on main conventions and conferences, and papers in which significant advances have been reported. The aim has been to provide a means by which any paper in the literature of electronics may be located. Emphasis is given to recent trends in the design of electronic equipment such as color television and computer memory.

*Electronics a bibliographical guide-2*, C. K. Moore, Royal Radar Establishment, UK, K. J. Spencer, H. Q. Library, Ministry of Aviation, U. K. (Plenum Publishing Corp., New York) 411 pp. \$18.00

### Junction transistors

The principle purpose of this book is to explain the properties of transistors and to show how their behavior can be described in a way equitable for circuit analysis. Written for students of engineering and physics this text presents more advanced ideas about transistor operation and also explains the operation and characterization of junction transistors to a point from which detailed circuit analysis and design can be undertaken.

*Junction Transistors*, John J. Sparkes, Senior Lecturer in Communications, Imperial College, London (Pergamon Press) 249 pp. \$3.95

### Design approach to electronic devices

This text, geared to students, discusses the operation, modeling and application of active devices with emphasis on semiconductor devices. The relation of Bode plots to the pole-zero analysis and the development and use of the piecewise linear model are covered. Each chapter contains a summary and problems of circuit design. Included are a list of symbols and quantities and data sheets on semiconductor devices.

*Electronics*. Roy H. Mattson, (John Wiley & Sons, Inc., New York) 620 pp. \$12.95.

# new from RADIATION: IC Operational amplifiers

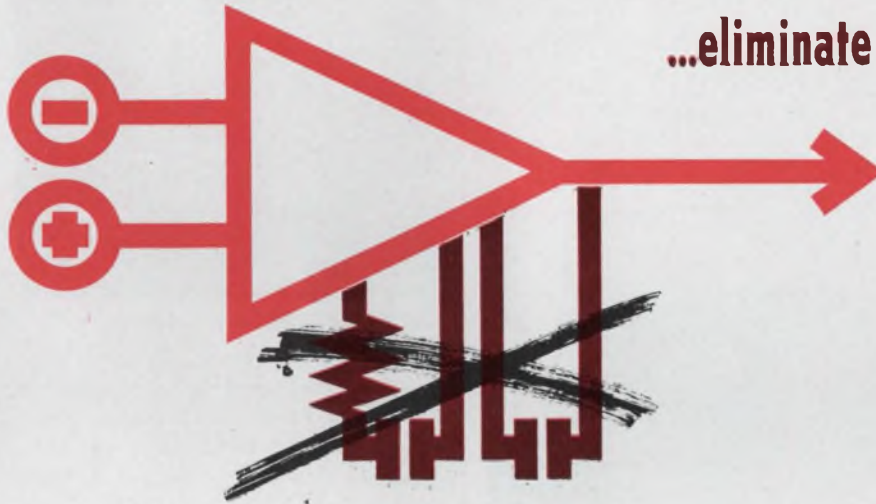

...eliminate stabilizing networks

Radiation announces a new line of universal building blocks for integrated analog circuitry. Three different types of operational amplifiers are available to serve your individual needs: general-purpose, broadband, and high-gain circuits.

These highly-stable wide band amplifiers operate at unity gain *without* external stabilization. Thus, design cost and packaging space are reduced.

Further, superior design provides outstanding performance: Parasitics are eliminated, thanks to Radiation's unique dielectric isolation technique. Tighter tolerances and improved temperature coefficients are achieved through use of thin film resistors over the oxide.

Radiation operational amplifiers are ready for *immediate* shipment. Write or phone for data sheets which include worst-case limits, and contain all information required by design engineers. Radiation Incorporated, Physical Electronics, Department ED-08, Melbourne, Florida 32901, Phone: (305) 723-1511, extension 554.

## Typical electrical characteristics

PARAMETER	UNIT	General Purpose	Broad Band	High Gain
		RA-238	RA-239	RA-240
Phase margin		60°	45°	60°
Bandwidth (unity gain)	MHz	7	15	6
Voltage gain		2,700	2,700	50,000
Offset voltage	mV	2.0	2.0	2.0
Offset current	nA	80	400	80
Thermal drift	$\mu\text{V}/^\circ\text{C}$	5	5	5
Output swing	$V_{P-P}$	21	21	9
Power consumption	mW	90	160	90
Common mode rejection	db	100	100	100
Power supply rejection	db	80	80	80
Input bias current	$\mu\text{A}$	0.4	1.2	0.4

Standard temperature range:  $-55^\circ\text{C}$  to  $+125^\circ\text{C}$

All Radiation integrated circuits are dielectrically isolated.



**RADIATION**  
INCORPORATED

Sales offices: Suite 622, 650 North Sepulveda Blvd., El Segundo, Calif. (213) 772-6371 ■ Suite 232, 600 Old Country Road, Garden City, N. Y. (516) 747-3730 ■ P.O. Box 37, Melbourne, Florida (305) 723-1511, extension 554.

Speed Inquiry to Advertiser via Collect Night Letter  
ON READER-SERVICE CARD CIRCLE 57

The Victor Imperial Digit-Matic can do anything other serial entry printers do. Only Victor does it for less.

For \$335 it lists 8-column figures from remote sources. It can do this on either 24 or 48 volt solenoids. Solenoid pulse timing: .025-.050 sec. "on" time; .025 sec. minimum "off" time.

And because it operates on printing press action, it reduces wear, eliminates parts, and assures uniform, clear printing.

For only \$50 more, the Digit-Matic will add and subtract as well. O.E.M. and quantity discounts available.

There are Victor service representatives covering every county in the United States.

Can the Victor Imperial Digit-Matic do anything at all? Just about. Write: Victor Comptometer Corporation, Business Machines Group, 3900 North Rockwell Street, Chicago, Illinois 60618.

**VICTOR**

**VICTOR**  
*Digit-matic*

Only \$335?  
Can it do  
anything at all?

ON READER-SERVICE CARD CIRCLE 58

## BOOK REVIEWS

### space communications systems

RICHARD F. FILIPOWSKY  
EUGEN I. MUEHLDORF



PRENTICE-HALL SPACE TECHNOLOGY SERIES

C. W. SEITZBERG and PAUL S. WOOD, Editors

INTERNATIONAL SERIES IN SPACE TECHNOLOGY

A comprehensive and practical treatment  
of the fundamentals and applications  
of space communication links from source to sink

### Space communications

Here under one cover is a compact, yet thorough and informative treatment of virtually every aspect of space communications systems. Divided into two parts, Fundamentals and Applications, the book begins with a chapter covering the motion and dynamics of a space vehicle. Proceeding through discussion and explanation of the environmental and reliability considerations involved in space communications system design, the propagation and noise problems involved, the authors conclude the Fundamentals section with a chapter devoted to types of space communications links and their design.

The second part, Applications, provides an interesting treatment of existing systems, their requirements and their performance. Appendices provided at the end of the book contain data related to system requirements, test plans, reliability, estimates, performance criteria, etc.

Throughout all parts of the book, the authors have emphasized the systems characteristics of space communications. In keeping with this systems concept, a large part of the material in this work is devoted to showing how the electronic systems which serve communications functions can be integrated with other electronic, thermal, mechanical and optical systems to satisfy requirements for a given space mission.

(continued on p. 128)

ON READER-SERVICE CARD CIRCLE 59 ➤



# PACKAGING WITH COORS CERAMIC

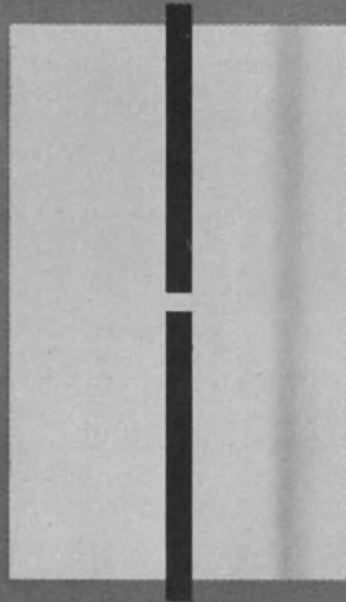

VACUUM SWITCHES

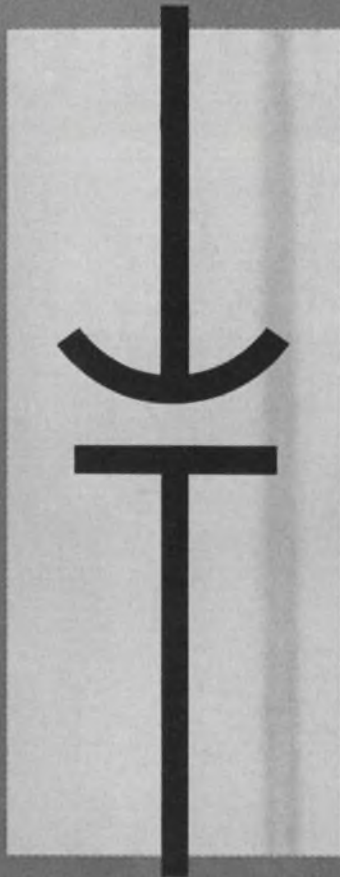

VACUUM CAPACITORS

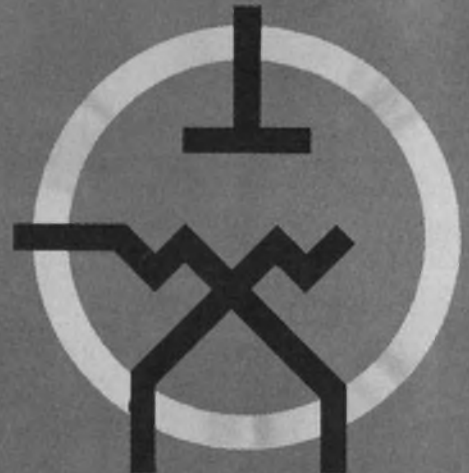

VACUUM TUBES

When your packaging application demands high strength and reliability — envelopes for vacuum switches, vacuum capacitors, vacuum tubes — use Coors high alumina ceramics. Outstanding properties include high dielectric characteristics at high frequencies, and high mechanical strength even at high temperatures. These materials can be metalized and subsequently brazed with bond strengths up to 15,000 psi. Coors has facilities for forming, for metalizing and for precision inspection of mass production quantities of dimensionally uniform envelopes. Small parts are dry-pressed . . . larger ones are isostatically formed. Write for "Ceramic Envelopes for Electronic Packaging," Data Sheet No. 7003, or call your nearest Coors regional sales manager: SOUTHERN CALIFORNIA: R. E. Ousley, (213) 347-3060, Los Angeles, Calif.; BAY AREA AND NORTHWEST: W. Everitt, (408) 245-2595, Sunnyvale, Calif.; MIDWEST: Tom Daly, (312) 529-2510, Chicago, Ill.; CENTRAL: Don Lewis, (216) 288-1000, Cleveland, Ohio; EAST COAST: Robert F. Doran, (516) 427-9506, Huntington, N. Y.; Herbert W. Larisch, (215) 563-4487, Philadelphia, Pa.; NEW ENGLAND: Warren G. McDonald, (617) 222-9520, Attleboro, Mass.; SOUTHWEST: William H. Ramsey, (713) 864-6369, Houston, Tex.; John West, (214) AD 1-4661, Richardson, Tex.

# Coors

## CERAMICS

ALUMINAS • BERYLLIAS • MAGNESIAS • SPECIAL OXIDES

Coors Ceramic Co., Golden, Colo.



# Automate Your Precision Operations

with **KAHLE**

**FULLY AUTOMATIC**

## **PRODUCTION MACHINES**

Performance  
Proven on  
Miniature  
and Sub-  
Miniature  
Electronic,  
Glass and  
General  
Industrial  
Components  
and  
Finished  
Products

This Kahle precision machine produces a two-piece component lead wire by butt welding a pre-cut slug of molybdenum to a Dumet wire. The pre-cut slug is automatically fed into a six-head indexing turret. The Dumet wire is straightened, cut and welded to the slug. Available for all types of miniature and sub-miniature lamps.

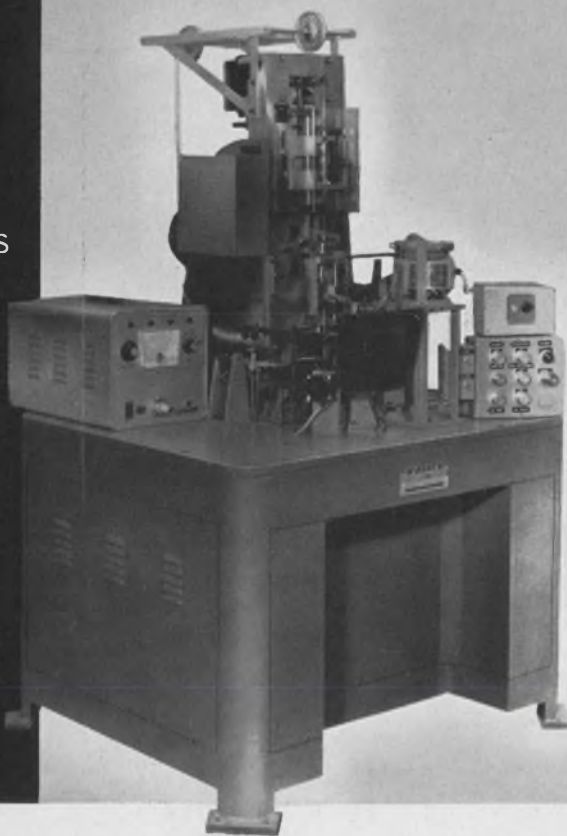

CAP      STUD

### **KAHLE Automatic Production, Assembly and Quality Control**

Ask KAHLE to recommend improved methods of production that will save you time and money. Fully automatic KAHLE machines can be supplied to assemble, inspect and test your components.

### **KAHLE Machines are Customer-Approved under Actual Operating Conditions**

Your equipment is run in our factory, using your materials in the presence of your engineers; the machine is not shipped to you unless you approve it!

**SAVE TIME AND MONEY** — Let professionals build your specialty production equipment for automation!

**KAHLE**

Designers and Builders  
of Automatic Equipment  
for High Speed Production  
for Over 30 Years

**Kahle Engineering Company**

3332 HUDSON AVE., UNION CITY, N. J. 07087

Telephone: (201) 867-6500

KAHLE EUROPEA — Via Spartaco 16, Caravaggio (Bergamo), Italy

ON READER-SERVICE CARD CIRCLE 60

### BOOK REVIEWS

(continued from p. 126)

Planned as both a text and a reference, the book succeeds on both counts. Practicing engineers as well as students will find it a useful addition to their libraries.

*Space Communications Systems*, Richard F. Filipowsky, Eugen I. Muehldorf (Prentice-Hall, Inc., Englewood Cliffs, N. J.) 575 pp.

### **Control systems**

Collections of papers given at a USSR Conference on Automatic Control and Computer Engineering are given in two volumes. They cover both analog and digital computing techniques.

Volume 1 examines problems of developing and applying resources of computer engineering in the automatic control of manufacturing processes. Examples for using computer system design and the automation of manufacturing processes are included.

Volume 2 deals with the dynamics of control systems containing computers. Non-linear theory of oscillations are examined, as are theories of impulse systems and of vibrational smoothing of non-linear characteristics of automatic control systems.

*Automatic Control and Computer Engineering*. V. V. Solodovnikov, ed. (Pergamon Press: New York). 2 vols.

### **Using oscilloscopes**

Latest methods for using an oscilloscope for faster, more proficient servicing, are included in this book. Tells how to make waveform tests and how to analyze the waveforms produced by defective circuits. Much of the book is related to television set testing, covering the various sections of both black and white and color TV sets in detail. Charts are found for some of the common circuits. The use of square waves to evaluate circuits and components is also explained. For each test described, information is included on equipment needed, connections required, procedure, and test evaluation. Includes many illustrations and waveforms.

*101 Ways to Use Your Oscilloscope*, Robert G. Middleton, (Howard W. Sams & Co., Inc., Indianapolis, Ind.) 192 pp. \$2.95

Say you started out to design a hi-rel regulator that would replace bulky DO-7 and 13 cans.

But still deliver at commercial prices.

First you'd tap management for quite a few kilobucks and a room full of the best brains.

Then, after both were spent, you'd find you'd developed a thermally-grown, oxide-passivated, silicon wafer. With brazed leads. Snug fitting slugs. And exclusive hermetic seal.

And you'd pass the word along that it'd take more heat and current than the old metal cans.

Now what?

You'd expand the line and wind up with twenty-eight each HW 1 watt or HM 400 mw micro-glass, micro-miniature regulators that you could deliver in a week.

Which is what we did right here.



**Hoffman** SEMICONDUCTOR

A Division of Hoffman Electronics Corporation, Hoffman Electronic Park, El Monte, California 91734

ON READER-SERVICE CARD CIRCLE 61

# These three **NIXIE®** tubes will fill **80%** of your **digital-readout** requirements



STANDARD RECTANGULAR



MINIATURE RECTANGULAR



LOW-COST SIDE-VIEWING

The most popular readout ever made—Type 8422. Combines *readability* (maximum viewing distance of 30 feet), *compact* size (0.6" character in a 1.0" x 0.8" end-reading rectangular envelope) and *high reliability* (MTBF of 1 million hours at 90% confidence level). Also available in a decimal-point version, Type B-59956. For high-density packaging (0.7 cu. in.) and minimal instrument height, it's the choice of virtually every important manufacturer of digital instrumentation.

Small wonder this readout (Type B-4998) is chosen when a combination of *compact* size (0.3" character in a 0.47" x 0.63" rectangular envelope), *long life* (200,000 hours dynamic life) and *readability* (maximum viewing distance of 14 feet) are needed. For the smallest electronic readout with BCD decoding and memory, use the B-4998 with the Burroughs BIP-9401A module. Small wonder, indeed!

Our new side-viewing NIXIE tube, Type B-5440. Combines *long-life* (average life of 600,000 hours) with *low cost* (\$4.95 in 1000 quantity). Tube has low profile and narrow width for minimum panel-area opening (you can line them up on less than 0.80" centers), and its new socket is especially designed for pc-board mounting. Independently-operable decimal points are optional at slight extra cost (Type B-5441).  
**Call or write for full information.**

See us at ISA Booth 1320  
See us at NEREM Booth 1B69-70  
See us at Fall Joint Computer Conference Booth 835-37

(and we've got the  
**NIXIE tubes** for that  
other 20%, too!)

*Only Burroughs manufactures NIXIE Tubes*



**Burroughs Corporation**

ELECTRONIC COMPONENTS DIVISION

PLAINFIELD, NEW JERSEY 07061

# Products



**Power FET** "on" resistance drops to  $4 \Omega$  while transconductance hits  $150,000 \mu\text{mho}$ . Page 132

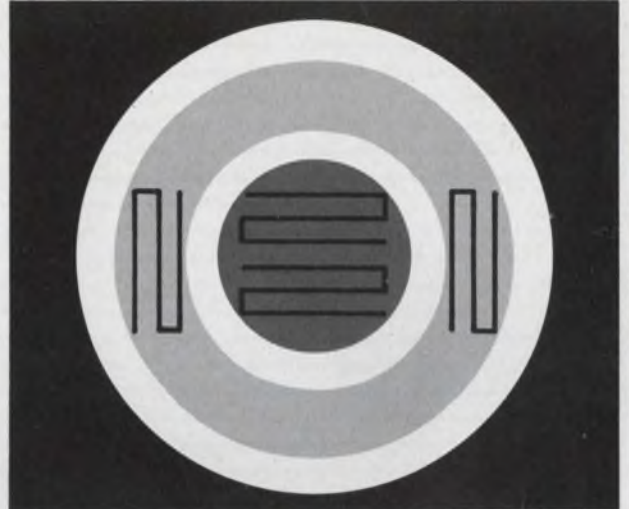

**Monolithic pressure sensor** uses a single silicon crystal as its diaphragm. Page 166

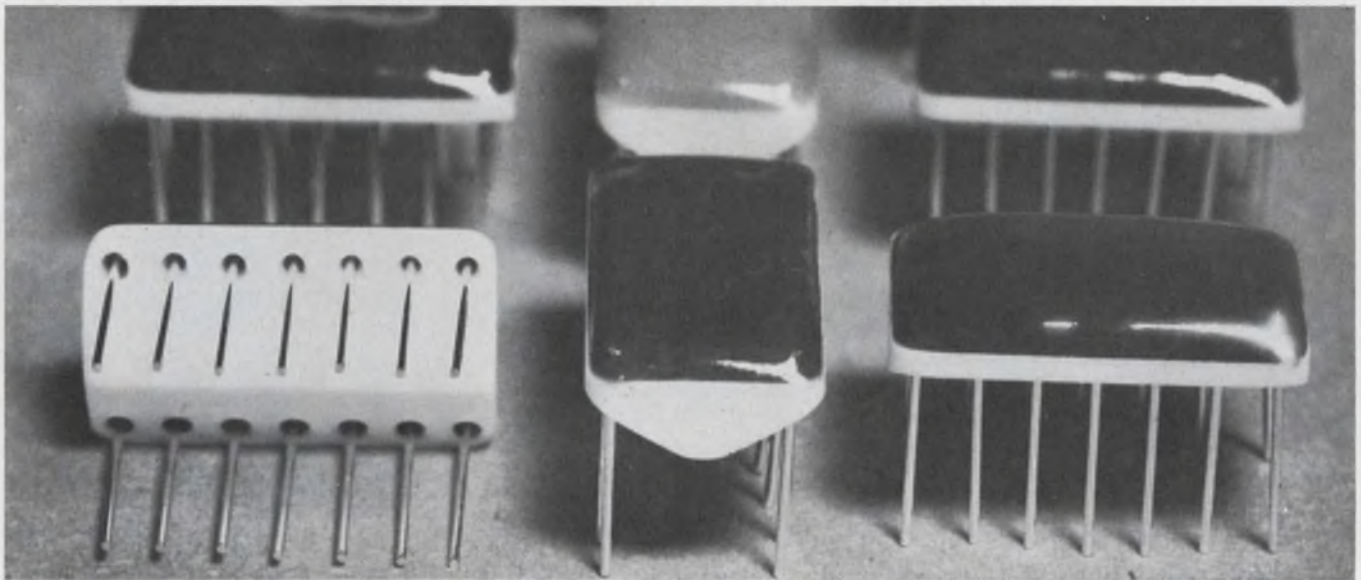

**Epoxy DTL circuits** in dual in-line package cut costs. The series consists of gates, J-K flip-

flops, buffers, line drivers, expanders and inverters. Page 136

## Also in this section:

**Epoxy transistors** in TO-18 can for low-cost, high-speed switching. Page 134

**4-bit storage registers** operate in BCD or biquinary mode. Page 138

**Circuit test board** uses stainless steel springs to secure components. Page 158

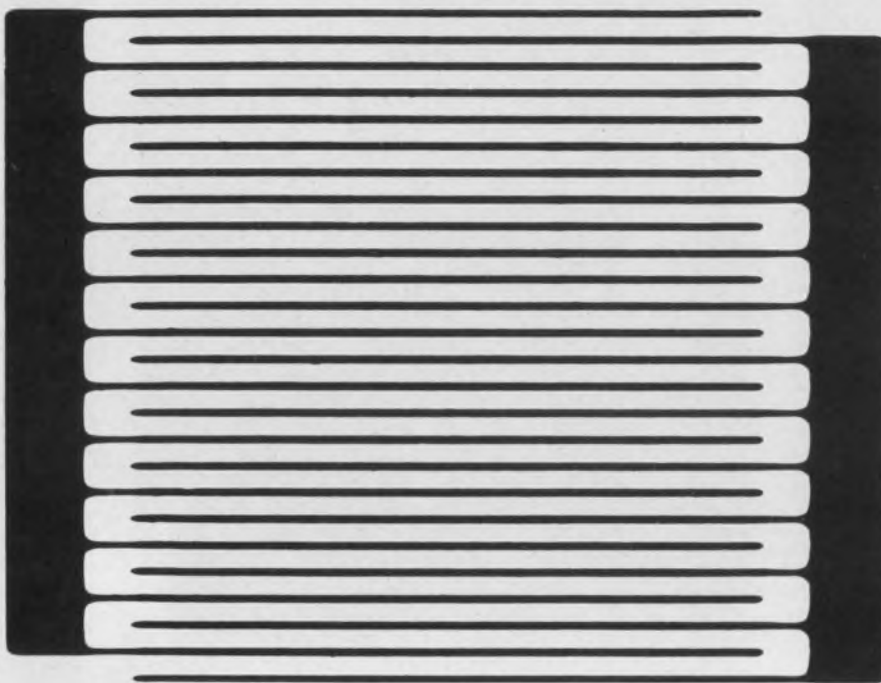

## Power FET "on" resistance reaches a new low

Two series of silicon n-channel field-effect transistors boast the lowest "on" resistance of any currently available device. The CP650 series of power and switching FETs and CM650 series switching FETs have maximums of 5 and 4  $\Omega$  respectively. Previous lows, achieved by Texas Instruments, have been in the 20- $\Omega$  range for their switching FETs. In addition, transconductances ( $g_m$ ) reach 150,000  $\mu\text{mho}$ , drain currents ( $I_{DSS}$ ) are 1.2 A and theoretical gain-bandwidth product is 1.5 GHz.

Low drive power requirements make the CP650 attractively for use in power supply regulators. As an RF amplifier (2 to 30 MHz), the CP650 has exhibited a dynamic range exceeding 140 dB. As a switch (CP652), the low  $R_{DS}$  and high-speed ( $T_{on}/T_{off} < 20$  ns driven from 50  $\Omega$ ) make these FETs suitable for high-speed D-to-A converters, core drivers or even low-current SCR replacements. Low leakage currents ( $I_{GSS}$  is less than 3 nA) coupled with inherent FET zero offset voltage suggest solid-state relay applications. Other applications include inverters and

current sources.

Other specifications include maximum capacitances of 20 pF gate-to-source and gate-to-drain. Breakdown voltages are 20 V.

The CP650 is packaged in a copper-base TO-5 can with the gate connected to case. The package dissipates 9 W at 25°C case. (The FETs should be useable up to 5 W at 800 MHz). The 25-channel device is an interdigitated design having a large active area with a total equivalent gate length of less than 1.5 in. The chip itself measures 40 x 40 mils.

The CM series of switching FETs has basically the same specs. Dissipation is only 400 mW derating at 2.3 mW/°C. Peak gate current is 100 mA and peak drain current is 400 mA. Drain currents are specified at 100 and 150 mA. Both devices have an operating and storage junction temperature range of -65 to 200°C.

P&A: \$26 to \$42 (CP series), \$25 to \$48 (CM series), (1 to 99); November. Crystalonics Div., Teledyne Inc., 147 Sherman St., Cambridge, Mass. Phone: (617) 491-1670.

Circle No. 117

## Diff-amp transistor

Differential base current drift of the A607 and A608 differential amplifier transistors is 1.5 nA/°C. With a differential voltage drift of 5  $\mu\text{A}/^\circ\text{C}$ , the A607 offers high gain stability against changes in current drain. Total variation in  $h_{FE}$  for collector currents from 10 to 100  $\mu\text{A}$  is 3 dB. Packaged in TO-5 cans, these transistors offer increased amplifier sensitivity and linearity.

Amperex Electronic Corp., Slattersville, R. I. Phone: (401) 762-9000.

Circle No. 118

## Laser chips

Operating at liquid nitrogen temperatures under pulsed conditions, these gallium arsenide phosphide laser chips are available at any wave length between 6500 and 8300 Å with spectral halfwidth of about 8 Å. The chip is mounted on a TO-46 solid Kovar header. Output is typically 0.5 W at 25 A with a 50-ns pulse and a repetition rate of 75 pps. Threshold currents are less than 15 A.

P&A: \$13 to \$19.50; stock. Monsanto Co., 800 N. Lindbergh Blvd., St. Louis. Phone: (314) 993-1000.

Circle No. 119

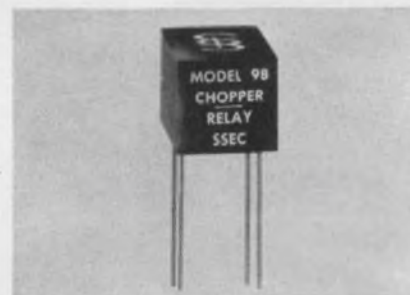

## Chopper-relay

This inertialess chopper-relay can be driven from dc to 5 kHz with complete isolation between either drive terminal and contact terminals. Noise is 25  $\mu\text{V}$  and dynamic range can be extended from  $\pm 75$   $\mu\text{V}$  to  $\pm 20$  V. Alternate application of a polarized or ac square wave causes the device to act as an spst chopper. Two units may be connected to form an spdt chopper or switch.

Solid State Electronics Corp., 15321 Rayen St., Sepulveda, Calif. Phone: (213) 785-4473.

Circle No. 120

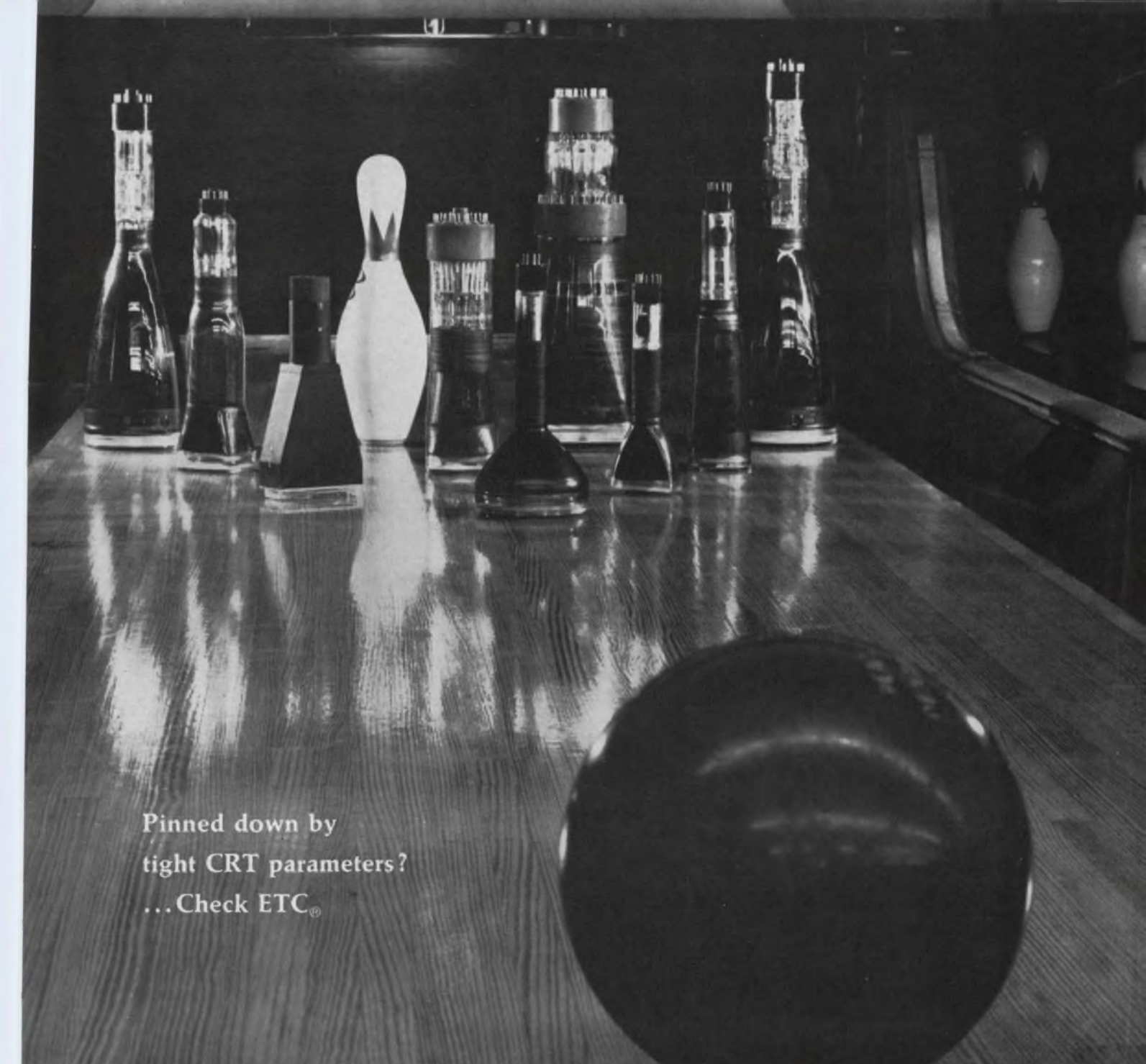

Pinned down by  
tight CRT parameters?  
... Check ETC<sup>®</sup>

## Tube capability is right down our alley

Challenge has been our game for nearly 30 years... the challenge of designing, engineering and producing new CRT's for special applications.

We meet this challenge continually, and from our modern R & D and manufacturing facilities have come many "firsts" in CRT development. Our contributions to industry, science and the military have earned us a reputation for solving the particularly difficult display problem.

Today, as a result of our 3-decades of pioneering activities in tube technology, we offer one of the largest lines of off-the-shelf CRT's in the industry. Each has undergone the quality-controlled product engineering and stringent testing required as a custom fabricated item. And each will provide more performance per dollar in the application for which it was designed.

Try "pinning us down" to your individual CRT needs, whether

they involve multi-gun displays, multi-layer phosphors, special bulb shapes, or ultra-high resolution.

You'll find us "right down your alley" when it comes to meeting your specs. Why not call us today ... or write for our complete capability catalog.

**GENERAL  
ATRONICS**  
ELECTRONIC TUBE DIVISION  
PHILADELPHIA • PENNSYLVANIA 19118





## Who says this is the finest trimmer available for the money?

## Only the users!

If we were to claim that the Model 84 is better and less expensive than any comparable trimmer available today, you would doubt us. If we said that we are offering in this half-inch, single-turn, wire-wound trimming potentiometer quality features unavailable anywhere else, you would suspect we were boasting. You might even doubt us when we stated that this trimmer really meets MIL-SPECS without faking — that is, with comfortable margins to spare.

And when we told you that the Model 84 price was half that of many larger square and rectangular models that perform to the same

environmental specs, you would be sure we were exaggerating.

So we won't tell you any of these things. Instead, we will just say that the Model 84 has been widely accepted as a standard in many important military applications and that our civilian users are enthusiastic in their praise. Beyond that, we won't try to sell you.

If you'd like a data sheet, contact us or your local Spectrol representative or distributor. Note that the Model 84 is rated at 1½ W. at 70°C, has a standard resistance tolerance of ±4%, and is completely immersible.

Spectrol Electronics Corporation  
17070 E. Gale Ave., City of Industry,  
California 91745

## SEMICONDUCTORS

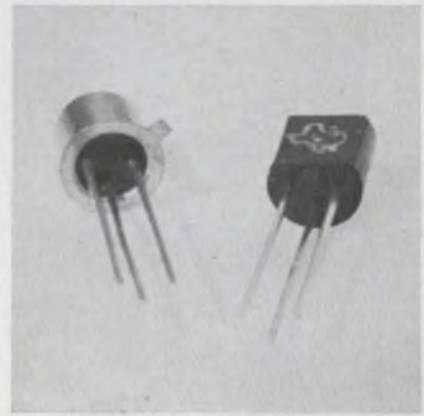

### TO-18 epoxy transistors

A family of one-piece plastic-encapsulated silicon transistors is packaged with leads in a standard TO-18 pin-circle configuration. Initial devices with the 100-mil diameter pin-circle include a family of complementary npn/pnp, high-speed low-level switches. Type numbers 2N4418 and 2N4419 (2369), 2N4420 (3014), 2N4421 (706), 2N4422 (3646 and 3013) and 2N4423 (2894) are direct plug-in replacements for the metal-can units shown in parentheses. Since no lead-forming is necessary, the transistor can be mounted flush on PC boards. Package height is 185 mils. Leads are silver-plated nickel.

P&A: \$0.45 (2N4419); stock.  
Texas Instruments Inc., 13500 N.  
Central Expressway, Dallas, Texas.  
Phone: (213) 235-3111.

Circle No. 121

### Low-noise MOSFET

A new single-gate MOSFET, the 3N128, is designed for vhf amplifiers, mixers and oscillators. It is also suited for use in low-frequency amplifier applications requiring a transistor having high-power gain and very high input impedance. In addition, the MOS process makes possible a feedback capacitance of 0.2 pF max. The 3N128 is an N-channel, depletion-type silicon device with a transconductance ranging from 5000 to 7300  $\mu$ mho. Typical power gain is 18 dB and noise figure is 4 dB at a drain current of 5 mA, a drain-to-source voltage of 15 V and a frequency of 200 MHz.

RCA, Electronic Components and Devices, Harrison, N. J. Phone: (201) 485-3900.

Circle No. 122

# spectrol

ON READER-SERVICE CARD CIRCLE 64



# When you've got to put out a fire...

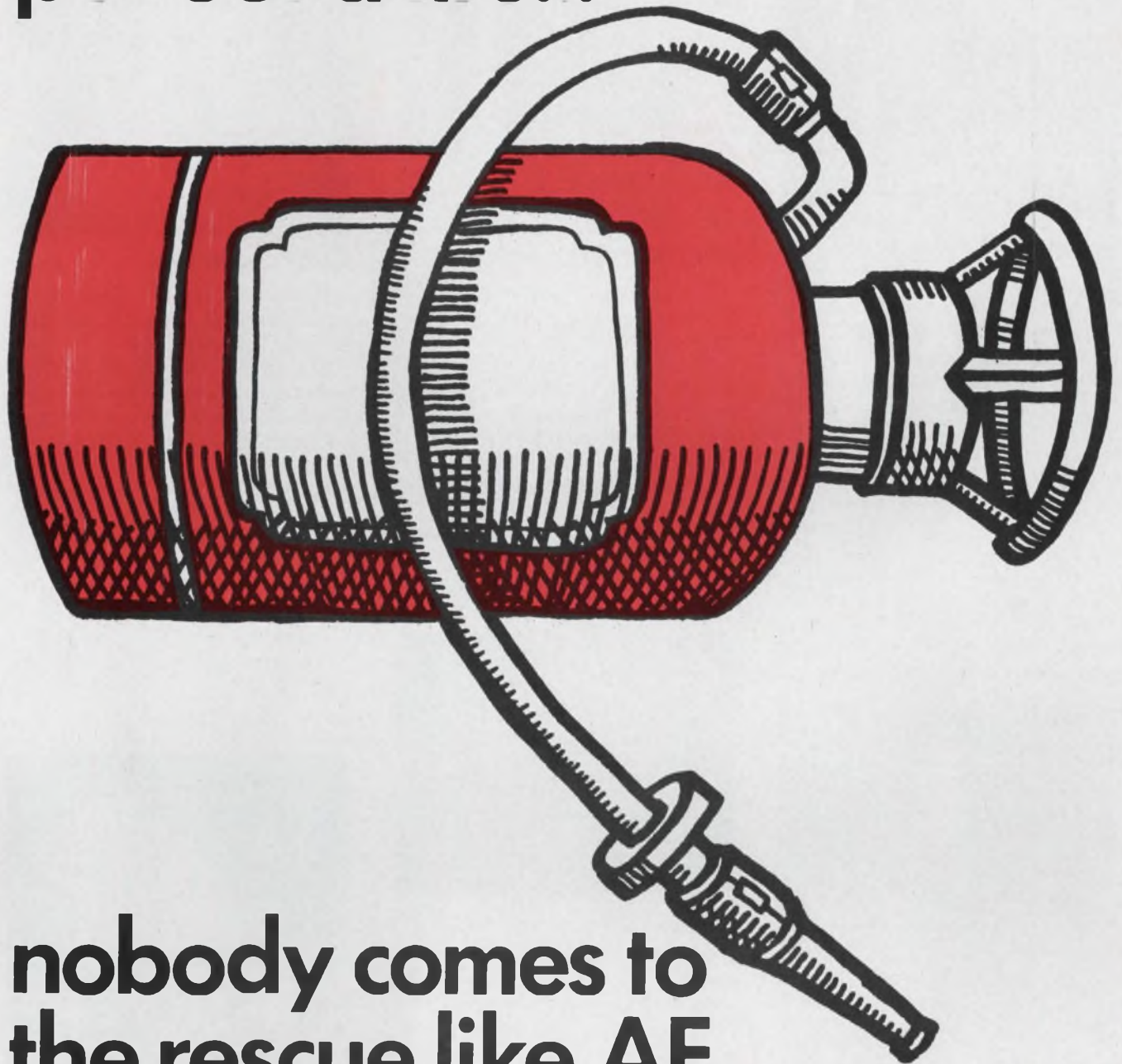

## nobody comes to the rescue like AE.

Got a burning question...like which relay is *exactly* right for a critical circuit?

Sound the alarm, and your AE man will speed you the answer. This is what he's trained to do. If your problem is a real four-alarm fire, your AE representative can call upon a staff engineer from our district office nearest you. This relay expert has thousands of relay application experiences to help him help you.

Nobody else in the relay business can offer this kind of "firehouse" service. AE can, because we're in the

telephone business, too. We know relays and switches and how to use them.

You'll find your AE man in the Yellow Pages, under "Relays." Call him, next time the heat's on. Or drop a line to Director, Relay Control Equipment Sales, Automatic Electric, Northlake, Illinois 60164.

### ***AUTOMATIC ELECTRIC***

SUBSIDIARY OF  
**GENERAL TELEPHONE & ELECTRONICS** **GTE**

ON READER-SERVICE CARD CIRCLE 65

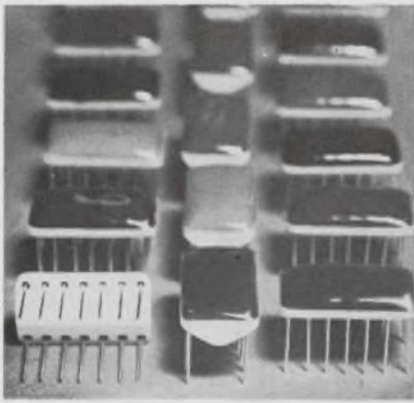

### Epoxy DTL ICs

Epoxy DTL circuits, designated the E-line, are standard 930 series DTL circuits in a dual in-line package. The family consists of gates, buffers, line drivers, and expanders. The J-K flip-flops have a typical toggle rate of 24 MHz. Special packaging features include standard 100-mil center-to-center spacing between round kovar leads and standard 300-mil spacing between lead ranks.

Price: \$1.40 to \$2.80 (100 to 1000). Microelectronics Div., Philco Corp., 2920 San Ysidro Way, Santa Clara, Calif. Phone: (408) 245-2966. *Circle No. 123*

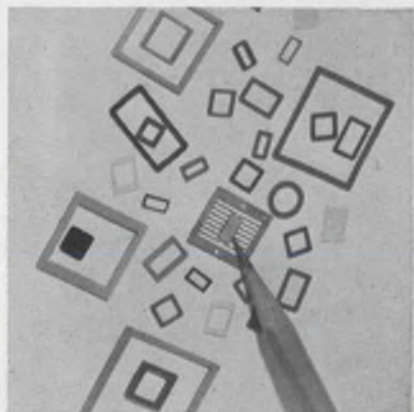

### Preformed glass frames

Preformed glass frames for sealing alumina or Kovar bases to their Kovar leads are offered. The preformed frame introduces a finite amount of sealing glass and can be shaker loaded into the sealing jigs. The frames are available in custom sizes with 0.02-in. minimum thickness and ranging from 1/4 x 1/8-in. up to 0.98-in.<sup>2</sup>.

P&A: \$10 to \$400/M, 5 to 8 wks. Glass Beads Co., P. O. Box 266, Latrobe, Pa. Phone: (412) 537-7791.

*Circle No. 124*

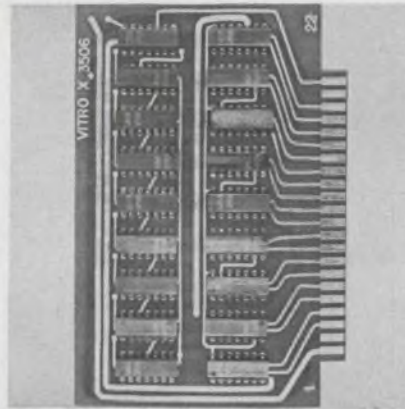

### Microcircuit modules

High-density logic modules can accommodate up to 18 removable microcircuits on a single card. All boards have been standardized for positive NAND logic functions at a voltage swing from 0 to 3 V. The DTL devices used have individual circuit speeds up to 10 MHz and equipment speeds above 5 MHz. Boards can be custom built.

Vitro Electronics, 919 Jesup-Blair Dr., Silver Spring, Md. Phone: (301) 585-1000.

*Circle No. 125*

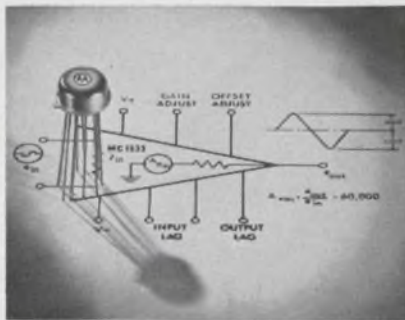

### IC op-amp

Designed for use as a summing amplifier, integrator or amplifier with operating characteristics as a function of external feedback components, this op-amp has open loop voltage gain of 40,000 min and 60,000 typical. Average temperature coefficient of input offset voltage is typically 3  $\mu$ V/ $^{\circ}$ C from 25 to 125 $^{\circ}$ C and 5  $\mu$ V/ $^{\circ}$ C from -55 to 25 $^{\circ}$ C. Input offset voltage is 5 mV max adjustable to zero by an external resistor. Full output voltage swing is  $\pm$ 12 V min with a  $\pm$ 15-V supply and 10-k $\Omega$  load.

P&A: \$34 (over 100); stock. Motorola Semiconductor Products Inc., Box 944, Phoenix. Phone: (602) 273-6900.

*Circle No. 126*

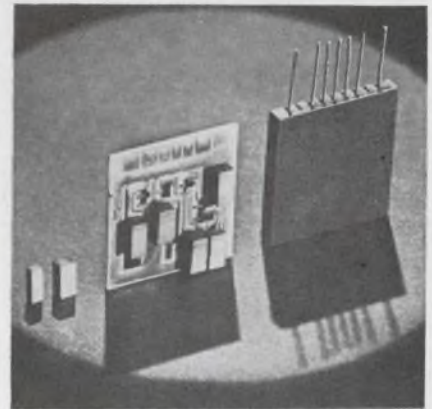

### Chip capacitor

Made of alternate layers of ribbon glass and dielectric material, fused into a monolithic chip, these miniature chip capacitors are metallized on the ends and can be soldered directly to the conductor on a substrate. The 0.19- x 0.95- x 0.08-in. version has a range of 0.012 to 0.051  $\mu$ F. Working voltage is 50 Vdc from -55 to 125 $^{\circ}$ C. Worst case capacitance change from accelerated life testing is 2% max for the lower capacitance values and 10% max for the higher values.

Corning Glass Works, Corning, N. Y. Phone: (607) 962-4444.

*Circle No. 127*

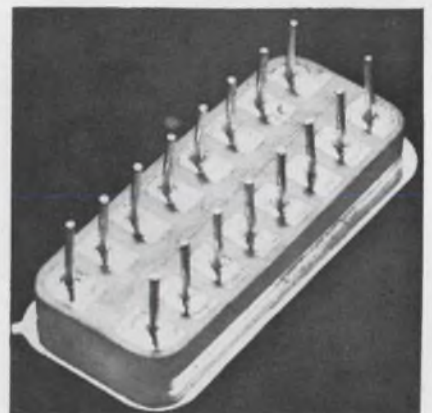

### 16-pin header assembly

A 16-pin dual-in-line header assembly for complex function ICs is designated HA-1496. The package is a high-temperature brazed construction using 95% aluminum oxide. Closure is made by capacitance discharge welding.

P&A: \$250 (set of 25 with covers and flanges); 6 to 8 wks. Mitronics Inc., 132 Floral Ave., Murray Hill, N. J. Phone: (201) 464-3300.

*Circle No. 128*



## Relay shipments rescheduled again? Next time call Leach!

One week delivery. That's a promise. At least on standard units. Even our new **SERIES K** for example. Here's a 10 amp 4PDT polarized relay offering maximum capabilities for the most severe aircraft, missile and aerospace applications. And we have built up an inventory to cover your requirements.

The **SERIES K** holds size and weight to an absolute minimum without sacrificing operating characteristics. It will withstand 100g shock, 30g, 70 to 3000 cps vibration, meets Mil-R-6106E and has a temperature

range of  $-70^{\circ}$  to  $+125^{\circ}$ C. Operate and release time is less than 15 milliseconds including bounce. Yet it measures only 1.000" x 1.015" x 1.015" and weighs less than 2.5 ounces. Need one? A dozen, a hundred? Even a thousand? Then call us today. You'll have them. Right on time.

Leach Corporation, Relay Division, 5915 Avalon Boulevard, Los Angeles, California 90003  
Phone (Area code 213) 232-8221  
Export: LEACH INTERNATIONAL S.A.



# LEACH

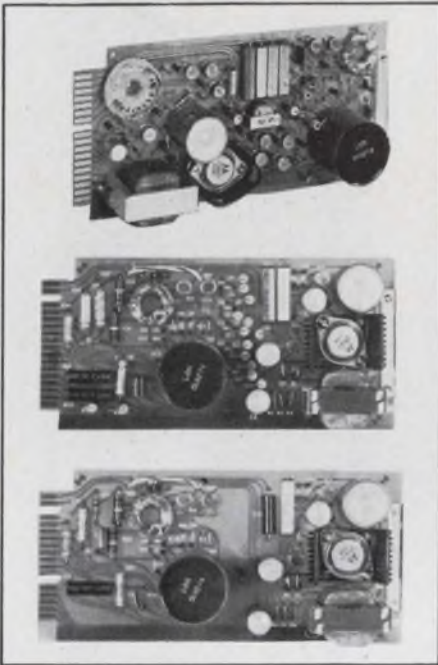

## Top performance... bottom price

Start with the excellent design features and simplified construction of our completely self-contained printed-circuit cards (the magnetic operational amplifier . . . the magnetic square-root extractor . . . the magnetic multiplier/divider) that are now available for your industrial control, scientific and laboratory applications.

Then consider our field-proven advanced design features that give you these advantages:

- Self-contained power supply
- Full input-output signal isolation
- Compatibility with either current or voltage signals.

For good measure, add high reliability, excellent stability and maintenance-free operation . . . all on a single printed-circuit card. That's why we build them for use in our systems and for others who demand this type of performance . . . at low cost.

Need more information? Write to: Components Division, Leeds & Northrup, North Wales, Pa. 19454.



**LEEDS & NORTHRUP**  
Philadelphia 44 • Pioneers in Precision

ON READER-SERVICE CARD CIRCLE 67

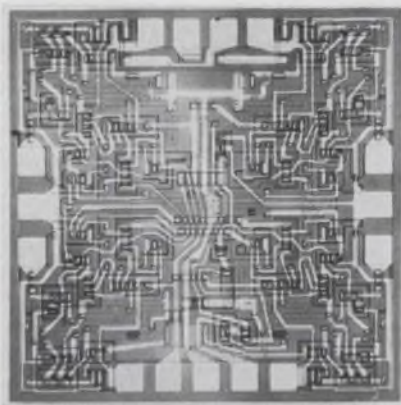

## 4-bit storage registers

Two monolithic silicon sub-systems, a 4-bit decade counter/storage register (S1289A) and a 4-bit binary counter/storage register (S1281A), incorporate four J-K flip-flops and 13 gates. Equivalent discrete component count is 160. The S1280A may be used in either the BCD or bi-quinary mode to provide the square wave output for frequency synthesis. This flexibility results from the incorporation of separate divide-by-two and divide-by-five functions on the chip. The S1281A contains separate one- and three-stage binary counters which may be cascaded by external connections to obtain a four-stage binary counter. The unit therefore provides division by 2, 4, 8 or 16. Both feature strobed single-ended parallel entry capability and are offered in a plastic dual-in-line plug-in package.

P&A: \$14.40 (100-up); immediate. Signetics Corporation, Sunnyvale, Calif. Phone: (408) 739-7700.

Circle No. 129

## Thermoelectric modules

A "building block" for temperature control applications, this thermoelectric module has flat surfaces, parallel to  $\pm 1/2$  mil. The metallized ceramic construction provides internal thermal stresses approximately  $1/2$  that of copper and  $1/4$  that of aluminum capped modules of the same size. The unit will pump 67 Btu/h max and provides an unloaded temperature differential of  $65^{\circ}\text{C}$  max when operated at 9 A and 4 V. The G9-65 measures 1.25 x 1.25 x 0.21 in.

EG&G, Inc., 160 Brookline Ave., Boston. Phone: (617) 267-9700.

Circle No. 130



## Wirewound networks

Available as voltage dividers, D-to-A ladder networks or other configurations, the smallest of these resistor networks measures 0.14- x 0.3- x 0.6-in. This unit will hold 6 resistors ranging from  $0.1 \Omega$  to 100 k $\Omega$  each with standard tolerance of 1% to 0.05%. Minimum lead spacing is 0.1-in. along the length with 0.05-in. minimum from edge of package to center of lead. Ribbon leads are available for IC compatibility.

Tri-King Industries, Inc., 8933 Quartz Ave., Northridge, Calif. Phone: (213) 882-1500.

Circle No. 131

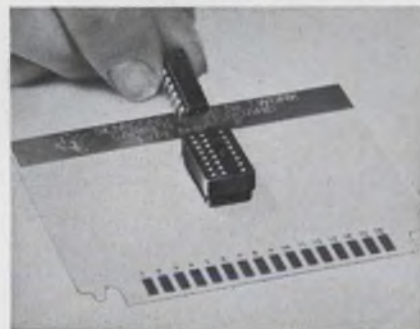

## IC test board

For the testing and operation of plug-in and in-line ICs, the "Pin Pack Test Board" will mate with standard 18-position edge connectors with contacts on 0.156-in. centers. Devices with up to 16 lead positions on 0.1-in. centers with round, square or rectangular leads can be accepted. Model MPC 6 has two rows of 8-lead sockets and will accept only the TI package. MPC 8 has three rows of 8-lead sockets and will accept all popular packages up to 16 leads.

Texas Instruments Inc., Metals & Controls Div., 34 Forest St., Attleboro, Mass. Phone: (617) 222-2800.

Circle No. 132



VA-244  
SERIES

# VARIAN KLYSTRONS FOR RELIABLE, MICROWAVE COMMUNICATION SYSTEMS

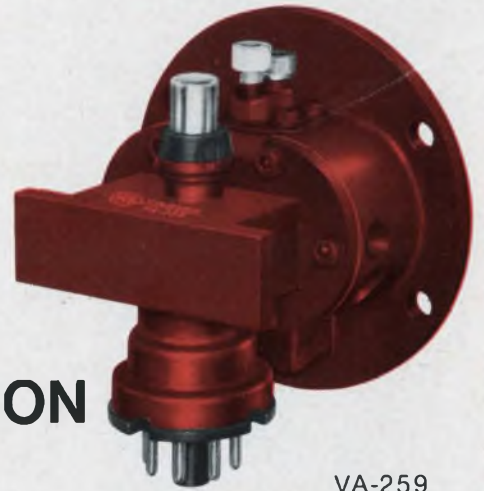

VA-259  
SERIES

**One railway microwave communication system uses 1,636 of these two Varian klystrons and, over a recent 24-month period, accumulated 1,000 years of experience with less than one day of down time (including all failures).**

For more complete information, write Palo Alto Tube Division, Executive Offices, 611 Hansen Way, Palo Alto, California. In Europe: Varian A.G., Zug, Switzerland. In Canada: Varian Associates of Canada, Ltd., Georgetown, Ontario.



Speed Inquiry to Advertiser via Collect Night Letter  
ON READER-SERVICE CARD CIRCLE 68

## Plated-Through-Hole Printed Circuit Boards Single or Multi-layer



## Specify American Circuit-Tronics

We can produce almost any p.c. board you'll ever want—standard, multi-layer, precious metal, module header, flexible, you name it! We'll meet your specs. Leadtime is cut because all manufacturing is done at one location. Prototypes are usually to you in less than 48 hours!



American Circuit-Tronics is also your immediate source for electronic assemblies and small, intricately shaped flat metal parts

Write today  
for your  
free brochure



**American Circuit-Tronics Corp.**



4229 Cass Avenue  
Detroit, Michigan 48201  
Telephone 313/831-6226

ON READER-SERVICE CARD CIRCLE 69

## TEST EQUIPMENT

### Meter relay



This horizontal line contactless meter relay employs a light-sensitive switch that provides positive on-off control and continuous reading above and below set-points. The relay provides either single (high or low) or double set-points, with high and low set-points adjustable over full scale length. Accuracy is 2% and repeatability is 0.3% with maximum dead band of 1%.

General Electric Co., 40 Federal, West Lynn, Mass. Phone: (617) 598-6000.

Circle No. 133

### Interval meter



Frequency, period, multiple period, time interval, ratio, multiple ratio and count can be measured with this six-digit in-line frequency time interval meter. The 10-MHz unit can "self-check" itself on all operational functions. Sensitivity is 100 mV and the input impedance is 1 M $\Omega$ .

P&A: \$1525; 30 days. Northeastern Engineering Inc., 130 Silver St., Manchester, N. H. Phone: (603) 622-6485.

Circle No. 134

### IF amplifier

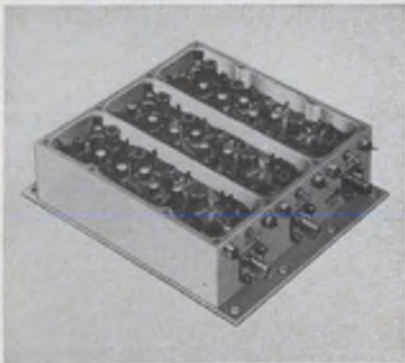

Measuring less than 7 in.<sup>3</sup> per channel, this three-channel IF amplifier is phase-and gain-matched. The unit has a 30-MHz center frequency, 10-MHz bandwidth and 13-dBm max linear output. Gain is 90 dB and gain control is 60 dB. Noise figure is 2.5 dB and, over age and range of  $-55$  to  $71^{\circ}\text{C}$ , phase match is  $\pm 2.5^{\circ}$  and gain match is  $\pm 1$  dB.

P&A: from \$99 per channel; 4 to 8 wks. RHG Electronics Lab., Inc., 94 Milbar Blvd., Farmingdale, N. Y. Phone: (516) 694-3100.

Circle No. 135

### Capacitance tester



Employing tunnel diodes and epoxy IC logic elements, this capacitance tester has a direct reading digital display with 3 in-line digits. Range is 0.1 to 99.9 pF with optional ranges and output functions available. Measurement time is less than 500 ms and the frequency at which capacitance is determined is 1 MHz.

P&A: \$1295; stock to 4 wks. Continental Device Corp., 12515 Chadron, Hawthorne, Calif. Phone: (213) 772-4551.

Circle No. 136

# New! -- Ballantine Solid State True RMS Voltmeter

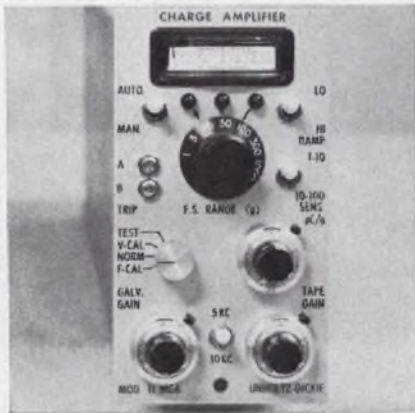

## Charge amplifier

Consisting of charge converters and signal conditioning amplifiers, this charge amplifier measures input signals from  $4 \times 10^{-3}$  to 100,000 pC without signal clipping. The converters change charge to voltage which is then amplified by the signal conditioning stage. Line-isolated individual power supplies eliminate ground loops and built-in filters reject undesired high frequencies. Frequency response is within  $\pm 5\%$  from 5 Hz to 30 kHz with no filter.

Unholtz-Dickie Corp., 2994 Whitney Ave., Hamden, Conn. Phone: (203) 288-3358.

Circle No. 137



## Spectrum analyzer

When used with communications receivers for narrow-band high-resolution analysis, this spectrum analyzer serves as a band-pass monitor with an input center frequency of 500 kHz. Sweep width is variable from 0 to 100 kHz or 0 to 2 kHz with afc. Sweep rate is 0.1, 1 or a variable 1 to 30 Hz. Bandpass amplitude response is  $\pm 10\%$  and variable resolution is 10 Hz to 2.7 kHz.

Probescope Co., Inc., 211 Robbins La., Syosset, N. Y. Phone: (516) 433-8120.

Circle No. 138

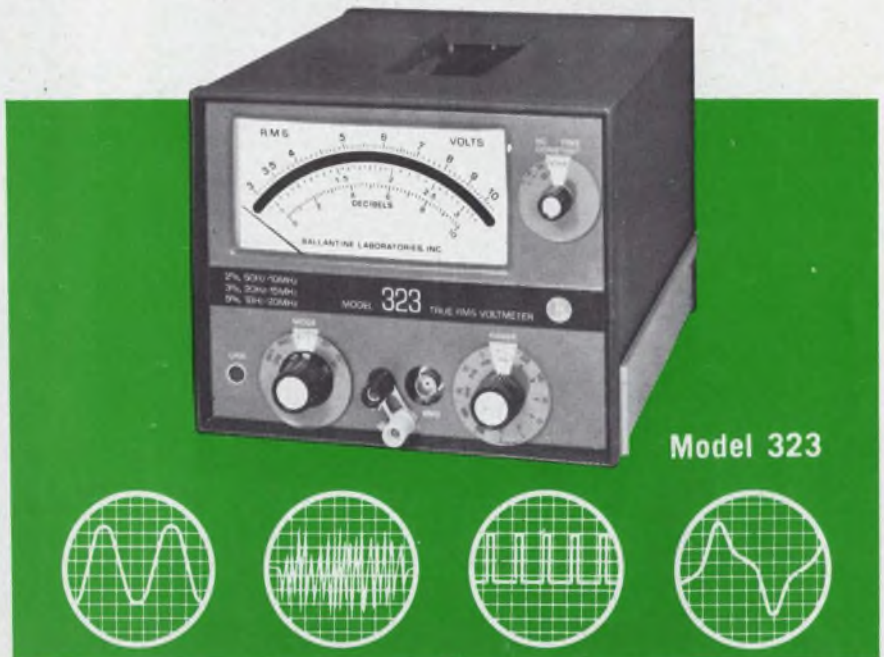

## Measures from 10 Hz to 20 MHz regardless of Waveform

Ballantine's new Model 323 is a rugged, all-solid-state voltmeter for True RMS measurements for 10 Hz to 20 MHz . . . and for a wide variety of waveforms. Use it as a completely portable instrument isolated from line effects (due to built-in rechargeable batteries), or plug it into the power line. (Model 323-01 is for use on power line, only.)

### FEATURES:

- ★ Measures True RMS of sine waves, square waves, noise voltages and a range of pulses
- ★ Frequency range of 10 Hz to 20 MHz
- ★ Voltage range of 300  $\mu$ V to 330 V. (As null detector to 70  $\mu$ V)
- ★ Unmatched accuracy: 2% of indication, 50 Hz to 10 MHz; 3% of indication, 20 Hz to 15 MHz; 5% of indication, 10 Hz to 20 MHz. Ballantine's accuracy of 2% means 2% of the actual indication, whether at the top or bottom of a scale
- ★ Operates from built-in rechargeable batteries or line power
- ★ Ideal for recorder applications — DC output of 0.1 to 1.0 V for each range simultaneous with meter reading
- ★ Crest factor: 5 at full scale to 15 at down scale
- ★ Separate isolated signal and case grounds
- ★ Optional 80 dB Attenuator Probe, Model 1301, for operation up to 10,000 V

Prices: Model 323, \$520 (Battery & Line)  
Model 323-01, \$485 (Line only)

Write for complete technical data today



**BALLANTINE LABORATORIES INC.**  
Boonton, New Jersey

CHECK WITH BALLANTINE FIRST FOR DC AND AC ELECTRONIC VOLTMETERS/AMMETERS/OHM METERS, REGARDLESS OF YOUR REQUIREMENTS. WE HAVE A LARGE LINE, WITH ADDITIONS EACH YEAR. ALSO AC/DC LINEAR CONVERTERS, AC/DC CALIBRATORS, WIDE BAND AMPLIFIERS, DIRECT-READING CAPACITANCE METERS, AND A LINE OF LABORATORY VOLTAGE STANDARDS FOR 0 TO 1,000 MHz.

Speed Inquiry to Advertiser via Collect Night Letter

ON READER-SERVICE CARD CIRCLE 70

**IF THIS  
MINIATURE METAL  
FILM RESISTOR  
DOESN'T CHANGE YOUR  
*design ideas***

*...try one of these*



Part No.	Power	Ohms	Tol.	Temp. Coef.
PME 50	1/20 W	10Ω to 1M	±1% to .1%	T-0, T-2, T-9
PME 55	1/10 W	10Ω to 3M	±1% to .1%	T-0, T-2, T-9
PME 60	1/8 W	49Ω to 7.5M	±1% to .1%	T-0, T-2, T-9
PME 65	1/4 W	49Ω to 20M	±1% to .1%	T-0, T-2, T-9
PME 70	1/2 W	24Ω to 30M	±1% to .1%	T-0, T-2, T-9
PME 75	1 W	49Ω to 50M	±1% to .1%	T-0, T-2, T-9

The stability and accuracy of Pyrofilm's PME metal film resistors makes their use ideal in applications where before only wire wound resistors could be used. These resistors are virtually unaffected by environmental conditions and withstand constant exposure to high moisture conditions without change in specifications. PME resistors meet or surpass all requirements of MIL-R-10509F.

Send for fact-filled literature sheet!

**PYROFILM RESISTOR  
COMPANY, INC.**

3 SADDLE ROAD • CEDAR KNOLLS, NEW JERSEY • 201-539-7110

ON READER-SERVICE CARD CIRCLE 71

## TEST EQUIPMENT



### Ac/dc meter

Available for ac mA/A or ac voltage measurements, this thermocouple ac meter has ±0.5% accuracy in the horizontal position. The magnetically shielded units employ wire-wound resistors of ±0.05% accuracy. The ac mA-ammeter has a range of 0, 10, 20, 50, 100, 200 and 500 mA ac/dc at 1.5 V and 0, 1, 2 and 5 A ac/dc. The ac voltmeter has a range of 0, 2, 5, 10, 20, 50, 100, 200 and 500 V at 143 Ω/V.

Price: \$250 (ac mA/A); \$300 (ac voltmeter). Triplet Electrical Instrument Co., Bluffton, Ohio. Phone: (419) 358-5015.

Circle No. 139

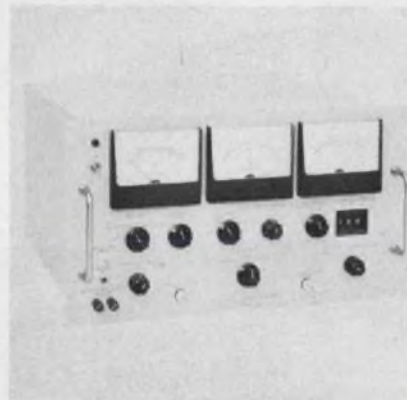

### Envelope delay unit

Covering a 30- to 750-kHz range, this unit measures delay distortion of the carrier frequencies. This instrument has crystal-controlled reference delays in 10-μs steps up to 200 μs for use in offsetting time delay. Resolution is 0.05 dB. The most sensitive scale is 2 μs full scale with 0.1-μs calibrations. The instrument has transformed-coupled output and input at 135 Ω.

Price: \$8100. Wiltron Co., 930 East Meadow Dr., Palo Alto, Calif. Phone: (415) 321-7428.

Circle No. 140





## In frequency agile radar, the real problem is tuning flexibility.

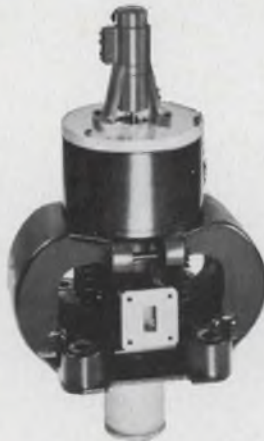

### **Our L-4500 Series magnetrons tune electromagnetically.**

Primarily developed for airborne radar systems, Litton's electromagnetically tuned magnetrons offer unequalled flexibility in all these tuning modes:

- High speed random tuning
- Precise electronic setting and resetting in flight
- Rapid tuning about a given frequency

Electromagnetic tuning, developed by Litton, is responsible for this superior versatility. It allows operation over all or any portion of the magnetron's tuning range with tuning rates to 5,000,000 mc/sec<sup>2</sup>

at Ku-band and 1,500,000 mc/sec<sup>2</sup> at X-band. Additionally, it provides a voltage reference signal proportional to the magnetron output frequency with an accuracy of approximately  $\pm .15\%$  under all environmental conditions.

Find out how Litton electromagnetically tuned magnetrons can add flexibility to your radar application. Send for Data Package. Electron Tube Division, San Carlos, Calif., or Williamsport, Pa.

 **LITTON INDUSTRIES**  
ELECTRON TUBE DIVISION

Speed Inquiry to Advertiser via Collect Night Letter  
ON READER-SERVICE CARD CIRCLE 72

# DUAL OUTPUT POWER SUPPLIES

**Guaranteed  
3-DAY  
Shipment!**



Dual output power supplies are housed in one case 3-5/16" x 4-5/32" x 4-11/16" high. Identical or different output voltages from 1.5 to 75 are available in 1 volt increments for each of the DC outputs. The graph below furnishes maximum current corresponding to output voltage. Select the two outputs needed and telephone Acopian for all the details — plus guaranteed 3-day shipment after receipt of your order.

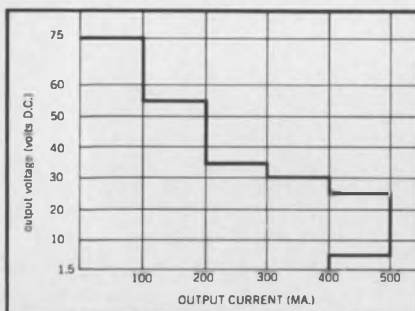

## TYPICAL SPECIFICATIONS

Input Voltage: 105 to 125 VAC

Line Regulation:  $\pm 0.5$  to  $\pm 0.05\%$   
(depending on model)

Load Regulation:  $\pm 1.0$  to  $\pm 0.05\%$   
(depending on model)

Ripple: 5 to 1 mv (depending on model)

No additional external heat sinking required.

Write for Acopian's 16-page catalog and price list to: Acopian Corp., Easton, Penna., or call collect (215) 258-5441.



ON READER-SERVICE CARD CIRCLE 73

## TEST EQUIPMENT

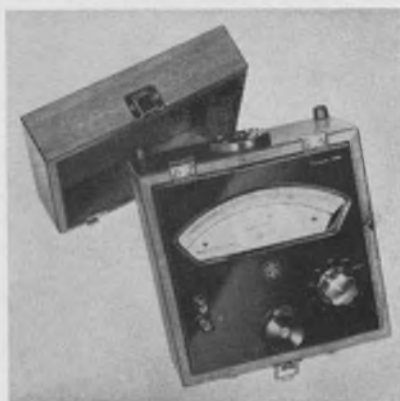

### True rms microammeter

With a low full-scale range of 50  $\mu$ A this true rms microammeter has eight ranges from 0.05 mA to 10 mA. The unit achieves 0.05% full scale accuracy for irregular waveforms having crest factors in excess of 4 and square waves up to several kHz. Repeatability is better than 0.1%. The instrument responds to inputs to 500 kHz with a  $\pm 0.5\%$  full-scale accuracy at the most sensitive ranges.

Greibach Instruments Corp., 315 North Ave., New Rochelle, N. Y. Phone: (914) 633-7900.

Circle No. 141

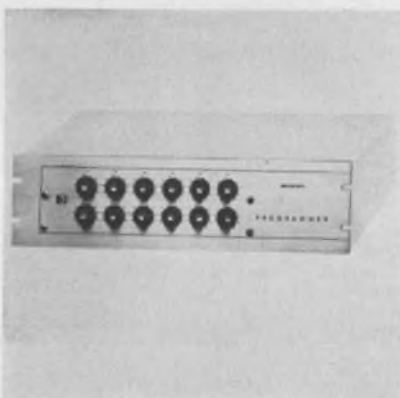

### Drum programmer

Precise dial adjustment of individual step times is provided by this programmer. The unit offers repeat accuracy of  $\pm 2\%$ . Plug-in drum pins can quickly modify the program. Standard time ranges available include 0.2 to 10 s, 1 to 100 s and 0.1 to 10 minutes per step. Twelve steps are provided. Output load capacity is 15 A (resistive) at 120 Vac. Operating voltage is 120 Vac (nominal).

ESNA, Agastat Div., 1027 Newark Ave., Elizabeth, N. J. Phone: (201) 352-2900. Circle No. 142



### Miniature probe

For portable and general purpose scopes in the dc- to 33-MHz range, this 10X attenuation probe can be compensated for scope or plug-in unit input capacitances of 15 to 47 pF. Risetime of the probe is 5 ns, input resistance is 10 M $\Omega$  and input capacitance is 11.5 to 14.5 pF. Voltage rating is 500 Vdc, ac peak or dc and ac peak combined. Peak-voltage derating is necessary for cw frequencies above 6 MHz—typically 105 V at 30 MHz.

P&A: \$27; Oct. Tektronix, Inc., Box 500, Beaverton, Ore. Phone: (503) 644-0161.

Circle No. 143



### Selective null detector

This tunable null detector has a sensitivity of 1  $\mu$ V for full-scale meter deflection, a frequency range of 15 Hz to 100 kHz and 5 to 10% bandwidth. It can be used as a sensitive detector in bridge balancing and as a low-noise preamp for increasing the sensitivity of scopes and VTVMs. The output amplifier has a linear or logarithmic response. Input impedance is 50 k $\Omega$  to 1 M $\Omega$  depending on gain control. Output impedance is about 300  $\Omega$  in series with 5 pF. Maximum output is about 1 V rms.

International Telephone & Telegraph Corp., 320 Park Ave., New York. Phone: (212) 752-6000.

Circle No. 144



SINGLE REJECTION CAVITY TYPE DIPLEXER—COM-  
PARABLE TO A PACK OF REGULAR SIZE CIGARETTES  
IN SIZE

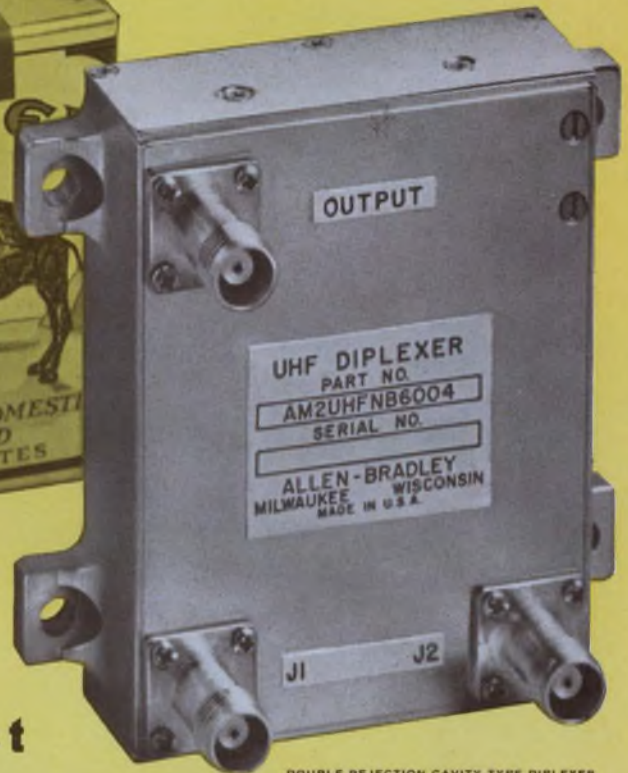

DOUBLE REJECTION CAVITY TYPE DIPLEXER

## New Ultra-Compact UHF antenna diplexers

for use in the 2.2 to 2.3 GHz frequency range

■ Allen-Bradley high frequency laboratories are pioneering the development of antenna multiplexers for use at ultra-high frequencies. The two diplexers for the 2.2 to 2.3 GHz band shown above are representative of Allen-Bradley's high frequency capability. These diplexers are rugged—designed to withstand acceleration of 15 G's; shocks of 100 G's (1 msec.); and vibration of  $\pm 10$  G's (30-2000 Hz). They're hermetically sealed for use at unlimited altitude and are stable over the temperature range from  $-50^{\circ}$  to  $+170^{\circ}$ F. The power handling capacity per channel is 20 watts.

Allen-Bradley engineers will be pleased to work with you. Please write: Allen-Bradley Co., 1344 South Second Street, Milwaukee, Wis. 53204. In Canada: Allen-Bradley Canada Ltd. Export Office: 630 Third Avenue, New York, N. Y., U.S.A. 10017.

### TYPICAL RESPONSE CURVES

WITH ONE REJECTION CAVITY PER CHANNEL

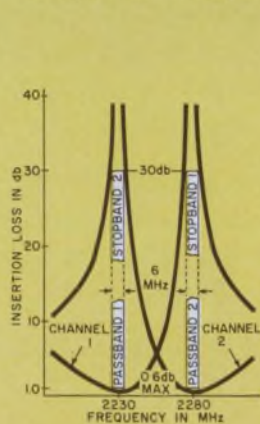

WITH TWO REJECTION CAVITIES PER CHANNEL

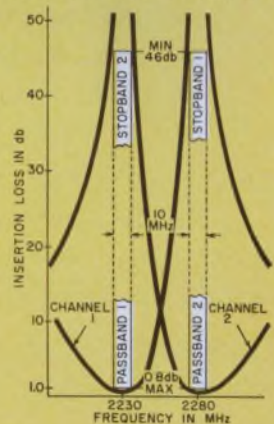

**ALLEN-BRADLEY**  
QUALITY ELECTRONIC COMPONENTS

985-148

ON READER-SERVICE CARD CIRCLE 74

# DVM WITH A MEMORY



MODEL 5202 \$1595

## ... and with a 50 nanosecond sample-and-hold aperture time!

The Micro Instrument Model 5202 is a dc to 20 MHz DVM that never forgets — and won't let you forget! Actually, its three instruments in one: a dc DVM; a single or repetitive pulse peak-reading DVM; and a sample-and-hold DVM.

The Model 5202 can be gated to accept any 50 nanosecond or longer segment of a waveform, hold it indefinitely, and digitize it for read-out on its 3-digit Nixie<sup>®</sup> tube display. And it makes no difference whether pulses are single or repetitive.

Check the following features. You'll see why the all solid-state Model 5202 is your best buy when it comes to monitoring random occurring transients and other voltages.

- No dead-time or loss of input, even during reset
- High input impedance — to 10 megohms
- Added flexibility through either ac or dc coupling
- Analog recorder and printer outputs
- 10-, 100-, and 1000-volt ranges

All of the Micro Instrument Model 5202's exceptional features are fully described in our technical literature. Send today for your copy of our 4-page brochure covering the theory of operation and specifications. No obligation, of course.

The Model 5202 illustrated is also available in rack-mounting configuration for \$1495.



12901 CRENSHAW BLVD., HAWTHORNE, CALIFORNIA 90250  
TELEPHONES: (213) 679-8237 & 772-1275

ON READER-SERVICE CARD CIRCLE 75

## TEST EQUIPMENT



### RF ratiometers

Reflection coefficient or vswr are measured by these RF ratiometers without the use of slotted lines. The ratio of incident and reflected signals is calibrated in % reflection coefficient and/or vswr. Reflection coefficient ranges are 0.1, 0.3 and 1% full scale. Accuracy is  $\pm 1\%$ . The RF signal source employed is modulated at 1000 Hz with an output of 50 mW nominal. The model 101 covers a 215- to 450-MHz range and model 102 covers a 450- to 960-MHz range.

Chrysler Corp., Huntsville, Ala.  
Phone: (205) 842-4710.

Circle No. 145

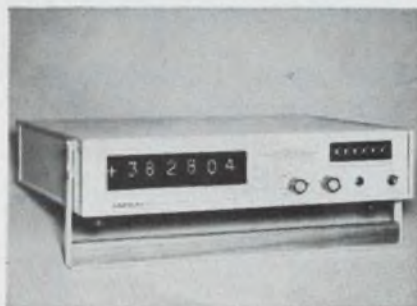

### 5-MHz counter/display

Employing silicon ICs, this bidirectional counter/display also counts in reverse at any rate between 0 and 5 MHz. The unit accepts quadrature or pulse input signals. Sine waves may range from 1 to 30 V p-p and square waves may have p-p amplitudes of 500 mV to 15 V. Optional axis-crossing detection modules multiply encoder resolutions by factors of 1, 2 and 4 (depending on system requirements).

P&A: \$1095 to \$1695; 6 wks.  
Janus Control Corp., 296 Newton St. Waltham, Mass. Phone: (617) 891-4700.

Circle No. 146

# STEP IN THE RIGHT DIRECTION WITH KEARFOTT STEPPER MOTORS

The logical step is to think of Kearfott for a wide variety of permanent magnet and variable reluctance stepper motors.

You get— • High Speed • High Quality • High Reliability • Variety of Stepping Angles • Non-resonant VR types which need no external electrical or mechanical damping devices.

It's even more logical when you're looking for logic components. Ask for Kearfott's completely transistorized driver and

logic circuits— • Rugged • Compact • Lightweight • Easily Mounted • Wide Operating Temperature Range • Pulse Shapers and Inverters Available.

Or how about these special stepper motors, which are typical of Kearfott's forward thinking in design— • Separable Rotor & Stator Stepper Motor for Gimbal Drive Applications • Special Stepper Motor for Space Applications.

Now look at the wide variety of standard steppers we offer:

## PERMANENT MAGNET AND VARIABLE RELUCTANCE STEPPER MOTORS

TYPE	SIZE	HOLDING TORQUE (in. oz.)	MAXIMUM STEPPING RATE (steps/sec.)	TOTAL POWER INPUT (watts)	WINDING RESISTANCE (ohms)	PHASING SEQUENCE TABLE NUMBER (for ccw rotation)	WEIGHT (oz.)	STEPPER MOTOR PART NUMBER	LOGIC-DRIVE CIRCUIT PART NUMBER
P.M. 90° Step Angle	5	.2	270	4.9	160	2	.7	CJ0 0191 750	C70 3531 301
	8	.6	320	5.2	600	1	1.5	CM4 0191 007	C70 3531 001
	8	.6	320	4.4	180	2	1.5	CM4 0191 012	C70 3531 301
	11	1.8	220	7.0	450	1	2.9	CR0 0191 750	C70 3531 001
	11	2.0	250	7.8	200	2	2.9	CR4 0191 002	C70 3531 302
	15	4.5	125	13.0	65	2	8.0	CT4 0191 001	C70 3531 302
P.M. 45° Step Angle	11	1.5	400	7.1	220	1	3.0	CR0 0193 750	C70 3531 001
	15	3.5	220	13.0	60	2	8.0	CT0 0193 750	C70 3531 302
	18	6.0	270	13.0	60	2	13.0	CV0 0193 750	C70 3531 302
V.R. 15° Step Angle	8	.5	1000	6.3	250	1	1.5	CM4 0192 001	C70 3531 104
	11	1.1	700	7.1	220	3	2.9	CR0 0192 750	C70 3531 201
	11	1.6	600	7.1	110	4	2.9	CR4 0192 001	C70 3531 402
	15	6.5	660	17.0	90	1	8.0	CT0 0192 750	C70 3531 103
	18	8.5	600	23.0	70	1	13.0	CV0 0192 750	C70 3531 103

NOTE: Operating voltage for all units is 28 volts dc. Temperature range for all motors is -54°C to +165°C (ambient + temp. rise). Duty for all units is continuous.

## STEPPER MOTOR DRIVER AND LOGIC ELECTRONICS

PART NUMBER	OUTPUT SEQUENCE	CURRENT OUTPUT MAX./LEG (amp)	DC POWER REQ. (+ volts)	NEGATIVE BIAS REQ. (- volts)	INPUT PULSE POLARITY*	INPUT PULSE AMPLITUDE (volts)	INPUT PULSE RISE TIME (μ sec max.)	PULSE WIDTH (μ sec min.)	WEIGHT (oz.)	TEMPERATURE RANGE (°C)	TYPICAL KEARFOTT MOTOR
C70 3531 001	Table 1	.2	28	12	Negative	15 to 30	5	10	2.0	-55 to +125	CR0 0193 750 CM4 0191 007
C70 3531 002	Table 3	.2	28	15	Positive	2.3 to 15	10	10	1.8	-55 to +95	CR0 0192 750
C70 3531 004	Table 3	.5	28	None	Negative	3 to 15	5	10	2.8	-55 to +125	CR0 0192 750
C70 3531 101	Table 1	.2	28	12	Positive	2.5 to 6	5	10	3.0	-55 to +125	CR0 0193 750
C70 3531 102	Table 1	1.0	28	12	Negative	2.5 to 6	5	10	3.5	-55 to +125	Multiple Loading (e.g. up to 5 CR0 0193 750 in parallel)
C70 3531 201	Table 3	.2	28	12	Positive	2.5 to 6	5	10	2.2	-55 to +125	CR0 0192 750
C70 3531 103	Table 1	.5	28	12	Negative	2.5 to 6	5	10	3.5	-55 to +125	CT0 0192 750 CV0 0192 750
C70 3531 301	Table 2	.2	28	12	Negative	2.5 to 10	5	10	3.5	-55 to +125	CM4 0191 012
C70 3531 302	Table 2	1.0	28	12	Negative	2.5 to 10	5	10	4.5	-55 to +100	CT4 0191 001 CT0 0193 750
C70 3531 401	Table 4	.2	28	12	Negative	2.5 to 10	5	10	3.5	-55 to +125	Reduced Power (drives CR0 0192 750, for reduced torque applications)
C70 3531 402	Table 4	1.0	28	12	Negative	2.5 to 10	5	10	4.5	-55 to +100	CR4 0192 001
C70 3531 104	Table 1	.2	28	12	Positive	2.5 to 6	5	10	3.0	-55 to +125	CM4 0192 001

\*Pulses with polarity reversed from that specified will also drive circuits, but with trigger occurring on trailing edge.

NOTES: 1. Units can be operated over a limited temperature range without applying a negative bias. Details on each unit will be supplied on request.  
2. Units also available which do not require a negative bias supply. Part numbers available on request.

## ELECTRICAL PHASING SEQUENCES

TABLE 1				TABLE 2				TABLE 3				TABLE 4					
Step	Yel.	Wht.	Red	Blk.	Step	Yel.	Blk.	Wht.	Red	Step	Red	Blk.	Yel.	Step	Red	Blk.	Yel.
1	0		0		1	0				1	0	0		1	0		
2	0			0	2		0			2		0	0	2		0	
3		0		0	3			0		3	0		0	3			0
4		0	0		4				0	4				4	0		
1	0		0		1	0				1	0	0		1	0		

"0" designates polarity of dc supply voltage.

Send for new stepper motor catalog and wall chart describing these motors in greater detail.

KEARFOTT PRODUCTS DIVISION

**GENERAL PRECISION INC.**

AEROSPACE GROUP  
LITTLE FALLS, NEW JERSEY

ON READER-SERVICE CARD CIRCLE 76

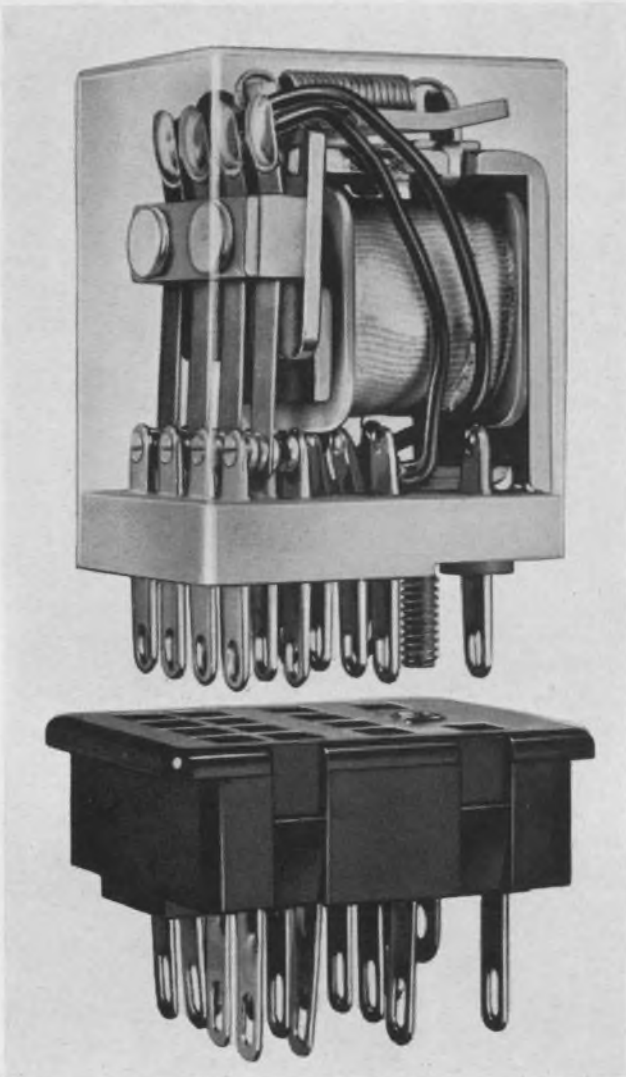

This is our Miniature 4-Pole Relay but we magnified it  $2\frac{1}{2}$  times to show you the kind of quality you can buy for \$4.10.

The Series JA is in all respects a high quality miniature 4 PDT relay for AC or DC operation. This is borne out by the fact that our customers have reported 40,000,000 mechanical operations without a single failure. The JA is excellent for computer, logic system and data processing applications. We could write an essay about its virtues but prefer to let the features and specifications speak for themselves.



Complete information including specifications and prices available in Bulletin #45.

LINE ELECTRIC COMPANY  
Division of Industrial Timer Corporation  
205 U.S. Highway 287, Parsippany, N.J.  
In Canada: Sperry Gyroscope Ottawa Ltd., Ont.

ON READER-SERVICE CARD CIRCLE 77

## TEST EQUIPMENT



### Digital voltmeter

An accuracy of 0.1% plus 1 digit is characteristic of this digital voltmeter. The unit compares input voltage to an internally-generated voltage from a zener reference diode and resistors. The unit has a floating input. Input impedance is 10 M $\Omega$  on all ranges. The instrument has five manually-selected ranges from 100 mVdc to 1000 Vdc full scale.

P&A: \$595; 60 days. Hewlett-Packard 1501 Page Mill Rd., Palo Alto, Calif. Phone: (415) 326-7000.

Circle No. 147



### Audio voltage standard

This convection-cooled audio voltage standard offers variable output from 1 mV to 1011 V. An internal oscillator provides full frequency coverage from 50 to 10,000 Hz. Basic absolute accuracy is  $\pm 0.035\%$ . Model 631 is capable of 10 VA of power with less than 0.1% distortion. A three-digit voltage deviation system permits calibrated plus and minus offsets at any voltage setting.

P&A: under \$6500; 60 days. Holt Instrument Laboratories, Oconto, Wis. Phone: (414) 834-2222.

Circle No. 148

# MIL-T SPEC LACING TAPE isn't right for every harness job!



• GUDEBROD sells plenty of it (Gudelace 18)

—but makes 172 other\* tapes too!

• Tapes for high temperatures,  
burnproof tapes, tapes for  
outer space and vacuum use.

• Tapes for heavy cabling and for  
small units, color coded tapes.

• They all tie tight.  
Ask about them.

\*And they all exceed MIL-T performance requirements

Saturn rocket inertial guidance stabilized platform produced at The Bendix Corporation's Eclipse-Pioneer Division. Wiring laced with Gudebrod Tape.

With every advancement in electronic technology, for every new electronic application there is need to review your harnessing practices and materials. If your harness department is struggling to make-do with the lacing tape they have always used—they may be wasting time and money as well as heading for rejects. Gudebrod has pioneered in producing special tapes—for particular applications, and to meet customer's specifications. Available at Gudebrod is a stock of 173 types of lacing tape—and a wealth of harnessing information. Why not consult with Gudebrod!

## GUDEBROD CABLE-LACER

The first hand tool engineered for wire harnessing. Handle holds bobbins, feeds tape as needed, grips tape for knotting. Speeds, eases harnessing. Pays for itself in time saving.

Area Code 215, WA 2-1122



# GUDEBROD BROS. SILK CO., INC.

FOUNDED IN 1870

*Electronics Division*

12 SOUTH 12th STREET, PHILADELPHIA, PENNSYLVANIA 19107

ON READER-SERVICE CARD CIRCLE 78

## Pin diode attenuator

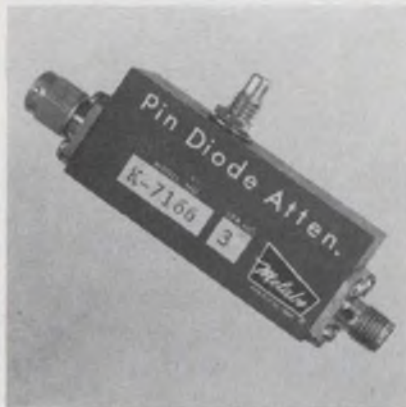

Providing 80 dB or more attenuation across the 1- to 8-GHz range, this pin diode attenuator has a minimum attenuation typically 2 dB. The component handles 250 mW avg or 100 W peak. Vswr is typically 2 for minimum attenuation and about 10 at full attenuation. Bias required for maximum attenuation is -100 mA at about 3 V.

Availability: 30 days. Melabs, 3300 Hillview Ave., Stanford Industrial Park, Palo Alto, Calif. Phone: (415) 326-9500.

Circle No. 149

## Rotary vane attenuator

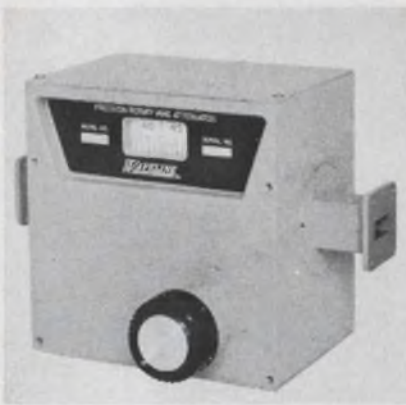

Readout is provided with this X-band rotary vane attenuator by a calibrated stainless steel tape which is viewed through a readout window. The window has dual index lines to reduce parallax error. Accuracy is  $\pm 2\%$  of the reading or  $\pm 0.1$  dB whichever is greater from 0 to 50 dB and  $\pm 3\%$  of the reading from 50 to 60 dB. Vswr is 1.15 max and insertion loss is less than 1 dB.

Waveline, Inc., Box 718, West Caldwell, N. J. Phone: (201) 226-9100.

Circle No. 150

## 30-W TWT

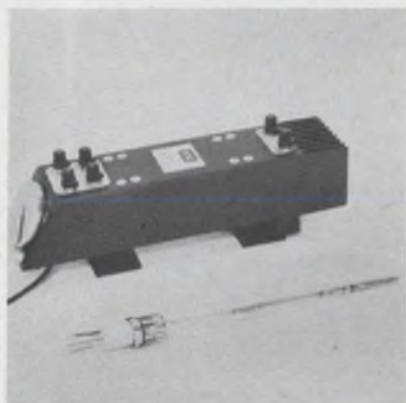

Output of 30 W in the 3.6- to 4.2-GHz band is provided by this TWT. The tube is for 1800-channel microwave links. With a typical gain of 43 dB at a working output of 20 W, saturated output is 30 W. The unit operates in a periodic permanent-magnet mount. Incorporated in the mount are RF input and output waveguide connections, deflection and matching adjustments, tube ejection control at either end of the mount and a convection cooler.

ITT Corp., 320 Park Ave., New York. Phone: (212) 752-6000.

Circle No. 151

## S-band antenna



Designed for airborne flush-mounting applications, this 14-oz antenna operates over the 2200- to 2300-MHz telemetry band with a vswr of 1.5 max. The radiation pattern of this annular slot antenna is similar to a dipole with linear polarization perpendicular to the plane of the aperture. An N connector jack is provided for input.

L. P. Associates, Inc., 11830 West Pico Blvd., Los Angeles. Phone: (213) 477-2762.

Circle No. 152

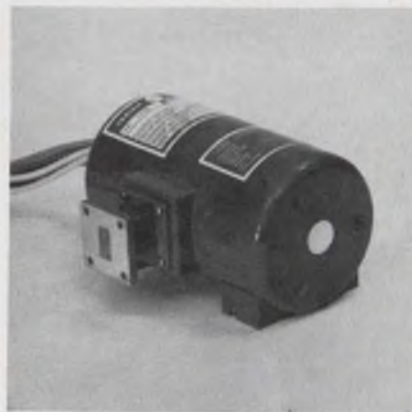

## Ku-band BWO

Delivering 50 to 100 mW over a 14- to 17-GHz tuning range, this backward-wave oscillator tube is magnetically shielded and permanent-magnet focused. This 4-lb convection-cooled unit is 3 in. in diameter and 6 in. long. Frequency adjustments are made by varying the helix voltage. The voltage-versus-frequency curve is exponential and continuous.

P&A: under \$1500; 60 days. Varian Associates, 611 Hansen Way, Palo Alto, Calif. Phone: (415) 326-4000.

Circle No. 153

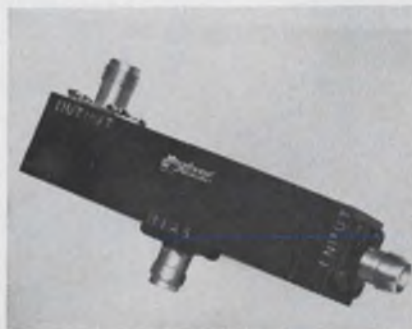

## Limiter-attenuator

This high-power limiter-attenuator provides receiver protection over the 2.2- to 2.3-GHz range with an insertion loss of 1 dB max, flat leakage of 50 mW and recovery time of 500 ns. Peak power is 1 kW and average power is 10 W. Applications include tracking, target detection and navigational radar. This component functions effectively as a controlled variable attenuator which increases the dynamic range of the overall radar system.

Microwave Associates Inc., Burlington, Mass. Phone: (617) 272-3000.

Circle No. 154



# New Mercury Relay Applications From Adlake

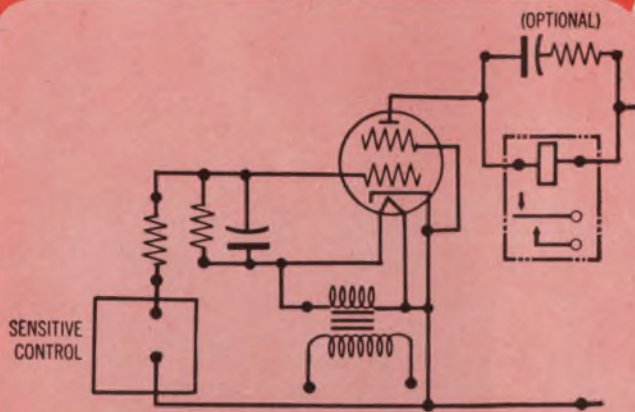

**MERCURY  
DISPLACEMENT  
RELAYS**

## *Small Currents Control "Heavy Duty" Load Relay*

In applications having extremely sensitive controls, this circuit illustrates how very small currents are capable of controlling an Adlake "Heavy Duty" load relay. Resistive loads of 35, 50 or 75 amperes at 120 volts, 60 cycles, are easily met up to 44 operations per minute. 100 ampere loads at the rate of 6 operations per minute.

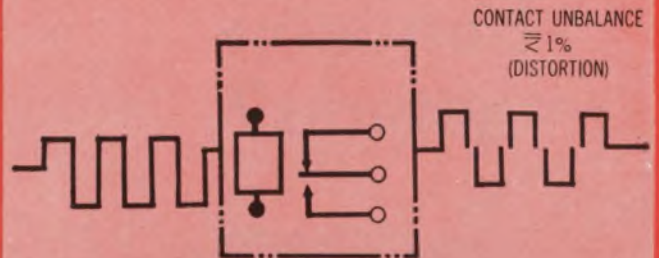

**MERCURY  
WETTED  
CONTACT  
RELAYS**

## *Ideal for Data Transmission or Tele-Typing*

Adlake Polar Relays—Form C—are ideal for data transmission or tele-typewriting where a series of equal length impulses represent an alpha-numeric character or function. Baud rates up to 120 are available with Contact Unbalance—Distortion—of 1% or less including transition. Transition time is normally 200 microseconds or less.

Backed by sound research and disciplined engineering, Adlake applies the industry's broadest line of mercury displacement and mercury wetted relays to the creative solution of design circuit problems. However unique or special your application, Adlake can assist you in developing it. For prompt, personal and knowledgeable attention to your relay needs, contact the one source that is the complete source in the mercury relay field. Contact Adlake today for catalog and further information.



**THE ADAMS & WESTLAKE COMPANY**

Dept. 1106 • Elkhart, Indiana 46514 • Phone (A.C. 219) CO 4-1141

WINDOWS & CURTAIN WALLS • DOORS & ENTRANCES • TRANSPORTATION EQUIPMENT • MERCURY RELAYS • CONTRACT MANUFACTURING  
ON READER-SERVICE CARD CIRCLE 79

who said  
plugwires  
can't be  
interchangeable  
between  
systems?



## MAC Panel's series 140 are!

MAC Panel's new Series 140 Plugwires are interchangeable with most existing systems. Another important engineering feature is the Ball-D-Tent design. It prevents accidental dislodging of the plugwires, and yet provides closely controlled extraction forces. Won't mar insert surface, either.

The complete line of Series 140 Plugwires is available in color-coded lengths ranging from 5 to 35 inches, and is available with Gold or Nickel plating in the following types:

### GOLD PLATED 140 WIRES

Manual Single Conductor Stack Plugs	Manual Dual Conductor Single Conductor Shielded
Manual 3 Pin Common	Two Conductor Shielded
Manual 4 Pin Common	Three Conductor Shielded
Manual 6 Pin Common	Four Conductor Shielded

### NICKEL PLATED 140 WIRES

Manual Single Conductor Stack Plugs	Manual 4 Pin Common
Manual 3 Pin Common	Manual 6 Pin Common
	Manual Dual Conductor

**ORDER NOW... AVAILABLE FOR  
IMMEDIATE DELIVERY**

**MAC**  
O.E.M. DIVISION

**MAC PANEL CO. High Point, N.C.**

ON READER-SERVICE CARD CIRCLE 80

## MICROWAVES

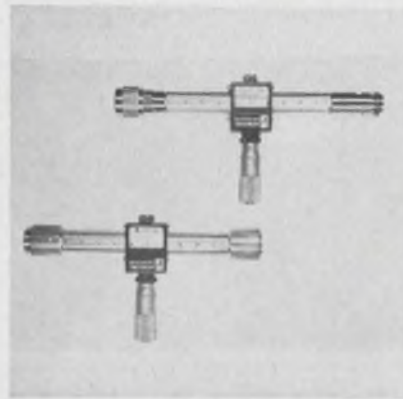

### Coax slide screw tuners

Available with either 7 mm or type N connectors, these resettable tuners can be used over the 12.4- to 18-GHz band. The units tune out reflections in a system or match individual components with a vswr of up to 5. They consist of a coax line section with a sliding carriage upon which an adjustable probe is mounted. The sliding carriage is aligned by teflon guides riding in a slot milled along the bottom length of the coax section.

Price: \$295 to \$345. Weinschel Engineering, Gaithersburg, Md. Phone: (301) 948-3434.

Circle No. 155

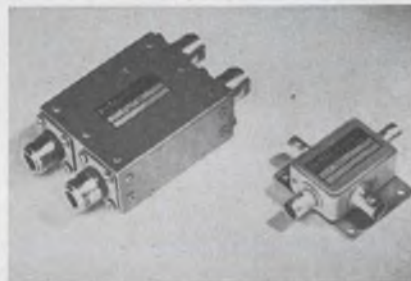

### Hybrid junctions

Four-port networks featuring 40- to 50-dB isolation typically, these broadband hybrid junctions provide continuous coverage from audio to microwave frequencies. Vswr is 1.35 max and insertion loss is 0.3 dB max. Power applied to any of the ports is split equally between two other arms while the fourth arm is isolated. The three units of the series cover 200 to 400 MHz, 250 to 500 MHz and 500 to 1000 MHz. All three have impedance of 50  $\Omega$  and amplitude balance of  $\pm 0.15$  dB.

Price: \$195. Merrimac Research & Development Inc., 517 Lyons Ave., Irvington, N. J. Phone: (201) 371-1616.

Circle No. 156

## FOR LOWER COST PRECISION ROTARY SWITCHING... TRY THESE:



## FOR TRULY OUTSTANDING DRY CIRCUIT SWITCHING... TRY THESE:



## FOR EASIER ROTARY SWITCH SPECIFICATION... TRY THESE:



## FOR FASTER ROTARY SWITCH DELIVERY... TRY THESE:



**IF YOU DO**, you'll find that Shallcross Series 1, 2 and 4 precision rotary switch lines offer:

**LOWER TOTAL COST** — INITIAL COSTS ARE NORMALLY LOWER (often 25 percent or more) than those for rotary switch counterparts claiming comparable quality. **INSTALLATION COSTS ARE REDUCED** by easily wired flared terminals (identified for location) and rugged construction features that virtually eliminate switch damage during harnessing. **MAINTENANCE AND REPLACEMENT COSTS ARE REDUCED** to the vanishing point by: (1) 50 in/lb stop strength ratings, (2) multiple contact wipers (for reliable circuit "making"), (3) positive action long life detents, (4) dust protection for internal switch parts, and (5) material-design combinations that reduce voltage breakdown and insulation

resistance failures. Add these cost "savers" to lower specification costs (below), and you'll see why Shallcross has the most economical top quality rotary switch line in the industry — as a matter of fact, an investigation will prove that Shallcross switches are often less in total cost than the lowest priced "clip types."

**OUTSTANDING DRY CIRCUIT SWITCHING** — Negligible "thermals," low contact resistances (1-2 milliohms typical from input to output), and low switching noise provide ideal dry circuit switching.

**EASIER SPECIFICATION** — Comprehensive cataloging, reproducible specification sheets (for easier drawing creation), and easily used part number systems expedite specification.

**FASTER DELIVERY** — Day-in-day-out deliveries for standard Shallcross switches equal any in the industry (eight distributors stock 1-3 deck "standards" — production quantities are normally shipped in two to three weeks).

The best values in quality rotary switching wear this brand—try them.



*shallcross*

SUBSIDIARY OF **CUTLER-HAMMER**

SHALLCROSS MANUFACTURING COMPANY, SELMA, N. C.  
ZIP CODE 27576 • TEL. 919 965-2341 • TWX 919 770-7839

ON READER-SERVICE CARD CIRCLE 81

# Now From AGASTAT®



The unmatched  
**ACCURACY,**  
**RANGE,**  
**RELIABILITY**  
of magnetic core  
counter circuitry—

**the newest principle in timing**

*(and right out of the catalog)*

Here's the circuit that could easily obsolete all other precision timers now on the market. Start with a high-frequency oscillator whose accuracy can be held to  $\pm 0.01\%$ , if necessary. Then feed these pulses into a square loop core whose count capacity and memory are as stable as the laws of physics themselves. The near-perfect duplication of these minute oscillator periods, stored and multiplied by the magnetic core counter, produces delay periods of any length with incredibly high repeatability.

In hardware terms, this means t/d/r's or multichannel systems out of the catalog, with these outstanding specs.

**ACCURACY:**  $\pm 0.25\%$  at fixed voltage and ambients is typical; less than  $\pm 2\%$  over 18-32 vdc and  $-55$  to  $125^\circ\text{C}$ , with  $\pm 0.05\%$  attainable in some models.

**EXTENDED RANGE:** from milliseconds to years, with 100:1 adjustability in stock models.

**RELIABILITY:** non-tantalum R-C, magnetic or crystal oscillators provide inherently superior stability and aging characteristics over conventional electronic timers.

More detailed specs are available in Bulletin SS-4; send for yours today. Dept. A31-53.

**AGASTAT TIMING INSTRUMENTS**  
ELASTIC STOP NUT CORPORATION OF AMERICA  
AGASTAT DIVISION • ELIZABETH, NEW JERSEY  
IN CANADA: ESNA LIMITED, 271 PROGRESS AVENUE, SCARBOROUGH, ONTARIO  
Speed Inquiry to Advertiser via Collect Night Letter  
ON READER-SERVICE CARD CIRCLE 82

## POWER EQUIPMENT



### Bench power supply

Regulation of 0.02%, 2-mV ripple and noise, 10-mV/day drift and 30- $\mu\text{s}$  transient response are features of this bench power supply. The unit incorporates two independent outputs rated at 0 to 32 V and 0 to 300 mA and variable current limiting from 30 to 250 mA. Separate 58- to 400-Hz power transformers and regulator circuits keep the two outputs independent and free from mutual interference as load currents or voltages change.

Availability: stock to 3 wks. Analog Devices, 221 Fifth St., Cambridge, Mass. Phone: (617) 491-1650.

Circle No. 157



### Switching regulators

Dc to dc switching regulators supply power for integrated circuits. They provide zero-up voltages from 10 to 250 Vdc, with power capabilities from 15 to 1500 W. Over-voltage protection is built in with a 65% efficiency. Special packaging can be provided.

Technipower Inc., 18 Marshall St., South Norwalk, Conn. Phone: (203) 866-9245.

Circle No. 158

# TEC-LITE TRANSISTORIZED INDICATORS FOR INTEGRATED CIRCUITS... CUSTOM DESIGNED AT STANDARD PRICES *For Discrete Component Circuitry, too.*

TEC-LITE "M" Series transistor controlled indicators operate from the low level output signals of integrated circuit packages. Neon or incandescent indicators are custom designed for operation from RTL current source and DTL current sink circuits yet are priced at catalog item levels. Input impedances of the indicators are specified to allow calculation of fan-out and fan-in according to the I-C circuit specifications. Optional integral, isolated momentary switches are actuated by depressing push-button lens.

TEC-LITE transistor controlled indicator devices are also available for application in discrete component systems. For complete information on the full line of TEC-LITE information display panels, digital readouts, indicators and switches contact your local TEC-Rep. or write direct.

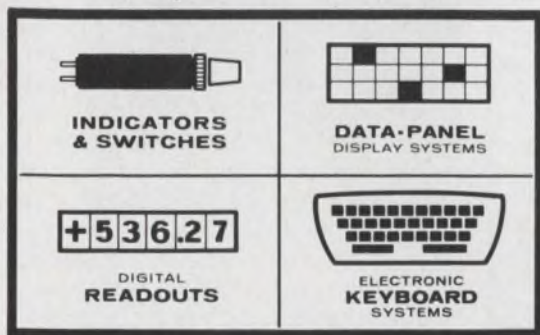

## Transistor Electronics Corporation

Box 6191  
Minneapolis, Minnesota 55424  
Phone (612) 941-1100

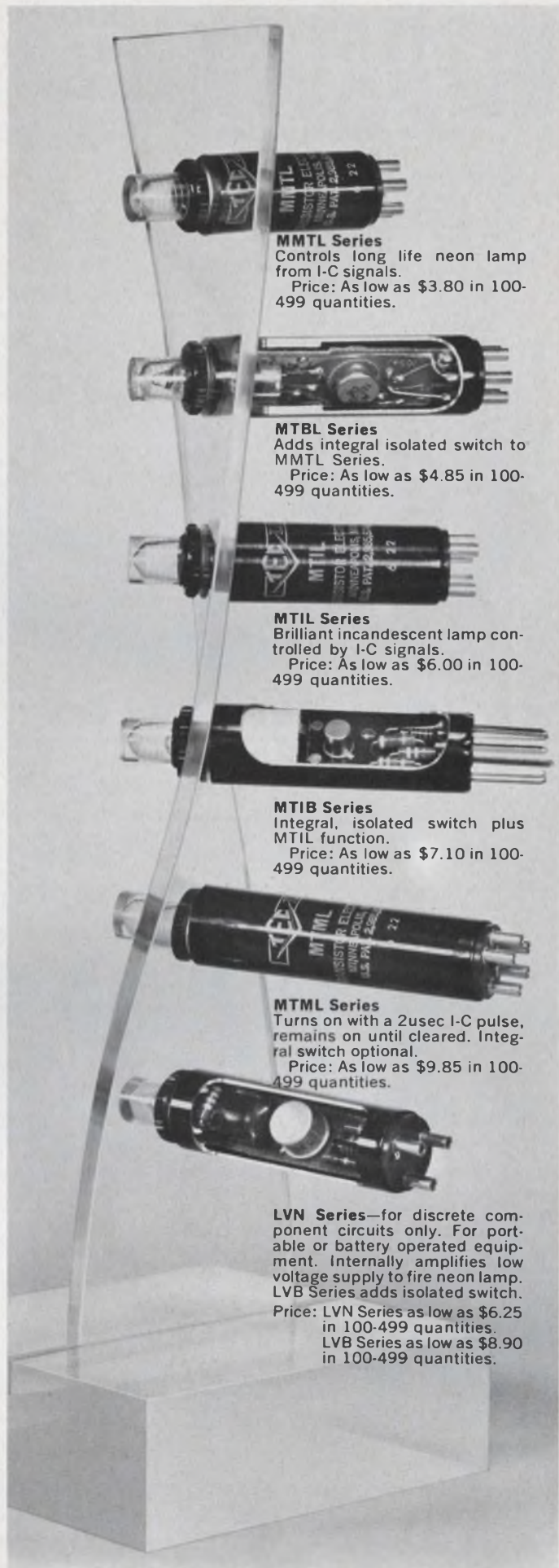

**MMTL Series**  
Controls long life neon lamp from I-C signals.  
Price: As low as \$3.80 in 100-499 quantities.

**MTBL Series**  
Adds integral isolated switch to MMTL Series.  
Price: As low as \$4.85 in 100-499 quantities.

**MTIL Series**  
Brilliant incandescent lamp controlled by I-C signals.  
Price: As low as \$6.00 in 100-499 quantities.

**MTIB Series**  
Integral, isolated switch plus MTIL function.  
Price: As low as \$7.10 in 100-499 quantities.

**MTML Series**  
Turns on with a 2usec I-C pulse, remains on until cleared. Integral switch optional.  
Price: As low as \$9.85 in 100-499 quantities.

**LVN Series**—for discrete component circuits only. For portable or battery operated equipment. Internally amplifies low voltage supply to fire neon lamp. LVB Series adds isolated switch.  
Price: LVN Series as low as \$6.25 in 100-499 quantities.  
LVB Series as low as \$8.90 in 100-499 quantities.

# ULTRADEX<sup>®</sup> AUTOMATIC INDEXING TABLES ACCURATE WITHIN 1/4 SECOND OF ARC



24" ULTRADEX with visual read-out remote control console for automatic indexing.

Designed for programming directly into any machine for completely automatic production where extreme accuracy in radial indexing is required.

ULTRADEX 12" and 24" diameter tables are available in models to index to any full, half, or quarter degree. Horizontal or vertical tables available. All-electric lifting mechanism, or electro-pneumatic for heavier loads.

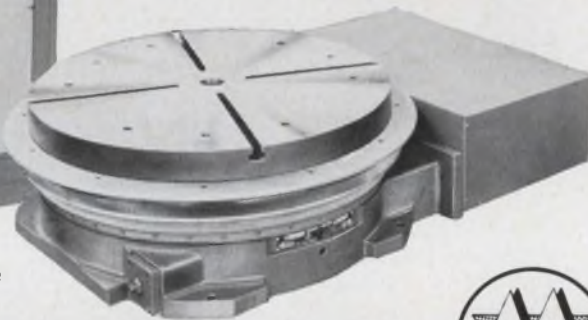

**AA INDUSTRIES, INC.**

350 FAIR STREET

DETROIT, MICHIGAN 48220

ON READER-SERVICE CARD CIRCLE 84



## POWER EQUIPMENT



### Voltage regulated supply

A voltage regulated power supply provides up to 300 mA over a range of 1.25 to 30 Vdc. Load regulation is  $\pm 0.5\%$  or 50 mV and line regulation over a range of 105 to 125 V is 10 mV. Output impedance is  $0.2 \Omega$  at 1 or 10 kHz. Full load ripple is 1 mV rms.

P&A: \$98; stock. Acopian Corp., Easton, Pa. Phone: (215) 258-6149.

Circle No. 159

## Lundey Clinch-Loc<sup>®</sup> Terminals... use a million (or more)? Some of our customers do!



609-TH 499-LP 599-W-3 499-W-2 599-DTH 599-WW 499-TH 601-TH 599-TH

*A unitary assembly (no loose parts) for significant assembly cost reduction.*

Lundey Clinch-Loc Terminals guarantee substantial savings because of low initial cost, significant assembly cost reduction and elimination of loose parts.

Our engineering facilities for standard, special and production applications are at your disposal. Write for detailed information or send special requirements for quotes.

U. S. Patents	Canadian Patents	Patents applied for
3,047,653	683,120	in France, Italy,
3,126,445	727,204	Germany and Japan
3,166,634		

High Quality Products of The Lundey Line

**Lundey Associates, Inc.**

694 Main Street Waltham, Mass. 02154

Phone 893-6064

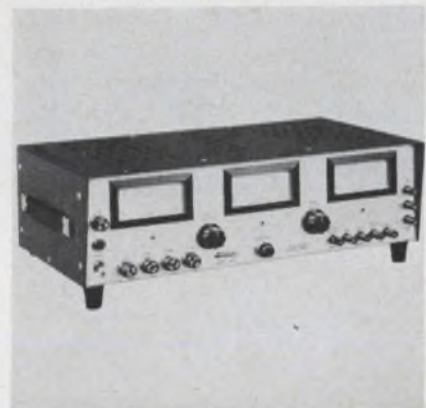

### Triple output supply

Hybrid tube and transistor circuitry completely protects this supply against shorts, overloads and high temperatures. Model 2909 is fully transistorized except for the series regulators. It features one filament output and three simultaneous dc outputs, each separately metered. One is fully adjustable from 0 to 500 at up to 0.2 A. A continuously adjustable bias supply and a fixed 300-V, 0.05-A auxiliary bias source can extend the main output to 800 V.

Price: \$465. Deltron Inc., Wissahickon Ave., North Wales, Pa. Phone: (215) 699-9261.

Circle No. 160



This automatic machine was developed to assemble Clinch-Loc Terminals with speed and flexibility for volume users. With an alternate track any Clinch-Loc Terminal can be used in this machine.

ON READER-SERVICE CARD CIRCLE 85

# MASKS

for

integrated circuitry

thin film devices

semiconductors

## PHOTOMASKS

NEW Perma-Chrome (metal film on glass).

High resolution photo emulsion.

## EVAPORATION MASKS

Electroformed nickel.

Etched molybdenum and stainless steel.

Bi-metal (electroformed nickel and copper).

Prompt quotations and deliveries.



Our new headquarters at  
ONE U.S. Highway 206, Somerville, N. J.



**TOWNE  
LABORATORIES, INC.**

SOMERVILLE, N.J. 08876 tel. 201-722-9500

ON READER-SERVICE CARD CIRCLE 86

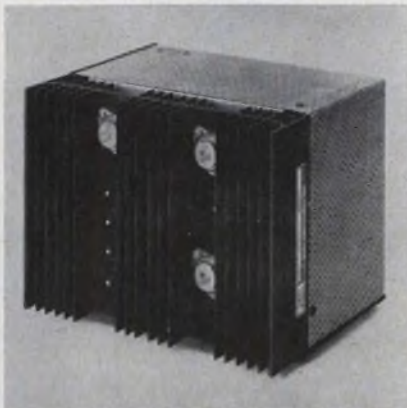

## Modular power supplies

All-silicon supplies are available with outputs from 0 to 400 Vdc at 0.1 to 20 A in 11 different case sizes. All models are available with either 0.5% or 0.01% regulation. All regulation and control circuitry is mounted on a plug-in PC board. Automatic overload and short protection, remote programming and remote sensing are standard. Heat sinking is not needed up to 71° C.

ACDC Electronics Inc., 2979 N. Ontario St., Burbank, Calif. Phone: (213) 849-2414.

Circle No. 161



## Voltage/current supply

This dc power supply can be used alternatively as voltage regulated power supply or as current regulated power supply, simultaneously offering current-limiting or voltage-limiting capabilities. The unit has an output of 0 to 36 V and 0 to 5 A with an input of 4 A. Constant load and line voltage is 0.005% or 0.5 mV and 0.01% or 1.0 mW. Constant current load is 1 mA/V change in output and 1 mA in constant current lines.

Price: \$330. NJE Corp., 20 Borright Ave., Kenilworth, N. J. Phone: (201) 272-6000.

Circle No. 162

ON READER-SERVICE CARD CIRCLE 41 ➤

this



not this



## Total quality control in Sigmund Cohn Corp. Gold Bonding Wire (99.99%)

Every production step is repeatedly checked to assure Gold Bonding Wire that meets our traditionally high standards... The same critical care is taken with the spooling and packing... The wire is respoiled on precision winding equipment especially designed by our plant engineers... Winding tension and pitch are fully controlled so, that the single layer winding will not shift or slip... This assurance is increased by the use of

**ME** (Matched Expansion) Spools.)

Write for latest brochure

**Sigmund Cohn Corp.**  
121 So. Columbus Avenue,  
Mt. Vernon, N.Y.



SINCE 1907



The single layer  
package  
is designed for:

400 feet of .0007"  
400 feet of .0010"  
250 feet of .0015"  
150 feet of .002"



If you thought  
our "Compact" was  
great @ \$17.50...

look what we have  
for \$9.\*



It's our new TCD filter. And for the money, it's the finest filter around. Bandwidth @ 6 db is 8 kc (minimum); at 60 db—20 kc (maximum). Transformer input provides a DC path and an input impedance of 40 K ohms, suitable for transistor and vacuum tube circuits. We designed it specifically for CB, mobile, aircraft and marine radios... put it in a package that's less than .6 cu. in. The following specs are for our standard model (but say the word and we'll custom design to your special requirements):

#TCD-4-8D20A	B/W @ 27°C		Impedance	
Insertion Loss: 5db max. Temp. Stability: less than 800 cps variation -20 to +60°C.	Center Freq. @ 6db 455 ± 1kc 8kc min.	max. @ 60db 20 kc max.	In 40 K ohms	Out 1.5 K ohms

\*For orders of 100 to 499. Complete TCD Prices: 1-24 — \$15 ea.; 25-99 — \$12 ea.; 100-499 — \$9 ea.; 500-1999 — \$7.50 ea.; 2000-4999 — \$6.50 ea. (Prices subject to change without notice.)

Send order or request for free Technical Brochure to:  
Piezoelectric Division, Clevite Corporation, 232 Forbes Road,  
Bedford, Ohio 44014.

**CLEVITE**

ON READER-SERVICE CARD CIRCLE 87

## PRODUCTION EQUIPMENT

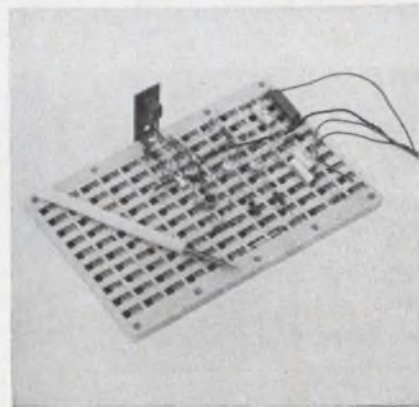

### Test circuit board

"Springboard," a solderless experimental circuit board, permits addition or removal of components without damage to leads. The board incorporates 120 ten-turn stainless steel springs that hold the components and act as connectors. All springs are electrically isolated, but several may be joined with jumpers if required. The boards measure 4-3/4 x 7-1/4 x 5/16-in.

Barry Instrument Corp., 10804  
Kaylor St., Los Alamitos, Calif.  
Phone: (213) 430-4913.

Circle No. 163

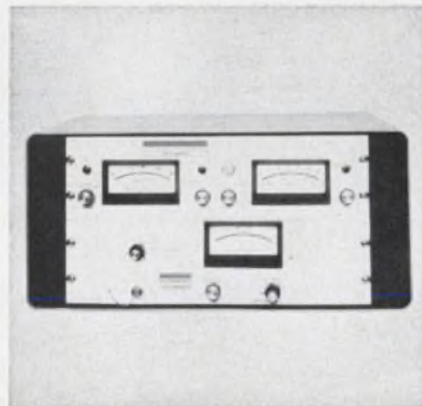

### Charge sensor

Electrostatic charges on paper and plastic insulating materials are detected and measured by this charge sensor. This unit also measures charge acceptance and rate of charge decay under light or dark conditions. An integral calibrated light source permits studies to be performed on rates of light or dark decay. The electrometer used has a sensitivity of 300 pA full scale and measures voltages from 10 mV full scale.

The Victoreen Instrument Co.,  
10101 Woodland Ave., Cleveland.  
Phone: (216) 795-8200.

Circle No. 164



# Any material that can help Western Electric cut down its phone bill must be something.

## Something called Plaskon Epoxy.

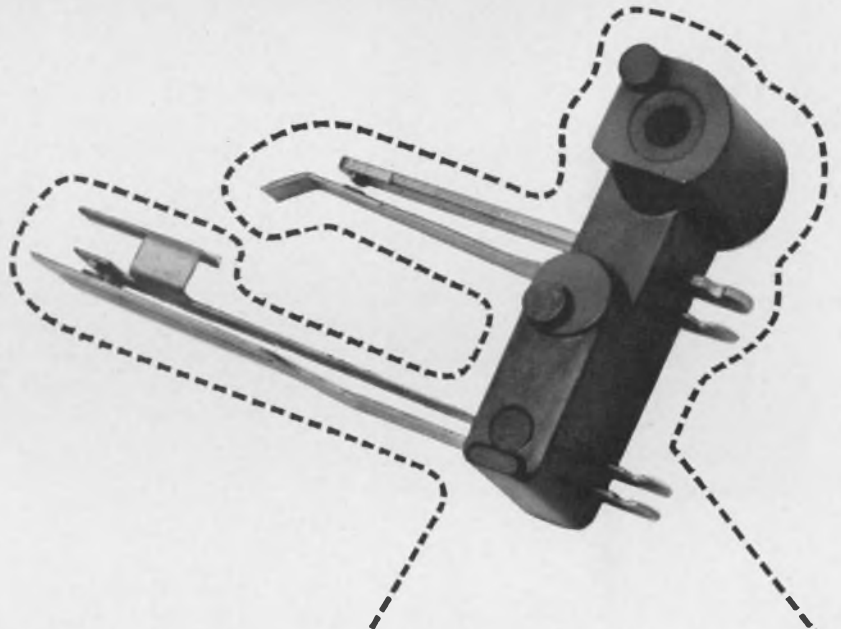

This phone dial relay switch used to be molded of soft-flow phenolic. Now it's made of a stronger, more versatile Plaskon® epoxy molding compound. Because of that, Western Electric was able to eliminate an expensive metal flange with no loss of strength. And at a substantial saving, considering the millions of parts that were made.

They were also able to use the existing molding equipment for the job.



Plaskon epoxies have excellent dimensional stability. They cure fast and shrinkage is often less than one percent. And because of great electrical insulation value, applications are numerous.

Allied Chemical has an extensive line of epoxy molding compounds, including DAP, phenolics and alkyds. Whatever your application requires, one of them should work best — and most economically. Call your Plastics Division representative for more information. Or, mail the coupon, and start saving right away

Gentlemen:

I'd like to know more about the complete line of Plaskon epoxy molding compounds. Please send me your technical brochure.

ED-10

Name \_\_\_\_\_

Company \_\_\_\_\_

Address \_\_\_\_\_

City \_\_\_\_\_ State \_\_\_\_\_

**PLASTICS  
DIVISION**  
POST OFFICE BOX 365  
MORRISTOWN, N. J.



ON READER-SERVICE CARD CIRCLE 88

1 + 1 = 3

## 1. IMPEDANCE AMPLITUDE METER



(Model 320) \$795

for rapid measurement of magnitude of impedance or transfer function.

## 1. BROADBAND PHASEMETER



(Model 301) \$795

Measures phase angle between two A.C. signals.



## 3. DIRECT AMPLITUDE-ANGLE READING OF VECTOR IMPEDANCE AND TRANSFER FUNCTION.

Model 320 . . . ■ Range: 1 ohm to 10 megohms ■ Capacitance: 0.1 pfd to 10,000 mfd. ■ Inductance: 1 microhenry to 100,000 henries

Model 301 ■ Input levels: 50 mv to 150 v rms, independent amplitudes, no attenuator controls. ■ 1° accuracy ■ Square wave output

Both are completely transistorized; operate from 5 Hz to 500 kHz; and are available in portable or rack mount. D.C. outputs available for graphic recording.

Use singly or combined.

Write for complete technical details and delivery information.

**DRANETZ**

ENGINEERING LABORATORIES, INC.  
1233 North Ave., Plainfield, N. J. 07062  
(201) 755-7080

DRANETZ . . . ■ For Complex Impedance-Admittance Meters, ■ Electroacoustical Transducer Test Equipment, ■ Current Transformers, ■ High Voltage Variable Capacitors, ■ Dielectric Measuring Systems.

(See our ad in EEM, pg. 1111)

TERRITORIES OPEN—South Atlantic States

ON READER-SERVICE CARD CIRCLE 89

## SYSTEMS



## Small-scale digital computer offers high speed

Suited for a wide range of scientific applications, the model 640 digital computer employs input/output and interrupt features designed especially for improving operations in hybrid and special computer-based systems. Utilizing monolithic integrated circuitry, the machine operates with a fixed, 16-bit instruction and data word, plus protect bit. A protected core memory, with up to 32,768 word storage capacity 1.65- $\mu$ s cycle time, a repertoire of 62 instructions, a multi-level interrupt capability and a capacity for communications with up to 64 peripheral devices also are featured. Maximum I/O rate is 1.2-million 8-bit bytes per second.

Options to the basic computer include expansions for teletype equipment, a direct memory-access channel, and memory expansions from the basic 4k words to 8k, 16k or 32k. Peripheral equipment available includes: low-cost, mass storage disk memory—up to 1/4-million words; a 300-line-per-minute line printer, high-speed paper tape punch and reader units with 120 and 300 characters-per-second capabilities, respectively; a card reader—400 cards per minute, a 100-card-per-minute, column binary card punch; a magnetic tape unit—36-kHz transfer rate.

Symbolic assembler, FORTRAN (ASA Standard), linking loader, debug, update, bootstrap, operations interpreter and other hybrid programming systems are available in the 640 software program.

P&A: less than \$30,000; Feb. (including software), Electronic Associates Inc., W. Long Branch, N. J. Phone: (201) 229-1100.

Circle No. 165

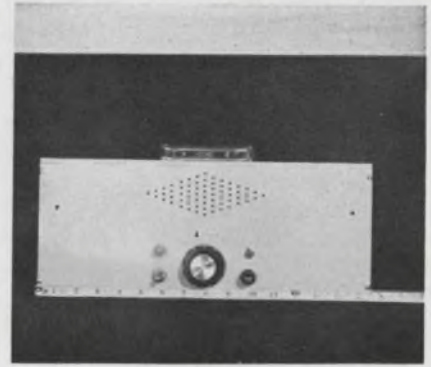

## Laser system

Capable of emitting 30 J at 1.06 microns or 15 J at 6943 Å, this head and power supply has a pulse duration of about 1 ms with a permissible repetition rate of 2 ppm at maximum energy. The head can be remotely operated up to 50 ft from the control unit. Power supply charge time is about 8 s. The controls may vary the output energy from the minimum of threshold to the maximum output.

Price: \$4965. Maser Optics, Inc., 89 Brighton Ave., Boston. Phone: (617) 254-7880.

Circle No. 166



## Scanning receivers

Model SR-9A scanning receiver continuously scans from 1.5 to 30 MHz, model SR-9B scans from 30 to 300 MHz and model SR-9C scans from 300 to 1000 MHz. RF preselection and swept local oscillators which are tuned by a self-contained sweep generator give the receivers a high spurious-free dynamic range. Frequencies are received on three separate up-conversion superheterodyne units packaged together and driven by a common sweep generator and power supply.

HRB-Singer, Inc., Science Park, State College, Pa. Phone: (814) 238-4311.

Circle No. 167

- ✦ HIGH OUTPUT: 15 VOLTS P-P INTO 75 OHMS
- ✦ WIDE BANDWIDTH: 100 kHz TO 225 MHz



# A new definition of capability: C-COR's Laboratory Amplifier

## SPECIFICATIONS

### 3 DB PASSBAND:

100 kHz to 225 MHz

### FLATNESS: MODEL 4375-S

±0.5 db, 1 MHz to 220 MHz

### OUTPUT CAPABILITY:

15 volts p-p, ±7.5 volts into 75 ohms; 12 volts p-p, ±6 volts into 50 ohms; 360 mw, 25 dbm for 1 db compression

### PULSE RESPONSE, MODEL 4375-P:

Rise time, 2 ns  
Fall time, 2 ns  
Overshoot and ringing, less than 5%

### INPUT IMPEDANCE:

50 or 75 ohms, selectable

### INPUT VSWR:

1.5/1 typical

### OUTPUT IMPEDANCE:

50 or 75 ohms, selectable

### OUTPUT VSWR:

2.0/1 max to 175 MHz,  
3.0/1 max to 220 MHz

### GAIN:

20, 40, or 60 db (fixed steps)  
Vernier control 0 to 6 db

### NOISE:

30 uv rms equivalent input

### CONNECTORS:

BNC

### OPERATING TEMPERATURE RANGE:

-20° C to +50° C

### POWER REQUIRED:

105 to 125 V, 50-60 cps; 25 watts

### PRICE:

\$995.00 f.o.b. factory, any model. Specify Model 4375-S for sine wave or 4375-P for pulse  
For relay rack mounting, order Model 1375-S or 1375-P

### HIGH Z PROBE:

\$125.00 Model 3691, sine wave, BW 10 hz-200 MHz, Model 3691A, pulse response, 2 ns rise time

C-COR now announces a long awaited amplifier: the Model 4375, for laboratory or systems use, which features wide bandwidth and high output. The 4375 is a compact, solid state unit. It utilizes C-COR's unique solid state distributed amplifier circuitry in the output stage to provide the high capability. The gain is switchable in steps of 20, 40, and 60 db by use of attenuators at the input. In addition, a 6 db continuously variable gain control is provided. This unit serves well as either a general signal amplifier, (or preamplifier) or as a fast rise time pulse amplifier. Orders are now being filled on this unit. To insure fast delivery, why not call us or your nearest C-COR rep. today?



*C-COR Electronics, Inc.*

60 DECIBEL ROAD • STATE COLLEGE, PENNA. 16801 • PHONE 814-238-2461

ON READER-SERVICE CARD CIRCLE 90

# NOW..



## INSTANT SWITCHING!

### ADJUSTABLE STOPS NOW AVAILABLE IN

# 1/2" ROTARY SWITCHES

**"Off-The-Shelf" shipments for INDUSTRY'S BEST DELIVERY!**

- • from 2 to 12 positions (shorting or non-shorting) available merely by moving external plate!
- • up to 6 poles available on one deck!
- • Instant switching to any desired number of circuit positions!
- • ideal for breadboard setups, laboratory stock, and prototype work—where rapid circuit modification may be desired.

Write for complete engineering information.

# RCL ELECTRONICS, Inc.

General Sales Office:  
One Hixon Place, Maplewood, New Jersey 07040

## SYSTEMS



### Data multiplexer

This STEP/SCAN data multiplexer uses a sampling switch with stepper-motor drive. The stepper motor can be programmed to drive past or to dwell on data points. One standard STEP/SCAN multiplexer provides up to 540 input data channels. Ten multiplexers can be combined into a coordinated system. Standard scanning rate is 100 channels/s. Contacts are rated at 10 mA, 10 Vdc with a resistance of 1  $\Omega$  max.

Fifth Dimension Inc., Route 206 Center, Princeton, N. J. Phone: (609) 924-5990.

Circle No. 168



### Ssb transceiver

Operating on four channels from 2 to 18 MHz, this single sideband transceiver has 100-W peak envelope power. The unit can provide transmission and reception for compatible AM and cw telegraph signals. Frequency of operation is controlled by crystals. Except for three vacuum tubes in the transmitter section, the transceiver is transistorized throughout. It operates on either 115/230 Vac, 50 to 60 Hz, 13.75 or 27.5 Vdc.

Wilcox Electric Co. Inc., 14th & Chestnut, Kansas City, Mo. Phone: (816) 231-0700.

Circle No. 169

# IRG

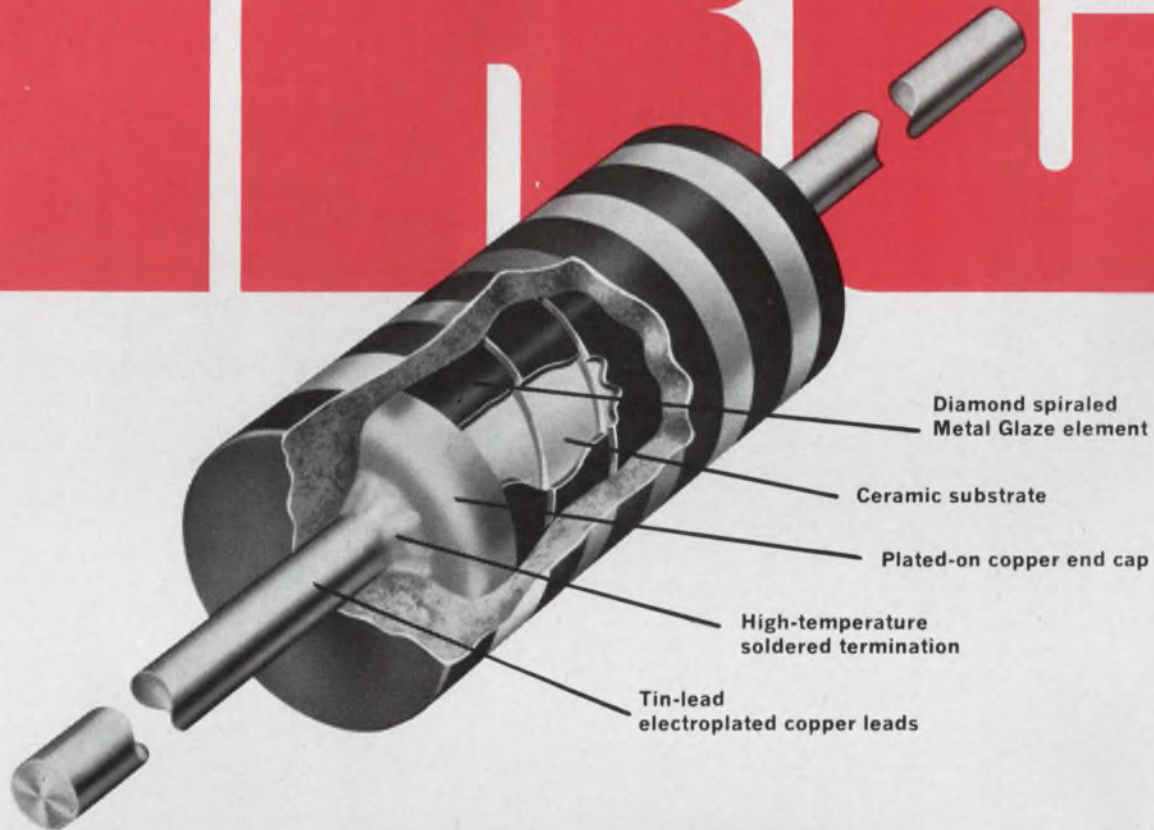

## New low-cost Metal Glaze<sup>®</sup> resistors for MIL-R-22684

4 times better load-life stability

IRC's new molded Metal Glaze resistors provide stability, reliability and precision unmatched anywhere for the price.

Tested for over 15 million unit hours, they meet or exceed all MIL-R-22684 requirements. Load life stability, for instance, is four times better than MIL allowance. Typical  $\Delta R$  is 0.5% after 1000 hours, full load at 70°C. Even at higher temperatures,  $\Delta R$  is still typically under MIL limits.

The Metal Glaze resistance element is extremely rugged. It is 100 times thicker than conventional films and is impervious to environmental extremes. The tough, uniform molded body resists solvents and the mechanical abuse of automatic machines.

New IRC molded Metal Glaze resistors are immediately available in four forms of packaging to cut your production costs. For complete data, prices and samples, write to: IRC, Inc., 401 N. Broad St., Philadelphia, Pa. 19108.

### CAPSULE SPECIFICATIONS

	RL07	RL20
MIL-R-22684B:	RL07	RL20
WATTAGE:	¼ W @ 70°C	½ W @ 70°C
RESISTANCE:	51 $\Omega$ thru 150K $\Omega$	10 $\Omega$ to 470K $\Omega$
TOLERANCES:	±2%, ±5%	±2%, ±5%
TEMPERATURE COEFFICIENT:	±200ppm/°C max.	±200ppm/°C max.
VOLTAGE:	250V max.	350V max.
SIZE:	.250" x .090" dia.	.375" x .138" dia.
IRC TYPE:	RG07	RG20



Speed Inquiry to Advertiser via Collect Night Letter  
ON READER-SERVICE CARD CIRCLE 92

# MODEL T-60 60 KHZ TIME CODE RECEIVER

- Round The Clock WWVB 60 KHZ Binary Time Code Broadcasts
  - Most Accurate Time Signal Available
  - Can Be Recorded Continuously
- Radio Station WWVB is broadcasting complete time information using a level shift carrier time code (10 db level changes). This code, which is binary coded decimal (BCD) is broadcast continuously and is synchronized with the 60 kHz carrier signal. The station identification is provided by a phase shift of

45 degrees forward at exactly 10 minutes after each hour and the reverse shift at exactly 15 minutes after each hour.

The Schmitt BCD output can be completely automated for continuous monitoring of extremely accurate real time and time interval information.

**MODEL T-60A**  
\$480.00  
3 1/2" x 19" rack panel with 5" depth behind panel. Includes 117v, 50 to 400 cps supply, or an external 12 to 16 volts may be used.



Write, wire or phone for complete catalog information.

**SPECIFIC PRODUCTS**

P. O. Box 425 / 21051 Costanzo Street / Woodland Hills, California 91364 / Phone: (Area Code 213) Diamond 0-3131



## SYSTEMS

### Digital recorder

As an incremental recorder, this unit will write packing densities of 200, 556 and 800 bits/in. at 0 to 300 characters/s and read 200 and 556 bits/in. at 0 to 300 characters/s. As a high-speed synchronous recorder, the unit will search both forward and reverse at 37.5 ips and write in the forward direction at the same speed. This incremental digital recorder has automatic vertical and horizontal generation of parity in the write mode.

Price: \$6000. Precision Instrument Co., 3170 Porter Dr., Palo Alto, Calif. Phone: (415) 321-5615.

Circle No. 211



### Digital data reader

This digital data reader can reduce 10,000 data points/day for output to such devices as key punches or paper tapes. The unit features X and Y readout with SCR-driven variable speed circuits and manually-selectable 14- or 22-position readout. Also provided are six fixed digits and full range zero shift, automatic polarity, time index multipliers and readout sequence interlocks. A keyboard gives additional digital data input and paper transport.

Gerber Scientific Instrument Co., Box 305, Hartford, Conn. Phone: (203) 644-1551.

Circle No. 212

### 10-kW transmitter

A high-frequency independent sideband transmitter automatically tunes and loads in 15 s max. Model 7500 is rated at 10 kW average and 10 kW peak envelope power and is designed for low distortion service in the 2- to 3-MHz band. Tuning is in 100-Hz increments. Accuracy and stability are 0.01 ppm/day. The unit will transmit four 3-kHz ISB or two 6-kHz ISB signals. Third order distortion products are 40 dB below a one-tone signal at full power output.

Litton Industries, New Rochelle, N. Y. Phone: (914) 636-1620.

Circle No. 213

### Calculator storage option

The Mathatron "auxiliary program storage" option can be added to the manufacturer's basic calculator for increased speed, capacity, and operational efficiencies. The auxiliary results in a total of 480 steps of program memory and 48 individually addressable storage registers. Each of the registers has one extra digit added to allow 2-digit addresses where necessary. Each stores a sign and 11 digits consisting of 9 digits and a 2-digits power of 10 exponent. The program memory is organized in 10 banks or loops of 48 steps. Storage register reference requires 3 steps.

Mathatronics Inc., 257 Crescent St., Waltham, Mass. Phone: (617) 894-0835.

Circle No. 214

### S-band TV transmitter

This solid-state S-band transmitter can be used with TV equipment having 75- $\Omega$  input impedance. It produces 20 mW at 2280 MHz with an undistorted bandwidth of  $\pm 9$  MHz. The unit operates on 28 W. An input signal of 1.4 V p-p drives the transmitter to a frequency deviation of 18 MHz. Signal response is flat within 1 dB for frequencies from 5 to 10 MHz. Housing is in a sealed aluminum-magnesium casting.

Brown Engineering Co., Inc., Huntsville, Ala. Phone: (205) 532-1336.

Circle No. 215

# NEW! *Four problem-solving P&B relays . . . all immediately available at factory prices from leading electronic parts distributors*



CH

## **Solid State Time Delay Relays for as little as \$17.50**

Here is a practical cost saving answer to many timing applications in the range of 1.0 to 180 seconds. You can save up to 60% on relay cost. They're available for AC or DC, knob adjustable, and accuracy is  $\pm 10\%$  over a  $-10^{\circ}\text{C}$  to  $+55^{\circ}\text{C}$  temperature range and include an internal 10 amp DPDT relay.

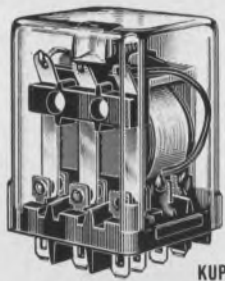

KUP

## **Versatile KUP relay can be a cost-saving answer to your plug-in relay problem**

Save up to \$2.00 each over similar relays with octal-type plugs. Get greater reliability, too. Relay has quick connect/solder terminals. Nylon socket (sold separately) rated for 10 amperes. One to three poles. Cover is heat and shock resistant lexan. For DC or AC operation.

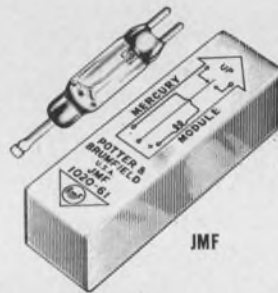

JMF

## **The answer to billions of trouble free operations and speeds up to 1 millisecond**

Mercury-wetted contact relay modules give you fast response, reliability, high sensitivity and extremely long life. Designed for printed-circuit mounting. Has SPDT, break-before-make (Form C) contact arrangement for single-side-stable or bi-stable operation.



JR

## **Reed Relays may replace expensive solid state devices**

In many applications JR reed relays may be used in place of more expensive solid state devices over which they have one basic advantage . . . they are not subject to inadvertent switching by line transients.

For applications where fast operate time, low power and long life are required. Their high sensitivity and compact size recommend them for data processing, computer equipment, logic circuitry, for voltage or current sensing and various other types of control circuits.

*and there are 60 other basic types to choose from . . .*

*They're all in this new Stock Catalog 100. Free from your electronic parts distributor. Ask for your personal copy today.*



## **POTTER & BRUMFIELD**

Division of American Machine & Foundry Company. Princeton, Indiana  
Export: AMF International, 261 Madison Avenue, New York, New York

Speed Inquiry to Advertiser via Collect Night Letter  
ON READER-SERVICE CARD CIRCLE 94



### Pressure sensor uses single silicon chip

An accurate and stable pressure sensor is made out of a single piece of semiconductor material. This monolithic solid state sensor utilizes the piezoresistive effect, in which the semiconductor changes resistance when strained. In the "Semiducer," the "diaphragm" is a single crystal of silicon, and the piezoresistive elements are diffused directly into its surface. Overall accuracy is within 0.4% of full scale. Ranges are 0 to 10 through 0 to 500 psia or psig. Low level output is 0 to 30, 40, 50 and 100 mV and high level output is 5 Vdc with optional electronics. Input and output impedance are  $1000 \Omega \pm 10\%$  at 22°C.

Giannini Controls Corp., 1600 S. Mountain Ave., Duarte, Calif. Phone: (213) 359-9141.

Circle No. 216



### Thermistor

Packaged in a borosilicate sleeve sealed on each end to molybdenum plugs, this thermistor features a positive temperature coefficient of 0.7%/°C. Linear resistance curve is between -55 and 125°C. The device can retrace its resistance vs temperature curve within a  $\pm 2^\circ$  tolerance. The unit is available in 32- $\Omega$  values ranging from 10  $\Omega$  to 2.7 k $\Omega$ , in both 5% and 10% tolerances.

P&A: \$2.80 (100-5000); stock. Texas Instruments Inc., 13500 N. Central Expwy., Dallas. Phone: (214) 235-3111.

Circle No. 217



### Phase generator

The constant-amplitude phase shift produced by this phase generator may be continuously varied between 0 and 360°. The resulting phase-shift is indicated in degrees on a dial face. Absolute accuracy is within 30 minutes of arc. Phase accuracy and zero position are unaffected by loads from open circuit down to 10 k $\Omega$ . Input is 115 V, 400 Hz and output is variable from 0 to 35 V by means of a 10-turn pot.

P&A: \$550; 4 wks. Theta Instrument Corp., Saddle Brook, N. J. Phone: (201) 843-6060.

Circle No. 218



### MV-to-current converter

Input signal spans ranging from 0 to 2 mV to 0 to 50 mV are converted into output ranges of 1 to 5, 4 to 20 or 10 to 50 mA by these dc amplifiers. Any incremented output range from 0 to 50 mA or 30 Vdc is available. The units feature 0.1% accuracy and 0.5- $\mu$ V/°C stability high-and-low impedance input windings and input, output and power isolation are provided.

Airpax Electronics Inc., P.O. Box 8488, Ft. Lauderdale, Fla. Phone: (305) 587-1100.

Circle No. 219

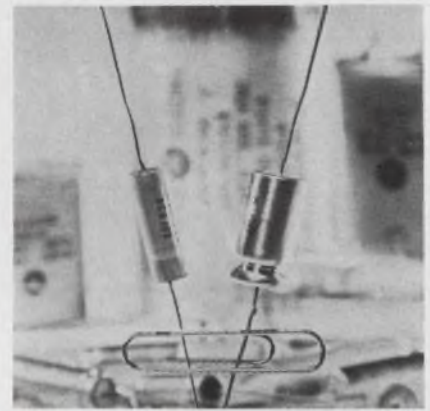

### Wet-slug capacitor

Supplied in polar form with insulated metal cases these capacitors have an operating range from -55 to 85°C and meet military vibration requirements of 2000 Hz, 15-G acceleration. Available in four tubular case sizes, the units have ratings from 6 to 60 V and range from 3.3 to 450  $\mu$ F. The units are suitable for filtering, bypass and coupling circuits.

General Electric, 392 S. Stratford Rd., Winston-Salem, N. C. Phone: (919) 725-9777.

Circle No. 220

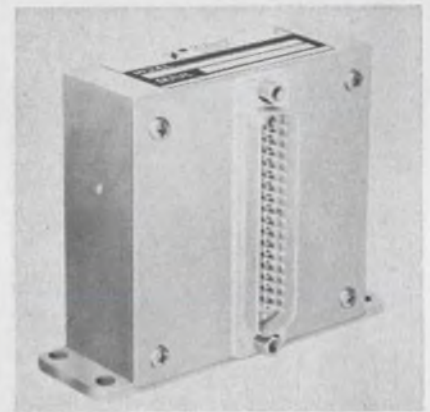

### Commutators

Using thin-film monolithic ICs, these high-level commutators/multicoders have an over-all accuracy of better than  $\pm 0.1\%$ . Back current is virtually eliminated by using FETs as switches (0.1  $\mu$ A nominal). The 2-pole 90-channel/pole unit is about 18.5 in.<sup>3</sup> and the 30-channel unit is about 10.5 in.<sup>3</sup> Offset is  $\pm 5$  mV max. The series is available with one or two poles and IRIG, PAM and PDM output format.

Teledyne Telemetry Co., Dynaplex Div., Box 341, Princeton, N. J. Phone: (609) 452-2550.

Circle No. 221





**These two  
heat shrinkables  
are hungry for  
tough mil-spec  
insulation  
problems.**

INSULTITE FROM E.C.C.

E. C. C. heat shrinkables are recognized  
under UL component file E39100.

**Feed them:**

New Insultite SR-350 eats up shock, strain, and vibration like only a semi-rigid, irradiated polyolefin can. It combines superior dielectric characteristics with high structural strength.

Insultite FP-301, on the other hand, has a flexible polyolefin appetite that devours mil-spec applications. Quickly. Totally.

SR-350 meets classes 3 and 4 of MIL-I-23053A and NASA MSFC 276A. FP-301 meets classes 1 and 2.

Both feature high abrasion resistance, superior voltage stand-off and excellent dielectric characteristics.

Both SR-350 and FP-301 shrink at a better than 2 to 1 shrink ratio when heat is applied.

Insultite SR-350 and FP-301 come in a variety of sizes and

colors. White, black, red, blue, and yellow, all easily printed for identification purposes, and clear where visual inspection is important. New SR-350 is available from  $\frac{3}{4}$ " to 1" ID. FP-301 comes in sizes from  $\frac{3}{4}$ " to 4" ID.

Whatever your insulation problem, think shrink with the Insultites. We offer commercial, military grade, flexible and semi-rigid tubing, heat-shrinkable end caps, and exclusive meltable inner-wall tape. Write today for free samples. (Specify diameters, please.)



**ELECTRONIZED CHEMICALS CORPORATION**

A subsidiary of High Voltage Engineering Corporation

Box 57, Burlington, Massachusetts, Area Code 617-272-2850

# Designed for Advanced Data Systems...



## The Series 400 TELCOM Receiver

### Look at these features...

- All solid state design
- Superior performance
- Completely modular, plug-in construction
- RF heads for VHF and S-Band telemetry, sweep tuned and wide band heads for surveillance applications
- Plug-in pre-detection recording converter, spectrum display, electrically switchable IF Filters

Interested? Get the detailed specifications. Write for your free copy of the DCS Series 400 TELCOM Receiver brochure.

Would you like an appointment to see a TELCOM Receiver for yourself? Just call the DCS office below nearest you...

Dept. ED-10-66 East Liberty Street, Danbury, Conn. 06813  
Telephone: 203-743-9241 • TWX 744-1990



**DATA-CONTROL SYSTEMS INC.**  
*Instrumentation for Research*

Sales Offices  
Silver Spring, Md., Huntsville, Winter Park, Long Beach, Santa Clara,  
Albuquerque  
Copenhagen London Rome Paris Munich Amsterdam

DCS 6-66

ON READER-SERVICE CARD CIRCLE 96

## COMPONENTS

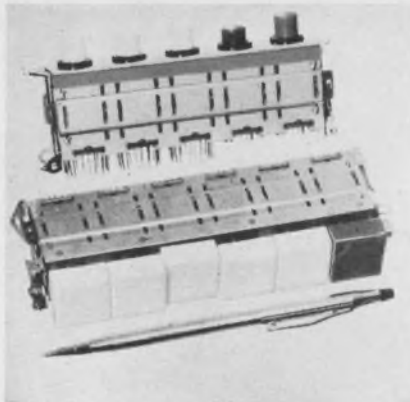

### Pushbutton switches

Either illuminated or non-illuminated, this line of switches provides six pdt contacts and round or square buttons that can be mounted in parallel rows. Life expectancy of the switches is  $10^6$  operations. These units can be provided for momentary contact, push-lock, push-release, inter-lock, and all lock. Contact ratings for a non-inductive load are 1 A at 30 Vdc or 0.5 A at 60 Vdc.

American Zettler Inc., 697 Randolph Ave., Costa Mesa, Calif.  
Phone: (714) 540-4190.

Circle No. 222

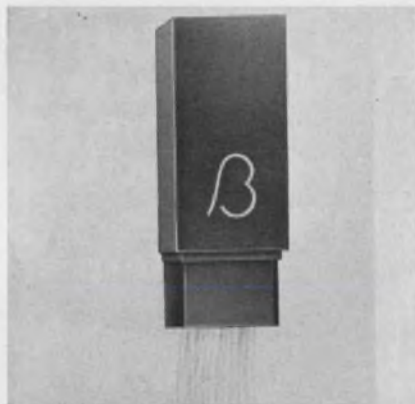

### Time delay relays

A timing range of 0.05 s to 22 minutes is provided by these time delay relays for any fixed time. Accuracy is  $\pm 5\%$  for all conditions of temperature or voltage. The relays are available as 2 A resistive and 1 A inductive at 28 Vdc, 10 A resistive and 5 A inductive at 28 Vdc or 110 Vac at 400 Hz. Solid-state circuitry is rated at 150 mA max, 20 mA min at 28 Vdc  $\pm 5\%$ , 2 V drop max. The relays meet MIL-R-5757D.

Betamite Electronic Devices,  
7001 West Imperial Highway, Los Angeles. Phone: (213) 673-5058.

Circle No. 223



# Voltmother

**This self-calibrating system can tend your entire brood of dc voltage sources and measuring devices—with 5 ppm accuracy.**

Our new 1045A DC Voltage Measuring System is designed to serve as your final authority on voltages ranging from above 1100 volts down to less than a volt. This range used to require two or more separate instruments.

The system's accuracy—5 ppm with 7 place resolution—is the best you can get. For all this range and accuracy, you don't have to be a fuss-budget with the 1045A. Even a fledgling technician can fly with six-place accuracy.

No external calibration is required to verify the system's accuracy. It functions as a voltage comparator, comparing voltages to saturated reference standard cells. As an added safeguard, the voltage of the standard cells is continuously monitored during the measurement.

Think of the many voltage devices used in your plant or lab that you rely on for consistently accurate readings: decade power supplies, potentiometric and digital volt-

meters, X-Y Recorders, pH meters, thermocouples, electrometers, reference voltage power supplies...

If the behavior of any of these instruments is open to question, consider how they might respond to the discipline of a good Voltmother. ESI, 13900 NW Science Park Drive, Portland, Oregon (97229).

The ESI 1045A Voltage Measuring System combines a direct-reading potentiometer, direct-reading standard cell comparator, and guarded voltbox. Price: \$4,200

	1000V	100V	10V	1V	0.1V
Limit of Error at Specified Voltages (in ppm)	11.7	4.1	3.6	4.6	21
Probable Error* (in ppm)	2.6	0.9	0.8	1.0	4.7

\*At least one-half of all measurements will be more accurate than the probable error.

Electro Scientific Industries **esi.**

ON READER-SERVICE CARD CIRCLE 97

# How many programmable calculators can solve this expression?

$$A = \sqrt[3]{3 \text{INV}(A)} - C_1 \text{INV}(A) + C_2 \text{INV}(A) + C_3^*$$

## ONLY ONE



## LOCI-2

This is one of many expressions, commonly used in engineering and science, which only **WANG'S LOCI-2**, of the available programmable electronic calculators, has the capability of solving. And it can provide the value of A in less than 5 seconds.

The extraordinary computational power of the **LOCI-2** is a natural result of its unique logarithmic approach to data manipulation. In fact, it actually approaches the performance of full-size computer systems in many of its capabilities, such as the on-line control of process and production systems.

If you are considering the purchase of a programmable calculator, avoid built-in limitations in logic power or flexibility. **LOCI-2** extends your computational horizons . . . yet costs no more than other, more limited, systems.

\*from  $\text{INV}(A) = \text{TAN}(A) - A$ ,

a familiar expression in gear design, used to determine the angle "A" when its involute,  $\text{INV}(A)$ , is known. Here is the keying sequence on the **LOCI-2**, given  $\text{INV}(A) = .05367$ , with the proper program card in the reader:

1. Prime
2. Key in . 05367 (INV(A))
3. W → S1
4. Po
5. Read A = 29.9860 Degrees

Investigate the capabilities of this unique, personal, programmable calculator. **LOCI-2** prices range from \$2750 to \$8450. Write today for complete details.

**WANG**  
LABORATORIES, INC.

DEPT. GGG10, 836 NORTH STREET  
TEWKSBURY, MASSACHUSETTS 01876  
TEL. (617) 851-7311

ON READER-SERVICE CARD CIRCLE 98

## COMPONENTS

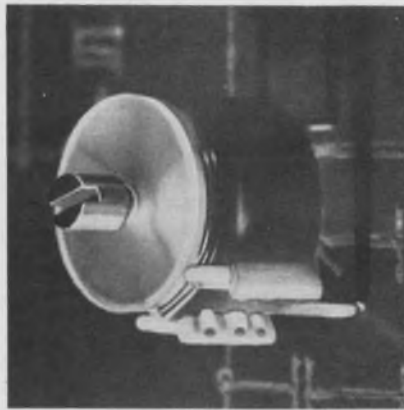

### Foil-dielectric trimmers

Available in ratings of 5, 10, 20 and 60 pF, these trimmers have a working voltage of 50 Vdc max and 360° rotation. Operating torque is less than 150 g-cm. The units can operate at frequencies above 100 MHz. The trimmer dielectric consists of thin polyethylene foils having high isolation resistance even under humid conditions. Both the foils and vanes are closely stacked on a plastic base having high vibration resistance.

Amperex Electronic Corp., Hicksville, N. Y. Phone: (516) 931-6200.

Circle No. 224



### Miniature relay

For up to 2-A multiple switching, this relay offers 2-, 4-, and 6-pole types for operation from 5-Vdc sources. Gold-plated contacts are rated for 10<sup>6</sup> operations at maximum load at 28 Vdc or 115 Vac resistive. Mechanical life is 10<sup>8</sup> operations. The units have applications in communications and data processing equipment, measuring instruments, process controls, recording devices and alarm systems.

Sigma Instruments Inc., 170 Pearl St., Braintree, Mass. Phone: (617) 843-5000. Circle No. 225

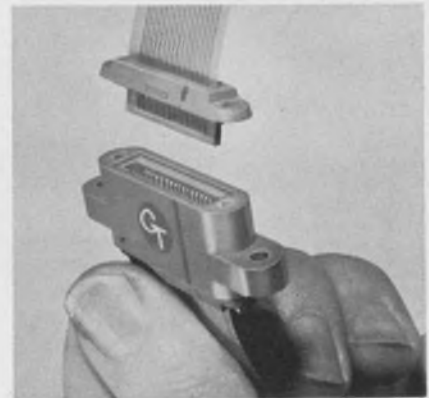

### Cable connector

Flat cable connectors eliminate insertion force against the surface of the conductor. The male plug enters the female portion of the connector without deflecting the contacts. The carrier block with its raised lead edge protects the front edge of the flat cable. As the cover cap is pressed into place the carrier block is moved forward and up, bringing the cable conductor into contact with the lug. Center-to-center spacing is 0.05-in.

Price: \$2 to \$10. G.T. Schjeldahl Co., Hwy. 3, Northfield, Minn. Phone: (507) 645-5633.

Circle No. 226

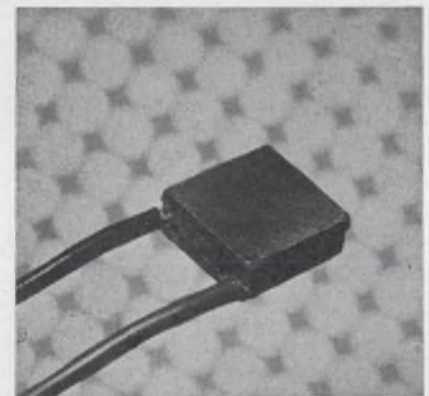

### Component cooler

For temperature control and cooling of small components, this thermoelectric module has a loaded heat pump capacity of 3.9 W max. Requiring an input of 9A, the unit has an unloaded temperature differential of 65°C. PC techniques applied to metalized ceramic end caps give electrically insulated module surfaces a higher breakdown voltage, improved cooling capability and rapid response.

P&A: \$24; stock. EG&G, Inc., 160 Brookline Ave., Boston. Phone: (617) 267-9700. Circle No. 227

# PNP

**silicon transistor**

**$BV_{CEO} = 200-500V.$**

**$HFE = 30 \text{ min.}$**

**$f_T = 30 \text{ Mc/s min.}$**

**plus**

# NPN

TO-5

5 WATTS

MD-14  
15 WATTS

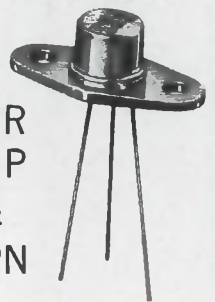

FOR  
PNP  
&  
NPN

**300V TO 1000V**

**50Mc GBW**

**5-15 WATTS**



35-10 36th Avenue, Long Island City 6, N. Y. • EXeter 2-8000

ON READER-SERVICE CARD CIRCLE 99

# JUST CUT TO PATTERN

Netic & Co-Netic Magnetic Shields



## HAND FORM IN SECONDS

A great convenience to design engineers, packaging engineers, R/D, etc. A fast inexpensive empirical tool to determine and shield the necessary components of systems. Use multiple layers if needed. Thicknesses from .002". Also widely used in automated or manual production line techniques.

Netic attenuates high intensity fields, Co-Netic low intensity fields. Permanently Pre-Annealed. Not affected by bending, vibration or shock. Minimum retentivity. Increases systems reliability.

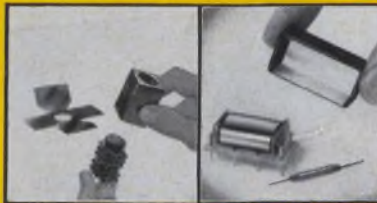

Module Shielding

Reed Relay



Wein Bridge Oscillator

Peelback Adhesive Foil

## MAGNETIC SHIELD DIVISION

Perfection Mica Company

1322 N. ELSTON AVENUE, CHICAGO, ILLINOIS 60622

ORIGINATORS OF PERMANENTLY EFFECTIVE NETIC CO-NETIC MAGNETIC SHIELDING

ON READER-SERVICE CARD CIRCLE 100

# TEST SOCKET

FOR FLAT PACK INTEGRATED CIRCUITS

8075 SERIES

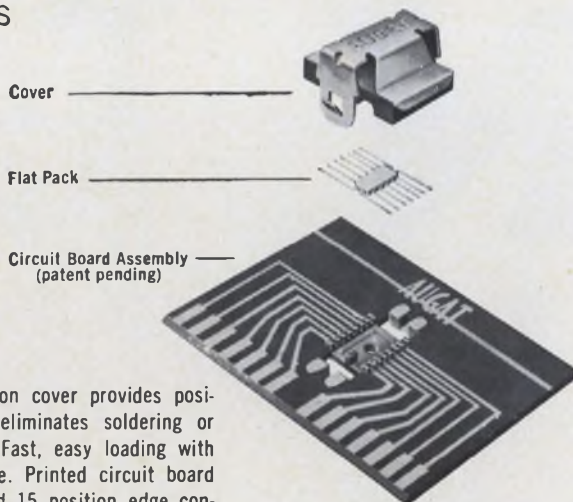

Exclusive snap-action cover provides positive contact and eliminates soldering or welding IC leads. Fast, easy loading with no IC lead damage. Printed circuit board plugs into standard 15 position edge connector. Accepts any size package up to 1/4 x 3/8, any number of leads up to 14.

Write for Catalog 364 on complete line of integrated circuit products for Testing Breadboarding and Packaging.

**Other applications**  
Dual-In-Line Packages  
TO-5 case size units  
T.I. Mech Pak Carrier

**AUGAT** INC. 31 PERRY AVE., ATTLEBORO, MASS. 02703

ON READER-SERVICE CARD CIRCLE 101

## COMPONENTS

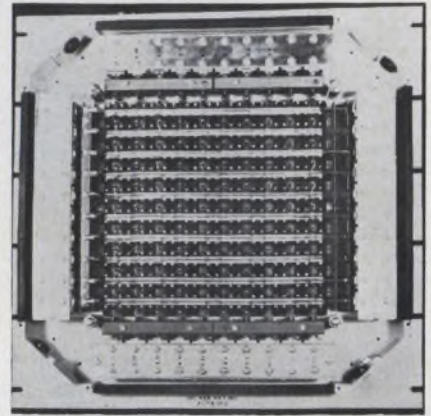

### Switching matrix

Requiring no wiring of contacts, this switching matrix has random or sequential switching. Two or more input points may be selected simultaneously by energizing the contact bar to move perpendicularly to the actuator bar. This action positions a bifurcated contact against a stationary input connector pin. Crosstalk is -80 dB at 4 kHz and capacitance is 1.5 pF.

P&A: \$650; 5 to 10 wks. McKee Automation Corp., 7315 Greenbush Ave., N. Hollywood, Calif. Phone: (213) 983-1193. Circle No. 228



### Plastic-film capacitors

The series L plastic-film extended-foil capacitors store from 25 to 1500 J in tubular cans at 5 kV. The units weigh from 5 oz to 14 lbs. The series M capacitors operate to 65°C at rated voltage (85°C with derating) at 12% less energy density than series L. Both series discharge at up to 50,000 A. Pulse repetition rates range to 100/s within their respective temperature ratings. The capacitors are rated from 2.5 to 10 kV.

Maxwell Laboratories, Inc., Box 20508, San Diego, Calif. Phone: (714) 281-8146. Circle No. 229

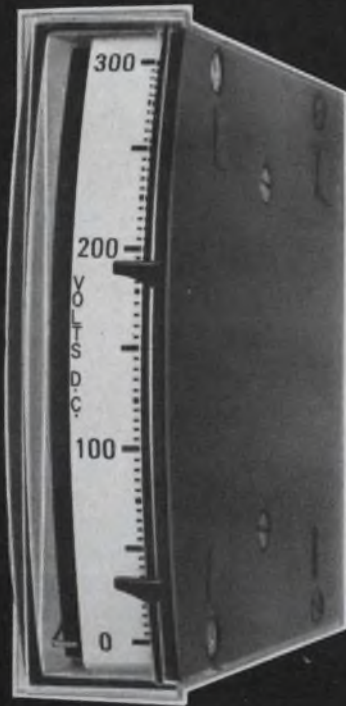

**THIS IS A COMPLETE  
CONTROL METER  
(ACTUAL SIZE)**

# PARKER MINITROL

Not only the most compact, but also the simplest, fastest-acting, most rugged and dependable yet to reach the market.

*Minitrol* ER35 (above), with 3½" scale, is ⅞" thin and 4½" deep, handles up to 300 MA at 100 V internally — thanks to the unique PARKER etched-coil movement and the new contactless, mirrorless, prismless all-solid-state photo switching. Modules for high-density monitor/control applications assemble 22 abreast in a 19" rack.

Surface-mounting models (right) have the same self-contained switching and brilliant performance in cases also ⅞" thin.

Ask for Bulletin M-5.



SR35/3½" SURFACE-MOUNTING



SBR35 & 45/3½" & 4½" SURFACE-MOUNTING



**PARKER INSTRUMENT CORP.** 200 HARVARD AVE / STAMFORD, CONN 06904 / (203) 325-4361 / TWX 710-474-3390

ON READER-SERVICE CARD CIRCLE 102

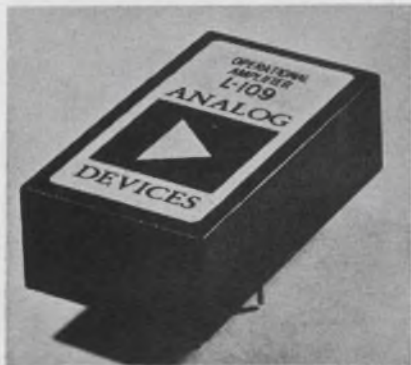

### 20-mA op-amp

Output of  $\pm 10$  V and 20 mA is characteristic of this dc differential op-amp. Open loop gain is 150,000 and gain-bandwidth product is 1.5 MHz. Voltage drift is  $20 \mu\text{V}/^\circ\text{C}$  and drift at each input is  $1.5 \text{ nA}/^\circ\text{C}$ , max. Differential current drift is  $0.5 \text{ nA}/^\circ\text{C}$ , slew rate is  $1.2 \text{ V}/\mu\text{s}$  and overload recovery time is 1 ms. The unit has  $\pm 20\text{-nA}$  offset,  $\pm 10\text{-V}$  common mode rating and 20-kHz full response.

P&A: \$55; stock. Analog Devices, 221 Fifth St., Cambridge, Mass. Phone: (617) 491-1650.

Circle No. 230

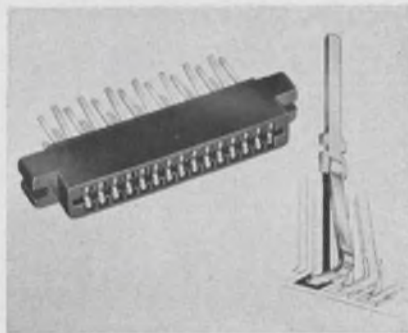

### PC board connector

This PC board connector has pre-loaded cantilever contacts with closely controlled gap uniformity. Contact pressure is independent of PC board insertion depth. The connector is available with selective gold plating which concentrates the gold in the contact area. Selective application of tin or tin-lead coating is optional. Comb contact formation permits simultaneous insertion of contacts for consistency of assembly and increased speed.

Price: \$0.01-1/4 /contact. Cinch Mfg. Co., 1026 S. Homan Ave., Chicago. Phone: (312) 632-2000.

Circle No. 231



### Frequency standard

Designed as a clock source for digital industrial control, this miniature flat pack frequency standard has a square wave output. The device operates over the 10-kHz to 3-MHz range. Stability from 200 kHz to 3 MHz is  $\pm 0.001\%$ . A crystal-controlled oscillator generates the primary frequency. Oscillator output is buffered and shaped for positive triggering of the binary that ensues. An internal voltage regulator stabilizes output frequency.

Robinson-Halpern Corp., 5 Union Hill Rd., West Conshohocken, Penn. Phone: (215) 825-1300.

Circle No. 232

## NOW... Same-Day Shipment of Cyclohm FANS and BLOWERS



**THE AIR MOVEMENT UNITS GUARANTEED FOR 5 YEARS TO REQUIRE NO MAINTENANCE OR RE-LUBRICATION**

Expanded facilities, day and night operations, enable us to maintain stocks of standard CYCLOHM Fans and Blowers available for immediate shipment. All units are powered by the Howard Unit Bearing Motor, with a history of millions of successful installations.

For list of availabilities, address Standard Motor Product Sales, 23 Broadway, Des Plaines, Ill., 60016. TWX 910-233-1658. For Fan Bulletin 9-03 and/or Blower Bulletin 8-01 address



**HOWARD INDUSTRIES**  
MSL INDUSTRIES, INC./MOTOR GROUP  
1760 STATE STREET  
RACINE, WIS. 53404

ON READER-SERVICE CARD CIRCLE 103

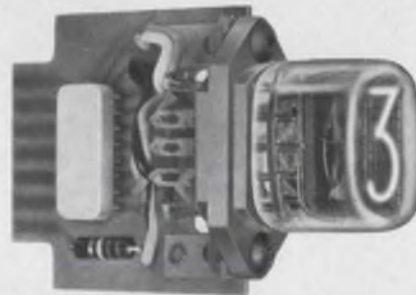

## NATIONAL<sup>®</sup> Readout Tube Drivers

TTL Integrated Circuit Drivers designed for National Readout Tubes.

Now available: Decoder/Driver and Decimal Counter/Driver.

- 15 MHz Counting Rate
- Compatible with all side view and end view readout tubes.

**NATIONAL**

REQUEST BULLETIN

**ELECTRONICS, INC.**

a varian subsidiary

PHONE: (312) 232-4300 • GENEVA, ILLINOIS, U.S.A.

ON READER-SERVICE CARD CIRCLE 104

ELECTRONIC DESIGN 23, October 11, 1966



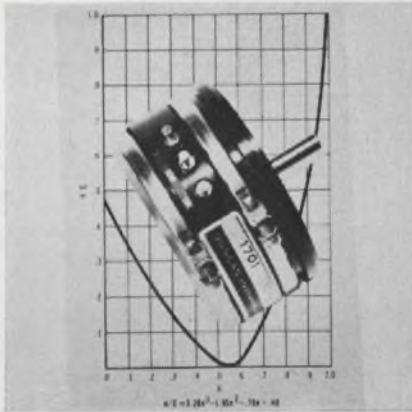

### Nonlinear pots

This family of nonlinear pots features low-noise windings, dual whisker in V-groove slip-ring design and a low-inertia rotor. A digital computer analyzes mathematical and graphical data defining the desired output function of the pot. This design information is used to program servo-controlled winding machines which produce the variable-pitch winding to meet the specified function.

Duncan Electronics Inc., 2865 Fairview Rd., Costa Mesa, Calif. Phone: (714) 545-8261.

Circle No. 179

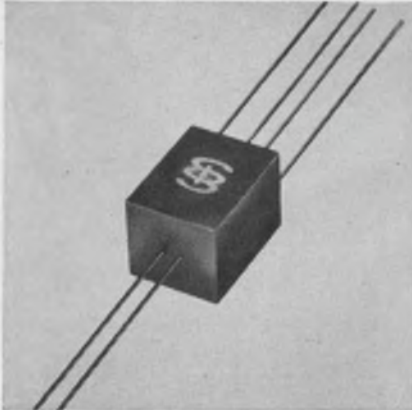

### Bistable latching relays

These polarized dc latching reed relays contain a single coil of reversible polarity which transfers the contacts to either of two stable states. A symmetrical magnetic latching design holds the contact open or closed for model 7051 (spdt) and closed for model 8051 (spst) until a reverse input changes contact state.

P&A: \$43 (model 8051), \$48 (model 7051); stock. Solid State Electronics Corp., 15321 Rayen St., Sepulveda, Calif. Phone: (213) 785-4473.

Circle No. 180

## Announcing new low-cost Ceramic Disc Variable Capacitors

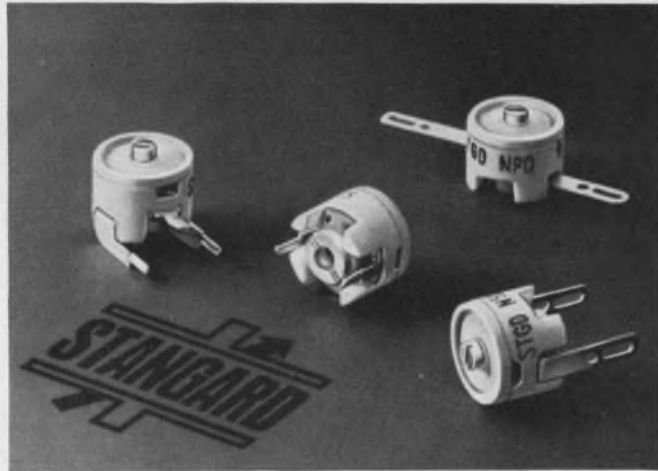

Capacitors shown enlarged 50%

### JFD Stangard DVC Capacitors

These new Stangard variable ceramic disc capacitors represent an optimum balance of high quality and low cost for commercial and industrial applications.

Eight wide  $\Delta C$  ranges, each available in 4 versatile mounting configurations, offer high Q and excellent stability in applications such as test equipment, communications equipment, low power transmitters, filters, delay lines, broadcast and television receivers, and other devices requiring adjustable capacitors.

Stangard DVC's offer a unique feature...easy adjustment... from either top or bottom. These  $\frac{3}{8}$ " diameter ceramic disc Stangard capacitors meet or exceed the applicable specifications of MIL-C-81.

Write for Bulletin STD-65.

**JFD**

TODAY'S COMPONENTS BUILT FOR TOMORROW'S CHALLENGES™

JFD ELECTRONICS CO. / COMPONENTS DIVISION 15th Avenue at 62nd Street Brooklyn, N. Y. 11219 / Phone 212-331-1000 • Sales Offices—Arcadia, Calif. Chi., Ill. / Balt., Md. / Saxonville, Mass. / Bklyn., N. Y. / New Hartford, N. Y. Cinn., Ohio / Phila., Pa. / Pitts., Pa. / Paris, France / Azor, Israel

if you make  
aerospace  
packages in  
small spaces

learn about  
the C10  
ceramic  
capacitor

...for critical design jobs

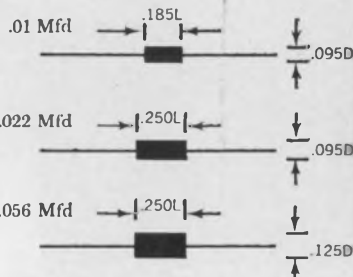

USCC now brings you the smallest complete ceramic capacitors with the highest capacitance per unit volume specially designed for extreme environmental conditions. Stable, long life with superior reliability. The C10 Series of miniature ceramic capacitors gives you performance unsurpassed in axial-lead capacitors today!

Capacitance Range: 1 pF to 3 Mfd at 1 kc  
Capacitance Tolerance:  $\pm 10\%$  (Std),  $\pm 5\%$  and 20% available  
Working Voltages: 50/100/200 VDC at 125°C  
Operating Temperature Range:  $-55^\circ$  to  $150^\circ\text{C}$ .

#### WITH PROVEN RELIABILITY

Used on:  
Saturn  
Apollo  
LEM  
OGO  
Mariner

**USCC**

U. S. CAPACITOR CORPORATION  
2151 LINCOLN STREET ■ BURBANK, CALIFORNIA 91504  
(213) 843-4222 ■ TWX: 213-846-0904

ON READER-SERVICE CARD CIRCLE 106

## COMPONENTS

### Solid-state relay

This solid-state relay has a range of 0 to 100  $\mu\text{A}$ dc with a set-point scale calibrated in increments of 1  $\mu\text{A}$ . Input resistance is 100  $\Omega$  for the entire current range and load rating is 1 A at 117 V, 60 Hz. Response time is 200 ms, accuracy is  $\pm 2\%$  under reference conditions and repeatability is typically  $\pm 0.5\%$ . Breakdown voltage is 500 Vac and common mode rejection is 250 Vdc max.

P&A: \$175, stock. Weston Instruments, Inc., 614 Frelinghysen, Newark, N. J. Phone: (201) 243-4700.

Circle No. 233

### Encoder devices

Nine new encoders include optical, magnetic and contacting types available with modifications. The line includes a size 31 gray code with a 5-million turn life, a high-reliability size 11 binary X, an optical incremental encoder, a size 23,

360-count and multi-360 turn encoder for use with IC logic, a magnetic encoder, an 8-digit per turn, self-selecting size 18 with a life of 7-1/2 million turns and a bi-polar, noise-free 100-million turn contacting encoder.

United Aircraft Corp., Norden Div., Norwalk, Conn. Phone: (203) 838-4471.

Circle No. 234

### Positive TC thermistor

An increase in resistance with temperature to up to 50% of instantaneous value/ $^\circ\text{C}$  is exhibited by this thermistor. Made from doped barium titanate, the device may be used up to  $170^\circ\text{C}$ . The switching point is a function of the material and does not change with time. Thermistors with switching temperatures in  $10^\circ$  increments are available from 55 to  $165^\circ\text{C}$ .

Pennsylvania Electronics Technology, Inc., 1397 Frey Rd., Pittsburgh. Phone: (412) 351-0890.

Circle No. 235

**SOMETHING MISSING?**

If the DUNCAN ELECTRONICS Short Form Catalog is missing from the opposite page, someone got to this issue before you.

But don't panic! Circle the number on the inquiry card and we'll see that you receive a copy immediately.

You'll find this catalog most useful in specifying and ordering DUNCAN precision potentiometers, turns-counting dials and commutator switches.

**de**

DUNCAN electronics, inc.  
2865 Fairview Rd., Costa Mesa, California  
TEL: (714) 545-8261 TWX: 910-595-1128

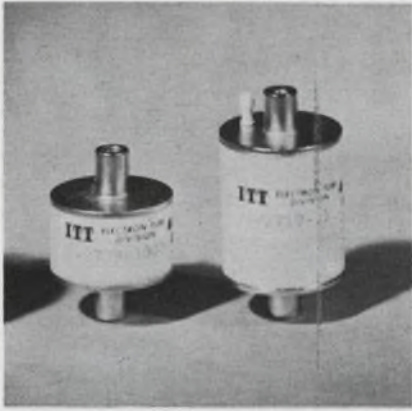

**Spark-gap protectors**

This line of ceramic-metal spark-gap protectors present a very high impedance until break-down impedance drops to a few ohms. These gaps are usable for high-voltage energy transfer with minimum switch dissipation. Type F-2709 gaps have breakdown voltages between 400 and 8000 V. Surge currents range to 3000 A and energy to 40 J. Type F-2719 gap has a standard breakdown of 400 V and handles peak currents of 25,000 A at 2.5 C to 200 A at 200 C.

ITT Corp., 320 Park Ave., New York. Phone: (212) 752-6000.

Circle 236

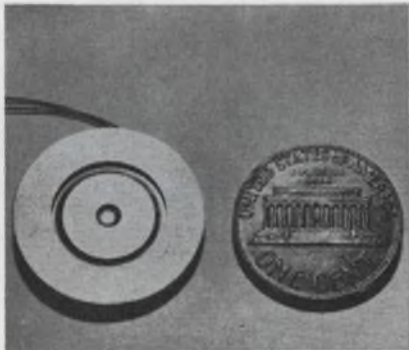

**Pressure transducer**

Air turbulence and pressure on surfaces are measured by this transducer. The unit has a pressure range of from 0 to 4 psig with a maximum overpressure capability of 10 psig. Output is 1000  $\Omega$  nominal (at 25°C). Temperature coefficient is 1%/°F, linearity is  $\pm 1\%$  (terminal), repeatability is 0.1% and hysteresis is 0.3% max. The sensing element is a nickel alloy.

Mechmetals Corp., 11431 Joanne Pl., Culver City, Calif. Phone: (213) 870-5671.

Circle 237

# MATCH THIS PERFORMANCE

IN A SPDT DIODE SWITCH

# IF YOU CAN!

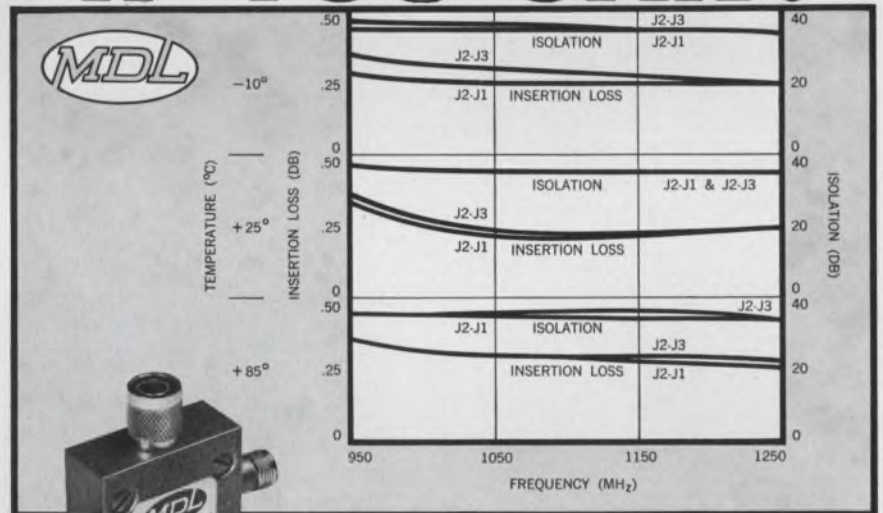

UNIT IS PRICED UNDER \$100.00 IN QUANTITY

**MATCHED OUTPUTS**

The Model DS-11-30-5-25 Diode Switch was designed for use in the TACAN band of frequencies. Matched performance between output ports versus temperature is better than 0.1 db.

**LOW HOLDING POWER**

Ideal for applications where power drain is critical, normal operation is obtained with only 50 MW holding power for the "on" port with negligible power used in the "off" port.

For further information regarding zero bias operation, connector trade-offs or other details, contact Joseph Brumbelow, director of our solid state department, at the address below.

WRITE FOR OUR FREE CATALOG ON SOLID STATE CIRCUITS

**MICROWAVE DEVELOPMENT LABORATORIES • INC.**  
 87 Crescent Road • Needham Heights • Massachusetts 02194  
 Telephone: 617-449-0700 • TWX 617-444-2695

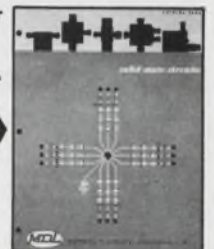

ON READER-SERVICE CARD CIRCLE 184

**Computers are getting smarter all the time...**



**This one even knows which ZT fork to use!**

ZT-designed four-fingered forks fan out the conductors and minimize stress on the strain relief clamp of this new computer designed for NASA. Thus, operating personnel no longer have the problem of conductors and pins pulling out of connector sockets.

— And, that's just the beginning of ZT's contribution to this computer: 60 conductor twisted ribbon cables were neatly jacketed with ZT GP-20 to relieve the blocking of air holes. Results: The necessary air flow was maintained... cables were insulated and protected from abrasion.

One more point to remember: Zippertubing® jacketing zips on, permits cable modifications and repairs as needed.

If you need help on special cable jacketing problems, call or write. Zippertubing® Company engineers are at your service.



**THE Zippertubing® co.**

Main Office and Plant:  
13000 S. Broadway, Los Angeles 61, Cal. • FA 1-3901  
Eastern Office and Warehouse:  
480 U.S. Hwy. 46, S. Hackensack, N.J. • HU 7-6261

## COMPONENTS



### Position transducer

Formed by depositing the resistive material onto a copper mandrel, this linear position transducer has essentially infinite resolution. Model 178 has typically 100- $\Omega$  noise level,  $\pm 300$  ppm/ $^{\circ}$ C max temperature coefficient and 5% resistance tolerance. Independent linearity is  $\pm 0.5\%$  with power rated at 1.5 W/in. at 40 $^{\circ}$ C. Operating range is -55 to 125 $^{\circ}$ C with an insulation resistance of 50 M $\Omega$ .

Bourns Inc., 6135 Magnolia Ave., Riverside, Calif. Phone: (714) 684-1700.

Circle No. 238



### Xenon flashtube

With internal trigger probes and a semi-flat top, this xenon flashtube has flash rates up to 600 pps and pulse duration of 15  $\mu$ s or less. In single flash operation the input per flash is 5 J max. Long term average input rating is 7 W. These flashtubes are available in aircooled, helical, bifilar, annular or U-shaped designs. Applications include laser stimulation, flash photolysis and medical research.

EG&G Inc., 160 Brookline Ave., Boston, Mass. Phone: (617) 267-9700.

Circle No. 239

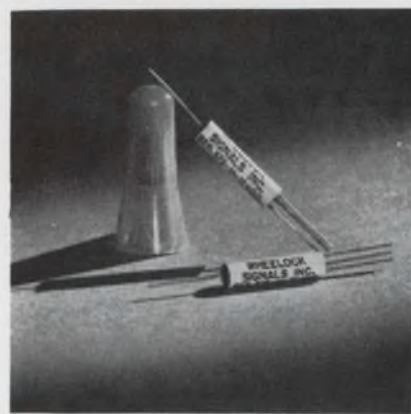

### Glass reed relay

Insulation resistance of this relay exceeds  $1 \times 10^{14} \Omega$  at 90 Vdc. This relay occupies 0.02 in.<sup>3</sup> and has an operating time of 0.4 ms max. Release time is 0.018 ms max, shock is 50 G and vibration is 50 G at 2000 Hz. Coil power is 60 to 70 mW sensitive and 160 to 230 mW non-sensitive, contacts are rated 7 W, 125 mA and open contact capacitance is 0.1 pF.

Availability: 4 to 5 wks. Wheelock Signals, 273 Branchport Ave., Long Branch, N. J. Phone: (201) 222-6880.

Circle No. 240



### FET buffer amplifier

Differential and common mode input of  $10^{10} \Omega$  is combined with input offset of  $\pm 0.2$  nA and 100-dB open-loop gain in this FET op-amp. The amplifier will deliver  $\pm 10$  V at 10 mA from dc to 100 kHz and has a unity gain bandwidth of 1 MHz. Slewing rate is 5 V/ $\mu$ s. In the unity gain non-inverting circuit, model 1557 draws 0.2 mA from the source. Flat response is maintained with up to 1000 pF load.

P&A: \$110; stock to 3 wks. Burr-Brown Research Corp., 6730 S. Tucson Blvd., Tucson. Phone: (602) 952-1111. Circle No. 241

# 'Pssst!'

*Want a peek at the most complete line of solenoids in the world?*



Here's a limited edition that's full of eye-popping excitement for red-blooded design engineers.

You'll thrill to large, clear photos of unadorned solenoids of all kinds, all shapes and sizes (the largest selection in all the world.)

You'll blush at the straightforward language of the electrical specifications—



the stark realism of the charts and dimensional drawings.

Best of all, this startling catalog is free. It belongs in your desk. Write today for bulletin GA.

We'll send it immediately in a plain brown wrapper. Guardian Electric Mfg. Co., 1550 West Carroll Avenue, Chicago, Illinois 60607.

**GUARDIAN**  **ELECTRIC**

ON READER-SERVICE CARD CIRCLE 186

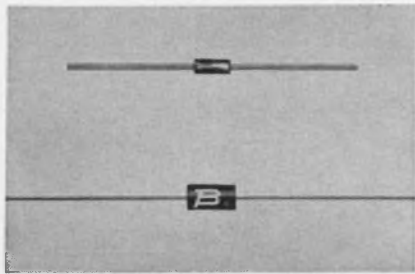

### Micromin capacitor

Encased in a high-temperature plastic molded body, this capacitor measures 0.1 x 0.2 in. and has a terminal strength of 5 lbs. It meets environmental conditions of MIL-C-11015C. The gold-plated nickel leads are weldable and solderable. Capacitance range is 10 to 10,000 pF and tolerances of 10% and 20% are available. Operating temperature range is -55 to 150°C, insulation resistance is 100 GΩ at 50 Vdc and power factor is 2.5% max.

Bourns, Inc., 1200 Columbia Ave., Riverside, Calif. Phone: (714) 684-1700.

Circle No. 242

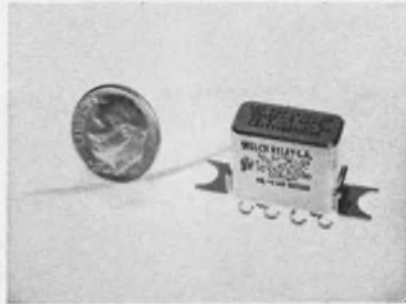

### Magnetic latch relay

Four internal diodes for steering and suppression are included in this relay. Flux, gas and humidity contamination are eliminated. The relay has an 18-V pull-in and 2-A dpdt contact ratings. Both 90- and 140-mV sensitivities are available in 8-, 9- or 10-pin headers. The unit can withstand 30-G vibration and meets MIL and NASA specs. The relay is all welded internally and welded to its can.

Welch Relay Co., Inc., 1871 S. Orange Dr., Los Angeles, Calif. Phone: (213) 933-9542.

Circle No. 243

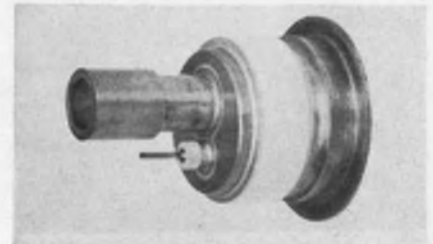

### Ceramic SCR housing

For encapsulating power or control rectifiers ranging from 16 to 500 A, this housing consists of a glazed alumina (ceramic) body brazed to a Kovar cap and an oxygen-free copper flange. The knife-edge seal permits flange yield during welding preventing stresses from being transmitted to the ceramic-to-metal joint. A ceramic-to-metal seal supports a small copper gate-lead tube which is welded to the gate wire.

Price: \$3.50 (in 25,000 lots). Ceramics International, 39 Siding Pl., Mahwah, N. J. Phone: (201) 529-2800.

Circle No. 244

**FREE SAMPLE** PROVE IT TO YOURSELF

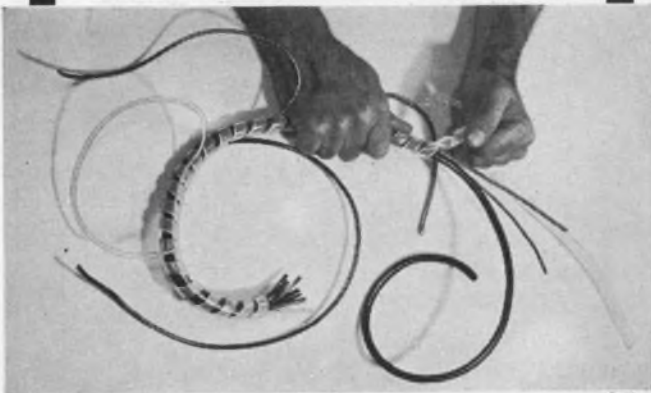

### SPIROBAND the wrap-around harness

SPIROBAND, the flexible spiral-wrapping, forms a firm bundle of wires...permits individual lead-offs or additions at any point...unwraps easily for changing cable make-up or tap position. Easier to apply than tape...retains its elasticity through any number of applications. Three sizes and three types of polyethylene—natural, ultraviolet resistant and fire retardant.

**OTHER ELECTROVERT PRODUCTS:** cradleclip, strapping, cable ties, markers, grommet strip, wavesoldering systems.

Sold Coast-to-Coast through Authorized Distributors

**ELECTROVERT INC.**  
86 Hartford Ave., Mount Vernon, N. Y. 10553  
Burbank, California Milwaukee, Wisconsin

ON READER-SERVICE CARD CIRCLE 187

### MITSUMI COMPONENTS

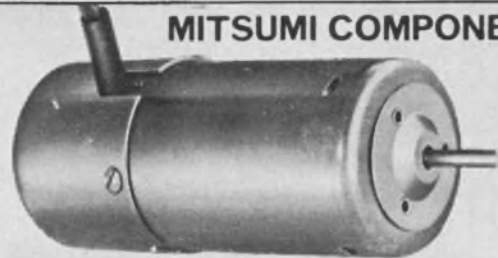

Who needs 55% efficiency in a micro motor 20mm or less in diameter? No one.

But it is a testimony to Mitsumi's ability to meet unusual specialty micro-electronics requirements. Micro-motor efficiency over 50% has been considered impossible for a motor as small as 20mm in diameter. Adoption of a new system in the magnetic circuit has upset this common concept.

Both electrical and mechanical noises have practically been eliminated by a built-in noise suppressor, and a specially constructed brush which has improved the rectifying capacity. Ask for Mitsumi when you need a reliable, quality micro motor for portable tape-recorders, record-players, measuring instruments and 8mm 2-speed movie cameras. Over 30 types of AC or DC micro motors immediately available.

#### MAIN PRODUCTS

- Polyethylene variable capacitors
- IF Transformers
- Micromotors
- Synchronous motors
- Front-end FM tuners
- UHF & VHF TV tuners
- CdS photoconductive cells
- Trimming potentiometers
- Various types of coils
- Various types of sockets
- Trimmer capacitors
- Various types of terminals
- Fuse holders



### MITSUMI ELECTRIC CO., LTD.

Main Office / 1056 Koadachi, Komae-machi, Kitatama-gun, Tokyo, Japan. Tel: 415-6211

Mitsumi Electronics Corporation / 11 Broadway, New York 4, N.Y. 10004, U.S.A. Tel: HA-5-3085-3086

Chicago Branch / 333, N. Michigan Avenue, Chicago, Illinois, 60601, U.S.A. Tel: 263-6007

ON READER-SERVICE CARD CIRCLE 188



### Solid-state oven

A fixed temperature operating environment for crystal or solid state components is provided by this oven. The unit employs an ac or dc adjustable proportional temperature control. Externally made adjustments over a range of 20°C are accurate within 0.1°C. Units are available from 6 to 120 Vac or 12 to 28 Vdc using 10 W. Cavity dimensions are 0.665 x 1.09 x 1.062 in.

P&A: \$125 (1 to 10); 30 days. Electronic Research Co., 10000 W. 75 St., Overland Park, Kansas. Phone: (913) 631-6700.

Circle No. 245

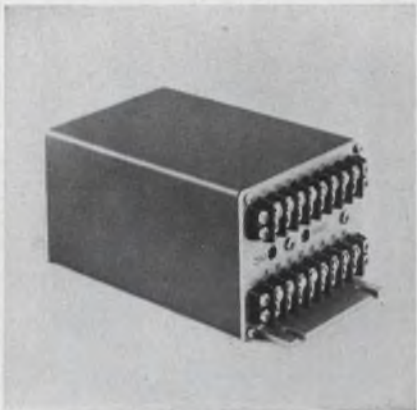

### Dc to ac converter

Offering linearity of better than 0.025% full scale, this converter has an output frequency directly proportional to the input voltage. Four input ranges from 10 mV to 10 V full scale have a 10-kHz full scale output for each range. The housing consists of a flange-mounted case with barrier strip screw terminal connectors for input and output. Adjustment pots give zero and range control.

P&A: \$350; 3 to 4 wks. Anadex Instruments Inc., 7833 Haskell Ave., Van Nuys, Calif. Phone: (213) 782-9527.

Circle No. 246

# if you want... PRECISE POSITIONING



- RAPID ACCELERATION
  - IMMEDIATE RESPONSE
- IN YOUR TAPE TRANSPORT  
CAPSTAN DRIVE**

## INLAND MOTOR has the answer in its DC DIRECT DRIVE TORQUE MOTORS

**Precise Positioning...** No gears — No backlash. The direct-drive torque motor shaft IS THE capstan itself... ensures high coupling "stiffness." It gives high mechanical resonant frequency offering design capabilities of an extremely wide servo bandwidth.

**Rapid Acceleration and Deceleration...** Produces more torque, size for size, than any other electro-mechanical device. As a capstan drive it has the highest, practical torque-to-inertia ratio.

**Immediate Response...** Since its torque is a direct function of applied current, independent of speed, response is positive and instantaneous at all operating speeds — limited only by the characteristics of the tape.

**Direct Coupling = Precise Positioning**

**High Torque — Low Inertia = Rapid Acceleration**

**DC Control = Immediate Response**



### TORQY SAYS:

If you would like full information on Inland's Torque Motors used as a capstan drive in a tape transport application or engineering assistance on a particular servo design problem, let us know... we'll be glad to help.



## INLAND MOTOR

CORPORATION  
RADFORD, VIRGINIA

703-639-3973

SUBSIDIARY OF **KOLLMORGEN**  
ON READER-SERVICE CARD CIRCLE 189

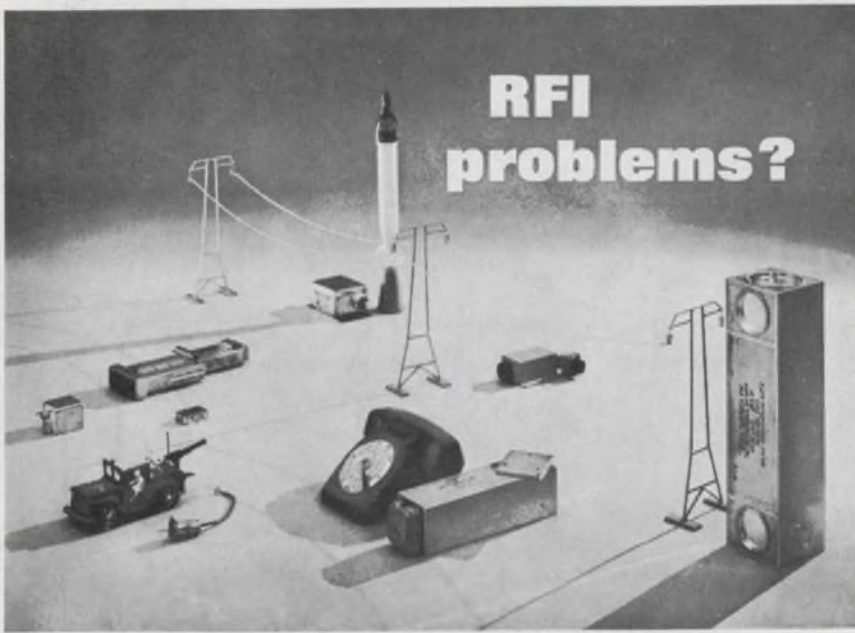

**SOLUTIONS — HOPKINS FILTERS!  
OBVIOUSLY IN ALL SIZES AND SHAPES!**

Where components and equipment generate conducted or radiated RFI, control measures must be taken to produce a compatible environment. Hopkins has in excess of 2,000 solutions to problems in RF Interference and designed proper filters for maximum noise suppression. When you are plagued with an RFI problem, Hopkins will solve it—and provide the engineering, design, prototype, testing and production of custom filters to specification.

Our service includes complete RFI testing to a wide variety of military specifications in our certified shielded enclosures.

We are here to solve your RFI filter problems and welcome your contact.

*Our literature is as close as your telephone or letter.*



**SINGLE & DUAL CIRCUIT FILTERS FOR POWER LINES**  
Data-Log Series 1960



**FILTERS FOR COMMUNICATION CIRCUITS**  
Data-Log 258B



**GENERAL PURPOSE RFI FILTERS**  
Data-Log RFI 2000



12900 Foothill Blvd., P.O. Box 191 • San Fernando, Calif. 91341  
Telephone: (213) 361-8691 • TWX 213-764-5998 • Cable: HOP

*A Subsidiary of Maxson Electronics Corporation*  
ON READER-SERVICE CARD CIRCLE 190

COMPONENTS



**2-W RF load resistor**

A short cylindrical film resistor as the center conductor of a matched tractrix housing gives this 2-W RF load resistor a vswr of 1.04 from dc to 1 GHz, 1.06 from 1 to 2 GHz and 1.1 from 2 to 4 GHz. The compact terminations are designed for 50- $\Omega$  transmission lines. They weigh 2 oz max. Model 8010 (female N connector) is 1-1/2 in. long and model 8011 (male N connector) is 1-5/8 in. long.

P&A: \$20; 60 days. Bird Electronic Corp., 30303 Aurora Rd., Cleveland. Phone: (216) 248-1200.

*Circle No. 247*



**Tunable analog filter**

A tuning range from 20 Hz to 2 MHz is handled in analog form by this tunable bandpass device. The instrument behaves as a cascade of low-pass and high-pass filters with 4-pole Butterworth response. Both high and low stop bands attenuate at 24 dB/octave. Nominal passband gain is unity. Cutoff accuracy is  $\pm 5\%$  of indicated frequency, high-pass or lowpass.

Spectrum Instruments, Inc., Box 474, Tuckahoe N. Y. Phone: (914) 779-8111.

*Circle No. 249*



# Why does Bodine test motor bearings electronically?

— to be sure Bodine Motors run quietly.

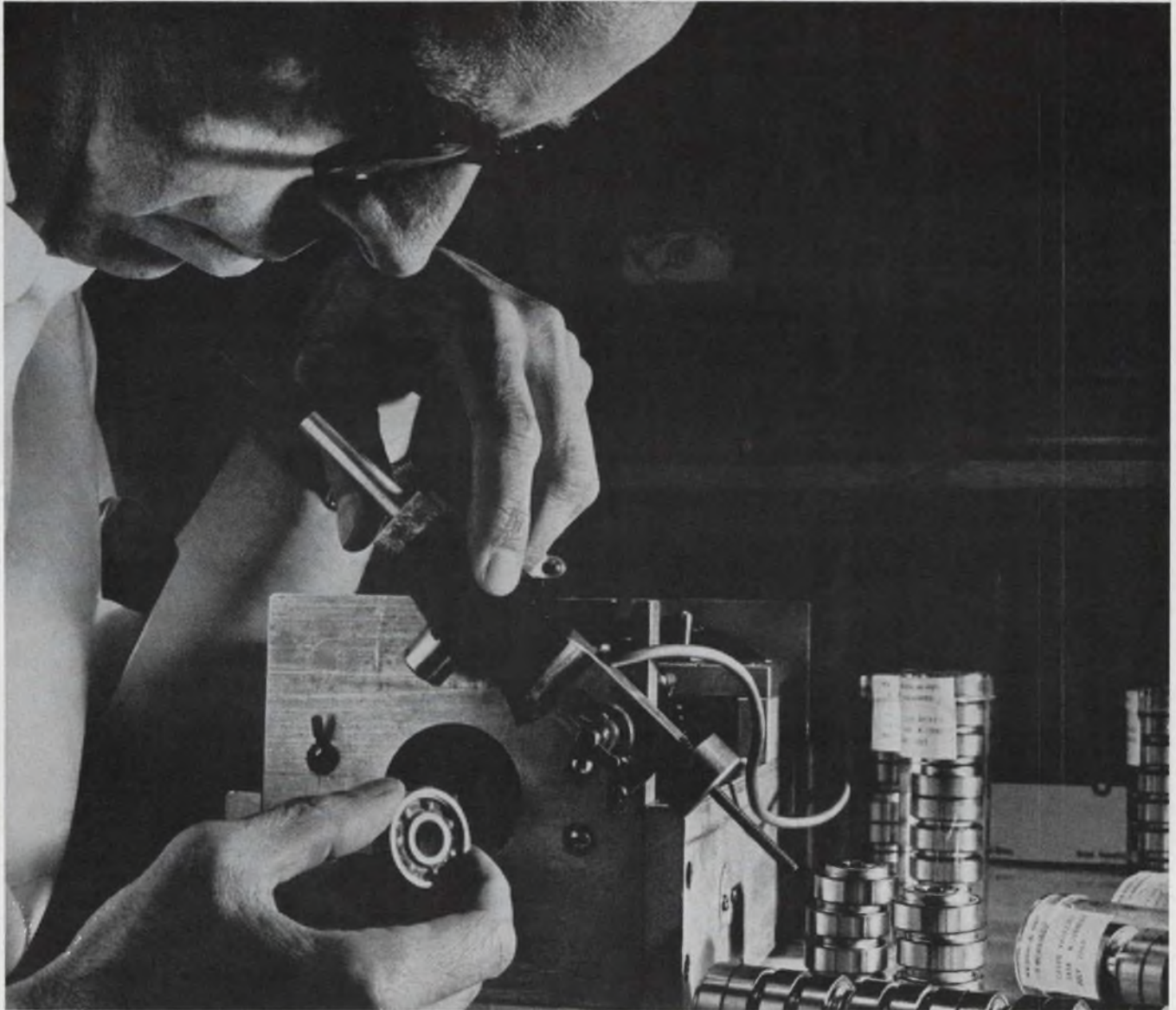

Ball bearings that create objectionable vibration and audible noise have a tough time finding their way into the Bodine motors which power your products. Our special electronic ball bearing tester helps weed out such potential noisemakers.

We purchase only low-noise motor bearings manufactured to special specifications. And we choose suppliers with great care.

But still, we test incoming bearings . . . for even slight variations in ball bearing manufacture can create un-

desirable noises in fractional and subfractional horsepower motors. Bodine motors must run quietly.

Checking for potential noisemakers is only one of many ways we control Bodine motor quality. Our controls begin with design, extend through production, through run-in and final inspection.

Doesn't your product deserve a controlled-quality motor? A Bodine motor.

Bulletin S-2E describes over 300 stock types and sizes from 1/2000 to 1/6 hp. Write Bodine Electric Co., 2528 W. Bradley Place, Chicago 60618.

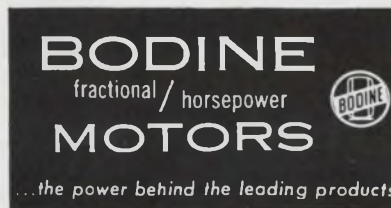

Speed Inquiry to Advertiser via Collect Night Letter  
ON READER-SERVICE CARD CIRCLE 191

# VECO THERMISTOR SENSOR ASSEMBLIES



VECO Thermistor Sensor Assemblies are complete ready-to-mount, temperature sensing units designed for a variety of applications. They can be readily attached by bolts or screws; threaded into walls or surfaces; inserted into sockets or affixed by solder, tape or cement to any convenient surface.

VECO Thermistor Sensor Assemblies are precision mechanical and electrical devices incorporating thermistors that exhibit a high negative temperature coefficient of resistance. Standard assemblies are stocked in a wide variety of housings and electrical characteristics. Special designs for specific customer requirements are available.

- Fast response
- High accuracy
- Shock resistant
- Compact
- Light weight
- No moving parts
- AC-DC-Low power consumption



## APPLICATIONS

- In-flight telemetry of surface, liquid and gas temperature data from aircraft, high-altitude weather balloons, missiles and satellites;
- Temperature measurement in geological and oceanographic studies;
- Temperature and temperature gradient measurements in micro-meteorological studies;
- Skin temperature measurements in psychological and physiological studies;
- Temperature measurement and control of electronic equipment, chemical processes, storage and conveyance facilities for the handling of perishable goods, and all types of heating, air conditioning and refrigeration processes;
- Liquid level control and measurement;
- Flow measurement and control of liquids and gases;
- Temperature monitoring and alarm such as in overheat protection of heavy machinery and fire control.

Write for Technical Bulletin MS081

VECO First in Progress • First in Service

J-6905



## COMPONENTS



## 7-mm connectors

Operating at up to 17 GHz, this family of 7-mm connectors, adapters and assemblies has a vswr of 1.037. At 17 GHz the 50- $\Omega$  connector has an insertion loss of 0.028 dB max. RF leakage of a mated pair is below the signal inside the coax line by a ratio greater than 120 dB. Direct current resistance of a pair is 1 m $\Omega$  max or the inner contact and 0  $\Omega$  for the outer contact. Electrical length variation of a pair is 0.002 in. max.

Amphenol Corp., 33 E. Franklin St., Danbury, Conn. Phone: (203) 743-9272. Circle No. 250

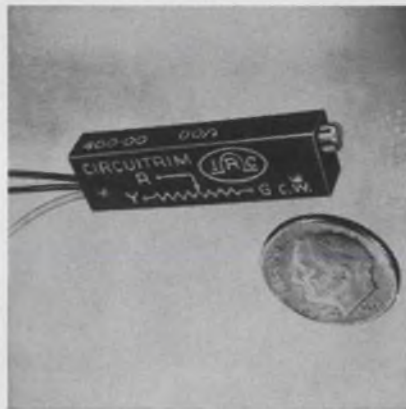

## 10- $\Omega$ to 50-k $\Omega$ trimmers

Meeting MIL-R-27208, this line of rectangular trimmers includes wirewound units. All trimmers have a one-piece corrosion-resistant shaft and wiper block system which isolates electrical elements. Teflon-insulated leads extend from the diallyl phthalate cases. Rated at 1 W at 70°C, the units are available from 10- $\Omega$  to 50-k $\Omega$  with  $\pm 5\%$  tolerance.

P&A: \$3.56 (100 lots); 4 wks. IRC Inc., 401 N. Broad St., Philadelphia. Phone: (215) 922-8900.

Circle No. 251

**Sensitive Research**

solve your  
problems with

**1/4%**

**Accuracies**



IN AC/DC VOLTAGE, CURRENT,  
POWER, AND POWER FACTOR  
PANEL METERS

- Accuracies to 0.25%
- Multi-range switching
- 5" or 7" scale lengths
- Edgewise or rectangular designs
- NBS traceability
- Reliable, friction-free diamond-tipped pivots

For complete data on the broad selection of Sensitive Research precision panel instruments, contact your local Singer Instrumentation representative, or write to: The Singer Company, Metrics Division, 915 Pembroke St., Bridgeport, Conn. 06608.



A Trademark of THE SINGER COMPANY

**SINGER**  
INSTRUMENTATION

EMPIRE • GERTSCH • PANORAMIC • SENSITIVE RESEARCH

S-66-12

ON READER-SERVICE CARD CIRCLE 193

ELECTRONIC DESIGN 23, October 11, 1966

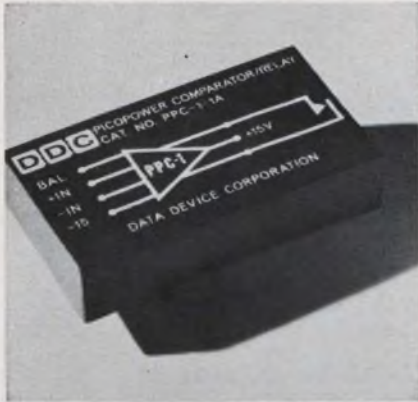

## Comparator/relay

Capable of functioning directly from low-level transducers or logic levels, this comparator/relay provides 1/2 A and 220 V. Relay contacts have a 1-ms max operating time from 1-pW signal inputs. Sensitivity is 300  $\mu$ V and input impedance is 400 k $\Omega$ . Using differential inputs the unit becomes a comparator which can trigger from 300- $\mu$ V differentials with 500- $\mu$ V repeatability. Input varies from microvolts to 8 V max.

P&A: \$35 to \$39.80, (1 to 9); stock. Data Device Corp., 240 Old Country Rd., Hicksville, N. Y. Phone: (516) 433-5330.

Circle No. 252



## High-G accelerometer

Weighing 13 gm, this accelerometer has a linear response up to the 100,000-G shock level. The low stress level of the sensor material, even at full-scale shock loads, eliminates sensitivity hysteresis and results in good repeatability. The unit operates from 2 Hz to 15 kHz and from -65 to 250°F. Charge sensitivity is 0.03 pC/G and internal capacitance is 115 pF.

Endevco Corp., 801 S. Arroyo Pkwy., Pasadena, Calif. Phone: (213) 795-0271. Circle No. 253

# UNIQUE, NEW BURR-BROWN OPERATIONAL AMPLIFIERS

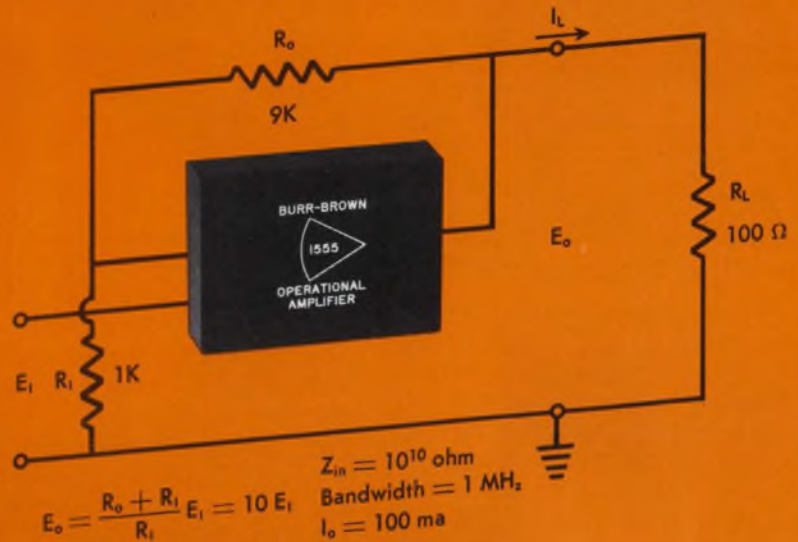

## PROVIDE WIDEBAND, FAST RESPONSE OPERATION IN BOTH INVERTING AND NON-INVERTING CIRCUITS

These three new Burr-Brown units offer bandwidths and slewing rates that are ten to fifty times better than most other general purpose amplifiers on the market today. Since you can operate both inputs, you can employ them in a wide variety of inverting, non-inverting, and differential configurations. The modular 0.6" x 1.8" x 2.4" epoxy package is ideally suited for any application. All three units are immediately available from stock.

### HIGHLIGHT SPECIFICATIONS

MODEL NUMBER	DESCRIPTION	RATED OUTPUT		BANDWIDTH		SLEW RATE	INPUT VOLTAGE DRIFT	INPUT CURRENT OFFSET	UNIT PRICE
		min	min	Unity Gain	Full Power				
		Volts	mA	typ Mc/s	min Kc/s	typ V/ $\mu$ s	typ $\mu$ V/ $^{\circ}$ C	typ nA	
1525	general purpose differential input	$\pm 10$	$\pm 20$	15	500	50	$\pm 10$	$\pm 5$	\$95
1555	differential input FET $10^{10}$ ohm input Z	$\pm 10$	$\pm 100$	15	1000	100	$\pm 10$	$\pm 0.1$	\$175
1527	differential input 100 mA output	$\pm 10$	$\pm 100$	15	1000	100	$\pm 10$	$\pm 5$	\$135

THESE NEW AMPLIFIERS ARE AVAILABLE FROM . . .

**JET STOCK**

Burr-Brown's "Jet Stock" program provides immediate or over-night delivery (U. S. only) of Burr-Brown operational amplifiers, connectors and accessories for your prototype design needs. Your order is shipped from your local Representative's "Jet-Stock." Call him, today.

ENGINEERING REPRESENTATIVES: ALABAMA, HUNTSVILLE (205) 534-1648  
 ALASKA, ANCHORAGE (907) 272-5231 / ARIZONA, PHOENIX (602) 254-6085  
 CALIF., LOS ANGELES (213) 245-9501, SAN FRANCISCO (415) 968-1608  
 COLO., DENVER (303) 388-4391 / CONN., MILFORD (203) 874-9222 / FLORIDA,  
 ORLANDO (305) 425-2764 / ILLINOIS, CHICAGO (312) 286-6824 / MD., SILVER  
 SPRING (301) 593-7144 / MASS., BOSTON (617) 245-4870 / MICH., DETROIT  
 (313) 353-3822 / MINN., MINNEAPOLIS (612) 781-1611 / MO., ST. LOUIS (314)  
 524-4800 / N.C., GREENSBORO (919) 273-1918 / N.J., CAMDEN (609) 365-2450  
 N.M., ALBUQUERQUE (505) 255-1638 / N.Y., ALBANY (518) 435-9649 BING  
 HAMTON (607) 723-9861, BUFFALO (716) 632-2727, MT. VERNON (914)  
 968-2200, NEW HARTFORD (315) 732-3775 / OHIO, CINCINNATI (513)  
 761-5432 CLEVELAND (216) 884-2001, DAYTON (513) 277-8911 / OKLA., TULSA  
 (918) 835-2481 / OREGON, PORTLAND (503) 292-8762 / TEXAS, DALLAS (214)  
 363-1671, HOUSTON (713) 928-5251 / UTAH, SALT LAKE CITY (801) 466-8709  
 WASH., SEATTLE (206) 622-0177 / CANADA, TORONTO (416) 293-7011, VAN  
 COUVER (604) 736-6377, WINNIPEG (204) 338-2884

FOR COMPLETE TECHNICAL INFORMATION including detailed Specification Sheets, Short-Form Catalog covering all products, and prices, use this publication's reader service card, call your nearest Burr-Brown Representative, or contact Burr-Brown direct.

Look for us at  
 NEC Booth #535  
 ISA Booth #2035  
 NEREM Booth #1H66



ON READER-SERVICE CARD CIRCLE 194

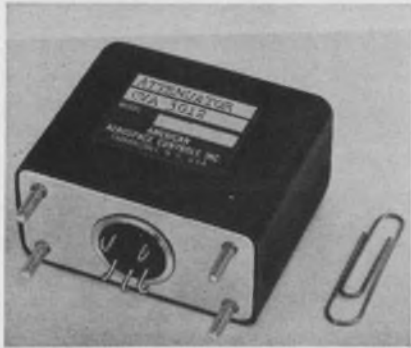

### Variable attenuators

Used for remote volume or gain control circuits, this line of infinite resolution and noiseless attenuators has control current from 0 to 10 mA dc to 0 to 40 mA ac. This current produces a voltage attenuation change of 6 dB. Each resistor in the attenuator circuit is rated at 500 Ω nominal. The attenuator circuit is rated for dc or ac to 10 V.

P&A: \$69.50 (1 to 9); 4 wks. American Aerospace Controls Inc., 129 Verdi St., Farmingdale, N. Y. Phone: (516) 694-5100.

Circle No. 254

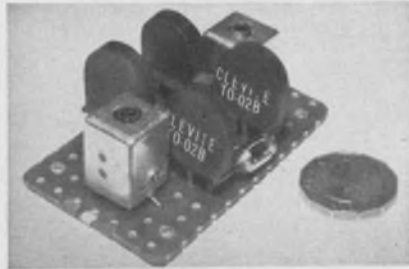

### Crystal filters

Provided with input and output matching transformers, type PF1 crystal filter has skeleton construction. Frequency is 457, 465 or 470 kHz  $\pm$  1 kHz. Bandwidth is 2.5 kHz at 6 dB and 9 kHz at 40 dB and insertion loss is about 5 dB. Type PF2, lacking matching transformers, has a frequency of 459, 467 or 472 kHz  $\pm$  1 kHz. Bandwidth is 3 kHz at 6 dB and 10 kHz at 40 dB and insertion loss is about 5 dB.

Price: \$12.50 (PF1), \$10.50 (PF2). Elliott Electronics, 3 Sandgate Ave., Tilehurst, Reading, Berkshire, England.

Circle No. 255

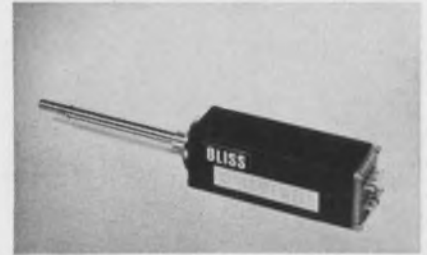

### Translatory pots

Translatory potentiometers are capable of handling power levels to 1 W per inch of stroke. Standard resistances range from 100 Ω to 40 kΩ/inch. This resistance is varied as the pot's shaft is slid into or out of the unit's housing. Both linear and nonlinear outputs are available. Both single or dual resistance elements with separate contact brushes and terminals are offered. Housings are anodized aluminum. Stroke lengths from 1/2 inch to 16 inches are standard.

E. W. Bliss Co., Gamewell Div., 1238 Chestnut St., Newton, Mass. Phone: (617) 244-1240.

Circle No. 256

## PERFORATED SCREENS FOR CENTRIFUGES

Stainless steel etched screens for extracting juices and crystals are resistant to acids, easy to clean, long lived — may be used wherever centrifuge requires small regular holes. Openings may be as small as .005 inches, on centers to your specification. \*\*\* Also available, back up plates for filter particle determination. Send us your problem in etched or formed metal — we produce to tolerances of  $\pm$  .000039 inches.

**BUCKBEE MEARS CO.**  
245 E. 6th ST., SAINT PAUL, MINN.

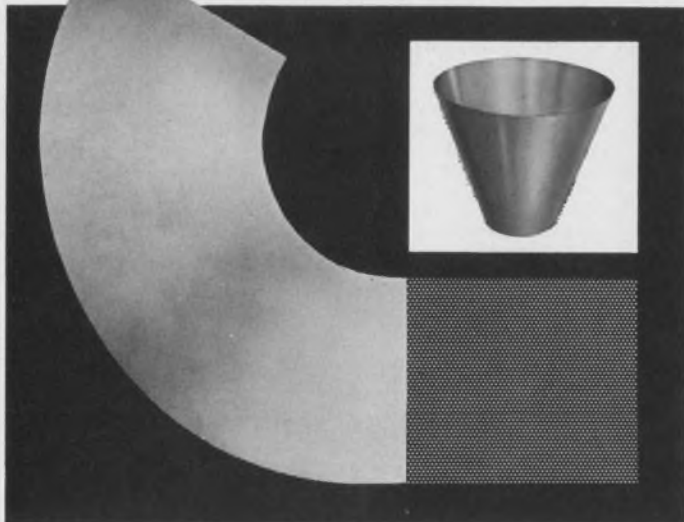

ON READER-SERVICE CARD CIRCLE 195

## DESICCANTS

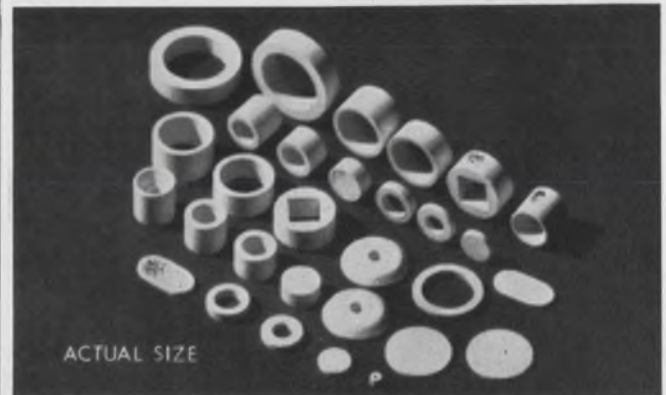

ACTUAL SIZE

## Moisture Getters!

High capacity Natrasorb®-A preforms for applications in transistors, semi-conductors, and instruments. These preforms combine the most reliable moisture control at low cost and precision. Can be mass-produced in any shape or size to suit your design requirements.

**NEW!** Natrasorb®-X for high reliability relays. Organic and other trace impurities removed to less than 10 ppm. Total protection against contact resistance due to contamination.

Send for literature on Natrasorb®-A and X.

© REG. T. M. MULTIFORM DESICCANT PRODUCTS INC.

**Multiform Desiccant Products Inc.**  
70 Chalmers Street • Buffalo, N. Y. 14214

ON READER-SERVICE CARD CIRCLE 196

ELECTRONIC DESIGN 23, October 11, 1966

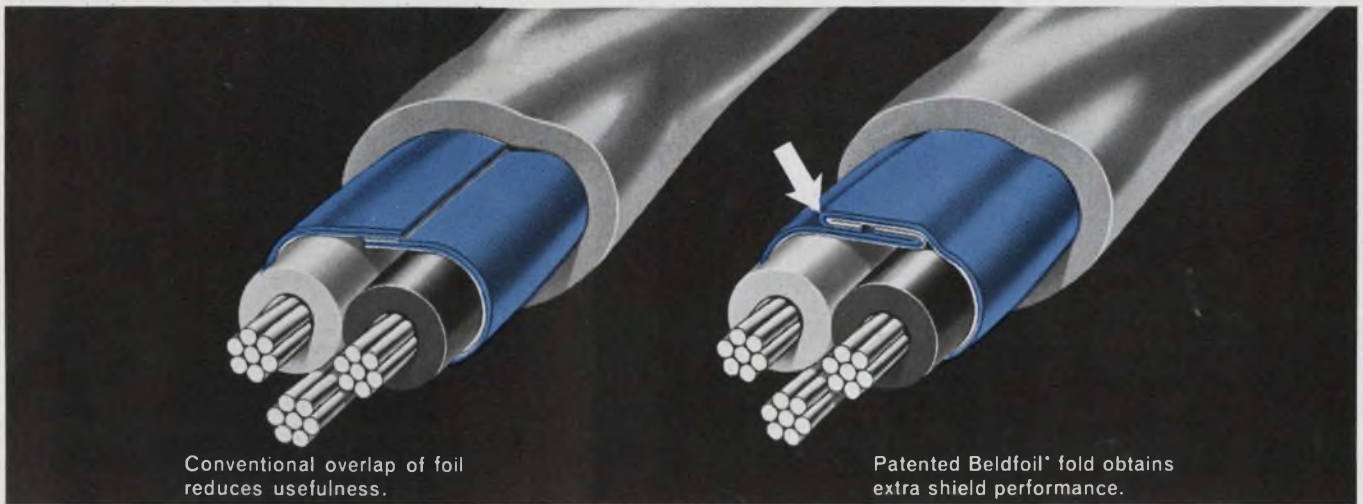

## It's in the fold!

By Frank Timmons, Chief Engineer, Electronics Division, Belden Manufacturing Company

There are a number of cables on the market today which utilize Mylar® Aluminum Shielding to eliminate noise, hum and cross-talk. These cables have been developed to meet the needs of equipment engineers who have found that standard braided and spiral shields are inadequate in reducing pick-up and transmitted noise.

There is a big difference in the various cables available . . . and the big difference is in the manner by which the Mylar Aluminum Shielding is applied to the cable. The cable which does the most effective job of eliminating noise, hum and cross-talk uses a unique, patented wrapping process that "folds back" one or both edges of the Mylar Aluminum Shielding. It provides "total shielding" and was introduced in 1957 by the Belden Manufacturing Company under the trade name, "Beldfoil."

It is evident that many interested persons do not completely understand the manner in which Mylar Aluminum Shielding is used in the manufacture of Beldfoil cable. Therefore, Frank Timmons, Chief Engineer of the Electronics Division at Belden's Richmond, Indiana plant answers some of the more frequently asked questions, and points up some of the more important benefits offered by Beldfoil.

**Q.** You talk about a patented process wherein the Mylar Aluminum Shielding is folded back . . . on one or both edges. Just how is this done?

**A.** First, let us define Mylar Aluminum Shielding . . . it is a lamination of Mylar insulation film from 0.0005" to 0.001" thick and aluminum foil of .00035" to .001" thickness, applied spirally around the shielded conductor or conductors to give 100% shield coverage.

In some instances the wires are wrapped with the metal foil on the outside as shown in the cross-sectional drawing Fig. 1.

Fig. 1

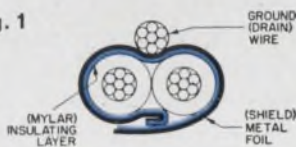

Note the heavy black line showing the foil edge folded back so that a full layer of Mylar "bonus insulation" is provided between the conductors and the foil shield, increasing the reliability of the cable.

Cables to be used at radio frequencies, or sensitive to radio frequency interference, may need the fold shown in Fig. 2. This fold creates a metal-to-metal connection which eliminates any possible inductive effect, and makes the shield the electrical equivalent of a solid aluminum tube.

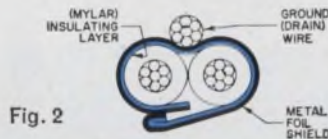

Fig. 2

Shields shown in Fig. 1 and 2 are used for cables with one pair of conductors.

For cables carrying multiple pairs of conductors, a different technique is used. On each pair, the aluminum foil is placed on the *inside*, with the Mylar layer on the *outside* (See Fig. 3). This is important because if the aluminum surface were on the outside we would have random metallic contact between the shields on the different pairs of wires. This would permit the voltages existing on one shield to generate currents in the adjacent shield, creating a transfer of energy or cross-talk between circuits.

Note that the outer edge of the shield is folded to tuck the edge of foil out of the way where it cannot short to the adjacent shield.

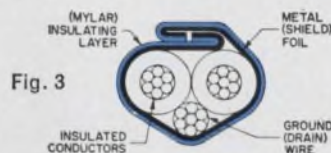

Fig. 3

The inner fold again provides the electrical equivalent of a solid aluminum tube. Belden calls this combination of two folds in one shield a "Z" fold because an end view of the unwrapped tape looks like the letter "Z".

ON READER-SERVICE CARD CIRCLE 197

**Q.** How much signal isolation results between pairs, when aluminum foil is on the inside, and Mylar layer outside?

**A.** This type of construction obtains isolation of more than 100 db between pairs, per thousand feet of cable, at 10 Kc. The short-circuited tape shield makes the cable quite suitable for use at frequencies ranging from audio to RF.

**Q.** Do any contact-resistance problems arise between the drain wire and the aluminum foil shield on Beldfoil?

**A.** No. Belden design and field service experience on millions of cable-feet in wide service environment have proved this point of reliability.

**Q.** Can Beldfoil shields be used over small single conductors as well as over large complex cables?

**A.** Yes. Belden applies it on groups from .050" to 1.25" OD.

**Q.** Design engineers are constantly faced with miniaturization problems. What about the size of Beldfoil shielded cables?

**A.** Beldfoil definitely reduces the diameter of multi-conductor cables . . . in some instances by as much as 66⅔%. The small diameter provides design engineers with extra conduit space, extra raceway, extra console and rack space.

**Q.** How can I determine which type of shield I should choose for a given cable?

**A.** Belden application engineers are available for engineering assistance. Or, you can obtain preliminary printed information by writing to Belden Manufacturing Company, Advertising Department, P.O. Box 5070-A, Chicago, Illinois 60680.

# Belden

8-7-5

\*Belden Trademark Reg. U.S. Pat. Off. †DuPont Trademark

The Kodak Instamatic M6 Movie Camera's battery-powered electric eye, with Vactec Cadmium Sulfide photocells, operates through the lens for high exposure accuracy.



## Part of Kodak's automatic ease

"You aim through here, and press here." That's the simplicity of Instamatic Kodaks. And Vactec furnishes part of the ease — photocells that automatically control exposure settings. Come to think of it, that's controlling quite a lot.

# vactec photocells

Vactec Selenium photocells are among the important components that help the Kodak Instamatic 804 Camera automatically integrate film speed, shutter speed, lens aperture and existing light to compute and set exposures faster than you could yourself.



You can always expect the finest in light sensitive devices from Vactec. A complete line of photocells is available for your products. Or, we will custom design units to meet special needs.

Write for Bulletin PCD-3 for Cadmium Sulfide and Selenide types; Bulletin SPV-4 for Selenium photoelectric types.

**VACTEC**  **INC.**

2423 Northline Industrial Blvd.  
Maryland Hts., Mo. 63045  
Area Code 314, HE. 2-4200

See Vactec's advertisement and listing in Section 3700 of EEM  
ON READER-SERVICE CARD CIRCLE 783

# Photocell Decay Problems?

Try Type 7H



Clairex Type 7H Photocells now offer decay times of .006 sec @ 100 ft-c. Couple this with 240 ohms @ 100 ft-c, CdS stability, and your problems are solved. Available in TO-18 and TO-5 cases. And 6 resistance ranges.

**CLAIREX**

"The LIGHT Touch in Automation and Control"  
1239 Broadway, New York, N.Y. 10001  
212 MU 4-0940

ON READER-SERVICE CARD CIRCLE 784

## COMPONENTS

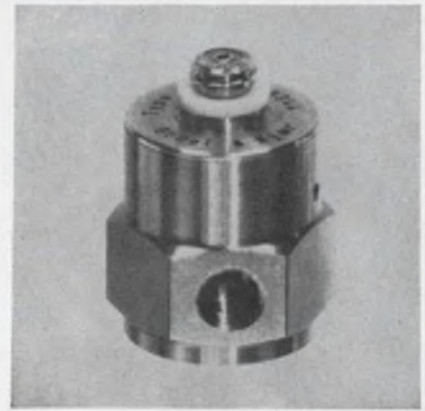

### Accelerometer

Vibration measurements at temperatures to 1000°C with water cooling are made by this accelerometer. Nominal sensitivity of 16 mV/G and nominal capacity of 1000 pF provide a range of 2 to 10,000 Hz and acceleration range of 0.01 to 2000 G with appropriate signal conditioner and accelerometer mounting.

P&A: \$105 to \$155; stock. B&K Instruments, Inc., 5111 West 164th St., Cleveland. Phone (216) 267-4800. *Circle No. 257*

### Rack/panel connector

This shell-less square rack/panel connector accommodates 34 crimp snap-in removable 5-A contacts plus 5 snap-in coax high-power and/or high-voltage contacts. The 5-A contacts accept #20, 22 or 24 AWG wire. The coax contacts have crimp or solder termination. High-voltage and high-power contacts for solder termination are also snap-in removable.

ITT Cannon Electric, 3208 Humboldt St., Los Angeles. Phone: (213) 225-1251.

*Circle No. 258*

### Flame-proof resistor

When overloaded up to 100 times rated power this tin-oxide low-power resistor will not burn. Designed for TV circuitry, the resistors will open instead of burning. An overload of 10 times rated power applied for 5 s causes a 5% resistance change. Rated at 2, 3, 4, 5, 7 and 10 W, the units have tolerances of 1, 2, 5 or 10%. Temperature coefficient is ±200 ppm from -55 to 150°C.

Availability: November. Corning Glass Works, Corning, N. Y. Phone: (607) 962-4444. *Circle No. 259*

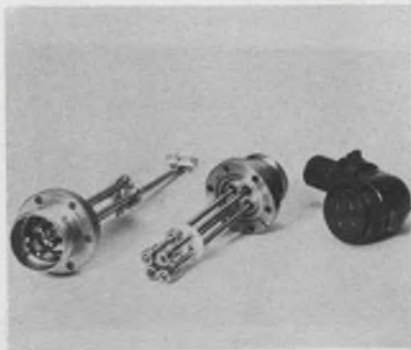

## Vacuum feedthroughs

Bakeable to 450°C, these ceramic-metal vacuum feedthroughs come with integral internal connectors and a standard MS connector. The units operate electrical devices or multiple-filament evaporation sources during vacuum processing or testing. They can also supply power to resistance heaters or sublimation or evaporation filaments. Ratings are 50 A/pin, 1 kV pin-to-pin and 2 kV pin-to-ground.

Varian Assoc., Vacuum Div., 611 Hansen Way, Palo Alto, Calif. Phone: (415) 326-4000.

Circle No. 260

## Binding posts

One 1/4-in. No. 32 nut mounts this pre-assembled binding post. A low-loss polyamide body insulates stud, providing a 5000 Vdc break-the stud, providing a 5000 Vdc breakdown at 15 A. Capacitance to a 1/8-in. panel is 3 pF. Insulation resistance is 200 MΩ min after MIL-T-5422B humidity test. Front projection is 25/32 in. open and 21/32 in. closed. The self-captivated fluted thumb nut cannot work loose.

E. F. Johnson Co., Waseca, Minn. Phone: (507) 835-2050.

Circle No. 261

## Crystal can relay

Type HF half-size crystal can relay is designed for low level to 2-A switching. Contact arrangement is two form C (dpdt) with bifurcated contacts. Standard 26.5-Vdc coil has resistance of 1250 Ω, operate sensitivity of 160 mW and nominal voltage power requirement of 560 mW. Operate time at nominal voltage is 4 ms max and bounce is 2 ms max at low level and 1 ms max at high level rating.

C. P. Clare & Co., 3101 Pratt Blvd., Chicago. Phone: (312) 262-7700.

Circle No. 262

## ENGINEERED PLASTIC PUMPS AND FILTERS For Virtually any Chemical or Corrosive Fluid Application

### CHEM-GARD HEAVY DUTY PLASTIC CENTRIFUGAL PUMPS . . .

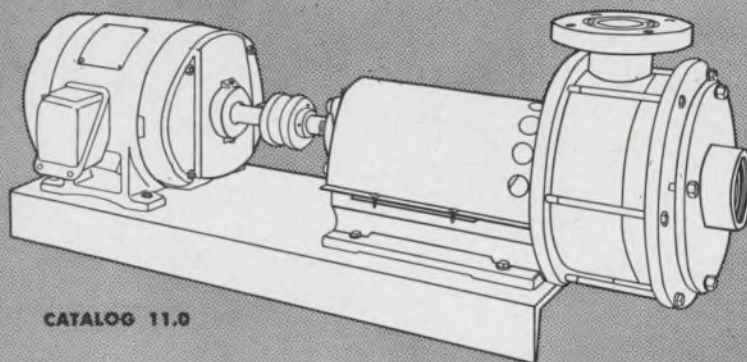

CATALOG 11.0

. . . embody the basic design and physical configurations dictated for efficient heavy duty fluid transfer pumps. In addition, these pumps utilize highly corrosion resistant Polypropylene and/or PVC materials for the fluid end. The result is a series of pumps of unique material utilization and design characteristics unlike any other centrifugal pumping equipment now in use for the conveyance of chemicals, pharmaceuticals and other fluids which require protection from metallic corrosion and contamination.

Models range in size from 5GPM to 300GPM at discharge heads to 170 feet.

### FLEXI-I-LINER PLASTIC SEALLESS ROTARY PUMPS . . .

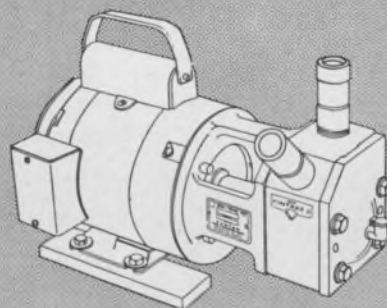

CATALOG 10.0

. . . resolve the single biggest problem in the transfer of corrosive or abrasive fluids by eliminating entirely the need for shaft seals or stuffing boxes of any sort. Flex-i-Liner pumps are self-priming, will operate wet or dry, and will handle a wide variety of acids, alkalis, abrasive slurries, viscous fluids and corrosive gases. The only parts in contact with the fluid are the body block and flexible liner. These are available in over sixty combinations of plastic and synthetic materials including Teflon, Viton A, Kel F, etc. Capacities from 1/3 to 40 GPM at heads to 50 psig.

### CHEM-GARD ALL PLASTIC PUMP-FILTER SYSTEMS "T" "T"

. . . provide a self priming filtration cycle totally free of metallic elements thus assuring a contamination and corrosion free course for even the most corrosive and sensitive solutions.

Filtration units in either PVC, PVDC, or lucite and furnished with polypropylene cartridges allow for depth filtration from 1 to 200 microns. Flow systems up to 1200 GPH are available.

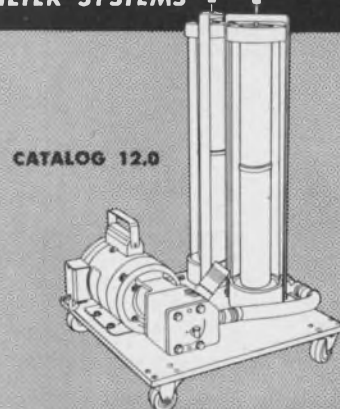

CATALOG 12.0

ENGINEERED PLASTIC PRODUCTS FOR FLUID HANDLING

**VANTON PUMP & EQUIPMENT CORP.**

201 Sweetland Avenue, Hillside, New Jersey

Area Code 201 - WA 6-2435

ON READER-SERVICE CARD CIRCLE 199

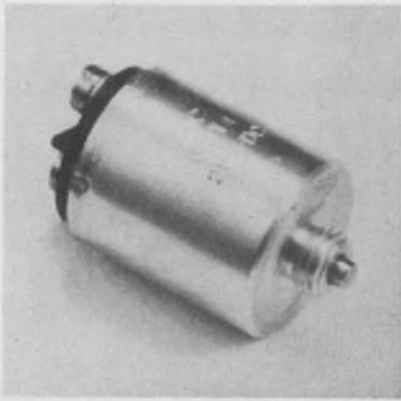

### Miniature solenoid

This continuous-duty solenoid pushes 1 lb at 0.05-in., 2 lbs at 0.025-in. or 3 lbs at 0.01-in. stroke. The 52-gram device measures 1.25-in. long. Operating range is 65 to 200°F. The unit uses 0.6 A max. Voltage range is 18 to 30 Vdc.

P&A: \$10 (1 to 4), \$5 (over 1000); stock. IMC Magnetic Corp., 570 Main St., Westbury, N. Y. Phone: (516) 334-7195.

Circle No. 263

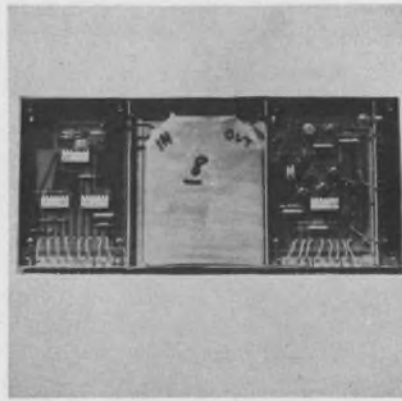

### Glass memory modules

A delay line and input-output circuitry are combined in this glass memory module for increased stability and reliability. Data rate is 9 Mbits/s, storage is up to 1600 bits and delay time is 200  $\mu$ s. These memories are made of glass having zero nominal temperature coefficient of time delay.

Corning Glass Works, Bradford, Pa. Phone: (814) 362-5571.

Circle No. 264

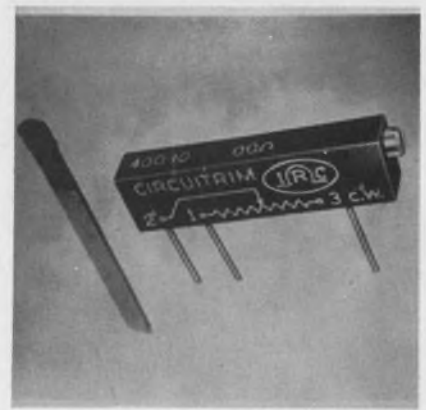

### Wirewound trimmers

These rectangular wirewound trimmers with in-line PC pins have diallyl phthalate cases with epoxy seals for very good humidity-proof characteristics. The units are available with resistance values from 10  $\Omega$  to 50 k $\Omega$  and  $\pm 5\%$  tolerance.

P&A: \$3.56 (100 lots): 4 wks. IRC, Inc., 401 N. Broad St., Philadelphia. Phone: (215) 922-8900.

Circle No. 265

## New Delay Timer for the O.E.M. Market.



Our new RB Delay Timer is designed to fill requirements of the original equipment manufacturer for a highly reliable, low cost, delay timer. It is all plastic construction for total insulation with 15 ampere load

contact capacity. Available in 6 models cycling from 5 seconds to 4 minutes, 30 seconds.

For complete Model RB technical information ask for Bulletin #307. For an RB prototype specify time cycle and voltage.



# INDUSTRIAL TIMER CORPORATION

65 U. S. HIGHWAY #287, PARSIPPANY, NEW JERSEY  
IN CANADA: SPERRY GYROSCOPE OTTAWA LIMITED, ONTARIO

ON READER-SERVICE CARD CIRCLE 204

## NEW! RED SHIELD LINE of Subminiature Shielded Inductors

- Unsurpassed "Q" to "L" ratio
- Exceptional "L" to size ratio
- High Self-Resonance
- Designed to MIL-C-15305C
- Maximum Coupling—3%—units side by side
- Stock—73 predesigned values
- Non-Flammable Envelope
- Operating Temperature —55° to 125° C.

### MICRO-RED

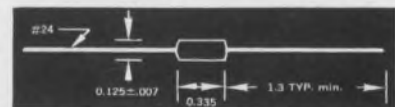

The "Micro-Red" is a shielded inductor that offers the largest inductance range 0.10 to 10,000 $\mu$ h in its size. "Q" to "L" ratio unsurpassed with excellent distributed capacity. Inductance tolerance  $\pm 10\%$  measured per MIL-C-15305C. Stocked in 61 predesigned values.

### MINI-RED

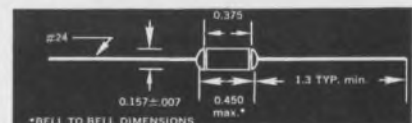

The "Mini-Red" offers the highest "Q" to "L" ratio available over inductance range 0.10 to 100,000 $\mu$ h in a shielded inductor this size. Inductance tolerance  $\pm 10\%$  measured per MIL-C-15305C. Stocked in 73 predesigned values.



Data Sheets: Write or Phone

## LENOX-FUGLE ELECTRONICS, INC.

475 Watchung Ave., Watchung, New Jersey 07060

Telephone code 201-756-1164-1165

ON READER-SERVICE CARD CIRCLE 205

ELECTRONIC DESIGN 23, October 11, 1966



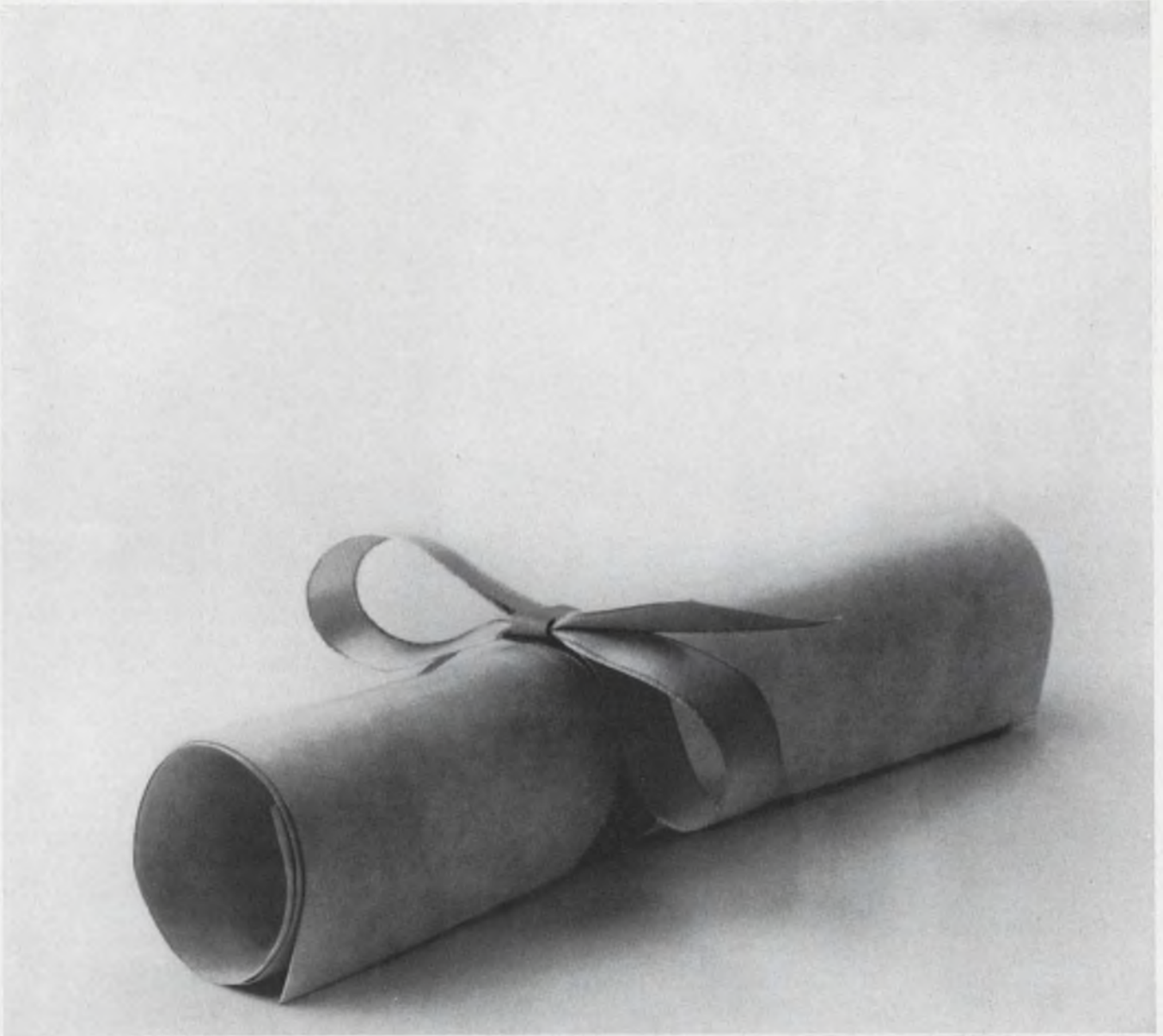

## It's only a beginning.

MIT says career engineers should spend 10% of their time keeping up with new technology. IBM agrees. Whatever degree you hold, you can't afford to stop learning.

If you worked at IBM's Office Products Division in Lexington, you could take graduate courses just across town at the University of Kentucky. Participate in the Accelerated Master's Degree Program there—using part of your actual work as thesis material. And if you qualified for the IBM Resident Graduate Program, you can do advanced

study almost anywhere.

These are only a few of the educational opportunities available through IBM Lexington. There are over 30 Voluntary Education Programs. Plus conferences with research and developmental managers from all other company divisions. And seminars with top scientists and engineers.

If you're looking for a location where you can keep growing while earning an excellent salary, better look into IBM Lexington—where engineers strike a balance between theory and

application, year in and year out.

Right now we have openings in development, product and manufacturing engineering; product testing; tool or manufacturing methods engineering; and mechanical design.

Write or call:

Mr. Thomas A. Viola  
Dept. 555V, IBM Corporation  
New Circle Road  
Lexington, Kentucky 40507  
Phone: 252-2250  
(Area Code 606)  
An Equal Opportunity  
Employer (M/F)

# IBM®

ON CAREER-INQUIRY FORM ON PAGE 111, CIRCLE 910

**BACK  
ON  
THE JOB..**

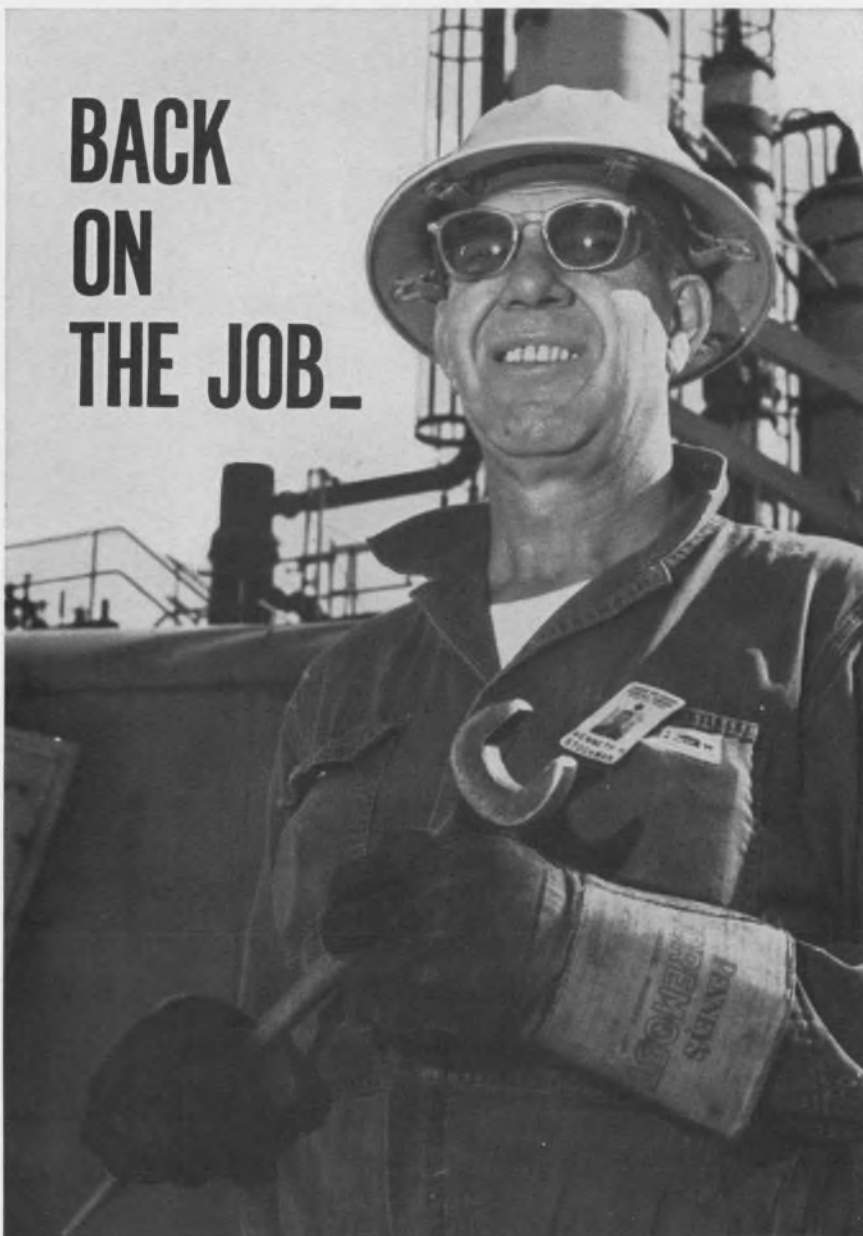

## Ken Stockman, Iron Worker, Survived His Heart Attack

Like most heart attack victims, Ken Stockman survived his first attack and went back to his job. Three out of four now do! Heart Fund dollars invested in research have helped make such progress possible through advances in diagnosis, treatment and rehabilitation.

But heart attack still kills 550,000 in the U.S. annually. Fight this Number 1 killer with the best weapon you have — a generous gift to your Heart Fund volunteer.

**Give... so more will live  
HEART FUND**



*Contributed by the Publisher*

## COMPONENTS

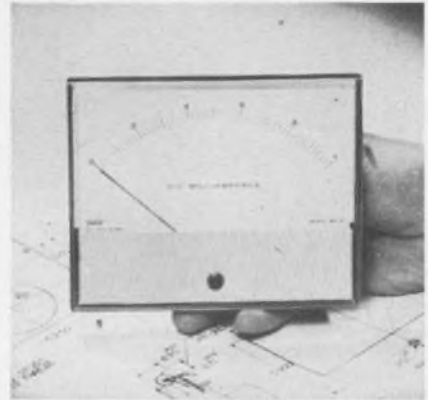

### Dc panel meters

These 5-1/2-in. dc panel meters are available as voltmeters, millivoltmeters, ammeters, milliammeters and microammeters with front-panel or bezel mounting. Ammeters feature a standard 50-mV drop. All meters are pivot and jewel or suspension construction. Standard accuracy is 2% and best accuracy is 1/2%. Either magnetic or non-magnetic panel standard calibration may be used. Breakdown voltage is 5 kV.

Availability: stock. Triplett Electrical Instrument Co., Bluffton, Ohio. Phone: (419) 358-5010.

*Circle No. 266*



### Crystal oscillators

Frequency stabilities of  $\pm 1$  ppm over a range of  $-40$  to  $70^{\circ}\text{C}$  and  $\pm 2$  ppm from  $-55$  to  $85^{\circ}\text{C}$  without an oven are characteristic of these temperature-compensated crystal oscillators. This stability is accomplished by a compensation network which has a voltage variable capacitor and thermistors with computer-selected values. Units are available in a range of 3 to 20 MHz.

P&A: \$250; 8 to 10 wks. Bulova Watch Co. Inc., 61-20 Woodside Ave., Woodside, N. Y. Phone: (212) 335-6000.

*Circle No. 267*



### Monitor control

Combining functions of an op-amp, differential amplifier and solid-state switch, this monitor control module accepts two separate inputs with a voltage differential as low as 10 mVdc or ac to control solid-state output switching to over 200 Hz. Impedance of each input is 2 M $\Omega$ . Common mode rejection is 60 dB at dc and 50 dB at 60 Hz.

Price: \$167.75. Maytronics Inc., P.O. Box 460, Colorado Springs, Colo. Phone: (303) 636-1301.

Circle No. 268



### Passive low-pass filter

Measuring 2-1/4 x 2 x 3-1/16 in., this passive low-pass filter has a maximum linear phase response from its cutoff frequency to three times its cutoff frequency. Minimum overshoot is less than 2% and insertion loss is 2 dB max. The unit is available with cutoff frequencies from 1 to 200 kHz and provides attenuation of 60 dB min in the stop-band to 1 MHz.

P&A: \$185; stock to 30 days. Guillemin Networks Inc., 170 Brookline Ave., Boston, Mass. Phone: (617) 536-5810.

Circle No. 269

# Here's a Great New Way to Buy Silicon DC Power Modules



MODEL  
LC322  
5" x 5" x 7"

*Introducing ERA's All-New, Wide-Range, Variable, 71°C, All-Silicon, Fully Repairable DC Power Modules at Exceptionally Low Prices*

ERA's new Value-Engineered DC Transpac® power modules provide, for the first time, all-silicon, high performance DC power in a wide range, variable, *low cost* module.

All units can be set to desired voltages by a simple external tap change and users will find that a single model can serve many voltage requirements. Stocking problems are reduced to a minimum and power module obsolescence is practically eliminated.

Output Voltage (DC)	Current 71°C	Size WxDxH (inches)	Weight (lbs.)	Model	Price
4-32	0-750 MA	4 x 4 x 6½	6.2	LC32P7	\$ 89.00
4-32	0-2 amps	5 x 5 x 7	8.5	LC322	\$115.00
4-32	0-5 amps	6¾ x 8½ x 7¼	16.8	LC325	\$179.00
4-32	0-10 amps	8¾ x 9½ x 7½	29.0	LC3210	\$215.00
30-60	0-1 amp	5 x 5 x 7	8.5	LC601	\$145.00

Over-Voltage Protector Option: Add \$35.00 to above prices and Suffix V to Model No. (i.e. LC325V, etc.).

#### SPECIFICATIONS

<b>Input:</b> 105-125 VAC, 50-400 cps	<b>Vernier Voltage:</b> External provision
<b>Ripple:</b> Less than 800 microvolts RMS or .005%, whichever is greater	<b>Transient Response:</b> Less than 50 microseconds
<b>Line Regulation:</b> Better than $\pm 0.01\%$ or 5 mv for full input change	<b>Operating Temperature:</b> -20°C to +71°C free air, full ratings
<b>Load Regulation:</b> Better than 0.05% or 8 mv for 0-100% load change	<b>Maximum Case Temperature:</b> 130°C
<b>Voltage Adjustment:</b> Taps / screw driver adjustment	<b>Temperature Coefficient:</b> Less than 0.01% per degrees C or 3 millivolts
<b>Short Circuit Protected:</b> Automatic recovery	<b>Long-Term Stability:</b> Within 8 millivolts (8 hours reference)
	<b>Remotely Programmable</b>



WRITE TODAY FOR CATALOG #147

**ELECTRONIC RESEARCH ASSOCIATES, INC.**

Dept. ED-10, 67 Sand Park Road, Cedar Grove, N. J. 07009 (201) Center 9-3000

SUBSIDIARIES: FRA Electric Co. ■ Advanced Acoustics Co. ■ ERA Dynamics Corp. ■ ERA Pacific, Inc. Speed Inquiry to Advertiser via Collect Night Letter

ON READER-SERVICE CARD CIRCLE 785

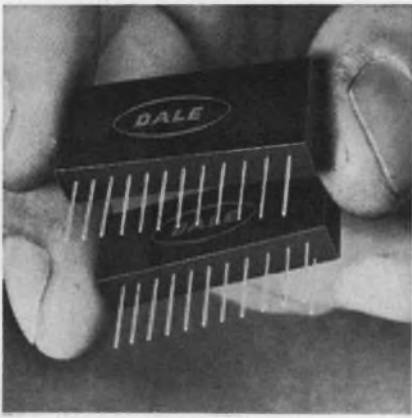

### Ladder networks

Containing wirewound resistance elements, these ladder networks can be used as voltage attenuators or digital-to-analog converters in computer systems. Resistors are packaged in matched sets and meet MIL-R-26 and -93. They are available from 0.1 to 2 W each and from 0.1  $\Omega$  to 500 k $\Omega$ . Resistors can be matched to within 0.005% and have a standard tolerance of 0.02% min.

Dale Electronics, Inc., Columbus, Neb. Phone: (402) 564-3131.

Circle No. 270

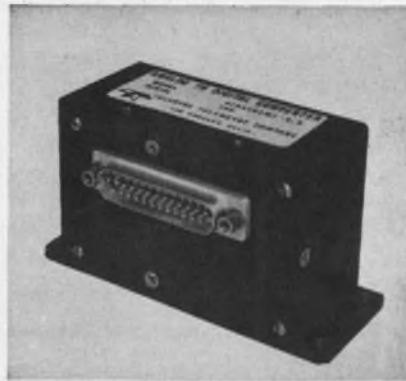

### A-to-D converters

Using thin-film monolithic ICs, this series of analog-to-digital converters provides up to 10-bit resolution on analog inputs with overall accuracy from  $\pm 0.4$  to  $\pm 0.1\%$ . Series 610 is available with internal clock or provisions for slaving to an external clock, 0- to 5-V unipolar and bipolar operation and word conversion rates from 1 to 50 kHz.

DynaPlex Div., Teledyne Telemetry Co., Aerospace Div., Box 341, Alexander Rd., Princeton, N. J. Phone: (609) 452-2250.

Circle No. 271

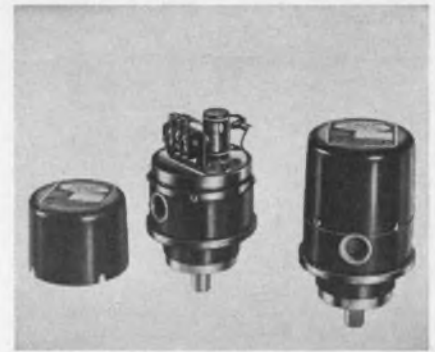

### Feedback sensor

Capable of withstanding large mechanical stresses, these feedback sensors have input to potentiometer ratios of 2:1, 1:1 or 1:2. Using single or multi-turn precision pots provides for input ranges from 1/2 to 20 turns for full pot range. Units are rated at 1 and 10 k $\Omega$ . Because the unit has a servo clamp mounting, the cover need not be removed for trimming and adjustment of the resistance value.

Jordan Controls Inc., 5607 W. Douglas Ave., Milwaukee. Phone: (414) 461-9200.

Circle No. 272



## R. F. INTERFERENCE PLAGUING YOU?



HOW ABOUT  
LITTELFUSE R.F.  
INTERFERENCE SHIELDED  
FUSE POSTS. MILITARY AND  
COMMERCIAL APPLICATIONS  
Write or phone for information

**LITTELFUSE**  
DES PLAINES, ILLINOIS

ON READER-SERVICE CARD CIRCLE 786

## USE COMPUTERIZED TECHNIQUES FOR BETTER, FASTER CIRCUIT DESIGNS AND DESIGN REVIEW . . . AT LESS COST

We will compute the performance of your proposed circuit, perform design reviews, or design to your requirements.

You write no equations—we work directly from your schematic.

- Nonlinear DC and transient analysis with continuous nonlinear semiconductor models
- Linear sinusoidal frequency analysis
- Results computer-plotted and printed

Free pickup and delivery twice daily in the Boston area.

### **DESIGN AUTOMATION, INC.**

809 Massachusetts Ave., Lexington, Mass. 02173  
Telephone (617) 862-8998

ON READER-SERVICE CARD CIRCLE 787

ELECTRONIC DESIGN 23, October 11, 1966

# Three new 400-volt silicon power transistors for military duty:



They're designed for high efficiency inverters, voltage and current regulators, control and switching circuits and high-power communications where extreme reliability is required.

DTS-423M is a NPN 3.5-amp 400-volt device in a TO-3 package, offering high sustaining voltage capability.

DTS-431M is a NPN 5-amp 400-volt device in a TO-3 package, offering higher gain and lower saturation resistance.

2N2580M is a NPN 10-amp 400-volt device in a TO-36 package for extra high power applications. Specifications on all three devices are based on full

mil-type environmental tests performed in an approved military qualification test lab.

Check with our nearest sales office or Delco Radio Distributor for full details.

TYPE	V <sub>CE0</sub>	V <sub>CB0</sub>	V <sub>CE0</sub> (sus)	I <sub>C</sub>	I <sub>B</sub>	h <sub>FE</sub> V <sub>CE</sub> =5V @ I <sub>C</sub>	R(sat) Max @ I <sub>C</sub>	Power Diss Max
DTS-423M	400V	400V	325V (min)	3.5A	2.0A	10 @ 2.5A	0.8 ohm @ 1.0A	100W
DTS-431M	400V	400V	325V (min)	5.0A	2.0A	10 @ 3.5A	0.28 ohm @ 2.5A	125W
2N2580M	400V	400V	325V (min)	10.0A	2.0A	4 @ 10.0A	0.14 ohm @ 5.0A	150W

**FIELD  
SALES  
OFFICES**

UNION, NEW JERSEY\*  
Box 1018 Chestnut Station  
(201) 687-3770

SYRACUSE, NEW YORK  
1054 James Street  
(315) 472-2668

DETROIT, MICHIGAN  
57 Harper Avenue  
(313) 873-6560

CHICAGO, ILLINOIS\*  
5151 N. Harlem Avenue  
(312) 775-5411

SANTA MONICA, CALIFORNIA\*  
726 Santa Monica Blvd.  
(213) 870-8807

General Sales Office:  
700 E. Firmin, Kokomo, Ind.  
(317) 459-2175

\*Office includes field lab and resident engineer for applications assistance.

**DELCO RADIO** 

Division of General Motors  
Kokomo, Indiana

ON READER-SERVICE CARD CIRCLE 788

# Ebert Guaranteed\* Reliability



**NEW EBERT *Hi-power* METAL TUBE MERCURY RELAYS ARE GUARANTEED TO PROVIDE LONG, MAINTENANCE-FREE LIFE EVEN IN PROBLEM ENVIRONMENTS**

**FACT:** Ebert *Hi-Power* Mercury Relays are available in 1, 2 and 3-pole units. Load ratings up to 40KW or 100 Amps. Load voltages up to 550 V.A.C. They are *un-matched* for continuous in-use reliability, durability, compactness and ease of installation.

**FACT:** Their *hermetically sealed, mercury-to-mercury* action eliminates contact problems.

**FACT:** Their epoxy-clad, *metal tube* construction withstands physical shock or rough handling.

**FACT:** Once you've tried an Ebert *Hi-Power* Relay you won't be satisfied with any other!

WRITE FOR FREE MANUAL AND 30-DAY FREE TEST DETAILS

Also available in solid state time delay and solid state hi-sensitive models

\*Guaranteed for one year against defects in materials and workmanship.



**EBERT ELECTRONICS CORP.**

130-10 JERICHO TURNPIKE  
FLORAL PARK, NEW YORK 11002

ON READER-SERVICE CARD CIRCLE 789

196

## COMPONENTS

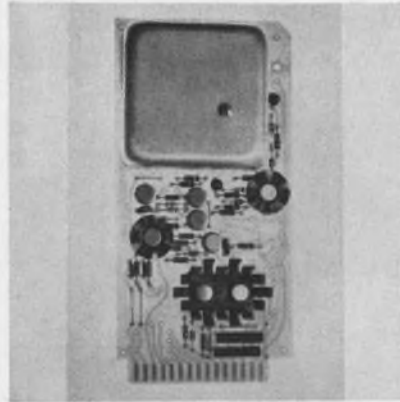

### 100-mA dc op-amp

An output of 100 mA at  $\pm 10$  V, 50 mA at  $\pm 20$  V or 20 mA at  $\pm 110$  V is provided by this dc op-amp. Input impedance is  $100\text{ G}\Omega$  shunted by 6 pF and dc gain is  $10^5$ . Output slewing limit is 20 V/ $\mu$ s. A guard driver neutralizes cable capacitance at the summing node to cut ac error. These all-silicon amplifiers are direct-coupled and therefore free of chopper noise and intermodulation distortion.

P&A: \$140 to \$180; stock to 60 days. Newport Laboratories, Box 2087, Newport Beach, Calif. Phone: (714) 540-4914.

Circle No. 273



### Op-amp has 40-V swing

Dc gain of 150,000, output of  $\pm 10$  mA and output drive of  $\pm 20$  V is provided by this dc differential op-amp. This unit features 1.5-MHz gain-bandwidth, 20-kHz full power output and 1.2-V/ $\mu$ s slewing rate. Drift is 20  $\mu$ V/ $^{\circ}$ C, offset is 20 nA max at 25 $^{\circ}$ C and current drift is 1.5 nA/ $^{\circ}$ C max from -25 to 85 $^{\circ}$ C. Typical uses occur in multiplier and log circuits where non-linear feedback is used.

Price: \$65. Analog Devices, 221 Fifth St., Cambridge, Mass. Phone: (617) 491-1650. Circle No. 274

BRANSON

# 6 POLE DOUBLE THROW CRYSTAL CAN RELAY

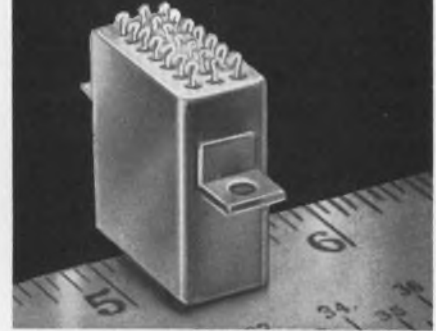

Available **FIRST** from Branson . . . Type AR 6-pole-double-throw crystal can relay by Branson is available immediately from stock. Ideally suited to multi-channel sampling and relay matrix type applications, it will switch a full 2 ampere load on all contacts. A complete range of coil voltages are available, in 7 case and 4 header styles. Several types of mating sockets are also available.

Send for complete technical details.

## OTHER BRANSON PRODUCTS



Relays...  
Our Only Business

BRANSON CORP.

VANDERHOOF AVENUE  
DENVER, NEW JERSEY  
(201) 625-0600

ON READER-SERVICE CARD CIRCLE 790

ELECTRONIC DESIGN 23, October 11, 1966

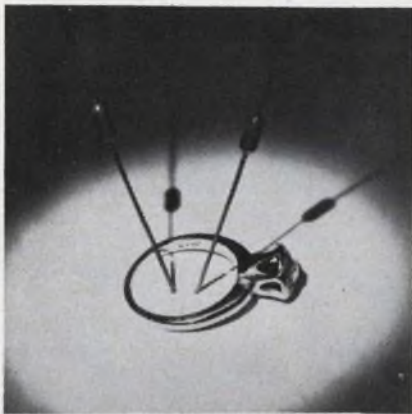

## Metal film resistors

Rated at 0.1 W, these metal film resistors have temperature coefficients of  $\pm 10$ , 25, 50 and 100 ppm/ $^{\circ}\text{C}$  and resistances from 10  $\Omega$  to 3 M $\Omega$ . The units have a protective covering and special end cap construction for high moisture and environmental protection. Measuring 0.25 x 0.095 in., the resistors are suitable for miniaturized equipment utilizing either conventional wiring or PC boards.

Pyrofilm Resistor Co., Inc., 3 Saddle Rd., Cedar Knolls, N. J. Phone: (201) 539-7110.

Circle No. 275



## Transducer amplifier

This transducer amplifier and bridge source uses 28 Vdc  $\pm 10\%$  at 50 mA and provides constant amplitude square wave bridge excitation adjustable from 4.5 to 5.5 V. Designed to accommodate bridges with impedance from 200 to 500  $\Omega$ , the unit gives 0- to 5-Vdc output from a 2-k $\Omega$  source for inputs having factors of 2 to 12 mV/V. Response is flat  $\pm 5\%$  from dc to 2.5 kHz.

Pioneer Magnetics Inc., 1745 Berkeley St., Santa Monica, Calif. Phone: (213) 393-0136.

Circle No. 276

**come to the  
PRIME source  
for fork  
contacts**

... **Methode**



Avnet stocks Methode's full line of connectors across the country . . . order today!

If you need fork contacts, delivery is often a matter of importance. Methode Electronics can supply your needs now. We are tooled and ready to serve you quicker, more dependably and more completely than ever before with fork contacts, receptacles, contact strips and disposable contact strips . . . all sizes available.

And Methode's fork contacts are fully interchangeable and fully compatible; featuring the originally designed split leg construction which will save you money.

Connectors available with 3 to 51 contacts. All popular termination styles.

We invite your inquiry.



Connector Division

**Methode Electronics, Inc.**

7447 W. Wilson Ave.

Chicago, Illinois 60656 • 312-867-9600

Licensed under Elco patents

ON READER-SERVICE CARD CIRCLE 791

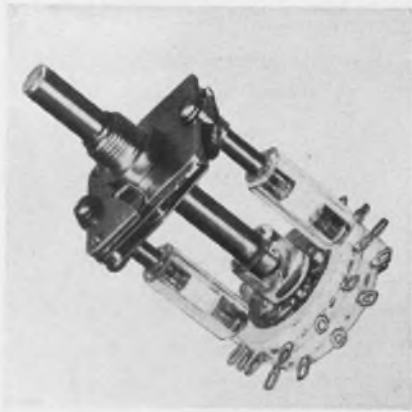

### Selector switches

An insulation resistance of  $10^5 \Omega$  min is provided by these selector switches with polycarbonate insulated shaft extensions and spacers. The isolated portion of the circuit can be floated up to 10 kV above ground. Shaft extensions are available in 3/8- to 1-7/8-in. lengths. Spacer length is 13/16 in.

Chicago Telephone of California Inc., 1010 Sycamore Ave., S. Pasadena, Calif. Phone: (213) 255-7186.

Circle 277

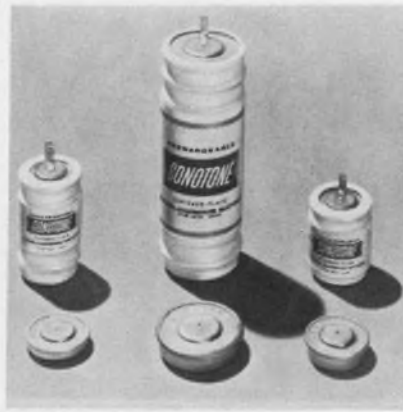

### Ni/Cd disc cells

A safety vent cover built into this disc cell provides protection from charging malfunctions. Sintered, rather than pasted, positive and negative plates are used. Three models are rated at 225 mA-hr, 150 mA-hr and 500 mA-hr. When the cells are improperly used, the cell vents release internal gasses and operation resumes.

Sonotone Corp., Elmsford, N. Y. Phone: (914) 592-9600.

Circle 278

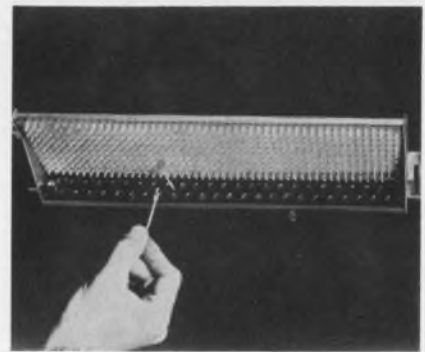

### Terminal block

Capable of accommodating 1000 connections, 500 on each side, this solderless connecting block has mounting holes spaced at 15-1/8 in. Male tabs for snap-on solderless terminals are spaced 5/16 in. apart. The tabs are set in a 14-1/2-in. glass-laminate epoxy insulating base. The base has 13/32-in. holes for use as a fanning strip for the terminated wires.

The Thomas & Betts Co., 36 Butler St., Elizabeth, N. J. Phone: (201) 354-4321.

Circle 279

# BI-DIRECTIONAL PROPORTIONAL MOTOR CONTROL

FOR VALVE OPERATORS — MACHINE TOOLS — SPEED CONTROL

## Features:

- ★ Small Size 2 3/8 x 8 x 3 1/2
- ★ SCR Control
- ★ Adjustable Current Limiting
- ★ AC or DC Signal Inputs
- ★ 50, 60, or 400 CPS Power Supply
- ★ Full Wave, Bi-directional Output

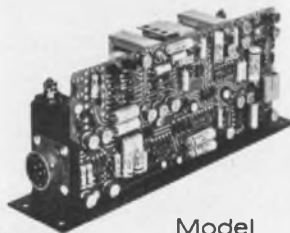

Model A570

Servo Amplifiers / Static Inverters / Power Supplies

## WESTAMP

SANTA MONICA, CALIFORNIA • 213+393-0401

ON READER-SERVICE CARD CIRCLE 792

## MAGNETIC READ/WRITE HEADS



- Compatible with all formats
- Standard and special models
- Single-gap, interlaced, dual-gap
- Single track to 56 tracks
- 7- and 9-channel compatibility
- 21-channel TIAC compatibility

For further information, write:

**INTERNATIONAL DATA PRODUCTS, INC.**

Attention: General Sales Manager  
151 SUNNYSIDE BLVD., PLAINVIEW, N.Y. 11803  
PHONE: 516-681-3200

ON READER-SERVICE CARD CIRCLE 793



# Information and the design engineer:

This definitive work fully examines this major system of information storage and retrieval

## DIGITAL MAGNETIC TAPE RECORDING:

PRINCIPLES AND COMPUTER APPLICATIONS  
Bernard B. Bycer

Design engineers have a dual interest in the storage and retrieval of information: they must be able to rapidly obtain and interpret large amounts of information for use in their own design work, and they are involved in the design of the systems which perform this function. Both of these interests are served in this comprehensive book by an eminent authority. The extent of the possibilities of the system is fully developed, so that the engineer may make fuller and more specific use of it; every operational aspect is covered in detail, providing a design guidebook for creation of the systems themselves, or for their inclusion in larger systems.

### CONTENTS

Magnetic Tape Recording • The Digital Magnetic Tape Transport • Digital Magnetic Heads • Principles of Digital Magnetic Recording • Coding Digital Magnetic Tape • Digital Magnetic Tape • The Organization of Data on Magnetic Tape • The Digital Tape Station • Computer Applications • Recent Developments and Applications • Appendices: Tape Reservoir Length, Demagnetization, Tape Access Time

### OTHER BOOKS OF INTEREST FROM HAYDEN

#### DESIGN OF TRANSISTORIZED CIRCUITS FOR DIGITAL COMPUTERS

Abraham I. Pressman. Complete design principles and practices. Primarily concerned with design of computer building blocks using transistors. 328 pages; illustrated, clothbound, #0215, \$9.95

#### BASICS OF DIGITAL COMPUTERS

John S. Murphy. An easy-to-follow, rapid means of mastering the fundamentals of digital computers. Fully illustrated for reinforcement. 416 pages, clothbound, #0073, \$9.50

#### BASICS OF DIGITAL COMPUTER PROGRAMMING

John S. Murphy. Thoroughly explains and illustrates the fundamental techniques of business-data computer programming. Provides the foundation for study of procedure languages. 118 pages, illustrated, Clothbound, #0406, \$4.95

#### COMPREHENSIVE FORTRAN PROGRAMMING

Teaches the widely-employed FORTRAN languages specifically as used by the IBM 1620 computer with an attached 1311 Disk Drive; the material applies to other prominent systems. 246 pages, illustrated, clothbound, #5647, \$6.95



318 PAGES  
230 ILLUSTRATIONS  
FULLY INDEXED  
EXTENSIVE BIBLIOGRAPHIES  
CLOTHBOUND, #5031, \$11.00

- 1 Offers complete and concise understanding of the entire field
- 2 Gives useful and practical information on all design aspects

## HAYDEN BOOK COMPANY, INC.

DEPARTMENTED-101-116 WEST 14th ST., NEW YORK, N.Y. 10011

### 10 Day Free Examination Offer!

Gentlemen:

Please send me the book(s) checked below for a 10-day free examination. At the end of ten days I will remit payment plus a few cents postage, or return the book(s) with no further obligation.

- DIGITAL MAGNETIC TAPE RECORDING, #5031, \$11.00  
 Design of Transistorized Circuits for Digital Computers, #0215, \$9.95  
 Basics of Digital Computers, #0073, \$9.50  
 Basics of Digital Computer Programming, #0406, \$4.95  
 Comprehensive FORTRAN Programming, #5647, \$6.95

Name \_\_\_\_\_ Title \_\_\_\_\_

Company \_\_\_\_\_

Address \_\_\_\_\_

City \_\_\_\_\_ State \_\_\_\_\_ Zip \_\_\_\_\_

Check for \$\_\_\_\_\_ is enclosed. Publisher pays postage with same return guarantee.



# FREE

## NEW 1967 *ALLIED* INDUSTRIAL ELECTRONICS CATALOG

552 Value-Packed Pages

Here's the standard of the industry from Allied, the world's largest distributor of electronic components and equipment. 552 pages. 64,000 items, scores of new products. Factory OEM prices. Same-day shipment. Get your personal copy now.

**ALLIED... WORLD'S LARGEST DISTRIBUTORS  
OF FAMOUS QUALITY BRANDS, FEATURES...**



**WIDEST SELECTION • SAME-DAY SHIPMENT**

See your Allied Catalog for Potter & Brumfield Relays: General Purpose, Special Purpose, Power, High Performance, Mercury Wetted Contact, Telephone types—all available from Allied's stock.

For FREE catalog, check reader service card or write direct to:

### *ALLIED ELECTRONICS*

Our 46th Year

Subsidiary of ALLIED RADIO CORPORATION, 100 N. Western Ave., Dept. 76-K, Chicago, Ill. 60680

ON READER-SERVICE CARD CIRCLE 821

# You name the meter. Ideal has it.

(or we'll make it for you)

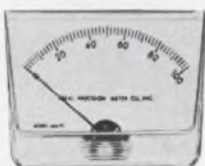

If one concentrates long and hard enough on panel meter development and engineering, one becomes expert.

IDEAL meters are used by all the Military and by leaders in defense and industry. For everything in meters—ruggedized or commercial, custom and stock, 1/2" to 7"—you can count on IDEAL, the proven leader.

Write for free 32-pg. catalog. Ideal Precision Meter Co., Inc., 218 Franklin St., Brooklyn, N.Y. 11222. (212) EVergreen 3-6904.

ON READER-SERVICE CARD CIRCLE 822

## COMPONENTS

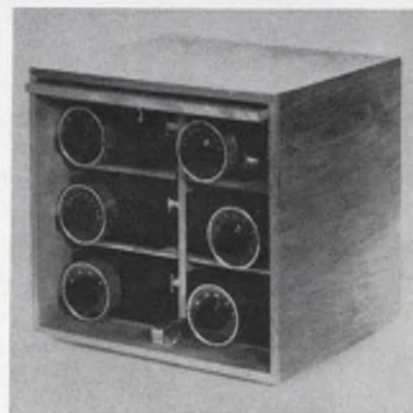

### Bandpass filter kits

These tunable bandpass filter kits provide continuous frequency coverage from 48 MHz to 4 GHz. Each kit contains five or six iris-coupled bandpass filters. The capacitively tuned 0.05-dB Chebyshev cavity filters have a 3-dB bandwidth of 5% and a tuning range of one octave. They are available in 3- or 5-section designs for 30-dB form factors of 3 and 1.8 respectively. Accuracy is  $\pm 1\%$  of center frequency.

P&A: \$2000 to \$3000; stock. Telonic Engineering Co., Box 277, Laguna Beach, Calif. Phone: (714) 494-7581.

Circle No. 280

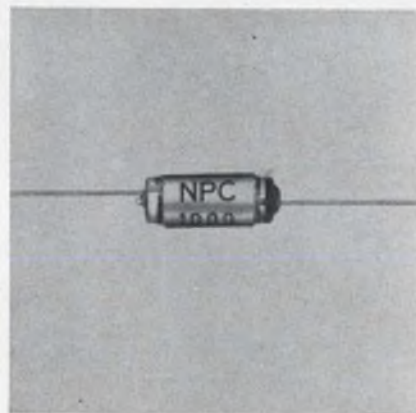

### Film capacitors

Available in capacitance ranges from 5 to 25,000 pF, these polystyrene film capacitors have a temperature coefficient of  $\pm 50$  ppm/ $^{\circ}$ C. Type L is rated at 160 wvdc and type H is rated at 630 wvdc. Capacitance tolerance is  $\pm 2.5\%$ , capacitance stability is 0.3% max and power factor is less than 0.03%. Q is 3000 min at 1 MHz at 25 $^{\circ}$ C.

Nucleonic Products Co., Inc., 3131 E. 12th St., Los Angeles. Phone: (213) 268-3464.

Circle No. 281

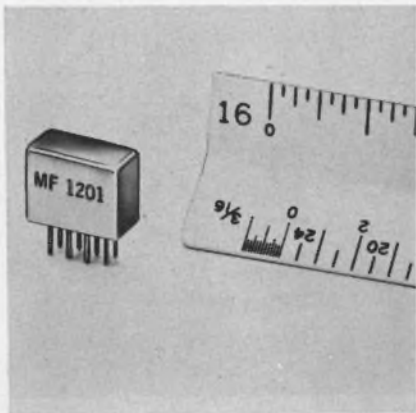

## Crystal can relay

Two dpdt contacts are provided by this crystal can relay. The standard 26.5 Vdc coil is rated at 1500  $\Omega$ . Operate sensitivity is 125 mW and nominal voltage power requirement is 470 mW. For low-level applications the unit is rated at 10,000 miss-free operations min. Operating time at nominal voltage is 8 ms max including bounce. The relay withstands vibrations of 20 G peak acceleration, 10 to 2000 Hz and shock of 65 G half sine wave, 11 ms  $\pm 1$  ms duration.

C. P. Clare & Co., 3101 Pratt Blvd., Chicago. Phone: (312) 262-7700. *Circle No. 282*

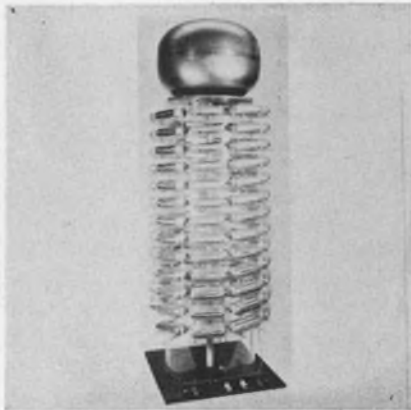

## Voltage divider

Reading accuracy to  $\pm 0.5\%$  at up to 100 kV is provided by this high voltage divider. Total resistance is 100 M $\Omega$  resulting in a 1-mA circuit loading at maximum voltage. Each resistor is electrostatically shielded to minimize corona effects. Tap points are 1, 10, 100 and 1000 V. The divider may be used with digital or other null balance readout instruments.

Beckman Instruments, Inc., 89 Commerce Rd., Cedar Grove, N. J. Phone: (201) 239-6200.

*Circle No. 283*

## HEAT SINK DISSIPATORS

Efficiency, light weight and economy are incorporated in a complete line of professionally engineered heat sinks available in a variety of sizes and shapes. Material: Aluminum 6063-T5 alloy, mill finish. Lengths to 5 ft. available. (Serrations--U.S. Pat. No. 3163207). Can be cut, drilled, anodized or painted to your specifications.

CATALOG SERIES — AHS

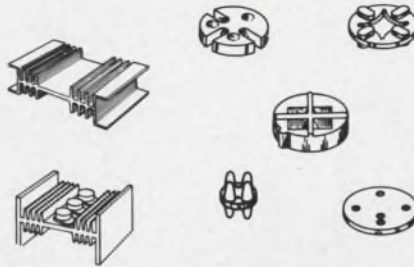
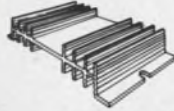

Many other heat sink, transistor pad and specialty items not shown are available. Write for additional information.

## DIALYL PHTHALATE TRANSISTOR PADS

Available with and without stand-offs in configurations for all applications, these pads are molded of glass-filled Dialyl Phthalate (MIL-M-14F SDG) and provide an excellent mounting base. They resist continuous exposure to 400 F and offer very high dielectric strength.

CATALOG SERIES — TPD

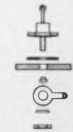
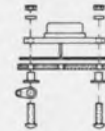

## NYLON TRANSISTOR PADS

Precision molded from Zytel 101 [MIL-P-20693], these pads provide an economical insulator and thermal barrier with high dielectric strength. Resist continuous exposure to 135 C.

CATALOG SERIES — TPN

## MOUNTING KITS

These and other standard kits incorporating mica, beryllium oxide or anodized aluminum insulators provide the parts necessary to mount all semi-conductors. Special materials and configurations can also be furnished to your specifications.

CATALOG SERIES — MK

When custom designs or modifications of standard electronic hardware parts are needed, our years of experience in the molding, extruding, stamping and fabrication of metal and plastic parts enables us to supply you with parts unsurpassable in quality.

We can help you successfully meet competition in today's highly competitive market.

## THE DELBERT BLINN CO.

P. O. BOX 2007 • POMONA, CALIFORNIA • PHONE (714) 623-1257 (213) 628-8794

ON READER-SERVICE CARD CIRCLE 823



POSITION ..... PRESS ..... PEEL

## TRANS-PAK Die-Cut SYMBOLS

THE FASTEST METHOD OF PREPARING PRINTED CIRCUIT MASTERS

NOW IN A NEW HANDY DISPENSER



Yes, here is the original TRANS-PAK "Position . . . Press . . . Peel" method with a brand new twist . . . a new, handy dispenser that makes the preparation of printed circuit masters easier than ever before. No inking, no cutting, no stripping. One convenient package gives you terminal pads, elbows, connectors, teardrops or any other symbol, die-cut to exacting tolerances for dimensional stability and distortion-free placement. Just reach for the dispenser and "press down" a perfect symbol. Takes just seconds.

TRANS-PAK pressure-sensitive die-cut symbols are available in black crepe paper and red translucent material. Never a die-charge for special orders.

POSITION TITLES, WORDS, LETTERS, NUMBERS IN SECONDS, TOO!



## ELECTRONIC MARKING KIT

Kit contains all the standard titles, codes, words, letters and numbers in dry transfer form. Rub lightly with a pencil and instantly they transfer onto schematics, terminal boards, printed circuit masters with ease. Elements appear crisp, sharp . . . look just like the finest printing. Won't move, crack or peel. Produce razor sharp copies in most reproduction processes.



Chart-Pak, Inc.  
634 River Road  
Leeds, Mass 01053



Please send catalog describing TRANS-PAK Printed Circuit Symbols.

I am interested in Deca-Dry Electronic Marking Kit!

Name ..... Title .....

Company .....

Address .....

City ..... State ..... Zip .....

Look in the Yellow Pages under Art Supplies, Charts/Business, Drafting Supplies, Tapes for your dealer's name.

ON READER-SERVICE CARD CIRCLE 824

# want to know more about two-minute fast-cycle vacuum coating?

• **Evaporative Coatings • Sputtering • Glow Discharge Cleaning** . . . uniform quality at the rate of a load of substrates **every two minutes**—cycle after cycle, all day long. Temescal Metallurgical Corporation has such a unit available—NOW!

Replace 8 bell jars and their operators with a single one-man unit only 1½ times the size of a bell jar . . . At a cost of only 2 bell jars.

Write for free booklet today.



2850 Seventh Street, Berkeley, California 94710  
Telephone: 415-841-5720

Department 103-B  
Temescal Metallurgical Corp.  
2850 Seventh Street  
Berkeley, California 94710

Please send me your free booklet, "FAST-CYCLE COATING."

Name \_\_\_\_\_  
Title \_\_\_\_\_  
Company \_\_\_\_\_  
Street \_\_\_\_\_  
City \_\_\_\_\_  
State \_\_\_\_\_ Zip No. \_\_\_\_\_

ON READER-SERVICE CARD CIRCLE 893

## Design Aids



### Motor control selector

For single- and three-phase, 110, 220- and 440-V general purpose NEMA 1 enclosure motors, this slide chart aids in specifying motor controls. Reversing and non-reversing magnetic starters, disconnect switches, circuit breakers, heater coils, manual starters and wire sizes are read out for motors rated at 1/2 through 400 hp. For a given fuse, circuit breaker, and wire rating, full load current is also specified. A unique pricing scale calculates discounts ranging from 5 to 50% for list prices ranging from \$5 to \$1000. For convenience, standard C and D scales are incorporated. Furnas Electric Co.

Circle No. 284

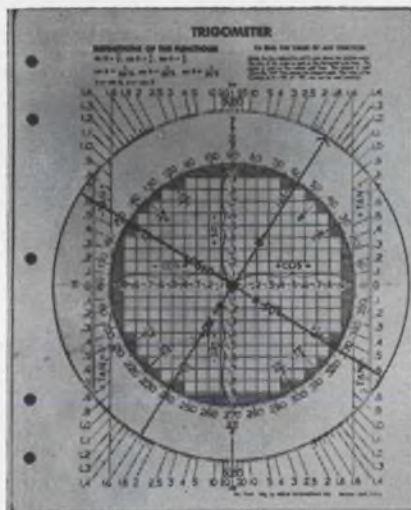

### Trigonometric calculator

One setting of the dial of this calculator gives sine, cosine, tangent and cotangent of any angle from 0 to 360° with sign. Without changing the setting, the same functions for 180° or ±90° are shown. In addition, the "Trigometer" enables transforming any of the trigonometric functions into the terms of any of the other functions. The 8-1/2 x 11-in. Mylar laminated calculator is punched to fit standard looseleaf notebooks.

Available for \$4.50 from Hoyle Engineering Co., 25408 W. Main St., Barstow, Calif.



### Microwave receiver rule

For any receiver noise bandwidth from 50 Hz to 30 MHz and noise figure from 0 to 50 dB, sensitivity can be read in dBm with this microwave receiver slide chart. Resultant vswr can also be calculated for a vswr of load between infinity and 1.1 and for a sum of backward and forward loss from 0 to -40 dB. In another window dBm can be calculated for any voltage between 1 μV to 1 V and resistance from 25 to 300 Ω. The reverse side of the chart contains C, D, A and L scales for convenience. Also included is a scale which gives percentage of power reflected for any vswr from 1 to 10. LEL Div., Varian Associates.

Circle No. 285



### TDR calculator

A forty-page application note on cable testing with time domain reflectometry accompanies this TDR calculator. The slide rule itself simplifies the techniques to the point where transmission line formulas are needed only for extreme accuracy. The distance/time scale converts electrical length to the metric and English units of distance, modified by the propagation velocity of the line used. The vswr/reflection coefficient scale converts to vswr for resistive discontinuities. Those discontinuities of a finite length are treated as complex impedances and calculated with the Smith chart in the booklet. The impedance scale calibrates the 1-cm markings of the CRT graticule to Ω, and may be based on any impedance on the slide rule. Hewlett-Packard, Colorado Springs Div.

Circle No. 286



**TAKE A POWDER**

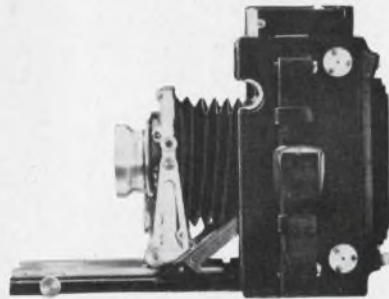

**TAKE A PICTURE**

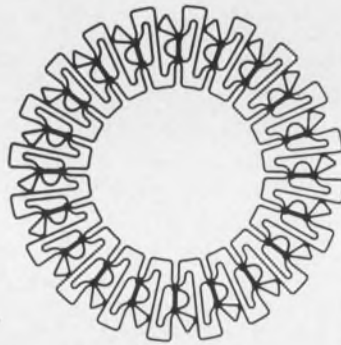

**MAKE A PART**

**Photofab<sup>®</sup> process holds tolerances  
on intricate parts to  $\pm 0.0005''$**

Flat components with oddball configurations and close tolerances are no longer production bugaboos, thanks to Magnetics' new photoetching process, Photofab<sup>®</sup>. This process delivers precision replicas in pilot or production quantities from nearly any magnetic or specialty alloy.

First, Magnetics' powder metallurgy capability develops an alloy strip with uniform magnetic and electrical properties from an exact blend of powdered metals. After the strip has been cold rolled to the specified thickness, it is then photoetched into any configuration that can be drawn on paper.

Frets, rotors, stators and head laminations are just a few of the parts which can be produced by this process—especially effective when material thicknesses of less than 0.001" are involved.

Consistent high quality in metallic properties, and reproducibility that meets your most exacting specifications are guaranteed by Magnetics Inc. The savings in days and dollars invested are, of course, tremendous.

Write Magnetics Inc., Butler, Pa. 16001, for more information on Photofab<sup>®</sup> (Dept. ED-103), or for data on custom blended alloys (Dept. ED-104).



Speed Inquiry to Advertiser via Collect Night Letter  
ON READER-SERVICE CARD CIRCLE 894

COPYRIGHT 1966 MAGNETICS, INC.

# New Literature

## Introduction to telemetry

"Introduction to Telemetry" includes definitions of technical terms, history and applications, telemetry techniques and equipment requirements. Techniques covered include FM/FM, PAM, PDM and PCM. Equipment requirements are discussed for signal conditioners, subcarrier oscillators, transmitters, RF amplifiers, antennas, preamps, multicouplers, receivers, discriminators, data display, magnetic tape recording, and data processing. International Electronic Research Corporation.

Circle No. 287



## Stepping motors

A stepping motor which directly converts digital pulse inputs to analog shaft output motion, is described in this 12-page booklet. Sigma Instruments, Inc.

Circle No. 288

## Axial lead component design

An 8-page manual, "Board design Guidelines for Axial Lead Components," considers machine assembly of axial lead devices. Board, hole and spacing considerations are discussed and specifications, insertion lead forms, component locations and wire control beneath the PC board are fully covered. The brochure is complete with schematics. Universal Instruments Corp.

Circle No. 289



## Switch catalog

This 44-page catalog covers rotary, thumbwheel, pushbutton, slide and special application switches. Construction details, engineering data, dimensional diagrams and specifications are given. In addition, a chart gives a cross-reference of competitive and MIL switches. The catalog also covers complete design information and application, offers sample switch kits, shows a sample detailed layout sheet and shows how to design special switches from standard switch components. Standard Grigsby Co.

Circle No. 290

## Power magnetics design

A rapid, explicit, step-by-step procedure for power transformer and inductor design using ferrite cores is given in this reference. Fundamental considerations, such as relationships between flux density and effective permeability, core loss vs frequency, flux density, and temperature, are discussed in conjunction with typical curves. Design procedures, including full mathematical treatment, are then separately explored. A full set of core-group charts and curves provides complete technical characteristics, dimensions, and winding data for over 100 standard ferrite cores suitable for power magnetics applications. Ferroxcube Corporation of America. Circle No. 291

## Magnetic cores

Fundamental factors affecting the selection and use of electrical steels are presented in this 32-page manual. Dealing specifically with steels for magnetic cores, emphasis is placed on how stresses effect magnetic properties and surface insulation. Data on the classification of electrical steels, core loss, lamination thickness, mechanical properties and factors in grade selection are included. Armco Steel Corp.

Circle No. 292

## IC and transistor hardware

Transistor and integrated circuit sockets, holders, bushings and pads are described in this 6-page bulletin. Complete dimensional specifications and engineering drawings for 12 types of sockets, 22 types of holders, 15 types of bushings and nine types of pads are given. The line is designed to accommodate components in TO-5 and TO-18 size cans with three to 12 leads. Sealectro Corp.

Circle No. 293



## Semiconductor cooling

Two catalogs on semiconductor cooling cover natural convection heat sinks, circuit board heat sinks, thermal retainers, mounting insulators, thermally conductive adhesives, thermal joint compounds, open airflow cooling assemblies, closed airflow cooling packages, liquid cooled plates, heat sink extrusions and special assemblies. The first catalog covers heat sinks for milliwatt to high-power semiconductors while the second covers standard commercial and military forced convection assemblies and liquid cooled plates. Wakefield Engineering Inc.

Circle No. 294

# This AE Type 44 Rotary Stepping Switch Thrives on Solitude.



So do all the rest of our hermetically sealed stepping switches. That's because we build switches so they can't bind, never overthrow.

Most of the secret's in our stepping mechanism. We don't use a pawl stop block. Instead, we use a unique "free-floating" pawl—with a set of stopping teeth on the end of the armature.

This way, the armature not only steps the wiper or cam assembly to the next position—it

also *locks* the rotor in the correct position. Overthrow is impossible. So is pawl wear and bind against a pawl stop block—even at low temperatures.

*Where* can you use these sealed switches? Almost anywhere. Some people take them out in the desert or down to the bottom of the ocean. Others fly them above 40,000 feet, where the mean temperature is  $-55$  degrees Centigrade. You might want them for a particularly dusty location in your shop.

*How* can you use reliable, versatile rotary stepping switches? There's a lot of helpful design information in our Circular #1698. It's yours for the asking. Just write the Director, Relay Control Equipment Sales, Automatic Electric Company, Northlake, Illinois 60164.

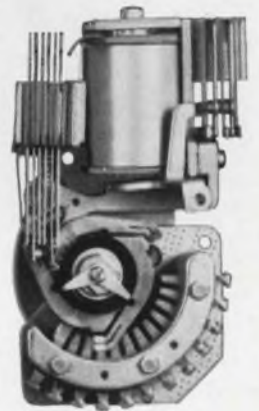

**AUTOMATIC ELECTRIC**  
SUBSIDIARY OF  
GENERAL TELEPHONE & ELECTRONICS **GTE**

ON READER-SERVICE CARD CIRCLE 825

# DESIGNING TAPE RECORDERS?

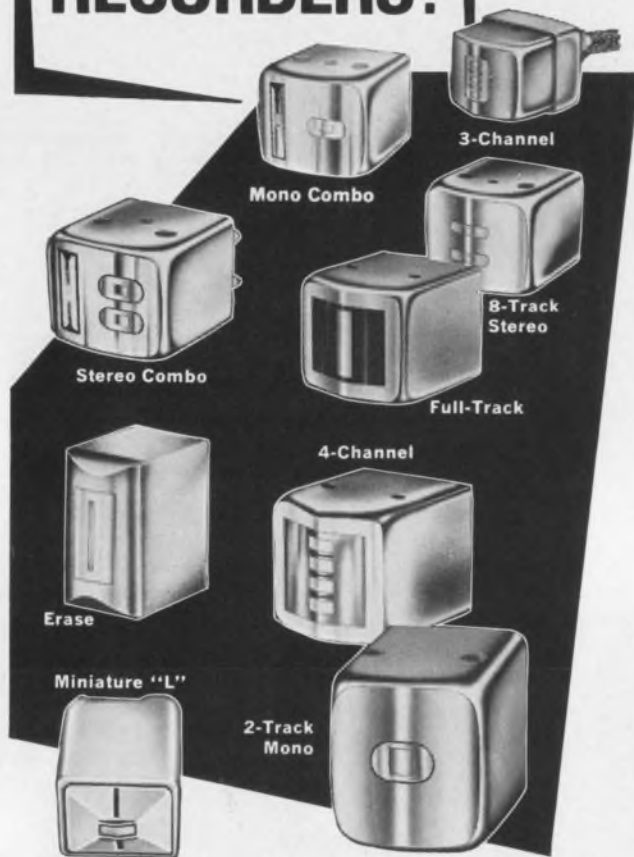

## Select the right head...fast!

Save time and cut costs with Nortronics' dynamic program of "engineering in depth"! Nortronics offers the design engineer the nation's broadest line of magnetic tape heads available today, plus valuable engineering support in head selection and mounting design for new equipment under development!

Choose from Premium or Standard Heads, in: 8-Track, 4-Track, 2-Track or Full Track styles; 4-Channel, 3-Channel, Stereo or Monophonic Types; with Hyperbolic, Cylindrical, Relieved or Extended Tip face contours. Wide range of impedances; deposited quartz gap spacing from 50 to 500 micro-inches; 9 different R/P and 5 different erase case sizes. Mounting: Base, Side, Rear and No-Mount design, plus a wide group of "stock" adjustable mounting assemblies.



Check  
Nortronics  
First!

For any tape head requirement, consult Nortronics... world's leading and most respected manufacturer of precision-quality magnetic tape heads!

# Nortronics®

8185-D 10th Ave. No. • Minneapolis, Minnesota 55427

ON READER-SERVICE CARD CIRCLE 826

## NEW LITERATURE



### Pulse transformer packages

This 4-page data sheet describes and illustrates 17 pulse transformer packages. It covers four-pin square packages, round, rectangular, radial lead and flat pack packages, as well as open construction transformers. Contemporary Electronics.

Circle No. 295

### Vibration control

"Built-in Damping" covers the theory and the design method for structural damping applications. Two application examples are included. The 16-page reprint considers vibration control with integrally damped laminates. Lord Manufacturing Corp.

Circle No. 296

### SCR control circuits

Seven single and three phase (half- and full-wave) circuits used in SCR control are diagrammatically pictured in this bulletin. Cross referenced to these circuits are the various models which are applicable to the circuits. These include card-mounted as well as enclosed units. Also cross referenced are normal pulse output units and hard firing units for high di/dt applications. The bulletin shows the firing pulses for all models, lists conduction angles, sensitivity, prices, model numbers and other information to aid in mating firing circuits and SCRs. The back page defines the general terms used in the industry such as snap-on, conduction angle, speed of response and on-to-off ratio. Firing Circuits, Inc.

Circle No. 297





## ARNOLD/TOROIDAL COIL WINDER

*sets up quickly...easy to operate...  
takes wide range of wire sizes*

### SPECIFICATIONS:

- Min. finished hole size: .18 in.
- Max. finished toroid O.D.: 4.0 in.
- Winding speed: 1500 turns/min.
- Wire range: AWG 44 to AWG 26
- Dual, self-checking turns counting system
- Loading (wire length) counter
- Core range: 9/32" I.D. to 4" O.D. to 1 1/2" high

### LABORATORY USE

- Change wire and core size in 45 sec.

### PRODUCTION USE

- 1500 turns per minute
- Insert core and load in 20 sec.

**\$890.00** includes all rings, counters and accessories



*immediate delivery. literature on request*

### ARNOLD MAGNETICS CORP.

6050 W. Jefferson Blvd., Los Angeles, Calif. 90016  
(213) 870-6284

ON READER-SERVICE CARD CIRCLE 827

## Come to MELPAR

*Where PERFORMANCE  
and RECOGNITION  
Come FIRST!*

At Melpar, our emphasis on individual recognition of accomplishments is not just a printed policy statement nor just a talking matter. It represents the very foundation of our personnel management system.

For more than 20 years, Melpar has enjoyed an enviable reputation as a leader in Space and Defense.

Are you qualified to join us?

*Immediate openings exist in the following areas:*

**Adaptive Systems • Antenna Systems • Communications • Countermeasures • Electro-Optical Data Processing • General Purpose Computer Applications • Information Systems • Intelligence Collection • Simulation and Training • Tactical Avionics**

*Write, in confidence, to:*

*Clarence Endsley, Professional Placement*

## MELPAR INC

A SUBSIDIARY OF WESTINGHOUSE AIR BRAKE COMPANY  
7734 ARLINGTON BOULEVARD, FALLS CHURCH, VIRGINIA  
(10 miles S.W. of Washington, D. C.)

*An equal opportunity employer M/F*

ON CAREER-INQUIRY FORM ON PAGE 111, CIRCLE 907

ELECTRONIC DESIGN 23, October 11, 1966



High Q  
comes  
in small  
packages



PLACE A  
DIME HERE

## Johanson

## 4700 Series MICRO-MINIATURE Highest Q Variable Air Capacitors

New Johanson 4700 Series variable air capacitors provide, in micro miniature size, the high Q important in demanding aerospace applications. In addition their ultra-rugged construction assures highest reliability in the most critical environments.

Available in printed circuit, turret and threaded terminal types.

### SPECIFICATIONS

Size: .145 diameter, 1/2" length

Q @ 100 MC, >5000

Q @ 250 MC, >2000

Capacity Range: 0.35 pF to 3.5 pF

Working Voltage: 250 VDC (test voltage, 500 VDC)

Insulation Resistance: > 10<sup>6</sup> Megohms

Temp. Range: -55°C to 125°C

Temp. Coefficient: 50±50 ppm/°C

*Write today for full data.*

## Johanson MANUFACTURING CORPORATION

400 Rockaway Valley Road, Boonton, N. J. 07005 (201) 334-2676

ELECTRONIC ACCURACY THROUGH MECHANICAL PRECISION.

ON READER-SERVICE CARD CIRCLE 883

When  
you're in  
the dark...

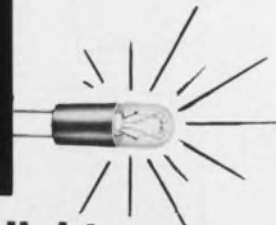

light up  
with Hudson  
lamps

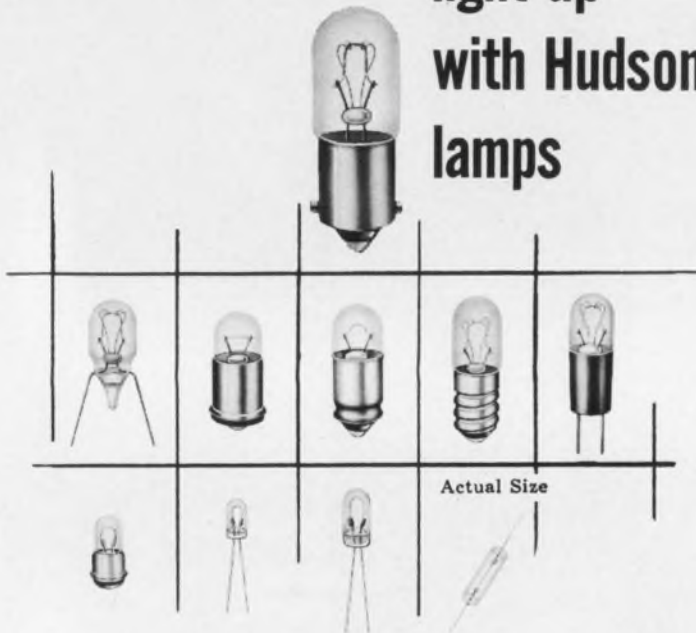

Lives to over 100,000 hours  
Install 'em and Forget 'em!

PROBLEMS OF SMALL SPACE ARE SOLVED in read-out devices, edge-lighted panels, illuminated switches, instruments, indicators and similar devices with miniature, sub-miniature and micro-miniature Hudson lamps immediately available from stock. Where standard lamps won't serve, special ones can be developed, such as the Tu-Pin and Axial Lead styles pioneered by Hudson to fill specific needs and now "shelf-items". You can depend on Hudson lamps to equal or better any others in standard or special applications.

Write for new catalog.

**Hudson LAMP COMPANY**  
Miniature Lamp Specialists



518 ELM STREET, KEARNY, NEW JERSEY 07032

ON READER-SERVICE CARD CIRCLE 884

## NEW LITERATURE

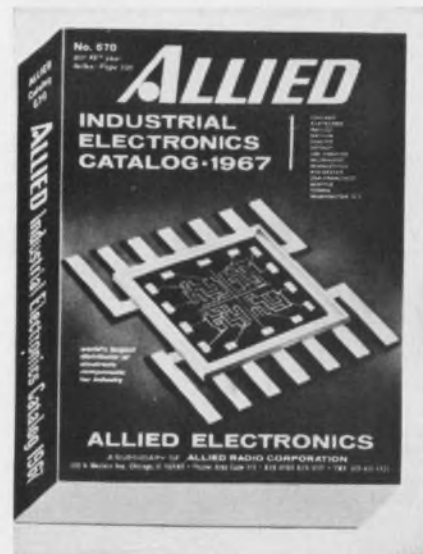

### Industrial electronics

The 1967 edition of Allied's catalog is designed for use by engineers, purchasing, research and maintenance people. The 548-page catalog lists over 60,000 electronic components, communications gear, sound and allied equipment produced by more than 600 manufacturers. 89 pages of semiconductors and IC devices include an enlarged section of additional specs to provide a reference and cross-indexed price guide of the products of major semiconductor manufacturers. Allied Electronics Corp.

Circle No. 298

### ABCs of polymers

The basic principles of polymer chemistry and an assessment of plastic's use in the future is detailed in this 12-page nontechnical guide. The booklet covers the molecular structure of polymers and explains their cohesive qualities, size and crystallinity. Mechanical, thermal, optical, electrical and chemical properties are covered. Ferro Corp.

Circle No. 299

### Pulse terminology

What is a pulse and how is it defined? "The New Pulse" includes 45 basic pulse definitions, most of which are illustrated. It is believed that these definitions not only approximate what most time domain practitioners think these words mean, but are unambiguous, rigorous and mathematically defensible. E-H Research Laboratories.

Circle No. 300

# EASTMAN 910<sup>®</sup> Adhesive... bonds carbide to magnesium in seconds

Speed is what business machines now have plenty of. IBM's 084 card sorter, for example, sorts 2,000 cards/minute—up 500% from the original design. Essential to higher speed was redesign of sorter's picker arm (the object that looks like a safety razor in the photo). Once carbon



steel, arm is now hollow magnesium faced with carbide. A bond formed in seconds with one drop of EASTMAN 910 Adhesive joins the two materials, holds up in wet grinding, takes 2,000 impacts/min.

EASTMAN 910 Adhesive will form bonds with almost any kind of material without heat, solvent evaporation, catalysts, or more than contact pressure. Try it on your toughest bonding jobs.

For technical data and additional information, write to Chemicals Division, EASTMAN CHEMICAL PRODUCTS, INC., subsidiary of Eastman Kodak Company, Kingsport, Tennessee. EASTMAN 910 Adhesive is distributed by Armstrong Cork Company, Industry Products Division, Lancaster, Pa.

## Here are some of the bonds that can be made with EASTMAN 910 Adhesive

Among the stronger: steel, aluminum, brass, copper; vinyls, phenolics, cellulose, polyesters, polyurethanes, nylon; butyl, nitrile, SBR, natural rubber, most types of neoprene; most woods. Among the weaker: polystyrene, polyethylene (shear strengths up to 150 lb./sq. in.).

ON READER-SERVICE CARD CIRCLE 885

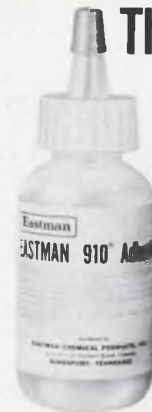

## There is no adhesive like EASTMAN 910<sup>®</sup> Adhesive

**SETS FAST**—Makes firm bonds in seconds to minutes.  
**VERSATILE**—Joins virtually any combination of materials.

**HIGH STRENGTH**—Up to 5,000 lb./in.<sup>2</sup> depending on the materials being bonded.

**READY TO USE**—No catalyst or mixing necessary.

**CURES AT ROOM TEMPERATURE**—No heat required to initiate or accelerate setting.

**CONTACT PRESSURE SUFFICIENT.**

**LOW SHRINKAGE**—Virtually no shrinkage on setting as neither solvent nor heat is used.

**GOES FAR**—One-pound package contains about 30,000 one-drop applications. (Or in more specific terms, approximately 20 fast setting one-drop applications for a nickel.)

The use of EASTMAN 910 Adhesive is not suggested at temperatures continuously above 175°F., or in the presence of extreme moisture for prolonged periods.

See Sweet's 1966 Product Design File 8a/Ea.

Now available! EASTMAN 910 Surface Activator  
When certain surface conditions inhibit rapid bond formation, use of EASTMAN 910 Surface Activator is suggested to restore the rapid polymerization of EASTMAN 910 Adhesive.

## ANOTHER WORLD'S SMALLEST Soshin's Dipped Mica Capacitors/DM05

Developed by SOSHIN ELECTRIC, the only mica capacitor maker in Japan with MIL-C-5C qualifications. This newest and its bigger brothers will meet all your requirements. Volume orders accepted.

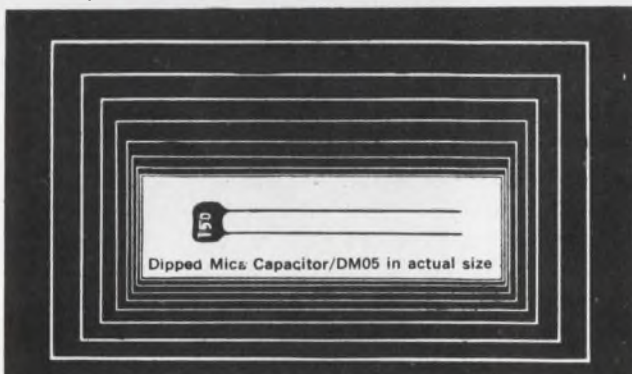

Types	Max Allowable Capacitance (pf)			Dimension (mm)								
	100 WV	300 WV	500 WV	100 WV			300 WV			500 WV		
Standard				L Max	W Max	T Max	L Max	W Max	T Max	L Max	W Max	T Max
DM05	200	130	—	7.0	5.0	3.5	7.0	5.0	3.5	—	—	—
DM10	440	390	330	8.5	5.5	3.5	8.5	5.5	3.5	8.5	5.5	3.5
DM15 (CM05)	2000	1200	510	13.0	11.0	6.5	12.5	10.5	6.0	12.0	10.0	5.5
DM19 (CM06)	10000	6800	5100	18.0	15.0	8.5	18.0	15.0	8.0	17.5	15.0	7.5

For further information, write to

**SOSHIN ELECTRIC CO., LTD.**  
18-18, Nakamagome 1-chome, Ohta-ku, Tokyo, Japan  
Cables: SOSHINCAPACITOR TOKYO

ON READER-SERVICE CARD CIRCLE 886

ELECTRONIC DESIGN 23, October 11, 1966



## GOOD FORTUNE AND PROSPERITY AWAIT ENGINEER ORDERING E-T POTS

E-T 3/8" 10-turn precision pots:

- cost \$4.50 or less, in production quantities
- meet or exceed existing, accepted specifications
- resistance range from 25 to 250,000 ohms
- linearity tolerance  $\pm 0.25\%$  (special to  $\pm 0.05\%$ )
- life expectancy (shaft revolutions) 2,000,000
- operating temperature range  $-55^{\circ}\text{C}$  to  $+125^{\circ}\text{C}$

Want more details? Write or phone the company that gives you more for your money in



**ELECTRO** quality, price and world-  
**TECHNIQUES** wide delivery . . .

11301 E. Ocean Ave., La Habra, Calif. 90631/(213) 691-0741  
MFRS. OF LINEAR AND NON-LINEAR PRECISION POTENTIOMETERS SINCE 1959

ON READER-SERVICE CARD CIRCLE 887

**completely  
new  
approach to  
Thyratron  
design**

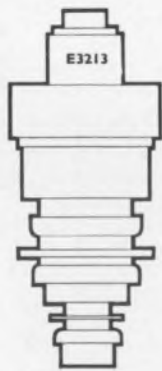
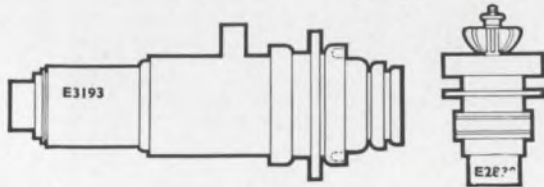
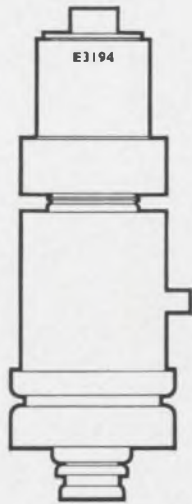

**for linear  
accelerator and  
high power  
radar  
applications**

*Cool grids—constant gas density with  
M-O V metal-bodied Thyratrons*

■ Deuterium filled for higher PASCHEN sparking potential. ■ Constant gas pressure, over wide range of ambient temperatures and supply voltages, given by reservoir system controlled by barretter and thermistor. ■ Cooled grid gives good delay time drift characteristics and a high Pb factor. ■ Compact construction.

	E2830	E3193	E3194	E3213
V <sub>a</sub> (pk)	20kV	35 kV	35 kV	70 kV
I <sub>a</sub> (pk)	5000 A	2000 A	5000 A	2500 A
I <sub>a</sub>	0.6 A	5.0 A	15.0 A	2.5 A
Rate of Rise of current	2,000 A/μs	7,500 A/μs	10,000 A/μs	7,500 A/μs
Jitter	2 ns	5 ns	5 ns	5 ns

## **Genalex** THE M-O VALVE CO. LTD

North American Sales Manager • David LaFrenais • 9 Codeco Court • Don Mills  
Ontario Canada • Telephone 416-447-5511 on reader-service card circle 166

ON READER-SERVICE CARD CIRCLE 888

## NEW LITERATURE



### TV equipment

This cable antenna TV equipment catalog gives specs, photos and prices for over 200 products. A section on engineering, construction and financing services available is included. Ameco, Inc.

Circle No. 301

### "Don't Disturb" sign

For the engineer constantly bothered in the lab by prowlers searching for test equipment for their own projects, this "DON'T DISTURB TEST SET UP" sign has a "Holy Experiment" theme. This multi-colored 6 x 12 in. sign will attract enough attention to your set-up so that all who see it will know that it should not be disturbed. Trygon Electronics, Inc.

Circle No. 302

### Wire and cable guide

This 20-page booklet gives technical data on the company's line of wire and cable. A section containing tables with weight comparisons between light wall insulation and conventional insulation is given. The booklet also has technical data including wire formulas for resistance and impedance calculations for electrical conductors and coax cable. A table presents nominal diameters, cross-sectional areas, weight and resistance of different hardness copper wires listed by AWG sizes. Inso-Electronic Products Inc.

Circle No. 303

### Random vibration testing

A 34-page booklet compares sine wave, wide band random and narrow band random vibration testing. An electrical analog of a mechanical test specimen was used for the comparison. Theoretical and actual test results are compared with a discussion of optimum operating procedures. B&K Instruments, Inc.

Circle No. 304

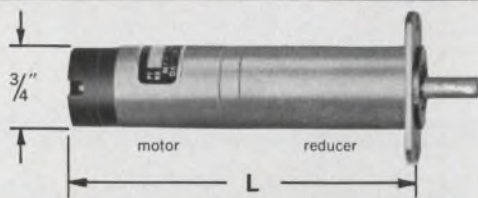

### 3/4" GEARHEAD MOTOR

Now you can get up to 300 oz. in. torque from a precision miniature gearmotor only 3/4" in diameter. Globe's Type SD permanent magnet d.c. motor with integral planetary gearhead provides 19 standard ratios, wound for 4 to 50 volts. Armatures can be wound to produce any speed-torque combination within the capacity of the motor. Can meet environmental and other applicable portions of MIL-M-8609. Request Bulletin SDG.

Speed Reduc. Ratio	Max. Cont. Torque Oz. In.	L	Speed Reduc. Ratio	Max. Cont. Torque Oz. In.	L
14.58	3.0	2 <sup>3</sup> / <sub>4</sub>	733	100	2 <sup>1</sup> / <sub>4</sub>
22.08	4.5		1108	150	
33.28	7.0		1853	200	
55.66	10	2 <sup>3</sup> / <sub>2</sub>	2799	300	3 <sup>1</sup> / <sub>8</sub>
84.11	14		4230	300	
127.1	21		6391	300	
192	30	2 <sup>1</sup> / <sub>4</sub>	10689	300	3 <sup>1</sup> / <sub>4</sub>
321	45		16150	300	
485	70		24403	300	
			36873	300	

GLOBE

Globe Industries, Inc., 2275 Stanley Ave.  
Dayton, Ohio 45404, Tel.: Area 513 222-3741



ON READER-SERVICE CARD CIRCLE 889

# Revolutionary Electronic Calculator

- Unmatched speed, versatility
- Simple to operate
- Single keystrokes provide all these functions

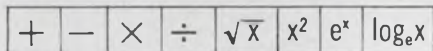

- Two independent accumulators for random data entry and retrieval
  - **LOW PRICE — FROM \$1690 to \$2095**  
Additional keyboard units from \$450
  - Time sharing units also available
- Write for complete details



DEPT. III-10, 836 NORTH ST., TEWKSBURY, MASS. 01876  
TEL (617) 851-7311

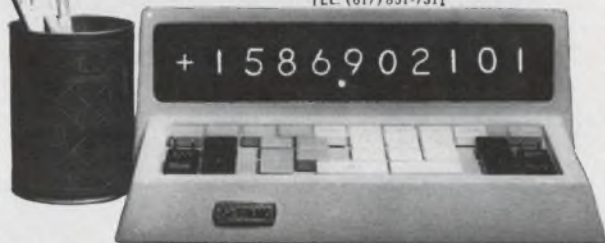

ON READER-SERVICE CARD CIRCLE 890

ELECTRONIC DESIGN 23, October 11, 1966

# THERMOFOIL HEATERS • SENSORS INTEGRATED CIRCUITS

## THIN-FLEXIBLE RESISTANCE ELEMENTS FOR HEATING AND TEMPERATURE SENSING



### INERTIAL GUIDANCE —

gyros, accelerometers, stable platforms.

**ELECTRO-MECHANICAL —**  
ovens, platens, recorders, temp baths, batteries.

**COMPUTERS —** memory planes.

**TEMPERATURE COMPENSATION —** electronic circuits.

**RESEARCH & DEVELOPMENT —**  
laboratory, prototypes.

### THERMOFOIL

Need closer temp control and improved equipment performance? THERMOFOILS provide fast warm-up/temp response, proven reliability with minimum space and weight. You can obtain higher heat densities, better heat transfer without "hotspots," convenient installation . . . standard heater or sensor models are available, or an element can be specially fitted to your equipment.



Use your letterhead to request this FREE THERMOFOIL heater sample for evaluation

### THERMAL-RIBBONS

Fast-response conversion of surface temperatures to accurate electrical readout for temperature measuring, recording, or control. Used with Thermal-Indicator or other lab equipment.

### TEMPERATURE PROBES, RESISTANCE THERMOMETERS

Many tip or stem sensitive stock models for accurate sensing of gas, liquid, solid temperatures in industrial, commercial, laboratory use.

### THERMAL-INDICATORS

Used with Thermal-Ribbons, Res. Thermometers, and Temp. Probes. Six models, direct reading from -100°C. to +200°C. or -148° F. to +392°F.

### PRECISION PLATINUM RESISTANCE THERMOMETERS

For highly precise measuring or control; long-term stability and accuracy.

### BUTTON-HEATERS

Disc shaped units for controlled heat. Available up to 150 watts.

### RESISTANCE TEMPERATURE DETECTORS

Rugged sensors for large motors, generators, transformers, etc. Permanently installed by molding or casting into equipment.

## MINCO PRODUCTS, INC.

740 WASHINGTON AVENUE NORTH — MINNEAPOLIS, MINN. 55401

TELEPHONE: (612) 338-6753

PLEASE SEND INFORMATION ABOUT —

TWX: 910-576-2848

- Thermal-Ribbons     Thermofoils     Res Temp. Detectors  
 Thermal-Indicators     Precision Thermometers     Send Complete Catalog  
 Temperature Probes     Button-Heaters     Have Rep. Call

NAME \_\_\_\_\_

COMPANY \_\_\_\_\_

ADDRESS \_\_\_\_\_

CITY \_\_\_\_\_

STATE \_\_\_\_\_

ZIP \_\_\_\_\_

TELEPHONE \_\_\_\_\_

EXTENSION \_\_\_\_\_

ON READER-SERVICE CARD CIRCLE 891

### Hermetic connectors

General information on nine general series of hermetic connectors, including MIL-C-5015, MIL-C-26500, MIL-C-266482 and NAS 1599 types is included in this 4-page brochure. ITT Cannon Electric.

Circle No. 305

### Reprints Available

The following reprints are available free and in limited quantities. To obtain single copies, circle the number of the article you want on the Reader-Service Card.

*Tools for Design of Adaptive Control Systems* (No. 306)

*Put FETs to Work in Electrometers* (No. 307)

*Thick Films—How and When to Use Them* (No. 308)

### Accuracy Policy

It is the policy of ELECTRONIC DESIGN:

To make reasonable efforts to insure accuracy of editorial matter.  
To publish promptly corrections brought to our attention.

To reserve the right to refuse any advertisement deemed misleading or fraudulent.

All editorial correspondence and manuscripts should be sent to:

Howard Bierman, Editor  
ELECTRONIC DESIGN  
850 Third Avenue  
New York, N. Y. 10022

### Subscription Policy

ELECTRONIC DESIGN is circulated free of charge to qualified design engineers in the U.S., Western European Continent and Britain. To establish your qualifications, send ELECTRONIC DESIGN the following information on your company's letterhead: Your name, engineering title, description of your design duties and a list of your company's major products. The letter must be signed by you personally.

Subscription rates for nonqualified subscribers—\$25 a year in the U.S., \$35 in all other countries. Single copy, \$1.50.

### Change of Address

A subscriber's change of address requires a restatement of his qualifications. To expedite the change, and to avoid missing any issues, send along a label from a back copy.

### Microfilm Copies

Microfilm copies of all 1961, 1962, 1963, 1964 and 1965 issues of ELECTRONIC DESIGN are available through University Microfilms, Inc., 313 N. First Street, Ann Arbor, Mich.

# Design Data from

## Your Micro-Electronics Tool Catalog



—BY RETURN MAIL!

The finest SWISS TWEEZERS for handling miniature and micro-miniature parts . . . all alloys in 42 patterns • PLIERS with miniature heads featuring the famous Lindstrom "Box Joint" Swedish pliers, perfect for precision work. • CUTTING NIPPERS . . . regular edges, semi-flush edges and full-flush edges. • CUTTING TWEEZERS for difficult and special wire cutting problems in confined areas. • SCISSORS for ribbon wire and light sheet metals made of Solingen Steel.

Write Today—Ask for Catalog No. 423.

**Hammel, Riglander & Co., Inc.**

P. O. Box 222  
New York, N. Y. 10014

**171**

## Nylon Clamps-Subminiature to Jumbo



For a huge variety of fastening requirements, nylon cable clamps are the preferred choice because of their superior insulating properties as well as their exceptional strength. An extremely wide range of types and sizes is described in this convenient four page brochure, which lists over a hundred configurations and sizes. Complete specifications are given covering both the clamps and the high quality nylon of which they are manufactured.

**Weckesser Company, Inc.**

4444 West Irving Park Road  
Chicago, Illinois 60641

**173**

## Automatic Component Sequencing System



Customer-proven punched tape controlled system sequences 10,000+ /hr. axial lead components and reel packages them ready for automatic insertion into printed circuit boards. Parts are fed from 39 interchangeable dispensing stations for lead taped as well as magazine loaded and corrugated cardboard packaged components. Sequence length is not limited to the number of input stations, nor is it necessary to load stations in sequence order. Well suited for long and short production runs. Send for new 8-page bulletin.

**Universal Instruments Corporation**

E. Frederick Street  
Binghamton, New York

**175**

## The Sig Gen—Book I



The Sig Gen Book I is a new publication available from Marconi Instruments, 111 Cedar Lane, Englewood, New Jersey. It deals with the use of signal generators in testing receivers and covers such subjects as: Source Impedance of Feeder Connected Receivers, Coupling to Loop Aerials, Signal-to-Noise Ratio, Automatic Gain Control, Plotting Response Characteristics, Measurement of Adjacent Channel Suppression and Spurious Response. For your copy write:

**MARCONI INSTRUMENTS, Dept. WAB**  
111 Cedar Lane  
Englewood, New Jersey

**172**

## Bus Bars For Noise Reduction



A 10 page Technical Bulletin is now available, describing a new concept in power or signal distribution. Basic mechanical and electrical design principles, along with descriptive pictures and diagrams, are included in this bulletin. These compact buses can replace bulky cable harnesses and repetitive wiring for computer or modular application. This method of construction satisfies the demanding requirements of low inductance and resistance of high speed, solid state systems, while controlling electrical noises.

**Eldre Components, Inc.**  
1239 University Avenue  
Rochester, New York 14607

**174**

## Potentiometers, Switches & Turns-Counting Dials



A four-page, two-color short-form catalog from Duncan Electronics, Inc., gives complete specifications and prices on Duncan's precision multi- and single-turn potentiometers for both military and commercial applications. Also included are details on Duncan's Series 60 and 80 turns-counting dials designed for use with multi-turn potentiometers; non-linear potentiometer information for log, trig, empirical, or other forms of non-linear functions; and precision commutator switches for use either individually or in ganged assemblies with potentiometers and other switching devices.

**Duncan Electronics, Inc.**  
2865 Fairview Road  
Costa Mesa, California 92626

**176**

## Advertising Representatives

**New York 10022**  
Robert W. Gascoigne  
Thomas P. Barth  
Samuel M. Deitch  
Richard W. Nielson  
850 Third Avenue  
(212) PLaza 1-5530  
TWX: 867-7866

**Philadelphia 19066**  
Fred L. Mowlds, Jr.  
P. O. Box 206  
Merion Station, Pa.  
(215) MO 4-1073

**Marblehead 01945**  
Richard Parker  
7 Redstone Lane  
(617) 742-0252

**Chicago 60611**  
Thomas P. Kavooras  
Berry Conner, Jr.  
720 N. Michigan  
(312) 337-0588

**Cleveland 44107**  
Robert W. Patrick  
8410 Treetower Drive  
Chagrin Falls, Ohio  
(216) 247-7670

**Los Angeles 90303**  
Stanley I. Ehrenclou  
Terrence D. Buckley  
W. James Bischof  
2930 W. Imperial Highway  
Inglewood, Calif.  
(213) 757-0183

**San Francisco**  
Ashley P. Hartman  
175 South San Antonio Rd.  
Ste. 243  
Los Altos, Calif. 94022  
(415) 941-3084

**Southwestern 75206**  
Tommy L. Wilson  
6200 North Central Expressway  
Dallas, Tex.  
(214) EMerson 1-2311

**London W. 1**  
Brayton C. Nichols  
44 Conduit Street

**Tokyo**  
Yoshihiro Takemura  
International Planning  
Service, Inc.  
Room 231 Tokyu-Mita Bldg.  
1, Shiba-Mita Koun-cho  
Minato-ku, Tokyo







# "ELECTRONIC DESIGN INCREASED THEIR LEAD IN READERSHIP . . . WILL BE THE NUMBER 1 BOOK ON OUR MEDIA SCHEDULE"

—Donald L. Van Beck, President  
Accutronics, Inc.



## ACCUTRONICS, INC. STUDIED READERSHIP IN '65 . . . AGAIN IN '66 ELECTRONIC DESIGN IS READ EVEN BETTER THAN BEFORE!

1965 STUDY 784 questionnaires mailed 212 returns			READERSHIP GAIN OR LOSS (Percent)		1966 STUDY 2,249 questionnaires mailed 448 returns		
Percent Read	Equivalent Weighted Score	Rank			Rank	Percent Read	Weighted Score
71.7	571	<b>1</b>	<b>ELECTRONIC DESIGN</b>	<b>+ 17.2%</b>	<b>1</b>	78.1	669
69.3	535	<b>2</b>	Electrical Design News	+ 3.6%	<b>2</b>	69.0	554
65.1	528	<b>3</b>	Electronic Equipment Engineering	- 1.3%	<b>3</b>	62.2	521
62.2	509	<b>4</b>	Electronics	- 1.6%	<b>4</b>	57.9	501
61.3	446	<b>5</b>	Electronic Industries	- 9.4%	<b>6</b>	56.0	404
59.5	402	<b>6</b>	Electronic Products	- 2.0%	<b>5</b>	60.5	410
47.2	363	<b>7</b>	IEEE Spectrum	+ 3.6%	<b>7</b>	46.4	376

Presentation limited to 7 top scoring publications. Ask your *Electronic Design* Representative for complete study.

### "ELECTRONIC DESIGN INCREASED ITS LEAD TO 78.1% (OF TOTAL MENTIONS)"

Donald L. Van Beck, President of Accutronics, Inc. writes:

"In both (our 1965 and 1966 surveys) *Electronic Design* pulled the highest percentage of readership. The highly significant result, however, is an increase of (total mentions) to 78.1% in 1966 over 71.7% in 1965.

"With the result of these surveys we can now prepare our media schedule for the best coverage of our market. *Electronic Design* will be the

Number 1 book on our media schedule for the new fiscal year."

To date, 58 companies have measured their customers' readership and given us the results to publish. 54 out of these 58 have been won by *Electronic Design*! What better basis can you find for selecting media? *Electronic Design* has proven again, and again and again that it is best read by OEM customers and prospects.

IF YOUR AD CAN SELL—IT WILL SELL BEST IN

**BPA** **Electronic Design** **ABP**

a HAYDEN publication

850 Third Avenue New York 10022 (212) PLaza 1-5530

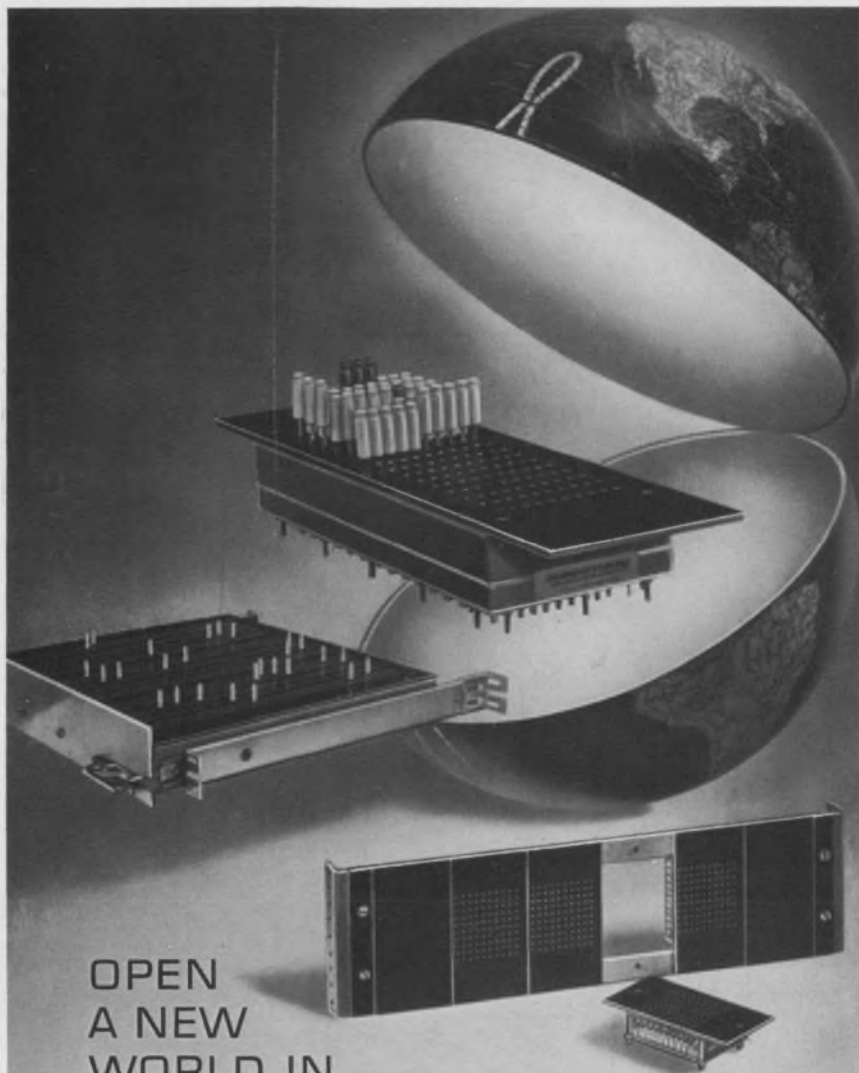

OPEN  
A NEW  
WORLD IN  
PROGRAMMING

## SEALECTROBOARD

offering unlimited versatility in programming, switching, and circuit control without patchcords or jumpers. Sealectroboard has a unit that can perform virtually any programming function with one to four contact decks, bussed contacts, shorting, skip, and component holding pins, and countless hole, contact and mounting configurations.

If your application calls for a fast, highly reliable, program-at-a-glance programming system, contact Sealectro. Our Applications Engineers are experts at solving programming problems.

P.S. *The price is right, too!*



PROGRAMMING DEVICES DIVISION

**SEALECTRO**  
CORPORATION

MAMARONECK, NEW YORK

Phone: 914 698-5600 TWX: 710-566-1110

Sealectro Ltd., Portsmouth, Hants, England

## Designer's Datebook

OCTOBER						
S	M	T	W	T	F	S
	2	3	4	5	6	7
8	9	10	11	12	13	14
15	16	17	18	19	20	21
22	23	24	25	26	27	28
29	30	31				

NOVEMBER						
S	M	T	W	T	F	S
						1
2	3	4	5	6	7	8
9	10	11	12	13	14	15
16	17	18	19	20	21	22
23	24	25	26	27	28	29
30	31					

### Oct. 18-20

**Seventh National Symposium of the Society for Information Display** (Boston, Mass.) Sponsor: S.I.D.; Glenn Whitham, Society for Information Display, P. O. Box 413, Wayland, Mass.

### Oct. 18-20

**2nd Annual International Telemetry Conference** (Los Angeles, Calif.) Sponsor: International Foundation for Telemetry; J. E. Hinde, Sandia Corp., P. O. Box 5800, Albuquerque, N. M.

### Oct. 24-26

**16th Annual IEEE Machine Tools Conference** (Milwaukee, Wisc.) Sponsor: IEEE, G-IGA; Grant L. Wittberger, Allen-Bradley Co., 1201 S. Second St., Milwaukee, Wisc.

### Oct. 24-27

**21st Annual ISA Instrument-Automation Conference & Exhibit** (New York) Sponsor: Instrument Society of America; Daniel R. Stearn, Instrument Society of America, 530 William Penn Pl., Pittsburgh, Pa.

### Nov. 2-4

**1966 Northeast Electronics Research and Engineering Meeting (NEREM)** (Boston, Mass.) Sponsor: IEEE, New England sections; T. A. Longo, IEEE Boston Office, 31 Channing St., Newton, Mass.

### Nov. 8-10

**1966 Fall Joint Computer Conference** (San Francisco, Calif.) Sponsor: American Federation of Information Processing Societies; W. Estler, 965 Lincoln Ave., Palo Alto, Calif. 94301.

### Nov. 14-17

**19th Annual Conference on Engineering in Medicine and Biology** (San Francisco, Calif.) Sponsor: IEEE and ISA; T. Weber, Beckman Instruments, 2500 Harbor Blvd., Fullerton, Calif.

# in meters

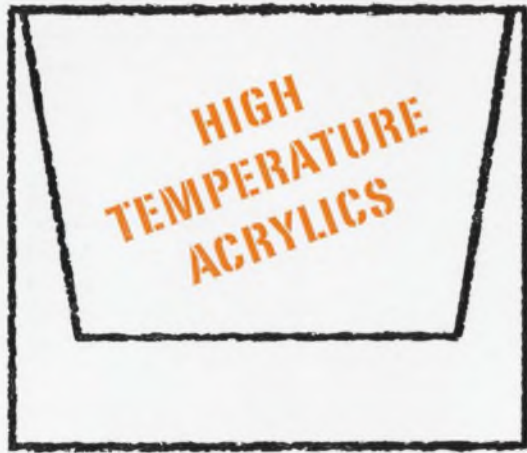

look for this



watch out for this



**QUALITY PLASTIC COVERS** have no substitute. Cheap plastics are full of headaches such as breakage due to embrittlement...networks of minute cracks...crazing from cleaners containing alcohol...yellowing...scratches in the window area. ■ There are many plastics used for meter windows. The best all-around choice currently is high-temperature acrylics. You will find Simpson meters use this material. Yes, it adds 1 or 2 percent to the cost. Is it worth it? There's no doubt about it, if you realize how much an equipment maker's reputation rides on his choice of components. ■ Write for Simpson Stock Catalog No. 2073 which lists over 1400 sizes and types. It's your guidebook to the most value per dollar in meters.

Write for reprint on  
"How to Specify  
Panel Meters"



**Simpson**  
INSTRUMENTS THAT STAY ACCURATE

**SIMPSON ELECTRIC COMPANY**  
5202 W. Kinzie Street, Chicago, Ill. 60644 • Phone: (312) ESTbrook 9-1121  
Representatives in Principal Cities . . . . . See Telephone Yellow Pages  
Export Dept.: 400 W. Madison St., Chicago, Ill. 60606 Cable, Simelco  
In Canada: Bach-Simpson Ltd., London, Ontario  
In India: Ruttonsha-Simpson Private Ltd., Vikhroli, Bombay

WORLD'S LARGEST MANUFACTURERS OF ELECTRONIC TEST EQUIPMENT.  
ON READER-SERVICE CARD CIRCLE 209



# RCA

## 2N4440 "overlay" new high performance version of 2N3375

$P_{out} = 5$  Watts min at 400 MHz  
with  $P_{in} = 1.7$  watts

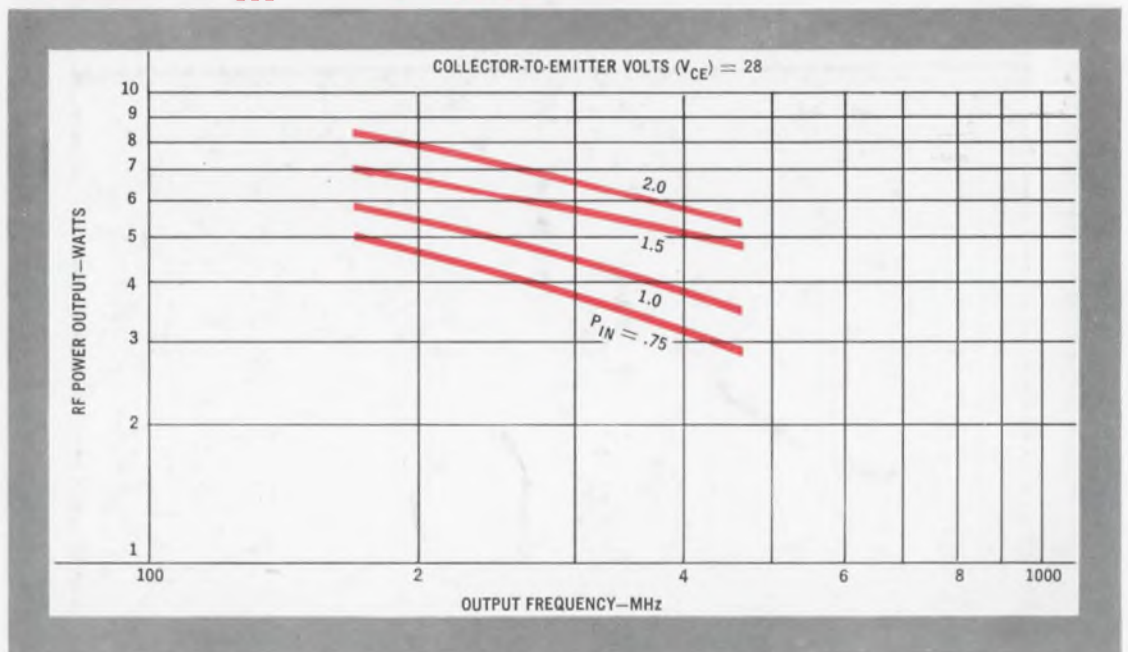

RCA now introduces 2N4440, a new high performance version of "overlay" type 2N3375—the industry's most famous rf-power device. Specified for Class A, B, and C service, this premium transistor extends solid-state performance for rf amplifier, multiplier, or oscillator service into the 175 to 400 MHz range.

The latest addition to RCA's extensive "overlay" family, 2N4440 offers:

$P_{out} = 5$  W (min.) @ 400 MHz;  $P_{in} = 1.7$  W  
 $P_{out} = 6.5$  W (typ.) @ 225 MHz;  $P_{in} = 1.7$  W  
 $BV_{ceV} = 65$  V (max.)  
 $BV_{cco} = 40$  V (max.)

Add to this performance the efficiency of an isolated-collector stud package (TO-60) and the increased reliability of 100% Power Rating Testing (each unit is tested at maximum power level for one second), and you have an important new design tool for VHF, UHF, and Microwave communications circuits.

For additional information, plus price and delivery, see your RCA Representative. For technical data, write: RCA Commercial Engineering, Section IG10-2, Harrison, N.J.

**Also available through your RCA Distributor**  
RCA Electronic Components and Devices



**The Most Trusted Name in Electronics**