

Oct.

BROADCAST  
**WRNY**  
STATION

25 Cents

# Science and Invention



THE TRUTH  
ABOUT  
ASTROLOGY

See Page 494

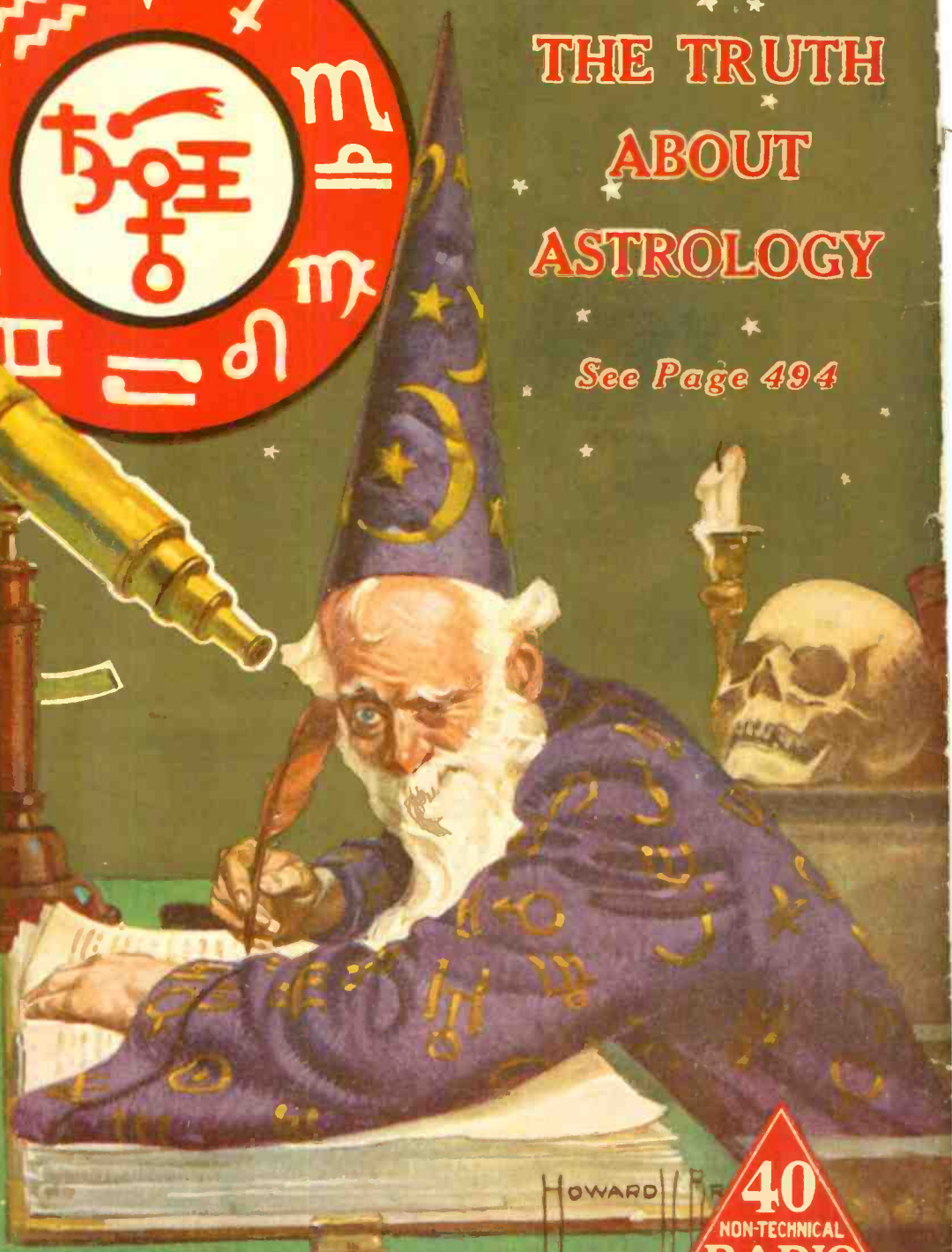

HOWARD

**40**  
NON-TECHNICAL  
**RADIO**  
**ARTICLES**

**30  
DAYS  
FREE  
TRIAL**

# 7 Tube Set Single Dial Radio

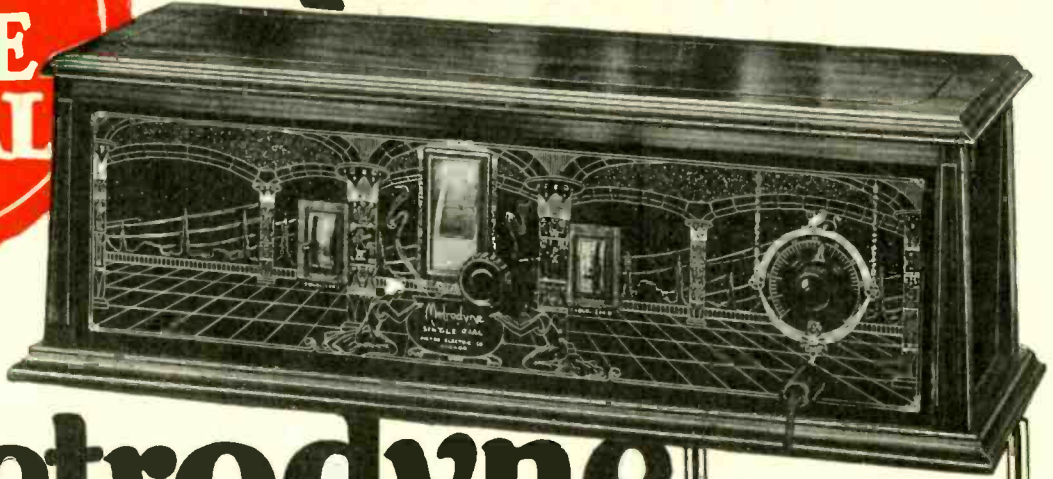

## The Metrodyne

**ONLY ONE DIAL TO TUNE**

**Retail Price**  
**\$75**

**Completely Assembled**  
**Big Discounts**  
**to Agents and Dealers**

**Wonderful offer direct from the factory! The world's greatest radio.** A perfect working, single dial control, 7 tube receiver. And just to prove our claims, we will ship it to your home for **30 days' free trial**. Test it under all conditions. Test it for distance, volume and tonal quality — and if you are not convinced that it is the best single dial set you ever heard, return it to the factory. We don't want your money unless you are completely satisfied.

**BIG PROFITS  
TO AGENTS AND DEALERS**

Our Agents and Dealers make big money selling Metrodyne Sets. You can work all or part time. Demonstrate the superiority of Metrodynes right in your home. Metrodyne Radios have no competition. Lowest wholesale prices. Demonstrating set on 30 days' free trial. Greatest money-making opportunity. Send coupon below—or a letter—for our agent's proposition.

## Metrodyne Super-Seven Radio

A single dial control, 7 tube, tuned radio frequency set. Approved by America's leading radio engineers. Designed and built by radio experts. Only the highest quality low loss parts are used. Magnificent, two-tone walnut cabinet. Artistically gilded genuine Bakelite panel, nickeled piano hinge and cover support. All exposed metal parts are beautifully finished in 24-k gold.

Easiest set to operate. Only one small knob tunes in all stations. The dial is electrically lighted so that you can log stations in the dark. The volume control regulates the reception from a faint whisper to thunderous volume, 1,000 to 3,000 miles on loud speaker! The Metrodyne Super-Seven is a beautiful and efficient receiver, and we are so sure that you will be delighted with it, that we make this liberal **30 days' free trial offer**. You to be the judge.

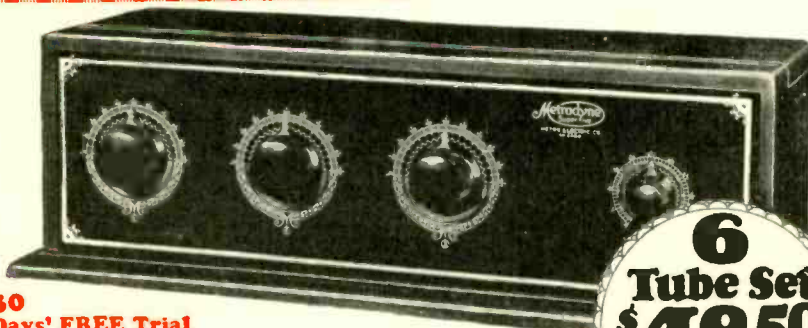

**30  
Days' FREE Trial**

## Metrodyne Super-Six

Another triumph in radio. Here's the new 1927 model Metrodyne 6 tube long distance tuned radio frequency receiving set. Approved by leading radio engineers of America. Highest grade low loss parts, completely assembled in a beautiful walnut cabinet. Easy to operate. Dials easily logged. Tune in your favorite station instantly on same dial readings every time. No guessing.

Mr. Howard, of Chicago, said: "While five Chicago broadcasting stations were on the air I tuned in seventeen out-of-town stations, including New York and San Francisco, on my loud speaker horn, very loud and clear, as though they were all in Chicago."

We are one of the pioneers of radio. The success of Metrodyne sets is due to our liberal **30 days' free trial offer**, which gives you the opportunity of trying before buying.

**6  
Tube Set**  
**\$48.50**  
**RETAIL PRICE**  
*Completely Assembled*

**MAIL THIS COUPON**

or send a postal or letter. Get our proposition before buying a radio. Deal direct with manufacturer—**Save Money.**

## Mail COUPON Below!

**Let us send you proof of Metrodyne quality**

F. L. Warnock, Greentown, Ind., writes: "I received the Metrodyne in good shape and am more than pleased with it. Got stations 2,000 miles away."

C. J. Walker, Mariposa, Calif., writes: "Received my Metrodyne Single Dial set O. K. I believe that these one-dial sets are going to be excellent sellers. I had no trouble in tuning in stations enough to satisfy anyone, so you will please send me another set."

Roy Bloch, San Francisco, Calif., writes: "Very often we travel from New York to the Hawaiian Islands quickly — from station to station — by means of the little tuning-knob which operates the electrically-lighted dial. The Metrodyne Single Dial Set is much easier to operate than any radio set I've ever seen."

We will send you hundreds of similar letters from owners who acclaim the Metrodyne as the greatest radio set in the world. A postal, letter or the coupon brings complete information, testimonials, wholesale prices, and our liberal **30 days' free trial offer**.

**METRO ELECTRIC COMPANY**  
2161-71 N. California Ave., Dept. 167  
Chicago, Illinois

Gentlemen:

Send me full particulars about Metrodyne 6 tube and 7 tube sets and your **30 days' free trial offer**

Name \_\_\_\_\_

Address \_\_\_\_\_

If you are interested in AGENT'S proposition, place an "X" in the square

**METRO ELECTRIC COMPANY**  
2161-71 N. California Ave. • Dept. 167 • Chicago, Illinois



*"They last twice as long as the smaller Batteries of equal voltage"*

"THAT'S a pretty broad statement, Tom. Won't you have to make it conditional on the number of tubes in the set or the use of the new power tubes?"

"No, sir! Under the same operating conditions—whether you use four, five tubes or more, whether you use a power tube that uses up to 135 volts, the Eveready Heavy-Duty No. 770 or the even longer-lived Eveready Layerbilt No. 486 will last twice as long as the smaller sized 45-volt batteries."

"Well, they ought to, they cost more."

"Yes, about a third more—but lasting twice as long, they cost much less."

"Your arithmetic is good, Tom, but if that's so, when I bought my set why did the dealer equip it with the smaller Eveready 772's? Why didn't he put in the Eveready Heavy-Duty Batteries?"

"He probably thought he was doing

NOTE: A "C" battery gives a quality of reception unobtainable without it and greatly increases the life of your "B" batteries.

you a favor—making your first investment cost you a little less. That little difference looks like a lot to a good many folks who are buying their first set, equipped with tubes, loud speaker, 'A' and 'B' batteries and everything."

Heavy-Duty batteries last twice as long as the smaller batteries of equal voltage. Eveready Heavy-Duty Batteries are the great contribution that the world's foremost electro-chemical

laboratories has made in "B" battery economy, dependability and satisfaction.

Dry "B" batteries give a noiseless current, pure D. C. (direct current), the kind that is essential if you prize pure tone.

Send for booklet, "Choosing and Using the Right Radio Batteries," which we will be glad to send you upon request. This booklet also tells about the proper battery equipment for use with the new power tubes. There's an Eveready dealer nearby.

Manufactured and guaranteed by  
NATIONAL CARBON CO., INC.  
New York San Francisco

Canadian National Carbon Co., Limited  
Toronto, Ontario

Tuesday night means Eveready Hour —  
9 P. M., Eastern Standard Time, through  
stations:

WEAF—New York	WSAT—Cincinnati
WJAR—Providence	WTAM—Cleveland
WEI—Boston	WWJ—Detroit
WTAG—Worcester	WGN—Chicago
WFI—Philadelphia	WOC—Dayton
WGR—Buffalo	WCCO—Minneapolis
WCAE—Pittsburgh	WCCO—St. Paul
	KSD—St. Louis

LEFT - Eveready Layerbilt No. 486.  
RIGHT - Eveready Dry Cell Radio "A" Battery, 1 1/2 volts.

**EVEREADY**  
**Radio Batteries**  
*-they last longer*

INDEX TO ADVERTISERS

# INDEX TO ADVERTISERS

<p><b>A</b></p> <p>American Bazaar, Inc. ....536, 567                  American Correspondence School of Law .....570                  American School of Aviation .....567                  American School .....551, 569                  American School of Music .....571                  American Telephone &amp; Telegraph Co. ....559                  Anita Company, Inc. ....569                  Arrow Battery Co. ....550                  Audel &amp; Co., Theo., Inside Back Cover                  AutoStrop Safety Razor Co. ....548</p> <p><b>B</b></p> <p>Balda Art Service .....572                  Bell Perfume Co. ....557                  Blandin, F. W. ....570                  Bliss Electrical School .....560                  Bogue Institute for Stammerers 544                  Brinkler School of Eating .....563                  Buescher Band Inst. Co. ....552                  Burns School of Wrestling ....572</p> <p><b>C</b></p> <p>Chemical Institute .....485                  Chicago Engineering Works . .481                  Chicago Solder Co. ....562                  Christensen School of Music .569                  Coast Guard Preparatory School 571                  Coleman, Watson Co. ....544                  Conrad Co., Inc. ....548, 552, 556, 558, 568                  Coyne Electrical School .....571                  Cushing, Jr., H. C. ....572</p> <p><b>D</b></p> <p>Diversified Sales Co. ....555                  Douglas, Lyle .....560</p>	<p><b>E</b></p> <p>Electro Magnetic Tool Co. ....573                  Evans, Victor J. ....545</p> <p><b>F</b></p> <p>Fawcett Publications, Inc. ....576                  Federal Mail Order Corp., 538, 550, 563, 570                  First Hawaiian Conservatory of Music .....561                  Fisher Mfg. Co., Adam .....544                  Franklin Institute .....557</p> <p><b>G</b></p> <p>Gerold Company, The .....550                  Gilson Slide Rule Company .....564                  Givens Chemical Company .....569                  Gordon, Milton .....570</p> <p><b>H</b></p> <p>Hardin-Lavin Co. ....572                  High School Home Study Bureau .....540                  Hobart Brothers .....561                  Hotel Martinique .....540</p> <p><b>I</b></p> <p>Ideal Aeroplane &amp; Supply Co. .563                  International Correspondence Schools .....544, 562, 570, 572                  International Studios .....561                  Irwin Aircraft Company .....570</p> <p><b>J</b></p> <p>Johnson, C. F. ....563                  Johnson Smith &amp; Co. ....539</p> <p><b>K</b></p> <p>Kelsey Co., The .....569                  Kenilworth Inn .....564</p>	<p><b>L</b></p> <p>Lacey &amp; Lacey .....542                  Lancaster &amp; Allwine .....542                  Liggett &amp; Myers Tobacco Co. ....563                  Lincoln Standard Aircraft Co. .569                  Lindstrom &amp; Co. ....560                  Long Eakins .....544</p> <p><b>Mc</b></p> <p>McGraw-Hill Book Co. ....547</p> <p><b>M</b></p> <p>M. M. Laboratories .....562                  Meccano Co. ....565                  Mellinger Tire &amp; Rubber Co. .550                  Metal Arts Co., Inc. ....569                  Metal Cast Products Co. ....560                  Metro Electric Co., Inside front cover                  Midwest Radio Corp. ....554                  Miller, Monroe .....544                  Mogle &amp; McClelland .....562                  Mokane Institute .....570                  Munn &amp; Company .....544</p> <p><b>N</b></p> <p>National Carbon Co. ....483                  National Radio Institute .....486                  Newman-Stern Co., The .....565                  New York Electrical School ....554</p> <p><b>O</b></p> <p>O'Brien, Clarence A. ....543                  Owen, Richard E. ....542                  Ozment, C. J. ....550</p> <p><b>P</b></p> <p>Parker, C. L. ....544                  Parks Ball Bearing Machine Co. 536                  Patterson Civil Service School. 571                  Plapao Company .....560                  Plymouth Rock Squab Co. ....540                  Polachek, Z. H. ....544                  Polk &amp; Co., R. L. ....538</p>	<p><b>Porter Chemical Co. ....555</b>                  Postal Pen Co. ....Back Cover                  Press Guild, Inc. ....546</p> <p><b>R</b></p> <p>Radio Association of America .562                  Radio Specialty Co. ....541                  Randolph &amp; Company .....542                  Randolph Radio Co. ....552                  Reliable Typewriter Co. ....555                  Russia Cement Co. ....549</p> <p><b>S</b></p> <p>Safety Auto Hat Rack Co. ....567                  School of Engineering, 538, 546, 573                  Scientific Apparatus Co. ....559                  Sea Arts Guild .....538                  Seaver Williams Co. ....570                  Shipman Ward Co. ....561                  Sincere Company .....562                  Standard Radio Co. ....559                  Strongfort, Lionel .....550</p> <p><b>T</b></p> <p>T. Garter Company .....571                  Tamblyn School .....562                  Tarbell System, Inc. ....535                  Tri-One Company .....550</p> <p><b>V</b></p> <p>Van Horne Co., The .....537</p> <p><b>W</b></p> <p>Washington School of Art .....555                  Washington School of Cartooning .....557                  Washington Show Card School .573                  Western Airplane Corp. ....572                  Witte Engine Works .....565                  World Battery Co. ....538, 572</p> <p><b>X Y Z</b></p> <p>Young Typewriter Co. ....540</p>
------------------------------------------------------------------------------------------------------------------------------------------------------------------------------------------------------------------------------------------------------------------------------------------------------------------------------------------------------------------------------------------------------------------------------------------------------------------------------------------------------------------------------------------------------------------------------------------------------------------------------------------------------------------------------------------------------------------------------------------------------------------------------------------------------------------------------------------------------------------------------------------------------------------------------------------------------------------------------------------------------------------------------------------------------------------------------------------------------------------------------------------------------------------------------------------------------------------------------------------------------------------------------------------------------------------------------------------------------------------------------------------------------------------------------------------------------------------------------------------------------------------------------------------------------------------------------------------------------------------------------	--------------------------------------------------------------------------------------------------------------------------------------------------------------------------------------------------------------------------------------------------------------------------------------------------------------------------------------------------------------------------------------------------------------------------------------------------------------------------------------------------------------------------------------------------------------------------------------------------------------------------------------------------------------------------------------------------------------------------------------------------------------------------------------------------------------------------------------------------------------------------------------------------------------------------------------------------------------------------------------------------------------------------------------------------------------------------------------------------------------------------------------------------------------------------------------------------------------------------------------------------------------------------------------------	---------------------------------------------------------------------------------------------------------------------------------------------------------------------------------------------------------------------------------------------------------------------------------------------------------------------------------------------------------------------------------------------------------------------------------------------------------------------------------------------------------------------------------------------------------------------------------------------------------------------------------------------------------------------------------------------------------------------------------------------------------------------------------------------------------------------------------------------------------------------------------------------------------------------------------------------------------------------------------------------------------------------------------------------------------------------------------------------------------------------------------------------------------------------------------------------------------------------------------------------------------------------------------------------------------------------------------------------------------------------------------------------------------------------------------------------------------------------------------------------------------------------------------------------------------------------------------------------------------------------------------------------------------------------------------------------	-----------------------------------------------------------------------------------------------------------------------------------------------------------------------------------------------------------------------------------------------------------------------------------------------------------------------------------------------------------------------------------------------------------------------------------------------------------------------------------------------------------------------------------------------------------------------------------------------------------------------------------------------------------------------------------------------------------------------------------------------------------------------------------------------------------------------------------------------------------------------------------------------------------------------------------------------------------------------------------------------------------------------------------------------------------------------------------------------------------------------------------------------------------------------------------------------------------------------------------------------------------------------------------------------------------------------------------------------------------------------------------------------------------------------------------------------------------------------------------------------------------------------------------------------------------------------------------

## SCIENCE and INVENTION READERS' BUREAU

TEAR ALONG THIS LINE

### Time and Postage Saver

IN every issue of SCIENCE AND INVENTION you undoubtedly see numerous articles advertised about which you would like to have further information. To sit down and write an individual letter to each of these respective concerns, regarding the article on which you desire information, would be quite a task. As a special service to our readers, we will write the letters for you, thus saving your time and money. Just write the names of the products about which you want

information, and to avoid error the addresses of the manufacturers, on the coupon below and mail it to us. If the advertiser requires any money or stamps to be sent to pay the mailing charges on his catalog or descriptive literature, please be sure to enclose the correct amount with the coupon. We will transmit to the various advertisers your request for information on their products. This service will appear regularly every month on this same page in SCIENCE AND INVENTION.

TO: READERS' SERVICE BUREAU,  
 EXPERIMENTER PUBLISHING CO., Inc., 53 Park Place, New York, N. Y.  
 FROM: WRITE YOUR NAME and ADDRESS HERE:

S&I 10-26

NAME .....  
 ADDRESS ..... CITY, STATE .....

Gentlemen: Please advise the firms listed below that I would like to receive detailed information on their product as advertised in the ..... issue of SCIENCE AND INVENTION.

 This form should not be used for technical questions.

NAME	ADDRESS (Street—City—State)	List here specific article on which you wish literature.	If Catalogue of complete line is wanted check in this column.
.....	.....	.....	.....
.....	.....	.....	.....

Check here if you are a dealer  
 Your Dealer's Name .....  
 Address .....

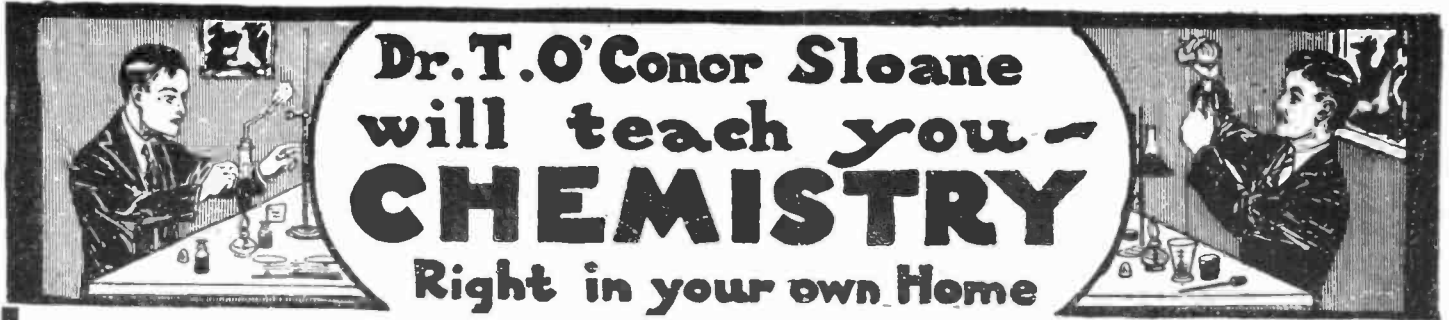

# Dr. T. O'Connor Sloane will teach you **CHEMISTRY** Right in your own Home

## Good Chemists Command High Salaries



**T. O'CONNOR SLOANE.**  
A.B., A.M., LL.D., Ph.D.

Noted Instructor, Lecturer and Author. Formerly Treasurer American Chemical Society and a practical chemist with many well known achievements to his credit. Not only has Dr. Sloane taught chemistry in the class-room but he was for many years engaged in commercial chemical work.

Industrial firms of all kinds pay tempting salaries to get the right men. Salaries of \$10,000 to \$12,000 a year are not unusual for chemists of exceptional abilities. Chemistry offers those who are ambitious and willing to apply themselves conscientiously the greatest opportunities of any vocation. Why be satisfied with small pay and hard, thankless work—learn the profession of Chemistry and your salary will depend only upon your own efforts and your own abilities.

The work of the chemist is extremely interesting. If you are fond of experimenting, if you like exciting and fascinating work, take up Chemistry. To the man who is dissatisfied with his present job, to the young man just deciding on his life work, Chemistry holds alluring charms, and countless opportunities. If you want to earn more money, the way is open through our course in Chemistry.

### NOW IS THE TIME TO STUDY CHEMISTRY

Never before has the world seen such splendid opportunities for chemists as exist today. The war has awakened the United States to the need of trained chemists and chemical engineers. Everywhere the demand has sprung up. In factories, mills, laboratories, electrical shops, industrial plants of all kinds, chemistry plays a vital part in the continuation and expansion of the business. In every branch of human endeavor the need for chemists has arisen. No profession offers such alluring opportunities and the next

ten years are going to show the greatest development in this science that this country has ever seen. Those who have the foresight and ambition to learn chemistry now will have the added advantages and greater opportunities afforded while the chemical field is growing and expanding.

## You Can Learn At Home

NO PREVIOUS SCHOOLING NEEDED

Dr. Sloane will teach you Chemistry in a practical and intensely interesting way. Our home study course written by Dr. Sloane himself is practical, logical and remarkably simple. It is illustrated by so many experiments that are performed right

### Experimental Equipment Given to Every Student

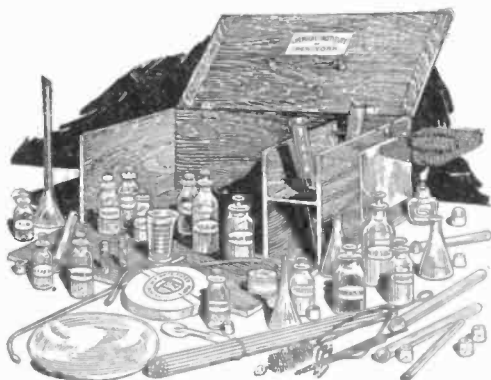

We give to every student without additional charge, this chemical equipment including fifty pieces of laboratory apparatus and supplies and thirty-nine different chemicals and reagents. The fitted heavy wooden box serves not only as a case for the outfit but also as a laboratory accessory for performing countless experiments. Full particulars about this special feature of our course are contained in our free book "Opportunities for Chemists."

from the start that anyone, no matter how little education he may have, can thoroughly understand every lesson. Dr. Sloane teaches you in your own home with the same individual and painstaking care with which he has already taught thousands in the class room. He will, in addition, give you any individual help you may need in your studies. This personal training will be of inestimable value to you in your future career.

### DIPLOMA AWARDED TO EACH GRADUATE

Upon graduation each student is awarded our Diploma in Chemistry, certifying that he has successfully completed his studies. Your name on this certificate will be a source of pride to you all your life, as well as an aid to obtaining a position in Chemistry.

### Easy Monthly Payments

You do not have to have even the small price of the course to start. You can pay for it in small monthly amounts or earn it as many others are doing. The cost is very low, and includes even the Chemistry outfit—there are no extras to buy with our course. Write us and let us explain how you can qualify for a trained technical position without even giving up your present employment.

### SPECIAL 30 DAY OFFER

Besides furnishing the student with his Experimental Equipment, we are making an additional special offer for a short while only. You owe it to yourself to find out about it. Write today for full information and free book, "Opportunities for Chemists." Send the coupon right now while it is fresh in your mind. Or just write your name and address on a postal and mail it to us.

### What Well-Known Authorities Say About Our Course

From Hudson Maxim.  
"Dr. Sloane has done a much-needed work in a much better way than anything of the kind has, heretofore, been done."

"Dr. Sloane has a remarkable faculty of presenting Science for self-instruction of the student in such a clear and understandable way as to be most readily grasped and assimilated."

"I, therefore, unreservedly recommend and place my highest indorsement on his work."

From Dr. W. W. de Kerlor.  
"I can not recommend your course too highly and I congratulate both you and Dr. Sloane on same."

From John A. Tennant.  
"This is something which has long been needed. Your long experience in the teaching of chemistry... assurance that the course will be practical as well as plain to the untrained students."

### What the Students Say:

"Your course has been worth \$50,000 to my concern."

"This is just like reading some fascinating fiction story."

"I have just been made Assistant Chemist of my concern."

"Your course is just what a person wants to start in the wonderful science of Chemistry."

"I find that your course is very interesting. I wait patiently for the next lesson."

"I find the study of chemistry more and more interesting at every lesson and you may be sure that I am getting into studying habit even more than I ever did even in my school days."

"I like the lessons so much that I honestly would not sell them for many times their price."

"I am taking this opportunity to express my satisfaction with your chemical lessons."

"I now have a fine position as chemist at the Du Pont Dye Works. It was thru your course alone that I have been so successful."

"I have written to different people about your course and they speak very highly of same."

"If I don't learn it isn't your fault for I find that your lessons contain a whole lot."

(Names and addresses on request.)

**Don't Wait -- Mail the Coupon NOW!**

**CHEMICAL INSTITUTE of NEW YORK, Inc.**

66—S WEST BROADWAY Home Extension Division 10 NEW YORK CITY

NAME .....

ADDRESS .....

CITY S. & L. Oct. STATE .....

**CHEMICAL  
INSTITUTE  
OF NEW YORK**  
Home Extension  
Division 10  
66-S-West B'way  
New York City

Please send me at once, without any obligation on my part, your free Book "Opportunities for Chemists," and full particulars about the Experimental Equipment given to every student. Also please tell me about your plan of payment and your special 30 day offer.



STATION WOC  
DAVENPORT

HERE'S WORK THAT IS  
ALMOST ROMANCE!

**Now Owns a Radio Store**

"The Radio business is rushing just now. Building many Super Heterodynes, also doing installation and repairing. To your course I owe all my success in the Radio profession." A. J. Ommodt, Bowman, N. Dak.

**Controls First Car by Radio**

"I operate the portable broadcasting station in rear car, driving front car by Radio control. Will operate this car from New York to Frisco—13 months trip. Then we take the car around the world—a three years' tour. I owe it all to you." Leo Paul, New York City.



# You Can Do What These Men Did!

## I Will Train You at Home to Fill a Big-Pay Radio Job



Get into the great new Big-pay Industry—Radio. If you're earning a penny less than \$50 a week, clip coupon now. Send for AMAZING FREE BOOK, "Rich Rewards in Radio." Why go along at \$25 or \$35 or \$45 a week, when you could earn \$50 to \$250 in the same six days, as a Radio Expert? Hundreds of N. R. I. trained men are doing it—why can't you? I'll train you just as I trained them—just as I trained the men whose letters you see on this page. I'll teach you quickly at home in your spare time to be a Radio Expert, and draw down big money for the easiest and most fascinating work in the world.

### \$50 to \$250 a Week as a RADIO EXPERT

It's the trained man, the Radio Expert, who gets the big jobs of this profession—paying \$75, \$100, \$200 a week and up. Free book gives all the facts. Every day N.R.I. trained men are taking good places in the Radio field—men like you—men like those whose stories I show you here. You can prepare just as they did by new practical methods, learn right at home in your spare time. Lack of experience no drawback—common schooling all you need. Our tested clear methods make it easy for you. We guarantee to train you successfully. Big Free Book contains all the proof.

#### Clip Coupon Now for FREE BOOK

Most amazing book on Radio ever written—full of facts and pictures—tells all about the great Radio field, how we prepare you and help you start. You can do what others have done—GET THIS BOOK. Send coupon today—no obligation.

J. E. Smith, Pres.  
**NATIONAL RADIO INSTITUTE**  
Dept. MX5  
Washington, D. C.

## RADIO NEEDS TRAINED MEN!

Read the true stories printed in this border of men who got out of the rut



Chief Engineer Station WEMC

"Please communicate with my two junior operators here who want to increase their knowledge of Radio. Being a graduate of your course I know they could do nothing better for themselves than study it for it is the way to success in this profession." John E. Fetzer, Chief Engineer, Station WEMC, Berrien Springs, Michigan.



Photo shows Graduate E. F. Spadoni in his own Radio store at Chicago, Ill. "Your course gets the credit," says Spadoni.

### RICH REWARDS in RADIO



**MAIL THIS NOW!**  
J. E. Smith, President  
**NATIONAL RADIO INSTITUTE**  
Dept. MX5 Washington, D. C.

Dear Mr. Smith: Without obligating me in anyway, send me your free book "Rich Rewards in Radio" and all information about your practical, home-study Radio course.

Name ..... Age .....  
Street Address .....  
Town ..... State .....

#### These Instruments Given FREE of Extra Cost

All instruments shown here and others sent to all my students free of extra cost under short time special offer. Clip coupon now—find out all about this big unequalled offer while you still have time to take advantage of it. This training is intensely practical—these instruments help you do the practical work.

#### My Radio Training is the "Famous Course That Pays for Itself"

Make more money quick when you take up this practical course.

I show you how to increase your earnings almost from the start of your course through practical pointers I give you.

Howard B. Luce of Friedens, Pa., made \$320 in 7 weeks during his spare time. D. H. Suitt of Newport, Ark., writes "While taking the course I earned in spare time work approximately \$900." Earl Wright of Omaha reports making \$400 in a short time while taking his course—working at Radio in his spare time only! Sylvester Senso, 207 Elm St., Kaukana, Wis., made \$500. These records not unusual—these men are a few of hundreds.

And when you graduate, my big Free Employment Department helps you get the job. You get just the same preparation and assistance toward success we gave C. C. Gielow, Chief Operator of the Great Lakes Radio Telegraph Co., E. W. Novy, Chief Operator of Station WRNY, Erle Chambers, Radio Engineer for Stewart-Warner, J. E. Fetzer, Chief Engineer of Station WEMC. The National Radio Institute, established 1914, today offers you the same opportunity these men had under a bond that guarantees you full satisfaction or money refunded. It's your big chance to get into the great Radio field—mail coupon TODAY for my big Free Book and proof!

### Originators of Radio Home-Study Training



\$70 in one Day for T. M. Wilcox

"I am in business for myself and recently made \$70 in one day. I was an electrician of rich experience and was occupying a splendid position as telephone superintendent when I enrolled with your course believing it would open up greater opportunities—have not been disappointed. Estimate that Radio will be worth tens of thousands of dollars to me in the next few years." T. M. Wilcox, Belle Island, Newfoundland.

#### Kimball With WMAQ Chicago

"Accepted a position with the Chicago Daily News Station WMAQ. My income practically doubled, thanks to your fine course. I handle all consultation also do operating." Keith Kimball, Station WMAQ, Chicago, Ill.



#### Promoted to Big Job

"Just been made Sales Manager of this Radio firm—received a very good increase in pay. Up to present have been getting salary which in 3 months enabled me to purchase a new car." R. Jones Bay City Mich.



# Science and Invention

HUGO GERNSBACK, *Editor-in-Chief*  
H. WINFIELD SECOR, *Managing Editor*  
DR. T. O'CONNOR, SLOANE, Ph.D., *Associate Editor*

Editorial and General Offices, - - - 53 Park Place, New York

"Those Who Refuse to Go Beyond Fact Rarely Get As Far As Fact" - - - HUXLEY

## THE ASTROLOGY HUMBUG

By HUGO GERNSBACK

ONE would think that in an enlightened age, such as we are pleased to call our present era, Astrological nonsense should have disappeared from the face of the earth long ago. The reverse is actually the fact, and Astrology is gaining supporters in a rather large strata of the public all over the world, who are preyed upon by these modern soothsayers and fakers in general.

Astrology originally was the science from which our present Astronomy sprang, but Astrology itself has long been discredited by science, as well as the better-educated classes. Astrology is a pseudo-science that feeds upon superstition and encourages it. Summed up in a few words, it may be said that Astrology is a superstition according to which the stars are believed to affect the destiny of human beings.

Just how the stars are supposed to affect humanity, no astrologer has ever ventured to say. The *modus operandi* of the so-called "horoscope" is usually that the more or less exact date of birth is connected in some way with the planets and constellations in general, but just what this connection is, no one has ever ventured to state, except vaguely.

For instance, take the planet Venus, a body roughly as large as the earth. We are asked to believe that this planet will exert an effect upon a person at birth. Why exactly at birth? Why not before birth, and why not after birth? The astrologers remain silent on this.

It is ludicrous for any intelligent person to believe that a heavenly body, a great distance removed, can have any effect whatsoever, whether gravitational, electro-magnetic, or psychic, on us little human beings, and there has never been a good reason advanced why this should be so. If a being of flesh and bone is affected, why not a horse—why not a gorilla—why not a whale? They should all be affected in the same manner.

Furthermore, if the astrologers are right, then every human being born at the same instant all over the earth should have exactly the same horoscope and the destiny of each should be exactly alike. This alone should convince any reasoning human being that everything contained in Astrology is Simon pure piffle, because every one knows that twins born at the same time, and people born at the same instant have *entirely different* careers and destinies. Some turn out to be eminently successful. Others become criminals, etc.

Then, too, astrologers, since olden times, have been careful to veil their language in such a manner that different "deductions" and interpretations can be made. The phrase, "You will make a journey," may be taken to mean a street car ride of six blocks, or it may refer to a trip to the other end of the world. We find the same thing all the way through the so-called "horoscopes"—always vague, always indefinite. If Astrology were an exact science, it would be possible to give exact data, which, of course, is never forthcoming, and moreover never will.

In the meanwhile, a large horde of astrologers and near-astrologers prey upon credulous souls whose intelligence rating, as a rule, is not very high, or who, otherwise, are so superstitious that their reasoning is thereby deadened. And let no one think that astrologers are not well paid. The price of horoscopes in this country varies anywhere from \$5 to \$300, depending upon how much these fakers can extort from their victims.

If Astrology were a harmless sport, no one would find fault, but the trouble is that astrologers actually confuse these simple mortals by preying upon their fears, and are often actually successful in doing great dam-

age to their clients. For instance, a client will be told that between October 1st and 8th the stars will be "against" him and he must not engage in any business contracts. What happens? The man, actually believing such nonsense, is afraid to go ahead with certain ventures that he might otherwise have undertaken, and in more than one case he has been the loser on this account. Auto-suggestion induced in these victims also does great mischief, and for the time being retards whatever progress they may be making in their life work.

The trouble so far has been that astrologers cannot be apprehended by law, for the reason that they are careful not to be classed with fortune tellers, whose activities are illegal in many states. They usually escape conviction for fraud, because they do not tell your fortune, but merely give you a "reading" from the supposed influence of the heavenly bodies.

And what about the predictions that never come true? We never hear anything about these, although they are naturally in the vast majority. To be certain, as in all things, an astrologer once in a while will strike a bull's eye. If you make enough guesses, you are apt to be right once in a while, too. This is the nature of things. Of course, if it happens, the astrologer is at once acclaimed as a great personage, and through the course of years he will accumulate enough evidence to show a quantity of "verified forecasts." Any shrewd astrologer who knows how to put his language can twist a forecast around to make it appear that the prediction was correct, but that can be done with practically anything else. You can stand on a street corner and make a pretty safe forecast of how many automobiles will pass a given corner during the next hour. If you have had a little experience, you will come pretty close to the facts. This is the law of averages.

By the same law, you can also forecast how many of a certain group of people will reach a certain age, and again you will be able to come close to the figure. The life insurance companies and many other institutions work on exactly such a plan, but none of these would be willing to make an *exact* forecast for any one individual.

On the other hand, most people never seem to consider the fact that even if there were such a thing as a "verified forecast," this would nullify itself for the following reasoning: Suppose it were forecast that you would die in a railroad wreck on a certain date. Naturally, knowing about the forecast, you would not go near a railroad that day, if you knew that the forecast was scientifically accurate. Consequently you would not be killed in a railroad wreck that day. Therefore, it must be plain that the forecast cannot be correct because the event does not take place as forecast, and if it does not occur, it can not hold true, scientifically or otherwise. The same logic must be applied to all astrological forecasts of this kind. If you know in advance what is going to happen, you can take measures to prevent its occurrence, and if it does not happen, the forecast is obviously wrong.

And if you still have doubts about astrologers, just give them the names of a few deceased persons, and you will receive the most remarkable horoscopes on nearly every one of them, and even the best ones will give you a good deal of amusement.

Also, please do not deceive yourself by joining that class of those simple mortals who tell you glibly that they had their horoscopes taken, "just for fun, of course," all the while insisting that they know it is a humbug. *Secretly* they think "there may be something to it after all." They may deceive you, but not themselves.

### THE GOLDEN AGE OF SCIENCE

is symbolized by the golden cover  
OF SCIENCE & INVENTION,  
LOOK FOR THE GOLD COVER  
every month!

Mr. Hugo Gernsback speaks every Monday at 9 P. M. from Station WRNY on various scientific and radio subjects.



Fig. 2. The photo above shows the effect of stacking a number of the zinc leaves produced in this process so that they indicate the features in relief, as in sculpture.

**T**HE possession of an artistic photograph of a relative or a friend is always a source of pleasure. It is placed in a carefully chosen frame, put in a prominent position, and regarded with much satisfaction—but it is never more than a photograph. How much more pleasant and flattering it would be to receive a beautiful portrait of bronze or silver—even of gold—of a person who is dear to you. Until now, only very wealthy people have been able to indulge their fancy by having a medal engraved in their image; everyone else has been limited to a common photograph. Celebrities are presented with medallions in commemoration of their activities, but not everyone has achieved the honor of being immortalized in bronze by a famous artist at the expense of the State.

Now everything is changed. A French inventor, M. Givaudan, has just constructed an apparatus which makes possible the casting of as many

# Modeling by Photography

By LUCIEN FOURNIER

medals as may be required from a series of photographic prints taken with the aid of a motion picture camera. Although the apparatus required is rather expensive, it is nevertheless a probable source of a good income to the operator. In place of going to the photographer's studio, as in the past, you will go to the "photo-sculptor's" place of business, and you will be able to order a dozen medals of any size desired and of as precious a material as the purse will allow.

For the benefit of those of our readers who would like to know how the thing is done, we are going to say a few words about the apparatus.

Look first at Fig. 2. This represents a gentleman who might very well figure in a museum of ethnography—he seems very thoroughly tattooed. This tattooing, however, is a result of a particular method of photography.

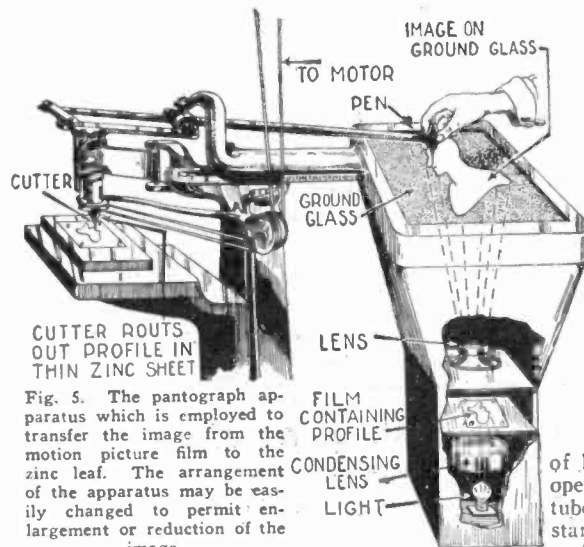

Fig. 5. The pantograph apparatus which is employed to transfer the image from the motion picture film to the zinc leaf. The arrangement of the apparatus may be easily changed to permit enlargement or reduction of the image.



Fig. 4. The accuracy with which the apparatus performs its function may be seen upon inspection of this portrait bas-relief. The portrait may be produced in any of the usual metals, or a cast in plaster may be made.

Imagine that the head has been cut up into slices, that each slice has been photographed separately, the skillfully cut-out profiles have been placed one upon the other; we have then an exact reproduction in relief of the subject.

The procedure which we have just indicated is hardly practical or advisable in making a medal; but if we may not cut the head into slices, we may easily photograph it by successive "slices" if we possess the necessary apparatus. It is this apparatus which M. Givaudan has invented, and which is seen in Fig. 1. You will probably say that it is an instrument of torture resurrected from the most barbarous epoch in the history of humanity, but the "patient" doesn't appear to suffer—he is simply posing before the lens of a motion picture camera. He is seated upon a bench which rolls on two rails and which moves him in spite

of himself as the camera operates. The five large tubes, in the form of a star, which surround him each contain a powerful electric light at their outer extremity. The light from these lamps brightly illuminates the head of the subject; but we have said that it is necessary to photograph the profile by successive slices or layers. Nothing could be more simple. You see that the head is surrounded by an iron strip; this strip serves to cast a shadow on the head in such a manner that we may obtain a series of profiles. (Continued on page 561)

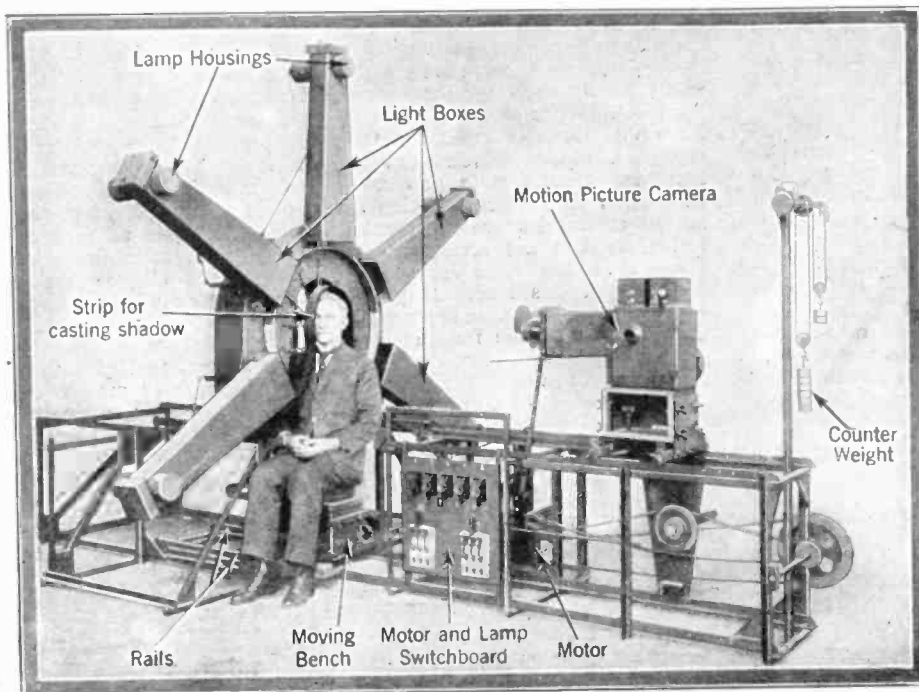
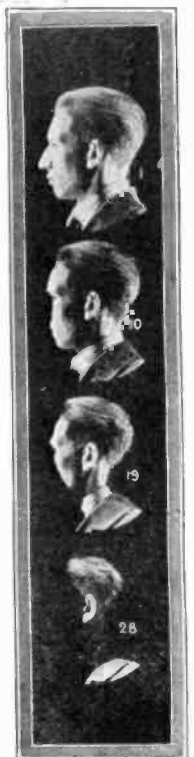

Fig. 1. At the left is seen the motion picture camera used in this process, with its accessory apparatus. The entire machine is controlled from the center switchboard.

Fig. 3. At the right are several of the photographs taken by the motion picture camera at different stages of the process. This shows the appearance of the motion picture film before the image is transferred to zinc.





# Houdini Outdoes Fakirs

**Houdini—The World's Most Famous Handcuff King, Proves That There Is No Trickery in Remaining in a Sealed Coffin for One and a Half Hours. Claims Cataleptic State Unnecessary.**

FOR quite a few months a Hindu fakir, Rahman Bey, has been demonstrating his powers of producing uncanny effects. He would enter a cataleptic state, would have himself buried in a coffin for from ten minutes to half an hour or thereabouts, and then would receive the attention of scientific men who would write up the "phenomenal feats." Harry Houdini, known throughout the world, demonstrated to a body of scientists and physicians that he could duplicate, and in fact do even more than the Hindu fakir without entering the cataleptic state, and thus proved that no man is superhuman. Houdini remained in a sealed coffin for one hour, thirty-one minutes and thirty seconds, surpassing the stunt of the Hindu mystic.

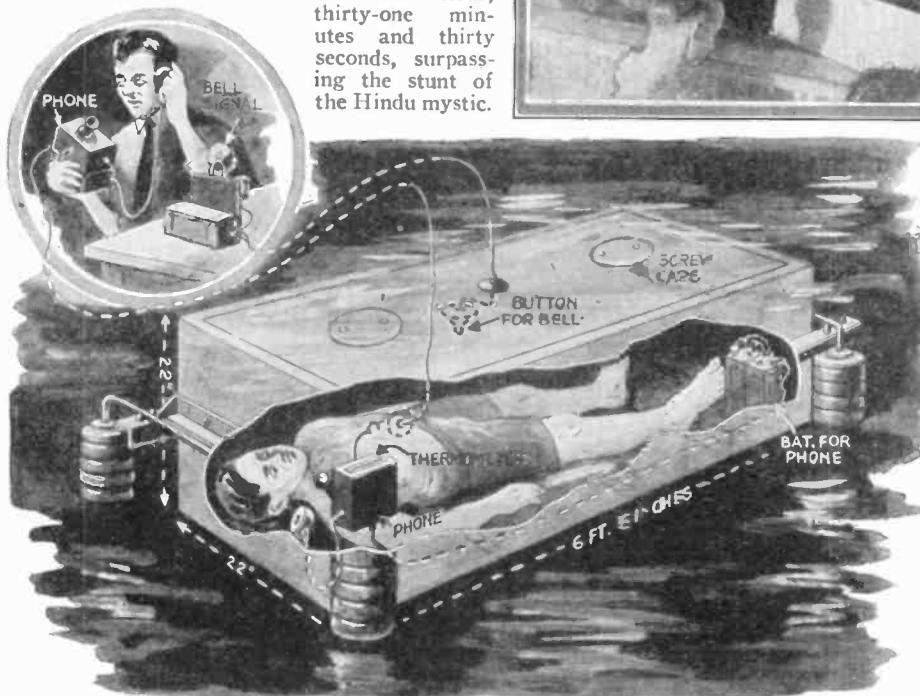
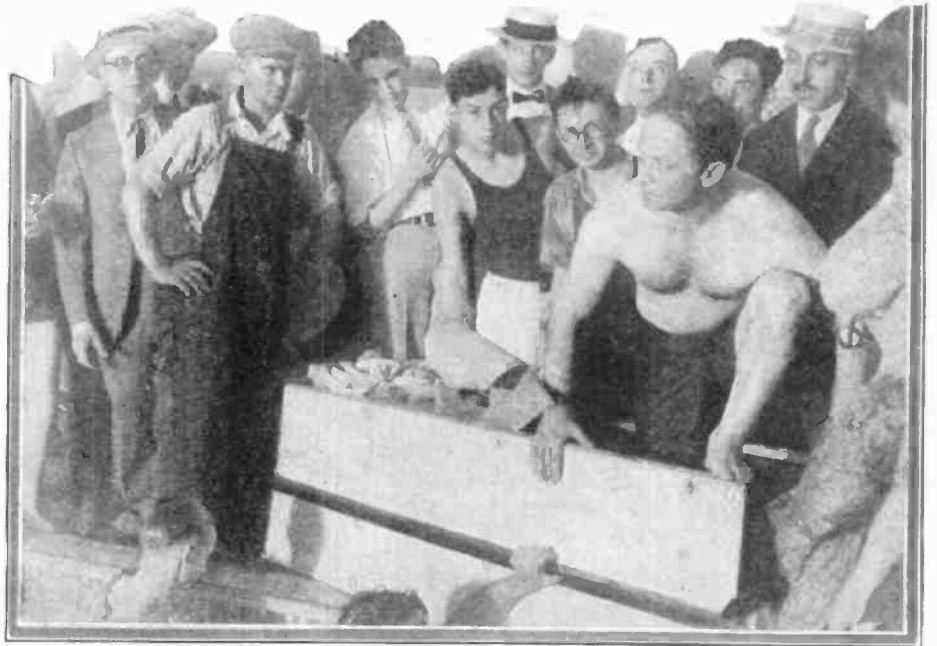

THE photo above shows Harry Houdini stepping out of the casket at the close of the experiment. The one at the left shows the size and arrangement in the casket, and the one below is a picture taken in the Hotel Shelton pool with the casket submerged.

Scientifically this experiment is of great value. It demonstrates that miners could remain underground in a closed area or that men could survive in a submarine much longer than was at first supposed, if they will keep their wits about them. During one hour approximately twenty-nine cubic feet of air is breathed. Approximately one and a half cubic feet of oxygen is absorbed, and one and a quarter cubic feet of carbon dioxide is excreted. Pulse on opening casket was too high to count and about 90 seconds later dropped to 142. No objectionable stuffy odor was noticeable. When the covers of the coffin were removed, the air rushed in violently, showing that the carbon dioxide did not replace the oxygen absorbed. In sand pit burials there is a sufficient amount of air penetrating between the grains of sand to permit of life over many hours.

DR. HERWOOD CARRINGTON wrote about Rahman Bey in the following terms in a newspaper article. "All medical authorities agree that it is impossible for a human being to live more than three to five minutes in a sealed coffin." Yet Houdini entered a sealed coffin at the Hotel Shelton pool and he remained therein for one hour, thirty-one minutes and thirty seconds, thus proving to Dr. Carrington that he is not an authority on medical subjects. Houdini disclaimed the exercise of any super-natural power and stated that every normal human being could get in the same coffin and stay there as long as he did, if the individual took care to breathe lightly and did not exert himself. Two editors of SCIENCE AND INVENTION Magazine carefully examined the casket before Houdini entered the same, and can attest to the fact that there was absolutely no deception practiced. No oxygen in any sealed containers entered the coffin. No air could get in. Houdini stripped, donned a bathing suit, and entered the casket, after which the cover was soldered in place. The caps were screwed on and then the entire casket was sunk into the pool. Weights were applied and men stood on the cover to prevent the casket from floating. Communication was had with Houdini by means of a telephone and a signal bell. The editors placed a thermometer in the casket. It read 99.2 at maximum.



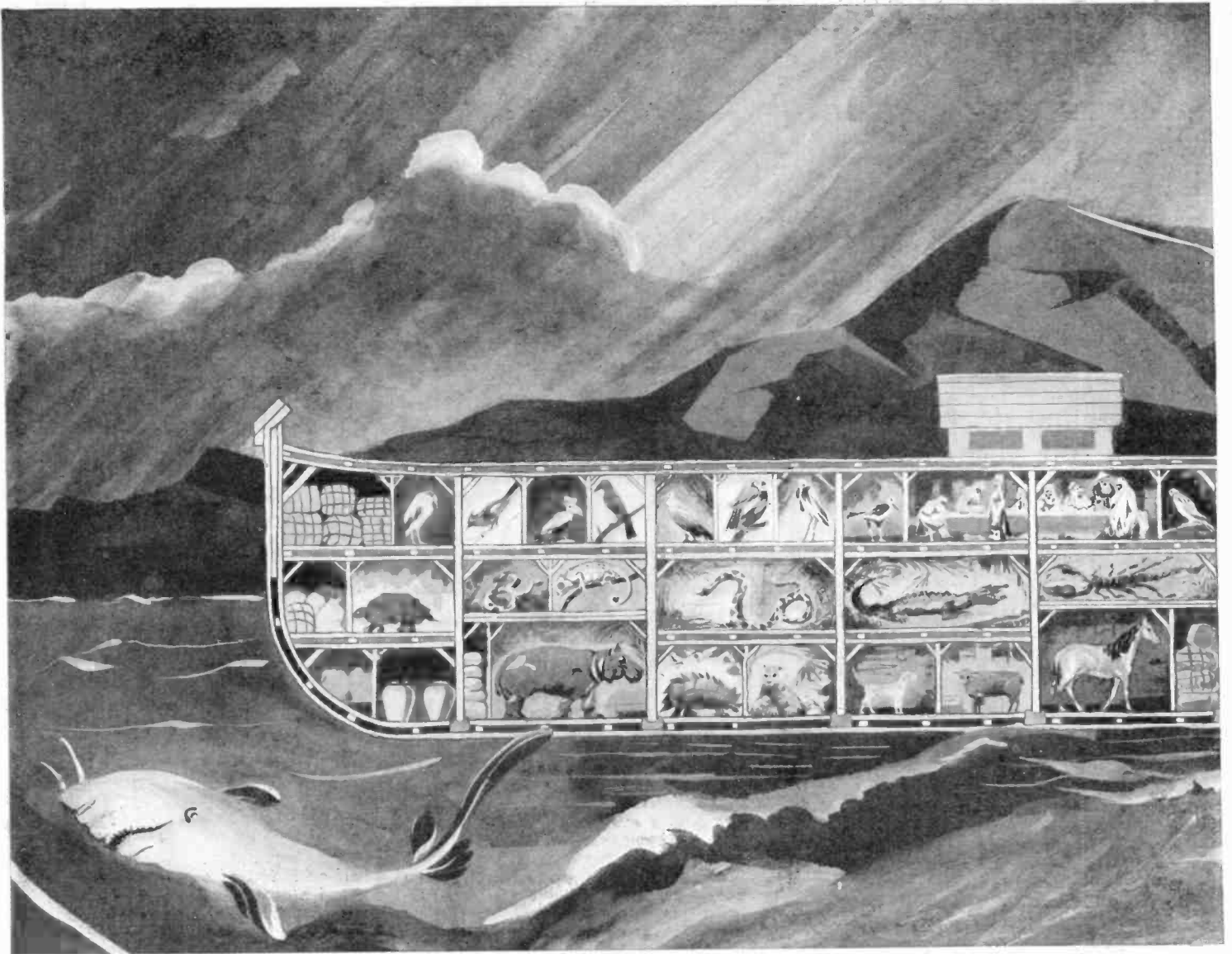

## Was Noah's Ark Possible?

"In the six hundredth year of Noah's life, in the second month, the seventeenth day of the month, the same day were all the fountains of the great deep broken up, and the windows of heaven were opened.

"And the rain was upon the earth forty days and forty nights.

"In the self same day entered Noah, and Shem, and Ham, and Japheth, the sons of Noah, and Noah's wife and the three wives of his sons with them, into the ark;

"They, and every beast after his kind, and all the cattle after their kind, and every creeping thing that creepeth upon the earth after his kind, and every fowl after his kind, every bird of every sort.

"And they went in unto Noah into the ark, two and two of all flesh, wherein is the breath of life."—(Genesis 7:11.)

THIS immortal quotation has always given rise to more or less of puzzlement in the minds of modern students of the Old Testament. How, you ask yourself, could Noah get all the animals, all the birds, all the insects into the ark and then store away enough food for this multitude and for the eight human passengers to last them three hundred and forty-six days? Yet it is all not quite so fantastic as it seems.

We are indebted to a keen student of Bible lore, Rev. J. Fleming Atkins of Ramsey, N. J., for a quantity of interesting information which he has compiled from Biblical records with the intention of showing that the Biblical account of the ark and its contents is quite plausible.

The actual dimensions of the ark are mathematically stated in Genesis 6, 15 and 16, where they are given as: length, 300 cubits; width, 50 cubits; depth, 30 cubits. Translated into modern terms, we have length, 450 feet; width, 75 feet; depth, 45 feet. Three stories or decks are specified, each story being—after allowing one foot for the flooring—14 feet high. Multiplying

450 by 75 gives us 33,750 square feet of surface per story, total 101,250 square feet of floor for the entire ark. This is slightly

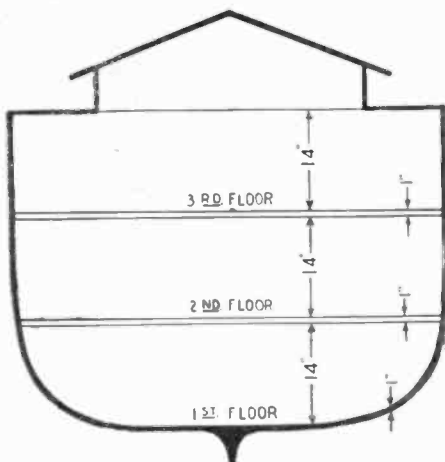

The diagram above, showing cross-section of Noah's ark, will give an idea of the amount of headroom and floor space available.



The average size of animals is about that of a common house cat. For each of the animals in the ark we have reserved ten sq. ft. of floor space and fourteen feet of headroom. Inspection of the drawing at the right will make it plain that more than sufficient room is provided.

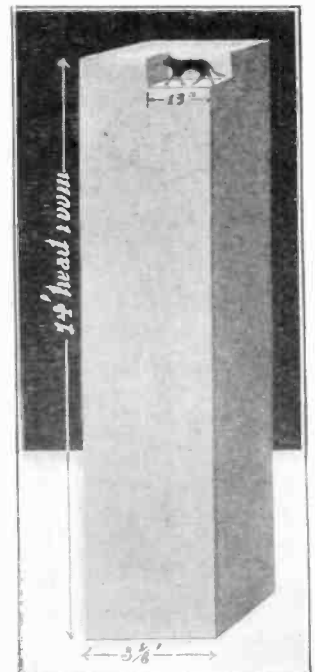

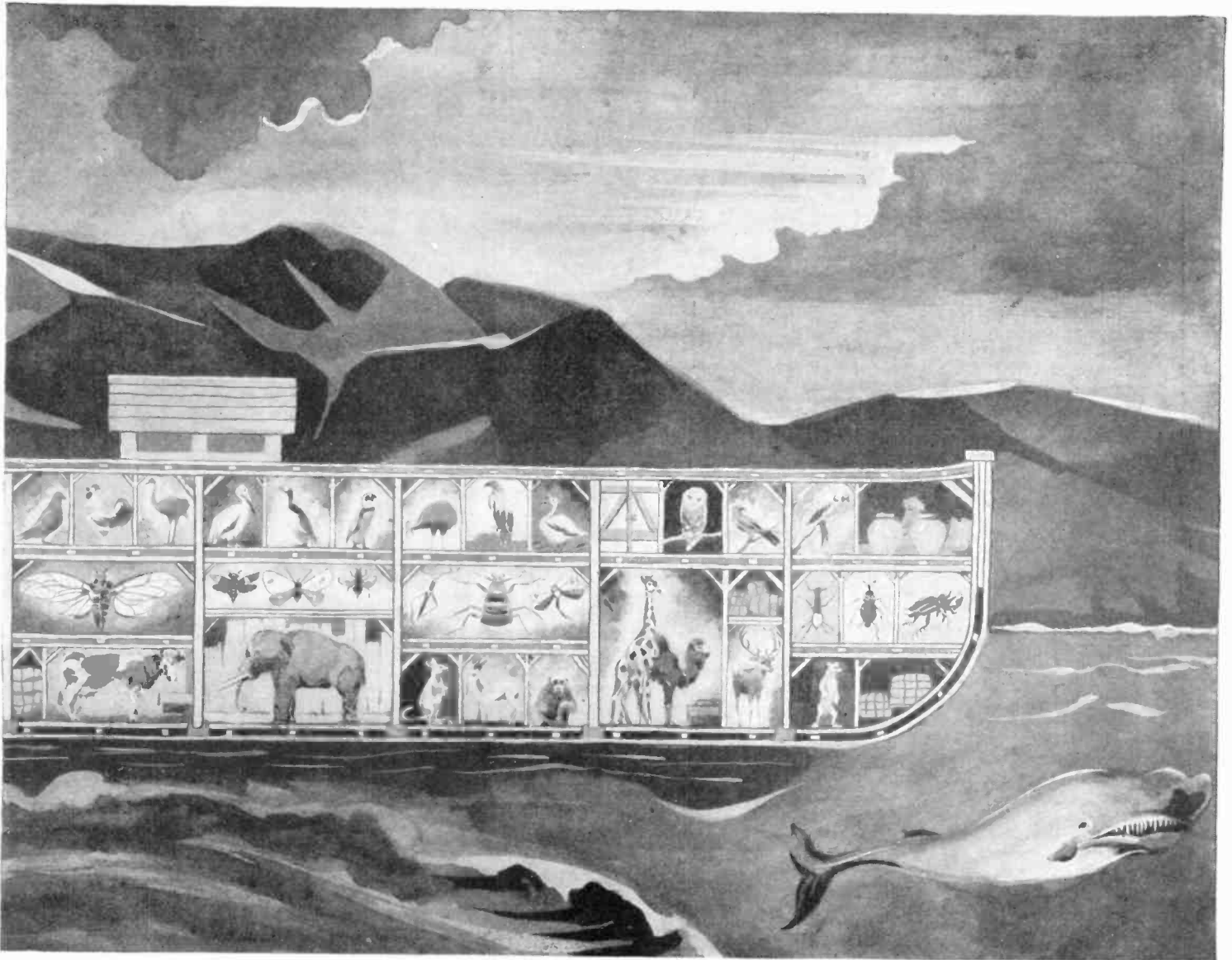

Our artist's impression of the way Noah probably placed the animals may not suit your ideas on proper housing, but a glance at the drawing above will help you to visualize one of the possible methods which might have been employed by the builders to provide space.

more than two acres. According to the best modern tonnage space rating, which allows about 1,000 pounds per square foot of deck space, a conservative estimate of the tonnage of the ark would be 32,000 tons, with possible extreme rating of 42,400 tons. The R.M.S. "Mauretania," rated at 30,969 tons, offers a modern comparison.

Dr. Alfred Russel Wallace, in his "Geographical Distribution of Animals," tells us that there are about 1,700 species of animals, 10,087 species of birds, 987 of reptiles, and approximately 100,000 of insects. The Bible tells us that at least two specimens of each species were included in the roster; in some cases seven pairs were listed. Now, the question is, how did Noah house all these creatures in the ark?

The steamers that carry livestock out of New York City allow about 20 square feet for each cow. We must consider, however, that the animals of the earth vary much in size. Dr. Wallace gives the average size as that of the common house cat, so we will take this as the average for

the animal species. There are 33,750 square feet to each floor, so we will put the animals on the first floor; 3,400 animals would have nearly 10 square feet each, and considering the average size we have agreed upon, that would be quite a palatial cabin. Of course we must allow for a great deal of food storage, but remember that we are considering only one layer of animals and the rest of the 14 feet of head room may be used to store the food.

The second floor we will allot to the insects and reptiles, for themselves and their food supply. In this space of 33,750 square feet we must place 200,000 insects and 1,974 reptiles. The insects of course average very small indeed, and the reptiles only slightly

larger. Computation shows us that we have about one-sixth of a square foot for each, that is, about 24 square inches. That should certainly be plenty of space.

We have remaining the entire upper or third floor for Noah and his family of seven, with 20,174 birds to sing for them. The birds would average very small, since the smaller species predominate, but we can allow about 1½ square feet of floor space for each to call his own, so the larger birds should be able to find plenty of room.

It seems incredible, even after reading these figures, that a pair of each of the world's creatures could be housed in a vessel considerably smaller than the average trans-

Atlantic steamer. We have, however, the evidence of the measurements given in the book of Genesis and the testimony of mathematics to assure us that the ark may be more than a legend.

"... And in the second month, on the seven and twentieth day of the month, was the earth dried. And God spake unto Noah, saying, 'Go forth of the ark...'"

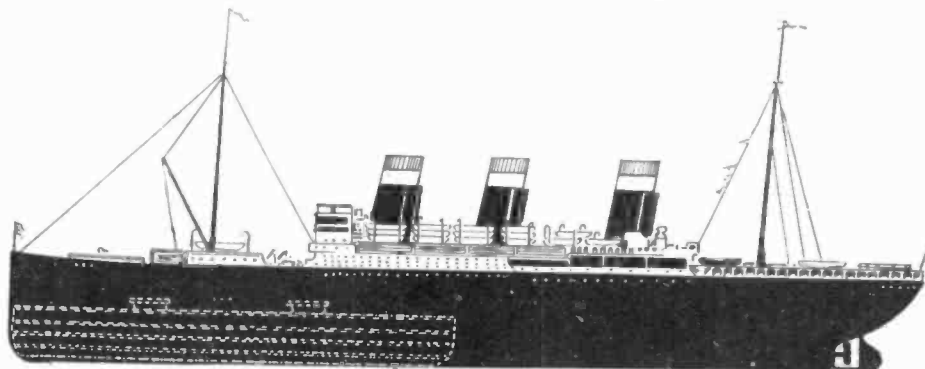

The ark was not so very large compared to a modern transatlantic liner as you will see from above drawing. The ark with its 450 feet of length is just about half as long as the "Leviathan."

# How Byrd Found North Pole

By WILLIAM P. SULLIVAN  
AERONAUTICAL ENGINEER

*The method employed by Commander Byrd and Floyd Bennett in locating their positions while navigating their aerial course from Spitzbergen to North Pole and return.*

**A** SUBJECT of great interest and yet very much of a mystery to most people is the method employed by Commander Byrd and Floyd Bennett in locating their positions while navigating their course by air from Spitzbergen to the North Pole and return.

To describe in a few simple words the many methods and instruments used in navigation would be difficult and since navigation for aircraft up to the present time has been in an undeveloped state as compared to the navigation of the sea and land, though similar in theory, a brief description of aircraft instruments and methods will be of interest.

Aerial navigation is a science by means of which aircraft are guided from one point to another above the earth's surface. In practice the pilot or navigator makes use of a number of different methods which enable him to follow his course and to determine his geographical position from time to time during the progress of the journey. In aerial navigation readings must be made more often and more quickly calculated than on sea or land because of the increased speed of the airplane. The rapid change in position of the airplane also makes readings with instruments difficult and inaccurate, making a number of rapid readings necessary, sometimes as many as six and the average taken, in order that readings having too great an error can be easily detected and omitted.

Ordinary navigation of the air at present consists of simple piloting. The pilot following a course and determining his positions by reference to distinctive landmarks, usually identified by reference to maps or charts. In a great many cases a course is followed simply by "dead reckoning." This consists of deducing the position from the direction and rate of travel. This method of course is inaccurate due to the inaccuracies of the instruments which determine speed or indicate direction. Under ordinary conditions on very short flights this method is suitable, but on longer flights entirely unreliable. This is especially so when high altitude is essential on the course, because of the unknown speed and direction of the air currents with reference to the ground. In any case the only reliable method of checking positions accurately is by astronomical observations, special compasses or radio bearings.

For purposes of air navigation the astronomical method offers the best advantages and has been reduced to a science through years of study in marine navigation. The method may be used by day or by night whenever the heavens are visible. Its practical application is simple and results can be obtained in a very few minutes. However, certain limits restrict its use, such as clouds at high altitudes, but the most serious restriction lies in the fact that in general only the sun can be seen in the day time and a complete determination cannot be made without the use of instruments other than the sextant. Most of the instruments used are similar to those used in marine navigation, changes being made to suit conditions met with while flying. Astronomical observations are now made with an improved type of bubble sextant designed for rapid readings, special compasses measuring the strength and direction of the earth's magnetic field while radio bearings are determined by the strength and direction of radio waves from stations on the ground. How-

ever, the theory of determining position by astronomical observations must first be understood.

The earth's surface and the heavens may be considered as two concentric spherical surfaces rotating with respect to each other, the heavens being at an infinite distance from the center. The relative position of the earth and heavens is determined by the time of day and day of the year. The axis of rotation, passing through the earth's poles, meets the celestial sphere at the celestial poles; and the plane of the earth's equator intersects the celestial sphere in the celestial equator. Planes passing through the poles intersect the sphere in great circles, which are called meridians. Similarly planes parallel to the equatorial plane determine small circles, known as parallels.

**P**ROBABLY there have been more questions asked as to how Commander Byrd and Floyd Bennett navigated their aerial route to the North Pole and return, than all others. In the accompanying article Mr. Sullivan has endeavored to make as clear as possible the astronomical method utilized by these two intrepid flyers in their remarkable flight to the North Pole and return. Mr. Sullivan is a well-known aeronautical engineer and has had a great deal of flying and design experience both in connection with dirigibles and airplanes. The author interviewed Commander Byrd as to the data here presented. Our readers will remember the author for many of the excellent and authoritative articles which have appeared in past numbers.

The location of any point on the earth's surface is specified by the coordinates of latitude and longitude. Latitude is the angular distance north or south of the equator measured on a meridian from zero at the Equator to 90° at the poles. North latitudes are reckoned as positive and south latitudes negative. Longitude is the angular distance along the Equator east or west of an arbitrary meridian measured in angular units or units of time from zero to 180° or zero to 12 hours, and positive or negative according to whether it is west or east. The arbitrary meridian commonly used is that of Greenwich near London. Longitudes may also be measured by the angles at the poles between the meridians, the zero meridian being that of Greenwich.

Several systems of coordinates are used in locating stars on the celestial sphere. In one system declination and right ascension are used, declinations on the celestial sphere being measured exactly as latitudes are measured on the earth. Right ascension corresponds to longitude but is measured eastward from an arbitrary zero, the first point of Aries, through the full circles of 360° or 24 hours. If the prime meridian be taken as passing through the observer's zenith, right ascension is replaced by hour angle and a second system is obtained in which the coordinates are declination and hour angle. Other systems are also employed but are not important for the purposes of navigation.

A straight line from any star to the center of the earth will meet the earth's surface in a point called the geographical position

of the star. If the star's declination and right ascension at the time are known, this point can be located in terms of latitude and longitude. The problems of the navigator consists of finding his geographical coordinates by locating himself with reference to the geographical position of one or more stars.

In the drawing on the opposite page, which is a representation of a portion of the earth's surface, P is the pole, Z is the position of the observer, and S is the geographical position of the star. These points form the vertices of a spherical triangle ZPS which is known as the "astronomical triangle." The angle at P is the hour angle, and the angle at Z is the azimuth of the star. The angle at S is called the parallactic or position angle. The navigator in solving this astronomical triangle is able to find his position in latitude and longitude.

The altitude of a star is its angular elevation measured from the observer's horizon towards its zenith. Therefore in order to find the altitude of a star the navigator requires some means for indicating his horizon. A reference line is furnished by a natural or artificial horizon.

The level surface of the sea affords the most convenient and accurate natural reference plane, if it is clearly visible. The surface of the land, if not too rugged, provides an even more convenient horizon as it is more sharply defined. But this natural horizon is not always available, because first of all it is of poor visibility at night; and in most cases while flying at high altitudes, it is obscured from view due to haze and cloud formations and as the aviator ascends it gradually disappears. With a further increase in altitude a horizon often reappears formed by an upper layer of fog or haze. These natural horizons are formed by atmospheric conditions and with the exception of the surface of the sea are inaccurate, as the observer has no means of determining whether or not they are truly horizontal. Therefore the sextant is provided with an artificial horizon.

The bubble level is the simplest form of artificial horizon and most convenient as far as sextants are concerned, but care must be taken to reduce acceleration errors, and it can only be used accurately while flying at uniform speed on a straight course while the reading is checked.

Aircraft sextants while not in general use, because of the scarcity of long distance flights, are being developed for future air travel, both for commercial use and in time of war. The theory, construction and operation are similar to those of the marine sextant, except for lightness and speed in operation. The angular field of view included in the index glass is made as large as possible, and the telescope is of low power and has a large field of view and is made to quickly change so as to observe with the naked eye. The arc is very clearly graduated with heavy lines and large figures.

The Byrd bubble sextant shown was designed and used by Commander Byrd in his North Pole flights and is an example of this type of instrument.

The next instruments of importance are the compasses. There are three types of these instruments, namely, the magnetic compass, the earth inductor compass and the gyroscopic compass. The gyroscopic compass has not yet been perfected for aircraft use.

(Continued on page 557)

# Method and Instruments Used on Polar Flight

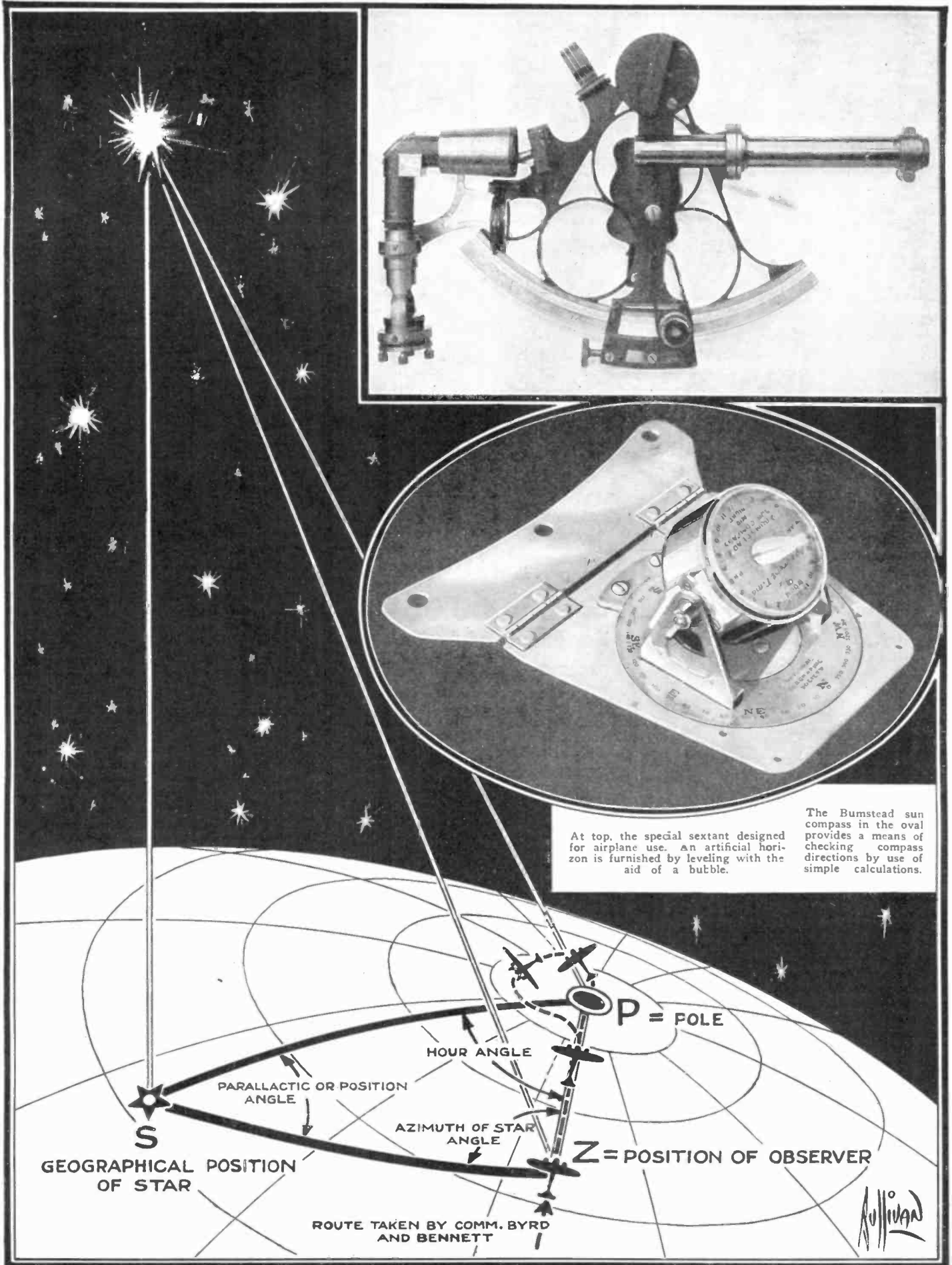

At top, the special sextant designed for airplane use. An artificial horizon is furnished by leveling with the aid of a bubble.

The Bumstead sun compass in the oval provides a means of checking compass directions by use of simple calculations.

The spherical triangle SPZ, called the "astronomical triangle", shows the measurements used by Byrd to find the direction of flight. The use of this

method of computation permitted the fliers to return to the point of departure without the aid of any visible landmarks whatever.

*Sullivan*

# The Truth About \$6,000.00 For Proofs of

By JOSEPH H.



Above—the Holland Twins reproduced from a photograph in the October, 1923, SCIENCE AND INVENTION Magazine, alike even to their finger tips. One was a criminal and the other a business man. To the left, Josefa Blazek, left and her Siamese twin, Rosa Dvorack, born at the same instant. The former was married and has a twelve year old son. The latter is a spinster. What happened to the stars in this case? Why were they not both married?

pressed in square inches would be nearly infinitesimal. If it is not gravity why is so much stress laid on conjunctions and oppositions of planets?

Mars — our most popular planet—exerts a gravitational pull of .00000000105 lbs. per square inch on the surface of this earth, while the gravitational pull of the Woolworth Building at a distance

of one-third of a mile or about one and one-half city blocks is .00000317 lbs. per square inch. It is seen, therefore, that the gravitational pull of one of our planets is only a three-millionth portion of the pull exerted by the Woolworth Building. It is also evident that the attraction of a row of buildings would be tremendously more powerful than that of all of the planets in conjunction or in a direct line extending from this earth.

Is this mysterious force light? No—for all of the planets are cold bodies. The term "cold" is used comparatively. The planets themselves do not give forth light of their own accord but merely reflect the light of the sun. Direct sunlight is billions and billions of times more powerful than the rays reflected by the planets. As a matter of fact, were the sun to be extinguished, life on this planet could not continue to exist but the light from the planets could be dispensed with. What other influence could there be? Let us assume that it is a psychic influence. Why then the necessity of conjunctions and opposition? The psychic influence should be present regardless of the position assumed by the planets, but a psychic influence is not a scientific influence. A man who does not believe in astrology could, under the circumstances, remain immune to any position assumed by any and all of the planets—and most men are.

We will let the astrologers answer the question "What is this mysterious influence?" Perhaps they can also account for the fact that twins born practically at the same moment may be widely different. A notable instance of this last assertion is the case of Abner and Albert Holland, two twins who were so much alike that none of their finger prints, with the exception of the small finger on the hand of each were different, yet one of these twins was a criminal and the other a successful business man. (see Oct. 1923 issue S. & I.) Perhaps the astrologers will tell us that one was born a few seconds after the other and consequently different "stars" ruled their lives. Then maybe they can explain the case of the Dvorack twins born joined back to back. Unquestionably their births must have been simultaneous, yet one of them is married and has a grown son and the other never married. Or maybe they could give us an explanation of the Siamese twins who were joined side to side at birth and were evidently born at the same second. One of the twins died more than an hour preceding the death of the other, and had there been a means of separating them the second one might have lived for a much longer time. Why did they not die at the same instant if the stars controlled their lives? Why did

**A**STROLOGY — that pseudo-science which caters to the credulous and the ignorant is being expounded to a greater extent every year by quacks and would-be astrologers. We do not mean to infer that all astrologers are quacks; some of them actually entertain the false belief that there is some truth in astrology and that it is not a pseudo-science as classed by Webster. Although Webster did not lay any claim to infallibility, his definition of astrology is not only held but supported by every modern scientist.

To say that the Editors of SCIENCE AND INVENTION Magazine have investigated astrology would be putting it mildly. But before entering further upon this subject, let us understand exactly what the term astrology means.

Although originally this term was applied to the science of the stars and was synonymous with our modern inference of the word astronomy, it is now restricted to that system of predicting future events and particularly the fortunes of men through the position of the heavenly bodies. Generally the date of birth of the individual whose horoscope is to be drawn up is the all-important consideration. The circle of the heavens is divided into twelve equal parts, six above the horizon and six below, which are called the twelve "houses." Through these houses the planets move regularly and the planets according to astrologers control each one of the houses. By the relative positions of the planets at the time of birth the horoscope is drawn up. Further, the question as to whether the planets are in conjunction or opposition is also the basis of the astrologer's calculation.

What, then, is this mysterious influence which the astrologer claims affects the lives of every person born not only in these United States but also in the entire world? The astrologers do not claim that there is any definite known power; that would be an absurd claim. If the force were gravity then the pull of Mars on this earth ex-

## \$6,000.00 For Proofs of Astrology

SCIENCE AND INVENTION Magazine holds that there is nothing scientific in Astrology, that Astrology is not a science and that statements made by astrologers unless very general cannot be entertained seriously.

Accordingly, this publication has decided to award an Astrology Prize of \$6,000 for the following:

\$5,000 will be paid to the astrologer or forecaster who will foretell three major events of such a nature that he will have no control over the outcome of the same. He must describe in advance each event in detail, giving the location and result or the casualties if the event is an accident.

\$1,000 will be paid to the astrologer or forecaster who will produce three accurate, detailed and perfect horoscopes, free of contradictions on the lives of three people whose initials will be given him when he requests the same and the birth dates will also be supplied by this office.

This contest closes October 1st, 1927, and all entries must reach us by that time. In event of a tie, prizes of an identical nature will be given those so tying.

Address all entries to Editor, Astrology, care of SCIENCE AND INVENTION Magazine, 53 Park Place, New York, N. Y.

# ASTROLOGY

KRAUS

not both of the Dvorack twins marry at the same time if the planets controlled them?

The instant that an astrologer makes the assertion that there may have been other extenuating circumstances he is stepping away from astrology. Practically everything we do in life is due to extenuating circumstances.

Approximately four years ago the writer sent the birth date of A. P. Peck—well known to our readers, to an astrological society on the West Coast. The members of this society drew up a horoscope for this birth date. In approximately thirty-nine pages of manuscript containing the report, there was not one single definite statement which was not contradicted elsewhere in the same manuscript. In one part it stated that the querist or subject was dead; in another that he was very ill and on page 14 it claimed that he was enjoying good health and on page 28 or 29 it stated that the querist would live to a ripe old age. How anyone can be dead, sick, alive and healthy at one and the same time is beyond our limited comprehension.

Every horoscope which we have seen has been nothing but a mass of nonsensical piffle, primarily designed to please the inquirer and give him just enough bombast so that he will be anxious to receive a further reading which will tickle his vanity even further. At the same time this tickles the pocketbook of the astrologer to the tune of anywhere from \$5.00 to \$100.00 or even more.

The movement of the planets around this earth and the gravitational pull between them is very slight. In fact, it is so weak that there is practically no effect on the movement of this earth in its orbit. Does anyone suppose that under the circumstances the planets could possibly affect human life? We are mere insects on this sphere of ours and if the sphere itself remains unaffected we also remain similarly uninfluenced. Why don't the astrologers take the moon into greater consideration and claim that the moon alone influences life on this earth? Is it not more reasonable to suppose that the

WHEN YOUR HOROSCOPE IS THE MIRROR  
OF YOUR FUTURE



"The Nation's Counselor."  
**PROF. GUSTAVE MEYER,**  
of the American Scientific Astrologer

Hudson, N. J., 481205 2nd., 1926.

Miss J. S. Lee, Jr.,  
34 - 18th Street,  
Jackson Heights, N. Y.

My dear Miss Lee:

According to the date of your birth, I find that you were born with the Zodiacal sign of Aries, and Pisces rising, and as the ruling planet of Aries is the fiery, evil, and martial Planet Mars, and of Pisces, the fiery, and fortunate Planet Jupiter, hence, Mars, and Jupiter, will be your ruling planets through life, and while you would experience quite a turbulent, and hard up hill struggle, and more clouds than sunshine, during your younger years, and many narrow escapes from death by accident, illness, or operation, and serious trouble, and will usually have to fight for your rights, or work quite hard for whatever you legitimately earn yourself, and that your shoulders would usually have to bear the responsibilities of others

of loss is then indicated through or to relatives on your father's side, also through servants, or inferiors, or not through small animals, During the early autumn months, guard against public enemies, quarrels, legal trouble, reverses, and trouble or loss through the public, and the opposite sex. During the late autumn, you will be in danger of bereavement, and should guard against losses by fire, robbery, or systematic robbery, also guard well any plans, or secrets, you may possess or such will become exposed to others, who will profit through them, also avoid religious arguments, and guard your morals, health, and temper, and such trouble, or loss is indicated through something connected with either the Church, publishing, or advertising, science, or literature, and traveling by water, yet, you will receive much honor, credit, benefit, and success if not advancement in position.

Yours truly,  
*Prof. G. Meyer*  
Scientific Astrologer.

moon, being so much nearer to this earth would affect every individual on this planet? Science admits today that the moon affects the tides. No doubt this view is universally held. So, if a mass of water can be caused to rise due to gravitational pull and if the earth itself can be slightly pulled out of its normal course by the gravitational influence of the moon on the earth, (and of course, similar influences of the earth on the moon), it might be plausible to assume that only this satellite affected human beings. As most astrologers argue, if the moon affects the earth, why cannot the planets affect man? Why should they if the planets do not affect the earth? The moon does affect the earth, yet the earth's satellite does not affect man at least no more so than the Woolworth Building.

At the left is a photographic copy of the first and last page of a horoscope as developed by Prof. Gustave Meyer who calls himself, "the Nation's Counselor." The birth date was absolutely accurate and correct to the minute, although a fictitious name was used. The author of this article prefixed his name with a Miss. The complete text of the horoscope will be found in this article.

Is there anyone so bold as to assume that he is born at a certain minute of a certain definite day and no one else in this entire world would be born at the same time? What has made Lieut. Becker a criminal when Paul Bartsch, naturalist; Joseph Frederick Berg, theologian; Robert Archibald Ashworth, clergyman; Gellert Allentan, chemist; James Pyper Bird, professor, etc., born during the same year and under the same sign are found in "Who's Who in America?" What has caused Lieut. Becker to be executed for his complicity in a murder case when these other men have attained high honors? Were the planets particularly unfavorable for one man and conveniently and accommodatingly changed in position when the others were born on the same date? The answer is of course apparent—"No!"

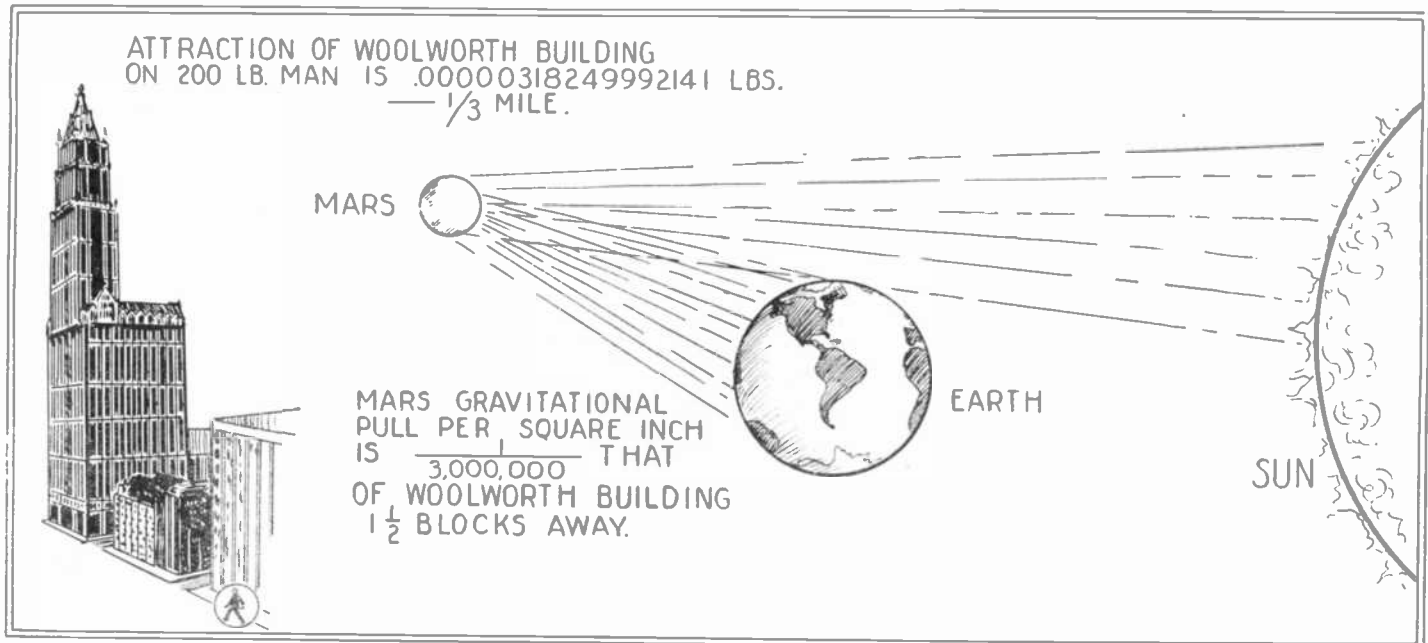

What is this mysterious influence which the stars hold in store for us? Is it gravity? No—for the gravitational pull of the Woolworth Building on man is considerably greater than that exerted by any of the planets. It cannot be light because the sun's rays are reflected from the planets. If

it is psychic, then it holds for only those who believe in astrology, who believe in the ridiculously super-natural. Of course everything super-natural is not ridiculous. SCIENCE & INVENTION Magazine is willing to be shown that astrology is a science.

# The Truth About Astrology

(Continued)

## \$6,000.00 for Proofs

There never was any science in astrology as we now know that term, and there will not be, and in order to prove this we are willing to pay \$6,000 to the individual astrologer or to the astrological society producing a horoscope in accordance with the conditions of our award. Please bear in mind that these conditions are ones which any scientist would gladly adhere to were he given the opportunity to work something out on a scientific basis. If astrology is the science which astrologers claim it to be, then it should be a simple matter for them to make a definite statement, without frills, without contradictions and without indefiniteness. The astrologer should be able to say that there will be a railroad wreck at a definite time and location, in which a definite number of people would be injured. If the stars affect each individual they certainly should affect a railroad train to a greater extent. They should be particularly disturbing to a steamship where thousands of lives are located on the same vessel at the same time.

The astrologer should have been able to tell us definitely of the sinking of the Antioch and should have been able to foretell of the daring sea rescue of Captain Fried and his crew on the "Roosevelt." But no, the astrologer will tell you "some vessel will be wrecked on the Atlantic Coast" and pick out a particularly hazardous part of the coast for his prediction. He doesn't say whether that vessel will have two souls

aboard or two thousand, whether it is a canoe or a liner.

He may tell you that an attempt will be made at Mussolini's life and probably will be ninety per cent correct. It has been done before and undoubtedly will be done again, but he makes no attempt to prognosticate the exact date of the attack or the conditions or the individual guilty of the deed.

An astrologer may also tell you that the Mississippi River will overflow its banks

turbances constantly occur and in view of the fact that earthquakes are perfectly natural the astrologer is bound to guess partly correct—but only as far as he goes and the difficulty is that he doesn't go far enough. He is just like a fortune-teller who states "you are about to cross water" and that crossing may be a river, a lake, the Atlantic or Pacific ocean or a rain pool.

Here is a typical sample of a horoscope. A girl, Florence B, was born on January 1st,

1899 at 10:20 A. M. These facts are known with exactness and were given to astrologers. We have had several horoscopes drawn up on her life. It so happened that on January 2nd, 1919, this young lady, Florence, caught cold. The cold was not of the ordinary variety, but rapidly developed into pneumonia and pleurisy and on January 9th, 1919 she died. Not one of the horoscopes made mention of a lung condition. All of them tell of narrow escapes from death, accident, illness and operation and they advise her to guard against kidney trouble, nervous complaints, fire, burns and a galaxy of other conditions, yet previous to that time, she had never been ill in her entire life and never even had those condi-

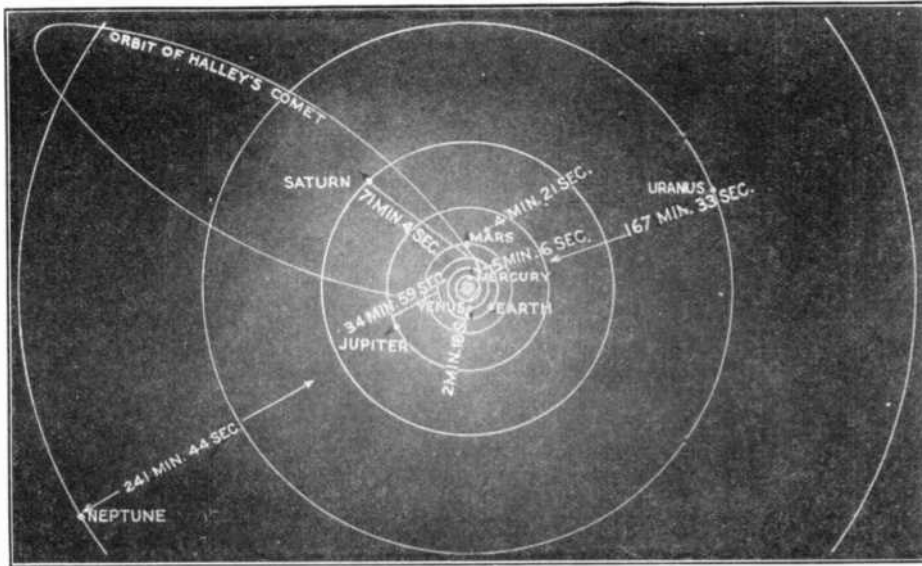

The above diagram illustrates the mean distance of the planets to the earth and the length of time that it would take for a beam of light to reach the earth from any of the planets. Thus if Jupiter is calculated to be in midheaven at the time of birth, it will be found that it passed midheaven more than four hours before it was even seen there. It takes light that long to reach us, assuming that the mean distance is used for the calculation. This distance will vary, dependent on the planets' positions.

during the spring of the following year and that there will be earthquake disturbances as well as volcanic eruptions. He doesn't name the volcano, nor the time of the event, nor say how serious the volcanic eruptions will be or the area which the earthquake would affect. Inasmuch as volcanic dis-

tions which one would class as the children's diseases. The first page of one of these horoscopes is here reproduced and the horoscope itself follows verbatim. In reading this "remarkable" horoscope note that the quotations in italics are ours.

(Continued on page 562)

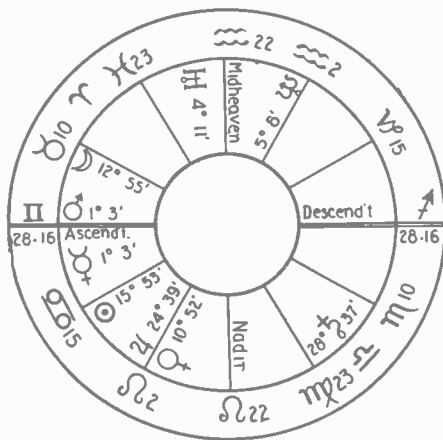

The above diagram illustrates a typical horoscope. The various insignias just inside of the outer circle may be analyzed by referring to the diagram at the right. Thus the sign immediately at midheaven is aquarius, the water bearer, and this is supposed to control the calves and ankles. The peculiar H just to the left of the word midheaven in the inner circle represents Uranus. The next symbol to the left is the moon, and continuing around we have Mars, Mercury, Sun, Jupiter and Venus, Saturn and Neptune.

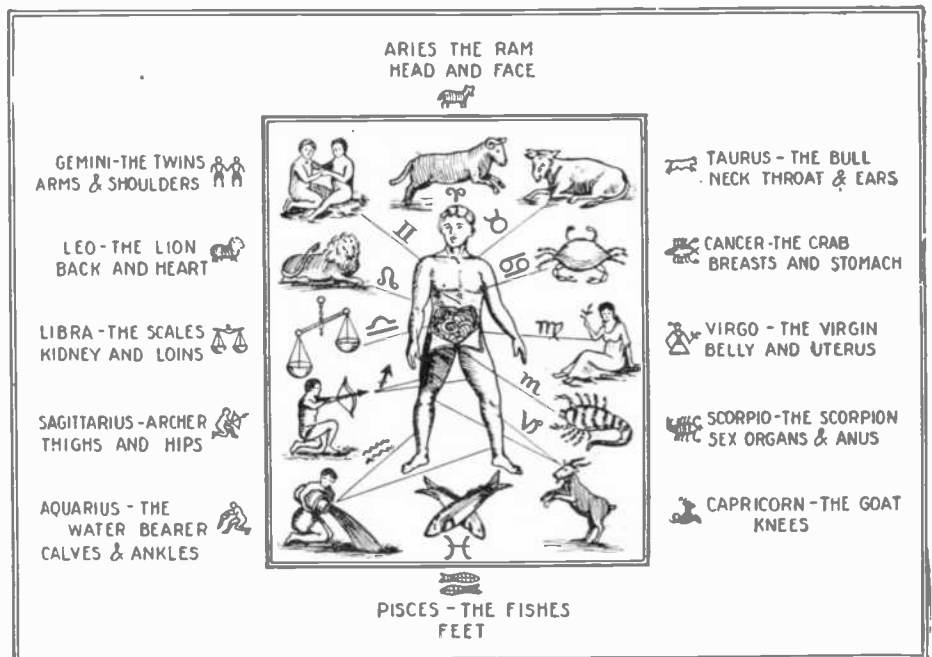

The diagram above is typical of old almanacs. The organs which the signs control are given.



# A Winter-Kitchen Garden

By DR. ERNEST BADE



Chives is one of the more common kitchen garden herbs used for salads and dressings and since it is comparatively easy to cultivate, it should not be lacking in the window garden.



Soupgreens is one of the necessities in the kitchen herb garden. Be sure to take only enough, when snipping the leaves, as is required. Do not waste the herbs.

**T**HE first signs of the coming fall can be noticed in the garden. The leaves are turning yellow, the grapes are assuming a deep blue color while the fiery red cheeks of the apples peek through the foliage. The leaves of the potato are nearly all yellow, a sure sign that these tubers have ripened under the ground and that they can now be harvested.

The dry sunny days of fall are the days of harvest. But one should not begin too soon, for all fruit and vegetables which are to be kept for winter use, must be thoroughly ripe. Otherwise they can not be kept in the cellar for any length of time. On the other hand there are quite a number of vegetables which are not injured by the winter's frost. These are left in the garden, and, when needed, are removed on some frost-free day, when the ground is open. But even these types of vegetables are best covered with a slight protective coat of straw. The evil effect of freezing is less a result of low temperature than the result of sudden warming or heating of the frozen vegetables. The covering will prevent the sudden change of temperature due to the heating effect of the sun's rays. In any case it will be found advantageous not to reap the crop before the first slight frosts of autumn set in. The frost sets a period to the growth of the plant, it has thoroughly ripened and can be kept fresh much longer than if picked too early.

Vegetables kept for winter use must be perfect in every respect. When the heads of winter cabbage have a tendency to burst before they are harvested, a condition prevalent during heavy rains in the fall, it becomes necessary to bend the plants to one side and this is accomplished by exerting a sudden jerk. The growth is partially stopped because numerous tiny root hairs have been destroyed

which prevent the absorption of sufficient moisture to burst the plant. The keeping of cabbages for winter use is best accomplished by removing the entire plant, roots and all, and placing them, roots upward and heads downward, in a shallow ditch or against same wall. Then they are covered with a layer of straw or of fallen leaves. Over this a layer of sand or soil about one foot thick is placed. In this way the cabbage can be kept throughout the entire winter.

Leaf and tuberous vegetables such as carrots, turnips, etc., can also be kept in ditches which should have a depth of one and a half feet. The soil which is removed from the ditch is used to build a wall around it. In this cavity the vegetables are placed in the same relative position as they grew and they are



Leek is another of the more important kitchen herbs. One, two or three of the more sturdy plants are planted in one pot.

heated cellars the vegetables will certainly begin to decay in a very short time. When the atmosphere is mild, ventilation must be provided. In cool or frost-free cellars the vegetables are placed in sand or soil, if necessary, the sand is placed in boxes. If space is lacking frames are made, one above the other, where the vegetables may be kept. Potatoes may be kept fresh by this method with absolute certainty, while celery is placed in sand. Carrots are kept in boxes or other containers, so that they may be covered with sand. Apples are spread on frames where they are placed one next to the other. If they are to be kept in boxes, then the apples must be carefully packed and the boxes placed upon strips of wood so that air may pass under the boxes whereby the condensing of moisture on the bottom of the box and rotting of the lower layers of apples is prevented.

Kitchen herbs for winter use are best kept in larger flower pots which, during the warmer days of autumn, may be kept out of doors either dug into the garden, or put into a window box just outside of the window until frost sets in. Then they can be brought into the kitchen and placed near the window, or they may be placed in the frost-free cellar near some well lighted windows.

Such a kitchen herb window garden consists of a number of such flower pots, each pot being placed on a saucer, first to protect the window sill from scratches, dirty spots, and stains caused by moisture, and secondary, for irrigating purposes, for these plants must also be watered at regular intervals. One pot of the following herbs will usually be sufficient.

(Continued on page 555)



One way of keeping cabbages throughout the winter is to turn them upsidedown with root pointing upward in a shallow ditch and cover with soil.

strung out in rows. The excavation is covered with boards which in turn are covered with straw or fallen leaves and soil. It is best to place the boards over this ditch in such a way that they slope downward and outward so that rain water may drain away from the vegetables. Since the process of respiration is not completely inhibited during this period of rest, the excavation will be slightly heated. Therefore a ventilating pipe or two is placed at each extremity of the ditch to carry away the heated air.

Vegetables will keep for many months in such a ditch provided that none of them are removed while the air is extremely cold. It is also important not to close the ditch too soon. It should remain open as long as the air is warm. If this is not done the plants begin to grow and decay sets in.

When vegetables are to be kept in the cellar, care must be taken to see that this place is well ventilated and dry. In damp and

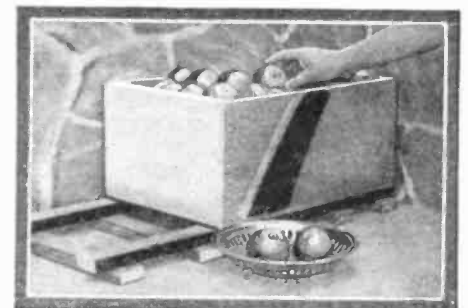

When apples are to be stored in boxes for winter use, raise the box from the floor with strips of wood to prevent moisture from collecting under the boxes and causing the apples to rot.

# How to Read Blueprints

## PART 1—HOUSE PLANS

**I**N the present article we shall consider some of the interesting and practical points about reading architect's blueprints for house construction. In a later article we will take up the reading of shop blueprints for machinery. The public at large is becoming more interested in the subject of blueprints for houses than ever before. This is partly due to the fact that there are several large house-building concerns who sell all of the lumber cut to size, together with rafters and other parts, which are shipped several hundred or even thousands of miles perhaps, to the place where it is to be erected. Many people supervise their own building erection and if they do not do this, they will still be interested in learning how to read blueprints, so that they may tell beforehand just how the house is going to look, both inside and out. The drawings presented herewith are copies of blueprints for a house constructed by the writer in a town located about twenty-five miles from New York City. The plans call for a six-room bungalow style house with bath, and the garage is built in the rear part of the cellar.

The drawing below shows the various symbols used by architects for indicating brick, stucco, concrete, marble, terra cotta, earth, etc. Plaster or other walls are shown either in white on the blueprints or else in other cases they may be tinted a light blue, caused by the architect shading the wall section with a pencil on the original tracing. Architects do not follow all of these symbols implicitly, and you may find some variation on blueprints drawn by your architect.

Fig. 2 below shows the method of indicating bath tubs, shower baths, laundry tubs or

trays, water closets, lavatories and kitchen sinks with drain boards. Doors and windows are usually recognizable even to those not familiar with blueprints of houses or other buildings, and Fig. 3 shows the principal accepted methods of illustrating various styles of doors. Reference to the large drawing on the opposite page shows how doors and windows as well as stairs are indicated on architectural blueprints.

Fig. 4 shows what is meant by scaling a blueprint. This is a simple little trick once you practise it a few times, using either an ordinary inch rule or else a boxwood scale, as supplied by stationery or drafting instrument concerns. As shown in Fig. 4 the scale there used is  $\frac{3}{4}$  inch equals one foot. Hence each  $\frac{1}{16}$ th is equal to one inch on the finished house. If you are going to read many blueprints, it will pay you to purchase a scale or two, such as  $\frac{1}{4}$  inch to the foot;  $\frac{3}{8}$  inch to the foot,  $\frac{1}{2}$  inch to the foot and  $\frac{3}{4}$  inch to the foot. A triangular scale carries all of these. Fig. 5 shows how chimneys are detailed on blueprints.

The large drawings on the opposite page show plan views of the house with six rooms and bath and also porch. You can obtain some practice by scaling off the rooms on this drawing by means of a piece of paper marked off in feet in accordance with the scale accompanying the floor plan. A special scale is provided for the semi-sectional view taken along the line A B indicated in the floor plan drawing. In looking at the sectional view it will be noted that the design of the doors, wood trim, etc., are shown as well as chimneys, posts supporting center girder under floor beams, etc.

This center girder is composed of three 2 x 8 inch girders spiked together. The rafters on the roof are spaced 16 inches center to center or outside centers (OC), which means measured from outer edge to outer edge of rafters. In reading dimensions of rooms, halls, etc., note whether dimension marks or arrows run to the surface of walls, or to the center line of walls.

The position of the electric lights in various rooms, halls and closets are generally indicated on all floor plan blueprints in the manner illustrated herewith. These general blueprints of houses do not, however, usually contain the details of where steam radiators, various side-wall electric outlets, etc., are to be located. The reason for this is that the plumber or heating engineer makes up special blueprints showing all the runs of the pipes and the exact location of radiators or hot air registers, if this system of heating is to be employed. You should make it a point to go over the blueprints with your plumber or heating engineer, and also the electrical layout blueprints with your electrician or electrical contractor, as there may be some things which you will not like once the house is finished. After you study blueprints a little and become accustomed to them you will find it relatively easy to understand about how a room will look with respect to the lighting fixtures as well as the plumbing and heating appointments. In some cases blueprints are either poorly printed or else not drawn in a clear manner, and then it is up to the prospective builder to ask his architect concerning any of the points which are not entirely clear.

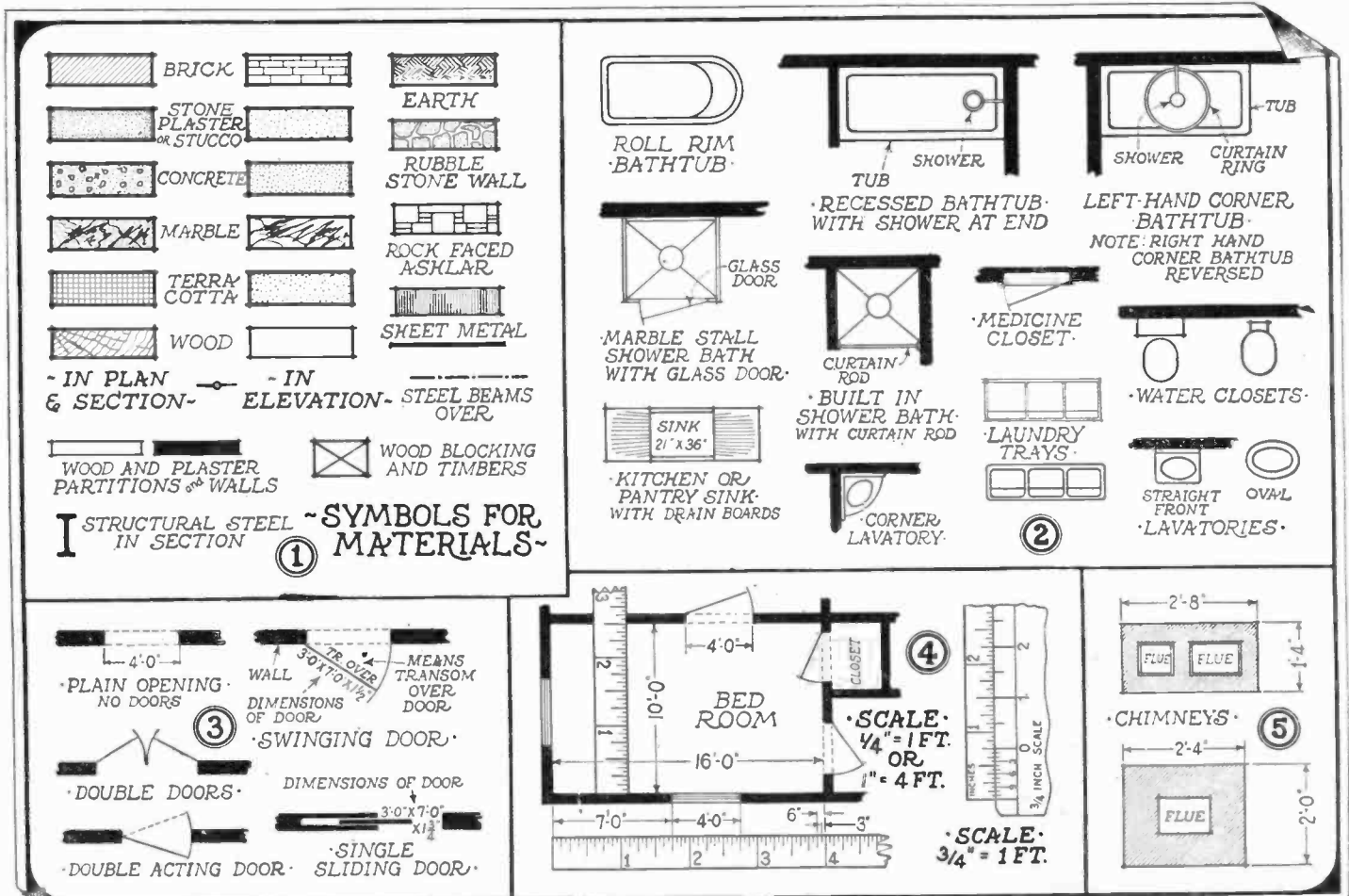

Fig. 1 above shows various symbols used by architects to indicate brick, concrete, marble, etc., on blueprints for houses and public buildings. Fig. 2 illustrates the usual symbols employed for indicating bath tub, shower bath, kitchen sink, lavatory, etc., on blueprints. Fig. 3 shows how various

styles of doors are drawn by architects, while Fig. 4 shows the meaning of scales in reference to plans and blueprints. With a common scale of  $\frac{1}{4}$  inch equals one foot,  $\frac{1}{16}$ th inch then equals 3 inches on the finished building. Fig. 5 shows how chimneys and flues are represented.

# Blueprints of House Explained



Front view of house, floor plans of which appear below.

Photo above shows rear and grade door side of bungalow.

③ WHEN PLANS SHOW THIS SYMBOL THE NUMERAL INDICATES NUMBER OF OUTLETS



• WINDOW •  
• DOOR •

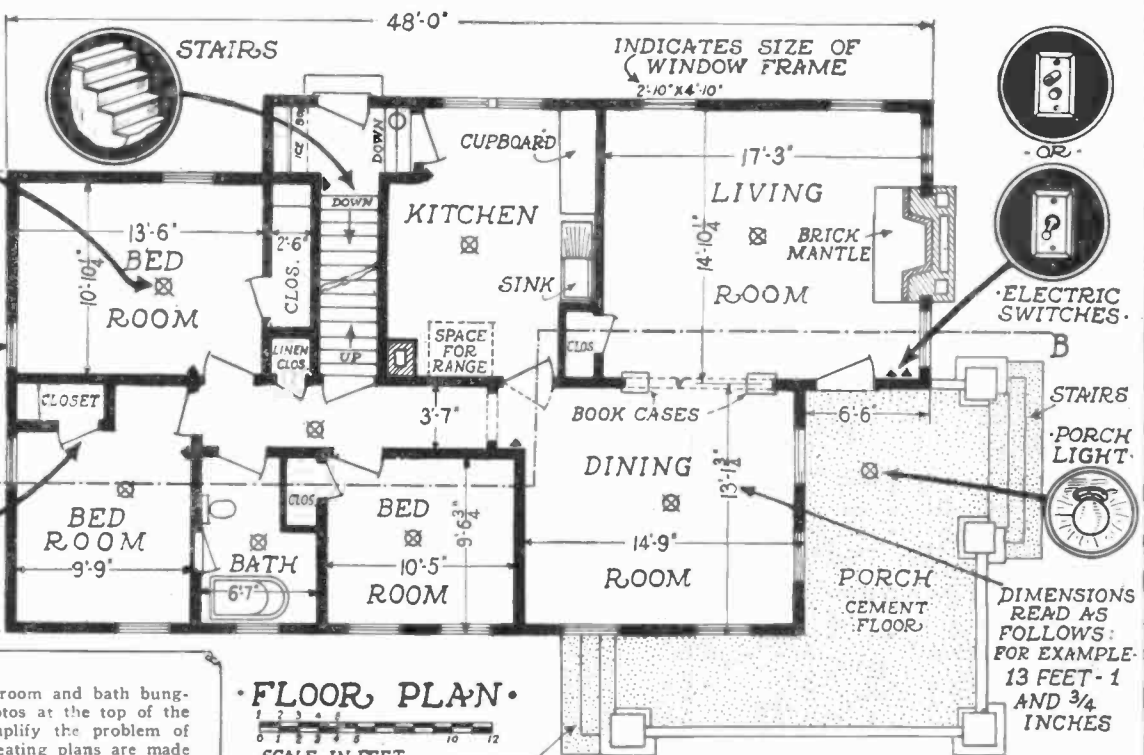

• FLOOR PLAN •

SCALE IN FEET

The floor plan of six room and bath bungalow illustrated in photos at the top of the page will help to simplify the problem of reading blueprints. Heating plans are made separate as well as the detailed electric wiring plans. Outlets and switches are shown.

A semi-sectional view of the residence here discussed is shown at left, this section being taken along the line A-B on the floor plan view above. Those interested in the subject of reading blueprints should procure a good book on the subject, and the editors will supply names of such treatises upon receipt of such request. Be careful to note where arrows on dimension lines terminate. Everyone should learn to read blueprints.

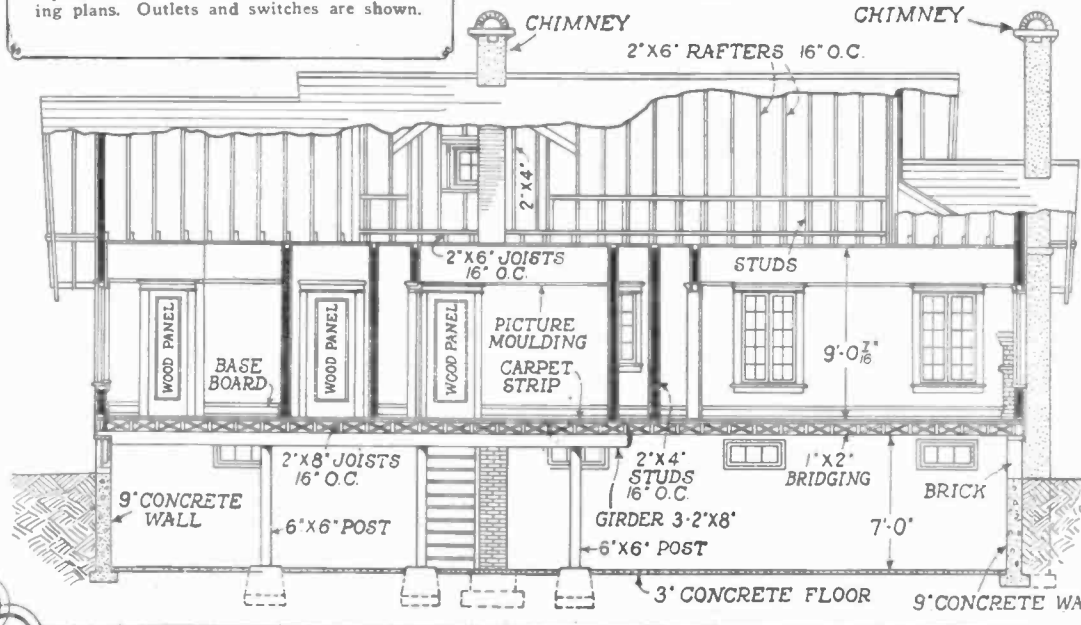

• LONGITUDINAL SECTION A-B •

SCALE IN FEET

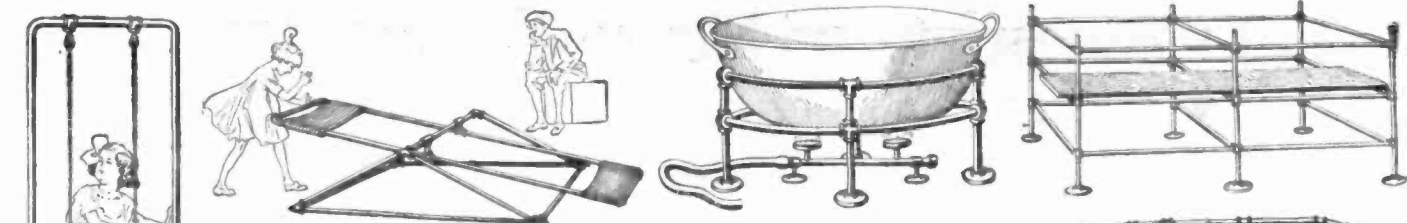

# PRIZE PIPE CONTEST

What Can You Make From Iron or Other Pipe? Prizes Will Be Awarded For the Best Designs Submitted.

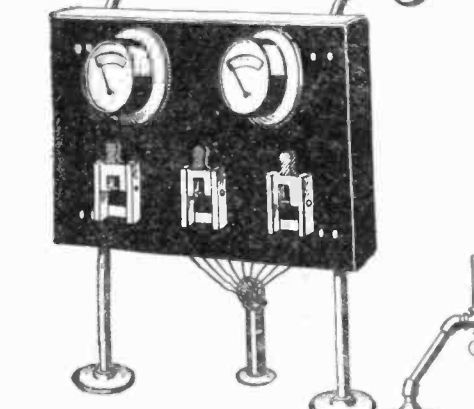
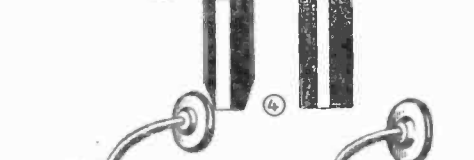
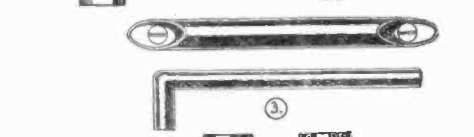
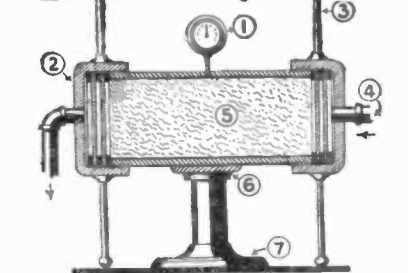
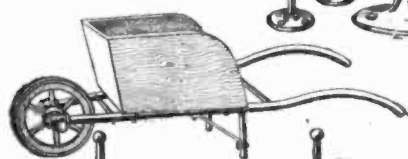
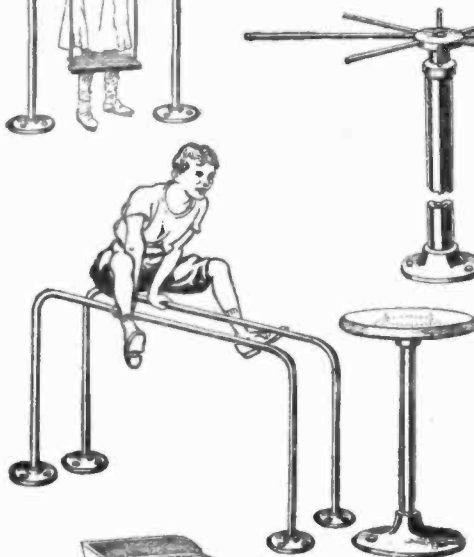

On this page are shown a number of uses for pipes and pipe fittings. We find in this series of illustrations reading from left to right at top of the page a swing, a see-saw, a large stand for holding a cauldron for the heating of chemicals and a suggestion for shelves. In the left-hand column we find a turnstile, a pair of parallel bars, a soda fountain seat, a wheelbarrow, a pressure oil filter in which oil enters at 4 and leaves at 2, after passing through the filtering substance at 5, and below this a hammer, a garden sprinkler, a latch and a leather punch illustrated in figures 1, 2, 3 and 4 respectively and a rack for holding a switchboard. At the bottom of this page a mechanism for agitating liquids is illustrated and to the right of this we find a lathe made entirely of pipe fittings, and a few wheels. On the right-hand column there is a rose arbor, a hose reel, a stair rail, a boiler for toy engines and a drill press. We are indebted to S. S. Kahn for this contest. Several of his suggestions appear on this page.

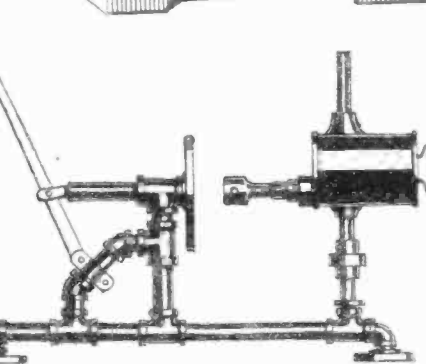
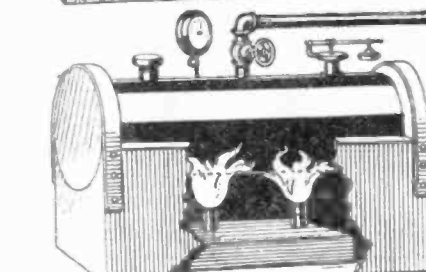
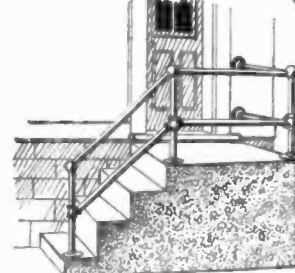
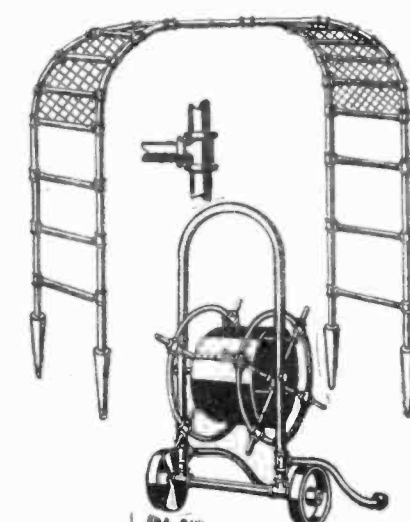

## \$100.00 in Prizes

for suggestions for the use of pipes and pipe fittings. Ten prizes will be awarded for the ten best suggestions for the use of pipe and pipe fittings. Everyone may enter this contest and an entry consists of legible drawings and a description of not more than 200 words of the device constructed or suggested, 90% of which must be of pipe fittings. Photographs are highly desirable although not essential.

Any Contestant may submit as many designs as he desires. In event of a tie for any of the awards, an award of an identical nature with the prize tied for will be given to each contestant so tying. This Contest closes midnight of November 24th, 1926, and all entries must be in our hands by that time.

### PRIZES

First Prize .....	\$25.00
Second Prize .....	20.00
Third Prize .....	15.00
Fourth Prize .....	10.00
Fifth to Tenth Prizes, inclusive,	\$5.00—\$30.00
	<b>\$100.00</b>

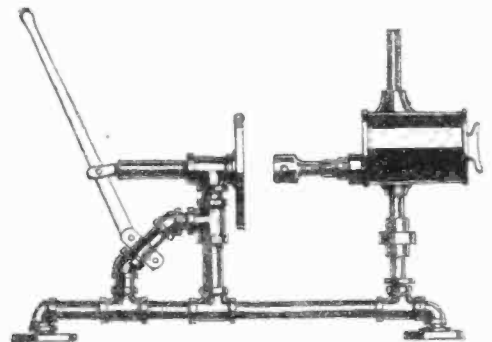
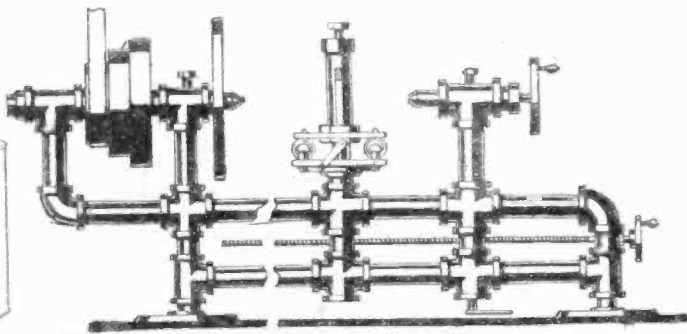
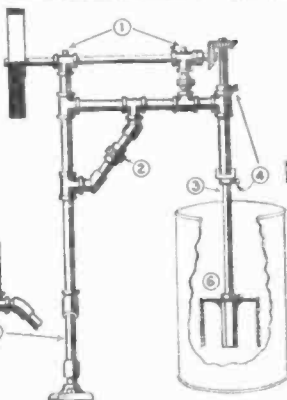

# MOTOR HINTS

By GEORGE A. LUERS

A New Monthly Department Prepared by a Well-Known Automotive Engineer

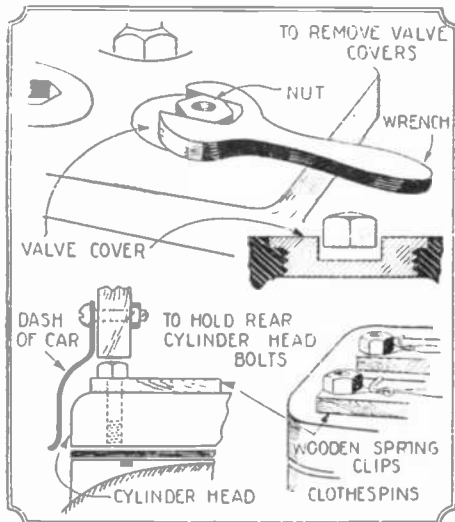

Various methods of removing valve cages and cylinder head bolts.

## FIRST AIDS WHEN WORKING ON CYLINDER HEADS

**V**ALVE covers in the cylinder head are usually fitted with an inserted socket, requiring a special type of wrench for removal. Merely because this wrench is not at hand is no excuse for leaving the valves unground.

The appended sketch, shows a simple and most satisfactory substitute for the wrench, which means is available to either the owner or the service station mechanic. A nut of a size to enter and fit the socket snugly, is used in conjunction with either an open end wrench or a monkey wrench. It is an easy obstacle to overcome when you just know the proper procedure.

On Ford cars and some other makes, cylinder head bolts interfere with the dash, vacuum tank and other close obstructions. It is necessary to remove the cylinder head and replace it with the bolt in its hole. To avoid such bolts dragging and mutilating the cylinder head gasket, is quite a feat. Often the head will be secured in place only to find that the gasket has been pulled and the water leaks out at the opening.

One of the most serviceable means for holding the bolts high enough to clear the gasket, is with wooden spring clips attached as shown.

## OPERATING THE HORN SIMILAR TO THE ACCELERATOR

Possibly, no part of the car's equipment calls for more frequent use than the horn. Some towns and counties require the horn

to be sounded at each road intersection.

When touring, it is advantageous to have a supplemental horn button placed on the floor of the car adjacent to the clutch pedal.

One of the best methods for operating this horn switch is with a lever extension, giving foot area, similar to an accelerator control.

The attached drawing shows in detail the method of obtaining this arrangement, which consists of an eighth inch sheet iron foot rest, hinged at the forward edge, with a small butt hinge, which rest is flared at the rear to give ample foot room.

In use it will be found that this horn control is far more serviceable than the hand button and also possesses a greater margin of safety through its accessibility and responsiveness.

## WATER CIRCULATION AND VARIOUS TESTS OF OPERATION

One of the motorist's chief difficulties with anti-freeze solution is the inability to determine when the solution is weak enough to freeze. On occasions the radiator is frozen. If the engine is started and run in this condition it may result with steaming and burst the radiator.

It is possible to safeguard against starting the engine when the circulating system fluid is frozen, by simple tests for fluidity.

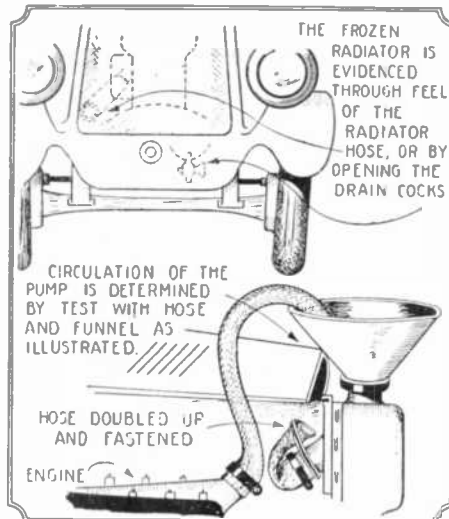

Various methods of testing water circulation.

The lower petcock on the radiator of the circulating pump can be opened momentarily. Failure to flow is immediately indicative of frozen solution, that is where the drain is not clogged.

Once opened, the drain will not clog, if this procedure of opening it each time to test before starting the engine, is carried out. Another practice which is of service, is a test at the rubber hose connections. Pressing the hose between his fingers, gives immediate evidence of the condition of the fluid inside.

What may happen when the engine is started when frozen, apart from the burst radiator, is that the impeller blades of the pump break and the circulation is rendered ineffective.

To test for a broken pump, is illustrated clearly in the attached sketch. In this the upper hose connection to the radiator is removed, a short length of rubber tubing connected to the outflow pipe from the engine, leads into a funnel at the filling spout of the radiator. The disconnected hose is doubled back and tied, thus improvising a stop for the flow of water.

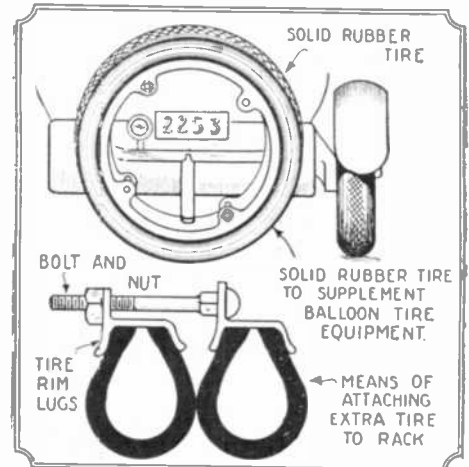

Simple means for carrying two spare tires.

When the engine is started, the action of the pump is to force a steady stream of water out of the hose and into the radiator.

## SPARE TIRES AND SPARE TIRE CARRIERS

Balloon tires are offenders in the way of picking up many small tacks or other puncturing objects. To such an extent is this true, that drivers of cars with these light sidewall tires are most frequently found carrying two spares.

One driver has found it an advantage with his car to supplement the pneumatic tire equipment with one spare solid type of tire on a standard rim.

To attach the extra tire to the usual tire rack and casing, a means which is favored by several motorists is that of using three or four long bolts and securing the lugs together as illustrated in the sketch.

## FORCE FEED GREASE NIPPLES

The wear of spindle bushings and the spindle bearings of iron wheels is usually evident after ten thousand miles of driving. The lost motion in these parts, contributes to unsatisfactory steering and front wheel wobble or shimmy.

One force feed grease nipple is placed in the body of the wheel spindle between the upper and lower bushings. Another force feed grease nipple is placed in the hub of the wheel, with the grease hole leading through and into the space between the bearings.

Periodic filling of the open spaces with grease assures a constant supply of the lubricant to the bushings and bearings.

A 21/64-inch drilled hole through hub and spindle, followed with a 1/8-inch pipe tap fits the parts to receive the grease nipple.

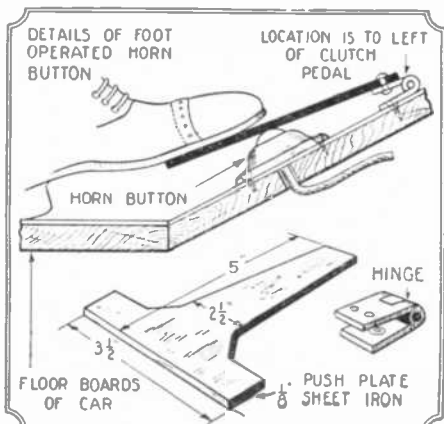

How to operate horn by foot pedal.

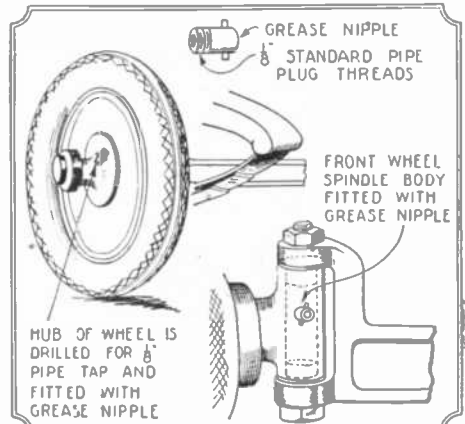

Extra lubrication for wheel hubs and spindles.

## Simplified Safety Markers Easily Applied

This traffic officer is standing in security in the center of a safety ring laid out by a recently developed and extremely simple to apply system of street marking.



THE problem of adequately marking streets and highways to facilitate traffic control has been greatly simplified through the perfection of a new method of applying lines and markers. No preparation of the street surface is necessary, and all the necessary labor may be done by unskilled workmen. All the usual warnings are available.

THE letters are painted in white water-proof traffic paint on heavy canvas backing. The back of each letter is faced with a special adhesive which adheres very strongly to any type of pavement. These markers are available in all the usual forms, and may be applied by simply laying in place without the addition of heat or pressure. The cost of this type of marking is considerably less than the cost of painting traffic signs, and due to the ease of employment, traffic need not be delayed for more than a few minutes.

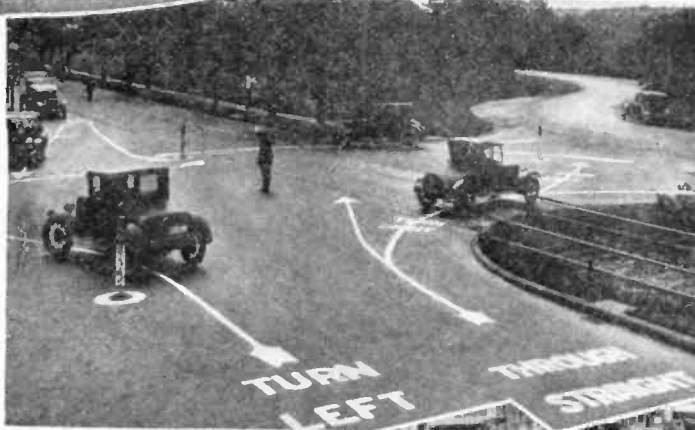

## Auto Hat Rack

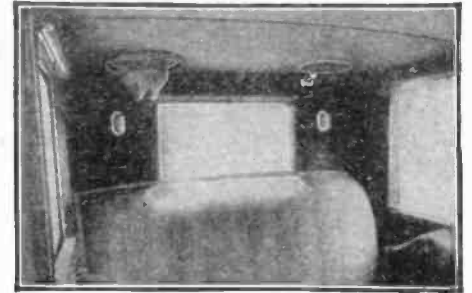

A new accessory for the automobile provides a place to put your hat so that it will not be crushed. The device consists of a heavy metal frame which clamps down over the brim of the hat and keeps it out of harm's way. An attractive nickle-plated finish is provided.

Safety Auto Hat Rack Co.

The policeman is keeping track of the length of time required to lay one of the new traffic signs. The only operation necessary is to place them in the proper position. The sun's heat and the weight of traffic does the rest. Insert shows use on cobblestone pavement.

—Wambler Corp.

## Vacuum Auto Gear Shift

A NEW automatic gear shift has been recently introduced which utilizes the partial vacuum created in the induction manifold of an internal combustion engine. In the vacuum gear shift this is effective by taking a lead from the intake pipe of the motor to a manually-operated valve, called the distributor, which in turn is connected with two cylinders which are of sufficient dimension to produce the necessary force to actuate the gear shifting mechanism. In each cylinder

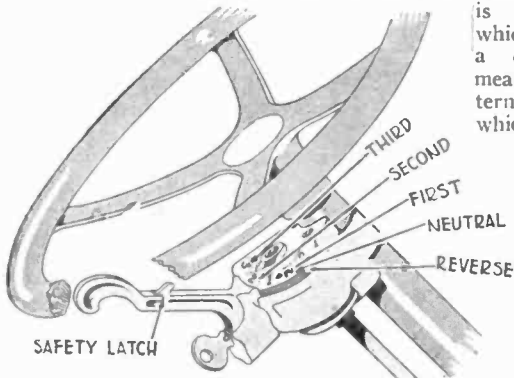

The speed-selecting handle may be operated with the fingertips without removing the hands from the steering wheel. A protective lock is used.

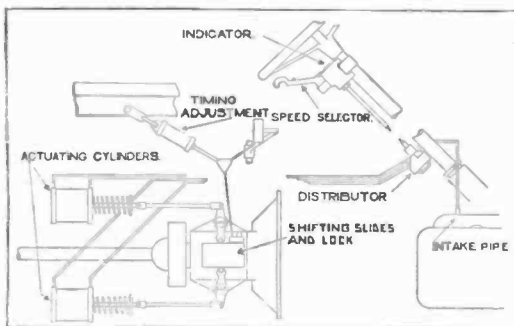

The above diagram shows the relation of the parts of the mechanism in complete detail.

is an air-tight piston which is normally held in a central position by means of a coil spring externally mounted and which operates in either direction. When vacuum is applied to either end of the cylinder, the opposite end is automatically open to the air by the distributor. The whole operation is controlled by a small, speed-selecting handle mounted underneath the steering wheel. The actual shifting of gears is accomplished the instant the clutch is thrown out. There is no possibility of stripping gears. The reverse gear cannot be actuated until a special latch has been released. Thus there is no possibility of going into reverse unintentionally or accidentally. It can be put on any car.



## Compression Loss Micrometer

ONE of the latest products of a manufacturer of precision instruments is an indicator which gauges the compression and compression loss in automobile cylinders without disassembling the motor. The only connection to the motor is through a spark plug opening. With the aid of this device leaking valves may be discovered, scored cylinders tested, leaking piston-rings checked, and all other causes of compression loss located and the extent of the loss measured accurately. It makes possible and practical a diagnosis of the condition of your motor.



Leak Micrometer Corp.



The room was as silent as the tomb of a Pharaoh. Soon the table seemed to rise from the floor, slowly—slowly. The eyes of the medium were glued upon us.

## Our Spiritualistic Investigations

By

*Dunninger.*

No. 3 OF A SERIES

THE night was stormy and wending my way homeward as best I could, I was thinking that whatever was not fastened down this night would surely be blown away . . . including myself.

Weird shadows and fantastic shapes loomed ahead of me and my thoughts shifted to the spirit world.

Pleasant thoughts these . . . on a night like this.

Finally I managed to navigate myself into the house and was getting out of my wet clothes when the telephone rang.

"Hello," in a not too social-like voice I yelled into that important instrument of contact with the outside world.

"Dunninger," came the voice of a friend. "how would you like to go spook hunting tonight?"

"Not so you could notice it," I replied. "I just got in and am soaking wet."

"You will want to see this new phenomena I have unearthed," went on the voice over the wire, "this is something that will make you sit up and give attention, Dunninger."

"Well . . . what is it?" I reluctantly queried.

"A creole that does the usual table lifting, materialization of forms and a dozen other mysterious things," came the answer.

"Where does she do her stuff?" I asked for the moment forgetting the deluge I had been caught in while homeward bound.

"Down here in Greenwich Village—just a bit East of 6th Ave. on 4th St.," replied my friend, "and Dunninger, I know the night is bad and all that but you must be on deck tonight at ten o'clock and see the fun."

"All right," I found myself saying, "meet me and we'll go around to the club and have a bite and from there on to this mystery woman's domain."

An hour later my friend was ushered in. He was as wet as a hen but his eyes shone

### \$21,000.00 for Spirits

More than two years ago SCIENCE AND INVENTION Magazine offered a prize of \$11,000.00 to anyone who could demonstrate his or her ability to communicate with the spirits or to give some definite form of a psychical demonstration which in itself was not trickery.

The result has been that mediums and spiritual organizations have been afraid to place proofs before us. Those weak attempts which have been made to demonstrate psychical phenomena were almost instantly proven fraudulent, and no medium has dared to contradict our findings.

In view of these facts, should we not consider all mediums fraudulent? Should we not consider every psychical manifestation as being trickery pure and simple, intended primarily to fleece those who visit the circle and who find solace in the words from the worst forms of charlatans, namely those who are being permitted to practise upon the poor, seeking words from loved ones?

To the \$10,000.00 which has been offered by Joseph F Rinn through this publication for Spiritual proofs and the \$1,000.00 in addition offered by SCIENCE AND INVENTION Magazine, we now add another \$10,000.00.

Dunninger, who writes exclusively for SCIENCE AND INVENTION Magazine and who is the Chairman of our PSYCHICAL INVESTIGATION Committee will personally pay \$10,000.00 to any medium or spiritualist who can present any psychical manifestation in so-called spiritualism, that he will not explain or that he cannot reproduce by natural means.

So now we have a total of \$21,000.00 offered for proofs of Psychical Manifestations. Spiritualists—get busy.

with anticipated excitement of what was to come.

Into fresh clothes and off again into the night. A night that would do credit to the theatrical genius of a Belasco for a stage or screen effect. During a cheerful meal my friend and I went over the so-called phenomena of this new exponent of the Shadow World.

"I'll tell you nothing further," taunted my companion after we had discussed various phases of this creole's powers, "you'll see for yourself and then some."

On again we wended our way but this time from the interior a cab through the windows of which we could see the swirling rain all about us and the play of the wind blowing in its wake anything not secured. There a man lost his umbrella. Here a newsboy homeward bound tried to battle the elements and save his papers. There a woman and a man bravely battled against the storm and an unruly umbrella.

A fine night. Truly just the sort of night to remind one of the haunting spectres that stalk majestically through haunted houses, castles and what not.

The cab came to a standstill . . . drawn up before a most ominous looking house, somber, ghostlike, mysterious.

Alighting we looked up and down the street. Not a soul in sight. The storm was continuing merrily. We walked or truthfully we were actually blown . . . Up the steps. Ringing the bell we waited for a second or so. It seemed like an hour . . . and the wind now began to whistle some eerie tune with now and then the accompaniment of scraping of boxes being moved by the wind's power but which seemed to us as if it was a sort of chorus of rattling bones by skeleton musicians.

The door opened and we were ushered in-

(Continued on page 536)

# Into the Fourth Dimension

SECOND INSTALLMENT

First American and Canadian Serial Rights

By RAY CUMMINGS

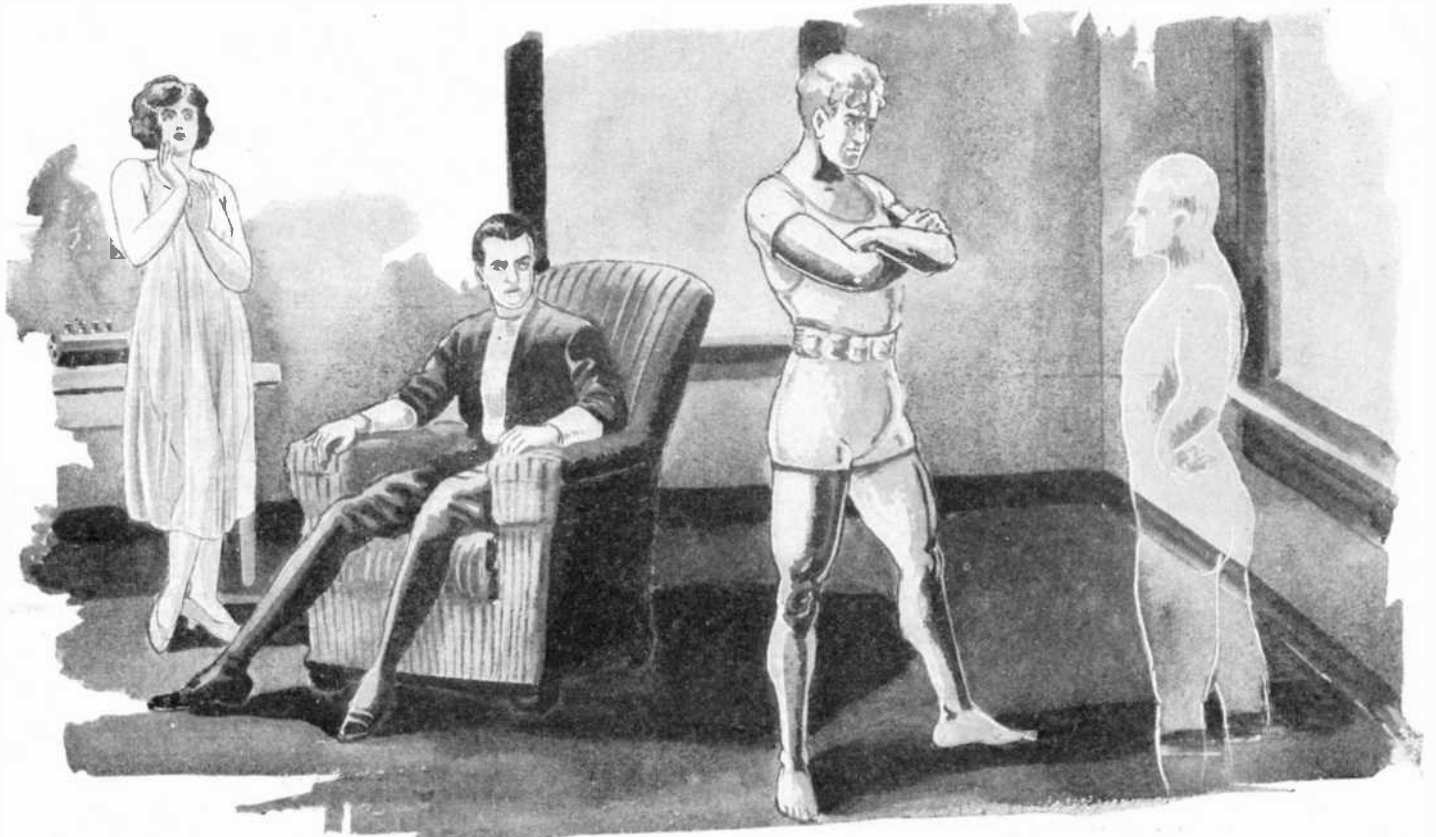

"I'm coming," said Will grimly. "It will do well to wait, for I shall be with it presently." He stood for a moment before the thing, contemplating it silently. Then he turned away, turned his back to it; and a new briskness came to his manner.

## CHAPTER III INTO THE SHADOWS

THERE were few preparations to make, for Wilton Grant had planned this thing very carefully. Our chief difficulty was with Bee. The girl was quite distraught; illness, the fear which for weeks had been dragging her down, completely submerged the scientist in her. And then abruptly she mastered herself, and smiled through her tears.

"That's more like it, Bee." Will glanced aside at me with relief. "I couldn't understand you. Why Bee, we've been working at this thing for years, and you—a real scientist, indefatigable."

"I'm all right now." She smiled at us—a brave smile though her lips were still trembling. "I'll not—disgrace you again. You're—about ready, aren't you?"

They had set aside a small room on the lower floor of the house—a sort of den which now was stripped of its accustomed hangings and furniture. It had two windows, looking out to the garden and lawn about the house. They were some six feet above the ground. It was a warm mid-summer evening; we had the lower sashes opened, but the shades fully drawn lest some neighbor or passerby observe us from without. On the floor of this room lay a mattress. There was a small table, a clock, two easy chairs. For the rest it was bare. Its white plaster walls, devoid of hangings, gave it somewhat the sanitary look of a room in a hospital.

We had been so occupied with Bee that Will had as yet given me no word of explanation. He left the little room now, returning in a moment with some articles which he deposited on the table. I eyed

### Into the Fourth Dimension

WHAT HAS GONE ON BEFORE

**R**OBERT MANSE, a correspondent in a New York Office of a Latin-American export house, in company with Wilton Grant and his sister Beatrice, nicknamed Bee for short, saw the first of the ghosts in February, 1946, a few miles from Rutland, Vermont. These ghosts were semi-transparent, glowing figures, much resembling human beings. Attempts to destroy them with bullets or clubs had no effect on the shadows. One could pass one's hand right through a ghost without feeling that there was any object in the vicinity. Later, the ghosts became more bold and more numerous, even molesting human beings and causing at least one death in Kansas, the direct result of heart failure, following the fright of encounter.

Sometime later, Will calls Rob on the telephone asking Rob to pay him a visit, claiming that his sister Bee is quite ill. During the visit Will makes mention that the ghosts or whatever they are have already arrived in the borderland between the consciousness of their realm and ours, and that they were coming out of this realm. Rob himself has discovered a means of entering into their borderland, whatever that may be and that even though his home is being watched by many of the ghosts, he will make the attempt tonight and turn these spirit-like creatures back into their former paths. While he takes the trip, Rob is to stay with Will's sister, Beatrice.

Now continue with the story.

them silently; a shiver of fear, apprehension, awe—I could not define it—passed over me. Will had placed on the table a carafe of water; a glass; a small vial containing a number of tiny pellets; a cylindrical object with wires and terminal posts which had the appearance of a crude home-made battery—four wires each some ten feet in length, terminating each in a circular metallic band.

I glanced at Bee. Outwardly now she was quite composed. She smiled at me.

"He'll explain in a moment. Rob. It's quite simple."

We were ready. By the clock on the table it was twenty minutes of ten. Will faced us.

"I'd like to start by ten o'clock," he began quietly. "The time-factor will be altered—I want to complete the difference—when I return—as closely as I can."

I had the ill grace to attempt an interruption, but he silenced me.

"Wait, Bob—twenty minutes is not a long time for what I have to say and do." He had motioned us to the easy chairs, and seated himself cross-legged on the mattress before us. His gaze was intent upon my face.

"This is not the moment for any detailed explanation, Rob. I need only say this: As I told you a while ago, the fundamental substance of which our bodies are composed is—not substance, but a mere vortex. A whirlpool, a vibration let me term it. And the quality of this vibration—this vortex—the time-factor controlling it, governs the material character of our conscious universe. From birth to death—from the beginning to the end—we and all the substance of our universe move along this unalterable, measured flow of time.

"Do I make my meaning clear? From—nothing but a vibrating whirlpool the magic of chemistry has built with this unalterable time-factor what we are pleased to call substance—material bodies. These material bodies have three varying dimensions—length, breadth and thickness. But each of them inherently is endowed also with the same basic time-factor. The rate of time-flow governing them, let me say, is identical."

He spoke now more slowly, with measured words as though very carefully to reach my understanding.



"You must conceive clearly, Rob, that every material body in our universe is passing through its existence at the same rate. Now if we take any specific point in time—which is to say any particular instant of time—and place in it two material bodies, those two material bodies must of necessity occupy two separate portions of space. That's obvious isn't it? Two bodies cannot occupy the same space at the same time.

"Now Rob, I have spoken of this unalterable, measured flow of time along which all our substance is passing. But it is *not* unalterable. I have found a way of altering it."

He raised his hand against my murmur, and went on, carefully as before. "What does this do? It gives a different basic vibration to matter. It gives a different rate of time-flow, upon which, building up from a fundamental vortex of changed character, we reach substance—a state of matter—quite different from that upon which our present universe reposes. A different state of matter, Rob—it still has length, breadth and thickness—but a different flow of time.

"You follow me? Now, if we take a material body of this—call it secondary state,—and place it in the same space with a body of our primary state, they can and do occupy that space without conflict at the same instant of time.

"Why? Ah Rob, it would take a keener mind than mine or yours to answer that, or to answer the why of almost anything. The knowledge we poor mortals have is infinitesimal compared to the knowledge we have not, and never will have. I can conceive vaguely however, that two primary bodies, placed in identical points of space and time would be moving through time at identical rates and thus stay together and conflict. Whereas, with a primary and a secondary body, their differing time-flows would separate them after what we might call a mere infinitesimal instant of coincidence."

His gesture waved away that part of the subject. He rose to his feet. "I have particularized even more than I intended, Rob. Let me say now, only that the pellets in this little vial contain a chemical which acts upon the human organism in the way I have pictured. It alters the fundamental vibration upon which this substance—these bones, this

flesh we call a body—this substance of my being, is built.

"Just a moment more, Rob, then you shall question me all you like. So much for the transmutation of organic substance. Inorganic substance—that table, my shirt, that glass of water—theoretically all of them could be transmuted as well. I have not, however, practically been able to accomplish that. But I have—invented, if you like, an inorganic substance which I can transmute. It is nameless; it is this."

He was coatless, and now he stripped off his white linen shirt. Like a bathing suit, he had on a low-cut, tight-fitting garment. It seemed a fabric thin as silk, yet I guessed that it was metallic, or akin to metal. A dull putty-color, but where the light struck it there was a gleam, a glow as of iridescence.

"This substance," he added, "I can—take with me. He indicated the wires, the battery if such it were. "By momentarily charging it, Rob, with the current I have stored here. It is not electrical—though related to it of course—everything is—our very bodies themselves—a mere form of what we call electricity."

He was disrobing; the gleaming garment fitted him from shoulder to thigh. About his waist was a belt with pouches; in the pouches small objects all of this same putty-colored substance.

I burst out, "This is all very well. But how—how will you get back?"

"The effect will wear off," he answered. "The tendency of all matter, Rob, is to return to its original state. I conceive also that in the case of human organism, the mind—the will—to some extent may control it. Indeed I am not altogether sure but that the mind, properly developed, might control the entire transmutation. Perhaps in this secondary state, it can, I am leaving that to chance, to experimentation."

I said, "How long will you be gone?"

He considered that gravely. "Literally, Rob, there is no answer to that—but I know what you mean, of course. I may undergo a mental experience that will seem a day, a week, a month—measured by our present standards. But to you, sitting here waiting for me—" He shrugged. "By that clock there, an hour perhaps. Or five hours—I hope no more."

My mind was groping with all that he had said. I was confused. There was so

much that I no more than vaguely half understood; so much that seemed just beyond the grasp of my comprehension. I seemed to have a thousand questions I would ask, yet scarce could I frame one of them intelligently. I said finally.

"You say you may be gone what will seem a day, yet by our clock here it will be only a few hours. This—this other state of existence then moves through time faster?"

"I conceive it so, yes."

"But then—are you going into the future. Will? Is that what it will be?"

He smiled, but at once was as grave as before. "Your mind is trying to reconcile two conditions irreconcilable. You may take an apple and try to add it to an orange and think you get two apple-oranges. But there is no such thing. Our future—let us call it that which has not yet happened to us but is going to happen. I cannot project myself into that. If I could—if I did—at once would the future be for me no longer the future, but the present.

"The conception is impossible. Or again—in this other state—I must of necessity exist always in the present. Nor can you compare them—reconcile one state of existence with the other." He stopped abruptly, then went on with his slow smile. "Don't you see, Rob, there are no words even, with which I can express it. I am trying to make you realize. That being reclined there, in the other room a while ago and watched us. Perhaps for what it conceived to be what we would conceive a day were we to experience it."

His smile turned whimsical. "The words become futile. Don't you see that? The future of that being is merely what has not yet happened to it. To compare that with our own consciousness is like trying to add an apple to an orange."

During all this Bee had sat watching us, listening to our talk, but had not spoken. And as, an hour before in the other room I had noticed her glancing fearsomely around, again now her gaze drifted away; and I heard her murmur.

"Oh, I hoped it would be gone—not come to us in here!"

We followed her gaze. Standing perhaps a foot lower than the floor of our room and slightly behind the side wall was that self-same spectral figure. The intent to watch

(Continued on page 544)

"Good," said Will. He seated himself cross-legged in the center of the mattress. In an agony of confusion and helplessness I watched while Bee attached the four wires to the garment he wore, one on each of his upper arms, and about his thighs where the short trunks ended.

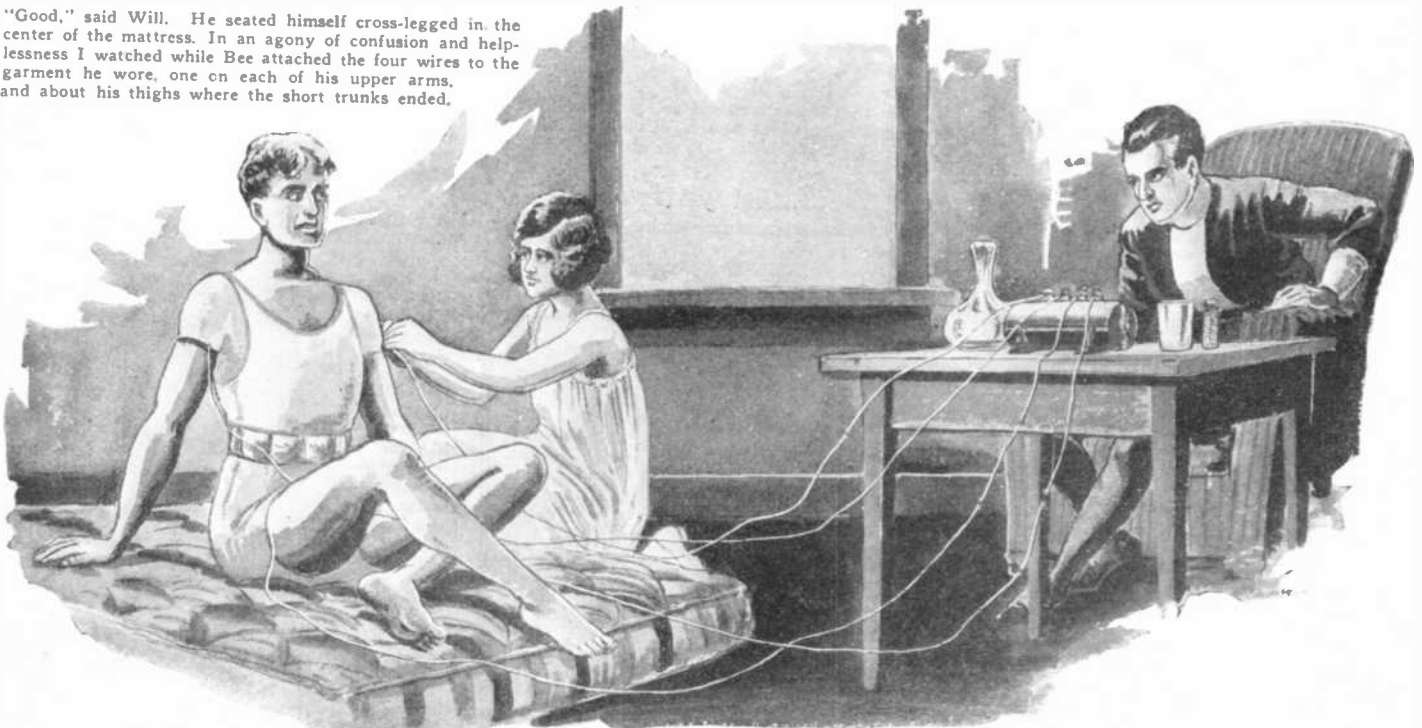

# The Home Scientific

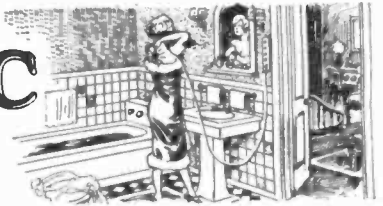
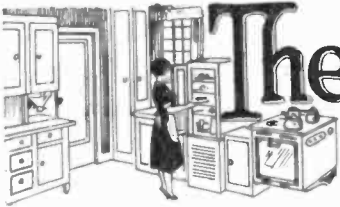

**AUTOMATIC TOASTER**



The editors took the remarkable toaster illustrated above apart in order to see how it operates. Inside there is a double heating element, the slice of bread being toasted on both sides at the same time. The small lever projecting from the front on the right side winds up a spring mechanism operating a clockwork-like mechanism. This is set by a knob immediately beneath the lever. When the desired time has elapsed, the lever at the right releases the one at the left, causing the toast to jump up and automatically shuts off the source of power. The switch is of carbon and self-adjustable. The toaster without a doubt is the finest thing on the market—Toastmaster.

**JIFFY INSULATORS**

For wiring irons, toasters, heaters, vacuum cleaners, lamps, etc., these rubber insulators may be very quickly applied to the wire. They are flexible and fit snugly. Heite Electric Mfg. Co.

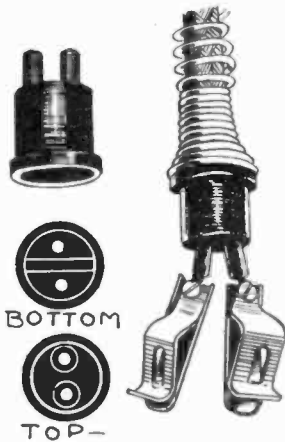

**BATTER MIXER**

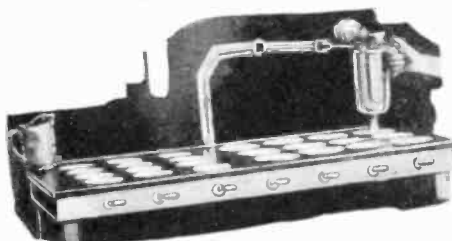

The nickel-plated receptacle for holding the batter is mounted on a stand provided with adjustable arms so that the device may be swung freely. A small motor on top mixes the batter and a trigger release permits the batter to pour out of the bottom of the receptacle onto the table stove. The device expedites pancake making in home with large families.—R. A. Moore.

**PANCAKE TURNER**

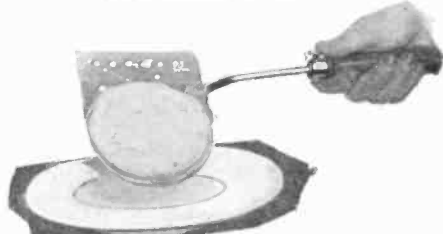

The turner illustrated above will enable the housewife to flip over a pancake very easily and quickly and will never cause the pancake to buckle up. It will be noted that a small button projects from the handle immediately under the thumb of the user. Pressing this button causes the turner to describe a complete arc.—R. A. Moore.

**SCREW-DRIVER HOLDS SCREWS**

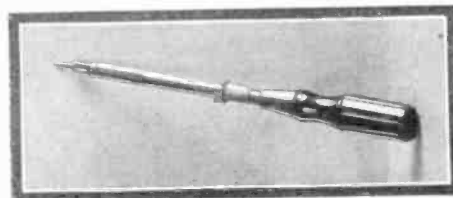

A screw-driver which will securely hold a screw in juxtaposition with the driving shank is illustrated above. Nearly any size of screw with any type of head may be used in this tool.—Diversified Sales Co.

**KNIFE SHARPENER**



Two steel pieces arranged so as to form a V-shaped slot produce the sharpening edges of the above device.—R. A. Moore.

**CREAM WHIPPER**

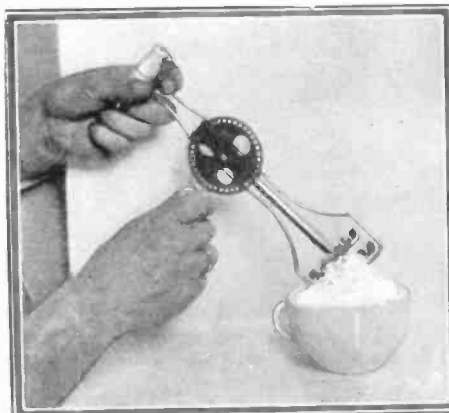

A beater which will fit into a cup and in which the blades rotate in opposite directions, yet which is simply constructed and practically fool-proof is the subject of the photograph above.—R. A. Moore.

**COMBINATION CHAIR**



The chair illustrated in the photograph above will accommodate a suitcase, a hat, an umbrella and an overcoat. The chair seat may be lifted so as to get at the hat. This combination should be ideal for the small home or for theatres and restaurants.

**SPOOL HOLDER**

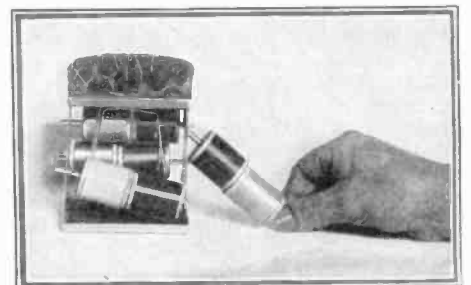

In the spool holder illustrated in the above photograph a pin cushion is provided and it will be observed that there are springs in back of the spools, preventing them from rolling and unnecessarily releasing thread.—R. A. Moore.

**BOTTLE HOLDER**

The interesting clamp here shown is for holding milk bottles and the like, the milk bottle being raised and pushed into the holder which closes around the neck of the bottle automatically.—R. A. Moore.



# Home Mechanics

## How to Build Cedar Chests

By WILLIAM M. BUTTERFIELD

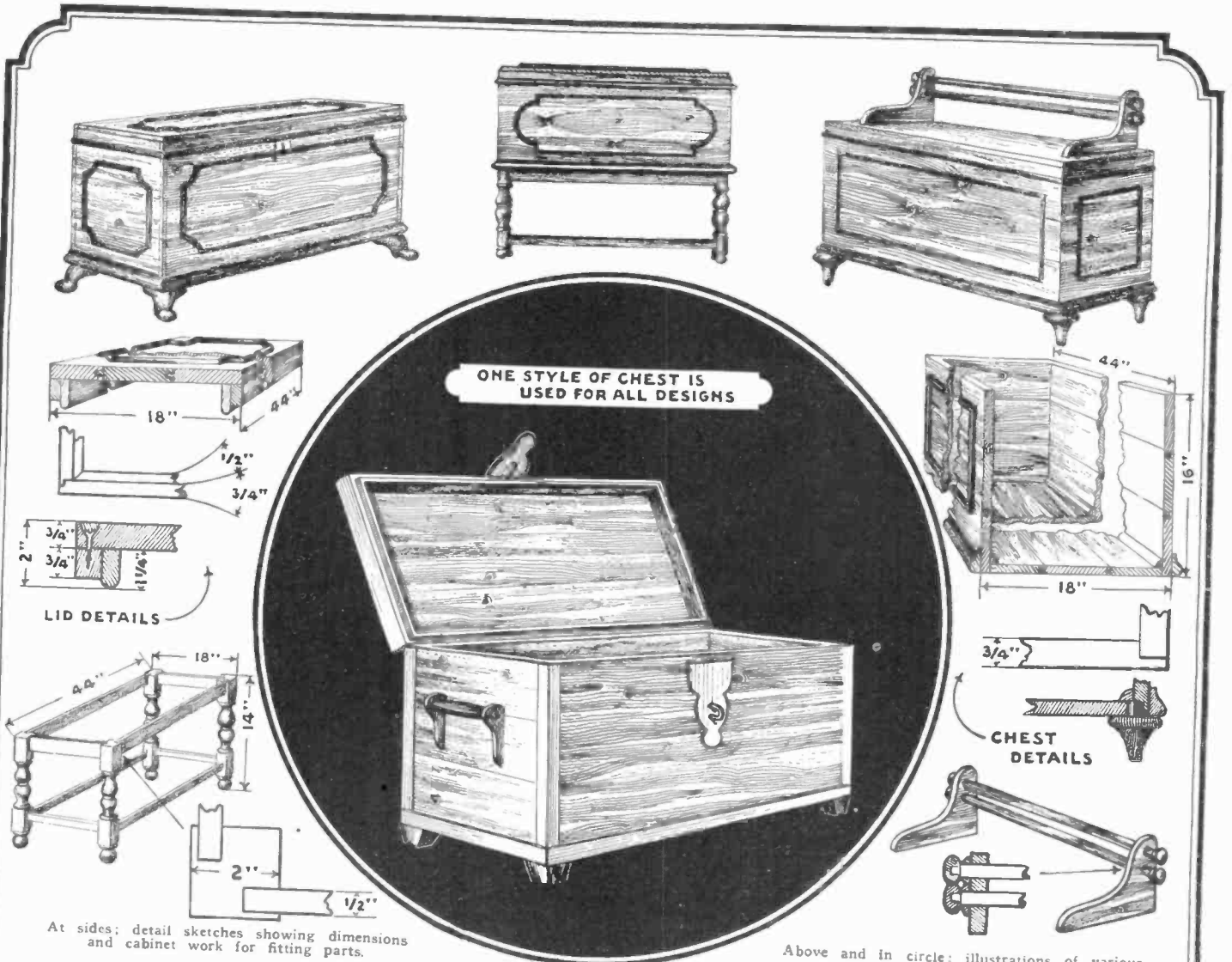

At sides; detail sketches showing dimensions and cabinet work for fitting parts.

Above and in circle; illustrations of various possible designs using this chest.

ONE style and size of cedar chest is used for all of the four designs shown on this page. The chest is 44 inches long, 18 inches wide and 18 inches deep.

About 70 feet of 6½-inch cedar lumber, ¾ inch thick, and 11 feet of 2-inch cedar ½ inch thick, is required for the chest.

Other items for the various designs are as follows:

40 ft. ¾-inch half round mahogany molding.

10 ft. 1 x 1½-inch o. g. mahogany molding.

3 ft. 10-inch cedar board 1 inch thick (for back rest).

2 ft. 6-inch cedar board ¾ inch thick (for handles).

7 ft. 1-inch mahogany pole (for back rest).

2 ft. 1-inch cedar pole (for handles).

26 ft. 4-inch sheet copper 1/16 thick (for binding, etc.)

2 ft. 7-inch sheet copper 1/16 thick (for locks, etc.)

1 2-inch copper padlock.

3 2-inch copper hinges (3 for each lid).

1 2-inch trunk lock (copper trimmed).

4 composition feet 5 inches high.

4 turned legs 6 inches high.

4 turned legs 14 inches long (mahogany).

22 feet 2-inch mahogany ½ inch thick (for leg frame).

The 6½-inch lumber should have a snug fitting tongue and groove and measure 6½ inches wide over all—the tongue and groove being ½ inch deep by ¾ inch wide. This lumber is cut for 6 pieces 18¼ inches long and 12 pieces 44¼ inches long. Three of the short pieces glued together form an end piece for the chest and three long ones glued together form a front, back, top or bottom piece.

It will be found advisable to pay a small extra charge over the cost of lumber to have the tongue and groove cut by machine at the mill.

The gluing process can be very satisfactorily carried out on a level floor in a narrow hall—the baseboards along the hall on both sides acting as the jaws of a vise. By placing any three pieces properly fitted and glued against one baseboard, a very heavy squeezing or forcing pressure may be obtained by placing extra pieces against the opposite baseboard and driving wedges. Heavy weights placed on

the piece to be glued will prevent it from "dishing" while drying.

When they have been glued together the six boards, each formed of 3 pieces, are cut, planed, sawed and smoothed in the usual way, or as a solid board. They are put together with glue and ⅛-inch brads.

The lid and chest are made first in one piece, that is, the height of the sides are made 17½ inches to which a ¾-inch top is secured with glue and screws. The screws should be about 3 inches apart, each screw is covered with a cedar plug ½ inch round and ¼ inch thick. With the top the chest measures 18¼ inches in depth.

The lid is then sawed from the chest, sawing on a 15⁄8-inch line. After smoothing the sawed edges and fitting the lid and chest closely together, the lip pieces are cut, shaped, and glued in place as shown in layout (lid details).

The bottom piece must fit snugly for it should be glued in place with ½-inch quarter-round molding glued in the top angles as shown (chest details).

Copper is a very popular trimming for

(Continued on page 560)



# MODEL DEPARTMENT



## Chinese Junk Wins this Month's Cup

Model Is Built by G. B. Douglas, of Montclair, N. J.

The photograph at the left shows this month's cup winner which is a model Chinese junk. The original vessel is eighty-nine feet over all, sixty-nine feet on the water line, and has a beam of twenty feet, nine inches, and a draught of four feet, nine inches, and a draught of four feet, three inches long over all. Mr. Douglas' work is exceptionally accurate and he is very careful and thorough. The cup which was awarded appears at the right.

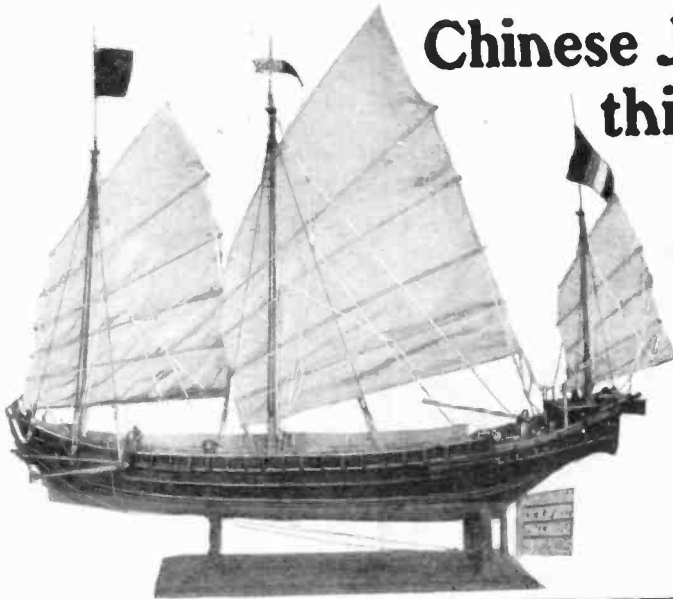

This cup is 17 1/2 inches high. A cup is awarded monthly.

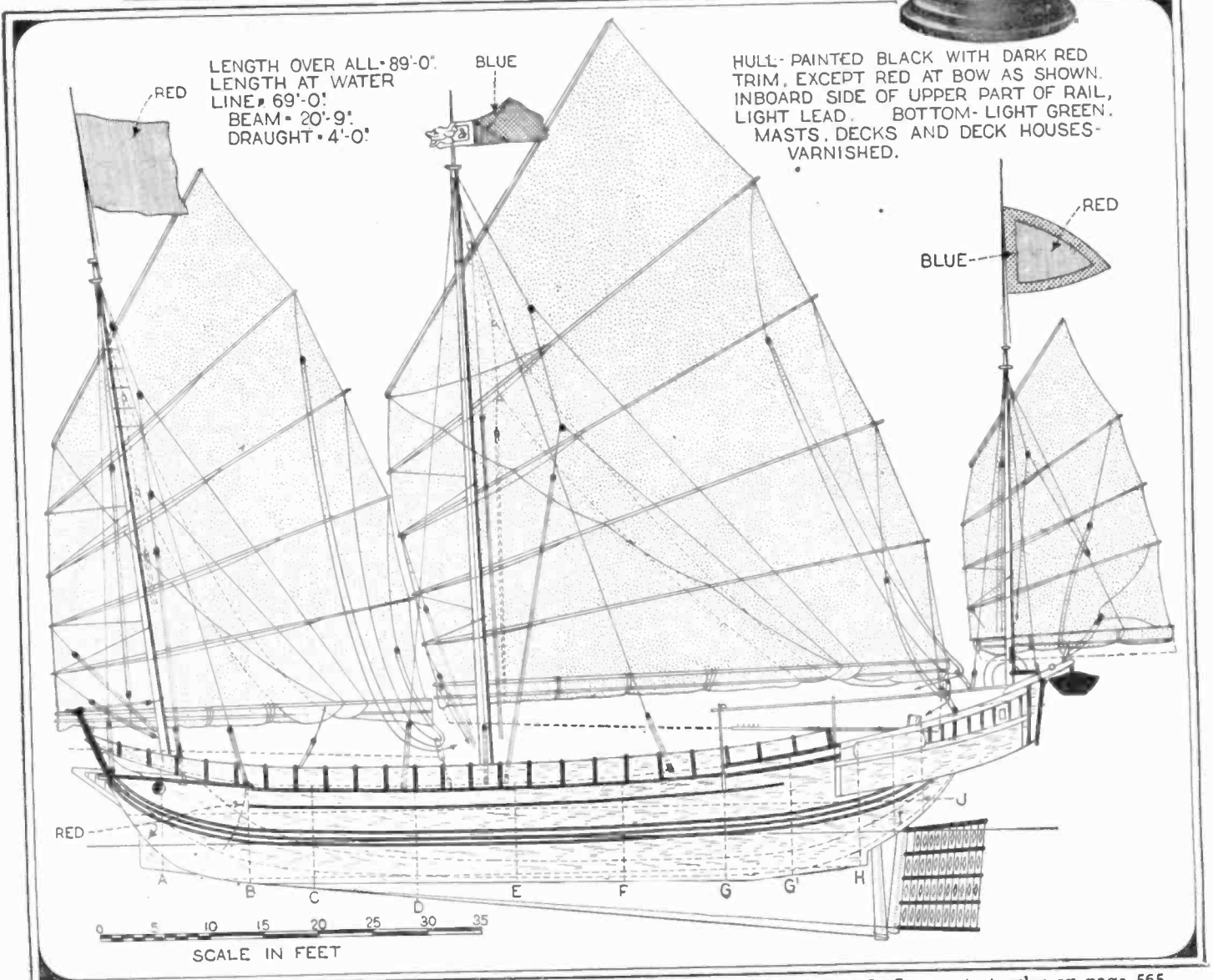

If you have not yet entered your model you cannot win a cup. Why not get busy? See contest rules on page 565

# The Cup Winner



THE hull of Mr. Douglas' Chinese junk was made from a solid block and dug out. The side rail with the perpendicular pieces was made of white holly and the perpendiculars are match sticks. The fittings over the hanging sides were quite difficult to make in order to get them even. Two cooking pots on the deck are made from two five and ten cent store thimbles. These attract considerable attention. The people rarely see that the capstan and the mizzen mast is four feet off center, nor do they see that there is a windlass for hoisting sails, anchor and rudder. The rudder is a large affair hung from a windlass so that it may be raised when the boat enters shallow water. A bulkhead just forward of the rudder fills with water which prevents the ship from turning a somersault. All Chinese junks have eyes painted on the bow, for a Chinaman says, "No have eye, no can see. No can see, no can go." The slots in the rudder make it easier to move the rudder. Note that the foot of the mast does not go to the bottom of the vessel.

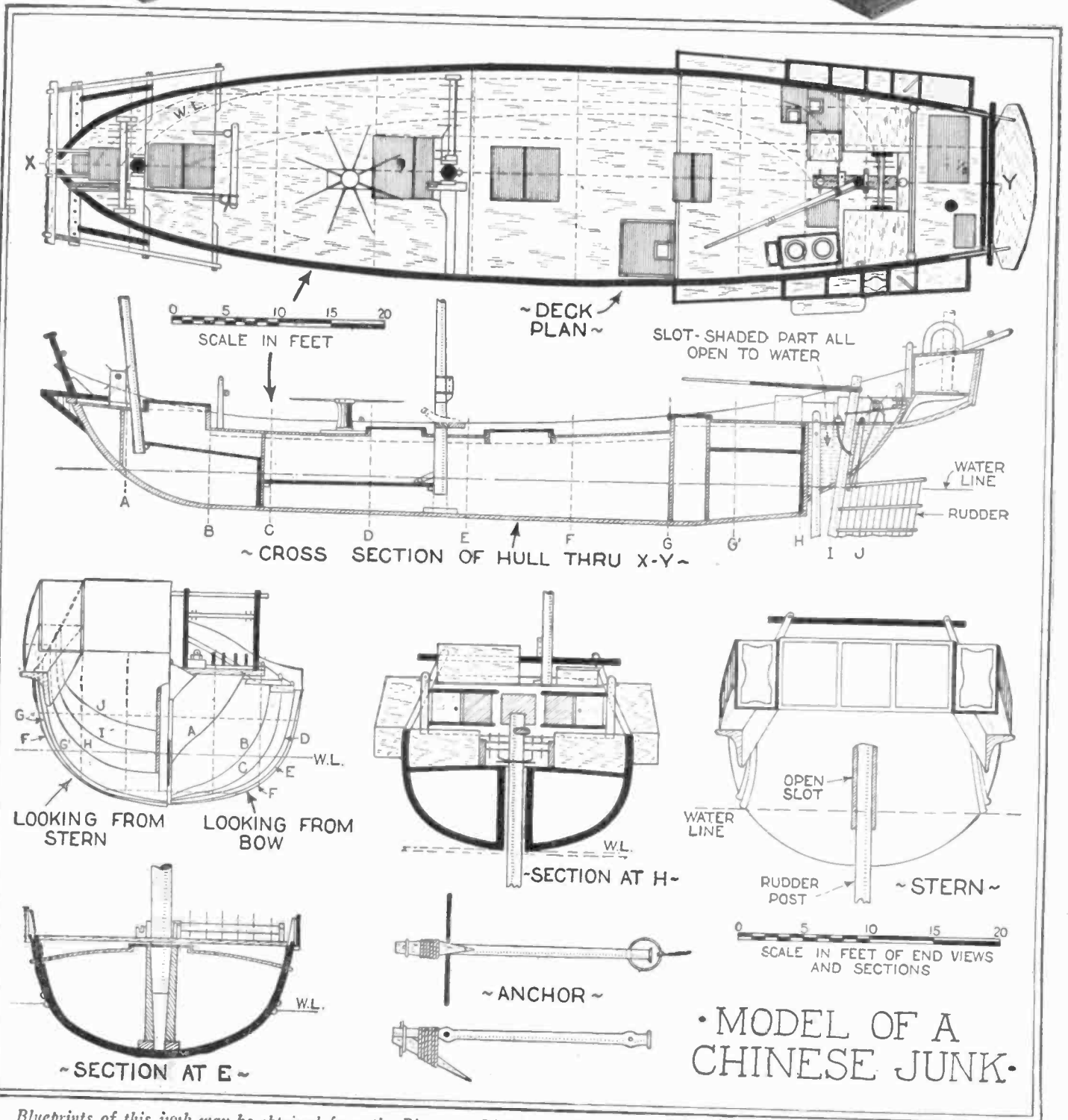

Blueprints of this junk may be obtained from the Blueprint Division of the Model Department at fifty cents for the complete set.

# AWARDS IN \$5,000.00 MATCHCRAFT CONTEST

First Prize \$100.00 Is Won by H. Gerdts, of Brooklyn, N. Y., for His Model of an Old Type Man O' War. Construction Is One Hundred Per Cent. Matches.

THIS remarkable model is fourteen inches long and twelve inches high. There are 18,000 matches in its construction, and it took the builder, Mr. Gerdts, five and a half months working nights and Sundays, to complete it. The sails were built up over different size bottles so as to give them the natural curve. The matches for the ropes are split so as to make them much thinner, and the ladders, ropes and guns are all made of this material.

The entire ship was sand-papered and varnished.

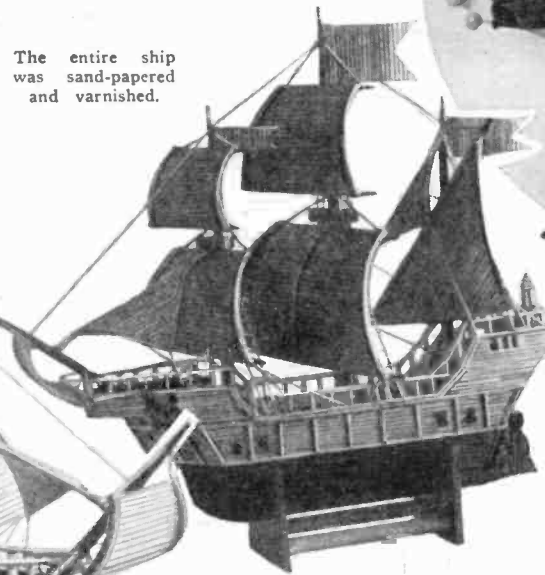
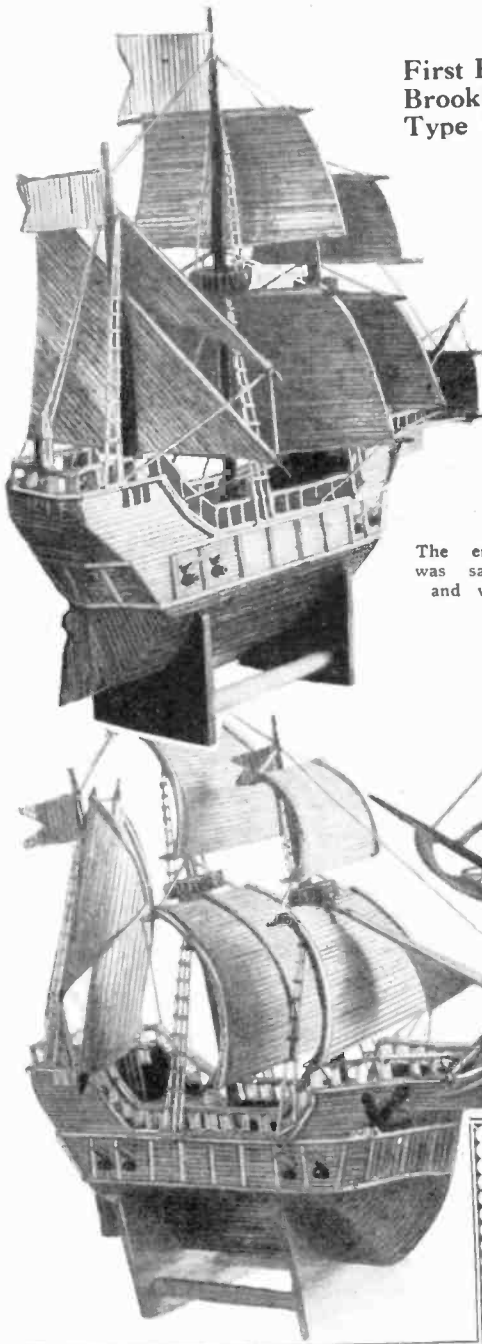

The comparative size of this remarkable model may be obtained by viewing the photograph of Miss Josephine Fitch who is holding the vessel.

## 16 Monthly Prizes

First Prize .....	\$100.00
Second Prize .....	75.00
Third Prize .....	50.00
Fourth Prize .....	35.00
Fifth Prize .....	25.00
Sixth Prize .....	20.00
Seventh Prize .....	15.00
Eighth Prize .....	12.50
9th to 16th Prizes of \$10.00 each .....	\$80.00

## \$5,000.00 Prize "Matchcraft" Contest

WATCH FOR PRIZES IN NOVEMBER ISSUE

(7) In order to win a prize, it is necessary that either models be submitted, or, if this is not practical, owing to their size, a 5"x7" photograph of the model may be sent in lieu of the model itself. The best models submitted each month will be awarded the prizes scheduled herewith.

(8) All models submitted to SCIENCE AND INVENTION Magazine will be promptly

returned to the builder, who will prepay all charges.

(9) Where SCIENCE AND INVENTION has any doubts as to the model (where photos only are submitted) complying with all the regulations, the judges may, at their discretion, request that the actual model be sent in for inspection, paying transportation charges both ways.

(10) This is a monthly contest, lasting for twelve months, each monthly contest closing on the first of the month following date of issue. Thus the contest for the month of October will close November 1, 1926, and prize winning announcements will be made in the January, 1927, issue. The November issue will contain August prize winning entries.

(11) Models must be shipped in a strong wooden box, never in a cardboard box, as SCIENCE AND INVENTION can not be held responsible for breakage in transit due to models having been improperly packed.

(12) When models are sent, be sure to affix tag, giving your name and address, to the model itself. In addition, put name and address on outside wrapper of package.

(13) Address all letters, packages, etc., to Editor, "Matchcraft" Contest, care SCIENCE AND INVENTION Magazine, 53 Park Place, New York.

FOR the present year, SCIENCE AND INVENTION magazine will award a total of \$5,000 in prizes, in a new contest. You are asked to make models, fashioning the same entirely from safety matches. Please observe the following simple rules:

- (1) Models submitted must contain at least 90 per cent. safety matches in their construction.
- (2) Models made of toothpicks, paper matches, or non-safety matches, are not eligible in this contest.
- (3) Models can not be built around boxes or other supporting articles. Walls, roofs, etc., must all be self-supporting and made of matches.
- (4) All liquid adhesives, such as glue, shellac, cements, etc., are permissible.
- (5) Models may be painted, gilded or silvered.
- (6) Models may be of any size.

Caution—Soak or cut heads from matches before building your model so that the models may be expressed or mailed. The strike-everywhere square cut Liberty matches can be used if the heads are cut off.

This contest started Dec. 1, 1925, and will terminate Dec. 1, 1926.

### IMPORTANT

QUITE a few matchcraft models from contestants arrive broken every month, due to faulty packing, or weak construction. It should be remembered that boxes are often violently thrown around in transit before they reach us. Make sure first that your model is constructed strongly enough to withstand severe shocks. Then, before you send us the model, after you have it packed as well as you know how, throw it up almost to the ceiling and let it come down on the floor. Open up the box and see if the model is not damaged. Only after such a test can you know that the model will arrive safely.

All First Prize Awards will henceforth become the property of the Experimenter Publishing Company and will be used for exhibition purposes.

**REMEMBER—** This is a monthly contest offering sixteen prizes every month. Don't hesitate, send in your model now!

# MATCHCRAFT AWARDS

Tea Kettle Wins Second Prize \$75.00—Microscope Third \$50.00 and Lynx Head Plaque Fourth \$35.00 In This Month's Contest.



SECOND PRIZE—\$75.00 is awarded this month to Fred Spinden, of Abington, Illinois, for his model of a tea kettle illustrated above. The kettle itself is nine and one half inches in diameter, and nearly six inches high.

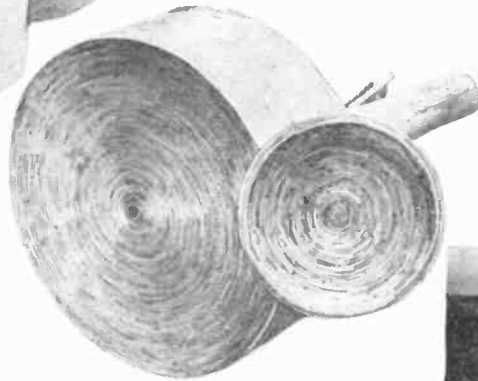

Thousands of matches entered into the construction of the tea kettle. Only a single layer of matches was used. Notice how each match was bent in order to give the kettle its curve. Mr. Spinden has repeatedly demonstrated his ability to bend matches.



The second prize entry is here held by Miss S. Bernstein.

A microscope made entirely of matches won the third prize in this month's contest.

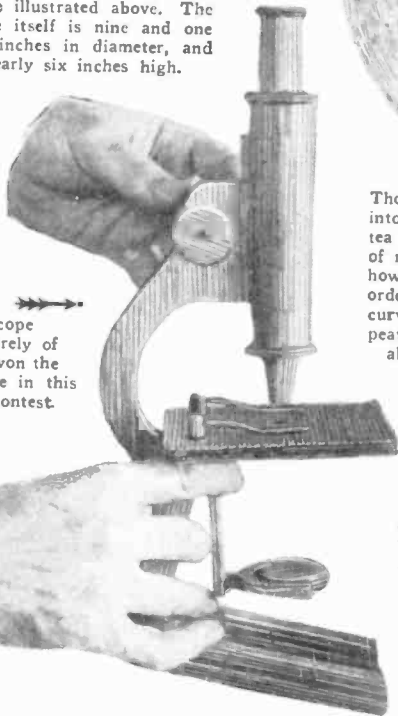

THIRD PRIZE—\$50.00 was awarded to Henry C. Thomas, of Charleston, North Carolina, for the construction at the left. The side holders are linked and the angle of the scope is adjustable.



FOURTH PRIZE—\$35.00 was won by Dr. E. Bade of Glen Head, L. I., for the lynx head plaque here illustrated which is just big enough to cover a cone speaker, although it may be used for a tray. The matches were carefully cut and bent and then glued in place so as to produce this artistic design.

TWELFTH PRIZE—\$10.00 is awarded to J. White, of Rochester, N. Y., for the sailor's sweetheart frame made up of several layers of matches. By means of a scroll saw the heart is cut out and the picture inserted under celluloid. A back of matches is then glued in place.



SIXTH PRIZE—\$20.00 was the award decided upon for the checkerboard here illustrated and built by Victor Roman, of New York City. Note that the matches in adjacent squares are laid at right angles to each other. Half the number of squares could be stained black for greater contrast.

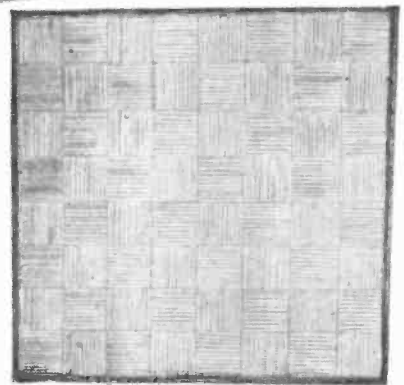

EIGHTH PRIZE—\$12.50 was won by C. F. Ewers, of Portland, Oregon, for the team of horses pulling a truck load of matchwood illustrated below.



SEVENTH PRIZE—\$15.00. The model of a horizontal steam engine illustrated below and made of matches was built by C. L. Brown, of Yonkers, N. Y. Although many steam engine models have been heretofore entered, no one has built a model which will actually work when air is delivered to it.

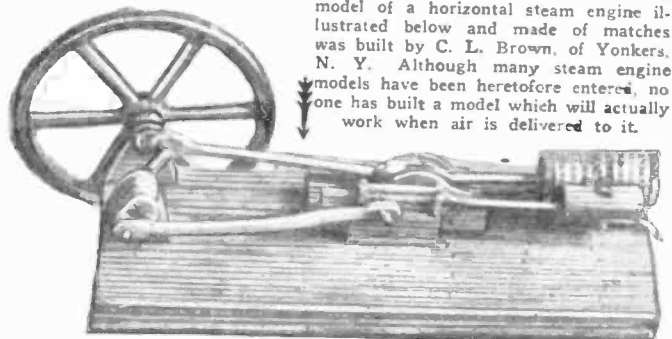

# FURTHER MATCHCRAFT AWARDS

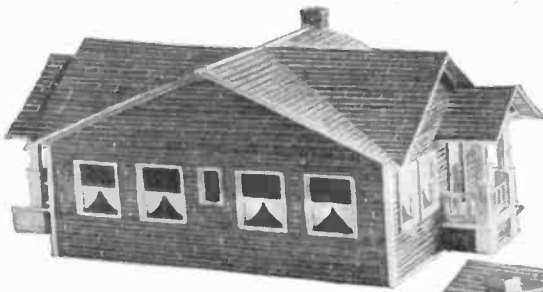

**THIRTEENTH PRIZE—\$10.00**  
The emblem of the Odd Fellows developed into a shelf and illustrated below was made by John Zeleznik, of Bridgeport, Ohio. Matches, glue and scroll saw combined with an artistic sense enabled its construction.

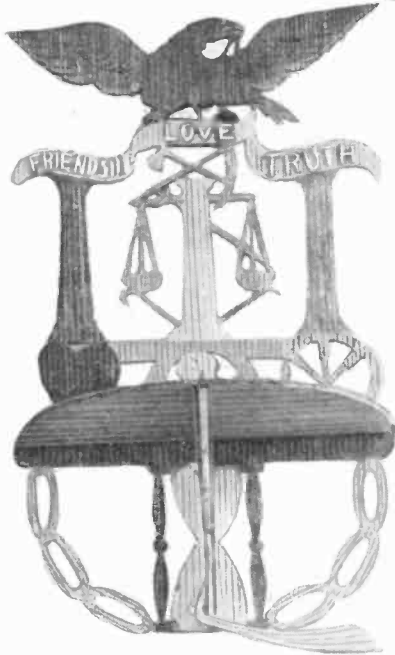

**FIFTEENTH PRIZE—\$10.00.** To the right we find a photograph of a farmhouse and a garage both of which were built of matches. The judges have stated repeatedly that only those portions of the construction made of matches would be considered in making the awards. Consequently the landscape and other decorations were ignored in the decisions. This construction is by Harry Goldstein of Springfield, Mass.

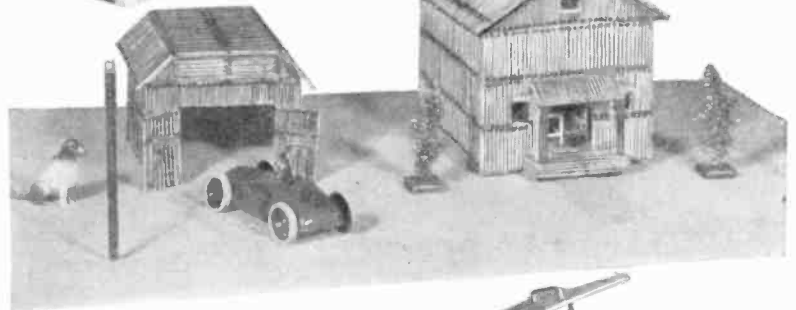

**ELEVENTH PRIZE—\$10.00.** The house illustrated in the two views at the left was built by W. Henkelman of New York City. The construction measures eleven inches long by six inches wide, and four and one half inches high. It has a front and a back porch and numerous curtained windows. No attempt has been made to outfit the interior, the building merely being constructed for exhibition purposes and is artistically painted. The photographs are taken from opposite sides.

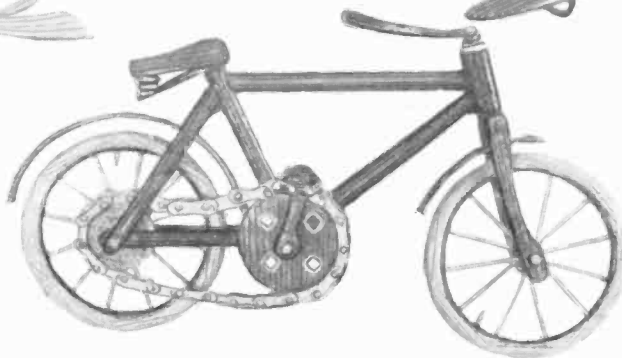

**FOURTEENTH PRIZE—\$10.00.** The most unique feature in the bicycle illustrated above is the fact that a chain made of matches rotates on two disks which are not even provided with sprockets. The friction of the chain on the disk is sufficient to cause the back wheel to turn when the pedals are rotated. Note the spring under the seat. Fred Spinden, second prize winner in this month's contest, made this model.

**NINTH PRIZE—\$10.00.** Alfred Roman and his brother Victor must have been busy this month because they both won prizes in the Matchcraft Contest. The airplane above was built by Al. An imitation engine appears in the model.

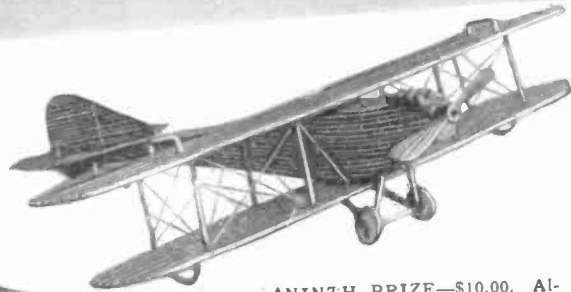

**FIFTH PRIZE—\$25.00** is given to Frank Schmulowitz of New York City for his construction resembling a candlestick and wire for an electric lamp. The match construction is eleven inches high.

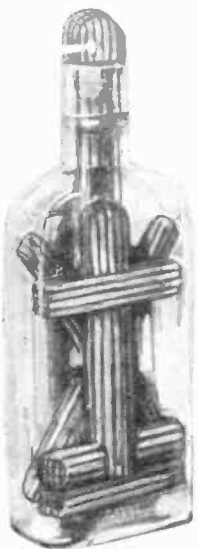

**SIXTEENTH PRIZE — \$10.00** was won by John Shields, of Midland, Md., for the two wooden matchcraft models of emblems built in glass bottles. In neither of the models can the stoppers be removed nor can the emblems be taken out.

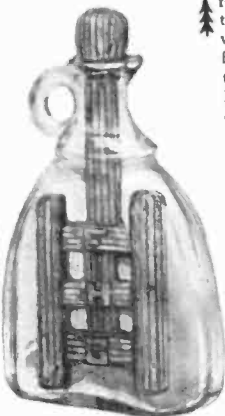

A different emblem placed in a different style of bottle.

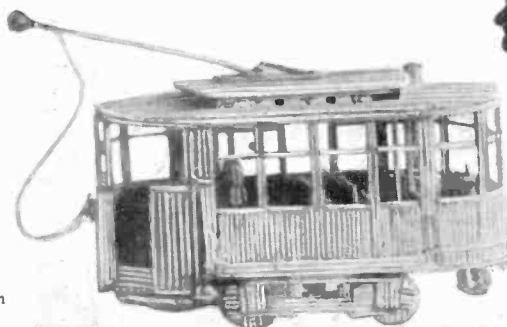

**TENTH PRIZE—\$10.00** is issued to Howard F. Wandrei of St. Paul, Minn., who built the trolley car illustrated at the left. This is one of those pay as you enter types and when one of the doors is pulled open, its companion automatically opens. Although only six inches long, the model is provided with a coin box, controls and a stove.





## Dust Control In Mines

THE great danger of explosion in mines is due in large part to the presence of coal dust in the atmosphere. The latest method of detecting the presence of a dangerous amount of explosive dust in mine shafts uses very simple apparatus familiar to radio fans. A highly charged condenser is inserted into the air outlet from each mine shaft, and the presence or absence of coal dust in the outgoing air changes the dielectric between the condenser plates. When the concentration of particles becomes dangerously high the condenser is discharged, causing the relay to operate and the alarm bell to ring. Under ordinary working conditions the amount of coal dust suspended in the atmosphere may be determined by the frequency with which the condenser discharges and the bell rings. If the operator on duty at the control board finds that too much dust is present, he simply increases the amount of incoming air by adjusting the intake fans. The fans are so arranged that in the case of emergency they may be reversed with equal effect to increase the amount of air introduced into the shafts. The hook-up inserted at right shows how ordinary radio apparatus may be used to reproduce the experiment. Figs. 1 to 6 illustrate the gradual collection of dust particles in the dielectric space which causes the condenser to discharge.

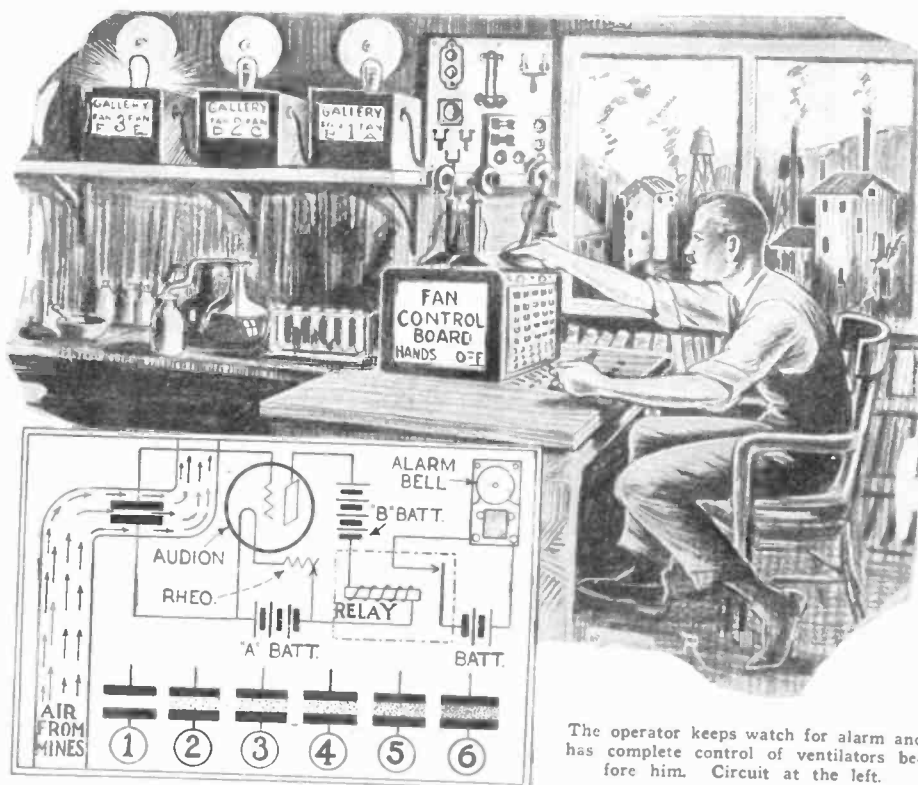

The operator keeps watch for alarm and has complete control of ventilators before him. Circuit at the left.

## World's Smallest Phonograph



The young lady at the right is showing you how to change a record on the new baby phonograph. The complete mechanism folds up into the unit shown above.



## How to Open an Umbrella

TRY hooking the handle of the umbrella under your knee, as shown in the illustration at the right, if your arms are full of packages when it begins to rain. This idea was conceived and sent to us by William A. Leifeld of Pottsville, Pa., who evidently learned from experience.



A SWISS manufacturer has recently placed on the market what is called the smallest phonograph in the world. It has a diameter of  $4\frac{1}{4}$  inches and is  $1\frac{3}{4}$  inches high. It works surprisingly well, and is very convenient to carry about as may be seen in the photo at the left.

## Self-Fitting Sealing Caps

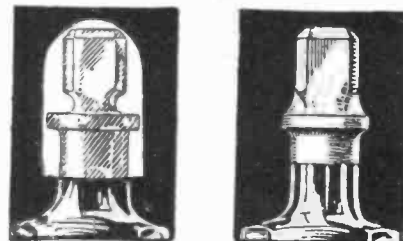

This transparent bottle cap shapes itself by shrinkage and hermetically seals the bottle. It is slipped over the stopper as at left and in about four hours it conforms itself to the contour of the bottle.

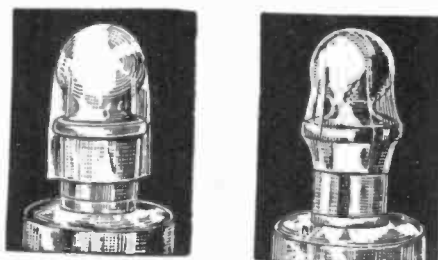

This shows how the seal may be applied to a round-stoppered bottle.

# Science Snapshots



Dancers and orchestra leaders should welcome the innovation shown in the photo at the left. This machine controls the tempo of the orchestra and indicates the speed at which the music is being played. The two dials seen on the front of the cabinet are indicators. The left dial shows the number of beats per minute so that the orchestra will not exceed the normal pace, while the dial on the right is connected to a pendulum which beats the time.

A remarkable piece of apparatus which brings science one step nearer to solving the secrets of the weather has been developed by Dr. Charles G. Abbot of the Smithsonian Institute. The "sun gun" shown at the right is an instrument which measures the amount of heat given off by the sun. He has found that this amount varies from day to day, and greater accuracy in long range weather forecasting is now anticipated.

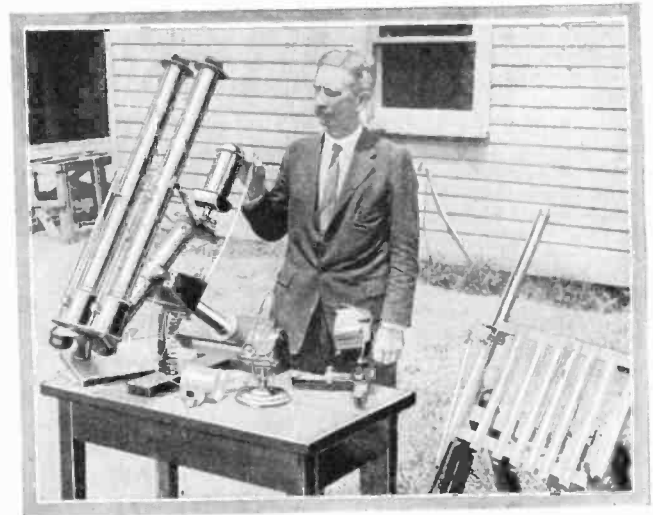

Below is shown a typewriter which may be converted into a machine for writing Braille characters by throwing a lever. The carriage is arranged in the same fashion as on the standard typewriter and manuscripts in the usual kind of type may be written without changing the machine.

The unusual looking typewriter at the right is designed to write the characters of the alphabet used by the blind. This system of writing, called the Braille system, employs a series of dots raised from the surface of the paper in different combinations to represent the various letters of the alphabet. The dots are punched by the six large keys, the seventh being a spacer key.

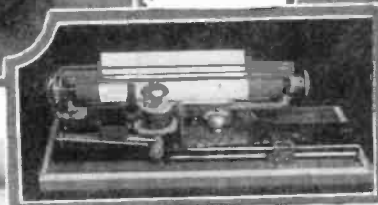
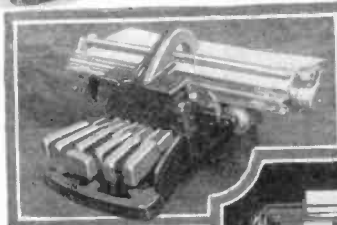

Dr. Richard C. Cabot, noted Boston physician recently announced the perfection of a method of recording heart-sounds permanently upon a phonographic record. As a result of 18 years of constant experimentation by Dr. Cabot, it is now possible for physicians to study abnormal conditions with the aid of a phonograph.

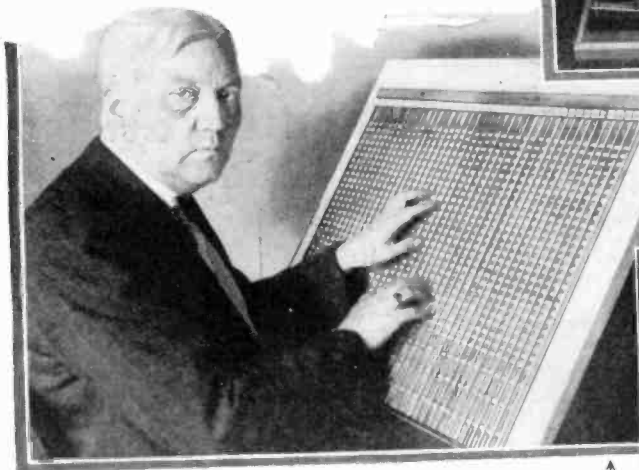

A seminar of medical experts and scientists recently convened at the Massachusetts General Hospital to witness tests and demonstration of Dr. Cabot's new recorder. The heart sounds are electrically amplified and engraved upon the phonographic disc record, after which they may be "played" on any the phonograph. The apparatus may also be used to record the action of the lungs.

A WASHINGTON attorney is the inventor of a new typewriter which he believes will revolutionize typewriting and do away with stenographers and typists. Above is shown the inventor at a dummy keyboard of the invention, which is the result of twenty-five years of continuous experimentation. The machine has a keyboard which contains forty alphabets and the total number of keys is 1,160, placed as may be seen above. This typewriter is the invention of a former court reporter, and he claims that in tests he has attained the speed of 283 words a minute without error. The instrument is so constructed that the typist need not watch the keyboard as the keys are spaced in a similar manner to those on our standard typewriter keyboard. This apparatus could find its field of usefulness in typing from dictation where high speed and accuracy are essential.



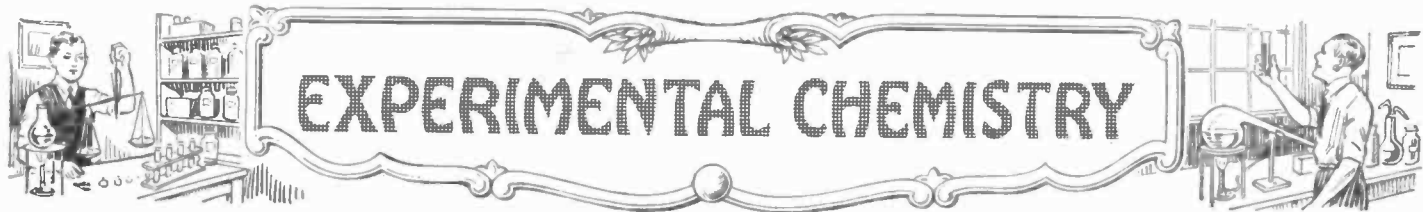

# The Testing of Wood and Grain Alcohols

By DR. E. BADE

**I**T is not at all difficult to distinguish between wood and grain alcohol or to detect the presence of wood alcohol in grain alcohol by a chemical reaction. Wood alcohol, as its name signifies, is de-

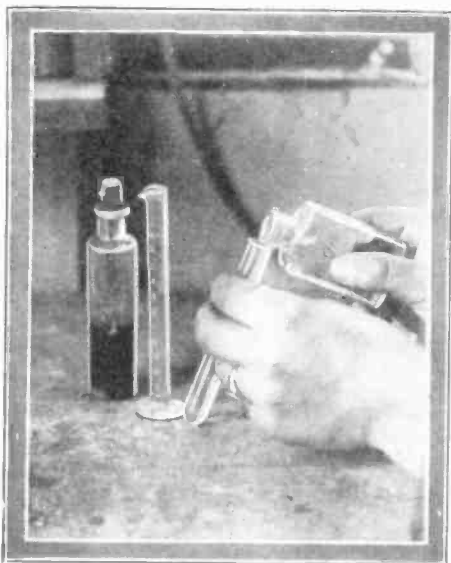

To 10 cc of alcohol add 10 drops of sodium nitroprusside solution in water. To this mixture add 2 cc of 10% sodium hydroxide solution as a test for acetone.

rived from wood, while grain alcohol is usually and most commonly, although not always, derived from the fermentation of the starch in grain or potatoes with the aid of malt. But this ethyl or grain alcohol may also be prepared from wood. In this process non-resinous wood, or wood from which the

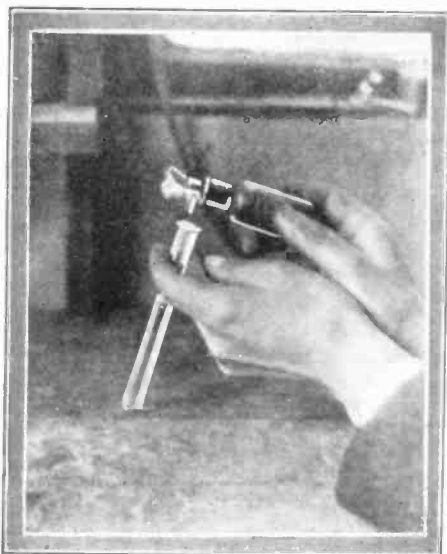

Add methyl orange to alcohol in test for acid.

resin has been extracted, is cut into small fragments and placed in a digester. A small amount of sulphuric acid is added and steam is permitted to enter. By careful regulation of the strength of the acid and the tem-

perature, the wood or cellulose combines with the water by means of the acid present and producing a simple sugar.

The substances in the digester are now treated with water which dissolves the acid and the sugar. After filtration the acid is neutralized with lime, and the sugar is changed to grain alcohol by fermentation.

Some of the impurities found in methyl alcohol are aldehyde, dimethyl acetate, acetone, higher ketones and chloroform. As a rule, especially for chemical work, the wood alcohol should be free from acetone. In order to test the alcohol, a color reaction is used, which will give a reaction for acetone, aldehyde and acetic acid. When 1% of acetone is present the color will be yellow-orange when a solution of sodium nitroferrocyanide (nitroprusside) is added. If acetic acid is present, a pale tint of red is developed which, after twenty minutes will



25 cc of the solution under test is distilled in a small flask in order to obtain a few drops of the solution.

fade in intensity. A freshly prepared solution of sodium nitroferrocyanide added to the wood alcohol and the liquid made alkaline by the addition of caustic soda, will develop a ruby red color if acetone is present. The intensity of color varies with the amount and nature of the impurities.

The same reaction is also applicable to ethyl alcohol, for determining definitely the presence of acetone in either alcohol. To 10 cc. of the liquid to be tested add 10 drops of a freshly prepared sodium nitroferrocyanide solution in water. Mix and add 2 cc. of a 10% solution of sodium hydroxide. The orange red tint developed when acetone is present fades to a clear yellow in about a half hour. In the meanwhile another test tube is used and the reaction just mentioned is repeated. But here, after the caustic soda has been added, the solution is made acid with acetic acid whereupon a purplish red color is produced when acetone is present. The color, within a half hour, will gradually change to a deeper blue.

The presence of acid or alkali is detected with the aid of phenolphthalein, litmus, or methyl orange, litmus being least sensitive.

The presence of wood alcohol in grain alcohol is most readily detected by a color



Dilute the alcoholic distillate with 5 cc of water, keep test tube cold, and plunge a spiral of red hot copper wire into the tube.

reaction. As little as 0.1% of wood alcohol in the ethyl alcohol may be detected. First take about 25 cc. of the suspected solution, place in a small flask and distill about 10 drops. This may be done without the aid of a condenser by inserting the goose neck

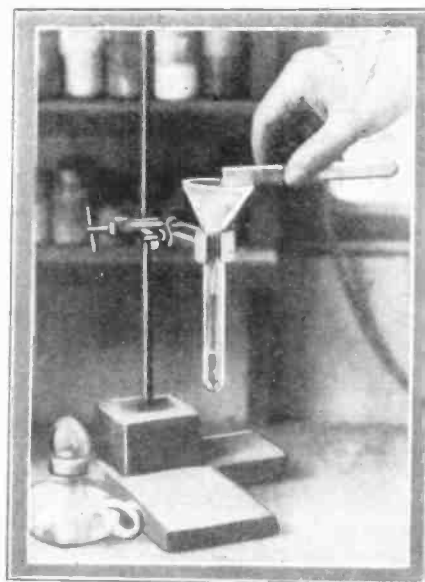

Filter after dipping the copper spiral.

as deeply as possible into a test tube which is surrounded by a slightly larger test tube containing cold water. Dilute the distillate with about 5 cc. of water and replace the water in the larger tube with fresh cold

water. Insert the small tube into the cold water and heat a small spiral of copper wire to red heat over a flame and quickly quench the metal in the alcohol solution which has been distilled off. Do this about five or six times and then filter the now oxidized solu-

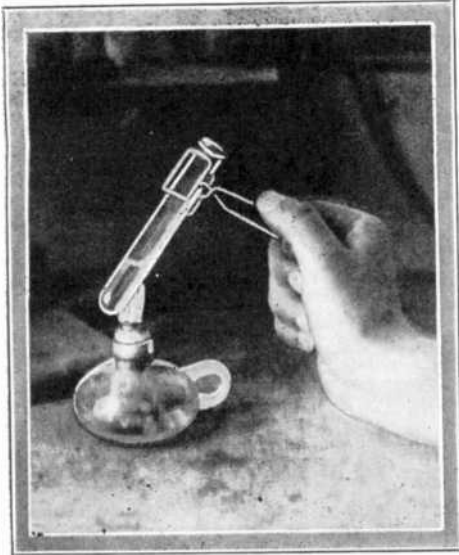

Boil the solution after the wire has been withdrawn.

tion. Boil for about one minute. Cool the solution and add 2 drops of a 0.5% resorcinol solution in water. Mix and carefully add two or three cc. of concentrated sulphuric acid in such a way that the acid runs to the bottom of the solution without mixing. Let the tube stand about three minutes. If no rose-colored ring has developed, less than 2% of wood alcohol is present, and if the ring develops within ten or fifteen minutes about 0.1% of wood alcohol is present. A yellowish brown ring, which may develop, is due to acetaldehyde produced by the oxidation of the ethyl alcohol and which may

not have been completely driven off by boiling. The ring must be rose red in color to show the presence of wood alcohol. In this case the wood alcohol is oxidized to formaldehyde.

The presence of aldehydes can usually be detected with the aid of a few drops of silver nitrate solution. After the liquid has been exposed to the light for 24 hours, the silver will be reduced to a black powder if aldehydes or other reducing agents were present.

Pyridine, which has been partially rectified, or bone oil, which contains a large amount of pyridine, is frequently used as a denaturant and its presence may be detected by the abundant crystal formation which is developed when 10 cc. of the alcohol is treated with 5 cc. of a 5% solution of anhy-

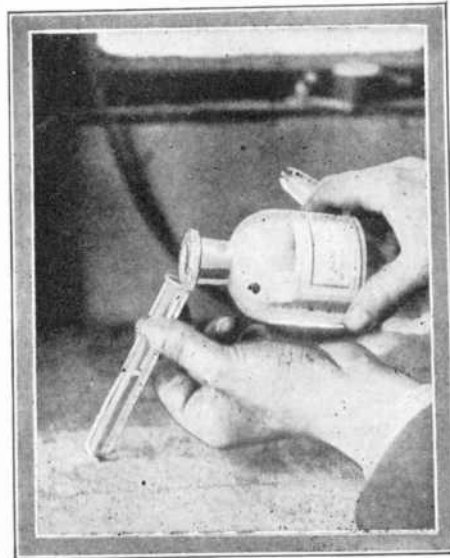

Add a dilute solution of the resorcinol and then concentrated sulphuric acid, poured down the side of the test tube so as to sink to the bottom.

drous cadmium chloride solution. The needle-like crystals are produced within 10 minutes when pyridine is present.

Amyl alcohol, otherwise known as fusel oil, can be detected in quantities as low as 0.05% when care is exercised during the

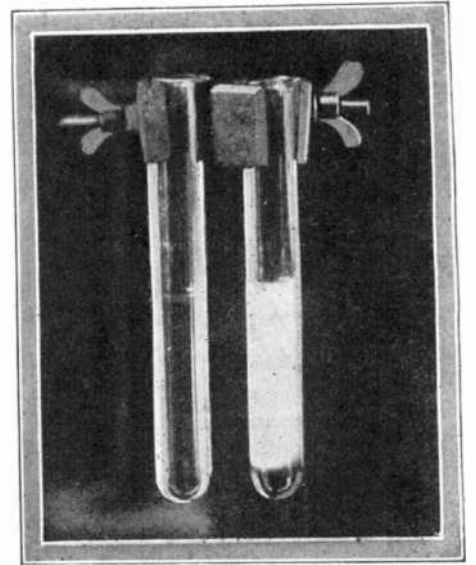

When wood alcohol is present in ethyl alcohol then a rose red ring is developed as well as rose colored flocks. The tube on the left shows the results obtained when no wood alcohol is present, and the tube on the right shows the presence of large quantities of wood alcohol.

operation of analysis. Five cc. of the alcohol are taken and diluted with 6 cc. of water. To this mixture 15 to 20 cc. of chloroform is added. The whole is thoroughly shaken up and the chloroform is then removed by decantation or by means of a separatory funnel. The chloroform in which the amyl alcohol is dissolved by this treatment, is evaporated in a watch crystal on a water bath and the fusel oil is left behind.

## Methods of Testing Milk

By JOE SILL

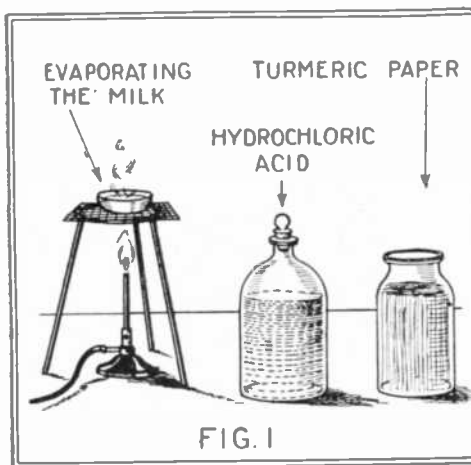

Fig. 1. Turmeric paper which is turned brownish-red by alkalis, curiously enough is turned almost the same color by an acid solution of boric acid.

### BORIC ACID

Evaporate a quantity of milk to dryness and incinerate the residue. Hydrochloric acid and water are then added and a strip of turmeric paper is immersed in the solution. The paper is then dried at 100° C. on a watch glass. If the turmeric paper is colored reddish brown, boracic acid is present. (See Fig. 1).

### SODIUM BI-CARBONATE

Evaporate and incinerate another quantity

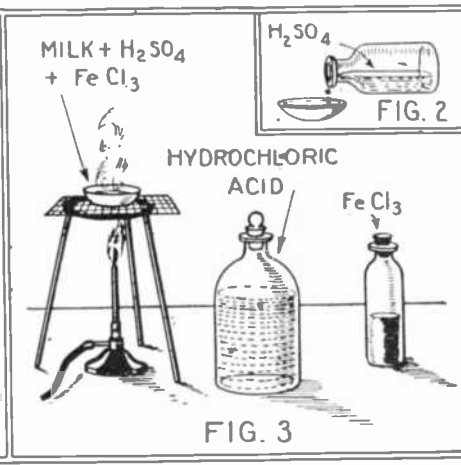

Fig. 2. Milk is evaporated and tested with acid for the presence of a bicarbonate.  
Fig. 3. Formaline in the presence of ferric chloride in acid solution gives a violet color.

### FORMALIN

Formalin is by far the most dangerous of the preservatives as it attacks the system especially of children.

The milk (about 50 cc.) is boiled with a solution of concentrated hydrochloric acid

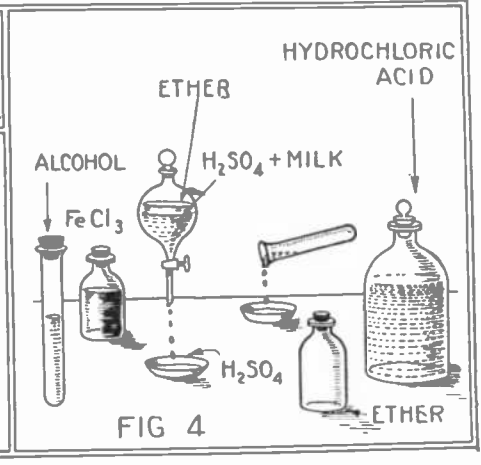

Fig. 4. Solid salicylic acid gives a similar color. The milk is treated with alcohol and ferric chloride solution after being evaporated to dryness and shaken up with ether.

### SALICYLIC ACID

20 cc. of milk are acidulated with sulphuric acid and shaken with ether; the ether solution is evaporated to dryness, and the residue is treated with alcohol and a little iron chloride solution, a deep violet color will be given by salicylic acid. (See Fig. 4).

and a trace of iron chloride when the milk will turn a violet color if formalin is present. (See Fig. 3).



# A Motor-Generator Battery Charger

By WILLIS L. JONES

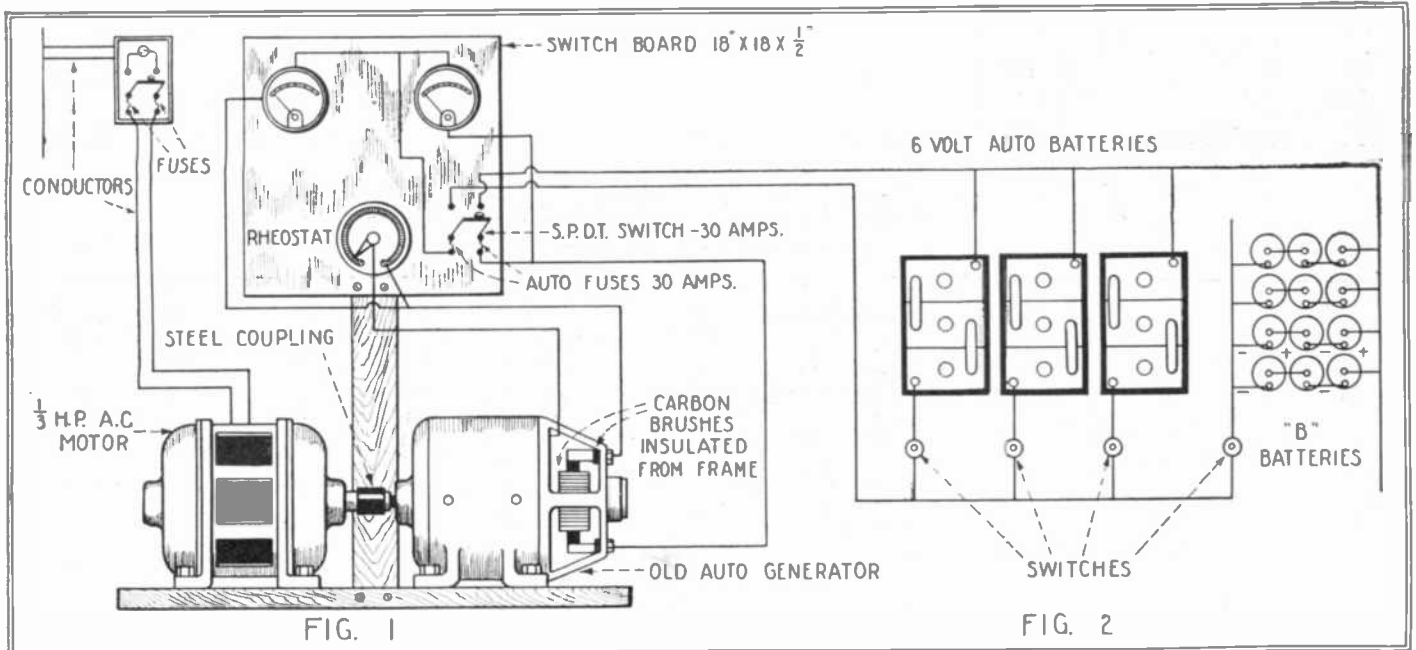

The mounting arrangement and panel construction of the motor-generator battery charger is shown above. A 1/3 horse-power alternating current

motor is coupled to a salvaged automobile generator. With this arrangement several six-volt batteries may be charged at the same time.

**T**HERE is nothing like a battery charger using a D.C. generator. No contact points to wear out; no expensive bulbs to burn out. Just a snap of a switch and this charger that I am about to describe, will hum away developing from 200 to 240 watts.

The generator used for this outfit was purchased from an "automobile graveyard"; every city of any size has one. Any kind of generator will do, but I find from past experiences of making several such apparatus, that the old style Delcos are more reliable, and will develop 30 amperes without overheating. That is provided it is in fair condition and not wet or oil-soaked from lying in or near water or oil. Before purchasing it, with one cell of dry battery or a regular 6-volt storage battery, test for shorts in the armature and field coils.

Connect one pole of the battery to the end of one field coil and touch the wire from the other pole to the generator frame. If there is a spark there is a short in the field coils, and the generator should be discarded, as field coils are very expensive to wire. If there is no spark and a slight magnetism is felt (ascertained by holding nail near field pole besting tested) the fields are O. K.

Next try the armature. Connect one pole of the battery to one segment of the commutator and touch the other pole of the battery to the shaft of the armature. If there is a short it will spark. Whether or not it should be discarded is up to the builder of the outfit, as the armature can be rewound by nearly any motor electrician, the cost being between \$5.00 to \$8.00. The writer found that nearly all of these places or "grave yards" have plenty of used generators and there is no need to take a defective one, because for about \$10.00 an excellent one can be obtained. The writer has

bought about 11 so far and \$10.00 is the highest price he has paid yet, the general prices were in the neighborhood of \$5.00 to \$6.00. Now disconnect the pole from the shaft and leaving the one pole on the segment of the commutator as before proceed to try out each segment to see that there are no loose connections. There should be a spark as each segment is touched; if there is none, then that segment is disconnected from the armature windings and should be resoldered to it. If there are no shorts or

loose connections, and the insulation intact, that is none of the covering off the wires, and if the generator is dry, which is a big factor, as water is a conductor of electricity, it can be called in good condition. The writer takes for granted that the mechanical condition is O. K. If the generator is of the 12-volt type two of the regular 6-volt batteries must be charged in series. The B batteries must be connected 6 cells in series instead of 3.

Fig. 1 on page IX shows the generator

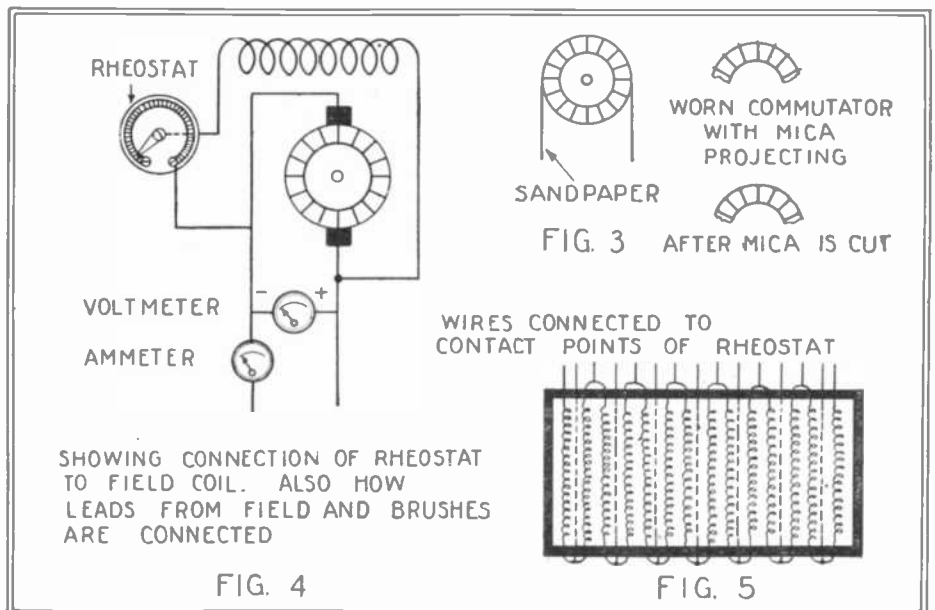

The drawing above shows the connection of the control rheostat to the field coil of the generator. The method of cleaning a worn commutator with sandpaper is also illustrated.

coupled to a 1/2-H.P. 60-Cyc., single phase A.C., 110-volt motor. A piece of iron pipe is reamed out to fit the shafts. Two 1/4-in. holes are drilled through the pipe and the shaft. Wire nails are then driven through and bent.

The base for the outfit is made from heavy wood about 36 inches long 8 inches wide and between 1 1/2 to 2 inches thick.

The switchboard for the generator is 18 inches long 12 inches wide and 1/2 inch thick. It is bolted to the base with 9-inch bolts 1/2 inch in diameter as per diagram. For this switchboard wood may be used as it is inexpensive, and there is no danger from fire, as this is a low voltage affair.

The switch is double-pole, single-throw, with a capacity of 30 amps. or over.

The ammeter and the voltmeter are used ones and costs approximately \$1.00 each. The ammeter registers from 1 to 30 amperes. The voltmeter from 1 to 14 volts.

The fuses are for 30 amperes maximum capacity. They protect the generator from short circuit.

The contact points for the rheostat are made from heavy thumb tacks; the contact lever from a piece of scrap copper. The resistance wire consists of single strands of picture wire. They are made in coils 1/4 inch in diameter and about 8 inches long. There are 3 feet in each coil. Each coil is attached to a small copper wire (see Fig. 8) and they are connected to the contact points of the rheostat. It is then placed in series with the field coils of the generator. (See Fig. 6).

If the commutator of the generator is rough or if the mica is projecting, sand-paper or cut it as shown in the illustrations.

Fig. 2 shows the method used in charging the batteries.

If only one battery is to be charged, and

the operator wants to charge it at a 5- to 10-ampere rate, by moving the handle of the generator rheostat located on the switchboard any desired output may be had. The least resistance in the path of the field coils the more current at the brushes and vice-versa.

While the batteries are charging be sure to remove the vent covers. Also do not spark the batteries or have lighted matches around while they are charging as there is danger of an explosion.

Also the more batteries charged at one time the cheaper. That is by charging about 5 at one time we take advantage of the full power of the prime mover if it be an electric motor.

If the builder does not want to charge more than one or two batteries at one time, then it is best to use a 1/4- or 1/6-H.P. motor.

## A Filter For Near Ultra-Violet Rays

By RAYMOND B. WAILES

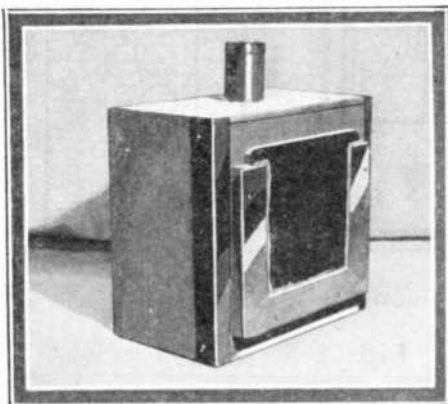

The exterior of the near ultra-violet ray filter box is shown above. It will be seen that the glass slide is tightly fitted into metal grooves which prevent the leakage of any extraneous rays into the box. The opening at the top holds an eye-piece for observation of the contents of the box in action.

MANY experimenters who have derived hours of instruction and amusement in their little shops or laboratories with phosphorescent or luminous substances know that the compounds experimented with become luminous only when exposed to a source of light, and that the fluorescence is very difficult to see because of the luminosity of the source of light. By using a glass which screens out the visible light and allows the near ultra-violet light to pass, one may continue the study of luminous bodies and the effects of ultra-violet light over a wider field than without using such a filter.

The filter described here is made from a

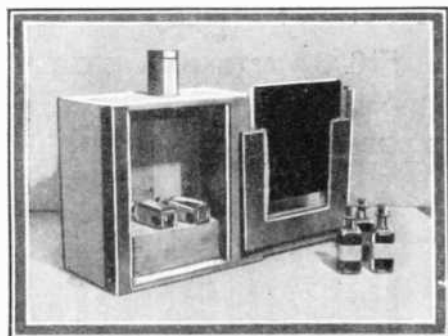

Substances to be tested for phosphorescence or luminescence are placed upon the stage shown just back of the sliding door. The filter box may also be used in experimenting with selenium cells, and to test the ultra-violet content of light from different sources under various conditions.

wooden box about ten inches square and is fitted with a square of glass known as G586AW which costs about two dollars.

This glass is transparent only to the rays of about 363 mu, that is, about the range of the near ultra violet rays. It keeps back all of the visible or "light" rays; so a lamp placed back of it cannot be seen. As the effects of fluorescence and phosphorescence are due in the main to ultra violet rays, this glass serves admirably for many interesting experiments.

The glass as sold is about 6 1/2" square. It should be fitted in a sheet metal holder upon the front of the wooden box, so that the metal overlaps the glass for about an inch, thereby making a light-tight fit. A strip of felt or flannel can be glued to the inside runners, making it doubly sure of being light-tight. As can be seen from the pictures, the lid of the box slides into a metal strip which serves to keep the visible light from the interior of the box. A cardboard carton or tube is fitted into a hole in the top of the box so that the observer may look into the interior in which the different substances are placed, and note the effect produced by the light or source of rays located on the outside of the box. A half inch hole is large enough for this purpose.

One of the most common sources of ultra violet rays is the electric arc lamp. If this be set up in operation in front, and if desired, some distance from the filter glass front of the box, and a solution of a two grain quinine capsule dissolved in a bit of acidulated water (which can be taken from a storage battery) is placed in a small bottle inside of the filter box, an intense blue fluorescence can be seen coming from the solution if viewed from the hole above. On cutting off the arc, the fluorescence ceases. An electric iron can be connected in series with the arc lamp for resistance. Beautiful fluorescences were obtained by the writer with an arc passing 10.8 amperes and having a voltage drop of 27 volts across it.

Other substances can be used instead of quinine salts. Cp.P. sublimed anthracene coated upon a sheet of paper with a mucilage solution will glow when placed in the box and exposed to the radiations coming through the filter glass from an electric arc. A water solution of aesculin or the solutions obtained from the sticky buds from a horse chestnut tree, soaked in water, gives a blue fluorescence. Eosin, erythrosine (aniline red) in water solution give a blue fluorescence. Fluorescein in a dilute caustic solution glows beautifully. Glass or cardboard coated with luminous zinc sulphide without any radium salt admixture also glows.

Holding the hand between the arc and the luminous object will cause a shadow of the

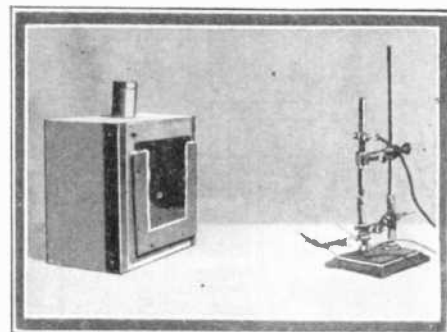

An arc light emits a considerable percentage of ultra-violet rays, hence it may be used in all the experiments spoken of in this article. The photograph above shows the proper position of the arc light relative to the filter box. It is possible to work with greater separation.

hand to be cast upon the luminous body, because the rays do not pass through the hand. If anthracene or phosphorescent zinc sulphide is coated upon a card and inserted in the box at an angle, the entire shadow of the hand can be distinctly seen when viewed through the hole. If the hand be withdrawn, the shadow will gradually fade out, because the substance has a lag in its luminous effect.

The filter box can also be used in experimenting with selenium cells. The cell can be inserted in the box and connected with its battery and indicating instrument and exposed to the ultra-violet rays coming through the glass from the source.

The box can also be used for determining the ultra-violet productive effect of different lamps and sources of light. Soaking the arc carbons in solutions of uranium salts increase the ultra-violet intensity of the arc formed in which they are used.

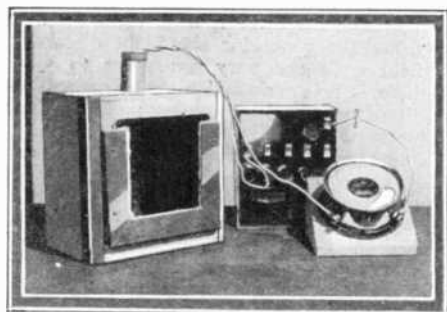

The apparatus may be arranged as shown when it is desired to test photo-electric or selenium cells under the action of ultra-violet rays. It should be carefully ascertained that no light whatever be permitted to leak through the seals into the filter box.



# THE CONSTRUCTOR



## Deaf-Phone and 2-Stage Amplifier

By A. P. PECK

**F**OR the person that is really hard of hearing, the average microphone, battery and sensitive receiver combination that now sold as a *deaf-phone*, is of little if any value. True enough, it is entirely portable and very handy in this respect, but of what value is it if it does not help its user? The writer was recently approached by a doctor who is very hard of hearing and who has extreme difficulty in communicating with his patients. He could hear sounds that were very loud and distinct, but the ordinary deaf-phone such as mentioned above, was of no help to him. He owned one of these combinations, and asked if it would not be possible to improve it in some way so that he could use it. He did not care particularly whether the apparatus was entirely portable, because it would be used at practically all times on his office desk.

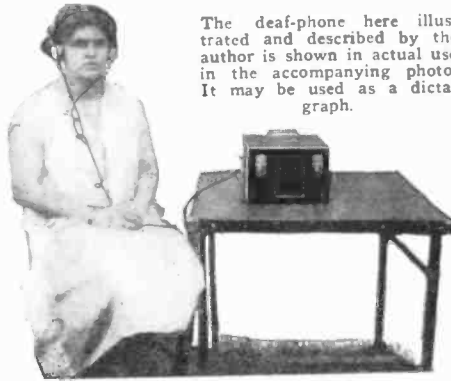

The deaf-phone here illustrated and described by the author is shown in actual use in the accompanying photo. It may be used as a dictagraph.

ratus were so good that we are quite sure that a good many readers of this magazine will be interested in the construction of the apparatus for their own purposes. The fin-

deafness, and its construction is so simple that even a man who is only slightly handy with tools should have no trouble in constructing it.

The doctor gave the writer his portable so-called *deaf-phone*, and the microphone incorporated in it was used as the pick-up medium in the new instrument. A small cabinet such as is used for portable radio sets was obtained, and a hole was cut in the front to accommodate the pick-up unit, and was so constructed that the microphone could be slipped into place and would be held there firmly. Back of this compartment an ordinary two-stage audio-frequency amplifier was laid out and wired up. The complete circuit diagram used is shown in Fig. 1. As will be seen, the "A" battery which supplies the filament circuit for the tubes is also in the microphone circuit and supplies the current for it.

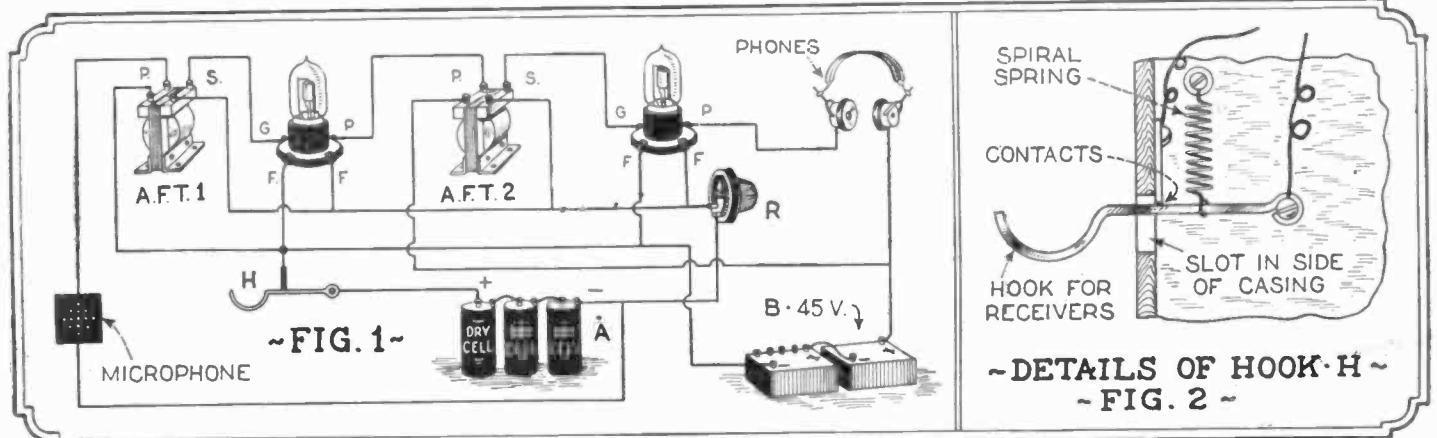

The simple form of amplifier circuit in which two dry-cell type tubes are employed, together with a microphone of the best quality obtainable. The filament circuit is opened by the hook switch "H".

The writer, therefore, set about designing such an instrument, using a principle that is well known to radio users—that of audio-frequency amplification by means of vacuum tubes. The results from the finished appa-

ished instrument is small and compact, and while it can hardly be carried around for use at all times, still it serves its own purpose very well. Such an instrument would be of great value to all afflicted with partial

A rather unique circuit breaker was used in this outfit, and was wired up as shown, so as to open both the filament circuit and the microphone circuit. It consists merely  
(Continued on page 559)

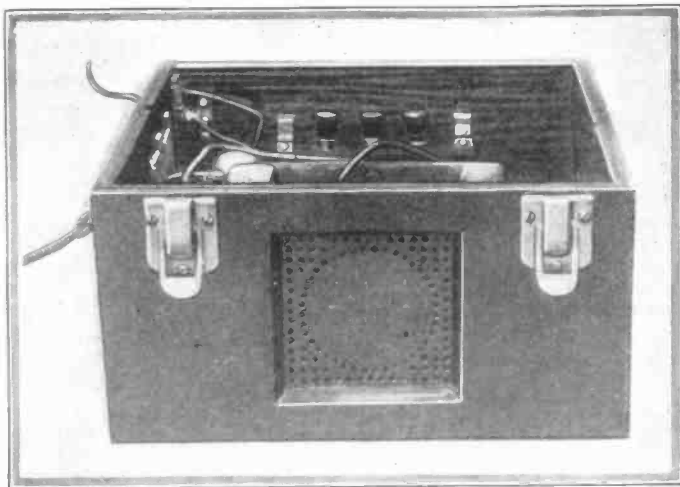

Front view of deaf-phone cabinet showing terminal posts and arrangement of microphone behind perforated grill. The weight is not excessive.

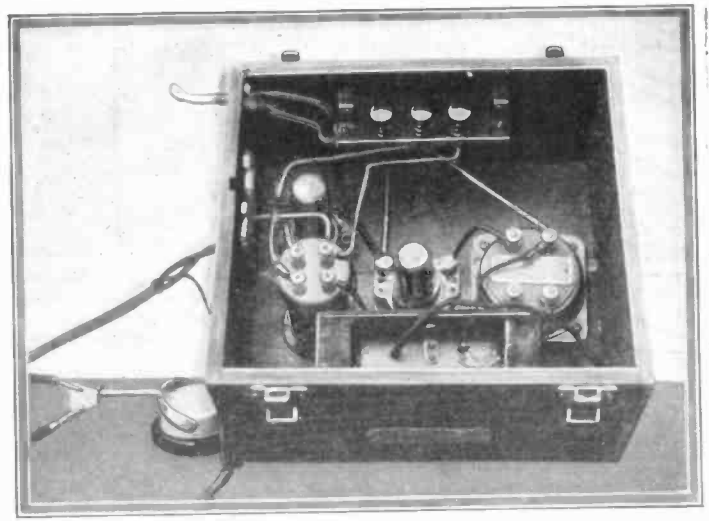

Top view of deaf-phone cabinet with lid removed. This view shows vacuum tubes as well as two audio frequency amplifying transformers.

# Simple High Temperature Furnaces

By WILLIAM CAPUNE

SAD to say, the fascinating realm of high temperature work has been closed, for the most part, to the average experimenter, and needlessly. There is a certain romance in fusing solid metals in a little furnace and bringing forth a substance so hard that files make no appreciable im-

pression on it, or a metal that melts when dropped into a cup of hot water! To be sure, a few hardy fellows have tried the electric arc for the production of high heat, but nearly all lighting circuits are designed for a much smaller load than the steady running of an arc requires; even with heavy resistances in the circuit the household lights dim very noticeably when the electrodes of the arc are brought together, recovering only a part of their former strength when the initial load has passed.

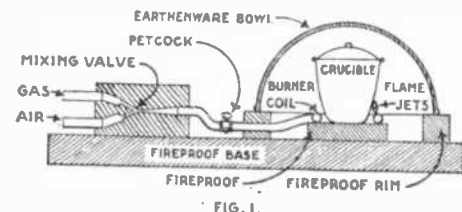

FIG. 1. A high temperature laboratory furnace burning a mixture of gas and air.

But there are other ways of producing high temperatures in the laboratory and in this article three of these, using flames, will be described. All the apparatus has been simplified to such things as are readily obtainable by anyone. The three hottest fuels that can be practically used in the small laboratory without exceptional cost, are illuminating gas, acetylene, and alcohol. In all the furnaces described, air under slight pressure is burned with the combustible gas. You are probably familiar with the use of illuminating gas in Bunsen burners, but a higher temperature, and one more suitable to convenient work, can be secured by the use of the little furnace shown in section in Fig. 1. The temperature attainable is over 3,300 degrees Fahrenheit.

The base can be of asbestos, brick, fireclay, or anything else unburnable. The central block is of the same material. The roof of the furnace is an ordinary earthenware mixing bowl, supported by a small rim. The rim may be of the same material as the base. Clay has the advantage in this case

the best, being relatively inexpensive and easily worked. Rubber tubing may be used wherever it is not exposed to heat. In the first furnace the base is made large enough to hold the inverted bowl without crowding and have enough room at one side for a "mixing valve," where illuminating gas is mixed with the air. The purpose of the

that it may be readily drilled for the passage of the gas tube. In all the places where a fire-resistant material is needed the writer has found that a mixture of ordinary Portland cement and fine sand, about one part of cement to six or seven of sand, makes an excellent job, and can be cast, holes and all, in shellacked cardboard molds to exactly the desired shape. Many of the patented "water putties" on the market are also good; the kind that set permanently when once dry. Soft, red building brick is an excellent material and may be worked with cold chisels and files with very little labor. For tubing, copper or brass is

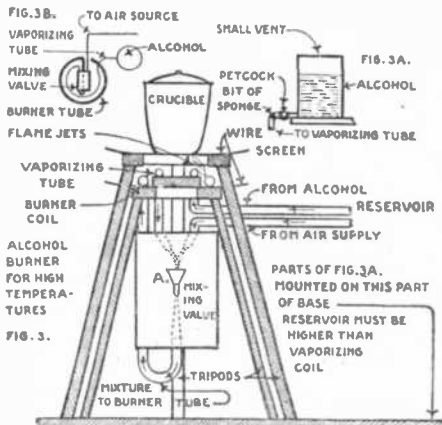

Here are the details of an alcohol furnace of special construction. The alcohol reservoir is illustrated at 3A and the vernier at 3B.

bowl is to reflect the heat down upon the central block on which the crucible is placed. Supported on the edge of this central block is a circle of metal tubing pierced at intervals with holes not much more than a 32nd of an inch in diameter. The size and number of

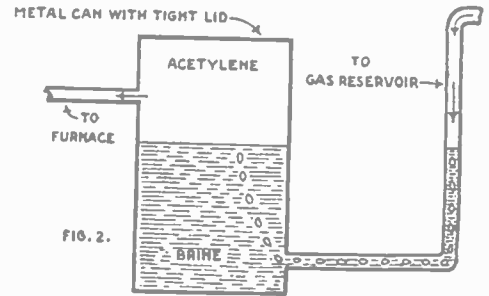

FIG. 2. A hydraulic valve for preventing accidents when using acetylene gas is simply made as above.

these holes depends, of course, on how big a source of gas you have and how great a pressure there is in the air line. The higher the air and gas pressures the larger the holes may be, and the greater will be the resulting furnace heat be. These holes should be drilled so that the jets from them will all point upward and toward the center of the dome of the bowl. One end of the tube is closed up. A stopcock may be inserted in the mixture-pipe on the furnace base as in Fig. 1.

The rim which supports the bowl has been mentioned. It should have a hole on the side of the base where your mixing valve will be placed and the end of the tubing should pass through this hole.

The mixing valve, despite its technical-sounding name, is not a complicated piece of apparatus. It is shown in section in Fig. 1. There are no particular dimensions necessary. It is made of wood well soaked in shellac or varnish to close the pores, and then dried. The passages which appear in cross-section in this view are in reality drilled holes. The area of the holes for the entrance of the gas and air should be smaller than the exit holes for the mixture, in the ratio of about 1 to 1.5. The gas and air holes are drilled until they nearly meet as shown, and then the smaller holes are drilled to the meeting point. The larger part of the mixture exit is drilled in for about 3/8 of an inch to take the end of the turn of tubing that is used for the burner. A small hole is then drilled to meet the junction of the other

(Continued on page 552)

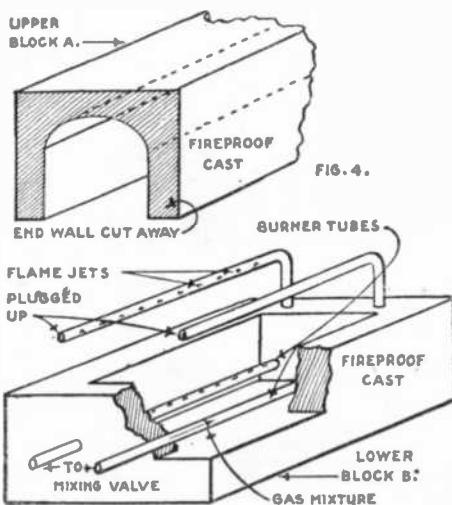

ACETYLENE FURNACE

A simply constructed furnace for burning acetylene gas and generating high temperature.

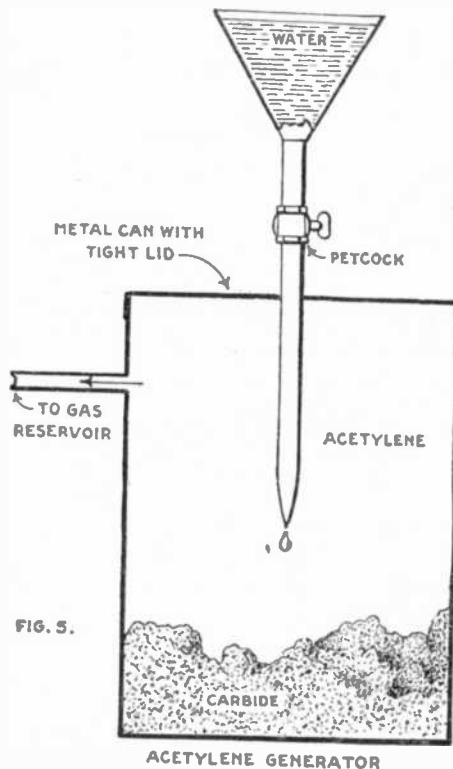

An acetylene gas generator is quite easy to make. The petcock controls the flow of water and hence the generation of gas.

the best, being relatively inexpensive and easily worked. Rubber tubing may be used wherever it is not exposed to heat.

In the first furnace the base is made large enough to hold the inverted bowl without crowding and have enough room at one side for a "mixing valve," where illuminating gas is mixed with the air. The purpose of the

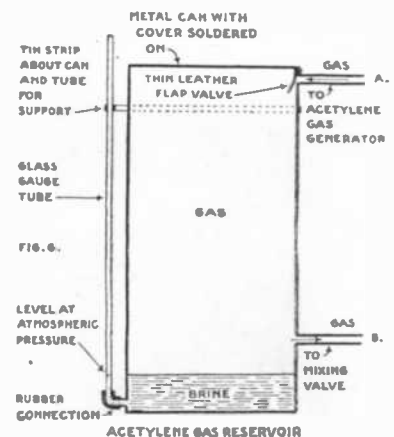

It is usually desirable to have a gas reservoir when employing acetylene for a laboratory furnace. Such a reservoir is simple in construction. All of the details are illustrated above and described in the text.





# HOW TO MAKE IT

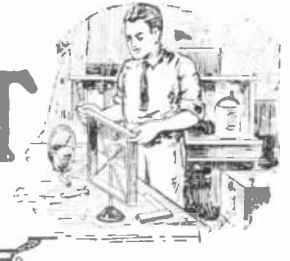

## Portraits Made On Leaves A Novelty



The two unusual portraits above were etched on a specially cured leaf by means of needles. The work is quite tedious but gives a very unusual effect. This work was done by a Waltham, Mass., artist, whose work on leaves is soon to be exhibited throughout the country.



Above we have a likeness of President Coolidge etched on a leaf by means of a needle, as shown in the picture. The leaves are specially cured and treated and the originator of this new novelty in the art world is able to obtain half-tone effects as well as line.



In this picture of an elk etched on a specially cured leaf, note the pretty background effects obtained by the artist, simply with the aid of needles. The leaves are not fragile and the color permanent.—H. H. Gallagher.

### Old Pistons

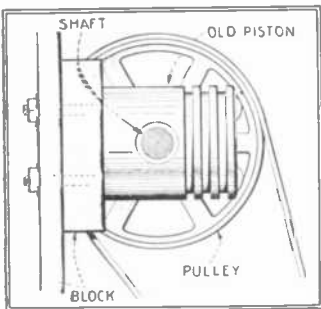

Old automobile engine pistons do not seem to have any particular use. They make good bearings for light line shafts however.—Harold Jackson

### Battery Handle

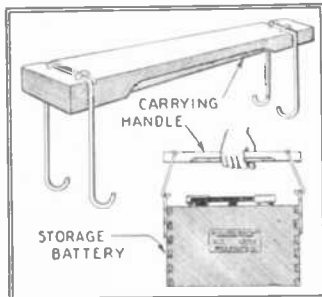

One frequently needs a good handle for carrying storage batteries with. Here is a very simple one made from a single piece of wood and two wire hooks.—Harold Jackson.

### Sky Rocket

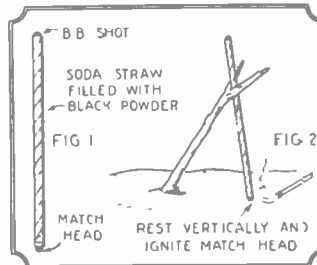

Home-made sky rockets in the larger sizes are not the easiest things in the world to make perhaps, but here is a simple idea which anyone can try out with but little trouble or expense. This sky rocket is made from a soda straw.—D. R. Brown.

### Parachute

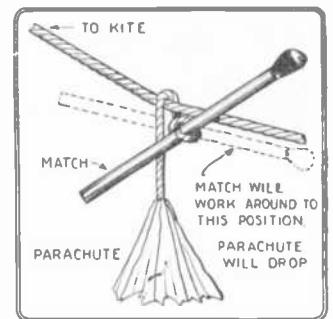

How parachute is arranged so as to be released a few minutes after the kite goes up. The sketch is self-explanatory.—Paul Good.

## Our Eyes Ever Deceive Us

Hold the picture of the bee and the flower with the black center line close to the nose. Watch closely and soon you will see the bee cross over to sip honey from the flower.



Things are not always what they seem and our eyes sometimes fool us. Take the case of the picture at the right showing a hat and a face. Hold this picture close to the nose; directly the hat will take its place over the top of the face.



Mr. S. Leonard Bastin, one of our English contributors, has sent us this interesting article on optical illusions.



Hold the picture of I and S at the left close to the eyes so that the center upright line just touches the nose. Suddenly you will see the familiar dollar sign take form.

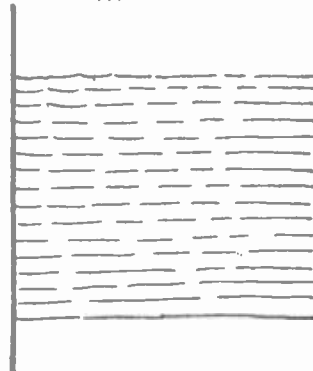

One of the best illusion pictures herewith and which the editors have experimented with themselves, is that shown at the left. Hold this picture close to the nose and suddenly you will see the fish take his place in the water. The distance between nose and sketch varies.



# WRINKLES

## RECIPES & FORMULAS



Edited by S. Gernsback

### CHEWING GUM WRINKLE

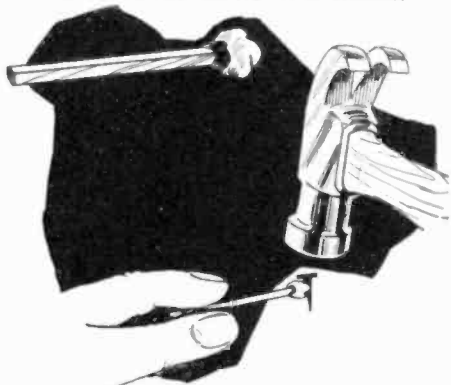

The builder-enthusiast who is forever hammering his fingers out of shape through trying to hold tiny screws or nails and hammer them at the same time, will find this device very handy. A piece of well worn chewing gum is stuck on the end of a match and the tack is imbedded in its surface as seen above. This kink should save many trips to the family medicine chest.

—William Wernick, Rep. No. 24,165.

### EAR PROTECTORS

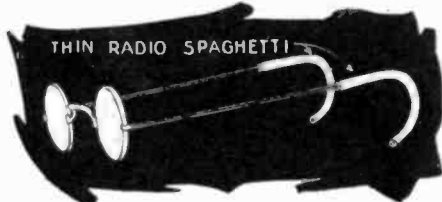

Short lengths of small radio spaghetti tubing when slipped over the ends of spectacle bows serve to protect the ears of the wearer from the cutting action of the metal bows. Such a device can add immensely to the comfort of the wearer without detracting in the least from his appearance.

—William A. Goldberg, Rep. No. 516.

### SOLDERING IRON STAND

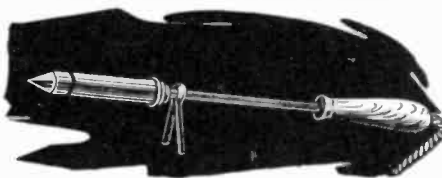

A large copper split rivet slightly spread out and adjusted as shown above near the point of an electric soldering iron will prevent the iron from injuring the table surface upon which it rests. Very little heat is conducted from the heating unit to the table-top due to the small area of the rivet.

### IMPROVED BUTTONS



Serviceable metal buttons which are handy for various uses may be easily made from upholsterer's nails. A pair of round-nosed pliers is employed to bend the shanks into the form of eyes. These buttons are similar to the type used on army uniforms.

—Harry E. Hudec, Rep. No. 23,475.

### ICE TONGS

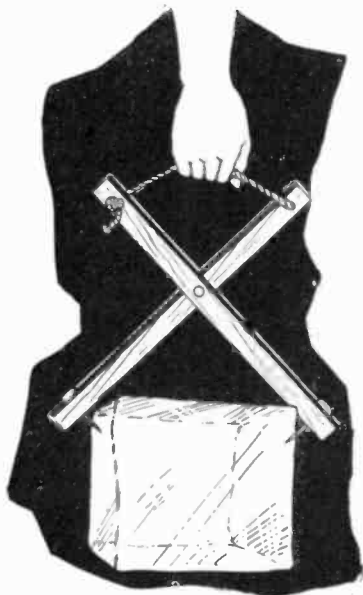

A serviceable ice carrier can be easily made by utilizing two pieces of wood, three large nails, and a section of rope as shown above. The claws exert a gripping action on the block of ice when tension is applied to the rope handle. In this case the amount of gripping power is proportional to the weight of the chunk of ice.

—Juan Estolas, Rep. No. 12,825.

### REMOVING GLASS STOPPERS

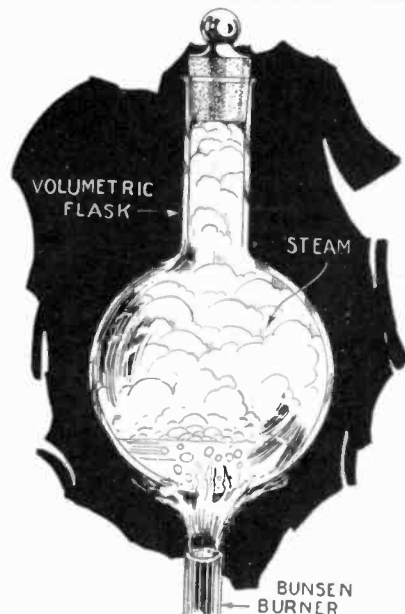

One of our contributors sends in this suggestion as to a method for removing ground glass stoppers from volumetric flasks. If a flask is gently heated the steam produced by the moisture in the flask or by any residual liquid will in most cases readily remove the stopper. By way of comment, we will add that it is also very likely to remove the experimenter unless he is very careful not to generate too high a pressure of steam. If he does, the flask will burst before the stopper comes out.

### MAKING SMALL DRILL

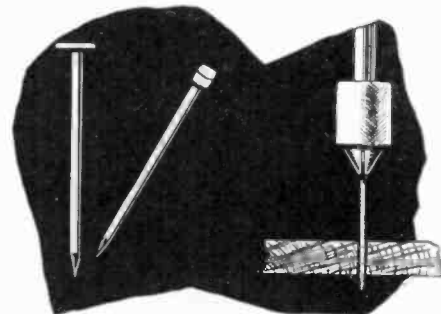

An ordinary wire nail can be used where a small drill is required for use in a standard brace. The head of the nail is beaten square so that it may be gripped by the jaws of the brace. Such a drill is a handy tool to have around for drilling switch-point holes.

—Ivy M. Howard, Rep. No. 19,697.

### ALARM CLOCK STOP

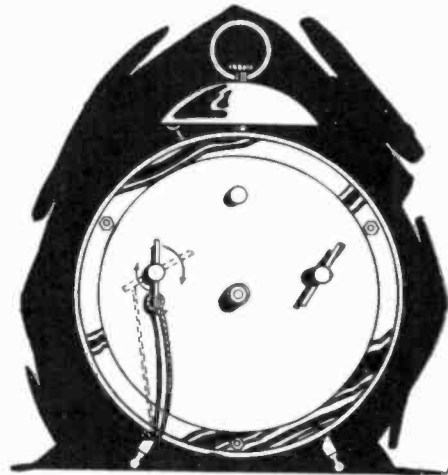

If you are a light sleeper and do not care to wake the entire household and immediate neighbors when it is time for you to run for the office, a string attached to one end of the alarm-wind key and anchored to one leg of the clock will prevent it from ringing any longer than needed. The length of the reveille is governed by the amount of slack permitted in the string.

—Wilson G. Walters, Rep. No. 6385.

### LETTERING PEN

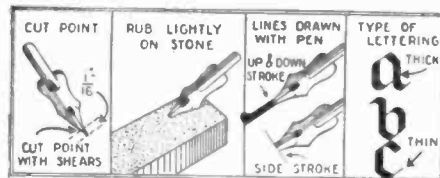

This was written with pen described above.

An ordinary banker's pen point may be operated upon with a pair of shears so as to produce a very serviceable lettering pen. One-sixteenth inch of the point is removed and the new point sharpened by rubbing lightly upon a stone. The method of employment is illustrated in the above specimen of lettering.

—Frank Schmulowitz.



# RADIO

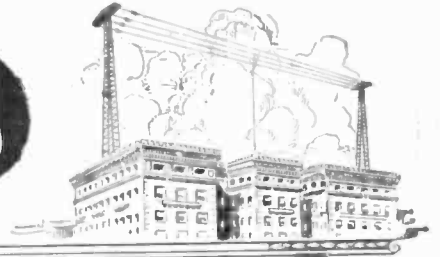

## Fonck's Plane Radio Equipped



Lieut. A. P. Snody, Dr. M. Lionel Stein and Capt. Rene Fonck are shown examining the radio equipment recently forwarded from France for use on the transatlantic flight. At left is the wind-driven generator, in the center the four tube receiver and at the right the 150-watt transmitter. Capt. Fonck is holding the reel upon which the antenna is wound.

Charles Clavier, who came all the way from France to install the equipment on the Fonck plane, is shown testing the 150-watt transmitter. Constant communication with land will be maintained by radio and it will be used to obtain bearings and to hold to the outlined course of the flight. In case of accident, the radio may prevent the chances of tragedy.



### Radio Aids Farmer

NO one connected with the proposed flight from New York to Paris, which is scheduled for September 1, has made the mistake of underestimating the importance of radio in the undertaking. The entire equipment was made in France; it is somewhat elaborate, but compact and efficient. The receiver is standard, but the transmitter is of particular interest. Three 50-watt tubes are used and the wavelength may be changed by inserting small telephone plugs into jacks to vary the inductance, covering a range of 300 to 2000 meters. Although short waves are more efficient, the metal of airplanes absorbs most of the radiated energy at high frequencies.

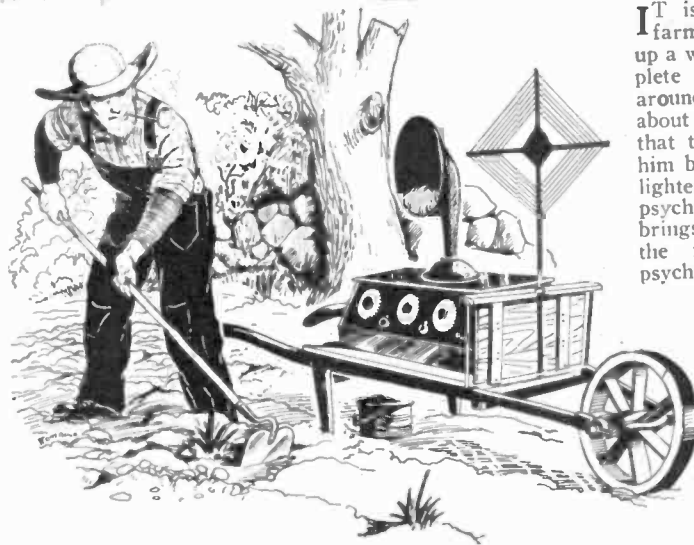

IT is reported that a truck farmer in New Jersey fitted up a wheel barrow with a complete radio set and carted it around with him as he went about his daily tasks. He found that the programs brought to him by the radio did much to lighten his toil through their psychological effect. This brings to mind the story of the farmer who tried the psychic effect of music on his cows. He put a phonograph in the barn at milking time to soothe the bovine spirit. One day the hired man put on a blues record by mistake and the day's production turned out to be buttermilk. A "hot" record was put on next and they wore out the floor Charles-toning.



The builder of this super-set is shown above comparing one of his first pre-war loose couplers with the latest thing out.

One of the more ambitious radio enthusiasts has built up the six control set illustrated in the two photos below. The set is so arranged that from one to six controls may be used at a time.

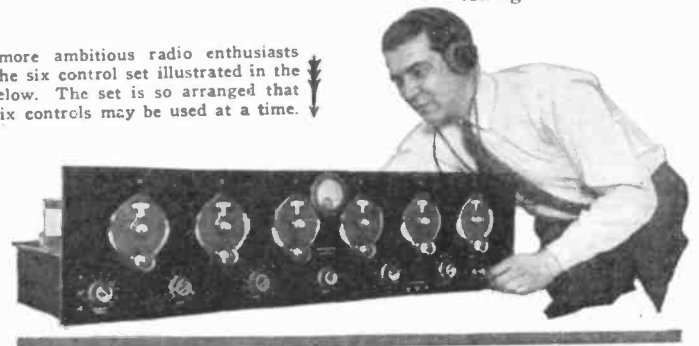

Front view of the set shown above will give an idea of the numerous controls which make this tuned radio frequency set a novelty.

# Likes and Dislikes of the Radio Audience

By CHARLES D. ISAACSON, Program Director,



**Florence Lesh**  
One of WRNY's most charming songsters and frequent visitor.



**Dick Hughes**  
Who, with his "uke," are regulars on WRNY programs.



**Sara Bair**  
A lovely and melodious interpreter of song from WRNY



**Harold Dart**  
A brilliant pianist presented at WRNY by John Adam Hugo.



**Percy Hemus**  
Great American baritone—an Edison Hour guest of WRNY



**Madeline Hunt**  
Star of the Radio Theatre Players who entertain you through WRNY



**The SS. "Majestic" Scamps**  
Who provided a most enjoyable number when they went on the air recently over WRNY.

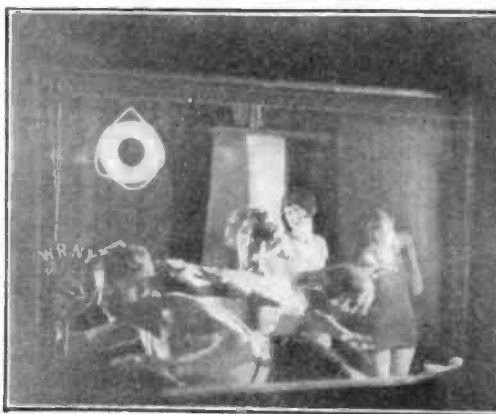

**ON THE BEACH AT WRNY**  
Starlight Park bathers, with Comtesse Du Barry, in a frolic.



**MacDowell Sisters**  
Who hail from Texas, often heard in soothing, soft Hawaiian music at WRNY.

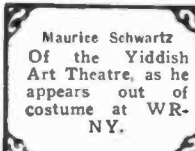

**Maurice Schwartz**  
Of the Yiddish Art Theatre, as he appears out of costume at WRNY.



**Helen Halprin**  
A most attractive pianiste, who graces WRNY programs.



**Dr. Sigmund Spaeth**  
has returned with his artists to WRNY.



**Xavier Cugat**  
Violinist - artist, sketches himself for WRNY fans.

**T**HE other day a most eccentric gentleman insisted that he be given the privileges of WRNY's microphone, and assured me that there would be a great deal of money in it for me, if I would let him speak just once. He would not tell me the character of the speech, because once it was told the secret was out. He did not mistrust me, but that was the situation. Further he could not write it—once he had been nearly killed for writing something.

Of course you will at once realize that the gentleman was suffering from a very definite mental aberration. But what he said was nevertheless interesting and useful. The way I was to receive the money was this: his first speech would announce the program for his further talks. Then I would be besieged by important people who would say to me "I will pay you so much for him to be allowed to speak," and others would come with "I will pay you so much if you will prevent him from making those speeches," and the side who offered me the most would win—there would be millions in it for me.

(Continued on page 538)

**Commander Edward Ellsberg**  
Who told over WRNY about the raising of the S-51, is shown with Diver Nelson.



**THE FIRST RADIO PRIZE FIGHT**  
Jimmie Rappaport and Bennie Martin in an event staged by Starlight Park at WRNY.

# Below 100 Meters

## What the U. S. Army and Amateurs Are Doing on the Higher Frequencies

THE latest organization to be formed for the purpose of promoting the art of radio communication is that known as the Army-Amateur Radio Net. This is being promoted by an affiliation of the U. S. Army Signal Corps and the American Radio Relay League. The purpose is to conduct experimental and research work on the short waves, the Army having recognized the excellent work being accomplished by the amateurs using these wave-lengths. Army control stations have

been situated in each Signal Corps area and assignments are being given to amateurs for co-operation with these stations. It is expected that much interesting data will be unearthed by this method. At the time of writing, amateurs throughout the country have expressed their desire to have their aid enlisted in this good work and already, things seem to be getting into shape for a most interesting period of radio work.

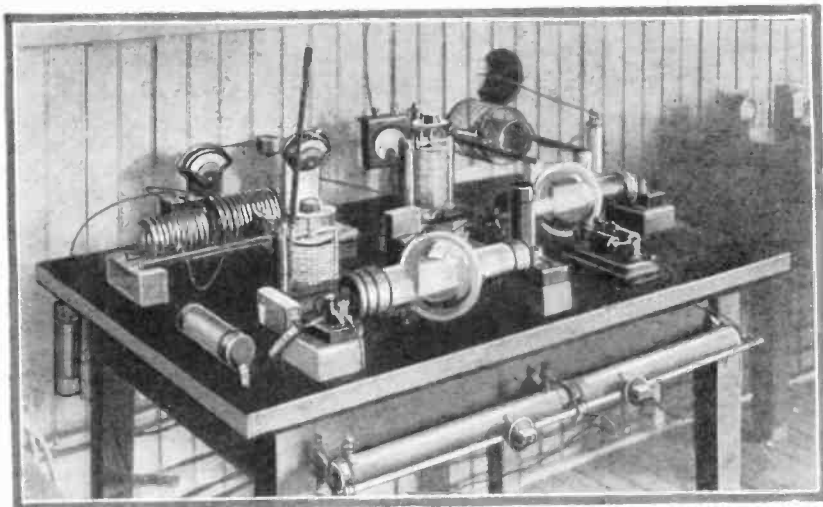

Short-wave station 2CXL is one of the foremost in the Army-Amateur Radio Net and the photograph directly above shows the master oscillator type of transmitter used at that station. This set has sent out signals that have been heard in practically all parts of the world. Its design is excellent. Note the accessibility of all parts as well as the neatness of wiring. The instruments are all arranged so that the shortest possible leads can be employed and the efficiency thus increased.

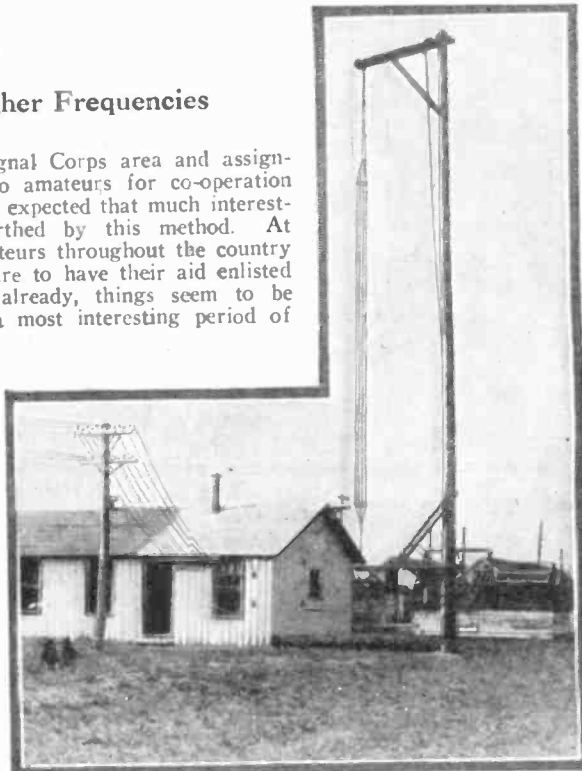

Above: The 65-foot mast at station 2CXL, the Army-Amateur control station of the second Signal Corps area at Fort Monmouth, N. J. A vertical antenna, one of the most efficient types possible to use for short-wave transmission is employed for operation on 40 meters. As can be seen, it consists of a multi-wire cage suspended directly above the operating room and so arranged that the lead-in will be short and direct. It would be well for transmitting amateurs interested in the higher frequencies to employ this type of aerial.

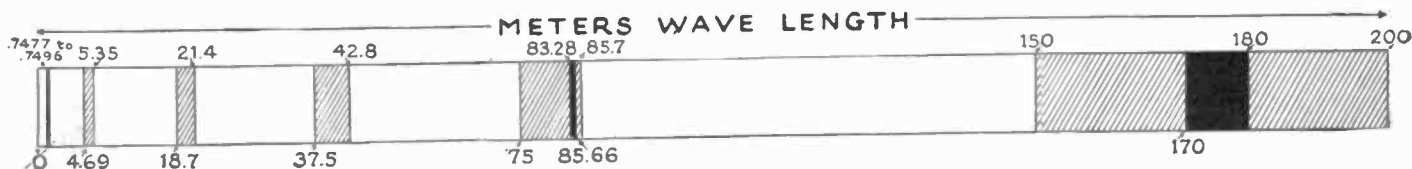

As shown in the chart, reproduced above, the amateurs of the United States are assigned to certain bands of wave-lengths ranging from .7477 to 200 meters. In our chart, the shaded portions indicate those bands devoted to code transmission. The solid black sections indicate spaces for radiophone work. Note the new small section of

wave-lengths in the so-called 80-meter ham-band that is now available for phone communication. This band has but recently been assigned and if we are to keep it for our permanent use, we must keep within its limits. Straying over the edge in order to avoid QRM must be avoided. Try this new phone band—it is great stuff.

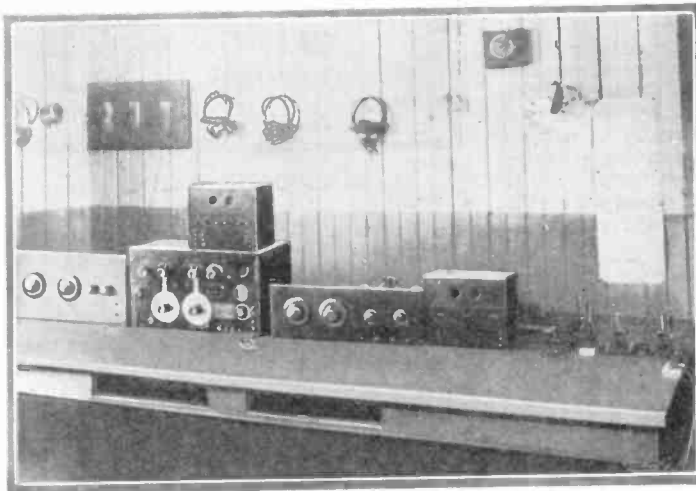

At 2CXL, of the Army-Amateur Radio Net, one of the neatest controlling layouts in existence is to be found. In the above illustration, the various receiving sets, amplifiers, control switches and keys are shown. Three standard table types of receivers are noticeable toward the left-hand end of the table.

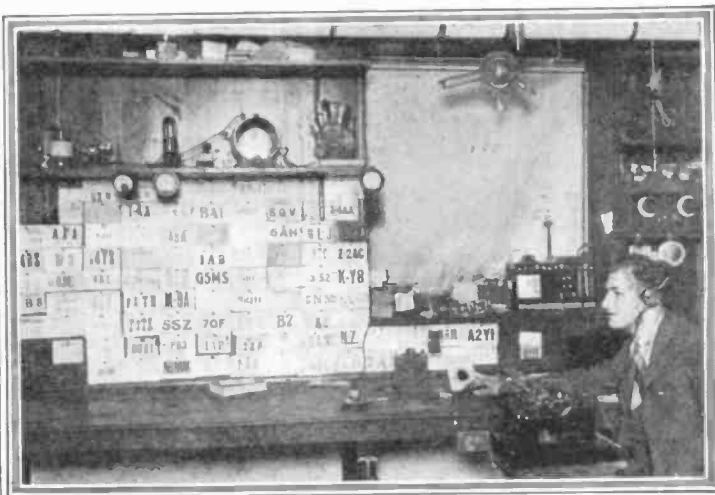

Above is an illustration of a typical amateur radio station. The transmitter is placed along the shelf shown to the left of the picture and directly below it are QSL or report cards from all parts of the world. This photo shows station 2APV with its operator and owner, Jack Berliant. Station 2APV has been heard in 27 countries.

# The Radio Fan's Own Page

Short-cuts And Kinks Make Experimenting Easier

By HERBERT E. HAYDEN

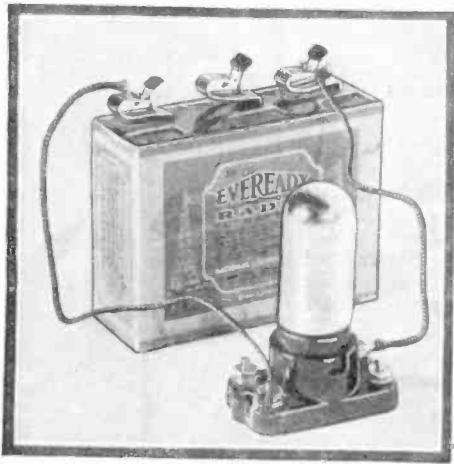

## TUBE REJUVENATION

It often happens, particularly with the "199" type of tubes, that the filament voltage is advanced to a point where the tube paralyzes and refuses to continue operation. When this has been done, it is often possible to save the tube for further use by rejuvenating the filament. This can be accomplished by means of the standard type of manufactured rejuvenator or very often by means of the little stunt shown above. Here the filament of the tube is connected directly across a 3- or 4½-volt "C" battery and allowed to burn for a period of 15 minutes to three-quarters of an hour without any plate voltage being applied.

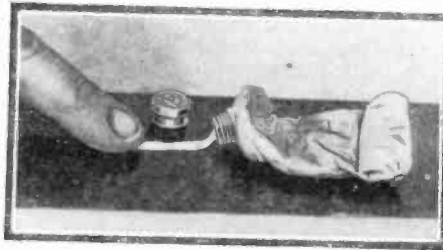

## ENGRAVING FILLER

After engraving a scale or symbol on a panel, the grooves can be filled with ordinary toothpaste as shown above, giving a very unusual and pleasing effect. Be sure that the scratches are completely filled and then remove the surplus paste with a soft, damp cloth.

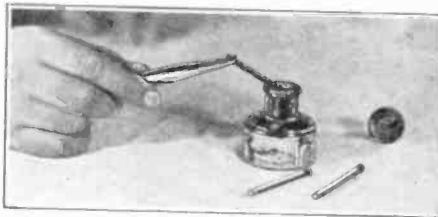

## GRID LEAKS

Experimental grid leaks or other resistances for various purposes can be made by dipping matchsticks or toothpicks into India ink, allowing them to soak for a few moments and then removing. To change the resistance, split the wood into various sized sections. Provide suitable mountings or connections.

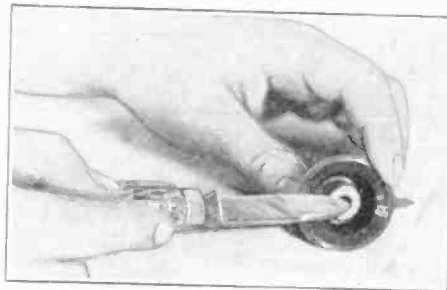

## BUSHING TIP

The bushings that are set into knobs or dials often come to the ultimate consumer with a small burr around the hole that prevents the indicator from being pushed upon a shaft. This burr can readily be removed by means of the point of a knife applied gently as shown in the photograph reproduced above. Insert the point and twist carefully until the burr is removed.

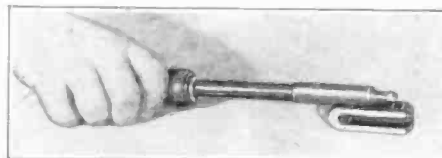

## SOLDERING IRON REST

Did you ever scorch the surface of the dining room table by carelessly laying the hot soldering iron thereon? If you have, you know the disastrous results. Protect the table and in fact any other surface by keeping a small porcelain insulator of the type shown above at hand and placing the iron in one of the grooves when it is not in use.

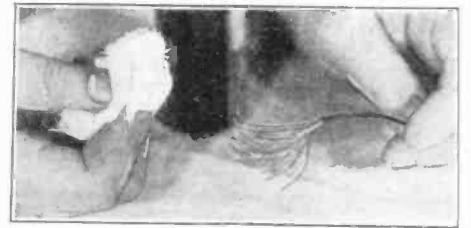

## CLEANING LITZ

Litzendraht wire or "Litz" as it is more frequently called, consists of a bundle of fine wire; each single wire is insulated from its neighbors by a coating of enamel. This enamel is exceptionally hard to remove from the small wires and disastrous results are frequently noted if it is attempted to remove this insulation by scraping. However, you need not worry any more about breaking the various strands and so rendering the wire less strong mechanically if you follow the system illustrated above. Saturate a piece of cloth with wood alcohol and after the external cable covering has been removed from the Litz, wipe the wires with this cloth and the enamel will come off.

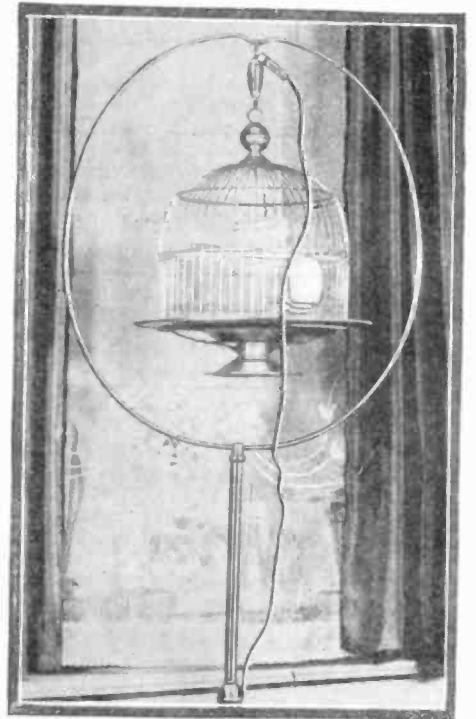

## BIRD CAGE AERIAL

We have all heard of various kinds of freak aerials. Bed springs, window screens, and even dishpans have been pressed into service at various times to act as collective agencies for radio waves. Here is a new one. Fasten a clip to the end of a piece of flexible wire long enough to reach from your bird's domicile to the antenna binding post of your radio receiving set. Fasten the clip to any metallic part of the bird cage and presto—you have an aerial. This idea should suggest many other makeshift and freak aerials to the ingenious radio fan readers.

According to the nature and ways of the bird you may figure on various interesting results in the line of static. A parrot of energetic loquacity will enable you to dispense with a loud-speaker, while a canary will give solo performances rivalling real broadcast singing (sometimes).—EDITOR.

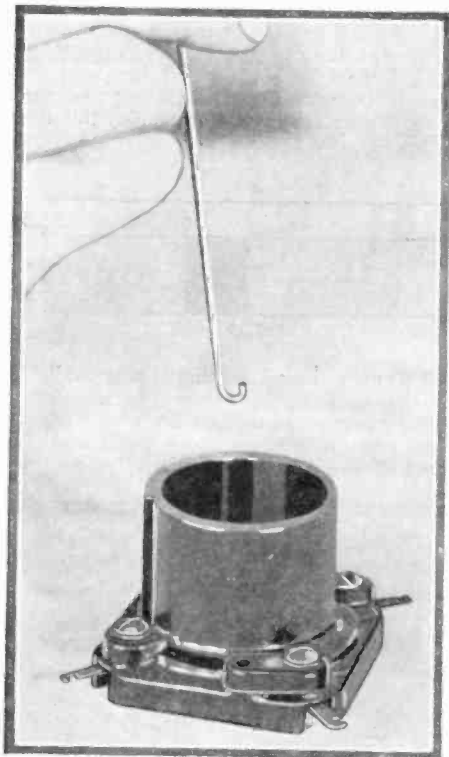

## IMPROVING SOCKET CONTACTS

After a vacuum tube socket has been in use for a considerable period of time, the contact springs get bent out of shape and no longer make satisfactory contact with the prongs of the tube. It is inconvenient and difficult to reach into the socket with the fingers and bend the springs upward. Therefore, the little bent wire illustrated above can be used with very good effect. Hook it under the spring and pull gently but firmly upward until the spring has assumed its original shape. It is well to go over all of the sockets of your set periodically with a hook in order to keep the set operating at its greatest efficiency.

# Monogram Receiver

By JOS. LIEBOWITZ

THIS novel radio set, of which a front view is shown at the right, shows a touch of personality in the grill work of the tone chamber. The opening in the panel at the left end of the set was cut in the shape of the letter "P", the initial of the owner, by careful use of a fret-saw. The circuit used is the standard regenerative, with an aperiodic primary, tickler plate circuit, and tuned secondary.

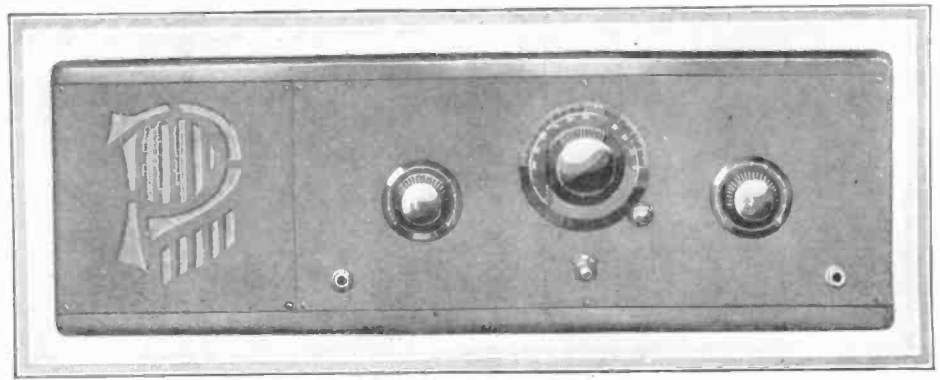

Above is seen the panel arrangement of the monogram radio. The jacks control the first and second stages of audio frequency, the first knob adjusts the plate coupling, the second controls the secondary variable condenser, and the third, the detector rheostat.

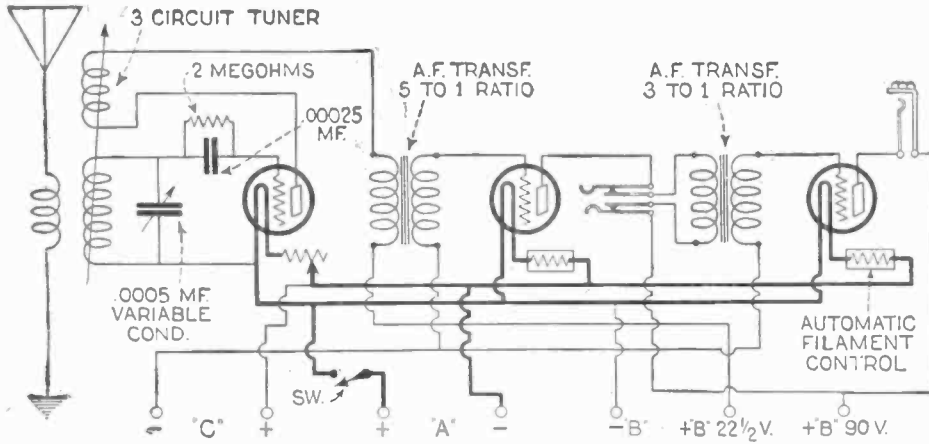

An inspection of the circuit diagram shown above reveals no novelties or trick features. The ever-popular three circuit tuner may be recognized, with condenser-tuned secondary and rotating tickler. Automatic filament control is provided for the amplifier tubes.

## CONSTRUCTION OF TONE CHAMBER

DIMENSIONS WILL DEPEND UPON SIZE OF CABINET.

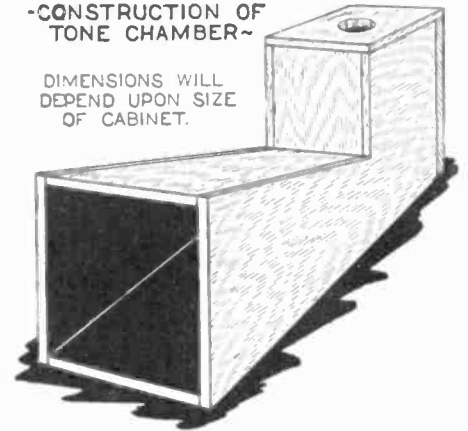

The tone chamber shown above may be constructed of three-ply wood veneer or, in case of necessity, of stiff paper or coardboard.

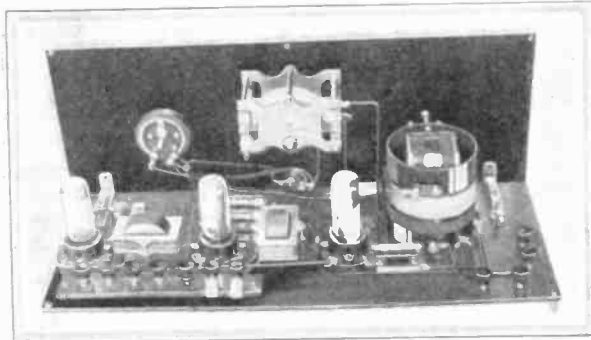

The arrangement of the apparatus may be seen in this photograph. Note that the transformer cores are at right angles. Be careful in wiring the set to keep the leads well apart, as your success in controlling regeneration depends on this.

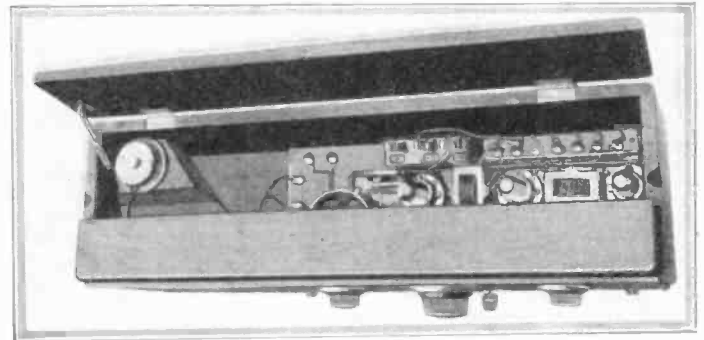

In the upper left of the above photo is seen the loud speaker unit, mounted on top of the tone chamber. The leads to the row of binding posts on the strip at the rear of the cabinet are carried through holes in the back wall, and may be bunched outside the set proper.

## An Automatic Battery Charging Regulator

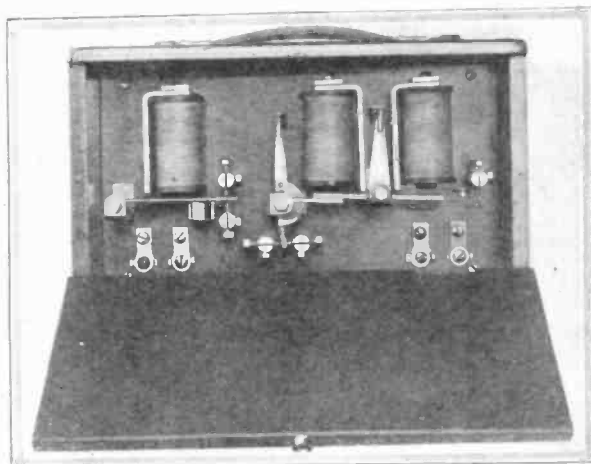

The instrument above, diagram at right, automatically connects and disconnects the "A" battery from charger. A system of relays opens and closes the line-circuit of the charger.

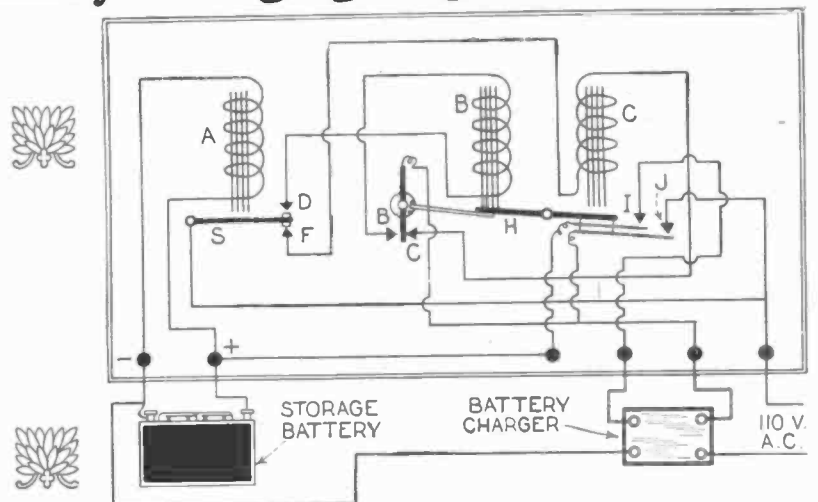

Drop in "A" battery voltage releases armature S, energizing coil C, and trips armature H to make contacts I and J. When voltage rises, S lifts, energizes coil B, trips H to break contacts I and J.

# Variable High Ohm Resistances

By OTTO SCHRIEBER, E.E., Austrian Radio Service

THE amateur who works with the usual resistance sold in stores, will often have had disappointments without being able to ascertain their cause, because, he will in all probability never think

take place by dragging a metal contact on the resistance material, but by touching it and lifting it off again. For even one passage over the resistance body will leave a track, which may change its value by hundreds or thousands of ohms.

thin brass spring is soldered. It is long enough to cover the entire length of the resistance rod, when pressed against it.

The method of operation is as follows: If the spring is pressed against the rod in the

One good method is to take an old resistance unit, remove the wire and replace it by a strip of heavy blotting paper which has been saturated with India ink (Fig. 1). One screw is used to fasten the blotting paper together (Fig. 1b) with a thin strip of brass, copper, or tin, (Fig. 1c) to the hard rubber or porcelain disk. This metal strip must be long enough to surround the entire paper strip, and serves to produce a constant variation in resistance by being pressed against it at various points. The pressure is exerted by a piece of stronger spring metal (Fig. 2)

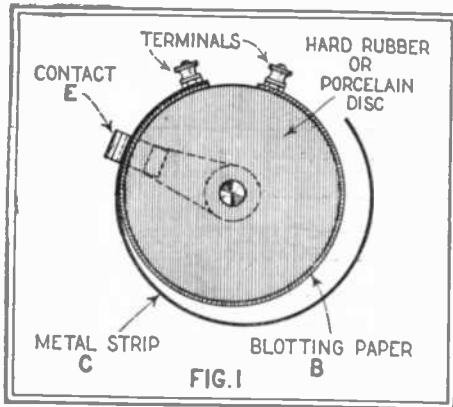

Here we show an end view of a variable high resistance for use in a radio set.

of the resistance as the faulty piece or even if he does think of it, he will hardly ever be able to change it. In any case, with some hook-ups, he will have to build a variable re-

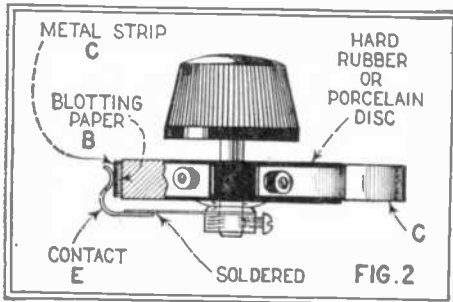

This shows more details of the type of resistance illustrated in Fig. 1 above.

sistance. The following tips will undoubtedly help.

In making a variable resistance it must be remembered that the regulation should not

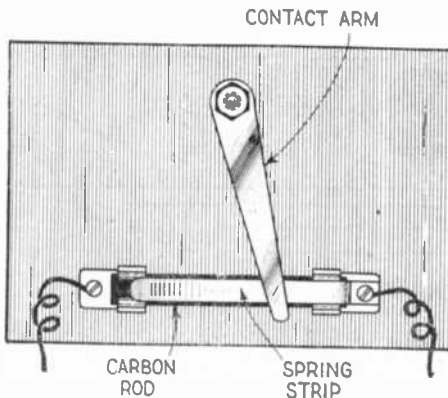
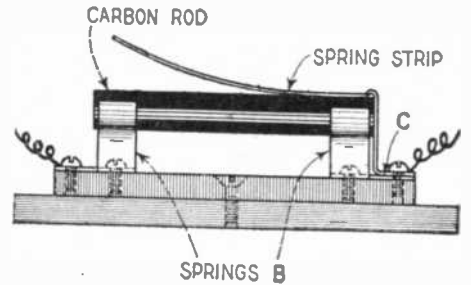

Fig. 3. Another type of variable high resistance uses a carbon rod as the resistor.

which is soldered to the old friction contact of the resistance unit, so that variations can be easily obtained by turning the knob. Connections are made at the two screws.

Fig. 3 shows the use of a high resistance rod such as carbon for a variable resistance. Here an ordinary rod holder is fastened to a hard rubber, bakelite, radion or celeron base, care being taken that the springs, which hold the rod, do not extend beyond its top, and that the latter is free the full length of its surface. At the contact point (C) a



The side view of the carbon rod resistor unit shows more constructional details.

center of the latter, only one half of the resistance is brought into play, as the current will pass from the center by the easiest path through the spring to the contact point, rather than pass through the covered half of the rod.

Figs. 4 and 5 show the mounting of the

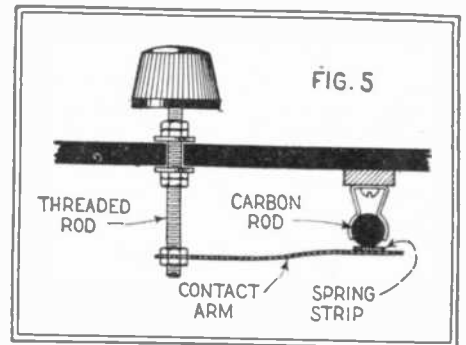

This shows how the control arm for the instrument shown in Fig. 3 is mounted.

contact and its axle. A long screw spindle may be used as shaft if washers and lock nuts are used on each side of the panel.

## Radio Sets for the Traveler

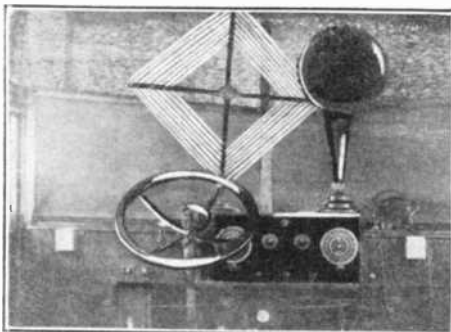

The above photograph shows a Super-Heterodyne type of receiver mounted in a specially designed automobile which the owner uses for camping. The loop folds so that it can be taken down and put away when traveling.

Photo by W. P. Ingersoll, courtesy General Electric Co.

RADIO receiving sets have become so much a part of our daily life that many of us are loathe to leave them behind when we have to travel for either business or pleasure. The photographs at the left and right show what two resourceful radio bugs have done, in order to have their favorite sets with them at all times. One motor camper has mounted his set in the front of his camp car where it is always available for use. A traveling photographer has made up a special carrying case in which he keeps his camera and his set. The set uses dry cell tubes and is self-contained.



Here we see the photographer's combination. The phones are kept in the cover, the camera is in the left-hand end of the case and to the right of it, a complete radio set is built.







# Scientific Humor

## WHY NOT? THE MISSISSIPPI FLOWS UPHILL

A colored preacher was telling his congregation about the children of Israel passing right through the Dead Sea.

"It was very simple you know. Water generally flows down hill, but in this 'ere case things was jes' reversed. The water done turn right around and flow right back up hill, leavin' the bottom of de sea jes' as dry as a cracked lip. Den all de poor children had to do wus jes' walk across."

"But," interrupted a young colored brother, "that would be against the law of gravitation. It couldn't be done."

"You jes' mind you own business suh! Dis what I am talking about was three thousand years ago. That was befo' the law of gravitation done been discovered."—*Oscar LeNormand.*

## ALL PARTS REPLACED



ANGRY MAN : "You told me when I bought a bicycle for my boy that you would replace any broken part."  
SALES MAN : "Absolutely, what does he want?"  
ANGRY MAN : "He wants two biceps muscles, a couple of knee pans, one elbow and two yards of cuticle, and he wants them right away."—*George Herzog, Reporter No. 21670.*

## AIRY RESISTANCE

Bo: "Why do they call her 'Bubbles?'"  
Zo: "'Cause she effervesces with joy when you ask her out but bursts when you touch her!"—*George McLaughlin.*

## WE'LL USE THIS ALSO

A BARBER TO A CUSTOMER: "Do you want a hair cut?"  
CUSTOMER: "No, I want them all cut."—*Douglas Wright.*

## A POCKET SIDE SHOW



*Frank Hillgartner.*

SON: "Papa, give me a nickel to see the sea serpent?"

TIGHTWAD PAPA: "Wasteful boy, here is a magnifying glass; go look at a worm."—

## A SAFETY FACTOR

The high pressure lightning rod salesman concluded his demonstrations with the emphatic statement: "Just think, it will draw lightning thirty feet."

"Pu-pu-putit thirty feet away from the house," said the farmer who stuttered.—*J. E. Johnson.*

## WE GO UP IN THE AIR AT THIS

RUB: "Did you know that flying machines are mentioned in the Bible?"

DUB: "No."

RUB: "Why, Esau sold his heirship to his brother Jacob."—*Clifton Ask.*

## SOME DON'T LAY ANY

PROFESSOR: "Why does a hen lay eggs only in the daytime?"

STUDENT: "Because she is a rooster at night."—*A. Schaefer.*

## First Prize \$3.00 THE LIMITATIONS OF SCIENCE



John was sent to study mathematics, and the teacher told him it was a true science. "For instance," he said, "if it takes one man twelve days to build a house, then twelve men can build it in a day."

John replied: "And if it takes two hundred and eighty-five men to build it in an hour, seventeen thousand two hundred and eighty in a minute, then one million, thirty-six thousand, eight hundred men can put it up in a second. Now I don't believe they could lay a single brick in that time. Again, if one ship can cross the Atlantic in twelve days, twelve ships should be able to cross it in one day. I don't believe that either, so I'm not going to study mathematics," and Johnny left the teacher studying it himself.

—*Henry Neff.*

**W**E receive daily from one to two hundred contributions to this department. Of these only one or two are available. We desire to publish only scientific humor and all contributions should be original if possible. Do not copy jokes from old books or other publications as they have little or no chance here. By scientific humor we mean only such jokes as contain something of a scientific nature. Note our prize winners. Write each joke on a separate sheet and sign your name and address to it. Write only on one side of sheet. We cannot return unaccepted jokes. Please do not enclose return postage.

All jokes published here are paid for at the rate of one dollar each, besides the first prize of three dollars for the best joke submitted each month. In the event that two people send in the same joke so as to tie for the prize, then the sum of three dollars in cash will be paid to each one.

## THE ROCK PILE

1ST GUEST: "These cakes are hard as stone!"

2ND GUEST: "Sure, didn't you hear her say, 'take your pick' when she passed them around?"—*Edward D. Muir.*

## IF WE LIVE LONG ENOUGH IT WILL!

"Oh, doctor, do you think the scar will show?" asked the fair young appendicitis patient.

"Can't say my dear, I'm not setting the styles this year."—*Mr. M. Eisenstadt, Reporter No. 25576.*



## ELECTRICITY A FOOD

PHYSIOLOGY TEACHER: "Johnny name a few important foods."

JOHNNY: "Electricity—"

PHYSIOLOGY TEACHER: "What—electricity a food?"

JOHNNY: "Yes, my physics teacher said it keeps wire alive."—*Jay M. Howard, Reporter No. 19697.*

## HEY—HAY

CITY BRED (pointing to haystack): "What kind of a house is that?"

COUNTRY BRED: "That ain't a house, that's hay."

CITY BRED: "Say! you can't fool me. Hay doesn't grow in a lump like that."—*Lawrence A. Brown, Reporter No. 23853.*

## WE'LL TRY THIS

"I went home quite a bit under the weather last night and my wife didn't suspect a thing."

"Couldn't she smell your breath?"

"That's just it."

I ran the last block home and when I got to her I was all out of breath."—*Lawrence A. Brown, Reporter No. 23583.*



## NO MISTAKE, ONLY A JOKE

ED: "Did Bill get his perpetual motion invention published in *Science and Invention*?"

TED: "Yes, he addressed it to Scientific Humor by mistake."—*L. E. Carpenter.*

## ETYMOLOGY

SON: "What is the difference between a train and a ship?"

FATHER: "A train travels on land and a ship on water."

SON: "Then why is it that when goods are sent by train it's called a shipment and when they are sent by boat it's called a cargo?"

—*Gustav Natapoff.*

## PLAY ON A DENTAL DRILL

A recruit was ordered to Sgt. Saas, Detail Sgt., to learn something about firing data instruments, and when told to report was heard to say, "It will be easy for me to learn as I can play any instrument made."—*Corporal John P. Olszewski.*



## IT'S BOUND TO COME THOUGH

RASTUS: "Nigger, ah sho does believe in dis evolution theory; you shoe does look like you 'volved from a monkey."

BROWN: "Nigger, ah believes in evolution, too, an' nigger you looks like you ain't 'volved yet."—*Fred Deniston.*

## IT SHOULD BE

CUSTOMER (to photographer who has only been in business a short time): "How's the photography business?"

PHOTOGRAPHER: "Oh, it's developing."—*O. Willis.*

## BOTH IN THE HEAD

GUSSIE: "The dentist told me I had a large cavity that needed filling."

MARY: "Did he recommend any special course of study?"—*M. R. Bercovitch.*



# LATEST PATENTS



## PORTABLE RADIATOR

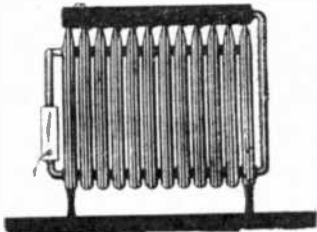

No. 1,580,704 issued to Thomas H. Willson. Portable electric radiator of a new design is illustrated above. The radiator consists of three distinct units. At the left of the drawing will be seen an electric coil heater which heats the water by contact. On top of the radiator is placed a hollow expansion chamber, which also acts as heat deflector to aid in ventilation. The radiator proper is partially filled with water, and the steam is permitted to flow into the expansion chamber.

## FOLDING COMB



No. 1,579,143 issued to Michael Rabb. Hair comb recently patented and illustrated above exhibits several new features. It is arranged to fold transversely so that it occupies a space one-third of its normal length. When in use it is held in position by two clips which are movable inwardly to permit the device to be folded. The clips are made sufficiently strong to permit the user to employ this comb in the usual manner. The comb may be considered more useful than the usual pocket variety, due to its large size when extended, but it is at the same time very compact when folded.

## LIGHT PLUG AERIAL



No. 1,591,177 issued to Einar Minge. This device is designed to act as an antenna for a radio set to be connected to light or other wired circuits so as to draw off or collect only the high frequency currents present therein, without interference with, or by, the local currents with low frequency in the same circuit. No direct connection to the wired circuit is afforded, but a capacitive coupling permits radio frequency currents to pass to the set and restrains the line currents.

## BOTTLE SAFETY HOLDER

No. 1,580,741 issued to Thomas John Lilly. The objects of this invention, which consists of a clamp to hold milk bottles, are to safeguard the contents of the bottle; to afford sanitary precautions in the delivery of milk in bottles; to facilitate the removal of the bottle by the housewife without resorting to keys, latches or other fastenings; to avoid great losses to the milk dealers

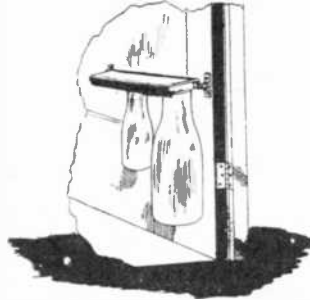

through the theft of bottles; and generally to provide a simple device within easy reach of the consumer so far as price is concerned and of a durable nature. The milk bottles are locked in position by a long pin which holds the clamp tightly against the neck of the bottle. This pin is so placed that it is impossible to remove it while the door is closed, but it may be easily removed when the door is open. The milk dealer simply snaps the clamp down after inserting the bottles, and the lock is automatically closed.

## ELECTRIC WINDSHIELD WIPER

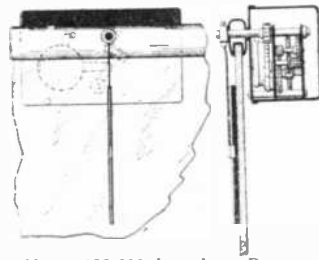

No. 1,588,399 issued to Raymond Anderson. Motor driven windshield cleaners used heretofore, if we should believe the inventor, have not been entirely satisfactory for several reasons. In the motor driven windshield cleaner most commonly used, the cleaner is oscillated continuously by a motor, but the continuous oscillating movement is objectionable because the cleaner is too frequently in front of the driver and obstructs his vision, and furthermore, the weight of the motor with the mechanism connecting it to the cleaner is excessive. This invention provides a windshield cleaner which is operated intermittently through the medium of a small continuously rotating motor which not only requires little current to run it, but is light in weight and admits of a construction which is practically noiseless and free of vibration inherent to its own construction and operation.

## RECEIVER ATTACHMENT



No. 1,580,938 issued to Clifford A. Wolf. The tired business man should find in this invention some relief from his worries. It consists of a metal frame which clips on to the end of the telephone receiver and is so formed that it rests upon the shoulder and makes it unnecessary to hold the receiver to the ear. The patent papers do not say what happens to the other end of the receiver, so we will not guarantee that this device will increase your business more than your vocabulary.

## INFRA-RED PAD



No. 1,589,338 issued to George Starr White. This invention relates to an appliance adapted to be held against the body of a subject, wherein ultra-red or infra-red rays are generated and passed through a screen which includes all of the visible rays of the spectrum and substantially all the ultra-violet rays. The appliance comprises the combination of an ultra-red ray generator and a covering sheet adapted to be so positioned that it may be interposed between the generator and the body of the subject. The appliance is flexible so that it adapts itself to the contour of any part of the body. Scientific investigation has demonstrated that ultra-red rays penetrate deeply into the body and are therein converted into heat. This heat has the property of stimulating the vascular system, thereby serving as a remedial agency.

## FLY POWER TOY

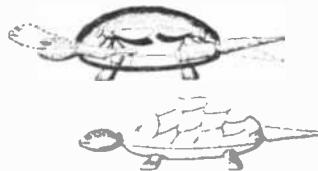

No. 1,591,905 issued to Oscar C. Williams. An artificial turtle made of pressed metal, paper, nut shells or other material is arranged as shown in the drawing above so that several flies or other insects may be introduced into the body. The flies in their movements strike against the pivoted levers connected to the head, tail and feet of the turtle and cause it to move in a life-like manner.

## RADIO CONDENSER

No. 1,588,438 issued to Harold N. Bliss. This new type of condenser appears to be about the most compact arrangement of gang condensers which has been proposed. A common rotor is provided which rotates within three separate sets of stator plates distributed as shown in the

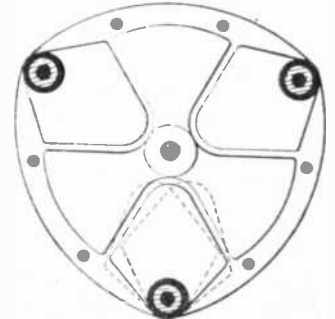

photograph, so that a cascade radio frequency amplifier or similar device may be operated from one control. The stator plates are made movable about a pivot so that the circuits may be balanced to compensate for differences in the constants of the radio-frequency transformers.

## SAFETY ASH TRAY

No. 1,588,565 issued to May Wing. The idea embodied in this invention is to provide a device, especially adapted for use on automobiles, so constructed that any live ashes or stubs of cigarettes or cigars introduced into it will positively be extinguished before the contents of the tray are emptied on the ground or elsewhere. By reason of the use of

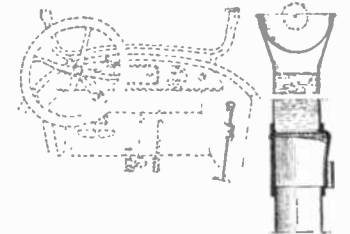

this device on an automobile, there will be no chance of any smoldering and live ashes being deposited on the ground in dry grass or leaves, and possibly starting a fire, assuming of course that the smoker makes use of the tray, which seems quite plausible in design. The user, after depositing any ashes, matches or stubs in a bowl at the top of this device, will upset the bowl into a funnel by turning a knob. This funnel leads the ashes into a water-filled pipe, thus definitely extinguishing the burning material. The bowl may then be again used, and the upsetting operation repeated, without necessarily emptying the water, which can be left in the pipe until refilling means are handy. The pipe is kept filled to a point where there is no danger of the water splashing out from the top of the funnel with any movement of the car.

**NOTICE TO READERS.** The above illustrated and described devices have recently been issued patent protection but are not as yet to our knowledge available on the market. We regret to advise that it is impossible to supply the names and addresses of inventors of the above devices to any of our readers. The only records available, and they are at

the Patent Office at Washington, D. C., give only the addresses of the inventors at the time of application for a patent. Many months have elapsed since that time, and those records are necessarily inaccurate. Therefore, kindly do not request such information. —EDITOR.



# THE ORACLE



The "Oracle" is for the sole benefit of all scientific students. Questions will be answered here for the benefit of all but only matter of sufficient interest will be published. Rules under which questions will be answered:

1. Only three questions can be submitted to be answered.
2. Only one side of sheet to be written on; matter must be typewritten or else written in ink; no penciled matter considered.

3. Sketches, diagrams, etc., must be on separate sheets. Questions addressed to this department cannot be answered by mail free of charge.
4. If a quick answer is desired by mail, a nominal charge of 50 cents is made for each question. If the questions entail considerable research work or intricate calculations, a special rate will be charged. Correspondents will be informed as to the fee before such questions are answered.

## USING HOT SPRINGS

(2123) Q. I. E. Hjartarson, Reykjavik, Iceland, asks us to give him our opinion as to the best practical method to use the energy, as electric or driving power, which is contained in the hot springs of Iceland. The problem must take into consideration the fact that the temperature of the springs is below the boiling point of water—actually about 70 to 80°C. He suggests the use of thermo-electric cells.

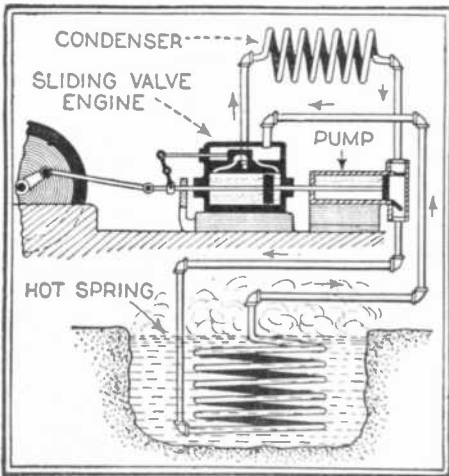

A suggested method for utilizing the energy contained in hot springs.

A. 1. The most obvious way of utilizing the heat of your hot springs would be to run a regular little steam engine with them, using some easily vaporized fluid instead of water to drive the engine. Such a fluid might be ether or gasoline, or some of the paraffins, and while the efficiency would undoubtedly be low, as you are utilizing natural heat or really waste heat, this would not matter. The problem you give us, however, has never been adequately solved.

## ATMOSPHERIC PRESSURE

(2124) Q. I. E. S. Spindler, S. San Francisco, Calif., asks: What if anything has atmospheric pressure to do with the process of breathing?

A. 1. As the atmospheric pressure is decreased, the amount of oxygen absorbed by the lungs is correspondingly decreased and consequently breathing has to be accomplished at a faster rate than ordinarily, in order to provide a sufficient amount of oxygen for the system.

( ) Q. 2. If a pair of beef lungs, freshly taken from the carcass without injury to the air passages, are placed inside an air-tight box with the open end of the trachea protruding through a hole in one side of the box, and the hole sealed up airtight around the trachea, will the lungs expand when the air is exhausted from the inside of the box? That is, would atmospheric pressure force outside air in through the trachea until the lungs are expanded to their full capacity, or would the lungs remain collapsed?

A. 2. The atmospheric pressure would cause the lungs to expand in precisely the same manner that it would cause a rubber balloon to expand under the same conditions.

## ANTI-FROSTING COMPOUND

(2125) Q. I. Thomas L. Winn, Somerville, Mass., inquires for a practical working formula for a preparation to keep window glass from frosting in cold weather. He has tried alcohol and glycerine, but finds the effect only temporary and the smell very disagreeable.

A. 1. A good formula to prevent windows from frosting is as follows:—Mix together 1000 parts of 62% alcohol and 55 parts of glycerine. Add something to the mixture to improve the odor, such as a few drops of oil of amber. Allow the mixture to settle and clarify and apply to the glass with a soft cloth. This is practically the only satisfactory formula for the purpose you require and the effect is quite lasting.

## WINNERS in the "What Can You Do With This Board?" Contest will be announced in the November number.

## THE ATOMIC THEORY

(2126) Q. I. J. C. Thomas, Berkshire, England, asks: Why is helium not decomposed into hydrogen as other elements are decomposed into helium and hydrogen?

A. 1. It is found that the radio-active elements are those of high atomic weight. Does it not seem more natural that an element of an atomic weight of 238 should disintegrate rather than one of an atomic weight of only 4? No one can tell what the future will bring out, and chemistry may yet disintegrate the elements of low atomic weights.

Q. 2. Why has hydrogen a fractional atomic number, while all other known elements have whole atomic numbers?

A. 2. Hydrogen was formerly taken as unity in the table of atomic weights. The effect of this was to throw a quantity of decimals into the atomic weights of other elements. By taking oxygen at 16 the atomic weights of other elements are made more nearly integral, and hydrogen loses its integral figure of atomic weight.

Q. 3. Do the statements in questions one and two tend to prove that hydrogen is not an element at all but merely a collection of negative electrons?

A. 3. As hydrogen possesses mass it cannot well be taken as made up of electrons, as an electron is almost void of mass, the mass of an atom being almost entirely in its positive (+) nucleus. As like charges repel like, how could a fixed collection of (-) electrons be conceived? It is the positive nucleus that holds negative electrons together.

## STORAGE BATTERY PLATES

(2127) Q. I. Forrest M. Wogoman, Marion, Indiana, asks us for information about the pastes used for making storage "B" batteries.

A. 1. The positive plates are pasted with a composition made as follows. Red lead 70%, litharge 8%, graphite 12%, whites of eggs 10%. The latter acts as a binder. The negative plates are pasted with a composition of 95% of litharge and 5% of finely divided asbestos fiber.

Both of these pastes are made up by using a solution of 5 parts of water and 1 part of sulphuric acid. Only enough of the liquid is used to make a very thick paste.

## FRYING EGGS ON ICE

(2128) Q. I. Paul H. Deaton, Smithville, Mo., requests information as to the method employed by magicians in frying eggs on ice.

A. 1. The experiment you mention is accomplished by means of a large powerful A.C. magnet concealed under the table upon which the ice is placed. The intense magnetic field causes the frying pan placed on top of the ice to become hot enough to fry the egg. The core of

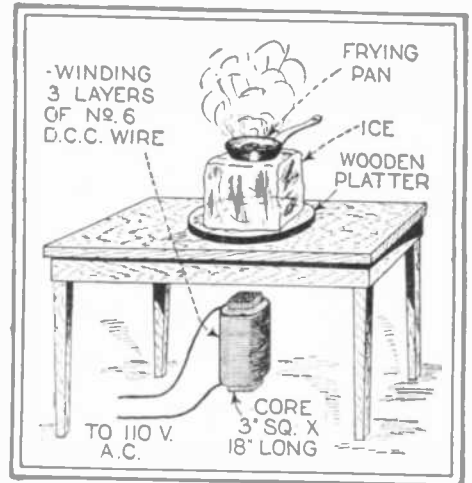

How to fry eggs in a pan placed on top of a cake of ice. The induced currents in the pan heat it.

the magnet used should be constructed of silicon steel strips and should be 18 inches long by 3 inches square. This should be wound for its entire length with three layers of No. 6 DCC magnet wire. It will draw about 40 amp.

## CRYSTAL DETECTOR

(2129) Q. I. Geo. A. Gerber, Burlington, Wis., requests data on the theory and practical operation of crystal detectors.

A. 1. The basic action of the crystal detector, or rectifier, as it is frequently and correctly called, is not due to any heat either at the surface or in the interior of the crystal, even though the application of a temperature in the neighborhood of 110° or more, improves the operation of the crystal detector, this does not necessarily mean at all that the device is heat operated, but simply means that the electronic structure of the crystal polarizes or aligns itself better at a high temperature than it does at a low temperature.

This matter of the action of crystal detectors has been thoroughly thrashed out for fifteen years and more by several investigators particularly by Mr. Greenleaf Whittier Pickard, Newton Center, Massachusetts, whose articles describing the rectifier action were published about 1910 in "Electrical Review and Western Electrician" Magazine, which can be referred to at public libraries. Also many of the modern radio text books cover this action of the crystal rectifier, and briefly expressed, it boils down to the fact that the crystal, having one electrode of relatively small area, permits a current to pass through it several hundred times better in one direction than it does in the other. As Professor Pickard and other investigators have pointed out, some crystals serve as rectifiers to a much better degree when they are slightly polarized by a low potential battery current applied by a finely adjusted device, such as a potentiometer. H. W. Secor, Managing Editor, of SCIENCE AND INVENTION published an exhaustive article on this with curves in "Modern Electrics" in 1910, which article was prepared in collaboration with Prof. Pickard.

One thing in favor of the crystal detectors is that the voice reproduction is very perfect and practically free from any noise, such as occurs when a vacuum tube detector is used. The writer has never seen a V.T. detector yet that gave clear speech without some straining noise.

**Science and Invention**

CORRESPONDENT REPORTER'S IDENTIFICATION

NO. 10000

*L. H. Shackner*

THE BEARER OF THIS CARD IS AN AUTHORIZED CORRESPONDENT-REPORTER OF SCIENCE AND INVENTION MAGAZINE THE PUBLISHERS OF SCIENCE AND INVENTION WILL APPRECIATE ANY COURTESY EXTENDED THEIR REPRESENTATIVE.

EXPERIMENTER PUBLISHING CO.

*Herbert Ball*

IN ORDER to present to the public the very latest scientific details, SCIENCE AND INVENTION maintains a large staff of field reporters. Any one of our readers is eligible to join this staff and, upon request, a reporter's card will be forwarded, together with complete instructions for gathering material. The reporter's card is illustrated above, and its use will gain admittance to many places that would otherwise be closed to the ordinary person. You need not have any special ability to obtain one of these cards, other than a desire to help others to gain knowledge.

Address Field Editor, SCIENCE AND INVENTION.  
Submitted manuscripts cannot be returned unless accompanied by postage.



# MAGIC "DUNNINGER" By

**THE MAN WHO MYSTIFIED**  
 Pres. Coolidge  
 Prince of Wales, Ex-President  
 Harding, Taft, Roosevelt,  
 and other celebrities  
 Writes Exclusively for  
**SCIENCE AND INVENTION**



NO. 43 OF A SERIES

## The Chameleon Bands

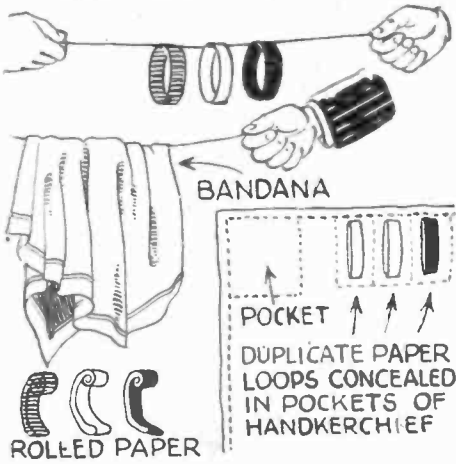

Endless paper bands of different colors are placed on a string, the ends of which are held by a spectator. The magician can remove any of the bands requested.

THREE endless loops of differently colored paper are arranged on a string as illustrated and two spectators are requested to hold the opposite ends of the string. A large bandana is displayed and the hands are covered with it. One of the spectators suggests a color and the performer reaching beneath the handkerchief mystically removes the chosen colored band from the string, the band itself being intact, and the string also being none the worse following this removal. The diagram explains the secret of the stunt. When one of the bands is to be removed it is torn, placed into the empty pocket and a corresponding duplicate is removed from the kerchief and displayed.

## The Mystic Bread

A LOAF of bread through which a ribbon has been passed and which projects from either end is displayed. A magician takes a knife and divides the loaf in half with a cut through the center thereby apparently also cutting ribbon. The pieces of bread are separated slightly to show that the ribbon has been cut, then they are joined together and the ribbon withdrawn intact.

Two pieces of ribbon are used. One was tucked into one end of the bread and the other is attached to a piece of string working down into table leg and into hands of assistant off stage. As the ribbon is drawn from bread after the cut the assistant gradually pulls the other end down into table leg and causes it to disappear.

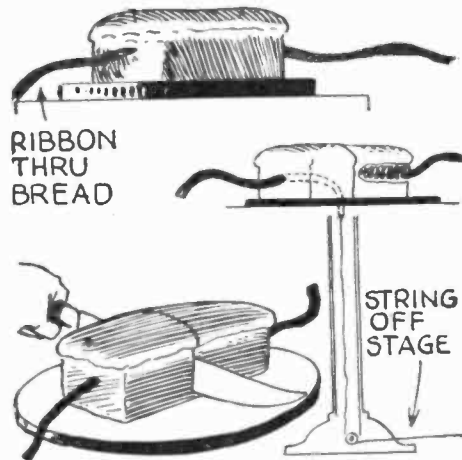

After passing a ribbon through a loaf of bread, the magician cuts the loaf, separates the halves and continues to draw the ribbon out. The method is here described.

## The Paper Birds

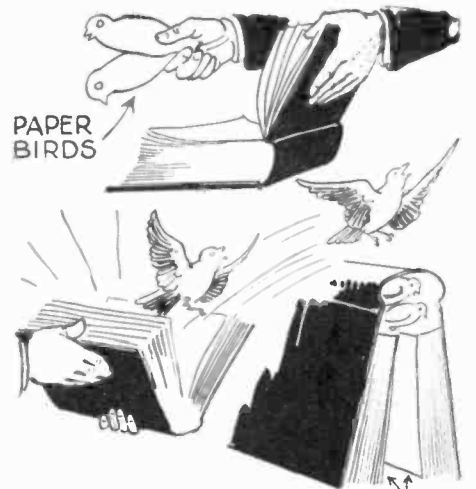

By this system the magician can convert two paper birds placed in the pages of a book into real live birds which fly out from between the pages.

A LARGE book is brought forth by wizard and a page or two is torn out of this book and handed to a spectator who is requested to cut two birds out of paper. These cut birds are placed in pages of the volume from which they were originally removed and a few words of enchantment uttered. A moment later the book is opened and two live doves fly out of the book itself. The pages of the book can be shown to be whole so that the spectators will not suspect that a box is found within pages. The book although of innocent appearance has a special compartment arranged at back. When opened at proper page the compartment is opened.

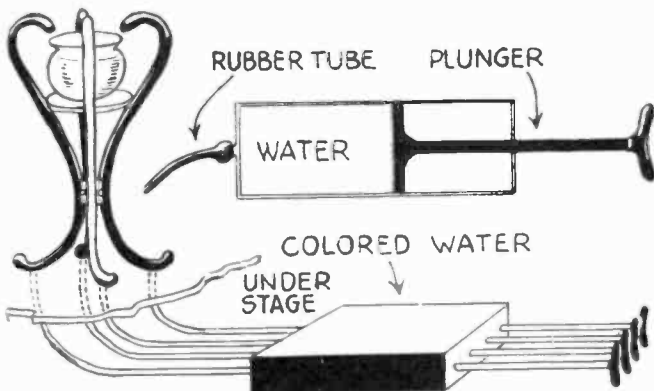

AN Orientally-clad Hindu passes a large ornamented bowl for inspection and then places the same in position upon a thin skeleton stand designed to receive it and resembling the stand found in our illustration. The bowl itself may be semi-transparent or perfectly transparent depending on whether or not the magician desires to cover it while it mysteriously fills itself. Making a few passes over the bowl it is found to be brim full of water which is poured into transparent containers. Each time that the bowl is filled it contains a differently colored solution, the colors being requested

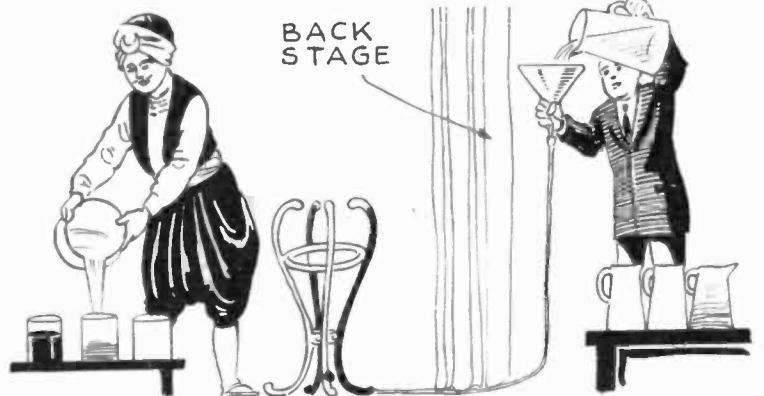

by members in the audience. The illustration clearly shows the method of operation. Beneath the stage an attendant operates one of the pumps forcing the previously prepared colored solution through the legs of the stand and into the bowl. For lyceum entertainment the method illustrated at the right may be employed in which the assistant utilizes the force of gravity to fill the bowl. In this particular method, after every filling the pipe must be laid flat on the floor so as to drain any colored water remaining in the upright portion of the stand and the rubber hose.



Dr. Harlan Tarbell, B.Sc. D.N.  
Master of Magic

I'll Teach YOU  
Real Professional

# Magic

At Home — BY MAIL

## Big Stage Illusions



Think of it! Master Illusions from Europe, India, China, Japan. Mysteries from the Ancients. Never before disclosed secrets of the Orient. Over 150 tricks from small effects to Big Stage Illusions, with nearly 1500 illustrations —that and more is what you get in the great Tarbell Course in Magic!

### Read This Great Endorsement

Dr. A. M. Wilson, Editor of the Sphinx, Official Organ of The Society of American Magicians, pays the Tarbell Course this tribute: "The greatest work on Magic ever attempted and will mark an epoch in Magic as great or greater than the revelations of Robert Houdini, Father of Modern Magic, 60 years ago."

The first and only  
Course in Magic  
ever offered to the  
public teaching real  
professional Magic!

## Secrets of the Orient

Yes, those great mysteries the Hindu fakir guards so jealously and famous Magicians have risked their lives to secure—these and MORE are YOURS in the great Tarbell Course. Many a mystery here is worth many times the whole cost of the entire Tarbell Course!



How many times have you watched some great magician and longed to be able to perform like that YOURSELF? With the great Tarbell Course this is NOW made possible and EASY. You can even become a Master Magician!

### Famous "Rabbit Trick"

This is one of the most popular tricks in Magic. It is always in demand, goes over big, brings a big price. Many professionals value this at \$100.00 or more—yet it is only one of the many priceless tricks you will soon learn and master in the great Tarbell Course.



## Real Professional Patter

Any magician will tell you that "Patter," the name given to the entertaining and diverting talk he gives with each trick, is highly important. In the great Tarbell Course you are given real professional "Patter." Yes, and you are even trained in "Showmanship." Think of it!

## Money-Back Guarantee Protects You

Think of it! Think of a great course in Magic giving you ALL this and then protecting you with an Iron Clad Guarantee, that will refund your money if you are not satisfied. You can't lose. You have everything to gain. The Tarbell Course is the greatest thing you have ever heard of! Mail coupon below and learn all about this wonderful course and what it will do for YOU!

## Get started on the road to big money!

You don't have to give up your present job or business. You don't have to be a "professional" to make big money with Magic. You can make nice money entertaining on-the-side as a semi-professional, or if you want to, you can become a big Magician, make big money and enjoy fame and glory. Mail coupon now and learn all the great limitless opportunities that are in store for you.

Tarbell System, Inc., Studio 14-27  
1920 Sunnyside Avenue  
CHICAGO, ILLINOIS

## Mail This Coupon NOW!

Tarbell System, Inc., Studio 14-27  
1920 Sunnyside Avenue, Chicago, Illinois  
Gentlemen: Without any obligation send me your free literature and information all about your wonderful "Tarbell Course in Magic." Also tell me about your great Special Price Offer and Easy Payment Plan—offered NOW for limited time only.

Name.....

Address.....

Age.....

# Novelties!

From The  
LEADING MAIL ORDER  
NOVELTY HOUSE IN AMERICA

### THE EXPLODING CIGAR



Biggest trick of the year—a real cigar. Harmless but shoots out fountain of sparks and fire. Everybody has fun with them.  
No. 1409 (Box of 50 Cigars) \$3.50

### Enormous Vibrating Eye



A burlesque sensation, enormous eye with spring that causes it to vibrate—for home fun, character impersonations, etc.  
No. 1297 15c each, 3 for 40c, 1 doz. \$1.35

### The Jewish Nickle



Fun with these never end, try them on the grocer, the street car conductor, your friends and watch their faces—keep a few on hand always.



No. 1195 10c each 3 for 25c 75c a Doz.

### Automatic Pistol Cigarette Case



A parisian vogue—looks like deadly weapon—but holds only cigarette—Protective as well as amusing—fools everybody.  
No. 1428 . . . . . Postpaid \$1.95

## Magic



### GREAT FIRE EATER

You can breathe fire, horrify everyone, Ha-mless—E-upment in Handsome box—become a sensation in your neighborhood.  
No. 1091 . . . . . 30c



### DISAPPEARING COIN TRICK

A simple trick, but positively undetectable—coins disappear and reappear at your will—amazing everyone—a sure-fire trick for fun.  
No. 1151 10c each 2 for 25c Doz. 75c

### SURPRISE BOUQUET

The best squirt trick ever invented. Bouquet in your button-hole, your friends smell it and presto a stream of water hits them in the eye. Get one now.  
No. 1338, Postpaid, 25c each 3 for 65c \$2.25 a Doz.

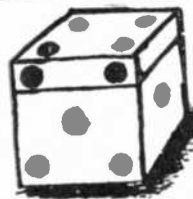

### Diabolical Dice

A real puzzle with dice—people say it can't be done—but it's easy—fools them all—a corker at a party—or among friends.  
No. 1004 . . . . . 25c

### 164-PAGE CATALOG FREE

Also with every \$2.50 order or more we will send you free a 50 cent book on Magic.

AMERICAN BAZAAR Inc.,

640 Broadway New York, N. Y.

### Our Spiritualistic Investigations

By "DUNNINGER"

(Continued from page 503)

to a sort of combination parlor and sitting room, the air thick with some sort of oriental incense the like of which I have never before come across.

The old woman who ushered us into this room was about as old, in looks, as the much spoken of Ann. She looked a thousand years old. Her skin was parched and dry . . . her eyes looked through us and she seemed to be thinking . . . thinking . . . thinking . . .

Not a word out of her. Not even a "good evening."

Bad as the night was a cheerful word or two would have made us feel a bit better. But no . . . this parched specimen reminded us of the sphinxes of ancient Egypt. Divested of our coats, hats and rubbers the sphinx gathered them up, turned and left the room. The door closed after her and she never put her hand on the door.

Strange? Yes . . . and with that odor of smouldering incense we were thinking that all the mysteries of heaven and earth were to take place in that house.

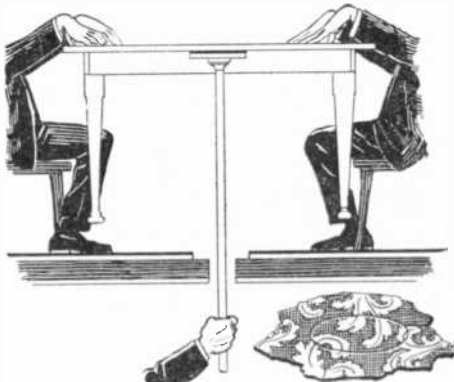

How "spirits" raised the table.

Suddenly . . . into the room walked a tall, handsome creole. She was one of the most beautiful of her type I have ever seen and I have played in the states where they are in abundance.

"Good evening," she ventured. "Very bad weather we are having."

"It certainly is," replied my friend, "the storm doesn't seem to cease."

"Like the marvels of the worlds we know nothing of," she returned. He voice was like that of a bell, clear and resonant.

"Are you holding a seance this evening?" asked my companion.

"I shall be happy to give one. But I am afraid there will only be you two, gentlemen, to attend. My clients are mostly old folks and it would be a hardship for them to venture forth into this sort of weather."

From her talk I could readily see that this creole had been well educated and was not the usual type of medium I have so frequently come in contact with during my investigations.

We both were ushered into the seance room by the medium, who kept the conversation in pro-aic channels.

Seating ourselves on either side of a plain table standing in the center of the room, the lights in the room of their own accord, grew dim. The medium seated herself across the room in a corner facing us.

We were requested to place our hands at the extreme corners of the table and the soles of our feet flat on the carpet beneath us, as far apart as convenience would allow.

(Continued on page 571)

# PARKS

## WOODWORKING MACHINES

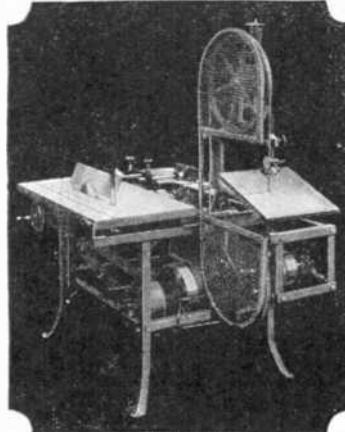

Cabinet Shop Special \$290 with motor

### See this PARKS this month!

October is "Parks Cabinet Shop Special month" with Parks dealers everywhere. In their showrooms, this wonderfully popular woodworker will be on display and in many instances in actual operation.

Parks Cabinet Shop Special No. 10 at \$290.00 is the handiest machine Parks ever built! Big enough to turn out first-class work—small enough to fit in a small shop or your basement—a real machine built for real work without freakish "stunt" designing. It makes practically any cut and includes rip and cut-off circular saw jointer, and hand saw. Lathe and shaper may be added at small extra cost. Every man who does cabinet making or woodworking of any kind wants this splendid machine. It is the biggest woodworking machinery value on the market today. Be sure to see this Parks this month.

#### in these dealers' showrooms

ALA: Moore, Handley, Hyde, Co., Birmingham; M. Gowin-Lyons Hwde. & Supply Co., Mobile; Alabama Mch. & Supply Co., Montgomery; ARK: Ben D. Schaad Mch. Co., Little Rock; CAL: Shaw-Palmer & Bakewell Co., Los Angeles; Harron-Rickard & McCom Co., San Francisco; COLO: H. W. Moore Equipment Co., Denver; CONN: Lunt, Jillson Co., Manchester; FLA: Cameron & Barkley Co., Jacksonville; Cameron & Barkley Co., Miami; Cameron & Barkley Co., Tampa; GA: R. S. Armstrong & Bros. Co., Atlanta; ILL: Woodworkers' Tool Works, Chicago; KY: Roy C. Wayne Supply Co., Louisville; LA: Clark D. Shaughnessy Co., New Orleans; MASS: Lunt, Jillson Co., Boston; MICH: River-side Mch. Dept., Detroit; McMullen Mch. Co., Grand Rapids; MINN: Katmo, Hyde, Co., St. Paul; MO: Standard Tool & Supply Co., Kansas City; S. T. Hatcher & Co., St. Louis; NEB: Diehl Mch. & Supply Co., Omaha; N. Y.: Interstate Mch. Co., Troy; Chas. E. Mapps, 173 Lafayette St., New York City; N. H.: Brackett & Shaw Co., Concord; N. CAR: Amer. Hwde. & Equip. Co., Charlotte; Raleigh Iron Works Co., Raleigh; OHIO: J. J. Baker, Columbus; OKLA: Universal Supply & Mch. Co., Tulsa; ORE: Portland Mch. Co., Portland; PA: K. O. Dittmars, Bourse Bldg., Philadelphia; Coblenz Tool & Supply Co., Erie; S. CAR: Cameron & Barkley Co., Charleston; TENN: Peglar, Mch. Co., Chattanooga; Idaho Mch. Co., Knoxville; Harill Supply Co., Nashville; Carriage & Wagon Supply Co., Memphis; TEX: Universal Supply & Mch. Co., Amarillo, Southern Implement Supply Co., Dallas; Don A. Carpenter & Co., El Paso; Pedan Iron & Steel Co., Houston; Pedan Iron & Steel Co., San Antonio; UTAH: Salt Lake Hwde. Co., Salt Lake; V.A.: James McGraw, Inc., Richmond, W. VA.; LaLanc, Equip. Co., Huntington; WIS: Stadbolt & Boyd Co., Milwaukee; WASH: Union Mch. & Supply Co., Seattle; FOK: EIGN: Sipe Mch. Agency, San Jose; Costa Rica: P. I. Zayas, Havana, Cuba; Welt Mch. Co., Vancouver, B. C.; Morris, Black & Matheon, Ltd., Auckland, N. Z.; West India Mch. & Supply Co., San Juan, P. R.; Bourmval & Co., Montreal; Can. Engineering Supply Co. of Australia, Ltd., Brisbane, Australia.

See this Parks by all means! If you can't, then write us for circular No. 10 and the new Parks catalog.

The Parks Ball Bearing Machine Co.,  
1533 KNOWLTON CINCINNATI, OHIO  
Canadian Factory: 200 Notre Dame East, Montreal, Can.

## BIG SURPRISES FOR YOU



Thousands of Unique Mystifying Tricks. Novelties—All kinds—All prices are ready for you.

Gentle and Trick Rings,

Jewelry, Disappearing Cards, Fun Making Things—Telescopes, Pistols, Magic of all Kinds.

Great Mind Reading Mystery! Different from anything you've ever seen. Don't miss it! Price 10c.  
WRITE FOR OUR 164 PAGE CATALOG  
**AMERICAN BAZAAR, INC.,**  
640 BROADWAY NEW YORK, N. Y.



# Your Speaker is not to Blame

Your speaker is a sensitive affair turning into voice and music the electrical impulses passed to it by the set.

An ordinary tube, of insufficient signal carrying capacity, should not be used in the last audio stage, for with its limited capacity it is overloaded and distortion of the signal results. These imperfections passed on to the speaker give unnatural and distorted reception.

## Put a Van Horne ADAPTED MOGUL 5VCX Power tube in the last audio stage

An Adapted Mogul 5 VCX power tube—as easy to apply as an ordinary tube—has almost double the signal carrying capacity of the ordinary tube. This greater capacity eliminates over-loading and distortion and it can be applied to any set without change in wiring.

With an Adapted Mogul 5 VCX power tube in your set you will immediately note an unusual improvement—a general increase in volume, a roundness of tone and clear cut reproduction in voice and music that is unobtainable when ordinary tubes are used.

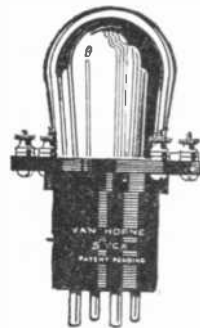

The Adapted Mogul 5 VCX like the non-microphonic Cushion Base 5 VAX is a Van Horne development manufactured under patent pending to J. S. Van Horne. All Van Horne tubes are made to improve reception, their satisfactory operation being unconditionally guaranteed.

One  
user  
says:

"Let me congratulate you on the splendid performance of Adapted Mogul 5 VCX Power Amplifier Tube.

"I found that these tubes give remarkable amplification and clarity. The tube actually gives considerable increase in volume when used without additional plate voltage or grid bias, but when 135 volts is applied to the plate the volume is virtually doubled."



For a great many years the Van Horne Company has manufactured vacuum products. The highly skilled workmanship that goes into every Van Horne tube is the result of years of experience and is one of the factors that make Van Horne tubes the highly efficient and dependable tubes that many thousands of users have found them to be. You are urged to become acquainted with the complete line of Van Horne Selected and Certified tubes. Your dealer will supply you with further information—or write for descriptive matter.

## THE VAN HORNE CO.

1005 Center St.

Franklin, Ohio



Corner of One of the Seven S. of E. Laboratories

# Take This Short Cut to Accomplish your Ambition

The field of electrical engineering offers wonderful opportunities for trained men to direct and carry out great industrial and commercial projects. Get a thorough and practical training here in our course of

## ELECTRICAL ENGINEERING with B. S. Degree in 3 Years

A faculty of specialists is leading hundreds of ambitious young men to sure success. Why not you?

If you are lacking some preparatory studies you can make them up here. This is an exceptional opportunity to become an electrical engineer in the shortest possible time.

## JUNIOR ELECTRICAL ENGINEERING

From 1 to 2 years in this course makes you a completely trained Junior Electrical Engineer—prepared to fill such positions as general plant superintendent, director of construction, superintendent of maintenance, chief draftsman, etc. The Junior Electrical Engineer is the man between the Electrical Engineer and the Electrician—a well paid position and a stepping stone to higher executive work. A grade school diploma or equivalent admits you without examination. New term opens every 6 weeks.

## COMMERCIAL ELECTRICAL ENGINEERING in 1 Year

Unparalleled opportunities for brilliant, successful careers in the new field of Commercial Electrical Engineering. To meet the extraordinary present-day demands for trained electrical business men, consulting and efficiency engineers, we offer this thorough, condensed and very practical training, especially adapted to high school graduates.

## PRACTICAL ELECTRICITY

In this complete 6 months' Electrical Course—8 hours daily—you can learn house, factory and theatre wiring, testing and meter work, A.C. and D.C. Armature Winding and all necessary mathematics.

A 3 months' course in A.C. and D.C. Armature Winding, or a 3 months' Course in Light and Motor Wiring and Testing is offered to those with limited time and means.

## AUTOMOTIVE ELECTRICITY

Electrical specialists who instinctively diagnose and locate automotive electrical troubles command high positions and are well paid. Specialize in starting, lighting, ignition and storage batteries and command a big job at a big salary.

## "EARN WHILE YOU LEARN"

We agree to provide for a limited number of worthy young men, half-time jobs at good wages, and permanent positions with unlimited prospects to all duly qualified graduates. Here is the opportunity of your life to acquire a thorough, practical training for big-paying profession that is in urgent need for trained men.

## ESTABLISHED 22 YEARS AGO

The S. of E. stands absolutely alone in the field of thorough, practical electrical education and in commercial and electrical engineering.

## NO NEED OF YOUR BEING WITHOUT AN S. OF E. TRAINING

It does not matter how old you are or what schooling you have had. Students from 15 years up to 30 are in attendance here.

Fill out the following coupon and mail it to-day.

## SCHOOL of ENGINEERING of Milwaukee

FOUNDED 1905

SCHOOL OF ENGINEERING OF MILWAUKEE  
1878, 415-417 Marshall Street, Milwaukee, Wis.

Without obligating me in any way, please mail free 24-page illustrated book, "Electricity and the One Best Way to Learn It," and particulars regarding the course I have marked with an X.

- ... Electrical Engineering.
- ... Electrotechnics.
- ... Commercial Electrical Engineering.
- ... Junior Electrical Engineering.
- ... Automotive Electricity.
- ... Armature Winding.
- ... Light, Motor Wiring and Testing.
- ... Practical Electricity.
- ... I am interested in your "Earn While You Learn" Plan.

Name ..... Age .....

Address .....

City ..... State .....

Education .....

## Likes and Dislikes of the Radio Audience

By CHARLES D. ISAACSON  
(Continued from page 524)

Perhaps he was right, that people would pay for the privilege of keeping something off the air. It is like the old song "Johnny Morgan plays the organ, his sister plays the drum, with a tum tun di dum. Oh the music is so sweet—people give them a penny to keep in another street." Whether a penny or the millions, who can tell? But the only way we, who are running programs, know what you want, is to learn from you.

### LETTERS FROM WRNY FANS

At WRNY we do get a tremendous amount of mail from people, who grow extremely enthusiastic about one thing or another, but everybody doesn't take the trouble to sit down to comment on everything which is liked, or anything which isn't. That is human nature.

Of course, we do have ways of learning much from our listeners. For instance, when WRNY took the momentous step of changing its wavelength to 374.8 meters, we didn't need to ask. We received. Every one of our dozen telephone lines was clogged all day long by fans who congratulated us—and some very few who didn't; I think the complaints came about in the ratio of one to two hundred congratulations. Then in poured the mail, more than three thousand letters the very first week. Isn't that wonderful?

### AN APPRECIATED FEATURE

Then, when the Edison German Hour program went on, the letters averaged one hundred and fifty a day for that feature alone. No doubt you have been following the summer concert course of the Edison Hour, taking you on a musical tour of all nations. By the time this reaches you, of course, that will be long past, and a new series of importance will be delighting you, as the Edison Ensemble bring it to you.

The month just passed has been particularly momentous. It marked the tieup of WRNY with Station WMAF of South Dartmouth, Mass. That powerful station, which operates on 440.9 meters, is owned by the millionaire philanthropist, Colonel E. H. R. Greene, and is reputed one of the greatest distance-achievers in the world. Every Tuesday and Thursday now you can hear WRNY programs on either wavelength.

### HOW AN ORCHESTRA IS MADE UP

Before I give you a rapid-fire resumé of the month's high spots, I will give you a little story of popular education in music. So I will tell you something about an orchestra, and the individual members of the family you hear in a concert, whether over the air or in a hall.

The average concert orchestra has these sections:

- Strings;
- Wood wind;
- Brass;
- Percussion.

The conductor with his baton gives the beat of the time, the spirit, and the whole direction to the meaning of the phrases. He is the soul of the orchestra; and a great conductor can make any body of good musicians into master musicians. A musician who merely beats time is not a real conductor.

The string section consists of the violins, violas, cellos and bass violins. The violins divide into firsts and seconds. At the first desk of the first violins is the concertmaster.

(Continued on page 540)

# PRICES CUT

## World STORAGE BATTERIES at Cost!



### LIMITED TIME OFFER!

For a limited time only, genuine World Storage Batteries can be gotten at actual cost. Every cent of profit has been cut out in order to keep our full factory organization busy during the slack season. Prices below are lowest in history. World Batteries are nationally known for dependable, long wearing performance. Solid Rubber Case prevents acid and leakage.

### Send No Money!

Just state battery wanted and we will ship same day order is received, by Express C.O.D. subject to examination on arrival. 5% discount for cash in full with order. Send your order now and get your World Batteries at actual manufacturing cost.

**WORLD BATTERY COMPANY**  
1219 So. Wabash Avenue  
Chicago, Ill.  
Dept. 19

**Solid Rubber Case Radio Batteries**  
6-Volt, 100-Ampere \$10.50  
6-Volt, 120-Ampere \$12.50  
6-Volt, 110-Ampere \$12.25

Set your Radio Dial for the new 1000 w. World Storage Battery Station **W S & C, Chicago.** Interesting programs every night.

**2-Year Guarantee Bond in Writing**  
Approved and Listed as Standard by Leading Authorities

Including Radio News Laboratories, Popular Science Institute of Standards, Popular Radio Laboratories, Radio Broadcast Laboratories, Radio in The Home, and Lefax, Inc.

**Solid Rubber Case Auto Batteries**  
6-Volt, 11-Plate \$10.50  
6-Volt, 13-Plate \$12.50  
12-Volt, 7-Plate \$15.25

KDKA WSBC WEAF KYW

# Free

## 60-page Reference Book

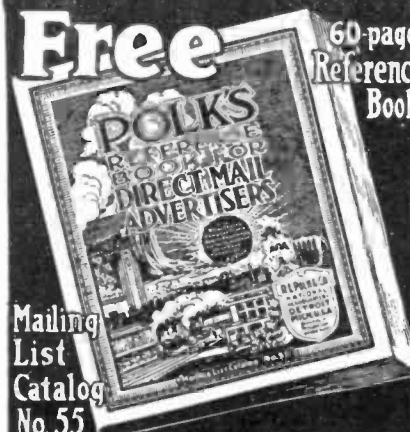

**Polk's Reference Book for DIRECT MAIL ADVERTISERS**

Mailing List Catalog No. 55

### Get Business by Mail

60 pages of vital business facts and figures. Who, where and how many your prospects are. 8,000 lines of business covered. Compiled by the Largest Directory Publishers in the world, thru information obtained by actual door-to-door canvass. Write for your FREE copy.

**R. L. POLK & CO., Detroit, Mich.**  
880 POLK DIRECTORY BLDG.  
Branches in principal cities of U. S.

## Ship Model Plans

and instructions. Easy to build and sell models. Magellan's Ship, 77c—Hudson's "Half Moon," 92c—Clipper, 82c—Santa Maria, \$1.02—Pirate Ship, 52c—all for \$3.90.

SEA ARTS GUILD  
405X ELEVENTH AVE. MILWAUKEE, WIS.



4 or 6" Barrel  
**6-Shot Finest Long Range Revolver**  
This gun "free" if you can beat our price anywhere—4 or 6 in. barrel, blue or nickel—22, 32, 38-or 22 caliber. Powerful, accurate, hard hitting. Money back guarantee. Pay on delivery \$6.25. Federal Mail Order. 581 Broadway, New York, Dept. X39.

Cut to \$6.25

### LUMINOUS PAINT

**Make Your Watches, Clocks, Etc., Visible by Night**

The very latest discovery in a scientific world. Hitherto, practically unobtainable except at a prohibitive price, we have at last succeeded in producing this remarkable LUMINOUS PAINT which, applied to the surface of any article, emits rays of white light, rendering it perfectly visible in the dark. THE DARKER THE NIGHT, THE MORE BRILLIANT IT SHINES. Quite simple to use. Anyone—you can do it. You can coat the push buttons or switch plates of your electric lights, match boxes, and innumerable other articles; make your own Luminous Crucifixes, Luminous Rosaries, etc. Bottle containing sufficient to coat several small articles. Price 25c. Larger sizes 50c and \$1 postpaid. Johnson Smith & Co., Dept. 364, Racine, Wis.

### The "Little Giant" Typewriter

**A First Class Writing Machine For \$1.50**

A perfect little typewriter for \$1.50. There are thousands of persons who would like to use a typewriter, but who need the expense attached to the purchase and use of a fifty or seventy-dollar machine. To such persons we confidently recommend our Little Giant. It is a compact, sturdy, reliable construction, so that anyone can quickly learn to operate it, and write as rapidly as they would with pen and ink. The letters of the alphabet are so arranged that the number 1 to 10, and the punctuation marks are grouped as to enable one to type your best girl typewritten love letters, address envelopes, make out bills, and do almost any kind of work not requiring a large, expensive machine. With each typewriter we send a tube of ink and full printed instructions for using the machine. Price complete \$1.50 by mail postpaid to any address in the world.

### Every Boy His Own Toy Maker

Greatest boys' book written. Tells how to make a Pinhole Camera, a Canoe, model Railroad, a Telephone, Boomerang, Telegraph Instrument, Box Kite, Football Machine, Microscope, Electric Motor, Electric Door Bell, Water Wheel, Paddle Boat, a pair of Skis, a Dog Sled, Bird House, Rabbit Yard, etc. 64 pages, 150 illustrations. PRICE, 10c postpaid; for 25c.

**JOHNSON SMITH & CO., Dept. 364, Racine, Wis.**

### REAL PISTOL Miniature Watch Charm Pistol

Shoots Blank Cartridges. Exact reproduction of a real pistol; actually fires REAL BLANK CARTRIDGES of miniature size. Illustration is actual size. 1 1/4 inches long, with ring at end for attaching to watch chain. Loads like a regular pistol. Pull the trigger and it goes off with a loud bang. Pistol in break-open type. Illustration shows position of loading. Made entirely of high grade steel, nickel plated, octagon barrel, handsomely engraved handles, complete in box with cleaning rod. PRICE \$1.75. Also furnished with pearl handles, \$2.50. BLANK CARTRIDGES, 50c per box of 25.

### BOYS! BOYS! BOYS! THROW YOUR VOICE

Into a trunk, under the bed or anywhere. Lots of fun fooling the teacher, policeman or friends.

### THE VENTRILO

a little instrument, fits in the mouth out of sight, used with above for Bird Calls, etc. Anyone can use it.

Never Fails. A 32-page book on ventriloquism, and the Ventrilo, ALL FOR 10c postpaid.

### MIDDEET BIBLE GREAT CURIOSITY

Smallest Bible in the world. Size of a postage stamp. 200 Pages. Said to bring good luck to the owner. A genuine work of art. Must be seen to be appreciated. Make good money selling them to friends, church acquaintances, etc. PRICE 15c each, 3 for 40c, 12 for \$1.35, 100 for \$7.50. Also obtainable in Leather Binding, with gold edges. Price 50c each, 3 for \$1.25, \$4.50 per doz. Magnifying Glass for use with Middet Bible, 15c

### Everything about the Ku Klux Klan

How it started and was suppressed in 1871—The New Ku Klux Klan—How organized—How members are enrolled—Oath of the Klan—Questions for Candidates—Creed—Objects of the Order—Obedience—Fidelity—Pledge of Loyalty—Ku Klux Klan and the Masons—The Jews—The Masons—Real R. of C. Oath—The Negro Ku Klux Klan, etc., etc. Latest and most complete book on the Klan published. Price, 35c, postpaid.

### Female SEX Indicator Male SEX INDICATOR

Hold the MAGIC INDICATOR over a man's hand—Instantly it moves in a straight line, backward and forward, under a woman's hand and it describes a complete and continuous circle. The same action can be obtained over a letter written by a man or woman, etc. It is fascinating; baffling. We have never been able to figure out how it's done—but we've never seen it fail. Many novel and entertaining tests may be performed with the Sex Indicator. For example, similar results can be obtained with animals, cats, dogs, rabbits, over birds, chickens, canaries, etc. Also used to predetermine the sex of chickens and birds, etc.—In fact it is sold as a patented egg tester in Europe. Price 25c, or 3 for 65c, postpaid.

### A Deluxe Edition of our new 1926 CATALOG

mailed on receipt of 35c. Handsome cloth binding. Only book of its kind. 180 pages of all the latest tricks in magic, the newest novelties, puzzles, games, sporting goods, interesting books, curiosities in seeds and plants, etc., etc. Obtainable elsewhere.

### STAGE MONEY

With a bunch of these bills, it is easy for each person of limited means to appear prosperous by flashing a roll of these bills at the proper time and peeling off a genuine bill or two from the outside of the roll, the effect created will be found to be all that can be desired. Prices, postpaid: 40 Bills 20c, 120 for 50c, or \$3.50 thousand postpaid.

### Wonderful X-Ray Tube

A wonderful little instrument producing optical illusions both surprising and startling. With it you can see what is apparently the bones of your fingers, the lead in a lead pencil, the interior of a pipe stem, and many other similar illusions. A mystery that no one has been able to satisfactorily explain. Price, 3 for 25c. 1 dozen 75c. Johnson Smith & Co.

### Good Luck Ring

Quaint and Novel Design

A VERY striking and uncommon ring, Silver finish, skill and cunning design, giving brilliant, flashing gem sparkling out of the eye. Said by many to bring Good Luck to the wearer, hence its name. Good Luck Ring. Very unique ring that you will take a pride in wearing. ONLY 25 CENTS.

### Exploding Cigarettes

JUST LIKE ORDINARY CIGARETTES. BUT SUCH REAL STARTERS! The box contains ten genuine cigarettes of excellent quality. They appear so real, but when each cigarette is about one-third smoked, the victim gets a very great surprise as the victim gets a "BANG!" A great mischief provoker yet entirely harmless. Price 25c per box.

### Popular Watch Charms

ONLY 3 for 40c; \$1.35 doz.

Very pretty little curiosities and decidedly novel. Fitted with Magnifying Lenses that enlarge the picture to a very surprising degree; in fact, it is even almost invisible in a clear picture could be possible in such a small compass, and how sharp and distinct they show up when you look through. Come in assorted views—Acres, views of Panama Canal, Lord's Prayer in type, etc.

### CIGARETTE MAKER

Roll your own and save money. Makes them better and quicker besides saving more than half. Use your favorite brand of tobacco. Neat, useful and handy. Pocket size, weighs 1/2 oz. Made entirely of metal, nickel-plated. Price 25c postpaid.

### MAGIC FLUTE

Wonderfully Sweet Toned and Musical

The Magic Flute, or Humantone, is a unique and novel musical instrument that is played with nose and mouth combined. There is just a little knack in playing it which, when once acquired after a little practice will enable you to produce very sweet music that somewhat resembles a flute. There is no fingering, and once you have altered it you can play all kinds of music with facility and ease. When played as an accompaniment to a piano or any other musical instrument, the effect is so charming as it is surprising.

### Novelty Badges

Kissing Permitt 10c Garter Inspector 10c

Two very novel metal badges, nickel plated, that you can wear, giving you fun out of all proportion to their trifling cost. 10c, each badge, 3 for 25c, or 75c per doz. postpaid.

### RESURRECTION PLANT

One of the most wonderful plants known. Possesses the strange power of turning in a few minutes from an apparently lifeless, dry herb to a BEAUTIFUL LIVING FERN-LIKE PLANT of a dark green color. Simply place the plant in saucer of water, it will open up and start to grow in 20 minutes. When taken out it will dry up and go to sleep until placed in water again. Fine house plant—summer or winter. 10 cents each or 3 for 25c. Agents Wanted postpaid.

### BLANK CARTRIDGE PISTOL

Price \$1.00 Postpaid

This will made and effectively. Pistol is modelled on the pattern of the latest type of revolver, the appearance of which is enough to scare a burglar, whilst, when loaded, it will probably prove just as effective as a revolver with real bullets, without the danger to life. Takes the standard .22 Calibre Blank Cartridges, that are obtainable most everywhere. Even the most timid women can use it with perfect safety and frighten a thief without risk to herself or anyone else. A Great Protection Against Burglars, Tramps and Bogs. You can have it lying about without the danger attached to other revolvers. We sell large numbers around the 4th of July. Well made of solid metal. PRICE ONLY \$1.00 Postpaid. Blank Cartridges 22-cal. shipped by express only, 50c per 100. Johnson Smith & Co., Dept. 364, Racine, Wis.

### Sneezing Powder Mystic Skeleton

Place a very small amount of this powder on the back of your hand and blow it into the air, and everyone in the room or car will begin to sneeze without knowing the reason why. It is most amusing to hear their remarks, as they never suspect the real source, but think they have caught it one from the other. Between the laughing and sneezing you yourself will be having the best of your life. For parties, political meetings, car rides, or any place at all where there is a gathering of people, it is the greatest joke out. Price 10c or 3 for 25c.

### Serpent's Eggs

Box contains 12 eggs. When it with a match, each one gradually hat-her itself into a snake. It is a snake a few feet long. It curls and twirls about in a most lifelike manner. Price per box 10c ppd.

### Microphone Transmitter Button

You can easily make a highly sensitive detector of sound waves. You can hear the sound waves of any conversation being held all over the house. You can connect up different rooms of a hotel. This outfit was used by secret service operatives during the war. It is being used on the stage. It is ultra-sensitive and is the greatest invention in microphones. You can mount the button almost anywhere—card boards, stove pipes, stiff calendars, on the wall behind a picture frame, etc. Button is so light and small it cannot be detected. Persons can be overheard without suspecting it. You can listen in on conversations in another room. A deaf person in the audience can hear the speaker. Connect up different rooms of other musical instrument, music can be heard hundreds of feet away. Button may be used to renew telephone transmitters; often makes an old line "talk-up" when nothing else will. The ideal microphone for radio use; carries heavy current and is extremely sensitive. Amplifies radio signals. Countless other similar uses will suggest themselves. Experiment first for hundreds of experiments along the lines of telephone, amplifiers, loud speakers, etc. Many fascinating stunts may be devised, such as holding the button against the throat or cheek to reproduce speech without sound waves. \$5.00 is given to anyone who sends in a new suggestion for the use of the Button providing the manufacturers find it suitable for use in their literature. PRICE \$1.00 POSTPAID ANYWHERE.

### ANARCHIST BOMBS

One of these glass vials dropped in a room full of people will cause more consternation than a limburger cheese. The smell entirely disappears in a short time. 10c a Box, 3 Boxes for 25c

### INVISIBLE INK

The most confidential messages can be written in invisible ink. Nine separate articles in one. Everybody delighted with it. Odd, curious and interesting. Lots of pleasure as well as very useful. It is a double Microscope for examining the wonders of nature. It is also an Opera Glass, a Stereoscope, a Burning Lens, a Reading Glass, a Telescope, a Pocket Mirror, and a Laryngoscope—for examining eye, ear, nose and throat. It is worth the cost to locate even one painful cinder in the eye. Folds flat and fits the pocket. Something great—you need one. Don't miss it. Sent by mail, postpaid. Price, only 35c or 3 for \$1.00 postpaid.

### ITCHING POWDER

This is another good practical joke; the intense discomfort of your victims to everyone but themselves is thoroughly enjoyable. All that is necessary to start the ball rolling is to deposit a little of the powder on a person's hand and the powder can be relied upon to do the rest. The result is a vigorous scratch, then some more scratch, and still some more. 10c box, 3 boxes for 25c or 75c per doz boxes postpaid.

### LOOK

Wonderful Instrument. Greatest thing yet. Nine separate articles in one. Everybody delighted with it. Odd, curious and interesting. Lots of pleasure as well as very useful. It is a double Microscope for examining the wonders of nature. It is also an Opera Glass, a Stereoscope, a Burning Lens, a Reading Glass, a Telescope, a Pocket Mirror, and a Laryngoscope—for examining eye, ear, nose and throat. It is worth the cost to locate even one painful cinder in the eye. Folds flat and fits the pocket. Something great—you need one. Don't miss it. Sent by mail, postpaid. Price, only 35c or 3 for \$1.00 postpaid.

### RESURRECTION PLANT

One of the most wonderful plants known. Possesses the strange power of turning in a few minutes from an apparently lifeless, dry herb to a BEAUTIFUL LIVING FERN-LIKE PLANT of a dark green color. Simply place the plant in saucer of water, it will open up and start to grow in 20 minutes. When taken out it will dry up and go to sleep until placed in water again. Fine house plant—summer or winter. 10 cents each or 3 for 25c. Agents Wanted postpaid.

ADDRESS ORDERS FOR ALL GOODS ON THIS PAGE TO **JOHNSON SMITH & CO., DEPT. 364, RACINE, WIS.** Postage Stamps Accepted



## "High School Graduates Preferred" —and I lost my opportunity!

Just the sort of a position I liked best. Just exactly what I wanted to do. I seemed to meet all the requirements, to have all the qualifications, but . . .

"High school graduate preferred! I knew what that meant. Someone else would get the position. Someone else—with more education than I—with more schooling.

Must that handicap follow me all through life? Must I always feel—inferior—just because I had been unable to go to high school? I had seen so many cases where the lack of high school training kept otherwise capable young men and young women from desirable positions that I felt terribly discouraged.

### I Become My Own Teacher

Imagine how delighted I was when I read an announcement by the High School Home Study Bureau that courses were being offered for self-study in spare time at home. I found that perfectly splendid instruction was offered in high school subjects—Algebra, Biology, Physics, Economics, Literature, Latin, Spanish, English, French, American and Ancient History.

I enrolled, and what a pleasure it was to study in my spare time at home! No teachers. No class work, no correspondence lessons. The fascinating Question and Answer Method makes everything so simple and understandable. I like it more each day. And now I am actually acquiring a high school training—making up for lost time!

### High School Training At Home

Anyone can now acquire the essentials of a high school education right at home—quickly and easily—through an amazing Question-and-Answer Method. This method is so practical that it is being used and highly endorsed by students and teachers in thousands of high schools. The astonishingly low price places the course within the reach of all. Lose no time! Find out all about the High School Home Study Bureau at once!

### Mail Coupon For Information

For full details, and an interesting booklet about the courses, mail this coupon today. High school graduates earn 23 times as much as grammar school graduates—give yourself the chance to qualify for a better position.

Mail this coupon today. No obligation. High School Home Study Bureau, Dept. 210, 31 Union Square, New York City.

High School Home Study Bureau, Dept. 210, 31 Union Square, New York City.

Send me all the information about your High School Home Study Course without cost or obligation to me.

Name .....  
Address .....  
City ..... State .....

## Likes and Dislikes of the Radio Audience

(Continued from page 538)

who is the chief man of the orchestra under the conductor. He is assistant to the conductor and speaks for the men. He gives definition to the bowing and phrasing and fingering; and in an orchestra, where there are as many as forty violins, you can realize the importance of this.

The violas are to the violins as the baritone is to the tenor, or the contralto to the soprano. The viola is played in the same manner as the violin, but the tone is five notes lower and more mellow.

The 'cello is played between the knees of the artist. It is to the violin as the bass is to the tenor. The viola, 'cello and the bass violins are the foundation of the string section. The bass violins are those big violins played by the artist, when he tries to reach up to the top.

### THE WIND INSTRUMENTS

Now comes the wood wind section, called that in spite of the fact that often the instruments are not of wood.

The flute and piccolo are held parallel with the lips, and the air is sent at right angles to the instruments.

Now in the brass, we have the trumpet, the slide trombone which all recognize.

Now for the percussion. That includes drums, tympani (another form of drum of hemispherical shape), the triangle, bells and all the traps. They make the noises, thunder, etc. Of course every good orchestra also adds the harp for special effect, and sometimes the xylophone and other instruments on occasions.

Now you have a panorama of the orchestra formation.

### A MONTH'S FEATURES AT WRNY

During the past month at WRNY we put on the first exclusive radio prize fight, between Jimmy Rappaport and Bennie Martini, with that old veteran Jimmy Macdonald refereeing the bantams. The event was staged by Starlight Park. Also, we had a real swimming contest at WRNY. Do you wonder how it was done? Look at the picture of the girls. One of them was the Comtesse du Barry.

For the Fourth we reproduced the actual events at the Congress in 1776 when the Declaration was signed. The voices of John Hancock, John Adams, Thomas Jefferson and the rest spoke up in the way they did in the historic days.

During the past month Louise Closser Hale and Olive Wyndham were heard in an Edison Hour prize play. One of the most beautiful musical events ever radioed began this month at WRNY with the A. Y. Cornell Opera Company. Such voices! Fresh, beautiful and dramatic. And at the piano was the distinguished pianist composer Charles Gilbert Spross.

As dramatic as anything I have ever heard was the speech of Commander Edward Ellsberg, who raised the submarine S-51. He told just how it was done; and we were all weeping, when we weren't so tense we could scarcely breathe. Commander Ellsberg is a real literary man and quite an orator.

Did you hear us the night we brought Punch and Judy back to the kiddies?

Have you been listening to my family concert parties on Wednesday nights?

I hope you are getting acquainted with my Bohemian child, Josefa Chekova, and my Italian boy, Alberto Terrasi, and my American-Irish infant, J. Milton Bevan, and my Spanish youngster, Alfonso Romero, and all the rest of that merry family.

See you again next month.

# Remember this when you visit New York

THE Hotel Martinique offers unusual comfort and convenience plus genuine economy to every New York visitor.

Clean, comfortable rooms as low as \$2.50 per day. Most economical restaurant service — club breakfast \$.45, delightful table-d'hote dinner \$1.25. Also a la carte at moderate prices.

The Martinique is located right in the heart of all activity, business and social. Every point in the city readily accessible—direct from the door.

On your next visit—stop at the Martinique. You'll thank us for the invitation.

A. E. Singleton  
Resident Manager



## Hotel MARTINIQUE

Affiliated with Hotel McAlpin

BROADWAY 32nd to 33rd STREETS

NEW YORK CITY

**TYPEWRITER  
PRICES REDUCED** Free Trial

ON ALL MAKES  
Big bargains, easy payments on late model Underwoods, Royals, L.C. Smiths, Remingtons, etc.—perfect machines expertly remanufactured by the "Young Process" guaranteed like new for five years. Shipped direct from our factory to you at big saving. Our big illustrated catalog sent free and without obligation to buy. Write for yours today.  
Dept. 116A  
Young Typewriter Co. 624 W. Randolph St., Chicago, Ill.



## SQUAB BOOK FREE

Breed squabs and make money. Sold by millions. Write at once for free 40-page book beautifully printed in colors telling how to do it. You will be surprised. PLIMOUTH ROCK SQUAB CO. 506 N. St., Melrose Highlands, Mass.



# Largest variety of Radio Parts!

1926  
EDITION  
No. 16

300  
Illustrations

8-Page  
log book of  
all U. S.  
Broadcast  
Stations

## RASCO RADIO PARTS CATALOG No 16

RASCO  
HAS  
IT

THIS  
68 PAGE  
RADIO  
CATALOGUE  
FREE

75 HOOKUPS

Radio Specialty Co.  
96-98 Park Place  
New York  
"ALL GOODS SENT PREPAID IN U.S.A."

## BUY FROM RADIO'S OLDEST MAIL ORDER HOUSE

WE are the oldest established, exclusive radio mail order house in the country. Our motto is "Quick Shipment." All orders are shipped within 24 hours. Quick, prompt, courteous service. We carry a larger variety of radio parts and findings than any other radio house in the country.

### "RASCO HAS IT"

It you are in need of certain small radio parts that other radio and mail order houses do not bother to carry, get the Rasco parts catalog, and you will find them there, anything from a screw to copper ribbon and telephone diaphragms, as well as thousands of other small radio findings. Just to mention a few:

Lugs, nuts, dials, vernier dial, jacks, plugs, every kind of knob, cords, panels, screws, sliders, washers, selenium, tinfoil, switches, crystals, cap nuts, Litz wire, cord tips, brass rods, resistances, name plates, spring binding posts, switch parts, metal ribbon, carbon balls, binding posts, all types, switch points, switch levers, lock washers, carbon grains, ground clamps, metal pointers, insulated tubing, low melting metal, antenna connectors, bus bar wire, as well as thousands of other articles.

We carry the Largest Variety of Small Radio Parts in the World.



### THE NEW RASCO CATALOG No. 16

Contains the Following Hookups

All Armstrong Circuits: These important circuits are explained clearly, all values having been given. Just to name a few of the Vacuum Tube circuits: The V.T. as a detector and one-step amplifier; Super Regenerator; one-step radio frequency amplifier and detector; three-stage audio frequency amplifier; short wave regenerative circuits; 4-stage radio frequency amplifier; radio and audio frequency amplifier; inductively coupled amplifier; all Reflex Circuits. This catalog is crammed full of small parts and radio findings, literally thousands of them. In addition there is much useful information contained herein.

If you will paste this coupon on a post card and mail today, we will be pleased to send you our new Catalog at once.

RADIO SPECIALTY CO.,  
100 Park Place, New York  
S.I.-10-'26  
You may send me, without charge or obligation, your NEW CATALOG No. 16. (Write on margin if you desire.)  
Name .....  
Street .....  
P. O. .... State .....

**RADIO SPECIALTY CO.**  
100 Park Place New York, N. Y.

# U.S. PATENTS



**SEND FOR THIS FORM**

## Don't Lose Your Rights

Before disclosing your invention to anyone send for blank form "Evidence of Conception" to be signed and witnessed. A sample form together with printed instructions will show you just how to work up your evidence and establish your rights before filing application for patent. As registered patent attorneys we represent hundreds of inventors all over the U. S. and Canada in the advancement of inventions. Our schedule of fees will be found reasonable. The form "Evidence of Conception" sample, instructions relating to obtaining of patent and schedule of fees sent upon request. Ask for them,—a post card will do.



Registered Patent Attorneys in U.S. and Canada  
255 Ouray Bldg., Washington, D. C.  
"Originators of form Evidence of Conception"

# PATENTS

## TO THE MAN WITH AN IDEA

I offer a comprehensive, experienced, efficient service for his prompt, legal protection and the development of his proposition.

Send sketch, or model and description, for advice as to cost, search through prior United States patents, etc. Preliminary advice gladly furnished without charge.

My experience and familiarity with various arts frequently enable me to accurately advise clients as to probable patentability before they go to any expense.

Booklet of valuable information and form for properly disclosing your idea, free on request. Write today.

**RICHARD B. OWEN, Patent Lawyer**  
164 Owen Building, Washington, D. C.  
41V Park Row, New York City

**TRADE-MARKS REGISTERED**

# INVENTORS

who derive largest profits know and heed certain simple but vital facts before applying for Patents. Our book Patent-Sense gives those facts; sent free. Write

**LACEY & LACEY**

644 F STREET, WASHINGTON, D. C.  
Established 1869



Edited By  
**Joseph H. Kraus**

In this Department we publish such matter as is of interest to inventors and particularly to those who are in doubt as to certain patent phases. Regular inquiries addressed to "Patent Advice" cannot be answered by mail free of charge. Such inquiries are published here for the benefit of all readers. If the idea is thought to be of importance, we make it a rule not to divulge all details, in order to protect the inventor as far as it is possible to do so.

Should advice be desired by mail a nominal charge of \$1.00 is made for each question. Sketches and descriptions must be clear and explicit. Only one side of sheet should be written on.

**NOTE:**—Before mailing your letter to this department, see to it that your name and address are upon the letter and envelope as well. Many letters are returned to us because either the name of the inquirer or his address is incorrectly given.

### CAPLESS FOUNTAIN PEN

(963) D. S. Elgin, N. S. Pittsburgh, Pa., says he has designed a fountain pen requiring no cap and which is instantaneously ready for use.

A. If a pen of the type described in your letter can be made so as to be practical and so as to operate every time that the user desires it to, it should certainly find a ready sale. However, we cannot comment further upon the system unless you desire to supply us with complete details.

### IDEA PROTECTION

(964) Henry Blume, New York, N. Y., wants to protect his idea of a perpetual motion machine before having a model made and asks us what he should do.

A. The simplest way to protect yourself would be by making up an evidence of conception which consists of drawing up a complete set of designs and specifications covering the device and having each sheet signed, sealed and dated by a notary public and before two witnesses. This establishes a claim of priority. The evidence is for your own files and only to be used in case of necessity for prosecuting infringers.

### COLLAR BUTTON

(965) John Becker, Warren, Idaho, has been granted a patent on a collar button made in the form of a hinge-like structure which is placed on the shirt band and then clamped under and around the collar. He has been unable to sell the idea on a royalty basis and asks us if he should go into the manufacture of the product.

A. You have probably discovered by this time that it will be difficult for you to place your idea on the market. The reason for this is quite obvious. There are entirely too many operations which must take place in order to fasten the collar to the shirt and the only apparent advantage is that it does not distort the button-hole tab of a collar. This advantage is slight and probably questionable. A collar fastener should in all cases be speedy in insertion; it should make it easier for the collar to be placed on the collar-band rather than make it more difficult. The less metal that touches the neck, the better that collar fastener. In your device the hinge is bound to irritate the neck; a good portion of the metal touches the neck constantly. The clasp must first be fitted down over the shirt band and then must be raised upon the collar itself after the collar has been located over the button.

We certainly would not suggest that you go to the expense of having the dies made for this particular device or try to sell the marketed article.

If there is any possible way of selling the invention, we would suggest that you do so, otherwise it would seem to us that the idea is a dead issue and could not possibly find a favorable market.

We do not think that \$450 is too much for the dies. A small die averages about \$200 and you will need more than one to make the finished article.

### CHAIN FASTENER

(966) Alex Barna, Belle Mead, N. J., asks our opinion of a log cabin fastener of seemingly conventional design.

A. We do not see any advantage whatsoever in your particular type of chain fastener. It does not appear to be any simpler or to have any advantages over the types of chain fasteners in use today. Possibly you could obtain a patent on your particular suggestion, but even at that, we are very much of the opinion that such a patent would not be at all valuable. We would, therefore, not advise you to invest any more time or money in the prosecution of this idea.

### TO SUE OR NOT TO SUE

(967) O. S. Whitehurst, Gloucester, N. C., claims that a certain concern has stolen his invention of a two-filament electric lamp and wonders what he can do about it.

A. If you can prove that the concern now manufacturing the two-filament electric light bulb actually infringed on your idea you can probably sue that concern.

You state merely that you have ample proof that you are the inventor thereof. That proof would have to consist in having built a working model of the device before it was actually patented by the concern now making the same.

Two-filament lights are old and have been known for a great many years. The main invention is the switching mechanism enabling the individual to operate either one filament or the other as desired.

### RADIATOR SIGNAL

(968) G. H. Wenn, New York, N. Y., asks our opinion of a semaphore signal to indicate if the water in the radiator of a gas engine is too hot.

A. In regard to the Stop and Go sign, or a semaphore, to indicate when the radiator of an automobile is too hot or cold, we would suggest that you look at the radiator caps of some of the automobiles in New York and you will find that the identical system is now in use.

This article may be purchased in any of the larger automobile supply stores.

### COOKIE CUTTER

(969) William Atherton, Ford City, Ontario, Canada, has designed a unique cookie cutter which rolls along as it cuts. He asks our opinion of the system.

A. It would seem that you have a rather clever little device for cutting dough. If the device could be properly financed and promoted, you should have no trouble in selling it through the medium of department and household furnishing stores. However, a device of this nature will not prove profitable to you unless you can manufacture it on a large scale or sell the rights to the idea. This could probably be done without applying for a patent and consequently you would save just that much money. Protect yourself by means of an evidence of conception which consists of drawing up a complete set of designs and specifications covering the device and having each sheet signed, sealed and dated by a notary public and before two witnesses. This evidence is for your own files and only to be used in case of necessity for prosecuting infringers.

# INVENTORS PROTECT YOUR IDEAS

Send for our Guide Book, **HOW TO GET A PATENT**, and Evidence of Invention Blank, sent Free on request. Tells our terms, methods, etc. Send model or sketch of your invention for **INSPECTION** and **INSTRUCTIONS FREE. TERMS REASONABLE. BEST REFERENCES.**

Name .....

Street .....

City .....

**RANDOLPH & CO.**  
Dept. 172, WASHINGTON, D. C.

**MY PATENT  
LAW OFFICES**



**JUST ACROSS  
STREET FROM  
U.S. PAT. OFF.**

# PATENTS

**INVENTORS**  
Write for these  
**FREE BOOKS!**



At the left is a view of my drafting and specification offices where a large staff of experienced experts are in my constant employ. All drawings and specifications are prepared under my personal supervision.

## PROTECT YOUR IDEAS Take the First Step Today—Action Counts

If you have a useful, practical, novel idea for any new article or for an improvement on an old one, you should communicate with a competent Registered Patent Attorney AT ONCE. Every year thousands of applications for patents are filed in the U. S. Patent Office. Frequently two or more applications are made for the same or substantially the same idea (even though the inventors may live in different sections of the country and be entirely unknown to one another). In such a case, the burden of proof rests upon the last application filed. Delays of even a few days in filing the application sometimes mean the loss of a patent. So lose no time. Get in touch with me at once by mailing the coupon below.

### No Charge for Information on How to Proceed

The booklet shown here contains valuable information relating to patent procedure that every inventor should have. And with it I will also send you my "Record of Invention" form, on which you can sketch your idea and establish its date before a witness. Such evidence may later prove valuable to you. Simply mail the coupon and I will send you the booklet, and the "Record of Invention" form, together with detailed information on how to proceed and the costs involved. Do this NOW. No need to lose a minute's time. The coupon will bring you complete information entirely without charge or obligation.

### Prompt—Careful Efficient Service

This large, experienced organization devotes its entire time and attention to patent and trademark cases. Our offices are directly across the street from the U. S. Patent Office. We understand the technicalities of patent law. We know the rules and requirements of the Patent Office. We can proceed in the quickest, safest and best ways in preparing an application for a patent covering your idea. Our success has been built on the strength of careful, efficient, satisfactory service to inventors and trademark owners located in every state in the Union.

## Clarence A. O'Brien

**Registered Patent Attorney**  
Member of Bar of: Supreme Court of the United States; Court of Appeals, District of Columbia; Supreme Court, District of Columbia; United States Court of Claims  
Practice confined exclusively to Patents, Trademarks, and Copyrights

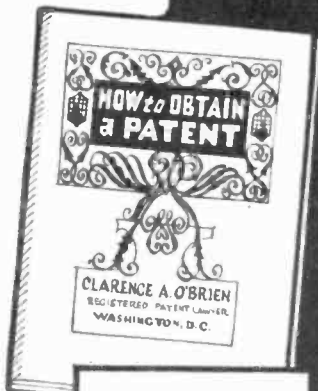

### Strict Secrecy Pre- served—Write Me in Confidence

All communications, sketches, drawings, etc., are held in strictest confidence in strong, steel, fireproof files, which are accessible only to authorized members of my staff. Feel free to write me fully and frankly. Your case will have my personal attention. It is probable that I can help you. Highest references. But **FIRST**—clip the coupon and get my free book. Do THAT right now.

## Mail this Coupon NOW.

**CLARENCE A. O'BRIEN**  
Registered Patent Attorney,  
53-M Security Savings & Commercial Bank Bldg.,  
Washington, D. C.  
Please send me your free book, "How to Obtain a Patent," and your "Record of Invention" form without any cost or obligation on my part.

Name .....

Address .....

(Important: Print or Write name clearly)



# "The Boss Didn't Even Know My Name"

"He said my face was more or less familiar and he remembered seeing me around, but he didn't even know my name until the I. C. S. wrote him that George Jackson had enrolled for a course of home study and was doing fine work."

"Who's George Jackson?" he asked. Then he looked me up. Told me he was glad to see I was ambitious. Said he'd keep his eye on me.

"He did too. Gave me my chance when Frank Jordan was sent out on the road. I was promoted over older men who had been with the firm for years."

"My spare-time studying helped me to get that job and to keep it after I got it. It certainly was a lucky day for me when I signed that I. C. S. coupon."

How much longer are you going to wait before you take the step that will bring you advancement and more money?

It takes only a moment to mark and mail this coupon and send it to the International Correspondence Schools at Scranton. Isn't it better to do this today than to wait a year or five years and then wish you had?

### Mail the Coupon for Free Booklet

**INTERNATIONAL CORRESPONDENCE SCHOOLS**  
Box 6165-E Scranton, Penna.

Oldest and largest correspondence schools in the world  
Without cost, please tell me how I can qualify for the position or in the subject before which I have marked an X:

#### BUSINESS TRAINING COURSES

- Business Management
- Industrial Management
- Personnel Organization
- Traffic Management
- Business Law
- Banking and Banking Law
- Accountancy (including C.P.A.)
- Nicholson Cost Accounting
- Bookkeeping
- Private Secretary
- Spanish  French
- Salesmanship
- Advertising
- Buyer Letters
- Show Card Lettering
- Stenography and Typing
- Business English
- Civil Service
- Railway Mail Clerk
- Common School Subjects
- High School Subjects
- Illustrating

#### TECHNICAL AND INDUSTRIAL COURSES

- Electrical Engineering
- Electric Lighting
- Mechanical Engineer
- Mechanical Draftsman
- Machine Shop Practice
- Railroad Positions
- Gas Engines Operating
- Civil Engineer
- Surveying and Mapping
- Metallurgy  Mining
- Steam Engineering  Radio
- Architect
- Architects' Blueprints
- Contractor and Builder
- Architectural Draftsman
- Concrete Builder
- Structural Engineer
- Chemistry  Pharmacy
- Automobile Work
- Airplane Engines
- Agriculture and Poultry
- Mathematics

Name..... Street..... Address..... City..... State.....

Occupation..... If you reside in Canada, send this coupon to the International Correspondence Schools Canadian Limited, Montreal

## Into the Fourth Dimension

By RAY CUMMINGS  
(Continued from page 505)

us, to enter perhaps into a frustration of our plans, with which my imagination now endowed its purpose, made me read into its attitude a tenseness of line; an alertness, even a guarded wariness which had not seemed inherent to it before. Was this thing indeed aware of our purpose? Was it waiting for Wilton Grant to come into the shadows to meet it upon its own ground? With an equality of contact, was it then planning to set upon him?

Bee was murmuring, "It's waiting for you. Will, it's waiting for you to come—" Shuddering words of apprehension, of which abruptly she seemed ashamed for she checked them, going to the table where she began adjusting the apparatus.

"I'm coming," said Will grimly. "It will do well to wait, for I shall be with it presently." He stood for a moment before the thing, contemplating it silently. Then he turned away, turned his back to it; and a new briskness came to his manner.

"Rob, I'm ready. Bee knows exactly



"Wilton's eyes were closed. They opened now, and his arm and hand with a wraith-like quality came upon them, were raised to a gesture. The signal, I would have stammered so to Bee, but already she had marked it and shut the current off. And very quietly, unhurried, she bent over and disconnected the wires, casting them aside.

what we are to do. I want you to know also, for upon the actions of you two, in a measure depends my life. I shall sit here on the mattress. Perhaps, if I am more distressed than I anticipate, I shall lie down. Bee will have charge of the current. There will come a point in my—departure when you must turn off the current, disconnect the wires from me. If I am able, I will tell you, or sign to you when that point is reached. If not—well then you, must use your own judgement."

"But I—I have no idea—" I stammered. Suddenly I was trembling. The responsibility thrust thus upon me seemed at that moment unbearable.

"Bee has," he interrupted quietly. "In general I should say you must disconnect when I have reached the point where I am—" He halted as though in doubt how to phrase it—"the point where I am half substance, half shadow."

To my mind came a mental picture which then seemed very horrible; but resolutely I put it from me.

"You're ready, Bee?" he asked. "Quite ready, Will." She was counting

# \$351.00 CLEARED IN ONE DAY

So writes W. H. Adams of Ohio. Letter from V. A. Marini of California reports \$11275 sales in three months. Jacob Gordon of New Jersey \$4000 profits in two months. Alexander of Pennsylvania "\$3000 profits in four months." Ira Shook \$365 sales in one day. Bram bought one outfit April 5 and 7 more by August 28. Iwata, bought one outfit and 10 more within a year. Mrs. Lane of Pittsburg says "sold 8000 packages in one day. J. R. Bert says "only thing I ever bought that equaled advertisement." John Culp says: "Everything going lovely. Crispette wrappers scattered all over town. It's a good world after all." Kellog, \$700 ahead end of second week.



### WE START YOU IN BUSINESS

Furnish secret formulas, raw material, and equipment. Little capital required; no experience needed.

### Build a Business of Your Own

No limit to the sale of Crispettes. Everybody likes them. It's a delicious food confection. Write for facts about a business that will make you independent. Start now, in your own town.

### Profits \$1000 a Month Easily Possible

Send postal for illustrated book of facts. It contains enthusiastic letters from others—shows their places of business, tells how and when to start, and all information needed. Free. Write now!

**LONG-EAKINS COMPANY**  
1053 High Street Springfield, Ohio

### PATENT YOUR IDEAS

Inventions developed. Patents secured in the U. S. & Foreign countries. Satisfactory Terms. Write, call or phone HANOVER 3562 for confidential advice and Invention Recording Blank.

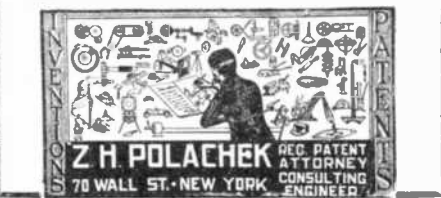

# PATENTS

BOOKLET FREE HIGHEST REFERENCES PROMPTNESS ASSURED BEST RESULTS  
Send drawing or model for examination and report as to patentability

**WATSON E. COLEMAN, Patent Lawyer**  
644 G Street, N. W., Washington, D. C.

# INVENTIONS Commercialized

ON A CASH OR ROYALTY BASIS  
PATENTED or UNPATENTED  
In Business 25 Years - Complete Facilities - References.  
Write **ADAM FISHER MFG. Co.**,  
205L Enright Ave. St. Louis, Mo.

# C. L. PARKER

Ex-Examiner U. S. Patent Office  
Attorney-at-Law and Solicitor of Patents  
McGill Building, Washington, D. C.  
Patent, Trade Mark and Copyright Law

# You can be quickly cured, if you STAMMER

Send 10 cents for 288-page book on Stammering and Stuttering, "Its Cause and Cure." It tells how I cured myself after stammering 20 yrs. B. N. Bogue, 8133 Bogue Bldg., 1147 N. III. St., Indianapolis

### BLUE BOOK ON PATENTS

and Priority Record blank gratis.  
**MONROE E. MILLER, PATENT LAWYER.**  
411-6 Ouray Building, WASHINGTON, D. C.  
ELECTRICAL AND MECHANICAL EXPERT

## PATENTS

TRADE MARKS DESIGNS  
FOREIGN PATENTS

## MUNN & Co.

PATENT ATTORNEYS

Associated since 1846 with the Scientific American  
1518 Scientific American Bldg., New York City  
525 Scientific American Bldg., Washington, D. C.  
1314 Tower Building, Chicago, Ill.  
667 Hobart Building, San Francisco, Cal.  
522 Van Nuys Building, Los Angeles, Cal.

Books and Information on Patents and Trade Marks by Request.

Insure your copy reaching you each month. Subscribe to SCIENCE AND INVENTION—\$2.50 a year. Experimenter Publishing Co., 53 Park Place, New York City.



out a number of the tiny pellets with hands untremling. The woman in Bee was put aside; she stood there a scientist's assistant, cool, precise, efficient.

"I think I should like less light," he said; and he turned off all the globes but one. It left the room in a flat, dull illumination. He took a last glance around. The window sashes were up, but the shades were lowered. A gentle breeze from outside fluttered me of them a trifle. Across the room the spectre, brighter now, stood immobile. The clock marked one minute of ten.

"Good," said Will. He seated himself cross-legged in the center of the mattress. In an agony of confusion and helplessness I stood watching while Bee attached the four wires to the garment he wore. One on each of his upper arms, and about his thighs where the short trunks ended.

Again I stammered, "Will, is this—is this all you're going to tell us?"

He nodded. "All there is of importance . . . A little tighter, Bee. That's it—we must have a good contact."

**\$5,000**  
for  
**Perpetual Motion**

When **SCIENCE AND INVENTION** Magazine was still in its infancy, the editors denied the possibility of constructing a perpetual motion machine using those forces of nature as we now know them.

Since that time the editors have received thousands of different designs for perpetual motion devices, and have received hundreds of circular letters soliciting finances for the building of perpetual motion machines.

The editors know that if they receive these letters, there are thousands of others in this country who get similar letters and who fall for the claims made in the numerous prospectuses giving the earning capacities of the various machines.

Most of the shares of stock for these perpetual motion machines are being sold at a rate of \$1.00 per share, although some inventors are trying to sell shares of stock at \$100.00 per share.

Therefore the editors of this publication say, "Just come in and show us—merely **SHOW** us—a working model of a perpetual motion machine and we will give you \$5,000.00. But the machine must not be made to operate by tides, winds, waterpower, natural evaporation or humidity. It must be perpetual motion."

"I mean," I persisted, "when you are— are shadow, will we be able to see you?"

He gestured. "As you can see that thing over there, yes."

His very words seemed unavoidably horrid. Soon he would be—a thing, no more.

"Shall you stay here, Will, where we can see you?"

He answered very soberly. "I do not know. That, and many other things, I do not know. I will do my best to meet what comes."

"But you'll come back here—here to this room, I mean?"

"Yes—that is my intention. You are to wait here, in those chairs. One of you always awake, you understand—for I will need you, in the coming back."

There seemed nothing else I would ask, and at last the moment had come. Bee handed him the pellets, and held the glass of water. For one brief instant I had the sense that he hesitated, as though here upon the brink the human fear that lies inherent to every mortal must have rushed forth to stay his hand. But an instant only, for calmly he placed the pellets in his mouth and washed them down with the water.

# PATENTS TRADE-MARKS AND COPYRIGHTS

## OUR OFFER: FOR THE PROTECTION OF YOUR INVENTION

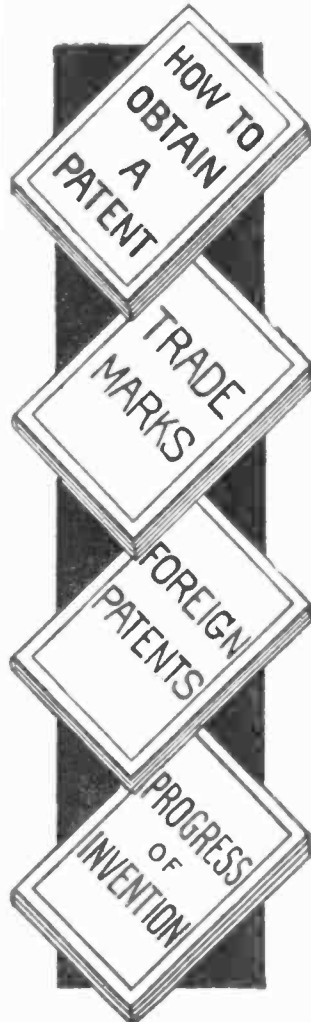

*YOUR FIRST STEP* before disclosing an invention. The inventor should write for our blank form—

### "Record of Invention"

This should be signed and witnessed and returned to us together with model or sketch and description of the invention for **INSPECTION and INSTRUCTIONS.**

NO CHARGE FOR THE ABOVE INFORMATION

**Our Four Books Mailed Free to Inventors**  
*Our Illustrated Guide Book*

### HOW TO OBTAIN A PATENT

Contains full instructions regarding U. S. Patents. Our Methods, Terms, and 100 Mechanical Movements illustrated and described.

### OUR TRADE MARK BOOK

Shows value and necessity of Trade Mark Protection. Information regarding *Trade Marks and unfair competition in trade.*

### OUR FOREIGN BOOK

We have Direct Agencies in Foreign Countries, and secure Foreign Patents in shortest time and at lowest cost.

### Progress of Invention

Description of World's Most Pressing Problems by Leading Scientists and Inventors.

## IMPORTANT

Do not submit your invention to anyone before you furnish proof that the invention is patentable or application has been filed. **IN ORDER TO HAVE YOUR CASE MADE SPECIAL TO AVOID DELAY YOU SHOULD TAKE THE PRECAUTION OF HAVING YOUR CASE MADE SPECIAL IN OUR OFFICE** to secure protection, save correspondence and secure early filing date in Patent Office. To secure special preparation of your case send \$25.00 on account with model, sketch and description of your invention.

All communications and Data Strictly Confidential. Interference and Infringement Suits Prosecuted. Our Organization offers **PERSONAL SERVICE** by Experienced Patent Solicitors and Draftsmen.

*We Regard a Satisfied Client* as our best advertisement, and furnish anyone, upon request, lists of clients in any state for whom we have secured patents.

*Highest References—Prompt Attention—Reasonable Terms*

WRITE TODAY

**FREE COUPON**

**VICTOR J. EVANS & CO., Patent Attorneys**  
New York Offices Philadelphia Offices Pittsburgh Offices  
1007 Woolworth Bldg. 714-715 Liberty Bldg. 514 Empire Bldg.  
Chicago Offices, 1114 Tacoma Bldg. San Francisco Offices, Hobart Bldg.  
Main Offices, 779 Ninth Street, Washington, D. C.

Gentlemen: Please send me **FREE OF CHARGE** your books as described above.  
Name..... Address.....

# Electrical Engineering

B.S. degree three years. I.e. at. Light, Power, AC-DC, Armature winding, Testing of Radio—Complete in 90 days.

**ONE YEAR—FOUR 90-DAY COURSES**

At the request of the United States Government, B. of E. Students made the Acceptance Test of this Huge Electrical Generating Unit built for the Panama Canal.

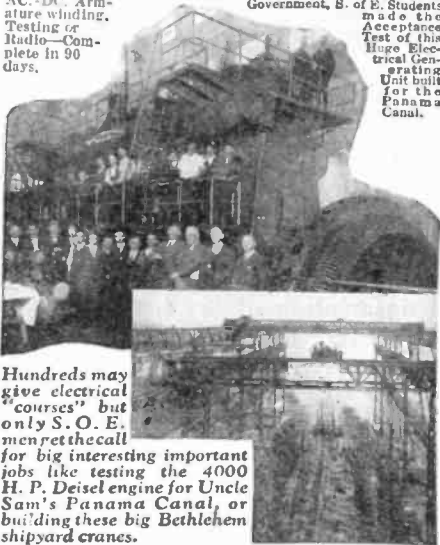

Hundreds may give electrical "courses" but only S. O. E. men get the call for big interesting important jobs like testing the 4000 H. P. Diesel engine for Uncle Sam's Panama Canal, or building these big Bethlehem shipyard cranes.

## PRACTICAL TRAINING!

We teach by scientific methods, under practical working conditions, all branches of Electrical Engineering. No matter what your age or education, there is a starting point for you at S. of E. Big concerns are pleading for trained men. We must get them.

**YOU ARE** a Graduated Electrician, Electro-technician or Commercial Electrical Engineer after a few months of S. O. E. training. Practical Engineers teach you. Men like Prof. Ball, assistant to Dr. Steinmetz for years. We bring the finest engineering talent in Milwaukee and the middle-west right into the school. Men who know what and how you should do things to make big pay. Hundreds of thousands in equipment for you to work with.

**\$3200 AND UP AWAITS** the S. O. E. man! Our graduates go to Commonwealth-Edison, Allis-Chalmers, Cutler-Hammer, Harnischfeger Corp'n, etc. Some of their biggest men are S. O. E. trained and on the lookout to help you when you come in.

### WE HELP YOU GET THE JOB

Our employment department places you. Low tuition. Splendid board and room reasonable. Daily broadcasting from school station. WSOE. School orchestra. Fraternities.

**ACT NOW FOR IMMEDIATE ENROLLMENT.** Due to enormous personal attention to each man our classes are filling rapidly. Our tuition fee is low. Refunded in full if you aren't satisfied. New book about S. O. E. now off the press and entirely FREE. If you want success in electricity send the coupon now.

## SCHOOL of ENGINEERING of Milwaukee

FOUNDED 1905  
Dept. 97, 415-17 Marshall St., Milwaukee, Wis. Bx 572

SCHOOL OF ENGINEERING OF MILWAUKEE  
Dept. 97, 415-17 Marshall St., Milwaukee, Wis. Bx 572

Without obligating me in any way, please mail free 72-page illustrated book, "Electricity and the One Best Way to Learn It," and particulars regarding the course I have marked with an X.

- ....Commercial Electrical Eng. ....Armature Winding
- ....Elec. Eng., B.S. Deg. in 3 yrs. ....Light, Heat, Power Wiring.
- ....Electrotechnics ....Testing
- ....Junior Electrical Eng. ....Practical Electricity
- ....Automotive Electricity ....Home Laboratory Service
- ....Radio Sales, Service and Broadcasting

Name.....Age.....  
Address.....  
City.....State.....  
Education.....

"Now—the current, Bee."  
His voice had not changed; but a moment after I saw him steady himself against the mattress with his hands; momentarily his eyes closed as though with a rush of giddiness, but then they opened and he smiled at me while anxiously I bent over him.  
"All right—Rob." He seemed breathless. "I think—I shall lie down." He stretched himself at full length on his back; and with a surge of apprehension I knelt beside him. I saw Bee throw on the little switch. She stood beside the table, and her hand remained upon the switch. Her face was pale, but impassive of expression. Her gaze was on her brother and I think I have never seen such an alert steadiness as marked it.

A moment passed. The current was on, but I remarked unmistakably that no sound came from it. The room indeed had fallen into an oppressive hush. The flapping shades momentarily had stilled. Only the clock gave sound, like the hurried thumping

**IMPORTANT**  
TO NEWSSTAND READERS

IN order to eliminate all waste and unsold copies it has become necessary to supply newsstand dealers only with the actual number of copies for which they have orders. This makes it advisable to place an order with your newsdealer, asking him to reserve a copy for you every month. Otherwise he will not be able to supply your copy. For your convenience, we are appending herewith a blank which we ask you to be good enough to fill in and hand to your newsdealer. He will then be in a position to supply copies to you regularly every month. If you are interested in receiving your copy every month, do not fail to sign this blank. It costs you nothing to do so.

To \_\_\_\_\_ Newsdealer

Address \_\_\_\_\_

Please reserve for me \_\_\_\_\_ copies of **SCIENCE & INVENTION** every month until I notify you otherwise, and greatly oblige,

Name \_\_\_\_\_

Address \_\_\_\_\_

of some giant heart, itself of all in the room most alive.  
Wilton Grant lay quiet. His eyes were fixed on the ceiling; he had gone a trifle pale and moisture was on his forehead, but his breathing, though faster, was unlabored.  
I could not keep silent. "You—all right, Will."

At once his gaze swung to me. A smile to reassure me plucked at his parted lips. "All—right, yes." His voice a half-whisper, not stressed, almost normal; and yet it seemed to me then that a thinness had come to it.

Another moment. The putty-colored garment he wore had lost the vague sheen of its reflected light and was glowing with an illumination now inherent to it. A silver glow, bright like polished metal; then with a greenish cast as though phosphorescent. And then, did I fancy that its light, not upon it or within it, but behind it, showed the garment turning translucent?

I became aware now of a vague humming. An infinitely tiny sound—a throbbing hum fast as the wings of a humming bird, near at hand, very clear, yet infinitely tiny. The battery—the current; and yet in a moment with a leaping of my heart, I knew it was not the current but a humming vibration

## Thousands Use These Ingenious TRANSMITTER UNITS

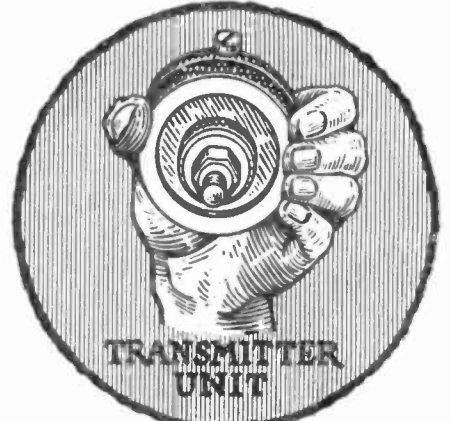

Here's a marvel of Engineering design—a practical miniature transmitter, used by thousands of radio fans and experimenters for amplification purposes. It is a most novel unit, having hundreds of uses. Every amateur should have two or three of these amplifiers in his laboratory.

**A FEW USES FOR THESE UNITS**

<p>~LOUD SPEAKER RETRANSMISSION~</p>	<p>~PHONOGRAPH MUSIC AT A DISTANCE~</p>
<p>~GRID LEAK~</p>	<p>~AMPLIFIER~</p>
<p>~ONE STAGE AMPLIFICATION~</p>	<p>~RADIO AMPLIFIER~</p>
<p>~TALKING LIGHT~</p>	<p>~DETECTOR~</p>
<p>~CODE PRACTICING DEVICE~</p>	<p>~BALDWIN PHONE AMPLIFIER~</p>

With each unit is mailed an eight-page instruction pamphlet containing suggestions for innumerable uses. Our supply is limited; avoid disappointment by ordering today. The coupon below is for your special convenience.

**SPECIALLY PRICED**  
While they last— **95c**  
(or Two for \$1.75) per unit

THE PRESS GUILD,  
66-5 West Broadway, New York, N. Y.  
Enclosed find 95c/\$1.75 for which send no postpaid one/two amplifier units as advertised.

Name \_\_\_\_\_  
Address \_\_\_\_\_  
City, State \_\_\_\_\_

from the body of Wilton Grant. A sense of revulsion, a fear—I have no memory adequately to name it—swept me. I rose hastily to my feet; as though to put a greater distance between us I moved backward, came upon a leather easy chair, sank into it, staring afrighted, fascinated at the body recumbent before me.

The change was upon it. A glow had come to the ruddy pink flesh of the arms and legs, bared chest, throat and face. The pink was fading, replaced, not by the white pallor of bloodlessness but by a glow of silver. A mere sheen at first; but it grew into a dissolving glow seeming progressively to substitute light for the solidity of human flesh.

And then I gasped. My breath stopped. For behind that glowing, impassive face I saw the solid outlines of the mattress taking form, saw the mattress through the face, the chest, the body lying upon it.

Wilton's eyes were closed. They opened now, and his arm and hand with a wraith-like quality come upon them, were raised to a gesture. The signal. I would have stammered so to Bee, but already she had marked it and shut the current off. And very quietly, unhurried, she bent over and disconnected the wires, casting them aside.

**A Few "Radio News" October Features**

"Wired Radio" and Its Applications.  
By M. L. Muhleman

Types of Audio Frequency Amplifiers.  
By Sylvan Harris

Assuring Safety in Radio Installations.  
By A. P. Peck

The Excelsior Receiver.  
The Infradyne Receiver.  
A "5 in 2" Receiver.  
New Developments in Radio Apparatus.  
By G. C. B. Rowe

A Perfect Static Shield.  
By Volney G. Mathison

"B" Battery Eliminators.  
By M. L. Muhleman

A New Amplifier and "B" Supply Unit.  
By A. H. Lynch and R. R. Mayo

"Echoing Silence," Part II.  
By George B. Ludlum

The humming continued; so faint, so rapid I might have fancied it was a weakness within my own ears. And presently it ceased.

Bee sat in the chair beside me. The body on the mattress was more than translucent now; transparent so that all the little tufts of the mattress-covering upon which it lay were more solidly visible than anything of the shadowy figure lying there. A shadow now; abruptly to my thought it was Wilton Grant no longer.

And then it moved. No single part of it: as a whole it sank gently downward, through the mattress, the floor, until a foot or so beneath, it came to rest. With realization my gaze turned across the room. The silent spectre was still there, standing beneath the floor, standing I realized, upon the same lower level where the shadow of Wilton Grant now was resting.

I turned back, saw Bee sitting beside me with white face staring at the mattress; and I heard myself murmur, "Is he all right do you think? He hasn't moved. Shouldn't he move? It's over now, isn't it?"

She did not answer. And then this wraith of Will did move. It seemed slowly to sit up; and then it was upright, wavering. I stared. Could I see the face of my friend? Could I mark this for the shadow of his

(Continued on page 548)



**Free Book**

with the library if you order NOW

Bishop's ELECTRICAL DRAFTING & DESIGN gives all of the practical working information that a man needs in order to handle any of the work he will meet with in the field.

The book covers general drafting practice—electric symbols and use—layout—switchboards—lighting—wiring for residences—substation—motors and motor wiring.

It is of the greatest value to any man in electricity. It gives you an understanding of electrical drawings and diagrams that will be of daily value to you in your work.

—order now for Bishop's ELECTRICAL DRAFTING AND DESIGN—FREE

**The Sure Way to Big Pay**

**B**IG salaries are paid in the electrical field for expert knowledge. The man who knows electricity in all its many phases—the man who has completely mastered the subject from A to Z—can pick his own job and name his own salary. The only way you can earn more is to learn more. Small knowledge means small pay. Learn the way to bigger pay. Become an expert. Croft will show you how. And the Croft way is the sure way to the big-pay job.

**Croft Library of Practical Electricity**

*8 volumes—3000 pages—2100 illustrations—flexible keratol*

In the eight books that make up the Croft Library will be found the essentials of a complete electrical education.

Volume One, by Palmer, contains a complete, practical course in mathematics. Volumes Two and Three present the fundamental facts and theories of electricity and its present-day applications.

Volume Four is a practical working manual covering the basic principles, operation and management of commonly used electrical machinery. Volume Five thoroughly covers modern central-station practice.

Volume Six tells how to install wiring and apparatus for practically all services under practically all conditions. Volume Seven covers the wiring of finished buildings and Volume Eight deals with the problems of electric illumination. The man who masters the information contained in these eight standard handbooks has his future success in the electrical field definitely assured.

**Know electricity as experts know it and earn an expert's pay**

No course, no set of books offer a quicker, surer method of mastering electricity than the Croft Library. It is founded on practice—on work as it is actually done. It is jammed from cover to cover with the kind of hard-headed, pay-raising facts you want. Written so that the beginner can easily understand it, yet so sound, so thorough that it is the daily guide of thousands of highly paid electrical workers and engineers. Croft shows you how to master the finer points of electrical practice. He teaches you electricity as experts know it and puts you in line for an expert's pay.

**Examine the books for 10 days free**

We want you to test our statements—we want you to compare the Croft books with others. Fill in and mail the coupon attached and we will send you the entire set of eight volumes for ten days' Free Examination. We take all the risk—pay all charges. You assume no obligation—you pay nothing unless you decide to keep the books. Then \$1.50 in ten days and the balance at the rate of \$2.00 a month. Send the coupon NOW and see the books for yourself.

When your first payment of \$1.50 is received we will send you your free copy of Bishop's Electrical Drafting and Design.

But act now—this offer will soon be withdrawn—and will never be made again. Don't miss it!

**No money down—small monthly payments—7c a day. ACT NOW**

**Start with this pay-raising set. Get this great book—FREE.**

**BIG BARGAIN OFFER COUPON**

McGRAW-HILL BOOK CO., INC.,  
570 Seventh Ave., New York

Gentlemen—  
Please send me the Croft Library of Practical Electricity (shipping charges prepaid) for 10 days' free examination. If satisfactory, I will send \$1.50 in 10 days and \$2 per month until \$19.50 has been paid. If not wanted, I will write you for return shipping instructions. Upon receipt of my first payment of \$1.50 I am to receive a copy of Bishop's Electrical Drafting and Design without additional charge. (Write plainly, fill in all lines.)

Name .....

Address .....

Position .....

Company .....

**Mail this Coupon**

SI 10-126



## New-way shaving More and more men are discovering it

Self-shaving in a professional manner with a barber-edge blade, speedy, super-comfortable. This is the daily delight of all who own Valet AutoStrop Razors.

Not amateurish. Not a substitute. But a better shave in every way.

Simpler. This unique razor sharpens its own blades. No unscrewing. No disassembly. Sharpen, shave and clean without removing the blade.

More economical. A new-like blade for every shave. The utmost in self-shaving satisfaction.

# Valet AutoStrop Razor

REG. U. S. PAT. OFF.

AutoStrop Safety Razor Co., 656 First Avenue, New York City

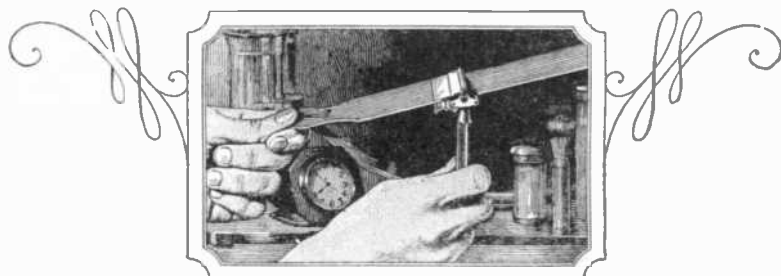

The Razor That Sharpens Itself

### Into the Fourth Dimension

(Continued from page 547)

familiar figure, garbed in that woven suit? It seemed so. And yet I think now that I was merely picturing my memory of him; for surely this thing wavering then before me was as formless, as indefinable, as elusive of detail as that other, hostile spectre across the room.

Hostile! It stood there, and then it too was moving. It seemed to sweep sidewise, then backward. Ah, backward! A triumph came to me that perhaps now a fear lay upon it. Backward, floating, walking or running I could not have told. But backward, beyond the walls, the house, smaller into the dimness of distance.

Was the shadow of Wilton Grant following it? I could not have said so. But it too, was now beyond the room. Moving away, growing smaller, dimmer until at last I realized that I no longer saw it.

We were alone Bee and I; alone to wait. The mattress at my feet was empty. I heard a sound. I turned. In the leather chair beside me Bee was sobbing softly to herself.

#### CHAPTER IV

#### THE RETURN

THE hours seemed very long. A singular desire for silence had fallen upon us. For myself, and it is my thought that the same emotion lay upon Bee, there were a myriad questions

To Readers of

#### "THE EXPERIMENTER"

You will find the best features of THE EXPERIMENTER preserved in SCIENCE & INVENTION, besides a brand new "Model Department". See the beautiful Silver Trophy cup for best model each month described elsewhere in this issue.

upon which idly I would have spoken. Yet of themselves so horrible, so fearsome seemed their import that to voice them would have been frightening beyond endurance.

Thus, we did not speak; save that at first I comforted Bee, clumsily as best I could, until at last she was calmer, smiling at me bravely, suggesting perhaps that I would sleep while she remained on watch.

The clock ticked off its measured passing of the minutes. An hour. Then midnight. The window shade was flapping again with the night wind outside. I rose to close the sash, but Bee checked me.

"He might want to come in that way. You understand, Rob—"

Memory came to me of the half-materialized spectre of that Kansas farmhouse, that apparition so ponderable of substance that it must perforce escape by the opened window. I turned back to my chair.

"Of course, Bee. I had forgotten."

We spoke in hushed tones, as though unseen presences not to be disturbed were around us. Another hour. Throughout it all with half closed eyes I lay back at physical ease in my chair, regarding the white walls of our little room so empty. We still kept the single dull light; dull, but it was enough to illumine the solid floor, that starkly empty mattress, the white ceiling, the four walls, closed door at my side, the two windows, one of gently flapping shade. And as musingly I stared, the sense of how constricted was my vision grew upon me. I could see a few feet to one blank

**FREE**

*This 84 Page*  
**Wonder Book of RADIO Bargains**



Send for it **TODAY**

**Save 1/3 to 1/2**

Send for this guide to Radio prices and Radio quality. All of our vast resources and radio experience have been utilized to assemble for you in one gigantic institution, the best and newest things in radio. The Randolph catalog is indeed the radio market place of the world—a masterpiece of merchandising that befits our house—the largest exclusive radio mail order house in the world.

**What Our Catalog Contains**

Over 2,000 items—from the most beautiful, fully equipped console model radio set, down to the smallest part or tool for the set builder—kits, parts, and supplies of every conceivable type and style. All beautifully illustrated and interestingly described. And to give this book added value, we have included radio data that makes it an invaluable text book for every lover of today's most fascinating and most wonderful achievement—RADIO.

**Radio Sets**

In this great radio market place you will find table model sets and console types with built-in loud speakers; the newest amphiphonic console sets; new Spanish period consoles; five, six, seven, and eight tube sets, with three dial, two dial, and the newest and most popular single simplified control. All sets are assembled in beautiful, genuine mahogany and walnut cabinets in a choice of latest types and designs.

**5 Tube sets as low as \$24.90**  
**Latest 1927 Models**

All Randolph sets are sold at amazingly low prices. No matter what kind of set you want—no matter how little you want to pay—you can select **YOUR SET AT YOUR PRICE** from the Randolph catalog.

**Radio Kits**

Includes the following well known circuits, designed and approved by the world's foremost radio engineers: Madison Moore Super; Victor-teen Super; Silver Marshal Six; Sargent's In-fradyne; Remler Super; Short Wave Kits; 9-in-Line Super; New Acme Reflex; Cockaday; Neutrodyne; Browning-Drake; all classes of radio frequency, Super Heterodyne and every other approved popular circuit.

**YOU MUST HAVE THIS BOOK**

Space limitations here prevent our telling you more about the Randolph Catalog. Simply fill out and mail the coupon—or you may send a postal or letter—and this truly remarkable Radio book will come to you **ABSOLUTELY FREE. MAIL THE COUPON NOW.**

**Randolph Radio Corporation**  
**180 North Union Avenue • Dept. 18 • Chicago, Ill.**

**Radio Parts and Supplies**

The Randolph catalog also contains a most complete line of "B" Battery Eliminators, including the famous Raytheon Eliminators; the latest type of Loud Speakers, Cone Speakers, a complete line of quality "A" power units—in fact, you will find listed in this wonder book every part that goes into the construction of a radio set, or any accessories you desire, at prices that mean a substantial saving to you.

**Free Radio Service**

Everyone has need for radio service. The average man has no time to keep up with the rapid developments of radio. We employ Radio Engineers who have made radio their life work. Their expert advice and helpful suggestions solve every radio problem of our customers.

**Our Guarantee**

Every article in our catalog is based on careful laboratory analyses and tests. We guarantee to back up every item in our catalog with our own as well as manufacturer's assurance of quality.

*Why We Save You Money*

Because we handle radio exclusively and sell a tremendous volume of everything in Radio, we can concentrate our buying power for the benefit of our customers.

Volume purchases regulate prices. We command rock bottom prices from manufacturers, and in many cases we contract for entire factory output of exclusive products. You will benefit by our great volume of purchases and sales, by securing anything you may want in radio at a substantial saving.

**This Coupon Brings the Great RADIO Book FREE**

**RANDOLPH RADIO CORPORATION**  
180 N. Union Ave., Dept. 18  
Chicago, Illinois

Send me—free—your 84-page, 1927 Radio Book.

Name \_\_\_\_\_

Street and No. \_\_\_\_\_

R. F. D. \_\_\_\_\_ Box \_\_\_\_\_

City \_\_\_\_\_ State \_\_\_\_\_

# Don't Wreck Your Married Life!



**STRONGFORT**  
Builder of Men

Are you going to commit a common crime by marrying a girl, when you know that you are a physical derelict, floundering around in the grip of diseases and ailments which you are afraid to acknowledge? Cut out attempts at deception. You can't fool anyone. The girl will find you out. What you are your children will be—and your weaknesses and defects will be visited upon them. It is the inexorable law of Nature. Your children, if you have any, will live to curse you.

You don't want to deceive the girl who loves and trusts you and wreck her life by making her the mother of little ones who will cause her to curse the day she married you. You want her to bear happy, healthy laughing children, who will grow up into strong, virile men and women, a source of joy and comfort to you both in your old age.

### Fit Yourself for Matrimony

It is a crime to marry when you know that you are not physically fit. That pure girl is blinded by her love for you and does not realize your deficiencies. She thinks you are a prince among men—the ideal of vigorous manhood. She pictures you as her husband and father of her children.

**THINK WHAT IS AHEAD FOR YOU!**—Disappointment, disgust, divorce, perhaps—and, if you marry and have children—what sort of children can you expect? If you are weak, nervous, sickly, watery-blooded, your children will be rickety, puny, scrupulous, sallow-faced weaklings of whom you will be ashamed.

**YOU KNOW** that you are not fit—you dare not marry in your present physical condition. The future looks dark and gloomy to you. But **CHEER UP!**—my hand is held out to you in friendship—I want to help you. **I CAN HELP YOU THROUGH**

## STRONGFORTISM

Science of Health and Strength

**STRONGFORTISM** has lifted thousands of weak, ailing, impotent discouraged men out of the bog of hopelessness and despair and placed them on the straight road to health, happiness and prosperity.

**STRONGFORTISM** has aided Nature in overcoming such ailments as Catarrh, Constipation, Indigestion, Rupture, Nervousness, Bad Blood, Poor Memory, Vital Depletion, Impotency, etc., and the results of neglecting and abusing the body.

**STRONGFORTISM** has restored the manhood they thought lost forever and has given them renewed confidence, vitality, ambition, success and fitted them for the responsibilities of marriage and parenthood.

### Write for My Free Book

The experience and research of a lifetime are contained in my wonderfully instructive book, "Promotion and Conservation of Health, Strength and Mental Energy." It will tell you frankly how you can make yourself over into a vigorous specimen of vital manhood with 100% pep, power and personality. It will show you how to be true to the best that is within you. It is absolutely free. Just check the subjects on the free consultation coupon on which you want special confidential information and send to me. It is a man-builder—a success maker and a lifesaver. Send for my free book right now—**TODAY**.

## LIONEL STRONGFORT

Physical and Health Specialist for over 25 Years

DEPT. 238 NEWARK, N. J.

-----CLIP AND SEND THIS COUPON-----  
**FREE CONSULTATION**  
**ABSOLUTELY CONFIDENTIAL**

MR. LIONEL STRONGFORT,  
Strongfort Institute, Dept. 238, Newark, N.J.

Please send me absolutely free my copy of your book, "Promotion and Conservation of Health, Strength and Mental Energy." I have marked (x) before the subjects in which I am most interested.

- |              |                  |                     |
|--------------|------------------|---------------------|
| ..Colds      | ..Weak Eyes      | ..Vital Losses      |
| ..Catarrh    | ..Flat Chest     | ..Lung Troubles     |
| ..Asthma     | ..Dependancy     | ..Poor Circulation  |
| ..Headache   | ..Emaciation     | ..Round Shoulders   |
| ..Rupture    | ..Rheumatism     | ..Youthful Errors   |
| ..Thinness   | ..Nervousness    | ..Manhood Restored  |
| ..Pimples    | ..Constipation   | ..Skin Troubles     |
| ..Insomnia   | ..Night Losses   | ..Stomach Disorders |
| ..Impotency  | ..Short Breath   | ..Increased Height  |
| ..Overweight | ..Weak Heart     | ..Muscular          |
| ..Weak Back  | ..Great Strength | ..Development       |

Name .....

Age..... Occupation.....

Street .....

City..... State.....

wall or another, or to the ceiling above, the floor below, but no further. Yet awhile ago, following the retreat of those white apparitions, my sight had penetrated beyond the narrow confines of this room into distances illimitable. And to me then came a vague conception of the vast mystery that lay unseen about us, unseen until peopled by things visible to which our sight might cling.

The realm of unthought things! Yet now I was struggling to think them. The realm of things unseen. Yet I had seen of them some little part. The wonder came to me then, were not perchance, unthought things non-existent until some mind had thought them, thus to bring them into being?

Two o'clock. Then three. Five hours. He had said he might return in five hours. I stirred in my chair, and at once Bee moved to regard me.

"He will be coming, soon," I said softly.

"It is five hours, Bee"

"Yes, he will be coming soon," she answered.

Coming soon! Again I strove with tired eyes to strain my vision through those solid walls. He would be coming soon; I would see him, far in the distance which his very presence would open up to me. Then—a

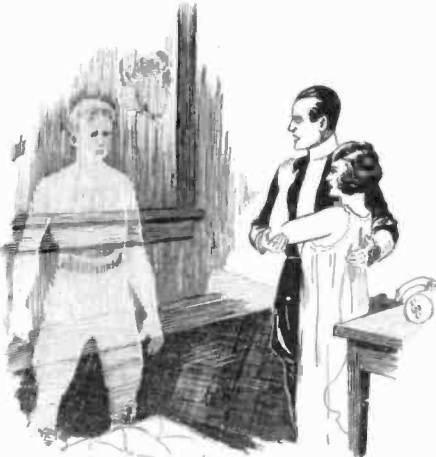

Bee's agonized call rang out. "Will! Is this you, Will?" We stood together; she clung to me. The figure advanced, stood now quite within our walls. No longer wholly spectral, a cast of green had come to it; a first faint semblance of solidity. It stood motionless; drooping, as though tired and spent. Was it Wilton Grant?

hour later, or nearly—I thought I saw him, but it was a glint of light on a tiny nail-head buried in the wall.

And then I saw him! Straight before us. Beyond the wall, with unfathomable distances of emptiness around him. It might have been our light gleaming upon an unnoticed protuberance of the rough plaster of the wall, so small was it; but it was not, for it moved, grew larger, probably coming toward us.

Bee saw it. "He's there! See him, Rob!" Relief in her tone, so full to make it almost tearful; but apprehension as well, for to her as to me came the knowledge that it might not be he.

Breathless we watched; waited; and the white luminosity came forward. Larger, taking form until we both could swear it was the figure of a man. Lower now, beneath the level of our floor. It came, stopped before us almost within the confines of the room.

We were on our feet. Was it Wilton Grant? Was this his tall, spare figure—this luminous, elusive white shape at which I gaped? Did I see his shaggy hair? Was that his brief woven garment? I prayed that my imagination might not be tricking me.

Bee's agonized call rang out. "Will! Is this you, Will?"

**WRITTEN 2-YEAR GUARANTEE**

## Battery Prices SMASHED!

To Consumers Only

Here is a real battery quality, guaranteed to you at prices that will astound the entire battery-buying public. Order Direct From Factory. Put the Dealer's Profit in your own pocket. You actually save much more than half, and so that you can be convinced of true quality and performance, we give a **Written 2-Year Guarantee**. Here is your protection! No need to take a chance. Our battery is right—and the price is lowest ever made. Convince yourself. Read the prices!

**Auto Batteries**      **Radio Batteries**

6Volt, 11 Plate, \$8.50      6Volt, 100 Amp. \$8.50  
 6Volt, 13 Plate, \$10.25      6Volt, 120 Amp. \$10.25  
 12Volt, 7 Plate, \$11.75      6Volt, 140 Amp. \$11.75

**Buy Direct—Send No Money**

We ask no deposit. Simply send name and address and style wanted. Batteries will be shipped same day we receive your order Express C.O.D. subject to your examination on arrival. Our guarantee accompanies each battery.

We allow 5% discount for cash in full with order. You cannot lose! Send your order today—**NOW!**

**ARROW BATTERY CO.**  
 Dept. 9 1215 So. Washab Ave., Chicago

## WADE BENCH LATHE

Absolutely Guaranteed

For Repair Shops, Amateur Mechanics, Model Makers, Inventors who want a real, accurate machine tool at a price within easy reach. A complete shop in itself. Capacity 4 in. diameter x 12 in. length. Handles metal, wood, and other materials. Turning—facing—boring—drilling—winding—thread cutting. The "Waide" is a bargain at several times the price. Guaranteed a high degree of accuracy, quality of materials, workmanship and finish.

The slider has travel entire length of bed. Lead screw inside bed. Hollow spindle.

No. 1 Lathe, plain headstock - \$28.00  
 No. 2 Lathe, back-geared - \$30.00

Either lathe with 18 in. length between centers, \$7.00 extra. Complete line of accessories. Also. By all means write for this free book.

**THE GEROLD COMPANY**  
 Dept. S-17, 120 Liberty St., New York

## Tire Agents Wanted

Use and introduce **MELLINGER CO. 15,000 MILES GUARANTEED**

Lowest Wholesale Prices in America. Shipped prepaid on approval. Make big money all or part time. No capital or experience. Sample sections furnished.

**YOUR TIRES FREE!**

Simply send name today for FREE BOOK, title how thousands do big business. Special Agents Offer. Wholesale Prices and FREE Sample Kit.

**MELLINGER TIRE & RUBBER CO.**

Dept. 411, Kansas City, Mo.      **WRITE**  
 Dept. 411, Philadelphia, Pa.      **NEAREST**  
 Dept. 411, Oakland, Calif.      **OFFICE**

## GAS BLOW TORCH and SOLDER IRON HEATER

Connects to any gas jet or gas connection. No air attachment necessary. Heats solder iron in less than a minute. For home use, repair shops, laboratories, manufacturing plants, and foundries. A wonder for the mechanic's work bench and for dentist.

A Blast 8" long, 1" in diameter—Intense Heat.

Postpaid \$1.00; Canada \$1.40

**TRI-UNE CO., Dept. 804B, 215 S. 15th Ave., Maywood, Ill.**

## FINAL SALE

**King of Revolvers**

Has all improvements of latest guns, \$35 value, left wheeler, safety hand ejector, guaranteed never out of order 6-shot, 32-20 or 38 cal. Send No Money. Pay on delivery \$8.99 plus postage. Satisfaction or money back. Federal Mail Order, 651 Broadway, New York, Dept. E80

Cut to \$8.99

## Handwriting Corrector

Wonderful, new device, guides your hand; corrects your writing in few days. Big improvement in three hours. No failures. Complete outline FREE. Write C. J. Ozment, Dept. 44 St. Louis, Mo.

Insure your copy reaching you each month. Subscribe to **SCIENCE AND INVENTION**—\$2.50 a year. Experimenter Publishing Co., 53 Park Pl., N. Y. C.

We stood together; she clung to me. The figure advanced, stood now quite within our walls. No longer wholly spectral, a cast of green had come to it; a first faint semblance of solidity. It stood motionless; drooping, as though tired and spent. Was it Wilton Grant? It moved again. It advanced, sank into the floor as though sitting down—sitting almost in the center of the mattress, though a foot beneath it. Significant posture! It had come to the mattress from whence it had departed. It was Wilton Grant!

We bent down. Bee was on her knees. Now we could see details, clearly now beyond all possibility of error. Will's drawn face, haggard, with the luminosity every moment fading from it, the lines of opaque human flesh progressively taking form.

He was sitting upright, his hands bracing him against that unseen level below us. Then one of his hands came up, queerly as though he were dragging it, and rested on the higher level of the mattress. His eyes, still strangely luminous, were imploring us. And then his voice; a gasp; and a tone thin as air.

"Raise—me! Lift—me up!"

Bee's cry was a horror of self-reproach, and I knew then that she must have neglected the instructions he had given her. We touched him; gripped him gently. Beneath my fingers his half ponderable flesh seemed to melt so that I scarce dared press against it. We raised him. There was little weight to resist us; but as we held him, the weight grew. Progressively more rapidly; and within my fingers I could feel the blessed solidity coming.

Again he gasped, and now in a voice of human labored accents. "Put me—down. Now—try it, Bee."

We lowered him. The mattress held him. At once he sank back to full length, exhausted, distressed—but uninjured. Bee gave him a restorative to drink. He took it gratefully; and now, quite of human aspect one more, he lay quiet, resting.

Bee's arms went down to him. "Oh Will—to have you back again—safe with us—you must go to sleep now—then you can tell us—"

"Sleep!" He sat up so abruptly it was startling; more strength had already come to him than I had realized. "Sleep!" He mocked the word; his gaze with feverish intensity alternated between us.

"Bee—Rob, this is no time for talk . . . No, I'm all right—quite recovered. Listen to me, both of you. What I have been through—seen, felt—you could never understand unless you experienced it. No time for talk—I must go back!"

A wildness had come to him, but I could see that he was wholly rational for all that; a wildness, born of the ordeal through which he had passed.

"I must go back, at once. The danger impending to our world here—is real—far worse than we had feared. Impending momentarily—I had feared it—but now I know. And I must go back. With you—I want you two with me. You'll go, Bee. Rob, will you go? Will you, Rob?"

A sudden calmness had fallen upon Bee. "I'll go of course," she said quietly.

"Yes, of course. And you, Rob? Will you go with us? We need you."

Would I go? Into the unnameable, the shadows of unthought, unseen realms, to encounter—what? A rush of human fear surged over me; a trembling; a revulsion; a desire to escape, to ward off this horror crowded thus upon me. Would I go? I heard my own voice say strangely:

"Why—why yes, Will, I'll go."

Go! Leave this world!

And my voice was telling them calmly that I would go!

END OF PART II

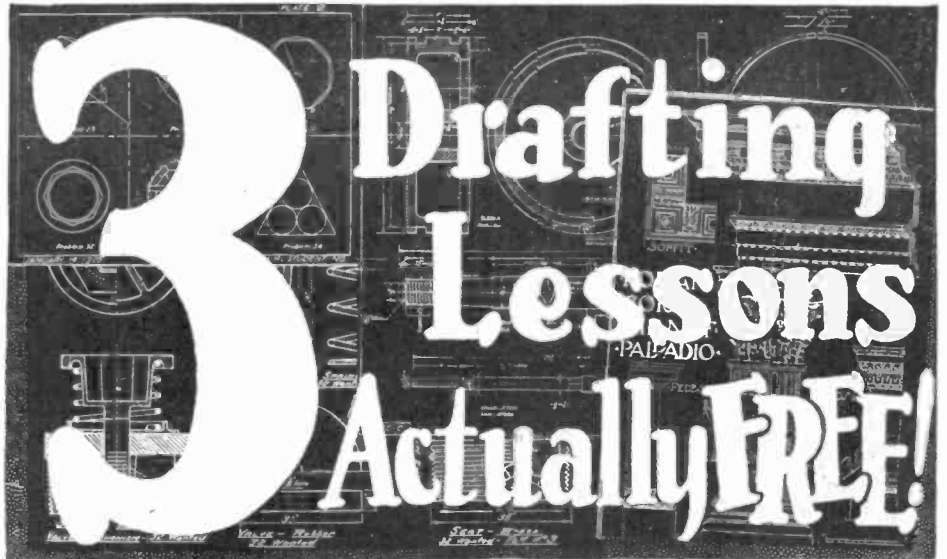

*to prove you can learn at home in spare time!*

We have invented a new, simplified way to teach Drafting—the first real improvement in Drafting home-instruction in history. We want you to see it, try it—without one penny of cost or obligation. We want to show you how we get away from the copying methods used in the past. See how we make you think, solve problems, do actual drafting room jobs from the first lesson!

**I will make this contract with you:**

When you enroll for our home-training in Drafting, we agree to give you:

1. Complete Drafting training, by the new Practice-Method.
2. Professional Drafting Outfit, as illustrated.
3. We will help you get a good Drafting position at a substantial increase in pay.
4. Or we'll refund every cent of your money.

*O'Malley*

The American School, a million dollar No-Profit Educational Institution now offers men a double service—training for a specific job, then finding the job. For one small price, on terms of only \$5 a month, you are now assured of definite benefits, both in position and salary.

**Draftsmen WANTED!**

70,000 fine jobs advertised this year, many at \$60 to \$125 a week. Get ready to fill one. Get out of the rut. Make something of yourself. Plan your future in Drafting. Even if you have only common schooling, even if you know nothing of Drafting, we guarantee to make you a real Draftsman or to refund your money! Special surprise offer right now to the first 500 men who answer this ad—reduced price, easy terms. Coupon brings complete information.

**A new, rapid, simplified way**

This new "Job-Method" gives you actual drafting-room jobs in a new one-step-at-a-time way. With pictures which you can understand almost without reading the "lessons." And that is why American School-trained Draftsmen can qualify for a good job at big pay when they graduate.

**Coupon brings complete details of this sensational offer!**



**5 HIGHWAYS TO SUCCESS!**

The big money in Drafting goes to men who specialize in Machine Design, or Electrical Drafting, or Architectural Drafting, or Structural, or Automotive. It isn't enough merely to know general Drafting practice. You must know how to calculate and design and plan original work. You need many Engineering subjects to fill the kind of a Drafting position that pays \$60 to \$125 a week. The American School now includes this specialized training in its Drafting course.

**COUPON**

**Brings 3 Lessons Free**

Get them. Test your own ability to learn Drafting and get ready for a fine job and big pay. Coupon also brings surprise offer, and complete information about your opportunities for success in Drafting. **MAIL IT TODAY!**

Chief Drafting Engineer  
**AMERICAN SCHOOL**  
 Dept. D-726  
 Drexel Ave. & 58th St., Chicago  
 Rush 3 Free Drafting Lessons, surprise offer, complete information, money-back guarantee, etc., to prove I can become a real Draftsman at home in spare time.

Name.....  
 Street No.....  
 City.....State.....

**Job Service Free to Students and Graduates:**

THE AMERICAN SCHOOL now offers its students and graduates, without cost, the services of an efficient Employment Department which keeps in touch with the employers of Draftsmen all over the United States. We have placed hundreds of men in good Drafting positions. We have made this training so complete, so practical, so easy to master, that our students are bound to make good. And, so, because the demand for real Draftsmen continues to exceed the supply and because this training actually prepares men for good Drafting positions, we back it with a Free Employment Service, free to employers, students, graduates.

**Professional Outfit Given**

Fine, imported instruments help you learn Drafting easily and quickly. These standard quality, full-size instruments, including board, table, triangles, T-square, ink, protractor, etc. given without extra charge to students.

Chief Drafting Engineer

**American School** Drexel Ave. and 58th St. Dept. D-726 Chicago, Ill.



## He puts the PEP in the party

He's indispensable! this popular fellow who puts the pep in the party with his sweet singing

### **BUESCHER**

### True Tone Saxophone

You, too, have a natural desire to produce music. "Oh! If I could only play some instrument" you have said to yourself. Then you have thought of long hours of practicing scales, with possible failure in the end, and you have been afraid to try. Listen!

#### You Can Teach Yourself

If you can whistle a tune, if you can beat time, you can learn to play the Buescher Saxophone, Easily! You can teach yourself, at home, in a few evenings. Three simple lessons given on request with each new Saxophone start you. You learn scales in an hour and start playing tunes in a week. Your progress will astonish and delight you and surprise your friends.

#### Try Before Buying. Easy Terms

Take home with you any Buescher instrument, Trombone, Cornet, Trumpet, Saxophone for six days' trial. Test it. See what you can do with it. If you like it, pay a little each month. Play as you Pay. Satisfaction guaranteed. Send for beautiful free catalog of any instrument and details of trial and payment plans. No obligation. Do this today.

**BUESCHER BAND INSTRUMENT CO.**  
Everything in Band and Orchestra Instruments  
1739 Buescher Block Elkhart, Indiana



### The Story of the SAXOPHONE

Gives complete history and tells why the Buescher is so easy to learn to play. In it you will find the first lesson chart. You must have this fine book.

**Clip the Coupon NOW!**

**BUESCHER BAND INSTRUMENT CO.** 306A  
1739 Buescher Block, Elkhart, Indiana.  
Gentlemen: Without obligating me in any way please send me your free literature. I am interested in the instrument checked below.  
Saxophone  Cornet  Trumpet  Trombone  Tuba   
Mention any other.....  
Name.....  
Address.....

### Simple High Temperature Furnaces

By WILLIAM CAPUNE  
(Continued from page 520)

two small holes, and reamed out in a long taper as shown. The other connections are best made by fitting a short section of metal tubing tightly into the holes in the mixing valve and connecting them to the gas and air sources with rubber tubing.

For safety's sake a hydraulic valve similar to that in Fig. 2 should be connected in the gas feed line. It consists merely of a tin can half filled with water, having two tubes soldered in its sides. The gas has to bubble through the water to secure exit to the furnace line and this water prevents the gas from burning back in the tube in case the pressure should drop. The air can be under almost any pressure, and almost any source is suitable: bellows, pump, tanks, blowers, or what not. If the experimenter sets out to make a motor-driven pump let me warn him to make the pump of large bore and stroke, particularly the bore.

To operate the furnace the gas is turned on, letting it run for a few moments until the air in the tubing has been blown out. The gas is then lighted and the air turned on gradually until an almost transparent blue flame with a dark blue center is secured. Crucibles placed in the focus of the ring of burning jets will be raised to temperatures high enough for the production of the alloys given at the end of this article.

For temperatures just a trifle lower than those given by this gas furnace an unusual type of alcohol burner is shown in Fig. 3. It depends on the idea of vaporizing the alcohol and mixing with air under pressure, thus securing a higher temperature and efficiency. Two tripods of different heights are mounted on a base, for convenience in moving about. On this same base, at one side, is made, in any fashion, a platform the height of the lower tripod. This supports the alcohol reservoir. The mixing valve for this burner may be the same as that described for the first case, but the wood should be soaked in varnish since alcohol will dissolve shellac. The valve is hung between the legs of the tripods as shown. A far better valve can be made by joining glass tubing into the same general form and size as the passages of the wooden model. In addition, a small vertical hole is drilled at A., running into the junction of the three internal tubes. When not being used this new hole should be plugged with a cork.

A tube leads from the alcohol reservoir, having a stopcock at the joint with the can, and, just past the stopcock, a wad of cotton string or a small piece of sponge wedged into the tube. This is to allow the passage of alcohol without an actual flow since the latter would send the alcohol spouting out of the burner holes. The tube from the alcohol reservoir leads around in a loop raised just off the lower tripod. The mixing valve connects with the other end, the port used for gas in Fig. 1 being connected to this tube. This tube has no burner holes in it; its sole purpose is to be heated by the burner tube, vaporizing the liquid alcohol within. The mixture part of the mixing valve is connected to another loop of tubing just outside the first, and which is placed on the surface of a sheet of screening covering the platform of the lower tripod. The other end of this loop is stopped up, the tube itself being pierced as was the case in the first furnace. These holes should be placed so that the jets of flame will point toward the tripod platform immediately above, the jets just passing by the vaporizing tube.

A hydraulic valve cannot be used with this alcohol burner since the vapor would be con-

# BIG SUMMER OFFER

**\$2 VALUE \$1  
..FOR..**

This is the biggest opportunity of the year.

To the readers of SCIENCE and INVENTION we have arranged to offer a big reduction in the famous Conrad Pattern's and E. I. Co. Books; millions of these have been bought by Radio Fans. They are recognized and sold by the best Radio stores and Newsdealers.

We offer any \$2.00 worth of these books and patterns you may select for \$1.

Think of it! \$2 for \$1. Just check \$2 worth from the list below and send \$1 with the coupon and we will mail you the materials at once.

LARGE ORDERS ACCEPTABLE IN THE SAME PROPORTION.

## MAIL THIS COUPON NOW!

THE CONRAD CO., Inc. S.I.10  
64 Church St., New York, N. Y.  
Gentlemen:—I enclose \$1, please send me the items checked below. (Items checked not to exceed \$2 worth.)

- E. I. BOOKS, regular price 25c**
- No. 1. Tips for the Radio Constructor.
  - No. 2. How to Make Practical Radio Receivers.
  - No. 3. Radio Questions Answered.
  - No. 5. Loud Talkers and How to Build Them.
  - No. 6. How to Tune Your Radio Set.
  - No. 7. One Hundred Radio Hook-ups.
  - No. 8. All About Radio Parts.
  - No. 9. History and Operation of Vacuum Tubes.
  - No. 10. The Neutrodyne and All About It.
  - No. 11. How Radio is Received.
  - No. 13. Reflex Radio Receivers.
  - No. 14. The Super-Heterodyne, Theory and Construction.

- CONRAD PATTERNS, regular price 50c**
- No. 2. How to Make a Two-Stage Amplifier
  - No. 4. How to Make a Reinartz Receiver.
  - No. 5. How to Make a Reflex Receiver.
  - No. 6. How to Make a Cockaday Receiver.
  - No. 9. How to Make the S.T. 100 Receiver.
  - No. 11. How to Make a Five-Tube Cockaday Receiver.
  - No. 12. How to Make a Portable Receiver.
  - No. 13. How to Make a Harkness Receiver.
  - No. 15. How to Make a Low Loss Receiver.
  - No. 16. How to Make the Tropadyne Superadio.
  - A. Radio Map of the U. S. on Cloth.
  - B. 20 Radio Diagrams and Hook-ups.
  - C. All About Aerials and Their Construction.
  - D. Radio Amateurs' Practical Design Data.

NAME .....

ADDRESS .....

CITY, STATE .....



densed to a liquid by its passage through the water. For this reason the alcohol reservoir should have a tight fitting lid pierced by only one small hole. Thus, if the alcohol vapor should burn back due to a fall in the air pressure or any other reason, the alcohol in the can would not burn because of lack of air.

In starting this burner a little alcohol is poured into the auxiliary tube A of the mixing valve and runs down into the burner where it can be lighted after waiting a moment to allow it to vaporize. The burning of this alcohol heats the other tube which contains alcohol, vaporizing the latter, which, flowing into the mixing valve, is mixed with air and blown into the burner tube. The object to be heated is placed on the screening across the upper tripod. Though most reactions that can be secured with the gas furnace are possible with this type of burner the cost is greater and the efficiency in heating operations extending over longer periods of time is much lower, due to radiation of heat into the surrounding air. The temperature attainable is about 3,000 degrees Fahrenheit.

The king of all laboratory furnaces is the acetylene furnace shown in Fig. 4. A temperature of over 4,500 degrees Fahrenheit is easily attainable with this type; in addition it is very cheap in operation and requires no piping for gas in the lab.

The furnace proper is shown in Fig. 4. Two blocks, A and B, are made or cast in the shape shown, the lower one having the two-burner tubes cast in it. Each tube is in the shape of a U with one branch lying along the bottom of the hollow in the lower block, B. The other end of each is plugged up and the usual holes are pierced in each, so that the jets of flame will point toward the center line lengthwise of the cavity. Stopcocks in both the air and gas pipes at the entrance to the mixing valve are necessary.

An acetylene gas generator is also necessary and may be made, or purchased very reasonably. A simple generator is shown in Fig. 5: the carbide is placed in the bottom of a large can and water, from a tube above having a stopcock in it, drips into the can. The reaction produces acetylene which is conducted through tubing to the reservoir shown in Fig. 6. After having experimented with all kinds of expansible reservoirs for maintaining an even pressure the writer has found the one shown to be the best of the simple types. A large coffee can is fitted with a 3/4" tube at the base which is connected with a long piece of glass tubing of the same size by a section of rubber hose. The longer the glass tubing the better. A little salt water is put in the bottom of the can and the gas enters at A, leaving at B. The pressure of the gas forces the water out into the tube, the height in the tube increasing with the pressure. Thus, the water in the glass tube forms only a gauge indicating the pressure and amount of gas in the tube and actually governs it to a certain extent, by the weight of its column. Hence the advantage of a long tube. A pressure of about 0.5 pound per square inch is exerted in the can by a column of strong salt solution twelve inches high. A larger tube does not increase the pressure for the same length of tubing. The entrance at A has a flap valve of thin, oiled leather which prevents the pressure from being taken back in the generator.

From B the gas is led through a hydraulic valve, filled in this case with brine, in which acetylene is only slightly soluble. From the hydraulic valve it goes into the mixing valve through the port which was marked "Gas" in Fig. 1.

To light this furnace the gas generator is started and the reservoir raised to its maximum pressure (from two to four pounds is excellent). If a higher pressure is desired and a higher air pressure is available the upper end of the glass tube may be closed

# How to Make Better Christmas Gifts

## Wonderful New Way to Improve Your Craftsmanship

LePage's NEW Books Will Show You How

NOW with the coming of the holiday, gift-making season, when the man who has a home workshop especially enjoys his hobby of making useful, practical gifts that can be used and appreciated by everyone in his home—come these two NEW LePage's Craft Books to show you how to make better Christmas Gifts and how to improve your craftsmanship. The titles of these two books are "LePage's Practical Suggestions for the Home Workshop," and "LePage's Gesso-Craft Book."

Naturally when you tackle the making of an article like a breakfast nook, ship model or cedar chest, you want to come as near as possible to equaling the skill of the trained cabinet-maker. One of the things which he knows that you also must know is how to make strong joints—joints that combine strength with gracefulness and beauty. The only way to do this is with the use of glue, and this is exactly the information given you in these books. They tell you how to make strong joints with glue, and not only with glue, but with glue in its most convenient form—LePage's Liquid Glue.



### Handiest tool in your workshop

Perhaps you have never thought of the special advantages of using LePage's Liquid Glue. It is always ready for immediate use. No weighing, soaking or heating is required. Its quality is always the same. It "sets" slowly enough so that you have plenty of time to place the joints together exactly as they should go. Slow setting also allows LePage's to penetrate the wood, increasing the strength of the joint. LePage's Liquid Glue is equal in strength to any animal glue. Buy a can for your workshop. It is the easiest, quickest, handiest form of Glue. Insist on LePage's.

### Improve your craftsmanship

These books also show you how to cover up small defects in your craftsmanship. Now and then a tool will slip and an error is made. Or there are holes to be filled where nails or screws have been countersunk. Or the edges of a joint are not exactly even. A simple new way to repair these defects is with the use of LePage's Gesso instead of putty. LePage's Gesso will stick to any surface—wood, metal, glass, etc. It can be sandpapered, planed and painted or stained just like wood. We give you in the small panel below a simple formula for making LePage's Gesso, but of course we tell you more about it in the books themselves, together with practical information on decorating your finished articles with Gesso.

### Send 10 cents for these NEW LePage's Books

THE practical and useful help of these two books is yours for only 10 cents. Just write your name and address on the coupon below, tear the coupon out and mail it to us today with 10 cents in coin or stamps, and we will at once send you a copy of these two LePage's Books, postage paid. Address, LePage's Craft League, Dept. NN1, Gloucester, Mass. Tear out the coupon now so that you will not forget it.

**Recipe for making LePage's GESSO**

To make one cup of LePage's Gesso, you need 1 gill can of LePage's Glue, 1 1/4 cups whiting, 3 teaspoons linseed oil and 2 teaspoons varnish. Place whiting in mixing bowl and pour in slowly in this order, LePage's Glue, linseed oil and varnish. Mix until smooth. All ingredients obtainable at nearest hardware store.



**LE PAGE'S LIQUID GLUE**  
Bottles, Tubes, Cans

LEPAGE'S CRAFT LEAGUE,  
Dept. NN1 Gloucester, Mass.

Gentlemen:—Enclosed you will find 10 cents (coin or stamps) in payment for LePage's Practical Suggestions for the Home Workshop, and LePage's Gesso-Craft Book. Please send a copy of each to:—

Name .....

Street .....

City ..... State .....



## Master Electricity By Actual Practice

The only way you can become an expert is by doing the very work under competent instructors, which you will be called upon to do later on. In other words, *learn by doing*. That is the method of the New York Electrical School.

Five minutes of actual practice properly directed is worth more to a man than years and years of book study. Indeed, Actual Practice is the only training of value, and graduates of New York Electrical School have proved themselves to be the only men that are fully qualified to satisfy EVERY demand of the Electrical Profession.

### The Only Institution of the Kind in America

At this "Learn by Doing" School a man acquires the art of Electrical Drafting; the best business methods and experience in Electrical Contracting, together with the skill to install, operate and maintain all systems for producing, transmitting and using electricity. A school for Old and Young. Individual instruction.

### Over 10,000 Graduates are Successful Men in the Electrical World

No previous knowledge of electricity, mechanics or mathematics is necessary to take this electrical course. You can begin the course now and by steady application prepare yourself in a short time. You will be taught by practical electrical experts with actual apparatus, under actual conditions.

The N. Y. E. S. gives a special course in Automotive Electricity. The course covers completely all systems of Ignition, Starters, Lighting, Storage Batteries and other electrical equipment on automobiles, motor-boats and aeroplanes, etc.

Let us explain our complete course to you in person. If you can't call, send now for 64-page book—it's FREE to you.

**New York Electrical School**  
29 West 17th Street, New York



New York Electrical School  
29 W. 17th St.,  
New York, N. Y.

Please send FREE and without obligation to me your 64-page book.

..... Name  
..... Street  
..... City

instead of being allowed to remain open. Thus, when the liquid rises in the tube it must compress the air above. In this case the pressure of the liquid column is equal to the value given for the open tube plus the pressure of the compressed air. This latter pressure is twice its ordinary pressure when the liquid half fills the tube, four times its ordinary pressure when the liquid has compressed the gas to a quarter its original volume, and so on.

When the pressure in the reservoir is maximum the gas is turned on and allowed to run a few seconds to clear the pipes of air and then lighted. When lighted the air pressure is gradually turned on until a flame that is nearly all transparent blue with a small bright blue central cone is produced. Too much air makes this cone larger, irregular in shape, and jerky; too much acetylene makes the large part of the flame bluer and more luminous, which is to be avoided.

Many remarkable things may be accomplished in the line of metallurgy, particularly with the illuminating and acetylene gas furnaces. Even platinum can be melted easily. An excessively hard and brittle iron that can scarcely be affected by a file can be produced by heating ordinary nails with powdered charcoal. When the mixture has been at the melting point for about half an hour it should be stirred well and then poured into a mold and cooled quickly, or poured into a water bath. The sudden cooling will produce a glass-hard surface. A very soft steel can be made from any cheap iron, such as nails, by blowing air into the molten iron in the crucible. The oxygen of the air will burn out the carbon which gives iron its hardness, and when cooled slowly it is even softer yet.

Statues, book ends, paper weights, and similar objects can be cast in such beautiful alloys as gunmetal, which is about 10% tin and the rest copper. By heating each metal separately and then pouring together while cooling a marbled appearance may be produced. The cooling should not be too slow, otherwise the alloy will be weak at the edges of the marbled parts and is likely to crack open.

That remarkable metal "Invar," which does not expand appreciably with changes in temperature, and is therefore used for the pendulums of accurate clocks, is composed of soft steel 65% and nickel 35%. A list of some of the common alloys is given below:

- Brass: 70% copper; 30% zinc.
- Bell Metal: 80% copper; 20% tin.
- High Strength Aluminum: 90% aluminum; 10% copper.

Pewter: lead and tin in almost any proportion.

Fusible metal: 50% bismuth; 25% lead; 25% tin; melts at about 150 degrees Fahrenheit.

Manganese Steel: 15% manganese; rest soft steel. (Easily made by melting up manganese dioxide and nails. Manganese steel retains its temper even at a dull red heat).

Chrome Steel: 2% chromium; 2% carbon; rest soft steel. (Very hard to work with cutting tools; used in making safes).

The reader can easily find many more interesting alloys to try, and there is an immense field for original work. The possibilities of various alloys of even the commoner metals are just beginning to be realized; because 50% carbon produces extreme hardness is not always a guide to what 30% or 75% will produce, besides there will be a variation in the hardness. There is no way of prophesying definitely beforehand what the characteristics of a new alloy will be.

In addition there are many other interesting reactions of a chemical nature which will take place only at high temperatures: iron may be completely burned away if exposed to a steady draft of air while it is molten.

## Enjoy a Big Powerful Radio: 30 Days Free!



**SEND COUPON FOR AMAZING SPECIAL OFFER!**  
NOTE: This offer is made to prospective buyers by famous big Radio Corporation, one of America's oldest reliable manufacturers of fine sets—seventh successful year. Many satisfied users in every state. Postal or coupon brings testimony of nearby users and proof Miraco's outperform sets costing up to 4 times as much. Very easy to install and operate this

**BEAUTIFUL - BIG - POWERFUL**  
**Ultra MIRACOUltra**  
**Selective**

Users everywhere report it gets programs Coast to Coast, also Canada, Cuba and Mexico, loud and clear on speaker; outperforms \$100 to \$200 sets. Some have heard Europe, So. America. Don't confuse it with small cheap sets. Unless trial proves it MOST SELECTIVE, CLAREST TONED and MOST POWERFUL DISTANCE-GETTER among beautiful big 5-tube sets, don't buy it. Every Miraco comes completely assembled, rigidly tested and fully guaranteed.

**Our Factory Prices Save You Up to 1/2!**  
**SEND NO MONEY!** Save or make NOW Only \$49.75

on sets, speakers, tubes, batteries—write for AMAZING OFFER. Radio's most marvelous value in a big FULLY GUARANTEED 5-tube 3-dial set. **Retain List**  
MIDWEST RADIO CORPORATION, Pioneer Builders of Sets  
400-A Miraco Bldg., Cincinnati, Ohio  
WITHOUT OBLIGATION, send free literature, AMAZING SPECIAL OFFER, testimony of users, etc.

Built like a \$200 set  
**MIRACO RADIO GETS 'EM COAST to COAST**  
Send for Proof!

**ONE DIAL CONTROL** Model (not illustrated) also offered, on 30 Days Free Trial. Enormous demand for Miraco's makes possible hosts of costly new refinements and improvements at lower prices than ever. Genuine Bakelite sloping panels, dials beautifully finished in walnut to match cabinets; Conquest E-Z Battery Cables; features (too numerous to mention) of high-priced sets.  
**Send Now For Latest Literature**

**27 in. long**  
**SPECIAL WHOLESALE PRICES** to user-agents who show the set to friends.  
**DEALERS WRITE!**  
NAME:  
ADDRESS:

## A Winter-Kitchen Garden

By DR. ERNEST BADE  
(Continued from page 497)

ficient: thyme, rosemary, sage, lavender, balm taragon and mint. Two pots of parsley and chives become necessary when they are to be cut quite often.

These plants do not require an especially warm room, a cool frost-free spot where they are able to receive plenty of light, is quite sufficient for their needs. Should some of these plants die back of their roots, the pots should be placed in a warm window where they will soon sprout. It is in this way, when regularly cared for, that all of the various kitchen herbs may be had fresh throughout the entire winter.

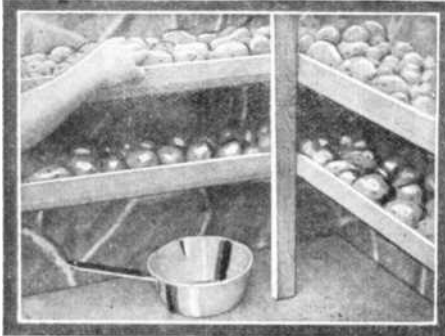

Potatoes placed on frames or shelves in the cellar keep them dry and well ventilated, thus keeping them far longer in a better condition through out the winter.

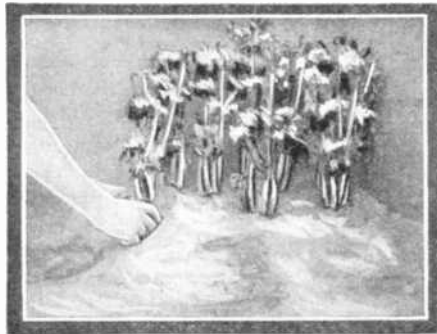

Celery should be kept in a dry and frost free cellar, the celery being placed upright in sand contained in boxes, or placed in one corner of the cellar.

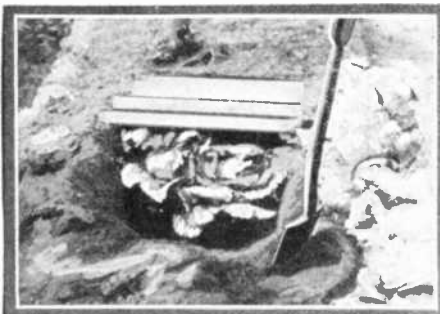

Another way to keep cabbages for winter use is to place them in a shallow ditch, roots downward, covering them with boards, straw and about a foot of soil.

(Continued on page 557)

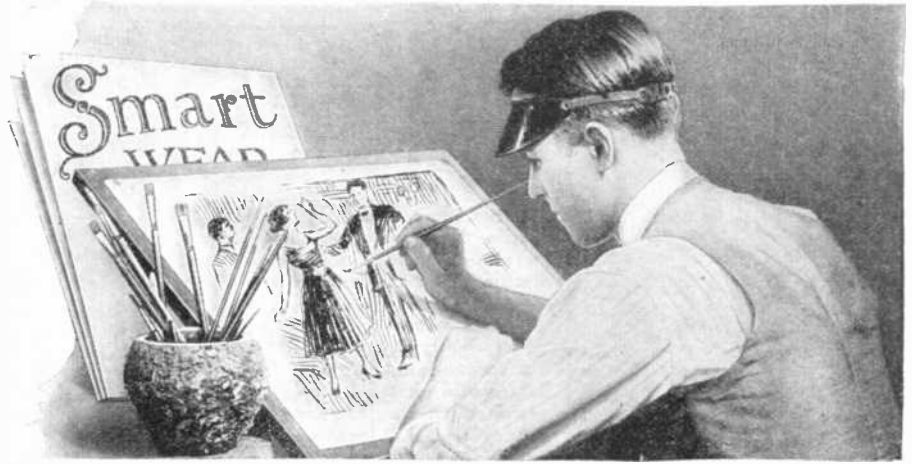

# How Would YOU Like to Earn \$108 For Three Days Work?

That's what a 21 year old graduate of Washington School of Art earned. YOU, too, can quickly become an Artist through this amazingly easy method.

**B**IG salaries are gladly paid to properly trained artists! Hundreds of our students—many of whom never had a drawing pencil in their hands before starting—now are earning handsome incomes. Here's a letter from a student in North Carolina who writes—

"I have been making mine a variety of work since I finished my studies with you—ranging from showcard pictures to pen and ink work and color designs—but devote most of my time to cover and magazine work.

"Recently a club in a nearby city decided to have some large scenic signs painted and asked me to submit a suggestive design sketch. I priced the work at \$108 each for about three days' work, and they took me right up.

"As you know, I made considerable money while studying with you, and through your aid I have been offered over twenty-five different positions with firms. I am twenty-one years old. I am certainly glad I took up the study of art. My work seems like play to me. As to the paying side of it, I do not work for less than \$10 per day and frequently make \$20.

"I heartily recommend the Washington School of Art to anyone who has a desire to study art. I am sure you have the best as well as the most economically priced course, and the most thorough instructors of any school in the United States."

## Become an Artist this Quick, Easy Way

YOU, too, without any previous training, and no matter how little apparent talent you may have, can now easily learn Illustrating, Designing and Cartooning through this amazingly easy home-study method.

Right now there is a tremendous demand for trained Commercial Artists. Magazines, newspapers, printing concerns, advertising agencies and business houses all gladly pay big money for good art work. Through this remarkable method YOU can easily and quickly get one of these high-paying artists' jobs.

### Mail Coupon for Free Book

A new handsomely illustrated book gives complete information on the thousands of splendid positions in Commercial Art and shows how this splendid method quickly enables you to enter this field. No obligation. Mail coupon NOW! Washington School of Art, Inc., Room 2610-D, 1115-15th St., N.W., Washington, D. C.

Washington School of Art, Inc., Room 2610-D  
1115-15th St., N.W., Washington, D. C.

Please send me without cost or obligation your new book on art, "Quick Easy Way to Become an Artist," and details of your attractive offer.

Name .....  
Please write plainly Mr., Mrs., or Miss.

Address .....

City ..... State.....

## Do Wonderful Chemical Tricks and Experiments with CHEM-CRAFT Junior!



Make your own ink, dye cloth, test water and soil, and learn about Chemistry. Surprise and puzzle your friends with Magic Chemical tricks; write secret letters with invisible ink; pour blue, brown and black liquid from a glass of water; make a magic pitcher of blue-ink; make your own magic writing paper. It's all easy if you have Chem-Craft Junior. Order now and get a Free copy of The Chem-Craft Chemist Magazine, full of chemical information, experiments and pictures. Order Now 50c Paid Porter Chemical Co. 105 Summit Ave. Hagerstown, Md.



## Automatic Screw Gripping SCREW DRIVER

**D I S C O**  
A Real Tool

Holds screws rigid for insertion or withdrawal. Fits any round, flat or hex head screw, from 9-32 in. to 3-8 in. head.



YOU NEED THIS!

Also used as a socket wrench for hex head nuts on electrical and radio work.

Order NOW and pay postman only on receipt—all charges prepaid \$1.50 AGENTS WANTED EVERYWHERE

Agent's demonstration sample \$1.00. Send this adv. and money order. Diversified Sales Co., S-577 Jackson Ave., Jersey City, N. J.

# Big, Revised FALL EDITION is Here!

## 6 BIG FEATURES

*Photos of American  
Radio Artists*

### ALL U. S. BROADCAST STATIONS

*(Listed three ways)*

In this New Fall Edition of Radio Review appears the most complete, up-to-date list of all U. S. Radio Broadcast stations in existence, listed 3 separate ways, Alphabetically by call letters, by wave-lengths, and by states and cities. It gives the wavelength in Meters and Kilocycles, the location, the ownership and the hours of operation of each station.

### LATEST LIST REVISED WAVE LENGTHS

### ALL CANADIAN BROADCAST STATIONS

*(Listed two ways)*

All Broadcast stations in Canada are listed in this section and in two different ways for the convenience of the reader. First, by call letters and second, by Provinces and cities. Like the listing of the U. S. Broadcast stations all details are given including ownership, power, Meter and Kilocycle wave-length, etc. This is a handy section for Fall D.X. work.

### ALL FOREIGN BROADCAST STATIONS

Besides the U. S. and Canadian stations Radio Review contains the finest list obtainable of Foreign Broadcast stations including even such countries as Jugoslavia, Poland, India, Peru, etc., giving Ownership, Call letters, Wave Length and Power.

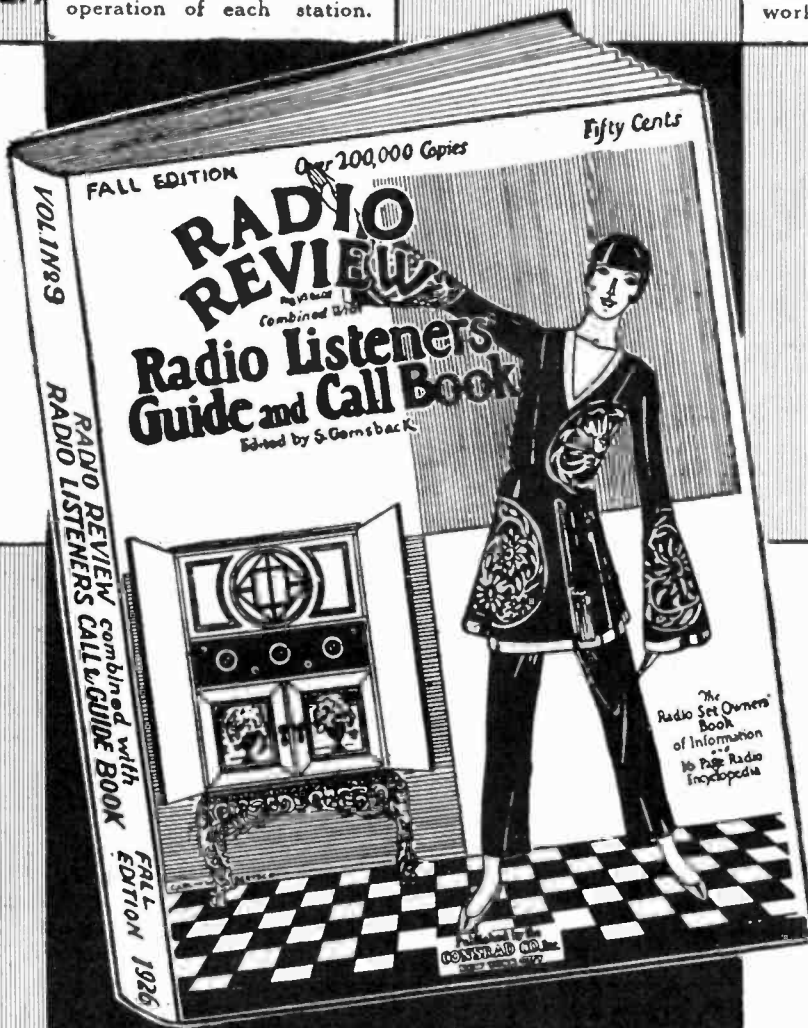

### SET OWNERS BOOK OF INFORMATION

Radio Review not only contains the Broadcast stations of the World but a big section of many pages gives the latest, finest information on how to operate, how to repair or improve a set, or how to build various accessories. It is of great value to every owner of a Receiver.

### CONSTRUCTION OF MODERN CIRCUITS

This section of Radio Review contains circuits of every description gathered from all over the world. All articles are of constructional nature and are fully illustrated with pictures, diagrams, etc. Each circuit is described completely and in detail. All the latest hook-ups are covered.

### S. GERNSBACK'S RADIO ENCYCLOPEDIA

In each issue is a special supplement of S. Gernsback's Radio Encyclopedia—this is not a dictionary but a regular Encyclopedia explaining fully every radio word. The supplement is profusely illustrated and is the most up-to-date and complete radio reference ever published. It is Radio's finest Encyclopedia.

# 50¢ - SOLD ON ALL NEWSSTANDS

Published by THE CONSRAD CO. Inc. 53 Park Place New York, N.Y.

**A Winter-Kitchen Garden**

(Continued from page 555)

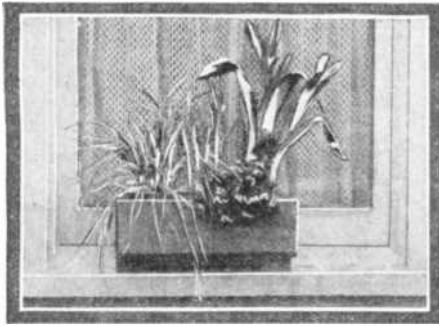

Kitchen herbs are kept growing all winter by planting in pots and keeping the pots on the window ledge in boxes until frost sets in; then the kitchen garden of herbs is removed to a window where it is protected from the frost.

**How Byrd found North Pole**

By WILLIAM P. SULLIVAN

(Continued from page 492)

The magnetic compass and the earth inductor compass indicate magnetic north and in order to find the time azimuth, the difference between magnetic and true norths, the magnetic declination must be known. This depends entirely upon the observer's geographical position.

The earth inductor compass does away with the usual form of pivoted needle and is the most modern form of aircraft compass. Current is generated in a coil rotated in the earth's magnetic field and it indicates electrically the direction of true north on instruments located in the cockpit. The generator or rotating coil is located at the rear and on top of the fuselage, the power being furnished by a small windmill.

Another form of compass used on this North Pole flight is called the Bumstead Sun Compass. This instrument checks the direction of true north astronomically by setting it with the sun by time methods and is equally accurate.

With such highly developed instruments for locating true positions accurately and speedily one can easily understand how it was possible for Commander Byrd and Floyd Bennett to fly directly to the pole from Spitzbergen, completely check their positions, and return to the exact spot from where they had departed fifteen hours before, with no landmarks to help them, depending entirely upon instruments.

**ANENT THE ROWMOBILE**

In the August number of SCIENCE AND INVENTION Magazine we featured, both on the cover and in the text pages of the magazine, a new German invention comprising a man propelled automobile, which was originally called the "Landskiff" on the other side of the ocean, but which the editors renamed the "Rowmobile" for American usage. Through a very strange coincidence, we have received a letter from the Row-Mobile Manufacturing Company of Oakland, California, calling our attention to the fact that they are manufacturing a children's vehicle which is propelled by a rowing action and which they call the Rowmobile. They also own the patent right on this device for use on rowboats, life boats, athletic and various other uses. They also own the copyright on the name Rowmobile. The rowmobile which is manufactured by this concern has a selective forward, neutral and reverse transmission with no dead centers.

# Learn Cartooning At Home This Quick Easy Way



—and earn while you learn like these other Washington School Students have done.

There's nothing remarkable about the four Washington School students on this page. And it would be just as easy to tell practically the same story about hundreds of others. They are only average people who did one simple thing: they enrolled in the Washington School of Cartooning. And now they are receiving the rewards of their training.

**Big Money Success Can Now Be Yours**

You don't need talent to learn Cartooning. Even if you've never touched a drawing pencil before. This thoroughly tested training quickly trains you right at home—through a plain, easy to understand method, perfected and carried out by a foremost cartooning school. Little theory—plenty of accomplishment. That's the secret that enables you to draw *saleable* cartoons sooner than you ever imagined possible!

Thousands of dollars are spent every year for cartoons. Capable cartoonists easily earn \$50 to \$280 a week—the topnotchers even more. YOU should have your share of these big money rewards—so act NOW!

**Send For Free Booklet**

Mail coupon for beautifully illustrated FREE booklet telling all about our students—their success—what they say—how they make money even while studying—and showing exactly how you, too, can prepare for this fascinating golden opportunity field. No obligation. Mail coupon NOW! Washington School of Cartooning, Room 2610 D, 1113-15th St., N.W., Washington, D. C.

Washington School of Cartooning, Room 2610-D, 1113-15th St., N.W., Washington, D. C.

Please send me without obligation, your illustrated FREE BOOKLET on Cartooning.

Name  (State whether Mr., Miss, or Mrs.)

Address

City  State

If under 16 years, please state age



**\$63.00 for One Poster**

"I think the lessons and methods of the Washington School are the best that one can find in the field of cartooning. A week after I received my diploma, I made \$63.00 for one poster."—M. C. P., Riga, Latvia, Europe.

**Made Over \$200.00 While Studying**

"I have made more than \$200.00 making advertisements of all kinds while studying the course under the guidance of the Washington School. I dare say there is not in America any better school of 'Cartooning'."—H. L., San Lorenzo, Porto Rico.



**Simple and Interesting**

"Your methods are so simple and interesting that a child could understand them. Before I was through with the course, I was offered more money for one week's work than the entire course cost me."—D. J., Fort Wadsworth, N. Y.



**Free From Bosses**

"I would advise anyone to enroll and study in spare time with the best school and instructors in the country and you will soon be in a high-paying profession, free from all bosses and spend your time as you wish."—S. G. C., Binghamton, N. Y.



## Want \$158 a Month to Commence?

Railway MAIL CLERKS

Get U. S. Government Jobs

Mail Carriers—Postoffice Clerks



Steady Work—No Layoffs—Paid Vacations  
TRAVEL—SEE YOUR COUNTRY  
COMMON EDUCATION SUFFICIENT  
Every boy 17 up should mail coupon at once.

Franklin Institute, Dept. B-179  
Rochester, N. Y.

Step: Rush to me without charge, (1) sample Railway Postal Clerk and Mail Carrier Examination questions; (2) tell me how to get a U. S. Government job; (3) Send list of U. S. Government Jobs now obtainable, and send sample coaching lessons.

Name   
Address



**ALL FREE**

10 year guar. Watch with chain and ring, large Eastman Kodak Film Camera or 22 cal. Hamilton Rifle yours for introducing finest assorted liquid perfume at 15c a bottle. Send for 20 bottles and choose gift as per offer in our catalog. We treat you—just write to BELL PERFUME CO., Dep. A943 Chicago, Ill.

**22 CAL. RIFLE**





# Earn a Second Income

How many people in the United States would deliberately turn down a worth-while opportunity to earn, in a bonafide method of business, an actual steady income over and above their present salary or income?

Very, very few.

Here is a new magazine, established with the worthy purpose of telling the millions in the United States of many actual, practical and specific means of making money—either as increased salary or as an additional income.

Articles in this new magazine are written by men and women who are experts on their subjects or are compiled by the editor from facts obtained from the best sources:

Walter MacIntosh in an article entitled "Turning Idle Hours into Golden Hours" says:

"One of our eminent practical psychologists has said that most people can do about three times more work than they think they can.

"We haven't all an equal amount of money. But we all have twenty-four hours a day—no less, no more. Many times, the difference between financial success and financial failure can be explained by the fact that the man who succeeded turned his spare time into money; while the man who failed simply wasted his spare time, because he placed no money value on it.

"The great mass of people just 'plug along,' earning only enough for the bare necessities of life, but wishing for some of the luxuries and extra comforts.

If those people only realized that profitable use of their spare time would bring some of the very luxuries and comforts that they long for, they would be turning spare time into money.

"Goethe said, 'One always has time enough, if one will apply it well.' Just make it a point to watch some of your friends and your business associates, and note how many of them, claiming to be 'rushed to death,' idle away hours that should be turned to good account. Also, be frank and courageous enough to watch yourself and see how you do the same thing.

You can't change the wasteful habits of others, but you can change your own. Make your spare time worth something to you!"

No longer do you have to wish that an opportunity for increasing your income present itself.

MONEY MAKING tells you of hundreds of ways, and tells you how to start, how others have succeeded, what rules to follow, what initial investment is necessary, and all the vital factors to success.

Nowhere else is this information compiled and presented in such a practical, useable manner.

Buy a copy of this new magazine from your nearest newsdealer now—if there is none near you, fill out the coupon below. For \$1.00 we will be glad to send you Money Making postpaid for five months.



## October

### PARTIAL LIST OF CONTENTS

Turning Idle Hours Into Golden Hours, *Walter MacIntosh*  
 The Open Air Profession, *Uthai Vincent Wilcox*  
 Starting in the Mail Order Business, *George R. Doxans*  
 Making Money Transplanting Forest Trees, *Armstrong Perry*  
 The Junk Man—A By-product of Civilization, *Walter Raleigh*  
 The Easiest People in the World to Sell to, *J. H. Thomas*  
 How to Start a Circulating Library, *W. M. Butterfield*  
 Goldfish Breeding, *H. Calvert*  
 Selling Farm Produce on the Spot to Motorists, *C. S. Longshore*  
 An Endless Chain Agency, *C. D. Reeves*  
 Taking the Kinks out of Produce Distribution, *S. Sachs*  
 If I Had \$100 to Start a Business, *Charles Weeks*  
 Successful Egg Farming, *S. N. Elliott*  
 Turning Dough Into Dollars, *Victor Carson*  
 Some Odd Ways of Earning Money, *Wm. C. Bartlett*  
 Direct Selling—What It Has to Offer, *Romanzo Nelson*  
 Finding Lost Articles, *Ernest A. Dench*  
 A Course in Window Trimming, *W. M. Ostrander*  
 Professional Shopping, *Harold R. Lister*  
 Real Estate—Where the Big Money Is, *Ralph Burch*  
 Law as a Profession, *M. B. Flaum*  
 How To Make Patents Pay, *Ross D. Breniser*  
 Money Making in Subscriptions, *Dr. E. Bade*  
 Mail Order Opportunity, *M. Perry*  
 Making Ornamental Flowers from Sea Shells, *Hazel F. Showalter*  
 Women's Department—You Can Make Money, *William Mallard*  
 How Country Women Sell Food Products, *Dorit K. Weigert*  
 How City Women Sell Food Products, *and many other smaller articles. Several departments including prize contest record.*

**25c On All Newsstands**  
*If Your Dealer Cannot Supply You Use Coupon*

**THE CONSRAD CO., Inc.**  
 53 Park Place New York, N. Y.

CONSRAD CO., Inc.,  
 53 Park Place, N. Y. City

Gentlemen:—I am enclosing \$1.00 for which kindly send me, postpaid, MONEY MAKING for 5 months.

Name .....

Address .....

City, State .....

## Deaf-Phone and 2-Stage Amplifier

By A. P. PECK

(Continued from page 519)

of a small hook projecting through a slot in the side of the cabinet and so placed that the reproducing receivers, when not in use, can be hung thereon, which action will open the circuits. The construction of this hook is simple in the extreme, and is clearly shown in Fig. 2. A spiral spring closes the circuit between the metallic hook and a small strip of copper or brass which is placed just above the slot. This piece projects downward slightly beyond the edge of the slot so that it will make good contact with the hook.

A single rheostat controls the filaments of the two tubes, which tubes are of the small dry-cell type, such as the UX-199. This rheostat can be used as a volume control, and by varying the resistance the reproduction of the voice can be regulated to suit the user. Also the incorporation of this rheostat allows the use of a 4½-volt battery, with its consequent longer life than that of a 3-volt battery.

The audio-frequency transformers used in this instrument can be of practically any kind. They need not be of the very best because they will not be called upon to amplify the extremes of sound vibrations that are found in radio music. The two that were used in the particular unit illustrated, are of a very old type but give excellent service for this particular work. Even the very cheapest of transformers could be pressed into service for the instrument with no detrimental effects. The ratio may be from 5 to 1 up to 10 to 1.

An ordinary microphone such as is used in telephones could probably not be used in a lay-out of this nature with any degree of satisfaction. These microphones usually require quite a high voltage, and furthermore, are not particularly sensitive to weak sounds. With the microphone from the portable deaf set, as shown in the photographs, it was possible to detect a whisper over ten feet away from the unit. The whisper was inaudible without the aid of the instrument, but could be heard quite plainly with it.

The microphone was the only part of the original deaf set that could be employed. The receiver that was formerly used in connection with it was far too delicate to employ in the last stage of a two-stage audio-frequency amplifier. It became completely paralyzed from the current. Therefore, a pair of standard radio receivers was used with very good results. Undoubtedly, a pair of small ear phones that fit within the ear and that have been described in this magazine heretofore, could be employed with this instrument. They are made in various resistances, and if used, a pair having a total resistance of 2,000 ohms at least, should be selected.

Taken as a whole, the results obtained with this apparatus were far better than with any other deaf-set that the writer has ever tested. Persons afflicted with poor hearing have tested the instrument and pronounced it quite satisfactory.

The only parts that had to be placed outside of the cabinet in the instrument illustrated were the head phones, the "A" battery and the 45-volt "B" battery. If a somewhat larger cabinet were used, the batteries could be placed within it, using a small 3-cell battery for the "A" and two small 22½ blocks for the "B" battery. In this way, the unit would be entirely self-contained, and would be really portable.

Telephoning over a ray of light

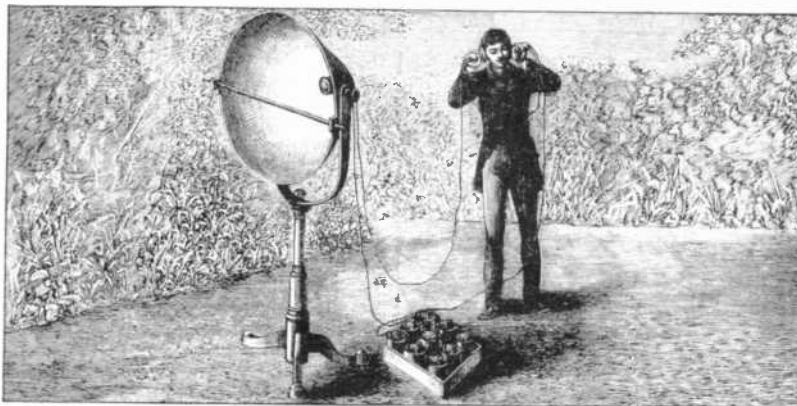

## Building on the Telephone Principle

FIFTY years ago Alexander Graham Bell discovered the principle of the telephone. His first telephone employed wire as the connecting path over which words passed. Four years later he used a beam of light instead of wire to carry speech between telephone instruments.

Today, both wire and wireless telephony are employed on every hand in the service of the nation. Wire telephony, with its thousands of central offices, its complex switchboards and millions of miles of wire, envelops the country, carrying for the American people 70,000,000 conversations every day. Wireless telephony is broad-

casting entertainment and carrying important information to the remotest regions.

But new applications of the telephone principle are still being found. In the loud speaker, in the deaf set, the electrical stethoscope, the improved phonograph, the telephone principle has been adapted by the Bell Telephone Laboratories to the uses of the physician, the public speaker and the musician. The scientific research and engineering skill, which enable America to lead the world in telephone service, are also bringing forth from the telephone principle other devices of great usefulness.

## AMERICAN TELEPHONE AND TELEGRAPH COMPANY AND ASSOCIATED COMPANIES

BELL SYSTEM



IN ITS SEMI-CENTENNIAL YEAR THE BELL SYSTEM LOOKS FORWARD TO CONTINUED PROGRESS IN TELEPHONE COMMUNICATION

**RADIO BOOK FREE**

Tells how you can make big money in world's newest and greatest field. Presents lifetime opportunity in Radio. Right now we want live agents and dealers in every locality. \$60 to \$100 a week easy. 40% to 60% Profit. Simply send name for this big illustrated book explaining liberal profit proposition and how to get latest radio goods at wholesale. Also prices on parts, sets and accessories and amazing special offers—all FREE. Write today

**Standard Radio Co.** 1412 Walnut St. Kansas City, Mo.

**5 Tube Set** only \$39.50 RETAIL

**Magnified 225 Diameters**

This is what the tip of a fly's leg is like when seen through the

**ULTRA LENS MICROSCOPE**

At last a high powered microscope is within the means of all who wish to study, observe and experiment with the vast world of minute objects invisible to the naked eye. Such fun it is, as well as educational. No technical training required, yet hundreds of scientists and teachers are using this instrument. Gives enormous magnification and perfect definition. Send \$7.50 for complete outfit. Send for descriptive literature.

**\$7.50 for Complete Outfit Prepaid**

Scientific Apparatus Corp., Dept. 203, Milton, Pa.

Insure your copy reaching you each month. Subscribe to Science & Invention—\$2.50 a year. Experimenter Publishing Co., 53 Park Place, N. Y. C.

# Great NEW Invention

for seekers of

## Health Power Beauty



Elco Health Generators at last are ready for you! If you want more health—greater power to enjoy the pleasures and delights about you, or if more beauty is your desire—write! Ask for the book on these inventions which has just been prepared. It will be sent to you without cost. It tells you how Elco Health Generators aid you in leaving the lethargy and hopelessness of bad health and weakness behind forever. Re-vitalize yourself. Bring back energy. Be wholly alive. Write today!

10 Days FREE Trial Write for FREE Book.



These great new inventions generate Violet Ray Vibration, Electricity and Ozone—combined or separate. They operate on the electric light in your home or on their own motive power at less than 50 cents per year. Elco Health Generators are positively the only instruments which can give you in one outfit Electricity, Violet Ray—Vibration and Ozone—the four greatest curative agents. Send the coupon below. Get the Free Book NOW!

For All These:



- Rheumatism
- Sore Throat
- Asthma
- Black Heads
- Catarra
- Insomnia
- Skin Diseases
- Hay Fever
- Neuralgia
- Deafness
- Pain
- Development
- Neuritis
- Obesity
- Paralysis
- Pimples
- Falling Hair
- Headache
- Lumbago
- Nervousness

Mail Coupon for Free Book

Do not put this paper down without sending the coupon. Don't go on as you are with pains and with almost no life and energy. You owe it to yourself to be a better man or woman. You were put here to enjoy life—not just to drag through it. So do not rest another day until you have put your name on the coupon here. That will bring the whole story of these great new inventions. Do it today—now.



Lindstrom & Company  
30 West Lake St., Dept 14-27 Chicago  
Please send me your free book, "Health-Power-Beauty" and full information of your 10-day Free Trial Offer.

Name.....  
Address.....

### How to Build Cedar Chests

By WILLIAM M. BUTTERFIELD  
(Continued from page 507)

cedar chests of the plain box variety. If it is used, all of the holes for the round head copper nails, used to secure the trimming to the chest, must be carefully spaced, lined and drilled, otherwise a very unsatisfactory trim will result. Care must also be taken in driving the brads used in gluing the chest so that they will not interfere with the copper nails.

American mahogany molding can be used to form panel effects, as a finish for the bottom of the chest or division point between lid and chest. The molding can be bent after steaming. It is glued and braded to the cedar as illustrated. A large assortment of composition molding is to be had at the furniture makers supply houses which may be used for decorating a cedar chest. This molding is put on with glue and brads.

Feet, legs, knobs, poles, hinges, locks, brads, screws can be found in various assortments at the supply houses. All of the laborious work in building a cedar chest need therefore be confined only to the construction of the chest—its trim being practically the simple assembling of parts already made.

For a leg frame, such as is illustrated in the top center view, four 2-inch square legs with turned center and bottom parts are used. Such legs are found in stock for chair making. Four front legs used for that purpose will answer. Or an old chair will provide legs by sawing off the back, thus making the four legs of one length.

The top rails for such a frame are 1/2 inch thick and 2 inches wide, the lower ones 1/2 inch thick and 1 inch wide. All parts are secured with wide tenons and mortises—the uncut full sizes of each rail forming its tenons.

The object of cedar in a chest is to drive away moths and other vermin with its odor, therefore in finishing a chest, it is desirable to use a finish that will not cover the wood thickly. Paint will not do, some wax finishes are useless and most varnishes are not to be thought of. A very thin coat of shellac answers very well for the inside, while for the outside, shellac somewhat thicker, in three or more coats is about all that can be used successfully. To obtain a high finish the various coats are polished and smoothed; first with pumice, then rotten stone and cedar oil, ending with a leather pad moistened in half cedar and half banana oil.

All metal trim should be fitted, and partially secured with nails or screws, before finishing either the inside or outside of the chest. The trim should then be removed and only replaced when the chest is completely finished. Mahogany or other wooden or composition trim is finished with the same materials and at the same time as the chest.

### TROPICS FIFTY MILES UP

Discussion of the observation of meteors, made during a lifetime by W. F. Denning, the English amateur astronomer, has revealed a totally new aspect of the upper air.

"It has been known for some time," says Professor H. H. Turner of London, "that the temperature, which falls rapidly as we ascend for the first few miles, ceases to fall about eight miles up. This is beyond the reach of airplanes and balloonists, but not beyond that of exploring toy balloons. Even their information, however, has a limit short of twenty miles.

Meteors have now extended our knowledge up to fifty miles and have shown that the atmosphere becomes actually hotter in a certain region of these upper strata; the climate becomes tropical as regards temperature.

## Stop Using a Truss



STUART'S PLAPAO-PADS are different from the truss, being mechanico-chemico applicators made self-adhesive purposely to hold the distended muscles securely in place. No straps, buckles or spring attached—cannot slip, so cannot chafe or press against the pubic bone. Thousands have successfully treated themselves at home without hindrance from work—most obstinate cases conquered. Reduced Fac-Simile Gold Medal. Soft as velvet—easy to apply—Inexpensive. Awarded Gold Medal and Grand Prix. Process of recovery is natural, so afterwards no further use for trusses. We prove it by sending Trial of Plapao absolutely FREE. Write name on Coupon and send TODAY. Plapao Co., 924 Stuart Bldg., St. Louis Mo.

Name.....  
Address.....  
Return mail will bring Free Trial Plapao

**Men wanted to manufacture Metal Toys and Novelties**  
NO SALESMANSHIP NECESSARY  
Demand exceeds supply and we co-operate with you in selling goods, also buy them from you. We put you in touch with the buyers. Guaranteed casting forms with complete outfit furnished for speedy production of Toys, Novelties, Ash Trays, Bookends, and other big all-year sellers. Absolutely no experience or machinery necessary. No special place needed. Small investment puts you on road to success. You do the manufacturing and we take care of the selling. Act immediately if you want to handle big 1926 wholesale orders now being placed. Strictly a business proposition. Catalog and information mailed on request.  
**METAL CAST PRODUCTS COMPANY**  
1696 Boston Road :: New York

**Electrical Engineering**  
Course for men of ambition and limited time. Over 4000 men trained. Condensed course in Theoretical and Practical Electrical Engineering including the closely related subjects of Mathematics and Mechanical Drawing taught by experts. Students construct motors, install wiring, test electrical machinery. Complete course in **One Year**. Prepare for your profession in the most interesting city in the world. School established 1893. Send for catalog. **BLISS ELECTRICAL SCHOOL**  
450 Takoma Ave., Washington, D. C.

**500 Tricks**  
**BIG BOOK 10c!**  
Be a Man of Mystery! Amaze and Mystify your friends. Easy to learn. This New 80-page Copy-righted Book tells how. Large Catalog of Magic Tricks, Jokes, Puzzles and Imported Novelties included. Send 10c today!  
**L. E. DOUGLAS**  
Station A-3, Dallas, Texas

## AMAZING STORIES

OCTOBER ISSUE

25c ON ALL NEWSSTANDS

Contents for October

**BEYOND THE POLE.** by A. Hyatt Verrill. Tell you about a wonderful people near the South Pole, of the captivity of a sailor and his travels through their terrible, yet wonderful country.

**THE DIAMOND LENS.** by Fitz-James O'Brien. One of the world's classics. Written years ago, but which retains its flavor. Brings in an exquisite microscopical being, the enchanting heroine of the story.

**THE PURCHASE OF THE NORTH POLE.** by Jules Verne. The concluding installment of this enthralling story. The author's ingenuity in evolving a cause for the fault in mathematics revealed in the last lines.

**A COLUMBUS OF SPACE.** by Garrett P. Serviss. The story draws to an end. Attack, adventure, captivity are all successfully coped with. And then comes a tragic termination.

**THE ISLAND OF DR. MOREAU.** by H. G. Wells. One of the most astounding stories ever written by the well-known author. Held our interest at a feverish pitch of excitement; we will not give away the contents to spoil it all for you.

**BLASPHEMERS' PLATEAU.** by Alexander Snyder. wherein some eminent scientists successfully experiment with infinite secrets, until they become drunk with their power. Then another scientist arrives on a friendly visit. It is a powerful and gripping story which is sure to hold your interest.

**EXPERIMENTER PUBLISHING CO., Inc.,**  
53 Park Place :: New York, N. Y.



**Modeling by Photography**  
By LUCIEN FOURNIER  
(Continued from page 488)

ies of photographs from the profile, each more and more diminished, as may be seen in the extremely curious third photograph.

Here is how the result is obtained. We have said that the patient who is having his portrait made is seated upon a bench mounted on rollers moving on two rails. As fast as the motion picture camera takes a view of the profile the bench moves back 1/10th of a millimeter from the lens, but as it moves back the shadow of the iron strip reduces the depth of the profile by 1/10th of a millimeter, so that the photograph taken after the first will be less complete, the third will give a profile still more reduced and the last will show nothing more than a tiny bit of the ear and a fragment of the collar. It is generally necessary to take about 80 successive profiles of the same subject.

Let us say at first that the motion picture camera perforates each negative at each of its angles at the moment of exposure. These negatives may then be easily separated. The individual frames are developed and printed. They are next placed one after the other in a pantograph apparatus which is represented in Fig. 5. It is seen that the negative is illuminated by a beam of light which projects the image on a sheet of ground glass. The stylus of the pantograph is held in the hand and the cutter, which is at the other extremity of the levers of the apparatus, cuts the exact profile of any desired dimensions from a sheet of zinc 1/10th of a millimeter thick.

We now have 80 zinc profiles. Let us assemble them, one upon the other in the order followed in taking the pictures. We now find that we have a profile in relief which is precisely that of the person seated before the lens.

With the assembled profiles a mold is made which permits reproductions of the profile in any medium desired. The sharp edges are rounded off, and we have a perfect reproduction of the portion of the original subject seen through the lens of the camera. This method may also be used to produce sculpture in the round by photographing the opposite side of the head also, joining the two resulting reliefs at the center.

We do not anticipate that this method of "photosculpture" will supersede to any great extent the methods now used, but it seems probable that the simplicity of the procedure and the comparative lack of skill required, will make it applicable in many fields at present limited by the supply of artistic talent. If the system is developed on a commercial scale it will probably take the same position relative to true sculpture that photography does to painting.

**DECLARES JOHN FITCH INVENTED STEAMBOAT**

Suggesting the construction of a new fire-proof Patent Office building in Washington, Representative Sol Bloom said recently that if there had been "adequate facilities" to preserve patent records in the early days of the nation John Fitch and not Robert Fulton would have been recognized as the inventor of the steamboat.

"Until recently," Mr. Bloom said, "it was believed that Robert Fulton was the one who first applied steam to the art of navigation. However, in examining the records of the United States Patent Office and other departments of the Federal and State Governments, it has been proven conclusively that John Fitch built and successfully operated a steamboat of his own conception as early as 1785."

**A Genuine Underwood No. 5**  
The ace of standard writing machines! The best business machine is best for you. Read our offer!

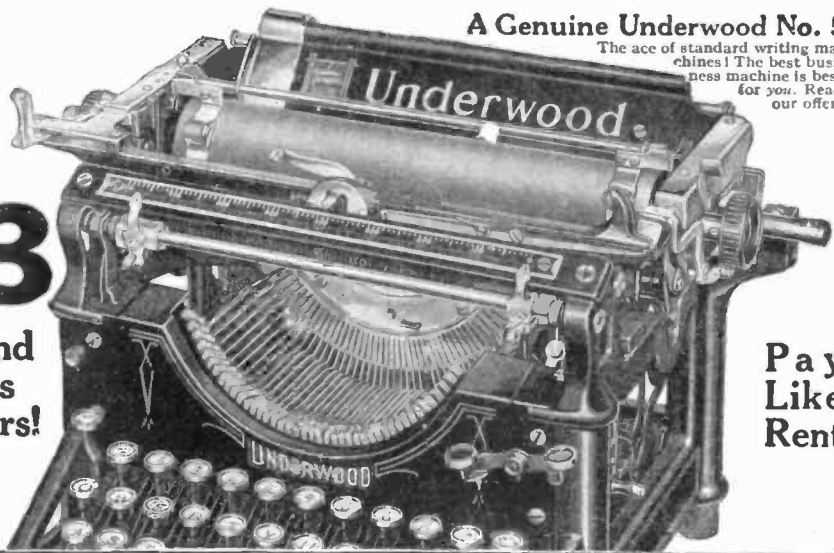

**\$3**  
—and  
It's  
Yours!

**Pay Like Rent**

**Own a Typewriter!**

**A Bargain You Can't Ignore! Every Member of the Family Will Use and Enjoy It! Try it Free and See!**



**GET YOUR typewriter now.** A genuine, Shipman-Ward rebuilt Underwood—"the machine you will eventually buy." Don't send a cent, but do get our special offer—valuable book on typewriting—**free.**

You can learn to write on this standard-keyboard Underwood in a day. In a week, you'll feel lost without it! The free trial will *prove* it. Our rebuilt plan gives you the *best* machine and a *big* saving.

your life. The trial is *free.* If you buy, our easy terms make it a pleasure to pay. There's no excuse now, for not owning a typewriter—and the finest make! We include all tools, cover, etc., all complete, all ready to write. Write us now. Deal direct; we are the largest factory of the kind; we offer the right machine at the right price; we sell the largest business houses.

Typist's Manual

**FREE**

Get our catalog free; quotes lowest prices and most liberal terms in existence. We'll send a manual free, too; it contains valuable instruction for learning rapid typing, useful pointers for all who use a typewriter, examples of business forms, social correspondence, work for others, etc. Clip coupon *now!*

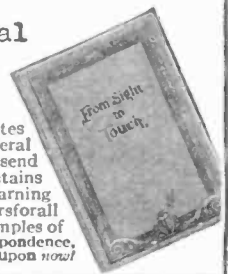

**Act NOW If Ever!**

Speak up, if you want one! Underwood No. 5 is so popular this lot we're completing now won't be long in selling! Rebuilt from top to bottom—*every single worn part replaced.* New typewriters are guaranteed for a year; we guarantee this one *five* years! That's our Better-Than-New Guarantee. And we guarantee a big saving!

We don't want a penny now. Nor any money at all, unless this proves the typewriter bargain of

**Mail This NOW For Free BOOK**

SHIPMAN-WARD MFG. CO.  
2167 Shipman Bldg., Chicago

Please send **FREE**, full offer, catalog, typing manual, and outline your free course in Touch Typewriting, without obligation!

Name \_\_\_\_\_  
Street or R. F. D. \_\_\_\_\_  
P. O. \_\_\_\_\_ State \_\_\_\_\_

**You-and This Machine Can Earn \$300 a Month**



Charge Batteries in 1-3 the usual time and at half the cost. Charge Batteries in 1-3 the usual time and at half the cost. Charge Batteries in 1-3 the usual time and at half the cost. Charge Batteries in 1-3 the usual time and at half the cost.

**30 DAYS' FREE TRIAL**—Find out about this wonderful money maker NOW! Built by Successful Manufacturers Since 1893. Bulletin M contains full particulars of the 30 Days' Free Trial Plan. Write for it today! HOBART BROS. CO. Box 810 Troy, Ohio

**Play the HAWAIIAN GUITAR Just as the Natives Do**

**FREE \$15 HAWAIIAN GUITAR and Case**

Only 4 Motions used in playing this fascinating instrument. Our native Hawaiian instructors teach you to master them quickly. Pictures show how. Everything explained clearly.

**Play in Half Hour** After you get the four easy motions you play harmonious chords with very little practice. No previous musical knowledge necessary.

**Easy Lessons** Even if you don't know one note from another, the 52 printed lessons and the clear pictures make it easy to learn quickly. Pay as you play.

**Free Guitar and Outfit** in Genuine Seal Grain Fabrikoid Case as soon as you order. Nothing to buy—everything furnished. No delay.

**Write at Once** You'll never be lonesome with this beautiful Hawaiian Guitar. Write for Special Offer and easy terms. A postcard will do. **ACT!**

**FIRST HAWAIIAN CONSERVATORY OF MUSIC, Inc.**  
9th Floor, Woodworth Bldg., Dept. 100, New York, N. Y.  
Approved as a Correspondence School Under the Laws of the State of New York

**Learn Photography at HOME**

Earn \$3000 to \$10,000 a year. Prepare quickly during spare time. Also earn while you learn. New easy method. Nothing else like it. Send at once for free book, "Opportunities in Modern Photography" and full particulars. Special offer open now. INTERNATIONAL STUDIOS, Inc. Dept. 1427 3601 Michigan Ave., Chicago, U. S. A.

**READ AMAZING STORIES**  
The Greatest Story Magazine in Years  
**25c--ON ALL NEWSSTANDS**

Insure your copy reaching you each month. Subscribe to Science & Invention—\$2.50 a year. Experimenter Publishing Co., 53 Park Place, N. Y. C.

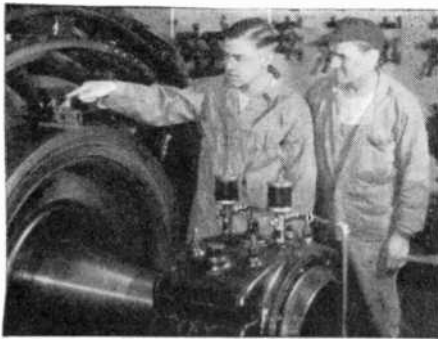

## Men Needed in Electricity

**NO PROFESSION** offers greater opportunity to-day than Electricity. Salaries of \$12 to \$30 a day are not uncommon and the opportunity for advancement is unlimited.

As Forrest Crissey said recently in *The Saturday Evening Post*—"The demand for electrical work is increasing immensely and electrical contractors assert that the supply of electrical workers cannot overtake the demand for several years."

Now is the time to prepare for a good position in this profitable, interesting profession. You can study right at home in spare time through the International Correspondence Schools—just as so many other men have done. The I. C. S. Electrical Courses have been endorsed by Thomas A. Edison and Charles P. Steinmetz—the late electrical wizard of the General Electric Co.

Just mark and mail the coupon printed below and full information about Electrical Engineering, Electric Lighting, Electric Wiring, Electric Railways, Radio or any other work of your choice will come to you by return mail.

Mail the Coupon To-day

----- TEAR OUT HERE -----  
**INTERNATIONAL CORRESPONDENCE SCHOOLS**  
 Box 6166-E, Scranton, Penna.

Oldest and largest correspondence schools in the world Explain, without obligating me, how I can qualify for the position, or in the subject, before which I mark X.

- |                                                     |                                                     |
|-----------------------------------------------------|-----------------------------------------------------|
| <input type="checkbox"/> <b>ELECTRICAL ENGINEER</b> | <input type="checkbox"/> <b>CHEMICAL ENGINEER</b>   |
| <input type="checkbox"/> Electrician                | <input type="checkbox"/> Pharmacy                   |
| <input type="checkbox"/> Electric Wiring            | <input type="checkbox"/> SALESMANSHIP               |
| <input type="checkbox"/> Electric Lighting          | <input type="checkbox"/> ADVERTISING MAN            |
| <input type="checkbox"/> Electric Car Running       | <input type="checkbox"/> Window Trimmer             |
| <input type="checkbox"/> Heavy Electric Traction    | <input type="checkbox"/> Show Card and Sign Painter |
| <input type="checkbox"/> Electrical Draftsman       | <input type="checkbox"/> RAILROAD POSITIONS         |
| <input type="checkbox"/> Electric Machine Designer  | <input type="checkbox"/> ILLUSTRATOR                |
| <input type="checkbox"/> Telegraph Expert           | <input type="checkbox"/> DESIGNER                   |
| <input type="checkbox"/> Practical Telephone        | <input type="checkbox"/> BUSINESS MANAGEMENT        |
| <input type="checkbox"/> MECHANICAL ENGINEER        | <input type="checkbox"/> Private Secretary          |
| <input type="checkbox"/> Mechanical Draftsman       | <input type="checkbox"/> Business Correspondent     |
| <input type="checkbox"/> Machine Shop Practice      | <input type="checkbox"/> BOOKKEEPER                 |
| <input type="checkbox"/> Toolmaker                  | <input type="checkbox"/> Stenographer and Typist    |
| <input type="checkbox"/> Gas Engineer               | <input type="checkbox"/> Cert. Pub. Accountant      |
| <input type="checkbox"/> CIVIL ENGINEER             | <input type="checkbox"/> Traffic Management         |
| <input type="checkbox"/> Surveying and Mapping      | <input type="checkbox"/> Commercial Law             |
| <input type="checkbox"/> Mining Engineer            | <input type="checkbox"/> GOOD ENGLISH               |
| <input type="checkbox"/> ARCHITECT                  | <input type="checkbox"/> STATIONARY ENGINEER        |
| <input type="checkbox"/> Architectural Draftsman    | <input type="checkbox"/> CIVIL SERVICE              |
| <input type="checkbox"/> Architects' Blue Prints    | <input type="checkbox"/> Railway Mail Clerk         |
| <input type="checkbox"/> PLUMBING AND HEATING       | <input type="checkbox"/> Textile Overseer or Supt.  |
| <input type="checkbox"/> Sheet Metal Worker         | <input type="checkbox"/> AGRICULTURE                |
| <input type="checkbox"/> Navigator                  | <input type="checkbox"/> Poultry Raising            |
|                                                     | <input type="checkbox"/> Automobiles                |
|                                                     | <input type="checkbox"/> Spanish                    |
|                                                     | <input type="checkbox"/> RADIO                      |

Name \_\_\_\_\_  
 Present Occupation \_\_\_\_\_ Business Address \_\_\_\_\_  
 Street and No. \_\_\_\_\_  
 City \_\_\_\_\_ State \_\_\_\_\_

**Thrill Your Friends!** Like a real Automatic \$1.79

Be on your Guard! Beware of holdup men and toughs. Carry a "Pioneer Automatic" and protect yourself. Looks just like a real Automatic. Lots of fun scaring your friends. Made of light weight metal. Full the trigger—and Zip!—it's a cigarette case.

**SEND NO MONEY!** Pay postman only \$1.75 plus postage on delivery. Satisfaction guaranteed.

SINCERE COMPANY  
 24 East 21st St. N.Y. Dep. 664

Read the Classified Advertisements on pages 574 and 575. You will find many bargains there!

## The Truth About Astrology

By JOSEPH H. KRAUS  
 (Continued from page 496)

"THE NATION'S COUNSELOR."  
 PROF GUSTAVE MEYER  
 American Scientific Astrologer

1140 Bloomfield St.,  
 Corner Twelfth Street,  
 Phone 2211 Hoboken

Hoboken, N. J., August, 2, 1926.

My dear Miss Kraus:

According to the data of your birth, I find that you were born with the Zodiacal Signs of Aries, and Pisces rising, and as the ruling Planet of Aries is the fiery, evil and martial Planet Mars, and of Pisces, the fiery, and fortunate Planet Jupiter, hence, Mars, and Jupiter, will be your ruling Planet through life, and while you would experience quite a turbulent and hard up hill struggle, and more clouds than sunshine, during your younger years (died—no operation) and many narrow escapes from death by accident, illness or operation, and serious trouble and will usually have to fight for your rights, or work quite hard for whatever you legitimately earn yourself, and that your shoulders would usually have to bear the responsibilities of others and you would be a martyr to duty, and the home, and will seldom if ever receive as much thanks for your kindness to others, (who does) as you really deserve, you will however, gradually rise in life far above your station at birth, and will acquire a fair amount of wealth, and enjoy success, and hard earned prosperity, slow but sure, and will always be sufficiently fortunate enough to come out of any difficulties in safety which others would not, hence, you should never despair, as you will always have a sprinkle of sunshine in the trail of every cloud, however, if you will only make your slogan "I can and I will" and overcome your too dictatorial, independent, and sarcastic nature, you will then overcome many obstacles towards success and happiness through life.

As you had the Sun posted in the sorrowful Sign of Capricorn, this shows that all of your undertakings through life will usually begin in doubt or darkness, (so does everyone—Ed.) however, I find that they will end with more light or hope than what you expect, yet, you will always be subject to melancholy spells when alone too long, hence, you should always keep active mentally, and physically, and avoid sad people, pictures, and stories, however, I find that you will usually be quite fond of such, and that you will usually be happy when you are sad.

You were born to lead, and not to be led, hence, you make a good manager, superintendent, demonstrator or designer, and will always love to dictate, lead and command.

You were also born to lead an eventful, checkered, and romantic life, and will see much of the world, and will profit through your own experience, as well as through that of others, however, your own experience will alternately (ultimately?—Ed) cost you dear, unless great care is exercised on your part, hence, you should always guard your morals, health, and temper, and guard yourself in speech, and actions, otherwise you will have much to regret.

I find that your mind will always be quite cool, calm, and collected in an emergency, yet, when such is over, you then collapse.

You will always be very peaceful, and slow to anger, and quick to see the point of an argument, however, if your temper is once aroused, you can then become very furious, sarcastic, bold, daring, unfeeling, dictatorial, and almost murderous, spiteful, and vindictive for the moment, yet, you are not revengeful, as you make a good friend, but a forgiving, and generous enemy.

You will always possess much tact, diplomacy, executive, and oratorical ability, and personal magnetism, or a strong personality, modesty, dignity, and timidity, and you will cultivate friends thereby, yet, you will always prefer a few friends to many acquaintances, hence, people will call you a poor mixer.

I find that people must first know you very well to really like you, otherwise, they will call you too independent, aristocratic, uppish, cold, or unfeeling, haughty, when in fact you are very sensitive, and good hearted, but not sufficiently demonstrative or enthusiastic in expressing your sentiment in words as you really prefer to do so in actions.

I find that you will always be given to building "Aircastles" so to speak, and that you will always love the country, mountains, quiet, and restful places, and will always be quite healthy, and fortunate living, in or near such places, and near large bodies of water.

You should always guard against much trouble to your head, eyes, and teeth, and feet.

You will always be very sly, shy, modest, reserved, shrewd, secretive, selfish, cautious, capricious, frivolous, skeptical, suspicious, and mistrustful, and will seldom if ever believe what you hear, only what you see, however, if you are once



**KESTER**  
 READY TO USE  
**METAL MENDER**  
 The Household Solder

Here's why thousands use Kester Metal Mender. **Simple**—Requires Only Heat! Anyone can use it. **Safe**—No messy pots or dangerous acids. **Sure**—Genuine Solder makes firm metal joints. **Satisfactory**—Works equally well on light or heavy, old or new work. **Economical**—Saves many times its price.

Your Dealer Can Supply You

**FREE SAMPLE**  
 Upon Request



**CHICAGO SOLDER COMPANY**  
 4201-347 Wrightwood Ave., Chicago, U.S.A.

## USE YOUR RADIO AS AN ELECTRIC PHONOGRAPH

Results equal to the new high priced Electric Phonographs now appearing on the market. Easy to hook up. Does not spoil set for Radio use. Send \$1.00 for complete plans.

**MOGLE & McCLELLAND**  
 REGENT BLDG. WINFIELD, KANSAS

## Chicago Man Discovers Gasoline Miracle.

What is this strange new miracle guaranteed to give 1250 gals. of gas at only 1-4c a gal. and to instantly remove and prevent all carbonyl \$1,000 reward backs our guarantee. Nothing ever like it! Not a mechanical device or gas dope. Needed only every 50,000 miles. Costs practically nothing. It is called **MOTOR-MYSTERY**, discovered by the eminent scientist, L. Forgrave.



Send no money. We trust you. Write quick for Free Trial, SWORN Proof and \$100 weekly salary guarantee to agents.

**Agents \$100.00 Weekly Salary Guaranteed**



**Begin Today—Write for My FREE BOOK.** I can make a good penman of you at home during spare time. Write for my FREE BOOK, "How To Become a Good Penman." It contains specimens and tells how others mastered penmanship by the Tamblyn System. Your name will be elegantly written on a card if you enclose stamp or postage. Write today for book. F.W. TAMBLYN, Edgemoor Bldg. Kansas City, U.S.A.

## \$75 WEEKLY BUILDING RADIO SETS

Join the Association! We train you to build and repair radio sets—start you in business—enable you to earn \$3 an hour upwards. Free 5-Tube Radio Set to members. Write for special limited-time plan whereby your membership need not cost you a cent. Write today!

**RADIO ASSOCIATION OF AMERICA**  
 Dept. 610 4513 Ravenswood Ave. Chicago, Ill.

## "Money Making"

The new magazine just out tells you hundreds of ways to make more money in your spare time or full time—All articles give detailed information—and are written by the best authorities.

See Full Page Advertisement on Page 558

convinced of that which you were previously suspicious or skeptical of, you then become one of the strongest advocates of that very thing, or subject in question.

While you can be easily led through your too trusting, over affectionate, ideal, good hearted, sensitive, sentimental, lonesome, and quite effeminate disposition, (see paragraph 3—Ed) as you are also very obstinate, head strong, firm, determined, and persistent (see paragraph above—Ed) I find that if you once make up your mind to do or say anything, that nothing can then cause you to ever do otherwise than that which you once determined to say or do, hence, you will owe much of your success through life to your indomitable will power, perseverance, and tenaciousness.

I find that you had much sorrow, trouble, and disappointments in your love affairs, and that you had some very serious love affairs, and opportunities for marriage around your 19th, 21st, 23rd, 25th years. (she died in her 20th year—Ed) however you can thank your lucky stars that you have never as yet married, as you would have been separated or divorced, and I should advise you to if possible, to remain single, unless you have a good day and hour selected for your marriage, as such would then modify much of the trouble otherwise indicated to occur in married life.

I find that you will have another very serious love affair, and good opportunity for marriage during the Autumn of this year, or the Winter of 1927 (in the spirit world?—Ed)

Your lucky months will always be from December 23rd to January 18th (died January 9—half way between—Ed) February 19th to March 19th, April 19th to May 21st, August 24th to September 22nd, and October 23rd to November 21st, and you should always choose these periods for any of your most important undertakings, and anyone born in these periods would be your best friends, and affinity, or the most harmonious for you in love affairs, and marriage.

On looking up your prospects for this year of 1926, (well, well—Ed) I find that there is quite a mixture of good and evil in store for you, however during the Summer, and Autumn months, you will profit through brilliant schemes, and will benefit greatly through the opposite sex, and the public, and in love affairs, and will be more popular, and sociable than usual, and will overcome adversaries, and will receive much honor, credit, benefit, preferment, and success, if not advancement in position, and will benefit through pleasures, and much benefit is indicated through or to your relatives, and through friends, especially powerful, influential, literary, and scientific friends, and you will realize your hopes and wishes through such friends in particular.

During the Summer months, you should then guard against financial and business troubles, extravagance, heavy financial reverses, and losses by fire, robbery, or systematic robbery, if not trouble and loss through property matters, also legal matters, however, you will make some very radical changes, and journeys, which will be for the best. (Anything else?—Ed)

During the late Summer, and also during the Autumn months, much trouble, or loss is indicated through or to any brothers, or sisters you may have, also through neighbors, letters, or writings, and traveling by railway, or auto, and in domestic affairs.

You should look well to whatever you sign or write, and be careful in making changes, and journeys, and guard against fire in the home. (And we paid \$5.00 for this!—Ed)

During the Autumn months, you will have a very serious love affair, and good opportunity for marriage, if not become engaged or be married.

1927.

Throughout this year, you will enjoy much better health, and more peace of mind than usual, also heavy financial benefits, much liberty, pleasure, success, and prosperity.

You will also benefit through friends, and the opposite sex, and in domestic affairs, and you will realize your hopes and wishes, and profit through brilliant schemes, and be more popular, and sociable than usual.

During the Winter months, if you are still single, you will have a very serious love affair, and good opportunity for marriage, if not be married. Your morals will be elevated, and you will benefit through something connected with either the Church, publishing, or advertisements, science, creditors, and traveling by water, however, much trouble, or loss is indicated through or to relatives, and through something connected with either the grave, property matters, or through people engaged in such. You should avoid underground places, and traveling in such, and going in or near public buildings in the course of erection.

During the Spring months, you will enjoy very heavy financial benefits, much liberty, and prosperity, and much benefit is indicated through or to relatives, also through neighbors, letters, or writings, and traveling by railway, auto, and in domestic affairs.

During the Summer months, your pleasures will be greatly handicapped, and you should avoid speculative ventures, and hazardous games of chance.

During the late Summer, and early Autumn, you should take a good blood and nerve tonic, and guard against serious illness, accident, or operation, and also stomach, bronchial, and kidney trouble, nervous complaints, and fire, burns, cuts, scalds, or bruises, (he omitted two or three things—Ed) and much trouble or loss is then indicated through or to relatives on your father's side also through servants, or inferiors, if not through small animals.

## Ever notice?

SOONER OR LATER most men reach a point, in everyday matters at least, where price is no longer all-important. They begin to look around for "something better." And it is by no means an accident that just at this point so many men turn to Fatima

# F A T I M A



"What a whale of a difference just a few cents make"

LIGGETT & MYERS TOBACCO CO.

## GALACITE Makes Your Tires PUNCTURE-PROOF in ONE minute



Tires hammered full of nails, leak no air. This startling new invention banishes tire trouble forever. Repairs punctures without taking the tire off the rim. Actually makes any tire puncture-proof for life. Seals instantly all punctures, slow leaks and porous places, often increases tire mileage from 10,000 to 12,000 miles by preserving rubber and keeping tires properly inflated. Positive money back guarantee means GALACITE must make good—or we will.

**AGENTS \$10,000 a Year IMMEDIATE Tremendous profits selling this revolutionary invention to car owners, Garages, Service Stations, etc. Earn up to \$10,000 a year with exclusive territory. Your name and address brings particulars by return mail. Send Today before someone else gets territory you want.**

C.F. JOHNSON & CO., 19 W. Jackson Blvd., Dept 357 Chicago, U.S.A.



## To Europe in 10 Hours!

FAST aeroplanes will do it some day; who knows how soon! Wouldn't you like to know something about them; how they are built and how they fly? Building and Flying your own Model Aeroplane is the best way to find out. You can see how the body and wings are joined; how the tail and rudder work; what the controls do. And when your Model flies in the air—that's the real thrill!

Ideal Scale Drawings and Building-Flying Instructions show how to make perfect 3-ft. Models of famous 'Planes. Complete Drawings and Instructions for any one of the following sent postpaid for 25 cents: Curtiss JN4D-2 Training Plane; De Havilland 'Round-the-World' Flyer; NC-4 Naval Seaplane; Bleriot, Nieuport or Tauba Monoplane; or Cecil Peoli Racer. (Set of 7—\$1.25 postpaid.) 48-pp. catalog of Model Aeroplane Parts and Supplies—5c postpaid.

IDEAL AEROPLANE & SUPPLY CO., 165-169 Spring Street New York

## EAT FOR OCCUPATION



Brainy meals make brain work easy. Muscle meals support muscular activity. Brain workers, singers, expectant mothers, laborers, all should eat to SUIT OCCUPATION, thereby not accumulating WASTE in the blood (basis of all disease). Efficiency booklet 10c.

Brinker School of Eating, Dept. 1-K 131 W. 72 St., N.Y.

## "HANDS UP" LOOKS LIKE A REAL AUTOMATIC

Protect your home. New Style Automatic. No Permit Necessary. Absolutely Safe and Harmless. Pull trigger. Top opens revealing Cigarette Case or holder for Hip Flask, Powder Puff, Coin Purse, etc. SEND NO MONEY. Pay postman \$1.69 plus postage FEDERAL MAIL ORDER CORPORATION 561 Broadway, New York. Dept. Y60



# “NOVELTIES”

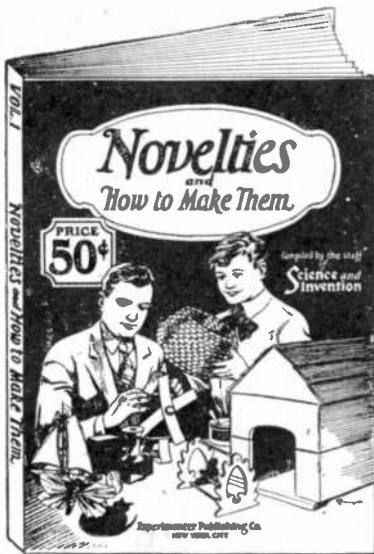

**NOVELTIES**  
contains 116 Pages, hundreds of illustrations and is published in the big magazine size 9 x 12 inches.

## How to Make them

Almost every home has an old clock around—Do you know that a great many surprising, fun making, and useful novelties can be made just from the old springs, the gears, etc.

NOVELTIES, the new book, compiled by the staff of SCIENCE & INVENTION shows you how to make hundreds of wonderful Novelties, mostly out of old scrap things laying around the house. 116 Pages, in this book, show pictures, diagrams and explanations of remarkable, interesting things to make in your spare time.

Every page has a big, wonderful surprise for you. There is no end to the simple, magical things you can make at home.

It is sold on all newsstands. Buy your copy now. If your dealer cannot supply you use the special coupon below.

### 50c On All Newsstands

EXPERIMENTER PUB. CO., Inc.,  
53 PARK PLACE, NEW YORK

Gentlemen:—I am enclosing 50c for one copy of NOVELTIES as advertised above.

NAME .....  
ADDRESS .....  
CITY, STATE .....

If you cannot obtain a copy in your locality use this coupon—

**EXPERIMENTER  
PUB. CO.,  
53 Park Place, N. Y.**



**THE MIDGET SLIDE RULE** instantly adds, subtracts, multiplies, divides, solves proportions, gives all roots and powers, Logarithms, Sines, Cosines, Tangents, Cotangents, Etc. Also gives decimal equivalents lettered and numbered drill and tap sizes. More than 110,000 sold, more than 2000 unsolicited testimonials. The Engine-divided scales are on white finished aluminum and are grease and waterproof. Diameter 1/2". Price with Instruction Book, \$1.50. Pocket Carrying Case, 50c extra. Cash or C. O. D. Catalogue free. Your money back if you are not satisfied. GILSON SLIDE RULE COMPANY. - NILES, MICH.

### KENILWORTH INN Asheville, N. C.

Comfortable rooms—best sports.  
Excellent food.  
REASONABLE RATES  
Write for Booklet  
ROSCOE A. MARVEL, Manager  
The HOME of HOSPITALITY  
"In The Land of The Sky"

### GENUINE “VALET” Auto-Strop RAZOR FREE

For \$1 you can get “RADIO NEWS”—Radio’s Greatest Magazine for 5 months—and also FREE—1 VALET Auto-Strop Razor.

Send \$1 Today to—  
EXPERIMENTER PUB. CO., Inc. :: 53 Park Place, New York

During the early Autumn months, guard against public enemies, quarrels, legal trouble, reverses and trouble or loss through the public, and the opposite sex.

During the late Autumn, you will be in danger of bereavement, and should guard against losses by fire, robbery, or systematic robbery, also guard well any plans, or secrets, you may possess or such will become exposed to others, who will profit through same. Also avoid religious arguments, and guard your morals, health and temper, and much trouble, or loss is indicated through something connected with either the Church, publishing or advertising, science, creditors, and traveling by water, yet, you will receive much honor, credit, benefit and success if not advancement in position.

Your truly,  
(Signed) Prof. G. Meyer

GM/MR Scientific Astrologer;

Thus, at one and the same time we find that the young lady is a martyr to duty and her home, and is good-hearted and yet she is cold, unfeeling, selfish and frivolous. She will have narrow escapes from death, illness and operation. Escapes?—She should guard against serious illness and kindred complaints, and fire, burns, bruises and animals, including relatives on her father’s side, servants and other inferiors, (pardon the wit—Ed) and yet she will always be healthy.

Please note the facts that the subject died January 9th, 1919.

Her lucky months are from December 23rd to January 18th, and again we reiterate she died on January 9th.

She should always choose these periods for her most important undertakings. Well, is not death an important undertaking? Perhaps the astrologer was right. Please remember that we are quoting directly from the horoscope. There are others that we could quote from but this one is infinitely more subtle. The claims are not as brazen as those of some other astrologers.

Again looking through the manuscript we also find that the subject will be cool, calm and collected in an emergency; and is peaceful, slow to anger and a forgiving and a generous enemy, which statement is directly contradicted by the statements that she is furious, sarcastic, bold, daring, unfeeling, dictatorial, spiteful and vindictive.

We note she will lead a checkered and romantic life and will travel, yet she loves the country, mountains and quiet restful places and is very shy.

Further she is cold, unfeeling and at the same time good-hearted, sensitive, and sentimental.

She is haughty yet lonesome. The manuscript tells us that she is shy, modest and reserved and also that she was born to lead, command, had executive and oratorical ability and personal magnetism.

These factors must befit one individual or another. An individual cannot be born to lead and at the same time be easily lead because she is too trusting. She must do one or the other. She cannot be sly and too trusting; she cannot possess personal magnetism and yet be lonesome; she cannot be unfeeling and yet sensitive.

Is there anyone in this country who can show us how a young lady can be tactful and possess diplomacy and yet be uppish, haughty and sarcastic? Can anyone show us how a cautious, skeptical, suspicious and mistrustful girl can be easily lead because she is too trusting and over-affectionate? Or perhaps someone will come forward and show us how a capricious, frivolous girl must fight for her rights, work hard, be persistent and show perseverance and tenaciousness? Then we have that case of the timid individual being a born leader, dictatorial and commanding.

Human beings are vain. They like to be told things which please them and naturally when an astrologer tells you things which are 50% true you think he is wonderful. The human being doesn’t stop to reflect or consider that that astrologer has made just as many statements which are 100% incorrect.

We did not fake the statements in above paragraphs. They are found in the horoscope. You can find them by jotting down the adjectives as you go along and then match one against the other. You will find that there are many more contradictions than those which we have given you.

The statement still rests that there is nothing in astrology; that it is buncomb, pure and simple; that only one-half of the statements and probably not even that many will fit any individual case, and not only will they fit that case in particular but all cases in general. Why do not these astrologers warn of a possible death? Why did the astrologers not tell us of the next step in the eventful life of 20-year-old Richard Reese Whittmore? We should like to change the definition of astrology to read: Astrology—a pseudo-science entirely discredited. It is pure bombast, nonsense, but was the livelihood of quite a few who catered to the credulous-minded, to those who would like to get a glimpse into the future by unscientific and unethical systems.

(More anon)

**Model Department**

(Continued from page 509)

**Rules for Model Contest**

1. A handsome trophy cup engraved with your name, will be awarded as the prize for the best model submitted during the month. The decision of the judges will be final and will be based upon, A—novelty of construction; B—workmanship; C—operating efficiency of the model as related to the efficiency of the device which the model simulates, and D—the care exercised in design and in submitting to us sketches and other details covering the model.
2. Models of all kinds may be entered. They may be working models or not, according to the subject that is being handled.
3. Models may be made of any available material, preferably something that is cheap and easily obtainable. Models made of matches should not be submitted to this department but should go to our Matchcraft Contest Editor.
4. Models must be submitted in all cases. Good photographs are also highly desirable and where the maker does not desire the model to be taken apart, legible drawings with all dimensions covering parts that are not accessible must be submitted.
5. Models should be securely crated and protected against damage in shipment and sent to us by parcel post, express or freight, prepaid. Models will be returned when requested.
6. Models for entry in any particular contest must reach this office on or before the 25th of the third month preceding date of publication. For instance, models for the November contest must reach us on or before the 25th of August.
7. Address all entries to Editor Model Department, c/o Science and Invention Magazine, 53 Park Place, New York City.

**ODD AND UNUSUAL PATENTS**

**Part II.**

Will appear in November number. Lack of space in this issue prevented its appearance this month.

You can't afford to miss the November number! It will contain articles on a great variety of new scientific subjects told in pictures and stories.



*Now you can build models in colors*

You've never seen anything like it, fellows—this new multicolor Meccano. Part after part gleams with brilliant colors, that's why the models you build are so realistic. And all of Meccano's famous engineering quality is still there. We wanted the best colors, so we selected Duco, the same that is used on the finest automobiles. It will not crack or peel, and Duco-finished parts cannot rust. Building with Meccano is dead easy—no study is required. Build your models in bright colors—you can do it only with the new

**MULTICOLOR MECCANO**

**Send for This FREE Book**

The Meccano Magazine—it tells all about Meccano and has many other fine features. Stories, contests, new models, puzzles, etc. Sent free for your name and address.

MECCANO COMPANY, Inc. Dept. J-1, Elizabeth, N. J.

**\$5 Down and You Can Buy Any WITTE Engine From 1½ to 7 H-p.**

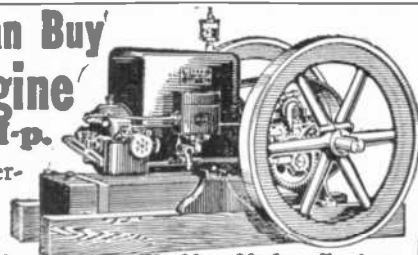

To Prove that this "super-powered" one-profit, light weight WITTE will save you one-half the time, labor and cost of any job on the place, I guarantee it to do the work of 3 to 5 hired hands.

The Most Modern Engine

**Burns Kerosene, Gasoline, Gas-Oil, Distillate or Gas—YET DELIVERS 25% or MORE POWER**

Cheapest to operate and guaranteed for a life-time. No cranking required. Compact and easily moved. Balanced fly-wheels with throttling governor that saves money. Fifty New Features—Write Me Today—a post card will do.

**Nearly a Year to Pay No Interest Charges—Scrap the Old One—Pay a Little of It Down on the New WITTE**

With my generous terms my engine pays for itself. Increases farm profits \$500 to \$1000 a year. Thousands say the WITTE is ten years ahead of any other make—simple and trouble-proof at rock-bottom, direct-to-you prices. Completely equipped with WICO Magneto, square, protected tank, die-cast removable bearings, speed and power regulator and throttling governor. All sizes 1½ to 30 H-P.

**FREE**—Write today for my big, new illustrated book and full details of my guaranteed offer. No obligation, absolutely free. Or, if interested, ask about our Log and Tree Saws, 3-in-1 Saw Rigs or Pump Outfits. ED. H. WITTE

**Witte Engine Works** 3755 Witte Building, Kansas City, Mo. 3755 Empire Building, Pittsburgh, Pa. 3755 Witte Bldg., San Francisco, Calif.

Quick shipments also made from nearest of these warehouses: Minneapolis, Minn., Atlanta, Ga., Trenton, N. J., Richmond, Va., Tampa, Fla., New Orleans, La., Dallas, Tex., Laredo, Tex., Denver, Colo., Billings, Mont., New York, N. Y., Albany, N. Y., Bangor, Me., Portland, Ore., and Los Angeles, California.

**BIG RADIO BARGAIN \$1.00 BOX CONTAINING OVER \$4.00 WORTH OF MISCELLANEOUS RADIO PARTS, AS LISTED—WHILE THEY LAST -- POST PAID**

These boxes have been made up from our surplus stock which we desire to dispose of before our Fall Radio Inventory. The \$1.00 price will move them quickly because of the tremendous value. Of keen interest to radio fans, set builders, experimenters, etc. Act promptly—the supply is limited!

**EACH BOX CONTAINS THESE ITEMS:**

- |                          |                           |                          |                                           |
|--------------------------|---------------------------|--------------------------|-------------------------------------------|
| 1 Rheostat               | 1 .0025 By-pass Condenser | 20 Asst. Binding Posts   | 1 Porcelain Tube                          |
| 1 Socket                 | 25 Switch Points          | 1 Tested Goldite Crystal | 2 Porcelain Knobs                         |
| 1 Phone Jack             | 10 Comp. Knobs            | 2 Tested Galena Crystals | 124 Pieces, worth over \$4.00, for \$1.00 |
| 2 Mica Grid Condensers   | 2 Sliders                 |                          |                                           |
| 1 Mica Phone Condenser   | 1 Comp. Dial              |                          |                                           |
| 1 Mica By-pass condenser | 50 Asst. Screws           |                          |                                           |
| 1 Paper Type Condenser   | 1 Westinghouse Grid Leak  |                          |                                           |

**The NEWMAN-STERN CO**  
The Newman-Stern Bldg.  
CLEVELAND - OHIO

# NEW!

## The Super-Heterodyne Book

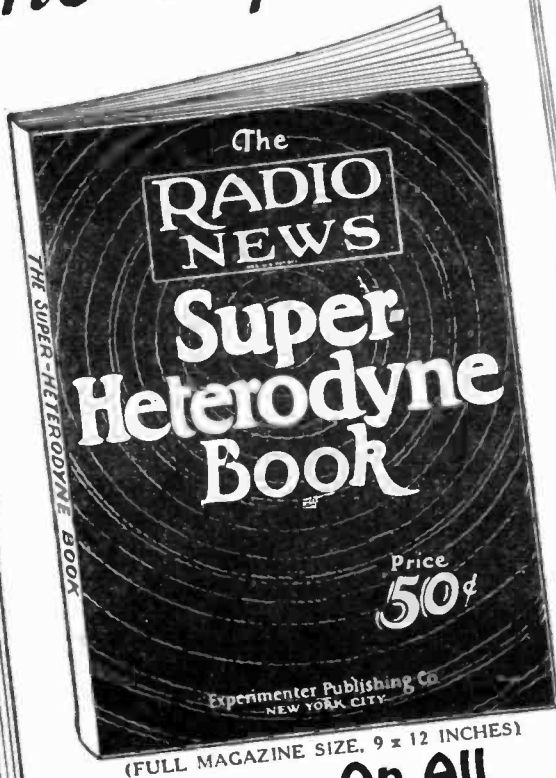

**50c** On All Newsstands

The greatest book of superheterodyne circuits, information and data ever compiled on these great receivers

Now!—a veritable encyclopedia on ALL existing forms of superheterodynes, giving the step-by-step advancement from the first, early hookups to the very latest and finest Super-Receiver of today.

All kinds of wiring diagrams on all the well known Supers. Notes on advanced hookups and constructional improvements with drawings. Valuable information including all patents covering Super-Heterodynes.

Information and data without end. Just the book for every man who owns a super or who wants to install or construct one of these powerful sets.

Get your copy today-- from any radio or newsdealer, or use the special coupon below.

### 1001 RADIO QUESTIONS & ANSWERS Meet Your Radio Problems and Beat Them

Radio Engineers Spent 7 Months to Give You This Valuable Book

A brand new book filled to the brim with a priceless array of selected Questions and Answers that are necessary to everyone in the construction, care and maintenance of modern sets, including information on hundreds of simple and complex circuits in common use today.

Contains 116 pages, 300 illustrations and is published in the large Magazine Size 9 x 12 inches.

PRICE 50c

### "RADIO NEWS" AMATEURS HANDBOOK

Read the Best in Radio

Selected Radio Articles by the Most Eminent Radio Engineers

116 pages, 300 illustrations, large size 9 x 12 inches

The "RADIO NEWS" Amateurs' Handbook is a large 116 page magazine size book containing a wide, varied and carefully selected array of the finest and most helpful radio articles that have appeared in the pages of Radio's Greatest Magazine, RADIO NEWS.

NEW 2nd EDITION.

PRICE 50c

### 500 RADIO WRINKLES

Get More From Your Receiver Use This Big Book Full of Shortcuts, Hints and Practical Ideas

A big book full of short cuts, hints and practical ideas. The 500 RADIO WRINKLES BOOK is a very comprehensive compilation of the best time and money saving hints that can be effected. Under fifteen separate and distinct headings, the entire field of radio apparatus and instruments has been covered in simple, understandable language.

Contains 116 pages, 300 illustrations and is published in the large Magazine Size 9 x 12 inches

PRICE 50c

IF YOUR RADIO OR NEWSDEALER CANNOT SUPPLY YOU USE THIS COUPON

EXPERIMENTER PUBLISHING CO., Inc.,  
53 Park Place, New York, N. Y.

Gentlemen:—Enclosed find \$..... for one copy of

SUPERHETERODYNE BOOK  1001 RADIO QUESTIONS and ANSWERS  AMATEURS' HANDBOOK  500 RADIO WRINKLES.

NAME .....

ADDRESS .....

CITY, STATE .....

These and other big books of the Experimenter Publishing Co., on various interesting and helpful subjects are sold at all newsstands throughout the country—ask your newsdealer to let you see them.

EXPERIMENTER PUBLISHING CO., Inc.,  
53 Park Place - - - New York, N. Y.

# The SAFETY AUTO HAT RACK

*A Great Idea!*



Not a novelty—a much needed auto accessory—saves many times its cost. Enables you to ride in comfort.

Here's the most sensible, needed auto accessory in years—provides a safe, permanent place for your hat while driving—No more crushed or lost hats—attached in a minute—same model for open or closed cars—hat is within reach at all times. Made of heavy metal, nicked or dull black—adds beauty to any car—Motorists demand it. \$1 with the coupon below brings this valuable accessory to your door postpaid—you save 50c as the regular price is \$1.50—Act Now—Insure the safety of your hats.

Agents Write for Attractive Proposition.

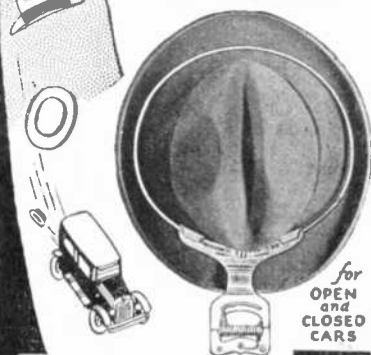

**SAFETY AUTO HAT RACK CO.**  
41 West 4<sup>th</sup> St. New York

SAFETY AUTO HAT RACK CO., Inc.,  
41 W. 4th St., New York City

Gentlemen:—I enclose \$1. Kindly send me one Auto Hat Rack, postpaid, at once.

Name .....

Address .....

City, State .....

### ATTENTION!

The Ross Radio ring is a miniature crystal radio receiving set. Wear it as a ring—use it as a radio. With a phone and aerial brings in local stations clearly and distinctly. Results guaranteed or money refunded.



PRICE 50c. POSTPAID

**AMERICAN BAZAAR, INC.**

Radio Department

640 BROADWAY, NEW YORK CITY

**THERE ARE RADIO BOOKS** and Patterns on all Radio Problems and Circuits. Write for FREE List. **THE CONSRAD COMPANY** 53 PARK PLACE : NEW YORK

## Important Things Inventors Should Know

By LEO T. PARKER

**G**ENERALLY speaking, all inventors are interested in making money. It is true that many persons have earned large sums of money through patents without understanding much about the basic laws that relate to them, but there are various simple rules of arriving at a reasonably accurate conclusion whether a new invention is destined to be profitable from a financial standpoint. The amount of profit derived from the sale of each article is important. The period of time over which the popularity of an invention is likely to continue is also worthy of consideration. For instance, many articles are salable only so long as a particular style or "craze" is in vogue, or until an early change of conditions makes its further use undesirable. Another very important thing that is often overlooked is whether the invention is salable throughout the year. Some articles can be sold only during the winter and others must wait for a summer season. A seasonable invention may not be desirable, particularly because a company organized solely for that business must necessarily survive a considerable portion of each year without incoming revenue. In order that seasonable inventions prove profitable sources of incomes, quite obviously, they must be unusual selling features during the short period they are salable. However, sometimes firms that specialize in general products can be induced to market a seasonable invention, and this class of concerns very often are the only ones which can satisfactorily promote the sale of such articles.

The general structure of an invention, also, must be considered. That is, whether of a complicated or simple nature. It is true many of the most complicated pieces of mechanism, such as the air brake, the lineo-type machine, printing press, and others, have proven unusually profitable for the inventors. On the other hand, some of the most simple ideas have made millionaires of the originators almost overnight. In fact, many simple and useful articles enjoyed a steady public demand all of the year round during the complete 17 years' life of the patent, and they, of course, are profitable inventions.

The universal adoption of an invention, irrespective of its simplicity or small selling price will result in a princely income to the patentee. There is at least one important advantage of patenting a simple invention and that is, even if the inventor is not successful in obtaining an outright purchaser of the patent, he can market it himself with a small investment and if the invention is accepted at all favorably by the public a comfortable income can be independently realized. But if the device is complicated and no firm can be interested to purchase the patent or manufacture it on a royalty basis, the inventor who has limited finances, always has difficulty to realize income from his labors of designing the device.

The possibilities of voluminous sales of a patented article should not be overlooked. For example, an individual once invented a very desirable article for use in penitentiaries, but inasmuch as the device sold at a low price and only one was needed in each penitentiary, even though he actually was successful in selling the invention to more than one-half of the prospects in the United States, he realized only a small amount of money from the patent. The invention practically was a failure so far as the profits derived from it are concerned. If this inventor had carefully considered his invention from all angles he would have saved himself trouble and labor which may have been utilized in perfecting and market-



# Aviation Brings Quick Success

**T**O young men of daring no other field of work offers such a fascination, such high pay, nor such opportunities for quick success as the field of Aviation. As yet, aviation is practically in its infancy. But now is the time to get in.

## Amazing Opportunities in Airplane Industries

In the automobile industry and in the moving picture business hundreds of men got rich by getting in at the start. They made their success before others woke up. Today, these lines offer no greater opportunities than a hundred and one others. **BUT AVIATION IS NEW.** Get in while the opportunities are big. All over the country there will be a clamor for trained men. It will not be a question of pay but of getting capable men.

## Become an Aviation Expert \$50 to \$100 per Week

The study of aviation is almost as fascinating as the actual work. Every lesson is full of interest. That is why it is easy to learn aviation. You do not have to make yourself study—it is like reading an interesting book that tells you things you have always wanted to know. Only one hour each evening will give you the basic training in a surprisingly short time.

One student, S. F. McNaughton, Chicago, says: "Your lessons are like a romance, and what is more, after one reading, the student gets a thorough understanding. One never tires of reading them." James Powers, Pa., another student, says, "I am indeed surprised that such a valuable course can be had from such practical men for so little cost."

### Fascinating—Daring—Big Paying

Prepare Now for One of These Positions

- Aeronautical Instructor \$60 to \$150 per week
- Aeronautical Engineer \$60 to \$75 per week
- Aeronautical Contractor \$100 to \$300 per week
- Enormous profits
- Aeroplane Repairman \$40 to \$60 per week
- Aeroplane Mechanician \$40 to \$60 per week
- Aeroplane Inspector \$50 to \$75 per week
- Aeroplane Salesman \$5000 per year and up
- Aeroplane Assembler \$40 to \$65 per week
- Aeroplane Builder \$75 to \$200 per week

### Personal Instruction

by Experienced Men  
Men who have had actual experience give you personal attention. They select the lessons, lectures, blueprints and bulletins. They tell you things that are essential in everyday practice. Each lesson is easy to read and understand.

## Get Big FREE Book—Now

Send coupon below for New Book, just out, "Opportunities in the Airplane Industry." It is interesting and instructive. It will show you many things you never knew before about aviation. We have but a limited supply of these books—send the coupon before they are all gone.

**American School of Aviation**  
3601 Michigan Ave., Dept. 1427 Chicago, Ill.

**American School of Aviation**  
3601 Michigan Ave., Dept. 1427 Chicago, Ill.  
Without any obligation, send me your Free Book, "Opportunities in the Airplane Industry", also information about your course in Practical Aeronautics.

Name .....

Street .....

City .....

State .....

# SPECIAL SUBSCRIPTION OFFER

116 PAGE BOOK GIVEN *FREE* WITH EVERY SIX MONTHS' SUBSCRIPTION TO

**FREE**

This Big 116 Page Illustrated Book

## "HOW TO MAKE IT"

Building your own home furniture, cameras, radio cabinets, sport devices, etc., is easy if you know what materials you need, and have an illustrated explanation on how to proceed. Then too, you can save a good deal of money by making these valuable things yourself.

"How to make it" a big book compiled from the great magazine "SCIENCE & INVENTION," is full to the brim with hundreds of up-to-date things to make at home. Things that can be made by any man with only a few simple tools.

Every home in the U. S. should have one of these books handy—worth its weight in gold.

116 Pages  
200 Illustrations  
Size 9 x 12 Inches



## RADIO'S GREATEST MAGAZINE

RADIO NEWS, with its 240 pages, is the largest radio magazine published. It is the outstanding authority in the radio field, carrying more new developments, more hookups and more news than any other radio magazine.

RADIO NEWS carries in every issue more than a dozen separate departments that cover every angle of the great industry from the beginner to the professional broadcaster or ship operator.

RADIO NEWS has been radio's greatest magazine since the very beginning of radio broadcasting.

(Regular Price \$2.50 the Year)

SEND ONLY \$1 FOR SIX MONTHS SUBSCRIPTION AND GET A COPY OF "HOW TO MAKE IT" FREE.

Published and Distributed by

## The Experimenter Publishing Co., Inc.

53 Park Place, New York, N. Y.

EXPERIMENTER PUB. CO., Inc.  
53 Park Place, New York, N. Y.

Gentlemen: I enclose \$1 for 6 months subscription to RADIO NEWS and one FREE copy of "HOW TO MAKE IT"

Name .....  
Address .....  
City, State .....

# 150 RADIO HOOKUPS

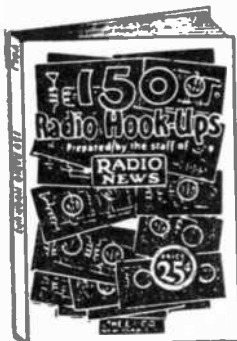

What more could you ask?—150 of the very finest, selected hookups most popular today. Each one completely explained and fully illustrated so that a complete receiver can be constructed from the information. No out-of-date Hookups—all the finest and best in common use today.

Don't miss this opportunity—All Radio and news dealers have fresh copies now. If there is no dealer near you write us direct enclosing 25 cents.

**Price 25c** Sold on all newsstands. If your newsdealers cannot supply you, order direct. We pay postage charges.

The Copy **CONSRAD COMPANY, INC.,**  
64 CHURCH STREET :: NEW YORK CITY, N. Y.

ing an invention having far better prospects of a large volume of sales.

Many of the most successful inventors are keen observers who take advantage of all opportunities. Some of them work solely to improve newly discovered arts before a multitude of other inventors are endeavoring to accomplish the same thing. On the other hand other successful inventors simply have confidence in their own ideas and do not hesitate to spend the required money to promote them irrespective of the kinds of inventions already patented. The inventor who selects a comparatively new field in which to make improvements, no doubt, is more likely to patent valuable things than the individual who tries to invent something new in machinery or other apparatus that is practically perfected, although of course there is room for improvements in all lines. An average individual may find it necessary to spend many months in diligent study before he thoroughly understands the mechanism of a locomotive, and yet he may conceive a very valuable improvement at first glance. Every now and then our attention is attracted to an inventor who almost instantaneously gained wealth and fame through a simple improvement of a complicated piece of mechanism with which he is less familiar than many other persons. Unquestionably it is the idea that counts.

Moreover numerous inventors have been made rich by accident, so to speak. Not long ago a United States patent was issued on an anti-theft device for aeroplanes. Such an invention is practically useless and worthless today, but if perchance someone perfects a safety device by which aeroplanes are made a popular means of transportation this inventor holds a basic patent from which he may receive millions of dollars in royalties.

Actual cases are numerous where seemingly unprofitable and useless inventions are made popular and come into great demand through an unlooked for change in circumstances. But sometimes the apparently accidental popularity of an invention is foreseen by an unusually observant inventor who believes the change will take place.

About fifteen years ago a certain foreigner who resides in New York obtained a basic patent on a popular improvement on automobiles. At the date the patent was issued the invention was advanced far beyond the existing needs and conditions, but after a few years the automobile industry grew up to the invention, so to speak, and a certain automobile manufacturer was very anxious to secure the patent rights of the once apparently worthless invention, but its inventor could not be located. A thorough search was instituted by leading detective agencies in this country and abroad, but without avail. The inventor has never been found although he is thought to be alive. As time passes the term of the patent grows shorter until now it has but a short period to run before its expiration. The present rights to this patent are worth many thousands of dollars and the amount of cash which the inventor might have received for it a few years ago is beyond accurate estimate. This inventor probably became discouraged and concluded that his invention was worthless and has forgotten about it.

Very often a new thought is an accidental occurrence. Howe, the inventor of the sewing machine, which netted more than two million dollars in royalties, worked from an idea which he received while sitting idly watching his wife make a child's dress. He was a laborer and testified in later court proceedings that he mentally compared the slow movements of his wife's fingers when making stitches, with the rapid reciprocal movements of a hammer machine which he had seen in operation. With the idea once in mind he determined to make a sewing machine for his wife's own individual use, not thinking at that early time that it might



## Build Your Own Airplane

Blueprints and Material Now Ready for Builders

**EASY TO BUY EASY TO FLY**

### The LINCOLN SPORT PLANE



100 Miles Per Hour with 30 H. P. Engine. Special Sale on Complete Set of Parts.

### The LINCOLN MONOPLANE



Real performance in a light Monoplane. Blue Prints are life size. A Motorcycle engine will give this plane real performance.

OUR NEW AIRCRAFT INSTRUCTION BOOK FLIGHT tells you how. Blue Prints of both planes on special sale NOW! Send 25c for illustrated book and constructional details.

Write today!

**LINCOLN STANDARD AIRCRAFT COMPANY**  
Dept. A 1 LINCOLN, NEBRASKA



Users Praise it as a Priceless Possession

### RESHAPE YOUR NOSE!

You can surely and safely mold your nose to beautiful proportions with the **ANITA NOSE ADJUSTER**

Shapes while you sleep or work—painlessly, comfortably. Results speedy and guaranteed. Physicians praise it highly. No metal to harm you.

FREE BOOKLET points way to facial beauty and happiness. Write for it today.

**The ANITA Co.** Gold Medal Won 1922  
ANITA Bldg., Dept. 1073 Newark, N. J.



**AXEL CHRISTENSEN**  
(Famous Vaudeville and Radio Star)

Will Teach You **JAZZ PIANO PLAYING** IN 20 LESSONS

His wonderful system has made thousands of successful pianists since 1903. There is a "Christensen School" in nearly every city—see your phone book for local address—or lessons given by mail.

IF SEND FOR FREE BOOKLET GET AXEL'S COMPLETE JAZZ INSTRUCTION BOOK, showing how to "Jazz Up" any tune, with new breaks, fills, bass and chord work, from your local teacher or sent postpaid for \$2.

**PIANO TEACHERS:** If there is no "Christensen School" in your town, this is your golden opportunity—write quick for lucrative proposition.

**CHRISTENSEN SCHOOLS OF POPULAR MUSIC**  
Suite 440 20 E. Jackson Blvd., Chicago

# PIMPLES

Cleared Up—often in 24 hours. To prove you can be rid of Pimples, Blackheads, Acne Eruptions on the face or body, Barbers' Itch, Eczema, Enlarged Pores, Oily or Shiny Skin, simply send me your name and address today—no cost—no obligation. CLEAR-TONE tried and tested in over 100,000 cases—used like toilet water—is simply magical in prompt results. You can repay the favor by telling your friends; if not, the loss is mine. WRITE TODAY.

E. S. GIVENS, 468 Chemical Bldg., Kansas City, Mo.

## Print Your Own

Cards, Stationery, Circulars, Paper, etc. Save money. Print for others, big profit. Complete outfits \$8.85. Job press \$11. \$29. Rotary \$149. All easy, rules sent. Write for catalog presses type etc. THE KELSEY CO., P-47, Meriden, Conn.

### THIS CLASS PIN 35¢

Silver plate, your choice, 3 colors enamel, any 3 letters and date. 12 or more 25c each. Sporting Silver, 55c. 12 or more 45c each. Free Catalog shows Rings, Pins, Emblems 20c to \$9.00 each.

685 Metal Arts Co., Inc., 7723 South Ave. Rochester, N. Y.

prove a profitable machine to manufacture and sell. But it was not long before keen business minds offered financial aid to the inventor of such a labor-saving piece of mechanism.

The facts prove that the first model of an entirely new invention seldom operates with such success, but to obtain a valid patent the patent laws merely require that the device is operable. For this reason, inventors should not become discouraged because their working models operate crudely. Basic patents may be obtained on crude models and the patentee may exact royalties from manufacturers of later improvements.

Very often individuals spend considerable time and money in perfecting an invention on which they expect to obtain a strong patent, and later learn that someone else already holds the basic patent.

Wise and experienced inventors never proceed blindly to spend money experimenting and making models and then file an application for a patent, without first searching the Patent Office records. Considerable time, money and disappointment will be saved inventors who adopt this method. It is far better to learn at once that a device is old and unpatentable than it is to waste valuable time and much money with high expectations which are later shattered. On the other hand a "search" is discouraging to a person who has invented a very valuable improvement and who may decide not to proceed to patent the invention, because certain apparently similar patents are found. Sometimes improvements on old and well-known devices are more valuable than the original and basic patents. This is true particularly because of the fact that considerable expense and difficulty may be experienced in introducing and establishing the usage of an entirely new thing, whereas an improvement of an already popular product is at once recognized as being valuable and the users of the old device may be readily influenced to purchase the improved invention. A great volume of sales can then be quickly effected without much expense. For these reasons all inventors should very carefully examine the patents found in searches of the Patent Office records before deciding not to patent the invention. Furthermore, it should be remembered that a valid and strong patent can be obtained on a combination of old and well-known elements, provided, of course, new and useful results are accomplished by the unitary functions of the structure comprising the old elements.

### TELEPHONE IMPOSSIBLE!

Here is an interesting clipping from a Boston newspaper published 61 years ago: "A man about 46 years of age, giving the name of Joshua Coppersmith, has been arrested in New York for attempting to extort funds from ignorant and superstitious people by exhibiting a device which he says will convey the human voice any distance over metallic wires so that it will be heard by the listener at the other end. He calls the instrument a 'telephone' which is obviously intended to imitate the word 'telegraph' and win the confidence of those who know of the success of the latter instrument without understanding the principles on which it is based. Well-informed people know that it is impossible to transmit the human voice over wires as may be done with dots and dashes and signals of the Morse Code, and that, were it possible to do so, the thing would be of no practical value. The authorities who apprehended this criminal are to be congratulated, and it is to be hoped that his punishment will be prompt and fitting, that it may serve as an example to other conscienceless schemers who enrich themselves at the expense of their fellow creatures."—Contributed by Lewis Braden.



## HIGH SCHOOL COURSE IN TWO YEARS

**YOU ARE BADLY** if you lack **HANDICAPPED** High School training. You cannot attain business or social prominence. You are barred from a successful business career, from the leading professions, from well-paid civil service jobs, from teaching and college entrance. In fact, employers of practically all worth-while positions demand High School training. You can't hope to succeed in the face of this handicap. But you can remove it. Let the American School help you.

**FIT YOURSELF FOR A BIG FUTURE** This course, which has been prepared by some of America's leading professors, will broaden your mind, and make you keen, alert and capable. It is complete, simplified and up-to-date. It covers all subjects given in a resident school and meets all requirements of a High School training. From the first lesson to the last you are carefully examined and coached.

**USE SPARE TIME ONLY** Most people idle away fifty hours a week. Probably you do. Use only one-fifth of your wasted hours for study and you can remove your present handicap within two years. You will enjoy the lessons and the knowledge you will gain will well repay the time spent in study.

Check and mail the coupon NOW for full particulars and Free Bulletin.

### American School

Dept. H-726  
Drexel Ave. and 58th St., Chicago

### American School

Dept. H-726 Drexel Ave. & 58th St., Chicago  
Send me full information on the subject checked and how you will help me win success.

- |                              |                            |
|------------------------------|----------------------------|
| .....Architect               | .....Lawyer                |
| .....Building Contractor     | .....Machine Shop Practica |
| .....Automobile Engineer     | .....Photoplay Writer      |
| .....Automobile Repairman    | .....Mechanical Engineer   |
| .....Civil Engineer          | .....Shop Superintendent   |
| .....Structural Engineer     | .....Employment Manager    |
| .....Business Manager        | .....Steam Engineer        |
| .....Cert. Public Accountant | .....Foremanship           |
| .....Accountant and Auditor  | .....Sanitary Engineer     |
| .....Bookkeeper              | .....Surveyor (& Mapping)  |
| .....Draftsman and Designer  | .....Telephone Engineer    |
| .....Electrical Engineer     | .....Telegraph Engineer    |
| .....Electric Light & Power  | .....High School (re-entr) |
| .....General Education       | .....Fire Insurance Exper. |
| .....Vocational Guidance     | .....Wireless Radio        |
| .....Business Law            | .....Undecided             |

Name.....

Address.....



## "I know he'll make good"

"I picked him because I know I can depend on him to handle more important work."

"He hasn't been here nearly so long as Tom Brown and Bob Adams, who thought they ought to get the job, but he knows ten times as much about this business."

"Why? Because he's trained! Because he studied and prepared himself for this very promotion while the other men idled away their time. I wish I had more men like him."

Why don't you study and get ready too? We'll be glad to help you if you will only make the start. And the way to do that is easy.

Choose the work you like best in the coupon below; then mark and mail it to the International Correspondence Schools today. This doesn't obligate you in the least, but it will bring you information that will help to start you on a successful career. This is your opportunity. Don't let it slip by.

Mail the Coupon for Free Booklet

### INTERNATIONAL CORRESPONDENCE SCHOOLS

Box 6168-E, Scranton, Penna.  
 Oldest and largest correspondence schools in the world  
 Without cost, please tell me how I can qualify for the position or in the subject before which I have marked an X:

- | BUSINESS TRAINING COURSES                                                 |                                                                      |
|---------------------------------------------------------------------------|----------------------------------------------------------------------|
| <input type="checkbox"/> Business Management                              | <input type="checkbox"/> Salesmanship                                |
| <input type="checkbox"/> Industrial Management                            | <input type="checkbox"/> Advertising                                 |
| <input type="checkbox"/> Personnel Organization                           | <input type="checkbox"/> Better Letters                              |
| <input type="checkbox"/> Traffic Management                               | <input type="checkbox"/> Show Card Lettering                         |
| <input type="checkbox"/> Business Law                                     | <input type="checkbox"/> Stenography and Typing                      |
| <input type="checkbox"/> Banking and Banking Law                          | <input type="checkbox"/> Business English                            |
| <input type="checkbox"/> Agency (including C.P.A.)                        | <input type="checkbox"/> Civil Service                               |
| <input type="checkbox"/> Nicholson Cost Accounting                        | <input type="checkbox"/> Railway Mail Clerk                          |
| <input type="checkbox"/> Bookkeeping                                      | <input type="checkbox"/> Common School Subjects                      |
| <input type="checkbox"/> Private Secretary                                | <input type="checkbox"/> High School Subjects                        |
| <input type="checkbox"/> Spanish                                          | <input type="checkbox"/> Illustrating                                |
| <input type="checkbox"/> French                                           |                                                                      |
| TECHNICAL AND INDUSTRIAL COURSES                                          |                                                                      |
| <input type="checkbox"/> Electrical Engineering                           | <input type="checkbox"/> Architect                                   |
| <input type="checkbox"/> Electric Lighting                                | <input type="checkbox"/> Architects' Blueprints                      |
| <input type="checkbox"/> Mechanical Engineer                              | <input type="checkbox"/> Contractor and Builder                      |
| <input type="checkbox"/> Mechanical Draftsman                             | <input type="checkbox"/> Architectural Draftsman                     |
| <input type="checkbox"/> Machine Shop Practice                            | <input type="checkbox"/> Concrete Builder                            |
| <input type="checkbox"/> Railroad Positions                               | <input type="checkbox"/> Structural Engineer                         |
| <input type="checkbox"/> Gas Engine Operating                             | <input type="checkbox"/> Chemistry <input type="checkbox"/> Pharmacy |
| <input type="checkbox"/> Civil Engineer                                   | <input type="checkbox"/> Automobile Work                             |
| <input type="checkbox"/> Surveying and Mapping                            | <input type="checkbox"/> Airplane Engines                            |
| <input type="checkbox"/> Metallurgy <input type="checkbox"/> Mining       | <input type="checkbox"/> Agriculture and Poultry                     |
| <input type="checkbox"/> Steam Engineering <input type="checkbox"/> Radio | <input type="checkbox"/> Mathematics                                 |

Name.....  
 Street.....  
 Address.....  
 City.....State.....

Occupation.....  
 If you reside in Canada, send this coupon to the International Correspondence Schools Canadian Limited, Montreal

## TELESCOPES

Amateur astronomers, here is an opportunity to own a good telescope.

PRICES \$12.00 AND UP  
 Send 10 cents for further information

ERNEST W. BLANDIN

1207 Columbia Terrace Peoria, Ill.

**TEXAS 38 CAL. RANGER**

ALL Prices Smashed!!

Buy now and save 60 percent. Newest model, case hardened frame, blue, 2 1/2 inch barrel, with side rod ejector, with special handles, used by every cow-puncher because of accuracy, dependability. SEND NO MONEY. Pay postman on delivery. \$9.25 plus postage. Money back guarantee. Federal Mail Order Corp. 651 Broadway, New York. Dept. S-80

## GOV'T POSITIONS

Men wanting forest ranger, railway mail clerk, internal revenue agent, postoffice clerk, carrier and field clerk positions. \$1,500 to \$2,700 year. Write for free particulars. MOKANE, Dept. 245, Denver, Colo.

## Book Review

**THE MAN NOBODY KNOWS**, by Bruce Barton. Stiff cloth covers 5 3/4" x 8 1/4", 220 pages. Published by The Bobbs-Merrill Co., Indianapolis, Ind. \$2.50.

This extremely popularly written book will doubtless live for many years and be found on the library or study table of many homes. Mr. Barton, who is a well-known writer of the present day, has here undertaken to show us in popular language what a wonderful business man and executive Jesus was. This book brings the old aspects of the subject up to date and mixes them with present day problems and human situations. It required a very careful study of the Bible and myriads of events in the life of Jesus to be able to write a book as well as this is written. It is interesting above all perhaps to know why the book was written, and the author in an opening preface tells "How it came to be written."

**ELECTRICAL AMUSEMENTS AND EXPERIMENTS**, by Charles R. Gibson, F.R.S.E. Stiff cloth covers, 5" x 7 3/4", illustrated, 214 pages. Published by J. B. Lippincott Co., Philadelphia, Pa.

A quantity of well-known electrical experiments somewhat modified in their descriptions and with new illustrations are given in the pages of this quite interesting work. The idea is to make young people do their own experimenting. The boy, or let us even say a girl, who constructs an operative microphone or telephone certainly deserves far more credit than one whose amusement comes from perhaps a \$150 model railroad. The whole idea of the book is to have young people do things for themselves. It is a sort of axiom with "those who know" that we learn more from our failures and mistakes than from any other source, and there are enough descriptions of home-made apparatus contained in this book to teach the young student how to overcome difficulties and how to do experiments in various branches of electricity with apparatus which he has made himself.

**MICROBE HUNTERS**. By Paul de Kruif. 358 pages. Illustrated. 6x8 1/2 inches. Board cover. Harcourt, Brace & Co., 383 Madison Ave., N. Y. C. Price, \$3.50.

There is a great fascination for the layman, as well as the scientist, in the subvisible world—the world that can be shown to us only by the use of a microscope. People as a whole realize that there are thousands of different kinds of "bugs", which in many ways affect our daily life and health, but there is an appalling lack of knowledge about them. We speak more or less glibly about vaccines, anti-toxins, the isolation of various germs, etc., but when the bottom of the matter is reached, there are many who are unable to tell the difference between the terms employed above.

Even though people are familiar with these various terms, the chances are that the names of the pioneers of the searchers of the world that is bounded by the limits of a drop of water, are just names and little more. Pasteur is a name that is familiar to nearly all, but who has heard the name of Leewenhoek mentioned at the same time? Yet this man was every bit as great as the energetic Frenchman, because he was really the Christopher Columbus of the microscopic world. This Dutchman, who had no scientific training whatsoever, discovered that drops of water have inhabitants by means of microscopes of his own construction.

About twenty years after Leewenhoek died there was born an Italian named Spallanzani, who started growing his own microbes in jars and studying them. Years later Pasteur found that microbes could be put to use in preventing disease by the use of vaccines; then came Koch, a German country doctor, who had only a microscope and had to improvise all his other apparatus, but as he grew older was considered the foremost microbe hunter in Germany, and identified a mosquito as the disseminator of malaria.

Other microbe hunters that are mentioned in Dr. de Kruif's book are Roux and Behring; Metchnikoff, the madcap Russian; Theobald Smith, the American who found out that ticks spread Texas fever among cattle; Bruce, Ross and Grassi, who found that malaria was spread by a certain mosquito; Walter Reed, the valiant American Army doctor, who found the remedy for yellow fever; and Paul Ehrlich, the German, who gave to the remedy he discovered for the world's most horrible disease, a number.

These men and their work Dr. de Kruif has told of in a manner that is only too seldom found in works of this nature. He presents his characters so that you feel their pleasures when they triumph and their sadness when their experiments turn out unsuccessful—in short he gives the human side of the investigators. If more books on kindred subjects could be written in this style, there is little doubt that there would be a great deal more interest shown among laymen in scientific matters. It is a book which we heartily recommend to everyone whether they be scientifically inclined or not, for it will give them some idea of what pioneer microbe investigators have accomplished.

**SW**

Rare Bargain!  
**HENSOLDT**  
 GERMAN  
**BINOCULAR**

FORTUNATE PURCHASE at advantageous price, HENSOLDT and MARESCHAL Prism Binoculars, MARESCHAL made by French Company famous since 1852 for Binoculars. HENSOLDT made by M. HENSOLDT & SONS, Wetzlar, Germany. These Binoculars are used by leading Military and Naval forces of the world! 8-Power Magnification; superb lenses; brilliant illumination; exquisite definition. Wide field of vision; individual eye-strength and width adjustments. Leather Case, neck and shoulder straps. Usual price \$12. Our price (while limited quantity lasts)..... **\$23.50**

LEND WINGS TO YOUR EYES!  
 CONQUER DISTANCE! See Miles away! Observe people, ships, game, scenes, sports OFF in the distance! Bring them right to your feet! Open NEW Worlds—glorious vistas! Double the Thrill of Dashing Sports! An all-year round pleasure giving investment. Indispensable for hunting, hiking, motoring, yachting, races, games, shooting, observation, bird and nature study, etc.  
 Yours For 10 DAYS' FREE Examination!

Send NO Money now! Pay NOTHING on delivery. ENJOY Binoculars for 10 Days' Trial Absolutely FREE!

If pleased, you may pay on Budget Plan: **\$5.00 MONTHLY**  
 or, if you wish to pay cash at end of 10 DAYS' deduct \$1.75 and send **\$21.75** in Check or Money Order for \$21.75 in FULL SETTLEMENT. Otherwise return them. Order NOW! Limited Quantity! Send NO Money! Pay NOTHING on Delivery!

**SEAVER-WILLIAMS CO.**  
 Importers, Exporters, National Mail-Order House  
 "Generations of Honorable Dealings"  
**365 WASHINGTON ST., BOSTON, MASS**  
 Largest Retailers of Binoculars in America.  
 Gentlemen—Send me the 8-POWER BINOCULARS for 10 days' FREE Trial on the above plan.  
 Hensoldt  Mareschal. Check preference.  
 Name.....  
 Address.....  
 Clip and mail this Adv. NOW. Please tell us something about yourself. We will appreciate and respect the information. THANK YOU. 8.1.10-26

## Book on Law Free

Write today for this new book. It tells you how a law training will shorten your road to success. It also carries a vital and inspiring message to every ambitious man. Find out about the opportunities that await the law trained man. Find out how you can learn law right in your own home. No obligations. The book is absolutely FREE.  
**Write Today**—now while we are making a special reduced tuition offer.  
 American Correspondence School of Law  
 3604 Michigan Ave. Dept. 1427, Chicago, Ill.

**FLY** Young man, learn aviation. Build this classy plane and learn to construct and operate aircraft. Use your motorcycle engine or our "Meteor" 20 h.p. motor. We furnish parts very reasonable to build this wonderful little "Meteorplane" the World's first successful Light Plane. Send \$3.50 for complete set of blue prints and parts price list of this latest Model M-T-2. IRWIN AIRCRAFT COMPANY 130-O-Street, Sacramento Calif.

## Be My Candy Agent

Make big money. Sell chocolate bars, fruit drops, nut clusters, chewing gum and popular packages, 50 kinds. All fast sellers. I make the best. Reason just starting. Free samples. Need agent at once. So answer this ad NOW.  
 MILTON GORDON, 1416 Vine St., Cincinnati, Dept. 1288

Insure your copy reaching you each month. Subscribe to **SCIENCE & INVENTION**—\$2.50 a year. Experimenter Publishing Co., 53 Park Place, New York City.



# STOP Worrying About Your Job and your Future

Don't be satisfied with ordinary low-paid jobs that get you nowhere—that you can lose by strikes, lockouts and layoffs. If you are an American citizen, 18 years or older you can get a Government Civil Service position. Pay is from \$1900 to \$2700 to start; work is steady, hours easy, vacations with pay, and plenty of chances for quick raises to better paid positions.

Let me train you to pass the U. S. Civil Service Examination with high rating so you will be eligible for one of the first Customs, Internal Revenue, Departmental Immigration, Postmaster, Post Office and Rural ranches. Hundreds of successful students. I was a Secretary and Secretary Examiner for eight years. Write for 48 page free book. Tells all. Send postal now to ARTHUR R. PATTERSON, Prin.

PATTERSON CIVIL SERVICE SCHOOL  
Dept. 182A. Wisner Bldg., Rochester, New York

## Science Now Discovers Wonderful Gasoline Economizer

A Chicago Scientist, designer of the first Stephens Motor Car in 1897, has recently astonished the motor world with the announcement of a new patented device which tests prove give automobiles twice the usual mileage on a gallon of gas in addition to tremendous new power. This remarkable invention, called the Thermo-Vac, has united for the first time, the two proven principles of thermostatic and vacuum control of gasoline consumption. The device is automatic, simple, economical, and can be attached without aid of tools in a few minutes by anyone. The inventor wants agents and is willing to send free sample and big income plan to anyone who will send name and address to Mack Laboratories, Dept. 863X, 720 Cass St., Chicago. Write today.

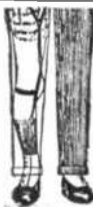

## BOW LEGS?

This Garter (pat'd) - Makes Trousers Hang Straight If Legs Bend In or Out Self Adjustable It Holds Sox Up—Shirt Down Not a "Form" or "Harness" No Metal Springs Free Booklet—Plain Sealed Envelope THE T. GARTER CO. Dept. 10 NEW LONDON, NEW HAMPSHIRE.

## MUSIC LESSONS FREE

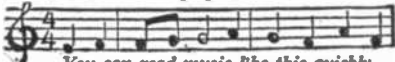

You can read music like this quickly IN YOUR HOME. Write today for our FREE booklet. It tells how to learn to play Piano, Organ, Violin, Mandolin, Guitar, Banjo, etc. Beginners or advanced players. Your only expense about 2c per day for music and postage used. AMERICAN SCHOOL of MUSIC, 57 Lakeside Bldg., CHICAGO



## BE AN OFFICER

IN THE U. S. COAST GUARD \$1,700 UP TO \$7,500 YEARLY \$750 yearly at the U. S. Academy while training. You rank Ensign to Captain in service. Age requirements 18 to 21. Write Dept. 18, for information. COAST GUARD PREPARATORY SCHOOL 4000 Ga. Ave. N.W. Washington, D.C.

Insure your copy reaching you each month. Subscribe to SCIENCE AND INVENTION—\$2.50 a year. Experimenter Publishing Co., 53 Park Place, New York, N. Y.

## Our "Spiritualistic Investigations"

By "DUNNINGER"

(Continued from page 536)

We were warned to move neither hands nor feet during the manifestation, as the medium took pains to explain that instances have been known where inattention and disobedience in matters spiritual, have been fatal to the medium.

After sitting in this position, which was far from comfortable, for a few moments . . . audible taps were heard coming from the table.

Slowly . . . distinctly came the knocks . . . one . . . two . . . three . . .

Then a few moments of silent waiting . . .

The room was as silent as the tomb of a Pharaoh.

Soon the table seemed to rise from the floor . . . slowly . . . slowly . . .

At last it was raised at least a foot from the floor. The eyes of the medium seemed glued upon us. The table hesitated, as it were, the spirits seemed to feel the presence of an unbeliever, so stated the medium.

In a droning voice, Madame Denton asked us to concentrate our minds upon things foremost in importance to ourselves, and to dear ones about us. We did so. Several distinct knocks were heard, supposedly in reply to our thoughts. The table had, by this time, returned to its original position on the floor. So slowly had this descension been made, that we scarcely noticed it. Several more taps were heard, and then Madame Denton asked us if we had been satisfied with her seance, and whether there were any further questions to be asked. Simultaneously we informed her there were no more questions to be answered.

We paid our fee, accepted the medium's invitation to a future call and departed.

It seems that both my friend and I had fully discovered the "modus operandi" employed by this faker. The illustration I believe my readers will find clearly descriptive. A pole, the top of which had been camouflaged to correspond with the rug, was operated from beneath. The table was placed in a manner such as to tip slightly, in answer to the questions put to it. Raps were likewise produced by this pole striking the lower surface of the table top.

The levitation of the table was accomplished by the pole being pushed up from below, so as to lift the table from the floor entirely. Our hands bearing down upon the table top, and seated opposite to one another, as we were, we, ourselves, quite well balanced the table, as would other subjects in our place do the same, and help deceive themselves.

Into the night, and the teeming rain, we went. My friend, knowing the method, by which this so called phenomena was accomplished, as he afterward explained, trusted that the medium might have mystified me, so as to furnish him an opportunity of describing one that I had over-looked. The truth of the matter was that much time and experimenting was devoted by the medium and her aides, in perfecting so unusual a method of accomplishing this so-called spook table arrangement, which has no doubt mystified numerous believers.

Spirits may come, and spirits may go, so say the mediums and prohibition officers, but table raps will go on forever. It is merely a matter of improving one's method, over that of the others, that spells fortune to and makes the most successful medium.



## LEARN ELECTRICITY In the Great Shops of COYNE



In 12 WEEKS

Earn \$60 to \$200 a Week

Get in the field that offers you the BIG PAY—BE AN ELECTRICAL EXPERT. Coyne is not a Correspondence School. Everything is practical. No books or useless theory. You do actual work on our huge outfit of electrical apparatus—everything from door-bells to power plants—everything to make you a \$60 to \$200 a week EXPERT. A Coyne trained man can take his place anywhere in the electrical world. Learn in Chicago, the Electrical Center of the World.

You Don't Need Education or Experience Coyne gives you education and experience by actual work. My training is practical and easy to understand.

Free Railroad Fare and Radio and Auto Course FREE!

Right now I am including a free course in Radio. Also a complete course in Auto, Truck and Tractor Electricity and Storage Batteries and I'll pay your railroad fare to Chicago.

Earn While You Learn—We help students to secure part time jobs to earn a good part of their living expenses while training and assist them to a big pay job on graduation.

SEND COUPON NOW!

Don't delay a minute—send that coupon right now for my big free catalog and full particulars of special offer. No obligation on your part at all. ACT NOW! COYNE Electrical School H. C. LEWIS, President Dept. 7683 1300-10 W. Harrison St. CHICAGO ILLINOIS

Get my Big Free Book

SPECIAL OFFER NOW

Mail this Coupon

H. C. LEWIS, Pres. Coyne Electrical School Dept. 7683 1300-10 W. Harrison St., Chicago Dear H. C.: Please send me free your big new catalog and full particulars of your courses. Free Railroad Fare Offer and two free

Name \_\_\_\_\_  
Address \_\_\_\_\_  
City \_\_\_\_\_  
State \_\_\_\_\_



## This man is sure of his job

HE SAW the handwriting on the wall. Men around him were being dropped right and left. He might have been the next to go but for a familiar coupon which he saw in a magazine. He tore it out and mailed it to Scranton.

Then one day his employer called him in. "Young man," he said, "I have just received a letter from the International Correspondence Schools telling me you have enrolled and have received a mark of 93 for your first lesson.

"I don't mind saying that this letter has saved your job. I had you on the list of men to be dropped. But I'm going to keep you now. And there are bigger things ahead for you. The man who thinks enough of his future to study his job is the kind of a man we want."

HOW about you? Are you sitting on the anxious bench wondering if you will be the next to go? Or are you training yourself so that you will not only be sure of your present job, but will be ready for the job ahead?

This is all we ask: Without cost or obligation, put it up to us to prove how we can help you. Just mark and mail this coupon.

### INTERNATIONAL CORRESPONDENCE SCHOOLS

Box 6167-E, Scranton, Penna.  
Oldest and largest correspondence schools in the world  
Without cost, please tell me how I can qualify for the position or in the subject before which I have marked an X:

- |                                                         |                                                 |
|---------------------------------------------------------|-------------------------------------------------|
| <input type="checkbox"/> Business Management            | <input type="checkbox"/> Salesmanship           |
| <input type="checkbox"/> Industrial Management          | <input type="checkbox"/> Advertising            |
| <input type="checkbox"/> Personnel Organization         | <input type="checkbox"/> Better Letters         |
| <input type="checkbox"/> Traffic Management             | <input type="checkbox"/> Show Card Lettering    |
| <input type="checkbox"/> Business Law                   | <input type="checkbox"/> Stenography and Typing |
| <input type="checkbox"/> Banking and Banking Law        | <input type="checkbox"/> Business English       |
| <input type="checkbox"/> Accountancy (including C.P.A.) | <input type="checkbox"/> Civil Service          |
| <input type="checkbox"/> Nicholson Cost Accounting      | <input type="checkbox"/> Railway Mail Clerk     |
| <input type="checkbox"/> Bookkeeping                    | <input type="checkbox"/> Common School Subjects |
| <input type="checkbox"/> Private Secretary              | <input type="checkbox"/> High School Subjects   |
| <input type="checkbox"/> Spanish                        | <input type="checkbox"/> French                 |
| <input type="checkbox"/> Illustrating                   |                                                 |
- 
- ### TECHNICAL AND INDUSTRIAL COURSES
- |                                                 |                                                  |
|-------------------------------------------------|--------------------------------------------------|
| <input type="checkbox"/> Electrical Engineering | <input type="checkbox"/> Architect               |
| <input type="checkbox"/> Electric Lighting      | <input type="checkbox"/> Architects' Blueprints  |
| <input type="checkbox"/> Mechanical Engineer    | <input type="checkbox"/> Contractor and Builder  |
| <input type="checkbox"/> Mechanical Draftsman   | <input type="checkbox"/> Architectural Draftsman |
| <input type="checkbox"/> Machine Shop Practice  | <input type="checkbox"/> Concrete Builder        |
| <input type="checkbox"/> Railroad Positions     | <input type="checkbox"/> Structural Engineer     |
| <input type="checkbox"/> Gas Engine Operating   | <input type="checkbox"/> Chemistry               |
| <input type="checkbox"/> Civil Engineer         | <input type="checkbox"/> Pharmacy                |
| <input type="checkbox"/> Surveying and Mapping  | <input type="checkbox"/> Automobile Work         |
| <input type="checkbox"/> Metallurgy             | <input type="checkbox"/> Airplane Engines        |
| <input type="checkbox"/> Steam Engineering      | <input type="checkbox"/> Agriculture and Poultry |
| <input type="checkbox"/> Radio                  | <input type="checkbox"/> Mathematics             |

Name.....  
Street.....  
Address.....  
City..... State.....

Occupation.....  
If you reside in Canada, send this coupon to the International Correspondence Schools Canadian Limited, Montreal

### BUY DIRECT SAVE HALF

GRADE A QUALITY GOODS at WHOLESALE

Any handy man can install his own plumbing and heating by our new, easy method. FREE installing plans show you how. You save waste and high labor cost with our cut-to-fit system. Fifty years of economy service to home owners, farmers, builders and mechanics. Million dollar plants behind our guarantee. Free Book shows everything in plumbing and heating fixtures and supplies. Write today. HARDIN-LAVIN COMPANY, 104-16 West Pershing Road, Chicago, Ill. ESTABLISHED 1876

SEND FREE BOOK

### Wrestling Book FREE

Tells how to be a great athlete and scientific wrestler—how to WIN. Startling secrets taught in wonderful lessons by world's champion Farmer Burns and Frank Gotch. Be strong, healthy, athletic. Handle big men with ease. Learn self defense. Be a leader. Men and boys, write for Free Book today. State your age. Farmer Burns School 1257 Railway Bldg., Omaha, Neb.

## Radio Wrinkles Clock Hand Dial Pointer

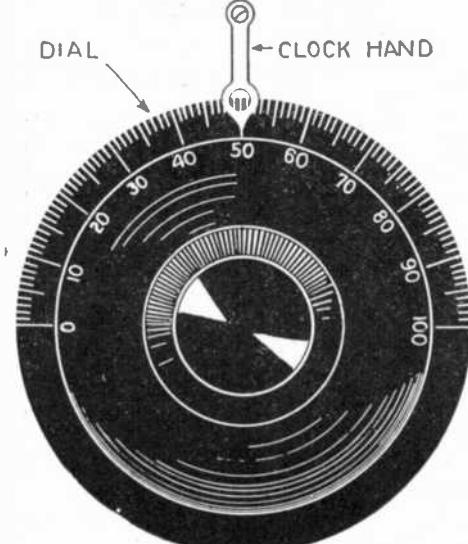

Use an old clock hand as a dial pointer to assist you in adjusting and logging your radio dials.—Fred Schlump.

## Geared Vernier Dial Adjustment

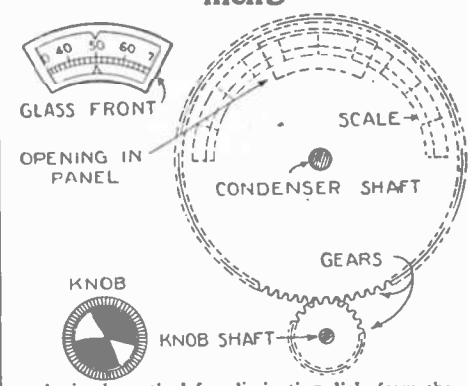

A simple method for eliminating dials from the front of your set and providing an efficient vernier control.—Author please send address.

## Plate Current Indicator

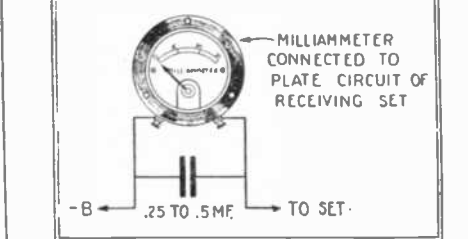

A milliammeter in the plate circuit of your receiving set shows current drawn by tubes. The shunt condenser prevents howling.

## Radio Vacuum Cleaner

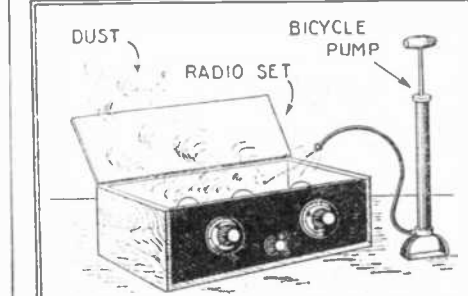

Dust collecting on instruments inside the radio cabinet will greatly lower their efficiency. Keep your set clean by using the system shown above.

**Silent "B" Power with World Radio Storage "B" Battery**

**12 Cells 24 Volts**  
Lasts Indefinitely—Pays for Itself  
Dependable. Quiet "B" power, clear without "hum." Economy you have never before thought possible. Convenience. Outstanding performance. Recharged for almost nothing. Solid rubber case insures against leakage or acid. Extra heavy glass jars. Heavy rugged plates. Approved and listed as standard by Pop. Radio Laboratories, Pop. Sci. Inst., Standards, Radio News Lab., Leisur, Inc., and other Radio authorities.

Extra Offer: 4 Batteries in series (96 Volts) \$10.50.  
**SEND NO MONEY!** Just state number of batteries wanted and we will ship same day order is received. Pay expressman after examining batteries. 5 per cent discount for cash with order. Send your order today—NOW!  
**WORLD BATTERY COMPANY**  
1219 So. Wabash Ave. Dept. 83 Chicago, Ill.  
Makers of the Famous World "A" Storage Battery  
Prices: 6-volt, 100 Amp. \$10.50; 120 Amp. \$12.50; 140 Amp. \$13.25.  
All equipped with Solid Rubber Case.

## World STORAGE BATTERIES

Set your Radio Dials for the new 1000-watt World Storage Battery Station, WSB, Chicago. Always something interesting.

RDKA - WEAF - WGN - WJS - KLU - KGO - KFAF - WJY - KOP

## Do Your Own Wiring And Save 50%

**STANDARD WIRING FOR ELECTRIC LIGHT AND POWER**  
CUSHING

Thousands of young men have become expert wiremen through the simple rules and tables given in this year's **STANDARD WIRING**. It contains The National Electrical Code explained and illustrated. New illustrated chapters on Outside Wiring and Inside Wiring for all systems for both direct and alternating currents; House and Residence Wiring, Garage Wiring, Theatre and Moving Picture House Wiring, Marine Wiring, Electric Sign Wiring, Radio Wiring, How to light the home. How to install, operate and care for Generators, Motors, Storage Batteries, Meters, Electric Ranges and every kind of wiring device for light, heat and power. 464 Pages, 381 Illustrations. Pocket Size. Sent Post Paid on receipt of Price **\$3.00**  
H. C. CUSHING, JR.  
13 West 55th Street New York

## Aviation

LEARN  
Take a W. A. C. Course in Applied Airplane Engineering. Many men earn \$2000 to \$10,000 a year. Big Free outfit of airplane parts. Write for Free catalog.  
**WESTERN AIRPLANE CORPORATION**  
"Dept. S-10" Monadnock Bldg., Chicago, Ill.

## "BECOME A LIGHTNING TRICK CARTOONIST"

Send \$1.00 for B-ginners instructions with Laugh Producing Program of 23 Comic Trick drawings. Catalog of Chalk Talk Supplies Free  
**BALDA ART SERVICE, Dept. 4, Oshkosh, Wisconsin.**

## How to Earn a Second Income

How many people would turn down a chance to double their present income?—It can be done—there are hundreds of ways—and there is a new magazine that tells you these ways and gives all the facts. Before you forget—  
**SEE PAGE 558**

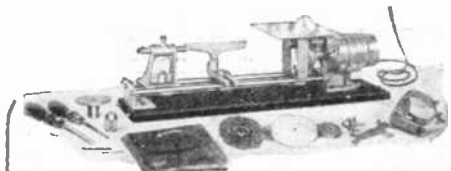

## Make Things at Home

You can make almost anything—Furniture, Garden Trellis, Flower Box, Toys, Radio Panel and Console and countless other things, with

### SpeedWay Shop and Tools

A compact metal and woodworking outfit for mechanics, householders and "handy" men. Driven by the famous SpeedWay motor. Tools quickly interchangeable.

#### 8 Motor Driven Tools

Bench Saw, Lathe, Jig-Saw, Grinder, Buffer, Portable Saw, Cleaner, Drill

Attach to any lamp socket and convert your bench to a complete private workshop. Have the chips flying in five minutes after receipt.

#### FREE INSTRUCTIONS

We furnish complete blue prints and instructions for making the items shown, and dozens of other useful articles with



#### SpeedWay Shop

for your own home or for sale. You can buy two or three units at first and add others as you need them.



Portable Saw Unit

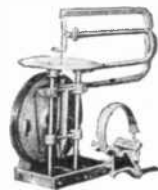

Jig-Saw Unit

#### ONLY \$10 DOWN

We make it easy to pay while you enjoy these sturdy tools in your own home. You can do Wood Turning, Bench Sawing, Scroll Sawing, Portable Sawing. You can do buffing, polishing, grinding and drilling either at the bench or anywhere there is a lamp socket.

#### 10 DAYS' TRIAL

Test the SpeedWay Shop for 10 days in your own home. If it does less than we claim, return it.

#### Free Blueprint Service

Each month for a year we furnish a free blueprint of your selection and help you in other ways to get maximum service from the SpeedWay Shop and Tools. Write for list of blueprints.

#### Write Today For Full Information

Every tool in the "Shop" is high grade, for regular work. A money maker for the small job man. Write today.

### Electro Magnetic Tool Company

1830 S. 52nd Ave., Cicero, Ill. (Adjoining Chicago)

Dept. 310, ELECTRO-MAGNETIC TOOL CO.

Dear Sirs: Please send me full particulars about 10-day free trial, free blue prints and \$10 down payment.

Name .....  
Address .....

## CLEVER SHOW CARDS EASY TO MAKE

EARN \$25 WEEKLY  
IN SPARE TIME  
\$50 TO \$100 IN FULL  
TIME

Learn at home—through amazingly simple method perfected by foremost show card expert. No previous training or ability needed. Simple as A.B.C. Every store needs original show cards. Demand steadily growing. Quick, steady profits. Work for others—or start your own business. It is easy to earn \$25 weekly in spare time—or from \$50 to \$100 in full time. Write NOW for Special Offer and beautifully illustrated FREE book giving whole story of big money opportunities in this fascinating field—and telling how you can prepare yourself quickly.



WASHINGTON SHOW CARD SCHOOL  
Room 2610-D, 1117-15th St., N.W., Washington, D.C.

### Battery Lead Protector

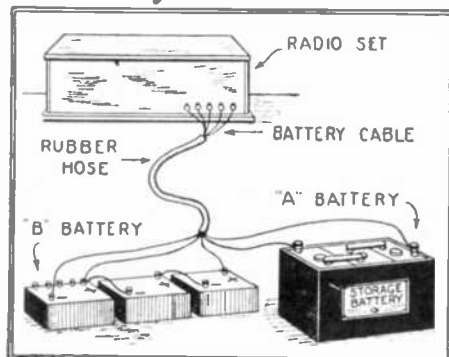

A rubber hose may be slipped over the battery leads to keep them together and prevent corrosion from acid fumes.

### Compact Rectifier Unit

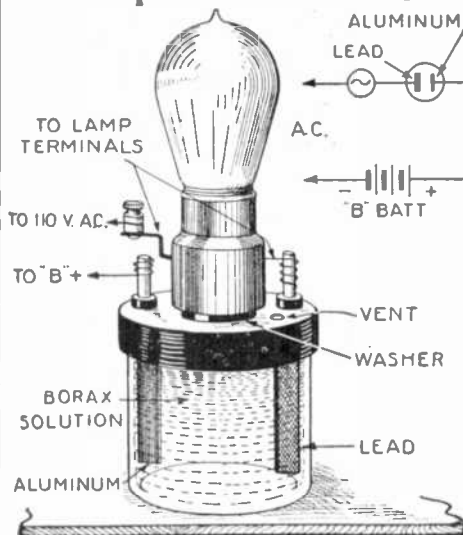

This unit for charging storage "B" batteries may be easily assembled and is very compact. —B. G. Switzer.

### Mounting Loud Speaker

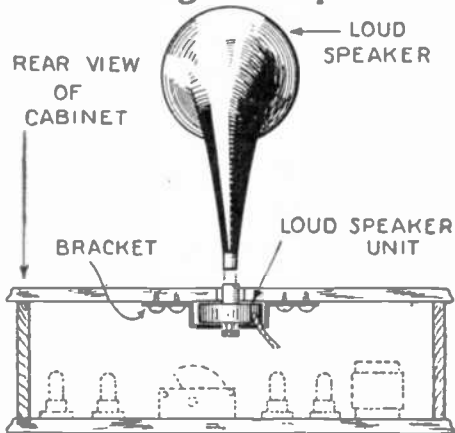

Brass strips may be used to mount a loud speaker unit on the top of your radio set. This will eliminate long leads.—B. G. Switzer.

### Cage Antenna Spreaders

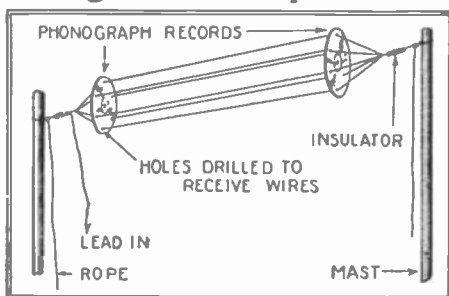

A number of phonograph records bolted together for strength may be used for cage antenna spreaders if drilled as shown to receive wires.—Fred Ebel.

## ELECTRICAL EXPERT'S OUTFIT



Complete when you enroll

\$50 VALUE. Real tools—no toys.

**HERE ARE THE TOOLS** that make money. Free, too, if you accept this special offer for S. of E. electrical training. Just a few happy hours each week at home means big success. Work that's full of thrills and fun. Send coupon for FREE book.

**OUR MONEY-BACK GUARANTEE BOND** means that your training must absolutely satisfy you or every penny is refunded. S. of E. training makes good—with you. Our 22 years' experience has shown us the one right way for success. Mr. Harnischfeger, president of the Harnischfeger Corp'n, one of the largest electrical concerns in America says, "The best recommendation I have for your school is the number of your graduates who have made good in our organization. Their training is right."

**LET THE OTHER FELLOW** slave away at \$25 a week. You get the real job with S. of E. training. Our men go to the Western Electric, Harnischfeger Corp., Commonwealth-Edison and other big electrical concerns. Or you go into business for yourself and be *Hundreds of S. of E. Students locate for themselves with our help and make big money.*

**\$65 A WEEK AND UP** is just ordinary pay in electrical work. Even common electricians make that much. But with S. of E. training you can be an electrical expert and get the big job.

**OPPORTUNITIES BY THOUSANDS** every day. No slack seasons. The electrical boom is just starting. S. of E. men are demanded first because our 22 years' experience means better and more practical training for our students.

**64 PAGE BOOK NOW FREE**—send for yours *A Personal Challenge*

"Whatever your present occupation we can train you for success in electricity. Put yourself in my hands!" Oscar Werwath, Pres.



copy free and post-paid. Money-Back guaranty that our course satisfies or money back. Mail coupon today without fail.

#### CLIP NOW!

School of Engineering, Dept. H678, Box 572, Milwaukee, Wis. Please send me the free and post-paid your 64 page book giving details of S. of E. training. Also details of your Money-Back guaranty.

#### \$65 A WEEK AND UP!

A chance of a real career in electricity for yourself. In business or rapid advancement with electrical concerns.

Name .....  
Address .....  
City ..... State .....

# Opportunity Ad-lets

YOU will find many remarkable opportunities and real bargains in these columns. It will pay you to read and investigate the offerings made every month by reliable firms, dealers and amateurs from all over the country. No matter what you may be seeking, whether supplies, automobile accessories, the opportunity to make money, or anything else, you will find listed here the best and most attractive specials of the month.

Advertisements in this section twelve cents a word for each insertion. Name and address must be included at the above rate. Cash should accompany all classified advertisements unless placed by an accredited advertising agency. No advertisement for less than 10 words accepted.

Ten per cent discount for 6 issues, 20 per cent discount for 12 issues. Objectionable or misleading advertisements not accepted. Advertisements for the December issue must reach us not later than October 10th.

## The Circulation of Science and Invention is over 150,000 and climbing every month

EXPERIMENTER PUBLISHING CO., INC., 53 Park Place, New York City, N. Y.

### Advertising Agencies

24 Words—355 Rural Weeklies \$14.20. Ad-Meyer, 4112-SI Hartford, St. Louis, Mo.

Advertising in all magazines and newspapers at publishers lowest rates. Book giving rates, closing dates, etc., 25c.—refunded first order. Taylor's Advertising Service, 315 Brown Bldg., Rockford, Ill.

### Agents Wanted

Agents—Best seller; Jem Rubber Repair for tires and tubes; supercedes vulcanization at a saving of over 80% per cent; put it on cold. It vulcanizes itself in two minutes and is guaranteed to last the life of the tire or tube; sells to every auto owner and accessory dealer. For particulars how to make big money and free sample, address Amazon Rubber Co., Philadelphia, Pa., Dept. 601.

\$50—\$200 a week. Genuine Gold Letters for store windows. Easily applied. Free samples. Liberal offer to general agents. Metallic Letter Co., 411 B, North Clark, Chicago.

\$10 daily silvering mirrors, plating and refinishing lamps, reflectors, autos, beds, chandeliers by new method. Outfits furnished. Write Gummetal Co., Ave. D, Decatur, Ill.

Bankrupt and Rummage Sales. Make \$50.00 daily. We start you, furnishing everything. Distributors, Dept. 171, 609 Division, Chicago.

Make Money Silvering Mirrors, refinishing auto head-lights, tableware, metal plating, bed stands, chandeliers. Outfits furnished. International Laboratories, Dept. 69, 309 Fifth Ave., New York.

Agents—New Plan, makes it easy to earn \$50.00 to \$100.00 weekly, selling shirts direct to wearer. No capital or experience needed. Represent a real manufacturer. Write now for FREE SAMPLES. Madison Company, 506 Broadway, New York.

Real Selling Sensation! Tremendous earnings whole or part time! Patented Hot Water Bottle Invention needed everywhere. Big commissions. Extra bonus. We deliver. Write quick. C919 Lobl Corp., Middleboro, Mass.

Gold Initials, easily applied on Automobiles. Biggest moneymaker today. Cost 5c, you get \$1.50. No experience needed. Free Samples. "Ralco" Monograms, 1013 Washington, Boston, Mass.

To sell Ray-O-Lite cigar and gas lighters. Big earnings. Sample 50c. Rapid Mfg. Co., 799-L Broadway, New York.

Agents: Our new household cleaning device washes and dries windows, sweeps, cleans walls, scrubs, mops. Costs less than brooms. Over half profit. Write Harper Brush Works, 152-3rd St., Fairfield, Iowa.

Boston Maid Frocks for Women and Children—nationally known—famously popular. From mill to wearers \$3.50 to \$20. Great income producer for men and women agents. Write for selling outfit. Bosworth Mills, B-18, Melrose, Mass.

Make-Sell Your Own Goods. Formulas, Processes. All kinds. All lines. Catalog, circulars free. D. Thaxly Co., Washington, D. C.

Agents—Biggest money makers ever offered. Sell offices, homes BESTPHONE, which makes both hands free while telephoning; MIDGET COLLAPSIBLE GARMENT HANGERS which everybody wants; and EVERIN Keyrings to hold change and keys. P. Kalina Company, 1308 Avenue N, Brooklyn, N. Y.

\$3.11 by Mail! Big Profits! Books, Formulas, Novelties, Bargains, Particulars Free. Ellico, B-523 S. Dearborn St., Chicago, Illinois.

Big money and fast sales. Every owner buys gold initials for his auto. You charge \$1.50; make \$1.35. Ten orders daily easy. Write for particulars and free samples. American Monogram Co., Dept. 71, East Orange, N. J.

Just Out—Patented apron without strings, straps, hooks or buttons. On or off in a jiffy. Over 100% profit. Commissions paid daily. Write for free sample offer. Sta-Put Co., 3310-C N. 11th St., St. Louis, Mo.

Newest invention! Abolishes kinks, snarls and automatically coils telephone, electric iron and lamp cords. Housewives, business men, companies actually buying 5 to 50. Free sample to workers. Neverknot, Dept. E-10, McClurg Bldg., Chicago.

Real Selling Sensation! Tremendous earnings whole or part time! Patented Hot Water Bottle Invention needed everywhere. Big commission. Extra bonus. We deliver. Write quick. C1019 Lobl Corp., Middleboro, Mass.

Real Money. For every man who wants to work. You can make \$10 every day selling McNeess Products. You can make whatever you want to if you can qualify for Resident Manager. Write for the facts. Furst-McNeess Co., 508, Sunlight Bldg., Freeport, Ill.

2 Wonderful Inventions! Startling plan gives customer free gold plated device making old phonograph sound like Orthophonic Victrola. Other Abolishes needles. Bradley sold 56 in 36 calls. Everplay, Desk E10, McClurg Bldg., Chicago.

Earn \$10 daily silvering mirrors, plating, refinishing metalware, chandeliers, headlamps, bedstands. Outfits furnished. N. Deeto Laboratories, 1133 Broadway, New York.

Selling Like Blazes! Eleven piece toilet goods assortment at \$2.00 with two piece carrying set FREE to your customers. 100% profit. Davis Products Co., Dept. 67, 1321 Carroll, Chicago.

### Agents Wanted (Continued)

\$15.00 daily in advance. No investment. Exclusive territory. Big season on. Rhinestone Initial Buckles sell on sight. Chilton Novelty Co., 606 Blue Island, Chicago.

66 Miles on 1 Gallon—Amazing New Auto Gas Saver. All makes. 1 Free. Critchlow, C-87, Wheaton, Ill.

Sell Japanese Perfumed Incense direct to homes. Particulars free. Bela Co., Los Angeles.

Agents Wanted to Advertise Our Goods and distribute free samples to consumers; 90c an hour; write for full particulars. American Products Co., 6122 American Bldg., Cincinnati, Ohio.

Amazing Discovery of Brahma Diamond Astonishes Jewelry World! Not Glass! Recognized by Science! Absolutely Guaranteed! Stands Tests! Sample Case Free! References required. Dept. 24, American Brahma Co., Flint, Mich.

### Airplanes, Aviation

Three foot flying model aeroplanes, 12 inch mounted propeller for 25c. Aero Shop, 3050 Huilbot Ave., Detroit, Mich.

Airplanes. How to build them and be sure they will fly. Learn the two most powerful influences on the stability and operation of an airplane, get our free information, blue prints and propeller literature. Crawford Airplane Manfr., 2225 American Ave., Long Beach, Calif.

### Battle Photos and War Relics

For Dens. Relics from Europe's battlefields (also medals). Illustrated catalogue (with sample war photos) 25c. Weich, 1889 Albany Ave., B'klyn, N. Y.

### Books

A New Book Just Out. 1000 Needed Inventions! Arranged as follows: General Problems; Automotive; Mechanical, Electrical; Chemical; Radio; Marine. Separate chapter on the Ten Most Needed Inventions. Nothing else like it has ever been published. Edited by Raymond Francis Yates, formerly Managing Editor of a leading scientific magazine. Over 100 pages, durably bound. Price only \$1.00. Money back after 10 days' examination if desired. Bureau of Inventive Science, Dept. 710, Rochester, N. Y.

### Business Opportunities

Free Book. Start Little Mail Order Business. Pier Company, 72AF Cortland Street, N. Y.

You can have a business profession of your own and earn big income in service fees. A new system of foot corrector; readily learned by anyone at home in a few weeks. Easy terms for training, openings everywhere with all the trade you can attend to. No capital required or goods to buy, no agency or soliciting. Address Stephenson Laboratory, 18 Buck Bay, Boston, Mass.

Stop Plodding! Be Successful. Operate a Tire Repair Shop. Make big profits in any locality. We teach you and furnish complete equipment \$100 up. Book of Opportunity free. Haywood's, 1312 South Oakley Avenue, Chicago.

Stocks—Bonds, Domestic-Foreign, bought-sold. Dealers in all marketable securities. Frank X. Everett & Co., 20 Broad St., New York.

Be a Laboratory expert. Earn from \$300 to \$300 monthly. Study Microbiology. Sanitation, Day, Evening classes, Diplomas, Degrees. Granted 71 Piece outfit Free to students. Write for our Free Prospectus to-day. International College of Microbiology, 7202 W. Grand Ave., Chicago, Ill.

Free Book—Start little mail order business. Popham, Box 431, Chicago.

Trymakers—Make money at home. Proposition and blueprint 50c. Wash-T-ko, 31st Office, Detroit, Mich.

We Start You in Business, furnishing everything. Men and women, opportunity to earn \$10.00 to \$100.00 weekly operating Ragsdale's Original "New System Specialty Candy Factories" anywhere; wholesale or retail. Valuable commercial candy book free. W. Hillyer Ragsdale, Drawer 129, East Orange, N. J.

"Modern Mail Order Methods" tells how to start a profitable mail order business with small capital. Late edition, price \$2.00. Full information free. Muddell Publishing Co., 3006, 7th Ave., Los Angeles.

### Chemistry

Experimenters. Chemical Apparatus—Radio catalogs, 1000 illustrations. Price 25c refunded on \$5.00 order. Laboratory Materials Company, 625 East 71st St., Chicago.

Experimenters. Students. Amateur Chemists! Read "Popular Chemistry" for experiments, formulas, chemical news, book reviews, chemical magic. Question-answer department every month. Subscription, \$1.00 per year, sample 10c. Special! Eight copies, all different, including how to make fireworks and lessons in determinative mineralogy, 50c (money order). Wright Press, Caldwell, New Jersey.

### Correspondence Courses

Used correspondence school courses. All kinds. Sold on repurchase basis. Big saving. Money back guarantee. Lists free. (Courses bought). Lee Mountain, Pisgah, Alabama.

Used Correspondence School Courses and Educational Books bought, sold, exchanged; Bargain Catalogue Free. Handling, 799-A Broadway, New York.

### Educational

Correspondence courses. All schools. Lowest prices. Terms, Catalog Free. Mention Subject. Fred. Goetz, 410-H Sansome, San Francisco.

### Farms, Land, Etc.

Ozark land; 10 acres near White River and proposed Dixie Lake, \$100, \$5 monthly. Asa Zimmerman, 1800 N. Fifth, Kansas City, Kansas.

### For Advertisers

Write Letters, Folders, Booklets, complete followup for manufacturers, mail order dealers. Long experience. Write for details. L. Taylor, 315 Brown Bldg., Rockford, Illinois.

### For Inventors

Inventors—Get this pamphlet, "What to Invent." No theory or guess work, but things actually asked for by manufacturers. Sent prepaid for only \$1.00. Inventor's Syndicate, 22 Paladium Bldg., St. Louis, Mo.

U. S. and foreign patents, trademarks, moderate rates, 22 years experience. George C. Heinicke, 32 Union Square, New York, registered in U. S. and Canada.

Unpatented Ideas Can Be Sold. I tell you how and help you make the sale. Free particulars (Copyrighted) Write W. T. Greene, 808 Jenifer Bldg., Washington, D. C.

Inventors! Use our special service for presenting your invention or patent to manufacturers. Adam Fisher Mfg. Co., 205-A Enright, St. Louis, Mo.

Your Chemical problems solved and working process furnished for Five Dollars. Write me. W. Steidman Richards, Consulting Chemist, Box 2102, Boston, Mass.

Save Wasteful Patent Expense; patented or unpatented inventions. Write us. Central Sales Agency, Independence, Mo.

Successful patent selling through cooperation. Booklet free. Chartered Association American Inventors, Barrister Building, Washington, D. C.

### Formulas

Formulas Silvering Mirrors, hundreds others with business library, for \$1.00 prepaid. Globe Novelty Co., South Bend, Ind.

### For Sale

At 1-3 to 1-4 the original cost rebuilt high grade analytical balances and microscopes; also weights. Guaranteed in good working order. A. L. Pohleir, Box 32, Norton, Mass.

### Games and Toys

Boys! Boys! Boys! Just issued, our 1926 catalog of Jewelry, Tricks, Puzzles, Novelties. Write for your copy. Dept. 6, American Bazaar, Inc., 610 B'way, New York.

### Help Wanted

Silvering Mirrors, French plate. Easily learned, immense profits. Plans free. Wear Mirror Works, Dept. 36, Escel-lor Springs, Mo.

All men-women, 18 to 60, wanting to qualify for Government Positions, \$140-\$250 monthly. Local or travelling. Write. Mr. Ozment, 293, St. Louis, Mo.

Detectives Earn Big Money. Travel. Excellent opportunity. Great demand everywhere. Experience unnecessary. Particulars free. Write. American Detective System, 1971 Broadway, N. Y.

Be a Detective. Work home or travel. Experience unnecessary. Particulars free. Write. George Wagner, former Government Detective, 1968 Broadway, N. Y.

Firemen, Brakemen, Baggage-men (white or colored), sleeping car, train porters (colored), \$150-\$250 monthly. Experience unnecessary. 897 Railway Bureau, East St. Louis, Ill.

**Help Wanted (Continued)**

\$95.00 to \$225.00 Month. Men-women 18 up. Get U. S. Government Jobs. Steady work. Life positions. Paid vacation. Common education sufficient. 32 page book with sample examination coaching and full particulars FREE. Write today sure. Franklin Institute, Dept. B19, Rochester, N. Y.

**Household Machine**

A large manufacturer of Commercial Refrigerating Machines desires successful design for a household machine. Address Box 255, Science and Invention.

**Machinery and Tools**

Concrete Building Block Machines and Molds. Catalogue free. Concrete Machine Co., 5 N. First St., St. Louis, Mo.

**Magic and Games**

Free with \$25 order our large die box. Send 20c for our large catalogue of tricks, puzzles, wigs, sensational escapes. Oaks Magical Co., Dept. 549, Oshkosh, Wis.

Books—Magic, Mysteries, Magic Tricks, Novelities, Catalogue Free. Singer, 200, Hancock, Wis.

Card tricks. Coin tricks. Hypnotism. Ventriloquism. 21 page books. Complete guides, 10c each. G. Fenner, 2191 Jefferson, Louisville, Ky.

Startling! Black Spot! Mystery—White powder placed on moist hand immediately turns spot black, only 10c. Fool your friends. Albert Kubel, 1101 E. Mesamensing Ave., Phila., Pa.

**Manufacturing**

To Order—Mechanical work, all branches. Models, Experimenting. Quantity production. Farma Engineering Works, Brooklyn Station, Cleveland, Ohio.

**Manuscripts Wanted**

Earn \$25 weekly. Spare time. Writing for newspapers, magazines. Experience unnecessary. Details Free. Press Syndicate, 987, St. Louis, Mo.

**Miscellaneous**

Beautiful registered bull pups \$15. Bulldogs, 501 Rockwood, Dallas, Texas.

Catch From 45 to 60 foxes in from 1 to 5 weeks' time; can teach any reader of this magazine how to get them. Just drop me a card for particulars. W. A. Hadley, Stansstead, Quebec, Canada.

Underground Treasures. Simple scientific method for locating. Free booklet explains. T. Santschl, Glen Ellyn, Ill.

Machine work of any kind wanted by well equipped shop. The Greaves-Klusman Tool Co., Cincinnati, O.

Model Makers Lathes 7x24. High grade equipment. Chucks slide rest-counter shaft tools. Also 1 1/2 H. P. gas engine. All like new. No reasonable offer refused. F. Murphy, 245 First St., Jersey City, N. J.

Lightning Electrolyte. Charges storage batteries instantly. Gallon costs 50c, sells \$10.00. Make is yourself. Guaranteed formula \$5.00. Write for free circulars. Murphy, Chemist, Tujunga, Calif. Box-C.

Chemical Questions Answered. Accurate information \$5.00. Smover, 80 Wall Street, New York.

Build yourself an electric clock! Blueprints and instructions of a novel model everybody can build. \$1. Particulars free. Albert Deibig, Electrical Engineer, 1690 Park Ave., New York.

**Motorcycles—Bicycles**

Don't buy a Bicycle Motor Attachment until you get our catalogue and prices. Shaw Mfg. Co., Dept. 6, Galesburg, Kansas.

**Musical Instruments**

Violas—Deep, Mellow, Soulful—on easy credit terms. High grade, wonderful instruments of my own make. Development of many years' experience. Write for book. Gustav A. Henning, 2121 Gaylord St., Denver, Colo.

Cornetists—Trombonists—Saxophonists—Clarinetists. Get "Free Printers". Name instrument. Virtuoso School, Dept. T, Buffalo, New York.

**Old Coins**

German Govt. Bond, 100,000 Mk. 1923 \$1.40, 5,000,000 Mk bond 1921, \$1.50. 100,000 Mk. bill and catalogue 10c. Norman Shultz, Box 716, Salt Lake City, Utah.

California Gold, quarter size, 27c; half-dollar size, 53c. Columbian nickel and catalogue, 10c. Norman Shultz, Box 716, Salt Lake City, Utah.

Wanted—Old coins (Indian head) pennies; big price paid; stamp for circular. Lane, Dept. B, 1101 Michigan, Chicago.

**Old Money Wanted**

\$2 to \$500 Each paid for hundred of Old or Odd Coins. Keep all old money. It may be very valuable. Send 10c for new Illustrated Coin Value Book, 4x8. Guaranteed Prices. Get Posted, We pay Cash. Clarke Coin Company, 11 Street, LeRoy, N. Y.

**Patent Attorneys**

Millions spent annually for ideas! Hundreds now wanted! Patent yours and profit! Write today for free book—tells how to protect yourself, how to invent, ideas wanted, how we help you sell, etc. American Industries, Inc., 212 Victor Bldg., Washington, D. C.

Richard E. Babcock, Patent Lawyer, Washington Loan & Trust Bldg., Washington, D. C. Booklet.

Monroe E. Miller, Ouray Bldg., Washington, D. C. Patent Lawyer; Mechanical, Electrical Expert. Booklet and Priority Record blank gratis.

Patents—Send for form "Evidence of Conception" to be signed and witnessed. Form, fee schedule, information free. Lancaster and Allwine, Registered Patent Attorney in United States and Canada, 212 Ouray Bldg., Washington, D. C.

Patents Procured; Trade Marks Registered—A comprehensive, experienced, prompt service for the protection and development of your ideas. Preliminary advice gladly furnished without charge. Booklet of information and form for disclosing idea free on request. Richard B. Owen, 130 Owen Bldg., Washington, D. C., or 41-T Park Row, New York.

Patents. Send for free booklet. Highest references. Best results. Promptness assured. Send model or drawing for examination and opinion. Watson E. Coleman, Patent Attorney, 614 G Street, N. W., Washington, D. C.

Cooperative Plan for safe-guarding and commercializing inventions before patenting. Write for free booklet. Ralph Burch, Patent Lawyer, 501 Jenifer Building, Washington, D. C.

**—PROOF—  
That Classified Advertising in  
Science & Invention  
Pays**

**THE RALCO SUPPLY CO.**  
Easily Applied and Permanent Monograms.  
Boston, Mass.  
SCIENCE & INVENTION: June 28, 1926.  
Sometime ago you asked us for a testimonial. We wish to advise you that we have not been keying Science & Invention for quite some time, as it has been one of our pick of choice in the past.  
We believe it reaches the right class of Agents, as we have good results from men obtained through your paper, as does the Agent.  
Thanking you, we are  
Very truly yours,  
**THE RALCO SUPPLY CO.**

**—still another one**

**OAKS MAGICAL CO.**  
Manufacturers of Advanced Magic  
Oshkosh, Wis.  
Jan. 25, 1926  
SCIENCE & INVENTION:  
In replying to your recent letter regarding our advertisement appearing month after month in your publication, will say that the results have always come out way on top.  
Very truly yours,  
**OAKS MAGICAL CO.**  
Per H. G. Harwood

**See Rates at Top Opposite  
Page Then Send Your Order.**

Unpatented Ideas Can Be Sold, I tell you how and help you make the sale. Free particulars (Copyrighted). Write W. T. Greene, 809 Jenifer Bldg., Washington, D. C.

Get your own patents, Application blanks, complete instructions \$1. Cutting Bros., Cambell, Calif.

Patents. Time counts in applying for patents. Don't risk delay in protecting your ideas. Send sketch or model for instructions or write for Free book, "How to Obtain a Patent" and "Record of Invention" forms. No charge for information on how to proceed. Communications strictly confidential. Prompt, careful, efficient service. Clarence A. O'Brien, Registered Patent Attorney, Security Bank Building (directly across street from patent office), Washington, D. C. See page 513.

Patents: Trade-Marks. Ten years experience in Patent Office. Consultation invited. Booklet. Geo. Beeler, 2001, 150 Nassau St., New York.

Patent-Sense—As one of the oldest firms in America we give inventors, at lowest consistent charge, a service noted for results, evidenced by many well-known Patents of extraordinary value. Book, Patent-Sense, free. Lacey & Lacey, 611 F St., Washington, D. C. Estab. 1869.

"Inventor's Advisor," the valuable Patentbook with 150 Mechanical movements and illustrations, sent free upon request. M. I. Labiner, Patent Attorney, 3 Park Row, New York.

"Inventors' Guide" free on request; gives valuable information and advice for all who have original ideas or improvements. Frank Ledermann, Registered Attorney and Engineer, 17th Floor, Woolworth Bldg., New York.

Successful patent selling through cooperation. Booklet free. Chartered Association American Inventors, Barrister Building, Washington, D. C.

**Patents**

Inventions commercialized. Patented or unpatented. Write Adam Fisher Mfg. Co., 205 Enright, St. Louis, Mo.

Two inventions—Two automatons and a plaster Paris process. Beware inventor's rights. William Haines, Habana, Cuba.

**Patents For Sale**

Mr. Inventor. If you have a patent or invention for sale, write Hartley, 38 Court St., Bangor, Me.

**Photography**

Have you a Camera? Write for free sample of our big magazine, showing how to make better pictures and earn money. American Photography, 118 Camera House, Boston, Mass.

**Photoplays Wanted**

\$\$\$ For Ideas. Photoplay Plots revised, criticized, copyrighted, marketed. Send for free booklet. Universal Scenario Company, 210 Security Bldg., Santa Monica & Western Ave., Hollywood, Calif.

**Printing, Printing Outfits and Supplies**

Print your own cards, stationery, circulars, paper, etc. Complete outfits \$8.85; Job Presses \$11, \$29; Rotary \$19. Print for others, big profit. All easy, rules sent. Write for catalog presses, type, paper, etc. Kelsey Company, P.O. Meriden, Conn.

**Salesmen Wanted**

Take orders for coffee, sugar, flour, meats, canned goods, staple groceries, also paints, radio sets, tires, auto and tractor oils. No capital or bond required. We deliver and collect. Permanent business. Big pay. Write at once, Hitchcock-Hill Co., Dept. 83, Chicago.

Minutes Pay Dollars demonstrating wonderful three-pound calculator. Details \$15.00. Work equals \$300 machines. Adds, subtracts, multiplies, divides automatically. Five year guarantee. Big demand; large profits, experience unnecessary. Write quick for liberal trial offer and protected territory. Lightning Calculator Co., Dept. W, Grand Rapids, Mich.

\$100-\$200 weekly. Retailers live wire specialty. \$10 weekly guaranteed against com. Reliable house. Guarantee dealers turnover or money back. Pay you to investigate. Appleton Novelty Co., Cedar Rapids, Iowa.

Sells for \$9.75. Prints ad on wrapping paper, envelopes, etc. \$1.00 commission. Send 10c for sample work. Automatic Ad-Stamper, Joplin, Mo.

A Paying Position Open to representative of character. Take orders shoes-hosiery direct to wearer. Good income. Permanent. Write now. Tanners Shoe Mfg. Co., 8-468 C Street, Boston, Mass.

Shop Representative. Sell Reed Micrometers to shop friends. Liberal commission. Reed Small Tool Works, 35-4 Hermon Street, Worcester, Mass.

**Song Poems**

Song Poem Writers—Send for proposition. Ray Hibbel, D21 2104 N. Keystone Ave., Chicago.

Free "Song Writers Guide", B24-1239 Elm, Green Bay, Wis.

**Stammering**

St-Stu-T-T-T-ering and Stammering Cured at Home. Instructive booklet free. Walter McDunnell, 105 Arcade, 1126 Granville Ave., Chicago, Ill.

Stop Stammering. All speech defects successfully cured. Samuel Robbins, 399 Boylston St., Boston.

**Stamps and Coins**

Stamps 100 All Different 3 cents. S. I. Quaker Stamp Company, Toledo, O.

Net Approvals on request. Premium. W. J. Wilkins, Tecumseh, Nebr.

**Typewriters**

Typewriters, all standard makes, \$10 up. Fully guaranteed. Free trial. Write for complete illustrated lists. Northwestern Exchange, 121 N. Francisco Ave., Chicago.

**Ventriloquism**

Ventriloquism taught almost anyone at home. Small cost. Rent 2c. stamp today for particulars and proof. Geo. W. Smith, Room 8-127, 125 N. Jefferson Ave., Peoria, Ill.

**Wanted**

Detectives Earn big Money. Work home or travel. Experience unnecessary. Write, George Wagner, former Government Detective, 1968 Broadway, N. Y.



# TWO-FISTED Action Fiction

Romp through the pages of that exciting  
Western-Adventure Magazine called

Ask for it  
at any  
newsstand  
25c

FAWCETT'S  
**Triple-X**  
MAGAZINE

October  
issue  
now on  
sale

Here's the biggest package of thrilling stories on the market—you'll find the brands of the best authors, profuse illustrations—and all you ante is two bits!

Throw your lass' rope over the October issue—and read:

**THE ROAD TO SANTA FE**, by J. Allan Dunn,

**THE CAMP BOSS**, by H. Bedford-Jones,

**SAY IT WITH GLOVES**, by Herbert L. McNary,

**DEAD OR ALIVE!** by Richard A. Martinsen,

**THE NESTERS' RETURN**, by William B. Corcoran,

and other tales of north woods, sea, mystery, and cow-country adventure



Let These Guides

Solve Your Problems

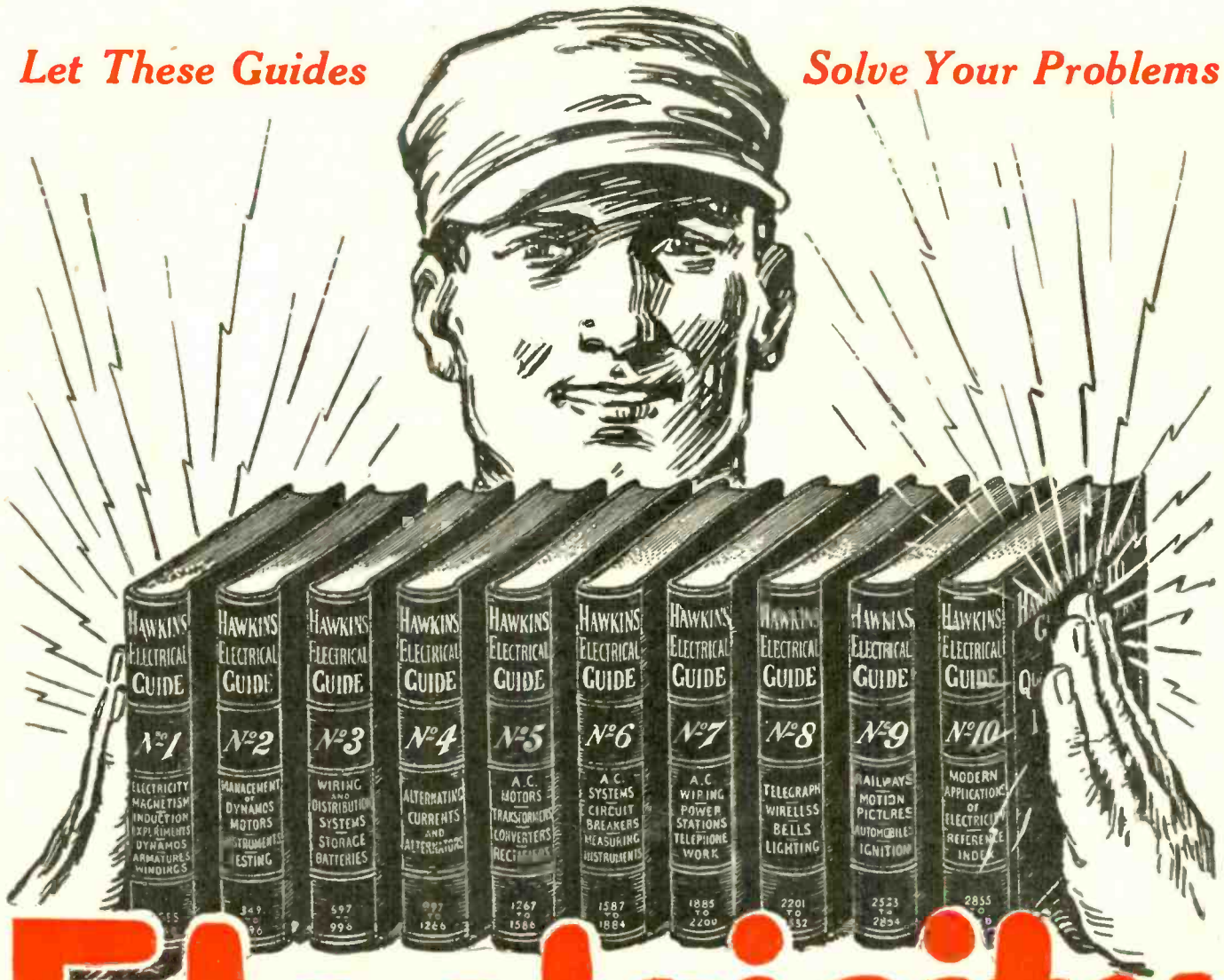

# Electricity at your finger ends

## HAWKINS ELECTRICAL GUIDES IN TEN VOLUMES

3500 PAGES  
4700 PICTURES

\$1 A VOLUME  
\$1 A MONTH

SEND NO MONEY—SEND ONLY THIS COUPON

Know the facts in Electricity. They mean more money and better position for you. Hawkins Guides tell you all you need to know about Electricity. Every important electrical subject covered so you can understand it. Easy to study and apply. A complete, practical working course, in 10 volumes. Books are pocket size; flexible covers. Order a set today to look over.

**LEARN ALL ABOUT**

Magnetism—Induction—Experiments—Dynamometers—Electric Machinery—Motors—Armatures—Armature Windings—Installing of Dynamometers—Electrical Instrument Testing—Practical Management of Dynamometers and Motors—Distribution Systems—Wiring—Wiring Diagrams—Sign Flashers—Storage Batteries—Principles of Alternating Currents and Alternators—Alternating Current Motors—Transformers—Converters—Rectifiers—Alternating Current Systems—Circuit Breakers—Measuring Instruments—Switchboards—Wiring—Power Stations—Installing—Telephone—Telegraph—Wireless—Bells—Lighting—Railways. Also many Modern Practical Applications of Electricity and Ready Reference Index of the ten numbers.

**SHIPPED FREE**

Not a cent to pay until you see the books. No obligation to buy unless you are satisfied. Send Coupon now—today—and get this great help library and see if it is not worth \$100 to you—you pay \$1.00 a month for ten months or return it.

THEO. AUDEL & CO.

65 West 23rd Street, New York City

Please submit me for free examination, HAWKINS ELECTRICAL GUIDE (Price \$1 a number). Ship at once prepaid, the 10 numbers. If satisfactory, I agree to send you \$1 within seven days and to further mail you \$1 each month until paid.

Name .....

Occupation .....

Employed by .....

Home Address .....

Reference .....

S. I., Oct.



# Only One Way You Can Get This Remarkable Pen!

*You must try it FIVE days before you can keep it!*

Equal to Any \$7 or \$8.75 Pen  
In Quality

Superior to Any Pen at Any  
Price in Performance

Only Way to Get the Postal:

“Buy Through One Who Owns One”—or Mail Coupon Below

THE man who invented this amazing pen consented to let us sell it only under one condition—that we work out a plan whereby the price would be within the reach of everyone, instead of selling it at \$7.00 or \$8.75, the price of other pens of equal quality.

Of course, it was impossible to sell this remarkable pen through the stores. Their profit alone on a \$7.00 or \$8.75 pen is *more than what you actually pay for the POSTAL RESERVOIR PEN*. And so we decided to let Uncle Sam do the selling for us—through the United States mails.

## The Pen That Says “Fill Me Up” When Empty

The POSTAL RESERVOIR PEN (named POSTAL because it is sold by mail only) is distinctive in design and contains features which are not found in any other pen. It is transparent, so you can always see when it needs filling. It is self-filling—employs an entirely new method, the easiest ever devised. Holds 3 to 4 times more ink than any other self-filling pen. Manufactured from same materials as used in highest priced pens. Never before have so many improvements and refinements been combined in a single, handsome, smooth-writing, never-clogging pen that you will be proud to own and delighted to use.

## How to Get the Postal Pen SEND NO MONEY

Simply fill in and mail the coupon. Do not send a penny! When you get your Postal Pen, you will also receive 5 post cards, each worth 50c on the purchase price of another pen. Every Postal Pen owner finds that his friends admire his remarkable pen and ask where they can get others like it.

You can easily sell your premium Postal Reservoir Pen, post cards for 50c each and earn back the full price of your Postcards which I may give you. You do not have to sell away or dispose of at 50c the cards—dispose of each. I will pay postman \$2.50 upon receipt of the pen. If after 5 days' use I desire to return the Postal Pen, you agree to refund purchase price. Send me the model I have checked.  Men's size  Women's size.

Don't Wait—  
tear off coupon  
and mail  
NOW!

Name .....

Address .....

City..... State.....



You Can See Right Through This Pen!

Costs Only  
**\$2<sup>50</sup>**

No Other Fountain Pen Like It!

### Read These Remarkable Postal Features

*It is Transparent*—You can always see exactly how much ink you've got. Can't run unexpectedly dry.

*It is Unbreakable*—You can even step on it without injuring it. A wonderful pen for lifetime service.

*It's the Smoothest Writing Pen You Ever Saw*—Big. Solid 14 Karat gold point, tipped with the finest iridium.

*It is Self-filling*—The easiest of all pens to fill.

*It Holds 3 to 4 Times More Ink Than Any Other Self-filling Pen*—Fill it once a month—and get real “writing mileage.”

*And Remember*—The materials and workmanship are guaranteed to be equal or superior to those found in any other pen whether sold at \$7.00, \$8.75 or more.

### Five Days' FREE TRIAL!

Send for your POSTAL Pen NOW. State whether you want men's or women's model. Use it five days and if you are not delighted with it, return it and your money will be promptly refunded. You are to be the sole judge. Compare it with any pen at any price. Remember the price is low only because our sales policy of manufacturer-to-user eliminates all in-between profits, commissions and handling. Send the coupon NOW and learn what real fountain pen satisfaction is!

# Postal

## RESERVOIR PEN

Actual Size is Larger Than This POSTAL PEN CO., INC., Desk 80, 25 West 43rd St., New York City