

RADIO

TODAY



BEARCAT DX-1000 REVIEW

THE ANSWER TO AN SWL'S PRAYERS?

1296MHz RECEIVER PROJECT A HIGH BAND FOR A LOW PRICE
 FIDELITY 1000 CONVERSION CB TO 10M
 TRIO TH-205E FIRST REVIEW FEEDING YOUR ANTENNA

R. WITHERS COMMUNICATIONS LTD

Manufacturers, importers and suppliers of world famous communications products
 584 HAGLEY ROAD WEST OLDBURY, WARLEY, BIRMINGHAM B68 0BS
 021-421 8201/2/3. CELLNET 0860 323056. PRESTEL MBX 214218216 FAX 0215614074

Amateur Radio. Business Radio. Radio Telephones. Sales. Service Accessories and antenna systems.



YAESU



RWC, WE HAVE MORE RADIO ALLIED SERVICES UNDER ONE ROOF THAN ANY OTHER UK COMPANY

RWC offer you more...

RWC are Radio Communication specialists and approved suppliers of ICOM and YAESU Business and Amateur Radios. We are also exclusive distributors for Kenpro handhelds and distributors of Uniden-Bearcat Short wave and scanning receivers. We specialise in the modification, improvement and frequency expansion (RX only for UK Market) of most brands of Amateur Radio Handhelds, Mobiles and Scanning Receivers. We also produce Mod-kits for CB to 10FM and PMR to Amateur Radio.

Here are some of our most popular Mods Kits, & Products.

OVER 100 Kits sold at Leicester!

10 Mtr MOD BOARD - Remember who did it first!

This is a complete modification board designed to fit all CB radios that incorporate modification board designed to fit all CB radios that have the SANYO LC7137 series of synthesizer chip, the unit comprises of a small pcb with six microchips and fits almost all current legal (CB 27/81) radios, the unit is supplied with full fitting instructions and can be fitted easily by most enthusiasts, with the current upsurge in interest in this band demand has been high as this means that over 90% of current CB radios can now be used on 10mtr amateur band.

PRICE £22.50 x £1.00 Post and packing (built & tested)

Works excellent in Cybernet, Binatone Lowe TX40G etc. *Check if your radio has the Sanyo chip fitted. We will fit unit for you £40.00 inclusive. P & P.



* Only suitable for experienced constructors.

KIT OF PARTS AVAILABLE £17.50 x £1 p&p.

*Only available from RWC see R&EW March 1985 for full circuit description etc.

New Storno CQM713/P3 2mtr Modification Kit

This new kit of parts enables conversion of the Storno 55ch Radiophone to the amateur 2mtr band. The end result is a 80ch 25Khz steps 25W transceiver with repeater shift and option of local or remote control BCD or Binary channels. The unit renders the ideal basis for a cost-effective mobile or Packet Radio transceiver or even Raynet emergency repeater! The kit comprises of two pcbs 2x adder chips, components (excluding external switches and pots) and 2x 7th overtone crystals and instructions and should present the average amateur with some constructional experience the minimum of difficulty. Why not have a go! Many parts available. Storno Mod Kit. **£29.50 Inc post.**

NEW

FRG9600 SCANNING RECEIVER



RWC Best seller £499 with mod & carriage

The FRG9600 Scanning receiver was first modified by RWC and now has coverage up to 950Mhz and improved receiver performance and S meter. We fit an additional BNC socket for frequencies above 460Mhz and are able to supply optional antennas to cover this range. This has been our most successful mod to date with many delighted customers, to our competition who copy the mod we say "Immitation is the best form of flattery!"

HF modification out soon!

Again we improve a fine HF transceiver by fitting our FAST TUNE FACILITY. The mod is "free of charge" at normal retail price, or send your rig, carriage paid and payment of £34.50 and we'll fit it for you. Can be fitted by experienced constructors. Built and tested kit at £20 Inc p&p.



INSIST THAT YOUR NEW 757 HAS OUR "FAST TUNE" MOD.....



FT-757 GX-RWC £925.00 with MOD fitted carriage inc.

RAYCOM RF AMPLIFIERS

All 1-3 Watts input SSB & FM options (FM only can be used for CW) built & tested

VHF UNITS (144-175MHZ)

Special models & bands available to order

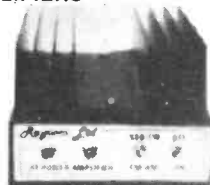

ORDER CODE	PRICE
45 FM/CW V45F	£62.30
35 FM/CW/SSB/AM V35L	£59.50
25 FM/CW V25F	£48.50
15 FM/CW/SSB/AM V15L	£49.50
15 FM/CW V15F	£39.50
All units use Mitsubishi or Toshiba power modules. Post & packing £2.50	

Please send large SAE for catalogues & price lists. Over 600 regular stock items ICOM YAESU KENWOOD FDK. etc. Instant credit for licencees and SWLS. Ask for our famous bi-weekly used list and RAYCOMS product (£1.00 refundable) catalogue or call us today for special offers.

NEW

NEW RAYCOM 13.8 VDC POWER UNITS (All AC 240 V)

1312 13.8V 10 A. MAX
 1308 13.8V 6 Amp Max
 1305 13.8V 5 Amp Max
 1303 13.8V 3 Amp Max

Model shown is 1308M 13.8V 6a metered. (built tested)

All models AC240V Input 110V available SAE for colour brochure

Model shown is 1308 13.8V 6a metered.

£59.00 post £5.00
£45.00 post £5.0
£28.50 post £3.00
£19.25 post £2.50

Better and "extended Range mods" (RX only for UK market) available for the following Models, ONLY available at RWC.

YAESU FT23 ICOM MICRO 2E
 YAESU FT73 ALINCO ALM203E
 ICOM IC28E/H KENPRO KT220EE
 ICOM IC48E REVCO RS2000E

Most of these latest models can be modified for up to 20MHz, extended coverage — call now for details some we modify free.

Remember who did it First!

N. Ireland Agents: Tom & Norman Greer Tel: 023126-645 eves.

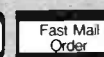
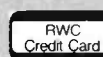

Tel: 021 421 8201 (24hr answerphone)

Telex: 334303 G TXAGWM

HAM RADIO CONTENTS

TODAY

VOLUME FIVE NO 3 MARCH 1987

Editor
 Dave Bradshaw, G1HRT
Assistant Editor
 Dave Bobbett, G4IRQ
Consultant Editor
 Steve Ireland, G3ZZD
Advertisement Manager
 Dave Gadsden, G4NXV
Classified Sales Executive
 Sue Curtis

Published by:
 Argus Specialist Publications Ltd
Distributed by:
 SM Distribution Ltd
Printed by:
 The Garden City Press Ltd
Design by:
 Argus Design Ltd

Editorial and Advertising address:
 (please mark your letter for the appropriate department)
 Ham Radio Today
 ASP Ltd
 1 Golden Square
 London W1R 3AB
 Tel: 01 437 0626

Subscriptions and back-issues:
 Ham Radio Today Subscription
 Dept, Infonet Ltd, Times House,
 179 The Marlowes, Hemel Hempstead, Herts HP1 1BB.
 Tel: (0442) 48432
Subscription rates:
 UK £17.30, o/seas surface £21,
 USA surface \$28, o/seas air £39.
 Back issues: £1.70 inc p&p

Member of the Audit Bureau of Circulation



Ham Radio Today is normally published on the first Friday in the month preceding cover date. The contents of this publication including all articles, designs, plans, drawings and programs and all copyright and other intellectual property rights therein belong to Argus Specialist Publications Limited. All rights conferred by the Law of Copyright and other intellectual property rights and by virtue of international copyright conventions are specifically reserved to Argus Specialist Publications Limited and any reproduction requires the prior written consent of the Company. © 1987 Argus Specialist Publications Ltd.
 All reasonable care is taken in the preparation of the magazine contents, but the publishers cannot be held legally responsible for errors. Where mistakes do occur, a correction will normally be published as soon as possible afterwards. All prices and data contained in advertisements are accepted by us in good faith as correct at the time of going to press. Neither the advertisers nor the publishers can be held responsible, however, for any variations affecting price or availability which may occur after the publication has closed for press.

REGULAR COLUMNS

LETTERS	10
Is the RAE unfair to disabled candidates?	
RADIO TODAY	12
Are you inadvertently ex-directory?	
LISTENING ON	44
When is a clandestine radio station really clandestine?	
RADIO TOMORROW	57
What are the local clubs up to? Find out here	

CONSTRUCTION

FIDELITY 1000 MOD	18
How to convert this popular CB rig to the 10m amateur band	
DUAL BAND CUBICAL QUAD	36
A cheap and effective way to improve your performance on 6 and 10	
1296 RECEIVER PROJECT	39
A new band, and here's the cheap way to monitor it	

FEATURES

HAMMING WITH UNCLE SAM	15
Participative rule making in the USA, and where to find contacts	
FEEDING YOUR ANTENNA	23
Louis Varney, G5RV, shows how to get your signal from here to there	

REVIEWS

BEARCAT DX-1000 REVIEW	28
A consumerish exterior belies a mean performer on HF	
KIT REVIEW: STORNO CQM 713E CONVERSION	28
A cheap way onto synthesised 2m	
TRIO TH-205E	53
Another 2m mini-handie? This one's different	
NEXT MONTH IN HAM RADIO TODAY	47
FREE READS' ADS	59
SPECIAL SUBSCRIPTIONS OFFER	63
Classified	64
Emporium Guide	65

NEW FOR '87. NEW FOR '87.

NEW! IC-275E, 25 WATT 2 METRE MULTIMODE.



The ICOM IC-275E is the most advanced all-mode transceiver available to the Amateur today. It features a new technological breakthrough in frequency synthesizer systems. This Direct Digital Synthesizer (DDS) operates in just 5 milliseconds, providing one of the fastest transceiver lock-up times available. Ideal for PACKET and AMTOR communication modes. The IC-275E has high sensitivity and dynamic range making it an ideal unit for contests and DX operation.

99 programmable memories can store frequency, mode, offset frequency and direction. A total of four scanning functions for easy access to a wide range of frequencies, memory scan, programmed scan, selected mode memory scan, lock-out scan.

A new LCD uses a soft orange backlight for ease of operating even in bright daylight. The C1-V communications interface for computer control via a serial port is mounted on the rear panel. Pass Band Tuning and Notch Filter Systems have been incorporated to provide clear operating reception.

This transceiver has a built in A.C power supply, but can also be used on 13.8v D.C for mobile or portable operation. Optional accessories available are AG25 Masthead pre-amplifier, VT36 Voice Synthesizer, FL83 CW Narrow Filter and CR64 High Stability XTAL.

To fully appreciate all the facilities of this sophisticated transceiver contact your local ICOM dealer or Thanet Electronics for further information.



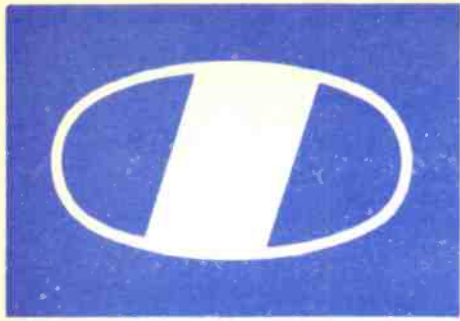

ICOM

NEW! IC-MICRO-2, MINI-HANDPORTABLE.

This is the smallest handportable from ICOM. The Micro-2, 2 metre FM measures only 148 x 31mm with the BP22 nicad battery pack. The Micro-2 is a hand-size transceiver which will equally fit most pockets.

On the top panel a clear LCD readout gives frequency, memory channel number, signal and R.F power bargraph. A LCD backlight is provided for viewing under difficult conditions. ICOM's innovation has replaced thumbwheel tuning with up/down toggle switches to select 1MHz, 100KHz or 12.5KHz steps. Scanning is possible by depressing and hold the 12.5KHz switch. 10 memories are provided and are automatically programmed by retaining what is selected by the toggle switches. Full repeater and simplex operation facilities including repeater access tone. An automatic power saving function reduces battery power consumption when in receiver mode. Output power is 1.5 watts or 100 milliwatts (low) with the BP22 nicad pack. 2.5 watts is possible with the BP24 pack.

The ICOM Micro-2 is very advanced 2 metre miniature handheld and yet still provides a simple mode of operation. This handy transceiver is supplied complete with BP22 nicad pack, A.C wall charger, helical antenna.

Optional accessories include the BC50 desk charger, rapidly charges the Micro-2 nicad packs in one hour, a variety of rechargeable nicad packs, dry cell battery pack, D.C regulator and soft cases. Contact Thanet Electronics or your local ICOM dealer for more details on this exciting new product.

Actual Size Photograph.
This shows the non-standard low capacity battery pack. N.B. Standard battery pack is normally the higher capacity BP22 as mentioned in text.



Thanet ICOM
Thanet ICOM
Thanet ICOM
Thanet ICOM
Thanet ICOM
Thanet ICOM
Thanet ICOM
Thanet ICOM
Thanet ICOM
Thanet ICOM
Thanet Electronics
Sea Street, Herne Bay, Kent CT6 8LD
Tel: (0227) 363859
Dept. HRT

PROFESSIONALS AND DISCERNING
RADIO AMATEURS ALWAYS CHOOSE



THE TOWER
PEOPLE

COMPACT LATTICE TOWERS—SLIMLINE TUBULAR MASTS

Telescopic—Tiltover, Fixed—Mobile from 3M to 60M.
Over 50 Models, suitable for a wide range
of civil and military applications such as:

- Radio Communications
- Amateur Radio
- CCTV and Surveillance
- Meteorological Monitoring
- Aero & Marine Nav Aids
- Flood Lighting etc.

Purpose designed using 4.5m and 3m section modules
for low retracted heights and cost effective shipping.
Engineered to B.S.I. standards and hot dip galvanised to
BS729 for protection. Wind loads are based on BS CP3
CHAP V PT 2 1972 for wind speeds up to 100mph/160kph.

RELIABILITY—QUALITY—KNOW HOW.

SEND S.A.E. FOR FULL DETAILS.

WE DESIGN—WE MAKE—WE SELL—DIRECT. No Middle Man.
At manufacturers prices—you get best value.

ALSO SPACE SAVER 3ele 4 BAND AQ6-20 BEAM
169-00 + 7-00 CARR.

Stock items normally sent within 7 days:
HP TERMS AVAILABLE

ALLWELD ENGINEERING

Factory 6, 232 Selsdon Road,
South Croydon, Surrey, CR2 6PL
Tel: 01-680 2995 (24 hr) 01-681 6734

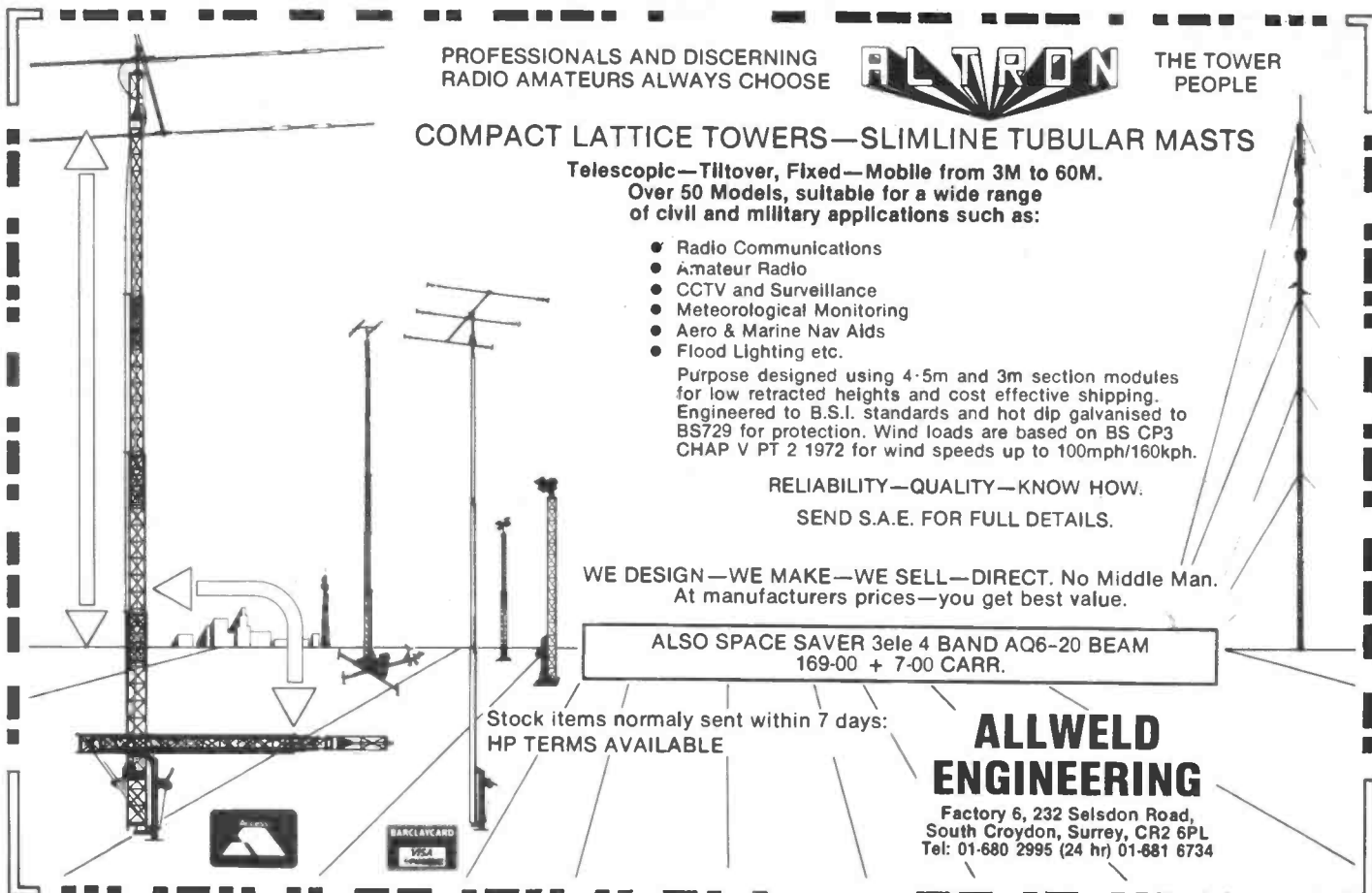

IF YOU BUY a kit or module from us the chances are it will be from the top best
sellers listed below. We are pleased to say that they just sell and sell and sell...
Shouldn't you have at least one in your shack?

70cms Modules

		Assembled	Kit
70FM05T4	500mW NBFM Transmitter	63.40	39.85
70FM05R5	NBFM Receiver	75.40	59.95
70FM10	10W Power Amplifier	56.45	45.50
70LIN3/LT	500mW Linear Amplifier	39.90	30.55
70PA2/S	RF Switched Pre-Amplifier	30.56	19.10
70PA5	GaAs FET Pre-Amplifier	23.60	14.75
TVUP2	70cms TV Converter	38.40	28.75
TVM1	70cms TV Modulator	11.60	7.25

24cms Modules

		Assembled	Kit
1250DC50	TV Down Converter	79.95	—
1250PA2	TV Pre-Amplifier	49.95	—
1240 TVT	Frequency Locked T'mitter	145.00	—
UFM01	420 MHz FMTV Exciter	41.25	28.25
VIDIF	IF Processor/Demodulator	63.75	—
SCT-2	Transmit Sound Modulator	16.50	—
SCR-2	Receive Sound De-M'lator	24.95	—
VD8P1	Pre-Emp/De-Emp Module	10.50	—

2M Modules

		Assembled	Kit
144PA4	2M MOSFET Pre-Amplifier	17.20	10.75
144PA4/S	RF Switch Pre-Amplifier	31.20	19.50
144LIN25B	RF Switched 25W Linear	49.20	35.75

General Accessories

		Assembled	Kit
TB2	Toneburst	7.50	4.70
PT3	Piptone	8.45	5.10
MPA2	Microphone Pre-Amplifier	6.25	4.60

All prices include VAT but please add £1.00 for postage and handling. Delivery is usually from stock or within 28 days.

A copy of our full list of modules and kits for practising amateurs is
available for the cost of an A4 size SAE

Unit 12-13
Youngs Industrial Estate
Aldermaston, Reading
Berkshire RG7 4PQ
Telephone: (07356) 71444 Telex: 846630





**HIGH
QUALITY
and
BRITISH
MADE**

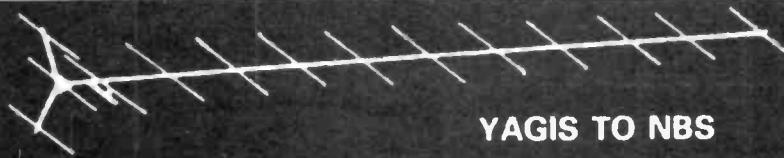

YAGIS TO NBS

ANTENNAS

**N.B.S, STANDARD ★ USER ADJUSTABLE MATCHING ★ 'N' SOCKET TERMINATION
P.T.F.E. INSULATED GAMMA ★ GAIN OPTIMISED ★ EASY ASSEMBLY ★ MADE IN U.K.**

Code	Model	Length	Gain	Cost inc. VAT	P&P Code
70cms					
432-5B	5 Ele	.7M	9.2	£19.49	B
432-19T/	19 Ele	2.2M	14.2 dBd	£40.94	A
ATV					
432-17X	17 Ele Crossed	2.2M	13.4 dBd	£56.55	A
432-17T	17 Ele Long	2.9M	15.0 dBd	£45.08	A
2M					
144-5	5 Ele	1.8M	9.2 dBd	£22.48	A
144-7T	7 Ele	1.6M	10.0 dBd	£27.77	A
144-8T	8 Ele Long	2.45M	11.0 dBd	£35.95	A
144-14T	14 Ele	4.5M	13.0 dBd	£53.72	A
144-19T	19 Ele	6.57M	14.2 dBd	£64.26	A
144-6X	6 Ele Crossed	2.5M	10.2 dBd	£45.71	A
144-GP	Ground Plane		Unity	£16.57	B
4M					
70/3	3 Ele	1.7M	7.1 dBd	£34.64	C
70/5	5 Ele	3.45M	9.2 dBd	£52.60	C
6M					
50/2	2 Ele		4.7 dBd	£32.00	A
50/3	3 Ele	2.39M	7.1 dBd	£39.95	A
50/5	5 Ele	4.77M	9.2 dBd	£59.90	A
CK50	50/2-50/3 Conversion kit			£11.50	B

POWER SPLITTERS

Specification:

CONNECTORS	'N' Type Socket
IMPEDANCE	50 Ohms
RETURN LOSS	Greater than 25dBd Across the Band
SWR	Less than 1.1 to 1 Across the Band
INSERTION LOSS	Less than 0.2dB
FREQUENCY	144-2 Way 135 - 155 MHz
TYPICAL BANDWIDTH	144-4 Way 138 - 154 MHz
	432-2 Way 400 - 500 MHz
	432-4 Way 410 - 490 MHz
Power Handling: Better than 2kw in a system with a VSWR of less than 2.0 to 1	
70cms	2 Way £23.46 B
	4 Way £27.60 B
2M	2 Way £30.60 B
	4 Way £34.50 B
SF4/432	Stacking Frame £29.75 B

NON-METALLIC MAST

A non-metallic mast is essential for best results where vertically mounted antennas and crossed yagis are required. MET have released a Re-inforced Polyester Pultrusion onto the market with comparable weight per metre as the same diameter aluminium tube. It is available in 1.5M and 3m lengths in both 1 1/2" and 2" diameter.

NON-METALLIC MAST

R.P.M. 1.5M (1 1/2" dia.)	With Fixing Clamp	£19.75	B
R.P.M. 3. M (1 1/2" dia.)	With Joiner and Resin	£39.50	B
R.P.M. 1.5M (2" dia.)	With Fixing Clamp	£22.25	B
R.P.M. 3. M (2" dia.)	With Joiner and resin	£44.50	B

Post & Package codes: A = £3.50 B = £1.95 C = £6.50

**NOW UNDER NEW MANAGEMENT
STILL MANUFACTURED TO THE SAME
HIGH STANDARDS**

BUT PLEASE DON'T FORGET...

We will be pleased to see all callers at our retail outlet in Bromsgrove. We are open six days a week and can be available some evenings if you phone in advance and make an appointment. Remember to call 0527 71165 and ask to speak to **ALAN** or **ANDY**, who will do their best to assist you.

**WE ALSO STOCK:
DRAE**

**R.S.G.B and P.W.
PUBLICATIONS**

MICROWAVE MODULES

ALINCO

S.E.M. **STARMASTER KEYS**



24 hrs



**TRADE AND EXPORT
ENQUIRIES WELCOMED**

ALM 203/E
**BEST PRICES EVER
ON ALL ALINCO
HABNHIELDS AND
MOBILES**



ALAN

ANDY

SEE US AT THE N.E.C. 27/28 MARCH



**BEST DEALS
EVER, RING
FOR DETAILS**

We still continue to stock a large range of amateur products and accessories. These are both new and second-hand. All secondhand products that are sold by us are fully tested and carry a 3 month warranty. So if you would like to visit a friendly dealer and be assured of a service that is second to none, remember our address and telephone number:
3 STOKE ROAD, ASTON FIELDS, BROMSGROVE. PHONE 0527 71165

**A. KELLY
ELECTRONICS &
COMMUNICATIONS**

3 STOKE ROAD
ASTON FIELDS
BROMSGROVE
WORCS. B60 3EQ

EXCITING PRODUCTS FOR THE RADIO ENTHUSIAST

NEW WELZ SP620



- 1.8-525MHz
- ★ Power AVGE/PEP 5VSWR
 - ★ 3w/20w/200w full scale
 - ★ Dual sensors switch selected
 - ★ S1 1.8-160MHz
 - ★ S2 140-525MHz
 - ★ Sens. S1 = 2w
 - ★ S2 = 3w
 - ★ Accuracy 10%

12 months parts and labour warranty

WELZ SP220



- 1.8-200MHz
- ★ Power AVGE/PEP & VSWR
 - ★ 1.8-200MHz SO239
 - ★ 2w/20w/200w full scale
 - ★ Sensitivity 1 watt
 - ★ Accuracy 10%

12 months parts and labour warranty

NEW DIAMOND D130H DISCONE



Now available from Diamond is the improved D130H, disc antenna. Offering complete coverage from 25-1300MHz. As an added bonus, it can be used to transmit on all amateur bands between 50-1300MHz. This new model has improved quality coaxial cable and uses N plug connectors.

OUR FAMOUS "COMPLETE GUIDE TO VHF/UHF FREQUENCIES 25-1300 MHz"

Everything you have always wanted to know about the VHF/UHF spectrum. Don't waste time hunting around in the dark. This guide will take you quickly and efficiently to the frequencies that interest you. Everything is covered including MARINE, CIVIL AND MILITARY AIRCRAFT, POLICE, FIRE, AMBULANCE, SPACE VEHICLES, AMATEUR RADIO REPEATERS, FULL DUPLEX FREQUENCY INFORMATION, PMR CHANNELS, RADIOPHONES, CELLULAR RADIO ETC. Now if that doesn't look like good value, then you don't recognise a bargain when you see one! Nearly 4000 copies sold since August. That's got to be a good recommendation. So don't be left in the dark. Order your copy today. £4.95 + 60p p&p.

Also Available:—
UK Listeners Confidential Frequency List (HF) £5.95 + 70p p&p.

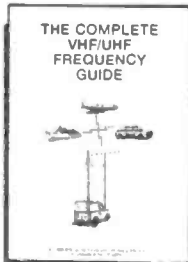

PANASONIC RF3100 150KHz-30MHz RECEIVER AT A REALISTIC PRICE £239

This Panasonic receiver covers 150KHz-30MHz with full digital readout and includes UDB/LSB/Narrow & Wide AM plus VHF FM 88-108MHz. Superb value for money, it can be operated from 240v AC or internal batteries. An internal whip is provided for portable use or an external antenna can be connected to the rear socket. There is nothing in this price range that can compete with the full backing of Panasonic in the UK you can buy from us with confidence.



NEW AC200 ALL-BAND ATU 3.5-30MHz

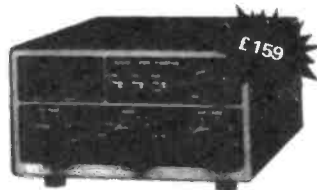

- ★ HF ATU & VSWR/PWR monitor
- ★ Power measurement 20w/200w
- ★ Switchable by-pass
- ★ Reduces harmonic radiation
- ★ Size 180/107/244mm
- ★ Matches 15-250 ohms: 50 ohms

RETAIL & MAIL ORDER:- 18-20, Main Road, Hockley, Essex SS5 4QS.

Tel: (0702) 206835, 204965

RETAIL ONLY:- 12, North Street, Hornchurch, Essex RM11 1QX.

Tel: (04024) 204965

Visa and Access by telephone. 24 hour securicor £6.50 extra.

AKD

TEL.
0438 351710

Unit 5
Parsons Green Estate
Boulton Road
Stevenage
Herts SG1 4QG

MAIL ORDER DEPT.
Stock Items Normally
Despatched within 48 hours,
21 days latest.



NEW Unifilter 'CLAMP-ON' RADIO-FREQUENCY CHOKE

Allows leads to be toroidally protected without the need to cut or remove plugs or connectors. Ideally suited for moulded plugs, leads, ribbon, and large diameter cables. Can easily be fitted and stacked in multiples to increase rejection. 'UNIFILTER' works by suppressing the interference currents that flow along the outside of cables without affecting the signals or power flowing inside. This means that you don't need to worry about upsetting normal operation or invalidating guarantees. Suitable for both reducing the emission of, or rejecting the effect of, 'common mode' interference as experienced on computer, hi-fi & speaker leads, as well as the normal mains & aerial cables.

UF 4 KIT (SUITABLE FOR SMALLER INSTALLATIONS) £9.89

UF 8 KIT (FOR MULTI INSTALLATIONS) £19.55

PHONE OR SAE FOR PRODUCT SPECIFICATION & APPLICATION NOTES

WA1

WAVEMETER

£24.95

HFC1

CONVERTER

£49.00

GPA1

PRE-AMP

£24.95



Our Waveabsorption meter for 2 Mtr transmitters meets licensing requirements range 120MHz to 450MHz, very sensitive, can also be used as field strength meter within its range. Requires PP3 type battery (not supplied).

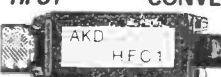

For the FRG 9600/965 our new HF Converter, connects to the aerial socket, and powered direct from the 8 Volt o/p of the FRG 9600. Tune from 100, 1Mhz to 160MHz, gives tuning range of 100KHz to 60MHz, uses double balanced mixer, with low pass filter on input.
★ Can be supplied with BNC termination for other scanners ★

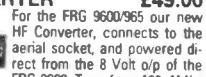

2 Mtr RF Pre-amp using BF961 dual gate FET 18 db gain; Low noise, 2Mhz Bandwidth SD 239 termination 25 watts through power. Failsafe switching, can be left in line when not required, auto RF sensing even at 1/2 watt, can be factory tuned between 28-170MHz.
★ Can also be tuned for 6-4 mtrs ★

A SELECTION OF OUR MOST POPULAR FILTERS (PHONE OR SEND SAE FOR FULL RANGE DATA SHEET)

RBF1

A range of UHF notch filters (for inner only) stocked at the following frequencies: 435MHz (70cms) channel 36 (for radar blips), 846MHz (RAF Boulmer interference) can be factory tuned from 420MHz to 890MHz.
£6.75 each
To order quote RBF1/ followed by type.

HPF1

Low insertion loss high pass filter with capacitive braid breaker for use with UHF TV, VIDEO & PRE-AMPS.
£6.75 each

HPFS

High pass filter with transformer braid breaker, better performance than HPF1 but the insertion loss is a little higher. 1-2db best for severe problems for UHF only.
£7.00 each

TNF2

A range of notch filters specifically tuned for the frequency of interference on inner and outer bandwidth >1Mhz (2Mhz above 100Mhz). VERY LOW INSERTION LOSS TYPICALLY <0.5db. Stocked for the following frequencies: 14Mhz, 21Mhz, 27.5Mhz (CB), 29Mhz, 50Mhz, 71Mhz, 145Mhz. Also spot tuned at any frequency to 300Mhz.
£6.75 each
To order quote TNF2/ and the frequency.

BB1

Transformer braid breaker >25db at 30Mhz, often used with other filters in our range for very severe interference. Ideal at the input of VCR and PRE-AMPS.
£6.75 each

IDEAL FOR CLUBS OR EMC GROUPS FOR EVALUATION OF INDIVIDUAL SITUATIONS DK1 FILTER KIT

Kit of all filters in our range (11 in all) except for RBF1/846Mhz.
£41.70

WE ALSO STOCK TORROID RINGS @ £2.50 PER PAIR.

★ EMC PROBLEMS ★

PHONE OUR TECHNICAL HELPLINE ON THE ABOVE PHONE NO. BETWEEN 10am & 12 NOON ANY WEEKDAY.

ALL PRODUCTS ARE AVAILABLE FROM US DIRECT MAIL ORDER OR C.O.D. ALSO AVAILABLE FROM LEADING AMATEUR RADIO DEALERS

ALL OUR PRODUCTS CARRY THE USUAL AKD 2 YEAR GUARANTEE. PRICES QUOTED ARE CORRECT AT TIME OF GOING TO PRESS AND INCLUDE VAT, POSTAGE & PACKING

RSGB NOW STOCK OUR FILTERS AND MEMBERS CAN OBTAIN THEM AT A DISCOUNT FROM RSGB HQ.

Props: RT & VEL Wagstaffe. Technical Adviser: John Armstrong

COMPARE THE REST - THEN COME TO THE BEST
 YOUR ONE SOURCE FOR RADIO
ARROW
 THE NAME YOU CAN TRUST
 FOR PRICE & AFTER SALES SERVICE
 SEE ARROW FOR THE CHEAPEST - THE BEST - THE LATEST

NEW R5000 TRIO receiver £859.00

NEW FT23R YAESU 2M Handy £249.00

NEW FT767GX YAESU H.F. with 2M & 70cm Call us for price!!

NEW FT727R YAESU DUAL BAND HANDY £399.00

NEW FT290R Mk II YAESU Allmode Portable £399.00

NEW TR751E TRIO 2M ALLMODE 25W Call us for details.

NEW MICRO II 2M FM ICOM Handy Call for price

AOR2002 Scanners SPECIAL PRICE Call us!!

The Cost Cutters
 SOME OF OUR PRICES ARE SO LOW WE DARE NOT QUOTE THEM - CALL IN NOW!
 0245 381626/381673

MEET OR BEAT
 ARROW WILL MEET OR BEAT
 ANY GENUINE U.K. PRICE
 CALL FOR OUR QUOTE & BUY FROM THE FIRM WITH THE BEST STOCK & SERVICE

APPROVED TRIO DEALER
 AUTHORIZED YAESU DEALER
 AUTHORIZED ICOM DEALER

Buy with confidence from ARROW. We are AUTHORIZED dealers for all major brands and have excellent spare stocks, technical support & full Manufacturers backing.



FT 23



FT27G 2m & 70cm HANDIE



TR751E

FANCY A SATELLITE TELEVISION SYSTEM?

New multi-standard Receivers with B-MAC & D2-MAC provision for DBS satellites now in.

Infra-Red fully remote system £1075.00

Install your own dish/system, easy instructions, complete basic system £695.00

If you would like our FREE article on SATV send SAE.



INTEREST FREE CREDIT!!

Available on most Major items over £150 sold at Rec. Retail Price

We offer 3 schemes:
 20% dep. balance 5 monthly payments
 1/3rd dep. balance 9 monthly payments
 50% dep. balance 12 monthly payments

ARROW CREDIT CARD

Holders may purchase Promotional or Discount offers over 24 months. If you don't have an ARROWCARD yet ask for details.

EXPORT PRICES

Arrow offer very special EXPORT prices to visitors or overseas mail order/Telephone Satisfied customers the World Over!!
 EXCHANGE RATES MAKE U.K. CHEAPEST. TRY US NOW.



NEW CHELMSFORD BY-PASS OPEN !!! WE ARE NOW ONLY TEN MINUTES BY CAR FROM M-25 LONDON ORBITAL MOTORWAY !! TAKE A12

ESSEX SHOWROOM
 Our main showrooms are at 5 The Street, Hatfield Peverel Essex. Situated just off the A12 main trunk road - plenty of free parking in our own car park. Now only 15 mins from M25 London Orbital Motorway (Chelmsford by-pass now open) Few mins. from Brit. Rail. station. Buses pass our door. Extensive workshop facilities.
 Open 9am-5pm. Closed Thursday.
 Tel: 0245 381626 or 381673

GLASGOW SHOWROOM
 Situated close to Kelvin Museum & Clyde Tunnel at 91 Dumbarton Road Patrick Cross Glasgow. Free parking close by. Large showrooms, full workshop facilities. Open six days 9am-5.30pm
 Tel: 041 339 6445

WELSH AGENT
 John Lewis GBUZL
 14 Carreg-y-gad Llanfair-p-g Anglesey
 Tel: 0248 714657
 Callers by appointment only please. English or Welsh spoken!

LEICESTER AGENT
 Alan Faint G4TZY
 33 Fairway Market Harborough Leics.
 Tel: 0858 62827
 Callers by appointment only please.

WIGAN AGENT
 Jim Cook G6TYB
 108 Wirral Drive Winstanley Wigan
 Tel: 0942 214969
 Callers by appointment only please.

NEW FROM KENPRO



FULLY COMPUTERIZED HAND HELD KT220 EE/T
 With facilities not yet available in other brands, look at the outstanding list of features and incorporating Kenpro's Legendary quality. This is a Top Line transceiver which should be amongst the most expensive, but our low overheads make it the Best Value for money available today.

- * Built in LCD Clock
- * 10 Memories for 10 Repeaters
- * 4 Scan Models * "Scanlock" locks out unwanted channels
- * 3.5 - 5 Watts Output
- * 1750 Tone Burst
- * CTCSS, DTMF, & Auto Dial
- * Very Sensitive L/Noise Rcvr
- * Auto Battery Save Function

Don't forget the trusty economy version continues to be available.

- KT 220 C/W ST ACC Basic £229.00
- KT 220 C/W Nicads etc £249.00
- KT 200 C/W ST ACC Basic £165.00
- KT 200 C/W Nicads etc £189.00
- KT 400 C/W Nicads etc £209.00

Full range of accessories available
 Post, PK & Ins Transceivers £5.00

HP/PERSONAL LOANS

RWC
HI-TEC WORLDWIDE LIMITED
 Importers, Exporters and Distributors of Specialist Communications

584 Hagley Road West, Quinton, Birmingham B68 OBS.
 Tel: 021-421 8201 (24hr) Telex: 334303 TXAGWM-G.



SPECTRUM COMMUNICATIONS
 MANUFACTURERS OF RADIO EQUIPMENT AND KITS

CB TO 10 FM CONVERSION BOARDS, suits all UK FM CB rigs to give 29.31 to 29.70MHz. Size only 63x40x13mm. Built and aligned board SC29 £15. Or send your rig and we'll fit it. £28 inc. return P&P for mobiles. £31 inc. for base rigs.

MULTIMODE CB CONVERSIONS, send your 120channel rig and we'll convert it to give 28.01 to 29.70MHz in straight sequences without gaps. Colt 1200DX, Cobra 148, Hy Gain 5, Multimode 2, Major M360, Tristar 747 & 777, Super Star 360, Concorde, etc., £62 inc. return P&P. Jumbo or Colt Excalibur 1200, £65 80Channel rigs such as Stalker 9 or Major M588 are modified to give 28.31 to 29.70MHz in straight sequence without gaps. £45.00 inc. return P&P. 200 Channel in 4 bands of 50 are converted to give 28.00 to 30.00MHz or 28.00 to 29.70MHz as required. Super Hy Gain 5, Lafayette 1800, Super Star 2000. £45.50 inc. return P&P. Nato 2000 £52.50, Super Star 2000-5x40CH £70. Colt 1600, 4x40CH, £65.50.

FREQUENCY MODEM adds FM to synthesized rigs with 455KHz IF. Type FM 455, PCB kit £6.50, PCB built £9.50.

FREQUENCY DEMODULATOR adds FM to receivers with 455KHz IF, suits R600 & R1000, FRG7 & FRG7000. Type FD455, PCB kit £5.50, PCB built £7.50.

FREQUENCY MODULATOR adds FM to synthesized rigs or rigs with clarifier, Type FM1000, PCB kit £3.00, PCB built £4.00.

RECEIVE CONVERTERS 2, 4 or 6 Metre aerial input with 10 metre IF or 4, 6, 10 or 20 metre aerial input with 2 metre IF, 26dB gain, low noise with OSC output. Types RC2-10, RC4-10, RC6-10, RC4-2, RC6-2, RC10-2, RC20-2, PCB kit £17.25, PCB built and tested £24.50, Boxed kit £25.00, Boxed built and tested £35.25.

TRANSMIT CONVERTERS, 2, 4 or 6 M, aerial output with 10 M, IF. 10.25mW to 1W drive 500mW output, matches receive converters. Types TC2-10, TC4-10, TC6-10, PCB kit £16.50, PCB built £25.75, Boxed kit £25.50, Boxed built £38.00.

TRANSMIT & RECEIVE CONVERTERS, combination boxed unit, 500mW output, types TRX2-10, TRX4-10, TRX6-10, Boxed kit £49.00, Boxed built and tested £89.50.

TRANSCIVE CONVERTER, single board version of receive & transmit converters, 500mW output, with repeater shift facility. Types TRC2-10, TRC4-10, TRC6-10, PCB kit £39, PCB built and tested £54, Boxed kit £54, Boxed built and tested £83.25.

TRANSMIT AMPLIFIER, unswitched, suitable for Transmit Converters, Transceiver Converters and MEON, 500mW in, 20W min output. Types TA2U2, TA4U2, TA6U2 PCB kit £40.50, PCB built & tested £48.75, Boxed kit £45.00, boxed, built and tested £53.00.

RECEIVE PREAMPS 2, 4, 6 or 10 metre, RF & DC switched, 0-2dB variable gain, low noise, 100W handling. Types RP2S, RP4S, RP6S, RP10S. Also masthead version DC coax fed, types RP2SM, RP6SM, PCB kit £12, PCB built and tested £16.75, Boxed kit £20.25, Boxed built and tested £27.00

NOISE SQUELCH squelches rig when noise is high. Allows reception between noise bursts. Type NS1000, PCB Kit £7.25, PCB Built £10.25.

VAT & P&P INC PRICES
 Delivery within 14 days subject to availability. 24 hr answering.



UNIT B6, MARABOUT INDUSTRIAL ESTATE, DORCHESTER, DORSET. TEL: 0305 62250



LETTERS

Raw deal for the disabled?

Dear HRT, As a newcomer to the world of amateur radio, a few thoughts come to mind. I happen to be disabled and am becoming more confined to the house. I also have difficulty in doing anything requiring close vision or following small detail. So, with the changes that have occurred, it seemed the right time to put a life long interest in listening to 'the little men on the wireless' to good use. The interest has been fostered by finding that friends I have made in other contexts have had the same interest in radio and are already licenced. They have been a great support in getting me going.

At this stage in proceedings, all I want to be able to do is to talk to other people. Now, please don't tell me that I could do that on the ubiquitous CB because I've found that to be very restricting both in extent and quality of conversation.

The other night, at about 3am I heard a very interesting conversation and I dearly wished that I could have joined in - always supposing that the participants would have been willing for me to do so. They were talking about their experiences during the last war, and making observations about the various consequences after the war of political decisions made during that time, when I was growing up. It was fascinating listening to them talking about their experiences which were so totally different from my own. It hardly seemed that they were talking about the same period in the same country. As I said before, I would dearly liked to have joined in because I am a sociologist and this was my kind of topic. On the whole this is not the quality of conversation to be found on CB! Even more to the point one of the operators was disabled and we had that in common as well.

This brings me to the point I would like to make about the RAE. It seems to be impossibly loaded towards those who may wish to construct and install their own equipment. This, I and others of similar degree of disability, would be unlikely to wish to do. I would prefer to have ready made equipment professionally installed. My days of climbing about on roofs of

any description are done for!

I think therefore, that it would be more sensible to divide the licencing not by whether one can do morse or not, but by the amount of practical expertise that can be acquired in various stages. Perhaps it would be appropriate to modify the American system but still leaving morse to the final stage. It seems ludicrous that the passing of morse test allows access to HF when all the main technical work has to be accomplished before one can be allowed access to the more restrictive VHF. Given that less technical know-how was needed, I could have been operating for some time. I have been bugged all along by the lack of a mathematical basis to work from. It was too difficult for me to attend the local FE college, so eventually with the help of the RAIBC and my local radio club I am preparing for the exam at home. Since I'm fully aware of the licencing regulations, having much more easily been able to absorb them, it is very frustrating that I have to wait to operate until I have passed the dreaded RAE. This, despite the fact that I could give an undertaking not to operate equipment that had not been professionally built, checked and installed. At this stage in the proceedings while recovering from recent surgery, there is no way I could build anything, so it couldn't cause trouble for anyone else. Yet I would love to be talking to those folk out there, particularly at 3am when I can't sleep and it seems that others can't either!

Charioteer!!

We don't normally print anonymous letters, but due to the content of this one, we made an exception.

2m To Cyprus?

Dear HRT, The reason for this letter is to give notice of a proposed project hopefully to be undertaken by the ZC4 clubs from both the Eastern and Western Sovereign Base Areas here in Cyprus to attempt to establish a 2m link between here and the United Kingdom.

The plan is that as we have just re-activated the Episkopi Radio Club that we try for a worthwhile project to get the club and ZC4 on the map

as it were. Accordingly we have decided that we should try for a project that would give the majority of members and the Amateur Radio Fraternity as a whole the most satisfaction and also stand a good chance of succeeding.

We understand that a two way link has been done on 4mtrs between 5B4AZ and GH4ASR/P in 1981 but as stated we are endeavouring to make a 2mtr contact which we believe has not been done before. The proposal is that we try and do this project during the last week on May 1987. Most of the work would be done during the weekend but we are hoping to man the station at least a few times during the week time, availability of personnel permitting of course.

The station itself will hopefully be located somewhere in the Troodos mountain range here in Cyprus, the highest point of which is somewhat in excess of 2000mtrs A.S.L.

At this moment in time we are unsure of the callsign to be used but we are naturally hopeful that it will be a full ZC4 call, however there is a bit of a problem about the legality of this and we may well have to use ZC4---/5B4 (a good combination nevertheless for DX hunters!!!).

We envisage at this time using CW to make any initial contact and, if conditions are then judged to be favourable, then switching to SSB. We hope to be able to provide some form of meteor-scattering equipment. It is also hoped that we can establish some form of Engineering link either on 50 or 70 MHz to enable us to monitor the band conditions. This will be of necessity receive only as we are not permitted these bands at the moment but by next year we may well be able to use these bands for amateur use. It is also proposed to use a HF link for establishing any initial contact with stations and to use as a talk back if required.

What I and the other members require are several things. Firstly and most importantly any information that anyone has on the type of equipment that we may need and any other information in the way of sound technical advice that people may wish to give us. Also we require somebody to be a link man in the UK to do any

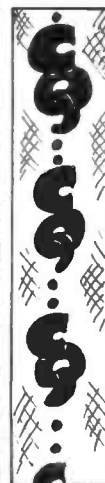

arranging that may be necessary in the way of arranging schedules with other UK stations.

We may also need the loan of some specialist equipment that we may not be able to obtain here in Cyprus but I think that any particular need cannot at the moment be highlighted as we are still in the middle of checking what we can get hold of here.

I will of course keep you informed of the progress of this project and I look forward to hearing from any club, society and/or individual who would like to partake in this experiment and to anyone who may be able to offer any advice which may be able to help us to get a successful result to this project.

Anyone wishing to contact me may do so at the address below and I will be more than glad to make note of any advice that they may care to make or the offer of any help that may also be offered.

A.L. Poore, ZC4AP/G0CAC
Station Manager of ZC4EPI, JSB,
BFP53, London.

Postal Prang

Dear HRT, Like a great number of your readers I have bought goods through your readers' adverts, this has all been fine until now. A valve type transverter arrived in early November; it was COD, after paying the PO I hurried home to unwrap my new toy eager to explore the delights of 70MHz that it would allow. Alas my delight was short lived, on opening the box and searching through the vast amount of straw inside I found a bent, twisted chassis. After duly filling the forms, for compensation for which an extra fee had been paid by the sender, I eventually had a visit from a post office bod to inspect the damage. These inspectors, however, seem to work strange unsociable

hours as they are only available until midday or before 9.30am Saturdays, a difficult proposal for the average working ham.

Now a month later I have a letter regretting to inform me that they are unable to compensate me as in the opinion of the enquiry officer the initial packing was unsuitable! Naturally on further inspection I found the small print that the post office is not responsible for failing to detect any "unsuitable" packing at the time they take your money for carriage and compensation.

As the goods were sent by someone who works with radio/electronic equipment I think he has an idea of what in normal circumstances constitutes sufficient packing. As a former lorry driver who has had occasion to handle very delicate loads I have an idea of the normal precautions taken with items marked "fragile" and the way such warnings can be ignored. No matter how you pack things a drop from the lorry etc is not something we usually anticipate!

I am the first to recognise the difficulty in handling items with PSUs in them, I nearly fell over once trying to lift an old HF linear in a shop, but this is no comfort when faced with the sad sight of a former transverter.

So a word to all readers don't feel too safe as you send off that trusty ft/TS XXX that it will all be OK, the responsibility is on you to protect against acts of God, nuclear holocaust or plain bad handling.

Martyn Bolt

We suggest that readers collect goods purchased through ads in person, so that this sort of problem can be avoided completely, and also so that the goods can be checked over thoroughly before any money changes hands. However, this is obviously not always possible.

If you do have difficulties with

the post office that you can't get sorted out by the normal channels, you can always write to the Head Postmaster for your area, and if that doesn't produce the desired outcome, you can go to the Post Office Users' National Council, Waterloo Bridge House, Waterloo Road, London SE1 8UA, telephone 01-928 9458.

Don't Be Put Off!

Dear HRT, may I be allowed to comment on the recent correspondence by 'Disillusioned G1? The treatment he received has also been meted out to us older radio amateurs. It has happened to me on the air and also once at Ally Pally. I obtained my first licence, in Canada, in 1959.

Whilst assisting on a stand in Ally Pally the year before the fire, an amateur with the call sign G3P?? came up and started chatting. After a few minutes he made the comment "Of course, you're quite new at this game". Knowing the approximate year he was licenced, I replied "I had my first licence in Canada in 1959". Whereupon, he turned on his heel and left without another word.

It is not possible to take that action on the air but don't be disillusioned, you young fellows, there are still more gentlemen on the air than cynics. Enjoy the hobby, especially try to obtain your full licence, I'm sure there are very few old-timers on 80 metres who will shun you, the reverse is the case.

Robert M Dotchin, G3WEP (ex VE3CXG)

We trust that the equivalent comments apply to the few but steadily increasing number of women amateurs too!

Please address correspondence to:
Letters, Ham Radio Today,
1, Golden Square,
LONDON W1R 3AB.

RADIO TODAY

Going Ex-Directory?

When re-applying for a lapsed licence or when making a new application radio amateurs should ensure that they are using an up to date application form (available in the latest "How to Become a Radio Amateur" — August 1986 — or on request from the DTI or RALU) otherwise they might find that their details will be withheld and their stations will not be included in the Amateur Call Books.

With the passing of the Data Protection Act, 1984, the application form used by radio amateurs was updated so that they had to say in a positive way that they wanted their details published. Many amateurs are still using old application forms which do not meet this need for positive affirmation of intention. This is in spite of the fact that copies of the new application form were circulated to colleges which run RAE courses, and in spite of the "How to Become a Radio Amateur" booklet being updated.

Applications made on the old forms will automatically be marked "details to be withheld", so unfortunately many amateurs will be excluded from future call books when they wished to be included. If this has happened in your case write to Radio Amateur Licensing Unit with a positive statement that you would like to see your personal details published in any future call books.

A number of amateurs' Standing Orders have not been kept up to date. Many are made out to the wrong amount (in which case the licence will not be issued) or they are made out to old Home Office and DTI accounts (which delays the issue of licences). If you are in any doubt about your Standing Order details, please contact RALU to confirm the correct details and then inform your bank of any alterations necessary.

Some old application forms also show the accounts address as Tolworth Tower. In fact all payments should be made out to the "Post Office" and sent to the

DEPARTMENT OF TRADE AND INDUSTRY
APPLICATION FOR AN AMATEUR RADIO LICENCE A DR B
(UK RESIDENTS)

PLEASE COMPLETE IN DARK INK AND BLOCK CAPITALS AFTER READING THE NOTES OVERLEAF
NOTE: IF YOU ARE APPLYING FOR A CLASS "A" LICENCE YOU MUST PROVIDE PROOF THAT YOU HAVE PASSED THE AMATEUR MORSE TEST WITHIN THE LAST 12 MONTHS.

1. TITLE (Mr, Ms, Prof, Dr etc) IF THIS IS A CLUB APPLICATION PLEASE STATE NAME OF CLUB

INITIALS (Up to 4 only)

SURNAME

CORRESPONDENCE ADDRESS

POSTCODE DATE RAE PASSED MONTH YEAR

DATE OF BIRTH (Day, Month, Year eg. 04/10/55) CENTRE NUMBER

TYPE OF LICENCE APPLIED FOR (A OR B) CANDIDATE NUMBER

2. STATION ADDRESS (if different from above)

POSTCODE

Do you wish to pay your renewals by standing order?

Do you wish your details withheld from publication? (Y) YES (N) NO

PREVIOUS UK CALL SIGN (IF ANY)

TELEPHONE NO. HOME OR/ & WORK

DECLARATION
I understand that failure to complete this document properly and accurately may invalidate my application and any licence issued may subsequently be revoked.

Signed Date

If you are under 18 years of age the signature of your parent or guardian is required.

Signed Date

NAME (block letters)

FOR POST OFFICE USE ONLY
Licence issued
Call sign allocated

Radio Amateur Licensing Unit, The Post Office, Postal Headquarters, Chetwynd House, CHESTERFIELD, Derbyshire S49 1PF.

Also note that RALU's telephone number is now 0246-217555; some amateurs are using the old telephone number (0246-207555) which has since

been re-allocated.

We would also mention that the RALU is making the list of licensed amateurs available to bodies other than the RSGB, but only for the purpose of compiling a call book. So there may well be a choice of call books on sale next year...

The latest edition of the Joerg Klingenfuss book 'Guide to Utility Stations' has just been published. The 1987 issue contains 475 pages of data on all modes up to 30MHz including FAX, RTTY, AMTOR and CW which are used by utility stations. The book costs £19.95 plus £1.65 p&p from: Interbooks, Stanley, Perth PH1 4QQ or phone 0738 828575.

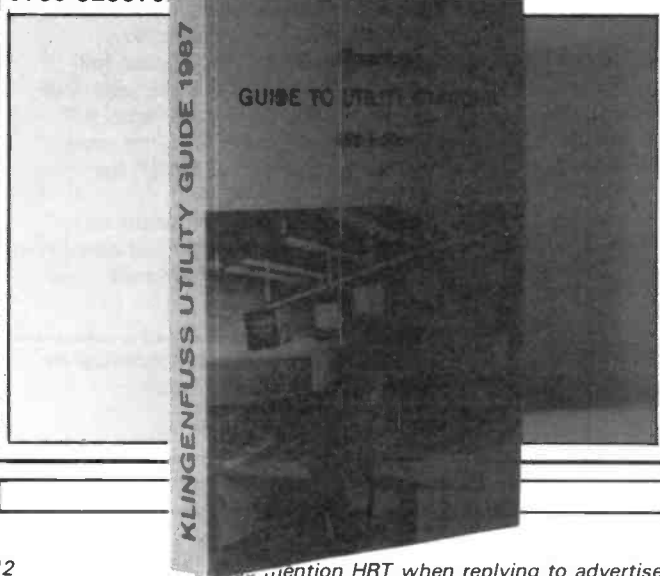

Paws for thought!

No the DTI hasn't liberalised amateur licensing to the point where they issue them to furry mammals — in fact this photo is nothing more than a shallow advertising ploy by Trevor, G6TJT, who wants us to mention AMRAC, the data communications group! TJT's

packet station shown here consists of an Atari ST, MFJ packet unit and an FT230 which gets him, at *purrrmitting*, on the Winchester digipeater 144.650MHz on a regular basis. For further information on AMRAC you can contact either Trevor Tugwell, or Kismet the cat at: 3 Westbury Close, Barton-on-Sea, New Milton, Hants.

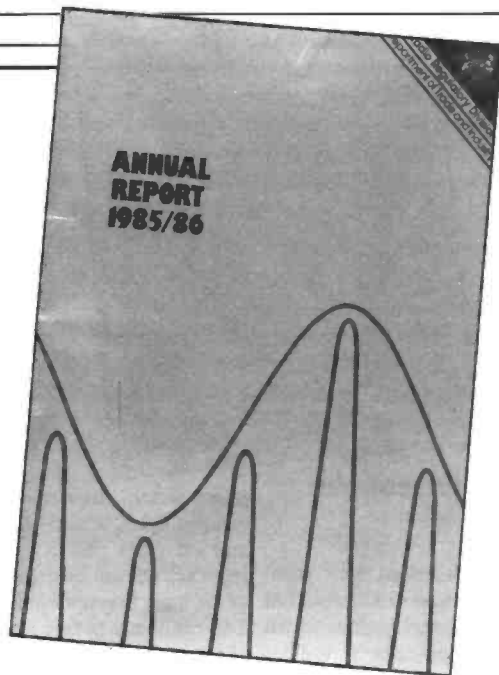

DTI Annual Report hits the streets

The first annual report from the DTI has been published covering all the activities of the recently renamed 'Radio-communications Division'. The 54-page full document makes very interesting reading as it covers virtually everything from Wireless Telegraphy Act prosecutions (1088 in 85/86) through to statistical analyses of licence allocations.

One interesting snippet shows the effect of the £21 RIS investigation fee which was introduced in July '85 — up until then complaints were being received at the rate of around 1900 per month but following the fee's introduction this plummeted to 375 a month, of which less than 50 per month required visits by the RIS. The inevitable conclusion must be, as we suggested at the time, that although *some* of the complaints were curable given better information on interference suppression, people generally would be more inclined to 'shut-up' rather than 'put-up' the £21 fee. This inevitably means that cases which would have been previously dealt with by 'impartial' RIS personnel must become translated into conflict between the supposed source of QRM and the victim i.e. the amateur and neighbours.

Other sections of the report carry details of the demise of the MV Communicator, host to the Laser 558 pirate station, which was put out of action in November 1985 after mechanical problems — however as most readers will know the ship is back in business again; when asked for a statement on this a spokesman for the DTI commented: "... well, we're not exactly having a party ...!"

Copies of the report, available at no charge, can be obtained from: DTI, Radiocommunications Division, Waterloo Bridge House, London, SE1 8UA.

Farewell to ARMS!

Owing to a colossal postal *faux pas* it would appear that virtually all the enquiries concerning the 'Amateur Radio Maintenance Service' went walkies, did a runner, ie. disappeared. At least 50 enquiries were returned to their senders by the Post Office instead of being sent on from the Freepost address. So, if you wrote to ARMS concerning their equipment repair insurance scheme, we have been asked to say 'Try again!'

The address to write is still: Amateur Radio Maintenance Service, FREEPOST, Ormskirk, Lancs L39 3AB.

G7? Must be a pirate

Wrong? Now that the G1 prefixes have run their course, new 'B' licences will be issued beginning with G7—. So please don't start reporting everyone to the RRD!

Rohde & Schwarz Miniport Receiver

Just by way of a change we thought we'd let readers have a glimpse of developments in the professional radio field by showing you the latest portable 'rig' from Rohde & Schwarz, which the person in the photo clearly seems to be quite excited about.

The new Miniport Receiver, EM100 from Rohde & Schwarz is a miniaturized professional receiver for the VHF-UHF range, having high input sensitivity and frequency setting accuracy through 20 to 1000MHz, and capable of battery operation for over four hours. Frequency setting is by means of the spinwheel or keypad and a disconnectable AFC ensures continuous tracking of unstable signals. IF bandwidth (7.5, 15, 150kHz) mode (AM or FM) can be selected and the unit has an adjustable squelch which generates the stop signal for memory or frequency scan. Frequency is displayed on a LCD readout with an accuracy of



1kHz and the PLL circuitry has a thermostat really controlled reference oscillator for high frequency accuracy.

And the price? A cool £8,075 excluding VAT ... and you thought that amateur prices were getting a bit steep!

Short Wave Mag buy-out

Following rumours late last year, it has been confirmed that Practical Wireless, itself the subject of a staff buy-out in 1985, has acquired Short Wave Magazine

just as SWM reaches its fiftieth birthday. Although it will still continue to be published on a monthly basis, the editorial direction will be significantly changed so as to cover DX'ing and TV matters — HRT would like to wish PW every success with their new venture.

Derby DARS National 2 metre contest

Derby DARS will be holding their national 2 metre contest on Sunday, 15th March this year between 13:00 and 17:00 GMT. The contest will consist of three sections: 1) full legal limit, 2) low power up to 25W, and 3) SWL

reports. Contacts with the club station G3ERD will attract extra points with all other stations being scored the same, contacts outside the UK will be considered to be extra counties so that the final score will consist of the stations points multiplied by the number of counties worked. Further details and the contest rules are available from: Derby DARS, 119 Green Lane, Derby DE1 1RZ.

Free radio book catalogue

Interbooks of Perth have announced a new catalogue detailing their range of radio and RTTY publications covering SWL'ing, aircraft, maritime and military radio. The catalogue is available free of charge from: INTERbooks, Stanley, Perth, Scotland PH1 4QQ. Tel: 073882-575 or 073883-708.

radio
and
rtty
books



FREE CATALOGUE
JANUARY 1987

UOSAT Store and Forward Success

The pioneering store-and-forward digital communications experiment (DCE) currently in orbit on the UOSAT 2 satellite has proved an unqualified success, says the University of Surrey. In eight months of experimental operation, the digital communications experiment has been used to relay up to 15 pages of text (100 kbytes) per day between inexpensive groundstations in the UK and the USA. Following this success groundstations in Australia, New Zealand and Alaska are now to join the network. Communications experiments with low-power highly portable ground terminals for use in remote or less-developed areas will begin soon.

UOSAT 2, built at the University of Surrey and now in a polar orbit at 700 km altitude, provides an ideal test bed for the store-and-forward communications concept. Using this technique, a message from one ground terminal is stored in memory on the satellite and delivered as the satellite passes over the destination ground terminal. The two ground terminals do not have to 'see' the satellite at the same time, and a single satellite can provide global communications coverage. This is unlike geostationary communications systems which require three satellites to provide world-wide coverage, and still cannot provide communications in the polar regions or in areas without access to large groundstations. As a store and forward satellite is in a relatively low orbit, ground terminals need use only low-power transmitters and small antennas.

There is growing government and commercial interest in store and forward communications; in particular the Swedish Space Corporation is now planning MAILSTAR — a dedicated store and forward satellite. Data gained from the UOSAT 2 DCE will be invaluable to designers of large scale store and forward systems. The University of Surrey ground control station, in an ongoing study funded by ESA, is collecting data from the DCE on both the long and short term effects of the low earth orbit environment on high density CMOS memories and other LSI devices necessary for a

store and forward transponder. Engineers with the University of Surrey and VITA (the USA-based Volunteers In Technical Assistance) have been using the DCE to evaluate access protocols and error detection and correction techniques that will perform efficiently on links to store and forward data using satellites in low earth orbit. The DCE, now providing a prototype communications facility within the Amateur Satellite Service is also providing valuable first hand information to designers of commercial communications systems.

The digital communications experiment is one of a number of space technology and space science experiments in orbit on the University of Surrey's UOSAT 2 satellite. The DCE was built by volunteers in the United States and Canada, co-ordinated by the Amateur Radio Satellite Corporation (AMSAT) and funded by VITA. VITA's interest in store and forward communications stems from a need for timely and accurate communications between volunteers in remote, less developed areas of the world (generally not served by geostationary communications networks) and technical advisors in the USA.

As readers will know, the University of Surrey UOSAT Unit has, for the past ten years, been a pioneering force in cost-effective spacecraft engineering, and has carried out many experiments in low cost spacecraft and ground station technology through its two successful spacecraft missions — UOSAT 1 and UOSAT 2, launched in 1981 and 1984 respectively as piggyback payloads on NASA Delta rockets. Both are still fully operational in orbit, providing valuable engineering and scientific data.

VITA is a private, non-profit, international development organisation. It makes available to individuals and groups in developing countries a variety of information and technical resources through needs assessment, program development support, remote and on site consulting services, information systems training and management of long-term field projects. Anyone willing to share his or her skills can become a VITA Volunteer. For more information, contact VITA at 1815 N. Lynn St, Suite 200, Arlington, VA 22209, USA.



New Greenwell Kit-Cat!

Hot on the heels of their components catalogue Greenwell Ltd have just produced another which is aimed specifically at the kit-conscious constructor. Within its pages enthusiasts will find kit-form amps, pre-amps, transmitters, receivers, power supplies,

panel meters, timers, doorbells, running lights, sound to light units and dimmers plus a number of interface add-on boards for many of the more popular home micros. The catalogue is free and can be obtained from: Greenwell Electronics, 443 Millbrook Road, Southampton SO1 0HX — or you can phone and request a copy on (0703) 772501/783740.

Stone-on-Trent Microwave repeater /beacon on air

During early November GB3SE was granted a licence by the DTI and on November 21st at 2100 hours, GB3SE was switched on into full repeater/beacon use. GB3SE can be found on 1297.05MHz whilst its input frequency is on 1291.075MHz. When not in repeater use the transmitter stays on air for beacon purposes and identification is by frequency shift keying at a rate of one callsign for every 35 seconds, each eighth callsign is transmitted using MCW.

Repeater use is obtained by the usual method of transmitting a 1750Hz tone burst. To acknowledge the fact that GB3SE has switched from beacon to repeater use, a letter "T" in morse code is transmitted, or a letter "H" or "L" if the carrier on the input is more than plus or minus 5kHz from the nominal input frequency — then this is followed by the repeater callsign GB3SE in MCW. For an indication as to when the repeater mode has finished (ie. the through audio is inhibited) a 400Hz tone of one second duration is transmitted and the next identification call-sign will be sent using FSK.

Apart from the beacon facility a number of other unusual features are incorporated. Frequency stability at 1.3GHz can be a problem, therefore with this in mind it was necessary to develop and build an electronic oven to house the crystal, making it possible to maintain the crystal temperature to better than $\pm 2^{\circ}\text{C}$, regardless of air temperature.

The transmitter and receiver frequencies are separated by 6MHz, but only crystal is used for both Tx and Rx. Should the transmitter move in frequency by 1kHz then the receiver would also move by the same amount and in the same direction, making split frequency operating by the user much easier. The repeater uses a phase loop type of audio discriminator, this has the useful feature of following off-channel signals and reproducing the recovered audio with minimum distortion.

All these features involved a high degree of development and therefore are believed to be unique to GB3SE. At the moment GB3SE is running six watts ERP, the aerials in use are two Alford slots (horizontal polarisation omni directional). During the first 24 hours of use a total of 12 different callsigns were monitored using the repeater facility. More information can be obtained from G8DZJ QTHR.



Hamming with UNCLESAM

US government agency rule-making is controlled by the Administrative Procedures Act which ensures that interested parties can, in a totally open framework, request rule-making proceedings and send their opinions on such proceedings directly to the regulators. The system works as follows:

If John Doe has a burning conviction that there should be, for example, a special exclusive frequency allocation for mode X3Q, he sends the FCC a "Petition for Rule Making" stating who he is, why he feels X3Q is important enough to deserve such and allocation, and exactly what he wants done. The Commission may reject the petition if it feels it has no merit whatsoever, but will usually place it on record by issuing a "Public Notice" entitled "Petition for Rule Making Filed", assign it a petition number RM , and invite comments from other interested parties.

There then follows a gestation period of anything from several months to several years, depending on the Commission's workload and priorities, after which it may publish a "Notice of Proposed Rule Making" (NPRM) outlining the actions it proposes to take. Alternatively, it may issue a "Notice of Inquiry" (NOI) setting out the scope of the problem addressed and inviting further comments, or it may even drop the matter entirely.

Following an NPRM or NOI, interested parties have no more than a couple of months to file comments and a further month for "reply comments", i.e. to comment on other people's comments. After the final deadline the Commission publishes

How do they make rules about amateur radio over the pond? Martin Atherton, G3ZAY, answers this and other stateside questions.

a "Report and Order", stating the new rules and the reasoning behind them, which goes forward for consideration at a public meeting with the Commissioners. The meeting may then adopt the new rules, modify them, or reject them. The final rules need not be identical with those suggested in the original rulemaking petition or NPRM but

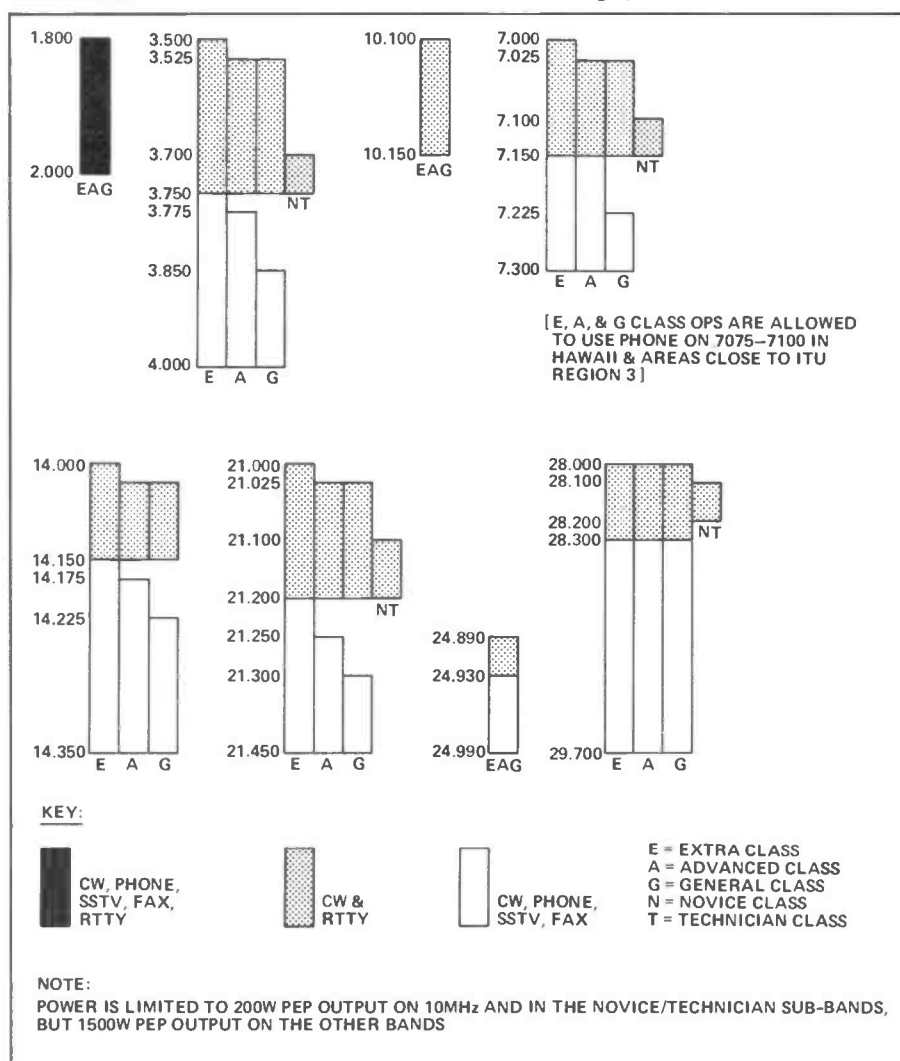

should have "some relationship" to them.

Anyone who objects to the new X3Q rules can file a "Petition for Reconsideration" but is unlikely to be successful in forcing a change unless he can introduce new evidence. His final option is to call for a judicial review, a process which usually succeeds only if the Commission has exceeded its authority or committed a "prejudicial error". The appeal courts lack specialised telecomms expertise and rarely over-rule on matters of judgement alone. K1MAN recently tried to have the Supreme Court hear his appeal that the FCC rules on power levels discriminated unfairly against AM users. Not surprisingly, he failed.

Another form of official output is the "Memorandum Opinion and Order" which is used to deny a "Petition for Rule Making", conclude a "Notice of Inquiry" (NOI), modify an earlier decision, or deny a "Petition for Reconsideration".

That then is the skeleton of the US rule-making process. Its openness is attractive but it is undoubtedly very expensive to administer and is not necessarily more responsive to amateur needs than the British system. In both countries much depends on the existence of a good working relationship between officialdom and a strong national amateur society.

Call Signs

Until recently you could always tell the approximate location of US operators by the numbers their callsigns; "6"s were in California, "2"s in New York or New Jersey, "1"s in New England, etc. The numbers were issued according to the address given on the licence application form and operators who moved into a new area had to get a new call or sign portable with the appropriate number as a suffix. Now, however, the FCC has decided that an operator need only advise the Commission of his new address and need not make any changes to his call. Now Hawaiian prefixes are turning up in Boston and vice-versa.

Calls themselves are divided into four groups, with the shortest (Group A) being assigned to extra class licencees and the longest (Group D) to novices & technicians.

The inset box gives full details of each callsign group.

In practice there are three types of exceptions to this general callsign rule. Firstly, there are not going to be enough short callsigns to go around, so once a short group is exhausted in a particular call area, the next longest group is used. Secondly, as licenseees are not compelled to change their calls when they upgrade, a long call may conceal a high class of operator. Finally, operators with short calls preceding the introduction of the system were allowed to keep them, so some short calls conceal low class operators.

Calls are currently assigned in strict rotation and it is impossible to choose a particular set of call letters,

even from those due for issue immediately. This situation arose after a scandal several years ago when an FCC staff member was convicted of charging \$100 for issuing specific callsigns. There is clearly demand for specific calls, however, and the ARRL (the US equivalent to RSGB) is now suggesting this aspect of callsign issuing should be "privatised". It has offered to take on the task if it is allowed to make charges to cover the costs of administration.

Bandplans

The US frequency allocations are a mixture of semi-voluntary and compulsory band-planning. Detailed

GROUP A CALL SIGNS			
Mainland USA	Pacific Area	Alaska Area	Atlantic Area
K### N### W### AA##-AK## KA##-KZ## NA##-NZ## WA##-WZ## AA###-AK###	AH## KH## NH## WH##	WL7\$ AL7\$ KL7\$ NL7\$	KP## NP## WP##
N.B. AH, KH, NH, & WH prefixes are not assigned in the contiguous 48 states.			
GROUP B CALL SIGNS			
Mainland USA	Pacific Area	Alaska Area	Atlantic Area
KA1\$ KB##-KZ## NA##-NZ## WA##-WZ##	AH###	AL7\$	KP###
N.B. KA prefixes are only assigned in the first call area. Other KA calls are issued to US military personnel in Japan.			
GROUP C CALL SIGNS			
Mainland USA	Pacific Area	Alaska Area	Atlantic Area
K#### N#### W####	KH### NH### WH###	KL7\$ NL7\$ WL7\$	NP### WP###
GROUP D CALL SIGNS			
Mainland USA	Pacific Area	Alaska Area	Atlantic Area
KA####-KZ#### WA####-WZ####	KH#### WH####	KL7\$ WL7\$	KP#### WP####
N.B. KH & WH prefixes are not assigned in the 48 mainland contiguous states. KC4AAA-AAF & KC4USA-USZ are reserved for Antarctica.			
# = number \$ = letter			
Group A calls are allocated to Extra Class licenseees, Group B to Advanced, Group C to General, and Group D to Novices & Technicians. When a group is exhausted, callsigns from the next lower group are used. e.g. Extra Class licenseees receive calls from Group B once all the Group A calls in their district have been assigned.			

knowledge of them is essential to the HF enthusiast looking for stateside QSOs as he might otherwise choose a part of the band which no, or very few, US operators are allowed to use. The plans are shown in detail in Figure 1. Note that the higher licence classes are allowed access to considerably more spectrum than the lower classes. In particular, the bottom 25kHz of the 80, 40, 20, & 15 metre bands are reserved for extra class licence holders (who have passed the 20 wpm CW test).

The basic splits between CW/RTTY and phone on each band are, contrary to UK practice, written into the licence conditions. Thus, for example, it is actually illegal for an American operator to use SSB on 14.025 or anywhere on 10MHz.

The FCC takes a robust approach to voluntary band-plans as well. Commission rules say that stations must be operated in keeping with good engineering and good amateur practice, and Commission statements have made it clear that they regard adherence to band-plans agreed by the amateur community

as an important part of good amateur practice. Hence the careful choice of the words semi-voluntary earlier in this section. US amateurs can lose their licences if they deliberately and persistently ignore a band-plan.

Power

Operators are expected to use the minimum power needed to maintain communication as long as this is no more than 1500W PEP output (but only 200W PEP on 10MHz or in the novice sub-bands). The rules on purchasing linear amplifiers to run this power level are extremely complicated because the FCC is trying to clamp down on illegal use by 27MHz Cbers.

Linears sold today in the USA do not include the 28MHz band. Amateur purchasers can write off to the manufacturer for a conversion kit, but they may only modify one linear each year and it must be for their own use. The same is true for amplifiers sold as kits.

Linears sold in the shops must be type accepted by the FCC and

must not be capable of operating between 24 & 28 MHz. There is an exact definition which says that they must have 0dB gain between 26 & 28 MHz, and no more than 6dB from 24-26 and 28-35MHz. Further, they must need at least 50W to drive them to their full output power and must never have a gain in excess of 15dB. There are even more rules which prohibit RF or front panel controlled Tx/Rx switching, and state that they must not include any features to facilitate modification to the CB band.

Those then are some more features of the exciting US amateur radio scene. Ham Radio Today readers are reminded that it is now possible to take the US licensing exams in the UK. Test sessions are held frequently in the Harrogate area and are also scheduled for the RSGB show at the NEC next March.

The first two British amateurs to pass the tests in this country were G3IZD and G3ZAY who qualified for Advanced and Extra Class licences respectively at tests held before the RSGB HF Convention.

WEST LONDON COMMUNICATIONS

61 FAIRFIELD ROAD,
WEST DRAYTON

West Drayton

447767/422200 (STD 0895)

(10 Lines)

3 MILES FROM LONDON AIRPORT

CB RADIO CHOICE OF 20 £10-£16 EA.
AERIALS FROM £2.50 EA.
STORNO CAR PHONES 900SA CHOICE OF
20 £100
EUROPES HIBAND FM 30 EA.
BASE STATION ANTENNAE (CHOICE OF
20) £20 EA.
VARIED AMATEUR RADIO EQUIPMENT FOR
SALE

WANTED. Best prices paid for second hand equipment.

Please note it is illegal to operate a transmitter without a licence.

The following equipment does not meet D.T.I. approval, all sets are sold without crystals and sold as seen and without warranty.

PYE MOTORPHONE CHOICE OF 10 £20 EA.
PYE CAMBRIDGES AM/FM CHOICE OF 20 £10 EA.
PYE WESTMINSTER AM/FM CHOICE OF 25 £25 EA.
PYE F30 BASE STATION CHOICE OF 5 £50 EA.
PYE UHF BASE STATION TRANSIT & RECEIVE £10 EA.
PYE VANGUARDS CHOICE OF 25 £5 EA.
STORNO 600 EX CAR PHONES CHOICE OF 20 £20 EA.
PYE CAMBRIDGE BOOT MOUNTS AM/FM (CHOICE OF 20
COMPLETE WITH CONTROL GEAR) £10 EA.
STORMO 700 DASH MOUNT LOW BAND FM ... £30 EA.
OLYMPIC AM HI-BAND £30 EA.
PYE PF8 HANDHELDS UHF (CHOICE OF 50) ... £20 EA.
PYE PF2 (CHOICE OF 30 COMPLETE WITH BATTERIES
AND MICS) £25 EA.
BASE STATION ANTENNAE FOR ALL FREQUENCIES
FROM £25 EA.
PYE PF5 UHF (CHOICE OF 20) £15 EA.
PF9 TRANSMITTER & RECEIVER £10 EA.
VARIOUS TEST EQUIPMENT FOR SALE

Books for radio amateurs

FDK

ELLIOTT ELECTRONICS

THE 'HAM SHACK'

APPOINTED DISTRIBUTOR

INSTANT HP AVAILABLE

OSY OLD MAN TO

AERIAL ACCESSORIES AND MASTS

JAYBEAM AMATEUR ANTENNAS

RIGS, ANTENNAS, SWR BRIDGES, POWER SUPPLIES, TEST GEAR, COMPONENTS, MORSE KEYS, COAXIAL CABLES, ROTATORS, MICS, PLUGS AND SOCKETS, SWITCHES

Call us on (0533) 553293
OR COME AND LOOK AROUND AT
26/28 Braunstone Gate, Leicester

AUT. MEMBER OF I.R.A. & YAESU

**SLOW SCAN T.V.
48K SPECTRUM 128K
TRANSMIT SCREENS AND TEXT**

Receive and Transmit pictures from your Spectrum. This superb programme and hardware allows you to join the exciting world of Slow Scan T.V. using your Spectrum to send and receive pictures around the world.

Allows you to Tx/Rx text and graphics.
Capture and re-transmit pictures.
Store pictures, print pictures, save pictures to tape.
8 picture stores on 48K, many more on 128K.
Picture Design Programme allows you to design personal test card, CQ call and much, much more.

If you have a camera and digitiser, these may be used with the programme to send personal pictures.
Tone Generator Hardware allows maximum computer processing time for accurate, clean signals.

The two programmes and very comprehensive instruction book, inc. P & P £25
Ready built interface and tone generator £42.75
As above with automatic PTT £47.50

S.A.E. for detail of interface and tone generator kits.

J.E.P. ELECTRONICS LTD.
New Road Complex, New Road, Kidderminster, DY10 1AL
Tel: (0562) 753893

FIDELITY 1000 MOD

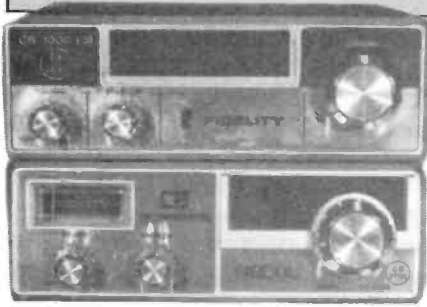

Photo 1. The two guises of the CB1000 rig

Legal 27MHz CB rigs are turning up cheap nowadays. So why not modify them to 10 metres? "Why not, indeed?" asks Roger Alban.

When the British government decided to legalise CB in the UK, the specification published, MPT 1320, was deliberately made very different from that used by American CB sets. The idea behind this was to put UK manufacturers in the running to produce home-grown CB rigs, rather than have the market flooded with cheap imports.

However, the specification caused a number of design problems, mainly associated with the PLL chips required to produce the appropriate frequencies. At the time, the available custom-designed chips for CB, like the LC7120, were suitable only for the US spec. Secondly, to achieve the specified frequencies, an additional crystal oscillator had to be used because the PLL chips available could not operate with inputs on their Fin pins higher than 5MHz.

MM55108N To The Rescue

There was, however, one rather obscure PLL chip, the MM55108N, which did not need an additional crystal oscillator for down-mixing, the problem being overcome by dividing the reference frequency by two and then tripling it externally using a tuned circuit, the resultant frequency then being appropriate for injection into the down-mixer. However, because the chip was, relatively speaking, rather elderly, this frequency could not be handled on-chip, so the down-mixer had to be external.

One feature of this PLL chip is

that the divide-by-N chain is programmed via an on-chip ROM (read only memory); the channel number is used to decide what N is programmed into the chain. Also, the ROM has an address line linked to the send/receive line, so a different N is used for send and receive.

The same PCB, using the MM55108N, was used in a number of ostensibly different CB rigs,

of a modified rig, so ignore the small piece of Veroboard shown attached to the side panel and you should have a pretty good idea of what to look for. In this photograph, the top lid of the PLL box, located on the component side of the PCB near the front panel, has been removed.

Frequency Generation

To understand the mod, we must first understand how the rig generates the required frequencies. A block schematic diagram is shown in Fig. 1. If you can't follow this explanation, do not worry too much because it will not prevent you from carrying out the mod; however, you may find it difficult to deal with any problems that may or may not come up.

A reference crystal oscillator operating at 10.24MHz is fed into the input of the fixed value reference dividing register. The reference frequency is first divided by a factor of 2, and then by a factor of 1024 to produce a 5kHz reference frequency which is fed to the phase detector. The output from the phase detector consists of a varying DC

including the Fidelity CB1000 and the GECOL sets. As a result, the mod described here should be possible on a number of different rigs, although in the author's experience the Fidelity is much the most common. The front panels of the Fidelity and GECOL rigs are shown in **Photo 1**, and other versions would be similar in lay-out.

However, to make a positive identification, it is necessary to remove the speaker cover and examine the component lay-out of the PCB. **Photo 2** shows the interior

Photo 2. General view of the internal component placement

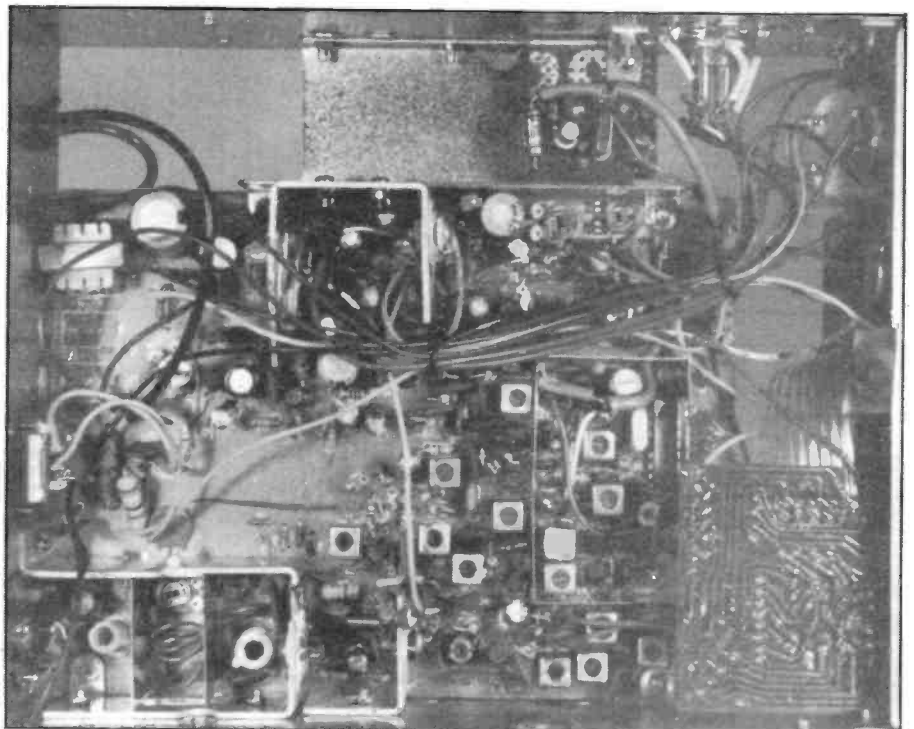

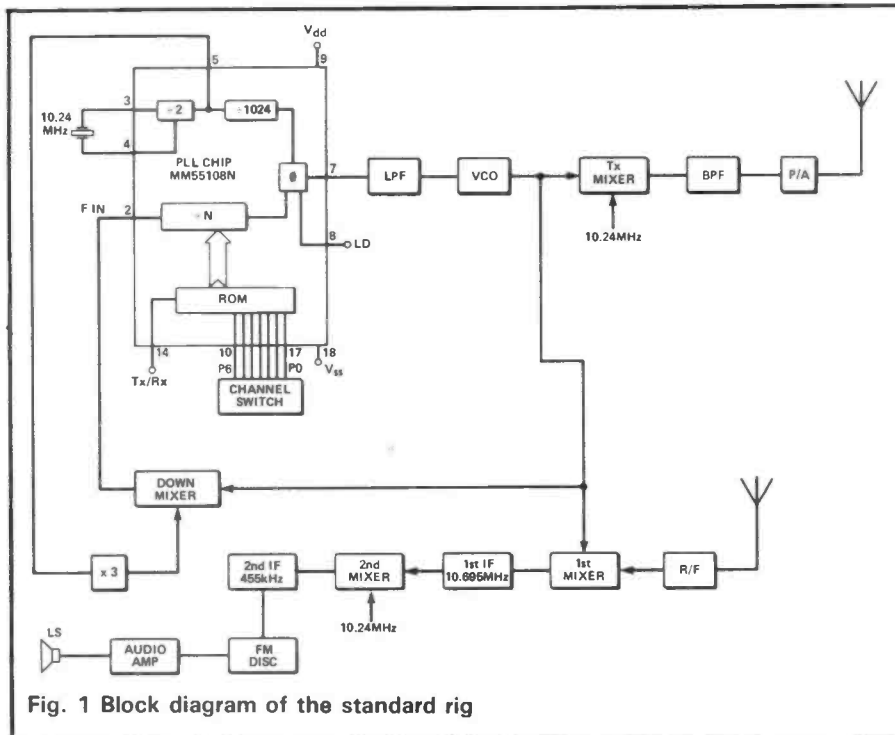

Fig. 1 Block diagram of the standard rig

mode, the frequency of the VCO will be different because the output of the VCO is now fed into the receiver first mixer. The frequency of the VCO on channel 20 receive will be 27.79125MHz minus 10.695MHz which equals 17.09625MHz. The value of Fin will be 17.09625MHz minus 15.36MHz which equals 1.73625MHz. For the loop to be locked the corresponding value of N for the programmable divider output to be 5kHz will be 1.73625MHz divided by 5kHz which equals 347.25. Again, we must have a whole value for N.

Let us assume that the correct value of N is 347. The value of Fin will be 347 x 5kHz which equals 1.735MHz. The VCO will be operating at 1.735MHz plus 15.36MHz which equals 17.095MHz. The receiver frequency will be 17.095MHz plus 10.695MHz which equals 27.79MHz which is 1.25kHz low. This error in receiver frequency is again within the terms of the UK specification.

component superimposed upon a 5kHz signal. The unwanted AC component is filtered out by a low pass filter, and the DC component is fed to a varicap diode which forms part of the VCO tuned circuit.

A small sample of the output frequency of the VCO is fed to the input of the down-mixer where it is mixed with a frequency of 15.36MHz. This stable fixed frequency signal is obtained by taking from pin 5 of the PLL chip half the reference oscillator frequency (5.12MHz) and tripling it to arrive at the required 15.36MHz. The output from the down mixer, which is $F_{vco} - 1.5 \times F_{ref}$, is fed via a low pass filter to Fin, the input to the programmable divided-by-N chain, on pin 2 of the PLL chip. The value of the logic levels applied to the programme lines will determine the value of N. The output from the programmable divider is fed to the other input of the phase detector.

The loop is said to be locked when both inputs to the phase comparator are at the same frequency, ie, 5kHz. On transmit, the output from the VCO is fed to the input of the transmit mixer where the VCO signal is mixed with a sample of the reference crystal oscillator frequency to produce the required transmit frequency. On receive, the output of the VCO is injected into the receiver first mixer to produce the first IF frequency of 10.695MHz.

To help illustrate the frequency relationships which exist within the design of the set, let us suppose that the set is operating on channel 20 in the transmit mode. From the handbook, the operating frequency for the set on channel 20 will be 27.79125MHz. The VCO will be operating at a frequency of 27.79125MHz minus 10.24MHz which equals 17.55125MHz. The output frequency from the down mixer which is fed into Fin will be 17.55125MHz minus 15.36MHz which equals 2.19125MHz. For the loop to be locked, the output from the programmable divider must be 5kHz, the same frequency as the reference input of the phase comparator. Therefore the value of N will have to be 2.19125MHz divided by 5kHz which equals 438.25.

This value for N must be wrong because we cannot have a value for N which is not a whole number. Let us assume that the true value of N is 438. The value of Fin will be 438 x 5kHz which will be 2.19MHz. The VCO will be operating at a frequency of 2.19MHz plus 15.36MHz which equals 17.55MHz. The transmitter frequency will be 17.55MHz plus 10.24MHz which equals 27.79MHz, 1.25kHz lower than the required frequency. This error in operating frequency is within the limits set by the UK specification of ± 1.5 kHz, paragraph 14.1.3., MPT 1320.

When the set is in the receive

10 Metre Operation

The question that now needs to be answered is: how do we convert this set to operate on the 10 metre band? The frequency injected into the down-mixer will have to be changed if we are to alter the operating frequency range of the set, but to what value? Let us again assume that the set is to operate on channel 20. For channel 30 to correspond to the 10 metre calling frequency of 29.60MHz, this being the author's standard practice, then channel 20 will have to correspond to an operating frequency of 29.50MHz.

On transmit, the VCO will be operating at a frequency of 29.50MHz minus 10.24MHz which equals 19.25MHz. Remember that the value of Fin will not be changed, ie. it will continue to operate at a frequency of 2.19MHz. Therefore the value of the frequency required to be injected into the down mixer to obtain this value of Fin will be 19.26MHz minus 2.19MHz which equals 17.07MHz. Therefore if we build a 17.07MHz crystal oscillator and inject this frequency into the down mixer we should be able to operate this set on the 10 metre band.

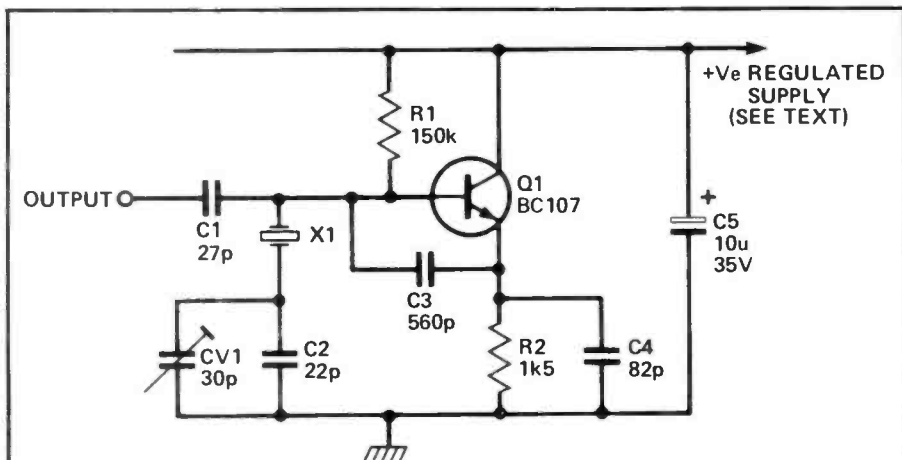
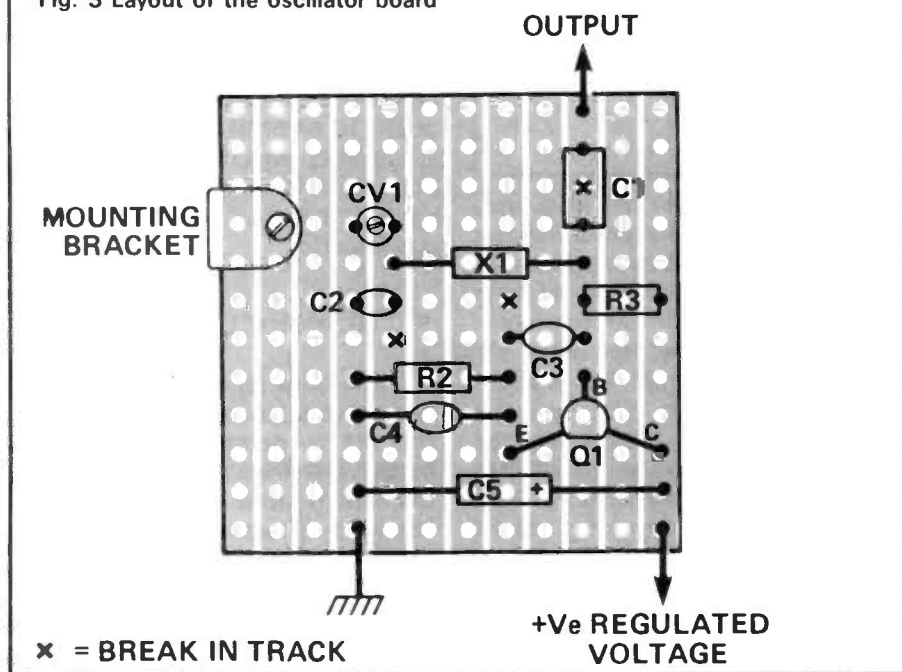

Fig. 2 Schematic of the add-on oscillator board

Fig. 3 Layout of the oscillator board



Let us check the calculation of the crystal oscillator frequency by calculating the receiver frequencies. On channel 20 receive, the value of N will be 347 as previously calculated for the un-modified set. The value of F_{in} will be $347 \times 5\text{kHz}$ which equals 1.735MHz. The VCO will be operating on a frequency of 1.735MHz plus the frequency of the new crystal oscillator of 17.07MHz which equals 18.805MHz. The receiver will be tuned to a frequency of 18.805MHz plus 10.695MHz which equals 29.50MHz, the same operating frequency as the transmitter. Hence we have proved the calculation.

The difference in the value of N between transmit and receive will remain the same irrespective of the channel selected. The logic values

required to produce the correct values of N for transmit and receive for each of the 40 channels is stored

Photo 3. Close-up of the crystal oscillator board

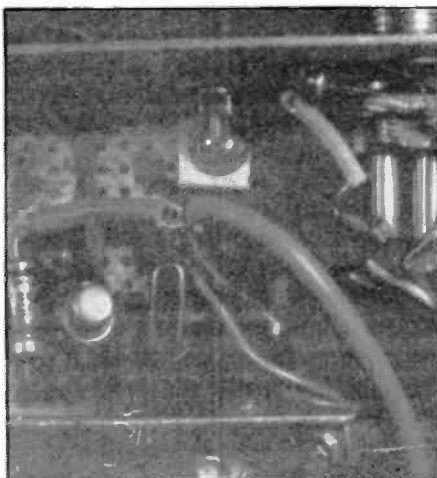

within the ROM, which forms part of the PLL chip. The ROM is addressed by seven programme lines P0 through to P6 and an additional programme line to select the different address for transmit and receive. One now starts to appreciate how useful and versatile this PLL chip is!

Before conversion

A start can now be made on the conversion of this set to operate on the FM portion of the 10 metre band, but before taking the soldering iron to the set it would be wise to first verify that it is functioning correctly and is free of any faults which could upset the modification. To carry out the modification work detailed below you will need an oscilloscope capable of resolving a 20MHz signal, a digital counter capable of measuring frequencies as high as 30MHz, and a stable signal generator capable of operating at 29.5MHz.

The first item that must be constructed is the down-mixer crystal oscillator. The circuit diagram of the crystal oscillator is shown in Fig. 2. The crystal X1 should operate in the fundamental mode at a frequency of 17.07MHz. When ordering this, ensure that the manufacturer is asked to supply a crystal that operates with about 30pF of capacitance in parallel and that it is supplied in a HC18u holder so that it can be soldered directly onto the crystal oscillator board.

The oscillator uses a Colpitts circuit and the operating frequency of the crystal can be altered by adjusting CV1. The transistor Q1 is a BC107. In fact, most of the

Photo 4. Tap point for the 8v supply

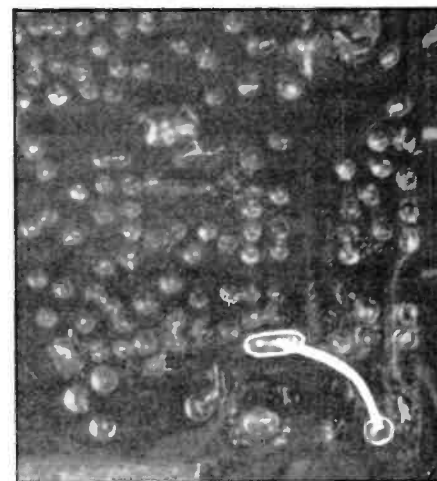

components with the exception of the crystal were obtained from the junk box which kept the cost of the modification down to the price of a new crystal.

The circuit was constructed on a small piece of Veroboard and the component layout as used by the author is shown in **Fig. 3**. A small L-shaped bracket can be used to attach the Veroboard to the side wall of the set. The exact location of the board can be seen in **Photo 3**; it is mounted on the right hand side wall of the set just behind the microphone socket. The required regulated 8V supply is obtained from the main PCB. **Photo 4** shows the take off point, which is the emitter of Q9, the 8 volt voltage regulating transistor.



Location of the 68pF capacitors across L4, 5 and 6

The output of the oscillator is coupled via miniature coaxial cable into the centre tap of the frequency tripling tuned circuit comprising L202 and C204. You will need to unsolder C209 and remove it from the PCB. This will prevent the output from pin 5 reaching the centre tap of L202. Inject the crystal oscillator output directly into the centre tap of L202 by connecting the inner conductor of the miniature coaxial cable to the point on the PCB where C209 was connected to the centre tap of L202. Be careful when using the soldering iron as the PCB track in this area of the circuitry is quite narrow and can be easily damaged. The outer braid of the coaxial cable can be soldered to the side wall of the screened PLL compartment. If it is your intention to replace the lid on the PLL compartment after the modification has been completed, the thin coaxial cable can be threaded under

the screen side wall as shown in **Photo 5**.

The operating frequency of the tripling tuned circuit will now be increased in frequency from 15.36MHz up to 17.07MHz. For the tuned circuit to become resonant at this higher frequency it will be necessary to remove C204.

On some sets you will find a screen plate attached to the track side of the PCB immediately below the PLL compartment. This screen plate must be removed by unsoldering the feet attaching it to the PCB.

Attach a 1.5pF capacitor to the 'hot' end of L202 and use this capacitor to couple the oscilloscope to the tuned circuit. Adjust the tuning core of L202 to obtain maximum signal amplitude on the oscilloscope. Adjust CT1 on the crystal oscillator board to obtain the correct operating frequency of 17.07MHz. The crystal oscillator should now be operating at the correct frequency with L202 resonant at this new frequency.

Remove the 1.5pF capacitor. Attach the oscilloscope to pin 8 of IC202. You will find that a test pin is provided on the PCB inside the PLL screened compartment. Pin 8 is the output of the PLL lock detector. Adjust the tuning core of the coil of the VCO tuned circuit, L201, until pin 8 is at logic level 1 on channel 20 transmit. Also check that pin 8 is at logic level 1 for channels 1 and 40. The best setting of the oscilloscope to observe the logic level is with the Y amplifier switched to DC and the gain set at 2 volts per division, and the timebase speed set to 0.2mS per division.

If pin 8 does not remain at logic level 1 on channel 20 in the receive mode, then CT202 will require to be adjusted. Check to ensure that pin 8 remains at logic level 1 on receive for channels 1 and 40 also. If not, re-adjust CT207 to achieve this result. The phase lock loop should now be locked on transmit and receive.

Transmitter Tuning

On transmit the output of the VCO is fed to the band pass filter. To tune this filter successfully it will be necessary to remove the internal 82pF capacitors which can be found in the base of the coil formers of L4, L5, and L6. These should be replaced with 68pF capacitors which

can be soldered onto the track side of the PCB beneath the base of each coil former. Carefully un-solder L4, L5, and L6 one at a time; you will *not* need to remove the screen can. The internal capacitors are located on the undersides of the coil formers. With a sharp knife cut the leads and remove the capacitors from the bases. Re-solder the coil formers back onto the PCB and add the external 68pF capacitor across the coil L4, L5 and L6, keeping the wires as short as possible.

The band pass filter should be tuned with a dummy load connected to the aerial socket of the set. With the set on channel 20, key the microphone and adjust the cores of L4, L5, and L6 for maximum output power. If you find it difficult to tune the band pass filter, you will need to connect the oscilloscope to C55 and adjust L207, L4, L5, and L6 for maximum signal.

With an RF wattmeter or SWR meter reading forward power and a 50 ohm dummy load connected to the aerial socket, adjust the tuning cores of L207, L4, L5, L6, L7, L8, and L9 for maximum output power. If you find it difficult to tune L7, you may find it helpful to remove the 10pF capacitor C105 which is in parallel with L7.

On one set modified, difficulty was experienced in turning the core of L9 which eventually resulted in the core being damaged. If this happens to you, you will need to remove the coil from the PCB and replace it with a rewound coil

Photo 5. Detail of the PLL area

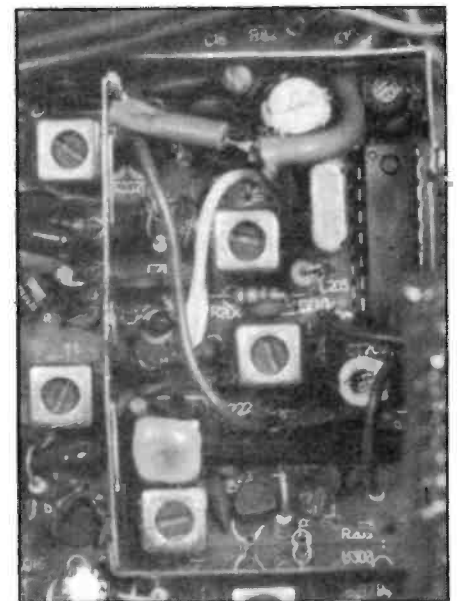

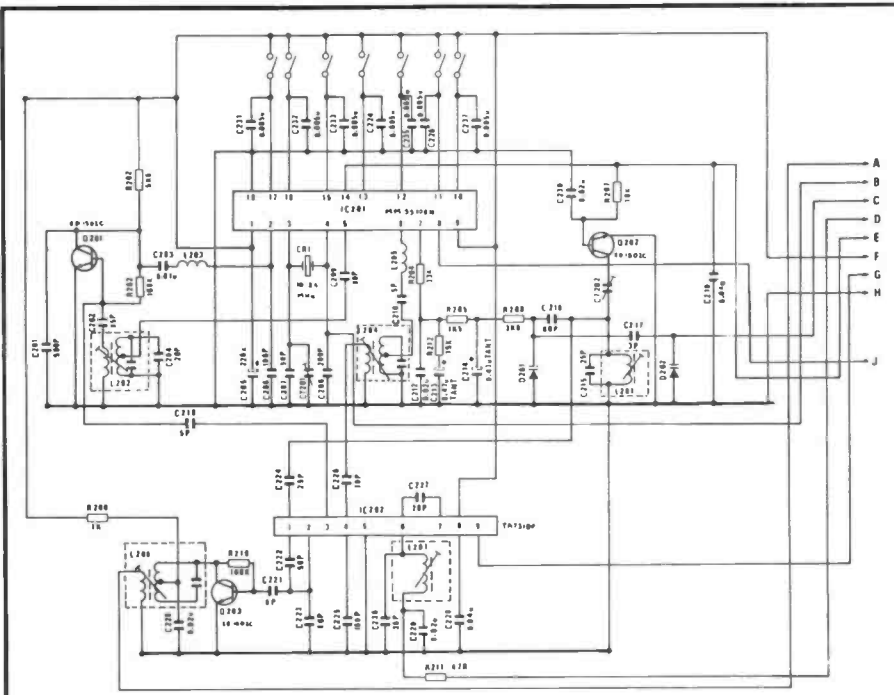

Fig. 4 Circuit diagram of the CB1000 PLL section

consisting of 5 turns of 20swg wound on a coil former which accepts a 6mm dia core.

Check the power level on channel 1 and channel 40. If the power output is not constant between channels 1 and 40, you will need to readjust the band pass filter cores to obtain an even output power over the entire 40 channels. You will probably find that the maximum power output is in the region of 3.5 watts. Only on one set has the author been able to achieve an output power of 4 watts! After tuning the transmitter for maximum output power adjust VR4 so that the needle of the S/RF meter on the front panel indicates the RF power reading on the wattmeter.

Finally, on channel 20 check the output frequency of the transmitter. It should be 29.50MHz. If not, readjust CT1 on the crystal oscillator board to achieve this output frequency. The transmitter should now be fully tuned.

Receiver Tuning

With a signal generator attached to the aerial socket inject a frequency of 29.30MHz on channel 20. The injected signal should be frequency modulated with a signal of 1KHz to cause the deviation to be +/-1.5KHz. The output of the signal generator should be increased until

the S-meter reads about S3. Now adjust the tuning cores of L1, L2, and L3 for maximum reading on the S-meter.

Reduce the output from the signal generator to again obtain an S-meter reading of S3. Readjust the tuning cores of L1, L2, and L3 to obtain a maximum S-meter reading. Now set the output of the signal generator to 100mV and adjust VR2 to obtain an S-meter reading of S9. The set should now be fully tuned.

Finally, with the station main receiver check for unwanted signals on transmit by tuning the main receiver 10kHz either side of the carrier frequency. If you are satisfied that the transmit signal is clean, replace the screen covers above and below the PLL circuitry and replace the covers of the set.

Spurii

When modifying a CB rig to operate on the amateur 10 meter band there will always be problems with spectrum purity because the rig is using mixes of frequencies different to those originally chosen by the set designer. The main problem encountered by the author here was an unwanted signal appearing on transmit around 1MHz from the carrier frequency. For example, when the set is operating on channel 30 transmit, i.e. carrier frequency

Components List

RESISTORS

R1 150k
R2 1k5

CAPACITORS

C1 27p
C2 22p
C3 560p
C4 82p
C5 10u 35V electrolytic
CV1 30p trimmer

SEMICONDUCTOR, ETC

Q1 BC107 or similar
X1 17.07MHz crystal — see text, veroboard, wire, miniature coaxial cable.

29.6MHz, the unwanted frequency was at 28.48MHz. Due to the closeness of the unwanted frequency to that of the carrier, the unwanted frequency is amplified by the transmitter stages. Fortunately the unwanted signal was 25db down on the carrier, and this can be further reduced with the use of a high Q tuning unit and resonant antenna.

This particular unwanted signal is generated by an unfortunate mix of frequencies on transmit between the VCO frequency and the reference frequency which is injected into the transmitter mixer. The unwanted frequency is derived by taking the second harmonic of the VCO and subtracting the reference frequency of 10.24MHz. After the reader modifies this set for use on 10 meters it is recommended that the unwanted frequency is at least 25db down on the carrier.

And The Results?

Signal reports received while using the set indicate that the audio quality is good. The author has found that the performance of the receiver section is particularly good; this is probably his most sensitive conversion to date, being capable of resolving signals as low as 0.1uV. The set has been used satisfactorily as the main station 10 metre rig as well as mobile, and it has now found a permanent home in the author's car where it gives good results when used in conjunction with a centre-loaded modified CB mobile antenna — but that's another story. With an output power of only 3.5 watts, mobile contacts over a distance of 12 miles have been achieved.

Feeding your ANTENNA

As the antenna is by far the most efficient piece of equipment in a radio station, up to 98% efficient when resonated, it is worthwhile to make sure that you feed the precious

without balun); quarter-wave verticals with ground plane (or effective earth system); and single or multi-band Yagi or quad beam antennas with built-in impedance

expected for a given length and type of feeder on the various amateur bands when the VSWR is 1:1.

When a coaxial feeder is used between the *output* of the ASTU and the antenna feed point (an 'unbalanced to unbalanced' system), the VSWR on this feeder can be measured, after correctly adjusting the ASTU so as to present a VSWR of virtually 1:1 to the transmitter output, by simply inserting the VSWR meter between the *output* of the ASTU and the station end of the coaxial feeder to the antenna. Then, knowing the length of this feeder and its loss in dB per 100 ft at the operating frequency when correctly terminated by a purely resistive load equal to its characteristic impedance Z_0 , the *extra loss* due to the measured VSWR can be found by reference to Fig. 1. The two loss figures are then added to give the total feeder loss.

For example, assuming the use of 80ft of RG8U coaxial cable feeder which has a Z_0 of 52 ohms, centre feeding a half-wave dipole antenna, which presents a resistive load of 75 ohms at the operating frequency, the mis-match is equivalent to $75/52 = 1.44:1$ VSWR. Since the loss in 100ft of RG8U when correctly terminated by a 52 ohm resistive load at 28MHz (the worst case for the HF bands, since feeder loss increases with increasing frequency) is 0.98dB, the loss for an 80 ft length with a VSWR of 1:1 will be $0.98 \times 0.8 = 0.78$ dB. With a VSWR of 1.44:1 the extra loss caused by this mis-match will be negligible, as indicated by the curve for a VSWR of 1.5:1 of Fig. 1.

However, this method will give a reasonably accurate result only if the feeder loss when *correctly* terminated is very small; say, 1dB or less. Because the *reflected* power which flows back along a feeder due to a mis-match at its far end is partially

It's no good having the latest super-rig and a back garden resembling an enlarged egg-slicer if the two aren't connected together properly. Louis Varney, G5RV, gives a few pointers.

RF power generated by your relatively inefficient transmitter (typical 50% DC to RF conversion) with as little loss as possible. There are many different types of antenna, which are chosen usually by the space available, and all types of antenna have one thing in common — they must be fed with the RF power via some form of feeder system.

There are two types of feeder system: balanced and unbalanced. A balanced feeder takes the form of a pair of spaced wires, either two separate wires using ceramic or plastic separators and commonly called an open wire feeder, or specially made twin lead or ribbon feeder. Open wire feeders can have characteristic impedances of anything from 300 to 600 ohms, while specially made balanced feeder cables have nominal impedances, usually 75 or 300 ohms, depending on type. As we shall see later, not all feeder cables are equal in performance.

Nowadays, amateur equipment is designed to work into unbalanced loads, ie coaxial cable with signal and earth, and a 50 ohm resistive load with a maximum VSWR of 2:1. There are only four types of antenna which can be fed directly from a coaxial cable: a centre-fed single band dipole (with or without a balun); a centre-fed multi-band trap dipole or nest of dipoles (with or

matching to accept a 50 ohm coaxial feed.

End-fed wire antennas and centre-fed multi-band antennas which do not use traps require the use of an antenna system tuning unit (ASTU or ATU, also called a transmatch). This transforms the complex impedance of the antenna, which has both resistive (voltage and current in phase) and reactive (voltage and current 90 degrees out of phase, capacitive and/or inductive) components, to an unbalanced 50 ohm resistive impedance suitable for the coaxial output from any modern transceiver.

What The ASTU Won't Do

It is important to note that, although the use of a suitable type of ASTU will ensure that the transmitter delivers its maximum power to the antenna system, it will *not* reduce or eliminate the VSWR on the feeder due to a mis-match at the antenna feed point. Whether the loss caused by the VSWR on the feeder is important or not depends upon the type of feeder used, its length and its loss per unit length when correctly terminated at the frequency in use. This loss is usually expressed in dB per 100 ft of feeder at a given frequency. Reference to any of the standard antenna handbooks will provide information on the loss to be

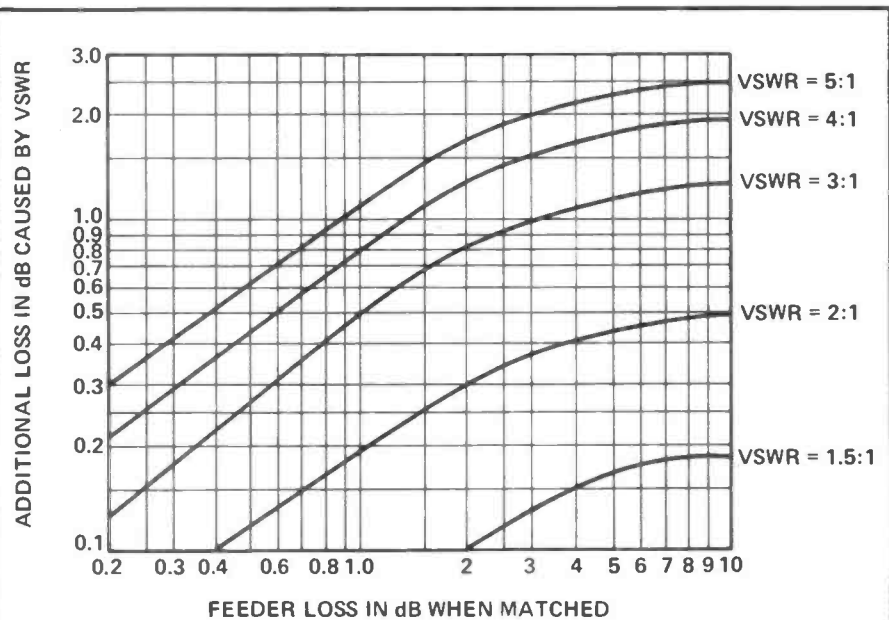

Fig. 1 Graph showing extra loss in dB on a feeder with known VSWR.

dissipated along the feeder on its return to the input end it follows that, for a feeder which has inherently moderate to high loss when correctly terminated, the observed VSWR *decreases* along its length going from the load end to the input end under mis-match conditions.

When Reflections Don't Matter

To take an extreme example, assuming that a given length of feeder at a given frequency has a loss of 3dB when correctly terminated, only 50% of the power put into the feeder reaches the load. If the mis-match at the load (the antenna feed point) is 4:1, 36% of the power reaching the load will be reflected back along the feeder. Thus, of the power originally put into the feeder, $0.5 \times 0.36 = 0.18$ or 18% will be reflected. This power, in turn, will be attenuated by 3dB in travelling back to the input end of the feeder so that only $0.18 \times 0.5 = 0.09$ or 9% of the original input power is actually returned to the input end of the feeder. With such a small proportion of the original input power re-appearing at this point, the VSWR measured there would only be about 1.18:1 whereas it is, in fact, 4:1 at the load end. However, if the feeder loss when correctly matched is less than 1dB, the VSWR measured at the input end of the feeder will be virtually the same as that measured at

the load (antenna) end.

Strictly speaking then, in order to know accurately the feeder loss under actual working conditions, the VSWR measurement should be made at the load or antenna end of the feeder. When a twin-wire feeder is used, a special balanced type of VSWR meter is required between the output of the appropriate unbalanced to balanced type of ASTU and the feeder to the antenna. However, VSWR meters of this type are not normally available, although they can be constructed. Fortunately, the power loss in a balanced feeder of the open-wire type or in the modern 300 ohm ribbon feeder with 'windows', of any length likely to be used in the space available in a back garden, will be negligible even with a high VSWR on such a feeder.

This does not apply to the quite 'lossy' 75 ohm receiving type twin-lead available in the UK and it is advisable to use not more than about 60 to 70ft of this type of feeder even when it is correctly terminated by a resistive load of 75 ohms, such as when used to centre-feed a half-wave dipole for a single band or a trap dipole or nest of dipoles for multi-band working. Even then, the loss at 3.5MHz will be 1.05dB and at 28MHz 2.87dB for a 70ft length. At 3.5MHz the loss may be considered to be negligible, but at 28MHz almost half the transmitter output power will be dissipated in the feeder. The special transmitter

(Beldon type 214-023) 75 ohm twin-lead available in the USA has a very much lower loss per unit length; only 1.4dB per 100ft at 28MHz.

It is interesting to note that a well constructed open-wire feeder has a loss of only 0.1dB per 100ft at 28MHz when correctly terminated. Even when used under mis-matched conditions with a VSWR of 10:1 or more, the total power loss is negligible. In the writer's opinion, this is a very strong argument in favour of the use of such low-loss feeder, especially when used to feed a multi-band antenna which does not use traps.

Such a feeder does not have to be the 'old fashioned' wide-spaced 600 ohm type which is, by some, objected to on aesthetic grounds. It can be constructed very easily and cheaply by using 16SWG enamelled copper wire and 1½ or 2 inch spacers cut from strips of ¼ inch thick plastic sheet or similar lengths of ¾ inch OD plastic tubing of the type used for beer or wine making. The characteristic impedance of such a feeder will be between 350 and 450 ohms but this is quite immaterial when it is used as a tuned feeder which, inevitably, will have a high standing wave on it with absolutely negligible loss.

The use of any twin-wire feeder under such conditions requires the use of a suitable type (unbalanced to balanced) of ASTU. It should be noted that, under such conditions of operation (ie. with a high VSWR) a balun should *not* be used in place of an ASTU since it cannot compensate for the reactive element which will be presented by the open-wire feeder at the station end. Under such conditions, the RF power loss in the balun will be dissipated in the form of heat in its windings and core. In extreme cases of relatively high power operation, say with 100 watts or more of RF, the windings may burn out and, in any case the core will be saturated and thus rendered ineffective.

When a tuned feeder is used, whether of the open-wire type or 300 ohm ribbon, difficulty may be experienced in tuning-out, or compensating for, the reactance presented at the station end when, on any particular frequency band, the *electrical* length of such a feeder, in conjunction with the antenna, is an *odd* number of ¼ wavelengths. This

is because, under such conditions, the odd $\frac{1}{8}$ wave presents a reactive component at the station end of the feeder which cannot satisfactorily be compensated for by either a series-tuned or parallel-tuned circuit. In such cases, the feeder should be lengthened or shortened by a few feet in order to avoid such a condition occurring on the band in question. Alternatively, a small amount of L or C may be used in series with each of the feeder conductors at the station end to 'tune out' this $\frac{1}{8}$ wave effect which, if not compensated for, may make it impossible to obtain a 1:1 VSWR on the coaxial feeder used between the transmitter output and the input to the ASTU on one particular band while, on all the other bands, a perfect match to the transmitter output is obtained.

Antenna Bandwidth

A resonant antenna behaves like a tuned circuit and has a Q value which, as in a tuned LC circuit, determines its *selectivity*. This Q value is, typically, about 15 for a resonant half wave dipole and is mainly dependent upon the ratio of antenna length to wire (or conductor) diameter, expressed in the same units. However, in the case of a Yagi beam antenna the effect of the much lower element length to conductor diameter ratio and of the tight mutual coupling between driven and parasitic elements can increase the Q value of such an antenna to 50 or more. Since the higher the Q value the more selective the antenna becomes, it follows that the range of frequencies within a given band over which a particular antenna will present a purely resistive load at its feed point becomes more and more limited the higher its Q value.

As the frequency fed to the antenna is varied above or below its resonant frequency the feed point presents a more and more reactive load to the feeder and, in consequence, even when a dipole fed by a 75 or 80 ohm feeder (coaxial or twinlead) presents a perfect match at the precise frequency for which the dipole is cut, as the transmitter frequency is varied up or down about this resonant frequency the feed point will present inductive or capacitive reactance to the feeder in addition to its resistive value. This will cause standing waves on the

feeder. Since this effect is a function of the percentage variation in frequency about the resonant frequency, it becomes more important on the lower HF bands, 1.8 and 3.5MHz, than on the higher frequency bands.

For example, a dipole cut to

resonate at 3.65MHz (the centre of the 80m band), at which frequency it presents a 1:1 VSWR to the feeder, will have a bandwidth of only about 180kHz (+90kHz) for a maximum acceptable VSWR of 2:1. At 28.85MHz the bandwidth for the same VSWR limit will be about

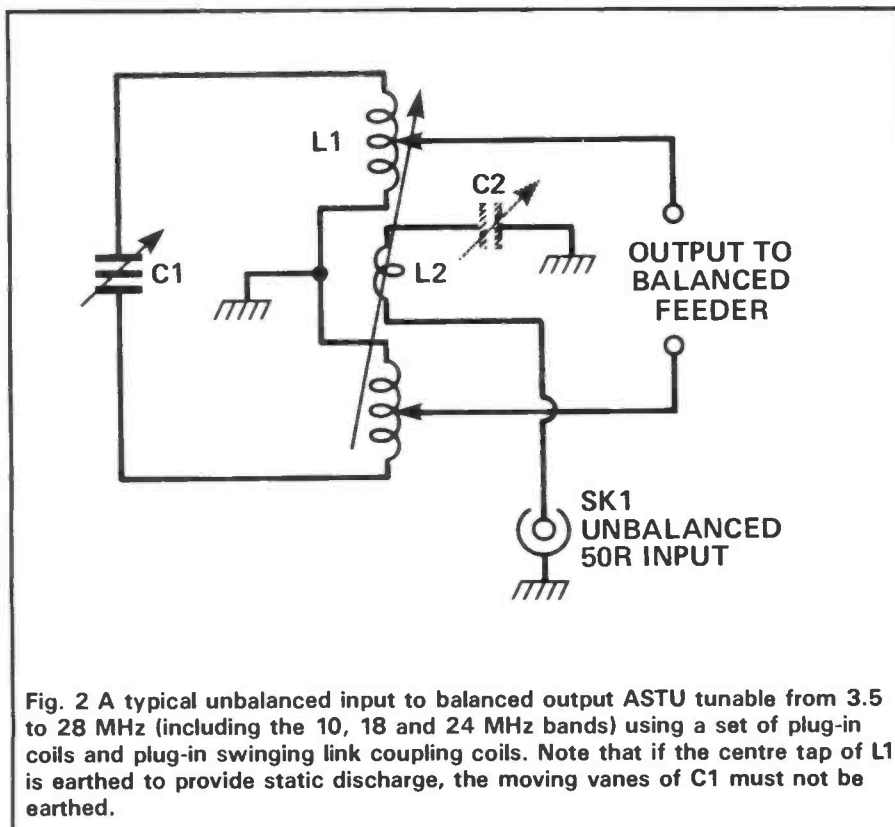

Fig. 2 A typical unbalanced input to balanced output ASTU tunable from 3.5 to 28 MHz (including the 10, 18 and 24 MHz bands) using a set of plug-in coils and plug-in swinging link coupling coils. Note that if the centre tap of L1 is earthed to provide static discharge, the moving vanes of C1 must not be earthed.

Components

C1: 13-250pF per section split-stator variable capacitor fitted with slow motion drive, shaft insulated from earth. (Nevada type TC-500, obtainable from Telecomms, 189 London Road, North End, Portsmouth, Hants PO2 9AE.)

L1: wound from 14 swg enamelled wire.

Band MHz	Turns	Coil i/d mm	Feeder taps	L2 turns**
3.5	17+17 c/w	63	7+7 t	5 c/w
7.0	11+11 c/w	63	3+3 t	5 c/w
10	9+ 9 c/w	40	3+3 t	5 c/w
14/18	6+ 6 *	40	2+2 t	3 c/w
21/24/28	5+ 5 *	40	2+2 t	3 c/w

* Turns spaced wire diameter.

** i/d 40 mm. c/w = close wound.

SK 1: coaxial socket.

Note 1: Approximate feeder tap positions are for a G5RV antenna fed with 84ft of o/w feeder to centre of antenna. Optimum tap positions for other antenna/feeder arrangements must be found by trial and error to obtain 1:1 VSWR on the 50 ohm coax feeder between transmitter and input to the ASTU.

Note 2: A 500pF variable capacitor C2 (shown by broken lines) may be used instead of the swinging link.

Note 3: An alternative to plug-in coils would be a coil turret assembly built around a suitable ceramic wafer switch. Each coil would then have its own link coil of the number of turns shown above.

1450kHz (+725kHz). Since the width of each of the new WARC bands, 10, 18 and 24MHz is so narrow, the variation of VSWR at the feed point of a dipole cut for resonance at the centre frequency of any one of those bands will be in-

significant over the whole range of frequencies in that band.

When an antenna and feeder system which requires the use of an ASTU is used, the overall bandwidth will also be influenced by the loaded Q value of the ASTU tuned circuit

and, in consequence, will be considerably less than that of a simple dipole antenna fed directly by a suitable feeder. For this reason, it is desirable for the ASTU LC circuit to have a loaded Q value of about 4 or 5. Otherwise, it will be necessary to re-tune the ASTU for even a few kHz change in frequency.

Although for maximum efficiency the unloaded Q value of the inductance and capacity forming the ASTU circuit should be as high as possible, the degree of coupling to the feeder and antenna system should be such as to produce the loaded Q required.

In practice, this means that the ASTU should be tuned and the loading (or degree of coupling) to the feeder/antenna system adjusted at the centre frequency of operation (eg. say 14050 for CW or 14200kHz for phone) so as to produce a 1:1 VSWR on the coaxial cable between the transmitter output and the ASTU input. This will be the condition which results in the widest operating bandwidth for an acceptable maximum VSWR of 2:1 at the output of a solid state PA stage and the maximum transfer of RF power to the antenna system. For this reason it is preferable to use an ASTU which provides a variable coupling facility.

The circuits shown in Fig. 2 and Fig. 3 are equally effective as unbalanced to balanced devices required between the unbalanced (coaxial) output of the transmitter and an antenna system which requires a balanced (twin-wire) feeder of any nominal impedance, i.e. anything from 75 ohms twinlead to 600 ohms open-wire feeder. The variable coupling control, the swinging link coil L2 in Fig. 2 or the variable capacitor C2 in Fig. 2 or C3 in Fig. 3 need be adjusted, in conjunction with C1 in each case, only at the centre frequency of the CW or phone section of the band in use to obtain a VSWR of 1:1. For QSY within a band, only C1 need be re-adjusted to maintain this VSWR at the output of the transmitter.

If a transmitter with a valve PA and pi-network output circuit is used, it is often possible to dispense with the use of a separate ASTU when feeding a multi-band antenna (such as a G5RV fed with 50 or 80 ohm coaxial cable) since the pi-network will transfer power efficiently to the reactive load presented

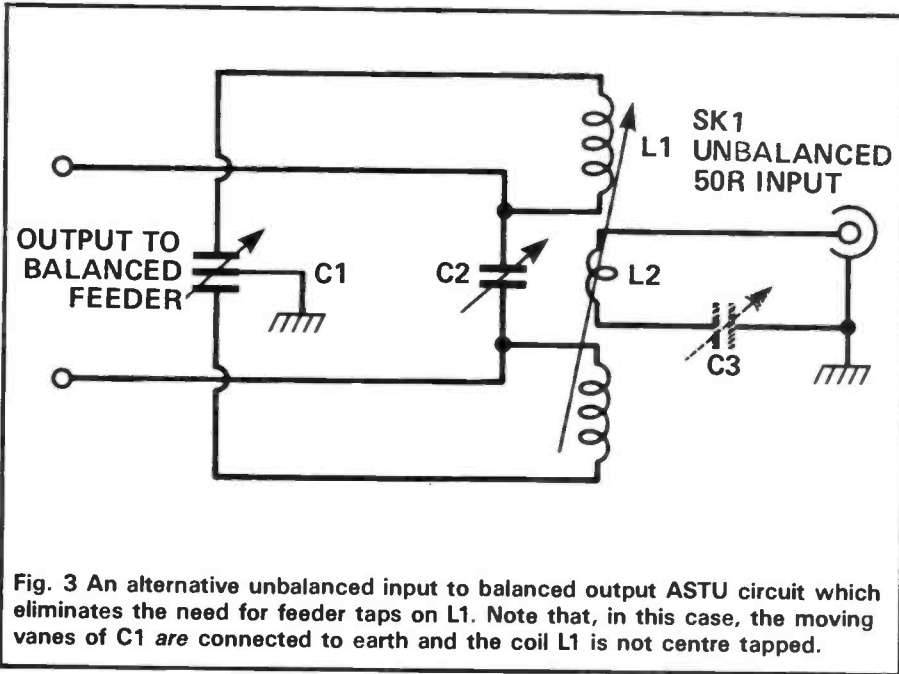

Fig. 3 An alternative unbalanced input to balanced output ASTU circuit which eliminates the need for feeder taps on L1. Note that, in this case, the moving vanes of C1 are connected to earth and the coil L1 is not centre tapped.

Components

- C1: 13-250pF per section split-stator variable capacitor (as Fig. 2).
- C2: 2 x 500pF receiver type variable capacitor (sections connected in parallel).
- C3: 500 pF receiver type variable capacitor (optional — see Note 3).

Band MHz	Turns	Coil i/d mm	L2 turns**
3.5	22+22 c/w	63	6 c/w
7.0	12+12 c/w	63	6 c/w
10	9+ 9 c/w	40	5 c/w
14/18	6+ 6 *	40	3 c/w
21/24/28	5+ 5 *	40	3 c/w

* Turns spaced wire diameter.

** i/d 40 mm.

SK1: coaxial socket.

Note 1: The coil turns of L1 for the 3.5 and 7.0 MHz bands are increased to compensate for the effect of C2 upon circuit resonance.

Note 2: Tuning procedure: with the appropriate coil L1 for the band in use plugged (or switched) in, the swinging link coil L2 is set at about half-mesh with L1 and C2 at about half maximum capacity, the tuning capacitor C1 is then adjusted for resonance at the operating frequency as indicated by minimum VSWR reading at the transmitter output. Link coupling is then increased or decreased as required to obtain even lower VSWR. Then C2 is adjusted to obtain the lowest possible VSWR, restoring resonance of the ASTU by slight re-adjustment of C1. The scale readings of C1 and C2 and the position of L2 (i.e. quarter in, half in or full in) are then logged for the centre frequency of each band and a calibration table is made so that re-setting of the controls for any band can be made in a few seconds. Tune-up should, of course, be done on low power.

Note 3: A 500pF receiver type variable capacitor C3 (shown by broken lines) may be used instead of the swinging link coil arrangement. In that case, each coil L1 would have its own built-in link coil of the number of turns shown above. Switched coils L1 and L2 may be used instead of plug-in coils.

at the station end of such a feeder and antenna system.

If it is desired, or found necessary, to use an ASTU with a coaxial feeder system, the unbalanced to unbalanced T-network circuit shown in Fig. 4 is recommended. The appropriate coil tap for the band in use is selected and C1, C2 are adjusted

approximately in step until a 1:1 VSWR at the transmitter output is obtained. This type of ASTU circuit may, of course, also be used in conjunction with a solid state or valve output transmitter working into a coaxial feeder which has standing waves on it, irrespective of the type of antenna in use.

Components

C1, C2: 160pF receiver type variable capacitors. Suitable for peak output power up to 100 watts.

L1: 22 turns 16 SWG enamelled copper wire close wound on a 40mm o/d paxolin or plastic tube former. Taps, counting from top of coil:-

Band MHz	Turns
3.5	22
7/10	8
14	5
18/21	4
24/28	3

SW1: ceramic wafer single pole 5 position switch.

SK1, SK2: coaxial sockets.

Note on Operation: after setting band switch to the required band, C1 and C2 should be adjusted 'in step' until minimum VSWR between transmitter and input to the ASTU is obtained. Coil taps may require to be altered + 1 turn to allow for the effect of a screening box or for the effects of the reactive component of the load applied to the output.

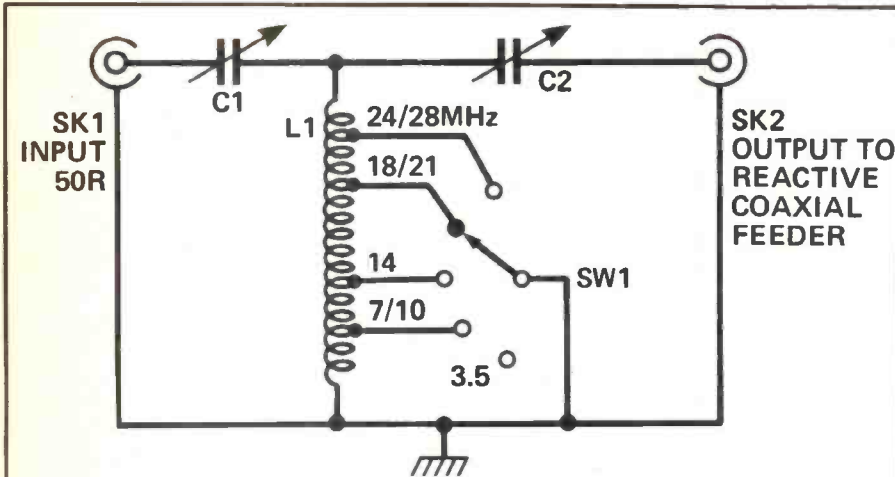

Fig. 4 'T' network, suitable for coaxial input and coaxial output (unbalanced to unbalanced) for 3.5 to 28 MHz operation.

RSCGB Presents

THE NATIONAL AMATEUR RADIO CONVENTION



MARCH 27-28
1987

NATIONAL EXHIBITION CENTRE, BIRMINGHAM
Friday & Saturday 10am-6pm

Comprehensive Lecture Programme - Introduction for Beginners
Major Equipment Exhibition - Large Component Marketplace
RSCGB Bookstall & Membership Services Stand
RSCGB Committee - Stands - Display Stands - and lots more!

TICKETS £2.50 (Children half price)

Car Parking FREE

Organised by the Radio Society of Great Britain



BELLE VUE RADIO AND ELECTRONICS Exhibition

by the Northern Amateur Radio Societies Association

in the

**CENTRAL HALL
BELLE VUE — MANCHESTER**



on
SUNDAY 15th MARCH 1987



Doors open at 11 am

The North's Premier Amateur Radio & Electronics Event

FEATURES

- * Inter-Club Quiz
- * Bring & Buy stall
- * R.S.G.B. Book stall
- * Grand Raffle
- * Amateur Computer stands
- * Club stands
- * R.S.G.B. Morse Tests
- * Restaurant & Bar
- * Play area for Children
- * Attractions for Ladies

Traders include

A.R.E. Communications, Arrow Electronics, J. Birkett, Brial Services, Display Electronics, Chester Electronics, The Computer Junk Shop, Greens Telecom, Harwood Trading, Heatherlite Mobile Mics., R.A. Kent, Linkbrook Ltd., M & B Radio, M.G.R. Services, Marco Trading, Minicost Trading, New Cross Radio, P.L.M. Communications, Practical Wireless, Quartslab, R.S.G.B., Royd Electronics, S.G.S. Electronics, Sandpiper Communications, Scarab Systems, W.H. Westlake, Witec Ltd., T.W. Wraith.

BELLE VUE HAS AMPLE CAR PARKS

RADIO TALK-IN ON S22 and SU8

ADMISSION £1 (OAP's 50p, under 14's free) BY RAFFLE TICKET AND EXHIBITION PLAN

ENTER AT REAR OF BELLE VUE - From Redgate Lane - OFF HYDE ROAD A57

BEARCAT DX-1000 REVIEW



The Bearcat DX-1000

Bearcat have dropped down in frequency for their first HF radio. Has the performance fallen too? Chris Lorek examines this alternative to the big three's offerings.

Features

Despite the large case, the set operates from a 12V nominal supply, either from internal batteries or from a small optional external power supply. The receiver covers from 10kHz to 30MHz, with selectable AM, FM, CW, LSB and USB modes. Filter bandwidths of 2.7kHz, 6kHz and 12kHz are independently selected, together with slow or fast AGC decay. Frequency selection is either by direct keyboard entry, rotary manual tuning in selectable 1kHz or 100Hz steps, Up/Down buttons with any pre-programmed step rate, or by recall of a pre-programmed memory channel. The latter facility gives you ten channels, each storing frequency and reception mode. A separate fine tune knob allows interpolation between frequency steps, giving approximately ± 2 kHz range.

An all-mode variable squelch is provided, together with a switchable noise blanker, the pulse length of which may also be switched between 30 μ s (fast) for impulse noise such as ignition interference,

At first glance, the DX-1000 seemed to be just yet another of those all-singing boxes which are often seen in high street electrical stores. These are designed to 'appeal' rather than 'perform', and once the novelty aspect has worn off they are frequently left tuned to a local medium wave broadcast station, just like any other 'tranny'. This receiver seems to have been aimed at the same market; but whilst looking around an amateur radio shop one Saturday morning, I couldn't help but notice that this was something different. Gone were all the tinny and squawky noises, just the pure interference free sound of radio amateurs chatting away.

New Pastures

The name 'Bearcat' has been uniquely associated with VHF/UHF

scanner receivers in the past, and it is fair to say that they are a respected name with more experience in this field than any other manufacturer. The production of a HF receiver is a radical change of direction, so it was with great interest that I took up the offer of a review sample. I particularly wanted to see whether their synthesiser experience had paid off in an area where strong signal handling and interference rejection is far more important than 1000 channel memories and maximum scanning rate.

The associated publicity information as well as the accompanying instructions go to great lengths in assuring the user that tuning in worldwide shortwave is very simple, yet the front panel hosts 45 knobs and buttons together with 15 LEDs and a digital display, could this be right? Let's find out . . .

and 20mS (slow) to suppress over the horizon radar pulses originating from both sides of the iron curtain. An RF attenuator gives 20dB and 40dB steps, and a variable tone control makes sure you get Radio Tirana or whatever to sound to your liking. An internal speaker is fitted at the front of the set, and facilities for headphones, tape recorder, and an external speaker are provided.

The reception frequency is shown to the nearest kHz by a five digit red LED display, further LEDs give indications of reception and operating modes. A back-lit meter shows relative signal strength and this is calibrated both in the usual S-points up to S9+40dB, plus a 1-5 SINPO scale for broadcast reception use. A dimmer switch allows you to cut down the brightness of all of the indicators, either for night-time use or to reduce battery drain. The frequency display doubles as a dual time-zone clock and may be used for unattended tape recording purposes in much the same way as a sophisticated video recorder timer. This allows up to five separate program recordings to be made, each with selectable frequency and mode by use of the memory channels.

Connections are provided on the rear panel for low and high impedance aerial inputs, ground, receiver muting, tape recorder audio and switching, external speaker, and 12V power, a standard headphone jack being fitted to the front panel. A small telescopic aerial which may clip onto the back is provided with the set, together with a length of plastic insulated wire for use as a more efficient temporary long-wire aerial.

The instruction manual gives clear operating instructions and HF reception background information, but gives no circuit details or user servicing information. The set measures 370mm(W) x 130mm(H) x 240mm(D) and weighs just under 6kg without batteries, 8kg with.

First Impressions

From the viewpoint of an ordinary user, I don't think my granny would be able to tune in Radio Australia very easily on it, despite Bearcat's wishes. As for myself, I believe it outclasses many other sets on features alone. I took a great dislike to the cheap, dare I say gaudy, pre-

sentation of the fascia and operating controls, with the use of silvered plastic knobs and buttons. A small further expense lavished in this area would have worked wonders I feel. A large, conspicuous carrying handle is provided, but I would not call it a portable set by any means, due to its size, weight, and aerial requirements.

I was very pleased with the 10kHz start to the frequency coverage, this is not often found on more expensive radios and it did rather surprise me; I was impressed with the range of selectable filter widths fitted as standard. Although I'm not an avid broadcast listener, the ability to pre-program a tape recording session would be very useful, as interesting shortwave programs have a habit of cropping up while we're otherwise occupied. Coupled, with a car cassette player or suchlike, this could restore 'normal' family life in some cases!

On The Air

The real test of course is how it operates on the air, no matter how many features a set has it's of no use if you can't hear the station you want due to poor adjacent frequency rejection. A shop demonstration using an unfamiliar aerial and ground system will show little of how any HF set will operate from your own location, and can often be deceiving in this respect, so off we go.

The set was placed in my shack

and tested on a variety of aerials, from a three element tribander and 160/80/40m trap dipole, down to the small whip aerial and even a length of wire thrown outside to simulate the wire aerial supplied.

It took quite a while to get used to operating the set, Bearcat's logic and mine did not seem to match up I'm afraid. However by keeping the instruction book handy, I did get the hang of it after an hour or so. I found the reception quality on SSB to be superb compared to other sets in the same price range, the 2.7kHz filter cutting adjacent stations down nicely. The 100Hz steps were a little off-putting when trying to achieve the best tonal balance and I feel 25Hz or even 50Hz would have been far better. I'm starting to get fussy of course as the fine tune control was available when required, and this did prove useful for accurate reception of narrow RTTY stations. For casual tuning around it was rarely used on SSB, and never required on AM or FM.

I never found the need to switch the attenuator in except to give my ears the occasional rest. Despite looking for an improvement in interference from intermod with use of the attenuator I just could not find it, showing a good front end dynamic range. Signals were not overloading the set when coupled to my 70m long trap dipole, but monster aerial owners trying to dig out weak DX on the broadcast bands

Internal view from above

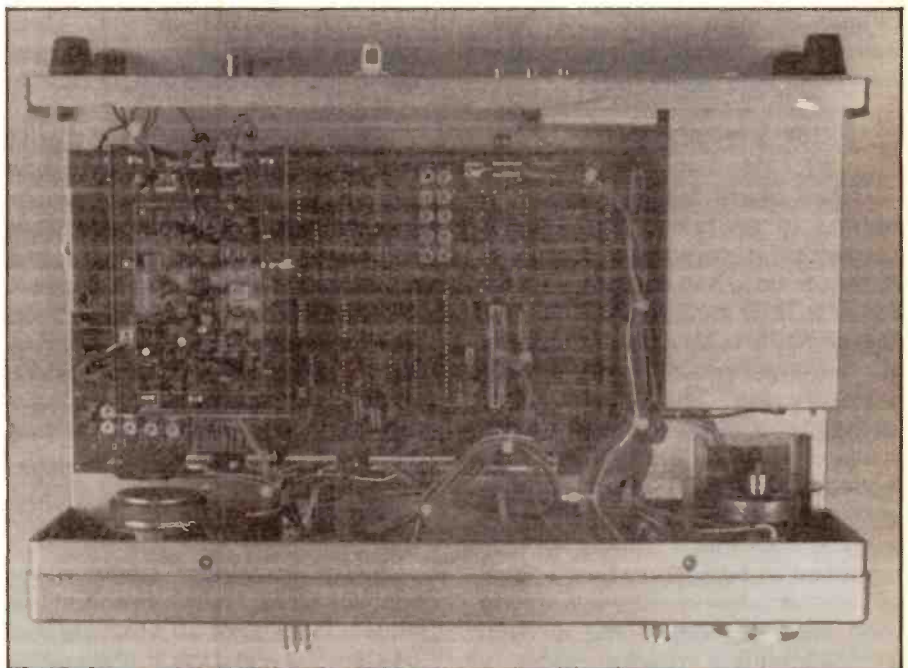

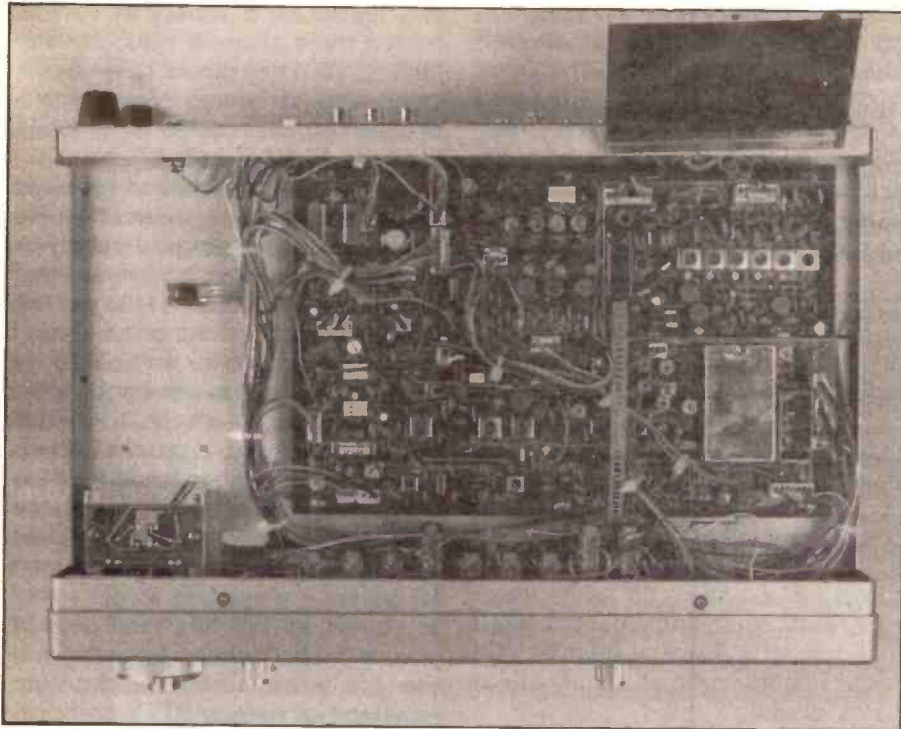

Internal shot taken from below

surrounded by high-power stations could possibly benefit from this facility, as could active aerial users. The all mode squelch was useful both in monitoring 29.6MHz FM for activity as well as the odd quiet 160m net frequency whilst doing other things in the shack. The AGC decay time was fine in the slow position, but when switched to 'fast' the decay was still around 750mS, too slow when listening to squelched FM or experiencing QRM when trying to copy weak SSB/CW stations. An AGC on/off switch coupled with a variable RF gain would have been useful, but we're starting to increase the complexity again here!

Filter Switching

I had mixed feelings about the method of switching the receiver bandwidth, it would have been convenient to have had automatic selection of 2.7kHz for SSB/CW, 6kHz for AM, and 12kHz for FM, as these are the settings most people would habitually use. This would cause further operating complications however if a different filter was required dependent upon interference conditions, so I shouldn't grumble too much should I, it is supposed to be easy to use — isn't it? I liked the feel of the main tuning knob and the finger hole is even provided with a rotating insert to

save wear and tear on the fingertips. I still shudder each time I use some Japanese amateur transceivers with *rubber* fingerholes!

Using short aerials such as the telescopic whip and a length of wire thrown out of the window still managed to pull in a reasonable number of stations, especially on the HF broadcast bands from the usual 100kW transmitters battling against each other to gain supremacy. This still shows a reasonable overall sensitivity which would be of use to flat dwellers and the like. Reception of Rugby on 60kHz was very clear using an outdoor aerial and the extended VLF range down to 10kHz proved fascinating.

When tuning to AM broadcast stations of known frequency, I was surprised to find that the receiver was operating around 4kHz low, this was found to occur on FM also, but not on other modes. The supplier was contacted and two further sets tested for this with no fault being found, showing the original review sample either slipped through Bearcat's inspection department or had developed the fault in use.

Circuitry

A dual conversion superheterodyne is used, with intermediate frequencies (IFs) of 40.455MHz and 455kHz. The high first IF gives good

image rejection, whilst the second allows good selectivity without the use of expensive multi-pole crystal filters. Dependent upon the receive frequency information gathered by the digital control processor, one of a bank of seven varicap-tuned front end filters is put into circuit and matched to the antenna by a switchable RF transformer for high or low impedance aerial. The bandpass filter output is fed to a 3SK73 FET RF amp, and passed to a pair of 3SK73's acting as the first mixer. The resultant IF signal is passed via a pair of monolithic dual crystal filters to give roofing selectivity and into a further 3SK73 amp and pair of 3SK73's which are used as the second mixer. Noise blanking switching is carried out at this stage and the processed signal is then passed to diode switched 455kHz ceramic filters, a metal encapsulated LF-C2A filter is used for SSB, whilst for AM and FM, LF-H6 and LF-H12 filters are used respectively.

Further IF amplification and AGC detection takes place, followed by separate detectors for AM, FM, and SSB/CW, with the S-meter and squelch both being AGC-level controlled. A CMOS analogue switch is used for audio routing (and hence mode selection) followed by separate amplifiers for loudspeaker and tape output.

One of the two Voltage Controlled Oscillators (VCO's) is selected dependent upon the receive frequency, and is controlled by a MC145154 synthesiser and uPD572C dual-modulus prescaler, under serial control from a custom microprocessor. A DC-DC converter provides a high voltage for the active reference filter, giving an increased tuning range for a given varicap coupling, hence better reciprocal mixing performance. A 1kHz reference is used, 100Hz steps being provided by a switched analogue voltage level to a varicap across the second local oscillator crystal, 'fine tuning' also being controlled at this point. Band segment data is fed to digital-analogue converters controlling VCO ranges as well as front end tuning via a further varicap.

General Construction

The set is constructed on a two-sided steel chassis with a wrap-around outer case. A large battery

enclosure takes up some of the space but there is still a bit of room to get your hands in for servicing, all components being leaded and discrete. The digital circuitry on the topside is effectively screened from the analogue RF circuitry mounted on the underside of the chassis. The RF front end, first injection oscillators and mixer are separately screened from the remainder of the circuitry which is mounted on one printed circuit board, except for the main VCO's which are mounted in a separate, individually screened box in the digital half of the receiver. Sub-boards for switches, displays and the tuning knob opto-coupler are mounted on the front panel and multiple board-mounted sockets mating with wired plugs are used for board interconnections.

The sensitivity was confirmed as being good but not oversensitive, showing a good compromise that allows a degree of protection from non-linearity, aided by the switchable attenuator facility. The blocking performance was better than I would have expected from a set in this price range, showing that the manufacturer's experience in switched and tuned front end stages has paid off. The intermodulation rejection (where two signals combine causing mixing products to occur with the modulation of both superimposed) was quite good but not over impressive, however again for a set of this price range far better than I would expect. The high first IF offers good image rejection, but the choice of 40.455kHz unfortunately place the images right in the middle of Broadcast Band II. However the rejection

of these measured extremely well indeed, in fact I had to add a high pass filter in line with the signal generator RF output to overcome the noise limitations of the measuring equipment itself!

The S-meter did not give a very wide dynamic range, and was limited to around 38dB — under no signal conditions, the needle hovered just under the S2 mark and was a little slow in moving on weak signals. OK for SWL use and comparative reports but not of course in the league of £1000+ transceivers in terms of absolute accuracy.

In measuring the RF selectivity I was pleased at the fast rate of fall-off, especially on SSB/CW. The shape factor was a little assymetrical on AM and FM but still very good with the ultimate rejection of all filter combinations being excellent for this type of equipment. As this receiver is designed for entertainment use as well as pure voice communication reception, I took the liberty of performing a quick measurement of audio response and distortion. With the tone control centred, the AM received fidelity was nicely shaped between 300Hz and 3kHz, the LF response limited by the tone control circuitry and the HF response by the filter selectivity. By decreasing the tone, LF boost was clearly pronounced, but to achieve any significant HF boost required the 12kHz filter to be switched in. This would allow good quality but only in clear band conditions of course and the measured AM distortion was found to be very acceptable at less than 3%. On SSB, the audio bandwidth was a little more restricted giving

clearer copy to the average SSB amateur signal, the distortion in this case of just less than 10% would in my opinion be perfectly adequate.

The AGC dynamic range was tested, and on SSB no problems were encountered right up to 3V PD input of signal level, but on AM overloading occurred with signal levels in excess of 37mV PD, ie. with the S-meter needle hard on the end stop. Only listeners living very close to transmitting stations and suchlike would need to place attenuation in to achieve undistorted reception.

Nice Specs, Shame About The Case

Despite its cosmetic appearance the set performs extremely well and it is deceiving in this respect. Many features are present which could not be found on the average Japanese receiver sold on the secondhand market for around the same price, and for this reason I feel it is excellent value for money if you are looking for an all-singing digital read-out set.

It really is a shame that Bearcat could not have given it a more professional image similar to their 100XL handheld scanner for example, rather than a flashy consumer appearance. This of course is a biased opinion from a radio amateur, but its performance and features I believe have been over engineered for the average, non-specialist, user. Congratulations Bearcat, for getting a good RF performance first time in a new venture, and at a fairly reasonable cost of £379.

Rear panel connections

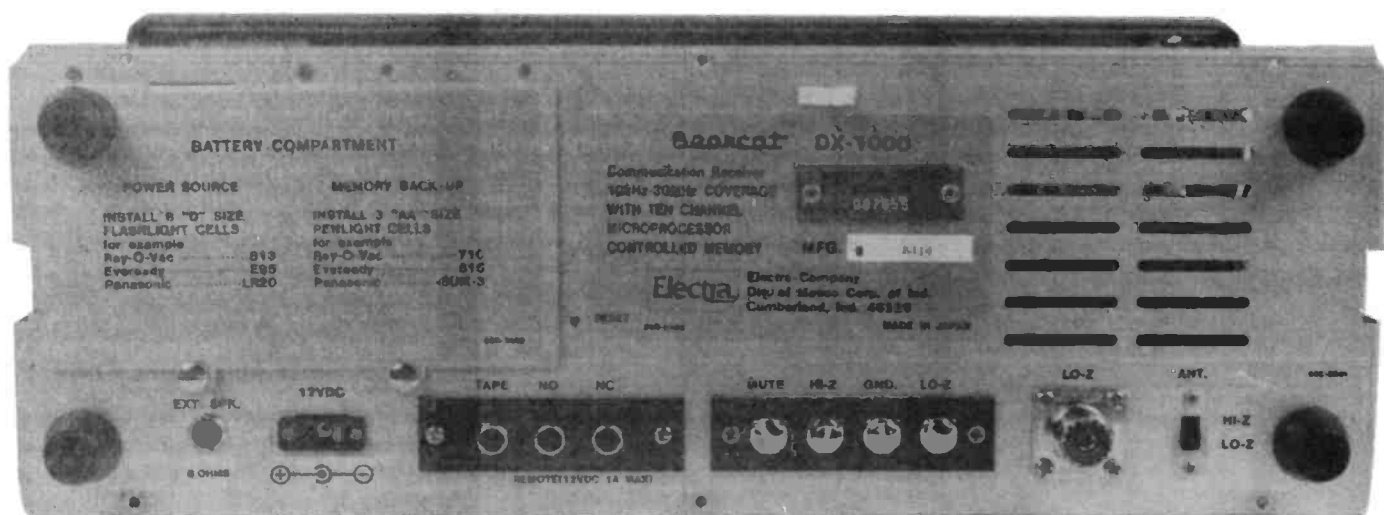

Laboratory Results

Sensitivity: Input level in μV pd at 50 ohm SO239 connection giving 12dB SINAD

Freq (MHz)	SSB/CW 2.4kHz b/w	AM (30% mod) 6kHz b/w	FM (1.5kHz dev) 12kHz b/w
0.150	0.326	2.14	0.950
0.500	0.324	2.13	0.941
1.0	0.208	1.93	0.746
2.0	0.192	1.52	0.653
4.0	0.280	2.26	0.871
6.0	0.223	1.81	0.887
8.0	0.160	1.57	0.656
10.0	0.113	1.47	0.657
12.0	0.195	1.76	0.752
14.0	0.308	2.40	1.000
16.0	0.250	2.01	0.879
18.0	0.218	1.80	0.818
20.0	0.250	1.87	0.851
22.0	0.274	2.23	0.937
24.0	0.294	2.25	0.945
26.0	0.282	2.15	0.941
28.0	0.250	1.93	0.886
30.0	0.249	2.02	0.944

Intermodulation Rejection: Level of two signals, separated by +100kHz and +200kHz, required to cause 12dB SINAD on-channel signal, measured using AM and 6kHz RX bandwidth

RX Freq (MHz)	Interfering Signal Level
2.0	2.70mV pd 65.0dB
7.0	3.60mV 66.5dB
15.0	5.12mV 67.3dB
28.0	2.64mV 62.7dB

Image Rejection: Level of signal separated by (2 x 40.455MHz) to cause 12dB SINAD on-channel signal, measured using AM and 6kHz RX bandwidth

RX Freq (MHz)	Interfering Signal Level
2.0	1.52V pd 120.0dB
7.0	1.34V 117.9dB
15.0	0.30V 102.7dB
28.0	0.96V 113.9dB

Blocking Rejection: Level of unmodulated interfering carrier required to cause degradation of 12dB SINAD on-channel signal to 6dB SINAD, measured using AM and 6kHz RX bandwidth

RX Freq (MHz)	Interfering signal separation		
	+ 100kHz	+ 1MHz	+ 10MHz
2.0	18.5mV pd 81.7dB	37.4mV pd 87.8dB	24.7mV pd 84.2dB
7.0	11.9mV 76.9dB	20.7mV 81.7dB	33.8mV 85.9dB
15.0	6.7mV 69.7dB	39.7mV 85.1dB	44.7mV 86.1dB
28.0	11.2mV 75.2dB	36.2mV 85.5dB	89.9mV 93.3dB

Attenuator Accuracy: Measured at 14.25MHz

Setting	Measured
20dB	20.5dB
40dB	41.4dB

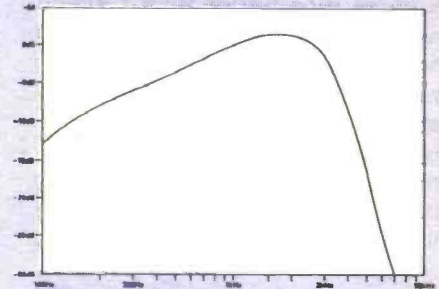

AM audio response — tone control centred and using 6kHz b/w.

S-Meter Linearity: Measured at 14.25MHz

Level	SSB/CW (2.7kHz b/w)		AM (6kHz b/w)	
	Value	dB	Value	dB
S2	21.9 μV pd	-16.7dB	24.6 μV pd	-16.4dB
S3	38.1	-11.9	42.7	-11.6
S4	57.0	-8.4	61.0	-8.5
S5	80.6	-5.4	88.1	-5.3
S6	98.0	-3.7	108.4	-3.5
S7	119.2	-2.0	131.8	-1.8
S8	132.2	-1.1	146.2	-0.9
S9	150.0	0dB ref	162.2	0dB ref
S9 + 10dB	205	+2.7	229	+3.0
S9 + 20dB	292	+5.8	327	+6.1
S9 + 30dB	557	+11.4	624	+11.7
S9 + 40dB	1.87mV	+21.9	2.14mV	+22.4

Overall Bandwidth: Measured at 10.7MHz (see accompanying graphs for full plots)

Filter b/w	-3dB	-6dB	-60dB
2.7kHz	1.8kHz	2.35kHz	9.00kHz
6kHz	2.60kHz	4.05kHz	19.55kHz
12kHz	4.45kHz	6.00kHz	26.95kHz

Audio Distortion: Measured with 2.0W output of 1kHz audio into 8 ohm load and 1mV Rx signal

Mode	Test Conditions	Distortion
SSB	2.7kHz b/w	9.70%
AM	6kHz b/w & 30% mod	2.68%
FM	12kHz b/w & 1.5kHz dev	4.12%

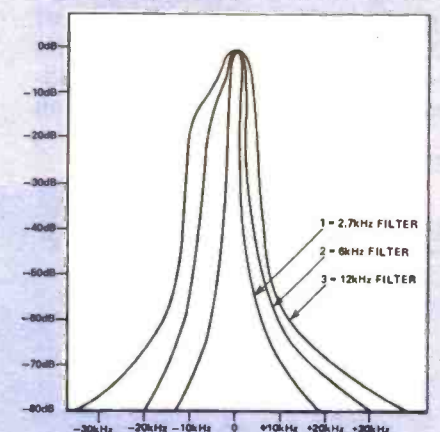

The DX-1000 RF bandwidth plots for (1) the 2.7kHz, (2) 6kHz and (3) 12kHz filters.

My thanks go to Ray Withers Communications Ltd of Birmingham for the loan of the review set.

TX-3 RTTY/CW/ASCII TRANSCEIVE

All the features you've ever wanted in this really top class program. Previous adverts give more details but some of the facilities are:

Split-screen, type-ahead operation, receive screen unwrap, 24 large memories, realtime clock, review store with output to screen or printer, callsign capture, save/load memories, review store and status, RTTY auto CR/LF, CW software filtering and much more. Uses interface or T.U. For **BBC-B** and **CBM 64**. Tape £20.

RX-4 RTTY/CW/SSTV AMTOR RECEIVE

This is still a best-selling program and it's easy to see why. Superb performance on 4 modes, switch modes at a keypress to catch all the action. Text and picture store with output to screen, printer and tape/disc. An essential piece of software for the SWL (and a lot of licensed hams also!) **SPECTRUM** needs no hardware, **BBC-B**, **CBM64** and **VIC20** need interface or can use a T.U. on CW and RTTY. Tape £25.

TIFI INTERFACE operates both these programs and has 2-stage RTTY and CW filters for improved reception, and transmit outputs for MIC, PTT and KEY. Kit £15 (assembled PCB + cables and connectors) or ready-made £25 in a box with all connections, inc. MIC plug for transmit. Extra MIC leads for extra rigs £3 each.

Our **MORSE TUTOR**, already well known for its ease of use and very effective operation, has now been **much improved with extra features** you have asked for. Comprehensive facilities for teaching the characters by sound, possibility of having 'difficult' characters sent more often, the addition of common punctuation marks to the vocabulary and 40 pre-recorded plain language texts for the run up to the test. All the old features are still there, also, to make this the easiest, fastest way to learn morse. For **BBC-B**, **ELECTRON**, **CBM64**, **VIC20**, **SPECTRUM**. Tape £6.

Also programs for **LOCATOR** £7, **LOGBOOK** £8 and **RAE MATHS** £9.

All BBC and CBM64 programs are available on **disc** at **£2 extra**.

Prices include VAT and p&p, 1st Class inland, airmail overseas, normally by return. Eire, C.I, BFPO deduct 13%.

technical software (HRT)

Fron, Upper Llandwrog, Caernarfon LL54 7RF
Tel: (0286) 881886



BINDERS

FOR YOUR VALUABLE COLLECTION
OF HAM RADIO TODAY

MAGAZINES

• SMART • EASY TO USE • TOP QUALITY
To ASP Readers Services, PO Box 35,
Wolsey House, Wolsey Road, Hemel
Hempstead, Herts HP2 4SS (0442-41221)

£5.20
inc
P&P

Please supply Ham Radio Today Binders
@ £5.20 inc. P&P

Total £ (Please make cheques payable to ASP Ltd.)

Years Required — 198.....198.....198.....198.....

Name

Address

Please allow 21 days for delivery



AMATEUR ELECTRONICS UK

G6XBH
G1RAS
G3UUS

R.A.S. (Nottingham)
Radio Amateur Supplies
Tel: 0602 280267



Visit your Local Emporium

Large selection of New/Used Equipment on Show

AGENTS FOR:

F.D.K.
AZDEN
ICOM
YAESU
ALINCO
KENPRO

ACCESSORIES:

Wels Range
Microwave Modules
Adonis Mics
Mutek Pre-Amps
Barenco Mast Supports
Agents for **VODAPHONE & CELLNET**

DRAE products
BNOS Linears and
PSUs

AERIALS: Tonna, Halbar, Jaybeam, New Diamond Range of Mobile Whips
Bring in your secondhand equipment for sale

JUST GIVE US A RING

Monday: CLOSED Tuesday-Saturday: 10am to 5pm

3 Farndon Green, Wollaton Park, Nottingham NG8 1DU
Off Ring Rd. between A82 (Derby Road) & A609 (Ilkeston Road)

£500 of Electronic Equipment
to be **WON** in the new

Circuit catalogue.



£1.20

★ £8 worth discount vouchers

★ 164 pages featuring over 3,000 products.

★ Many new products, plus all the old favourites

★ £500 worth of electronic equipment and components to be won in our catalogue competition.

★ On sale at your newsagent from 16th October, or direct from the address below.



Circuit Distribution Ltd



Park Lane, Broxbourne, Herts, EN10 7NQ Tel: (0992) 444111. Tlx: 22478

MRT 3/87

Name

Address

Postcode.....

HF

VHF/UHF

Receivers

Tick your special interest
I enclose £1, please send me a copy of the Lowe Catalogue and current Price List.

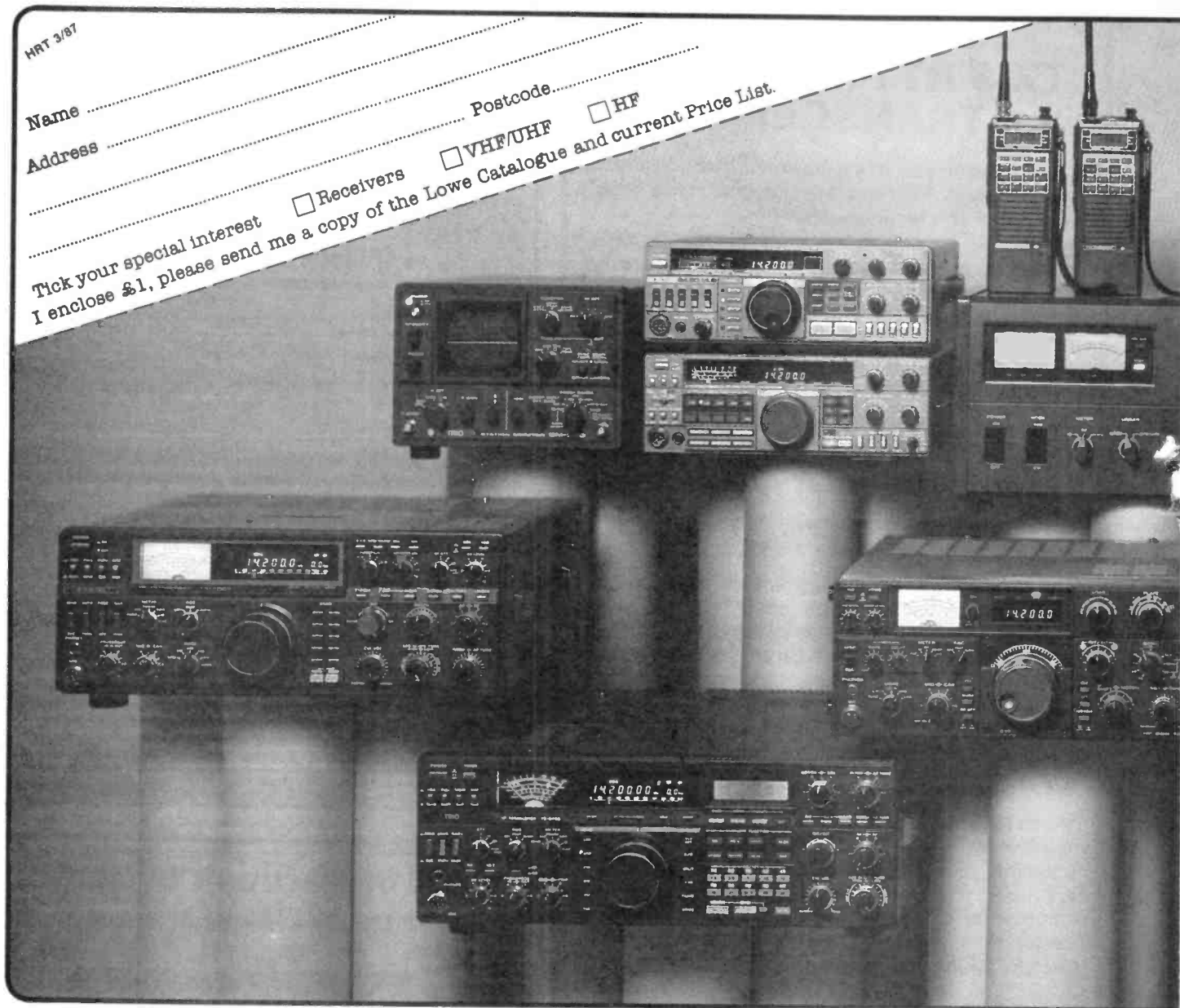

- 1 TS9406 HF transceiver.** Modes > USB, LSB, CW, FSK, FM, AM. Frequency range > transceive 160 to 10 metres, receive 160 kHz to 30 MHz. Power input > 250 watts PEP, AM 140 watts. Power supply > internal psu, 240 VAC. Features > 40 memories, 2 VFOs, provision for internal ATU, keyboard frequency entry, SSB IF slope tuning, CW variable band width, CW full break-in, IF notch filter, Audio filter, variable CW pitch, optional voice synthesizer etc.
- 2 TS9306 HF transceiver.** Modes > USB, LSB, CW, FSK, AM. Frequency range > transceive 160 to 10 metres, receive 160 kHz to 30 MHz. Power input > 250 watts, AM 80 watts DC. Power supply > internal psu, 240 VAC. Features > 8 memories, 2 VFOs, optional internal ATU, CW full break-in, SSB IF slope tuning, CW variable band width, IF notch filter, audio filter etc.
- 3 TS4406 HF transceiver.** Modes > USB, LSB, CW, FSK, FM, AM. Frequency range > transceive 160 to 10 metres, receive 100 kHz to 30 MHz. Power input > 200 watts PEP, AM 110 watts DC. Power requirement > 13.8 VDC, transmit 20 amps. Features > 100% duty cycle, optional internal ATU, CW full break-in, IF shift, notch filter, 100 memories, keyboard frequency entry, manual or automatic bandwidth selection optional voice synthesizer etc.
- 4 TS4306 HF transceiver.** Modes > USB, LSB, CW, AM and optional FM. Frequency range > transceive 160 to 10 metres, receive 160 kHz to 30 MHz. Power input > SSB 250 watts PEP, CW 200 watts DC, FM 120 watts, AM 60 watts. Power requirement > 13.8 VDC, transmit 20 amps. Features > 8 memories, 2 VFOs, memory and programmable band scan, IF shift, notch filter etc.
- 5 TS8306 HF transceiver.** Modes > USB, LSB, CW. Frequency range > 160 to 10 metres. Power input > 220 watts PEP, CW 180 watts DC.

Power requirement > 240 VAC. Features > pair of 6146B valves in PA, variable band width tuning, notch filter, IF shift, RF speech processor etc.

6 TS8306P HF transceiver. Modes > USB, LSB, CW. Frequency range > 160 to 10 metres. Power input > 220 watts PEP, CW 180 watts DC. Power requirement > 240 VAC. Features > pair of 6146B valves in PA, IF shift, notch filter etc.

7 SM220 station monitor. Features > TX and RX waveform monitoring, trapezoid linearity check, two tone test generator, wide band oscilloscope, panoramic display (band scan) with optional BSS unit having 40 kHz/200 kHz sweep width. Versatile and invaluable station accessory.

8 TL922 HF linear amplifier. Modes > SSB, CW, RTTY. Frequency range > 160 to 10 metres. Power input > SSB 2000 watts PEP, CW 1000 watts DC. Drive > 80 watts or more for full output. Power requirement > 240 VAC, 14 amps. Features > class AB2 grounded grid amplifier using a pair of EIMAC 3-500Z valves.

9 TS670 Quad band transceiver. Modes > USB, LSB, CW, AM and optional FM. Frequency range > 40, 15, 10, 8 metres. Power output > USB, LSB, CW, FM 10 watts, AM 4 watts. Power requirement > 13.8 VDC, 4 amps. Features > 80 memories, 2 VFOs, keypad frequency selection, optional general coverage receive board etc.

10 TM201A two metre mobile. Mode > FM. Frequency > 144 to 146 MHz. Power output > 25 watts. Power requirement > 13.8 VDC, 5.5 amps. Features > compact, 2 VFOs, 5 memories, priority alert, memory and programmable band scan, full repeater facilities, includes external speaker, mobile mount and up/down microphone.

11 TM411E seventy centimetre mobile transceiver. Mode > FM. Frequency > 430 to 440 MHz. Power output > 25 watts. Power

requirement > 13.8 VDC, 6.9 amps. Features > digital code squelch, tilting front panel, 2 VFOs, 5 memories, priority alert, memory and programmable band scan, full repeater facilities, includes external speaker, mobile mount and up/down microphone.

12 TM211E two metre version of TM411E mobile transceiver.

13 TM250E two metre mobile transceiver. Mode > FM. Frequency range > 144 to 146 MHz. Power output > 45 watts. Power requirement > 13.8 VDC, 9.6 amps. Features > large display, illuminated keypad, optional digital channel link, high output power, optional voice synthesizer etc.

14 TH41E seventy centimetre handheld transceiver. Mode > FM. Frequency range > 430 to 440 MHz. Power output > 1 watt or 150 mW. Power requirement > 7.2 VDC from supplied nicad pack. Features > compact, slim and lightweight, thumbwheel switch frequency selection, full repeater facilities etc.

15 TH21E Two metre version of TH41E.

16 TR2600E two metre handheld transceiver. Mode > FM. Frequency range > 144 to 146 MHz. Power output > 2.5 watts or 0.3 watts in low power position. Power requirement > 8.4 VDC from supplied nicad pack. Features > compact and lightweight, 10 memories, memory scan, programmable band scan, keyboard frequency selection, digital code squelch, full repeater facilities etc.

17 TR3600E Seventy centimetre version of TR2600E. Note, does not include nicad or mains charger.

18 TS711E two metre base station transceiver. Modes > USB, LSB, CW, FM. Frequency range > 144 to 146 MHz. Power output > 25 watts. Power requirement > internal

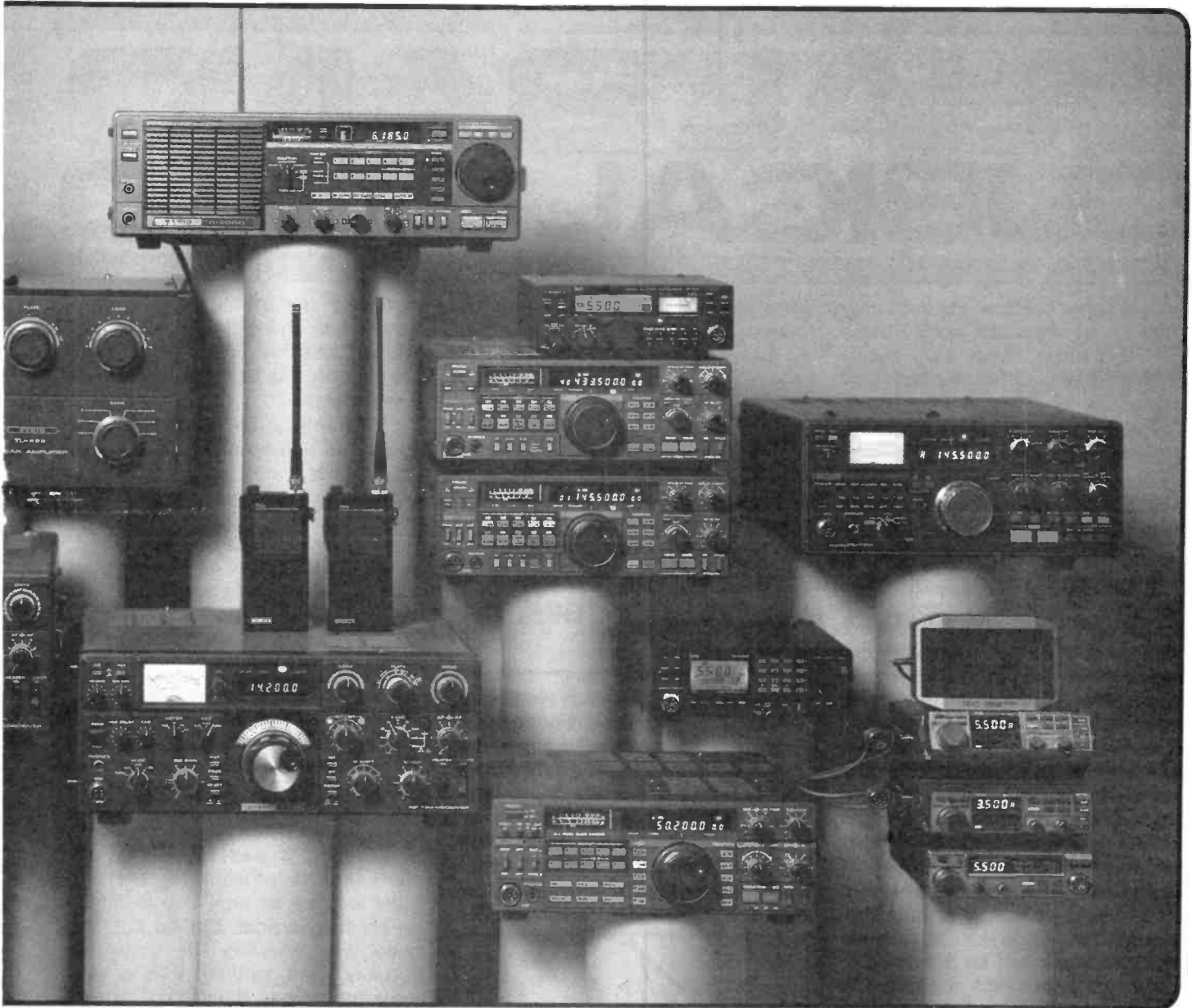

power supply 240 VAC or 13.8 VDC at 6.5 amps. Features 10 Hz step dual VFOs, IF shift, auto mode selection, 40 memories retaining frequency, mode, simplex or repeater shift, tone burst. Programmable band scan, memory scan, free running or stepping VFO, digital code squelch etc.

19 TS811E seventy centimetre version of TS711E.

20 TR751E two metre mobile/base station transceiver. Modes USB, LSB, CW, FM. Frequency range 144 to 146 MHz. Power output 25 watts. Power requirement 13.8 VDC at 6 amps. Features auto mode selection according to band plan, excellent receive performance, 2 VFOs, 12.5 kHz steps on FM, alert channel, all mode squelch, memory frequencies can be transferred to VFO, optional digital channel link, optional voice synthesizer, full repeater facilities etc.

21 TS780 dual band base station transceiver. Modes USB, LSB, CW, FM. Frequency range 144 to 146 and 430 to 440 MHz. Power output 10 watts. Power requirement 240 VAC or 13.8 VDC at 5 amps. Features full coverage of two metres and seventy centimetres in one transceiver, 10 memory channels, 2 VFOs, memory scan, band scan, IF shift, full repeater facilities, VOX operation, free running or click stop VFO etc.

22 R2000 general coverage receiver. Modes USB, LSB, CW, FM, AM. Frequency range 150 kHz to 30 MHz. Power requirement 240 VAC or 13.8 VDC. Features optional internal VHF converter covering from 118 to 174 MHz, 10 memories storing frequency, band and mode. Memory scan, programmable band scan, all mode squelch, tone control, slow or fast AGC, high and low impedance aerial terminals, remote switching from internal clock (tape recorder), receiver muting etc.

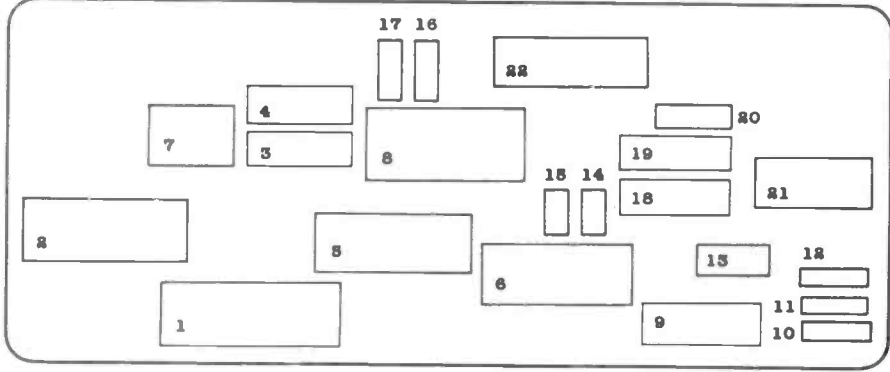

the TRIO range

from

LOWE ELECTRONICS LTD.

Chesterfield Road, Matlock, Derbyshire DE4 5LE
 Telephone 0629 2817, 2430, 4057, 4995
 Telex 377482 LOWLEC G

DUAL BAND CUBICAL QUAD

Even at the present sunspot low there is a lot of interest in the 50 and 28MHz bands. These two bands combine many different modes of propagation: sporadic E, tropo, meteor-scatter and other form of propagation are all to be found on these bands at some time or other. The availability of low cost easily

receiver to be present in the constructors shack.

Cubical Quad Design Parameters

At the spacing (ie. boom length) of 0.12 of a wavelength the gain of a two-element quad is theoretically

optimum length of 0.12 of a wavelength on 28MHz) a gain of 6dB will still be achieved on 50MHz, the spacing on this band being 0.22 of a wavelength.

With this boom length radiation resistance will be around 72 ohms on 28MHz, and 120 ohms on 50MHz, both offering a reasonable match to 75 or 50 ohm feeder. In practice, when fed through a 1:1 balun, SWR figures on the writer's quad at the design frequency are 1.15 to 1 on 28MHz, and 1.5 to 1 on 50MHz, each quad having a separate feedline.

Gain figures are difficult to evaluate, unless extensive equipment is available. A simple test was carried out by the writer 28MHz by switching from a ground-mounted five-eighth wavelength vertical to the quad, which has an average height of 35 feet. It was found that on short-skip (European) signals the quad was on average two S-points up on the vertical, but on DX the quad was allowing the writer to actually work stations that simply were not there on the vertical. Whilst this test is subjective, a reference dipole was not available at the time, there is no doubt in the writer's mind that the quad out-performs the vertical by three or four S-points at DX.

For a little trouble and a few pounds, you could be working stations on 28 and 50MHz that you can't even hear at the moment. Roger Thomas, GW4BCD, shows how it's done.

convertible equipment for these bands has led to an enormous increase in amateur activity, especially on ten metres. With the eventual improvement in band conditions as we approach sunspot maximum in 3 or 4 years time there will be a fascinating amount of propagation data to be obtained from this part of the spectrum, especially as we in the UK are now allowed to transmit on 50MHz.

It has been said that on ten metres at sunspot maximum a piece of wet string will work the world. This may have been true at a time when the amateur population of Europe was a fraction of what it is today, but during the next sunspot peak there will be far more competition to work the DX. The proverbial piece of string will still bring them back sometimes, but there is no doubt that the amateur who invests some time in building the best antenna available will reap the benefit. That 2 kilowatt amplifier is useless if you can't hear them!

With these points in mind the writer felt that a description of his two-element dual band quad would be of interest to readers. This design features around 7dB of gain on both bands, low angle radiation, light weight, and can be built for a few pounds. The only piece of test gear needed to tune up the quad is a dip oscillator, assuming a transceiver or

7.2 dB and the radiation resistance around 70 ohms, depending to some extent on the quad's height above ground. When designing a dual-band quad a compromise has to be made, unless a purpose built angled spider can be made or bought. Fortunately the Quad is a low-Q antenna, and if a boom length of .50 inches is decided upon (this being the

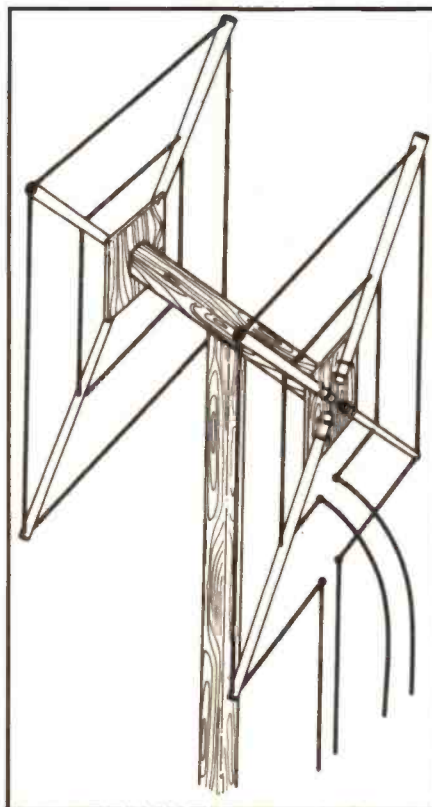

Construction

Conventional quad construction was used in the prototype, with a piece of 2" x 2" timber for the boom, and two squares of 12" x 12" x 3/4" ply for the end pieces. All timber in the quad was given two coats of grey household paint to guard against warping. Eight bamboo poles 7' long were used as spreaders, these being wrapped in insulation tape to retard splitting. It is of course better to use fibreglass spreaders, but these are quite expensive, and were not available when the writer build his quad. The bamboos in the

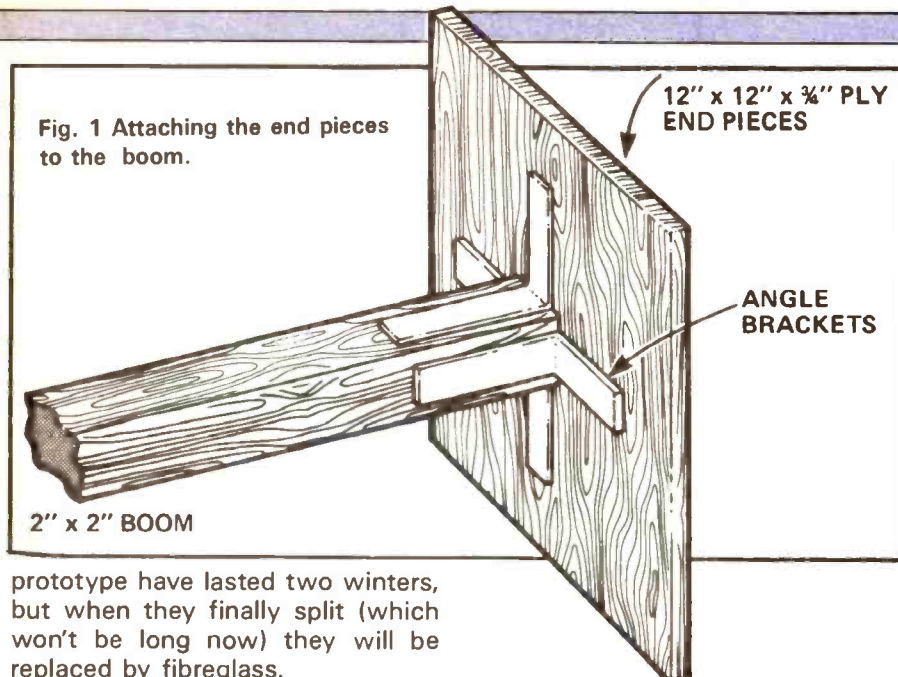

prototype have lasted two winters, but when they finally split (which won't be long now) they will be replaced by fibreglass.

A summary of the hardware needed is given in the components list, all of which should be easily available at the larger DIY store. Reference to Figures 1 to 3 will show construction of the spider and positioning of the spreaders. Reference to Table 1 gives drilling dimensions and wire lengths for the two bands.

There is a choice when it comes to making the reflector element. One alternative is to settle for a fixed length closed loop, which is resonant slightly LF of the driven loop, and have no means of tuning the quad for best front-to-back ratio. The

Components List

- 50' of 2" x 2" timber.
- 2 no. pieces 12" x 12" x 3/4" plywood.
- 8 no. 4" galvanized angle brackets.
- 16 no. galvanized U bolts.
- Nuts, bolts and washers to suit above, all plated or galvanized.
- 120' 16 gauge enamelled copper wire (not critical - any reasonably strong wire will do).
- Note - if the U bolts are difficult to obtain, it is possible to use galvanised threaded rod bent to suit.

	50MHz	28MHz
Total loop length driven element	19'4"	34'4"
Total loop length closed reflector	20'8"	36'4"
Total loop length tuned reflector	19'4"	34'4"
Stub length	9"	16"
Drilling dimension 'D'	34"	74"

Table 1. Dimension Chart for dual band Quad

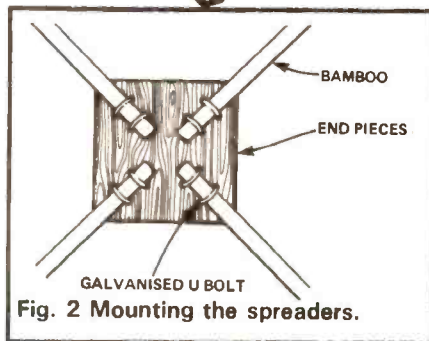

other alternative is to make the reflector loop the same size as the driven loop, adding a stub which can be adjusted for best front-to-back ratio. The latter method is the soundest theoretically, but in practice can be quite difficult to achieve, as it has to be done with the quad at its final operating height.

The writer has found that in use

there is very little difference in performance between his quad, which used a tuned reflector, and the quad made by a near neighbour, GW4ZVO, which uses a closed loop reflector carefully cut to the dimensions shown in Table 1. If you can manage to tune the reflector in-situ, it is wiser to make the reflector tunable. Dimensions for both methods are shown in Table 1.

Tuning The Quad

Having built the quad to the dimensions shown in Table 1 the next job is to get the driven element resonant on the required frequency. If the dimensions given in the table were followed closely, it will be found that the driven element will not be far from the required frequency, possibly slightly low. With the driven element 4' to 6' from the ground, attach a one or two turn link coil across the ends of this element as shown in Fig. 4. Do not attach the feeder at this stage.

Make sure the GDO is fairly accurate by finding its signal on a receiver of known accuracy, then loosely couple the GDO to the link coil. Adjust the length of the loop until the GDO shows resonance approximately 200kHz low of the desired frequency. It will be found that when the quad is lifted well clear of the ground (over 25') its resonant frequency will rise by this amount.

The feeder can now be attached through a suitable balun, and the SWR checked. This operation has to

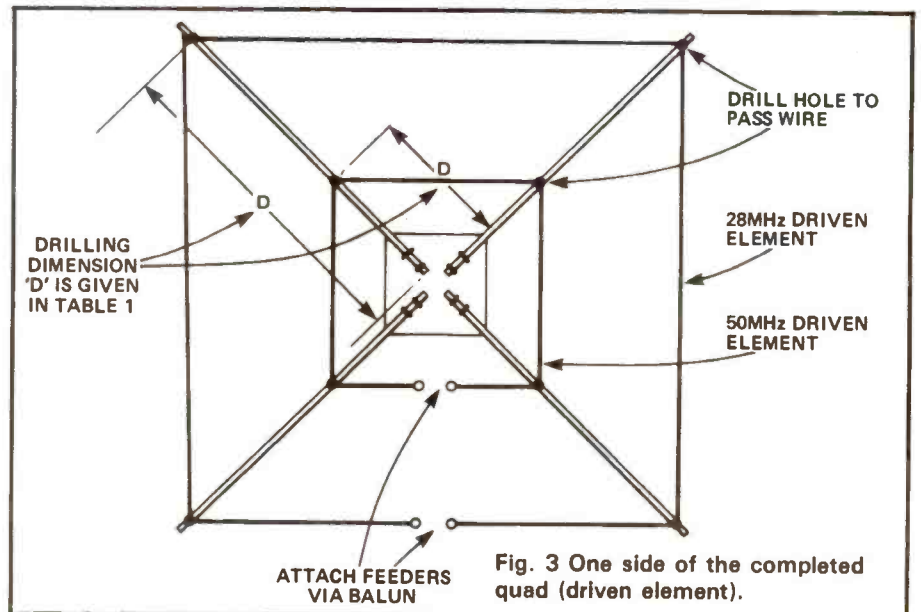
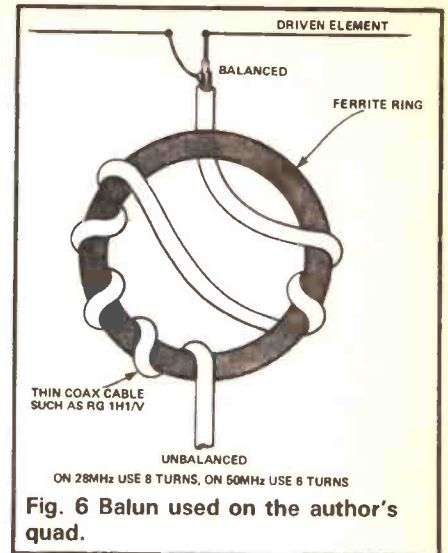
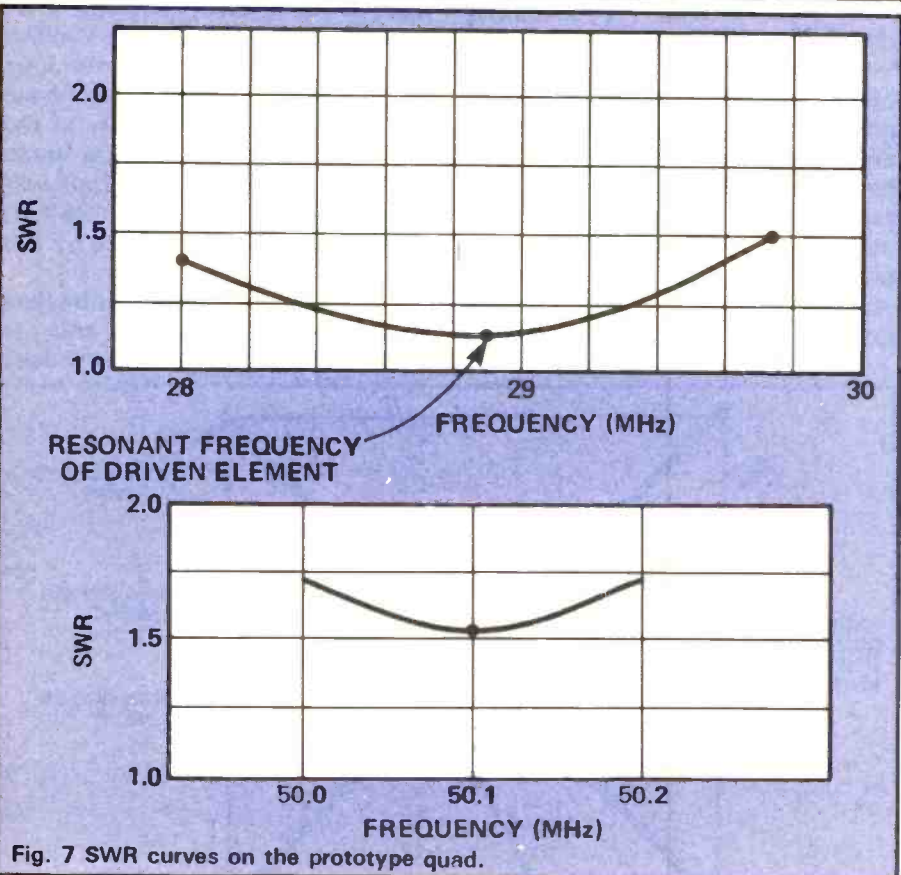
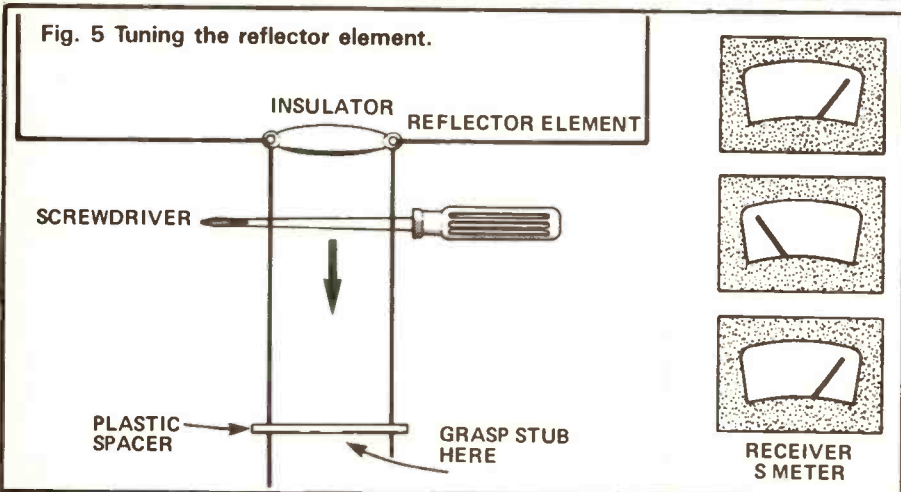
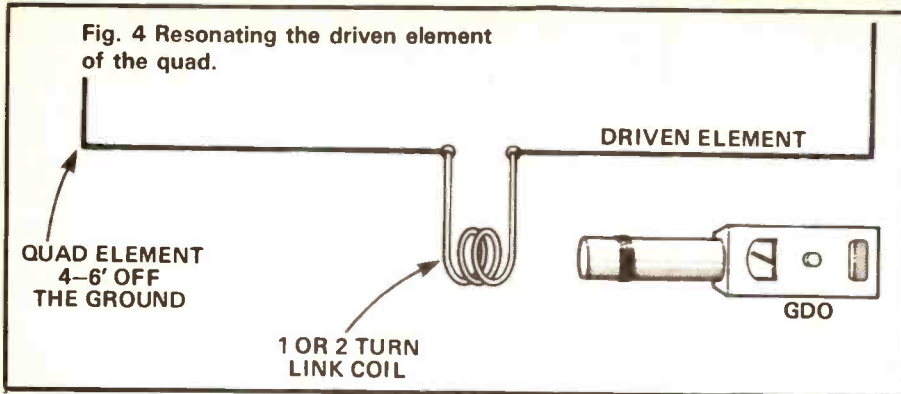

Fig. 3 One side of the completed quad (driven element).



its final height. For this operation a stable low level signal is needed, such as a GDO placed around 300' behind the reflector. A signal generator with a short antenna (about 2' of wire) could be used, or a local amateur could help by generating a very low power carrier. Two people are needed for this operation, one to tune the reflector, the other to watch the S meter of the receiver used. As shown in Fig. 5, simply slide a screwdriver down the length of the stub until a dip in S-meter reading is seen on the receiver. This dip should be quite pronounced, between two and four S-points. Mark the point on the stub, and solder a wire across the stub, cutting off the excess wire. Reflector tuning is now complete.

Front to back ratio for the quad using this method of tuning should approach 25 dB.

Use Of A Balun

Reference to Fig. 6 shows the type of balun used by the writer on the prototype quad. A balun should always be used with the quad, as attaching the feedline directly to the driven element can seriously degrade performance, due to radiation from the feeder. Quite apart from this, the writer found it impossible to get the SWR on the prototype quad below 2.5:1 until a balun was used, even with the driven element at resonance.

Thanks go to Bill, GW4 THK, for his help in putting the quad together.

be carried out on both bands of course, but it will be found there is very little inter-action between the two loops. Figure 7 shows the SWR

curve on the writer's quad which was cut for 28.900 and 50.100MHz. Tuning the reflector as previously mentioned is done with the quad at

1296 RECEIVER PROJECT

With the advent of a number of newly licenced repeaters around the country, 23cms is becoming increasingly popular. Repeaters are not just helping amateurs to make new friends, but also serving as the focal point for local activity where one can discuss new ideas and techniques of operating in this exciting band.

To ensure that you can get the most pleasure from using 23cms our receiver has been designed to give a versatile, high performance, yet very cost effective means of monitoring the band. Gone is the need to tie up other pieces of expensive equipment plugged into converters — instead our receiver, which is self contained on a single PCB, can be used to listen to the local activity.

Circuit Description

The oscillator used on the UHF OSC MULT assembly is a standard Colpitts design operating at 64MHz with the collector load tuned to the third harmonic. Frequency adjustment of the oscillator is achieved by L2 in series with the crystal. It should be noted that L2 should be tuned fully in, ie. the ferrite core tuned towards the bottom of the coil to ensure operation of the oscillator

Interested in 23cm but can't spare the odd few hundred quid to get onto the band? Here's an economical way of getting to hear what you're missing, designed by David Allen of Camtech Electronics.

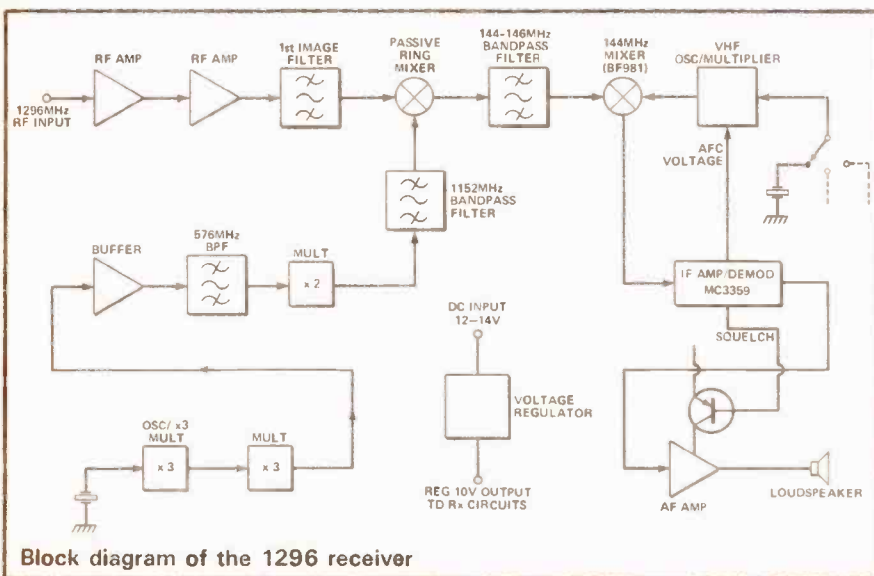
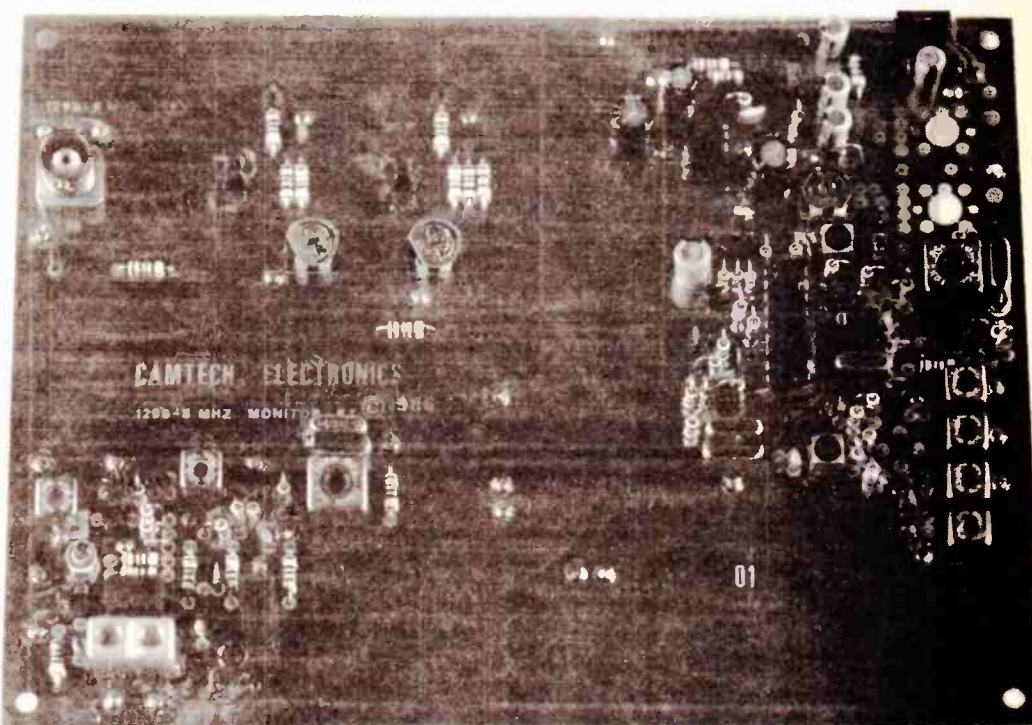

prior to adjusting to final frequency. The output of the oscillator is tuned by L3 and fed to the base of Q4 via capacitive tap C21 and C22.

Q4 is an upside-down UHF multiplier, ie. a PNP transistor operating at the third harmonic of the oscillator output. The reasons for using a PNP semiconductor here are that one can save a resistor and capacitor and ensure that L4 is at RF ground rather than rely on ambiguous decoupling. CV2 and C25 tune L4 and also form an impedance transformer to match the base of Q5. It should be noted that L4 should not have a ferrite core fitted and if one is present it should be removed, C24 provides the necessary emitter decoupling.

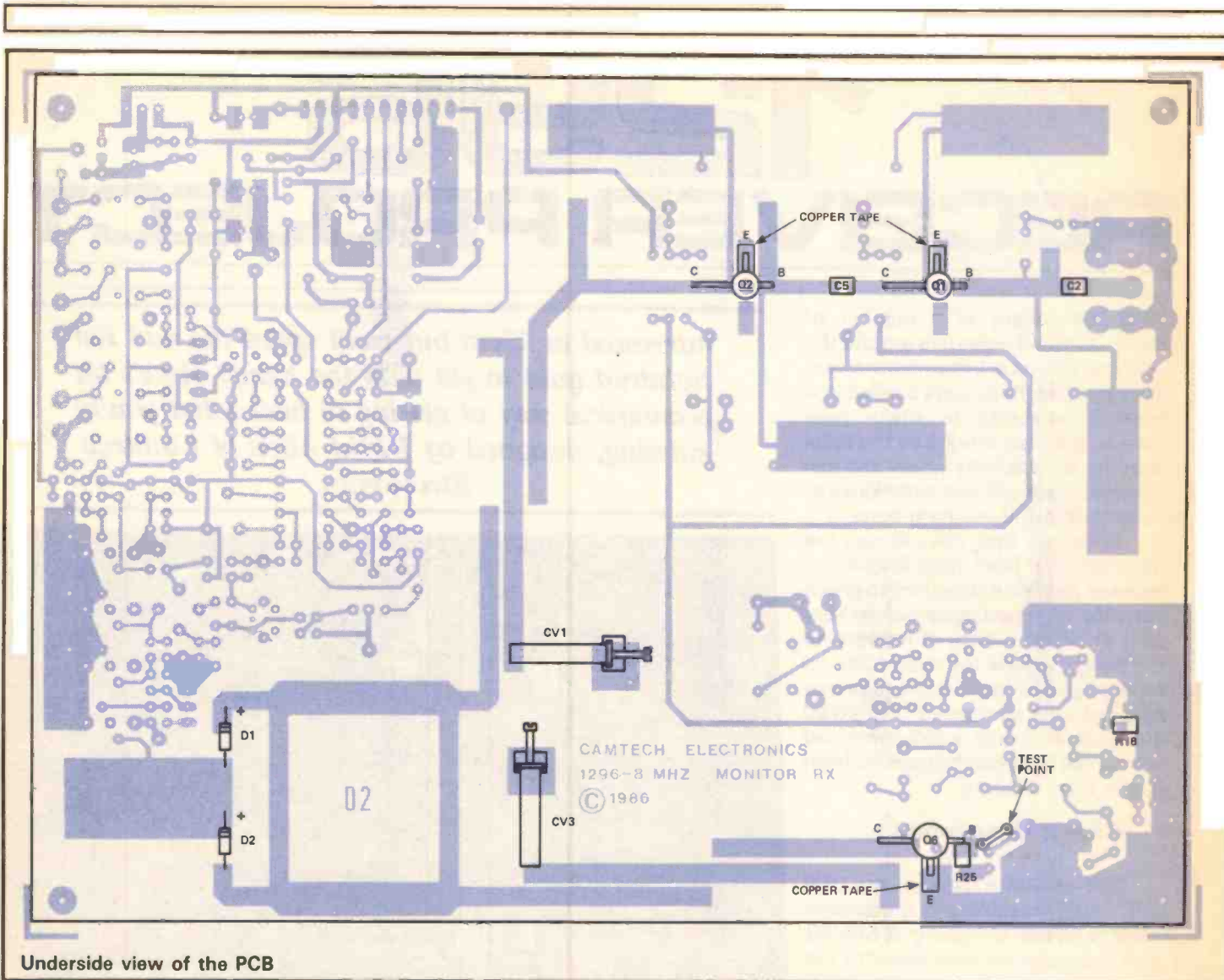

Underside view of the PCB

Q5 is a UHF buffer amplifier which has a gain of approximately 10dB. D3, in the bias chain of Q5, provides temperature compensation, ensuring a reasonably constant output under varying ambient temperature fluctuations. The output of Q5 is connected to L5 which is a 220nH choke providing bias and is suitably damped by R19 (100ohms) which guards against instability. The output of Q5 is finally coupled to L6 via C26.

L6 is a UHF band pass helical filter with a centre frequency of 576MHz. This ensures a clean signal is applied to the second UHF (1152MHz) multiplier and reduces unwanted receiver spuri caused in the mixer by high levels of signals harmonically related to the crystal fundamental. When alignment is carried out, the oscillator, first UHF multiplier and buffer amplifier performance may be checked quite easily as the output of the helical

filter is a nominal 50 ohm impedance. The level of signal at this point should be in the region of 10-15mW at 576MHz.

The second UHF multiplier Q6 is biased in class B operation by R23, D4 and R24. R26 reduces the drive to Q6 but also ensures that the helical filter is correctly terminated with a nominal 50 ohm load. The output of this multiplier is fed to a microstripline filter etched onto the copper laminated glass fibre board. C30 is also formed by microstrip techniques and the filter is finely tuned by CV3 which is a PTFE piston trimmer. Finally the output of the second UHF multiplier filter is applied to the mixer at a level of 7dBm (5mW).

The RF amplifier design uses two low noise bipolar semiconductors and has a gain of approximately 18dB. The noise figure of the RF amplifier is 2dB which gives the receiver such an outstanding performance. On our first prototype

board with an IF sensitivity of 0.25uV PD (the input level required for 12dB SINAD) the sensitivity at the input of the receiver/converter was 0.16uV PD. Bias is applied by the use of quarterwave transformers on the base and collector of each transistor and are matched by extensive use of microstriplines. The bias current into these two devices can be controlled by RV1 and RV2 respectively and should be set to approximately 10mA. Details of how to set the current in these devices is given in the alignment section below. The output of the RF amplifier is applied to a halfwave microstrip image rejection filter tuned by CV1 and coupled into the mixer.

The mixer is a 360 degree hybrid balanced ring which provides cancellation of the local oscillator injection at the RF amp port; this reduces unwanted spurious emissions from the receiver. Diodes used in the mixer are of the Schottky series type and the

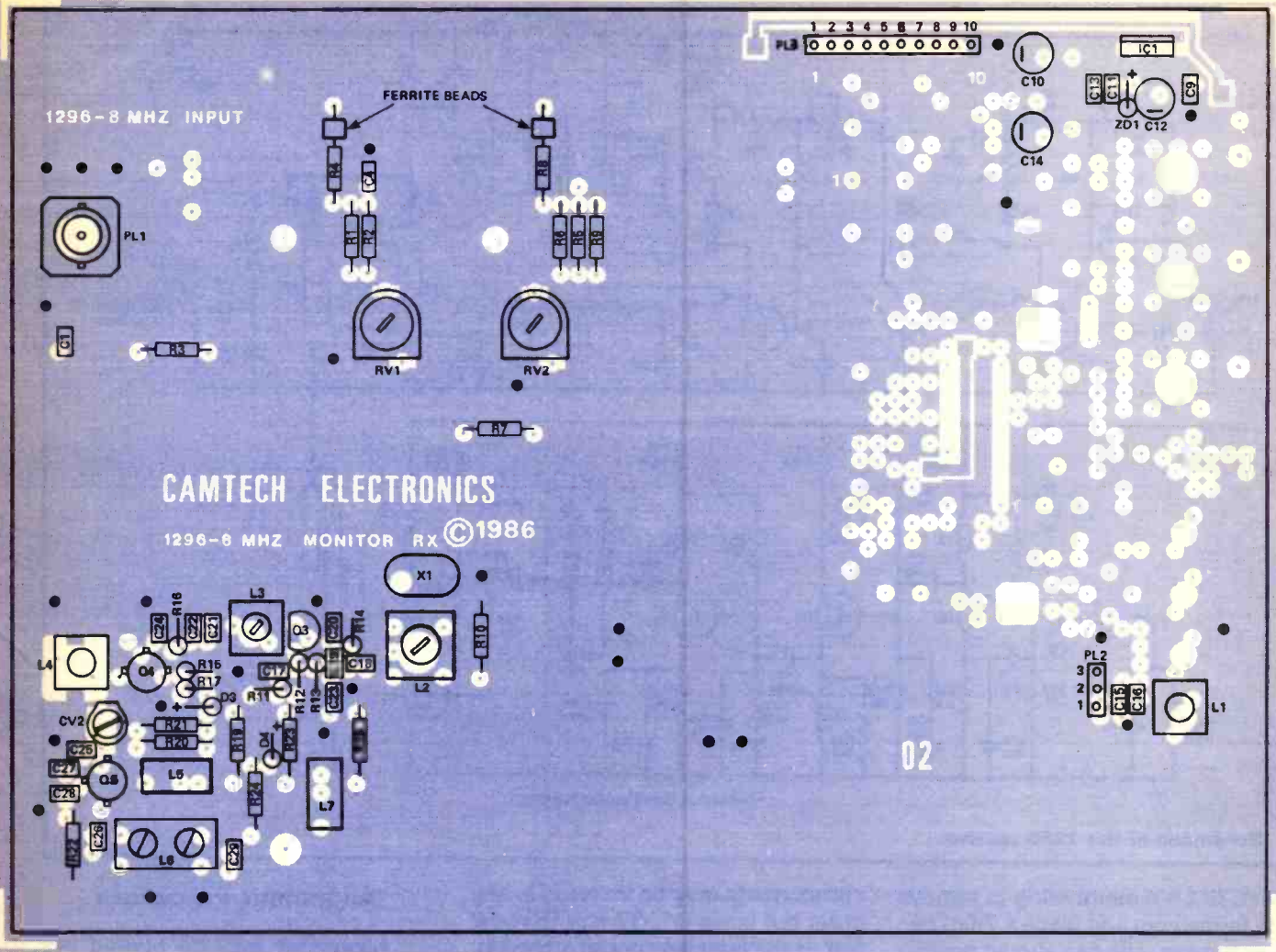

Top view of the circuit board

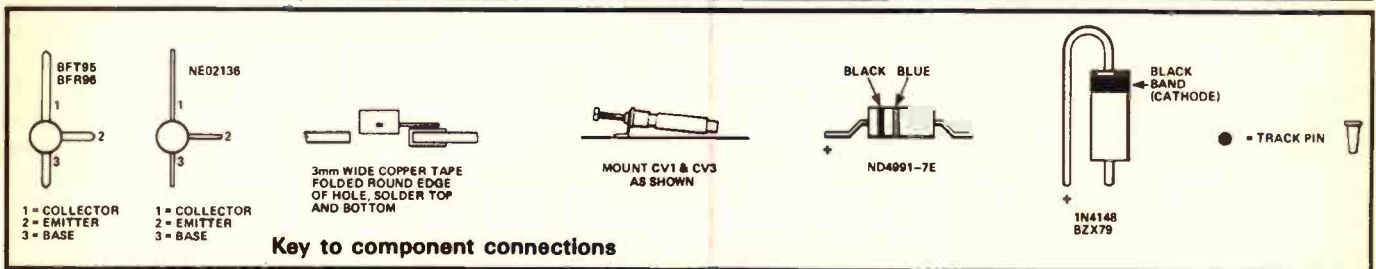

output of the mixer is passed via a low pass filter consisting of L1 and C16 to PL2 (144-146MHz IF output). The output of PL2 can be either coupled to the IF section on the board or connected directly to a VHF receiver. *Note extreme care should be taken if this equipment is coupled to a transceiver! The mixer/ RF amplifier will not tolerate watts of RF from your rig if you inadvertently key the transmitter up.*

Construction

Read all this section carefully before starting assembly.

Construction of the receiver/ converter should not be hurried and one should take the time to check each component for correct type/ value before insertion and also inspect each completed solder joint for shorts, dry joints etc. The time required to build the receiver/ converter should be several evenings, and if you do it more quickly you'll make mistakes.

It is absolutely essential that modern tools be used for the assembly, such as small long nose pliers, side cutters, a low wattage soldering iron suitable for the components used and thin multicored

self-fluxing solder. If you have little experience of soldering and component assembly then we strongly recommend that either you get a friend to build the kit for you or you purchase a ready assembled board. Please note that Camtech Electronics cannot be held responsible, and they will not service any modules that have not been soldered to an adequately high standard.

Start construction by identifying the PCB track pins which are shown on the component overlay drawings. These pins should be pushed firmly into the board from the component side and soldered top and bottom.

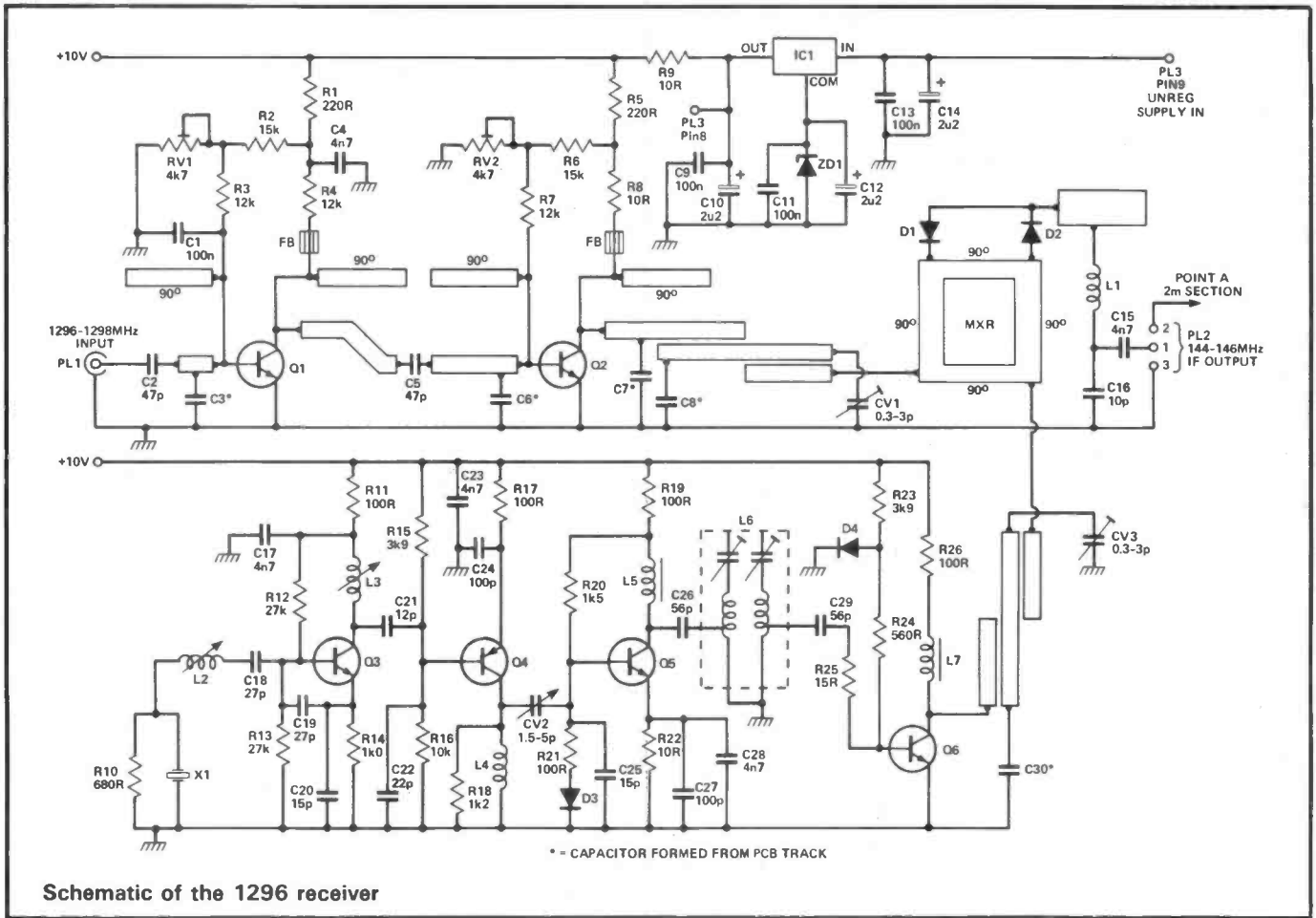

Schematic of the 1296 receiver

Next, fit L4 remembering to remove the ferrite core and place a 7mm can over the top. The can should now be soldered to both the top and bottom of the PCB where the legs of the can pass through the board. The same instruction applies to L6 (helical filter) and all four legs of the can should be soldered top and bottom. You can now position the resistors and capacitors except for C29, soldering each individually as you progress. (C29 is fitted after alignment of the first local oscillator multiplier, refer to the alignment section).

Certain components are polarised, eg. electrolytic capacitors and diodes. The component overlay drawings give details of polarity, which must be observed carefully. When fitting the local oscillator crystal, carefully tack solder the can to the top ground plane.

As you build the board up it is a good idea to cross off each component from the parts list as it is fitted to avoid confusion later on. When trimming component leads, ensure that they are cut close to the board, ie. less than 2mm. All other

components may be inserted in any order but leave Q1, Q2 and Q6 until last as they require special attention.

Q1, Q2 and Q6 are fitted to the underside of the PCB and all must have their emitters connected to the top ground plane by a narrow strip of copper tape. With each transistor, start by cutting a 3mm wide piece of copper tape about 15mm long and insert it through the hole in the PCB. Next, bend the tape around the edge of the hole and locate the transistor so that the body of the transistor lies in the hole with the leads flush with the PCB, sandwiching the copper tape in-between (see diagram). Ensure at this stage that the tape does not short to adjacent tracks before soldering the transistor and copper tape to the underside of the board. When the bottom of the board is neatly soldered invert the board and trim the copper tape to about 3mm and then solder the tape to the top ground plane.

Although the PCB is double sided there is no additional top soldering required as the PCB track pins provide the necessary earthing.

Alignment Procedure

Alignment may be carried out with the minimum of test equipment, in fact you need only a multimeter and a diode probe to align the local oscillator to 576MHz, with the final 1152MHz multiplier and the RF amplifier being aligned by tuning into your local repeater. Before you start the alignment the following preliminary settings should be made:

1. Tune L2 fully in, ie. the ferrite core tuned towards the bottom of the former to ensure operation of the oscillator.
2. On L3, tune the ferrite core so that it is flush with the top of the coil former.
3. Remove the ferrite cores from L1 and L4.
4. On L6, adjust the tuning slugs so that they are flush with the top of the can, then screw both tuning slugs in two turns.
5. Set RV1 and RV2 fully anti-clockwise.
6. Solder a 47 ohm resistor between the output of the helical filter (L6) and ground, keeping lead lengths to an absolute minimum.

Connect +12 volts DC to PL3 pin 9 and the earth to PL3 pin 10. Measure the DC voltage on PL3 pin 8, which should be a nominal regulated 10 volts. With a diode probe coupled to the base of Q4, tune L3 for maximum current indication (typically 30 to 40uA). Remove the diode probe from Q4 and connect it to the base of Q5 and tune CV2 for maximum; note that CV2 will have two tuning points at the wanted frequency as well as two resonances at lower order harmonics. The correct tuning point for CV2 occurs when the capacitor is at around its minimum capacitance setting and this point is shown on the illustrated drawing. Connect the diode probe to the output of the helical filter L6 (test point on drawing) and tune L6 one turn in either direction for a maximum. L3 and CV2 may be retuned for maximum before removing the diode probe and the 47 ohm load resistor from the output of the filter. Next remove the power supply from the board and fit C29.

CV1 and CV3 should now be adjusted so that the capacitor tuning screws are unscrewed 8mm from the body of the capacitor, ie. the distance between the base of the head of the screw and the body of the capacitor is 8mm. Reconnect the power supply and couple a multimeter set to 3V FSD across R1. Adjust RV1 for 1.3 to 1.5 volts drop across R1. Repeat the above procedure for R5, adjusting RV2 for 1.3 to 1.5 volt drop across R5.

Before proceeding further it should be noted that because some of the circuitry is realised in microstrip there should be a gap of at least 20mm from the underside of the PCB and its surroundings. The RF amp can now be coupled to a suitable 23cm aerial and connect PL2 pin 1 (IF output) and PL2 pin 3

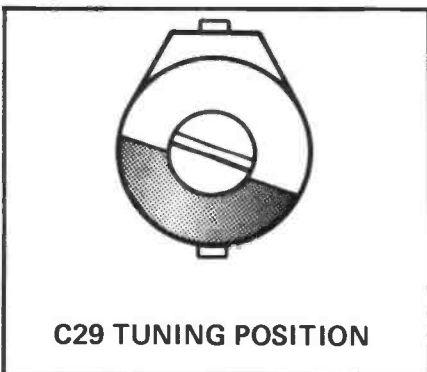

Specification

Frequency range	1296 to 1298MHz
Demodulation	FM
Number of channels	3 (crystal controlled)
RF sensitivity	0.25uV for 12dB SINAD typ
Adjacent ch. selectivity	60dB typ
AFC range	+/- 5kHz
Audio output power	600mW into 8 ohm
Power supply	12 to 15 volts DC
Size of PCB	185mm x 135mm

(earth) to a VHF two-metre receiver. Tune the receiver to find your local 23cm repeater (which should be within 50kHz of where you'd expect) and tune L2 so that the direct reading in kHz at two metres corresponds to the frequency allocation of the repeater. Finally, tune CV1, CV3 and L6 for maximum sensitivity.

The final part of this 23cm receiver is to be concluded next month with the full description, assembly and alignment of the 2m IF part of the circuit. Combined with the converter, this forms a unique single board receiver. Complete kits will be available from Cirkit Holdings PLC, Park Lane, Broxbourn, Herts. Tel 0992 444111. Price £60 exc. VAT.

There are a number of capacitors

Special Features

IF output available from 144 to 146MHz as standard.
Electronically-switched channel selection by use of PIN diodes.
Scanning possibly using the optional scanning PCB.
External squelch defeat input.
External squelch status output.

and microstrip lines formed from the actual copper track, and obtaining the correct values for these components will depend not only on the track geometry but also on the dielectric constant of the board itself. For this reason, we do not recommend attempting to make your own PCB and we will not, contrary to our usual practice, publish the foil patterns.

Components List

RESISTORS

R1,R5	220R
R2,6	15k
R3,7	12k
R4,8,9,22	10R
R10	680R
R11,17,19,21,26	100R
R12,13	27k
R14	1k0
R15,23	3k9
R16	10k
R18	1k2 chip
R20	1k5
R24	560R
RV1,2	4k7 preset pot
R25	15R chip

CAPACITORS

C1,9,11,13	100n
C2,5	47p chip cap
C3,6,7,8,30	printed on PCB
C4,15,17,23,28	4n7
C10,12,14	2u2 16V electrolytic
C16	10p
C18,19	27p
C20,25	15p
C21	12p
C22	22p
C24,27	100p

C26,29	56p
CV1,3	0.3-3p trimmer
CV2	1.5-5p trimmer

SEMICONDUCTORS

Q1,2	NEO2136
Q3	BF199
Q4	BFT95
Q5,6	BFR96
IC1	7805 regulator
ZD1	BZX79C4V7 (4V7 zener)
D1,2	ND4991-7E
D3,4	1N4148

INDUCTORS

L1	MC108 green
L2	KXNK3767EK
L3	MC108 yellow
L4	MC108 white
L5,7	7BA 220nH
L6	252MX-1558F

MISCELLANEOUS

X1	64MHz crystal (see text)
PL1	PCB BNC connector
PL2	3 pin connector to suit
PL3	10 pin connector to suit
	2 off ferite beads; 3 off 7mm cans for coils; 29 off track pins; PCB; copper tape.



Radio Austria's QSL cards are certainly worth having — but how do you get a QSL card from a clandestine station? Answer: you don't . . .

After you have been scouring the short wave bands for some time, you will undoubtedly come across the strains of the first few bars of the 'Blue Danube Waltz' by Johann Strauss, played on an electric piano. This is the identification signal of Radio Austria International, played usually for a few minutes every half-hour before the beginning of each language transmission from this station. Radio Austria International is usually very well received in Britain, given the right time of day and frequency.

It does not broadcast any programmes specifically for listeners in Britain: instead programmes are radiated to the whole of Europe via

omni-directional antennas. This is presumably because this is a relatively small station and broadcasts only in German, English, French and Spanish, and they want their programmes to be heard by as many people as possible who may understand English (or German, for that matter) as a second language.

The mainstay of Radio Austria International's English-language programme is called 'Report From Austria'. It is a news-magazine type programme, sometimes encompassing some music as well. All transmissions start with a news bulletin, and for those interested in current affairs, this station is often first with the news of developments at the various

conferences which take place in Vienna, such as OPEC meetings or the Conference on Security and Cooperation in Europe. After the news is a review of the Austrian newspapers, a look at Austria's weather and then a different feature on each day of the week. This could be on the economy (a subject apparently dear to most Austrians' hearts!), the arts, music—a recent feature was about the Military Musicians of Upper Austria which has members who have gone on to international stardom, recipes, tourism etc.

On Tuesdays is a review of the week's sports events in Austria, while on Sundays — when programming is somewhat different — the transmission starts with a 'DX programme', which should be of interest to all who like messing about with radios.

Basically, Radio Austria International produces a single 25 or 30 minute long programme each day in English, French and Spanish, with the bulk of its output being in German. Each programme is repeated several times a day, directed

Radio Austria International studios at the Österreichischer Rundfunk (ORF) centre in Vienna. (On the roof of the building, in the middle, can just be seen the 3-element beam of ORF's amateur radio club station!).

In the 1970's, ORF had hoped to utilize the medium wave transmitter on 1475kHz for broadcasts to Europe. This QSL was issued for reception reports on this transmitter when it was broadcasting Austrian home service programmes.





A couple of Radio Austria International's spectacular colour QSL cards.

to different parts of the world depending on propagation and peak-listening times in the countries of reception. Most of the repeats, however, are also broadcast for Europe via the omni-directional antennas mentioned earlier.

Frequencies to look for Radio Austria International on are: 5.945, 6.000, 6.155 and 7.210MHz, with 6.155 usually producing the best reception in southern England. At 0830-0900, for example, there is a programme in English which is mainly intended for listeners in the Far East and Australasia, but it is also broadcast for Europe on lower frequencies.

At the time of writing (mid December) this 0830 GMT programme is on 6.000, 6.155, 7.210, 11.840 and 15.410MHz and although Radio Austria International, in common with most international broadcasters, does change its frequencies four times a year, the frequencies intended for listeners in Europe remain largely the same year in and year out. Another transmission in English, also well-heard on 6.000 and 6.155MHz, is at 1230-1300 GMT.

Radio Austria International, being a relatively small station, does not have huge teams of monitors around the world to supply it with reception reports, and so is more interested that most stations in receiving

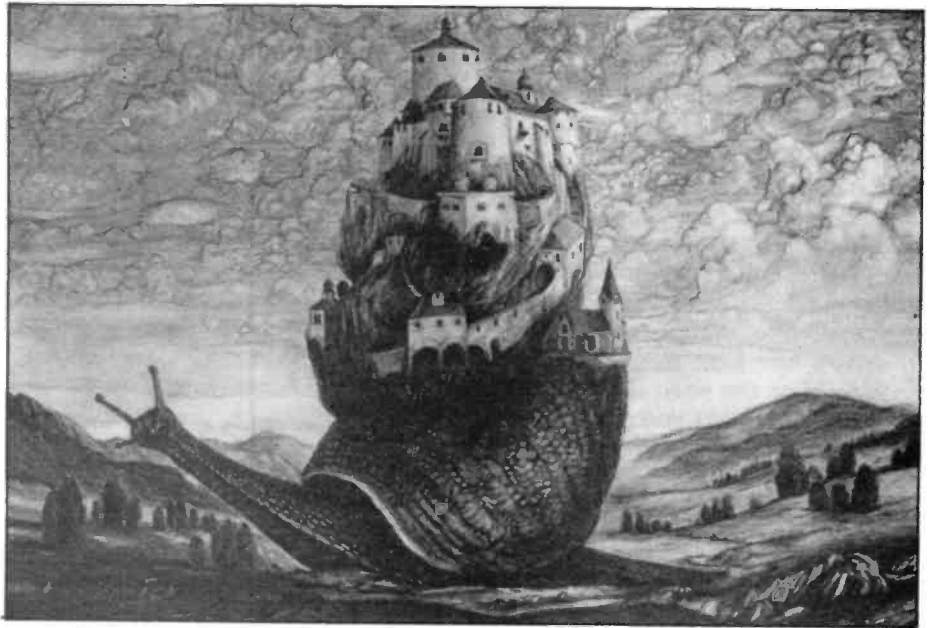

detailed and accurate reception reports from individual listeners. I have dealt with how to send in reception reports to stations in earlier articles, but Radio Austria International even has its own printed reception report forms which it will send after they have received the first report from you, by way of encouragement to send in more. As a further enticement, it issues quite spectacular QSL cards depicting Austrian tourist scenes or contemporary art reproductions (see illustrations). The address is simply: Radio Austria International, A-1136 Vienna, Austria.

A QSL card from Radio Australia for their 250kW, 11.945MHz outlet. The picture shows a radio telescope located at Parkes, New South Wales.

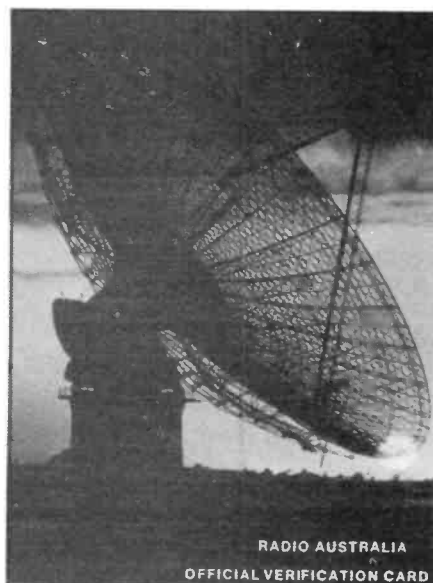

From Austria to Australia . . .

Some time ago, Radio Australia revealed its 'Talkback' programme that it had at last received sufficient funds from the Australian government to commence construction of a new training site. This is to be located at Brandon, a small settlement near the town of Ayr, on the Barrier Reef coast of Queensland.

Initially, three old 10 kilowatt transmitters were being taken there from the now-defunct Lyndhurst transmitter site which suggests that Radio Australia did not perhaps get

Sometimes QSLs can be works of art as well: this card from Radio Espana Independiente was designed by none other than Picasso himself!



quite as much funding as it had hoped! . According to the report on 'Talkback', the Brandon site should be operational with test transmissions by the middle of this year — listen to 'Talkback' for more details of when this comes on the air.

'Talkback' is heard best in Britain on Sundays at 0910-0930 GMT on 9.655MHz. Other frequencies worth trying are 9.580 and 11.720MHz at the same time, though 9.655MHz is invariably the best frequency. This channel is on the air at present from 0700 to 1030 GMT and although no longer specifically beamed towards Britain, it is intended for the Pacific area, which means that the Radio Australia antenna is beaming 'long path' towards us, over the Pacific and South America. Theoretically at least, spring and autumn are the best times of year for reception of Pacific stations and I must say that after almost twenty years in the radio-listening game it still gives me a thrill to listen to Radio Australia booming in like a European signal.

The Secret Broadcasters

In almost all parts of the world where there is some sort of conflict going on you will find clandestine broadcasters attempting to put their side of the argument over to the various factions. Many stations broadcast with only very low power, or with highly irregular schedules or variable frequencies, and very few broadcast in English, so it can be quite a challenge to try to log some of them.

In the past it was much easier to hear certain clandestine stations in Britain, as there were three powerful and highly professional stations broadcasting to Spain and Portugal. With the return to democracy in both these countries in the mid-1970's the stations closed down voluntarily, but for a while Radio Portugal Libre, Radio Espana Independiente and Radio Euzkadi ('The Voice of the Basque Underground') could be heard with good strength every day. All these stations were pro-socialist, the first two almost certainly coming from transmitters in Eastern Europe. Radio Euzkadi, which used to sign-on with announcements in Spanish, English and French as well as the Basque language, announced a P.O. Box in Paris, although it was widely believed that the transmitters were

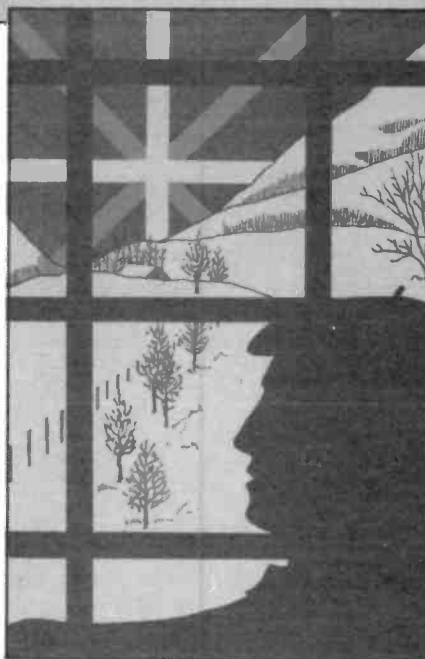

QSL from the former clandestine station Radio Euzkadi, 'The Voice of the Basque Underground'. The design shows an imprisoned Basque with the red, green and white Basque flag "rising" from behind the Pyrenees.

in South America, possibly Venezuela.

Today, with the situation in Western Europe more stable, you have to look further afield to hear clandestine broadcasters. The Gulf War is a fertile ground for such stations, with anti-Iranian stations

Only a 'pseudo-clandestine' station, Radio Liberty is financed mainly by the USA government and broadcasts news to the Soviet Union from transmitters in West Germany, Spain and Portugal.



broadcasting from Iraq and anti-Iraq stations broadcasting from Iran.

The situation in Iran is rather confusing though, as apart from the anti-Iranian, pro-Iraqi stations, there are also anti-Iranian pro-monarchist stations probably broadcasting from Egypt and anti-Iranian pro-communist stations coming from Afghanistan or possibly the Soviet Union. As if this were not enough, the Iranians reciprocate with pro-Islamic, anti-communist stations broadcasting to Afghanistan!

Another area of the world where clandestine stations are much in evidence is north Africa, and particularly Libya. An anti-Gadaffi station called 'The Voice of the Libyan People' can sometimes be heard in Britain, though it is heavily jammed by Libya. Libya itself is responsible for several of these stations: most are short-lived affairs, and either anti-Jewish, anti-Tunisian or anti-whomever Libya is arguing with at the time.

One, however, which has been on the air for a long time calls itself 'Chadian National Radio' despite the fact that it is not in Chad! It can be heard virtually every evening with sometimes quite good reception on the rather odd frequency of 6009kHz. Programmes are in a mixture of French, Arabic and Chadian local languages and presumably are anti-Chadian government in nature. There is also a lot of African music broadcast.

It can sometimes be difficult to decide what the definition of a 'clandestine' station is. A 'true' clandestine is probably best described as one broadcasting from a secret location *within* the intended country of reception. There are, however, very few of these around, for obvious reasons (in many countries the operators of such a station would probably be shot for treason!). A few, though, exist or have existed, such as 'Radio Solidarity' in Poland which apparently still turns up for a quick half-hour transmission from time to time. Others are known to exist in Afghanistan, run by the anti-government rebels, but naturally these are almost impossible to hear in Britain.

At the other end of the scale is the large, professional, government-run station broadcasting propaganda programmes on short-wave across international boundaries. These are

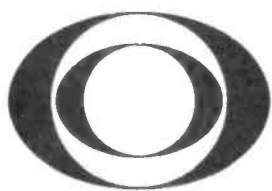

ORF
ÖSTERREICH



Osterreichs
Auslandsdienst
auf Kurzwelle

Austria calling
on short wave

Autriche
ondes courtes

Austria en
onda corta

Radio Austria International station logo.

well-heard in the Tamil parts of Sri Lanka.

If it is not easy to get information on the times and frequencies of clandestine broadcasters, it is even less easy to get QSL cards out of them, as many do not wish to publicise their own efforts. One source of information, though, is that of well-known 'clandestine-fan' John Campbell, who broadcasts reports on Radio Netherland's 'Media Network' programme on Thursdays.

One clandestine that many British radio amateurs will have heard, without realising what it was, is the 'Voice of the Liberation of Iran' which broadcasts daily in Farsi at 1630-1730 GMT on 7080kHz, in the middle of the 40 metre band. They also have a transmitter on 9027kHz, and both are very strong. This is one of the pro-monarchist stations mentioned earlier and is probably located in Egypt. So not *all* the intruders in the 40 metre band can be blamed on Radio Tirana, and it just shows what a hopeless task it is trying to clear the amateur bands of intruders, when not even the governments concerned would admit to the existence of some stations!

really no more than independent external broadcasting organisations, and the best examples of these are Radio Free Europe and Radio Liberty. The former broadcasts in East European languages, the latter in various languages of the Soviet Union, such as Azerbaijani, Tatar-Bashkirian and Uighur as well as Russian. Both are financed by the American government and broadcast from transmitters in Germany, Portugal and Spain.

Most clandestine broadcasters fall somewhere between these two extremes though, and are run by

groups of individuals living abroad who are opposed to the government in their homelands, with or without the tacit support of the government in their host-countries. There used to be a host of anti-Castro stations run by Cuban emigrés in Florida, often using amateur transmitters in the 7MHz band, until they were all raided and closed down by the American FCC. Similarly, there is a station called 'The Voice of Tamil Eelam' using an amateur transmitter on approximately 7MHz and believed to be in Southern India. It is apparently

HAM

RADIO

**NEXT
MONTH**

TODAY

IC275 2m Multi-mode Base Station Review

We usually avoid the 'super-rig' reviews but this one *does* deserve the title. Chris Lorek canters round the circuit to see how it runs.

Bearcat 100XL Scanner

You don't need that suit-case sized scanner any more. This one fits in your pocket and offers a good deal more than many of its larger relatives.

HB9CV

Not *another* article on HB9CVs, we hear you moan. But have you ever tried making one for 23 cms? The results could surprise you.

Whilst the above articles are at an advanced stage of preparation, we cannot guarantee that they will appear in the next issue of 'Ham Radio Today'.

IC12E Review

Icom now offer an FM portable in their 23cms range. But just how good is it and is it worth the outlay? We investigate.

DXing the Minquiers

High on the DX buff's list of collectables, this one's almost as difficult to get to as it is to pronounce!

Ham International Update

An alternative conversion to get this CB rig onto 10 metres — but this time without the sproggies. Ian Abel shows the way to a cleaner output and gets ready for the end of the sun-spot minimum.

KIT REVIEW

Storno CQM713

Judging by the amount of interest generated from the HRT series on converting surplus PMR gear for use on the amateur bands, it is no surprise that rally stalls are quickly selling out. This was highlighted at the Leicester Exhibition, when a modification kit launched for the Storno CQM713 radiophone was so



natively, the radio may be remote mounted as originally intended, and a tiny control box made up to fit whatever space is available in the car.

The microphone amplifier in the original set is normally fitted into the telephone handset and a balanced 600ohm level is presented to the multiway connector. The modification board incorporates a suitable transistor amplifier interface, allowing a dynamic fist mic or suchlike to be used. Note however that the mic input line is *not* at earth potential, so watch out when wiring your socket.

The channel frequency information is also fed down the multiway socket, in the form of binary logic levels. These control a low-frequency synthesiser, operating between

Psst! Interested in a 20 watt fully synthesized two metre rig for as little as £60? G4HCL gets to grips with the Withers conversion for the Storno CQM 713.

popular that all were sold on the first day, a hurried trip by the dealer to replenish stocks for the second day had the same effect! The HRT exhibition tream however managed to get their hands on one and here we reveal all!

it entirely from the radio unit. This would then allow space for the modification board as well as switches, indicators, and even a small loud-speaker if you wish to convert the set into a stand-alone unit. Alter-

The Box in the Boot

The CQM713 is a unit designed to fit remotely in your car boot or under the seat, linked originally to a control box and handset by a multiway cable. It was designed to operate on 55, 25kHz spaced channels, between 158.550 and 159.900MHz on transmit, and 163.050 and 164.400MHz on receive. The tuning range of the RF circuits will however go down to 144MHz quite easily without circuit modification. What *is* needed however, is modification of the control system and synthesiser mixer frequency. This has been performed using a small PCB and a pair of specially manufactured crystals, which are marketed as a kit by R. Withers Communications.

Control System

For radiophone usage, a sequential tone encoder/decoder system is needed to interface between the base control giving telephone number and channel, but we can happily bypass this or even remove

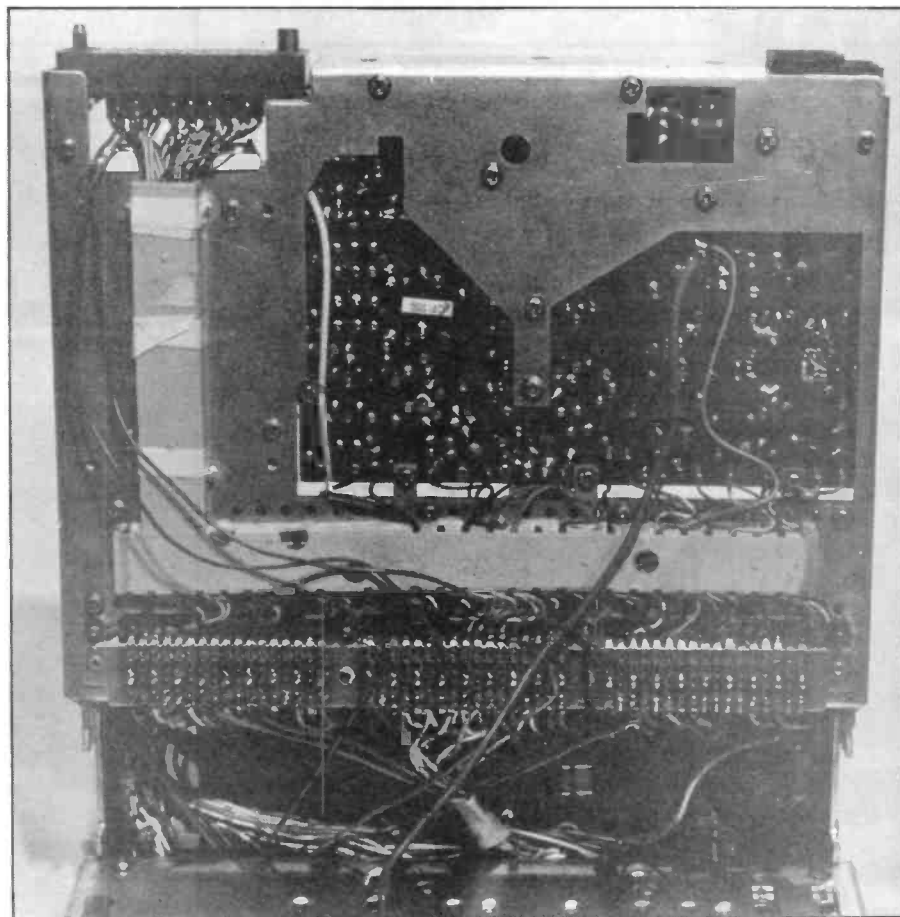

16.075 and 17.425MHz on both transmit and receive. The final RF frequency is achieved by mixing the synthesiser output with one of two crystal controlled signals (one for Tx and one for Rx), modification to 2m being simply a matter of changing these crystals and retuning. One complication that may arise is that we amateurs could require such luxuries as automatic repeater shift and a listen-on-input facility, causing crystal switching problems. An alternative to this is to perform binary addition of the logic control lines using simple adder ICs, and it is the latter method that has been incorporated on the mod board.

Transceiver Modifications

Open the chassis of the transceiver by removing all the M3 pozidrive screws on the outer cover of the set and by slackening the two remaining slotted screws at each side of the front panel — the outer case and front panel may now be slid off. Open the inner chassis by unscrewing two slotted screws at the rear underside and hinge open the two halves, just like a book. Firstly, we must provide a 5V rail to the mod board digital ICs, and a further 5V PTT switching line. Locate pins C and H on the rear multiway

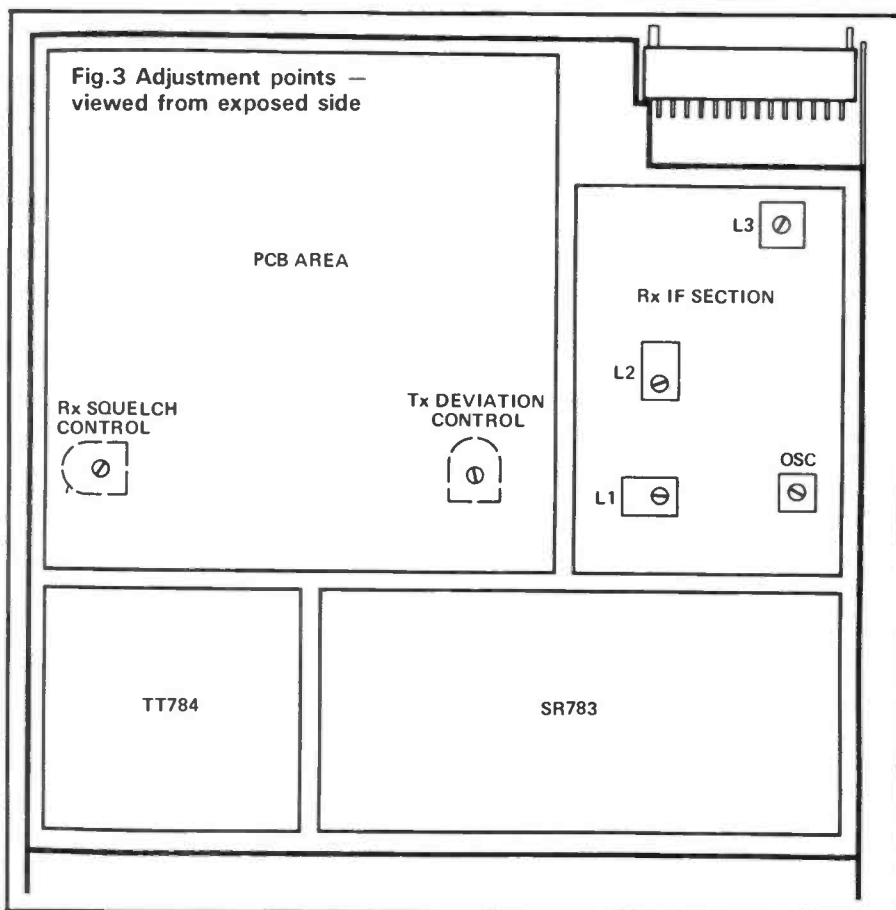

socket, cut and discard the wires connecting to these. Connect in their place insulated wires from pin C to terminal 17 group A on the main tagstrip, and from pin H to terminal 11 group B, again on the main tagstrip

(see Fig.1 and accompanying photographs).

If you know your set is in good working order then fine, if not however the instructions accompanying the modification board suggest you test the transceiver using a good dummy load before ripping it apart. I found by operating the set in its unmodified state with the mod board plugged in and with no channel switches connected, it would correctly receive on 164.450MHz and transmit on 159.950MHz not, as the instructions state, 159.550MHz.

Discarding the old control boards

The RF circuitry is well screened, so to get at it simply prise off the push-on metal panels to expose the boards and adjustment points (Fig.2). Remove the two miniature HC45u crystals using a soldering iron and long nose pliers or tweezers, and in their place solder in the new crystals, marked 'T' and 'R' for Tx and Rx respectively. These are the larger HC18u case size, so you must insulate the cases and lay them horizontally across the board rather than place them back in their clips.

If you'd like to discard the old

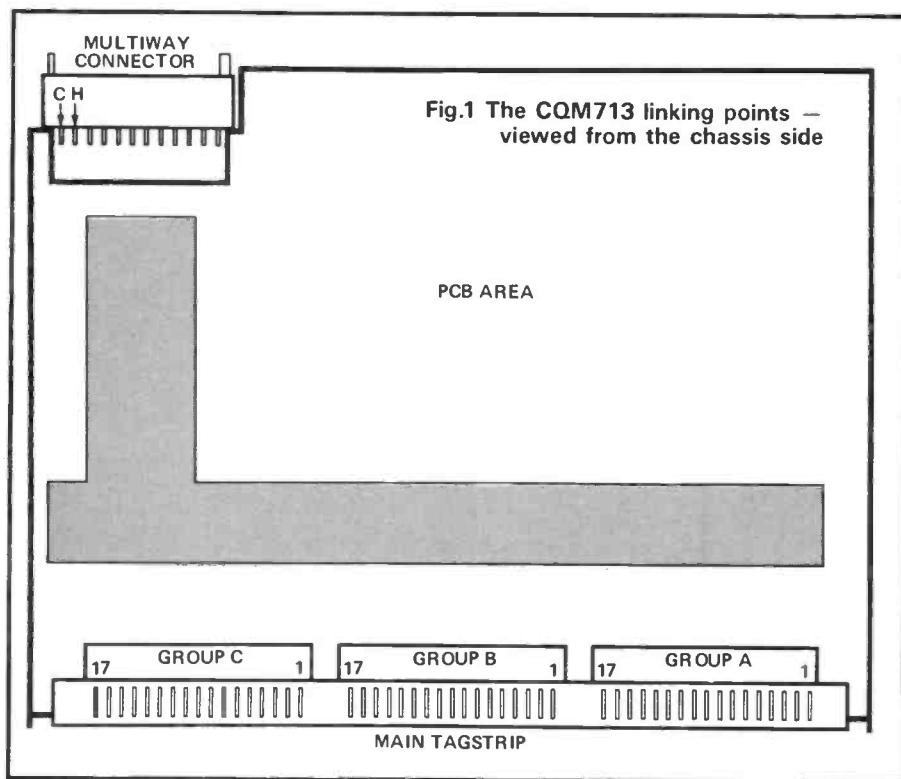

control boards completely to make room for your own circuitry, then connect the following links on the main tagstrip;

- 1) Link pin 7 group A to pin 9 group A
- 2) Link pin 12 group A to pin 1 group C
- 3) Remove the three tone logic PCBs, cutting the lacing and insulating the discarded wires, but *do not* cut the wires soldered to the three-terminal 5V regulator mounted on the side of the chassis.

Multiway Cable Wiring

If you wish to use the set as a remote unit as opposed to a dash-mount, then make sure you obtain the matching cable and plug. The radiophone normally uses a 24 way cable which has multi-coloured wires for identification. However not all of these are used and as we need to use new terminals on the multi-way connector for the binary control lines etc, the cable connector must be re-wired. I found it easiest to desolder the existing wires rather than cut the cable and re-strip and tin all the wires, but it's up to you as long as a neat job is the end result.

Table 1 shows the connections required, the first colour is the main wire insulator colour and the second is the tracer (the thinner colour strips). You should have four wires left over, these being green, brown/grey, green/grey and red/brown. These may be insulated rather than simply cropped short as you might find a future use for them — in scanning applications perhaps.

Modification Board

This is a small PCB measuring 87mm x 60mm, housing two 4560 CMOS adder ICs, a 600ohm microphone amplifier, connection points for controls and indicators, and a diode matrix fitted to a further sub-board. It enables two methods of frequency control, either by adding a pair of BCD thumbwheel switches to give a numerical readout, or by using the matrix board and wiring in a pair of normal 10-way rotary switches. Toggle switches give logic inputs to the adder ICs to perform 600kHz shifts. The end result is a BCD (Binary Coded Decimal) output corresponding to eighty 25kHz channel steps, covering the 2MHz wide 2m band. The more ambitious

amongst us can no doubt dream up many other control methods such as digital shift registers and displays linked to scanning circuitry, but the

original concept of the conversion was simplicity and low cost. May I suggest that if you have an old broken CB transceiver that uses an

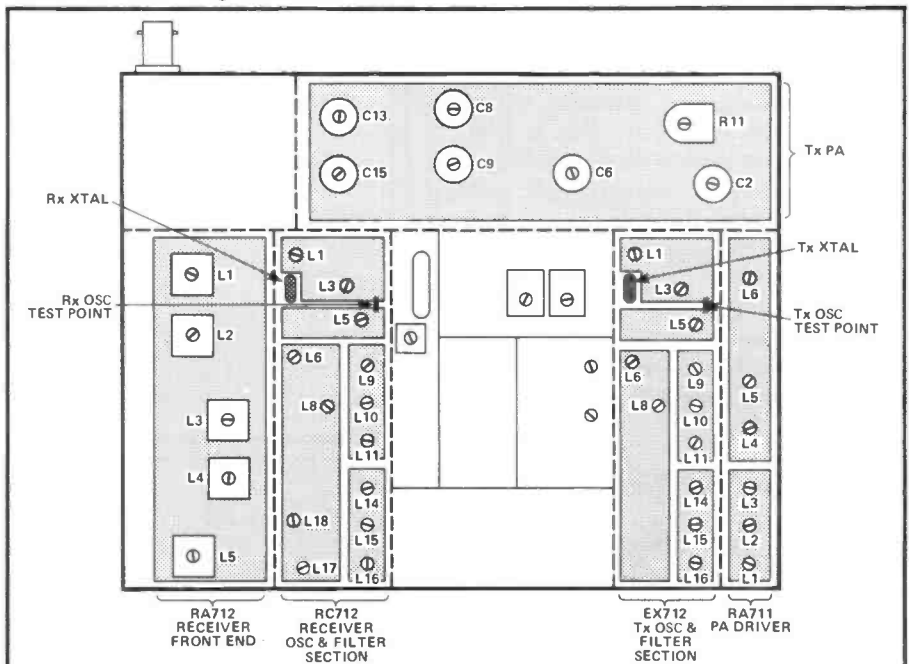
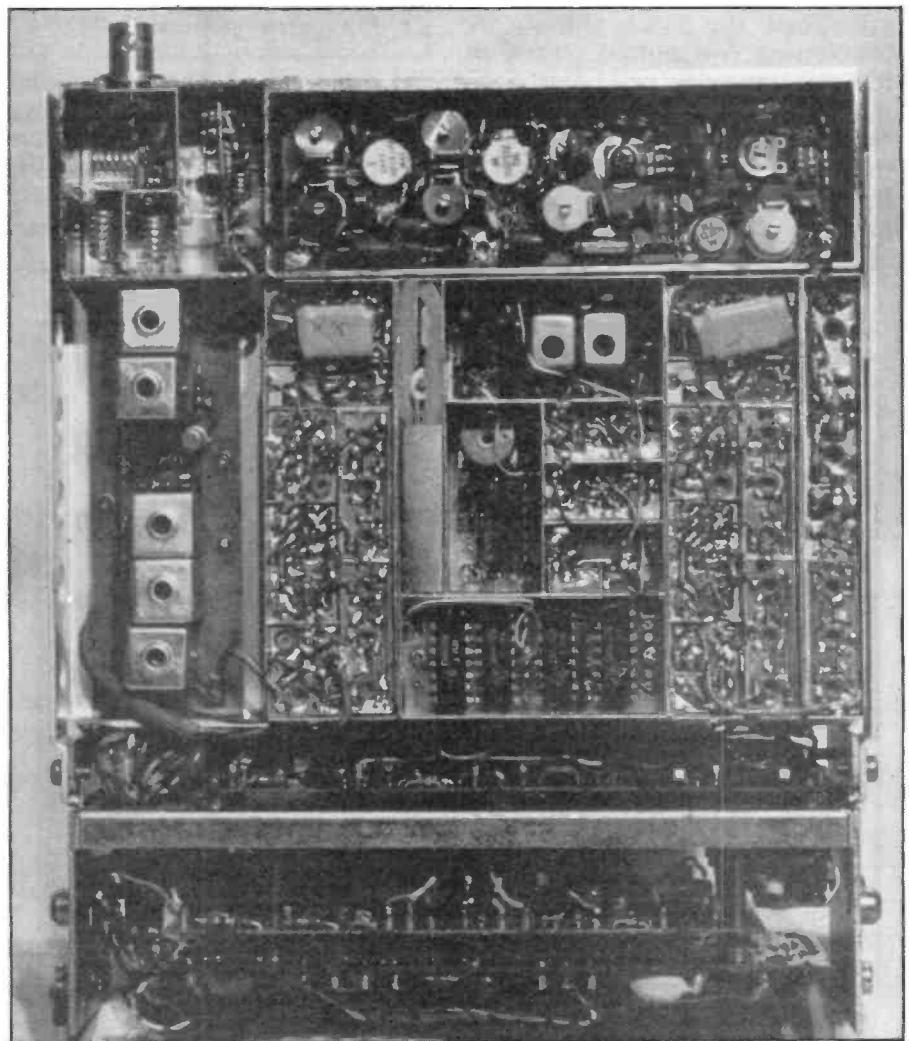
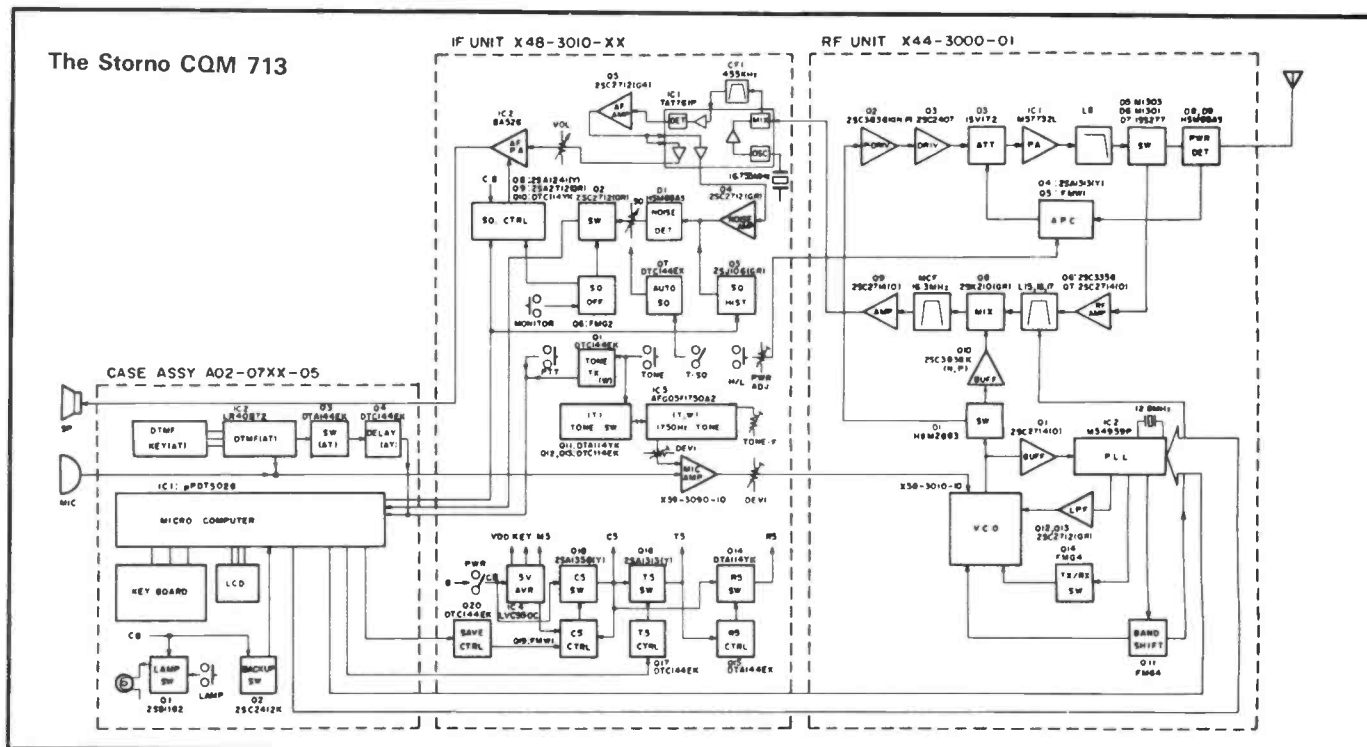

Fig.2 Board location and alignment diagram for the CQM 713



The Storno CQM 713



LC7137 or LC7136 synthesiser IC (or an LC7120/LC7130 if it's a naughty AM set!) that you remove the switch and display sub-board in its entirety and use this as a channel control, as the output lines are in the required BCD format.

There is a catch with whatever control method you use, in that the channel numbers are inverted. Due to the original Storno design, the frequency decreases with each increase in channel number, ie. channel 1 is the highest frequency whilst channel 55 is the lowest, this is of course carried over to the 2m modification. However one easily gets used to the fact, and it can be solved by further digital logic if you're really fussy! Table 2 gives the channel/frequency relationship.

Receiver Alignment

First make sure you have a suitable *non-metallic* adjustment tool to tune nylon adjusters visible in the set. *Don't* be tempted to 'make do' with a watchmaker's screwdriver or the like, as disaster will surely strike. I used a Radiospares trimming tool, but if you don't have something suitable to hand then a filed down knitting needle or matchstick works wonders.

You will also need a frequency counter or a diode probe, together with a power meter and a 2m rig with an S-meter. Start by temporarily

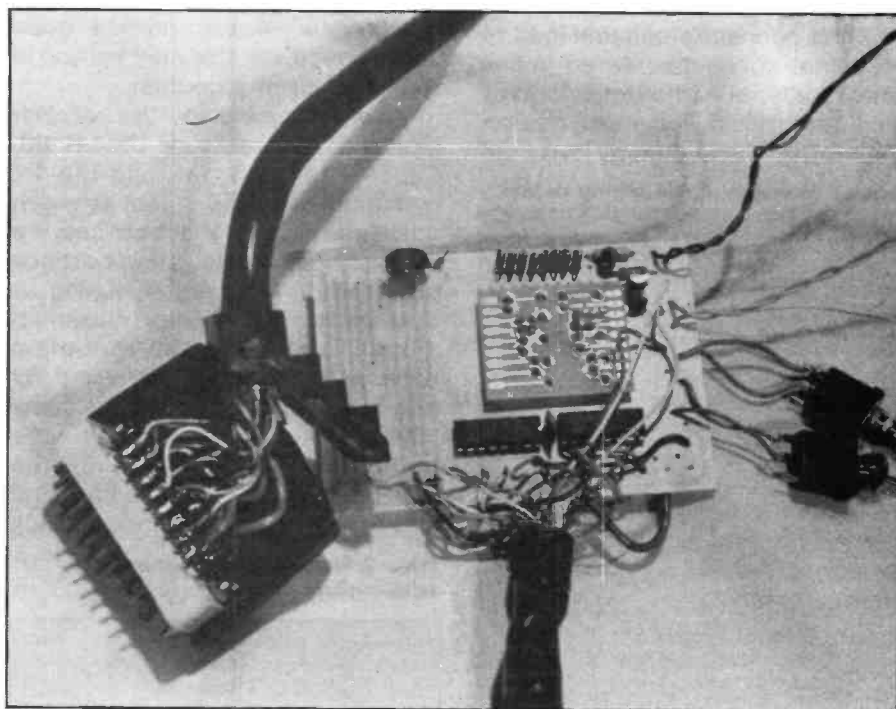

The conversion board and multiway wiring detail

linking the yellow/grey squelch defeat control lead (N) to negative; switch on and adjust the volume pot to give a suitable noise level. With your probe or frequency counter on the receive oscillator test point, ie. the short blue insulated wire (see Fig.2), tune L3 on the RC712 section until you get a reading. If you are using a counter, tune L3 and L1 until you get a reading of exactly 134.225MHz, which is the fre-

quency of the 7th overtone Rx mix crystal. If not, then radiate a strong local signal from the working 2m set and tune L1 and L3 for least distorted speech, making sure you have both sets on the same channel. Now that we have the receiver on frequency, we can start to re-align for best performance.

By progressively reducing the off-air 2m signal level, tune L5, L6, L8, L9, L10, L11, L14, L15 and L16 on

the RC712 section for best quieting of noise. Then go onto the RA712 section, which is the front end, and tune L1, L2, L3, L4 and L5 — again for best signal corresponding with maximum quieting level, reducing the received signal as necessary to aid alignment. By now the set should be capable of receiving off-air signals, so 'fine tune' each coil (including L1 and L3 if originally adjusted without a counter) for absolute best reception of a weak signal. I managed to achieve 0.22µV pd sensitivity for 12dB SINAD which is quite reasonable when compared with the average Japanese box. The IF section should already be aligned, however the squelch control is a pre-set (see Fig.3), and you may adjust this if you wish to give a more sensitive level or even bring the connections out to the front panel for a variable control.

Transmitter Alignment

First connect a suitable load to the aerial connector via an in-line power meter or some other form of level detector. If you must use an aerial rather than a dummy load then

Table 1 Multiway cable wiring details

CODE	DESCRIPTION
A	Not used
B	Not used but also -ve
C	Orange; 5V Tx
D	Grey/red; Binary 8 tens
E	Not used
F	Brown; PTT
G	Not used
H	Green/brown; 5V rail
I	Not used
J	Yellow/green; Binary 4 tens
K	Not used
L	Not used
M	Not used
N	Yellow/grey; Squelch defeat
O	Not used
P	Not used
Q	Not used
R	Black - Link to AA; -Ve Gnd
S	Yellow; Loudspeaker AF
T	Black/yellow; Volume pot
U	Yellow/white; Binary 2 tens
V	Blue/brown; Binary 8 units
W	Not used
X	Yellow/brown; Binary 1 tens
Y	Green/white; Binary 4 units
Z	Not used
AA	Black; -ve Gnd
BB	Not used
CC	Red/yellow; Binary 2 units
DD	Not used but also -ve
EE	Not used
FF	Grey/white; Volume pot
GG	Not used
HH	Green/red; Binary 1 units
II	Not used
JJ	White; Mic input
KK	Thick blue; 12V DC switched
LL	Thick red; 12V DC input
MM	Brown/white; Volume pot slider
NN	Link to KK

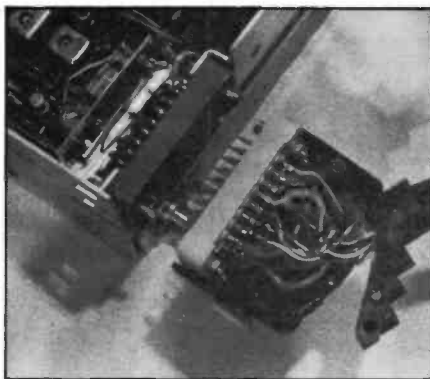

Close-up of the multiway plug

please make sure you choose a frequency where you won't be causing interference! Keep the transmitter keyed by grounding the brown PTT line (F) and connect your counter or probe to the transmitter oscillator test point, again a short blue insulated wire (see Fig.2) and tune L3 on the EX712 section for an indication. If you're using a counter, tune L1 and L3 for exactly 128.525MHz, the frequency of the 7th overtone transmit mix crystal. If you have a good airband receiver, this may aid you in the absence of a counter.

Now by using the 2m receiver alongside the set, tune L5, L6, L8, L9, L10, L11, L14, L15 and L16 for maximum received signal strength again making sure that both sets are on the same channel. Then continue onto the RA711 section, tuning L1 through to L6 again for maximum signal, reducing the coupling between the two sets as required. By now, you should be getting some indication of RF power on your meter, so continue tuning the variable capacitors on the PA stage for absolute maximum, then go back

Table 2 Frequency & channel relationships

BCD Input	BCD Tens		BCD Units		FREQ (MHz)
	MSB	LSB	MSB	LSB	
00	0000	0000			146.000
01	0000	0001			145.975
02	0000	0010			145.950
03	0000	0011			145.925
04	0000	0100			145.900
05	0000	0101			145.875
06	0000	0110			145.850
07	0000	0111			145.825
08	0000	1000			145.800
09	0000	1001			145.775
10	0001	0000			145.750
20	0010	0000			145.500
30	0011	0000			145.250
40	0100	0000			145.000
50	0101	0000			144.750
60	0110	0000			144.500
70	0111	0000			144.250
80	1000	0000			144.000

and fine tune all the transmitter stages until the set is completely aligned for maximum power output. You should get around 20W output, I achieved just over this, but you may finally adjust R11 on the TX PA to set your desired output level. I did find a slight problem on L5 and L6 of the RA711 section, where excessive drive caused instability in the PA. This may have been an isolated case, but if you find that the output power jumps quickly in level as you tune, then I would suggest slightly detuning L5 in one direction whilst detuning L6 in the other direction to reduce the overall drive level.

If you originally adjusted L1/L3 with a counter, your set should now be on frequency, if not then set these to give centre frequency from an off-air report. Your deviation should be close to 5kHz already, but Fig.3 shows the position of the deviation control should you wish to vary it. The other unmarked adjustments in Fig.2 are the synthesiser VCO (Voltage Control Oscillator) and reference crystal oscillator adjustments, these should all be spot on and hence will not need adjustment.

Replace the internal screens to the boards, checking to ensure that the performance is not affected when you do this. You may need to very slightly re-tune the adjustments on a trial-and-error basis if you find this happens, although I found no problems occurred in the test set.

Second Rig

So there we are, for around £60 you've got yourself a synthesised 2m rig, either as a first set for the band or possibly as a permanent remote mounted mobile set to save you lugging the FT290 about. A remote mount makes the rig far less prone to theft with the main set being hidden away out of view and just a tiny box under the dash or in the glove compartment. Because PMR equipment such as this is designed to strict professional specifications, it will easily outperform most amateur sets in regard to strong signal handling, adjacent channel rejections and transmitter modulation quality and RF cleanliness and that can't be bad!

My thanks go to R. Withers Communications Ltd for loan of the equipment and conversion kit.

TRIO TH-205E

REVIEW

In these days of multi-function priority scanning coupled with keypad entry of literally everything on micro-miniature handhelds, Trio must have stepped back and said (English translation); "Surely a lot of these amateurs just want an economic, straightforward and easy to use set". Off went their design team and the end result was the TH-205E. With many and varied operating functions being available cheaply and simply just by the use of one IC, it is possibly a little surprising that Trio have gone backwards in time by introducing a chunky set with limited facilities. However, by looking closely, you can see that everything to do with the set is bang up-to-date, but the designed-in features have produced a sturdy, straightforward handheld at a competitive price. Gadget oriented amateurs will find little to please them, but others please read on . . .

Features

The set offers operation on FM over 144-146MHz in 5kHz steps, frequency change being made by a pair of Up/Down step buttons. The standard 600kHz repeater shift is selectable by a small 'offset/R' push-button, this cycling between +600kHz, -600kHz, and simplex. Pressing the small 'M' button followed by 'offset/R' gives a momentary listen on input facility. Three memories are available, each with their own access button and these store the operation frequency together with any programmed offset. A locking push switch on the top panel gives you an automatic 1750Hz toneburst at the beginning of each transmission.

Simple automatic scanning of the band in 5kHz steps is initiated by a press of the 'scan' button, the set locking onto frequency when the squelch raises. Manual scanning occurs by keeping one of the Up/Down buttons pressed, but this

The Trio TH-205E comes hot on the heels of the latest crop of 2 metre handies. But is it good enough to catch up with them? Chris Lorek assesses the form.

The new TH-205E handy

stops as soon as you let go — a sliding 'F.Lock' switch stops accidental frequency shifts. An LCD readout gives an indication of the operation frequency, offset, memory channel if in use, together with 'Busy', 'On Air', and low battery warning displays. This may be backlit for night-time use by pressing a further small 'Lamp' button. Rotary controls for volume and squelch are fitted to the top panel, together with sockets for external speaker, mic, and power supply. A 135mm long 'stubby' helical fits onto a BNC connector, which also allows connection of an external aerial for home or mobile use.

A side-mounted PTT bar is complemented by a further 'monitor' bar which raises the squelch on receive, although this is mainly designed to be used together with an optional sub-tone encoder/decoder module. A further top-panel locking

push button selects high or low power on transmit. A range of nicad batteries give variable transmit power and lifetime capabilities, extending from 800mAh and 1.6Ah at 7.2V, 500mAh at 8.4V, to 800mAh at 12V. The transmitter gives a nominal 1.5W at 7.2V, 2.5W at 8.4V, and 5W at 12V, with a low power of 500mW in all cases.

The 8.4V nicad

is supplied with the set, together with a plug-in wall socket battery charger.

A range of option accessories include soft protective cases, belt clip, speaker mic, headphones, DC cable, and a dry battery case as well as the different nicad packs. The set measures 69mm(W) x 180mm(H) x 38mm(D) and weighs 520g with the supplied battery.

Initial Thoughts

In holding the set, one is given an impression of sturdiness and ruggedness, more akin to commercial sets rather than those destined for the amateur market. I really did feel like throwing the set around to check it's resistance to this as I'm sure it would stand up to rough treatment, but Lowe Electronics would probably not speak to me again! The battery pack is a very positive 'twist-on' attachment, which is quite different from the usual slide-on method

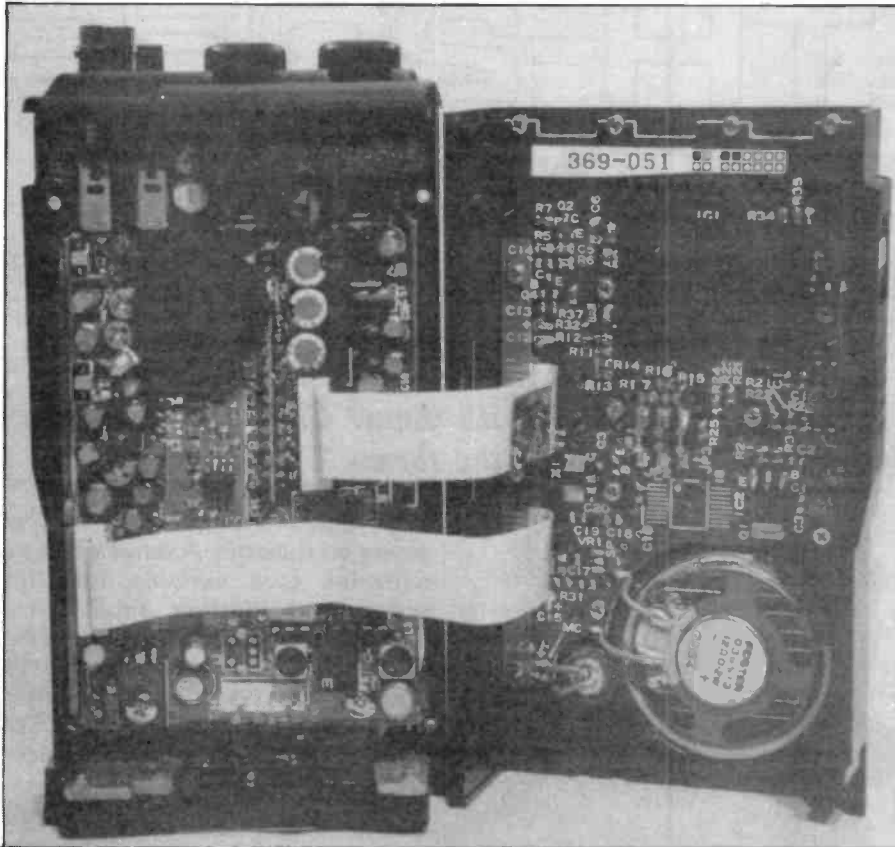

Internal view of the unit

which is often a little wobbly.

I didn't like the 5kHz steps, I feel 12.5kHz increments would have been more useful for the majority of UK users. The supplied user manual gives excellent operating instructions and even a circuit diagram of the set which pleased me, some manufacturers just don't seem to bother doing this now with the lower-cost amateur sets. I still would have thought that adjustment points for deviation, toneburst length and so on could have been shown, but I can't complain too much as these could be worked out together with the circuit diagram by someone competent enough to know what they were doing in the first place.

Open The Box

Out came the screwdrivers to see what was hidden inside. The set is constructed on a metal diecast rear panel which also acts as the PA heatsink, together with tough synthetic wrap-around front and top panel sections. Three separate PCBs are used, one mounted on the front panel houses the control side, and two further plug-in boards carrying analogue circuitry are stacked above each other in the main body. Virtually

all the circuitry is of the surface mounted 'chip' variety.

On receive, the usual dual-conversion superheterodyne is used with IFs of 16.3MHz and 455kHz. The aerial input is passed via a varicap tuned circuit to a bipolar 2SC3356 front end, this feeding straight into a bipolar 2SC2714 operating (usually) in common base mode. Then via three further varicap-tuned bandpass networks into the



Close up of the front panel

2SK210 FET mixer to achieve the first IF signal. This is passed via a single monolithic dual crystal filter (which has a wire link fitted in the space intended for a cascaded filter) then into the TA7761P subsystem IC. Here the main selectivity is achieved with a small CFU455E ceramic filter and further IF amplification takes place, coupled with detection and audio preamplification. Noise squelch amplification and detection are carried out separately with the final audio being boosted to loud-speaker level by a BA526 IC.

The transmit side is a straightforward pair of amplifier stages driven from the VCO, feeding an M57732L PA module followed by a block low-pass filter and PIN diode aerial switch. Frequency generation is carried out independently for Rx and Tx with a pair of final-frequency VCOs, but with a switched output which is rather unusual in that it is controlled by an M54959P synthesiser IC which is itself under serial control from the multi-legged custom micro. The usual lithium back-up battery is fitted, although the lifetime of this is not quoted, neither are any details given of user replacement.

In Use

The set was tested in home, mobile, and of course portable use. As to be expected, it was indeed very easy to use, however as I am a self-confessed gadget lover, I did find it limited in that although memory channels were fitted, one or two more could have been useful. Frequency change and memory channel access were extremely simple, especially useful when operating the set mobile. The bandscan was handy to gain an idea of occupancy before putting a call out, but limited in use as a general monitor for two reasons. The first was that the scan stopped as soon as the squelch was raised, which was invariably 5kHz or 10kHz off the station's centre frequency — giving distorted reception. The second was that the scan did not resume when the signal disappeared. The set gave reasonable rejection of 25kHz spaced signals, but those 12.5kHz away did cause problems.

Transmit audio reports were very pleasing, there was ample mic gain to give a 'punch' to the signal but

Fig.1 Schematic of the TH-205E

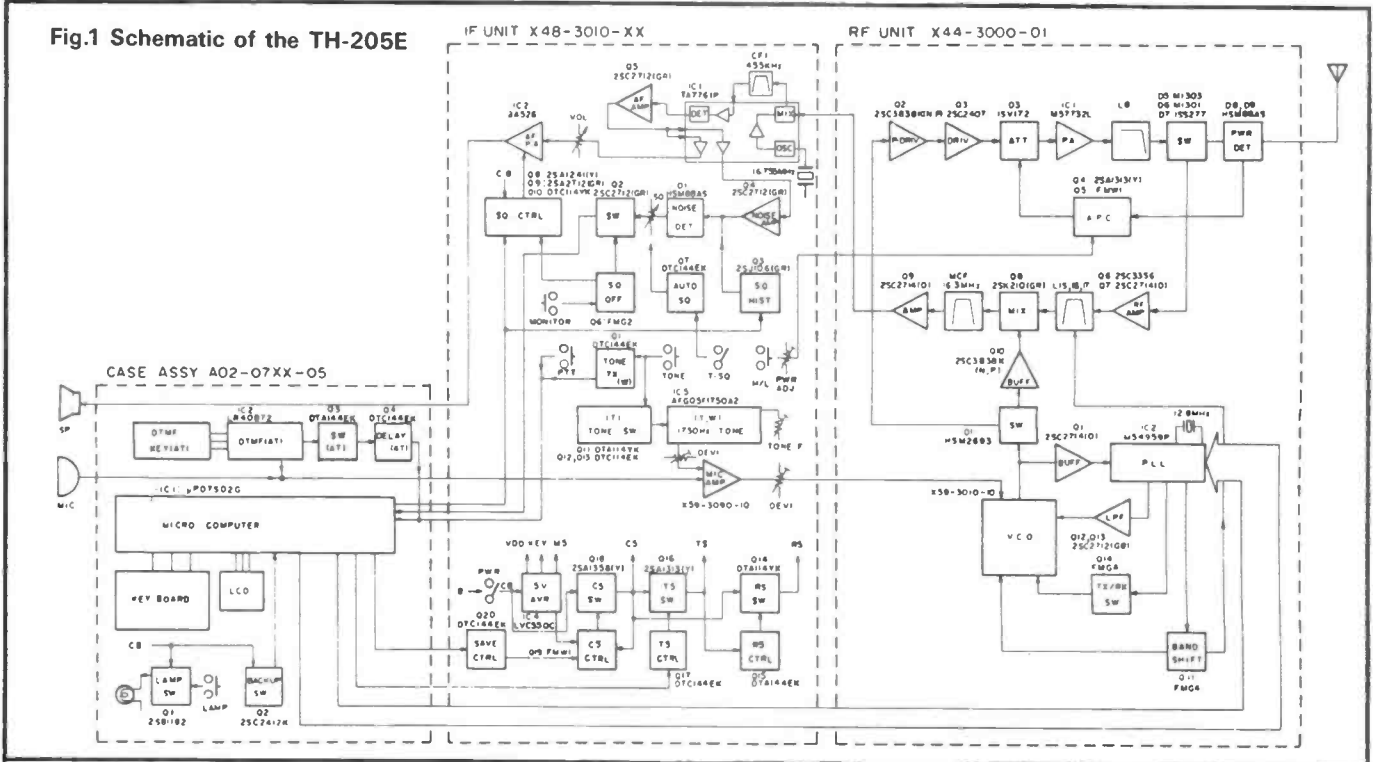

this also tended to make me sound like a long distance runner with breath noises whilst walking along. The receive sensitivity was very good and in my shack the addition of an outboard GASFET preamp caused little improvement. I found the maximum squelch setting a bit limiting in that I could not squelch out fully copyable but still noisy signals when monitoring the local repeater on an external aerial, but I'm probably getting fussy as it is a portable designed primarily to receive relatively weak signals from its helical, which is did admirably. There was plenty of audio available from the built-in speaker.

It was possible to QSY directly

Detail of the top panel



from a recalled memory channel by pressing the Up or Down buttons and I found this very useful although the facility is *not* mentioned in the manual. A slight 'funny' occurs if you press a memory button twice, in that it puts you back to the frequency last selected. This was sometimes useful, sometimes annoying, depending on whether the last frequency was 'dialled up' or a memory channel. To give an example, if 144.750 was dialled up then memory 1 recalled, 144.750 could be regained simply by pressing button 1 again. But if memory 2 was the starting point, then you could not get back to 144.750 except by a long QSY. The manual was a little unclear on this.

Battery pack is of a novel 'twist-on' design



Laboratory Tests

The receiver sensitivity was confirmed as being very good indeed, I was rather impressed! The squelch threshold was also very good, to allow detection of weak signals, but the maximum squelch setting measured at just over 10dB SINAD, confirming the on-air result. The

Not the smallest, but certainly a rugged rig



Laboratory Results Receiver

Image Rejection: Increase in level of signal at -32.6MHz to give identical 12dB SINAD signals **71.5dB**

Squelch Sensitivity

Threshold	0.056 μV PD (2dB SINAD)
Maximum	0.130 μV (10.5dB SINAD)

Receive Current Consumption

No signal economiser standby	19mA average
Mid volume	48mA
Max volume	70.5mA
	137mA

Transmitter

Peak Deviation	4.76kHz
Toneburst Deviation	3.29kHz
Frequency Accuracy	-290Hz at switch-on

Harmonics/Spurii

2nd Harmonic	-77dBc
3rd Harmonic	-62dBc
4th Harmonic	Less than -90dBc
5th Harmonic	-82dBc
6th Harmonic	less than -90dBc

All other outputs less than -90dBc

TX Power and Current Consumption

Supply Voltage	7.2V	8.4V	12.0V
Low Power	0.53W/520mA	0.53W/520mA	0.53W/520mA
High Power	2.56W/1.14A	3.44W/1.25A	5.34W/1.40A

Blocking: Increase over 12dB SINAD level of signal 1MHz away to cause 6dB degradation in 12dB SINAD on-channel signal.

+1MHz	94dB
-1MHz	96dB

Intermodulation Rejection: Increase in level over 12dB SINAD level of two interfering signals giving identical 12dB SINAD on-channel 3rd order intermodulation product.

Spacing	Rejection
25/50kHz	64dB
50/100kHz	63dB

Maximum Audio Output: Measured at 1kHz on the onset of clipping, into an 8ohm load.

465mW	(8.4V supply)
-------	---------------

Adjacent Channel Selectivity: Measured as increase in level of interfering signal, modulated with 400Hz at 30% system deviation, above 12dB SINAD ref level to cause 6dB degradation of 12dB SINAD on-channel signal.

Separation	Rejection
+ 12.5 kHz	31dB
- 12.5 kHz	23dB
+ 25kHz	57dB
- 25kHz	58dB

Sensitivity	0.139 μV PD for 12dB SINAD
-------------	---------------------------------------

adjacent channel rejection was a little disappointing but not unexpected; from opening the set up one can clearly see that economies have been made in this area. The lack in measured intermod performance can be explained by the good sensitivity — the use of a pair of cascaded bipolars in the front end with their inherent large gain means that you can't have the best of both worlds unfortunately. The receive current consumption was quite reasonable, and the economiser facility would give a good battery life when monitoring a quiet channel.

The transmitter measured quite well on all counts and the low power output was well regulated with all supply voltages. The high power setting gave a useful output, always within specification and with reasonable efficiency, helping to extend battery life. The deviation was set nicely within the 5kHz maximum, something I have always found with Trio but not, unfortunately, with other manufacturers.

Conclusions

I was impressed with the concept of the set's ease of use combined with its simplicity and ruggedness. I only found one minor 'funny' in its operation, but then I'm a fussy so-and-so. The lab tests show the set to be good on transmit but a bit of a compromise on receive, however for its intended use as a portable with a small aerial I feel the compromise is on the right side in having excellent sensitivity. Having said that, the strong signal handling is still as good as some more expensive up-to-date portables which don't offer such good sensitivity. Trio have clearly taken a gamble in its introduction and it will be interesting to see if it pays off by finding a good market, as the price (£218 including charger) is very reasonable indeed in my opinion.

My thanks go to Lowe Electronics Ltd. for the loan of the review equipment.

RADIO Tomorrow

- 2 Feb** Welwyn/Hatfield ARC: Computer Programming.
Todmorden DARS: AGM.
Burnham Beeches RC: 2nd Surplus equipment sale.
- 3 Feb** Loughborough DARS: Night on the air.
Harpenden ARC: Talk 'AX25 on a BBC B' by G4OAV.
Fyld ARS: 'Amateur television, Pt 2' by G3AEP.
- 4 Feb** Trowbridge DARC: Main meeting.
Lincoln SWC: CW Activity Night, Committee Meeting.
Three Counties ARC: Talk 'Weather satellites' by Boyce Jefferies.
Fareham DARC: Natter.
Rolls Royce ARC: Social night by Harvey Garlick.
- 5 Feb** Spen Valley ARS: Talk 'Satellite TV' by Mike Cox G8HUA.
Pontefract DARS: VZDEO 'DXpedition to Lord Howe Isles'.
Salop ARS: Packet Radio Demo.
Bredhurst RTS: Talk 'Amateur Radio in the Soviet Union' by G3FXB.
Vale of Evesham RAC: 'Secondhand equipment' by Alan Kelly.
- 6 Feb** Coventry ARS: Quiz night.
Reading DAR: Regular meeting.
Maidstone YMCA ARS: EMC Interference.
AMRAC: Meeting.
Aberdeen ARS: Junk sale.
YL Activity Day.
- 8 Feb** Bury RS: Hamfeast at Mosses Youth & Community Centre, Cecil Street, Bury, Lancs. Tel. G1PKO for details on 061 764 5018.
- 9 Feb** Milton Keynes DARS: Talk 'Technical aspects of Electronics Organs' by Chappell of Bond Street.
Sutton Coldfield RS: 'Operation Rayleigh' by John Layton, G4AAL.
- 10 Feb** Loughborough DARS: Magazine reviews.
Workshop ARS: Night on air (club contest) using G3RCW.
Macclesfield DRS: Talk 'The Lowdown on Hi-Fi' by GODMU.
Verulam ARC: Activity evening.
- 11 Feb** Stockport SWC: Talk '10GHz TV' by GOBTA G6IGM.
Fareham DARC: Talk 'Interpretation of RX Specs'.
Stockport RS: Junk sale.
Lincoln SWC: '10GHz TV' by GOBTA and G6IGM.
SE Kent (YMCA) ARC: Film night.
- 12 Feb** Pontefract DARS: Natter Night.
Salop ARS: Natter Night.
Southgate ARC: 'Computer technology' by John Young G4KZD.
Edgeware DRS: 'Electromagnetic compatibility (EMC)' by Ian G4IUZ.
- 13 Feb** Coventry ARS: Night on the air.
Maidstone YMCA ARS: Natter, RAE & CW.
Loughton DARS: Talk 'Electrical Safety' by G6FWT.
Wimbledon DARS: Mini-Lecture & Natter Night.
Aberdeen ARS: debate 'Amateur radio would improve if all amateur repeaters were closed down tomorrow'.
Bristol FM TV Group: Lecture and demonstration by Roger G4ZQF and Shaun G8VPG.
- 16 Feb** Felixstowe DARS: Visit to RAYNET Communications Centre, Ipswich Police HQ.
Welwyn/Hatfield ARC: Club Project (Informal).
Todmorden DARS: Chat Night.
Burnham Beeches RC: Lecture 'Weather Satellites'.
YL/OM Contest.
- 17 Feb** Halifax DARS: Junk Sale.
Harpenden ARC: Practical AX25 night.
Fylde ARS: 'Direction finding with simple equipment' by G8GG.
- 18 Feb** Stockport RS: Natter Night.
Lincoln SWC: CW/RAE Activity Night.
Fareham DARC: Natter Night.
- 19 Feb** Spen Valley ARS: Talk: 'Beekeeping' by Tim Clough, G4PHR.
Pontefract DARS: Raynet AGM.
Salop ARS: Talk 'Safe Mobile Operation by Inst. of Advanced Motoring'.
Bredhurst RTS: Antique Radio Demo by Tony Skinner.
- 20 Feb** Coventry ARS: Mini Lectures.
Maidstone YMCA ARS: RSGB Video.
Aberdeen ARS: 'DXing on UHF/VHF with less than average station' by Graham Sangster.
N. Bristol ARC: 70cm activity night.
- 21 Feb** Fareham DARC: AGM.
Lincoln SWC: Special Event Station GBORAG for College Rag Week 21st to 28th Feb.
- 23 Feb** Sutton Coldfield RS: Computer evening.
- 24 Feb** Workshop ARS: Talk on power supplies by Mike, G8VHB.
Waterside SWC: TBA.
Verulam ARC: 'Radio control models' by Ian Bradbury.
- 25 Feb** SE Kent (YMCA) ARC: 'Air traffic control'.
Crawley ARC: Lecture by G3MXJ.

- 25 Feb Lincoln SWC: Junk Sale.
Fareham DARC: 'Telecoms within Electricity Supply' by G4VNN.
- 26 Feb Salop ARS: HF on air.
Edgeware DRS: On air and CW evening.
BYLARA Contest.
- 27 Feb Coventry ARS: Night on air.
Maidstone YMCA ARS: Natter RAE & CW.
Loughton DARS: Films from RSGB.
Wimbledon DARS: Talk 'IBA TV Broadcasting by G3VA'.
Aberdeen ARS: 'A newcomer's guide to 4m' by Alan Duncan.
N. Bristol ARC: VHF activity night.
- 28 Feb Bredhurst RTS: Rainham Radio Rally.
BYLARA Contest.
YL-OM Contest.
Crawley ARC: Visit to Farnborough.
- 1 Mar **YL/OM contest.**
- 2 Mar Welwyn/Hatfield ARC: RSGB speaker.
Todmorden DARS: RNLI talk.
YL/OM contest.
- 3 Mar Harpenden ARC: Satellites and amateurs by John G4JOV.
Fylde ARS: Aurora, what it causes, Pt. 1 by G2FKZ (tape-slide show).
- 4 Mar Three Counties ARC: 'EMC' by John Greenwell.
Rolls Royce ARC: Construction contest.
- 5 Mar Bredhurst RTS: Talk 'Homebrewing station test equipment' by Colin G3VTT.
Spenn Valley ARS: Talk 'Public service communications' by Bob Comas G4YTE.
Pontefract DARS: Components fair planning.
Horsham ARC: Spring junk sale.
Salop ARS: Visit to Shropshire Stow printshop.
Vale of Evesham RAC: 'Test your spec' by Dave G3PGQ and John G3DEF.
- 6 Mar Coventry ARS: Computer evening (using your own if possible).
Axe Valley ARC: Torbay club's NFD Video.
Maidstone YMCA ARS: Junk sale.
AMRAC: Meeting.
Aberdeen ARS: Junk sale.
YL Activity Day.
- 7 Mar **Blue Star Rally, Newcastle.**
- 8 Mar **Second Annual Wythall Radio Club Rally,** Wythall Park, Silver Street, Wythall, S. Birmingham; opens 12 noon, trades club stands, talk in on S22, admission 50p.
- 9 Mar Felixstowe DARS: Visit Sainsbury superstore, Warren Heath.
Milton Keynes DARS: 'American Scientists' by USAF Chicksands.
Sutton Coldfield RS: Projects think tank.
- 10 Mar Worksop ARS: Mag sale.
Macclesfield DRS: 'History of morse' by GOAMU.
- 11 Mar Fareham DARC: Junk sale.
- 12 Mar Pontefract DARS: Talk 'Memories of radio in WW2'.
- 13 Mar Coventry ARS: Night on the air.
Loughton DARS: Talk 'Basic AC theory' by G8DZH.
Aberdeen ARS: 'Portable meteor scatter DXpedition' by Stewart Cooper GM4AFF.
N. Bristol ARC: Bring & buy sale.
- 15 Mar Derby DARS: Derby DARS National 144-145MHz contest for Radio Today.
Crawley ARC: Visit to Dungeness 'A' power station.



"Should be O.K., I oiled it today."

- 16 Mar Todmorden DARS: Chat night.
- 17 Mar Halifax DARS: RSGB Region 2 Rep — G4EJP.
Fylde ARS: 'Modifying a receiver for top band D/F' demonstration.
- 18 Mar Three Counties ARC: 'Introduction to packet radio' by Jeff Ward K8KA.
SE Kent: Natter night + committee.
- 19 Mar Bredhurst RTS: AGM.
Spenn Valley ARS: Preliminary AGM.
Salop ARS: Fox hunt.
- 20 Mar Coventry ARS: An 'outside' speaker.
Aberdeen ARS: Amateur TV demonstration by Tony Thomasson GMOGAT.
N. Bristol ARC: Packet radio demo.
- 22 Mar **Mid Devon Rally, The Pannier Market,** Tiverton; opens 10 am, talk in on S22, easy access, excellent parking. Contact G4TSW, O PO Box 3, Tiverton, Devon EX16 6RS.
- 23 Mar Felixstowe DARS: AGM.
Sutton Coldfield ARS: Annual junk sale.
- 24 Mar Worksop ARS: Video night.
Bristol FM TV Group: AGM.
- 25 Mar Fareham DARC: Talk 'Equipment reliability' by Keith GTNWN.
Stockport RS: 'Kiss' by Dave G8UQC.
SE Kent (YMCA) ARC: Construction evening.
- 26 Mar Edgeware ARS: 'Propagation' by John G3SJE.
- 27 Mar **RSGB convention/NEC.**
Loughton DARS: Night on the air.
Aberdeen ARS: 'Propagation' by Findley Baxter GM3VEY (for beginners).
N. Bristol ARC: CW activity night.
Coventry ARS: Night on the air.
- 28 Mar **RSGB convention/NEC.**

Will club secretaries please note that the deadline for the May segment of Radio Tomorrow (covering radio activities from 1st April to 1st June) is 19th February

Free Readers' ADS

HRT MARCH 1987
Cut off this corner
using a photocopy of the coupon
and attach it to the ad you send in.

HEATHKIT Amateur receiver model RAI. 100KC crystal calibrator, circuit - service manual. 10,15,20,40,80 and 160 meter bands. S meter, Q multiplier input. Spare set valves. Good working order. £125. Darlington, Co Durham, phone 281 702.

SHARP M2711. Computer and software for sale, over one hundred pounds of software including locator program. Best offer secures as space is needed. Write: G6BKX QTHR or phone 021 526 6850.

SUPER STAR 2000 four blocks of 50 channels covers 25-965 to 28.005MHz no gaps, pristine condition, uses PTB125A4X Cybernetic board easily converted to 10m. £175 ono. Tel 0934 511604, after 5pm.

ICOM 240 2m FM mobile transceiver 10W, manual, PUS for base use, also 7/8 whip aerial and SWR power meter. £65 ono. Phone (0727) 63726.

YAESU FRG7, 0-30MHz receiver, USB, LSB, AM, CW, very good condition, £125 ono. Contact: Ossie on Gravesend (0474) 326036, evenings best.

WESTREX mechanical printer (teletype) RS232 compatible working order, complete with paper and punch tape, offers and swaps invited, anything for shack considered. Old valve receiver or what have you. Telephone 0623 659341, anytime.

YAESU FT290R for sale. Mu-Tek board fitted, nicads, charger, soft case, £265 ovno or might exchange for scanner, or HF receiver. Please phone Eric G1IYH QTHR on 01 874 7553, SW London.

2M SSB rig, Totsuko TR2100M with muter pre-amp, £100. Sem multifilter, £30. Jaybeam DE/2M, £20. Wanted HF rig FT107 FT101ZD or similar, phone Richard G4TGJ, Potters Bar 41449, between 13th December and 10th January or write QTHR.

YAESU FT102 HF transceiver all modes including FM, processor, compressor, 240

watts, PEP mint condition, original packaging and manual only, used on RX complete with Addonis AM 303, mic, £575 ono. Tel Farnham (0252) 713824, after 5.30.

FOR SALE. TV 6" Verga mono, UHF, VHF ideal for continental reception DX, battery, mains, £55. 0283 221870, between 8pm and 9pm.

SOMMERCAMP FT790R transceiver, £240. Alinco 70cms linear amp, £40. Bremsa power supply, £10. Channel master rotator, £35. Popular Electronics 2M linear preamp, £250 or nearest offers. Enquiries, phone Buxton 71674.

FOR SALE. AR88D, very good condition, £80. 28 foot mast/aerial (telescopic) complete with fittings, £20. Phone Colin on Brownhills 0543 373384.

HF STATION. Yaesu FLDx400 TX, 80m thro' 10m, CW, SSB, Am. Matching FRDx400 RX 80m thro' 10m plus 2m, CW, SSB, AM, FM. Recently revalved and realigned. All leads and manuals. £185. GOAMZ QTHR, Kent. Tel: 0634 376991.

SHARP portable deluxe FM, LW, MW, SW from 1.6MHz to 26.5MHz, AFC BFO. Battery or AC, manual, ex cond. £50. Buyer collects. (01 794) 9790.

SCANNERS have thousands of interesting frequency allocations also many scanner and radio mods, plus all sorts of BLG circuits for A list of what I've got send SAE to PO Box 71, Bournemouth, BH9 1DT.

BARGAIN complete station comprising Trio TS830S 10-160M transceiver, Yaesu FC107 ATU, Trio MC50 mic. All in mint condition and very little used. Genuine reason for sale. £745. Phone Hook, Hants (025672) 2724, after 6pm.

EDDYSTONE 730/4 500KC/S-30MC/S with spare set new valves, working order, £60. Tono receive terminal, good condition, £120. Hy-gain 12 AVQ 10-15-20M, £30. Ad-

vance signal gen SG62a, reasonable condition, £20. All above with manuals. Phone Mr Russell 0734 (Reading) 428603.

ORGAN GENERATOR. PCB 8" x 4" 96 note, 5 footages + 5 drawbars, £40 post paid. FRG7700 + memory, slight readout fault, offers. Seon Smyth 0437 71181.

COMPLETE receiver station. Trio R600 - Global AT1000 ATU, brand new microwave modules, 144MHz converter and G5RV antenna. Original packing, all items mint condition, sell for £240. Phone Tony, Wrexham 0978 757435, Sunnyside, New Road, Coedpoeth, Wrexham, Clwyd, N. Wales.

T1200 2 meter FM handheld transceiver memory scanning functions, bty charger, plus 5/8th mobile mag mount, mobile mike J pole, 4 watt max output, ideal first amateur station. £150. HF5V plus radial kit. £50. G4ZXC 0454 414397.

MINIATURE rack with three 19" panels, one carrying HV PSU another carrying loudspeaker, grey sprayed, cover included, only £25. Also many VHF crystals at 75p each. SAE for list from G5UM, Houghton, Leicester LE7 9JJ. **CREED 444** teleprinter, £30; G3PLX amtor board complete, £25; 20 amp fully regulated and protected power supply. £50. Want 1541/1570 CBM 64 disk drive/printer, WHY. Tony 0375 378783 (Grays, Essex).

NIKON FM2. Plus five lenses in aluminium case, plus powerful flashgun, tripod, brollies, stands, filters and other bits. Also Yashica TLR 2 1/4 plus bits. Complete outfit worth £400. Exchange for 2 metre base station, Yaesu, Icom, etc. Phone John 0602 303278.

REALISTIC DX302 digital HF, full coverage receiver, AM, USB, LSB, CW, built-in pre-selector. Good sensitivity, mains or battery, complete with manual, very good condition. £100 or possible ex-

change old quality cameras or 3-6hp outboard motor. John, Rotherham 374747.

FOR SALE. Heath 100E 100W, AM/CW transmitter, £40 ono. Marconi counter frequency/meter TF1417/2 with frequency converter. £30 ono or swap WHY for any above. John 0326 290711.

ICOM 240 2M FM mobile transceiver plus manual with P.S.U. for base use, also SWR power meter and 7/8 whip aerial. £65 ono. Tel St Albans (0727) 63726.

SALE ICOM 240 2M TX, £100. Sale Azden mobile Mike, MEX-55, Goose-Neck, £15. Both plus carriage. Phone Ray 047 985 254.

100 METRES twin axial cable, 100ohm R.S. type 388-316. Brand new, cost £72.45, accept £18. Also Alinco linear amp with pre-amp, brand new unwanted gift from wife. Bargain at £46. Mike G6MNX (0904) 422773, QTHR, York. **AR88LF** £40. COL46159 £20. APT power unit £20. Solartron digital meter £35. Need attention, offers R10Y, CR100 advance 1000MHz oscillator, Marconi instruments with manuals, Solatron scope, buyer collects. Wanted Radiovision Commander. Bushnell, 39 Ringwood Road, Maidstone, Kent. Phone 0622 670612.

FOR SALE: Heathkit DX40) CW/AM TXmitter and VF1U external VFO £50. Heathkit SB620 Scanalyser/monitor, scope £50. Heathkit HW7 QRP transceiver complete with PSU £50. All have manuals including circuits etc. Call Trevor G4RFM on (0983) 523623 anytime. (10W). **KW204 TX** worked over 100 countries, but needs slight adjustment. Must clear. Bargain at £75. Ian, tel Staines (0784) 50947.

SCANNER SX200N, eighteen months old and in mint condition. £200. Tel Keynsham 61589 (Bristol).

SSTV. Stop! Look! Listen! Do you own a Sinclair Spectrum, do you want slowscan television without hardware, for the

best pictures from this superb programme to transmit and receive. £4.50. A. Morgan, 78 Bridge Street, Downham Market, Norfolk O366 384735.

2 METRE multimode transceiver, Icom IC-245E with computerised remote unit IC-RM3, good condition with manuals. £250. Microwave modules, transverter 2 meters to 70cms, with input attenuator. £90. Phone 04574 5468, G8BEQ, Glossop, Derbyshire.

HAM INTERNATIONAL JUMBO 26.065-28.305 + 10KC + legal FM. £150 ono. Cobra 148 GTL £90 ono. (0392) 51879.

DUE TIME wasters, re-advertising ST5 terminal unit 45-50 baud micro, also Creed 444 380 hrs only, ex condition, plenty of paper rolls for printer and perforator. £100 the two. Basingstoke 882825.

AMATEUR RADIO programs for the Sinclair ZX Spectrum, slowscan television, transmit and receive, morse TX/RX, amateur TV test card generator, prefix locator. Excellent quality £4.95 each or all four for £15. A. Morgan, 78 Bridge Street, Downham Market, Norfolk O366 384735.

TR9130 2 meter multi-mode 25W for sale, offers around £380. 18 months old, hardly used, excellent condition. Phone John Hughes on Cardiff (0222) 594045, after 6pm.

HY-GAIN V 10 meter multimode USB, LSB, CW, AM, FM, cover 27.6012 to 29.700. Professionally converted. £110. Tel 0553 760614. Norfolk.

FOR SALE or exchange, Shimizu SS105S QRP rig (10w), TL120 200w pep linear, 48K Spectrum, ZX microdrive, ZX interface 1 for either IC735 TS440, TS430, plus PSU, all items cost £878.90 when new, three years old, will accept £615.90 ovno. I'll also pay the postage to you, or you can collect. Any offers? **YAESU FRG7700** plus FRT7700 with memory, excellent condition, £265. Please write K. Phillips, 11 Woolcot Street, Bristol BS6 6QH (G1POJ).

YAESU FT290 multimode, Nicads, charger, soft case, boxed, immaculate, £250. Daiwa power SWR meter, £20; DRAE wavemeter, £10;

power supply, 7A, £12; Jaybeam 5x7 plus cable, Daiwa DR700 rotor, £60; all boxed. Oscilloscope Solartron, 0-6MHz, twin beam, £60. Sheffield 642095.

FOR SALE, Bearcat 220FB, VHF/UHF scanner, 240v/12v, box/mobile mount, £140 ono. Tel 0708 47998, G4FQF, QTHR.

TRIO TS8305, immaculate condition, £650, Trio TR9130, boxed, bracket, mic, etc, £350. Wanted good condition Jaybeam TB3 or 4ELT TET HB34D, can deliver or collect 50 miles from Manchester. 0625 527250 after 6 pm.

KW1000 linear 572B's, good condition, diagram plus operating conditions, shorted turns on HT winding. Good replacement transformer offered, also replacement smoothing condensers and new rectifier panel if required. Requires triple receiver, type .0005 condenser. Phone for details, G5LP, 0246 590253, buyer collects.

FDK multi 725X, 144-148MHz, good condition, £180 ono. Reason for sale, HF mobile. Tel 01-247 6097, daytime only.

TEKTRONIX plug-ins, type D-high gain, M-four trace, K-fast rise, H-wide band, G-OK but needs new plug. All in excellent working condition. Also Heathkit lab scope 5" model 10-12 with leads and manual, will sell or swap for computer hardware or why. 051 3346859.

FOR SALE, FT270RH, 45 watt, 2 metre mobile, vgc, bargain at £290. Would exchange for cheaper 2 metre mobile with cash adjustment. Ring me now on 0249 712009, Wilts.

TRIO TS130V, £345. FT290R with Mutek Nicads charger, case plus 25w linear, plus 3/4 antenna, £320. Capco SPC300 2kw ATU, £145. All in mint condition and little used. With free boxes of course. F4FPU, QTHR. 0707 320741.

SONY ICF-6700w multi-band receiver, 1.6-29.5MHz SSB + CW, MW, FM, digital, wide and narrow, mains/battery, perfect condition, £160 or exchange VHS video recorder. Phone George, Riseborough (091) 2515204.

YAESU FT7 SSB/CW, 10w mobile with brkt, good con-

dition, crystal required for 10 meters, also linear amp, FL-110, 10-15-20-40-80 and 160, 100 watt, vgc, manuals, price both items, together £275, buyer collects, or pays postage. Tel 01-556 7759, Leyton, eves after 6 pm.

TWO radiophones, mobile SS channel with Selcall. Ex-BT manual service. 158-165MHz. Full working order. Possible modification for marine, 2m or scanning, going cheap. First reasonable offer secures. Telephone 0325 720257.

FOR SALE, realistic PRO2003 scanner, 60 channel memory, perfect condition, bought May '86, original packing, genuine reason for sale, bought HF receiver, £175 ono, complete with aerial. Wanted, Yaesu YR901 SP901. Phone Jon, 0636 (Newark) 77944 after 5 pm.

SONY ICF 2001 scanner, £125 ono. Marc portable receiver, air, marine, PSB, SW, battery, mains, £55 ono. Sony ST70 stereo, AM, FM tuner, £35. Harvard 410T 40 channel CB, £20. Leak stereo 30, plus amplifier, £60 ono. Leeds 0532 588729.

FOR SALE, FT290R, 2 metre, all mode, £200 ono. Telephone 0406 25333.

SEM TRANSMATCH with easy tune, sell £40, buyer collects. Tel 01-794 9790.

RECEIVER, Lowe SRX-30, good condition, original handbook, receives CW, SSB, AM, £75. Tel Wellingborough (0933) 625484, buyer collects.

SCANNER owners. I have photocopies of Tandy Scanners PRO30, PRO31, PRO32, PRO2021 and Thandar TC200 freq. counter, £5 + post for copy. Also thousands of UK freqs. in book form, never published, 5 years work. Ring 04738 5526. Wanted, Motorola MT700 circuits please.

FT290, six months old, used 20 times approx. Two metre dist. here and just got a licence, £290 ono. Exchange for superb CW/SSB rig, eg. Argosy. Trevor, 14 Barn Street, Haverfordwest, Dyfed SA61 1TG.

SX200 scanning receiver, good condition, boxed with instruction manual and power supply unit, £150. Telephone 0392 214007 after 6 pm.

AOR 2002 scanning receiver

with GPV5 and GPV7 coils, £375. Icom IC-ZE handheld with case and sp/mike, £125. Signal R532 airband scanning receiver with Nicad pack charger case, PSU and helical, £175. Equipment in mint condition. Tel Ian, 0509 502989.

TS530SP for sale, immaculate condition, hardly ever used, emigrating forces sale. Boxed, ready for pick up, £600. No time wasters please. Ring Tony after 6 pm, 051-260 9296.

TS530S with CW filter just fitted, 230 ATU, 230 speaker and filters, remote VFO, dummy load, vertical antenna plus accessories, little used, excellent condition, £500 or exchange 2 metre station. Please phone Jeff, 0484 645923.

VINTAGE U.S. Army signal Corps frequency meter BC-221 AH, in mint condition, complete with canvas, field hoods, calibration charts and phones, £50. Signal Corps test set, EE-65-B, looks new, £40. Bookham 52569 evenings.

FOR SALE, Trio R600, excellent condition, many extras, cost £330, will sell £280 ono. For details phone (0633) 853583 after 6 pm.

YAESU FRG-7700 RX, vgc, £240; also Sinclair ZX Spectrum plus computer, vgc, as new, books, £70. Need money for BBC computer. Please tel. Eddie, GW4-OMF, Powys (0544) 267140, evenings only, after 7 pm.

HEATHKIT receiver HR1680, £50; FRG7 receiver, £125; Joymatch tuning unit, £10. Reigate (07372) 42597.

USA 1986 call book, £8.50 plus p&p. G31ZJ. 35 Abbey Way, Farnborough, Hants. Tel 0252 548561.

JAYBEAM Parabeam, still boxed, never used, £40. Telephone Dinnington (0909) 565443.

YAESU FT270RH 45 watt, 2 metre mobile, very good condition, RRP £469, bargain at £290. Wanted, 10w 70cm mobile standard, C7900. Ring Jon on 0249 712009 (Wilts).

FOR SALE, standard C5800E 2 metre multi-mode with excellent MM, pre-amp, £200. Standard 7900E, 70cms, FM mobile rig, £120. Datong morse keyboard, model MK, £60. Des Dowson, G3BYX, 19 Dundee Street, Darlington, Co.

Durham DL1 1JX. Ring (0325) 58315 anytime, 11 am to 9 pm.

FT290N multi-mode 2m tncvr, Ni-cads charger, mobile, bracket, carrying case, rubber duck, vgc, £250. R. Bailey, 35 Rose Way, Cirencester, Glos GL7 1PS.

NEW SSTV TX/RX, improved TX and RX, £10. Ham multi-mode 2 service manual, £5. CB radio conversion crystal, 20.870MHz gives you 28.315 Mhz to 28.755MHz, £3. Also 19.880MHz, 15.810MHz, 15.360MHz, £3 each. 10.240 MHz, 50p each. The CP PLL data book, £3. The Screwdrivers Expert Guide, £3.50. Paul Goodrum, 9 Ryston Close, Downham Market, Norfolk. Tel (0366) 388615.

SSB (German) 13cms, equipment brand new to clear, SRM13, STM13, SLO13, RX/TX mixers and local oscillator and SLA13 linear (4w), £340 ono. EME 25w 2C39BA/7289 linear with valve, PSU card and Toroidal transformer, £330 ovno. Phone Paul, G4XHF (0293) 515201.

ZX SPECTRUM 48K, plus computer, with books, 100 games, interface and tape recorder, with leads, £60 ono. Phone Daniel 01-958 7586. **SALE**, coaxial relays, 12 volt, type 951, UR43 cable, up to 460MHz, £4 each. Tel 061 9699305.

AR88D with manual, good condition, daily use, £85. Somerset 0278 781513.

FOR SALE, Icom R70 receiver, fitted with FL44A XTAL IF filter for superior pass-band tuning in AM and SSB modes, £495 ono. A. Edge, 3 Albert Road, Bognor Regis PO21 1NL.

YAESU FRG7, general coverage receiver, 500KHz-30MHz. Little used, £100 ono. Tel Mintlaw (0771) 22821 (evenings).

FOR SALE, Collins TCS12 transmitter with HB, PSU and CCT diagrams, in FB working condition, £30. Trio TR2300 with 15w PA, Nicads and charger, £110, boxed and FB condition. Phone Mick Mansfield 811681 (0623), QTHR.

LINEAR amplifier, 100w mains, 27-30, £40. Marine R/Tel, 12v, working 160m. Rack mounted QRO marine receiver, power supply, transmitter, vgc, offers. Exchange 70cm RX/TX. WWII 38 set ditto 18 set. New 813, £10.

Other valves, 5763 etc. Phone 0268 792079.

ICOM IC25E, 25w, FM mobile, £175. SMW 12v, 25A PSU, £90. Kawasaki Z400 motorcycle, 1980, 16,000 miles, £325, all ono. G8XCL, 0679 20954 (Lydd, Kent).

ICOM 720A HF100w, RX/TX, 0-30MHz, £550. ICSSMS, £25. 934MHz Delta 40 ch, £295. Pre-amp, £65. Co-linear, £20. Twin beam, £25. Rotator, £30. 27MHz silver rod, £12. **SWR/PWR** meter, £10. 7 amp PSU, £20. 3 amp, £12. Tel 021 4766121 after 6 pm

I HAVE for sale two Calcomp plotters-graphics. 300 steps per minute. One-tenth millimetre steps. Interfaced to BA 10/1. Drum length approx 31 inches. Best offer secures. Will split or exchange for good rigs, etc. Tel 0248 355635.

TEN metre FM DNT, MHO FM 29310 to 29710KHz, never used on TX, £30. G1010, QTHR. Telephone 044-46-42122.

TRIO R-2000 communications RX with SSB/AM/FM/CW modes. Programmable memory, scan, store features, mint condition, hardly used, with manual, box, £400. Dressler ARA30, active antenna system for shortwave listening, £80 both items, under one year old, genuine sale. Tel 01-390 2650. Carriage extra.

OMEGA, all bands, HF transceiver (GW3WPO design, built from his kits), well constructed and working pair, MRF454 in final, 70w output on CW, £300. Carriage by arrangement. Write GD3RFH or phone 0624 842571 for full details.

FT980 transceiver, excellent condition, as new, with manual, £995 will secure this superb rig. Phone GOCJU, East Grinstead 312374.

FDK M700EX 2m FM transceiver, 1w to 25w, variable output, mobile, mounting bracket, as new, £110. TONO MR150 2m linear, 10w in, 30w out, £75. G3MEW, QTHR, Portsmouth (0705) 820315.

TRIO/KENWOOD TS530SP transceiver, as new, £595. National HRO-M, power, 9 coils, rack-mount, very clean, £75. Hallicrafter S72, mains/battery, 8 valves, £50. Echo phone, commercial, gen. cov., £45. 1934 McMichael, mains, £35. Ferranti, 1934, battery,

£25. 1938 G.E.C., mains, £18. Rolls/Caydon, 1929, portable, £35. G4ERU, Bournemouth 510400.

UNIDEN CR-2021 communications RX, AM/FM,SSB/CE 150KHz-30MHz, digital tuning, LCD display scanning, 6 memories, 76-108MHz, FM, battery/mains, C/W PSU, boxed, as new, £110 ono. G1SWX. Tel 0252 621137, Fleet (Hants).

SUPERSTAR 360, FM, multi-mode, suitable conversion to amateur 10m band, C/W mobile, mounting bracket, instruction book, mic, in original makers box, unmodified, untampered with, excellent condition, genuine offers please. G1SWX, phone 0252 621137, Fleet (Hants).

FT290R 2m multi-mode, listen on input, Mutek front end, Nicads charger, case MMB11, mobile, mounting bracket, flexi whip, vgc, £290 ono. G1SWX, phone 0252 621137, Fleet (Hants).

ADVANCE J1 audio signal generator, £25. Wayne Kerr CT53 R.F. signal generator 8.9 to 300MHz, £25. Datone PCI short wave to 2 meter converter, £70. Wanted, hi band, FM, PMR (cheap), also PF1S (cheap). Chris Barker, QTHR. Please tel. 0782 46570, G1EZZ.

HEATHKIT HW-8, QRP transceiver, headphones and comprehensive manual, vgc, £85 ono, buyer collects. Also wanted complete HF station, FT1012D, TS430S or similar, why? Cash waiting. GOAMF or GOAMH (0323) 898515, Seaford, Sussex.

SELLING Panasonic RFB50L, 10 band double superheterodyne shortwave receiver with AM/FM/LW, compact size, 174w, 112h, 33d, MM band width control and wave change buttons, plus book shape carrying case, one year old, bargain, £90. Swindon 0793 812592.

SABTRONICS 8610A, 600MHz, digital frequency counter, with manual, packing and Nicads. Nice condition, £60. Dave Logan, 27 Shaw Street, Mottram, near Hyde, Cheshire SK14 6LE. Mottram 62799.

GEC hi-band transceiver. 3 channel. Modern style, one pair crystallised to work together on 167MHz. Easily returned for use on 2 metres.

Good working order, £70 per pair, complete with mikes and speakers. Yeovil 25225.

YAESU FT480R, multi-mode, 1w or 10w output. Listen on input. good condition, £250. TS520S mint, 160-10m, HF transceiver, 100w+, CW Shure 444, box, manual, an excellent rig, buyers inspect/collect, £375. Phone Reading (0734) 596485 after 8.30 pm or weekends).

SPC 3000 3KW Rollercoaster transmatch, built to last a lifetime, vgc, cost £300. Offers around £200 or exchange FT709R or multiformat colour (dichroic head) photographic enlarger 6x6cm to 35mm or Commodore daisywheel printer. Phone GOCCU, 0272 717226.

YAESU FT107S, HF SSB/CW/FSK/AM transceiver. A rare opportunity to obtain the 10w version of this excellent Solid State rig, £345. Wanted, TS700, FT221, etc. 2m multiple, linear. Tel Neil G4SEN, 02620 275192 (Cheshire).

FOR SALE, Meccano Number 10 Set. All 100%, original "Binns Road" parts, complete, vgc, will sell to best offer above £700. Call Cyril (anytime) (04023) 45969.

RECEIVER DX302 generator, coverage, £120. Alinco ELH730G, 70cms linear, slight fault, PA good, £30, both ovno. 01-697 8407.

SPEAKERS, two, cabinet (wood), stereo speakers, size 12"x8", as new, £12. Phone 0274 728219, Bradford, W. Yorks.

RTTY system. Commodore 64 with tape recorder, interface and 2 programmes. TX and RX on CW and RTTY, RX only on CW, RTTY, AMTOR SSTV, £125 or p/x for Yaesu FT709 or 70cm hand-held, why? Tel Malcolm, Shrewsbury 0743 67087.

FOR SALE, Yaesu FT101B transceiver, nice condition, only used for receiving, manual etc. Also KW202 receiver, also in good condition, £300 or swap, p/x for a good Solid State digital rig. Call or write Paul Vernon, 23 Ramsey Avenue, Layton, Blackpool, Lancs. **YAESU FT101E**, also Yaesu YC601 digital counter, the pair £190, FRG7RX, £135, buyer collects. 0795 538196 (Kent). **MAGAZINES**, PW, 1960-84; Practical TV, 1951-83; Radio Constructor, 1953-81; R &

EW, Jan-Aug '82; Electronics and Computing, June '81-May '82. Most years complete. Offers to Crawley (0293) 31409. Buyers collect or pay postage.

SALE, Icom 290D 25w, 2m mobile, multi-mode, excellent rig, £295. AOR2001 scanner, vgc, £195. Yaesu FT404R, UHF, hand-held, 6ch. with sp. mic, case, mobile PSU, 15w PA included, radio mic and battery, unused, £145. Call Chris, G61HN, 095 2452711. **FT790** MM30L amp FRG7HF RX black/white TV camera, Wood & Douglas, 10 watts, TX met 17, element, beam, poles, rotator, control cable, 30 to 512MHz scanner with mods to cover up to 900MHz, complete station, £700 ono, may split. Call John on Burgess Hill 04446 44532.

COLLECTORS item, 19 set workshop manual, best offer secures, Datong DF set with aerials, good condition, £200; Mirage VHF linear 160w for 10w 1N, £160, with preamp and remote switch, FTV 107 with modules box, manual, vgc. Martyn, F4SUI. Tele 0924 495916.

FOR sale, MMT144/28 transverter, new, hardly used, 2 months old, 10 watts output, sell for £90 ono. Would prefer to exchange for Yaesu FC700 tuner unit to go with my FT77 to make a match. Howard, G10YH (0235) 813160, Oxford area.

FOR sale, Grundig Satellite 3000 digital globe receiver, as new, op. manual, £200 ono. Walton on Thames 226287.

COLLINS R390/A/URR receiver, 0-32 megs, GC, including manual, £260, plus carriage. Yaesu FP707 20 amp power supply, vgc, £95. MM144/28 transverter, vgc, £75, all ono. Tel. GWOFGM, 0970 828062 weekends or evenings.

TS120S, immaculate, £360. SEM ATU £30, LPF £18. Daiwa SWR meter, £35. Power supply, £45. W3DZZ trap dipole, £25. FT290R, Mutek, Nicads, leather case, charger, £240. BNOS power supply, £35. ZL with Kenpro rotator, £65. All excellent. Tel. 0621 740773 (Essex).

TRS80 colour computer 2, 64K, cassette recorder, printer, pnp/rtty/cw/amtor box, joysticks, art gallery, colour file, type-tutor, eight games,

plus TRS80/dragon converter tape, also software with rtty box, lot for £150 ono. Will split if necessary. G6SVG QTRR, Redhill 61399.

SCANNER service manuals for Tandy Pro 30, Pro 31, Pro 32, Pro 2021 and Thandar TC200 freq counter, £5+p. Wanted: Motorola MT700 circuits. I also have many thousands of UK freq's in book form, never published. Ring for above anytime, 04738 5526.

ICOM 735 with power supply, mint condition, £790 ono. Icom 3200E, dual band FM mobile with dual band antenna, £420 ono. Complete rtty station, BBC B, sideways ROM including rtty, monitor, quality printer, terminal, console, valued £920, sell £600 ono. 0227 276004.

TRIO 9R59DS general coverage receiver with bandsread amateur bands. Very good condition with speaker, manual and twelve months guarantee. Price £80. Tel. (0554) 771722 any evening after 10 pm.

WANTED

WANTED, Eddystone receiver 358 or 1334 with coils. 0924 263389.

WANTED, Racal RA117, working order not important. Ring Taunton 0823 75776 evenings.

WANTED, Practical Wireless, 1930, 1960, George Newnes Books, Bernards Books, 1-2-3 valve receivers, shortwave transistor, superhets, Practical Wireless Circuits Book, 1968, 1970. 18 Bideford Close Pk North, Swindon, Wilts SN3 2LB.

WANTED, RCA AR88D RX working or not for rebuild, Xtal calibrator No. 10 for 62 set and commercially made PSU for R1155 RX. Phone Harwich 502195.

WANTED, WWII BC610 TX in reasonable condition. G2DYM QTHR, 03986-215.

WANTED, Murphy type 618 TX (AP100333) amp power unit (AP100336). Aerial plug, AM type 161 (10H/184). Marconi RX mains power units type 889A or 966A with plugs and cables. Peter, G4FUY QTHR, Reading 733633.

WANTED, handbooks, circuit diagrams, for Bendix RAI re-

ceiver and Racal 509A oscilloscope, purchase or borrow, all expenses paid. GW4SRO, 65 Michaelston Road, Culverhouse Cross, Cardiff CF5 4SX. Tel 593057.

WANTED, 144MHz h/held SSB portable IC202 or Mitsuho SB5 etc. C58 also considered. Phone Ron, G8VYJ, 0635 46442 after 4 pm.

WANTED, a plastic connector which plugs into rear of Alinco ELH-230 linear amplifier. Please contact Peter, telephone Crowborough (08926) 63061 evenings, QTHR.

WANTED, FT757GX or TS430S, state price and condition. Will collect. Declan Farnan, 230 Castle Park, Galway, Eire.

WANTED, NATO 2000, must be in perfect working order and no screwdriver in side, £90 offered. 0283 221870, DXTV VHF 6" or 5". For sale: Yaesu 7700, memory, in box, hardly used, also 7700 ATU, £300, Avanti CB aerial, offers. Phone 0283 221870.

WANTED, memory unit for Yaesu FRG 7700 receiver. Phone 0243 671506.

PLEASE help. I am desperate. Wanted, manual for Lafayette HA800 receiver or copy. All costs refunded. T. P. McClelland, 25 Emmett Road, Inchicore, Dublin, Ireland.

WANTED, photocopies or original manuals for BC-314D receiver and Hammarlund Super-pro receiver, also urgently required un-serviceable R1155 receiver for spares, condition not important. Mr. Cecil Duncan, Roadside Cottage, Hoswick, Sandwick, Shetland. Phone (09505) 405.

WANTED, Trio 830 AT230 or FT102, FC102 or similar, to set up HF station, buy complete or separate, will collect, cash waiting. Tel. Gordon, Bristol 0272 832177, also TS430 possible.

WANTED, mobile mount bracket for FDK multi 800D. Also wanted external frequency display model DD-800. Does anybody have a handbook for Panasonic DR48 receiver that I could buy or copy. 0375 640275, ask for Dave.

HF RECEIVER or transceiver, CW only, wanted for one time service operator on verge of retiring and wishing to pursue

an old love. Phone evenings 0625-876133.

WANTED, MM ATV transmitter, GWO, reasonable price. Phone 0400 30103.

WANTED, two metre monitor search, 9 model or similar receiver that uses VFO and crystals. Fair price paid. Send details to Mr. A. H. Daniels, 37 Burnet Avenue, Guildford, Surrey GU1 1YF or tel. Guildford 0483 578236, ask for Tony.

WANTED, Yaesu 2m FT290R portable transceiver, complete with carrycase, Nicads charger, etc. Also wanted Yaesu FT209RH hand-held. 5W/5W output TX/RX 144-148MHz with programmable keypad, ten memories and built-in Vox 6, will travel. Good price paid. John, 01-272-9275, London.

WANTED, general coverage SW RX in good condition, also wanted UHF or VHF digital scanner and 2m amateur RX, both in good condition. Send details to M.M., 3 Burnside Place, Millpark, Oban, Argyll, Scotland PA34 4JZ.

WANTED, packet radio programme for ZX Spectrum 48K, any price. Phone Belgium 03-4804151, or via P.O. Box 135, 2500 Lier, Belgium (Paul Baeten).

WANTED, QRP HF mobile rig, TS130V or FT7 in GWO, also Belcom 120LS or Sombri-lamp 788DX in GWO. Bob, ECU QTHR, 0563 35738.

WANTED, Eddystone 880/4 or similar high stability general coverage communications receiver. GOEQK. Phone 0734 782236.

EXCHANGE

EXCHANGE Mosley TA32JR 2 Ele triband for ATU plus VSWR power meter. GW6ZKJ.

EXCHANGE KDK 2mtr FM radio, Totsuko TR2100M 2mtr sideband, Mirage 80 watt linear with preamp and remote control, rotator with 6 element quad, for FT707 or similar. 0420 85520 anytime.

EXCHANGE Sinclair QL computer, 1 year old, very little use. Any amateur equipment or £100 ovno. Alan Gibson, G1EUU, 68 Aire Road, Grantham, Lincs NG31 7QP. Stop.

EXCHANGE FT290 for HF transceiver, FT101, KW2000 etc. WHY. GODRT, P. Quedest, 252 Barton Hill Drive, Minster, Sheerness, Kent ME12 3LZ.

BIG

SUBSCRIPTION SAVINGS FOR YOU!

Take advantage of these fantastic money saving subscription offers to these magazines. Hurry, this amazing offer is for a limited period only.

UNITED KINGDOM

OVERSEAS (Accelerated surface post)

	Normal Price	Sale Price	Please Tick	Normal Price	Sale Price	Please Tick
A&B Computing	£21.80	£18.00	<input type="checkbox"/>	£26.00	£20.80	<input type="checkbox"/>
Computer Gamer	£16.80	£13.00	<input type="checkbox"/>	£21.50	£17.20	<input type="checkbox"/>
Your Commodore	£16.80	£13.00	<input type="checkbox"/>	£21.50	£17.20	<input type="checkbox"/>
ZX Computing Monthly	£15.00	£12.00	<input type="checkbox"/>	£18.00	£14.40	<input type="checkbox"/>
Citizens' Band	£16.90	£13.52	<input type="checkbox"/>	£22.00	£17.60	<input type="checkbox"/>
Ham Radio Today	£17.30	£14.40	<input type="checkbox"/>	£21.00	£16.80	<input type="checkbox"/>
Electronics Digest	£11.30	£ 8.30	<input type="checkbox"/>	£14.00	£11.20	<input type="checkbox"/>
Electronics Today International	£18.10	£14.40	<input type="checkbox"/>	£22.50	£18.00	<input type="checkbox"/>
Video Today	£16.90	£13.52	<input type="checkbox"/>	£21.00	£16.80	<input type="checkbox"/>
Which Video?	£16.90	£13.52	<input type="checkbox"/>	£21.00	£16.80	<input type="checkbox"/>
Photography	£16.00	£12.00	<input type="checkbox"/>	£21.50	£16.00	<input type="checkbox"/>
Photoplay	£17.90	£14.32	<input type="checkbox"/>	£21.50	£17.20	<input type="checkbox"/>
Clocks	£30.80	£24.64	<input type="checkbox"/>	£35.00	£28.00	<input type="checkbox"/>
Woodworker	£16.90	£13.52	<input type="checkbox"/>	£21.00	£16.80	<input type="checkbox"/>
Popular Crafts	£17.90	£14.32	<input type="checkbox"/>	£21.50	£17.20	<input type="checkbox"/>
Winemaker & Brewer	£13.70	£10.96	<input type="checkbox"/>	£17.00	£13.60	<input type="checkbox"/>
Aeromodeller	£25.10	£20.08	<input type="checkbox"/>	£29.00	£23.20	<input type="checkbox"/>
Military Modelling	£16.90	£13.00	<input type="checkbox"/>	£21.00	£16.80	<input type="checkbox"/>
Model Boats	£16.10	£13.00	<input type="checkbox"/>	£20.00	£16.00	<input type="checkbox"/>
Radio Control Model Cars	£19.10	£14.00	<input type="checkbox"/>	£21.50	£17.20	<input type="checkbox"/>
Model Engineer	£27.40	£22.00	<input type="checkbox"/>	£32.50	£26.00	<input type="checkbox"/>
Radio Control Boat Modeller	£ 8.50	£ 7.50	<input type="checkbox"/>	£11.50	£ 9.20	<input type="checkbox"/>
R C M & E	£15.80	£12.00	<input type="checkbox"/>	£20.00	£16.00	<input type="checkbox"/>
Radio Control Scale Aircraft						
Quarterly	£ 9.70	£ 8.00	<input type="checkbox"/>	£11.50	£ 9.20	<input type="checkbox"/>
Radio Modeller	£16.10	£13.00	<input type="checkbox"/>	£20.00	£16.00	<input type="checkbox"/>
Sea Classic International	£10.30	£ 9.00	<input type="checkbox"/>	£12.50	£10.00	<input type="checkbox"/>
Scale Models International	£18.00	£13.00	<input type="checkbox"/>	£20.00	£16.00	<input type="checkbox"/>
Your Model Railway	£16.00	£12.00	<input type="checkbox"/>	£25.00	£20.00	<input type="checkbox"/>

(Offer ends 30th April 1987)

Please commence my subscription(s) with the issue.

I enclose my cheque/postal order for £..... made payable to Argus Specialist Publications Ltd.

or debit £..... from my Access/Barclaycard No.

valid from to Signature

Name

Address

Send this form with your remittance to: *Subscriptions Savings Offer (S.087)*
INFONET LTD., Times House, 179 The Marlowes, Hemel Hempstead, Herts. HP1 1BB.

HAM RADIO CLASSIFIED

TODAY

Lineage: 48p per word VAT inclusive (minimum 15 words) Semi Display: (minimum 2 cms) £7.35 per single column centimetre. Ring for information on series bookings/ discounts. All advertisements in this section must be prepaid. Advertisements are accepted subject to the terms and conditions printed on the advertisement rate card (available on request).



01-437 0699 Ext 289. Send your requirements to: Ham Radio Today Class. Dept., ASP Ltd., 1 Golden Square, London W1R 3AB

COURSES

RADIO AMATEUR LICENCE

Start training now - No previous knowledge required. Study for 3-6 months. Post Coupon now for free brochure - without obligation:

Radio & Telecommunications Correspondence School, 12 Moor View Drive, Teignmouth, Devon. Tel: 06267 - 79398.

(HRT/F)

NAME:

ADDRESS:

POST CODE:

AERIALS

ANTI-T.V.I. Aerials, traps for beams or wire aerials, baluns, kits etc. Data 26p large SAE. Aerial guide £1. G2DYM Uplowman. Tiverton, Devon EX16 7PH (03986) 215.

NEW SHOP LUTON: Come to us for your aerial requirements! We also repair, install and calibrate amateur equipment. Wide range of CB & p.m.r. also available. Ring 0582-458310.

PACKET RADIO SOFTWARE

GROSVENOR SOFTWARE

G4BMK

AX25 Packet Radio DRAGON 32/64 and TANDY Color A breakthrough in Packet Radio - AX25 stand-alone software in ROM cartridge, plus a built VHF 1200 Baud modem for just £99! Full AX25 implementation with up to 6 simultaneous connections, optional beacon, and digipeater operation. HF kit available soon. Send SAE for full details of this and RTTY CW SSTV and AMTOR.

2 Beacon Close, Seaford, East Sussex BN25 2JZ (0323) 89337R

COMPUTER EQUIPMENT

* * * 68008 SINGLE BOARD COMPUTER, contains:- Disc Interface, Colour Display, 8K Monitor, Megabyte RAM, 2 Serial/ Parallel Ports, RTC, runs SK-DOS-68K. Bare P.C.B. or built. Also 6809 Micro-Set System. S.A.E. Ralph Allen Eng, Forncett-End, Norwich.

SOFTWARE

SLOW SCAN TELEVISION

TRANSMIT AND RECEIVE SS.T.V. PICTURES WITH THIS SUPER ZX SPECTRUM PROGRAMME

No Hardware needed, only £4.95

P GOODRUM
9 RYSTON CLOSE
DOWNHAM MARKET,
NORFOLK PE38 9BD
Tel: 0366 388615

ICOM PORTABLES

MRZ COMMUNICATIONS LTD.
STOKE ON TRENT
MRZ Desk Top PSU for Icom portables:
2E/4E/02E/04E
Incorporating overvoltage protection; over-current shutdown models available for PMR/Marine Icoms.
ICOM-AMATEUR-PMR-MARINE-AIR
YAESU-AMATEUR
TEL: 0782-619658
(24 Hours - 7 days a week)

SERVICE MANUALS

SERVICE MANUALS. Amateur radio, test, audio, TV, video etc. Thousands stocked. SAE enquiries. Mauritron (HRT), 8 Cherrytree Road, Chinnor, Oxon.

EVENTS

NEW

BLUE STAR RALLY

NEW

ORGANISED BY

THE TYNESIDE
AMATEUR RADIO SOCIETY
IN ASSOCIATION WITH

THE
NEWCASTLE
BREWRIES LIMITED

Saturday 7th March 1987 From 11am to 5pm

North East Exhibition Centre
High Gosforth Park
(Newcastle Racecourse)

FROM THE SOUTH VIA A1: ONTO A1(T) THROUGH TYNE TUNNEL
FOLLOW A1(T) ONTO A6125 TOWARDS NEWCASTLE.

FROM THE NORTH VIA A1 & A697:

ONTO THE A1(T) TOWARDS NEWCASTLE THEN ONTO A6125.

FROM WEST VIA A69; TURN ONTO A696 AND THEN
A6127 TOWARDS NEWCASTLE CITY CENTRE —
TURN ONTO NORTH ROAD A6125.

(WATCH FOR SIGN POSTS — GOSFORTH RACECOURSE
AND RALLY).

CARDS, STICKERS

QSL CARDS. Gloss or tinted cards. SAE for samples to TWROG Press, Dept HRT, Penybont, Gellilydan, Blaenau Ffestiniog, Gwyndd LL41 4EP.

QSL CARDS. - try me for quality and price. S.A.E. for samples. A.W. Bailey (G3YNI) Breardown Press, Wick Lane, Lympsham, Somerset.

WALKIE TALKIES

QUALITY WALKIE TALKIES. Long Range, Private Satisfaction or refund. £24.99/pair, (normally £31.49), 48 Hrs delivery. Xenon (Dept CB9), 24 Wharnciffe Street, Barnsley, Yorkshire.

FOR SALE

COMPONENT BARGAINS

Transformers 12-0-12v at 50mA £1
Small relays 12v coil SPCO £1
IC sockets 14 & 16 pin 8p. 28 pin 20p
1N4148 2p. 1N4004 4p. Zener 5.1v 6p. 20pF ceramic trimmers 7mm. OD. 5p. Xtal 22MHz HC18 £1. 1.843MHz HC33 £1
Caps. 0.1 250v 4p. 1mH chokes 10p
SAE for list. P&P 50p per order.

P. Smith, 3, Raven Avenue, Tibshelf, Derbyshire, DE5 5NR.

MISCELLANEOUS

HEATHKIT U.K. spares and service centre. CEDAR ELECTRONICS, Unit 12, Station Drive, Bredon, Tewkesbury, Glos. Tel: 0684 73127.

TEST EQUIPMENT

CAVITY WAVEMETERS AS REVIEW IN FEB H.R.T.

144 MHz to 2500 MHz, and 430 MHz to 2500 MHz.
10 GHz Wavemeter Kits. Electronic Weather Stations. Solid Brass Based Morse Keys.

S.A.E. for more information to:-
PAUL SERGENT G4 ONF
8 GURNEY CLOSE,
COSTESSEY,
NORWICH NR5 0HB
(0603) 747782

Ring 01-437 0699
for details
of our series
discounts.

KITS

SOUTHERN ELECTRONICS

"AUTOMATIC REPEATER TONE BURST"
Kit Form £9.95
Ready Built £14.95

COMING SOON, A NEW PRODUCT
THE "LED BATTERY MONITOR"

SOUTHERN ELECTRONICS
47 Jocketts Road, Hemel Hempstead,
Herts. HP1 2JX

CB AND ACCESSORIES

THE NORTH's Leading C.B. Distributors including 934 Mhz equipment. Please ring 0388-528464. Ian Fisher Communications, CB Works, Stanhope, Co. Durham DL13 2YT.



DON'T MISS THE DEADLINE!
OUR NEXT COPY DATE IS
25th FEBRUARY
For The MAY Issue

CLASSIFIED ADVERTISING TERMS & CONDITIONS

Our terms for new advertisers (semi-display and lineage) are strictly pro-forma payments until satisfactory reference can be taken up (excluding recognised advertising agencies). Cheques and PO's should be crossed and made payable to:

ARGUS SPECIALIST PUBLICATIONS LTD.,
and send together with the advertisement to:
THE CLASSIFIED DEPT., L/H,
NO: 1 GOLDEN SQUARE, LONDON, W1R 3AB.

There are no reimbursements for cancellations. Advertisements arriving too late for a particular issue will be inserted in the following issue unless accompanied by instructions to the contrary.

All advertising sales are subject to Government regulations concerning VAT. Advertisers are responsible for complying with the various legal requirements in force eg: The Trade Description Act, Sex Discrimination Act & The Business Advertisements (Disclosure) Order 1977.

FULL TERMS & CONDITIONS OF ADVERTISING AVAILABLE ON REQUEST.

EMPORIUM GUIDE

BIRMINGHAM

AE AMATEUR ELECTRONICS LTD
510-512 Alum Rock Road, Alum Rock,
Birmingham B8 3HX.
Tel: 021-327 1497/6313
YAESU DISTRIBUTORS TO THE UK.

CHESHIRE

DW ELECTRONICS G3 XCF
Amateur Radio Supplies
71 Victoria Rd, Widnes ICOM
Tel: 051-420 2559
Open Mon-Sat 9.30-6 (closed Thurs)
We supply Yaesu, Icom, Tonna, Jaybeam,
Microwave Modules, Datongs, etc.

KENT

Thanet

ELECTRONICS
2 Stanley Road, Herne Bay, Kent
Tel: (0227) 369464
Open Mon-Sat 9-5.30pm
except Thursday 9-1pm

BIRMINGHAM

CENTRE ELECTRONICS
345 Stockfield Road, Yardley, Birmingham B25 8JP
Specialist in the sale and service of Ex Government and Vintage Radio and Test Equipment.
(Many spares in stock).
Telephone enquiries to 0676 32560

Special delivery service

Shop open Thursdays, Fridays and Saturdays

DEVON

AGRIMOTORS
Merton CB & Radio Centre
Merton Garage & Post Office, Merton.
Nr. Oakhampton EX20 3DZ.
Open 6 days 9-6
(Sundays by appointment)
Specialists in 934MHz
Suppliers of all 27MHz and 934MHz equipment

LANCASHIRE

AMATEUR ELECTRONICS/HOLDINGS G3LLL.
YAESU, JAYBEAM, DRAE, DATONG, BLACK STAR COUNTERS, ETC. FT 101 EXPERTS.
6US6C 6KD6 12BY7A Original type approved valves & our own Double Balanced Mixer and new band WARC Kits for original FT 101 MK1-E S.A.E. List. Full Yaesu range. 15 mins Junction 31 M6. Free parking. Call and consult G3LLL without obligation.
45 JOHNSTON STREET, BLACKBURN B82 1EF.
(0254) 59595. CLOSED THURSDAY.

BIRMINGHAM

R. WITHERS COMMUNICATIONS
584 Hagley Road West
Oldbury, Warley B68 0BS
(Quinton B'Ham) Tel: 021-421 8201/2/3
Opening hours 9-5.30pm Late nights Thurs-Fri.
Send just £1.00 (refundable against purchase)
for latest catalogue + our exclusive products & used list.

DORSET

BUSINESS COMMUNICATION IS EASY IN HRT.
FOR ADVERTISING PHONE
SUE CURTIS ON 01-437-0699

LANCASHIRE

G4 DXH VIDEO ELECTRONICS
For ICOM, DRAY, WELLS, DAIWA
DATONG, 934 MHz Equipment, Log-books, Rotators, Cable etc.
Open 9-5pm, Closed Wednesdays.
141 LANCASTER ROAD, MORECAMBE,
LANCASHIRE LA4 5QJ
PHONE (0524) 418873

BIRMINGHAM

HEWARD'S HOME STORES LTD.
(Est. 1963)
822/4 Kingstanding Rd., Birmingham B44 9RT.
Tel: 021-354 2083
G4RJM with 38 years in The Radio Trade
Ham Equipment urgently wanted!
Open: Mon-Sat 9-8

ESSEX

SELECTRONIC
The UK's leading suppliers of 934MHz personal radio equipment
203 High Street, Canvey Island, Essex
Tel: 0268 691481
(Open Mon-Sat 9-5.30)
Amateur radio equipment also in stock

LONDON

DRESSLER UK LTD
191 Francis Rd., Leyton, E10
Open 9-5.30 Monday-Friday 10-5 Saturday
Authorised dealers for:
Dressler, Yaesu, Icom, Standard, Kenwood, Datong, SCM, Microwave Modules, Tonna
Tel: 01-558 0854/558-1415 Telex: 8953609

MERSEYSIDE

ARE COMMUNICATIONS LTD

For Yaesu Icom & Kenwood
Phone us for the best deals on all
amateur radio equipment.
38 Bridge St, Earlestown,
Newton-le-Willows, Merseyside.
Phone Peter G4KKN on 09252-29881
Opening hours Monday-Saturday 10am-5pm

YORKSHIRE

**Amateur Electronics UK
Alan Hooker**



42 Netherhall Road,
Doncaster



Tel - 0302 25690

Large stocks of electronic
components.

N. WALES

**NORTH WALES AMATEUR
RADIO MART**

AMATEUR RADIO — CB RADIO — MARINE
RADIO — P.M.R.
25 ABBEY STREET
RHYL

Open Monday-Saturday: 11am-5.30pm
All repairs and accessories available ex
stock. Mail order welcome.
Tel: 0745-51579

NORFOLK

D.P. HOBBS (Norwich) Ltd
13 St. Benedicts Street, Norwich
Tel: 615788



Open Mon-Sat 9-5.30
Thurs 9-1pm
Stockists of:



YAESU, FDK, ICOM, JAYBEAM
& Electronic Component Specialists

SCOTLAND

**JAYCEE ELECTRONICS
JOHN GM30PW**

20 WOODSIDE WAY, GLENROTHES

FIFE KY7 5DF

Tel: 0592 756962

Open: Tues-Sat 9-5



Full Range of YAESU & TRIO Goodies.
Quality Secondhand Equipment In Stock.
JAYBEAM — MICROWAVE MODULES — LAR

WILTSHIRE

Get on the right
wavelength. Use Ham
Radio Today and
Citizen Band for
Advertising.

NOTTINGHAMSHIRE

SP ELECTRONICS

48 Limby Road
Huckhall, Nottingham
Tel: (0602) 640377

Open Monday-Saturday 8.30-5.30

SURREY

GUILDFORD COMMUNICATIONS
34 Aldershot Rd., Guildford

Open Mon-Fri 8am-6.30pm
Sat 8am-5.30pm

Secondhand wanted



ASDEN



0483-574434

WORCESTERSHIRE

A. KELLY

Electronics & Communication equipment.
3 Stoke Road, Aston Fields, Bromsgrove,
Worcs B60 3EQ.
RSGB Publications, Mutek, DRAE, Microwave
Modules, Star Masterkeys, TAL aerials, Alinco.
OPEN 6 DAYS A WEEK EVENINGS
BY APPT. 0527-71165.

**HAM
RADIO
TODAY**

Lineage 48p per word (inc VAT). Minimum 15 words. Semi display £7.35 + VAT per single column centimetre. Minimum 2cms. No reimbursements for cancellations. All ads must be pre-paid. Write your advert in BLOCK CAPITALS in the grid below, ticking the section you wish it to appear under, INCLUDING YOUR NAME AND ADDRESS IN THE WORD COUNT and send it to HAM RADIO TODAY, ADVERTISEMENT DEPARTMENT, NO: 1 GOLDEN SQUARE, LONDON W1R 3AB.

- FOR SALE COURSES COILS & CHOKES AERIALS CB & ACCESSORIES OTHER Please state

CLASSIFIED COUPON

ALL CLASSIFIED ADVERTISEMENTS MUST BE PRE-PAID. THERE ARE NO REIMBURSEMENTS FOR CANCELLATIONS.

I enclose my Cheque/Postal Order for £..... for..... insertions, made payable to Argus Specialist Publications. (Delete as necessary)

PLEASE DEBIT MY ACCESS/BARCLAYCARD NO

EXPIRY DATE

£..... FOR..... INSERTIONS



Name

Address

POST CODE

DAYTIME TEL NO.

Signature Date

IF YOU DO NOT WISH TO CUT YOUR MAGAZINE, PHOTOCOPY THIS FORM



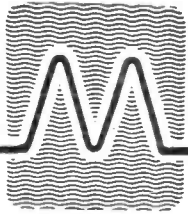

MICROWAVE MODULES LTD

**BRING A TOUCH OF CLASS IN 1987
WITH THE CONNOISSEUR'S CHOICE
IN POWER AND PERFECTION**



At Microwave Modules Ltd, we believe that the new look of our range of linear amplifiers makes them simply the best. The addition of the new brushed aluminium front panel has transformed the appearance of an already superb range of products. Our company's policy is customer satisfaction, not just with service, but also with products that have style.

We're ahead of the times with our range and will be staying that way. Visit one of the many retailers who handle our range, perhaps the Lowe chain of shops, or SMC. Alternatively, our roadshow is visiting many of the mobile rallies this year, so stop and say hello and look at perfection for yourselves.

IF IT'S MICROWAVE MODULES IT'S GOT TO BE GOOD

LINEAR AMPS

		TOTAL inc. VAT	POST RATE
MML28/100-S	10m 100W Linear, 10W input	129.95	C
MML144/30-LS	2m 30W Linear, 1 or 3W input	94.30	B
MML144/50-S	2m 50W Linear, 10W input	106.95	B
MML144/100-S	2m 100W Linear, 10W input	149.95	C
MML144/100-HS	2m 100W Linear, 25W input	159.85	C
MML144/100-LS	2m 100W Linear, 1 or 3W input	169.95	C
MML144/200-S	2m 200W Linear, 3, 10, 25W input	334.65	D
MML432/30-L	70cm 30W Linear, 1 or 3W input	169.05	C
MML432/50	70cm 50W Linear, 10W input	149.50	C
MML432/100	70cm 100W Linear, 10W input	334.65	D

TRANSVERTERS

MMT144/28	2m Linear Transverter, 10W o/p	129.95	B
MMT144/28-R	2m Linear Transverter, 25W o/p	236.90	B
MMT432/28-S	70cm Linear Transverter	195.50	D
MMT1296/144-G	23cm Linear Transverter	258.75	B
MMX1268/144	1268MHz Transmit Up-Converter	195.50	D
MMT 50/144	6m Linear Transverter 20W o/p	245.00	B

MICROPROCESSOR

MM2001	RTTY to TV Converter	189.00	B
MM4001-KB	RTTY Transceiver with keyboard	299.90	D
MMS1	The Morsetalker	115.00	B
MMS2	Advanced Morse Trainer	169.00	B

ATV

MMC435/600	70cm ATV Converter, UHF output	35.65	A
MTV435	70cm ATV 20W Transmitter	197.80	B

CONVERTERS

MMC50/28	6m down to 10m Converter	35.65	A
MMC144/28	2m down to 10m Converter	35.65	A
MMC144/28-HP	2m High Performance Converter	47.90	A
MMC432/28-S	70cm down to 10m Converter	39.90	A
MMC432/144-S	70cm down to 2m Converter	39.90	A
MMK1296/144	23cm down to 2m Converter	129.95	B
MMK1691/137.5	1690MHz WX Satellite Converter	145.00	B

PRE AMPS

MMG144V	2m RF Switched GaAsFET Preamp	37.90	A
MMG1296	23cm GaAsFET Preamp	75.00	A
MMG1691	1690MHz GaAsFET Preamp	129.95	B

OTHER PRODUCTS

MMD1500P	1500MHz Divide by Ten Prescaler	119.60	A
MMR3/25	3dB 25 Watt Attenuator	19.95	A
MMR7/3	7 dB 3 Watt Attenuator	14.50	A
MMR15/10	15 dB 10 Watt Attenuator	14.50	A

Postage/Packing Charges:

A = 1.84 C = 4.60
B = 3.91 D = 5.98

DURING THIS YEAR OUR TEAM WILL BE FOR MORE CLUB LECTURES. TO BE SURE THAT WE DO NOT MISS YOURS PLEASE RING MICK, G4EFO, ON 0403 730 767.



VISA

WELCOME

MICROWAVE MODULES Ltd

BROOKFIELD DRIVE, AINTREE, LIVERPOOL L9 7AN, ENGLAND

Telephone: 051-523 4011. Telex. 628608 MICRO G

CALLERS ARE WELCOME, PLEASE TELEPHONE FIRST

**HOURS:
MONDAY-FRIDAY
9-12.30, 1-5.00
E & O.E.**

NEVADA 934 MHz EQUIPMENT

Have you tried this exciting new band yet? Available for private or business use, by simply purchasing a £10 licence from any post office. Range is from 10 - 250 miles according to your location and WX conditions.

DELTA 1 934 Mhz TRANSCIVER



£365

THE DELTA 1 IS A STATE OF THE ART TRANSCIVER AND NOW IN USE BY OVER 70% OF 934 MHz ENTHUSIASTS!

- FEATURES:
- Scan facility.
 - 16 channel memory/scan.
 - Sensitive RX.

ACCESSORIES

- P7M-E Mag. Mount. 7dBi Antenna £44
 - P714R-E GTR Mount 7dBi Antenna £66
 - PA7-E Base Colinear 7dBi Antenna £79
 - PA15 Base Colinear 11dBi Antenna £39
 - TC12L 12 Element Beam 18dBi Antenna £135
 - HRA 934L in line Pre-amp £139.95
 - HRA 900 Masthead Pre-amp
- PLUS MANY MORE ITEMS.
Send £1 for our full 934 Mhz catalogue.

TELECOMMS BUMPER CATALOGUES

- CB £1
- AMATEUR £1
- 934 MHz £1

Each catalogue is packed full of info. and includes a £2 voucher.

NEVADA AMATEUR PRODUCTS

HIGH POWER VARIABLE CAPACITORS



IDEAL FOR ATU'S OR AMPLIFIERS UP TO 3kW
TC 500... 26-500 pF £28 (£2 p.p.)
TC 250... 13-250 pF £19.95 (£1 p.p.)

HIGH POWER "ROLLER COASTER" VARIABLE INDUCTOR



Suitable for 1 kW ATU
Freq. 1.8...30 MHz

SPECIAL OFFER
TC250, TC500, & ROLLER COASTER.
COMPLETE FOR **£59** (£2 p.p.)

2 MTR EQUIPMENT

2 MTR HANDHELD

CT1600 A superbly sensitive new handheld covering 142-149MHz
● Repeater shift **£179**
● High/low power 1.5/0.5 Watt
● Thumbwheel selector



Each set supplied CW re-chargeable battery pack and free mains charger unit.

VHF MOBILE AMP

B110 144MHz 110 Watt W/Pre Amp. £169
B42 144MHz 40 Watt £64.66
LA05435 144MHz 45 Watt £69.75

Full range of 144 MHz mobile amplifiers in stock see our Ham Catalogue.

RF AMPLIFIERS

All amplifiers except broadband (2-30 MHz) models are tuned for 29.6 MHz centre freq. Should you require a lower freq. ie. 28.5 MHz please state when ordering. Export models available for 26-30 MHz.

MOBILE AMPLIFIERS C.T.E. MOD 767

76 Watts FM
INPUT:- 05-10 Watts
SWITCHABLE:- Class AB, Class C
SUPPLY:- 13.8 Volt
REMOTE CONTROL FACILITY

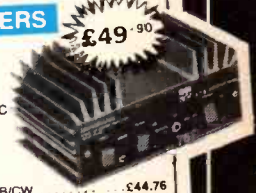

- C.T.E. MOD 737 50W FM AM/SSB/CW £44.76
- C.T.E. MOD 767 80W FM AM/SSB/CW £49.90
- C.T.E. MCD 757 150W FM Broadband £116.87
- ZETAGI B35 25W FM 26-30MHz £22.23
- ZETAGI B150 70W FM 26-30MHz £49.96
- ZETAGI B300 150W FM (2-30MHz) £136.00
- NEVADA TC35 30W FM 26-30MHz £23.75

MAINS OPERATED AMPLIFIERS

- C.T.E. DC9 Solid State 150W FM (Broadband) £199.31
- ZETAGI B132 150W FM Solid State (Broadband) £119.00

SCANNING RECEIVERS

C.T.E. DISCONE WIDEBAND ANTENNA

RECEIVE 70-700 MHz
TRANSMIT 70-500MHz
MAX POWER 500W
GAIN 35dB



WIDEBAND DISCONE RECEIVING ANTENNA (3 Element) 70-500MHz £24.95

NEW BEARCAT H/HELD SCANNING RX. MODEL 100XL

Receives 8 bands plus aircraft band. 16 Channels, priority keyboard lock and lighted display.
66-88 MHz 118-174 MHz 406-512 MHz



BEARCAT 175XL

Base receiver covers:-
66-88MHz
118-174MHz
406-512MHz
with 16 channel memory/scan



BEARCAT DX1000 COMMUNICATIONS RECEIVER

Direct access communications 10KHz-30MHz with 10 channel micro-processor controlled memory.



TEST EQUIPMENT

ZETAGI DL150 RF DUMMY LOAD AND POWER METER

A very accurate unit for the service dept. or discerning enthusiast.
FREQ:- 0.5MHz-500MHz
POWER:- 150 Watt Max in 3 ranges 0-3, 0-15, 0-150W.

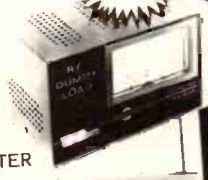

ZETAGI 500 SWR AND POWER METER

For the enthusiast who wants the very best. A twin meter unit with push button control for either 75 OHM or 50 OHM cable.
FREQ:- 3-200MHz
POWER:- Up to 2kW



FD 1350 1.3GHz FREQUENCY COUNTER

FREQ:- 10Hz-135GHz
SENSITIVITY:- 43mV at 1GHz
DISPLAY:- 8 Digit
SUPPLY:- 9-12 Volt DC



NEVADA

HIGH QUALITY BRITISH MADE 29MHz FM PRODUCTS

NEVADA TC35 DX R.F. POWER AMP. WITH HARMONIC FILTER

INPUT:- 1-4 Watts
OUTPUT:- 25-30 Watts
SUPPLY:- 13.8V DC
FREQ:- 26-30 MHz

Can be centred on 29.6 MHz or 28.5 MHz (state which). A new top quality amp. which now features harmonic filter to reduce harmonic OIP.



NEVADA TC27 RX RECEIVER PRE-AMP FOR 26-30MHz

A superior low noise pre-amplifier for 29MHz FM operation. Variable gain -6dB's to +18dB's suitable for use with transceivers up to 25 Watts output.

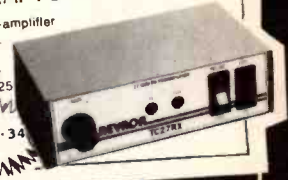

TELECOMMS

HOTLINE (24 HOURS)
0705 662145
189 LONDON ROAD, PORTSMOUTH,
HANTS, PO2 9AE,
TELEX 869107 TELCOM G

USE YOUR CREDIT CARD (AMERICAN EXPRESS ACCESS OR VISA) FOR IMMEDIATE DISPATCH.

TRADE ENQUIRIES WELCOME.

WORLDWIDE DISTRIBUTORS OF AMATEUR & PERSONAL RADIO EQPT.