

FEBRUARY 1980 Volume 5, Number 2 \$2.50 in USA/\$2.95 in Canada

BYTE

the small systems journal
A MCGRAW-HILL PUBLICATION



ROBERT
79 TANNER

KONIGSBERG

GRAPH THEORY

WE HAVE A 6809 FOR YOU

POWER SUPPLY

Modular plug-in construction with computer grade filters and a 25 AMP rectifier bridge. Blower fan is standard equipment. All connections to the power line are beneath the safety shield.

INTERFACE

Convenient serial or parallel I/O cards have DB-25 connectors mounted directly on the circuit board. Up to 16 interface devices may be installed on the address decoded I/O bus. Programming strips are provided for input and output baud rate selection on each port. All outputs are fully buffered.

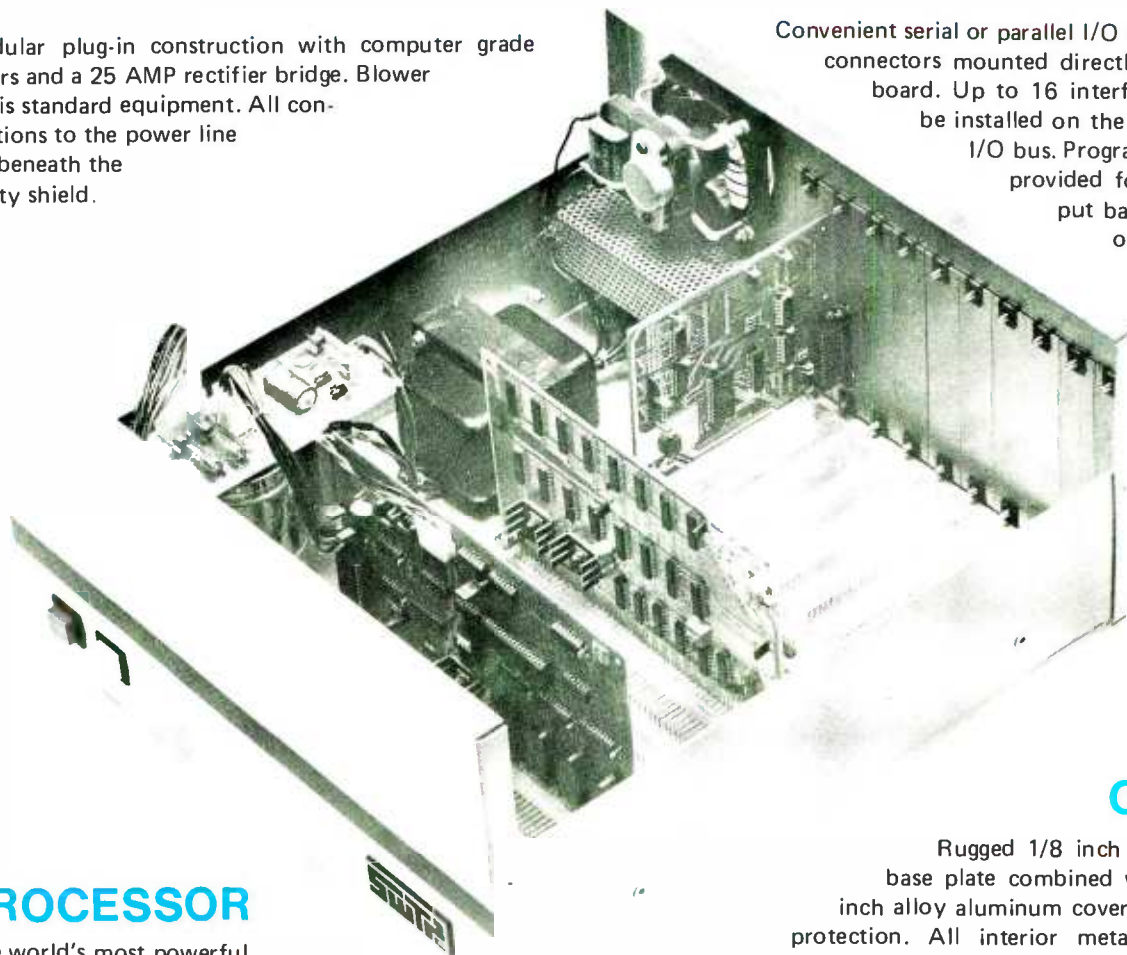

PROCESSOR

The world's most powerful eight-bit processor, the Motorola MC6809, plus 2K byte monitor ROM that is 2716 EPROM compatible and full buffering on all output lines. Built-in multiuser capability, just add I/O cards to operate a multi-terminal system.

CABINET

Rugged 1/8 inch alloy aluminum base plate combined with a solid 1/8 inch alloy aluminum cover for unsurpassed protection. All interior metal is conversion coated. The cover is finished with a super tough textured epoxy.

MEMORY— You can purchase the computer with either 8K bytes of RAM memory (expandable to 56K), or with the full 56K. The efficient, cool running dynamic memory used in this system is designed and manufactured for us by "Motorola Memory Systems Inc."

PERIPHERALS— The wide range of peripheral hardware that is supported by the 6809 includes: dot matrix printers (both 80 and 132 column), IBM Electronic 50 typewriter, daisy wheel printers, 5-inch floppy disk system, 8-inch floppy disk systems and a 16 megabyte hard disk.

SOFTWARE— The amount of software support available for the 6809 is incredible when you consider that it was first introduced in June, 1979. In addition to the FLEX9 operating system, we have a Text Editor, Mnemonic Assembler, Debug, Sort-Merge, BASIC, Extended BASIC, MultiUser BASIC, FORTRAN, PASCAL and PILOT.

69/K Computer Kit with 8K bytes of memory	\$ 495.00
69/A Assembled Computer with 8K bytes of memory	\$ 595.00
69/56 Assembled Computer with 56K bytes of memory.....	\$1,495.00



SOUTHWEST TECHNICAL PRODUCTS CORPORATION
219 W. RHAPSODY
SAN ANTONIO, TEXAS 78216

(512) 344-0241



Low-cost hard disk computers are here

11 megabytes of hard disk and 64 kilobytes of fast RAM in a Z80A computer for under \$10K. Two floppy drives, too. Naturally, it's from Cromemco.

It's a reality. In Cromemco's new Model Z-2H you get all of the above and even more. With Cromemco you get it all.

In this new Model Z-2H you get not only a large-storage Winchester hard disk drive but also two floppy disk drives. In the hard disk drive you get unprecedented storage capacity at this price—11 megabytes unformatted.

You get speed—both in the 4 MHz Z80A microprocessor and in the fast 64K RAM which has a chip access time of only 150 nanoseconds. You get speed in the computer minimum instruction execution time of 1 microsecond. You get speed in the hard disk transfer rate of 5.6 megabits/sec.

EXPANDABILITY

You get expandability, too. The high-speed RAM can be expanded to 512 kilobytes if you wish.

And the computer has a full 12-slot card cage you can use for additional RAM and interface cards.

BROADEST SOFTWARE SUPPORT

With the Z-2H you also get the broadest software support in the

microcomputer field. Software Cromemco is known for. Software like this:

- Extended BASIC
- FORTRAN IV
- RATFOR (RATional FORtran)
- COBOL
- Z80 Macro Assembler
- Word Processing System
- Data Base Management

with more coming all the time.

SMALL, RUGGED, RELIABLE

With all its features the new Z-2H, including its hard disk drive, is still housed in just one small cabinet.

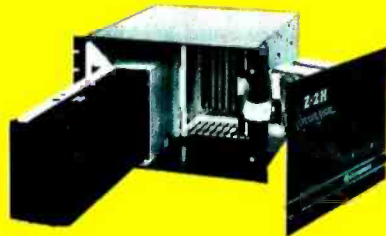

Hard disk drive at lower left can be interchanged just by sliding out and disconnecting plug. Seven free card slots are available. Z-2H includes printer interface card.

Included in that cabinet, too, is Cromemco ruggedness and reliability. Cromemco is time-proved. Our equipment is a survey winner for reliability. Of course, there's Cromemco's all-metal cabinet. Rugged, solid. And, there's the heavy-duty power supply (30A @ 8V, 15A @ +18 V, and 15A @ -18V) for circuitry you'll sooner or later want to plug into those free card slots.

CALL NOW

With its high performance and low price you KNOW this new Z-2H is going to be a smash. Look into it right now. Contact your Cromemco computer store and get our sales literature. Find out when you can see it. Many dealers will be showing the Z-2H soon—and you'll want to be there when they do.

PRESENT CROMEMCO USERS

We've kept you in mind, too. Ask about the new Model HDD Disk Drive which can combine with your present Cromemco computer to give you up to 22 megabytes of disk storage.

Cromemco
i n c o r p o r a t e d

280 BERNARDO AVE., MOUNTAIN VIEW, CA 94040 • (415) 964-7400
Tomorrow's computers now

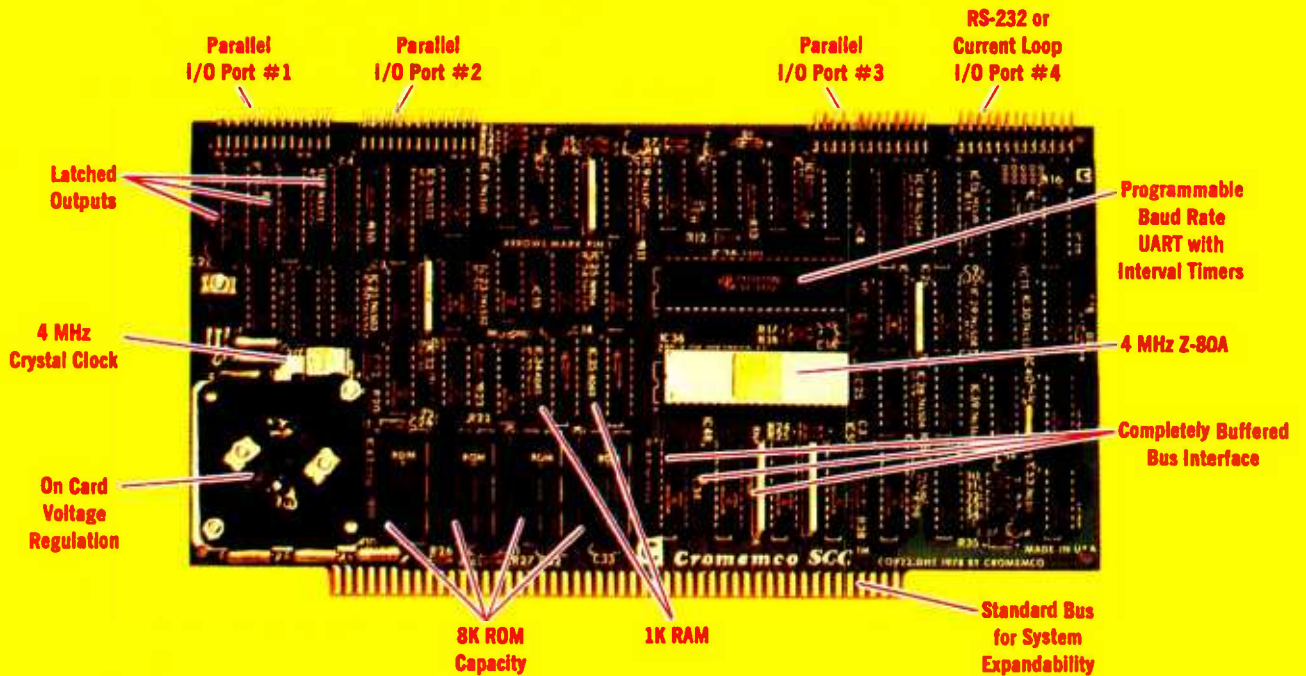

The single card computer with the features that help you in real life

COMPLETE COMPUTER

In this advanced card you get a professional quality computer that meets today's engineering needs. And it's one that's complete. It lets you be up and running fast. All you need is a power supply and your ROM software.

The computer itself is super. Fast 4 MHz operation. Capacity for 8K bytes of ROM (uses 2716 PROMs which can be programmed by our new 32K BYTESAVER® PROM card). There's also 1K of on-board static RAM. Further, you get straightforward interfacing through an RS-232 serial interface with ultra-fast speed of up to 76,800 baud — software programmable.

Other features include 24 bits of bi-directional parallel I/O and five on-board programmable timers.

Add to that vectored interrupts.

ENORMOUS EXPANDABILITY

Besides all these features the Cromemco single card computer gives you enormous expandability if you ever need it. And it's easy to expand. First, you can expand with the new Cromemco 32K BYTESAVER PROM card mentioned above. Then there's Cromemco's broad line of S100-bus-compatible memory and I/O interface cards. Cards with features such as relay interface, analog interface, graphics interface, optoisolator input, and A/D and D/A conversion. RAM and ROM cards, too.



Card Cage



32K BYTESAVER PROM card

EASY TO USE

Another convenience that makes the Model SCC computer easy to use is our Z-80 monitor and 3K Control BASIC (in two ROMs). With this optional software you're ready to go. The monitor gives you 12 commands. The BASIC, with 36 commands/functions, will directly access I/O ports and memory locations — and call machine language subroutines.

Finally, to simplify things to the ultimate, we even have convenient card cages. Rugged card cages. They hold cards firmly. No jiggling out of sockets.

AVAILABLE NOW/LOW PRICE

The Model SCC is available now at a low price of only \$450 burned-in and tested (32K BYTESAVER only \$295).

So act today. Get this high-capability computer working for you right away.



Cromemco

incorporated

Specialists in computers and peripherals

280 BERNARDO AVE., MOUNTAIN VIEW, CA 94040 • (415) 964-7400



page 32



page 72

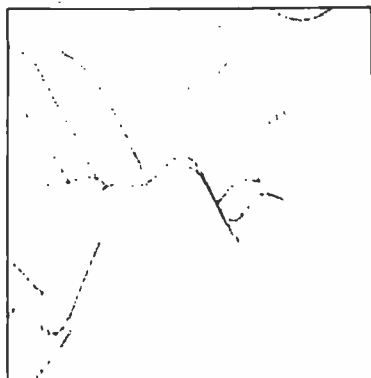

page 140

Foreground

18 A FIRST LOOK AT GRAPH THEORY APPLICATIONS by *Michael Ashbrook and Helmut Zinn*

If the use of graph theory raises a question, this article will supply an answer. The authors introduce the fundamental concepts of graph theory and two methods of directed-graph storage.

32 A COMPUTER-CONTROLLED WOOD STOVE by *Steve Ciarcia*

Steve Ciarcia shows how he uses his computer to monitor and control a Hydrostove—a wood stove that heats water piped through it.

72 A COMPUTER-CONTROLLED LIGHT DIMMER, Part 2: Implementation by *John H Gibson*

Part 2 of this article shows how to construct the design that was presented in the January 1980 BYTE, using the Heathkit ET-3400 microprocessor trainer.

92 IMPLEMENTING DYNAMIC DATA STRUCTURES WITH BASIC FILES by *Ted Carter*

Using linked lists to maintain sorted files is one way to deal with limited memory, large files, and additions and deletions to these files.

106 A FAST, MULTIBYTE BINARY TO BINARY-CODED-DECIMAL CONVERSION ROUTINE by *Michael McQuade*

This general-purpose algorithm performs these conversions and assembler programs for the 8080 processor.

192 A FINANCIAL ANALYSIS PROGRAM by *John H Lehman*

Most investors will agree that financial stability and success require an organized systematic means of assessing investments. The program written by John Lehman can output the typical information required for such a financial report.

202 ANOTHER PLOTTER TO TOY WITH, REVISITED: Design and Construction Details by *Robert K Newcomb*

Robert Newcomb tells how to construct and program the low-cost plotting system described by Peter Lucas in the February 1979 BYTE. Robert uses a KIM-1 and various electromechanical parts.

Background

58 SOLVING PROBLEMS INVOLVING VARIABLE TERRAIN, Part 1: A General Algorithm by *Scott T Jones*

The method described by Scott Jones can be applied to a wide range of problems in business and industry as well as conflict simulations and games.

116 A QUAD TERMINAL INTERFACE by *Stephen A Alpert*

Building this interface solves the occasional problem of having one interface port and the need to use three or four peripherals.

128 COMPARISON OF SOME HIGH-LEVEL LANGUAGES by *Robert A Morris*

Some programming languages are more appropriate to a particular application than others. This comparison will help you choose the right language from the many possibilities.

176 BASIC FORMATTED OUTPUT by *William D Roch*

The feature provided here will give your BASIC package the control where a particular piece of information will appear on a line when you are performing input and output routines.

Nucleus

6 Editorial: The Seven Bridges of Königsberg

14 Letters

69 BYTE News

82, 86 Programming Quickies: Gasuse; String Comparator for Horizon

88 Clubs and Newsletters

140, 146, 172, 174 Technical Forum:

Some Example Plots; Introduction to Code Tightening; Mining the Skip Chain

for Extra Bytes of Code; Audio Meter for Your TRS-80; Algebraic Identities Are Not Numerical Identities

154 Event Queue

162, 208 BYTE's Bits

168, 208 BYTE's Bugs

188 Book Reviews

212 What's New?

255 Unclassified Ads

256 Reader Service, BOMB

Publishers

Virginia Londoner, Gordon R Williamson

Associate Publisher

John E Hayes

Assistant

Jill E Callihan

Editorial Director

Carl T Helmers Jr

Executive Editor

Christopher P Morgan

Senior Book Editor

Blaise W Liffick

Editors

Richard S Shuford, Gregg Williams

Assistant Editor

Bob Braisted

Editorial Assistants

Faith Ferry

New Products Editor**Clubs, Newsletters**

Charles Freiberg

Drafting

Jon Swanson

Production Director

Nancy Estle

Senior Copy Editor

David William Hayward

Copy Editors

Faith Hanson, Warren Williamson,

Robin M Moss, Anthony J Lockwood

Art Director

Ellen Bingham

Production Art

Wai Chiu Li, Christine Dixon,

Holly Carmen LaBossiere, Deborah Porter

Typographers

Cheryl A Hurd, Debe L Wheeler,

Sherry McCarthy

Advertising Director

Patricia E Burgess

Assistants

Ruth M Walsh, Marion Gagnon

Adv/Prod Coordinator

Thomas Harvey

Marketing Coordinator

Laura A Hanson

Circulation Manager

Gregory Spitzfaden

Assistants

Pamela R Heaslip, Agnes E Perry,

Melanie Bertoni, Barbara Ellis

Dealer Sales

Anne M Baldwin

Receptionist

Jacqueline Earnshaw

Traffic Department

Mark Sandagata, Thomas Yanni

Controller

Daniel Rodrigues

Assistant

Mary E Fluhr

National Advertising Sales Representatives:

Hajar Associates Inc

East

280 Hillside Av, Needham Heights MA 02194

(617) 444-3946

521 Fifth Av, New York NY 10017

(212) 682-5844

Midwest

664 N Michigan Av, Suite 1010,

Chicago IL 60611 (312) 337-8008

West, Southwest

1000 Elwell Ct, Suite 227, Palo Alto CA 94303

(415) 964-0706/(714) 540-3554

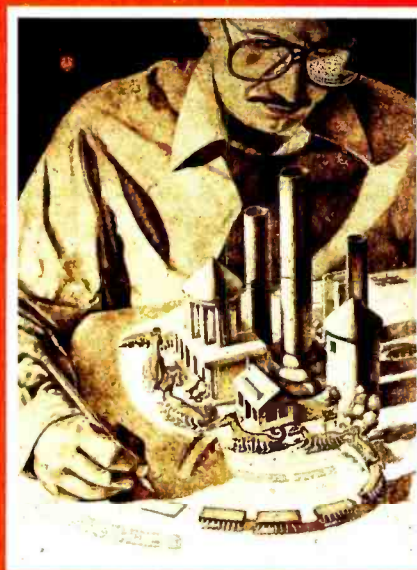

ON THE COVER

Topology is the theme of this month's cover painting, "The Seven Bridges of Königsberg" by Robert Tinney. It is a fanciful representation of a classical, topological problem made famous by the Swiss mathematician Euler, and it has a more than passing resemblance to the works of the Swiss artist M C Escher. The celebrated problem is discussed in detail by Carl Helmers in this month's editorial, and the painting is also loosely inspired by the theme article, "A First Look at Graph Theory Applications," by Ashbrook and Zinn. Sharp-eyed readers might spot a visual reference to another famous mathematical problem hidden in the cover.

Officers of McGraw-Hill Publications Company: Paul F. McPherson, President; Executive Vice Presidents: James E. Boddort, Gene W. Simpson; Group Vice President: Daniel A. McMillan; Senior Vice President-Editorial: Ralph R. Schulz; Vice Presidents: Kemp Anderson, Business Systems Development; Stephen C. Croft, Manufacturing; Robert B. Doll, Circulation; James E. Hackett, Controller; William H. Hammond, Communications; Eric B. Herr, Planning and Development; John W. Paten, Sales; Edward E. Schirmer, International.

Officers of the Corporation: Harold W. McGraw Jr, President, Chief Executive Officer and Chairman of the Board; Robert F. Landes, Senior Vice President and Secretary; Ralph J. Webb, Treasurer.

BYTE is published monthly by BYTE Publications Inc, 70 Main St, Peterborough NH 03458, a wholly-owned subsidiary of McGraw-Hill, Inc. Address all mail except subscriptions to above address: phone (603) 924-9281. Address subscriptions, change of address, USPS Form 3579, and fulfillment questions to BYTE Subscriptions, PO Box 590, Martinsville NJ 08836. Second class postage paid at Peterborough NH 03458 and at additional mailing offices—USPS Publication No. 102410 (ISSN 0360-5280). Canadian second class registration number 9321. Subscriptions are \$18 for one year, \$32 for two years, and \$46 for three years in the USA and its possessions. In Canada and Mexico, \$20 for one year, \$36 for two years, \$52 for three years. \$32 for one year air delivery to Europe. \$32 surface delivery elsewhere. Air delivery to selected areas at additional rates upon request. Single copy price is \$2.50 in the USA and its possessions, \$2.95 in Canada and Mexico, \$4.00 in Europe, and \$4.50 elsewhere. Foreign subscriptions and sales should be remitted in United States funds drawn on a US bank. Printed in United States of America.

Address all editorial correspondence to the editor at the above address. Unacceptable manuscripts will be returned if accompanied by sufficient first class postage. Not responsible for lost manuscripts or photos. Opinions expressed by the authors are not necessarily those of BYTE. Entire contents copyright © 1980 by BYTE Publications Inc. All rights reserved.

BYTE® is available in microform from University Microfilms International, 300 N Zeeb Rd, Dept PR, Ann Arbor MI 48106 USA or 18 Bedford Row, Dept PR, London WC1R 4EJ ENGLAND.



Subscription WATS Line: (800) 258-5485

Office hours: Mon-Thur 8:30 AM - 4:30 PM, Friday 8:30 AM - Noon, Eastern Time

MICROANGELO™ HIGH RESOLUTION GRAPHICS SUBSYSTEM

\$1995.00

Light Pen Optional



- 512 x 484 resolution display supervised by its own Z80 microprocessor
- 32K bytes of dual port memory give a completely undisturbed screen image
- Resident software emulates an ASCII terminal and provides graphics routines for point, line, region, and light pen usage, and more
- Compatible with any S-100 system, yet easily interfaced to other computers
- 72 key keyboard with graphics function keys
- 15" high performance monitor

SUBSYSTEMS

By
Micro Diversions

WORDSMITH™ VIDEO SUBSYSTEM

\$1595.00



- Wordsmith Word Processor software
- 40-line page display
- Selectric layout keyboard plus 20 Wordsmith function keys
- 15" high performance monitor
- Compatible with S-100 systems
- Complete documentation

Call or write:
Micro Diversions, Inc.
8455-D Tyco Road
Vienna, Virginia 22180
(703) 827-0888

**Look for
Shugart drives
in personal
computer systems
made by these
companies.**

Altos Computer Systems
2378-B Walsh Avenue
Santa Clara, CA 95050

Apple Computer
10260 Bandley Dr.
Cupertino, CA 95014

Commodore Business Machines, Inc.
3330 Scott Boulevard
Santa Clara, CA 95050

Digital Microsystems Inc.
(Formerly Digital Systems)
4448 Piedmont Ave.,
Oakland, CA 94611

Industrial Micro Systems
633 West Katella, Suite L
Orange, CA 92667

North Star Computer
2547 9th Street
Berkeley, CA 94710

Polymorphic Systems
460 Ward Dr.
Santa Barbara, CA 93111

Problem Solver Systems
20834 Lassen Street
Chatsworth, CA 91311

Processor Applications Limited
2801 E. Valley View Avenue
West Covina, CA 91792

Technico Inc.
9130 Red Branch Road
Columbia, MD 21045

Texas Electronic Instruments
5636 Etheridge
Houston, TX 77087

Thinker Toys
1201 10th Street
Berkeley, CA 94710

 **Shugart**

Editorial

The Seven Bridges of Königsberg

by Carl Helmers

Covers, like editorial themes, are sometimes drawn from interesting subjects intended as themes for an issue. But divergences can occur. This month, the nominal theme for the issue is the topic of graph theory. It takes only one article to suggest such a cover theme, and the article "A First Look at Graph Theory Applications" by Michael Ashbrook and Helmut Zinn provided the initial suggestion. But our actual cover is inspired by a historical problem in mathematics which led to the definition of a much broader field: topology.

This generalization occurred as a result of trying to find a nice neat visual image that fits the topic of graph theory. In order to concoct a cover idea on graph theory, the first step is to start searching around for some theme on a diagram of nodes and interconnecting segments which is not some hackneyed abstract pun. In order to construct a visual image for a cover, I needed to find some seminal problem with dramatic visual import. This problem must define and suggest the general field of endeavor. So, I proceeded to hunt around.

A good forest in which to hunt mathematical images is an excellent four-volume set of books entitled *The World of Mathematics*, by James R Newman, published by Simon and Schuster in 1956, and still available at a cost of \$39.95. On the covers of the four volumes we find the description "a small library of the literature of mathematics, from A'h-mose the Scribe to Albert Einstein, presented with commentaries and notes." These books present a selection of original papers by mathematicians, with introductions and commentary by the editor. As serious or recreational reading for those interested in mathematical subjects, I highly recommend it.

So, naturally, I turned to the index of Mr Newman's book. I knew that somewhere in that 2535-page work I might find some visual image with which artist Robert Tinney could work to create a cover. It did not take long to find the appropriate image. On pages 570 thru 599 we find Mr Newman's commentary on graph theory, which is really an illustrative subset of a much more general field, topology. Following three pages of editor's commentary, the two papers reproduced in this section of the book are Leonhard Euler's memoir "The Seven Bridges of Königsberg" (1735) and a survey article "Topology," by Richard Courant and Herbert Robbins, taken from their book *What Is Mathematics?* (Oxford University Press, 1941). When I encountered the problem of the Seven Bridges of Königsberg in the form of Euler's paper, I knew we had a cover image.

The problem is quite simply stated: a city, Königsberg, is built on an island in the river Pregel (see figure 1). We wish to find out if it is possible to cross all seven bridges in an afternoon's walk without crossing any bridge more than once.

Figure 1: Map of the town of Königsberg in Prussia, reproduced from Euler's paper on the subject, first published in 1735. Within the town there is an island called Kneiphof, labeled A in the figure, around which flows the river Pregel. Seven bridges, labeled a, b, c, d, e, f, and g, cross the two branches of the river. The various land areas of the town are labeled A, B, C, and D.

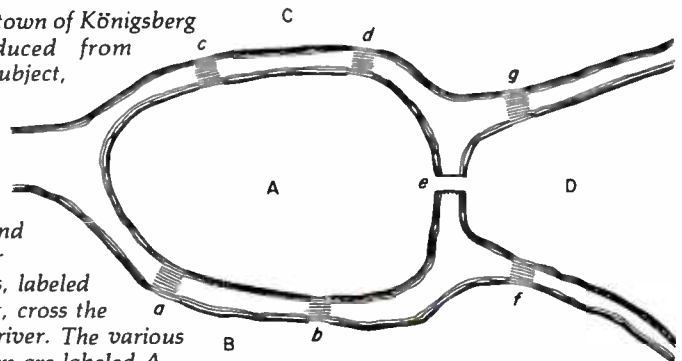

"My 8 to 5 minifloppy™ now works nights and weekends."



"I own a fast-growing business and before I bought my computer system I put in a lot of late hours keeping up with my accounting and inventory control. Now the computer does my number crunching quickly, so I have time after hours to have some fun with the system. My son and I started out playing Star Trek on the system, and now we're learning to play chess.

"When I was shopping around for my system, the guys in the computer stores demonstrated all the unique features of the minifloppy. I've got to admit that at first I didn't really understand all the technical details. But now that I use the system every day, I really appreciate the minifloppy's fast random access and data transfer. I like the reliability, too.

"I'm glad I went with Shugart drives. Look, when you lay out your own money for a system, you want dependable performance and good value. Do what I did. Ask for the system with the minifloppy."

If it isn't Shugart, it isn't minifloppy.

 Shugart Associates

435 Oakmead Parkway, Sunnyvale, California 94086

See opposite page for list of manufacturers featuring Shugart's minifloppy in their systems.

™ minifloppy is a registered trademark of Shugart Associates

What Euler did, in an eminently readable argument in his paper, is to prove that it is indeed *not* possible. He proves that the popular hobby of the Königsberg folk of seeking that magic path could never succeed. In so doing, he helped to found the science of topology. According to Newman in his commentary on the paper,

The problem — to cross the seven bridges in a continuous walk without recrossing any of them — was regarded as a small amusement of the Königsberg townsmen. Euler, however, discovered an important scientific principle concealed in the puzzle. He presented his simple and ingenious solution to the Russian Academy at St Petersburg in 1735. His method was to replace the land areas by points and the bridges by lines connecting these points. The points are called vertices; a vertex is called odd or even according as the number of lines leading from it are odd or even. The entire configuration is a graph; the problem of crossing the bridges reduces to that of traversing the graph with one continuous sweep of the pencil without lifting it from the paper. If the graph contains more than two odd vertices, it may be traversed in one journey but it is not possible to return to the starting point. The general principle is that if the graph contains $2n$ odd vertices where n is any integer, it will require exactly n distinct journeys to traverse it. . . .

Thus began a "vast and intricate theory [topology]," still young and growing, yet already one of the great forces of modern mathematics.

Now we had the general outline of the image. Fine details remained to be worked out with Robert. Now, Robert Tinney and I know of a number of artists that we regard as extremely interesting in general style and subject matter. There are, for example, the direct and conscious influences of Maxfield Parrish and Norman Rockwell on Robert's style of painting as often seen in covers of *BYTE*. However, we have of late been getting immersed in the fascinating art of M C Escher. Part of this fascination has been lying dormant since Martin Gardner's series of articles on Escher and tessellations of the plane in *Scientific American* (see his "Mathematical Games" column in the July 1975 (page 112), August 1975 (page 112), December 1975 (page 116), January 1977 (page 110), and June 1978 (page 18) issues). The fascination is of course greatly rekindled by the recent publication of the book *Gödel, Escher, Bach* by computer scientist Douglas R Hofstadter.

So, given the theme of the seven bridges of Königsberg, the added input of a recursive-programming computer-science pun clearly evident in the image, and a fascination with Escher's style, Robert chose to produce a cover image inspired by the art of Escher. The result is what you see. ■

In Next Month's *BYTE*

The March 1980 *BYTE* will be devoted to "Computers and the Sciences." The theme articles will cover diverse topics such as "Electron Behavior in Chemical Bonds," "Electronic Planimetry," "Chemistry Program for the Apple Computer," and a "Deraillieur Speed-Calculation Program."

An Update on Direct Cursor Addressing and UCSD Pascal

In last month's editorial on the Apple Pascal system, I made some comments about difficulties in getting the UCSD System to emit the cursor addressing character of my Computer Peripherals Corp "COPS-10" terminal. This terminal requires the sequence of "control-P, <Y+32>, <X+32>" to directly address a given location on the screen.

It turns out that the UCSD Pascal System (not just the Apple II version) gobbles "control-P" characters on output, whether through use of *WRITE*, *WRITELN* or even *UNITWRITE*. Naturally, it became a challenge to find out how to emit a control-P.

So, trying brute force as a first method of solution, I wrote an assembly language program using the UCSD Pascal System's 6502 assembler. This assembly language program simply set up the parameters for the routine "SHOUT" within the Apple II serial card's read-only memory, then called that routine to emit the control-P character. I proved it worked by writing a Pascal *GOTOXY* procedure and test program.

The UCSD Assembler proved more than adequate for my purposes, in its 6502-oriented version running on the Apple. A most useful feature is its macro-instruction facility with conditional assembly. The Apple documentation of the UCSD System includes examples of assembly language interfaces which proved to be quite a helpful model. There was one convention that I had to worry about for a few assemblies. This was the fact that the assembler only allows hexadecimal integer constants. The assembler also demands uppercase only for tokens, although lowercase works fine in comments.

Of course, the version of the Pascal *GOTOXY* that used this assembly language procedure had to have an external procedure definition. This presented no problem when compiling without any special compiler options. But the manual points out (and experience confirms) that the "{*SU-*" option must be active when compiling the code file that will be linked into the system by *BINDER*. Every time I try to compile with the required {*SU-*} compiler toggle, I get a Pascal syntax error #183, "External declaration not allowed at this nesting level." This was in spite of the fact that the "PROCEDURE *CTRLP3*; EXTERNAL;" sequence is at the outer (PROGRAM) level of nesting.

I tried everything I could think of: linking before *BINDER*, not linking, using it with the {*SU*} toggle and without, etc. I even recalled the existence of a magical UCSD Pascal compiler toggle "{*ST+*", which is required for compilation of super-large systems programs. When used with the {*SU-*} option, I could get the program to compile and link with the assembly language program—but then *BINDER* would not accept it. Clearly it was all to no avail. Would I be stuck with the *GOTOXY* cursor kludge of

```
<home> <LF> . . . <LF> <HT> . . . <HT>
```

forever?

At Intersystems, "dump" is an instruction. Not a way of life.

(Or, when you're ready for IEEE S-100, will your computer be ready for you?)

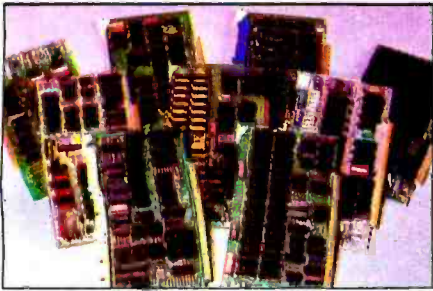

We're about to be gadflies again.

While everyone's been busy trying to convince you that large buses housed in strong metal boxes will guarantee versatility and ward off obsolescence, we've been busy with something better. Solving the *real* problem with the first line of computer products built from the ground up to conform to the new IEEE S-100 Bus Standard. Offering you extra versatility in 8-bit applications today. And a full 16 bits tomorrow.

We call our new line Series II™. And even if you don't need the full 24-bit address for up to 16 megabytes (!) of memory right now, they're something to think about. Because of all the perform-

ance, flexibility and economy they offer. Whether you're looking at a new mainframe, expanding your present one or upgrading your system with an eye to the future. (Series II boards are compatible with most existing S-100 systems and *all* IEEE S-100 Standard cards as other manufacturers get around to building them.)

Consider some of the features: Reliable operation to 4MHz and beyond. Full compatibility with 8- and 16-bit CPUs, peripherals and other devices. *Eight* levels of prioritized interrupts. Up to 16 individually-addressable DMA devices, with IEEE Standard overlapped operation. User-selectable functions addressed by DIP-switch or jumpers, eliminating soldering. And that's just for openers.

The best part is that all this heady stuff is available now! In our advanced processor—a full IEEE Bus Master featuring Memory Map™ addressing to a full megabyte. Our fast, flexible 16K Static RAM and 64K Dynamic RAM boards. An incredibly versatile and

economical 2-serial, 4-parallel Multiple I/O board. 8-bit A/D-D/A converter. Our Double-Density High-Speed Disk Controller. And what is undoubtedly the most flexible front panel in the business. Everything you need for a complete IEEE S-100 system. Available separately, or all together in our new DPS-1 Mainframe!

Whatever your needs, why dump your money into obsolete products labelled "IEEE timing compatible" or other words people use to make up for a lack of product. See the future now, at your Intersystems dealer or call/write for our new catalog. We'll tell you all about Series II and the new IEEE S-100 Bus we helped pioneer. Because it doesn't make sense to buy yesterday's products when tomorrow's are already here.

Intersystems™

Ithaca Intersystems Inc.,
1650 Hanshaw Road/P.O. Box 91,
Ithaca, NY 14850
607-257-0190/TWX: 510 255 4346

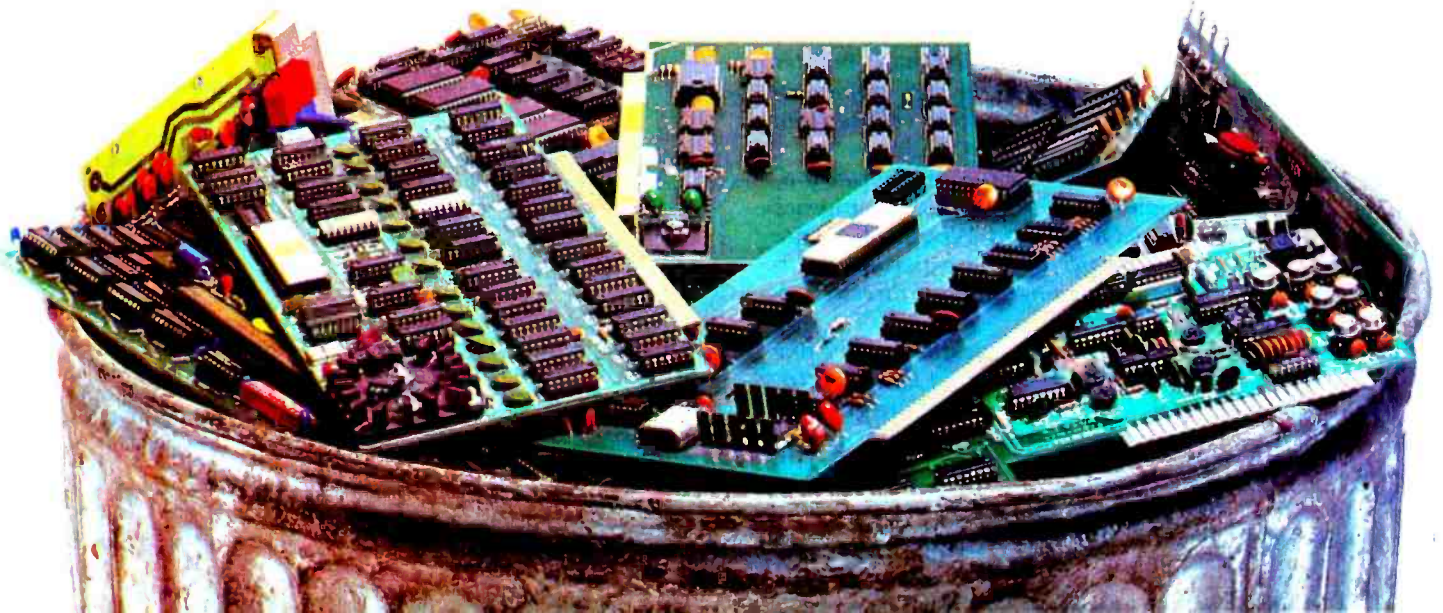

Well, impossible problems lead to new solutions when frustrations get high enough. One solution would of course be a new terminal that had the necessary cursor control keys (the up/down/left/right arrows) but used a different direct addressing sequence.

On the day I solved the problem, I was talking with Cameron Jones about getting the UCSD Pascal System version for my New England Digital Synclavier music synthesizer. (Cameron Jones, Syndey Alonzo, and Jon Appleton are the co-inventors of the Synclavier.) As the Synclavier and its ABLE/60 computer comes delivered, its native language is XPL. So implementing a UCSD Pascal system becomes a problem of implementing the core interpreter in XPL.

As I was talking on the phone with Cameron, I finally realized what was wrong. The cursor addressing character of my terminal is an ASCII DLE character which is also known as control-P when emitted from a keyboard. And the UCSD System will always eat control-P characters, since this is the spaces-compression escape character of ".TEXT" files! Cameron pointed out that the specification of the UCSD Pascal UNITWRITE routine is that it will do spaces decompression.

So I had to have a character that looks like a control-P to the terminal but not like a control-P to UCSD Pascal. This character is of course a character with the integer value 144. Its value is obtained by turning on the high-order bit in an 8-bit character by adding 128 to the control-P character code's value of 16. While the Pascal program's character data value are 8 bits, the terminal only looks at the low-order 7 bits. Thus, if the low-order looks like a control-P, turning on the high-order bit will keep Pascal from thinking it really is a DLE while allowing the terminal to think it is.

Everything else immediately simplified and fell in place. Listing 1 shows the final version of the GOTOXY procedure, which now emits an 8-bit

pseudo-control-P character that gets interpreted by the terminal as a 7-bit control-P character.

Of course, by getting frustrated by this problem, I explored the use of assembly language features of the UCSD System. I learned how to link successfully to assembly language programs, use the macroassembler that comes with the system, and unwind parameters from the Pascal stack in assembly language programs. I will probably never again use an assembly language program with a Pascal program. But if I need to for some reason of speed, I now know it is possible. This short note and this month's editorial were the first texts I edited using the new version of GOTOXY; the results are quite an improvement — I am no longer limited by rather artificial delays required by last month's cursor addressing kludge.

Listing 1:

```
(ssu-s)
PROGRAM GOTOXY
  ( The final version of the GOTOXY procedure, used with Apple Pascal )
  ( and the Computer Peripherals Corporation COPS-10 terminal. The )
  ( ASCII (7 bit) sequence! )
  ( <ctrl P> <+32> <x+32> )
  ( causes direct cursor addressins. )
PROCEDURE FGOTOXY(x_axis,w_axis: INTEGER)
  ( COPS 10 - GOTOXY )
CONST
  control_P = 144 (high order bit on; but no effect 16+128!)
VAR
  x,w : INTEGER;
  abute : PACKED ARRAY[0..03] OF CHAR;
BEGIN
  ( ... how do we send a "control P" when the Pascal UNITWRITE will )
  ( gobble it because it thinks that it is spaces compression chr- )
  ( actor? Well, recognize that the terminal only pays atten- )
  ( tion to 7 low order bits. Thus if we send a control P with )
  ( the high order bit on, then UNITWRITE will saw "aha that is not )
  ( a control P" and the terminal will saw "aha that is a control P" )
  abute[0] := CHR(control_P);
  UNITWRITE(1,abute,1..1);

  x := x_axis + 32;
  w := w_axis + 32;
  IF x > 111 THEN x := 111; (111 = 79 + 32)
  IF x < 32 THEN x := 32;
  IF w > 55 THEN w := 55; (55 = 23 + 32)
  IF w < 32 THEN w := 32;
  abute[0] := CHR(x);
  UNITWRITE(1,abute,1..1);
  abute[0] := CHR(w);
  UNITWRITE(1,abute,1..1);
END (soLoxy);

BEGIN ( # DUMMY MAIN # )
END.
(ssu-s)
```

On Eclipses, Next Month's Editorial and the West Coast Computer Faire. . .

As you read this February 1980 issue of BYTE, I will be embarking on a journey to make the technological fantasy of last July's editorial ("Computers and Eclipses," page 8) real. In the March 1980 editorial, I plan to describe some of the details of the computer system which will control my Nikon F2A camera in automatic photography of the 1980 solar eclipse from Kenya in Africa.

I am scheduled to leave for Kenya on February 6, 1980, joining a small expedition of solar physics experimenters organized by Norm Whyte of Monte Rio, California. Norm is performing experiments involving a custom designed camera under direct computer control of an Apple II.

The only uncertainty is what the weather will be like at our observation site on the morning of February 16, 1980. Whatever the weather, readers who are going to the West Coast Computer Faire in San Francisco in March 1980 will be able to see the results in a talk

entitled "Microcomputers in Africa: A Travelogue of The 1980 Eclipse."

Norm and I will be presenting this talk as part of the technical program. It will feature slides made during the trip showing the setup and equipment (as well as scenery) and—weather permitting—slides of the eclipse itself. . . .CH

Articles Policy

BYTE is continually seeking quality manuscripts written by individuals who are applying personal computer systems, designing such systems, or who have knowledge which will prove useful to our readers. For a more formal description of procedures and requirements, potential authors should send a large (9 by 12 inch, 30.5 by 22.8 cm), self-addressed envelope, with 28 cents US postage affixed, to BYTE Author's Guide, 70 Main St, Peterborough NH 03458.

Articles which are accepted are purchased with a rate of up to \$50 per magazine page, based on technical quality and suitability for BYTE's readership. Each month, the authors of the two leading articles in the reader poll (BYTE's Ongoing Monitor Box or "BOMB") are presented with bonus checks of \$100 and \$50. Unsolicited materials should be accompanied by full name and address, as well as return postage.

New from SSM.



80 Character Video

With 80 characters per line our VB3 is the perfect video interface for word processing. It produces a standard 80x24 display of upper and lower case characters or as much as 80x51 for a full page of text. The matrix for graphic display goes up to 160x204. And with optional EPROM, as many as 256 user programmed characters or symbols can be produced.

VB3 is memory mapped for rapid screen updating. But it occupies memory only when activated. So one or more VB3s can be located at the same address with a full 65K of memory still available to the user.

It generates both U.S. and European TV rates and meets the new IEEE S-100 standard. Other features include keyboard input, black on white or white on black, one level of grey, underline, strike thru, blinking char., blank-out char., and programmable cursor. Software includes a CP/M compatible driver and a powerful terminal simulator.

VB3 is available in several configurations. Retail prices start at \$375 kit, \$440 assembled.

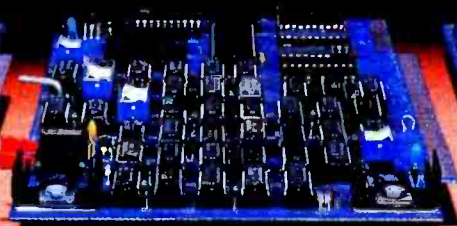

Z-80 CPU

We spent over a year designing the CB2 to assure that it will be the most fully S-100 compatible Z-80 CPU on the market.

It operates at 2MHz or 4MHz by DIP switch selection and includes two sockets for 2716/2732 EPROMs or TMS 4016 2K RAMs. Memory sockets can be disabled. Separate run/stop and single step switches allow system evaluation without the benefit of a front panel.

CB2 also features an MWRITE signal, firmware vector jump, and an output port to control 8 extended address lines (allowing use of more than 65K of memory). Jumper options generate the new IEEE S-100 signals to insure future S-100 compatibility.

Retail price—\$210 kit, \$275, assembled.

Our line, CPU, Video, I/O, RAM, EPROM, EPROM Programmer, Music, Prototyping, Terminator, Extender, and Mother boards. Available assembled or as kits.



8080 CPU

Our new CB1A is identical to our popular CB1 with the exception that the on-board RAM has been increased from 256 bytes to a full 1K.

It also features an optional 2K of 2708 EPROMs, power-on/reset vector jump, MWRITE, parallel input port with status and DIP switch addressing.

Retail price—\$159 kit, \$219 assembled.



2116 Walsh Avenue
Santa Clara, CA 95050 (408) 246-2707

Send for our free brochure and find out why SSM has become the favorite of discerning Hobbyists and OEMs.



mainframe power for your micro system

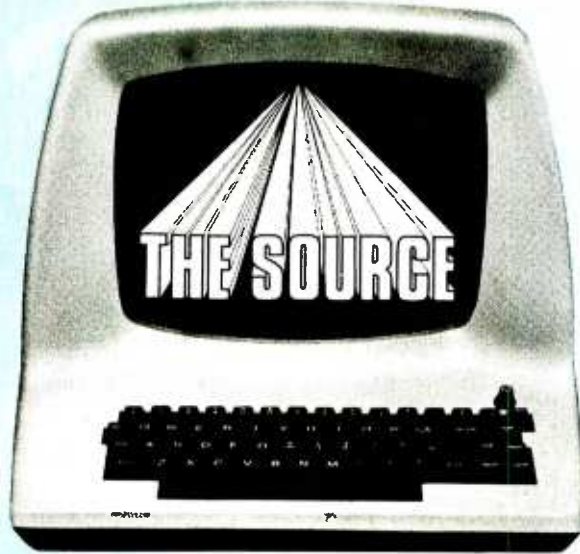

Announcing a new information/communication network to add power and utility to your microcomputer

Now, you can access with your microcomputer a powerful information processing and data communication network. It's called THE SOURCE.

With THE SOURCE, you can get more use and value from any micro system at a very low price.

Through your telephone, you can get instant access to the United Press International wire service, all major stock exchanges, the New York Times Consumer Data Base . . . and dozens of other useful and powerful information resources through an easy-to-use keyword and key term indexing system.



The New York Times Consumer Data Base is at your fingertips . . . with simple key term indexing.

In short, THE SOURCE can revolutionize your personal and business life . . . and multiply the value of your micro a thousand times!

Information and communication resources you can use every day.

THE SOURCE is not a toy . . . and is not to be confused with the collections of computer games and other individual software offerings.

Instead, THE SOURCE is a carefully selected on-line library of the most useful information and communication resources available today.

Need to make travel arrangements? THE SOURCE can give you the complete schedules of all U.S. airlines, plus available hotel rooms, restaurant reviews, entertainment information, and even the weather forecast in all major U.S. cities. And, you can instantly charge your reservations to your credit card directly from your terminal!

Need help with your personal finances? THE SOURCE gives you complete personal accounting services including checkbook balancing, income tax preparation assistance, and much, much more.

And for your business, THE SOURCE offers accounts payable and receivable, general ledger, payroll, a simplified data base manage-



The latest news, weather, sports, and features from United Press International . . . with keyword search.

ment system, list compilation and management systems, order entry, sales commission reports, cash flow analysis, and much more.

Need to keep abreast of fast-breaking news? THE SOURCE gives you an instant link with the United Press International wire service to give you the full story, hours before the SEVEN O'CLOCK NEWS!

Need information on persons, places, or events? THE SOURCE gives you immediate key term access to the New York Times Consumer Data Base containing over 5,000 abstracts.

Need to communicate instantly with a friend or associate? THE SOURCE

provides you with an immediate nationwide terminal-to-terminal communication ability at a cost lower than telegrams, express mail, or courier services.

(This service alone will more than pay for the modest cost of THE SOURCE).

Need up-to-the minute stock market reports? THE SOURCE goes even further and gives you instant reporting on stocks, precious metals, bonds, commodities, and other important markets . . . plus valuable background reports on selected corporations, industry trends, and other vital subjects.

Multiply the storage and computing power of your micro system.

When you need greater capacity and speed for larger or more com-



Communicate instantly to any other SOURCE user in the U.S. for as little as 4.6¢ per minute!

plex computing jobs, THE SOURCE is your perfect back-up.

With unlimited capacity and no charges for CPU time, THE SOURCE can execute your largest jobs and most complicated programs in several languages including EXTENDED BASIC, FORTRAN, RPG II, and COBOL. Plus you get text editing, debugging systems and much more . . . at a fraction of the cost of adding more stand alone capacity to your present micro system.

Immediate compatibility with your personal computer

Using a low-cost acoustic coupler or modem and a telephone (a local call from over 250 U.S. cities), THE SOURCE is compatible with almost all micro systems including:

- | | |
|--------|-----------------|
| APPLE | COMPUCOLOR |
| PET | NORTH STAR |
| TRS-80 | OHIO SCIENTIFIC |
| HEATH | EXIDY |
| ALTAIR | CROMENCO |
| MSAI | |

(For other systems, please write for information.)



Get immediate access to all stock exchange information, foreign currency reports, commodities and much more!

Awesome power at a modest price

The low cost of THE SOURCE comes as a surprise to everyone. The world of information of THE SOURCE can be accessed for \$15.00 per hour (prime time) and *only* \$2.75 per connect hour at night, weekends and holidays!*

At this low price, the entire family can use THE SOURCE's many re-

sources without a dent in the pocket-book.

A no obligation introduction to the source.

Now is the time to discover how THE SOURCE can put a world of knowledge and entertainment at your fingertips. Use the no obligation free coupon below to get the details of how you can take advantage of THE SOURCE.



Complete airline schedules and travel information are as near as your terminal. You can reserve and charge your ticket and travel accommodations instantly.

*Non-prime time connect hours are 6:00 p.m. to 7:00 a.m. (local time) Monday through Friday and all day Saturday, Sunday and holidays. Non-prime connect time is \$2.75 an hour. The prime time usage charge is \$15.00 an hour. There is a minimum monthly charge of \$5.00 and disk storage charges are calculated at 3-1/3 cents/2048 character block/day.

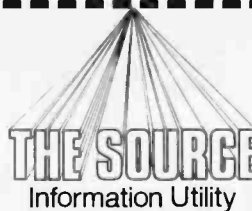

The SOURCE Free Information Request

Please send me your FREE information guide to THE SOURCE. I understand I am under no obligation.

I currently have a personal computer:

MAKE: _____

MODEL: _____

Please send me information on compatible microcomputers and data terminals including the special low-cost terminal equipment packages offered by THE SOURCE.

NAME: _____

ADDRESS: _____

CITY: _____

STATE: _____ ZIP: _____

Please mail this coupon to:
Telecomputing Corporation of America
 1616 Anderson Road □ McLean, Virginia 22102

B2/80A

Letters

8086 Software Needed

I am interested in designing systems based on 8086 processors. Does anyone have some useful systems software to sell? I am particularly interested in file-handling software and operating systems in general. I am interested in purchasing source listings and I am prepared to visit software houses on my next trip to the US.

Martin Healey
Computer Systems Consultant
9 Ennerdale Close
Penylan, Cardiff CF2 5NZ
GREAT BRITAIN

Battle of the Buses

In the October 1979 "BYTE News," page 107, Sol Libes contends, in an item about the S-100 bus, that "those who wish to have a machine capable of get-

ting the maximum benefits of microprocessors must go the S-100 route." While Mr Libes was comparing the S-100 bus to all-in-one systems, such as the TRS-80 and PET, his statement leaves out a number of computer systems with as much capability as S-100 systems, perhaps more in some cases. For example, the SwTPC S/09 and the Ohio Scientific Challenger III Series are two systems that come to mind. The former uses a 6809 processor with the SS-50 bus (see October BYTE, inside front cover), and the latter uses 6800, 6502, and Z80 processors and apparently OSI's own bus (see back cover, same issue). Both of these systems have a 20-bit address bus for large memories. SwTPC and several other companies make SS-50 bus systems using the 6800. Other non-S-100 bus systems include the Heath H8 and H11. Any of these systems, and probably others that I have left out, can be as good for serious personal computer

users as any S-100 bus computer. The S-100 bus is *not* the only possible route.

Mr Libes also writes that "the S-100 bus is not processor dependent." This statement is debatable, in spite of the existence of S-100 boards for a number of microprocessors. Several signals on the S-100 bus are generated *ONLY* by the 8080. Any other processor must be "bent" into generating (or responding to) these 8080-specific signals.

Personal computing could use a truly processor-independent bus. I feel that the S-100 bus will not be totally satisfactory in this role.

The mention of specific products in this letter does not necessarily constitute endorsement of these products. My point is simply that there are other buses besides the S-100, and that systems using these other buses can be just as capable as S-100 systems.

Jim Howell
5472 Playa Del Rey
San Jose CA 95123

Author Libes replies:

Thank you for your letter regarding my comments on S-100 systems in the October BYTE News column. Despite the views expressed in your letter, I still stand by my view that "those who wish to have a machine capable of getting maximum benefits of microprocessors must go the S-100 route." I agree with you that SS-50 and OSI Challenger III systems offer more power than integrated systems such as the TRS-80, Apple and PET. However, they still leave much to be desired compared to S-100. I will explain shortly.

Further, I also stand by my statement that "the S-100 bus is not processor dependent." The fact is that presently there are manufacturers selling six different 8-bit processor boards (8080, 8085, Z80, 6502, 6800 and 6809) and five different 16-bit processor boards (9900, LSI-11, 8086, Z8000 and Pascal Microengine) for S-100 systems. This means that eleven microprocessors have already been interfaced to the S-100. I do not know of any other system with this processor independence. Many of these microprocessors could not even be interfaced to buses such as the SS-50 or OSI without sacrificing performance.

When it comes to maximum power and flexibility the S-100 offers the following advantages over all other systems:

- More software available. There are several times more languages, operating systems and applications packages for S-100 systems than for any other system.

SUPERPASCAL

5-10 times faster...
and more!

Meet Pascal/Z,TM the fast, flexible compiler with higher speed, greater efficiency and improved debugging:

- True Z-80 native code Pascal compiler—5-10X faster than competing P-code implementations—no interpreter required.
- The only multi-tasking Pascal—produces ROMable re-entrant code.
- Optimized for fastest execution—recognizes and exploits special cases.
- Easily transportable—all hooks to your system made through support library.
- Includes standard floating point package. Single copy on CP/M-compatible disk includes compiler, companion macro-assembler & source of the library, \$395. OEM licenses available. Write or call for more information.

InterSystemsTM

Ithaca Intersystems Inc., 1650 Hanshaw Road/P.O. Box 91,
Ithaca, NY 14850/607-257-0190/TWX: 510255 4346

© 1979 Ithaca Intersystems Inc.

WHY WE'RE NUMBER

1

ONE

If you did not get our 52 page 1980
ENGINEERING SELECTION GUIDE in the
January issue of BYTE, send \$1.00 for
your copy today.

PRIORITY ONE ELECTRONICS
16723-B ROSCOE BLVD.
SEPULVEDA, CA 91343



- There are currently close to two dozen different manufacturers of S-100 mainframes and about fifty manufacturers of over 400 S-100 plug-in boards. This is many times more than for any other system.
- There is greater computer power capability with S-100. What other system has direct addressing of up to 16 megabytes of memory (24 address lines) and 64 K input/output ports (16 address lines), up to eleven vectored interrupt lines, up to sixteen masters on the bus (with priority), up to twenty-three plug-in slots on the motherboard, up to 10 MHz clock on the bus, plug-in operator front panel, and more.
- The S-100 bus is now standardized by the Institute of Electrical and Electronic Engineers (IEEE) assuring conformance among manufacturers.

Regarding your reference to the H8 bus, note that Heath has discontinued production of this unit. Besides, it was dedicated exclusively to the 8080 and therefore was destined to an early death. The Heath H11 is essentially the same as and uses the same bus specifications as a Digital Equipment Corp LSI-11. Few other firms support the LSI-11 with products within the price range of the

typical hobbyist. The hardware and software facilities, compared to the S-100, are limited and expensive.

Again, thank you for reading my column and I welcome any further comments you wish to make regarding my opinions.

Sol Libes

Pi in the Sky

As I get older, I forget more and more often that the "tricks" I sometimes use may not be common knowledge. I have recently come across several short programs that evaluate π to five or six decimal places. These are good programs, and I salute their authors. I, however, use the shortest of all programs for π and would like to pass it on. It gives an approximate answer that is in error by 27 parts in 100 million. Since this is well within the allowable error of most computers, I use it without hesitation in all computer programming expressions.

Here goes. To enter π accurate to six decimal places, write in its place $1/(113/355)$. That's all there is to it! The value of that expression is 3.14159292, while π is 3.14159265

This little gem was taught to me for use on the slide rule, back during the 1940s. I pulled it out of my memoirs recently when I got my first microcomputer.

Please note that the denominator is easily remembered as the first three odd integers, doubled. The order of their appearance is obvious.

Emory W Sprenkle Jr
POB 542 (53 Allen Rd)
Billerica MA 01821

Keep Telling It Like It Is . . .

Thank you for the November editorial regarding pseudoscience and biorhythms in particular. It was certainly refreshing to have a hobbyist magazine of BYTE's reputation so clearly delineate between harmless biorhythm algorithms for the sake of computing recreation and the unscientific foundations of biorhythmic theory. Too many supposedly educated and intelligent people seem to have fallen into the "computer generated, therefore true . . ." trap you described. Perhaps you have caused some of them to *critically examine* the unsupportable premises of biorhythmic theory. Now if I could just get the campus radio station to stop broadcasting horoscopes . . .

Thomas Dolash
Assistant Professor of Physics
Physics and Engineering Dept
Vincennes University
Vincennes IN 47591

Good Humor Needed

I have found your magazine to be very educational and of excellent quality. I look forward to getting the new issue each month. However, I have a suggestion that I think might make your magazine even better and would be enjoyed by all your readers. Why not add a "Jokes & Riddles" column and a comic strip or two, and maybe a few "one-framers"? I realize that your magazine tries to present a serious approach, but I think that this addition would be a plus, and a bit of humor would make it more fun for everyone. So how about it?

William P Carlson
Rosewood Cir
North Syracuse NY 13212

You would not believe the number of unsolicited cartoons we get that are anchored in the dark ages of computing prior to personal computing.

The problem is finding cartoon and humor generators who also understand the current era in computing. . . .CH ■

The
Self-Indexing
Query System

WHAT'SIT?

Wow! How'd All That Stuff get In There?



**COMPUTER
HEADWARE**

BOX 14694
SAN FRANCISCO 94114

clearly readable printouts clearly remarkable price

The \$625* Heathkit H14 Printer. You'll pay hundreds more for a printer with its features.

Where else can you buy a microprocessor-based printer with the H14's features and copy quality for under a thousand dollars?

The Heathkit H14 prints up to 165 characters per second, one full line every two seconds.

5 x 7 dot matrix and finest quality impact printhead give you clear, easy-to-read images.

All functions are microprocessor-controlled for reliable performance and more efficient use of your computer.

You get:

- Standard 96-character ASCII set—UPPER and lower case.
- Operator or software selectable line width: 132, 96 and 80 characters per line.
- Compatibility with any computer having RS-232C or 20 MA current loop serial interface with handshaking.
- Sprocket paper feed, with adjustable spacing, keeps paper moving smoothly.
- "Paper out" and "paper jammed" signals prevent loss of data.

- Selectable baud rates from 110 to 4800.
- Convenience of standard fan-fold paper, 2.5 to 9.5 inches wide.
- Chrome wire rack keeps paper neat.

Price includes connecting cables, paper rack and ribbon. Just add paper and you're ready to run. And service on the H14 is close by at any of 55 Heathkit Electronic Centers throughout the U.S.

Complete details on the remarkable H14 are in the newest, free Heathkit Catalog. Send for yours today or pick one up at your Heathkit Electronic Center.

*"Whatever your computer, this printer is an excellent complement ...an excellent value."
— Creative Computing Magazine*

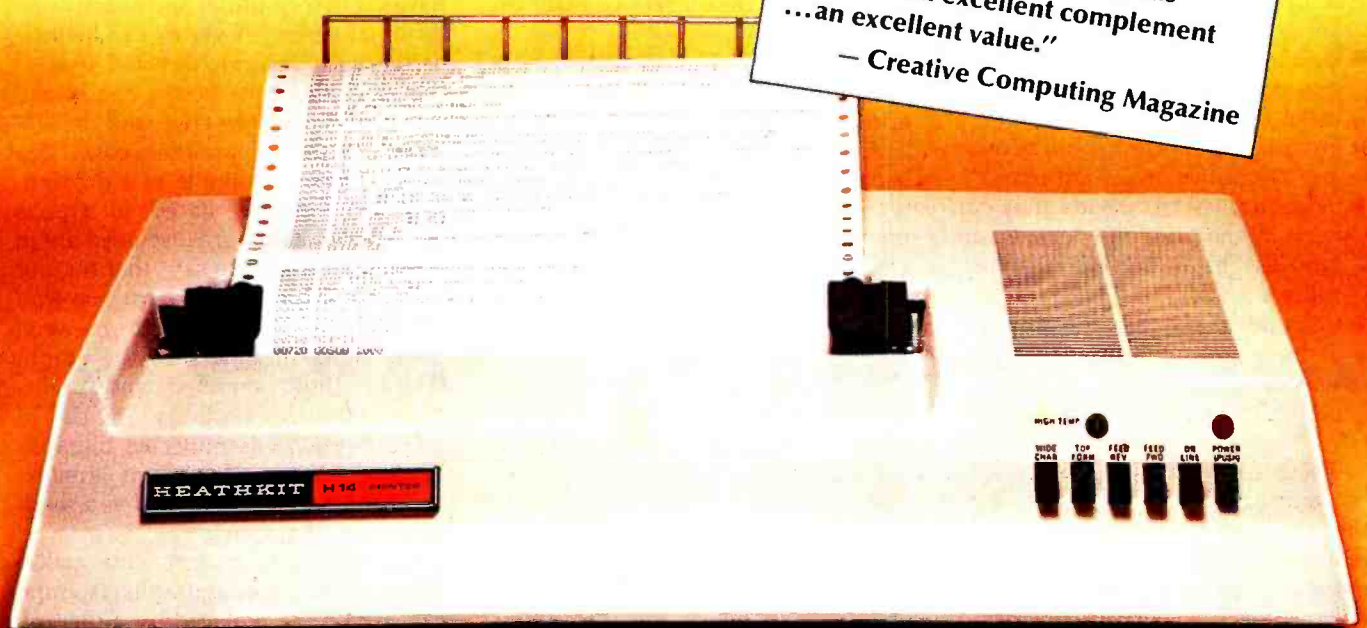

FREE CATALOG See the complete line of Heathkit Computer Products, including printers, video terminals, floppy disk systems and software, in the new, 104-page Heathkit Catalog. It describes nearly 400 exciting kits for your



home, work or pleasure — all at build-it-yourself savings. Send for yours today or pick one up at your Heathkit Electronic Center† where Heathkit Products are displayed, sold and serviced. See your white pages for center nearest you.

*In kit form, F.O.B. Benton Harbor, MI. Also available completely assembled at \$895 F.O.B. Benton Harbor, MI. Prices are subject to change without notice.
†Units of Veritechnology Electronics Corporation

Heathkit®

Heath Company, Dept. 334-622, Benton Harbor, MI 49022

A First Look at Graph Theory Applications

Michael Ashbrook
Helmut Zinn
Wilhelm Epstein Str 27
6000 Frankfurt am Main 50
WEST GERMANY (BRD)

What do the following problems have in common?

- Finding the shortest route between two particular cities on a complicated road map.
- Finding the shortest route between any two cities on a road map.
- Selecting a set of roads that connects all the cities on your map and has less total mileage than any other such set.
- Calculating the maximum amount of liquid that can flow through a system of interconnected pipelines per unit of time.

These four real-life problems can be interpreted in terms of graph theory and can be solved by remarkably simple and efficient programs. The problems belong to a much larger category of operations-research problems; these were selected as examples because of their comparative simplicity. Algorithms for solving such problems along with the necessary background for understanding them will be examined.

While our terminology follows that of Narsingh Deo, our programs are quite different from his. If you become interested in solving more graph-theoretic problems on your own, you will find his book a stimulating introduction. (See *Graph Theory with Applications to*

Engineering and Computer Science by Narsingh Deo, Prentice-Hall, Inc, 1974.)

Fundamental Technology and Concepts

A *graph* consists of a set of *vertices* (singular: *vertex*) and a set of *edges* that connect the vertices. In the previous examples the cities are the vertices and the roads are the edges. In drawings and diagrams the vertices of a graph are shown as dots or as tiny circles; the edges are shown as lines. A vertex and an edge are said to be *incident* if they touch. This relation of being incident holds the graph together.

A *digraph* (short for directed graph) consists of a set of vertices and a set of *directed edges*. Real-life examples of digraphs include systems of canals in which the water flows from point to point only in the downhill direction, electric networks in which the current flows only in one direction, and systems of one-way streets. The vertex from which a directed edge starts is called the *initial vertex* of the edge; that would be the point at the higher end of a canal. The vertex at which a directed edge ends is called the *terminal vertex* of the edge; that would be the point at the lower end of the canal.

Remember that each edge is incident (touches) with exactly two ver-

tices, therefore every directed edge has exactly one initial and exactly one terminal vertex. A vertex can be incident with several directed edges, therefore the same vertex can be the initial vertex of one edge and the terminal vertex of another edge. See figure 1 for an example of a digraph.

Unless explicitly stated, all graphs and digraphs that are discussed are in one piece. That is to say, that for any two vertices there is at least one way to travel back and forth between them along the edges of the graph. Graphs (both directed and undirected) with this property are said to be *connected*. Disconnected digraphs are not discussed in this context because they can be treated as a set of connected digraphs.

For a similar reason, this article will concentrate on digraphs. A graph can usually be replaced by a digraph with the same set of vertices and exactly two directed edges, going in opposite directions, for every undirected edge of the original graph.

There are many ways to represent a digraph in a computer. Each method

About the Authors

Michael Ashbrook became interested in operations research after first studying mathematics. Helmut Zinn became involved with small computers through his work in electromechanical engineering. Both collaborate at the Technische Hochschule in Darmstadt.



We're looking for the most original use of an Apple since Adam.

What in the name of Adam do people do with Apple Computers?

You tell us.

In a thousand words or less.

If your story is original and intriguing enough, you could win a one-week all-expense paid trip for two to Hawaii. Which is the closest we could come to paradise.

Win fabulous prizes for creative writing.

To enter, drop by your nearest Apple dealer and pick up an entry blank. Fill it out. Then write an article, in 1000 words or less, describing the unusual or interesting use you've found for your Apple.

A jury of independent judges will cast the deciding vote for the grand prize: a week for two, airfare included, in Hawaii.

The judges will also choose 16 additional winners, two each from eight categories:

graphics/music, entertainment, home, business, education, scientific, professional, and industrial. And each winner will choose from a long list of longed-after Apple peripherals—from Apple Disk II's to Graphics Tablets to printers. Or you can take a \$250 credit towards the purchase of any Apple product.

The contest ends March 31, 1980. All winners will be notified by May 15.

Entry forms are available at your participating Apple dealer. Call 800-538-9696, (800-662-9238 in California), for the one nearest you.

Mail the entry blank, your article and any photos to: Apple Computer, "What in the name of Adam" contest, 10260 Bandlely Drive, Cupertino, CA 95014.

And may the juiciest application win.



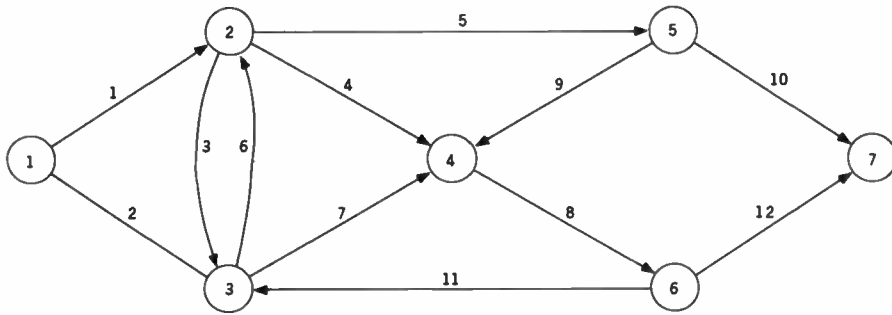

Figure 1: Example of a digraph (directed graph) that has seven vertices and twelve directed edges.

has its advantages and its drawbacks; each has its applications. The two basic methods used to encode a digraph will now be discussed.

A Matrix Called DIGRAPH

Consider a digraph containing a certain number of vertices n_v . The n_v vertices of this digraph are represented by the natural numbers from 1 to n_v . The edges of the digraph are represented by the entries of an n_v by n_v matrix called DIGRAPH. If the digraph has a directed edge from the vertex i to the vertex j , then the entry

DIGRAPH(i, j) of matrix DIGRAPH that is in the i -th row and the j -th column has a nonzero value, DIGRAPH(i, j) $\neq 0$. If there is no edge from vertex i to vertex j , the matrix entry DIGRAPH(i, j) is 0.

The matrix DIGRAPH can be used to store additional information about the digraph. If DIGRAPH is the mathematical model of a road map, the nonzero entries can be used to represent the distance from city i to city j . If you need to store no more data about an edge than the two vertices i, j which it connects, then the

A directed graph (digraph) consists of a set of vertices and a set of directed edges.

presence of the edge in the digraph is usually indicated by setting DIGRAPH(i, j) = 1.

The matrix DIGRAPH is best suited for small-scale applications which involve no more than roughly fifty vertices. A digraph with n_v vertices can be stored as a matrix that requires $(n_v)^2$ storage locations.

Disadvantages of Matrix Storage

In large-scale applications involving several hundred vertices, the matrix DIGRAPH often becomes sparse (or sparsely populated). The proportion of entries that are equal to zero increases. This happens because the real-life structures that are being stored as digraphs have relatively few edges compared to the number of edges which they could have.

Every town in the United States could be connected with all of the other towns by a direct road. As a practical matter, however, any given town is linked directly to only a few neighboring communities. Therefore, the DIGRAPH matrix of the total road system consists almost entirely of zeroes that mean nothing but the absence of a direct road between most combinations of two given towns. This matrix is very large and cannot be stored efficiently.

Increasing Storage Efficiency

In order to solve large-scale problems using a limited amount of storage space, a more efficient way of storing digraphs is necessary. Space should not be wasted on 0s that represent nonexistent edges.

As before, the n_v vertices of the digraph are represented by the numbers 1 to n_v . The edges are listed as pairs of numbers; the edge from vertex i to vertex j is shown as the pair (i, j).

Suppose the digraph has a certain number of edges, n_e , then these edges can be expressed as an n_e -by-2 array called EDGE. Each row (i, j) of the EDGE array specifies one edge; the first entry i stands for the edge's initial vertex i , and the second entry j stands for the terminal vertex j of the

TURN-ON!

Now have full computer control of up to 256 lights, appliances and even wall switches **without special wiring**. The SciTronics REMOTE CONTROLLER permits direct control of the inexpensive BSR remote line-carrier switches sold by Sears, Radio Shack and many others.

HOW IT WORKS: Writing 3 control words to the controller board sends one of 6 instructions over the a-c line to the desired switch. The instructions include any remote on, off, all off, any light bright, dim, or all on. Reading the board tells if busy.

FEATURES:

- ★ FULL S-100 COMPATIBILITY—all lines fully buffered, board address dip switch selectable to span 65K.
- ★ FULL TRS-80-1 COMPATIBILITY—board housed in attractive woodgrained case with power supply and connector cable allows direct connection to TRS-80-1 expansion port.
- ★ COMPATIBLE WITH OTHER SYSTEMS—combination of on-board select switches and complete connector wiring information allows ease of use with Apple II, PET, KIM, SYM, HEATH HB, plus others.
- ★ SYSTEM SELECT SWITCHES—choose active high or low inputs, addressed or I/O drive, parallel or serial entry, non S-100 inputs like VMA, clocking on any transition.
- ★ SIMPLE TO USE—sample software included for all systems listed, all IC's socketed.

APPLICATIONS:

- ★ Make your entire home, business or apartment "computer controlled"
- ★ Save energy by controlling lights and appliances
- ★ Control lights and alarms for security systems



REMOTE CONTROLLER BOARD \$159.

ENCASED SELF POWERED CONTROLLER FOR TRS-80-1 \$184.

remote switches not included

Send check or money order to:

SciTronics Inc.
523 S. Clewett St., P.O. Box 5344
Bethlehem, PA 18015
(215) 868-7220

Please list system with which you plan to use controller. Master Charge and Visa accepted. PA residents add sales tax.

people who play the computer specify Verbatim®

Virtuoso performers at computer keyboards deserve the ultimate in recording quality. That's why you should specify Verbatim brand diskettes, minidisks, cartridges and data cassettes for your computer or word processing system.

At Verbatim, the whole message is quality. We specialize in digital data recording media and have become the world leader by setting the standards for flawless, dropout-free magnetic media. Every size, every format, and available everywhere. Order them from

your computer supplies dealer.
Simply specify Verbatim.

For the name of your nearest Verbatim distributor, call:

800-538-1793
In California call:
(408) 737-7771 collect
Verbatim Corporation
323 Soquel Way
Sunnyvale, CA 94086

In Europe:
Verbatim S.A.
Case Postale 296
1215 Genève 15
Switzerland
Telephone: 41(22) 34-90-55
Telex: 22647 ITGE CH.



New on the North Star Horizon: 18Mb Hard Disk Drive!

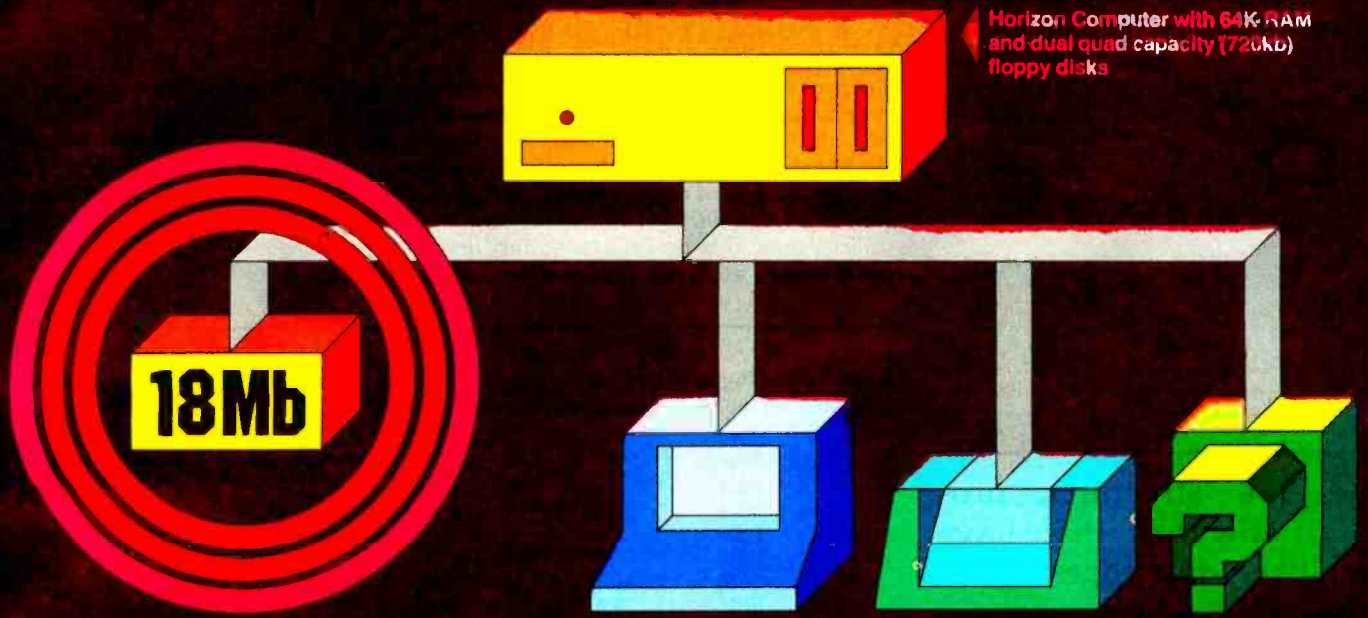

Up to four 18Mb Winchester-type hard disk drives

Display terminal

Letter-quality or dot matrix printer

Horizon I/O flexibility allows expansion to meet your needs

Unsurpassed Performance and Capacity!

North Star now gives you hard disk capacity and processing performance never before possible at such a low price! Horizon is a proven, reliable, affordable computer system with unique hardware and software. Now the Horizon's capabilities are expanded to meet your growing system requirements. In addition to hard disk performance, the Horizon has I/O versatility and an optional hardware floating point board for high-performance number crunching. The North Star large disk is a Century Data Marksman, a Winchester-type drive that holds 18 million bytes of formatted data. The North Star controller interfaces the drive(s) to the Horizon and takes full advantage

of the high-performance characteristics of the drive. Our hard disk operating system implements a powerful file system as well as backup and recovery on floppy diskette.

Software Is The Key!

The Horizon's success to date has been built on the quality of its system software (BASIC, DOS, PASCAL) and the very broad range and availability of application software. This reputation continues with our new hard disk system. Existing software is upward compatible for use with the hard disk system. And, with the dramatic increase in on-line storage and speed, there will be a continually expanding library of readily available application software. For more information, see your North Star dealer!

NorthStar

North Star Computers Inc.
1440 Fourth St.
Berkeley, CA 94710
(415) 527-6950 TWX/Telex 910-366-7001

HORIZON — HD-1

Horizon computer with 64K RAM, 2 quad capacity mini drives and one HD-18 hard disk drive **\$9329**

HD-18

Additional 18Mb hard disk drive for expansion of HD-1, or your present Horizon **\$4999**

SYS-1N

Complete Horizon HD-1 plus 80 x 24 display terminal and NEC Spinwriter printer **\$13,239**

SYS-1A

Complete Horizon HD-1 with 80 x 24 display terminal and Anadex printer **\$11,319**

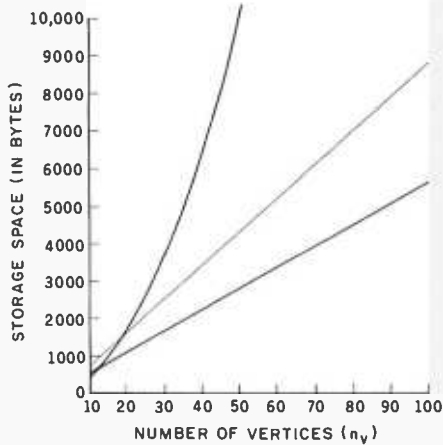

Figure 3: Graph showing storage space requirements (st) of a digraph plotted as a function $st(n_v)$ of the number of vertices (n_v) in a given digraph. It should be assumed that four bytes are required to store a decimal number.

The upper curve (black) shows the function $st(n_v)$ when you use the method of storing your digraph representation in the matrix DIGRAPH.

Storage requirements of the list-oriented storage scheme vary according to the number of edges (n_e). The equation is $st(n_v, n_e) = 2n_v + 4n_e$. If the digraph has some constant k times as many edges as it has vertices (represented by the equation $n_e = kn_v$), then the equation of storage space becomes

$$st(n_v) = 2n_v + 4kn_v = (4k + 2)n_v$$

The curve for the case $k=3$ is shown in red (when there are three times as many edges as vertices), and the curve for $k=5$ is shown in blue.

One fact illustrated by this diagram is that the list-storage approach is more efficient in use of storage space than the matrix approach so long as the digraph being stored has few edges compared to the number of edges that it could have (a sparsely populated [or just sparse] digraph). In terms of the equations here, sparseness means that k is much smaller than n_v . The list-oriented storage method becomes relatively more efficient than matrix storage as digraphs become more sparse.

Listing 1: The digraph input and concatenation program in BASIC. This program was developed on an Exidy Sorcerer computer system.

Real-life structures produce digraphs that have relatively few edges.

The list-oriented digraph representation is illustrated in figure 2.

Searching the Lists

Suppose you want to find those edges that have i as their initial vertex. Look at VERTEX(i , 1); if its value is zero, there are no such edges in the digraph. If its value is some nonzero value x , the first such edge is found in the x -th row of EDGE. If the value of the edge's initial pointer, PTR(x , 1), is zero, there are no more such edges in the digraph. (POINTER is a reserved word in our BASIC interpreter, so we have to use the abbreviation PTR.) If PTR(x , 1) equals some nonzero value y , the next such edge is found in the y -th row of EDGE and the new pointer is found in PTR(y , 1).

Continue to follow the pointers from edge to edge until a pointer with the value zero is found, which tells you that you have now found all the edges that have i as their initial vertex. If you substitute the value 2 wherever 1 occurs in the preceding paragraph, then there is an adequate explanation of the systematic search for all edges that have i as their terminal vertex.

The same scheme that has been

```

10 REM .....
20 REM *
30 REM * DIGRAPH INPUT AND CONCATENATION *
40 REM *
50 REM * COPYRIGHT 79/4 BY *
60 REM * MICHAEL ASHBROOK & HELMUT ZINN *
70 REM * FRANKFURT AM MAIN *
80 REM *
90 REM .....
100 REM READ AND LINK EDGE LIST
110 INPUT "NUMBER OF VERTICES"; NV
120 INPUT "NUMBER OF EDGES "; NE
130 DIM VERTEX(NV, 2)
140 REM VERTEX(V, 1) = EDGE WITH V AS INITIAL VERTEX
150 REM VERTEX(V, 2) = EDGE WITH V AS TERMINAL VERTEX
160 DIM EDGE(NE, 2), PTR(NE, 2)
170 REM EDGE(E, 1) = INITIAL VERTEX OF EDGE E
180 REM EDGE(E, 2) = TERMINAL VERTEX OF EDGE E
190 REM PTR(E, 1) = NEXT EDGE WITH THE SAME INITIAL VERTEX
200 REM PTR(E, 2) = NEXT EDGE WITH THE SAME TERMINAL VERTEX
210 FOR E=1 TO NE
220 PRINT E; "EDGE (INITIAL VERTEX, TERMINAL VERTEX) ";
230 INPUT EDGE(E, 1), EDGE(E, 2)
240 NEXT E
250 REM SETTING UP THE POINTERS
260 REM L=1 IMPLIES INITIAL POINTER OR VERTEX
270 REM L=2 IMPLIES TERMINAL POINTER OR VERTEX
280 FOR L=1 TO 2
290 FOR E=1 TO NE
300 V=EDGE(E, L)
310 IF VERTEX(V, L)=0 THEN PTR(E, L)=0: GOTO 330
320 PTR(E, L)=VERTEX(V, L)
330 VERTEX(V, L)=E
340 NEXT E
350 NEXT L
360 PRINT
370 PRINT " VERTEX LIST";
380 PRINT TAB(20); "EDGE LIST";
390 PRINT TAB(40); "POINTER LIST"
400 N=NV: IF NV < NE THEN N=NE
410 FOR I=1 TO N
420 IF I > NV THEN GOTO 440
430 PRINT I; VERTEX(I, 1); VERTEX(I, 2);
440 IF I > NE THEN GOTO 470
450 PRINT TAB(20); I; EDGE(I, 1); EDGE(I, 2);
460 PRINT TAB(40); I; PTR(I, 1); PTR(I, 2);
470 PRINT
480 NEXT I
490 END

```



“Intelligence” is the latest intelligent reason to choose Marksman disks.

Century Data's Marksman brought Winchester capacity and reliability to the mini/micro marketplace.

Systems designers haven't seen anything else like it for the money before or since. What's more, it's available.

And now it has the intelligence to match — a storage system interface that's built right in.

Intelligence gives you an even bigger headstart on incorporating Winchester into your system than before. Interfacing now takes only 4 or 5 days instead of 4 or 5 months.

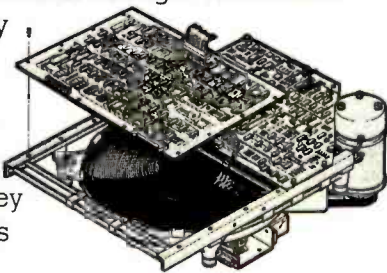

Already, we've had customers up and running diagnostics on Marksman in less than a day and systems which were shippable to users in less than a month.

And Century provides the application information to make your software job quick and inexpensive. Give us a call today and we'll help you bring 10, 20 or even 40 MB on line smartly.

Century Data Systems, 1270 N. Kraemer Blvd., Anaheim, CA 92806. Phone: (714) 632-7500.

WE FEEL LIKE A NEW COMPANY



Century Data Systems

A Xerox Company

Listing 2: A sample execution of the program of listing 1 using data from figure 1. An interpretation of the output is given in figure 2.

```

RUN
NUMBER OF VERTICES? 7
NUMBER OF EDGES ? 12
1 EDGE (INITIAL VERTEX, TERMINAL VERTEX) ? 1,2
2 EDGE (INITIAL VERTEX, TERMINAL VERTEX) ? 1,3
3 EDGE (INITIAL VERTEX, TERMINAL VERTEX) ? 2,3
4 EDGE (INITIAL VERTEX, TERMINAL VERTEX) ? 2,4
5 EDGE (INITIAL VERTEX, TERMINAL VERTEX) ? 2,5
6 EDGE (INITIAL VERTEX, TERMINAL VERTEX) ? 3,2
7 EDGE (INITIAL VERTEX, TERMINAL VERTEX) ? 3,4
8 EDGE (INITIAL VERTEX, TERMINAL VERTEX) ? 4,6
9 EDGE (INITIAL VERTEX, TERMINAL VERTEX) ? 5,4
10 EDGE (INITIAL VERTEX, TERMINAL VERTEX) ? 5,7
11 EDGE (INITIAL VERTEX, TERMINAL VERTEX) ? 6,3
12 EDGE (INITIAL VERTEX, TERMINAL VERTEX) ? 6,7

```

VERTEX LIST	EDGE LIST	POINTER LIST
1 2 0	1 1 2	1 0 0
2 5 6	2 1 3	2 1 0
3 7 11	3 2 3	3 0 2
4 8 9	4 2 4	4 3 0
5 10 5	5 2 5	5 4 0
6 12 8	6 3 2	6 0 1
7 0 12	7 3 4	7 6 4
	8 4 6	8 0 0
	9 5 4	9 0 7
	10 5 7	10 9 0
	11 6 3	11 0 3
	12 6 7	12 11 10

READY

introduced to store digraphs can be used for storing *undirected* graphs by ignoring the distinction between initial and terminal vertices and pointers. In the case of undirected graphs, a single pointer would serve as well as two pointers and occupy less storage space. If you are enterprising, you can work out the details of this variation and write the appropriate program yourself. Figure 3 compares storage requirements.

Generating Lists Under Program Control

Have you wondered why the lists have been searched from bottom to top and why the pointers are linked backwards? By doing so, you can simplify the task of generating the pointer lists.

The Nassi-Schneiderman chart given in figure 4 shows the logic followed by the BASIC program of listing 1. Here is some additional explanation. Numerals refer to line numbers in listing 1.

- 300 Assume that you are linking the initial pointers (with $L=1$). The initial vertex of edge E is stored in V .
- 310 If the vertex number V has not been recorded as an initial vertex up to now, you have found the end of its chain of initial pointers. Skip line 320 because there is no previous pointer to link up with.
- 320 If V has been previously recorded as an initial vertex, get the location of its earlier occurrence in EDGE from VERTEX and set the initial pointer $PTR(E, 1)$ of edge E to point to this location.
- 330 Record the location E of V in list EDGE in $VERTEX(V, L)$. This is the lowest location of V in EDGE that is known at this time. If V occurs again as an initial vertex further down in EDGE, this lower location will be recorded.

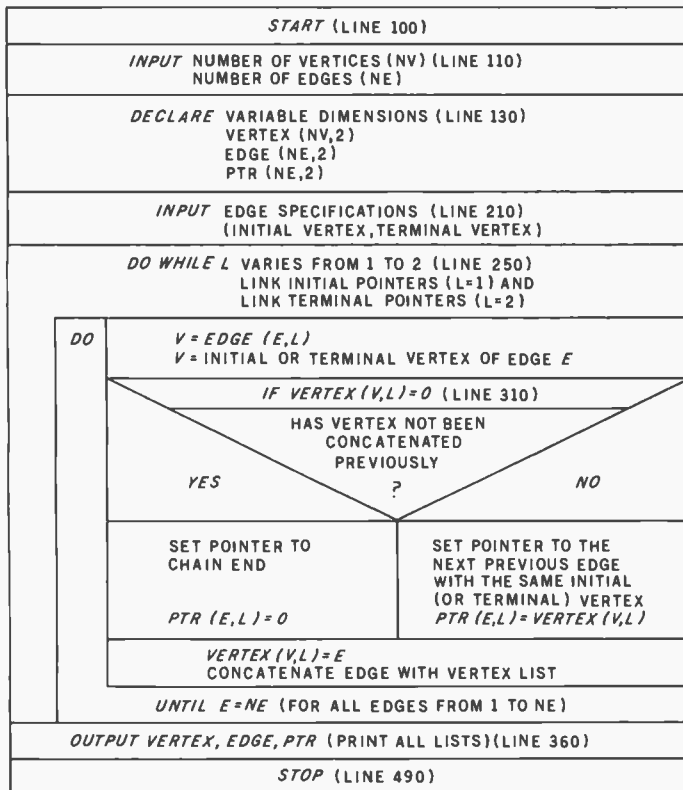

Figure 4: A Nassi-Schneiderman chart showing the algorithm used by the BASIC program of listing 1. Nassi-Schneiderman charts are a system of stylized flowcharts that are designed for use with structured programming techniques. The chart is read from top to bottom. Line numbers refer to lines in the BASIC program in listing 1.

Graph Applications

Some obvious examples of graphs and digraphs that occur in the real world have been mentioned: communication and transportation networks. There are more abstract systems that also have an undirected or directed graph structure.

Complicated projects consisting of



MODEL 800 • WITH SUNFLOWERS

A NEW MASTERPIECE IN PRINTERS

Sometimes the true value of a product fails to relate to its selling price. Van Gogh's paintings once sold for less than \$1,000. Base 2's MODEL 800 printer sells for less than \$1,000, but it does more than printers costing twice its price (and a lot more than a Van Gogh painting).

Besides being beautiful to look at, the MODEL 800 prints up to six different character fonts with embedded elongation in any of five line densities (72, 80, 96, 120 and 132 characters per line), prints up to three copies and is equipped with a long-life cartridge ribbon. With such versatility as four interface modes (IEEE 488, industry standard parallel, 20ma current loop and RS232), baud rates up to 19,200, and with accommodations for 115VAC or 230VAC operation, the MODEL 800 matches any system decor.

As a rite of further new world refinement, the MODEL 800 can be optionally equipped with high speed paper advance and graphics output, a versatile tractor feed mechanism, terminal buffer memory, tabs and form feed.

Requiring only a square foot of space, the MODEL 800 is smaller than its contemporaries; its rugged aluminum construction is designed to stand the test of time.

Isn't it time you added a new masterpiece to your collection?

Recommended retail price:

Standard MODEL 800	\$499
High speed paper advance	50
Tractor mechanism	50
Terminal buffer memory	50

base 2 inc. P.O. BOX 3548 FULL., CAL. 92634 / (714) 992-4344

FOR THE VERY BEST IN NORTHSTAR® COMPATIBLE SOFTWARE

DATA BASE MANAGERS SPECIALII \$10.00 OFF of Selector-III C2

SELECTOR-III C2: SuperSoft is proud to offer the Selector-III C2 at a special \$10.00 discount. Selector III allows instant recall of any record using any information item in the record. This makes Selector-III the most powerful Data Base Management System in micro-computers today! You can define a data format and begin entering your data in minutes. Helps bring applications on line in hours instead of months. (Note: Selector-III C2 requires CP/M and C BASIC-2, not supplied - also 48K Ram required for some applications) Selector-III C2 is: \$335.00 (\$10.00 off list!). (Manual alone: \$20.00)

INSURANCE AGENTS

CRS - Client Record System. A complete program package for the Insurance agent. CRS will provide you with very fast online access to your client records, print reports and mail labels, and give you all the information you will need to increase your sales through the use of CRS as a MARKETING TOOL.

CRS stores a complete record for each client that includes the name, address, telephone #, as well as provisions for customer #, salesman # and up to six policies (expandable, if needed). Write for details.

CRS comes with two(2) user's manuals, one for the owner, and one for office personnel (minimal system: one drive, 40K RAM starting 2000H) \$250.00 (Manual: \$40.00)

TEXT PROCESSORS

TFS - Text Formatting System. At last a full featured text processor for NorthStar that you can rely on! TFS has left & right margin justification, page numbering, chaptering, page headings, centering, paged output & MORE. Supports powerful text manipulation including: global & local 'search and change,' file merges and block moves. This means that you can restructure your text file at any time to look the way you want it to, you can even 'chain' files together from disk for documents larger than your current memory.

TFS is completely 'load and go' therefore you can start using it at once. You get two(2) user's manual: one is a Quick Start manual to get you going in minutes, the other is an in depth study of TFS. (TFS requires RAM from 0000H to 2000H) \$75.00 (Manual only: \$20.00)

SPEECH SYNTHESIZER SOFTWARE

'ANGLOPHONE' - Lets any 8080/Z80 computer convert ordinary English into phonetic codes to drive Votrax, computaker, and TRS-80 Voice synthesizers. This is a hardworking, tested program suitable for use in the most demanding situations. (Details below). Inquire for specific prices and media.

COMPUTER AIDED INSTRUCTION

M I S S - Microcomputer Instructional Support System. A complete, self-contained CAI package applicable to home, school or business education. Includes everything needed to create a sophisticated computer learning environment. MISS allows one to create any type lesson complete with wrong answer branching, re-test, and complete record keeping. The student is prompted 100% of the way and need have no special knowledge. A special feature is the optional use of a unique algorithm which separates spelling errors from incorrect responses. Absolutely no programming knowledge is required. MISS is completely interactive and maintains complete records on any number of students and lessons (limited only by disk space). MISS is a completely flexible system that will allow you to either create lessons or to purchase pre-programmed lessons which run under MISS. Complete with user's manual....\$40.00 (Manual alone: \$10.00)

ASSEMBLERS

ARIAN - A complete 8080 assembler that interfaces directly to your DOS. ARIAN is completely 'load and go'. Features include: dynamic file and RAM allocation, custom disk and RAM command capability, several library routines directly accessible by the user. Also, a complete text editor, and system executive. ARIAN is both powerful and easy to learn and use; it is an assembler that you can grow with. Comes complete with a 51 page user's manual (ARIAN requires RAM from 0000H to 2000H) \$50.00 (Manual alone: \$10.00)

ARIAN Utility Package - Several disk based utilities. Includes a complete DEBUG Package: \$50.00

PROGRAMMING LANGAUGES

'Tiny' Pascal - This is famous Chung/Yuen 'tiny' Pascal. **FAST - ELEGANT - STRUCTURED.** Local and global variables plus procedure and function independence make 'tiny' Pascal great for high speed applications. Compiles to 8080 code that executes up to 25 times faster than BASIC. You also receive SOURCE to 'tiny' Pascal written in Pascal. This means that you can compile the compiler! Add features, relocate, etc. (you will need 36K to do this) \$40.00

UTILITIES

D E B E - (Does Everything But Eat!) This is a must for NorthStar user's. You can: **COMPACT & EXPAND BASIC** programs. Compacting removes unnecessary spaces and remarks. This saves money and makes programs run faster. Expanding puts them back again.

Cross-reference BASIC programs by variables and transfer statements. Global substitutions of variables and transfer statements. Formatted print outs of BASIC programs as well. \$40.00

SPECIFY SINGLE OR DOUBLE DENSITY

TRS-80 COMPATIBLE SOFTWARE

'Tiny' Pascal FOR TRS-80

Now you too can have Pascal! The famous Chung/Yuen 'tiny' Pascal has been specially designed for the TRS-80! The full power and elegance of 'tiny' Pascal is at your command. Programs written in 'tiny' Pascal run at least 4 times faster than the same program in BASIC! 'tiny' Pascal is also a great way to learn Pascal programming, & fun too.

Best of all, you only need a 16K Level II TRS-80! No disk is required. The 'tiny' Pascal operating system is self-contained and very easy to use.

'Tiny' Pascal is a subset of standard Pascal & includes: RECURSIVE PROCEDURE/FUNCTION, IF THEN ELSE REPEAT/UNTIL, 'PEEK' & 'POKE', WHILE DO, CASE, MORE! (Plus full graphics for your TRS-80).

You can save and load programs to and from tape in both source or compiler form. You get all this and more, plus a user's manual for \$40.00

SPEECH SYNTHESIZER SOFTWARE

'ANGLOPHONE': At last you can take complete advantage of your TRS-80 voice synthesizer. Forget about cumbersome phonetic codes. With 'Anglophone' you can simply use ordinary English. Completely interfaces with BASIC, or just about any other programming language. 'Anglophone' applies sophisticated pronunciation rules to transform normal English spelling into speech using the TRS-80 Voice Synthesizer. Minimum hardware: Level II, 16K, Voice Synthesizer. Comes complete with user's manual and test program.\$45.00

Energy-Miser

Energy-Miser is a complete heating/cooling analysis program for your home, office or business! With Energy-Miser you can calculate heat loss because of poor insulation, leaky doors and windows, poor planning and more. With Energy-Miser you can predict the annual savings on your utility bills for various improvements or modifications, including: use of solar power, better insulation, opening and closing drapery, etc.

But there is even more: Energy-Miser can also calculate your Return on Investment. That is, you can find your break point for converting to solar, for insulating better, etc. Energy-Miser even takes into consideration the Energy Tax Credit! Energy-Miser is a program designed to save you money!

Energy-Miser is a proven program written by a professional and includes a complete user's manual for \$22.50. (Minimum System 16K Level II, No Disk Required)

'TALKING TERMINAL': The 'Talking Terminal' program turns a TRS-80 into a talking computer terminal. The 'Talking Terminal' program receives input from a remote computer and converts it to spoken words. Its many user options include: Instant Replay, spelled speech, silent or pronounced punctuation, and more. Minimum hardware: Level II, 16K, Voice Synthesizer, RS-232C board and expansion interface.\$145.00



ALL ORDERS PREPAID OR C.O.D.
ILLINOIS RESIDENTS ADD 5% SALES TAX
(217) 344-7596

SUPERSOFT
P.O. Box 1628
Champaign, IL 61820

thousands of interdependent *tasks* are often planned with the aid of graph-theoretic methods. The tasks can be considered as the vertices of a digraph; their interdependencies can be expressed as directed edges.

This approach allows managers to visualize the problems about which they must make decisions, and gives the managers the opportunity to delegate routine work to the computer. The maximum and minimum times for project completion and the effects of delays upon parts of the project or upon the whole project can be calculated by simple software routines.

The first large-scale project to

which these methods were successfully applied was the development of the Polaris missile system. Today, use of *project networks* is a standard management technique.

If you are interested in applying graph theory to the social sciences, you should read *Structured Models: An Introduction to the Theory of Directed Graphs* by Harary, Norman, and Cartwright.

Closing Observation

This article cannot end without observing that almost all users of computers are intimately familiar with one form of directed graph, the flowchart. ■

REFERENCES

1. Aho, A V, J E Hopcraft, and J D Ullman. *The Design and Analysis of Computer Algorithms*. Addison-Wesley Publishing Co, Reading, MA, 1974.
2. Christofides, N. *Graph Theory: An Algorithmic Approach*. Academic Press, New York, 1975.
3. Deo, N. *Graph Theory with Applications to Engineering and Computer Science*. Prentice-Hall Inc, Englewood Cliffs, NJ, 1974.
4. Harary, F, R Z Norman, and D Cartwright. *Structural Models: An Introduction to the Theory of Directed Graphs*. John Wiley and Sons Inc, New York, 1965.
5. Ore, O. "Theory of Graphs," *Colloquium Publications of the American Mathematical Society*, American Mathematical Society, Providence, RI, volume 38, 1962.

I've finally found a personal computer I respect.

It's not surprising that professionals get excited about the Compucolor II. It's a totally-integrated 8080A system with full color graphics display, built-in 51K mini-disk drive, and the best cost performance ratio available in a personal computer.

The complete system is only \$1895*. And that price includes 8K user RAM, RS-232C compatibility and random access file capabilities.

Our 8 foreground and background colors will boost your comprehension, while introducing you to an exciting new dimension in BASIC programming. The vector graphics have 16,484 individually-accessible plot blocks. And the 13" diagonal measure screen gives you 32 lines of 64 ASCII characters. You also have the flexibility that comes with 16K Extended Disk BASIC ROM.

Compucolor II offers a number of other options and accessories, like a second disk drive and expanded keyboard, as well as expandability to 32K of user RAM. Of course we also have a whole library of low-cost Sof-Disk™ programs, including an assembler and text editor.

Visit your nearest computer store for details. And while you're there, do some comparison testing. With all due respect to the others, once you see it, you'll be sold on the Compucolor II.



**Compucolor®
Corporation**



*U.S. Domestic Price
Includes extra software packages
Unretouched photo of screen

Compucolor Corporation • Intecolor Drive • Technology Park/Atlanta • Norcross, Georgia 30092 • Telephone 404/449-5996

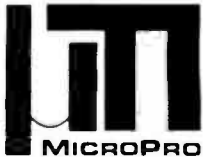

MicroPro International Corporation

"Professional Quality Software You Can Count On, Now!"

WORD-STAR^{T.M.}

Super-Sort^{T.M.}
and
Word-Master^{T.M.}

are now available on

TRS 80^{T.M.}
and
Heath 89^{T.M.}

For more information and the name of your nearest dealer, contact MicroPro International Corporation.
Dealer/Distributor/O.E.M. Inquires Invited

MICROPRO INTERNATIONAL CORPORATION
1299 4th Street, San Rafael, California 94901
Telephone (415) 457-8990 Telex 340388

Runs under Digital Research CP/M or its derivatives, in 48K RAM
CP/M is a Trademark of Digital Research

Note: MicroPro offers a reward for reporting and successful prosecution of unauthorized copying.

Word Star, Super Sort and Word Master are Trademarks of MicroPro International Corporation

TRS 80 is a Trademark of Tandy Corporation

Heath 89 is a Trademark of Heath Corporation

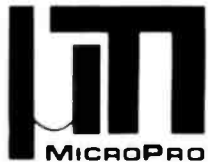

MicroPro International Corporation

"Professional Quality Software You Can Count On, Now!"

WORD-STAR™

THE BEST GETS BETTER! Yes, in just a few months, thousands of users now know that WORD-STAR™ is the word processing product that truly transforms the performance of Z-80, 8085, and 8080 microcomputers into a class with systems costing far more. Look at these recent enhancements: Print spooling; directory; foreign language adaptability; microspace justification; mailing list merge; CP/M*1.4, 2.0 & MPM compatible, and more. Examine our features and order yours now!

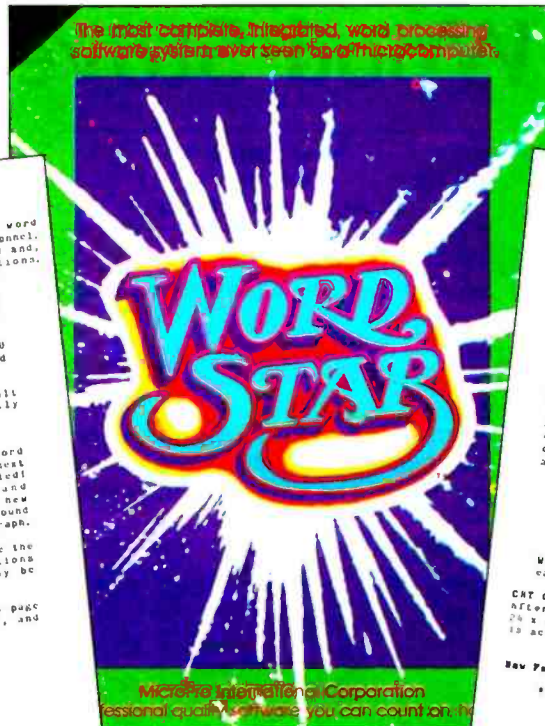

CHARACTER OF WORDSTAR

WordStar is a screen oriented, CP/M compatible, integrated word processing system specifically designed for non-technical personnel. Text and command functions are fully prompted (a help level) and performed on-screen with complete cursor tracking of all functions. Concurrent printing while editing improves operator productivity.

- Cursor-tracked Screen Display:** Under user control, the CRT screen acts as a movable "window" into the text; all key strokes receive immediate visual updating.
- Automatic Disk Buffering:** Text is moved between disk and CPU memory with no user intervention. Thus, file size is limited only by disk capacity.
- On-Screen Printer-Size Text Formatting:** Using the default margins or user-set margins, entered text is automatically formed into right and left justified lines. Range-right is a user settable line. The Word-Wrap feature means that as you type past the right margin, the word break typed is moved to the left margin, justified and the previous line is redisplayed, justified and you can change the margin settings and the new line is redisplayed all or part of the text with the new settings. Partial re-justification allows cutting the text around an illustration or for any other purpose such as this paragraph.
- Split-Screen Help Menus:** Four user-settable levels provide the learning operator with comprehensive prompting instructions without the need to refer to a manual. Help levels may be changed at any time to allow full screen utilization.
- Status Line:** Constantly updated, the status line displays page number, cursor line and column, name of file under edit, and command(s), if any, in current operation.
- Powerful Editing Commands:** include delete character, word, line or block; set/clear character, word, line or block; copy, delete and variable tab stop; find/replace; write/read from/to output to disk; file/return to place markers; additional files; set/return to place markers; on-screen insert toggle; and more.
- Dynamic Page Break Display:** A horizontal dotted line, not part of the text, is shown on the screen at the point a printer page break would occur. The page break line is dynamically repositioned when text entry or deletion affects page size. Visual edits of a print page allow even an inexperienced operator to perform sophisticated text composition.

WordStar Directory (continued)

Concurrent Print Function: Editing and printing simultaneously.

Pagination and Formatting:

- User override of default top/bottom margins.
- Variable heading/footer length default.
- Conditional and absolute pagination directives.

Printer Support: A wide range of letter quality and line ad type compatible printers. Features supported include bidirectional printing, underline, Double Strike, Boldface, and underline.

Superscripts, Subscripts, Variable Character Pitch: (pica, and Alternate Mission Color are fully supported on Diablo, Nec, and Qume printers. Print enhancements may be used in all combinations. For example, underlined and boldface subscripts are supported.

- Microspace Justification: When
- Printing justified text on a
- space in each line is evenly
- distributed.

WordStar is compatible with a wide variety of hardware, and can share files with other software:

CRT Compatibility: WordStar's video edit function will operate after suitable installation, on any CRT or video board 15 x 24, 24 x 80, or larger that has cursor positioning functions and that is accessible as a CP/M console device.

New Features include:

- **Directory display:** Using a triple split screen WordStar allows scrolling text, and CP/M file directory independently on screen.
- **Install Program:** Generates a version of WordStar for use on most popular terminals and printers without the need for any "patching". Allows full speed, 1200 baud, printer operation.
- **Foreign Language:** As WordStar's menus and messages are mostly external to the operating program they lend themselves to translated versions.

MicroPro Price List:

	Software/Manual		Software/Manual
Word-Star™	\$495/40	Super-Sort I™	\$250/25
Word-Master™	\$150/25	Super-Sort II™	\$200/25
Tex-Writer™	\$ 75/15	Super-Sort III™	\$150/25
Word-Star Merge Function™	\$150/25		

For more information and the name of your nearest dealer, contact MicroPro International Corporation. Dealer/Distributor/O.E.M. Inquires Invited

MICROPRO INTERNATIONAL CORPORATION
1299 4th Street, San Rafael, California 94901
Telephone (415) 457-8990 Telex 340388

*Runs under Digital Research CP/M or its derivatives, in 48K RAM

Note: Micro Pro offers a reward for reporting and successful prosecution of unauthorized copying.

A Computer-Controlled Wood Stove

Steve Ciarcia
POB 582
Glastonbury CT 06033

"Come inside, Roger, and get out of the cold." I held my kitchen door ajar as he crossed the front yard towards me. Great clouds of leaves blown by the cold wind furiously encircled him. The landscape was stark and gray, and all weather indicators pointed toward an impending snowstorm.

Roger, a local electrician, had come by to discuss some electrical work I needed done on a new garage I was building. As he stepped through the doorway he remarked, "Sure looks like snow. Have you got enough gas for your Jeep in case you need to plow yourself out of this wilderness?"

Roger's remark reminded me that the terms "picturesque" and "remote" are often synonymous when describing a home in Connecticut. The only place I had been able to buy a house with more than half an acre of land was 25 miles from civilization. And while Roger's controlled, old Yankee humor prevented him from laughing out loud as he spoke, the thought of me, basically a kid from the city, independently plowing my 300 yards of driveway seemed to produce a slow-forming look of amusement.

The Jeep he was referring to was about 20 years old and was used only for plowing. I rather enjoyed the straightforward task of rearranging snow with it. A certain spirit of excitement came over me each time I stepped into the driver's seat and

asked myself the all-important question posed by every adventurer: "I wonder if this heap will start?"

My neighbor, who shares the chore of plowing, thought I was a sissy when I finally added lights to the Jeep for night driving. Somehow, not seeing the rocks makes hitting them



Photo 1: The Hydrostove is installed in the corner of the Circuit Cellar. Take note of the two copper pipes coming out the rear of the stove into the wall. The pipes, which are buried behind the wall and above the ceiling, go to the furnace, which is 35 feet away.

more fun for him. I never did ask him how he had broken the driveshaft the previous year.

I continued my masochistic thoughts of the Jeep. "It should be okay," I said, "but frankly, if it breaks down, I think I'll just hibernate in the cellar for the winter."

Roger still had not taken his coat off as he added, "You might expect to enjoy such an arrangement, but I think you will find that you need outside services more than you think."

"Give me an example."

Roger uncomfortably shrugged his shoulders. Something other than the conversation was bothering him.

"Oil is a good example. You heat with oil, right? How do you propose to fill your oil tank if the truck can't get down the driveway? I'll bet this glass barn you have here almost requires a direct pipeline to the refinery."

I did not exactly relish having my contemporary home called a glass barn but there was some merit to his statement. I retorted, "Who needs..."

Roger interrupted me in mid-statement. "Speaking of heat... what are you running here, a sauna?"

"Take your coat off, Roger. Maybe then you won't be so hot. I'm not so sure you even need both the wool shirt and sweater you have on."

Tossing his coat across to the nearest chair and tugging on his sweater, he continued. "Whenever I

“onComputing™ really makes personal computers easy to understand.”



Written in non-technical language, onComputing™ contains articles on the capabilities of microcomputers, getting started, latest reviews of personal computers, where to purchase and how to use your computer.

An anyone can learn the fundamentals of using a computer. **onComputing** readers receive practical advice and helpful hints on how to get the most out of a personal computer, explanations of computer terminology, and, periodically, an updated list of active computer clubs.

Benefit from the experience of other computer enthusiasts. Articles in **onComputing** are written by well known authors as well as competent amateurs. They share their ideas on how to use the computer as a tool for business, education, home entertainment, laboratory work and other applications.

Computer experts edit **onComputing** for the new user, not the computer professional. The editors combine their esoteric knowledge of computer science and equipment to produce concise, non-technical material which can be readily understood by anyone interested in using a computer— for fun or profit.

onComputing, Inc.
70 Main St., Peterborough, NH 03458

Start your subscription today.

EVERY THREE MONTHS onComputing will bring the latest developments in the field of personal computing: use, applications, books, selection—all in an easy-to-read style.

onComputing Subscription Dept. P.O. Box 307, Martinsville, NJ 08836

REGULAR subscription rate:

- U.S. 1 yr. (4 issues) @ \$8.50
- Canada & Mexico, 1 yr. (4 issues) @ \$10.00
- FOREIGN (to expedite service, please remit in U.S. funds drawn on a U.S. bank.)
- Europe (and all other countries, except above), 1 yr. @ \$12.00—surface delivery.
- Start my subscription with current issue. Start with Vol. 1 No. 1
- Bill Visa Bill Master Charge Bill me (North America only)

Card Number _____

Expiration _____

Signature _____

Name (please print) _____

Street/Apartment Number _____

City _____

State/Province/Country Code _____

7M89



Photo 2: Logs up to 24 inches in length are placed in a grate which consists of water-filled tubes.

visit anyone during the winter I presume their house is at 60 degrees like mine. It must be 12 degrees outside, and..." he walked over to the thermostat, "according to this it's 75 degrees in here!"

"I don't usually have it this warm, I was just testing the heating system now that it's computer-controlled."

"What's there to control? Turn the oil burner on longer and it gets hotter."

"Who said anything about an oil burner?"

"Electric heat is even worse!" he quickly added.

"We have oil heat... but it hasn't been on for two days. All I have now is one wood stove."

Roger's momentary blank stare and open mouth were instantly replaced with a look of disbelief. Standing there by the thermostat he quickly scanned the room. With extreme skepticism he replied, "What are you handing me? A twelve-hundred-square-foot room, twelve-foot ceiling, three hundred square feet of glass and seventy-five degrees? I don't see any stove!" Roger walked over to a hot-air duct near one of the windows, stooping down and holding his open palm over the opening he exclaimed, "Wood stove, phooie! There's hot air coming out of this duct. You have the oil burner on!"

"No, Roger. I have a wood stove down in the Circuit Cellar that is plumbed directly into the central heating system."

"A wood stove? In a hot-air heating system?"

"Well actually, Roger, my heating system is both hot water and hot air, and the wood stove heats water. It's called a hydronic wood stove."

"What the heck is a hydronic wood stove?"

Roger was definitely at a loss for words. I put my hand on his shoulder

and said, "Think of it as Yankee ingenuity. Come on downstairs and I'll explain how it works."

A Hydronic Wood Stove

A hydronic wood stove is just what the name implies. It is a wood stove that heats water. The particular wood stove that I have is trade-named Hydrostove and it is made by Hydro-Heat Division, Ridgeway Steel, POB 382, Ridgeway PA 15853. Photo 1 shows it installed in the corner of the Circuit Cellar.

The Hydrostove looks like an ordinary wood stove. It is constructed of cast iron and weighs about 400 pounds. The difference between it and a regular wood stove is in the method of heat removal from the burning wood and the ability to channel the energy output into the central heating system.

A regular wood stove produces only radiant energy and is generally a one-room heater unless fans or convection registers are employed to spread the heat around. The surface temperature of such stoves can approach the temperature of the burning wood itself, and great care must be taken to keep combustible material more than 4 feet away.

Typical wood-stove operation is to put in a full load of wood, get it good and hot (warming up the room to around 75° F), and then close the dampers to reduce the heat output. This is the only way to keep the room from becoming unbearably hot. An unfortunate byproduct of this process is that a slow, smoldering fire creates creosote buildup in the chimney. Since only the area directly around the stove is heated, it is likely that an adjacent room will be terribly cold unless fans are used to blow the heat around.

The Hydrostove looks like a regular wood stove, but it operates quite differently. Rather than a solid cast-iron grate, the hydronic stove's firebox is a network of water-filled pipes. These pipes completely encircle the fire, with the burning wood being placed directly on the pipes. Photos 2 and 3 demonstrate this. The inlet and outlet of this water jacket are accessible through two pipe fittings on the rear of the stove. (Since I knew that I wanted a hydronic stove when I built the Circuit Cellar, I had the pipes installed behind the brick wall and



Photo 3: In operation, the heat from the fire warms the water in the tubes. This is a relatively small fire. The fire box is usually filled.

From PERCOM

One-Drive System:
\$399. (40-track) & \$675. (77-track)
Two-Drive System:
\$795. (40-track drives) & \$1350. (77-track drives)
Three-Drive System:
\$1195. (40-track drives) & \$2025. (77-track drives)
Requires Expansion Interface, Level II BASIC & 16K RAM.

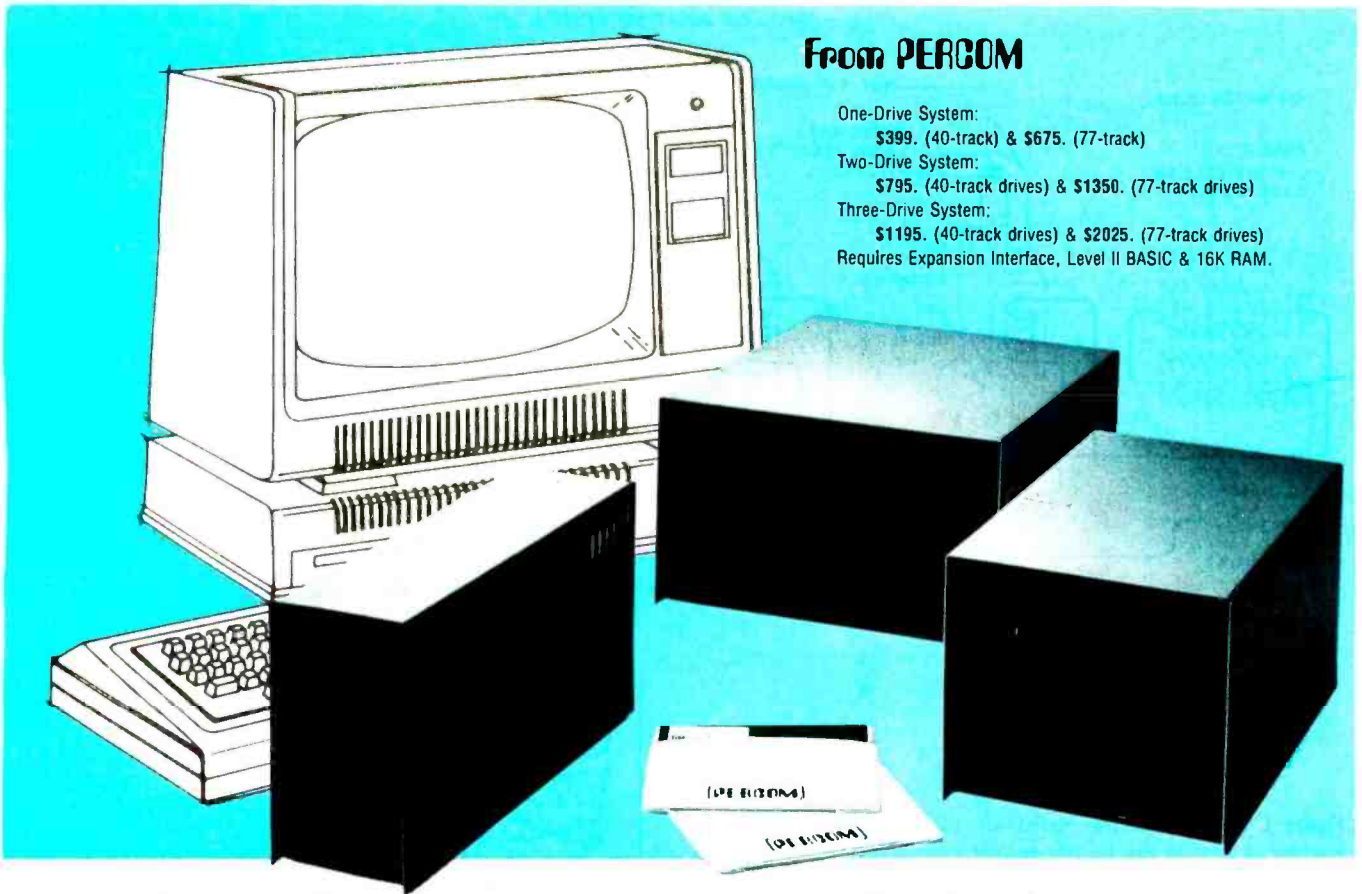

Low Cost Add-On Storage for Your TRS-80*. In the Size You Want.

When you're ready for add-on disk storage, we're ready for you.
Ready with six mini-disk storage systems — 102K bytes to 591K bytes of
additional *on-line* storage for your TRS-80*.

- Choose either 40-track TFD-100™ drives or 77-track TFD-200™ drives.
- One-, two- and three-drive systems immediately available.
- Systems include Percom PATCH PAK #1™, on disk, at no extra charge. PATCH PAK #1™ de-glitches and upgrades TRSDOS* for 40- and 77-track operation.
- TFD-100™ drives accommodate "flippy disks." Store 205K bytes per mini-disk.
- Low prices. A single-drive TFO-100™ costs just \$399. Price includes PATCH PAK #1™ disk.
- Enclosures are finished in system-compatible "Tandy-silver" enamel.

Whether you need a single, 40-track TFD-100™ add-on or a three-drive add-on with 77-track TFD-200™s, you get more data storage for less money from Percom.

Our TFD-100™ drive, for example, lets you store 102.4K bytes of data on one side of a disk — compared to 80K bytes on a TRS-80* mini-disk drive — and 102.4K bytes on the other side, too. Something you can't do with a TRS-80* drive. That's almost 205K bytes per mini-disk.

And the TFD-200™ drives provide 197K bytes of on-line storage per drive

— 197K, 394K and 591K bytes for one-, two and three-drive systems.

PATCH PAK #1™, our upgrade program for your TRSDOS*, not only extends TRSDOS* to accommodate 40- and 77-track drives, it enhances TRSDOS* in other ways as well. PATCH PAK #1™ is supplied with each drive system at no additional charge.

The reason you get more for less from Percom is simple. Peripherals are not a sideline at Percom. Selling disk systems and other peripherals is our main business — the reason you get more engineering, more reliability and more back up support for less money.

In the Product Development Queue . . . a *printer interface* for using your TRS-80* with any serial printer, and . . . the *Electric Crayon*™ to map your computer memory onto your color TV screen — for games, animated shows, business displays, graphs, etc. Coming PDQ!

™ TFD-100, TFD-200, PATCH PAK and Electric Crayon are trademarks of PERCOM DATA COMPANY.

*TRS-80 and TRSDOS are trademarks of Tandy Corporation and Radio Shack which have no relationship to PERCOM DATA COMPANY.

PERCOM

PERCOM DATA COMPANY, INC.
211 N. KIRBY • GARLAND, TX. • 75042

To order add-on mini-disk storage for your TRS-80*, or request additional literature, call Percom's toll-free number: 1-800-527-1592. For detailed Technical Information call (214) 272-3421.

Orders may be paid by check or money order, or charged to Visa or Master Charge credit accounts. Texas residents must add 5% sales tax.

Percom 'peripherals for personal computing'

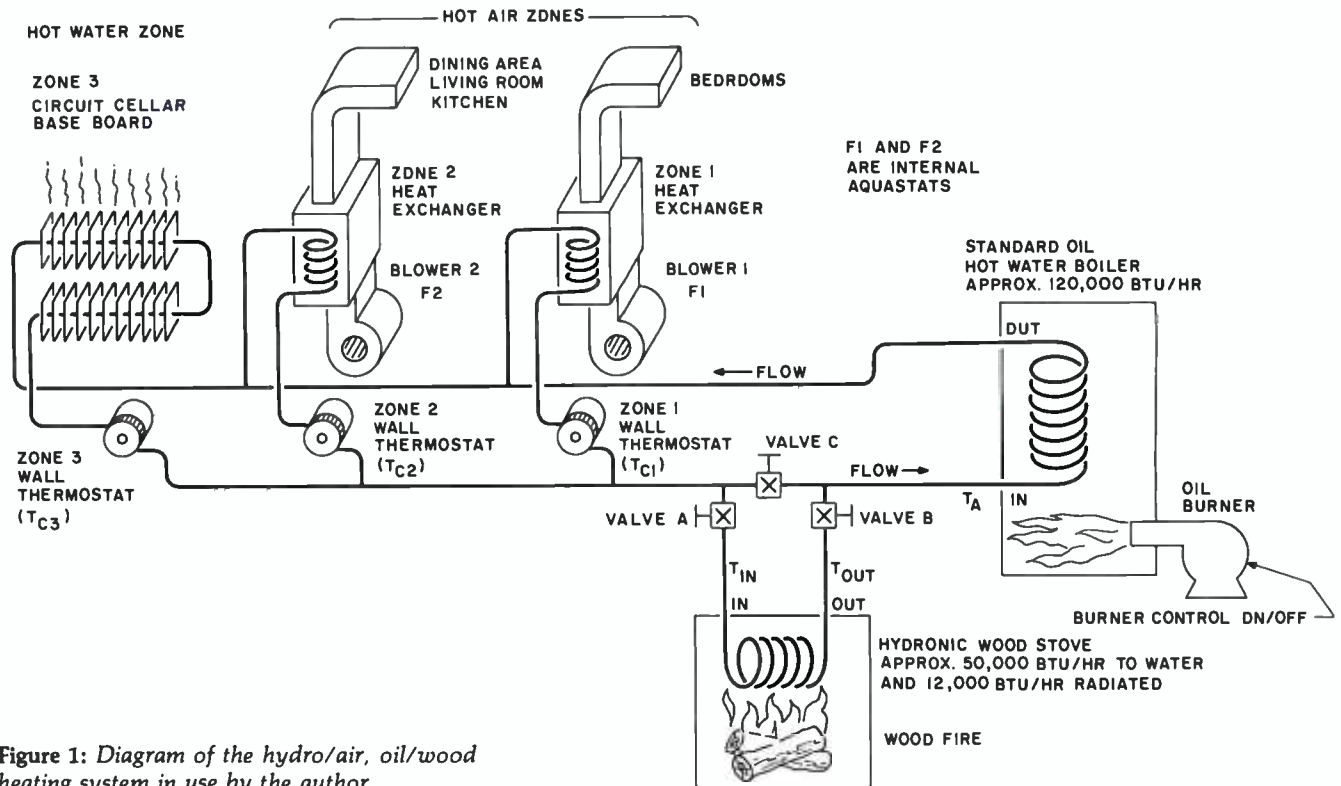

Figure 1: Diagram of the hydro/air, oil/wood heating system in use by the author.

through the ceiling. The oil burner is about 35 feet from the Hydrostove.) When a fire is started in the stove, the heat is extracted through the water rather than being radiated directly into the room.

With dry, hard wood, the stove generates about 62,000 BTU per hour (with an additional 12,000 BTU per hour going up the chimney) and is quoted by the manufacturer to be about 85% efficient. I cannot say at this time exactly how much of this is transferred to the water as opposed to how much is radiated. I can only state my experience: with the stove burning at full capacity for 6 hours, the brick wall 1 foot from the stove is on-

ly warm to the touch, and wood can be piled next to the stove (about 2 inches away) with no possibility of ignition. For this same 6-hour period, the Circuit Cellar temperature will never exceed 75° F unless a higher temperature is set on the central heating system thermostat. You would definitely know that it is a hot stove, but anyone inspecting the raging fire inside is usually quite surprised how little heat is felt in comparison to a regular wood stove.

A New England Experiment—First, the Basics

The heating system shown in figure 1 is commonly called a hydro/air

system. It consists of an oil hot-water boiler and hot-air heat distribution. The oil burner heats water, which in turn circulates through a hot-water heat exchanger. A fan blows over the heat exchanger coils and circulates the hot air through the ducts to each room. Such a system combines the even-temperature, residual-heating benefits of a hot-water circulator with the pleasant, humidified, filtered warmth of a hot-air system. A third zone of baseboard heat was added when the Circuit Cellar was built.

Perhaps the best way to start is to explain how an oil-fired hot-water heating system works. Neglect for a moment zones 1 and 2 and the

Note: The heating system in this article is installed in my home and was built to my specifications. I do not intend this as a general construction article, but rather a documented discussion of the elements of the system with emphasis on the controls involved. I must point out that while this article specifically describes a computer-controlled hydro heating system,

general use of a Hydrostove does not require the sophisticated control I have outlined. It is only the unique combination of machinery and an empirically determined operating algorithm that suggests ease of operation through computerization. In truth, the computer's primary value is in the addition of a significant measure of safety rather than the convenience

implied. Through its attachment as a supervisory controller, the computer can more accurately maintain safe operating temperatures and dump excess heat in an overtemp condition. As of the time of this writing, two cords of wood have been burned in the stove testing this complete system and the result has been safe, satisfying, and reliable operation.



**free
freight!**



MICROWORLD

New Products

Texas Instruments 99/4 Home Computer



Superior sound, color and graphics; low price includes 13" color monitor, built-in equation calculator, 16-bit CPU, TI BASIC with 13 digit precision and more!

Call for price!

Televideo 920B



Low-cost terminal loaded with features: full-function keyboard plus 11 special function keys, field reverse, reverse blanking, character insert and delete, line insert and delete, line/page erase, line/page send, self-protect mode, self-test, full 24x80 display, ASCII keyboard!

Call for price!

Zenith Z-89 All-in-One Computer



Two Z80 microprocessors, built-in mini-floppy drive, 25x80 display, upper and lower case, direct cursor addressing, 16K, expandable to 48K! DOS supports MICROSOFT BASIC and Assembly languages.

Call for price!

MicroWorld Attacks Inflation With Free Freight, Low Pricing . . .

MicroWorld introduces the most attractive mail-order offer in the computer industry. *The nation's largest inventory*, plus our own automated order processing, allows us to pass along unrivaled cost savings. And now, as an additional measure to counter inflation, we offer *free freight* on any product featured on this page. We'll pay the surface freight on all pre-paid products in this ad, to any of 18,000 U.S. tariffed locations. *No handling charges*, add-on costs, insurance fees or credit card fees! Most items are *in stock* for fast delivery at exceptional discounts!

Call us before you buy anywhere else. Find out *their* total cost. Then compare with our low, freight-free price. Our industry-trained staff stands behind every order. We're *the source you can trust*. We grew up with the microelectronics revolution. We helped pioneer its growth. Our Free Freight program, our attractive pricing, and off-the-shelf delivery are our "thanks" to the thousands of satisfied computer users who made MicroWorld the *world's leading mail-order source* for microcomputers and peripherals!

Soroc IQ 120



High quality, text editing terminal, 73-key board, built-in 2K RAM, RS232 interface.

\$789

Comprint GP



Low priced electrostatic matrix printer, 225 cps; ideal for personal computers, or professional applications requiring second printer.

\$499

Heath WH14

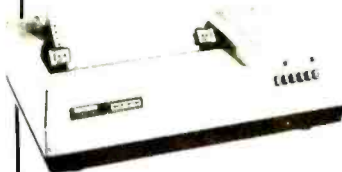

Fully assembled impact printer, 5x7 dot matrix, RS232; sprocket feed adjusts to form sizes

Call for price!

Novation Cat



Call for price!

Acoustic modem with originate or answer modes over phone lines; compatible with any Bell 103 modem.

Hazeltine 1500



7x10 matrix, baud rates to 19,200; full keyboard with numeric pad, all 128 ASCII codes. Excellent warranty!

Call for price!

TI 810

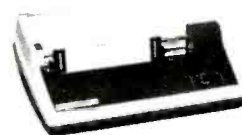

150 cps, RS 232C tractors, 3" to 15" form width; bi-directional printing. An industry standard.

\$1589.

Centronics 730



100 cps, parallel, 3-way feed, 80 character buffer . . . the new price leader in small printers from Centronics.

Call for price!

North Star Horizon



Quad- or double-density kits available while supply lasts!

Call for price!

TOLL-FREE 1-800-528-1418



HERE'S WHAT THE DOCTOR PRESCRIBES FOR YOUR AILING MICROCOMPUTER:

muLISP from the Soft Warehouse

- Over 80 primitively defined LISP functions.
- Infinite precision integer arithmetic expressed in any desired radix base from 2 through 36.
- Automatic dynamic memory management performed by an efficient garbage collector.
- Flexible but structured program control constructs including an extended COND and multiple exit LOOP.
- Extremely fast execution speed achieved by the use of shallow binding, address typing, and a closed pointer universe.

The Soft Warehouse can fill your prescription with the muLISP-79™ Software System. It is fully integrated into the popular CP/M™ Operating System and available for a number of different drives.

If *Math Anxiety* is your affliction, we also offer the muMATH-79™ Symbolic Math System. Read about it in the August '79 issue of *BYTE*.

Call or write us directly for more information.

©Copyright The Soft Warehouse 1979



the
SOFT WAREHOUSE™

P.O. Box 11174, Honolulu, Hawaii 96828
Telephone (808) 734-5801

Hydrostove in figure 1. Think of it strictly as the oil burner connected to one circulator pump and the zone 3 baseboard. This is essentially what many homes have. There may be multiple rooms, but only one circulation loop.

Most people think that the thermostat on the wall turns the oil burner on. Actually, this thermostat only controls the on/off operation of the circulator pump; it generally has no direct connection to the burner itself. Operation of the boiler depends upon the temperature of the water flowing into the heating coil section and the temperature setting T_A of the *aquastat* (water conduit thermostat). Water flows from the hot-water boiler to the baseboard and is drawn back through the circulator pump to the boiler again. If the temperature of this water is greater than the *aquastat* setting, the burner stays off. If however, the temperature is below T_A , the burner turns on, adding heat until the water in the loop reaches T_A . Usually T_A has a wide hysteresis; the high and low limit of variation is separated by about 20° F. For most boilers the low setting is 160° F, and the high is 180° F. The hysteresis reduces the frequency of oil burner starts.

To get heat in a room, you turn up the wall thermostat, which starts the pump. As the water moves through the baseboard, it loses heat to the room. The water is then reheated by the oil burner.

Now, consider the addition of the Hydrostove as shown in figure 1. Any water circulating through zone 3 will necessarily pass through the coils of the stove if valves A and B are opened and C is closed. This circulation in itself does nothing to the operation of the heating system. If, however, you build a fire in the Hydrostove as in photo 3, heat is added to the water returning from the baseboard and flowing into the boiler. If the fire is large enough, the temperature of the water flowing out of the Hydrostove is greater than T_A , the oil burner never turns on, and the house will effectively be heated by the Hydrostove.

There are a few other considerations. Unlike the oil burner which can be selectively turned on when heat is needed, once the wood stove is on, it runs for quite a while and the heat

must be *continuously* removed; otherwise, the water in the pipes will turn to steam. Pressure-relief valves will keep the system from exploding, but who wants a steam bath in their living room? In a single-zone system, the circulator pump must remain on until the fire is out. In a gravity-feed system, the pump must stay on until the fire is lowered to the point where the water stays below the boiling point and can effectively be radiated by the heating loop.

Consider the Hydrostove as a continuous source of heat. If the Hydrostove is cranked up to produce 40,000 BTU per hour, then 40,000 BTU per hour must somehow be removed. The task of heat dumping is much easier on a multi-zone system. Take for example, three zones with capacities of 40,000 BTU, 30,000 BTU, and 20,000 BTU, respectively. Whether or not a room thermostat is calling for heat, you must turn on either the pump for zone 1, or the pumps for both zones 2 and 3. Consider the case when zones 2 and 3 are used as heat dumps. If the zone 1 thermostat were to trip suddenly, the control system would have to make a choice. It could add zone 1 to the pool and share 40,000 BTU among three zones or immediately drop zones 2 and 3 off the line and send everything to zone 1 until it reaches its thermostat setting again. While the previous choice can easily be made, load sharing is an interesting consideration. It is much easier to switch zones on and off while performing load sharing than to try to directly control the heat output of the wood fire to any degree.

An additional complication occurs when using heat exchangers. Heat exchangers cannot effectively transfer heat unless the blower is on. The fans in these units are thermostatically controlled. When the water flowing through the exchanger reaches a set temperature, the fan turns on, extracting heat. There is considerable delay and overshooting in the operation of these units. While the *average* hourly heat transfer of a heat exchanger might be 40,000 BTU, it may be 10,000 BTU with the blower off and 50,000 BTU with it on. In a quick heat-dump situation, it is sometimes necessary to override the blower thermostat and force the



theirs.



ours.

So you didn't think documentation made a difference.

Sure, MicroSource is flexible, powerful, versatile. Sure, it's sophisticated yet simple: the first **user-oriented** software. But you may not be aware of the biggest difference of all. **Documentation.** The most extensive in the industry.

Support makes a difference, too. The support of some of the world's leading microcomputer people. The support of stringent field testing and follow up. The invaluable support of business software experts dedicated to helping you manage information in real-world environments. Not just when you acquire software, but as you implement, as you train, as you **use** Microsource to solve your contemporary business problems.

The MicroSource Difference means dealer support, too: we back every dealer with our experience, our

knowledge, our integrity. Plus, the materials and resources **he** needs to provide the finest in software solutions and data base management.



From AutoScribe™, the versatile word processing package that means business . . . to Bookkeeper™, designed by a CPA to produce efficient client writeups. From the powerful LedgerPlus™ financial package to MoneyBelt™, the flexible accounting system, both for small to medium sized businesses . . . or small to medium sized departments of big corporations. TimeKeeper™ — for the professional practice or the corporate service department — bills for time, when time means money. All MicroSource is backed by exhaustive operations manuals, incomparable factory support, and system expandability. It runs on North Star, Vector Graphics, Heath Data Systems, Apple and TRS-80 . . . before long, CP/M, Cromemco, Data General and MicroNOVA. Sample the MicroSource difference.

MicroSource™

Ask your dealer about powerful, user-oriented MicroSource software. Or call the telephone number below for the nearest MicroSource dealer near you.

1425 W. 12th Pl. · Tempe, AZ 85281 · 602-894-9247

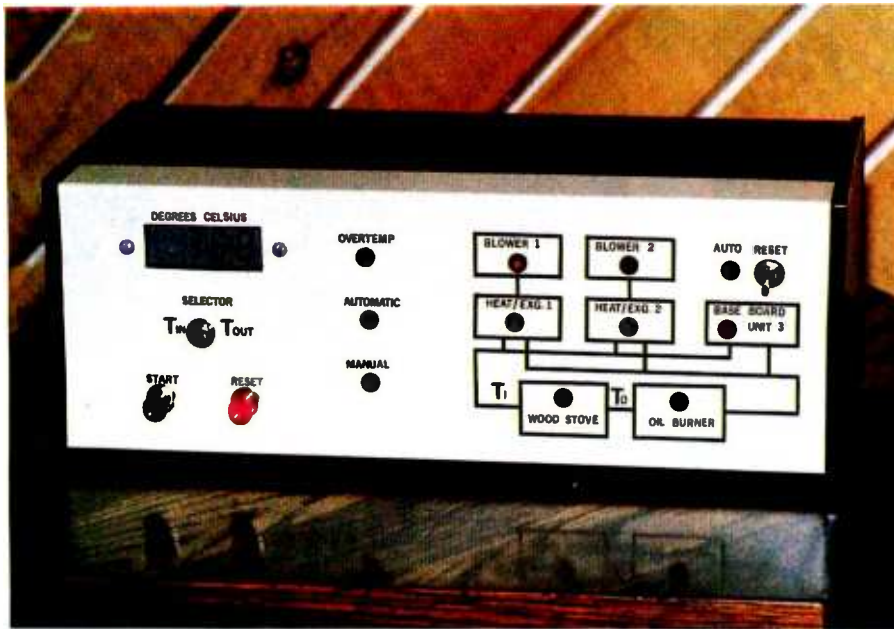

Photo 4: The computer I/O interface for the heating control system is attractively housed. It includes a display of either the input or output temperature of the Hydrostove and a real-time status display of the circulators and blowers.

blower on to maintain stable conditions throughout the rest of the system.

Using a Hydrostove

How much you benefit from the addition of a hydronic wood stove depends quite heavily on the rest of your heating system. Above all, it must be capable of taking the full heat

output of the wood fire. This can be 62,000 BTU per hour. Since my oil burner is rated at 120,000 BTU per hour, and I had added the third zone of baseboard to the Circuit Cellar, I concluded that the connection would be quite safe.

My usual method of manual operation is to use the stove only on very cold days and to build as large a fire

as possible. It is initially started with both dampers open, but once the fire is going strong the flue damper is closed to reduce the amount of heat going up the chimney. At the time the fire is started, the zone 1 circulator pump is turned on continuously with a switch, overriding the motor-start relay. This keeps some water flowing through the stove at all times. Zones 2 and 3 are normally left in their "heat on demand" thermostat-controlled mode. If the Circuit Cellar cooled down and its circulator pump kicked in, it would be drawing heat from the stove along with zone 1.

Our house is large, but given my method of use, no single heating zone can sustain the full output of the Hydrostove for long periods of time. Generally, the water temperature will be between 75° and 90° C. To maintain a 20° to 22° C (68° to 72° F) temperature through the house on a very cold day, I have to keep the fire box continually filled. This means filling the stove with wood every 3 to 4 hours. (Before you choke and compare it to 12 hours for a regular airtight stove, remember that I am talking about heating a whole house). After a few hours of use, even in this large house, the temperature in the rooms in zones 2 and 3 will reach the wall-thermostat set points, no longer continuously demanding heat from the stove. This leaves all the heat going to zone 1.

Soon, the temperature of the water coming out of the wood stove starts to climb above the safe high limit of 88° C (measured 35 feet away at the furnace). When the indicator hits around 98° C, a loud noise can be heard in the pipes because the higher temperature water nearest the hot coals within the stove is turning to steam. Unless you want the safety valve to blow, filling the room with steam, you have to override the automatic settings of either or both of the thermostats of zones 2 and 3 to get rid of some of the excess heat. It may also be necessary to manually turn on the heat-exchanger blowers for zones 1 and 2 for the reasons I previously outlined.

This occurrence is rare, and I generally have about 10 minutes to react to the situation and throw all the manual switches required. After using the system and determining that this is a potential problem, I installed a digital temperature indicator that

Control Outputs Signal	Type	Function
TC ₁	Contact closure 200 mA	Circulator pump - zone 1
TC ₂	Contact closure 200mA	Circulator pump - zone 2
TC ₃	Contact closure 200 mA	Circulator pump - zone 3
F ₁	Solid state relay 5 A 220 VAC	Heat exchanger blower zone 1
F ₂	Solid state relay 5 A 220 VAC	Heat exchanger blower zone 2
XFER	Contact closure 5 A 115 VAC	Oil burner power
Inputs Status	Level	Function
TC ₁	TTL	
TC ₂	TTL	0 pump off 1 pump on
TC ₃	TTL	
F ₁	TTL	0 blower off 1 blower on
F ₂	TTL	
T _{in}	Analog	
T _{out}	Analog	range 40° to 240° F 4° to 115° C

Table 1: Computer I/O lines used with the heating control system.

SuperBrain™



The Honor Graduate

There's been a lot of talk lately about intelligent terminals with small systems capability. And, it's always the same. The systems which make the grade in performance usually flunk the test in price. At least that was the case until the SuperBrain graduated with the highest PPR (Price/Performance Ratio) in the history of the industry.

For less than \$3,000*, SuperBrain users get exceptional performance for just a fraction of what they'd expect to pay. Standard features include: two dual-density mini-floppies with 320K bytes of disk storage, up to 64K of RAM to handle even the most sophisticated programs, a CP/M Disk Operating System with a high-powered text editor, as-

sembler and debugger. And, with SuperBrain's S-100 bus adapter, you can even add a 10 megabyte disk!

More than an intelligent terminal, the SuperBrain outperforms many other systems costing three to five times as much. Endowed with a hefty amount of available software (BASIC, FORTRAN, COBOL), the SuperBrain is ready to take on your toughest assignment. You name it! General Ledger, Accounts Receivable, Payroll, Inventory or Word Processing . . . the SuperBrain handles all of them with ease.

Your operators will praise the SuperBrain's good looks. A full ASCII keyboard with a numeric keypad and function keys. A non-glare, dynamically focused, twelve inch screen. All in an attractive desktop unit weighing less than a standard

office typewriter. Sophisticated users will acclaim SuperBrain's twin Z-80 processors which transfer data to the screen at 38 kilobaud! Interfacing a printer or modem is no problem using SuperBrain's RS-232C communications port. But best of all, you won't need a PhD in computer repair to maintain the SuperBrain. Its single board design makes servicing a snap!

So don't be fooled by all the freshman students in the small systems business. Insist on this year's honor graduate . . . the SuperBrain.

 **INTERTEC
DATA
SYSTEMS®**

2300 Broad River Road, Columbia, SC 29210
(803) 798-9100 TWX: 810-666-2115

*Quantity one. Dealer inquiries invited.

Circle 22 on inquiry card.

Why not kill two birds with one stone?

If you have an Apple* and you want to interface it with parallel and serial devices, we have a board for you that will do both. It's the AIO.TM

Serial Interface.

The RS-232 standard assures maximum compatibility with a variety of serial devices. For example, with the AIO you can connect your Apple* to a video terminal to get 80 characters per line instead of 40, a modem to use time-sharing services, or a printer for hard copy. The serial interface is software programmable, features three handshaking lines, and includes a rotary switch to select from 7 standard baud rates. On-board firmware provides a powerful driver routine so you won't need to write any software to utilize the interface.

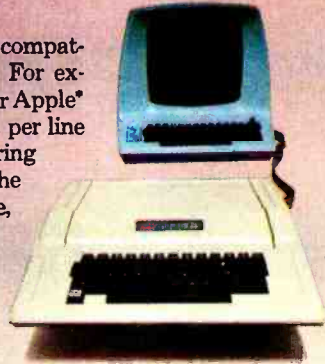

Parallel Interface.

This interface can be used to connect your Apple* to a variety of parallel printers. The programmable I/O ports have enough lines to handle two printers simultaneously with handshaking control. The users manual includes a software listing for controlling parallel printers or, if you prefer, a parallel driver routine is available in firmware as an option. And printing is only one application for this general purpose parallel interface.



Two boards in one.

The AIO is the only board on the market that can interface the Apple to both serial and parallel devices. It can even do both at the same time. That's the kind of innovative design and solid value that's been going into SSM products since the beginning of personal computing. The price, including PROMs and cables, is \$135 in kit form, or \$175 assembled and tested. See the AIO at your local computer store or contact us for more information.



2116 Walsh Avenue
Santa Clara, California 95050
(408) 246-2707

*Apple is a
TM of Apple
Computers,
Inc.



AIO
Serial & Parallel
Apple Interface

allowed me to monitor the system as I worked at my desk in the Circuit Cellar. When I saw that the temperature was going above 88° C, I would throw the manual override on the zone 2 circulator pump. If the temperature did not drop, I would continue with the other heat dumping methods. It has never gotten to a point where these maneuvers prove insufficient or where the fire has to be put out. Experience has shown that zone 2's volume of 15,000 cubic feet provides a terrific sink for excess heat. Normal use in this mode barely raises its temperature more than 2° F above its nominal 66° F thermostat setting. (I do not want to leave you with the impression that there is one 90° F room in the house.)

I have not described anything thus far that specifically requires computerization other than for convenience. The real reason is a rather insignificant detail that is discovered only after actually using the stove. A Hydrostove definitely saves oil, as stated. When its output temperature is greater than the aquastat set point, the oil burner does not come on. The problem arises during startup and shutdown when the stove output temperature (T_{out}) is less than the setting of the aquastat (T_A). The circulator pump has to remain on while there is a fire but, because the circulation loop is running and returning at less than T_A , the oil burner keeps coming on. *Catch 22!!*

If this were a matter of 10 minutes or so, it would not be so bad; but shutdown to the point where the circulator pump can be turned off can take several hours. The alternative is to cut the power to the oil burner when the wood stove is on and restore it when the fire is out. This is what I initially did, until I was staying up all night to shut the stove off. The alternative was to wake up to a very cold house, turn the oil burner on, and have to wait a half-hour to take a hot shower.

Aside from taking in a tenant who would watch the Hydrostove temperature in exchange for room and board, the only reasonable alternative was a more intelligent control system. With the proper sensors, a device could monitor the heat output of the stove ($T_{out} - T_{in}$), and when it dropped to a predetermined safe point, automatically restore power to

Circle 23 on inquiry card.



new products from

Micro Data Base Systems, Inc.

HDBS - HIERARCHICAL DATA BASE MANAGEMENT SYSTEM

MDBS - OUR FULL NETWORK DATA BASE MANAGEMENT SYSTEM

HDBS FEATURES	ADDITIONAL FEATURES IN MDBS
<ul style="list-style-type: none"> • HIERARCHICAL DATA STRUCTURES 	<ul style="list-style-type: none"> • HIERARCHICAL AND FULL NETWORK DATA STRUCTURES (CODASYL ORIENTED)
<p>COMMANDS TO ADD, DELETE, UPDATE, SEARCH AND TRAVERSE THE DATA BASE</p> <p>SORTED, FIFO, LIFO, NEXT AND PRIOR SET ORDERING PROVIDED</p> <p>STRAIGHTFORWARD USE OF ISAM-LIKE STRUCTURES</p>	
<ul style="list-style-type: none"> • READ/WRITE PROTECTION AT FILE LEVEL • ONE-TO-MANY SET RELATIONSHIPS ALLOWED 	<ul style="list-style-type: none"> • MULTIPLE LEVELS OF READ/WRITE PROTECTION AT ITEM, RECORD, SET AND FILE LEVELS • EXPLICIT REPRESENTATION OF ONE-TO-ONE, ONE-TO-MANY, MANY-TO-ONE AND MANY-TO-MANY SETS
<p>NAMES OF DATA ITEMS, RECORDS, SETS AND FILES ARE WHOLLY USER DEFINABLE</p> <p>WRITTEN IN MACHINE LANGUAGE FOR MAXIMAL EXECUTION EFFICIENCY AND MINIMAL MEMORY USAGE</p> <p>SUPPORTS DATA BASE SPREAD OVER SEVERAL DISK DRIVES (MAX. 8). DISKS MAY BE MINI- OR FULL-SIZED FLOPPIES OR HARD DISKS.</p> <p>ROUTINES ARE CALLABLE FROM BASIC, PASCAL, FORTRAN, COBOL AND MACHINE LANGUAGE</p> <p>RECORDS CAN BE MAINTAINED IN A NUMBER OF SORTED ORDERS.</p>	
<ul style="list-style-type: none"> • RECORD TYPES MAY OWN OTHER OCCURRENCES OF THE SAME RECORD TYPE • A SINGLE SET MAY HAVE MULTIPLE OWNER AND MEMBER RECORD TYPES 	

NEW DYNAMIC RESTRUCTURING SYSTEM

MDBS-DRS FEATURES

ALLOWS ITEM, RECORD AND/OR SET TYPES TO BE ADDED TO OR DELETED FROM AN EXISTING MDBS DATA BASE. THIS ALLOWS THE USER TO RE-DESIGN A DATA BASE AFTER IT IS ALREADY ON-LINE.

THIS FEATURE CAN ONLY BE ADDED TO THE MDBS SYSTEM.

REQUIREMENTS

- Z-80 APPROXIMATELY 16K MEMORY -
- 8080 AND 6502 APPROXIMATELY 20K MEMORY -
- IN ADDITION TO THE OPERATING SYSTEM, HOST LANGUAGE, USER'S PROGRAM AND SOME BUFFER AREA

HDBS and MDBS PACKAGES INCLUDE

DDL DATA DEFINITION LANGUAGE ANALYZER/EDITOR. The user specifies data structures to be used in a Concise Data Definition Language (DDL). The Data Definition Language Analyzer/Editor allows the user to interactively create and edit DDL Specifications and to initialize the data base for use based on these specifications.

260 PAGE USERS MANUAL with extensive documentation of the Data Base Management System

DMS DATA MANAGEMENT ROUTINES. These are the routines callable from the host language (BASIC, PASCAL, etc.) which perform the data base operations of finding, adding, and deleting records; fetching and storing data items; and traversing the (possibly complex) data structure.

SAMPLE APPLICATION PROGRAM AND DDL FILES

RELOCATOR TO RE-ORG ALL ROUTINES

SYSTEM SPECIFIC MANUAL to show how to bring up our software on your computer



WE ACCEPT



MICRO DATA BASE SYSTEMS, INC

P.O. BOX 248 LAFAYETTE, IN 47902
(317) 742-7388

RUNS UNDER

- CP/M* WITH MICROSOFT BASIC, COBOL AND FORTRAN
- NORTHSTAR DOS WITH NORTHSTAR BASIC
- TRSDOS* AND DISK BASIC
- NEWDOS AND DISK BASIC
- APPLE* DOS AND APPLE* SOFT BASIC
- MACHINE LANGUAGE CALLABLE FORMS

CP/M is a registered trademark of Digital Research Corp.
TRS-80 is a registered trademark of Radio Shack/Tandy Corp.
Apple is a registered trademark of Apple Computers, Inc.

HDBS - Z80 VERSION	\$250
8080 and 6502 VERSIONS	\$325
MANUAL ONLY	\$ 35
UPGRADE TO MDBS	\$550
MDBS - Z80 Version	\$750
8080 and 6502 VERSIONS	\$825
MANUAL ONLY	\$ 35
MACHINE LANGUAGE CALLABLE FORMS ADD	\$ 75
MDBS - DRS	\$100
MANUAL ONLY	\$ 5

FOR FREE PRIMER CONTACT MDBS.

ADD \$2.50 (\$6.00 IF FOREIGN) TO NON-CASH ORDERS FOR HANDLING AND SHIPPING. INDIANA RESIDENTS ADD 4%.

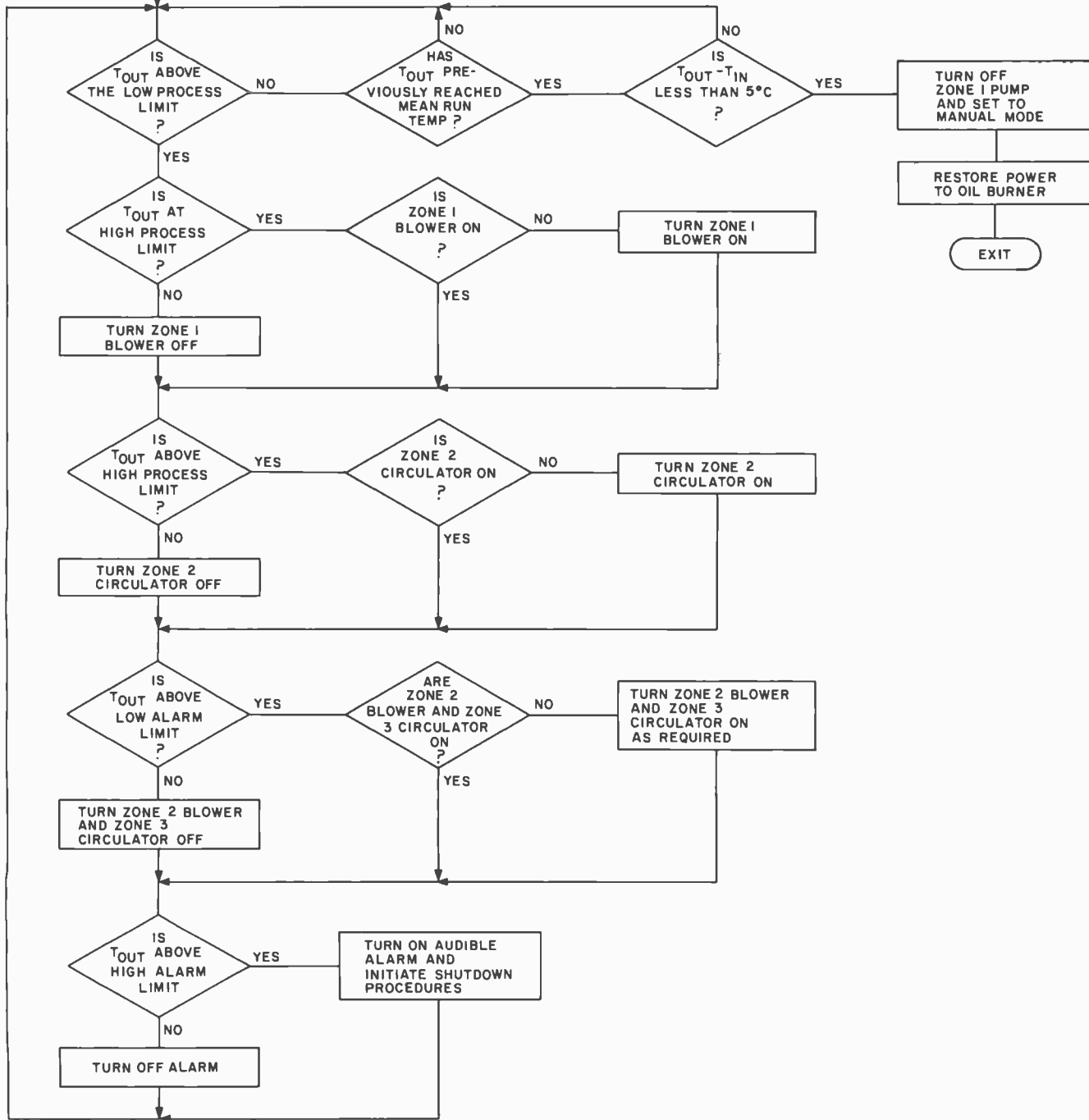
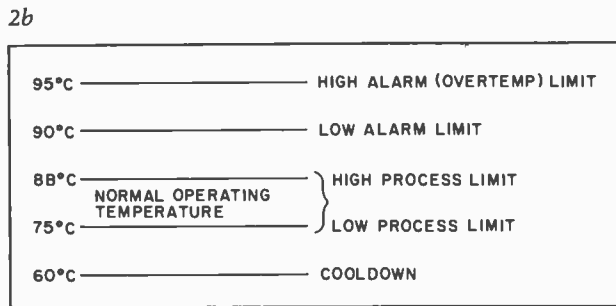
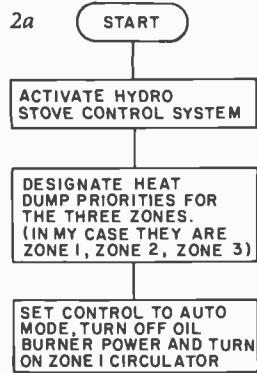

Figure 2: (a) Logic flow for the automatic distribution of Hydrostove heat when output in a three-zone combination hydro and air heating system. (b) Points of importance in the operating temperature range of the system. The actual set points for process and alarm limits depend upon placement of temperature sensors and may vary a few degrees.

In BYTE, algorithmic flow is assumed to proceed down and to the right unless an arrowhead is present to indicate otherwise.

Get Word Power!

with 
WUP Daisy™
WORD PROCESSOR

**The best is now
even better...**

**New Features
New Commands
New Capabilities
New Manual**

Features Editor:

- Interactive editing with Dynamic Screen Imaging
- Direct insert with word wrap
- Extensive disk handling: DIR, ERASE, disk change, etc.
- Insert/Delete/Move
- Step by Character, Word, Line, Paragraph, Page, Screen
- 26 Temporary buffers
- Find/Replace with conditional test

Formatter:

- Fully integrated with Editor
- On-screen Preview
- Extended Page, Margin and Indent control
- Hyphenation
- Super- and Sub-scripting
- Operator prompts and input
- Center, underline, bold face, red print
- Type face control, height, pitch,
- Header/footer lines
- Page number control



**LIMITED
TIME OFFER!**
FREE MAIL MERGE™
form letter mailing
list package

★ ★ **COMING SOON** ★ ★

I/OS™ — new update from TSA/OS
I/Pascal™ — full Compiler/Linker system
I/SAL™ — new Structured Z80/8080
Assembler/Linker/Debugger system
... and more

Software for I/OS — TSA/OS — CDOS — SDOS —
other 8080/Z80 OS*M operating systems

Circle 25 on inquiry card.

Contact your dealer or...

InfoSoft
SYSTEMS INCORPORATED
25 SYLVAN ROAD SOUTH
WESTPORT, CONN 06880
(203) 226-8937

Type of wood	Pounds per cubic foot	BTU per cord	Equivalent gallons (gallons per cord) fuel oil
Hardwoods			
1. White Ash	37.5	23,037,000	165
2. Cherry	31.0	19,043,920	136
3. Hickory	45.0	27,644,400	198
4. Maple (red)	33.5	20,579,720	147
5. Oak (chestnut)	41.0	25,187,120	180
6. Walnut	34.5	21,194,040	151
7. Willow	24.0	14,743,680	105
Softwoods			
8. Douglas Fir	30.0	18,429,600	132
9. Ponderosa Pine	25.0	15,358,000	110
10. White Spruce	25.0	15,358,000	110

Table 2: Comparison of wood heat values for various species of wood available in North America and their equivalent in gallons of fuel oil per cord of wood. (These estimates are generally accepted by industry.)

the burner and shut off the circulator-pump override.

Computer-Controlled Heating System

My heating system is not technically a computer-controlled wood stove. It is rather a system designed specifically to efficiently distribute the heat from a wood stove, to safely dump excess heat in an effective manner, and most importantly, to restore the entire system to its standard configuration when the fire is out. I am merely outlining one application of the many that are conceivable when the heating system has been connected to a computer. Complete energy management is a possibility; or, at the very least, total energy out-

put can be closely monitored and recorded. I am working on these areas, but for now, the topic is control.

Virtually any personal computer can suffice as the controller. The logic is straightforward and relatively uncomplicated. It is outlined in the flowchart shown in figure 2. Proper control of the three zones and the Hydrostove requires a special interface to connect the computer to the various blowers and pumps. Table 1 is a list of the signals in question.

The control outputs from the computer are, in essence, all contact closures, whether it be through mechanical or solid-state relays. The use of relays provides electrical isolation between the computer and the

heating system. It further prevents potentially dangerous loops between 115- and 220-VAC powered components.

The three zone thermostats are low-voltage AC circuits that can be directly controlled through a reed relay, as shown in figure 3. The relay contacts are connected in parallel with the thermostat. With the thermostat contacts open, a logic 1 control signal closes the relay and provides an alternate current path to pull in the pump-start relay. By monitoring the voltage across the relay contacts, it is possible to directly monitor the activity of the circulator pump and determine its operational status at any time. If the contacts are open, current flows through the optoisolator light-emitting diode (LED), producing a logic 0 status at the output. When closed, no current flows and the logic value is 1. My application required only the ability to turn on a pump which may not already be running. However, to accommodate complete functional control of the pumps, the thermostat can be disconnected as shown.

The interface to the heat exchanger blowers, shown in figure 4, is similar. This time however a solid-state 7 A 220 VAC relay is used. The power to the blower is 5 A 220 V rather than low voltage AC as before. A 7 A solid-state relay was chosen because of its size and low cost.

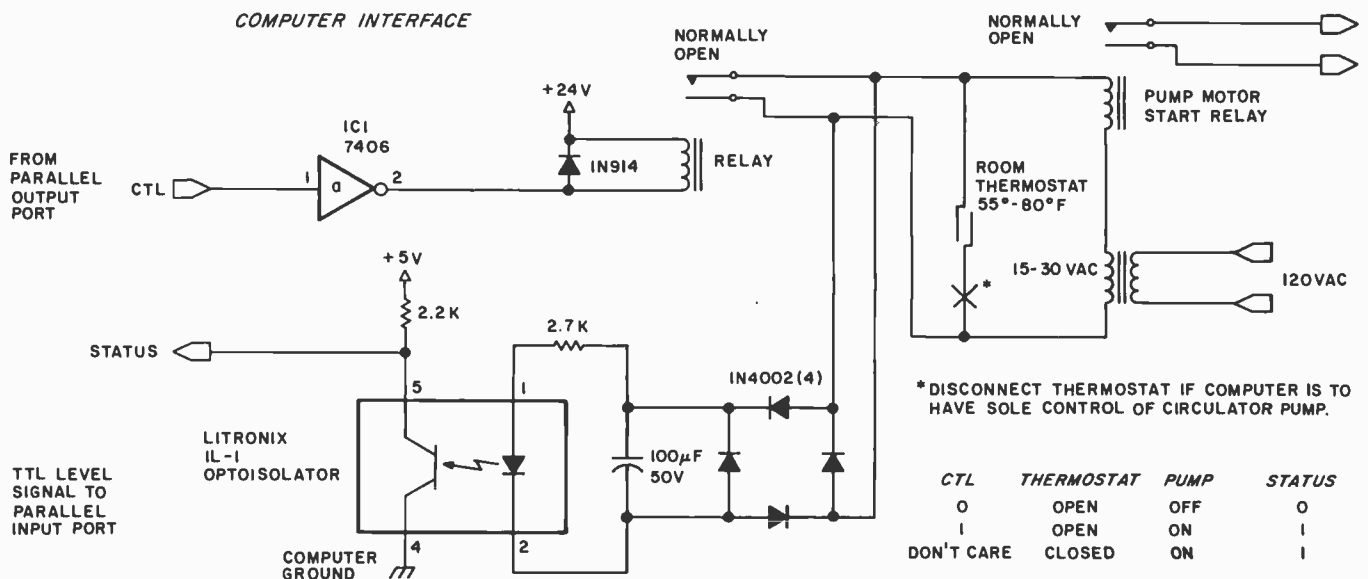
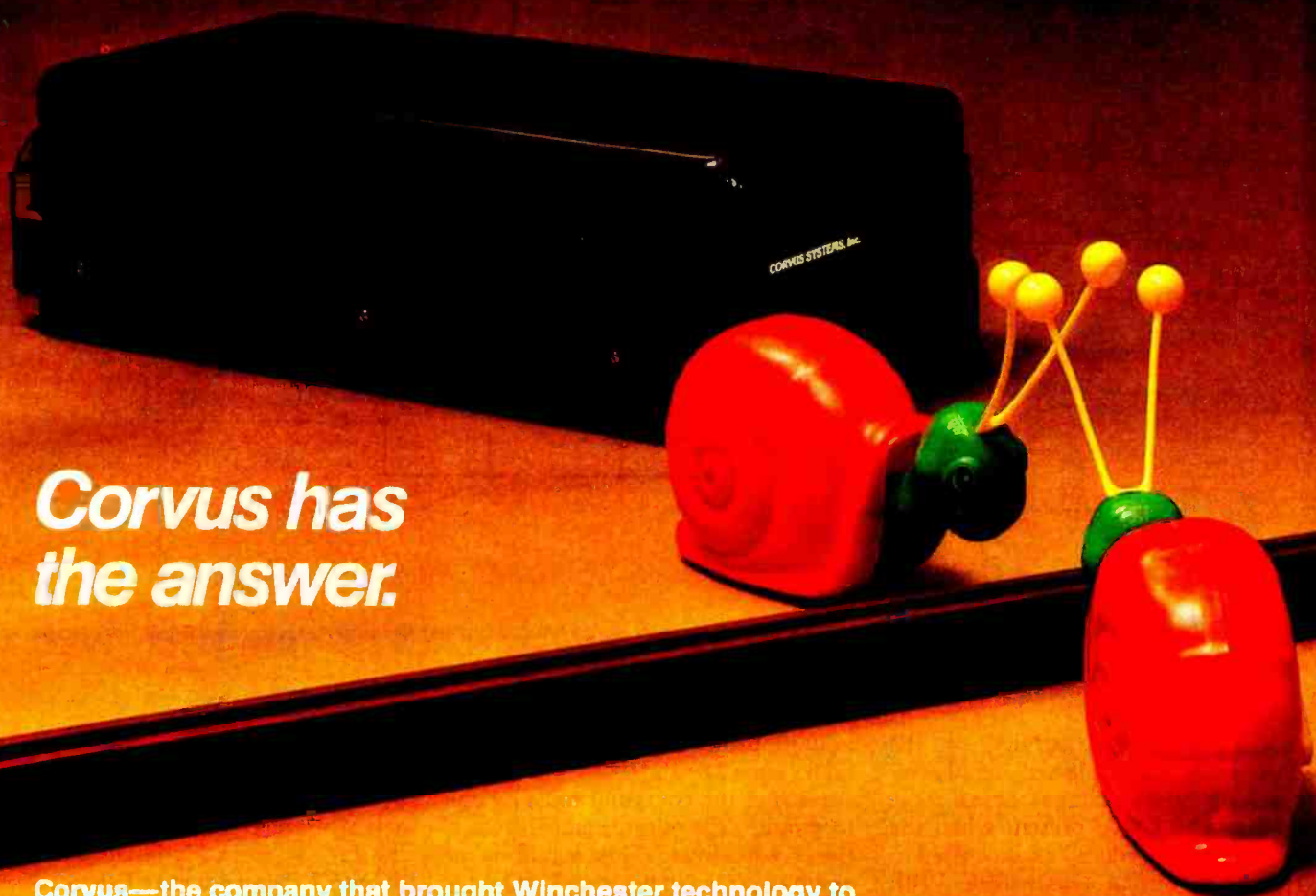

Figure 3: Isolated interface for computer control of a typical oil-fired, hot-water, 1/4-horsepower circulator pump. The 7406 open-collector inverter (IC1) requires a 5 V supply to pin 14 and a ground connection to pin 7.

CONCERNED ABOUT WINCHESTER BACKUP?



*Corvus has
the answer.*

Corvus—the company that brought Winchester technology to the microcomputer—is now delivering the solution to backup for less than \$1500.

It's called the Corvus MIRROR®, a backup employing low-cost removable media with a total capacity of up to 100 million bytes each. In approximately ten minutes, you can transfer an entire ten million byte disk without operator intervention.

Corvus is the company that gives you a complete systems solution to the mass storage needs of microcomputers. Our systems have fully compatible hardware and software for the Apple† (Including Apple Pascal), S-100 Bus, TRS-80‡, and now the LSI-11 and ALTOS computers. We utilize proven Winchester technology with IMI-7710 drives. Up to four eight-inch disks can be used with our Z-80 based controller.

Interested in our new removable-media backup or our pace setting Winchester systems? Both are available now. Call or write for full information.

CORVUS SYSTEMS, Inc.

900 S. Winchester Boulevard
San Jose, California 95128
408/248-0461

†Apple is a registered trademark of Apple Computers, Inc.
‡TRS-80 is a registered trademark of Radio Shack, a Tandy Co.

Circle 28 on Inquiry card.

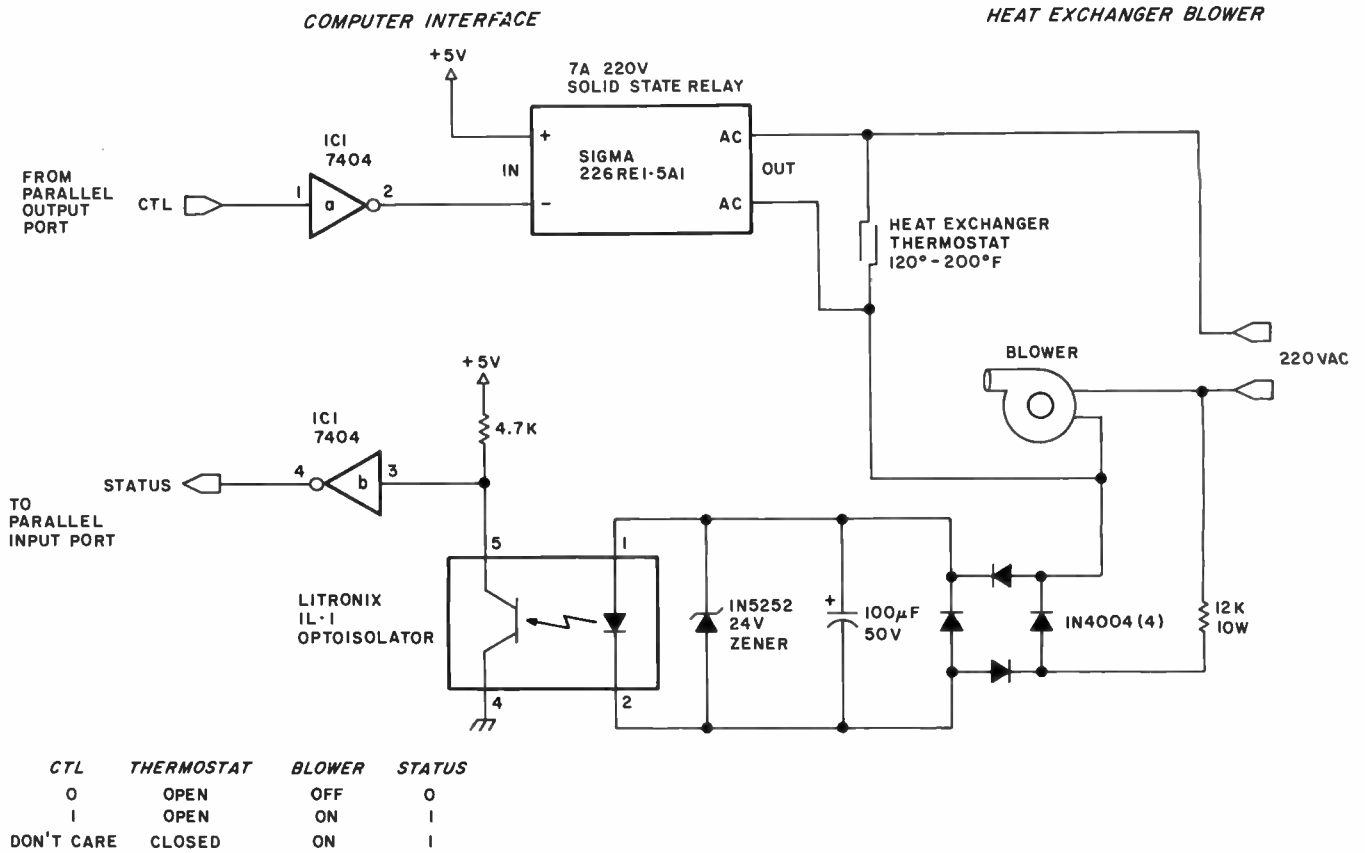

Figure 4: Isolated interface for computer control of a heat-exchanger blower fan. The 7404 hex inverter requires a 5 V power supply to pin 14 and a ground connection to pin 7.

Monitoring the activity of the blowers is accomplished simply by checking the voltage across the motor. The 220 V present when the motor is on is reduced and rectified to run an optoisolator as before. With

voltage present, the status output is high (logic 1).

Finally, the computer must be able to monitor the output temperature of the Hydrostove. This signal is an analog voltage that is proportional to

temperature. Various sensors such as thermistors or thermocouples could be used, but a more practical device is a temperature sensor device such as the LM334 from National Semiconductor. When configured as in figure 5, the output of IC1 (monitored at V_{in}) is 10 mV per degree Celsius. It may have a nominal offset of something like 2.5 V, but if the temperature rises 10° C the output will go up 100 mV. ICs 2 and 3 provide gain and offset adjustment and are configured to prohibit accidental negative excursion of the output if the temperature sensor goes open circuit. The result is a circuit that converts a change in temperature to a change in voltage. By adjusting the gain and offset, 0° C can be an output of 0 V and 100° C can be 1 or 10 V. A Fahrenheit scale can be just as easily calibrated by setting a different gain and offset.

To read this signal, the computer must have an analog-to-digital converter interface. This can be either a true successive-approximation analog-to-digital converter as in figure 6, or the discrete set-point level detector of figure 7. The choice



Photo 5: An internal view of the I/O controller containing relays, optoisolators, and analog interface components.

Step up to your next computer.



STEP UP TO A C4P FROM OHIO SCIENTIFIC

You know about computers. In fact, you probably own one now. One that you might be thinking of expanding. We have a better idea. Take a giant step into the personal computing future with an amazing, new C4P from Ohio Scientific.

SPEED SEPARATES THE COMPUTERS FROM THE TOYS

The C4P MF has execution speed that is twice as fast as Apple II or Commodore PET and over THREE times as fast as TRS-80. They are many times faster than the recently introduced flock of video game type computers. And, as if that weren't fast enough, the C4P nearly doubles its speed when equipped with the GT option.

Just look at the back panel of the C4P MF.

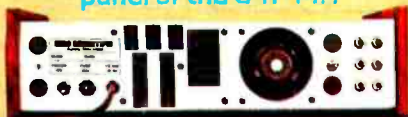

All the I/O you'll ever need!

Apple II, Commodore PET, TRS-80, and Atari 800 are registered trade names of Apple Computer Inc., Commodore Business Machines Ltd., Radio Shack, Atari, respectively.

SOUND

- 1—programmable tone generator 200 — 20KHz
- 1—8 bit companding digital to analog converter for music and voice output.

HUMAN INPUT EXPANSION

- 2—8 axis joystick interfaces
- 2—10 key pad interfaces

HOME INTERFACE

- 1—AC-12 AC remote control interface

DISPLAY

- 32 x 64 with upper and lower case 2048 Characters.
- 256 x 512 effective Graphic Points
- 16 Colors

SOFTWARE

Ohio Scientific offers a comprehensive library of both systems and applications software for the C4P.

The C4P is an outstanding premium computer — years ahead of the market. We know because there's nothing quite like it for the price, anywhere. And probably won't be for a very long time.

C4P \$698

8K BASIC-in-ROM, 8K of static RAM and audio cassette interface. Can be directly expanded to 32K static RAM and two mini-floppy disks.

C4P MF \$1695

All the features of the C4P plus real time clock, home security system interface, modem interface, printer interface, 16 parallel lines and an accessory BUS. The C4P MF starts with 24K RAM and a single mini-floppy and can be directly expanded to 48K and two mini-floppies. Over 45 diskettes now available including games, personal, business, educational and home control applications programs as well as a real time operating system, word processor and a data base management system.

Computers come with keyboards and floppies where specified. Other equipment shown is optional.

For literature and the name of your local dealer, CALL 1-800-321-8850 TOLL FREE.

OHIO SCIENTIFIC
1333 SOUTH CHILLICOTHE ROAD
AURORA, OH 44202 • (216) 562-3101

Circle 27 on Inquiry card.

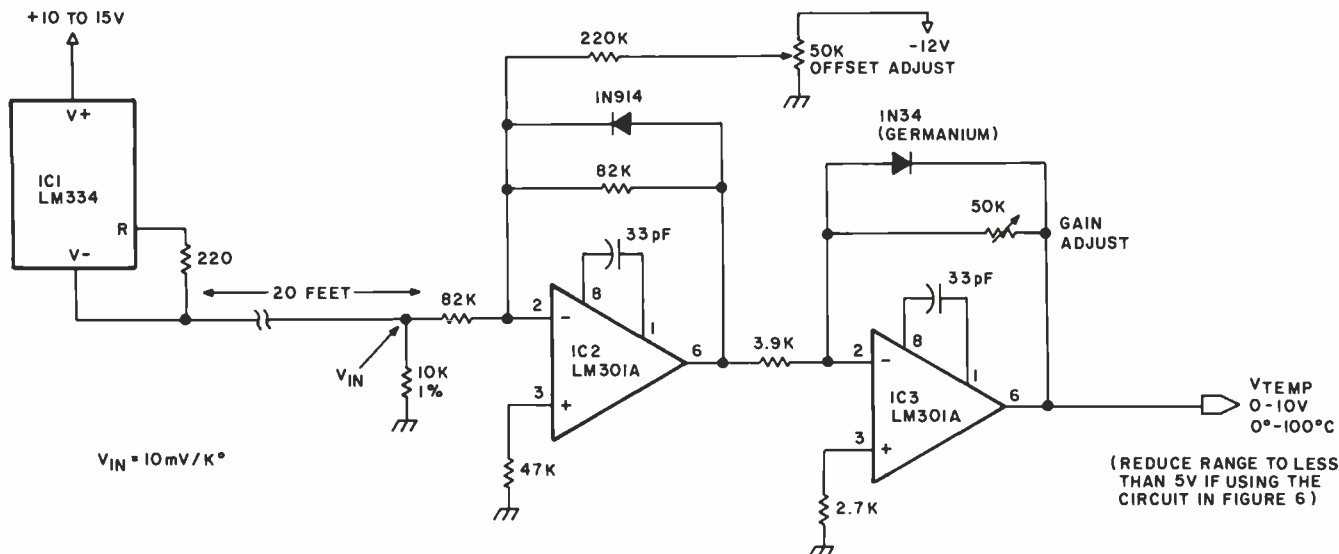

Figure 5: Solid-state temperature sensor. The range of the output voltage (V_{TEMP}) is reduced to less than 5 V if the circuit in figure 6 is used.

depends upon whether you need to know the exact temperature or just significant set points.

If data acquisition is the dominant consideration, then consider the circuit of figure 6. IC8 is an 8-channel, 8-bit analog-to-digital converter that is bus-compatible with most microprocessors. Figure 8 outlines its internal structure. As configured, it is attached to function as ports F8 through FF, with port F8 corresponding to input channel 0, and port FF corresponding to channel 7. The volt-

age on channel 0 is read by initiating an output to port F8. This causes the address of 000 to be stored and the conversion process started. After about 100 microseconds, the time necessary for conversion, the channel analog value can be obtained by reading an input from port F8. A similar procedure is used to set and read the other channels.

If you are interested strictly in control, then the circuit of figure 7 is much simpler to use. If a 0 to 10 V input represents a range of 0 to 100° C and there are eight comparators, each could be set to trigger 12.5° C higher than the preceding one. A better approach is to arrange the majority of set points to cover the control and alarm range rather than to cover insignificant temperature ranges. For example, bit b_0 could be set to trigger at 60° C. It is not necessary to care much about temperatures below that point. The range of prime interest is

from about 75° C to 95° C. Dedicating 5 set points within this range, another perhaps between 60° C and 75° C and a final overtemp indicator at 98° C should prove more than adequate.

My system uses a combination of both interfaces, using set points for control inputs and a true analog-to-digital converter to determine actual heat output from the stove.

A further enhancement is a visual display indicating the real-time status of the system components and a readout of the actual temperature. The prototype controller is shown in photos 4 and 5. It serves as the interface between the heating system and the computer, and contains most of the electronics described in this article as well as other enhancements not discussed at this time. While all the control decisions are actually made by the computer, the display gives me

Text continued on page 56

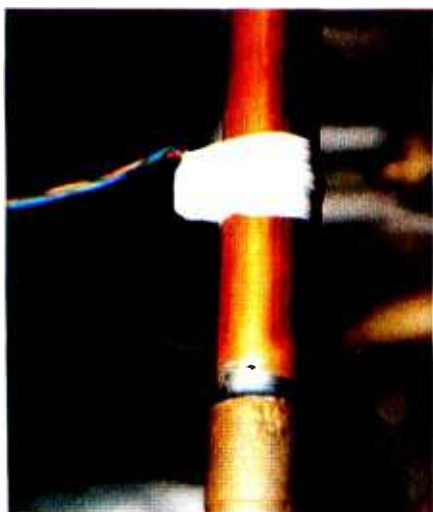

Photo 6: To effectively use this control device, it is important to have accurate temperature measurements. The LM334 temperature sensor is easily attached to the Hydrostove return pipe by wrapping Teflon plumbing tape around it.

Number	Type	+ 5 V	GND	- 12 V	+ 15 V
IC1	LM334	see figure 5			
IC2	LM301A			4	7
IC3	LM301A			4	7
IC4	LM339		12		3
IC5	LM339		12		3
IC6	REF-01	see figure 7			
IC7	LM301			4	7
IC8	ADC0808	see figure 6			
IC9	74LS30	14	7		
IC10	74LS02	14	7		
IC11	7400	14	7		

Table 3: Power and ground connections for the integrated circuits that are used in the circuits of figures 5, 6, and 7.



Here's to your health! Six Vitafacts™ programs for you and your family.

Being healthy and happy is so very important. And now you can use your Apple™, PET/CBM™ or TRS-80™ computer to help stay that way.

Introducing six new Personal Software™ Vitafacts Series programs for your health: Growing Up, Heart Attacks, Talking About Sex, Drinking & Drugs, Birth Control, and Your Blood Pressure.

Using a Vitafacts program is like getting advice from your family doctor. Accurate, up-to-date medical information about physical and mental health, presented in a friendly, straightforward way. You'll feel even more confident knowing that each program is approved and endorsed by The College of Family Physicians in Canada, where the Vitafacts Series is created by The Richmond Software Group and Medifacts Ltd.

Each program includes a manual with diagrams and glossary, a computer cassette, and an audio cassette. The audio tape uses short dramas and straight talk to tell the story. Then the computer exercises verify your new knowledge. And because you use your knowledge right away, you remember more. It's fun! And a great way to learn.

Growing Up helps families cope with the teenage years. Teenagers learn more about their physical and emotional changes, and parents learn more about helping their children through it all.

Heart Attacks describes what one is, how to recognize it, what to do

when someone is experiencing one, and—most important—how to help prevent one.

Talking About Sex, presented by two of Canada's foremost sex counselors, offers to adults the proper information and appropriate attitude for a satisfying sex life.

Drinking & Drugs. No lecturing or talking down. Just straight facts about the very real dangers of alcohol and drugs. Prepared for teenagers, but good for adults.

Birth Control explains clearly and completely conception, birth and prevention of unwanted pregnancies. Important information for teenagers, and helpful for adults.

Your Blood Pressure. No one is immune to the risks of high blood pressure. Knowledge is your best defense, and this program has the information.

"Vita" means "Life" in Latin. We hope these programs make your life healthier and happier.

Retail price is just \$19.95.

Ask your Personal Software dealer for a demonstration, and for our new catalog. Call or write to find your nearest dealer. (408) 745-7841. Personal Software, Inc., 592 Weddell Dr., Sunnyvale, CA 94086.



PERSONAL SOFTWARE



TM—Vitafacts is a trademark of Medifacts Ltd., Apple is a trademark of Apple Computer, Inc.; PET is a trademark of Commodore Business Machines, Inc.; TRS-80 is a trademark of the Radio Shack Div. of Tandy Corp.

Circle 28 on inquiry card.

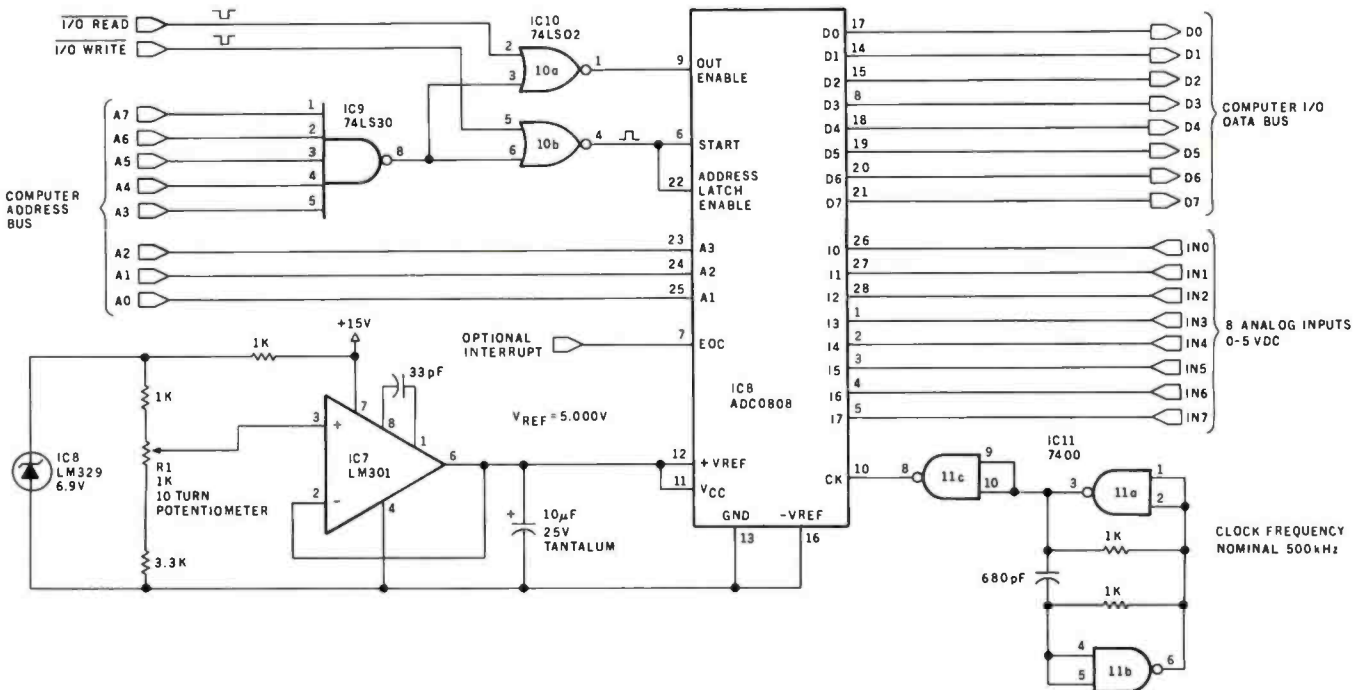

Figure 6: An 8-channel, 8-bit analog-to-digital (A/D) converter using a National Semiconductor ADC0808 data acquisition device.

FINALLY, Apple II[®] software for the discerning computerist, and the not-so-discerning beginner

AppleAids[™]

Little Tricks[™]

A series of carefully explained subroutines containing a potpourri of useful programming techniques in Integer Basic and Applesoft, such as specific key stroke identification, timing loops, disappearing question marks on input, no question marks on input, and many more. Cassette (24K) 14.95 Disk (32K) 19.95

Scroll Control[™]

Have you ever wondered why you cannot list an Integer Basic or Applesoft program one screen-page at a time? So have we, and we did something about it! Our machine language Scroll Control, hidden in RAM so as not to "bump" into your program, can be engaged or disengaged at a flick of the keyboard. Why be frustrated when instead you can control the scroll? Cassette 9.95 Disk 14.95

Compulaw[™] Series

*Alitax Estimator[™]

This Applesoft program, prepared under the supervision of an attorney, estimates disposable income after alimony and child support payments and federal taxes. For use by laymen and attorneys. 1980 tables. Cassette (24K) 9.95 Disk (32K) 14.95

*Pensioner[™]

A companion to Alitax Estimator in Applesoft designed to calculate the present value of a pension in states in which a pension is subject to division in marital dissolution cases. Cassette (24K) 9.95 Disk (32K) 14.95

N.J. res. add 5% sales tax

Apple II and Applesoft are registered trademarks of Apple Computer, Inc. Add \$1.50 /item, shipping and handling *professional, but not a substitute for legal advice

Form-It-Out[™]

A series of routines in Integer Basic and Applesoft containing detailed explanation and examples of programming techniques necessary to professionalize your screen output. Included are right and center justification, windowing, tabbing, cursor positioning among others. Cassette (24K) 14.95 Disk (32K) 19.95

Track & Sector List[™]

This is the ultimate disk utility. Instead of a catalog, have you ever seen those dreaded words "I/O ERROR"? Is all lost? NO! Now your disk may be saved. Also you can eliminate bad sectors, remove control characters imbedded in file names, and more. This machine language program is supplemented by extensive tutorial documentation worth its weight in gold. Disk only (32K) 29.95

Hex and Decimal Learning Tree[™]

My ABC's[™]

An early learning Integer Basic program using over one hundred and fifty high resolution graphic letters and pictures in a drill-and-practice format designed to develop identification of capital and small letters, and association of letters with pictures. Scoring capability allows monitoring. Child tested and teacher recognized. Cassette (48K) 14.95 Disk 19.95

Now I Can Rhyme[™]

A companion to My ABC's in Integer Basic. The child selects those high resolution pictures which rhyme. Score-keeping capability allows monitoring. Incorporates progressive levels of difficulty. Cassette (48K) 14.95 Disk (48K) 19.95

SOFTAGON
INCORPORATED

P.O. Box 774M
Morristown, NJ 07960
(201) 539-3770



BYTE^{T.M.} is available in microform

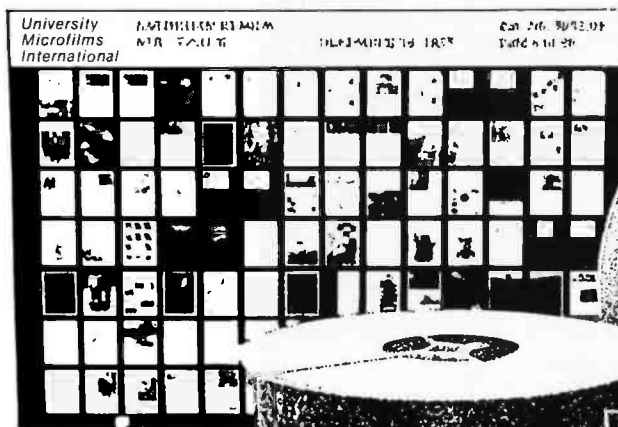

Please send me additional information.

Name _____

Institution _____

Street _____

City _____

State _____ Zip _____

University Microfilms International

300 North Zeeb Road
Dept. P.R.
Ann Arbor, MI 48106
U.S.A.

18 Bedford Row
Dept. P.R.
London, WC1R 4EJ
England

VOLTAGE REFERENCE

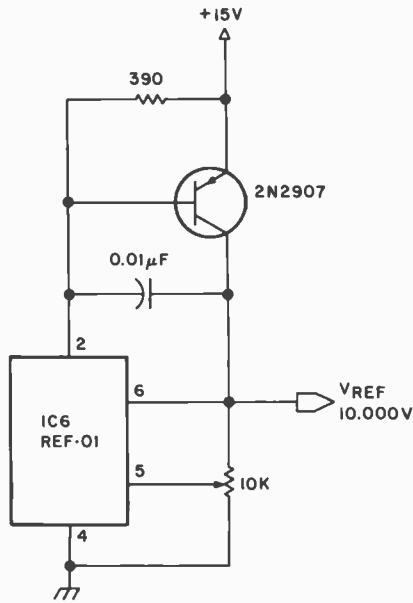

NOTE: COMPARATOR OUTPUT IS LOGIC 0 WHEN V_{IN} IS LESS THAN SETPOINT.
 OUTPUT IS LOGIC 1 WHEN V_{IN} IS EQUAL TO OR GREATER THAN SETPOINT.

SETPOINT ADJUST POTS

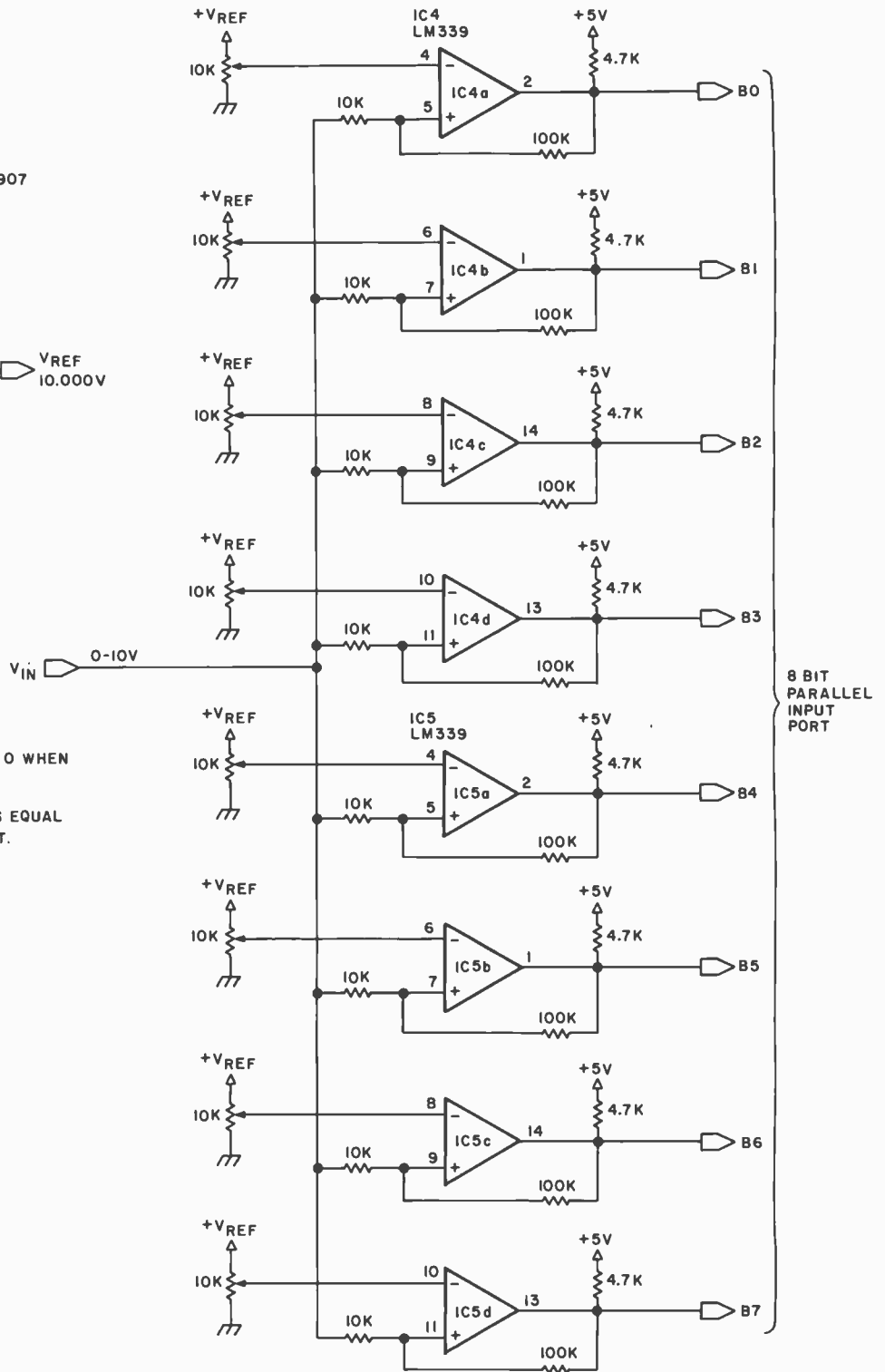

Figure 7: A discrete set-point-level detector. This method is cheaper than the method shown in figure 6 and can be used only when it is necessary to detect a small number of temperature ranges. The eight comparators on the right-hand side of the figure are wired to have their outputs go from logical 0 to logical 1 when a certain temperature (determined by the position of the 10 K potentiometer) is exceeded. The status of the eight bits can be used to determine what range of temperature the interface is currently in. The voltage reference integrated circuit REF-01 (IC1) may be obtained from Precision Monolithics, 1500 Space Park Dr, Santa Clara CA 95050.

DELTA IS READY . . .

WITH SYSTEMS AND SOFTWARE!

. . . Feel Free to Mix and Match

SYSTEM 1



\$1750.00

Twin Mini W/32K



\$139.00

Leedex Monitor



\$110.00

Keyboard



\$499.00

Base 2

SYSTEM 2

MULTIUSER CAPABLE



\$1650.00

32K S-100 Mainframe



\$775.00

T/V 912 Terminal



\$1750.00

TI 810



\$1350.00

**1 Megabyte
Double Density Storage**

SYSTEM 3

MULTIUSER CAPABLE



\$1950.00

64K S-100 Mainframe



\$985.00

T/V 920 Terminal



\$3450.00

Diablo 1620



\$1850.00

**2 Megabyte
Quad Density Storage**

SYSTEM 4

MULTIUSER

† (Dealers Only)



Desk Enclosure



32 Megabyte Disk



AT&T Model 300

Software:

CPM 1.4 \$115.00
CPM 2.0 \$150.00
MPM MULTI-USER . . . \$350.00

CBASIC \$115.00
MBASIC \$300.00
FORTRAN \$395.00
COBAL \$625.00
PASCAL \$265.00

WORDSTAR \$495.00
ACCTS. PAYABLE . . . \$699.00
ACCTS. RECEIVABLE . . \$699.00
GENERAL LEDGER . . . \$899.00
SUPERSORT \$225.00

DATABASE \$150.00
INVENTORY \$440.00
QSORT \$ 95.00
NAD \$ 79.00
LETTERRIGHT \$180.00

West:

DELTA PRODUCTS

1653 E. 28th Street
Long Beach, Calif. 90806
Tel: (213) 595-7505

Circle 31 on Inquiry card.



Telex: 182-126 DELTMAR SGHL

East:

DELTA PRODUCTS

1254 South Cedar Road
New Lenox, Illinois 60451
Tel: (815) 485-9072

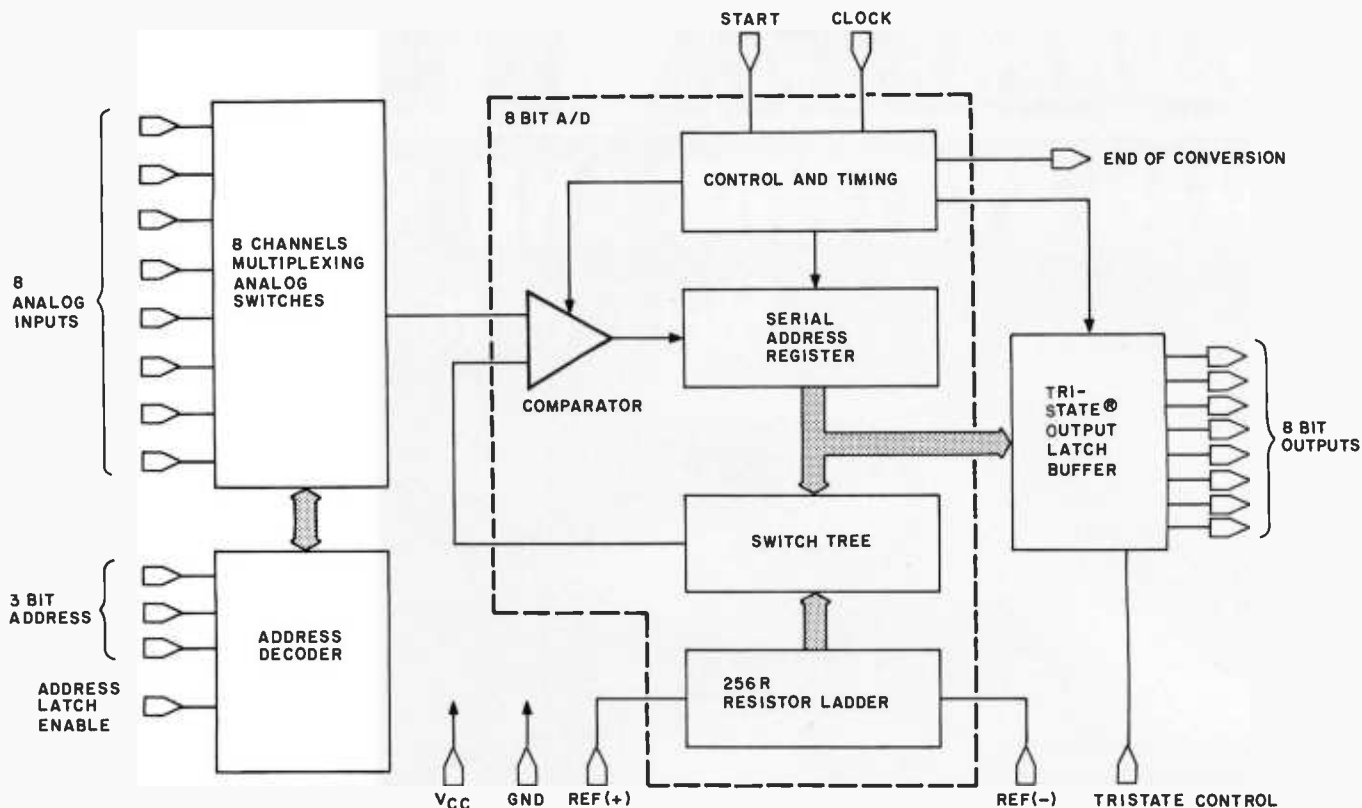

Figure 8: National Semiconductor's ADC0808/0809 CMOS data acquisition system. The 8-bit converter uses successive approximations. The device interface is to most 8-bit microprocessors.

Text continued from page 50:
the added satisfaction that everything is working correctly.

Back to Roger's Visit

Roger studied the stove very carefully. He was surprised at the simplicity of the idea of supplemental wood heat, but somewhat aghast at the overall complexity of the entire system. The concept of computer control did not concern him in the least but I sensed that my apparent independence from OPEC fostered a little competitive jealousy.

"What about wood? You still will have to get wood for the stove," Roger commented, pointing out a possible serious limitation.

"I'm surprised you didn't notice when you drove in. There are eight cords of wood piled outside. I don't expect to use them all this winter. Wood, unlike oil, is one of those things you can easily stockpile if you have enough storage space."

"Oh yeah, I did notice a few piles beside the driveway."

Roger was perplexed. He had obviously begun to believe the petroleum company propaganda. The thought of missing an oil delivery meant total destruction of civilization

as far as he was concerned. But he just could not believe that the addition of a wood stove meant independence. Suddenly he smiled as he thought of a sobering reality that I might have overlooked.

"You have to keep the circulator pumps running when the stove is going, right? And if the fire is real hot you may in fact need the blowers on as well?"

"Sure, why?"

Roger had found the Achilles' heel of my heating system. The Hydrostove as I had it configured needed power to run all the pumps and blowers. The actual heat might come from a wood fire, but distribution of the heat throughout the house depended upon the local electric utility. Roger quickly commented, "What happens if the power goes out?"

"Well, I suppose I should be concerned, but I'll have four or five minutes to react."

Roger laughed. "React to what? Living in a steam bath?"

"Perhaps I should show you. Follow me." I led Roger out of the cellar into the garage. In one corner was a large mechanical contraption, part of which was a two-cylinder

engine. Pipes and wires came to it from different directions, all converging at a central control box adjacent to the motor. Without explaining the intricate details involved with this permanent installation (the heating system was enough for Roger this time) I said, "If the utility power goes out, I throw the emergency transfer switch and start my 5-kilowatt generator. It's large enough to run the whole house and then some."

Hesitating, then striking out with one last effort, "You still need gasoline and that doesn't look like a very big tank."

"Sorry Roger, I thought of that too. This particular unit runs on both gasoline and propane. There's a 100-gallon propane tank outside the garage just for the generator"

"I give up!"

It is just as well that he did. Eventually he would notice the trench going across the driveway from the house to the new garage. When he is installing the wiring for it I hope he doesn't ask why I am running insulated copper pipes underground across to the garage.

NEXT MONTH: Investigate the new Intel 8088 processor and build your own five-chip computer. ■

26 MEGABYTES

\$4995.



DRIVE A HARD BARGAIN!

Suddenly, S-100 microcomputer systems can easily handle 100 million bytes. Because Morrow Designs™ now offers the first 26 megabyte hard disk memory for S-100 systems—the DISCUS M26™ Hard Disk System.

It has 26 megabytes of useable memory (29 megabytes unformatted). And it's expandable to 104 megabytes.

The DISCUS M26™ system is delivered complete—a 26 megabyte hard disk drive, controller, cables and operating system—for just \$4995. Up to three additional drives can be added, \$4495 apiece.

The DISCUS M26™ system features the Shugart SA4008 Winchester-type sealed media hard disk drive, in a handsome metal cabinet with fan and power supply.

The single-board S-100 controller incorporates intelligence to supervise all data transfers, communicating with the CPU via three I/O ports (command, status, and data). The controller has the ability to generate interrupts at the completion of each command to increase system throughput. There is a 512 byte sector buffer on-board. And each sector can be individually write-protected for data base security.

The operating system furnished with DISCUS M26™ systems is the widely accepted CP/M* 2.0.

See the biggest, most cost-efficient memory ever introduced for S-100 systems, now at your local computer shop. If unavailable locally, write Morrow Designs™ 5221 Central Avenue, Richmond, CA 94804. Or call (415) 524-2101, weekdays 10-5 Pacific Time.

*CP/M is a trademark of Digital Research.

Circle 32 on Inquiry card.

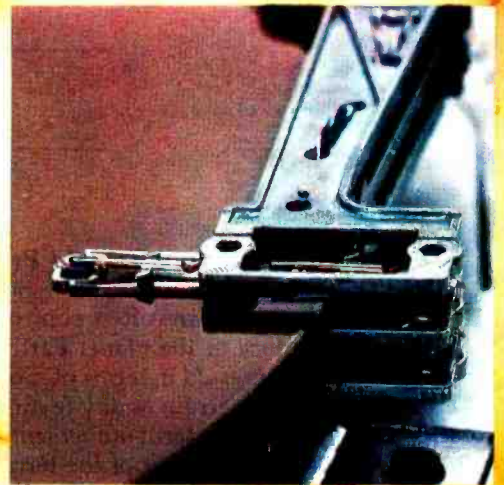

MORROW DESIGNS™
Thinker Toys™

Solving Problems Involving Variable Terrain

Part 1: A General Algorithm

Scott T Jones
271 NW 38th St
Boca Raton FL 33431

A General Definition of Terrain Problems

In business, in industry, and especially in conflict simulation, problems are often confronted that involve terrain, the surface of the planet Earth. These problems can usually be expressed in terms of movement on a map. This article defines terrain as any feature on the map that affects movement. The term *movement cost* will be defined as the quantitative effect of the terrain on movement.

An example of a hiker traveling cross-country from one town to another town will be used. The hiker may travel one mile across level ground in 15 minutes, while requiring 30 minutes to travel one mile when the ground is sloping gradually upward. It can be said that the *movement cost* for the terrain called level ground is one, while the movement cost of the terrain called upward-sloping ground is two. Here the movement cost is in terms of time.

For another example, consider a construction company building a road. The cost to build one mile of roadway over solid ground might be \$100,000, while the cost to build one mile of road over marshy ground might be \$500,000. Thus, you can say that the movement cost is one for solid terrain and five for marshy terrain. In this case, the movement cost is expressed in terms of money.

In both examples, there is an existing problem of moving from one point to another across a terrain map while incurring the minimum movement cost. Now examine another variation of this problem.

Consider a cable television company that is investigating the extension of underground coaxial cables out to a new area. It is known that these new cables will provide a fixed return on investment due to the increased number of customers. Therefore, only a fixed amount of money can be spent to place these cables. Using a map of the terrain and the known costs of placement over the various types of terrain to be encountered, the company can decide whether the extension is feasible.

The purpose of this article is to describe a general solution to these and other related problems.

Representing Generalized Terrain Problems

The first step in solving a terrain problem is to superimpose a grid on the map that is to be used. This will allow you to refer to each location on the map via its coordinates and identify a particular type of terrain with each location.

For simplicity, a standard rectangular grid and coordinate system will be utilized. The map is now a matrix of squares that can be referred to by their row and column in the matrix. The size of the squares should be chosen so that each square effectively has only one type of terrain in it.

The second step is to determine the movement cost for each type of terrain. This requires that a study be made to determine the type of cost involved in the problem. This cost must then be scaled so the movement-cost figure for

Text continued on page 62

6809 PROCESSING POWER!

The Percom SBC/9™. Only \$199.95.

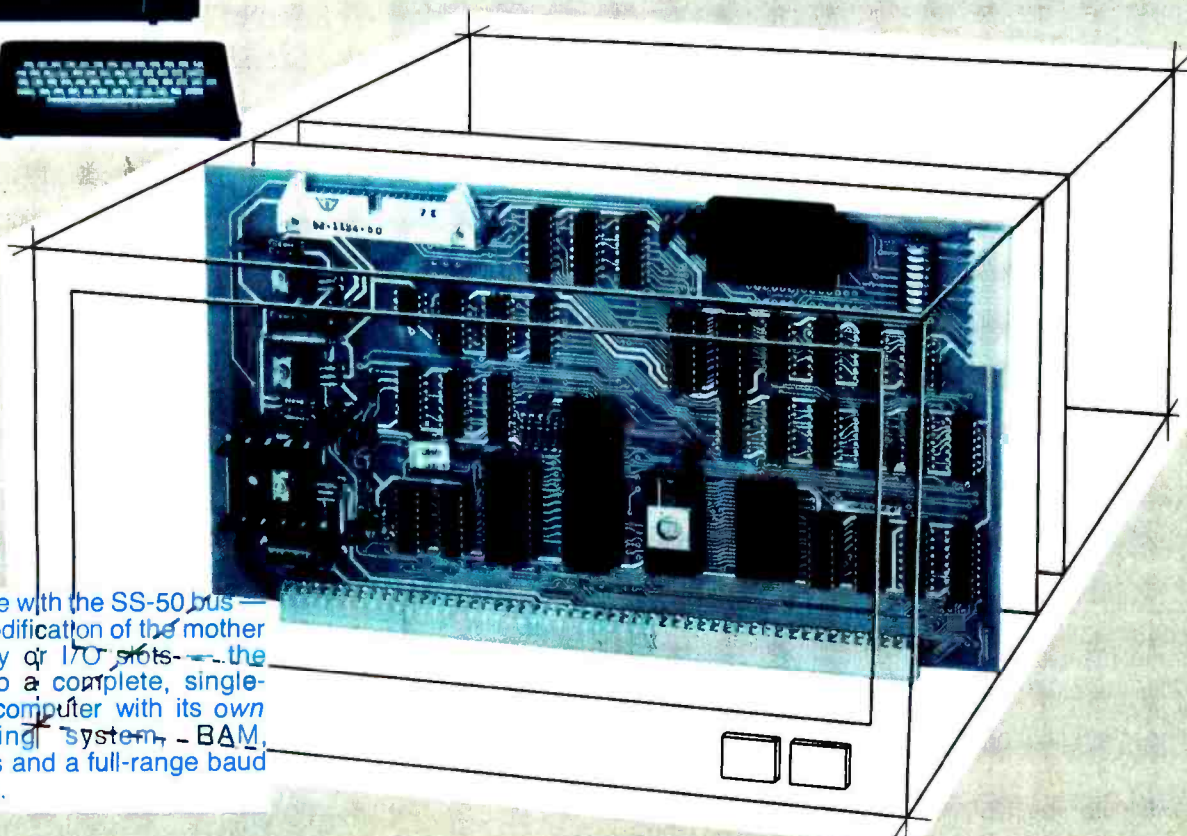

Fully compatible with the SS-50 bus — requiring no modification of the mother board, memory or I/O slots — the SBC/9™ is also a complete, single-board control computer with its own ROM operating system, BAM, peripheral ports and a full-range baud clock generator.

Make the SBC/9™ the heart of your computer and put to work the most outstanding microprocessor available, the 6809.

the Mighty 6809

Featuring more addressing modes than any other eight-bit processor, position-independent coding, special 16-bit instructions, efficient argument-passing calls, autoincrement/autodecrement and more, it's no wonder the 6809 has been called the "programmer's dream machine."

Moreover, with the 6809 you get a microprocessor whose programs typically use only one-half to two-thirds as much RAM space as required for 6800 systems, and run faster besides.

And to complement the extraordinary 6809, the Percom design team has developed PSYMON™, an extraordinary 6809 operating system for the SBC/9™.

PSYMON™ — Percom SYstem MONitor

Although PSYMON™ includes a full complement of operating system commands and 15 externally callable "™ trademark of Percom Data Company, Inc.

utilities, what really sets PSYMON™ apart is its easy hardware adaptability and command extensibility.

For hardware interfacing, you merely use simple, specific device driver routines that reference a table of parameters called a Device Control Block (DCB). Using this technique, interfacing routines are independent of the operating system.

The basic PSYMON™ command repertoire may be readily enhanced or modified. When PSYMON™ first receives system control, it initializes its RAM area, configures its console and then 'looks ahead' for an optional second ROM which you install in a socket provided on the SBC/9™ card. This ROM contains your own routines that may alter PSYMON™ pointers and either subtly or radically modify the PSYMON™ command set. If a second ROM is not installed, control returns immediately to PSYMON™.

- Provision for multi-address, 8-bit bidirectional parallel I/O data lines for interfacing to devices such as an encoded keyboard.
- A serial interface Reader Control output for a cassette, tape punch/reader or similar device.
- An intelligent data bus: multi-level data bus decoding that allows multiprocessing and bus multiplexing of other bus masters.
- Extended address line capability — accommodating up to 16 megabytes of memory — that does not disable the on-board baud rate clock or require additional hardware in I/O slots.
- On-board devices which are fully decoded so that off-card devices may use adjoining memory space.
- Fully buffered address, control and data lines.

The SBC/9™, complete with PSYMON™ in ROM, 1K of RAM and a comprehensive users manual™ costs just \$199.95.

PERCOM

PERCOM DATA COMPANY, INC.
211 N. KIRBY GARLAND, TEXAS 75042
(214) 272-3421

Percom 'peripherals for personal computing'

To place an order or request additional literature call toll-free 1-800-527-1592. For technical information call (214) 272-3421. Orders may be paid by check, money order, COD or charged to a VISA or Master Charge account. Texas residents must add 5% sales tax.

Circle 25 on inquiry card.

PRICES AND SPECIFICATIONS SUBJECT TO CHANGE WITHOUT NOTICE.

Welcome to Percom's Wide World

SS-50 Bus LFD-400™ and LFD-800™ Systems

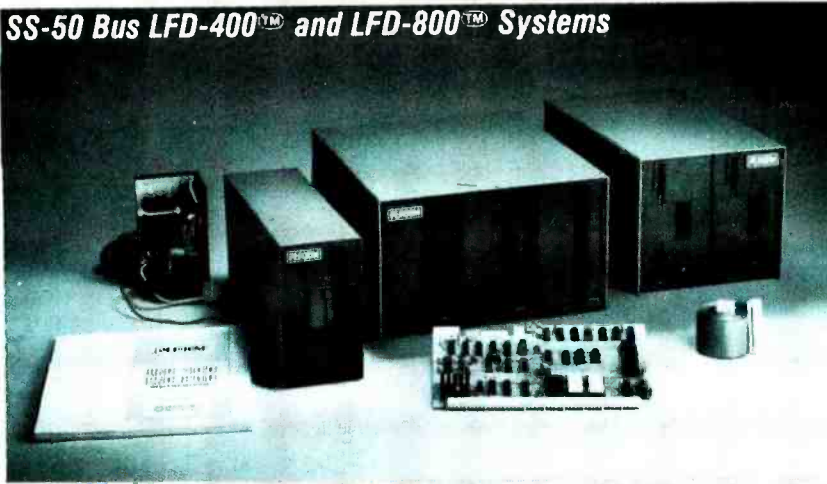

Each LFD mini-disk storage system includes:

- drives with integral power supplies in an enamel-finished enclosure
- a controller/interface with ROM operating system plus extra ROM capacity
- an interconnecting cable
- a comprehensive 80-page users manual

Circle 34 on Inquiry card.

Low-Cost Mini-Disk Storage in the Size You Want.

Percom LFD mini-disk drive systems are supplied complete and ready to plug in the moment they arrive. You don't even have to buy extra memory. Moreover, software support ranges from assembly language program development aids to high-speed disk operating systems and business application programs.

The LFD-400™ and -400EX™ systems and the LFD-800™ and -800EX™ systems are available in 1-, 2- and 3-drive configurations. The -400, -400EX drives store 102K bytes of formatted data on 40-track disks, and data may be stored on either surface of a disk. The -800, -800EX drives store 200K bytes of formatted data on 77-track disks.

The LFD-1000™ systems (not pictured) have dual-drive units which store 800K bytes on-line. The LFD-1000™ controller accommodates two drive systems so that a user may have as much as 1.6M bytes on-line.

Mini-disk storage system prices:

MODEL	1-DRIVE SYSTEM	2-DRIVE SYSTEM	3-DRIVE SYSTEM
For the SS-50 Bus:			
LFD-400™	\$ 599.95	\$ 999.95	\$1399.95
LFD-800™	895.95	1549.95	2195.95
For the EXORciser® Bus:			
LFD-400EX™	\$ 649.95	\$1049.95	\$1449.95
LFD-800EX™	945.95	1599.95	2245.95
LFD-1000™	(dual) \$2495.00	(quad) \$4950.00	—

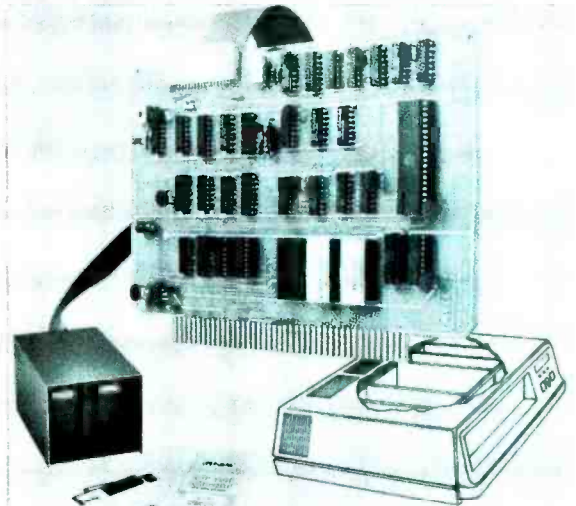

EXORciser® Bus LFD-400EX™, -800EX™ Systems

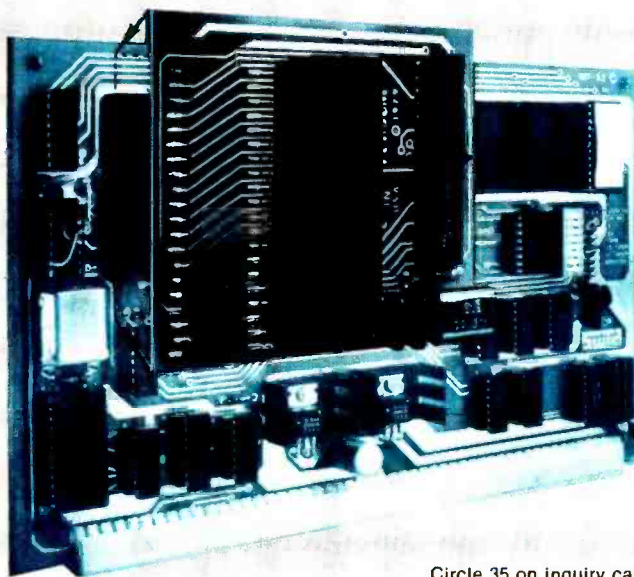

Circle 35 on inquiry card.

Upgrade to 6809 Computing Power. Only \$69.95

Although designed with the SWTP 6800 owner in mind, this upgrade adapter may also be used with most other 6800 and 6802 MPUs. The adapter is supplied assembled and tested, and includes the 6809 IC, a crystal, other essential components and user instructions. Restore your original system by merely unplugging the adapter and a wire-jumpered

DIP header, and re-inserting the original components. Also available for your upgraded system is PSYMON™ (Percom SYstem MONitor), the operating system for the Percom 6809 single-board computer. PSYMON™ on 2716 ROM costs only \$69.95. On diskette (source and object files), only \$29.95.

Data Terminal & Two-Cassette Interface — the CIS-30+



Circle 36 on Inquiry card.

- Interface to data terminal and two cassette recorders with a unit only 1/10 the size of SWTP's AC-30.
- Select 30, 60 or 120 bytes per second cassette data encoding. Dependable self-clocking operation.
- Ordinary functions may be accomplished with 6800 Mikbug® monitor
- Optional mod kits make CIS-30+ work with any microcomputer. (For MITS 680b, ask for Tech Memo TM-CIS-30+-09.)
- KC Standard/Bi-Phase-M (double frequency) cassette data encoding. Dependable self-clocking operation.
- Ordinary functions may be accomplished with 6800 Mikbug® monitor

Prices: Kit, \$79.95; Assembled, \$99.95. Prices include a comprehensive instruction manual. Also available: Test Cassette, Remote Control Kit (for program control of recorders), IC Socket Kit, MITS 680b mod documentation and Universal Adapter Kit (converts CIS-30+ for use with any computer).

of 6800 Microcomputing.

Circle 38 on inquiry card.

6800/6809 SOFTWARE

System Software

6800 Symbolic Assembler — Specify assembly options at time of assembly with this symbolic assembler. Source listing on diskette \$29.95

Super BASIC — a 12K extended random access disk BASIC for the 6800 and 6809. Supports 44 commands and 31 functions. Interprets programs written in both SWTP 8K BASIC (versions 2.0, 2.2 & 2.3) and Super BASIC. Features: 9-digit BCD arithmetic, Print Using and Linput commands, and much more. Price \$49.95

TOUCHUP™ — Modifies TSC's Text Editor and Text Processor for Percom mini-disk drive operation. Supplied on diskette complete with source listing \$17.95

Operating Systems

INDEX™ — This easy-to-use disk-operating and file management system for 6800 microcomputers is fast. I/O devices are serviced by interrupt request. INDEX™ accesses peripherals the same as disk files — new devices may be added without changing the operating system. Other features: unlimited number of DOS commands may be added • over 60 system entry points • display only those files at or above user-specified file activity level • versions available for SWTP MF-68, Smoke's BFD-68 and Motorola's EXORciser*. Price \$99.95

MINIDOS-PLUSX™ — An extension of the original MINIDOS™ for LFD-400™ mini-disk systems. MINIDOS-PLUSX™ manipulates files by six-character names. Supports up to 31 files. Resident commands include Initialize, Save, Allocate, Load, Files (directory list), Rename and Delete. Supplied on 2708 ROM with a minidiskette that includes transient utilities such as Copy, Backup, Create, Pack and Print Directory. Price \$34.95

PSYMON™ — Percom SYstem MONitor for the Percom single-board/SS-50-bus-compatible 6809 computer accommodates user's application programs with any mix of peripherals **without** modifying programs. PSYMON™ also features character echoing to devices other than the communicating device, sophisticated register and memory dump routines and more. Price (on 2716 ROM) \$69.95

WINDEX™ — Described in detail elsewhere on this page.

Business Programs

General Ledger — For 6800/6809 computers using Percom LFD mini-disk storage systems. Requires little or no knowledge of bookkeeping because the operator is prompted with non-technical questions during data entry. General Ledger updates account balances immediately — in real time, and will print financial statements immediately after journal entries. User selects and assigns own account numbers; tailors financial statements to firm's particular needs. Provides audit trail. Runs under Percom Super BASIC. Requires 24K bytes of RAM. Supplied on minidiskette with a comprehensive users manual. Price \$199.95

FINDER™ — This general purpose data base manager is written in Percom Super BASIC. Works with 6800/6809 computers using Percom LFD-400™ mini-disk drive storage systems. FINDER™ allows user to define and access records using his own terminology — customize file structures to specific needs. Basic commands are New, Change, Delete, Find and Pack. Add up to three user-defined commands. FINDER plus Super BASIC require 24K bytes of RAM. Supplied on minidiskette with a users manual. Price \$99.95

Mailing List Processor — Powerful search, sort, create and update capability plus ability to store 700 addresses per minidiskette make this list processor efficient and easy to use. Runs under Percom Super BASIC. Requires 24K bytes of RAM. Supplied on minidiskette with a users manual. Price \$99.95

From the Software Works

Development and debugging programs for 6800 μ Cs on diskette:

Disassembler/Source Generator	\$30.95
Reloc'ing Disas'mblr/Segmented Text Gen	\$40.95
Disassembler/Trace	\$25.95
Support Relocator Program	\$25.95
Relocating Assembler/Linking Loader	\$55.95
SmithBUG** (2716 EPROM)	\$70.00

Circle 37 on inquiry card.

1/2-Price Special on Hemenway Software!

CP/68 \ddagger disk operating system	\$ 49.97
STRUBAL+ \ddagger compiler	\$124.97
EDIT68 text editor	\$ 19.97
MACRO-Relocating Assembler	\$ 39.97
Linkage Editor (LNKEDT68)	\$ 24.97
Cross Reference utility	\$ 14.97

™ trademark of Percom Data Company, Inc.

* trademark of Motorola Corporation

‡ trademark of Hemenway Associates Company

**SmithBUG is a trademark of the Software Works Company

This programmable VIDEO DISPLAY CONTROLLER

processes display changes instantly in real-time. The Electric Window™ resides completely in main memory so control is accomplished by direct MPU access to the character-store memory and display control registers. Peer at the screen and you look right into video display memory space while you input and manipulate text — an indispensable feature for efficient screen editing and word processing. The Electric Window™. It's worth looking into. Features include:

- Programmable CRT controller chip that provides extraordinary versatility in software control of horizontal and vertical formatting, cursor positioning, scrolling and Start/Reset functions.
- A standard ASCII 128-unit ROM character generator which generates easy-to-read 7 x 12 dot-matrix characters with lower case descenders. Plus
- Provision for an optional ROM that may be programmed for special symbols or characters.
- Resides entirely in 2K on-board RAM mapped into main memory.

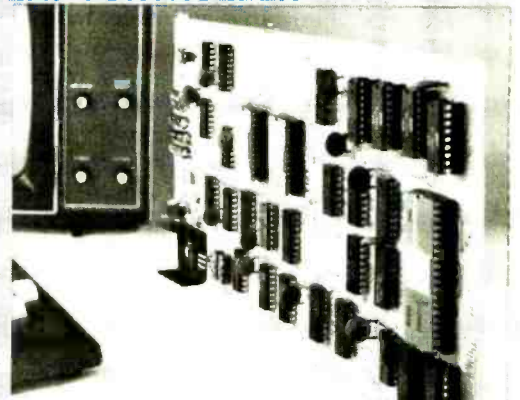

The Electric Window.™ Worth Looking Into. \$249.95

- An optional software driver program called WINDEX™ that complements the fast, hardware-implemented functional capability of the controller. WINDEX™ will auto-link to PSYMON™, the monitor for the Percom SBC/9™ single board computer. The ROM version of WINDEX™ costs \$39.95. The minidiskette version (with source and object files) sells for \$29.95.
- Up to 24 80-character lines — programmable.
- Program control of display highlighting.
- Program interlaced or non-interlaced scan.
- Use either standard video monitor or modified tv.

Now Available! the SBC/9™ MPU/Control Computer

(Single-Board-Computer/6809) — stands alone as a control computer, but also compatible with the SS-50 bus for use as an MPU card. Includes PSYMON™ (Percom System MONitor) in a 1K ROM and provides for additional 1K of ROM. Also includes 1K of RAM. Features: Super Port — provision for multi-address, 8-bit bidirectional data lines • an intelligent data bus for multi-level data bus decoding • an on-board 110-baud to 19.2 kbaud clock generator • extended address capability — to 16 megabytes — without disabling baud clock or adding hardware. And much more. Supplied with PSYMON™ and comprehensive users manual. Price \$199.95

See full page ad elsewhere in this magazine for all of the SBC/9™ features.

Full Feature Prototyping PC Boards

All of the features needed for rapid, straightforward circuit prototyping. Use 14-, 16-, 24- and 40-pin DIP sockets • SS-50 bus card accommodates 34- and 50-pin ribbon connectors on top edge, 10-pin Molex connector on side edge • I/O card accommodates 34-pin ribbon connector and 12-pin Molex on top edge

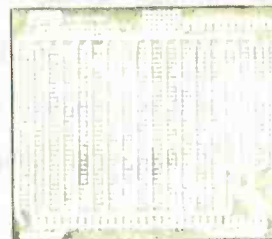

I/O Bus Card: \$14.95

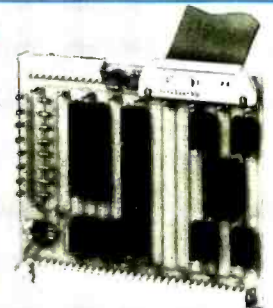

- I/O card is 1-1/4 inches higher than SWTP I/O card • interdigitated power conductors • contacts for power regulators and distributed capacitance bypassing
- use wire wrap, wiring pencil or solder wiring • tin-lead plating over 2-oz copper conductors wets quickly, solders easily
- FR4-G10 epoxy-glass substrate.

Circle 40 on inquiry card.

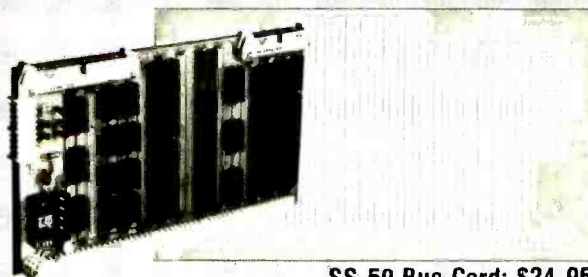

SS-50 Bus Card: \$24.95

To place an order or request additional literature call toll-free 1-800-527-1592. For technical information call (214) 272-3421. Orders may be paid by check, money order, COD or charged to a VISA or Master Charge account. Texas residents must add 5% sales tax.

PRICES AND SPECIFICATIONS SUBJECT TO CHANGE WITHOUT NOTICE.



PERCOM DATA COMPANY, INC.
211 N. KIRBY GARLAND, TEXAS 75042
(214) 272-3421

Text continued from page 58:

each type of terrain is an integer multiple of the cost unit.

The movement cost for any one square on the terrain map is considered to be the cost to *enter* the terrain area represented by that square. If you are currently in square X, and wish to move to square Y, then consider the cost of moving *into* square Y as the movement cost for square Y. The movement cost of square X, the current square, has no effect on the calculation; the movement cost is affected only by the nature of the terrain you are about to enter.

The result of determining movement costs is a cost matrix, C, where $C(I,J)$ is the movement cost of the terrain in the square in the I-th row and J-th column of the map. For all terrain which is effectively impossible to enter, or for which entrance is prohibited, $C(I,J) = 0$ is assigned.

The third step is to generate *terrain masks*. First determine *max*, which is the maximum value found among all the movement costs in C. Then for all values k such that $1 \leq k \leq C_{max}$ you define the terrain mask T_k where $T_k(I,J)$ is 1 if $C(I,J) = k$, and $T_k(I,J) = 0$ otherwise.

Now you should define a *scatter function* for the problem. The function will produce scatter mappings for use with the terrain masks generated above. The input to this

W W W W W W W W	blank	=	Clear
W W R R W W			
W R R W	R	=	Rough
W R J J J W	J	=	Jungle
W J J J W			
W J W W			
W W W W W	W	=	Water
W W W W W W W W			

Figure 1: Map of a small island with clear, rough, and jungle terrain. The map is represented on a rectangular grid.

0 0 0 0 0 0 0 0	
0 0 2 2 1 1 0 0	
0 1 2 2 1 1 1 0	
0 1 2 3 3 3 1 0	C
0 1 3 3 3 1 1 0	
0 1 3 1 1 1 0 0	
0 1 1 1 0 0 0 0	
0 0 0 0 0 0 0 0	

Figure 2: A movement cost matrix for the island map of figure 1.

0 0 0 0 0 0 0 0	0 0 0 0 0 0 0 0	0 0 0 0 0 0 0 0
0 0 0 0 1 1 0 0	0 0 1 1 0 0 0 0	0 0 0 0 0 0 0 0
0 1 0 0 1 1 1 0	0 0 1 1 0 0 0 0	0 0 0 0 0 0 0 0
0 1 0 0 0 0 1 0	0 0 1 0 0 0 0 0	0 0 0 1 1 1 0 0
0 1 0 0 0 1 1 0	0 0 0 0 0 0 0 0	0 0 1 1 1 0 0 0
0 1 0 1 1 1 0 0	0 0 0 0 0 0 0 0	0 0 1 0 0 0 0 0
0 1 1 1 0 0 0 0	0 0 0 0 0 0 0 0	0 0 0 0 0 0 0 0
0 0 0 0 0 0 0 0	0 0 0 0 0 0 0 0	0 0 0 0 0 0 0 0
T1	T2	T3

Figure 3: The three terrain masks that will be superimposed on the movement cost matrix of figure 2.

function is a boolean array of starting positions (1, if yes; 0, if no). The output is another boolean array of ending positions of moves of distance one from the starting positions. Since distance is a factor, you must define a *metric*, or distance function, for this problem.

Example of the Procedure

In figure 1, there is a map of a small island with terrain of three types: clear, rough, and jungle. The map has been placed on an 8 by 8 rectangular grid, and each grid square is clearly identified as being a single type of terrain.

Let us return to our hiker traveling cross-country on foot. Suppose that he requires 10 minutes to travel through one square of clear terrain, 20 minutes for rough terrain, and 30 minutes for jungle terrain. The terrain type "water" is effectively impassable in this problem. Thus, the movement cost is in terms of 10-minute periods of time, and you can construct the cost matrix C as shown in figure 2. Since 3 is the maximum movement cost value found in C, you will have three terrain masks: T1, T2, T3 as shown in figure 3.

Using a rectangular grid, there is a choice between two obvious distance functions with strictly integer values. The first distance function is the "city" metric, which defines the distance between points (a,b) and (c,d) as $|a-c| + |b-d|$ where $|x|$ is the absolute value of x . This function derives its name from the fact that in the rectangular system of streets found in a city, no movement is allowed diagonally through blocks. All distances are in terms of the net distance north or south added to the net distance east or west.

The second distance function is the "square" metric, which defines the distance between points (a,b) and (c,d) as the maximum of $|a-c|$ and $|b-d|$. Its name is derived from the fact that the shape of the area containing all squares that are N or less units distant is a square, for any integer N .

Scatter Functions

Now it is necessary to define scatter functions CSC and SSC for the "city" and "square" distance functions, respectively. Let A be a matrix the same as C; that is, an 8 by 8 matrix. Let $A(I,J) = 0$ for all I and J, except for the one location on the map that is to be used as the starting position. $A(I,J)$ will be 1 for the starting location. Matrix A is the input to the scatter function. B will be designated as the output matrix. The notation $X(A)$ to represent the results of applying the function X to the matrix A will also be used. For the city distance function, the function

Oregon Software Introduces

The Pascal Software Tool

OMSI PASCAL V1.2™

We at Oregon Software are pleased to announce that V1.2, our improved version of Pascal-1, is now available. The value of Pascal in computer software design is becoming widely recognized, and our V1.2 version contains significant enhancements in ease of operation and reliability.

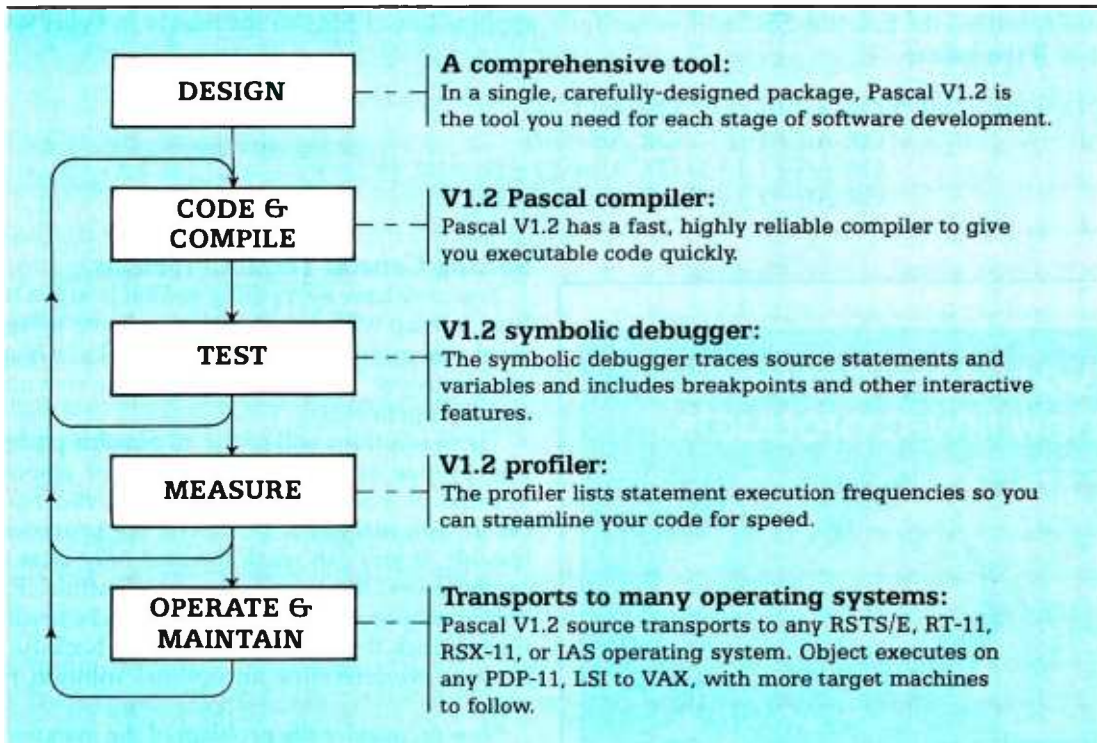

Oregon Software guarantees the performance of Pascal V1.2. We also include in the purchase price our technical support during the first year of operation.

Write or call for more details about Pascal V1.2. Ask to see our user manuals, example programs, and benchmarks.

PDP, RSTS/E, RSX, VAX, and IAS are trademarks of Digital Equipment Corporation.

Oregon Software

2340 S.W. Canyon Road • Portland, Oregon 97201 • (503) 226-7760 • TWX: 910-464-4779

DISTRIBUTORS

Australia: Sydney;
Network Computer Services
390-3677

Canada: Vancouver;
Valley Software
(604) 524-9741

England: Stafford;
Hours Computing Ltd.
0785-44221

Japan: Tokyo;
Rikei Corporation
03-345-1411

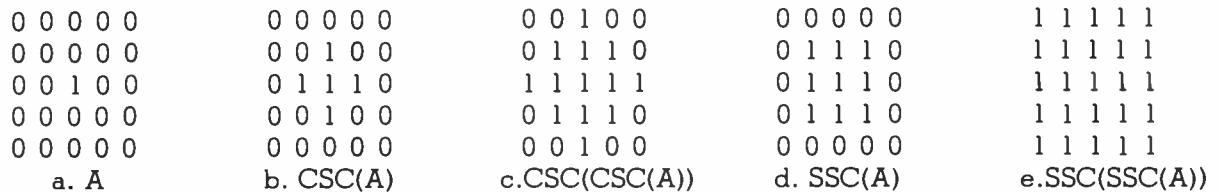

Figure 4: Figure 4a is an example of a starting matrix, A. Figure 4b represents the matrix after the CSC (city) scatter function has been applied. The CSC function is then applied a second time to obtain the matrix in figure 4c. Figures 4d and 4e represent the results obtained after applying the SSC (square) scatter function to the matrix in figure 4a once and twice.

CSC will assign to each element of B the value:

$$B(I,J) = \text{CSC}(A(I,J)) = A(I,J) \text{ OR } A(I,J+1) \\ \text{OR } A(I,J-1) \\ \text{OR } A(I+1,J) \text{ OR } A(I-1,J)$$

where OR represents the logical OR operation. For the square distance function, the function SSC will assign to each element of B the value:

$$B(I,J) = \text{SSC}(A(I,J)) = A(I,J) \text{ OR } A(I,J+1) \text{ OR } A(I,J-1) \\ \text{OR } A(I+1,J) \text{ OR } A(I-1,J) \\ \text{OR } A(I+1,J+1) \text{ OR } A(I+1,J-1) \\ \text{OR } A(I-1,J+1) \text{ OR } A(I-1,J-1)$$

In both cases, all matrix elements $A(I,J)$ that lie outside the matrix A are to be considered zero, such as $A(0,0)$.

Figure 4a gives an example of a 5 by 5 starting matrix, A. Figure 4b represents the result of applying the CSC function to that matrix. In figure 4c, the result of applying CSC to the matrix in figure 4b can be seen. Figures 4d and 4e represent the matrices obtained after one and two applications of SSC to the matrix in figure 4a.



Now you can really expand your horizons with the tiny-c structured programming language. The tiny-c owner's manual (including 8080 and PDP-11 source code and tiny-c in C) is still just \$40. And we've added these new formats to really egg you on: TRS-80 Level II SYSTEM Format Cassette; CP/M Diskettes with 8080 Source; PDP-11 Diskette; North Star 5" Diskette; KIM and SYM cassettes. And there's more, all available for \$50 or less. Order your tiny-c owner's manual today and get the whole story. Call or write: tiny c associates, P.O. Box 269, Holmdel, N.J. 07733. (201) 671-2296.

You'll quickly discover tiny-c is all it's cracked up to be.

New Jersey residents include 5% sales tax. Visa and MasterCard accepted. Include charge plate number with order.



Solving General Terrain Problems

You now have everything needed to solve terrain problems: a map with a grid and coordinate system, a movement cost matrix, a set of terrain masks, a matrix of starting positions, and a distance function with associated scatter function.

These solutions will probe all possible paths, incrementing by one unit at a time until your resources are exhausted or your goal is reached. If you reach the goal before you run out of resources, the proposed journey is feasible; if you can reach the goal only after running out of resources, the proposal is not feasible. Furthermore, once a proposed journey is proven to be feasible, you can then retrace the path from the goal back to the starting position to determine an optimal solution to the problem.

Now reconsider the problem of the man walking on the island of figure 1. The city metric and the scatter function CSC will be used. Let the walker's starting point be the square (3,5) on the map in figure 1; that is the clear terrain in the third row and the fifth column. During the first 10 minutes the hiker will expend one unit of cost and can, therefore, move one square north to (2,5) or one square east to (3,6). The hiker cannot move south or west to (4,5) or (3,4) since he has not yet expended enough cost units. Figures 5 and 6a show his starting location matrix and his matrix of possible new locations after 10 minutes, since each of these positions requires only one more unit of movement cost. After another 10 minutes, the hiker can reach the clear terrain squares at (2,6) and (3,7) by moving from the squares reached after first 10 minutes. The hiker could also have reached the rough terrain square (3,4). This would be possible by moving west for 20 minutes from the starting position at square (3,5). All

MicroDaSys Software™ - CP/M™ Compatible

The Pencil Sharpener™ - Now with subscripts and superscripts! The form letter merge utility for the Electric Pencil II™. \$195. Order Code: PS1.

Osborne Accounting Packages. Complete CBASIC II source diskettes of the best accounting software at the lowest price. Accounts Payable, Receivable, Payroll and General Ledger. \$99 each. Order Codes: APO, ARO, PCO, GLO.

6800 and 6809 Cross Assemblers for 8080 and Z80 CP/M Systems. Full Mnemonic assemblers with complete options specification and output formatting. \$89 each. Order Codes: ASM68, ASM69.

For all software specify format: 8", 5" North Star, 5" Micropolis.

We Need Your Help!

An International Company Called MicroDaSys has designed a dynamite solution for the small businessman seeking a computer. We call it the "millie"™. It's a system that combines the absolute best business software available with fast, dependable hardware.

The "millie" is the smartest buy a small business can make. It comes with the most powerful accounting, word processing and applications software available. And to take advantage of that power, the "millie" uses the S-100 bus, eight inch disk drives and the universal CP/M operating system. It can be programmed in BASIC, FORTRAN, Pascal and dozens of other languages. Best of all, "millie" prices start at under \$3000. The one illustrated includes a reproduction-quality printer and full accounting and word processing software for just \$6995. "Millie" has been in use for over a year in the US, Europe, South America and Australia. It is a proven design, regularly updated as the state-of-the-art advances.

But an international company can't knock on doors. Without branch offices in every city of the US (and the world) we have the same problem as dozens of other computer manufacturers. We simply can't contact all of the small businessmen who could benefit from our "millie". That's where you come in.

We seek your help. Sell our "millie" as a complete, integrated system to your neighborhood businesses, universities, writers and other professionals. If

you're reading this magazine you probably have all the expertise required to demonstrate and sell "millies". All that's really required is the motivation to seek out prospective customers and the ability to present "millie's" features to them in a way most understandable to them. Put us in your customer's place.

We offer you a piece of the exciting computer market, the chance to work with the most sophisticated software and hardware available, and best of all, a handsome commission and no minimum purchase requirements (not even one!)

It's easy to sell "millies". You will be supported by an international advertising campaign, a dependable system made by a well known manufacturer, and the best documentation available. All you need is the enterprise to seek out new customers and provide them with the support they need (perhaps earning your own consulting fees) during and after installation. We will even supply you with potential sales leads in your area — Reader Service Questionnaires, Direct Mail Inquiries, and Telephone Responses. These are people who want you to sell them a "millie"! All you need to do is act!

You've got nothing to lose! There are absolutely no strings, no minimum purchases, no special degrees or instruction required, no retail store necessary. All that is required is the sincere desire to earn money selling our computers. Join the fascinating field of computer sales now. The market is ready if you are! Write or call today for your introductory sales package and complete info.



For distribution in the Netherlands contact:
Computer Programming International BV
Burg Penstraat 3, Postbus 288, 3740AG Baarn, Holland

* CP/M is a registered trademark of Digital Research Corp.

Circle 43 on inquiry card.

MicroDaSys S-100 Products

8P2SM I/O Card. Eight 8-bit parallel I/O ports with handshaking, one serial RS-232 I/O port, one modem I/O port. Kit \$149, Assembled \$199. Order Codes 8P2SMK, 8P2SMA.

MD690a S-100 6800 CPU card. 10K PROM space, 1K RAM, 2400 baud cassette interface, 2 Parallel I/O Ports. Kit \$198, Assembled \$258. Order Codes: MD690aK, MD690aA

New!

ColorMaster™ 80 × 25 Full Color Memory-mapped Video Board. Kit \$399, Assembled \$499. Order Codes: CMK, CMA.

4P4S I/O Card. Four 8 bit parallel I/O ports with handshaking, four serial RS-232 or TTL I/O ports. Kit \$199, Assembled \$249. Order Codes: 4P4SK, 4P4SA.

Super Z™ - The amazing system on a board. Z80 Processor, two parallel I/O ports, serial RS-232 I/O port, counter/timer, 2708/2716 EPROM, and 48K Dynamic Ram -All on one card! Assembled only \$950. Order Code: SZ.

Manuals for hardware and software are \$15, creditable towards purchase.

6809!

Single Board Computer



S-100 Compatibility, 6809 Computability

- 1K RAM • RS-232 level shifters
- 10K PROM space • 20 I/O lines
- Parallel keyboard input
- Memory-mapped video firmware
- Fully S-100 compatible (including 8080 type I/O)
- MONBUG II monitor included
- 2400 baud cassette interface

\$299 Assembled
\$239 Kit

Order Codes:
MD690bA
MD690bK

Disk Format:
(if applicable)

Please rush me the following...

Quantity	Order Code	Unit Price	Amount
			\$5
Shipping Total			

MicroDaSys P.O. BOX 36051, LOS ANGELES, CA 90036, USA
Dept B1 Phone: (213) 935-4555 TWX: 910-321-2378

NAME _____ Exp. Date: _____
COMPANY _____
ADDRESS _____
CITY _____ STATE _____ Calif. residents add 6%
ZIP _____

Check here for:
 Millie Sales Package

BUILDING BLOCKS OF THE FUTURE

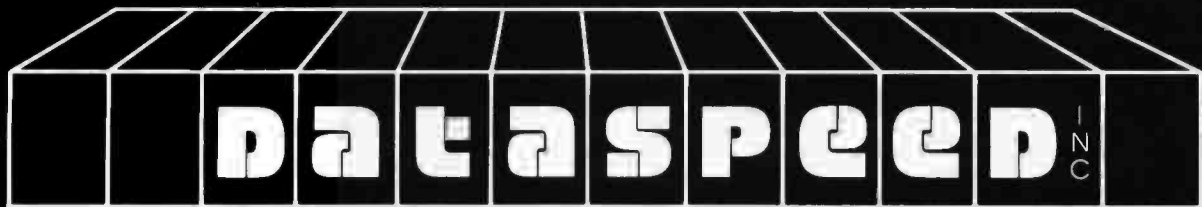

S-100 BUS PRODUCTS

THE CONDUCTOR™

A versatile dual density floppy disk controller. Backed up with dual density CP/M™ (\$150) and available NOW!!!

\$325 assembled

VIDEO CONTROLLER

Memory mapped 80 x 24 with dual character sets (programmable!) user rom space and HARDWARE SCROLLING. Firmware available.

\$349 assembled

DISK SYSTEMS

All the hardware you need for a COMPLETE floppy disk system. PLUS—FREE Osborne Accounting software. Just add CP/M and a computer

Single disk—**\$1149**

Dual **\$1849**

All DATASPEED products are fully assembled and tested and warranted.

DATASPEED, INC.,
1300 NOE ST.
SAN FRANCISCO
CA. 94131
(415) 641-8947

Heuristics

SpeechLink™

2000

Talk To Your Computer . . .

- Voice data entry to the Apple® computer
- Voice control of your Apple® system
- User variable vocabulary (64 words and up)
- Applesoft & Integer Basic compatible with or without disk operating system

Useful For . . .

- Collecting inventory data
- Running the Apple® as a terminal
- Controlling production test equipment (say "test 2")
- Menu selection of programs (say "stocks")
- Entering stock market data
- Educational programs for the kids (say "square")

See your computer dealer.
Model 2000 suggested retail price
\$259, model 20A \$189.

Heuristics
INC

1285 HAMMERWOOD AVENUE
SUNNYVALE, CALIFORNIA 94086
408/734-8532

Apple® is a registered trademark of Apple Computer Corporation

```
0 0 0 0 0 0 0 0
0 0 0 1 3 2 0 0
0 0 0 2 4 3 2 0
0 0 0 0 1 0 1 0
0 0 0 0 0 0 0 0
0 0 0 0 0 0 0 0
0 0 0 0 0 0 0 0
0 0 0 0 0 0 0 0
```

S3

Figure 8: The third scatter sum using the city scatter function (CSC) for the island example. All moves which are made must conform to the city metric (distance function).

scatter maps M_0 through M_k . S_k will be referred to as the k -th scatter sum. Note that $S_0 = M_0$. Figure 8 shows the third scatter sum for the function CSC.

The algorithm for finding an optimal path is as follows: beginning at your goal, follow a path of strictly increasing elements of S_n until you reach your starting position, choosing the most rapidly increasing path if more than one exists. Since all the possible locations in M_k are in M_{k+1} , for all k , the more quickly a location is reached from the starting point, the higher its value will be in each scatter sum.

For example, if the clear terrain square (4,7) was your goal, you would use the third scatter sum, S3, which is in figure 8. Following the movement restrictions imposed by the city function, you will consider only those locations given by the scatter of the current location to determine the next location on your path. Thus, you will choose your next location from the squares (4,8), (4,6), (5,7) and (3,7).

Square (3,7) will be chosen, since it has the maximum value in S3. In the same manner, squares (3,6) and (3,5) will be chosen so that your optimal path from starting point to goal is (3,5) to (3,6) to (3,7) to (4,7). In the same manner, you can find that the optimal path from (3,5) to (2,4) is by way of (2,5).

When you try to find the optimal path and there are, at some point between the goal and start, two or more possible locations from which to choose, you can randomly choose any one of them with equal success. This algorithm, therefore, will find an optimal path, but not necessarily the only such path.

In Part 1 I have discussed some general terrain problems and demonstrated a few solutions using a rectangular grid. This method is very easy to implement with two-dimensional boolean arrays and lends itself well to most of the problems that will be encountered. One notable exception, however, is the conflict simulation or "war game." These games are usually played on terrain maps of a battlefield, upon which a grid of hexagons is superimposed.

This hexagonal grid (or hex grid) resembles a honeycomb. It eliminates the need for two different metrics, since there are no diagonals, but it requires the definition of a new system of coordinates.

In Part 2 I shall define this coordinate system, a distance function, and a scatter function. I shall also discuss the representation of specific terrain-related game features such as directional terrain (roads and bridges) and "no-exit" terrain (zones-of-control). ■

BYTE News . . .

VOICE-CONTROLLED CONSUMER PRODUCTS: At a recent electronics show in Japan, several Japanese manufacturers demonstrated voice-response and voice-activation of many consumer products. Sanyo, Toshiba, Sharp, Sony, Hitachi, and Matsushita demonstrated a wide variety of consumer products that respond to oral commands. Using microprocessor-controlled speech analyzers and synthesizers, the processors controlled television channel selection, volume and color control, and operated video games and clocks. Some units talked back to confirm user commands.

It is expected that many of these products will be commercially available in a year or two. Present technology allows registration of up to three persons in the voice-recognition circuit. Manufacturers agree that the voice recognition is not 100% perfect, but that it will be in time.

SOME HOME COMPUTERS FAIL FCC RFI SPECS: The Federal Communications Commission (FCC) has released the results of their tests of personal computer systems for radio-frequency interference (RFI). RFI has become an increasing problem to television and FM radio reception, similar to the citizen's band radio interference problem several years ago. The FCC has proposed as a standard a radiation limit of 100 microvolts per meter at a 3-meter distance.

Early last year the FCC tested the Radio Shack, Apple, Heath, Texas Instruments (TI), Commodore PET, and Southwest Technical Products personal computers. Only the Texas Instruments and Commodore systems met the specification. Atari had submitted and passed the specification earlier.

The standard goes into effect July 1, 1980, and all manufacturers have declared their intention to make necessary modifications to assure compliance with the specifications.

CENTRONICS REVEALS NEW PRINTING METHOD: In a press conference held on November 13, 1979, Centronics Data Corp of Hudson, New Hampshire, demonstrated a new method of printing on paper. A single stylus driven by voice coils through a parallelogram flexure mechanism presses a carbon ribbon against paper to form characters in almost the same way as people write using pens and pencils. Character fonts are switched by changing the controlling software; an almost infinite variety of symbols may be produced, including mathematical, Greek, Chinese, Cyrillic, and Arabic character sets. The prototype Quietwriter typewriter devices print with excellent quality at a speed of 17 cps for English-language character sets. Products using the Quietwriter mechanism may be sold beginning about the third quarter of 1981.

NEW LISP SYSTEM: The LISP Co (T.(L.C)) of Los Gatos, California, has completed their first version of LISP for the Z80. It is a dialect of the MIT LISP-Machine LISP, complete with strings, I/O streams, Muddle's parameter-description mechanism, and comprehensive documentation. This version was done for a major personal computer manufacturer; (T.(L.C)) will soon announce their own version that will include hardware to support the LISP programming environment.

HOBBYIST ELECTRONIC MAIL SYSTEM FORMING: Hobbyists are setting up a low-cost mail system using their microcomputers. This is possible using a \$12 software package from the Personal Computer Network (PCNET) committee. With it, a personal computer owner can set up his machine to automatically dial another system or systems at a preset time (usually late at night), deliver messages, and return a status report (delivered or not delivered).

Hobbyists are also setting up dial-in, free-access message systems for discussion purposes using the FORUM-80 software and Radio Shack TRS-80s. Three forums are already in operation: forums devoted to tracing family histories (in Fairfax, Virginia), information on engineering applications of microcomputers (Olathe, Kansas), and applications of microcomputers for the handicapped (Memphis, Tennessee). For more information on these applications, contact Jon Tara, c/o SEMCO, POB 9578, Detroit MI 48202.

COMPUTER COMPANIES GO INTO RETAILING: The latest computer stores are those set up by Digital Equipment Corp (DEC), IBM, and NCR. Following the innovative experiences in computer retailing established by Tandy Corp and independent stores, the traditional computer manufacturers have decided to meet the challenge head on. DEC already has in operation almost twenty "computer stores" where customers can sample the DEC small computers. However, the stores have no inventory and purchases are shipped from a distribution center.

IBM now stocks their 5110 small business systems at fifty centers where a purchaser can get a system on a cash-and-carry basis. These centers were originally opened to demonstrate and train users, and then the retail operation was added. A typical system sells for \$16,000.

NCR has opened two pilot stores in Cincinnati to sell cash registers and small computers in the \$15,000 price range. Data General is selling its MicroNOVA system through fifty independent dealers, and Texas Instruments is beginning computer demonstrations in its San Francisco store.

With the cost of small business computer systems decreasing, the profit margin is no longer enough to support the high-cost selling techniques of large computer systems.

MOTOROLA, TANDY AND WESTERN UNION INTRODUCE "GREEN THUMB" SYSTEMS: Sponsored by a grant from the US Department of Agriculture, Motorola and Western Union will set up an experimental agricultural video-telephone information system known as Project Green Thumb. Tandy Corp will manufacture the terminals to be located in 200 farm homes in Kentucky. Farmers, via telephone lines, will be able to access weather, market, and agriculture data from remote computers.

RANDOM NEWS: Atari has filed an appeal with the Federal Communications Commission (FCC) to stay the decision (reported in last month's BYTE News) in which the FCC granted Texas Instruments a waiver on permissible interference standards for personal computers. Atari feels that if other companies can pass the specification, then the TI request should not have been granted . . . Texas Instruments will soon have competition in the voice synthesis area. National Semiconductor Corp and ITT Semiconductor are both showing samples of their new synthesizer parts. These integrated circuits are aimed at low-price consumer applications such as talking clocks, telephone-answering equipment and automobile warning devices . . . Texas Instruments has introduced four new terminals that have dual-matrix print heads. The head prints two characters with each pass across the page enabling the unit to print 120 characters per second . . . MIT (Massachusetts Institute of Technology) has received a development contract worth several million dollars from Heath Co and Exxon Enterprises. The contract calls for the MIT Computer Science Laboratory to develop an advanced cartridge-disk-based 16-bit microcomputer system for use in office automation. Although initial plans called for MIT to use Zilog's 16-bit microprocessor, it is reported that they have switched to the Motorola 68000 to use memory more efficiently. Both Heath and Exxon will have nonexclusive manufacturing rights, and Exxon will have exclusive software rights . . . Chuck Peddle, the developer of the 6502 microprocessor, the KIM-1, and PET computers, has a new product. It is the Commodore 4500 4-bit microprocessor. It represents a radical departure from the 6502 architecture . . . Researchers at Bell Labs announced the development of an improved electrochromic display using iridium. It consumes less power and could be cheaper to produce than light-emitting diode and liquid-crystal type displays. It does not have to be energized continuously and is pulsed to turn on and off.

APOLOGY DUE: In the September 1979 BYTE News column, I reported on 16-bit 8086 processor boards for S-100 systems. I regret that I omitted mention of a company that has been making such a board since December 1978. The company is Tecmar Inc, 23414 Greenlawn Ave, Cleveland OH 44122. They sell a complete line of S-100 boards to make up a complete system.

RANDOM RUMORS: Apple Computer will soon introduce the Apple III, and it is rumored that it will not use the 6502 microprocessor. Apple is keeping a tight lid on their plans (bit-slice, perhaps?) for this unit. . . Digital Research, the firm that developed CP/M, the most popular disk operating system for microcomputer systems, will soon announce a version of CP/M for the Intel 8086 16-bit microprocessor, which will include an assembler program. . . IMI (International Memories Inc) of Cupertino, California, the first company to ship 8-inch, Winchester-technology, hard disk drives, is rumored to be planning to show a 5¼-inch, 3-megabyte Winchester drive at the 1980 National Computer Conference in June. Rumor is that there will be at least one other such drive shown at the NCC. . . .

MAIL: I receive a large number of letters each month, as a result of this column. If you wish a response please include a stamped, self-addressed envelope.

Sol Libes
Amateur Computer Group of New Jersey (ACG-NJ)
1776 Raritan Rd
Scotch Plains NJ 07076

SYNCHRO-SOUND

The ORIGINAL Computer People
who KNOW Computers
and offer EVERYTHING you need
in Small Computer Systems



TERMINALS

ADDS Regent 25

LEAR SIEGLER

ADM 3A
ADM 31
ADM 42

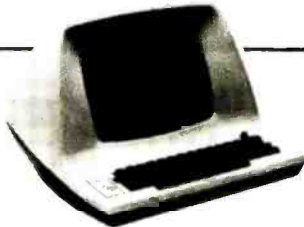

HAZELTINE

1400	1500	Mod 1
1410	1510	Edit
1420	1520	



PRINTERS

QUME Sprint

5/45 KSR
5/55

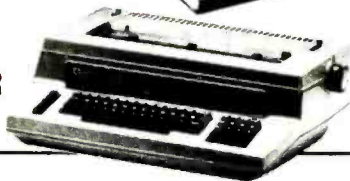

DECwriter IV
LA 34

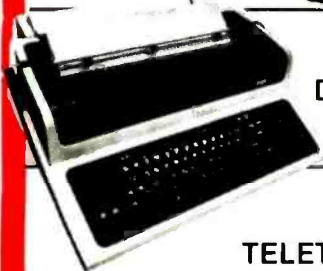

TELETYPE
43



CENTRONICS

779-2 | 703-0
700-2 | 730



A PERFECT
SUPER SPECIAL MATCHED PAIR!



Texas Instrument
810 Multi Copy
Impact Printer
150 characters per sec.
bi-directional printing



Interc
Super Brain
Computer Terminal
Dble. Density Dual Mini-
Floppies, CPM based
Development or Business System

ONLY \$3995.

COMPUTERS

DIGITAL SYSTEMS

DSC 2
Dble. Density
Dual Drive Disk

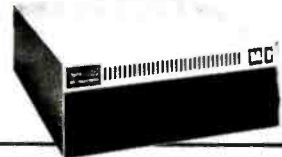

NORTHSTAR

HORIZON II
HORIZON II Quad



CROMEMCO
System 3

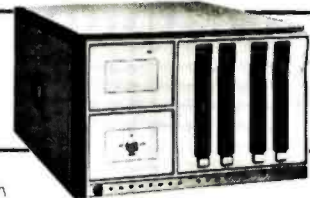

ATARI

400
800



MORE SPECIALS

Okidata SL125	\$2595.00	Livermore Accoustic Coupler	\$249.00
Okidata SL300	2995.00	Centronics Micro Printer	349.00
Persci 277 Dble Density	1395.00	5" Scotch Diskette Box	34.95
Imsai PCS 80/15	499.00	8" Scotch Diskette Box	39.95
Televideo 912, 920	CALL		

MANY OF OUR PRICES ARE TOO LOW
TO ADVERTISE. PLEASE CALL OR WRITE

We carry a full line of Alpha-Micro Products.
We have a full staff of Programmers and Computer
Consultants to design, configure and deliver a Turnkey
Computer System to meet your specific requirements.



SYNCHRO-SOUND ENTERPRISES, INC.

THE COMPUTER PEOPLE

193-25 Jamaica Ave., Jamaica, New York 11423 • TWX 710-582-5886

PHONE ORDERS, CALL:
New York-212/468-7067
Los Angeles-213/628-1808
Chicago-312/641-3010
Dallas-214/742-6090

A Computer-Controlled Light Dimmer

Part 2: Implementation

John H Gibson
Physics Department
Alma College
Alma MI 48801

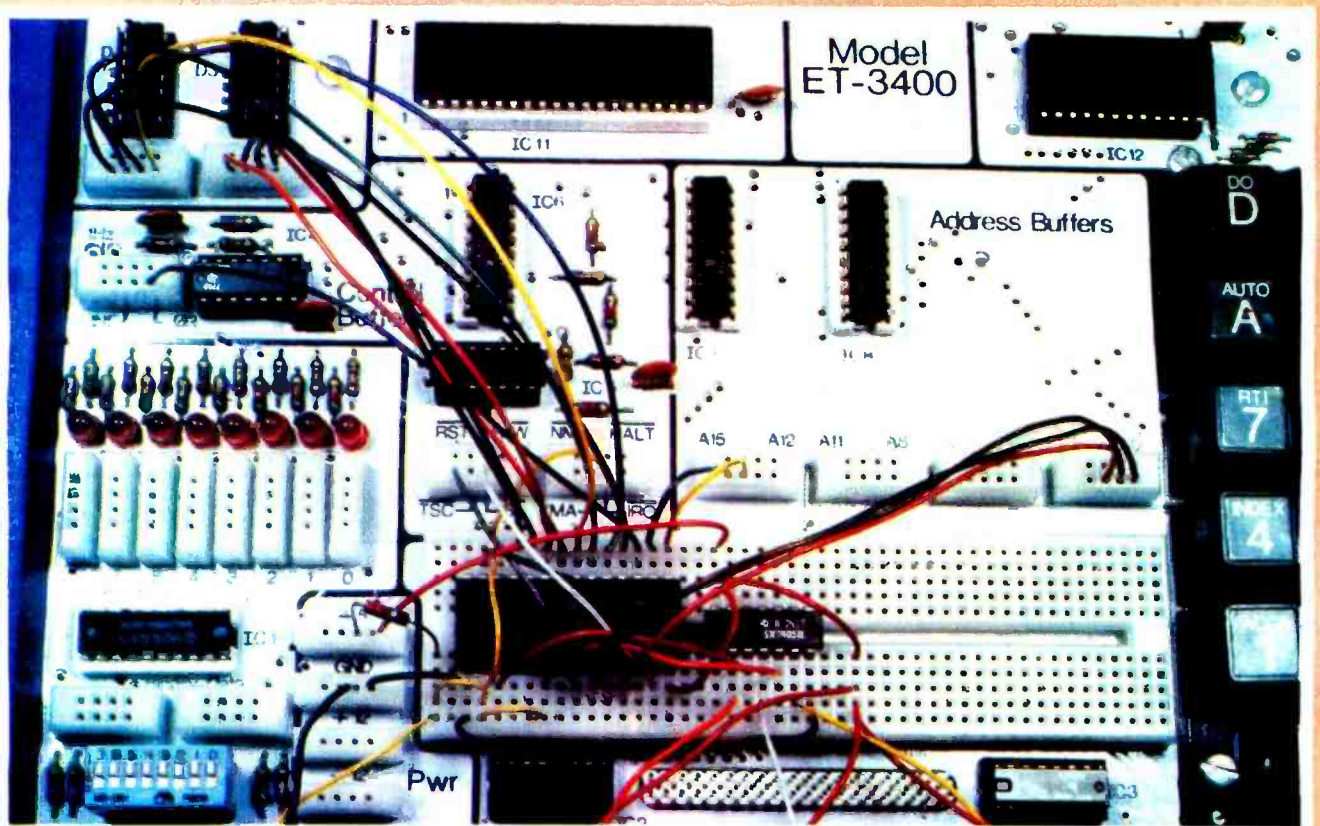

Photo 3: Close-up view of the Heathkit ET-3400 microprocessor trainer wired for use with the demonstration program. The ET-3400 programmable timing module is connected to the trainer's data bus via the eight wires from the left corner of the picture. The synchronizing signal is transmitted over the yellow-black twisted pair at the bottom of the picture. The red-orange, red-white, and red-yellow twisted pairs carry the output trigger pulses to the three AC phase controls.

The numbering of the photos, figures, and tables is continued from part 1 of this article, January 1980 BYTE, page 56.

In part 1 is an examination of the basic principles and techniques for achieving proportional AC phase control with a microcomputer and a programmable timer. I would now

like to present a completely worked-out demonstration program designed to run on a Heathkit ET-3400 microprocessor trainer. This demonstration program will operate three lamp circuits, giving you keyboard control over the lamps that are to be faded on and off.

In addition to the ET-3400 trainer, you will need an MC6840 programmable timer module, a 7405 hex in-

verter (open collector), a synchronizer (from figure 5 in part 1), and three AC phase controls (each from the circuit of figure 9 in part 1).

Here is a step-by-step procedure for making the demonstration program work:

- 1) Plug the MC6840 and the 7405 integrated circuits into the ET-3400 trainer's breadboard socket.

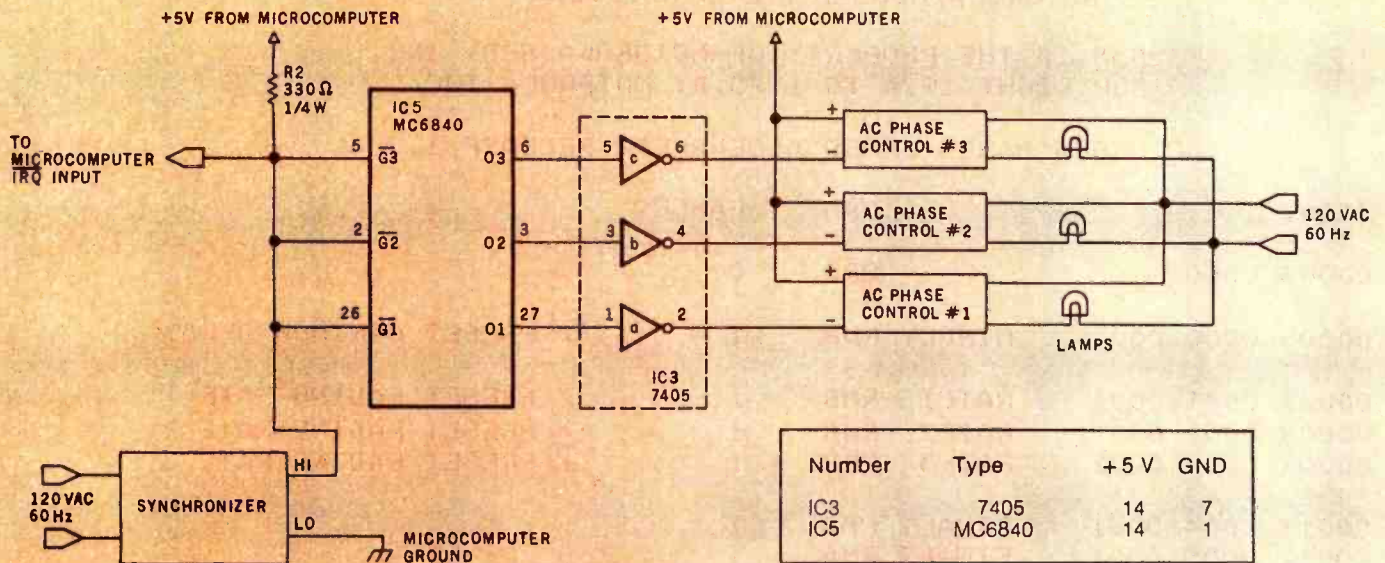

Figure 10: Wiring diagram for proportional power control of three AC lamp circuits. Connections between the MC6840 programmable timer and the ET-3400 microprocessor trainer have been omitted for clarity.

- 2) Make the connections between the MC6840 and the ET-3400 trainer as shown in table 2.
- 3) Wire the circuit shown in figure 10.
- 4) Load the FADER2 program in listing 1 beginning at location hexadecimal 0100.
- 5) Memory location 0000 stores a minimum delay number for all lamps. If you want the lamps to reach maximum brightness, it should be preset to 00.
- 6) Fading rates for the three lamps should be preset in memory locations 0001, 0002, and 0003. Setting each of these rate values to hexadecimal FF will cause each lamp to go from complete darkness to full brightness in about 2 seconds. At the opposite extreme, setting each rate value to 01 will cause this change to take 9 minutes.
- 7) Location hexadecimal 017F con-

tains the output-pulse-width value hexadecimal 1E that was computed in part 1 of this article. This pulse width was computed for a microprocessor clock frequency of 1 MHz. If your system's clock frequency is different, you will have to recompute this pulse width.

A pulse width that is too short will not permit the lamps to darken completely; a pulse width that is too long will cause the lamps to flicker or flash back on at full brightness just when you expect them to be completely dark.

- 8) The program (listing 1, p. 74) begins execution at location hexadecimal 0100, initializing all variable locations. With the program running, pushing keys 0 thru 7 will fade the lamps on and off in different combinations, according to the binary value of the keys pressed. The lamps' changing values will appear on the ET-3400's six seven-segment readouts.

- 9) You can stop the program without turning off the lamps by pushing the 9 (break) key. With the program stopped, you may examine and change registers, all without affecting the lamps. You may then restart the program at location

6840	6840 Pin Numbers	ET-3400
V_{cc}	1	GND
V_{ee}	14	+ 5 V
RESET	8	RST
IRQ	9	no connection
RS0	10	A0
RS1	11	A1
RS2	12	A2
R/W	13	R/W
CS0	15	A14
CS1	16	A15
Enable	17	$\phi 2$
D0	25	D0
D1	24	D1
D2	23	D2
D3	22	D3
D4	21	D4
D5	20	D5
D6	19	D6
D7	18	D7

Table 2: Connections to be made between the Heath ET-3400 microprocessor trainer and the MC6840 programmable timer.

hexadecimal 0110, which retains previous values in the variable locations.

This demonstration program should be enough to fire your imagination to think of your own applications for this lamp control technique. I will be interested in hearing about programs and applications developed by BYTE readers.

Author's Note

I am indebted to Professor Kameswara Rao, of National Semiconductor, Santa Clara CA, for his advice and technical support. This lamp control program was developed and tested in his electronics laboratory at Western Michigan University with the use of a Motorola M6800 cross-assembler resident on Western's PDP-10 computer.

Listing 1: FADER2, a program written in assembler language for the Motorola M6800 processor to control the light dimmer.

MOTOROLA M68SAM CROSS-ASSEMBLER

M68SAM IS THE PROPERTY OF MOTOROLA SPD, INC.
 COPYRIGHT 1974 TO 1975 BY MOTOROLA INC

MOTOROLA M6800 CROSS ASSEMBLER, RELEASE 1.2

```

00001          NAM      FADER2

00003 0000          ORG      0

00005 0000 0001    MINDLY RMB      1      / PRESET MINIMUM DELAY

00007 0001 0001    RATE1  RMB      1      / PRESET FADING RATE 1
00008 0002 0001    RATE2  RMB      1      / PRESET FADING RATE 2
00009 0003 0001    RATE3  RMB      1      / PRESET FADING RATE 3

00011 0004 0001    FINAL1 RMB      1
00012 0005 0001    FINAL2 RMB      1
00013 0006 0001    FINAL3 RMB      1

00015 0007 0001    DELAY1 RMB      1
00016 0008 0001    DELAY2 RMB      1
00017 0009 0001    DELAY3 RMB      1

00019 000A 0001    INTER1 RMB      1
00020 000B 0001    INTER2 RMB      1
00021 000C 0001    INTER3 RMB      1

00023          00F7    UIRQ   EQU     $00F7    / MONITOR VECTORS HERE ON IRQ

00025          * ADDRESSES IN PROGRAMMABLE TIMING MODULE

00027          8000    CR1   EQU     $8000
00028          8001    CR2   EQU     CR1+1
00029          8000    CR3   EQU     CR1

00031          8002    M1    EQU     CR1+2    / MSB OF LATCH 1
00032          8003    L1    EQU     CR1+3    / LSB OF LATCH 1

00034          8004    M2    EQU     CR1+4    / MSB OF LATCH 2
00035          8005    L2    EQU     CR1+5    / LSB OF LATCH 2

00037          8006    M3    EQU     CR1+6    / MSB OF LATCH 3
00038          8007    L3    EQU     CR1+7    / LSB OF LATCH 3

00040          * THESE ET-3400 MONITOR SUBROUTINES ARE USED

00042          FC00    RESET EQU     $FC00    / RETURN TO MONITOR
00043          FDF4    INCH  EQU     $FDF4    / INPUT CHAR FROM KEYBOARD
00044          FCBC    REDIS EQU     $FCBC    / RESET DISPLAY TO 1ST LED
00045          FD7B    DSPLY EQU     $FD7B    / DISPLAY ROUTINE

00047          * MAKE A COLD START FROM THIS ADDRESS - $0100
  
```

Listing 1 continued on page 76

The Source for 6800/6809 Software

Technical Systems Consultants, Inc. is The Source for your 6800/6809 systems software needs. From FLEX™, the standard disk operating system of the 680X family, to Sort/Merge, your systems requirements can be filled with the highest quality software in the industry. Nowhere else can you find such variety from a single source. Here are some of the most popular:

Program Name	6800	6809
FLEX for SWTPc	\$90	\$90
FLEX for SSB	90	90
Extended BASIC	100	100
Extended BASIC Precompiler	50	50
BASIC	65	65
BASIC Precompiler	40	40
FLEX Sort/Merge	75	75
Text Editing System	40	35
Assembler	40	40
Text Processing System	60	N/A
Debug Package	55	75
FLEX Utilities	100	60

These packages are available on either 8" or 5" soft-sectored FLEX diskettes (5" 6800 is FLEX 2.0). Price includes user's manual and object code diskette. Certain programs are available on cassette. Contact Technical Systems Consultants for pricing. All orders should include 3 percent for postage and handling (8 percent on foreign orders). Master Charge and Visa are welcome.

™FLEX is a trademark of Technical Systems Consultants, Inc.



technical systems
consultants, inc.
Box 2574, West Lafayette, IN 47906
(317) 463-2502

Listing 1 continued:

```
00049 0100                ORG      $100

00051                * INITIALIZE DELAYS SO ALL LAMPS ARE OFF

00053 0100 86 FF  CLDSTR LDA A  #$FF      / MAXIMUM DELAY VALUE
00054 0102 CE 0004          LDX    #FINAL1  / INITIALIZE POINTER

00056 0105 A7 00  INITIA STA A  0,X      / STORE #$FF HERE
00057 0107 08          INX          / POINT TO NEXT VARIABLE
00058 0108 8C 000D      CPX    #INTER3+1  / LAST VARIABLE?
00059 010B 26 F8          BNE    INITIA  / RETURN IF NOT DONE

00061 010D 01          NOP
00062 010E 01          NOP
00063 010F 01          NOP

00065                * MAKE A WARM START FROM THIS ADDRESS - $0110

00067 0110 0F          WRMSTR SEI          / MASK IRQ WHILE INITIALIZING

00069                * THESE STEPS CONFIGURE THE TIMERS FOR SINGLE-SHOT
00070                * OPERATION WITH TURN-ON DELAY M(L+1)T AND OUTPUT
00071                * PULSE WIDTH LT.

00073 0111 86 B6          LDA A  #$B6      / CONTROL WORD FOR CR3, CR1
00074 0113 C6 B7          LDA B  #$B7      / CONTROL WORD FOR CR2

00076 0115 B7 8000      STA A  CR3      / CONFIGURE TIMER 3
00077 0118 F7 8001      STA B  CR2      / CONFIGURE TIMER 2
00078 011B B7 8000      STA A  CR1      / CONFIGURE TIMER 1

00080                * ON IRQ, THE ET-3400 VECTORS TO LOCATION
00081                * UIRQ. WE MUST PROVIDE A JUMP INSTRUCTION
00082                * AND A VECTOR TO TRANSFER TO OUR PROGRAM'S
00083                * IRQ SERVICE ROUTINE AT LOCATION #CYCLE.

00085 011E 86 7E          LDA A  #$7E      / LDA A WITH JUMP COMMAND
00086 0120 97 F7          STA A  UIRQ      / STORE JUMP COMMAND AT UIRQ

00088 0122 CE 0137      LDX    #CYCLE  / JUMP TO THIS LOCATION
00089 0125 DF F8          STX    UIRQ+1  / STORE #CYCLE AT UIRQ VECTOR

00091 0127 0E          CLI          / CLEAR IRQ MASK

00093                * MAIN PROGRAM LOOP

00095 0128 BD FDF4 KEY   JSR    INCH      / GET HEX VALUE OF KEY PUSHED

00097 012B 81 09          CMP A  #$09      / IS IT "BREAK" KEY?
00098 012D 26 04          BNE    CONT      / BRANCH IF NOT "BREAK"

00100 012F 0F          SEI          / SET IRQ MASK
00101 0130 7E FC00      JMP    RESET    / GO TO ET-3400 MONITOR RESET
```

Listing 1 continued on page 78

worldwide best selling textbook

rodnay zaks

microprocessors

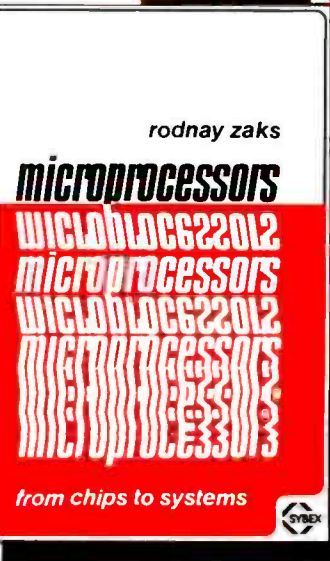

This bestseller on microprocessors offers a basic introduction to microcomputer systems. The step-by-step presentation assumes no prior knowledge of the subject. The author covers all aspects of microprocessing, from the basic concepts to advanced interfacing techniques, guiding the reader from Fundamental Concepts, through Systems Components and Interfacing, all the way to Systems Development. Based on the author's extensive experience in research and education. Used by schools and universities worldwide.

2nd Edition 420 pp., 200 illus., Ref. C201, \$10.95

TO ORDER:

By Phone: (415) 848-8233. Visa, MC, American Express

By Mail: Indicate quantity desired. Pre-payment required

Shipping: Add \$1.50 per book (UPS) or 75c (4th Class-allow 4 weeks delivery)

Tax: In California please add tax

**AVAILABLE AT BOOKSTORES
AND COMPUTER STORES
EVERYWHERE**



Dept. WW
2020 Milvia Street
Berkeley, CA 94704

Please send me _____ copy(s)
 Name _____
 Company _____
 Address _____
 City _____ State _____ Zip _____
 Charge my _____ Visa _____ MasterCard _____
 _____ American Express _____
 Card Number _____ Exp. Date _____
 Signature _____
 Send me your detailed catalog

Listing 1 continued:

```
00103 0133 8D 09   CONT   BSR   NEWFN   / SET NEW FINAL VALUES
00104 0135 20 F1           BRA   KEY     / GET NEXT CLOSED KEY VALUE

00106                * IRQ INTERRUPT SUBROUTINE

00108 0137 8D 1E   CYCLE  BSR   CHANGE  / CHANGE DELAY VALUES
00109 0139 8D 3E           BSR   LOAD    / LOAD TIMERS WITH NEW DELAYS
00110 013B 8D 54           BSR   SHOW   / DISPLAY DELAY VALUES
00111 013D 3B           RTI

00113                * SUBROUTINE TO CHANGE FINAL VALUES

00115 013E 81 07   NEWFN  CMP  A   #$07   / VALID HEX VALUE?
00116 0140 22 14           BHI   NEWFN4  / BRANCH IF NOT VALID

00118 0142 CE 0004           LDX   #FINAL1 / POINT TO FINAL1

00120 0145 46           NEWFN1 ROR  A           / SHIFT LAMP(X) BIT INTO C
00121 0146 24 04           BCC   NEWFN2  / BRANCH TO DIM LAMP

00123 0148 D6 00           LDA  B   MINDLY / LDA B WITH MIN DELAY
00124 014A 20 02           BRA   NEWFN3

00126 014C C6 FF   NEWFN2 LDA  B   #$FF   / LDA B WITH MAX DELAY

00128 014E E7 00   NEWFN3 STA  B   0,X    / STA B FINAL(X)

00130 0150 08           INX           / POINT TO NEXT LAMP
00131 0151 8C 0007           CPX   #FINAL3+1 / LAST LAMP DONE?
00132 0154 26 EF           BNE   NEWFN1  / RETURN IF NOT DONE

00134 0156 39           NEWFN4 RTS

00136                * ROUTINE FOR CHANGING DELAY NUMBERS

00138 0157 CE 0001 CHANGE LDX   #RATE1 / POINT TO LAMP 1

00140 015A E6 09   CHNG1 LDA  B   9,X    / LDA B INTER(X)
00141 015C A6 06           LDA  A   6,X    / LDA A DELAY(X)

00143 015E A1 03           CMP  A   3,X    / CMP DELAY(X) WITH FINAL(X)
00144 0160 22 08           BHI   BRITER  / BRANCH IF DELAY(X)>FINAL(X)
00145 0162 27 0A           BEQ   RESTOR  / BRANCH IF DELAY(X)=FINAL(X)

00147 0164 EB 00   DIMMER ADD  B   0,X    / B = INTER(X) + RATE(X)
00148 0166 89 00           ADC  A   #$00   / A = DELAY(X) + CARRY
00149 0168 20 04           BRA   RESTOR

00151 016A E0 00   BRITER SUB  B   0,X    / B = INTER(X) - RATE(X)
00152 016C 82 00           SBC  A   #$00   / A = DELAY(X) - BORROW

00154 016E E7 09   RESTOR STA  B   9,X    / STA B INTER(X)
00155 0170 A7 06           STA  A   6,X    / STA A DELAY(X)

00157 0172 08           INX           / POINT TO NEXT LAMP
00158 0173 8C 0004           CPX   #RATE3+1 / DONE WITH ALL 3 LAMPS?
```

Listing 1 continued on page 80

MicronET

It's off and running. And delivering as promised.

What is MicroNET?

It is the personal computing service of CompuServe, Incorporated. CompuServe is a nationwide commercial time sharing computer network with large-scale mainframes. MicroNET allows the personal computer user access to CompuServe's large computers, software and disc storage during off-peak hours (from 6 PM to 5 AM weekdays, all day on Saturdays, Sundays and most holidays).

What do I get?

You can use our powerful processors with X-Basic, Fortran, Pascal, Macro-10, AID or APL. You get 128K bytes of storage free (just access it at least once a month). Software includes games—including networking multi-player games—personal, business and educational programs.

In addition, there is the MicroNET National Bulletin Board for community affairs,

for sale and wanted notices and the MicroNET Electronic Mail System for personal messages to other MicroNET users. You can even sell software via MicroNET.

NEW! MicroQUOTE, a security information system for corporate stocks and public debt.

NEW! MicroNET Software Exchange with dozens of new programs available for downloading to your personal computer at a specified charge.

NEW! Executive programs for TRS-80, Apple II and CP/M systems (so your machine and ours can talk to each other error-free). You can switch between terminal and local mode while on line.

What do I have to have to use MicroNET?

The standard 300 baud modem. MicroNET has local phone

service in most major cities (see below) and a reduced phone charge in over a hundred others.

What is the cost?

We've saved the best for last. There is a one-time hook-up charge of only \$9.00! Operating time—billed in minutes to your VISA or MasterCard—is only \$5.00 an hour.

Want more information?

Good. Write to us at the address below. We'll send you a full packet of information about MicroNET.

CompuServe

Personal Computing Division
Dept. B
5000 Arlington Centre Blvd.
Columbus, Ohio 43220

MicroNET is available via local phone calls in the following cities: Akron, Atlanta, Boston, Canton, Chicago, Cincinnati, Cleveland, Columbus, Dallas, Dayton, Denver, Detroit, Houston, Indianapolis, Los Angeles, Louisville, Memphis, West Caldwell (NJ), New York, Philadelphia, Pittsburgh, San Francisco, Stamford (CT), St. Louis, Toledo, Tucson and Washington, D.C.

Access to the MicroNET service is available in 153 other cities for an additional charge of \$4.00 per hour.



"... but the really impressive stuff is in the back room."

Listing 1 continued:

```
00159 0176 26 E2          BNE    CHNG1    / RETURN TO DO NEXT LAMP
00161 0178 39            RTS

00163                    * THIS ROUTINE LOADS THE TIMER LATCHES

00165 0179 CE 8002 LOAD   LDX    #M1      / POINT TO M1

00167 017C 96 07          LDA    A    DELAY1
00168 017E C6 1E          LDA    B    #1E      / OUTPUT PULSE WIDTH
00169 0180 A7 00          STA    A    0,X     / LOAD M1 WITH DELAY1
00170 0182 E7 01          STA    B    1,X     / LOAD L1 WITH PULSE WIDTH

00172 0184 96 08          LDA    A    DELAY2
00173 0186 A7 02          STA    A    2,X     / LOAD M2 WITH DELAY2
00174 0188 E7 03          STA    B    3,X     / LOAD L2 WITH PULSE WIDTH

00176 018A 96 09          LDA    A    DELAY3
00177 018C A7 04          STA    A    4,X     / LOAD M3 WITH DELAY3
00178 018E E7 05          STA    B    5,X     / LOAD L3 WITH PULSE WIDTH

00180 0190 39            RTS

00182                    * THIS ROUTINE SHOWS THE THREE DELAY VALUES ON
00183                    * THE ET-3400'S SIX 7-SEGMENT READOUTS.

00185 0191 BD FCBC SHOW   JSR    REDIS    / RESET DISPLAY TO 1ST LED
00186 0194 CE 0007        LDX    #DELAY1  / START DISPLAY WITH DELAY1
00187 0197 C6 03          LDA    B    #03   / DISPLAY 3 BYTES
00188 0199 BD FD7B        JSR    DSPLAY   / DISPLAY DELAY1, 2 AND 3

00190 019C 39            RTS

00192                    END
```

SYMBOL TABLE

MINDLY	0000	RATE1	0001	RATE2	0002	RATE3	0003	FINAL1	0004
FINAL2	0005	FINAL3	0006	DELAY1	0007	DELAY2	0008	DELAY3	0009
INTER1	000A	INTER2	000B	INTER3	000C	UIRQ	00F7	CR1	8000
CR2	8001	CR3	8000	M1	8002	L1	8003	M2	8004
L2	8005	M3	8006	L3	8007	RESET	FC00	INCH	FD74
REDIS	FCBC	DSPLAY	FD7B	CLDSTR	0100	INITIA	0105	WRMSTR	0110
KEY	0128	CONT	0133	CYCLE	0137	NEWFN	013E	NEWFN1	0145
NEWFN2	014C	NEWFN3	014E	NEWFN4	0156	CHANGE	0157	CHNG1	015A
DIMMER	0164	BRITER	016A	RESTOR	016E	LOAD	0179	SHOW	0191 ■

STOP --

Now... You, the small systems user can enjoy the advantages of HI-performance *low cost* computer graphics

HIPLØT™ Digital Plotters

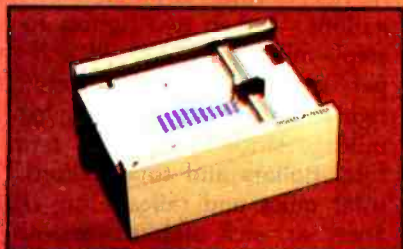

The perfect small system output device

- Displays data in easy to read graphical format
- Both aerial and parallel inputs built-in
- Used standard 8 1/2" x 11" paper (DIN A4)
- Plotting speed up to 2 1/2 ips (60 mm per sec)
- Resolution 1 both 0.01 and 0.005 in. (0.1 mm and 0.2 mm)
- Speed rate and stop rate easily changed
- Completely assembled and ready to use
- Priced at \$1095

HIPAD™ Digitizers

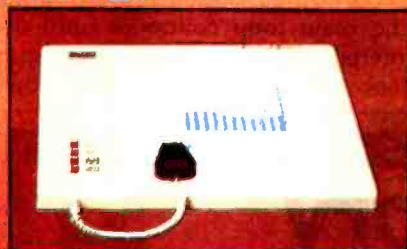

The perfect small system input device

- Resolution and repeatability of 0.005 in. (0.1 mm)
- Origin is completely relocatable
- RS232C and 6-pin parallel interface selectable at the connector
- Accuracies of ± 0.015 in. (0.4 mm)
- Optional LCD display shows actual values being inputted
- Digitizing surface 11" x 11" (28 mm x 28 mm)
- Priced at \$795

For complete information contact Houston Instrument, One Houston Square, Austin, Texas 78753. (512)837-2620. For rush literature requests persons outside Texas call toll free 1-800-531-5205. In Europe contact Houston Instrument, Rochesterlaan 6, 8240 Gistel Belgium. Phone 059/27 74 45.

houston instrument | DIVISION OF BAUSCH & LOMB
"the graphics - recorder company"

HIPLØT Circle Inquiry #222

HIPAD Circle Inquiry #223

TM Trademark of Houston Instrument

U.S. Domestic Price Only

HIPLØT & UL Listed

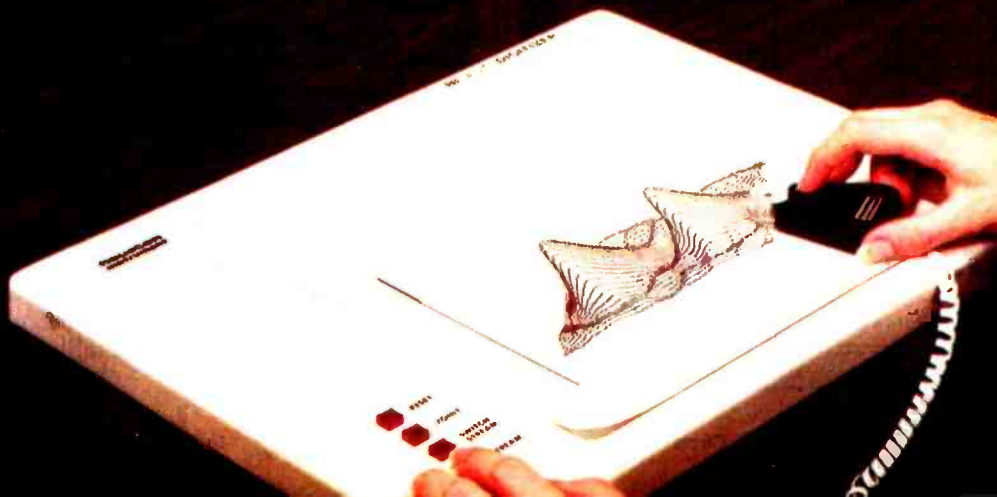
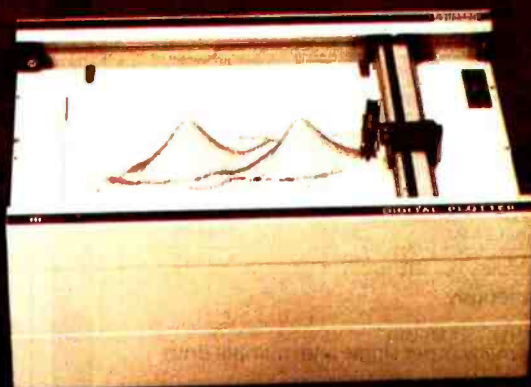

Programming Quickies

Gasuse

Mike R Firth, 4712 Northway Dr,
Dallas TX 75106

Gasuse is a program I wrote to use facts I record in a notebook in my car to produce useful information. I note the mileage of my car, the cost of the gas, and usually the gallons and dollars of the purchase along with the

state of purchase and date (for tax purposes). Aside from the special features noted below, the program in listing 1 consists of the initialization routine (lines 1010 thru 1084), the main loop (1100 thru 1900), and routines to allow for missing information (2000 thru 2190) and printer output. The main loop continues until 0 is entered for the miles. The program does not permit entering a lower

mileage than the last mileage reading. The missing information section will permit computations if two of the three items— price, gallons, cost— are known.

The information printed out includes the entered (or calculated) numbers—miles at purchase, dollars, gallons — then two figures for this step—miles since last fill and miles per gallon. Then there are total figures—miles since start of trip and mileage since the start in terms of total dollars and total gallons. The total miles and mileage are figured anew at each step to smooth out errors.

Notes on odd items: lines 40 and 50 save retyping the commands used on the Wang for disk storage. U\$ contains the character to move the cursor up one line. This results in the display being solid information, neatly arranged, with data entered on the bottom lines. The Select Print statements after line 8100 are the means of assigning the printed output. Only one device can be selected at a time, where 005 is the video terminal and 215 is the fast printer. Lines 9400 thru 9406 are special functions that relate to special keys on the terminal and permit controlled listing of the program. Wang uses % for image statements, where most BASICS use : in my experience.

Table 1 is an example output from listing 1. (See table 1 and listing 1 on page 124.) Please note that while two of the segment mileage figures vary considerably (17.9 and 40.1), the average mileage stays in the mid-twenties. One reason that segment mileage will vary is that the tank is not filled to the same point each time. If 10 gallons are used in 250 miles, but only 5 are purchased the program will give twice the mileage for that segment. However, when one has to fill-up with 10 gallons after only 125 miles, the mileage will drop.

Note that the totals are run up each time the program is run, which represent a page in your notebook—all the gas purchased on a trip or a month's driving. To add to a list, simply take the old list's starting mileage and the final totals as the first entry, (see table 1 for example).

Disk Memory Power Supplies

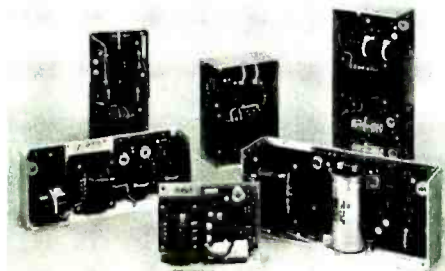

Power-One, a leading supplier to the Disk Drive industry, now offers a complete line of power supplies for FLOPPY DISK and new WINCHESTER FIXED DISK applications.

Call or Write for our New Catalog.

WINCHESTER FIXED DISK

SHUGART - CENTURY - MICROPOLIS are just a few drives powered by this new universal model. Powers (1) Winchester drive plus controller circuitry.

1st Output	2nd Output	3rd Output	Model	Price (1-9)
+ 5V @ 9A	- 12V @ .8A	+ 24V @ .5A/4.5A PK	CP384	\$120.00

FLOPPY DISK - 5 1/4" MEDIA

BASF - SHUGART - PERTEC - SIEMENS plus all other popular 5 1/4" media drives.

1st Output	2nd Output	Model	Price (1-9)
+ 5V @ .5A/ .7A PK	+ 12V @ .9A/1.8A PK	CP340	\$ 44.95
+ 5V @ 2A	+ 12V @ 4A	CP323	\$ 74.95

CP323 powers up to (4) drives simultaneously.

FLOPPY DISK - 8" MEDIA

SHUGART - PERSCI - CDC - WANGCO plus many other single and multiple drive applications.

1st Output	2nd Output	3rd Output	Model	Price (1-9)
+ 5V @ 1A	- 5V @ .5A	+ 24V @ 1.5A/1.7A PK	CP205	\$ 69.95
+ 5V @ 2.5A	- 5V @ .5A	+ 24V @ 3A/3.4A PK	CP206	\$ 91.95
+ 5V @ 3A	- 5V @ .6A	+ 24V @ 5A/6A PK	CP162	\$120.00
+ 5V @ 1.7A/2.2A PK	- 5V @ .15A/.2A PK	+ 24V @ .2A/3A PK	CP272A	\$ 91.95
+ 5V @ 2A	+ 12V @ .4A	- 12V @ .4A	HTAA-16W	\$ 49.95

CP272A powers Percsi Drives (includes unregulated 7 - 10V @ 1.2A/10A PK). HTAA-16W powers Percsi controller.

POWER-ONE D.C. POWER SUPPLIES

Power One Drive • Camarillo, CA 93010 • (805) 484-2806 • TWX 910-336-1297
Eastern Regional Headquarters • (518) 399-9200

DIGITAL RESEARCH

CP/M FLOPPY DISKETTE OPERATING SYSTEM... Packages supplied on diskette complete with 8080 assembler, list editor, 8080 debugger and various utilities...

MAC - 8080 Macro Assembler... Pseudo Ops include RPL, RPL, REPT, TITLE, PAGE, and MACLIB...

MICROSOFT... BASIC-80 - Disk Extended BASIC, ANSI compatible... BASIC COMPILER - Language compatible with BASIC-80...

MICRO FOCUS... STANDARD CIS COBOL - ANSI 74 COBOL standard compiler fully validated by U.S. Navy tests...

HD85 - Hierarchical Data Base System... HD85 with FILES, SETS, RECORD and ITEMS which are all user defined...

MBDS - Macro Data Base System... MBDS-DRS - MBDS with Dynamic Restructuring System for product which changes data bases when new ITEMS, RECORDS or SETS are needed...

Software for most popular 8080/280 computer disk systems including NORTH STAR, ICOM, MICROPOLIS, DYNABYTE DB812 & DB814, EXIDY SORCERER, SD SYSTEMS, ALTAIR, VECTOR MZ, MECCA, 8" IBM, HEATH H17 & H89, HELIOS, IMSAI VDP42 & 44, REX, NYLAC, INTERTEC, VISTA V80 and V200, TRS-80 MODEL I and MODEL II, ALTOS, OHIO SCIENTIFIC and IMS 5000 formats.

EIDOS SYSTEMS... KISS - Keyed Index Sequential Search... KBASIC - Microsoft Disk Extended BASIC with all KISS facilities...

MICROPRO... SUPER-SORT - Sort, merge, extract utility as absolute executable program or linkable module in Microsoft format...

WORD-STAR - Menu driven visual word processing system for use with standard terminals... WORD-STAR MAIL MERGE - As above with option for processing in series of personalized documents...

WORD-MASTER Text Editor - In one mode has support of CP/M's ED commands including global searching and replacing... DATASAT - Professional forms control entry and display system for key-business data capture...

PASCALM - Compiler generates P code from extended language... PASCALMT - Subset of standard PASCAL, generates ROMable 8080 machine code...

STRUCTURED SYSTEMS GROUP... GENERAL LEDGER - Interactive and Heuristic systems providing personal and corporate accounting... ACCOUNTS RECEIVABLE - Open item system with output for internal aged reports and customer-oriented statement and billing purposes...

ACCOUNTS PAYABLE - Provides aged statements of accounts by vendor with check writing for selected invoices... ALGOL-40 - Powerful block-structured language compiler featuring economical run time dynamic allocation of memory...

INVENTORY CONTROL SYSTEM - Performs control functions of adding and subtracting stock items... ANALYST - Customized data entry and reporting system... PAYROLL SYSTEM - Maintains employee master file, computes payroll withholding for FICA, Federal and State taxes...

GRAMHAM-DORIAN SOFTWARE SYSTEMS... GENERAL LEDGER - An on-line system accounting packages are automatically posted... ACCOUNTS PAYABLE - Maintains vendor list and check writing... ACCOUNTS RECEIVABLE - Creates full balance reports, prepares statements, ages accounts and records invoices...

INVENTORY CONTROL SYSTEM... ANALYST... PAYROLL SYSTEM... INVENTORY SYSTEM... JOB COSTING - Designed for general contractors... APARTMENT MANAGEMENT SYSTEM - Financial management system for rentals and security deposits of apartment projects...

CASH REGISTER - Maintains lists on daily sales... WNY C - Interactive interpretive system for teaching structured programming techniques... BDCS COMPILER - Supports most major features of language, including Structures, Arrays, Pointers...

WNYMTHS C COMPILER - The ultimate in systems software tools... POLYVIEW/80 - Full screen editor for any CRT with XY cursor positioning... POLYTEX/80 - Text formatter for word processing applications...

ALGOL-40... Z80 DEVELOPMENT PACKAGE - Consists of (1) disk line assembler, (2) Z80 relocating assembler, (3) Z80/Mosk mem-mocks, conditional assembly and cross reference table capabilities... ZDT - Z80 Monitor Debugger: to break and examine registers with standard Z80/Mosk mem-mock...

DISTEL - Disk based disassembler to Intel 8080 or TDU/XTM Z80 source code... DISLOG - As DISTEL to Z80/Mosk mem-mock files... XASM-68 - New hardware assembler with nested conditionals and Z80 pseudo operations...

XASM-65 - New hardware assembler for MOS technology... TEXTWRITER III - Text formatter to justify and paginate letters and other documents... POSTMASTER - A comprehensive package for mail list maintenance... WHATSYT - Interactive data-base system using associative tags to retrieve information...

YVABASIC Interactive Process Control BASIC - Full disk BASIC featuring unique commands to handle files, rotate and shift, and to test and set bits... SMALL/80 Structured Macro Assembled Language - Package of powerful general purpose text macro processor and SMALL structured language compiler... SELECTOR III-C2 - Data Base Processor to create and maintain multiple key data bases...

CPM374X - Has full range of functions to create or re-name an IBM 3741 volume, display directory information and edit the data set contents... BASIC UTILITY OISK - Consists of (1) CRUNCH-14 - Compacting utility to reduce the size of programs... THE STRING BIT - Fortran character string handling...

BSTAM - Utility to transfer computer to another also equipped with PC/M transfer file transfers all full data loaded... FLOPPY Disk Kit - Template and instructions to modify single sided 5 1/4" diskettes for use of second side and slide gated drives... PASCAL USER MANUAL AND REPORT - By Kenneth and W. J. Taylor... THE C PROGRAMMING LANGUAGE - By Brian Kernighan and Dennis Ritchie...

Lower prices!

All Micropro prices are discounted!

Gramham-Dorian prices are discounted!

Structured Systems prices are discounted!

Lower prices!

Everything on shipping list #9 runs on 64K TRS-80 model II

★★★★★ SUPPLIES & NOTICES

HEAD CLEANING DISK II - Cleans the drive read/write head in 10 seconds... FLOPPY SAVER Protector for center holes of 5 1/4" floppy disks... PASCAL USER MANUAL AND REPORT - By Kenneth and W. J. Taylor... THE C PROGRAMMING LANGUAGE - By Brian Kernighan and Dennis Ritchie

★★★★★

Lifeboat Associates, 2248 Broadway, N.Y., N.Y. 10024 (212) 580-0082 Telex: 220501 (New number!)

Software for most popular 8080/280 computer disk systems including NORTH STAR, ICOM, MICROPOLIS, DYNABYTE DB812 & DB814, EXIDY SORCERER, SD SYSTEMS, ALTAIR, VECTOR MZ, MECCA, 8" IBM, HEATH H17 & H89, HELIOS, IMSAI VDP42 & 44, REX, NYLAC, INTERTEC, VISTA V80 and V200, TRS-80 MODEL I and MODEL II, ALTOS, OHIO SCIENTIFIC and IMS 5000 formats.

*The Software Supermarket is a trademark of Lifeboat Associates



Tell it and forget it...

... the new CY500 stored program stepper motor controller runs its own program, freeing your host computer for other jobs.

No more one-pulse, one-step operation requiring your host computer to tie itself down to a stepper motor. Now Cybernetic Micro Systems brings you a function-oriented stored program stepper motor controller that allows the user, or host computer, to program it and forget it...

The CY500 executes 22 hi-level instructions, either in command mode or as a sequence of internally-stored commands, using single byte code such as 'P' for position, 'R' for rate, and 'S' for slope. Parameter values can be expressed in ASCII-decimal for keyboard programming or binary code from the host computer. Parallel or serial communication.

The stored program capability allows the use of 'DO-WHILE' program looping and 'WAIT-UNTIL' operation. Ten different operational modes allow absolute or relative positioning, full- or half-step operation, hardware or software control of direction, start/stop, ... and many more.

Numerous input and output control lines allow synchronizing the CY500 with external events or devices and allow each step to be triggered. Stepping at rates up to 3500 steps/sec, the CY500 also provides ramp-up, slew, and ramp-down operation, all under software control. Two interrupt lines request the host's attention if needed.

This +5 volt N-MOS TTL-compatible controller is available from stock, today, for only \$95.00. Contact Cybernetic Micro Systems. We want to see you program your stepper motor and then ... forget it.



Cybernetic Micro Systems
445-203 South San Antonio Road
Los Altos, California 94022
(415) 949-0666

(Use your MASTER CHARGE or VISA charge card)

Listing 1: Gasuse program for determining mileage, gas efficiency, and keeping track of gas expenses.

```

10      REM PROGRAM GAS TO FIGURE MILEAGE
40      REM SCRATCH F "GASUSE"
50      REM SAVE DC F ("GASUSE") "GASUSE"
110     U$ = HEX(OC)
1010    PRINT " I COMPUTE AND DISPLAY GAS MILEAGE"
1020    PRINT "  ENTER ZERO FOR UNKNOWN FIGURES, I WILL TRY"
1030    PRINT "  ENTER ZERO FOR MILES TO STOP"
1032    PRINT
1035    PRINT "  ENTER  1. FOR SCREEN DISPLAY"
1037    PRINT "        2. FOR PRINTER OUTPUT"
1039    INPUT P9
1040    PRINT
1050    PRINT "STARTING MILES";
1060    INPUT M0
1070    M7 = M0
1075    IF P9 = 2 THEN 8100
1080    PRINT USING 1081
1081    % COST DISTANCE TOTAL AVE TOTAL TOTAL
1082    PRINT USING 1083
1083    %MILES GAL MILEAGE MILES MILEAGE COST GAL
1084    PRINT
1100    PRINT U$; "NEXT MILES";
1110    INPUT M1
1115    IF M1 = 0 THEN 1900
1120    IF M1 > M7 THEN 1130
1124    PRINT U$; " THIS MILES LESS THAN LAST, OR SAME"
1126    GOTO 1100
1130    PRINT U$; "  GALLONS";
1140    INPUT G1
1160    PRINT U1; "  DOLLARS";
1170    INPUT D1
1190    IF G1 = 0 THEN 2000
1195    IF D1 = 0 THEN 2100
1200    REM
1210    M8 = M1-M0
1220    D8 = D8 + D1
1230    G8 = G8 + G1
1245    IF P9 = 2 THEN 8150
1248    PRINT U$;
1250    PRINT USING 1252,M1,D1,G1,M1-M7,(M1-M7)/G1,M1-M0;M8/G8,D8,G8
1252    %##### $###.## ##.# ### ##.# ##### ##.# $###.## ##.#
1255    PRINT
1260    M7 = M1
1290    GOTO 1100
1900    STOP
2000    PRINT U$; " GALLONS ENTERED AS ZERO, ENTER CENTS/GALLON";
2010    INPUT C1
2020    IF D1 = 0 THEN 2080
2030    G1 = D1/(C1/100)
2050    GOTO 1200
2080    PRINT U$; " DOLLARS ALSO ZERO, NO CALCULATION POSSIBLE";
2090    GOTO 1100
2100    PRINT U$; " DOLLARS ENTERED AS ZERO, ENTER CENTS/GALLON";
2110    INPUT C1
2120    D1 = G1*(C1/100)
2130    IF D1 = 0 THEN 2180
2150    GOTO 1200
2180    PRINT U$;" CALCULATION RESULT IS ZERO; REENTER "
2190    GOTO 1100
8100    SELECT PRINT 215(80)
8110    PRINT USING 1081
8111    PRINT USING 1083
8115    SELECT PRINT 005(64)
8120    GOTO 1084
8150    SELECT PRINT 215(84)
8160    PRINT USING 1252,M1,D1,G1,M1-M7,(M1-M7)/G1,M1-M0;M8/G8,D8,G8
8170    SELECT PRINT 005(64)
8180    PRINT U$;TAB(64)
8190    GOTO 1260
9400    DEFFN'0 "LISTS"
9404    DEFFN'1 " ,9999"
9406    DEFFN'2 "'000,9999"

```

MILES	COST	GAL	DISTANCE	MILEAGE	TOTAL MILES	AVE MILEAGE	TOTAL COST	TOTAL GAL
1202	\$4.19	7.5	201	26.8	201	26.8	\$4.19	7.5
1453	\$5.75	10.1	251	24.8	452	25.6	\$9.94	17.6
1604	\$2.59	5.0	151	30.2	603	26.6	\$12.53	22.6
1715	\$3.45	6.2	111	17.9	714	24.7	\$15.98	28.8
1995	\$3.95	6.9	280	40.1	994	27.7	\$19.93	35.7

Table 1: Sample output from listing 1. To determine accurate gas usage take an average over several results.

Circle 52 on inquiry card.



HOW STANLEY BEEHER AND MICROSOFT'S COBOL-80 TURNED THE OFFICE ON ITS EAR.

Stanley's office staff says Stanley always stays one step ahead. So no one was surprised when he showed up with Microsoft's COBOL-80 for the office computer. That's when things started happening.

As Stanley explains, "Suddenly, the whole business operation is more efficient. I use it for everything: inventory, payroll, record keeping, customer and employee files. Since COBOL is the standard language for business and commercial applications, more programs are written in COBOL than any other language. Believe me, nothing beats it in terms of powerful use of disk files, data manipulation facilities and interactive terminal communications."

Stanley added loudly, "And that's versatility and efficiency I'd like to see more of around here."

"My COBOL-80 package from Microsoft includes the MACRO-80 assembler, LINK-80 linking loader and LIB-80 relocatable library manager. I can even call FORTRAN, BASIC, assembler and COBOL modules from a COBOL-80 program. It's perfect—a total software development package," exclaimed Stanley.

Microsoft's COBOL-80 is an ANSI-74 standard COBOL that supports such advanced data manipulation verbs as COMPUTE, INSPECT, STRING, UNSTRING AND SEARCH; three-dimensional arrays; full COPY facility; and com-

plete screen handling capability. The optional packed decimal format saves on mass storage by as much as 40%. And as Stanley puts it, "With my floppy disk system, that's a big plus."

Stanley can't say enough about his new addition to the office. "COBOL-80 supports indexed and relative files, including DYNAMIC access, FILE STATUS, START, READ NEXT, DELETE and REWRITE. Best of all, interactive ACCEPT/DISPLAY gives the most powerful screen handling capability possible.

"Frankly," says Stanley, "Microsoft COBOL-80's performance is so superior it's set a whole new standard of efficiency for my staff. My new motto? 'Shape up or ship out.' Thanks Microsoft, my office will never be the same."

The COBOL-80 package for the CP/M or ISIS-II operating system with documentation is \$750. Documentation may be purchased separately for \$20. Dealer purchases and OEM license agreements available on request.

MICROSOFT



10800 N.E. Eighth Suite 819
Bellevue, Washington 98004
206/455-8080 Telex 328945

We set the standard.

Circle 53 on inquiry card.

String Comparator for Horizon

Richard W Lindberg, 9302 Mayrene Dr,
Garden Grove CA 92641

As a recent purchaser of a personal computer, and an even more recent subscriber to BYTE, I look for programming articles to help expand the horizon of my Horizon. I scanned the September 1979 issue as soon as it arrived, and was intrigued by the article "A Similarity Comparator for Strings," by T C O'Haver on page 58. Realizing changes would be necessary, I immediately set out to translate it to run in North Star BASIC.

The first change required was the replacement of the string operator MID\$(A\$,I,1) with A\$(I,I) in statements 130, 140, 230, and 240. (Note that North Star also allows

Listing 1: Similarity comparator program in North Star BASIC, adapted from the program by T C O'Haver.

```

8      DIM A$(64),B$(64),Z$(64),A1$(64),B1$(64)
10     T=0
20     P=3
30     !"FIRST WORD",
40     INPUT A1$
50     A=LEN(A1$)
55     A$(1,A)=A1$
60     !"SECOND WORD",
70     INPUT B1$
75     IF A1$=B1$ THEN !"EXACT MATCH"
80     B=LEN(B1$)
85     B$(1,B)=B1$
90     IF A>B THEN B=A
100    FOR M=1 TO B
110      C=0
120      FOR I=1 TO M
130        K$=A$(B-M+I,B-M+I)
140        L$=B$(I,I)
150        IF K$=L$ THEN C=C+1
160      NEXT I
170      C=C*I*P
180      T=T+C
190    NEXT M
200    FOR M=B+1 TO 2*B-1
210      C=0
220      FOR I=1 TO 2*B-M
230        K$=A$(I,I)
240        L$=B$(M-B+I,M-B+I)
250        IF K$=L$ THEN C=C+1
260      NEXT I
270      C=C*I*P
280      T=T+C
290    NEXT M
300    S=100*T/B*I*P
310    !S,"% "
320    T=0
325    B$=Z$
330    GOTO 70
340    END

```

the implied LET and the use of ! for PRINT.) The next change was the addition of a DIMension statement to allow strings greater than 10 characters in length. Then when trying to compare two strings of different length, the computer threw me out! This necessitated having enough blanks in the shorter string to match the length of the longer one. To accomplish this, strings A\$ and B\$ were set to 64 blanks by the dimension statement, and temporary strings A1\$ and B1\$ were used to read in the input string data and compute the lengths A and B. A1\$ was then placed in the first A characters of A\$, and B1\$ in the first B characters of B\$, leaving the remaining characters blank. Blank string Z\$ is used to reset B\$ to blanks before testing a new string, otherwise there would be unwanted characters left in B\$ if the previous string were longer than the new string. This was noticed when I followed O'Haver's test sequence, and found that POO gave a 100% match with POOL, because the previous test string was COOL and the L was still there. So with the addition of line 325, I knocked the L out of it and had the program running. The address strings took many seconds to run.

Listing 1 gives the program as adapted to North Star BASIC Version 5.0, and listing 2 shows a sample run for comparison with the published run. Note that the agreement is quite good except for POOL ROOM, MAIL ROOM, and the long address strings. These differences are possibly due to the addition of the trailing blanks to fill the shorter string. A speedier version would be even more useful, and I am looking forward to the assembly language version — who would like to write it?

Listing 2: Two sample executions of the program in listing 1.

```

RUN
FIRST WORD ?POOL
SECOND WORD ?POOL
EXACT MATCH
103.125%
?POOR
45.3125%
?COOL
45.3125%
?POO
45.3125%
?POLO
28.125%
?LOOP
18.75%
?PAIL
12.5%
?POOL ROOM
20.164609%
?MAIL ROOM
3.0178326%
?PO/OL
14.4%
?OOOO
40.625%

RUN
FIRST WORD ?T.C. O'HAVER 710 HILLSBORO DR. SILVER
SPRING MD.
SECOND WORD ?TOM O'HAVER 710 HILLSBORO DR. SILVER
SPRING MD.
77.241074%
?R.D. O'HAVER 710 HILLSBOROUGH RD. SILVER SPRINGS FL.
14.492063% ■

```



APPLE OWNERS — EXPAND YOUR SYSTEM WITH 8" FLOPPY DISK FROM *WIZARD*!

Many software programs are restricted by the 116 K available on the 5" disk drives now on the market. Some business programs require 12 or more diskettes, which can be both confusing and error inducing.

***WIZARD* offers four solutions:**

" <i>WIZARD</i> 1 + 1" : single 8" drive system; 256 K	\$1695.
" <i>WIZARD</i> 2 + 2" : two 8" drive system; 516 K	\$2495.
" <i>WIZARD</i> PLUS" : two 8" drives, double sided; over 1 megabyte	\$3150.
" <i>WIZARD</i> 10" : 10 megabyte Winchester drive, formatted as one file.	\$4795.

All systems are ready to run, fully assembled and tested, and include:

SHUGART full size 8" floppy disk drive(s).

Controller Card for your Apple (48K RAM required)

All interface software, cables, connectors, cabinet and power supply.

ONE YEAR parts and labor warranty from defects in material and workmanship.

WATCH FOR NEW *WIZARD* PRODUCTS FROM D&T ELECTRONICS:
we are currently developing other hardware and business software.

ALL SYSTEMS AVAILABLE NOW (stock to two weeks).

SEE YOUR LOCAL APPLE DEALER, OR CONTACT THESE *WIZARD* DISTRIBUTORS:

MAR-COMP
175 East Edgewood Drive
McMurray, PA 15317
(412) 531-5445

COMPUTER DISTRIBUTORS, INC.
PO BOX 9194
Austin, TX 78766
(512) 345-9729

DEALER INQUIRIES INVITED

SOFTWARE: We have software available to run on these expanded capacity systems; please send for our list.

If you are a software writer and have programs currently on 5" that would benefit from the expanded capacity of our 8" systems, we would like to hear from you.

WIZARD is a registered trademark of D&T Electronics, Inc.
Apple is a registered trademark of Apple Computer, Inc.

Clubs and Newsletters

Sorcerer User's Group in Ann Arbor MI

The Sorcerer User's Group and their newsletter, *The Sorcerer's Apprentice*, are based in Ann Arbor MI. The group meets once a month at the Newman Computer Exchange and the newsletter is printed every month and a half. The group's object is to spread Sorcerer-related information to all owners and to get as much out of the machine as possible. Contact Dave Bristol, 1530 Washtenaw, Ann Arbor MI 48104.

Computer Group for Medicine and Science

Microcomputers in
Medicine and the Sciences

Association is an organization devoted to aiding members of the medical and scientific communities gain working knowledge of computers and their uses in research and practical applications. Meetings are accredited seminars covering languages and applications of microcomputers. They meet in the Chemistry Building, Rm 105, University of South Florida, Tampa FL, on the fourth Thursday of the month at 7:30 PM. Their newsletter is called *MIMSA News*.

Software World

Called the *Software World*, this quarterly publication from England contains programs, book

reviews, new products, and computer related business items. The subscription rate in the US is \$64 a year. The newsletter is one of a series of three software related publications from A P Publications Ltd, 322 St John St, London EC1V 4QH ENGLAND.

Compucolor User's Group

The Canadian Compucolor User's Group meets on the second Wednesday of every month and invites users as well as interested onlookers to join and utilize the program library. For more information, contact House of Computers Inc, 368 Eglinton Ave W, Toronto, Ontario M5N 1A2 CANADA.

Club 1802 Newsletter

Club 1802 is a newsletter published for users of microcomputers which are based upon the 1802 processor. Programs, book and program reviews, want ads, items for sale and letters on related subjects are included. The newsletter is published twelve times a year and current rates are scheduled to be about \$10 a year. For more information, contact *Club 1802*, POB 985, Dickinson TX 77539.

Apple Dayton

This Apple II users group alternates their meeting dates between the second Wednesday of odd numbered months and the second Thursday of even numbered months to allow different people to attend at least bi-monthly. Meetings are held at Computer Solutions, 1932 Brown St,

Dayton OH, at 7:30 PM. For more information, contact Apple Dayton, Robert W Rennard, 2281 Cobble Stone Ct, Dayton OH 45431.

Sorcerer User's Group Newsletter

The Exidy Monitor is a monthly newsletter intended for users of Sorcerer microcomputers. The newsletter contains programs and other technical articles plus a software library buyer's guide for members and nonmembers. For information, write to *The Exidy Monitor*, c/o Computer Mart of Massachusetts, 1395 Main St, Waltham MA 02154.

Computer Club in Central Nebraska

Compusers is a new club for anyone interested in computing, particularly owners or prospective owners of microcomputers of any make. Meetings are held on the third Monday of each month at 8 PM. Dues, by-laws, and permanent officers are not yet established. For more information, contact Rocky Friend, POB 2064, Hastings NE 68901. Their monthly newsletter is also available from the same address.

West German Microcomputer Club for Radio Amateurs

The DAFG/GART German Amateur Radio Teleprinter Group has 1300 members who use SDK-85, KIM-1, PET 2001, TRS-80, Apple II, and other microcomputers for amateur radio operation in RTTY, FAX, SSTV, or CW. The membership fee is DM 35.00 annually. The newsletter, *RTTY*, is published six times a year. For more information, contact Manfred N May, Herrenstr.56, D 5014 Kerpen-Sndf. Or contact R F Matthaei, Beisserstr.45, D 2000 Hamburg-63, uC-Referat, WEST GERMANY.



computer mart
of new jersey

the
microcomputer
people®

**THE VITAL
INGREDIENT:
EXPERTISE**

Before you buy your new microcomputer, chances are you have a lot of questions. Important questions that could mean the difference between a working system and a wasted system. The vital ingredient is expertise. The microcomputer people at Computer Mart are expert at answering your questions and helping you put together the best system for your application. Whether it's for business, the home, or the laboratory, come see the experts at Computer Mart of New Jersey. We have the vital ingredient.

Computer Mart of New Jersey
504 Route 27
Iselin, N.J. 08830
(201) 283-0600

HOURS:
Open at 10 am,
Tuesday through Saturday

MICROTEK

SO RELIABLE WE GIVE YOU

365 DAYS WARRANTY

360	361	362	363	364
355	356	357	358	359
350	351	352	353	354
345	346	347	348	349
340	341	342	343	344
335	336	337	338	339
330	331	332	333	334
325	326	327	328	329
320	321	322	323	324
315	316	317	318	319
310	311	312	313	314
305	306	307	308	309
300	301	302	303	304
295	296	297	298	299
290	291	292	293	294
285	286	287	288	289
280	281	282	283	284
275	276	277	278	279
270	271	272	273	274
265	266	267	268	269
260	261	262	263	264
255	256	257	258	259
250	251	252	253	254
245	246	247	248	249
240	241	242	243	244
235	236	237	238	239
230	231	232	233	234
225	226	227	228	229

TOTAL PEACE OF MIND.

We are business people, just like you. We wouldn't stick our neck out unless we were certain we could back our claims and promises to the last letter. We wouldn't offer a legally binding long-term warranty on our Microtek MT-80, unless we were positive of its solid reliability.

We are sure that our versatile, alphanumeric line printer will provide you consistent, dependable performance. This is why we give you, not the usual 90-days in fine print, but an incredible 365-days warranty. We stand behind every product we make.

LOADED WITH INNOVATIONS

- 40, 80 or 120 columns (software selectable)
- Non-thermal paper, pin feed
- 125 CPS, 70 lines per minute
- 9 x 7 dot matrix
- Vertical format unit
- 96-character ASCII (upper and lower case)
- Adjustable forms width to 9 1/2"
- Parallel, serial (RS-232C), and IEEE-488 interfaces available

OUR UNIT PRICE

\$750. Parallel
\$835. Serial (RS-232C)
\$895. IEEE-488

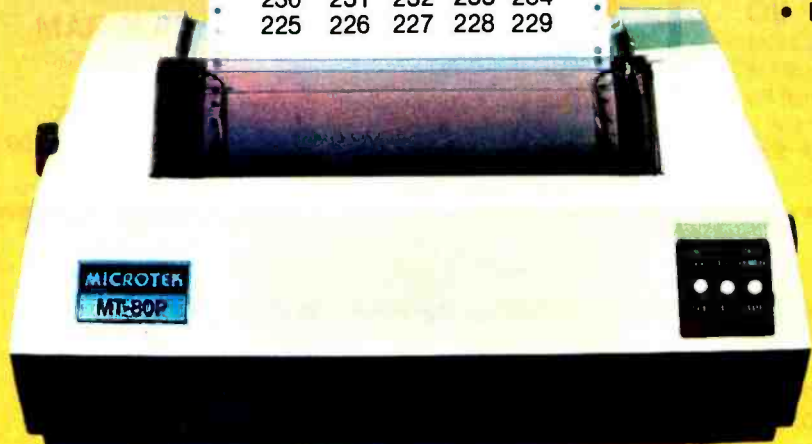

RELIABILITY

For more information contact:
MICROTEK, Inc.
7844 Convoy Court
San Diego, CA 92111
Tel. (714) 278-0633

Circle 56 on Inquiry card.

Free Newsletter on Process Instrumentation Systems

A newsletter series entitled *ControLoops* covers the fundamentals of industrial process instrumentation and control systems. Theory and implementation on unit control systems including cascade control, auctioneering, and feedforward control, plus application diagrams are featured in the series. For a free subscription to *ControLoops*, contact E Ross Forman, Manager — Instrumentation Engineering Group, Day and Zimmermann Inc, 1818 Market St, Philadelphia PA 19103.

PAX (Program Analysis Exchange) Succeeds 52-Notes in a New Format

PAX is a publication devoted to the analysis and evaluation of widely used personal computing software

currently on the public market for which good supporting documentation is not known to exist. Back issues of *PAX* and *52-Notes* are available for \$1 each. Write to Richard C Vanderburgh, 9459 Taylorsville Rd, Dayton OH 45424, to obtain information on contributing articles.

Ontario Society for Microcomputers in Education

A group of seventy educators have started the Ontario Society of Microcomputers in Education in order to coordinate individual efforts and provide a clearinghouse for the exchange of information on equipment, curricular materials, and teaching methods. The group's aims are to promote the use of microcomputers in all aspects of education, share knowledge of hardware and software, develop strategies for demonstrating the uses

of microcomputers in the classroom, to assist in the development of software to meet specific curricular needs, and more. For more information, contact N Soltseff, Unit for Computer Science, McMaster University, Hamilton, Ontario, L8S 4K1 CANADA.

International Computer Club

The International Society of Personal Computerists was organized to promote and advance personal computing on a world-wide basis. The society's services include free software, free consultation, custom programming, conversions from one BASIC system to another, and group discounts on software and hardware purchases. *Tid-Bits*, the newsletter, is of broad general interest to computer users and hobbyists. The society publishes several other newsletters

tailored to Apple users, Heath users, TRS-80 users, beginners, and nonusers. Membership is \$15. Contact International Society of Personal Computerists, 4554 Cristy Way, Castro Valley CA 94546.

Southern New Hampshire Apple Group

The Southern New Hampshire Apple Core meets once a month. The group is dedicated to Apple users, and they currently have plans to give public demonstrations of computers. Their newsletter is entitled *SNAC Facts* and it contains information concerning the meetings, items of general interest, and short programs. The members are building a disk library and are interested in hearing from other Apple users. Dues are \$6 per year. For more information, contact SNAC, Computerland of Nashua, 419 Amherst St, Nashua NH 03060. ■

SPECIALIZING IN QUALITY MICROCOMPUTER HARDWARE

INDUSTRIAL • EDUCATIONAL • SMALL BUSINESS • PERSONAL

BUILDING BLOCKS FOR MICROCOMPUTER SYSTEMS, CONTROL & TEST EQUIPMENT

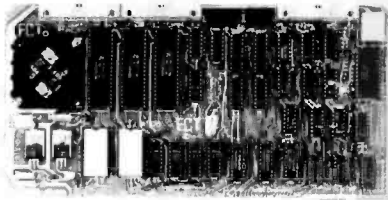

R² I/O
2K ROM
2K RAM
3 Serial Ports
1 Parallel Port
WIRED: \$295.00

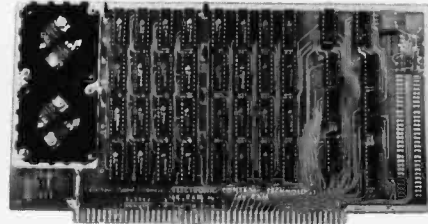

16 K RAM
FULLY STATIC
MEMORY
KIT: \$279.00
WIRED: \$310.00

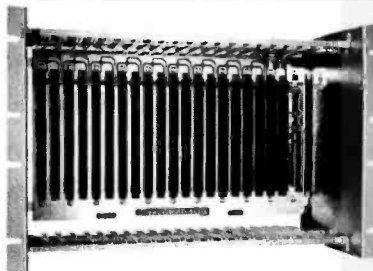

ECT-100-F
RACKMOUNT
CARD CAGES
KIT: \$200.00
WIRED: \$250.00

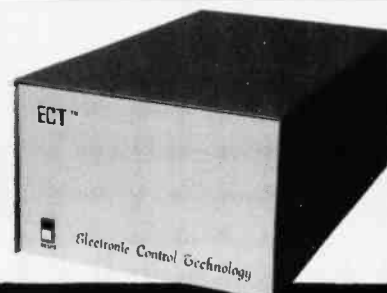

TT-10
TABLE TOP
MAINFRAMES
KIT: \$340.00
WIRED: \$395.00

POWER SUPPLIES, CPU's, MEMORY, OEM VARIATIONS

ELECTRONIC CONTROL TECHNOLOGY (201) 686-8080

763 RAMSEY AVE.
HILLSIDE, N.J. 07205

TEX and METAFONT, New Directions in Typesetting

by Donald E. Knuth

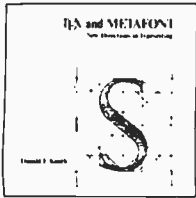

TEX and METAFONT, New Directions in Typesetting describes two systems that are going to change the typesetting/publications world. TEX is a system for typesetting technical text currently being implemented in PASCAL. It is in the public domain and is available to all who are involved in computerized typesetting. METAFONT, a system for design of alphabets suited to implementation on raster-based devices, permits a designer to give a completely precise definition to an infinite variety of typefaces. TEX and METAFONT are unique and powerful achievements whose concepts will be useful to: authors and publishers; programmers and system designers in typesetting, graphics, and office automation; typeface designers and commercial artists; compositors; university computing centers; and manufacturers of typesetting equipment. Foreword by Gordon Bell. A co-publication of Digital Press and the American Mathematical Society. 1979, 360 pp., ISBN 0-932376-02-9, paperback, \$12*.

Data Processing Technology and Economics, Second Edition

by Montgomery Phister, Jr.

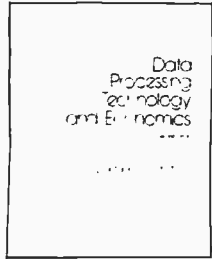

Data Processing Technology and Economics, Second Edition, is a comprehensive study of the data processing industry from its inception through 1978-79. It provides quantitative data and insightful narrative on four topic areas: the marketplace, products, applications, and costs. Coverage includes operating costs (to the user) and development, manufacturing, marketing, and maintenance costs (to the supplier). Other topics include hardware and software reliability, computer (and peripheral) population, system performance with multiprogramming, software performance and usage, I/O technologies and costs, computer use by industry and government, principal applications, human performance factors, and the important computers. **Data Processing Technology and Economics** is for users, applications programmers and systems analysts, system programmers, hardware designers, and managers. A co-publication of Digital Press and the Santa Monica Publishing Company. 1979; 736 pp.; hardbound (ISBN 0-932376-03-7), \$29.95*; paperback (ISBN 0-932376-02-9), \$24.95*.

Computer Engineering: A DEC View of Hardware Systems Design

by C. Gordon Bell, J. Craig Mudge, and John E. McNamara

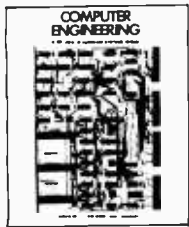

Computer Engineering: A DEC View of Hardware Systems Design is the story of hardware systems design practiced at Digital Equipment Corporation from 1957-77. It provides a set of case studies of classic design principles and techniques practiced under the real-world constraints of marketplace economics and continually evolving technology; an overview of the computer industry—insight into the complexities of its interrelated forces and an historical perspective; and a description of the development of families of machines. **Computer Engineering** is for people who want to understand the evolution of hardware systems design: hardware systems designers, university students (used in computer architecture courses at Caltech and UC/Berkeley); management of companies planning systems or planning to buy systems; software engineers; users. 1978, 585 pp., ISBN 0-932376-00-2, hardbound, \$19.95*.

Technical Aspects of Data Communication

by John E. McNamara

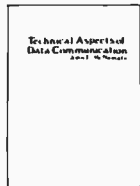

Technical Aspects of Data Communication provides a practical approach to the nuts-and-bolts problems and solutions in configuring communications systems. It describes common pitfalls in systems design and ways to avoid them, while also serving as a useful reference tool. **Technical Aspects of Data Communication** is intended to fit between books that treat data communication solely on a system level and hardware manuals that specify in detail the function of each bit in each register. The book features: comparison of protocols (DDCMP, BISYNC, SDLC), extensive explanation of interface standards (CCITT/V.44, RS232C, RS422, RS423) comprehensive appendices (how far—how fast?, modem options, codes (Baudot, ASCII, and others), UART, format and speed table for asynchronous communication, channel conditioning). Other topics covered are the 20-milliampere loop, telephone switching systems, error detection, and digital transmission and packet switching networks. 1977, 382 pp., ISBN 0-932376-01-0, hardbound, \$19.95*.

digital

Digital Press, Educational Services
Digital Equipment Corporation
12-A Esquire Rd., Billerica, MA 01862

ORDERING INFORMATION

*Prices are U.S. only. (Contact your nearest office of Digital Equipment Corporation, Educational Services for prices outside U.S.) Ten percent discount for two or more copies. Shipping and handling charges will be added to all orders not prepaid.

Please specify number of copies:

- _____ **TEX and METAFONT, New Directions in Typesetting**
_____ **Data Processing Technology and Economics, Second Edition**
 hardbound paperback
_____ **Computer Engineering: A DEC View of Hardware Systems Design**
_____ **Technical Aspects of Data Communication**

Check enclosed.

Please invoice me. (Specify billing address if different from shipping address.)

Remit to: Dept.DPC, Digital Press, at the address above.

Circle 58 on inquiry card.

Implementing Dynamic Data Structures with BASIC Files

Ted Carter
902 Pinecrest
Richardson TX 75080

In many computer applications where a large amount of information is to be stored, the need arises to sort, insert, and delete items efficiently using random-access tape or disk-based files. A common method of implementing a mailing list, for example, is to add new names to the end of the current file and to delete names by putting a blank field in place of the names to be deleted. This minimizes the number of time-consuming reads and writes to the file.

However, when this mailing list has to be printed in zip-code order, for example, the task becomes extremely slow as the number of names increases. This is because the number of file accesses increases exponentially with the number of items to be sorted. One possible solution is to actually sort the file so that it is always in order. This is impractical because it necessitates the same sort operation as before, plus a complete rewrite of the file.

With close examination of the problem, you might decide that the file should always be kept in order by inserting a new name in its proper place. This is a good idea, but requires that you must move, on the

average, $N/2$ names (for a file of N names) to make room for the new names. Again, with large files, this may take an inordinately large amount of time.

In order to solve these problems successfully and efficiently, you need a data structure that will permit an insertion and deletion of components without having to worry about where new components fit or what happens to the empty space left by deletion. The tool needed to create such a structure is called a *pointer*. This is simply a number that points to the location of a desired piece of data. Using disk files, for example, a pointer to a piece of data is its actual record number on the disk file. This takes advantage of the random access capabilities of a disk file so as to directly locate and read the data using the pointer value.

Using pointers, a *linked list*, the simplest type of dynamic data structure, can be built. In order to build the linked list, every data record must

be accompanied with a pointer to the next element in the linked list. Therefore, space must be reserved in the file for a pointer value within each data record.

A linked list is shown pictorially in figure 1. In a disk file, for example, you could store the base pointer value in the first record of the file. However, you need some way of knowing that the last data item Z does not point to anything. This can be accomplished by storing some special number not in the range of possible pointer values, such as zero, as the pointer value associated with the last data item. An important thing to realize is that records X , Y , and Z can *physically* be in any order on the disk. However, they are *linked* in order and can be retrieved in order with absolutely no comparing or sorting.

Record insertion is also relatively simple. The ordered list is scanned until the element to be added is greater than or equal to the current

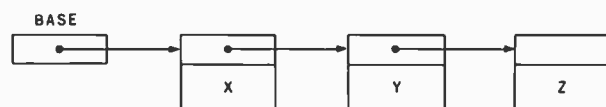

Figure 1: Example of a linked list. In this picture, X , Y , and Z are records containing the information that is to be stored. The boxes on top represent a portion of memory connected with each record that contains the address of the next record in the list. These are called pointers. The first record in the file, called the base record, points to the first data record in the file but does not contain data itself. This is because the base record also contains a pointer (not shown) to the first available space for new records.

About the Author

Ted Carter is employed at the Texas Instruments Corporate Engineering Center. In 1978, he founded Software Industries, a custom software house. His interests include computer speech synthesis and computer automation.

THE INFLATION FIGHTER



* \$749

* Suggested retail price.
Substantial OEM and dealer
discounts available

You can't buy more
capability for less . . . But
you can buy less for more.

MPI presents the perfect answer to your inflation-riddled printer budget. THE MODEL 88T DOT MATRIX PRINTER. The first in a series of new full-capability low-cost printers designed specifically for the general use computer market. The Model 88T is a fully featured printer with a dual tractor/pressure-roll paper feed system and a serial or parallel interface. The tractor paper feed system provides the precision required to handle multi copy fanfold forms, ranging in width from 1 inch to 9.5 inches. For those applications where paper costs are important, the pressure-roll feed can be used with 8.5 inch roll paper. A long-life ribbon cartridge gives crisp, clean print without messy ribbon changing. The microprocessor controlled interface has 80, 96 or 132 column formatting capability while printing upper and lower case characters bi-directionally at 100 characters per second.

With all of these features, **plus** quality construction, continuous duty print head and attractive styling, the Model 88T would easily sell at the competition's "under \$1000" (\$999.⁹⁹) tag. But we are offering it for only \$749; this should make you happy and several hundred dollars richer.

Write for complete specifications and pricing information.



MICRO PERIPHERALS, INC. 2099 WEST 2200 SOUTH / SALT LAKE CITY, UTAH 84119 / (801) 973-6053

TRS-80, Apple II
and S-100 owners.

Busy Box.™

**It makes your
computer
do things
it never
did before.**

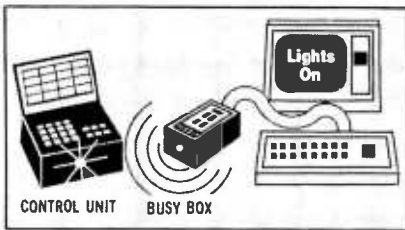

MicroMint introduces a new wireless AC remote control interface for the Sears and BSR X-10 home control system. Use your present TRS-80 Level II, Apple II or S-100 computer to provide complete home security through control of lights, appliances and motors with a few simple Basic commands. Buss compatible with virtually all microcomputers. Completely assembled — Just plug in and turn on!

As featured in:
"COMPUTERIZE A HOME"
BYTE, January 1980

**BUSY
BOX™**



- Assembled and tested. Busy Box \$79.95
- Cable and connector for TRS-80 14.95
- Cable and adapter for Apple II 29.95
- Cable and adapter for S-100 34.95
- Power Supply (necessary for TRS-80) 9.95

NY residents add 7% sales tax.

To order call (516) 374-6793

or write: The MicroMint Inc.

917 Midway
Woodmere, NY 11598

Dealer inquiries invited.

TRS-80 is trademark of Tandy Corp.
Apple II is trademark of Apple Computer

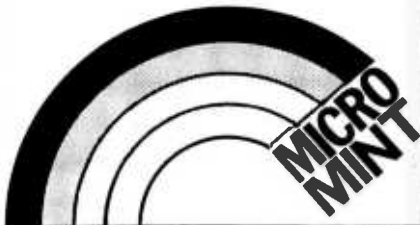

The number of file accesses increases exponentially with the number of items to be sorted.

element and less than the next element in the list. The new element is then inserted between these two elements. For example, assume that Y2 is to be inserted before Z and after Y, as in figure 2a. This is achieved by placing Y2 physically in the first free position on the file, making Y2 point to where Y pointed, and making Y point to Y2, as in figure 2b.

The process of deleting an element is easier. Consider deleting Y2 from the list in figure 2b. By making Y point to where Y2 pointed before Y2 was deleted, the result is the list in figure 2a.

In some situations, an improvement on the linked-list data structure is the *doubly linked ring*, shown in figure 3. With this structure, you may

scan from either direction, often facilitating an insertion and deletion either before or after an element. For ease of explanation and understanding, a simple singly linked list as in figure 1 will be used in the examples given in this article.

Implementing the Linked List

When implementing a linked list using random-access files, some additional problems must be solved. An element can be inserted in the linked list easily enough, but the computer must know where the first empty disk file is located. Secondly, when deleting an element, the disk file location of the deleted record should be recovered for later use.

These problems could be solved by marking the record to be deleted and later searching for the first empty or marked record when adding a new element. A much better solution is to create a linked list of free records. When adding a new element, a record is taken out of the linked list of free records and inserted in the ordered

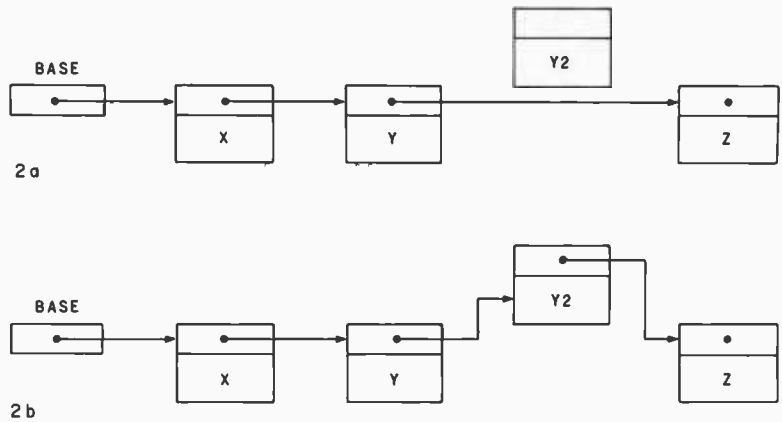

Figure 2: The process of insertion in a linked list. Figure 2a shows a new record, Y2 (probably physically located after nodes X, Y, and Z), before it is linked into its proper place in the list. To link it into the list, as in figure 2b, only the pointers in Y and Y2 must be changed.

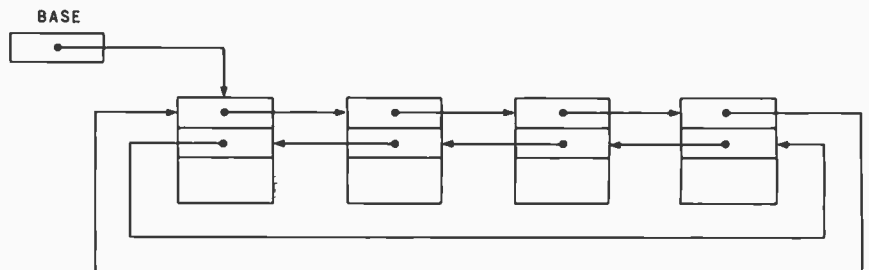
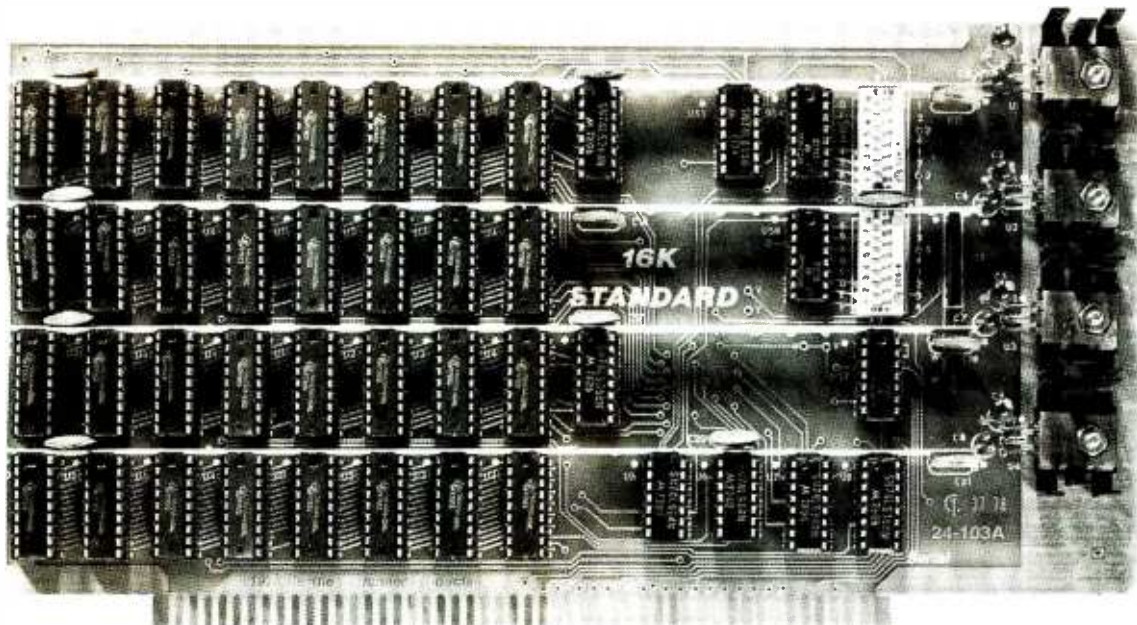

Figure 3: Example of a doubly linked ring. In this kind of linked list, each record contains a pointer to the previous as well as to the next record in the list. This has certain advantages in some applications, although it creates more memory overhead in each node. Doubly linked lists are not discussed in this article.



16K RAM

**Fully Static
250 nsec.**

\$295

The model 24-103 "STANDARD" RAM was designed for the smaller system which does not require bank select. It has been in production since late 1978 and has earned an enviable record for reliability. Although it does not have some of the options of the commercial cards listed below, its manufacturing quality has not been cut in any way. The card has DIP switch addressing—any continuous

16K on 4K boundaries. All inputs are buffered and it comes fully assembled and guaranteed for one year. Prices for the card with 250 nsec. memory chips start at \$295 and drop to \$255 for quantities 5-9. You may deduct an additional \$30 per board if you have a 2 Mhz. system and can get by with 450 nsec. chips.

OTHER S-100 BUS STATIC RAMS

16K PLUS

This board has been sold primarily to dealers/system integrators during the past 18 months. It has become the reliability standard against which other boards are compared. It is fully static, 16K by 8 bits, and a premium quality product featuring all Schmitt trigger signal inputs. The board has been optimized for the Cromemco system using output port 40H for its bank select. It also has "start-up options" which allow the board to come up in either the enabled or disabled condition. It is addressable by DIP switches to any continuous 16K on 4K boundaries. Prices with 250 nsec. chips: 1-4 cards, \$395; 5-9, \$325. You may deduct \$30 more for 450 nsec. chips.

16K APEX

The board is very similar to the PLUS card. It differs in that its bank select can use any of 256 output port addresses and it can be addressed on 16K boundaries only. Pricing is the same as for the PLUS.

8/16 RAM

This board was designed for the 1980s. It is configured as 16K by 8 bits when accessed by an 8-bit processor and configured 8K by 16 bits when used with a 16-bit processor. The configuration switching is automatic and is done by the board sampling the "Sixteen Request" signal sent out by all 16-bit processors. The board has all the high noise immunity circuits of the PLUS and APEX as well as "extended addressing". Extended addressing is a replacement for bank select and makes use of a total of 24 address lines to give a directly addressable range of over 16 megabytes. This card ensures that your new memory purchases will not be soon obsoleted. It comes with 250 nsec. chips only and is guaranteed to run with our 8086 with an 8 Mhz. clock. Prices: 1-4, \$445; 5-9, \$345.

MEMORY CHIPS

From time to time we have surplus 4044 type 4K by 1 memory chips. Call for current availability and price.

HOW TO ORDER

There are two ways to go. You can check with your local dealer or order direct from the factory. Bank cards, personal checks, CODs okay. There is a ten day return privilege on factory orders. All boards are guaranteed for one year—both parts and labor. Shipped prepaid from stock.

**CHECK THE READER SERVICE CARD
FOR INFORMATION ABOUT OUR
16-BIT 8086 PRODUCTS**



Seattle Computer Products, Inc.

1114 Industry Drive, Seattle, WA. 98188
(206) 575-1830



250/750

BREAKING THE SOUND BARRIER

1,031/97



7,771

THE TRAP DOOR

1,031/97

September 1977

March 1979

Byte Cover Prints -- Limited Editions.

The September '77 and March '79 covers of BYTE are now each available as a limited edition art print, personally signed and numbered by the artist, Robert Tinney.

These prints are strictly limited to a quantity of 750 for each cover, and no other editions, of any size, will ever be published. Each print is 18" x 22", printed on quality, coated stock, and signed and numbered in pencil at bottom.

The price of each print is \$25. This includes 1) a signed and numbered print; 2) a Certificate of Authenticity, also signed personally by the artist and witnessed, attesting to the number of the edition (750), and the destruction of the printing plates; and 3) first class shipment in a heavy-duty mailing tube.

To order your limited edition art print, fill out and mail the order form below.

Send me _____ "Breaking the Sound Barrier" prints at \$25 each, and _____ "Trap Door" prints at \$25 each. I understand this price includes Certificate of Authenticity and first class shipment.

- I have enclosed check or money order to Robert Tinney Graphics.
- Charge this to my Master Charge or Visa

Card # _____ Expires: _____

Ship my print(s) to:

Name _____

Address _____

City _____ State _____ Zip _____

Send order to:

robert tinney graphics

P.O. Box 45047 • Baton Rouge, LA 70895



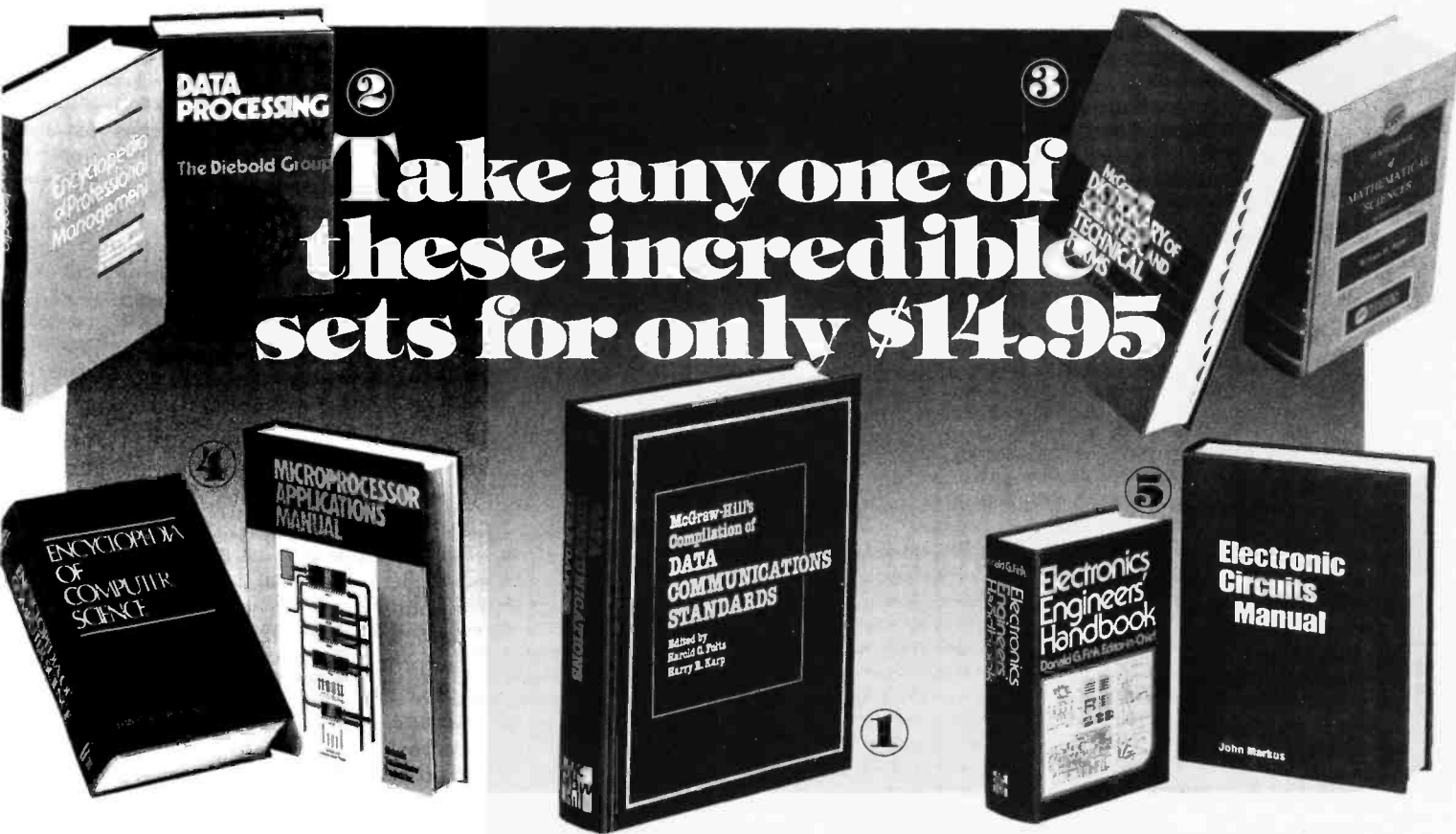

Take any one of these incredible sets for only \$14.95

Join the **Computer Professionals' Book Club** now— and save up to \$150 on professional books you thought only libraries could afford!

Now these fundamental reference books can be yours for only a fraction of their cost! Take your choice of these sets—worth as much as \$165—for only \$14.95 when you join the Club.

These high quality publishers' editions are just a token of the opportunities the Club provides to help you build your professional library. As a Club member you'll watch your savings add up fast on the latest and best publications in the field—books on programming techniques, computer architecture, languages, distributed systems, data communications, and other vital areas you won't find covered in your local bookstore.

Why YOU should join now!

- **BEST BOOKS IN YOUR FIELD**—Books are selected from a wide range of publishers by expert editors and consultants to give you continuing access to the latest books in your field.
- **BIG SAVINGS**—Build your library and save money, too! We guarantee savings of at least 15% off publishers' list prices on every book. Usually 20%, 25%, or even higher!
- **BONUS BOOKS**—You'll immediately begin to participate in our Bonus Book Plan that saves you 70-80% off the publisher's price of many books.
- **CONVENIENCE**—Fourteen times a year you'll receive the Club Bulletin FREE, fully describing the Main Selection and alternate selections, together with a dated reply card. If you want the Main Selection, you simply do nothing—it will be shipped automatically. If you want an alternate selection—or no book at all—you simply indicate it on the regular reply card and return it by the date specified. You will have at least 10 days to decide. If, because of late mail delivery of the Bulletin, you should receive a book you do not want, just return it at the Club's expense.

As a Club member, you agree only to the purchase of four books over a two-year period.

- 1 **Data Communications Standards** edited by Harold C. Folts and Harry R. Karp. Publisher's Price. \$185.00. (Counts as a Set.) Code #450/579
- 2 **Automatic Data Processing Handbook** edited by The Diebold Group. 976 pages. 269 illustrations. **Encyclopedia of Professional Management** edited by Lester R. Bittel. Combined Publisher's Price. \$68.45. Code #789/304
- 3 **CRC Handbook of Mathematical Sciences** edited by William H. Beyer. **Dictionary of Scientific and Technical Terms** edited by Daniel Lapedes. 1,800 pages. 3,000 illustrations. Combined Publisher's Price. \$89.45. Code #789/339
- 4 **Encyclopedia of Computer Science** edited by Anthony Raiston and Chester L. Meek. **Microprocessor Applications Manual** by Motorola Semiconductor Products, Inc. 720 pages. Illustrated. Combined Publisher's Price. \$98.00. Code #789/312
- 5 **Electronics Engineers' Handbook** edited by Donald G. Fink. **Electronic Circuit Manual** by John Markus. 988 pages. Combined Publisher's Price. \$94.00. Code #789/320

Computer Professionals' Book Club
P.O. Box 582, Hightstown, New Jersey 08520



Please enroll me as a member and send me the set indicated, billing me for only \$14.95, plus local tax, postage and handling. If not satisfied, I may return the set within 10 days and my membership will be canceled. I agree to purchase a minimum of four books during the next two years as outlined under the Club plan described in this ad. Membership in the Club is continuous but cancelable by me any time after the four-book purchase requirement has been fulfilled.

Write Code # of set you want here

Orders from outside the U.S. must be prepaid with international money orders in U.S. dollars.

Charge my VISA MASTER CHARGE* Exp. Date _____

Credit Card # _____ *MC Bank # _____

Signature _____

Name _____

Address _____

City, State, Zip _____

Corporate Affiliation _____

This order subject to acceptance by McGraw-Hill. All prices subject to change without notice. Offer good only to new members. A postage and handling charge is added to all shipments.

P39453

Listing 1: Program to create a linked list file. This program, written in CBASIC, creates a small file that contains forward pointers to the next available record. The first record, which is initialized to "2,3", points to the first data record in the file (record 2) and to the first empty (available) record in the file (record 3). The second record, initialized in line 25, is a sentinel record that denotes the end of the file. It is always the last data record in the file and has a forward pointer of zero.

```

REM  CREATE A FILE WITH A LINKED LIST OF FREE RECORDS
REM  -----
REM
REM---There will be 10 free records in the sample file.
10   FILELENGTH=10
REM---Create the file with a record length of 22. Give
REM---it the file number of one.
15   CREATE "DATA.FIL" RECL 22 AS 1
REM---Put pointer in for the ordered linked data list
REM---and list of free records.
20   PRINT #1: 2,3
REM---Put sentinel with highest possible value at end
REM---of linked list of data.
25   PRINT #1: 0,"zzzzzzzzzzzzzzzz"
REM---Create the linked list of free records by making
REM---each one point to the next record.
30   FOR Z=4 TO FILELENGTH+2 : PRINT #1: Z,"" : NEXT Z
REM---Make the last free list record pointer equal
REM---zero to signify the end of the list.
35   PRINT #1: 0,""
40   CLOSE 1

```

Listing 2: Program to add a record to a linked list file. This program uses the forward pointers to chain through the linked list until the proper place for the new record is found. The only pointers that need to be changed are those on the record being added and the record immediately preceding it.

```

REM  THIS PROGRAM ADDS SOME ALPHANUMERIC DATA TO OUR FILE
REM  WHILE KEEPING IT IN ALPHABETICAL ORDER.
REM  -----
REM
REM---Open file #1 with record length of 22.
10   OPEN "DATA.FIL" RECL 22 AS 1
REM---Set pointers to start of linked lists.
15   READ #1,1: BASEPOINTER, NEXTFREE
20   IF NEXTFREE=0 THEN PRINT"File is full" : GOTO 90
REM---Get data to add.
25   INPUT"New data:";NEWDATA$
REM---Left justify data in a field of blanks.
30   NEWDATA$=LEFT$(NEWDATA$+ " ",14)
REM---Set pointers to start of list.
35   POINTER=BASEPOINTER : NEXTPOINTER=BASEPOINTER
REM---Search loop which traverses the linked list to
REM---find the proper place to insert the new data.
40   TRAILPOINTER=POINTER : PREVDATA$=DATA$
45   POINTER=NEXTPOINTER : READ #1,POINTER: NEXTPOINTER,DATA$
50   IF NEWDATA$>DATA$ THEN 40
REM---Insert our NEWDATA$ in the linked list
REM---after the element pointed to by TRAILPOINTER.
REM---Get the place to physically put the new record by
REM---taking a record out of the free linked list.
55   READ #1,NEXTFREE: NEXTRECORD
REM---If TRAILPOINTER=POINTER, then the base pointer must
REM---be modified in order to add at the beginning.
60   IF TRAILPOINTER<>POINTER THEN 75
65   PRINT #1,1: NEXTFREE, NEXTRECORD
70   PRINT #1,NEXTFREE: BASEPOINTER, NEWDATA$: GOTO 90
REM---Now take record out of free linked list.
75   PRINT #1,1: BASEPOINTER, NEXTRECORD
REM---Now make the new item point to where the record
REM---pointed to by TRAILPOINTER pointer, make the record
REM---pointed to by TRAILPOINTER point to new item.
80   PRINT #1,NEXTFREE: POINTER, NEWDATA$
85   PRINT #1,TRAILPOINTER: NEXTFREE, PREVDATA$
90   CLOSE 1

```

list. When deleting a record from the ordered list, the record that has just been removed is added to the linked list of free records so that it can be used the next time an element is to be added.

The following example uses linked lists and random-access files. For the sake of simplicity, assume that each record consists of one pointer to the next record in the list and one string of data. Since there are two linked lists, the first logical record will contain two pointers, one to the first data element, the second to the first free record.

The program of listing 1, written in CBASIC, creates a data file capable of holding ten data entries of fourteen characters each. The file created by this program is shown in listing 5a. Notice that data record number two, the first in the linked list of data, has a zero for its forward pointer and is filled with "z"s, the highest possible data going in alphabetical order. Such a dummy record, usually called a *sentinel*, will always be the last element of the linked list. The sentinel is also used to locate the end of the linked list when the linked list is traversed in ascending order. Although programs can be written without the sentinel record, the sentinel greatly simplifies them.

The program of listing 2 adds a record to the linked list. It gets the data to be added and scans the linked list (keeping a pointer to the previous record) until the record to be added is alphabetically less than the one being read. When this occurs, the new item should be added immediately before the one being read. This is accomplished by making the new record point to the record being read and making the previous record point to the new record. When inserting a new item at the very beginning of the linked list, a special case exists that must be accounted for, since the base pointer in the first record must be changed to point to the new record.

Listing 5b shows what the data looks like after adding a piece of data named "First item". Listing 5c and listing 5d show the contents of the file after the addition of several new entries to the file. Note that the path of the linked list is such that the data is always in alphabetical order.

IS YOUR Z80 HALF ASLEEP?

Don't settle for less than the total performance built into your Z80 Computer. Wake up its entire potential with an OASIS Operating System—the high-powered, professional software package that takes full advantage of Z80 power.

Utilizing optimized Z80 code, OASIS makes the system run faster. More and better tools let you develop software faster, too.

It's easy to use because all the tools you need are included: ISAM files, hard and floppy disk support, editor, user accounting with logon, password privilege level, and file security. Options: BASIC Compiler, spooler, text editor and output processor,

development package, and more.

The BASIC Compiler is also an *interpreter, complete with debugger*. It makes programs run faster, takes less memory, and provides software security. A first for micros, it's an OASIS exclusive.

FEATURES: Single- & Multi-User / User Accounting / Multi-Tasking / File & Record Security / Logon, Password & Privilege Protection / Keyed (ISAM), Direct & Sequential Files / Hard & Floppy Disk Support / Extensive Documentation

OASIS PRODUCTS: Single-User Operating System / Multi-User Operating System / Macro Re-locating Assembler / Debugger / Linker / Editor / Output Text Formatter / Spooler / Communications Package / Sort / Diagnostic & Maintenance Utilities / Interactive EXEC Language / Re-entrant BASIC Compiler

OASIS IS AVAILABLE FOR: Altos / Billings / Digital Microsystems / Digital Group / Cromemco / Vector Graphic / Micromation / CompuCorp / North Star / Onyx / Bell Controls / TRS-80 Mod II / Vormex and others

Multi-User OASIS, available for most computer configurations, gets even more performance out of your system. It has all the Single-User features, *PLUS a re-entrant BASIC Compiler*, file and record locking, variable time-slicing, user-to-user communications, and extended memory addressing. All fully upward compatible with Single-User.

Documentation?...complete and extensive. And, of course, there's plenty of application software.

OASIS operating systems, languages, development packages, system utilities—all fully integrated, all from one source.

Ask your dealer or manufacturer. Or send the coupon direct, today.

MAKES MICROS RUN LIKE MINIS.



Order OASIS direct from:
Phase One Systems, Inc.
 7700 Edgewater Drive, Suite 830
 Oakland, CA 94621

Telephone (415) 562-8085 TWX 910-366-7139

My computer configuration (specify make, disk system, etc.)

Name _____

Street Address (No Box No.) _____

City _____ State _____ Zip _____

PLEASE SEND ME:

OASIS (Includes Manual)	Manual Only	Amount
<input type="checkbox"/> Single-User System \$150	<input type="checkbox"/> \$17.50	
<input type="checkbox"/> BASIC Compiler \$100	<input type="checkbox"/> \$15	
<input type="checkbox"/> Multi-User System \$250	<input type="checkbox"/> \$17.50	
<input type="checkbox"/> Re-entrant BASIC Compiler \$145	<input type="checkbox"/> \$15	
System and BASIC Manual	<input type="checkbox"/> \$27.50	
Complete OASIS Products Manual	<input type="checkbox"/> \$50	
Complete Information	<input type="checkbox"/> \$1	
	Shipping	\$2
	\$1 for C.O.D.	
	California residents add sales tax	
	TOTAL	

Check Enclosed VISA

UPS C.O.D. Mastercharge

Card Number: _____

Expiration Date: _____

Signature: _____

Listing 3: Program to list a linked-list file. This program uses the forward pointers to print out the records in the order in which they are encountered. This example corresponds to printing out the data fields in ascending alphabetic order.

```

REM THIS PROGRAM LISTS OUR ALREADY SORTED FILE.
REM -----
REM
REM--Open file #1 with record length of 22.
10 OPEN "DATA.FIL" RECL 22 AS 1
REM--Set pointer to start of linked list.
15 READ #1,1: POINTER
REM--Loop to traverse list and print data
REM--until POINTER is zero.
20 READ #1,POINTER: POINTER,DATA$
25 IF POINTER<>0 THEN PRINT DATA$: GOTO 20
30 CLOSE 1

```

Listing 4: Program to delete a record from a linked list file. This program deletes a given record by changing the pointer of its previous record. The pointers in record 1 and the deleted record are changed so that this record is the first record of the linked group of free (available) records.

```

REM DELETE A DATA ITEM FROM OUR MAIN LINKED LIST AND
REM ADD IT TO OUR LINKED LIST OF FREE RECORDS.
REM -----
REM
REM--Open file #1 with record length of 22.
10 OPEN "DATA.FIL" RECL 22 AS 1
15 INPUT"Data to delete:":DATA$
REM--Left justify data in a field of blanks.
20 DATA%=LEFT$(DATA$+" ",14)
REM--Set pointers to beginning of linked list.
25 READ #1,1: BASEPOINTER, NEXTFREE
30 POINTER=BASEPOINTER: NEXTPOINTER=BASEPOINTER
REM--Search loop traverses the linked list until it
REM--finds a match or runs out of data.
35 TRAILPOINTER=POINTER: PREVDATA%=DATAIN$
40 POINTER=NEXTPOINTER
45 READ #1,POINTER: NEXTPOINTER, DATAIN$
50 IF NEXTPOINTER=0 THEN PRINT"No match found.": GOTO 75
55 IF DATAIN$<>DATA$ THEN 35
REM--Delete the record pointed to by POINTER by making the
REM--record pointed to by TRAILPOINTER point to the record
REM--after the one pointed to by POINTER.
60 IF TRAILPOINTER=POINTER THEN BASEPOINTER=NEXTPOINTER \
ELSE PRINT #1,TRAILPOINTER: NEXTPOINTER, PREVDATA$
REM--Add the now unused record pointed to by pointer to the
REM--free linked list.
65 PRINT #1,POINTER: NEXTFREE,""
70 PRINT #1,1: BASEPOINTER, POINTER
75 CLOSE 1

```

The program of listing 3 and its output in listing 5e will clarify any confusion in following the list. This program traverses the linked list of data and prints each item out as it is read. It can be concluded, from the brevity of listing 3, that printing a sorted list is much easier with the use of a linked-list file organization.

Listing 4 shows the solution to the problem of deleting a given data item and placing the free space back into the linked list of free records. The program scans the linked list until it reaches the end of the file or finds the data to be deleted. When the data to be deleted has been found, the previous record is made to point to where the deleted record points. As in listing 2, deleting the first item in the linked list results in a special case, and the base pointer must be modified. The deleted record is then added to the linked list of free records. Listing 5f shows the data file after the "Fourth" data item has been deleted. Note the "6" in the first line of listing 5f, which points to the first free record, the record that has just been deleted.

Although the concept of the linked list may be difficult to understand, it is a very powerful tool. If, in the mailing list example, the information needs to be sorted by more than one field, it is simple to create a linked list for each field to be sorted and to make room for the additional pointers.

Other modifications are possible; for example, the linked list could spread over more than one file on a disk or over more than one disk by having the pointers preceded by a

TELEVIDEO TVI 912

Smart CRT

- Microprocessor Based
- Upper/Lower Case Standard
- Numeric Keypad Standard
- One Page of Memory Standard
- Many Video Modes, Editing Modes

\$840.00 + \$35.00 Shipping

Options:

- Serial Printer Port \$60.00
- Second Page Memory \$60.00

announcing . . .

NOISEMAKER & NOISEMAKER II

S-100 Bus Apple II Bus

Soundboards Use GI AY 3-8910 I.C.
To Generate Sound Effects Under Software Control

- On Board Audio Amp
- Breadboard Area for Easy Interfacing

PCB Only, \$34.95 Ill. Residents Add Sales Tax

Ackerman Digital Systems, Inc.

110 North York Road • Suite 208 (312) 530-8992
Elmhurst, Illinois 60126



We make our Floppys as if your job depends on them. Because it does.

In your work, data is too important to lose. So if you use a Floppy Disk with even a minor flaw—like a dropout—you risk a lot. That's why Maxell has taken the danger out of Floppy Disks.

Maxell: the worlds most dependable Floppy Disks.

We've devoted two generations to building our reputation as manufacturers of the world's finest magnetic media. Our Floppy Disk technology achieves a consistency that is rarely equalled . . . and never surpassed.

Even the jackets our floppys come in are made to resist heat and mechanical shock. And they're specially treated to prevent the build-up of static charges, so they do their part to increase the total reliability of their precious contents.

Made better than most specifications.

To guarantee complete interchangeability, all Maxell floppys conform to ISO, ECMA, ANSI, JIS, and IBM standards.

Circle 62 on inquiry card.

But even more important to you, Maxell's own tolerances are tougher than the industry's.

And our inflexible Quality Control inspections permit nothing to blemish our hard-earned reputation.

So when your job depends on full data retrieval, depend on Maxell Floppy Disks. They work best . . . and so will you.

Maxell offers the full range of Floppy Disks, from standard 8-inch to 5¼-inch, plus Data Cassettes. *Dealer inquiries invited.*



maxell[®]
DATA PRODUCTS
The Quality Alternative

Maxell Corporation of America. Data Products Group
60 Oxford Drive, Moonachie, NJ 07074 Tel. (201) 440-8020

Listing 5: Examples of linked list files. The contents of the file created by listing 1 are shown in listings 5a, 5b, 5c, 5d, and 5f. In each case, the records are numbered 1 through 12, with record 1 at the top. Listing 5a shows the contents of the file just after it has been created by the program in listing 1. Listings 5b, 5c, and 5d show the file after one, two, and five records, respectively, have been added. Listing 5e shows the result of running the program of listing 3. The data appears listed in ascending alphabetic sequence. Listing 5f shows the file after the fourth node has been deleted. Note that the available record pointer in record 1 points to line 6, the location of the line that has just been deleted.

```
(5a)  2,3
0,"zzzzzzzzzzzzzzzz"
4,""
5,""
6,""
7,""
8,""
9,""
10,""
11,""
12,""
0,""
```

```
(5b)  3,4
0,"zzzzzzzzzzzzzzzz"
2,"First item  "
5,""
6,""
7,""
8,""
9,""
10,""
11,""
12,""
0,""
```

```
(5c)  3,5
0,"zzzzzzzzzzzzzzzz"
4,"First item  "
2,"Second item "
6,""
7,""
8,""
9,""
10,""
11,""
12,""
0,""
```

```
(5d)  7,8
0,"zzzzzzzzzzzzzzzz"
6,"First item  "
5,"Second item "
2,"Third      "
4,"Fourth     "
3,"Fifth      "
9,""
10,""
11,""
12,""
0,""
```

```
(5e)  ADR2 LIST
CRUN VER 2.04
Fifth
First item
Fourth
Second item
Third
```

```
(5f)  7,6
0,"zzzzzzzzzzzzzzzz"
4,"First item  "
5,"Second item "
2,"Third      "
8,""
3,"Fifth      "
9,""
10,""
11,""
12,""
0,""
```

digit specifying the file or disk-drive number. A slightly better solution for very large data bases is to use pointers to create a tree structure. However, operations involving trees are very involved, and a discussion of them is outside the scope of this article. Those interested in this subject are encouraged to read the book *Algorithms + Data Structures = Programs* by Niklaus Wirth, listed in the references.

Uses of the Linked List

The concepts of linked lists and pointers can also be used to handle data that has a variable amount of additional information associated with it. One particular problem that is unmanageable without linked lists involves a theatre-booking program where you have a movie film and an unknown, highly variable number of dates for which it is scheduled to be used. Because of the uncertainty

The concepts of linked lists and pointers can also be used to handle data that has a variable amount of additional information associated with it.

involved with the scheduling process, it is usually unacceptable to either limit the number of dates that can be associated with a film or to reserve enough space per film to handle even the most heavily scheduled film.

One solution to this scheduling problem makes use of a linked list. A file containing the essential information for each film can also have, for each record describing a film, a pointer that points to a linked list of date records (each record containing a date and its associated information). Traversing the linked list of dates for any one film is both fast and easy, and each film takes up only as much space for date records as is needed.

The programs and ideas presented here can be converted to work in any programming language that allows some sort of random-access files. In cases where a linked list is applicable, necessity for the additional storage space for the pointers and the slightly increased program complexity are both far outweighed by the ability to directly access related data items with a minimum of searching and sorting.

The difficulty arises in determining whether or not to use linked lists in a particular application. There are, unfortunately, no fixed criteria since the choice of a method will depend on such factors as the computer's disk capabilities, the number of data items, the length of the data items, how often the data will be sorted, and how often the data base will change. You should, however, plan the data base before doing any programming, taking into account the possible methods and the tradeoffs involved. ■

REFERENCES

1. Grogono, Peter, *Programming in Pascal*, Addison-Wesley, Reading MA, 1973.
2. Wirth, Niklaus, *Algorithms + Data Structures = Programs*, Prentice-Hall, Englewood Cliffs NJ, 1976.

NEW FROM MOUNTAIN HARDWARE. CONTROL FROM YOUR APPLE.

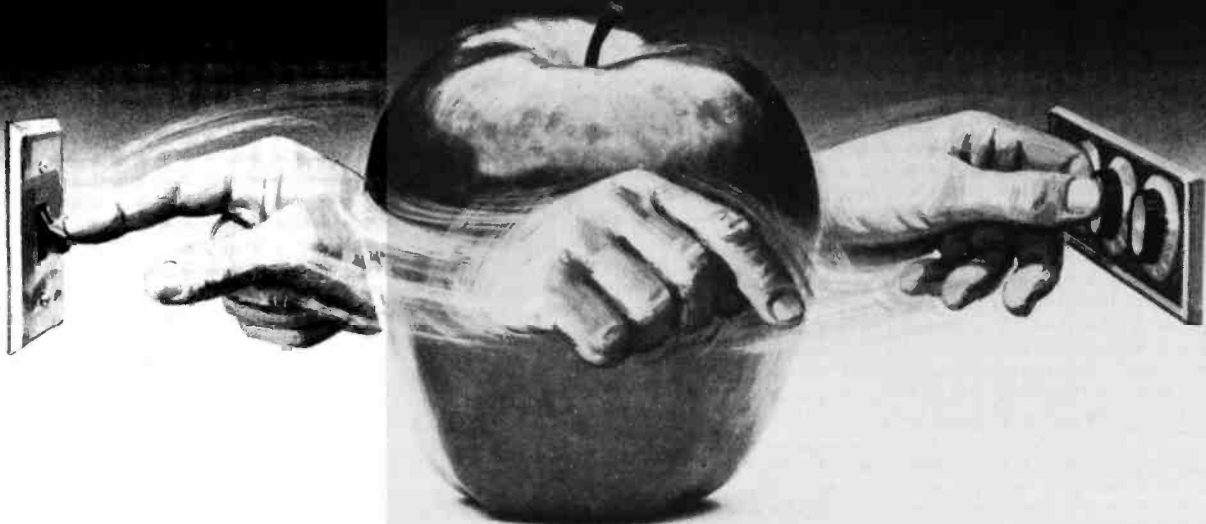

INTROL/X-10.

COMPUTERIZE YOUR HOME.

The Introl/X-10 peripheral system for your Apple* Computer allows you to remotely control lights and electrical appliances in your home.

YOU'RE ALREADY WIRED.

Introl/X-10 operates by utilizing your computer's intelligence to command the BSR System X-10 to send signals over regular 110 volt household wiring. That means you can control any electrical device in your home without additional wiring.

READY TO USE.

Introl/X-10 comes with complete software to control devices on pre-determined schedules, and features:

- Control devices at a specific time.
- Select a daily or weekly schedule.
- Specify a day of the week, or an exact date for a particular event.
- Specify an interval of time for an event.
- Rate device wattages for a running account of power consumption during your schedule for energy management.
- Used with our Apple Clock™ your schedules may run in "background" while other programs may run at the same time in "foreground."

EVERYTHING YOU NEED.

The Introl Controller board plugs into a peripheral slot of your Apple. With an ultrasonic transducer it transmits control signals to the BSR/X-10 Command Console which may be plugged into any convenient AC outlet near your computer. On command, signals are sent to remote modules located at the devices you wish to control. Up to 16 remote module addresses may be controlled from your Apple.

AVAILABLE NOW.

The Introl/X-10 System consists of the Introl Controller board with timer and ultrasonic transducer, the X-10 Command Console and three remote modules. \$279. Complete and tested. If you already have a BSR System X-10, the Introl Controller board is available separately for \$189. Additional remote modules are available at \$15. See your computer dealer for a demonstration. Or, return the coupon below for complete information.

Available through computer dealers worldwide

*Apple is a trademark of Apple Computer Inc.
BSR/System X-10 is a trademark of BSR, Ltd.

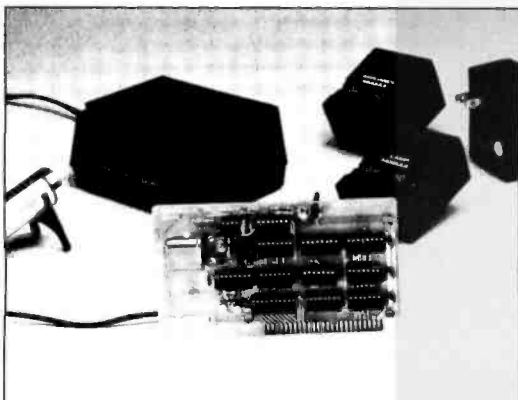

Mountain Hardware, Inc.

LEADERSHIP IN COMPUTER PERIPHERALS
300 Harvey West Blvd., Santa Cruz, CA 95060
(408) 429-8600

Sounds great.

Home control from my Apple?

That sounds like a great system. Send me all the details.

Name _____

Address _____

City _____ State _____ Zip _____

Phone _____

PUT YOUR IDEAS

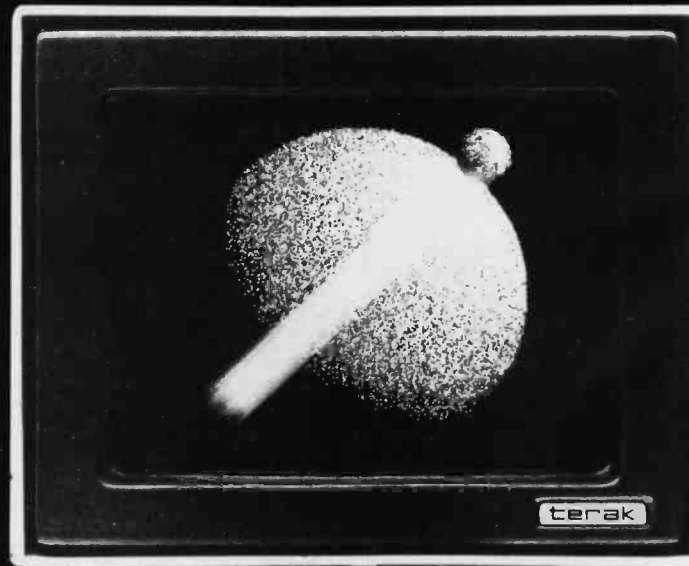
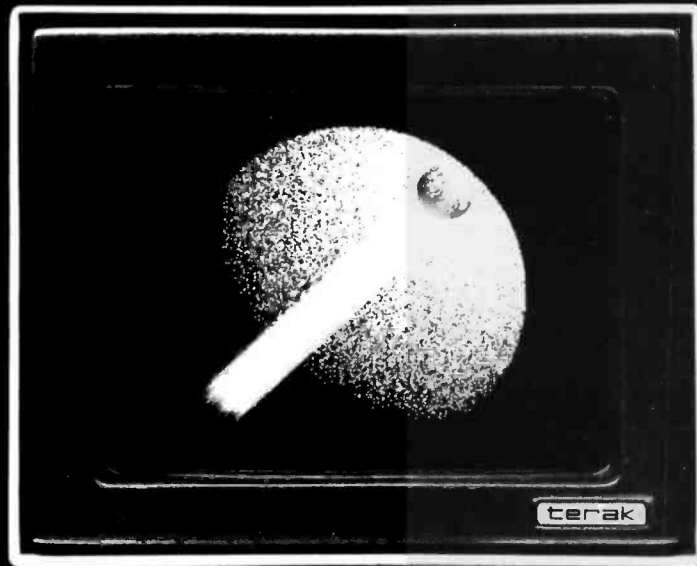
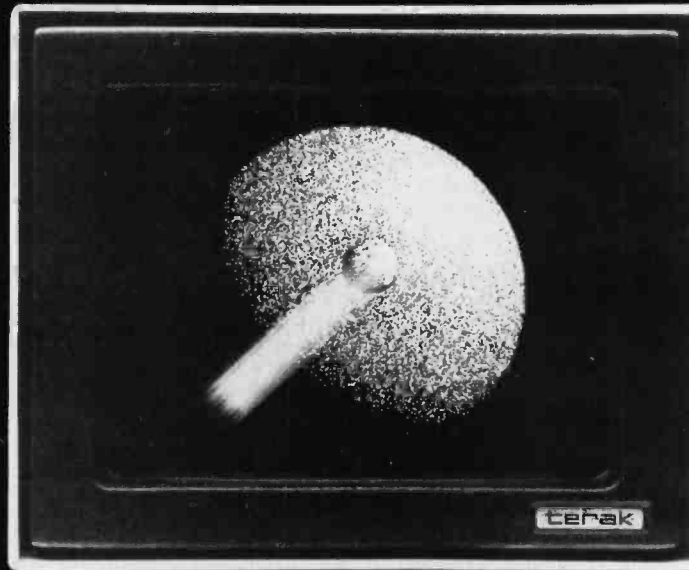
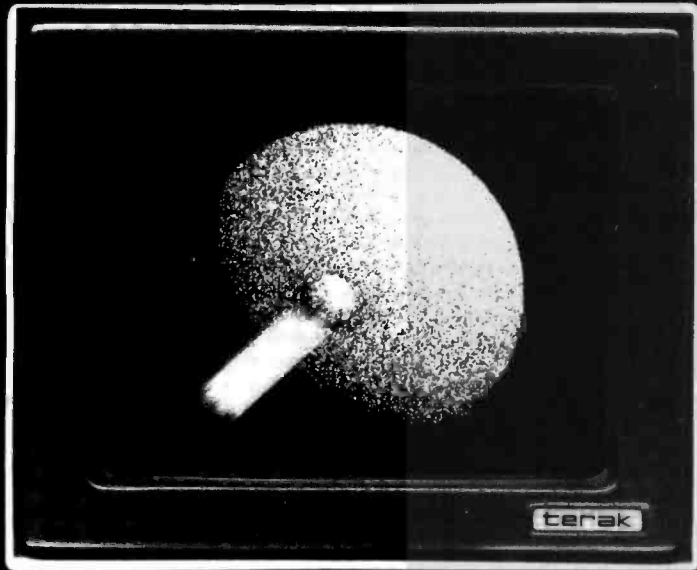
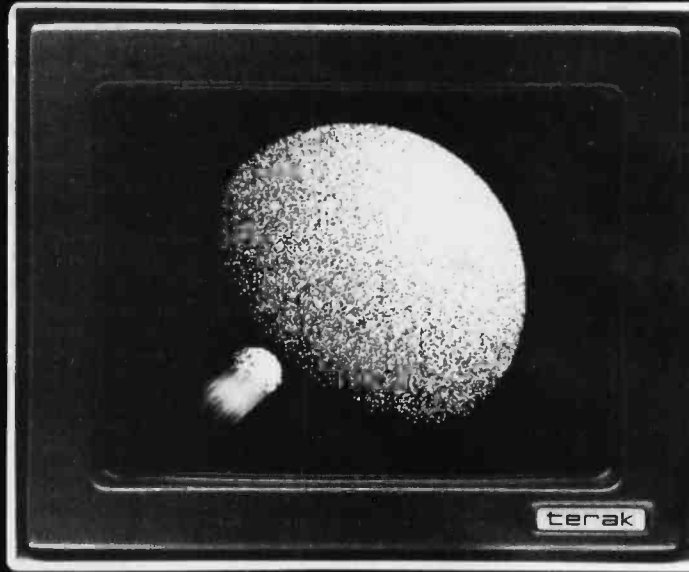
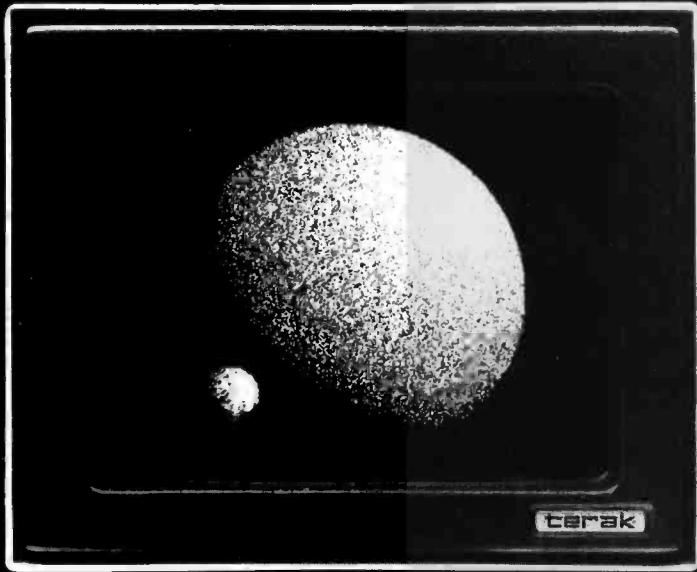

IN MOTION FOR \$7,850.

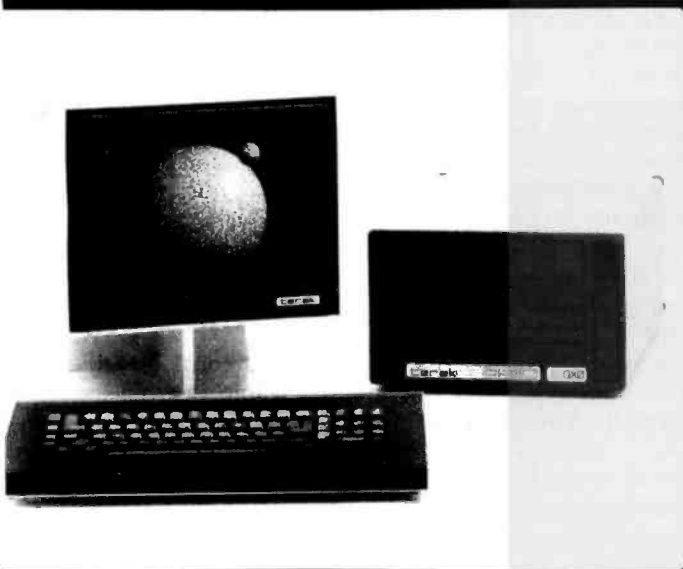
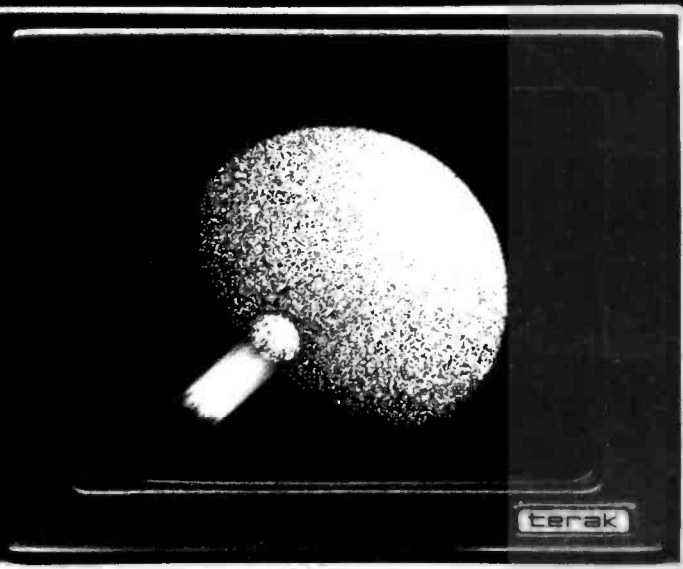

These are actual unretouched photos.

Invest in a Terak 8510/a desk top graphics computer for only \$7,850, and you'll get the performance of systems costing thousands of dollars more.

The Terak is based on a powerful DEC LSI-11* microcomputer which provides a medium resolution animation capability that until now could only be achieved through larger, more expensive systems.

The Terak operates in either stand-alone or on-line environments, and is fully compatible with DEC hardware.

An independently controlled 4K read/write memory allows the creation of unlimited character sets which permits the display of virtually any language or symbol set that may be required.

There's more. A two-port memory structure means you can display text and animated graphics simultaneously.

The best part is the software. Terak provides comprehensive, easy-to-use operating systems using UCSD PASCAL**, DEC RT-11*, BASIC, APL and FORTRAN IV languages.

If you have a limit on your budget but not your ideas, buy the best price performer in the business. You'll be joining a worldwide community of satisfied users.

For more information, write Terak Corporation, 14405 North Scottsdale Road, Scottsdale, Arizona 85254. Or call (602) 991-1580.

terak
CORPORATION

Circle 64 on inquiry card.

*A trademark of Digital Equipment Corp.

**A trademark of the Regents of the University of California.

©1979 Terak Corporation
Animation by Michael Smith,
University of Utah,
Computer Aided Instruction Group.

A Fast, Multibyte Binary to Binary-Coded-Decimal Conversion Routine

Michael R McQuade
School of Electrical Engineering
Van Leer Building
Georgia Institute of Technology
Atlanta GA 30332

A problem which has confronted users of small computer systems over the years has been the incompatibility of the number representation required by output devices and that used for internal processing. Output devices used by the small systems need to receive binary-coded-decimal (BCD) or ASCII (American Standard Code for Information Interchange) data representations, while the microprocessor is most efficient when handling a straight binary number. Several solutions to the problem exist, and as would be expected, each has its own advantages and disadvantages.

Some users choose to initially store all numbers in their binary-coded-decimal representation and do all subsequent processing in this format. This has the advantage of easy and quick conversion of the numbers into the required output format. At worst, the binary-coded-decimal represented number must be converted to an ASCII format. This requires attaching a fixed 4-bit prefix to each binary-coded-decimal digit.

A disadvantage associated with this approach is that arithmetic operations take longer to perform, since the results must be decimally adjusted after each operation. Also, more memory is required to store the binary-coded-decimal form of the number than is required for its straight binary equivalent. A direct result of this increased memory requirement is the need to perform more

memory-access operations to transfer the numbers into and out of the processor. Memory accesses are a very time-consuming operation.

For the users who choose a straight, binary-number representation for internal storage, the advantages of efficient memory utilization and straightforward arithmetic are gained. The question of how to convert the numbers to an acceptable output format for the display device still remains to be answered. This question basically reduces down to converting the binary numbers to binary-coded-decimal form.

Methods of Conversion

There are three basic approaches in wide use. The first approach is to count the binary number down to 0 while incrementing its binary-coded-decimal counterpart up from 0 using modulo-10 counting. Modulo-10 counting performs a decimal-adjust operation after each incremental addition. This method is conceptually easy and requires a minimum of program code if the microprocessor has a decimal-adjust instruction. The counting method can, however, be very time-consuming if large numbers are being converted. For some applications this time penalty would be irrelevant (eg: if the output device is very slow when compared to the processor's cycle time). For a slow output device, any time savings realized by using a faster conversion routine usually has to be wasted in a wait loop.

The second approach is to use some form of table lookup routine. Assuming that the table is extensive enough, the lookup technique performs a very fast conversion. The drawback to this technique is that as the size of the numbers being handled gets larger, either a great deal of memory must be dedicated to the table, or some type of divide-with-remainder scheme must be imple-

About the Author

Mike McQuade is currently working towards a PhD degree in the Computer Architecture Laboratory at the School of Electrical Engineering at the Georgia Institute of Technology. He has instructed computer courses there, and has taught short microprocessor courses for the Institute of Electrical and Electronics Engineers at both national and regional levels.

WHY DOESN'T EVERY COMPUTER SPECIALIST MOVE TO HUGHES IN SOUTHERN CALIFORNIA?

We need you. But frankly, not everybody you meet along the software trail is good enough to help us stay out in front.

If you are skilled and experienced and ambitious enough, you can join our growing group right now, while we're heavily into pre-production development and test of the highly advanced AN/APG 65 radar system.

And what is that to you? A chance to work on radar data processors, programmable signal processors, test software, or systems integration.

Eventually, when a big assignment like that is wrapped up, what happens? Hughes people roll right along to others of the company's 1,500 long-term projects worth more than \$4 billion. You won't run out of challenges here.

It's a great place to spend a winter — and a career.

Now — which of our needs is your area of special interest?

Systems Requirements

Analyze and determine system software requirements and algorithm development in conjunction with senior scientists. Perform simulation tests of new systems.

System Interfaces

Develop a complete overview of software-hardware systems, involving microprocessors, solid-state devices, receiver-exciter-transmitter-antenna developments, interactive displays, and test station evolution.

Concentrate on support software, operating program maintenance, tactical programming, strategic system studies, algorithm development, simulation, or applications software.

Test Software

Help advance the state of test control software and diagnostics to meet hardware tactical and reconnaissance needs.

System Evaluation

Develop application software for analyzing test data to improve system performance.

Altogether, the growing Hughes population of computer specialists needs to grow even faster by adding systems engineers; systems analysts; applications, diagnostic, and test programmers; and software engineers.

There's a place for you in our marvelous working climate. We'll provide relocation assistance, good pay, excellent benefits.

A Los Angeles suburb near work will supply the good after-hours and weekend life.

You bring the focused imagination. Is it a deal?

First, send us a resume showing your past salaries and responsibilities. Write to: Hughes Aircraft Company, Radar Systems, Professional Employment, Dept. B-1, P.O. Box 92426, Los Angeles, CA 90009.



RADAR SYSTEMS

U.S. Citizenship Required. Equal Opportunity M/F/HC Employer.

Circle 65 on inquiry card.



mented. The division scheme allows the table size to remain small, but it causes the conversion time to increase. As was pointed out earlier, this may not be important. If the processor being used does not have a decimal-adjust instruction and the numbers encountered are not too large, this second method is very popular.

The third approach in converting from straight binary to binary-coded decimal is to use an algorithm based on the structure of the binary number system. Given the binary number:

$$b_n b_{n-1} b_{n-2} \dots b_2 b_1 b_0$$

where each of the b s can represent either a 1 or a 0, and b_n is the most significant bit, it can be expanded as:

$$b_n \times 2^n + b_{n-1} \times 2^{n-1} + \dots + b_1 \times 2^1 + b_0 \times 2^0 \quad (\text{Form I}).$$

Form I is not conducive to an iterative-type binary to binary-coded decimal conversion routine, but can be rewritten as:

$$(\dots((b_n \times 2) + b_{n-1}) \times 2 + \dots + b_1) \times 2 + b_0 \quad (\text{Form II}).$$

Form II contains only the decimal numbers 0, 1, and 2, which have the same representations in either straight binary or binary-coded decimal. Straight binary and binary-coded-decimal representations of a number differ only for numbers greater than 9. While straight binary adheres strictly to position weighting in powers of 2, binary-coded decimal treats each decimal digit of the number *independently* and represents it as a 4-bit straight binary number.

If Form II is implemented using binary-coded-decimal arithmetic (performing a decimal adjust after each addition), the final result will be in binary-coded-decimal representation. Form II lends itself to an iterative-type implementation which allows it to be coded to easily accommodate any size number.

Carry	Auxiliary Carry	Correction Factor
0	0	10011010
0	1	10100000
1	0	11111010
1	1	00000000

Table 1: Correction factors in binary for the binary to binary-coded-decimal (BCD) conversion algorithm.

Much has been said about performing a decimal-adjust operation when operating on numbers in the binary-coded-decimal format. When two binary-coded-decimal numbers are added by the processor's straight binary-adding accumulator, the result is not in binary-coded-decimal form. It is necessary to perform one more operation after each addition to correct for the fact that the processor's arithmetic logic is designed to add straight binary numbers. This extra operation is the decimal adjust. Many of the microprocessors on the market today have the decimal-adjust operation contained in their instruction sets.

If the processor being used does not contain a decimal-adjust instruction, it is still possible to perform a decimal-adjust operation. What must be done is to allow for the fact that a binary-coded-decimal number uses only ten of the sixteen possible 4-bit combinations for each digit. If two binary-coded-decimal numbers are added together, and the least significant 4 bits of the result have a value greater than 9, then 6 must be added to the result. It is necessary to add 6 to skip over the six unallowed BCD bit combinations. The next 4 bits of the result are then tested, and 6 is added to them if necessary. This is repeated across the entire result.

A Better Method

The above method works in theory but is rather awkward to program. Let us examine a method based on the above theory which lends itself to straightforward programming. The method will be for 8-bit processors,

S-100 USERS: GIVE YOUR COMPUTER THE GIFT OF SIGHT!

The DS-80 Digisector® is a random access video digitizer. It works in conjunction with a TV camera (either interlaced or non-interlaced video) and any S-100 computer conforming to the IEEE standards. Use it for:

- Precision Security Systems
- Moving Target Indicators
- Computer Portraiture
- Fast To Slow Scan Conversion
- Robotics
- Reading UPC Codes, schematics, paper tape, musical scores



● IMAGE PROCESSED BY DS-80 ●

CHECK THESE FEATURES:

- High resolution** — a 256 x 256 picture element scan
- Precision** — 64 levels of grey scale
- Speed** — Conversion time of 14 microseconds per pixel
- Versatility** — scanning sequences user programmable
- Economy** — a professional tool priced for the hobbyist; comes fully assembled, tested and burned in, with fully commented portrait printing software.

Price: \$349.95 MasterCharge and Visa

THE **MICRO**
WORKS

P.O. BOX 1110, DEL MAR, CA 92014 714-756-2687

Telecommunications R&D Software Engineers

*Reaching Out To The Challenge
of Our Environment . . .*

San Francisco Peninsula

Designing the world's most advanced computer-controlled telephone systems and office of the future products requires the world's finest talent: Yours.

Your Ideas Count

Help prepare for the future at BNR INC., a center of excellence in structured software design and implementation techniques. We perform high level language software engineering and microcode/firmware development, using digital switching techniques for a network of computerized EPABX's providing data and call processing feature services for our clients. We are aided in this development work by our fully-equipped, modern lab, including on-site interactive timesharing systems.

If you are self-motivated, have proven design skills and you are challenged by: enhancing hardware/software interfaces, real-time systems, computer networks, software tools and applied software engineering . . . join us.

We offer excellent salaries, one of the best benefits programs on the San Francisco Peninsula, a progressive and stimulating environment, and outstanding opportunities for personal recognition and growth.

For immediate consideration, send your resume to Ellen Ohmer, Employment Manager, BNR INC., Mail Stop 785, P.O. Box 10121, 3174 Porter Drive, Palo Alto, CA 94304. An equal opportunity employer.

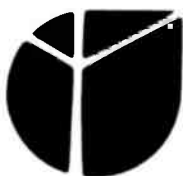

BNR

Subsidiary of
Bell-Northern Research
The R & D Laboratory for
Northern Telecom and Bell Canada

Listing 1: The multibyte binary to binary-coded-decimal (BCD) conversion algorithm coded as a subroutine for the 8080 microprocessor.

```

; THE SUBROUTINES ALWAYS SAVE THE CONTENTS OF REGISTERS A
; D E H L AND THE STATUS FLAGS. IF THE CONTENTS OF REGISTERS
; B C NEED TO BE SAVED THE CALLING ROUTINE MUST EXPLICITLY DO IT.

;*****BINARY TO BCD CONVERSION SUBROUTINE*****

; THE SUBROUTINE CONVERTS A MULTI-BYTE BINARY NUMBER TO ITS EQUIVALENT
; MULTI-BYTE BINARY CODED DECIMAL (BCD) REPRESENTATION. THE BYTES
; OF BOTH NUMBERS ARE STORED IN MEMORY IN ASCENDING ORDER WITH
; THE LEAST SIGNIFICANT BYTE IN THE LOW END OF THE MEMORY STACK. THE
; REQUIRED PARAMETERS NEEDED TO BE PASSED ARE:

;           H L GETS ADDRESS OF LOW ORDER BYTE OF BINARY NUMBER
;           D GETS NUMBER OF BYTES IN BINARY NUMBER
;           E GETS NUMBER OF BYTES IN BCD RESULT AREA

; THE SUBROUTINE ASSUMES THAT THE BINARY NUMBER WILL FIT IN THE SUPPLIED
; NUMBER OF BCD BYTES. THE ROUTINE WILL FILL IN THE BCD BYTES WITH
; LEADING ZEROS IF NECESSARY.

0000 F5      DBBCD: PUSH   PSH           ;SAVE STATUS
0001 48      MOV     C,E             ;COPY # OF BCD BYTES TO C
0002 E5      PUSH   H               ;SAVE ADDR OF BINARY # ON STACK
0003 216400  LXI     H,BCDNL        ;LOAD HL WITH ADDR OF BCD #
0005 3600    LAB16: MVI     M,0      ;ZERO OUT MEMORY LOCATION
0008 23      INX     H               ;INCREMENT HL
0009 00      DCR     C               ;DECREMENT C
000A C20600  JNZ     LAB16          ;IF C=0 BRANCH FROM LOOP
000D 7A      MOV     A,D             ;PUT # OF BINARY BYTES IN A
000E 87      ADD     A               ;MULTIPLY BY 8 TO GET # OF BITS
000F 87      ADD     A
0010 87      ADD     A
0011 47      MOV     B,A             ;STORE # OF BITS IN B
0012 AF      XRA     A               ;SET CARRY TO ZERO
0013 4A      MLOOP: MOV    C,D       ;PUT # OF BINARY BYTES IN C

0014 E1      POP     H               ;RESTORE ADDR OF BINARY # TO HL
0015 38      DCX     SP              ;LEAVE HL ON STACK
0016 38      DCX     SP              ;PUT BINARY BYTE IN A
0017 7E      RLOOP: MOV    A,M       ;SHIFT BYTE LEFT & FILL WITH CARRY
0018 0F      RDC     A               ;REPLACE BYTE
0019 77      MOV    M,A             ;DECREMENT C
001A 00      DCR     C
001B C22200  JZ      LAB17          ;BRANCH FROM LOOP IF LAST BYTE
001E 23      INX     H               ;INCREMENT HL
001F C31700  JMP     RLOOP           ;JUMP TO START OF ROTATE LOOP
0022 E1      LAB17: POP    H         ;RESTORE HL POINTER TO LOW ORDER BINARY BYTE
0023 38      DCX     SP              ;LEAVE HL ON STACK
0024 38      DCX     SP              ;SKIP FILL WITH ONE IF NO CARRY
0025 D25900  JNC     LAB18          ;FILL WITH ONE
0028 34      INR     M               ;FILL WITH ONE
0029 48      LAB18: MOV    C,E         ;PUT # OF BCD BYTE IN C
002A 216400  LXI     H,BCDNL        ;LOAD HL WITH ADDR OF BCD
002D 3E00    LAB20: MVI     A,0      ;ZERO OUT A
002F BE      RDC     M               ;ADD BCD BYTE TO A WITH CARRY
0030 27      DAA     A               ;CONVERT RESULT TO BCD
0031 77      MOV    M,A             ;SAVE NEW BCD BYTE
0032 D23A00  JNC     LAB19          ;SKIP REST IF NO CARRY
0035 23      INX     H               ;POINT TO NEXT BCD BYTE
0036 00      DCR     C               ;DECREMENT C
0037 C22D00  JNZ     LAB20          ;IF C=0 LEAVE LOOP
003A 48      LAB19: MOV    C,E         ;PUT # OF BCD BYTE IN C
003B 05      DCR     B               ;DECREMENT BIT COUNT
003C C94E00  JZ      LAB40          ;EXIT MAIN LOOP IF COUNT = 0
003F 216400  LXI     H,BCDNL        ;LOAD HL WITH ADDR OF BCD
; CARRY=0 ENTERING NEXT LOOP WHICH
; MULTIPLIES BCD # BY TWO
0042 7E      LAB21: MOV    A,M         ;PUT BCD BYTE IN A
0043 0E      RDC     M               ;ADD BCD BYTE TO ITSELF WITH CARRY
0044 27      DAA     A               ;CONVERT RESULT TO BCD
0045 77      MOV    M,A             ;SAVE NEW BCD BYTE
0046 23      INX     H               ;POINT TO NEXT BCD BYTE
0047 00      DCR     C               ;DECREMENT C
0048 C24200  JNZ     LAB21          ;IF C=0 LEAVE LOOP
004B C31300  JMP     MLOOP           ;DO FOR ALL BITS OF BINARY #
004E E1      LAB40: POP    H         ;RESTORE HL
004F F1      POP    PSH           ;RESTORE STATUS
0050 C9      RET                    ;RETURN

```

DISCOUNT PRICES

Microcomputers & Peripherals

BITS
BYTES
BOOKS
BARGAINS

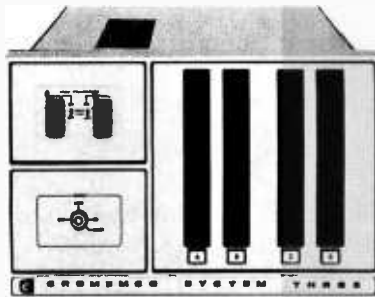

Cromemco • SWTPC • Lear-Siegler
Hazelintec • RCA • North Star
Verbatim • Perkin Elmer and others

Fast, off the shelf delivery.
Call TOLL FREE 800/523-5355

MARKETLINE SYSTEMS, Inc.
2337 Philmont Ave., Huntingdon Valley, Pa. 19006
215/947-6670 • 800/523-5355

Dealer Inquiries Invited

since they are the most popular. First it is necessary to keep track not only of the carry out of the eighth bit position, but also the carry from the fourth to fifth bit position. This second carry will be referred to as the *auxiliary carry*.

- (1) Add the binary number 01100110 to the first number.
- (2) Add the second number to the result generated in step 1. Keep track of both the carry and auxiliary carry from this addition. The carry generated here is the true carry to the next higher digit.
- (3) Based on the carry and auxiliary carry generated in step 2, add one of the correction factors shown in table 1 to the result of step 2.

The result has now been decimally adjusted.

The program shown in listing 1 and the flowchart shown in figure 1 provide an implementation of Form II using binary-coded-decimal arithmetic for the Intel 8080 microprocessor. It uses the decimal-adjust (DAA) instruction in the 8080's instruction set. A simple program shown in listing 2 converts data from binary-coded decimal to ASCII representation. The conversion from binary-coded-decimal to ASCII entails taking each of the two 4-bit, binary-coded-decimal digits, putting them in a byte, and appending the binary prefix 0011. Both programs are coded as subroutines, since these forms are usually more convenient to include in larger programs.

The binary-to-binary-coded-decimal subroutine of



Put the BYTE on the IRS with Aardvark

In an era when computers are an integral part of business and entertainment, and computer software is more and more sophisticated, Aardvark is yet another breed in advanced computer software. Aardvark's Micro Tax series is a true user-oriented Federal Income Tax package. Specifically developed by qualified tax professionals for use on personal home computers, this low-cost, time-saving Aardvark Micro Tax package accurately and efficiently computes your federal income tax liability. Aardvark will display and fill in facsimile Form 1040 and related schedules and, if connected to a Centronics printer, will print out these facsimile forms auto-

matically. Each program is designed to use the appropriate tax table or rate schedule. The more advanced Micro Tax II and III also calculate Income Averaging, Maximum Tax on Earned Income, Minimum Tax and Alternative Minimum Tax. The Aardvark package is compatible with Apple II and TRS-80 users and includes an indexed instruction manual and input forms for easy input of tax data. To see how Aardvark can be tax-deductible, check the instructions in the binder of the manual. You can also use the binder to store pertinent 1979 tax records. Cure your headaches this tax season, order today...and put the BYTE on the IRS with Aardvark!

MICRO TAX I \$25
 Form 1040
 Schedule A
 Schedule B
 Schedule TC
 (will not calculate Income Averaging, Max Tax or Alternative Minimum Tax)

MICRO TAX II \$35
 Form 1040
 Schedule A
 Schedule B
 Schedule G (Inc. Avg.)
 Schedule TC
 Form 4625 (Minimum Tax)
 Form 4726 (Max Tax)
 Form 6251 (Alt. Min. Tax)

MICRO TAX III \$50
 Program 2 plus
 Schedule C
 Schedule D
 Schedule E
 Schedule SE
 Form 2119 - Sale of Personal Residence

When Ordering Specify:
 TRS-80 16K Level II Basic
 Apple II 32K with Applesoft Basic
 Apple II 16K Micro with Applesoft ROM Card

Aardvark Software

Coming Soon - Micro Tax Package for PET and TI Systems.

P.O. Box 26505 Milwaukee, WI 53213



24 hrs.

Call TOLL FREE 1-800-558-8570.

7 days



In Wisconsin 1-414-289-9988

©Aardvark Software Inc. 1979

Circle 68 on inquiry card.

PUZZLE YOUR COMPUTER

Your computer can make puzzles for you to solve with these new cassettes from Program Design.



Minicrossword

Two Minicrossword programs invent crossword puzzles and display them on the screen. Words are drawn from a huge pool of words so hundreds of different puzzles are possible. The computer gives you the clues and scores you on how well you do.

Two Codeword puzzles on the same cassette use the same words in a word-guess game. The 4 programs are a vocabulary and spelling development system for adults and high schoolers.

TRS-80 Level II (16K), or APPLE II Applesoft \$14.95



Astro Word Search Series

The computer makes hundreds of the popular word-search type puzzles from words in its memory. Words are hidden across, down, diagonally – forward and backward in a maze of letters. The computer flashes the words you find and scores you on how well you do. Teaches vocabulary and facts in a fun way.

Astro Word Search: Geography

(geographical place names)
Junior High to adult – Level II, 16K \$14.95

Astro Word Search: Spanish

(Spanish vocabulary words)
High School to adult – Level II, 16K \$14.95

Look for these titles at your participating Computerlands and other fine computer stores.

Or order direct from Program Design,
11 Idar Court, Greenwich, CT 06830 (203) 661-8799.
Master Charge, Visa. Add 5% shipping.

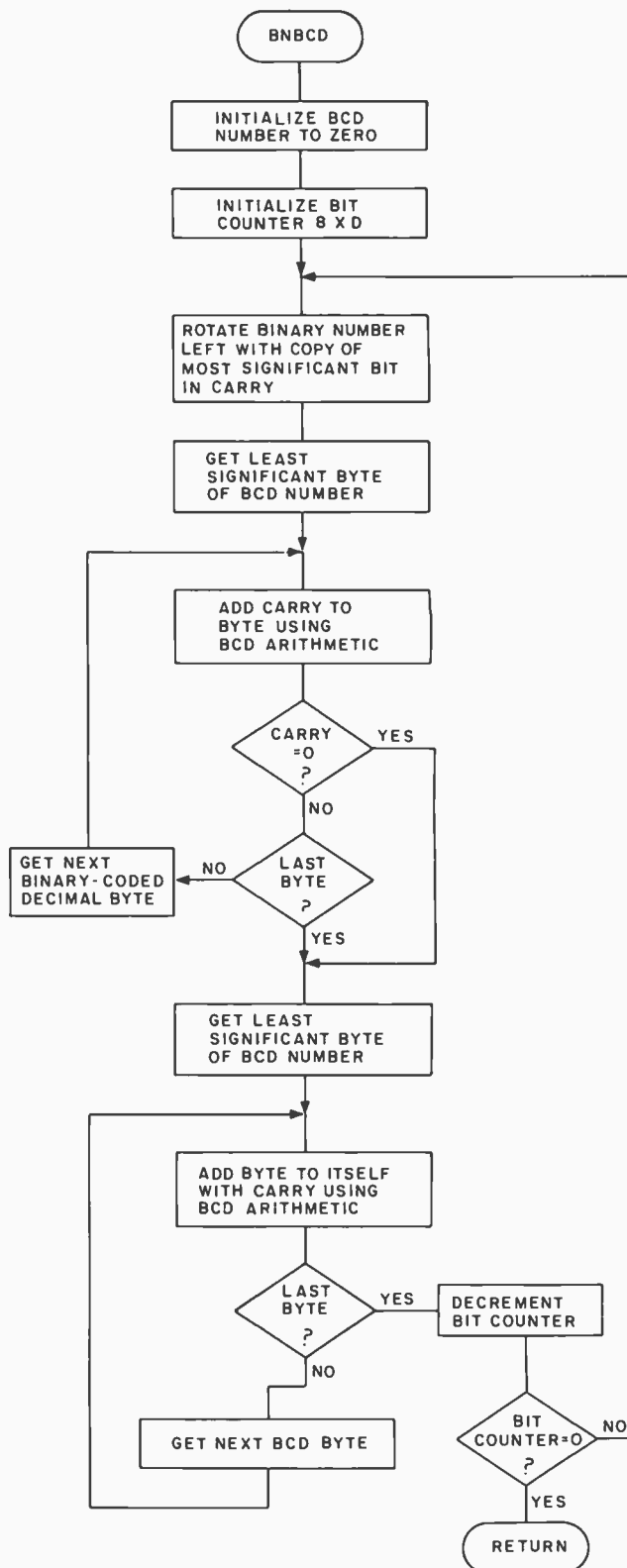

Figure 1: Flowchart of the algorithm for the binary to binary-coded-decimal (BCD) conversion subroutine.

listing 1 requires contiguous memory locations to hold the binary-coded-decimal result. The address of the memory location for the low-order byte of the binary-coded-decimal number has been labeled BCDNLL (binary-coded-decimal number location) in the subroutine. The

HI THERE!

It has come to our attention that many of our customers are not aware of the wide variety of products we have available. Following is a list of all our current major products and prices. Watch BYTE for new items.

HARDWARE

SOFTWARE

Part No.	Description	Price
MEM-32K-ASM	Tarbell 32k Static Memory for S-100 bus	725.00
MEM-16K-ASM	Tarbell 16k Static Memory for S-100 bus	440.00
	(Memories only come assembled & checked out)	
CI-ASM	Cassette Interface Assembled & Checked out	175.00
CI-KIT	Cassette Interface Kit	120.00
FDI-ASM	Floppy Disk Interface Assembled & Checked out	265.00
FDI-KIT	Floppy Disk Interface Kit	190.00
DD-ASM	Double Density Floppy Disk Interface A&T	425.00
DD-KIT	Double Density Floppy Disk Interface Kit	325.00
VDS-II	Vertical Disk Subsystem	1888.00
VDS-IID	Double Density Disk Subsystem	1999.00
PS270	PerSci Model 270 Dual Floppy Disk Drive	1295.00
SIM120	Siemens Model 120-8 Single Floppy Disk Drive	495.00
SHU800	Shugart 800/801 Floppy Disk Drive	525.00
CP272	Power Supply for PerSci 270 Dual Drive	125.00
CP206	Power Supply for PerSci 299	120.00
CP206	Power Supply for Two Siemens or Shugart	120.00
TBAS-CAS	Tarbell Cassette BASIC on cassette incl manual	48.00
TBAS-DSK	Tarbell Disk BASIC on CP/M disk incl manual	48.00
	Note: the following two items can only be ordered with Tarbell Disk or Cassette BASIC:	
TBAS-LST	Tarbell BASIC source listing on paper	25.00
TBAS-SRC	Tarbell BASIC source on 2 CP/M disks	25.00
PTSW+LST	Proc Tech Assembler/Editor with listing	15.00
EMPL-CAS	EMPL micro APL on cassette & instructions	15.00
EMPL-DSK	EMPL micro APL on CP/M disk & instructions	20.00
CPM-2.0	CP/M 2.0 Operating system incl documentation	150.00
CPM-1.4	CP/M 1.4 Operating system incl BASIC-E on disk	70.00
CPM-1.4-M	CP/M 1.4 on soft-sectored MINI-FLOPPY disk	70.00
CPM-MS	CP/M 1.4 Operating system manual set (of six)	25.00
BASE-MAN	BASIC-E Compiler Manual (works with CP/M)	5.00
BASE-LST	BASIC-E Source Listing (in PL/M)	15.00
PBLC-DMN-1	Public Domain Disk #1 - includes DISKTEST, BASIC-E, CBIOS, FORMAT, TAPELIB, etc on disk	10.00
PBLC-DMN-2	Public Domain Disk #2 - includes Double Density FORMAT, DISKTEST, Auto-BIOS for 1.4 & 2.0; FORTH	15.00
CBAS-DSK	CBASIC-2 disk	85.00
CBAS-MAN	CBASIC-2 manual	15.00
SPLR	KLH Systems Spooler for CP/M on disk	70.00
FAST	FAST! Screen-oriented Editor/Assembler for CP/M	100.00
TELE-COM	Software to operate D.C. Hayes Modem Remote	195.00
POLYVUE	Screen-Oriented CP/M Editor	135.00
PASCAL/MT	Meta-Tech Pascal Compiler for CP/M	99.95

Prices are subject to change without notice.
 California residents please add 6% sales tax.
 For quick delivery, see your local Tarbell dealer.



Circle 70 on inquiry card.

950 Dovlen Place, Suite B
 Carson, California 90746

(213) 538-4251

(213) 538-2254

Listing 2: A subroutine to convert a single-byte, 2-digit, binary-coded-decimal number to two single-byte ASCII characters, coded for the 8080 microprocessor.

```

;*****BCD TO ASCII SUBROUTINE*****
; THE SUBROUTINE TAKES A TWO DIGIT BCD NUMBER IN MEMORY POINTED TO BY
; HL AND CONVERTS IT TO ASCII. THE MOST SIGNIFICANT DIGIT IS PUT
; IN REGISTER B WHILE THE LEAST SIGNIFICANT DIGIT IS PUT IN REGISTER C.

0051 F5      ASCII: PUSH   PSH          ;SAVE STATUS
0052 3E0F    MVI     A,00001111B      ;PUT LEAST SIGNIFICANT DIGIT MASK IN A
0054 A6      ANA     M              ;MASK OFF LEAST SIGNIFICANT DIGIT
0055 F630    ORI     00110000B      ;CONVERT TO ASCII
0057 4F      MOV     C,A          ;PUT IN REG C
0058 3E08    MVI     A,11110000B    ;PUT MOST SIGNIFICANT DIGIT MASK IN A
005A A6      ANA     M              ;MASK OFF MOST SIGNIFICANT DIGIT
005B 0F      RRC
005C 0F      RRC
005D 0F      RRC
005E 0F      RRC              ;ROTATE RIGHT FOUR PLACES
005F F630    ORI     00110000B      ;CONVERT TO ASCII
0061 47      MOV     B,A          ;PUT IN REG B
0062 F1      POP     PSH          ;RESTORE STATUS
0063 C9      RET
0064          BCDNL: DS     31      ;START OF BCD NUMBER
0066          END

```

number is ordered upwards in memory. Register E must contain the number of bytes in the binary-coded-decimal number when the subroutine is called. If more bytes are specified than are needed, the extra will be filled with leading zeros.

The other parameters which must be passed to the subroutine are the number of bytes in the binary number and the address of the low-order byte of the binary

number. The number of bytes in the binary number is to be in register D, while the address of the low-order byte is in register pair HL. The binary number is assumed to be stored in memory using the same convention as the binary-coded-decimal number. The more significant bytes are found at increasing memory addresses.

By having register pair HL point to the binary number, the routine can be used to convert all binary numbers required by the user's program without moving them to a specific location. All results are put in the same location, since this is temporary storage needed only until the number is sent to the display device.

The binary to binary-coded-decimal conversion subroutine provided can handle binary numbers of any length up to and including 31 bytes. This corresponds to a decimal number in excess of 4.5×10^{74} with a full 75 significant digits. This should be adequate to handle any physical quantity encountered. To establish a reference, it is only about 1.5×10^{21} angstroms from the earth to the sun. (An angstrom is one ten-billionth of a meter, that is $1/10^9$, and is normally used to measure the wavelength of light.)

The routines provided have been tested using a high-speed line printer as an output device. The routines were fast enough to allow the line printer not to wait when being sent a stream of 6-digit numbers. While the routines have been tested and were fast enough for the desired applications, an extensive effort was not made to eliminate every unneeded processor cycle. The object code provided in listings 1 and 2 will also execute on an Intel 8085 or a Zilog Z80 microprocessor. ■

TRS MOD I and MOD II PROGRAMS FROM

∞ BASIC for Level II and Disk Systems \$49.95

Full MATRIX Functions - 30 BASIC commands!!
Mathematical and common matrix functions. Change arrays in mid-program. Complete array handling. Tape array read and write, including strings. Common subroutine calls.

Over 50 more STRING Functions as BASIC commands!! String manipulation, translation, compression, copying, search, screen control, pointer manipulation and utility functions. Includes multikey multivariable machine language sorts. Load only machine language functions that you want! Where you want in memory! Relocating linking loader! More than you ever expected!!

∞ BUSINESS (Requires Infinite BASIC) \$29.95

20 Business oriented functions including:
Printer Automatic Pagination with headers and footers!
Packed Decimal Arithmetic (+, -, *, /) 127 digits!
Binary array searched and hash code generator!

COMPROC Command Processor for Disk Systems \$19.95

Auto your disk to perform any sequence of DOS commands, machine language loads, BASIC, memory size, run program, respond to input statements, etc. Single BASIC command file defines execution! Includes auto key-debounce, screen print and lower case software driver.

New Products Jan/Feb! We answer reader response inquiries!!

ATTN/ System Houses - We license usage of our routines!
TRS Add-On OEM's - Direct BASIC commands tailored for your hardware.

REMODEL + PROLOAD Specify 16, 32, or 48K Memory \$34.95
RENUMBER any portion or all of BASIC program. Line references adjusted.

MOVE any portion of a BASIC program from one location to another.

DELETE lines or ranges of lines while using the utility.

MERGE all or any portion of a program from tape. (Load lines 300-500 from your tape to existing program at line 1000 with renumbering on the way in!)

SAVE combined/merged programs, or any portion to tape with **VERIFY**.

COPYSYS Copy Systems Tapes (Editor/Assembler Format) \$14.95

GSF (16, 32, or 48K) \$24.95

18 Machine language routines using 'USR' calls. Includes RACET sorts, array handling, and fast lines and scrolls.

DOSORT (Specify 32 or 48K - 2 disk minimum) \$34.95

Sort/Merge multi-diskette sequential files. Multiple keys and variables. Includes GSF - machine language sorts, comparators and string handling.

MOD II SUPPORT

RACET is supporting the MOD III!

Call or write for current information! We have a MOD II Superzap and other assembly language tools!

Ask your dealer if he carries our products!

DEALERS! We will work with you directly or through our distributors.

CHECK, VISA, M/C, C.O.D. • Calif. Residents add 6% • Telephone Orders Accepted (714) 637-5016

WHEN ORDERING PLEASE ADVISE PUBLICATION SOURCE

702 Palmdale, Orange CA 92665

SUPERBRAIN™

The Honor Graduate

OEM's . . .

End Users . . .

Computer Dealers . . .

\$2995!

SuperBrain users get exceptional performance for just a fraction of what they'd expect to pay. Standard system features include: two double density mini-floppies with 320K bytes of disk storage, 64K of RAM memory to handle even the most sophisticated programs, a CP/M Disk Operating System with a high powered text editor, assembler, debugger and a disk formator. And, with SuperBrain's S-100 bus adaptor, you can add all the programming power you will ever need . . . even a 10 megabyte disk!

SuperBrain's CP/M operating system boasts an overwhelming amount of available software in BASIC, FORTRAN, COBOL, and APL. Whatever your application . . . General Ledger, Accounts Receivable, Payroll, Inventory or Word Processing . . . SuperBrain is tops in its class. But best of all, SuperBrain tackles your toughest jobs for less than one-third the cost of other similar systems.

You'll appreciate the careful attention given to every engineering detail. Standard SuperBrain features include: a full ASCII keyboard with numeric pad and user-programmable function keys. A non-glare, dynamically focused, 12-inch CRT for sharp images everywhere on the screen. Twin Z80 microprocessors to insure efficient data transfer to auxiliary peripheral devices. A universal RS-232 communications port for serial data transmission. And, a single board design to make servicing a snap!

Performance and packaging have never been better matched. Your operators will appreciate SuperBrain's good looks. You'll appreciate SuperBrain's outstanding value. Twin Z80A processors, dual double density disk drives, and a high resolution CRT terminal. All in a single, smart looking, self-contained desktop unit. And, all for a price that's substantially less than the competition!

Make no mistake about it. The freshman students in the small systems business can't begin to compete with this year's honor graduate. The SuperBrain. The only system at the top of its class in price and performance



*Superbrain is a registered trademark of Intertec Data Systems.

System Specifications

CPU	
Microprocessors	Twin Z80A's with 4MHz Clock Frequency. One Z80A (the host processor) performs all processor and screen related functions. The second Z80A is "down-loaded" by the host to execute disk I/O. When not processing disk data, the second Z80 may be programmed by the host for other processor related functions.
Word Size	8 bits
Execution Time	1.0 microseconds register to register
Machine Instructions	158
Interrupt Mode	All interrupts are vectored
Floppy Disk	
Storage Capacity	320K total bytes formatted on two double density drives. Optional external 10-300 megabyte hard disk storage is available using optional S-100 bus adaptor
Data Transfer Rate	250K bits/second
Average Access Time	250 milliseconds .35 milliseconds track-to-track
Media	5 1/4 inch mini-disk
Disk Rotation	300 RPM
Internal Memory	
Dynamic RAM	64K bytes dynamic RAM
Static RAM	256 bytes of static RAM is provided in addition to the main processor RAM. This memory is used for program and/or data storage for the auxiliary processor
ROM Storage	1K bytes standard. Allows ROM "bootstrapping" of system at power-on. ROM storage is 2708 compatible and may be reprogrammed by the user for custom applications
CRT	
Display Size	12-inch, dynamically focused P4 phosphor
Display Format	25 lines x 80 characters per line
Character Font	8 x 8 character matrix on a 8 x 12 character field
Line Drawing Characters	Eleven special graphics symbols used for form generation
Display Presentation	Light characters on a dark background. Reversible through keyboard/program selection.
Bandwidth	20 MHz
Cursor	Reversed image (block cursor)
Communications	
Screen Data Transfer	Memory mapped at 38 kilobaud. Serial transmission of data at rates up to 9600 bps.
Auxiliary Interface	Universal RS 232 asynchronous. Synchronous interface optional.
Parallel Interface	Radio Shack TRS 80 compatible
S-100 Bus	Printed circuit edge connector provided for connection of optional S-100 bus adaptor.
Transparent Mode	Enables display of all incoming and outgoing control codes
Parity	Choice of even, odd, marking, or spacing
Transmission Mode	Half or Full Duplex. One or two stop bits
Addressable Cursor	Direct positioning by either discrete or absolute addressing
System Utilities	
Disk Operating System	CP/M
DOS Software	An 8080 disk assembler, debugger, text editor and file handling utilities.
Optional Software	
FORTRAN	ANSI standard. Relocatable, random and sequential disk access
COBOL	ANSI standard. Relocatable, sequential, relative and indexed disk access
BASIC	Sequential and random disk access. Full string manipulation, interpreter
Application Packages	Extensive software development tools are available including software for the following applications: Payroll, Accounts Receivable, Accounts Payable, Inventory Control, General Ledger and Word Processing
Keyboard	
Alphanumeric Character	Generates all 128 upper and lower case ASCII characters
Special Features	N-Key Rollover. Automatic repeat (at 15 CPS). Keyboard lock/unlock
Numeric Pad	0-9, decimal point, comma, minus and four user-programmable function keys.
Special Functions Keys	Up to 64 user-defined two-key function sequences
Cursor Control	Up, down, forward, backward, and home
Internal Construction	
Cabinetry	Structural foam
Component Layout	Two board modular design. All processor related functions and hardware are on a single printed circuit board. All video and power related circuits on a separate single board. These two boards are interconnected via a single 22-pin ribbon cable.
Mounting	CRT and two circuit boards mounted to base. CRT in a rigid steel frame. Disk Drive assembly mounted into upper cover for ease of servicing.
Environment	
Weight	Approximately 45 pounds
Physical Dimensions	14 1/4" (H) x 21 1/4" (W) x 23 1/4" (D)
Environment	Operating: 0° to 50° C Storage: 0° to 85° C. 10 to 95% rel. humidity, non condensing
Power Requirements	115 VAC, 60 HZ, 1 AMP (optional 230VAC/50HZ mode) available

*Specifications subject to change without notice

DEALER/OEM QUANTITIES AND SPECIAL PRICING AVAILABLE VIA MICROAMERICA DISTRIBUTING

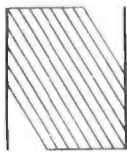

NEECO

679 Highland Ave.
Needham, MA
02194

Microcomputer Systems Division

Mon-Fri 9:30-5:30
MasterCharge &
Visa Accepted

(617) 449-1760
Telex: 951021

MICROAMERICA DISTRIBUTING
"Nationwide distributors of Computer Equipment"

21 Putnam Street
Needham, MA
02194

(617) 449-4310

A Quad Terminal Interface

Stephen A Alpert
11 Ridgewood Dr
Auburn MA 01501

Every now and then, a micro or mini-computer owner may be fortunate enough to have more than one terminal and probably a modem or two. Unfortunately, there never seem to be enough interfaces to the computer system to connect all these

devices into the system at the same time. This article chronicles my local solution to the problem.

Through luck and a lot of hard work, my computer system consists of a Digital Equipment Corporation PDP-11/10 processor, a video monitor, a teleprinter, a modem and only one terminal interface. Conveniently, the video monitor, which serves as the main console, is driven directly off the processor. This still meant that there was a deficiency of one terminal interface.

After reviewing the schematic for the interface that I had, I started a design to essentially duplicate that board. A friend jokingly suggested that a design should be generated to drive several terminals at once. Taking that thought seriously, my course of action had been charted.

The creation of this quad terminal interface involves ideas applicable to almost any sort of processor that uses memory addressed IO. That is, the processor contains no special IO instructions, but instead addresses specific memory addresses to communicate with the status registers and buffers of the peripheral devices. This trade-off means that the devices look like memory and the processor can therefore be equipped with additional instructions at the loss of memory space.

In the case of the PDP-11 series, the processor has a 16 bit data bus and an 18 bit address bus. In this byte addressable machine, the maximum user address space is 32 K words. However, the processor automatically takes all addresses in the range of 160000 to 177777 octal and maps them to 760000 to 777777 octal. (Digital Equipment Corporation uses octal notation in all software.) That means the user memory space is limited to 28 K words with the addresses generated by the processor for 124 K to 128 K specified for the IO page.

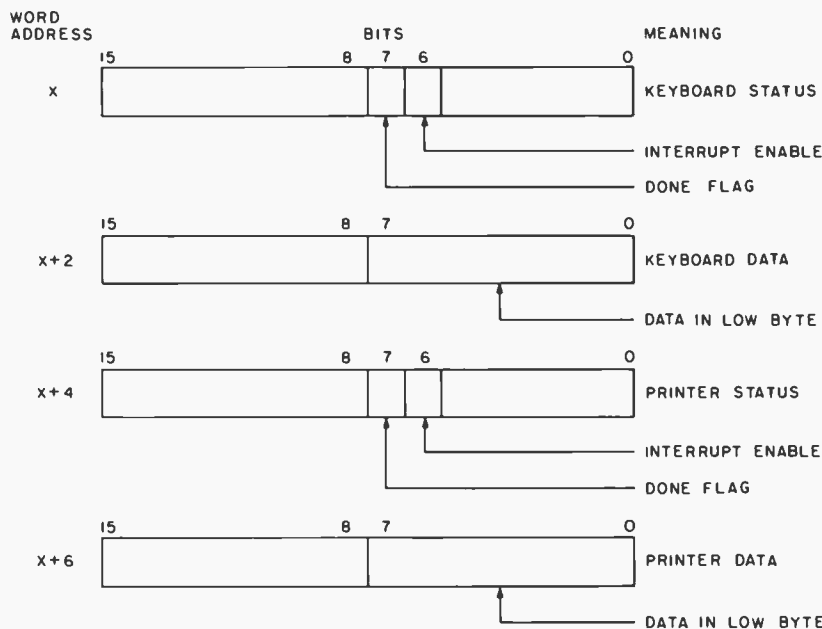

Figure 1: Addresses required for a single terminal are the low bytes of four consecutive words.

- Each terminal requires four words of 16 bits each. The bits in a word are numbered 0 to 15 from right to left. Hence, the low byte in a word contains bits 7 thru 0 and the high byte contains bits 15 thru 8.
- The first word contains only two bits of interest. Bit 7, the most significant bit in the low byte, is the keyboard *done* flag. It is set when a byte is received as input. It is cleared by a bus initialization (BUS INIT) or a processor read of the data. Bit 6 is an interrupt enable bit for the keyboard. When set, an incoming character will cause an automatic vectored interrupt through the processor.
- The low byte of the second word contains the keyboard data.
- The third word is arranged like the first word but is used for the printer side of the terminal. Bit 7 is set by a bus initialization signal (BUS INIT) or when the interface can accept another byte from the computer and is cleared when a byte is sent to the terminal.
- The low byte of the fourth word is the data buffer for the printer.

Table 1: Device addressing organization for interface configuration shown in figure 1.

About the Author

Stephen Alpert is an associate professor of computer science at Worcester MA Polytechnic Institute. He was the first vice chairman of the ACM's special interest group for minicomputers (SIGMINI) and is a software consultant to Digital Equipment Corporation through Hias Inc. He has owned a mini-computer since 1973.

Stephen wishes to thank R Hully, the president of Hias Inc, for the use of personnel during construction of this equipment.

The organization for the device addressing used on the interface in figure 1 is summarized in table 1. This structure is imposed primarily by the requirement to maintain compatibility with the interfaces supported by the existing software. Essentially, the interface should look to the software exactly like four separate terminal interfaces. A microprocessor could easily utilize this memory layout in consecutive bytes in page zero.

Without the interrupt enable (IE) bit set, the keyboard status register must be constantly checked by the program for the presence of a byte of data. This overhead is wasteful and serves no utility except in the case where the processor has nothing else to do. The processor can acknowledge an interrupt by automatically jumping to a special location in page zero whenever an interrupt occurs. A routine must either poll the individual devices or, via some kind of acknowledge instruction, get information off the bus pertaining to an address of the desired routine or identification of the device requesting the interrupt. This software overhead in a minicomputer makes for very inefficient performance. Also, what happens when more than one device requests service simultaneously? Interrupt masking of some sort is needed. What about a possible priority based on the requests?

The PDP-11 processor eliminates these problems by utilizing hardware priority arbitration and vectored interrupt logic. The processor allows four levels of interrupt requests and a nonprocessor request mode for direct memory access (DMA). Once the processor decides to allow an interrupt request, it issues a BUS GRANT on one of the four lines corresponding to the different interrupt levels. This grant line is fed in sequence from one device to the next. Each device that does not want the grant is responsible for passing it along to the next device as shown in figure 2. In this way, the device closest to the processor always

gets the grant first in the case of simultaneous requests on the same line. After the grant has been received by the requesting device, that device is responsible for asserting an interrupt service request and simultaneously asserting a 9 bit address on the data lines of the processor's single bus. The processor will accept this address not as an address of a routine, but rather as a pointer to a pair of words. The first word contains the address of the interrupt service routine and the second word contains a new processor status word. The old program counter and processor status word are saved on the processor's stack. This complete sequencing requires approximately 7 μ s in the PDP 11/10.

From the previous discussion, it is apparent that the interface must properly decode 16 distinct word addresses, four for each terminal, along with the proper read or write lines. Furthermore, to eliminate redundant hardware, and save space on an interface board, the logic must do some of its own decoding and encoding of addresses and data. The program counter and

Text continued on page 120

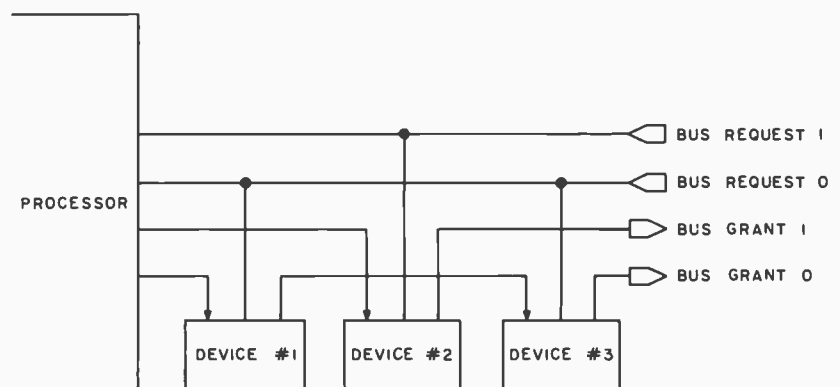

Figure 2: Typical bus request and grant arrangement with two levels. Requests are asserted on a particular request line of the processor. Grants are generated from the processor and daisy chained through the devices associated with that level.

"Gimme, gimme

There's only one small computer that can give you your heart's desire: Sorcerer™ from Exidy.

You don't mean to be greedy. But you're part of the new "Gimme" generation with big plans for the future. You expect your computer to be flexible enough to keep up. Only one system on the market today can do that: the Exidy Sorcerer.

Z80 & Plug-In ROM Software Packs

The Sorcerer uses the popular Z80 microprocessor as its "brain-center." Combine this with Exidy's plug-in ROM PACs™ and you've got a dynamite computing center right at your fingertips.

Our ROM PACs are special plug-in software cartridges that turn your Sorcerer into all sorts of different computer centers instantly. Just pop a STANDARD BASIC PAC™ into Sorcerer, and you're ready to program any application in high-level BASIC. Or plug in a DEVELOPMENT PAC™ and you have a low-cost Z80 software development system costing less than \$1700.

If words are your life, consider our WORD-PROCESSOR PAC™. It turns your Sorcerer into a modern text editing and formatting system for less than \$2600. This cartridge offers many benefits, including: automatic text wraparound, search and replace commands, and powerful macro programming.

And, to make it easy for you to put your own particular application software in ROM, we've also provided an EPROM PAC™. It has sockets for four user-supplied EPROMs with capacity up to 16K bytes.

S-100 Expansion & 128 User-Defined Symbols

The Sorcerer was created to withstand "Gimme" attacks. It's designed to be the hub of a busy computing operation now, and tomorrow when your demands increase or change.

Sorcerer's standard features, such as high-resolution

graphics, and the capability to define up to 128 of your own letters and symbols, give you an amazing flexibility to do things you simply can't accomplish with any other computer.

Our S-100 expansion unit lets you take advantage of the many useful S-100 peripherals currently available from dozens of manufacturers. And that includes everything from music and speech synthesizers for the hobbyist to appliance controllers for the home and the latest Winchester disk drives for small business computer applications.

It's also easy with Sorcerer to add on a printer, an acoustic coupler, or a modem, because our system has built-in parallel and RS232 Serial I/O ports (features normally offered as add-on options by most other small computer makers today).



"Gimme, gimme!"

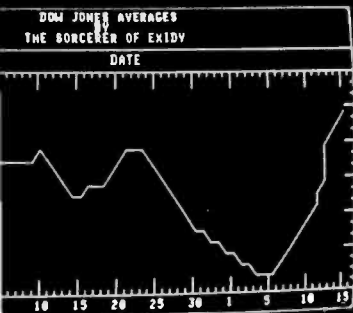

The best of Sorcerer

Hardware

Price*

- The Sorcerer Computer:** 16K RAM expandable to 48K. 4K ROM-resident operating system has built-in printer driver. 50-pin I/O connector for S-100 expansion. 25-pin parallel interface; 25-pin serial interface. Serial interface operates one or two cassette recorders. Graphic resolution of 240x512, 30 lines of 64 characters, 8x8-dot matrix. Character generator contains full ASC II set (upper & lower case), plus standard graphic symbols. User may define up to 128 characters. Keyboard is 63-key data processing type, plus 16-key numeric pad. **\$1295**
(16K model)
\$1395
(32K model)
\$1495
(48K model)
- Video Display:** industrial grade 12-inch CRT (P31 phosphor). **\$ 499**
- Display Disk:** single unit package containing two quad density dual floppy disks (630K bytes) with controller and 12-inch industrial grade CRT (P31 phosphor). Includes CP/M™ and Microsoft disk-extended BASIC. **\$2995**
- Floppy Disk Subsystems:** single dual-density floppy disk (120K bytes) and controller in one package. Includes CP/M™ and Microsoft disk-extended BASIC. **\$1150**
- S-100 Expansion Unit:** self-contained 10-amp power supply and motherboard with 6 card slots. Daisy chain units for more slots. **\$ 419**

Software

- Development PAC™ **\$ 99**
- Word Processing PAC™ **\$ 199**
- EPROM PAC™ **\$ 49**
- Microsoft Disk-Extended BASIC **\$ 300**
- CP/M™ Operating System **\$ 145**

*U.S. domestic prices only. Subject to change without notice.
CP/M is a Registered Trademark of Digital Research

Satisfy that urge

When you discover the many exciting ways Sorcerer can satisfy all your "Gimme" urges, you'll say: "I'm in sheer Exidy." For the name of your nearest dealer, or additional information, write or call our Marketing Communications Department.

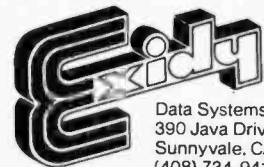

Data Systems Division
390 Java Drive
Sunnyvale, CA 94086
(408) 734-9410

Circle 73 on Inquiry card.

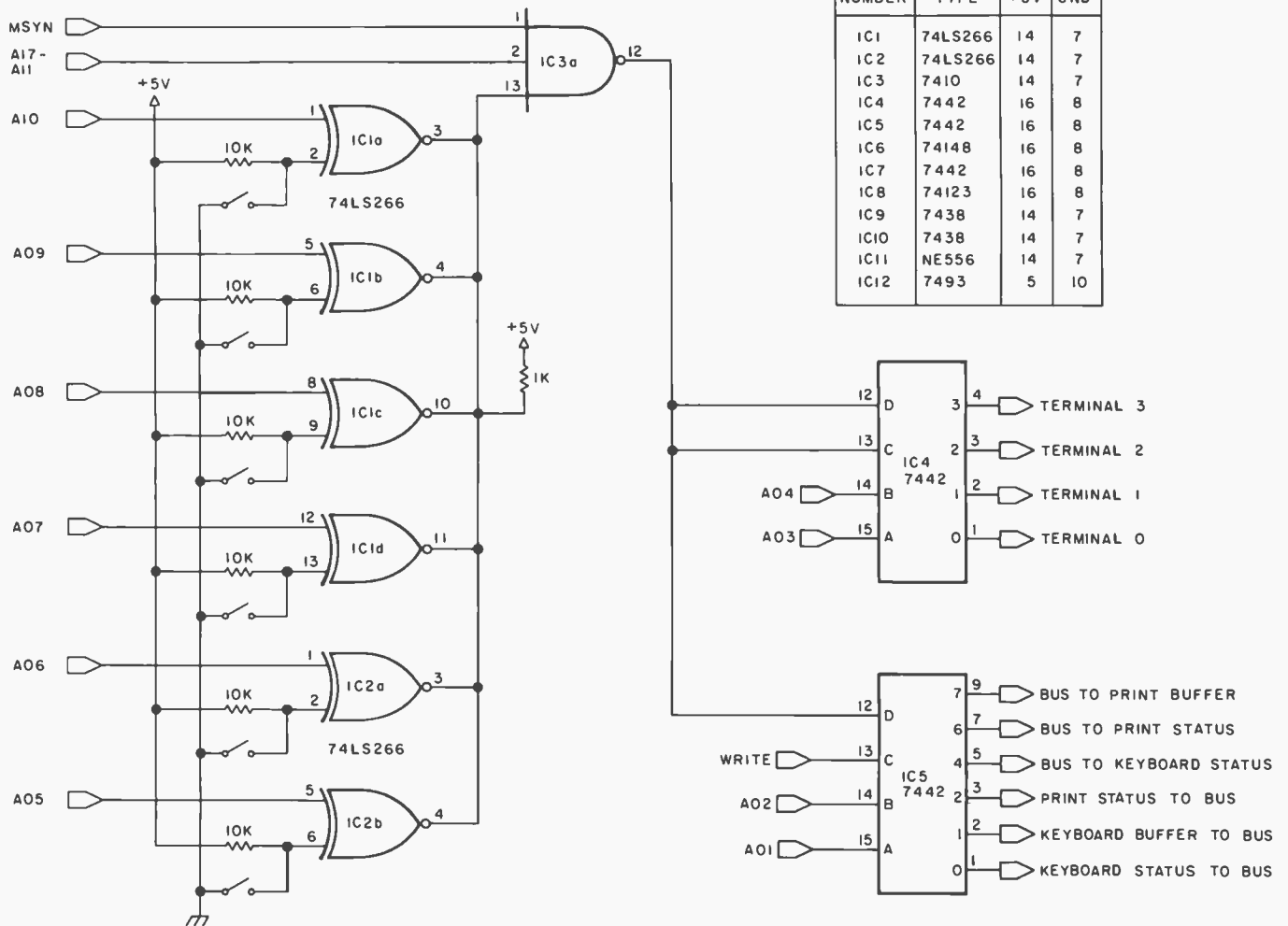

Figure 3: Address decoding circuitry.

Text continued from page 117: processor status word for the service routines are placed in low memory of addresses less than octal 776 by the software and not by the hardware.

The memory words necessary for this interface will consist of D type flip flops for the status registers since only two bits are needed per word. The input and output data buffers may be hooked directly to the UARTs. UART is, of course, an abbreviation for the Universal Asynchronous Receiver Transmitter, a device which converts parallel bytes of data into a serial stream of bits in an industry standard, time ordered format. The specific UART used in this design is the General Instruments part numbered AY-5-1013.

The address decoding circuitry is shown in figure 3. All signals are conditioned by bus receivers and are not considered valid until the processor asserts a master synchronization signal (MSYN). The 74LS266 is a 4 bit digital comparator with open collector outputs that are "wire ORed" to detect the

proper setting of six address lines. The address may be selected by the adjustment of the switches. A pair of 7485 magnitude comparators could have been used in series since they only require a 48 ns delay to compare six bits. The MSYN signal is not asserted until at least 75 ns after the address lines have been activated. Notice the use of two 7442s, binary coded decimal decoders. Since all addresses are in consecutive words, given a base address, say X, the first terminal will use addresses X to X+6, the second terminal will use addresses X+10 to X+16, and so on. IC4 will only assert one of its lower four output lines if the address is in the range for that terminal. IC5 is used with the low address bits and the read or write control lines to indicate which action must be done for the specified terminal. Note that the keyboard data buffer is a "read only" memory and the printer data buffer is a "write only" memory.

The UARTs used in this interface require a transistor-transistor logic load

Bit Pad One™ is the small, low-cost digitizer that lets you add a graphics or menu capability to any data processing system. It's perfect for data entry, CRT cursor control, games, mapping and countless business applications like order entry and inventory control.

Bit Pad One is small in size, but big in reliable capability.

The 11" x 11" active area has a resolution of 0.005" which is comparable to digitizers found in expensive turnkey graphic design systems.

Best of all, Bit Pad One is designed and built by Summagraphics, the leading manufacturer and OEM supplier of data tablets and digitizers.

Bit Pad One. It's bringing digitizing down to earth.



Summagraphics
corporation

35 Brentwood Ave., Box 781
Fairfield, CT 06430
(203) 384-1344.

Central Office: 3785 Varsity Dr., Ann Arbor, MI 48104, (313) 973-1710.

Western Office: 1102 West 17th St., Santa Ana, CA 92706, (714) 541-8261.

European Office: 14 rue de l'Ancien-Port, 1201 Geneva, Switzerland, phone 022/31 39 40.

**Bit by bit,
the world is coming
to Bit Pad One.**



Circle 74 on inquiry card.

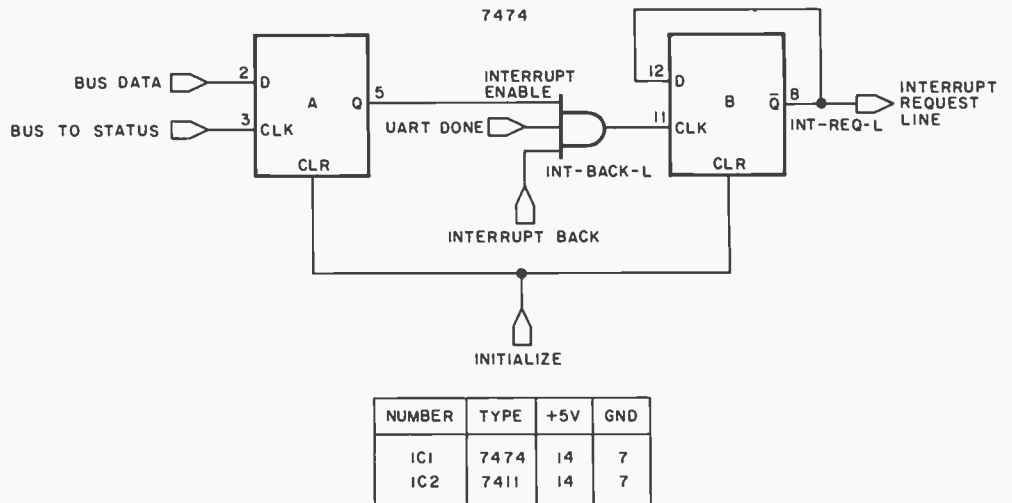

Figure 4: The interrupt logic for each UART consists of a pair of these circuits: one for transmit and one for receive. For the complete interface, eight copies of this circuit are required, so the sections of the 7474 circuits are referenced in text by A and B.

(1.6 mA) for the data inputs and have three state data outputs capable of driving one transistor-transistor logic load. Since the data ports had to be buffered to correctly interface to the processor bus, all input data ports could be wired in parallel and the same for the output data ports. All individual signals to and from each UART must be conditioned via AND or NAND gates to insure communication with the correct terminal unit.

The most difficult task remained: designing the necessary interrupt logic. It was desirable to make the priority of all keyboards higher than any of the printers. This way, no characters would be lost. The inclusion of four terminal drivers on a single board forces a significant increase in the complexity of the interrupt logic.

The interrupt logic consists of two related sections. The first section required properly generating an interrupt from either the input or output side of the UART. Figure 4 shows the circuit for one side of a UART. This circuit appears eight times in the completed board. The interrupt enable bit must have been set through a 7474 flip flop section labeled A in figure 4. Initially, the B section of the 7474 is off so the interrupt request line (INT REQ L) is high and not asserted. Likewise, the interrupt back line (INT BACK L) is high and not asserted. When a character is received (in the case of the receiver side of the UART), UART DONE causes a low to high level transition on the clock input of the B section of the flip flop. Since \bar{Q} was high,

D is high and Q is then asserted, making the interrupt request line (\bar{Q}) active. This signal then serves as input to the interrupt arbitration logic. The interrupt back line (INT BACK L) will remain high until the actual vectoring takes place. After that, a low to high transition on the interrupt back line will cause the B section of the 7474 to shut off and stay off until either the interrupt enable or the UART done line is cleared and set again. As a convenience, any processor write operation to the status register will also reset the UART making the UART done line wait for the next character to be received.

The interrupt arbitration logic is in figure 5. Interrupt requests are arbitrated by the 74148 8 line to 3 line priority encoder. With the enable input (EI) line normally low, the gate status (GS) output will go low when at least one of the inputs is low, signaling an interrupt request had been posted. The outputs of IC6 will be a binary encoding of the one's complement of the highest priority input signal that is asserted low. When the processor acknowledges the request, the proper vector information, which is made up of a combination of switch settings and 74148 outputs, will be put onto the bus through the 7438 bus drivers. See table 2 for an enumeration of the vectoring. Observe that the bus is at ground potential for an address bit of 1. At the same time, the D3 input to IC7 will go low asserting an output line corresponding to the interrupt. When the interrupt sequence is done, the D3 input goes high and the cor-

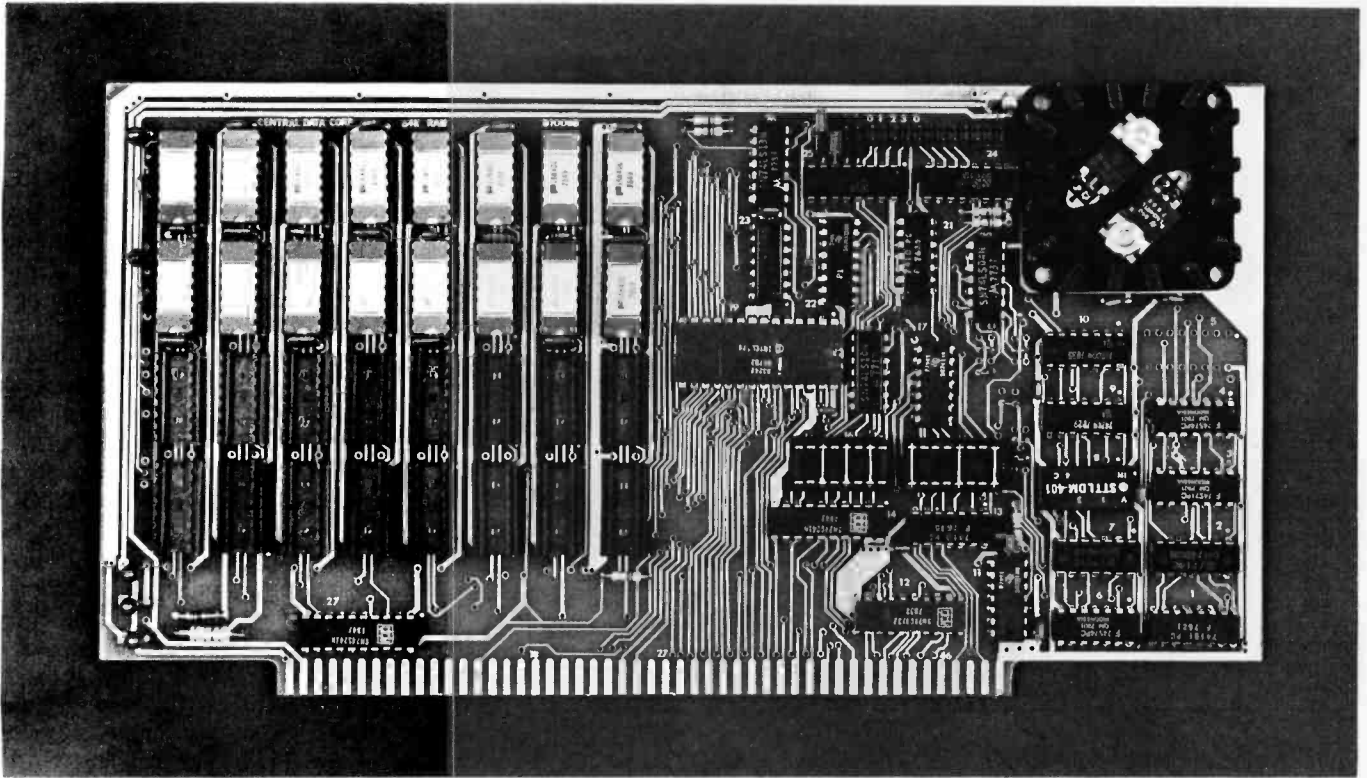

32K Board Pictured Above

Why Not the Best?

From The Dynamic RAM Company.

2MHz	4MHz
16K—\$249	\$259
32K—\$375	\$395
48K—\$500	\$530
64K—\$625	\$665

We have now been shipping our 2MHz dynamic RAM boards for over two years. Hundreds of 4MHz boards have been going out every month since early 1979. Our reliability is proven in the thousands of systems which contain our board. Many quality-minded systems houses across the country and overseas are using our boards for their equipment.

Our prices still beat all. Despite rising 16K memory chip prices (at least from reputable suppliers), Central Data continues to give you the best buy in memory today. Nobody offers a board with a capacity of 64K, assembled, tested, and guaranteed for a full year at the price we do. Circle 75 on inquiry card.

Deselect around PROMs. Our boards have the important deselect feature which lets you overlap any fixed memory in your system with no interference.

Our features make the board easily used and expanded. You address our boards on 16K boundaries with mini-jumps (small shorting plugs that slide over wire-wrap pins) near the top of the board for easy access. If you want to expand your board after you have purchased it, all that you need to do is add memory. We can supply you with expansion packages (\$150-2MHz, \$160-4MHz) which include eight RAMs that you can depend on as well as two mini-jumps for addressing. And of course, our board **never** generates wait states.

Low power consumption keeps your computer running cool and reliable. The total power consumption of our 16K board is typically less than 4 watts (+8V @ 300ma, +16V @ 150ma and

–16V @ 20ma). Boards with additional memory typically increase power consumption only 1 watt per 16K!

Standard S-100 Interface. Our board is designed to interface with any standard S-100 CPU. All of the timing of the board is independent of the processor chip, and the board is set up for different processors by changing two plugs on the board.

Call or write us today. That will guarantee a fast response with more information on the board. Or make an order — you'll probably have the board in two weeks! **If you're interested, also ask for a catalog on our Z8000 16-bit processor board designed for the MULTIBUS.** All of these products are available to your local dealer, also.

Central Data Corporation, 713 Edgebrook Drive, PO Box 2530, Station A, Champaign, IL 61820. (217) 359-8010

Central Data

responding interrupt back line goes high clearing its respective D flip flop from figure 4. Simultaneously, IC8 is triggered to time out the gate status output of IC6. This is necessary because the remainder of the interrupt logic requires the gate status line to go high before it can be asserted to request another interrupt.

Unfortunately, there is a period of about

50 to 100 ns when the bus drivers are active that a higher priority interrupt could perhaps sneak through IC6 and deskew the correct data. This problem could probably be eliminated by giving the higher communication rate terminals a higher priority or by using an extra set of latches.

If all the UARTs were driven off the same clock source, the interrupts could only occur simultaneously (in which case the arbitration works correctly) or at least spread apart by an interval equal in length to 16 times the transmission rate. This would be 26 μ s at 2400 bps. Feeling that the odds of two people typing two keys within 100 μ s of each other is quite small, the circuit remains as presented. The interrupt enable bits and the done flags are reported back to the user through 74153s, dual 4 line to 1 line data selectors. The input to these signals comes from the interrupt enable signals of the 7474s and from the UARTs directly.

Interrupt	74148 Output			Octal to 7442	Vector Offset
	A2	A1	A0		
KBD 0	L	L	L	0	+ 0
KBD 1	L	L	H	1	+10
KBD 2	L	H	L	2	+20
KBD 3	L	H	H	3	+30
PRINT 0	H	L	L	4	+ 4
PRINT 1	H	L	H	5	+14
PRINT 2	H	H	L	6	+24
PRINT 3	H	H	H	7	+34

Table 2: Vector table generated by the 74148 and 7442 (IC1 and IC2 in figure 5) combination through the bus drivers.

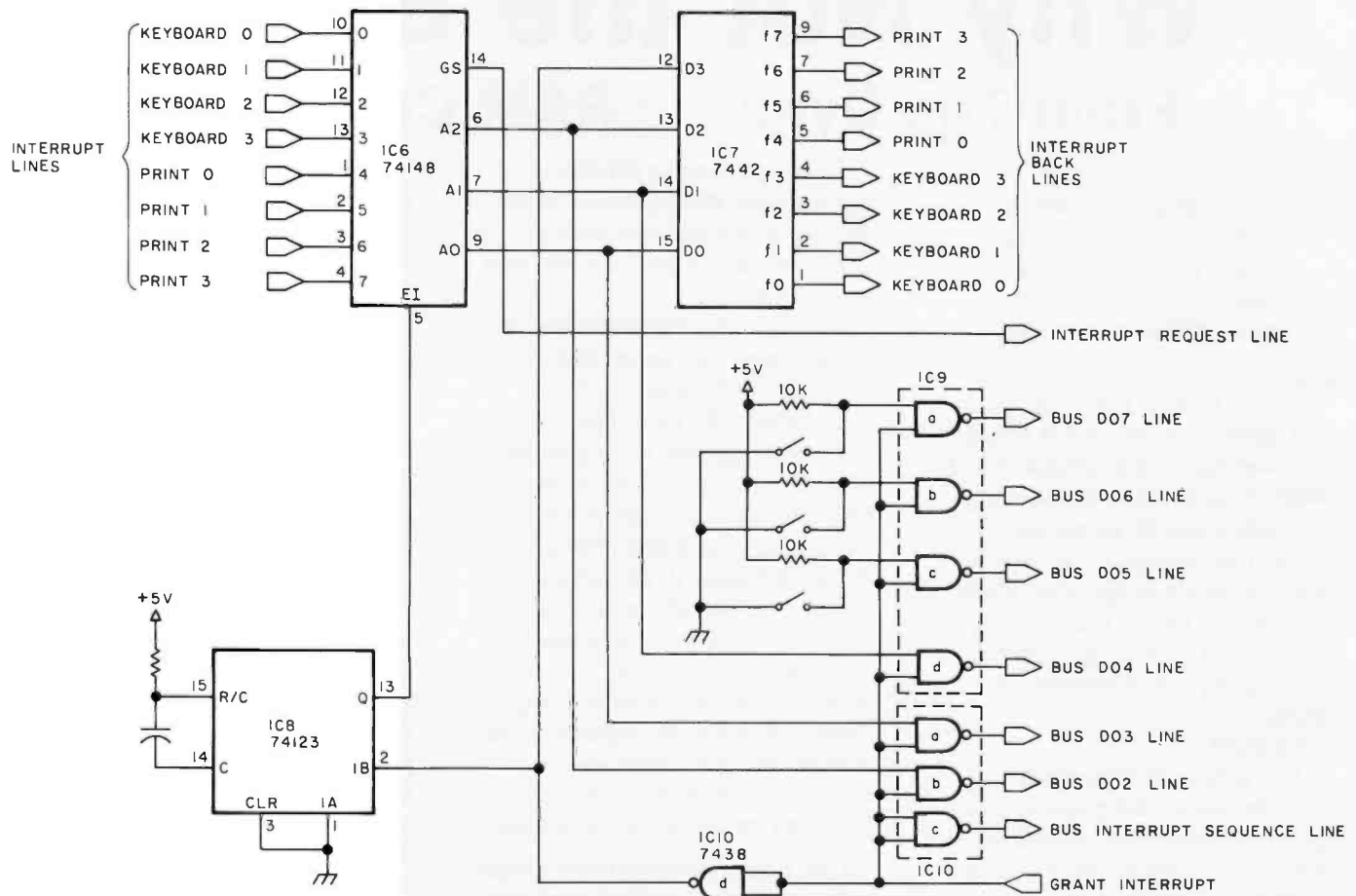

Figure 5: The interrupt arbitration logic interfaces the requests from the UARTs to the remainder of the bus interrupt sequence logic. Note that the 74148s can be wired in serial to control even more requests.

An additional item: in trying to keep my costs to a minimum, my clock driver consisted of an NE556 dual timer and a 7493 divide by 16 counter instead of a MC14411 bit rate generator. Luckily, the NE556 was the only part not in my rather well stocked junk box at the start of this effort. The clock circuit is shown in figure 6. Current market price for four terminal interface boards for the PDP-11 is about \$1600. This interface required some four months of spare time to design and debug. The time has been well worth the effort. My 20 mA teleprinter, operating at 110 bps, and my EIA modem, operating at 300 bps, are currently attached to this interface with two ports still open. Now I have a single terminal interface left over with no use for it. I guess I will have to find another terminal. ■

BIBLIOGRAPHY

1. *PDP-11 Peripherals Handbook*, Digital Equipment Corp, Maynard MA, published yearly.
2. *Signetics Logic Data Manual*, Signetics Corp, Sunnyvale CA, published yearly.

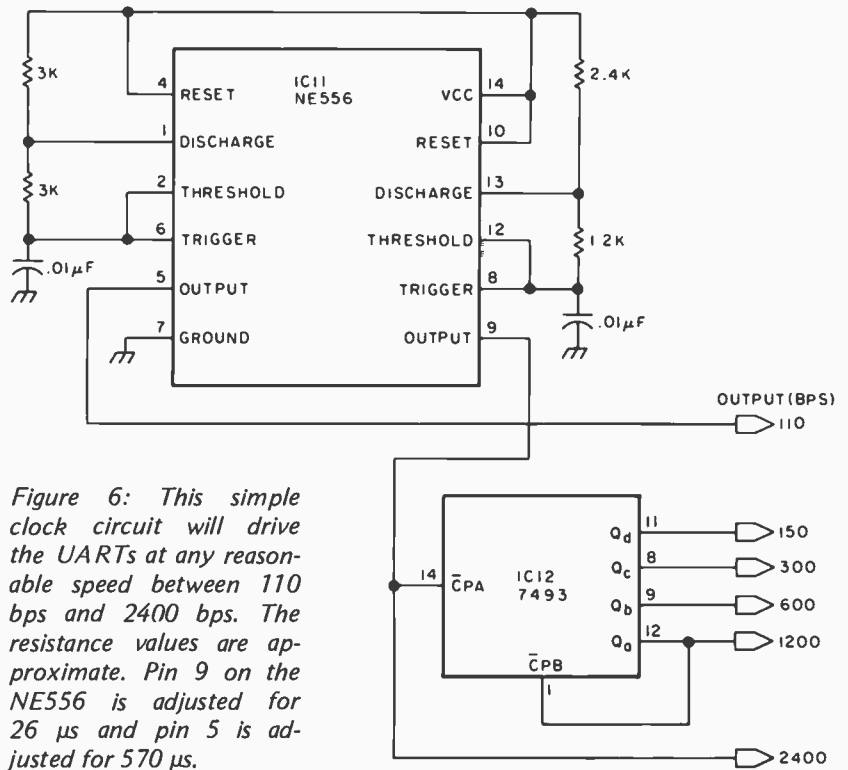

Figure 6: This simple clock circuit will drive the UARTs at any reasonable speed between 110 bps and 2400 bps. The resistance values are approximate. Pin 9 on the NE556 is adjusted for 26 μ s and pin 5 is adjusted for 570 μ s.

CP/M[®] : = PASCAL;

- Compiler executes under the CP/M operating system in as little as 32K bytes of RAM.
- Interactive Symbolic Debugger which enables the programmer to examine variables, set a breakpoint, and trace procedure calls interactively at run time.
- Pascal/MT[®] compiles at the rate of 600 lines per minute on a 2 MHz 8080.
- Programs Execute up to 10 TIMES FASTER than popular interpretive Pascals.
- The code generated is 8080 object code which is ROMable with a minimum run time overhead of 1.5K bytes.
- Interrupt procedures allows the programmer to write interrupt drivers for I/O and other real time tasks in Pascal/MT.
- Bit manipulations of variables may be preformed with the built-in procedures: SETBIT, CLRBIT, TSTBIT, SHL, SHR, SWAP, LO, HI.
- Memory, Input and Output ports may be directly accessed from Pascal/MT.
- Assembly language subroutines may be called from Pascal/MT.
- Software floating point, is standard, in addition, this package is compatible with the AMD9511 hardware floating.
- AMD9511 hardware floating point drivers are available with the purchase of the run time package source library.
- Business arithmetic version of Pascal/MT is also available. This package supports an 18 digit BCD with 4 fixed decimal places.
- Pascal data structures supported are: ENUMERATION AND SUBRANGE TYPES, RECORD, ARRAY, REAL, INTEGER, CHAR, and BOOLEAN.
- Not implemented are: SETS, GOTO, GET, PUT.

AVAILABLE FROM

FMG CORPORATION
P.O. Box 16020
Fort Worth, Texas 76133
(817) 294-2510

MT MicroSYSTEMS
8672 I Via Mallorca
La Jolla, Ca. 92037
(714) 223-5566 ext. 289

Lifeboat Associates
2248 Broadway
New York, N.Y. 10024
(212) 580-0082

* CP/M is a trade name of Digital Research.

* Pascal/MT is a trademark of MT MicroSYSTEMS.

**NEECO
PROUDLY
ANNOUNCES...**

The Source

*FROM TCA



**THE
SOURCE
(DATA BASE)**

- ★ **Access UPI Stock Reports**
- ★ **Access N.Y. Times News Wire**
- ★ **Access All Data Base Information**
- ★ **Save and Load Programs/Data**
- ★ **Dump to 2040 Disk then Print**

NEECO Source Kit \$99.95 (Smart Terminal Software and Cable)

CAT Acoustic Modem . . . \$199.95 (Recommended Acoustic Coupler)

Source Hook-Up \$100.00 (Also available from TCA)

DEALER/OEM QUANTITIES AND SPECIAL PRICING AVAILABLE VIA MICROAMERICA DISTRIBUTING



NEECO

679 Highland Ave.
Needham, MA
02194

Mon-Fri 9:30-5:30
MasterCharge &
Visa Accepted

(617) 449-1760
Telex: 951021

MICROAMERICA DISTRIBUTING

"Nationwide distributors of Computer Equipment"

21 Putnam Street
Needham, MA
02194

(617) 449-4310

Microcomputer Systems Division
Circle 77 on inquiry card.

Circle 72 on inquiry card.

NEECO

Microcomputer Systems Division

**PROUDLY ANNOUNCES THE NEWEST
HARDWARE AND SOFTWARE FOR YOUR PET!****The PET is now a truly sophisticated
Business System with the announcement
of these peripherals and software packages.****FREE
SOFTWARE
& PET DUST
COVER!**
(Offer ends
2/28/80)NEW
NEW
NEW

PRODUCT	DESCRIPTION	PRICE	AVAILABILITY
PET 2001—8KN (Large Keys)	8K RAM	\$ 795	IMMEDIATE
PET 2001—8K	8K RAM	\$ 795	IMMEDIATE
PET 2001—16KN (Large Keys)	16K RAM*	\$ 995	IMMEDIATE
PET 2001—32KN (Large Keys)	32K RAM	\$1295	IMMEDIATE
PET 2023 PRINTER	ROLL FEED	\$ 695	IMMEDIATE
PET 2022 PRINTER	TRACTOR/ROLL	\$ 795	IMMEDIATE
ROMRETRO KIT	UPDATED O/S	\$ 90	IMMEDIATE
PET 2040	DUAL FLOPPY*	\$1295	IMMEDIATE
PET C2N	2nd Cassette	\$ 95	IMMEDIATE

*The 16K/32K (large keyboard) units do not include a cassette drive. Order C2N Cassette. 2040 Floppy Drive requires a 16K or 32K unit. 8K RAM Retrofit available July.

ALL PETS ARE FULLY TESTED BY NEECO BEFORE SHIPMENT. NEECO IS A FULL CUSTOMER-ORIENTED COMPANY. CALL FOR OUR FREE CATALOG. ALL ORDERS OVER \$795 WILL RECEIVE A FREE NEECO PET DUST COVER AND \$100 OF SOFTWARE FROM OUR CATALOG IF YOU MENTION YOU SAW THIS AD.

PET-DISK BASED BUSINESS SOFTWARE

SOFTWARE/APPLICATION	REQUIRES	AUTHOR	AVAILABILITY	PRICE
WORDPRO II / WORD PROCESSING	2040 + 16K PET	PRO/MICRO	IMMEDIATE	\$100
WORDPRO III / WORD PROCESSING	2040 + 32K PET	"	JANUARY	\$200
GENERAL LEDGER	"	CMS SOFTWARE	IMMEDIATE	\$295*
ACCOUNTS PAYABLE	"	"	JANUARY	\$295*
ACCOUNTS RECEIVABLE	"	"	JANUARY	\$295*
MAILING LIST	"	"	IMMEDIATE	\$100
MICROLEDGER	"	COMPUMAX	"	\$140
MICROPAY	"	"	"	\$140
MICROREC	"	"	"	\$140
MICROINV	"	"	"	\$140
MICROPEERS	"	"	"	\$140

*The CMS Software (G/L, A/R, A/P) are based on Osborne & Associates trial tested business basic software. Software is complete with full documentation and user instructions. All packages require a printer for output. Commodore recommends the NEC Spinwriter (available from NEECO) as the output printer for WORDPRO.

PRODUCTS ARE AVAILABLE TO DEALERS VIA MICROAMERICA DISTRIBUTING (617-449-4310)

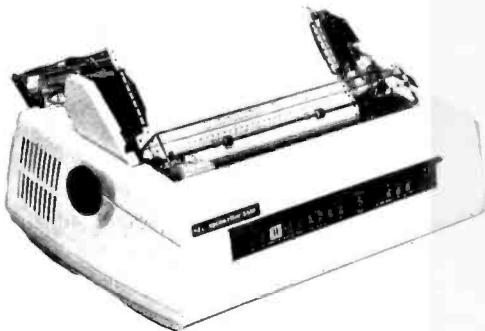
**FOR WORD PROCESSING
NEC IS BEST!****THE NEC SPINWRITER**
MODEL 5530-P (Centronics I/O
modified for PET)**\$2995**

*Price includes IEEE interface to PET. IEEE Port is available for use with 2040 Dual Disk.

*The NEC 5530-P is the output printer recommended by Commodore for their Word Processing System.

NEECO679 Highland Ave.
Needham, MA
02194Mon-Fri 9:30-5:30
MasterCharge &
Visa Accepted**(617) 449-1760**
Telex: 951021**MICROAMERICA DISTRIBUTING**

"Nationwide distributors of Computer Equipment"

21 Putnam Street
Needham, MA
02194**(617) 449-4310**

Comparison of Some High-Level Languages

Robert A Morris
Associate Professor
Department of Mathematics
University of Massachusetts
at Boston
Boston MA 02125

Different languages are appropriate for different tasks: multilingual ability is as useful in the computer world as it is in the human world.

The time is not far off when microprocessor users will begin the serious use of high level languages other than the BASIC supplied for many current machines. There are many projects hither and yon to implement contemporary languages in microcomputer form, and the emergence of 16 bit processors will probably accelerate this trend. Indeed, even now microcomputer users have a practical way to use high level languages: using the personal computer as an intelligent interactive editing terminal and sending source code over telephone lines to be compiled and executed by a large remote time-sharing computer. For many such tasks, the connection time (the charge levied by the big computer operators for merely listening to your terminal) is a substantial fraction of the total cost. But this time is short compared to the data entry time, which will be entirely on the user's own system.

Unfortunately, most information about languages is gleaned from people who have a stake in a particular language due to a greater familiarity with it. Different languages are appropriate for different tasks. Multilingual ability is as useful in the computer world as it is in the human world. To this end I would like to describe the differences and similarities between major general purpose programming languages, and offer opinions about how these differences might affect your choice of a high level language.

A number of the conclusions I draw can be attributed to questions of style, and many whose personal programming styles are different might take issue or even umbrage at what I offer. Nevertheless, I claim the critical reviewer's prerogative to offer opinion, and hope only that it is clearly identified. One precaution to the novice and to the initiate: In comparing programming languages, I assume that the specific choices are equally well implemented. Unquestionably the worst

version of language A may be far harder to use than the best version of language B, even if in principle the opposite is the case.

My own particular bias is that I am not interested in "number crunching": that is, the use of the computer for scientific or statistical calculations which are complex, lengthy (in terms of machine time), and which often run repeatedly with different data. For such so called *production* programs the programming expense is usually small compared with the computing expense, and there is a premium on efficient programs. Suppose one writes a program to solve a system of linear equations by Gauss' method with the principal intention of understanding that method. It then becomes irrelevant that an additional 10 hours of programming effort can produce a 50 percent increase in running speed. The program will run only a few times for a few seconds.

Finally, I admit I am a mathematician. Mathematicians think in unusual ways, especially about computers. I once baffled a computer professional when I told him that most of the programs I write, once written and correct, never needed to be run. Programming as a logical and esthetic discipline is not a very comfortable idea to many professionals. In any case, writing a program in order to understand an algorithm, instead of vice versa, is a commendable use of computers and one which colors my own thinking.

In many organizations some system of phantom money is in effect for computer use. The users and their departments often have budgets but do not spend any money. Rather they simply have some restriction put on their use if this budget is expended. Indeed it has been argued that certain computer use, like library use, should be completely without accounting. Nevertheless, it is common to talk of one or another solution being expensive, and this is to

Build your own microcomputer as you learn computer technology at home.

New from NRI! The Most Complete and Up-to-date Home Study Course Ever Offered

As the microprocessor revolutionizes the computer world and microcomputers appear almost everywhere, NRI brings you a new, convenient, and effective way to keep up with this expanding technology. It's NRI's Computer Technology Course, created and designed exclusively for learning at home in your spare time.

Featuring NRI's Exclusive Dual Language Microcomputer

NRI goes beyond book learning to give you practical, "hands-on" experience in designing circuitry, interfacing components, programming, and troubleshooting. As you learn, you actually assemble NRI's designed-for-learning microcomputer, incorporating the latest advances in the state of the art. It looks and operates like the finest of its kind, actually does more than many commercial units. But NRI engineers have designed components and planned assembly so it demonstrates important principles, gives you working experience in detecting and correcting problems. And it's yours to keep, put to work in your own home or business.

You also build and keep your own test instruments, including a transistorized volt-ohm meter and CMOS digital frequency counter. And NRI's Discovery Lab[®] broadens your horizons with specialized experiments and theory demonstrations.

The Proven Way to Learn at Home

You don't have to worry with travel, classes, or time lost from work when you learn the NRI way. As they have for more than 60



years of teaching technical subjects, NRI brings the material to you. You study in your spare time, at your convenience, using "bite-size" lessons that program material into logical segments for easier assimilation. You perform experiments and build equipment using kits we supply. And your personal NRI instructor is always available for consultation should you have questions or problems. Over a million students have already shown the effectiveness of NRI training.

Choice of Courses

Several courses are available, depending upon your needs and background. NRI's Master Course in Computer Technology starts with the fundamentals, explores basic electronics and digital theory, the total computer world, and the microcomputer. The Advanced Course, for students already versed in electronics and general computers, concentrates on the microprocessor and microcomputer. In both courses, you build all instruments and your own computer.

Send for Free Catalog... No Salesman Will Call

Get the details on these exciting new courses in NRI's free, 100-page catalog. Shows all kits and equipment, lesson outlines, and full information, including facts on other electronics courses. Mail the coupon today and we'll rush your catalog. No salesman will ever call. Keep up with the latest technology as you learn on your own computer. If coupon has been removed, write to NRI Schools, Computer Department, 3939 Wisconsin Ave., Washington, D.C. 20016.



NRI Schools
McGraw-Hill Continuing
Education Center
3939 Wisconsin Avenue
Washington, D.C. 20016

NO SALESMAN WILL CALL

Please check for one free catalog only.



All career courses approved under GI Bill.
 Check for details.

- Computer Electronics Including Microcomputers
- TV/Audio/Video Systems Servicing
- Complete Communications Electronics with CB • FCC Licenses • Aircraft, Mobile, Marine Electronics
- CB Specialists Course
- Amateur Radio • Basic and Advanced

- Digital Electronics • Electronic Technology • Basic Electronics
- Small Engine Repair
- Electrical Appliance Servicing
- Automotive Mechanics
- Auto Air Conditioning
- Air Conditioning, Refrigeration, & Heating Including Solar Technology

Name _____ (Please Print) _____ Age _____

Street _____

City/State/Zip _____

Accredited by the Accrediting Commission of the National Home Study Council

170-020

CP/M^{®2}

NOW BETTER THAN EVER

- Control Program for Microcomputers.
- Includes Editor, Assembler, Debugger, Utilities.
- Supports Floppy Disks and Hard Disks.
For 8080, 8085, Z-80, MDS, Cromemco.
- \$150-Diskette and Documentation
- \$25-Documentation only

MP/M[™]

NEW INDUSTRY STANDARD

- Multi-terminal access.
- Multi-programming.
- CP/M-compatible.
- Real-time features.
- \$300-Diskette and Manual
- \$25-Manual only

DIGITAL RESEARCH

OPTIONAL SOFTWARE PACKAGES

MAC[™] MACRO ASSEMBLER:

- Compatible with new Intel macro standard.
- Complete guide to macro applications.
- \$90-Diskette and Manual.

SID[™] SYMBOLIC DEBUGGER:

- Symbolic memory reference.
- Built-in assembler/diassembler.
- \$75-Diskette and Manual.

TEX[™] TEXT FORMATTER:

- Powerful text formatting capabilities
- Text prepared using CP/M Editor.
- \$75-Diskette and Manual.

DESPOOL[™]

- Background print utility.
- Use with CP/M
- \$50-Diskette and Manual.

DIGITAL RESEARCH[®]

P.O. Box 579 • Pacific Grove, California 93950
(408) 649-3896

be understood as being a vague and relative term, taking into account such factors as computing charges, programmer's time and storage charges for data and programs in or outside the machine.

I will discuss essentially three languages: BASIC, FORTRAN, and ALGOL (together with PL/I). I'll also take a cursory look at Pascal and give a brief description of APL together with the reasons for not including it in this survey. These languages are fairly standardized so that if one has learned them on one machine, there is very little relearning necessary for another. Indeed, aside from minor punctuation differences, one rarely encounters machine dependent features of these languages except for input and output (IO). Thus it is often practical to transport programs from one machine to another with very little rewriting except for the IO, but in some circumstances this can be substantial.

Many BYTE readers know BASIC already, but I will describe it so that a broader audience might be reached. In some of the following examples I have abused programming language punctuation in the interest of comprehensibility.

BASIC

BASIC is an acronym for Beginner's All-purpose Symbolic Instruction Code. It was developed originally at Dartmouth University and designed as a conversational interactive language, meaning that the user is essentially in immediate and constant contact with the computer. A good BASIC translator will give some diagnostic messages even as the user types in the program. In any case the system will attempt to indicate to the user the point at which a linguistic error occurs. This is true for most high level languages whether conversational or not, but the conversational feature and the similarity of BASIC to ordinary mathematical notation make it a particularly easy language to learn and use. In fact, it is the language of choice when the program to be written is short, say 20 commands or less, and the manipulation no more than high school algebra. BASIC is typically available on the interactive minicomputers used in many high schools. It looks like this:

```
100 LET X=Y=3
200 LET Z=5
300 LET W=3*(X+(Y/2))
400 PRINT W
500 END
```

BASIC is an inherently expensive language in terms of time, because it is interpreted rather than compiled. This means that the program is translated into machine

The VIP hobby computer: Start programming for only \$99.

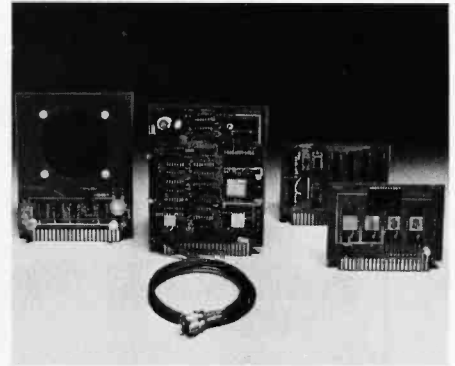

**New! VP 111
Microcomputer \$99.
Assembled* and tested.**

Features:

- RCA 1802 Microprocessor.
- 1K Bytes static RAM.
- Expandable on-board to 4K.
- Expandable to 32K Bytes total.
- 512 Byte ROM operating system.
- CHIP-8 interpretive language or machine language programmable.
- Hexadecimal keypad.
- Audio tone generator.
- Single 5-volt operation.
- Video output to monitor or modulator.
- Cassette interface—100 Bytes/sec.
- Instruction Manual with 5 video game listings, schematics, CHIP-8, much more!

Ideal for low-cost control applications.

Expandable to full VIP capability with VP-114 Kit.

*User need only connect cables (included), a 5-volt power supply, and speaker.

**New low price! \$199.
The original VIP .. \$199.
Completely assembled
and tested.**

All the features of the VP-111 plus:

- A total of 2K Bytes static RAM.
 - Power supply.
 - 8 Bit input port.
 - 8 Bit output port.
 - I/O port connector.
 - System expansion connector.
 - Built-in speaker.
 - Plastic cover.
- Three comprehensive manuals:
- VIP Instruction Manual—20 video game listings, schematics, much more.
 - VIP User's Guide—operating instructions and CHIP-8 for the beginner.
 - RCA 1802 User's Manual (MPM-201B) - complete 1802 reference guide.

**COSMAC VIP lets you add
computer power a board
at a time.**

With easy-to-buy options, the versatile RCA COSMAC VIP means even more excitement. More challenges in graphics, games and control functions. For everyone, from youngster to serious hobbyist.

Built around an RCA COSMAC microprocessor, the VIP is easy to program and operate. Powerful CHIP-8 interpretive language gets you into programming the first evening. Complete documentation provided.

Send the coupon now...

Complete the coupon below and mail to: RCA VIP Customer Service, New Holland Avenue, Lancaster, PA 17604.

Or call toll free (800) 233-0094 to place your Master Charge or VISA credit card order. In Pennsylvania, call (717) 397-7661, extension 3179.

RCA

Please send me the RCA COSMAC VIP items indicated.

Type	Description	Price
<input type="checkbox"/> VP-111	New low cost Microcomputer (See description above)	\$99
<input type="checkbox"/> VP-114	Expansion Kit for VP-111—Includes 3K RAM, I/O Port and connectors...	\$ 76
<input type="checkbox"/> VP-711	VIP—The original VIP Microcomputer (See description above)	\$199
<input type="checkbox"/> VP-44	RAM On-Board Expansion Kit—Four 2114 RAM IC's. Expands VP 711 memory to 4K bytes	\$ 36
<input type="checkbox"/> VP-590	VIP Color Board—Converts VIP to color. Four background and eight foreground colors	\$ 69
<input type="checkbox"/> VP-595	VIP Simple Sound Board—Provides 256 programmable frequencies. For simple music or sound effects. Includes speaker	\$ 30
<input type="checkbox"/> VP-550	VIP Super Sound Board—Turns your VIP into a music synthesizer! Two independent sound channels. On-board tempo control. Outputs to audio system.	\$ 49
<input type="checkbox"/> VP-570	VIP Memory Expansion Board—Plug-in 4K RAM memory	\$ 95
<input type="checkbox"/> VP-580	VIP Auxiliary Keypad—Adds two-player interactive capability. 16-key keypad with cable. Connects to sockets on VP-590 or VP-585	\$ 20
<input type="checkbox"/> VP-585	VIP Keypad Interface Board—Interfaces two VP-580 Auxiliary Keypads to VIP.	\$ 15

<input type="checkbox"/> VP-560	VIP EPROM Board—Interfaces two 2716 EPROMs to VIP.	\$ 34	<input type="checkbox"/> VP-611	ASCII/Numeric Keyboard—Same as VP-601 plus 16 key numeric keypad.	\$ 80
<input type="checkbox"/> VP-565	VIP EPROM Programmer Board—Programs 2716 EPROMs. With software.	\$ 99	<input type="checkbox"/> VP-620	Cable: Connects ASCII keyboards to VIP.	\$ 20
<input type="checkbox"/> VP-575	VIP Expansion Board—Provides 4 buffered and one unbuffered expansion sockets.	\$ 59	<input type="checkbox"/> VP-700	VIP Tiny BASIC ROM Board—BASIC code stored in 4K of ROM.	\$ 39
<input type="checkbox"/> VP-576	VIP Two-Board Expander—Allows use of 2 Accessory Boards in either I/O or Expansion Socket.	\$ 20	<input type="checkbox"/> VP-710	VIP Game Manual—Listing for 16 exciting games.	\$ 10
<input type="checkbox"/> VP-601	ASCII Keyboard—128-character ASCII Encoded alphanumeric keyboard.	\$ 65	<input type="checkbox"/> VP-720	VIP Game Manual—II—More exciting games (Available 2nd qtr. '80)	\$ 10
			<input type="checkbox"/> MPM-201B	CDP1802 User Manual—(Included with VP-711)	\$ 5
			<input type="checkbox"/>	Please send more information.	—

Enclosed is \$_____ for items checked plus shipping & handling charge of \$3.00.

Add your state and local taxes \$_____ Total enclosed \$_____

I enclose check or money order or, charge my VISA/Bank Americard

Master Charge.

Credit card account No. _____

Master Charge Interbank No. _____ Expiration date: _____

Signature (required for credit card orders): _____

Name (please type or print): _____

Street address: _____ City: _____

State & Zip: _____ Telephone: () _____

Make checks payable to RCA Corp. Prices and specifications are subject to change without notice.

Osborne/McGraw-Hill means documented software



NOW AVAILABLE

OSBORNE/McGraw-Hill's popular business software series in CBASIC-21

Thoroughly tested, reliable programs with complete source listings, our **Payroll with Cost Accounting, Accounts Payable and Accounts Receivable** and **General Ledger** tell you how to begin; how to make changes; how to turn your computer into a productive part of your business. Printed in a loose-leaf format, easily inserted into your own binder, you can add to the book as you add to the programs.

DEALERS: The source listings from each book are available on disk for just \$250 — with no licensing agreements. Call or write for our dealer information package.

The books are also available in Wang BASIC.

Order Form:

Please send me the following books:

Title	Price	Quantity	Amount
Payroll w/Cost Acctg. - CBASIC			\$20.00
Accounts Payable/Receivable - CBASIC			\$20.00
General Ledger - CBASIC			\$20.00

Tax: Calif. residents only
6% / 6½% BART

Shipping: allow 4 weeks
45¢ per book USA, \$4.00 foreign

Name: _____

Address: _____

City: _____ State: _____

ZIP: _____ Phone: _____

Please send information package for end user dealer.



OSBORNE/McGraw-Hill
630 Bancroft Way, Dept. B2
Berkeley, CA 94710

For faster shipment or credit card, phone (415) 548-2805

language each time it is executed, rather than translated once and stored in machine form. The technical differences between interpreters and compilers are not otherwise relevant here. Roughly speaking, with an interpreter one does much less cajoling of the computer to get it to pay attention to one's program.

BASIC programs are easy to alter. To change a line, simply retype the offending line number followed by the new text, then a carriage return. The new line replaces the old and one can try to execute again. Thus, getting a program working right can involve very little waiting.

Many large computers operate in *batch* mode. This means that the user submits the program to the operator, typically on punched cards, and waits for it to be processed in turn. In such an environment the interactive feature is of no use. Although some batch systems have BASIC processors, it seems pointless to use the language this way.

For complicated problems, especially of a mathematical nature, BASIC has some severe deficiencies, even though it is probably the best first language to learn where it is available. One of the biggest of these is the difficulty of writing a BASIC program in pieces. "Passing parameters" can be a very messy business in BASIC and it is usually important to make sure that there is no confusion over the names of the variables. Generally, different variables must have different names, and the same variables the same name throughout a program. Fully-implemented FORTRAN avoids these pitfalls (in a somewhat unnatural fashion), and in ALGOL and PL/I they cannot arise at all. The mathematician's penchant for calling all independent variables *t* or *x* may be freely indulged in ALGOL, cautiously so in FORTRAN, and not at all in BASIC. This is particularly important when one is writing general routines to be plugged into several programs which may not have even been conceived yet.

FORTRAN

FORTRAN looks like this:

```
I=2
J=3
K=I+J
WRITE(6,10) K
10 FORMAT(I1)
```

The WRITE statement, if mysterious, is at least formal and standard. It instructs the machine to write on output unit 6, probably a printer or the user's terminal, according to format statement 10, the present value of the variable K.

Respectable modern FORTRAN compilers allow the programmer the option of ignoring the format and outputting the results in some standard fashion.

FORTRAN stands for FORMula TRANslator. It is the oldest and most widely used language for scientific computing. FORTRAN compilers for most machines produce extremely efficient machine language programs because demand is so great and the language has such a long history. For this reason, also, there are many compilers with excellent diagnostic features, such as the University of Waterloo's WATFOR and WATFIV systems available for large IBM machines and even optimizing compilers which attempt to improve on the programmer's efforts.

However, as we shall see, some of the classic features of FORTRAN are the very ones that should make people shun it. But because it is so familiar, it is difficult to convince FORTRAN adherents that the language is detrimental to their efforts. Of course, for production programs, efficiency is a legitimate reason to use it. Writers of more ephemeral programs should be aware of the extent to which the other languages around them are being improved and be sure the sacrifices are needed. There are two major objections to FORTRAN: it is difficult to write readable programs; and it is difficult to structure programs in a logical way that reflects the programmer's mathematical ideas for the solution of the given problem. I do not claim that these tasks are impossible. But it is widely agreed that typical FORTRAN programs are unreadable. This is often caused by bad habits encouraged by the language. A common experience with large FORTRAN programs is that some months after writing one, even the programmer's writer must study it at length to find out how it works. For another reader, this job may be immense.

One of the main reasons for this is the way in which logical alternatives are considered and acted upon in FORTRAN (and BASIC, for that matter). One of the principal powers of a computer is its ability to alter its course of action according to conditions that may not be known at the time the program is written, but which may be known only when it is executed. In FORTRAN and BASIC the alternative course of action is numbered (in BASIC all statements are numbered) and a program may contain a statement such as IF (condition to be tested) THEN GO TO 55. If the condition is not met, the computer executes the next instruction, but if it is met it executes the series of instructions which begins with

APPLE II® DISK SOFTWARE DATA BASE MANAGER - IFO PROGRAM

The IFO (Information File Organizer) can be used for many applications such as sales activity, inventory, check registers, balance sheets, client/patient records, billing and much more. This can be accomplished easily and quickly without prior programming knowledge.

Up to 1000 records with a maximum of 20 headers and 10 report formats can be stored on a diskette. Information can be sorted and searched (3 levels). Mathematical functions can be performed to manipulate the information. Subtotals and totals can be calculated on any numeric field.

Requires 48K and Applesoft II on ROM (or Apple II Plus). Accommodates serial/parallel printers. Error protection devices provided. Program diskette and instruction manual - \$100.

MAILING LIST PROGRAM - Print labels sorted or searched by 6 fields. On-screen editing. Line up routine. \$34.99

INVENTORY, TAX PROGRAM AND PAYROLL AVAILABLE NOW.

Send check/money order to:
**SOFTWARE TECHNOLOGY for
COMPUTERS (STC)**
P.O. Box 428
Belmont MA 02178

TRS-80* PERIPHERALS

DISK DRIVES \$349
40 tracks, with power supply & case and cable
VERBATIM DISKETTES \$3.00
DYSAN DISKETTES \$4.60

16k MEMORY KITS \$79
for TRS-80, APPLE, SORCERER
w/jumpers and instructions
ONE YEAR GUARANTEE!!!!

PRINTERS from \$379
from CENTRONICS, INTREGAL
DATA, NEC SPINWRITER,
TEXAS INSTRUMENTS.
ALL AT GREAT SAVINGS!!

TRS-80 computers in stock!!

We also carry APPLE, SORCERER, PET. SO SALES products. WE WILL NOT BE UNDERSOLD.

TRS-80 SOFTWARE

GAMES	UTILITIES	BUSINESS
ANDROID NIM \$14.00 nim robots that wink and respond. Excellent graphics and sound.	NEWOOS+ \$99.00 Enhanced ODS. Contains many improvements over TRSDOS. 7 useful utilities built in. For 40 track use also.	GL, AR, AP, PAYROLL INTERACTIVE \$350. reports include unbilled invoices, open/closed accounts, ageing. Trial balance, income statement, balance sheet. Handles 200 accounts, 1750 transactions.
STAR TREK III \$14.00 Travel through the galaxy on the Enterprise and destroy Klingons. New updated version.	NEWOOOS \$49.00 Same as above without utilities.	Stand alone of each \$95
AIR RAID \$14.00 Real time shooting gallery.	SYSTEM INTEGRATION TEST \$29.00 tests memory, disk drives, and printer.	INVENTORY II \$99.00 activity listing, complete listing, selected listing, minimum quantity search, 1000 items per disk
SARGON:CHESS \$19.00 Best chess for TRS-80	MICROSOFT FORTRAN \$325.00	ALL ABOVE PROGRAMS
LIBRARY 100 \$49.00 100 games, utilities, and business programs in one package.	CPM \$150.00	BY SBBS
Great value!	RENUMBER \$14.00 disk	ELECTRIC PENCIL \$99.00 by Michael Shryver
ADVENTURE \$14.00 disk	G2 LEVEL III \$49.00	disk \$150.00 BEST word processor for the TRS-80
	FORTH by MMS \$65.00	
	GSF by RACET \$24.00	

The above list is just a brief summary of some of our most popular software. We have a large selection of other software for many uses and for many computers. Documentation for any of our programs is available on request. If you have any questions, please call. We would like to hear from you.

TO ORDER, CALL OR WRITE:

MIDWEST COMPUTER PERIPHERALS



PO BOX 437
WILMETTE, IL 60091
(312) 251-5028

NEW YEARS SPECIAL
10% Discount on all Software orders over \$100

*TRS-80 is a Registered Trademark of Tandy Corp.

statement number 55. However, people never think in this way even if the alternative courses of action are too complicated to remember in detail. Instead of bearing in mind *where* the alternatives may be found, one always keeps in mind *what* they are, perhaps in some brief mnemonic form. Thus the ALGOL statement:

```
IF GCD(A,B)≠1 THEN
P:=SMALLEST.COMMON.PRIME.DIVISOR(A,B)
ELSE
P:=MIN(A,B)
```

is surely more informative than the FORTRAN version:

```
IF (GCD(A,B).NE.1) THEN GO TO 55
P=MIN(A,B)
GO TO 65
55 . . .code describing how to find smallest
common prime
65 continuation of program
```

I am not suggesting that ALGOL knows how to find the smallest common prime. Of course, the words SMALLEST.COMMON.PRIME.DIVISOR(A,B) must also be defined in the program, just as they would at line 55 in the FORTRAN program. But the FORTRAN programmer, in the interest of intelligibility, must add comments, both at line 55 and at the appeal to it, telling the reader what is going on. The necessity of adding comments (words which explain the program to the reader but which are ignored by the computer) is a sign that the conventions of human thought have been sacrificed to the conventions of the programming language. This is a common occurrence in FORTRAN and almost impossible to avoid with the use of GO TO statements (see reference 6 for an exposition of this point and its history).

The second mathematical objection to FORTRAN is that dummy variables are somewhat restricted. They occur automatically in subprograms (small portions of a program which are executed repeatedly but each time with different values assigned to their parameters), but otherwise are essentially absent. This means that some care must be taken in writing complicated programs so that variable names are not confused. Because of this it is difficult to transport pieces from one program to another. A skilled FORTRAN programmer told me that his biggest headache is having to constantly rewrite the same algorithm. That favorite phrase of mathematicians "we are done because we are reduced to a previously solved case" is very difficult to put in practice in FORTRAN and BASIC but quite easy in ALGOL and PL/I. FORTRAN subprograms are not recursive.

That is, unlike their ALGOL counterparts, they cannot appeal to themselves in their own definition. This subtle difference can have extreme consequences in nonnumeric calculations, but this is beyond our scope.

ALGOL-like Languages

ALGOL is the ALGOritmic Language developed around 1960 (a standard and quite commonly available version is called ALGOL 60). Originally intended as a language for specifying algorithms for publication, it is now widely implemented and used in scientific environments, especially in Europe. A portion of the language PL/I is similar to ALGOL, and the remarks below generally apply to it. Since PL/I is supported by IBM for its machines far more than is ALGOL, users of IBM equipment may prefer to keep it in mind. Pascal is a kind of second generation ALGOL 60 to which most of the comments in this section apply.

Simple ALGOL appears much like BASIC:

```
BEGIN
INTEGER X,Y,Z;
X:=3; Y:=2; Z:=X+Y; PRINT(Z);
END.
```

This program does what the BASIC example does. The differences are in punctuation. ALGOL commands are separated by semicolons, whereas BASIC requires each to have a line number. ALGOL uses the symbol := to assign a value to a variable while BASIC requires the theme LET x=3 (though some versions make LET optional).

Most notable is that the *type* of each variable must be specified; in this example each variable is declared to be an integer. In BASIC no distinction is made between integers and real numbers, while in FORTRAN, if a variable name begins with (usually) I,J,K,L,M or N it is understood to be an integer. Otherwise it is a real variable with some understood accuracy convention (complex variables are also allowed in FORTRAN and most ALGOL implementations). These conventions can be overridden by the programmer, and readability need not be sacrificed in FORTRAN.

One main feature of ALGOL which makes it attractive for mathematical and logical problems is that it is a *block structured* language. By definition a block is a piece of code that begins with BEGIN and ends with END. There may be blocks within blocks nested as deeply as physical limits imposed by the actual computer will allow. Within each block one may declare the names of variables which are to exist only within that block. These variables do not have any existence outside that block and indeed,

GENERAL LEDGER PAYROLL ACCOUNTS RECEIVABLE & PAYABLE

Flexible and sophisticated business software that is among the highest quality on the market. Originally developed by OSBORNE & ASSOCIATES and rapidly becoming a standard. Our service is support. We will send you these programs with the proper I/O and CRT specific subroutines for your hardware configuration. Get back to business and leave the programming to us. Include hardware description with order.

- Accounts Receivable and Payable 145.00
- Payroll (California) 145.00
- Non California state tax calculations
(please inquire) 15-250.00
- General Ledger 145.00
- Multiple profit center option for G/L 25.00
- Manuals (each) 15.00

All programs in CBASIC under CP/M (includes source)

UTILITIES

- DOS MOVER for NORTH STAR. Moves DOS and BASIC anywhere you want it. (i.e., from 2A00 to 0000) 35.00
- ALS-8 MOVER on North Star Disk 35.00

Synergetic Computer Products

3885 Magnolia Drive • Palo Alto, CA 94306
(415) 856-6049

Visa • Mastercharge • COD • Certified Check
CP/M is a trademark of Digital Research

THE ESSENCE of output quality

- Any IBM SELECTRIC® can be converted to produce high quality output at an affordable price!
- *Interfaces* directly to S100, Parallel, RS-232 or IEEE-488.
- *Compatible* with TRS-80, Sorcerer, Pet, Apple, Horizon, etc.
- *Why* be printer bound? Prices from \$496 to \$575.

Call today.



Backspace and Tab Available NOW!

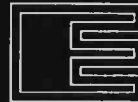

Escon Products, Inc.
171 Mayhew Way, Suite 204
Pleasant Hill, Ca., 94523
(415) 935-4590

VULCAN = DBMS

THE PROFESSIONAL DATABASE MANAGEMENT SYSTEM

For 8080/Z80 systems under CP/M or PTDOS

- * **VULCAN** is a complete database management system that has 38 powerful, easy to learn, English-like commands to manipulate files, records, fields, and scratch-pad variables.
- * **VULCAN** has a command repertoire which includes such commands as: SORT, REPORT, APPEND, INSERT, EDIT, COPY, REPLACE, LOCATE, DISPLAY, DO, LIST, and LOOP.
- * **VULCAN** structured data records can be selectively chosen for processing using complex Boolean, string, or mathematical expressions.
- * **VULCAN** can be used in interactive or program mode. The program mode uses modern structured command programs to combine powerful DBMS operations.
- * **VULCAN** is written in assembly language for efficient information processing and requires 36K bytes CP/M system and one or more disk drives.
- * **VULCAN** can accept or store data in standard ASCII files to be compatible with BASIC, FORTRAN, etc.

*VULCAN (CP/M or PTDOS) \$490
Manual only \$ 25

SCDP

Software Consultation Design and Production

6542 Greeley St.
Tujunga, CA 91042 (213) 352-7701

California residents add 6% sales tax.

Main/Frames from \$200

Main/Frames from \$200

- 14 Basic Models Available
- Assembled & Tested
- Power Supply:
8v@15A, ± 16v@3A
- 15 Slot Motherboard (connectors optional)
- Card cage & guides
- Fan, line cord, fuse, power & reset switches, EMI filter
- 8v@30A, ± 16v@10A option on some models

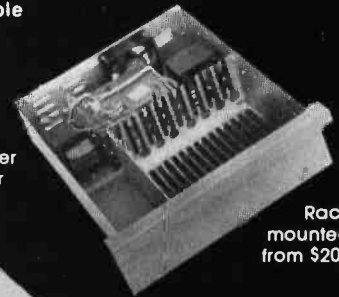

Rack mounted from \$200

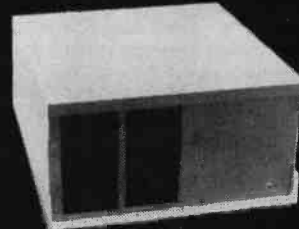

8" Floppy Main/Frame (Includes power for drives and mainframe) from \$365

Write or call for our brochure which includes our application note:
'Building Cheap Computers'

INTEGRAND

8474 Ave. 296 • Visalia, CA 93277 • (209) 733-9288
We accept BankAmericard/Visa and MasterCharge

Books from BITS inc

PASCAL

MICROCOMPUTER PROBLEM SOLVING USING PASCAL
by Kenneth L. Bowles

This book is designed both for introductory courses in computer problem solving at the freshman and sophomore college level, and for individual self-study. Graphics is stressed in this version of the book. A complete single-user software system based on PASCAL has been developed at the University of California at San Diego, where the author is a professor in the Department of Applied Physics and Information Science. This system embodies extensions to the standard PASCAL which include the necessary functions and procedures for handling graphics and strings. 563pp.

#077 \$9.80

PASCAL USER MANUAL AND REPORT
(Second Edition) by K. Jensen and N. Wirth

The manual is directed towards those who have some familiarity with computer programming and who wish to get acquainted with the PASCAL language. It is mainly tutorial and includes many helpful examples to demonstrate the various features of the language. The Report is a concise reference for both programmers and implementors. It defines Standard PASCAL, which constitutes a common base between various implementations of the language. 167pp.

#088 \$7.90

NEW A PRACTICAL INTRODUCTION TO PASCAL
by I.R. Wilson and A.M. Addyman

PASCAL will soon supercede BASIC, and for good reason. It is a simple and efficient language, encouraging structured programming. Wilson and Addyman have written an introduction to PASCAL suitable for first time or experienced programmers. Describing PASCAL using syntax diagrams, the book encourages the step-wise refinement technique of structured programming. Over 60 programs are included as examples, and seven of its 14 chapters are devoted to data structures. 148pp.

#218 \$7.90

PROGRAMMING IN PASCAL
by Peter Gorgono

This book is an excellent introduction to one of the fastest growing programming languages today. The text is arranged as a tutorial containing both examples and exercises to increase reader proficiency in PASCAL. Besides sections on procedures and files, there is a chapter on dynamic data structures such as trees and linked lists. These concepts are put to use in an example bus service simulation. 359pp.

#099 \$11.50

NEW

BEGINNER'S MANUAL FOR THE UCSD PASCAL SYSTEM
by Kenneth L. Bowles

Here from the originator of UCSD PASCAL is a system orientation guide and reference manual. It explains the use of the screen editor, file manager, and compiler with quizzes for PASCAL self study and guides to use of disk files and libraries of specialized routines. Appendices with specific instructions for the Apple II, TRS-80, and Terak 8510A implementations are included. (If you're just learning PASCAL, the book *Microcomputer Problem Solving Using PASCAL* by Bowles is recommended as a companion text.) This book will have you running your PASCAL programs quickly, even if you have no computer experience. 229pp.

#249 \$11.95

NEW

THE BYTE BOOK OF PASCAL
Blaise W. Liffick, editor

BYTE has compiled their wealth of articles on PASCAL in this book to provide a general introduction to the language. Two versions of a PASCAL compiler, a P-code interpreter, a chess playing program, and an APL interpreter written in PASCAL are also included. Step up to a powerful language. 242pp. Hardcover

#251 \$25.00

(Postage \$.75/item or \$1.00 outside U.S. to a maximum postal charge of \$3.00)

DIAL YOUR BANK CARD ORDERS
TOLL FREE 800-258-5477

BITS inc Books to erase the impossible 1B020

25 Route 101 West, PO Box 428, Peterborough, NH 03458

outside the block there may be other variables with the same name and they will not be confused. Consider the following program:

```
BEGIN
  INTEGER X,Y;
  X:=3;Y:=2;
  BEGIN
    INTEGER X,Z;
    X:=6;Z:=X+Y; PRINT(X);PRINT(Z);
  END;
  PRINT(X);
END.
```

The variable X in the inner block bears no relation to the X in the outer block and references to it in the inner block behave as though there were no X in the outer block. The Y in the inner block, however, has not been declared there, so *it* refers to the next most global occurrence of Y: namely that in the outer block. This program will output:

6 8 3

The first two numbers are produced by the print statements in the inner block, the last by that in the outer block.

This example is a trivial illustration, but the reader will appreciate that no care whatsoever need be taken with the naming of those variables whose existence is not needed outside the algorithm of which they are part. For this reason, algorithms are easily transported from one program to another. The possible sources of confusion arising from these so called *local variables* are approximately the same as those arising in ordinary mathematical discourse: "the variable x here is not the same as the variable x in the previous section."

Another feature of ALGOL and PL/I that adds to the ease of structuring programs is the existence of condition testing phrases other than IF. For example, one may use the sequence WHILE... condition to be tested... DO... something. Not only is this close to our way of thinking, but it has surprising implications for the programming solutions which are naturally suggested by the language. Such structures have been urged for FORTRAN and may well be included in future versions. They are beginning to appear in nonstandard versions of FORTRAN already.

What are the disadvantages of ALGOL? Foremost is that even the most commonly used mathematical procedures are often not preprogrammed into the system as they are in BASIC and FORTRAN. Thus, although arrays are a standard data type in ALGOL, there are no matrix manipulation functions such as BASIC's LET MAT A = B + C. The programmer is responsible for adding the routines to perform these operations. Because of the transportability we have

discussed, this is not particularly difficult. In many systems, these routines could be stored on a high speed storage device such as a magnetic disk, easing the task even further. Thus, each programmer or group may have to build a library of standard routines, whereas in BASIC and FORTRAN large libraries are usually already provided.

These functions often include many transcendental functions and sophisticated procedures, but ALGOL libraries may contain little more than elementary functions. This is largely a historical development and may be expected to change as ALGOL becomes more widely used. This drawback is of little consequence if one's application is nonnumeric. At this writing I am programming procedures in ALGOL to calculate with polynomials over finite fields. Since it is too much to expect any library to have a routine to calculate the zeta function of a curve, I am not terribly restricted by the skimpy offerings of ALGOL libraries.

Even more consequential, because of its limited libraries, is the fact that ALGOL tends to require more programming effort for IO than FORTRAN or BASIC. Simply getting numbers in and out is generally easy, but adjusting format or IO of text may be a complicated task. IO is at least standardized, if cumbersome, in FORTRAN and BASIC. However, IO is not part of the official definition of ALGOL, which burdens it with machine dependent features.

Pascal

Pascal is a modern language derived from ALGOL 60 that addresses itself to a very important issue we have not dealt with so far in this elementary exposition: data structures.

Pascal allows the user to define and manipulate new types of data beyond the fundamental types (integers, reals, arrays, strings) which appear in the older languages. Further, it does so in a completely recursive fashion, which adds considerable power to this feature. These matters are beyond the scope of this article, but, as designed, Pascal is easy to learn, powerful and very much like ALGOL in nature.

APL

APL stands for A Programming Language. It is a high powered language designed to make the handling of matrices and vectors particularly easy, and as such it is very successful. Its adherents tend to be emphatic about its value as a general purpose language. My own view is that its array orientation is a disadvantage for structuring complicated

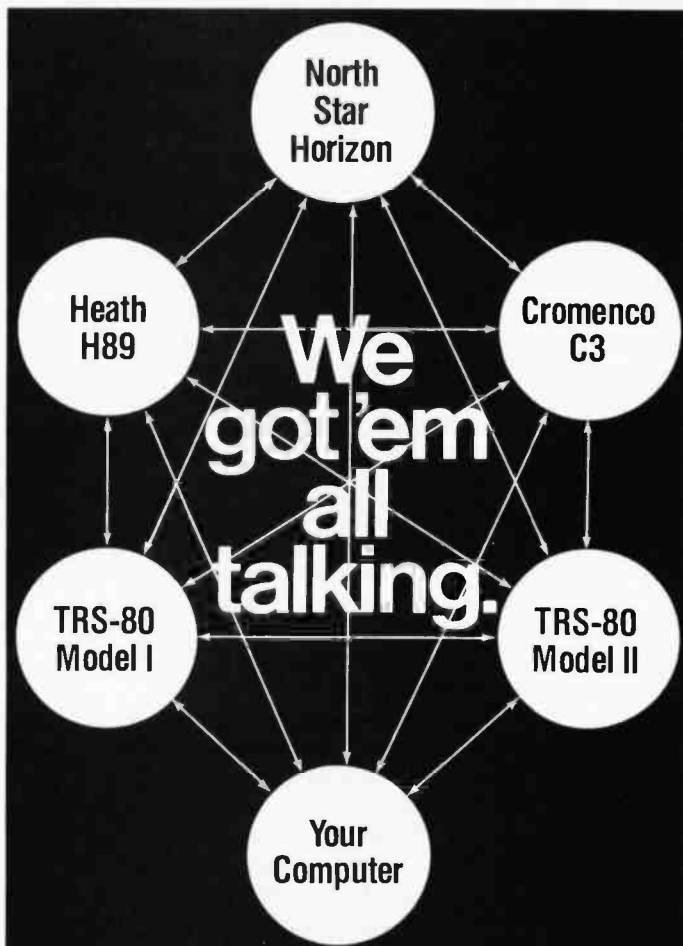

“BSTAM”

Byrom Software Telecommunications Access Method

The missing link between any CP/M or TRSDOS computers!

A commercially oriented telecommunications facility for transmitting and receiving CP/M* and TRSDOS** files, BSTAM has BIG computer features for your micro:

- links computers directly at 9600 baud with UARTS, or via phone lines using modems
- full speed data transfer without hex conversion overhead
- full wildcard expansions to send * .COM, etc.
- reliable error detection and automatic retry with console messages for status and errors

It's Terrific!
We use it ourselves!

\$150 PER COMPUTER **\$5** MANUAL ALONE

*CP/M is a trademark of Digital Research

**TRSDOS is a trademark of Tandy Corporation

Lifeboat Associates

2248 Broadway New York, N.Y. 10024 (212) 580-0082 Telex: 220501

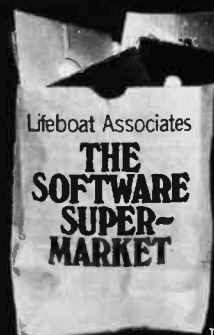

programs unrelated to array handling. The language does not encourage the writing of readable programs. It is easy and tempting to write very compact, cryptic programs (however, this is a human decision and not really forced by the language). The present view of programming languages is that the elementary data and control structures of the language shape the programmer's way of thinking about solutions. Because of its underlying array orientation, I prefer to put APL with special purpose languages and omit it from this discussion, even though it is so widely used that it can not be regarded as an exotic language.

Exotic Languages

A number of special purpose languages and systems have arisen as the result of research in computer languages. An annual survey of languages is published by the Association for Computing Machinery.

Some of these special purpose languages, like the algebraic manipulation systems, may be particularly complex or difficult to use, although appealing to the mathematically

inclined. Others, while exciting in prospect, are only beginning to be implemented. Anyone wishing to explore these languages should first gain some traditional programming skill and establish a close relationship with the professionals at the computer center where you are using them, because the exotic products do not always behave as promised and sometimes need a little coaxing from the systems programmers.

Acknowledgements

None of the ideas expressed here is original. They have been percolating in the computer field for a few years, but apparently are still regarded by some as controversial. The names often associated with them are Dijkstra, Wirth, Knuth and Hoare, whose works set them out in detail. I thank Richard Palais for nudging me toward ALGOL and thence to a consideration of these ideas. I wrote this article using a computerized text formatter adapted from the RATFORMATter of Kernighan and Plaugher (see bibliography) who were the first to insist that there is such a thing as literacy in programming.

Low Power 32K RAM for Heath® H8 computers only \$479

AVAILABLE FOR IMMEDIATE DELIVERY
DG-32D 32K RAM FEATURES:

- ✓ Plugs into Heath® H8 Computer
- ✓ Ready to use. Fully assembled, tested & burned in.
- ✓ Operates with existing Heath memory
- ✓ Protected Memory Output Buffers in the event of Address error.
- ✓ Utilizes popular 4116 RAM devices
- ✓ Memory Address DIP switch changeable
- ✓ Arranged as 4 Independent 8K Blocks
- ✓ Low Power Consumption: Less than 6 watts, typical
- ✓ Transparent Refresh
- ✓ One year guarantee
- ✓ Compatible with all current H8 peripherals.

**16K MEMORY CHIP SET FOR
H88-H89 \$89.00**

Heath® and H8 are registered trademarks of the Heath Corporation, Benton Harbor, Michigan.

D·G ELECTRONIC DEVELOPMENTS CO.

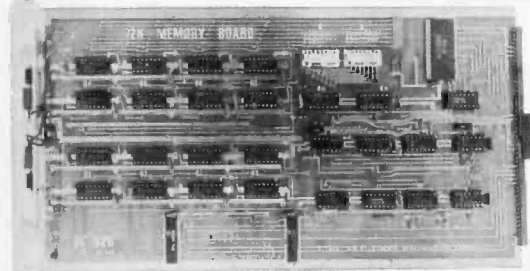

D·G Electronic Developments Co. brings you a totally compatible, fully assembled and tested 32K RAM for Heath® H8 computers. The DG-32D has less than 6 watts power consumption. This allows you to add a full 32K bytes of Random Access Memory without taxing or replacing your computer's power supply. Engineered to plug-in and run without any user modifications, the DG-32D can be used with or without existing H8 RAM without modification. Protection of the memory output buffers is provided in the event of assigning two blocks to the same address space. The DG-32D is the ideal answer to expansion of the Heath H8 computer . . . Low power consumption, low price, high capacity, total engineering and exacting production methods.

Ordering Information: DG-32D RAM available only from DG Electronic Developments Co., P.O. Box 1124, 1827 South Armstrong, Denison, Texas 75020. Check, money-order, VISA or Master Charge. Phone orders accepted on-charge orders. NO COD's. Foreign orders add 30%. Texas residents add 5%. For VISA or Master Charge orders call 214-465-7805. \$479.00 freight prepaid. (Allow 3 weeks for personal checks to clear through banks.)

ATTENTION HEATH® OWNERS

Getting Started

The bibliography which follows contains my own favorite introductory texts. Consult local opinion also, because personal explanation is one of the most useful tools in learning programming. If a particular book is highly regarded by people around you, your questions may be more easily answered by others familiar with it. Two other warnings are necessary: you cannot understand programming without writing and running programs; and be wary of the machine manufacturer's language manuals — they are often written for someone who already knows the language or some other high level language. But check them for minor differences with your text. With ALGOL you will probably have to learn the IO from the manual.■

BIBLIOGRAPHY

1. Kernighan, B and Plaugher, P, *Software Tools*, Addison-Wesley, Reading MA, 1976.
2. Dahl, O J, Dijkstra, E W, and Hoare, C A, *Structured Programming*, Academic Press, New York, 1972.
3. Floyd, R W, *Introduction to Programming and the ALGOL W Language*, Department of Computer Science, Stanford University. ALGOL W is an extension of ALGOL 60 written at Stanford for the IBM 360, and if you have it, you'll find this book particularly useful. If you are adventuresome, consider using it anyway, using the machine manufacturer's manual to sort out the differences. Like McCracken, it's just a beginning.
4. Jensen, K and Wirth, N, *Pascal User Manual and Report, second edition*, Springer-Verlag, New York, 1974. Not a programming primer, but definitely a Pascal primer. A small amount of any programming experience will suffice to read it (an all too brief introduction attempts to substitute for this experience). It also contains the "Report," the official definition of Pascal, which may prove interesting to those who have never seen such a document.
5. Kemeny, J G, and Kurtz, T E, *BASIC Programming*, Wiley, Somerset NJ, 1971. By the fathers of BASIC.
6. Knuth, D E, and Wirth, N, *ACM Computing Surveys*, volume 6, number 4, 1974. Special issue on programming with articles by these two authors and others.
7. Luehmann, A W, and Nevison, J M, "Computer Use Under a Free Access Policy,"

Science, number 184, May 31 1974, pages 957 thru 961.

8. McCracken, D D, *A Guide to ALGOL Programming*, Wiley, Somerset NJ. The problem with this and other ALGOL primers familiar to me is that they don't really discuss the features of ALGOL that make it powerful. But it is fine for getting started.
9. McCracken, D D, *A Guide to FORTRAN IV Programming*, Wiley, 1972. A widely used text. Included are excellent discussions on points of style and efficiency, and an appendix on the WATFOR and WATFIV compiler. They are often used at universities running IBM systems. They will ease the learning of FORTRAN, as will this book.
10. Weinberg, G M, *PL/I Programming: A Manual of Style*, McGraw Hill, New York, 1970. Yet another beginning.
11. Wirth, N, *Systematic Programming: An Introduction*, Prentice-Hall, Englewood Cliffs NJ, 1973.

Also see *Communications of the ACM*, volume 19, number 12, 1976.

ASCII encoded keyboards as low as \$65.*



The RCA VP-601 keyboard has a 58 key typewriter format for alphanumeric entry. The VP-611 (\$15 additional*) offers the same typewriter format plus an additional 16 key calculator type keypad.

Both keyboards feature modern flexible membrane key switches with contact life rated at greater than 5 million operations, plus two key rollover circuitry.

A finger positioning overlay combined with light positive activation key pressure gives good operator "feel", and an on-board tone generator gives aural key press feedback.

The unitized keyboard surface is spillproof and dustproof. This plus the high noise immunity of CMOS circuitry makes the VP-601 and VP-611 particularly suited for use in hostile environments.

The keyboards operate from a single 5-volt, DC power supply, and the buffered output is TTL compatible. For more information contact RCA Customer Service, New Holland Avenue, Lancaster, PA 17604.

Or call our toll-free number: 800-233-0094.

*Optional User Price. Dealer and OEM Prices Available.

Some Example Plots

David Dameron 402 E O'Keefe St, Apt 27, E Palo Alto CA 94303

I have been reading BYTE since it was first published in 1975 and have enjoyed its articles, especially those on plotting graphics. My computer is a Cromemco Z80 with 48 K bytes of programmable memory and a 5-inch disk drive. This configuration gives about 20 K bytes of available user memory with 16 K BASIC. My plotter is a Sylvanhills DFT-2, run from a parallel port. I modified the plotter to use stepping-motor X,Y movements, under computer control after reading "Taking the First Step" (February 1978 BYTE, page 35). It now has 300 points per inch of resolution using 15-degree stepping motors.

After the basic vector control software was completed, one of the first routines I entered was a character generator: "A Plot is Incomplete Without Characters" (July 1976 BYTE, page 64). Inspired by "Venus de Plotto"

(February 1977 BYTE, cover), I entered various three-dimensional routines, for example: "Hidden Line Subroutines for Three-Dimensional Plotting" (May 1978 BYTE, page 49). You can see that BYTE has greatly contributed to this plotting system.

The three-dimensional plot "Waves" (figure 1) is an example of the hidden line routines. There are 141 points in the X direction and 156 in the Y direction. It is the sum of four radially-damped sinusoidal waves rotated in three dimensions. The program took about 10 hours to run with a 4 MHz clock, divided evenly between point calculation and the actual plotting, which was done concurrently. Listing 1 is a *chord* program which produces the output in figure 2 (page 144).

This sample output took about 90 minutes to plot; a

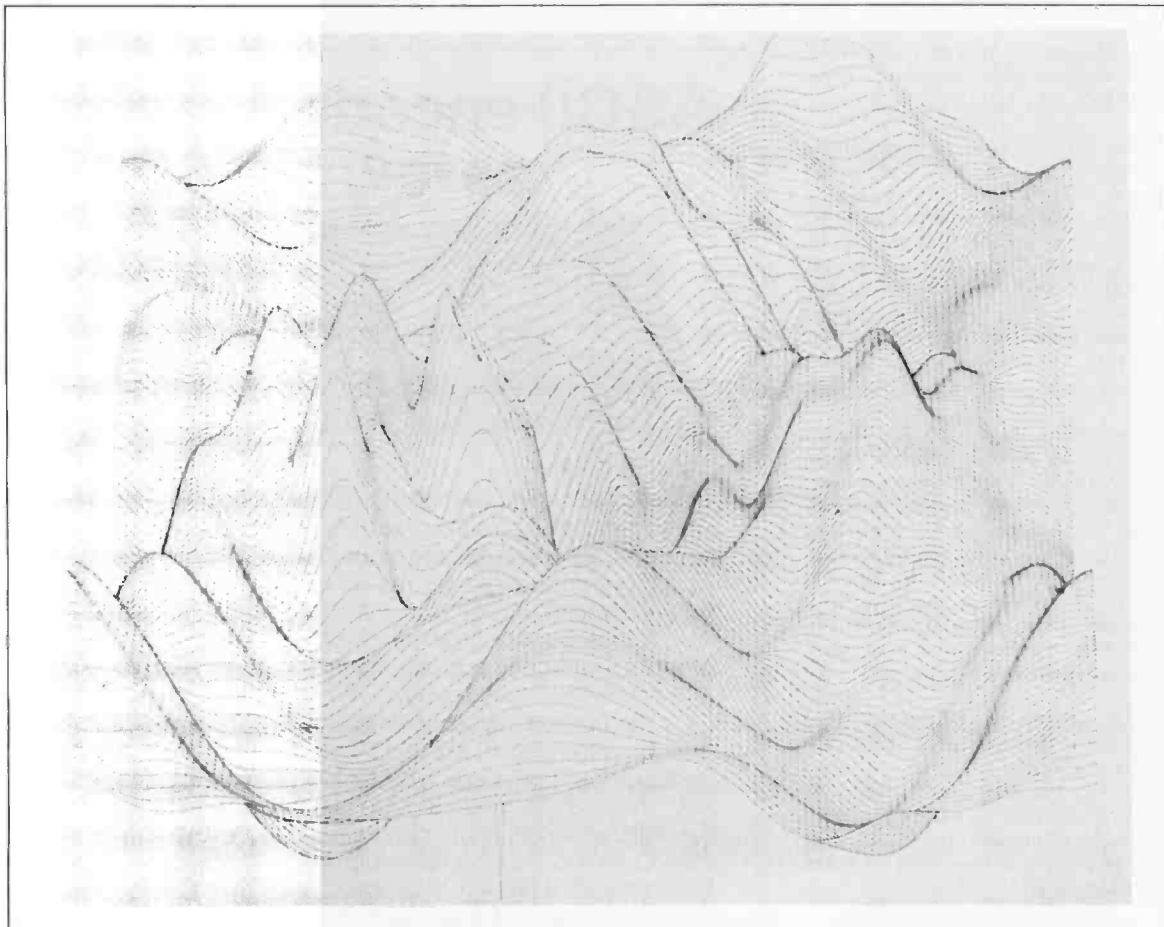
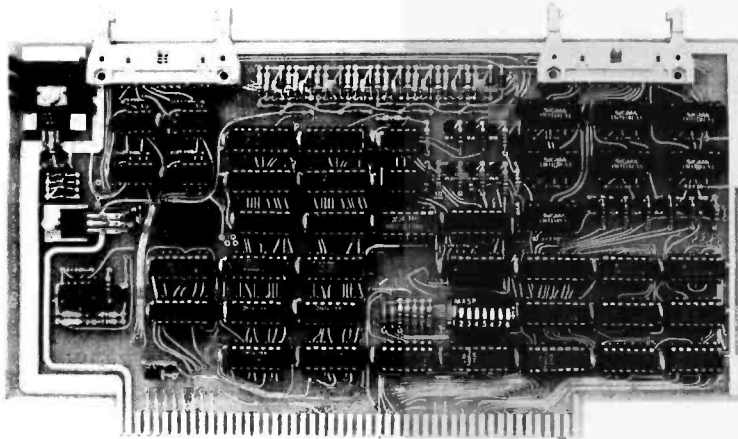

Figure 1: Three-dimensional wave program output which took 10 hours to produce.

IDS Announces S-100 Energy Management Module

The 100-EMM Energy Management Module provides temperature measurement at four separate locations indoors or out; monitors eight (8) doors, windows, or fire sensors; controls six external devices via relay or optoislator; and provides an intrusion alarm with battery backup (alarm operates even during primary power outages). Put the 100-EMM to use in your home or business and claim a 30% tax credit for the cost of your S-100 computer system including the 100-EMM. (Purchasing the 100-EMM can actually save you several times its cost in tax credits. Full instructions for filing are included in the 100-EMM manual.)



**BUY THIS S-100 BOARD
AND GET UP TO A 30%
TAX CREDIT BASED ON
THE COST OF YOUR
COMPUTER SYSTEM!**

**100-EMM Energy Management Module
Assembled and Tested \$395.00
Kit \$345.00**

Options for 100-EMM:

CP-52 Cable Panel - Terminates two 26-conductor flat cables in 26 screwlugs. Use it for convenient interconnection of the 100-EMM to the "outside world". **\$45.00**

CABL-26-STD 26-Conductor Flat Ribbon Cable - Four feet in length with connectors for 100-EMM and CP-52 above. **\$35.00** Other lengths available on special order. Add **\$1.00** per foot.

OTHER PRODUCTS FROM IDS. The most complete source of S-100 compatible modules for process control, data acquisition, energy management, and data communications.

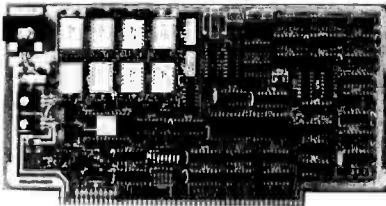

88-MODEM S-100 ORIGINATE/ANSWER MODEM WITH AUTO-DIALER. Software selectable baudrate provides any baudrate from 66-600 baud. Provides 1.5 stop bits when operated in 5-bit code mode. Auto-answer programs available for CROMEMCO CDOS, CP/M, North Star Horizon and MDS, and Alpha Micro.

Assembled and Tested \$395.00 Kit \$245.00

88-UFC UNIVERSAL FREQUENCY COUNTER

Four software selected inputs. Measure frequency from 0-650 MHz and period from .1uS to 1 Second. Extensive software included.

Assembled and Tested \$299.00 Kit \$199.00 Temperature-Compensated Crystal Oscillator option **\$145.00**

88-SAI SYNCHRONOUS/ASYNCHRONOUS INTERFACE

The most versatile serial interface on the market. Computer access/control of all data and handshake lines and provision for masked interrupts, inversion of any input or output signal, and onboard baudrate generation for 110, 134.5, 150, 300, 600, 1200, 2400, 4800, 9600, and many other baud rates. Many more features.

Assembled and Tested \$299.00 Kit \$199.00

88-SPM TIME OF DAY CLOCK with battery backup. Set the clock with three out instructions: no delays! Programs included in North Star BASIC, CBASIC, and 8080 assembly language.

Assembled and Tested with crystal option \$199.00 Kit less crystal option \$99.00 Crystal Option Kit \$25.00

88-RCB RELAY CONTROL BOARD

16 Relays on one board. Control appliances, production equipment, or even musical instruments (See BYTE Magazine Sept 1977 page 12)

Assembled and Tested \$299.00 Kit \$199.00

**INTERNATIONAL
DATA SYSTEMS, INC.**

Mailing Address:

Post Office Box 17269
Dulles International Airport
Washington, DC 20041
Telephone (703)661-8442

Shipping Address:

400 West Service Road, Suite 130
Dulles International Airport
Washington, DC 20041 USA
TELEX 901112 IDS CTLX

```

10 REM DRAWS ALL CHORDS WITHIN AN N-GON 7/16/78 240 J2=1 : F=1
20 REM USES DIMENSIONS IN PLOTTER RASTERS 250 N1=N
30 REM WRITTEN BY DAVID H. DAMERON 260 IF I=N/2 THEN N1=I
40 REM INITIALIZE PLOTTER HERE. 270 REM J1=FROM, J2=TO POINT
50 INPUT "NUMBER OF SIDES? ",N 280 REM MAKE J1=PREVIOUS J2 UNLESS TAKEN (H(J1)=1)
60 DIM B(N),C(N) 290 REM IF TAKEN INCREMENT J1 TILL I FOUND, LIFT PEN
70 INTEGER I,J,H(N) 300 FOR J=1 TO N1
80 INPUT "RADIUS OF PLOT? ",R 310 J1=J2
90 P1=6.2831853/N 320 IF H(J1)=0 THEN 360
100 FOR I=1 TO N 330 J1=J1+1 : IF J1>N THEN J1=J1-N
110 B(I)=R+10*R*COS((I-1)*P1) 340 F=1
120 C(I)=R+10*R*SIN((I-1)*P1) 350 GOTO 320
130 NEXT I 360 J2=J1+I
140 FOR I=1 TO INT(N/2) 370 IF J2>N THEN J2=J2-N
150 REM DRAW LINES TO I'TH NEIGHBOR 380 H(J1)=1
160 FOR J=1 TO N 390 REM F=1 IS A FLAG TO LIFT THE PEN
170 H(J)=0 400 REM IF F=1 THEN MOVE TO B(J1),C(J1) WITH PEN LIFTED
180 NEXT J 410 REM CALL VECTOR ROUTINE HERE.
190 IF I<>N/2 THEN 240 420 F=0
200 REM DRAW ONLY 1/2 LINES IF DIAMETERS 430 REM DRAW TO B(J2),C(J2) HERE. INSERT VECTOR ROUTINE HERE.
210 FOR J=N/2+1 TO N 440 NEXT J
220 H(J)=1 450 NEXT I
230 NEXT J 460 STOP

```

Listing 1: Program Chord produces a series of chords for a given circle. The sample output is shown in figure 2 (page 144). This listing was made by the author's system using a plotter.

little backlash can be seen at the vertices of the 29-sided polygon. The listing was plotted on this system with characters four times the minimum size. This routine was written to remove some of the unnecessary plotter X,Y motion from that of just cycling through all the vertices for both the starting and ending points. Plotter routines should be inserted at lines 390 and 430 to suit a particular system. At 390, move to B(J1), C(J1) with the pen lifted. At 430, draw a line to B(J2), C(J2) with the pen down.

I use the system in my work plotting graphs and other

forms of data, and I hope to eventually sell some of the computer graphics I have produced. It is stimulating and fun to create various plot outputs on the spot, now that the hardware has been debugged and is running. The plotter output is not limited to ink drawings on paper. A needle or other engraving point may be mounted in the pen holder (a small clamp) for drawing etching lines in a zinc plate through a thin layer of an acid resisting substance. The plots can then be etched by dumping the plate in an acid bath for an appropriate time period.

WE ARE KNOWN FOR OUR PROMPT, COURTEOUS SERVICE

★ HAZELTINE CRT'S ★★ NEW, LOW PRICES ★

1500 (assembled) \$885.
1510 \$980.
1520 \$1,210.
50 Hz option available for all models \$100.
German, French, Danish character sets \$30.

IBM 3101 CRT \$1,295

Human engineered terminal. Selectric-like Keyboard.
Dense dot matrix.

IMS 5000 and IMS 8000 Complete Z80 systems starting at \$2,050. 4 I/O ports, 1K EPROM bootstrap loader, double density drives, 5¼ or 8" disks. S-100 bus. 12 slot mainframe. A beautiful, high quality system. Runs CP/M.

TELETYPE MODEL 43

4320 AAA (TTL interface) \$985.
4320 AAK (RS232 interface) \$1,085.
with transformer to operate on 50 Hz., 220 v.
installed inside cabinet \$75.

PAPER TIGER \$950.

Graphics option. add \$199.

DECwriter 35/36 upgrade

INCREASE BAUD RATE TO 1200 \$750.
Specs available.

INTERTEC SUPER BRAIN \$2,885.

Dual Z80, dual double density floppies, 32K RAM (expandable) 4Mhz., CP/M, Contained in Intertube II.

INTERTUBE II \$875.

SOROC IQ 120 \$865.

IMS 16K Fully static memory, 250 ns \$285.

MARINCHIP SYSTEMS 9900 16 BIT CPU

Price includes DOS, BASIC, word processor, text editor, linking loader
Assembled \$700.
Kit \$550.
Complete systems configured from \$5,700.

DRIVES

SIEMENS 8" double density, Shugart compatible \$450.
PER SCI 277 \$1,210.
299B \$1,700.
INNOTRONICS 2 drives with cabinet and power ... \$1,565.
Shugart compatible. Extremely reliable.

CONTROLLERS:

Tarbell single density \$255.
double density \$385.
Konan S-100, hard disk controller \$1,550.

TEI Mainframes completely tested and assembled

12 slot \$433.
22 slot \$609.

MODEM: "THE CAT" from Novation \$190.

Originate/answer, 300 baud. Incredibly compact!

CENTRONICS, TEXAS INSTRUMENTS, PRINTERS, DIABLO, NEC SPINWATER, DEC LA 34, PET, TRS-80 ALSO AVAILABLE.

TO ORDER: We ship within 24 hours of receipt of certified check, bank check or money order. Credit cards add 4%. Personal checks: allow ten days.

COD'S ACCEPTED AT NO EXTRA CHARGE.
Shipping charge: \$13. for terminal, \$4. for memory, modems.
N.Y. residents add sales tax. Prices and availability subject to change without notice. **DEALER INQUIRIES INVITED.**

WE EXPORT TO ALL COUNTRIES OVERSEAS CALLERS USE (212) 448-6298 OR TWX: 710 588 2844 CABLE: OWENS ASSOC.

We have no reader inquiry number. Please call or write. Product sheets available.

JOHN D. OWENS ASSOCIATES, INC.

12 SCHUBERT STREET STATEN ISLAND, NEW YORK 10305 (212) 448-6283 (212) 448-6298

A BUSINESS PROPOSITION

from

INTERTEC DATA SYSTEMS

Dear Computer Enthusiast:

As a result of the phenomenal growth our company has experienced during the past year, there are now many excellent opportunities in our national dealership program. And as a result of this expansion in our dealership network, there are new employment opportunities in the marketing and technical divisions of our company. We'd like to talk about these opportunities for just a minute.

Our two major products, the InterTube II Video Terminal and the SuperBrain Video Computer are, to say the least, an overwhelming success. This widespread acceptance and demand for our products naturally requires the establishment and maintenance of a comprehensive dealer/service network. Many retailers and other microcomputer resellers have already joined our team. They are now realizing the true advantages our unsurpassed price/performance products can give them. How about you? Isn't it time you breathed a little new life into your operation? Dealership and OEM contracts are now being established in many areas. Call us today and discuss your requirements. You'll find us to be quite responsive.

Of course, our ability to successfully penetrate and maintain our position in this ever-increasingly competitive marketplace is due to the support of our many marketing, technical and service personnel. As our marketshare increases, so does our requirement for qualified personnel. We are presently recruiting marketing representatives to work closely with our dealers in the field. A sales/management background in this industry would qualify you for consideration for one of these positions. Also, we are in search of technical personnel to assist us here in South Carolina in supporting the varied applications our customers have for our products. At present, we are recruiting Basic, Fortran and Assembly language programmers as well as lab and production technicians.

Whatever your interests may be, dealership or employment, we urge you to carefully consider the advantages of association with our company. Pause for just a moment and give us a call at 803/798-9100. And if you don't believe us, ask the industry experts. They will tell you we're on the way to the top! So, why not join us now and enjoy the ride.

Best Regards,

The Marketing Department
INTERTEC DATA SYSTEMS CORPORATION

Dear Intertec,

Yes, I'm interested! Please call me with more information about the opportunities I've checked below.

- Dealership Programs
- OEM Arrangements
- Marketing positions presently available in my area.
- Technical Support positions available at the factory
- Other (specify) _____

If you're interested in dealership or OEM arrangements, please send us some detailed information on the nature of your present business including: 1) type of business; 2) length of time in business; 3) number of employees in sales, service and administrative positions; 4) products presently represented and/or manufactured, and 5) your application for our products.

If you're interested in employment, whether it be in a field marketing position or a technical factory position, please enclose a resume detailing your experience and salary requirements.

Don't delay! Give us your name and address below and return this advertisement to:

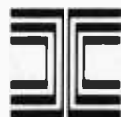

INTERTEC DATA SYSTEMS
The Marketing Department
2300 Broad River Road
Columbia, South Carolina 29210

If you're in a big hurry to reap the benefits of association with Intertec, skip the form and call us direct at 803-798-9100. Just ask for someone in the Marketing Department.

Your name _____

Company _____

Street _____

City, State & Zip _____

Telephone (_____) _____

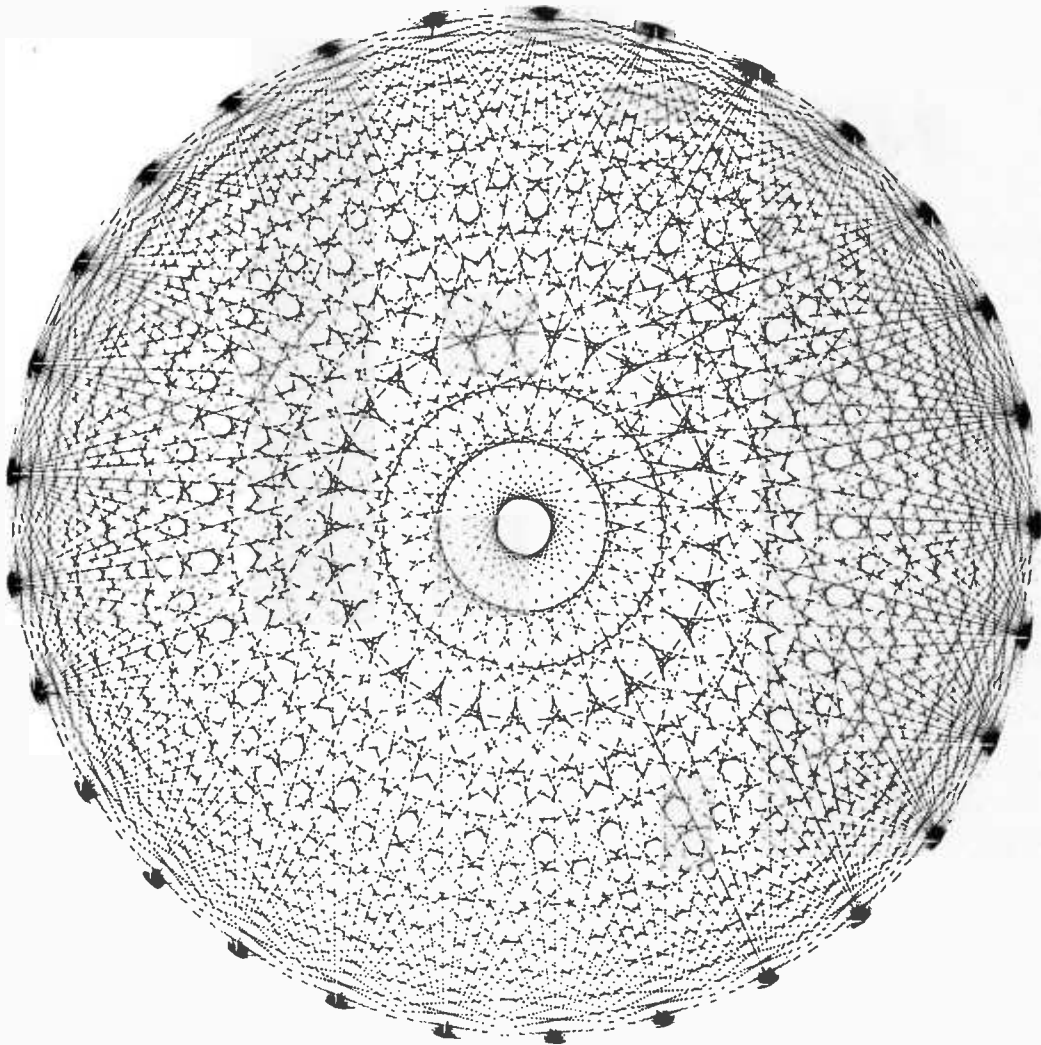

Figure 2: Sample output of the Chord program written in BASIC. This figure took 90 minutes to produce. ■

AGENS™

LOW COST ASSEMBLY GENERATION SYSTEM

You can assemble machine language programs for any of the popular 8 and 16 bit microcomputers.

You can use this meta-assembler to generate procedures and structures that best fit your applications.

This system is hosted on your Z-80 computer using CP/M and 24K or more bytes of memory.

The Works. Iterative passes for forward ref optimization, subscripts, remote names, macros, functions, externals, relocation classes and more.

BONUS: Source link loader file so you can customize your system.

\$170: AGENS on 8" diskette, Loader, sample generators and manual.

\$27: Manual only.

RBB Software Products™

P.O. BOX 2111
YORBA LINDA, CALIFORNIA 92686
(714) 637-5965



How COMPUMAX stacks up to the competition

COMPARISON SHOPPING? STOP HERE!

IMPORTANT QUESTIONS ABOUT BUSINESS SOFTWARE	COMPUMAX	OSBORNE/McGRAW HILL	PEACHTREE SOFTWARE	STRUCTURED SYSTEMS
What programs are available? <i>Are they INTERACTIVE?</i>	INTERACTIVE: GENERAL LEDGER ACC'TS PAYABLE ACC'TS REC'BLE INVENTORY PAYROLL/PERSONNEL	INTERACTIVE: GENERAL LEDGER ACC'TS PAYABLE ACC'TS REC'BLE NON-INTERACTIVE: PAYROLL	INTERACTIVE: GENERAL LEDGER ACC'TS PAYABLE ACC'TS REC'BLE PAYROLL NON-INTERACTIVE: INVENTORY	INTERACTIVE: GENERAL LEDGER ACC'TS PAYABLE ACC'TS REC'BLE NON-INTERACTIVE: STOCK CONTROL INVENTORY
What versions are available?	TRS-80, APPLE II COMMODORE PET MICROSOFT, CBASIC2 CP/M MICROPOLIS: EXIDY SORCERER, VECTOR MZ, DYNABYTE CROMEMCO III	WANG CBASIC2 CP/M	MICROSOFT CP/M	CBASIC2 CP/M
What is the price?	MICROLEDGER, A/P, A/R, INV, PERS: \$140.-each. MAXILEDGER, A/P, A/R: \$350.-each.	GL, A/P, A/R, PAYROLL: \$250.-each. Cost of configuring must be added!	GL, A/P, A/R, PAYROLL, INVENTORY \$1000 each.	GL \$995.- A/P \$750.- A/R \$750.- INV. \$500.-
Hardware options	40 column CRT 64 column CRT 80 col. terminal 80 col. printer included	64 col. CRT only 132 column printer only	80 col. CRT only 132 column printer only	cursor addressable terminal only 132 column printer only.
Is source code included?	YES, INCLUDING PROGRAM FLOWCHARTS.	YES	YES	NO
What type of after-purchase support is offered?	1 YR WARRANTY & CORRECTION OF DEFECTS INDIVIDUAL PROGRAM AUTHORS AVAILABLE FOR QUESTIONS.	NONE	1 YR WARRANTY & CORRECTION OF DEFECTS THROUGH DEALER.	TECHNICIANS AVAILABLE FOR QUESTIONS. UPDATES MADE AVAILABLE FOR A FEE.

COMPUMAX is

your one-stop shop for all your business bookkeeping software.

You've been led down the path before, but not this time. No more promises of turnkey computers without the key. It's YOUR turn to tell the computer how to run the business, not vice versa.

With COMPUMAX software you have a beginning. With 5 years of experience and over 3,000 systems installed, they are professionals, when it comes to solutions for the businessman.

COMPUMAX software is designed with CHANGE in mind, since everybody really wants his own touch added. The programs are SIMPLE, YET ELOQUENT.

COMPUMAX supplies ready, working programs. You can, then, easily customize them, as your additional requirements develop.

Or do as many have done—keep it simple by running the programs in their ready form. Join the microcomputer revolution the simple way.

For a demo, visit your local computer store. If your local retailer does not carry COMPUMAX software, have him give us a call at (415) 321-2881.

COMPUMAX

505 HAMILTON AVENUE PALO ALTO, CA 94301

Z_S - SYSTEMS



64K RAM BOARD

The Z_S SYSTEMS 64K RAM board is designed to operate in any Z80 based microcomputer having S-100 bus. It uses 16K dynamic RAM chips, & features:

- Board select
- Bank select
- Transparent on-board refresh
- 2 or 4MHz operation (w/ no wait state)
- Memory disable

Compatible with Cromemco and M/PM multiuser. Fully assembled, burned in, & tested. Available from stock to 60 days

As low as \$500.00 in quantities of 100

Price of one \$695.00

With 16K RAM \$359.00
Plus shipping charges



FLOPPY DISK CONTROLLER

Handles with no modification up to:

- * 4 standard 8" drives (Shugart or compatible) or
 - * 3 minidrives 5"
- Run with 2 or 4 MHz CPU

Use CP/M Disk Operating System Using the 1771 LSI controller
Price of one \$245.00
PC board only \$35.00

SEND FOR FREE INFORMATION

6 months warranty on our boards with normal use

Z_S-SYSTEMS

PO Box 1847, San Diego, CA 92112
(714) 447-3997

TERMINALS FROM TRANSNET

PURCHASE FULL OWNERSHIP AND LEASE PLANS

DESCRIPTION	PURCHASE PRICE	PER MONTH		
		12 MOS.	24 MOS.	36 MOS.
LA36 DECwriter II	\$1,695	\$162	\$ 90	\$ 61
LA34 DECwriter IV	1,295	124	69	47
LA120 DECwriter III KSR	2,295	220	122	83
VT100 CRT DECscope	1,895	182	101	68
VT132 CRT DECscope	2,295	220	122	83
DT80/1 DATAMEDIA CRT	1,895	182	101	68
T1745 Portable Terminal	1,595	153	85	57
T1765 Bubble Memory Terminal	2,795	268	149	101
T1810 RO Printer	1,895	182	101	68
T1820 KSR Printer	2,195	210	117	79
T1825 KSR Printer	1,695	162	90	61
ADM3A CRT Terminal	875	84	47	32
QUME Letter Quality KSR ...	3,195	306	170	115
QUME Letter Quality RO	2,795	268	149	101
HAZELTINE 1410 CRT	875	84	47	32
HAZELTINE 1500 CRT	1,195	115	64	43
HAZELTINE 1552 CRT	1,295	124	69	47
DataProducts 2230 Printer ..	7,900	757	421	284
DATAMATE Mini Floppy	1,750	168	93	63

FULL OWNERSHIP AFTER 12 OR 24 MONTHS
10% PURCHASE OPTION AFTER 36 MONTHS

ACCESSORIES AND PERIPHERAL EQUIPMENT

ACOUSTIC COUPLERS • MODEMS • THERMAL PAPER RIBBONS • INTERFACE MODULES • FLOPPY DISK UNITS
PROMPT DELIVERY • EFFICIENT SERVICE



TRANSNET CORPORATION

1945 ROUTE 22, UNION, N.J. 07083

201-688-7800

TWX 710-985-5485

Technical Forum

Introduction to Code Tightening

Geoffrey Gass, 5240 SW Dosch Rd, Portland OR 97201

"Why should a programmer be so obsessed with pinching and scraping to save a few bytes of code?" asks the representative from Behemoth Computers Inc. In his part of the universe, whether a program takes 110,000 bytes or 120,000 bytes is of no particular moment.

"What a damned tangle!" echoes one of his customers. "Haven't they ever heard of top down programming?" His part of the computer universe is concerned with programs written and understandable by interchangeable programmers, so any new job applicant capable of peeling his own bananas can pick up where the last programmer left off at the time of his unfortunate starvation.

In a smaller part of the universe occupied by minicomputer users and programmers, "tightening up the code" very early became a necessary practice to get useful programs into more confined memory spaces.

An even cozier corner, of course, is that of the personal computer programmer, who may have to spend many hours in tightening, trimming and squeezing to get a couple of quarts of program into his one-quart memory.

The tightest quarters of all (they might be described as "two-by-two by you") are those occupied by the microprocessor programmer fitting useful programs and modules into read-only memories (ROMs) for dedicated systems or monitors. Read-only memories come in relatively small, fixed sizes. The first estimate of what can be done in a given size read-only memory is always excessive of course, but in any typical project the absolute hardware limits are set very early, and it's up to the programmer to get as many as possible of the originally promised features into the fixed module size.

If by chance there are a couple of no-operation instructions (NOPs) in the final coding, then there is immediate pressure to do some tightening and squeezing to add another feature or two. If, as is more probably the case, the first coding runs long, then there is more intense pressure to squeeze, pare, tighten and rewrite every conceivable way to get the program genie into the bottle. (Even if the hardware decision is reversed and the read-only memory space doubled, program expectations will be increased until they again overflow the assigned space. This is a corollary of Parkinson's law; it is amply verified.)

The successful programmer in this environment is the one who gets the job done. It takes a substantial repertoire of techniques and a good eye for spotting loose coding and redundant logic to do a successful job of fitting the required functions into a fixed domain of memory. Though he may earn the scorn of the Behemoth man

("cheese-parer!") and the bitter enmity of the user who wants to reach in and borrow some of his subroutines, he wins in the marketplace when his product does more for less money, weight, power or space (or simply gets to the market sooner because of fewer hardware redesigns in the development cycle).

The object of this discussion is to present some of the tricks of the programmer's trade by which redundant logic and loose code can be tightened up to get maximum function into minimum memory space. But please heed the warning note at the end, lest you get yourself into a cleverness box from which there's no escape!

Redundant logic can be illustrated by the following sequence:

CMPA	#20	Compare ACCA to the value 20.
BMI	CODIN	Less than 20? Go to CODIN.
BEQ	DELIM	Equal to 20? Go to DELIM routine.
BGT	TEXTIN	Over 20? Treat as text input.

Obviously, the last instruction is redundant. If the accumulator is not less than or equal to 20, it must be more than 20, and the third test is unnecessary. Frequently, the redundancy is more subtle, being determined by external parameters which make certain conditions impossible, and therefore unnecessary to test for.

Loose coding may be illustrated by this nice, straightforward top down subroutine for a 6800 string print operation:

PDATA	LDAA	0,X	Get data byte per index register.
	CMPA	#04	Check for EOT (string terminator).
	BEQ	EXIT	If EOT, return to calling program.
	JSR	OUTEEE	Not EOT. Output this character.
	INX		Step index register to next location.
	BRA	PDATA	Go back for next byte.
EXIT	RTS		Return to calling program.

The routine uses 13 bytes. The sharp programmer notes immediately that it has two branches in it, one of them unconditional. An unconditional branch is always somewhat suspect in itself; in a short routine already containing a conditional branch, it's doubly suspect.

Here's how Wiles and Felix optimized the routine in Motorola's MIKBUG read-only memory. By moving the entry point to the middle of the routine, the unconditional branch can be thrown out and the loop closed by the conditional branch alone:

PDATA2	JSR	OUTEEE	Output the character.
	INX		Step to next location.
PDATA1	LDAA	0,X	Enter here. Get character per XR.
	CMPA	#04	Check for EOT.
	BNE	PDATA2	If not EOT, output the character.
	RTS		Was EOT. Return to calling program.

Now we are down to 11 bytes. To save even more, the system could be changed to use 00 (NUL) rather than 04 (EOT) as the string terminator symbol. Because the N and Z bits of the condition code register in the Motorola 6800 respond automatically to a LOAD operation (this is not true of the 8080 and some other processors; you have to know the fine print to do a good job of code tightening), the comparison can be thrown out:

PDATA2	JSR	OUTEEE	Output the character.
	INX		Step to next.
PDATA1	LDAA	0,X	Enter here. Get character per XR.

HIGH SPEED PRINTER

"OKIDATA CP.110" Prints an 8-1/2" by 11" page in less than 60 seconds.

- Modular power supply 110/220 V. with circuit breaker, power cord & on/off switch
 - Self test circuit included
 - Full 80 character lines
 - High speed: 110 characters per second
 - Bidirectional print
 - Uses low cost standard 8-1/2" TTY paper
- INTERFACE FOR
TRS80 & Apple \$50.00
Service Manual \$20.00

\$650⁰⁰
REG. \$1200.00

BRAND NEW
INDUSTRIAL SURPLUS



INTERTUBE TERMINAL

\$779⁰⁰

SPECIAL
INTRODUCTORY
PRICE

Shipped Freight Collect

- 12" Display
- Numeric Keypad
- Reverse Video
- Upper & Lower Case
- Line, Char. Insert/Delete

EXPORT BUSINESS
WELCOME

INTERNATIONAL ELECTRONICS EQUIPMENT CORP.

P.O. BOX 522542, MIAMI, FLORIDA 33152 • (305) 595-2386



STOP PLAYING GAMES

TRS-80 (Level II)
PET
APPLE
OTHERS

- Calculate odds on HORSE RACES with ANY COMPUTER using BASIC.
- SCIENTIFICALLY DERIVED SYSTEM really works. This system was written and used by computer experts and is now being made available to home computer owners. This method is based on storing data from a large number of races on a high speed, large scale computer. 23 factors taken from the "Daily Racing Form" were then analyzed by the computer to see how they influenced race results. From these 23 factors, ten were found to be the most vital in determining winners. NUMERICAL PROBABILITIES of each of these 10 factors were then computed and this forms the basis of this REVOLUTIONARY NEW PROGRAM.
- SIMPLE TO USE: Obtain "Daily Racing Form" the day before the races and answer the 10 questions about each horse. Run the program and your computer will print out the odds for all horses in each race. COMPUTER POWER gives you the advantage!
- YOU GET: 1) TRS-80 (Level II) Cassette
2) Listing of BASIC program for use with any computer.
3) Instructions on how to get the needed data from the "Daily Racing Form".
4) Tips on using the odds generated by the program.
5) Sample form to simplify entering data for each race.



MAIL COUPON OR CALL TODAY

3G COMPANY, INC. DEPT. BT (503) 357-9889
RT. 3, BOX 28A, GASTON, OR 97119

Yes, I want to use my computer for FUN and PROFIT. Please send me _____ programs at \$19.95 each.

Enclosed is: check or money order Master Charge Visa

Card No. _____ Exp date _____
NAME _____
ADDRESS _____
CITY _____ STATE _____ ZIP _____

START USING YOUR COMPUTER FOR
FUN and PROFIT!

It's subLOGIC for graphics!

ANIMATION PACKAGE for the APPLE II

BE CREATIVE with the SubLOGIC A2-3D1 high-speed animation package for your Apple. Generate scenes or drawings, view them from varying distances and angles, or even orbit.

All you need is 16K RAM and the creative urge. Cassette \$45, or disk \$55. See your dealer or order direct (add \$1.50 shipping). Visa & Mastercard accepted.



We're open 9 to 6, Monday thru Friday, central time. Give us a call.

The engineering & graphics people
(217) 359-8482

subLOGIC
Box V, Savoy, IL 61874

Radio Shack [®] DEALER
COMPUTER SPECIALISTS



15% Discount on TRS-80's - I AND ACCESSORIES

FAST 100 cps Centronics 730 PRINTER... \$800.00
HIGHLY RELIABLE LOBO DRIVES... \$375.00

MICRO MANAGEMENT SYSTEMS
DOWNTOWN PLAZA SHOPPING CENTER
115 C SECOND AVE. S.W.
CAIRO, GEORGIA 31728
912-377-7120

BNE PDATA2 Not 00? Output it and get next.
RTS Was 00. Return.

Now, the job is all done in nine bytes, a 30 percent saving in code. (This trick could not be used in MIKBUG, since some of the strings contained NULs.)

For the read-only memory programmer, that could mean the difference between fitting and not fitting the allocated hardware. For the home hacker who hand-assembles his code it could be the difference between rewriting these few bytes and rewriting several pages of code (and risking a blowup if an address or offset is overlooked). It's not hard to guess which approach is best!

A Word of Warning

Here's a word of warning though: if you learn a lot of tricks and start applying them all in your original coding, there will be nowhere to tighten up if you run over. Your coding will also be much harder to understand later when you want to do something slightly different with it.

It's a little pathetic to see a routine loaded with twists, kinks, and convoluted logic, followed by a string of NOPs, revealing that the programmer was just performing logical games for his or her own amusement, or else swiped the routine from someone else without understanding it!

So, the best programming practice is to go with relatively loose and straightforward top down programming in the initial approach to a problem, and to save the tricks until you really need them. ■

Mining the Skip Chain for Extra Bytes of Code

Geoffrey Gass, 5240 SW Dosch Rd, Portland OR 97201

Need bytes? Go where the code is, and start prospecting.

Somewhere, a program will probably be checking a value or input against several reference values, performing various actions according to the results of comparisons. A common filter construction uses a *skip chain*, a procedure which gobbles up a lot of code. This is therefore a good place to start a mine, smelter and refinery.

A typical skip chain might look like this (coding is for the Motorola 6800, but the process is essentially the same for all machines):

CTRL1	CMPA	#\$18	Check for CANcel.
	BNE	CTRL2	Not CAN? Skip next.
	LDX	BUFAD	Was CAN. Get start point.
	STX	BUFLOC	Reset "current" location.
	BRA	BUFIN	Go get revised data.
CTRL2	CMPA	#\$0F	Check for CTRL/0 (backspace).
	BNE	CTRL3	Not CTRL/0? Skip the following.
	CPX	BUFAD	Was CTRL/0. Check current position in buffer.
	BEQ	BUFIN	At start? Can't backspace. Forget it.

The COMPUTER FACTORY

TO ORDER CALL (212) 687-5000

SUPERBRAIN™

INTERTEC
DATA
SYSTEMS

32K
ONLY
\$2995

64K \$3245

More than an intelligent terminal, the SuperBrain outperforms many other systems costing three to five times as much. Endowed with a hefty amount of available software (BASIC, FORTRAN, COBOL), the SuperBrain is ready to take on your toughest assignment. You name it! General Ledger, Accounts Receivable, Payroll, Inventory or Word Processing... the SuperBrain handles all of them with ease.

NOW IN STOCK

FEATURES INCLUDE:

- Two dual-density minifloppies with 320K bytes of disk storage
- 32K of RAM to handle even the most sophisticated programs
- a CP/M Disk Operating System with a high-powered text editor, assembler and debugger.

AVAILABLE SOFTWARE • Accounts Receivable/Payable \$125
• General Ledger \$125 • Payroll with cost accounting \$125
• Wordstar \$500 • Selector III-C2 \$395 • M Basic-80 \$350
• C Basic \$125 • M Basic Compiler \$400.



THE
IMAGINATION MACHINE by APF
**PRICE BREAK ALL
FOR ONLY \$595**

Includes all these Features:

- 10K Disk Basic (up to 4 disks) • 9K User RAM expandable to 42K • 8 Colors Hi-Res. (256 x 192) • Music Synthesizer • Digital Cassette with Microphone & Speaker • Built In RF Modulator • Full sized Keyboard • 2 Joy Sticks & Numeric Pads.



MINIMAX

The Minimax Series Computer is an integrated, compact unit containing the CPU, Disk Storage, 12" CRT, and Full Style Keyboard.

FEATURES:

- 2 Megahertz 6502 CPU
 - 108K System RAM • High Res. Graphics (240 x 512) • Serial & Parallel I/O
- MINIMAX I—8 Megabyte \$4495**
MINIMAX II—2.4 Megabyte \$5995

Commodore Computer

These low cost Commodore PE1 Business Computers have virtually unlimited business capabilities: Accounts Receivable, Inventory Records, Payroll, and other accounting functions.

PET 16N & 32N COMPUTERS

- Full size keyboard
- 16 or 32,000 Bytes Memory
- Level III Operating System
- Full Screen Editor
- Upper/lower case & 64 graphic characters

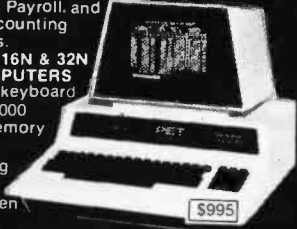

PET DUAL FLOPPY DISK

- Stores 360,000 Bytes on-line
- Microprocessor controlled
- Uses single or dual sided floppies

HI-SPEED PRINTER

- 150 characters per second • Up to 4 copies 8 1/2" wide
- Microprocessor Controlled • Prints All Graphics
- Full Formatting Capability



PERIPHERALS FOR PET

• 24K Memory Expansion	\$499
• 16K Memory Expansion	399
• PET to RS232 Serial	169
• 2 Way Serial/Communication	229
• Modem Board for PET	375
• Analog to Digital Board for 16 Devices	275
• Second Cassette Drive	95

Great PET Software

DATABASE MANAGEMENT SYSTEM—Six modules comprising 48K of programming allows you to: create, edit, delete, display, print, sort, merge, etc.—databases of up to 10,000 records. Printer routines included. 60 Pages of documentation for 16-32K PET and 2040 Dual Disk...
Cost \$125

KRAM—Keyed Random Access Method—The new, ultra-fast access method for the PET Disk, provides keyed retrieval/storage of data, in either direct or sequential mode, by either full or partial key values. Written in 6502 machine code. Eliminates the need for "Sort" routines...
Cost \$79.95



NEW!

APPLE II PLUS ONLY \$1195

A complete self-contained computer system with APPLESOFT floating point BASIC in ROM, full ASCII keyboard in a light weight molded carrying case.

Features Include:

- auto-start ROM • Hi-Res graphics and 15 color video output.
- Expandable to 48K.

Supertalker.....	\$ 279	Micromodem.....	\$ 379
Disk.....	595	Programmer's Aid.....	50
Add-on Disk.....	495	Speechlab.....	229
Pascal Card.....	495	Communication Card.....	225
Business Software.....	625	Modem.....	200
Monitor.....	159	EPROG Programmer.....	100
Printer Card.....	180	Graphics Tablet.....	\$795

NEW! CENTRONICS 704

\$1895 List \$2500

- 180 cps Bi-Directional • Up to 15" Paper Width • 9 x 9 Matrix
- Upper/Lower Case • Tractor Feed • RS-252 Serial Interface



\$ 1595 Complete

- 16K model \$ 1895**
- 32K model \$ 2195**



CompuColor II

COMPUCOLOR II Disk-Based Model 3 Advanced hardware and software technology gives you:

- 13" Color Display
- Advanced Color Graphics
- 51K Disk Built-In
- 16K ROM Operating System
- 8K RAM User Memory
- 4K RAM Refresh
- 8080A Microcomputer
- RS-232 I/O

ANDERSON JACOBSON

841 I/O Terminal Ideal for word processing and small business needs:
• ASCII Code
• 15 cps Printout
• High Quality Selective Printing
• Use Keyboard for PET
• Reliable heavy duty Mechanism
• Completely Refurbished by A.J.
• Service in 15 Major Cities
Plus \$35 Freight-In Charge



Only \$949



ATARI 800
Personal computer

Only \$529



ATARI 400
Personal Computer



TEXAS INSTRUMENTS
TI-99/4
HOME COMPUTER

Only \$1150 Includes 13 Color Monitor!

Over 1000 software tapes, books, disks on display. Come in and browse.



Data General
10 Megabyte System \$17,040

DATA GENERAL

micro NOVA

The ultimate in small Business Computers when matched with COMPUTER FACTORY's minicomputer. Software: Accounts Receivable/Payable, Inventory Control/ Order Entry, Genreal Ledger, Payroll Systems... from \$12,140 for 64K computer with cabinet, printer terminal, video terminal dual disk and multi-user operating system!

RADIO SHACK • PET • SORCERER • APPLE • COMPUCOLOR • ETC. PRINTERS • PRINTERS • PRINTERS

The COMPUTER FACTORY'S extensive inventory and wide selection of computer printers assures you of finding the printer best suited for your needs and specifications. The following printers work well with all known personal computers.

CENTRONICS 779	\$ 945
TRENDCOM 100	375
TRENDCOM 200	595
PAPER TIGER 440	5995
XYMEC1000	2495
XEROX1740	2810



FREE

\$35 of Software with purchase of any computer on this page.



Min Credit Card Order \$75



Open Mon.-Fri. 10-6 Sat. 10-4

N.Y. residents add 8% sales tax
• Same day shipment on prepaid and credit card orders • Add \$5 shipping for computers \$3 for hoards \$1 each cassette tape.

TO ORDER CALL (212) 687-5000

(46th St.)

The COMPUTER FACTORY

485 Lexington Avenue 750 Third Avenue New York, N.Y. 10017

Foreign order desk - Telex 640055

	DEX		OK for backspace. Step back 1.
	STX	BUFLOC	New "current position."
	BRA	BUFIN	Go get corrected input.
CTRL3	CMPA	#\$12	Check for CTRL/R (restart).
	BEQ	LININ	CTRL/R? Start all over.
	BRA	BUFIN	All others, back to BUFIN.

There is nothing seriously wrong with the routine as shown, but it uses up 29 bytes in making three comparisons, and all of the operations but one end up by branching to BUFIN. Two of the BRA BUFIN instructions are unnecessary. Since all of the tests are for equality, the quantity in A is obviously going to match at only one test. So why bother jumping out early to avoid the other tests?

Another redundancy in this particular instance is not quite so obvious unless you see the rest of the routine. Note that in the CTRL2 sequence, a backspace is performed by decrementing the index register and putting the index register value into BUFLOC. Evidently, the index register carries the "current position" and is equal to BUFLOC when first entering the routine. There are two STX BUFLOC instructions in the routine. Could they be consolidated? The answer is yes, if we do not mind stuffing the index register into BUFLOC for all incoming codes. Try this:

CTRL1	CMPA	#\$18	Check for CAN.
	BNE	CTRL2	Not CAN? Skip.
	LDX	BUFAD	Was CAN. Change XR content.
CTRL2	CMPA	#\$0F	Check for CTRL/0 (backspace).

	BNE	CTRL3	Not CTRL/0. Park XR and check for CTRL/R.
	CPX	BUFAD	Check position.
	BEQ	CTRL3	At start? No backspace. Drop on through.
			Step back 1.
CTRL3	DEX	BUFLOC	New or old XR value.
	STX	BUFLOC	New or old XR value.
	CMPA	#\$12	Final test, for CTRL/R.
	BEQ	LININ	If CAN or CTRL/0, will fall through.
	BRA	BUFIN	All except CTRL/R, back to BUFIN.

Now the routine is down to 23 bytes: possibly a significant saving in a program being squeezed for memory space.

Note that what we are doing here is to trade redundant code for redundant operations, a frequently encountered tradeoff. To save a few bytes of code we have stretched execution time significantly. For keyboard interactive routines (as in the example), the execution time is unimportant. In a much used mathematics subroutine on the other hand (eg: multiple precision add or multiply), execution time will be much more important, since the subroutine may be called thousands of times in one calculation, and an optimum tradeoff would be more likely in the direction of code redundancy to gain speed of execution (counting machine cycles, not bytes of memory).

The next time you are squeezed for space, and speed is not critical, take a look at your skip chains: they may be able to furnish all the bytes you need, with a little refining. ■

U.S. ROBOTICS, INC. 1035 W. LAKE ST. CHICAGO, ILL. 60607		<p style="text-align: center;"><i>Connect your TRS-80, Apple or ANY other computer to the phone lines with the...</i></p> <p style="text-align: center;">USR-330 Originate/Auto-Answer Modem</p> <div style="text-align: center;">  <p>\$339</p> </div> <p>FCC certified for direct connection to phone lines via standard extension phone jack</p> <ul style="list-style-type: none"> • 0-300 Baud • Bell 103/113 compatible • Stand Alone • RS232 • 1 Year Warranty • Crystal Controlled • State of the Art LSI circuitry • 5 stage active filters
<p style="text-align: center;"><i>Call now for a quotation (312) 733-0497</i></p> <p style="text-align: center;">The 550 BANTAM from Perkin-Elmer</p> <div style="text-align: center;">  <p>\$799</p> </div> <p style="text-align: center;">All the features of the Hazeltine 1400 & LSI ADM-3A plus</p> <ul style="list-style-type: none"> • Upper/Lower Case • 7x10 Character Matrix • White or Black Characters • Transparent Mode • Addressable Cursor • Tab Function • Backspace Key • Shiftlock Key • Print Key • Integrated Numeric Pad • Editing Functions • Extremely Compact: 15" W x 19" D x 14" H • Silent fan-free operation 	<p style="text-align: center;">LA34 DECwriter IV</p> <div style="text-align: center;">  <p>\$1199</p> </div> <ul style="list-style-type: none"> • Tabs • 132 columns • 10, 12, 13.2, 16.5 characters/inch • 2, 3, 4, 5, 8 or 12 lines/inch • Optional tractor feed • 110 or 300 baud • RS232C/ASCII • Friction feed/up to 15" wide paper • 9x7 dot matrix, impact printing • Upper/lower case 	<p style="text-align: center;">PENRIL 300/1200 MODEM</p> <p style="text-align: center;">Originate/Auto-Answer</p> <div style="text-align: center;">  <p>\$799</p> </div> <ul style="list-style-type: none"> • 0-300 or 1200 baud • Bell 212A & 103/113 compatible • 1 year warranty • Stand alone • RS232 • Full duplex over voice grade phone lines • FCC certified for direct connection to phone lines via RJ11C voice jack (standard extension phone jack)
<p style="text-align: center;">All products in stock!</p>	<p style="text-align: center;">Teletype Model 43 KSR</p> <p style="text-align: center;">\$1049</p> <ul style="list-style-type: none"> • 110 or 300 baud • RS232C/ASCII • Pin feed/8 1/2" H x 11" W paper is perfect for filing and copying. 	<div style="text-align: center;">  <p>\$159</p> </div> <p style="text-align: center;">USR-310 Originate Acoustic Coupler</p> <div style="text-align: center;">  <p>\$159</p> </div> <ul style="list-style-type: none"> • 132 columns • Upper/lower case, true descenders • Dot matrix, impact printing

An Extraordinary Offer to introduce you to the benefits of Membership in

ELECTRONICS BOOK CLUB

invites you to take this 826-p. Computer Library for only

49¢

HOW TO DESIGN, BUILD & PROGRAM YOUR OWN WORKING COMPUTER SYSTEM

The complete computer design, construction, programming, testing, and de-bugging!

BY ROBERT P. STARBUCK

You Get BOTH of these HUGE Books

for only **49¢**

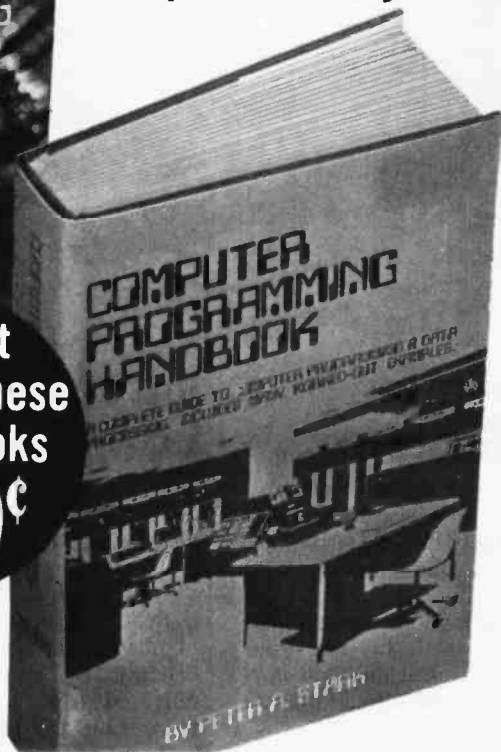

How to Design, Build & Program Your Own Working Computer System

Here's the complete computer build-it book, including design, construction, programming, testing, and de-bugging! It's a 2-in-1 volume that combines both hardware and software—that provides ALL the details you need to build your own computer... and program it! It's a concise and very readable guide to homebrewing your own computer system complete from power supply to terminals. Much data is also included to allow you to modify or add to an existing computer system. Here you'll find just the information you need to make intelligent design decisions, to incorporate the hardware you need, to test each component as you build, and to rig your creation for expanded capabilities. This new manual explores the applications and interface possibilities of a wide variety of computer hardware and software, and examines them in terms of specifications, in terms of actual computer-building problems and solutions. Not only does it fully illustrate the know-how that goes into building a computer with easy step-by-step methods, it also shows you as each segment is built how to program and test the operation of each of the self-built plug-in module boards. This is perhaps close to the ultimate in owner-built computer construction techniques—you see how to assemble the hardware, how to test it in the operating system, and then how to program it. You first learn how to select and customize a central processor, and from there you just keep on building, step by step, until you've concocted the computer system you're after. Each Chapter gives you more goodies to pour in; each section will help you create greater design sophistication. 308 pgs., 138 illus. list \$14.95

Computer Programming Handbook

A complete guide to computer programming and data processing, with scores of worked-out examples. It's an extremely comprehensive, informative, and interesting work on computer programming (and data processing in general), including number systems, languages, and application of languages to the kinds of real-world problems computers are programmed to solve. This GIANT text (25 Chapters plus Appendices—518 pages) covers all three types of computer languages—machine, symbolic, and problem-oriented; each language type is covered in detail—complete with worked-out examples which include computer printouts and actual results. Throughout, the author emphasizes the importance of techniques to get answers from a computer, rather than focusing on the complexities of the languages themselves. This approach simplifies the learning process and makes it easier to relate the problems involved in programming to the capabilities of the equipment. The problem-oriented language portion focuses on FORTRAN IV, and all illustrative programs have been computer-tested where necessary to make sure they are operationally sound and workable and contain no errors. If ever there was a one-book, first-class course on computer programming and data processing, this is it! 518 pgs., 114 illus. List \$12.95

Let us send you this 2-volume, 826-page Computer Library as part of an unusual offer of a Trial Membership in Electronics Book Club.

Here are quality hardbound volumes, each especially designed to help you increase your know-how and enjoyment of electronics and computers. Whatever your interest, you'll find Electronics Book Club offers practical, quality books that you can put to immediate use and benefit. Among selections offered, for example, are *Artificial Intelligence*; *The Complete Microcomputer Systems Handbook*; *The GIANT Book of Computer Projects*; *Illustrated Dictionary of Microcomputer Terminology*; *The A to Z Book of Computer Games*; *57 Practical Programs & Games in BASIC*; *Microprocessor Cookbook*, etc.

This extraordinary offer is intended to prove to

you, through your own experience, that these very real advantages can be yours... that it is possible to keep up with the literature published in your areas of interest, and to save substantially while so doing. As part of your Trial Membership, you need purchase as few as four books during the coming 12 months. You would probably buy at least this many anyway, without the substantial savings offered through Club Membership.

To start your Membership on these attractive terms, simply fill out and mail the coupon today. You will receive the 2-volume Computer Library for 10-day inspection. YOU NEED SEND NO MONEY. If you're not delighted, return the books within 10 days and your Trial Membership will be cancelled without cost or obligation.

ELECTRONICS BOOK CLUB, Blue Ridge Summit, Pa. 17214

Facts About Club Membership

- The 2 introductory books carry a publisher's retail price of \$27.90. They are yours for only 49¢ for both (plus postage/handling) with your Trial Membership.
- You will receive the Club News, describing the current Selection, Alternates, and other books, every 4 weeks (13x a year).
- If you want the Selection, do nothing; it will be sent to you automatically. If you do not wish to receive the Selection, or if you want to order one of the many Alternates offered, you simply give instructions on the reply form (and in the envelope) provided, and return it to us by the date specified. This date allows you at least 10 days in which to return the form. If, because of late mail delivery, you do not have 10 days to make a decision and so receive an unwanted Selection, you may return it at Club expense.
- To complete your Trial Membership you need buy only four additional monthly Selections or Alternates during the next 12 months. You may cancel your Membership any time after you purchase these four books.
- All books—including the Introductory Offer—are fully returnable after 10 days if you're not completely satisfied.
- All books are offered at low Member prices, plus a small postage and handling charge.
- Continuing Bonus: If you continue after this Trial Membership, you will earn a Dividend Certificate for every book you purchase. Three Certificates plus payment of the nominal sum of \$1.99 will entitle you to a valuable Book Dividend of your choice which you may choose from a list provided Members.

ELECTRONICS BOOK CLUB

Blue Ridge Summit, Pa. 17214

Please open my Trial Membership in ELECTRONICS BOOK CLUB and send my 2-volume Computer Library, invoicing me for only 49¢ plus shipping. If not delighted, I may return the books within 10 days and owe nothing, and have my Trial Membership cancelled. I agree to purchase at least four additional books during the next 12 months after which I may cancel my membership at any time.

Name _____ Phone _____

Address _____

City _____

State _____ Zip _____

(Valid for new Members only. Foreign and Canada add 15%.) BY-210

PIMS Personal Information Management System



Improve your life style

Learn how you can unleash the power of a personal computer for your own benefit. A ready-to-use data base management program.

SCELB I Publications

Personal Information Management System

For business and for pleasure. Increase your personal capabilities . . . save money . . . improve your ability to plan . . . locate important facts quickly. PIMS is a ready-to-use information (data base) management system for computers like the TRS-80, PET, etc. Have your computer manage tax deductions, department store charges, plan your day. Use it to keep your mailing list, do simple accounts receivable and payable. And much more! Includes easy-to-read manual and source listing. Written by the SCELB I staff.

Only \$9.95 No. 10

Introduction to Low Resolution GRAPHICS

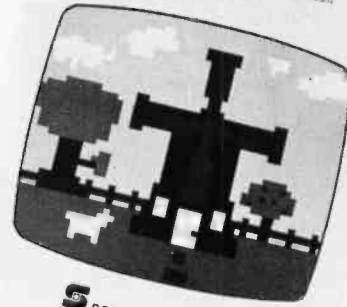

SCELB I Publications

Introduction to Low Resolution Graphics

Now you can produce amazing computer graphics — even if you can't draw a straight line. Literally! Learn how to draw lines and shapes, make graphs, draw pictures and even do animations. The simple secrets of how to do all this are contained in this new book by Nat Wadsworth. You'll be able to produce a deck of playing cards . . . a clown that winks . . . a football grid . . . and an animated football game. Also tells how to synchronize computer-generated sounds to your illustrations.

Just \$9.95 No. 65

SERIOUS

Understanding Microcomputers

Accepted as the standard! 300 page easy reading text. Explains exactly how a microprocessor works. Intro to programming in BASIC. Complete glossary. Just \$9.95 No. 90

UNDERSTANDING MICROCOMPUTERS

and small computer
systems



© 1978 by Peter Horst

Microcomputer Potpourri

A pocket-size reference for the beginner and pro alike. Full digest on understanding microcomputers. Data and diagrams on all the popular chips. Glossary. Only \$2.95 No. 70

MICRO COMPUTER



POTPOURRI

Learn Micro-Computers

A new multi-media information package for the beginner. You get Understanding Microcomputers book plus high-quality cassette. Great for self-study. Just \$14.95 No. 40



Calculating with BASIC

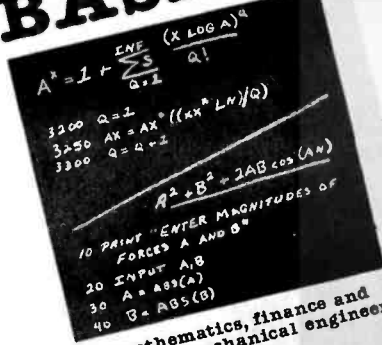

For mathematics, finance and statistics, mechanical engineering and electronics
 SCELBI Publications

6502 SOFTWARE Gourmet Guide & COOKBOOK



Put Together Your Own 6502 Programs Using These Time Tested Recipes

- General Purpose Routines —
- Conversion Routines —
- Search and Sort Routines —
- Floating Point Routines —
- 6502 Instruction Set —
- And More —

SCELBI Publications

Calculating with BASIC

Use your computer to calculate home mortgage payments, interest rates, payback periods and more! Shows how to apply the BASIC language to practical problems and equations. Covers the fields of mathematics, finance and statistics, mechanical engineering and electronics. For fun, the games of Hangman and Space Capture are provided. Written by Raymond Guido. Ideal for the businessman, scientist, engineer or student. Complete routines are worked out and ready for you to use.

Just \$7.95 No. 30

Z80, 8080, 6800 & 6502 Software Cookbooks

There's one for each of these popular microprocessors. With the right SCELBI Gourmet Guide and Cookbook, you'll be able to put together programs without having to start from scratch. You'll have the most useful routines at your command — already programmed and ready-to-use. Search and sort routines. Many general purpose utility routines. I/O and interrupt programming. How to control and manipulate stacks. Code and numeric conversion routines. Plus more!

For 6502, No. 99, \$10.95; for 6800, No. 50, \$10.95 for 8080, No. 60, \$10.95; for Z80, No. 75, \$14.95

READING

Z80 Instruction Handbook

Convenient pocket size guide to the powerful Z80 instruction set. Machine codes presented in octal and hex format. Instructions also indexed alphabetically.

Only \$4.95 No. 20

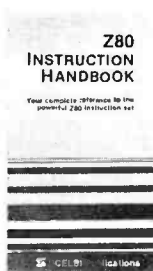

Free catalog

10 pages of books for business or pleasure.

No. AA



See SCELBI books at your favorite computer or electronics store, or use coupon for direct mail.

SCELBI Publications
 20 Hurlbut Street, Elmwood, CT 06110

IMPORTANT ORDERING INFO! Include \$1.00 shipping/handling charges for each item. Prices shown are for North American customers. Master Charge, VISA, Postal and Bank Money Orders preferred. Allow 4 weeks for delivery.

- | | | | |
|---------------------------------|---------------------------------|---------------------------------|---------------------------------|
| <input type="checkbox"/> No. 10 | <input type="checkbox"/> No. 20 | <input type="checkbox"/> No. 30 | <input type="checkbox"/> No. 40 |
| <input type="checkbox"/> No. 50 | <input type="checkbox"/> No. 60 | <input type="checkbox"/> No. 65 | <input type="checkbox"/> No. 70 |
| <input type="checkbox"/> No. 75 | <input type="checkbox"/> No. 90 | <input type="checkbox"/> No. 99 | <input type="checkbox"/> No. AA |

Name (please print) _____

Card No. _____

Bank No. _____ Exp. Date _____

Address _____

City/State _____ Zip _____

Signature _____ Date _____

Event Queue

FEBRUARY 1980

February 6

Invitational Computer Conference, Ft Lauderdale FL. This conference is directed to the quantity buyer and will feature the newest developments in computer and peripheral technology. Contact B J Johnson and Associates, 2503 Eastbluff Dr, Suite 203, Newport Beach CA 92660.

February 12-14

Data Communications Conference and Exhibition, Harbour Castle Hilton, Toronto Ontario, Canada.

Panel sessions, presentations, workshops, and technical sessions related to the field of data communications will be featured. Network control, management,

performance and architecture; communications hardware and software; fiber optics; distributed data processing; and international communications policies are some of the subject areas that will be discussed.

The exhibition at the convention center will feature over 100 exhibitors.

For more information, contact Whitsted Publishing Ltd, Suite 2504, 2 Bloor St W, Toronto, Ontario M4W 3E2 CANADA.

February 11-13

Programming the 6502 in Machine and Assembly Language, George

Washington University, Washington DC. This course is aimed at engineers, scientists, mathematicians and students who need to learn

how to develop special-purpose microcomputer systems for their own use. Familiarity with FORTRAN or BASIC will be helpful. For more information, contact Director of Continuing Engineering Education, George Washington University, Washington DC 20052, (202) 676-6106.

February 11-13

Configuration Management, George Washington University Washington DC. The objectives of this course are to review the impact of latest Department of Defense directives and instructions in the configuration management (CM) area; explain policy for practical applications; and clarify the role of CM in meeting program/project objectives. Engineers, program managers, production, quality control, and purchasing people are invited to attend. Familiarity with the contents of MIL-STD-480 is a prerequisite. Contact the Director, Continuing Engineering Education, George Washington University, Washington DC 20052, (202) 676-6106.

February 13-15

The IEEE International Solid State Circuits Conference, San Francisco CA. This conference is a forum for the presentation of advancements in every aspect of solid state circuits. It will cover design, performance, fabrication, testing, and applications in digital, analog, microwave, and other areas of new solid state circuits,

device structures, phenomena and systems. For more information, contact Lewis Winner, 301 Almeria Ave, POB 343788, Coral Gables FL 33134.

February 18-21

European Information Management Exhibition and Conference, Wembley Conference Centre, London England. This show will exhibit microcomputer systems and peripheral items with demonstrations and applications focused on problem solving for the management executive. Contact Expoconsul, 420 Lexington Ave, New York NY 10017.

February 22-23

Louisiana Computer Exposition, University of Southwestern Louisiana, Lafayette LA. This conference is entitled "Distributed Systems Based on Mini and Micro Computers." It will cover programming languages, operating systems, evaluation of distributed systems, design criteria for distributed systems, and other related topics. There will be exhibitions of equipment and papers will be read and discussed. For more information, contact the Computer Science Dept, University of Southwestern Louisiana, POB 44330, Lafayette LA 70504.

February 25-27

Communication Networks '80, Shoreham Americana Hotel, Washington DC. This conference and exposition

CATCH THE S-100 INC. BUS!



	LIST PRICE	OUR SPECIAL CASH PRICE
Shugart SA400 w/Cabinet & AC Power Supply Kit	529.00	359.00
Integral Data Paper Tiger Model w/Graphics	1194.00	1020.00
Integral Data Paper Tiger Model w/o Graphics	995.00	850.00
Godbout Active Terminator Kit	35.00	29.00
D.C. Hayes Micromodem 100 Assembled & Tested	399.00	341.00
Intertec's Intertube 80x25 U/L Case	995.00	779.00

Subject to Available Quantities • Prices Quoted Include Cash Discounts. Shipping & Insurance Extra.

We carry all major lines such as S.D. Systems. Cromemco. IMSAI. Vector Graphics. North Star. Sanyo. ECT. TEI. Godbout. Thinker Toys. Hazelline. IMC. For a special cash price telephone us.

Bus. . . **S-100, inc.**
Address. . . **7 White Place**
Clark, N.J. 07066
Interface. . . **201-382-1318**

In order to gain optimum coverage of your organization's computer conferences, seminars, workshops, courses, etc, notice should reach our office at least three months in advance of the date of the event. Entries should be sent to: Event Queue, BYTE Publications, 70 Main St, Peterborough NH 03458. Each month we publish the current contents of the queue for the month of the cover date and the two following calendar months. Thus a given event may appear as many as three times in this section if it is sent to us far enough in advance.

THE ORIGINAL MAGAZINE FOR OWNERS OF THE TRS-80™* MICROCOMPUTER

SOFTWARE
FOR TRS-80™
OWNERS

H & E COMPUTRONICS INC.

MONTHLY
NEWSMAGAZINE
FOR TRS-80™
OWNERS

MONTHLY NEWSMAGAZINE Practical Support For Model I & II

- PRACTICAL APPLICATIONS
- BUSINESS
- GAMBLING • GAMES
- EDUCATION
- PERSONAL FINANCE
- BEGINNER'S CORNER
- NEW PRODUCTS
- SOFTWARE EXCHANGE
- MARKET PLACE
- QUESTIONS AND ANSWERS
- PROGRAM PRINTOUTS
- AND MORE

PROGRAMS AND ARTICLES PUBLISHED IN OUR FIRST 12 ISSUES INCLUDE THE FOLLOWING:

- A COMPLETE INCOME TAX PROGRAM (LONG AND SHORT FORM)
- INVENTORY CONTROL
- STOCK MARKET ANALYSIS
- WORD PROCESSING PROGRAM (FOR DISK OR CASSETTE)
- LOWER CASE MODIFICATION FOR YOUR VIDEO MONITOR OR PRINTER
- PAYROLL (FEDERAL TAX WITHHOLDING PROGRAM)
- EXTEND 16-DIGIT ACCURACY TO TRS-80™ FUNCTIONS (SUCH AS SQUARE ROOTS AND TRIGONOMETRIC FUNCTIONS)
- NEW DISK DRIVES FOR YOUR TRS-80™
- PRINTER OPTIONS AVAILABLE FOR YOUR TRS-80™
- A HORSE SELECTION SYSTEM*** ARITHMETIC TEACHER
- COMPLETE MAILING LIST PROGRAMS (BOTH FOR DISK OR CASSETTE SEQUENTIAL AND RANDOM ACCESS)
- RANDOM SAMPLING*** BAR GRAPH
- CHECKBOOK MAINTENANCE PROGRAM
- LEVEL II UPDATES*** LEVEL II INDEX
- CREDIT CARD INFORMATION STORAGE FILE
- BEGINNER'S GUIDE TO MACHINE LANGUAGE AND ASSEMBLY LANGUAGE
- LINE RENUMBERING
- AND CASSETTE TIPS, PROGRAM HINTS, LATEST PRODUCTS COMING SOON (GENERAL LEDGER, ACCOUNTS PAYABLE AND RECEIVABLE, FORTRAN 80, FINANCIAL APPLICATIONS PACKAGE, PROGRAMS FOR HOMEOWNERS, MERGE TWO PROGRAMS, STATISTICAL AND MATHEMATICAL PROGRAMS (BOTH ELEMENTARY AND ADVANCED) AND

NOTICE

Pursuant to a consent judgement entered in the United States District Court for the District of Massachusetts, H & E Computronics, Inc. hereby gives notice that it is not and has never been an authorized Radio Shack dealer or outlet, that products or services offered for sale or sold by it are not and were not approved or warranted by Radio Shack or Tandy Corporation, and that only products or services purchased directly from Radio Shack or its authorized retail outlets carry the warranty of Radio Shack and Tandy Corporation. If you have placed an order, still outstanding, with H & E Computronics, Inc., for products or services, in the belief that those products or services were manufactured, approved or warranted by Radio Shack or Tandy Corporation, you may cancel that order and obtain a full refund of any money paid or deposited, simply by writing to the address below.

FREE
↳

WORD PROCESSING PROGRAM (Cassette or Disk)

For writing letters, text, mailing lists, etc., with each new subscriptions or renewal.

LEVEL II RAM TEST (Cassette or Disk)

Checks random access memory to ensure that all memory locations are working properly.

DATA MANAGEMENT SYSTEM (Cassette or Disk) -Complete file management for your TRS-80™

SEND FOR OUR 36 PAGE SOFTWARE CATALOG (INCLUDING LISTINGS OF HUNDREDS OF TRS-80™ PROGRAMS AVAILABLE ON CASSETTE AND DISKETTE). \$2.00 OR FREE WITH EACH SUBSCRIPTION OR SAMPLE ISSUE.

COMPUTRONICS INC.
MATHEMATICAL APPLICATIONS SERVICE
Box 149 New City, New York 10956



24 HOUR
ORDER
LINE
(914) 425-1535



ONE YEAR SUBSCRIPTION \$24 _____ TWO YEAR SUBSCRIPTION \$48 _____ SAMPLE OF LATEST ISSUE \$4 _____
START MY SUBSCRIPTION WITH ISSUE _____ (#1-July 1978 • #7-January 1979 • #12-June 1979 • #18-January 1980)
NEW SUBSCRIPTION _____ RENEWAL _____

CREDIT CARD NUMBER _____ EXP. DATE _____
SIGNATURE _____
NAME _____
ADDRESS _____

*** ADD \$6/YEAR (CANADA, MEXICO)-ADD \$12/YEAR AIR MAIL-OUTSIDE OF U.S.A., CANADA & MEXICO ***

* TRS-80™ IS A TRADEMARK OF TANDY CORPORATION

will cover business communications. For program information, contact the Director of Program Development, The Conference Company, 60 Austin St, Newton MA 02160. For exhibit information, contact the national sales manager, Communications Networks '80, POB 96, Haddon Heights NJ 08035.

February 25-27

3rd International Learning Technology Congress and Exposition, Sheraton

Washington Hotel, Washington DC. Applications and technologies for the use of microcomputers and video disks as well as traditional technological issues in education and training will be discussed. In addition to the technical sessions, exhibits will range from video disk and media-based systems to computer-based instruction systems. Contact the Society for Applied Learning Technology, 50 Culpeper St, Warrenton VA 22186, (703) 347-0055.

February 25-27

Microprocessor Peripherals Workshop, Montgomery AL. This hands-on workshop includes 27 hours of instruction, with a take-home option and one microcomputer station for every two participants. Contact Paul A Willis, POB 29, Arlington VA 22210.

February 25-28

Compcon '80, Jack Tar Hotel, San Francisco CA. The conference theme is "VLSI: New Architectural

Horizons." It will be devoted to developing advanced technologies for computers. Contact Compcon Spring '80, POB 639, Silver Spring MD 20901.

February 26-28

Nepcon West '80, Anaheim Convention Center, Anaheim CA. The conference and exhibit will deal with the latest advances in electronics by covering such topics as wave soldering, etching, automated assembly, die attaching, hybrid circuit packaging, photo lithography, precious metal recovery, laser annealing, and much more. For further information, contact ISCM Inc, 222 W Adams St, Chicago IL 60606.

February 26-29

Office/Korea/80, Korea Exhibition Center, Seoul Korea. Exhibits at this exposition will include the range of products needed in offices from computers, word processing equipment and software to stationery, supplies, furniture and services. Information about the show may be obtained from Expoconsul, a division of Clapp and Poliak, 420 Lexington Ave, New York NY 10017.

February - August

Microprocessor Design Courses. The course is aimed at professional design engineers and covers fundamentals of microprocessor operations, programming, architecture and input/output integration. It will also cover Z80 and 8085 processors, working with the STD BUS and the designing and documenting of software. Tuition for the course is \$400. The courses will be held in major cities throughout the US. Contact Elma Barnes, PRO-LOG, 2411 Garden Rd, Monterey CA 93940, or phone (408) 328-4745.



Cat.TM Someday there won't be a phone without one.

The only way to realize the full potential of your small business or personal computer is to tie it in with other computers. And the best way to do that is with a Cat acoustic modem.

A Cat modem lets your computer talk face to face with any other compatible computer or terminal within reach of your phone, over standard telephone lines.

You can work at home using the computer at your office. Send or receive data from anywhere. Or swap programs.

Fast, accurate, reliable—and under \$199.

Cat. Someday there won't be a computer without one.

Cat by
Novation

Tie your computer into the world.

Call for details

(800) 423-5410

In California (213) 996-5060



Available at Hamilton/Avnet, Kierulff Electronics, Byte Shops, Computerland, and your local computer store.

Novation, Inc., 18664 Oxnard Street, Tarzana, California 91356

MARCH 1980

March 1

Exploring Small Computers,

Back-Up

'Security... for your
S-100 hard disk data'

The availability of fast, reliable, high capacity hard disk storage for the S-100 computer market has created a wave of excitement. It has also underscored the somber necessity for a reliable means of backup. No serious application is practical without a dependable, economical method for backup and archiving of critical on-line data.

Now, CSSN breaks the barriers to hard disk applications by offering the complete solution for data security . . . a cartridge tape drive (13.4 megabyte capacity), fully S-100 interfaced, and software to make it work. — BACKUP IS NOW A REALITY!



*Put your valuable data on-line with a hard disk . . .
Save it off-line with our Back-Up Solution*

Circle 108 on Inquiry card.

CSSN

COMPUTER SERVICE SYSTEMS NETWORK

120 BOYLSTON STREET • FOURTH FLOOR • BOSTON, MASSACHUSETTS 02116 • (617) 482-2343 • TWX (710) 321-1913 • INCORPORATED

Albion College, Albion MI. This fair will feature exhibits and seminars on microcomputers and their applications in business, education, and the home. Contact D W Kammer, Dept of Physics, Albion College, Albion MI 49224.

March 3-5

Office Automation Conference, Georgia World Congress Center, Atlanta GA. A combination conference and exhibition of office computer systems has

been developed to help management understand the growing technology of business computer systems. For more information, contact H A Bruno and Associates Inc, 78 E 56th St, New York NY 10022.

March 4 and 5

8th Annual Midwest Digital Equipment Exhibit and Seminar, Thunderbird Motel Minneapolis MN. Manufacturers of computer terminals, data communication equipment, peripherals, data

acquisition systems and digital test instruments will display their products. Seminars will be held both days. For further information, contact John Bastys Countryman Associates Co, 1821 University Ave, St Paul MN 55104.

March 6-8

Microprocessor Peripherals Workshop, Chattanooga TN. See February 25-27 for details.

March 10-12

1980 National Office Exhibi-

tion and Conference, Automotive Building, Exhibition Pl, Toronto Canada. Subject areas of the conference will include energy conservation, small business computers, micrographics, word processing, telecommunications, copiers, office landscaping, and many others. There will be approximately 100 exhibitors presenting their products and giving demonstrations.

For more information, contact Whitsed Publishing Ltd, Suite 2504, 2 Bloor St W, Toronto, Ontario M4W 3E2 CANADA.

March 14-16

West Coast Computer Faire, Civic Auditorium and Brooks Hall, San Francisco CA. An expected 15,000 attendees, over 340 exhibits, and more than 100 conference speakers will highlight this year's program. Exhibitor and speaker information may be requested from the Computer Faire, 333 Swett Rd, Woodside CA 94062.

March 17-20

Interface '80, Miami Beach Convention Center, Miami Beach FL. This conference and exposition is devoted to data communications, distributed data processing, and networking. Approximately 1000 exhibitors are anticipated and attendance is expected to exceed 12,000. For information, contact Interface '80, 160 Speen St, Framingham MA 01701.

March 17-21

Applied Time Series Analysis, University of California at Los Angeles CA. This course is designed for engineers, scientists, programmers, economists and other users of digital time series who require modern methods of data analysis using the fast Fourier transform (FFT), digital filtering, power spectral densities and correlation functions. The lectures cover topics relating to the Fourier transform, sampling linear systems, convolution, covariance, digital filtering,

64KB RAM MEMORIES

LSI-11 - \$750.00 ● SBC 80/10 - \$750.00
S-100 - \$750.00 ● 6800 - \$750.00 ● 6800-2 - \$995.00



CI-6800-2 64K x 9



CI-S100 64K x 8

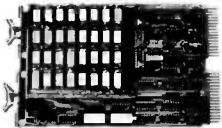

CI-1103 32K x 16

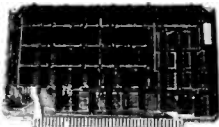

CI-6800 64K x 8



CI-8080 64K x 8

CI-6800-2 — 16KB to 64KB. Plugs directly into Motorola's EXORciser I or II. Hidden refresh up to 1.5 Mhz. Cycle stealing at 2 Mhz. Addressable in 4K increments with respect to VXA or VUA. Optional on Board Parity. 64K x 9 \$995.00.

CI-S100 — 16KB to 64KB. Transparent hidden refresh. No wait states at 4 Mhz. Compatible with Alpha Micro and all Major 8080, 8085 and Z80 Based S100 Systems. Expandable to 512 K bytes thru Bank Selecting. 64K x 8 \$750.00.

CI-1103 — 16KB to 64KB on a single dual height board. On board hidden refresh. Plugs directly into LSI 11/2, H11 or LSI 11/23. Addressable in 2K word increments up to 256 K Bytes. 8K x 16 \$390.00. 32K x 16 \$750.00.

CI-6800 — 16KB to 64KB on a single board. On board hidden refresh. Plugs directly into EXORciser I and compatible with Rockwell's System 65. Addressable in 4K increments up to 64K. 16K x 8 \$390.00. 64K x 8 \$750.00.

CI-8080 — 16KB to 64KB on a single board. Plugs directly into MDS 800 and SBC 80/10. Addressable in 4K increments up to 64K. 16 KB \$390.00. 64K \$750.00.

Test and burned-in. Full year warranty.



Chrislin Industries, Inc.

Computer Products Division

31352 Via Colinas • Westlake Village, CA 91361 • 213-991-2254



The line your reputation should be on.

When a computer supplier or retailer sells equipment, his reputation is on the line.

And when the customer has to justify his investment decision, his reputation is on the line too.

So, naturally, everybody's a lot better off on a reliable line. Like ours.

With a name like Industrial Micro Systems, we wouldn't think of building anything short of industrial standards... even our S-100 products.

No short cuts or jumpers.

All of our boards — CPU, memory and controllers — are made from real fiberglass instead of a plastic substitute. And contacts are gold plated over a copper-nickel barrier of nickel.

Every disk enclosure features a heavy-gauge steel chassis, and a heavy duty power supply. Built to take it.

Then come our complete systems. Aside from the disk drives, we manufacture every component that goes into them. Even the desk that goes around them. So

we can vouch for rugged reliability inside and out.

Two complete systems:

Our new Series 5000 features a megabyte of storage on integral mini-floppies. And our Series 8000 is all business too. It can handle up to three megabytes on 8-inch drives. A large library of software, growing daily, includes CP/M,* PASCAL, and FAMOS.**

Breaking the 64k barrier.

Using Industrial Micro Systems 32k memory boards with Memory Management, our systems can handle up to 576k RAM internally.

More in store.

That's not the end of the line. It's growing all the time, along with our reputation for quality. Put your reputation on the line. Our line.

For more details just call or write. Supplier/dealer inquiries welcomed.

Industrial Micro Systems, 628 N. Eckhoff, Orange, CA 92668. (714) 978-6966

INDUSTRIAL MICRO SYSTEMS

The great unknown.

power and cross-spectral density functions, and introductions to new methods in spectral analysis and rotating machinery analysis. For more information, contact UCLA Extension, 10995 Le Conte Ave, Los Angeles CA 90024.

March 20

Electronic Road Shows, Castaways Restaurant, Burbank CA. This traveling exhibition of components, materials, and instruments is being produced by the Electronic Representatives Association (ERA). Over eighty ERA member firms will participate, and products from over 700 electronic companies will be displayed. For more information, contact the Southern California ERA office 20969 Ventura Blvd, Suite 9, Woodland Hills CA 91364.

March 24-26

Data Entry Management and Supervision Seminar, Cherry Hill NJ. This course deals with the practical aspects of data entry, and the problems encountered that are common to supervisors and managers. Concepts, techniques, motivation, training, and productivity will be covered. The fee is \$415 for subscribers of MIC publications and \$445 for non-subscribers. For more information, contact MIC, 140 Barclay Ctr, Cherry Hill NJ 08034.

March 24-28

Fourth European Conference on Electrotechnics, Stuttgart. This conference will review recent developments, trends, and applications in the field of microelectronics. Microprocessors, computer communication, industrial electronics applications of microelectronics in the automobile and in medicine, and other topics will be covered. The conference language will be English. Contact Professor Dr W E Proebster, IBM Deutschland

GmbH, Postfach 80 08 80, D-7000 Stuttgart 80 GERMANY (BRD).

March 26-28

Viewdata '80, Wembley Conference Centre, London England. Viewdata 80 is an international exhibition and conference on video-based systems and microcomputer industries. The British Post Office is presenting the Prestel Show which is about electronic mail services.

Contact TMAC, 680 Beach St, Suite 428, San Francisco CA 94109.

March 30

Greater Baltimore Hamboree and Computerfest, Maryland State Fairgrounds, Timonium MD. Personal, dealer, and small business computer displays and exhibits will be featured. Space is available outside for tailgate sales and swaps. For more information, contact Joseph Lochte Jr, 2136 Pine Valley Dr, Timonium MD 21093.

March - June

Computer and Office Systems Expo and Conference. This is an exposition for marketers of office systems equipment. The show and conference will focus on the local problems and opportunities of each region. The exposition and conference will be held in major cities around the nation. Contact The Conference Co, 60 Austin St, Newton MA 02160, or phone (617) 964-4550.

APRIL 1980

April 1 and 2

Southeast Printed Circuits and Microelectronics Exposition, Sheraton-Twin Towers Convention Center, Orlando FL. This show is a specialized event devoted entirely to the packaging, production and testing of printed circuits, multilayers, semiconductor devices, and hybrids

in the Southeast. Conferences are aimed at electronics specialists. Contact ISCM, 222 W Adams St, Chicago IL 60606.

April 9-11

The Practical APL Conference, Washington DC. This conference is addressed to business executives and systems designers. For more information, contact Joan Gurgold, STSC, 7 Holland Ave, White Plains NY 10603.

April 9-11

International Conference on Acoustics, Speech and Signal Processing, Fairmont Hotel, Denver CO.

The IEEE Acoustics, Speech and Signal Processing Society is sponsoring this conference devoted to experimental and theoretical aspects of signal processing, speech, and acoustics. For more information, contact IEEE, 1100 14th St, Denver CO 80202.

April 11-12

10th Annual Virginia Computer Users Conference. This conference is sponsored by the Virginia Tech ACM student chapter. The topics of discussion will be programming languages and system and personnel management. For more information, contact VCUC10, 562 McBryde Hall, VPI&SU, Blacksburg VA 24061.

April 13-16

A Gateway to the Use of Computers in Education, Chase Park Plaza Hotel, St Louis MO. The purpose of this convention is to provide a forum for the exchange of information and ideas between individuals, to inform educators of developments in computer technology, and to expose participants to innovations in computing which can be utilized in the field of education.

Educators are encouraged to exhibit and make presentations of instructional microprocessor materials

during the convention. Contact the Association for Educational Data Systems (AEDS), POB 951, Rolla MO 65401.

April 14-18

High-Speed Computer Organization, 6266 Boelter Hall, UCLA Extension, Los Angeles CA. This course is for computer designers, system architects, project leaders and managers. The course provides an understanding of the principles of high-speed computer organization and their use in cost-effective systems. Several commercial and paper high-speed computers are presented and compared.

For more information, contact UCLA Extension at POB 24901, Dept K, UCLA Extension, Los Angeles CA 90024.

April 21-25

National Micrographics Association 29th Annual Conference and Exposition, Sheraton Center Hotel and Coliseum, New York NY. The theme for the show is "Focus on Productivity in Office Management." Highlighting the conference and exposition will be presentations and talks concerning the use in offices for computer systems and related items.

For more information, contact the Conference Dept, National Micrographics Association, 8719 Colesville Rd, Silver Spring MD 20910.

April 23-25

International DP Training Conference, Hyatt Regency, Chicago IL. The theme for this event will be "The 1980s: The Information Decade." The conference is a symposium for data processing experts and corporate training executives. For information, contact Deltak Inc, 1220 Kensington Rd, Oak Brook IL 60521. ■

MICROSOFT CONSUMER PRODUCTS CONTINUING THE MICROSOFT TRADITION

Microsoft set the standard in microcomputer system software. We know more about the structure and capabilities of today's microcomputers than anyone else. And now we're using that power in a whole new way!

Announcing Microsoft Consumer Products. Distinctive software packages backed by the Microsoft name. Each is created by a top-notch programmer and comes to you fully documented, at a cost you can afford.

Microsoft Editor/Assembler-Plus.* Now get every feature of Radio Shack's Editor/Assembler and T-Bug all in one package. PLUS—many "big computer" features to simplify your programming, editing and debugging. All in a low cost cassette package. Don't waste time creating both source and object tapes—Assembler-Plus assembles directly into memory. Supports macros and conditional assembly, too. Editor-Plus simplifies editing with extra commands like Substitute, Move, Copy and Extend. And Z-Bug,** the most powerful debugger ever available for the TRS-80, has single step execution, direct execution in calculator mode and symbolic references. And, you can use up to 8 breakpoints at a time, with no need to remove a breakpoint before proceeding. For the 16K, Level II, cassette TRS-80. Priced at \$29.95.

Microsoft Adventure. Only Microsoft offers Adventure complete, as originally written for the DEC PDP-10, now implemented on personal computers. The ultimate fantasy/logic game, Adventure allows you to explore the depths of the "Colossal Cave," collecting treasures and magic, solving puzzles, avoiding hazards and adversaries—including the dreaded killer dwarves. Don't be fooled by imitation or incomplete versions. Only Microsoft has it all. Adventure fills an entire disk with everything you need for your exploration. Written by Gordon Letwin, of SOFTWIN, Associates. Adventure for the TRS-80 requires a single-disk, 32K system. For the Apple II,** a single-disk, 32K system with either the standard disk or language card system. For just \$29.95.

Microsoft Typing Tutor. There's no easier way to master your keyboard! Faster and more efficient than any other teaching method, Typing Tutor helps you if you're starting from scratch or simply building speed. The secret lies in Typing Tutor's exclusive TRM™ or "Time Response Monitoring" software. TRM monitors your keyboard 20 times per second so the computer can evaluate your skill. Your speed. Your errors. Your weakest keys. Typing Tutor tells you where you stand then automatically adjusts itself to help you improve. Written by Dick Ainsworth and Al Baker of the Image Producers, Inc. For the Apple II with 16K and Apple BASIC or the TRS-80 with 16K and Level II BASIC. Priced at \$14.95.

Microsoft Level III BASIC. Upgrade your Level II TRS-80 and increase your programming efficiency without additional hardware. Microsoft Level III loads from cassette tape on top of the Level II ROM. It gives you every feature of Disk BASIC except disk file commands. But that's not all—Level III's high-speed graphics turn your TRS-80* into a virtual electronic drawing board. And there's program renumbering, long error messages, quick shift-key entries, time-limit INPUT statements and many more features. System requirements: Level II BASIC and 16K. Occupies 5.2K RAM. Priced at \$49.95.

Where To Buy. Microsoft Consumer Products are sold by computer retailers nationwide. If your local computer store doesn't have them, call us. Phone (206) 454-1315. Or write Microsoft Consumer Products, 10800 Northeast Eighth, Suite 819, Bellevue, WA 98004.

*TRS-80 is a trademark of Radio Shack Corp. **Apple II is a trademark of Apple Computer, Inc.™ Editor/Assembler-Plus and Z-Bug are trademarks of Microsoft. TRM is a trademark of The Image Producers, Inc.



MICROSOFT

CONSUMER PRODUCTS

Ken Bowles'
Current Activities:
Training in Pascal...
notes by C Helmers

In the last year or so, we have been placing much emphasis on the computer language Pascal, with particular attention to the University of California at San Diego (UCSD) system which, by being available, has become a de facto standard for small-computer, Pascal-oriented systems software. Dr Kenneth Bowles of UCSD was the originator of the project which generated the UCSD system, and he is its prime mover.

As a professor of Computer Science and Electrical Engineering at UCSD, Dr Bowles has been instrumental in the implementation of Pascal on small computers, starting with the LSI-11-based Terak machine, and now including all the major 8-bit microprocessor designs. Since its inception in 1974, UCSD Pascal has been licensed to more than 1000 individuals and organizations. With the recent availability on the Apple II, North Star Horizon, and other major personal computer systems, the UCSD software has become a major, machine-independent, industry-wide standard for an operating system and compiler. Due to the nonprofit status of the University of California, the system has been recently spun off to an independent software company, Softech Micro Systems of San Diego, California.

Dr Bowles' purposes in developing the UCSD Pascal system included the desire to make widely available a convenient and machine-independent structured programming language and operating system. The non-



Photo 1: *The hands-on aspect of Ken's Integrated Computer Systems continuing education course on Pascal is provided by use of a number of portable computers such as the Apple II Pascal system. Ken is shown here demonstrating a point to some students.*

commercial intellectual success of the Bell Laboratories UNIX operating system, with its language C, was doubtlessly an inspiration for the UCSD concept of a machine-independent operating system and language. As a teaching device in schools and universities, the intellectual popularity of the Pascal language was part of the reason for choosing it as a suitable vehicle for widespread teaching of programming concepts and convenient application programming. Also key to the choice of Pascal as a language to

pursue was the fact that its originators, Niklaus Wirth and Kathleen Jensen, had designed a concise but robust high-level language which was first (and most typically) implemented through the highly machine-independent technique of simulating a virtual "P-machine" on conventional machines. The rest is history. An operating system with many interactive features, editors and file management programs was written in Pascal along with the compiler; the code was made available and when the response got too large

for the university's "non-profit" political environment, the system's marketing and maintenance operations were assigned to a commercial company.

Ken is now participating in the continuing education programs of a company called Integrated Computer Systems Inc. This company specializes in intensive training courses given in major cities, as a sort of traveling road show intended for potential users of high-technology tools such as the Pascal language. Ken's course is designed for engineers, scientists and programmer/analysts who plan to use Pascal for the development of software systems. The class features exercises involving text processing, interactive data collection, dynamic graphic display and real-time control applications. Class sizes are strictly limited to (typically) 36 students in order to provide maximum hands-on activity.

The course is operated for four days (Tuesday thru Friday). Each attendee receives a diploma and one Continuing Education Unit for each 10 hours of participation. The Continuing Education Unit is a nationally recognized credit awarded by universities and educational organizations for participation in such programs. (Scheduled time each day of the four-day schedule is from 9 AM to 6 PM, so in principle one could obtain 3.6 such units from the course given attendance of the full four-day schedule.) The price is \$795 including all materials, luncheons and coffee breaks. The following dates are presently scheduled:

San Francisco CA:
February 12-15, 1980

PUTTING IT ALL TOGETHER



INVENTORY CONTROL

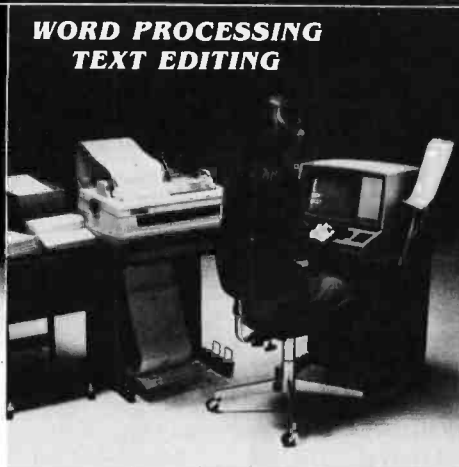

**WORD PROCESSING
TEXT EDITING**

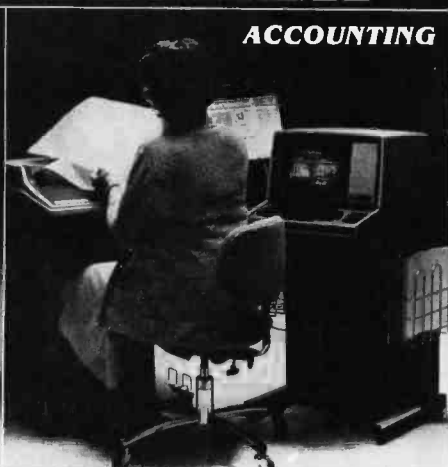

ACCOUNTING

Four-User North Star Horizon with 29 Megabyte Hard Disk Interface

INCLUDING:

48K RAM per user
Two 360K 5 1/4" disk drives (as many as four, optional)

Two printers:

One Texas Instruments TI 810 dot matrix, 150 character per second, bi-directional, tractor feed printer with all available options
One NEC Spinwriter 5510 document quality, full-character printer with friction feed and tractor feed
Deluxe printer stands and paper trays for both printers

One Discus 29 megabyte (26 megabyte formatted) Winchester technology, fixed hard disk unit with controller, cabinet, power supply, all cables, ports and connectors, completely interfaced to DOS and BASIC, CP/M, PASCAL and Micro Mike's interrupt-driven, bank-switching timesharing (as many as four 29 megabyte hard disk units, seven users, optional)

One custom computer/hard disk desk, Executive model, three CRT stands, thirty 5 1/4" diskettes

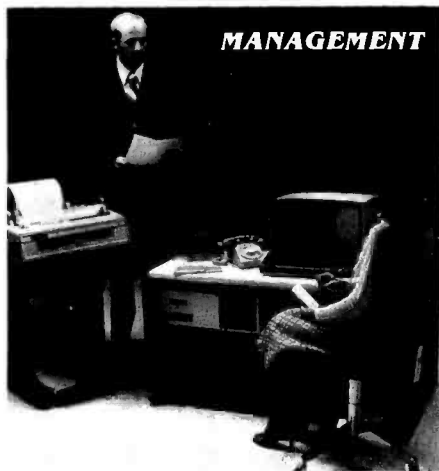

MANAGEMENT

*Micro Mike's, Incorporated Program Library Membership, including:

- General Ledger
- Accounts Receivable
- Accounts Payable
- Inventory
- CSUB (Common SUBroutines)
- Payroll
- Mail list
- Word Processing/Text Editing
- Project Cattle Profits
- Timesharing
- DOSCHG (eight inch drive interface to DOS and BASIC)
- Commodities Charts

and many outstanding utilities programs and public domain software

*All programs available separately.
Total System \$23,719

Micro Mike's, Inc. thoroughly "burns in" and tests all systems delivered as *integrated hardware/software systems*, under timesharing conditions, the ultimate test of a complete computer system. This "burning-in" and testing procedure continues, non-stop, for a minimum of three days and nights, insuring the end user the highest quality, trouble-free integrated hardware/software system possible.

Micro Mike's, Inc. will, for a fee, deliver and set up a system anywhere in the USA. Personal user training and/or custom programming is also available.

*Complete North Star
Horizon Service Center
Call or write for
descriptive literature*

making technology uncomplicated . . . for People



Discus 29 megabyte Winchester technology fixed, sealed hard disk units completely interfaced to DOS and BASIC, CP/M and PASCAL for most S-100 buss computer systems, ready to go, including controller, cabinet and power supply, all cables, ports and connectors \$5,495

Additional 29 megabyte drive, cabinet and power supply \$4,495



Micro Mike's, Inc. offers a complete selection of top-notch business software. Among comprehensive programs are:

- Time and Expense package for accountants, attorneys, and other professionals
- Patient Daily Record Program (Doctor/Patient Ledger) for Physicians
- Land Subdivision package
- Pharmacy
- Motel Reservation with Night Audit
- Banker's Trust
- Feedlot
- Oil/Gas Producer's package
- many more



IN STOCK:

North Star Horizons
Discus double density or quad capacity eight inch drives for S-100 buss systems

Printers: Texas Instruments TI 810, NEC Spinwriter, IDS-440 Paper Tiger

Armadillo Armor 5 1/4" protective diskette shipping cartons . . . \$45 per hundred

Used Intertec Intertube CRTs, as-is condition, close-out. \$495

Mike's

MICRO MIKE'S, INCORPORATED
905 South Buchanan
Amarillo, Texas 79101 U.S.A.
806-372-3633

FOR YOU YOUR WIFE YOUR CHILD YOUR HOME YOUR SCHOOL YOUR BUSINESS

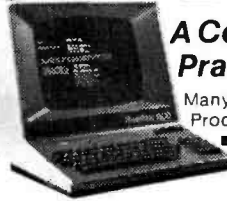

A Computer System Both Practical and Affordable!

- Many uses for your computer. ■ Word Processing ■ Accounting ■ Bookkeeping
- Games ■ Personal Records ■ Menu Planning ■ Educational Development
- Tax Preparation ■ Homework, etc.

BYTE SHOP EAST offers a wide selection of hardware to meet your specific needs; SORCERER, PET, APPLE, NORTH STAR, IMSAI, DIGITAL, and many, many others. BYTE SHOP EAST has a complete library of books and magazines to meet your needs.

Come in to our computer stores for a FREE demonstration!

BYTE SHOP EAST, INC

130 East 40th St.
(Corner of Lexington Ave.)
New York 10016
Tues.-Fri. 10 - 6 Sat. 10 - 5
(212) 889-4204

2721 Hempstead Turnpike
(Just East of Wantagh Pkwy)
Levittown, N.Y. 11756
Tues.-Fri. 12 - 8 Sat. 10 - 5
(516) 731-8116

New Robotype™

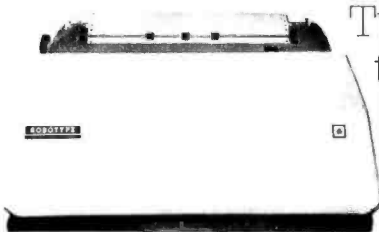

Turns your typewriter into a quality output printer!

- easily connects to any computer
- serial and parallel interface
- all electronics included—ready to use from package
- connects to IBM Selectric II typewriter in just one minute
- adapts to a variety of typewriters—no modifications
- compatible with Radio Shack TRS-80, Apple II, Pet, etc.
- Centronics interface compatible
- available from stock in 30 days

Put a Robotype to work on your typewriter for under \$1,000. Call (614) 436-3163 today!
Dealer, distributors, and word processor OEM inquiries welcome.

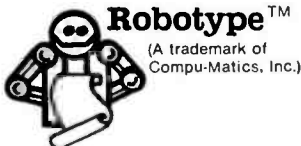

Robotype™
(A trademark of Compu-Matics, Inc.)

Applied Computer Systems, Inc. 

77 East Wilson Bridge Road • Worthington, Ohio 43085

Washington DC:
March 4-7, 1980

Los Angeles CA:
March 11-14, 1980

Atlanta GA:
March 18-21, 1980

Houston TX:
April 15-18, 1980

Boston MA:
April 29-May 2, 1980

San Diego CA:
May 6-9, 1980

For further information and enrollment forms, contact Integrated Computer Systems Inc, 3304 Pico Blvd, Santa Monica CA 90405, or phone (213) 450-2060.

Call for Papers—1980 LISP Conference

A call for papers has been announced for the August 24 thru August 27 LISP Conference at Stanford University. The topics should cover languages and theory, programming aspects, architecture, and applications of LISP. Other related items are welcome. Authors are requested to send four copies of a full draft paper not exceeding 4500 words, and a one-page abstract, by March 14, 1980 to the Conference Head. The abstract should provide sufficient detail to allow the committee to apply uniform criteria for acceptance. Authors will be notified of acceptance or rejection by May 16, 1980. For inclusion in the proceedings, final papers are due by June 27, 1980. Send papers to John R Allen, Stanford Artificial Intelligence Lab, Stanford University, Stanford CA 94305, or phone (415) 497-4971 for further details.

Bulletin Board Notes

A computerized bulletin board system (CBBS) is now in operation in Cambridge Massachusetts, thanks to the diligent labors of David Mitton and other members of

the New England Computer Society. Running the CBBS code written by Ward Christensen and Randy Suess on a Processor Technology Sol-20, the system is available around the clock. Two data rates are supported, 110 and 300 bits per second (bps). The telephone number to access the system is (617) 864-3819.

A description of a CBBS appeared in the article "Hobbyist Computerized Bulletin Board," by Christensen and Suess, in the November 1978 BYTE, page 150.

Call a Computer for Computers

If you want to purchase computer equipment, software, terminals, supplies, or any other related equipment, call (813) 885-4811 and talk to a computer. There is no charge but calls are limited to 3 minutes; however, if necessary, you can call again. There should be a listing of the items needed. To access the system: set your terminal for 300 bps operation, set the modem for full duplex originate operation, call (813) 885-4811, after the terminal is on-line enter any character and a carriage return. The system will respond "PLEASE LOG IN", then enter the string "HELLO-Z999," (only the characters underlined), then follow the directions on the terminal to search the file.

To place a listing with the service, contact Basic Online Software Systems Corp, POB 22412, Tampa FL 33622.

Cafeteria Chain Pioneers Computerized Cost Control of Recipes

A chain of cafeterias serving the Los Angeles public has developed a restaurant menu-planning system to minimize the effects of rapid inflation and skittish agricultural commodity prices.

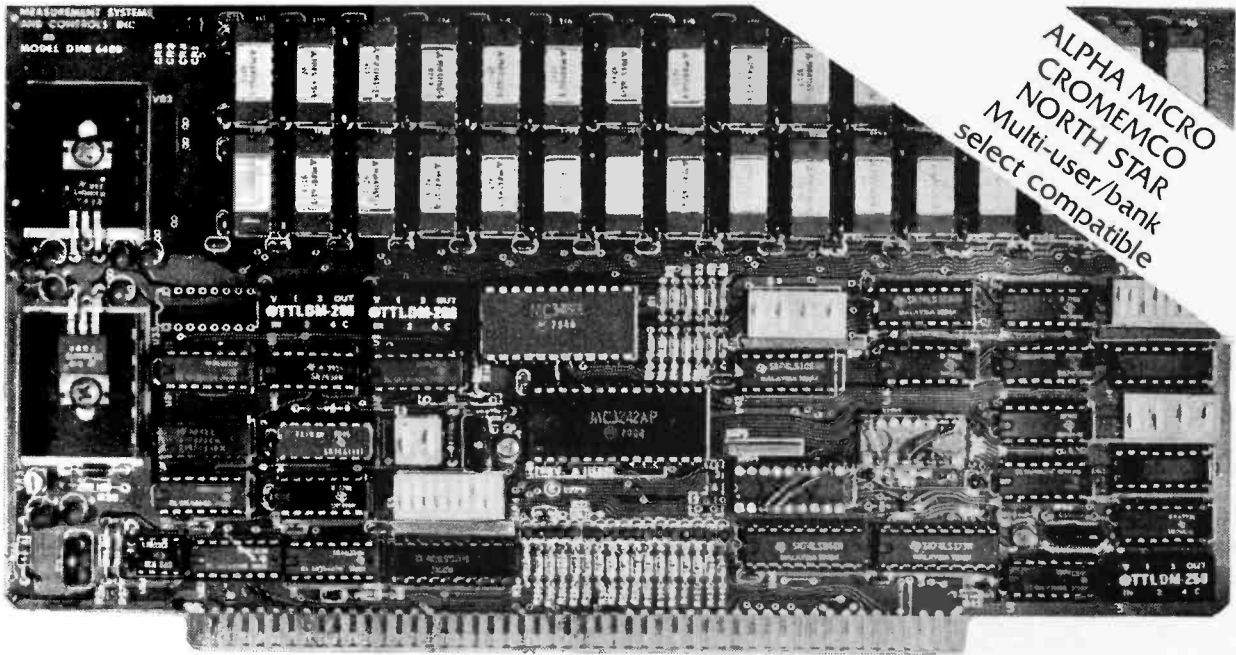

Model DMB-6400 Series dynamic 64k byte RAMS incorporate the features which are standard in the DM-6400 Series and adds bank select for multi-user-timesharing applications.

- ALPHA MICRO, CROMEMCO, and NORTH STAR output port bank select.
- Memory bank size can be incremented to 64k bytes in 16k increments.
- Four (4) 16k byte, functionally independent memory banks.
- Eight (8) 64k byte banks of memory per output port for expansion to 512k bytes for each output port.

Model DM-6400 Series dynamic 64k memory boards feature IEEE S-100 compatible timing and on board transparent refresh.

- Memory selectable and deselectable in 4k byte increments.
- 25 MHz on board crystal oscillator for independent timing.

DMB-6400 and DM-6400 Common Features:

- 4 MHz Z80 operation with no wait states.
- Tested and burned-in.
- Low power- 8 watts maximum.
- Reliable, expandable memories.

ONE YEAR GUARANTEE

THE FOLLOWING PRODUCTS ARE AVAILABLE

- | | | | |
|---|---|--|--|
| <input type="checkbox"/> DMB-6400/64K RAM | <input type="checkbox"/> DMB-3200/32K RAM | <input type="checkbox"/> DM-6400/64K RAM | <input type="checkbox"/> DM-3200/32K RAM |
| <input type="checkbox"/> DMB-4800/48K RAM | | <input type="checkbox"/> DM-4800/48K RAM | |

ATTRACTIVELY DISCOUNTED OEM AND DEALER QUANTITY PRICES AVAILABLE

U.K. & EUROPEAN REPRESENTATIVE:
 ABACUS COMPUTERS LTD.
 62, NEW CAVENDISH STREET
 LONDON, W1M 7LD U.K.
 TEL: 01-580/8841 TELEX: 881-3085

AUSTRALIAN REPRESENTATIVE:
 COMPUTERLAND OF MELBOURNE
 555 COLLINS STREET
 MELBOURNE, VIC3000
 TEL: 625581

MEASUREMENT
 systems & controls
 incorporated

867 North Main Street • Orange, CA 92668
 Telephone: 714/633-4460

The menu planners at Clifton's Cafeterias enter current commodity pricing information into a Data General Corp computer system, and obtain the exact cost for each of 2500 recipes possible on Clifton's menus.

The CS/40 system has reduced the menu recost time from 9 months to 6 hours and could save the cafeteria chain about \$50,000 annually. In addition to the food purchasing and recipe maintenance, the system can handle the

payroll for 600 employees and do accounts payable, a general ledger and a cash journal. The system includes a printer, four video terminals, a magnetic tape drive and a potential 250 K bytes of memory storage on the disk drives.

The CS/40 business system has reduced errors, provided current information, and has allowed for more interesting and more varied menus.

Contact the P R Dept, Data General Corp, Rt 9,

Westboro MA 01581, for more information.

Chicago Library Offers Public Computers and a Computerized Reference Service

To permit the public to experience computer-assisted instruction (CAI), to perform basic computer routines and to gain experience in programming, microcomputers have been installed in the Business/-

Science/Technology Division of the Central Library, the Popular Library in the Cultural Center, the Woodson Regional Library, and the Lincoln Park Branch, all agencies of the Chicago Public Library.

The system includes video displays, software, training manuals, but no printers. It runs on BASIC, and has 8 K bytes of programmable memory. Engineers, businessmen, students developing chess skills, and people balancing their checkbooks have been using the devices. If usage increases substantially, the Library will consider the purchase of additional units for other branches in the library system.

Their other service provides millions of references to books, periodicals, reports, all on a wide range of subjects. Where manual research can take hours or even days, the computerized service can reduce to only a few minutes the time usually required for a thorough research study. For this service, the first 5 minutes of computer time are free and each additional minute costs \$1.50. Contact the Business/Science/Tech- nology Division in the Central Library at 425 N Michigan Ave, Chicago IL 60611, or call (312) 269-2915.

Apple Education Foundation Advances Learning Methods Through Microcomputers

Initially funded by Apple Computer, the nonprofit foundation will offer support and resources to organizations and individuals who are pioneering learning methods through the use of microcomputers. Funding authorizations through 1980 are valued in excess of \$250,000. The foundation will distribute hardware equipment for both developmental and demonstration projects involved in producing instructional computing materials. The foundation's primary

YOU THINK YOU'VE SEEN WORD PROCESSING SOFTWARE?

The **MAGIC WAND**TM Word Processing System offers you the best features of any system in the micro market

FEATURES INCLUDE:

- Full-screen text editor
 - Simple, control key operation
- Edit programs as well as text
 - Assemble, compile or run programs without modification
- Files larger than memory
 - Files up to 256K
- Library files
 - Merge part or all of one file with another
- Spool printing
 - Print a file while editing another
- Easy page formatting
 - Simple commands set margins, page length, etc.
- Override commands at run-time
 - Give any command from the keyboard as well as in file
- Variable pitch control
 - Change pitch in mid-line, even mid-word
- Up to 128 user-defined variables
 - String, numeric or dollar format
- Form letter generation from external data files
 - Compatible with both sequential and fixed-record files
- Conditional commands
 - Any command may be conditional
- Print to disk and/or printer
 - Save all or part of output on disk
- Switch from specialty printer to CP/M list device
 - Print the same file on either specialty or standard printer

EASE OF OPERATION

With all its power, the MAGIC WAND is remarkably easy to use. This is no accident. The command structure is designed to be flexible and logical so that you can perform basic functions with a minimum of commands.

We have included in the manual a step-by-step instructional program, for the person who has never used a word-processor before. The trainee uses sample files from the system disk and compares his work to simulated screens and printouts.

In addition to the lessons, the manual has a complete documentation of the command structure, special notes for programmers, an introduction to CP/M for non-programmers and a glossary. The manual is typeset, rather than typewritten, for greater legibility.

We have written the manual in non-technical English, because we want you to read it. We don't overload you with a bunch of jargon that could confuse even a PhD in Computer Sciences.

We send out newsletters so that users of the MAGIC WAND can learn special applications of the print commands. For example, we might show you how to create a mailing list or set up an index for a file.

In short, we've done everything we can to make things easy for you. Because the best software in the world is just a bunch of code if you can't use it.

For more information, call or write:

small business applications, inc.

3220 Louisiana • Suite 205 • Houston, Texas 77006 • 713-528-5158

CP/M is a registered trademark of Digital Research Corp.

TIME after TIME

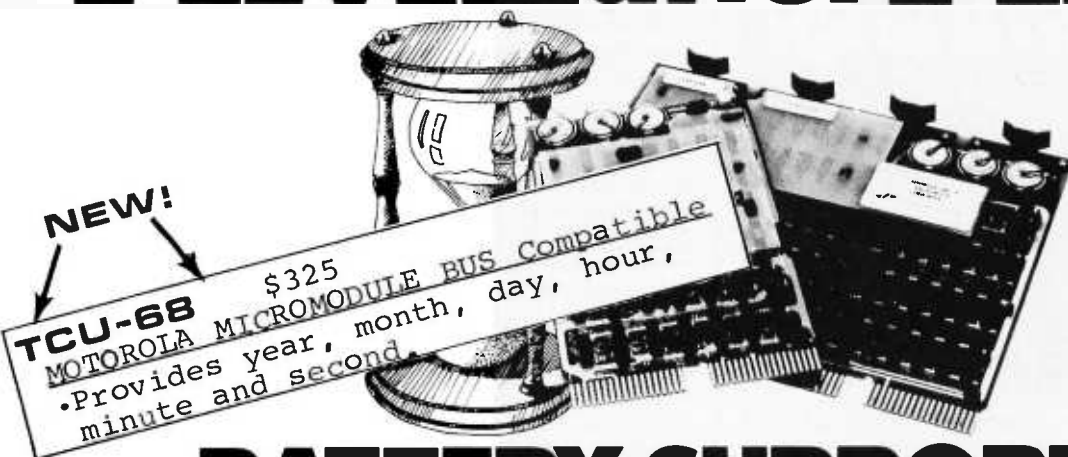

BATTERY SUPPORTED CALENDAR CLOCKS

PDP-11*

TCU-100 • \$495

- Provides month, day, hour, minute and second.
- Can interrupt on date/time, or periodic intervals.

TCU-150 • \$460

- Provides year, month, day, hour, minute and second.
- Automatic leap year.
- Patches for RSX-11M, RT-11 FB/SJ VO2, VO3 and UNIX.

LSI-11/2*

TCU-50D • \$325

- Provides month, day, hour, minute and second.
- Dual size board.
- Patches for RT-11 SJ/FB VO2, VO3B.

Lockheed SUE

TCU-200 • \$550

- Provides year, month, day, hour, minute, second and milli-second.
- Interval interrupts between 1/1024 seconds and 64 seconds.

Computer Automation (Naked Mini)

TCU-310 • \$385

- Provides year, month, day, hour, minute and second.

*Trademark of Digital Equipment Corporation

Multi-Bus**

TCU-410 • \$325

- Provides year, month, day, hour, minute and second.
- SBC/BLC compatible.

HP 2100

TCU-2100 • \$395

- Correct time restored after power failure.
- Compatible with the HP TBG card.

Serial Clock (RS 232 or 20 mA)

SLC-1 • \$640

- Connects between any terminal and host computer.
- Provides date, time and more!

All Digital Pathways TCUs have on board NICAD batteries to maintain time and date during power down. Timing is provided by a crystal controlled oscillator. Prices are U.S. domestic single piece. Quantity discounts available.

For more information on these products, contact:
Digital Pathways Inc.
4151 Middlefield Road
Palo Alto, CA 94306
Phone: (415) 493-5544

**Trademark of Intel Corporation

***Trademark of Computer Automation Incorporated



DIGITAL PATHWAYS

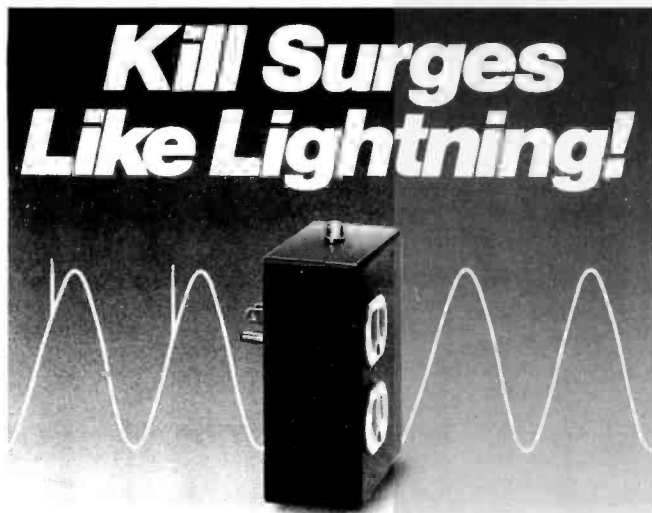

Surge Sentry 120 works in parallel with the power line to shunt destructive power surges in less than 1 nanosecond! Triggers at 10% above the nominal peak voltage. Plugs into any standard 120-volt outlet for immediate protection.

Ideal for small computers, communications, medical, and other sensitive electronic equipment. Suggested retail price \$89.50. OEM model also available. Call or write:

RK = R&K Enterprises

643 South 6th Street, San Jose, CA 95112
(408) 288-5565.

Dealer inquiries invited.

DEC LSI-11 Components

Dependable service
at discount prices

Domestic
and Export

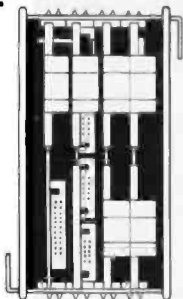

Mini Computer Suppliers, Inc.

25 Chatham Rd., Summit, N.J. 07901
Since 1973

(201) 277-6150 Telex 13-6476

©Mini Computer Suppliers, Inc.
1979

goal is to place hardware into the hands of people who will further those educational methods that best take advantage of the personal microcomputer's capabilities.

As continuing evidence of its commitment to education, the foundation will sponsor the Education Program Information Center (EPIC). EPIC will support microcomputer users in developing new instructional programs and in obtaining available information on educational materials. Authors are encouraged to submit their work to the center for review and feedback on the most effective uses and placements of their materials.

Both the Apple Education Foundation and EPIC may be contacted through the Apple Education Foundation, 20605 Lazaneo Dr, Cupertino CA 95014.

AIDs for Apple Dealers

AIDs (Apple Independent Dealers) was formed by and for independent Apple dealers, ie: those dealers with no direct contractual agreement or connection with any national chain or franchise. AIDs will provide a framework for improved communication, education, and support to its members, which will also be of benefit to consumers. This will include sharing of information on new software and hardware evaluations, successful marketing and problem solving, advertising ideas and more.

Full membership for qualified dealers is \$35 per year. For more information, contact Harry Sweeney, (503) 228-5242 or send a self-addressed, stamped envelope to AIDs, POB 06126, Portland OR 97206.

Report Studies Threat to Auto Electronics from Electric Fields

With the increased use of electronic control systems in automobiles, there is con-

cern about possible malfunction or deterioration of function due to ambient electrical fields created by radio and television transmitters, high-powered radar, power transmission lines, or lightning strokes.

Researchers at the National Telecommunications and Information Administration (NTIA) have surveyed sources emanating energy across the radio-frequency portion of the electromagnetic spectrum. Their report indicates that vehicles might sometimes — although rarely — be exposed to radio-frequency fields of 5 kV per meter which may cause the vehicle to become inoperative or may even damage its electronics.

The report is available from the National Technical Information Service, 5285 Port Royal Rd, Springfield VA 22161 for \$4.50. The accession number is PB 294-819/AS. For further information, contact NTIA Office of Congressional and Public Affairs (202) 377-1832. ■

BYTE's Bugs

Correct Reversi Termination

I would like to point out a programming error in "Reversi," which was published in the November 1979 BYTE, on page 76. The problem with the program is that it recognizes the end-of-game criterion too early, allowing the occurrence of a player not having a move only twice throughout the length of the game. This is due to the fact that counter-variable T3 is never re-initialized when a player is able to move. I recommend insertion of the following code: 296 LET T3=0.

Darrell Pittman
4225 Forest Dr
Port Arthur TX 77640 ■

By Netronics

ASCII/BAUDOT, STAND ALONE

Computer Terminal

COMPLETE FOR ONLY \$149⁹⁵

The Netronics ASCII/BAUDOT Computer Terminal Kit is a microprocessor-controlled, stand alone keyboard/terminal requiring no computer memory or software. It allows the use of either a 64, or 32 character by 16 line professional display format with selectable baud rate, RS232-C or 20 ma. output, full cursor control and 75 ohm composite video output.

The keyboard follows the standard typewriter configuration and generates the entire 128 character ASCII upper/lower case set with 96 printable characters. Features include onboard regulators, selectable parity, shift lock key, alpha lock jumper, a drive capability of one TTY load, and the ability to mate directly with almost any computer, including the new Explorer/85 and ELF products by Netronics.

The Computer Terminal requires no I/O mapping and includes 1k of memory, character generator, 2 key rollover, processor controlled cursor control, parallel ASCII/BAUDOT to serial conversion and serial to video processing—fully crystal controlled for superb accuracy. PC boards are the highest quality glass epoxy for the ultimate in reliability and long life.

VIDEO DISPLAY SPECIFICATIONS

The heart of the Netronics Computer Terminal is the microprocessor-controlled Netronics Video Display Board (VID) which allows the terminal to utilize either a parallel ASCII or BAUDOT signal source. The VID converts the parallel data to serial data which is then formatted to either RS232-C or 20 ma. current loop output, which can be connected to the serial I/O on your computer or other interface, i.e., Modem.

When connected to a computer, the computer must echo the character received. This data is received by the VID which processes the information, converting it to video suitable to be displayed on a TV set (using an RF modulator) or on a video monitor. The VID generates the cursor, horizontal and vertical sync pulses and performs the housekeeping relative to which character and where it is to be displayed on the screen.

Video Output: 1.5 P/P into 75 ohm (EIA RS-170) • Baud Rate: 110 and 300 ASCII • Outputs: RS232-C or 20 ma. current loop • ASCII Character Set: 128 printable characters—

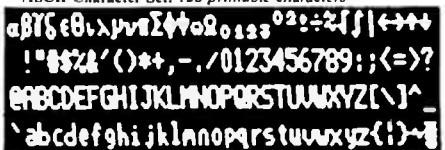

BAUDOT Character Set: A B C D E F G H I J K L M N O P Q R S T U V W X Y Z - ? * 3 S H () , . 0 1 4 1 5 7 ; 2 / 6 8 • Cursor Modes: Home, Backspace, Horizontal Tab, Line Feed, Vertical Tab, Carriage Return. Two special cursor sequences are provided for absolute and relative X-Y cursor addressing • Cursor Control: Erase, End of Line, Erase of Screen, Form Feed, Delete • Monitor Operation: 50 or 60Hz (jumper selectable).

Continental U.S.A. Credit Card Buyers Outside Connecticut

CALL TOLL FREE 800-243-7428

To Order From Connecticut Or For Technical Assistance, Etc. Call (203) 354-9375

Netronics R&D Ltd., Dept. PE-9
333 Litchfield Road, New Milford, CT 06776

Please send the items checked below—

- Netronics Stand Alone ASCII Keyboard/Computer Terminal Kit, \$149.95 plus \$3.00 postage & handling.
- Deluxe Steel Cabinet for Netronics Keyboard/Terminal In Blue/Black Finish, \$19.95 plus \$2.50 postage and handling.
- Video Display Board Kit alone (less keyboard), \$89.95 plus \$3 postage & handling.
- 12" Video Monitor (10 MHz bandwidth) fully assembled and tested, \$139.95 plus \$5 postage and handling.
- RF Modulator Kit (to use your TV set for a monitor), \$8.95 postpaid.
- 5 amp Power Supply Kit In Deluxe Steel Cabinet ($\pm 8VDC$ @ 5 amps, plus 6-8 VAC), \$39.95 plus \$2 postage & handling.

Total Enclosed (Conn. res. add sales tax) \$ _____

- By—
- Personal Check Cashiers Check/Money Order
- Visa Master Charge (Bank # _____)

Acct. # _____
Signature _____ Exp. Date _____

Print Name _____

Address _____

City _____

State _____ Zip _____

Send Me More Information

Start Computing For Just \$129.95 With An 8085-Based Professional Computer Kit—

Explorer/85

100% compatible with all 8080A and 8085 software & development tools!

No matter what your future computing plans may be, Level "A"—at \$129.95—is your starting point.

Starting at just \$129.95 for a Level "A" operating system, you can now build the exact computer you want. Explorer/85 can be your beginner's system, OEM controller, or IBM-formatted 8" disk small business system... yet you're never forced to spend a penny for a component or feature you don't want and you can expand in small, affordable steps!

Now, for just \$129.95, you can own the first level of a fully expandable computer with professional capabilities—a computer which features the advanced Intel 8085 cpu, thereby giving you immediate access to all software and development tools that exist for both the 8085 and its 8080A predecessor (they are 100% software compatible)—a computer which features onboard S-100 bus expansion—plus instant conversion to mass storage disk memory with either 5-1/4" diskettes or standard IBM-formatted 8" disks.

For just \$129.95 (plus the cost of a power supply, keyboard/terminal and RF modulator, if you don't have them already), Explorer/85 lets you begin computing on a significant level... applying the principles discussed in leading computer magazines... developing "state of the art" computer solutions for both the industrial and leisure environment.

Level "A" Specifications

Explorer/85's Level "A" system features the advanced Intel 8085 cpu, an 8355 ROM with 2k deluxe monitor/operating system, and an 8155 ROM I/O—all on a single motherboard with room for RAM/ROM/PROM/EPROM and S-100 expansion, plus generous prototyping space.

Level "A" makes a perfect OEM controller for industrial applications and is available in a special Hex Version which can be programmed using the Netronics Hex Keypad/Display.)

PC Board: glass epoxy, plated through holes with solder mask • I/O: provisions for 25-pin (DB25) connector for terminal serial I/O, which can also support a paper tape reader

...provision for 24-pin DIP socket for hex keypad/display... cassette tape recorder input... cassette tape recorder output... speaker output... LED output indicator on SOD (serial output) line... printer interface (less drivers)... total of four 8-bit plus one 6-bit I/O ports • Crystal Frequency: 6.144 MHz • Control Switches: reset and user (RST 7.5) interrupt... additional provisions for RST 5.5, 6.5 and TRAP interrupts onboard • Counter/Timer: programmable, 14-bit binary • System RAM: 256 bytes located at F800, ideal for smaller systems and for use as an isolated stack area in expanded systems... RAM expandable to 64k via S-100 bus or 4K on motherboard.

System Monitor (Terminal Version): 2k bytes of deluxe system monitor ROM located at F000 leaving 0000 free for user RAM/ROM. Features include tape load with labeling... tape dump with labeling... examine/change contents of memory... insert data... warm start... examine and change all registers... single step with register display at each break point, a debugging/training feature... go to execution address... move blocks of memory from one location to another... fill blocks of memory with a constant... display blocks of memory... automatic baud rate selection... variable display line length control (1-255 characters/line)... channelized I/O monitor routine with 8-bit parallel output for high speed printer... serial console in and console out channel so that monitor can communicate with I/O ports.

System Monitor (Hex Version): Tape load with labeling... tape dump with labeling... examine/change contents of memory... insert data... warm start... examine and change all registers... single step with register display at each break point, a debugging/training feature... go to execution address... move blocks of memory from one location to another... fill blocks of memory with a constant... display blocks of memory... automatic baud rate selection... variable display line length control (1-255 characters/line)... channelized I/O monitor routine with 8-bit parallel output for high speed printer... serial console in and console out channel so that monitor can communicate with I/O ports.

System Monitor (Hex Version): Tape load with labeling... tape dump with labeling... examine/change contents of memory... insert data... warm start... examine and change all registers... single step with register display at each break point, a debugging/training feature... go to execution address... move blocks of memory from one location to another... fill blocks of memory with a constant... display blocks of memory... automatic baud rate selection... variable display line length control (1-255 characters/line)... channelized I/O monitor routine with 8-bit parallel output for high speed printer... serial console in and console out channel so that monitor can communicate with I/O ports.

Netronics R&D Ltd., Dept. RE 10
333 Litchfield Road, New Milford, CT 06776

Please send the items checked below—

- Explorer/85 Level "A" Kit (ASCII Version), \$129.95 plus \$3 p&h.
- Explorer/85 Level "A" Kit (Hex Version), \$129.95 plus \$3 p&h.
- 8k Microsoft BASIC on cassette tape, \$64.95 postpaid.
- 8k Microsoft BASIC in ROM Kit (requires Levels "B," "D," and "E"), \$99.95 plus \$2 p&h.
- Level "B" (S-100) Kit, \$49.95 plus \$2 p&h.
- Level "C" (S-100 6-card expander) Kit, \$39.95 plus \$2 p&h.
- Level "D" (4k RAM) Kit, \$69.95 plus \$2 p&h.
- Level "E" (EPROM/ROM) Kit, \$5.95 plus 50¢ p&h.
- Deluxe Steel Cabinet for Explorer/85, \$49.95 plus \$3 p&h.
- ASCII Keyboard/Computer Terminal Kit (features a full 128 character set, upper & lower case, full cursor control, 75 ohm video output convertible to baudot output, selectable baud rate, RS232-C or 20 ma. I/O, 32 or 64 character by 16 line formats, and can be used with either a CRT monitor or a TV set (if you have an RF modulator), \$149.95 plus \$2.50 p&h.
- Hex Keypad/Display Kit, \$69.95 plus \$2 p&h.
- Deluxe Steel Cabinet for ASCII Keyboard/Terminal, \$19.95 plus \$2.50 p&h.
- Power Supply Kit ($\pm 8V$ @ 5 amps) in deluxe steel cabinet, \$39.95 plus \$2 p&h.
- Gold Plated S-100 Bus Connectors, \$4.85 each, postpaid.
- RF Modulator Kit (allows you to use your TV set as a monitor), \$8.95 postpaid.
- 16k RAM Kit (S-100 Board expands to 64k), \$199.95 plus \$2 p&h.
- 32k RAM Kit, \$329.95 plus \$2 p&h.
- 48k RAM Kit, \$459.95 plus \$2 p&h.
- 64k RAM Kit, \$589.95 plus \$2 p&h.
- 16k RAM Expansion Kit (to expand any of the above up to 64k), \$139.95 plus \$2 p&h each.
- Intel 8085 cpu User's Manual, \$7.50 postpaid.
- Special Computer Grade Cassette Tapes, \$1.90 each or 3 for \$5, postpaid.
- 12" Video Monitor (10 MHz bandwidth), \$139.95 plus \$5 p&h.
- North Star Double Density Floppy Disk Kit (One Drive) for Explorer/85 (includes 3 drive S-100 controller, DOS, and extended BASIC with per-

By Netronics

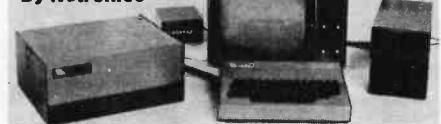

registers... single step with register display at each break point... go to execution address. Level "A" in the Hex Version makes a perfect controller for industrial applications and can be programmed using the Netronics Hex Keypad/Display.



Hex Keypad/Display.

Hex Keypad/Display Specifications

Calculator type keypad with 24 system defined and 16 user defined keys. 6 digit calculator type display which displays full address plus data as well as register and status information.

Level "B" Specifications

Level "B" provides the S-100 signals plus buffers/drivers to support up to six S-100 bus boards and includes: address decoding for onboard 4k RAM expansion select-able in 4k blocks... address decoding for onboard 8k EPROM expansion select-able in 8k blocks... address and data bus drivers for onboard expansion... wait state generator (jumper selectable), to allow the use of slower memories... two separate 5 volt regulators.



Explorer/85 with Level "C" card cage.

Level "C" Specifications

Level "C" expands Explorer's motherboard with a card cage, allowing you to plug up to six S-100 cards directly into the motherboard. Both cage and cards are neatly contained inside Explorer's deluxe steel cabinet.

Level "C" includes a sheet metal superstructure, a 5-card gold plated S-100 extension PC board which plugs into the motherboard. Just add required number of S-100 connectors

Level "D" Specifications

Level "D" provides 4k or RAM, power supply regulation, filtering decoupling components and sockets to expand your Explorer/85 memory to 4k (plus the original 256 bytes located in the 8155A). The static RAM can be located anywhere from 0000 to EFFF in 4k blocks.

Level "E" Specifications

Level "E" adds sockets for 8k of EPROM to use the popular Intel 2716 or the TI 2516. It includes all sockets, power supply regulator, heat sink, filtering and decoupling components. Sockets may also be used for soon to be available RAM IC's (allowing for up to 12k of onboard RAM).

Order A Coordinated Explorer/85 Applications Pak!

Experimenter's Pak (SAVE \$12.50)—Buy Level "A" and Hex Keypad/Display for \$199.90 and get FREE Intel 8085 user's manual plus FREE postage & handling!

Student Pak (SAVE \$24.45)—Buy Level "A," ASCII Keyboard/Computer Terminal, and Power Supply for \$319.85 and get FREE RF Modulator plus FREE Intel 8085 user's manual plus FREE postage & handling!

Engineering Pak (SAVE \$41.00)—Buy Levels "A," "B," "C," "D," and "E" with Power Supply, ASCII Keyboard/Computer Terminal, and six S-100 Bus Connectors for \$514.75 and get 10 FREE computer grade cassette tapes plus FREE 8085 user's manual plus FREE postage & handling!

Business Pak (SAVE \$89.95)—Buy Explorer/85 Levels "A," "B," and "C" (with cabinet), Power Supply, ASCII Keyboard/Computer Terminal (with cabinet), 16k RAM, 12" Video Monitor, North Star 5-1/4" Disk Drive (includes North Star BASIC) with power supply and cabinet, all for just \$1599.40 and get 10 FREE 5-1/4" minidiskettes (\$49.95 value) plus FREE 8085 user's manual plus FREE postage & handling!

Continental U.S.A. Credit Card Buyers Outside Connecticut

CALL TOLL FREE 800-243-7428

To Order From Connecticut Or For Technical Assistance, Etc. Call (203) 354-9375

sonalized disk operating system—just plug it in and you're up and running! \$699.95 plus \$5 p&h.

- Power Supply Kit for North Star Disk Drive, \$39.95 plus \$2 p&h.
- Deluxe Case for North Star Disk Drive, \$39.95 plus \$2 p&h.
- Experimenter's Pak (see above), \$199.90 postpaid.
- Student Pak (see above), \$319.85 postpaid.
- Engineering Pak (see above), \$514.75 postpaid.
- Business Pak (see above), \$1599.40 postpaid.

Total Enclosed \$ _____
(Conn. res. add sales tax) By—
 Personal Check M.O./Cashier's Check Visa Master Charge
(Bank # _____)

Acct. # _____
Signature _____ Exp. Date _____

Print Name _____

Address _____

City _____

State _____ Zip _____

Send Me Information



6 South Street • Milford, New Hampshire 03055 • (603) 673-5144

DISK EXPANSION PACKAGE

This package includes everything necessary to add disk capabilities to your TRS-80. To buy everything in this package would normally cost \$1100 at your local Radio Shack store. We start with the Radio Shack expansion interface and add 16K RAM. You also receive a Percom 40-track disk drive with a dual drive cable. To start you off right, we've added the NEWDOS (40-track) disk operating system and a box of BASF diskettes. Also, the Percom data separator, the component which Radio Shack forgot.

\$899.95
SAVE \$181.00

SMALL BUSINESS PACKAGE

An ideal starter package for the small business. Includes a TRS-80 with 16K RAM and Level II BASIC, an expansion interface with an additional 16K RAM installed, two Percom disk drives with cable and data separator, NEWDOS disk operating system (40 track version) and the Centronics 730 line printer.

\$2799.95
SAVE \$579.00

DELUXE EXPANSION PACKAGE

This package includes a 32K expansion interface with the Percom data separator installed, two Percom TFD-100 disk drives and a 4-drive cable, NEWDOS+ operating system and 2 boxes of BASF diskettes.

\$1449.95
SAVE \$354.00

DELUXE BUSINESS PACKAGE

Includes all the necessities for a small-to-medium size business to become computerized. Includes a Level II TRS-80 with 16K RAM installed and modified to display upper and lower case letters with Electric Pencil, a 32K RAM expansion interface with the Percom data separator installed, three Percom TFD-10 disk drives and a 4-drive cable, a Centronics 779-2 tractor feed printer, a 40-track NEWDOS and Electric Pencil Word Processor software. We have even added a system desk and printer stand.

\$3799.95
SAVE \$628.00

**TOLL-FREE
ORDER
1-800-258-1790**



TRS-80 COMPUTERS:
Level-I 4K \$499 \$449
Level-I 16K, w/keypad \$729 \$659
Level-II 4K \$619 \$559 \$350 \$500
Level-II 16K \$669 \$450 \$625
Level-II 16K, w/keypad \$849 \$769 \$475 \$675

PRINTERS:

	LIST PRICE	OUR PRICE	USED OFFER	USED PRICE
Line Printer III	\$1999	\$1849		
Centronics 779-2	\$1598	\$1095	\$655	\$850
Line Printer II	\$999		\$545	\$750
Centronics 730	\$999	\$899	\$545	\$750
Centronics P1 *	\$499	\$419	\$250	\$358
Quick Printer II	\$219	\$197	\$100	\$150
QP-II Exp. Int. Cable	\$20	\$18		
* Cable required	\$39	\$35		



	LIST PRICE	OUR PRICE	USED OFFER	USED PRICE
EXPANSION INTERFACE:				
.... OK	\$299	\$269	\$165	\$230
.... 16K	\$448	379/403	\$245	\$340
.... 32K	\$597	479/537	\$325	\$440

DISK DRIVES:

Percom, TFD-100, 40-track		\$399		
Percom, dual TFD-100		\$795		
Percom, TFD-200, 77-track		\$675		
2-drive cable		\$29		
4-drive cable		\$39		
Radio Shack, -0	\$499	\$469	\$290	\$390
Radio Shack, -1, 2, 3	\$399	\$459	\$270	\$370

ACCESSORIES:

Telephone Interface	\$199	\$179	\$100	\$150
16K Memory Kit		\$99		
16K Memory Kit for E.I.		\$95		
RS232-C Interface	\$99	\$89	\$55	\$75
TRS-232 Interface		\$49.95		
Data Dubber		\$49.95		

IMPORTANT!

* COD orders require 25% cash deposit

* Prices subject to change

* Prices do not include shipping

NO SUBSTITUTIONS ON PACKAGE PRICES

*Radio Shack and TRS-80 are trademarks of Tandy Corporation.

NEW SOFTWARE!

Original ADVENTURE (Microsoft) \$29.95
 Galactic Empire 16K L II \$14.95
 Alien Invasion 16K L II \$ 9.95
 Kriegspiel (wargame) 16K L II. \$ 7.95
 Oil Baron 16K L II \$ 7.95

Casino Anthology 16K L II.... \$ 7.95
 TRS-80 Opera Theatre..... \$ 9.95
 Print Spooler (Disk)..... \$24.95
 Floppy Disk Diagnostic (Disk)\$24.95
 File Manager 80..... \$49.95

COMPLETE IN FEBRUARY SOFTSIDE!

Simulation of flying the United States shuttle. The ultimate flight simulation! Based on actual flight characteristics and instrument display of the space shuttle.

File Manager 80 by Nepenthe. \$49.95 32K Disk
 Directory 16K Disk \$9.95
 Automated Disk Directory \$14.95 32K Disk. Requires NewDOS.
 Level III BASIC by Microsoft. \$49.95
 Level I In Level II by Apparat. Level II, 16K \$15.00
 Fortran by Microsoft. 32K - 2 Disks. New low price \$150.00 (includes macro-assembler.)
 NEWDOS by Apparat \$49.95
 NEWDOS+ by Apparat \$99.95
 Machine Language Monitor by Small Systems Software. Level II, 16K \$26.95
 Renumber by Lance Micklus. Level II, available in 16 through 48K (specify when ordering) \$7.95
 Renumber source listing \$20.00

Three Monitors for Disk by Small Systems Software. Disk for 16 through 48K (all in one) \$29.95
 KVP Extender by Lance Micklus. Tape - \$29.95; Disk - \$34.95
 KVP 232 by Lance Micklus - KVP adapted for the TRS-232. Tape - \$29.95
 ST80 Smart Terminal Level II, 16K \$49.95
 ST80D Smarter Terminal for disk systems. \$79.95
 Micro Text Editor by Don Coons. Level II, 4K or 16K \$9.95
 Text-80 by Frank B. Rowlett, Jr. For 32K disk systems \$59.95
 8080-Z80 Conversion Level II, 16K \$14.95
 STAD Trace Monitor 16, 32 and 48K \$24.95

Electric Pencil by Michael Shrayner. Powerful machine language word processing system. Level II, 16K tape - \$100; Disk version - \$150

Spool will print an ASCII file to a parallel line printer at the same time you are using your computer for another program. For 32K Disk Systems only. Will NOT work with NEWDOS. (2.3 or VTOS 3.0 OK) On cassette \$19.95, on Disk \$24.95.

TRS-80 Opera Theatre Magnificent sound! by Richard Taylor. \$9.95
 Challenge Word game with sound. By Richard Taylor \$9.95
 Oil Baron by Paul Knechtel \$7.95
 Galactic Empire by Douglas Carlston \$7.95
 Casino Anthology Slot Machine, Stud and Draw Poker. \$7.95.
 Alien Invasion \$9.95
 Concentration by Lance Micklus. Level II, 16K \$7.95
 Amazon' Mazes by Robert Wallace. Level II, 16K \$7.95
 Time Bomb by David Bohlke. Level II, 16K \$4.95
 Tycoon by David Bohlke. Level II, 16K \$7.95
 9 Games for Preschool Children by George Blank. Level II, 16K \$9.95
 Space Battles by Level IV, Level II, 16K Tape or 32K Disk, Tape - \$14.95, Disk - \$19.95
 Star Trek III.4 by Lance Micklus Level II, 16K \$14.95

Snake Eggs by Leo Christopherson. With sound - Level II, 16K \$14.95
 Life Two by Leo Christopherson. With sound -Level II, 16K \$14.95
 Android Nim by Leo Christopherson. With sound - Level II, 16K \$14.95
 Cubes by Leo Christopherson Level II, 16K \$9.95
 Bee Wary by Leo Christopherson, with sound. Level II, 16K, \$14.95
 Mastermind II by Lance Micklus \$7.95
 Mastermind II - Source List \$20.00
 X-Wing II by Chris Freund. Level II, 16K \$9.95
 Talpan by Art Canfil. Level II, 16K \$9.95
 Sargon Chess by Dan and Kathe Spracklen. Level II, 16K \$19.95
 Sargon II by Dan and Kathe Spracklen. Level II, 16K, \$29.95.
 Pork Barrel by George Blank. Level II, 16K \$9.95
 Kamikaze by Russell Starkey. Level II, 16K \$7.95
 Bridge Challenger Level II, 16K, \$14.95.

Adventures by Scott Adams
 Adventureland
 2. Pirates Cove
 3. Mission Impossible
 4. Voodoo Castle
 5. The Count
 6. Strange Odyssey
 7. Fun House
 8. Pyramid Of Doom
 16K Level II tape \$14.95 each
 1, 2, and 3 on disk \$39.95
 4, 5, and 6 on disk \$39.95
 'Round the Horn by George Blank. Level II, 16K \$9.95
 Barricade by Small Systems Software. Machine Language \$9.95
 Journey To The Center Of The Earth by Greg Hassett. Level II, 16K Tape \$7.95
 Pentominoes by John Adamson. Level II, 16K \$7.95
 Mean Checkers Machine by Lance Micklus. Level II, 16K; tape, \$19.95; disk \$24.95.
 Kriegspiel by Ron Potkin. Level II, 16K, \$7.95.

Inventory System II.3 by M. Kelleher. Improved version, \$79.95
 Inventory 'S' by Roger W. Robitaille, Sr. Level II, 16K Tape - \$24.95; 32K Disk - \$39.95
 Payroll by Stephen Hebbler. For disk systems. 32K \$29.95

Accounts Receivable II by S. Hebbler. 32K disk systems \$39.95
 Appointment Log by Michael Kelleher. Level II, 16K \$9.95
 Mail List II by Roger W. Robitaille, Sr. 32K disk systems \$99.95

Small Business Bookkeeping II by R. W. Robitaille, Sr. Level II, 16K. With journal - \$36.95 disk, \$31.95 tape. \$29.95 disk, \$24.95 tape.

Math Drill by K. L. Brown. Level II, 16K \$4.95
 RPN Calculator by Russell Starkey. Level II, 16K \$9.95
 Ham Radio by Michael Kelleher. Level II, 16K \$9.95
 Histogram/Scattergram by Gary S. Breschini. Level II, 16K \$9.95

Amateur Radio advanced version for 32K disk \$24.95
 Electronics Assistant by John Adamson. Level II, 16K \$9.95
 Preflight by Stephen Hebbler. Level II, 16K \$20.00

Basic Statistics by Steve Reisser. Level II, 16K \$20.00
 Drill Masters by Computer Graphics - specify title desired. Level II, 16K \$7.95 ea. German, Russian, Italian, Spanish, or Music Theory.
 Keyboard by John Adamson. Level II, 16K \$9.95

Sargon Handbook by Dan & Kathe Spracklen. \$14.95 plus \$1.00 shipping and handling
 The BASIC Handbook by Dr. David A. Lien. \$14.95 plus \$1
 Z80 Instruction Handbook by Scelbi Publications \$4.95 + \$1.
 Learning Level II by David A. Lien. \$15.95 plus \$1
 Z-80 Software Gourmet Guide and Cookbook from Scelbi. \$14.95 + \$1.
 The Little Book Of BASIC Style by John Nevison. \$5.95 plus \$1
 TRS-80 Assembly Language Programming by William Barden, Jr. \$3.95 plus \$1 shipping
 Introduction to TRS-80 Graphics by Don Inman. \$7.95 plus \$1

TO ORDER:

- IMPORTANT:**
- PRICES DO NOT INCLUDE SHIPPING.
 - All C.O.D.'s or special delivery orders are a minimum of \$5 for special handling.
 - When ordering Percom add \$5 each, packaging and handling fee.
 - Prices subject to change without notice. We are not responsible for typographical errors.

1-800-258-1790

CALL TOLL-FREE
 (9AM - 9PM EST.)

* TRS-80 is a registered trademark of Radio Shack and Tandy Corporation.

TSE
The Software Exchange
 6 South Street, Box 68, Milford, NH 03055 603-673-5144

ASK FOR OUR FREE CATALOG!

UTILITIES

GAMES

BUSINESS

SPECIAL PURPOSE

BOOKS

Audio Meter for Your TRS-80

David F Miller, 7462 Lawler Ave, Niles IL 60648

Perhaps I am old-fashioned, but I like to know what is happening when I CLOAD or CSAVE a tape on my TRS-80. I modified the CTR-41 cassette recorder to allow me to hear over its internal speaker what is going in and coming out at all times, but that did not tell me enough about the levels involved.

As you have probably discovered, audio levels in and out of the cassette port are very important for the successful loading and saving of your hard-fought-for efforts on tape. Interpolating the volume control settings of the cassette unit on playback can produce a degree of accuracy, but not for tapes received from others. The only sure way to understand what is going on is a visual indicator. The best device would be an oscilloscope, but I could not see dedicating my oscilloscope permanently to this type of duty.

The metering circuit shown in figure 1 has proven to be adequate for day-to-day monitoring and can be supplemented by the oscilloscope when a difficult tape is encountered. If you have an oscilloscope, look at the ear-phone output of the cassette recorder while playing back a tape. What you will see is a constant synchronization



Photo 1: A view of the audio metering box which connects to the Radio Shack TRS-80.

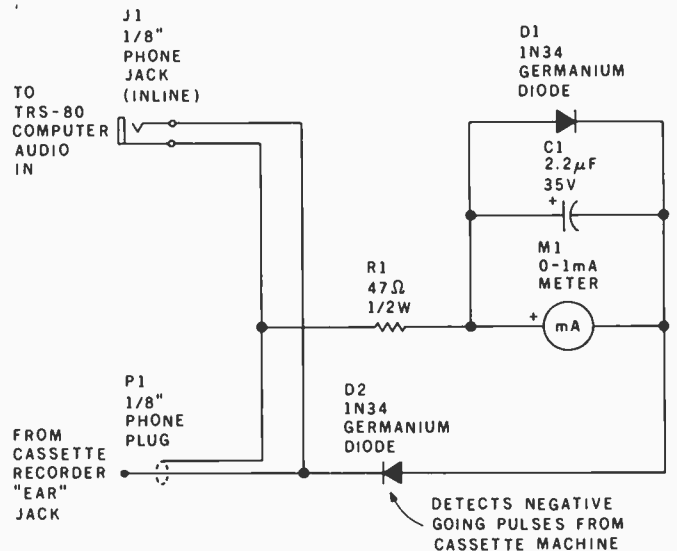

	RADIO SHACK NUMBER
C1	272-1407
D1 & D2	276-1123
J1 & P1	274-283
M1	22-052 OR EQUIVALENT
R1	271-009

Figure 1: Schematic for the TRS-80 audio metering box. The 2 diodes used must be germanium diodes.

train of negative pulses occurring at a frequency of 500 Hz, with negative data pulses popping in and out at 1000 Hz. (These figures are for Level II. Level I figures are half, or 250 Hz and 500 Hz.)

The metering circuit shown in figure 1 samples these negative pulses, rectifies and filters them, and drives the 1 mA meter movement. With the values shown, the meter will read about half scale with the volume on the cassette unit set at 5 (normal setting for Level II tapes). To trim the meter reading for your individual needs, change the value of the electrolytic capacitor across the meter (more capacity for a higher reading); this will probably have the most noticeable effect. You could also increase or decrease the 47 ohm series resistor, but watch for possible "loading" effects if you go too low in value (the value shown shows no such effects). The diode across the meter acts to protect the movement when high levels are encountered (such as during a tape search in fast forward or rewind with the "play" button also engaged). Both diodes are specified as germanium because there is only 0.3 V barrier potential (ie, voltage drop) across a germanium type, whereas a silicon diode has 0.7 V drop.

The earphone jack on the CTR-41, and most other recorders, outputs the audio signal from the record amplifier when in the record mode, so you will see what is CLOADed and what is CSAVEed.

Photo 1 shows how my unit is packaged. I mounted a 1/8 inch phone jack on the rear of the plastic meter box which accepts the plug to the TRS-80. This jack should be insulated from the box if you use a metal enclosure, or

COMPUPRO™ CONTINUES TO DELIVER.

Whether it's memory, motherboards, I/O boards, enclosures, or any of our family of products, CompuPro™ delivers what you want at prices you can afford.

Looking for memory? Our boards are fully static, low power, run at 4 or 5 MHz, support a number of popular busses, include a 1 year limited warranty, and generally come in 3 configurations to suit your exact needs. For lowest cost, choose an "unkit" with sockets and bypass caps pre-soldered in place for easy assembly. When you can't wait to get going, order one of our assembled versions. For critical systems, specify boards qualified under our **Certified System Component (CSC)** high reliability program. These boards are extensively tested, burned in for at least 200 hours, and are immediately replaced in event of failure within 1 year of invoice date.

Looking for other peripherals? We mix leading edge technology, design savvy, and volume buying to deliver the right product at the right price. See our list below for pricing.

Memory name	Bus & Notes	Unkit	Assm	CSC
8K Econoram* IIA	S-100	\$149	\$179	\$239
16K Econoram IV	S-100	\$289	\$339	\$429
16K Econoram VIIA-16	S-100	\$299	\$349	\$439
24K Econoram VIIA-24	S-100	\$419	\$499	\$605
16K Econoram IX-16	Dig Grp	\$319	\$379	n/a
32K Econoram IX-32	Dig Grp	\$559	\$639	n/a
32K Econoram X	S-100	\$549	\$669	\$789
32K Econoram XI	SBC/BLC	n/a	n/a	\$1050
16K Econoram XIII A-16	S-100 (1)	\$349	\$419	\$519
24K Econoram XIII A-24	S-100 (1)	\$469	\$539	\$649
32K Econoram XIII A-32	S-100 (1)	\$579	\$699	\$849
16K Econoram XIV	S-100 (2)	\$299	\$359	\$459
16K Econoram XV-16	H8 (3)	\$329	\$395	n/a
32K Econoram XV-32	H8 (3)	\$599	\$729	n/a

*Econoram is a trademark of Godbout Electronics

- (1) Compatible with all bank select systems (Cromemco, Alpha Micro, etc.); addressable on 4K boundaries.
- (2) Extended addressing (24 address lines). Single block addressable on 4K boundaries.
- (3) Bank select option for implementing memory systems greater than 64K.

NEW YEAR SPECIAL

250 ns 16K dynamic RAMs
8/\$64!

Perfect for memory expansion in a number of machines (TRS-80** Model I and Model II, Exidy Sorcerer, Heath H89, Apple, etc.), and you can't beat our price: 8 high speed chips for \$64! Add \$3 if you'd like 2 dip shunts plus TRS-80** programming instructions to expand memory. These are 250 ns (4 MHz), dynamic RAMs... but quantities are limited, so hurry is you want to take advantage of this super deal.

**TRS-80 is a trademark of the Tandy Corporation.

PASCAL/M™ + MEMORY SPECIAL

PASCAL can give a microcomputer with CPM more power than many minis. For a limited time only, you can buy an assembled Econoram X, plus our totally standard Wirth PASCAL/M™ 8" diskette, for \$799 (regular combined price, \$999). Includes manual, plus Wirth's definitive book on PASCAL; specify Z-80 or 8080/8085 version. Diskette is also available separately for \$350.

2708 EROM BOARD \$85 unkit

4 independently addressable 4K blocks, with dip-switch selectable jump start built right into the board. Includes all support chips and manual, but does not include EROMs.

THESE PRODUCTS ARE GENERALLY AVAILABLE FROM YOUR LOCAL COMPUTER STORE.

ACTIVE TERMINATOR BOARD \$34.50 kit

Plugs into any S-100 motherboard (although ours don't need it) to reduce ringing, crosstalk, noise, and other buss-related problems.

THE GODBOUT COMPUTER BOX

\$259 desktop, \$299 rack mount (introductory price)

The ideal home for your computer. With fan, dual AC outlets and fuseholder, power switch, heavy-duty line filter, black anodized front panel (with textured vinyl painted cover for desk top version); pre-drilled base accepts our high-performance motherboards or similar types by Vector, California Digital, and others. Rack mount version includes slides for easy pull-out from rack. This functional, versatile, and handsome enclosure does justice to the finest computer systems.

HIGH-PERFORMANCE S-100 MOTHERBOARDS

6 slot: \$ 89 unkit, \$129 assm 12 slot: \$129 unkit, \$169 assm
19 slot: \$174 unkit, \$214 assm

Unkits have edge connectors and termination resistors pre-soldered in place for easy assembly. These boards exceed the latest S-100 specs and will work with 5 to 10 MHz CPUs. Includes true active termination, grounded Faraday shield between all buss signal lines, and edge connectors for all slots.

S-100 MEMORY MANAGER BOARD \$59 unkit \$85 assm \$100 CSC

Add bank select and extended addressing to older S-100 machines (Altair, IMSAI, Sol, and others). Use with our new extended addressing boards, or retrofit our high density Econorams for use with the Memory Manager to get added memory space for your computer.

MULLEN S-100 EXTENDER BOARD \$49 kit

Includes logic probe and general purpose breadboard section. Ideal for troubleshooting and analysis.

3P PLUS S "Interfacer II" S-100 I/O BOARD \$199 unkit \$249 assm \$324 CSC

Incorporates 1 channel of serial I/O (RS-232 with full handshake), along with 3 full duplex parallel ports plus a separate status port. The parallel section uses Tri-State (tm National Semiconductor) octal latches for latched data, input and output with 24 mA drive current, attention/enable/strobe bits for each parallel port (with selectable polarity), interrupts for each input port, and separate connectors with power for each channel.

2S "Interfacer I" S-100 I/O BOARD \$199 unkit \$249 assm \$324 CSC

Dual RS-232 ports with full handshake; use EIA232C line drivers and receivers (1488, 1489), or current loop (20 mA), or TTL signals on both ports. On-board crystal timebase with independently selectable Baud rates for each port (up to 19.2 Kbaud). Hardware UARTs don't tie up the CPU.

CompuPro™

from

GODBOUT
ELECTRONICS

Bldg. 725, Oakland Airport, CA 94614

TERMS: Cal res add tax. Allow 5% for shipping, excess refunded. VISA®/Mastercharge® call our 24 hour order desk at (415) 562-0636. COD OK with street address for UPS. Prices good through cover month of magazine.

use an in-line female 1/8 inch phone jack and avoid having to keep the jack above possible outside grounds. A short shielded cable exits the meter box, terminates in an 1/8 inch phone plug, and plugs into the recorder ear jack.

That is all there is to it! If your cassettes are marked with the meter readings that are obtained on playback, you should be able to load almost anything on the first pass. If you see the level on playback begin to drop over a period of time, you will know that the tape heads need cleaning. I think you will find that this is a useful accessory. ■

Algebraic Identities Are Not Numerical Identities

Alan B Forsythe PhD, University of California Los Angeles
Department of Biomathematics, School of Medicine
Los Angeles CA 90024

The development of statistical software can present some adverse computational problems. In "Elements of Statistical Computation" (January 1979 BYTE, page 182), I demonstrated the tip of this iceberg with two algorithms

for calculating the standard deviation for some data. The first algorithm, the one given in many texts, incorrectly gives zero as the answer. The simple modification given in that article corrects the defect. This clearly shows the fallacy of simply coding the computational procedures given in standard textbooks.

Subsequently, J G Bliss erroneously speculated that a division by four rather than five ($N-1$ rather than N) probably accounts for the incorrect answer. (See "Statistical Computations Recomputed," June 1979 BYTE, page 193.) As my original article pointed out, the root of the problem is the fact that digital computers have finite precision. Algebraic identities are *not* numerical identities. Thus, when very large numbers are added or subtracted, the last few digits are lost due to truncation. When faced with deviations from large numbers, the user has to be very careful with the computational formula employed. That is why a better answer can be obtained using the last algorithm given in the article.

A simple example on the TRS-80 is:

PRINT 1000000+1

The resulting display shows 1E6. That is, one million plus one is reported to equal one million. The single-precision representation is not adequate for this problem.

The heart of the computation of the standard deviation is the sum of the squares of the deviations about the mean. Algebraically this can be deduced from the sum of the squares of the individual values and their sum. The original article demonstrates that the use of this algebraic identity leads to the subtraction of two very large numbers and thereby to the loss of the critical digits. The computed result for the sum of squares of the deviations is zero. It is now clear that if a computationally poor procedure yields zero, then it certainly does not matter if we divide by five or four. In either case, we still get zero.

Why is there any question whether to divide by N or $N-1$ in the calculation of the standard deviation? When given the values for the entire population, then divide by N ; when working with a *sample*, then divide by $N-1$. The example in the original article was a sample from a much larger population and so the correct divisor of $N-1$ was used.

Mr Bliss references an accounting and auditing textbook. If, in the auditing situation, in order to verify each and every of the thousands of bills paid, then the divisor should be N . However, if only a sample was drawn, then $N-1$ is the appropriate divisor for the standard deviation.

Since I am a statistician and not an accountant, I will not argue with Mr Bliss about accounting. If his usual procedure is to exhaustively study all transactions, rather than a sample, then he should divide by N . My experience with sampling from large populations has been that great economy of effort can be realized without much loss in precision with the use of an appropriate sampling plan. ■

REFERENCES

- Bliss, J F, "Statistical Computations Recomputed," BYTE, June 1979, page 193.
- Forsythe, A B, "Elements of Statistical Computation," BYTE, January 1979, page 182.

***** 6800/6809 SOFTWARE *****

ACCOUNTS PAYABLE #1300 PRODUCE FINANCIAL REPORTS, PRINT CHECKS, SPECIAL CONTROL LETTER, REPORTS BY VENDOR NUMBER, INVOICE NUMBER, AGED AND HISTORY FILE, AUTO SORTING OF VENDOR AND INVOICE FILES, PLUS CHECK AND PRE CHECK JOURNALS.	\$600.00
ACCOUNTS RECEIVABLE #1500 PRODUCES FINANCIAL REPORTS, PRINTS STATEMENTS, PRODUCES REPORTS BY CUSTOMER ACCOUNT NUMBER, INVOICE BY CUSTOMER ACCOUNT NUMBER AND INVOICE BY INVOICE NUMBER, PRINT AGED REPORT AND TRIAL BALANCE, KEEPS HISTORY FILE AND AUTO SORTING OF FILES.	\$600.00
GENERAL LEDGER #100 PROGRAM UPDATES TO LEDGER FILES AND ALSO GENERATES REPORTS ON PAYROLL, SALES, ACCOUNTS PAYABLE, CASH AND EXPENSE STATISTICS, BALANCE SHEET AND PROFIT & LOSS REPORTS. INFORMATION CAN BE GENERATED FOR YEAR END TAXES, 941 AND 42 FORMS.	\$595.00
INVENTORY I, #600 INVENTORY FOR A SMALL COMPANY, PRODUCES ACTIVITY REPORTS FOR DAY, MONTH AND YEAR, MINIMUM QUANTITY SEARCH, INVENTORY LIST BY CLASS, BY VENDOR OR COMPLETE WITH TOTALS AND FINANCIAL REPORT.	\$100.00
INVENTORY II, #700 PRODUCE INVENTORY REPORTS BY DESCRIPTION OR VENDOR, PRINT ACTIVITY REPORTS FOR ONE DAY, ONE MONTH OR ONE YEAR, QUICK SEARCH BY PART NUMBER, PRODUCE TOTAL INVENTORY AND FINANCIAL REPORT. (FOR ONE STORE)	\$200.00
INVENTORY III, #800 SAME AS INVENTORY II, #700, BUT PRODUCES REPORTS FOR EIGHT STORES.	\$300.00
SHIPPING/RECEIVING PRODUCE YOUR BUSINESS FINANCIAL REPORT, PRODUCE REPORTS ON SALES, ACCOUNTS RECEIVABLE AND LAST PURCHASE BY CUSTOMER. PRINT MAILING LABELS AND PRINT CUSTOMERS BILLS.	\$ 75.00
MAILING LABELS #100 PRINT MAILING LABELS FROM YOUR COMPLETE FILE, FOR A PARTICULAR CITY OR STATE. USE ONE-PART MAILING LABELS.	\$ 50.00
MAILING LABELS #400 SAME AS #100, BUT ALSO PRINTS LABELS BY NAMES. USE MULTIPLE-PART LABELS.	\$125.00
BASIC 09 UPGRADED FOR 6809 AND 6809S. RUNS 30% FASTER AND CAN BE USED WITH EXISTING 6800 PROGRAMS TO BE USED WITH 6809 SYSTEMS. NO MANUAL.	\$ 59.95

*** CUSTOMIZED PROGRAMS FOR YOUR BUSINESS REQUIREMENTS ***

CHARGE YOUR ORDER TO YOUR VISA OR MASTER CHARGE



Available from Computer Stores or order direct from:

OMNI TRONICS INC. 1897 RT. 33, CONCORD SQUARE, HAMILTON SO., NJ 08600

Super Values! . . .

Complete Computer!



SUPERBRAIN® by Intertec

- Totally self-contained in a single box
- 32K, 48K, or 64K Version
- Uses two Z-80 CPU's
- Commercial-type terminal with 12" monitor (like the Intertube)
- Dual double-density minifloppies w/360 Kilobytes of storage capacity
- I/O ports included
- Expandable (if needed) with an external S-100 bus interface
- Comes with CP/M™ operating system
- Extensive software support with 32K of RAM, List \$2995
Call for price and delivery

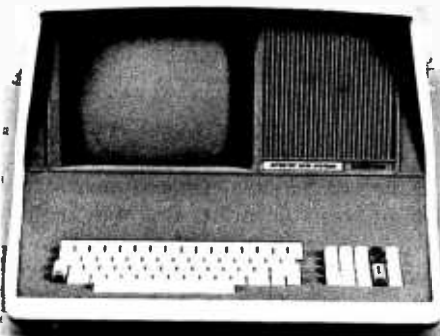

INTERTUBE II by Intertec

- 12" Display
 - 24 x 80 format
 - 18-key numeric keypad
 - 128 upper/lower case ASCII characters
 - Reverse video, blinking
 - Complete cursor addressing and control
 - Special user-defined control function keys
 - Protected and unprotected fields
 - Line insert/delete and character insert/delete editing
 - Eleven special line drawing symbols
- (shipping \$10)

\$799

North Star Horizon 1's & 2's
Double & Quad Density
16K, 32K, 48K, 64K models
Kits or Assembled
Kits available as
low as \$1349
Most Models in Stock
Call for Price & Delivery

BANTAM 550

PERKIN ELMER



NOW FROM
US AT
\$799

Add \$20 for
anti-glare
CRT

(shipping \$10)

DECwriter II \$1490
Teletype 43 Printers starting at \$880
Lear Siegler ADM3A \$849

ANADEX 80-COLUMN DOT MATRIX PRINTER

Complete upper and lower case ASCII char. set, bi-directional at 84 lines/min. Features RS232 20/60 mil current loop and Centronix parallel interface. Ideal for use with TRS-80, Sorcerer, Cromemco, and North Star systems.

OUR PRICE ONLY **\$895**
(shipping \$10)

T.I. 810

Bi-directional
150 cps
Logic-Seeking
Adjustable
Tractor



Basic Unit
\$1695

(shipped freight collect)

All prices subject to change and all offers subject to withdrawal without notice. Prices in this ad are for prepaid orders. Slightly higher prices prevail for other-than-prepaid orders, i.e., C.O.D., credit card, etc.

— WRITE FOR FREE CATALOG —

MiniMicroMart, Inc.

1618 James Street, Syracuse NY 13203 (315) 422-4467 TWX 710-541-0431

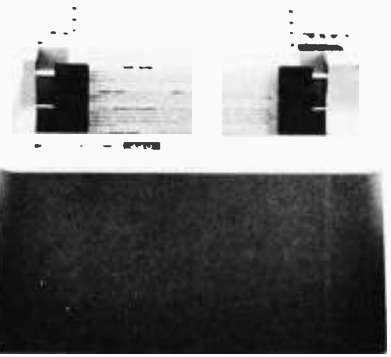

PAPER TIGER

IDS-440 Paper Tiger basic unit, List \$995 **\$895**
IDS-440G above w/graphics option, incl. buffer, List \$1194 **\$1069**
IP-125 w/1210 option, \$838 **\$724**
IP-225 w/1210,1250 op, \$988 **\$834**
IP-225 w/tractor, 1210, 1250, 1221 (2K buffer), 1241 (graphics) **\$899**



NEC Spinwriter™

The Fantastic Letter-Quality
Printer at 55 cps

RO's as low as **\$2475**
(shipped freight collect)

CENTRONICS PRINTERS

730 New, friction, & tractor **\$ 895**
779-1 60 cps, same as TRS 80 printer **\$ 949**
779-2 with tractor, List \$2350 **\$1049**
702-2 120 cps, bi-directional, tractor, VFU **\$1995**
703-2 185 cps, bi-directional, tractor, VFU **\$2395**
(shipped freight collect)



Circle 124 on inquiry card.



BASIC Formatted Output

Listing 1: BASIC source code for the editing routines. Lines 100 to 927 are the driver program for the text editor. Lines 9000 to 9997 are the actual text editor. The editor is located at a high line number so it may be used with many BASIC programs. When using the editor, care must be taken not to use any line numbers in your driver program higher than 9000. The editor is broken into several routines. Lines 9000 through 9185 define the format that will be used. The format statement will be familiar to readers who have worked with FORTRAN format statements. Lines 9200 to 9268 parse the format statement. The parsed format is stored in arrays V\$ and V as described in the text.

Lines 9300 to 9548 are the free format input routine. The data is entered with commas separating the individual units. This routine then takes the data and puts it into the desired form.

Lines 9600 to 9997 take care of formatted output. The format used is a table developed by a routine such as that in lines 9200 to 9268.

```
100 REM TEST PROGRAM FOR FORMAT SUBROUTINES
110 REM
200 DIM V$(30),V(30),Y(3,30)
210 E$="ENTER"
220 G$="FORMAT"
230 H$="FREE FORM"
240 I$="FORMATTED"
250 J$="STRINGS IN QUOTES"
260 K$=" & VARIABLES"
300 INPUT "INSTRUCTIONS (Y OR N):";Y$
310 IF Y$="N" GOTO 370
320 PRINT: PRINT "USE CODE FOR FOLLOWING TESTS"
330 PRINT "1 =";G$;" & TABLE"
340 PRINT "2 =";G$;" , ";H$;K$
350 PRINT "3 =";G$;" , ";I$;" STRING";K$
360 PRINT "4 = INPUT";G$;" , ";H$;" OUTPUT";G$
370 INPUT "ENTER CODE:";A$
375 PRINT
380 IF A$="?" GOTO 320
384 IF A$="END" OR A$="E" THEN STOP
386 A=VAL(A$)
390 ON A GOTO 400,500,700,800
400 PRINT E$;G$
410 INPUT F$
420 GOSUB 9060
425 PRINT: PRINT
430 FOR K=1 TO Y9-1
440 PRINT Y(1,K);Y(2,K);Y(3,K)
450 NEXT K
460 PRINT
470 GOTO 370
500 PRINT E$;G$
510 INPUT F$
520 PRINT E$;H$;J$
530 INPUT Z$
540 GOSUB 9060
550 GOSUB 9400
```

Listing 1 continued on page 178

William D Roch
24000 Bessemer St
Woodland Hills CA 91367

If your BASIC interpreter has a PRINT USING capability, you should have no trouble printing reports or other similar output. If not, then you are at an apparent impasse with the standard BASIC output that left-justifies everything at fixed positions on a line, an approach that has many limitations.

The routines in listing 1, lines 9000 to 9997, solve this problem and produce a formatted output. Also included are routines for reading an unformatted string and placing the fields in numerical or string arrays, and a routine for establishing arrays for a formatted input record. In addition, lines 100 to 927 are a test program that can be used to get the feel of how these routines work.

Why Format Records?

There are several advantages to working with formatted string records:

- The position of each field in a record is always constant.
- Only one variable name is needed to input, read or print. Counting fields when there is more than one record type involved is no problem — you need only check a record type code and break up the record with the proper format statement.
- Records may be created and changed with one string type editor rather than an individual program or modification for each set of records.
- Most business type applications use formatted records.

Format Definition Routine

Our primary concern is describing the appearance of the record format to the rou-

Text continued on page 185

What you 'C' is what you get!

C Compiler for CP/M*

New, and available now! An easily affordable compiler incorporating most of the features of the full C language.

BD SOFTWARE

System requirements: CP/M and at least 24K of RAM

Variable Types: char, int, unsigned

Composite Types: arrays, structures, unions

Pointers: to variables, structures, unions and functions

Features: is a structured language, all functions (Programs) recursive; more powerful expression operators than any other von Neumann type language; allows free-formatted source; close enough to UNIX** C to make conversions feasible.

Speed: On 2 MHz 8080, the statement
for (i = 1; i < 30000; i++) x = 5;
takes about 4 seconds to execute.

Package contains: compiler, linker, library manager; standard function library; sample source files include games, a terminal emulator with disk I/O plus the source for many standard library functions; BDS C User's Guide; Book—*The C Programming Language* by Dennis Ritchie and Brian Kernighan of Bell Labs. **Price: \$110**

Recipient of the Computer Lib Seal of Approval

*CP/M is a trademark of Digital Research Corp.

**UNIX is a trademark of Bell Laboratories

Lifeboat Associates

2248 Broadway, New York, N.Y. 10024 (212) 580-0082 · Telex 668585

Retro-Graphics™

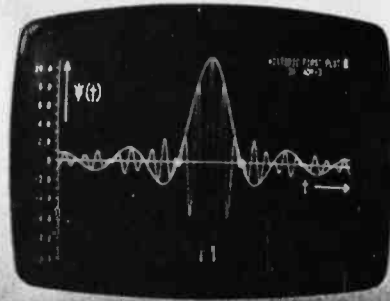

For your Dumb Terminal. The Retro-Graphics PC card mounts easily in the Lear Siegler ADM-3A to provide you with an affordable graphics computer terminal.

Features:

- Z-80 Based
- 512 by 250 Dot Matrix
- Simple Plug-in Interconnect
- Point Plotting
- Automatic Vector Generation
- Optional TEKTRONIX Software Compatibility

You will be impressed with the packaging, performance and price of the Retro-Graphics card. Write or phone today for complete specifications.

DIGITAL ENGINEERING, INC.

1775 Tribute Road
Sacramento, CA 95815
(916) 920-5600

NEW!

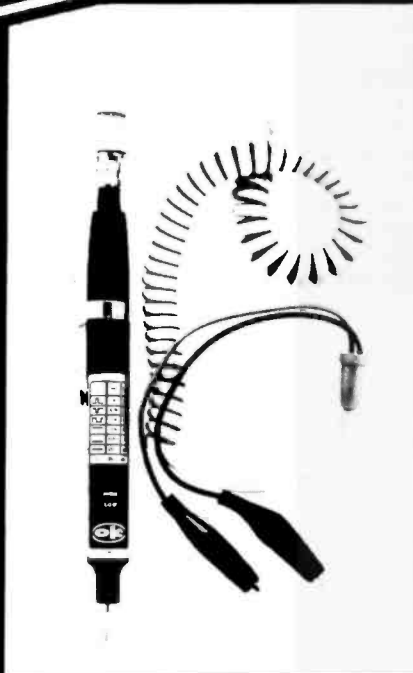

PRB-1 DIGITAL LOGIC PROBE

Compatible with DTL, TTL, CMOS, MOS and Microprocessors using a 4 to 15V power supply. Thresholds automatically programmed. Automatic resetting memory. No adjustment required. Visual indication of logic levels, using LED's to show high, low, bad level or open circuit logic and pulses. Highly sophisticated, shirt pocket portable (protective tip cap and removable coil cord).

- DC to > 50 MHZ
- 10 Nsec. pulse response
- 120 K Ω impedance
- Automatic pulse stretching to 50 Msec.
- Automatic resetting memory
- Open circuit detection
- Automatic threshold resetting
- Compatible with all logic families 4-15 VDC
- Range extended to 15-25 VDC with optional PA-1 adapter
- Supply O.V.P. to ± 70 VDC
- No switches/no calibration

\$36⁹⁵*

* ADD \$2.00 FOR SHIPPING
(N. Y. CITY AND STATE RESIDENTS ADD TAX)

OK MACHINE & TOOL CORPORATION

3455 Conner St., Bronx, N.Y. 10475 (212) 994-6600 / Telex 125091

Bringing Music Home

LET MICRO MUSIC TURN YOUR APPLE II INTO A FAMILY MUSIC CENTER!

- . Sing along
- . Compose
- . Play
- . Learn from Specialists



VISIT THE APPLE DEALER NEAREST YOU AND ASK FOR A DEMONSTRATION OF MMI'S MUSIC COMPOSER™

The MUSIC COMPOSER is an APPLE II® compatible, low-cost music system designed by the folks at MMI. Our music software was designed by leading experts in music education. A simple step-by-step instruction manual leads you through entering, displaying, editing, and playing music with up to four voices—soprano, alto, tenor, and bass. You can change the sound of each voice to reed, brass, string, or organ sounds and you can even color your own music sounds!

HAVE FUN! THE MUSIC COMPOSER comes complete with an instruction manual, software disk or cassette—in either Integer or Applesoft ROM BASIC, and the MICRO MUSIC DAC music card. Just plug the MICRO MUSIC DAC into the APPLE extension slot and connect the audio cable to a speaker.

Suggested retail price \$220.

Ask your local dealer for information on MMI music software products, or contact:

MMI
 Micro Music Inc
 (309) 452-6991
 309 Beaufort, University Plaza, Normal, IL 61761

Listing 1 continued:

```

560 PRINT: PRINT "STRINGS"
570 FOR K=1 TO V1
580 PRINT VS(K)
590 NEXT
600 PRINT: PRINT "NUMBERS"
610 FOR K=1 TO V2
620 PRINT V(K)
630 NEXT
640 PRINT
650 GOTO 370
700 PRINT ES:GS
710 INPUT FS
720 GOSUB 9060
730 PRINT: PRINT ES:IS:JS
740 INPUT ZS
750 GOSUB 9260
760 GOTO 560
800 PRINT ES:GS
810 INPUT FS
820 GOSUB 9060
830 PRINT ES:HS:JS
840 INPUT ZS
850 PRINT ES:" OUTPUT":GS
860 INPUT FS
870 GOSUB 9060
875 GOSUB 9400
880 GOSUB 9650
890 PRINT: PRINT US: PRINT
900 GOTO 370
927 REM
8998 REM
8999 REM
9000 REM   FORMAT DEFINITION SUBROUTINE [SUB I/O IA.0]
9003 REM
9006 REM THIS ROUTINE BREAKS UP A 'FORTRAN' TYPE FORMAT
9009 REM STATEMENT INTO A TABLE FOR USE WITH [SUB IB.IC.ID]
9010 REM EXAMPLE:
9012 REM   FS="(A3,4X,2F7.2,X,3I6)"
9015 REM   A3   - 3 CHAR STRING (3A - BAD ENTRY)
9018 REM   4X   - 4 BLANKS (4X6 - 6 IGNORED)
9021 REM   2F7.2 - 2 REAL NOS OF 7 CHARS W/ 2 DECIMAL PLACES
9024 REM   X    - 1 BLANK
9027 REM   3I6  - 3 INTEGERS 6 CHAR LONG
9030 REM
9033 REM INPUT:
9036 REM   FS - FORMAT
9039 REM OUTPUT:   DIM AS REQUIRED
9040 REM   V1  - STRING FIELD COUNT
9041 REM   V2  - NUMBER FIELD COUNT
9042 REM   Y(1,K) - TYPE 1=STRING, 2=INTEGER, 3=REAL, 4=BLANK
9045 REM   Y(2,K) - FIELD START POSITION IN INPUT OR OUTPUT RECORD
9048 REM   Y(3,K) - LENGTH OF FIELD
9051 REM   Y9   - NO OF FIELDS INCLUDING BLANKS + 1
9054 REM VARIABLE NAMES USED:
9057 REM   FS,US,WS,XS,V1,V2,V3,V4,V5,V6,V7,V8,V9,Y(1,K),Y9
9058 REM
9060 V1=1
9069 V2=1
9072 V5=1
9075 Y9=1
9081 Y(2,1)=1
9084 WS=""
9087 US="AIFX .)."
9090 FOR V7=2 TO LEN(FS)
9093 XS=MIDS(FS,V7,1)
9096 FOR V8=1 TO 8
9099 IF XS=MIDS(US,V8,1) GOTO 9112
9100 NEXT V8
9103 IF XS>="0" AND XS<="9" GOTO 9142
9106 PRINT "FORMAT ERROR (":XS:)"
9109 STOP
9112 IF V8<5 GOTO 9121
9115 V8=V8-4
    
```

Listing 1 continued on page 180

MICAH

OSBORNE BUSINESS SOFTWARE

in CBASIC2 or CROMEMCO 16K BASIC

★ features ★

- Four Complete Packages...
 - General Ledger
 - Accounts Receivable
 - Accounts Payable
 - Payroll with Cost Accounting
- Strong support from Osborne Manuals
- CBASIC2 runs under CP/M or under CDOS version 1.07 on Cromemco computers
- 16K BASIC runs on Cromemco computers
- Cursor addressing routines for Hazeltine, Lear Siegler and Cromemco (Beehive) Terminals
- Source Codes and Installation Instructions provided along with disks
- Automatic Command Start-up
- Easy to apply to all of your business and systems needs

★ hardware required ★

- One or more 8" or 5" Floppy Drives
- CRT with cursor addressing
- 132-Column Printer

\$95 per package

TO ORDER
Add \$5 for shipping.
Call: add n. 12% Sales Tax.
CREDIT CARDS ACCEPTED

• DEALER INQUIRIES INVITED •

MICAH'S PRODUCTS OF DISTINCTION

- OSBORNE BUSINESS SOFTWARE (in CBASIC2 & 16K)
- BIOS (CP/M in Cromemco Computers)
- MICROBIT (Portable Printer Graphics)
- DUP/1 (Disk Utilities for CP/M and CDOS)
- DUP/2 (Disk Utilities for Cromemco)
- DUP/3 (DOP/2 Expanded) Printer Drivers)
- STOOD (Cromemco Format Utility)
- EXPAND (Run Cromemco Software on CP/M)
- BLACKJACK (Tutorial Casino Action)
- DRIVE (Customized Printer Drivers)
- DBMS Conversion to NAD

• Call or Write for Free Catalogue and More Information •

★ We will Customize any of our programs at our Standard Consulting Rates ★

Ah! MICAH . . . Satisfyin' Software

That turns your system on!
MICRO Applications and Hardware

• CONSULTANTS and SOFTWARE DEVELOPERS •

MICAH Box 22212 San Francisco, California 94122 USA phone: 415/664-0778

WE CARRY —

- CROMEMCO
- NORTH STAR
- VECTOR GRAPHICS
- THINKER TOYS
 - NEC
- CENTRONICS
- INTERTUBE — \$750.00
- SERENDIPITY
- SOROC — \$775.00
- TEXAS INSTRUMENTS

Professional A/R, A/P, Ledger, Payroll, Medical Billing software with customization available. Send for our catalog — Send for quote.

Call for quote.

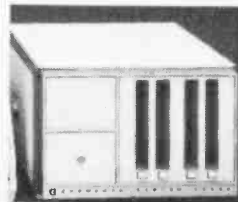

SARA-TECH COMPUTERS

P.O. Box 692
Venice, FL
33595

(813) 485-3559



BITS PROGRAMMER PADS™

VISA



For Fastest Service

CALL TOLL FREE 800-258-5477
FOR BANK CARD ORDERS

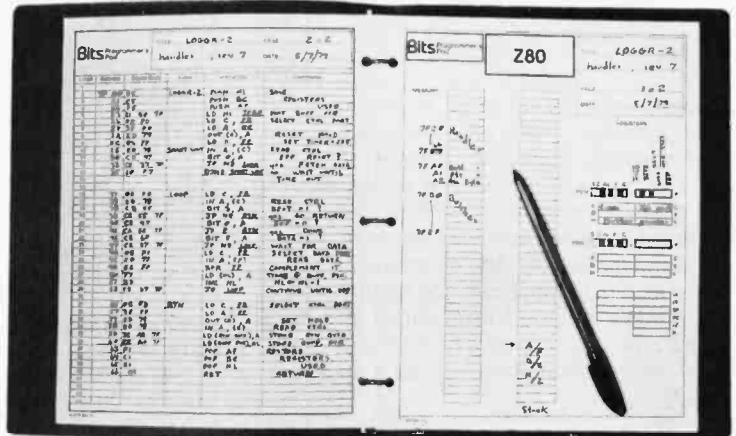

Good programming deserves good documentation. BITS Inc. has developed a programming form to help assembly language programmers write and preserve their programs in a loose-leaf notebook format. **BITS PROGRAMMER PADS™** are now available for the 8080A, Z-80, 1802, 6800, and 6502 microprocessors. On one side of the form the processor's register architecture is laid out along with continuous memory locations. This allows the details of your program's register use, stack manipulations, indexed addressing, and table and data storage to be permanently recorded. The other side is for your program or subroutine listing. Its source listing is entered in the instructions, labels and comments columns. Assembling is done next by filling in the object

code column which is wide enough for two or three byte instructions. Memory locations are assigned in the address column. If revision or relocation of the program is necessary, the address column can be renewed using typewriter correction tape (a white paper tape about 1/3" wide) and memory addresses reassigned.

BITS PROGRAMMER PADS will protect the effort you have put into your programs and take some of the pain out of hand assembly. Each 50-page pad is printed on durable stock paper, and prepunched for a standard three-ring notebook. They are available for \$2.50 each plus postage and handling (75¢ for one pad, \$1.25 for two or more domestic; \$1.00 per pad to a maximum charge of \$4.00 foreign.)

BITS Inc Books to erase the impossible

25 Route 101 West, PO Box 428, Peterborough, NH 03458

1B020

DESKS AND STUFF

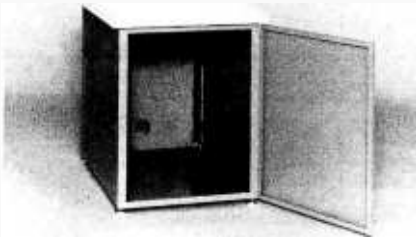
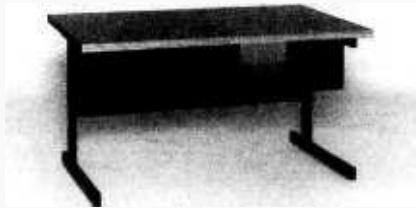

Computer terminals, business systems, lab components . . . they all need desks and enclosures. That's what we're all about. Computer Furniture and Accessories offers a standard line of furniture suitable for a wide variety of applications. Handsome, rugged, economical furniture in all shapes, sizes and colors. Basic models shipped from stock in days, not months. And we're nice people to deal with. What more could you ask for?

CF&A

**Computer Furniture and
Accessories, Inc.**
1441 West 132nd Street
Gardena, CA 90249
(213) 327-7710

Listing 1 continued:

```

9118 GOTO 9139
9121 V9=V8
9130 V6=V6+1
9133 IF V6=2 THEN V5=VAL(W$)
9136 GOTO 9181
9139 IF V8<>4 GOTO 9151
9142 W$=W$+X$
9145 V6=1
9148 GOTO 9184
9151 V4=VAL(W$)
9153 IF V5=0 THEN V5=1
9154 IF V9=4 THEN V4=V5
9157 IF V9=4 THEN V5=1
9160 FOR V3=1 TO V5
9161 Y(1,Y9)=V9
9163 Y(3,Y9)=V4
9166 Y(2,Y9+1)=INT(Y(2,Y9)+V4)
9169 Y9=Y9+1
9170 IF V9=2 OR V9=3 THEN V2=V2+1
9171 IF V9=1 THEN V1=V1+1
9172 NEXT V3
9175 V5=1
9178 V6=1
9181 W$=""
9184 NEXT V7
9185 RETURN
9190 REM
9192 REM
9200 REM BREAKS UP A FORMATTED STRING SUBROUTINE [SUB I/O 1B.0]
9203 REM
9206 REM THIS SUBROUTINE BREAKS UP A FORMATTED STRING RECORD FROM:
9209 REM 1. READ FROM INPUT STATEMENT
9212 REM 2. READ FROM DATA STATEMENT
9215 REM 3. FORMATTED INPUT - STRING MUST BE IN QUOTES (")
9218 REM 4. INPUT STATEMENT USING BASIC PATCHED FOR USE
9219 REM WITH RO-CHE MULTI-CASSETTE CONTROLLER
9221 REM INTO STRING AND NUMBER ARRAYS BASED ON A TABLE BUILT
9224 REM INTO THE PROGRAM OR FROM PARAMETERS CREATED BY [I/O 1A.0]
9227 REM
9230 REM INPUT:
9233 REM Z$ - INPUT STRING
9236 REM Y(K,1)- PARAMETER TABLE
9239 REM Y9 - NO OF FIELDS INCLUDING BLANK FIELDS
9242 REM OUTPUT:
9245 REM VS(1) - STRING FIELD ARRAY
9248 REM V(1) - NUMBER FIELD ARRAY
9251 REM VARIABLE NAMES USED:
9254 REM VS(1),Z$,V(1),V1,V2,V7,Y(1,K),Y9
9260 V1=0
9266 V2=0
9269 FOR V7=1 TO Y9-1
9272 ON Y(1,V7) GOTO 9275,9284,9284,9290
9275 V1=V1+1
9278 VS(V1)=MID$(Z$,Y(2,V7),INT(Y(3,V7)))
9281 GOTO 9290
9284 V2=V2+1
9287 V(V2)=VAL(MID$(Z$,Y(2,V7),INT(Y(3,V7))))
9290 NEXT V7
9293 Z$=""
9296 RETURN
9297 REM
9298 REM
9300 REM FREE FORM INPUT SUBROUTINE [SUB I/O 1C.0]
9303 REM
9306 REM THIS ROUTINE ACCEPTS A FREE FORM INPUT STRING AND PRO-
9309 REM DUCES A STRING AND/OR NUMBER ARRAY BASED ON A TABLE BUILT
9312 REM INTO THE PROGRAM OR CREATED BY [SUB I/O 1A].
9315 REM BLANKS ARE USED AS DELIMITERS BETWEEN FIELDS.
9316 REM STRING FIELDS CONTAINING BLANKS OR WITH
9318 REM LEADING OR TRAILING BLANKS MUST BE
9321 REM ENCLOSED WITH A DELIMITER. NUMERIC FIELDS ARE
9324 REM EDITED FOR NON-NUMERIC CHARACTERS. IF THE INPUT
9327 REM STRING HAS TOO MANY FIELDS THE EXTRA FIELDS WILL

```

Listing 1 continued on page 182

APPLE COMPUTER™ IFR SIMULATOR NOW YOUR APPLE CAN FLY!

The latest version of Aircraft flight simulator includes dual navigation radios and allows the pilot to actually fly instrument landings using ILS and Glide slope.

After the approach, a plot is presented showing the flight path.

This one program gives your Apple™ more flight simulator power than most \$10,000 machines on the market today, AND FOR ONLY \$19.95.

**Available from
Programmers Software Exchange
Box 199
Cabot Arkansas 72023.
(501) 843-6037**

NO FRILLS! NO GIMMICKS! JUST GREAT DISCOUNTS MAIL ORDER ONLY

HAZELTINE			
1400		} Call For Prices	
1410			
1420			
1500			
1500(Kit)			
CENTRONICS			
779-2	995.00		
700-2	1350.00		
703 tractor	2195.00		
Micro Printer	395.00		
730	975.00		
NORTHSTAR			
Horizon I assembled ..	1629.00		
kit	1339.00		
Horizon II assembled ..	1999.00		
kit	1599.00		
TELETYPE			
Mod 43	995.00		
INTERTEC			
Superbrain	2195.00		
DIGITAL SYSTEMS			
Computer	\$4345.00		
Double Density			
Dual Drive	2433.00		
TELEVIDEO			
912		} Call For Prices	
920			
DEC			
LA 34	1149.00		
CROMEMCO			
System III \$1000 off ..	4990.00		
TEXAS INSTRUMENTS			
810 Printer	1595.00		
ATARI 800	795.00		
ADDS Regent 25	CALL		
Optima Cabinets (New) . . .	99.95		
5" Scotch Diskette	Box/29.95		
8" Scotch Diskette	Box/34.95		

Most items in stock for immediate delivery. Factory-fresh, sealed cartons.

DATA DISCOUNT CENTER

Box 100 135-53 Northern Blvd., Flushing, New York 11354, 212/465-6609

N.Y.S. residents add appropriate Sales Tax. Shipping FOB N.Y.
BankAmericard, Master Charge add 3%. COD orders require 25% deposit.

SAVE THE WHALE

The Fin Whale is the world's greatest long-distance communicator.

Scientists believe that loud, deep-tone, low-frequency sounds made by Fin Whales (frequencies around 20 hertz, or cycles per second) actually travel underwater for distances of at least 500 miles, and under optimum conditions might carry for a radius of over 4,000 miles, potentially reaching an area greater than the entire Atlantic Ocean.

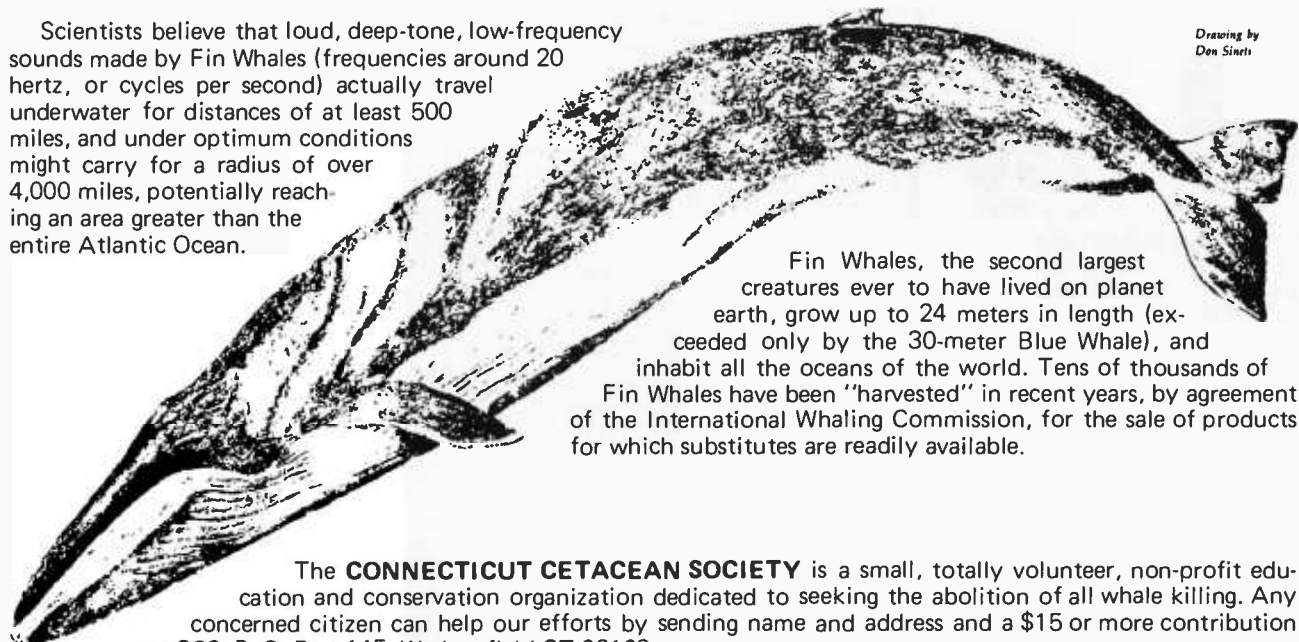

Fin Whales, the second largest creatures ever to have lived on planet earth, grow up to 24 meters in length (exceeded only by the 30-meter Blue Whale), and inhabit all the oceans of the world. Tens of thousands of Fin Whales have been "harvested" in recent years, by agreement of the International Whaling Commission, for the sale of products for which substitutes are readily available.

The **CONNECTICUT CETACEAN SOCIETY** is a small, totally volunteer, non-profit education and conservation organization dedicated to seeking the abolition of all whale killing. Any concerned citizen can help our efforts by sending name and address and a \$15 or more contribution to: CCS, P. O. Box 145, Wethersfield CT 06109.

New CRT SENSATION!

You have been reading about our astounding high performance microcomputer products. Our X-9000 Pascal MICROENGINE™ CPU that executes Pascal 13x faster than an LSI-11 and 3x faster than a PDP11-34. Our X-920 CRT matches the features of the SOROC IQ140. Our X-8000 16-bit CPU addresses 8M bytes of memory directly and is coming soon!

™Trademark Western Digital Corporation

DISPLAY/EDIT TERMINAL Model X-920



\$920

\$820 (Without 18 function keys)

STANDARD FEATURES (partial list)

- Microprocessor controlled
- Serial RS232C and 20 ma current loop
- 10 baud rates—75 to 19,200
- 24 lines x 80 characters
- 96 ASCII displayable characters
- Upper and lower case
- 12 x 10 character resolution
- Dual intensity display
- Clear full intensity data only
- Programmable reverse video
- Programmable underline
- 105 keys with alpha lock
- 14 key numeric pad with decimal
- 16 special function keys
- 8 edit function keys
- 2 block transmission keys
- Self test mode
- Protect mode
- Block mode
- 80 storable tabbing
- Insert/delete character and line
- Scrolling
- Addressable cursor
- A host of other features, including cursor controls and remote commands such as clear to nulls, spaces, end of line, end of screen; set hi, lo, zero intensity; set blink; etc.
- Optional screen print & 2nd page memory

For our system or for yours, in commercial, technical, educational or personal applications, the Computex X-920 is unmatched in its class.

All features of the Hazeltine 1400 and ADM-3A Plus: 128 ASCII characters
 7 x 10 matrix ... Reverse video ... Print key
 Shiftlock ... Transparent mode ... Backspace ...
 Tabbing ... Integrated numeric pad.



\$799

List price \$956

PERKIN-ELMER (Model 550)

Off the shelf delivery now on the Model X-920 and P-E Model 550. Add 40 lb. shipping. **Customer satisfaction is guaranteed.** Full refund with the return of any product within 10 days. X-9000 CPU \$2995, Pascal MICROENGINE™ owners manual \$19.95; X-920 operators manual \$10, postpaid. **Cash prices.** 10% down guarantees priority. IL residents add 5% sales tax. **Master Charge** and **Visa** accepted.

Computex stands for competence. We **service what we sell.** Written hardware warranty. Nationwide service contracts. Custom software. We provide **expert technical support.**

(312) 684-3183
COMPUTEX
 Microcomputer Systems
 "The Computer Experts"
 5710 Drexel Avenue
 Chicago, IL 60637

Listing 1 continued:

```

9330 REM BE IGNORED.
9333 REM IF THE INPUT STRING HAS TOO FEW FIELDS THE EXTRA
9336 REM FIELDS WILL BE 'BLANKED' OR 'ZEROED'. FOR
9339 REM BLANK FIELDS - ENTER '0' FOR NUMERIC AND ONE BLANK
9342 REM ENCLOSED BY DELIMITERS FOR STRINGS.
9345 REM
9348 REM INPUT:
9351 REM Z$ - INPUT STRING
9354 REM Y(I,K) - PARAMETER TABLE
9357 REM Y9 - NO OF FIELDS INCLUDING BLANKS + 1
9360 REM D$ - DELIMITER
9369 REM OUTPUT:
9372 REM V$(I) - STRING FIELDS ARRAY
9375 REM V(I) - NUMERIC FIELDS ARRAY
9376 REM ERR - 1-OK, 2-ERROR
9378 REM VARIABLE NAMES USED:
9381 REM D$,V$(I),W$,X$,V(I),V1,V2,V3,V4,V5,V6,V7,Y9
9400 FOR V3=1 TO V1
9403 V$(V3)=" "
9406 NEXT V3
9409 FOR V3=1 TO V2
9412 V(V3)=0
9415 NEXT V3
9416 REM ANY DELIMITER MAY BE USED
9418 D$="# "
9421 V1=0
9424 V2=0
9427 V4=1
9430 V5=0
9433 V6=1
9434 W$=" "
9435 ERR=1
9436 FOR V7=1 TO LEN(Z$)
9439 IF Y(1,V6)<>4 GOTO 9448
9442 V6=V6+1
9445 GOTO 9439
9448 X$=MID$(Z$,V7,1)
9451 IF X$<>D$ GOTO 9469
9454 V4=V4+1
9457 IF V7=LEN(Z$) GOTO 9515
9460 IF V4=2 GOTO 9545
9463 V4=1
9466 GOTO 9545
9469 IF X$=" " GOTO 9503
9472 V3=1
9475 IF Y(1,V6)=1 GOTO 9493
9478 IF X$>="0" AND X$<="9" GOTO 9493
9481 IF X$="-" GOTO 9493
9484 IF X$="." AND Y(1,V6)=3 GOTO 9493
9487 PRINT "FIELD (";V6;") NOT NUMERIC"
9490 ERR=2: RETURN
9493 V5=V5+1
9494 IF V5>INT(Y(3,V6)) GOTO 9545
9496 W$=W$+X$
9499 IF V7=LEN(Z$) GOTO 9512
9500 GOTO 9545
9503 IF V4=2 GOTO 9493
9506 IF V3=2 GOTO 9512
9509 V3=2
9512 IF Y(1,V6)<>1 GOTO 9524
9515 V1=V1+1
9518 V$(V1)=W$
9521 GOTO 9530
9524 V2=V2+1
9527 V(V2)=VAL(W$)
9530 V6=V6+1
9533 IF V7=LEN(Z$) GOTO 9548
9536 V5=0
9539 W$=" "
9542 IF V6=Y9 GOTO 9548
9545 NEXT V7
9548 RETURN
9600 REM FORMATTED OUTPUT SUBROUTINE [SUB I/O ID.0]
    
```

Listing 1 continued on page 184

CP/M® SOFTWARE TOOLS

NEW ED-80 TEXT EDITOR

ED-80 offers a refreshing new approach for the creation and editing of program and data files conversationally—and it saves you money. Its powerful editing capabilities will satisfy the most demanding professional—yet it can still be used by the inexperienced beginner. **Look at These Outstanding Features:**

- FULL SCREEN window displays with forward and backward scrolling for editing your data a page-at-a-time, rather than line-by-line.
- Provides you with all the features found on the large mainframe and minicomputer editors, such as IBM, UNIVAC, CDC, and DEC.
- Commands include forward or backward LOCATE, CHANGE, and FIND; and INSERT, DELETE, REPLACE, APPEND, SAVE, PRINT, WINDOW, MACRO, TABSET, SCALE, DUMP, and others.
- Compatible with existing CP/M edit and text formatted files, with CBASIC, and with Microsoft's MBASIC, FORTRAN, COBOL, and ASSEMBLER.
- CHANGE commands allow you to make conditional changes and to use variable length strings.
- Designed for CP/M and derivative operating systems, including LIFEBOAT, CDOS, IMDOS, DOS-A, ADOS, etc.
- GET and PUT commands for concatenating, moving, duplicating, and merging your edit files on the same or different diskettes.
- Provides you with fast memory-to-memory COPY commands, and an intermediate buffer for copying lines over-and-over.
- Saves your last LOCATE, CHANGE, FIND, and APPEND command for easy re-execution.
- Simple line-oriented commands for character string editing.
- Safeguards to prevent catastrophic user errors that result in the loss of your edit file.
- INLINE command for your character-oriented editing.
- Designed for today's CRT's, video monitors, and teletypewriter terminals.
- Thoroughly field tested and documented with a comprehensive User's Manual and self-instructional tutorial.

And remember—in today's interactive programming environment—your most important software tool is your text editor. ED-80 is already working in industry, government, universities, and in personal computing to significantly cut program development time and to reduce high labor costs. Why not let ED-80 begin solving your text editing problems today? ED-80 is protected by copyright and furnished under a paid-up license for use on a single computer system. Single Density Diskette and Manual: \$99.00, or the Manual alone: \$20.00 (credited with purchase of the Diskette). Specify Disk make/model, 5" or 8", hard or soft sectored. ORDER NOW and we'll pay the postage!

SOFTWARE DEVELOPMENT & TRAINING, INC.
Post Office Box 4511 — Huntsville, Alabama 35802

Dealer Inquiries Welcomed

© CP/M is a trademark of Digital Research



APPLE • CENTRONICS • TEXAS INSTRUMENTS
HORIZON • VECTOR GRAPHIC • CROMENCO
• RADIO SHACK • HP • MICROPOLIS • SOROC
• OSI • SWTP • M • IBM • NEC •
PET • DIABLO • HAZELTINE
• HEATH • D • IMSAI •
DEC • PET • • SOL
• WANG • • LSI •



WE'VE GOT YOU COVERED!

Cover Craft Dust Covers protect your hardware and your investment. Save maintenance, downtime and look great. Our Dust Covers come in hundreds of sizes each custom designed to fit a particular model of terminal, CPU, Line Printer, Floppy Disk, They're a proven way to help eliminate dust and dirt accumulation, improve system reliability and save many times the cost in reduced maintenance and downtime. What's more, your satisfaction is 100% guaranteed.

Cover Craft Dust Covers are available from your local computer retailer **\$6.95 - \$9.95** or contact Cover Craft.

Can you afford to wait any longer?

COVER CRAFT

P.O. Box 555, Amherst, NH 03031
Telephone (603)889-6811

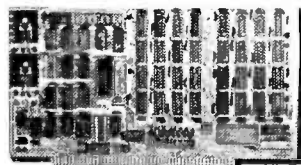

64K BYTE EXPANDABLE RAM

DYNAMIC RAM WITH ON BOARD TRANSPARENT REFRESH GUARANTEED TO OPERATE IN NORTHSTAR, CROMENCO, VECTOR GRAPHICS, SOL, AND OTHER 8080 OR Z-80 BASED S100 SYSTEMS *4MHZ Z-80 WITH NO WAIT STATES.

- * SELECTABLE AND DESELECTABLE IN 4K INCREMENTS ON 4K ADDRESS BOUNDARIES.
- * LOW POWER—8 WATTS MAXIMUM.
- * 200NSEC 4116 RAMS.
- * FULL DOCUMENTATION
- * ASSEMBLED AND TESTED BOARDS ARE GUARANTEED FOR ONE YEAR AND PURCHASE PRICE IS FULLY REFUNDABLE IF BOARD IS RETURNED UNDAMAGED WITHIN 14 DAYS.

ASSEMBLED / TESTED

64K RAM	\$595.00
48K RAM	\$529.00
32K RAM	\$459.00
16K RAM	\$389.00
WITHOUT RAM CHIPS	\$319.00

S100 MAINFRAME AND CARD CAGE

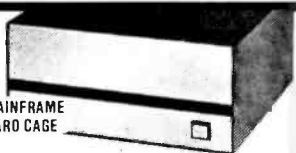

- * W/ SOLID FRONT PANEL \$239.00
- * W/ CUTOUTS FOR 2 MINI-FLOPPIES \$239.00
- * 30 AMP POWER SUPPLY \$119.00



VISTA V-200 MINI-FLOPPY SYSTEM

- * S100 DOUBLE DENSITY CONTROLLER
- * 204 KBYTE CAPACITY FLOPPY DISK DRIVE WITH CASE & POWER SUPPLY
- * MODIFIED CPM OPERATING SYSTEM WITH EXTENDED BASIC \$695.00
- * EXTRA DRIVE, CASE & POWER SUPPLY \$395.00

16K X 1 DYNAMIC RAM

THE MK4116-3 IS A 16,384 BIT HIGH SPEED NMOS DYNAMIC RAM. THEY ARE EQUIVALENT TO THE MOSTEK, TEXAS INSTRUMENTS, OR MOTOROLA 4116-3.

- * 200 NSEC ACCESS TIME, 375 NSEC CYCLE TIME.
- * 16 PIN TTL COMPATIBLE.
- * BURNED IN AND FULLY TESTED.
- * PARTS REPLACEMENT GUARANTEED FOR ONE YEAR.

\$8.50 EACH IN QUANTITIES OF 8

BETA COMPUTER DEVICES
P.O. BOX 3465
ORANGE, CALIFORNIA 92665
(714) 633-7280

CALIF RESIDENTS PLEASE ADD 6% SALES TAX. MASTERCHARGE & VISA ACCEPTED. PLEASE ALLOW 14 DAYS FOR CHECKS TO CLEAR BANK. PHONE ORDERS WELCOME.

KIM/SYM/AIM-65—32K EXPANDABLE RAM
DYNAMIC RAM WITH ON BOARD TRANSPARENT REFRESH THAT IS COMPATIBLE WITH KIM/SYM/AIM-65 AND OTHER 6502 BASED MICROCOMPUTERS.

- * PLUG COMPATIBLE WITH KIM/SYM/AIM-65. MAY BE CONNECTED TO PET USING ADAPTOR CABLE. SS44-E BUS EDGE CONNECTOR.
- * USES +5V ONLY (SUPPLIED FROM HOST COMPUTER BUS), 4 WATTS MAXIMUM.
- * BOARD ADDRESSABLE IN 4K BYTE BLOCKS WHICH CAN BE INDEPENDENTLY PLACED ON 4K BYTE BOUNDARIES ANYWHERE IN A 64K BYTE ADDRESS SPACE.
- * BUS BUFFERED WITH 1 LS TTL LOAD.
- * 200NSEC 4116 RAMS.
- * FULL DOCUMENTATION
- * ASSEMBLED AND TESTED BOARDS ARE GUARANTEED FOR ONE YEAR, AND PURCHASE PRICE IS FULLY REFUNDABLE IF BOARD IS RETURNED UNDAMAGED WITHIN 14 DAYS.

ASSEMBLED / TESTED

WITH 32K RAM	\$419.00
WITH 16K RAM	\$349.00
WITHOUT RAM CHIPS	\$279.00
HARD TO GET PARTS ONLY (NO RAMS)	\$109.00
BARE BOARD AND MANUAL	\$49.00

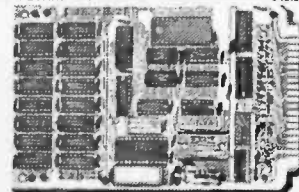

Listing 1 continued:

```

9603 REM
9606 REM THIS ROUTINE ACCEPTS ARRAYS OF STRING AND NUMBER
9609 REM FIELDS AND PRODUCES A FORMATTED STRING RECORD
9612 REM BASED ON A TABLE BUILT INTO THE PROGRAM OR CREATED
9614 REM BY [SUB A/O TABLE BUILD PROGRAM].
9616 REM NUMBERS ARE RIGHT JUSTIFIED. DECIMAL POSITION
9618 REM OF REAL NUMBERS ARE HELD AND TRAILING ZEROS ARE
9621 REM ADDED IF REQUIRED.
9622 REM
9624 REM INPUT:
9627 REM VS(1) - STRING FIELD ARRAY
9630 REM V(1) - NUMBER FIELD ARRAY
9633 REM Y(I,K) - PARAMETER TABLE
9636 REM Y9 - NO OF FIELDS INCLUDING BLANKS + 1
9639 REM OUTPUT:
9642 REM US - OUTPUT STRING RECORD
9645 REM VARIABLE NAMES USED
9648 REM US.VS(1).WS.YS.V(1).V1.V2.V3.V4.V5.V6.V7.V8.V9.Y(I,K).Y9
9649 REM
9650 US=""
9652 V1=0
9654 V2=0
9656 FOR V9=1 TO Y9-1
9658 WS=""
9660 VS=Y(1,V9)
9663 V3=INT(Y(3,V9))
9666 ON V5 GOTO 9668,9689,9689,9669
9668 V1=V1+1
9669 FOR V8=1 TO V3
9671 IF V5<>1 GOTO 9675
9672 YS=MID$(VS(V1),V8,1)
9675 IF YS="" OR V5=4 THEN YS=" "
9678 IF V5=2 OR V5=3 THEN YS="*"
9681 WS=WS+YS
9684 NEXT V8

```

DATA TERMINAL EQUIPMENT — FROM MICROMAIL



LA34 DECwriter IV

\$ 999.00

- Upper/lower case, 9x7 dot matrix
- 10, 12, 13.2, 16.5 characters/inch
- 2, 3, 4, 6, 8 or 12 lines/inch
- 22"W x 7"H x 15½"D, 25 lbs.
- 110 or 300 baud, RS 232C serial ASCII
- Friction feed, paper width to 15"

SOROC IQ 120 **\$740.00**

- RS 232C, upper/lower case, full ASCII
- Numeric keypad, protected fields
- Cursor keys plus addressable cursor
- Auxiliary extension port



SOROC IQ 140 **\$1,130.00**

- RS 232C and 20mA current loop
- Extensive editing features
- 25th line terminal status display
- 16 function keys (32 with shift)



New from DIABLO

DIABLO 1640 **\$2,920.00**
Receive-only **\$2,525.00**

High-quality daisywheel printing at 45 cps.

DIABLO 1650 **\$3,070.00**
Receive-only **\$2,675.00**

Metal daisywheel printing at 40 cps.

T.I. 810 printer **\$1,599.00**

- Includes upper/lower case
- 150 characters per second
- RS 232C serial interface
- Adjustable forms tractor

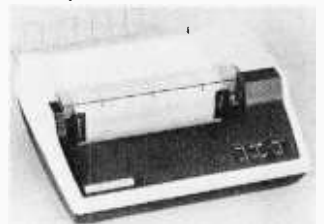

NEC Spinwriter

Call or write for prices

To Order: Send certified check (personal or company checks require two weeks to clear) including handling* and 6% sales tax if delivered within California.

*Handling: Less than \$2,000, add 2%; over \$2,000, add 1%. Everything shipped freight collect in factory cartons with manufacturer's warranty.

MICROMAIL
MICROMAIL • BOX 3297 • SANTA ANA, CA 92703
(714) 731-4338

Listing 1 continued:

```

9685 US=US+WS
9687 GOTO 9760
9689 V2=V2+1
9690 V7=INT(V(V2))
9693 V7=LEN(STR$(V7))-1
9694 YS=STR$(V(V2))
9696 IF LEFT$(YS,1)=". " THEN V7=V7+1
9697 IF MID$(YS,2,1)=". " THEN V7=V7-1
9698 IF LEFT$(YS,1)="- " GOTO 9701
9699 IF V(V2)>1.0 GOTO 9701
9700 V7=0.0
9701 IF LEFT$(YS,1)<>". " THEN YS=MID$(YS,2)
9703 V4=(Y(3,V9)*10)-(V3*10)
9706 IF V5=3 GOTO 9721
9708 IF V3-LEN(YS)=0 GOTO 9716
9709 FOR V8=1 TO V3-LEN(YS)
9712 WS=WS+" "
9715 NEXT V8
9716 WS=WS+YS
9718 GOTO 9757
9721 IF V7-1>=V3-V4 GOTO 9669
9724 IF INT(V(V2))=V(V2) THEN YS=YS+"."
9727 V6=0
9728 V7=V4+V7+1
9729 V7=V3-V7
9731 FOR V8=1 TO V3
9733 IF INT(V7+.005)>(V8-1) GOTO 9748
9736 V6=V6+1
9739 VS=MID$(YS,V6,1)
9742 IF VS="" THEN VS="0"
9743 WS=WS+VS
9745 GOTO 9754
9748 WS=WS+" "
9754 NEXT V8
9757 US=US+WS
9760 NEXT V9
9763 RETURN
9997 END

```

Copies of these routines are available for \$5 on paper tape or Tarbell format cassettes for 8 K V3.1, 3.2 and 4.0 BASIC from Elliam Associates, 24000 Bessemer St, Woodland Hills CA 91367.

Record Description	
Product Class	A2
Product Code	A6
Description	A15
Vendor Code	I3
Quantity On Order	I4
Quantity On Hand	I4
Sold Year To Date	I4
Unit Sales Price	F7.2

Format Statement	
F\$="	(A2,A6,A15,I3,I4,I4,I4,I4,F7.2)"

Data Record							
TWHD110V	Tape Winder	107	45	37	123	27.00	
V\$(1)	V\$(2)	V\$(3)	V(1)	V(2)	V(3)	V(4)	V(5)

Table 1: Format statement and corresponding data record. The descriptions for formats used here are FORTRAN types. The product class is an alphanumeric quantity having two characters, the product code consists of six alphanumeric characters and the description of 15 characters. The particular vendor code is a 3 digit integer. The quantity on order, on hand and the number sold up to this date are all 4 digit integers. The unit sales price is a 7 digit floating point number with two digits after the decimal place and four digits before the decimal place.

Text continued from page 176:

tinc. This is done with a FORTRAN type format statement which defines:

- A = Alphabetic or String Field.
- I = Integer Number.
- F = Floating Point or Real Number.
- X = Blank.

Table 1 shows how these formats are used. The format definition routine takes the format string statement (F\$) and converts it into a 3 column array (V). The first column defines the type of field: string, alphanumeric, integer, real, or blank. The second column provides the starting position of the field within the record. The third field provides the length of the field and number of decimal positions. This routine creates a parameter table that is used by the other routines.

The parameter table could also be built using values from DATA statements read into the proper variables thus eliminating the table build routine. Once the table is created, it can be used with INPUT, READ and PRINT

statements to convert the input or output string into string and number array variables. Any number of formats may be used in a program, but the format definition routine must be rerun each time a different format is used.

Fixed Form Input

The normal action of BASIC requires an entry for each field listed as a variable with an INPUT statement. This is a nuisance when you have an input and output (IO) field record and the last five entries are blank most of the time. The fixed form input does not require that the trailing fields be entered, since they will be blanked or zero filled. It is sometimes easier to keep the keyed input in neat columns (fixed format) rather than following one field after another (normal BASIC).

Example:

Normal BASIC
14,16,98
1457,258,7
2,3,7
Fixed Format
14 16 98
1457 258 7
2 3 7

The main advantage is in inputting formatted records from cassette tape or floppy disk. (See formatted output section, para-

graph after next, for further discussion of external IO.)

Free Form Input

Now that formatted input has been presented, let's look at the advantages and disadvantages of free form input. The major advantage is that data fields need only be separated by a blank and the routine will reformat that field to its proper place in the input record. Strings and numbers may be intermixed, but strings containing leading blanks or blanks within the string must be enclosed with a delimiter. The routine delimiter is a pound sign (#), although any character might be used. Blank fields must also be enclosed with delimiters, and numeric fields require a zero. Each method has its advantages and drawbacks depending on the type of data being handled. An example is shown in table 2.

Table 2: In this example a free form input is read by a formatting routine and stored on a record as indicated.

Example:	
keyed input	TW HD110V #TAPE WINDER #107 45 123 27.0
format	F\$="(A2,A6,A15,I3,I4,F7.2)"
record	TWHD100VTAPE WINDER 107 45 123 27.00

Table 3: Examples of how the format will affect the data that is being output. Note that some of the resulting output formats are indented. This is a result of leading blanks created to satisfy the format requirements for certain cases.

Data Format	Format Statement	Output Format
ABCDE	A6	ABCDE
ABCDEFG	A6	ABCDEF
123	I4	123
12345	I4	****
12.34	F6.2	12.34
12.3475	F6.2	12.35
12.	F6.2	12.00
11234.1	F6.2	*****

Table 4: Format and example output using the format and the data in table 3.

F\$="(A2,X,A6,X,A15,I3,I5,F8.3)"
TW HD100V Tape Winder 107 45 37 123 27.00

Table 5: Some typical transformations that may be performed on the stored and formatted data. The last line is the result of these transformations using the given format.

V\$(1)="Retail Value O/H"	change a string
V\$(2)=V\$(3)	move a string
V(1)=V(3)*V(5)	calculate a value
F\$="(A16,2X,A15,F8.2)"	format
Retail Value O/H Tape Winder 199.00	output record

Formatted Output

The formatted output routine uses the parameter table values and the variable array values in the V array and places them in the output string. Blanks as called out in the format statement are included. Strings are left justified (start in the first position of the field) and numeric values are right justified (any spaces appear on the left). Numeric values larger than the field call out cause the field to be filled with asterisks. Floating point (real) numbers with fewer than the required decimal places are zero filled. Numbers with more decimal places than the format allows are rounded as shown in table 3. Taking table 2 as an example input, the data could be printed with a different format such as in table 4.

About the Routines

The line numbers used by these routines are set high (above location 9000 in memory) so that BASIC programs can be written under them. Care must be taken that your programs do not have line numbers higher than 9000. All of the variable names used in each routine are listed in the comments. These variable names must not be used in your programs. All the comments are included before the routines so they may be deleted to save space.

More About Records

Obviously, it takes only a minimum amount of extra code to switch fields, add string constants and perform mathematical functions. Using the input data record of table 1, the transformations in table 5 may be made.

Once these routines are in your library, it is a simple matter to load them into memory, to key in your program and to add format statements. ■

TRS-80® CP/M® & CBASIC® BUSINESS SOFTWARE

All MOD II CP/M's are **not** created equal . . .
Find out why ours is the **Better Business Buy!**

Model I CP/M (rel. 1.5) \$150.00
 Model II CP/M (rel. 2.0) 250.00
APH (Automated Patient History) 175.00
RESIDENTIAL PROPERTY ANALYSIS
 system 300.00

The Genuine Article:

Osborne & Assoc. CBASIC source programs—
O&A Payroll w/Cost Accounting \$250.00
O&A Accts. Rec./Accts. Payable . . . 250.00
O&A General Ledger w/Cash Journal . 250.00
O&A CBASIC books for above (each) . . . 15.00

Send 30¢ SASE for CP/M Users Group software list & free "CP/M Primer".

* TRS-80 is a registered trademark of Radio Shack, a Tandy company
 * CP/M is a registered trademark of Digital Research
 * CBASIC is a registered trademark of Software Systems



(714) 848-1922

8041 NEWMAN AVENUE • SUITE 208 • HUNTINGTON BEACH, CALIFORNIA 92647

SAVE!! TRS-80



10, 15 Percent and More!

on computers, peripherals, software and other Radio Shack® products.

Offered Exclusively By

Pan American Electronics, Inc.

1117 CONWAY
MISSION, TEXAS 78572

A Radio Shack®

Authorized Sales Center

Toll Free 800/531-7466
Texas & Main No. 512/581-2765

NO TAXES collected on out-of-state shipments.
 FREE delivery available on minimum orders.
WARRANTIES honored by Radio Shack®.

CONSIDER THIS:

Portable Terminals at Typewriter Prices!

Now, while supplies last, you can lease or purchase a high-performance portable data terminal from Computer Devices, Inc., for about the same price you'd expect to pay for a professional electric typewriter!

Consider the Hardware:

We have limited quantities of remanufactured Teleterm®—both the CDI Model 1030 and the wide-carriage CDI Model 1132—available for immediate delivery. Each model is equipped with a standard typewriter keyboard, quiet thermal printer and an integral acoustic coupler. User selectable parity and full duplex transmission allow compatibility with any remote computer system.

Consider the Prices*:

The CDI Model 1030 Teleterm rents for only \$65/month (maintenance included) on a month-to-month basis—no term commitment—

or may be purchased outright for only \$785! The CDI Model 1132 wide carriage Teleterm rents month-to-month for \$100, or may be purchased for only \$1485! And both portable terminals are backed by a full 90-day warranty (on purchase) and CDI's 56 nationwide service centers.



As low as \$65 per month!

Consider the Features:

- 80 or 132 characters per line
- Quiet thermal printing up to 30 cps
- True portability—less than 25 lbs. with carrying case
- Compatible with all time-sharing systems
- Integral modem and acoustic coupler
- RS-232 connector plus additional CDI accessory connector
- Full upper/lower ASCII keyboard
- Low, low price

Visa and Master Charge accepted for purchase, but supplies are limited. So act now! Call toll-free, 800-225-1230 (in Massachusetts call 617-273-1550), or write for complete details. Computer Devices, Inc., 25 North Avenue, Burlington, MA 01803.



*Prices subject to change without notice.

We travel in the best companies

Book Reviews

Let's Talk LISP

by Laurent Siklossy
Prentice-Hall,
Englewood Cliffs NJ 1976
237 pages hardcover
\$14.20

Let's Talk LISP is a fun and useful book to read, at least for those of us who learn best when the material is presented in an interesting way. This is especially helpful for LISP, because for someone who is familiar with traditional programming languages, LISP seems very peculiar at first. After reading *Let's Talk LISP* and writing a few programs, I wondered how I had managed to avoid LISP for so long.

The structure of the book is extremely straightforward.

The first two chapters introduce the fundamental building blocks of LISP. After that, the reader is led through function definitions, recursion, MAP functions, and assorted elements of the language. Midway through the book, the author demonstrates how to write a LISP interpreter in LISP, and discusses the storage functions of LISP. At this point the reader has been introduced to almost everything in the language, but is probably not certain how to write a program. The remainder of the book consists of programming examples.

The first question which one should ask of a LISP book is how it treats language variations; LISP is not standardized. There are two major dialects (EVAL

and EVALQUOTE), and many variations between implementations of the same dialect. The author discusses both of the major dialects, and points out where implementations are likely to differ. I have used two versions of LISP: a large version running on an Amdahl 470 and a Z80 version which was adapted from *Dr Dobb's Journal of Computer Calisthenics and Orthodontia*, number 30. Neither of these implementations matched the language used in *Let's Talk LISP*, but neither of them required much work to make the sample programs run. In short, the book attempts to cover possible differences, and gets most of them, but unless you are using MACLISP at MIT, you will have to make some changes.

If you want to learn LISP and you are not turned off by a lighthearted but thorough treatment of the subject, *Let's Talk LISP* is a good book to read.

John A Lehman
716 Hutchins #2
Ann Arbor MI 48103

Gödel, Escher, Bach: An Eternal Golden Braid

Douglas R Hofstadter
Basic Books
New York 1979
742 pages plus notes and references, hardcover
\$18.95

Gödel, Escher, Bach is a book of youthful wisdom and deep beauty. It spans the domains of art, science and philosophy — a fact which evidently causes considerable consternation to book store clerks, who occasionally misshelve it with the "occult."

At some fundamental level, the works of Bach, Escher and Gödel may be seen as variant manifestations of a single common theme. Hofstadter uses this theme of recursion or self-reference to unify his exploration of questions and issues from such apparently disparate fields as artificial intelligence and molecular biology.

Gödel, Escher, Bach is an enchanting book, in the same sense that Lewis Carroll's writings are enchanting. Although Hofstadter, a contemporary American, writes more idiomatically and with less polish than Lewis Carroll, the book's childlike exuberance, together with artistic forms, whimsical passages and concealed meanings, make it a sheer delight. The entire book has the form of a fugue — it is what it is about. Prose and dialogues alternate. The latter are in the spirit of Lewis Carroll and each imitates the form of a particular Bach composition.

Hofstadter is a physicist by training and a computer scientist by vocation. Students of artificial intelligence will appreciate his deeply knowledgeable treatment of this subject. Of particular interest are his remarks concerning

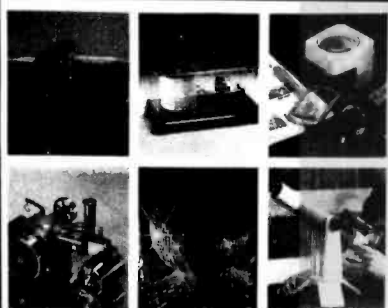

Edmund Scientific Catalog

1980 Spring, Summer, Catalog #1912



Edmund makes science fun!!!

Free! Edmund Scientific Catalog

Explore with us!

Over 4,000 exciting products in our Free

100 page color catalog . . . Astronomy
• Biofeedback • Binoculars • Fiber
Optics • Magnifiers • Diffraction Grating
• Lab Equipment • Lasers • Health •
Lenses • Magnets • Treasure Hunting
• Unique Lighting • Weather . . . and
much more . . . In the **Edmund World
of Science!**

Edmund has a proud 38 year record
of service to the hobbyist, serious amateur
and professional!

Rush me your free catalog!

Name _____
Company _____
Address _____
City _____
State _____ Zip _____

Clip and Mail Coupon Today to:

Edmund Scientific Co., Dept. 2017 KH04
Edscorp. Building, Barrington, N.J. 08007

No. 153

©1980 Edmund Scientific Co.

TRS-80 LEVEL II \$750. COMPLETE SYSTEM

The world's most popular microcomputer, with 16K of memory and Level 11 basic for only \$750, complete with full 90 day Radio Shack warranty. We accept check, money order or phone orders with Visa or MasterCard. (Shipping costs added to charge orders).

Disk drives, printers, peripherals, software and games . . . you name it, we've got it (Both Radio Shack & other brands). Write or call for our complete price list.



Shown is Level I. Level II includes Alphanumeric keypad.

C&S ELECTRONICS MART Ltd.

AUTHORIZED DEALERSHIP **Radio Shack**

32 E. Main Street • Milan Michigan 48160 • (313) 439-1400

COMPUTER ENTHUSIASTS, CLUBS DISCOVER BADGE POWER



Discover the power to inform, surprise, humor, protest or identify. Badge-A-Minit gives you that power and more! This is the system that started a badge and button making revolution. With the patented, BUT-N-LOK dies, sturdy hand die press and badge parts (that cost just pennies each), you create pinback badges. Use any slogan, emblem or photo-it's quick it's easy, it's inexpensive. Make one or one hundred, any time, any place. **LOWEST PRICE EVER.** Here's a complete badgemaking system at a new, low price. Starter kit includes steel and Lexan die press; precision molded, color-coded dies; quality, virgin metal badge parts; and illustrated instructions. Everything you need for \$17.95. **FREE CATALOG.** Send this coupon today. Receive the new 64-page, all color Badge-A-Minit catalog, free. See how your Badge-A-Minit creates keychains, mirrors, magnetic and adhesive badges. Includes many products useful for your office, club or home.

NEW LOW PRICE only \$17.95



BADGE-A-MINIT, Ltd., Dept. BY20
Box 618, Civic Industrial Park, LaSalle, IL 61301

- YES. RUSH ME the Badge-A-Minit starter kit for only \$17.95 plus \$1.75 shipping. (Ill. res. add \$.90 tax)
- Personal check or m.o. enclosed Use charge card below: VISA Mastercharge
- SEND ME FREE. the all color Badge-A-Minit catalog. Am. Express Diners Club

Credit Card # _____

Interbank # (MC) _____ Exp. date _____

Signature _____

Name _____

Address _____

City _____

State _____ Zip _____

UNCONDITIONAL MONEY BACK GUARANTEE

Dealerships Available

MULTI-TERMINAL
SMALL BUSINESS COMPUTERS



SYSTEM 40

IBC System 40 with 64K byte memory, 2.4M byte disk storage, cabinet, and multi-user operating system with BASIC	\$4,700	• Up to 6 CRT's/printers can operate independently and simultaneously. System 40 has dynamic memory allocation, reentrant code, and vectored interrupt. Operating system runs foreground, background, interactive, and batch. BASIC has multiple key ISAM.
Additional 2.4M byte disk storage	1,950	
Additional 20M byte disk storage (winchester)	4,000	• Applications software for accounting, order entry/inventory control, and manufacturing available soon.
CRT terminal	895	
Printer 150 cps	1,895	
Character printer (55 cps)	2,695	

IBC/INTEGRATED BUSINESS COMPUTERS
22010 Wilmington Ave., Suite 306, Carson, CA 90745
(213) 518-4245 *dealer prices

CCS

CORPORATE COMPUTER SYSTEMS, INC.
675 Line Road, Aberdeen, New Jersey 07747 Telephone 201-583-4422



THE PROGRAMMING LANGUAGE
HEWLETT PACKARD 1000 USERS
HAVE BEEN WAITING FOR.

- Interfaces to the complete HP1000 software base
- Machine control found previously only in assembly language
- Easily supports Structured Programming
- Includes the portable I/O Library with Printf and Scanf
- Macro-prepass
- Compiles on the HP RTE-IV
- Allows embedded assembler

representations of knowledge, and his speculations concerning the future of artificial intelligence. For example,

"Question: Will a computer program ever write beautiful music? Speculation: Yes, but not soon. Music is a language of emotions, and until programs have emotions as complex as ours, there is no way a program will write anything beautiful . . . To think — and I have heard this suggested — that we might soon be able to command a preprogrammed mass-produced mail-order twenty-dollar desk-model 'music box' to bring forth from its sterile circuitry pieces which Chopin or Bach might have written had they lived longer is a grotesque and shameful misestimation of the depth of the human spirit . . ."

Psychologists and other scientists who study humans are customarily reluctant to deal with such elusive topics as "consciousness" or "free will." Hofstadter has no such reticence, and consequently contributes unique and appealing insights to these subjects. In view of the book's global frame of reference, it is important to stress that the author is not reckless. On the contrary, one of his topics concerns the "nature of evidence," and in this regard it is clear that his own implicit criteria of acceptable evidence are definitely conservative. Neither is he a bigot, scientific or otherwise. His approach to centuries-old problems and dilemmas is characterized by carefulness and fair-mindedness.

An interesting paradox arises from the observation that no two human brains are perfectly isomorphic; yet humans have a powerful ability to communicate with other humans, however remote in time or place.

Hofstadter invents the concept of a "partial software isomorphism" between the brains of people who have similar thinking styles. An analysis of "Jabberwocky" translations clearly reveals the impossibility of exact translation between even closely related languages. One cannot help thinking that Hofstadter's book itself must represent the ultimate challenge for a translator. The dialogues not infrequently contain more than two levels of meaning. There are puns and acrostics, word puzzles and number puzzles — indeed, levels of meaning sometimes communicate with one another.

Although the prose is tractable, it is manifestly impossible to convey the true flavor of the book or to completely describe its subject matter in a brief review. Perhaps the best synopsis is found in the book on page 370, where the author diagrams a "tiny portion" of his "semantic network." This

"tiny portion" contains more than 100 interrelated symbols including: Truth vs provability, Gödel code, Genetic code, Recursion, Figure vs ground, Escher, Canons and fugues, RICER-CAR, Holism vs reductionism, Minds, Computers, Turing and more. What Hofstadter has to say on these subjects is uniquely interesting because it is founded on knowledge, derived by honest (unprejudiced) reasoning and expressed with a simple lucidity.

In the past few decades, much has been said and written about "intelligence," a concept now suspect but once thought to have a clear intuitive meaning. Whatever human intelligence is, one feels that this book manifests its highest qualities. *Gödel, Escher, Bach* is an exceptionally good book. ■

W Lloyd Milligan
8604 Maywood Dr
Columbia SC 29209



compaq
microsystems

There is nothing like a
DAIM

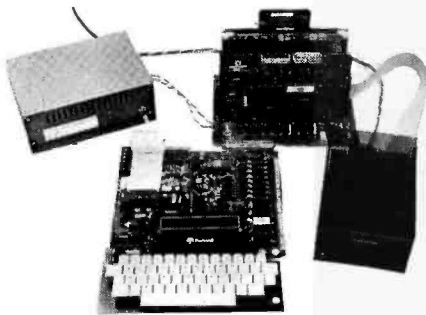

A complete disk system for the Rockwell Aim 65. Uses the Rockwell Expansion Motherboard. Base price of \$850 (U.S.) includes controller with software in Eprom, disk power supply and one packaged Shugart SA400 Drive.

224 SE 16th St.
P.O. BOX 687

AMES, IA 50010
(515) 232-8187

SOFTWARE TOOLS

- C compilers and cross-compilers for PDP-11's, LSI-11's, 8080's and Z/80's, with complete runtime library. **The full language is supported with efficient code generation.**
- Interface libraries giving access to all system directives for UNIX*, RT-11, RSX-11M, RSTS/E, IAS, CP/M, CDOS and ISIS-II.
- A-Natural narrative assembler for 8080's and Z/80's with librarian and linking loader.
- Over 175 installations in less than one year.

*UNIX is a trademark of Bell Laboratories.

Continuing maintenance and training available. An affordable alternative to Assembler, Fortran or Pascal, for as little as \$500 per compiler binary license. Catalogue and references available upon request.

Write to

Whitesmiths, Ltd.

127 East 59th Street · New York NY 10022 · 212 799-1200

MAGSAM™

KEYED FILE MANAGEMENT SYSTEM

Sophisticated applications made simple.

Put data at your fingertips... easily accessed, displayed, and updated by key. MAGSAM™ allows your CBASIC programs to create and access sophisticated keyed file structures through simple CBASIC statements.

Powerful, affordable, and easy to use.

MAGSAM™ is now available in three versions offering an array of features and capabilities. Standard MAGSAM™ features include random by key, sequential by key, generic by key, randomly by record number, and physical sequential access techniques. Each MAGSAM™ Package includes the MAGSAM™ file manager, tutorial program, file dump utility, User Guide, Reference Card, and one year update service.

- **MAGSAM™** — Most advanced version. Secondary Indexing with any number of keys, and Record and Key Deletion with automatic reuse of freed space. \$145†
- **MAGSAM II™** — Single Key support with full Record and Key Delete capability. \$99†
- **MAGSAM I™** — Entry level version. Single Key support without Delete functions. \$75†
- **MAGSAM™ User Guide** only — comprehensive tutorial and reference manual. \$15

Available for 8" soft sector, Micropolis, and TRS-80 disk formats. Requires CP/M™ or derivative and CBASIC. Distributed as CBASIC subroutines in source form.

Visa and Masterchagre welcome. Dealer and OEM inquiries invited.



MICRO APPLICATIONS GROUP

7300 CALDUS AVENUE
VAN NUYS, CA 91406

* Trademark of Digital Research † Single site license

THE BEST MICRO COMPUTER - Exporter -



Fast + Efficient

Our Foreign Customers Receive:

- Purchasing Agent's Service
- Wholesale Discounts
- 220 V/50 Hz Power

Products

NORTH STAR	TELEVIDEO
TEXAS INSTRUMENTS	BASE 2
SOROC	KONAN CORPORATION
INDUSTRIAL MICRO	CENTRONICS
HAZELTINE	INTEGRAL DATA
EXIDY SORCERER	VERBATIM
MICRO PERIPHERALS	+ More

P.O. Box 1118 Scottsdale, Arizona 85252 U.S.A.
Tel: 602-994-3435 TELEX: 165745

BYTE BACK ISSUES FOR SALE

The following Issues are available:

- 1976: July, November
- 1977: March, May thru December
- 1978: February thru October, December
- 1979: January thru December except March

Cover price for each issue through August 1977 is \$1.75 Domestic; \$2.75 Canada and Mexico; \$3.75 Foreign. September 1977 through October 1979 issues are \$2.50 Domestic; \$3.25 Canada and Mexico; \$4.00 Foreign. November 1979 to current is \$3.00 Domestic; \$3.75 Canada and Mexico; \$4.50 Foreign.

Send requests with payment to:

• **BYTE Magazine**
70 Main St, Peterborough NH 03458
Attn: Back Issues



CP/M 2.0



Expand the horizons of your TRS-80 model II with the industry standard operating system, CP/M version 2.0, and get these advantages over TRSDOS:

- compatible with hundreds of existing software packages
- **wide choice** of programming languages: BASIC, PASCAL, FORTRAN, COBOL, C, ASSEMBLER, and others
- **faster** disk access
- **more storage** per diskette
- assembler, editor, file handler, and dynamic debugger **included** with the operating system

Introductory price: \$175 including manuals



For full details about how CP/M 2.0 can improve the performance of your TRS-80 model II, contact:

PICKLES & TROUT
P.O. BOX 1206, GOLETA, CA 93017. (805) 967-9563

CP/M is a trademark of Digital Research Inc. TRS-80 is a trademark of Tandy Corp.

TRS-80 MOD II

A Financial Analysis Program

John A Lehman
716 Hutchins #2
Ann Arbor MI 48103

Introduction

Financial analysis, as it will be used in this article, means the study and analysis of financial statements. Financial statements are the documents which are produced by an accounting system; they report the position of a firm (such as the balance sheets shown in table 1) and how well it has done over the last period (income statements). They are used both by small businesses and by major corporations. The latter are required to make public statements in annual reports and in filings with the Securities and Exchange Commission; these statements serve as one of the primary sources of information to investors.

The program logic described in figure 1 is versatile enough to work on the financial statements of almost any company, although some statements may first need to be consolidated a bit. The basic tools used to analyze statements are ratios and percentages. These can be calculated for a firm, and then compared with both the firm's previous performance and with other firms in the same in-

dustry. In this way, a comprehensive study can evaluate the position of the firm and identify trends in performance.

There are a number of different people who can make use of this sort of analysis. Investors form a major group. Those who wish to make their own investment decisions rather than follow the suggestions of a broker or other advisor, usually want to base their investments on something more than blind faith. The analysis of financial statements is a good way to begin evaluating prospective investments. Unfortunately, many investors wish to evaluate a fairly large number of possibilities. This may present problems because the detailed analysis of ratios and percentages needed to evaluate your investments requires a great deal of time to calculate. This is where the personal computer comes in. With this program, you can evaluate a set of detailed reports in about the same time it takes to calculate a simple percentage analysis with a calculator. The results may be used as is, or used as inputs to any statistical calculations which you wish to use. In short, a personal computer can significantly reduce the time spent on the tedious calculations involved in financial analysis, and leave the analyst more

time for creative thought.

Investors are not the only ones who can use this sort of program. Banks regularly use ratio and percentage analysis to evaluate loan applications from businesses. Many banks are well equipped with computing facilities. But the businessman who is applying for the loan is often not. A banker is likely to be impressed if the financial statements submitted with the loan application include ratios and percentages. Not only does it make the banker's job easier, but it indicates that the applicant is well prepared.

A pro forma statement is a useful indicator to provide. These are forecasts of your financial position at some future point (eg: when the loan falls due). The program will also calculate pro formas.

Aside from using all of these financial indicators to impress the bank, a small businessman might want to use them to analyze his business. Where are things going well, and what weaknesses could stand some attention? There is plenty of available documentation which shows how to interpret ratios and percentages, but again, the calculations are tedious.

This program might also prove useful for the financial analyst—professional or academic. Since I count myself in the latter category, I have

About the Author

John A Lehman is a doctoral student in business administration at the University of Michigan.

Table 1: The financial statements from the MITS corporation before it was absorbed. These figures come from the Annual Report. This illustrates the format used in a standard financial report.

MITS INC		
Balance Sheet		
December 31 1975 and 1974		
Assets		
	<u>1975</u>	<u>1974</u>
Current Assets:		
Cash	\$ 112,461	\$ 30,596
Accounts receivable, less allowance for doubtful accounts of \$5,500, \$2,500 in 1974 (Note 2)	258,790	35,808
Notes receivable, stockholder	350	350
Inventories (Note 2)	640,432	266,219
Current portion of prepaid expenses	104,809	33,986
Total current assets	<u>1,116,842</u>	<u>366,959</u>
Property, plant and equipment (at cost) (Notes 2 and 3):		
Tooling	225,821	117,669
Transportation	130,607	8,140
Shop equipment	55,150	13,349
Office equipment	40,305	24,931
Leasehold improvements	12,749	9,848
Drafting equipment	5,753	2,694
	<u>470,385</u>	<u>176,631</u>
Less accumulated depreciation	<u>119,248</u>	<u>58,233</u>
	<u>351,137</u>	<u>118,398</u>
Other assets:		
Deposits	1,766	240
Deferred portion of prepaid expenses	29,938	—
	<u>31,704</u>	<u>240</u>
	<u>\$ 1,499,683</u>	<u>\$ 485,597</u>

See accompanying accountants' report and notes to financial statements.

Liabilities and Stockholders' Equity (Deficit)		
	<u>1975</u>	<u>1974</u>
Current liabilities:		
Accounts payable - trade	\$ 331,791	\$ 171,279
Customer deposits	455,425	85,517
Working capital loans (Note 2)	321,463	406,963
Current portion of long-term debt (Note 3)	39,288	8,602
Accrued liabilities	83,327	17,944
Total current liabilities	<u>1,231,294</u>	<u>690,305</u>
Deferred portion of long-term debt (Note 3)	<u>118,626</u>	<u>1,080</u>
Commitments (Note 4)		
Stockholders' equity:		
Common stock, \$.01 par value, 25,000,000 shares authorized, 947,495 shares issued in 1975, 902,940 shares issued in 1974	9,475	9,029
Additional paid-in capital	294,683	250,575
Retained deficit	<u>(153,295)</u>	<u>(465,392)</u>
	150,863	(205,788)
Less treasury stock, at cost, 1,100 shares	1,100	—
	<u>149,763</u>	<u>(205,788)</u>
	<u>\$ 1,499,683</u>	<u>\$ 485,597</u>

Table 1 continued on page 194

Table 1 continued:

MITS INC		
Statement of Income (Loss)		
Years ended December 31 1975 and 1974		
	1975	1974
Sales	\$ 3,240,772	\$ 959,972
Cost of sales	2,112,551	794,579
Gross profit	1,128,221	165,393
Expenses:		
Selling	441,596	152,407
Administrative	265,274	176,295
Other income and deductions	109,254	50,795
	816,124	379,497
Net income (loss)	\$312,097	\$ (214,104)
Net income (loss) per common share	\$.33	\$ (.24)

See accompanying accountants' report and notes to financial statements.

Try a Really Different Kind of Software for Your TRS-80, PET, or APPLE!

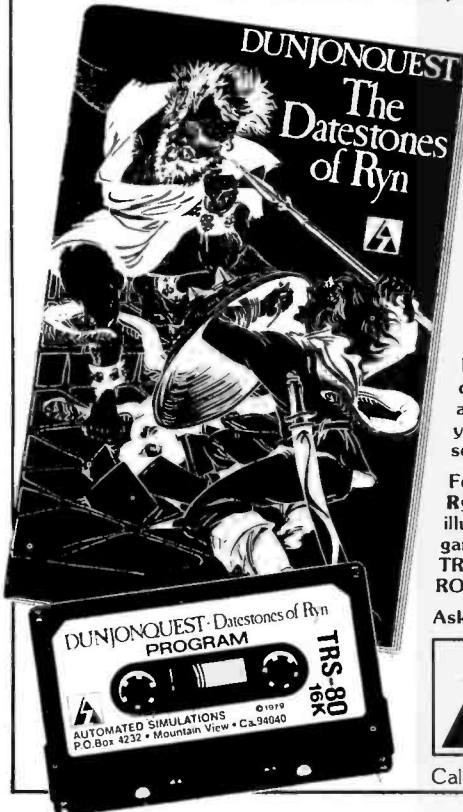

Cross swords with a band of dastardly robbers in their mountain lair in the **Datestones of Ryn**. You explore the caverns shown on your video display and vanquish the monsters in real time. You have just 20 minutes to recover the precious Datestones before time itself stops.

Monsters—Melees—Magic!

The **Datestones of Ryn** introduces you to the superlative DUNJONQUEST game system. Other games in the series may pit you against an evil wizard or the frightful insectoid monsters of the god Apsai. In the **Datestones** your main opponents are human, but look out for other nasty critters lurking in the darkness. You have 14 different commands ranging from moving (as fast or as slow as you like so long as you don't tire yourself out) to searching the walls for secret doors.

For just \$14.95 you get the **Datestones of Ryn** on cassette ready to play, and a superbly illustrated booklet that tells you all about the game. Please specify the version you want — TRS-80 (Level II, 16K), PET (16K old or new ROMS), or APPLE (32K Applesoft).

Ask your dealer or send today to:



AUTOMATED SIMULATIONS

Dept. R2
P.O. Box 4232
Mountain View, Ca. 94040

California residents please add 6% sales tax.



no doubt that the program is indeed useful for such people. I wrote this program to handle analytical problems which I had to perform quite often. Again, the outputs from this program may be used as they are, or as inputs to additional analyses.

Overview of the Program

The program in listing 1 is set up to work on standard financial statements with data for up to ten periods. It is arranged to use a standard chart of accounts for the income statement and balance sheet. Since the chart of accounts is not very specific, more detailed statements will have to be condensed first. This would be necessary for analysis in any case, since ratios are not usually calculated on the basis of all of the different categories of inventory, etc. The ten periods allowed may be either in years or quarters, and the output will be labeled correspondingly. Ten periods were selected since many annual reports and other published financial statements include ten-year summaries.

For whichever periods are entered, the user may select either a ratio analysis, a percentage analysis, or both. The ratio analysis subroutine calculates fourteen different ratios.

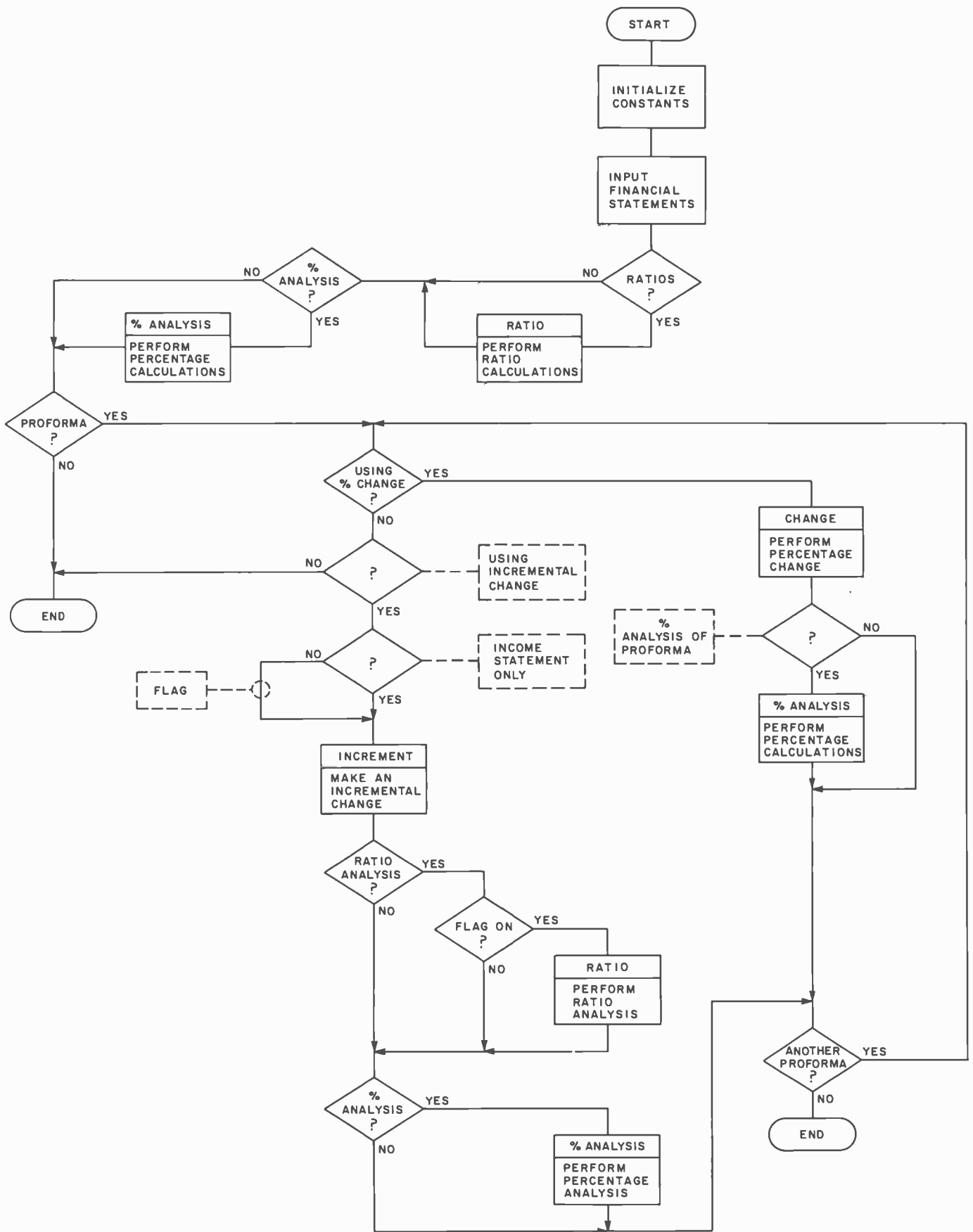

Figure 1: Flowchart of the financial analysis program.

Listing 1: BASIC listing of the financial analysis program. The entire program and the memory space required for BASIC can be stored in 16 K bytes of memory. A sample output of the program analyzing two years of data is also included.

```

10 REM FINANCIAL ANALYSIS, RATIO & %
20 REM ALSO DOES PROFORMAS USING % OP ABSOLUTE INCREMENTS
21 REM Z(33,11) IS THE MATRIX FOR THE FINANCIAL STATEMENTS
22 REM PERIOD ELEVEN IS THE SPACE FOR THE PROFORMAS
23 REM N$ IS THE ACCOUNT NAMES VECTOR
24 REM R$ IS THE RATIO NAMES, R() THE RATIO VALUES
25 REM Q INDICATES QUARTERS OR YEARS, C$=COMPANY NAME
26 REM B IS A FIRST CELL POINTER, M IS A LAST CELL POINTER
27 REM SWITCH CHANGES BETWEEN THE TELETYPE AND THE VIDEO DISPLAY
28 REM UP TO TEN PERIODS CAN BE TESTED FOR. STATEMENTS 21-29
29 REM SHOULD BE REMOVED IF YOU HAVE 16 K OR LESS OF MEMORY.
30 REM BY JOHN A LEHMAN
40 DIM Z(33,10),N$(33),R(13,13),R$(13)
50 FOR I=1 TO 33:READ N$(I):NEXT I
60 DATA "SALES","OTH REV","TOT INC","CGS","DEPR","SGA"
70 DATA "INT","TAX","DIV","TOTAL EXP","NET INC"
80 DATA "CASH","RCBLS","INV","PPE ITEMS","TOT CUR"
90 DATA "LAND","BLDG/EQ","ACC DEPR","TOT FIXED","OTH AS"
100 DATA "TOT ASTS","ACCTS PBL","NOTES PBL","CUR LT"
110 DATA "OTHER LIAB","CUR LIAB","LT DEBT","TOT LIAB"
120 DATA "C STK","APIC","RE","TOT CR"
130 FOR I=1 TO 13:READ R$(I):NEXT I
140 DATA "CURRENT","ACID","RCBL TO","INV TO","ASSET TO","PROF ON SALES"
150 DATA "ROA","ROI","EPS","PAYOUT","EBT-EQU","T INT EARNED","BK/SHARE"
160 INPUT "QUARTERS OR YEARS";A$
170 IF LEFT$(A$,1)="Q" THEN 210
180 IF LEFT$(A$,1)="Y" THEN 250
190 GOTO 160
200 REM QUARTERS. L$ IS A LABEL
210 L$="QUARTERS"
220 LET Q=.25
230 REM AN INCREMENT
240 GOTO 270
250 L$="YEARS "
260 Q=1
270 INPUT "COMPANY NAME";C$
280 INPUT "FOR HOW MANY PERIODS DO YOU HAVE FIGURES";N
290 INPUT "BEGINNING WITH JANUARY OF WHAT YEAR";Y
300 ? "OK, FIGURES FOR ";N;L$;" BEGINNING IN ";Y
310 FOR J=1 TO 33
320 FOR K=1 TO N
330 Y1=INT(Y+Q*K-1)
340 ? N$(J);" FOR ";Y1
350 INPUT Z(J,K)
360 NEXT K
370 NEXT J
380 FOR J=1 TO N
390 ? "# SHARES OUTSTANDING PERIOD ";J;" ?"
400 INPUT H(J)
410 NEXT J
420 INPUT "CORRECTIONS";A$:IF LEFT$(A$,1)="N" THEN 440
430 INPUT "WHICH ACCT# & PD#";J,K:INPUT "VALUE";Z(J,K):GOTO 420
440 E=1:REM 1ST CELL POINTER
450 SWITCH
460 "DO YOU WANT A LIST OF COMPARATIVE FINANCIAL RATIOS?"
470 " PLEASE ANSWER YES OR NO. THE ALTERNATIVE IS COMPARATIVE %"
480 INPUT A$
490 IF LEFT$(A$,1)="Y" THEN 530
500 IF LEFT$(A$,1)="N" THEN 540
510 ? "PLEASE ANSWER YES OR NO"
520 GOTO 460
530 GOSUB 1030
540 INPUT "DO YOU WANT COMPARATIVE % FROM INCOMES STMT & BS";A$
550 IF LEFT$(A$,1)="Y" THEN 590
560 GOTO 940
570 ? "PLEASE ANSWER YES OR NO"
580 GOTO 540
590 GOSUB 1310
600 GOSUB 1410
610 INPUT "DO YOU WANT TO CREATE A PROFORMA INCOME STATEMENT";A$
620 IF LEFT$(A$,1)="Y" THEN 650
630 IF LEFT$(A$,1)="N" THEN 1840
640 GOTO 610
650 INPUT "DO YOU WANT TO USE % CHANGES FROM LAST PERIOD";A$
660 IF LEFT$(A$,1)="N" THEN 710
670 IF LEFT$(A$,1)="Y" THEN 690
680 GOTO 650
690 GOSUB 1510
700 GOTO 940

```

Listing 1 continued on page 198

These include the following: current, quick, acid test, accounts receivable in days, inventory turnover, asset turnover, profit on sales, return on assets, return on investment, earnings per share (simple), dividend payout, debt/equity, times interest earned, and book value per share. A detailed description of the use of these ratios and how they are calculated is included in the glossary at the end of this article. Percentages will be calculated for each period in two groups. Income statement items will be presented as percent of total sales; balance sheet items will be presented as percent of total assets.

In addition to the above analyses, the program will calculate pro forma income statements and balance sheets. As I mentioned earlier, a pro forma statement is a prediction of what that statement will look like at a given time. The statements for the last period are the basis upon which the program calculates pro forma statements. These may be done by assuming a constant percentage change for all accounts, or by giving dollar amounts by which each account is predicted to change. As well as calculating the pro forma statements, the program will do ratio and/or percentage analyses on the pro formas if desired. This is particularly useful when examining the effects of alternate possibilities. It is possible to come up with several alternatives for the coming period and observe the forecasted result for each one.

Computer Program

The financial analysis program has been written in BASIC and runs in 16 K bytes or more, including the space required for BASIC, but not including the space required for the system monitor. If you are running it with only 16 K (as I do) you will either have to remove some of the remark statements from the listing or adjust the dimension (DIM) statement to handle less than ten periods.

The only peripheral-dependent part of the program is the SWITCH statement which occurs at lines 450 and 1840. This is used to switch the logical console device between user defined and the Teletype. The configuration upon which I run it allows me to set up all of the statements

CP/M SOFTWARE

Word Processing For CP/M

FMT Text Formatter \$75

Use FMT and your text editor to convert your CP/M system to a powerful word processor. FMT features include automatic page headings and footings, page numbering, centering, underscoring, external file merging, and in-line console input. FMT works with any video, CRT, or hardcopy terminal and printer combination. Added capabilities for daisy-wheel printers: superscripting, subscripting, and half-line spacing.

Run Cromemco Software Under CP/M

ADAPT Software Interface \$50

Now you can get Cromemco software to run on your CP/M system. ADAPT interfaces those powerful Cromemco packages (except for Multi-User BASIC) to any CP/M Version 1.4 system without patching. ADAPT works without changes for any memory size.

Fast RATFOR

RATFOR (RATional FORtran) \$95

RATFOR lets you write structured code that translates to MicroSoft or Cromemco FORTRAN. TSW's RATFOR (RATional FORtran) precompiler runs at more than 1000 statements per minute. Documentation includes "Software Tools" book by Kernighan and Plauger. (ADAPT and RATFOR packages combined \$125)



THE SOFTWARE WORKS
8369 Vickers
San Diego, CA 92111
(714) 569-1721

* CP/M is a trademark of Digital Research.

Z-80/TRS-80™ Users BOOK YOU'VE WANTED NOW CAN BE YOURS THE Z-80: HOW IT WORKS (THE PROGRAMMERS PERSPECTIVE)

By Monte Corum

- Best Most Complete Reference Yet
- cpu Operation Explained
- Addressing Modes Demystified
- Register Functions Described
- Instructions Defined
- Interrupts Diagrammed
- Cycles Outlined
- Formats Described
- Execution Described in Text, Notation and Diagrams
- Meaningful Analysis of 698 Commands in Formatted, Usable Tables
- Simple, Consistent Notation and Formats
- A Programmer's Book, Beginner or Experienced
- Ideal Text for Class Instruction
- Price: \$17.95 Plus Tax and Shipping
- VISA & MSTRCHRG-NUMBER AND EXP. DATE
- PREPAID WE SHIP

MICROWARE ASSOCIATES, INCORPORATED
9301 N. 58th St. DPT. AAA
SCOTTSDALE, AZ. 85253

DEALER INQUIRIES INVITED

™ TRS-80 IS A TRADEMARK OF TANDY CORP.

To further improve service to our customers we have installed a toll-free WATS line in our Peterborough, New Hampshire office. If you would like to order a subscription to BYTE, or if you have a question related to a BYTE subscription, you are invited to call* (800)258-5485 between 8:00 AM and 4:30 PM Eastern Time. (Friday 8 AM - Noon). *Calls from continental U.S. only.

BYTE's New Toll-free Subscriber W.A.T.S. Line

(800) 258-5485

We thank you and look forward to serving you.

9178

TOLL FREE ORDERING



These Fine Products and More

NORTHSTAR	ASM	KIT	TERMINAL	
HRZ-1-16K-D	1600.	1275.	SOROC IQ-120	760.
HRZ-1-32K-D	1995.	1580.	HAZELTINE 1400	760.
HRZ-2-32K-D	2300.	1900.	HAZELTINE 1500	940.
HRZ-1-32K-Q	2300.	1750.	HAZELTINE 1510	1050.
HRZ-2-32K-Q	2700.	2230.	TELEVIDEO 912	700.
			TELEVIDEO 920	750.
RAM-16K	365.	325.	PRINTERS	
RAM-32K	565.	515.	BASE-2	450.
FPB-A	285.	220.	TI-810	1580.
MDS-A-D	710.	660.	CENTRONICS-799	970.
MDS-A-Q	880.	830.	NEC-5510	2550.
EXTRA DRIVE-D	—	350.	NEC-5520	2800.
EXTRA DRIVE-Q	—	525.		
HARD DISC SYSTEM CALL			SOFTWARE—DISCS—MISC	
Most NorthStar computers come standard with real wood cover, 2 serial ports, 1 parallel port, real time clock, disc operating system and NorthStar basic.			AUTOSCRIBE	325.
			VERBATUM DISCS (10)	28.
			5 FOOT RS-232 CABLE	20.
			10 FOOT RS-232 CABLE	25.

WE WILL TRY TO BEAT ANY ADVERTISED PRICE

A. E. I.

4341 W. Commonwealth Ave Suite D
Fullerton, Calif. 92633

(714) 739-4701 (800) 854-6003

Listing 1 continued:

```

710 ? "DO YOU WANT TO MAKE INCREMENTAL CHANGES FROM"
720 INPUT "THE LAST PERIOD USING AMOUNTS OF CHANGE";A$
730 IF LEFT$(A$,1)="N" THEN 860
740 IF LEFT$(A$,1)="Y" THEN 770
750 ? "PLEASE ANSWER YES OR NO"
760 GOTO 710
770 ? "DO YOU WANT JUST THE INCOME STATEMENT (ENTER IS) OR"
780 INPUT "INCOME STATEMENT+BALANCE SHEET (ENTER ANYTHING ELSE)";Z$
790 IF Z$="IS" THEN 840
800 F=33
810 REM POINTS TO LAST ACCOUNT TO BE USED
820 GOSUB 1700
830 GOTO 860
840 F=11
850 GOSUB 1700
860 INPUT "DO YOU WANT A RATIO ANALYSIS OF THE PROFORMA (IF ANY)";A$
870 IF LEFT$(A$,1)="Y" THEN 890
880 IF LEFT$(A$,1)="N" THEN 940
890 LET N=1
900 IF Z$<>"IS" THEN 930
910 ?"CAN'T CALC WITH JUST INC STATEMENT"
920 GOTO 940
930 GOSUB 1030
940 INPUT "DO YOU WANT A % ANALYSIS OF THE PROFORMA";A$
950 IF LEFT$(A$,1)="Y" THEN 980
960 IF LEFT$(A$,1)="N" THEN 1000
970 GOTO 940
980 N=M
990 GOSUB 1310
1000 INPUT "DO YOU WANT ANOTHER PROFORMA";A$
1010 IF LEFT$(A$,1)="Y" THEN 650
1020 IF LEFT$(A$,1)="N" THEN 1840
1030 REM SUBROUTINE TO CALCULATE RATIOS
1040 FOR I=B TO N
1050 R(1,1)=Z(16,1)/Z(27,1):REM CURRENT RATIO
1060 R(2,1)=(Z(12,1)+Z(13,1))/Z(27,1):REM ACID TEST
1070 R(3,1)=365/(Z(1,1)/Z(13,1)):REM RECL DAYS
1080 R(4,1)=365/(Z(4,1)/Z(14,1)):REM INV TO
1090 R(5,1)=Z(1,1)/Z(22,1):REM ASSET TO
1100 R(6,1)=Z(11,1)/Z(1,1):REM PROFIT ON SALES
1110 R(7,1)=Z(11,1)/Z(22,1):REM ROA
1120 R(8,1)=Z(11,1)/(Z(33,1)-Z(29,1)):REM ROI
1130 R(9,1)=Z(11,1)/H(1):REM EPS
1140 R(10,1)=Z(9,1)/Z(11,1):REM DIV PD
1150 R(11,1)=Z(29,1)/Z(22,1):REM D/E
1160 R(12,1)=(Z(11,1)+Z(9,1)+Z(8,1)+Z(7,1))/Z(7,1):REM T.I.E
1170 R(13,1)=(Z(33,1)-Z(29,1))/H(1):REM BK/SHARE
1180 NEXT I
1190 INPUT "MOVE PAPER TO TOP OF PAGE & PRESS A KEY";A$
1200 ? C$,"RATIO ANALYSIS":?
1210 ? "RATIOS FOR ";N;L$;" BEGINNING IN ";Y: ?
1220 FOR I=1 TO 13
1230 ? R$(I)
1240 FOR J=B TO N
1250 Y1=INT(Y+Q*J-1)
1260 ? Y1,R(I,J)
1270 NEXT J
1280 NEXT I:?:?:?
1290 RETURN
1300 REM SUBROUTINE TO DO % ANALYSIS
1310 INPUT "MOVE PAPER TO TOP OF PAGE & PRESS A KEY";A$
1320 ? "INCOME STATEMENT ITEMS AS % OF TOTAL INCOME"
1330 FOR I=1 TO 11
1340 ? N$(I)
1350 FOR J=B TO N
1360 Y1=INT(Y+Q*J-1)
1370 R(J,1)=Z(I,J)/Z(3,J)*100
1380 ? Y1,R(J,1):NEXT J
1390 NEXT I: ?
1400 RETURN
1410 ? "E.S. ITEMS AS % OF TOTAL ASSETS": ?
1420 FOR I=12 TO 33
1430 ? N$(I)
1440 FOR J=1 TO N
1450 Y1=INT(Y+Q*J-1)
1460 R(J,1)=Z(I,J)/Z(22,J)*100
1470 ? Y1,R(J,1):NEXT J
1480 NEXT I:?:?:?
1490 RETURN
1500 REM SUBROUTINE TO CALCULATE PROFORMA WITH % CHANGES
1510 M=N+1:REM SAVE LAST CELL POINTER
1520 B=M
1530 FOR I=1 TO 9
1540 ? "CHANGE FOR ";N$(I)

```

Listing 1 continued on page 200

using a video display and then have the results printed on the Teletype. If your system does not allow for the SWITCH command, you can leave it out with no ill effects.

If you have more than 16 K bytes of memory, you may want to extend the strings from lines 60 thru 120 and 140 thru 150. This will make the output more readable.

Glossary

accounts receivable in days: *Accounts receivable are divided by total sales to produce receivable turnover per year, then divided by 365. This gives some indication of how fast receivables are being collected. Values vary with industry. Generally, the lower the number of days, the better.*

asset turnover: *Net sales divided by average total assets. This is one indication of how well assets are being used.*

book value per share: *Common stock divided by the number of shares. How much the shares of stock are worth in an accounting sense.*

current ratio: *A current account is cash or anything which can be converted into cash within one year. The current ratio is obtained by dividing the current assets by current liabilities. If the ratio is one, debts which must be paid within one year are just covered by assets which are expected to be received within one year. To maintain financial peace of mind the current ratio should be greater than one.*

debt/equity ratio: *Total liabilities divided by total assets (also referred to as total equities). How much of the firm's capital was furnished by creditors as opposed to owners. It varies by industry, but the lower the better for safety, and the higher the better for earnings per share. This contradiction is due to something called leverage, which is a fancy term for investing other people's money and keeping the profits.*

dividend payout: *Cash dividends divided by net income. This shows how much of earnings were paid to investors as opposed to those kept for*

6809!

INTRODUCING THE NEW STATE-OF-THE-ART IN MICROCOMPUTER SOFTWARE.

Call or write today for our
free catalog.

MICROWARE

5835 Grand Ave. • P.O. Box 4865
Des Moines, IA 50304 • 515/279-8844

ED SMITH'S SOFTWARE WORKS NEW 6809 SOFTWARE TOOLS

CROSSMAC A 6800 TO 6809 CROSS ASSEMBLER version of RRMAC which runs on your 6800 to produce relocatable 6809 object code from existing (6800) or new (6809) source files. Handles deleted 6800 instructions via macros. Supplied with 6809 machine language linking loader.

M68CX \$200.00

RRMAC RELOCATABLE RECURSIVE MACROASSEMBLER and LINKING LOADER for 6809. The one macro assembler with real macro capabilities. Retains all features of 6800 version.

M69RR \$150.00

M6809 RELOCATABLE DISASSEMBLER AND SEGMENTED SOURCE TEXT GENERATOR. An invaluable tool for modifying large object programs for reassembly on your system.

M69RS \$50.00

M6809 RELOCATING ASSEMBLER and LINKING LOADER is a version of RRMAC without its macro capabilities. Retains all of RRMAC's programmer convenience features.

M69AS \$75.00

All programs come complete with Programmer's Guide and extensively commented assembly listing. Available on cassette or mini-floppy. Specify cassette, SSB disk, mini-Flex disk or FLEX 2.0 disk.

Order directly by check or MC/Visa. California residents add 6% sales tax. Customers outside of U.S. or Canada add \$5 for air postage & handling.

Dealer inquiries welcome. FLEX is a trademark of TSC

Ed Smith's **SOFTWARE WORKS**
P.O. Box 339, Redondo Beach, CA 90277, (213) 373-3350

the ULTIMATE in CHEAP VIDEO

BOOK & KIT
ONLY \$42.95

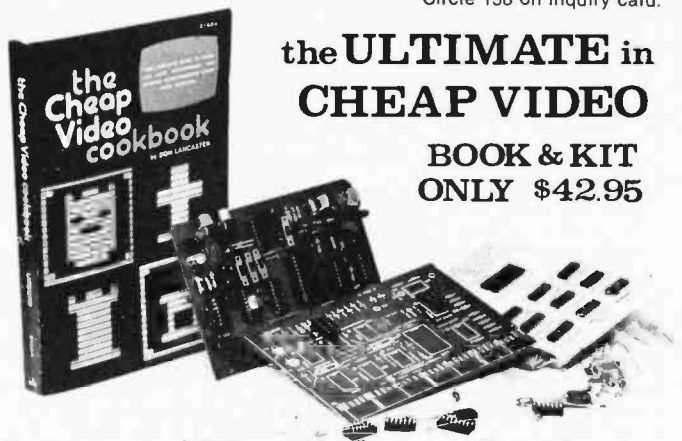

Don Lancaster's "Cheap Video" concept allows almost unlimited options, including:

- * Scrolling · Full performance cursor.
- * Line/Character formats of 16/32, 24/80, 32/64 ... or almost anything.
- * Graphics - up to 256 X 256 B&W; 96 X 128 COLOR (requires low-cost option modules)
- * Works with 6502, 6800 and other micros.

SPECIAL OFFER: Buy the Kit (upper case alphanumeric option included) & get the Book at 1/2 price.

FA&A ELECTRONICS, DEPT 11-B, 1020 W. WILSHIRE BLVD., OKLAHOMA CITY, OK 73116

I'm Sold, PLEASE RUSH..... () SEND FREE CATALOG

- () TVT-65g Kit & Cheap Video Cookbook - \$42.95 (enclosed)
- () TVT-65g Kit only (book required for assembly) - \$39.95

name: _____

address: _____

city: _____ state: _____ zip: _____

FA&A ELECTRONICS Dept. 2-B, 1020 W. WILSHIRE BLVD., OKLAHOMA CITY, OK 73116



BET, YOU DIDN'T KNOW!

OAE's new **PP-2708/16** PROM Programmer is the only programmer with all these features:

- Converts a PROM memory socket to a table top programmer: No complex interfacing to wire—just plug it into a 2708 memory socket*
- A short subroutine sends data over the address lines to program the PROM
- Programs 2 PROMS for less than the cost of a personality module. (2708s and TMS 2716s)
- Connect 2 or more in parallel — super for production programming
- Complete with DC to DC switching inverter and 10

turn cermet trimmers (for precision pulse width and amplitude alignment)

- All packaged in a handsome aluminum case

PP-2708/16 .. A & T \$325.

PP-2716 (Programs Intel's 2716) A & T \$295.

OAE

Oliver Advanced Engineering, Inc.
676 West Wilson Avenue
Glendale, Calif. 91203
(213) 240-0080

Listing 1 continued:

```

1550 INPUT P
1560 Z(1,M)=Z(1,(M-1))*(1+(P/100))
1570 NEXT I
1580 LET Z(3,M)=Z(1,M)+Z(2,M)
1590 Z(10,M)=0
1600 FOR I=4 TO 9
1610 LET Z(10,M)=Z(10,M)+Z(1,M)
1620 Z(11,M)=Z(3,M)-Z(10,M)
1630 NEXT I
1640 INPUT"MOVE PAPER TO TOP OF PAGE AND PRESS A KEY";A$
1650 ? C$:?
1660 FOR I=1 TO 11
1670 ? N$(I),Z(1,M)
1680 NEXT I:?:?:?
1690 RETURN
1700 REM CALCULATE PROFORMA WITH INCREMENTALS
1710 M=N+1
1720 B=M
1730 FOR I=1 TO F
1740 ?"AMOUNT OF CHANGE FOR ";N$(I)
1750 INPUT P
1760 LET Z(1,M)=Z(1,(M-1))+P
1770 NEXT I
1780 INPUT"MOVE PAPER TO TOP OF PAGE & PRESS A KEY";A$
1790 ? C$:?
1800 FOR I=1 TO F
1810 ? N$(I),Z(1,M)
1820 NEXT I:?:?:?
1830 RETURN
1840 SWITCH
1850 END

```

DO YOU WANT A LIST OF COMPARATIVE FINANCIAL RATIOS?
PLEASE ANSWER YES OR NO. THE ALTERNATIVE IS COMPARATIVE 1
? YES
MOVE PAPER TO TOP OF PAGE & PRESS A KEY?

K

RATIO ANALYSIS	
RATIOS FOR 2 YEARS BEGINNING IN 1974	
CURRENT	
1974	.53159
1975	.907047
ACID	
1974	.0961952
1975	.301513
RCBL TO	
1974	13.6149
1975	29.1469
INV TO	
1974	122.291
1975	110.652
ASSET TO	
1974	1.97689
1975	2.16097
PROF ON SALES	
1974	-.223032
1975	.0963033
ROA	
1974	-.440909
1975	.208109
ROI	
1974	1.04041
1975	2.08394
EPS	
1974	-.237236
1975	.329392
PAYOFF	
1974	0
1975	0
EBT-EQU	
1974	1.42378
1975	.900137
T INT EARNED	
1974	-6.1368
1975	8.80243
BK/SHARE	
1974	-.228021
1975	.158062

Listing 1 continued on page 201

use by the firm. This should be high for an income stock and low for a growth stock (all other things being equal).

earnings per share: How much the firm made per share of common stock. Often this and the price/earnings ratio are the only things investors look at. There are actually two ways of calculating the earnings per share ratio; the more complicated one would require a program much longer than that provided in this article. Both types of earnings per share ratios are required in annual reports, so it is best to rely on both for needed information if a firm has a complicated capital structure.

inventory turnover: The cost of goods sold is divided by average inventory, and this is divided by 365.

profit on sales: Net income divided by net sales. This provides a very conservative estimate of profits. Therefore, it is frequently used when companies wish to appear as though they are not making much of a profit.

quick ratio (acid test): Unlike the current ratio, the quick ratio does not consider inventory and prepaid expenses as current assets. The quick ratio takes cash, marketable securities, and accounts receivable, and divides these by current liabilities. The result is the proportion of liabilities falling due within one year, which can be covered by assets sure to be worth cash. It is normally a little less than one.

return on assets: Net income divided by average total assets. How much you are making on what you have to make it with. As with any profit measure, the higher the better.

return on investment: Net income divided by the quantity assets minus liabilities. This shows how much the firm made on what the owners put into it. Assets which were bought with borrowed money are not included in the base.

times interest earned: The quantity of net income plus interest and tax payments divided by interest charges. This indicates how much more the firm made than was required to pay the interest on its debt. A firm which has a times interest earned ratio of less than one is bankrupt.

Listing 1 continued:

DO YOU WANT COMPARATIVE % FROM INCOMES STMT & BS? YES

MOVE PAPER TO TOP OF PAGE & PRESS A KEY?

K
INCOME STATEMENT ITEMS AS % OF TOTAL INCOME

SALES	
1974	100
1975	100
OTH REV	
1974	0
1975	0
TOT INC	
1974	100
1975	100
CGS	
1974	82.7711
1975	65.1867
DEPR	
1974	2.08339
1975	1.88227
SGA	
1974	34.2408
1975	21.8118
INT	
1974	3.12509
1975	1.23427
TAX	
1974	0
1975	0
DIV	
1974	0
1975	0
TOTAL EXP	
1974	39.5321
1975	25.183
NET INC	
1974	-22.3032
1975	9.63033

B.S. ITEMS AS % OF TOTAL ASSETS

CASH	
1974	6.3007
1975	7.49898
RCBLS	
1974	7.37402
1975	17.2563
INV	
1974	54.823
1975	42.7045
PPD ITEMS	
1974	6.99943
1975	6.98874
TOT CUR	
1974	75.5686
1975	74.4719
LAND	
1974	0
1975	0
BLDG/EQU	
1974	36.374
1975	31.3656
ACC DEP	
1974	11.992
1975	7.95155
TOT FIXED	
1974	24.382
1975	23.4141
OTH AS	
1974	.0494237
1975	2.11405
TOT ASSETS	
1974	100
1975	100
ACCTS PEL	
1974	35.2718
1975	22.1241
NOTES PEL	
1974	83.8067
1975	21.4354
CUR LT	
1974	1.77143
1975	2.61975
OTHER LIAB	
1974	21.3059
1975	35.9244

CUR LIAB	
1974	142.156
1975	82.1036
LT DEBT	
1974	.222407
1975	7.91007
TOT LIAB	
1974	142.378
1975	90.0137
C STK	
1974	1.85936
1975	.6318
APIC	
1974	51.6014
1975	19.6497
RE	
1974	-95.8391
1975	-10.2218
TOT CR	
1974	100
1975	100

DO YOU WANT TO CREATE A PROFORMA INCOME STATEMENT? YES

DO YOU WANT TO USE % CHANGES FROM LAST PERIOD? YES

CHANGE FOR SALES

? 100

CHANGE FOR OTH REV

? 0

CHANGE FOR TOT INC

? 100

CHANGE FOR CGS

? 50

CHANGE FOR DEPR

? 50

CHANGE FOR SGA

? 50

CHANGE FOR INT

? 50

CHANGE FOR TAX

? 50

CHANGE FOR DIV

? 50

MOVE PAPER TO TOP OF PAGE AND PRESS A KEY?

MTS

SALES	6.48154E+06
OTH REV	0
TOT INC.	6.48154E+06
CGS	3.16893E+06
DEPR	91500
SGA	1.06031E+06
INT	60000
TAX	0
DIV	0
TOTAL EXP	4.38063E+06
NET INC	2.10091E+06

DO YOU WANT A % ANALYSIS OF THE PROFORMA? YES

MOVE PAPER TO TOP OF PAGE & PRESS A KEY?

K
INCOME STATEMENT ITEMS AS % OF TOTAL INCOME

SALES	
1976	100
OTH REV	
1976	0
TOT INC	
1976	100
CGS	
1976	48.89
DEPR	
1976	1.4117
SGA	
1976	16.3588
INT	
1976	.925705
TAX	
1976	0
DIV	
1976	0
TOTAL EXP	
1976	67.5862
NET INC	
1976	32.4138

DO YOU WANT ANOTHER PROFORMA? NO

Another Plotter to Toy With, Revisited

Design and Construction Details

Robert K Newcomb
502 Washington Ave
Wilmette IL 60091

Following the suggestion of Peter Lucas in the February 1979 issue of BYTE ("Another Plotter to Toy With," page 66) I built a plotter using an Etch-A-Sketch and two stepper motors. After solving the interface problem, I connected it to an I/O (input/output) port on my KIM-1 which is equipped with a teletypewriter, 8 K bytes of extra memory, and Tiny BASIC. Photo 1 shows the result: stepper motors mounted on the Etch-A-Sketch, along with a circuit board. The KIM-1 controls the apparatus using 4 bits of an I/O port. The stepper motors can be driven by any other computer having 4 bits of transistor-transistor logic (TTL) level output available.

The Etch-A-Sketch proved to be able to draw bar graphs with excellent results, drawing an even, horizontal baseline, while accurately reproducing data from the computer's memory. I later tried geometric figures, including a parabola. Because each step is only 0.0085 inches (0.216 mm), the device gives good approximations of curves. The main limitation of my plotting system resides in the inability of Tiny BASIC to handle fractional numeric values.

Stepping Motors and Drivers

North American Philips series 82701 stepping motors were chosen for drivers, even though the Etch-A-Sketch does not require all of the torque that these motors can produce. The extra torque will come in

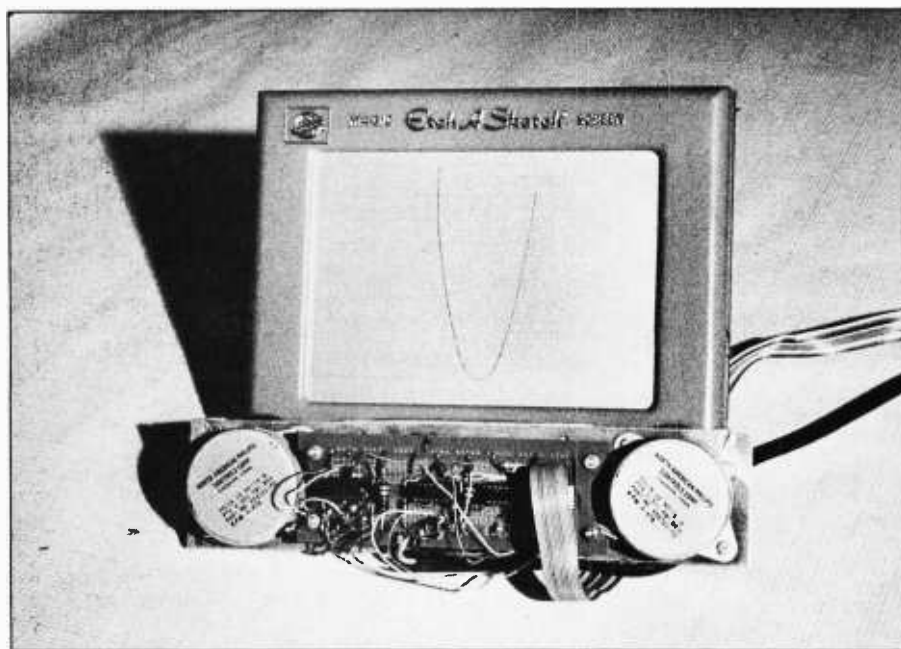

Photo 1: The stepper motor and control assembly is mounted on the Etch-A-Sketch. The knobs have been removed to allow attachment of the driven gears to the shafts.

handy if you later wish to drive something else. The motors are driven by North American Philips (or Signetics) SAA 1027 driver integrated circuits which produce the succession of pulses needed to energize the four windings on each motor. Each driver receives toggling pulses to rotate the motor shaft, while a high or low-level signal on the rotation input determines direction. A single 7406 buffer takes 5 V from the output ports and provides 12 V switching to both

drivers. Figure 1 shows the circuit diagram. Each motor has an output torque of 7 ounce-inches at fifty steps per second and drives the Etch-A-Sketch through a 5 to 8 reduction gear.

Electrical Construction

A pre-etched and drilled Calctro J4-404 circuit board was used, after I sawed off the ends (to clear the stepper motors) and drilled holes for stand-offs. Two 14-pin integrated cir-

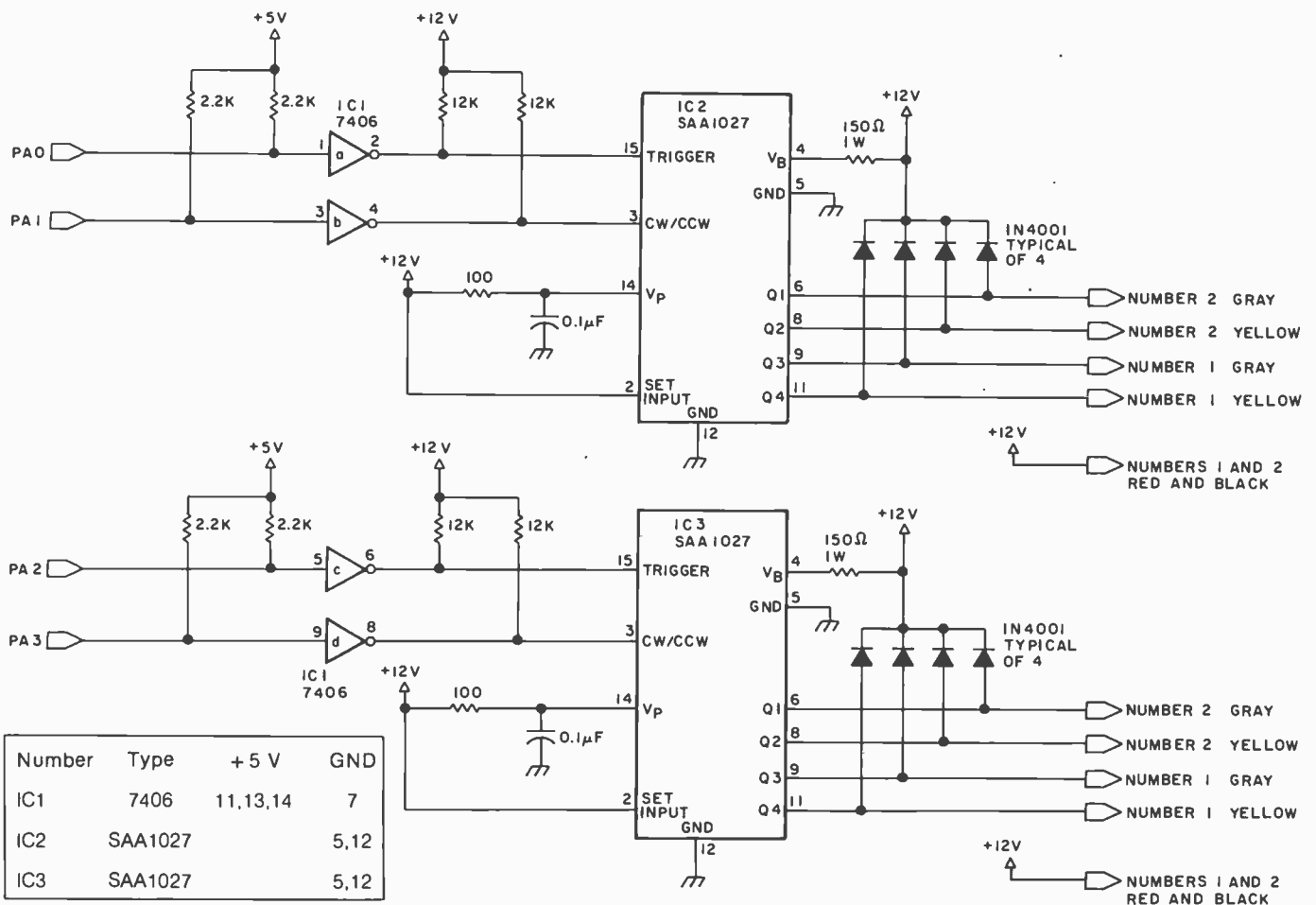

Figure 1: Schematic diagram of the stepper motor control and drive circuit. The integrated circuit IC2 controls the X axis; IC3 drives the motor for the Y axis.

cuit sockets were mounted, one for the 7406 buffer and one to receive flat wire connections from the computer. For the 12 V power supply, run a two conductor, #18 cord directly to a fused (1½ A) unregulated 12 V power supply (18 V maximum peak). Number 22 wire should be used for all other connections. The last step in wiring should be to connect the stepper motors.

Mechanical Construction

The motor frame is a 3/16 inch (0.476 cm) thick aluminum plate, cut to 2½ by 11 inch (6.35 by 27.94 cm) dimensions, with the stepping motors mounted on 8¼ inch (20.95 cm) centers to match the Etch-A-Sketch. You must drill clearance holes for the motor shafts (big enough to clear the twenty-tooth gears), and drill for the following items: four holes for circuit board stand-offs, two mounting holes per motor, and two holes at each end for the locating pieces that center the Etch-A-Sketch under the motor

mount. Use of a drill press speeds up this work considerably. These locating pieces are 3/8 by 1 by 1 1/8 inches (0.95 by 2.54 by 4.76 cm) long and are tapped at the top for two screws each, and at bottom for two screws which hold a 1/4 by 1 by 11 inch (0.635 by 2.54 by 27.94 cm) clamp piece that keeps the motor mount and Etch-A-Sketch together. Tack or staple two pieces of 3/8 inch (0.476 cm) outside diameter rubber tubing to a piece of 3/4 by 1 by 4 3/8 inch (1.9 by 2.5 by 12.4 cm) wood to form a cushioned spacer between the motor mount and the Etch-A-Sketch. This prevents the plastic housing from cracking and spaces the assembly so that the gears line up. The driven gears (thirty-two teeth) are screw clamped to the Etch-A-Sketch control shafts after the knobs have been pulled off the device. When you slide the Etch-A-Sketch into place, move it until the gears mesh and bottom out against one another, and then slide it back about 1/32 of

an inch (0.08 cm). Lubricate the gears with a small amount of grease.

Programming

The first programming to be done is a routine which will rotate the stepping motors in the desired direction, one at a time. To move the Etch-A-Sketch stylus in the +Y (up) direction, output port pin PA1 should be set equal to 0 and pin PA0 is then toggled. For -Y (movement down), set PA1 to 1 and toggle PA0. Movement right and left (+X and -X) works the same way with pin PA3 setting direction. A machine language program which does this, written for the KIM-1, is given in listing 1. Figure 2 gives the flowchart, and listing 2 gives the code for a program to move the stylus along the Y axis according to data in memory, while the stylus moves one unit in the +X direction.

If a series of memory locations contain a value of 0, the stylus will move only horizontally. If a memory location contains a 1, the stylus will move

VERSAWRITER



A BRAND NEW DRAWING SYSTEM for your Apple II!

The VersaWriter is a digitizer drawing board that lets you create *any* picture in full color, with high resolution graphics on your Apple monitor. Ideal for mass graphics, you can trace, edit, save and recall what you draw. It can be a pointer in games, or a digitizer for charts and diagrams. It's a simple-to-use system for students, artists, engineers and graphic programmers.

The VersaWriter plugs directly into the Apple's game I/O and requires Disk II, Applesoft ROM and 32K of memory.

We're offering the VersaWriter at an **Introductory Price of only \$179.95** while current supply lasts. The VersaWriter is normally priced at \$199.00, so take advantage of this opportunity by ordering your VersaWriter today.

Ask for our free catalog of software and products for Apple.

Dealer inquiries are welcome.

©Rainbow Computing 1980

VERSAWRITER B:2

SPECIAL INTRODUCTORY OFFER

Please send my VersaWriter to:

Name _____

Street _____

City _____

State _____ Zip _____

Please send more information.

Send me your Free Catalog.

Charge to my VISA Mastercharge

Card No. _____

Exp. Date _____

Signature _____

Add \$5.00 shipping and handling. Calif. residents add 6% sales tax. Delivery is 2-4 weeks.

RAINBOW COMPUTING, INC.
 9719 Reseda Blvd., Northridge, Ca 91324
 Telephone: (213) 349-5560

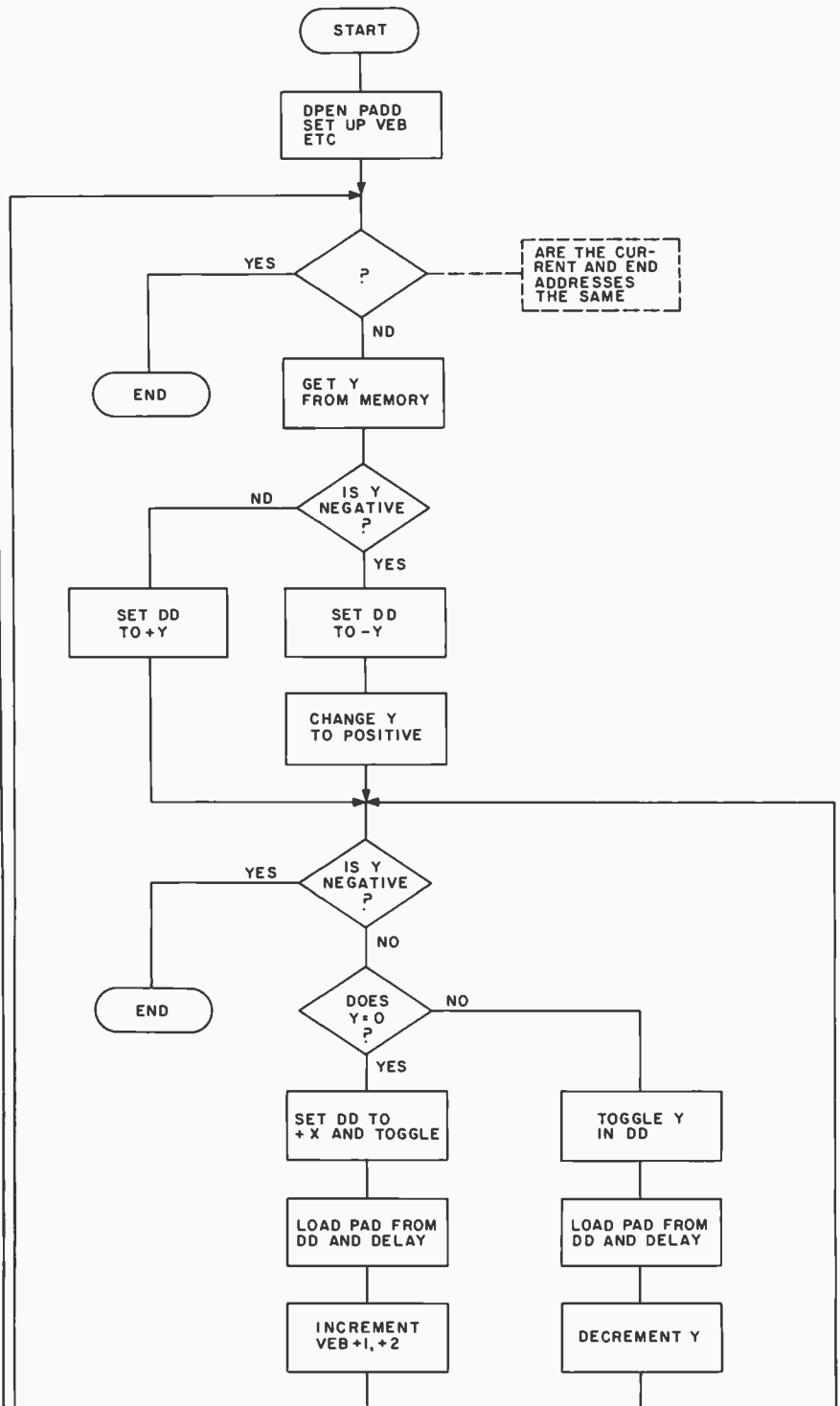

Figure 2: Flowchart of the routine in listing 2 which moves the stylus along the Y axis according to plot data in memory while maintaining constant movement along the X axis.

up at a 45° angle. To load the plotting data from BASIC, we set up two jumps to machine language subroutines as shown in listing 3. The first subroutine sets up a memory pointer. The second subroutine increments this pointer to load consecutive memory locations each time

the BASIC program calls it. A Tiny BASIC parabola plotting program using these instructions is given as listing 4.

When you set up your programs, it is nice to avoid running off the Etch-A-Sketch screen, although no harm will result. Thus you should try not

Listing 1: Routines written in 6502 assembler for the KIM-1 to move the Etch-A-Sketch stylus along a single axis by individually activating the stepper motors.

Address	Hexadecimal Code	Label	Op Code Mnemonic	Operand	Commentary
3A40	A9 0F		LDAIM	\$000F	SUBROUTINE TO OPEN PADD
3A42	8D 01 17		STA	PADD	
3A45	60		RTS		
3B1C	A0 FF	SPEED	LDYIM	\$00FF	SUBROUTINE TO SET SPEED
3B1E	A2 20		LDXIM	\$0020	
3B20	CA		DEX		
3B21	D0 FD		BNE	\$3B20	
3B23	88		DEY		
3B24	D0 F8		BNE	\$3B1E	
3B26	A5 DE		LDAZ	\$00DE	
3B28	AA		TAX		
3B29	A5 DF		LDAZ	\$00DF	
3B2B	A8		TAY		
3B2C	60		RTS		
3A46	20 40 3A			JSR	
3A49	A9 01		LDAIM	\$0001	
3A4B	8D 00 17		STA	PAD	
3A4E	20 1C 3B		JSR	SPEED	
3A51	A9 00		LDAIM	\$00	
3A53	8D 00 17		STA	PAD	
3A56	20 1C 3B		JSR	SPEED	
3A59	4C 49 3A		JMP	\$3A49	
3A66	20 40 3A		JSR	\$3A40	MOVES STYLUS IN MINUS Y DIRECTION UNTIL INTERRUPTED SET Y ROTATION ON, Y TRIGGER ON
3A69	A9 03		LDAIM	\$0003	
3A6B	8D 00 17		STA	PAD	
3A6E	20 1C 3B		JSR	SPEED	
3A71	A9 02		LDAIM	\$0002	
3A73	8D 00 17		STA	PAD	
3A76	20 1C 3B		JSR	SPEED	
3A79	4C 69 3A		JMP	\$3A69	
3A86	20 40 3A		JSR	\$3A40	
3A89	A9 04		LDAIM	\$0004	
3A8B	8D 00 17		STA	PAD	
3A8E	20 1C 3B		JSR	SPEED	
3A91	A9 00		LDAIM	\$00	
3A93	8D 00 17		STA	PAD	
3A96	20 1C 3B		JSR	SPEED	
3A99	4C 89 3A		JMP	\$3A89	
3AA6	20 40 3A		JSR	\$3A40	MOVES STYLUS IN MINUS X DIRECTION UNTIL INTERRUPTED SET X ROTATION ON, X TRIGGER ON
3AA9	A9 0C		LDAIM	\$000C	
3AAB	8D 00 17		STA	PAD	
3AAE	20 1C 3B		JSR	SPEED	
3AB1	A9 08		LDAIM	\$0008	
3AB3	8D 00 17		STA	PAD	
3AB6	20 1C 3B		JSR	SPEED	
3AB9	4C A9 3A		JMP	\$3AA9	

Listing 2: Program written for the KIM-1 which moves the stylus along the X axis at a constant rate while movement along the Y axis is varied according to plot data stored in memory.

Address	Hexadecimal Code	Label	Op Code Mnemonic	Operand	Commentary	
3B11	A5 DD	LODPAD	LDAZ	\$00DD	THIS ADDS LOADING OF THE OUTPUT PORT TO THE TIMING SUBROUTINE OF LISTING 1	
3B13	8D 00 17		STA	PAD		
3B16	8A		TXA			
3B17	85 DE		STAZ	\$00DE		
3B19	98		TYA			
3B1A	85 DF		STAZ	\$00DF		
3B30	A9 0F		LDAIM	\$000F	THIS IS THE PROGRAM SHOWN IN FIGURE 2. ZERO PAGE LOCATIONS CC THROUGH CF ARE VECTOR EB. LOCATION DD IS STORAGE FOR PORT A DATA	
3B32	8D 01 17		STA	PADD		
3B35	ADF5 17		LDA	SAL		
3B38	85 CC		STAZ	CURADL		
3B3A	ADF6 17		LDA	SAHI		
3B3D	85 CD		STAZ	CURADH		
3B3F	A9 AD		LDAIM	\$00AD		
3B41	85 CB		STAZ	GETY		
3B43	A9 A8		LDAIM	\$00A8		
3B45	85 CE		STAZ	\$00CE		
3B47	A9 60		LDAIM	\$0060		
3B49	85 CF		STAZ	\$00CF		
3B4B	A5 CC	COMEND	LDAZ	CURADL		COMPARE VEB + 1, VEB + 2 WITH END ADDRESS
3B4D	CD F7 17		CMP	ENDALO		

Listing 2 continued on page 206

Listing 2 continued:

3B50	A5 CD		LDAZ	CURADH	
3B52	ED F8 17		SBC	ENDAHI	
3B55	B0 43		BCS	END	TO END IF ADDRESSES MATCH
3B57	20 CB00		JSR	GETY	
3B5A	10 0E	YPLUS	BPL	SETPLS	Y POSITIVE
3B5C	A9 02		LDAIM	\$0002	
3B5E	05 DD		ORAZ	\$00DD	SET ROTATION IN DD FOR - Y
3B60	85 DD		STAZ	\$00DD	
3B62	98	MITOPL	TYA		CHANGE - Y TO + Y
3B63	49 FF		EORIM	\$00FF	
3B65	A8		TAY		
3B66	C8		INY		
3B67	4C 70 3B		JMP	YMINUS	JUMP PAST SET PLUS ROTATION
3B6A	A9 FD	SET PLS	LDAIM	\$00FD	SET Y ROTATION FOR PLUS
3B6C	25 DD		ANDZ	\$00DD	
3B6E	85 DD		STAZ	\$00DD	
3B70	98	YMINUS	TYA		Y IS STILL MINUS, END ROUTINE
3B71	30 27		BMI	END	
3B73	F0 0D		BEQ	\$3B82	Y = 0, BRANCH
3B75	A9 01	TOGY	LDAIM	\$0001	TOGGLE Y IN DD
3B77	45 DD		EORZ	\$00DD	
3B79	85 DD		STAZ	\$00DD	
3B7B	20 11 3B		JSR	LODPAD	LOAD PAD FROM DD AND DELAY
3B7E	88		DEY		DECREMENT Y
3B7F	4C 70 3B		JMP	YMINUS	JUMP BACK TO SECOND "IS Y MINUS"
3B82	A9 07		LDAIM	\$0007	SET DD TO PLUS X
3B84	25 DD		ANDZ	\$00DD	
3B86	85 DD		STAZ	\$00DD	
3B88	A9 04	TOGX	LDAIM	\$0004	TOGGLE X IN DD
3B8A	45 DD		EORZ	\$00DD	
3B8C	85 DD		STAZ	\$00DD	
3B8E	20 11 3B		JSR	LODPAD	LOAD PAD FROM DD AND DELAY
3B91	E6 CC		INCZ	CURADL	INCREMENT VEB + 1
3B93	D0 02		BNE	\$3B97	
3B95	E6 CD		INCZ	CURADH	INCREMENT VEB + 2
3B97	4C 4B 3B		JMP	COMEND	REPEAT
3B9A	00	END	BRK		END

Listing 3: Machine language subroutines which are called from the Tiny BASIC program of listing 4. The first routine sets up a memory pointer. The second routine increments the pointer to load consecutive memory locations each time the BASIC program calls it.

Address	Hexadecimal Code	Label	Op Code Mnemonic	Operand	Commentary
1780	A9 8D		LDAIM	\$008D	SET UP MEMORY POINTER WITH
1782	85 DA		STAZ	\$00DA	MEMORY STARTING ADDRESS
1784	A9 00		LDAIM	\$00	SET LOW STARTING ADDRESS
1786	85 DB		STAZ	SUBPAD	
1788	A9 02		LDAIM	\$0002	SET HIGH STARTING ADDRESS
178A	85 DC		STAZ	\$00DC	STARTING ADDRESS DEFAULT
178C	A9 60		LDAIM	\$0060	IS 0200.
178E	85 DD		STAZ	\$00DD	
1790	60		RTS		RETURN
1791	20 DA00		JSR	\$00DA	LOAD MEMORY WITH CONTENTS
1794	E6 DB		INCZ	SUBPAD	OF ACCUMULATOR
1796	D0 02		BNE	\$179A	
1798	E6 DC		INCZ	\$00DC	INCREMENT MEMORY POINTER
179A	60		RTS		RETURN

Listing 4: Program written for the KIM-1 in Tiny BASIC to plot a parabola using the machine language routines of listing 3.

```

100 LET N = USR (6016)
105 REM THIS IS 1780 HEXADECIMAL
110 LET C = - 120* 120/10
120 LET A = - 119
130 LET B = A*A/10
140 LET D = B - C
150 LET C = B
160 IF D = - 2 THEN LET D = - 3
190 IF D = 2 THEN LET D = 3
200 LET D = D/3
210 LET N = USR(6033,0,D)
215 REM THIS EQUALS 1791 HEXADECIMAL
216 REM SUBROUTINE IS ENTERED WITH D IN ACCUMULATOR
220 LET A = A + 1
230 IF A > 120 GOTO 250
240 GOTO 130
250 END

```

Parts List

2 gears: Sterling S1268ZS20AP1 (32 pitch, 32 teeth) or equivalent
2 hubs: Sterling E62-4 (3/16 inch bore for above) or equivalent
2 gears: Sterling S1086ZH2920P1 (32 pitch, 20 teeth, 1/4 Inch bore) or equivalent
2 stepper motors: North American Phillips Controls Corp K82701P2
2 stepper motor driver Integrated circuits: Signetics SAA1027
1 circuit board: Calectro J4-404
Miscellaneous sheet aluminum and screws, wood block, and rubber tubing.

A limited quantity of kits of the above items (ready to assemble with no cutting or drilling necessary) are available from the author for \$109 postpaid, plus tax for Illinois residents.

The following items are stocked by most electronic distributors:

2 16-pin soldertail integrated circuit sockets
2 14-pin soldertail integrated circuit sockets
1 type 7406 integrated circuit hex inverting driver
4 2.2K ohm 1/4 W resistors
4 12K ohm 1/4 W resistors
2 100 ohm 1/2 W resistors
2 150 ohm 1 W resistors
2 0.1 μ F 36 V capacitors
8 1N4001 rectifier diodes
1 0.001 μ F 16 V capacitor

to use more than 790 (decimal) memory locations in the program of listing 3. The total of all negative or positive numbers in the parabola plotting program of listing 4 should be less than decimal 558.

The stepper drivers generate some electrical noise. I have no trouble with BASIC crashing, provided that the 12 V supply is off. For cassette recording, both 12 V and 5 V supplies should be off. For playback, both supplies can be on. Before disconnecting the I/O ports from the Etch-A-Sketch, push reset (RS) to switch the ports to their high impedance position. This eliminates the possibility of destroying the 7406 buffer device.

Once you have loaded the program into memory and have stored it on a cassette, plug the connections from the 7406 buffer into your computer and turn on the 12 V supply (with the 1 1/2 A fuse in place). Using the monitor, execute the appropriate subroutines from listing 1 to move the stylus to the desired origin (typically upper left). Starting execution at hexadecimal location 3B30 will plot whatever data is contained in memory.

With experience in programming, you can set up a grid against which plotting can be done. The fine line produced by the Etch-A-Sketch makes measuring easy. Two advantages of the Etch-A-Sketch are that you don't use any memory preserving information on the screen, and the device is completely nonvolatile.

Begin a plot today, shut down your system before finishing, and weeks later you can come back and continue the plot. You will also experience the

satisfaction of watching your computer move things in the real world, rather than manipulate shadows on a television screen. ■

NOW, FROM MOUNTAIN HARDWARE. THE 100,000 DAY CLOCK.™

Put your S-100 Computer on the clock.

A real time clock could double the utility of your computer. Time events in 100 μ S increments for up to 100,000 days (over 273 years). Program events for the same period with real time interrupts that permit pre-programmed activities to take place...without derailing on-going programs. Maintain a log of computer usage. Call up lists or appointments. Time and date printouts. Time events. An on-board battery keeps the clock running in the event of power outage.

Mountain Hardware also offers a complete line of peripheral products for many fine computers.



Available at your dealer's. Now.

Mountain Hardware, Inc.

300 Harvey West Blvd.
Santa Cruz, CA 95060 (408) 429-8600

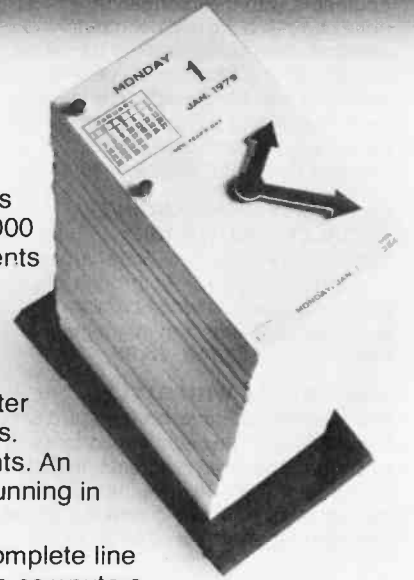

DEFINITELY DIFFERENT . . .



FROM HAYDEN

New! Z-80 AND 8080 ASSEMBLY LANGUAGE PROGRAMMING (Spracklen) An extensive introductory look at assembly language programming for the 8080 and Z-80 processors. Programming techniques are presented along with the instructions. Numerous diagrams and examples are provided, plus exercises with answers. #5167-0, \$7.95

New! DESIGNING MICROCOMPUTER SYSTEMS (Pooch & Chattergy) Provides both hobbyists and electronics engineers with the information necessary to build microcomputer systems. Also discusses the hardware aspects of microcomputer systems, including microprocessor architecture, input and output ports, interrupt systems, programmable clocks, memory units, etc. #5679-6, \$8.95

New! SIXTY CHALLENGING PROBLEMS WITH BASIC SOLUTIONS (Spencer) Will sharpen your programming skills through games, puzzles, science problems, business problems and mathematical recreations. #5180-8, \$6.95

New! PASCAL WITH STYLE: Programming Proverbs (Ledgard & Nagin) A style guide for writing more accurate, error-free programs. Includes samples of PASCAL programs and a special chapter showing how to use the top-down approach. #5124-7, \$6.95

Available at your local computer store.

Hayden Book Company, Inc.
50 Essex Street, Rochelle Park, NJ 07662

BYTE's Bits

Personal Computers for the Handicapped

The Applied Physics Laboratory of Johns Hopkins University is the location of a project being organized by Paul L Hazan. This project is a program for the application of personal computers to the problems of people with various physical handicaps.

Various applications include simple computer-controlled communications aids for quadriplegics, interfaces between computers that allow hearing-impaired individuals to communicate via telephone, and other very inexpensive applications of off-the-shelf hardware. A design contest with substantial prizes is being considered.

Those interested in more details may contact Paul L Hazan, Assistant to the Director for Advanced Computer Technology, Johns Hopkins University, Applied Physics Laboratory, Johns Hopkins Rd, Laurel MD 20810. ■

BYTE's Bugs

Chess Moves Rechecked

Thanks to John Gropper for pointing out an error in "Alpha-Beta Pruning," by W D Maurer (November 1979 BYTE, page 84). Figure 1 gives white's second move as Q-N7. The correct move is Q-N8. The move is shown correctly in figure 2. ■

CROMEMCO

Hard Disk!



• Full 11-megabyte hard disk system • fast Z80A 4 MHz processor • two floppy disk drives • 64K RAM memory • RS232 special interface • printer interface • extensive software available

List \$9995 **Our Price \$8489**

THE HDD — 11/22 megabyte hard disk system, for use with existing systems. DMA controller, transfer rate of 5.6 megabytes/sec. HDD-11, List \$6995 . . . **OUR PRICE ONLY \$5939**
HDD-22, List \$11,995 \$10,189

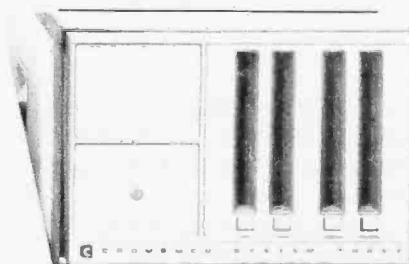

CROMEMCO SYSTEM 3

Features 4 MHz CPU, 64K of RAM, dual-sided PerSci 299B floppy disk drive (provision for installing a second 299B), RS232C interface, printer interface. All Cromemco systems are assembled and tested, ready to use.

With 64K of RAM, List \$6585 **ONLY \$5485**
— NOW DOUBLE THE CAPACITY! —

CROMEMCO SYSTEM 2

With 64K of RAM, two minifloppy disk drives, RS232 interface and printer interface board.

System 2 w/64K RAM, List \$3990 **\$3390**

Z-2 COMPUTER SYSTEM

— Can be rack mounted. Z-80 processor, 21 slots, power supply, front cover panel. Includes fan and all edge connectors. Assembled and tested. CRO-10000-A (Z-2W), List \$995 \$845



Z-2D DISK COMPUTER

— similar to Z-2 but comes with floppy disk controller, DOS, and minifloppy disk drive. A complete system with the addition of a RAM board. CRO-10020-A (D2D-W), List \$1990 \$1689

CROMEMCO BOARDS

CRO-31010-A (SCC-W) 4 MHz Single Card Computer, Assem./tested, List \$450 \$382
CRO-310001-K (ZPU-K) 4 MHz CPU card, Kit 250
CRO-31000-A (ZPU-W) Above, assembled 335
CRO-32020-A (16KZ-W) 16K RAM card with bank select, assem./tested, List \$595 495

SHIPPING, HANDLING & INSURANCE: Add \$2 for boards. Assembled systems shipped freight collect. All prices subject to change and all offers subject to withdrawal without notice. Above prices are for prepaid orders. Slightly higher prices prevail for other-than-prepaid orders.

WRITE FOR FREE CATALOG  

MiniMicroMart

1618 James St., Syracuse NY 13203
(315) 422-6666 TWX 710-541-0431

Circle 162 on inquiry card.

ENHANCE YOUR COMPUTER LIBRARY...



with a complete a PAPERBYTE® and

YOU JUST BOUGHT A PERSONAL WHAT is filled with practical ideas for using a personal computer at home or work. It will take you through the steps necessary to write your own computer programs, and then show you how to use structured design techniques to tackle a variety of larger projects. The book contains over 60 ready-to-use programs written in Radio Shack TRS-80 Level II BASIC in the areas of educational games, financial record keeping, business transactions, disk-based data file and word processing.

ISBN 0-07-018492-5

Authors: Thomas Dwyer and Margot Critchfield

Pages: 256 Price: \$11.95

BEGINNER'S GUIDE FOR THE UCSD PASCAL SYSTEM is written by the originator of the UCSD Pascal System. This highly informative book is designed as an orientation guide for learning to use the UCSD Pascal System. Once familiar with the system, you will find the guide an invaluable reference tool for creating advanced applications. This book features tutorial examples of programming tasks in the form of self-study quiz programs.

ISBN 0-07-006745-7

Author: Kenneth Bowles

Pages: 184 Price: \$11.95

PAPERBYTE BOOKS are BYTE BOOKS with bar codes included!

SUPERWUMPUS is an exciting computer game incorporating the original structure of the WUMPUS game along with added features to make it even more fascinating. Programmed in both 6800 assembly language and BASIC, SUPERWUMPUS is not only additively fun, but also provides a splendid tutorial on setting up unusual data structures. This is a PAPERBYTE® book.

ISBN 0-07-019342-8

Author: Jack Emmerichs

Pages: 56 Price: \$6.00

TINY ASSEMBLER 6800: Version 3.1 has an updated version of the user's guide, the source, object and PAPER-

BYTE® bar code formats of both Version 3.0 and 3.1. This book is the most complete documentation possible for Jack Emmerichs' Tiny Assembler.

ISBN 0-07-019341-X

Author: Jack Emmerichs

Pages: 80 Price: \$9.00

RA6800ML: AN M6800 RELOCATABLE MACRO

ASSEMBLER provides the necessary background for coding programs in the 6800 assembly language, and for understanding the innermost operations of the Assembler. The PAPERBYTE® bar code representation of the Assembler's relocatable object file is included.

ISBN 0-07-028056-8

Author: Jack E. Hemenway

Pages: 184 Price: \$25.00

LINK68: AN M6800 LINKING

LOADER provides everything necessary for the user to easily learn about the system. In addition to the source code and PAPERBYTE® bar code listings, there is a detailed description of the major routines of the Linking Loader, including flowcharts.

ISBN 0-07-024120-1

Authors: Robert D. Grappel

& Jack E. Hemenway

Pages: 72 Price: \$8.00

BASEX, a new compact, compiled language for microcomputers, has many of the best features of BASIC and the 8080 assembly language — and it can be run on any of the 8080 style microprocessors: 8080, Z-80, or 8085. Subroutines in the BASEX operating system typically execute programs up to five times faster than equivalent programs in a BASIC interpreter — while requiring only about half the memory space. The author, Paul Warme, has also included a BASEX loader program which is capable of relocating programs anywhere in memory. This is a PAPERBYTE® book.

ISBN 0-07-068290-9

Author: Paul Warme

Pages: 88 Price: \$8.00

TRACER: A 6800 DEBUGGING PROGRAM includes a reprint of "Jack and the Machine Debug" (from the December 1977 issue of BYTE

magazine), TRACER program notes, complete assembly and source listing in 6800 assembly language, object program listing, and machine readable PAPERBYTE® bar codes of the object code.

ISBN 0-07-024121-X

Authors: Robert D. Grappel

& Jack E. Hemenway

Pages: 24 Price: \$6.00

MONDEB: AN ADVANCED M6800 MONITOR-DEBUGGER features ease of use and minimum memory requirements while retaining maximum versatility. The result is an extremely versatile program. The size of the entire MONDEB is less than 3K. This is a PAPERBYTE® book.

ISBN 0-07-049556-4

Author: Don Peters

Pages: 88 Price: \$5.00

BAR CODE LOADER contains the general bar code loader algorithm description in flowchart form plus detailed assemblies of program code for 6800, 6502, and 8080 processors. Individuals with computers based on these processors can use the software directly. Individuals with other processors can use the provided functional specifications and detail examples to create equivalent programs. This is a PAPERBYTE® book.

ISBN 0-07-008856-X

Author: Ken Budnick

Pages: 32

Price: \$2.00

K2FDOS: A FLOPPY DISK OPERATING SYSTEM FOR THE 8080. K2FDOS is a complete software package and includes all the information and specific routines necessary to bootstrap and run a powerful floppy disk operating system on an 8080-based microcomputer. This small (4K), but powerful, system includes many of the file handling features of large operating systems. It comes complete with source code listings in the hexadecimal format, and machine readable (PAPERBYTE®) bar code format listings for individual K2FDOS programs.

ISBN 0-07-069206-8

Author: Kenneth B. Welles

Pages: 192

Price: \$20.00

Assortment of BYTE BOOKS™!

The following **BYTE BOOKS** are collections of favorite articles from past issues of **BYTE** magazine, plus new material.

THE BYTE BOOK OF COMPUTER MUSIC combines the best computer music articles from past issues of **BYTE** magazine with exciting new material — all written for the computer experimenter interested in this fascinating field.

An ardent do-it-yourselfer or arm-chair musicologist will find this book to be a useful addition to the library.

ISBN 0-07-043097-7

Editor: Christopher P. Morgan

Pages: 144 Price: \$10.00

CIARCIA'S CIRCUIT CELLAR offers a detailed look at the marvelous projects which let you do useful things with your microcomputer. Each article is a complete tutorial. Using amusing anecdotes to introduce the articles and an easy-going style, Steve presents each project so that even a neophyte need not be afraid to try it.

ISBN 0-07-010960-5

Author: Steve Ciarcia

Pages: 128 Price: \$8.00

THE BYTE BOOK OF PASCAL is a general introduction to Pascal and contains numerous articles, language forums and letters from past issues of **BYTE** magazine. In addition, this book contains several important pieces of software including two versions of a Pascal compiler - one written in BASIC and the other in 8080 assembly language; a p-code interpreter written in both Pascal and 8080 assembly languages; a chess playing program; and an APL interpreter written in Pascal.

ISBN 0-07-037823-1

Editor: Blaise W. Liffick

Pages: 342 Hardcover Price: \$25

PROGRAMMING TECHNIQUES is a series of collected articles concerned with the art and science of computer programming. The first volume in the Programming Techniques series is entitled **PROGRAM DESIGN**. The purpose of the book is to provide the personal computer user with the techniques needed to design efficient, effective, maintainable programs.

ISBN 0-07-037825-8

Editor: Blaise W. Liffick

Pages: 96 Price: \$6.00

SIMULATION is the second volume in the Programming Techniques series. Both theoretical and practical applications are included. Particularly stressed is simulation of motion, in-

cluding wave motion and flying objects, and the use of simulation for experimentation.

ISBN 0-07-037826-6

Editor: Blaise W. Liffick

Pages: 126 Price: \$6.00

NUMBERS IN THEORY AND PRACTICE is the third book in the series. It includes information of value to both the novice and the experienced personal computer user. The mechanics of the binary system are discussed, including software division and multiplication, as well as floating point numbers, numerical methods, random numbers, and the mathematics of computer graphics.

ISBN 0-07-037827-4

Editor: Blaise W. Liffick

Pages: 192 Price: \$8.95

BITS & PIECES is the fourth volume in the Programming Techniques series. It covers various topics of interest to programmers. It is a collection of the best articles from past issues of **BYTE** magazine plus new material collected specifically for the series, on subjects such as multiprogramming, stacks, interrupts, optimization, and real-time processing.

ISBN 0-07-037828-2

Editor: Blaise W. Liffick

Pages: 160 Price: \$8.95

(available Spring '80)



Circle 163 on inquiry card.

Please send

_____	_____	_____	_____
Name	Title	Company	
_____	_____	_____	_____
Street	City	State/Province	Code

Check enclosed in the amount of \$_____

Bill Visa Bill Master Charge

Card No. _____ Exp. Date _____

Add 60¢ per book to cover postage and handling.

- _____ copies of Superwumpus
- _____ copies of Tiny Assembler 6800
- _____ copies of RA6800ML: An M6800 Relocatable Macro Assembler
- _____ copies of LINK68: An M6800 Linking Loader
- _____ copies of BASEX
- _____ copies of TRACER: A 6800 Debugging Program
- _____ copies of MONDEB: An Advanced M6800 Monitor-Debugger
- _____ copies of You Just Bought a Personal What?
- _____ copies of Beginner's Guide for the UCSD Pascal System
- _____ copies of Bar Code Loader
- _____ copies of K2FDOS: A Floppy Disk Operating System for the 8080
- _____ copies of The BYTE Book of Computer Music
- _____ copies of Ciarcia's Circuit Cellar
- _____ copies of The BYTE Book of Pascal
- _____ copies of Program Design
- _____ copies of Simulation
- _____ copies of Numbers in Theory and Practice
- _____ copies of Bits & Pieces



70 Main Street,
Peterborough, New Hampshire 03458

What's New?

PERIPHERALS

90 M Byte Disk Subsystem

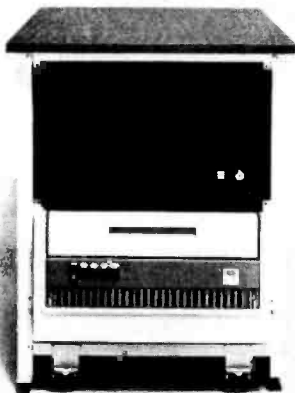

The model AM 410 90 M byte (formatted) disk subsystem is based on the CDC Phoenix drive. The unit consists of 75 bytes of fixed disk capacity combined with 15 M bytes of removable cartridge. The controller is interrupt driven and operates on full 512-byte sector data transfers. The AM 410 has an average access time of 30 milliseconds and provides full cyclic redundancy check (CRC) and sentinel bit error checking capabilities. Up to four drives can be connected to one controller for a total storage capacity of 360 M bytes of data. The AM 410 is designed to work with Alpha Micro's AMOS operating system and other operating systems on either the 8- or the 16-bit S-100 bus. The self-contained unit is available from Alpha Micro, 17881 Sky Park N, Irvine CA 92714, for under \$15,000.

Circle 451 on inquiry card.

Printers and Plotters for the Apple II, PET, TRS-80

Axiom Corp, 5932 San Fernando Rd, Glendale CA 91202, has introduced the EX-801 and EX-820 series printers and plotters for the Apple II, PET, and TRS-80. Each printer can be plugged into the different microcomputers without any special user adaptation.

The EX-801 features the full 96-character ASCII set, 80 characters per line, 80 columns, and full user control of individual dots in graphics mode.

The EX-820 includes all the features of the EX-801 plus the capability of being a full plotter that can generate schematics, musical scores, charts and other displays. The EX-820 can print any graphics image with up to 128 dots per inch resolution.

The price for the EX-801 is \$535.

Circle 452 on inquiry card.

The Sorcerer's Voice

The model SV-100 is a self-contained device that generates tones, musical notes, and sound effects. The unit plugs into the parallel output port of the Sorcerer and features a built-in speaker. The SV-100 utilizes twenty-one tones including twelve musical notes. A cassette includes an INTRO for the SV-100; SDEFT, a sound effects program; MUSIC, a real-time music composition program; and HORSE, a horse race game with sound effects.

The SV-100 is available from Indiana Digital Corp, POB 3755, South Bend IN 46619, for \$49.95.

Circle 453 on inquiry card.

100% Error Free Floppy Disks

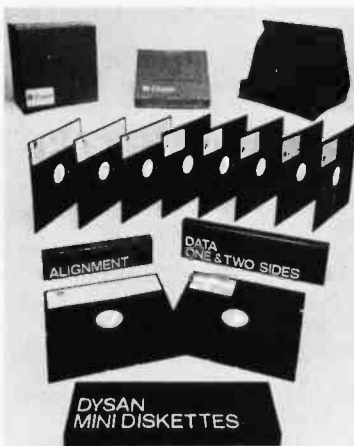

Error free single- and double-sided 5-inch floppy disks in 35- or 40-track versions are available from Dysan Corp, 5440 Patrick Henry Dr, Santa Clara CA 95050. They are available in hard- or soft-sectored versions.

Circle 454 on inquiry card.

Standard Letter-Quality, Wide Carriage Printer

The CPT Rotary V is an up to 40 character per second (cps) serial printer with letter-quality printout, a metal daisy print wheel, and the printer can be used with the CPT 6000 and 8000 word processing systems. Featured are an adjustable platen for multiple part forms, ribbon lift for position accuracy, and bidirectional paper feed for forms fill-in applications. The Rotary V is priced at \$4000 and is available from CPT Corp, 1001 2nd St S, Hopkins MN 55343.

Circle 455 on inquiry card.

Universal Graphics Display Peripheral

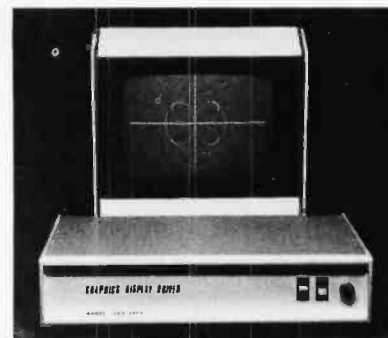

The G-Box is a peripheral device which can be used with any computer to add high-density graphics. The video image output is a matrix of 512 by 240 dots with an expansion capability. Connection to the computer is through an RS-232 serial link. The G-Box accepts standard ASCII codes and it does not require assembly language routines. It can be controlled from BASIC and other languages. Interfaces for joysticks, serial and parallel ports, a light pen interface, and other options are built into the unit. The G-Box can be adapted to work on the TRS-80, Heath, Commodore, North Star, and other microcomputers. Prices range from approximately \$350 for the primary version (without cabinet), up to over \$2000 for terminal units with full options. Contact Objective Design Inc, POB 20325, Tallahassee FL 32304.

Circle 456 on inquiry card.

Where Do New Products Items Come From?

The information printed in the new products pages of BYTE is obtained from "new product" or "press release" copy sent by the promoters of new products. If in our judgment the information might be of interest to the personal computing experimenters and homebrewers who read BYTE, we print it in some form. We openly solicit releases and photos from manufacturers and suppliers to this marketplace. The information is printed more or less as a first in first out queue, subject to occasional priority modifications. While we would not knowingly print untrue or inaccurate data, or data from unreliable companies, our capacity to evaluate the products and companies appearing in the "What's New?" feature is necessarily limited. We therefore cannot be responsible for product quality or company performance.

What's New?

SOFTWARE and PERIPHERALS

IBM to CP/M or CP/M to IBM Transfer Utility Program

The IBM2CPM program uses an IBM or equivalent mainframe to develop systems for microcomputers using cross-compilers and assemblers. The resulting source programs are transferred to the microcomputer via a standard 8-inch floppy disk. This system enables a microcomputer to act as a data entry system for a large mainframe. The program features interactive operation that allows users to specify which files to copy, the ability to display the directory on an IBM standard interchange floppy disk, and more. IBM2CPM is available from Precision Computer Systems Inc, 1737 N First St, San Jose CA 95112 for \$95.

Circle 457 on inquiry card.

Bus(iness) 1

Designed for SwTPC 6800 and PET systems, this package contains thirty programs, including payroll, cash flow, profit and loss accounting, stock control, invoices, sales ledger, updating address files, and more. The package can run up to four companies, eight bank accounts, fifty agents, 999 customers or suppliers, 1000 stock items and two-hundred employees, depending on disk storage. The program can run in 20 K bytes of memory and has been adapted to the 6502 processor. It costs \$275 plus value added tax (VAT). For more information, contact G W Computers Ltd, 89 Bedford Court Mansions, Bedford Ave, London WC1 ENGLAND.

Circle 458 on inquiry card.

Software Protection for S-100 Bus Systems

International Product Development Inc, 1708 Stierlin Rd, Mountain View CA 94043, has developed the LW100 board that operates with standard software, as well as protected software that can be copied for a user's computer. Each LW100 board contains a key that is different from all other boards. The protected software has a key lock programmed to work with only one computer. Manufacturers and software houses that wish to protect their software would supply the customer with a LW100 board and protected software. Future sales to that customer require only the protected software that works with the customer's keyed computer. The cost for the board is \$139.

Circle 459 on inquiry card.

WIZRD Multitasking Disk Operating System

Wintek's system includes true device-independent (virtual) input/output (I/O); HEAP memory management for efficient memory allocation for I/O buffers; and command indirection, which allows commands to be read from files with no operator intervention. It is helpful for systems used by untrained operators. WIZRD is included with Wintek's 48 K, dual-drive SPRINT 68 microcomputer for \$3995, or alone for \$495. For information, contact Wintek Corp, 1801 South St, Lafayette IN 47904.

Circle 460 on inquiry card.

Word Processor for Apple II and Apple II Plus Systems

Super-Text is a multiple paging system that allows users to view two text screens simultaneously, keep notes or instructions on one text screen and edit on the other. It features full floating cursor and cursor control; insertion and deletion of characters, words or lines; tabbing; justification; full scrolling; movement to the last change made in the text; global search and replace; block operations; and advanced file handling and print controls. The system runs in 48 K bytes of memory and costs \$99.95. It is available from Muse Co, 7112 Darlington Dr, Baltimore MD 21234.

Circle 461 on inquiry card.

Text Formatter for UCSD Pascal Systems

Using the Moonshadow Text Formatter, documents produced with the screen editor are post-processed to provide underlining, automatic pagination, and other essential text-processing functions. It takes standard Pascal text files, operates on them, and sends fully formatted text output to the console display, a printer, or a disk file. Moonshadow Text Formatter provides a full range of formatting functions, plus advanced features such as combining of files into one document, variables in text (for form letters), and output character translation (for printers using nonstandard character sets).

The program is written in UCSD Pascal and works on systems using either North Star 5-inch floppy disks or IBM format 8-inch floppy disks. It is available from Merrimack Systems, POB 5218, Redwood City CA 94063, for \$99.

Circle 462 on inquiry card.

APL for the 8080, 8085, and Z80

Softronics APL has most of the functions and operators of full APL, including n-dimensional inner and outer product, reduction, compression, general transpose, reversal, take, drop, execute and format, system functions and variables, and system commands. It runs under the CP/M operating system, residing in 30 K bytes of memory. In addition to standard ASCII mnemonic representations, it supports typewriter and bit-pairing ASCII-APL character sets. The shared variable mechanism allows CP/M disk input and output. Softronics APL comes with an optional driver program for video display with programmable character generator. It is priced at \$350 on disk, with a user's manual. For more information, contact Softronics, 36 Homestead Ln, Roosevelt NJ 08555.

Double-Sided Dual Disk Drive

The Micro Squared M-250 unit is capable of single or double density and consists of two double-sided drives, a power supply, cable, and chassis. It has 140 tracks, with a capacity of 358 K bytes of memory. The double-density feature allows 875 K bytes of memory storage. The unit also features a write protect sensor, time erase timing circuits internal to the disk drive, and has a sensor that stops the spindle drive motor rotation when no disk is installed. The unit costs \$1195 and is available from Micro Squared Inc, Suite 5B, 7131 Owensmouth Ave, Canoga Park CA 91303.

Circle 463 on inquiry card.

Pertec Introduces 8-Inch, 20 M Byte Winchester Drive

This new drive will use a limited motion, 50 ms average access rotary positioner. The Mini-Wini can perform diagnostic routines without the help of the central processing unit by creating a bidirectional bus interface using a 6801 microprocessor. The Mini-Wini has the same physical dimensions, mounting scheme and voltage requirements as floppy disk drives, but offers more storage space than floppy disks. The price is \$3000 and is available from Pertec Computer Corp, 9600 Irondale, Chatsworth CA 91311.

Circle 464 on inquiry card.

What's New?

SOFTWARE

North Star List Processor

HELPH5 is a collection of subroutines which use dynamic memory assignment to perform list processing. The user can create a sequential set of array elements which describe objects. By filing sets on and removing sets from various lists, complex processes can be simulated. Available subroutines include Create, Destroy, File First, File Last, File Ranked—which places an entity on a sorted list based on the value of a selected array element—Remove First, Remove Last, and Remove. Four debug-

ging routines allow the user to print all the objects on a list, determine if a particular object is on a specified list, if an array element has a specified value, and print the array elements for a particular entity.

HELPH5 is written in North Star BASIC and needs a minimum of 32 K bytes of programmable memory. The price is \$48, including a user's manual and sample simulation program. Contact American Planning Corp, 4600 Duke St, Suite 425, Alexandria VA 22304.

Circle 465 on inquiry card.

NEVADA COBOL for Microcomputers

NEVADA COBOL translates source language programs into machine language on 8080, Z80 and 8085 microprocessors. Designed for small businesses using microcomputers, it features random access file support; sequential files, both fixed and variable length; debugging capability; copy statement; character string, 16-bit binary and packed decimal (COMP-3); 18-bit accuracy; hexadecimal non-numeric

literals; and an interactive ACCEPT/DISPLAY. The compiler, which is a subset of ANSI-74, generates programs at a rate up to 650 lines per minute on an 8080-based system. Operating under Processor Technology's operating system (PTDOS), the compiler requires a minimum of 32 K bytes of programmable memory. *The NEVADA COBOL Programmers Reference Manual* is available for \$25 and the Diskette is \$275, from Ellis Computing, 1480 17th Ave, San Francisco CA 94122.

Circle 466 on inquiry card.

Library Cross-Reference for Floppy Disks

The CATALOG system provides a means to index up to 200 single- or double-density 5-inch floppy disks. Using the alphabetical lists of files produced by CATALOG, any program or data file can be located in a few seconds. The name, extension, size, date and disk number for each file is listed in each of three reports. These reports are organized by the date within extension within name, extension within name within disk number, and date within

name within extension. A list of disks is provided after each use of the CATALOG program. The program runs on 8080 or Z80 microprocessors with 48 K bytes of memory, floppy disk, video display and printer. The program requires CP/M with Microsoft MBASIC or MITS/Pertec Disk Extended BASIC. The SORT System is required for use of CATALOG. The CATALOG System is priced at \$95 and is available from the Software Store Ltd, 706 Chippewa Sq, Marquette MI 49855.

Circle 467 on inquiry card.

6809 Systems Software

Technical Systems Consultants Inc, POB 2574, W Lafayette IN 47906, has developed software which includes a 6809 version of the popular FLEX disk operating system, a text editor, a resident assembler, BASIC interpreter, and an assembly language debug package. Most software written for 6800 FLEX can be reassembled for 6809 by changing any equates into FLEX to the proper addresses. FLEX features dynamic file allocation, random and sequential files, printer spooling, batch job type program entry, automatic space compression, user start-up facility, and English error

messages. The resident 6809 assembler accepts 6809, 6800, and 6801 mnemonics so that existing software can be immediately reassembled to produce 6809 object code.

FLEX is available for the SwTPC disk systems on a 5- or 8-inch floppy disk. The other software is available on a standard 5- or 8-inch FLEX disk which may be used on any soft-sectored 6809 FLEX disk system. Cassette versions are available for all but FLEX. Including the text editor and assembler, the FLEX package is \$90. The BASIC interpreter is \$65, and the debug package is \$75.

Circle 468 on inquiry card.

Six Software Programs for Apple Users

These six programs from Williamsville Publishing require an Apple II with 32 K bytes of programmable memory, one disk drive, Disk II, Applesoft II in read-only memory (ROM) on a firmware card. The programs include Book Library; Record Library; Malum II...Imperial Roman Programmable Computer By Command of Caesar, which takes the Latin equivalent of BASIC commands and uses Roman numerals for numeric input and output; Graphics Game; Checkbook Program; and Page Processor.

Individual disks sell for \$19.95 from Williamsville Publishing Co, POB 250, Fredonia NY 14063.

Circle 469 on inquiry card.

Software for Radio and Television Stations

Solar Computer Systems Corp, 2360 43rd Ave E, Suite 308, Seattle WA 98112, has a series of software programs designed to run on Smoke Signal Broadcasting's Chieftan Systems that are of interest to radio and television stations. Available programs include audience measurement, attitude research, music research, lifestyle surveys, ARBITRON analyses and more. Information is available upon request.

Circle 470 on inquiry card.

Math Program Performs Symbolic Operations for Algebra, Trigonometry, and Calculus

This symbolic mathematics system enables users to solve polynomial multiplications, symbolic differentiations and integrations, simplification of trigonometric expressions, and exact solutions of nonlinear equations. The muMATH-79 programs run on 8080, 8085, and Z80 systems using TRSDOS, standard CP/M, or upward compatible operating systems such as Cromemco CDOS, or IMSAI IMDOS. The program is useful for engineers and scientists in checking or deriving lengthy analytical data. It is also useful for artificial intelligence applications as well as for students and teachers in math education. The price for the package is \$190. For more information, contact The Soft Warehouse, POB 11174, Honolulu HI 96828.

Circle 471 on inquiry card.

What's New?

SYSTEMS

Single Board Computer Supports Pascal

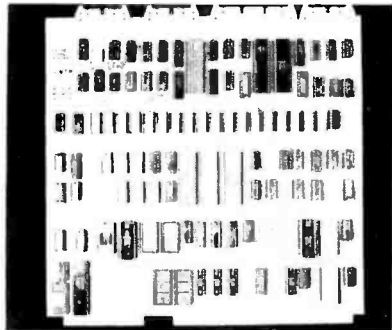

DOSC Inc, 500 Fifth Ave, New York NY 10033, has announced its TCB-85 single board microcomputer capable of supporting CP/M and Pascal. The 64 K board is compatible with Intel's Multibus and features a dual-density floppy disk controller that supports up to four disk drives or two double-sided disks, video display controller with up to 80 characters by 25 lines, RS-232 serial input/output (I/O) port, parallel printer interface, scanned keyboard interface, vectored interrupts, and three timers.

The price is \$1500 per unit.

Circle 472 on inquiry card.

Versatile Business Manager System

This system includes a Versatile 4 Dual Drive computer, a Texas Instruments 810 RO Tractor Feed Printer, application software for business, and a movable table. The business software includes a General Ledger, Accounts Payable and Receivable, Inventory, Personnel/Payroll, and Labor Job Cost Analysis. The system is priced at under \$8500 and is available from CDS Inc, Building 3, Drummond Plaza, Newark DE 19711.

Circle 473 on inquiry card.

Compucolor II System

Compucolor Corp, POB 569, Norcross GA 30071, has developed three models of the Compucolor II. Model 3 has 8 K bytes of programmable memory, the Model 4 has 16 K bytes, and the Model 5 provides 32 K bytes of memory. The Compucolor II uses an 8080A microprocessor and includes 16 K bytes of read-only memory. One RS-232C serial port is provided for a printer or modem. The Compucolor II features a keyboard that is separate

Hewlett-Packard Introduces Personal Computer for Professionals

The HP-85 is a complete computer system designed for use in business and industry by engineers, scientists, accountants, and investment analysts. It can also be used in the home by hobbyists and as an instructional computer in secondary schools, colleges, and universities.

The system features a video display, thermal printer, tape cartridge, and graphics capability in a package the size of a typewriter. It is equipped with four input/output (I/O) ports to allow the user to expand the system to include plotters, printers, disk drives, and other peripherals that are already on the market.

The HP-85 comes with 16 K bytes of programmable memory and can be expanded to 32 K by plugging an optional memory module into one of the ports on the back of the machine. The graphics display is useful to engineers for plotting functions and for test analysis, and to business persons to plot statistics. The display on the screen can be easily printed out on the built-in printer.

The system has a 5-inch, high-resolution, black and white video display with 16 lines of display and 32 characters per line. The thermal printer, which operates in both alphanumeric



and graphics modes, prints two 32-character lines per second. The HP-85 tape drive uses HP Data Cartridges, which have a capacity of 200 K bytes, and feature a tape directory that enables the system to automatically find exact tape locations of recorded programs and data.

The HP-85 measures 41 by 46 by 15 cm (16 by 18 by 6 inches), and weighs 9.06 kg (under 20 pounds). It comes with a user's manual and a standard application software package that contains 15 programs. The price of the HP-85 is \$3250. For more information, contact Inquiries Manager, Hewlett-Packard Co, 1507 Page Mill Rd, Palo Alto CA 94304.

Circle 474 on inquiry card.

8086 and 8088-Based Microcomputers

Microbyte, 2499 Cerritos Ave, Signal Hill CA 90806, has introduced two 16-bit 8086 and 8088 microprocessor-based computers with real-time clock, priority vectored interrupts, four port serial input and output (I/O) board that supports four terminals, 32 K bytes of programmable memory, dual-density floppy disk controller that supports up to four drives with direct memory ad-

dress (DMA) data transfer, video display and keyboard, 19-slot backplane, and an interrupt switch-on from console to allow re-boot of the system without register destruction. The systems use Microbyte DOS86 batch operating system software and also feature 4 K bytes of programmable memory on-board, 24 operand addressing modes, three programmable timers, and more. The approximate prices for the 8086 and 8088 are \$4000 and \$3900, respectively.

Circle 475 on inquiry card.

from the processor and video display unit. The video terminal has erase-line and erase-page commands; two character sizes; fifteen plot modes; local, full, and half duplex modes; full cursor control; and other functions. The system uses Disk BASIC 8001 with an interpreter in read-only memory. Twenty-nine statement types, three command types, nineteen mathematical functions, and nine string functions are included.

One 5-inch floppy disk is built into

the main unit. The capacity for each side of a 5-inch disk is 51.2 K bytes.

The video display features eight colors with 32 lines and 64 characters per line. The usable screen area is 23 cm (9 inches) wide by 17 cm (6.75 inches) high. Compucolor has developed software for the system including games, small business applications, home finance, and other programs. The prices for the three models are \$1495, \$1695, and \$1995.

Circle 476 on inquiry card.

What's New?

PUBLICATIONS

Short Form Catalog of Modems and Accessories

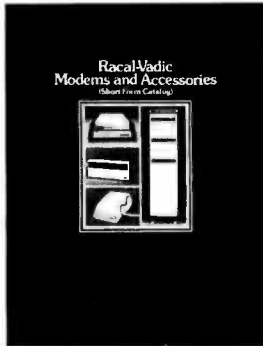

This six-page catalog contains Racal-Vadic's 1200 bits per second (bps) full-duplex acoustic coupler; the "50" series of direct connect modems; and the VA3467 triple modem which emulates a Racal-Vadic VA3400 series modem, a Bell 212A, or a Bell 103. Other products include Bell-compatible 300 bps, 1200 bps half-duplex, and 2400 bps modems; CCITT compatible modems; automatic dialers; and a Multiline Automatic Calling System, which can handle up to 60 modems for each dialing port. For further information, contact Racal-Vadic, 222 Caspian Dr, Sunnyvale CA 94086.

Circle 477 on inquiry card.

Introduction to VLSI Systems

Introduction to VLSI Systems, by Carver Mead and Lynn Conway, deals with the theory and practice of designing, fabrication, and implementing of silicon chips, and it provides detailed coverage of the underlying physics to complete very large-scale integration (VLSI) digital computer systems. *Introduction to VLSI Systems* is suitable as a textbook and reference book for graduate and undergraduate courses.

The book is available from Addison-Wesley Publishing Co, Reading MA 01867, for \$25.95.

Circle 478 on inquiry card.

1979 Mapping Collection from Harvard Library of Computer Graphics

This six volume collection has been structured to give an organization every kind of information it may need about computer mapping. The collection features works on management's use of maps; natural resource and environmental applications; urban, regional, and

Sharp APL Reference Manual

This text is complete with illustrations and examples, and it discusses the features of Sharp APL in terms understandable by beginners and professional programmers alike. Some of the topics reviewed are syntax of APL, event trapping, primitive functions and operations, structure of data, shared variables, report formatting, batch APL, and line editing in Sharp APL. The manual is available for \$18 from I P Sharp Associates Ltd, 145 King St W, Toronto, Ontario M5H 1J8, CANADA.

Circle 479 on inquiry card.

Communication Fiber-optics Short Form Catalog



Valtec Corp's catalog, which includes their optical fibers and cables, fiberoptic modems and interfaces, and baseband video links, covers every application from computer terminal connections to long-haul telephone and CATV trunking.

To obtain a copy of the catalog, write Valtec Corp, Communication Fiber-optics, 99 Hartwell St, West Boylston MA 01583.

Circle 480 on inquiry card.

state applications; computer mapping in education; mapping software and cartographic data bases; thematic map design; and sections on cadastral systems and use of satellite derived data. The cost is \$45 for the first volume, and \$30 for each additional selection. The complete six volume set is \$150. Contact the Laboratory for Computer Graphics, Harvard University, 48 Quincy St, Cambridge MA 02138.

Circle 481 on inquiry card.

Publication for the Ohio Scientific Challenger 1P

Getting Started With Your Challenger 1P introduces the fundamentals of C1P BASIC and explains its characteristics, limitations, and useful features. This document discusses calculator and program mode, input and output, data representation, and program storage on cassette. It also describes C1P control and logic, including testing and branching, subroutine use, and logical operations. This beginner's workbook contains exercises and sample programs. It is available from dealers or by writing to TIS, POB 921, Los Alamos NM 87544. The price is \$5.95 plus \$1 for postage and handling.

Circle 482 on inquiry card.

Microprocessor User's Guide

The Microprocessor User's Guide contains articles written by engineers for other engineers and corporate managers with a production-oriented, problem solving approach in mind. The 78-page booklet focuses on designing with microprocessors; engineering design approach to microprocessors; microprocessor architecture; analysis of 6800, 8080/8085 and Z80 architectures; and analysis of single-chip microprocessors. Pro-Log's STD BUS, a bus structure for 8-bit microprocessors, is examined in detail.

The guide is available at no charge from Pro-Log Corp, 2411 Garden Rd, Monterey CA 93940.

Circle 483 on inquiry card.

Using a Programmable Calculator Instead of a Central Computer

Providing techniques for using calculators in the HP-67/97 or TI-59 families, the *Handbook of Electronic Design and Analysis Procedures Using Programmable Calculators* offers programs and programming techniques for solving problems in network analysis, active and passive filter design, high frequency amplifier design, and engineering mathematics. Documentation including flowcharts, algorithms, sample problems, tips, and references clarify many aspects of problem solution. The book is available for \$26.50, from Van Nostrand Reinhold Electrical/Computer Science and Engineering Series, 135 W 50th St, New York NY 10020.

Circle 484 on inquiry card.

What's New?

MISCELLANEOUS

GPIB Controller Implements IEEE 488 Bus and RS-232 Standard

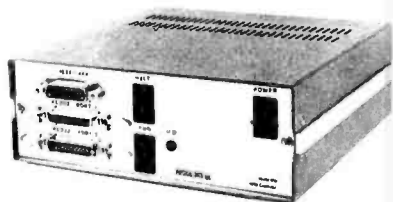

The Model 609 GPIB Controller can be used in place of programmable calculators, microcomputers, or as intelligence for a data collector logger system. Programs in BASIC enter in 4 K bytes of programmable memory, then are transferred to an internal programmable read-only memory (PROM). This eliminates the tape loading routines and insures that, when the controller is turned on, the program is present and ready. The Model 609 has control

features such as serial or parallel poll and reception of binary-coded decimal (BCD) or ASCII messages, the ability to be transparent in a large system, and a front panel pass/fail test system. The front panel contains all connectors and controls and has been designed to eliminate inadvertent false operation. The unit costs \$1395. For more information, contact Physical Data Inc, Dept 37, 8220 SW Nimbus Ave, Beaverton OR 97005. Circle 485 on inquiry card.

National Introduces New Addition to One Chip Data Acquisition System Family

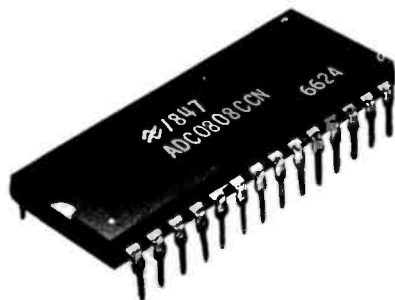

Available in two versions, the ADC0808 and ADC0809 complementary MOS (CMOS) integrated circuits incorporate the essential elements of a microprocessor-compatible data-acquisition system onto a single chip, including an 8-bit analog-to-digital (A/D) converter, an 8-channel multiplexer and microprocessor-compatible control logic. The ADC0808/09 uses a successive approximation conversion technique with a high-impedance chopper stabilized comparator which makes the device virtually immune to temperature, long term drift, and input offset errors, and it provides effective and accurate conversion while running on only 15 milliwatts. A 256R voltage ladder network approach was chosen to guarantee against missing codes. Resolution is 8 bits, and the ADC0808/09 can perform a conversion in 100 microseconds. Latched and decoded address inputs and outputs make possible interfacing to the 8080, 8085, Z80, 6800, and National's 8060 SC/MP microprocessor, among others.

For more information on prices and availability, contact Keith Mueller, National Semiconductor, 2900 Semiconductor Dr, Santa Clara CA 95051.

Circle 486 on Inquiry card.

Magnetic Bubble Mass Storage for DEC Microcomputers

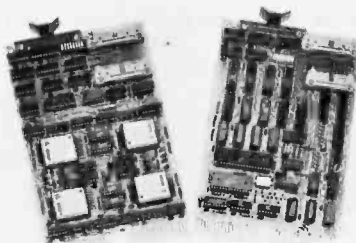

This new LSI-11-compatible bubble memory system is comprised of a dual height controller module (designated Bubbl-Board MBC-11) and one or more dual height bubble memory modules (designated Bubbl-Pac MBB-11). The MBC-11 controller contains its own 8-bit

microprocessor and is capable of controlling up to 16 MBB-11 bubble memory modules. The microprocessor handles bubble device formatting and control, as well as interfacing the bubble memory system to the LSI-11 bus structure. The controller maps standard floppy disk track and sector addresses into bubble device page addresses, so that the bubble memory is fully compatible with all DEC software for the LSI-11, including the mass storage operating systems such as RT-11. The bubble memory system appears just like a floppy disk to the processor, though with much faster access time. Data storage is absolutely nonvolatile. Each MBB-11 bubble memory module uses one LSI-11 chassis slot and contains 46 K bytes of storage. Access time to the first data byte averages less than 7 ms.

The MBC-11 is priced at \$650 and the MBB-11 at \$950. Contact Bubbl-Tec, 3120 Crow Canyon Rd, San Ramon CA 94583. Circle 487 on Inquiry card.

The Ruler That Thinks

The Panasonic Electronic Ruler/Computer uses a small displacement measuring wheel to directly measure lengths, distances, areas, and volumes, in linear, square, or cubic units, in any scale, from any document. A multifunction calculator is integrated in the ruler permitting measured data to be used automatically in computations. Intermediate measurements can be stored in the calculator's memory to yield a total quantity. The computer displays values directly in millimeters, centimeters or meters, and converts to either inches or feet simply by pressing a function key. The Electronic Ruler/Computer can measure any regular or irregular surface, such as curved walls, floors, containers, etc. Documents to be measured need not be in original scale; variations caused by reduction or enlargement can be programmed into the computer with results automatically displayed in the original scale.

Additional features include addressable memory; metric and area con-



version; percent, add-on, and discount computations; automatic square root and π ; floating decimal point system; mixed calculations, and more.

The Electronic Ruler/Computer is priced at \$99.95. For further information, contact the distributors, Chafitz Inc, 1055 First St, Rockville MD 20850.

Circle 488 on Inquiry card.

What's New?

MISCELLANEOUS

S-100 Communications Board

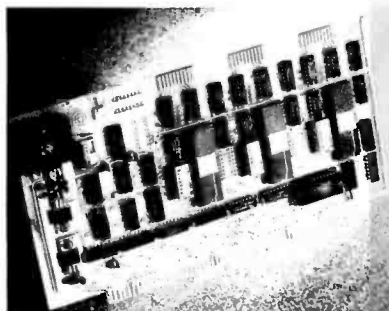

Designed specifically for S-100 applications, Inco's six port EIA/RS-232 board, based on the Zilog Z80A, features synchronous and asynchronous communications at a wide range of data rates. The board also contains two real-time clocks programmable in several modes, and meets the proposed IEEE S-100 standards. It performs hardware cyclic redundancy check (CRC) generation and checking, and provides standard protocol support. The board, documentation and a software guide are available for \$895 from Inco Inc, 7916 Westpark Dr, McLean VA 22102.

Circle 489 on inquiry card.

Floppy Disk Controller Board for the TM990

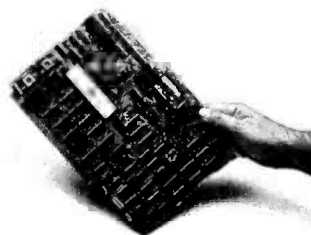

A floppy disk controller compatible with the TM990 series of microcomputer board products has been announced by

Texas Instruments Inc, POB 1433, MS 6404, Houston TX 77001. The TM990/303 board supports up to four double-sided drives. The board is programmable for data encoding formats and number and types of disk drives. The TM990/303 has the ability to interface to single- and dual-density drives. The controller is compatible with IBM 3740 and TI disk formats. Data transfer format and stepper motor rates are both programmable. In addition, the controller also features write precompensation, soft-sector compatibility, internal phase acquisition, and address mark detection. The board is priced at \$845.

Circle 490 on inquiry card.

MC6809 Microprocessor Development Systems



Motorola has announced six update packages to adapt a user's previous EXORciser I, IA, or II systems to MC6809 system design. These products enable designers to develop and debug any system centered around this power-

ful eight-bit microprocessor. The new EXORciser II and EXORterm 220 differ from the MC6800 units in current production in that they contain a microprocessing module with a M6809 component complement, as well as extending the capabilities of other internal modules to MC6809 specifications. EXORciser and EXORterm systems can be upgraded to permit M6809 designs by adding an MC6809 microprocessing module, a DEbug module, a floppy-disk controller, programmable read-only memory (PROM) firmware, and an MC6809 MDOS floppy disk, containing a macroassembler and video editor. By updating these units for operation with the MC6809 modules, the features of EXORciser II, such as dynamic systems bus, dual memory map, memory parity, second-level interrupt vectors, and more, are achievable.

The prices for the updating systems are \$3200. The prices for the complete MC6809-based EXORciser and EXORterm development systems range from \$7900 to \$9365. For additional information, contact Motorola Inc, POB 20912, Phoenix AR 85036.

Circle 491 on inquiry card.

Power Saver from Power Dynamics

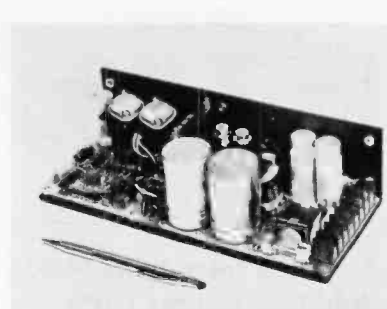

Power Dynamics has developed a single output open frame switcher. The unit measures 7 by 10 by 23 cm (2.75 by 4 by 9 inches). It is available in all the standard output voltages from 5 to 48 volts. The price is \$175. For more information, contact Power Dynamics Corp, 9421 Telfair Ave, Sun Valley CA 91352.

Circle 492 on inquiry card.

Device for Remote Control of Electrical Devices

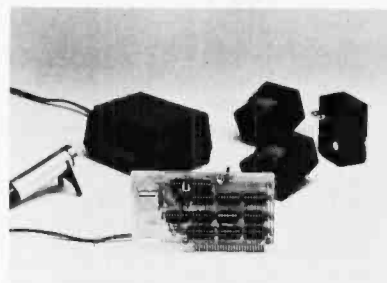

Introl/X-10 allows Apple users to remotely control 110 V AC devices by commands sent through a BSR/System X-10 Command Console over existing building wiring. The unit comes with software to control devices on predetermined schedules. It provides for selection of daily or weekly schedules, specification of the exact date for a particular event, specification of intervals of time for an event, and, for energy management, device wattage ratings for power consumption accounting. The system consists of the Introl Controller board with timer and ultrasonic transducer, the BSR/X-10 Command Console, and three Remote Modules for \$279. The Introl/X-10 Controller Card costs \$189 and additional remote modules are available for \$15. For more information, contact Mountain Hardware Inc, 300 Harvey West Blvd, Santa Cruz CA 95060.

Circle 493 on inquiry card.

What's New?

MISCELLANEOUS

32 K Byte Static Memory Boards for 6800/6809

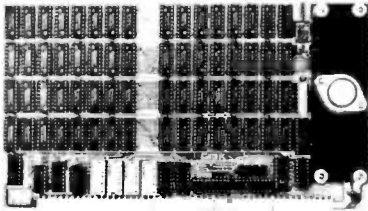

Gimix, 1337 W 37th Pl, Chicago IL 60609, is delivering a fully static 32 K byte programmable memory board for use with the SS-50 (6800) and SS-50C (6809) bus. The board features four independently dip-switch addressable 8 K byte blocks. Each block can be addressed to any 8 K boundary or disabled. The board is capable of decoding the four additional address lines of the SS-50C bus to allow memory decoding up to 1 M bytes. The switches enable or

disable the extended addressing and set it to one of sixteen possible banks. The board is designed for high noise immunity. The price of the full 32 K board is \$548.15. The 16 K version costs \$328.12 and 24 K version costs \$438.14. Both can be expanded to contain up to 32 K bytes of memory.

Circle 510 on inquiry card.

Lowercase and Keyboard Modification Kit for TRS-80

This kit includes wire, solder, control key, 2102 memory device, slide switch, mounting hardware, and documentation. The low power 2102 memory part is connected to a slide switch that allows the TRS-80 to be used with or without lowercase letters. To minimize the chance of damage to the 2102, its connecting wires have been pre-assembled. The control key has gold-plated contacts for long life and can be easily mounted on the keyboard. The kit is priced at

Low Power, 32 K Programmable Memory for Heath H8 Computers

A board with 32 K bytes of programmable memory, using less than 6 W of power and compatible with current Heath peripherals, is available from D-G Electronic Developments Co, 3223 Forest Ln, Garland TX 75042. Other features include circuit protection to prevent damage to memory output buffers if two blocks are assigned to the same address space, memory addressing controlled by a dual in-line (DIP) switch, and it is arranged as four independently addressable 8 K byte blocks with transparent refresh. The price for the board is \$479, and it comes fully assembled and tested.

Circle 511 on inquiry card.

\$19.95, and is available from Emmanuel B Garcia Jr and Associates, 3950 N Lake Shore Dr, Rm 2310, Chicago IL 60613.

Circle 512 on inquiry card.



FREE! Up to \$170 in merchandise with purchase of one of following PET-CBM items !!!

Axiom EX-801 PET Printer (with graphics)	\$ 475.00
Axiom EX-820 PET Plotter	\$ 749.00
Anderson Jacobson 841 Selectric	\$1015.00
Leedex Video 100 12" Monitor	\$ 119.00
Heath WH19 Terminal (factory asm.)	\$ 770.00
Heath WH14 Printer (factory asm.)	\$ 735.00
IEEE-RS232 Printer Adaptor for PET	\$ 88.00

BETSI PET to S-100 Interface	\$ 119.00
PET Connectors-Parallel or IEEE	\$ 1.95
Cassette Port	\$ 1.45
Hands on Basic with a PET	\$ 9.45
Programming the 6502 (Zaks)	\$ 9.45
6502 Applications Book (Zaks)	\$ 10.45
6500 Manuals (MOS Technology)	\$ 6.50
Programming a Microcomputer: 6502	\$ 8.45
6502 Assembly Language (Osborne) NEW!	\$ 8.10

KIM-1 \$159 (add \$30 for power supply)	SYM-1 \$209
BAS-1 Microsoft ROM Basic for SYM	\$ 85
Memory Plus (KIM, SYM, AIM)	\$195
SYM Assembler in ROM	\$ 85
SEA-16 New 16K Static RAM	\$325
Seawell Motherboard - 4K RAM Space	\$139
KTM-2/80 Synertek Video Board	\$349
S-100 16K Static RAM Kit	SALE \$219
TIS PET Workbooks - set of 6	\$ 21.50
Dust Cover for PET	\$ 8.90

All Books and Software 15% Off
 CBM Word Processor for PET - Machine Language Auto Scroll, insert, delete, form letter append, etc. 8K Version \$24.00 16K or 32K with disk \$89.00

Cassettes (all tapes guaranteed) AGFA PE611 Premium quality, high out put lownoise in 5 screw housing with labels:

C-10	10/5.65	50/25.00	100/48.00
C-30	10/6.90	50/30.00	100/57.00

PET SPECIALS

*FREE

PET 16N 16K full size graphics keyboard	\$ 995	\$130
PET 16B 16K full size business keyboard	\$ 995	\$130
PET 32N 32K full size graphics keyboard	\$1295	\$170
PET 32B 32K full size business keyboard	\$1295	\$170
PET 8N 8K full size graphics keyboard	\$ 795	\$100
PET 2040 DUAL DISK DRIVE-343,000 bytes	\$1295	\$170
PET 2022 Tractor Feed Printer	\$ 995	\$130
PET 2023 Pressure Feed Printer	\$ 849	\$110
PET C2N External Cassette Deck	\$ 95	\$ 12
Used 8K PETs (limited quantities)	\$ 495	

*Amount of Free Merchandise with Purchase of PET-CBM Item.

2716 EPROM (5 volt)	\$ 39
6550 RAM (for 8K PET)	\$ 12.70
6502 \$9.75	6522 \$9.00
2114 L 450 ns \$5.35	24@ \$4.95
	100 @ \$4.45



MINIMAX by COMPU/THINK

MINIMAX I (8 Megabyte Disks) \$4495
 MINIMAX II (2.4 Megabyte Disks) \$5995

SPECIAL - MINIMAX prices include Compu/Think PAGEMATE Database and Report Writer at no charge.

The most advanced complete microcomputer system available. Includes CPU, 12" CRT, Full Keyboard, 2 Quad-Density Disk Drives, 2 Megahertz 6502 Hybrid Processor (double speed), 108 K System Memory, High Resolution (512 x 240) Graphics, Programmable Character Fonts, Microsoft Extended BASIC, DOS with Random Access I/O, Full Complement of I/O Ports, Monitor with Debug, Trace, and Tiny Assembler, Fifth (PL/M and Forth combination) Interpreter, Complete editing and entry with split screen capability, 64 Microprogrammable Opcodes, Business software (with Database) available.

ATARI - INTRODUCTORY SPECIAL

ATARI 400, Atari 800 and all Atari Modules 20% OFF.

Programmers Toolkit - PET ROM Utilities	\$ 44.90
Sargon II (TRS-80 or Apple) NEW!	\$ 24.90
Microchess for PET (Peter Jennings)	\$ 17.90
PET 4 Voice Music System	\$ 29.90
4 Voice Music Monitor for PET	\$ 15.90
CmC Word Processor program for PET	\$ 25.00
Adventures by Scott Adams	15% Off



SALE

3M "Scotch" 8" Disks	10/\$31.00
3M "Scotch" 5" diskettes	10/\$31.50
Verbatim 5" diskettes	10/\$26.50
Diskette Storage Pages	10/\$ 3.95
Disk Storage Boxes 8" \$2.85 5 1/4" \$1.95	(Write for quantity prices)

115 E. Stump Road
 Montgomeryville, PA 18936

(215) 699-8386
 699-5826

A B Computers

WRITE FOR COMPLETE CATALOG

Add \$1.00 per order for shipping.
 We pay balance of UPS surface charges on all prepaid orders.

What's New?

MISCELLANEOUS

tinyFORTH 2.1 for TRS-80

The Software Farm, POB 2304, Reston VA 22090 has developed the tinyFORTH 2.1 system for TRS-80 systems. Programs written in tinyFORTH can run faster and use less memory than similar programs in BASIC because tinyFORTH includes a

compiler in addition to an interpreter. This system includes a powerful text editor, a Z80 assembler, and a graphics package. The tinyFORTH system occupies 8 K bytes of memory and comes with cassette tape and documentation for 16 K Level II TRS-80s. The system costs \$29.95.

Circle 500 on inquiry card.

32 K Structured BASIC

Cromemco 32 K Structured BASIC, which runs in 64 K Cromemco Systems, assists a programmer in building a program from logical blocks of code. This facilitates program development and reduces debugging and maintenance of programs. It contains all features of 16 K BASIC plus long variable names of up to 31 characters, statement labels that replace statement numbers to reference lines in a BASIC program, an

in-line BASIC editor, a keyed sequential access method (KSAM), procedures, and control structures including *if . . . then . . . else, while . . . endwhile, and repeat . . . until.*

Cromemco 32 K Structured BASIC is available for use on Cromemco systems on 8-inch or 5-inch floppy disks for \$295. For additional information, contact Cromemco Inc, 280 Bernardo Ave, Mountain View CA 94043.

Circle 501 on inquiry card.

Motorola Introduces MC68000 Design Module

Motorola has introduced the MEX68KDM, an MC68000 design module. The MEX68KDM permits easy chip evaluation, using either an EXORciser development system or an IBM370 or PDPII, in conjunction with cross-computer software. For system emulation, the module includes 32 K bytes of programmable memory, two 16-bit parallel input/output (I/O) ports, three 16-bit programmable timers and two serial RS-232 ports.

MEX68KDM includes MACSbug, a powerful 16-bit microprocessor debugging tool. Once a memory file is resident in programmable memory, a user may

begin his program debugging. The memory map for the MEX68KDM allows for the use of any of the on-card I/O and additional external memory or I/O. A 6800 bus interface card is provided to allow the MEX68KDM to read or write data to an external memory or I/O card. The design module may be used in a stand-alone mode, in an EXORciser development system in the nonexpanded bus mode, or in a card cage with standard 6800 memory.

The design module with two RS-232 cables is priced at \$1795. Contact Motorola Semiconductor Inc, POB 20912, Phoenix AZ 85036, for more information.

Circle 502 on inquiry card.

PROSYS I System

Aimed primarily at the process control and industrial/measurement markets, the system allows a process control engineer or technician to communicate with a digital computer-controlled process system. PROSYS I includes the ADAC System 1000 enclosure with the 64 K byte version of the Digital Equipment Corp LSI-11/2 microcomputer, dual-port serial interface, single drive, double-density floppy disk and video terminal. The software resides in less than 32 K bytes of memory. The software includes an operating system. The system can accommodate up to eighteen PROSYS I optional modules. The price for the system is \$14,000, and it is available from ADAC Corp, 70 Tower Office Park, Woburn MA 01801.

Circle 503 on inquiry card.

Multiuser Operating System for Micropolis Microdisk

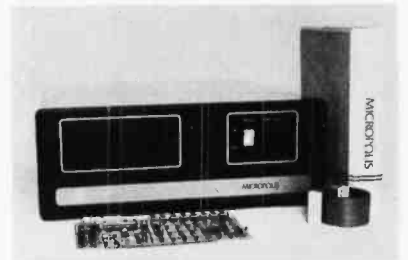

Micropolis Corp, 7959 Deering Ave, Canoga Park CA 91304, is marketing their fully integrated rigid disk subsystem which includes their 8-inch rigid disk drive with up to 31.2 M bytes of formatted data storage capacity, an intelligent disk adapter-interface card, and a software package for microcomputer systems that use the S-100 bus. The Microdisk subsystems are available in capacities of 6.2, 18.7 and 31.2 M bytes and are expandable by daisy chaining. Up to three add-on modules may be connected to a master unit. Prices for the Microdisk system begin at under \$5000.

Circle 504 on Inquiry card.

S-100 16-Channel 12-Bit Analog to Digital Converter Board

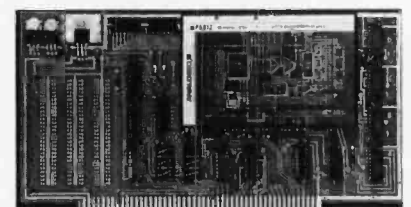

The Tecmar S-100 Analog to Digital (A/D) board interfaces the Analogic MP 6812 Complete Data Acquisition System to the S-100 bus. The board accepts sixteen single ended inputs and has data rates up to 30 kHz with twelve bit accuracy. The total of multiplex settling time and sample-hold acquisition time is about 7 microseconds. The board provides two's complement right-justified outputs and variable voltage ranges. The board may be configured to act as an input/output (I/O) device or to act as a memory mapped device. The board requires little software. The price is \$495, and it is available from Tecmar Inc, 23414 Greenlawn Ave, Cleveland OH 44122.

Circle 505 on inquiry card.



What's New?

MISCELLANEOUS

Network Information Resource

The SOURCE is a computer-based electronic message and information system. It allows users to send messages over computer terminals via a nationwide switching network. The SOURCE provides advanced electronic mail features such as text editing, scanning, delayed delivery, interactive conversation, and bulletin boards. It also acts as an information supermarket offering news, educational programs, travel and shopping services, and much more. To use the SOURCE, subscribers need only a microcomputer or terminal. The cost of the service is \$100 initial registration fee plus \$2.75 an hour. The service is \$15 an hour between 7 AM and 6 PM, Monday thru Friday. For information, contact Telecomputing Corp of America, 1616 Anderson Rd, McLean VA 22102.

Circle 506 on inquiry card.

S-100 Card Adds Sound

Two General Instrument AY-3-8910 programmable sound generators are interfaced to the S-100 bus on the Noisemaker to create sounds and noises. The board provides six tone generators, two noise sources, two envelope generators and four 8-bit input/output ports. Sound effects and noises may be created and added to graphics and computer games. An on-board audio amplifier and breadboard area allows inclusion of the board into any system. The Noisemaker is available now as an unpopulated, solder masked and screened, printed circuit board for \$34.95. Contact Ackerman Digital Systems, Suite 208, 110 York Rd, Elmhurst IL 60126.

Circle 507 on inquiry card.

Double-Density Floppy Disk Interface

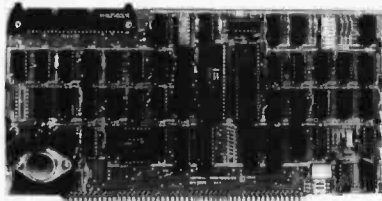

Tarbell Electronics has released its new interface board, which is supplied with the BASIC INPUT/OUTPUT SYSTEM software for CP/M on single-density floppy disk, permitting users to mix single- and double-density disks. As

many as four drives can be selected, using either single- or double-density. The 8-inch, Shugart-compatible disk interface contains phase-lock-loop and write precompensation, and the bootstrap programmable read-only-memory (PROM) is disabled on completion of the bootstrap operation, freeing all 64 K bytes of memory for other use. Extended addressing capability provides eight additional address bits as specified by the new IEEE standard, allowing direct transfers to and from any location within a 16 M byte address range. The interface comes with BIOS for CP/M on floppy disk for \$425 from Tarbell Electronics, 950 Dowlan Pl, Suite B, Carson CA 90746.

Circle 508 on Inquiry card.

Package Turns Exidy Sorcerer into Z80 Development System



Available for \$99, a software package called the Development Pac can turn an Exidy Sorcerer into a sophisticated, cassette-based, Z80 development system. The package includes four modules: a

designer's debugging tool (DDT), a line-oriented text editor, a relocating assembler, and a linking loader. All can operate with the Sorcerer's dual cassette interface to allow tape-based system development. The system supports global symbols for intermodule communication and allows the user to define the input/output (I/O) devices for source code, object code, and listings. The debugging tool allows the user to display and modify any programmable memory location or any Z80 register. Using the Development Pac, a programmer can design a program that is far larger than the Sorcerer's memory without having to worry about size limits, due to partitioning of memory and two predefined buffers that can be used for program storage. The package is available from Exidy Data Systems, 2599 Garcia Ave, Mountain View CA 94043.

Circle 509 on inquiry card.



8086 Boards

CPU with Vektored Interrupts \$650.
PROM-I/O \$495.
RAM 8K x 16/16K x 8 \$395.

ANALOG Boards

A/D 16 Channel, \$495.
12 Bit, High Speed
D/A 4 Channel, \$395.
12 Bit, High Speed



VIDEO DIGITIZATION

Real Time Video \$850.
Digitizer and Display
Computer Portrait System \$4950.

S-100 Boards

Video and/or Analog
Data Acquisition
Microcomputer Systems



The High Performance S-100 People

TECMAR, INC.

23414 Greenlawn • Cleveland, OH 44122
(216) 382-7599

TRS-80 E.S. SERIAL I/O

- Can input into basic
- Can use LLIST and LPRINT to output, or output continuously
- RS-232 compatible
- Can be used with or without the expansion bus
- On board switch selectable baud rates of 110, 150, 300, 600, 1200, 2400, parity or no parity odd or even, 5 to 8 data bits, and 1 or 2 stop bits. D.T.R. line
- Requires +5, -12 VDC
- Board only \$19.95 Part No. 8010, with parts \$59.95 Part No. 8010A, assembled \$79.95 Part No. 8010C. No connectors provided, see below.

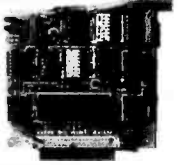

EIA/RS-232 connector Part No. DB25P \$6.00, with 9' 8 conductor cable \$10.95 Part No. DB25P9.



3' ribbon cable with attached connectors to fit TRS-80 and our serial board \$19.95 Part No. 3CAB40.

MODEM

- Type 103
- Full or half duplex
- Works up to 300 baud
- Originate or Answer
- No coils, only low cost components
- TTL input and output-serial
- Connect 8 Ω speaker and crystal mic. directly to board
- Uses XR FSK demodulator
- Requires +5 volts
- Board only \$7.60 Part No. 109, with parts \$29.95 Part No. 109A



DISKETTES



Box of 10, 5" 8" \$29.95, Plastic box, holds 10 diskettes, 5" - \$4.50, 8" - \$6.50.

APPLE II** SERIAL I/O INTERFACE

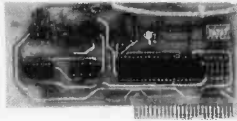

Baud rate is continuously adjustable from 0 to 30,000

- Plugs into any peripheral connector
- Low current drain. RS-232 input and output
- On board switch selectable 5 to 8 data bits, 1 or 2 stop bits, and parity or no parity either odd or even
- Jumper selectable address
- SOFTWARE
- Input and Output routine from monitor or BASIC to teletype or other serial printer
- Program for using an Apple II for a video or an intelligent terminal.

Also can output in correspondence code to interface with some electrics. • Also watches DTR • Board only \$15.00 Part No. 2, with parts \$42.00 Part No. 2A, assembled \$62.00 Part No. 2C

8K EPROM PIICEON

Saves programs on PROM permanently (until erased via UV light) up to 8K bytes. Programs may be directly run from the program saver such as fixed routines or assemblers. • S-100 bus compatible • Room for 8K bytes of EPROM non-volatile memory (2708's). • On-board PROM programming • Address relocation of each 4K of memory to any 4K boundary within 64K • Power on jump and reset jump option for "turnkey" systems and computers without a front panel • Program saver software available • Solder mask both sides • Full silkscreen for easy assembly. Program saver software in 1 2708 EPROM \$25. Bare board \$35 including custom coil, board with parts but no EPROMS \$139, with 4 EPROMS \$179, with 8 EPROMS \$219.

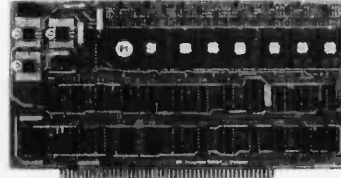

WAMECO PRODUCTS WITH

ELECTRONIC SYSTEMS PARTS

- FDC-1 FLOPPY CONTROLLER BOARD** will drive shugart, pertek, remex 5" & 8" drives up to 8 drives, on board PROM with power boot up, will operate with CPM (not included). PCB \$42.95
- FPB-1 Front Panel.** (Finally) IMSAI size hex displays. Byte or instruction single step. PCB \$42.95
- MEM-1A 8Kx8 fully buffered, S-100, uses 2102 type RAMS.** PCB \$24.95, \$168 Kit
- GMB-12 MOTHER BOARD,** 13 slot, terminated, S-100 board only \$69.95 Kit \$34.95
- CPU-1 8080A Processor board S-100 with 8 level vector interrupt PCB** \$25.95 \$69.95 Kit
- RTC-1 Realtime clock board.** Two independent interrupts. Software programmable. PCB \$25.95, \$60.95 Kit
- EPM-1 1702A 4K EPROM card PCB** \$25.95 \$49.95 with parts less EPROMS
- EPM-2 2708/2716 16K/32K EPROM card PCB** \$24.95 \$49.95 with parts less EPROMS
- GMB-9 MOTHER BOARD.** Short Version of GMB-12. 9 Slots PCB \$30.95 \$67.95 Kit
- MEM-2 16Kx8 Fully Buffered 2114 Board PCB** \$25.95, \$269.95 Kit

T.V. TYPEWRITER

- Stand alone TVT
- 32 char/line, 16 lines, modifications for 64 char/line included
- Parallel ASCII (TTL) input
- Video output
- 1K on board memory
- Output for computer controlled cursor
- Auto scroll
- Non-destructive cursor
- Cursor inputs: up, down, left, right, home, EOL, EOS
- Scroll up, down
- Requires +5 volts at 1.5 amps, and -12 volts at 30 mA
- All 7400, TTL chips
- Char. gen. 2513
- Upper case only
- Board only \$39.00 Part No. 106, with parts \$145.00 Part No. 106A



TAPE INTERFACE

- Play and record Kansas City Standard tapes
- Converts a low cost tape recorder to a digital recorder
- Works up to 1200 baud
- Digital in and out are TTL-serial
- Output of board connects to mic. in of recorder
- Earphone of recorder connects to input on board
- No coils
- Requires +5 volts, low power drain
- Board only \$7.60 Part No. 111, with parts \$29.95 Part No. 111A



UART & BAUD RATE GENERATOR

- Converts serial to parallel and parallel to serial
- Low cost on board baud rate generator
- Baud rates: 110, 150, 300, 600, 1200, and 2400
- Low power drain +5 volts and -12 volts required
- TTL compatible
- All characters contain a start bit, 5 to 8 data bits, 1 or 2 stop bits, and either odd or even parity.
- All connections go to a 44 pin gold plated edge connector
- Board only \$12.00 Part No. 101, with parts \$35.00 Part No. 101A, 44 pin edge connector \$4.00 Part No. 44P

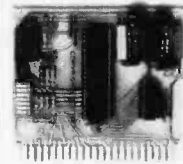

HEX ENCODED KEYBOARD E.S.

This HEX keyboard has 19 keys, 16 encoded with 3 user definable. The encoded TTL outputs, 8-4-2-1 and STROBE are debounced and available in true and complement form. Four onboard LEDs indicate the HEX code generated for each key depression. The board requires a single +5 volt supply. Board only \$15.00 Part No. HEX-3, with parts \$49.95 Part No. HEX-3A, 44 pin edge connector \$4.00 Part No. 44P.

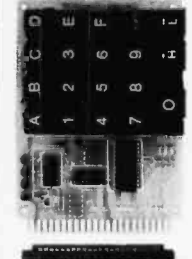

RS-232/ TTL INTERFACE

- Converts TTL to RS-232, and converts RS-232 to TTL
- Two separate circuits
- Requires -12 and +12 volts
- All connections go to a 10 pin gold plated edge connector, kit \$ 9.95 Part No. 232A 10 Pin edge connector \$3.00 Part No. 10P.

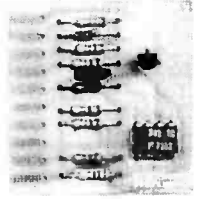

RS-232/TTY INTERFACE

This board has two active circuits, one converts RS-232 to 20mA, and the other converts 20mA to RS-232. Requires +12 and -12 volts. \$9.95 Part No. 600A Kit.

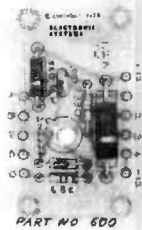

S-100 BUS ACTIVE TERMINATOR

Board only \$14.95 Part No. 900, with parts \$24.95 Part No. 900A

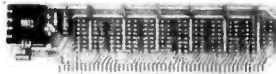

DC POWER SUPPLY

- Board supplies a regulated +5 volts at 3 amps, +12, -12, and -5 volts at 1 amp.
- Power required is 8 volts AC at 3 amps., and 24 volts AC C.T. at 1.5 amps.
- Board only \$12.50 Part No. 6085, with parts excluding transformers \$42.50 Part No. 6085A



To Order: Mention part no. description, and price. In USA shipping paid by us for orders accompanied by check or money order. We accept C.O.D. orders in the U.S. only, or a VISA or Master Charge no., expiration date, signature, phone no., shipping charges will be added. CA residents add 6.5% for tax. Outside USA add 10% for air mail postage and handling. Payment must be in U.S. dollars. Dealer inquiries invited. 24 hour order line (408) 448-0800



Send for FREE Catalog . . . a big self-addressed envelope with 41¢ postage gets it fastest!

ELECTRONIC SYSTEMS Dept. B P. O. Box 21638, San Jose, CA USA 95151

COMPUCRUISE

Put a computer in your car, which gives you the most effective and functional cruise control ever designed, plus complete trip computing, fuel management systems, and a remarkable accurate quartz crystal time system.

So simple a child can operate, the new CompuCruise combines latest computer technology with state-of-the-art reliability in a package which will not likely be available on new cars for years to come.

- Cruise Control • Time, E. T., Lap Timer, Alarm
- Time, Distance, Fuel to Arrival • Time, Distance, Fuel to Empty • Time, Distance and Fuel on Trip • Current or Average MPG, GPH • Fuel Used, Distance since Fillup • Current and Average Vehicle Speed
- Inside, Outside or Coolant Temperature
- Battery Voltage • English or Metric Display. \$169.95 without cruise control \$129.95.



FLOPPY DISK STORAGE BINDER

This black vinyl three-ring binder comes with ten transparent plastic sleeves which accommodate either twenty, five-inch or ten, eight-inch floppy disks. The plastic sleeves may be ordered separately and added as needed. A contents file is included with each sleeve for easy identification and organizing. Binder & 10 holders \$14.95 Part No. B800; Extra holders 95¢ each. Part No. 800



OPTO-ISOLATED PARALLEL INPUT BOARD FOR APPLE II

There are 8 inputs that can be driven from TTL logic or any 5 volt source. The circuit board can be plugged into any of the 8 sockets of your Apple II. It has a 16 pin socket for standard dip ribbon cable connection. Board only \$15.00. Part No. 120, with parts \$69.95. Part No. 120A.

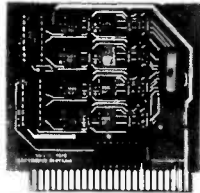

TIDMA

- Tape Interface Direct Memory Access • Record and play programs without bootstrap loader (no prom) has FSK encoder/decoder for direct connections to low cost recorder at 1200 baud rate, and direct connections for inputs and outputs to a digital recorder at any baud rate • S-100 bus compatible • Board only \$35.00 Part No. 112, with parts \$110 Part No. 112A



SYSTEM MONITOR

8080, 8085, or Z-80 System monitor for use with the TIDMA board. There is no need for the front panel. Complete with documentation \$12.95.

16K EPROM

Uses 2708 EPROMs, memory speed selection provided, addressable anywhere in 65K of memory, can be shadowed in 4K increments. Board only \$24.95 part no. 7902, with parts less EPROMs \$49.95 part no. 7902A.



ASCII KEYBOARD

TTL & DTL compatible • Full 67 key array • Full 128 character ASCII output • Positive logic with outputs resting low • Data Strobe • Five user-definable spare keys • Standard 22 pin dual card edge connector • Requires +5VDC, 325 mA. Assembled & Tested. Cherry Pro Part No. P70-05AB. \$119.95.



ASCII KEYBOARD

53 Keys popular ASR-33 format • Rugged G-10 P.C. Board • Tri-mode MOS encoding • Two-Key Rollover • MOS/DTL/TTL Compatible • Upper Case lockout • Data and Strobe inversion option • Three User Definable Keys • Low contact bounce • Selectable Parity • Custom Keycaps • George Risk Model 753. Requires +5, -12 volts. \$59.95 Kit.

ASCII TO CORRESPONDENCE CODE CONVERTER

This bidirectional board is a direct replacement for the board inside the Trendata 1000 terminal. The on board connector provides RS-232 serial in and out. Sold only as an assembled and tested unit for \$229.95. Part No. TA 1000C

DISK JACKET™

Made from heavy duty .0095 matte plastic with reinforced grommets. The mini-diskette version holds two 5-1/4 inch diskettes and will fit any standard three ring binder. The pockets to the left of the diskette can be used for listing the contents of the disk. Please order only in multiples of ten. \$9.95/10 Pack.

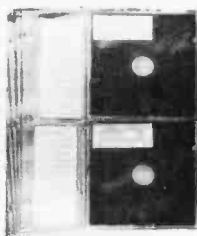

ATARI 800

Computer with 8K \$995.00, disk drive \$549.00, printer \$599.99

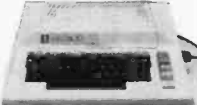

VIDEO TERMINAL

16 lines, 64 columns • Upper and lower case • 5x7 dot matrix • Serial RS-232 in and out with TTL parallel keyboard input • On board baud rate generator 75, 110, 150, 300, 600, & 1200 jumper selectable • Memory 1024 characters (7-21L02) • Video processor chip SFF96364 by Neculonic • Control characters (CR, LF, →, ←, ↑, ↓, non destructive cursor, CS, home, CL • White characters on black background or vice-versa • With the addition of a keyboard, video monitor or TV set with TV interface (part no. 107A) and power supply this is a complete stand alone terminal • also S-100 compatible • requires +16, & -16 VDC at 100mA, and 8VDC at 1A. Part No. 1000A \$199.95 kit.

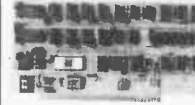

RS-232/20mA INTERFACE

This board has two passive, opto-isolated circuits. One converts RS-232 to 20mA, the other converts 20mA to RS-232. All connections go to a 10 pin edge connector. Requires +12 and -12 volts. Board only \$9.95, part no. 7901, with parts \$14.95 Part No. 7901A.



COMPUCOLOR II

Model 3, 8K \$13.95, Model 4, 16K \$14.95, Model 5, 32K \$16.95. Prices include color monitor, computer, and one disk drive.



PET COMPUTER

With 16K & monitor - \$795. Dual Disk Drive - \$10.95



apple II or APPLE II PLUS

16K - \$975, 32K - \$1059, 48K - \$1123. Disk & cont. \$589



CASSETTE TAPE ERASER



REMOVES RECORDINGS IN ONE SECOND! The process eliminates static positive / negative ions and maintains original tone quality with minimal tape hiss • To improve tone quality • To reduce hissing • For quick and easy to erase • No battery or liquid required • Powerful and effective action • Unconditional 2 year guarantee. ERASER-8 \$19.95.

16K RAMS

For the Apple, TRS-80 or Pet \$8 each Part No. 4116/2117.

APPLE II HOBBY/PROTOTYPING CARD

\$14.95 Part No. 7907

T.V. INTERFACE

- Converts video to AM modulated RF, Channels 2 or 3. So powerful almost no tuning is required. On board regulated power supply makes this extremely stable. Rated very highly in Doctor Dobbs' Journal. Recommended by Apple • Power required is 12 volts AC C.T., or +5 volts DC • Board only \$7.60 part No. 107, with parts \$13.50 Part No. 107A

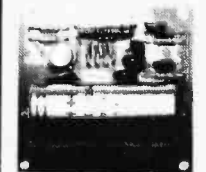

PARALLEL TRIAC OUTPUT BOARD FOR APPLE II

This board has 8 triacs capable of switching 110 volt 6 amp loads (660 watts per channel) or a total of 5280 watts. Board only \$15.00 Part No. 210, with parts \$119.95 Part No. 210A.

To Order: Mention part no., description, and price. In USA shipping paid by us for orders accompanied by check or money order. We accept C.O.D. orders in the U.S. only, or a VISA or Master Charge no., expiration date, signature, phone no., shipping charges will be added. CA residents add 6.5% for tax. Outside USA add 10% for air mail postage and handling. Payment must be in U.S. dollars. Dealer inquiries invited. 24 hour order line (408) 448-0800



Send for FREE Catalog... a big self-addressed envelope with 41¢ postage gets it fastest!

ELECTRONIC SYSTEMS Dept. B P. O. Box 21638, San Jose, CA USA 95151

The DATA-TRANS 1000

A completely refurbished
IBM Selectric Terminal with
built-in ASCII Interface.

\$1495

Features:

- 300 Baud
- 14.9 characters per second printout
- Reliable heavy duty Selectric mechanism
- RS-232C Interface
- Documentation included
- 60 day warranty - parts and labor
- High quality Selectric printing
- Off-line use as typewriter
- Optional tractor feed available
- 15 inch carriage width



HOW TO ORDER DATA-TRANS 1000

1. We accept Visa, Master Charge. Make cashiers checks or personal check payable to:

DATA-TRANS

2. All orders are shipped F.O.B. San Jose, CA
3. Deliveries are immediate

For orders and information
DATA-TRANS
2154 O'Toole St.
Unit E
San Jose, CA 95131
Phone: (408) 263-9246

SERIAL I/O

Four Serial I/O RS-232 ports, S-100 Bus. Software or jumper selectable baud rates (110, 300, 600, 1200, 2400, 4800, 9600, 19.2K), on board Xtal baud rate generator, Addressing, switch selectable. Parity or no parity (odd or even) switch selectable, 1 or 2 stop bits, 5 to 8 bits/character. Board only \$29.95. Part No. 7908. With parts (kit) \$199.95. Part No. 7908A.



TELPAR

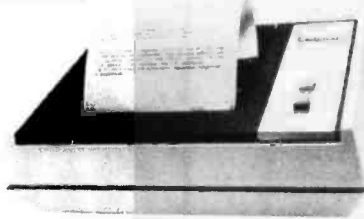

TTL parallel, TTL serial, RS232C serial, 20 mil loop serial. Quiet, clean — no ribbons or ink; 24 characters/second; Upper/lower case 96 ASCII characters; Signalling rates: Serial Mode — 110 or 300 Baud; Parallel mode — up to 960 characters/second; For applications over 48 columns, automatically prints on next line; Prints 1 character at a time — ideal for interactive applications; Local line feed for advancing paper; Parity check (odd, even or none); ASCII control codes: back space, carriage return, line feed (implemented as a new line), vertical tab (1 line), negative vertical tab (on receipt of ESC, VT), Bell (9 microsecond pulse on receipt of BEL) PS-48C Printer \$699, with Keyboard, \$895. Paper roll 5 1/2" x 164" \$3.00

44 BUS MOTHER BOARD

Has provisions for ten 44 pin (.156) connectors, spaced 3/4 of an inch apart. Pin 20 is connected to X, and 22 is connected to Z for power and ground. All the other pins are connected in parallel. This board also has provisions for bypass capacitors. Board cost \$15.00 Part No. 102. Connectors \$3.00 each Part No. 44WP.



GAME PADDLES & SOUND

For Your TRS 80 (Level II or Disk)

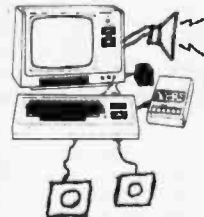

Includes: 2 game paddles, interface, software, speaker, power supply, full documentation including: schematics, theory of operation, and user guide; plus 2 games on cassette (Pong and Starship War). \$79.95 Complete Part No. 7922C

LEEDEX MONITOR

12" Black and White • 12 MHz Bandwidth • Handsome Plastic Case • \$139.00



DIGITAL CASSETTE

5 min. each side. Box of 10 \$9.95.



To Order: Mention part no. description, and price. In USA shipping paid by us for orders accompanied by check or money order. We accept C.O.D. orders in the U.S. only, or a VISA or Master Charge no., expiration date, signature, phone no., shipping charges will be added. CA residents add 6.5% for tax. Outside USA add 10% for air mail postage and handling. Payment must be in U.S. dollars. Dealer inquiries invited. 24 hour order line (408) 448-0800



Send for FREE Catalog . . . a big self-addressed envelope with 41¢ postage gets it fastest!

ELECTRONIC SYSTEMS Dept. B P. O. Box 21638, San Jose, CA USA 95151

Dial: 402-987-3771

HOTLINE

YOU NEED CRISP, HIGH CONTRAST BLACK-WHITE and VIVID COLOR ALPHA-NUMERICS/GRAPHICS CAPABILITIES FROM YOUR VIDEO MONITOR IF YOU WANT REALLY SUPER-LOOKING IMAGES FROM YOUR COMPUTER!!!

AS SPECIALISTS IN VIDED IMAGING, we think we have the right monitor or modulator for your system. Our product line includes the popular "Micro-Verter" (OSI and Apple Inc. approved UHF color modulator), a variety of color and B-W monitors, color cameras, B-W cameras, Audio subcarrier kits and parts. FREE CATALOG UPON REQUEST. Dealers welcomed. Well established program with over 400 dealers.

GET FREE DETAILS VIA OUR HOTLINE!!!

ATV Research 13-B BROADWAY DAKOTA CITY, NE. 68731

Circle 166 on inquiry card.

SURPLUS ELECTRONICS

ASCII ASCII

IBM SELECTRIC BASED I/O TERMINAL WITH ASCII CONVERSION INSTALLED \$645.00

- Tape Drives • Cable
- Cassette Drives • Wire
- Power Supplies 12V15A, 12V25A, 5V35A Others. • Displays
- Cabinets • XFMRs • Heat Sinks • Printers • Components

Many other items, SEND \$1.00 FOR CATALOG REFUNDABLE FIRST ORDER
WORLDWIDE ELECT. INC.
 130 Northeastern Blvd.
 Nashua, NH 03060

Phone orders accepted using VISA or MC
 Call 603-889-7661

Circle 167 on inquiry card.

C-10 **SHORT CASSETTES** 50 FT.

Qty.	Price
1	\$1.00
10	\$0.75
50	\$0.65

Premium tape and cassettes acclaimed by thousands of repeat order microcomputer users. Price includes labels, cassette box and shipping in U.S.A. VISA and M/C orders accepted. California residents add sales tax. Phone (415) 968-1604.

MICROSETTE CO.
 475 Ellis Street
 Mt. View, CA 94043

Circle 168 on inquiry card.

SATELLITE TRACKING SOFTWARE

STI
 SAT TRAK INTERNATIONAL

APPLE II SORCERER TRS-80

An international group of professionals offers ready-to-use software for business, professionals or schools to allow you to operate your own SPACE CENTRE and SATELLITE TRACKING SITE. The same SOPHISTICATED ALGORITHMS are in both BASIC and FORTRAN. All programs use E-COMPUTER for segment or educational use. Each program series generates LATITUDE LONGITUDE ALTITUDE AZIMUTH ELEVATION THROUING DECREASE for any time PAST-PRESENT or FUTURE, plus these features:

- TRAK (World Map Display) • VISIBL (ALL PA55 options)
- LOOK (Interchange to see satellite double precision not req'd)
- OBS (Produces New Elements) • 30 50 sat data base (expandable)
- UPDAT (data management program) • full SELF TEST mode
- 20 page operators manual • handles all types of orbits

STI 124	TRAK/UPDAT - GRAPHICS (specify computer, cassette or disk)	\$50
STI 0005	POSN/LOOK/OBS/UPDAT (specify computer, cassette or disk)	\$25
STI 900C	TRAK/POSN/LOOK/OBS/UPDAT cassette (specify computer)	\$39
STI 900D	TRAK/POSN/LOOK/OBS/UPDAT disk (specify computer)	\$49
STI 900E	FORTRAN LISTING POSN/LOOK/OBS - 19 SUPEROUTLINES	\$40
STI 900F	with ASCII STANDARD CARD FORMAT 1900 CARDS	\$65
STI 900B	BASIC LISTING (Microsoft Basic, specify computer)	\$20

Air Mail FREE except \$4.00 US outside North America

Send cheque/money order to:
SAT TRAK International
 c/o Computerland of Colorado Springs
 4543 Templeton Gap Road
 Colorado Springs CO USA 80909
 Colorado residents add 5% sales tax.

Circle 172 on inquiry card.

TRS-80 users

Learn FORTH

FORTH is a structured high level language that dramatically cuts program development time. You can expand the FORTH language by defining new operations and data types. FORTH programs are compiled to reduce memory space and speed execution.

tinyFORTH is a complete version of the powerful FORTH language tailored to the TRS-80. The tinyFORTH system includes FORTH, a text editor, an assembler, graphics, and cassette I/O.

Learn FORTH on your own computer. The tinyFORTH user's manual contains hundreds of examples to teach you FORTH in a hands-on style.

tinyFORTH for 16k level II TRS-80:
 Cassette and full documentation \$29.95
 Documentation only \$ 9.95

All orders are fully guaranteed. And \$1.50 for postage and handling. Order with check, money order, Visa, or MasterCard.

Write for a FREE booklet describing FORTH.

The Software Farm
 Box 2304 Dept. A15 Reston, VA 22090

Circle 170 on inquiry card.

Put **SARGON II¹** on Disk

Send a SASE and \$5 to:
RCV Consultants, Dept B
 9459 Taylorsville Road
 Dayton, Ohio 45424

for complete instructions enabling you to copy your Hayden tape to disk. Implementation relocates the tape-loaded machine-language code from low to high memory during DOS operation, and during game-play disables the monitor vectors which would point into SARGON II code, thus avoiding critical memory conflicts.

All you have to do is type in and run a 4-statement BASIC program, and it does everything necessary to make the tape-loaded SARGON II code ready for disk storage, retrieval, and game-play. As a bonus, you get to keep the DOS 2.2 Keyboard debounce feature during SARGON II operation!

Requires a TRS-80² Model I Level II 32 K with one disk drive, and a DOS 2.2 diskette.

1 Copyright 1979 By Hayden Book Company
 2 Trade Mark of the Tandy Corporation

Circle 171 on inquiry card.

THE SWITCH

OPTO ISOLATED 120 VAC SOLID STATE SWITCH

- INPUT 5 VDC 2 MA (TTL)
- ISOLATION 1500 VDC
- OUTPUT 6 A 120 VAC 720 W
- SIZE 2 x 2 1 CHANNEL
- SIZE 2 x 8 4 CHANNEL

PRICE KIT TESTED UNIT
 1 CH. \$9.95 \$12.50
 4 CH. \$34.95 \$44.95

ADD 6% SALES TAX IN CALIFORNIA AND \$1.00 SHIPPING & HANDLING FOR ORDERS LESS THAN \$20. ADD 4% FOR VISA OR M.C.

JOHN J. BELL
 P.O. BOX 338
 REDWOOD CITY, CA 94064
 (415) 367-1137

Circle 172 on inquiry card.

STATIC RAM CHIPS

FACTORY PRIME From the same shipment we use in our professional quality boards.

2114L 450 ns.	\$5.90	200 ns.	\$6.90
4044 450 ns.	\$5.90	250 ns.	\$6.90

Add \$5.00 Handling on Orders Under \$200.00

32K STATIC RAM BOARD
 FOR THE SS50 AND SS50C BUS (SWTP etc.)

- SS50C Extended Addressing (can be disabled).
- 4 separate 8K blocks.
- Low power 2114L RAMS (2 AMPS Typical for 32K).
- Socketed for 32K
- Write Protect
- Gold Bus Connectors

16K	\$328.12
24K	\$438.14
32K	\$548.15

Phone, write, or see your dealer for details and prices on our broad range of Boards and Systems for the SS50/SS50C bus including our **UNIQUE 80x24 VIDEO BOARD**, and our AC Power Control Products for all computers.

GIMIX INC.

1337 W. 37th Place • Chicago, IL 60609
 (312) 927-5510 • TWX 910-221-4055

The Company that delivers.
 Quality Electronic products since 1975.
 GIMIX® and GHOST™ are Registered Trademarks of GIMIX INC.

Circle 173 on inquiry card.

UC 2000 system A

The best choice in mainframes !

- \$100 CARD FRAME
- AXIAL BLOWER
- 22 MHZ 12" CRT MONITOR
- ASSEMBLED & TESTED
- 18 AMP POWER SUPPLY
- READY FOR YOUR CARDS
- UPPER & LOWER CASE
- \$895.00 OEM QUANT. ONE ASCII KEY BOARDS

oo INFINITE
 incorporated T.M.

Celebrate Our 13th Year
 819 E. STRAWBRIDGE, MELBOURNE, FL 32901 - (305) 724-1588

Circle 174 on inquiry card.

EXCITING MAIL ORDER DISCOUNTS



NOVATION CAT

ACOUSTIC MODEM

- ANSWER, ORIGINATE
- 300 BAUD
- BELL 103
- LOW PROFILE DESIGN

\$179⁰⁰

LEEDEX VIDEO 100

- 12" BLACK & WHITE MONITOR
- VIDEO BANDWIDTH 12 MHz±3db
- COMPOSITE VIDEO INPUT

\$129⁰⁰

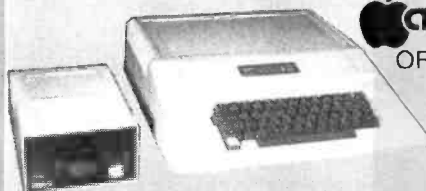

Apple II 16k
OR APPLE II PLUS
\$975

APPLE II 32K \$1050
APPLE II 48K \$1125

• COLOR • GRAPHICS • SOUND

• APPLE II ACCESSORIES •

APPLE SOFT BASIC CARD.....	\$155	APPLE DISK II	\$440
DC HAYES MICROMODEM	\$335	WITH CONTROLLER CARD	\$495
ALF MUSIC SYNTHESIZER.....	\$240	PASCAL LANGUAGE SYSTEM.	\$450
CORVUS 10 MEGABYTE DRIVE	\$4,650	INTEGER BASIC CARD	\$155

SD EXPANDORAM

• 64K S-100 DYNAMIC RAM BOARD	WITHOUT MEMORY.....	\$149.00
• WORKS WITH Z-80, 8080 & 8085	16K KIT.....	215.00
• POWER CONSUMPTION 5 WATTS	32K KIT.....	269.00
• BANK SELECT • PHANTOM REFRESH	48K KIT.....	349.00
• NO WAIT STATES REQUIRED	64K KIT.....	409.00

ADD \$50 FOR ASSEMBLED & TESTED

SOROC IQ 120

- SERIAL RS232C
- FULL ASCII II UPPER/LOWER CASE
- NUMERIC KEYPAD CURSER KEYS
- SCREEN CONTROL & PROTECTED FIELDS

\$750⁰⁰

• ALSO AVAILABLE •

SOROC IQ 140 \$1,225.⁰⁰



- 2.80 MICROPROCESSOR
- 30x64 CHARACTER DISPLAY
- S-100 COMPATIBLE EXPANDABLE
- SERIAL AND PARALLEL I/O
- DUAL CASSETTE I/O
- 64 USER DEFINABLE CHARACTERS
- 240x512 HIGH RESOLUTION GRAPHICS
- RESIDENT 4K MONITOR ROM
- FULL SIZE ASCII KEYBOARD
- UPPER LOWER CASE AND NUMERIC KEYPAD

16K \$995 32K \$1,145 48K \$1295

SORCERER™



• TO ORDER •

Phone orders invited, using credit cards. Or send cashiers check or money order that draws on a U.S. bank. Please add 3% (\$10 Minimum) for handling, shipping (air service) and insurance, or equipment will be shipped freight collect. California residents add 6% sales tax. All equipment is in factory cartons with the manufacturer's warranty. Equipment is subject to price change and availability without notice.

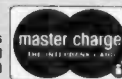

VISA



COMPUTER SPECIALTIES

6363 EL CAJON BLVD., SUITE 208,
SAN DIEGO, CA. 92115 • (714) 579-0330

MEMOREX Floppy Discs

Lowest prices. **WE WILL NOT BE UNDERSOLD!** Buy any quantity 1-1000. Visa, Mastercharge accepted. Call free (800)235-4137 for prices and information. All orders sent postage paid.

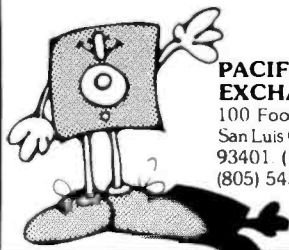

PACIFIC EXCHANGES
100 Foothill Blvd.
San Luis Obispo, CA
93401. (In Cal. call
(805) 543-1037)

Circle 229 on inquiry card.

**\$ MINI FLOPPY AT \$
\$ STORE DISCOUNT \$**

**SINGLE SIDED-\$225.00
DOUBLE SIDED-\$345.00**

**CABINETS-CABLES AND
POWER SUPPLIES ARE
ALSO AVAILABLE**

**INTERFACE, INC
20932 CANTARA ST
CANOGA PARK, CA 91304**

(213) 341-7914

Circle 230 on inquiry card.

**Save More Than 80%
North Star—Intertube
Thinker Toys—Microtek
The Smartest Computers at the Smartest Price
Quad & Double Density**

	List	Only
Horizon-1-32K-D Kit	\$1999	\$1585
Horizon-2-32K-D Kit	2399	1905
Assembled & Tested	2765	2195
Horizon-2-32K Kit Quad	2799	2225
Assembled & Tested	3215	2555
Pascal for North Star on Disk		49
Powerful North Star BASIC		FREE
ZTEI PT 212 Computer 5 mHz	8000	6250
Thinker Toys Discus/2D A&T	1149	949
Duscus/2 + 2 1.2 Megabytes A&T	1549	1299
Measurement system memory		640
A&T 4mHz 64 K		
Godbout Memory		Call for price
Intertube II Smart Terminal	995	745
Microtek Printer	750	875
Anadex Printer	995	875
Florida Data Printer 600 CPS 4300	Call for price	
Maryellen Word Processor Your Best Buy	38	
Textwriter III	125	
EZ-80 Tutorial Learn Machine Language	25	
PDS For North Star Better Than CP/M	99	
Compiler for Horizon Secret Superfast Code	100	
10% Off Software Prices With Computers		
Verbatim the Best Diskettes Box of 10		99
Which Computers Are Best? Brochure...		FREE
North Star Documentation Refundable		20
W/HRZ		

**American Square Computers
Kivett Dr • Jamestown NC 27888
(919) 885-1108**

Circle 231 on inquiry card.

NEW PRODUCTS!

Super Color S-100 Video Kit \$99.95
Expandable to 256 x 192 high resolution color graphics. 6847 with all display modes computer controlled. Memory mapped. 1K RAM expandable to 6K. S-100 bus 1802, 8080, 8085, Z80 etc.

Gremlin Color Video Kit \$59.95
32 x 16 alpha/numerics and graphics; up to 8 colors with 6847 chip; 1K RAM at E000. Plugs into Super Elf 44 pin bus. Not expandable to high resolution Graphics.

Quest Super Basic

Quest, the leader in inexpensive 1802 systems announces another first. Quest is the first company worldwide to ship a full size **Basic for 1802** systems. A complete function **Super Basic** by Ron Center including floating point capability with scientific notation (number range ±1.7E²⁹), 32 bit integer ±2 billion; Multi dim arrays; String arrays; String manipulation; Cassette I/O. Save and load. Basic, Data and machine language programs; and over 75 Statements. Functions and Operators.

Easily adaptable on most 1802 systems. Requires 12K RAM minimum for Basic and user

Elf II Adapter Kit \$24.50
Plugs into Elf II providing Super Elf 44 and 50 pin bus plus S-100 bus expansion (With Super Expansion). High and low address displays, state and mode LED's optional \$18.00.

1802 16K Dynamic RAM Kit \$149.00
1802/S-100 expandable to 32K. Hidden refresh w/clocks up to 4 MHz w/no wait states Addl. 16K RAM \$79.00.

programs. Cassette version in stock now. ROM versions coming soon with exchange privilege allowing some credit for cassette version.

Super Basic on Cassette \$40.00

Tom Pittman's 1802 Tiny Basic Source Listing now available. Find out how Tom Pittman wrote Tiny Basic and how to get the most out of it. **Never offered before. \$19.00**

S-100 4-Slot Expansion \$ 9.95

Super Monitor VI.1 Source Listing \$15.00
Coming Soon: Assembler, Editor, Disassembler, DA/AD, Super Sound/Music, EPROM programmer.



RCA Cosmac Super Elf Computer \$106.95

Compare features before you decide to buy any other computer. There is no other computer on the market today that has all the desirable benefits of the **Super Elf** for so little money. The **Super Elf** is a small single board computer that does many big things. It is an excellent computer for training and for learning programming with its machine language and yet it is easily expanded with additional memory, Full Basic, ASCII Keyboards, video character generation, etc.

Before you buy another small computer, see if it includes the following features: ROM monitor; State and Mode displays; Single step; Optional address displays; Power Supply; Audio Amplifier and Speaker; Fully socketed for all IC's; Real cost of in warranty repairs; Full documentation.

A 24 key HEX keyboard includes 16 HEX keys plus load, reset, run, wait, input, memory protect, monitor select, and single step. Large, on board displays provide output and optional high and low address. There is a 44 pin standard connector slot for PC cards and a 50 pin connector slot for the Quest Super Expansion Board. Power supply and sockets for all IC's are included in the price plus a detailed 127 pg. instruction manual which now includes over 40 pgs. of software. Info. including a series of lessons to help get you started and a music program and graphics target game.

Many schools and universities are using the **Super Elf** as a course of study. DEM's use it for training and research and development.

Remember, other computers only offer Super Elf features at additional cost or not at all. Compare before you buy. **Super Elf Kit \$106.95, High address option \$8.95, Low address option \$9.95.** Custom Cabinet with drilled and labelled plexiglass front panel \$24.95. Expansion Cabinet with room for 4 S-100 boards \$41.00. NiCAD Battery Memory Saver Kit \$6.95. All kits and options also completely assembled and tested.

Questdata, a 12 page monthly software publication for 1802 computer users is available by subscription for \$12.00 per year.

Tiny Basic Cassette \$10.00, on ROM \$38.00, original Elf kit board \$14.95. 1802 software; Moew Video Graphics \$3.50. Games and Music \$3.00. Chip 8 Interpreter \$5.50.

Super Expansion Board with Cassette Interface \$89.95

This is truly an astounding value! This board has been designed to allow you to decide how you want it optioned. The **Super Expansion Board** comes with 4K of low power RAM fully addressable anywhere in 64K with built-in memory protect and a cassette interface. Provisions have been made for all other options on the same board and it fits neatly into the hardware cabinet alongside the **Super Elf**. The board includes slots for up to 6K of EPROM (2708, 2758, 2716 or TI 2716) and is fully socketed. EPROM can be used for the monitor and Tiny Basic or other purposes.

subroutines allowing users to take advantage of monitor functions simply by calling them up. Improvements and revisions are easily done with the monitor. If you have the **Super Expansion Board** and **Super Monitor** the monitor is up and running at the push of a button.

Other on board options include Parallel Input and Output Ports with full handshake. They allow easy connection of an ASCII keyboard to the input port. RS 232 and 20 ma Current Loop for teletype or other device are on board and if you need more memory there are two S-100 slots for static RAM or video boards. Also a 1K Super Monitor version 2 with video driver for full capability display with Tiny Basic and a video interface board. Parallel I/O Ports \$9.85, RS 232 \$4.50, TTY 20 ma I/F \$1.95, S-100 \$4.50. A 50 pin connector set with ribbon cable is available at \$15.50 for easy connection between the **Super Elf** and the **Super Expansion Board**.

A **1K Super ROM Monitor \$19.95** is available as an on board option in 2708 EPROM which has been preprogrammed with a program loader/editor and error checking multi file cassette read/write software, (relocatable cassette file) another exclusive from Quest. It includes register save and readout, block move capability and video graphics driver with blinking cursor. Break points can be used with the register save feature to isolate program bugs quickly, then follow with single step. The **Super Monitor** is written with

Power Supply Kit for the complete system (see Multi-volt Power Supply).

TERMS: \$5.00 min. order U.S. Funds. Calif residents add 6% tax. BankAmericard and Master Charge accepted. Shipping charges will be added on charge cards.

Same day shipment. First line parts only. Factory tested. Guaranteed money back. Quality IC's and other components at factory prices.

INTEGRATED CIRCUITS

7400TL	LM323M-5	5.95	CD4021	1.25
7400N	LM323N-12	1.50	CD4022	1.10
7400A	LM323A-15	1.50	CD4023	.75
7400B	LM323B-15	1.50	CD4024	.75
7400C	LM323C-15	1.50	CD4025	.75
7410N	LM3301-1	1.00	CD4026	2.00
7410A	LM3301-15	1.60	CD4027	.66
7410B	LM3301-15	1.60	CD4027	.66
7420N	LM3324N	1.15	CD4028	.85
7420A	LM3324N	1.55	CD4029	1.00
7420B	LM3324N	1.55	CD4030	1.00
7420C	LM3324N	1.55	CD4030	1.00
7420D	LM3324N	1.55	CD4031	1.02
7420E	LM3324N	1.55	CD4032	1.42
7420F	LM3324N	1.55	CD4033	1.02
7420G	LM3324N	1.55	CD4034	.85
7420H	LM3324N	1.55	CD4035	.85
7420I	LM3324N	1.55	CD4036	.85
7420J	LM3324N	1.55	CD4037	.85
7420K	LM3324N	1.55	CD4038	.85
7420L	LM3324N	1.55	CD4039	.85
7420M	LM3324N	1.55	CD4040	.85
7420N	LM3324N	1.55	CD4041	.85
7420O	LM3324N	1.55	CD4042	.85
7420P	LM3324N	1.55	CD4043	.85
7420Q	LM3324N	1.55	CD4044	.85
7420R	LM3324N	1.55	CD4045	.85
7420S	LM3324N	1.55	CD4046	.85
7420T	LM3324N	1.55	CD4047	.85
7420U	LM3324N	1.55	CD4048	.85
7420V	LM3324N	1.55	CD4049	.85
7420W	LM3324N	1.55	CD4050	.49
7420X	LM3324N	1.55	CD4051	1.13
7420Y	LM3324N	1.55	CD4052	1.13
7420Z	LM3324N	1.55	CD4053	1.13
7430N	LM3334N	4.40	CD4054	1.13
7430A	LM3334N	4.40	CD4055	.71
7430B	LM3334N	4.40	CD4056	.71
7430C	LM3334N	4.40	CD4057	.71
7430D	LM3334N	4.40	CD4058	.71
7430E	LM3334N	4.40	CD4059	.71
7430F	LM3334N	4.40	CD4060	.71
7430G	LM3334N	4.40	CD4061	.71
7430H	LM3334N	4.40	CD4062	.71
7430I	LM3334N	4.40	CD4063	.71
7430J	LM3334N	4.40	CD4064	.71
7430K	LM3334N	4.40	CD4065	.71
7430L	LM3334N	4.40	CD4066	.71
7430M	LM3334N	4.40	CD4067	.71
7430N	LM3334N	4.40	CD4068	.71
7430O	LM3334N	4.40	CD4069	.71
7430P	LM3334N	4.40	CD4070	.71
7430Q	LM3334N	4.40	CD4071	.71
7430R	LM3334N	4.40	CD4072	.71
7430S	LM3334N	4.40	CD4073	.71
7430T	LM3334N	4.40	CD4074	.71
7430U	LM3334N	4.40	CD4075	.71
7430V	LM3334N	4.40	CD4076	.71
7430W	LM3334N	4.40	CD4077	.71
7430X	LM3334N	4.40	CD4078	.71
7430Y	LM3334N	4.40	CD4079	.71
7430Z	LM3334N	4.40	CD4080	.71
7440N	LM3334N	4.40	CD4081	.71
7440A	LM3334N	4.40	CD4082	.71
7440B	LM3334N	4.40	CD4083	.71
7440C	LM3334N	4.40	CD4084	.71
7440D	LM3334N	4.40	CD4085	.71
7440E	LM3334N	4.40	CD4086	.71
7440F	LM3334N	4.40	CD4087	.71
7440G	LM3334N	4.40	CD4088	.71
7440H	LM3334N	4.40	CD4089	.71
7440I	LM3334N	4.40	CD4090	.71
7440J	LM3334N	4.40	CD4091	.71
7440K	LM3334N	4.40	CD4092	.71
7440L	LM3334N	4.40	CD4093	.71
7440M	LM3334N	4.40	CD4094	.71
7440N	LM3334N	4.40	CD4095	.71
7440O	LM3334N	4.40	CD4096	.71
7440P	LM3334N	4.40	CD4097	.71
7440Q	LM3334N	4.40	CD4098	.71
7440R	LM3334N	4.40	CD4099	.71
7440S	LM3334N	4.40	CD4100	.71
7440T	LM3334N	4.40	CD4101	.71
7440U	LM3334N	4.40	CD4102	.71
7440V	LM3334N	4.40	CD4103	.71
7440W	LM3334N	4.40	CD4104	.71
7440X	LM3334N	4.40	CD4105	.71
7440Y	LM3334N	4.40	CD4106	.71
7440Z	LM3334N	4.40	CD4107	.71
7450N	LM3334N	4.40	CD4108	.71
7450A	LM3334N	4.40	CD4109	.71
7450B	LM3334N	4.40	CD4110	.71
7450C	LM3334N	4.40	CD4111	.71
7450D	LM3334N	4.40	CD4112	.71
7450E	LM3334N	4.40	CD4113	.71
7450F	LM3334N	4.40	CD4114	.71
7450G	LM3334N	4.40	CD4115	.71
7450H	LM3334N	4.40	CD4116	.71
7450I	LM3334N	4.40	CD4117	.71
7450J	LM3334N	4.40	CD4118	.71
7450K	LM3334N	4.40	CD4119	.71
7450L	LM3334N	4.40	CD4120	.71
7450M	LM3334N	4.40	CD4121	.71
7450N	LM3334N	4.40	CD4122	.71
7450O	LM3334N	4.40	CD4123	.71
7450P	LM3334N	4.40	CD4124	.71
7450Q	LM3334N	4.40	CD4125	.71
7450R	LM3334N	4.40	CD4126	.71
7450S	LM3334N	4.40	CD4127	.71
7450T	LM3334N	4.40	CD4128	.71
7450U	LM3334N	4.40	CD4129	.71
7450V	LM3334N	4.40	CD4130	.71
7450W	LM3334N	4.40	CD4131	.71
7450X	LM3334N	4.40	CD4132	.71
7450Y	LM3334N	4.40	CD4133	.71
7450Z	LM3334N	4.40	CD4134	.71
7460N	LM3334N	4.40	CD4135	.71
7460A	LM3334N	4.40	CD4136	.71
7460B	LM3334N	4.40	CD4137	.71
7460C	LM3334N	4.40	CD4138	.71
7460D	LM3334N	4.40	CD4139	.71
7460E	LM3334N	4.40	CD4140	.71
7460F	LM3334N	4.40	CD4141	.71
7460G	LM3334N	4.40	CD4142	.71
7460H	LM3334N	4.40	CD4143	.71
7460I	LM3334N	4.40	CD4144	.71
7460J	LM3334N	4.40	CD4145	.71
7460K	LM3334N	4.40	CD4146	.71
7460L	LM3334N	4.40	CD4147	.71
7460M	LM3334N	4.40	CD4148	.71
7460N	LM3334N	4.40	CD4149	.71
7460O	LM3334N	4.40	CD4150	.71
7460P	LM3334N	4.40	CD4151	.71
7460Q	LM3334N	4.40	CD4152	.71
7460R	LM3334N	4.40	CD4153	.71
7460S	LM3334N	4.40	CD4154	.71
7460T	LM3334N	4.40	CD4155	.71
7460U	LM3334N	4.40	CD4156	.71
7460V	LM3334N	4.40	CD4157	.71
7460W	LM3334N	4.40	CD4158	.71
7460X	LM3334N	4.40	CD4159	.71
7460Y	LM3334N	4.40	CD4160	.71
7460Z	LM3334N	4.40	CD4161	.71
7470N	LM3334N	4.40	CD4162	.71
7470A	LM3334N	4.40	CD4163	.71
7470B	LM3334N	4.40	CD4164	.71
7470C	LM3334N	4.40	CD4165	.71
7470D	LM3334N	4.40	CD4166	.71
7470E	LM3334N	4.40	CD4167	.71
7470F	LM3334N	4.40	CD4168	.71
7470G	LM3334N	4.40	CD4169	.71
7470H	LM3334N	4.40	CD4170	.71
7470I	LM3334N	4.40	CD4171	.71
7470J	LM3334N	4.40	CD4172	.71
7470K	LM3334N	4.40	CD4173	.71
7470L	LM3334N	4.40	CD4174	.71
7470M	LM3334N	4.40	CD4175	.71
7470N	LM3334N	4.40	CD4176	.71
7470O	LM3334N	4.40	CD4177	.71
7470P	LM3334N	4.40	CD4178	.71
7470Q	LM3334N	4.40	CD4179	.71
7470R	LM3334N	4.40	CD4180	.71
7470S	LM3334N	4.40	CD4181	.71
7470T	LM3334N	4.40	CD4182	.71
7470U	LM3334N	4.40	CD4183	.71
7470V	LM3334N	4.40	CD4184	.71
7470W	LM3334N	4.40	CD4185	.71
7470X	LM3334N	4.40	CD4186	.71
7470Y	LM3334N	4.40	CD4187	.71
7470Z	LM3334N	4.40	CD4188	.71
7480N	LM3334N	4.40	CD4189	.71
7480A	LM3334N	4.40	CD4190	.71
7480B	LM3334N	4.40	CD4191	.71
7480C	LM3334N	4.40	CD4192	.71
7480D	LM3334N	4.40	CD4193	.71
7480E	LM3334N	4.40	CD4194	.71
7480F	LM3334N	4.40	CD4195	.71
7480G	LM3334N	4.40	CD4196	.71
7480H	LM3334N	4.40	CD4197	.71
7480I	LM3334N	4.40	CD4198	.71
7480J	LM3334N	4.40	CD4199	.71
7480K	LM3334N	4.40	CD4200	.71
7480L	LM3334N	4.40		

C/MOS (DIODE CLAMPED)

4001	22	4024	-75	4069	-45	FA83	-95
4002	22	4025	-27	4071	-20	FA151	1.75
4003	22	4027	45	4072	-35	FA152	1.75
4009	45	4078	85	4081	-70	FA160	1.70
4011	22	4030	-35	4516	-100	FA163	1.00
4012	22	4035	-97	4520	-170	FA165	1.75
4013	40	4043	95	FA200	-27	FA173	1.30
4014	100	4044	85	FA202	-27	FA174	1.20
4015	100	4045	-95	FA208	-30	FA175	1.90
4016	100	4046	-95	FA210	-30	FA177	1.30
4017	145	4049	75	FA214	-120	FA193	1.40
4019	50	4050	95	FA216	-60	FA200	50
4019	15	4052	100	FA218	-27	FA200	50
4020	110	4061	110	FA273	-75	FA214	1.30
4021	110	4053	110	FA274	-60	FA215	1.30
4022	100	4065	1.75	FA83	-30		
4023	22	4066	70	FA28	-50		

TTL REED RELAY - 5PST 5V 20ma \$1.00

1868	DI032	RELEAF AEE	1.00	4112	5.00
1868	DI032	RELEAF AEE	1.20	4112	5.00
1914	DI032	RELEAF AEE	1.20	4112	5.00
2114	DI032	RELEAF AEE	1.20	4112	5.00
2114	DI032	RELEAF AEE	1.20	4112	5.00
2114	DI032	RELEAF AEE	1.20	4112	5.00
2114	DI032	RELEAF AEE	1.20	4112	5.00
2114	DI032	RELEAF AEE	1.20	4112	5.00
2114	DI032	RELEAF AEE	1.20	4112	5.00
2114	DI032	RELEAF AEE	1.20	4112	5.00
2114	DI032	RELEAF AEE	1.20	4112	5.00
2114	DI032	RELEAF AEE	1.20	4112	5.00
2114	DI032	RELEAF AEE	1.20	4112	5.00
2114	DI032	RELEAF AEE	1.20	4112	5.00
2114	DI032	RELEAF AEE	1.20	4112	5.00
2114	DI032	RELEAF AEE	1.20	4112	5.00
2114	DI032	RELEAF AEE	1.20	4112	5.00

DAC-08BC - 8 bit DAC - \$9.95

8" DISKETTES - HARD SECTOR \$1.75, 10/16.00

CRYSTALS \$3.45 ea.	RIBBON CABLE
2.000 MHz 6.144 MHz	FLAT (COLOR CODED)
4.000 MHz 8.000 MHz	#30 WIRE
3.571 MHz 10.000 MHz	26 cond. - .50"/per foot
5.000 MHz 20.000 MHz	48 cond. - .75"/per foot
6.000 MHz	50 cond. - .90"/per foot
6.000 MHz	60 cond.

UNIVERSAL 4Kx8 MEMORY BOARD KIT \$69.95

32 2102-1 fully buffered 16 address lines, on board decoding for any 4 of 64 pages, standard 44 pin bus, may be used with F8 & KIM

SILICON SOLAR CELLS \$10.00

4" diameter 4V at 1 AMP

LED READOUTS

FCS 8024 4 digit	DL-707 C.A.	3"	\$ 75	
C.C. 8" display	DL 747 C.A.	6"	\$1.50	
FND 503 C.C.	5"	85	HP3400 B" C.A	\$1.95
FND 510 C.A.	5"	85	HP3405 B" C.A	\$1.95
DL 704 C.C.	3"	85		

Terms: FOB Cambridge, Mass.
 Send 25¢ for our catalog featuring Transistors and Rectifiers
 145 Hampshire St., Cambridge, Mass.
 Minimum Mail Order \$5.00.

PRINTED CIRCUIT BOARD

4" x 8" DOUBLE SIDED EPOXY BOARD 1/16" thick \$5.00 ea. 5/52.60

EPOXY glass vector board 1/16" thick with 1/10" spacing \$1.95

VERIPAX PC BOARD \$12.95
 Our new Prototyping board is a hi density 4 1/2 x 6 1/2" single sided 1/16" G-10 board. It will hold 40, 24, 16 (34 units), 14 & 8 pin IC's. There are three buses, +5V, ground, and a floating bus. There is a pad for a TO-220 regulator. There is a 22 pin edge connector with 156" spacing.

7 WATT LD-65 LASER DIODE IR \$8.95

25 watt Infra Red Pulse 1 SG 2006 equiv.) Laser Diode (Spec sheet included) \$24.95

MINIATURE MULTI-TURN TRIM POTS

100, 2K, 5K, 10K, 20K, 1Meg. \$75 each 3/32.00

2N 3820 P FET	\$ 45
2N 5456 N FET	\$ 45
ER 900 TRIGGER DIODES	4 \$1.00
2N 6028 PRUG UJT	\$ 65

FP 100 PHOTO TRANS. \$1.50

RED, YELLOW, GREEN

LARGE LED's 2" 6/51.00

RED/GREEN BIPOLAR LED's 2" .95

TIL-118 OPTO ISOLATOR \$1.75

MOT-6 OPTO ISOLATOR \$1.80

1 WATT ZENERS: 3.3, 4.7, 5.1, 5.6, 9.1, 10, 12, 15, 18, or 22V \$6/51.00

Silicon Power Rectifiers

PRV 1A	3A	12A	50A	125A	240A
100	06	14	35	90	3.70
200	07	20	40	1.30	4.75
400	09	25	65	1.50	6.50
600	11	30	80	2.00	8.50
800	15	35	100	2.50	10.50
1000	20	45	125	3.00	12.50

IN 4148 IN914 \$15/51.00
 or .01 of 25V ceramic disc caps .16/\$1.00, \$5.00/100

REGULATORS

323K - 5V 3A	\$.75	340K - 12, 15	
309K	\$ 1.60	or 24 V.	\$ 1.50
723	\$.50	340T - 5, 6, 8, 12	
320T		15, 18 or 24VS 1.30	
5, 12, or 15 V		79MG \$1.35	

TRANSISTOR SPECIALS

2N6233-NPN SWITCHING POWER	\$1.95
MRF 8004 a CB RF Transistor NPN	\$.75
2N3772 NPN Si TO-3	\$1.00
2N4908 PNP Si TO-3	\$1.00
2N5086 PNP Si TO-92	\$ 4.00
2N1317 NPN Si RF	\$.55
2N3919 NPN Si TO-3 RF	\$1.50
2N1420 NPN Si TO-5	\$3/51.00
2N3767 NPN Si TO-66	\$.70
2N2222 NPN Si TO-18	\$1.00
2N3055 NPN Si TO-3	\$.60
2N3804 NPN Si TO-92	\$6/51.00
2N3906 PNP Si TO-92	\$6/51.00
2N5296 NPN Si TO-220	\$.50
2N6109 NPN Si TO-220	\$.55
2N3638 PNP Si TO-5	\$6/51.00
MPSA 13 NPN Si	\$1/51.00

TTL IC SERIES

7400	-17	7450	-37	74155	-65
7401	-17	7412	-25	74160	-85
7402	-17	7413	-25	74161	-85
7403	-17	7414	-42	74162	-120
7404	-24	7415	-49	74163	-85
7405	-24	7416	-45	74164	-85
7406	-33	7417	-45	74165	-85
7407	-33	7418	-80	74170	-1.60
7410	-17	7419	-75	74172	1.20
7411	-22	7420	-60	74174	-75
7412	-22	7421	-80	74175	-75
7413	-42	7422	-80	74176	-75
7414	-40	7423	-85	74177	-75
7415	-38	7424	-85	74178	-75
7416	-33	7425	-80	74179	-75
7417	-37	7426	-60	74180	-78
7418	-33	7427	-80	74181	-75
7419	-31	7428	-60	74182	-75
7420	-35	7429	-60	74183	-75
7421	-37	7430	-33	74184	-75
7422	-37	7431	-37	74185	-75
7423	-37	7432	-37	74186	-75
7424	-37	7433	-37	74187	-75
7425	-37	7434	-37	74188	-75
7426	-37	7435	-37	74189	-75
7427	-37	7436	-37	74190	-75
7428	-37	7437	-37	74191	-75
7429	-37	7438	-37	74192	-75
7430	-37	7439	-37	74193	-75
7431	-37	7440	-37	74194	-75
7432	-37	7441	-37	74195	-75
7433	-37	7442	-37	74196	-75
7434	-37	7443	-37	74197	-75
7435	-37	7444	-37	74198	-75
7436	-37	7445	-37	74199	-75
7437	-37	7446	-37	74200	-75

NO. 30 WIRE WRAP WIRE SINGLE STRAND 100' \$1.40

ALCO MINIATURE TOGGLE SWITCHES

MTA 106 SPDT	\$ 1.05
MTA 206 DPDT	\$ 1.70
MTA 206 P.DPDT CENTER OFF	\$ 1.85
M2D 206 P.DPDT CENTER OFF	\$ 1.85
LEVER SWITCH	\$ 1.85

Full Wave Bridges

PRV	2A	6A	25A
100	1.40	1.40	1.40
200	1.30	2.20	2.20
400	1.00	1.65	3.30
600	1.30	1.90	4.40

SANKEN AUDIO POWER AMPS

S-1010 G 10 WATTS	\$ 6.75
S-1020 G 20 WATTS	\$12.95
S-1050 G 50 WATTS	\$25.90

TANTALUM CAPACITORS

.22UF 35V 5/51.00	6.8UF 35V 4/51.00
.47UF 35V 5/51.00	10UF 10V \$.25
1UF 35V 5/51.00	22UF 25V \$.40
2.2UF 20V 5/51.00	15UF 35V 3/51.00
3.3UF 20V 4/51.00	30UF 6V 5/51.00
4.7UF 15V 5/51.00	100UF 15V \$.70
	150UF 15V \$.95
	68 UF 15V \$.50

DIODES

1N4001	1N4002	1N4003	1N4004	1N4005	1N4007
1N4001	1N4002	1N4003	1N4004	1N4005	1N4007
1N4001	1N4002	1N4003	1N4004	1N4005	1N4007

TTL IC SERIES

7400	-17	7450	-37	74155	-65
7401	-17	7412	-25	74160	-85
7402	-17	7413	-25	74161	-85
7403	-17	7414	-42	74162	-120
7404	-24	7415	-49	74163	-85
7405	-24	7416	-45	74164	-85
7406	-33	7417	-45	74165	-85
7407	-33	7418	-80	74170	-1.60
7410	-17	7419	-75	74172	1.20
7411	-22	7420	-60	74174	-75
7412	-22	7421	-80	74175	-75
7413	-42	7422	-80	74176	-75
7414	-40	7423	-85	74177	-75
7415	-38	7424	-85	74178	-75
7416	-33	7425	-80	74179	-75
7417	-37	7426	-60	74180	-78
7418	-33	7427	-80	74181	-75
7419	-31	7428	-60	74182	-75
7420	-35	7429	-60	74183	-75
7421	-37	7430	-33	74184	-75
7422	-37	7431	-37	74185	-75
7423	-37	7432	-37	74186	-75
7424	-37	7433	-37	74187	-75
7425	-37	7434	-37	74188	-75
7426	-37	7435	-37	74189	-75
7427	-37	7436	-37	74190	-75
7428	-37	7437	-37	74191	-75
7429	-37	7438	-37	74192	-75
7430	-37	7439	-37	74193	-75
7431	-37	7440	-37	74194	-75
7432	-37	7441	-37	74195	-75
7433	-37	7442	-37	74196	-75
7434	-37	7443	-37	74197	-75
7435	-37	7444	-37	74198	-75
7436	-37	7445	-37	74199	-75
7437	-37	7446	-37	74200	-75

INTEGRAL CIRCUITS

LM201	75	LM301	748 - 25
LM102	30	LM307	30
LM103	75	LM308	75
LM311	75	LM318	-1.20
LM318	-1.20	LM319	-1.10
LM324	-95	LM339	-1.10
LM339	-1.10	LM358	-7.0
LM358	-7.0	LM370	-1.15
LM370	-1.15	LM380	-95
LM380	-95	LM382	-1.25
LM382	-1.25	LM386	-80
LM386	-80	LM387	-1.25
LM387	-1.25	LM388	-2.20
LM388	-2.20	LM389	-1.75
LM389	-1.75	LM390	-2.50
LM390	-2.50	LM392	-2.50
LM392	-2.50	LM393	-1.10
LM393	-1.10	LM394	

Moonshadow Text Formatter for UCSD Pascal™ Systems

The UCSD Pascal™ system contains a screen-oriented text editor which is convenient, but which is not suited to word processing. It cannot underline, paginate automatically, or perform other essential text-processing functions. The Moonshadow Text Formatter (MTF) from Merrimack Systems solves this problem.

With the Moonshadow Text Formatter, documents produced with the screen editor are post-processed to provide these missing functions. It takes standard Pascal text files, operates on them, and sends fully formatted text output to the console display, a printer, or a disk file.

Moonshadow Text Formatter provides, in addition to a full range of formatting functions, advanced features including the combination of files into one document, variables in text (for form letters), and output character translation.

The Moonshadow Text Formatter is written in UCSD Pascal™, and is available for North Star Apple II, LSI-II, and 8080/280 systems with IBM Format 8" floppy disks.

All this for \$99.00 from

Merrimack Systems
POB 5218
Redwood City, CA 94063
(415) 365-6281

California residents should include 6% sales tax. Also available: North Star Pascal personalization for SOUSOLOS — just transfer three files and you're up with Pascal. \$25.00

Circle 180 on inquiry card.

New from
Vantage Data Products
550 West 200 South
Suite 8
Provo, Utah 84601
(801) 377-6687



Communications/Control CPU Card

- CPU - Z-80 1K RAM
16 bit interval timer and interrupt
EPROM* 2708 standard (2716 optional)
- Serial Communications-RS-232 interface,
UART Complete MODEM capability,
programmable baud rates, etc.
- Parallel I/O - 16 bits in (TTL), 16 bits Out (TTL)
- Power - on and external reset
*EPROM not included

\$195 assembled, tested, with warranty and documentation

Immediate delivery from stock!
All orders shipped prepaid
MC, VISA, phone orders welcome
Utah residents add 4% sales tax

Circle 181 on inquiry card.

STATISTICAL DATA

DATABANK programs contain 10 years of monthly statistical data on ten related subjects. Information is the most current available. Each cassette is date stamped. Includes graphs, tables, trends, comparisons, update routine, and external input.

Programs available for TRS-80 L2, 16K

- General Economy
- Manufacturing & Trade
- Industrial Production
- Money & Credit
- Money Rates & Yields
- Commodity Spot Prices
- Mortgage Terms & Yields
- Foreign Exchange Rates
- Energy Production
- Petroleum Production

\$29.95 each 3 for \$84.95
Cassette storage album included with order for six or more programs.



DATABANK POB 9283
Ft Lauderdale, FL 33310

Circle 182 on inquiry card.

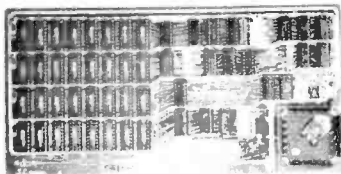

16K STATIC MEMORY (RAM)

250 nsec Access Time. Assembled, tested, and Guaranteed. \$300.00

Fully Static - TMS 4044

S-100 Bus - Buffered lines. Dip Sw address in 2, 8K blocks 4K incr.. Write Protect. Phantom disable. Battery backup, fully Socketed.

Bank Select - Port 40H (Cromemco Software Comp.), 80H or COH.

Guarantee - One full year. To order, call for Visa, M.C. or C.O.D. (\$4 fee.) Personal check o.k. M.O. speeds shipping. Stock to 72 hour delivery. Illinois residents add 5 1/2% tax.

S. C. DIGITAL

P.O. Box 906, Aurora, IL 60507
Phone: (312) 897-7749

Circle 183 on inquiry card.

DISCOUNT PRICES

NORTH STAR
APPLE II
POLYMORPHIC
INTERACT
HAZELTINE
SOROC
CENTRONICS
MICROTEK
INTERTUBE
& Others

Call for Prices
(301) 694-8884

FREDERICK COMPUTER PRODUCTS

Municipal Airport
Frederick, MD. 21701

Circle 184 on inquiry card.

SUPPLIES



- FLOPPY DISKS, MINI OR STANDARD MEMDREX OR 3M
- 3M DATA CARTRIDGES DC300A, DC100A
- 3M DIGITAL CASSETTES
- 3M OR MEMOREX AUDIO CASSETTES, C-80
- 3M DISK CARTRIDGES

WE OFFER:

- COMPETITIVE PRICING
- IMMEDIATE DELIVERIES (Any Quantity)
- UNCONDITIONAL GUARANTEE

BETA BUSINESS SYSTEMS
8369 VICKERS ST., #G
SAN DIEGO, CA 92111
(714) 565-4505



Circle 185 on inquiry card.

H9 OWNERS!

Now you too can have graphic capabilities similar to those of the TRS-80 with GRAFIX. No modification to existing circuit boards is required. GRAFIX simply plugs into existing IC sockets.

Comes with complete instructions. Full 6 month warranty.

Kit \$59.95

Assembled and tested \$69.95

Northwest Computer Services, Inc.

8503 N.E. 30th Avenue
Vancouver, WA 98665

Circle 186 on inquiry card.

Texas Instrument 99-4 Computer	\$ 990.
TI 810 Printer	\$1590.
Centronic Printers:	
730-1 Parallel	\$ 799.
730-2 Serial	\$ 859.
779-1 Friction Feed	\$ 959.
779-2 Tractor Feed	\$ 999.
Comprint 912 Par	\$ 475.
912 Ser	\$49.
Anadex with Par & Serial Interface	\$ 799.
Commodore Business Machines:	
PET 2001-8K Computer	\$ 695.
PET 2001-16K	\$ 895.
PET 2001-32K	\$1090.
PET 2022 Trac. Fed Printer	\$ 899.
PET 2023 Frig. Fed	\$799.

\$75. Free Software with PET Machines

Intertec Superbrain

North Star Computer and Acc.

** Save \$ Save \$ **

Display Terminals:

Intertube II	\$ 775.
Hazeltine 1400	\$ 690.
1410	\$ 785.
1500	\$ 990.

Immediate Delivery from Stock.

Multi-Business Computer System
28 Marlborough Street
Portland, Conn. 06480
(203) 342-2747



SEARCHING THROUGH
YOUR ENTIRE

NORTH STAR

BASIC PROGRAM LISTINGS.

WITH OUR NEW "SCAN" COMMAND YOU CAN INSTANTLY DISPLAY OR PRINT -

- ALL LINES THAT CONTAIN A SELECTED VARIABLE
- ALL OCCURRENCES OF GOSUB OR GOTO TO A PARTICULAR LINE NUMBER.
- ALL REFERENCES TO ANY LINE NUMBER
- ALL OCCURRENCES OF ANY CHARACTER, NUMBER, LINE NUMBER, GROUP OF CHARACTERS OR ANYTHING THAT IS CONTAINED IN ANY BASIC LINE.

This is not one of those "funny programs written in BASIC." It is a machine language addition to BASIC that resides completely within NORTH STAR BASIC. It will not affect normal BASIC or DOS. It is self loading and can be loaded separately to operate with BASIC or saved along with BASIC as a copy of BASIC with the "Scan" command. Does not change memory available to BASIC. Easy to understand instructions.

- Available for version 6 as well as 14 digit basic
- State your version when ordering
- Dealer inquiries invited

PHONE ORDERS ACCEPTED
ORDER TODAY **ONLY \$2750** On disk
USE YOUR VISA OR MASTERCARD CARD (California residents add 6% tax)

ELECTRONIC TECHNICIANS
SOFTWARE SERVICES
1072 CASITAS PASS RD.
CARPINTERIA, CA 93013
805-684-2541



Circle 188 on inquiry card.

HOBBY WORLD ELECTRONICS

America's Largest Mail-Order Computer Store



CALL TOLL FREE:
(800) 423-5387 USA

IN CALIF:
(800) 382-3651

LOCAL & OUTSIDE USA
(213) 886-9200



74LS

Order by Cat No. 999 and type

NO.	PRICE	NO.	PRICE
74LS00	.28	74LS157	1.45
74LS01	.19	74LS158	.69
74LS02	.29	74LS160	.99
74LS03	.19	74LS161	1.10
74LS04	.89	74LS162	.99
74LS05	.35	74LS163	.99
74LS08	.29	74LS164	1.25
74LS09	.25	74LS165	.89
74LS10	.29	74LS168	.99
74LS11	.59	74LS169	.99
74LS12	.29	74LS170	1.69
74LS13	.59	74LS173	1.29
74LS14	1.25	74LS174	.99
74LS15	.39	74LS175	.99
74LS20	.29	74LS181	2.25
74LS21	.29	74LS190	1.10
74LS22	.29	74LS191	1.10
74LS26	.25	74LS192	1.10
74LS27	.35	74LS193	1.10
74LS28	.39	74LS194	1.10
74LS30	.29	74LS195	1.10
74LS32	.39	74LS196	.89
74LS33	.39	74LS197	1.65
74LS37	.39	74LS221	1.25
74LS38	.32	74LS240	4.50
74LS40	.33	74LS241	2.40
74LS42	.89	74LS242	1.50
74LS47	.89	74LS243	2.50
74LS48	.79	74LS244	2.60
74LS51	.29	74LS247	1.10
74LS54	.29	74LS248	1.10
74LS55	.29	74LS251	1.99
74LS73	.44	74LS253	.99
74LS74	.59	74LS257	.99
74LS75	.49	74LS258	.99
74LS76	.45	74LS259	1.99
74LS83	.89	74LS260	.69
74LS85	1.25	74LS261	1.75
74LS86	.45	74LS266	.99
74LS90	.49	74LS273	1.50
74LS92	.75	74LS275	4.50
74LS93	.59	74LS279	.75
74LS95	.99	74LS283	.79
74LS96	1.15	74LS293	1.95
74LS107	.39	74LS295	.99

TTL

Order by Cat No. 999 and type

7400	.16	74109	.55
7401	.18	74116	1.95
7402	.18	74120	1.25
7403	.18	74121	.35
7404	.19	74122	.39
7405	.19	74123	.49
7406	.19	74125	.39
7407	.19	74126	.44
7408	.19	74128	.49
7409	.19	74132	.69
7410	.19	74136	.75
7411	.25	74139	.69
7412	.25	74141	.79
7413	.35	74143	2.75
7414	.60	74145	.65
7416	.19	74148	1.12
7417	.25	74150	.89
7420	.19	74151	.59
7422	.79	74153	.59
7423	.22	74154	.99
7425	.25	74155	.75
7426	.35	74156	1.12
7427	.19	74157	.65
7432	.25	74160	.85
7437	.25	74161	.79
7438	.25	74162	.89

74LS109	.45	74LS298	.79
74LS112	.29	74LS365	.85
74LS113	.29	74LS366	.79
74LS114	.29	74LS367	.85
74LS122	.49	74LS368	.85
74LS123	.99	74LS373	3.05
74LS124	1.35	74LS374	1.95
74LS125	.89	74LS377	3.90
74LS126	.39	74LS378	1.25
74LS132	.79	74LS386	6.3
74LS138	.88	74LS393	1.95
74LS139	.98	74LS395	1.45
74LS145	1.25	74LS399	2.95
74LS151	.67	74LS424	1.95
74LS153	.79	74LS668	1.25
74LS154	1.79	74LS670	2.49
74LS155	.89	81LS 96	1.45
74LS156	.69	81LS 97	1.55

7439	.27	74163	.79
7440	.45	74164	.89
7441	.70	74165	.89
7442	.49	74166	1.29
7443	.59	74170	1.59
7444	.59	74171	.99
7445	.69	74174	.85
7446	.69	74175	.79
7447	.59	74176	.79
7448	.69	74177	.75
7450	.19	74179	.89
7451	.19	74270	.79
7453	.19	74181	1.89
7454	.19	74182	1.25
7456	.19	74184	1.95
7470	.33	74185	1.95
7472	.28	74190	1.25
7473	.35	74191	1.25
7474	.29	74192	.75
7475	.39	74193	.75
7476	.35	74194	.89
7479	.475	74195	.69
7480	.49	74196	.89
7481	.99	74197	.89
7482	.99	74198	1.49
7483	.59	74199	1.49
7485	.69	74221	1.45
7486	.35	74251	1.09
7489	1.75	74273	1.10
7490	.39	74278	3.00
7491	.55	74279	8.5
7492	.43	74298	.95
7493	.43	74365	.68
7494	.79	74386	.68
7495	.65	74376	.68
7496	.65	74368	.68
7497	2.90	74393	3.25
74100	1.42	8197	1.65
74107	.29		

MICROPROCESSORS

Order by Cat No. 999 and type

TYPE NO.	PRICE
Z80 A	12.75
1802	16.50
6502	14.50
6800	6.50
8035	11.75
8080 A	6.60
8085	15.95
TMS 9900	49.00

MICROPROCESSOR SUPPORTS

Order by Cat No. 999 and type

NO.	PRICE	NO.	PRICE
8212	2.95	Z80A CTC	13.95
8214	4.95	Z80A S10	55.00
8216	2.60		
8224	3.95	6810	5.95
8226	3.95	6820i/6520	6.96
8228	5.95	6821	6.95
8238	6.75	6828	11.95
8251	6.95	6850	9.95
8253	11.50	6852	6.50
8255	7.95	6860	9.95
8257	15.95		
8259	18.95	1822	18.95
8279	9.50	1852	7.50
8271	17.50	1854	13.95
Z80A-P10	13.95	1861	15.95

16K MEMORY ADD-ON

\$75 2 for \$140
For TRS-80, Apple, Exidy
 Installs in minutes. No special tools required. Complete with detailed instructions. Wt 4 oz.
1156A For TRS-80 without buffered cable
1156B For TRS-80 with buffered cable
1156C For Apple
1156D For Exidy Sorcerer

HOW TO ORDER:
 Pay by check, MasterCard, Visa, or COD. Charge orders please include expiration date. Foreign pay in U.S. funds. Order by phone or mail, or at our retail. **MINIMUM ORDER \$10.** please include phone number and major area office you are ordering from. Prices valid thru last day of cover date. **SHIPPING:** USA: add \$2.00 for the first 2 lbs. (we round add 35¢ for airfrt) lb. for air add 75¢ for add'l lb. **FOR-IE:** surface add \$3.00 for first 2 lbs. 60¢ per add'l lb. Air add \$11.00 for first 2 lbs. 51¢ for each add'l lb. **CODS:** \$1 add'l. Guaranteed satisfaction for 120 days or your money back! Not responsible for typographical errors. Some items subject to prior sale. We reserve the right to limit quantities.

SEND FOR FREE CATALOG:
FEATURING:
 Computers and accessories, disk drives, printers, integrated circuits, LEDs, semiconductors, books, software, connectors, plus more and more! The widest selection at the lowest prices! Circle our reader service number or phonewrite today for your copy!

RAMS/EPROMS

Order by Cat No. 999 and type

TYPE NO.	PRICE
2101-250	1.95
2101-450	1.25
2102-650	.79
2102-450	1.10
2102-250	1.25
2111-400	2.95
2114-300	7.25
2114-200	6.75
4027P-2	3.90
TMS 4045-450	6.50
TMS 4045-300	7.25
4116-300	11.65
4116-250	12.75
4116-200	13.75
4116-150	14.90
9050 CDC	4.50
91102-450	.79
1702 A	4.25
TMS 2532	86.00
2708	9.15
2716	27.00

19511 Business Center Dr. Dept. B2 Northridge, Ca. 91324

BUILD YOUR OWN LOW COST

MICRO-COMPUTER POWER SUPPLIES

FOR S-100 BUS, FLOPPY DISCS, ETC.

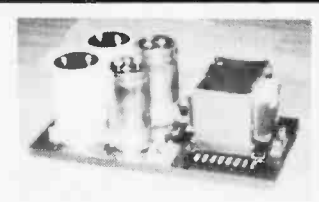
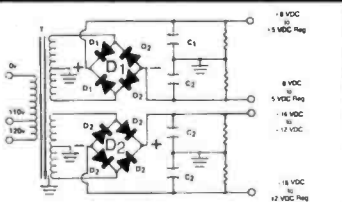

POWER TRANSFORMERS (WITH MOUNTING BRACKETS)

ITEM NO.	USED IN KIT NO.	PRI. WINDING TAPS	SECONDARY WINDING OUTPUTS			SIZE W x D x H	UNIT PRICE
			2x8 Vac	2x14 Vac	2x24 Vac		
T ₁	1	0V, 110V, 120V	2x7.5A	2x2.5A		3 3/4" x 3 5/8" x 3 1/8"	21.95
T ₂	2	0V, 110V, 120V	2x12.5A	2x3.5A		3 3/4" x 4 3/8" x 3 1/8"	27.95
T ₃	3	0V, 110V, 120V	2x9A	2x2.5A	2x2.5A	3 3/4" x 4 3/8" x 3 1/8"	29.95
T ₄	4	0V, 110V, 120V	2x4A		2x3A	3 3/4" x 3 5/8" x 3 1/8"	21.95

POWER SUPPLY KITS (OPEN FRAME WITH BASE PLATE, 3 HRS. ASSY. TIME)

ITEM	USED FOR	@+8 Vdc	@-8 Vdc	@+16 Vdc	@-16 Vdc	@+28 Vdc	SIZE WxDxH	UNIT PRICE
KIT 1	15 CARDS SOURCE	15A		2.5A	2.5A		12"x6"x4 7/8"	51.95
KIT 2	SYSTEM SOURCE	25A		3A	3A		12"x6"x4 7/8"	58.95
KIT 3	DISC SYSTEM	15A	1A	2A	2A	4A	14"x6"x4 7/8"	66.95
KIT 4	DISC SOURCE	8A	1A			5A	10"x6"x4 7/8"	49.95

DISC DRIVE POWER SUPPLY "R3" ASSEY. & TESTED, OPEN FRAME, SIZE: 9" (W) x 5" (D) x 5" (H) 59.95
SPECS: +5V @ 5A REGULATED, -5V @ 1A REG., +24V @ 5A REG., SHORTS PROTECT.
IDEAL FOR 2 SHUGART 801/851 OR SIEMANS FDD 100-8/200-8 DISK DRIVES & ROCKWELL AIM-65.
SHIPPING FOR EACH TRANSFORMER: \$4.75. FOR EACH POWER SUPPLY: \$5.00 IN CALIF. \$7.00 IN OTHER STATES. CALIF. RESIDENTS ADD 6% SALES TAX. OEM WELCOME.

SUNNY INTERNATIONAL (TRANSFORMERS MANUFACTURER)
 Telephone: (213) 633-8327

STORE:
 7245 E. ALONDRA BLVD.
 PARAMOUNT, CA 90723
STORE HOURS: 9 AM-6 PM

MAIL ORDER:
 P.O. BOX 4296
 TORRANCE, CA 90510



DIGITAL RESEARCH COMPUTERS

(214) 494-1505

16K EPROM CARD-S 100 BUSS

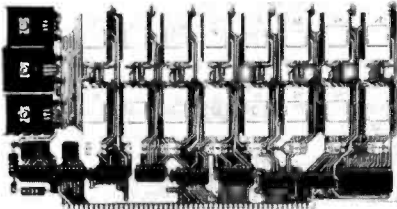

\$59.95
KIT

FIRST TIME OFFERED!
BLANK PC BOARD - \$28

USES 2708's!

Thousands of personal and business systems around the world use this board with complete satisfaction. Puts 16K of software on line at **ALL TIMES!** Kit features a top quality soldermasked and silk-screened PC board and first run parts and sockets. Any number of EPROM locations may be disabled to avoid any memory conflicts. Fully buffered and has WAIT STATE capabilities.

OUR 450 NS 2708'S
ARE \$8.95 EA. WITH
PURCHASE OF KIT

ASSEMBLED
AND FULLY TESTED
ADD \$25

8K LOW POWER RAM KIT-S 100 BUSS SALE

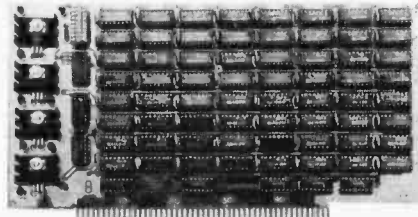

PRICE
CUT!

\$119.50
KIT

21L02
(450 NS RAMS!)

Thousands of computer systems rely on this rugged, work horse, RAM board. Designed for error-free, NO HASSLE, systems use.

Blank PC Board w/Documentation
\$29.95

Low Profile Socket Set...13.50
Support IC's (TTL & Regulators)
\$9.75

Bypass CAP's (Disc & Tantalums)
\$4.50

ASSEMBLED AND FULLY
BURNED IN ADD \$30

ALL ASSEMBLED BOARDS
ARE TESTED AT 4MHZ.

16K STATIC RAM KIT-S 100 BUSS

PRICE CUT!

\$259 KIT

FOR 4MHZ
ADD \$25

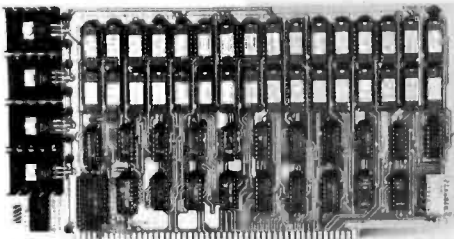

KIT FEATURES:

1. Addressable as four separate 4K Blocks.
2. ON BOARD BANK SELECT circuitry. (Cromemco Standard!). Allows up to 512K on line!
3. Uses 2114 (450NS) 4K Static Rams.
4. ON BOARD SELECTABLE WAIT STATES.
5. Double sided PC Board, with solder mask and silk screened layout. Gold plated contact fingers.
6. All address and data lines fully buffered.
7. Kit includes ALL parts and sockets.
8. PHANTOM Is jumpered to PIN 67.
9. LOW POWER: Under 1.5 amps TYPICAL from the +8 Volt Buss.
10. Blank PC Board can be populated as any multiple of 4K.

BLANK PC BOARD W/DATA-\$33

LOW PROFILE SOCKET SET-\$12

SUPPORT IC'S & CAPS-\$19.95

ASSEMBLED & TESTED-ADD \$30

OUR #1 SELLING
RAM BOARD!

16K STATIC RAM SS-50 BUSS

PRICE CUT!

\$249 KIT

FULLY STATIC
AT DYNAMIC
PRICES

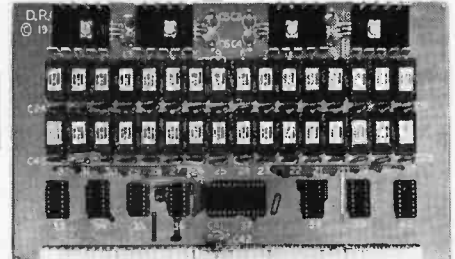

FOR SWTPC
6800 BUSS!

ASSEMBLED AND
TESTED - \$30

KIT FEATURES:

1. Addressable on 16K Boundaries
2. Uses 2114 Static Ram
3. Runs at Full Speed
4. Double sided PC Board Solder mask and silk screened layout. Gold fingers.
5. All Parts and Sockets included
6. Low Power: Under 1.5 Amps Typical

BLANK PC BOARD-\$26 COMPLETE SOCKET SET-\$12
SUPPORT IC'S AND CAPS-\$19.95

PROC. TECH. QUITS THE MICROPROCESSOR BUSINESS!
FACTORY CLOSE OUT - SPECIAL PURCHASE!
#16KRA

16K S-100 Dynamic Ram Board \$149.95

We purchased the remaining inventory of PT's popular 16K Ram Board when they recently closed their plant. Don't miss the boat! These are brand new, fully tested, ASSEMBLED and ready to go. All are sold with our standard 90 day limited warranty!!
Orig. \$429 each! 72 Page Full Manual, Included Free!

Z-80 PROGRAMMING MANUAL

By MOSTEK, or ZILOG. The most detailed explanation ever on the working of the Z-80 CPU CHIPS. At least one full page on each of the 158 Z-80 instructions. A must reference manual for any user of the Z-80, 300 pages.

\$12.95

SALE! LOW POWER - 250NS 8 FOR
2114 RAM SALE! \$55

4K STATIC RAM'S. MAJOR BRAND, NEW PARTS.

These are the most sought after 2114's, LOW POWER and 250NS FAST.
SPECIAL SALE: \$7.50 ea. or 8 For \$55

Digital Research Computers
(OF TEXAS)

P.O. BOX 401565 • GARLAND, TEXAS 75040 • (214) 494-1505

Perfect for
OEM's

S-100 Z80 CPU CARD

\$159.95

WIRED!
NOT A KIT!

4 MHZ

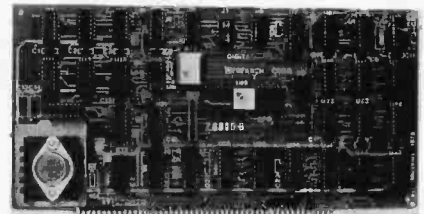

ASSEMBLED AND TESTED! READY TO USE! Over 3 years of design efforts were required to produce a TRUE S-100 Z80 CPU at a genuinely bargain price!

BRAND NEW!

FEATURES:

- * 2 or 4 MHZ Operation.
- * Generates MWRITE, so no front panel required.
- * Jump on reset capability.
- * 8080 Signals emulated for S-100 compatibility.
- * Top Quality PCB. Silk Screened. Solder Masked. Gold Plated Contact Fingers.

NEW! G.I. COMPUTER SOUND CHIP

AY3-8910. As featured in July, 1979 BYTE! A fantastically powerful Sound & Music Generator. Perfect for use with any 8 Bit Microprocessor. Contains: 3 Tone Channels, Noise Generator, 3 Channels of Amplitude Control, 16 Bit Envelope Period Control, 2-8 But Parallel /O 3 D to A Converters, plus much more! All in one 40 Pin DIP. Super easy to interface to the S-100 or other busses.

SPECIAL OFFER: \$14.95 each Add \$3 for 64 page Data. Manual.

TERMS: Add \$1.00 postage. we pay balance. Orders under \$15 add 75¢ handling. No C.O.D. We accept Visa and MasterCard. Tex. Res. add 5% Tax. Foreign orders (except Canada) add 20% P & H. 90 Day Money Back Guarantee on all items.



MICRO BUSINESS WORLD MAIL ORDER

Immediate response to your orders (verbal or written). Phone (213) 371-1660

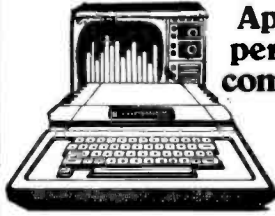

Apple II personal computer.

16K Regular or Plus \$ CALL

Disk II with controller \$ CALL
 Disk II without controller \$ CALL
 PASCAL Language Card \$ CALL
 CALL for our lowest prices ever. We carry all peripherals and interface boards for the APPLE. European versions available.

DYSAN DISKETTES

THE CADILLAC OF THE FLOPPY DISKS AT LOW LOW PRICES 8" (BOX OF 10)

3740/1 sgl side/sgl density 4.00 ea
 3740/1D sgl side/dbl density 6.50 ea
 5" (BOX OF 5)

104/1 soft sector 4.00 ea
 107/1 10 sectors 4.00 ea
 105/1 16 sectors 4.00 ea

For each 2 boxes of 8" or 4 boxes of 5" you get one plastic storage case, but hurry — supply is limited.

ATARI 800 Personal Computer System

Packed with: Computer Console, Basic Language Card, Education System Master Cartridge, Cassette Recorder, TV Modulator, 8K Memory (expandable to 48K), Power Supply & all Books and Manuals \$ CALL

ATARI 400 Personal Computer System for less

Packed with: Computer Console, Basic Language Cartridge, Power Supply, TV Modulator, and all Books and Manuals \$ CALL

ATARI Program Recorder \$ CALL

ATARI Software, Roms, Cassettes \$ CALL

ATARI Expansion Memory: \$ CALL

8K Module or 16K Module \$ CALL

CALL for our lowest prices ever.

ZENITH DATA SYSTEMS: Smart Video Terminal



Z-19 has a Z80 Microprocessor, Numeric Keypad and 8 function key \$895.00



Z-89 Computer System: includes: Z19 Display, a built in 5 1/4" Floppy Disk, 2 serial ports, and 16K of memory. 2295.00 48K Memory version 2595.00

EPSON (A SEIKO COMPANY)

TX-80 Printer with 64 graphics characters 7x5 dot matrix (7x6 in graphics) Double width characters

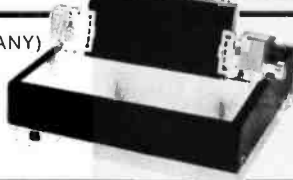

Tractor Feed Model \$695.00
 Friction Feed Model \$595.00

TRS80 Interface & Cable \$50.00

Pet Interface & Cable \$80.00

APPLE Interface & Cable \$80.00

RS232 Interface & Cable \$80.00

Plastic Floppy Disk Holder

(up to 10) 8" \$3.95

(up to 10) 5" \$3.25

16K RAM set of 8 4116's 200 ns or better \$65.00

Prices subject to change without notice. VISA and MASTER CHARGE WELCOME (Add 3%). Allow 2 weeks for cashiers check to clear. 4 weeks for personal checks. Add 2% for shipping and handling. Calif. residents add 6% sales tax. U.S. and International dealer inquiries invited.



MICRO BUSINESS WORLD

15818 Hawthorne Boulevard
 Lawndale, California 90260
 (213) 371-1660

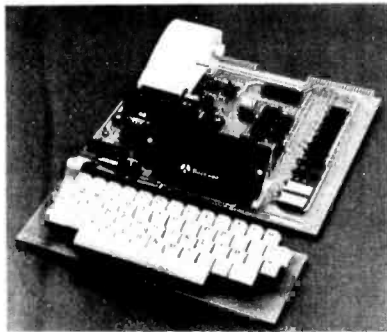

AIM 65

AIM 65 is fully assembled, tested and warranted. With the addition of a low cost, readily available power supply, it's ready to start working for you. It has an addressing capability up to 65K bytes, and comes with a user-dedicated 1K or 4K RAM.

- Thermal Printer
- Full-Size Alphanumeric Keyboard
- True Alphanumeric Display
- Proven R6500 Microcomputer System Devices
- Built-In Expansion Capability
- TTY and Audio Cassette Interfaces
- ROM Resident Advanced Interactive Monitor
- Advanced Interactive Monitor Commands

PRICE: \$375.00 (1K RAM) \$369.00

Plus \$4.00 UPS (shipped in U.S. must give street address), \$10 parcel post to APO's, FPO's, Alaska, Hawaii, Canada, \$25 air mail to all other countries

We manufacture a complete line of high quality expansion boards. Use reader service card to be added to our mailing list, or U.S. residents send \$1.00 (International send \$3.00 U.S.) for airmail delivery of our complete catalog.

Circle 193 on Inquiry card.

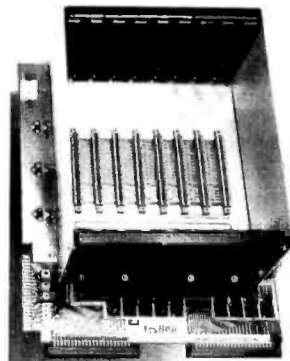

VAK-1 MOTHERBOARD

- Designed specifically for use with the AIM-65, SYM-1, and KIM-1 microcomputers
- Standard KIM-4* Bus
- Fully buffered Address and Data Bus
- Provides 8 expansion board slots
- Complete with rigid card-cage
- All IC's are socketed
- Provides separate jacks for one audio-cassette, TTY, and Power
- Completely assembled (except for card-cage)

We manufacture a complete line of high quality expansion boards. Use reader service card to be added to our mailing list, or U.S. residents send \$1.00 (International send \$3.00 U.S.) for airmail delivery of our complete catalog.

*Product of MOS Technology



2967 W. Fairmount Avenue • Phoenix, AZ 85017 • (602) 265-7564

PRICE: \$129.00
 We also carry the SYM-1 Microcomputer with manuals \$269.00

ComputerCity

(Formerly the CPU Shop)™

When the people
behind the products count!

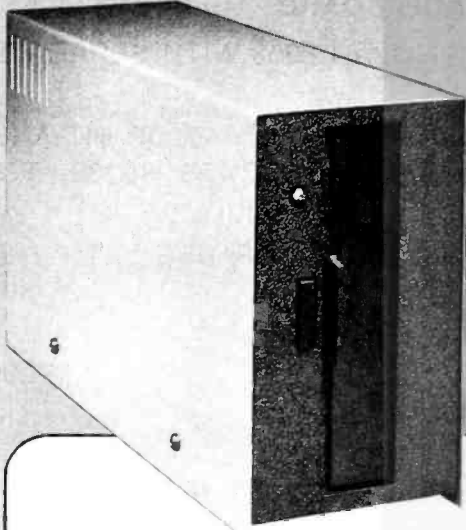

SPECIALS

	Regular Price	Sale Price
North Star Horizon I 32 K, quad-density, assembled and tested	\$2564	\$2174
North Star Horizon II 32 K, quad-density, assembled and tested	\$3215	\$2719
TI-810 Printer	\$1895	\$1589
Leedex Monitor	\$ 149	\$ 109

ComputerCity Sampler Disk Drives

When you're ready to add disk storage to your TRS-80*, we're here to help. Our CCI-100™ and -200™ drives offer more capacity than Radio Shack 35-Track (85K Bytes) drives. These drives are fully assembled, tested and ready to plug-in the moment you receive them. They can be intermixed with each other and Radio Shack drives on the same cable. 90 day warranty.

CCI-100™ 40 Track (102K Bytes) **\$399.00** CCI-200™ 77 Track (197K Bytes) **\$675.00**

Printers

Letter Quality High Speed Printer

NEC Spinwriter: Includes TRS-80* interface software, quick change print fonts, 55 CPS, bidirectional, high resolution plotting, graphing, proportional spacing and tractor feed assembly. 90 day warranty

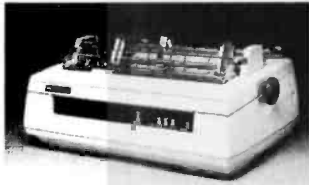

\$2979.00
Also: Centronics, Paper Tiger, HI Plot Digital Plotter

16K Memory Up-grade Kits
Fast and ultrareliable **\$99.00**

DISK OPERATING SYSTEMS

NEWDOS by Apparat† **\$49.95**
NEWDOS "PLUS" by Apparat† **\$99.95**
DOS 3.0 by the original author of 2.1 **\$49.95**

DISKETTE TRS-80*

BUSINESS SOFTWARE BY SBSG

Free enhancements and upgrades to registered owners for the cost of media and mailing. 30 day free telephone support. User reference on request.

Fully Interactive Accounting Package: General Ledger, Accounts Payable, Accounts Receivable and Payroll. Report generating.

Complete Package (requires 3 or 4 drives) **\$475.00**

Individual Modules (requires 2 or 3 drives) **\$125.00**

Inventory II: (requires 2 or 3 drives) **\$ 99.00**

Mailing List Name & Address II (requires 2 drives) **\$129.00**

Intelligent Terminal System ST-80 III: **\$150.00**

The Electric Pencil from Michael Shrayner **\$150.00**

File Management System: **\$ 49.00**

Budget Control Program II by CSA **\$ 49.95**

Cash Register System II by CSA **\$ 99.00**

ComputerCity™

A division of CPU Industries, Inc.
175 Main Street, Dept. B-2 Charlestown, MA 02129

Hours: 10AM - 6PM (EST) Monday - Saturday
For detailed information, call 617/242-3350
Massachusetts residents add 5% Sales Tax

™ CCI-100 & -200 are ComputerCity Inc. trademarks
TRS-80 is a trademark of Radio Shack, a Tandy Corporation †Requires Radio Shack TRSDOS
Prices subject to change without notice

TO ORDER CALL TOLL FREE 1-800-343-6522

Massachusetts residents call 617/242-3350

Retail Store Locations:

175 Main Street, Charlestown, MA
K Mart Plaza, Manchester, NH
50 Worcester Road (Rt. 9), Framingham, MA
165 Angell Street, Providence, RI

Visa and Master Charge accepted

Franchise and dealer inquiries invited

WAMECO

THE COMPLETE PC BOARD HOUSE EVERYTHING FOR THE S-100 BUSS

INTRODUCTORY SPECIAL

IOB-1 SERIAL/PARALLEL INTERFACE BOARD

- * TWO PARALLEL DATA PORTS PROGRAMMABLE USING AN 8255 WITH SEPARATE HANDSHAKING.
 - * ONE SERIAL PORT USING AN 8251 WITH PROVISIONS FOR PARITY, STOP BIT AND CHARACTER LENGTH. BAUD RATES 110 TO 9600 BAUD. OUTPUTS RS232, TTL AND CURRENT LOOP.
 - * KANSAS CITY STANDARD CASSETTE INTERFACE, 300 BAUD FOR USE WITH THE SERIAL INTERFACE.
 - * STATUS MAY BE POLLING SOFTWARE OR VECTURED INTERRUPTS.
- PCBD (SPECIAL FEB. PRICE)\$29.95 AFTER FEB.\$31.95
KIT TO BE ANNOUNCED LATER.

FUTURE PRODUCTS: 80 CHARACTER VIDEO BOARD.

Z-80 CPU BOARD WITH RAM, ROM AND PROGRAMMABLE VECTOR INTERRUPTS.

**DEALER INQUIRIES INVITED, UNIVERSITY DISCOUNTS AVAILABLE
AT YOUR LOCAL DEALER**

MOST PRODUCTS FOR IMMEDIATE SHIPMENT. NO 4-8 WEEK DELAYS REQUIRED FOR OTHERS.



WAMECO INC. 111 GLENN WAY #8, BELMONT, CA 94002 (415) 592-6141



CALIFORNIA COMPUTER SYSTEMS

- 16K RAM BOARD. Fully buffered addressable in 4K blocks. IEEE standard for bank addressing 2114's.
PCBD\$ 26.95 Kit 450 NSEC\$249.95
- PT-1 PROTO BOARD. Over 2,600 holes 4" regulators. All S-100 buss functions labeled, gold fingers.
PCBD\$25.95
- PT-2 PROTO BOARD. Similar to PT-1 except set-up to handle solder tail sockets. PCBD\$25.95
- CCS MAIN FRAME. Kit (S-100)\$349.95
- APPLE EXTENDER. Kit\$22.95
- APPLE IEEE INSTRUMENTATION INTERFACE KIT 7490. Kit\$275.00
- ARITHMETIC PROCESSOR FOR APPLE 7811A. Kit\$350.00
- APPLE ASYNCHRONOUS SERIAL INTERFACE 7710A. Kit\$89.95
- APPLE SYNCHRONOUS SERIAL INTERFACE 7712A. Kit\$89.95

ALL OTHER CCS PRODUCTS AVAILABLE



- PB-1 2708 & 2716 Programming Board with provisions for 4K or 8K EPROM. No external supplies require textool sockets. Kit\$129.95
- CB-1A 8080 Processor Board. 2K of PROM 256 BYTE RAM power on/rest Vector Jump Parallel port with status. Kit\$129.95 PCBD\$30.95
- VB-3 80 x 55 VIDEO BOARD. Graphic included TBD
- IO-4 Two serial I/O ports with full handshaking 20/60 ma current loop: Two parallel I/O ports. Kit\$130.00 PCBD\$26.95
- VB-1B 64 x 16 video board, upper lower case Greek composite and parallel video with software, S-100. Kit\$125.00 PCBD\$26.95
- CB-2 Z80 CPU BOARD. Kit\$185.95
- AIO APPLE SERIAL/PARALLEL\$159.95

ALL OTHER SSM PRODUCTS AVAILABLE



WAMECO INC.

- FDC-1 FLOPPY CONTROLLER BOARD will drive shugart, pertek, remlc 5" & 8" drives up to 8 drives, on board PROM with power boot up, will operate with CPM™ (not included). PCBD\$42.95
- FPB-1 Front Panel. IMSAI size, hex displays. Byte, or instruction single step. PCBD\$47.50
- MEM-1A 8K x 8 fully buffered, S-100, uses 2102 type rams. PCBD\$25.95
- QM-12 MOTHER BOARD, 13 slot, terminated, S-100 board only\$34.95
- CPU-1 8080A Processor board S-100 with 8 level vector interrupt. PCBD\$26.95
- RTC-1 Realtime clock board. Two independent interrupts. Software programmable. PCBD.....\$23.95
- EPM-1 1702A 4K Eprom card. PCBD\$25.95
- EPM-2 2708/2716 16K/32K EPROM CARD. PCBD\$25.95
- QM-9 MOTHER BOARD. Short Version of QM-12. 9 Slots. PCBD\$30.95
- MEM-2 16K x 8 Fully Buffered 2114 Board PCBD\$26.95
- PTB-1 POWER SUPPLY AND TERMINATOR BOARD PCBD\$25.95
- 8080A\$9.95 2708\$9.49
8212 2.49 2114 (450 NS) low pwr 5.99
8214 4.49 2114 (200 NS) low pwr 6.99
8224 3.49 2102A-4L 1.20

FEB. SPECIAL SALE ON PREPAID ORDERS

(Charge cards not included on this offer)

IOB-1 SERIAL/PARALLEL INTERFACE BOARD. Two parallel ports 8255, one serial port 8251, one Kansas City standard cassette.
PCBD (Introductory)\$24.95

MIKOS PARTS ASSORTMENT

WITH WAMECO AND CYBERCOM PCBDS

MEM-2 with MIKOS #7 16K ram
with L2114 450 NSEC\$249.95

MEM-2 with MIKOS #13 16K ram
with L2114 250 NSEC\$279.95

MEM-1 with MIKOS #1 450 NSEC 8K RAM\$119.95

CPU-1 with MIKOS #2 8080A CPU\$ 94.95

QM-12 with MIKOS #4 13 slot mother board\$ 89.95

RTC-1 with MIKOS #5 real time clock.....\$ 54.95

EMP-1 with MIKOS #10 4K 1702 less EPROMS\$ 49.95

EPM-2 with MIKOS #11 16-32K EPROMS less EPROMS\$ 59.95

QM-9 with MIKOS #12 9 slot mother board\$ 79.95

FPB-1 with MIKOS #14 all parts for front panel\$134.95

MIKOS PARTS ASSORTMENTS ARE ALL FACTORY MARKED PARTS. KITS INCLUDE ALL PARTS LISTED AS REQUIRED FOR THE COMPLETE KIT LESS PARTS LISTED. ALL SOCKETS INCLUDED.



(415) 592-1800

P. O. Box 424 • San Carlos, California 94070

Please send for IC, Xistor and Computer parts list

VISA or MASTERCARD. Send account number, interbank number, expiration date and sign your order. Approx. postage will be added. Check or money order will be sent post paid in U.S. If you are not a regular customer, please use charge, cashier's check or postal money order. Otherwise there will be a two-week delay for checks to clear. Calif. residents add 6% tax. Money back 30-day guarantee. We cannot accept returned IC's that have been soldered to. Prices subject to change without notice. \$10 minimum order. \$1.50 service charge on orders less than \$10.00.

save TRS-80

on add-on products for.....

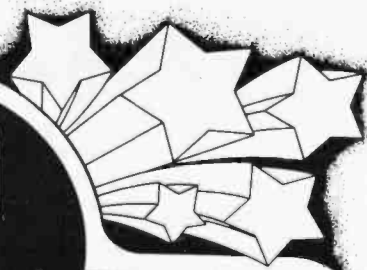

TRS-80 COMPATIBLE DISK DRIVES

The largest family of disk drives from the largest supplier, drives come complete with power supply and cabinet

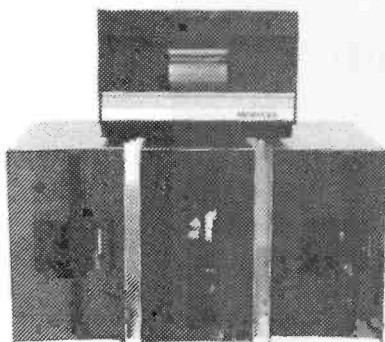

TF-1 Pertec FD200, 40 track	\$382
TF-3 Shugart SA400, same as tandy	\$389
B51 MPI 851, 40 track	\$379
TDF-1 Dual Head, 35 track	\$499

220 versions available.

NOW! SUPER & MAX DISKS

SUPER: 77 tracks on one 5¼ diskette that's 197K of storage with New DOS+	\$695
MAXI DISK I: 10 Megabyte hard disk with 5 fixed 5 removable with controller.	\$6299
MAXI DISK II: 9.8 Megabyte on one disk using Winchester technology. Unit is sealed in unit for added protection	\$5349

LINE PRINTERS

NEW!

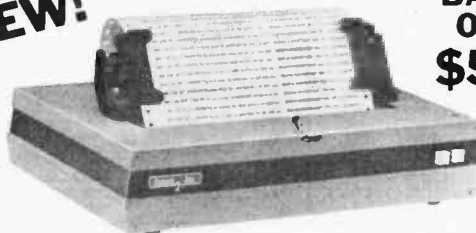

BASE 2 ONLY
\$599.

The new base 2 printer, prints 60 lpm, 80 & 132 col. formats. It has tractor feed w/RS232, IEEE & centronic interface.

DP800 ANADEX 80 column, 112 cps	\$950
LP779 Centronics 779	\$1099
LP730 Centronics 730	\$950
LP700 Centronics 700	\$1495
LP701 Centronics 701	\$1759
LP702 Centronics 702	\$1895
Spin-1 Spinwriter	\$2499

MOD II DISK DRIVES NOW AVAILABLE

ADD-ON DRIVE FOR ANY MICROCOMPUTER DOES NOT INCLUDE POWER OR CABINET

Pertec FD200	\$282
Pertec FD250 (dual head)	\$349
Shugart SA400 (unused)	\$286
Shugart SA800	\$479
MPI B51	\$279
MPI B52 (dual head)	\$349

SOFTWARE

NEW DOS+ over 200 modifications, corrections and enhancements to TRS DOS Includes utilities.	
35 Track NEWDOS+	\$99
40 track NEWDOS+	\$110
AJA Word Processor	\$75
AJA Business Program	\$250
Racet Infinite Basic	\$49.95
Disk Drive Alignment Program	\$109
Radex Data Base	\$99.95
Electric Pencil	\$150

NEW PRODUCTS

Small Systems Interface (RS232)	\$49.95
Expansion Interface W32K	\$499.95
AC Line Filter	\$18.95
AC Isolater (6 connectors)	\$45.95
Mode M	\$179.95
Verbatim 5¼ Diskettes	\$3.39
16 Key Pad Kit (no soldering)	\$68
16K Memory (Keyboard)	\$89
16K Expansion (Interface)	\$86

ALL PRICES CASH DISCOUNTED • FREIGHT FOB/FACTORY



MICROCOMPUTER TECHNOLOGY INCORPORATED

3304 West MacArthur Blvd
Santa Ana, CA 92704
(714) 979-9923



7310 E. Princeton Ave.
Denver, CO 80222
(303) 758-7275

pparat, Inc.

asap
computer
products, inc.

11542-1 KNOTT ST.
GARDEN GROVE,
CA 92641
(800) 854-6411
(714) 891-2663

IMSAI CONNECTORS

100 PIN - SOLDER TAIL
\$3.00 each
10 for **\$2.75** each

2708's
450NS
\$8.50 ea.
or
8/\$60

CERAMIC CAPS
1 @ 12 VOLTS
10c ea.
or
100/\$9.00

2114's

LO-PWR
300 NS.
1-16 PCS.
\$5.25 ea.
17 UP
\$5.00 ea.

MICROBYTE 16K RAM BOARD

- FULLY S-100 COMPATIBLE
- USES LO-PWR 4KX1, MM5257's
- 2 MHZ OR 4 MHZ
- 4K BANK ADDRESSABLE
- EXTENDED MEMORY MANAGEMENT
- NO DMA RESTRICTIONS
- ASSEMBLED & TESTED

2MHZ \$250 - 4MHZ \$265

MICROBYTE 32K RAM BOARD

- FULLY S-100 COMPATIBLE
- USES LO-PWR 4KX1, MM5257's
- 2MHZ OR 4MHZ
- BANK ADDRESSABLE
- EXTENDED MEMORY MANAGEMENT
- 8-BIT OUTPUT PORT
- NO DMA RESTRICTIONS
- ASSEMBLED & TESTED

2MHZ \$525 - 4MHZ \$540

LO-PRO SOCKETS

	1-24	25-99	100 up
14 PIN	.15	.14	.13
16 PIN	.16	.15	.14
18 PIN	.19	.17	.15
20 PIN	.27	.25	.23
24 PIN	.35	.31	.27
28 PIN	.40	.33	.29
40 PIN	.50	.46	.41

4116's (250NS)
ADD ON MEMORY FOR APPLE, TRS 80, HEATH, ETC.
8 for \$64.00
or
16 for \$120.00

REGULATORS

320T-5	90
320T-12	90
340T-5	80
340T-12	70
78H05	4.75
78L12	35

MISC. COMPONENTS

	1-9	10-99	100 up
LM339	.70	.65	.59
LM348	1.00	.92	.85
LM377	1.10	1.00	.95
LM380	.80	.75	.70
LM3900	.55	.50	.44
DM8216	2.10	2.00	1.90
8080A	4.50	4.25	4.00
8251	5.00	4.80	4.50

SA800 DISK DRIVE
INSTALLED IN DUAL CABINET W/PWR SUPPLY ASSEMBLED & TESTED
(1) DRIVE INSTALLED **\$695.00**
(2) DRIVES INSTALLED **\$1125.00**

2716's
5-VOLT ONLY
450 NS.
\$32.00 ea.
or
8 for \$240

ASK FOR OUR NEW CATALOG

ORDERING INFO
NAME, ADDRESS, PHONE
SHIP BY: UPS OR MAIL
SHIPPING CHR.G: ADD \$2.50
UP TO (5) LBS. CREDIT CARDS WILL BE CHARGED APPROPRIATELY

TERMS
WE ACCEPT CASH, CHECK, MONEY ORDERS, VISA & MASTER CHR.G. (U.S. FUNDS ONLY)
TAX: 6% CALIF. RES.

DIGITAL MULTIMETERS
Hickok LX303 \$69.50

Sinclair PDM35
Reg. \$69.95
\$49.95

3 1/2-Digit Portable DMM
Model 2800
Reg. \$435.00

MURAPHONE Cordless Telephone System
Reg. \$89.95
\$74.95

Portable VOM Multitester
Model VM520
Reg. \$19.95

HICKOK Digital CB In-Line Tester
Model 388
Reg. \$399.00

100 MHz 8-Digit Counter
Model MAX100
Reg. \$150.00
\$127.50

Logic Monitor
Model LM-1
Reg. \$59.95

Telephone Answering
Model 1500
Reg. \$349.95
\$249.95

6" x 9" 3-Way Speaker
Model BP2000-69TR
\$149.95

Beckman TECH 310
\$130.

Miniature High Fidelity 3-Way Stereo Speakers
Model HF-9
\$69.50

Portable Oscilloscopes
15 MHz Dual Trace Triggered Miniscope
Model MS-215
Reg. \$435.00
\$369.95

Function Generator
Model 2001
Reg. \$185.95
\$157.95

Attache Style Tool Case
Model TC100VST
Reg. \$471
\$279.95

Weller Xcelite

Service Master Tool Kit
Model 99-SM
Reg. \$69.95
\$47.50

Meter
Model 820
Reg. \$190.00

Wahl Cordless Soldering Iron
Model 7800
\$29.95

30 MHz Dual Trace Triggered Miniscope
Model MS-15
Reg. \$319.00
\$269.95

30 MHz Dual Trace Triggered Miniscope
Model MS-230
Reg. \$559.00
\$479.95

Proto Board Preassembled Boards
Model PB-104
Reg. \$154.95
\$49.95

ESD Proto Board with Built-in Power Supplies
Model PB-203A
Reg. \$154.95
\$129.95

ESD 3 1/2-Digit 0.1% Digital Capacitance Meter
Model 3001
Reg. \$190.00
\$170

Simpson 461
Reg. \$149.95

Logic Probe
Model LP-1
\$44.95

RC Circuit Box
Model WC 412A
Reg. \$49.95
\$42.

Magnifier Lamp
Model MG10A
\$49.95

30 MHz LEADER Dual Trace with Delay Line
Model LBO-520
\$899.95

Weller Controlled Output Soldering Station
Model WTCPN
Reg. \$77.50
\$49.95

BSR X-10
Reg. \$79.50

ESD 30 MHz Portable Frequency Counter
Model 1827
Reg. \$130.00
\$65.

8-Dash Car Stereos
Model C-777
\$52.50

Cassette Tape Player
Model CAS-888
\$57.50

Stereo Power Booster
Model POW-40
\$24.95

FORDHAM
855 Conklin St. Farmingdale, N.Y. 11735
Master Charge • BankAmericard • VISA
COD • Check • Money Order
N.Y. State residents add appropriate sales tax
TOLL FREE (800) 645-9518
In N.Y. State call (516) 752-0050

10-DAY FREE TRIAL

Send for our
FREE Catalog



\$100 FREE ACCESSORIES WITH 16K or 32K PET

When you buy a 16K or 32K PET, apply \$100 toward PET accessories. FREE. Just indicate on your order that you have reduced the cost of your accessories by \$100.

FREE Terminal Package with 8K PETS

See Special Below

FREE SAVE \$98

PET ACCESSORIES

8K-Keyboard N	\$795
16K-Keyboard B	\$995
16K-Keyboard N	\$995
32K-Keyboard B	\$1,295
32K-Keyboard N	\$1,295

B—large keyboard (graphics not on keys)
N—large keyboard with graphics symbols

SANYO MONITORS

9-inch
reg. \$240



15-inch.
reg. \$400

SALE! \$169

SALE! \$279

apple II plus

\$200 FREE ACCESSORIES

The new Apple II with Applesoft BASIC built-in! Eliminates the need for a \$200 Firmware Card and includes new Autostart ROM for easy operation. This combined with the FREE accessories from NCE could save you up to \$400 on a 48K Apple II system!

16K Apple II Plus — \$1195 (take \$100 in free accessories)
32K Apple II Plus — \$1345 (take \$150 in free accessories)
48K Apple II Plus — \$1495 (take \$200 in free accessories)

Apple II Accessories	
General Business	\$625
PASCAL	\$495
Integer BASIC ROM Card	\$200
VI-SI-Calc	\$149
Centronics Printer Interface	\$225
Disk and Controller	\$595
Parallel Printer Card	\$180
Communications Card	\$225
Hi-Speed Serial Card	\$195
Firmware Card	\$200

IN STOCK NOW!

EVERY ITEM IN THIS ADVERTISEMENT IS IN STOCK AND READY TO SHIP, EXCEPT WHERE NOTED.

PAPER TIGER 440SPE

The Graphics Printer for Apple II

Now you can print illustrations, block letters, charts, graphs, and more—all under software control. And with the expanded buffer, the Paper Tiger can hold the text from an entire 24-line-by-80-column CRT screen. **\$1194.00**

Commodore Dual Floppy Disk Drive	\$1,295.00
Commodore Printer (friction feed)	\$849.00
Commodore Printer (tractor feed)	\$995.00
Second Cassette from Commodore	\$95.00
Commodore PET Service Kit	\$30.00
Beeper- Tells when tape is loaded	\$24.95
Petunia- Play music from PET	\$29.95
Video Buffer- Attach another CRT	\$29.95
Combo- Petunia and Video Buffer	\$49.95
TNW Bi-Dir. RS-232 printer X-face	\$229
KIM 1 (A Single Board Computer from Commodore)	\$179.00

PET OWNERS ...

REMOTE TERMINAL for only \$98

A self-contained module and program cassette enables your PET to function as a 300 baud terminal. Supports Upper/Lower case, Rubout, Escape & all control functions. Output is TTL.

FREE WITH PET PURCHASE



CAT COUPLER

New 300 baud Originate/Answer Acoustic Coupler Looks good, works great **priced at \$189**

NEW from Heath Data Systems

The All-In-One Computer

Dual Z-80 Processors • Built-In 102K Floppy Disk • 16K to 48K RAM • 25 x 80 Character Display • Upper/Lower Case and Line Graphics • 80 Character Keyboard with Keypad • 8 User-definable Keys • Two BASIC's and Auto-Script Word Processing available • Can support CP/M

Heath's third generation of computers is a compact, hi-style desktop unit which includes a complete terminal, a computer and a disk All-In-One! System includes Bootstrap in ROM, other programs available separately. HDOS operating system includes Heath's BASIC, an assembler and text editor along with important disk utilities. Microsoft language requires HDOS.

WH89 with 16K RAM	\$2,295
WH89 with 32K RAM	\$2,445
WH89 with 48K RAM	\$2,595
WH17 Second Disk Drive	\$550
Dual-port Serial Interface	\$85
HDOS Operating System	\$100
Microsoft BASIC	\$100
Word Processing	\$395

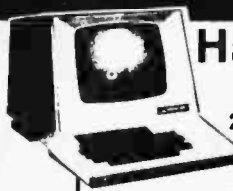

Hazeltine 1400

Immediate Delivery—
2-Year Factory Warranty

LIST SALE
~~\$850~~ **\$649**

Hazeltine 1410 — \$835	Hazeltine 1510 — \$1195
Hazeltine 1500 — \$1069	Hazeltine 1520 — \$1499

Lear Siegler's ADM-3A

The ADM-3A is industry's favorite dumb terminal for some very smart reasons:

- 12 in. diagonal screen
- Full or half duplex operation at 11 selectable data rates
- 1920 easy-to-read characters in 24 rows of 80 letters
- Typewriter-style keyboard
- RS-232 C Interface extension port
- Direct cursor addressing

Our Low Sale Price **\$795**

ZENITH COLOR VIDEO MONITOR

Zenith's first color video display designed specifically for computers.

This 13-inch monitor is Zenith's first color video display designed specifically for computers. Features include automatic color level, color processing and degaussing circuits.

Zenith Color Monitor **\$499.00**

FREE Just Released Compumart's New Fall/Winter 1979 Catalog.

We've just published our catalog and it's packed with new products and money saving specials. Our illustrated 32-page book features microcomputers and microcomputer systems from Apple, Commodore PET, Heath, and Exidy Sorcerer. Also covered are the Commodore's KIM and Rockwell's AIM. A broad selection of terminals, books, software and peripherals are presented in detail. The text is thorough and provides a wealth of technical information. To get your FREE copy write to our address below. Please include the dept. number to speed handling.

CENTRONIC'S 779-2 PRINTER

TRACTOR FEED **SALE PRICE \$1095**

- Parallel Interface
- Continuous variable printing density 80-132 characters per line
- 5x7 dot matrix
- Form thickness control
- Horizontal and vertical form positioning
- Used with controller (Apple general business software)

JUST ARRIVED. We've just received shipments of the following Centronics printers. Call us for complete specs.

730-1	\$995
730-3	\$1045
753-9 (9x9 Matrix)	\$2,795
704-9 (9x9 Matrix)	\$1,995

NCE/CompuMart SINCE 1971

DEPT. KB20, 270 THIRD ST.,
CAMBRIDGE, MA 02142

To Order: **1 (800) 343-5504**

In Mass.: **1 (617) 491-2700**



Member:
Computer Dealers
Association

IMPORTANT ORDERING INFORMATION

All orders must include 4% shipping and handling. Mass. residents add 5% sales tax; Mich. residents 4%, for sales tax.

Phones open from 9:30 a.m. to 5:30 p.m. EST Mon.-Fri. • P.O.'s accepted from D&B rated companies — shipment contingent upon receipt of signed purchase order • Sorry no C.O.D.'s • All prices are subject to change without notice • Most items in stock for immediate shipment — call for delivery quotation • In the Ann Arbor area? Our retail store is open 11:00 a.m. to 7:00 p.m. Tues.-Fri., 10:00 a.m. to 5:00 p.m. Saturdays (closed Sun. and Mon.)

If not satisfied, return your purchase with-in 10 days for full refund of purchase price!

page

Precut Wire Wrap Wire

PRECUT WIRE SAVES TIME AND COSTS LESS THAN WIRE ON SPOOLS

Kynar precut wire. All lengths are overall, including 1" strip on each end. Colors and lengths cannot be mixed for quantity pricing. All sizes listed are in stock for immediate shipment. Other lengths available. Choose from colors: Red, Blue, Yellow, Orange, Black, White, Green and Violet. One inch tubes are available at 50¢. State second choice on colors when possible.

Length	100	500	1,000	Length	100	500	1,000
2.5 inches	1.04	2.98	5.16	6.5 inches	1.60	5.37	9.84
3	1.08	3.22	5.65	7	1.66	5.63	10.37
3.5	1.13	3.46	6.14	7.5	1.73	5.89	10.91
4	1.18	3.70	6.62	8	1.78	6.15	11.44
4.5	1.23	3.95	7.12	8.5	1.82	6.41	11.97
5	1.28	4.20	7.61	9	1.87	6.76	12.51
5.5	1.32	4.48	8.10	9.5	1.92	6.93	13.04
6	1.37	4.72	8.59	10	1.99	7.26	13.57

Kit #1	\$7.95	Kit #2	\$19.95	KIT #3	\$24.95	Kit #4	\$44.95	#30 Spools
Less than 2.7¢/ft. (#30)		Less than 2¢/ft. (#30)		Less than 1.7¢/ft. (#30)		Less than 1.6¢/ft. (#30)		1-4 5-9 10+
250 3" 100 4"		250 2½" 250 5"		500 2½" 500 4½"		1000 2½" 1000 4½"		50 ft. 1.75 1.60 1.40
250 3" 100 5"		500 3" 100 5½"		500 3" 500 5"		1000 3" 1000 5"		100 ft. 3.00 2.75 2.50
100 4" 100 6"		500 3½" 250 6"		500 3½" 500 5½"		1000 3½" 1000 5"		250 ft. 4.75 4.50 4.25
		500 4" 100 6½"		500 4" 500 6"		1000 4" 1000 6"		500 ft. 8.50 8.00 7.50
		250 4½" 100 7"						1000 ft. 14.50 12.50 10.50

Wire Wrap Tool

BATTERY HOBBY TOOL*

- Auto Indexing
- Anti-Overwrapping
- Modified Wrap

BW2630	Tool	\$19.85
BT30	#30 Bit	2.95
BT2628	#26 Bit	7.95
BC1	Batteries & Charger	...	11.00

*Requires 2 "C" Nicad Batteries



Solderless Breadboarding

SK10 2/\$25.00 ~~\$16.60~~

The SK10's unique matrix configuration is embedded in a high temperature plastic molding. It gives you 64 pairs of 5 common spring contacts for principle circuit construction and a series of common buss strips (8) of 25 connections each.

Dimensions: .33" h x 2.2" w x 6.5" l

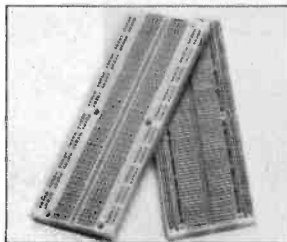

TI Edge Card Connectors

44 pin ST (.156" centers)	1.95
100 pin ST (.125" centers)	2.50
100 pin WW (.125" centers)	2.95

All connectors gold plated.

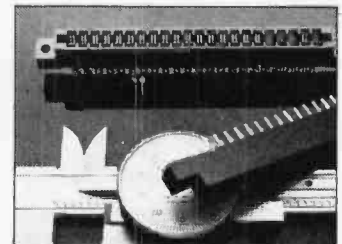

RNIC Sockets

RN HIGH RELIABILITY eliminates trouble. "Slide-wipe" contacts make 100% greater surface contact with the wide, flat sides of your IC leads for positive electrical connections.

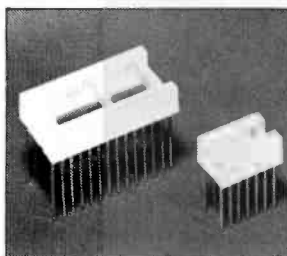

WIRE WRAP SOCKETS	Size	Quant./Tube	Price Ea.	Price/Tube
3-level Gold	08 pin WW	52	.31	\$16.12
Closed Entry Design	14 pin	60	.32	\$19.20
	16 pin	52	.34	\$17.68
All prices include Gold	18 pin	23	.50	\$11.50
	20 pin	21	.65	\$13.65
2-level Sockets	22 pin	19	.70	\$13.30
Also Available	24 pin	10	.70	\$7.00
Sockets sold at these prices by the tube only.	28 pin	10	.95	\$9.50
	40 pin	7	1.20	\$8.40

ORDERING INFORMATION

- Orders under \$25, add \$2 handling
- Blue Label or First Class, add \$1 (up to 3 lbs.)
- CODs, VISA & MC orders will be charged shipping
- Most orders shipped next day

AVAILABLE AT SELECTED LOCAL DISTRIBUTORS

page

135 E. Chestnut Street 5A, Monrovia, California 91016 Phone (213) 357-5005

Circle 203 on inquiry card.

California Digital

Post Office Box 3097 B • Torrance, California 90503

FREE Paper Tiger



With Purchase of The INTEGRAL DATA 440

Your Choice, \$200 Value

- 1) Graphics Option Package
 - 2) Interface for APPLE II
 - 3) TRS-80 Printer Interface
- California Digital has recently researched the complete low cost printer market. It is our opinion that the IDS440 Paper Tiger is, without doubt, the most versatile and offers the best value of any printer costing under \$1,000.

This quality dot matrix printer incorporates such features as software selectable character size to allow print densities upto 132 characters per line. Full forms handling capabilities and tractor feed mechanism adjustable to 9.5". The Paper Tiger is engineered to accept either parallel or RS232 serial ASCII. 110/220V.50/60Hz.

***** \$995.00 plus shipping *****

software selectable character size to allow print densities upto 132 characters per line. Full forms handling capabilities and tractor feed mechanism adjustable to 9.5". The Paper Tiger is engineered to accept either parallel or RS232 serial ASCII. 110/220V.50/60Hz.

S-100 Mother Board

Quiet Buss

\$2995
1803-18
18 slot
IMSAI

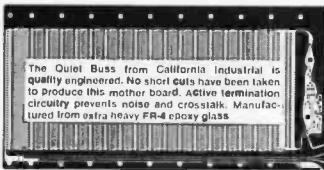

The Quiet Buss from California Industrial is quality engineered. No short cuts have been taken to produce this mother board. Active termination circuitry prevents noise and crosstalk. Manufactured from extra heavy FR-4 epoxy glass.

TELETYPE MODEL 43

4320 KEYBOARD
TTL AAA \$1050
RS232 AAK 1150
Friction ... AAE 1100 plus shipping
103 Modem AAB 1575



Minidisk Drive for TRS-80

your choice \$388.
Lobo or Vista
Includes Interface Cable



SYSTEM X-10

It's not often that California Digital ventures into the distribution of consumer products, but we have recently come across a product that appears so unique that we just had to add it to our product line. This is the System X-10 manufactured by the BSI turntable company. This space age system will remotely control any light or appliance in your home or office. Command signals are transmitted from the command console over your existing wiring. From your bed or easy chair you can control up to 16 different electrical devices inside and outside your home. Use the System X-10 to control your stereo, television or any light fixture on the premises.

The modular system is available in the following configurations:
 Ultrasonic Master Control Console \$34.85
 Battery Operated Ultrasonic Controller 19.95
 Appliance Module, Lamp Module or Wall Switch 13.95

FREE PLASTIC LIBRARY CASE

with purchase of each box of Verbatim mini-diskettes. \$5 value.

\$24.95

BOX of 10
DISKETTES

CONNECTORS

your choice
DB25P male plug & hood
or
DB25S female
\$3.25

Qty. fe. male hd.
10 3.05 1.95 1.15
25 2.95 1.79 1.05
100 2.65 1.67 .85
500 2.25 1.60 .85
1K 1.97 1.37 .73

Edge Connectors

GOLD 100 PIN
IMSAI/ALTAIR

Imesai solder .125x.250 \$2.95 3/4 7.50
Imesai w/.125 centers \$4.95 3/4 13.00
Altair solder all .140 row \$5.95 3/4 15.00

SPECIALS
22/44 Kim eyelet .156" \$1.95 3/4 5.00
25/50 solder tab .156" \$1.09 3/4 12.00
36/72 wide post w/.156" \$1.95 3/4 15.00

Authorized Distributor

740-0 IBM m soft format.	\$39.00	50+	\$3.50
740-2 Double density soft	65.00	6.00	
741-0 Double density	53.00	1.90	
743-0 Double/Doucle	70.00	6.60	
740-32 8 1/4 Hard sector	39.09	3.30	
744-0(10)(16) 5 1/4 mini	39.00	3.30	
Library case for any above:	Add \$3.00		
834 A Data Cassette	5.50		
DC100 Mini Cartridge	16.00		
DC300 Data Cartridge	20.00		
920() Disk Cartridge	39.00		

Shugart Associates

SA800-R Floppy Disk Drive

The most cost effective way to store data processing information, when random recall is a prime factor. The SA800 is fully compatible with the IBM 3740 format. Write protect circuitry, low maintenance & Shugart quality.

\$449.50

\$85 KEYBOARD
ASCII ENCODED

KEYTRONIC ASCII & ASCII complement.
 *Ten key data pad
 *Cursor controls
 *Six user switches
 *Alpha Lock
 *Auto repeat
 *Single 5 volt.
 *Class reed.

NEW

MEMORY

TRS-80 \$65

APPLE II 65

16k memory (8) 4116's

Installation is simple. Anyone who has ever changed a spark plug should be able to up-grade his microcomputer.

How can California Digital offer these memory up-grade sets at 25% below our competition? Simple, we buy in volume, wholesale to dealers and sell the balance directly to owners of personal micro-systems. These 16K dynamic memory circuits are factory prime and unconditionally guaranteed for one full year. NOW, before you change your mind, pick up the telephone and order your up-grade memory from California Digital. Add \$3 for TRS80 jumpers.

Regent 25

\$850

through years of research the ASDI Corporation has evolved a low maintenance, extremely durable CRT terminal capable of withstanding an abusive 24 hour duty cycle. The Regent 25 features line 8081 microprocessor based control circuitry along with the Cherry Switch long life capacitive keyboard, 16 key cursor and numeric pad doubles to allow for user definable screen functions. Easy-drawing lower case characters along with a fully addressable cursor moves the Regent 25 to the ideal word processing terminal.

It also features a screen capable of displaying 80 upper and lower case ASCII characters and 32 control codes. This terminal is screen selectable to display six European languages.

All 8888 (plus shipping) the Regent 25 offers the best value in today's CRT terminal market. Anticipated data upon request.

The Imagination Machine

by APF
A BRILLIANT COMPUTER
WHOSE TIME HAS COME

\$495

THE IMAGINATION MACHINE is brilliant in concept, design and engineering. It reads and processes information in a most sophisticated manner. It has a built-in keyboard, a scrolling alphanumeric display and a high resolution, scrolling color display screen of 40 characters by 24 lines.

As a computer the Imagination Machine will be used for personal and family communications, business, education and entertainment. Because the Imagination Machine is a 16K 8081 microprocessor based computer, it can be used for a wide range of applications. It can be used for word processing, data entry, file management, and more. It can be used for a wide range of applications. It can be used for a wide range of applications.

STATIC	1-31	32-99	100-5C	-999	1K+
211.02 450nS.	1.19	.99	.95	.90	.85
211.02 250nS.	1.49	1.39	1.25	*	*
2114 1Kx4 450	5.95	5.50	5.25	4.75	4.50
2114 1Kx4 300	8.95	8.50	8.00	*	*
4044 4Kx1 450	5.95	5.50	5.25	*	*
4044 4Kx1 250	9.95	9.50	9.00	*	*
4045 1Kx4 450	8.95	8.50	8.00	*	*
4045 1Kx4 250	9.95	9.50	9.00	*	*
5257 low pow.	5.95	5.50	5.00	4.80	4.60

PORTABLE DATA ENTRY SYSTEM

\$139.50

These used data terminals were originally designed for chain store inventory control and order entry systems. The operator enters the inventory control number, merchandise on hand and the unit price. After all pertinent data has been entered into the recorder, the main warehouse is telephoned, the handset is placed in the acoustic coupler and all the recorded information is transmitted back to the master computer. With a little imagination and one of these portable entry systems, you should be able to exchange programs and computer information with associates across the country. All units were removed from service in working condition. Original cost \$2,500. Each system comes complete with:

- Portable Cassette Drive Unit
- Removable Entry Keyboard with LED Display
- Five Gould "D" NiCads
- Acoustical Coupler
- Battery Charger
- DB25 Cable
- Shoulder strap
- Full Documentation

DISCOUNT Wire Wrap Center

IC SOCKETS

Wire wrap	low profile
pin	ea. 25 50 ea. 25 50
8	17: 16 15
14	37: 36 35 18 17 16
16	38 37 36 19 18 17
24	99 93 85 36 35 34
40	169 155 139 63 60 58

\$2995
8W630

OK HOBBY WRAP-30 wire wrap & strip tool
\$545

SPST
KYNAR WIRE WRAP
50ft. **\$98**
500 1,000 11,000
\$9. \$15. \$105.

PROMS	1-15	16-63	64+
1702A 2K	4.95	4.50	4.00
2708 8K	9.95	9.50	9.00
2716 3x16K	39.95	35.00	*
2716 T1	24.88	20.00	*
2532	85.00	*	*

VISA
master charge

(213)679-9001
All merchandise sold by California Digital is premium grade. Sorry, no COD's. Orders are shipped the same day received. California residents add 6%. Foreign orders add 10%. Orders over \$25, when accompanied by payment, are shipped at our expense. Otherwise, please add \$2.

BYTE February 1980 239

FLOPPY SYSTEMS

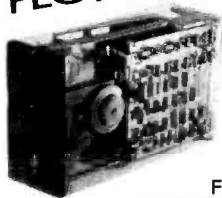

8" Siemens FDD120-8D
All Siemens options included in this drive may be configured hard or soft and single or double density. We find this to be an extremely reliable drive. \$430.00

Fully Shugart compatible.
5 1/4" BASF Magical Miniature Mini drive only 2/3 the size of others is reliable and durable and quickly gaining in popularity with our customers. Single or dual density fast access times \$259.00

Tarbell Controller may be re-configured to control 5 1/4" drives and includes short cable for one drive. **KIT \$179.00, ASM \$265,** but only \$219 with purch. of 2 drives.

Cable Kits For 8" Drives with 10' 50 cond. cable and connectors. Also power cable and connectors. Flat cable assem if you wish. For one drive 27.50, two 33.95, three 38.95

Cable Kits for 5 1/4" Drives as above, but 34 cond. For one drive 24.95, two 29.95.

"Power One" Model CP206 Power Supply adequate for at least two drives. 2.8A/24V 2.5A/5V, 0.5A/-5V beautiful quality. \$99.00

CABINETS for FDD120 and 801R drives, or CP206 supply. Matte finish in mar resistant black epoxy paint and stacking design 29.95

DISKETTES
(3M, MRX, BASF, Georgia Magnetics, & Victor Borge)
8" \$39.95/10
5 1/4" \$29.95/10

32K - \$490.00 16K - \$290.00

NEW!! - CHRISLIN 64K Dynamic RAM \$750.00
(Showing Amazing Similarity to Tarbell's unit)
(16K Shown in photo)

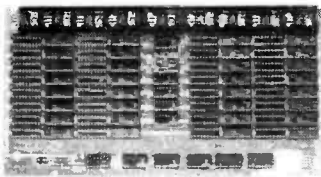

32K - \$549.00 16K - \$349.00

"BACK TO SCHOOL" KEYBOARD SPECIAL

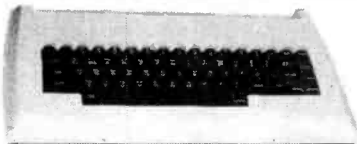

CHERRY "PRO" Keyboard \$119.00
Streamlined Custom Enclosure \$34.95
BOTH ONLY \$124.95 !!!!!!!

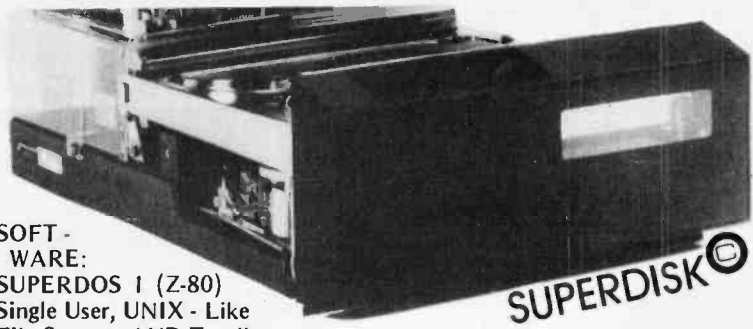

10MB Drive \$3300

S - 100 DMA CONTROL

POWER UNIT \$395.00

SOFTWARE:
SUPERDOS 1 (Z-80)
Single User, UNIX - Like File System, AND Totally Upward Compatible From "XX/X" (What did you say, Digital Research??)

PS: SUPERDOS-1 runs on the TRS-80, and can transform it from a toy computer to a real business machine !!!

For the first time in something like 10 years, a new STANDARD in removable media has evolved. Selected by Datapoint, and others who have not yet announced, this drive is beautifully simple and easy, if not trivial to maintain. 920kBy/sec. transfer rate, 3600 RPM 39 lbs and only 125 Watts.

Daisy Wheel Printers

Qume Sprint 3\45

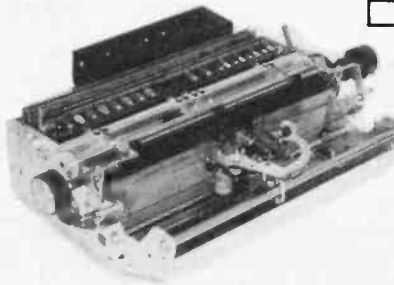

PRINTER (factory warr.) \$1199.00
POWER SUPPLY (Boschert) \$349.00
(shown mounted on rear of printer)
COMBINATION SPECIAL \$1699.00

DATA DISPLAY MONITORS

Used 12" Sylvania monitors. Composite Video, 15 MHz, 120VAC. Re-built with NEW P39 anti-glare tube \$119.00
New P4, 109.00, used P4 79.00.
U-fix model, 10/\$300.00



"OEM STYLE" as above, will fit any case. (Both versions serviced by qualified tech). Identical to above but subtract \$12.00

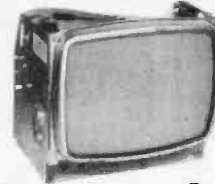

Doppler Motion Sensor Intrusion Detector

Extremely effective microwave motion detector for detecting unwanted visitors. Ignores mice and other non-larcenous creatures. Operates on 12VDC or from small transformer supplied. Output is relay closure for alarm control interface, or to switch on lights annunciators. Will operate THROUGH door of closet or thin wall. Best application seems to be to turn on outside lights to help invited guests, and to intimidate unwanted ones. \$159.00
Water Repellent Cover \$24.95

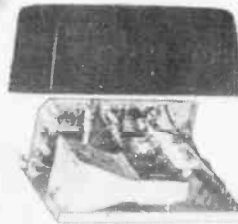

Electrolabs

POB 6721, Stanford, CA 94305
415-321-5601 800-227-8266
Telex: 345567 (Electrolab Pla)
Visa MC Am. Exp.

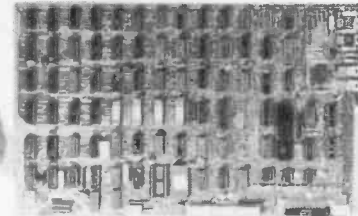

ESAT 200B

BI-LINGUAL 80x24 COMMUNICATING TERMINAL

Scrolling, full cursor, bell, 8x8 matrix, 110 - 19,200 baud, Dual Font Applications. Arabic & Hebrew, Multilingual Data Entry Forms Drawing, Music, & Switchyards. \$349.00

SOCKET SPECIAL



"Won't Let Go"

Low Profile

Solder Tail

1 CENT/ Pin !! (0.75/1000's)

8 14 16 18 20 22 24 28 40

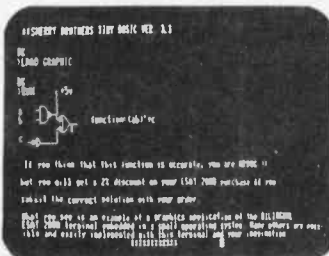

CP/M* Source Code -- FREE! when you purchase "OS-1"

Electrolab's new operating system for the Z-80 designed to have exactly the appearance of UNIX**, including virtual I/O, "set TTY", a tree and a shell, filters and pipes PLUS total compatibility with CP/M software!

OS-1

FEATURES

(Because OS-1 is truly a comprehensive "OS", and not merely a file handling "DOS", we have changed the name from "Superdos" to "OS-1")

VIRTUAL I/O - copy with a single command between floppy and hard disk, or from TTY to printer to tape to disk... etc., etc.

No messy I/O routines to write, & no awkward transfers.

SECURITY - 9 modes of file protection, user and login protection.

MULTI-USER - up to 256 passwords. (non-simultaneous users)

16MBy FILE SIZE - but no limit to no. of directories per device, thus allowing EASY implementation of gigantic storage devices.

"SET TTY" - for printer or crt: tabs, page width, buffer, cursor, UC/LC, fonts, formfeed, arbitrary control characters etc., etc.

"LOGIN" - automatically executes user selected programs and "set TTY".

OCCUPIES 12KBy - only 50% larger than CP/M, but 500% more features.

CP/M & CDOS COMPATABLE - your library is guaranteed to run!

* (Naturally, we are not giving away the version of CP/M written by Digital Research. Please pardon our pun, but they might object. What we ARE giving you is a greatly enhanced version of CP/M which resides on OS-1, and allows the user of OS-1 to run any and all of his programs, packages or system utilities which are already running on CP/M. We give you the source code at no charge so that you may modify any part of the CP/M to suit your own system requirements. At no charge, you also receive the enhancement allowing 4MBy files instead of 256K.)

OS-1 (with debugger, linker and screen oriented editor)	\$199.00
Update service, per year	29.00
Symbolic Debugger	150.00
MACRO-Assembler (Creates relocatable code)	150.00
"C" Compiler	660.00
FORTRAN Compiler	100.00
BASIC Compiler (very fast)	350.00

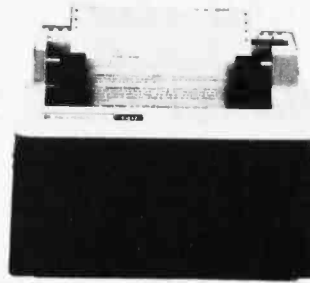

PAPER TIGER

IDS MODEL 440

- 8 Software Selectable Character Sizes
- Parallel & Serial Interface
- 98 ASCII Character set, upper & Lower case
- Forms length control
- Tractor Feed \$995.00
- Graphics option with 2K CRT screen buffer add \$199.00

DYNAMIC DEVICES MODEM

- Acoustically coupled modem assembly set
- Asynchronous 0-300 Baud
- Switchable originate or answer modes
- Operates full or half duplex mode
- 15 minute assembly \$149.95

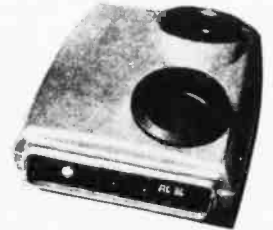

NEW YEAR'S IC SPECTACULAR

(While Supply Lasts)

MEMORY & EPROM

2114-	\$ 3.00	5204	69.00
2114-2	6.99	2708	8.95
Pd411	2.50	2516	35.00
2107 (pull outs)	2.00	2716	35.00

TMS2716	19.00
2732	95.00
CPU	
1802CD	\$19.95
6502	6.25
Z-80	9.95
Z-80A	12.95
8080A	8.99
8085	22.00
8741	79.00

ELECTROLABS

POB 6721 Stanford, CA 94305
415-321-5601 800-227-8266
Telex: 345567 (Electrolab Pla)

FLOPPY CONTROLLERS

1771	\$26.95
1791	37.95
Pd372	39.00

MISCELLANEOUS (CALL US!!)

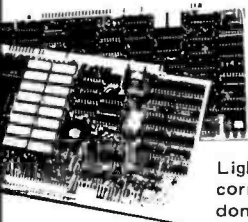

Graphics

High Resolution 480 x 512
for B&W and Color Imaging and Graphics

Light pen, A-D, D-A, TV synchro (needs no time base correction or adjustment with anything between random interface & NTSC commercial standard). T.V. single frame grabber ("snapshot"). Up to 1 Byte of attributions per pixel.

LSI-100 & S-100 applied to:

Graphic Presentation - such as computer generated animation & other graphic displays up to 256 colors & up to 256 b&w gray scales. **Image Analysis** - using built-in FRAME GRABBER, for medical image enhancement, contour analysis, & pattern recognition. **Commercial TV Tilting & Advertising** - using synchronization capability. **Interactive graphics** - using light pen accessory.

BASIC CONFIGURATION -

LSI-11 \$1995. S-100 \$1265.
For TRS-80/Exidy Add \$595.00
Includes: Data Board - 32K (480 x 512 x 1 pixel) D-A 16 level video generator. Video Synchronization Circuitry. Address Control & Timing Board.

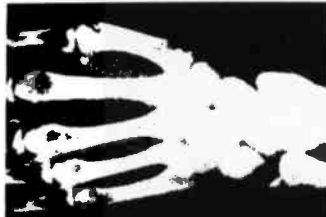

FEATURES - High speed. DMA or 2KBy window memory mapped interface. Full NTSC commercial color capability. Low power consumption. Excellent Software **Options - Accessories - Software**
Options include: light pen, auxiliary outputs, text mode, memory and much more. Accessories include: b&w and color cameras and monitors. Software: "Plot" 2D or 3D, "Tilting", "Contour", "Image Enhancement", "Vector Curve Generation".

Call for price and details

*CPM and **UNIX trademarks of Digital Research and Western Electric respectively.

Circle 206 on inquiry card.

Electrolab's System Switcher Model SP04



Tames

RAW POWER

for the

LSI-11/23

And Hard Disks

FEATURES:

- * Brown-Out Proof
- Line Frequency Indifferent
- Very Low EMI
- U.L. Approved
- 20 KHz
- High Efficiency
- Soft Start
- Extremely Lightweight
- Open Frame Design
- Short Circuit and OV Protection
- 20,000 Hour MTBF (MIL 217B)
- Adaptable to Un-Interruptable Power applications:
- and
- Low Cost!! (just look at DEC's price)

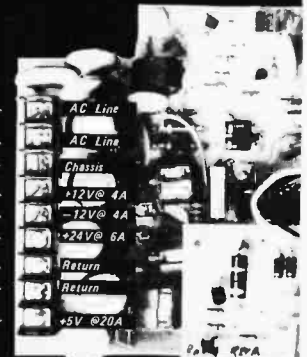

Electrolabs



MATCHMAKER TECHNOLOGY

TURNKEY DISK SUBSYSTEMS

DISK IS IN!!!

For those who wish to avoid the aggravation, fussing, irritation, annoyance etc., of assembling your own subsystem, plug in and GO!!!

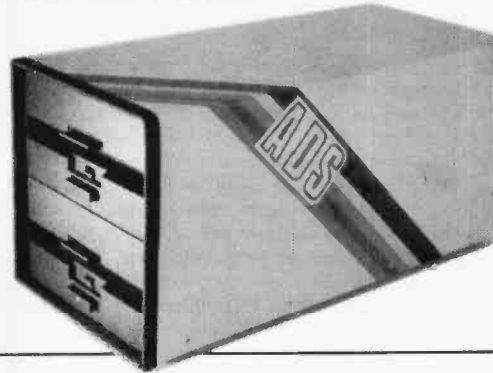

✓ SORCERER

✓ TRS-80

✓ APPLE

✓ HPIB

✓ PET

APPLE

FEATURES:

- 2 8" Floppy DISK DRIVES (Single Sided)
- Color Coordinated Cabinet with Power Supply
- Expanded version of APPLE-DOS
- Single Density Disk Controller
- Full Cabling, Connectors + Documentation
- Assembled and Tested
- Plug In and GO!!!

\$1695.00

OPTIONS:

- 2 8" Double Sided Drives (In place of Single Sided) **\$2395.00**
- 16K Internal Memory Expansion Kit **69.00**

PET

Prices and specifications same as for APPLE except PET Operates via PET-DOS

TRS-80

Prices and specifications same as for SORCERER with following exceptions:

- Expansion Interface necessary
- Space for up to 48K plug-in dynamic memory on Controller Card
- Software package as above **\$ 995.00**

SORCERER

FEATURES:

- 2 8" Single Sided Floppy Disk Drives
- Single and/or Double Density
- Color Coordinated Cabinet with Power Supply
- Full RS-232 Interface
- OS-1 Disk Operating System (Fully CP/M compatible) CP/M is a registered trademark of Digital Research
- Full Cabling, Connectors + Documentation
- Assembled and Tested
- One S-100 Slot available for Memory Expansion
- Plug In and GO!!! **\$2195.00**

OPTIONS:

- 2 8" Double Sided Drives (In place of Single Sided) **\$2845.00**
- 32K Dynamic RAM Memory Board, Assembled and Tested **\$ 299.00**
- 16K Dynamic RAM Internal Memory Expansion Kit **\$ 69.00**
- Deluxe Business Software package includes:
 - C BASIC
 - WORD PROCESSING SOFTWARE
 - INTERACTIVE "Big 4":
 - General Ledger, Accts. Payable, Accts. Rec. and Payroll **\$ 695.00**
- 10 MBY Removeable Hard Disk - Call for Details

ANOTHER Fine Product brought to you exclusively by the folks at:

In California: 415-321-5601
Outside Cal: 800-227-8266

Electrolabs
POB 6721, Stanford, Ca. 94305

Worldwide:
TLX: 345567 Electrolabs PLA

REED RELAY
9 - 15 VOLT D.C. Normally Open
CONTACTS: 1 Amp Max Switch 2 Amps Max Carry
BODY SIZE: Approx. 1 inch long 1/2 inch high

S.P.S.T. 1500 ohm coil \$1.15 each
3.P.S.T. 750 ohm coil \$1.50 each

D.P.S.T. 1200 ohm coil \$1.30 each

LARGE QUANTITIES AVAILABLE

TANTALUM CAPS
1 MFD 35 VDC 20%

5 for \$1.00
Large Quantities Available

22/44 EDGEBOARD CONNECTOR
TIN SOLDER TAIL .156" x .200"

LARGE QUANTITIES AVAILABLE

\$1.35 each 10 for \$12.50

1 1/2 AMP FULL WAVE BRIDGE RECTIFIER
400 PIV
2 for \$1.00

TO-3 HOUSE MARKED DARLINGTON TRANSISTOR
16 Amps 80 Volts
150 Watts
Similar to: MJ4030 PNP
Similar to: MJ4033 PNP
Specify NPN or PNP

C-H D.P.D.T. PRINTED CIRCUIT MINI TOGGLE
14 Amps @ 125 vac
on-on

ALL ELECTRONICS CORP.
905 S. Vermont Ave. • Los Angeles, Calif. 90006
DEPT. BY-1 (213) 380-8000

TERMS
• Quantity Limited
• Min. Order \$10.00
• Add \$1.50 Shipping USA
• Calif. Res. Add 6%
• Prompt Shipping

STORE & WAREHOUSE HOURS
Mon - Fri. 9 AM - 5 PM
Saturday 10 AM - 3 PM

SEND FOR OUR FREE CATALOG

Circle 208 on inquiry card.

MICROLEASE!

A unique nationwide leasing program designed to facilitate the purchase and sale of computers and peripherals.

Whether you are buying or selling, **MICROLEASE** is your best leasing choice.

Excellent Rates. Fast Service by Computer Professionals.

EVERGREEN

22 Concord Avenue
Cambridge, MA 02138
(617) 868-3425

Circle 209 on Inquiry card.

16 K RAMS & RAM CONTROLLERS

16 K X 1 DYNAMIC RAMS MK4116P3
• 200 NSEC ACCESS/375 NSEC CYCLE TIMES
• 16 PIN/TTL COMPATIBLE
• ALL CHIPS BURNED IN AND FULLY TESTED
• PRICE WITH DATA SHEET \$68.00 IN QTY OF 8/T THAT'S \$8.50 EACH

6800/6502 64K BYTE RAM & CONTROLLER SET
MAKE 64K BYTE MEMORY FOR YOUR 6800 OR 6502
THIS SET INCLUDES:
• 32 MSK 4116-3, 16K X 1, 200 NSEC RAMS
• 1 MC3480 MEMORY CONTROLLER
• 1 MC3242A MEMORY ADDRESS MULTIPLEXER AND COUNTER
• DATA & APPLICATION SHEETS. PARTS TESTED AND GUARANTEED.
\$295.00 PER SET

DYNAMIC MEMORY CONTROLLER MC3480L
• GENERATES RAS/CAS & REFRESH TIMING FOR 16K TO 64K BYTE MEMORIES
• PRICE WITH DATA SHEET: \$13.95 EACH

MEMORY ADDRESS MUX/COUNTER MC3242AP
• MUX ADDRESS & REFRESH COUNTER FOR 16K TO 64K BYTE MEMORIES
• PRICE WITH DATA SHEET: \$12.50 EACH

QUANTITY DISCOUNTS AVAILABLE
ALL ORDERS POSTPAID. U.S. FUNDS OR INTERNATIONAL ORDERS CHECK OR MONEY ORDER. VISA/BANK. ALSO ACCEPTED SEND ACC. NO. EXPIRATION DATE & INTERBANK NO. WITH SIGNED ORDER. CALIF. RESIDENTS PLEASE ADD 6% SALES TAX. PHONE ORDERS (714) 633-2460

MEASUREMENT SYSTEMS & CONTROLS, INC.
MEMORY DEVICES DIVISION
867 NORTH MAIN ST., ORANGE, CA 92668

Circle 210 on inquiry card.



APPLE II

8" DISK CONTROLLER

APPLE DOS COMPATIBLE

- DOUBLES APPLE II™ STORAGE
- SHUGART 800/801 COMPATIBLE
- STANDARD IBM™ 3740 FORMAT
- CP/M™, UCSD PASCAL™ CAPABILITY

Available at your local APPLE Dealer: \$400.

SVA SORRENTO VALLEY ASSOCIATES
11722 SORRENTO VALLEY RD.
SAN DIEGO, CA 92121

Circle 211 on inquiry card.

FLOPPY DISK REPAIR

- *PerSci, Shugart Apple*
- *Quick Turnaround*
- *Reasonable prices*

Computer Service Center
1023 N. LaBrea
Hollywood, CA 90038
213-851-2226

Circle 212 on Inquiry card.



SPRINT 68 MICROCOMPUTER

CONTROL COMPUTER DEVELOPMENT SYSTEM

6800 MPU, serial I/O, 48K RAM, dual 8" drives, WIZRD multitasking DOS, Editor, Assembler, 12K BASIC all for \$3995.

SOFTWARE OPTIONS
C compiler, PL/W compiler, PASCAL

HARDWARE OPTIONS
EROM Programmer, analog I/O, parallel I/O, 488 GPIB

WINTERK Corp
1801 South Street
Lafayette, IN 47904
Phone: (317) 742-8428

Circle 213 on inquiry card.

TRS-80, PET, APPLE, SORCERER

Hardware/Software Systems

Available Now:

- **HAM INTERFACE** -- including the most sophisticated RTTY systems money can buy.
- **Baudot and ASCII printer interfaces.**
- **Electra Sketch[®], ANIMATION GRAPHICS Compiler.**

Write or call for free catalog

MACROTRONICS, inc.
1125 N. Golden State Blvd.
Suite G (A) Turlock, CA. 95380
(209) 634-8888/667-2888

We are experiencing telephone difficulties, please keep trying.

Circle 214 on inquiry card.

HOW CAN I GROW B TREES?

ORDER MICRO B +™

- Get fast insertion, retrieval and deletion of index entries.
- Never need to reorganize your index; no matter how often it is updated.

MICRO B+ SOURCE CODE \$195
MICRO B+ DEMO DISK \$25
SHIPPING \$2 USA. \$5 FOREIGN

Available in 8" format for CBASIC-II and MICROSOFT Basic Version 5.

FAIR COM 2606 Johnson Drive
Columbia, Mo. 65201
314-445-3304

Check/VISA/Mastercharge

Circle 215 on Inquiry card.

CASSETTE DUPLICATION

TRS-80 (I & II), PET, APPLE, KIM, ATARI

Quality software duplication is more than copying cassettes. Microsette duplication uses a proprietary high speed duplicator designed specifically for computer program duplication. The finished products are of consistent quality, guaranteed to load. Minimum order is 100 with discounts for higher quantities. Call (415) 968-1604 for details.



MICROSETTE CO.
475 Ellis Street
Mt. View, CA 94043

Circle 216 on Inquiry card.

7400 TTL			
SN7400N	16	SN7470N	.29
SN7401N	18	SN7471N	.25
SN7402N	18	SN7472N	.25
SN7403N	18	SN7473N	.35
SN7404N	18	SN7474N	.50
SN7405N	20	SN7475N	.50
SN7406N	29	SN7476N	.50
SN7407N	29	SN7477N	.50
SN7408N	29	SN7478N	5.00
SN7409N	18	SN7479N	.50
SN7410N	18	SN7480N	.50
SN7411N	25	SN7481N	1.25
SN7412N	25	SN7482N	.25
SN7413N	40	SN7483N	.59
SN7414N	70	SN7484N	.79
SN7415N	25	SN7485N	.79
SN7416N	25	SN7486N	.35
SN7417N	25	SN7487N	1.15
SN7418N	25	SN7488N	.59
SN7419N	40	SN7489N	1.25
SN7420N	25	SN7490N	.45
SN7421N	39	SN7491N	.59
SN7422N	39	SN7492N	.43
SN7423N	25	SN7493N	.65
SN7424N	25	SN7494N	.65
SN7425N	29	SN7495N	.65
SN7426N	29	SN7496N	3.00
SN7427N	25	SN7497N	.65
SN7428N	25	SN7498N	.65
SN7429N	39	SN7499N	.65
SN7430N	20	SN7470N	.29
SN7431N	25	SN7471N	.25
SN7432N	25	SN7472N	.25
SN7433N	25	SN7473N	.35
SN7434N	25	SN7474N	.50
SN7435N	25	SN7475N	.50
SN7436N	25	SN7476N	.50
SN7437N	25	SN7477N	.50
SN7438N	25	SN7478N	5.00
SN7439N	25	SN7479N	.50
SN7440N	20	SN7480N	.50
SN7441N	20	SN7481N	1.25
SN7442N	20	SN7482N	.25
SN7443N	20	SN7483N	.59
SN7444N	20	SN7484N	.79
SN7445N	20	SN7485N	.79
SN7446N	20	SN7486N	.35
SN7447N	20	SN7487N	1.15
SN7448N	20	SN7488N	.59
SN7449N	20	SN7489N	1.25
SN7450N	20	SN7490N	.45
SN7451N	20	SN7491N	.59
SN7452N	20	SN7492N	.43
SN7453N	20	SN7493N	.65
SN7454N	20	SN7494N	.65
SN7455N	20	SN7495N	.65
SN7456N	20	SN7496N	3.00
SN7457N	20	SN7497N	.65
SN7458N	20	SN7498N	.65
SN7459N	20	SN7499N	.65
SN7460N	20	SN7470N	.29



8K Bytesaver II

Memory Capacity: 8K Bytes
Memory Type: 2788 PROM or equivalent
Memory Access Time: 450 nanoseconds
Wait States at 2MHz: none required
Wait States at 4MHz: one per machine cycle
Bus: S-100
Power Requirements: +8V @ 0.8A
 +15V @ 0.2A
 -18V @ 0.4A
Operating Environment: 0-55°C
Assembled

8KBS-W ... \$245.00



TIMEX T1001
LIQUID CRYSTAL DISPLAY
CLASS II
FIELD EFFECT

4 DIGIT - 5 CHARACTERS
THREE FUNCTIONS
2.00" x 1.20" PACKAGE
INCLUDES CONNECTOR

T1001-Transmissive \$7.95
T1001A-Reflective 8.25

TELEPHONE/KEYBOARD CHIPS		
AV-5-9100	Push Button Telephone Dialler	\$14.95
AV-5-9200	Rotary Dialler	14.95
AV-5-9500	CMOS Clock Generator	4.95
KC05-2376	Keypad Encoder (8 keys)	14.95
KC05-16	Keypad Encoder (16 keys)	7.95
KC922	Keypad Encoder (16 keys)	7.95
KC923	Keypad Encoder (20 keys)	5.25
ICM CHIPS		
ICM7045	CMOS Precision Timer	24.95
ICM7205	CMOS LED Stopwatch/Timer	19.95
ICM7207	Oscillator Controller	7.50
ICM7208	Seven Decade Counter	19.95
ICM7209	Clock Generator	6.95
NMOS READ ONLY MEMORIES		
MC16S571	128 X 9 X 7 ASCII Shifted with Greek	13.50
MC16S574	128 X 9 X 7 Math Symbol & Pictures	13.50
MC16S575	128 X 9 X 7 Alpha Control Char Gen	13.50

MISCELLANEOUS		
TL074CN	Quad Low Noise Bi-Et Op Amp	2.49
TL494CN	Switching Regulator	4.49
TL496CP	4-Input Switching Regulator	1.75
11C90	Divide 10/11 Prescaler	19.95
98H90	Hi-Speed Divide 10/11 Prescaler	11.95
4N33	Photo-Darlington Opto-Isolator	3.95
MK5024D	Top Octave Filter Generator	17.50
59M2-2-PM	59M2 CMOS Clock Driver	4.95
TL308	27-Dip 10m. display w/16log. logic chip	10.95
MM5320	Tv Camera Sync. Generator	14.95
MM5330	4 1/2 Digit DPM Logic Block (Special)	21.95
LM1418	1.25% Digital Potentiometer Set	25.00/64
MC1433P	3 1/2 Digit A/D Converter	13.95

LITRONIX ISO-LIT 1
Photo Transistor Opto-Isolator
(Same as MCT 2 or 4N25)
49¢ each

SN 76477
SOUND GENERATOR
Generates Complex Sounds
Low Power - Programmable
\$3.95 each

TV GAME CHIP AND CRYSTAL			
AY-3-8500-1	And 2.01 MHz Crystal (Chip & Crystal includes score display, 6 games and select angles)	7.95/set	
XR205	\$8.40	XR2242CP	1.50
XR210	4.40	XR2264	4.25
XR215	6.40	XR2356	3.20
XR220	1.55	XR2567	2.99
XR230	1.55	XR2600	1.25
XR-L555	5.00	J22206KB	19.95
XR555	.99	XR1800	3.20
XR556	.99	XR2206	4.40
XR567CP	.99	XR2207	4.25
XR567CT	1.25	XR2208	1.50
XR1310P	.95	XR2209	1.75
XR1468CN	3.85	XR2211	5.25
XR1485	1.95	XR2212	3.45
XR1489	1.95	XR2240	3.45

DIODES						
TYPE	VOLTS	PRICE	TYPE	VOLTS	PRICE	
1N745	3.3	400m	4110	1N4004	200 PIV 1 AMP	121.00
1N751	5.1	400m	4110	1N4005	600 PIV 1 AMP	101.00
1N752	5.6	400m	4110	1N4006	800 PIV 1 AMP	101.00
1N753	6.2	400m	4110	1N4007	1000 PIV 1 AMP	101.00
1N754	6.8	400m	4110	1N4350	50 200m	61.00
1N757	9.0	400m	4110	1N4478	75 100m	151.00
1N758	12.0	400m	4110	1N4479	75 100m	121.00
1N959	8.2	400m	4110	1N4733	5.1 1w	28
1N965	15	400m	4110	1N4734	5.6 1w	28
1N932	6.3	500m	28	1N4735	6.2 1w	28
1N5234	6.3	500m	28	1N4736	6.2 1w	28
1N5235	6.8	500m	28	1N4737	6.8 1w	28
1N5236	7.5	500m	28	1N4742	12 1w	28
1N5242	12	500m	28	1N4744	15 1w	28
1N5245	15	500m	28	1N1183	50 PIV 35 AMP	1.60
1N5246	15	500m	28	1N1184	60 PIV 35 AMP	1.60
1N4854	180	7m	5110	1N1185	150 PIV 35 AMP	1.70
1N4854	180	10m	5110	1N1186	200 PIV 35 AMP	1.80
1N4401	50 PIV 1 AMP	121.00	1N1188	400 PIV 35 AMP	1.80	

SCR AND FW BRIDGE RECTIFIERS			
C38D	15A @ 400V	SCR(N1849)	\$1.95
C38M	35A @ 600V	SCR	1.95
2N2328	1.5A @ 300V	SCR	1.95
MCA 980-1	12A @ 50V	FW BRIDGE REC.	1.95
MCA 980-3	12A @ 200V	FW BRIDGE REC.	1.95

TRANSISTORS			
C1061	.50	2N3904	411.00
MPSA05	.20	2N3905	411.00
MPSA06	511.00	2N3905	411.00
1N518	511.00	2N3905	411.00
1N519	611.00	2N3905	411.00
40A09	1.75	PN3567	311.00
40A10	1.75	PN3568	411.00
40B23	1.75	PN3569	311.00
2N918	411.00	PN3570	411.00
2N2219A	211.00	MPS3702	511.00
2N2221A	411.00	2N4374	511.00
2N2222A	511.00	MPS3704	511.00
PN2222C Plastic	711.00	2N3756	511.00
2N3934	511.00	MPS3705	511.00
2N3936A	511.00	2N3757	511.00
2N4848	411.00	MPS3706	511.00
2N2906	411.00	2N3707	511.00
PN2207	511.00	2N3708	511.00
PN2207A Plastic	711.00	2N3724A	511.00
2N4848	411.00	2N3725	511.00
2N3904	411.00	2N3726	511.00
2N3905	411.00	2N3727	511.00
MJ2955	1.25	2N3728	2.25
2N3903	211.00	2N3923	2.25
2N3904	211.00	2N3924	311.00

CAPACITOR						
MINIATURE ALUMINUM ELECTROLYTIC CAPACITORS	Radial Lead					
10µf	1.5	10-10-39	100	1.9	10-99-100	
22µf	0.5	04	.001µf	05	04	
47µf	0.05	04	0.03	04	035	
100µf	0.05	04	0.03	022µf	05	
220µf	0.05	04	0.03	017µf	06	
470µf	0.05	04	0.03	012µf	05	
10VOLT MYLAR FILM CAPACITORS						
.001mf	12	10	07	022mf	13	
.0022	12	10	07	010mf	21	
.0047	12	10	07	07mf	27	
.01mf	12	10	07	22mf	33	
+20% DIPPED TANTALUM (SOLID) CAPACITORS						
1.35V	28	23	17	5.0V/25V	30	
2.25V	28	23	17	2.25V/5V	31	
13.5V	28	23	17	3.25V/5V	31	
33V	28	23	17	4.75V/5V	31	
47.5V	28	23	17	6.8V/5V	31	
68.5V	28	23	17	15.25V/5V	31	
1.035V	28	23	17	22V/5V	31	
MINIATURE ALUMINUM ELECTROLYTIC CAPACITORS						
4750µf	15	13	10	47.5V/50	15	
10050µf	16	14	11	47.5V/50	16	
3.350V	14	12	09	1015V/50	15	
4.75V/50	15	13	10	1.05V/50	16	
1015V/50	15	13	10	1.05V/50	16	
1015V/50	12	10	07	1.05V/50	16	
22.25V	17	15	12	4.75V/50	15	
22.25V	24	20	18	10.5V/50	16	
100/25V	19	17	15	1015V/50	14	
220/25V	25	21	19	1015V/50	15	
1000/50V	35	30	28	47.5V/50	24	
2200/50V	32	28	25	1015V/50	19	
1000/25V	45	41	38	47.5V/50	15	
470/25V	33	29	27	100/50V	35	
1000/16V	35	30	27	220/16V	23	
2200/16V	30	25	25	470/25V	31	

DISCRETE LEADS						
XC556R	red	5/51	.126" dia.	XC209R	red	4/51
XC556G	green	4/51		XC209G	green	4/51
XC556Y	yellow	4/51		XC209Y	yellow	4/51
XC556C	clear	4/51				
200" dia.						
XC22R	red	4/51	.185" dia.	XC256R	red	5/51
XC22G	green	4/51		XC256G	green	4/51
XC22Y	yellow	4/51		XC256Y	yellow	4/51
XC22C	clear	4/51		XC256C	clear	4/51
MV10B	170" dia.	4/51				
MV50	.085" dia.	6/51	.190" dia.	XC111R	red	5/51
				XC111Y	yellow	4/51
				XC111C	clear	4/51

RCA LINEAR			
CA3012	2.15	CA3028N	2.00
CA3023T	2.56	CA3038N	1.60
CA3035T	2.48	CA3038A	.85
CA3039T	1.35	CA3039N	3.75
CA3040N	1.30	CA3041N	1.39
CA3059N	3.25	CA3140T	1.25
CA3060N	3.25	CA3160T	1.25
CA3080T	85	CA3141N	59
CA3081N	2.00	CA3009N	3.01
IC SOLDERABLE - LOW PROFILE (TIN) SOCKETS			
50-100			
8 pin LP	.517	16	15
14 pin LP	.22	21	.20
18 pin LP	.29	27	.27
20 pin LP	.34	32	.30
14 pin ST	\$.27	25	.24
16 pin ST	.30	27	.25
18 pin ST	.35	32	.30
24 pin ST	.49	45	.42
8 pin SG	\$.30	.27	.24
14 pin SG	.35	.32	.29
18 pin SG	.38	.35	.32
18 pin SG	.52	.47	.43
50-100			
8 pin WW</			

One-Stop Component Center

AUTHORIZED DISTRIBUTORS

ALABAMA Crapwell Huntsville Mobile ALASKA Anchorage Anchorage Flagstaff Sierra Vista Yuma ARKANSAS Little Rock CALIFORNIA Anaheim Azusa Bellflower Berkeley Brea Buena Park Chula Vista Cypress Davis El Monte Fontana Fresno Glendale Harbor City Hawaiian Gardens Hollywood La Habra Lancaster Long Beach Mission Viejo Modesto Monterey Morro Bay National City Oceanside Oxnard Palmdale Palo Alto Palo Alto Pasadena Paso Robles Redding Sacramento Sacramento San Carlos San Diego San Diego San Fernando San Francisco San Jose San Jose San Luis Obispo San Rafael Santa Barbara Santa Cruz Santa Fe Springs Santa Maria Santa Rosa South Lake Tahoe Suisun City Sunnysvale Torrance Torrance Vacaville Vallejo Van Nuys Walnut Creek Westminster Whittier Whittier COLORADO Aurora Colorado Springs Denver Denver CONNECTICUT Avon Bridgeport Milford New Haven Westport DELAWARE New Castle FLORIDA Ft. Lauderdale Gainesville Hialeah Lakeland Lakeland Miami Miami Oakland Park Orlando Panama City Pensacola Tampa Tampa	Tucker Bros. Industrial Electronic Supply Lafayette Radio Electronics The Electronic Company TV Mart Jim's Audio & Stereo Repair B & S Electronics Yuma Electronics Southern Electronics Company Heathkit Electronic Center Amco Electronics Earl's Hobby Shop Al Lasher Electronics Century Electronics Ford Electronics S.J. Electronics Lion Electronics SCR Electronics Paradyne Consumer Electronics Kimball & Stark Fontana Electronics Sparky Electronics Eagle Electronics Buff's Electronics Carson Electronics Pacific Radio Exchange A.B.C. Electronics Consumer Electronics Scott Radio Supply Inc. Tower Electronics Corp. Computer Magic Pacific Radio Zackit Coast Electronics Willy's Electronics Electronic Center Dow Radio Radio Shack A.S.C. Palmdale U.S. Electronics Zack Electronics Dow Radio Inc. Mission Electronics Radio Mart Heathkit Electronic Center Zackit Salinas Radio J&H Outlet Store Radio Shack A.S.C. Mira Mesa Byte Shop San Fernando Electronics Zack Electronics Peninsula Electronic Supply Inc. United Radio & TV Supply Mid-State Electronic Supply Electronics Plus Lombard Electronics Santa Cruz Electronics Industrial Electronics Cap's Communications Electronics Inc. CalPine Electronics Byte Shop Sunnysvale Electronics SE Electronics Torrance Electronics D.C. Electronics Zackit Thrifty Electronics Supply Inc. MicroSun Computer Center JK Electronics D & S Electronics Whittier Electronics Company Aurora Electronics Centennial Electronics Inc. Amptec Inc. Mt. Coin Distributing Co. Heathkit Electronic Center Bridgeport Computer Daz Electronics Customized Computer Systems Computerworks Delaware Amateur Supply Computers For You Lafayette Radio Heathkit Electronic Center Lakeland Specialty Electronics Herman Electronics N & G Distributors Lafayette Radio Southeast Micro-Data Corp. Bay-Mar Electronics Inc. Grice Electronics Inc. AMF Electronics Microcomputer Systems	GEORGIA Atlanta Atlanta Columbus Stone Mountain HAWAII Aiea Honolulu IDAHO Boise Caldwell ILLINOIS Carbondale Decatur Evanston Groveland Mount Prospect Niles Normal Peoria Peoria Rockford Schaumburg Schaumburg Skokie Villa Park INDIANA East Chicago Evansville Gary IOWA Ames Clinton Davenport Des Moines Des Moines KANSAS Hutchinson Hutchinson Kansas City Mission Salina Wichita KENTUCKY Lexington Louisville Richmond LOUISIANA Baton Rouge Baton Rouge Baton Rouge Houma Lake Charles Metairie New Orleans MARYLAND Annapolis Baltimore Baltimore Baltimore Churchville Damascus Frederick Glen Burnie Hagerstown La Vale Rockville Rockville Silver Spring Towson Towson Towson Towson MASSACHUSETTS Peabody Pittsfield Waltham Wellesley Worcester MICHIGAN Adrian Ann Arbor Ann Arbor Bay City Canton Clawson Detroit East Detroit East Lansing Flint Flint Garden City Grand Rapids Grand Rapids Grand Rapids Jackson Lansing Livonia Livonia Midland Milan Muskegon Niles Oak Park	Atlanta Computer Mart CompuShop Radio Wholesale Coleman's Electronics Delcoms Hawaii Integrated Circuit Supply Custom Electronics A-Gem Supply Inc. Picks Electronics Main Street Computer Co. Tri-State Electronic Corp. Moyer Electronics Tri-State Electronic Corp. Computer Land B-N Computer Works Computer Land of Peoria Warren Radio Co. Computer Store of Rockford Data Domain of Schaumburg Lifegate Computer Melvin Electronics Acro Electronics Corp. Hutch & Son Inc. Allmet Electronic Supply Electronic Supply Inc. Bridge Electronics Computer Center Memory Bank Gifford Brown Incorporated Radio Trade Supply Co. Hutchinson Electronics Electronic Supplis Sales Heathkit Electronic Center Electronics Inc. Amateur Radio Equipment Co. Radio Electronic Equipment Co. Peerless Electronic Equipment Co. Madison County Electronics Davis Electronics Supply Co. Menard Electronics Inc. Pelican Electronics Pelican Electronics Pelican Electronics Wm. B. Allen Supply Co. J & B Electronics Inc. American Distributing Co. Everything Electronic Harco Electronics Tritronics Inc. Churchville Electronics Damascus CB Frederick Computer Products Inc. Revacto Custom Computing Inc. J & M Electronics Computer Workshop Heathkit Electronic Center Computers Etc. Baynesville Electronic Inc. Computers, Etc. Computers Unlimited Heathkit Electronic Center Heathkit Electronic Center Pittsfield Radio Co. Inc. Computer Mart Inc. Heathkit Electronic Center RM Electronics Inc. E & B Electronics Inc. Lafayette Radio Kinde Distributing Company The Electronic Connection Radio Supply & Engineering Co. Heathkit Electronic Center Heathkit Electronic Center Lafayette Radio Hobby Electronic Center Shand Electronics Inc. Computer Center Micro Computer World Radio Parts Inc. Warren Radio Company Fulton Radio Supply Co. Fulton Radio Supply Co. Lafayette Radio Radio Supply & Engineering Co. Inc. Computronix Corporation C & S Electronics Mart Ltd. H.R. Electronics Niles Radio Supply Lafayette Radio	MICHIGAN (Continued) Pontiac Port Huron Saginaw Saginaw Sterling Heights Traverse City Traverse City MINNESOTA Duluth Hopkins Minneapolis St. Paul Winona MISSOURI Bridgeton El Dorado Springs Florissant MONTANA Billings Bozeman Great Falls NEBRASKA Lincoln Lincoln North Platte Omaha Omaha NEVADA Las Vegas NEW JERSEY Cherry Hill Fall Lawn Ocean Pensauken Pompton Lakes Ramsey Vineland NEW MEXICO Farmington NEW YORK Albany Albany Albany Bloomington Buffalo Cortland Endwell Ithaca Jamestown Jericho Kingston Kingston Middletown Newburgh New York New York Orchard Park Poughkeepsie North White Plains Rensselaer Rochester Troy Utica Vestal Wappingers Falls White Plains NORTH CAROLINA Greensboro Morhead City Raleigh NORTH DAKOTA Fargo Fargo OHIO Bucyrus Cincinnati Columbus Reynoldsburg Toledo Wickliffe Youngstown OKLAHOMA Oklahoma City Oklahoma City Oklahoma City Tulsa OREGON Albany Beverton Corvallis Eugene Eugene Ontario Portland Salem Salem PENNSYLVANIA Bradock Chambersburg Drexel Hill Drums Erie Paoli	Electronic Supply Main TV Radio Electronics Electronic Mart Bell Electronics Lafayette Radio Traverse City Electronic Supply Northwest Radio of Duluth Inc. Heathkit Electronic Center Pal Electronics Heathkit Electronic Center Hiwatha Electronics Inc. Forsythe Computers Beckman Electronics Computer Country Conley Radio Supply Electronic Service & Distributing Inc. Arts Electronics Altair Computer Center Scott Electronic Supply Inc. Scott Electronic Supply Corp. Heathkit Electronic Center Omaha Computer Store Century 23 The Computer Emporium Heathkit Electronic Center Heathkit Electronic Center Lafayette Radio Computer Corner Typetronic Computer Store Lafayette Radio Electronics Micro-Computer Service Fort Orange Electronics Action Audio Inc. Greylock Electronics Stansifer Radio Co. Inc. Radio Equipment Corp. Action Audio Inc. Computer Tree Inc. Action Audio Inc. Warren Radio Heathkit Electronic Center Action Audio Inc. Greylock Electronics Action Audio Inc. Action Audio Inc. Aristo Craft Manhattan Electronics Corp. Radio Equipment Corp. Action Audio Inc. Greylock Electronics Heathkit Electronic Center Com-Tech Electronics Heathkit Electronic Center Trojan Electronics Am-Com Electronics Harvey Electronics Action Audio Inc. The Computer Corner Pair Electronics Baer Electronic Systems Byte Shop of Raleigh The Computer Company S & S Electronics Mead Electronics Heathkit Electronic Center Heathkit Electronic Center Universal Amateur Radio Heathkit Electronic Center Amateur Electronic Supply Ross Radio Company Bits, Bytes & Micras Heathkit Electronic Center Trice Wholesale Electronics High Technology Oregon Ham Sales Norvay Electronics Zero-Gee Books Eugene Amateur Radio Supply Miller Electronics Portland Radio Supply Comm-Shack Computer Pathways Leff Electronics Sunrise Electronic Distributing Kass Electronics Distributors Mr. D's Digital Electronics Warren Radio Personal Computer Corporation	PENNSYLVANIA (Continued) Philadelphia Philadelphia Phoenixville Pittsburgh Pittsburgh Wilkes Barre York RHODE ISLAND Cranston Pawtucket Warwick TENNESSEE Clarksville Cookeville Nashville Knoxville Memphis Memphis Memphis Nashville Oakridge Tullahoma TEXAS Beaumont Dallas Dallas Dallas Fort Worth Houston McAllen McAllen San Antonio San Antonio UTAH Midvale Provo Salt Lake City Salt Lake City VERMONT Essex Junction VIRGINIA Alexandria Alexandria Arlington Blacksburg Charlottesville Colonial Heights Falls Church Hampton McLean Norfolk Norfolk Portsmouth Richmond Vienna Virginia Beach Warrenton WASHINGTON Bellevue Everett Kennewick Longview Moses Lake Pasco Richland Seattle Seattle Seattle Spokane Tacoma Tacoma WEST VIRGINIA Morgantown Morgantown Wheeling WISCONSIN West Allis CANADA Albarta Calgary British Columbia: Prince George Vancouver Vancouver Ontario: Toronto Toronto ENGLAND Berkshire GLAM PANAMA Panama City Panama City SINGAPORE SINGAPORE SINGAPORE SINGAPORE Stockholm Umea WEST INDIES Port of Spain, Trinidad	Heathkit Electronic Center Resco Electronics (Market St.) Stevens Electronics Heathkit Electronic Center Tydings Company Hamline Electronics G.Y.C. Company Jabbour Electronics City Jabbour Electronics City Heathkit Electronic Center Masronics Wagon's Stereo Center Electra Distributing Co. Shields Electronics Supply Inc. Bluff City Electronics Sere-Rose & Spencer Electronics Warren Radio Company Eddie Warner's Parts Company National Electronics H & H Electronics Co. Inc. Electro-Hut CompuShop Heathkit Electronic Center Ram Micro Systems The Ingenuity Concept Interactive Computers Broadway Electronics Carlos Franco Electronics Appliance & Equipment Co. Sherman Electronics Supply Inc. Heathkit Electronic Center Alpine Electronic Supply Co. Best Distributing Computerland of Salt Lake Lafayette Radio Computers Plus Inc. Heathkit Electronic Center Arlington Electronic Wholesalers Scotty's Radio & TV Inc. Graves Electronics Southside Radio Comm. Crossroad Electronics Electronic Sales Inc. Tyson's Computer Emporium Avec Electronics Corp. Prest Electronics Electronics Unlimited Avec Electronics Corp. Electronic Equipment Bank Heathkit Electronic Center Radio Shack ABC Communications ABC Communications C & J Electronics Inc. Progress Electronics Ron's Electronics Riverview Electronics C & J Electronics ABC Communications Amateur Radio Supply Empire Electronics Personal Computers C & G Electronics Northwest Radio Supply The Computer Corner Electro Distributing Co. Inc. Lafayette Radio Associate Store Olson Electronics CompuShop Alberta Ltd. Elwest Technical Services Ltd. CompuShop House of Computers NewBear Computing Store Marianas Electronics Sonitel, S.A. Tropelco, S.A. Applied Digital System Inter-Trade (P.T.E.) Ltd. Sys-Tech LSI Electronics HB Interkomponent The Hobby Center
--	--	---	---	---	--	---	---

For Distributor Information, write or phone JIM-PAK[®], 1355 Shoreway Road, Belmont, CA 94002 (415) 592-8097

Function Generator Kit

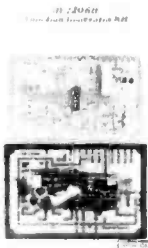

Provides three basic waveforms: sine, triangle and square wave. Frequency range from 1 Hz to 100K Hz. Output amplitude from 0 volts to over 6 volts (peak to peak). Uses a 12V supply or a ±6V split supply. Includes chip, P.C. Board, components & instructions.

JE2206B \$19.95

Digital Thermometer Kit



Dual sensors — switching control for indoor/outdoor or dual monitoring. Continuous LED .8" ht. display. Range: -40°F to 199°F / -40°C to 100°C. Accuracy ±1° nominal. Set for Fahrenheit or Celsius. Simulated walnut case. AC wall adapter included. Size: 3¼" h x 6-5/8" w x 1-3/8" d.

JE300 \$39.95

Digital Stopwatch Kit



Use Intersil 7205 Chip. Plated thru double-sided P.C. Board. Red LED display. Times to 59 minutes, 59.59 seconds with auto reset. Quartz crystal controlled. Three stopwatches in one: single event, split (cumulative) and taylor (sequential timing). Uses 3 penlite batteries.

Size: 4.5" x 2.15" x .90"

JE900 \$39.95

4-Digit Clock Kit



Bright .357" ht. red display. Sequential flashing colon. 12 or 24 hour operation. Black extruded aluminum case. Pressure switches for hours, minutes and hold functions. Includes all components, case and wall transformer. Size: 3¼" x 1¼" x 1¼"

JE730 \$14.95

6-Digit Clock Kit



Bright .300 ht. common cathode display. Uses MM-5314 clock chip. Switches for hours, minutes and hold functions. Hours easily viewable to 20 ft. Simulated walnut case. 115VAC operation. 12 or 24 hour operation. Includes all components, case and wall transformer. Size: 6¼" x 3-1/8" x 1¼"

JE701 \$19.95

Jumbo 6-Digit Clock Kit



Four .630" ht. and two .300" ht. comm. anode displays. Uses MM5314 clock chip. Switches for hrs., mins., and hold functions. Hours viewable to 30 ft. Sim. walnut case. 115VAC operation. 12 or 24 hour operation. Incl. all components, case and wall transformer. Size: 6¼" x 3-1/8" x 1¼"

JE747 \$29.95

Regulated Power Supply Kit



Uses LM309K. Heat sink provided. PC board construction. Provides solid 1 amp @ 5 volts. Includes components, hardware & instructions. Size: 3½" x 5" x 2" h

JE200 \$14.95

Multi-Voltage Board Kit



ADAPTS TO JE200
SUPPLIES ±5V, ±9V and ±12V
Independent load rating at single terminal. ±12V: 160mA, ±9V: 200 mA, -5V: 250mA. DC/DC converter with +5V input. Toroidal hi-speed switching XMFR. Short circuit protection. PC board construction. Piggy-back to JE200 board. Size: 3¼" x 2" x 9/16" h

JE205 \$12.95

Variable Power Supply Kit



Full 1.5 amp @ 5-10V output. Up to .5 amp @ 15V output. Heavy duty transformer. Three-terminal I.C. voltage regulator. Heat sink provided for cooling efficiency. PC board construction. 120VAC input. Size: 3½" x 5" x 2" h

JE210 \$19.95

62-Key ASCII Encoded Keyboard Kit



The JE610 ASCII KEYBOARD KIT can be interfaced into most any computer system. The JE610 kit comes complete with an industrial grade keyboard switch assembly (62-keys), IC's, sockets, connector, electronic components and a double-sided printed wiring board. The keyboard assembly requires +5V @ 150mA and -12V @ 10mA for operation. Features: 60 keys generate the full 128 characters, upper and lower case ASCII set. Fully buffered. Two user-define keys provided for custom applications. Caps lock for upper case-only alpha characters. Utilizes a 2376 (40-pin) encoder read-only memory chip. Outputs directly compatible with TTL/DTL or MOS logic arrays. Easy interfacing with a 16-pin dip or 18-pin edge connector.

JE610 \$79.95

Hexadecimal Encoder Kit

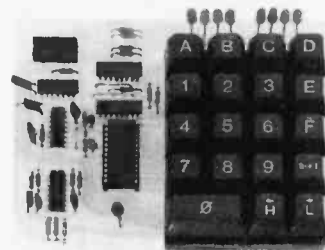

FULL 8-BIT LATCHED OUTPUT — 19-KEY KEYBOARD

The JE600 ENCODER KEYBOARD provides two separate hexadecimal digits produced from sequential key entries to allow direct programming for 8-bit microprocessor or 8-bit memory circuits. Three (3) additional keys are provided for user operations with one having a bistable output available. The outputs are latched and monitored with 9 LED readouts. Also included is a key entry strobe. Features: Full 8-bit latched output for microprocessor use. Three user-define keys with one being bistable operation. Debounce circuit provided for all 19 keys. 9 LED readouts to verify entries. Easy interfacing with standard 16-pin IC connector. Only +5VDC required for operation.

JE600 \$59.95

(Prices Subject To Change)

SD EXPANDORAM *The Ultimate S-100 Memory*

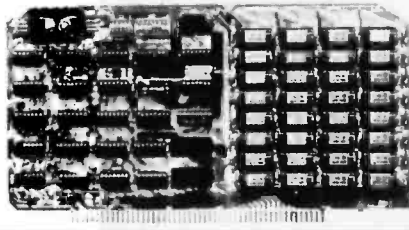

EXPANDO 64 KIT (4116)	List Price	Sale Price
16K ..	\$385.00	\$239.00
32K ..	\$550.00	\$309.00
48K ..	\$715.00	\$379.00
64K ..	\$880.00	\$449.00

The EXPANDORAM is available in versions from 16K up to 64K, so for a minimum investment you can have a memory system that will grow with your needs. This is a dynamic memory with the invisible on-board refresh, and IT WORKS!

- Interfaces with Altair, IMSAI, SOL-8, Cromemco, SBC-100, and others.
- Bank Selectable
- Phantom Power 8VDC, ± 16VDC, 5 Watts
- Lowest Cost Per Bit
- Uses Popular 4116 RAMS
- PC Board is double sided solder masked and has silk-screen parts layout.
- Extensive documentation clearly written
- Complete Kit includes all Sockets for 64K
- Memory access time: 375ns, Cycle time: 500ns.
- No wait states required
- 16K boundaries and Protection via Dip Switches
- Designed to work with Z-80, 8080, 8050 CPU's

DISC DRIVES



SHUGART SA 400 5 1/4"
 512KB 3.5 inch
 SHUGART SA 400
 with attractive metal case with
 built-in Data Cable Lock
 Top and Bottom cover
 1050 SA400C \$135.00
 SHUGART SA400
 512KB 3.5 inch
 Authorized Dealer & Guaranteed
 1050 SA400C \$135.00
 SHUGART SA400
 512KB 3.5 inch
 8 1/2 inch floppy or cassette
 drive, head or soft sector, auto
 format and more
 SHUGART 8018 \$450.00
 Capacity 100,000
 double sided double density
 \$890.00

DISC CONTROLLER
SD "VERSAFLOPPY" KIT
 The Versatile Floppy Disk
 Controller List Price
\$250.00
SALE PRICE
\$189.95

SHOP & COMPARE SPECIAL



M-XVI
 The true 16K Static Ram module
 for S-100 bus systems.
 ASSEMBLED & TESTED - 100% BURN IN
 The M-XVI gives you unbelievable expansion
 capability for your S-100 bus system - even beyond
 64K. Manufactured to the highest industry stan-
 dards documented and designed to make
 assembly, use, and programming a snap. The
 M-XVI board is a true revolution for the serious
 hobbyist and use in practical business or in-
 dustrial applications.

	Reg.	Sale Priced
2016BA 450ns 2MHz	\$349.95	\$295.00
2016BB 300ns 4MHz	\$389.95	\$329.00
2016BY Bare Board only		\$29.95



VERSAFLOPPY II DOUBLE DENSITY, DOUBLE SIDED, DISC CONTROLLER

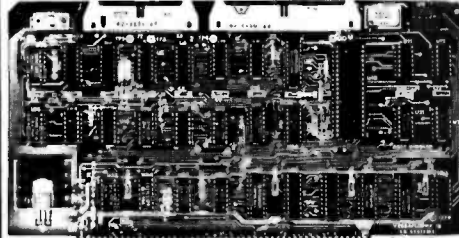

SDS-VERSAFLOPPY II KIT List Price **\$350.00** Sale Price **\$325.95**

GENERAL DESCRIPTION:
 Versafloppy II is a flexible disk drive
 controller that incorporates a wide
 range of capabilities into one board. It
 operates with double density soft sec-
 tored format which provides 985,800
 bytes of storage on a double sided 8
 inch diskette and 129,920 bytes per
 side on a five inch mini-diskette. The
 Versafloppy II directly controls many
 popular disk drives. These include:
 Shugart SA400 and SA450, Shugart
 SA800 and SA850, Mayflower MF500
 and MF700, Per Set 70 and 272, and
 Siemens, BSI 105.

- S-100 Bus IEEE Standard Compatible
- IBM-3740 Compatible Soft Sector Format for Single Density Drives
- Operates with both Standard (8") and Mini (5") Drives Simultaneously
- Provides Control for Double Sided Operation
- Operates with Z80, 8080, and 8085
- Central Processing Unit
- Controls up to four drives
- Vectored Interrupt Operation Optional
- Control and Diagnostic Software Available in PROM
- SDOS Disk Operating System Compatible

THE MICROBYTE M32KSS 32K STATIC MEMORY BOARD ASSEMBLED & TESTED SAVE \$120.00

- Fully S100 Bus Compatible, IMSAI, SOL, ALTAIR, ALPHA MICRO, • Uses National's Low Power 5257 4K x 1 Static Rams. • 2 MHz or 4MHz operation. • Gold contacts for higher reliability. • On board single 5 amp regulator. • On board single 5 amp regulator. • Thermally designed heat sink board operating temperature (70°C). • Commercially designed power bus, 7 ground bus bars, 0.1 uf of decoupling capacitors. • Fully tri-state buffered. • Inputs fully low power Shottky Schmitt. Trigger buffered on all address and data lines. • Phantom Its jumper selectable to pin 67.
- Each 4K hardware or software selectable. • One on board 8-bit output port enables or disables the 32K in 4K blocks. • Selectable port address. • 4K banks can be selected or disabled on power on clear or reset. • Will operate with or without front panel. • Compatible with ALPHA MICRO, with extended memory management for selection beyond 64K. • No DMA restriction. • Low power consumption 2.3 - 2.5 amps. • Fully warranted for 120 days from date of shipment.

ASSEMBLED & TESTED SHIPPING WEIGHT 2 lbs.

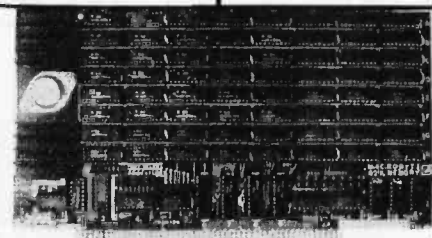

M32 KSS-H (4 MHz)
 List \$680
SALE \$560.00

M32 KSS-L (2 MHz)
 List \$650
SALE \$530.00

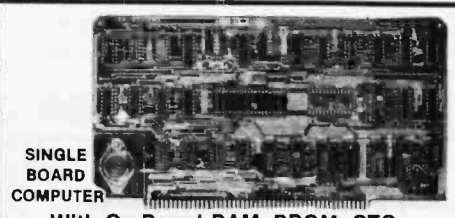

SINGLE BOARD COMPUTER
 With On-Board RAM, PROM, CTC

- S-100 Bus Compatible
- Z80 Central Processing Unit
- 1024 Bytes of Random Access Memory
- 8K Bytes of PROM using 2716
- Parallel Input and Output Ports
- Four Channel Counter/Timer (Z80-CTC)
- Software Programmable Baud Rate Generator
- No Front Panel Required for Operation

	List Price	Sale Price
SDS-SBC-100 2MHZ KIT	\$295.00	\$249.95
SDS-SBC-200 4MHZ KIT	\$320.00	\$289.95

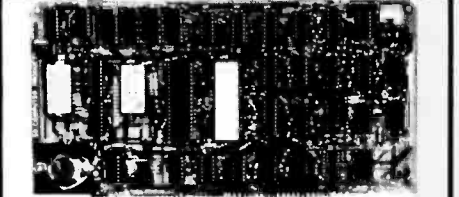

VDB-8024 VIDEO DISPLAY BOARD
 With on-board Z80 Microprocessor

- S-100 bus Compatible
- Full 80 Characters by 24 Lines Display
- Characters Displayed by High Resolution 7 x 10 Matrix
- Composite of TTL Video Output
- Keyboard Power and Interface
- Forward and Reverse Scrolling Capability
- Blinking, Underlining, Field Reverse, Field Protect and Combinations
- Full Cursor Control
- 96 Upper and Lower Case Characters
- 32 Special Character Set
- 128 Additional User Programmable Characters (Optional)
- On-Board Z80 Microprocessor
- 2K Bytes Independent On-Board RAM Memory
- Glitch-Free Display

	List Price	Sale Price
SDS-VDB-8024 KIT	\$370.00	\$329.95



PROM-100
 Programming Board
 for PROM Development
NEW

SD SYSTEMS' PROM-100 is a versatile PROM programming board offering complete EPROM programming capability. The board operates on the industry standard S-100 Bus. Support software verifies the erasure of EPROM and verifies the loaded program. SD SYSTEMS' PROM-100 offers a support software listing with its operations manual.

- S-100 Bus Compatible
- Programs the Following EPROM s: 2708, Intel 2758, 2716, 2732 and Texas Instruments 2516
- Dip Switch Selection of EPROM type
- 25 VDC Programming Pulse Generated On Board
- Maximum Programming time: 16,384 Bits in 100 Seconds
- Power Requirement: + 8VDC at 300 ma.; + 16 VDC at 100 ma.; - 16 VDC at 60 ma.
- TTL compatible
- Software Provides for Reading of Object File from SDOS, CP/M or PROM and Programming Into EPROM
- Program Verification • Verification of Erasure
- Zero Insertion Force Socket

	List Price	Sale Price
SDS-PROM-100 KIT	\$200.00	\$175.00

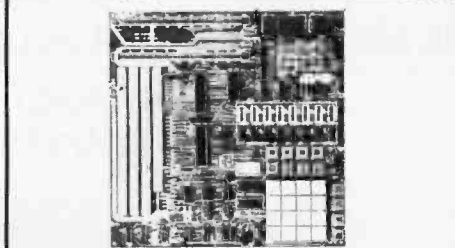

Z80 STARTER KIT
 A Complete Microcomputer On A Board

- Z80 CPU with 158 Instructions
- On-Board Keyboard and Display
- On-Board PROM Programmer for Single Voltage PROMS (2716, 2758, TI2516)
- Kansas City Standard Cassette Interface
- Simple Key Controlled Audio Cassette Load and Dump
- Expansion Provision for Mounting Two S-100 Connectors (Sockets Not Included)
- Wire Wrap Area for Custom Circuitry
- Single Step through RAM or PROM
- Memory Examine and Change
- Port Examine and Change
- Z80 CPU Register and Change
- 2K Byte ZBUG Monitor in ROM
- 1K Bytes of RAM (Expandable to 2K Bytes)
- A 4 Channel Hardware Counter/Timer (Z80-CTC)
- Two Bi-Directional 8-Bit I/O Ports (Z80-P10)
- Up to 5 Programmable Breakpoints
- Switch Selectable PROM or Monitor Restart
- Vectored Interrupts provided by Z80-CTC and

	List Price	Sale Price
SDS-Z80 STARTER KIT	\$340.00	\$279.95

PRIORITY ONE ELECTRONICS
 16723K Roscoe Blvd. Sepulveda, CA 91343
 Terms: Visa, MC, BAC, Check, Money Order, C.O.D. U.S. Funds Only. CA residents add 6% sales tax.
 Minimum order \$10.00 Prepaid U.S. orders less than \$75.00 include 5% shipping and handling.
 MINIMUM \$2.50. Excess refunded. Just in case... please include your phone no.
 Prices subject to change without notice.
 We will do our best to maintain prices thru Feb. 1980
 phone orders welcome (213) 894-8171, (800) 423-5633
 OEM and Institutional Inquiries Invited.

800-423-5633
EXCEPT CA, AK, HI.
 (213) 894-8171

SEE OUR 52 PAGE AD IN JANUARY BYTE

SEE OUR 52 PAGE AD IN JANUARY BYTE

4 MHZ EXPANDORAM II KIT

The S-100 Memory Board for the 80's

SD SYSTEMS' ExpandoRAM II is a state-of-the-art dynamic RAM board with capacities from 16K bytes (4116) to 256K bytes (4164). It operates on the industry S-100 Bus. The ExpandoRAM II's design allows eight boards to operate from the same S-100 Bus. Page mode operation provides the system with the capability of servicing multiple users without RAM interference. Invisible refresh and synchronization with wait states provide greater reliability, and processing speeds up to 4 Mhz.

The ExpandoRAM II is compatible with most S-100 CPU's based on the Z80 microprocessor. When other SD SYSTEMS 200 series boards are combined with the ExpandoRAM II, they create a microcomputer with exceptional capabilities and features.

- S-100 Bus Compatible
- Up to 4Mhz Operation
- Expandable Memory from 16K to 256K
- DIP Switch Selectable Boundaries
- Uses 16K (4115) or 64K (4164) Memory Devices
- Page Mode Operation Allows up to 8 Memory Boards on Bus
- Operates with Z80 CPU's
- Phantom Output Disable
- Invisible Refresh (Synchronized with Wait States)

NEW

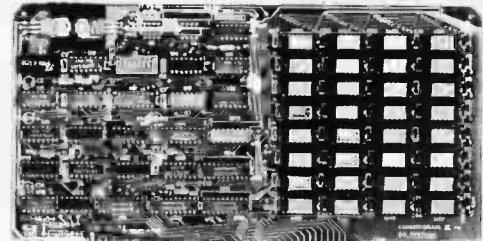

SDS - EXPANDOPRAM II KIT (4116)

	List Price	Sale Price	List Price	Sale Price
16K . . .	\$460.00	\$295.00	48K . . .	\$960.00
32K . . .	\$710.00	\$370.00	64K . . .	\$1210.00
				\$520.00

8803 MOTHER BOARD FOR S-100 BUS MICRO-COMPUTERS

Includes 12 16Kx1 RAM chips for 4.5, 4.12, 12 buses and installed mounting sockets. Working solder-shielded copper solderable cover glass with white markings for component locations. 610 epoxy glass beads with 2 ounce copper solder plated and 0.38 diam. pin holes for leads. Solder mask with copper windows on etched circuits to avoid accidental short circuits. Mounts 11 receptacles with 100 contacts (2 rows) on 125 centers with 250 foot spacing. Vector part number 8801-2, or mounts 10 receptacles plus interconnections to smaller mother board for expansion. Includes etched circuits and instructions for option of active, but not, or trailing terminations. Large buses, 5V and GND (10 AMP), ±12V or 16V (17 AMP). Current ratings are per MIL-STD-275 with 100% margin. Fits in Vector gas enclosures. Fits in SAM 8080 microcomputer as expansion board.

Price: \$29.50

8800V Universal Microcomputer/processor plugboard, use with S-100 bus. Complete with heat sink & hardware. 5.3" x 10" x 1/16"

1-4	5-9	10-24
\$19.95	\$17.95	\$15.95

8801-1

Same as 8800V except plain, less power buses & heat sink

1-4	5-9	10-24
\$15.22	\$13.79	\$12.18

Plugboards

3682 9.6" x 4.5" \$12.97

3682-2 6.5" x 4.5" \$9.81

Hi-Density Dual-In-Line Plugboard for Wire Wrap with Power & Gnd. Bus Epoxy Glass 1/16" 44 pin con. spaced .156

3677 9.6" x 4.5" \$10.90

3677-2 6.5" x 4.5" \$9.74

Gen. Purpose D.I.P. Boards with Bus Pattern for Solder or Wire Wrap. Epoxy Glass 1/16" 44 pin con. spaced .156

3662 6.5" x 4.5" \$8.95

3662-2 9.6" x 4.5" \$11.45

P pattern plugboards for IC's Epoxy Glass 1/16" 44 pin con. spaced .156

CARD EXTENDER

Card Extender has 100 contacts 50 per side on .125 centers-Attached connectors compatible with S-100 Bus Systems. \$25.83

3690 6.5" 22/44 pin .156 ctrs. Extenders . . . \$13.17

SALE S-100 BUS EDGE CONNECTORS * SALE

CO 1 (MSA) Style Card Guides \$11.00

S100-WWG 50/100 Cont. 125 ctrs. 3 LEVEL WIRE WRAP (25" 140, posts on 250 spaced rows. GOLD PLATED)

1-4	5-9	10-24
\$4.75	\$4.00	\$3.75

S100-STG 50/100 Cont. 125 ctrs. DIP SOLDER TAIL on 250 spaced rows for VECTOR, (MSA), CROMENCO motherboards GOLD PLATED

1-4	5-9	10-24
\$4.10	\$3.80	\$3.50

S100SE 50/100 Cont. 125 ctrs. PIERCED SOLDER EYELET TAILS GOLD

1-4	5-9	10-24
\$5.00	\$4.50	\$4.00

S100ALT 50/100 Cont. 125 ctrs. DIP SOLDER TAIL on 140 spaced rows for ALTAIR motherboards. GOLD PLATED

1-4	5-9	10-24
\$4.50	\$4.25	\$4.00

Other Popular Edge Connectors

D224-5WW 22/44 Cont. 156 ctrs. WIRE WRAP TAILS GOLD.

1-4	5-9	10-24
\$3.95	\$3.70	\$3.40

D224-5SE 22/44 Cont. 156 Ctrs. PIERCED SOLDER EYELET TAILS GOLD PLATED.

1-4	5-9	10-24
\$3.00	\$2.60	\$2.20

RS232 & "D" TYPE CONNECTORS *

P = Plug-Male S = Socket-Female C = Cover-Hood

PART NO.	DESCRIPTION	1-4	5-9	10-24
DE-9P	9 Pin Male	1.50	1.30	1.20
DE-9S	9 Pin Female	2.15	2.05	1.95
DE-9C	9 Pin Cover	1.50	1.30	1.15
DA15P	15 Pin Male	2.20	2.00	1.80
DA15S	15 Pin Female	3.20	3.00	2.80
DA15C	15 Pin Cover	1.80	1.45	1.30
DB-25P	25 Pin Male	2.80	2.60	2.50
DB-25S	25 Pin Female	3.75	3.65	3.40
DB51212-1	1 pc. Gray Hood	1.65	1.40	1.20
DB1225-1A	2 pc. Black Hood	1.80	1.60	1.50
DB110963-3	2 pc. Gray Hood	1.80	1.55	1.35
DC37P	37 Pin Male	3.95	3.80	3.80
DC37S	37 Pin Female	5.75	5.50	5.20
DC37C	37 Pin Cover	2.20	1.95	1.75
DD50P	50 Pin Male	4.95	4.75	4.50
DD50S	50 Pin Female	7.50	7.20	6.90
DD50C	50 Pin Cover	2.50	2.20	2.10
D20418-S	Hardware Set (2 pair) Connector for CENTRONICS 700 SERIES: Amphenol 57-30360 for back of Centronics 700 Series printers	1.4	1.00	.80
		1.4	1.00	.70

1/16 Vector BOARD

.042 dia holes on 0.1 spacing for IC's

Phenolic

PART NO.	SIZE	PRICE
64P44XXXP	4.5x6.5"	\$1.56 \$1.40
169P44XXXP	4.5x17"	\$3.69 \$3.32

Epoxy Glass

PART NO.	SIZE	PRICE
64P44	4.5x6.5"	\$1.79 \$1.61
84P44	4.5x8.5"	\$2.21 \$1.99
169P44	4.5x17"	\$4.52 \$4.07
169P84	8.5x17"	\$8.83 \$7.95

3 LEVEL GOLD WIRE WRAP SOCKETS*

Sockets purchased in multiples of 50 per type may be combined for best price.

	1-9	10-24	25-99	100-249	250-999
8 pin	.40	.36	.34	.31	.27
14 pin	.44	.43	.41	.39	.37
16 pin	.55	.47	.45	.41	.39
18 pin	.70	.60	.55	.50	.45
20 pin	.90	.80	.75	.65	.62
22 pin	.95	.85	.80	.70	.65
24 pin	.95	.85	.80	.70	.65
28 pin	1.25	1.15	1.00	.95	.90
40 pin	1.65	1.45	1.35	1.20	1.10

All sockets are GOLD 3 level closed entry. 2 level Tail Low Profile, Tin Sockets and Dip Plugs available. CALL FOR QUOTATION.

3M SCOTCH® BRAND DISKETTES

Part No.	Slides Density	Sectoring	Price Box of 10
740-OP	1/2single	Soft/HBM	\$39.95
740-2-OP	2/2single	Soft/HBM	\$75.00
740-3-OP	3/2single	Soft/HBM	\$39.95
740-3-OP	3/2single	Soft/HBM	\$75.00
741-0	1/2double	Soft	\$59.00
744-OK	1/2single	Soft-(TRS-80)	\$51.00*
744-10K	1/2single	Soft/10	\$51.00*
744-16K	1/2single	Soft/16	\$51.00*

*Price Includes Kas-ette/10 Storage Box a \$5.00 Value (TRS-80) "DON'T SETTLE FOR ANYTHING LESS THAN SCOTCH"

P.C. BOARD HOLDER 315

PRICE: \$18.98

315-S same as 315 but with 14" bar to accommodate "S100" boards. PRICE: \$19.98

HORIZONTAL JAW VISE HEAD 304

PRICE: \$14.49

STANDARD VISE HEAD 303

PRICE: \$13.49

STANDARD VISE HEAD 300

PRICE: \$13.49

VISE HEAD WITH LOCK SCREW 366

PRICE: \$18.49

WIDE OPENING VISE HEAD 380

PRICE: \$14.49

PANAVISE TILTS, TURNS, AND ROTATES TO ANY POSITION. IT HOLDS YOUR WORK EXACTLY WHERE YOU WANT IT.

PANAVISE

LOW-PROFILE BASE 305

STANDARD BASE 300

PRICE: \$13.49

PRICE: \$13.49

PRICE: \$13.49

PRICE: \$14.49

PRICE: \$18.49

PRICE: \$14.49

NOVATION CAT ACOUSTIC MODEM

Regular \$198.00

\$174.95

- 0-300 Baud
- Bell 103
- Answer, Originate

TRS-80/APPLE MEMORY EXPANSION KITS

4116's RAMS from Leading Manufacturers (16Kx1 200/250ns)

8 for \$75.00

Add \$3.00 for programming Jumpers for TRS-80 Keyboard

DEALERS CALL FOR PRICING

MEMORY MEMORY

2102LIP	Low Power 450ns in lots of 25	\$1.10
2102AL-2	Low Power 250ns in lots of 25	\$1.25
2114-3L	1Kx4 300ns Low Power	8/\$50.00
5257-3L	4Kx1 300ns Low Power	8/\$55.00
2708 8K	450ns EPROM	8/\$65.00 \$9.00
2716 16K	5 Volt Only EPROM	\$40.00

Vector WRAP POST

for .042 dia. holes (all boards on this page)

T44/C pkg. 100 . . . \$ 2.34

T44/M pkg. 1000 . . . \$14.35

A-13 hand installing tool . . . \$ 4.19

PRIORITY ONE ELECTRONICS®

16723K Roscoe Blvd. Sepulveda, CA 91343

Terms: Visa, MC, BAC, Check, Money Order, C.O.D. U.S. Funds Only. CA residents add 6% sales tax. Minimum order \$10.00 Prepaid U.S. orders less than \$75.00 include 5% shipping and handling, MINIMUM \$2.50. Excess refunded. Just in case . . . please include your phone no. Prices subject to change without notice. We will do our best to maintain prices thru Feb. 1980

ORDER TOLL FREE 1-800-423-5633

except CA, AK, HI, CALL (213) 894-8171

phone orders welcome (213) 894-8171, (800) 423-5633

OEM and Institutional inquiries invited.

SEE OUR 52 PAGE AD IN JANUARY BYTE

SEE OUR 52 PAGE AD IN JANUARY BYTE

JADE Computer Products

74LS CHIPS 15% OFF !!!

MEMORY PRICES REDUCED !!!

S D SYSTEMS SALE !!!

OUR BEST SELLING MEMORY EXPANDORAM

EXPANDABLE TO 64K USING 4116 RAMS

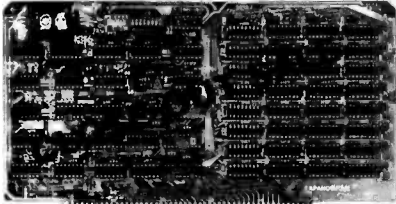

Interfaces with most popular S-100 boards
Bank selectable; PHANTOM provision
Draws only 5 watts fully populated
Designed to work with Z-80, 8080, and 8085 systems
No wait states required
16K boundaries & protect via dip switches
Kits come with sockets for full 64K
Invisible refresh

MEM-16130K (16K KIT)	\$239.95
MEM-16130A (16K A&T)	\$289.95
MEM-32131K (32K KIT)	\$309.95
MEM-32131A (32K A&T)	\$359.95
MEM-48132K (48K KIT)	\$379.95
MEM-48132A (48K A&T)	\$429.95
MEM-64133K (64K KIT)	\$449.95
MEM-64133A (64K A&T)	\$499.95

S D SYSTEMS PROM-100

VERSATILE EPROM PROGRAMMER

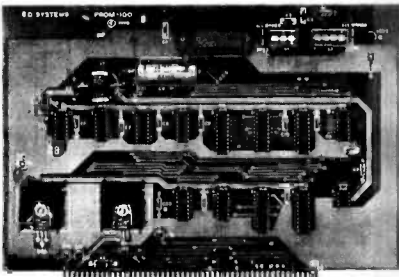

S-100 bus compatible (note: board height 7")
Dip switch selects 2708, 2716, 2732, 2758, or 2516's
25 VDC programming pulse generated on board
Programming time only 100 seconds for 16K bits
Support software listing provided in manual
Program and erasure verification
Software provides for reading of object file from
CP/M and programming into EPROM

MEM-99520K (KIT)	\$175.95
MEM-99520A (A&T)	\$225.95

S D SYSTEMS EXPANDOPROM

EXPANDABLE TO 32K USING 2716 EPROMS

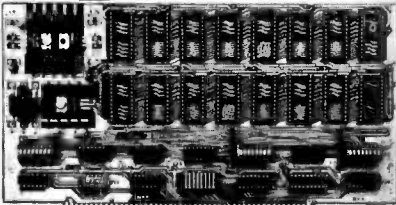

S-100 bus compatible, uses 2708 or 2716 EPROMs
Dip switches allow selection of: each EPROM, 16K
or 32K boundary, wait states

MEM-32220K (KIT)	\$149.95
MEM-32220A (A&T)	\$199.95

GET THE INSIDE TRACK JADE DOUBLE-D DOUBLE DENSITY DISK CONTROLLER

Read/write single or double density, 8" or 5 1/4" drives
On board Z-80 insures reliable operation
CP/M compatible in either single or double density
Density is software selectable
Up to 4 single or double sided, single or double
density drives may be mixed on the same system
EIA level serial printer interface on board-up to 9600
baud (perfect for despooling operations)
All the hard work of disk access is done by the on
board Z-80A and 2K memory, leaving your host
CPU free for its normal duties
Uses IBM standard formats for proven reliability
THIS BOARD REALLY WORKS !!!!!

IOD-1200K (DOUBLE-D KIT)	\$285.00
IOD-1200A (DOUBLE-D A&T)	\$349.00
IOD-1200D (MANUAL ONLY)	\$15.00

S D SYSTEMS VERSAFLOPPY II DOUBLE DENSITY DISK CONTROLLER

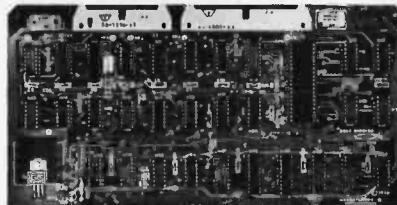

Single or double density floppy disk controller
985600 bytes on 8" double sided diskettes
259840 bytes on double sided 5 1/4" diskettes
S-100 bus (IEEE) standard compatible
IBM 3740 format in single density
8" and 5 1/4" drives controlled simultaneously
Operates with Z-80, 8080, and 8085 CPU's
Controls up to 4 drives
Vectored interrupt operation optional

IOD-1160K (KIT)	\$335.95
IOD-1169A (A&T)	\$385.95

S D SYSTEMS VERSAFLOPPY VERSATILE FLOPPY DISK CONTROLLER

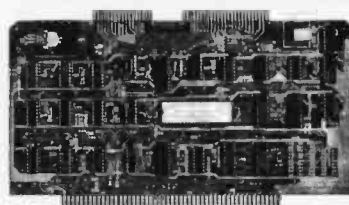

IBM 3740 soft sectored format
S-100 Z-80 or 8080 compatible
Controls up to 4 single or double sided drives
Compatible with all popular disk drives
CP/M compatible
Listings for control software included

IOD-1150K (KIT)	\$189.95
IOD-1150A (A&T)	\$239.95

NEW 2 OR 4 MHz REV. C BOARD THE JADE BIG Z

Z-80 CPU BOARD WITH SERIAL I/O PORT
2 or 4 MHz switchable, on-board 2708, 2716, or 2732
EPROM useable in SHADOW mode (full 64K RAM)
Automatic MWRITE generation if no front panel
On-board USART for sync or async RS232

CPU-30201K (KIT)	\$159.00
CPU-30201A (A & T)	\$209.00

S D SYSTEMS EXPANDORAM II 4 MHz RAM BOARD EXPANDABLE TO 256K

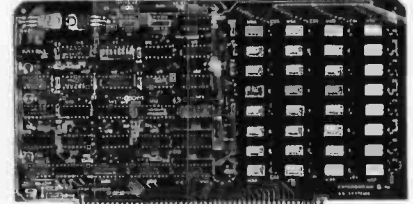

S-100 bus compatible, up to 4 MHz operation
Expandable memory from 16K to 256K
Dip switch selectable boundaries
Page-mode allows up to 8 boards on the same bus
Invisible refresh; PHANTOM output disable
Designed to operate in Z-80 based systems

MEM-16631K (16K KIT)	\$295.95
MEM-16631A (16K A&T)	\$345.95
MEM-32632K (32K KIT)	\$369.95
MEM-32632A (32K A&T)	\$419.95
MEM-48632K (48K KIT)	\$444.95
MEM-48632A (48K A&T)	\$494.95
MEM-64632K (64K KIT)	\$519.95
MEM-64632A (64K A&T)	\$569.95

S D SYSTEMS VDB-8024

80 X 24 I/O MAPPED VIDEO BOARD

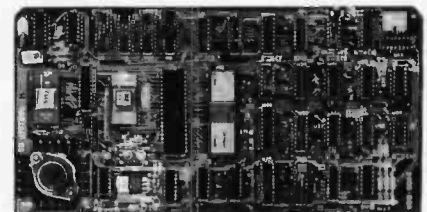

80 character by 24 line display, 7 X 10 dot matrix
Composite or separate TTL video outputs
On-board keyboard interface with power
On-board Z-80 and 2K RAM
Blink, underline, reverse, protect, up/down scroll
Upper/lower case characters, 32 special characters
Optional 128 user-programmable characters

IOV-1020K (KIT)	\$329.95
IOV-1020A (A&T)	\$389.95

S D SYSTEMS SBC-100/200 2 OR 4 MHz SINGLE BOARD COMPUTER

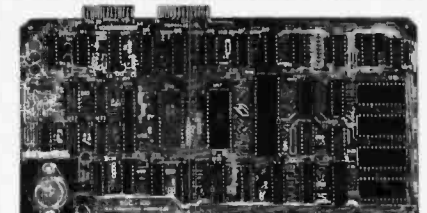

S-100 bus compatible Z-80 CPU
1K of on-board RAM
4 EPROM sockets accommodates 2708, 2716, or 2732
One parallel and one serial I/O port
4-channel counter timer chip (Z-80 CTC)
Software programmable serial baud rates

CPC-30100K (2 MHz KIT)	\$249.95
CPC-30100A (2 MHz A&T)	\$299.95
CPC-30200K (4 MHz KIT)	\$289.95
CPC-30200A (4 MHz A&T)	\$339.95

PRICES SLASHED FOR FEBRUARY! CALL TOLL-FREE AND SAVE

800-421-5809 CONTINENTAL U.S.

800-262-1710 INSIDE CALIFORNIA

S D SYSTEMS Z-80 STARTER KIT COMPLETE Z-80 MICROCOMPUTER

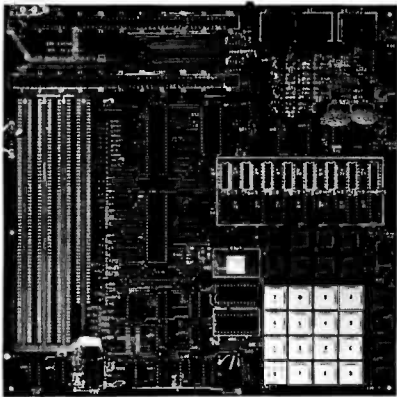

On-board keyboard, display, EPROM programmer, and cassette interface
On-board S-100 interface
Wire-wrap area and room for 2 S-100 connectors
Two 8-bit parallel I/O ports, 4-channel CTC, 5 programmable breakpoints
Examine and change memory, I/O ports, or register
CPS-30010K (KIT) \$279.95
CPS-30010A (A&T) \$349.95

CP/M 2.0

Digital Research has done it again! This new release of their industry standard disk operating system is bound to be an even bigger hit than the original version. All of the fundamental file-size restrictions of release 1 have been eliminated, while maintaining full compatibility with the earlier versions. This new release can be field-configured by the user for a single mini-disk up through a multiple drive hard-disk system with 128 megabyte capacity. Field configuration can be accomplished easily through use of the Macro Library (DISKDEF) provided with CP/M 2.0.

A powerful operating system for only ... \$150.00

JADE'S NEW MOTHERBOARDS THE ISO-BUS

WE'RE PROUD OF OUR MOTHER!

6-SLOT	
BARE BOARD	\$24.95
KIT	\$49.95
ASSEMBLED & TESTED	\$59.95
12-SLOT	
BARE BOARD	\$39.95
KIT	\$89.95
ASSEMBLED & TESTED	\$99.95
18-SLOT	
BARE BOARD	\$59.95
KIT	\$129.95
ASSEMBLED & TESTED	\$149.95

SPECIAL PACKAGE PRICE ROCKWELL AIM-65 THE HEAD-START IN MICROCOMPUTERS

KIM-1 compatible
On-board printer
Full ACSII keyboard

AIM-65 w/1K RAM..\$375.00
AIM-65 w/4K RAM..\$450.00
8K BASIC ROM..\$100.00
POWER SUPPLY..\$59.95
CASE for AIM-65..\$49.95

4K Assembler/Editor..\$80.00
Special Package Price \$599.00
4K AIM-65, 8K BASIC ROM, Power Supply, and Case.

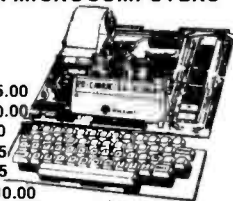

JADE MEMORY EXPANSION KITS FOR TRS-80 APPLE EXIDY

Everything you need to add 16K of memory to your computer. Your kit comes neatly packaged with easy to follow instructions. In just minutes your computer is ready to tackle more advanced software.

\$75.00

AVAILABLE IN FEBRUARY NEW JADE P/S I/O PARALLEL/SERIAL/INTERRUPT BOARD

Z-80 SIO/PIO, 2 CTCs, expands to 2 SIOs, 4 CTCs
4 serial ports (async, sync, bisync, SDLC/HDLC)
2 parallel ports with full handshake
Software baud rate generators, interval timers, counters, and generates 32 vectored interrupts
Designed especially for MP/M multi-user multi-tasking operating systems. For use with Z-80 only
IOI-1045B (BARE BOARD) \$45.00
IOI-1045K (KIT) \$169.95
IOI-1045A (A & T) \$224.95

MICROPROCESSORS		6800 PRODUCT	
F8	\$16.95	6821P	\$5.25
Z80 (2MHz)	\$10.95	6828P	\$12.00
Z80A (4MHz)	\$14.95	6834P	\$16.95
CDP1802CD	\$24.95	6850P	\$4.80
6502	\$11.95	6852P	\$7.50
6800	\$12.50	6850P	\$9.25
6802	\$20.00	6862P	\$12.00
8008-1	\$15.95	6875L	\$7.30
8035	\$24.00	6880P	\$2.50
8035-B	\$24.00	CHARACTER GENERATORS	
8080-A	\$10.00	2513 Upper	\$7.95
8085	\$23.00	2513 Lower	\$6.75
TMS9900TL	\$49.95	2513 Upper (5 volt)	9.75
8080A SUPPORT DEVICES		2513 Lower (5 volt)	\$13.00
8212	\$5.00	MCM6571 up scan	\$13.00
8214	\$4.85	MCM6571A down scan	\$10.95
8216	\$2.95	PROMS	
8224 (2MHz)	\$4.30	1702A	\$5.00
8226	\$2.75	2708	\$8.95
8228	\$6.40	2716	\$39.95
8230	\$6.40	2716 (5v)	\$39.95
8243	\$8.00	2758 (5v)	\$30.00
8251	\$7.50	DYNAMIC RAMS	
8253	\$20.00	4116/416D	8 for \$74.95
8255	\$6.40	2104/4096	\$4.75
8257	\$19.95	2107B-4	\$3.95
8259	\$19.95	TMS4027/4096	\$4.75
8275	\$69.95	STATIC RAMS	
8279	\$17.70	21L02 (450ns)	\$1.50
USRT		21L02 (250ns)	\$1.75
S2350	\$10.95	2101-1	\$2.95
UARTS		2111-1	\$3.25
AYS-1013A	\$5.25	2112-1	\$2.95
AYS-1014A	\$8.25	2114L (450ns)	\$5.75
TR1602B	\$5.25	2114L (300ns)	\$5.95
TMS6011	\$5.95	TMS4044 (450ns)	\$8.00
IM6403	\$9.00	TMS4044 (300ns)	\$9.95
BAUD RATE GENERATORS		410D (200ns)	\$9.95
MC14411	\$10.00	4200A (200ns)	\$9.95

INTEGRAL DATA SYSTEMS THE PAPER TIGER 132 COLUMN DOT MATRIX PRINTER

Up to 198 CPS
1.75 to 9.5 inch adjustable tractor and friction feed.
Parallel and serial interface.

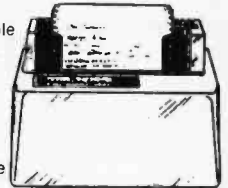

98 character ASCII set.
80 to 132 columns.
6 or 8 lines per inch.
Eight software selectable character sizes.
110, 300, 600, or 1200 baud.
PRM-33440 \$995.00
PRM-33441(with graphics & 2K buffer) .. \$1195.00

GUARANTEED PREMIUM QUALITY JADE DISKETTES MAGNIFICENT MAGNETIC MEDIA!

5 1/4" single sided, single density, box of 10	
MMD-5110103 (SOFT SECTOR)	\$29.95
MMD-5111003 (10 SECTOR)	\$29.95
MMD-5111603 (16 SECTOR)	\$29.95
5 1/4" double sided, double density, box of 10	
MMD-5220103 (SOFT SECTOR)	\$39.95
8" single sided, single density, box of 10	
MMD-8110103 (SOFT SECTOR)	\$34.95
8" single sided, double density, box of 10	
MMD-8120103 (SOFT SECTOR)	\$55.95
8" double sided, double density, box of 10	
MMD-8220103 (SOFT SECTOR)	\$57.95

SPST DIP SWITCHES



PART NUMBER	NUMBER OF SWITCHES	PRICE
SWD-103	3	\$1.00 \$1.18
SWD-104	4	\$1.05 \$1.20
SWD-105	5	\$1.10 \$1.24
SWD-106	6	\$1.15 \$1.28
SWD-107	7	\$1.20 \$1.30
SWD-108	8	\$1.25 \$1.34
SWD-109	9	\$1.30 \$1.36
SWD-110	10	\$1.35 \$1.38



16 PIN ZIP* DIP II	\$5.50
24 PIN ZIP* DIP II	\$7.50
40 PIN ZIP* DIP II	10.25

* ZERO INSERTION PRESSURE

SPECIAL FEBRUARY PRICE! NOVATION CAT ACOUSTIC COUPLER/MODEM



\$175.00

Let your computer talk to other computers!
Bell Systems 103 compatible
300 baud, answer or originate
IOM-5200A (SALE PRICED) \$175.00

JADE Computer Products

4901 W ROSECRANS, HAWTHORNE, CA 90250
213-679-3313

PLACE ORDERS TOLL FREE

800-262-1710 INSIDE CALIFORNIA 800-421-5809 CONTINENTAL U.S.

WRITE FOR OUR FREE 1979 CATALOG
FOR CUSTOMER SERVICE OR TECHNICAL INQUIRIES
CALL 213-679-3317

TERMS OF SALE: Cash, checks, money orders, and credit cards accepted. Minimum order \$10.00. California residents add 6% sales tax. Minimum shipping and handling charge \$2.50. Prices are for U.S. and Canadian delivery only and are subject to change without notice. For export prices and information send for a JADE INTERNATIONAL CATALOG.



APPLE II PLUS**

(limited offer)
16K only **\$990.00**

Disk I	475.00	Firmware Card	175.00
Disk II w/Controller	575.00	Proto Card	22.00
Pascal Card	475.00	M & R Modulator	29.95
Parallel Printer Card	165.00	Sanyo Cassette	54.96
Communications Card	210.00	16K Upgrade Kit	69.95
Business Software Pkg.	625.00	Apple Radio Car	159.00
10 Megabyte Hard Disk	4695.00	8 Floppy Controller	350.00
D.C. Hayes Modem	349.95	Heuristics Speechlab	179.95



ADVANCED COMPUTER PRODUCTS

FLOPPY DISK DRIVES

MPI B51-6 1/4" 40 tracks	279.00	PERSCI Model 277 Dual	1195.00
Shugart SA400-5 1/4" 35 tracks	295.00	WANGO/SIEMENS 5 1/4" Drive	290.00
Shugart 800/801R B	495.00	MPI B52 5 1/4" Dual	395.00
Siemens Shugart Compatible		WANGO/SIEMENS 282 Dual 5 1/4"	395.00
Model 120-BD	449.00		

TI 99/4



Finally! We've heard so much about it and we are proud to offer:
• Color • Up to 72K • 16 Color Graphics • Music • Sound • Solid State Software

LIMITED QTY. **\$1150.00**

TRS-80/APPLE MEMORY EXPANSION KITS

4116's
16K (200/250 ns.)
3 pcs. for **\$69.95**
w/instructions & jumpers.

EXIDY SORCERER



\$1099 w/16K
\$1249 w/32K
\$1449 w/48K

User programmable or use cartridges. Combines the desirable features of the PET, APPLE and TRS-80 into a complete expandable computer system.
** I/O expansion kit \$149.00
** Vista Exidy Dual Floppy Add-on \$1199.00

** New Word Processing Pac \$ 250.00

- ★ INCLUDES:
Keyboard & enclosure
90 day Warranty
MICROSOFT BASIC
Video & Cassette Cable
Complete Documentation
- ★ \$100 Expansion Module Add \$299.00
- ★ Cassette recorder Add \$44.95
- ★ Sanyo 9" Monitor Add \$169.95

Z80 Starter Kit \$249

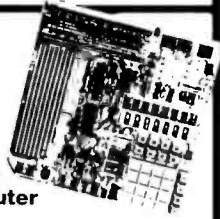

A Complete Microcomputer on a Board
★ Z80 Central Processing Unit with 158 Instructions.
★ On-Board Keyboard and Display.
★ Kansas City Standard Cassette Interface.
★ PROM Programmer Built on-board.
★ Expansion provision for two S-100 Connectors.
★ Wire Wrap area for custom circuitry.



HICKOK LX303 \$74.95

.5%, 3 1/2 digit 19 Range DVM, 1/2" LCD displays runs 200 hrs on 1 battery. 10 Meg Ohm Input. 1 yr. guarantee, made in U.S.A., test leads included.

Available Accessories

RC-3 115V AC Adapter	\$7.50
CC-3 Deluxe Padded Vinyl Carrying Case	\$7.50
VP-10 X10 DCV Probe Adapter/Protector 10 Kv	\$14.95
VP-40 40 Kv DC Probe	\$35.00
CS-1 10 Amp Current Shunt	\$14.95

SOL-20 WITH CP/M

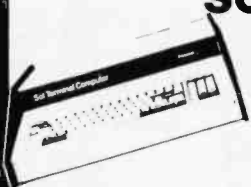

Now you can use the SOL-20 and take advantage of the unlimited CP/M based software that is available.

NEW **\$1095.00**
USED **\$795.00**

SOL nKRA (expandable to 65K) RAM boards. Assembled and socketed w/o memory, data delay and proms.
Only \$139.95

Data Delay Lines	\$29.95
Sol-20 Keyboards	Only \$139.95
Sol Keyboard Enclosure	\$44.95

... and it's COLOR SALE \$100.00 OFF

"The Compucolor II"

a personal colorgraphics system for the modern computer man

- ★ Color Graphics 13" Color CRT
- ★ Proven 8080A CPU System
- ★ 16K Extended Disk Basic
- ★ Up to 117" Key Keyboard
- ★ Up to 32K RAM
- ★ Minidisk Drive 51.2K Bytes/Side



Model 3 w/8K, 72 Key Keyboard, RS232	\$1595.00
Model 4 w/16K, 72 Key Keyboard, RS232	\$1895.00
Model 5 w/32K, 72 Key Keyboard, RS232	\$2195.00
Options: 101 Key Keyboard	Add \$150.00
117 Key Keyboard	Add \$225.00
Formatted Diskettes	2/59.95
Programmed Diskettes	\$19.95
Diskette Library Inc. Hangman, Othello, Math Chess: Starrek, Blackjack, Cubic Tic Tac Toe, Finance Vol. I, Finance Vol. II, Bonds and Securities, Assembler, Text Editor, Personal Data Base	\$19.45 - \$29.00

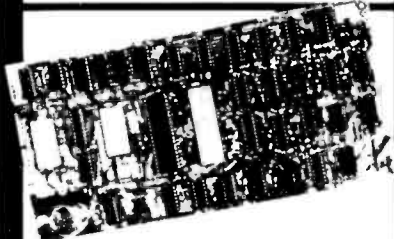

VDB-8024 Video Display Board \$319 KIT

With On-Board Z80 Microprocessor
★ Full 80 Characters by 24 lines display.
★ Characters displayed by High Resolution 7 x 10 Matrix.
★ Keyboard Power and Interface.
★ Composite Video Output.
★ Separate TTL Level Synchronization and Video Outputs.
★ 2K Bytes Independent On-Board Memory.
★ On-Board Z80 Microprocessor.
★ Glitch Free Display.

ATARI 800 & 400



ATARI 800 \$899.00

- Includes:
Computer Console
BASIC Language Cartridge
Education System Master Cartridge
BASIC Language Programming Manual
800 Operator's Manual w/Notebook
Atari 410 Program Recorder
Guide to BASIC Programming
Cassette
BK RAM Module
Power Supply
TV Switch Box

ATARI 400 \$499.00

- Includes:
Computer Console
BASIC Language Cartridge
BASIC Language Programming Manual
400 Operator's Manual w/Notebook
Power Supply
TV Switch Box

KIM-1 Now only \$179.00

- ★ Power Supply Add \$59.95
- ★ Cassette Recorder Add \$44.95
- ★ Sanyo 9" Monitor Add \$169.00
- Add enclosure \$29.95.

AIM 65 \$375.00

- ★ On Board 20 column alphanumeric printer
- w/1K RAM \$375.00
- w/4K RAM \$450.00
- Assembler ROM Add \$85.00
- BASIC IN ROM Add \$100.00
- Power Supply Add \$69.95
- Enclosure Add \$49.95

SYM-1 IN STOCK Now \$219.00

- ★ KIM-1 Compatible
- ★ 4K ROM Monitor
- ★ 1K Bytes 2114 RAM
- ★ 512K Memory Expansion
- ★ User EPROM 2716 reg. \$49.00
- ★ Power Supply Add \$59.95
- ★ Cassette Recorder Add \$44.95
- ★ Sanyo 9" Monitor Add \$169.95
- SYM Enclosure \$39.95

Buy now and receive \$100.00 worth of discount coupons:

- ★ SRX-1 1K Static RAM exp. reg. \$42.00 disc. \$32.00
- ★ PEK-1 I/O Port disc. \$50.00 reg. \$60.00
- ★ SW-1 B51-1 Basic ROM (micro80), reg. \$159.00 disc. \$129.00
- ★ KTM-2 CRT/TV Keyboard reg. \$349.00 disc. \$319.00

SBC-100 Z-80 based singleboard computer by SD Systems

- ★ 1K RAM
- ★ RS232 port
- ★ 4 channel counter/timer

Kit	\$239.00
Assembled	\$369.00

Cromemco Z80 4 MHz Computer Single Card \$450.00

Cromemco's Single Card Computer is a complete computer which brings the power of the Z-80 and the flexibility of the S-100 bus to the dedicated computer environment.

SEC With Assembled Processor: 21MHz Z80
Instruction Set: 158 instructions and the 70 instructions of the 8080
ROM Capacity: 8K Bytes located from address 0000 to 1FFF
ROM Type: Intel 2716 PROM or equivalent
RAM Capacity: 1K Bytes located from address 2000 to 23FF
RAM Type: 1045 Static

RCA COSMAC VIP NEW LOW PRICE \$249.00

Assembled. Regular price \$299.95
w/Sanyo 9" Monitor \$169.95

The Supermarket for TRS-80* Add-on Components (and other computers, too)

in stock now. Immediate delivery.

The VISTA V-80 Disk Drive System

- 23% more storage capacity than TRS-80
- 120 day warranty
- 40 track patch at NO CHARGE

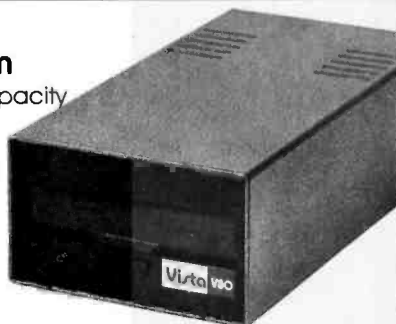
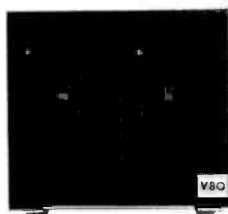

Single drive system \$ 395.00
 Two drive system \$ 770.00
 Four drive system \$ 1450.00
 Two drive cable \$ 29.95
 Four drive cable \$ 39.95

The VISTA V-80 Expansion Module

- Provides double density modification to your current Radio Shack diskette interface (lets you format diskettes in either single or double density).
- Increases storage capacity up to 204K bytes (on single 40 track drive).
- Includes all hardware and software.

\$239.00

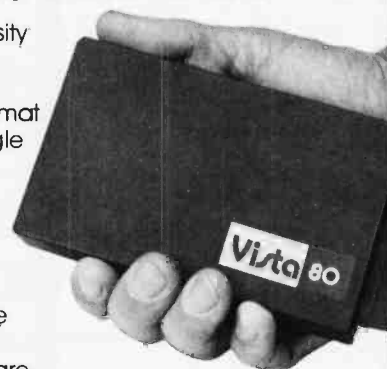

The VISTA Model II

- Provides one, two or three drives.
- Adds up to 1.5 million bytes of on-line storage.
- 120 day warranty
- Does everything Radio Shack's expansion system will do...for less!

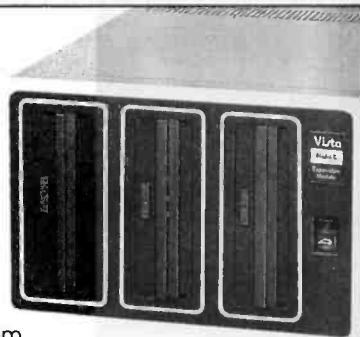

\$1000.00 Single drive Expansion System
\$1550.00 Two drive Expansion System
\$2100.00 Three drive Expansion System
\$ 525.00 Additional drives alone

The TRS-80 Printers

Centronics 730... **\$945.00**
 7x7 dot matrix-80 column
 Anadex DP8000... **\$895.00**
 9x7 dot matrix-80 column
 VISTA Printer... **\$745.00**
 5x7 dot matrix-80 column
 Cables **\$27.50 each**



Other Products

1. VISTA Verbatim diskettes (hard or soft sector) Certified 40 track **\$ 38.95**
2. 16K RPM upgrade kits, guaranteed for 120 days. **PRIME PRODUCT** **\$ 74.50**
3. NEW! DOS + **\$ 110.00**
4. LNW expansion bare board **\$ 66.95**
5. H.C. Pennington book, **TRS-80 Disk and Other Mysteries** **\$ 18.95**
6. DDT Disco-Tech disk drive timer **\$ 19.95**
7. Cryptext (An Encryption Module) **\$299.00**

Add On Drives

MPI B51 40 Track, Double Density-204K **\$275.00**
 MPI B52 Dual Head, Double Density-408K **\$375.00**
 Siemens FDD100-5 40 Track Double Density 204K **\$275.00**
 Siemens FDD100-5 Flippy, records both sides **\$290.00**
 Siemens FDD100-8 8" Single Sided Drive **\$448.00**

The VISTA V-200 for Exidy

- Completely packaged system, tested and ready to plug in, includes: power supply, two 40 track drives, case, controller, all cabling and total CPM documentation.
 - Storage capacity from 400K to 1.2 meg.
 - System software-VISTA CP/M Disk Operating System and BASIC-E Compiler recorded on 5-1/4" diskettes.
- Price: Starting as low as **\$1199.00**

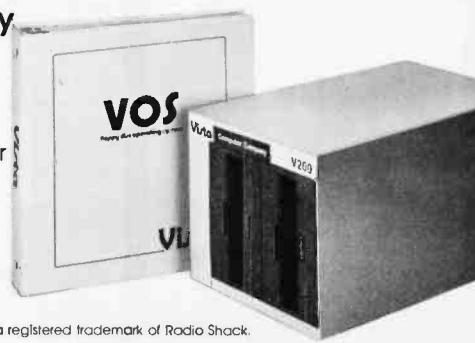

CALL TOLL-FREE 800-854-8017

*TRS-80 is a registered trademark of Radio Shack.

The Vista Computer Company 1401 Borchard Street • Santa Ana, California 92705 • 714/953-0523

Unclassified Ads

FOR SALE: No longer allowed access to timesharing system, so I must sell. I have a complete working terminal featuring a XITEX SCT-100 terminal board, ASCII keyboard, modem, power supply, RF modulator, and all cables. Reasonable offers start at \$250. I'll pay shipping. Scott Swanson, RR #2 POB 247, Blue Grass IA 52726, (319) 381-2036.

FOR SALE: Three Heath H11 (or DEC PDP-11/03) static memory boards 4 K by 16. Practically new. \$200 each or \$575 for all three. M Lowenstein, 79 Larkspur Rd, Stamford CT 06903, (203) 853-7856.

FOR SALE: Magazine sets: BYTE issue #1 to issue #16, *Creative Computing* volume 1 #4 to volume 2 #6, *Kilobaud* issue #1 to issue #12, *Microtek* volume 1 #1 to volume 1 #2, and *Personal Computing* volume 1 #1 to volume 1 #6. Excellent condition. Please quote offer. F J Scavo, 1811 Court St, Syracuse NY 13208.

FOR SALE: Three Digital Group 8 K memory boards. 450 ns. Very reliable. \$140 each. M S Judy, 6401 Hamilton Av, Cincinnati OH 45224, (513) 542-2787.

FOR SALE: Heathkit computer system. Includes H9 video terminal, H8 computer with 8 K memory, serial input/output (I/O) cassette interface, all manuals and cables. Less than one-year-old. \$900 for entire system. B Hiesel, POB 35, Cudahy WI 53110.

FOR SALE: Heathkit factory assembled and working H11 system (equivalent to LSI/PDP-11), with I/O memory and interfaces plus H10 paper-tape reader punch. Total cost over \$3400, best reasonable offer accepted. Mr Block, POB 231, Hallandale FL 33009, (305) 456-6209.

TRS-80 USERS: Tiny-c and Assembler programming bulletin. Send SASE for information. Rob Varty, 2193 Haygate Cr, Mississauga Ontario, CANADA L5K 1L7.

FOR SALE: Four printers with keyboards (\$395 each), reconditioned Singer, dot-matrix impact, 80-character ASCII, 110/300 bps, asynchronous, RS-232 interface, friction or pin feed. M Osedo, 1367 Nanawale Pl, Kailua HI 96734.

FOR SALE: TI 751 Baudot RO thermal printer. New print-head, manuals, not working; \$150. RCA Cosmac-based video game as sold by Radio Shack; \$50. Ralph Droms, Whitmore Lab, University Park PA 16802.

FOR SALE: Sell or trade Heath H8 mainframe. H8-1 4 K memory, H8-2 parallel input/output (I/O), H8-5 serial and cassette I/O. Godbout Econoram VI 12 K memory, and system software. Want \$750 or OSi 1P with 12 K, C2-4P with 8 K, or C2-8P with 4 K. Also have Digital Group TVC-64 for \$100 and Radio Shack ASCII keyboard for \$25. Robert Howarth Jr, RFD #1 POB 36, Lisbon NH 03585, (603) 838-6469.

FOR SALE: Line printer, Tally T-2200, 200 lines per minute, 132 columns, 5 by 7 matrix, up to six copies, adjustable tractors, 6/8 lpi, 8-channel VFU, parallel interface. Cost \$5000, asking \$1600. Also available: warranty, service contract, other interfaces. John Marshall, POB 242, Renton WA 98055, (206) 226-0981.

FOR SALE: Poly 88 system. 32 K programmable memory, 3 K erasable read-only memory, 16 by 64 video with graphics and hardware scroll, keyboard, real-time clock, serial port, high-speed cassette, 9 inch monitor, documentation, and software; \$1700 Canadian. North Star FPB; \$275 Cdn. input/output (I/O) board with 2708 programmer, three parallel ports, two digital-to-analog (D/A) converters, 16-channel analog-to-digital (A/D) converter, sockets for 8 K programmable memory; \$100 Cdn. Michael Dunn, 45 Livingston Rd #501, West Hill Ontario, CANADA M1E 1K8, (416) 266-1635.

FOR SALE: TRS-80 Level 1 microcomputer. Only seven months old. Voice synthesizer and manual included. Eighteen popular software and game programs also included. Computer in great condition. Keyboard, cassette recorder, and video display are also included. Demonstration tape included with voice synthesizer. \$1211. Rob Wiley, 1009 S Sterling Av, Tampa FL 33609.

FOR SALE: ELF II system with two 4 K memory boards (factory tested), Giant Board (factory tested), ASCII keyboard, AP-1 5 A power supply (± 8 V DC, 20 V AC/PP), RF modulator, Tiny BASIC cassette, complete documentation. Main board may have one or more defective integrated circuits. Will sell for \$275. R C Saunders, 8902 River Rd, Richmond VA 23229, (804) 740-8071.

WANTED: TRS-80 business software disks. I want to purchase programs for business applications at an affordable cost. They can also be in TRS-CPM version or TRS-Microsoft-FORTRAN. Douglas Gilson, Rua Sambaiba 516 Leblon, Rio de Janeiro, BRAZIL.

FOR SALE: Digital Group system. 30 K random access memory, 4 K erasable-programmable read-only memory with custom monitor/debugger, dual Phi-Decks, CDC floppy, Sylvania 12-inch video display, custom front panel, paper-tape reader, interfaces for audio cassette, Tally printer, and programmer; \$2200. Optional electronic pinball machine; \$400. Bought a larger system. J Kalafatas, 483 Park St, N Reading MA 01864, (617) 275-1800 ext 446 days.

WANTED: Information on Electronics Information Services (EIS) Model #ET-39 Teletewriter. Mike Middleton, 1713 W Eva, Phoenix AZ 85021.

FOR SALE: Digital Group four-board system with 10 K random access memory, four P/Os, video and cassette interface, large mother board, and all documentation. Includes power supplies (5 V at 12 A, 12 V and 5 V at 1 A) and ASCII keyboard. Bought for \$1150, will sell for \$750 or best offer. Marvin Jones, 2600 NW 30, Oklahoma City OK 73112.

FOR SALE: SOL-20 in original box complete with monitor and cassette recorder; \$1495. 8 K random-access-memory board; \$100. GPM programmable-read-only-memory board; \$60. Uses 2708 programmable read-only memories. Mountain Hardware 100,000 day clock; \$100. Bob Haworth, POB 92, Boring OR 97009, (503) 663-6206.

FOR SALE: Teletype ASR33 terminal with paper-tape reader/punch. Bell modem, touch-tone dialer, card auto-dialer, speaker with volume control, manual modem control buttons, and cables; recently reconditioned. \$425 plus shipping. Mike Dearing, Rt 3, Spring Green WI 53588, (608) 588-2991.

FOR SALE: Friden Flexowriter Model SPD. Includes parallel interface, but circuit needs minor work. Relays have been stripped, but will be included in the package. Friden schematics included. \$100. John Kane, 2193 Charles Dr, Stevensville MI 49127, (616) 429-8353.

WANTED: Any or all copies of Processor Technology's ACCESS newsletter. Peter Wayner, 37 Grandview Dr, Latham NY 12110.

FOR SALE: SwTPC 6800 computer system assembled. Includes: MP-68 processor, 8 K random access memory, MP-S, MP-L, AC-30, CT-1024, two Superscope C-101A cassette decks, 4 K and 8 K BASIC tapes, Motorola K9TS-460Q video monitor/TV, Expander Model 123P Black Box printer, custom walnut, leather, and acrylic case, complete system documentation. Asking \$1950 plus shipping. R H Gay, 48 Maine St, Brunswick ME 04011, (207) 725-5835.

Unclassified Policy

Readers who are soliciting or giving advice, or who have equipment to buy, sell or swap should send in a clearly typed notice to that effect. To be considered for publication, an advertisement must be clearly noncommercial, typed double spaced on plain white paper, contain 75 words or less, and include complete name and address information.

These notices are free of charge and will be printed one time only on a space available basis. Notices can be accepted from individuals or bona fide computer users clubs only. We can engage in no correspondence on these and your confirmation of placement is appearance in an issue of BYTE.

Please note that it may take three or four months for an ad to appear in the magazine.

FOR SALE: RCA Cosmac VIP assembled with video modulator. All in good working condition. All documentation. \$160. Philip Best, 19 Brookside Ln, Mansfield Center CT 06250, (203) 429-5633.

FOR SALE: Centronics Micro Printer, RS-232, electrographic printing, 4.6 inches wide; 20,400 characters per line; with twenty rolls of paper, \$350 or offer. C Looney, 3406 Notre Dame St, Hyattsville MD 20783.

FOR SALE: Electronic Systems Apple II serial input/output (I/O). Assembled and tested. RS-232 input and output; up to 30,000 bits per second (bps). Plugs into Apple. Software routine included. \$45. Bill Carlquist, 6253 Hollywood Blvd Suite 202, Hollywood CA 90028, (213) 461-4643.

FOR SALE: Heathkit IG-102 signal generator 100 KC to 110 MC, \$60 or best offer. Bell and Howell O-Scope single trace with Heathkit probes, \$150 or best offer. Heathkit how to use programs for signal generator and VTM, \$30 each or best offer. Full documentation with above. Brian Hummerl, 96 Hollywood Dr, Middletown PA 17057, (717) 939-7646 Mon-Wed 5:00-9:00 ET.

FOR SALE: Four Phi-Decks dress cabinets and Digital Group controller. Asking \$700. Peter Bornstein, 120 Ocean Pky, Brooklyn NY 11218, (212) 438-0949.

WANTED: Early issues of BYTE up to September 1976. Please send invoice (needed for Exchange Control) stating price. R L Bissessar, 52 Joyeau St, Curepe Trinidad, TRINIDAD AND TOBAGO, West Indies.

FOR SALE: Very large personal book collection. Subjects include electronics (engineering and technical levels), microcomputers, reference books, college texts, self-study courses, aviation, etc. Send 25c and SASE for complete listing. Also for sale, all new parts and chassis for unregulated power supply. +5 V at 25 A, -5 V at 3 A, +1-12 V at 3 A. Worth over \$60. You pay \$25 plus shipping. William Blair, POB 81042, DMAFB AZ 85707.

SWAP: OSi Challenger II owner willing to swap programs and information. Have a variety of programs from *101 Computer Games*, *24 Tested, Ready-To-Run Programs In Basic*, etc. Most 8 K but some will run in 4 K. (I have Assembler and Extender Monitor so I can run and to some extent modify machine-language programs.) Barry L Beal, RFD #1 POB 160, Machias ME 04654.

WANTED: Computerized options markets (C B O E, etc) and their underlying stocks are my interest, including multiple regression analysis, simulation, trading systems development, and computer interface with a securities quotation machine. I would like to correspond with those interested in trading ideas, programs, data bases, etc. J Spillane, Rd 1 POB 138, Sicklerville NJ 08081.

Reader Service

To get further information on the products advertised in *BYTE*, fill out the reader service card with your name and address. Then circle the appropriate numbers for the advertisers you select from the list. Add a 15-cent stamp to the card, then drop it in the mail. Not only do you gain information, but our advertisers are encouraged to use the marketplace provided by *BYTE*. This helps us bring you a bigger *BYTE*. *Correspond directly with company.

Inquiry No.	Page No.	Inquiry No.	Page No.	Inquiry No.	Page No.	Inquiry No.	Page No.
68	Aardvark Software 111	143	Edmund Scientific 188	*	Micro Pro International 30, 31	118	R & K Enterprises 168
237	A B Computers 219	206	Electrolabs 240	168	Microsette 225	71	RACET Computers 114
61	Ackerman Digital Systems 100	206	Electrolabs 241	216	Microsette 243	*	Rainbow Computing Inc 204
221	Advanced Computer Prod 252, 253	206	Electrolabs 242	53	Microsoft 85	*	RBB 144
208	All Electronics Corp 243	57	Electronic Control Technology 90	111	Microsoft (Consumer Prod Div) 161	91	RCA Solid State 139
231	American Square Computers 226	103	Electronics Book Club 151	21	Micro Source 39	81	RCA Solid State 131
19	Apparat 235	164	Electronic Systems 222, 223, 224	56	Microtek 89	171	RCV Consultants 225
9	Apple Computer 19	188	Electronic Technicians 229	155	Microware Assoc. 197	193	RNB Enterprises 232
114	Applied Computer Systems 164	87	Escon 135	157	Microware Midwest 199	194	RNB Enterprises 232
200	ASAP Computer Products 236	209	Evergreen 243	66	The Micro Works 108	105	S-100 154
166	ATV Research 225	73	Exidy 118, 119	19	Micro World 37	130	Sara Tech 179
153	Automated Simulations 194	215	FAIRCOM 243	84	Midwest Computer Peripherals 133	*	SAT-TRAK International 225
156	Avionic Enterprises (A.E.I.) 197	201	Fordham Radio Supply 236	196	Mikos 234	183	S C Digital 229
146	Badge-A-Minit 189	184	Frederick Computer Products 229	119	Mini Computer Suppliers 168	85	SCDP 135
14	base 2, Inc 27	173	Glimx 225	124	Mini Micro Mart 175	104	Scelbi 152, 153
172	John Bell 225	122	Godbout Electronics 173	162	Mini Micro Mart 208	10	SciTronics 20
185	Beta Business Systems 229	224	Graham Dorlan CIII	32	Morrow/Thinker Toys 57	60	Seattle Computer Products 95
*	Beta Computer Devices 183	106	H & E Computronics 155	63	Mountain Hardware 103	*	Shugart 6, 7
*	Bits, Inc 136, 179	161	Hayden Book Company 208	160	Mountain Hardware 207	151	Sigma International 191
*	BNR 109	8	Health Company 17	59	mpi 93	116	Small Business Computer App 166
163	BYTE Books 209, 210, 211	45	Heuristics 68	76	MT MicroSYSTEMS 125	228	Ed Smith's Software Works 199
113	Byte Shop East 164	189	Hobby World 230	77	NEECO 126	29	Softagon Inc 52
*	BYTE WATS 197	232	Houston Instruments 81	78	NEECO 127	227	Softside 170
144	C & S Electronics Mart 189	233	Houston Instrument 81	120	Netronics 169	137	Software Dev & Training 183
204	California Digital 239	65	Hughes Aircraft Co (Radar Sys) 107	300	Netronics 169	121	The Software Exchange 171
75	Central Data 123	145	IBC 189	186	Northwest Computer Services 229	170	The Software Farm 225
13	Century Data 25	110	Industrial Micro Systems 159	12	North Star 23	83	Software Tech for Computers (STC) 133
109	Chrislin Industries 158	174	Infinite Inc. 225	107	Novation 156	20	The Soft Warehouse 38
234	Compas Microsystems 190	25	Infosoft Systems Inc 45	79	NRI Schools 129	154	The Software Works 197
16	Compucolor Corp 29	88	Integrand 135	225	Ohio Scientific Instrument CIV	178	Solid State Sales 228
202	CompuMart 237	230	Interface Inc 226	27	Ohio Scientific Instrument 49	211	Sorrento Valley Associates 243
95	CompuMax 145	92	International Data Systems 141	127	OK Machine and Tool 177	223	Southwest Tech Products Corp CII
49	CompuServe 79	98	International Elec Equip Corp 147	159	Oliver Advanced Engineering 199	4	SSM 11
195	Computer City 233	22	Intertec Data Systems 41	123	onComputing 33	23	SMM 42
142	Computer Devices 187	94	Intertec Data Systems 143	41	Oregon Software 63	100	SubLOGIC 148
54	Computer Distributors 87	6	Ithaca Intersystems 9	82	Osborne/McGraw-Hill 132	74	Summagraphics 121
*	The Computer Factory 149	220	Ithaca Intersystems 14	93	Owens Associates 142	190	Sunny International 230
132	Computer Furniture & Acc 180	217	Jade Company 250, 251	229	Pacific Exchanges 226	15	Supersoft 28
*	Computer Headware 16	218	Jameco 244, 245	203	Page Digital 238	48	Sybox 77
55	Computer Mart of NJ 88	*	Jim-Pak 246, 247	158	PAIA 199	46	Synchro Sound 71
212	Computer Service Ctr. 243	214	Lifeboat Associates 83, 137, 177	141	Pan Am Electronics (A Radio Shack Auth. Sales Ctr.) 187	86	Synergistic Computer Products 135
108	Computer Serv SysNtwrk (CSSN) 157	54	Macrotronics 243	18	Per Com Data 35	70	Tarbelle Electronics 113
175	Computer Specialties 226	67	MAR-COMP 87	34	Per Com Data 60	47	Technical Sys Consultants (TSC) 75
136	CompuText 182	62	Markellne 110	33	Per Com Data 59	*	Tec-Mar 221
147	Corporate Computer Sciences 189	115	Maxell Data Products 101	35	Per Com Data 60	5	Telecomputing Corp of Am 12, 13
26	Corvus Systems 47	210	McGraw-Hill Book Company 97	34	Per Com Data 60	64	Terak 104, 105
138	Cover Craft 183	120	Measurement Sys & Controls 165	36	Per Com Data 60	99	3 G Computer Inc 147
1	Cromemco 1, 2	189	Measurement Sys & Controls 243	37	Per Com Data 61	*	Robert Tinney Graphics 96
52	Cybernetic Micro Systems 84	129	Merrimack Systems 229	38	Per Com Data 61	42	Tiny C 64
140	Cybernetics Inc 187	180	MICAH 179	39	Per Com Data 61	97	TransNet 146
182	DATABANK 229	72	Microamerica 115	40	Per Com Data 61	102	US Robotics 150
134	Data Discount Center 181	150	Micro Applications Group 191	28	Personal Software 51	181	Vintage Data Products 229
44	DATASPEED 67	192	Micro Business World 232	*	Phase One Systems 99	11	Verbatim 21
165	Data Trans 224	198	Microcomputer Technology Inc 235	152	Pickles & Trout 191	222	Vista Computer Company 254
31	Delta Products 55	43	MicroDaSys 65	51	Power One 82	179	VR Data 238
90	DG Electronics 138	24	Micro Data Base Systems 43	7	Priority One 15	197	Wameco 224
126	Digital Engineering 177	*	Micro Diversions 5	219	Priority One 248, 249	149	Whitesmith's Ltd 190
58	Digital Equipment Corp (DEC) 91	139	Micromall 184	69	Program Design Inc 112	213	WIntek 243
117	Digital Pathways 167	101	Micro Management Systems 148	133	Programmers Software Exch 181	167	Worldwide Electronics 225
191	Digital Research Computers 231	112	Micro Mikes 163	177	Quest 227	96	Z ₆ Systems 146
80	Digital Research Corp (CA) 130	128	Micro Mint 94				
			Micro Music 178				

BOMB — *BYTE*'s Ongoing Monitor Box

Article #	Page	Article	Author
1	18	A First look at Graphic Theory Applications	Ashbrook and Zinn
2	32	A Computer-Controlled Wood Stove	Ciarcia
3	58	Solving Problems Involving Variable Terrain, Part 1: A General Algorithm	Jones
4	72	A Computer-Controlled Light Dimmer, Part 2: Implementation	Gibson
5	92	Implementing Dynamic Data Structures With BASIC Files	Carter
6	106	A Fast, Multibyte Binary to Binary-Coded-Decimal Conversion Routine	McQuade
7	116	A Quad Terminal Interface	Alpert
8	128	Comparison of Some High-Level Languages	Morris
9	176	BASIC Formatted Output	Roch
10	192	A Financial Analysis Program	Lehman
11	202	Another Plotter to Toy With, Revisited: Design and Construction Details	Newcomb

Ciarcia - Highlight of November Games

It was a close race, but Steve Ciarcia won by a nose in the last lap of the November BOMB for his article "The Intel 8086," (page 14). But so close behind were Macdonald and Gursel with "Solving Soma Cube and Polyomino Puzzles," (page 26) that the judges decided to award first place to both teams. Amazingly enough, the same close race was run for second place which will be awarded both to Gary S Sivak for "A Special Spacecraft Simulator" (page 104) and "Alpha-Beta Pruning" by Dr Maurer, (page 84). Standard deviations for all four articles were between 1.12 and 1.10. ■

There's A World of Difference In Business Software!

Graham-Dorian's Integrated, On-Line Programs Are Fast, Efficient, And Easy To Use.

Rely on Graham-Dorian, a full-line computer software manufacturer, for sophisticated programs — the most detailed on the market today. They're ready to go to work immediately or to be tailored for even more specific needs.

On-line capabilities enable you to make a single entry and update all affected files. An inquiry into a file at any time provides up-to-date information — no batching or sorting of input data.

The programs are easy to use. Messages on the video display guide you each step of the way. Programs make use of indexed sequential and chained files for fast and convenient retrieval of data with efficient use of disk space.

Order on standard eight-inch disk or various mini-floppy formats. Each program contains a free user's manual and hard copy source listing.

- **Accounts Receivable** — Records invoices, prepares statements and trial balance reports, etc. Automatically reports aging of accounts in periods of 30, 60, and 90 days, with each item listed separately.
- **Accounts Payable** — Vendor lookup and change, entering vendor invoices, writing checks (many options), cash flow analysis, accounts payable check register, and vendor list. Ideal for analyzing expenditures by vendor and by due date.

- **General Ledger** — Includes lookup and change, making journal entries, trial balance, transaction register, chart of accounts, financial statements, and monthly closing.

- **Job Costing** — Provides work order lookup, enters labor transactions, material set-up, progress report of hours, labor distribution report, weekly labor reset, actual versus estimated cost per job.

- **Inventory** — Can be connected with cash register for point of sale inventory control. Number of on-line items limited only by disk space available.

- **Cash Register** — Creates daily sales reports containing information on gift certificates, payouts, overrings, refunds, and how much in each category a salesperson sold.

- **Payroll** — Handles 100% of all necessary payroll functions including state income tax tables for your state. Ideally suited for both large and small companies.

- **Apartment** — Said one user, "Obviously, this was developed by apartment owners." The package fills virtually all the needs of apartment owners and managers. Ideal for projects with 75 units or more.

- **CBASIC-2** — The most comprehensive and powerful commercially oriented BASIC available today. Enhancements over CBASIC-1: integer variables, multiple line functions, CHAINing with COMMON variables, additional predefined functions, etc.

Compatible with many computers: Northstar, IMSAI, Altos, Cromenco, Industrial Micro Systems, Radio Shack TRS-80 Model II, SD Systems, Digital Microsystems, Dynabyte DB8/2, Micropolis MOD II, Vector MZ, and other 8080, 8085, and Z-80-based systems.

See your GDSS dealer or send for information packet and sample runs.



Circle 224 on inquiry card.

Graham-Dorian Software Systems, Inc.

A Division of Graham-Dorian Enterprises

211 N. Broadway / Wichita, KS 67202 / (316) 265-8633

The Microcomputers you should take seriously.

The Challenger III Series is the micro-computer family with the hardware features, high level software and application programs that serious users in business and industry demand from a computer system, no matter what its size.

Since its introduction in August, 1977, the Challenger III has become one of the most successful microcomputer systems in small business, educational and industrial development applications. Tens of thousands of Challenger III's have been delivered and today hundreds of demonstrator units are set up at systems dealers around the country.

The Challenger III systems offer features which make their performance comparable with today's most powerful mini-based systems. Some of these features are:

Three processors today, more tomorrow.

The Challenger III Series is the only computer system with the three most popular processors — the 6502A, 68B00 and Z-80. This allows you to take maximum advantage of the Ohio Scientific software library and programs offered by independent suppliers and publishers. And all Challenger III's have provisions for the next generation of 16 bit micros via their 16 bit data BUS, 20 address bits, and unused processor select codes. This means you'll be able to plug a CPU expander card with two or more 16 bit micros right in to your existing Challenger III computer.

Systems Software for three processors.

Five DOS options including development, end user, and virtual data file single user systems, real time, time share, and networkable multi-user systems.

The three most popular computer languages including three types of BASIC plus FORTRAN and COBOL with more

languages available from independent suppliers. And, of course, complete assembler, editor, debugger and run time packages for each of the system's microprocessors.

Applications Software for Small Business Users.

Ready made factory supported small business software including Accounts Receivable, Payables, Cash Receipts, Disbursements, General Ledger, Balance Sheet, P & L Statements, Payroll, Personnel Files, Inventory and Order Entry as stand alone packages or integrated systems. A complete word processor system with full editing and output formatting including justification, proportional spacing and hyphenation.

OS-DMS, the software star.

Ohio Scientific offers an Information Management system which provides end user intelligence far beyond what you would expect from even the most powerful mini-systems. Basically, it

allows end users to store any collection of information under a Data Base Manager and then instantly obtain information, lists, reports, statistical analysis and even answers to conventional "English" questions pertinent to information in the Data Base. OS-DMS allows many applications to be computerized without any programming!

The "GT" option yields sub-microsecond microcomputing.

Ohio Scientific offers the 6502C microprocessor with 150 nanosecond main memory as the GT option on all Challenger III Series products. The system performs an average of 1.5 million instructions per second executing typical end user applications software (and that's a mix of 8, 16 and 24 bit instructions!).

Mini-system Expansion Ability.

Challenger III systems offer the greatest expansion capability in the microcomputer industry, including a full line of over 40 expansion accessories.

Networking and Distributed Processing

OS-65U level 3 now provides networking capabilities as well as time sharing ability allowing Challenger III based systems to be expanded to meet the most demanding business applications.

Prices you have to take seriously.

The Challenger III systems have phenomenal performance-to-cost ratios. The C3-S1 with 48K static RAM, dual 8" floppies, RS-232 port, BASIC and DOS has a suggested retail price of under \$4000. 80 megabyte disk based systems start at under \$13,000. Our OS-CP/M software package with BASIC, FORTRAN and COBOL is only \$600, and other options are comparably priced.

For literature and the name of your local dealer, CALL 1-800-321-6850 TOLL FREE.

Circle 225 on inquiry card.

C3-B wins Award of Merit at WESCON '78 as the outstanding microcomputer application for Small Business.

The Challenger III Series from Ohio Scientific.

C3-B

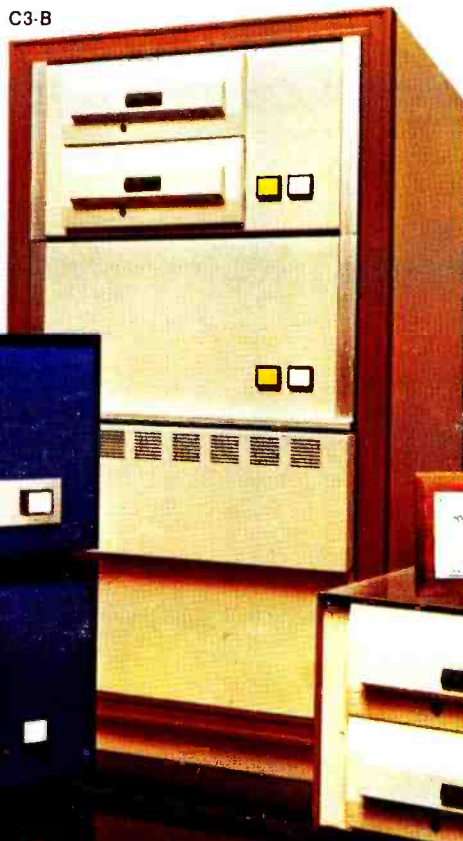

C3-S1



C3-OEM



OHIO SCIENTIFIC
1333 SOUTH CHILLICOTHE ROAD
AURORA, OH 44202 • [216] 562-3101